Wood Casegoods, Tables, Relevant, and Unison

Volume 3

Terms and Conditions	A2
Sample Order Form	A8
Participating Steelcase Dealers	A10
Steelcase Showrooms and Manufacturing Locations	A15

Product Information

Steelcase Wood Furniture (SIN 711.8)

Arbor	B1
Walden	C1
Impact	D1

Steelcase Tables

8500 Tables (SIN 711.11)	E1
Convene Conference Tables and Coordinating Furniture (SIN 711.8)	F1

Relevant (SIN 711.2)

G1

Unison Systems Furniture (SIN 711.8)

H1

Resources

J1

Surface Materials for Steelcase Wood Furniture and Tables	J2
Color Availability Matrices for Steelcase Wood Furniture and Tables	J4
Lock and Keying	J6
Style Number Index	J10

► For a list of all trademarks, refer to the last page of this specification guide.

Terms and Conditions

Customer Information

For more information, please contact your participating Steelcase GSA dealer.

For more information, please contact your participating Steelcase GSA dealer.

For more information, please contact your participating Steelcase GSA dealer.

For more information, please contact your participating Steelcase GSA dealer.

For more information, please contact your participating Steelcase GSA dealer.

For more information, please contact your participating Steelcase GSA dealer.

Sample Order Form

Sample Order Form

ORDER FOR SUPPLIES OR SERVICES			PAGE	OF	PAGES
IMPORTANT: Mark all packages and papers with contract and/or order numbers.					
DATE OF ORDER 1 6-1-04	CONTRACT NO. (If any) 2 GS-28F-8021H	ORDER NO. 3 10 - 000	REQUISITION/REFERENCE NO.		
ISSUING OFFICE (Address correspondence to) 4 GSA 1 Town Street City, State, Zip Name and Telephone Number		SHIP TO: (Consignee and address, ZIP Code) 5 GSA 2 Town Street City, State, Zip Name and Telephone Number			
TO: CONTRACTOR (Name, address and ZIP Code) 6 Steelcase Inc. c/o Participating Dealer 901 44th Street, SE Grand Rapids, MI 49508 Attn: Major Account Services CH-2W-SS (GSA)		Cage Code: 39880		TYPE OF ORDER <input type="checkbox"/> A. PURCHASE — Reference your _____ Please furnish the following on the terms and conditions specified on both sides of this order and on the attached sheets, if any, including delivery as indicated. This purchase is negotiated under authority of: <input type="checkbox"/> B. DELIVERY — Except for billing instructions on the reverse, this delivery order is subject to instructions contained on this side only of this form and is issued subject to the terms and conditions of the above-numbered contract.	
ACCOUNTING AND APPROPRIATION DATA			REQUISITIONING OFFICE		
			BUSINESS CLASSIFICATION (Check appropriate box(es)) 20 <input type="checkbox"/> SMALL <input checked="" type="checkbox"/> OTHER THAN SMALL <input type="checkbox"/> DIS-ADVANTAGED <input type="checkbox"/> WOMEN-OWNED		
FCA DESTINATION 7		GOVERNMENT NO.	DELIVER TO FCA DESTINATION ON OR BEFORE (Date) 8 ARO date	DISCOUNT TERMS 9 Net 30 days	
PLACE OF INSPECTION AND ACCEPTANCE					

(See reverse for Rejections)

ITEM NO. (A)	SUPPLIES OR SERVICES (B)	QUANTITY ORDERED (C)	UNIT (D)	UNIT PRICE (E)	AMOUNT (F)	QUANTITY ACCEPTED (G)
1	10 One lot of Steelcase Office Furniture: See attached specifications	13 1		14 \$000	15 \$000	
2	11 Design: \$55.36/hour	2 hrs		\$000	\$000	
3	12 Installation	1		\$000	\$000	
SEE BILLING INSTRUCTIONS ON REVERSE		SHIPPING POINT	GROSS SHIPPING WEIGHT	INVOICE NO.		(H) TOT. ◀ (Cont. pages)
		MAIL INVOICE TO: (Include ZIP Code) 17 GSA, 3 Town Street, City, State, Zip			16 \$000	(I) GRAND TOTAL ◀

UNITED STATES OF AMERICA BY (Signature) 18 Contracting Officer signature and telephone no.	NAME (Typed) 19 John Doe, Department Manager TITLE: CONTRACTING/ORDERING OFFICER
--	---

- 1 Order date
- 2 Contract number
- 3 Order number
- 4 Issuing office: Requestor name and telephone number
- 5 Shipping address: Contact name and telephone number
- 6 Contractor:
Steelcase Inc.
c/o Participating Dealer
901 - 44th Street, S.E.
Grand Rapids, MI 49508
Attn: Major Account Services CH-2W-SS (GSA)
- 7 FCA destination
- 8 ARO date (After Receipt of Order)
- 9 Terms: Net 30 days
- 10 Complete product description, including SIN number, style number, all applicable surface materials.
- 11 Separate line for design
- 12 Separate line for installation
- 13 Quantity ordered
- 14 Individual unit price
- 15 Amount (quantity x unit price)
- 16 Total cost
- 17 Invoice address
- 18 Authorized contracting officer signature and telephone number
- 19 Authorized contracting officer name and title (typed)
- 20 Steelcase is the seller of record and is not registered as "small," "disadvantaged," or "woman-owned." If one of these boxes is checked in error, a modification will be required.

Please note on order that all invoice payments must be sent to:

Steelcase Inc.
P.O. Box 99315
Chicago, IL 60693

Participating Steelcase Dealers

Alabama

Bodine Inc.
2141 14th Avenue South
Birmingham, AL 35205-3921
Phone: (205) 933-9100
Fax: (205) 933-8607

Hudson Office Supply Inc.
2401 North Range
Dothan, AL 36303-5865
Phone: (334) 792-3155
Fax: (334) 793-2761

Ivan Allen Workspace
Suite 102
200 Westside Square
Huntsville, AL 35801
Phone: (256) 551-2728
Fax: (256) 551-2748

Kyser OfficeWorks Inc.
2400 Spruce Street
Montgomery, AL 36107-3150
Phone: (334) 834-9400
Fax: (334) 262-0701

OEC Business Interiors
104 East I-65 Service Road North
Mobile, AL 36607-2501
Phone: (251) 471-3368
Fax: (251) 471-0019

OSCO Inc.
229 Grant Street SE
Decatur, AL 35601-2511
Phone: (256) 340-5100
Fax: (256) 340-5108

Alaska

Capital Office Systems
1120 East 35th Avenue
Anchorage, AK 99508-4257
Phone: (907) 777-1500
Fax: (907) 777-1515

Capital Office Systems
5312 Commercial Blvd.
Juneau, AK 99801-7214
Phone: (907) 586-2830
Fax: (907) 780-2290

Arizona

Walsh Brothers Office
Environments
1636 North Central Avenue
Phoenix, AZ 85004-1623
Phone: (602) 252-6971
Fax: (602) 252-8222

Walsh Brothers Office
Environments Inc.
1201 East Broadway Blvd.
Tucson, AZ 85719-5822
Phone: (520) 792-4200
Fax: (520) 791-9568

Arkansas

Today's Office Inc.
717 West 7th Street
Little Rock, AR 72201-4044
Phone: (501) 375-5050
Fax: (501) 375-1350

California

BKM Office Environments
Suite A
2111 Portola Road
Ventura, CA 93003-7723
Phone: (805) 339-6388
Fax: (805) 336-9131

BKM San Diego
Suite A
9650 Chesapeake Drive
San Diego, CA 92123-1386
Phone: (858) 569-4700
Fax: (858) 277-8931

One Workplace L. Ferrari
1057 Montague Expressway
Milpitas, CA 95035-6818
Phone: (408) 263-1001
Fax: (408) 719-5700

One Workplace L. Ferrari
475 Brannan Street
San Francisco, CA 94107-1731
Phone: (415) 357-2200
Fax: (415) 357-2201

Peninsula Business Interiors
325 Main Street
Salinas, CA 93901-2705
Phone: (831) 757-4107
Fax: (831) 757-1339

Peninsula Business Interiors LLC
Suite 102
4057 West Shaw Avenue
Fresno, CA 93722-6212
Phone: (559) 275-4111
Fax: (559) 275-0101

Tangram Interiors
2850 South Red Hill Avenue
Santa Ana, CA 92705
Phone: (949) 955-6700
Fax: (949) 955-6799

Tangram Interiors
9200 Sorensen Avenue
Santa Fe Springs, CA 90670-2645
Phone: (562) 365-5000
Fax: (562) 777-9742

United Corporate Furnishings
1780 North Market Blvd.
Sacramento, CA 95834
Phone: (916) 553-5900
Fax: (916) 553-5800

Colorado

Office Outfitters & Planners Inc.
749 Main Street
Grand Junction, CO 81501-3535
Phone: (970) 245-6300
Fax: (970) 245-6301

OfficeScapes
272 South Academy Blvd
Colorado Springs, CO 80910-2714
Phone: (719) 574-1113
Fax: (719) 574-1133

OfficeScapes
9900 East 51st Avenue
Denver, CO 80238-2430
Phone: (303) 574-1115
Fax: (303) 574-1116

OfficeScapes
Suite 180
4812 McMurry Avenue
Fort Collins, CO 80525-6222
Phone: (970) 223-5959
Fax: (970) 223-5858

Delaware

Corporate Interiors Inc.
223 Lisa Drive
New Castle, DE 19720-4193
Phone: (302) 323-9100
Fax: (302) 323-9251

Florida

American Business Interiors
2015 Waverly Place
Melbourne, FL 32901-5444
Phone: (321) 723-5003
Fax: (321) 984-4221

Capital Business Interiors Inc.
132-1 Hamilton Park Drive
Tallahassee, FL 32304
Phone: (850) 383-4225
Fax: (850) 383-7555

Interior Design Services Inc.
1618 Main Street
Sarasota, FL 34236-5811
Phone: (941) 954-0791
Fax: (941) 953-3299

Interior Design Services Inc.
Suite 100
11200 9th Street North
St. Petersburg, FL 33716-2349
Phone: (727) 576-7055
Fax: (813) 222-0972

Leitz & Reed Office Products
2116 South Highway 77
Lynn Haven, FL 32444-4622
Phone: (850) 271-2600
Fax: (850) 271-0076

OEC Business Interiors
1601 NW 80th Boulevard
Gainesville, FL 32606-9140
Phone: (352) 332-1192
Fax: (352) 333-8002

OEC Business Interiors
2393 SW College Road
Ocala, FL 34474
Phone: (352) 620-2888
Fax: (352) 620-2891

OEC Business Interiors
3914 North Davis Highway
Pensacola, FL 32503-2746
Phone: (850) 438-1100
Fax: (850) 432-0003

Office Furniture & Design Concepts
2323 Cleveland Avenue
Ft. Myers, FL 33901-3541
Phone: (239) 337-1212
Fax: (239) 337-4910

Office Interiors of Florida
Suite 1
10800 NW 103rd Street
Miami, FL 33178-1049
Phone: (305) 887-4881
Fax: (305) 885-1930

Perdue Office Interiors
8443 Baymeadows Road
Jacksonville, FL 32256-7440
Phone: (904) 737-5858
Fax: (904) 737-6088

Thomas W. Ruff & Company -
Miami
3201 Commerce Parkway
Miramar, FL 33025-3908
Phone: (954) 435-7300
Fax: (954) 435-7212

Thomas W. Ruff & Company -
Orlando
911 South Orlando Avenue
Maitland, FL 32751-6407
Phone: (407) 628-2400
Fax: (407) 628-8941

Thomas W. Ruff & Company - Palm
Beach
Suite 2
7830 Byron Drive
West Palm Beach, FL 33404-3332
Phone: (561) 840-8600
Fax: (561) 840-1873

Georgia

Commercial Furnishings
112 West Macon Park Drive
Macon, GA 31210-6812
Phone: (478) 757-9190
Fax: (478) 757-9806

DeKalb Office Environments
1320 Ridgeland Parkway
Alpharetta, GA 30004
Phone: (770) 360-0200
Fax: (770) 360-0305

Ivan Allen Workspace
Suite 3
2925 Ledo Road
Albany, GA 31707-1267
Phone: (229) 439-7418
Fax: (229) 435-1279

Ivan Allen Workspace
Suite 200
730 Peachtree Street NE
Atlanta, GA 30308-1210
Phone: (404) 760-8700
Fax: (404) 760-8673

Ivan Allen Workspace
Suite E
3021 River Watch Pkwy
Augusta, GA 30907-3246
Phone: (706) 863-4828
Fax: (706) 228-4987

Lee Office Equipment Company
201 West Hill Avenue
Valdosta, GA 31601-5692
Phone: (229) 244-0177
Fax: (229) 247-3406

McWaters Inc.
117 Prosperity Drive
Garden City, GA 31408-9551
Phone: (912) 352-9000
Fax: (912) 352-2034

Hawaii

Interior Showplace Ltd.
956 Queen Street
Honolulu, HI 96814-4118
Phone: (808) 593-8420
Fax: (808) 591-8324

Idaho

Bangs Office Products Inc.
435 West Center Street
Pocatello, ID 83204-3241
Phone: (208) 232-1233
Fax: (208) 232-8759

Office Environment Company
1605 Fairview Avenue
Boise, ID 83702-5120
Phone: (208) 385-0507
Fax: (208) 385-9392

Illinois

Egyptian Business Furniture
129 West Main Street
Belleville, IL 62220-1501
Phone: (618) 234-2323
Fax: (618) 236-3295

Environetx
1351 East Irving Park Road
Itasca, IL 60143-2300
Phone: (630) 875-3700
Fax: (630) 875-3701

Environetx
Suite 106 & 107
1111 Burlington Avenue
Lisle, IL 60532-1703
Phone: (630) 875-3700
Fax: (630) 434-8126

Johnson & Associates Business
Interiors
4 NW
223 West Erie Street
Chicago, IL 60610
Phone: (312) 649-0074
Fax: (312) 649-0342

Lincoln Office
Unit 2C
202 South Eldorado Road
Bloomington, IL 61704-4482
Phone: (309) 663-1835
Fax: (309) 662-4211

Lincoln Office
Suite E-1
1906 Fox Drive
Champaign, IL 61820-7338
Phone: (217) 363-3901
Fax: (217) 363-3902

Lincoln Office
4575 16th Street
Moline, IL 61265-7013
Phone: (309) 736-0101
Fax: (309) 736-0202

Lincoln Office
7707 North Knoxville Avenue
Peoria, IL 61614-2014
Phone: (309) 693-2444
Fax: (309) 692-1018

Lincoln Office
681 East Linton Avenue
Springfield, IL 62703-5902
Phone: (217) 541-1000
Fax: (217) 541-1001

Office Concepts
965 West Chicago Avenue
Chicago, IL 60622-5413
Phone: (312) 942-1100
Fax: (312) 942-9840

Office Concepts
13820 West Business Center Drive
Lake Forest, IL 60045-1181
Phone: (847) 573-8890
Fax: (847) 573-8891

Office Equipment Company of
Chicago
900 North Church Road
Elmhurst, IL 60126-1014
Phone: (630) 589-5500
Fax: (630) 589-5637

Indiana

Business Furniture Corp.
6102 Victory Way
Indianapolis, IN 46278-2934
Phone: (317) 216-1600
Fax: (317) 216-1602

Corporate Design Inc.
Suite A
1419 West Lloyd Expressway
Evansville, IN 47710-1002
Phone: (812) 422-3000
Fax: (812) 422-3413

Lincoln Office
1200 Arrowhead Court
Crown Point, IN 46307-8222
Phone: (219) 662-2777
Fax: (219) 662-7770

Iowa

Frohwein Contract Interiors
Highway 6 West
218 Second Street
Coralville, IA 52241-2608
Phone: (319) 338-3135
Fax: (319) 338-7484

Officelements LLC
713 Nebraska Street
Sioux City, IA 51101-1103
Phone: (712) 255-0181
Fax: (712) 255-0203

Pioneer Workspace Solutions
1239 First Avenue S.E.
Cedar Rapids, IA 52402-5007
Phone: (319) 364-8148
Fax: (319) 364-1882

Workspace Inc.
309 Locust Street
Des Moines, IA 50309-1788
Phone: (515) 288-7090
Fax: (515) 288-0250

Kansas

Scott Rice Office Interiors
1425 East Douglas Avenue
Wichita, KS 67211-1640
Phone: (316) 269-2700
Fax: (316) 269-3527

Scott Rice Office Works
14720 West 105th Street
Lenexa, KS 66215-4414
Phone: (913) 888-7600
Fax: (913) 227-7793

Kentucky

Cardinal Office Systems
400 East Main Street
Bowling Green, KY 42101-2241
Phone: (270) 781-5858
Fax: (270) 781-5884

Cardinal Office Systems
576 East Main Street
Frankfort, KY 40601-2343
Phone: (502) 875-3300
Fax: (502) 875-2782

Cardinal Office Systems
101 Bradley Drive
Nicholasville, KY 40356-9121
Phone: (859) 885-6161
Fax: (859) 885-9610

Office Resources Inc.
816 East Broadway
Louisville, KY 40204-1053
Phone: (502) 589-8400
Fax: (502) 589-8408

Louisiana

A.D. Wynne Company Inc.
710 Baronne Street
New Orleans, LA 70113-1062
Phone: (504) 522-9558
Fax: (504) 522-7070

Bath Business Services
610 Market Street
Shreveport, LA 71101-3643
Phone: (318) 221-7141
Fax: (318) 425-7117

General Office Supply Company
1003 Jefferson Street
Lafayette, LA 70501-7915
Phone: (337) 237-2563
Fax: (337) 234-2287

Maine

Office Environments of New
England
2 City Center
Portland, ME 04101-4010
Phone: (207) 774-4900
Fax: (207) 774-8155

Participating Steelcase Dealers, continued

Maryland

Arbee Associates
111 Market Place
Baltimore, MD 21202-4035
Phone: (410) 385-5180
Fax: (410) 385-5199

Arbee Associates
950 Wind River Lane
Gaithersburg, MD 20878-1974
Phone: (301) 963-3900
Fax: (301) 977-1734

Office Suppliers Inc.
13716 Crayton Blvd.
Hagerstown, MD 21742-2335
Phone: (301) 797-3120
Fax: (301) 797-1407

US Business Interiors Inc.
575 South Charles Street
Baltimore, MD 21201-2428
Phone: (410) 547-8700
Fax: (410) 547-6677

US Business Interiors Inc.
8800 Lottsford Road
Largo, MD 20774
Phone: (301) 350-8700
Fax: (301) 350-9393

Massachusetts

Office Environments of New
England
280 Summer Street
Boston, MA 02210-1131
Phone: (617) 439-4900
Fax: (617) 439-4131

Office Environments of New
England
810 Boston Turnpike
Shrewsbury, MA 1545
Phone: (508) 842-3000
Fax: (508) 842-2723

Workplace Solutions
59 Interstate Drive
West Springfield, MA 01089-5100
Phone: (413) 736-1802
Fax: (413) 736-6145

Michigan

Allied Office Interiors Inc.
701 Salzburg Avenue
Bay City, MI 48706-5390
Phone: (989) 895-8574
Fax: (989) 895-8545

Allied Office Interiors Inc.
Suite 17
8185 Holly Road
Grand Blanc, MI 48439-2444
Phone: (810) 953-7100
Fax: (810) 953-6146

Allied Office Interiors Inc.
5133 West Grand River Avenue
Lansing, MI 48906-9117
Phone: (517) 886-0072
Fax: (517) 886-0014

Custer Office Environments Inc.
45 Ottawa Ave NW
Grand Rapids, MI 49503-2602
Phone: (616) 458-6322
Fax: (616) 458-1117

Custer Office Environments Inc.
5200 South Sprinkle Road
Kalamazoo, MI 49002-2055
Phone: (269) 342-3919
Fax: (269) 342-3923

WorkPlace Integrators
Suite 4700
30800 Telegraph Road
Bingham Farms, MI 48025-4536
Phone: (248) 430-2345
Fax: (248) 430-2346

Minnesota

General Office Products Company
4521 Highway 7
Minneapolis, MN 55416-4098
Phone: (952) 925-7500
Fax: (952) 925-7531

Mississippi

Barefield & Company
251 West South Street
Jackson, MS 39203-3636
Phone: (601) 354-4960
Fax: (601) 353-6231

OEC Business Interiors
525 Pass Road
Gulfport, MS 39507-2906
Phone: (228) 868-1040
Fax: (228) 864-0040

Missouri

Color-Art Integrated Interiors
1325 North Warson Road
Saint Louis, MO 63132-1807
Phone: (314) 432-3000
Fax: (314) 993-2752

Marathon Office Interiors
1725 Paris Road
Columbia, MO 65201-5571
Phone: (573) 875-7115
Fax: (573) 875-7116

Scheffer's Office Furn & Business
Machines
Unit B
320 South Plaza Way
Cape Girardeau, MO 63703-5854
Phone: (573) 472-2422
Fax: (573) 472-1293

Scheffer's Office Furn & Business
Machines
1558 State Highway H
3 Miles North on H Highway
Sikeston, MO 63801-9420
Phone: (573) 472-2422
Fax: (573) 472-1293

Montana

Capital Office Equipment & Design
Inc.
648 North Jackson Street
Helena, MT 59601-3629
Phone: (406) 442-3480
Fax: (406) 442-3419

Missoula's Office City
115 West Broadway Street
Missoula, MT 59802-4217
Phone: (406) 543-7171
Fax: (406) 543-4254

Peterson's Quality Office
Equipment
502 North 32nd Street
Billings, MT 59101-6003
Phone: (406) 245-5151
Fax: (406) 245-7516

Western Office Equipment
317 2nd Street South
Great Falls, MT 59405-1802
Phone: (406) 761-7473
Fax: (406) 761-0245

Nebraska

Eakes Office Plus
2911 13th Street
Columbus, NE 68601-4829
Phone: (402) 564-2679
Fax: (402) 564-0295

Eakes Office Plus
617 West Third Street
Grand Island, NE 68801-5946
Phone: (308) 382-8026
Fax: (308) 382-7401

Eakes Office Plus
839 West Second Street
Hastings, NE 68901-5099
Phone: (402) 463-2537
Fax: (402) 463-6802

Eakes Office Plus
2401 Avenue A
Kearney, NE 68847-5498
Phone: (308) 234-2538
Fax: (308) 234-2540

Eakes Office Plus
520 North Vine Street
North Platte, NE 69101-3954
Phone: (308) 534-7800
Fax: (308) 534-3936

Sheppard's Business Interiors Inc.
Suite 431
140 North 8th Street
Lincoln, NE 68508-1351
Phone: (402) 441-0070
Fax: (402) 476-9710

Sheppard's Business Interiors Inc.
725 South 72nd Street
Omaha, NE 68114-4665
Phone: (402) 393-8888
Fax: (402) 393-0113

Nevada

Machabee Office Environments
6435 Sunset Corporate Drive
Las Vegas, NV 89120-2798
Phone: (702) 263-8800
Fax: (702) 263-8801

Machabee Office Environments
130 South Center Street
Reno, NV 89501-1539
Phone: (775) 329-3145
Fax: (775) 786-5710

New Jersey

Arbee Associates
2 Stahuber Avenue
Union, NJ 07083-5023
Phone: (908) 686-3900
Fax: (908) 686-6034

General Office Environments
18 Railroad Avenue
Rochelle Park, NJ 07662-4101
Phone: (201) 845-0010
Fax: (201) 845-0034

General Office Environments
65 Clyde Road
Somerset, NJ 08873-3485
Phone: (732) 873-6900
Fax: (732) 873-3357

W.S. Goff Company Inc.
400 South Main Street
Pleasantville, NJ 08232-3032
Phone: (609) 641-4165
Fax: (609) 641-1690

New Mexico

Business Environments
4121 Prospect Avenue, N.E.
Albuquerque, NM 87110-3817
Phone: (505) 888-4400
Fax: (505) 889-9146

New York

AFD Contract Furniture Inc.
88 West End Avenue
New York, NY 10023-6301
Phone: (212) 721-7100
Fax: (212) 721-7175

Business Environments by Ras Inc.
161 River Street
Troy, NY 12180-3807
Phone: (518) 458-7922
Fax: (518) 458-7463

Hudson Bay Environments
One Fordham Plaza
New York, NY 10458-5871
Phone: (718) 933-3000
Fax: (718) 933-3033

Merkel-Donohue
1 Woodbury Boulevard
Rochester, NY 14604-1895
Phone: (585) 325-7696
Fax: (585) 325-3065

Prentice Office Environments
472 Franklin Street
Buffalo, NY 14202-1302
Phone: (716) 884-8452
Fax: (716) 884-0894

Stevens Office Interiors
1449 Erie Boulevard East
Syracuse, NY 13210-1250
Phone: (315) 479-5595
Fax: (315) 428-1688

Waldner's Business Environments
125 Route 110
Farmingdale, NY 11735-4864
Phone: (631) 844-9300
Fax: (631) 694-3503

Waldner's Business Environments
215 Lexington Avenue, 9th Floor
New York, NY 10016-6023
Phone: (212) 696-7500
Fax: (212) 696-7699

Waldner's Business Environments
401 Theodore Fremd Avenue
Rye, NY 10580-1422
Phone: (914) 921-1500
Fax: (914) 921-0991

North Carolina

Benton Office Products Inc.
301 Nash Street West
Wilson, NC 27893-3834
Phone: (252) 237-6176
Fax: (252) 237-9316

Contract Office Furnishings Inc.
1023 West 14th Street
Winston-Salem, NC 27105-5811
Phone: (336) 724-6912
Fax: (336) 722-2704

Office Environments Inc.
11415 Granite Street
Charlotte, NC 28273-6429
Phone: (704) 714-7200
Fax: (704) 714-7400

Office Environments of Asheville Inc.
1070 Tunnel Road
Asheville, NC 28805-2014
Phone: (828) 299-3300
Fax: (828) 299-3046

Storr Office Environments Inc.
496 Gallimore Dairy Road, Suite A
Greensboro, NC 27409-9202
Phone: (336) 217-4500
Fax: (336) 217-4501

Storr Office Environments Inc.
10800 World Trade Blvd.
Raleigh, NC 27617
Phone: (919) 313-3700
Fax: (919) 313-3701

Williams Office Environments Inc.
407 Ray Avenue
Fayetteville, NC 28301-4915
Phone: (910) 483-0354
Fax: (910) 486-4077

North Dakota

Fireside Office Products Inc.
1713 East Bismarck Expressway
Bismarck, ND 58504-6706
Phone: (701) 258-8586
Fax: (701) 223-9598

Gaffaney's of Grand Forks
1809 13th Avenue North
Grand Forks, ND 58203-2323
Phone: (701) 746-6466
Fax: (701) 746-0737

Hannaher's Inc.
4324 20th Avenue SW
 Fargo, ND 58103-4434
Phone: (701) 277-7222
Fax: (701) 277-7097

Professional Business Interiors Inc.
Suite 3
710 31st Avenue SW
Minot, ND 58701-7033
Phone: (701) 837-4848
Fax: (701) 837-4865

Ohio

Everybody's Inc.
5225 Springboro Pike
Dayton, OH 45439-2970
Phone: (937) 293-1010
Fax: (937) 293-7501

Loth Mbi Inc.
3574 East Kemper Road
Cincinnati, OH 45241-2009
Phone: (513) 554-4900
Fax: (513) 554-8737

Ohio Desk Company
1122 Prospect Avenue E
Cleveland, OH 44115-1292
Phone: (216) 623-0600
Fax: (216) 623-0611

Thomas W. Ruff & Company
1114 Dublin Road
Columbus, OH 43215-1039
Phone: (614) 487-4000
Fax: (614) 487-4306

Oklahoma

Scott Rice
2900 North Hemlock Circle
Broken Arrow, OK 74012-1185
Phone: (918) 362-4300
Fax: (918) 362-4303

Scott Rice
7501 Broadway Ext
Oklahoma City, OK 73116-9015
Phone: (405) 848-2224
Fax: (405) 848-3999

Oregon

SmithCFI
135 NW Park Avenue
Portland, OR 97209-3394
Phone: (503) 226-4151
Fax: (503) 226-9233

Pennsylvania

A. Pomerantz
701 Market Street, Suite 7000
Philadelphia, PA 19106-1597
Phone: (215) 408-2100
Fax: (215) 408-2110

Corporate Interiors
2900 Potshop Lane
Norristown Business Campus
Norristown, PA 19403
Phone: (610) 631-5400
Fax: (610) 631-2720

Creative Business Interiors Ltd.
210 Division Street
Kingston, PA 18704-2715
Phone: (570) 288-7211
Fax: (570) 288-8553

Franklin Interiors
Suite 600
2740 Smallman Street
Pittsburgh, PA 15222-4720
Phone: (412) 261-2525
Fax: (412) 255-4089

McCartney's Inc.
819 Howard Avenue
Altoona, PA 16601-4727
Phone: (814) 944-8139
Fax: (814) 949-6197

Phillips Group
501 Fulling Mill Road
Middletown, PA 17057-5926
Phone: (717) 944-0400
Fax: (717) 948-5289

Phillips Office Products
1630 Manheim Pike
Lancaster, PA 17601-6800
Phone: (717) 560-9999
Fax: (717) 560-9996

South Carolina

Aiken Office Supply Inc.
2560 Whiskey Road
Aiken, SC 29803-9664
Phone: (803) 648-8339
Fax: (803) 649-4470

McWaters Inc.
1104 Shop Road
Columbia, SC 29201-4743
Phone: (803) 256-8303
Fax: (803) 252-5567

White Office Furniture Ltd.
109 Hampton Street
Rock Hill, SC 29730-4509
Phone: (803) 328-1821
Fax: (803) 324-5207

Wulbern-Koval Company Inc.
1111 Morrison Drive
Charleston, SC 29403-3119
Phone: (843) 577-7666
Fax: (843) 577-7299

Young Office Environments
1280 Ridge Road
Greenville, SC 29607-4626
Phone: (864) 281-9500
Fax: (864) 281-9555

South Dakota

Interstate Office Products Inc.
220 South Main Avenue
Sioux Falls, SD 57104-6310
Phone: (605) 339-0300
Fax: (605) 339-1989

Klein's Office Furniture
208 West Capitol Avenue
Pierre, SD 57501-2307
Phone: (605) 945-3118
Fax: (605) 945-3119

Western Stationers
714 Saint Joseph Street
Rapid City, SD 57701-2721
Phone: (605) 342-3310
Fax: (605) 342-4746

Participating Steelcase Dealers, continued

Tennessee

Interior Design Services Inc.
209 Powell Place
Brentwood, TN 37027-7522
Phone: (615) 376-1200
Fax: (615) 376-1245

Ivan Allen Workspace
2444 Broad Street
Chattanooga, TN 37408-2909
Phone: (423) 265-4400
Fax: (423) 265-7402

Ivan Allen Workspace
Suite 100
2030 Falling Waters Road
Knoxville, TN 37922-5891
Phone: (865) 690-8022
Fax: (865) 690-0853

Memphis Business Interiors
4539 West Distriplex Drive
Memphis, TN 38118-7280
Phone: (901) 360-8899
Fax: (901) 360-8370

Workspace Interiors
402 East Market Street
Kingsport, TN 37660-4828
Phone: (423) 392-2600
Fax: (423) 392-2601

Texas

Abilene Printing & Stationery
218 Cedar Street
Abilene, TX 79601-5720
Phone: (915) 677-2673
Fax: (915) 675-6963

Baker Office Products
1301 13th Street
Lubbock, TX 79401-3915
Phone: (806) 763-2500
Fax: (806) 747-1601

BKM Total Office of Texas L.P.
Suite 100
9755 Clifford Drive
Dallas, TX 75220-5332
Phone: (214) 902-7200
Fax: (214) 902-7201

Hodges Business Interiors Inc.
308 State Highway 75 North
Huntsville, TX 77320-3181
Phone: (936) 295-5708
Fax: (936) 295-5264

Rockford Business Interiors
211 East Riverside Drive
Austin, TX 78704-1203
Phone: (512) 442-0703
Fax: (512) 442-6555

Texas Wilson Office Furniture & Services
655 Richland Hills Drive
San Antonio, TX 78245-2149
Phone: (210) 647-8800
Fax: (210) 647-3110

West Supply Company
2 South Chadbourne Street
San Angelo, TX 76903-5875
Phone: (325) 655-8181
Fax: (325) 655-5480

Yochem's Business Interiors
1901 Lipan Street
Corpus Christi, TX 78408-4035
Phone: (361) 882-2937
Fax: (361) 882-3534

Utah

MidWest Office Furniture
987 South West Temple
Salt Lake City, UT 84101-2988
Phone: (801) 359-7681
Fax: (801) 355-2713

Vermont

Business Interiors
150 Pioneer Drive
Williston, VT 05495-7543
Phone: (802) 862-0434
Fax: (802) 862-0729

Business Interiors
85-91 Main Street
Brattleboro, VT 05301-3257
Phone: (802) 254-7151
Fax: (802) 254-7150

Virginia

Barrows
1302 Rockland Ave
Roanoke, VA 24012-3838
Phone: (540) 362-5700
Fax: (540) 362-4826

Creative Office Environments
1101 East Laburnum Avenue
Richmond, VA 23222-2212
Phone: (804) 329-0400
Fax: (804) 321-3134

Creative Office Environments LLC
1242 Executive Blvd.
Chesapeake, VA 23320-2807
Phone: (757) 549-4801
Fax: (757) 549-2795

Pifer Office Supply
1620 South Loudoun Street
Winchester, VA 22601-4405
Phone: (540) 667-4040
Fax: (540) 667-6656

Washington

Bank & Office Interiors Inc.
6th Floor
5601 Sixth Avenue South
Seattle, WA 98108-2522
Phone: (206) 768-8000
Fax: (206) 768-0236

Bank & Office Interiors Inc.
411 East North Foothills Drive
Spokane, WA 99207-2161
Phone: (509) 483-1000
Fax: (509) 483-1011

West Virginia

Syscan Furniture Solutions
2800 Seventh Avenue
Charleston, WV 25312-1727
Phone: (304) 744-4686
Fax: (304) 744-4980

Syscan Furniture Solutions
1704 Milesground Road
Morgantown, WV 26505-8349
Phone: (304) 284-0200

Wisconsin

Forrer Business Interiors Inc.
555 West Estabrook Blvd.
Milwaukee, WI 53212
Phone: (414) 906-3200
Fax: (414) 906-3299

Steelcase Showrooms and Manufacturing Locations

Steelcase Showrooms and
Manufacturing Locations

Showrooms

Atlanta

Steelcase Inc.
Suite AL-175
One Peachtree Center
303 Peachtree Street NE
Atlanta, GA 30303
Phone: (404) 523-2201

Boston

Steelcase Inc.
Floor 16
155 Federal Street
Boston, MA 02110
Phone: (617) 482-2990

Chicago

Steelcase Worklife Chicago
Suite 1118
1032 Merchandise Mart
Chicago, IL 60654
Phone: (312) 321-3720

Cleveland

Steelcase Inc.
1122 Prospect Ave. E
Cleveland, OH 44115-1229
Phone: (216) 696-5770

Dallas

Steelcase Inc.
Suite 300
3131 McKinney Avenue
Dallas, TX 75204
Phone: (214) 871-3044

Denver

Steelcase Inc.
9960 East 51st Street
Denver, CO 80238
Phone: (303) 298-1888

Detroit

Steelcase Inc.
3000 Town Center
Concourse B, Suite 80
Southfield, MI 48075
Phone: (248) 353-9940

Florida

Steelcase Inc.
Suite 160N
4000 Hollywood Boulevard
Hollywood, FL 33021
Phone: (954) 986-5300

Grand Rapids

Steelcase Inc.
901 44th Street, SE
Grand Rapids, MI 49508
Phone: (616) 247-2710

Houston

Steelcase Inc.
6869 Old Katy Road
Houston, TX 77024
Phone: (713) 880-2111

Indianapolis

Steelcase Inc.
6102 Victory Way
Suite A
Indianapolis, IN 46278
Phone: (317) 216-1420

Irvine

Steelcase Inc.
19100 Von Karman Avenue
Suite 180
Irvine, CA 92612-6557
Phone: (949) 225-9970

Minneapolis

Steelcase Inc.
800 LaSalle Avenue
Suite 1700
Minneapolis, MN 55402
Phone: (612) 332-1820

New Jersey

Steelcase Inc.
400 Interpace Parkway
Building D 4th Floor
Parsippany, NJ 07054
Phone: (973) 331-3400

New York

Steelcase Worklife New York
4 Columbus Circle
New York, NY 10019
Phone: (212) 445-8800

Philadelphia

Steelcase Inc.
One Liberty Place
1650 Market Street, 28th Floor
Philadelphia, PA 19103
Phone: (215) 561-5331

San Francisco

Steelcase Inc.
475 Brannan Street, Suite 110
San Francisco, CA 94107
Phone: (415) 344-6700

Santa Monica

Steelcase Inc.
1630 Stewart Street
Suite 110
Santa Monica, CA 90404
Phone: (310) 586-2600

Seattle

Steelcase Inc.
1191 2nd Avenue, Suite 1550
Seattle, WA 98101
Phone: (206) 464-1670

St. Louis

Steelcase Inc.
Suite 100
1325 North Warson Road
Chesterfield, MO 63132
Phone: (314) 997-9700

Washington D.C.

Steelcase Inc.
Suite 900
1090 Vermont Avenue, NW
Washington, D.C. 20005
Phone: (202) 962-6760

Manufacturing Sites

Athens

214 Durham Drive
Athens, AL 35611
Phone: (256) 232-8112

Brayton International Inc.

PO Box 7288
High Point, NC 27264
Phone: (336) 434-4151

City of Industry

288 Mayo Avenue
City of Industry, CA 91789
Phone: (909) 859-2300

Details—Operations

216 Durham Drive
Athens, AL 35611
Phone: (256) 232-6770

Grand Rapids

901 44th Street, SE
Grand Rapids, MI 49508
Phone: (616) 247-2710

Fletcher

Cane Creek Industrial Park
Old Airport Road
Fletcher, NC 28732
Phone: (828) 684-2241

Grand Rapids Wood Furniture

4300 44th Street, SE
Grand Rapids, MI 49512
Phone: (616) 698-5735

Canada

One Steelcase Road West
7200 Woodbine Avenue
Markham, ON L3R OT3
Phone: (905) 475-6333

Steelcase Design Partnership Companies (SDP)

Brayton International Inc.— Office

255 Swathmore Ave.
High Point, NC 27263
Phone: (336) 434-4151

Details—Corporate/Product Development

25 Ottawa SW
Grand Rapids, MI 49503
Phone: (616) 234-0400

Metro

7220 Edgewater Drive
Oakland, CA 94621-3004
Phone: (510) 567-5200

Steelcase Design Partnership (SDP) Showroom

5th Floor
901 44th Street, SE
Grand Rapids, MI 49508
Phone: (616) 475-2000

Vecta

1800 S. Great Southwest Parkway
Grand Prairie, TX 75051
Phone: (972) 641-2860



Arbor

Arbor casegoods provide a full range of components to create high-performance workspaces with a refreshingly simple and elegant contemporary design. Two distinctive edge profiles are available.



Statement of Line

B2



Specification Information

Desks (SIN 711.8)	B6
Transaction Worksurfaces and Tackboards (SIN 711.8)	B12
Returns (SIN 711.8)	B14
Pedestal Substitutions for Use with Modular Returns (SIN 711.8)	B18
Bridges (SIN 711.8)	B20
Bullet-Shape Tables (SIN 711.8)	B22
P-Shape Tables (SIN 711.8)	B24
Modular Credenza Assemblies (SIN 711.8)	B26
Pedestal Substitutions for Use with Modular Credenza Assemblies (SIN 711.8)	B28
Straight Workcentre Credenzas (SIN 711.8)	B30
Corner Workcentre Credenzas (SIN 711.8)	B31
Service Modules (SIN 711.8)	B32
Lateral Files (SIN 711.8)	B34
Wardrobes and Storage Cabinets (SIN 711.8)	B36
Bookcases (SIN 711.8)	B38
Mobile Pedestals (SIN 711.8)	B40
Corner Units (SIN 711.8)	B41
Accessories (SIN 711.8)	B42

Arbor

Statement of Line

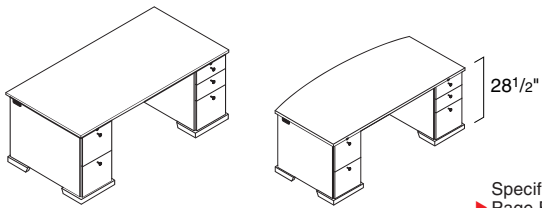

Specifying
▶ Page B6

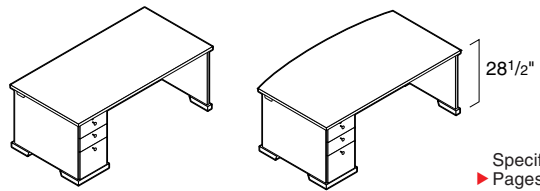

Specifying
▶ Pages B8–B11

Double-Pedestal Desks

	65 1/4"W	72"W
31 1/2"D	■	
36"D		●
37 1/2"D	■	

■ = Straight worksurface ● = Bowed worksurface

Single-Pedestal Desks*

	65 1/4"W	72"W
31 1/2"D	■	
36"D		●
37 1/2"D		● ■

■ = Straight worksurface ● = Bowed worksurface

* Drawings show left-hand units. Right-hand units are also available.

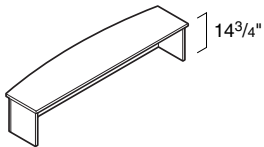

Specifying
▶ Page B12

Transaction Worksurfaces

	65 1/4"W	72"W
18 1/8"D	●	
19"D		●

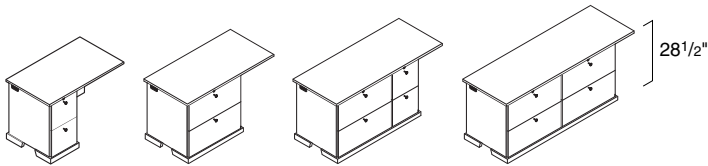

Specifying
▶ Pages B14–B17

Returns*

	42"W	49 5/16"W	60"W	72"W
21 1/2"D		☐ ☐	☐ ☐	☐ ☐
25 1/2"D		☐ ☐ ☐	☐ ☐	☐ ☐

☐ = Return with file/file pedestal ☐ = Return with lateral file
 ☐☐ = Return with lateral file and file/file pedestal ☐☐☐ = Return with two lateral files

* Drawings show left-hand units. Right-hand units are also available.

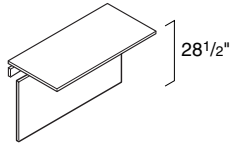

Specifying
▶ Page B20

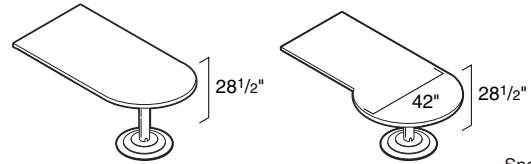

Specifying
▶ Pages B22–B25

Bridges

	49 ⁵ / ₁₆ "W
21 ¹ / ₂ "D	●
25 ¹ / ₂ "D	●

Bullet-Shape and P-Shape* Tables without End Panels

	49 ⁵ / ₁₆ "W	60"W	72"W
31 ¹ / ₂ "D	●■	●■	●■
37 ¹ / ₂ "D	●	●	●

● = Bullet-shape table ■ = P-shape table
* Drawings show left-hand units. Right-hand units are also available.

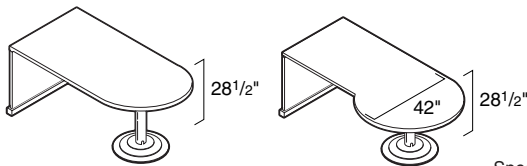

Specifying
▶ Pages B22–B25

Bullet-Shape and P-Shape* Tables with End Panels

	72"W
31 ¹ / ₂ "D	■
37 ¹ / ₂ "D	●

● = Bullet-shape table ■ = P-shape table
* Drawings show left-hand units. Right-hand units are also available.

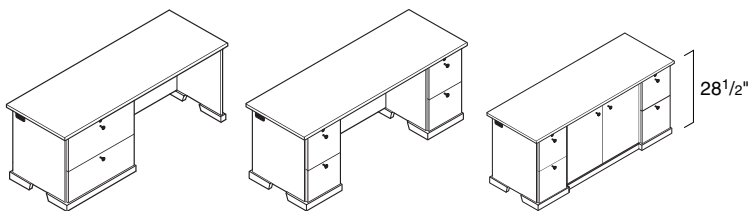

Specifying
▶ Page B26

Modular Credenza Assemblies*

	72"W
25 ¹ / ₂ "D	●

* Asymmetrical drawing shows left-hand unit. Right-hand unit is also available.

Arbor Statement of Line, continued

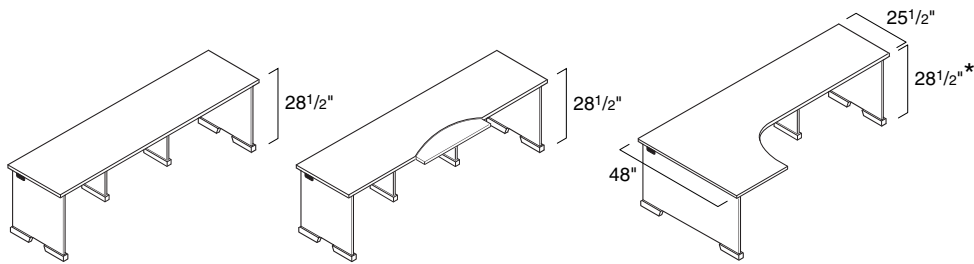

Specifying
▶ Pages B30–B31

Workcentre Credenzas

97³/₁₆"W 113¹/₈"W

25¹/₂"D ■▲ ■▲

31¹/₂"D ■● ■●

■ = Straight workcentre credenza ● = Straight workcentre credenza with integrated adjustable worksurface ▲ = Corner workcentre credenza
* Drawing shows left-hand unit. Right-hand unit is also available.

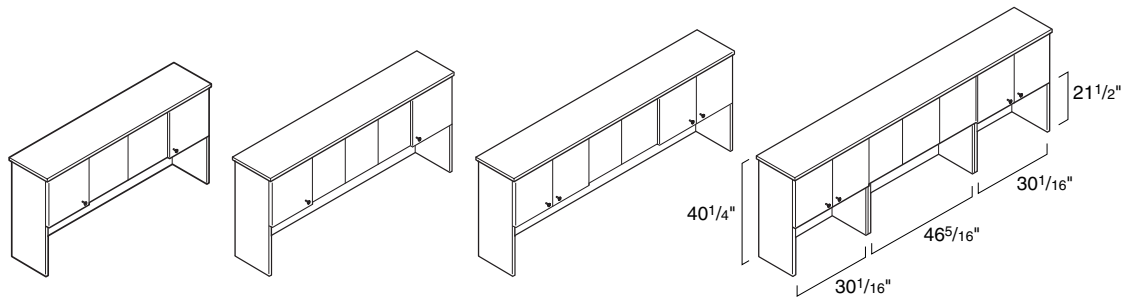

Specifying
▶ Page B32

Service Modules

64¹/₂"W 71⁵/₁₆"W 80¹/₂"W 96⁷/₁₆"W 112³/₈"W

16⁵/₈"D ● ● ● ● ●

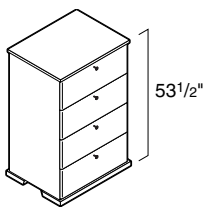

Specifying
▶ Page B34

Lateral File

32⁵/₈"W

25"D ●

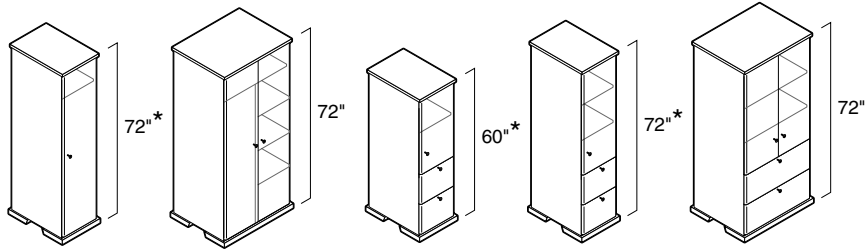

Specifying
▶ Page B36

Wardrobe and Storage Cabinets

16¹/₁₆"W 32⁵/₈"W

25"D ● ●

* Drawings show door hinged on right. Units are also available with door hinged on left.

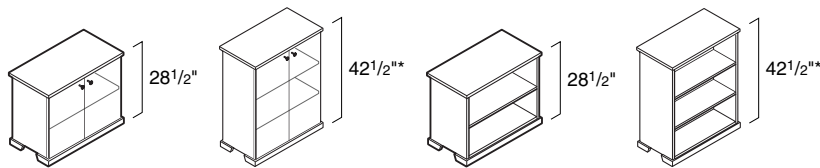

Specifying
▶ Page B38

Bookcases

32⁵/₈"W

16⁵/₈"D ●

* 42¹/₂"H bookcases are also available as stacking units.

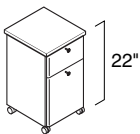

Specifying
▶ Page B40

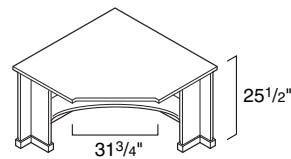

Specifying
▶ Page B41

Mobile Pedestal

17⁷/₁₆"W

22¹/₁₆"D ●

Corner Unit

48"W

25¹/₂"D ●

Modular Double-Pedestal Desks

SIN 711.8

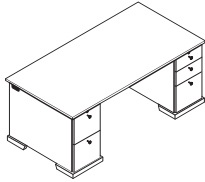

Standard Includes	Required to Specify
<ul style="list-style-type: none"> • Desk: wood veneer • Worksurface with square edge or camber edge • Full-height modesty panel • 16"W full-height pedestals with removable backs • Security panel on back of pedestals • Knob drawer pulls: 0835 Black paint • Lock, keyed random: 9250 Ember Chrome • Side grommets: black plastic only • One pencil tray per desk: black plastic only • One partition per box drawer: black plastic only • One hanging file system per file drawer • Leveling glides: black only 	<ol style="list-style-type: none"> 1 Style number 2 Wood veneer color number for desk 3 Options, if selected (see below) <p>▶ See <i>Surface Materials</i>, page J2.</p>

Options	Price	Required to Specify
Surface Materials <ul style="list-style-type: none"> • Customiz stain on wood 	Prices at right	Specify with <i>Customiz stain</i> . ▶ See <i>Surface Materials Reference Manual</i> .
Drawer Pulls <ul style="list-style-type: none"> Knob drawer pulls <ul style="list-style-type: none"> • Nickel Bow drawer pulls <ul style="list-style-type: none"> • Black • Nickel Rail drawer pulls <ul style="list-style-type: none"> • Black • Nickel 	No cost No cost No cost	Specify with <i>9211 Nickel knob pulls</i> . Specify with <i>0835 Black bow pulls</i> . Specify with <i>9211 Nickel bow pulls</i> . Specify with <i>0835 Black rail pulls</i> . Specify with <i>9211 Nickel rail pulls</i> .
Center Drawer <ul style="list-style-type: none"> • Factory-installed center drawer: wood 	+\$191	Specify with <i>WWCD24</i> .
Grommets <ul style="list-style-type: none"> • 4"-square worksurface grommets: black plastic only • Channel grommet: black plastic only 	+\$ 58 +\$250	Left and right: Specify with <i>WWTPLR</i> . Specify with <i>WWTPF</i> .
Pedestal Substitutions <ul style="list-style-type: none"> • Box, box, file • File, file 	No cost No cost	Specify with <i>box/box/file pedestal</i> and location. Specify with <i>file/file pedestal</i> and location.
Keying <ul style="list-style-type: none"> • Factory- and field-installed keying 		▶ Page J8
Related Products <ul style="list-style-type: none"> • Accessories 		▶ Page B42

Specification Information

Dimensions			Knee-space Width	Style Number	Base Price	Option (Add \$ to Base Price)
D	W	H				
:	:	:	:	:	:	Customiz
:	:	:	:	:	:	Stain

With 16"W Pedestals

Square Edge Profile							
	31½"	65¼"	28½"	31¾"	ASD6630	\$2699	+\$320
	37½"	72"	28½"	38¾"	ASD7236	\$2934	+\$320

Camber Edge Profile							
	31½"	65¼"	28½"	31¾"	ARD6630	\$2699	+\$320
	37½"	72"	28½"	38¾"	ARD7236	\$2934	+\$320

With Bow Worksurface and 16"W Pedestals

Square Edge Profile							
	36"	72"	28½"	38¾"	ASC7236	\$3335	+\$320

Camber Edge Profile							
	36"	72"	28½"	38¾"	ARC7236	\$3335	+\$320

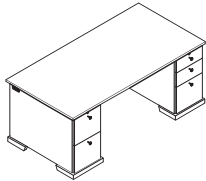

- Left: two file drawers
- Right: two box and one file drawer

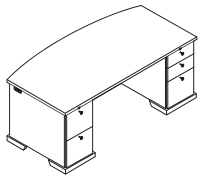

- Left: two file drawers
- Right: two box and one file drawer

Modular Single-Pedestal Desks

SIN 711.8

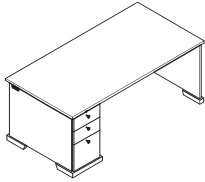

Standard Includes	Required to Specify
<ul style="list-style-type: none"> • Desk: wood • Worksurface with square edge or camber edge • Full-height modesty panel • 16"W full-height pedestal with removable back • Security panel on back of pedestal • Knob drawer pulls: 0835 Black paint • Lock, keyed random: 9250 Ember Chrome • Side grommets: black plastic only • One pencil tray per desk: black plastic only • One partition per box drawer: black plastic only • One hanging file system per file drawer • Leveling glides: black only 	<ul style="list-style-type: none"> 1 Style number 2 Wood color number for desk 3 Options, if selected (see below) ▶ See <i>Surface Materials</i>, page J2.

Options	Price	Required to Specify
Surface Materials <ul style="list-style-type: none"> • Customiz stain on wood 	Prices at right	Specify with <i>Customiz stain</i> . ▶ See <i>Surface Materials Reference Manual</i> .
Drawer Pulls <ul style="list-style-type: none"> Knob drawer pulls <ul style="list-style-type: none"> • Nickel Bow drawer pulls <ul style="list-style-type: none"> • Black • Nickel Rail drawer pulls <ul style="list-style-type: none"> • Black • Nickel 	No cost No cost No cost	Specify with <i>9211 Nickel knob pulls</i> . Specify with <i>0835 Black bow pulls</i> . Specify with <i>9211 Nickel bow pulls</i> . Specify with <i>0835 Black rail pulls</i> . Specify with <i>9211 Nickel rail pulls</i> .
Center Drawer <ul style="list-style-type: none"> • Factory-installed center drawer: wood 	+\$191	Specify with <i>WWCD24</i> .
Grommets <ul style="list-style-type: none"> • 4"-square worksurface grommets: black plastic only • Channel grommet: black plastic only 	+\$ 58 +\$250	Left and right: Specify with <i>WWTPLR</i> . Specify with <i>WWTPF</i> .
Pedestal Substitution <ul style="list-style-type: none"> • File, file 	No cost	Specify with <i>file/file pedestal</i> and location.
Keying <ul style="list-style-type: none"> • Factory- and field-installed keying 		▶ Page J8
Related Products <ul style="list-style-type: none"> • Accessories 		▶ Page B42

Specification Information

Dimensions D	W	H	Knee-space Width	Style Number	Base Price	Option (Add \$ to Base Price)
						Customiz Stain

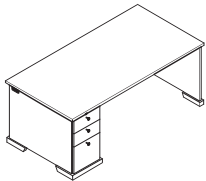

• Left: two box and one file drawer

Left-Hand Single-Pedestal Desks

Square Edge Profile						
31½"	65¼"	28½"	47½"	ASDM6630L	\$2440	+\$320
37½"	72"	28½"	53½"	ASDM7236L	\$2672	+\$320
Camber Edge Profile						
31½"	65¼"	28½"	47½"	ARDM6630L	\$2440	+\$320
37½"	72"	28½"	53½"	ARDM7236L	\$2672	+\$320

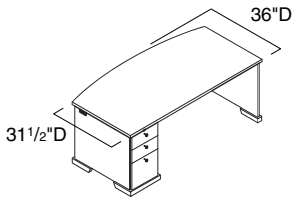

• Left: two box and one file drawer

Left-Hand Single-Pedestal Desks with Bow Worksurface

Square Edge Profile						
36"	72"	28½"	53½"	ASCM7236L	\$3075	+\$320
Camber Edge Profile						
36"	72"	28½"	53½"	ARCM7236L	\$3075	+\$320

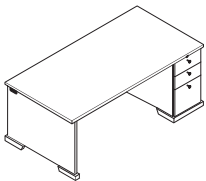

• Right: two box and one file drawer

Right-Hand Single-Pedestal Desks

Square Edge Profile						
31½"	65¼"	28½"	47½"	ASDM6630R	\$2440	+\$320
37½"	72"	28½"	53½"	ASDM7236R	\$2672	+\$320
Camber Edge Profile						
31½"	65¼"	28½"	47½"	ARDM6630R	\$2440	+\$320
37½"	72"	28½"	53½"	ARDM7236R	\$2672	+\$320

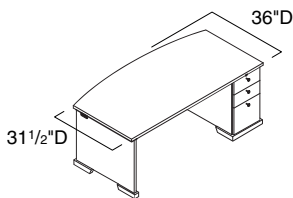

• Right: two box and one file drawer

Right-Hand Single-Pedestal Desks with Bow Worksurface

Square Edge Profile						
36"	72"	28½"	53½"	ASCM7236R	\$3075	+\$320
Camber Edge Profile						
36"	72"	28½"	53½"	ARCM7236R	\$3075	+\$320

Non-Modular Single-Pedestal Desks

SIN 711.8

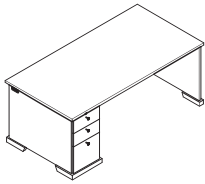

Standard Includes	Required to Specify
<ul style="list-style-type: none"> • Desk: wood • Worksurface with square edge or camber edge • Full-height modesty panel • 16"W full-height pedestal with removable back • Security panel on back of pedestal • Knob drawer pulls: 0835 Black paint • Lock, keyed random: 9250 Ember Chrome • Side grommets: black plastic only • One pencil tray per desk: black plastic only • One partition per box drawer: black plastic only • One hanging file system per file drawer • Leveling glides: black only 	<ul style="list-style-type: none"> 1 Style number 2 Wood color number for desk 3 Options, if selected (see below) ▶ See <i>Surface Materials</i>, page J2.

Options	Price	Required to Specify
Surface Materials <ul style="list-style-type: none"> • Customiz stain on wood 	Prices at right	Specify with <i>Customiz stain</i> . ▶ See <i>Surface Materials Reference Manual</i> .
Drawer Pulls <ul style="list-style-type: none"> Knob drawer pulls <ul style="list-style-type: none"> • Nickel Bow drawer pulls <ul style="list-style-type: none"> • Black • Nickel Rail drawer pulls <ul style="list-style-type: none"> • Black • Nickel 	No cost No cost No cost	Specify with <i>9211 Nickel knob pulls</i> . Specify with <i>0835 Black bow pulls</i> . Specify with <i>9211 Nickel bow pulls</i> . Specify with <i>0835 Black rail pulls</i> . Specify with <i>9211 Nickel rail pulls</i> .
Center Drawer <ul style="list-style-type: none"> • Factory-installed center drawer: wood 	+\$191	Specify with <i>WWCD24</i> .
Grommets <ul style="list-style-type: none"> • 4"-square worksurface grommets: black plastic only • Channel grommet: black plastic only 	+\$ 58 +\$250	Left and right: Specify with <i>WWTPLR</i> . Specify with <i>WWTPF</i> .
Pedestal Substitution <ul style="list-style-type: none"> • File, file 	No cost	Specify with <i>file/file pedestal</i> and location.
Keying <ul style="list-style-type: none"> • Factory- and field-installed keying 		▶ Page J8
Related Products <ul style="list-style-type: none"> • Accessories 		▶ Page B42

Specification Information

Dimensions			Knee-space Width	Style Number	Base Price	Option (Add \$ to Base Price)
D	W	H				
						Customiz Stain

Left-Hand Single-Pedestal Desks

Square Edge Profile						
31½"	65¼"	28½"	47½"	ASD6630L	\$2440	+\$320
37½"	72"	28½"	53½"	ASD7236L	\$2672	+\$320
Camber Edge Profile						
31½"	65¼"	28½"	47½"	ARD6630L	\$2440	+\$320
37½"	72"	28½"	53½"	ARD7236L	\$2672	+\$320

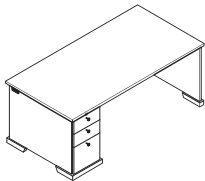

• Left: two box and one file drawer

Left-Hand Single-Pedestal Desks with Bow Worksurface

Square Edge Profile						
36"	72"	28½"	53½"	ASC7236L	\$3075	+\$320
Camber Edge Profile						
36"	72"	28½"	53½"	ARC7236L	\$3075	+\$320

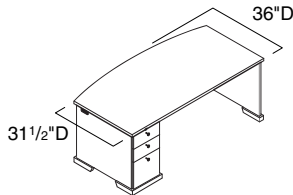

• Left: two box and one file drawer

Right-Hand Single-Pedestal Desks

Square Edge Profile						
31½"	65¼"	28½"	47½"	ASD6630R	\$2440	+\$320
37½"	72"	28½"	53½"	ASD7236R	\$2672	+\$320
Camber Edge Profile						
31½"	65¼"	28½"	47½"	ARD6630R	\$2440	+\$320
37½"	72"	28½"	53½"	ARD7236R	\$2672	+\$320

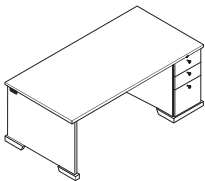

• Right: two box and one file drawer

Right-Hand Single-Pedestal Desks with Bow Worksurface

Square Edge Profile						
36"	72"	28½"	53½"	ASC7236R	\$3075	+\$320
Camber Edge Profile						
36"	72"	28½"	53½"	ARC7236R	\$3075	+\$320

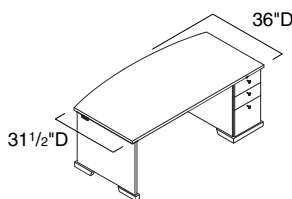

• Right: two box and one one file drawer

Transaction Worksurfaces and Tackboards

SIN 711.8

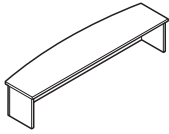

Standard Includes	Required to Specify
-------------------	---------------------

- | | |
|--|---|
| <ul style="list-style-type: none"> • Bow-front transaction worksurface: wood • Worksurface with square edge or camber edge • Attachment hardware • Tackboard, if selected: vertical surface fabric price group 1 | <ol style="list-style-type: none"> 1 Style number 2 Wood color number for transaction worksurface 3 Fabric color number for tackboard, if selected 4 Options, if selected (see below) <p>▶ See <i>Surface Materials</i>, page J2.</p> |
|--|---|

Surface Materials	Options	Price	Required to Specify
-------------------	---------	-------	---------------------

Surface Materials	<ul style="list-style-type: none"> • Customiz stain on wood 	Prices below	Specify with <i>Customiz stain</i> . ▶ See <i>Surface Materials Reference Manual</i> .
	Tackboard <ul style="list-style-type: none"> • Fabric price group 1 • Fabric price group 2 • Fabric price group 3 • Fabric price group 4 • Fabric price group 5 • Fabric price group COM 	No cost +\$ 12 +\$ 46 +\$ 62 +\$100 +\$ 15	Specify fabric color number. Specify fabric color number. Specify fabric color number. Specify fabric color number. Specify fabric color number. ▶ See <i>Surface Materials Reference Manual</i> .

Specification Information						
Dimensions	D			Style Number	Base Price	Option
	D	W	H			

.....
.....
.....
.....
.....
.....

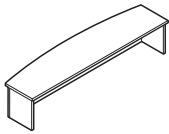

For Use on 65"W Desks

	Square Edge Profile	18 ¹ / ₈ "	65 ¹ / ₄ "	14 ³ / ₄ "	ASG6617	\$551	+\$60
	Camber Edge Profile	18 ¹ / ₈ "	65 ¹ / ₄ "	14 ³ / ₄ "	ARG6617	\$551	+\$60

For Use on 72"W Desks

	Square Edge Profile	19"	72"	14 ³ / ₄ "	ASG7217	\$654	+\$60
	Camber Edge Profile	19"	72"	14 ³ / ₄ "	ARG7217	\$654	+\$60

Tackboards

For Use in Interior of 66"W Transaction Worksurface							
.....
.....
For Use in Interior of 72"W Transaction Worksurface							
.....
.....

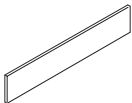

Modular Right-Hand Returns

SIN 711.8

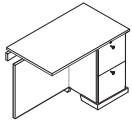

Tip: For use with left-hand single-pedestal desk.

Tip: Grommets are available on 25 1/2"D returns only.

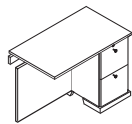

• Right: two file drawers

Standard Includes	Required to Specify
<ul style="list-style-type: none"> Return: wood Worksurface with square edge or camber edge Full-height modesty panel that swings <i>Exception: Modesty panel on 49 5/16"W returns with one 16"W and one 32"W pedestal does not swing</i> Full-height pedestals with removable backs Security panel on back of pedestals Knob drawer pulls: 0835 Black paint Lock, keyed random: 9250 Ember Chrome Side grommet on 25 1/2"D returns: black plastic only One hanging file system per file drawer Attachment hardware Leveling glides: black only 	<ol style="list-style-type: none"> Style number Wood color number for return Options, if selected (see below) ▶ See <i>Surface Materials</i>, page J2.

Options	Price	Required to Specify
Surface Materials	<ul style="list-style-type: none"> Customiz stain on wood 	Prices below and at right Specify with <i>Customiz stain</i> . ▶ See <i>Surface Materials Reference Manual</i> .
Drawer Pulls	<ul style="list-style-type: none"> Knob drawer pulls Nickel 	No cost Specify with <i>9211 Nickel knob pulls</i> .
	<ul style="list-style-type: none"> Bow drawer pulls Black Nickel 	No cost No cost Specify with <i>0835 Black bow pulls</i> . Specify with <i>9211 Nickel bow pulls</i> .
	<ul style="list-style-type: none"> Rail drawer pulls Black Nickel 	No cost No cost Specify with <i>0835 Black rail pulls</i> . Specify with <i>9211 Nickel rail pulls</i> .
Grommets	<ul style="list-style-type: none"> 4"-square worksurface grommet on 25 1/2"D return: black plastic only Channel grommet on 25 1/2"D return: black plastic only 	+\$ 29 +\$250 Center: Specify with <i>WWTPC</i> . Specify with <i>WWTPF</i> .
Pedestal Substitutions	<ul style="list-style-type: none"> 16"W pedestals 32"W pedestals 	▶ Page B18 ▶ Page B18
Keying	<ul style="list-style-type: none"> Factory- and field-installed keying 	▶ Page J8
Related Products	<ul style="list-style-type: none"> Accessories 	▶ Page B42

Specification Information							
Dimensions	D	W	H	Knee-space Width	Style Number	Base Price	Option (Add \$ to Base Price)
							Customiz
							Stain

With One 16"W Pedestal

Square Edge Profile	D	W	H	Knee-space Width	Style Number	Base Price	Option
	21 1/2"	42"	28 1/2"	25 1/2"	ASR4220PR	\$1460	+\$174
	25 1/2"	42"	28 1/2"	25 1/2"	ASR4224PR	\$1535	+\$174
	25 1/2"	49 5/16"	28 1/2"	32 1/2"	ASR4824PR	\$1666	+\$174
Camber Edge Profile	D	W	H	Knee-space Width	Style Number	Base Price	Option
	21 1/2"	42"	28 1/2"	25 1/2"	ARR4220PR	\$1460	+\$174
	25 1/2"	42"	28 1/2"	25 1/2"	ARR4224PR	\$1535	+\$174
	25 1/2"	49 5/16"	28 1/2"	32 1/2"	ARR4824PR	\$1666	+\$174

▶ Specification information continued on next page

► Specification Information, continued

Specification Information

Dimensions			Knee-space Width	Style Number	Base Price	Option (Add \$ to Base Price)
D	W	H				
						Customiz Stain

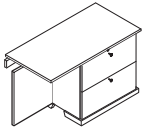

• Right: two-drawer lateral file

With One 32"W Pedestal

Square Edge Profile							
	21½"	49 ⁵ / ₁₆ "	28½"	15¼"	ASR4820LR	\$1636	+\$174
	25½"	49 ⁵ / ₁₆ "	28½"	15¼"	ASR4824LR	\$1712	+\$174
	21½"	60"	28½"	27¼"	ASR6020LR	\$1766	+\$174
	25½"	60"	28½"	27¼"	ASR6024LR	\$1842	+\$174
Camber Edge Profile							
	21½"	49 ⁵ / ₁₆ "	28½"	15¼"	ARR4820LR	\$1636	+\$174
	25½"	49 ⁵ / ₁₆ "	28½"	15¼"	ARR4824LR	\$1712	+\$174
	21½"	60"	28½"	27¼"	ARR6020LR	\$1766	+\$174
	25½"	60"	28½"	27¼"	ARR6024LR	\$1842	+\$174

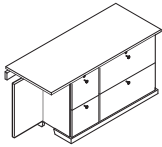

• Right: two file drawers and one two-drawer lateral file

With One 16"W Pedestal and One 32"W Pedestal

Square Edge Profile							
	21½"	49 ⁵ / ₁₆ "	28½"	N.A.	ASR4820LPR	\$1812	+\$174
	25½"	49 ⁵ / ₁₆ "	28½"	N.A.	ASR4824LPR	\$1887	+\$174
	21½"	60"	28½"	11¼"	ASR6020LPR	\$1943	+\$174
	25½"	60"	28½"	11¼"	ASR6024LPR	\$2019	+\$174
	21½"	72"	28½"	23¼"	ASR7220LPR	\$2075	+\$174
	25½"	72"	28½"	23¼"	ASR7224LPR	\$2150	+\$174
Camber Edge Profile							
	21½"	49 ⁵ / ₁₆ "	28½"	N.A.	ARR4820LPR	\$1812	+\$174
	25½"	49 ⁵ / ₁₆ "	28½"	N.A.	ARR4824LPR	\$1887	+\$174
	21½"	60"	28½"	11¼"	ARR6020LPR	\$1943	+\$174
	25½"	60"	28½"	11¼"	ARR6024LPR	\$2019	+\$174
	21½"	72"	28½"	23¼"	ARR7220LPR	\$2075	+\$174
	25½"	72"	28½"	23¼"	ARR7224LPR	\$2150	+\$174

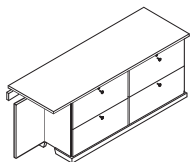

• Right: two, two-drawer lateral files

With Two 32"W Pedestals

Square Edge Profile							
	21½"	72"	28½"	N.A.	ASR7220LLR	\$2182	+\$174
	25½"	72"	28½"	N.A.	ASR7224LLR	\$2257	+\$174
Camber Edge Profile							
	21½"	72"	28½"	N.A.	ARR7220LLR	\$2182	+\$174
	25½"	72"	28½"	N.A.	ARR7224LLR	\$2257	+\$174

Modular Left-Hand Returns

SIN 711.8

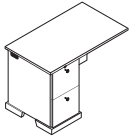

Tip: For use with right-hand single-pedestal desk.

Standard Includes	Required to Specify
<ul style="list-style-type: none"> Return: wood Worksurface with square edge or camber edge Full-height modesty panel that swings <i>Exception: Modesty panel on 49⁵/₁₆"W returns with one 16"W and one 32"W pedestal does not swing</i> Full-height pedestals with removable backs Security panel on back of pedestals Knob drawer pulls: 0835 Black paint Lock, keyed random: 9250 Ember Chrome Side grommet on 25¹/₂"D returns: black plastic only One hanging file system per file drawer Attachment hardware Leveling glides: black only 	<ol style="list-style-type: none"> Style number Wood color number for return Options, if selected (see below) ▶ See <i>Surface Materials</i>, page J2.

Options	Price	Required to Specify
Surface Materials <ul style="list-style-type: none"> Customiz stain on wood 	Prices below and at right	Specify with <i>Customiz stain</i> . ▶ See <i>Surface Materials Reference Manual</i> .
Drawer Pulls <ul style="list-style-type: none"> Knob drawer pulls <ul style="list-style-type: none"> Nickel Bow drawer pulls <ul style="list-style-type: none"> Black Nickel Rail drawer pulls <ul style="list-style-type: none"> Black Nickel 	No cost No cost No cost	Specify with <i>9211 Nickel knob pulls</i> . Specify with <i>0835 Black bow pulls</i> . Specify with <i>9211 Nickel bow pulls</i> . Specify with <i>0835 Black rail pulls</i> . Specify with <i>9211 Nickel rail pulls</i> .
Grommets <ul style="list-style-type: none"> 4"-square worksurface grommet on 25¹/₂"D return: black plastic only Channel grommet on 25¹/₂"D return: black plastic only 	+\$ 29 +\$250	Center: Specify with <i>WWTPC</i> . Specify with <i>WWTPF</i> .
Pedestal Substitutions <ul style="list-style-type: none"> 16"W pedestals 32"W pedestals 		▶ Page B18 ▶ Page B18
Keying <ul style="list-style-type: none"> Factory- and field-installed keying 		▶ Page J8
Related Products <ul style="list-style-type: none"> Accessories 		▶ Page B42

Tip: Grommets are available on 25¹/₂"D returns only.

Specification Information

Dimensions	Knee-space	Style	Base	Option
D	W	Number	Price	(Add \$ to Base Price)
H	Width			Customiz Stain
D	W	H	Width	Number
Price	Option	(Add \$ to Base Price)	Customiz Stain	

With One 16"W Pedestal

Square Edge Profile	Dimensions	Knee-space	Style	Base	Option
Square Edge Profile	D	W	Number	Price	(Add \$ to Base Price)
Square Edge Profile	H	Width			Customiz Stain
Square Edge Profile	D	W	H	Width	Number
Square Edge Profile	Price	Option	(Add \$ to Base Price)	Customiz Stain	

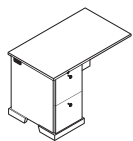

• Left: two file drawers

▶ Specification information continued on next page



► Specification Information, continued

Specification Information

Dimensions			Knee-space Width	Style Number	Base Price	Option (Add \$ to Base Price)
D	W	H				

Arbor

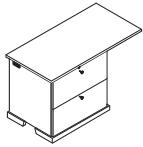

With One 32"W Pedestal

Square Edge Profile							
	21½"	49 ⁵ / ₁₆ "	28½"	15¼"	ASR4820LL	\$1636	+\$174
	25½"	49 ⁵ / ₁₆ "	28½"	15¼"	ASR4824LL	\$1712	+\$174
	21½"	60"	28½"	27¼"	ASR6020LL	\$1766	+\$174
	25½"	60"	28½"	27¼"	ASR6024LL	\$1842	+\$174
Camber Edge Profile							
	21½"	49 ⁵ / ₁₆ "	28½"	15¼"	ARR4820LL	\$1636	+\$174
	25½"	49 ⁵ / ₁₆ "	28½"	15¼"	ARR4824LL	\$1712	+\$174
	21½"	60"	28½"	27¼"	ARR6020LL	\$1766	+\$174
	25½"	60"	28½"	27¼"	ARR6024LL	\$1842	+\$174



• Left: two-drawer lateral file

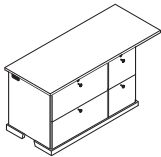

With One 32"W Pedestal and One 16"W Pedestal

Square Edge Profile							
	21½"	49 ⁵ / ₁₆ "	28½"	N.A.	ASR4820LPL	\$1812	+\$174
	25½"	49 ⁵ / ₁₆ "	28½"	N.A.	ASR4824LPL	\$1887	+\$174
	21½"	60"	28½"	11¼"	ASR6020LPL	\$1943	+\$174
	25½"	60"	28½"	11¼"	ASR6024LPL	\$2019	+\$174
	21½"	72"	28½"	23¼"	ASR7220LPL	\$2075	+\$174
	25½"	72"	28½"	23¼"	ASR7224LPL	\$2150	+\$174
Camber Edge Profile							
	21½"	49 ⁵ / ₁₆ "	28½"	N.A.	ARR4820LPL	\$1812	+\$174
	25½"	49 ⁵ / ₁₆ "	28½"	N.A.	ARR4824LPL	\$1887	+\$174
	21½"	60"	28½"	11¼"	ARR6020LPL	\$1943	+\$174
	25½"	60"	28½"	11¼"	ARR6024LPL	\$2019	+\$174
	21½"	72"	28½"	23¼"	ARR7220LPL	\$2075	+\$174
	25½"	72"	28½"	23¼"	ARR7224LPL	\$2150	+\$174



• Left: one two-drawer lateral file and two file drawers

With Two 32"W Pedestals

Square Edge Profile							
	21½"	72"	28½"	N.A.	ASR7220LLL	\$2182	+\$174
	25½"	72"	28½"	N.A.	ASR7224LLL	\$2257	+\$174
Camber Edge Profile							
	21½"	72"	28½"	N.A.	ARR7220LLL	\$2182	+\$174
	25½"	72"	28½"	N.A.	ARR7224LLL	\$2257	+\$174

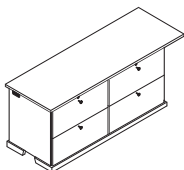

• Left: two, two-drawer lateral file

Pedestal Substitutions

for Use with Modular Returns

SIN 711.8



Tip: Pedestals are for substitution on a return only. They are not available as a separate item.

Tip: Specify 20"D pedestals for substitution on 21½"D returns. Specify 24"D pedestals on 25½"D returns.

Standard Includes	Required to Specify
<ul style="list-style-type: none"> • Full-height pedestal with removable back • Security panel on back of pedestal • Knob drawer pulls: 0835 Black paint • One partition per box drawer, if selected: black plastic only • One hanging file system per file drawer 	<p>1 Add the pedestal substitution style number to the return specifications and designate the location. <i>Example: ASR7220LLR with ASJD3220 left</i></p> <p>2 Options, if selected (see below)</p>

Options	Price	Required to Specify
Drawer Pulls		
Knob drawer pulls		
• Nickel	No cost	Specify with 9211 Nickel knob pulls.
Bow drawer pulls		
• Black	No cost	Specify with 0835 Black bow pulls.
• Nickel	No cost	Specify with 9211 Nickel bow pulls.
Rail drawer pulls		
• Black	No cost	Specify with 0835 Black rail pulls.
• Nickel	No cost	Specify with 9211 Nickel rail pulls.

Specification Information

Depth	Style Number	Add/Subtract \$ to Credenza Base Price

16"W Substitute Pedestals

For Use with Square Edge Profile

20"	ASJE1620	+\$33
24"	ASJE1624	+\$33

For Use with Camber Edge Profile

20"	ARJE1620	+\$33
24"	ARJE1624	+\$33

► Specification Information continued on next page



• Two box and one file drawer

► Specification Information, continued

Specification Information

Depth	Style Number	Add/Subtract \$ to Credenza Base Price
-------	--------------	--

32"W Substitute Pedestals

For Use with Square Edge Profile

20"	ASJEE3220	+\$ 66
24"	ASJEE3224	+\$ 66

For Use with Camber Edge Profile

20"	ARJEE3220	+\$ 66
24"	ARJEE3224	+\$ 66

For Use with Square Edge Profile

20"	ASJPP3220	No cost
24"	ASJPP3224	No cost

For Use with Camber Edge Profile

20"	ARJPP3220	No cost
24"	ARJPP3224	No cost

For Use with Square Edge Profile

20"	ASJEP3220	+\$ 33
24"	ASJEP3224	+\$ 33

For Use with Camber Edge Profile

20"	ARJEP3220	+\$ 33
24"	ARJEP3224	+\$ 33

For Use with Square Edge Profile

20"	ASJPE3220	+\$ 33
24"	ASJPE3224	+\$ 33

For Use with Camber Edge Profile

20"	ARJPE3220	+\$ 33
24"	ARJPE3224	+\$ 33

For Use with Square Edge Profile

20"	ASJD3220	-\$128
24"	ASJD3224	-\$128

For Use with Camber Edge Profile

20"	ARJD3220	-\$128
24"	ARJD3224	-\$128

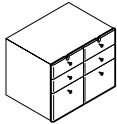

- Left: two box and one file drawer
- Right: two box and one file drawer

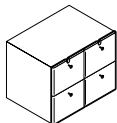

- Left: two file drawers
- Right: two file drawers

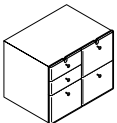

- Left: two box and one file drawer
- Right: two file drawers

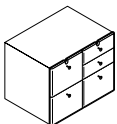

- Left: two file drawers
- Right: two box and one file drawer

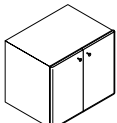

- Double-door cabinet

Bridges

SIN 711.8

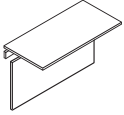

Tip: Channel grommet is available on 25 1/2" D bridge only.

Standard Includes		Required to Specify	
<ul style="list-style-type: none"> • Bridge: wood • Worksurface with square edge or camber edge • Removable full back panel that swings, if selected • Attachment hardware 		<ul style="list-style-type: none"> 1 Style number 2 Wood color number for bridge 3 Options, if selected (see below) ▶ See <i>Surface Materials</i>, page J2. 	
Options	Price	Required to Specify	
Surface Materials	• Customiz stain on wood	Prices below	Specify with <i>Customiz stain</i> . ▶ See <i>Surface Materials Reference Manual</i> .
Grommets	• 4"-square worksurface grommet: black plastic only • Channel grommet on 25 1/2" D bridge: black plastic only	+\$ 29 +\$250	Center: Specify with <i>WWTPC</i> . Specify with <i>WWTPF</i> .
Related Products	• Accessories	▶ Page B42	

Specification Information					
Dimensions			Style Number	Base Price	Option
D	W	H			(Add \$ to Base Price) Customiz Stain
·	·	·	·	·	·
·	·	·	·	·	·
·	·	·	·	·	·

Bridges with Removable Back Panel

Square Edge Profile						
	21 1/2"	49 5/16"	28 1/2"	ASB4820	\$892	+\$129
	25 1/2"	49 5/16"	28 1/2"	ASB4824	\$973	+\$129
Camber Edge Profile						
	21 1/2"	49 5/16"	28 1/2"	ARB4820	\$892	+\$129
	25 1/2"	49 5/16"	28 1/2"	ARB4824	\$973	+\$129

Bridges without Back Panel

Square Edge Profile						
	21 1/2"	49 5/16"	28 1/2"	ASB4820NMP	\$757	+\$129
	25 1/2"	49 5/16"	28 1/2"	ASB4824NMP	\$838	+\$129
Camber Edge Profile						
	21 1/2"	49 5/16"	28 1/2"	ARB4820NMP	\$757	+\$129
	25 1/2"	49 5/16"	28 1/2"	ARB4824NMP	\$838	+\$129

Bullet-Shape Tables

SIN 711.8

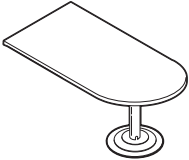
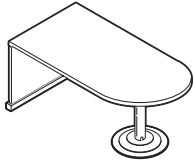

Tip: Specify tables with an end panel for attachment to a bridge or return. Specify tables without an end panel for attachment to a kneespace or workcentre credenza.

Standard Includes		Required to Specify
<ul style="list-style-type: none"> • Table: wood • Column: black textured paint only • Contemporary disk base: 7207 Black textured paint • Worksurface with square edge or camber edge • Leveling glides on tables with end panel: black only • Attachment hardware for tables without end panel 		<ul style="list-style-type: none"> 1 Style number 2 Wood color number for table 3 Options, if selected (see below) ▶ See <i>Surface Materials</i>, page J2.
Options		Required to Specify
Surface Materials	<ul style="list-style-type: none"> • Customiz stain on wood 	Prices at right Specify with <i>Customiz stain</i> . ▶ See <i>Surface Materials Reference Manual</i> .
	Disk base <ul style="list-style-type: none"> • Bronze • Copper • Pewter 	No cost No cost No cost Specify with 7331 <i>Bronze base</i> . Specify with 7332 <i>Copper base</i> . Specify with 7333 <i>Pewter base</i> .
Grommets	<ul style="list-style-type: none"> • 4"-square worksurface grommet: black plastic only • 2¼"-diameter round worksurface grommet: black plastic only 	+\$29 +\$29 Centered in panel-supported end of worksurface: Specify with <i>WWTPC</i> . Centered above column: Specify with <i>WWTRPC</i> .
Related Products	<ul style="list-style-type: none"> • Accessories 	▶ Page B42

Specification Information

Dimensions			Style Number	Base Price	Option (Add \$ to Base Price)
D	W	H			
:	:	:	:	:	Customiz
:	:	:	:	:	Stain

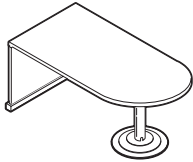

Bullet-Shape Tables with End Panel

Square Edge Profile					
37½"	72"	28½"	ASUF7236	\$2324	+\$144
Camber Edge Profile					
37½"	72"	28½"	ARUF7236	\$2324	+\$144

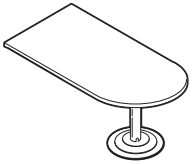

Bullet-Shape Tables without End Panel

Square Edge Profile					
31½"	49 ⁵ / ₁₆ "	28½"	ASUA4830	\$1769	+\$ 84
37½"	49 ⁵ / ₁₆ "	28½"	ASUA4836	\$1902	+\$ 84
31½"	60"	28½"	ASUA6030	\$1914	+\$ 84
37½"	60"	28½"	ASUA6036	\$2045	+\$ 84
31½"	72"	28½"	ASUA7230	\$2055	+\$ 84
37½"	72"	28½"	ASUA7236	\$2187	+\$ 84
Camber Edge Profile					
31½"	49 ⁵ / ₁₆ "	28½"	ARUA4830	\$1769	+\$ 84
37½"	49 ⁵ / ₁₆ "	28½"	ARUA4836	\$1902	+\$ 84
31½"	60"	28½"	ARUA6030	\$1914	+\$ 84
37½"	60"	28½"	ARUA6036	\$2045	+\$ 84
31½"	72"	28½"	ARUA7230	\$2055	+\$ 84
37½"	72"	28½"	ARUA7236	\$2187	+\$ 84

P-Shape Tables

SIN 711.8

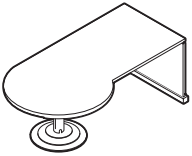
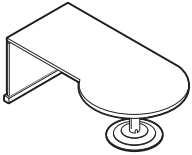

Tip: Specify tables with an end panel for attachment to a bridge or return. Specify tables without an end panel for attachment to a kneespace or workcentre credenza.

Standard Includes		Required to Specify	
<ul style="list-style-type: none"> Table: wood Column: black textured paint only Contemporary disk base: 7207 Black textured paint Worksurface with square edge or camber edge Leveling glides on tables with end panel: black only Attachment hardware for tables without end panel 		<ul style="list-style-type: none"> 1 Style number 2 Wood color number for table 3 Options, if selected (see below) ▶ See <i>Surface Materials</i>, page J2. 	
Options		Price	Required to Specify
Surface Materials	<ul style="list-style-type: none"> Customiz stain on wood 	Prices at right	<ul style="list-style-type: none"> Specify with <i>Customiz stain</i>. ▶ See <i>Surface Materials Reference Manual</i>.
	Disk base		
	<ul style="list-style-type: none"> Bronze Copper Pewter 	<ul style="list-style-type: none"> No cost No cost No cost 	<ul style="list-style-type: none"> Specify with 7331 <i>Bronze base</i>. Specify with 7332 <i>Copper base</i>. Specify with 7333 <i>Pewter base</i>.
Grommets	<ul style="list-style-type: none"> 4"-square worksurface grommet: black plastic only 2¼"-diameter round worksurface grommet: black plastic only 	<ul style="list-style-type: none"> +\$29 +\$29 	<ul style="list-style-type: none"> Centered in panel-supported end of worksurface: Specify with <i>WWTPC</i>. Centered above column: Specify with <i>WWTRPC</i>.
Related Products	<ul style="list-style-type: none"> Accessories 		▶ Page B42

Specification Information

Dimensions			Style Number	Base Price	Option (Add \$ to Base Price)
D	W	H			

Left-Hand P-Shape Tables with End Panel

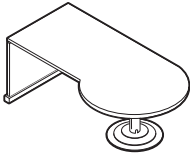

Square Edge Profile					
31½"	72"	28½"	ASPF7242L	\$2501	+\$144

Camber Edge Profile					
31½"	72"	28½"	ARPF7242L	\$2501	+\$144

Right-Hand P-Shape Tables with End Panel

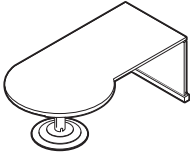

Square Edge Profile					
31½"	72"	28½"	ASPF7242R	\$2501	+\$144

Camber Edge Profile					
31½"	72"	28½"	ARPF7242R	\$2501	+\$144

Left-Hand P-Shape Tables without End Panel

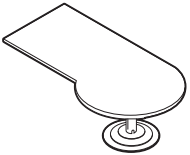

Square Edge Profile					
31½"	49 ⁵ / ₁₆ "	28½"	ASPA4842L	\$2080	+\$ 84
31½"	60"	28½"	ASPA6042L	\$2222	+\$ 84
31½"	72"	28½"	ASPA7242L	\$2364	+\$ 84

Camber Edge Profile					
31½"	49 ⁵ / ₁₆ "	28½"	ARPA4842L	\$2080	+\$ 84
31½"	60"	28½"	ARPA6042L	\$2222	+\$ 84
31½"	72"	28½"	ARPA7242L	\$2364	+\$ 84

Right-Hand P-Shape Tables without End Panel

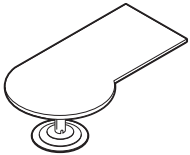

Square Edge Profile					
31½"	49 ⁵ / ₁₆ "	28½"	ASPA4842R	\$2080	+\$ 84
31½"	60"	28½"	ASPA6042R	\$2222	+\$ 84
31½"	72"	28½"	ASPA7242R	\$2364	+\$ 84

Camber Edge Profile					
31½"	49 ⁵ / ₁₆ "	28½"	ARPA4842R	\$2080	+\$ 84
31½"	60"	28½"	ARPA6042R	\$2222	+\$ 84
31½"	72"	28½"	ARPA7242R	\$2364	+\$ 84

Modular Credenza Assemblies

SIN 711.8

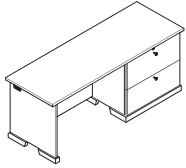

Tip: All credenza assemblies are shipped assembled.

Tip: Credenzas are standard with pedestal configurations shown. Pedestal substitutions are available.

▶ Page B28

Tip: Specify a grommet if you plan to install a service module with shelf light above the credenza.

Standard Includes		Required to Specify	
<ul style="list-style-type: none"> Credenza: wood Worksurface with square edge or camber edge Full-height modesty panel in kneespace that swings, if selected Full-height pedestals with open backs Security panel on back of pedestals Knob drawer pulls: 0835 Black paint Lock, keyed random: 9250 Ember Chrome Side grommets: black plastic only One hanging file system per file drawer Leveling glides: black only 		<ul style="list-style-type: none"> 1 Style number 2 Wood color number for credenza 3 Options, if selected (see below) ▶ See <i>Surface Materials</i>, page J2. 	
Options	Price	Required to Specify	
Surface Materials	<ul style="list-style-type: none"> Customiz stain on wood 	Prices at right	Specify with <i>Customiz stain</i> . ▶ See <i>Surface Materials Reference Manual</i> .
Drawer Pulls	Knob drawer pulls		
	<ul style="list-style-type: none"> Nickel 	No cost	Specify with <i>9211 Nickel knob pulls</i> .
	Bow drawer pulls		
<ul style="list-style-type: none"> Black Nickel 	No cost No cost	Specify with <i>0835 Black bow pulls</i> . Specify with <i>9211 Nickel bow pulls</i> .	
Rail drawer pulls			
	<ul style="list-style-type: none"> Black Nickel 	No cost No cost	Specify with <i>0835 Black rail pulls</i> . Specify with <i>9211 Nickel rail pulls</i> .
Pedestal Back Panels	<ul style="list-style-type: none"> Finished back panels for pedestals: wood 	+\$502	Add suffix BP to style number.
Grommets	<ul style="list-style-type: none"> 4"-square worksurface grommets: black plastic only 	+\$ 58	Left and right: Specify with <i>WWTPLR</i> .
	<ul style="list-style-type: none"> Channel grommet: black plastic only 	+\$250	Specify with <i>WWTPF</i> .
Pedestal Substitutions	<ul style="list-style-type: none"> 16"W pedestals 		▶ Page B28
	<ul style="list-style-type: none"> 32"W pedestals 		▶ Page B28
Keying	<ul style="list-style-type: none"> Factory- and field-installed keying 		▶ Page J8
Related Products	<ul style="list-style-type: none"> Accessories 		▶ Page B42

Specification Information

Dimensions			Knee-space Width	Style Number	Base Price	Option (Add \$ to Base Price)
D	W	H				
:	:	:	:	:	:	Customiz Stain

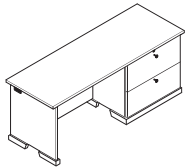

• Right: two-drawer lateral file

Credenza with One 32"W Lateral File and Left-Hand Kneespace

Square Edge Profile	
25½" 72" 28½" 37½" AS7224KL \$2575 +\$278	
Camber Edge Profile	
25½" 72" 28½" 37½" AR7224KL \$2575 +\$278	

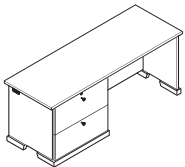

• Left: two-drawer lateral file

Credenza with One 32"W Lateral File and Right-Hand Kneespace

Square Edge Profile	
25½" 72" 28½" 37½" AS7224LK \$2575 +\$278	
Camber Edge Profile	
25½" 72" 28½" 37½" AR7224LK \$2575 +\$278	

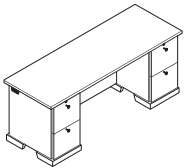

• Left: two file drawers
• Right: two file drawers

Credenza with Two 16"W Pedestals and Center Kneespace

Square Edge Profile	
25½" 72" 28½" 38¾" AS7224PKP \$2575 +\$278	
Camber Edge Profile	
25½" 72" 28½" 38¾" AR7224PKP \$2575 +\$278	

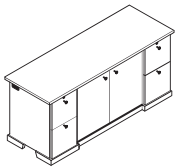

• Left: two file drawers
• Center: double-door cabinet
• Right: two file drawers

Credenza with Two 16"W Pedestals and Double-Door Cabinet

Square Edge Profile	
25½" 72" 28½" N.A. AS7224PDP \$2756 +\$278	
Camber Edge Profile	
25½" 72" 28½" N.A. AR7224PDP \$2756 +\$278	

Tip: Pedestal substitution is not available for the double-door cabinet.

Pedestal Substitutions

for Use with Modular Credenza Assemblies

SIN 711.8



Tip: Pedestals are for substitution on credenza assemblies only. They are not available as a separate item.

Tip: Specify pedestal substitutions to fill credenza, left to right.

Standard Includes	Required to Specify
<ul style="list-style-type: none"> • Full-height pedestal with open back • Security panel on back of pedestal • Knob drawer pulls: 0835 Black paint • One partition per box drawer, if selected: black plastic only • One hanging file system per file drawer 	<p>1 Add the pedestal substitution style number to the credenza assembly specifications and designate the location. <i>Example: AS7224PKP with ASJE1624 left</i></p> <p>2 Options, if selected (see below)</p>

Options	Price	Required to Specify
Drawer Pulls		
Knob drawer pulls		
• Nickel	No cost	Specify with 9211 Nickel knob pulls.
Bow drawer pulls		
• Black	No cost	Specify with 0835 Black bow pulls.
• Nickel	No cost	Specify with 9211 Nickel bow pulls.
Rail drawer pulls		
• Black	No cost	Specify with 0835 Black rail pulls.
• Nickel	No cost	Specify with 9211 Nickel rail pulls.

Specification Information

Depth	Style Number	Add/Subtract \$ to Credenza Base Price

16"W Substitute Pedestals

For Use with Square Edge Profile

24"	ASJE1624	+\$33
-----	-----------------	-------

For Use with Camber Edge Profile

24"	ARJE1624	+\$33
-----	-----------------	-------

► Specification Information continued on next page



• Two box and one file drawer

► Specification Information, continued

Specification Information

Depth	Style Number	Add/Subtract \$ to Credenza Base Price
-------	--------------	--

32"W Substitute Pedestals

For Use with Square Edge Profile

24"	ASJEE3224	+\$ 66
-----	------------------	--------

For Use with Camber Edge Profile

24"	ARJEE3224	+\$ 66
-----	------------------	--------

For Use with Square Edge Profile

24"	ASJPP3224	No cost
-----	------------------	---------

For Use with Camber Edge Profile

24"	ARJPP3224	No cost
-----	------------------	---------

For Use with Square Edge Profile

24"	ASJEP3224	+\$ 33
-----	------------------	--------

For Use with Camber Edge Profile

24"	ARJEP3224	+\$ 33
-----	------------------	--------

For Use with Square Edge Profile

24"	ASJPE3224	+\$ 33
-----	------------------	--------

For Use with Camber Edge Profile

24"	ARJPE3224	+\$ 33
-----	------------------	--------

For Use with Square Edge Profile

24"	ASJD3224	-\$128
-----	-----------------	--------

For Use with Camber Edge Profile

24"	ARJD3224	-\$128
-----	-----------------	--------

For Use with Square Edge Profile

24"	ASJL3224	No cost
-----	-----------------	---------

For Use with Camber Edge Profile

24"	ARJL3224	No cost
-----	-----------------	---------

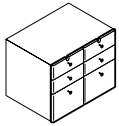

- Left: two box and one file drawer
- Right: two box and one file drawer

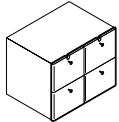

- Left: two file drawers
- Right: two file drawers

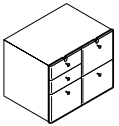

- Left: two box and one file drawer
- Right: two file drawers

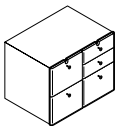

- Left: two file drawers
- Right: two box and one file drawer

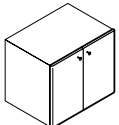

- Double-door cabinet

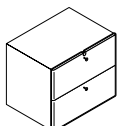

- Two lateral file drawers

Straight Workcentre Credenzas

SIN 711.8

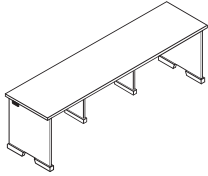

Tip: Specify a grommet if you plan to install a service module with shelf light above the credenza.

Standard Includes	Required to Specify
<ul style="list-style-type: none"> • Workcentre credenza: wood • Worksurface with square edge or camber edge • Finished apron located beneath the worksurface: wood • Side grommets: black plastic only • Leveling glides: black only 	<ol style="list-style-type: none"> 1 Style number 2 Wood color number for workcentre credenza 3 Options, if selected (see below) <p>▶ See <i>Surface Materials</i>, page J2.</p>

Options	Price	Required to Specify
Surface Materials <ul style="list-style-type: none"> • Customiz stain on wood 	Prices below	Specify with <i>Customiz stain</i> . ▶ See <i>Surface Materials Reference Manual</i> .
Full Back Panel <ul style="list-style-type: none"> • Finished full back panel: wood 	+\$874	Add suffix BP to style number.
Grommets <ul style="list-style-type: none"> • 4"-square worksurface grommets: black plastic only • Channel grommet: black plastic only 	+\$ 58 +\$250	Specify with <i>WWTPLR</i> . Specify with <i>WWTPF</i> .
Related Products <ul style="list-style-type: none"> • Accessories 		▶ Page B42

Specification Information

Dimensions	Style Number	Base Price	Option
D W H	Number	Price	(Add \$ to Base Price)
:	:	:	Customiz Stain

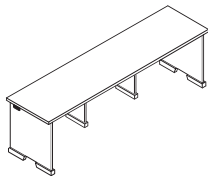

Straight Workcentre Credenzas

Square Edge Profile	Dimensions	Style Number	Base Price	Option
D W H	Number	Price	(Add \$ to Base Price)	Customiz Stain
:	:	:	:	:
:	:	:	:	:

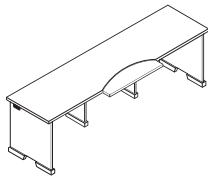

Straight Workcentre Credenzas with Integrated Adjustable Worksurface

Square Edge Profile	Dimensions	Style Number	Base Price	Option
D W H	Number	Price	(Add \$ to Base Price)	Customiz Stain
:	:	:	:	:
:	:	:	:	:

Corner Workcentre Credenzas

SIN 711.8

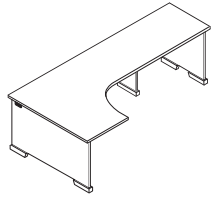

Tip: Specify a grommet if you plan to install a service module with shelf light above the credenza.

Standard Includes	Required to Specify
<ul style="list-style-type: none"> Workcentre credenza: wood Worksurface with square edge or camber edge Finished apron located beneath the worksurface: wood Side grommets: black plastic only Leveling glides: black only 	<ol style="list-style-type: none"> Style number Wood color number for workcentre credenza Options, if selected (see below) <p>▶ See <i>Surface Materials</i>, page J2.</p>

Options	Price	Required to Specify
Surface Materials <ul style="list-style-type: none"> Customiz stain on wood 	Prices below	Specify with <i>Customiz stain</i> . ▶ See <i>Surface Materials Reference Manual</i> .
Full Back Panel <ul style="list-style-type: none"> Finished full back panel: wood 	+\$874	Add suffix BP to style number.
Grommets <ul style="list-style-type: none"> 4"-square worksurface grommets: black plastic only Channel grommet: black plastic only 	+\$ 58 +\$250	Specify with <i>WWTPLR</i> . Specify with <i>WWTPF</i> .
Related Products <ul style="list-style-type: none"> Accessories 		▶ Page B42

Specification Information

Dimensions	Style Number	Base Price	Option
D	W	H	(Add \$ to Base Price)
:	:	:	Customiz Stain

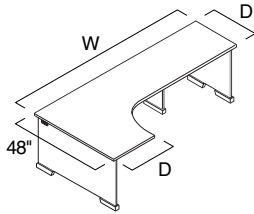

Left-Hand Corner Workcentre Credenza

Square Edge Profile	D	W	H	Style Number	Base Price	Option
	25½"	97¾"	28½"	ASX9748L	\$2587	+\$278
	25½"	113⅛"	28½"	ASX11348L	\$2824	+\$278
Camber Edge Profile	D	W	H	Style Number	Base Price	Option
	25½"	97¾"	28½"	ARX9748L	\$2587	+\$278
	25½"	113⅛"	28½"	ARX11348L	\$2824	+\$278

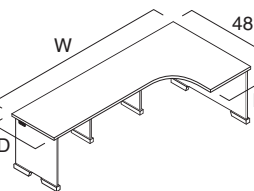

Right-Hand Corner Workcentre Credenza

Square Edge Profile	D	W	H	Style Number	Base Price	Option
	25½"	97¾"	28½"	ASX9748R	\$2587	+\$278
	25½"	113⅛"	28½"	ASX11348R	\$2824	+\$278
Camber Edge Profile	D	W	H	Style Number	Base Price	Option
	25½"	97¾"	28½"	ARX9748R	\$2587	+\$278
	25½"	113⅛"	28½"	ARX11348R	\$2824	+\$278

Service Modules

SIN 711.8

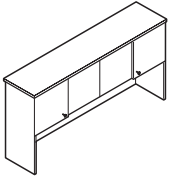

Tip: 112³/₈"W service modules ship knocked down (K.D.) and must be assembled in the field.

Standard Includes		Required to Specify	
<ul style="list-style-type: none"> • Service module with finished back: wood • Top with square edge or camber edge • Knob door pulls: 0835 Black paint • Tackboard: vertical surface fabric price group 1 • Two vertical wire managers: black plastic only • Recessed for optional shelf light • Attachment hardware 		<ol style="list-style-type: none"> 1 Style number 2 Wood color number for service module 3 Fabric color number for tackboard 4 Options, if selected (see below) <p>▶ See <i>Surface Materials</i>, page J2.</p>	
Options	Price	Required to Specify	
Surface Materials	<ul style="list-style-type: none"> • Customiz stain on wood 	Prices at right	Specify with <i>Customiz stain</i> . ▶ See <i>Surface Materials Reference Manual</i> .
Tackboard			
<ul style="list-style-type: none"> • Fabric price group 1 • Fabric price group 2 • Fabric price group 3 • Fabric price group 4 • Fabric price group 5 • Fabric price group COM 	No cost +\$ 12 +\$ 46 +\$ 62 +\$100 +\$ 15		Specify fabric color number. Specify fabric color number. Specify fabric color number. Specify fabric color number. Specify fabric color number. ▶ See <i>Surface Materials Reference Manual</i> .
Door Pulls	Knob door pulls		
	<ul style="list-style-type: none"> • Nickel 	No cost	Specify with <i>9211 Nickel knob pulls</i> .
	Bow door pulls		
	<ul style="list-style-type: none"> • Black • Nickel 	No cost No cost	Specify with <i>0835 Black bow pulls</i> . Specify with <i>9211 Nickel bow pulls</i> .
	Rail door pulls		
	<ul style="list-style-type: none"> • Black • Nickel 	No cost No cost	Specify with <i>0835 Black rail pulls</i> . Specify with <i>9211 Nickel rail pulls</i> .



Specification Information

Dimensions			Style Number	Base Price	Option (Add \$ to Base Price)
D	W	H			
:	:	:	:	:	Customiz
:	:	:	:	:	Stain

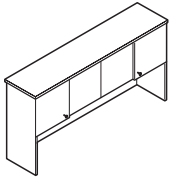

Service Modules with Four Hinged Doors

Square Edge Profile					
16 ⁵ / ₈ "	64 ¹ / ₂ "	40 ¹ / ₄ "	ASV66	\$2559	+\$239
16 ⁵ / ₈ "	71 ⁵ / ₁₆ "	40 ¹ / ₄ "	ASV72	\$2739	+\$239
Camber Edge Profile					
16 ⁵ / ₈ "	64 ¹ / ₂ "	40 ¹ / ₄ "	ARV66	\$2559	+\$239
16 ⁵ / ₈ "	71 ⁵ / ₁₆ "	40 ¹ / ₄ "	ARV72	\$2739	+\$239

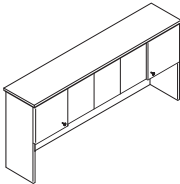

Service Modules with Five Hinged Doors

Square Edge Profile					
16 ⁵ / ₈ "	80 ¹ / ₂ "	40 ¹ / ₄ "	ASV81	\$2915	+\$239
Camber Edge Profile					
16 ⁵ / ₈ "	80 ¹ / ₂ "	40 ¹ / ₄ "	ARV81	\$2915	+\$239

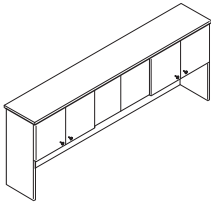

Service Modules with Six Hinged Doors

Square Edge Profile					
16 ⁵ / ₈ "	96 ⁷ / ₁₆ "	40 ¹ / ₄ "	ASV97	\$3134	+\$352
Camber Edge Profile					
16 ⁵ / ₈ "	96 ⁷ / ₁₆ "	40 ¹ / ₄ "	ARV97	\$3134	+\$352

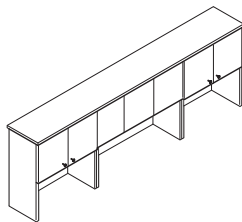

Service Modules with Seven Hinged Doors

Square Edge Profile					
16 ⁵ / ₈ "	112 ³ / ₈ "	40 ¹ / ₄ "	ASV113	\$3352	+\$352
Camber Edge Profile					
16 ⁵ / ₈ "	112 ³ / ₈ "	40 ¹ / ₄ "	ARV113	\$3352	+\$352

Lateral Files

SIN 711.8



Standard Includes	Required to Specify
-------------------	---------------------

- | | |
|--|--|
| <ul style="list-style-type: none"> • Lateral file with finished back: wood • Top with square edge or camber edge • Knob drawer pulls: 0835 Black paint • Lock, keyed random: 9250 Ember Chrome • One hanging file system per file drawer • Leveling glides: black only | <ul style="list-style-type: none"> 1 Style number 2 Wood color number for lateral file 3 Options, if selected (see below) ▶ See <i>Surface Materials</i>, page J2. |
|--|--|

Options	Price	Required to Specify
---------	-------	---------------------

Surface Materials	<ul style="list-style-type: none"> • Customiz stain on wood 	Prices below	Specify with <i>Customiz stain</i> . ▶ See <i>Surface Materials Reference Manual</i> .
Drawer Pulls	Knob drawer pulls		
	<ul style="list-style-type: none"> • Nickel 	No cost	Specify with <i>9211 Nickel knob pulls</i> .
	Bow drawer pulls		
<ul style="list-style-type: none"> • Black • Nickel 	No cost No cost	Specify with <i>0835 Black bow pulls</i> . Specify with <i>9211 Nickel bow pulls</i> .	
Rail drawer pulls			
	<ul style="list-style-type: none"> • Black • Nickel 	No cost No cost	Specify with <i>0835 Black rail pulls</i> . Specify with <i>9211 Nickel rail pulls</i> .
Keying	<ul style="list-style-type: none"> • Factory- and field-installed keying 		▶ Page J8

Specification Information					
Dimensions			Style Number	Base Price	Option
D	W	H			

:	:	:	:	:	:
:	:	:	:	:	:
:	:	:	:	:	:
:	:	:	:	:	:

Lateral Files with Four Drawers

	Square Edge Profile					
	25"	32 ⁵ / ₈ "	53 ¹ / ₂ "	ASFL432	\$3302	+\$212
	Camber Edge Profile					
	25"	32 ⁵ / ₈ "	53 ¹ / ₂ "	ARFL432	\$3302	+\$212
:	:	:	:	:	:	:

Wardrobes and Storage Cabinets

SIN 711.8

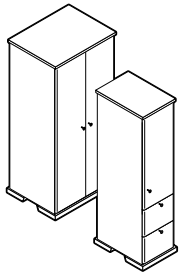

Standard Includes		Required to Specify	
	<ul style="list-style-type: none"> Cabinet with finished back: wood Top with square edge or camber edge Knob pulls: 0835 Black paint Lock, keyed random: 9250 Ember Chrome One hanging file system per file drawer Leveling glides: black only 		<ul style="list-style-type: none"> 1 Style number 2 Wood color number for cabinet 3 Options, if selected (see below) ▶ See <i>Surface Materials</i>, page J2.
Options		Price	Required to Specify
Surface Materials	<ul style="list-style-type: none"> Customiz stain on wood 	Prices below and at right	Specify with <i>Customiz stain</i> . ▶ See <i>Surface Materials Reference Manual</i> .
Pulls	Knob pulls		
	<ul style="list-style-type: none"> Nickel 	No cost	Specify with 9211 Nickel knob pulls.
	Bow pulls		
	<ul style="list-style-type: none"> Black Nickel 	No cost No cost	Specify with 0835 Black bow pulls. Specify with 9211 Nickel bow pulls.
	Rail pulls		
	<ul style="list-style-type: none"> Black Nickel 	No cost No cost	Specify with 0835 Black bow pulls. Specify with 9211 Nickel bow pulls.
Keying	<ul style="list-style-type: none"> Factory- and field-installed keying 		▶ Page J8

Specification Information					
Dimensions	D		Style Number	Base Price	Option (Add \$ to Base Price)
	W	H			
					Customiz Stain

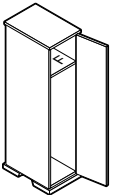

Wardrobes

	Square Edge Profile with Door Hinged on Left				
	25" 16 ¹¹ / ₁₆ " 72"	ASS1672WR	\$2605	+\$316	
	Square Edge Profile with Door Hinged on Right				
	25" 16 ¹¹ / ₁₆ " 72"	ASS1672WL	\$2605	+\$316	
	Camber Edge Profile with Door Hinged on Left				
	25" 16 ¹¹ / ₁₆ " 72"	ARS1672WR	\$2605	+\$316	
	Camber Edge Profile with Door Hinged on Right				
	25" 16 ¹¹ / ₁₆ " 72"	ARS1672WL	\$2605	+\$316	

▶ Specification Information continued on next page

► Specification Information, continued

Specification Information

Dimensions			Style Number	Base Price	Option (Add \$ to Base Price)
D	W	H			

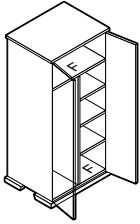

Storage Cabinets with One Wardrobe Left and Four Shelves Right

Square Edge Profile					
25"	32 ⁵ / ₈ "	72"	ASS3272P	\$3302	+\$445
Camber Edge Profile					
25 ³ / ₄ "	32 ⁵ / ₈ "	72"	ARS3272P	\$3302	+\$445

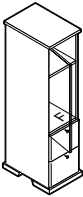

Storage Cabinets with Two File Drawers Below and One Shelf Above

Square Edge Profile with Door Hinged on Left					
25"	16 ¹ / ₁₆ "	60"	ASS1660FR	\$2786	+\$265
Square Edge Profile with Door Hinged on Right					
25"	16 ¹ / ₁₆ "	60"	ASS1660FL	\$2786	+\$265
Camber Edge Profile with Door Hinged on Left					
25"	16 ¹ / ₁₆ "	60"	ARS1660FR	\$2786	+\$265
Camber Edge Profile with Door Hinged on Right					
25"	16 ¹ / ₁₆ "	60"	ARS1660FL	\$2786	+\$265

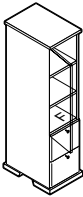

Storage Cabinets with Two File Drawers Below and Two Shelves Above

Square Edge Profile with Door Hinged on Left					
25"	16 ¹ / ₁₆ "	72"	ASS1672FR	\$3037	+\$316
Square Edge Profile with Door Hinged on Right					
25"	16 ¹ / ₁₆ "	72"	ASS1672FL	\$3037	+\$316
Camber Edge Profile with Door Hinged on Left					
25"	16 ¹ / ₁₆ "	72"	ARS1672FR	\$3037	+\$316
Camber Edge Profile with Door Hinged on Right					
25"	16 ¹ / ₁₆ "	72"	ARS1672FL	\$3037	+\$316

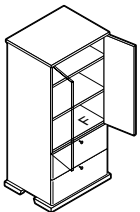

Storage Cabinets with Two Lateral File Drawers Below and Two Shelves Above

Square Edge Profile					
25"	32 ⁵ / ₈ "	72"	ASS3272L	\$3569	+\$445
Camber Edge Profile					
25"	32 ⁵ / ₈ "	72"	ARS3272L	\$3569	+\$445

Bookcases

SIN 711.8

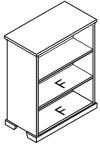

Tip: Bookcases with doors are non-locking.

Tip: Bookcases that have four or five shelves must be placed against a wall.

Standard Includes	Required to Specify
<ul style="list-style-type: none"> Bookcase with finished back: wood Top with square edge or camber edge Knob pulls on doors: 0835 Black paint Leveling glides on freestanding bookcases: black only 	<ul style="list-style-type: none"> 1 Style number 2 Wood color number for bookcase 3 Options, if selected (see below) ▶ See <i>Surface Materials</i>, page J2.

Options	Price	Required to Specify
Surface Materials <ul style="list-style-type: none"> Customiz stain on wood 	Prices at right	Specify with <i>Customiz stain</i> . ▶ See <i>Surface Materials Reference Manual</i> .
Door Pulls <p>Knob door pulls</p> <ul style="list-style-type: none"> Nickel <p>Bow door pulls</p> <ul style="list-style-type: none"> Black Nickel <p>Rail door pulls</p> <ul style="list-style-type: none"> Black Nickel 	No cost No cost No cost No cost	Specify with <i>9211 Nickel knob pulls</i> . Specify with <i>0835 Black bow pulls</i> . Specify with <i>9211 Nickel bow pulls</i> . Specify with <i>0835 Black rail pulls</i> . Specify with <i>9211 Nickel rail pulls</i> .

F = Fixed shelf

Specification Information

Dimensions			Number of Shelves	Style Number	Base Price	Option (Add \$ to Base Price) Customiz Stain
D	W	H				

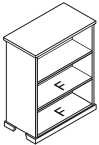

Freestanding Open Bookcases

Square Edge Profile						
	16 ⁵ / ₈ "	32 ⁵ / ₈ "	28 ¹ / ₂ "	1 fixed, 1 adjustable	ASKN232	\$ 997 +\$155
	16 ⁵ / ₈ "	32 ⁵ / ₈ "	42 ¹ / ₂ "	2 fixed, 1 adjustable	ASKN332	\$1239 +\$155
	16 ⁵ / ₈ "	32 ⁵ / ₈ "	60"	2 fixed, 2 adjustable	ASKN432	\$1486 +\$288
	16 ⁵ / ₈ "	32 ⁵ / ₈ "	72"	2 fixed, 3 adjustable	ASKN532	\$1729 +\$288
Camber Edge Profile						
	16 ⁵ / ₈ "	32 ⁵ / ₈ "	28 ¹ / ₂ "	1 fixed, 1 adjustable	ARKN232	\$ 997 +\$155
	16 ⁵ / ₈ "	32 ⁵ / ₈ "	42 ¹ / ₂ "	2 fixed, 1 adjustable	ARKN332	\$1239 +\$155
	16 ⁵ / ₈ "	32 ⁵ / ₈ "	60"	2 fixed, 2 adjustable	ARKN432	\$1486 +\$288
	16 ⁵ / ₈ "	32 ⁵ / ₈ "	72"	2 fixed, 3 adjustable	ARKN532	\$1729 +\$288

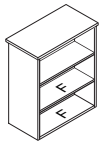

Stacking Open Bookcases

Square Edge Profile						
	16 ⁵ / ₈ "	32 ⁵ / ₈ "	42 ¹ / ₂ "	2 fixed, 1 adjustable	ASKS332	\$1033 +\$155
Camber Edge Profile						
	16 ⁵ / ₈ "	32 ⁵ / ₈ "	42 ¹ / ₂ "	2 fixed, 1 adjustable	ARKS332	\$1033 +\$155

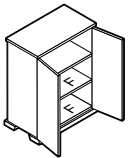

Freestanding Bookcases with Wood Doors

Square Edge Profile						
	16 ⁵ / ₈ "	32 ⁵ / ₈ "	28 ¹ / ₂ "	1 fixed, 1 adjustable	ASKD232	\$1507 +\$155
	16 ⁵ / ₈ "	32 ⁵ / ₈ "	42 ¹ / ₂ "	2 fixed, 1 adjustable	ASKD332	\$1800 +\$155
Camber Edge Profile						
	16 ⁵ / ₈ "	32 ⁵ / ₈ "	28 ¹ / ₂ "	1 fixed, 1 adjustable	ARKD232	\$1507 +\$155
	16 ⁵ / ₈ "	32 ⁵ / ₈ "	42 ¹ / ₂ "	2 fixed, 1 adjustable	ARKD332	\$1800 +\$155

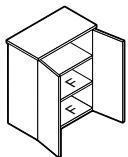

Stacking Bookcases with Wood Doors

Square Edge Profile						
	16 ⁵ / ₈ "	32 ⁵ / ₈ "	42 ¹ / ₂ "	2 fixed, 1 adjustable	ASKW332	\$1595 +\$155
Camber Edge Profile						
	16 ⁵ / ₈ "	32 ⁵ / ₈ "	42 ¹ / ₂ "	2 fixed, 1 adjustable	ARKW332	\$1595 +\$155



Additional Shelf

13"	30"	1"	N.A.	WWS	\$ 162	N.A.
-----	-----	----	------	------------	--------	------

F = Fixed shelf

Mobile Pedestals

SIN 711.8



Standard Includes	Required to Specify
-------------------	---------------------

- | | |
|--|--|
| <ul style="list-style-type: none"> • Mobile pedestal: wood • Top with square edge or camber edge • Knob drawer pulls: 0835 Black paint • Lock, keyed random: 9250 Ember Chrome • One partition per box drawer: black plastic only • One hanging file system per file drawer • One pencil tray per pedestal: black plastic only • Casters: black only | <ul style="list-style-type: none"> 1 Style number 2 Wood color number for pedestal 3 Options, if selected (see below) ▶ See <i>Surface Materials</i>, page J2. |
|--|--|

Options	Price	Required to Specify
---------	-------	---------------------

Surface Materials	<ul style="list-style-type: none"> • Customiz stain on wood 	Prices below	Specify with <i>Customiz stain</i> . ▶ See <i>Surface Materials Reference Manual</i> .
Drawer Pulls	<p>Knob drawer pulls</p> <ul style="list-style-type: none"> • Nickel <p>Bow drawer pulls</p> <ul style="list-style-type: none"> • Black • Nickel <p>Rail drawer pulls</p> <ul style="list-style-type: none"> • Black • Nickel 	No cost	Specify with <i>9211 Nickel knob pulls</i> . Specify with <i>0835 Black bow pulls</i> . Specify with <i>9211 Nickel bow pulls</i> . Specify with <i>0835 Black rail pulls</i> . Specify with <i>9211 Nickel rail pulls</i> .
Keying	<ul style="list-style-type: none"> • Factory- and field-installed keying 		▶ Page J8

Specification Information					
Dimensions	Style Number			Base Price	Option

Dimensions	Style Number			Base Price	Option
D	W	H	Number	Price	(Add \$ to Base Price)
:	:	:	:	:	Customiz
:	:	:	:	:	Stain
:	:	:	:	:	:
:	:	:	:	:	:
:	:	:	:	:	:
:	:	:	:	:	:
:	:	:	:	:	:
:	:	:	:	:	:
:	:	:	:	:	:
:	:	:	:	:	:
:	:	:	:	:	:
:	:	:	:	:	:
:	:	:	:	:	:
:	:	:	:	:	:
:	:	:	:	:	:
:	:	:	:	:	:
:	:	:	:	:	:
:	:	:	:	:	:
:	:	:	:	:	:
:	:	:	:	:	:
:	:	:	:	:	:
:	:	:	:	:	:
:	:	:	:	:	:
:	:	:	:	:	:
:	:	:	:	:	:
:	:	:	:	:	:
:	:	:	:	:	:
:	:	:	:	:	:
:	:	:	:	:	:
:	:	:	:	:	:
:	:	:	:	:	:
:	:	:	:	:	:
:	:	:	:	:	:
:	:	:	:	:	:
:	:	:	:	:	:
:	:	:	:	:	:
:	:	:	:	:	:
:	:	:	:	:	:
:	:	:	:	:	:
:	:	:	:	:	:
:	:	:	:	:	:
:	:	:	:	:	:
:	:	:	:	:	:
:	:	:	:	:	:
:	:	:	:	:	:
:	:	:	:	:	:
:	:	:	:	:	:
:	:	:	:	:	:
:	:	:	:	:	:
:	:	:	:	:	:
:	:	:	:	:	:
:	:	:	:	:	:
:	:	:	:	:	:
:	:	:	:	:	:
:	:	:	:	:	:
:	:	:	:	:	:
:	:	:	:	:	:
:	:	:	:	:	:
:	:	:	:	:	:
:	:	:	:	:	:
:	:	:	:	:	:
:	:	:	:	:	:
:	:	:	:	:	:
:	:	:	:	:	:
:	:	:	:	:	:
:	:	:	:	:	:
:	:	:	:	:	:
:	:	:	:	:	:
:	:	:	:	:	:
:	:	:	:	:	:
:	:	:	:	:	:
:	:	:	:	:	:
:	:	:	:	:	:
:	:	:	:	:	:
:	:	:	:	:	:
:	:	:	:	:	:
:	:	:	:	:	:
:	:	:	:	:	:
:	:	:	:	:	:
:	:	:	:	:	:
:	:	:	:	:	:
:	:	:	:	:	:
:	:	:	:	:	:
:	:	:	:	:	:
:	:	:	:	:	:
:	:	:	:	:	:
:	:	:	:	:	:
:	:	:	:	:	:
:	:	:	:	:	:
:	:	:	:	:	:
:	:	:	:	:	:
:	:	:	:	:	:
:	:	:	:	:	:
:					

Corner Units

SIN 711.8

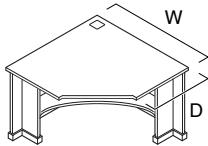

Tip: Corner unit is not freestanding. Corner unit links two returns to form an L-shape configuration. Single-pedestal desk, bridge, corner unit, and return connect to form a U-shape configuration.

Standard Includes	Required to Specify
-------------------	---------------------

- Corner unit: wood
- Worksurface with square edge or camber edge
- 4"-square worksurface grommet in back corner: black plastic only
- Leveling glides: black only

- 1 Style number
- 2 Wood color number for corner unit
- 3 Options, if selected (see below)
- ▶ See *Surface Materials*, page J2.

Options	Price	Required to Specify
---------	-------	---------------------

Surface Materials

- Customiz stain on wood

Prices below

Specify with *Customiz stain*.

▶ See *Surface Materials Reference Manual*.

Related Products

- Keyboard shelf

▶ Page B42

Specification Information

• Dimensions			• Front Edge Width	• Style Number	• Base Price	• Option (Add \$ to Base Price)
D	W	H				

	• Square Edge Profile					
	25½"	48"	28½"	32"	ASYU4824	\$2143 +\$209

	• Camber Edge Profile					
	25½"	48"	28½"	32"	ARYU4824	\$2143 +\$209

Accessories

SIN 711.8

Field-Installed Wood Center Drawer

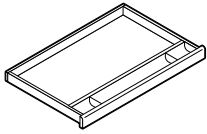

Tip: Field-installed wood center drawer attaches to a desk, corner unit, or 31½"D workcentre credenza.

Standard Includes	Required to Specify
<ul style="list-style-type: none"> • Non-locking center drawer: wood • Convenience tray • Attachment hardware 	1 Style number 2 Wood color number for center drawer 3 Options, if selected (see below) ▶ See <i>Surface Materials</i> , page J2.

Options	Price	Required to Specify
• Customiz stain on wood Surface Materials	No cost	Specify with Customiz stain. ▶ See <i>Surface Materials Reference Manual</i> .

Specification Information				
• Dimensions			• Style	• Base
D	W	H	Number	Price
21"	24¼"	2½"	WFCD24	\$192

Field-Installed Keyboard Shelf

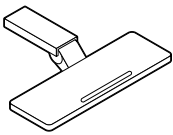

Tip: Keyboard shelf attaches to a return, bridge, corner unit, or credenza.

Standard Includes	Required to Specify
<ul style="list-style-type: none"> • Keyboard shelf: black paint only • Tray on keyboard shelf: black vinyl only 	Style number

Specification Information			
• Dimensions		• Style	• Price
D	W	Number	
10"	30"	WWYK30	\$252

Field-Installed Square Grommet

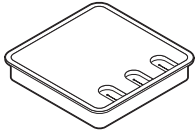

Standard Includes	Required to Specify
<ul style="list-style-type: none"> Grommet: black plastic only 	Style number

Specification Information

• Dimensions		• Style	• Price
D	W	Number	
4"	4"	WWGS	\$19
:	:	:	:

Field-Installed Round Grommet



Standard Includes	Required to Specify
<ul style="list-style-type: none"> Grommet: black plastic only 	Style number

Specification Information

• Width	• Style	• Price
	Number	
2 1/4"	WWGR	\$19
:	:	:



Walden

Walden offers a comprehensive selection of casegood components characterized by clean, rectilinear styling available in all wood veneer or wood veneer with laminate top. Three distinctive edge profiles are available and integral pulls provide a simple, uncluttered look.



Statement of Line

C2



Specification Information

Double-Pedestal Desks (SIN 711.8)	C4
Single-Pedestal Desks (SIN 711.8)	C8
Typing-Height Returns (SIN 711.8)	C16
Desk-Height Returns (SIN 711.8)	C18
Bridges (SIN 711.8)	C21
Bullet-Shape Tables (SIN 711.8)	C22
Credenzas (SIN 711.8)	C24
Service Modules and Tackboards (SIN 711.8)	C34
Lateral Files (SIN 711.8)	C36
Bookcases (SIN 711.8)	C38
VDT/Printer Tables (SIN 711.8)	C40
Accessories (SIN 711.8)	C41

Walden

Statement of Line

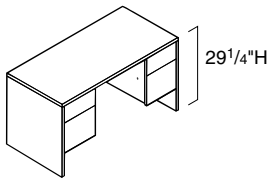

Specifying
▶ Pages C4–C7

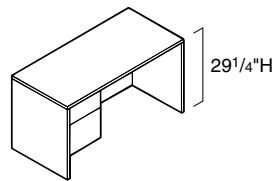

Specifying
▶ Pages C8–C14

Double-Pedestal Desks

	60"W	66"W	72"W
30"D	●	●	
36"D			●

Single-Pedestal Desks*

	66"W	72"W
30"D	●	
36"D		●

*Drawing shows left-hand unit. Right-hand unit is also available.

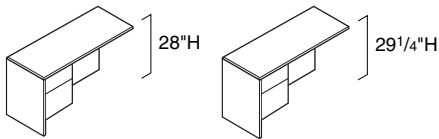

Specifying
▶ Pages C16–C20

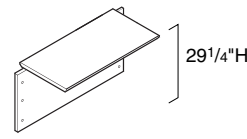

Specifying
▶ Page C21

Returns*

	48"W
24"D	●

*Drawing shows left-hand unit. Right-hand unit is also available.

Bridges

	48"W
24"D	●

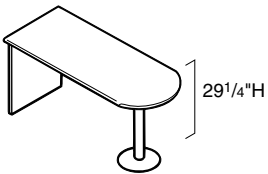

Specifying
▶ Page C22

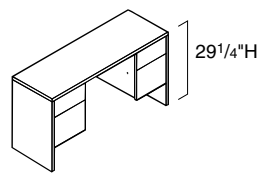

Specifying
▶ Pages C24–C31

Bullet-Shape Tables

	72"W
36"D	●

Credenzas

	66"W	72"W
20"D	●	●

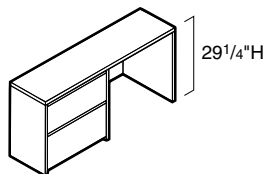

Specifying
▶ Page C32

Credenzas with Lateral Files

72"W	
20"D	●

*Drawing shows left-hand unit. Right-hand unit is also available.

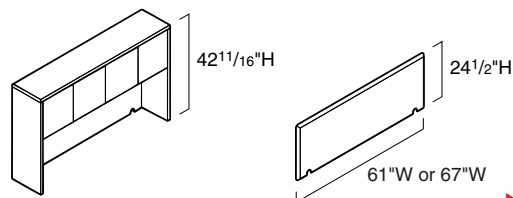

Specifying
▶ Pages C34–C35

Service Modules and Tackboards

66"W	72"W
15 9/16"D	●

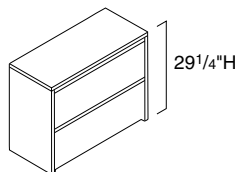

Specifying
▶ Page C36

Lateral Files

36"W	
20"D	●

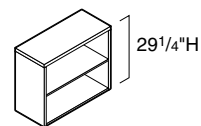

Specifying
▶ Page C38

Bookcases

36"W	
15 9/16"D	●

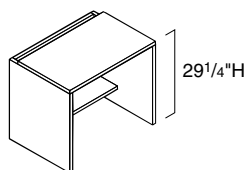

Specifying
▶ Page C40

VDT/Printer Tables

36"W	
23 15/16"D	●

Double-Pedestal Desks

SIN 711.8

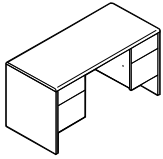

Standard Includes	Required to Specify
<ul style="list-style-type: none"> • 29¼"H desk: wood • Worksurface with radius, square, or chamfer edge: wood or laminate • Locks, keyed random: 9250 Ember Chrome • One pencil tray per desk: black plastic • One partition per box drawer: wood • Leveling glides: black only 	<ol style="list-style-type: none"> 1 Style number 2 Wood or laminate color number for worksurface 3 Wood color number for desk 4 Options, if selected (see below) <p>▶ See <i>Surface Materials</i>, page J2.</p>

	Options	Price	Required to Specify
Surface Materials	<ul style="list-style-type: none"> • Customiz stain on wood 	Prices at right	Specify <i>with Customiz stain</i> . ▶ See <i>Surface Materials Reference Manual</i> .
Grommets	<ul style="list-style-type: none"> • Factory-installed grommets: black plastic only 	No cost	Left and right: Specify <i>with WWTPBLR</i> .
Keying	<ul style="list-style-type: none"> • Factory- and field-installed keying 		▶ Page J6
Related Products	<ul style="list-style-type: none"> • Accessories 		▶ Page C41

Specification Information

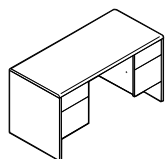

Dimensions		Knee-space Width	Style Number	Base Price	Option (Add \$ to Base Price) Customiz Stain on Wood
D	W				





- Left: one box and one file drawer
- Right: one box and one file drawer

With 3/4-Height Pedestals and 3/4-Height Back Panel

Wood Worksurface

Radius Edge Profile						
	30"	60"	27 1/4"	W4526030	\$1546	+\$320
	30"	66"	33 1/4"	W4526630	\$1658	+\$320
	36"	72"	39 1/4"	W4527236	\$1772	+\$320
Square Edge Profile						
	30"	60"	27 1/4"	W4426030	\$1546	+\$320
	30"	66"	33 1/4"	W4426630	\$1658	+\$320
	36"	72"	39 1/4"	W4427236	\$1772	+\$320
Chamfer Edge Profile						
	30"	60"	27 1/4"	W4826030	\$1546	+\$320
	30"	66"	33 1/4"	W4826630	\$1658	+\$320
	36"	72"	39 1/4"	W4827236	\$1772	+\$320

Laminate Worksurface

Radius Edge Profile						
	30"	60"	27 1/4"	L4526030	\$1367	N.A.
	30"	66"	33 1/4"	L4526630	\$1479	N.A.
	36"	72"	39 1/4"	L4527236	\$1593	N.A.
Square Edge Profile						
	30"	60"	27 1/4"	L4426030	\$1367	N.A.
	30"	66"	33 1/4"	L4426630	\$1479	N.A.
	36"	72"	39 1/4"	L4427236	\$1593	N.A.
Chamfer Edge Profile						
	30"	60"	27 1/4"	L4826030	\$1367	N.A.
	30"	66"	33 1/4"	L4826630	\$1479	N.A.
	36"	72"	39 1/4"	L4827236	\$1593	N.A.

Walden

Double-Pedestal Desks, continued

SIN 711.8

Specification Information

Dimensions		Knee-space Width	Style Number	Base Price	Option (Add \$ to Base Price) Customiz Stain on Wood
D	W				

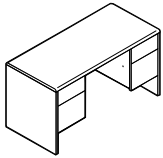

- Left: one box and one file drawer
- Right: one box and one file drawer

With 3/4-Height Pedestals and Full-Height Back Panel

Wood Worksurface

Radius Edge Profile					
30"	60"	27 1/4"	W4626030	\$1671	+\$320
30"	66"	33 1/4"	W4626630	\$1784	+\$320
36"	72"	39 1/4"	W4627236	\$1897	+\$320

Square Edge Profile					
30"	60"	27 1/4"	W4726030	\$1671	+\$320
30"	66"	33 1/4"	W4726630	\$1784	+\$320
36"	72"	39 1/4"	W4727236	\$1897	+\$320

Chamfer Edge Profile					
30"	60"	27 1/4"	W4926030	\$1671	+\$320
30"	66"	33 1/4"	W4926630	\$1784	+\$320
36"	72"	39 1/4"	W4927236	\$1897	+\$320

Laminate Worksurface

Radius Edge Profile					
30"	60"	27 1/4"	L4626030	\$1492	N.A.
30"	66"	33 1/4"	L4626630	\$1605	N.A.
36"	72"	39 1/4"	L4627236	\$1718	N.A.

Square Edge Profile					
30"	60"	27 1/4"	L4726030	\$1492	N.A.
30"	66"	33 1/4"	L4726630	\$1605	N.A.
36"	72"	39 1/4"	L4727236	\$1718	N.A.

Chamfer Edge Profile					
30"	60"	27 1/4"	L4926030	\$1492	N.A.
30"	66"	33 1/4"	L4926630	\$1605	N.A.
36"	72"	39 1/4"	L4927236	\$1718	N.A.

Specification Information

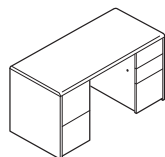

Dimensions		Knee-space Width	Style Number	Base Price	Option (Add \$ to Base Price) Customiz Stain on Wood
D	W				





- Left: two file drawers
- Right: two box and one file drawer

With Full-Height Pedestals and Full-Height Back Panel

Wood Worksurface

Radius Edge Profile						
	30"	60"	27 1/4"	WFR26030	\$1759	+\$320
	30"	66"	33 1/4"	WFR26630	\$1873	+\$320
	36"	72"	39 1/4"	WFR27236	\$1985	+\$320
Square Edge Profile						
	30"	60"	27 1/4"	WFS26030	\$1759	+\$320
	30"	66"	33 1/4"	WFS26630	\$1873	+\$320
	36"	72"	39 1/4"	WFS27236	\$1985	+\$320
Chamfer Edge Profile						
	30"	60"	27 1/4"	WFC26030	\$1759	+\$320
	30"	66"	33 1/4"	WFC26630	\$1873	+\$320
	36"	72"	39 1/4"	WFC27236	\$1985	+\$320

Laminate Worksurface

Radius Edge Profile						
	30"	60"	27 1/4"	LFR26030	\$1580	N.A.
	30"	66"	33 1/4"	LFR26630	\$1694	N.A.
	36"	72"	39 1/4"	LFR27236	\$1806	N.A.
Square Edge Profile						
	30"	60"	27 1/4"	LFS26030	\$1580	N.A.
	30"	66"	33 1/4"	LFS26630	\$1694	N.A.
	36"	72"	39 1/4"	LFS27236	\$1806	N.A.
Chamfer Edge Profile						
	30"	60"	27 1/4"	LFC26030	\$1580	N.A.
	30"	66"	33 1/4"	LFC26630	\$1694	N.A.
	36"	72"	39 1/4"	LFC27236	\$1806	N.A.



Single-Pedestal Desks

with Left-Hand Pedestal

SIN 711.8

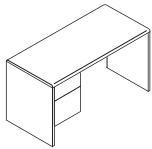

Standard Includes	Required to Specify
<ul style="list-style-type: none"> • 29¼"H desk: wood • Worksurface with radius, square, or chamfer edge: wood or laminate • Lock, keyed random: 9250 Ember Chrome • One pencil tray per desk: black plastic • One partition per box drawer: wood • Leveling glides: black only 	<ol style="list-style-type: none"> 1 Style number 2 Wood or laminate color number for worksurface 3 Wood color number for desk 4 Options, if selected (see below) <p>▶ See <i>Surface Materials</i>, page J2.</p>

Options	Price	Required to Specify
Surface Materials <ul style="list-style-type: none"> • Customiz stain on wood 	Prices at right	Specify <i>with Customiz stain</i> . ▶ See <i>Surface Materials Reference Manual</i> .
Grommets <ul style="list-style-type: none"> • Factory-installed grommets: black plastic only 	No cost	Left and right: Specify <i>with WWTPBLR</i> .
Keying <ul style="list-style-type: none"> • Factory- and field-installed keying 		▶ Page J6
Related Products <ul style="list-style-type: none"> • Accessories 		▶ Page C41

Specification Information

Dimensions		Knee-space Width	Style Number	Base Price	Option (Add \$ to Base Price) Customiz Stain on Wood
D	W				

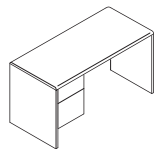

• Left: one box and one file drawer

With 3/4-Height Pedestal and 3/4-Height Back Panel

Wood Worksurface

Radius Edge Profile					
30"	66"	48 ³ / ₁₆ "	W4516630L	\$1355	+\$320
36"	72"	54 ³ / ₁₆ "	W4517236L	\$1440	+\$320
Square Edge Profile					
30"	66"	48 ³ / ₁₆ "	W4416630L	\$1355	+\$320
36"	72"	54 ³ / ₁₆ "	W4417236L	\$1440	+\$320
Chamfer Edge Profile					
30"	66"	48 ³ / ₁₆ "	W4816630L	\$1355	+\$320
36"	72"	54 ³ / ₁₆ "	W4817236L	\$1440	+\$320

Laminate Worksurface

Radius Edge Profile					
30"	66"	48 ³ / ₁₆ "	L4516630L	\$1176	N.A.
36"	72"	54 ³ / ₁₆ "	L4517236L	\$1261	N.A.
Square Edge Profile					
30"	66"	48 ³ / ₁₆ "	L4416630L	\$1176	N.A.
36"	72"	54 ³ / ₁₆ "	L4417236L	\$1261	N.A.
Chamfer Edge Profile					
30"	66"	48 ³ / ₁₆ "	L4816630L	\$1176	N.A.
36"	72"	54 ³ / ₁₆ "	L4817236L	\$1261	N.A.



Single-Pedestal Desks with Left-Hand Pedestal, continued

SIN 711.8

Specification Information

Dimensions		Knee-space Width	Style Number	Base Price	Option (Add \$ to Base Price) Customiz Stain on Wood
D	W				

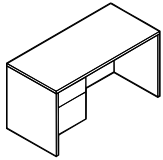

• Left: one box and one file drawer

With 3/4-Height Pedestal and Full-Height Back Panel

Wood Worksurface

Radius Edge Profile					
30"	66"	48 ³ / ₁₆ "	W4616630L	\$1476	+\$320
36"	72"	54 ³ / ₁₆ "	W4617236L	\$1564	+\$320
Square Edge Profile					
30"	66"	48 ³ / ₁₆ "	W4716630L	\$1476	+\$320
36"	72"	54 ³ / ₁₆ "	W4717236L	\$1564	+\$320
Chamfer Edge Profile					
30"	66"	48 ³ / ₁₆ "	W4916630L	\$1476	+\$320
36"	72"	54 ³ / ₁₆ "	W4917236L	\$1564	+\$320

Laminate Worksurface

Radius Edge Profile					
30"	66"	48 ³ / ₁₆ "	L4616630L	\$1297	N.A.
36"	72"	54 ³ / ₁₆ "	L4617236L	\$1385	N.A.
Square Edge Profile					
30"	66"	48 ³ / ₁₆ "	L4716630L	\$1297	N.A.
36"	72"	54 ³ / ₁₆ "	L4717236L	\$1385	N.A.
Chamfer Edge Profile					
30"	66"	48 ³ / ₁₆ "	L4916630L	\$1297	N.A.
36"	72"	54 ³ / ₁₆ "	L4917236L	\$1385	N.A.

Specification Information

Dimensions		Knee-space Width	Style Number	Base Price	Option (Add \$ to Base Price) Customiz Stain on Wood
D	W				

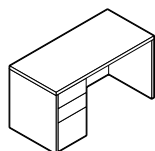

• Left: two box and one file drawer

With Full-Height Pedestal and Full-Height Back Panel

Wood Worksurface

Radius Edge Profile						
30"	66"	48 ³ / ₁₆ "	WFR16630L	\$1560	+\$320	
36"	72"	54 ³ / ₁₆ "	WFR17236L	\$1652	+\$320	
Square Edge Profile						
30"	66"	48 ³ / ₁₆ "	WFS16630L	\$1560	+\$320	
36"	72"	54 ³ / ₁₆ "	WFS17236L	\$1652	+\$320	
Chamfer Edge Profile						
30"	66"	48 ³ / ₁₆ "	WFC16630L	\$1560	+\$320	
36"	72"	54 ³ / ₁₆ "	WFC17236L	\$1652	+\$320	

Laminate Worksurface

Radius Edge Profile						
30"	66"	48 ³ / ₁₆ "	LFR16630L	\$1381	N.A.	
36"	72"	54 ³ / ₁₆ "	LFR17236L	\$1473	N.A.	
Square Edge Profile						
30"	66"	48 ³ / ₁₆ "	LFS16630L	\$1381	N.A.	
36"	72"	54 ³ / ₁₆ "	LFS17236L	\$1473	N.A.	
Chamfer Edge Profile						
30"	66"	48 ³ / ₁₆ "	LFC16630L	\$1381	N.A.	
36"	72"	54 ³ / ₁₆ "	LFC17236L	\$1473	N.A.	



Single-Pedestal Desks

with Right-Hand Pedestal

SIN 711.8

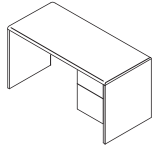

Standard Includes	Required to Specify
-------------------	---------------------

- 29¼"H desk: wood
- Worksurface with radius, square, or chamfer edge: wood or laminate
- Lock, keyed random: 9250 Ember Chrome
- One pencil tray per desk: black plastic
- One partition per box drawer: wood
- Leveling glides: black only

- 1 Style number
 - 2 Wood or laminate color number for worksurface
 - 3 Wood color number for desk
 - 4 Options, if selected (see below)
- ▶ See *Surface Materials*, page J2.

Options	Price	Required to Specify
---------	-------	---------------------

Surface Materials	• Customiz stain on wood	Prices at right	Specify <i>with Customiz stain</i> . ▶ See <i>Surface Materials Reference Manual</i> .
Grommets	• Factory-installed grommets: black plastic only	No cost	Left and right: Specify <i>with WWTPBLR</i> .
Keying	• Factory- and field-installed keying		▶ Page J6
Related Products	• Accessories		▶ Page C41

Specification Information

Dimensions D W	Knee-space Width	Style Number	Base Price	Option (Add \$ to Base Price) Customiz Stain on Wood

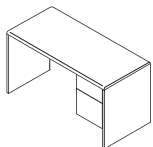

• Right: one box and one file drawer

With ¾-Height Pedestal and ¾-Height Back Panel

Wood Worksurface

Radius Edge Profile

30"	66"	48 ³ / ₁₆ "	W4516630R	\$1355	+\$320
36"	72"	54 ³ / ₁₆ "	W4517236R	\$1440	+\$320

Square Edge Profile

30"	66"	48 ³ / ₁₆ "	W4416630R	\$1355	+\$320
36"	72"	54 ³ / ₁₆ "	W4417236R	\$1440	+\$320

Chamfer Edge Profile

30"	66"	48 ³ / ₁₆ "	W4816630R	\$1355	+\$320
36"	72"	54 ³ / ₁₆ "	W4817236R	\$1440	+\$320

Laminate Worksurface

Radius Edge Profile

30"	66"	48 ³ / ₁₆ "	L4516630R	\$1176	N.A.
36"	72"	54 ³ / ₁₆ "	L4517236R	\$1261	N.A.

Square Edge Profile

30"	66"	48 ³ / ₁₆ "	L4416630R	\$1176	N.A.
36"	72"	54 ³ / ₁₆ "	L4417236R	\$1261	N.A.

Chamfer Edge Profile

30"	66"	48 ³ / ₁₆ "	L4816630R	\$1176	N.A.
36"	72"	54 ³ / ₁₆ "	L4817236R	\$1261	N.A.

Specification Information

Dimensions		Knee-space Width	Style Number	Base Price	Option (Add \$ to Base Price) Customiz Stain on Wood
D	W				

With 3/4-Height Pedestal and Full-Height Back Panel

Wood Worksurface

Radius Edge Profile

	30"	66"	48 ³ / ₁₆ "	W4616630R	\$1476	+\$320
	36"	72"	54 ³ / ₁₆ "	W4617236R	\$1564	+\$320

Square Edge Profile

	30"	66"	48 ³ / ₁₆ "	W4716630R	\$1476	+\$320
	36"	72"	54 ³ / ₁₆ "	W4717236R	\$1564	+\$320

Chamfer Edge Profile

	30"	66"	48 ³ / ₁₆ "	W4916630R	\$1476	+\$320
	36"	72"	54 ³ / ₁₆ "	W4917236R	\$1564	+\$320

Laminate Worksurface

Radius Edge Profile

	30"	66"	48 ³ / ₁₆ "	L4616630R	\$1297	N.A.
	36"	72"	54 ³ / ₁₆ "	L4617236R	\$1385	N.A.

Square Edge Profile

	30"	66"	48 ³ / ₁₆ "	L4716630R	\$1297	N.A.
	36"	72"	54 ³ / ₁₆ "	L4717236R	\$1385	N.A.

Chamfer Edge Profile

	30"	66"	48 ³ / ₁₆ "	L4916630R	\$1297	N.A.
	36"	72"	54 ³ / ₁₆ "	L4917236R	\$1385	N.A.

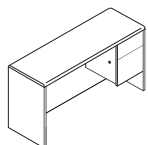

• Right: one box and one file drawer

Single-Pedestal Desks with Right-Hand Pedestal, continued

SIN 711.8

Specification Information

Dimensions		Knee-space Width	Style Number	Base Price	Option (Add \$ to Base Price) Customiz Stain on Wood
D	W				

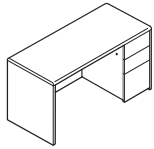

• Right: two box and one file drawer

With Full-Height Pedestal and Full-Height Back Panel

Wood Worksurface

Radius Edge Profile					
30"	66"	48 ³ / ₁₆ "	WFR16630R	\$1560	+\$320
36"	72"	54 ³ / ₁₆ "	WFR17236R	\$1652	+\$320
Square Edge Profile					
30"	66"	48 ³ / ₁₆ "	WFS16630R	\$1560	+\$320
36"	72"	54 ³ / ₁₆ "	WFS17236R	\$1652	+\$320
Chamfer Edge Profile					
30"	66"	48 ³ / ₁₆ "	WFC16630R	\$1560	+\$320
36"	72"	54 ³ / ₁₆ "	WFC17236R	\$1652	+\$320

Laminate Worksurface

Radius Edge Profile					
30"	66"	48 ³ / ₁₆ "	LFR16630R	\$1381	N.A.
36"	72"	54 ³ / ₁₆ "	LFR17236R	\$1473	N.A.
Square Edge Profile					
30"	66"	48 ³ / ₁₆ "	LFS16630R	\$1381	N.A.
36"	72"	54 ³ / ₁₆ "	LFS17236R	\$1473	N.A.
Chamfer Edge Profile					
30"	66"	48 ³ / ₁₆ "	LFC16630R	\$1381	N.A.
36"	72"	54 ³ / ₁₆ "	LFC17236R	\$1473	N.A.

SIN 711.8



Typing-Height Returns

SIN 711.8

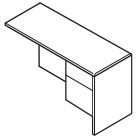

Tip: Right-hand return must be connected to a left-hand single-pedestal desk. Left-hand return must be connected to a right-hand single-pedestal desk.

Standard Includes		Required to Specify	
<ul style="list-style-type: none"> • 28"H typing-height return: wood • Worksurface with radius, square, or chamfer edge: wood or laminate • Full-height back panel and 3/4-height pedestal • One partition per box drawer: wood • Attachment hardware • Leveling glides: black only 		<ul style="list-style-type: none"> 1 Style number 2 Wood or laminate color number for worksurface 3 Wood color number for return ▶ See <i>Surface Materials</i>, page J2. 	
Options		Price	
Surface Materials	<ul style="list-style-type: none"> • Customiz stain on wood 	Prices at right	Specify with <i>Customiz stain</i> . ▶ See <i>Surface Materials Reference Manual</i> .
Grommets	<ul style="list-style-type: none"> • Factory-installed grommet: black plastic only 	No cost	Specify with <i>WWTPBC</i> .
Wire-Access Back Panel	<ul style="list-style-type: none"> • Reduced-height back panel for outlet access. 20" clear access from floor to back panel. 	No cost	Specify with <i>wire-access back panel</i> .
Related Products	<ul style="list-style-type: none"> • Accessories 		▶ Page C41

Specification Information

Dimensions		Knee-space Width	Style Number	Base Price	Option (Add \$ to Base Price) Customiz Stain on Wood
D	W				

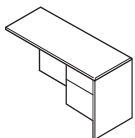

• Right: one box and one file drawer

Right-Hand Return

Wood Worksurface

Radius Edge Profile					
	24"	48"	31 ⁵ / ₈ "	W46D4824R	\$956 +\$174
Square Edge Profile					
	24"	48"	31 ⁵ / ₈ "	W47D4824R	\$956 +\$174
Chamfer Edge Profile					
	24"	48"	31 ⁵ / ₈ "	W49D4824R	\$956 +\$174

Laminate Worksurface

Radius Edge Profile					
	24"	48"	31 ⁵ / ₈ "	L46D4824R	\$856 N.A.
Square Edge Profile					
	24"	48"	31 ⁵ / ₈ "	L47D4824R	\$856 N.A.
Chamfer Edge Profile					
	24"	48"	31 ⁵ / ₈ "	L49D4824R	\$856 N.A.

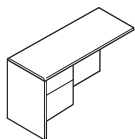

• Left: one box and one file drawer

Left-Hand Return

Wood Worksurface

Radius Edge Profile					
	24"	48"	31 ⁵ / ₈ "	W46D4824L	\$956 +\$174
Square Edge Profile					
	24"	48"	31 ⁵ / ₈ "	W47D4824L	\$956 +\$174
Chamfer Edge Profile					
	24"	48"	31 ⁵ / ₈ "	W49D4824L	\$956 +\$174

Laminate Worksurface

Radius Edge Profile					
	24"	48"	31 ⁵ / ₈ "	L46D4824L	\$856 N.A.
Square Edge Profile					
	24"	48"	31 ⁵ / ₈ "	L47D4824L	\$856 N.A.
Chamfer Edge Profile					
	24"	48"	31 ⁵ / ₈ "	L49D4824L	\$856 N.A.

Walden

Desk-Height Returns

SIN 711.8

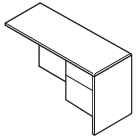

Tip: Right-hand return must be connected to a left-hand single-pedestal desk. Left-hand return must be connected to a right-hand single-pedestal desk.

Standard Includes		Required to Specify	
<ul style="list-style-type: none"> • 29¼"H desk-height return: wood • Worksurface with radius, square, or chamfer edge: wood or laminate • Lock, keyed random: 9250 Ember Chrome • One partition per box drawer: wood • Attachment hardware • Leveling glides: black only 		<ol style="list-style-type: none"> 1 Style number 2 Wood or laminate color number for worksurface 3 Wood color number for return 4 Options, if selected (see below) <p>▶ See <i>Surface Materials</i>, page J2.</p>	
Options		Price	
Surface Materials	<ul style="list-style-type: none"> • Customiz stain on wood 	Prices at right	Specify with <i>Customiz stain</i> . ▶ See <i>Surface Materials Reference Manual</i> .
Grommets	<ul style="list-style-type: none"> • Factory-installed grommet: black plastic only 	No cost	Specify with <i>WWTPBC</i> .
Wire-Access Back Panel	<ul style="list-style-type: none"> • Reduced-height back panel for outlet access. 20" clear access from floor to back panel. 	No cost	Specify with <i>wire-access back panel</i> .
Keying	<ul style="list-style-type: none"> • Factory- and field-installed keying 		▶ Page J6
Related Products	<ul style="list-style-type: none"> • Accessories 		▶ Page C41

Specification Information

• Dimensions		• Knee-space Width	• Style Number	• Base Price	• Option (Add \$ to Base Price) • Customiz Stain on Wood
D	W				

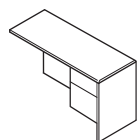

• Right: one box and one file drawer

Right-Hand Returns with 3/4-Height Pedestal and Full-Height Back Panel

Wood Worksurface

Radius Edge Profile	
24" 48" 31 5/8"	W46F4824R \$1001 +\$174

Square Edge Profile	
24" 48" 31 5/8"	W47F4824R \$1001 +\$174

Chamfer Edge Profile	
24" 48" 31 5/8"	W49F4824R \$1001 +\$174

Laminate Worksurface

Radius Edge Profile	
24" 48" 31 5/8"	L46F4824R \$ 901 N.A.

Square Edge Profile	
24" 48" 31 5/8"	L47F4824R \$ 901 N.A.

Chamfer Edge Profile	
24" 48" 31 5/8"	L49F4824R \$ 901 N.A.

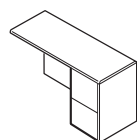

• Right: two file drawers

Right-Hand Returns with Full-Height Pedestal and Full-Height Back Panel

Wood Worksurface

Radius Edge Profile	
24" 48" 31 5/8"	WFRF4824R \$1213 +\$174

Square Edge Profile	
24" 48" 31 5/8"	WFSF4824R \$1213 +\$174

Chamfer Edge Profile	
24" 48" 31 5/8"	WFCF4824R \$1213 +\$174

Laminate Worksurface

Radius Edge Profile	
24" 48" 31 5/8"	LFRF4824R \$1113 N.A.

Square Edge Profile	
24" 48" 31 5/8"	LFSF4824R \$1113 N.A.

Chamfer Edge Profile	
24" 48" 31 5/8"	LFCF4824R \$1113 N.A.

Desk-Height Returns, continued

SIN 711.8

Specification Information

• Dimensions		• Knee-space Width	• Style Number	• Base Price	• Option (Add \$ to Base Price) • Customiz Stain on Wood
D	W				

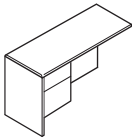

• Left: one box and one file drawer

Left-Hand Returns with 3/4-Height Pedestal and Full-Height Back Panel

Wood Worksurface

Radius Edge Profile	
	24" 48" 31 5/8" W46F4824L \$1001 +\$174
Square Edge Profile	
	24" 48" 31 5/8" W47F4824L \$1001 +\$174
Chamfer Edge Profile	
	24" 48" 31 5/8" W49F4824L \$1001 +\$174

Laminate Worksurface

Radius Edge Profile	
	24" 48" 31 5/8" L46F4824L \$ 901 N.A.
Square Edge Profile	
	24" 48" 31 5/8" L47F4824L \$ 901 N.A.
Chamfer Edge Profile	
	24" 48" 31 5/8" L49F4824L \$ 901 N.A.

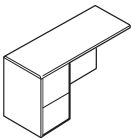

• Left: two file drawers

Left-Hand Returns with Full-Height Pedestal and Full-Height Back Panel

Wood Worksurface

Radius Edge Profile	
	24" 48" 31 5/8" WFRF4824L \$1213 +\$174
Square Edge Profile	
	24" 48" 31 5/8" WFSF4824L \$1213 +\$174
Chamfer Edge Profile	
	24" 48" 31 5/8" WFCF4824L \$1213 +\$174

Laminate Worksurface

Radius Edge Profile	
	24" 48" 31 5/8" LFRF4824L \$1113 N.A.
Square Edge Profile	
	24" 48" 31 5/8" LFSF4824L \$1113 N.A.
Chamfer Edge Profile	
	24" 48" 31 5/8" LFCF4824L \$1113 N.A.

Bridges

SIN 711.8

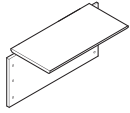

Tip: Bridge must be connected to a left-hand, single-pedestal desk and right hand, single-pedestal kneespace credenza **or** be connected to a right-hand, single-pedestal desk and left-hand, single-pedestal kneespace credenza. Bullet-shape table can be used in place of a single-pedestal desk.

Standard Includes		Required to Specify	
	<ul style="list-style-type: none"> Bridge: wood Worksurface with radius, square, or chamfer edge: wood or laminate ¾-height back panel Attachment hardware 		<ol style="list-style-type: none"> Style number Wood or laminate color number for worksurface Wood color number for back panel <p>▶ See <i>Surface Materials</i>, page J2.</p>
Options	Price	Required to Specify	
Surface Materials	<ul style="list-style-type: none"> Customiz stain on wood 	Prices below	Specify with <i>Customiz stain</i> . ▶ See <i>Surface Materials Reference Manual</i> .
Grommets	<ul style="list-style-type: none"> Factory-installed grommet: black plastic only 	No cost	Specify with <i>WWTPBC</i> .
Wire-Access Back Panel	<ul style="list-style-type: none"> Reduced-height back panel for outlet access. 20" clear access from floor to back panel. 	No cost	Specify with <i>wire-access back panel</i> .
Related Products	<ul style="list-style-type: none"> Accessories 		▶ Page C41

Specification Information

Dimensions			Style Number	Base Price	Option
D	W	H			(Add \$ to Base Price)
.....
.....
.....
.....
.....

Wood Worksurface

	Radius Edge Profile	24"	48"	29¼"	W45U4824	\$540	+\$129
	Square Edge Profile	24"	48"	29¼"	W44U4824	\$540	+\$129
	Chamfer Edge Profile	24"	48"	29¼"	W48U4824	\$540	+\$129

Laminate Worksurface

	Radius Edge Profile	24"	48"	29¼"	L45U4824	\$465	N.A.
	Square Edge Profile	24"	48"	29¼"	L44U4824	\$465	N.A.
	Chamfer Edge Profile	24"	48"	29¼"	L48U4824	\$465	N.A.

Walden

Bullet-Shape Tables

SIN 711.8

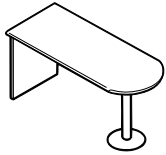

Tip: Bullet-shape table with end panel must be attached to a bridge or return for stability.

Standard Includes	Required to Specify
-------------------	---------------------

<ul style="list-style-type: none"> • 29¼"H worksurface with radius, square, or chamfer edge: wood or laminate • End panel support: wood • Column and disk base: black paint only • Leveling glides: black only 	<ol style="list-style-type: none"> 1 Style number 2 Wood or laminate color number for worksurface 3 Wood color number for end panel support <p>▶ See <i>Surface Materials</i>, page J2.</p>
--	--

Options	Price	Required to Specify
---------	-------	---------------------

Surface Materials	<ul style="list-style-type: none"> • Customiz stain on wood 	Prices below Specify with <i>Customiz stain</i> . ▶ See <i>Surface Materials Reference Manual</i> .
Grommets	<ul style="list-style-type: none"> • Factory-installed grommet: black plastic only 	No cost Specify with <i>WWTPBC</i> .
Related Products	<ul style="list-style-type: none"> • Accessories 	▶ Page C41

Specification Information

Dimensions	Knee-space	Style	Base	Option
D	W	Number	Price	(Add \$ to Base Price)
				Customiz Stain on Wood
:	:	:	:	:
:	:	:	:	:

Wood Worksurface

	Radius Edge Profile	36"	72"	28"	W45BF7236	\$1434	+\$144
	Square Edge Profile	36"	72"	28"	W44BF7236	\$1434	+\$144
	Chamfer Edge Profile	36"	72"	28"	W48BF7236	\$1434	+\$144

Laminate Worksurface

	Radius Edge Profile	36"	72"	28"	L45BF7236	\$1309	N.A.
	Square Edge Profile	36"	72"	28"	L44BF7236	\$1309	N.A.
	Chamfer Edge Profile	36"	72"	28"	L48BF7236	\$1309	N.A.

Credenzas

with 3/4-Height Pedestal
SIN 711.8

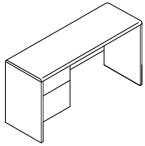

Standard Includes	Required to Specify
-------------------	---------------------

- | | |
|---|--|
| <ul style="list-style-type: none"> • 29 1/4"H credenza: wood • Worksurface with radius, square, or chamfer edge: wood or laminate • Touch latch on double-door cabinet • Lock, keyed random: 9250 Ember Chrome • One partition per box drawer: wood • Leveling glides: black only | <ol style="list-style-type: none"> 1 Style number 2 Wood or laminate color number for worksurface 3 Wood color number for credenzas 4 Options, if selected (see below) <p>▶ See <i>Surface Materials</i>, page J2.</p> |
|---|--|

Options	Price	Required to Specify
---------	-------	---------------------

Surface Materials	<ul style="list-style-type: none"> • Customiz stain on wood 	Prices below and at right	Specify with <i>Customiz stain</i> . ▶ See <i>Surface Materials Reference Manual</i> .
Grommets	<ul style="list-style-type: none"> • Factory-installed grommet: black plastic only 	No cost	Specify with <i>WWTPBLR</i> .
Wire-Access Back Panel	<ul style="list-style-type: none"> • Reduced-height back panel for outlet access. 20" clear access from floor to back panel. 	No cost	Specify with <i>wire-access back panel</i> .
Keying	<ul style="list-style-type: none"> • Factory- and field-installed keying 		▶ Page J6
Related Products	<ul style="list-style-type: none"> • Accessories 		▶ Page C41

Specification Information

• Dimensions		• Knee-space Width	• Style Number	• Base Price	• Option (Add \$ to Base Price)
• D	• W				
..... Customiz Stain on Wood

With One Left-Hand 3/4-Height Pedestal and Full-Height Back Panel

Wood Worksurface

	Radius Edge Profile	20"	72"	54 3/8"	W46Q7220L	\$1431	+\$278
	Square Edge Profile	20"	72"	54 3/8"	W47Q7220L	\$1431	+\$278
	Chamfer Edge Profile	20"	72"	54 3/8"	W49Q7220L	\$1431	+\$278

Laminate Worksurface

	Radius Edge Profile	20"	72"	54 3/8"	L46Q7220L	\$1281	N.A.
	Square Edge Profile	20"	72"	54 3/8"	L47Q7220L	\$1281	N.A.
	Chamfer Edge Profile	20"	72"	54 3/8"	L49Q7220L	\$1281	N.A.

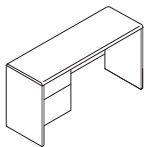

• Left: one box and one file drawer

Specification Information

• Dimensions		• Knee-space Width	• Style Number	• Base Price	• Option (Add \$ to Base Price) • Customiz Stain on Wood
D	W				

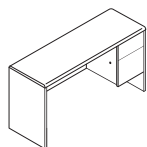

• Right: one box and one file drawer

With One Right-Hand 3/4-Height Pedestal and Full-Height Back Panel

Wood Worksurface

Radius Edge Profile						
20"	72"	54 ³ / ₈ "	W46Q7220R	\$1431	+\$278	

Square Edge Profile						
20"	72"	54 ³ / ₈ "	W47Q7220R	\$1431	+\$278	

Chamfer Edge Profile						
20"	72"	54 ³ / ₈ "	W49Q7220R	\$1431	+\$278	

Laminate Worksurface

Radius Edge Profile						
20"	72"	54 ³ / ₈ "	L46Q7220R	\$1281	N.A.	

Square Edge Profile						
20"	72"	54 ³ / ₈ "	L47Q7220R	\$1281	N.A.	

Chamfer Edge Profile						
20"	72"	54 ³ / ₈ "	L49Q7220R	\$1281	N.A.	



SIN 711.8

Specification Information

Dimensions D W	Knee-space Width	Style Number	Base Price	Option (Add \$ to Base Price) Customiz Stain on Wood
-------------------	---------------------	-----------------	---------------	--

With Two 3/4-Height Pedestals and 3/4-Height Back Panel

Wood Worksurface

Radius Edge Profile					
20"	66"	33 1/4"	W45P6620	\$1479	+\$278
20"	72"	39 1/4"	W45P7220	\$1583	+\$278
Square Edge Profile					
20"	66"	33 1/4"	W44P6620	\$1479	+\$278
20"	72"	39 1/4"	W44P7220	\$1583	+\$278
Chamfer Edge Profile					
20"	66"	33 1/4"	W48P6620	\$1479	+\$278
20"	72"	39 1/4"	W48P7220	\$1583	+\$278

Laminate Worksurface

Radius Edge Profile					
20"	66"	33 1/4"	L45P6620	\$1329	N.A.
20"	72"	39 1/4"	L45P7220	\$1433	N.A.
Square Edge Profile					
20"	66"	33 1/4"	L44P6620	\$1329	N.A.
20"	72"	39 1/4"	L44P7220	\$1433	N.A.
Chamfer Edge Profile					
20"	66"	33 1/4"	L48P6620	\$1329	N.A.
20"	72"	39 1/4"	L48P7220	\$1433	N.A.

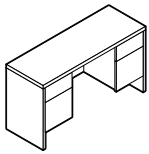

- Left: one box and one file drawer
- Right: one box and one file drawer

Specification Information

Dimensions		Knee-space Width	Style Number	Base Price	Option (Add \$ to Base Price)
D	W				
:	:	:	:	:	Customiz Stain on Wood

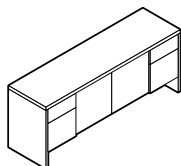

- Left: one box and one file drawer
- Center: double-door cabinet
- Right: one box and one file drawer

Tip: Double doors do not lock.

Full-Storage Credenza with 3/4-Height Pedestals and 3/4-Height Back Panel

Wood Worksurface

Radius Edge Profile						
20"	66"	N.A.	W45H6620	\$1617	+\$278	
20"	72"	N.A.	W45H7220	\$1686	+\$278	
Square Edge Profile						
20"	66"	N.A.	W44H6620	\$1617	+\$278	
20"	72"	N.A.	W44H7220	\$1686	+\$278	
Chamfer Edge Profile						
20"	66"	N.A.	W48H6620	\$1617	+\$278	
20"	72"	N.A.	W48H7220	\$1686	+\$278	

Laminate Worksurface

Radius Edge Profile						
20"	66"	N.A.	L45H6620	\$1467	N.A.	
20"	72"	N.A.	L45H7220	\$1536	N.A.	
Square Edge Profile						
20"	66"	N.A.	L44H6620	\$1467	N.A.	
20"	72"	N.A.	L44H7220	\$1536	N.A.	
Chamfer Edge Profile						
20"	66"	N.A.	L48H6620	\$1467	N.A.	
20"	72"	N.A.	L48H7220	\$1536	N.A.	

Walden

Credenzas

with Full-Height Pedestal

SIN 711.8

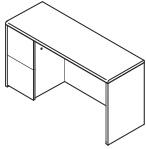

Standard Includes	Required to Specify
<ul style="list-style-type: none"> • 29¼"H credenza: wood • Worksurface with radius, square, or chamfer edge: wood or laminate • Touch latches on double-door cabinet • Lock, keyed random: 9250 Ember Chrome • One partition per box drawer: wood • Leveling glides: black only 	<ol style="list-style-type: none"> 1 Style number 2 Wood or laminate color number for worksurface 3 Wood color number for credenzas 4 Options, if selected (see below) <p>▶ See <i>Surface Materials</i>, page J2.</p>

Options	Price	Required to Specify
Surface Materials <ul style="list-style-type: none"> • Customiz stain on wood 	Prices below and at right	Specify with <i>Customiz stain</i> . ▶ See <i>Surface Materials Reference Manual</i> .
Grommets <ul style="list-style-type: none"> • Factory-installed grommet: black plastic only 	No cost	Specify with <i>WWTPBLR</i> .
Wire-Access Back Panel <ul style="list-style-type: none"> • Reduced-height back panel for outlet access. 20" clear access from floor to back panel. 	No cost	Specify with <i>wire-access back panel</i> .
Keying <ul style="list-style-type: none"> • Factory- and field-installed keying 		▶ Page J6
Related Products <ul style="list-style-type: none"> • Accessories 		▶ Page C41

Specification Information					
Dimensions	Knee-space	Style	Base	Option	
D	W	Number	Price	(Add \$ to Base Price)	
				Customiz Stain on Wood	

With One Left-Hand Full-Height Pedestal and Full-Height Back Panel

Wood Worksurface						
	Radius Edge Profile					
20"	72"	54¾"	WFRQ7220L	\$1567	+\$278	
	Square Edge Profile					
20"	72"	54¾"	WFSQ7220L	\$1567	+\$278	
	Chamfer Edge Profile					
20"	72"	54¾"	WFCQ7220L	\$1567	+\$278	
Laminate Worksurface						
	Radius Edge Profile					
20"	72"	54¾"	LFRQ7220L	\$1417	N.A.	
	Square Edge Profile					
20"	72"	54¾"	LFSQ7220L	\$1417	N.A.	
	Chamfer Edge Profile					
20"	72"	54¾"	LFCQ7220L	\$1417	N.A.	

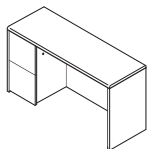

• Left: two file drawers

Specification Information

Dimensions		Knee-space Width	Style Number	Base Price	Option (Add \$ to Base Price)
D	W				
:	:	:	:	:	Customiz Stain on Wood

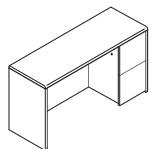

• Right: two file drawers

With One Right-Hand Full-Height Pedestal and Full-Height Back Panel

Wood Worksurface

Radius Edge Profile						
	20"	72"	54 ³ / ₈ "	WFRQ7220R	\$1567	+\$278
Square Edge Profile						
	20"	72"	54 ³ / ₈ "	WFSQ7220R	\$1567	+\$278
Chamfer Edge Profile						
	20"	72"	54 ³ / ₈ "	WFCQ7220R	\$1567	+\$278

Laminate Worksurface

Radius Edge Profile						
	20"	72"	54 ³ / ₈ "	LFRQ7220R	\$1417	N.A.
Square Edge Profile						
	20"	72"	54 ³ / ₈ "	LFSQ7220R	\$1417	N.A.
Chamfer Edge Profile						
	20"	72"	54 ³ / ₈ "	LFCQ7220R	\$1417	N.A.



SIN 711.8

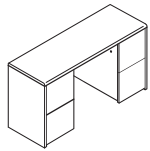

- Left: two file drawers
- Right: two file drawers

Specification Information

• Dimensions		• Knee-space Width	• Style Number	• Base Price	• Option (Add \$ to Base Price) Customiz Stain on Wood
D	W				

With Two Full-Height Pedestals and Full-Height Back Panel

Wood Worksurface

Radius Edge Profile					
20"	66"	33¼"	WFRP6620	\$1693	+\$278
20"	72"	39¼"	WFRP7220	\$1800	+\$278
Square Edge Profile					
20"	66"	33¼"	WFSP6620	\$1693	+\$278
20"	72"	39¼"	WFSP7220	\$1800	+\$278
Chamfer Edge Profile					
20"	66"	33¼"	WFCP6620	\$1693	+\$278
20"	72"	39¼"	WFCP7220	\$1800	+\$278

Laminate Worksurface

Radius Edge Profile					
20"	66"	33¼"	LFRP6620	\$1543	N.A.
20"	72"	39¼"	LFRP7220	\$1650	N.A.
Square Edge Profile					
20"	66"	33¼"	LFSP6620	\$1543	N.A.
20"	72"	39¼"	LFSP7220	\$1650	N.A.
Chamfer Edge Profile					
20"	66"	33¼"	LFCP6620	\$1543	N.A.
20"	72"	39¼"	LFCP7220	\$1650	N.A.

Specification Information

Dimensions		Knee-space Width	Style Number	Base Price	Option (Add \$ to Base Price)
D	W				
					Customiz Stain on Wood

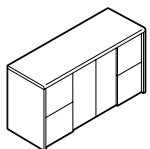

- Left: two file drawers
- Center: double-door cabinet
- Right: two file drawers

Tip: Double doors do not lock.

Full-Storage Credenza with Full-Height Pedestals and Full-Height Back Panel

Wood Worksurface

Radius Edge Profile		Knee-space Width	Style Number	Base Price	Option (Add \$ to Base Price)
D	W				
20"	66"	N.A.	WFRH6620	\$1830	+\$278
20"	72"	N.A.	WFRH7220	\$1898	+\$278
Square Edge Profile		Knee-space Width	Style Number	Base Price	Option (Add \$ to Base Price)
D	W				
20"	66"	N.A.	WFSH6620	\$1830	+\$278
20"	72"	N.A.	WFSH7220	\$1898	+\$278
Chamfer Edge Profile		Knee-space Width	Style Number	Base Price	Option (Add \$ to Base Price)
D	W				
20"	66"	N.A.	WFCH6620	\$1830	+\$278
20"	72"	N.A.	WFCH7220	\$1898	+\$278

Laminate Worksurface

Radius Edge Profile		Knee-space Width	Style Number	Base Price	Option (Add \$ to Base Price)
D	W				
20"	66"	N.A.	LFRH6620	\$1680	N.A.
20"	72"	N.A.	LFRH7220	\$1748	N.A.
Square Edge Profile		Knee-space Width	Style Number	Base Price	Option (Add \$ to Base Price)
D	W				
20"	66"	N.A.	LFSH6620	\$1680	N.A.
20"	72"	N.A.	LFSH7220	\$1748	N.A.
Chamfer Edge Profile		Knee-space Width	Style Number	Base Price	Option (Add \$ to Base Price)
D	W				
20"	66"	N.A.	LFCH6620	\$1680	N.A.
20"	72"	N.A.	LFCH7220	\$1748	N.A.

Walden

Credenzas

with Lateral Files

SIN 711.8

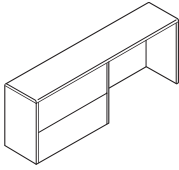

Standard Includes	Required to Specify
<ul style="list-style-type: none"> • 29¼"H credenza: wood • Worksurface with radius, square, or chamfer edge: wood or laminate • Lock, keyed random: 9250 Ember Chrome • Leveling glides: black only 	<ol style="list-style-type: none"> 1 Style number 2 Wood or laminate color number for worksurface 3 Wood color number for credenzas 4 Options, if selected (see below) <p>▶ See <i>Surface Materials</i>, page J2.</p>

Options	Price	Required to Specify
Surface Materials <ul style="list-style-type: none"> • Customiz stain on wood 	Prices at right	Specify with <i>Customiz stain</i> . ▶ See <i>Surface Materials Reference Manual</i> .
Grommets <ul style="list-style-type: none"> • Factory-installed grommet: black plastic only 	No cost	Specify with <i>WWTPBLR</i> .
Wire-Access Back Panel <ul style="list-style-type: none"> • Reduced-height back panel for outlet access. 20" clear access from floor to back panel. 	No cost	Specify with <i>wire-access back panel</i> .
Keying <ul style="list-style-type: none"> • Factory- and field-installed keying 		▶ Page J6
Related Products <ul style="list-style-type: none"> • Accessories 		▶ Page C41

Specification Information

Dimensions		Knee-space Width	Style Number	Base Price	Option (Add \$ to Base Price)
D	W				
					Customiz Stain on Wood

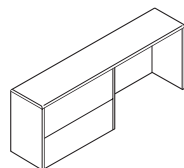

• Left: two-drawer lateral file

With One Left-Hand Lateral File and Full-Height Back Panel

Wood Worksurface

Radius Edge Profile		Knee-space Width	Style Number	Base Price	Option (Add \$ to Base Price)
D	W				
20"	72"	34 ¹³ / ₁₆ "	W46Y7220L	\$1668	+\$278

Square Edge Profile		Knee-space Width	Style Number	Base Price	Option (Add \$ to Base Price)
D	W				
20"	72"	34 ¹³ / ₁₆ "	W47Y7220L	\$1668	+\$278

Chamfer Edge Profile		Knee-space Width	Style Number	Base Price	Option (Add \$ to Base Price)
D	W				
20"	72"	34 ¹³ / ₁₆ "	W49Y7220L	\$1668	+\$278

Laminate Worksurface

Radius Edge Profile		Knee-space Width	Style Number	Base Price	Option (Add \$ to Base Price)
D	W				
20"	72"	34 ¹³ / ₁₆ "	L46Y7220L	\$1518	N.A.

Square Edge Profile		Knee-space Width	Style Number	Base Price	Option (Add \$ to Base Price)
D	W				
20"	72"	34 ¹³ / ₁₆ "	L47Y7220L	\$1518	N.A.

Chamfer Edge Profile		Knee-space Width	Style Number	Base Price	Option (Add \$ to Base Price)
D	W				
20"	72"	34 ¹³ / ₁₆ "	L49Y7220L	\$1518	N.A.

With One Right-Hand Lateral File and Full-Height Back Panel

Wood Worksurface

Radius Edge Profile		Knee-space Width	Style Number	Base Price	Option (Add \$ to Base Price)
D	W				
20"	72"	34 ¹³ / ₁₆ "	W46Y7220R	\$1668	+\$278

Square Edge Profile		Knee-space Width	Style Number	Base Price	Option (Add \$ to Base Price)
D	W				
20"	72"	34 ¹³ / ₁₆ "	W47Y7220R	\$1668	+\$278

Chamfer Edge Profile		Knee-space Width	Style Number	Base Price	Option (Add \$ to Base Price)
D	W				
20"	72"	34 ¹³ / ₁₆ "	W49Y7220R	\$1668	+\$278

Laminate Worksurface

Radius Edge Profile		Knee-space Width	Style Number	Base Price	Option (Add \$ to Base Price)
D	W				
20"	72"	34 ¹³ / ₁₆ "	L46Y7220R	\$1518	N.A.

Square Edge Profile		Knee-space Width	Style Number	Base Price	Option (Add \$ to Base Price)
D	W				
20"	72"	34 ¹³ / ₁₆ "	L47Y7220R	\$1518	N.A.

Chamfer Edge Profile		Knee-space Width	Style Number	Base Price	Option (Add \$ to Base Price)
D	W				
20"	72"	34 ¹³ / ₁₆ "	L49Y7220R	\$1518	N.A.

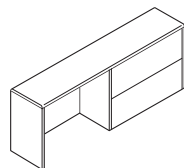

• Right: two-drawer lateral file

Service Modules and Tackboards

SIN 711.8

Service Modules

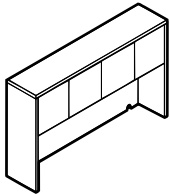

Standard Includes	Required to Specify
<ul style="list-style-type: none"> • Service module with radius, square, or chamfer edge: wood • Two vertical wire managers: black plastic • Grommets in left and right corners of the back panel • Attachment hardware 	<ul style="list-style-type: none"> 1 Style number 2 Wood color number for service modules 3 Options, if selected (see below) ▶ See <i>Surface Materials</i>, page J2.

Options	Price	Required to Specify
Surface Materials <ul style="list-style-type: none"> • Customiz stain on wood 	Prices below	Specify with <i>Customiz stain</i> . ▶ See <i>Surface Materials Reference Manual</i> .

Specification Information

• Dimensions			• Style Number	• Base Price	• Option (Add \$ to Base Price)
D	W	H			
Radius Edge Profile					
15 ⁹ / ₁₆ "	66"	42 ¹¹ / ₁₆ "	W45SM66	\$1497	+\$239
15 ⁹ / ₁₆ "	72"	42 ¹¹ / ₁₆ "	W45SM72	\$1593	+\$239
Square Edge Profile					
15 ⁹ / ₁₆ "	66"	42 ¹¹ / ₁₆ "	W44SM66	\$1497	+\$239
15 ⁹ / ₁₆ "	72"	42 ¹¹ / ₁₆ "	W44SM72	\$1593	+\$239
Chamfer Edge Profile					
15 ⁹ / ₁₆ "	66"	42 ¹¹ / ₁₆ "	W48SM66	\$1497	+\$239
15 ⁹ / ₁₆ "	72"	42 ¹¹ / ₁₆ "	W48SM72	\$1593	+\$239

Field-Installed Tackboards

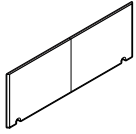

Standard Includes	Required to Specify
-------------------	---------------------

- Tackboard: vertical surface fabric price group 1

- 1 Style number
- 2 Fabric color number for tackboards
- 3 Options, if selected (see below)
- ▶ See *Surface Materials*, page J2.

	Options	Price	Required to Specify
--	---------	-------	---------------------

Surface Materials	• Fabric price group 1	No cost	Specify fabric color number.
	• Fabric price group 2	+\$ 12	Specify fabric color number.
	• Fabric price group 3	+\$ 46	Specify fabric color number.
	• Fabric price group 4	+\$ 62	Specify fabric color number.
	• Fabric price group 5	+\$100	Specify fabric color number.
	• Fabric price group COM	+\$ 15	▶ See <i>Surface Materials Reference Manual</i> .

Specification Information				
Dimensions			Style	Base
D	W	H	Number	Price

3/8"	61"	24 1/2"	W45TB66	\$162
3/8"	67"	24 1/2"	W45TB72	\$175

Walden

Lateral Files

SIN 711.8

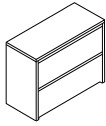

Standard Includes	Required to Specify
<ul style="list-style-type: none"> Lateral file: wood Top with radius, square, or chamfer edge: wood or laminate Lock, keyed random: 9250 Ember Chrome Leveling glides: black only 	<ol style="list-style-type: none"> Style number Wood or laminate color number for top Wood color number for lateral file Options, if selected (see below) <p>▶ See <i>Surface Materials</i>, page J2.</p>

Options	Price	Required to Specify
Surface Materials <ul style="list-style-type: none"> Customiz stain on wood 	Prices below	Specify with <i>Customiz stain</i> . ▶ See <i>Surface Materials Reference Manual</i> .
Keying <ul style="list-style-type: none"> Factory- and field-installed keying 		▶ Page J6

Specification Information					
Dimensions			Style Number	Base Price	Option (Add \$ to Base Price)
D	W	H			
:	:	:	:	:	Customiz Stain on Wood

Wood Worksurface

	Radius Edge Profile	20"	36"	29¼"	W45LF3629	\$1187	+\$128
	Square Edge Profile	20"	36"	29¼"	W44LF3629	\$1187	+\$128
	Chamfer Edge Profile	20"	36"	29¼"	W48LF3629	\$1187	+\$128

Laminate Worksurface

	Radius Edge Profile	20"	36"	29¼"	L45LF3629	\$1062	N.A.
	Square Edge Profile	20"	36"	29¼"	L44LF3629	\$1062	N.A.
	Chamfer Edge Profile	20"	36"	29¼"	L48LF3629	\$1062	N.A.

F = Fixed shelf



VDT/Printer Tables

SIN 711.8

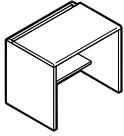

Standard Includes	Required to Specify
<ul style="list-style-type: none"> • Table: wood • Top with radius, square, or chamfer edge: wood or laminate • 3/4-height back panel • 1 1/2"D x 33 3/8"W paper slot • Leveling glides: black only 	<ol style="list-style-type: none"> 1 Style number 2 Wood or laminate color number for top 3 Wood color number for table 4 Options, if selected (see below) <p>▶ See <i>Surface Materials</i>, page J2.</p>

Options	Price	Required to Specify
Surface Materials <ul style="list-style-type: none"> • Customiz stain on wood 	Prices below	Specify with <i>Customiz stain</i> . ▶ See <i>Surface Materials Reference Manual</i> .
Related Products <ul style="list-style-type: none"> • Accessories 		▶ Page C41

Specification Information

• Dimensions	• Style	• Base	• Option
D W H	Number	Price	(Add \$ to Base Price)
:	:	:	Customiz Stain on Wood

Wood Worksurface

	Radius Edge Profile	23 15/16" 36" 29 1/4"	W45PT3624	\$750	+\$149
	Square Edge Profile	23 15/16" 36" 29 1/4"	W44PT3624	\$750	+\$149
	Chamfer Edge Profile	23 15/16" 36" 29 1/4"	W48PT3624	\$750	+\$149

Laminate Worksurface

	Radius Edge Profile	23 15/16" 36" 29 1/4"	L45PT3624	\$687	N.A.
	Square Edge Profile	23 15/16" 36" 29 1/4"	L44PT3624	\$687	N.A.
	Chamfer Edge Profile	23 15/16" 36" 29 1/4"	L48PT3624	\$687	N.A.

Accessories

SIN 711.8

Reference Shelf

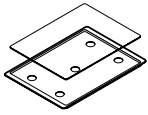

Standard Includes	Required to Specify
<ul style="list-style-type: none"> Reference shelf: black plastic only Insert: clear plastic only 	Style number

Specification Information

• Dimensions			• Style	• Price
D	W	H	Number	
9½"	12¾"	¾"	EE91530	\$22

Rails For Lateral File Drawers

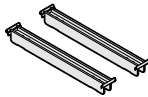

Standard Includes	Required to Specify
<ul style="list-style-type: none"> Two rails: black paint only 	Style number

Specification Information

• Dimensions			• Style	• Price
D	W	H	Number	
17/8"	15½"	1½"	NC900RW	\$21

Rail for File Drawers



Tip: Not for use in lateral file drawers. Order Service Part 44N005621 for lateral file drawer.

Standard Includes	Required to Specify
<ul style="list-style-type: none"> Rail: black paint only 	Style number

Specification Information

• Dimensions			• Style	• Price
D	W	H	Number	
17/8"	12½"	5/8"	W45FR	\$12

SIN 711.8

Field-Installed Grommet Package

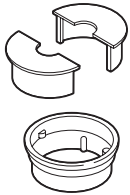

Standard Includes		Required to Specify	
<ul style="list-style-type: none"> Three-piece grommet: black plastic only 		Style number	
Specification Information			
Dimensions		Style Number	Price
Overall Diameter	Inside Diameter		
2"	1¾"	W6GMT	\$23

Field-Installed Wood Center Drawer

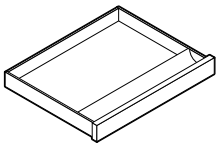

Tip: Not for use on returns, bridge, or credenzas.

Standard Includes		Required to Specify	
<ul style="list-style-type: none"> Center drawer with convenience tray: wood Attachment hardware 		1 Style number 2 Wood color number for center drawer 3 Options, if selected (see below) ▶ See <i>Surface Materials</i> , page J2.	
Options		Price	Required to Specify
Surface Materials	<ul style="list-style-type: none"> Customiz stain on wood 	No cost	Specify with <i>Customiz stain</i> . ▶ See <i>Surface Materials Reference Manual</i> .
Specification Information			
Dimensions			Style Number
D	W	H	
15 ¹ / ₁₆ "	18 ⁷ / ₈ "	2 ¹ / ₄ "	W45CWD
			\$159

Pullout Keyboard Shelf

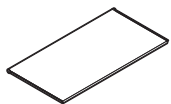

Tip: For use on VDT/printer tables with wood worksurface.

Standard Includes		Required to Specify	
<ul style="list-style-type: none"> Keyboard shelf: wood Attachment hardware 		1 Style number 2 Wood color number for shelf 3 Options, if selected (see below) ▶ See <i>Surface Materials</i> , page J2.	
Options		Price	Required to Specify
Surface Materials	<ul style="list-style-type: none"> Customiz stain on wood 	No cost	Specify with <i>Customiz stain</i> . ▶ See <i>Surface Materials Reference Manual</i> .
Specification Information			
Dimensions			Style Number
D	W	H	
16"	32 ⁷ / ₁₆ "	¾"	W45CTS
			\$128

Impact



Statement of Line

Configured Components	D2
Buildup Components	D4



Specification Information

Double-Pedestal Desks (SIN 711.8)	D12
Single-Pedestal Desks (SIN 711.8)	D14
Bullet-Shape Desks (SIN 711.8)	D16
Returns (SIN 711.8)	D18
Credenzas (SIN 711.8)	D20
Freestanding Corner Units (SIN 711.8)	D22
Tech Center Worksurfaces (SIN 711.8)	D23
Tech Center Leaves (SIN 711.8)	D24
Desk Worksurfaces (SIN 711.8)	D26
Credenza Worksurfaces (SIN 711.8)	D28
Bridge Worksurfaces (SIN 711.8)	D30
Return Worksurfaces (SIN 711.8)	D32
Run-Off Worksurfaces (SIN 711.8)	D34
Metal Flex Bases (SIN 711.8)	D36
Support Panels (SIN 711.8)	D37
Desk Modesty Panels (SIN 711.8)	D38
Finished Back Panels (SIN 711.8)	D39
Pedestals for Use with Worksurfaces (SIN 711.8)	D40
Mobile Pedestals (SIN 711.8)	D48
Tall Lateral Files (SIN 711.8)	D50
Towers (SIN 711.8)	D52
Overhead Storage (SIN 711.8)	D56
Hutches (SIN 711.8)	D60
Tackboards (SIN 711.8)	D62
Bookshelf for Use on or Under Worksurfaces (SIN 711.8)	D63
Worksurface Accessories (SIN 711.8)	D64
Power and Communication Accessories (SIN 711.8)	D65

Impact Configured Components

Statement of Line

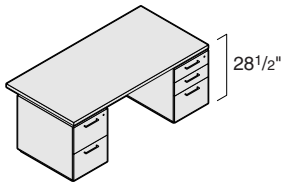

Specifying
▶ Page D12

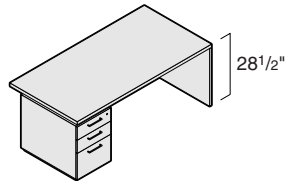

Specifying
▶ Page D14

Double-Pedestal Desks

	66"W	72"W	78"W
30"D	●	●	
36"D	●	●	●

Single-Pedestal Desks*

	66"W	72"W	78"W
30"D	●	●	
36"D	●	●	●

*Drawing shows left-hand unit. Right-hand unit is also available.

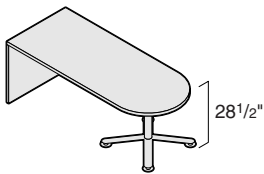

Specifying
▶ Page D16

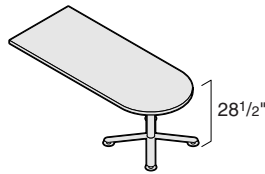

Specifying
▶ Page D16

Bullet-Shape Desks with End Panel and Metal Flex Base

	72"W
30"D	●
36"D	●

Bullet-Shape Run-Offs with Metal Flex Base

	48"W	54"W	60"W	66"W
31 1/2"D	●	●	●	●

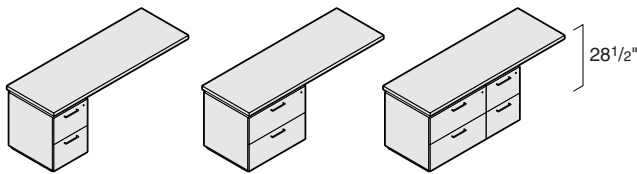

Specifying
▶ Page D18

Returns*

	42"W	48"W	54"W	60"W	66"W	72"W	78"W
25"D	☐	☐	☐	☐	☐	☐	☐

☐ = Return with file/file pedestal ☐ = Return with lateral file

☐☐ = Return with lateral file and file/file pedestal

* Drawings show left-hand units. Right-hand units are also available.

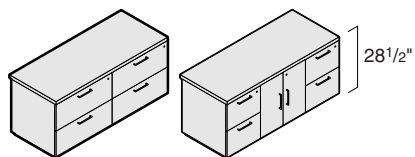

Specifying
▶ Page D20

Credenzas

	60"W	66"W	72"W
25"D	●	●	●

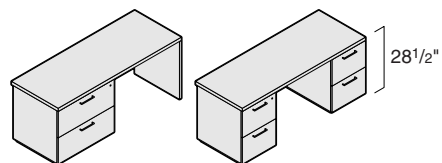

Specifying
▶ Page D20

Kneespace Credenzas*

	66"W	72"W	78"W	84"W	90"W	96"W
25"D	●	●■	■	■	■	■

* Asymmetrical drawing shows left-hand unit. Right-hand unit is also available.

- Center kneespace credenza
- Left-hand or right-hand credenza

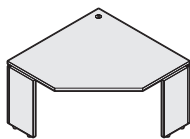

Specifying
▶ Page D22

Freestanding Corner Units

	48"W
48"D	●

Impact Buildup Components

Statement of Line

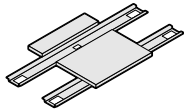

Specifying
▶ Page D23

Tech Center Worksurface

30"W
36"D ●

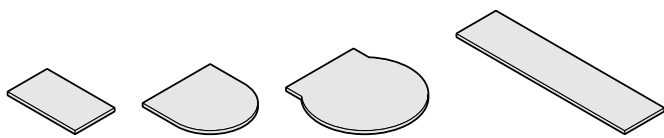

Rectangular

Bullet

Conference

Extended for return
and bridge applications

Specifying
▶ Page D24

Tech Center Leaves

	21"W	25"W	38½"W	48"W
Rectangular 36"D	●			
Bullet 36"D			●	
Conference 48"D				●
Extended return 90"D		●		
Extended bridge 90"D		●		

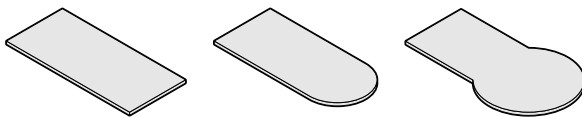

Rectangular

Bullet

Conference

Specifying
▶ Page D26

Desk Worksurfaces

	66"W	72"W	78"W	84"W
Rectangular 30"D	●	●	●	
Rectangular 36"D	●	●	●	●
Bullet 30"D	●	●	●	
Bullet 36"D	●	●	●	●
Conference 42"D		●	●	
Conference 48"D			●	●

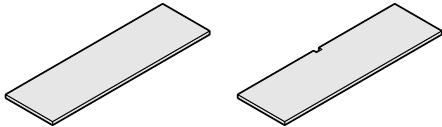

Specifying
▶ Page D28

Credenza Worksurfaces

	54"W	60"W	66"W	72"W	78"W	84"W	90"W	96"W	102"W	108"W
25"D	●	●	●	●	●	●	●	●	●	●

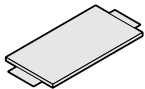

Specifying
▶ Page D30

Bridge Worksurfaces

	42"W	48"W	54"W
25"D	●	●	●

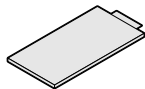

Specifying
▶ Page D32

Return Worksurfaces

	36"W	42"W	48"W	54"W	60"W	66"W	72"W	78"W	84"W
25"D	●	●	●	●	●	●	●	●	●

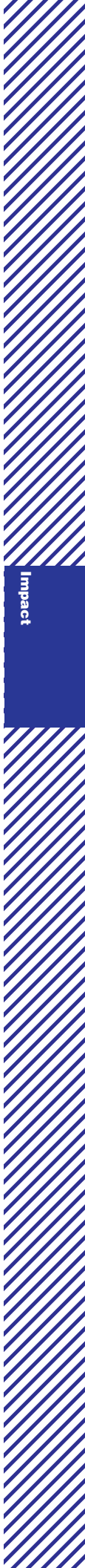

Impact Buildup Components Statement of Line, continued

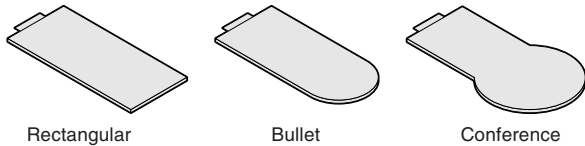

Specifying
▶ Page D34

Run-Off Worksurfaces

	48"W	54"W	60"W	66"W	72"W	78"W
Rectangular 30"D			●	●	●	
Rectangular 36"D			●	●	●	
Bullet 30"D	●	●	●	●		
Bullet 36"D			●	●	●	
Conference 42"D	●	●	●	●	●	●



Specifying
▶ Page D36

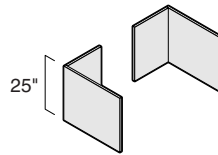

Specifying
▶ Page D37

Metal Flex Bases

	24"D	30"D
X configuration	●	●

End Panels

	18"W
24"D	●
30"D	●



Specifying
▶ Page D37

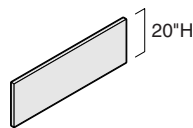

Specifying
▶ Page D38

Kneespace Panels

	1½"W
12"D	●

Modesty Panels

	54"W	60"W	66"W	72"W	78"W
¾"D	●	●	●	●	●

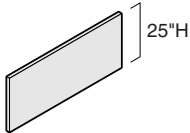

Specifying
▶ Page D39

Finished Back Panels for Credenzas and Returns

	54"W	60"W	66"W	72"W	78"W	84"W	90"W	96"W	102"W	108"W
3/4"D	●	●	●	●	●	●	●	●	●	●

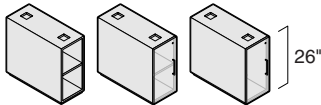

Specifying
▶ Page D40

12"W Pedestals for Use with Tech Center Worksurfaces*

	12"W
30"D	●

* Drawings show doors with left-hand hinges. Right-hand hinged doors are also available.

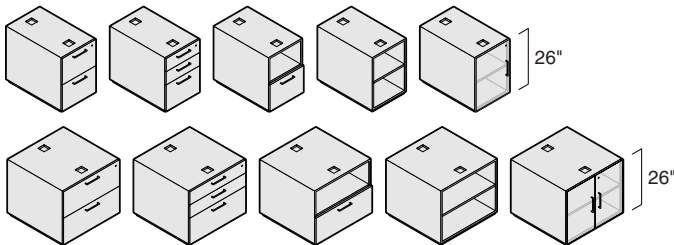

Specifying
▶ Page D40

18"W and 30"W Pedestals for Use with Tech Center Worksurfaces*

	18"W	30"W
30"D	●	●

* Drawings show doors with left-hand hinges. Right-hand hinged doors are also available.



Impact Buildup Components Statement of Line, continued

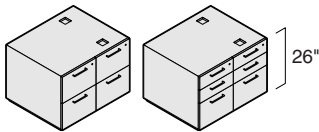

Specifying
▶ Page D40

36"W Pedestals for Use with Tech Center Worksurfaces

36"W

30"D ●

36"W pedestals are handed for applications where a large amount of slip-fit is desired and to prevent pedestal width from crowding kneespace.

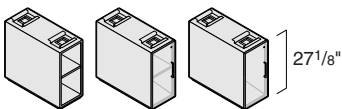

Specifying
▶ Pages D42–D47

12"W Pedestals for Use with Desk, Return, Credenza, and Run-Off Worksurfaces*

12"W

24"D ●

30"D ●

* Drawings show doors with left-hand hinges. Right-hand hinged doors are also available.

24"D pedestals are for use with 30"D desk and run-off worksurfaces and 25"D return and credenza worksurfaces.

30"D pedestals are for use with 36"D desk and run-off worksurfaces.

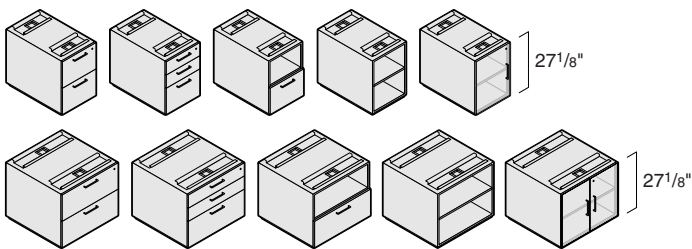

Specifying
▶ Pages D42–D47

18"W and 30"W Pedestals for Use with Desk, Return, Credenza, and Run-Off Worksurfaces

18"W 30"W

24"D ● ●

30"D ● ●

24"D pedestals are for use with 30"D desks, run-off worksurfaces, and 25"D return and credenza worksurfaces.

30"D pedestals are for use with 36"D desks and run-off worksurfaces.

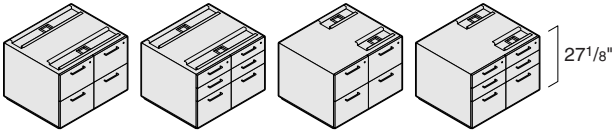

Specifying
▶ Pages D44–D47

36"W Pedestals for Use with Desk, Return, Credenza, and Run-Off Worksurfaces

36"W

24"D ●

30"D ●

24"D pedestals are for use with 30"D desks and 25"D return and credenza worksurfaces.
30"D pedestals are for use with 36"D desks and run-off worksurfaces.

Certain 36"W pedestals are handed for applications where a large amount of slip-fit is desired and to prevent pedestal width from crowding kneespace.

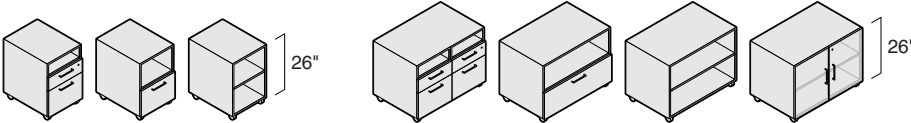

Specifying
▶ Page D48

Mobile Pedestals

18"W 36"W

24"D ● ●

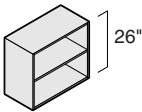

Specifying
▶ Page D63

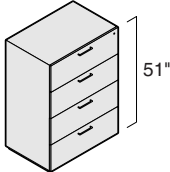

Specifying
▶ Page D50

Bookshelf for Use on or Under Worksurfaces

30"W

15"D ●

Tall Lateral Files

30"W 36"W

24"D ● ●



Impact Buildup Components Statement of Line, continued

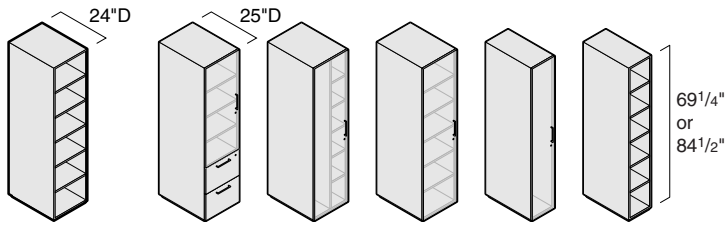

Specifying
▶ Page D52

12"W and 18"W Towers*

	12"W	18"W
24"D	●	●
25"D	●	●

*Drawings show doors with left-hand hinges. Right-hand hinged doors are also available.

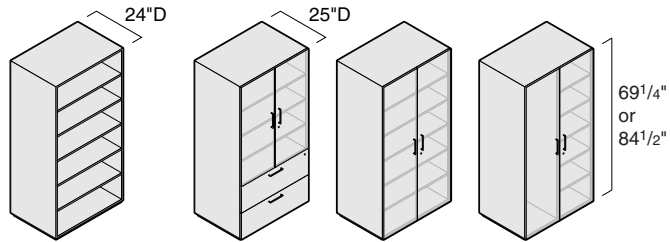

Specifying
▶ Page D54

30"W and 36"W Towers*

	30"W	36"W
24"D	●	●
25"D	●	●

*Drawings show doors with left-hand hinges. Right-hand hinged doors are also available.

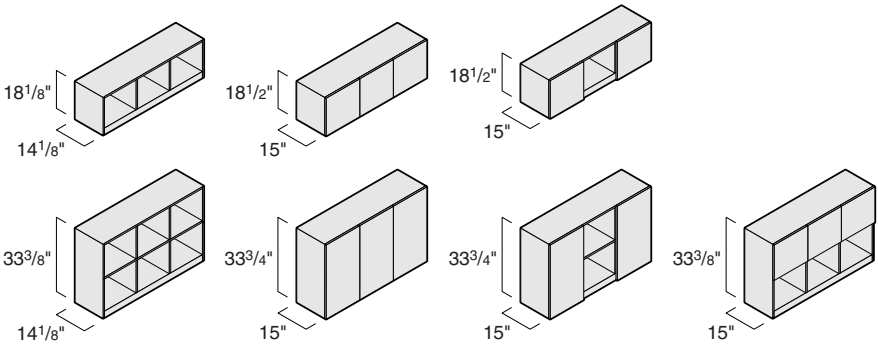

Specifying
Pages D56–D59

Overhead Storage*

	54"W	60"W	66"W	72"W	78"W	84"W	90"W	96"W
All open storage	●	●	●	●	●	●	●	●
All closed storage	●			●			●	
Outside closed, inside open	●	●	●	●	●	●	●	●
Top closed, bottom open*	●			●			●	

*Top closed, bottom open, overhead storage is available on 33 3/8"H overhead storage only.

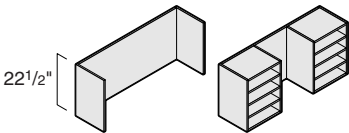

Specifying
Page D60

Hutches for Use with Overhead Storage

	54"W	60"W	66"W	72"W	78"W	84"W	90"W	96"W
14 1/8"D	●	●	●	●	●	●	●	●

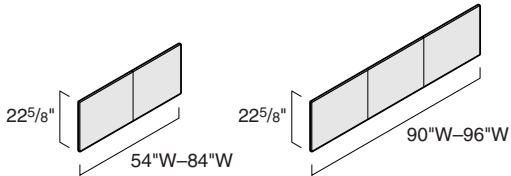

Specifying
Page D62

Tackboards for Use with Overhead Storage

	54"W	60"W	66"W	72"W	78"W	84"W	90"W	96"W
1"D	●	●	●	●	●	●	●	●

Double-Pedestal Desks

SIN 711.8

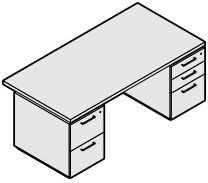

Tip: To specify different pedestal configurations or contrasting surface materials, use build-up components.

► Pages D23–D47

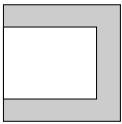

Square edge profile

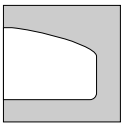

Tapered edge profile

Standard Includes		Required to Specify	
<ul style="list-style-type: none"> • Desk: wood • Worksurface with square or tapered edge profile on front and back edges • Square edge profile on side edges • Modesty panel • Full-height, field-installed pedestals with bevel, deco, or Nile pulls • Locks, keyed random: 9201 Polished Chrome • One hanging file system per file drawer • Leveling glides: black only 		<ol style="list-style-type: none"> 1 Style number with appropriate edge profile suffix (see edge profiles below) 2 Wood color number for desk 3 Pulls and paint or metal color number (see below) 4 Options, if selected (see below) <p>► See <i>Surface Materials</i>, page J2.</p>	
Options	Price	Required to Specify	
Front and Back Edge Profile	<ul style="list-style-type: none"> • Square edge profile No cost • Tapered edge profile No cost 	Add suffix A to style number. Add suffix B to style number.	
Surface Materials	<ul style="list-style-type: none"> • Customiz stain +\$320 <p>Full-fill finish</p> <ul style="list-style-type: none"> • On 30"D desk +\$ 60 • On 36"D desk +\$ 84 	Specify with <i>Customiz stain</i> . ► See <i>Surface Materials Reference Manual</i> .	
Drawer Pulls	<ul style="list-style-type: none"> • Bevel pull No cost • Deco pull No cost • Nile pull No cost 	Specify with <i>bevel pull</i> and select 0835 Black, 4799 Platinum, 9201 Polished Chrome, or 9211 Nickel. Specify with <i>deco pull</i> and select 0835 Black, 4799 Platinum, 9201 Polished Chrome, or 9211 Nickel. Specify with <i>Nile pull</i> and select 0835 Black, 4799 Platinum, 9201 Polished Chrome, or 9211 Nickel.	
Grommets	<ul style="list-style-type: none"> • Left-hand grommet: Platinum paint only +\$75 • Right-hand grommet: Platinum paint only +\$75 • Center grommet: Platinum paint only +\$75 	Specify with <i>GRMMT1</i> . Specify with <i>GRMMT2</i> . Specify with <i>GRMMT3</i> .	
Lock and Keying	<p>Lock</p> <ul style="list-style-type: none"> • Ember Chrome No cost <p>Keying</p> <ul style="list-style-type: none"> • Factory- and field-installed keying 	Specify with <i>9250 Ember Chrome lock</i> . ► Page J8	
Related Products	<ul style="list-style-type: none"> • Power and communication accessories ► Page D65 • Center drawer ► Page D64 		

Tip: Your specification is not complete until you add a suffix to define the work-surface edge profile.

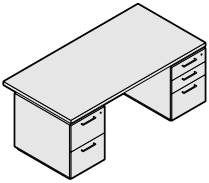

- Left: two file drawers
- Right: two box drawers and one file drawer

Tip: Pedestals and modesty panel are installed in the field and either pedestal can be placed in the left- or right-hand position.

Specification Information

• Dimensions			• Knee-	• Style	• Base
D	W	H	space	Number	Price

Double-Pedestal Desks

30"	66"	29"	30"	D2D3066__	\$3411
30"	72"	29"	36"	D2D3072__	\$3534
36"	66"	29"	30"	D2D3666__	\$3682
36"	72"	29"	36"	D2D3672__	\$3805
36"	78"	29"	42"	D2D3678__	\$3939

Single-Pedestal Desks

SIN 711.8

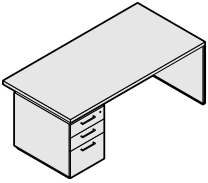

Tip: To specify different pedestal configurations or contrasting surface materials, use build-up components.

► Pages D23–D47

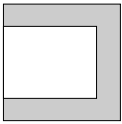

Square edge profile

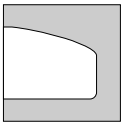

Tapered edge profile

Standard Includes		Required to Specify	
	<ul style="list-style-type: none"> Desk: wood Worksurface with square or tapered edge profile on front and back edges Square edge profile on side edges Modesty panel Field-installed end panel Full-height, field-installed pedestal with two box drawers and one file drawer and bevel, deco, or Nile pulls Lock, keyed random: 9201 Polished Chrome One hanging file system per file drawer Leveling glides: black only 		<ol style="list-style-type: none"> Style number with appropriate edge profile suffix (see edge profiles below) Wood color number for desk Pulls and paint or metal color number (see below) Options, if selected (see below) <p>► See <i>Surface Materials</i>, page J2.</p>
Options	Price	Required to Specify	
Front and Back Edge Profile	<ul style="list-style-type: none"> Square edge profile: No cost Tapered edge profile: No cost 	Add suffix A to style number. Add suffix B to style number.	
Surface Materials	<ul style="list-style-type: none"> Customiz stain: +\$320 <p>Full-fill finish</p> <ul style="list-style-type: none"> On 30"D desk: +\$ 60 On 36"D desk: +\$ 84 	Specify with <i>Customiz stain</i> . ► See <i>Surface Materials Reference Manual</i> . Specify with <i>full-fill finish</i> and select wood color number. Specify with <i>full-fill finish</i> and select wood color number.	
Drawer Pulls	<ul style="list-style-type: none"> Bevel pull: No cost Deco pull: No cost Nile pull: No cost 	Specify with <i>bevel pull</i> and select 0835 Black, 4799 Platinum, 9201 Polished Chrome, or 9211 Nickel. Specify with <i>deco pull</i> and select 0835 Black, 4799 Platinum, 9201 Polished Chrome, or 9211 Nickel. Specify with <i>nile pull</i> and select 0835 Black, 4799 Platinum, 9201 Polished Chrome, or 9211 Nickel.	
Grommets	<ul style="list-style-type: none"> Left-hand grommet: Platinum paint only: +\$75 Right-hand grommet: Platinum paint only: +\$75 Center grommet: Platinum paint only: +\$75 	Specify with <i>GRMMT1</i> . Specify with <i>GRMMT2</i> . Specify with <i>GRMMT3</i> .	
Lock and Keying	<p>Lock</p> <ul style="list-style-type: none"> Ember Chrome: No cost <p>Keying</p> <ul style="list-style-type: none"> Factory- and field-installed keying 		Specify with <i>9250 Ember Chrome lock</i> . ► Page J8
Related Products	<ul style="list-style-type: none"> Power and communication accessories 		► Page D65

Tip: Your specification is not complete until you add a suffix to define the work-surface edge profile.

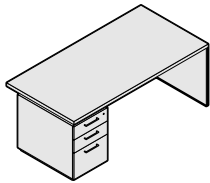

• Left: two box and one file drawer

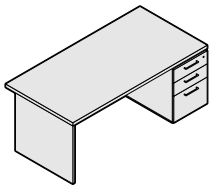

• Right: two box and one file drawer

Tip: Pedestals and end panels are installed in the field.

Specification Information

Dimensions			Knee-space	Style Number	Base Price
D	W	H			

Left-Hand Single-Pedestal Desks

30"	66"	29"	48"	D1D3066L _	\$2916
30"	72"	29"	54"	D1D3072L _	\$3039
36"	66"	29"	48"	D1D3666L _	\$3142
36"	72"	29"	54"	D1D3672L _	\$3265
36"	78"	29"	60"	D1D3678L _	\$3399

Right-Hand Single-Pedestal Desks

30"	66"	29"	48"	D1D3066R _	\$2916
30"	72"	29"	54"	D1D3072R _	\$3039
36"	66"	29"	48"	D1D3666R _	\$3142
36"	72"	29"	54"	D1D3672R _	\$3265
36"	78"	29"	60"	D1D3678R _	\$3399

Bullet-Shape Desks

SIN 711.8

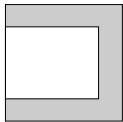

Square edge profile

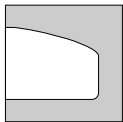

Tapered edge profile

Tip: Orientation on bullet-shape desk refers to curved side of worksurface relative to position of the user.

Standard Includes

- Bullet-shape desk: wood
- Worksurface with square or tapered edge profile on front and back edges
- Square edge profile on attachment side
- Field-installed metal X-flex base: paint or metal
- Field-installed end panel, if selected: wood to match worksurface
- Attachment hardware

Required to Specify

- 1 Style number with appropriate edge profile suffix (see edge profiles below)
- 2 Wood color number for desk
- 3 Paint or metal color number for metal X-flex base:
 - 0835 Black
 - 4798 Sterling
 - 4799 Platinum
- 4 Options, if selected (see below)
 - ▶ See *Surface Materials*, page J2.

	Options	Price	Required to Specify
Front and Back Edge Profile	<ul style="list-style-type: none"> • Square edge profile • Tapered edge profile 	No cost No cost	Add suffix A to style number. Add suffix B to style number.
Surface Materials	<p>Customiz stain</p> <ul style="list-style-type: none"> • On desks with end panel • On run-off <hr/> <ul style="list-style-type: none"> • Full-fill finish <p>Metal X-flex base</p> <ul style="list-style-type: none"> • Brushed Aluminum • Polished Aluminum 	+\$144 +\$ 84 +\$ 84 +\$325 +\$325	Specify with <i>Customiz stain</i> . Specify with <i>Customiz stain</i> . ▶ See <i>Surface Materials Reference Manual</i> . Specify with <i>full-fill finish</i> and select wood color number. Specify with <i>8042 Brushed Aluminum</i> . Specify with <i>8046 Polished Aluminum</i> .
Grommets	<p>Left-hand desk with end panel</p> <ul style="list-style-type: none"> • Right-hand grommet: Platinum paint only • Center grommet: Platinum paint only <hr/> <p>Right-hand desk with end panel</p> <ul style="list-style-type: none"> • Left-hand grommet: Platinum paint only • Center grommet: Platinum paint only <hr/> <p>Run-off</p> <ul style="list-style-type: none"> • Center grommet for left-hand applications: Platinum paint only • Center grommet for right-hand applications: Platinum paint only 	+\$ 75 +\$ 75 +\$ 75 +\$ 75 +\$ 75 +\$ 75	Specify with <i>GRMMT2</i> . Specify with <i>GRMMT3L</i> . Specify with <i>GRMMT1</i> . Specify with <i>GRMMT3R</i> . Specify with <i>GRMMT3L</i> . Specify with <i>GRMMT3R</i> .
Related Products	<ul style="list-style-type: none"> • Power and communication accessories 		▶ Page D65

Tip: Your specification is not complete until you add a suffix to define the work-surface edge profile.

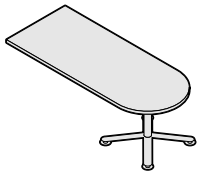
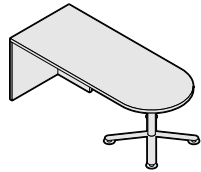
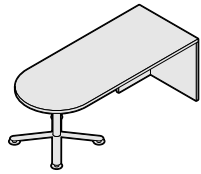

Tip: Metal flex base and end panels are installed in the field.

Specification Information

Dimensions			Style	Base
D	W	H	Number	Price

Left-Hand Bullet-Shape Desks with End Panel and 24" X-Flex Base

30"	72"	29"	DBD3072L _	\$2424
36"	72"	29"	DBD3672L _	\$2575

Right-Hand Bullet-Shape Desks with End Panel and 24" X-Flex Base

30"	72"	29"	DBD3072R _	\$2424
36"	72"	29"	DBD3672R _	\$2575

Bullet-Shape Run-Offs with 24" X-Flex Base

30"	48"	29"	DBR3048 _	\$1597
30"	54"	29"	DBR3054 _	\$1670
30"	60"	29"	DBR3060 _	\$1743
30"	66"	29"	DBR3066 _	\$1816

Returns

SIN 711.8

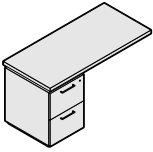

Tip: Specify right-hand returns for use with left-hand single-pedestal desks. Specify left-hand returns for use with right-hand single pedestal desks.

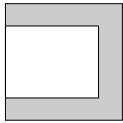

Square edge profile

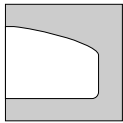

Tapered edge profile

Standard Includes		Required to Specify	
<ul style="list-style-type: none"> Return: wood Worksurface with square or tapered edge profile on front edge Coped edge on attachment side Square edge profile on back and side edges Full-height, field-installed pedestals with bevel, deco, or Nile pulls Lock, keyed random: 9201 Polished Chrome One hanging file system per file drawer Leveling glides: black only Attachment hardware 		<ol style="list-style-type: none"> Style number with appropriate edge profile suffix (see edge profiles below) Wood color number for return Pulls and paint or metal color number (see below) Options, if selected (see below) <p>▶ See <i>Surface Materials</i>, page J2.</p>	
Options	Price	Required to Specify	
Front Edge Profile	<ul style="list-style-type: none"> Square edge profile: No cost Tapered edge profile: No cost 	Add suffix A to style number. Add suffix B to style number.	
Surface Materials	<ul style="list-style-type: none"> Customiz stain: +\$174 <p>Full-fill finish</p> <ul style="list-style-type: none"> On 42", 48" and 54"W returns: +\$ 41 On 60"W and wider returns: +\$ 60 	Specify with <i>Customiz stain</i> . ▶ See <i>Surface Materials Reference Manual</i> . Specify with <i>full-fill finish</i> and select wood color number. Specify with <i>full-fill finish</i> and select wood color number.	
Drawer Pulls	<ul style="list-style-type: none"> Bevel pull: No cost Deco pull: No cost Nile pull: No cost 	Specify with <i>bevel pull</i> and select 0835 Black, 4799 Platinum, 9201 Polished Chrome, or 9211 Nickel. Specify with <i>deco pull</i> and select 0835 Black, 4799 Platinum, 9201 Polished Chrome, or 9211 Nickel. Specify with <i>nile pull</i> and select 0835 Black, 4799 Platinum, 9201 Polished Chrome, or 9211 Nickel.	
Grommets	<p>Left-hand return</p> <ul style="list-style-type: none"> Left-hand grommet: Platinum paint only: +\$ 75 Center grommet: Platinum paint only: +\$ 75 <p>Right-hand return</p> <ul style="list-style-type: none"> Right-hand grommet: Platinum paint only: +\$ 75 Center grommet: Platinum paint only: +\$ 75 	Specify with <i>GRMMT1</i> . Specify with <i>GRMMT3</i> . Specify with <i>GRMMT2</i> . Specify with <i>GRMMT3</i> .	
Lock and Keying	<p>Lock</p> <ul style="list-style-type: none"> Ember Chrome: No cost <p>Keying</p> <ul style="list-style-type: none"> Factory- and field-installed keying 	Specify with <i>9250 Ember Chrome lock</i> . ▶ Page J8	
Related Products	<ul style="list-style-type: none"> Power and communication accessories 	▶ Page D65	

Tip: Your specification is not complete until you add a suffix to define the work-surface edge profile.

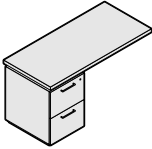

• Left: two file drawers

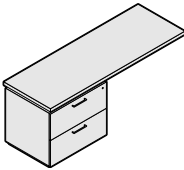

• Left: two lateral file drawers

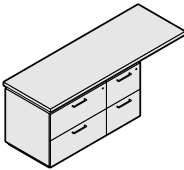

• Right: two lateral file drawers and two file drawers

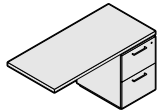

• Right: two file drawers

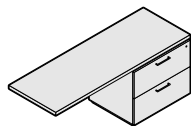

• Right: two lateral file drawers

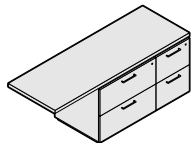

• Right: two lateral file drawers and two file drawers

Tip: Pedestals are installed in the field.

Specification Information

Dimensions			Knee-space	Style Number	Base Price
D	W	H			

Left-Hand Returns

With One 18"W Pedestal

25"	42"	29"	24"	DR2542L__	\$1434
25"	48"	29"	30"	DR2548L__	\$1507

With One 30"W Pedestal

25"	54"	29"	24"	DR2554L__	\$1580
25"	60"	29"	30"	DR2560L__	\$2513
25"	66"	29"	36"	DR2566L__	\$2586
25"	72"	29"	42"	DR2572L__	\$2659

With One 30"W Pedestal and One 18"W Pedestal

25"	78"	29"	30"	DR2578L__	\$3747
-----	-----	-----	-----	------------------	--------

Right-Hand Returns

With One 18"W Pedestal

25"	42"	29"	24"	DR2542R__	\$1434
25"	48"	29"	30"	DR2548R__	\$1507

With One 30"W Pedestal

25"	54"	29"	24"	DR2554R__	\$1580
25"	60"	29"	30"	DR2560R__	\$2513
25"	66"	29"	36"	DR2566R__	\$2586
25"	72"	29"	42"	DR2572R__	\$2659

With One 30"W Pedestal and One 18"W Pedestal

25"	78"	29"	30"	DR2578R__	\$3747
-----	-----	-----	-----	------------------	--------

Credenzas

SIN 711.8

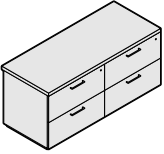

Tip: To specify different pedestal configurations or contrasting surface materials, use build-up components.

► Pages D23–D47

Tip: Configured credenzas are for applications without overhead storage only.

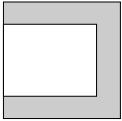

Square edge profile

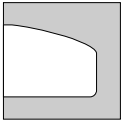

Tapered edge profile

Standard Includes		Required to Specify	
<ul style="list-style-type: none"> Credenza: wood Worksurface with square or tapered edge profile on front edge Square edge profile on side edges Full-height, field-installed pedestals with bevel, deco, or Nile pulls Field-installed end panel on kneespace credenza: wood Locks, keyed random: 9201 Polished Chrome One hanging file system per file drawer Leveling glides: black only 		<ol style="list-style-type: none"> Style number with appropriate edge profile suffix (see edge profiles below) Wood color number for credenza Pulls and paint or metal color number (see below) Options, if selected (see below) <p>► See <i>Surface Materials</i>, page J2.</p>	
Options	Price	Required to Specify	
Front Edge Profile	<ul style="list-style-type: none"> Square edge profile: No cost Tapered edge profile: No cost 	Add suffix A to style number. Add suffix B to style number.	
Surface Materials	<ul style="list-style-type: none"> Customiz stain: +\$278 <p>Full-fill finish</p> <ul style="list-style-type: none"> On credenzas less than 96"W: +\$ 60 On 96"W credenzas: +\$ 84 	Specify with <i>Customiz stain</i> . ► See <i>Surface Materials Reference Manual</i> . Specify with <i>full-fill finish</i> and select wood color number. Specify with <i>full-fill finish</i> and select wood color number.	
Drawer Pulls	<ul style="list-style-type: none"> Bevel pull: No cost Deco pull: No cost Nile pull: No cost 	Specify with <i>bevel pull</i> and select 0835 Black, 4799 Platinum, 9201 Polished Chrome, or 9211 Nickel. Specify with <i>deco pull</i> and select 0835 Black, 4799 Platinum, 9201 Polished Chrome, or 9211 Nickel. Specify with <i>nile pull</i> and select 0835 Black, 4799 Platinum, 9201 Polished Chrome, or 9211 Nickel.	
Grommets	<ul style="list-style-type: none"> Left-hand grommet: Platinum paint only: +\$ 75 Right-hand grommet: Platinum paint only: +\$ 75 Center grommet: Platinum paint only: +\$ 75 	Specify with <i>GRMMT1</i> . Specify with <i>GRMMT2</i> . Specify with <i>GRMMT3</i> .	
Lock and Keying	<p>Lock</p> <ul style="list-style-type: none"> Ember Chrome: No cost <p>Keying</p> <ul style="list-style-type: none"> Factory- and field-installed keying 	Specify with <i>9250 Ember Chrome lock</i> . ► Page J8	
Related Products	<ul style="list-style-type: none"> Power and communication accessories 	► Page D65	

Tip: Your specification is not complete until you add a suffix to define the work-surface edge profile.

Tip: Configured credenzas are for applications without overhead storage only.

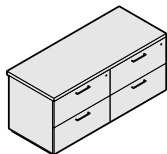

- Four lateral file drawers

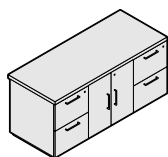

- Left: two file drawers
- Center: double-door cabinet
- Right: two file drawers

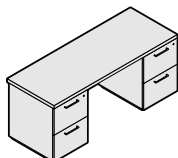

- Left: two file drawers
- Right: two file drawers

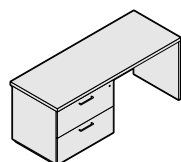

- Left: two lateral file drawers
- Right: knee-space

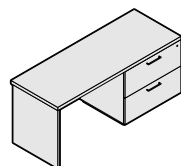

- Left: knee-space
- Right: two lateral file drawers

Tip: Pedestals and end panels are installed in the field.

Specification Information

Dimensions			Knee-space	Style Number	Base Price
D	W	H			

Full Credenzas

With Four Lateral File Drawers

25"	60"	29"	N.A.	DC2L2560	\$4388
25"	72"	29"	N.A.	DC2L2572	\$4676

With Two File/File Pedestals and Double-Door Cabinet

25"	66"	29"	N.A.	DC2566	\$4316
25"	72"	29"	N.A.	DC2572	\$4460

Center Kneespace Credenzas

25"	66"	29"	30"	DCK2566	\$2741
25"	72"	29"	36"	DCK2572	\$2814

Left-Hand Credenzas

25"	72"	29"	42"	DCK2572L	\$3179
25"	78"	29"	48"	DCK2578L	\$3252
25"	84"	29"	54"	DCK2584L	\$3325
25"	90"	29"	60"	DCK2590L	\$3868
25"	96"	29"	66"	DCK2596L	\$4210

Right-Hand Credenzas

25"	72"	29"	42"	DCK2572R	\$3179
25"	78"	29"	48"	DCK2578R	\$3252
25"	84"	29"	54"	DCK2584R	\$3325
25"	90"	29"	60"	DCK2590R	\$3868
25"	96"	29"	66"	DCK2596R	\$4210

Freestanding Corner Units

SIN 711.8

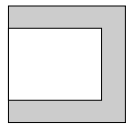
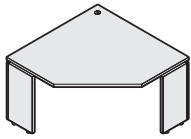

Square edge profile

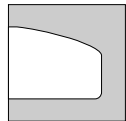

Tapered edge profile

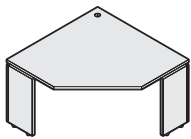

Tip: Your specification is not complete until you add a suffix to define the worksurface edge profile.

*Tip: Freestanding corner units are to be used with credenza worksurfaces only. They are **not** designed to connect with returns.*

Standard Includes	Required to Specify
-------------------	---------------------

<ul style="list-style-type: none"> • Return: wood • Worksurface with square or tapered edge profile on front edge • Square edge on attachment side • Square edge profile on back and side edges • Full-height, field-installed support panels • Leveling glides: black only • Attachment hardware • Round grommet 	<ol style="list-style-type: none"> 1 Style number with appropriate edge profile suffix (see edge profiles below) 2 Wood color number 3 Options, if selected (see below) <p>▶ See <i>Surface Materials</i>, page J2.</p>
---	--

Options	Price	Required to Specify
---------	-------	---------------------

Front Edge Profile <ul style="list-style-type: none"> • Square edge profile • Tapered edge profile 	No cost No cost	Add suffix A to style number. Add suffix B to style number.
Surface Materials <ul style="list-style-type: none"> • Customiz stain • Full-fill finish 	+\$209 +\$209	Specify with <i>Customiz stain</i> . ▶ See <i>Surface Materials Reference Manual</i> . Specify with <i>full-fill finish</i> and select wood color number.

Related Products <ul style="list-style-type: none"> • Credenza worksurfaces 	▶ Page D28
---	------------

Specification Information

Dimensions	Style	Base
D W H	Number	Price
:	:	:
:	:	:

Freestanding Corner Units

48"	48"	29"	DC4848__	\$1900
:	:	:	:	:

Tech Center Worksurfaces

SIN 711.8

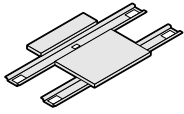

Tip: You must specify a tech center leaf for use on each side of the tech center work surface.

▶ Page D24

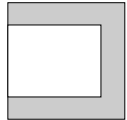

Square edge profile

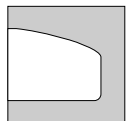

Tapered edge profile

Tip: Order five technology covers to conceal the technology trough on tech center work surfaces.

▶ Page D65

Tip: You must use pedestals for use with 36"D tech center work surfaces.

▶ Page D40

Tip: Your specification is not complete until you add a suffix to define the work surface edge profile.

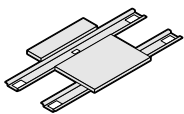

Tip: Tech center work surfaces must be supported by 30"D end panels or pedestals for use with tech center work surface.

▶ Page D40

Standard Includes	Required to Specify
-------------------	---------------------

- Tech center work surface: wood or leather
- Work surface with square or tapered edge profile on front and back edges
- Square edge profile on side edges
- Technology trough: black metal only
- Attachment hardware

- 1 Style number with appropriate edge profile suffix (see edge profiles below)
 - 2 Wood or leather color number for work surface
 - 3 Options, if selected (see below)
- ▶ See *Surface Materials*, page J2.

Options	Price	Required to Specify
Front and Back Edge Profile <ul style="list-style-type: none"> • Square edge profile • Tapered edge profile 	No cost No cost	Add suffix A to style number. Add suffix B to style number.
Surface Materials <ul style="list-style-type: none"> • Customiz stain on wood • Full-fill finish on wood 	+\$41 +\$41	Specify with <i>Customiz stain</i> . ▶ See <i>Surface Materials Reference Manual</i> . Specify with <i>full-fill finish</i> and select wood color number.
Related Products <ul style="list-style-type: none"> • Metal flex bases • Power and communication accessories • Pedestals for use with tech center work surfaces 		▶ Page D36 ▶ Page D65 ▶ Page D40

Specification Information

Dimensions	Style Number	Base Price
D W		

Tech Center Worksurface

Wood		
36"	30"	DSW3630__ \$ 920
Leather		
36"	30"	DSW3630L__ \$1690
:	:	:

Tech Center Leaves

SIN 711.8

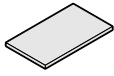

Tip: Tech center leaves are for use on each side of a tech center worksurface.
▶ Page D23

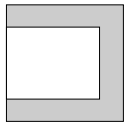

Square edge profile

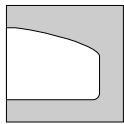

Tapered edge profile

Standard Includes	Required to Specify
<ul style="list-style-type: none"> Tech center leaf, if selected: wood Rectangular leaf worksurface, if selected, with square or tapered edge profile on front and back edges Bullet and conference leaf worksurfaces, if selected, with square or tapered edge profile on front, back, and radius edges Extended leaf worksurface, if selected, with square or tapered edge profile on user's and front edges Square edge profile on side edges <i>Exception: Coped edge profile on attachment side of extended leaf worksurface for use as a bridge</i> Attachment hardware 	<ol style="list-style-type: none"> Style number with appropriate edge profile suffix (see edge profiles below) Wood color number for leaf Options, if selected (see below) ▶ See <i>Surface Materials</i>, page J2.

Options	Price	Required to Specify
Front and Back Edge Profile <ul style="list-style-type: none"> Square edge profile Tapered edge profile 	No cost No cost	Add suffix A to style number. Add suffix B to style number.
Surface Materials	Customiz stain <ul style="list-style-type: none"> On rectangular leaf +\$24 On bullet leaf +\$41 On conference and extended leaves +\$60 	Specify with <i>Customiz stain</i> . Specify with <i>Customiz stain</i> . Specify with <i>Customiz stain</i> . ▶ See <i>Surface Materials Reference Manual</i> .
	Full-fill finish <ul style="list-style-type: none"> On rectangular leaf +\$24 On bullet leaf +\$41 On conference and extended leaves +\$60 	Specify with <i>full-fill finish</i> and select wood color number. Specify with <i>full-fill finish</i> and select wood color number. Specify with <i>full-fill finish</i> and select wood color number.
Related Products	<ul style="list-style-type: none"> Power and communication accessories Metal flex bases Cable manager 	▶ Page D65 ▶ Page D36 ▶ Page D67

Tip: Your specification is not complete until you add a suffix to define the work-surface edge profile.

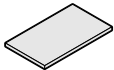

Tip: Bullet leaf must be supported by 24" metal flex bases.

▶ Page D36

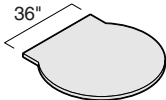

Tip: Conference leaf must be supported by 30" metal flex bases.

▶ Page D36

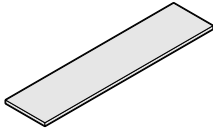

Tip: Tech center desks are not designed for use with bridges or returns. Use extended leaves to create "L" and "U" configurations.

Specification Information

• Dimensions		• Style	• Base
D	W	Number	Price

Rectangular Leaf

36"	21"	DSL3621 __	\$ 310
:	:	:	:

Bullet Leaf

36"	38½"	DSB3636 __	\$ 660
:	:	:	:

Conference Leaf

48"	48"	DSC4848 __	\$ 800
:	:	:	:

Extended Leaves

For Use as a Left-Hand Return

90"	25"	DSE9025L __	\$1254
-----	-----	--------------------	--------

For Use as a Right-Hand Return

90"	25"	DSE9025R __	\$1254
-----	-----	--------------------	--------

For Use as a Left-Hand Bridge

90"	25"	DSE9025LU __	\$1567
-----	-----	---------------------	--------

For Use as a Right-Hand Bridge

90"	25"	DSE9025RU __	\$1567
:	:	:	:



Desk Worksurfaces

SIN 711.8

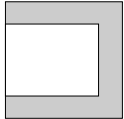
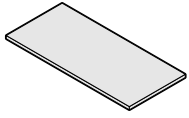

Square edge profile

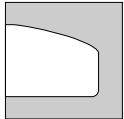

Tapered edge profile

Tip: Bullet and conference desk worksurfaces can be installed in either a left- or right-hand orientation in the field. However, when you specify a factory-installed grommet, you must choose either a left- or right-hand orientation, and the work-surface will no longer be non-handed. Left-hand worksurfaces extend to the left and are attached to the right relative to the user. Right-hand orientation is opposite relative to the user.

Standard Includes		Required to Specify	
<ul style="list-style-type: none"> • Desk worksurface: wood • Worksurface with square or tapered edge profile on front and back edges • Square edge profile on side edges 		1 Style number with appropriate edge profile suffix (see edge profiles below) 2 Wood color number for worksurface 3 Options, if selected (see below) ▶ See <i>Surface Materials</i> , page J2.	
Options	Price	Required to Specify	
Front and Back Edge Profile <ul style="list-style-type: none"> • Square edge profile • Tapered edge profile 	No cost No cost	Add suffix A to style number. Add suffix B to style number.	
Surface Materials <ul style="list-style-type: none"> • Customiz stain • Full-fill finish 	Prices at right Prices at right	Specify with <i>Customiz stain</i> . ▶ See <i>Surface Materials Reference Manual</i> . Specify with <i>full-fill finish</i> and select wood color number.	
Grommets	Rectangular desk worksurface <ul style="list-style-type: none"> • Left-hand grommet: Platinum paint only +\$75 • Right-hand grommet: Platinum paint only +\$75 • Center grommet: Platinum paint only +\$75 	Specify with <i>GRMMT1</i> . Specify with <i>GRMMT2</i> . Specify with <i>GRMMT3</i> .	
	Bullet and conference desk worksurface, left-hand applications <ul style="list-style-type: none"> • Right-hand grommet: Platinum paint only +\$75 • Center grommet: Platinum paint only +\$75 	Specify with <i>GRMMT2</i> . Specify with <i>GRMMT3L</i> .	
	Bullet and conference desk worksurface, right-hand applications <ul style="list-style-type: none"> • Left-hand grommet: Platinum paint only +\$75 • Center grommet: Platinum paint only +\$75 	Specify with <i>GRMMT1</i> . Specify with <i>GRMMT3R</i> .	
Related Products	<ul style="list-style-type: none"> • Power and communication accessories • Metal flex bases • Pedestals • Cable manager 	▶ Page D65 ▶ Page D36 ▶ Pages D42–D47 ▶ Page D67	

Tip: Your specification is not complete until you add a suffix to define the work-surface edge profile.

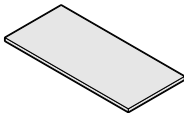

Specification Information

• Dimensions		• Style Number	• Base Price	• Option	
D	W			(Add \$ to Base Price)	Customiz
:	:	:	:	Stain	Finish

Rectangular Desk Worksurfaces

30"	66"	DWD3066 __	\$ 781	+\$ 60	+\$ 60
30"	72"	DWD3072 __	\$ 854	+\$ 60	+\$ 60
30"	78"	DWD3078 __	\$ 938	+\$ 84	+\$ 84
36"	66"	DWD3666 __	\$ 932	+\$ 84	+\$ 84
36"	72"	DWD3672 __	\$1005	+\$ 84	+\$ 84
36"	78"	DWD3678 __	\$1089	+\$ 84	+\$ 84
36"	84"	DWD3684 __	\$1173	+\$ 84	+\$ 84
:	:	:	:	:	:

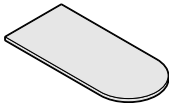

Tip: Bullet desk worksurfaces must be used with 24" metal flex bases.
▶ Page D36

Bullet Desk Worksurfaces

30"	66"	DWB3066 __	\$1316	+\$ 60	+\$ 60
30"	72"	DWB3072 __	\$1389	+\$ 60	+\$ 60
30"	78"	DWB3078 __	\$1473	+\$ 84	+\$ 84
36"	66"	DWB3666 __	\$1467	+\$ 84	+\$ 84
36"	72"	DWB3672 __	\$1540	+\$ 84	+\$ 84
36"	78"	DWB3678 __	\$1624	+\$ 84	+\$ 84
36"	84"	DWB3684 __	\$1708	+\$ 84	+\$ 84
:	:	:	:	:	:

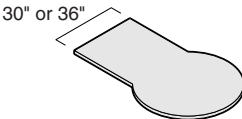

Tip: 42"D conference desk worksurfaces must be used with 24" metal flex bases, and 48"D conference desk worksurfaces must be used with 30" metal flex bases.
▶ Page D36

Conference Desk Worksurfaces

42"	72"	DWP4272 __	\$1579	+\$107	+\$107
42"	78"	DWP4278 __	\$1663	+\$107	+\$107
48"	78"	DWP4878 __	\$1657	+\$135	+\$135
48"	84"	DWP4884 __	\$1730	+\$135	+\$135
:	:	:	:	:	:



Credenza Worksurfaces

SIN 711.8

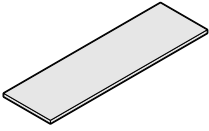

Tip: When creating credenza configurations, any knee-space greater than 54"W must have a center knee-space panel.

▶ Page D37

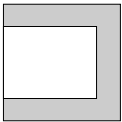

Square edge profile

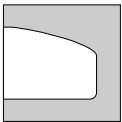

Tapered edge profile

Standard Includes	Required to Specify
<ul style="list-style-type: none"> Credenza worksurface: wood Worksurface with square or tapered edge profile on front edge Square edge profile on all other sides 	<ol style="list-style-type: none"> Style number with appropriate edge profile suffix (see edge profiles below) Wood color number for worksurface Options, if selected (see below) <p>▶ See <i>Surface Materials</i>, page J2.</p>

	Options	Price	Required to Specify
Front Edge Profile	• Square edge profile	No cost	Add suffix A to style number.
	• Tapered edge profile	No cost	Add suffix B to style number.
Surface Materials	• Customiz stain	Prices at right	Specify with <i>Customiz stain</i> .
	• Full-fill finish	Prices at right	▶ See <i>Surface Materials Reference Manual</i> . Specify with <i>full-fill finish</i> and select wood color number.
Grommets	• Left-hand grommet: Platinum paint only	+\$75	Specify with <i>GRMMT1</i> .
	• Right-hand grommet: Platinum paint only	+\$75	Specify with <i>GRMMT2</i> .
	• Center grommet: Platinum paint only	+\$75	Specify with <i>GRMMT3</i> .
Related Products	• Power and communication accessories		▶ Page D65
	• Cable manager		▶ Page D67

Tip: Your specification is not complete until you add a suffix to define the work-surface edge profile.

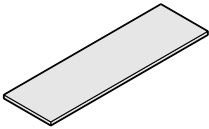
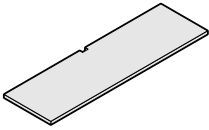

Specification Information

• Dimensions		• Style Number	• Base Price	• Option	
D	W			(Add \$ to Base Price)	Customiz
:	:	:	:	Stain	Finish

Credenza Worksurfaces for Use with Overhead Storage

25"	54"	DWCC2554__	\$ 565	+\$41	+\$41
25"	60"	DWCC2560__	\$ 638	+\$60	+\$60
25"	66"	DWCC2566__	\$ 711	+\$60	+\$60
25"	72"	DWCC2572__	\$ 784	+\$60	+\$60
25"	78"	DWCC2578__	\$ 857	+\$60	+\$60
25"	84"	DWCC2584__	\$ 930	+\$60	+\$60
25"	90"	DWCC2590__	\$1003	+\$60	+\$60
25"	96"	DWCC2596__	\$1345	+\$84	+\$84
:	:	:	:	:	:

Credenza Worksurfaces for Use without Overhead Storage

25"	54"	DWC2554__	\$ 565	+\$41	+\$41
25"	60"	DWC2560__	\$ 638	+\$60	+\$60
25"	66"	DWC2566__	\$ 711	+\$60	+\$60
25"	72"	DWC2572__	\$ 784	+\$60	+\$60
25"	78"	DWC2578__	\$ 857	+\$60	+\$60
25"	84"	DWC2584__	\$ 930	+\$60	+\$60
25"	90"	DWC2590__	\$1003	+\$60	+\$60
25"	96"	DWC2596__	\$1345	+\$84	+\$84
25"	102"	DWC25102__	\$1418	+\$84	+\$84
25"	108"	DWC25108__	\$1491	+\$84	+\$84
:	:	:	:	:	:

Bridge Worksurfaces

SIN 711.8

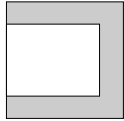
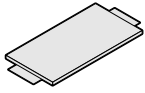

Square edge profile

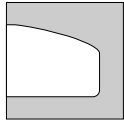

Tapered edge profile

Standard Includes		Required to Specify	
<ul style="list-style-type: none"> Bridge worksurface: wood Worksurface with square or tapered edge profile on front edge Coped edge on attachment sides Square edge profile on back edge Attachment hardware 		<ol style="list-style-type: none"> Style number with appropriate edge profile suffix (see edge profiles below) Wood color number for worksurface Options, if selected (see below) <p>▶ See <i>Surface Materials</i>, page J2.</p>	

	Options	Price	Required to Specify
Front Edge Profile	<ul style="list-style-type: none"> Square edge profile Tapered edge profile 	<p>No cost</p> <p>No cost</p>	<p>Add suffix A to style number.</p> <p>Add suffix B to style number.</p>
Surface Materials	<ul style="list-style-type: none"> Customiz stain Full-fill finish 	<p>+\$41</p> <p>+\$41</p>	<p>Specify with <i>Customiz stain</i>.</p> <p>▶ See <i>Surface Materials Reference Manual</i>. Specify with <i>full-fill finish</i> and select wood color number.</p>
Grommets	<ul style="list-style-type: none"> Center grommet: Platinum paint only 	<p>+\$75</p>	<p>Specify with <i>GRMMT3</i>.</p>
Related Products	<ul style="list-style-type: none"> Power and communication accessories Cable manager 		<p>▶ Page D65</p> <p>▶ Page D67</p>

Tip: Your specification is not complete until you add a suffix to define the work-surface edge profile.

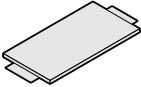

Specification Information

• Dimensions		• Style	• Base
D	W	Number	Price

Bridge Worksurface

25"	42"	DWU2542__	\$419
25"	48"	DWU2548__	\$492
25"	54"	DWU2554__	\$565
:	:	:	:



Return Worksurfaces

SIN 711.8

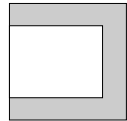
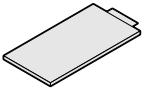

Square edge profile

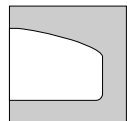

Tapered edge profile

Standard Includes		Required to Specify	
<ul style="list-style-type: none"> Return worksurface: wood Worksurface with square or tapered edge profile on front edge Coped edge on attachment side Square edge profile on back and side edges Attachment hardware 		<ol style="list-style-type: none"> Style number with appropriate edge profile suffix (see edge profiles below) Wood color number for worksurface Options, if selected (see below) <p>▶ See <i>Surface Materials</i>, page J2.</p>	
Options	Price	Required to Specify	
Front Edge Profile	<ul style="list-style-type: none"> Square edge profile: No cost Tapered edge profile: No cost 	Add suffix A to style number. Add suffix B to style number.	
Surface Materials	<p>Customiz stain</p> <ul style="list-style-type: none"> On 36"–54"W worksurfaces: +\$41 On 60"–84"W worksurfaces: +\$60 <p>Full-fill finish</p> <ul style="list-style-type: none"> On 36"–54"W worksurfaces: +\$41 On 60"–84"W worksurfaces: +\$60 	Specify with <i>Customiz stain</i> . Specify with <i>Customiz stain</i> . ▶ See <i>Surface Materials Reference Manual</i> . Specify with <i>full-fill finish</i> and select wood color number. Specify with <i>full-fill finish</i> and select wood color number.	
Grommets	<p>Left-hand return</p> <ul style="list-style-type: none"> Left-hand grommet: Platinum paint only: +\$75 Center grommet: Platinum paint only: +\$75 <p>Right-hand return</p> <ul style="list-style-type: none"> Right-hand grommet: Platinum paint only: +\$75 Center grommet: Platinum paint only: +\$75 	Specify with <i>GRMMT1</i> . Specify with <i>GRMMT3</i> . Specify with <i>GRMMT2</i> . Specify with <i>GRMMT3</i> .	
Related Products	<ul style="list-style-type: none"> Power and communication accessories Cable manager 	▶ Page D65 ▶ Page D67	

Tip: Your specification is not complete until you add a suffix to define the work-surface edge profile.

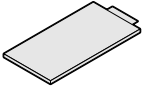

Tip: When creating return configurations, any knee-space greater than 54"W must have a center knee-space panel.
 ▶ Page D37

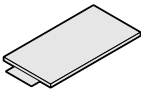

Specification Information

• Dimensions		• Style	• Base
D	W	Number	Price

Left-Hand Return Worksurfaces

25"	36"	DWL2536L__	\$346
25"	42"	DWL2542L__	\$419
25"	48"	DWL2548L__	\$492
25"	54"	DWL2554L__	\$565
25"	60"	DWL2560L__	\$638
25"	66"	DWL2566L__	\$711
25"	72"	DWL2572L__	\$784
25"	78"	DWL2578L__	\$857
25"	84"	DWL2584L__	\$930
:	:	:	:

Right-Hand Return Worksurfaces

25"	36"	DWL2536R__	\$346
25"	42"	DWL2542R__	\$419
25"	48"	DWL2548R__	\$492
25"	54"	DWL2554R__	\$565
25"	60"	DWL2560R__	\$638
25"	66"	DWL2566R__	\$711
25"	72"	DWL2572R__	\$784
25"	78"	DWL2578R__	\$857
25"	84"	DWL2584R__	\$930
:	:	:	:



Run-Off Worksurfaces

SIN 711.8

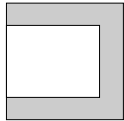
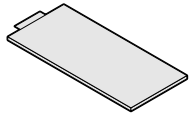

Square edge profile

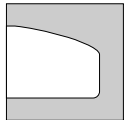

Tapered edge profile

Tip: Run-off worksurfaces can be installed in either a left- or right-hand orientation in the field. However, when you specify a factory-installed grommet, you must choose either a left- or right-hand orientation, and the work surface will no longer be non-handed. Left-hand work surfaces extend to the left and are attached to the right relative to the user. Right-hand orientation is opposite relative to the user.

Standard Includes	Required to Specify
<ul style="list-style-type: none"> Run-off work surface: wood Work surface with square or tapered edge profile on front and back edges Coped edge on attachment side Square edge profile on opposite side Attachment hardware 	<ol style="list-style-type: none"> Style number with appropriate edge profile suffix (see edge profiles below) Wood color number for work surface Options, if selected (see below) <p>▶ See <i>Surface Materials</i>, page J2.</p>

Options	Price	Required to Specify
Front and Back Edge Profile <ul style="list-style-type: none"> Square edge profile Tapered edge profile 	No cost No cost	Add suffix A to style number. Add suffix B to style number.
Surface Materials <ul style="list-style-type: none"> Customiz stain Full-fill finish 	Prices at right Prices at right	Specify with <i>Customiz stain</i> . ▶ See <i>Surface Materials Reference Manual</i> . Specify with <i>full-fill finish</i> and select wood color number.
Grommets	<p>Rectangular work surface, left-hand application</p> <ul style="list-style-type: none"> Left-hand grommet: Platinum paint only +\$75 Center grommet: Platinum paint only +\$75 <p>Rectangular work surface, right-hand application</p> <ul style="list-style-type: none"> Right-hand grommet: Platinum paint only +\$75 Center grommet: Platinum paint only +\$75 <p>Bullet and conference work surface, left-hand application</p> <ul style="list-style-type: none"> Center grommet: Platinum paint only +\$75 <p>Bullet and conference work surface, right-hand application</p> <ul style="list-style-type: none"> Center grommet: Platinum paint only +\$75 	Specify with <i>GRMMT1</i> . Specify with <i>GRMMT3L</i> . Specify with <i>GRMMT2</i> . Specify with <i>GRMMT3R</i> . Specify with <i>GRMMT3L</i> . Specify with <i>GRMMT3R</i> .
Related Products	<ul style="list-style-type: none"> Power and communication accessories Metal flex bases Cable manager 	<p>▶ Page D65</p> <p>▶ Page D36</p> <p>▶ Page D67</p>

Tip: Your specification is not complete until you add a suffix to define the work-surface edge profile.

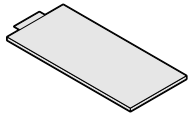

Tip: Rectangular run-off worksurfaces must be attached to a credenza worksurface at one end and supported by pedestals, support panel, or an X-flex base at the other end.

► Pages D28, D36–D37, and D42–D47

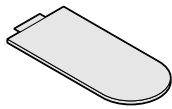

Tip: Bullet run-off worksurfaces must be attached to a credenza worksurface at one end and supported by a 24" X-flex base at the other end.

► Pages D28 and D36

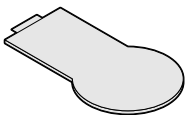

Tip: 42"D conference run-off worksurfaces must be attached to a credenza worksurface at one end and supported by a 24" X-flex base at the other end.

► Pages D28 and D36

Specification Information

• Dimensions		• Style Number	• Base Price	• Option	
D	W			(Add \$ to Base Price)	Customiz
				Stain	Finish

Rectangular Run-Off Worksurfaces

30"	60"	DWDR3060	\$ 781	+\$ 60	+\$60
30"	66"	DWDR3066	\$ 854	+\$ 60	+\$60
30"	72"	DWDR3072	\$ 938	+\$ 60	+\$60
36"	60"	DWDR3660	\$ 932	+\$ 60	+\$60
36"	66"	DWDR3666	\$1005	+\$ 84	+\$84
36"	72"	DWDR3672	\$1089	+\$ 84	+\$84

Bullet Run-Off Worksurfaces

30"	48"	DWBR3048	\$1097	+\$ 60	+\$ 60
30"	54"	DWBR3054	\$1170	+\$ 60	+\$ 60
30"	60"	DWBR3060	\$1243	+\$ 60	+\$ 60
30"	66"	DWBR3066	\$1316	+\$ 60	+\$ 60
30"	72"	DWBR3072	\$1389	+\$ 60	+\$ 60
36"	60"	DWBR3660	\$1394	+\$ 60	+\$ 60
36"	48"	DWBR3648	\$1248	+\$ 60	+\$ 60
36"	54"	DWBR3654	\$1321	+\$ 60	+\$ 60
36"	66"	DWBR3666	\$1467	+\$ 84	+\$ 84
36"	72"	DWBR3672	\$1540	+\$ 84	+\$ 84

Conference Run-Off Worksurfaces

42"	48"	DWPR4248	\$1438	+\$ 60	+\$ 60
42"	54"	DWPR4254	\$1511	+\$ 60	+\$ 60
42"	60"	DWPR4260	\$1584	+\$ 84	+\$ 84
42"	66"	DWPR4266	\$1657	+\$ 84	+\$ 84
42"	72"	DWPR4272	\$1730	+\$107	+\$107
42"	78"	DWPR4278	\$1803	+\$107	+\$107

Metal Flex Bases

SIN 711.8

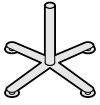

Tip: Use 24" flex base with worksurfaces that are 30"D to 42"D. Use 30" flex base with worksurfaces greater than 42"D.

Standard Includes	Required to Specify
-------------------	---------------------

- Metal X-flex base: paint or metal
- Glides: black plastic
- Attachment hardware

- 1 Style number
- 2 Paint or metal color number for base:
0835 Black
4798 Sterling
4799 Platinum
- 3 Options, if selected (see below)
▶ See *Surface Materials*, page J2.

Surface Materials	Options	Price	Required to Specify
-------------------	---------	-------	---------------------

- | | | | |
|--------------------------|---------------------|--------|--------------------------------------|
| Surface Materials | • Brushed Aluminum | +\$150 | Specify with 8042 Brushed Aluminum. |
| | • Polished Aluminum | +\$150 | Specify with 8046 Polished Aluminum. |

Specification Information				
• Dimensions			• Style	• Base
D	W	H	Number	Price

24"	24"	27"	CFLEXX24	\$902
30"	30"	27"	CFLEXX30	\$989
:	:	:	:	:

Support Panels

SIN 711.8

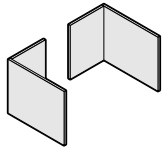

Standard Includes	Required to Specify
<ul style="list-style-type: none"> Panel: wood Leveling glides: black plastic only Attachment hardware 	<ul style="list-style-type: none"> 1 Style number 2 Wood color number for panel 3 Options, if selected (see below) ▶ See <i>Surface Materials</i>, page J2.

Options	Price	Required to Specify
Surface Materials <ul style="list-style-type: none"> Customiz stain 	+\$24	Specify with <i>Customiz stain</i> . ▶ See <i>Surface Materials Reference Manual</i> .

Specification Information

Dimensions			Style	Base
D	W	H	Number	Price

Left-Hand End Panels

For Use with Credenzas, Returns, and 30"D Desks and Run-Offs

24"	18"	25¼"	DEP2418L	\$520
-----	-----	------	-----------------	-------

For Use with 36"D Desks and Run-Offs

30"	18"	25¼"	DEP3018L	\$535
-----	-----	------	-----------------	-------

Right-Hand End Panels

For Use with Credenzas, Returns, and 30"D Desks and Run-Offs

24"	18"	25¼"	DEP2418R	\$520
-----	-----	------	-----------------	-------

For Use with 36"D Desks and Run-Offs

30"	18"	25¼"	DEP3018R	\$535
-----	-----	------	-----------------	-------

Kneespace Panel

12"	1½"	27"	DKP121	\$470
-----	-----	-----	---------------	-------

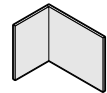
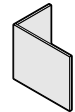

Tip: Any kneespace greater than 54"W requires one kneespace panel.

Desk Modesty Panels

SIN 711.8

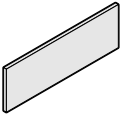

Tip: To achieve the desired aesthetic, modesty panel should be specified 6" narrower than the worksurface it will attach to.

Standard Includes	Required to Specify
<ul style="list-style-type: none"> Modesty panel: wood Attachment hardware 	<ol style="list-style-type: none"> Style number Wood color number for panel Options, if selected (see below) <p>▶ See <i>Surface Materials</i>, page J2.</p>

Options	Price	Required to Specify
Surface Materials <ul style="list-style-type: none"> Customiz stain On 54"W modesty panel +\$41 On 60"W and wider modesty panel +\$60 		Specify with <i>Customiz stain</i> . Specify with <i>Customiz stain</i> . ▶ See <i>Surface Materials Reference Manual</i> .

Specification Information			
Dimensions		Style Number	Base Price
W	H		
54"	20"	DM2554	\$600
60"	20"	DM2560	\$600
66"	20"	DM2566	\$650
72"	20"	DM2572	\$700
78"	20"	DM2578	\$750

Finished Back Panels

for Credenzas and Returns

SIN 711.8

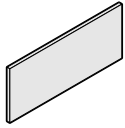

Tip: Finished back panels are designed to be taller and wider than modesty panels. Order a finished back panel the same width as the worksurface it will attach to.

Standard Includes	Required to Specify
<ul style="list-style-type: none"> • Back panel: wood • Attachment hardware 	1 Style number 2 Wood color number for panel 3 Options, if selected (see below) ▶ See <i>Surface Materials</i> , page J2.

Options	Price	Required to Specify
Surface Materials <ul style="list-style-type: none"> • Customiz stain 	Prices below	Specify with <i>Customiz stain</i> . ▶ See <i>Surface Materials Reference Manual</i> .

Specification Information				
• Dimensions D	• Dimensions W	• Style Number	• Base Price	• Option
				(Add \$ to Base Price)
				• Customiz Stain
54"	25"	DF2554	\$ 500	+\$41
60"	25"	DF2560	\$ 550	+\$60
66"	25"	DF2566	\$ 600	+\$60
72"	25"	DF2572	\$ 650	+\$60
78"	25"	DF2578	\$ 700	+\$60
84"	25"	DF2584	\$ 750	+\$60
90"	25"	DF2590	\$ 800	+\$60
96"	25"	DF2596	\$1063	+\$84
102"	25"	DF25102	\$1113	+\$84
108"	25"	DF25108	\$1163	+\$84
:	:	:	:	:



Pedestals for Use with 36"D Tech Center Worksurfaces

SIN 711.8

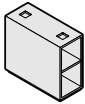

Tip: These pedestals should be used under 36"D tech center worksurfaces only.

Standard Includes	Required to Specify
<ul style="list-style-type: none"> • Full-height pedestals with recessed base and removable back: wood • Bevel, deco, or Nile pulls: paint or metal • Lock, keyed random: 9201 Polished Chrome <i>Exception: Pedestals with open shelf and file drawer do not lock.</i> • One hanging file system per file drawer • Leveling glides: black only • Adjustable shelf in pedestals with two open shelves only 	<ol style="list-style-type: none"> 1 Style number 2 Wood color number for pedestal 3 Pulls and paint or metal color number (see below) 4 Options, if selected (see below) <p>▶ See <i>Surface Materials</i>, page J2.</p>

Options	Price	Required to Specify
Surface Materials Customiz stain <ul style="list-style-type: none"> • On 12"W & 18"W pedestals • On 30"W & 36"W pedestals 	+\$ 84 +\$181	Specify with <i>Customiz stain</i> . Specify with <i>Customiz stain</i> . ▶ See <i>Surface Materials Reference Manual</i> .
Drawer Pulls <ul style="list-style-type: none"> • Bevel pull • Deco pull • Nile pull 	No cost No cost No cost	Specify with <i>bevel pull</i> and select 0835 Black, 4799 Platinum, 9201 Polished Chrome, or 9211 Nickel. Specify with <i>deco pull</i> and select 0835 Black, 4799 Platinum, 9201 Polished Chrome, or 9211 Nickel. Specify with <i>nile pull</i> and select 0835 Black, 4799 Platinum, 9201 Polished Chrome, or 9211 Nickel.
Lock and Keying <ul style="list-style-type: none"> • Ember Chrome Keying <ul style="list-style-type: none"> • Factory- and field-installed keying 	No cost	Specify with <i>9250 Ember Chrome lock</i> . ▶ Page J8
Related Products <ul style="list-style-type: none"> • Power and communication accessories 		▶ Page D65

Specification Information

Dimensions			Style	Base
D	W	H	Number	Price

12"W Pedestals

With Two Open Shelves

30"	12"	26"	DPD3012S	\$717
-----	-----	-----	-----------------	-------

With Two Shelves and Door Hinged on Left

30"	12"	26"	DPE3012S	\$792
-----	-----	-----	-----------------	-------

With Two Shelves and Door Hinged on Right

30"	12"	26"	DPF3012S	\$792
-----	-----	-----	-----------------	-------

Power Pedestal with Door Hinged on Left

30"	12"	26"	DPL3012S	\$792
-----	-----	-----	-----------------	-------

Power Pedestal with Door Hinged on Right

30"	12"	26"	DPR3012S	\$792
-----	-----	-----	-----------------	-------

▶ Specification information continued on next page

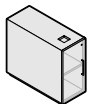
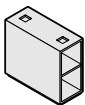

Tip: Power pedestals have removable panels in the kneespace side to accommodate CPUs and power and communication outlets.

► Specification Information, continued

Specification Information

Dimensions			Style Number	Base Price
D	W	H		

18"W Pedestals

With Two File Drawers

30"	18"	26"	DPA3018S	\$1075
-----	-----	-----	-----------------	--------

With Two Box Drawers and One File Drawer

30"	18"	26"	DPB3018S	\$1075
-----	-----	-----	-----------------	--------

With Open Shelf and File Drawer

30"	18"	26"	DPC3018S	\$ 931
-----	-----	-----	-----------------	--------

With Two Open Shelves

30"	18"	26"	DPD3018S	\$ 787
-----	-----	-----	-----------------	--------

With Two Shelves and Door Hinged on Left

30"	18"	26"	DPE3018S	\$ 862
-----	-----	-----	-----------------	--------

With Two Shelves and Door Hinged on Right

30"	18"	26"	DPF3018S	\$ 862
-----	-----	-----	-----------------	--------

30"W Pedestals

With Two Lateral File Drawers

30"	30"	26"	DPA3030S	\$1945
-----	-----	-----	-----------------	--------

With Two Wide Box Drawers and One Lateral File Drawer

30"	30"	26"	DPB3030S	\$1945
-----	-----	-----	-----------------	--------

With Open Shelf and Lateral File Drawer

30"	30"	26"	DPC3030S	\$1720
-----	-----	-----	-----------------	--------

With Two Open Shelves

30"	30"	26"	DPD3030S	\$1495
-----	-----	-----	-----------------	--------

With Double Doors

30"	30"	26"	DPE3030S	\$1645
-----	-----	-----	-----------------	--------

36"W Pedestals

With Four File Drawers for Left-Hand Application

30"	36"	26"	DPG3036LS	\$2469
-----	-----	-----	------------------	--------

With Four File Drawers for Right-Hand Application

30"	36"	26"	DPG3036RS	\$2469
-----	-----	-----	------------------	--------

With Four Box Drawers and Two File Drawers for Left-Hand Application

30"	36"	26"	DPH3036LS	\$2469
-----	-----	-----	------------------	--------

With Four Box Drawers and Two File Drawers for Right-Hand Application

30"	36"	26"	DPH3036RS	\$2469
-----	-----	-----	------------------	--------

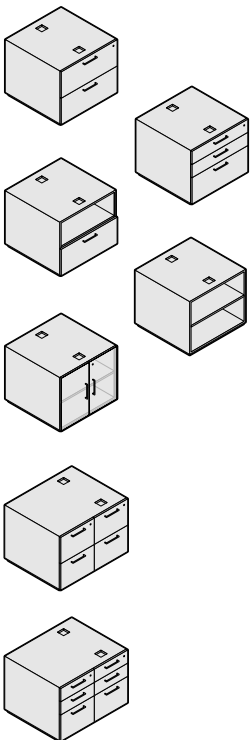
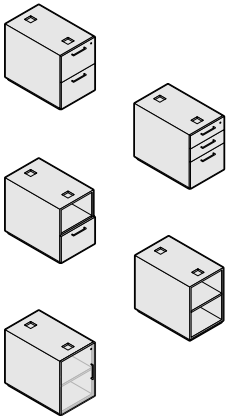

Tip: 36"W pedestals are handed to prevent width of pedestal from encroaching on kneespace. Orientation is relative to the user.

12"W and 18"W Pedestals

for Use with 30"D Desk and Run-Off Worksurfaces and 25"D Return and Credenza Worksurfaces

SIN 711.8

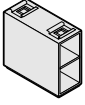

Tip: These pedestals can be used only under 30"D desk and runoff worksurfaces, and 25"D return and credenza worksurfaces.

Standard Includes	Required to Specify
<ul style="list-style-type: none"> • Full-height pedestals with recessed base and removable back: wood • Bevel, deco, or nile pulls: paint or metal • Lock, keyed random: 9201 Polished Chrome <i>Exception: Pedestals with open shelf and file drawer do not lock.</i> • One hanging file system per file drawer • Leveling glides: black only • Metal rail for attachment to worksurface and routing of cords and cables: black paint only • Adjustable shelf in pedestals with two open shelves only 	<ol style="list-style-type: none"> 1 Style number 2 Wood color number for pedestal 3 Pulls and paint or metal color number (see below) 4 Options, if selected (see below) <p>▶ See <i>Surface Materials</i>, page J2.</p>

	Options	Price	Required to Specify	
Surface Materials	• Customiz stain	+\$57	Specify with <i>Customiz stain</i> . ▶ See <i>Surface Materials Reference Manual</i> .	
	Drawer Pulls	• Bevel pull	No cost	Specify with <i>bevel pull</i> and select 0835 Black, 4799 Platinum, 9201 Polished Chrome, or 9211 Nickel. Specify with <i>deco pull</i> and select 0835 Black, 4799 Platinum, 9201 Polished Chrome, or 9211 Nickel. Specify with <i>nile pull</i> and select 0835 Black, 4799 Platinum, 9201 Polished Chrome, or 9211 Nickel.
		• Deco pull	No cost	
• Nile pull		No cost		
Lock and Keying	Lock <ul style="list-style-type: none"> • Ember Chrome 	No cost	Specify with <i>9250 Ember Chrome lock</i> .	
	Keying <ul style="list-style-type: none"> • Factory- and field-installed keying 		▶ Page J8	
Related Products	• Power and communication accessories		▶ Page D65	

Specification Information

Dimensions			Style Number	Base Price
D	W	H		

12"W Pedestals

With Two Open Shelves

24"	12"	27 ¹ / ₈ "	DPD2412	\$ 717
-----	-----	----------------------------------	----------------	--------

With Two Shelves and Door Hinged on Left

24"	12"	27 ¹ / ₈ "	DPE2412	\$ 792
-----	-----	----------------------------------	----------------	--------

With Two Shelves and Door Hinged on Right

24"	12"	27 ¹ / ₈ "	DPF2412	\$ 792
-----	-----	----------------------------------	----------------	--------

Power Pedestal with Door Hinged on Left

24"	12"	27 ¹ / ₈ "	DPL2412	\$ 792
-----	-----	----------------------------------	----------------	--------

Power Pedestal with Door Hinged on Right

24"	12"	27 ¹ / ₈ "	DPR2412	\$ 792
-----	-----	----------------------------------	----------------	--------

18"W Pedestals

With Two File Drawers

24"	18"	27 ¹ / ₈ "	DPA2418	\$1015
-----	-----	----------------------------------	----------------	--------

With Two Box Drawers and One File Drawer

24"	18"	27 ¹ / ₈ "	DPB2418	\$1015
-----	-----	----------------------------------	----------------	--------

With Open Shelf and File Drawer

24"	18"	27 ¹ / ₈ "	DPC2418	\$ 871
-----	-----	----------------------------------	----------------	--------

With Two Open Shelves

24"	18"	27 ¹ / ₈ "	DPD2418	\$ 727
-----	-----	----------------------------------	----------------	--------

With Two Shelves and Door Hinged on Left

24"	18"	27 ¹ / ₈ "	DPE2418	\$ 802
-----	-----	----------------------------------	----------------	--------

With Two Shelves and Door Hinged on Right

24"	18"	27 ¹ / ₈ "	DPF2418	\$ 802
-----	-----	----------------------------------	----------------	--------

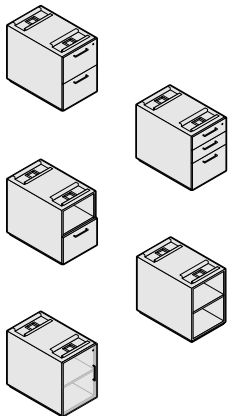
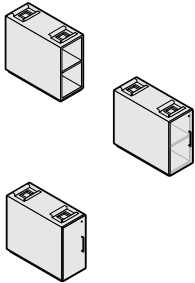

30"W and 36"W Pedestals

for Use with 30"D Desk and Run-Off Worksurfaces, and 25"D Return and Credenza Worksurfaces

SIN 711.8

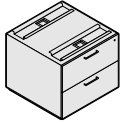

Tip: These pedestals can be used only under 30"D desk worksurfaces and 25"D return and credenza worksurfaces.

Standard Includes	Required to Specify
<ul style="list-style-type: none"> • Full-height pedestals with recessed base and removable back: wood • Bevel, deco, or Nile pulls: paint or metal • Lock, keyed random: 9201 Polished Chrome <i>Exception: Pedestals with open shelf and file drawer do not lock.</i> • One hanging file system per file drawer • Leveling glides: black only • Metal rail for attachment to worksurface and routing of cords and cables: black paint only • Adjustable shelf in pedestals with two open shelves only 	<ol style="list-style-type: none"> 1 Style number 2 Wood color number for pedestal 3 Pulls and paint or metal color number (see below) 4 Options, if selected (see below) <p>▶ See <i>Surface Materials</i>, page J2.</p>

	Options	Price	Required to Specify	
Surface Materials	• Customiz stain	+\$128	Specify with <i>Customiz stain</i> . ▶ See <i>Surface Materials Reference Manual</i> .	
	Drawer Pulls	• Bevel pull	No cost	Specify with <i>bevel pull</i> and select 0835 Black, 4799 Platinum, 9201 Polished Chrome, or 9211 Nickel. Specify with <i>deco pull</i> and select 0835 Black, 4799 Platinum, 9201 Polished Chrome, or 9211 Nickel. Specify with <i>Nile pull</i> and select 0835 Black, 4799 Platinum, 9201 Polished Chrome, or 9211 Nickel.
		• Deco pull	No cost	
• Nile pull		No cost		
Lock and Keying	Lock • Ember Chrome	No cost	Specify with <i>9250 Ember Chrome lock</i> .	
	Keying • Factory- and field-installed keying		▶ Page J8	
Related Products	• Power and communication accessories		▶ Page D65	

Specification Information

Dimensions			Style Number	Base Price
D	W	H		

30"W and 36"W Pedestals

With Two Lateral File Drawers

24"	30"	27 ¹ / ₈ "	DPA2430	\$1875
24"	36"	27 ¹ / ₈ "	DPA2436	\$1946

With Two Wide Box Drawers and One Lateral File Drawer

24"	30"	27 ¹ / ₈ "	DPB2430	\$1875
24"	36"	27 ¹ / ₈ "	DPB2436	\$1946

With Open Shelf and Lateral File Drawer

24"	30"	27 ¹ / ₈ "	DPC2430	\$1650
24"	36"	27 ¹ / ₈ "	DPC2436	\$1721

With Two Open Shelves

24"	30"	27 ¹ / ₈ "	DPD2430	\$1425
24"	36"	27 ¹ / ₈ "	DPD2436	\$1496

With Double Doors

24"	30"	27 ¹ / ₈ "	DPE2430	\$1575
24"	36"	27 ¹ / ₈ "	DPE2436	\$1646

36"W Pedestals

With Four File Drawers, Non-Handed

24"	36"	27 ¹ / ₈ "	DPG2436	\$2396
-----	-----	----------------------------------	----------------	--------

With Four File Drawers for Left-Hand Application

24"	36"	27 ¹ / ₈ "	DPG2436L	\$2396
-----	-----	----------------------------------	-----------------	--------

With Four File Drawers for Right-Hand Application

24"	36"	27 ¹ / ₈ "	DPG2436R	\$2396
-----	-----	----------------------------------	-----------------	--------

With Four Box Drawers and Two File Drawers, Non-Handed

24"	36"	27 ¹ / ₈ "	DPH2436	\$2396
-----	-----	----------------------------------	----------------	--------

With Four Box Drawers and Two File Drawers for Left-Hand Application

24"	36"	27 ¹ / ₈ "	DPH2436L	\$2396
-----	-----	----------------------------------	-----------------	--------

With Four Box Drawers and Two File Drawers for Right-Hand Application

24"	36"	27 ¹ / ₈ "	DPH2436R	\$2396
-----	-----	----------------------------------	-----------------	--------

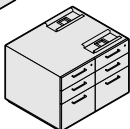
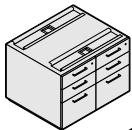
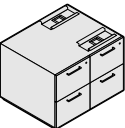
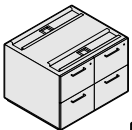
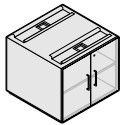
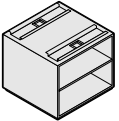
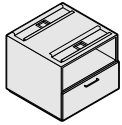
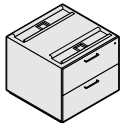

Tip: 36"W pedestals are handed for applications where a large amount of slip-fit is desired, and to prevent pedestal width from crowding kneespace. Orientation is relative to the user.

Pedestals for Use with 36"D Desk and Run-Off Worksurfaces

SIN 711.8

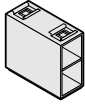

Tip: These pedestals can be used only under 36"D desk and run-off worksurfaces.

Standard Includes	Required to Specify
<ul style="list-style-type: none"> • Full-height pedestals with recessed base and removable back: wood • Bevel, deco, or Nile pulls: paint or metal • Lock, keyed random: 9201 Polished Chrome <i>Exception: Pedestals with open shelf and file drawer do not lock.</i> • One hanging file system per file drawer • Leveling glides: black only • Metal rail for attachment to worksurface and routing of cords and cables: black paint only • Adjustable shelf in pedestals with two open shelves only 	<ol style="list-style-type: none"> 1 Style number 2 Wood color number for pedestal 3 Pulls and paint or metal color number (see below) 4 Options, if selected (see below) <p>▶ See <i>Surface Materials</i>, page J2.</p>

Options	Price	Required to Specify
Surface Materials <ul style="list-style-type: none"> • Customiz stain • On 12"W & 18"W pedestals • On 30"W & 36"W pedestals 	<ul style="list-style-type: none"> • +\$ 84 • +\$181 	<p>Specify with <i>Customiz stain</i>. Specify with <i>Customiz stain</i>. ▶ See <i>Surface Materials Reference Manual</i>.</p>
Drawer Pulls <ul style="list-style-type: none"> • Bevel pull • Deco pull • Nile pull 	<ul style="list-style-type: none"> • No cost • No cost • No cost 	<p>Specify with <i>bevel pull</i> and select 0835 Black, 4799 Platinum, 9201 Polished Chrome, or 9211 Nickel. Specify with <i>deco pull</i> and select 0835 Black, 4799 Platinum, 9201 Polished Chrome, or 9211 Nickel. Specify with <i>nile pull</i> and select 0835 Black, 4799 Platinum, 9201 Polished Chrome, or 9211 Nickel.</p>
Lock and Keying <ul style="list-style-type: none"> • Lock • Ember Chrome • Keying • Factory- and field-installed keying 	<ul style="list-style-type: none"> • No cost 	<p>Specify with <i>9250 Ember Chrome lock</i>. ▶ Page J8</p>
Related Products <ul style="list-style-type: none"> • Power and communication accessories 		▶ Page D65

Specification Information

Dimensions			Style	Base
D	W	H	Number	Price

12"W Pedestals

With Two Open Shelves

30"	12"	27 ¹ / ₈ "	DPD3012	\$717
-----	-----	----------------------------------	----------------	-------

With Two Shelves and Door Hinged on Left

30"	12"	27 ¹ / ₈ "	DPE3012	\$792
-----	-----	----------------------------------	----------------	-------

With Two Shelves and Door Hinged on Right

30"	12"	27 ¹ / ₈ "	DPF3012	\$792
-----	-----	----------------------------------	----------------	-------

Power Pedestal with Door Hinged on Left

30"	12"	27 ¹ / ₈ "	DPL3012	\$792
-----	-----	----------------------------------	----------------	-------

Power Pedestal with Door Hinged on Right

30"	12"	27 ¹ / ₈ "	DPR3012	\$792
-----	-----	----------------------------------	----------------	-------

▶ Specification information continued on next page

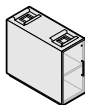
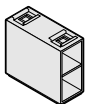

► Specification Information, continued

Specification Information

Dimensions			Style Number	Base Price
D	W	H		

18"W Pedestals

With Two File Drawers

30"	18"	27 ¹ / ₈ "	DPA3018	\$1075
-----	-----	----------------------------------	----------------	--------

With Two Box Drawers and One File Drawer

30"	18"	27 ¹ / ₈ "	DPB3018	\$1075
-----	-----	----------------------------------	----------------	--------

With Open Shelf and File Drawer

30"	18"	27 ¹ / ₈ "	DPC3018	\$ 931
-----	-----	----------------------------------	----------------	--------

With Two Open Shelves

30"	18"	27 ¹ / ₈ "	DPD3018	\$ 787
-----	-----	----------------------------------	----------------	--------

With Two Shelves and Door Hinged on Left

30"	18"	27 ¹ / ₈ "	DPE3018	\$ 862
-----	-----	----------------------------------	----------------	--------

With Two Shelves and Door Hinged on Right

30"	18"	27 ¹ / ₈ "	DPF3018	\$ 862
-----	-----	----------------------------------	----------------	--------

30"W Pedestals

With Two Lateral File Drawers

30"	30"	27 ¹ / ₈ "	DPA3030	\$1945
-----	-----	----------------------------------	----------------	--------

With Two Wide Box Drawers and One Lateral File Drawer

30"	30"	27 ¹ / ₈ "	DPB3030	\$1945
-----	-----	----------------------------------	----------------	--------

With Open Shelf and Lateral File Drawer

30"	30"	27 ¹ / ₈ "	DPC3030	\$1720
-----	-----	----------------------------------	----------------	--------

With Two Open Shelves

30"	30"	27 ¹ / ₈ "	DPD3030	\$1495
-----	-----	----------------------------------	----------------	--------

With Double Doors

30"	30"	27 ¹ / ₈ "	DPE3030	\$1645
-----	-----	----------------------------------	----------------	--------

36"W Pedestals

With Four File Drawers for Left-Hand Application

30"	36"	27 ¹ / ₈ "	DPG3036L	\$2469
-----	-----	----------------------------------	-----------------	--------

With Four File Drawers for Right-Hand Application

30"	36"	27 ¹ / ₈ "	DPG3036R	\$2469
-----	-----	----------------------------------	-----------------	--------

With Four Box Drawers and Two File Drawers for Left-Hand Application

30"	36"	27 ¹ / ₈ "	DPH3036L	\$2469
-----	-----	----------------------------------	-----------------	--------

With Four Box Drawers and Two File Drawers for Right-Hand Application

30"	36"	27 ¹ / ₈ "	DPH3036R	\$2469
-----	-----	----------------------------------	-----------------	--------

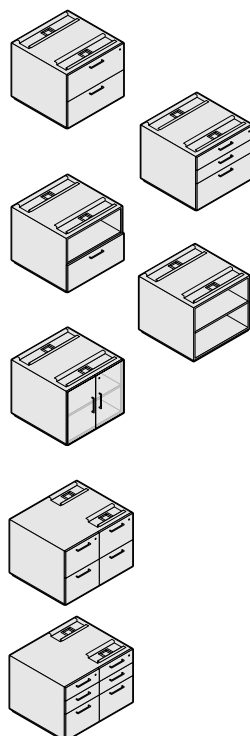
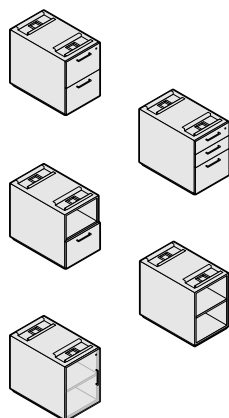

Tip: 36"W pedestals are handed to prevent width of pedestal from encroaching on kneespace. Orientation is relative to the user.

Mobile Pedestals

SIN 711.8

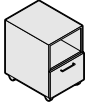

Standard Includes	Required to Specify
<ul style="list-style-type: none"> Mobile pedestal: wood Bevel, deco, or Nile pulls: paint or metal Lock, keyed random: 9201 Polished Chrome <i>Exception: Pedestals with open shelf and file drawer do not lock.</i> One hanging file system per file drawer Casters: black only Adjustable shelf in pedestal with two open shelves only 	<ol style="list-style-type: none"> Style number Wood color number for pedestal Pulls and paint or metal color number (see below) Options, if selected (see below) <p>▶ See <i>Surface Materials</i>, page J2.</p>

Options	Price	Required to Specify
Surface Materials <ul style="list-style-type: none"> Customiz stain On 18"W mobile pedestals On 36"W mobile pedestals 	<ul style="list-style-type: none"> +\$ 57 +\$128 	<ul style="list-style-type: none"> Specify <i>with Customiz stain</i>. Specify <i>with Customiz stain</i>. <p>▶ See <i>Surface Materials Reference Manual</i>.</p>
Drawer Pulls <ul style="list-style-type: none"> Bevel pull Deco pull Nile pull 	<ul style="list-style-type: none"> No cost No cost No cost 	<ul style="list-style-type: none"> Specify <i>with bevel pull</i> and select 0835 Black, 4799 Platinum, 9201 Polished Chrome, or 9211 Nickel. Specify <i>with deco pull</i> and select 0835 Black, 4799 Platinum, 9201 Polished Chrome, or 9211 Nickel. Specify <i>with Nile pull</i> and select 0835 Black, 4799 Platinum, 9201 Polished Chrome, or 9211 Nickel.
Lock and Keying <ul style="list-style-type: none"> Lock Ember Chrome Keying Factory- and field-installed keying 	<ul style="list-style-type: none"> No cost 	<ul style="list-style-type: none"> Specify <i>with 9250 Ember Chrome lock</i>. <p>▶ Page J8</p>
Related Products <ul style="list-style-type: none"> Power and communication accessories 		<p>▶ Page D65</p>

Specification Information

Dimensions			Style Number	Base Price
D	W	H		

18"W Mobile Pedestals

With Open Shelf and File Drawer

24"	18"	23 ⁵ / ₈ "	DPC2418M	\$ 971
-----	-----	----------------------------------	-----------------	--------

With Open Shelf, Box Drawer, and File Drawer

24"	18"	23 ⁵ / ₈ "	DPB2418M	\$1115
-----	-----	----------------------------------	-----------------	--------

With Two Open Shelves

24"	18"	23 ⁵ / ₈ "	DPD2418M	\$ 827
-----	-----	----------------------------------	-----------------	--------

36"W Pedestals

With Two Open Shelves, Two Box Drawers, and Two File Drawers

24"	36"	23 ⁵ / ₈ "	DPH2436M	\$2496
-----	-----	----------------------------------	-----------------	--------

With Open Shelf and One Lateral File Drawer

24"	36"	23 ⁵ / ₈ "	DPC2436M	\$1821
-----	-----	----------------------------------	-----------------	--------

With Two Open Shelves

24"	36"	23 ⁵ / ₈ "	DPD2436M	\$1596
-----	-----	----------------------------------	-----------------	--------

With Shelves Double Doors

24"	36"	23 ⁵ / ₈ "	DPE2436M	\$1746
-----	-----	----------------------------------	-----------------	--------

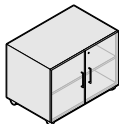
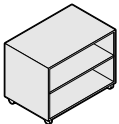
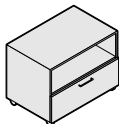

Tall Lateral Files

SIN 711.8



Standard Includes	Required to Specify
<ul style="list-style-type: none"> Lateral file with recessed base: wood Bevel, deco, or Nile pulls: paint or metal Lock, keyed random: 9201 Polished Chrome One hanging file system per file drawer Leveling glides: black only 	<ol style="list-style-type: none"> Style number Wood color number for pedestal Pulls and paint or metal color number (see below) Options, if selected (see below) <p>▶ See <i>Surface Materials</i>, page J2.</p>

Options	Price	Required to Specify
Surface Materials <ul style="list-style-type: none"> Customiz stain 	+\$212	Specify with <i>Customiz stain</i> . ▶ See <i>Surface Materials Reference Manual</i> .
Drawer Pulls <ul style="list-style-type: none"> Bevel pull Deco pull Nile pull 	No cost	Specify with <i>bevel pull</i> and select 0835 Black, 4799 Platinum, 9201 Polished Chrome, or 9211 Nickel. Specify with <i>deco pull</i> and select 0835 Black, 4799 Platinum, 9201 Polished Chrome, or 9211 Nickel. Specify with <i>nile pull</i> and select 0835 Black, 4799 Platinum, 9201 Polished Chrome, or 9211 Nickel.
Lock and Keying <ul style="list-style-type: none"> Lock <ul style="list-style-type: none"> Ember Chrome Keying <ul style="list-style-type: none"> Factory- and field-installed keying 	No cost	Specify with <i>9250 Ember Chrome lock</i> . ▶ Page J8
Related Products <ul style="list-style-type: none"> Power and communication accessories 		▶ Page D65

Specification Information

• Dimensions			• Style	• Base
D	W	H	Number	Price

Tall Lateral Files

24"	30"	51"	DL42430	\$3275
24"	36	51"	DL42436	\$3275





12"W and 18"W Towers

SIN 711.8

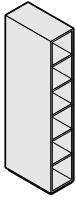

Standard Includes	Required to Specify
<ul style="list-style-type: none"> • Tower with recessed base and unfinished back: wood • Bevel, deco, or Nile pulls: paint or metal • Lock, keyed random: 9201 Polished Chrome • One hanging file system per file drawer • Leveling glides: black only 	<ol style="list-style-type: none"> 1 Style number 2 Wood color number for tower 3 Pulls and paint or metal color number (see below) 4 Options, if selected (see below) <p>▶ See <i>Surface Materials</i>, page J2.</p>

Options	Price	Required to Specify
Surface Materials <ul style="list-style-type: none"> • Customiz stain 	+\$265	Specify with <i>Customiz stain</i> . ▶ See <i>Surface Materials Reference Manual</i> .
Door fronts		
<ul style="list-style-type: none"> • Translucent glass door fronts 	+\$100 per door	Add suffix G to style number.
Pulls		
<ul style="list-style-type: none"> • Bevel pull 	No cost	Specify with <i>bevel pull</i> and select 0835 Black, 4799 Platinum, 9201 Polished Chrome, or 9211 Nickel.
<ul style="list-style-type: none"> • Deco pull 	No cost	Specify with <i>deco pull</i> and select 0835 Black, 4799 Platinum, 9201 Polished Chrome, or 9211 Nickel.
<ul style="list-style-type: none"> • Nile pull 	No cost	Specify with <i>nile pull</i> and select 0835 Black, 4799 Platinum, 9201 Polished Chrome, or 9211 Nickel.
Lock and Keying		
Lock <ul style="list-style-type: none"> • Ember Chrome 	No cost	Specify with <i>9250 Ember Chrome lock</i> .
Keying <ul style="list-style-type: none"> • Factory- and field-installed keying 		▶ Page J8
Related Products <ul style="list-style-type: none"> • Power and communication accessories 		▶ Page D65

Specification Information

• Dimensions			• Style	• Base
D	W	H	Number	Price

Open Shelves

24"	12"	69¼"	DTE2512	\$1840
24"	18"	69¼"	DTE2518	\$2300
24"	12"	84½"	D2TE2512	\$1932
24"	18"	84½"	D2TE2518	\$2415

▶ **Specification information continued on next page**

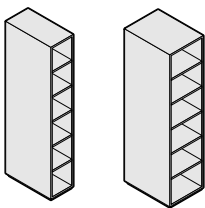

Tip: 12"W towers must be attached to adjacent elements and cannot stand alone.

► Specification Information, continued

Specification Information

Dimensions			Style Number	Base Price
D	W	H		

Two File Drawers Below and Shelves Above

Door Hinged on Left

25"	18"	69¼"	DTA2518	\$2688
25"	18"	84½"	D2TA2518	\$2803

Door Hinged on Right

25"	18"	69¼"	DTB2518	\$2688
25"	18"	84½"	D2TB2518	\$2803



Tip: Door and file/file drawers have separate locks.

Wardrobe

Door Hinged on Left

25"	12"	69¼"	DTF2512	\$1940
25"	12"	84½"	D2TF2512	\$2032

Door Hinged on Right

25"	12"	69¼"	DTG2512	\$1940
25"	12"	84½"	D2TG2512	\$2032



Wardrobe on Left and Shelves on Right

Door Hinged on Left

25"	18"	69¼"	DTF2518	\$2500
25"	18"	84½"	D2TF2518	\$2615

Door Hinged on Right

25"	18"	69¼"	DTG2518	\$2500
25"	18"	84½"	D2TG2518	\$2615



Tip: Wardrobe portion of tower has interior dimensions of 8⅛"W x 23½"D.

Shelves

Door Hinged on Left

25"	12"	69¼"	DTC2512	\$1940
25"	18"	69¼"	DTC2518	\$2400
25"	12"	84½"	D2TC2512	\$2032
25"	18"	84½"	D2TC2518	\$2515

Door Hinged on Right

25"	12"	69¼"	DTD2512	\$1940
25"	18"	69¼"	DTD2518	\$2400
25"	12"	84½"	D2TD2512	\$2032
25"	18"	84½"	D2TD2518	\$2515

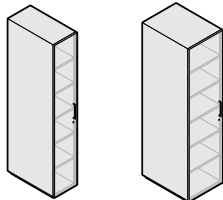

30"W and 36"W Towers

SIN 711.8

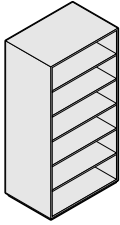

Standard Includes		Required to Specify	
	<ul style="list-style-type: none"> • Tower with recessed base and unfinished back: wood • Bevel, deco, or Nile pulls: paint or metal • Lock, keyed random: 9201 Polished Chrome • One hanging file system per file drawer • Leveling glides: black only 		<ol style="list-style-type: none"> 1 Style number 2 Wood color number for tower 3 Pulls and paint or metal color number (see below) 4 Options, if selected (see below) <p>▶ See <i>Surface Materials</i>, page J2.</p>
Options	Price	Required to Specify	
Surface Materials	<ul style="list-style-type: none"> • Customiz stain +\$445 	Specify <i>with Customiz stain</i> . ▶ See <i>Surface Materials Reference Manual</i> .	
	Door fronts		
	<ul style="list-style-type: none"> • Translucent glass door fronts +\$100 per door 	Add suffix G to style number.	
Pulls	<ul style="list-style-type: none"> • Bevel pull No cost • Deco pull No cost • Nile pull No cost 	Specify <i>with bevel pull</i> and select 0835 Black, 4799 Platinum, 9201 Polished Chrome, or 9211 Nickel. Specify <i>with deco pull</i> and select 0835 Black, 4799 Platinum, 9201 Polished Chrome, or 9211 Nickel. Specify <i>with Nile pull</i> and select 0835 Black, 4799 Platinum, 9201 Polished Chrome, or 9211 Nickel.	
Lock and Keying	Lock		
	<ul style="list-style-type: none"> • Ember Chrome No cost 	Specify <i>with 9250 Ember Chrome lock</i> .	
	Keying		
	<ul style="list-style-type: none"> • Factory- and field-installed keying 	▶ Page J8	
Related Products	<ul style="list-style-type: none"> • Power and communication accessories 	▶ Page D65	

Specification Information

Dimensions			Style Number	Base Price
D	W	H		

Open Shelves

24"	30"	69¼"	DTE2530	\$3220
24"	36"	69¼"	DTE2536	\$3542
24"	30"	84½"	D2TE2530	\$3381
24"	36"	84½"	D2TE2536	\$3719

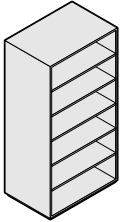

Two Lateral File Drawers Below and Shelves with Double Doors Above

25"	30"	69¼"	DTA2530	\$3870
25"	36"	69¼"	DTA2536	\$4192
25"	30"	84½"	D2TA2530	\$4031
25"	36"	84½"	D2TA2536	\$4369

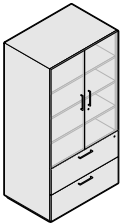

Tip: Door locks separately from lateral files.

Shelves and Double Doors

25"	30"	69¼"	DTD2530	\$3420
25"	36"	69¼"	DTD2536	\$3742
25"	30"	84½"	D2TD2530	\$3581
25"	36"	84½"	D2TD2536	\$3919

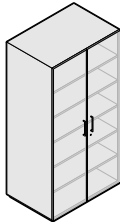

Wardrobe Left, Shelves Right, and Double Doors

25"	30"	69¼"	DTF2530	\$3520
25"	36"	69¼"	DTF2536	\$3842
25"	30"	84½"	D2TF2530	\$3681
25"	36"	84½"	D2TF2536	\$4019

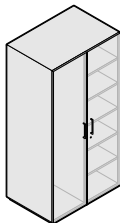

Tip: Wardrobe section has interior dimensions of 11⅞"W x 23½"D.



Single-Height Overhead Storage

SIN 711.8

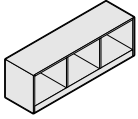

Tip: Single-height overhead storage must be supported either by a hutch for stand-alone applications or a tackboard when spanning between two 69¼"H towers. Hutches come standard with a tackable panel and do not require a separate stand-alone tackboard.

Standard Includes	Required to Specify
-------------------	---------------------

- Overhead storage: wood veneer
- Attachment hardware

- 1 Style number
- 2 Wood color number for overhead storage
- 3 Options, if selected (see below)
- ▶ See *Surface Materials*, page J2.

Surface Materials	Options	Price	Required to Specify
-------------------	---------	-------	---------------------

Surface Materials

Customiz stain

- On 54"W–84"W overhead storage +\$239
- On 90"W–96"W overhead storage +\$352

- Specify with *Customiz stain*.
- ▶ See *Surface Materials Reference Manual*.

Door fronts

- Translucent glass door fronts +\$ 75 per door

- Add suffix **G** to style number.

Related Products

- Underline task lights from Details
- Hutch
- Tackboard

- ▶ See Details electronic catalog or Details market manager to place an order.
- ▶ Page D60
- ▶ Page D62

Specification Information

Dimensions			Number of Doors	Style Number	Base Price
D	W	H			

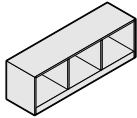

All-Open Storage

14 1/8"	54"	18 1/8"	0	DH1554D	\$1770
14 1/8"	60"	18 1/8"	0	DH1560D	\$1890
14 1/8"	66"	18 1/8"	0	DH1566D	\$2040
14 1/8"	72"	18 1/8"	0	DH1572D	\$2190
14 1/8"	78"	18 1/8"	0	DH1578D	\$2340
14 1/8"	84"	18 1/8"	0	DH1584D	\$2490
14 1/8"	90"	18 1/8"	0	DH1590D	\$2640
14 1/8"	96"	18 1/8"	0	DH1596D	\$2790

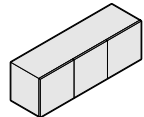

All-Closed Storage

15"	54"	18 1/2"	3	DH1554A	\$1995
15"	72"	18 1/2"	4	DH1572A	\$2490
15"	90"	18 1/2"	5	DH1590A	\$3015

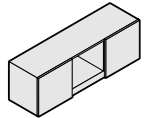

Outside Closed and Inside Open

15"	54"	18 1/2"	2	DH1554B	\$1920
15"	60"	18 1/2"	2	DH1560B	\$2040
15"	66"	18 1/2"	2	DH1566B	\$2190
15"	72"	18 1/2"	2	DH1572B	\$2340
15"	78"	18 1/2"	2	DH1578B	\$2490
15"	84"	18 1/2"	2	DH1584B	\$2640
15"	90"	18 1/2"	2	DH1590B	\$2790
15"	96"	18 1/2"	2	DH1596B	\$2940

Tip: Interior height of storage space is 14 1/4"H.

Tip: Single-height overhead storage must be supported either by a hutch for stand-alone applications or a tackboard when spanning between two 69 1/4"H towers. Hutchies come standard with a tackable panel and do not require a separate stand-alone tackboard.

Double-Height Overhead Storage

SIN 711.8

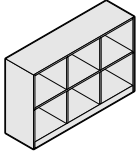

Tip: Double-height overhead storage must be supported either by a hutch for stand-alone applications or a tackboard when spanning between two 84½"H towers. Hutches come standard with a tackable panel and do not require a separate stand-alone tackboard.

Standard Includes		Required to Specify	
<ul style="list-style-type: none"> Overhead storage: wood veneer Attachment hardware 		1 Style number 2 Wood color number for overhead storage 3 Options, if selected (see below) ▶ See <i>Surface Materials</i> , page J2.	
Surface Materials	Options	Price	Required to Specify
	Customiz stain		
	<ul style="list-style-type: none"> On 54"W–84"W overhead storage +\$352 On 90"W–96"W overhead storage +\$465 		Specify with <i>Customiz stain</i> . ▶ See <i>Surface Materials Reference Manual</i> .
	Door fronts		
	<ul style="list-style-type: none"> Translucent glass door fronts on all closed storage and outside closed storage +\$ 95 per door Translucent glass door fronts on top closed and bottom open storage +\$ 75 per door 		Add suffix G to style number. Add suffix G to style number.
Related Products	<ul style="list-style-type: none"> Underline task lights from Details Hutch Tackboard 		▶ See Details electronic catalog or Details market manager to place an order. ▶ Page D60 ▶ Page D62

Specification Information

Dimensions			Number of Doors	Style Number	Base Price
D	W	H			

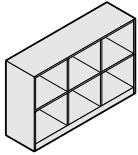

All-Open Storage

14 1/8"	54"	33 3/8"	0	D2H1554D	\$2370
14 1/8"	60"	33 3/8"	0	D2H1560D	\$2490
14 1/8"	66"	33 3/8"	0	D2H1566D	\$2640
14 1/8"	72"	33 3/8"	0	D2H1572D	\$2790
14 1/8"	78"	33 3/8"	0	D2H1578D	\$2940
14 1/8"	84"	33 3/8"	0	D2H1584D	\$3090
14 1/8"	90"	33 3/8"	0	D2H1590D	\$3240
14 1/8"	96"	33 3/8"	0	D2H1596D	\$3390

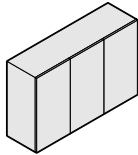

All-Closed Storage

15"	54"	33 3/4"	3	D2H1554A	\$2670
15"	72"	33 3/4"	4	D2H1572A	\$3190
15"	90"	33 3/4"	5	D2H1590A	\$3740

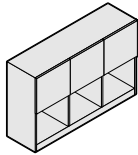

Top Closed and Bottom Open

15"	54"	33 3/8"	3	D2H1554C	\$2595
15"	72"	33 3/8"	4	D2H1572C	\$3090
15"	90"	33 3/8"	5	D2H1590C	\$3615

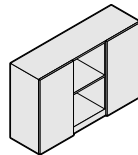

Outside Closed and Inside Open

15"	54"	33 3/4"	2	D2H1554B	\$2570
15"	60"	33 3/4"	2	D2H1560B	\$2690
15"	66"	33 3/4"	2	D2H1566B	\$2840
15"	72"	33 3/4"	2	D2H1572B	\$2990
15"	78"	33 3/4"	2	D2H1578B	\$3140
15"	84"	33 3/4"	2	D2H1584B	\$3290
15"	90"	33 3/4"	2	D2H1590B	\$3440
15"	96"	33 3/4"	2	D2H1596B	\$3590

Tip: Interior height of storage space is 14 1/4"H on top and 14 1/4"H below.

Tip: Double-height overhead storage must be supported either by a hutch for stand-alone applications or a tackboard when spanning between two 84 1/2"H towers. Hutchies come standard with a tackable panel and do not require a separate stand-alone tackboard.

Hutches for Use with Overhead Storage

SIN 711.8

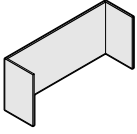

Tip: Overhead storage is supported either by hutches or by spanning between two 84½"H towers.

Standard Includes		Required to Specify	
<ul style="list-style-type: none"> Hutch: wood veneer Tackboard: fabric price group 1 Attachment hardware 		1 Style number 2 Wood color number for hutch 3 Fabric color number for tackboard 4 Options, if selected (see below) ▶ See <i>Surface Materials</i> , page J2.	
Options	Price	Required to Specify	
Surface Materials			
Customiz stain on hutches			
• On 54"W–90"W hutches	+\$ 60	Specify with <i>Customiz stain</i> . ▶ See <i>Surface Materials Reference Manual</i> .	
• On 96"W hutches	+\$ 84		
Customiz stain on organizer hutches			
• On 54"W–60"W hutches	+\$ 42	Specify with <i>Customiz stain</i> . ▶ See <i>Surface Materials Reference Manual</i> .	
• On 66"W–96"W hutches	+\$ 54		
Tackboard			
• Fabric price group 1	No cost	Specify fabric color number. Specify fabric color number. Specify fabric color number. Specify fabric color number. Specify fabric color number. Specify fabric color number. ▶ See <i>Surface Materials Reference Manual</i> .	
• Fabric price group 2	+\$ 12		
• Fabric price group 3	+\$ 46		
• Fabric price group 4	+\$ 62		
• Fabric price group 5	+\$100		
• Fabric price group COM	+\$ 15		
Slatwall	• Details 36"W slatwall panel with tackboard on either side: 8043 Clear Anodized Aluminum or 8044 Black Anodized Aluminum	No cost	Add suffix S to style number and select 8043 Clear Anodized Aluminum or 8044 Black Anodized Aluminum.

Specification Information

Dimensions			Style Number	Base Price
D	W	H		

Hutches

14 1/8"	54"	22 1/2"	DT1554	\$ 800
14 1/8"	60"	22 1/2"	DT1560	\$ 850
14 1/8"	66"	22 1/2"	DT1566	\$ 900
14 1/8"	72"	22 1/2"	DT1572	\$ 950
14 1/8"	78"	22 1/2"	DT1578	\$1000
14 1/8"	84"	22 1/2"	DT1584	\$1050
14 1/8"	90"	22 1/2"	DT1590	\$1100
14 1/8"	96"	22 1/2"	DT1596	\$1150

Organizer Hutches

14 1/8"	54"	22 1/2"	DWS1554	\$1300
14 1/8"	60"	22 1/2"	DWS1560	\$1350
14 1/8"	66"	22 1/2"	DWS1566	\$1400
14 1/8"	72"	22 1/2"	DWS1572	\$1450
14 1/8"	78"	22 1/2"	DWS1578	\$1550
14 1/8"	84"	22 1/2"	DWS1584	\$1600
14 1/8"	90"	22 1/2"	DWS1590	\$1700
14 1/8"	96"	22 1/2"	DWS1596	\$1775

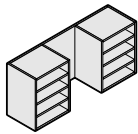
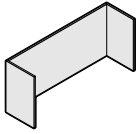

Tip: Slatwall is not available on 54"W, 60"W and 66"W organizer hutches.

Tackboards

for Use with Overhead Storage Suspended Between Towers

SIN 711.8

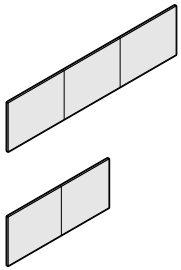

Tip: 90"W and 96"W tackboards ship as three pieces.

Standard Includes	Required to Specify
-------------------	---------------------

- Tackboard: fabric price group 1
- Attachment hardware and cleats

- 1 Style number
 - 2 Fabric color number for tackboard
 - 3 Options, if selected (see below)
- ▶ See *Surface Materials*, page J2.

Surface Materials	Options	Price	Required to Specify
-------------------	---------	-------	---------------------

Surface Materials

Tackboard

- Fabric price group 1 No cost
- Fabric price group 2 +\$ 12
- Fabric price group 3 +\$ 46
- Fabric price group 4 +\$ 62
- Fabric price group 5 +\$100
- Fabric price group COM +\$ 15

- Specify fabric color number.
Specify fabric color number.
Specify fabric color number.
Specify fabric color number.
Specify fabric color number.
Specify fabric color number.
▶ See *Surface Materials Reference Manual*.

Slatwall

- Details 36"W slatwall panel with tackboard on either side: 8043 Clear Anodized Aluminum or 8044 Black Anodized Aluminum No cost

- Add suffix **S** to style number and select 8043 Clear Anodized Aluminum or 8044 Black Anodized Aluminum.

Specification Information				
• Dimensions			• Style Number	• Base Price
D	W	H		

22"	54"	22 ⁵ / ₈ "	DT2254	\$176
22"	60"	22 ⁵ / ₈ "	DT2260	\$183
22"	66"	22 ⁵ / ₈ "	DT2266	\$190
22"	72"	22 ⁵ / ₈ "	DT2272	\$197
22"	78"	22 ⁵ / ₈ "	DT2278	\$204
22"	84"	22 ⁵ / ₈ "	DT2284	\$211
22"	90"	22 ⁵ / ₈ "	DT2290	\$218
22"	96"	22 ⁵ / ₈ "	DT2296	\$225
:	:	:	:	:

Bookshelf for Use on or Under Worksurfaces

Bookshelf for Use on or Under Worksurfaces

SIN 711.8

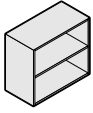

Standard Includes	Required to Specify
<ul style="list-style-type: none"> • Bookshelf: wood veneer • Leveling glides: black only 	<ul style="list-style-type: none"> 1 Style number 2 Wood color number for bookshelf 3 Options, if selected (see below) ▶ See <i>Surface Materials</i>, page J2.

Options	Price	Required to Specify
Surface Materials <ul style="list-style-type: none"> • Customiz stain 	+\$155	Specify with <i>Customiz stain</i> . ▶ See <i>Surface Materials Reference Manual</i> .

Specification Information				
• Dimensions			• Style	• Base
D	W	H	Number	Price
15"	30"	26"	DB3026	\$1200



Worksurface Accessories

SIN 711.8

Wood Center Drawer

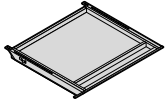

Tip: Dimensions given are outside dimensions.
 ▶ For inside dimensions, see Wood Casegoods and Tables Specification Guide.

Standard Includes	Required to Specify
<ul style="list-style-type: none"> • Non-locking center drawer: wood • Mounting frame: black paint only 	<ul style="list-style-type: none"> 1 Style number 2 Wood color number for center drawer 3 Option, if selected (see below) ▶ See <i>Surface Materials</i>, page J2.

Options	Price	Required to Specify
Surface Materials <ul style="list-style-type: none"> • Customiz stain 	No cost	Specify with <i>Customiz stain</i> . ▶ See <i>Surface Materials Reference Manual</i> .

Specification Information				
• Dimensions			• Style	• Price
D	W	H	Number	
23"	21 1/4"	2 1/4"	E60014	\$255

SIN 711.8

Technology Covers

Standard Includes	Required to Specify
<ul style="list-style-type: none"> Technology covers: powdercoat finish 	1 Style number 2 Powdercoat finish number ▶ See <i>Surface Materials</i> , page J2.

Specification Information

Dimensions			Style	Base
D	W	H	Number	Price



Round Dish Cover

4 1/2"	6"	1/4"	DAA84	\$50
:	:	:	:	:



Square Dish Cover

4 1/2"	6"	1/4"	DAB84	\$50
:	:	:	:	:



Wire Access Grommet Cover

4 1/2"	6"	1/4"	DAC84	\$50
:	:	:	:	:



Square Cover

4 1/2"	6"	1/4"	DAX84	\$50
:	:	:	:	:

Tip: Tech center worksurfaces require five technology covers to conceal the wire management trough.

SIN 711.8

Power Boxes and Power/Communication Boxes

Standard Includes	Required to Specify
<ul style="list-style-type: none"> • Power box • Power/communication box with adapters for two customer-supplied data couplers/jacks 	Style number

Specification Information

• Dimensions			• Style Number	• Price
D	W	H		

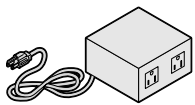

Power Boxes

3"	3"	1"	SPP	\$149
----	----	----	------------	-------

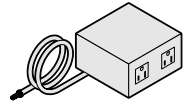

Hardwired Power Boxes

3"	3"	1"	SPPH	\$309
----	----	----	-------------	-------

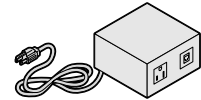

Power/Communication Boxes

3"	3"	1"	SPC	\$150
----	----	----	------------	-------

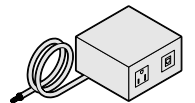

Hardwired Power/Communication Boxes

3"	3"	1/4"	SPCH	\$229
----	----	------	-------------	-------

Tip: Jacks can be purchased by calling any of the manufacturers listed below:

- AMP Corporation 1.800.522.6752
- Leviton 1.800.722.2082
- Lucent 1.800.344.0223
- Krone 1.800.775.5766
- Panduit 1.800.777.3300

Field-Installed Round Grommet



Standard Includes	Required to Specify
<ul style="list-style-type: none"> • Grommet: paint or metal • Installation instructions 	1 Style number 2 Paint or metal color number ▶ See <i>Surface Materials</i> , page J2.

Specification Information

• Dimensions			• Style Number	• Price
D	W	H		

2 1/2"	2 1/2"		PTGRMT	\$50
--------	--------	--	---------------	------

Cable Manager

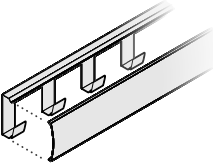

Standard Includes	Required to Specify
<ul style="list-style-type: none"> Plastic extrusion with adhesive backer for vertical usage and attachment hardware for horizontal usage under worksurface: black only 	Style number

Specification Information

Dimensions			Style	Price
D	W	H	Number	
1 1/8"	48"	3 1/2"	TCM48	\$74

For Use with All Cabinets, Under Worksurfaces, and All End Panel Applications

1 1/8"	48"	3 1/2"	TCM48	\$74
--------	-----	--------	--------------	------





Steelcase 8500 Tables



Statement of Line

E2



Product Information

Specifying 8500 Tables (SIN 711.11)

E4

Specifying Power and Communication Accessories for Tables
(SIN 711.11)

E6

8500 Tables

Statement of Line

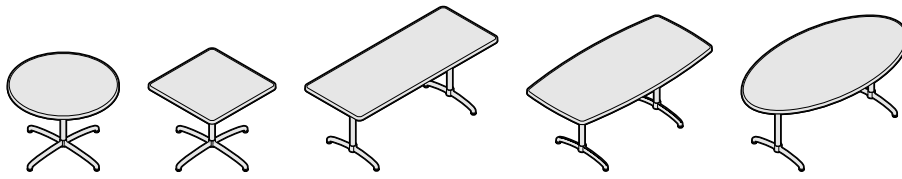

Specifying
▶ Page E4

8500 Series Tables

	30"W	35"W	36"W	42"W	45"W	48"W	54"W	60"W	65"W	70"W	72"W	78"W	96"W	120"W	150"W	180"W
25"D		■			■			■								
30"D	● ■				■			■	■	■						
35"D		■						■	■	■						
36"D			●								■					
42"D				●								●	■			
48"D						●							●	■	■	■
54"D							●									

● = Round table ■ = Square table ■ = Rectangle table ■ = Boat-shape table ● = Oval table

Power and Communication Accessories for Tables

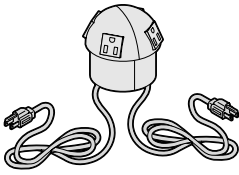

Power Spheres
Specifying
▶ Page E6



Power and Communication Spheres
Specifying
▶ Page E6



Communication Sphere
Specifying
▶ Page E7

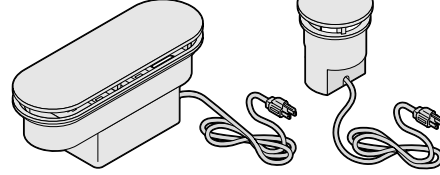

Oval Power and Communication Port
Specifying
▶ Page E7

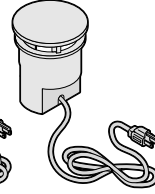

Round Power and Communication Port
Specifying
▶ Page E8



Wire Manager
Specifying
▶ Page E8



Wire Guide Clips
Specifying
▶ Page E8

8500 Series Tables

SIN 711.11



Tip: When specifying a 9201 Polished Chrome base only, specify a paint color number for the column.

Standard Includes	Required to Specify
-------------------	---------------------

- 28½"H table top: laminate
- Edge: soft vinyl
- Column: paint
- Base: textured paint
- Adjustable leveling glides: black plastic

- 1 Style number
 - 2 Laminate color number for table top
 - 3 Vinyl edge color number
 - 4 Paint color number for column
 - 5 Textured paint color number for base
 - 6 Options, if selected (see below)
- ▶ See *Surface Materials*, page J2.

Surface Materials	Options	Price	Required to Specify
-------------------	---------	-------	---------------------

Surface Materials

- Accent laminate +\$60
- Open Line laminate +\$60
- Polished Chrome column and base Prices below
- Polished Chrome base with painted column Prices below

- ▶ See *Surface Materials Reference Manual*.
- ▶ See *Surface Materials Reference Manual*. Specify with 9201 Polished Chrome column and base.
- Specify with 9201 Polished Chrome base only and select paint color number for column.

Specification Information					
---------------------------	--	--	--	--	--

Diameter	Dimensions			Column Diameter	Style Number	Base Price	Options (Add \$ to Base Price)
	D	W	H				
							Polished Chrome Column and/or Base
						Laminate with Vinyl Edge	



Round Table

30" dia.	N.A.	N.A.	28½"	2¼"	853000	\$506	+\$140
36" dia.	N.A.	N.A.	28½"	2¼"	853600	\$562	+\$140
42" dia.	N.A.	N.A.	28½"	2½"	854200	\$632	+\$140
48" dia.	N.A.	N.A.	28½"	2½"	854800	\$722	+\$140
54" dia.	N.A.	N.A.	28½"	2½"	855400	\$827	+\$140



Square Table

N.A.	30"	30"	28½"	2¼"	853030	\$538	+\$140
N.A.	35"	35"	28½"	2½"	853535	\$593	+\$140

Specification Information

Dimensions			Column Diameter	Knee-space	Style Number	Base Price	Options (Add \$ to Base Price)
D	W	H					
						Laminate with Vinyl Edge	Polished Chrome Column and/or Base

Rectangular Table

25"	35"	28½"	2¼"	N.A.	853525	\$ 538	+\$140
30"	45"	28½"	2½"	N.A.	854530	\$ 718	+\$140

with Two T-Bases

30"	60"	28½"	2¼"	30"	856030	\$ 780	+\$140
30"	65"	28½"	2¼"	35"	856530	\$ 812	+\$140
30"	70"	28½"	2¼"	40"	857030	\$ 827	+\$140
35"	60"	28½"	2¼"	30"	856035	\$ 827	+\$140
35"	65"	28½"	2¼"	35"	856535	\$ 853	+\$140
35"	70"	28½"	2¼"	40"	857035	\$ 882	+\$140

Oval Table

42"	78"	28½"	2¼"	42"	857842	\$1465	+\$140
48"	96"	28½"	2½"	48"	859648	\$1666	+\$140

Boat-Shape Table

with Straight End

30"/35"	60"	28½"	2¼"	30"	856035S	\$ 827	+\$140
30"/35"	65"	28½"	2¼"	35"	856535S	\$ 853	+\$140
30"/35"	70"	28½"	2¼"	40"	857035S	\$ 882	+\$140

with Curved End

30"/36"	72"	28½"	2¼"	42"	85723630	\$1004	+\$140
36"/42"	96"	28½"	2½"	54"	85964236	\$1465	+\$140
38"/48"	120"	28½"	2½"	36"	851204838	\$2786	+\$173
38"/48"	150"	28½"	2½"	51"	851504838	\$3732	+\$173
38"/48"	180"	28½"	2½"	66"	851804838	\$3852	+\$173

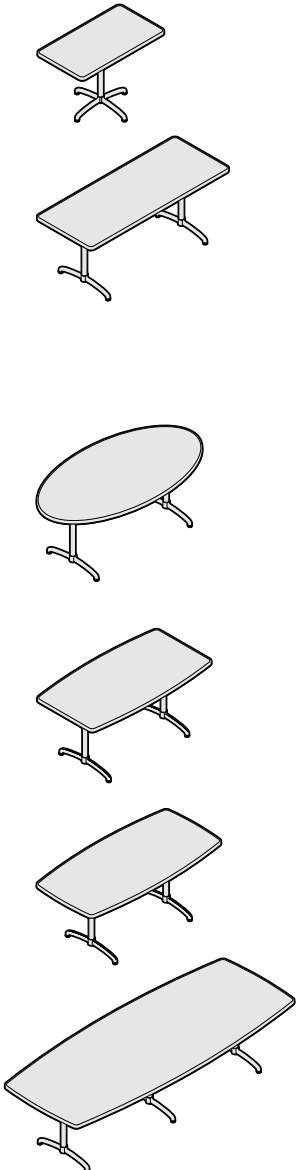

8500 Tables

Power and Communication Accessories for Tables

SIN 711.11

Power Spheres

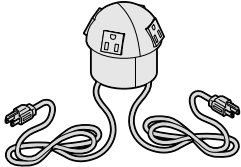

Tip: Sphere is field installed. Use a 3" diameter drill to cut mounting hole at desired location.

Standard Includes				Required to Specify
<ul style="list-style-type: none"> Sphere with four simplex electrical outlets: black plastic Two 6' power cords (each rated at 15 amps), if selected: black plastic Two 6' Greenfield conduits (each rated at 15 amps), if selected: metal 				Style number
Specification Information				
Dimensions			Style	Price
D	W	H	Number	
Four Electrical Outlets with 6' Power Cords				
3 ³ / ₈ "	3 ³ / ₈ "	3"	PTDMGB1	\$164
Four Electrical Outlets with 6' Greenfield Conduits for Hard Wiring				
3 ³ / ₈ "	3 ³ / ₈ "	3"	PTDMGB2	\$283

Power and Communication Spheres

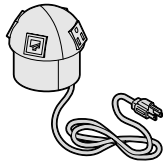

Tip: Sphere is field installed. Use a 3" diameter drill to cut mounting hole at desired location.

Tip: Face plates in sphere accommodates standard voice/data jacks. Order jacks by calling any of the manufacturers listed below:

- AMP Corporation
1.800.522.6752
- Leviton 1.800.722.2082
- Lucent 1.800.344.0223
- Krone 1.800.775.5766
- Panduit 1.800.777.3300

Standard Includes				Required to Specify
<ul style="list-style-type: none"> Sphere with two simplex electrical outlets: black plastic Face plates to accommodate two customer-supplied voice/data jacks: black plastic 6' power cord with plug rated at 15 amps, if selected: black plastic 6' Greenfield conduit for hardwiring, if selected: metal 				Style number
Specification Information				
Dimensions			Style	Price
D	W	H	Number	
Sphere with One 6' Power Cord				
3 ³ / ₈ "	3 ³ / ₈ "	3"	PTDMGB3	\$164
Sphere with One 6' Greenfield Conduits for Hard Wiring				
3 ³ / ₈ "	3 ³ / ₈ "	3"	PTDMGB4	\$232

Communication Sphere



Tip: Sphere is field installed. Use a 3" diameter drill to cut mounting hole at desired location.

Tip: Order jacks by calling any of the manufacturers listed below:

- AMP Corporation
1.800.522.6752
- Leviton 1.800.722.2082
- Lucent 1.800.344.0223
- Krone 1.800.775.5766
- Panduit 1.800.777.3300

Standard Includes	Required to Specify
<ul style="list-style-type: none"> • Sphere with face plates to accommodate four customer-supplied voice/data jacks: black plastic 	Style number

Specification Information

• Dimensions			• Style	• Price
D	W	H	Number	
3 ³ / ₈ "	3 ³ / ₈ "	3"	PTDMGB5	\$164

Oval Power and Communication Port

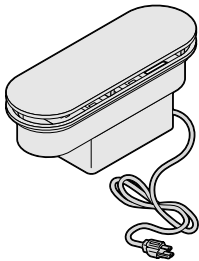

Tip: Port is field installed. You must specify a factory-cut mounting hole in tables to accommodate oval port. Hole needed for oval port cannot be field cut.

Tip: Order jacks by calling any of the manufacturers listed below:

- AMP Corporation
1.800.522.6752
- Leviton 1.800.722.2082
- Lucent 1.800.344.0223
- Krone 1.800.775.5766
- Panduit 1.800.777.3300

Standard Includes	Required to Specify
<ul style="list-style-type: none"> • Oval unit with four electrical outlets and circuit breaker: black plastic • Oval cap: black plastic • 6' power cord with plug rated at 15 amps • Adapters for up to six customer-supplied data couplers/jacks 	Style number

Specification Information

• Dimensions			• Style	• Price
D	W	H	Number	
12 ³ / ₈ "	3 ⁷ / ₈ "	4 ⁹ / ₁₆ "	PTRLGB1	\$329

Power and Communication Accessories for Tables, continued

SIN 711.11

Round Power and Communication Port

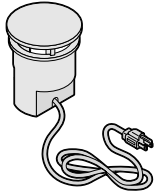

Tip: Port is field installed. You can specify a factory-cut mounting hole in tables to accommodate port. Or use a 3" diameter drill to cut mounting hole in desired location in a table or any worksurface.

Tip: Order jacks by calling any of the manufacturers listed below:

- AMP Corporation
1.800.522.6752
- Leviton 1.800.722.2082
- Lucent 1.800.344.0223
- Krone 1.800.775.5766
- Panduit 1.800.777.3300

Standard Includes	Required to Specify
-------------------	---------------------

- Round unit with two electrical outlets: black plastic
- Round cap: black plastic
- 6' power cord with plug rated at 15 amps: black plastic
- Adapters for two customer-supplied data couplers/jacks

Style number

Specification Information				
---------------------------	--	--	--	--

• Dimensions			• Style Number	• Price
D	W	H		
4 1/4"	4 1/4"	4 5/16"	PTRSGB1	\$256
:	:	:	:	:

Wire Manager



Standard Includes	Required to Specify
-------------------	---------------------

- 25" wire manager with double-sided tape: black plastic

Style number

Specification Information				
---------------------------	--	--	--	--

• Dimensions			• Style Number	• Price
D	W	H		
1"	3/4"	25"	PTWM25	\$12
:	:	:	:	:

Wire Guide Clips



Tip: Recommended for painted metal surfaces only.

Standard Includes	Required to Specify
-------------------	---------------------

- Carton of 20 adhesive-backed wire guide clips: black plastic only

Style number

Specification Information	
---------------------------	--

• Style Number	• Price
32WCP	\$21
:	:

Convene



Statement of Line **F2**



Application Topics

Availability of Conference Top Options	
Round, Square, and Cushion Tops	F8
Oval Tops	F9
Rectangular, Boat-Shape, and Racetrack Tops	F10
Specifying Conference Top Options	F12



Specification Information

Wood Conference Table Tops (SIN 711.8)	F14
Laminate Conference Table Tops (SIN 711.8)	F26
Bases for Conference Tables (SIN 711.8)	F36
Power and Communication Accessories (SIN 711.8)	F44
Contemporary-Style Furniture (SIN 711.8)	F46
Transitional-Style Furniture (SIN 711.8)	F56

Convene Statement of Line

Conference Tables and Bases

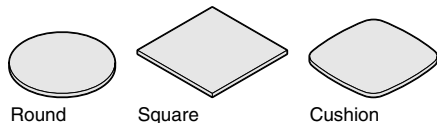

Specifying
▶ Pages F14–F16,
F26–F28

Round, Square, and Cushion Table Tops

	36"W	42"W	48"W	54"W	60"W	66"W	72"W
36"D	● ■						
42"D		● ■					
48"D			● ■				
54"D				● ■			
60"D					● ■		
66"D						●	
72"D							●

● = Round ■ = Square and Cushion

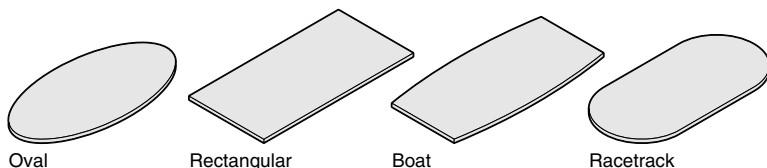

Specifying
▶ Pages F18–F25,
F29–F35

Oval, Rectangular, Boat-Shape, and Racetrack Tops

	60"W	66"W	72"W	84"W	96"W	108"W	120"W	144"W	168"W	192"W	216"W
36"D	● ■	● ■	● ■	● ■							
42"D			● ■	● ■	● ■	● ■					
48"D					● ■	● ■	● ■	● ■	■		
54"D						● ■	● ■	● ■	■		
60"D							● ■	● ■	● ■	■	
66"D								● ■	● ■	● ■	■
72"D									● ■	● ■	● ■

● = Oval ■ = Rectangular, Boat-Shape, and Racetrack

Conference Tables and Bases, continued

Specifying
▶ Pages F36–F43

Conference Table Bases



T-flex
base



X-flex
base



U-panel
base



X-panel
base



Rectangular
base



Contemporary
disk base



Transitional
disk base



Circular drum
base



Half drum
base



Elliptical drum
base

Contemporary-Style Coordinating Furniture

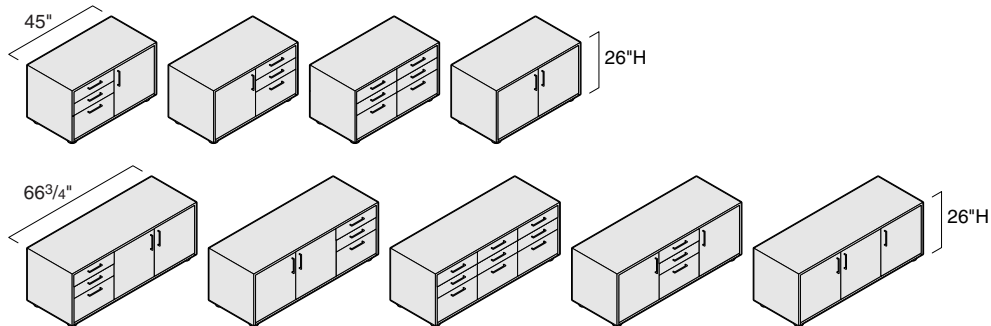

Specifying
▶ Page F46

Storage Credenzas

	45"W	67"W
24"D	●	●

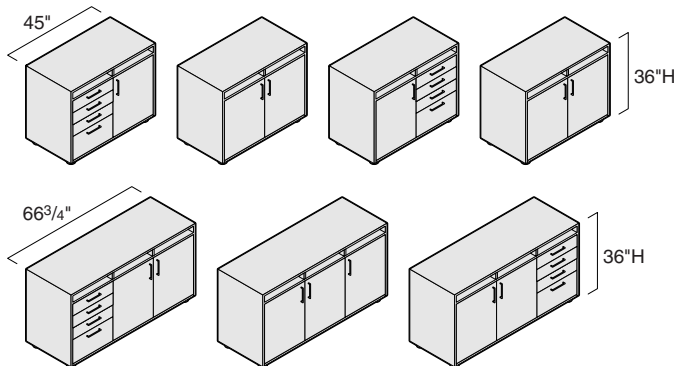

Specifying
▶ Page F48

Buffet-Height Credenzas

	45"W	67"W
24"D	●	●

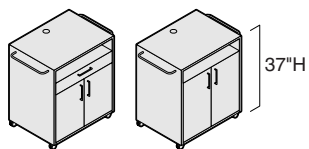

Specifying
▶ Page F50

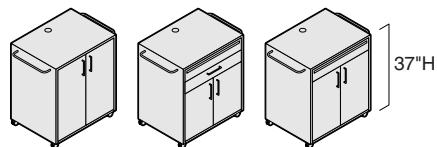

Specifying
▶ Page F52

Media Carts

	32"W
24"D	●

Hospitality Carts

	32"W
24"D	●

Contemporary-Style Coordinating Furniture, continued

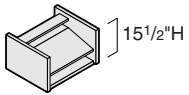

Specifying
▶ Page F54

Table Top Lectern

	25"W
22"D	●

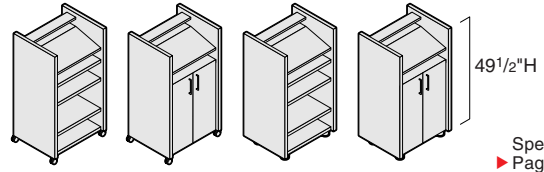

Specifying
▶ Page F54

Full-Height Lecterns

	25"W
22"D	●

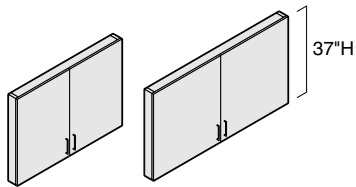

Specifying
▶ Page F55

Wallboards

	56"W	70"W
5"D	●	●

Transitional-Style Coordinating Furniture

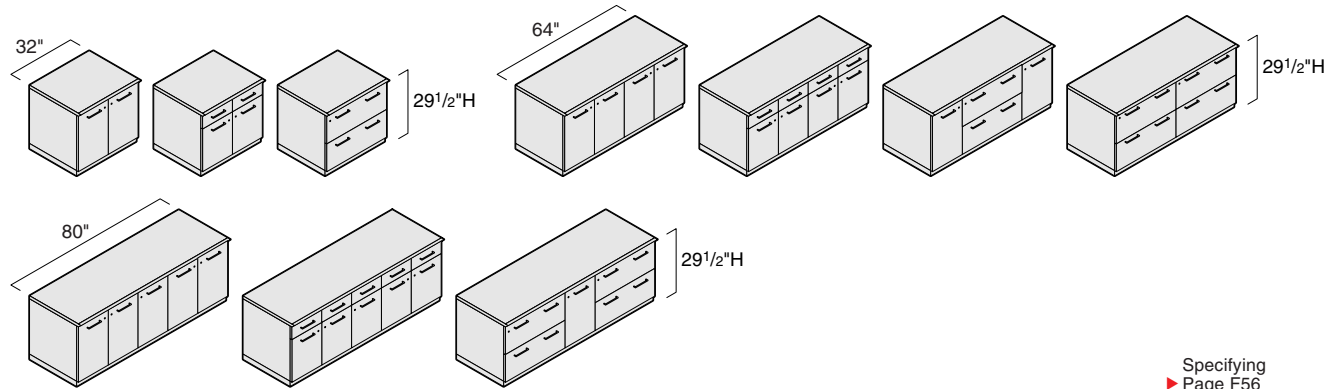

Specifying
▶ Page F56

Storage Credenzas

	32"W	64"W	80"W
25 1/4"D	●	●	●

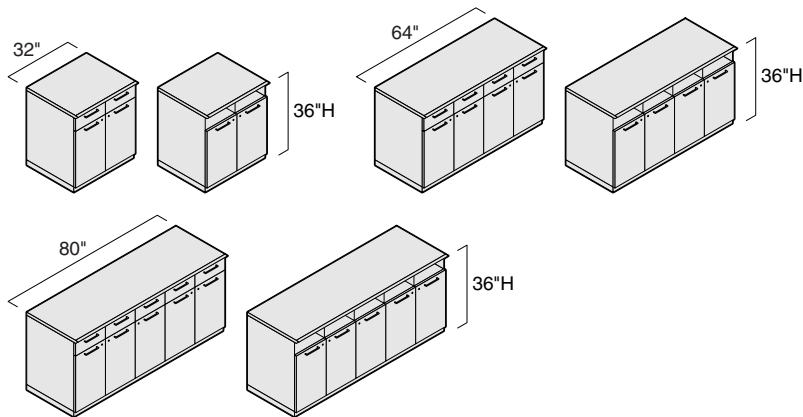

Specifying
▶ Page F58

Buffet-Height Credenzas

	32"W	64"W	80"W
25 1/4"D	●	●	●

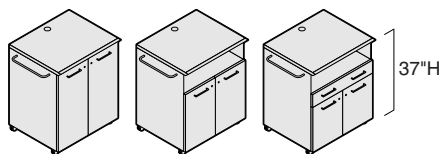

Specifying
▶ Page F60

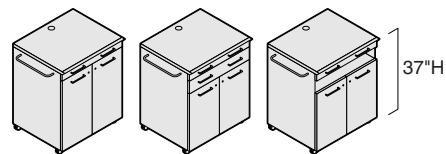

Specifying
▶ Page F61

Media Carts

	32 1/2"W
25"D	●

Hospitality Carts

	32 1/2"W
25"D	●

Transitional-Style Coordinating Furniture, continued

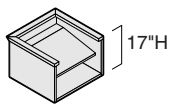

Specifying
▶ Page F62

Table Top Lectern

27½"W

23½"D ●

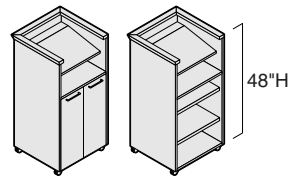

Specifying
▶ Page F62

Full-Height Lecterns

27½"W

23½"D ●

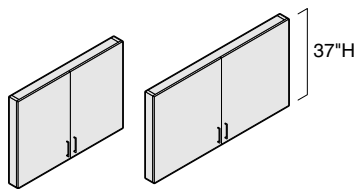

Specifying
▶ Page F63

Wallboards

56"W

70"W

5"D ●

Availability of Conference Top Options

Round, Square, and Cushion Tops

▶ See *Wood Caseworks and Tables Specification Guide for Power and Communication Accessory Locations.*

Round Tops	36" diameter	42" diameter	48" diameter	54" diameter	60" diameter	66" diameter	72" diameter	Square Tops	36"W	42"W	48"W	54"W	60"W	Cushion Tops	36"W	42"W	48"W	54"W	60"W
------------	--------------	--------------	--------------	--------------	--------------	--------------	--------------	-------------	------	------	------	------	------	--------------	------	------	------	------	------

Grommets

▶ Page F12 for Specifying information

One 2 1/2" round	■	■	■	■	■	■	■	■	■	■	■	■	■	■	■	■	■
Two 2 1/2" round	•	•	•	•	•	•	•	•	•	•	•	•	•	•	•	•	•
Four 2 1/2" round	•	•	•	•	•	•	•	•	•	•	•	•	•	•	•	•	•

Power Channels

▶ Page F12 for Specifying information

One power channel	•	•	•	•	•	•	•	•	•	•	•	•	•	•	•	•	•
Two power channels	•	•	•	•	•	•	•	•	•	•	•	•	•	•	•	•	•

Power Units

▶ Page F13 for Specifying information

One power unit	■	■	■	■	■	•	•	■	■	■	■	■	■	■	■	■	■
Two power units	•	•	•	•	•	■	■	•	•	•	•	•	•	•	•	•	•
Four power units	•	•	•	•	•	•	•	•	•	•	•	•	•	•	•	•	•
Six power units	•	•	•	•	•	•	•	•	•	•	•	•	•	•	•	•	•

Factory-Cut Hole for Power and Communication Sphere

▶ Page F13 for Specifying Information

One 3"-diameter hole	■	■	■	■	■	•	•	■	■	■	■	■	■	■	■	■	■
Two 3"-diameter holes	•	•	•	•	•	•	•	•	•	•	•	•	•	•	•	•	•
Four 3"-diameter holes	•	•	•	•	•	•	•	•	•	•	•	•	•	•	•	•	•

Factory-Cut Hole for Round Power and Communication Port

▶ Page F13 for Specifying information

One 3 1/2"-diameter hole	■	■	■	■	■	•	•	■	■	■	■	■	■	■	■	■	■
Two 3 1/2"-diameter holes	•	•	•	•	•	•	•	•	•	•	•	•	•	•	•	•	•
Four 3 1/2"-diameter holes	•	•	•	•	•	•	•	•	•	•	•	•	•	•	•	•	•

Factory-Cut Hole for Oval Power and Communication Port

▶ Page F13 for Specifying information

One 12"W hole	•	•	•	•	•	•	•	•	•	•	•	•	•	•	•	•	•
Two 12"W holes	•	•	•	•	•	•	•	•	•	•	•	•	•	•	•	•	•

Legend

- = Not available
- = Available

Availability of Conference Top Options

Oval Tops

► See *Wood Caseworks and Tables Specification Guide for Power and Communication Accessory Locations.*

Oval Tops	36"D				42"D				48"D				54"D				60"D				66"D				72"D			
	60"W	66"W	72"W	84"W	72"W	84"W	96"W	108"W	84"W	96"W	108"W	120"W	108"W	120"W	144"W	120"W	144"W	168"W	144"W	168"W	192"W	168"W	192"W	216"W				

Grommets

► Page F12 for Specifying information

One 2 1/2" round	■	■	■	■	■	■	■	■	■	■	■	■	■	■	■	■	■	■	■	■	■	■	■	■
Two 2 1/2" round	■	■	■	■	■	■	■	■	■	■	■	■	■	■	■	■	■	■	■	■	■	■	■	■
Four 2 1/2" round	■	■	■	■	■	■	■	■	■	■	■	■	■	■	■	■	■	■	■	■	■	■	■	■

Power Channels

► Page F12 for Specifying information

One power channel	■	■	■	■	■	■	■	■	■	■	■	■	■	■	■	■	■	■	■	■	■	■	■	■
Two power channels	■	■	■	■	■	■	■	■	■	■	■	■	■	■	■	■	■	■	■	■	■	■	■	■

Power Units

► Page F13 for Specifying information

One power unit	■	■	■	■	■	■	■	■	■	■	■	■	■	■	■	■	■	■	■	■	■	■	■	■
Two power units	■	■	■	■	■	■	■	■	■	■	■	■	■	■	■	■	■	■	■	■	■	■	■	■
Four power units	■	■	■	■	■	■	■	■	■	■	■	■	■	■	■	■	■	■	■	■	■	■	■	■
Six power units	■	■	■	■	■	■	■	■	■	■	■	■	■	■	■	■	■	■	■	■	■	■	■	■

Factory-Cut Hole for Power and Communication Sphere

► Page F13 for Specifying information

One 3"-diameter hole	■	■	■	■	■	■	■	■	■	■	■	■	■	■	■	■	■	■	■	■	■	■	■	■
Two 3"-diameter holes	■	■	■	■	■	■	■	■	■	■	■	■	■	■	■	■	■	■	■	■	■	■	■	■
Four 3"-diameter holes	■	■	■	■	■	■	■	■	■	■	■	■	■	■	■	■	■	■	■	■	■	■	■	■

Factory-Cut Hole for Round Power and Communication Port

► Page F13 for Specifying information

One 3 1/2"-diameter hole	■	■	■	■	■	■	■	■	■	■	■	■	■	■	■	■	■	■	■	■	■	■	■	■
Two 3 1/2"-diameter holes	■	■	■	■	■	■	■	■	■	■	■	■	■	■	■	■	■	■	■	■	■	■	■	■
Four 3 1/2"-diameter holes	■	■	■	■	■	■	■	■	■	■	■	■	■	■	■	■	■	■	■	■	■	■	■	■

Factory-Cut Hole for Oval Power and Communication Port

► Page F13 for Specifying information

One 12"W hole	■	■	■	■	■	■	■	■	■	■	■	■	■	■	■	■	■	■	■	■	■	■	■	■
Two 12"W holes	■	■	■	■	■	■	■	■	■	■	■	■	■	■	■	■	■	■	■	■	■	■	■	■

Legend

- = Not available
- = Available

Specifying Conference Top Options

Grommets



▶ See Availability of Conference Top Options, pages F8–F10.

Options	Price	Required to Specify
• One 2½"-round grommet	+\$ 50	Center: Specify <i>with CGRC</i> and select 0835 Black, 9201 Polished Chrome, or 9211 Nickel.
• Two 2½"-round grommets	+\$ 100	Left/Right: Specify <i>with CGRLR</i> and select 0835 Black, 9201 Polished Chrome, or 9211 Nickel.
• Four 2½"-round grommets	+\$ 200	Left/Center/Center/Right: Specify <i>with CGRLCCR</i> and select 0835 Black, 9201 Polished Chrome, or 9211 Nickel.

Power Channels

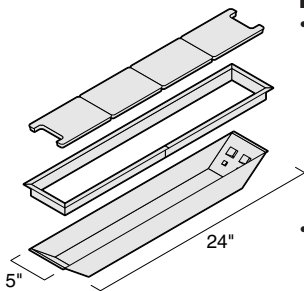

▶ See Availability of Conference Top Options, pages F8–F10.

Options	Price	Required to Specify
• One power channel —Power channel with four electrical outlets and 6' conduit for hardwiring in the field —Faceplates to accommodate four customer-supplied voice/data receptacles —Two square and two wire access covers: powder-coated wood —Sleeve: paint or metal	+\$ 949	Center: Specify <i>with CPCC</i> and select cover color: 7604 Platinum (default), 7605 Black, or 7621 Snow. Select sleeve color: 0835 Black, 4799 Platinum (default), 8042 Brushed Aluminum, or 9201 Polished Chrome.
• Two power channels —Two power channels each with four electrical outlets and 6' conduit for hardwiring in the field —Faceplates to accommodate eight customer-supplied voice/data receptacles —Four square and four wire access covers: powder-coated wood —Two sleeves: paint or metal	+\$1898	Left/Right: Specify <i>with CPCLR</i> and select cover color: 7604 Platinum (default), 7605 Black, or 7621 Snow. Select sleeve color: 0835 Black, 4799 Platinum (default), 8042 Brushed Aluminum, or 9201 Polished Chrome.

Tip: Power channel conduit must be hardwired in the field.

Tip: Power channels cannot be used on tops supported by X-panel bases.

Tip: Power channels cannot be used on 54"D x 120"W oval tops supported by T- or X-flex bases.

Tip: Technology covers are included with power units and power channels. Specify additional covers only if you need a different style or replacements.

Tip: Power channels cannot be used on 60"D x 144"W rectangle, boat, or racetrack tops with cabriole bases.

Power Units

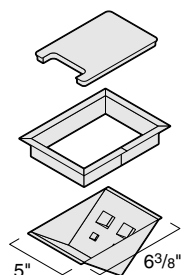

▶ See Availability of Conference Top Options, pages F8–F10.

Tip: Power unit conduit must be hardwired in the field.

Tip: Power unit cannot be used on tops supported by T- and X-flex bases, disk bases or cabriole bases.

Tip: Technology covers are included with power units and power channels. Specify additional covers only if you need a different style or replacements.

Options	Price	Required to Specify
<ul style="list-style-type: none"> One power unit <ul style="list-style-type: none"> —One power unit with two electrical outlets and 6' conduit for hardwiring in the field —Faceplates to accommodate two customer-supplied voice/data receptacles —One wire access cover: powder-coated wood —Sleeve: paint or metal 	+\$ 289	Specify with <i>CPU1</i> and select cover color: 7604 Platinum (default), 7605 Black, or 7621 Snow. Select sleeve color: 0835 Black, 4799 Platinum (default), 8042 Brushed Aluminum, or 9201 Polished Chrome.
<ul style="list-style-type: none"> Two power units <ul style="list-style-type: none"> —Two power units each with two electrical outlets and 6' conduit for hardwiring in the field —Faceplates to accommodate four customer-supplied voice/data receptacles —Two wire access covers: powder-coated wood —Two sleeves: paint or metal 	+\$ 578	Specify with <i>CPU2</i> and select cover color: 7604 Platinum (default), 7605 Black, or 7621 Snow. Select sleeve color: 0835 Black, 4799 Platinum (default), 8042 Brushed Aluminum, or 9201 Polished Chrome.
<ul style="list-style-type: none"> Four power units <ul style="list-style-type: none"> —Four power units each with two electrical outlets and 6' conduit for hardwiring in the field —Faceplates to accommodate eight customer-supplied voice/data receptacles —Four wire access covers: powder-coated wood —Four sleeves: paint or metal 	+\$1156	Specify with <i>CPU4</i> and select cover color: 7604 Platinum (default), 7605 Black, or 7621 Snow. Select sleeve color: 0835 Black, 4799 Platinum (default), 8042 Brushed Aluminum, or 9201 Polished Chrome.
<ul style="list-style-type: none"> Six power units <ul style="list-style-type: none"> —Four power units each with two electrical outlets and 6' conduit for hardwiring in the field —Faceplates to accommodate twelve customer-supplied voice/data receptacles —Six wire access covers: powder-coated wood —Six sleeves: paint or metal 	+\$1734	Specify with <i>CPU6</i> and select cover color: 7604 Platinum (default), 7605 Black, or 7621 Snow. Select sleeve color: 0835 Black, 4799 Platinum (default), 8042 Brushed Aluminum, or 9201 Polished Chrome.

Factory-Cut Hole for Power and Communication Accessories

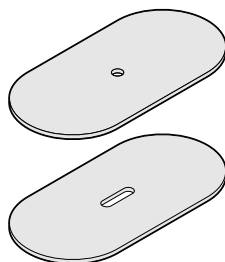

▶ See Availability of Conference Top Options, pages F8–F10.

Tip: Remember to order the power and communication ports and spheres separately.

▶ See Wood Casegoods and Tables Specification Guide

Tip: Round ports cannot be used on tops supported by disk or cabriole bases.

Tip: Spheres cannot be used on tops supported by cabriole bases with two or four posts.

Options	Price	Required to Specify
Hole for power and communication sphere		
<ul style="list-style-type: none"> One 3" diameter hole 	+\$23	Center: Specify with <i>CPSC</i> . Left/Right: Specify with <i>CPSLR</i> . Left/Center/Center/Right: Specify with <i>CPSLCCR</i> .
<ul style="list-style-type: none"> Two 3" diameter holes 	+\$46	
<ul style="list-style-type: none"> Four 3" diameter holes 	+\$92	
Hole for round power and communication port		
<ul style="list-style-type: none"> One 3 1/2" diameter hole 	+\$23	Center: Specify with <i>CSPC</i> . Left/Right: Specify with <i>CSPLR</i> . Left/Center/Center/Right: Specify with <i>CSPLCCR</i> .
<ul style="list-style-type: none"> Two 3 1/2" diameter holes 	+\$46	
<ul style="list-style-type: none"> Four 3 1/2" diameter holes 	+\$92	
Hole for oval power and communication port		
<ul style="list-style-type: none"> One 12"W hole 	+\$23	Center: Specify with <i>CLPC</i> . Left/Right: Specify with <i>CLPLR</i> .
<ul style="list-style-type: none"> Two 12"W holes 	+\$46	

Tip: Oval ports cannot be used on 54"D x 120"W supported by T- or X-flex bases. They also cannot be used on 54"D x 144"W oval tops supported by X-panel bases.

Round Wood Conference Table Tops

SIN 711.8

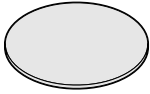

Tip: Your specification is not complete until you add a third letter to the style number to define the table top edge profile.

Standard Edge Profiles For Diameter Tops 36"-60"

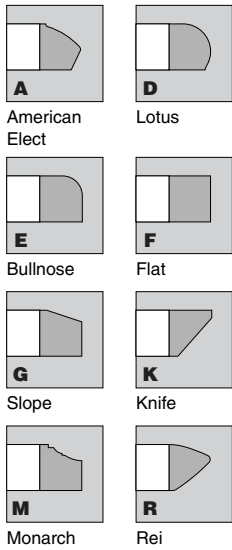

Large Edge Profiles For Diameter Tops 66"-72"

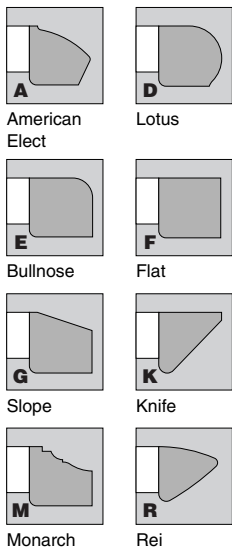

Standard Includes	Required to Specify
-------------------	---------------------

- | | |
|---|--|
| Standard Includes | Required to Specify |
| <ul style="list-style-type: none"> Table top: wood veneer with solid wood edge | <ol style="list-style-type: none"> 1 Style number with appropriate edge profile letter indicated in the space provided (For example, CW_R36 becomes CWFR36 for flat edge profile) <ul style="list-style-type: none"> ▶ See edge profiles below. 2 Wood veneer color number for top 3 Options, if selected (see below) <ul style="list-style-type: none"> ▶ See <i>Surface Materials</i>, page J2. |

Options	Price	Required to Specify
---------	-------	---------------------

- | | | |
|-------------------|---|--|
| Surface Materials | <ul style="list-style-type: none"> Customiz stain on wood Prices below Full-fill finish on wood No cost | Specify with <i>Customiz stain</i> .
▶ See <i>Surface Materials Reference Manual</i> . Specify full-fill finish number. |
|-------------------|---|--|

- Additional Options**
- ▶ See *Availability of Conference Top Options*, pages F8–F10.
 - ▶ See *Specifying Conference Top Options*, page F12.

Specification Information

Diameter	Style Number	Base Price	Option (Add \$ to Base Price)
36"	CW_R36	\$1086	+\$ 41
42"	CW_R42	\$1306	+\$ 60
48"	CW_R48	\$1644	+\$ 60
54"	CW_R54	\$2136	+\$107
60"	CW_R60	\$2480	+\$107
66"	CW_R66	\$2995	+\$135
72"	CW_R72	\$3492	+\$174

Square Wood Conference Table Tops

SIN 711.8

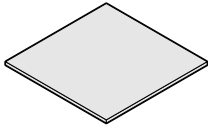

Tip: Your specification is not complete until you add a third letter to the style number to define the table top edge profile.

Standard Edge Profiles For Tops 36"W-60"W

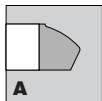

A
American
Elect

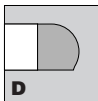

D
Lotus

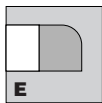

E
Bullnose

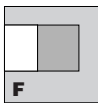

F
Flat

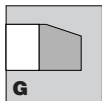

G
Slope

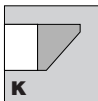

K
Knife



M
Monarch

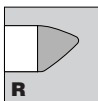

R
Rei

Standard Includes	Required to Specify
-------------------	---------------------

- Table top: wood veneer with solid wood edge

- 1 Style number with appropriate edge profile letter indicated in the space provided (For example, CW_S36 becomes CWFS36 for flat edge profile)
 - ▶ See edge profiles below.
- 2 Wood veneer color number for top
- 3 Options, if selected (see below)
 - ▶ See *Surface Materials*, page J2.

Surface Materials	Options	Price	Required to Specify
-------------------	---------	-------	---------------------

- | | | | |
|-------------------|----------------------------|--------------|--|
| Surface Materials | • Customiz stain on wood | Prices below | Specify with <i>Customiz stain</i> . |
| | • Full-fill finish on wood | No cost | ▶ See <i>Surface Materials Reference Manual</i> . Specify full-fill finish number. |

- Additional Options**
- ▶ See *Availability of Conference Top Options*, pages F8-F10.
 - ▶ See *Specifying Conference Top Options*, page F12.

Specification Information

• Dimensions		• Style Number	• Base Price	• Option (Add \$ to Base Price)
D	W			
36"	36"	CW_S36	\$ 890	+\$ 41
42"	42"	CW_S42	\$1071	+\$ 60
48"	48"	CW_S48	\$1348	+\$ 60
54"	54"	CW_S54	\$1916	+\$107
60"	60"	CW_S60	\$2545	+\$107
:	:	:	:	:

Cushion Wood Conference Table Tops

SIN 711.8

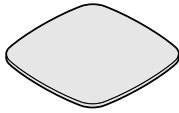

Tip: Your specification is not complete until you add a third letter to the style number to define the table top edge profile.

Standard Edge Profiles For Tops 36"W-60"W

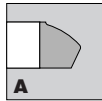

American Elect

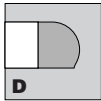

Lotus

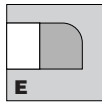

Bullnose

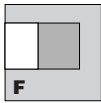

Flat

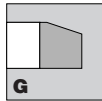

Slope

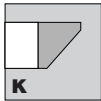

Knife

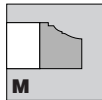

Monarch

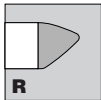

Rei

Standard Includes	Required to Specify
-------------------	---------------------

- Table top: wood veneer with solid wood edge

- Style number with appropriate edge profile letter indicated in the space provided (For example, CW_C36 becomes CWFC36 for flat edge profile)
 - ▶ See edge profiles below.
- Wood veneer color number for top
- Options, if selected (see below)
 - ▶ See *Surface Materials*, page J2.

Surface Materials	Options	Price	Required to Specify
-------------------	---------	-------	---------------------

- | | | | |
|-------------------|----------------------------|--------------|--|
| Surface Materials | • Customiz stain on wood | Prices below | Specify with <i>Customiz stain</i> . |
| | • Full-fill finish on wood | No cost | ▶ See <i>Surface Materials Reference Manual</i> . Specify full-fill finish number. |

- Additional Options**
- ▶ See *Availability of Conference Top Options*, pages F8–F10.
 - ▶ See *Specifying Conference Top Options*, page F12.

Specification Information

• Dimensions		• Style Number	• Base Price	• Option (Add \$ to Base Price)
D	W			
36"	36"	CW_C36	\$1068	+\$ 41
42"	42"	CW_C42	\$1285	+\$ 60
48"	48"	CW_C48	\$1617	+\$ 60
54"	54"	CW_C54	\$2299	+\$107
60"	60"	CW_C60	\$3054	+\$107
:	:	:	:	:

Oval Wood Conference Table Tops

SIN 711.8

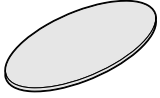

Standard Includes	Required to Specify
-------------------	---------------------

- Table top: wood veneer with solid wood edge

- 1 Style number with appropriate edge profile letter indicated in the space provided (For example, CW_J3660 becomes CWFJ3660 for flat edge profile)
 - ▶ See edge profiles at right.
- 2 Wood veneer color number for top
- 3 Options, if selected (see below)
 - ▶ See *Surface Materials*, page J2.

	Options	Price	Required to Specify
--	---------	-------	---------------------

Surface Materials

- Customiz stain on wood
- Full-fill finish on wood

Prices at right
No cost

- Specify *with Customiz stain*.
▶ See *Surface Materials Reference Manual*.
Specify full-fill finish number.

Additional Options

- ▶ See *Availability of Conference Top Options*, pages F8–F10.
- ▶ See *Specifying Conference Top Options*, page F12.

Tip: Your specification is not complete until you add a third letter to the style number to define the table top edge profile.

Specification Information

• Dimensions		• Style Number	• Base Price	• Option (Add \$ to Base Price)
D	W			
36"	60"	CW_J3660	\$ 1890	+\$ 60
	66"	CW_J3666	\$ 2031	+\$ 84
	72"	CW_J3672	\$ 2177	+\$ 84
	84"	CW_J3684	\$ 2469	+\$107
42"	72"	CW_J4272	\$ 2478	+\$107
	84"	CW_J4284	\$ 2714	+\$107
	96"	CW_J4296	\$ 3060	+\$135
	108"	CW_J42108	\$ 3417	+\$135
48"	84"	CW_J4884	\$ 2980	+\$135
	96"	CW_J4896	\$ 3160	+\$135
	108"	CW_J48108	\$ 3859	+\$174
	120"	CW_J48120	\$ 4725	+\$174
54"	108"	CW_J54108	\$ 4427	+\$200
	120"	CW_J54120	\$ 5140	+\$200
	144"	CW_J54144	\$ 6103	+\$246
60"	120"	CW_J60120	\$ 5492	+\$218
	144"	CW_J60144	\$ 7384	+\$264
	168"	CW_J60168	\$ 9672	+\$280
66"	144"	CW_J66144	\$ 8191	+\$280
	168"	CW_J66168	\$10,083	+\$320
	192"	CW_J66192	\$10,999	+\$360
72"	168"	CW_J72168	\$11,771	+\$360
	192"	CW_J72192	\$12,972	+\$400
	216"	CW_J72216	\$14,077	+\$440

Standard Edge Profiles For Tops 60"W-120"W

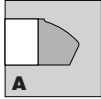

American Elect

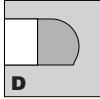

Lotus

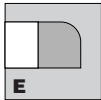

Bullnose

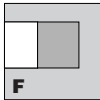

Flat

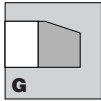

Slope

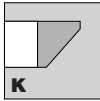

Knife

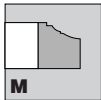

Monarch

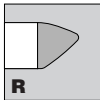

Rei

Large Edge Profiles For Tops 144"W and Wider

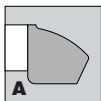

American Elect

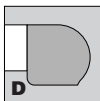

Lotus

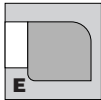

Bullnose

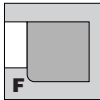

Flat

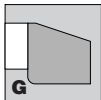

Slope

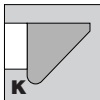

Knife



Monarch

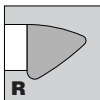

Rei



Rectangular Wood Conference Table Tops

SIN 711.8

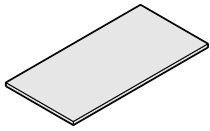

Standard Includes	Required to Specify
-------------------	---------------------

- Table top: wood veneer with solid wood edge

- 1 Style number with appropriate edge profile letter indicated in the space provided (For example, CW_T3660 becomes CWFT3660 for flat edge profile)
 - ▶ See edge profiles at right.
- 2 Wood veneer color number for top
- 3 Options, if selected (see below)
 - ▶ See *Surface Materials*, page J2.

	Options	Price	Required to Specify
--	---------	-------	---------------------

Surface Materials

- | | |
|----------------------------|-----------------|
| • Customiz stain on wood | Prices at right |
| • Full-fill finish on wood | No cost |

- Specify *with Customiz stain*.
- ▶ See *Surface Materials Reference Manual*. Specify full-fill finish number.

Additional Options

- ▶ See *Availability of Conference Top Options*, pages F8–F10.
- ▶ See *Specifying Conference Top Options*, page F12.

Tip: Your specification is not complete until you add a third letter to the style number to define the table top edge profile.

Specification Information

**Standard Edge Profiles
For Tops 60"W-120"W**

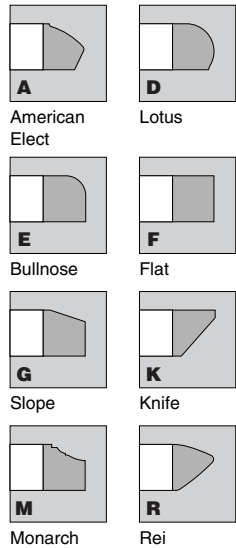

**Large Edge Profiles
For Tops 144"W and
Wider**

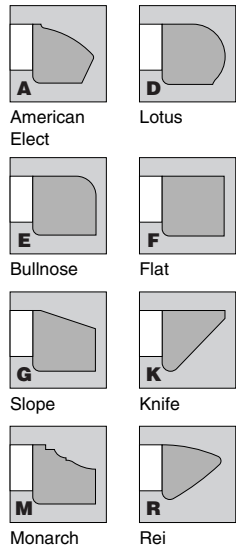

Dimensions		Style Number	Base Price	Option (Add \$ to Base Price)
D	W			
36"	60"	CW_T3660	\$ 1627	+\$ 60
	66"	CW_T3666	\$ 1750	+\$ 84
	72"	CW_T3672	\$ 1875	+\$ 84
	84"	CW_T3684	\$ 2127	+\$107
42"	72"	CW_T4272	\$ 2134	+\$107
	84"	CW_T4284	\$ 2337	+\$107
	96"	CW_T4296	\$ 2635	+\$135
	108"	CW_T42108	\$ 2943	+\$135
48"	84"	CW_T4884	\$ 2567	+\$135
	96"	CW_T4896	\$ 2722	+\$135
	108"	CW_T48108	\$ 3324	+\$174
	120"	CW_T48120	\$ 4070	+\$174
54"	144"	CW_T48144	\$ 4488	+\$218
	108"	CW_T54108	\$ 3812	+\$200
	120"	CW_T54120	\$ 4426	+\$200
	144"	CW_T54144	\$ 5256	+\$246
60"	168"	CW_T54168	\$ 6367	+\$280
	120"	CW_T60120	\$ 4730	+\$218
	144"	CW_T60144	\$ 6359	+\$264
	168"	CW_T60168	\$ 8330	+\$280
66"	192"	CW_T60192	\$ 8596	+\$320
	216"	CW_T60216	\$ 8867	+\$360
	144"	CW_T66144	\$ 7446	+\$280
	168"	CW_T66168	\$ 9167	+\$320
72"	192"	CW_T66192	\$ 9999	+\$360
	216"	CW_T66216	\$11,580	+\$400
	168"	CW_T72168	\$10,700	+\$360
	192"	CW_T72192	\$11,793	+\$400
216"	216"	CW_T72216	\$12,797	+\$440

Boat-Shape Wood Conference Table Tops

SIN 711.8

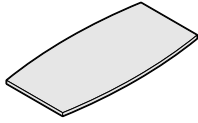

Standard Includes	Required to Specify
-------------------	---------------------

- Table top: wood veneer with solid wood edge

- 1 Style number with appropriate edge profile letter indicated in the space provided (For example, CW_B3660 becomes CWFB3660 for flat edge profile)
 - ▶ See edge profiles at right.
- 2 Wood veneer color number for top
- 3 Options, if selected (see below)
 - ▶ See *Surface Materials*, page J2.

	Options	Price	Required to Specify
--	---------	-------	---------------------

Surface Materials

- | | |
|----------------------------|-----------------|
| • Customiz stain on wood | Prices at right |
| • Full-fill finish on wood | No cost |

- Specify *with Customiz stain*.
- ▶ See *Surface Materials Reference Manual*. Specify full-fill finish number.

Additional Options

- ▶ See *Availability of Conference Top Options*, pages F8–F10.
- ▶ See *Specifying Conference Top Options*, page F12.

Tip: Your specification is not complete until you add a third letter to the style number to define the table top edge profile.

Specification Information

**Standard Edge Profiles
For Tops 60"W-120"W**

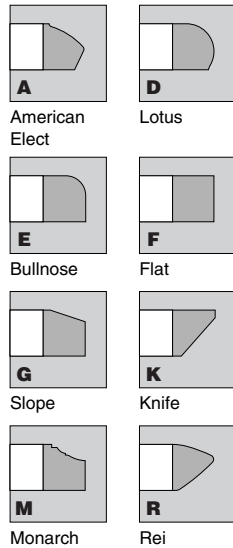

**Large Edge Profiles
For Tops 144"W and
Wider**

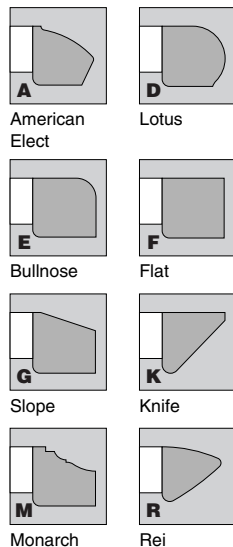

Dimensions		Style Number	Base Price	Option (Add \$ to Base Price)
D	W			
30"/36"	60"	CW_B3660	\$ 1890	+\$ 60
	66"	CW_B3666	\$ 2031	+\$ 84
	72"	CW_B3672	\$ 2177	+\$ 84
	84"	CW_B3684	\$ 2469	+\$107
36"/42"	72"	CW_B4272	\$ 2478	+\$107
	84"	CW_B4284	\$ 2714	+\$107
	96"	CW_B4296	\$ 3060	+\$135
	108"	CW_B42108	\$ 3417	+\$135
41"/48"	84"	CW_B4884	\$ 2980	+\$135
	96"	CW_B4896	\$ 3160	+\$135
	108"	CW_B48108	\$ 3859	+\$174
	120"	CW_B48120	\$ 4725	+\$174
46"/54"	144"	CW_B48144	\$ 5211	+\$218
	108"	CW_B54108	\$ 4427	+\$200
	120"	CW_B54120	\$ 5140	+\$200
	144"	CW_B54144	\$ 6103	+\$246
51"/60"	168"	CW_B54168	\$ 7392	+\$280
	120"	CW_B60120	\$ 5492	+\$218
	144"	CW_B60144	\$ 7384	+\$264
	168"	CW_B60168	\$ 9672	+\$280
56"/66"	192"	CW_B60192	\$ 9981	+\$320
	216"	CW_B60216	\$10,295	+\$360
	144"	CW_B66144	\$ 8191	+\$280
	168"	CW_B66168	\$10,083	+\$320
61"/72"	192"	CW_B66192	\$10,999	+\$360
	216"	CW_B66216	\$12,738	+\$400
	168"	CW_B72168	\$11,771	+\$360
	192"	CW_B72192	\$12,972	+\$400
216"	216"	CW_B72216	\$14,077	+\$440

Convене

Racetrack Wood Conference Table Tops

SIN 711.8

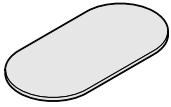

Standard Includes	Required to Specify
-------------------	---------------------

- Table top: wood veneer with solid wood edge

- 1 Style number with appropriate edge profile letter indicated in the space provided (For example, CW_K3660 becomes CWFK3660 for flat edge profile)
 - ▶ See edge profiles at right.
- 2 Wood veneer color number for top
- 3 Options, if selected (see below)
 - ▶ See *Surface Materials*, page J2.

	Options	Price	Required to Specify
--	---------	-------	---------------------

Surface Materials

- | | | |
|----------------------------|-----------------|--|
| • Customiz stain on wood | Prices at right | |
| • Full-fill finish on wood | No cost | |

- Specify *with Customiz stain*.
- ▶ See *Surface Materials Reference Manual*. Specify full-fill finish number.

Additional Options

- ▶ See *Availability of Conference Top Options*, pages F8–F10.
- ▶ See *Specifying Conference Top Options*, page F12.

Tip: Your specification is not complete until you add a third letter to the style number to define the table top edge profile.

Specification Information

**Standard Edge Profiles
For Tops 60"W-120"W**

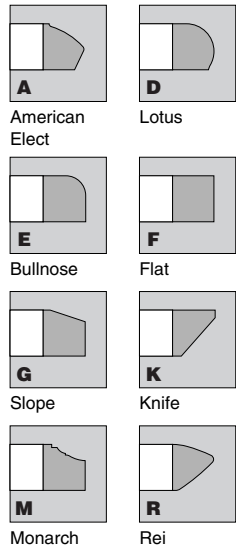

**Large Edge Profiles
For Tops 144"W and
Wider**

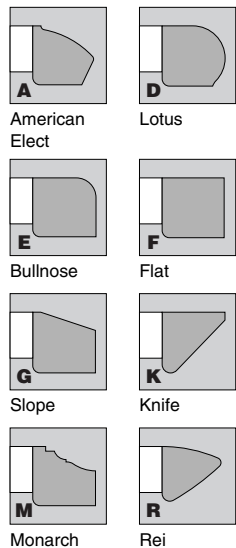

Dimensions		Style Number	Base Price	Option (Add \$ to Base Price)
D	W			
36"	60"	CW_K3660	\$ 1803	+\$ 60
	66"	CW_K3666	\$ 1939	+\$ 84
	72"	CW_K3672	\$ 2079	+\$ 84
	84"	CW_K3684	\$ 2357	+\$107
42"	72"	CW_K4272	\$ 2366	+\$107
	84"	CW_K4284	\$ 2591	+\$107
	96"	CW_K4296	\$ 2920	+\$135
	108"	CW_K42108	\$ 3261	+\$135
48"	84"	CW_K4884	\$ 2844	+\$135
	96"	CW_K4896	\$ 3016	+\$135
	108"	CW_K48108	\$ 3683	+\$174
	120"	CW_K48120	\$ 4511	+\$174
	144"	CW_K48144	\$ 4974	+\$218
54"	108"	CW_K54108	\$ 4226	+\$200
	120"	CW_K54120	\$ 4906	+\$200
	144"	CW_K54144	\$ 5825	+\$246
	168"	CW_K54168	\$ 7056	+\$280
60"	120"	CW_K60120	\$ 5242	+\$218
	144"	CW_K60144	\$ 7048	+\$264
	168"	CW_K60168	\$ 9233	+\$280
	192"	CW_K60192	\$ 9528	+\$320
	216"	CW_K60216	\$ 9827	+\$360
66"	144"	CW_K66144	\$ 7819	+\$280
	168"	CW_K66168	\$ 9625	+\$320
	192"	CW_K66192	\$10,498	+\$360
	216"	CW_K66216	\$12,159	+\$400
72"	168"	CW_K72168	\$11,235	+\$360
	192"	CW_K72192	\$12,382	+\$400
	216"	CW_K72216	\$13,438	+\$440

Round Laminate Conference Table Tops

SIN 711.8

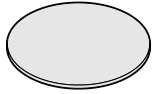

Tip: Your specification is not complete until you add a third letter to the style number to define the table top edge profile.

Standard Includes	Required to Specify
-------------------	---------------------

- | | |
|--|--|
| Standard Includes | Required to Specify |
| <ul style="list-style-type: none"> Table top: laminate with solid wood edge | <ol style="list-style-type: none"> Style number with appropriate edge profile letter indicated in the space provided (For example, CL_R36 becomes CLFR36 for flat edge profile) See edge profiles below. Laminate color number for top Wood finish number for edge profile Options, if selected (see below) <p>▶ See <i>Surface Materials</i>, page J2.</p> |

Standard Edge Profiles For Diameter Tops 36"–60"

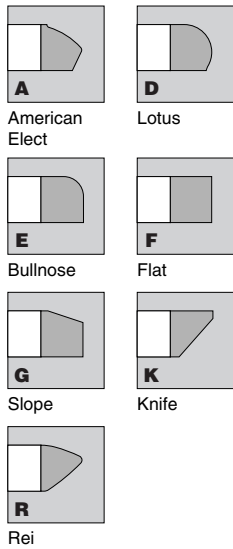

Options	Price	Required to Specify
Surface Materials <ul style="list-style-type: none"> Customiz stain on wood edge profile Open Line laminate 	Prices below +\$60 plus cost of laminate	Specify with <i>Customiz stain</i> . ▶ See <i>Surface Materials Reference Manual</i> . ▶ See <i>Surface Materials Reference Manual</i> .

Additional Options ▶ See *Availability of Conference Top Options*, pages F8–F10.
 ▶ See *Specifying Conference Top Options*, page F12.

Specification Information

Diameter	Style Number	Base Price	Option (Add \$ to Base Price)
36"	CL_R36	\$1026	+\$21
42"	CL_R42	\$1235	+\$30
48"	CL_R48	\$1553	+\$30
54"	CL_R54	\$2018	+\$54
60"	CL_R60	\$2344	+\$54
66"	CL_R66	\$2831	+\$68
72"	CL_R72	\$3300	+\$87
⋮	⋮	⋮	⋮

Large Edge Profiles For Diameter Tops 66"–72"

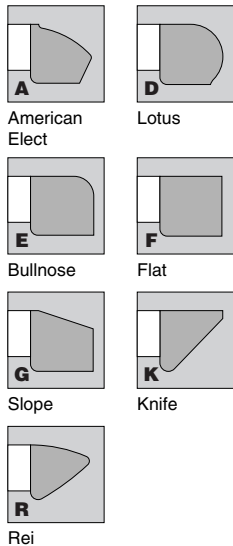

Square Laminate Conference Table Tops

SIN 711.8

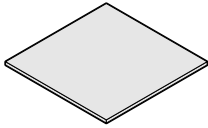

Tip: Your specification is not complete until you add a third letter to the style number to define the table top edge profile.

Standard Edge Profiles For Tops 36"W-60"W

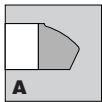

American Elect

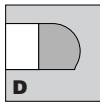

Lotus

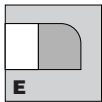

Bullnose

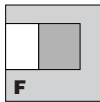

Flat

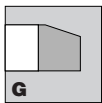

Slope

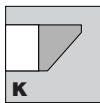

Knife

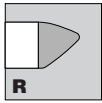

Rei

Standard Includes	Required to Specify
-------------------	---------------------

- | | |
|--|--|
| <ul style="list-style-type: none"> Table top: laminate with solid wood edge | <ol style="list-style-type: none"> Style number with appropriate edge profile letter indicated in the space provided (For example, CL_S36 becomes CLFS36 for flat edge profile) <ul style="list-style-type: none"> ▶ See edge profiles below. Laminate color number for top Wood finish number for edge profile Options, if selected (see below) <ul style="list-style-type: none"> ▶ See <i>Surface Materials</i>, page J2. |
|--|--|

Surface Materials	Options	Price	Required to Specify
-------------------	---------	-------	---------------------

- | | | | |
|---|---|--|--|
| <ul style="list-style-type: none"> Customiz stain on wood edge profile Open Line laminate | <ul style="list-style-type: none"> Customiz stain on wood edge profile Open Line laminate | Prices below

+\$60
plus cost of laminate | Specify with <i>Customiz stain</i> .
▶ See <i>Surface Materials Reference Manual</i> .
▶ See <i>Surface Materials Reference Manual</i> . |
|---|---|--|--|

Additional Options

- ▶ See *Availability of Conference Top Options*, pages F8–F10.
- ▶ See *Specifying Conference Top Options*, page F12.

Specification Information

Dimensions		Style Number	Base Price	Option (Add \$ to Base Price)
D	W			
36"	36"	CL_S36	\$ 841	+\$21 Customiz Stain
42"	42"	CL_S42	\$1012	+\$30
48"	48"	CL_S48	\$1274	+\$30
54"	54"	CL_S54	\$1810	+\$54
60"	60"	CL_S60	\$2406	+\$54

Cushion Laminate Conference Table Tops

SIN 711.8

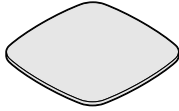

Tip: Your specification is not complete until you add a third letter to the style number to define the table top edge profile.

Standard Edge Profiles For Tops 36"W-60"W

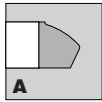

American Elect

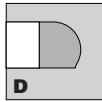

Lotus

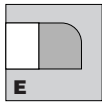

Bullnose

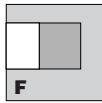

Flat

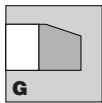

Slope

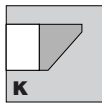

Knife

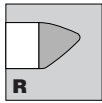

Rei

Standard Includes	Required to Specify
-------------------	---------------------

- Table top: laminate with solid wood edge

- Style number with appropriate edge profile letter indicated in the space provided (For example, CL_C36 becomes CLFC36 for flat edge profile)
 - ▶ See edge profiles below.
- Laminate color number for top
- Wood finish number for edge profile
- Options, if selected (see below)
 - ▶ See *Surface Materials*, page J2.

Options	Price	Required to Specify
---------	-------	---------------------

Surface Materials

- Customiz stain on wood edge profile
- Open Line laminate

Prices below
+\$60
plus cost of laminate

- Specify with *Customiz stain*.
- ▶ See *Surface Materials Reference Manual*.
 - ▶ See *Surface Materials Reference Manual*.

Additional Options

- ▶ See *Availability of Conference Top Options*, pages F8–F10.
- ▶ See *Specifying Conference Top Options*, page F12.

Specification Information

• Dimensions		• Style Number	• Base Price	• Option (Add \$ to Base Price)
D	W			
36"	36"	CL_C36	\$1010	+\$21
42"	42"	CL_C42	\$1215	+\$30
48"	48"	CL_C48	\$1528	+\$30
54"	54"	CL_C54	\$2172	+\$54
60"	60"	CL_C60	\$2886	+\$54
:	:	:	:	Customiz Stain

Oval Laminate Conference Table Tops

SIN 711.8

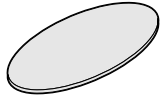

Tip: Your specification is not complete until you add a third letter to the style number to define the table top edge profile.

Standard Edge Profiles For Tops 60"W-120"W

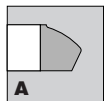

American Elect

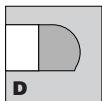

Lotus

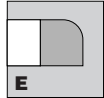

Bullnose

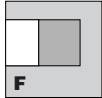

Flat

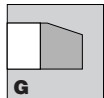

Slope

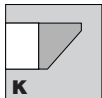

Knife

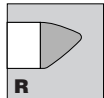

Rei

Large Edge Profiles For Tops 144"W and Wider

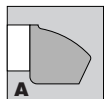

American Elect

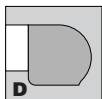

Lotus

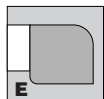

Bullnose

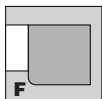

Flat

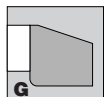

Slope

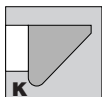

Knife

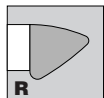

Rei

Standard Includes	Required to Specify
-------------------	---------------------

- Table top: laminate with solid wood edge

- 1 Style number with appropriate edge profile letter indicated in the space provided (For example, CL_J3660 becomes CLFJ3660 for flat edge profile)
 - ▶ See edge profiles below.
- 2 Laminate color number for top
- 3 Wood finish number for edge profile
- 4 Options, if selected (see below)
 - ▶ See *Surface Materials*, page J2.

Options	Price	Required to Specify
---------	-------	---------------------

Surface Materials

- Customiz stain on wood edge profile
- Open Line laminate

Prices below
+\$60
plus cost of laminate

- Specify with *Customiz stain*.
- ▶ See *Surface Materials Reference Manual*.
 - ▶ See *Surface Materials Reference Manual*.

Additional Options

- ▶ See *Availability of Conference Top Options*, pages F8–F10.
- ▶ See *Specifying Conference Top Options*, page F12.

Specification Information

Dimensions		Style Number	Base Price	Option (Add \$ to Base Price)
D	W			
36"	60"	CL_J3660	\$ 1790	+\$ 30
	66"	CL_J3666	\$ 1924	+\$ 42
	72"	CL_J3672	\$ 2063	+\$ 42
	84"	CL_J3684	\$ 2339	+\$ 54
42"	72"	CL_J4272	\$ 2347	+\$ 54
	84"	CL_J4284	\$ 2571	+\$ 54
	96"	CL_J4296	\$ 2899	+\$ 68
	108"	CL_J42108	\$ 3237	+\$ 68
48"	84"	CL_J4884	\$ 2823	+\$ 68
	96"	CL_J4896	\$ 2993	+\$ 68
	108"	CL_J48108	\$ 3656	+\$ 87
	120"	CL_J48120	\$ 4477	+\$ 87
54"	108"	CL_J54108	\$ 4194	+\$100
	120"	CL_J54120	\$ 4869	+\$100
	144"	CL_J54144	\$ 5782	+\$123
60"	120"	CL_J60120	\$ 5203	+\$109
	144"	CL_J60144	\$ 6996	+\$132
	168"	CL_J60168	\$ 9163	+\$140
66"	144"	CL_J66144	\$ 7760	+\$140
	168"	CL_J66168	\$ 9553	+\$160
	192"	CL_J66192	\$10,420	+\$180
72"	168"	CL_J72168	\$11,151	+\$180
	192"	CL_J72192	\$12,290	+\$200
	216"	CL_J72216	\$13,336	+\$220

Convене

Rectangular Laminate Conference Table Tops

SIN 711.8

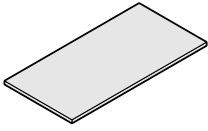

Standard Includes	Required to Specify
-------------------	---------------------

- Table top: laminate with solid wood edge

- 1 Style number with appropriate edge profile letter indicated in the space provided (For example, CL_T3660 becomes CLFT3660 for flat edge profile)
 - ▶ See edge profiles at right.
- 2 Laminate color number for top
- 3 Wood finish number for edge profile
- 4 Options, if selected (see below)
 - ▶ See *Surface Materials*, page J2.

Surface Materials	Options	Price	Required to Specify
-------------------	---------	-------	---------------------

Surface Materials

- Customiz stain on wood edge profile
- Open Line laminate

Prices at right
+\$60
plus cost of laminate

- Specify with *Customiz stain*.
- ▶ See *Surface Materials Reference Manual*.
 - ▶ See *Surface Materials Reference Manual*.

Additional Options

- ▶ See *Availability of Conference Top Options*, pages F8–F10.
- ▶ See *Specifying Conference Top Options*, page F12.

Tip: Your specification is not complete until you add a third letter to the style number to define the table top edge profile.

Specification Information

Dimensions		Style Number	Base Price	Option
D	W			(Add \$ to Base Price)
Customiz Stain				
36"	60"	CL__T3660	\$ 1546	+\$ 30
	66"	CL__T3666	\$ 1662	+\$ 42
	72"	CL__T3672	\$ 1781	+\$ 42
	84"	CL__T3684	\$ 2020	+\$ 54
42"	72"	CL__T4272	\$ 2027	+\$ 54
	84"	CL__T4284	\$ 2221	+\$ 54
	96"	CL__T4296	\$ 2503	+\$ 68
	108"	CL__T42108	\$ 2796	+\$ 68
48"	84"	CL__T4884	\$ 2439	+\$ 68
	96"	CL__T4896	\$ 2585	+\$ 68
	108"	CL__T48108	\$ 3157	+\$ 87
	120"	CL__T48120	\$ 3867	+\$ 87
	144"	CL__T48144	\$ 4264	+\$109
54"	108"	CL__T54108	\$ 3621	+\$100
	120"	CL__T54120	\$ 4205	+\$100
	144"	CL__T54144	\$ 4993	+\$123
	168"	CL__T54168	\$ 6048	+\$140
60"	120"	CL__T60120	\$ 4494	+\$109
	144"	CL__T60144	\$ 6041	+\$132
	168"	CL__T60168	\$ 7914	+\$140
	192"	CL__T60192	\$ 8166	+\$160
	216"	CL__T60216	\$ 8423	+\$180
66"	144"	CL__T66144	\$ 7055	+\$140
	168"	CL__T66168	\$ 8684	+\$160
	192"	CL__T66192	\$ 9473	+\$180
	216"	CL__T66216	\$10,971	+\$200
72"	168"	CL__T72168	\$10,137	+\$180
	192"	CL__T72192	\$11,172	+\$200
	216"	CL__T72216	\$12,124	+\$220

Standard Edge Profiles For Tops 60"W-120"W

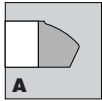

American Elect

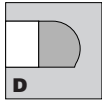

Lotus

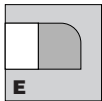

Bullnose

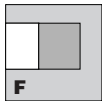

Flat

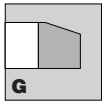

Slope

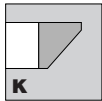

Knife

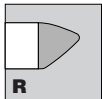

Rei

Large Edge Profiles For Tops 144"W and Wider

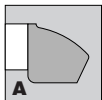

American Elect

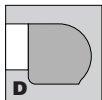

Lotus

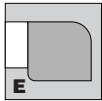

Bullnose

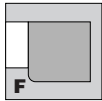

Flat

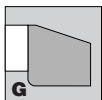

Slope

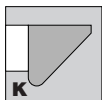

Knife

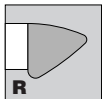

Rei

Boat-Shape Laminate Conference Table Tops

SIN 711.8

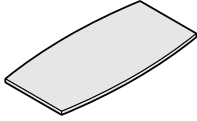

Standard Includes	Required to Specify
-------------------	---------------------

- Table top: laminate with solid wood edge

- 1 Style number with appropriate edge profile letter indicated in the space provided (For example, CL_B3660 becomes CLFB3660 for flat edge profile)
 - ▶ See edge profiles at right.
- 2 Laminate color number for top
- 3 Wood finish number for edge profile
- 4 Options, if selected (see below)
 - ▶ See *Surface Materials*, page J2.

Surface Materials	Options	Price	Required to Specify
-------------------	---------	-------	---------------------

Surface Materials	• Customiz stain on wood edge profile	Prices at right	Specify with <i>Customiz stain</i> .
	• Open Line laminate	+\$60 plus cost of laminate	▶ See <i>Surface Materials Reference Manual</i> . ▶ See <i>Surface Materials Reference Manual</i> .

- Additional Options**
- ▶ See *Availability of Conference Top Options*, pages F8–F10.
 - ▶ See *Specifying Conference Top Options*, page F12.

Tip: Your specification is not complete until you add a third letter to the style number to define the table top edge profile.

Specification Information

Dimensions		Style Number	Base Price	Option
D	W			(Add \$ to Base Price)
				Customiz Stain
30"/36"	60"	CL_B3660	\$ 1790	+\$ 30
	66"	CL_B3666	\$ 1924	+\$ 42
	72"	CL_B3672	\$ 2063	+\$ 42
	84"	CL_B3684	\$ 2339	+\$ 54
36"/42"	72"	CL_B4272	\$ 2347	+\$ 54
	84"	CL_B4284	\$ 2571	+\$ 54
	96"	CL_B4296	\$ 2899	+\$ 68
	108"	CL_B42108	\$ 3237	+\$ 68
41"/48"	84"	CL_B4884	\$ 2823	+\$ 68
	96"	CL_B4896	\$ 2994	+\$ 68
	108"	CL_B48108	\$ 3656	+\$ 87
	120"	CL_B48120	\$ 4477	+\$ 87
	144"	CL_B48144	\$ 4937	+\$109
46"/54"	108"	CL_B54108	\$ 4194	+\$100
	120"	CL_B54120	\$ 4869	+\$100
	144"	CL_B54144	\$ 5781	+\$123
	168"	CL_B54168	\$ 7003	+\$140
51"/60"	120"	CL_B60120	\$ 5203	+\$109
	144"	CL_B60144	\$ 6995	+\$132
	168"	CL_B60168	\$ 9163	+\$140
	192"	CL_B60192	\$ 9456	+\$160
	216"	CL_B60216	\$ 9753	+\$180
56"/66"	144"	CL_B66144	\$ 7760	+\$140
	168"	CL_B66168	\$ 9553	+\$160
	192"	CL_B66192	\$10,420	+\$180
	216"	CL_B66216	\$12,068	+\$200
61"/72"	168"	CL_B72168	\$11,151	+\$180
	192"	CL_B72192	\$12,290	+\$200
	216"	CL_B72216	\$13,336	+\$220

Standard Edge Profiles For Tops 60"W-120"W

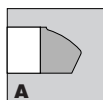

American Elect

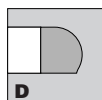

Lotus

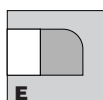

Bullnose

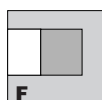

Flat

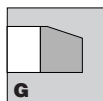

Slope

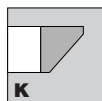

Knife

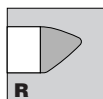

Rei

Large Edge Profiles For Tops 144"W and Wider

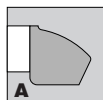

American Elect

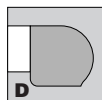

Lotus

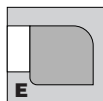

Bullnose

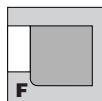

Flat

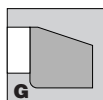

Slope

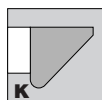

Knife

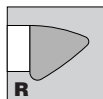

Rei

Racetrack Laminate Conference Table Tops

SIN 711.8

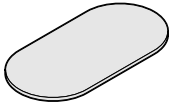

Standard Includes	Required to Specify
-------------------	---------------------

- Table top: laminate with solid wood edge

- 1 Style number with appropriate edge profile letter indicated in the space provided (For example, CL_K3660 becomes CLFK3660 for flat edge profile)
 - ▶ See edge profiles at right.
- 2 Laminate color number for top
- 3 Wood finish number for edge profile
- 4 Options, if selected (see below)
 - ▶ See *Surface Materials*, page J2.

Options	Price	Required to Specify
---------	-------	---------------------

Surface Materials

- Customiz stain on wood edge profile
- Open Line laminate

Prices at right
+\$60
plus cost of laminate

- Specify with *Customiz stain*.
- ▶ See *Surface Materials Reference Manual*.
 - ▶ See *Surface Materials Reference Manual*.

Additional Options

- ▶ See *Availability of Conference Top Options*, pages F8–F10.
- ▶ See *Specifying Conference Top Options*, page F12.

Tip: Your specification is not complete until you add a third letter to the style number to define the table top edge profile.

Specification Information

Dimensions		Style Number	Base Price	Option (Add \$ to Base Price)
D	W			
36"	60"	CL_K3660	\$ 1708	+\$ 30
	66"	CL_K3666	\$ 1837	+\$ 42
	72"	CL_K3672	\$ 1969	+\$ 42
	84"	CL_K3684	\$ 2233	+\$ 54
42"	72"	CL_K4272	\$ 2241	+\$ 54
	84"	CL_K4284	\$ 2454	+\$ 54
	96"	CL_K4296	\$ 2767	+\$ 68
	108"	CL_K42108	\$ 3090	+\$ 68
48"	84"	CL_K4884	\$ 2695	+\$ 68
	96"	CL_K4896	\$ 2858	+\$ 68
	108"	CL_K48108	\$ 3490	+\$ 87
	120"	CL_K48120	\$ 4273	+\$ 87
54"	144"	CL_K48144	\$ 4712	+\$109
	108"	CL_K54108	\$ 4003	+\$100
	120"	CL_K54120	\$ 4648	+\$100
	144"	CL_K54144	\$ 5518	+\$123
60"	168"	CL_K54168	\$ 6685	+\$140
	120"	CL_K60120	\$ 4966	+\$109
	144"	CL_K60144	\$ 6677	+\$132
	168"	CL_K60168	\$ 8747	+\$140
66"	192"	CL_K60192	\$ 9026	+\$160
	216"	CL_K60216	\$ 9310	+\$180
	144"	CL_K66144	\$ 7407	+\$140
	168"	CL_K66168	\$ 9118	+\$160
72"	192"	CL_K66192	\$ 9946	+\$180
	216"	CL_K66216	\$11,519	+\$200
	168"	CL_K72168	\$10,644	+\$180
	192"	CL_K72192	\$11,731	+\$200
216"	CL_K72216	\$12,730	+\$220	

Standard Edge Profiles For Tops 60"W-120"W

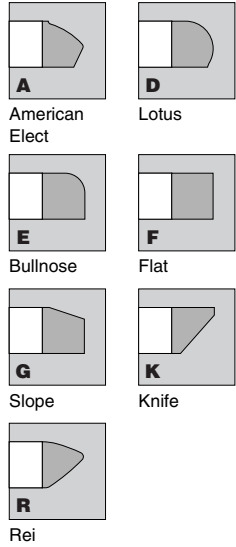

Large Edge Profiles For Tops 144"W and Wider

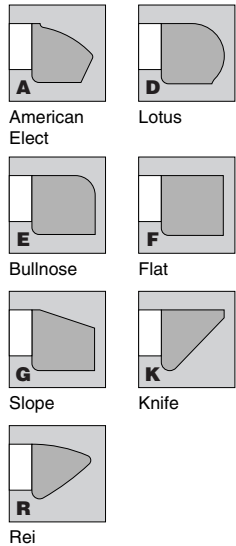

Bases for Conference Tables

SIN 711.8

Metal Flex Bases

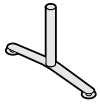

Tip: Power units cannot be used on tops supported by T- or X-flex bases. All other power and communication optional accessories can be used on these bases.

Tip: Oval ports and power channels cannot be used on 54"D x 120"W oval tops supported by flex bases.

Standard Includes	Required to Specify
<ul style="list-style-type: none"> • Metal flex base: paint or metal • Attachment hardware 	1 Style number 2 Paint or metal color number for base: 0835 Black 4798 Sterling 4799 Platinum 3 Options, if selected (see below) ▶ See <i>Surface Materials</i> , page J2.

Surface Materials	Options	Price	Required to Specify
	T-flex base		
	<ul style="list-style-type: none"> • Brushed Aluminum • Polished Aluminum 	+\$150 +\$150	Specify with 8042 Brushed Aluminum. Specify with 8046 Polished Aluminum.
	X-flex base		
	<ul style="list-style-type: none"> • Brushed Aluminum • Polished Aluminum 	+\$150 +\$150	Specify with 8042 Brushed Aluminum. Specify with 8046 Polished Aluminum.

Specification Information

• Dimensions			• Style	• Base
D	W	H	Number	Price

T-Flex Base

24"	24"	27½"	CFLEXT24	\$595
30"	30"	27½"	CFLEXT30	\$695

X-Flex Base

24"	24"	27½"	CFLEXX24	\$902
30"	30"	27½"	CFLEXX30	\$989

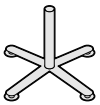
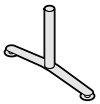

U- and X-Panel Bases

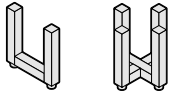

Tip: Power channels cannot be used on tops supported by X-panel bases.

Tip: Oval ports cannot be used on 54"D x 144"W oval tops supported by X-panel bases.

Standard Includes	Required to Specify
-------------------	---------------------

- U- or X-panel base: wood
- Wire management cavity
- Cylinder feet: paint or metal
- Attachment hardware

- 1 Style number
- 2 Wood color number for base
- 3 Paint or metal color number for feet:
 - 0835 Black
 - 4799 Platinum
 - 8042 Brushed Aluminum
 - 8046 Polished Aluminum
- 4 Options, if selected (see below)
 - ▶ See *Surface Materials*, page J2.

Options	Price	Required to Specify
---------	-------	---------------------

Foot Details

- Square feet

No cost

Specify with *square feet* and select 0835 Black, 4799 Platinum, 8042 Brushed Aluminum, or 8046 Polished Aluminum.

Specification Information						
• Dimensions			• Style	• Base	• Option	
D	W	H	Number	Price	(Add \$ to Base Price)	

D	W	H	Style Number	Base Price	Option
•	•	•	•	•	• Customiz Stain

U-Panel

4"	18"	27½"	CWUPC418	\$ 735	+\$41
4"	24"	27½"	CWUPC424	\$ 840	+\$60
6"	30"	27½"	CWUPC630	\$1050	+\$79
6"	36"	27½"	CWUPC636	\$1155	+\$98
•	•	•	•	•	•

X-Panel

24"	24"	27½"	CWXPC424	\$1100	+\$60
30"	30"	27½"	CWXPC630	\$1300	+\$79
36"	36"	27½"	CWXPC636	\$1400	+\$98
•	•	•	•	•	•



Bases for Conference Tables, continued

SIN 711.8

Rectangular Bases

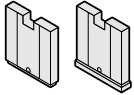

Standard Includes	Required to Specify
<ul style="list-style-type: none"> Rectangular base: wood Removable panel for access to wire cavity Recessed toe kick on base, if selected: metallic finish Wood molding on base, if selected: wood to match base Glides: black plastic Attachment hardware 	<ol style="list-style-type: none"> Style number Wood color number for base Metallic finish color number for recessed toe kick, if selected: <ul style="list-style-type: none"> 0835 Black 8042 Brushed Aluminum 8046 Polished Aluminum Options, if selected (see below) <ul style="list-style-type: none"> ▶ See <i>Surface Materials</i>, page J2.

Options	Price	Required to Specify
Surface Materials <ul style="list-style-type: none"> Customiz stain on wood 	Prices below	Specify with <i>Customiz stain</i> . ▶ See <i>Surface Materials Reference Manual</i> .

Specification Information					
Dimensions			Style	Base	Option
D	W	H	Number	Price	(Add \$ to Base Price)
:	:	:	:	:	Customiz Stain

With Recessed Toe Kick

18"	4"	27½"	CWREC418	\$ 650	+\$41
24"	4"	27½"	CWREC424	\$ 700	+\$60
30"	6"	27½"	CWREC630	\$ 855	+\$79
36"	6"	27½"	CWREC636	\$ 975	+\$98
:	:	:	:	:	:

With Wood Molding

18"	4"	27½"	CWRET418	\$ 762	+\$41
24"	4"	27½"	CWRET424	\$ 826	+\$60
30"	6"	27½"	CWRET630	\$1023	+\$79
36"	6"	27½"	CWRET636	\$1175	+\$98
:	:	:	:	:	:



Rectangular Bases with Feet



Standard Includes	Required to Specify
<ul style="list-style-type: none"> Rectangular base: wood Removable panel for access to wire cavity Cylinder feet: paint or metal Attachment hardware 	<ol style="list-style-type: none"> Style number Wood color number for base Paint or metal color number for feet: <ul style="list-style-type: none"> 0835 Black 4799 Platinum 8042 Brushed Aluminum 8046 Polished Aluminum Options, if selected (see below) <ul style="list-style-type: none"> ▶ See <i>Surface Materials</i>, page J2.

Options	Price	Required to Specify
Surface Materials <ul style="list-style-type: none"> Customiz stain on wood 	Prices below	Specify with <i>Customiz stain</i> . ▶ See <i>Surface Materials Reference Manual</i> .
Foot Detail <ul style="list-style-type: none"> Square feet 	No cost	Specify with <i>square feet</i> and select 0835 Black, 4799 Platinum, 8046 Polished Aluminum, or 9211 Nickel.

Specification Information					
• Dimensions			• Style Number	• Base Price	• Option (Add \$ to Base Price)
D	W	H			
18"	4"	27½"	CWREF418	\$ 750	+\$41
24"	4"	27½"	CWREF424	\$ 800	+\$60
30"	6"	27½"	CWREF630	\$ 955	+\$79
36"	6"	27½"	CWREF636	\$1075	+\$98
:	:	:	:	:	:



Bases for Conference Tables, continued

SIN 711.8

Disk Bases



Tip: Power units and round and oval parts cannot be used on tops supported by disk bases.



Standard Includes	Required to Specify
-------------------	---------------------

- Disk base: 7207 Black
- Glides: black plastic
- Attachment hardware

Style number

Specification Information				
• Dimensions			• Style	• Price
D	W	H	Number	

Contemporary

24"	24"	27"	TBD2428C	\$565
30"	30"	27"	TBD3028C	\$637

Transitional

24"	24"	27"	TBD2428N	\$565
30"	30"	27"	TBD3028N	\$637

Circular Drum Bases

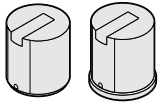

Standard Includes	Required to Specify
-------------------	---------------------

- Circular drum base: wood
- Removable panel for access to wire cavity
- Hole in bottom of base for floor monument access
- Recessed toe kick on base, if selected: metallic finish
- Wood molding on base, if selected: wood to match base
- Glides: black plastic
- Attachment hardware

- 1 Style number
- 2 Wood color number for base
- 3 Metallic finish number for recessed toe kick, if selected:
 - 0835 Black
 - 8042 Brushed Aluminum
 - 8046 Polished Aluminum
- 4 Options, if selected (see below)
 - ▶ See *Surface Materials*, page J2.

Options	Price	Required to Specify
---------	-------	---------------------

- | | | |
|--------------------------|--|---|
| Surface Materials | <ul style="list-style-type: none"> • Customiz stain on wood | Prices below

Specify with <i>Customiz stain</i> .
▶ See <i>Surface Materials Reference Manual</i> . |
|--------------------------|--|---|

Specification Information

• Dimensions			• Style	• Base	• Option
D	W	H	Number	Price	(Add \$ to Base Price)
					Customiz Stain



With Recessed Toe Kick

18"	18"	27½"	CWCIRC18	\$ 800	+\$41
24"	24"	27½"	CWCIRC24	\$ 900	+\$60
30"	30"	27½"	CWCIRC30	\$1050	+\$79
36"	36"	27½"	CWCIRC36	\$1200	+\$98

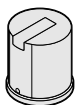

With Wood Molding

18"	18"	27½"	CWCIRT18	\$1016	+\$41
24"	24"	27½"	CWCIRT24	\$1144	+\$60
30"	30"	27½"	CWCIRT30	\$1334	+\$79
36"	36"	27½"	CWCIRT36	\$1525	+\$98

Bases for Conference Tables, continued

SIN 711.8

Half Drum Bases

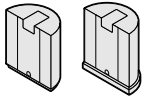

Standard Includes **Required to Specify**

- Half drum base: wood
- Removable panel for access to wire cavity
- Hole in bottom of base for floor monument access
- Recessed toe kick on base, if selected: metallic finish
- Wood molding on base, if selected: wood to match base
- Glides: black plastic
- Attachment hardware

- 1 Style number
- 2 Wood color number for base
- 3 Metallic finish color number for recessed toe kick, if selected:
 - 0835 Black
 - 8042 Brushed Aluminum
 - 8046 Polished Aluminum
- 4 Options, if selected (see below)
 - ▶ See *Surface Materials*, page J2.

Options **Price** **Required to Specify**

Surface Materials

- Customiz stain on wood

Prices below

Specify with *Customiz stain*.
▶ See *Surface Materials Reference Manual*.

Specification Information

• Dimensions			• Style	• Base	• Option
D	W	H	Number	Price	(Add \$ to Base Price)
:	:	:	:	:	Customiz Stain

With Recessed Toe Kick

9"	18"	27½"	CWHDC18	\$ 700	+\$41
12"	24"	27½"	CWHDC24	\$ 750	+\$60
15"	30"	27½"	CWHDC30	\$ 900	+\$79
18"	36"	27½"	CWHDC36	\$1040	+\$98
:	:	:	:	:	:

With Wood Molding

9"	18"	27½"	CWHDT18	\$ 890	+\$41
12"	24"	27½"	CWHDT24	\$ 953	+\$60
15"	30"	27½"	CWHDT30	\$1144	+\$79
18"	36"	27½"	CWHDT36	\$1321	+\$98
:	:	:	:	:	:



Elliptical Drum Bases

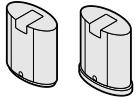

Standard Includes	Required to Specify
-------------------	---------------------

- Elliptical drum base: wood
- Removable panel for access to wire cavity
- Hole in bottom of base for floor monument access
- Recessed toe kick on base, if selected: metallic finish
- Wood molding on base, if selected: wood to match base
- Glides: black plastic
- Attachment hardware

- 1 Style number
- 2 Wood color number for base
- 3 Metallic finish color number for recessed toe kick, if selected:
 - 0835 Black
 - 8042 Brushed Aluminum
 - 8046 Polished Aluminum
- 4 Options, if selected (see below)
 - ▶ See *Surface Materials*, page J2.

Options	Price	Required to Specify
---------	-------	---------------------

Surface Materials

- Customiz stain on wood

Prices below

Specify with *Customiz stain*.
▶ See *Surface Materials Reference Manual*.

Specification Information

• Dimensions			• Style	• Base	• Option
D	W	H	Number	Price	(Add \$ to Base Price)
					Customiz Stain

With Recessed Toe Kick

12"	24"	27½"	CWELC24	\$ 900	+\$60
15"	30"	27½"	CWELC30	\$1050	+\$79
18"	36"	27½"	CWELC36	\$1200	+\$98

With Wood Molding

12"	24"	27½"	CWELT24	\$1144	+\$60
15"	30"	27½"	CWELT30	\$1334	+\$79
18"	36"	27½"	CWELT36	\$1525	+\$98



Power and Communication Accessories

SIN 711.8

Technology Covers

Standard Includes	Required to Specify
<ul style="list-style-type: none"> Technology covers: powder coat wood finish 	<ul style="list-style-type: none"> 1 Style number 2 Powder coat finish number ▶ See <i>Surface Materials</i>, page J2.

Specification Information

• Dimensions			• Style	• Price
D	W	H	Number	



Round Dish Cover

4½"	6"	¼"	DAA84	\$50
-----	----	----	--------------	------



Square Dish Cover

4½"	6"	¼"	DAB84	\$50
-----	----	----	--------------	------



Wire Access Grommet Cover

4½"	6"	¼"	DAC84	\$50
-----	----	----	--------------	------



Square Cover

4½"	6"	¼"	DAX84	\$50
-----	----	----	--------------	------

Tip: Technology covers are included with power units and power channels. Specify additional covers only if you need a different style or replacements.
 ▶ See *Power Channels* and *Power Units*, pages F12–F13.

Power Boxes and Power/Communication Boxes

Tip: Power boxes can provide power/data access in lecterns and media carts.

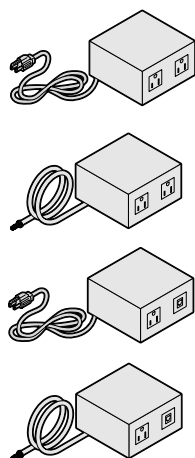

Tip: Jacks can be purchased by calling any of the manufacturers listed below:

- AMP Corporation 1.800.522.6752
- Leviton 1.800.722.2082
- Lucent 1.800.344.0223
- Krone 1.800.775.5766
- Panduit 1.800.777.3300

Standard Includes	Required to Specify
-------------------	---------------------

- Power box
- Power/communication box with adapters for two customer-supplied data couplers/jacks

Style number

Specification Information				
• Dimensions			• Style	• Price
D	W	H	Number	

Power Boxes

3"	3"	1"	SPP	\$149
----	----	----	------------	-------

Hardwired Power Boxes

3"	3"	1"	SPPH	\$309
----	----	----	-------------	-------

Power/Communication Boxes

3"	3"	1"	SPC	\$150
----	----	----	------------	-------

Hardwired Power/Communication Boxes

3"	3"	1"	SPCH	\$229
----	----	----	-------------	-------

Field-Installed Round Grommet



Standard Includes	Required to Specify
-------------------	---------------------

- Grommet: paint or metal
- Installation instructions

- 1 Style number
- 2 Paint or metal color number
- ▶ See *Surface Materials*, page J2.

Specification Information				
• Dimensions			• Style	• Price
D	W		Number	

2 1/2"	2 1/2"		PTGRMT	\$50
--------	--------	--	---------------	------

Contemporary-Style Storage Credenzas

SIN 711.8

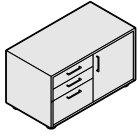

Standard Includes	Required to Specify
<ul style="list-style-type: none"> • Credenza: wood • Finished back panel: wood to match credenza • Pulls: paint or metal • Locks, keyed random: 9250 Ember Chrome • One adjustable shelf behind each door • One hanging file folder frame per file drawer: black plastic • Cylinder feet: paint or metal 	<ol style="list-style-type: none"> 1 Style number 2 Wood veneer color number for credenza 3 Pulls (see below) 4 Paint or metal color number for feet 5 Options, if selected (see below) <p>▶ See <i>Surface Materials</i>, page J2.</p>

	Options	Price	Required to Specify
Surface Materials	<ul style="list-style-type: none"> • Customiz stain on wood 	+\$278	Specify with <i>Customiz stain</i> . ▶ See <i>Surface Materials Reference Manual</i> .
Pulls	<ul style="list-style-type: none"> • Tab pull • Deco pull • Jazz pull • Nile pull 	No cost +\$ 10 each +\$ 10 each +\$ 10 each	Specify with <i>tab pull</i> and select 0835 Black, 4799 Platinum, 9201 Polished Chrome, or 9211 Nickel. Specify with <i>deco pull</i> and select 0835 Black, 4799 Platinum, 9201 Polished Chrome, or 9211 Nickel. Specify with <i>jazz pull</i> and select 0835 Black, 4799 Platinum, 9201 Polished Chrome, or 9211 Nickel. Specify with <i>nile pull</i> and select 0835 Black, 4799 Platinum, 9201 Polished Chrome, or 9211 Nickel.
Foot Detail	<ul style="list-style-type: none"> • Square feet 	No cost	Specify with <i>square feet</i> and select 0835 Black, 4799 Platinum, 8042 Brushed Aluminum, or 8046 Polished Aluminum.
Lock and Keying	<p>Lock</p> <ul style="list-style-type: none"> • Polished Chrome <p>Keying</p> <ul style="list-style-type: none"> • Factory- and field-installed keying 	No cost	Specify with <i>9201 Polished Chrome lock</i> . ▶ Page J8
Translucent Doors	<p>Doors</p> <ul style="list-style-type: none"> • Non-locking translucent glass doors 	+\$100 per door	Add suffix G to style number.
Grommets	<ul style="list-style-type: none"> • Two 2½"-round worksurface grommets 	+\$100	Left/right: Specify with <i>CGRLR</i> and select 0835 Black, 9201 Polished Chrome, or 9211 Nickel.

Tip: Specify 4799 Platinum finish on pulls to match translucent door frame.

Specification Information

Dimensions			Style	Base
D	W	H	Number	Price

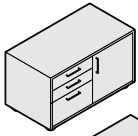

Credenza with Left-Hand Drawers and Right-Hand Door

24"	45"	26"	CWDL4526	\$2387
-----	-----	-----	-----------------	--------

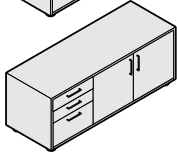

Credenza with Left-Hand Drawers and Right-Hand Double Doors

24"	67"	26"	CWDL6726	\$3380
-----	-----	-----	-----------------	--------

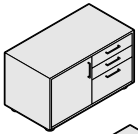

Credenza with Right-Hand Drawers and Left-Hand Door

24"	45"	26"	CWDR4526	\$2387
-----	-----	-----	-----------------	--------

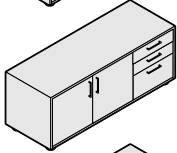

Credenza with Right-Hand Drawers and Left-Hand Double Doors

24"	67"	26"	CWDR6726	\$3380
-----	-----	-----	-----------------	--------

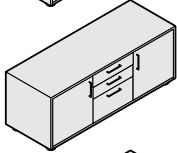

Credenza with Center Drawers and Right- and Left-Hand Doors

24"	67"	26"	CWDC6726	\$3380
-----	-----	-----	-----------------	--------

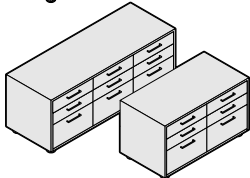

Credenzas with All Drawers

24"	45"	26"	CWDWC4526	\$2507
-----	-----	-----	------------------	--------

24"	67"	26"	CWADC6726	\$3550
-----	-----	-----	------------------	--------

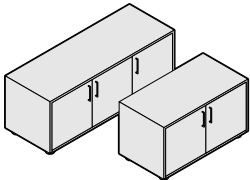

Credenzas with All Doors

24"	45"	26"	CWDDC4526	\$2273
-----	-----	-----	------------------	--------

24"	67"	26"	CWTDC6726	\$3219
-----	-----	-----	------------------	--------

Contemporary-Style Buffet-Height Credenzas

SIN 711.8

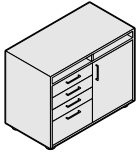

Standard Includes	Required to Specify
<ul style="list-style-type: none"> • Buffet-height credenza: wood • Finished back panel: wood to match credenza • Pulls: paint or metal • Locks, keyed random: 9250 Ember Chrome • Two adjustable shelves behind each door • One hanging file folder frame per file drawer: black plastic • Cylinder feet: paint or metal 	<ol style="list-style-type: none"> 1 Style number 2 Wood veneer color number for credenza 3 Pulls (see below) 4 Paint or metal color number for feet 5 Options, if selected (see below) <p>▶ See <i>Surface Materials</i>, page J2.</p>

	Options	Price	Required to Specify
Surface Materials	<ul style="list-style-type: none"> • Customiz stain on wood 	+\$278	Specify with <i>Customiz stain</i> . ▶ See <i>Surface Materials Reference Manual</i> .
Pulls	<ul style="list-style-type: none"> • Tab pull • Deco pull • Jazz pull • Nile pull 	No cost +\$ 10 each +\$ 10 each +\$ 10 each	Specify with <i>tab pull</i> and select 0835 Black, 4799 Platinum, 9201 Polished Chrome, or 9211 Nickel. Specify with <i>deco pull</i> and select 0835 Black, 4799 Platinum, 9201 Polished Chrome, or 9211 Nickel. Specify with <i>jazz pull</i> and select 0835 Black, 4799 Platinum, 9201 Polished Chrome, or 9211 Nickel. Specify with <i>nile pull</i> and select 0835 Black, 4799 Platinum, 9201 Polished Chrome, or 9211 Nickel.
Foot Detail	<ul style="list-style-type: none"> • Square feet 	No cost	Specify with <i>square feet</i> and select 0835 Black, 4799 Platinum, 8042 Brushed Aluminum, or 8046 Polished Aluminum.
Lock and Keying	<p>Lock</p> <ul style="list-style-type: none"> • Polished Chrome <p>Keying</p> <ul style="list-style-type: none"> • Factory- and field-installed keying 	No cost	Specify with <i>9201 Polished Chrome lock</i> . ▶ Page J8
Translucent Doors	<p>Doors</p> <ul style="list-style-type: none"> • Non-locking translucent glass doors 	+\$150 per door	Add suffix G to style number.
Grommets	<ul style="list-style-type: none"> • Two 2½"-round worksurface grommets 	+\$100	Left/right: Specify with <i>CGRLR</i> and select 0835 Black, 9201 Polished Chrome, or 9211 Nickel.

Tip: Specify 4799 Platinum finish on pulls to match translucent door frame.

Specification Information

Dimensions			Style	Base
D	W	H	Number	Price

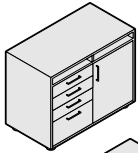

Buffet-Height Credenza with Left-Hand Drawers and Right-Hand Door

24"	45"	36"	CWDLC4536	\$2745
:	:	:	:	:

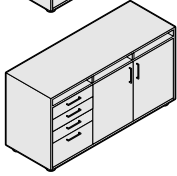

Buffet-Height Credenza with Left-Hand Drawers and Right-Hand Double Doors

24"	67"	36"	CWDLC6736	\$3887
:	:	:	:	:

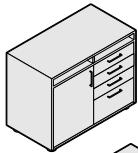

Buffet-Height Credenza with Right-Hand Drawers and Left-Hand Door

24"	45"	36"	CWDRC4536	\$2745
:	:	:	:	:

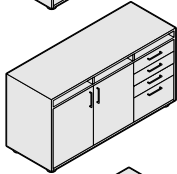

Buffet-Height Credenza with Right-Hand Drawers and Left-Hand Double Doors

24"	67"	36"	CWDRC6736	\$3887
:	:	:	:	:

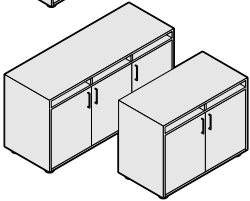

Buffet-Height Credenzas with All Doors

24"	45"	36"	CWDDC4536	\$2614
:	:	:	:	:

24"	67"	36"	CWDDC6736	\$3702
:	:	:	:	:

Contemporary-Style Media Carts

SIN 711.8



Standard Includes	Required to Specify
<ul style="list-style-type: none"> Media cart: wood Pulls: paint or metal Side handles: paint or metal to match pulls Locks, keyed random: 9250 Ember Chrome Wire management cavity and back panel fold-down door 2 1/2"-round grommet: paint or metal Locking casters, if selected: black plastic Cylinder feet, if selected: paint or metal 	<ol style="list-style-type: none"> Style number Wood veneer color number for media cart Pulls (see below) Paint or metal color number for grommet Paint or metal color number for feet, if selected Options, if selected (see below) <p>▶ See <i>Surface Materials</i>, page J2.</p>

Options	Price	Required to Specify
Surface Materials <ul style="list-style-type: none"> Customiz stain on wood 	+\$155	Specify <i>with Customiz stain</i> . ▶ See <i>Surface Materials Reference Manual</i> .
Pulls <ul style="list-style-type: none"> Tab pull Deco pull Jazz pull Nile pull 	No cost +\$ 10 each +\$ 10 each +\$ 10 each	Specify <i>with tab pull</i> and select 0835 Black, 4799 Platinum, 9201 Polished Chrome, or 9211 Nickel. Specify <i>with deco pull</i> and select 0835 Black, 4799 Platinum, 9201 Polished Chrome, or 9211 Nickel. Specify <i>with jazz pull</i> and select 0835 Black, 4799 Platinum, 9201 Polished Chrome, or 9211 Nickel. Specify <i>with nile pull</i> and select 0835 Black, 4799 Platinum, 9201 Polished Chrome, or 9211 Nickel.
Foot Detail <ul style="list-style-type: none"> Square feet 	No cost	Specify <i>with square feet</i> and select 0835 Black, 4799 Platinum, 8042 Brushed Aluminum, or 8046 Polished Aluminum.
Lock and Keying <ul style="list-style-type: none"> Lock <ul style="list-style-type: none"> Polished Chrome Keying <ul style="list-style-type: none"> Factory- and field-installed keying 	No cost	Specify <i>with 9201 Polished Chrome lock</i> . ▶ Page J8
Translucent Doors <ul style="list-style-type: none"> Non-locking translucent glass doors 	+\$150 per double doors	Add suffix G to style number.

Tip: Specify 4799 Platinum finish on pulls to match translucent door frame.

Specification Information

Dimensions			Style	Base
D	W	H	Number	Price

Media Carts with Casters

With Open Shelf, Drawer, Double Doors, and One Adjustable Shelf in the Cabinet

24"	32"	37"	CWDWCMED	\$2081
-----	-----	-----	-----------------	--------

With Open Shelf, Double Doors, and One Fixed Shelf and One Adjustable Shelf in the Cabinet

24"	32"	37"	CWOSCMED	\$1888
-----	-----	-----	-----------------	--------

Media Carts with Feet

With Open Shelf, Drawer, Double Doors, and One Adjustable Shelf in the Cabinet

24"	32"	37"	CWDWCMEDF	\$2281
-----	-----	-----	------------------	--------

with Open Shelf, Double Doors, and One Fixed Shelf and One Adjustable Shelf in the Cabinet

24"	32"	37"	CWOSCMEDF	\$2088
-----	-----	-----	------------------	--------

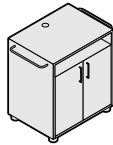

Contemporary-Style Hospitality Carts

SIN 711.8

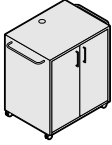

Standard Includes	Required to Specify
<ul style="list-style-type: none"> • Hospitality cart: wood • Pulls: paint or metal • Side handles: paint or metal to match pulls • Locks, keyed random: 9250 Ember Chrome • Non-skid pad for cart top • 2 1/2"-round grommet: paint or metal • Locking casters: black plastic 	<ol style="list-style-type: none"> 1 Style number 2 Wood veneer color number for hospitality cart 3 Pulls (see below) 4 Paint or metal color number for grommet 5 Options, if selected (see below) <p>▶ See <i>Surface Materials</i>, page J2.</p>

Options	Price	Required to Specify	
Surface Materials <ul style="list-style-type: none"> • Customiz stain on wood 	+\$155	Specify <i>with Customiz stain</i> . ▶ See <i>Surface Materials Reference Manual</i> .	
Pulls <ul style="list-style-type: none"> • Tab pull • Deco pull • Jazz pull • Nile pull 	No cost +\$ 10 each +\$ 10 each +\$ 10 each	Specify <i>with tab pull</i> and select 0835 Black, 4799 Platinum, 9201 Polished Chrome, or 9211 Nickel. Specify <i>with deco pull</i> and select 0835 Black, 4799 Platinum, 9201 Polished Chrome, or 9211 Nickel. Specify <i>with jazz pull</i> and select 0835 Black, 4799 Platinum, 9201 Polished Chrome, or 9211 Nickel. Specify <i>with nile pull</i> and select 0835 Black, 4799 Platinum, 9201 Polished Chrome, or 9211 Nickel.	
Lock and Keying <ul style="list-style-type: none"> • Polished Chrome 	No cost	Specify <i>with 9201 Polished Chrome lock</i> .	
		Keying <ul style="list-style-type: none"> • Factory- and field-installed keying 	▶ Page J8
Translucent Doors <ul style="list-style-type: none"> • Non-locking translucent glass doors 	+\$150 per double doors	Add suffix G to style number.	

Tip: Specify 4799 Platinum finish on pulls to match translucent door frame.

Specification Information

Dimensions			Style	Base
D	W	H	Number	Price

Hospitality Carts

With Double Doors and Two Fixed Shelves and One Adjustable Shelf in the Cabinet

24"	32"	37"	CWDDCHP	\$1982
-----	-----	-----	----------------	--------

With Pull-Out Shelf, Drawer, Double Doors, and One Adjustable Shelf in the Cabinet

24"	32"	37"	CWDWCHP	\$2081
-----	-----	-----	----------------	--------

With Pull-Out Shelf, Double Doors, and One Fixed Shelf and One Adjustable Shelf in the Cabinet

24"	32"	37"	CWOSCHP	\$1888
-----	-----	-----	----------------	--------

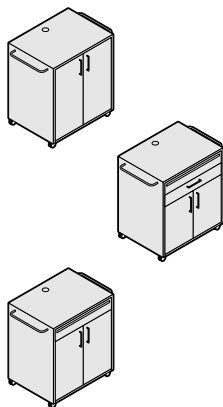

Contemporary-Style Lecterns

SIN 711.8

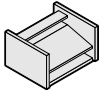

Standard Includes	Required to Specify
<ul style="list-style-type: none"> Lectern: wood Pulls on non-locking doors, if selected: paint or metal Task light on full-height lecterns Wire management channel Cylinder feet, if selected: paint or metal Locking casters, if selected: black plastic 	<ol style="list-style-type: none"> Style number Wood veneer color number for lectern Pulls (see below) Paint or metal color number for feet, if selected Options, if selected (see below) <p>▶ See <i>Surface Materials</i>, page J2.</p>

Options	Price	Required to Specify
Surface Materials <ul style="list-style-type: none"> Customiz stain on table top lectern Customiz stain on full-height lectern 	+\$ 80 +\$155	Specify <i>with Customiz stain</i> . ▶ See <i>Surface Materials Reference Manual</i> . Specify <i>with Customiz stain</i> . ▶ See <i>Surface Materials Reference Manual</i> .
Pulls <ul style="list-style-type: none"> Tab pull Deco pull Jazz pull Nile pull 	No cost +\$10 each +\$10 each +\$10 each	Specify <i>with tab pull</i> and select 0835 Black, 4799 Platinum, 9201 Polished Chrome, or 9211 Nickel. Specify <i>with deco pull</i> and select 0835 Black, 4799 Platinum, 9201 Polished Chrome, or 9211 Nickel. Specify <i>with jazz pull</i> and select 0835 Black, 4799 Platinum, 9201 Polished Chrome, or 9211 Nickel. Specify <i>with nile pull</i> and select 0835 Black, 4799 Platinum, 9201 Polished Chrome, or 9211 Nickel.
Foot Detail <ul style="list-style-type: none"> Square feet 	No cost	Specify <i>with square feet</i> and select 0835 Black, 4799 Platinum, 8042 Brushed Aluminum, or 9201 Polished Chrome.

Specification Information

Dimensions			Style	Base
D	W	H	Number	Price

Table Top Lectern

22"	25"	16½"	CWCLECT	\$1050
-----	-----	------	----------------	--------

Full-Height Lecterns

With Casters and Two Fixed and Two Adjustable Open Shelves

22"	25"	49½"	CWCLEC	\$1986
-----	-----	------	---------------	--------

With Casters, Non-Locking Door, and One Fixed and Two Adjustable Shelves in the Cabinet

22"	25"	49½"	CWCLECD	\$2286
-----	-----	------	----------------	--------

With Feet and Two Fixed and Two Adjustable Open Shelves

22"	25"	49½"	CWCLECF	\$2186
-----	-----	------	----------------	--------

With Feet, Non-Locking Door, and One Fixed and Two Adjustable Shelves in the Cabinet

22"	25"	49½"	CWCLECDF	\$2486
-----	-----	------	-----------------	--------

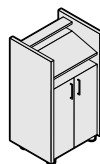
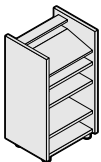
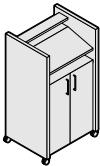
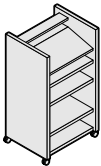
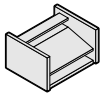

Contemporary-Style Wallboards

SIN 711.8

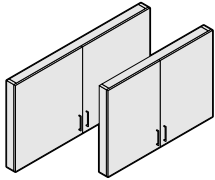

Tip: Interior writing surface accommodates magnets. Surface is also suitable for projection.

Standard Includes	Required to Specify
-------------------	---------------------

- Wallboard doors with full 180° hinges and pegs to hang flip-chart pads: wood
- Tackable surface on door interior: 2166 Forbo bulletin board
- Pulls: paint or metal
- Interior writing surface for dry-erase markers: white porcelain
- Installation hardware

- 1 Style number
 - 2 Wood veneer color number for wallboard
 - 3 Pulls (see below)
 - 4 Options, if selected (see below)
- ▶ See *Surface Materials*, page J2.

Options	Price	Required to Specify
---------	-------	---------------------

Surface Materials	• Customiz stain on wood	+\$ 84	Specify with <i>Customiz stain</i> . ▶ See <i>Surface Materials Reference Manual</i> .
Pulls	• Tab pull	No cost	Specify with <i>tab pull</i> and select 0835 Black, 4799 Platinum, 9201 Polished Chrome, or 9211 Nickel.
	• Deco pull	+\$ 10 each	Specify with <i>deco pull</i> and select 0835 Black, 4799 Platinum, 9201 Polished Chrome, or 9211 Nickel.
	• Jazz pull	+\$ 10 each	Specify with <i>jazz pull</i> and select 0835 Black, 4799 Platinum, 9201 Polished Chrome, or 9211 Nickel.
	• Nile pull	+\$ 10 each	Specify with <i>nile pull</i> and select 0835 Black, 4799 Platinum, 9201 Polished Chrome, or 9211 Nickel.
Marker Board Door Interiors	• Marker board surface on door interiors	+\$150	Specify with <i>marker board doors</i> .

Specification Information

• Dimensions			• Style	• Base
D	W	H	Number	Price
5"	56"	37"	CWAWLB56	\$2067
5"	70"	37"	CWAWLB70	\$2450

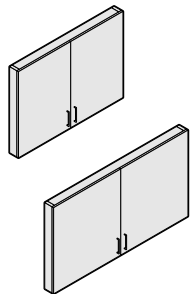

Transitional-Style Storage Credenzas

SIN 711.8

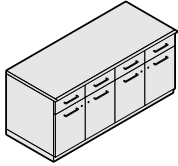

Standard Includes	Required to Specify
-------------------	---------------------

- Credenza: wood
- Finished back panel with wire access cutouts: wood to match credenza
- Pulls: paint or metal
- Locks, keyed random: 9250 Ember Chrome
- One adjustable shelf behind each door
- One hanging file folder frame per file drawer: black plastic

- 1 Style number with appropriate edge profile letter indicated in the space provided. (For example, CWDD_3229 becomes CWDDF3229 for flat edge profile)
 - ▶ See edge profiles below.
- 2 Wood veneer color number for credenza
- 3 Pulls (see below)
- 4 Options, if selected (see below)
 - ▶ See *Surface Materials*, page J2.

Edge Profiles

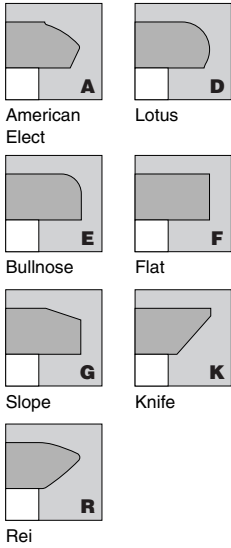

Options	Price	Required to Specify
---------	-------	---------------------

Surface Materials	• Customiz stain on wood	+\$278	Specify <i>with Customiz stain</i> . ▶ See <i>Surface Materials Reference Manual</i> . Specify full-fill finish color number for credenza top.
	• Full-fill finish on credenza top	No cost	
Pulls	• Tab pull	No cost	Specify <i>with tab pull</i> and select 0835 Black, 4799 Platinum, 9201 Polished Chrome, or 9211 Nickel. Specify <i>with deco pull</i> and select 0835 Black, 4799 Platinum, 9201 Polished Chrome, or 9211 Nickel. Specify <i>with jazz pull</i> and select 0835 Black, 4799 Platinum, 9201 Polished Chrome, or 9211 Nickel. Specify <i>with nile pull</i> and select 0835 Black, 4799 Platinum, 9201 Polished Chrome, or 9211 Nickel.
	• Deco pull	+\$ 10 each	
	• Jazz pull	+\$ 10 each	
	• Nile pull	+\$ 10 each	
Lock and Keying	Lock		Specify <i>with 9201 Polished Chrome lock</i> . ▶ Page J8
	• Polished Chrome	No cost	
	Keying		
	• Factory- and field-installed keying		
Grommets	• One 2½"-round worksurface grommet available on 32"W credenzas	+\$ 50	Center: Specify <i>with CGRC</i> and select 0835 Black, 9201 Polished Chrome, or 9211 Nickel. Left/right: Specify <i>with CGRLR</i> and select 0835 Black, 9201 Polished Chrome, or 9211 Nickel. Left/center/right: Specify <i>with CGRLCR</i> select 0835 Black, 9201 Polished Chrome, or 9211 Nickel.
	• Two 2½"-round worksurface grommets available on 64"W and 80"W credenzas	+\$100	
	• Three 2½"-round worksurface grommets available on 80"W credenzas	+\$150	

Tip: Your specification is not complete until you add a fifth letter to the style number to define the edge profile.

Specification Information

Dimensions			Style	Base
D	W	H	Number	Price

Credenzas with All Doors

25"	32"	29½"	CWDD_3229	\$1709
25"	64"	29½"	CWDD_6429	\$3222
25"	80"	29½"	CWDD_8029	\$3625

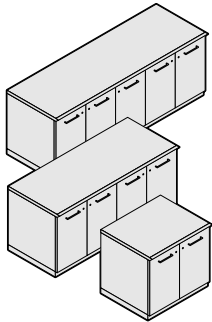

Credenzas with Box Drawers and Doors

25"	32"	29½"	CWBD_3229	\$1880
25"	64"	29½"	CWBD_6429	\$3545
25"	80"	29½"	CWBD_8029	\$3987

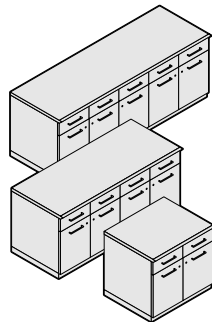

Credenzas with Lateral File Drawers

25"	32"	29½"	CWLF_3229	\$1880
25"	64"	29½"	CWLL_6429	\$3545

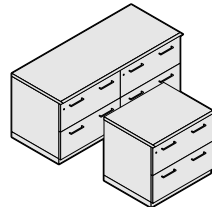

Credenzas with Lateral File Drawers and Doors

25"	64"	29½"	CWLD_6429	\$3545
25"	80"	29½"	CWLD_8029	\$3987

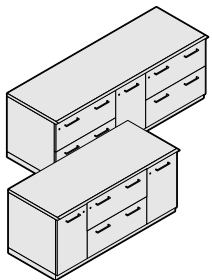

Transitional-Style Buffet-Height Credenzas

SIN 711.8

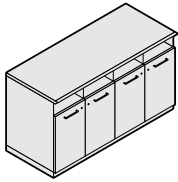

Standard Includes	Required to Specify
<ul style="list-style-type: none"> • Buffet-height credenza: wood • Finished back panel with wire access cutouts: wood to match credenza • Pulls: paint or metal • Locks, keyed random: 9250 Ember Chrome • Two adjustable shelves behind each door • One hanging file folder frame per file drawer: black plastic 	<p>1 Style number with appropriate edge profile letter indicated in the space provided. (For example, CWOD_3236 becomes CWODF3236 for flat edge profile)</p> <p>▶ See edge profiles below.</p> <p>2 Wood veneer color number for credenza</p> <p>3 Pulls (see below)</p> <p>4 Options, if selected (see below)</p> <p>▶ See <i>Surface Materials</i>, page J2.</p>

Edge Profiles

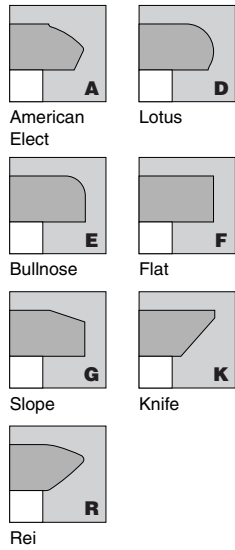

Options	Price	Required to Specify
<p>Surface Materials</p> <ul style="list-style-type: none"> • Customiz stain on wood +\$278 • Full-fill finish on credenza top No cost 		<p>Specify <i>with Customiz stain</i>.</p> <p>▶ See <i>Surface Materials Reference Manual</i>. Specify full-fill finish color number for credenza top.</p>
<p>Pulls</p> <ul style="list-style-type: none"> • Tab pull No cost • Deco pull +\$ 10 each • Jazz pull +\$ 10 each • Nile pull +\$ 10 each 		<p>Specify <i>with tab pull</i> and select 0835 Black, 4799 Platinum, 9201 Polished Chrome, or 9211 Nickel.</p> <p>Specify <i>with deco pull</i> and select 0835 Black, 4799 Platinum, 9201 Polished Chrome, or 9211 Nickel.</p> <p>Specify <i>with jazz pull</i> and select 0835 Black, 4799 Platinum, 9201 Polished Chrome, or 9211 Nickel.</p> <p>Specify <i>with nile pull</i> and select 0835 Black, 4799 Platinum, 9201 Polished Chrome, or 9211 Nickel.</p>
<p>Lock and Keying</p> <ul style="list-style-type: none"> • Polished Chrome No cost <p>Keying</p> <ul style="list-style-type: none"> • Factory- and field-installed keying 		<p>Specify <i>with 9201 Polished Chrome lock</i>.</p> <p>▶ Page J8</p>
<p>Grommets</p> <ul style="list-style-type: none"> • One 2½"-round worksurface grommet available on 32"W credenzas +\$ 50 • Two 2½"-round worksurface grommets available on 64"W and 80"W credenzas +\$100 • Three 2½"-round worksurface grommets available on 80"W credenzas +\$150 		<p>Center: Specify <i>with CGRC</i> and select 0835 Black, 9201 Polished Chrome, or 9211 Nickel.</p> <p>Left/right: Specify <i>with CGRLR</i> and select 0835 Black, 9201 Polished Chrome, or 9211 Nickel.</p> <p>Left/center/right: Specify <i>with CGRLCR</i> and select 0835 Black, 9201 Polished Chrome, or 9211 Nickel.</p>

Tip: Your specification is not complete until you add a fifth letter to the style number to define the edge profile.

Specification Information

Dimensions			Style	Base
D	W	H	Number	Price

Buffet-Height Credenzas with Open Shelves and Doors

25"	32"	36"	CWOD_3236	\$1966
25"	64"	36"	CWOD_6436	\$3365
25"	80"	36"	CWOD_8036	\$3786

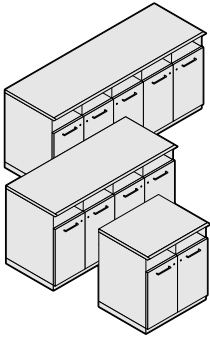

Buffet-Height Credenzas with Box Drawers and Doors

25"	32"	36"	CWBD_3236	\$2162
25"	64"	36"	CWBD_6436	\$3702
25"	80"	36"	CWBD_8036	\$4164

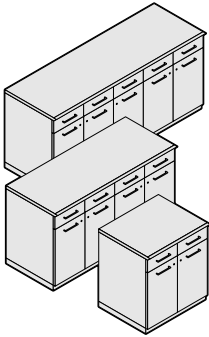

Transitional-Style Media Carts

SIN 711.8



Standard Includes	Required to Specify
-------------------	---------------------

- Media cart: wood
- Pulls: paint or metal
- Side handles: paint or metal to match pulls
- Locks, keyed random: 9250 Ember Chrome
- Wire management cavity and back panel fold-down door
- 2½"-round grommet: paint or metal
- Locking casters: black plastic

- 1 Style number with appropriate edge profile letter indicated in the space provided. (For example, CWDD_MED becomes CWDDFMED for flat edge profile)
 - ▶ See edge profiles below.
- 2 Wood veneer color number for media cart
- 3 Pulls (see below)
- 4 Paint or metal color number for grommet
- 5 Options, if selected (see below)
 - ▶ See *Surface Materials*, page J2.

Edge Profiles

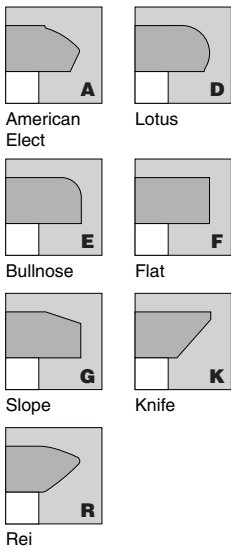

Tip: Your specification is not complete until you add a fifth letter to the style number to define the edge profile.

Options	Price	Required to Specify
---------	-------	---------------------

Surface Materials	• Customiz stain on wood	+\$155	Specify <i>with Customiz stain</i> . ▶ See <i>Surface Materials Reference Manual</i> . Specify full-fill finish color number for top.
	• Full-fill finish on top	No cost	
Pulls	• Tab pull	No cost	Specify <i>with tab pull</i> and select 0835 Black, 4799 Platinum, 9201 Polished Chrome, or 9211 Nickel. Specify <i>with deco pull</i> and select 0835 Black, 4799 Platinum, 9201 Polished Chrome, or 9211 Nickel. Specify <i>with jazz pull</i> and select 0835 Black, 4799 Platinum, 9201 Polished Chrome, or 9211 Nickel. Specify <i>with nile pull</i> and select 0835 Black, 4799 Platinum, 9201 Polished Chrome, or 9211 Nickel.
	• Deco pull	+\$10 each	
	• Jazz pull	+\$10 each	
	• Nile pull	+\$10 each	
Lock and Keying	Lock		Specify <i>with 9201 Polished Chrome lock</i> . ▶ Page J8
	• Polished Chrome	No cost	
	Keying		
	• Factory- and field-installed keying		

Specification Information

• Dimensions			• Style	• Base
D	W	H	Number	Price

Media Carts

With Double Doors and Two Fixed Shelves and One Adjustable Shelf in the Cabinet

25"	32½"	37"	CWDD_MED	\$1982
-----	------	-----	-----------------	--------

With Open Shelf, Drawer, Double Doors, and One Adjustable Shelf in the Cabinet

25"	32½"	37"	CWDW_MED	\$2081
-----	------	-----	-----------------	--------

With Open Shelf, Double Doors, and One Fixed Shelf and One Adjustable Shelf in the Cabinet

25"	32½"	37"	CWOS_MED	\$1888
-----	------	-----	-----------------	--------

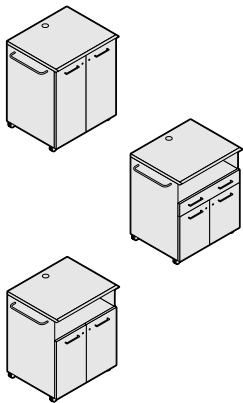

Transitional-Style Hospitality Carts

SIN 711.8

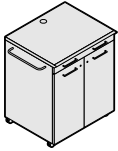

Standard Includes	Required to Specify
-------------------	---------------------

- Hospitality cart: wood
- Pulls: paint or metal
- Side handles: paint or metal to match pulls
- Locks, keyed random: 9250 Ember Chrome
- Non-skid pad for cart top
- 2 1/2" round grommet: paint or metal
- Locking casters: black plastic

- 1 Style number with appropriate edge profile letter indicated in the space provided. (For example, CWDD_HP becomes CWDDFHP for flat edge profile)
- ▶ See edge profiles below
- 2 Wood veneer color number for hospitality cart
- 3 Pulls (see below)
- 4 Paint or metal color number for grommet
- 5 Options, if selected (see below)
- ▶ See *Surface Materials*, page J2.

Edge Profiles

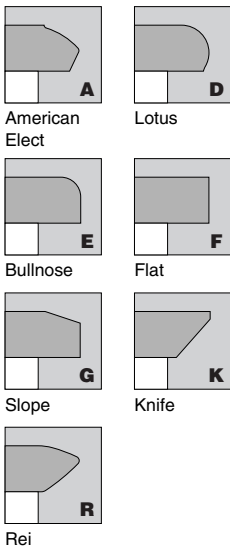

Tip: Your specification is not complete until you add a fifth letter to the style number to define the edge profile.

Options	Price	Required to Specify
---------	-------	---------------------

Surface Materials	• Customiz stain on wood	+\$155	Specify with <i>Customiz stain</i> .
	• Full-fill finish on top	No cost	▶ See <i>Surface Materials Reference Manual</i> . Specify full-fill finish color number for top.
Pulls	• Tab pull	No cost	Specify with <i>tab pull</i> and select 0835 Black, 4799 Platinum, 9201 Polished Chrome, or 9211 Nickel.
	• Deco pull	+\$10 each	Specify with <i>deco pull</i> and select 0835 Black, 4799 Platinum, 9201 Polished Chrome, or 9211 Nickel.
	• Jazz pull	+\$10 each	Specify with <i>jazz pull</i> and select 0835 Black, 4799 Platinum, 9201 Polished Chrome, or 9211 Nickel.
	• Nile pull	+\$10 each	Specify with <i>nile pull</i> and select 0835 Black, 4799 Platinum, 9201 Polished Chrome, or 9211 Nickel.
Lock and Keying	Lock		
	• Polished Chrome	No cost	Specify with <i>9201 Polished Chrome lock</i> .
	Keying		
	• Factory- and field-installed keying		▶ Page J8

Specification Information

Dimensions			Style	Base
D	W	H	Number	Price

Hospitality Carts

With Pull-Out Shelf, Drawer, Double Doors, and One Adjustable Shelf in the Cabinet

25"	32"	37"	CWDW_HP	\$2081
-----	-----	-----	----------------	--------

With Pull-Out Shelf, Open Shelf, Double Doors, and One Adjustable Shelf in the Cabinet

25"	32"	37"	CWOS_HP	\$1888
-----	-----	-----	----------------	--------

With Pull-Out Shelf, Double Doors, and One Fixed Shelf and One Adjustable Shelf in the Cabinet

25"	32"	37"	CWDD_HP	\$1982
-----	-----	-----	----------------	--------

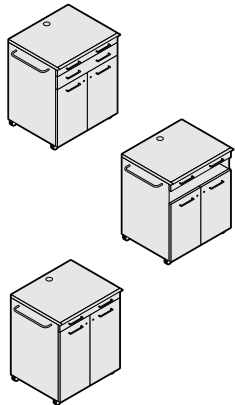

Transitional-Style Lecterns

SIN 711.8

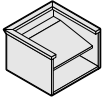

Standard Includes	Required to Specify
-------------------	---------------------

- Lectern: wood
- Pulls on non-locking door, if selected: paint or metal
- Task light on full-height lecterns
- Wire management channel
- Locking casters on full-height lecterns: black plastic

- 1 Style number with appropriate edge profile letter indicated in the space provided. (For example, CW_LECT becomes CWFLECT for flat edge profile)
 - ▶ See edge profiles below.
- 2 Wood veneer color number for lectern
- 3 Pulls (see below)
- 4 Options, if selected (see below)
 - ▶ See *Surface Materials*, page J2.

Edge Profiles

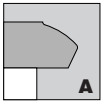

American Elect

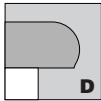

Lotus

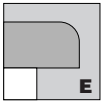

Bullnose

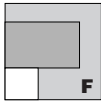

Flat

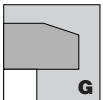

Slope

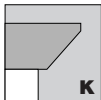

Knife

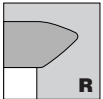

Rei

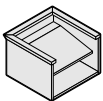

Options	Price	Required to Specify
---------	-------	---------------------

Surface Materials	• Customiz stain on table top lectern	+\$ 80	Specify with <i>Customiz stain</i> . ▶ See <i>Surface Materials Reference Manual</i> . Specify with <i>Customiz stain</i> . ▶ See <i>Surface Materials Reference Manual</i> .
	• Customiz stain on full-height lectern	+\$155	

Pulls	• Tab pull	No cost	Specify with <i>tab pull</i> and select 0835 Black, 4799 Platinum, 9201 Polished Chrome, or 9211 Nickel. Specify with <i>deco pull</i> and select 0835 Black, 4799 Platinum, 9201 Polished Chrome, or 9211 Nickel. Specify with <i>jazz pull</i> and select 0835 Black, 4799 Platinum, 9201 Polished Chrome, or 9211 Nickel. Specify with <i>nile pull</i> and select 0835 Black, 4799 Platinum, 9201 Polished Chrome, or 9211 Nickel.
	• Deco pull	+\$10 each	
	• Jazz pull	+\$10 each	
	• Nile pull	+\$10 each	

Specification Information

• Dimensions			• Style	• Base
D	W	H	Number	Price

Table Top Lectern

23½"	27½"	17"	CW_LECT	\$1050
------	------	-----	----------------	--------

Full-Height Lecterns

With Two Fixed and Two Adjustable Open Shelves

23½"	27½"	48"	CW_LEC	\$1986
------	------	-----	---------------	--------

With Non-Locking Door and One Fixed and Two Adjustable Shelves in the Cabinet

23½"	27½"	48"	CW_LECD	\$2286
------	------	-----	----------------	--------

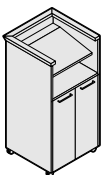
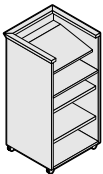

Tip: Your specification is not complete until you add a fifth letter to the style number to define the edge profile.

Transitional-Style Wallboards

SIN 711.8

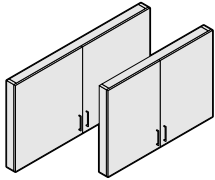

Tip: Interior writing surface accommodates magnets. Surface is also suitable for projection.

Standard Includes	Required to Specify
-------------------	---------------------

- Wallboard doors with full 180° hinges and pegs to hang flip-chart pads: wood
- Tackable surface on door interior: 2166 Forbo bulletin board
- Pulls: paint or metal
- Interior writing surface for dry-erase markers: white porcelain
- Installation hardware

- 1 Style number
 - 2 Wood veneer color number for wallboard
 - 3 Pulls (see below)
 - 4 Options, if selected (see below)
- ▶ See *Surface Materials*, page J2.

Options	Price	Required to Specify
---------	-------	---------------------

Surface Materials	• Customiz stain on wood	+\$ 84	Specify with <i>Customiz stain</i> . ▶ See <i>Surface Materials Reference Manual</i> .
Pulls	• Tab pull	No cost	Specify with <i>tab pull</i> and select 0835 Black, 4799 Platinum, 9201 Polished Chrome, or 9211 Nickel.
	• Deco pull	+\$ 10 each	Specify with <i>deco pull</i> and select 0835 Black, 4799 Platinum, 9201 Polished Chrome, or 9211 Nickel.
	• Jazz pull	+\$ 10 each	Specify with <i>jazz pull</i> and select 0835 Black, 4799 Platinum, 9201 Polished Chrome, or 9211 Nickel.
	• Nile pull	+\$ 10 each	Specify with <i>nile pull</i> and select 0835 Black, 4799 Platinum, 9201 Polished Chrome, or 9211 Nickel.
Marker Board Door Interiors	• Marker board surface on door interiors	+\$150	Specify with <i>marker board doors</i> .

Specification Information

• Dimensions			• Style	• Base
D	W	H	Number	Price
5"	56"	37"	CWAWLB56	\$2067
5"	70"	37"	CWAWLB70	\$2450

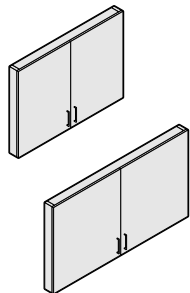

Relevant

► For more detailed product information, see the *Relevant Systems Furniture Specification Guide* or consult your Steelcase dealer.



Statement of Line

G2



Specifying

Shells (SIN 711.2)	G19
Worksurfaces (SIN 711.2)	G61
Tables (SIN 711.2)	G95
Hatchbacks and Media Carts (SIN 711.2)	G107
Borders (SIN 711.1)	G117
Storage (SIN 711.2)	G121
Wiring and Cabling (SIN 711.2)	G177

Surface Materials

G197

Resources

G203

Relevant

Statement of Line

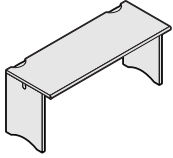

Specifying
▶ Pages G20–G31

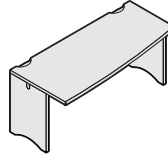

Specifying
▶ Pages G32–G37

Rectangular Shells

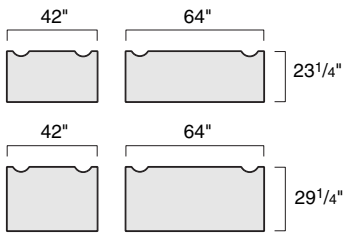

Bowed Transition Shells*

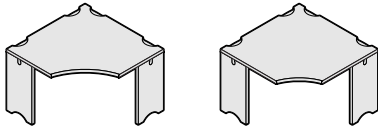
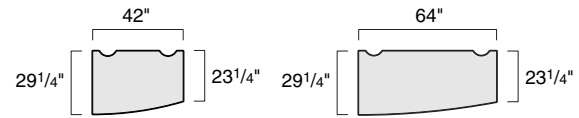

Specifying
▶ Pages G38–G43

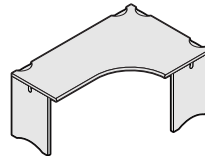

Specifying
▶ Pages G44–G49

Corner Shells

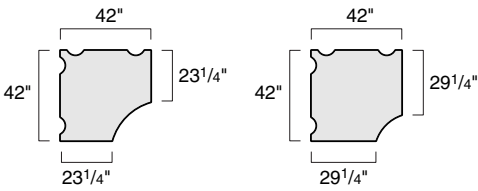

Extended Corner Shells

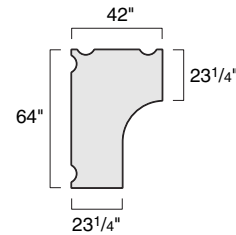

* Drawings show left-hand units. Right-hand units are also available.

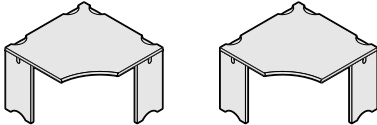

Specifying
▶ Pages G50–G55

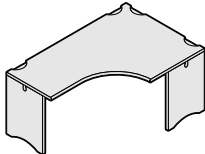

Specifying
▶ Pages G56–G60

Transitional Corner Shells

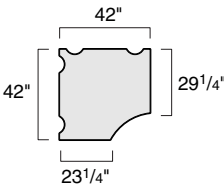

Transitional Extended Corner Shells

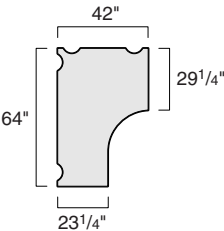

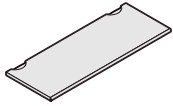

Specifying
▶ Pages G62–G63

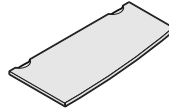

Specifying
▶ Pages G64–G65

Rectangular Worksurfaces

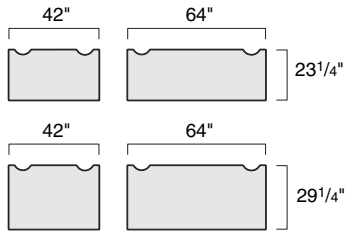

Bowed Transition Worksurfaces*

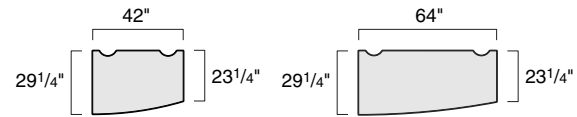

* Drawings show left-hand units. Right-hand units are also available.



Specifying
▶ Pages G66–G67

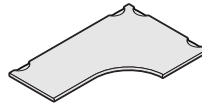

Specifying
▶ Pages G68–G69

Corner Worksurfaces*

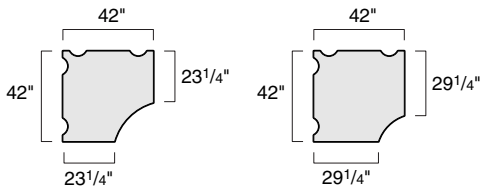

Extended Corner Worksurfaces*

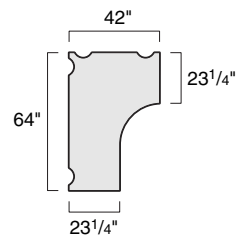

Specifying
▶ Pages G70–G71

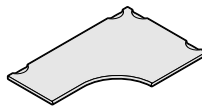

Specifying
▶ Pages G72–G73

Transitional Corner Worksurfaces*

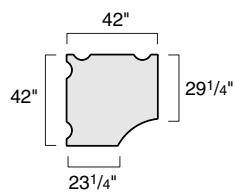

Transitional Extended Corner Worksurfaces*

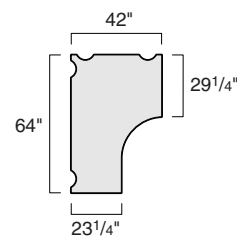

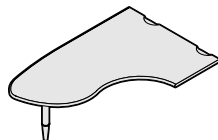

Specifying
▶ Page G74

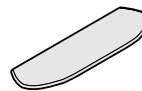

Specifying
▶ Page G76

Pier-Top Worksurfaces*

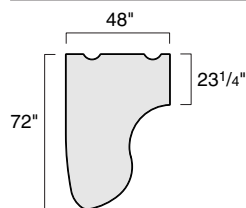

Spanner Tops



Specifying
▶ Pages G77–G78

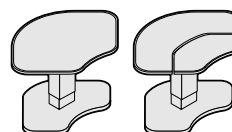

Specifying
▶ Pages G79–G80

Breadboard-Top Worksurfaces*

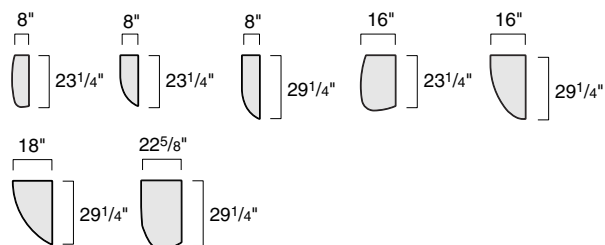

Adjustable-Height Corner Worksurfaces

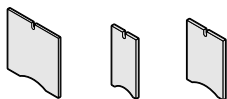
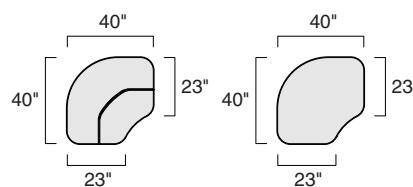

Specifying
▶ Pages G81–G84

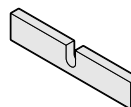

Specifying
▶ Page G85

Full- and Half-Depth End Panels

	13 1/2"D	19 1/4"D	23 1/4"D
27 1/8"H	●	●	●
39 5/8"H	●	●	●

Note: 27 1/8"H end panels are for use in seated-height applications.
39 5/8"H end panels are for use in standing-height applications.

Slip-Fit End Panels

	19 1/4"D	25 1/4"D
4"H	●	●



Specifying
▶ Page G86

Corner End Panels

	17½"D
27⅛"H	●
39⅝"H	●

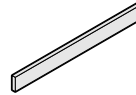

Specifying
▶ Pages G87–G89

Back Rails

	42"L	64"L
4"H	●	●
16"H	●	●

Note: 4"H back rails are for use with seated-height (27⅛"H) end panels only. 16"H back rails are for use with standing-height (39⅝"H) end panels only.

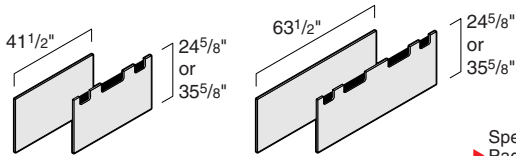

Specifying
▶ Pages G90–G93

Modesty Panels

	42"W	64"W
24⅝"H	●	●
35⅝"H	●	●



Specifying
▶ Page G96



Specifying
▶ Page G97

Shield-Top Tables

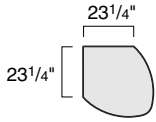

Lemon-Top Tables

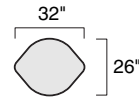

Specifying
▶ Page G98

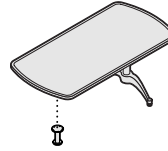

Specifying
▶ Page G99

Teaming Tables

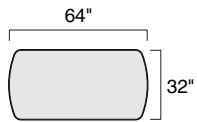

Teaming Tables with Hitch

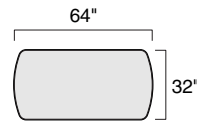

Specifying
▶ Page G100

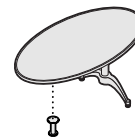

Specifying
▶ Page G101

Runaround Tables

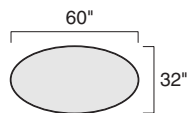

Runaround Tables with Hitch

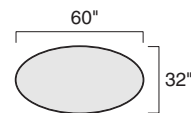

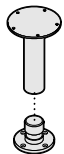

Specifying
▶ Page G102



Specifying
▶ Page G103

Table Hitch

Idea Island Tables

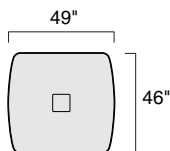

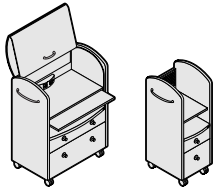

Specifying
▶ Pages G108–G111



Specifying
▶ Pages G112–G115

Hatchbacks

	16"W	31 ⁷ / ₈ "W
21 ¹ / ₄ "D	●	●

Media Carts

	31 ⁷ / ₈ "W
21 ¹ / ₄ "D	●

Relevant Statement of Line, continued

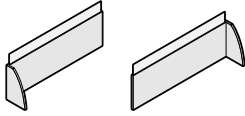

Specifying
▶ Pages G118–G119

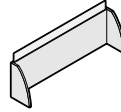

Specifying
▶ Page G120

Personal Borders with One Border End Panel

	28½"W	50½"W
20½"H	●	●

Personal Borders with Two Border End Panels

	42"W	64"W
20½"H	●	●

Relevant Statement of Line, continued

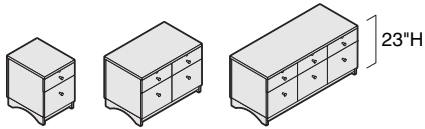

Specifying
▶ Pages G122, G126

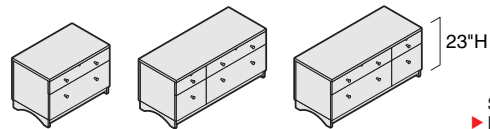

Specifying
▶ Pages G124, G130

Low-Boy Pedestals

	16"W	31 ⁷ / ₈ "W	47 ¹³ / ₁₆ "W
20 ¹ / ₁₆ "D	●	●	●
26 ¹ / ₁₆ "D	●	●	●

Low-Boy Lateral Files

	31 ⁷ / ₈ "W	47 ¹³ / ₁₆ "W
20 ¹ / ₁₆ "D	●	●
26 ¹ / ₁₆ "D	●	●

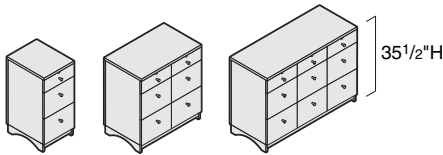

Specifying
▶ Pages G122, G128

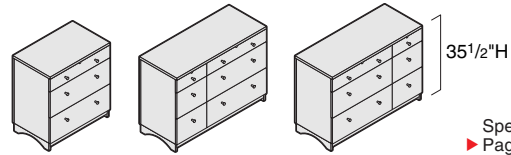

Specifying
▶ Pages G124, G132

Mid-Boy Pedestals

	16"W	31 ⁷ / ₈ "W	47 ¹³ / ₁₆ "W
20 ¹ / ₁₆ "D	●	●	●
26 ¹ / ₁₆ "D	●	●	●

Mid-Boy Lateral Files

	31 ⁷ / ₈ "W	47 ¹³ / ₁₆ "W
20 ¹ / ₁₆ "D	●	●
26 ¹ / ₁₆ "D	●	●

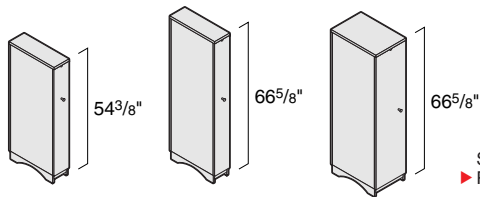

Specifying
▶ Pages G134–G141

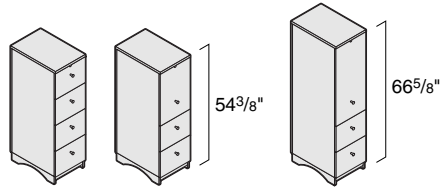

Specifying
▶ Pages G142–G149

Wardrobes

	8"W	16"W
24 ¹ / ₈ "D	●	●

Tall-Boy Cabinets

	16"W
24 ¹ / ₈ "D	●

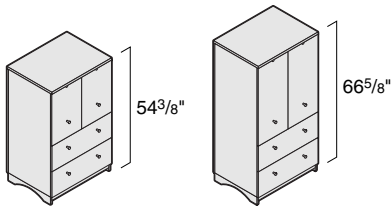

Specifying
▶ Pages G150–G153

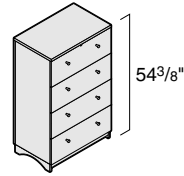

Specifying
▶ Pages G154–G157

Vertical Cabinets

32"W
24 1/8"D ●

Four-High Lateral Files

32"W
24 1/8"D ●

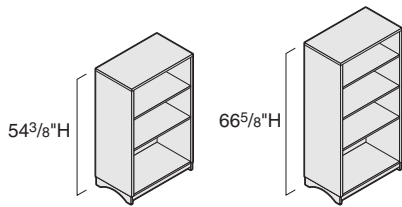

Specifying
▶ Pages G158–G159

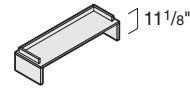

Specifying
▶ Page G160

Bookcases

32"W 19"D
54 3/8"H ● ●
66 5/8"H ● ●

Amenity Shelves

42"W 64"W
13 1/2"D ● ●

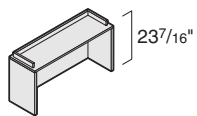

Specifying
▶ Page G161

Open Hutches

42"W 64"W
13 1/2"D ● ●

Relevant Statement of Line, continued

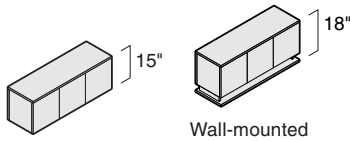

Specifying
▶ Pages G162–G165



Specifying
▶ Page G166

Overhead Binder Bins

	42"W	64"W
13½"D	●	●

Tackboards for Use Inside Hutches

	39½"W	61½"W
17"H	●	●



Specifying
▶ Page G167

Tackboards for Use on Sides of Wardrobes, Tall-Boy Cabinets, Vertical Cabinets, Four-High Lateral Files, and Bookcases

	22½"W
50½"H	●
62½"H	●



Specifying
▶ Page G168

Tackboards for Use on Back of Hutches

	41½"W	63½"W
21"H	●	●



Specifying
▶ Page G169

Tackboards for Use with Personal Borders

	27"W	40½"W	49"W	62½"W
12"H	●	●	●	●



Specifying
▶ Page G170

Tackboards for Use on Back of Wardrobes, Tall-Boy Cabinets, Vertical Cabinets, Four-High Lateral Files, and Bookcases

	7½"W	15½"W	23¼"W	31¼"W	39¼"W
50½"H	●	●	●	●	●
62½"H	●	●	●	●	●

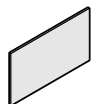

Specifying
▶ Page G171

Tackboards for Use on Back of Seated-Height Shells

	41½"W	63½"W
24½"H	●	●

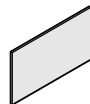

Specifying
▶ Page G172

Tackboards for Use on Back of Amenity Shelf or Hutches with Overhead Binder Bin

	41½"W	63½"W
25¾"H	●	●
38"H	●	●



Specifying
▶ Page G173

Markerboards for Use on Sides of Wardrobes, Tall-Boy Cabinets, Vertical Cabinets, Four-High Lateral Files, and Bookcases

	22½"W
50½"H	●
62½"H	●



Specifying
▶ Page G175

Markerboards for Use on Back of Hutches

	41½"W	63½"W
21"H	●	●



Specifying
▶ Page G174

Markerboards for Use on Back of Wardrobes, Tall-Boy Cabinets, Vertical Cabinets, Four-High Lateral Files, and Bookcases

	15½"W	23¼"W	31¼"W	39¼"W
50½"H	●	●	●	●
62½"H	●	●	●	●

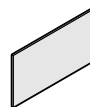

Specifying
▶ Page G175

Markerboards for Use on Back of Amenity Shelf or Hutches with Overhead Binder Bin

	41½"W	63½"W
25¾"H	●	●
38"H	●	●

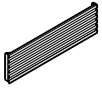

Specifying
▶ Page G176

Slatwall Panels for Use Inside Hutches

	39½"W	61½"W
12"H	•	•

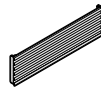

Specifying
▶ Page G176

Slatwall Panels for Use with Personal Borders

	27"W	40½"W	49"W	62½"W
12"H	•	•	•	•

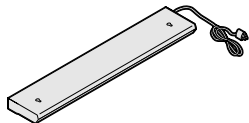

Task lights
Specifying
▶ Page G178

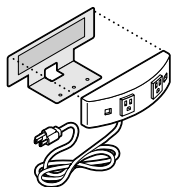

Power communication box
Specifying
▶ Page G179

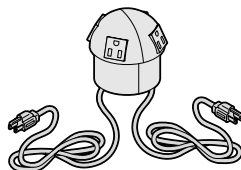

Power spheres
Specifying
▶ Page G181

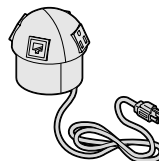

Power and communication spheres
Specifying
▶ Page G181



Communication spheres
Specifying
▶ Page G182

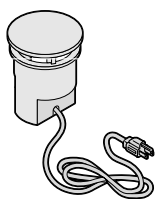

Round power and communication port
Specifying
▶ Page G182

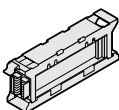

Power modules
Specifying
▶ Page G183

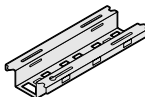

Mounting bracket
Specifying
▶ Page G184

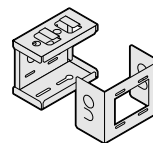

Communication module
Specifying
▶ Page G184

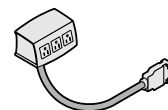

Convenience tri-receptacles with modular harness
Specifying
▶ Page G185

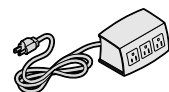

Convenience tri-receptacles with power cord and plug
Specifying
▶ Page G186



Convenience communication outlet housing
Specifying
▶ Page G186

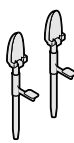

Above-worksurface clamp kit
Specifying
▶ Page G187

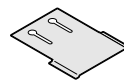

Below-worksurface mounting bracket
Specifying
▶ Page G187

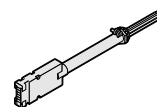

Floor power infeed
Specifying
▶ Page G188

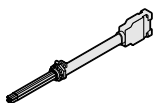

Multipurpose power infeeds
Specifying
▶ Page G189

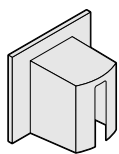

Modular infeed cover
Specifying
▶ Page G189

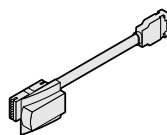

Beltway power outfeed
Specifying
▶ Page G190

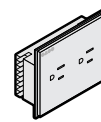

Receptacles
Specifying
▶ Page G191

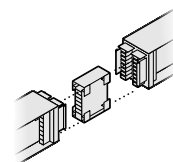

Block-to-block connector
Specifying
▶ Page G192

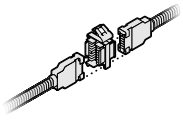

Harness-to-harness connector
Specifying
▶Page G192

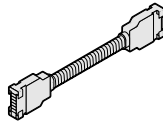

Modular harnesses
Specifying
▶Page G194

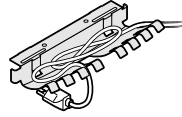

Cord and cable manager
Specifying
▶Page G196

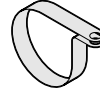

Harness clips
Specifying
▶Page G196

Specifying Relevant Shells

► For more detailed product information, see the *Relevant Systems Furniture Specification Guide* or consult your Steelcase dealer.



Shells

Rectangular Shells (SIN 711.2)	G20
Bowed Transition Shells (SIN 711.2)	G32
Corner Shells (SIN 711.2)	G38
Extended Corner Shells (SIN 711.2)	G44
Transitional Corner Shells (SIN 711.2)	G50
Transitional Extended Corner Shells (SIN 711.2)	G56

24"D Rectangular Shells

with Wood Veneer Worksurface, End Panels, and Back Rail

SIN 711.2

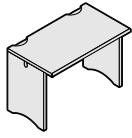

Tip: Additional shell configurations are possible by building them from components.

Tip: If shell with modesty panel in place of back rail is required, specify modesty panel separately.

Standard Includes		Required to Specify
<ul style="list-style-type: none"> • Worksurface: wood veneer • Bullnose edge profile on user's side: wood • Scallop grommets with cable-management insert: black only • Two full-depth end panels: wood veneer • Back rail: wood veneer • Wire manager: black plastic only • Grommets in end panels: black plastic only • Leveling glides: black only • Attachment hardware 		<ul style="list-style-type: none"> 1 Style number 2 Wood color number for shell 3 Options, if selected (see below) ▶ See <i>Surface Materials</i>, page G198.
Options	Price	Required to Specify
End Panels <ul style="list-style-type: none"> Shell with two full-depth end panels (24") Shell with two slip-fit end panels (24") Shell with two half-depth end panels (24") Shell with one full-depth (24") and one half-depth (24") end panel Shell with one full-depth (24") and one slip-fit (24") end panel Shell with one half-depth (24") and one slip-fit (24") end panel 	<ul style="list-style-type: none"> No cost -\$134 -\$ 74 -\$ 37 -\$ 67 -\$104 	<ul style="list-style-type: none"> Specify <i>Config 1</i>. Specify <i>Config 2</i>. Specify <i>Config 3</i>. Specify <i>Config 4</i>. Specify <i>Config 5</i>. Specify <i>Config 6</i>.
Surface Materials	Full-fill finish on 42"W shell worksurface only: <ul style="list-style-type: none"> • Full-fill finish +\$ 41 	<ul style="list-style-type: none"> Specify with <i>full-fill finish</i> and select wood color number. ▶ See <i>Surface Materials</i>, page G198.
	Full-fill finish on 64"W shell worksurface only: <ul style="list-style-type: none"> • Full-fill finish +\$ 60 	<ul style="list-style-type: none"> Specify with <i>full-fill finish</i> and select wood color number. ▶ See <i>Surface Materials</i>, page G198.
	Customiz stain on 42"W shell with: <ul style="list-style-type: none"> • Two full-depth end panels (24") +\$147 • Two slip-fit end panels (24") +\$147 • Two half-depth end panels (24") +\$147 • One full-depth end panel and one half-depth end panel (24") +\$147 • One full-depth end panel and one slip-fit end panel (24") +\$147 • One half-depth end panel and one slip-fit end panel (24") +\$147 	<ul style="list-style-type: none"> Specify <i>Config 1</i>. Specify with <i>Customiz stain</i>. Specify <i>Config 2</i>. Specify with <i>Customiz stain</i>. Specify <i>Config 3</i>. Specify with <i>Customiz stain</i>. Specify <i>Config 4</i>. Specify with <i>Customiz stain</i>. Specify <i>Config 5</i>. Specify with <i>Customiz stain</i>. Specify <i>Config 6</i>. Specify with <i>Customiz stain</i>.
	Customiz stain on 64"W shell with: <ul style="list-style-type: none"> • Two full-depth end panels (24") +\$166 • Two slip-fit end panels (24") +\$166 • Two half-depth end panels (24") +\$166 • One full-depth end panel and one half-depth end panel (24") +\$166 • One full-depth end panel and one slip-fit end panel (24") +\$166 • One half-depth end panel and one slip-fit end panel (24") +\$166 	<ul style="list-style-type: none"> Specify <i>Config 1</i>. Specify with <i>Customiz stain</i>. Specify <i>Config 2</i>. Specify with <i>Customiz stain</i>. Specify <i>Config 3</i>. Specify with <i>Customiz stain</i>. Specify <i>Config 4</i>. Specify with <i>Customiz stain</i>. Specify <i>Config 5</i>. Specify with <i>Customiz stain</i>. Specify <i>Config 6</i>. Specify with <i>Customiz stain</i>.
Related Products	<ul style="list-style-type: none"> • Breadboard-top worksurfaces • Modesty panels • Center drawer • Keyboard shelf • Cable manager 	<ul style="list-style-type: none"> ▶ Page G77 ▶ Page G90 ▶ Page G94 ▶ Page G94 ▶ Page G180

Specification Information

• Dimensions			• Style	• Base
D	W	H	Number	Price
23¼"	42"	28½"	TWRSH4224	\$ 981
23¼"	64"	28½"	TWRSH6424	\$1150



24"D Rectangular Shells

with Wood Veneer Worksurface and Laminate End Panels and Back Rail



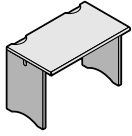



SIN 711.2



Tip: Additional shell configurations are possible by building them from components.

Tip: If shell with modesty panel in place of back rail is required, specify modesty panel separately.

Standard Includes	Required to Specify
<ul style="list-style-type: none"> • Worksurface: wood veneer • Bullnose edge profile on user's side: wood • Scallop grommets with cable-management insert: black only • Two full-depth end panels: laminate • Back rail: laminate • Wire manager: black plastic only • Grommets in end panels: black plastic only • Leveling glides: black only • Attachment hardware 	<ol style="list-style-type: none"> 1 Style number 2 Wood color number for worksurface 3 Laminate color number for end panels and back rail 4 Options, if selected (see below) <p>▶ See <i>Surface Materials</i>, page G198.</p>

Options	Price	Required to Specify
End Panels		
 Shell with two full-depth end panels (24")	No cost	Specify <i>Config 1</i> .
 Shell with two slip-fit end panels (24")	-\$128	Specify <i>Config 2</i> .
 Shell with two half-depth end panels (24")	-\$ 64	Specify <i>Config 3</i> .
 Shell with one full-depth (24") and one half-depth (24") end panel	-\$ 32	Specify <i>Config 4</i> .
 Shell with one full-depth (24") and one slip-fit (24") end panel	-\$ 64	Specify <i>Config 5</i> .
 Shell with one half-depth (24") and one slip-fit (24") end panel	-\$ 96	Specify <i>Config 6</i> .
Surface Materials		
Full-fill finish on 42"W shell worksurface only:		
• Full-fill finish	+\$ 41	Specify with <i>full-fill finish</i> and select wood color number. ▶ See <i>Surface Materials</i> , page G198.
Full-fill finish on 64"W shell worksurface only:		
• Full-fill finish	+\$ 60	Specify with <i>full-fill finish</i> and select wood color number. ▶ See <i>Surface Materials</i> , page G198.
Customiz stain on 42"W shell with:		
• Two full-depth end panels (24")	+\$ 41	Specify <i>Config 1</i> . Specify with <i>Customiz stain</i> .
• Two slip-fit end panels (24")	+\$ 41	Specify <i>Config 2</i> . Specify with <i>Customiz stain</i> .
• Two half-depth end panels (24")	+\$ 41	Specify <i>Config 3</i> . Specify with <i>Customiz stain</i> .
• One full-depth end panel and one half-depth end panel (24")	+\$ 41	Specify <i>Config 4</i> . Specify with <i>Customiz stain</i> .
• One full-depth end panel and one slip-fit end panel (24")	+\$ 41	Specify <i>Config 5</i> . Specify with <i>Customiz stain</i> .
• One half-depth end panel and one slip-fit end panel (24")	+\$ 41	Specify <i>Config 6</i> . Specify with <i>Customiz stain</i> .
Customiz stain on 64"W shell with:		
• Two full-depth end panels (24")	+\$ 60	Specify <i>Config 1</i> . Specify with <i>Customiz stain</i> .
• Two slip-fit end panels (24")	+\$ 60	Specify <i>Config 2</i> . Specify with <i>Customiz stain</i> .
• Two half-depth end panels (24")	+\$ 60	Specify <i>Config 3</i> . Specify with <i>Customiz stain</i> .
• One full-depth end panel and one half-depth end panel (24")	+\$ 60	Specify <i>Config 4</i> . Specify with <i>Customiz stain</i> .
• One full-depth end panel and one slip-fit end panel (24")	+\$ 60	Specify <i>Config 5</i> . Specify with <i>Customiz stain</i> .
• One half-depth end panel and one slip-fit end panel (24")	+\$ 60	Specify <i>Config 6</i> . Specify with <i>Customiz stain</i> .
• Open Line laminate	+\$ 60 plus cost of laminate	▶ See <i>Surface Materials Reference Manual</i> .

▶ Options continued on next page

SIN 711.2

► Options continued

	Options	Price	Required to Specify
Related Products	<ul style="list-style-type: none"> • Breadboard-top worksurfaces • Modesty panels • Center drawer • Keyboard shelf • Cable manager 		<ul style="list-style-type: none"> ► Page G77 ► Page G90 ► Page G94 ► Page G94 ► Page G180

Specification Information

• Dimensions			• Style	• Base
D	W	H	Number	Price
23¼"	42"	28½"	TWRSH4224L	\$ 870
23¼"	64"	28½"	TWRSH6424L	\$1037



24"D Rectangular Shells

with Laminate Worksurface, End Panels, and Back Rail

SIN 711.2

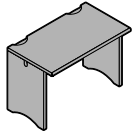

Tip: Additional shell configurations are possible by building them from components.

Tip: If shell with modesty panel in place of back rail is required, specify modesty panel separately.

Tip: All laminate surfaces have a solid color default PVC edge.

▶ See Color Coordination List, page G200.



Standard Includes	Required to Specify
-------------------	---------------------

- Worksurface: laminate
- Bullnose edge profile on user's side: vinyl (PVC) black only
- Scallop grommets with cable-management insert: black only
- Two full-depth end panels: laminate
- Back rail: laminate
- Wire manager: black plastic only
- Grommets in end panels: black plastic only
- Leveling glides: black only
- Attachment hardware

- 1 Style number
- 2 Laminate color number for shell
- 3 Options, if selected (see below)
- ▶ See *Surface Materials*, page G198.

Surface Materials	Options	Price	Required to Specify
-------------------	---------	-------	---------------------

Surface Materials	• Open Line laminate	+\$ 60 plus cost of laminate	▶ See <i>Surface Materials Reference Manual</i> .
-------------------	----------------------	------------------------------	---

End Panels	Options	Price	Required to Specify
	Shell with two full-depth end panels (24")	No cost	Specify <i>Config 1</i> .
	Shell with two slip-fit end panels (24")	-\$128	Specify <i>Config 2</i> .
	Shell with two half-depth end panels (24")	-\$ 64	Specify <i>Config 3</i> .
	Shell with one full-depth (24") and one half-depth (24") end panel	-\$ 32	Specify <i>Config 4</i> .
	Shell with one full-depth (24") and one slip-fit (24") end panel	-\$ 64	Specify <i>Config 5</i> .
	Shell with one half-depth (24") and one slip-fit (24") end panel	-\$ 96	Specify <i>Config 6</i> .

Related Products	Options	Required to Specify
Related Products	<ul style="list-style-type: none"> • Breadboard-top worksurfaces • Modesty panels • Center drawer • Keyboard shelf • Cable manager 	<ul style="list-style-type: none"> ▶ Page G77 ▶ Page G90 ▶ Page G94 ▶ Page G94 ▶ Page G180

Specification Information

• Dimensions			• Style	• Base
D	W	H	Number	Price
23¼"	42"	28½"	TLRSH4224	\$626
23¼"	64"	28½"	TLRSH6424	\$758

30"D Rectangular Shells

with Wood Veneer Worksurface, End Panels, and Back Rail

SIN 711.2

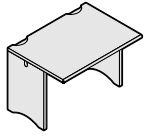

Tip: Additional shell configurations are possible by building them from components.

Tip: If shell with modesty panel in place of back rail is required, specify modesty panel separately.

Standard Includes		Required to Specify
<ul style="list-style-type: none"> • Worksurface: wood veneer • Bullnose edge profile on user's side: wood • Scallop grommets with cable-management insert: black only • Two full-depth end panels: wood veneer • Back rail: wood veneer • Wire manager: black plastic only • Grommets in end panels: black plastic only • Leveling glides: black only • Attachment hardware 		<ul style="list-style-type: none"> 1 Style number 2 Wood color number for shell 3 Options, if selected (see below) ▶ See <i>Surface Materials</i>, page G198.
Options	Price	Required to Specify
End Panels <ul style="list-style-type: none"> Shell with two full-depth end panels (30") Shell with two slip-fit end panels (30") Shell with two half-depth end panels (24") Shell with one full-depth (30") and one half-depth (24") end panel Shell with one full-depth (30") and one slip-fit (30") end panel Shell with one half-depth (24") and one slip-fit (30") end panel 	<ul style="list-style-type: none"> No cost -\$160 -\$ 88 -\$ 80 -\$124 	<ul style="list-style-type: none"> Specify <i>Config 1</i>. Specify <i>Config 2</i>. Specify <i>Config 3</i>. Specify <i>Config 5</i>. Specify <i>Config 6</i>.
Surface Materials	Full-fill finish on 42"W shell worksurface only: <ul style="list-style-type: none"> • Full-fill finish +\$ 41 	<ul style="list-style-type: none"> Specify with <i>full-fill finish</i> and select wood color number. ▶ See <i>Surface Materials</i>, page G198.
	Full-fill finish on 64"W shell worksurface only: <ul style="list-style-type: none"> • Full-fill finish +\$ 60 	<ul style="list-style-type: none"> Specify with <i>full-fill finish</i> and select wood color number. ▶ See <i>Surface Materials</i>, page G198.
	Customiz stain on 42"W shell with: <ul style="list-style-type: none"> • Two full-depth end panels (30") +\$147 • Two slip-fit end panels (30") +\$147 • Two half-depth end panels (24") +\$147 • One full-depth (30") and one half-depth (24") end panel +\$147 • One full-depth (30") and one slip-fit (30") end panel +\$147 • One half-depth (24") and one slip-fit (30") end panel +\$147 	<ul style="list-style-type: none"> Specify <i>Config 1</i>. Specify with <i>Customiz stain</i>. Specify <i>Config 2</i>. Specify with <i>Customiz stain</i>. Specify <i>Config 3</i>. Specify with <i>Customiz stain</i>. Specify <i>Config 4</i>. Specify with <i>Customiz stain</i>. Specify <i>Config 5</i>. Specify with <i>Customiz stain</i>. Specify <i>Config 6</i>. Specify with <i>Customiz stain</i>.
	Customiz stain on 64"W shell with: <ul style="list-style-type: none"> • Two full-depth end panels (30") +\$166 • Two slip-fit end panels (30") +\$166 • Two half-depth end panels (24") +\$166 • One full-depth (30") and one half-depth (24") end panel +\$166 • One full-depth (30") and one slip-fit (30") end panel +\$166 • One half-depth (24") and one slip-fit (30") end panel +\$166 	<ul style="list-style-type: none"> Specify <i>Config 1</i>. Specify with <i>Customiz stain</i>. Specify <i>Config 2</i>. Specify with <i>Customiz stain</i>. Specify <i>Config 3</i>. Specify with <i>Customiz stain</i>. Specify <i>Config 4</i>. Specify with <i>Customiz stain</i>. Specify <i>Config 5</i>. Specify with <i>Customiz stain</i>. Specify <i>Config 6</i>. Specify with <i>Customiz stain</i>.
Related Products	<ul style="list-style-type: none"> • Breadboard-top worksurfaces • Modesty panels • Center drawer • Keyboard shelf • Cable manager 	<ul style="list-style-type: none"> ▶ Page G77 ▶ Page G90 ▶ Page G94 ▶ Page G94 ▶ Page G180

Specification Information

• Dimensions			• Style	• Base
D	W	H	Number	Price
29 1/4"	42"	28 1/2"	TWRSH4230	\$1130
29 1/4"	64"	28 1/2"	TWRSH6430	\$1333



30"D Rectangular Shells

with Wood Veneer Worksurface and Laminate End Panels and Back Rail



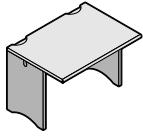



SIN 711.2



Tip: Additional shell configurations are possible by building them from components.

Tip: If shell with modesty panel in place of back rail is required, specify modesty panel separately.

Standard Includes	Required to Specify
<ul style="list-style-type: none"> • Worksurface: wood veneer • Bullnose edge profile on user's side: wood • Scallop grommets with cable-management insert: black only • Two full-depth end panels: laminate • Back rail: laminate • Wire manager: black plastic only • Grommets in end panels: black plastic only • Leveling glides: black only • Attachment hardware 	<ol style="list-style-type: none"> 1 Style number 2 Wood color number for worksurface 3 Laminate color number for end panels and back rail. 4 Options, if selected (see below) <p>▶ See <i>Surface Materials</i>, page G198.</p>

Options	Price	Required to Specify
End Panels		
 Shell with two full-depth end panels (30")	No cost	Specify <i>Config 1</i> .
 Shell with two slip-fit end panels (30")	-\$140	Specify <i>Config 2</i> .
 Shell with two half-depth end panels (24")	-\$ 76	Specify <i>Config 3</i> .
 Shell with one full-depth (30") and one half-depth (24") end panel	-\$ 38	Specify <i>Config 4</i> .
 Shell with one full-depth (30") and one slip-fit (30") end panel	-\$ 70	Specify <i>Config 5</i> .
 Shell with one half-depth (24") and one slip-fit (30") end panel	-\$108	Specify <i>Config 6</i> .
Surface Materials		
Full-fill finish on 42"W shell worksurface only:		
• Full-fill finish	+\$ 41	Specify with <i>full-fill finish</i> and select wood color number. ▶ See <i>Surface Materials</i> , page G198.
Full-fill finish on 64"W shell worksurface only:		
• Full-fill finish	+\$ 60	Specify with <i>full-fill finish</i> and select wood color number. ▶ See <i>Surface Materials</i> , page G198.
Customiz stain on 42"W shell with:		
• Two full-depth end panels (30")	+\$ 41	Specify <i>Config 1</i> . Specify with <i>Customiz stain</i> .
• Two slip-fit end panels (30")	+\$ 41	Specify <i>Config 2</i> . Specify with <i>Customiz stain</i> .
• Two half-depth end panels (24")	+\$ 41	Specify <i>Config 3</i> . Specify with <i>Customiz stain</i> .
• One full-depth (30") and one half-depth (24") end panel	+\$ 41	Specify <i>Config 4</i> . Specify with <i>Customiz stain</i> .
• One full-depth (30") and one slip-fit (30") end panel	+\$ 41	Specify <i>Config 5</i> . Specify with <i>Customiz stain</i> .
• One half-depth (24") and one slip-fit (30") end panel	+\$ 41	Specify <i>Config 6</i> . Specify with <i>Customiz stain</i> .
Customiz stain on 64"W shell with:		
• Two full-depth end panels (30")	+\$ 60	Specify <i>Config 1</i> . Specify with <i>Customiz stain</i> .
• Two slip-fit end panels (30")	+\$ 60	Specify <i>Config 2</i> . Specify with <i>Customiz stain</i> .
• Two half-depth end panels (24")	+\$ 60	Specify <i>Config 3</i> . Specify with <i>Customiz stain</i> .
• One full-depth (30") and one half-depth (24") end panel	+\$ 60	Specify <i>Config 4</i> . Specify with <i>Customiz stain</i> .
• One full-depth (30") and one slip-fit (30") end panel	+\$ 60	Specify <i>Config 5</i> . Specify with <i>Customiz stain</i> .
• One half-depth (24") and one slip-fit (30") end panel	+\$ 60	Specify <i>Config 6</i> . Specify with <i>Customiz stain</i> .
• Open Line laminate	+\$ 60 plus cost of laminate	▶ See <i>Surface Materials Reference Manual</i> .

▶ Options continued on next page

SIN 711.2

► Options continued

	Options	Price	Required to Specify
Related Products	<ul style="list-style-type: none"> • Breadboard-top worksurfaces • Modesty panels • Center drawer • Keyboard shelf • Cable manager 		<ul style="list-style-type: none"> ► Page G77 ► Page G90 ► Page G94 ► Page G94 ► Page G180

Specification Information

• Dimensions			• Style	• Base
D	W	H	Number	Price
29¼"	42"	28½"	TWRSH4230L	\$1007
29¼"	64"	28½"	TWRSH6430L	\$1208



30"D Rectangular Shells

with Laminate Worksurface, End Panels, and Back Rail

SIN 711.2

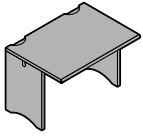

Tip: Additional shell configurations are possible by building them from components.

Tip: If shell with modesty panel in place of back rail is required, specify modesty panel separately.

Tip: All laminate surfaces have a solid color default PVC edge.

▶ See *Color Coordination List*, page G200.

Standard Includes	Required to Specify
-------------------	---------------------

- Worksurface: laminate
- Bullnose edge profile on user's side: vinyl (PVC) black only
- Scallop grommets with cable-management insert: black only
- Two full-depth end panels: laminate
- Back rail: laminate
- Wire manager: black plastic only
- Grommets in end panels: black plastic only
- Leveling glides: black only
- Attachment hardware

- 1 Style number
- 2 Laminate color number for shell
- 3 Options, if selected (see below)
- ▶ See *Surface Materials*, page G198.

Surface Materials	Options	Price	Required to Specify
-------------------	---------	-------	---------------------

Surface Materials	• Open Line laminate	+\$ 60 plus cost of laminate	▶ See <i>Surface Materials Reference Manual</i> .
-------------------	----------------------	------------------------------	---

End Panels	Options	Price	Required to Specify
------------	---------	-------	---------------------



Shell with two full-depth end panels (30")

No cost

Specify *Config 1*.



Shell with two slip-fit end panels (30")

-\$140

Specify *Config 2*.



Shell with two half-depth end panels (24")

-\$ 76

Specify *Config 3*.



Shell with one full-depth (30") and one half-depth (24") end panel

-\$ 38

Specify *Config 4*.



Shell with one full-depth (30") and one slip-fit (30") end panel

-\$ 70

Specify *Config 5*.



Shell with one half-depth (24") and one slip-fit (30") end panel

-\$108

Specify *Config 6*.

Related Products	Options	Page
------------------	---------	------

- Breadboard-top worksurfaces
- Modesty panels
- Center drawer
- Keyboard shelf
- Cable manager

- ▶ Page G77
- ▶ Page G90
- ▶ Page G94
- ▶ Page G94
- ▶ Page G180

Specification Information

• Dimensions			• Style	• Base
D	W	H	Number	Price
29¼"	42"	28½"	TLRSH4230	\$756
29¼"	64"	28½"	TLRSH6430	\$938

Bowed Transition Shells

with Wood Veneer Worksurface, End Panels, and Back Rail

SIN 711.2

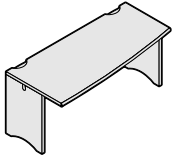

Tip: Additional shell configurations are possible by building them from components.









Tip: If shell with modesty panel in place of back rail is required, specify modesty panel separately.

Standard Includes	Required to Specify
-------------------	---------------------

- Worksurface: wood veneer
- Bullnose edge profile on user's side: wood
- Scallop grommets with cable-management insert: black only
- Two full-depth end panels: wood veneer
- Back rail: wood veneer
- Wire manager: black plastic only
- Grommets in end panels: black plastic only
- Leveling glides: black only
- Attachment hardware

- 1 Style number
 - 2 Wood color number for shell
 - 3 Options, if selected (see below)
- ▶ See *Surface Materials*, page G198.

End Panels	Options	Price	Required to Specify
------------	---------	-------	---------------------

End Panels	 Shell with two full-depth end panels	No cost	Specify <i>Config 1</i> .
	 Shell with two half-depth end panels (24")	-\$ 74	Specify <i>Config 2</i> .
	 Shell with one full-depth (24") and one half-depth (30") end panel	-\$ 44	Specify <i>Config 3</i> .
	 Shell with one full-depth (30") and one half-depth (24") end panel	-\$ 7	Specify <i>Config 4</i> .
	 Shell with one full-depth (30") and one slip-fit (24") end panel	-\$ 23	Specify <i>Config 5</i> .
	 Shell with one half-depth (30") and one slip-fit (24") end panel	-\$ 67	Specify <i>Config 6</i> .
	 Shell with one full-depth (24") and one slip-fit (30") end panel	-\$ 36	Specify <i>Config 7</i> .
	 Shell with one half-depth (24") and one slip-fit (30") end panel	-\$ 73	Specify <i>Config 8</i> .
	 Shell with two slip-fit end panels	-\$134	Specify <i>Config 9</i> .

Surface Materials	Full-fill finish on worksurface only	Price	Required to Specify
-------------------	--------------------------------------	-------	---------------------

Surface Materials	• Full-fill finish	+\$ 60	Specify with <i>full-fill finish</i> and select wood color number. ▶ See <i>Surface Materials</i> , page G198.
-------------------	--------------------	--------	---

Customiz stain on 42"W shell with:

• Two full-depth end panels	+\$166	Specify <i>Config 1</i> . Specify with <i>Customiz stain</i> .
• Two half-depth end panels (24")	+\$166	Specify <i>Config 2</i> . Specify with <i>Customiz stain</i> .
• One full-depth (24") and one half-depth (30") end panel	+\$166	Specify <i>Config 3</i> . Specify with <i>Customiz stain</i> .
• One full-depth (30") and one half-depth (24") end panel	+\$166	Specify <i>Config 4</i> . Specify with <i>Customiz stain</i> .
• One full-depth (30") and one slip-fit (24") end panel	+\$166	Specify <i>Config 5</i> . Specify with <i>Customiz stain</i> .
• One half-depth (30") and one slip-fit (24") end panel	+\$166	Specify <i>Config 6</i> . Specify with <i>Customiz stain</i> .
• One full-depth (24") and one slip-fit (30") end panel	+\$166	Specify <i>Config 7</i> . Specify with <i>Customiz stain</i> .
• One half-depth (24") and one slip-fit (30") end panel	+\$166	Specify <i>Config 8</i> . Specify with <i>Customiz stain</i> .
• Two slip-fit end panels	+\$166	Specify <i>Config 9</i> . Specify with <i>Customiz stain</i> .

▶ Options continued on next page

SIN 711.2

► Options continued

Options	Price	Required to Specify
Surface Materials (continued)	Customiz stain on 64"W shell with:	
• Two full-depth end panels	+\$166	Specify <i>Config 1</i> . Specify with <i>Customiz stain</i> .
• Two half-depth end panels (24")	+\$166	Specify <i>Config 2</i> . Specify with <i>Customiz stain</i> .
• One full-depth (24") and one half-depth (30") end panel	+\$166	Specify <i>Config 3</i> . Specify with <i>Customiz stain</i> .
• One full-depth (30") and one half-depth (24") end panel	+\$166	Specify <i>Config 4</i> . Specify with <i>Customiz stain</i> .
• One full-depth (30") and one slip-fit (24") end panel	+\$166	Specify <i>Config 5</i> . Specify with <i>Customiz stain</i> .
• One half-depth (30") and one slip-fit (24") end panel	+\$166	Specify <i>Config 6</i> . Specify with <i>Customiz stain</i> .
• One full-depth (24") and one slip-fit (30") end panel	+\$166	Specify <i>Config 7</i> . Specify with <i>Customiz stain</i> .
• One half-depth (24") and one slip-fit (30") end panel	+\$166	Specify <i>Config 8</i> . Specify with <i>Customiz stain</i> .
• Two slip-fit end panels	+\$166	Specify <i>Config 9</i> . Specify with <i>Customiz stain</i> .
Related Products	<ul style="list-style-type: none"> • Breadboard-top worksurfaces • Modesty panels • Center drawer • Keyboard shelf • Cable manager 	<ul style="list-style-type: none"> ► Page G77 ► Page G90 ► Page G94 ► Page G94 ► Page G180

Specification Information

Dimensions				Style Number	Base Price
A	B	W	H		

Left-Hand Shell

23¼"	29¼"	42"	28½"	TWBTH4224L	\$1084
23¼"	29¼"	64"	28½"	TWBTH6424L	\$1254

Right-Hand Shell

29¼"	23¼"	42"	28½"	TWBTH4224R	\$1084
29¼"	23¼"	64"	28½"	TWBTH6424R	\$1254

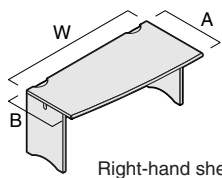
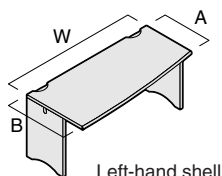

Bowed Transition Shells

with Wood Veneer Worksurface and Laminate End Panels and Back Rail

SIN 711.2

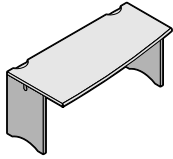

Tip: Additional shell configurations are possible by building them from components.









Tip: If shell with modesty panel in place of back rail is required, specify modesty panel separately.

Standard Includes	Required to Specify
-------------------	---------------------

- Worksurface: wood veneer
- Bullnose edge profile on user's side: wood
- Scallop grommets with cable-management insert: black only
- Two full-depth end panels: laminate
- Back rail: laminate
- Wire manager: black plastic only
- Grommets in end panels: black plastic only
- Leveling glides: black only
- Attachment hardware

- 1 Style number
 - 2 Wood color number for worksurface
 - 3 Laminate color number for end panels and back rail
 - 4 Options, if selected (see below)
- ▶ See *Surface Materials*, page G198.

Options	Price	Required to Specify
---------	-------	---------------------

Options	Price	Required to Specify
End Panels		
 Shell with two full-depth end panels	No cost	Specify <i>Config 1</i> .
 Shell with two half-depth end panels (24")	-\$102	Specify <i>Config 2</i> .
 Shell with one full-depth (24") and one half-depth (30") end panel	-\$ 38	Specify <i>Config 3</i> .
 Shell with one full-depth (30") and one half-depth (24") end panel	-\$ 32	Specify <i>Config 4</i> .
 Shell with one full-depth (30") and one slip-fit (24") end panel	-\$ 64	Specify <i>Config 5</i> .
 Shell with one half-depth (30") and one slip-fit (24") end panel	-\$102	Specify <i>Config 6</i> .
 Shell with one full-depth (24") and one slip-fit (30") end panel	-\$ 70	Specify <i>Config 7</i> .
 Shell with one half-depth (24") and one slip-fit (30") end panel	-\$103	Specify <i>Config 8</i> .
 Shell with two slip-fit end panels	-\$134	Specify <i>Config 9</i> .

Surface Materials	Full-fill finish on worksurface only	
	• Full-fill finish	+\$ 60
		Specify with <i>full-fill finish</i> and select wood color number. ▶ See <i>Surface Materials</i> , page G198.

Customiz stain on 42"W shell with:

- | | | |
|---|--------|---|
| • Two full-depth end panels | +\$ 41 | Specify <i>Config 1</i> .
Specify with <i>Customiz stain</i> . |
| • Two half-depth end panels (24") | +\$ 41 | Specify <i>Config 2</i> .
Specify with <i>Customiz stain</i> . |
| • One full-depth (24") and one half-depth (30") end panel | +\$ 41 | Specify <i>Config 3</i> .
Specify with <i>Customiz stain</i> . |
| • One full-depth (30") and one half-depth (24") end panel | +\$ 41 | Specify <i>Config 4</i> .
Specify with <i>Customiz stain</i> . |
| • One full-depth (30") and one slip-fit (24") end panel | +\$ 41 | Specify <i>Config 5</i> .
Specify with <i>Customiz stain</i> . |
| • One half-depth (30") and one slip-fit (24") end panel | +\$ 41 | Specify <i>Config 6</i> .
Specify with <i>Customiz stain</i> . |
| • One full-depth (24") and one slip-fit (30") end panel | +\$ 41 | Specify <i>Config 7</i> .
Specify with <i>Customiz stain</i> . |
| • One half-depth (24") and one slip-fit (30") end panel | +\$ 41 | Specify <i>Config 8</i> .
Specify with <i>Customiz stain</i> . |
| • Two slip-fit end panels | +\$ 41 | Specify <i>Config 9</i> .
Specify with <i>Customiz stain</i> . |

▶ Options continued on next page

SIN 711.2

► Options continued

Options	Price	Required to Specify
Surface Materials (continued)	Customiz stain on 64"W shell with:	
• Two full-depth end panels	+\$60	Specify <i>Config 1</i> . Specify with <i>Customiz stain</i> .
• Two half-depth end panels (24")	+\$60	Specify <i>Config 2</i> . Specify with <i>Customiz stain</i> .
• One full-depth (24") and one half-depth (30") end panel	+\$60	Specify <i>Config 3</i> . Specify with <i>Customiz stain</i> .
• One full-depth (30") and one half-depth (24") end panel	+\$60	Specify <i>Config 4</i> . Specify with <i>Customiz stain</i> .
• One full-depth (30") and one slip-fit (24") end panel	+\$60	Specify <i>Config 5</i> . Specify with <i>Customiz stain</i> .
• One half-depth (30") and one slip-fit (24") end panel	+\$60	Specify <i>Config 6</i> . Specify with <i>Customiz stain</i> .
• One full-depth (24") and one slip-fit (30") end panel	+\$60	Specify <i>Config 7</i> . Specify with <i>Customiz stain</i> .
• One half-depth (24") and one slip-fit (30") end panel	+\$60	Specify <i>Config 8</i> . Specify with <i>Customiz stain</i> .
• Two slip-fit end panels	+\$60	Specify <i>Config 9</i> . Specify with <i>Customiz stain</i> .
• Open Line laminate	+\$ 60 plus cost of laminate	► See <i>Surface Materials Reference Manual</i> .
Related Products	• Breadboard-top worksurfaces • Modesty panels • Center drawer • Keyboard shelf • Cable manager	► Page G77 ► Page G90 ► Page G94 ► Page G94 ► Page G180

Specification Information

Dimensions				Style	Base
A	B	W	H	Number	Price
Left-Hand Shell					
23¼"	29¼"	42"	28½"	TWBTH4224LL	\$ 967
23¼"	29¼"	64"	28½"	TWBTH6424LL	\$1135
Right-Hand Shell					
29¼"	23¼"	42"	28½"	TWBTH4224RL	\$ 967
29¼"	23¼"	64"	28½"	TWBTH6424RL	\$1135

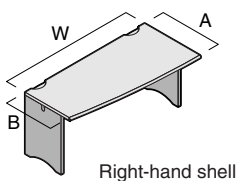
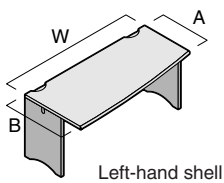

Bowed Transition Shells

with Laminate Worksurface, End Panels, and Back Rail

SIN 711.2

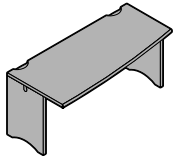

Tip: Additional shell configurations are possible by building them from components.

Tip: If shell with modesty panel in place of back rail is required, specify modesty panel separately.

Standard Includes

- Worksurface: laminate
- Bullnose edge profile on user's side: vinyl (PVC) black only
- Scallop grommets with cable-management insert: black only
- Two full-depth end panels: laminate
- Back rail: laminate
- Wire manager: black plastic only
- Grommets in end panels: black plastic only
- Leveling glides: black only
- Attachment hardware

Required to Specify

- 1 Style number
 - 2 Laminate color number for shell
 - 3 Options, if selected (see below)
- ▶ See *Surface Materials*, page G198.

Options

Surface Materials	Options	Price	Required to Specify
	• Open Line laminate	+\$ 60 plus cost of laminate	▶ See <i>Surface Materials Reference Manual</i> .

End Panels	Options	Price	Required to Specify
	Shell with two full-depth end panels	No cost	Specify <i>Config 1</i> .
	Shell with two half-depth end panels (24")	-\$102	Specify <i>Config 2</i> .
	Shell with one full-depth (24") and one half-depth (30") end panel	-\$ 38	Specify <i>Config 3</i> .
	Shell with one full-depth (30") and one half-depth (24") end panel	-\$ 32	Specify <i>Config 4</i> .
	Shell with one full-depth (30") and one slip-fit (24") end panel	-\$ 64	Specify <i>Config 5</i> .
	Shell with one half-depth (30") and one slip-fit (24") end panel	-\$102	Specify <i>Config 6</i> .
	Shell with one full-depth (24") and one slip-fit (30") end panel	-\$ 70	Specify <i>Config 7</i> .
	Shell with one half-depth (24") and one slip-fit (30") end panel	-\$102	Specify <i>Config 8</i> .
	Shell with two slip-fit end panels	-\$134	Specify <i>Config 9</i> .

Related Products	Options	Price	Required to Specify
	• Breadboard-top worksurfaces		▶ Page G77
	• Modesty panels		▶ Page G90
	• Center drawer		▶ Page G94
	• Keyboard shelf		▶ Page G94
	• Cable manager		▶ Page G180

Specification Information

Dimensions				Style Number	Base Price
A	B	W	H		
:	:	:	:	:	:

Left-Hand Shell

23 1/4"	29 1/4"	42"	28 1/2"	TLBTH4224L	\$717
23 1/4"	29 1/4"	64"	28 1/2"	TLBTH6424L	\$865

Right-Hand Shell

29 1/4"	23 1/4"	42"	28 1/2"	TLBTH4224R	\$717
29 1/4"	23 1/4"	64"	28 1/2"	TLBTH6424R	\$865

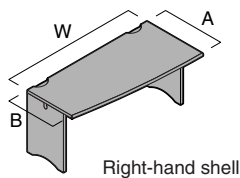
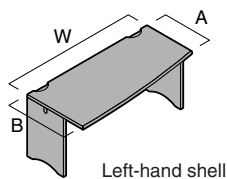

Corner Shells

with Wood Veneer Worksurface, End Panels, and Back Rails

SIN 711.2

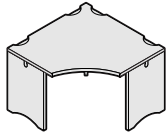

Tip: Additional shell configurations are possible by building them from components.

Tip: If shell with modesty panel in place of back rail is required, specify modesty panel separately.

Standard Includes	Required to Specify
-------------------	---------------------

- Worksurface: wood veneer
- Bullnose edge profile on user's side: wood
- Scallop grommets with cable-management insert: black only
- Two full-depth end panels: wood veneer
- Back rails: wood veneer
- Wire manager: black plastic only
- Grommets in end panels: black plastic only
- Leveling glides: black only
- Attachment hardware
- One corner end panel support: wood veneer

- 1 Style number
 - 2 Wood color number for shell
 - 3 Options, if selected (see below)
- ▶ See *Surface Materials*, page G198.

End Panels	Options	Price	Required to Specify
------------	---------	-------	---------------------

24" application



Shell with two full-depth end panels (24")

No cost

Specify *Config 1*.



Shell with two slip-fit end panels (24")

-\$134

Specify *Config 2*.



Shell with two half-depth end panels (24")

-\$ 74

Specify *Config 3*.



Shell with one full-depth (24") and one half-depth (24") end panel

-\$ 37

Specify *Config 4*.



Shell with one full-depth (24") and one slip-fit (24") end panel

-\$ 67

Specify *Config 5*.



Shell with one half-depth (24") and one slip-fit (24") end panel

-\$104

Specify *Config 6*.

30" application



Shell with two full-depth end panels (30")

No cost

Specify *Config 1a*.



Shell with two slip-fit end panels (30")

-\$160

Specify *Config 2a*.



Shell with two half-depth end panels (24")

-\$ 88

Specify *Config 3a*.



Shell with one full-depth (30") and one half-depth (24") end panel

-\$ 44

Specify *Config 4a*.



Shell with one full-depth (30") and one slip-fit (30") end panel

-\$ 80

Specify *Config 5a*.



Shell with one half-depth (24") and one slip-fit (30") end panel

-\$124

Specify *Config 6a*.

Surface Materials

Full-fill finish on worksurface only

- Full-fill finish

+\$ 84

Specify with *full-fill finish* and select wood color number.
▶ See *Surface Materials*, page G198.

24" application

Customiz stain on shell with:

- Two full-depth end panels (24")
- Two slip-fit end panels (24")
- Two half-depth end panels (24")
- One full-depth (24") and one half-depth (24") end panel
- One full-depth (24") and one slip-fit (24") end panel
- One half-depth (24") and one slip-fit (24") end panel

+\$255
+\$255
+\$255
+\$255
+\$255
+\$255

Specify *Config 1*.
Specify with *Customiz stain*.
Specify *Config 2*.
Specify with *Customiz stain*.
Specify *Config 3*.
Specify with *Customiz stain*.
Specify *Config 4*.
Specify with *Customiz stain*.
Specify *Config 5*.
Specify with *Customiz stain*.
Specify *Config 6*.
Specify with *Customiz stain*.

▶ Options continued on next page

SIN 711.2

► Options continued

Options	Price	Required to Specify	
Surface Materials (continued)	30" application Customiz stain on shell with: <ul style="list-style-type: none"> Two full-depth end panels (30") Two slip-fit end panels (30") Two half-depth end panels (24") One full-depth (30") and one half-depth (24") end panel One full-depth (30") and one slip-fit (30") end panel One half-depth (24") and one slip-fit (30") end panel 	+\$255 +\$255 +\$255 +\$255 +\$255 +\$255	Specify <i>Config 1a</i> . Specify with <i>Customiz stain</i> . Specify <i>Config 2a</i> . Specify with <i>Customiz stain</i> . Specify <i>Config 3a</i> . Specify with <i>Customiz stain</i> . Specify <i>Config 4a</i> . Specify with <i>Customiz stain</i> . Specify <i>Config 5a</i> . Specify with <i>Customiz stain</i> . Specify <i>Config 6a</i> . Specify with <i>Customiz stain</i> .
Related Products	<ul style="list-style-type: none"> Breadboard-top worksurfaces Modesty panels Center drawer Keyboard shelf Cable manager 	<ul style="list-style-type: none"> ► Page G77 ► Page G90 ► Page G94 ► Page G94 ► Page G180 	

Specification Information

Dimensions					Style Number	Base Price
A	B	C	D	H		
23¼"	23¼"	42"	42"	28½"	TWCH4224	\$1528
29¼"	29¼"	42"	42"	28½"	TWCH4230	\$1680

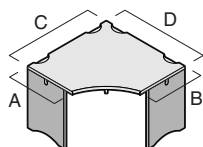

Corner Shells

with Wood Veneer Worksurface and Laminate End Panels and Back Rails

SIN 711.2

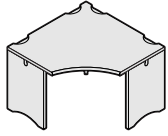

Tip: Additional shell configurations are possible by building them from components.

Tip: If shell with modesty panel in place of back rail is required, specify modesty panel separately.

Standard Includes	Required to Specify
<ul style="list-style-type: none"> • Worksurface: wood veneer • Bullnose edge profile on user's side: wood • Scallop grommets with cable-management insert: black only • Two full-depth end panels: laminate • Back rails: laminate • Wire manager: black plastic only • Grommets in end panels: black plastic only • Leveling glides: black only • Attachment hardware • One corner end panel support: laminate 	<ol style="list-style-type: none"> 1 Style number 2 Wood color number for worksurface 3 Laminate color number for end panels and back rails 4 Options, if selected (see below) <p>▶ See <i>Surface Materials</i>, page G198.</p>

End Panels	Options	Price	Required to Specify	
 <hr/> 	24" application Shell with two full-depth end panels (24")	No cost	Specify <i>Config 1</i> .	
	Shell with two slip-fit end panels (24")	-\$128	Specify <i>Config 2</i> .	
	Shell with two half-depth end panels (24")	-\$ 64	Specify <i>Config 3</i> .	
	Shell with one full-depth (24") and one half-depth (24") end panel	-\$ 32	Specify <i>Config 4</i> .	
	Shell with one full-depth (24") and one slip-fit (24") end panel	-\$ 64	Specify <i>Config 5</i> .	
	Shell with one half-depth (24") and one slip-fit (24") end panel	-\$ 96	Specify <i>Config 6</i> .	
	30" application			
	Shell with two full-depth end panels (30")	No cost	Specify <i>Config 1a</i> .	
	Shell with two slip-fit end panels (30")	-\$140	Specify <i>Config 2a</i> .	
	Shell with two half-depth end panels (24")	-\$ 76	Specify <i>Config 3a</i> .	
	Shell with one full-depth (30") and one half-depth (24") end panel	-\$ 38	Specify <i>Config 4a</i> .	
	Shell with one full-depth (30") and one slip-fit (30") end panel	-\$ 70	Specify <i>Config 5a</i> .	
Shell with one half-depth (24") and one slip-fit (30") end panel	-\$108	Specify <i>Config 6a</i> .		

Surface Materials	Full-fill finish on worksurface only	<ul style="list-style-type: none"> • Full-fill finish +\$ 84 	Specify with <i>full-fill finish</i> and select wood color number. ▶ See <i>Surface Materials</i> , page G198.
--------------------------	---	---	---

	24" application Customiz stain on shell with:		
	<ul style="list-style-type: none"> • Two full-depth end panels (24") +\$ 84 • Two slip-fit end panels (24") +\$ 84 • Two half-depth end panels (24") +\$ 84 • One full-depth (24") and one half-depth (24") end panel +\$ 84 • One full-depth (24") and one slip-fit (24") end panel +\$ 84 • One half-depth (24") and one slip-fit (24") end panel +\$ 84 		Specify <i>Config 1</i> . Specify with <i>Customiz stain</i> . Specify <i>Config 2</i> . Specify with <i>Customiz stain</i> . Specify <i>Config 3</i> . Specify with <i>Customiz stain</i> . Specify <i>Config 4</i> . Specify with <i>Customiz stain</i> . Specify <i>Config 5</i> . Specify with <i>Customiz stain</i> . Specify <i>Config 6</i> . Specify with <i>Customiz stain</i> .

▶ Options continued on next page

SIN 711.2

► Options continued

Options	Price	Required to Specify
Surface Materials (continued)	30" application Customiz stain on shell with: <ul style="list-style-type: none"> Two full-depth end panels (30") +\$84 Two slip-fit end panels (30") +\$84 Two half-depth end panels (24") +\$84 One full-depth (30") and one half-depth (24") end panel +\$84 One full-depth (30") and one slip-fit (30") end panel +\$84 One half-depth (24") and one slip-fit (30") end panel +\$84 	Specify <i>Config 1a</i> . Specify with <i>Customiz stain</i> . Specify <i>Config 2a</i> . Specify with <i>Customiz stain</i> . Specify <i>Config 3a</i> . Specify with <i>Customiz stain</i> . Specify <i>Config 4a</i> . Specify with <i>Customiz stain</i> . Specify <i>Config 5a</i> . Specify with <i>Customiz stain</i> . Specify <i>Config 6a</i> . Specify with <i>Customiz stain</i> .
	<ul style="list-style-type: none"> Open Line laminate +\$ 60 plus cost of laminate 	► See <i>Surface Materials Reference Manual</i> .
Related Products	<ul style="list-style-type: none"> Breadboard-top worksurfaces Modesty panels Center drawer Keyboard shelf Cable manager 	► Page G77 ► Page G90 ► Page G94 ► Page G94 ► Page G180

Specification Information

Dimensions					Style Number	Base Price
A	B	C	D	H		
23¼"	23¼"	42"	42"	28½"	TWCH4224L	\$1342
29¼"	29¼"	42"	42"	28½"	TWCH4230L	\$1482

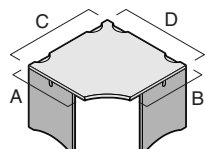
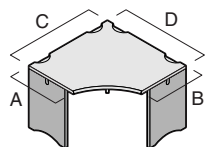

Corner Shells

with Laminate Worksurface, End Panels, and Back Rails

SIN 711.2

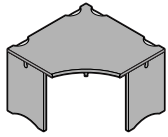

Tip: Additional shell configurations are possible by building them from components.













Tip: If shell with modesty panel in place of back rail is required, specify modesty panel separately.

Tip: All laminate surfaces have a solid color default PVC edge.

▶ See Color Coordination List, page G200.

Standard Includes	Required to Specify
<ul style="list-style-type: none"> • Worksurface: laminate • Bullnose edge profile on user's side: vinyl (PVC) black only • Scallop grommets with cable-management insert: black only • Two full-depth end panels: laminate • Back rails: laminate • Wire manager: black plastic only • Grommets in end panels: black plastic only • Leveling glides: black only • Attachment hardware • One corner end panel support: laminate 	<ul style="list-style-type: none"> 1 Style number 2 Laminate color number for shell 3 Options, if selected (see below) ▶ See <i>Surface Materials</i>, page G198.

Options	Price	Required to Specify
Surface Materials <ul style="list-style-type: none"> • Open Line laminate 	+\$ 60 plus cost of laminate	▶ See <i>Surface Materials Reference Manual</i> .

End Panels	Options	Price	Required to Specify	
     	24" application Shell with two full-depth end panels (24")	No cost	Specify <i>Config 1</i> .	
	Shell with two slip-fit end panels (24")	-\$128	Specify <i>Config 2</i> .	
	Shell with two half-depth end panels (24")	-\$ 64	Specify <i>Config 3</i> .	
	Shell with one full-depth (24") and one half-depth (24") end panel	-\$ 32	Specify <i>Config 4</i> .	
	Shell with one full-depth (24") and one slip-fit (24") end panel	-\$ 64	Specify <i>Config 5</i> .	
	Shell with one half-depth (24") and one slip-fit (24") end panel	-\$ 96	Specify <i>Config 6</i> .	
	     	30" application Shell with two full-depth end panels (30")	No cost	Specify <i>Config 1a</i> .
		Shell with two slip-fit end panels (30")	-\$140	Specify <i>Config 2a</i> .
		Shell with two half-depth end panels (24")	-\$ 76	Specify <i>Config 3a</i> .
		Shell with one full-depth (30") and one half-depth (24") end panel	-\$ 38	Specify <i>Config 4a</i> .
Shell with one full-depth (30") and one slip-fit (30") end panel		-\$ 70	Specify <i>Config 5a</i> .	
Shell with one half-depth (24") and one slip-fit (30") end panel		-\$108	Specify <i>Config 6a</i> .	

Related Products	Options	Required to Specify
<ul style="list-style-type: none"> • Breadboard-top worksurfaces • Modesty panels • Center drawer • Keyboard shelf • Cable manager 		<ul style="list-style-type: none"> ▶ Page G77 ▶ Page G90 ▶ Page G94 ▶ Page G94 ▶ Page G180

Specification Information

Dimensions					Style Number	Base Price
A	B	C	D	H		
23 1/4"	23 1/4"	42"	42"	28 1/2"	TLCH4224	\$1093

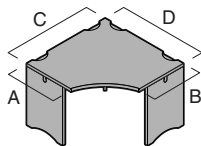

29 1/4"	29 1/4"	42"	42"	28 1/2"	TLCH4230	\$1212
---------	---------	-----	-----	---------	-----------------	--------

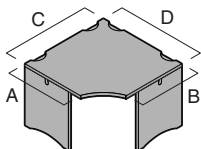

Extended Corner Shells

with Wood Veneer Worksurface, End Panels, and Back Rails

SIN 711.2

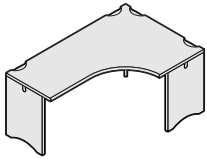

Tip: Additional shell configurations are possible by building them from components.

Tip: If shell with modesty panel in place of back rail is required, specify modesty panel separately.

Standard Includes	Required to Specify
-------------------	---------------------

- Worksurface: wood veneer
- Bullnose edge profile on user's side: wood
- Scallop grommets with cable-management insert: black only
- Two full-depth end panels: wood veneer
- Back rails: wood veneer
- Wire manager: black plastic only
- Grommets in end panels: black plastic only
- Leveling glides: black only
- Attachment hardware
- One corner end panel support: wood veneer

- 1 Style number
 - 2 Wood color number for shell
 - 3 Options, if selected (see below)
- ▶ See *Surface Materials*, page G198.

End Panels	Options	Price	Required to Specify
------------	---------	-------	---------------------



Shell with two full-depth end panels

No cost

Specify *Config 1*.



Shell with two slip-fit end panels

-\$134

Specify *Config 2*.



Shell with two half-depth end panels

-\$ 74

Specify *Config 3*.



Shell with one full-depth and one half-depth end panel

-\$ 37

Specify *Config 4*.



Shell with one full-depth and one slip-fit end panel

-\$ 67

Specify *Config 5*.



Shell with one half-depth and one slip-fit end panel

-\$104

Specify *Config 6*.

Surface Materials	Full-fill finish on worksurface only	Price	Required to Specify
-------------------	--------------------------------------	-------	---------------------

- Full-fill finish

+\$ 84

Specify with *full-fill finish* and select wood color number.
▶ See *Surface Materials*, page G198.

Customiz stain on shell with:

- Two full-depth end panels +\$255
- Two slip-fit end panels +\$255
- Two half-depth end panels +\$255
- One full-depth and one half-depth end panel +\$255
- One full-depth and one slip-fit end panel +\$255
- One half-depth and one slip-fit end panel +\$255

Specify *Config 1*.
Specify with *Customiz stain*.
Specify *Config 2*.
Specify with *Customiz stain*.
Specify *Config 3*.
Specify with *Customiz stain*.
Specify *Config 4*.
Specify with *Customiz stain*.
Specify *Config 5*.
Specify with *Customiz stain*.
Specify *Config 6*.
Specify with *Customiz stain*.

Related Products	Options	Page
------------------	---------	------

- Breadboard-top worksurfaces
- Modesty panels
- Center drawer
- Keyboard shelf
- Cable manager

- ▶ Page G77
- ▶ Page G90
- ▶ Page G94
- ▶ Page G94
- ▶ Page G180

Specification Information

Dimensions					Style	Base
A	B	C	D	H	Number	Price

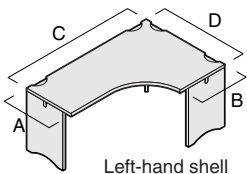

Left-Hand Shell

23¼"	23¼"	64"	42"	28½"	TWECH4264L	\$1730
------	------	-----	-----	------	-------------------	--------

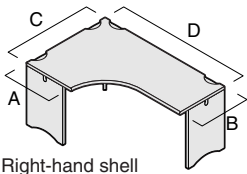

Right-Hand Shell

23¼"	23¼"	42"	64"	28½"	TWECH4264R	\$1730
------	------	-----	-----	------	-------------------	--------

Extended Corner Shells

with Wood Veneer Worksurface and Laminate End Panels and Back Rails

SIN 711.2

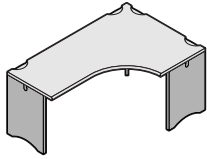

Tip: Additional shell configurations are possible by building them from components.

Tip: If shell with modesty panel in place of back rail is required, specify modesty panel separately.

Standard Includes	Required to Specify
<ul style="list-style-type: none"> • Worksurface: wood veneer • Bullnose edge profile on user's side: wood • Scallop grommets with cable-management insert: black only • Two full-depth end panels: laminate • Back rails: laminate • Wire manager: black plastic only • Grommets in end panels: black plastic only • Leveling glides: black only • Attachment hardware • One corner end panel support: laminate 	<ol style="list-style-type: none"> 1 Style number 2 Wood color number for worksurface 3 Laminate color number for end panels and back rails 4 Options, if selected (see below) <p>▶ See <i>Surface Materials</i>, page G198.</p>

End Panels	Options	Price	Required to Specify
	Shell with two full-depth end panels	No cost	Specify <i>Config 1</i> .
	Shell with two slip-fit end panels	-\$128	Specify <i>Config 2</i> .
	Shell with two half-depth end panels	-\$ 64	Specify <i>Config 3</i> .
	Shell with one full-depth and one half-depth end panel	-\$ 32	Specify <i>Config 4</i> .
	Shell with one full-depth and one slip-fit end panel	-\$ 64	Specify <i>Config 5</i> .
	Shell with one half-depth and one slip-fit end panel	-\$ 96	Specify <i>Config 6</i> .

Surface Materials	Full-fill finish on worksurface only		
	<ul style="list-style-type: none"> • Full-fill finish 	+\$ 84	Specify with <i>full-fill finish</i> and select wood color number. ▶ See <i>Surface Materials</i> , page G198.

Customiz stain on shell with:			
	• Two full-depth end panels	+\$ 84	Specify <i>Config 1</i> . Specify with <i>Customiz stain</i> .
	• Two slip-fit end panels	+\$ 84	Specify <i>Config 2</i> . Specify with <i>Customiz stain</i> .
	• Two half-depth end panels	+\$ 84	Specify <i>Config 3</i> . Specify with <i>Customiz stain</i> .
	• One full-depth and one half-depth end panel	+\$ 84	Specify <i>Config 4</i> . Specify with <i>Customiz stain</i> .
	• One full-depth and one slip-fit end panel	+\$ 84	Specify <i>Config 5</i> . Specify with <i>Customiz stain</i> .
	• One half-depth and one slip-fit end panel	+\$ 84	Specify <i>Config 6</i> . Specify with <i>Customiz stain</i> .
	• Open Line laminate	+\$ 60 plus cost of laminate	▶ See <i>Surface Materials Reference Manual</i> .

Related Products		
<ul style="list-style-type: none"> • Breadboard-top worksurfaces • Modesty panels • Center drawer • Keyboard shelf • Cable manager 	<ul style="list-style-type: none"> ▶ Page G77 ▶ Page G90 ▶ Page G94 ▶ Page G94 ▶ Page G180 	

Specification Information

Dimensions					Style Number	Base Price
A	B	C	D	H		

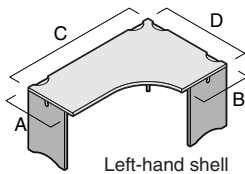

Left-Hand Shell

23¼"	23¼"	64"	42"	28½"	TWECH4264LL	\$1542
------	------	-----	-----	------	--------------------	--------

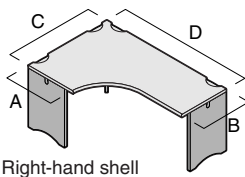

Right-Hand Shell

23¼"	23¼"	42"	64"	28½"	TWECH4264RL	\$1542
------	------	-----	-----	------	--------------------	--------



Extended Corner Shells

with Laminate Worksurface, End Panels, and Back Rails

SIN 711.2

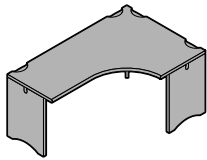

Tip: Additional shell configurations are possible by building them from components.

Tip: If shell with modesty panel in place of back rail is required, specify modesty panel separately.

Tip: All laminate surfaces have a solid color default PVC edge.

▶ See Color Coordination List, page G200.

Standard Includes







- Worksurface: laminate
- Bullnose edge profile on user's side: vinyl (PVC) black only
- Scallop grommets with cable-management insert: black only
- Two full-depth end panels: laminate
- Back rails: laminate
- Wire manager: black plastic only
- Grommets in end panels: black plastic only
- Leveling glides: black only
- Attachment hardware
- One corner end panel support: laminate

Required to Specify

- 1 Style number
- 2 Laminate color number for shell
- 3 Options, if selected (see below)
- ▶ See *Surface Materials*, page G198.

Options

Options	Price	Required to Specify
Surface Materials	• Open Line laminate +\$ 60 plus cost of laminate	▶ See <i>Surface Materials Reference Manual</i> .

End Panels	Price	Required to Specify
 Shell with two full-depth end panels	No cost	Specify <i>Config 1</i> .
 Shell with two slip-fit end panels	-\$128	Specify <i>Config 2</i> .
 Shell with two half-depth end panels	-\$ 64	Specify <i>Config 3</i> .
 Shell with one full-depth and one half-depth end panel	-\$ 32	Specify <i>Config 4</i> .
 Shell with one full-depth and one slip-fit end panel	-\$ 64	Specify <i>Config 5</i> .
 Shell with one half-depth and one slip-fit end panel	-\$ 96	Specify <i>Config 6</i> .

Related Products	Reference
• Breadboard-top worksurfaces	▶ Page G77
• Modesty panels	▶ Page G90
• Center drawer	▶ Page G94
• Keyboard shelf	▶ Page G94
• Cable manager	▶ Page G180

Specification Information

Dimensions					Style Number	Base Price
A	B	C	D	H		

Left-Hand Shell

23¼"	23¼"	64"	42"	28½"	TLECH4264L	\$1150
------	------	-----	-----	------	-------------------	--------

Right-Hand Shell

23¼"	23¼"	42"	64"	28½"	TLECH4264R	\$1150
------	------	-----	-----	------	-------------------	--------

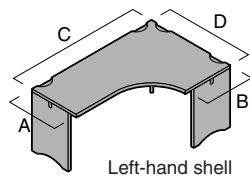

Left-hand shell

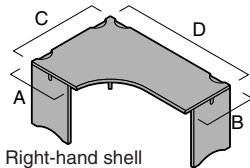

Right-hand shell

Transitional Corner Shells

with Wood Veneer Worksurface, End Panels, and Back Rails

SIN 711.2

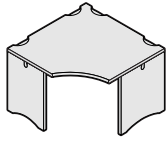

Tip: Additional shell configurations are possible by building them from components.

Tip: If shell with modesty panel in place of back rail is required, specify modesty panel separately.

Standard Includes	Required to Specify
<ul style="list-style-type: none"> • Worksurface: wood veneer • Bullnose edge profile on user's side: wood • Scallop grommets with cable-management insert: black only • Two full-depth end panels: wood veneer • Back rails: wood veneer • Wire manager: black plastic only • Grommets in end panels: black plastic only • Leveling glides: black only • Attachment hardware • One corner end panel support: wood veneer 	<ul style="list-style-type: none"> 1 Style number 2 Wood color number for shell 3 Options, if selected (see below) ▶ See <i>Surface Materials</i>, page G198.

End Panels	Options	Price	Required to Specify
	Shell with two full-depth end panels	No cost	Specify <i>Config 1</i> .
	Shell with two slip-fit end panels	-\$147	Specify <i>Config 2</i> .
	Shell with one half-depth (24") and one half-depth (30") end panel	-\$118	Specify <i>Config 3</i> .
	Shell with one full-depth (30") and one half-depth (24") end panel	-\$ 37	Specify <i>Config 4</i> .
	Shell with one full-depth (24") and one half-depth (30") end panel	-\$ 44	Specify <i>Config 5</i> .
	Shell with one full-depth (30") and one slip-fit (24") end panel	-\$ 67	Specify <i>Config 6</i> .
	Shell with one half-depth (30") and one slip-fit (24") end panel	-\$111	Specify <i>Config 7</i> .
	Shell with one full-depth (24") and one slip-fit (30") end panel	-\$ 80	Specify <i>Config 8</i> .
	Shell with one half-depth (24") and one slip-fit (30") end panel	-\$117	Specify <i>Config 9</i> .

Surface Materials	Full-fill finish on worksurface only	Price	Required to Specify
	<ul style="list-style-type: none"> • Full-fill finish 	+\$ 84	Specify with <i>full-fill finish</i> and select wood color number. ▶ See <i>Surface Materials</i> , page G198.

Customiz stain on shell with:	Price	Required to Specify
<ul style="list-style-type: none"> • Two full-depth end panels 	+\$255	Specify <i>Config 1</i> . Specify with <i>Customiz stain</i> .
<ul style="list-style-type: none"> • Two slip-fit end panels 	+\$255	Specify <i>Config 2</i> . Specify with <i>Customiz stain</i> .
<ul style="list-style-type: none"> • Two half-depth end panels (24") 	+\$255	Specify <i>Config 3</i> . Specify with <i>Customiz stain</i> .
<ul style="list-style-type: none"> • One full-depth (30") and one half-depth (24") end panel 	+\$255	Specify <i>Config 4</i> . Specify with <i>Customiz stain</i> .
<ul style="list-style-type: none"> • One full-depth (24") and one half-depth (30") end panel 	+\$255	Specify <i>Config 5</i> . Specify with <i>Customiz stain</i> .
<ul style="list-style-type: none"> • One full-depth (30") and one slip-fit (24") end panel 	+\$255	Specify <i>Config 6</i> . Specify with <i>Customiz stain</i> .
<ul style="list-style-type: none"> • One half-depth (30") and one slip-fit (24") end panel 	+\$255	Specify <i>Config 7</i> . Specify with <i>Customiz stain</i> .
<ul style="list-style-type: none"> • One full-depth (24") and one slip-fit (30") end panel 	+\$255	Specify <i>Config 8</i> . Specify with <i>Customiz stain</i> .
<ul style="list-style-type: none"> • One half-depth (24") and one slip-fit (30") end panel 	+\$255	Specify <i>Config 9</i> . Specify with <i>Customiz stain</i> .

Related Products	Options	Required to Specify
<ul style="list-style-type: none"> • Breadboard-top worksurfaces • Modesty panels • Center drawer • Keyboard shelf • Cable manager 		<ul style="list-style-type: none"> ▶ Page G77 ▶ Page G90 ▶ Page G94 ▶ Page G94 ▶ Page G94 ▶ Page G180

Specification Information

Dimensions					Style	Base
A	B	C	D	H	Number	Price

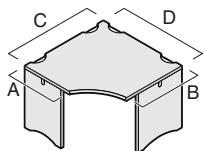

Left-hand worksurface

Left-Hand Shell

23 1/4"	29 1/4"	42"	42"	28 1/2"	TWCH42L	\$1597
:	:	:	:	:	:	:

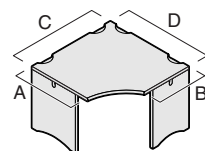

Right-hand worksurface

Right-Hand Shell

29 1/4"	23 1/4"	42"	42"	28 1/2"	TWCH42R	\$1597
:	:	:	:	:	:	:



Transitional Corner Shells

with Wood Veneer Worksurface and Laminate End Panels and Back Rails

SIN 711.2

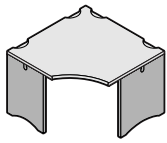

Tip: Additional shell configurations are possible by building them from components.

Tip: If shell with modesty panel in place of back rail is required, specify modesty panel separately.

Standard Includes	Required to Specify
<ul style="list-style-type: none"> • Worksurface: wood veneer • Bullnose edge profile on user's side: wood • Scallop grommets with cable-management insert: black only • Two full-depth end panels: laminate • Back rails: laminate • Wire manager: black plastic only • Grommets in end panels: black plastic only • Leveling glides: black only • Attachment hardware • One corner end panel support: laminate 	<ol style="list-style-type: none"> 1 Style number 2 Wood color number for worksurface 3 Laminate color number for end panels and back rails 4 Options, if selected (see below) <p>▶ See <i>Surface Materials</i>, page G198.</p>

End Panels	Options	Price	Required to Specify
	Shell with two full-depth end panels	No cost	Specify <i>Config 1</i> .
	Shell with two slip-fit end panels	-\$134	Specify <i>Config 2</i> .
	Shell with one half-depth (24") and one half-depth (30") end panel	-\$102	Specify <i>Config 3</i> .
	Shell with one full-depth (30") and one half-depth (24") end panel	-\$ 32	Specify <i>Config 4</i> .
	Shell with one full-depth (24") and one half-depth (30") end panel	-\$ 38	Specify <i>Config 5</i> .
	Shell with one full-depth (30") and one slip-fit (24") end panel	-\$ 64	Specify <i>Config 6</i> .
	Shell with one half-depth (30") and one slip-fit (24") end panel	-\$102	Specify <i>Config 7</i> .
	Shell with one full-depth (24") and one slip-fit (30") end panel	-\$ 70	Specify <i>Config 8</i> .
	Shell with one half-depth (24") and one slip-fit (30") end panel	-\$102	Specify <i>Config 9</i> .

Surface Materials	Full-fill finish on worksurface only	Required to Specify
	<ul style="list-style-type: none"> • Full-fill finish +\$ 84 	Specify with <i>full-fill finish</i> and select wood color number. ▶ See <i>Surface Materials</i> , page G198.

Customiz stain on shell with:		
	<ul style="list-style-type: none"> • Two full-depth end panels +\$ 84 • Two slip-fit end panels +\$ 84 • Two half-depth end panels (24") +\$ 84 • One full-depth (30") and one half-depth (24") end panel +\$ 84 • One full-depth (24") and one half-depth (30") end panel +\$ 84 • One full-depth (30") and one slip-fit (24") end panel +\$ 84 • One half-depth (30") and one slip-fit (24") end panel +\$ 84 • One full-depth (24") and one slip-fit (30") end panel +\$ 84 • One half-depth (24") and one slip-fit (30") end panel +\$ 84 	Specify <i>Config 1</i> . Specify with <i>Customiz stain</i> . Specify <i>Config 2</i> . Specify with <i>Customiz stain</i> . Specify <i>Config 3</i> . Specify with <i>Customiz stain</i> . Specify <i>Config 4</i> . Specify with <i>Customiz stain</i> . Specify <i>Config 5</i> . Specify with <i>Customiz stain</i> . Specify <i>Config 6</i> . Specify with <i>Customiz stain</i> . Specify <i>Config 7</i> . Specify with <i>Customiz stain</i> . Specify <i>Config 8</i> . Specify with <i>Customiz stain</i> . Specify <i>Config 9</i> . Specify with <i>Customiz stain</i> .
	<ul style="list-style-type: none"> • Open Line laminate +\$ 60 plus cost of laminate 	▶ See <i>Surface Materials Reference Manual</i> .

Related Products	Required to Specify
<ul style="list-style-type: none"> • Breadboard-top worksurfaces • Modesty panels • Center drawer • Keyboard shelf • Cable manager 	<ul style="list-style-type: none"> ▶ Page G77 ▶ Page G90 ▶ Page G94 ▶ Page G94 ▶ Page G180

Specification Information

Dimensions					Style	Base
A	B	C	D	H	Number	Price

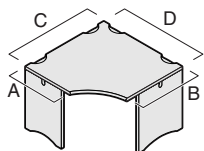

Left-hand worksurface

Left-Hand Shell

23¼"	29¼"	42"	42"	28½"	TWTCH42LL	\$1405
:	:	:	:	:	:	:

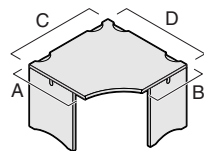

Right-hand worksurface

Right-Hand Shell

29¼"	23¼"	42"	42"	28½"	TWTCH42RL	\$1405
:	:	:	:	:	:	:

Transitional Corner Shells

with Laminate Worksurface, End Panels, and Back Rails

SIN 711.2

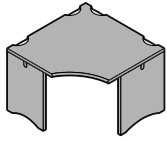

Tip: Additional shell configurations are possible by building them from components.

Tip: If shell with modesty panel in place of back rail is required, specify modesty panel separately.

Tip: All laminate surfaces have a solid color default PVC edge.

▶ See Color Coordination List, page G200.

Standard Includes

- Worksurface: laminate
- Bullnose edge profile on user's side: vinyl (PVC) black only
- Scallop grommets with cable-management insert: black only
- Two full-depth end panels: laminate
- Back rails: laminate
- Wire manager: black plastic only
- Grommets in end panels: black plastic only
- Leveling glides: black only
- Attachment hardware
- One corner end panel support: laminate

Required to Specify

- 1 Style number
 - 2 Laminate color number for shell
 - 3 Options, if selected (see below)
- ▶ See *Surface Materials*, page G198.

Options

Surface Materials	Options	Price	Required to Specify
	• Open Line laminate	+\$ 60 plus cost of laminate	▶ See <i>Surface Materials Reference Manual</i> .

End Panels	Options	Price	Required to Specify
	Shell with two full-depth end panels	No cost	Specify <i>Config 1</i> .
	Shell with two slip-fit end panels	-\$134	Specify <i>Config 2</i> .
	Shell with one half-depth (24") and one half-depth (30") end panel	-\$102	Specify <i>Config 3</i> .
	Shell with one full-depth (30") and one half-depth (24") end panel	-\$ 32	Specify <i>Config 4</i> .
	Shell with one full-depth (24") and one half-depth (30") end panel	-\$ 38	Specify <i>Config 5</i> .
	Shell with one full-depth (30") and one slip-fit (24") end panel	-\$ 64	Specify <i>Config 6</i> .
	Shell with one half-depth (30") and one slip-fit (24") end panel	-\$102	Specify <i>Config 7</i> .
	Shell with one full-depth (24") and one slip-fit (30") end panel	-\$ 70	Specify <i>Config 8</i> .
	Shell with one half-depth (24") and one slip-fit (30") end panel	-\$102	Specify <i>Config 9</i> .

Related Products	Options	Required to Specify
	• Breadboard-top worksurfaces	▶ Page G77
	• Modesty panels	▶ Page G90
	• Center drawer	▶ Page G94
	• Keyboard shelf	▶ Page G94
	• Cable manager	▶ Page G180

Specification Information

Dimensions					Style Number	Base Price
A	B	C	D	H		
23 1/4"	29 1/4"	42"	42"	28 1/2"	TLTCH42L	\$1155

Left-Hand Shell

23 1/4"	29 1/4"	42"	42"	28 1/2"	TLTCH42L	\$1155
---------	---------	-----	-----	---------	-----------------	--------

Right-Hand Shell

29 1/4"	23 1/4"	42"	42"	28 1/2"	TLTCH42R	\$1155
---------	---------	-----	-----	---------	-----------------	--------

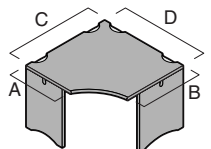

Left-hand worksurface

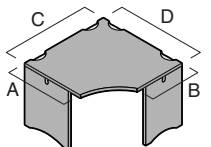

Right-hand worksurface

Transitional Extended Corner Shells

with Wood Veneer Worksurface, End Panels, and Back Rails

SIN 711.2

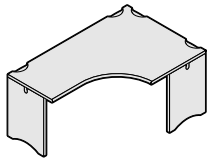

Tip: Additional shell configurations are possible by building them from components.

Tip: If shell with modesty panel in place of back rail is required, specify modesty panel separately.

Standard Includes	Required to Specify
<ul style="list-style-type: none"> • Worksurface: wood veneer • Bullnose edge profile on user's side: wood • Scallop grommets with cable-management insert: black only • Two full-depth end panels: wood veneer • Back rails: wood veneer • Wire manager: black plastic only • Grommets in end panels: black plastic only • Leveling glides: black only • Attachment hardware • One corner end panel support: wood veneer 	<ul style="list-style-type: none"> 1 Style number 2 Wood color number for shell 3 Options, if selected (see below) ▶ See <i>Surface Materials</i>, page G198.

End Panels	Options	Price	Required to Specify
	Shell with two full-depth end panels	No cost	Specify <i>Config 1</i> .
	Shell with two slip-fit end panels	-\$147	Specify <i>Config 2</i> .
	Shell with one half-depth (24") and one half-depth (30") end panel	-\$118	Specify <i>Config 3</i> .
	Shell with one full-depth (30") and one half-depth (24") end panel	-\$ 37	Specify <i>Config 4</i> .
	Shell with one full-depth (24") and one half-depth (30") end panel	-\$ 44	Specify <i>Config 5</i> .
	Shell with one full-depth (30") and one slip-fit (24") end panel	-\$ 67	Specify <i>Config 6</i> .
	Shell with one half-depth (30") and one slip-fit (24") end panel	-\$111	Specify <i>Config 7</i> .
	Shell with one full-depth (24") and one slip-fit (30") end panel	-\$ 80	Specify <i>Config 8</i> .
	Shell with one half-depth (24") and one slip-fit (30") end panel	-\$117	Specify <i>Config 9</i> .

Surface Materials	Full-fill finish on worksurface only	Price	Required to Specify
	<ul style="list-style-type: none"> • Full-fill finish 	+\$ 84	Specify with <i>full-fill finish</i> and select wood color number. ▶ See <i>Surface Materials</i> , page G198.

Customiz stain on shell with:	Price	Required to Specify
<ul style="list-style-type: none"> • Two full-depth end panels 	+\$255	Specify <i>Config 1</i> . Specify with <i>Customiz stain</i> .
<ul style="list-style-type: none"> • Two slip-fit end panels 	+\$255	Specify <i>Config 2</i> . Specify with <i>Customiz stain</i> .
<ul style="list-style-type: none"> • Two half-depth end panels (24") 	+\$255	Specify <i>Config 3</i> . Specify with <i>Customiz stain</i> .
<ul style="list-style-type: none"> • One full-depth (30") and one half-depth (24") end panel 	+\$255	Specify <i>Config 4</i> . Specify with <i>Customiz stain</i> .
<ul style="list-style-type: none"> • One full-depth (24") and one half-depth (30") end panel 	+\$255	Specify <i>Config 5</i> . Specify with <i>Customiz stain</i> .
<ul style="list-style-type: none"> • One full-depth (30") and one slip-fit (24") end panel 	+\$255	Specify <i>Config 6</i> . Specify with <i>Customiz stain</i> .
<ul style="list-style-type: none"> • One half-depth (30") and one slip-fit (24") end panel 	+\$255	Specify <i>Config 7</i> . Specify with <i>Customiz stain</i> .
<ul style="list-style-type: none"> • One full-depth (24") and one slip-fit (30") end panel 	+\$255	Specify <i>Config 8</i> . Specify with <i>Customiz stain</i> .
<ul style="list-style-type: none"> • One half-depth (24") and one slip-fit (30") end panel 	+\$255	Specify <i>Config 9</i> . Specify with <i>Customiz stain</i> .

Related Products	Options	Page
<ul style="list-style-type: none"> • Breadboard-top worksurfaces • Modesty panels • Center drawer • Keyboard shelf • Cable manager 		<ul style="list-style-type: none"> ▶ Page G77 ▶ Page G90 ▶ Page G94 ▶ Page G94 ▶ Page G94 ▶ Page G180

Specification Information

Dimensions					Style Number	Base Price
A	B	C	D	H		

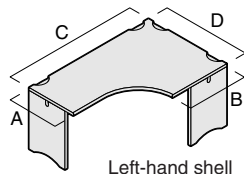

Left-Hand Shell

23 1/4"	29 1/4"	64"	42"	28 1/2"	TWCH4264L	\$1846
---------	---------	-----	-----	---------	------------------	--------

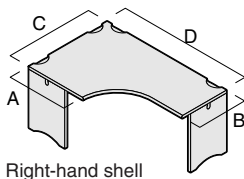

Right-Hand Shell

29 1/4"	23 1/4"	42"	64"	28 1/2"	TWCH4264R	\$1846
---------	---------	-----	-----	---------	------------------	--------



Transitional Extended Corner Shells

with Wood Veneer Worksurface and Laminate End Panels and Back Rails

SIN 711.2

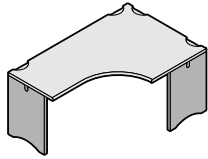

Tip: Additional shell configurations are possible by building them from components.

Tip: If shell with modesty panel in place of back rail is required, specify modesty panel separately.

Standard Includes	Required to Specify
<ul style="list-style-type: none"> • Worksurface: wood veneer • Bullnose edge profile on user's side: wood • Scallop grommets with cable-management insert: black only • Two full-depth end panels: laminate • Back rails: laminate • Wire manager: black plastic only • Grommets in end panels: black plastic only • Leveling glides: black only • Attachment hardware • One corner end panel support: laminate 	<ol style="list-style-type: none"> 1 Style number 2 Wood color number for worksurface 3 Laminate color number for end panels and back rails 4 Options, if selected (see below) <p>▶ See <i>Surface Materials</i>, page G198.</p>

End Panels	Options	Price	Required to Specify
	Shell with two full-depth end panels	No cost	Specify <i>Config 1</i> .
	Shell with two slip-fit end panels	-\$134	Specify <i>Config 2</i> .
	Shell with one half-depth (24") and one half-depth (30") end panel	-\$102	Specify <i>Config 3</i> .
	Shell with one full-depth (30") and one half-depth (24") end panel	-\$ 32	Specify <i>Config 4</i> .
	Shell with one full-depth (24") and one half-depth (30") end panel	-\$ 38	Specify <i>Config 5</i> .
	Shell with one full-depth (30") and one slip-fit (24") end panel	-\$ 64	Specify <i>Config 6</i> .
	Shell with one half-depth (30") and one slip-fit (24") end panel	-\$102	Specify <i>Config 7</i> .
	Shell with one full-depth (24") and one slip-fit (30") end panel	-\$ 70	Specify <i>Config 8</i> .
	Shell with one half-depth (24") and one slip-fit (30") end panel	-\$102	Specify <i>Config 9</i> .

Surface Materials	Full-fill finish on worksurface only	Price	Required to Specify
	• Full-fill finish	+\$ 84	Specify with <i>full-fill finish</i> and select wood color number. ▶ See <i>Surface Materials</i> , page G198.

Customiz stain on shell with:			
	• Two full-depth end panels	+\$ 84	Specify <i>Config 1</i> . Specify with <i>Customiz stain</i> .
	• Two slip-fit end panels	+\$ 84	Specify <i>Config 2</i> . Specify with <i>Customiz stain</i> .
	• Two half-depth end panels (24")	+\$ 84	Specify <i>Config 3</i> . Specify with <i>Customiz stain</i> .
	• One full-depth (30") and one half-depth (24") end panel	+\$ 84	Specify <i>Config 4</i> . Specify with <i>Customiz stain</i> .
	• One full-depth (24") and one half-depth (30") end panel	+\$ 84	Specify <i>Config 5</i> . Specify with <i>Customiz stain</i> .
	• One full-depth (30") and one slip-fit (24") end panel	+\$ 84	Specify <i>Config 6</i> . Specify with <i>Customiz stain</i> .
	• One half-depth (30") and one slip-fit (24") end panel	+\$ 84	Specify <i>Config 7</i> . Specify with <i>Customiz stain</i> .
	• One full-depth (24") and one slip-fit (30") end panel	+\$ 84	Specify <i>Config 8</i> . Specify with <i>Customiz stain</i> .
	• One half-depth (24") and one slip-fit (30") end panel	+\$ 84	Specify <i>Config 9</i> . Specify with <i>Customiz stain</i> .
	• Open Line laminate	+\$ 60 plus cost of laminate	▶ See <i>Surface Materials Reference Manual</i> .

Related Products	Options	Required to Specify
<ul style="list-style-type: none"> • Breadboard-top worksurfaces • Modesty panels • Center drawer • Keyboard shelf • Cable manager 		<ul style="list-style-type: none"> ▶ Page G77 ▶ Page G90 ▶ Page G94 ▶ Page G94 ▶ Page G180

Specification Information

Dimensions					Style	Base
A	B	C	D	H	Number	Price

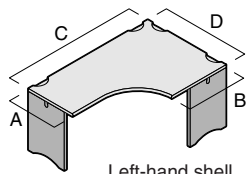

Left-hand shell

Left-Hand Shell

23 1/4"	29 1/4"	64"	42"	28 1/2"	TWTCH4264LL	\$1652
---------	---------	-----	-----	---------	--------------------	--------

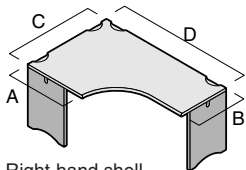

Right-hand shell

Right-Hand Shell

29 1/4"	23 1/4"	42"	64"	28 1/2"	TWTCH4264RL	\$1652
---------	---------	-----	-----	---------	--------------------	--------

Transitional Extended Corner Shells

with Laminate Worksurface, End Panels, and Back Rails

SIN 711.2

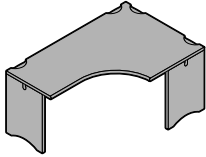

Tip: Additional shell configurations are possible by building them from components.

Tip: If shell with modesty panel in place of back rail is required, specify modesty panel separately.

Tip: All laminate surfaces have a solid color default PVC edge.

▶ See *Color Coordination List*, page G200.

Standard Includes

- Worksurface: laminate
- Bullnose edge profile on user's side: vinyl (PVC) black only
- Scallop grommets with cable-management insert: black only
- Two full-depth end panels: laminate
- Back rails: laminate
- Wire manager: black plastic only
- Grommets in end panels: black plastic only
- Leveling glides: black only
- Attachment hardware
- One corner end panel support: laminate

Required to Specify

- 1 Style number
 - 2 Laminate color number for shell
 - 3 Options, if selected (see below)
- ▶ See *Surface Materials*, page G198.

Options

Surface Materials	Options	Price	Required to Specify
	• Open Line laminate	+\$ 60 plus cost of laminate	▶ See <i>Surface Materials Reference Manual</i> .

End Panels	Options	Price	Required to Specify
	Shell with two full-depth end panels	No cost	Specify <i>Config 1</i> .
	Shell with two slip-fit end panels	-\$134	Specify <i>Config 2</i> .
	Shell with one half-depth (24") and one half-depth (30") end panel	-\$102	Specify <i>Config 3</i> .
	Shell with one full-depth (30") and one half-depth (24") end panel	-\$ 32	Specify <i>Config 4</i> .
	Shell with one full-depth (24") and one half-depth (30") end panel	-\$ 38	Specify <i>Config 5</i> .
	Shell with one full-depth (30") and one slip-fit (24") panel	-\$ 64	Specify <i>Config 6</i> .
	Shell with one half-depth (30") and one slip-fit (24") end panel	-\$102	Specify <i>Config 7</i> .
	Shell with one full-depth (24") and one slip-fit (30") end panel	-\$ 70	Specify <i>Config 8</i> .
	Shell with one half-depth (24") and one slip-fit (30") end panel	-\$102	Specify <i>Config 9</i> .

Related Products	Options	Required to Specify
• Breadboard-top worksurfaces		▶ Page G77
• Modesty panels		▶ Page G90
• Center drawer		▶ Page G94
• Keyboard shelf		▶ Page G94
• Cable manager		▶ Page G180

Specification Information

Dimensions					Style Number	Base Price
A	B	C	D	H		

Left-Hand Shell						
23¼"	29¼"	64"	42"	28½"	TLTCH4264L	\$1256

Right-Hand Shell						
29¼"	23¼"	42"	64"	28½"	TLTCH4264R	\$1256

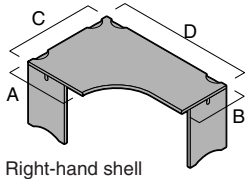
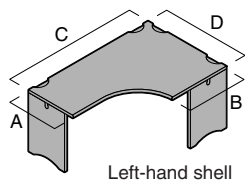

Specifying Relevant Worksurfaces

► For more detailed product information, see the *Relevant Systems Furniture Specification Guide* or consult your Steelcase dealer.

Worksurfaces

Rectangular Worksurfaces (SIN 711.2)	G62
Bowed Transition Worksurfaces (SIN 711.2)	G64
Corner Worksurfaces (SIN 711.2)	G66
Extended Corner Worksurfaces (SIN 711.2)	G68
Transitional Corner Worksurfaces (SIN 711.2)	G70
Transitional Extended Corner Worksurfaces (SIN 711.2)	G72
Pier-Top Worksurfaces (SIN 711.2)	G74
Spanner Tops (SIN 711.2)	G76
Breadboard-Top Worksurfaces (SIN 711.2)	G77
Adjustable-Height Corner Worksurfaces (SIN 711.2)	G79

Related Products

Full-Depth End Panels (SIN 711.2)	G81
Half-Depth End Panels (SIN 711.2)	G83
Slip-Fit End Panels (SIN 711.2)	G85
Corner End Panels (SIN 711.2)	G86
Back Rails (SIN 711.2)	G87
Modesty Panels (SIN 711.2)	G90
Accessories (SIN 711.2)	G94

Wood Veneer Rectangular Worksurfaces

SIN 711.2

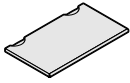

Tip: Remember to specify two end panels and one back rail or modesty panel. Back rails or modesty panels are required for structural integrity. Do **not** omit them.

Tip: Use 27¹/₈"H end panels and 4"H back rails to create seated-height stations. Use 39⁵/₈"H end panels and 16"H back rails to create standing-height stations.

Standard Includes		Required to Specify	
<ul style="list-style-type: none"> • Worksurface: wood veneer • Bullnose edge profile on user's side: wood • Scallop grommets with cable-management insert: black only • Wire manager: black plastic only • Flat bracket 		<ol style="list-style-type: none"> 1 Style number 2 Wood color number for worksurface 3 Options, if selected (see below) <p>▶ See <i>Surface Materials</i>, page G198.</p>	
Surface Materials	Options	Price	Required to Specify
	<ul style="list-style-type: none"> • Full-fill finish on worksurface only • Customiz stain on wood veneer 	<p>Prices below</p> <p>Prices below</p>	<p>Specify with <i>full-fill finish</i> and select wood color number.</p> <p>▶ See <i>Surface Materials</i>, page G198.</p> <p>Specify with <i>Customiz stain</i>.</p> <p>▶ See <i>Surface Materials Reference Manual</i>.</p>
Related Products	<ul style="list-style-type: none"> • Breadboard-top worksurfaces • Full-depth end panels • Half-depth end panels • Slip-fit end panels • Back rails • Modesty panels • Center drawer • Keyboard shelf • Cable manager 		<ul style="list-style-type: none"> ▶ Page G77 ▶ Page G81 ▶ Page G83 ▶ Page G85 ▶ Page G87 ▶ Page G90 ▶ Page G94 ▶ Page G94 ▶ Page G180

Specification Information				
Dimensions		Style Number	Base Price	Option
D	W			
23 ¹ / ₄ "	42"	TWRS4224	\$445	+\$41
23 ¹ / ₄ "	64"	TWRS6424	\$601	+\$60
29 ¹ / ₄ "	42"	TWRS4230	\$506	+\$41
29 ¹ / ₄ "	64"	TWRS6430	\$696	+\$60
:	:	:	:	:

Laminate Rectangular Worksurfaces

SIN 711.2

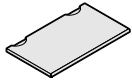

*Tip: Remember to specify two end panels and one back rail or modesty panel. Back rails or modesty panels are required for structural integrity. Do **not** omit them.*

Tip: Use 27¹/₈"H end panels and 4"H back rails to create seated-height stations. Use 39⁵/₈"H end panels and 16"H back rails to create standing-height stations.

Tip: All laminate surfaces have a solid color default PVC edge.
 ▶ See *Color Coordination List*, page G200.

Standard Includes	Required to Specify
<ul style="list-style-type: none"> • Worksurface: laminate • Bullnose edge profile on user's side: vinyl (PVC), black only • Scallop grommets with cable-management insert: black only • Wire manager: black plastic only • Flat bracket 	<ul style="list-style-type: none"> 1 Style number 2 Laminate color number for worksurface 3 Options, if selected (see below) ▶ See <i>Surface Materials</i>, page G198.

Options	Price	Required to Specify
Surface Materials <ul style="list-style-type: none"> • Open Line laminate 	+\$60 plus cost of laminate	▶ See <i>Surface Materials Reference Manual</i> .
Related Products <ul style="list-style-type: none"> • Breadboard-top worksurfaces • Full-depth end panels • Half-depth end panels • Slip-fit end panels • Back rails • Modesty panels • Center drawer • Keyboard shelf • Cable manager 		<ul style="list-style-type: none"> ▶ Page G77 ▶ Page G81 ▶ Page G83 ▶ Page G85 ▶ Page G87 ▶ Page G90 ▶ Page G94 ▶ Page G94 ▶ Page G180

Specification Information			
Dimensions		Style	Base
D	W	Number	Price
23 ¹ / ₄ "	42"	TLRS4224	\$201
23 ¹ / ₄ "	64"	TLRS6424	\$322
29 ¹ / ₄ "	42"	TLRS4230	\$255
29 ¹ / ₄ "	64"	TLRS6430	\$426
:	:	:	:

Laminate Bowed Transition Worksurfaces

SIN 711.2

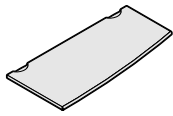

*Tip: Remember to specify two end panels and one back rail or modesty panel. Back rails or modesty panels are required for structural integrity. Do **not** omit them.*

Tip: Use 27 1/8"H end panels and 4"H back rails to create seated-height stations. Use 39 5/8"H end panels and 16"H back rails to create standing-height stations.

Tip: All laminate surfaces have a solid color default PVC edge.
▶ See *Color Coordination List*, page G200.

Standard Includes	Required to Specify
-------------------	---------------------

- Worksurface: laminate
- Bullnose edge profile on user's side: vinyl (PVC), black only
- Scallop grommets with cable-management insert: black only
- Wire manager: black plastic only
- Flat bracket

- 1 Style number
- 2 Laminate color number for worksurface
- 3 Options, if selected (see below)
- ▶ See *Surface Materials*, page G198.

Surface Materials	Options	Price	Required to Specify
-------------------	---------	-------	---------------------

Surface Materials	• Open Line laminate	+\$60 plus cost of laminate	▶ See <i>Surface Materials Reference Manual</i> .
-------------------	----------------------	--------------------------------	---

Related Products	Options	Price	Required to Specify
------------------	---------	-------	---------------------

Related Products	<ul style="list-style-type: none"> • Breadboard-top worksurfaces • Full-depth end panels • Half-depth end panels • Slip-fit end panels • Back rails • Modesty panels • Center drawer • Keyboard shelf • Cable manager 		<ul style="list-style-type: none"> ▶ Page G77 ▶ Page G81 ▶ Page G83 ▶ Page G85 ▶ Page G87 ▶ Page G90 ▶ Page G94 ▶ Page G94 ▶ Page G180
------------------	--	--	---

Specification Information

• Dimensions			• Style	• Base
A	B	W	Number	Price
:	:	:	:	:

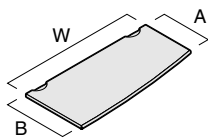

Left-hand worksurface

Left-Hand Worksurface

23 1/4"	29 1/4"	42"	TLBT4224L	\$254
23 1/4"	29 1/4"	64"	TLBT6424L	\$391
:	:	:	:	:

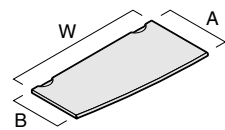

Right-hand worksurface

Right-Hand Worksurface

29 1/2"	23 1/4"	42"	TLBT4224R	\$254
29 1/2"	23 1/4"	64"	TLBT6424R	\$391
:	:	:	:	:

Wood Veneer Corner Worksurfaces

SIN 711.2



Tip: Remember to specify two end panels, two 42" back rails or modesty panels, and one corner end panel. Back rails or modesty panels are required for structural integrity. Do **not** omit them.

Tip: Use 27¹/₈"H end panels and 4"H back rails to create seated-height stations. Use 39⁵/₈"H end panels and 16"H back rails to create standing-height stations.

Standard Includes	Required to Specify
-------------------	---------------------

- | | |
|---|---|
| Standard Includes | Required to Specify |
| <ul style="list-style-type: none"> • Worksurface: wood veneer • Bullnose edge profile on user's side: wood • Scallop grommets with cable-management insert: black only • Wire manager: black plastic only • Flat bracket | <ol style="list-style-type: none"> 1 Style number 2 Wood color number for worksurface 3 Options, if selected (see below) <p>▶ See <i>Surface Materials</i>, page G198.</p> |

Options	Price	Required to Specify
---------	-------	---------------------

- | | | |
|-------------------|--|---|
| Surface Materials | <ul style="list-style-type: none"> • Full-fill finish on worksurface only <p>Prices below</p> | Specify with <i>full-fill finish</i> and select wood color number.
▶ See <i>Surface Materials</i> , page G198. |
| | <ul style="list-style-type: none"> • Customiz stain on wood veneer <p>Prices below</p> | Specify with <i>Customiz stain</i> .
▶ See <i>Surface Materials Reference Manual</i> . |

Related Products	Required to Specify
------------------	---------------------

- | | |
|---|---|
| Related Products | Required to Specify |
| <ul style="list-style-type: none"> • Breadboard-top worksurfaces • Full-depth end panels • Half-depth end panels • Slip-fit end panels • Corner end panels • Back rails • Modesty panels • Center drawer • Keyboard shelf • Cable manager | <ul style="list-style-type: none"> ▶ Page G77 ▶ Page G81 ▶ Page G83 ▶ Page G85 ▶ Page G86 ▶ Page G87 ▶ Page G90 ▶ Page G94 ▶ Page G94 ▶ Page G180 |

Specification Information

• Dimensions				• Style Number	• Base Price	• Option (Add \$ to Base Price)
A	B	C	D			
23 ¹ / ₄ "	23 ¹ / ₄ "	42"	42"	TWC4224	\$649	+\$41
29 ¹ / ₄ "	29 ¹ / ₄ "	42"	42"	TWC4230	\$713	+\$41

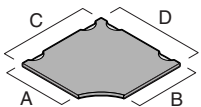
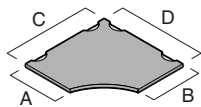

Laminate Corner Worksurfaces

SIN 711.2



*Tip: Remember to specify two end panels, two 42" back rails or modesty panels, and one corner end panel. Back rails or modesty panels are required for structural integrity. Do **not** omit them.*

Tip: Use 27 1/8"H end panels and 4"H back rails to create seated-height stations. Use 39 5/8"H end panels and 16"H back rails to create standing-height stations.

Tip: All laminate surfaces have a solid color default PVC edge.
▶ See *Color Coordination List*, page G200.

Standard Includes	Required to Specify
-------------------	---------------------

- Worksurface: laminate
- Bullnose edge profile on user's side: vinyl (PVC), black only
- Scallop grommets with cable-management insert: black only
- Wire manager: black plastic only
- Flat bracket

- 1 Style number
- 2 Laminate color number for worksurface
- 3 Options, if selected (see below)
- ▶ See *Surface Materials*, page G198.

Options	Price	Required to Specify
---------	-------	---------------------

Surface Materials	• Open Line laminate	+\$60 plus cost of laminate	▶ See <i>Surface Materials Reference Manual</i> .
--------------------------	----------------------	--------------------------------	---

Related Products	Required to Specify
------------------	---------------------

- Breadboard-top worksurfaces
- Full-depth end panels
- Half-depth end panels
- Slip-fit end panels
- Corner end panels
- Back rails
- Modesty panels
- Center drawer
- Keyboard shelf
- Cable manager

- ▶ Page G77
- ▶ Page G81
- ▶ Page G83
- ▶ Page G85
- ▶ Page G86
- ▶ Page G87
- ▶ Page G90
- ▶ Page G94
- ▶ Page G94
- ▶ Page G180

Specification Information

• Dimensions				• Style Number	• Base Price
A	B	C	D		
23 1/4"	23 1/4"	42"	42"	TLC4224	\$400
29 1/4"	29 1/4"	42"	42"	TLC4230	\$443

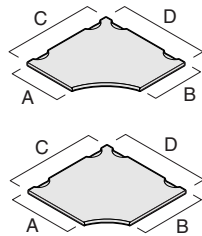

Laminate Extended Corner Worksurfaces

SIN 711.2

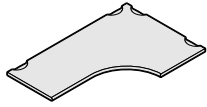

*Tip: Remember to specify two end panels, one 42" back rail, one 64" back rail or modesty panel, and one corner end panel. Back rails or modesty panels are required for structural integrity. Do **not** omit them.*

Tip: Use 27 1/8"H end panels and 4"H back rails to create seated-height stations. Use 39 5/8"H end panels and 16"H back rails to create standing-height stations.

Tip: All laminate surfaces have a solid color default PVC edge.
▶ See *Color Coordination List*, page G200.

Standard Includes	Required to Specify
-------------------	---------------------

- Worksurface: laminate
- Bullnose edge profile on user's side: vinyl (PVC), black only
- Scallop grommets with cable-management insert: black only
- Wire manager: black plastic only
- Flat bracket

- 1 Style number
- 2 Laminate color number for worksurface
- 3 Options, if selected (see below)
- ▶ See *Surface Materials*, page G198.

Surface Materials	Options	Price	Required to Specify
-------------------	---------	-------	---------------------

- | | | | |
|-------------------|----------------------|--------------------------------|---|
| Surface Materials | • Open Line laminate | +\$60
plus cost of laminate | ▶ See <i>Surface Materials Reference Manual</i> . |
|-------------------|----------------------|--------------------------------|---|

Related Products	Options	Price	Required to Specify
------------------	---------	-------	---------------------

- | | | | |
|------------------|-------------------------------|--|-------------|
| Related Products | • Breadboard-top worksurfaces | | ▶ Page G77 |
| | • Full-depth end panels | | ▶ Page G81 |
| | • Half-depth end panels | | ▶ Page G83 |
| | • Slip-fit end panels | | ▶ Page G85 |
| | • Corner end panels | | ▶ Page G86 |
| | • Back rails | | ▶ Page G87 |
| | • Modesty panels | | ▶ Page G90 |
| | • Center drawer | | ▶ Page G94 |
| | • Keyboard shelf | | ▶ Page G94 |
| | • Cable manager | | ▶ Page G180 |

Specification Information

Dimensions				Style Number	Base Price
A	B	C	D		

Left-Hand Worksurface

23 1/4"	23 1/4"	64"	42"	TLEC4264L	\$446
:	:	:	:	:	:

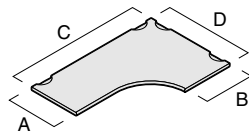

Left-hand worksurface

Right-Hand Worksurface

23 1/4"	23 1/4"	42"	64"	TLEC4264R	\$446
:	:	:	:	:	:

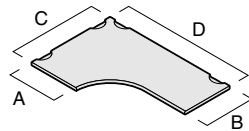

Right-hand worksurface

Laminate Transitional Corner Worksurfaces

SIN 711.2



*Tip: Remember to specify two end panels, two 42" back rails or modesty panels, and one corner end panel. Back rails or modesty panels are required for structural integrity. Do **not** omit them.*

Tip: Use 27 1/8"H end panels and 4"H back rails to create seated-height stations. Use 39 5/8"H end panels and 16"H back rails to create standing-height stations.

Tip: All laminate surfaces have a solid color default PVC edge.
▶ See *Color Coordination List*, page G200.

Standard Includes	Required to Specify
-------------------	---------------------

- Worksurface: laminate
- Bullnose edge profile on user's side: vinyl (PVC), black only
- Scallop grommets with cable-management insert: black only
- Wire manager: black plastic only
- Flat bracket

- 1 Style number
- 2 Laminate color number for worksurface
- 3 Options, if selected (see below)
- ▶ See *Surface Materials*, page G198.

Options	Price	Required to Specify
---------	-------	---------------------

Surface Materials	• Open Line laminate	+\$60 plus cost of laminate	▶ See <i>Surface Materials Reference Manual</i> .
--------------------------	----------------------	--------------------------------	---

Related Products	Price	Required to Specify
------------------	-------	---------------------

- Breadboard-top worksurfaces
- Full-depth end panels
- Half-depth end panels
- Slip-fit end panels
- Corner end panels
- Back rails
- Modesty panels
- Center drawer
- Keyboard shelf
- Cable manager

- ▶ Page G77
- ▶ Page G81
- ▶ Page G83
- ▶ Page G85
- ▶ Page G86
- ▶ Page G87
- ▶ Page G90
- ▶ Page G94
- ▶ Page G94
- ▶ Page G180

Specification Information

• Dimensions				• Style	• Base
A	B	C	D	Number	Price

Left-Hand Worksurface

23 1/4"	29 1/4"	42"	42"	TLTC42L	\$424
:	:	:	:	:	:

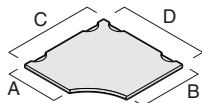

Left-hand worksurface

Right-Hand Worksurface

29 1/4"	23 1/4"	42"	42"	TLTC42R	\$424
:	:	:	:	:	:

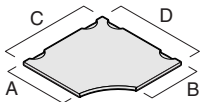

Right-hand worksurface

Laminate Transitional Extended Corner Worksurfaces

Laminate Transitional
Extended Corner
Worksurfaces

SIN 711.2

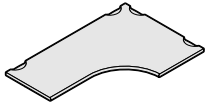

*Tip: Remember to specify two end panels, one 42" back rail, one 64" back rail or modesty panel, and one corner end panel. Back rails or modesty panels are required for structural integrity. Do **not** omit them.*

Tip: Use 27 1/8"H end panels and 4"H back rails to create seated-height stations. Use 39 5/8"H end panels and 16"H back rails to create standing-height stations.

Tip: All laminate surfaces have a solid color default PVC edge.
▶ See *Color Coordination List*, page G200.

Standard Includes	Required to Specify
-------------------	---------------------

- Worksurface: laminate
- Bullnose edge profile on user's side: vinyl (PVC), black only
- Scallop grommets with cable-management insert: black only
- Wire manager: black plastic only
- Flat bracket

- 1 Style number
- 2 Laminate color number for worksurface
- 3 Options, if selected (see below)
- ▶ See *Surface Materials*, page G198.

Surface Materials	Options	Price	Required to Specify
-------------------	---------	-------	---------------------

- | | | | |
|--------------------------|----------------------|--------------------------------|---|
| Surface Materials | • Open Line laminate | +\$60
plus cost of laminate | ▶ See <i>Surface Materials Reference Manual</i> . |
|--------------------------|----------------------|--------------------------------|---|

Related Products	Options	Price	Required to Specify
------------------	---------	-------	---------------------

- | | | | |
|-------------------------|---|--|---|
| Related Products | <ul style="list-style-type: none"> • Breadboard-top worksurfaces • Full-depth end panels • Half-depth end panels • Slip-fit end panels • Corner end panels • Back rails • Modesty panels • Center drawer • Keyboard shelf • Cable manager | | <ul style="list-style-type: none"> ▶ Page G77 ▶ Page G81 ▶ Page G83 ▶ Page G85 ▶ Page G86 ▶ Page G87 ▶ Page G90 ▶ Page G94 ▶ Page G94 ▶ Page G180 |
|-------------------------|---|--|---|

Specification Information

Dimensions				Style	Base
A	B	C	D	Number	Price

Left-Hand Worksurface

23 1/4"	29 1/4"	64"	42"	TLTC4264L	\$514
:	:	:	:	:	:

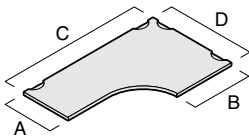

Left-hand worksurface

Right-Hand Worksurface

29 1/4"	23 1/4"	42"	64"	TLTC4264R	\$514
:	:	:	:	:	:

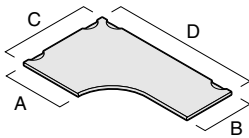

Right-hand worksurface

Pier-Top Worksurfaces

SIN 711.2

Wood Veneer Pier-Top Worksurfaces

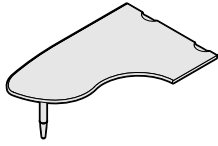

*Tip: Remember to specify one end panel, one corner end panel, and one 42" back rail or modesty panel. Back rail or modesty panel is required for structural integrity. Do **not** omit them.*

Tip: Use 27 1/8" H end panels and 4" H back rails to create seated-height stations. Use 39 5/8" H end panels and 16" H back rails to create standing-height stations.

Standard Includes	Required to Specify
-------------------	---------------------

- Worksurface: wood veneer
- Bullnose edge profile on user's side: wood
- Scallop grommets with cable-management insert: black only
- Column leg base: black only
- Wire manager: black plastic only
- Column leg

- 1 Style number
- 2 Wood color number for worksurface
- 3 Options, if selected (see below)
- ▶ See *Surface Materials*, page G198.

Options	Price	Required to Specify
---------	-------	---------------------

Surface Materials

- Full-fill finish on worksurface only
- Customiz stain on wood veneer

Prices below

Prices below

- Specify with *full-fill finish* and select wood color number.
- ▶ See *Surface Materials*, page G198.
- Specify with *Customiz stain*.
- ▶ See *Surface Materials Reference Manual*.

Related Products

- Full-depth end panels
- Half-depth end panels
- Slip-fit end panels
- Corner end panels
- Back rails
- Modesty panels
- Cable manager

- ▶ Page G81
- ▶ Page G83
- ▶ Page G85
- ▶ Page G86
- ▶ Page G87
- ▶ Page G90
- ▶ Page G180

Specification Information

Dimensions				Style Number	Base Price	Option (Add \$ to Base Price)
A	B	C	H			

Left-Hand Pier-Top Worksurface

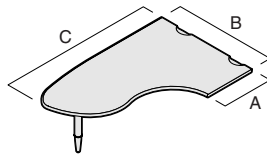

Left-hand worksurface

Seated-height

23 1/4"	48"	72"	28 1/2"	TWPT4872L	\$1462	+\$84
---------	-----	-----	---------	------------------	--------	-------

Standing-height

23 1/4"	48"	72"	40 3/4"	TWPTS4872L	\$1513	+\$84
---------	-----	-----	---------	-------------------	--------	-------

Right-Hand Pier-Top Worksurface

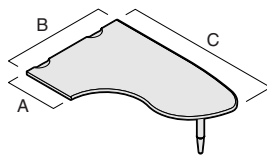

Right-hand worksurface

Seated-height

23 1/4"	48"	72"	28 1/2"	TWPT4872R	\$1462	+\$84
---------	-----	-----	---------	------------------	--------	-------

Standing-height

23 1/4"	48"	72"	40 3/4"	TWPTS4872R	\$1513	+\$84
---------	-----	-----	---------	-------------------	--------	-------

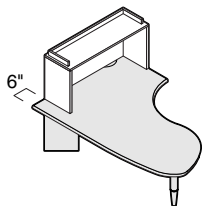

Tip: Use 42"W hutches and overhead binder bins on 48" side of pier-top worksurface to provide 6" clear space on the visitor's side.

Laminate Pier-Top Worksurfaces

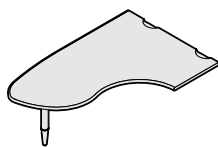

Tip: Remember to specify one end panel, one corner end panel, and one 42" back rail or modesty panel. Back rail or modesty panel is required for structural integrity. Do **not** omit them.

Tip: Use 27¹/₈"H end panels and 4"H back rails to create seated-height stations. Use 39⁵/₈"H end panels and 16"H back rails to create standing-height stations.

Tip: All laminate surfaces have a solid color default PVC edge.
▶ See Color Coordination List, page G200.

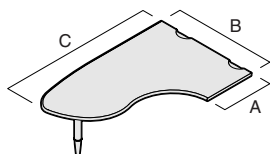

Left-hand work surface

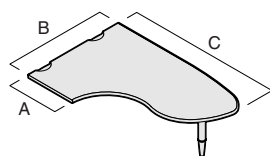

Right-hand work surface

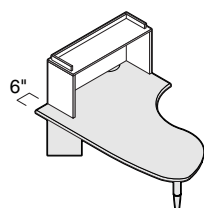

Tip: Use 42"W hutches and overhead binder bins on 48" side of pier-top work surface to provide 6" clear space on the visitor's side.

Standard Includes	Required to Specify
-------------------	---------------------

- Worksurface: laminate
- Bullnose edge profile on user's side: vinyl (PVC), black only
- Scallop grommets with cable-management insert: black only
- Column leg base: black only
- Wire manager: black plastic only

- 1 Style number
- 2 Laminate color number for work surface
- 3 Options, if selected (see below)
- ▶ See *Surface Materials*, page G198.

Options	Price	Required to Specify
---------	-------	---------------------

- | | | | |
|--------------------------|----------------------|------------------------------|---|
| Surface Materials | • Open Line laminate | + \$60 plus cost of laminate | ▶ See <i>Surface Materials Reference Manual</i> . |
|--------------------------|----------------------|------------------------------|---|

Related Products	Required to Specify
------------------	---------------------

- | | |
|-------------------------------|-------------|
| • Breadboard-top worksurfaces | ▶ Page G77 |
| • Full-depth end panels | ▶ Page G81 |
| • Slip-fit end panels | ▶ Page G85 |
| • Corner end panels | ▶ Page G86 |
| • Back rails | ▶ Page G87 |
| • Modesty panels | ▶ Page G90 |
| • Cable manager | ▶ Page G180 |

Specification Information

Dimensions				Style Number	Base Price
A	B	C	H		

Left-Hand Pier-Top Worksurface

Seated-height					
---------------	--	--	--	--	--

23 ¹ / ₄ "	48"	72"	28 ¹ / ₂ "	TLPT4872L	\$1133
----------------------------------	-----	-----	----------------------------------	------------------	--------

Standing-height					
-----------------	--	--	--	--	--

23 ¹ / ₄ "	48"	72"	40 ³ / ₄ "	TLPTS4872L	\$1183
----------------------------------	-----	-----	----------------------------------	-------------------	--------

Right-Hand Pier-Top Worksurface

Seated-height					
---------------	--	--	--	--	--

23 ¹ / ₄ "	48"	72"	28 ¹ / ₂ "	TLPT4872R	\$1133
----------------------------------	-----	-----	----------------------------------	------------------	--------

Standing-height					
-----------------	--	--	--	--	--

23 ¹ / ₄ "	48"	72"	40 ³ / ₄ "	TLPTS4872R	\$1183
----------------------------------	-----	-----	----------------------------------	-------------------	--------

Spanner Tops

SIN 711.2

Wood Veneer Spanner Tops

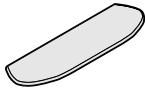

Tip: Always use full-depth end panels to support work-surfaces to which the spanner top attaches. Do **not** use half-depth end panels.

Tip: **TWST4818** tops can be used with all work-surfaces. **TWST6023** tops can be used with all work-surfaces except corner and transitional corner work-surfaces, or refer to application matrix, *Understanding Spanner Tops*, in the Relevant Specification Guide.

Standard Includes		Required to Specify	
	<ul style="list-style-type: none"> Spanner top: wood veneer Bullnose edge profile on user's side: wood Support for spanner top: black only Alignment brackets and attachment hardware 		<ol style="list-style-type: none"> Style number Wood color number for spanner top Options, if selected (see below) <p>▶ See <i>Surface Materials</i>, page G198.</p>
Options		Price	Required to Specify
Surface Materials	<ul style="list-style-type: none"> Full-fill finish on worksurface only 	Prices below	Specify with <i>full-fill finish</i> and select wood color number. ▶ See <i>Surface Materials</i> , page G198. Specify with <i>Customiz stain</i> . ▶ See <i>Surface Materials Reference Manual</i> .
	<ul style="list-style-type: none"> Customiz stain on wood veneer 	Prices below	

Specification Information				
Dimensions		Style	Base	Option
D	W	Number	Price	(Add \$ to Base Price)
18"	46½"	TWST4818	\$685	+Full-Fill or Customiz Stain

For Use with Two 24"D Worksurfaces

18"	46½"	TWST4818	\$685	+\$24
-----	------	-----------------	-------	-------

For Use with Two 30"D Worksurfaces

22⅝"	58½"	TWST6023	\$844	+\$41
------	------	-----------------	-------	-------

Laminate Spanner Tops

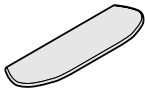

Tip: Always use full-depth end panels to support work-surfaces to which the spanner top attaches. Do **not** use half-depth end panels.

Tip: All laminate surfaces have a solid color default PVC edge.

▶ See *Color Coordination List*, page G200.

Tip: **TLST4818** tops can be used with all work-surfaces. **TLST6023** tops can be used with all work-surfaces except corner and transitional corner work-surfaces, or refer to application matrix, *Understanding Spanner Tops*, in the Relevant Specification Guide.

Standard Includes		Required to Specify	
	<ul style="list-style-type: none"> Spanner top: laminate Bullnose edge profile on user's side: vinyl (PVC), black only Support for spanner top: black only Alignment brackets and attachment hardware 		<ol style="list-style-type: none"> Style number Laminate color number for spanner top Options, if selected (see below) <p>▶ See <i>Surface Materials</i>, page G198.</p>
Options		Price	Required to Specify
Surface Materials	<ul style="list-style-type: none"> Open Line laminate 	+\$60 plus cost of laminate	▶ See <i>Surface Materials Reference Manual</i> .

Specification Information			
Dimensions		Style	Base
D	W	Number	Price
18"	46½"	TLST4818	\$431

For Use with Two 24"D Worksurfaces

18"	46½"	TLST4818	\$431
-----	------	-----------------	-------

For Use with Two 30"D Worksurfaces

22⅝"	58½"	TLST6023	\$536
------	------	-----------------	-------

Breadboard-Top Worksurfaces

SIN 711.2

Wood Veneer Breadboard-Top Worksurfaces

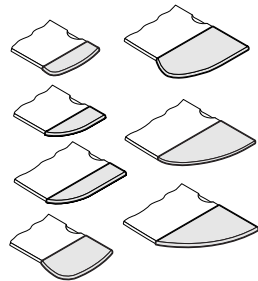

Tip: Not all breadboard tops can be used with all worksurfaces. Refer to the specification information below or to the application matrix, *Understanding Breadboard-Top Worksurfaces*, in the Relevant Specification Guide for assistance in specifying the correct breadboard top for your application.



Standard Includes	Required to Specify
-------------------	---------------------

- Worksurface: wood veneer
- Bullnose edge profile: wood
- Breadboard support: black only
- Alignment bracket and attachment hardware

- 1 Style number
 - 2 Wood color number for worksurface
 - 3 Options, if selected (see below)
- ▶ See *Surface Materials*, page G198.

Options	Price	Required to Specify
---------	-------	---------------------

Surface Materials

- Full-fill finish on worksurface only

Prices below

Specify with *full-fill finish* and select wood color number.

- Customiz stain on wood veneer

Prices below

- ▶ See *Surface Materials*, page G198.
Specify with *Customiz stain*.
▶ See *Surface Materials Reference Manual*.

Specification Information			
---------------------------	--	--	--

Dimensions		Style	Base	Option
D	W	Number	Price	(Add \$ to Base Price)
				Full-Fill or Customiz Stain

Left-Hand Breadboard-Tops

For use with all worksurfaces

23 1/4"	8"	TWBB248L	\$253	+\$24
23 1/4"	16"	TWBB2416L	\$275	+\$24

For use with extended corner, transitional extended corner, rectangular, and bowed transitional worksurfaces

29 1/4"	16"	TWBBC3016L	\$292	+\$24
29 1/4"	22 5/8"	TWBB3023L	\$316	+\$24

For use with corner, transitional corner and bowed transitional worksurfaces

23 1/4"	8"	TWBBC248L	\$253	+\$24
---------	----	------------------	-------	-------

For use with corner and transitional corner worksurfaces

29 1/4"	8"	TWBBC308L	\$270	+\$24
29 1/4"	18"	TWBBC3018L	\$308	+\$24

Right-Hand Breadboard-Tops

For use with all worksurfaces

23 1/4"	8"	TWBB248R	\$253	+\$24
23 1/4"	16"	TWBB2416R	\$275	+\$24

For use with extended corner, transitional extended corner, rectangular, and bowed transitional worksurfaces

29 1/4"	16"	TWBBC3016R	\$292	+\$24
29 1/4"	22 5/8"	TWBB3023R	\$316	+\$24

For use with corner, transitional corner and bowed transitional worksurfaces

23 1/4"	8"	TWBBC248R	\$253	+\$24
---------	----	------------------	-------	-------

For use with corner and transitional corner worksurfaces

29 1/4"	8"	TWBBC308R	\$270	+\$24
29 1/4"	18"	TWBBC3018R	\$308	+\$24

Breadboard-Top Worksurfaces, continued

SIN 711.2

Laminate Breadboard-Top Worksurfaces

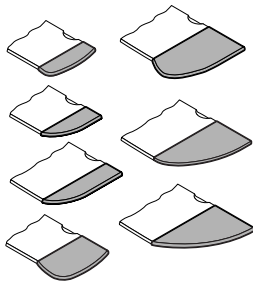

Tip: Not all breadboard tops can be used with all worksurfaces. Refer to the specification information below or to the application matrix, *Understanding Breadboard-top Worksurfaces*, in the Relevant Specification Guide for assistance in specifying the correct breadboard top for your application.

Tip: All laminate surfaces have a solid color default PVC edge.
 ▶ See *Color Coordination List*, page G200.

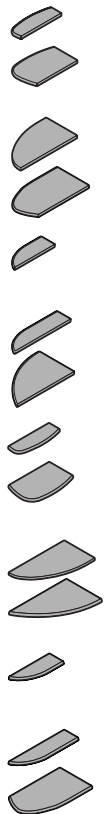

Standard Includes	Required to Specify
<ul style="list-style-type: none"> • Worksurface: laminate • Bullnose edge profile: vinyl (PVC) • Breadboard support: black only • Alignment bracket and attachment hardware 	<ul style="list-style-type: none"> 1 Style number 2 Laminate color number for worksurface 3 Options, if selected (see below) ▶ See <i>Surface Materials</i>, page G198.

Options	Price	Required to Specify
Surface Materials <ul style="list-style-type: none"> • Open Line laminate 	+\$60 plus cost of laminate	▶ See <i>Surface Materials Reference Manual</i> .

Specification Information

Dimensions	Style Number	Base Price
D	W	

Left-Hand Breadboard Tops

For use with all worksurfaces

23¼"	8"	TLBB248L	\$187
23¼"	16"	TLBB2416L	\$209

For use with extended corner, transitional extended corner, rectangular, and bowed transitional worksurfaces

29¼"	16"	TLBBC3016L	\$225
29¼"	22⅝"	TLBB3023L	\$254

For use with corner, transitional corner, and bowed transitional worksurfaces

23¼"	8"	TLBBC248L	\$191
------	----	------------------	-------

For use with corner and transitional corner worksurfaces

29¼"	8"	TLBBC308L	\$204
29¼"	18"	TLBBC3018L	\$242

Right-Hand Breadboard Tops

For use with all worksurfaces

23¼"	8"	TLBB248R	\$187
23¼"	16"	TLBB2416R	\$209

For use with extended corner, transitional extended corner, rectangular, and bowed transitional worksurfaces

29¼"	16"	TLBBC3016R	\$225
29¼"	22⅝"	TLBB3023R	\$254

For use with corner, transitional corner, and bowed transitional worksurfaces

23¼"	8"	TLBBC248R	\$191
------	----	------------------	-------

For use with corner and transitional corner worksurfaces

29¼"	8"	TLBBC308R	\$204
29¼"	18"	TLBBC3018R	\$242

Adjustable-Height Corner Worksurfaces, continued

SIN 711.2

Laminate Adjustable-Height Corner Worksurfaces

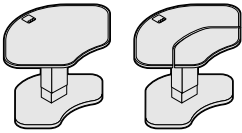

Tip: Split surface features a latch-adjustable front surface that is height-adjustable independently from the back surface, with a range of up 7" and down 5¾".

Tip: Adjustable-height corner worksurface is designed to be installed with 1" space separating it from adjacent worksurfaces to eliminate pinch points.

Tip: All laminate surfaces have a solid color default PVC edge.
 ▶ See Color Coordination List, page G200.

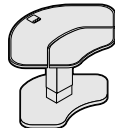
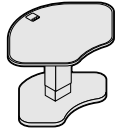

Standard Includes	Required to Specify
-------------------	---------------------

- Worksurface: laminate
- Bullnose edge profile: vinyl (PVC), black only
- Adjustable-height column mechanism with electric motor: black only
- Relevant base: black only
- Attachment hardware kit
- Grommet in worksurface: black plastic
- Wire manager: black plastic only

- 1 Style number
- 2 Laminate color number for worksurface
- 3 Options, if selected (see below)
- ▶ See *Surface Materials*, page G198.

Options	Price	Required to Specify
---------	-------	---------------------

Surface Materials	• Open Line laminate	+\$60 plus cost of laminate
--------------------------	----------------------	-----------------------------

Specification Information				
• Dimensions			• Style	• Base
D	W	H	Number	Price

:	:	:	:	:
---	---	---	---	---

Solid Surface

23"	40"	26"-40"	TLHAS4224	\$2298
:	:	:	:	:

Split Surface

23"	40"	26"-40"	TLHASP4224	\$2818
:	:	:	:	:

Full-Depth End Panels, continued

SIN 711.2

Laminate Full-Depth End Panels



▶ See *Worksurface Application Guidelines* in the *Relevant Specification Guide*.

Tip: Use 27 1/8" H end panels to create seated-height stations. Use 39 5/8" H end panels to create standing-height stations.

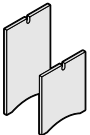
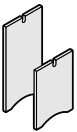

Tip: All laminate surfaces have a solid color default PVC edge.
▶ See *Color Coordination List*, page G200.

Standard Includes	Required to Specify
<ul style="list-style-type: none"> • End panel: laminate • Leveling glides: black only • Alignment plate and attachment hardware • Grommet: black plastic only • Spacer: black plastic 	<ul style="list-style-type: none"> 1 Style number 2 Laminate color number for end panel 3 Options, if selected (see below) ▶ See <i>Surface Materials</i>, page G198.

Options	Price	Required to Specify
Surface Materials <ul style="list-style-type: none"> • Open Line laminate 	+\$60 plus cost of laminate	▶ See <i>Surface Materials Reference Manual</i> .

Specification Information

Dimensions	Style	Base
D H	Number	Price

For Use with 24"D Worksurfaces

Seated-height			
19 1/4"	27 1/8"	TLEP24	\$157
Standing-height			
19 1/4"	39 5/8"	TLSHEP24	\$188

For Use with 30"D Worksurfaces

Seated-height			
23 1/4"	27 1/8"	TLEP30	\$195
Standing-height			
23 1/4"	39 5/8"	TLSHEP30	\$215

Half-Depth End Panels, continued

SIN 711.2

Laminate Half-Depth End Panels



Tip: Don't use a half-depth end panel to support a breadboard or spanner top. Always use a full-depth or slip-fit end panel.
 ▶ See *Worksurface Application Guidelines* in the *Relevant Specification Guide*.

Tip: Use 27 1/8" H end panels to create seated-height stations. Use 39 5/8" H end panels to create standing-height stations.

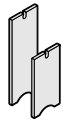

Tip: Style numbers TLHEP24 and TLSHHEP24 should be used to support 24"D worksurfaces only, not 30"D worksurfaces.

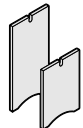

Tip: All laminate surfaces have a solid color default PVC edge.
 ▶ See *Color Coordination List*, page G200.

Standard Includes	Required to Specify
-------------------	---------------------

- End panel: laminate
- Leveling glides: black only
- Alignment plate and attachment hardware
- Grommet: black plastic only
- Spacer: black plastic

- 1 Style number
 - 2 Laminate color number for end panel
 - 3 Options, if selected (see below)
- ▶ See *Surface Materials*, page G198.

Options	Price	Required to Specify
---------	-------	---------------------

Surface Materials	• Open Line laminate +\$60 plus cost of laminate	▶ See <i>Surface Materials Reference Manual</i> .
--------------------------	--	---

Specification Information		
---------------------------	--	--

Dimensions	Style	Base
D H	Number	Price

For Use with 24"D Worksurfaces

Seated-height

13 1/2"	27 1/8"	TLHEP24	\$125
---------	---------	----------------	-------

Standing-height

13 1/2"	39 5/8"	TLSHHEP24	\$155
---------	---------	------------------	-------

For Use with 30"D Worksurfaces

Seated-height

19 1/4"	27 1/8"	TLEP24	\$157
---------	---------	---------------	-------

Standing-height

19 1/4"	39 5/8"	TLSHEP24	\$188
---------	---------	-----------------	-------

Slip-Fit End Panels

SIN 711.2

Wood Veneer Slip-Fit End Panel

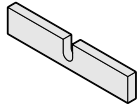

Standard Includes	Required to Specify
<ul style="list-style-type: none"> • End panel: wood veneer • Alignment plate and attachment hardware • Grommet: black plastic only • Spacer: black plastic 	<ul style="list-style-type: none"> 1 Style number 2 Wood color number for end panel 3 Options, if selected (see below) ▶ See <i>Surface Materials</i>, page G198.

Options	Price	Required to Specify
Surface Materials <ul style="list-style-type: none"> • Customiz stain on wood veneer 	Prices below	<ul style="list-style-type: none"> Specify with <i>Customiz stain</i>. ▶ See <i>Surface Materials Reference Manual</i>.

Specification Information			
Dimensions	Style	Base	Option
D H	Number	Price	(Add \$ to Base Price)
			Customiz Stain on Wood

For Use with 24"D Worksurfaces Only

19¼"	4"	TWSEP24	\$129	+\$41
------	----	----------------	-------	-------

For Use with 30"D Worksurfaces Only

23¼"	4"	TWSEP30	\$160	+\$41
------	----	----------------	-------	-------

Laminate Slip-Fit End Panel

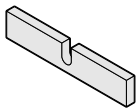

Tip: All laminate surfaces have a solid color default PVC edge.
▶ See *Color Coordination List*, page G200.

Standard Includes	Required to Specify
<ul style="list-style-type: none"> • End panel: laminate • Alignment plate and attachment hardware • Grommet: black plastic only • Spacer: black plastic 	<ul style="list-style-type: none"> 1 Style number 2 Laminate color number for end panel 3 Options, if selected (see below) ▶ See <i>Surface Materials</i>, page G198.

Options	Price	Required to Specify
Surface Materials <ul style="list-style-type: none"> • Open Line laminate 	+\$60 plus cost of laminate	▶ See <i>Surface Materials Reference Manual</i> .

Specification Information			
Dimensions	Style	Base	Option
D H	Number	Price	(Add \$ to Base Price)

For Use with 24"D Worksurfaces Only

19¼"	4"	TLSEP24	\$ 93
------	----	----------------	-------

For Use with 30"D Worksurfaces Only

23¼"	4"	TLSEP30	\$125
------	----	----------------	-------

Corner End Panels

SIN 711.2

Wood Veneer Corner End Panel



Tip: Specify one corner end panel for use with pier-top, corner, transitional corner, transitional extended corner, and extended corner worksurfaces.

Tip: Use 27¹/₈"H end panels to create seated-height stations. Use 39⁵/₈"H end panels to create standing-height stations.

Standard Includes	Required to Specify
<ul style="list-style-type: none"> • Corner end panel: wood veneer • Leveling glides: black only • Attachment hardware • Grommet: black plastic only 	<ol style="list-style-type: none"> 1 Style number 2 Wood color number for corner end panel 3 Options, if selected (see below) <p>▶ See <i>Surface Materials</i>, page G198.</p>

Options	Price	Required to Specify
Surface Materials <ul style="list-style-type: none"> • Customiz stain on wood veneer 	Prices below	Specify with <i>Customiz stain</i> . ▶ See <i>Surface Materials Reference Manual</i> .

Specification Information

Dimensions	Style Number	Base Price	Option
D H			(Add \$ to Base Price)
.....
.....
.....
.....
.....
.....
.....
.....
.....
.....

Seated-height				
17 ¹ / ₂ "	27 ¹ / ₈ "	TWCEP24	\$199	+\$41
Standing-height				
17 ¹ / ₂ "	39 ⁵ / ₈ "	TWSHCEP24	\$251	+\$60
.....

Laminate Corner End Panel



Tip: Specify one corner end panel for use with pier-top, corner, transitional corner, transitional extended corner, and extended corner worksurfaces.

Tip: Use 27¹/₈"H end panels to create seated-height stations. Use 39⁵/₈"H end panels to create standing-height stations.

Tip: All laminate surfaces have a solid color default PVC edge.
 ▶ See *Color Coordination List*, page G200.

Standard Includes	Required to Specify
<ul style="list-style-type: none"> • Corner end panel: laminate • Leveling glides: black only • Alignment plate and attachment hardware • Grommet: black plastic only 	<ol style="list-style-type: none"> 1 Style number 2 Laminate color number for corner end panel 3 Options, if selected (see below) <p>▶ See <i>Surface Materials</i>, page G198.</p>

Options	Price	Required to Specify
Surface Materials <ul style="list-style-type: none"> • Open Line laminate 	+\$60 plus cost of laminate	▶ See <i>Surface Materials Reference Manual</i> .

Specification Information

Dimensions	Style Number	Base Price
D H		Price
.....
.....
.....
.....
.....
.....
.....
.....
.....

Seated-height		
17 ¹ / ₂ "	27 ¹ / ₈ "	TLCEP24 \$157
Standing-height		
17 ¹ / ₂ "	39 ⁵ / ₈ "	TLSHCEP24 \$206
.....

Back Rails

SIN 711.2

4"H Wood Veneer Back Rails

For Use with Seated-Height (27¹/₈"H) End Panels only

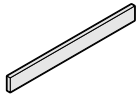

Tip: Back rails or modesty panels are required for structural integrity. Do not omit them. For straight work-surfaces, specify one back rail or modesty panel of a length that corresponds to the worksurface width. For corner worksurfaces, specify one 42" and one 64" back rail or modesty panel. For pier tops, specify one 42" back rail or modesty panel.

Standard Includes	Required to Specify
<ul style="list-style-type: none"> • Back rails: wood veneer • Attachment hardware 	1 Style number 2 Wood color number for back rail 3 Options, if selected (see below) ▶ See <i>Surface Materials</i> , page G198.

Options	Price	Required to Specify
Surface Materials <ul style="list-style-type: none"> • Customiz stain on wood veneer 	Prices below	Specify with <i>Customiz stain</i> . ▶ See <i>Surface Materials Reference Manual</i> .

Specification Information				
• Dimensions		• Style Number	• Base Price	• Option
L	H			
42"	4"	TWBS42	\$144	+\$24
64"	4"	TWBS64	\$157	+\$24
.

4"H Laminate Back Rails

For Use with Seated-Height (27¹/₈"H) End Panels only

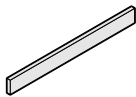

Tip: Back rails or modesty panels are required for structural integrity. Do not omit them. For straight work-surfaces, specify one back rail or modesty panel of a length that corresponds to the worksurface width. For corner worksurfaces, specify one 42" and one 64" back rail or modesty panel. For pier tops, specify one 42" back rail or modesty panel.

Standard Includes	Required to Specify
<ul style="list-style-type: none"> • Back rail: laminate • Attachment hardware 	1 Style number 2 Laminate color number for back rail 3 Options, if selected (see below) ▶ See <i>Surface Materials</i> , page G198.

Options	Price	Required to Specify
Surface Materials <ul style="list-style-type: none"> • Open Line laminate 	+\$60 plus cost of laminate	▶ See <i>Surface Materials Reference Manual</i> .

Specification Information				
• Dimensions		• Style Number	• Base Price	• Option
L	H			
42"	4"	TLBS42	\$111	
64"	4"	TLBS64	\$122	
.

Tip: All laminate surfaces have a solid color default PVC edge.
 ▶ See *Color Coordination List*, page G200.

Relevant

Back Rails, continued

SIN 711.2

16"H Wood Veneer Back Rails with Full Wood Back

For Use with Standing-Height (39⁵/₈"H) End Panels only

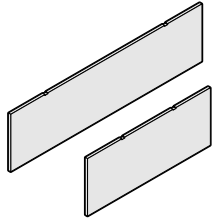

Tip: Back rails or modesty panels are required for structural integrity. Do **not** omit them. For straight work-surfaces, specify one back rail or modesty panel of a length that corresponds to the worksurface width. For corner worksurfaces, specify one 42" and one 64" back rail or modesty panel. For pier tops, specify one 42" back rail or modesty panel.

Standard Includes		Required to Specify
<ul style="list-style-type: none"> • Back rails: wood veneer • Attachment hardware 		1 Style number 2 Wood color number for back rail 3 Options, if selected (see below) ▶ See <i>Surface Materials</i> , page G198.

Options	Price	Required to Specify
Surface Materials <ul style="list-style-type: none"> • Customiz stain on wood veneer 	Prices below	Specify with <i>Customiz stain</i> . ▶ See <i>Surface Materials Reference Manual</i> .

Specification Information				
Dimensions		Style	Base	Option
L	H	Number	Price	(Add \$ to Base Price)
.....
.....
.....
.....
.....
.....
.....
.....
.....

Standing Height

42"	16"	TWSBS42	\$186	+\$41
64"	16"	TWSBS64	\$201	+\$60
.....

16"H Laminate Back Rails with Full Laminate Back

For Use with Standing-Height (39⁵/₈"H) End Panels only

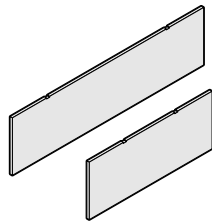

Tip: Back rails or modesty panels are required for structural integrity. Do **not** omit them. For straight work-surfaces, specify one back rail or modesty panel of a length that corresponds to the worksurface width. For corner worksurfaces, specify one 42" and one 64" back rail or modesty panel. For pier tops, specify one 42" back rail or modesty panel.

Standard Includes		Required to Specify
<ul style="list-style-type: none"> • Back rail: laminate • Attachment hardware 		1 Style number 2 Laminate color number for back rail 3 Options, if selected (see below) ▶ See <i>Surface Materials</i> , page G198.

Options	Price	Required to Specify
Surface Materials <ul style="list-style-type: none"> • Open Line laminate 	+\$60 plus cost of laminate	▶ See <i>Surface Materials Reference Manual</i> .

Specification Information				
Dimensions		Style	Base	Option
L	H	Number	Price	(Add \$ to Base Price)
.....
.....
.....
.....
.....
.....
.....
.....
.....

Standing Height

42"	16"	TLSBS42	\$153
64"	16"	TLSBS64	\$168
.....

Tip: All laminate surfaces have a solid color default PVC edge.
▶ See *Color Coordination List*, page G200.

16"H Wood Veneer Back Rails with Communication Pass Through Trough

For Use with Standing-Height (39⁵/₈"H) End Panels only

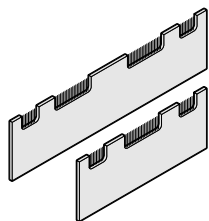

Tip: Back rails or modesty panels are required for structural integrity. Do **not** omit them. For straight work-surfaces, specify one back rail or modesty panel of a length that corresponds to the worksurface width. For corner worksurfaces, specify one 42" and one 64" back rail or modesty panel. For pier tops, specify one 42" back rail or modesty panel.

Standard Includes		Required to Specify
-------------------	--	---------------------

- Back rails: wood veneer
- Attachment hardware
- Brush grommet

- 1 Style number
 - 2 Wood color number for back rail
 - 3 Options, if selected (see below)
- ▶ See *Surface Materials*, page G198.

Options	Price	Required to Specify
---------	-------	---------------------

- Surface Materials**
- Customiz stain on wood veneer

Prices below

- Specify with *Customiz stain*.
▶ See *Surface Materials Reference Manual*.

Specification Information

Dimensions		Style Number	Base Price	Option (Add \$ to Base Price)
L	H			
.....
.....
.....
.....

Standing Height

42"	16"	TWSBSC42	\$191	+\$41
64"	16"	TWSBSC64	\$212	+\$60
.....

16"H Laminate Back Rails with Communication Pass Through Trough

For Use with Standing-Height (39⁵/₈"H) End Panels only

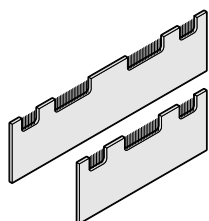

Tip: Back rails or modesty panels are required for structural integrity. Do **not** omit them. For straight work-surfaces, specify one back rail or modesty panel of a length that corresponds to the worksurface width. For corner worksurfaces, specify one 42" and one 64" back rail or modesty panel. For pier tops, specify one 42" back rail or modesty panel.

Standard Includes		Required to Specify
-------------------	--	---------------------

- Back rail: laminate
- Attachment hardware
- Brush grommet

- 1 Style number
 - 2 Laminate color number for back rail
 - 3 Options, if selected (see below)
- ▶ See *Surface Materials*, page G198.

Options	Price	Required to Specify
---------	-------	---------------------

- Surface Materials**
- Open Line laminate

+\$60 plus cost of laminate

- ▶ See *Surface Materials Reference Manual*.

Specification Information

Dimensions		Style Number	Base Price
L	H		
.....
.....
.....

Standing Height

42"	16"	TLSBSC42	\$160
64"	16"	TLSBSC64	\$177
.....

Tip: All laminate surfaces have a solid color default PVC edge.
▶ See *Color Coordination List*, page G200.

Relevant

Laminate Modesty Panels

Full Laminate Back

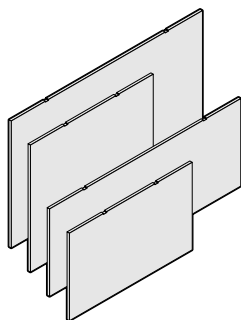

Tip: Use modesty panel when no power or communication pass through is required and in aisle applications where the back of the unit is visible.

Tip: All laminate surfaces have a solid color default PVC edge.
 ▶ See *Color Coordination List*, page G200.

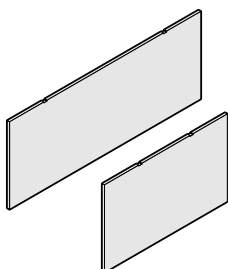

Standard Includes		Required to Specify	
-------------------	--	---------------------	--

- | | |
|--|---|
| <ul style="list-style-type: none"> • Modesty panel: laminate • Attachment hardware | <ul style="list-style-type: none"> 1 Style number 2 Laminate color number for modesty panel 3 Options, if selected (see below) ▶ See <i>Surface Materials</i>, page G198. |
|--|---|

Options	Price	Required to Specify
---------	-------	---------------------

- | | | |
|---|--------------------------------|---|
| Surface Materials <ul style="list-style-type: none"> • Open Line laminate | +\$60
plus cost of laminate | ▶ See <i>Surface Materials Reference Manual</i> . |
|---|--------------------------------|---|

- | | |
|--|--|
| Related Products <ul style="list-style-type: none"> • Rectangular worksurfaces • Bowed transition worksurfaces • Corner worksurfaces • Extended corner worksurfaces • Transitional corner worksurfaces • Transitional extended corner worksurfaces • Pier-top worksurfaces | <ul style="list-style-type: none"> ▶ Page G62 ▶ Page G64 ▶ Page G66 ▶ Page G68 ▶ Page G70 ▶ Page G72 ▶ Page G74 |
|--|--|

Specification Information

Dimensions	Style	Base
L H	Number	Price

Seated-Height

41½"	24⅝"	TLFMP4224	\$323
63½"	24⅝"	TLFMP6424	\$410
:	:	:	:

Tip: Replace a 4" back rail with seated-height modesty panel where more privacy is required beneath a seated-height worksurface.

Standing-Height

41½"	35⅝"	TLFSMP4236	\$366
63½"	35⅝"	TLFSMP6436	\$454
:	:	:	:

Tip: Replace a 16" back rail (full wood or communications pass-through) with standing-height modesty panel where more privacy is required beneath a standing-height worksurface

Modesty Panels, continued

SIN 711.2

Wood Veneer Modesty Panels

Communication Pass-Through Trough

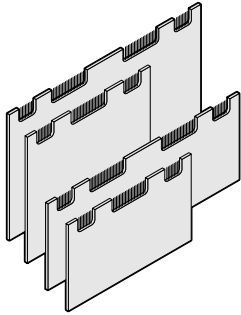

Tip: Use modesty panel when power or communication pass-through is required between back-to-back workstations.

Standard Includes **Required to Specify**

- Modesty panel: wood veneer
- Attachment hardware
- Brush grommet

- 1 Style number
- 2 Wood color number for modesty panel
- 3 Options, if selected (see below)
- ▶ See *Surface Materials*, page G198.

Options **Price** **Required to Specify**

Surface Materials

- Customiz stain on wood veneer

Prices below

- Specify with *Customiz stain*.
- ▶ See *Surface Materials Reference Manual*.

Related Products

- Rectangular worksurfaces
- Bowed transition worksurfaces
- Corner worksurfaces
- Extended corner worksurfaces
- Transitional corner worksurfaces
- Transitional extended corner worksurfaces
- Pier-top worksurfaces

- ▶ Page G62
- ▶ Page G64
- ▶ Page G66
- ▶ Page G68
- ▶ Page G70
- ▶ Page G72
- ▶ Page G74

Specification Information

• Dimensions		• Style Number	• Base Price	• Option (Add \$ to Base Price)
W	H			

Seated-Height

41 1/2"	24 5/8"	TWMPP4224	\$396	+\$ 84
63 1/2"	24 5/8"	TWMPP6424	\$538	+\$135

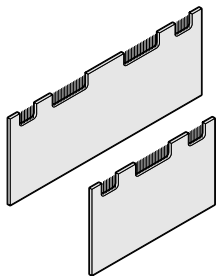

Tip: Replace a 4" back rail with seated-height modesty panel where more privacy is required beneath a seated-height worksurface.

Standing-Height

41 1/2"	35 5/8"	TWSMPP4236	\$454	+\$ 84
63 1/2"	35 5/8"	TWSMPP6436	\$572	+\$135

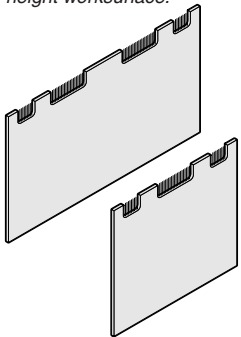

Tip: Replace a 16" back rail (full wood or communications pass-through) with standing-height modesty panel where more privacy is required beneath a standing-height worksurface.

Laminate Modesty Panels

Communication Pass-Through Trough

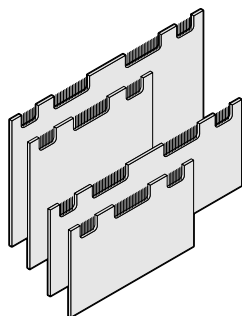

Tip: Use modesty panel when power or communication pass-through is required between back-to-back workstations.

Tip: All laminate surfaces have a solid color default PVC edge.
 ▶ See *Color Coordination List*, page G200.

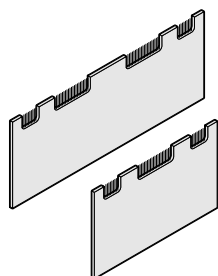

Tip: Replace a 4" back rail with seated-height modesty panel where more privacy is required beneath a seated-height worksurface.

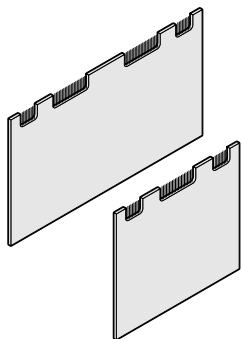

Tip: Replace a 16" back rail (full wood or communications pass-through) with standing-height modesty panel where more privacy is required beneath a standing-height worksurface.

Standard Includes	Required to Specify
-------------------	---------------------

- | | |
|---|---|
| <ul style="list-style-type: none"> • Modesty panel: laminate • Attachment hardware • Brush grommet | <ul style="list-style-type: none"> 1 Style number 2 Laminate color number for modesty panel 3 Options, if selected (see below) ▶ See <i>Surface Materials</i>, page G198. |
|---|---|

Options	Price	Required to Specify
---------	-------	---------------------

- | | | |
|---|--------------------------------|---|
| Surface Materials <ul style="list-style-type: none"> • Open Line laminate | +\$60
plus cost of laminate | ▶ See <i>Surface Materials Reference Manual</i> . |
|---|--------------------------------|---|

Related Products	Options	Price	Required to Specify
------------------	---------	-------	---------------------

- | | | | |
|--|--|--|--|
| <ul style="list-style-type: none"> • Rectangular worksurfaces • Bowed transition worksurfaces • Corner worksurfaces • Extended corner worksurfaces • Transitional corner worksurfaces • Transitional extended corner worksurfaces • Pier-top worksurfaces | | | <ul style="list-style-type: none"> ▶ Page G62 ▶ Page G64 ▶ Page G66 ▶ Page G68 ▶ Page G70 ▶ Page G72 ▶ Page G74 |
|--|--|--|--|

Specification Information

Dimensions	Style Number	Base Price
W H		

Seated Height

41 1/2"	24 5/8"	TLMPP4224	\$334
63 1/2"	24 5/8"	TLMPP6424	\$440
:	:	:	:

Standing Height

41 1/2"	35 5/8"	TLSMPP4236	\$380
63 1/2"	35 5/8"	TLSMPP6436	\$473
:	:	:	:

Accessories

SIN 711.2

Center Drawer

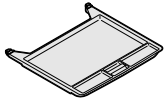

Standard Includes	Required to Specify
<ul style="list-style-type: none"> • Drawer: black textured plastic only • Slides: black plastic only • Attachment hardware 	Style number

Specification Information

• Dimensions			• Style	• Price
D	W	H	Number	
19"	21"	1 ³ / ₈ "	ASHC1921X1	\$46

Keyboard Shelf

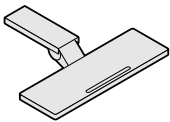

Tip: Keyboard shelf attaches to underside of worksurface.

Tip: Products on this page are included here to simplify your planning. Remember that they have different pricing terms than Steelcase Wood products.

▶ See Details for more products.
 Details
 25 Ottawa Avenue SW
 4th Floor, Arena Station
 Grand Rapids, MI 49503
 Telephone 1.800.833.0411

Standard Includes	Required to Specify
<ul style="list-style-type: none"> • Keyboard shelf: black paint only • Tray on keyboard shelf: black vinyl only 	Style number

Specification Information

• Dimensions		• Style	• Price
D	W	Number	
10"	30"	WWYK30	\$252

Mousepad

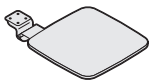

Tip: Mousepad can be field installed on worksurfaces or hatchbacks, providing a rotating surface for a mouse to be supported. Specify mousepad separately.

Standard Includes	Required to Specify
<ul style="list-style-type: none"> • Mousepad • Attachment hardware 	Style number

Specification Information

• Dimensions		• Style	• Price
D	W	Number	
8 ³ / ₈ "	8 ³ / ₈ "	TMP1	\$131

Specifying Relevant Tables

► For more detailed product information, see the *Relevant Systems Furniture Specification Guide* or consult your Steelcase dealer.

Tables

Shield-Top Tables (SIN 711.2)	G96
Lemon-Top Tables (SIN 711.2)	G97
Teaming Tables (SIN 711.2)	G98
Teaming Tables with Hitch (SIN 711.2)	G99
Runaround Tables (SIN 711.2)	G100
Runaround Tables with Hitch (SIN 711.2)	G101
Hitch (SIN 711.2)	G102
Idea Island Tables (SIN 711.2)	G103

Shield-Top Tables

SIN 711.2

Wood Veneer Shield-Top Table

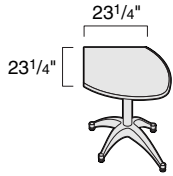

Standard Includes		Required to Specify	
	<ul style="list-style-type: none"> • Top: wood veneer • Bullnose edge profile: wood • Base: black only • Leveling glides: black only 		1 Style number 2 Wood color number for top 3 Options, if selected (see below) ▶ See <i>Surface Materials</i> , page G198.
Options		Price	Required to Specify
Surface Materials	• Full-fill finish on worksurface only	Prices below	Specify with <i>full-fill finish</i> and select wood color number. ▶ See <i>Surface Materials</i> , page G198.
	• Customiz stain on wood veneer	Prices below	Specify with <i>Customiz stain</i> . ▶ See <i>Surface Materials Reference Manual</i> .
Base	• Mobile base with two locking and two non-locking 2 1/4" diameter casters: black only	+\$100	Add the suffix M to the style number.
	• Mobile base with pneumatic height adjustment 26 5/8"H to 36 5/8"H black only	+\$250	Add the suffix MP to the style number.

Specification Information					
Dimensions			Style	Base	Option
D	W	H	Number	Price	(Add \$ to Base Price)
23 1/4"	32"	28 1/2"	TWSH3224	\$1047	+ \$41 Full-Fill or Customiz Stain

Laminate Shield-Top Table

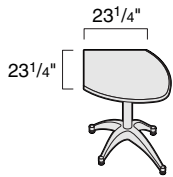

Tip: All laminate surfaces have a solid color default PVC edge.
▶ See *Color Coordination List*, page G200.

Standard Includes		Required to Specify	
	<ul style="list-style-type: none"> • Top: laminate • Bullnose edge profile: black vinyl (PVC) • Base: black only • Leveling glides: black only 		1 Style number 2 Laminate color number for top 3 Options, if selected (see below) ▶ See <i>Surface Materials</i> , page G198.
Options		Price	Required to Specify
Base	• Mobile base with two locking and two non-locking 2 1/4" diameter casters: black only	+\$100	Add the suffix M to the style number.
	• Mobile base with pneumatic height adjustment 26 5/8"H to 36 5/8"H: black only	+\$250	Add the suffix MP to the style number.

Specification Information					
Dimensions			Style	Base	
D	W	H	Number	Price	
23 1/4"	32"	28 1/2"	TLSH3224	\$798	

Lemon-Top Tables

SIN 711.2

Wood Veneer Lemon-Top Table



Standard Includes	Required to Specify
-------------------	---------------------

- | | |
|---|---|
| <ul style="list-style-type: none"> • Top: wood veneer • Bullnose edge profile: wood • Mobile base with pneumatic height adjustment: black only • Two locking and two non-locking 2¼" diameter casters: black only | <ul style="list-style-type: none"> 1 Style number 2 Wood color number for top 3 Options, if selected (see below) ▶ See <i>Surface Materials</i>, page G198. |
|---|---|

Options	Price	Required to Specify
---------	-------	---------------------

- | | | |
|--|---|--|
| Surface Materials <ul style="list-style-type: none"> • Full-fill finish on worksurface only • Customiz stain on wood veneer | <p>Prices below</p> <p>Prices below</p> | <p>Specify with <i>full-fill finish</i> and select wood color number.</p> <p>▶ See <i>Surface Materials</i>, page G198.</p> <p>Specify with <i>Customiz stain</i>.</p> <p>▶ See <i>Surface Materials Reference Manual</i>.</p> |
|--|---|--|

Specification Information					
---------------------------	--	--	--	--	--

• Dimensions			• Style Number	• Base Price	• Option (Add \$ to Base Price)
D	W	H			
26"	32"	26 ⁵ / ₈ "–36 ⁵ / ₈ "	TWLT3226	\$1184	+\$24

Laminate Lemon-Top Table



Standard Includes	Required to Specify
-------------------	---------------------

- | | |
|---|---|
| <ul style="list-style-type: none"> • Top: laminate • Bullnose edge profile: black vinyl (PVC) • Mobile base with pneumatic height adjustment: black only • Two locking and two non-locking 2¼" diameter casters: black only | <ul style="list-style-type: none"> 1 Style number 2 Laminate color number for top ▶ See <i>Surface Materials</i>, page G198. |
|---|---|

Specification Information				
---------------------------	--	--	--	--

• Dimensions			• Style Number	• Price
D	W	H		
26"	32"	26 ⁵ / ₈ "–36 ⁵ / ₈ "	TLLT3226	\$936

Relevant

Teaming Tables

SIN 711.2

Wood Veneer Teaming Table



Standard Includes		Required to Specify	
	<ul style="list-style-type: none"> • Top: wood veneer • Bullnose edge profile: wood • Pair of T-bases: black only • Leveling glides: black only 		1 Style number 2 Wood color number for top 3 Options, if selected (see below) ▶ See <i>Surface Materials</i> , page G198.
Options		Price	Required to Specify
Surface Materials	• Full-fill finish on worksurface only	Prices below	Specify with <i>full-fill finish</i> and select wood color number. ▶ See <i>Surface Materials</i> , page G198.
	• Customiz stain on wood veneer	Prices below	Specify with <i>Customiz stain</i> . ▶ See <i>Surface Materials Reference Manual</i> .
Base	• Mobile base with two locking and two non-locking 2¼" diameter casters: black only	+\$100	Add the suffix M to the style number.

Specification Information					
• Dimensions			• Style Number	• Base Price	• Option (Add \$ to Base Price)
D	W	H			
32"	64"	28½"	TWTT3264	\$2229	+Full-Fill or Customiz Stain +\$60

Laminate Teaming Table



Standard Includes		Required to Specify	
	<ul style="list-style-type: none"> • Top: laminate • Bullnose edge profile: vinyl (PVC), black only • Pair of T-bases: black only • Leveling glides: black only 		1 Style number 2 Laminate color number for top 3 Options, if selected (see below) ▶ See <i>Surface Materials</i> , page G198.
Options		Price	Required to Specify
Base	• Mobile base with two locking and two non-locking 2¼" diameter casters: black only.	+\$100	Add the suffix M to the style number.

Specification Information				
• Dimensions			• Style Number	• Base Price
D	W	H		
32"	64"	28½"	TLTT3264	\$1924

Teaming Tables with Hitch

SIN 711.2

Wood Veneer Teaming Table with Hitch

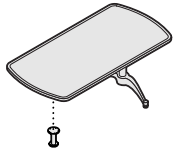

Tip: Teaming tables with mobile base are **not** recommended for use with stationary low-boy storage and table hitch.

Standard Includes		Required to Specify	
	<ul style="list-style-type: none"> • Top: wood veneer • Bullnose edge profile: wood • One T-base: black only • Leveling glides: black only • Table hitch: black only 		1 Style number 2 Wood color number for top 3 Options, if selected (see below) ▶ See <i>Surface Materials</i> , page G198.
Options		Price	Required to Specify
Surface Materials	• Full-fill finish on worksurface only	Prices below	Specify with <i>full-fill finish</i> and select wood color number. ▶ See <i>Surface Materials</i> , page G198.
	• Customiz stain on wood veneer	Prices below	Specify with <i>Customiz stain</i> . ▶ See <i>Surface Materials Reference Manual</i> .
Base	• Mobile base with one locking and one non-locking 2¼" diameter caster: black only	+\$50	Add the suffix M to the style number.

Specification Information					
Dimensions			Style Number	Base Price	Option (Add \$ to Base Price)
D	W	H			
32"	64"	28½"	TWTTTH3264	\$2293	+Full-Fill or Customiz Stain +\$60

Laminate Teaming Table with Hitch

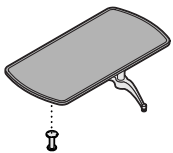

Tip: Teaming tables with mobile base are **not** recommended for use with stationary low-boy storage and table hitch.

Standard Includes		Required to Specify	
	<ul style="list-style-type: none"> • Top: laminate • Bullnose edge profile: vinyl (PVC), black only • One T-base: black only • Leveling glides: black only • Table hitch: black only 		1 Style number 2 Laminate color number for top 3 Options, if selected (see below) ▶ See <i>Surface Materials</i> , page G198.
Options		Price	Required to Specify
Base	• Mobile base with one locking and one non-locking 2¼" diameter caster: black only.	+\$50	Add the suffix M to the style number.

Specification Information				
Dimensions			Style Number	Base Price
D	W	H		
32"	64"	28½"	TLTTH3264	\$1994

Relevant

Runaround Tables

SIN 711.2

Wood Veneer Runaround Table



Standard Includes		Required to Specify	
<ul style="list-style-type: none"> • Top: wood veneer • Bullnose edge profile: wood • Pair of T-bases: black only • Leveling glides: black only 		<ol style="list-style-type: none"> 1 Style number 2 Wood color number for top 3 Options, if selected (see below) <p>▶ See <i>Surface Materials</i>, page G198.</p>	
Options		Price	Required to Specify
Surface Materials	• Full-fill finish on worksurface only	Prices below	Specify with <i>full-fill finish</i> and select wood color number. ▶ See <i>Surface Materials</i> , page G198.
	• Customiz stain on wood veneer	Prices below	Specify with <i>Customiz stain</i> . ▶ See <i>Surface Materials Reference Manual</i> .
Base	• Mobile base with two locking and two non-locking 2¼" diameter casters: black only	+\$100	Add the suffix M to the style number.

Specification Information					
Dimensions			Style Number	Base Price	Option (Add \$ to Base Price)
D	W	H			
32"	60"	28½"	TWRA3260	\$1982	Full-Fill or Customiz Stain

Laminate Runaround Table



Standard Includes		Required to Specify	
<ul style="list-style-type: none"> • Top: laminate • Bullnose edge profile: vinyl (PVC), black only • Pair of T-bases: black only • Leveling glides: black only 		<ol style="list-style-type: none"> 1 Style number 2 Laminate color number for top 3 Options, if selected (see below) <p>▶ See <i>Surface Materials</i>, page G198.</p>	
Options		Price	Required to Specify
Base	• Mobile base with two locking and two non-locking 2¼" diameter casters: black only.	+\$100	Add the suffix M to the style number.

Specification Information					
Dimensions			Style Number	Base Price	
D	W	H			
32"	60"	28½"	TLRA3260	\$1674	

Runaround Tables with Hitch

SIN 711.2

Wood Veneer Runaround Table with Hitch

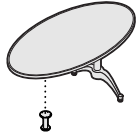

Tip: Runaround tables with mobile base are **not** recommended for use with stationary low-boy storage and table hitch.

Standard Includes		Required to Specify	
	<ul style="list-style-type: none"> • Top: wood veneer • Bullnose edge profile: wood • One T-base: black only • Leveling glides: black only • Table hitch: black only 		<ol style="list-style-type: none"> 1 Style number 2 Wood color number for top 3 Options, if selected (see below) <p>▶ See <i>Surface Materials</i>, page G198.</p>
Options		Price	Required to Specify
Surface Materials	• Full-fill finish on worksurface only	Prices below	Specify with <i>full-fill finish</i> and select wood color number. ▶ See <i>Surface Materials</i> , page G198.
	• Customiz stain on wood veneer	Prices below	Specify with <i>Customiz stain</i> . ▶ See <i>Surface Materials Reference Manual</i> .
Base	• Mobile base with one locking and one non-locking 2¼" diameter caster: black only	+\$50	Add the suffix M to the style number.

Specification Information					
Dimensions			Style Number	Base Price	Option (Add \$ to Base Price)
D	W	H			
32"	60"	28½"	TWRAH3260	\$2048	+Full-Fill or Customiz Stain +\$60

Laminate Runaround Table with Hitch

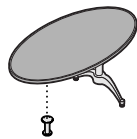

Tip: Runaround tables with mobile base are **not** recommended for use with stationary low-boy storage and table hitch.

Standard Includes		Required to Specify	
	<ul style="list-style-type: none"> • Top: laminate • Bullnose edge profile: vinyl (PVC), black only • One T-base: black only • Leveling glides: black only • Table hitch: black only 		<ol style="list-style-type: none"> 1 Style number 2 Laminate color number for top 3 Options, if selected (see below) <p>▶ See <i>Surface Materials</i>, page G198.</p>
Options		Price	Required to Specify
Base	• Mobile base with one locking and one non-locking 2¼" diameter caster: black only.	+\$50	Add the suffix M to the style number.

Specification Information					
Dimensions			Style Number	Base Price	
D	W	H			
32"	60"	28½"	TLRAH3260	\$1743	

Hitch

for Use with Teaming and Runaround Tables
SIN 711.2

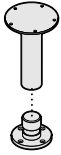

Standard Includes	Required to Specify
-------------------	---------------------

- Metal linkage rings: black only
- Attachment hardware

Style number

Specification Information			
Dimensions		Style	Price
Diameter	Height	Number	

Dimensions		Style	Price
Diameter	Height	Number	
3 1/2"	4 1/2"	TTH1	\$133
:	:	:	:

Idea Island Tables

SIN 711.2

Wood Veneer Idea Island Table



Standard Includes	Required to Specify
-------------------	---------------------

- Top: wood veneer
- Bullnose edge profile: wood
- Two swing shelves: cast aluminum, black only
- Four lapboards: black plastic only
- Hardware attachment kit
- Leveling glides with base: black only
- Organizer tray: black only
- Pair of T bases: black only

- 1 Style number
- 2 Wood color number for top
- 3 Options, if selected (see below)
- ▶ See *Surface Materials*, page G198.

Options	Price	Required to Specify
---------	-------	---------------------

Surface Materials	• Full-fill finish on worksurface only	Prices below	Specify with <i>full-fill finish</i> and select wood color number. ▶ See <i>Surface Materials</i> , page G198.
	• Customiz stain on wood veneer	Prices below	Specify with <i>Customiz stain</i> . ▶ See <i>Surface Materials Reference Manual</i> .

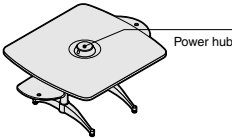

Power and Communications Center	• Power hub	+\$350	Add the suffix P to the style number.
--	-------------	--------	--

Casters	• Two locking and two non-locking 2¼" diameter casters: black only	+\$100	Add the suffix M to the style number.
----------------	--	--------	--

Specification Information

Dimensions			Style Number	Base Price	Option (Add \$ to Base Price)
D	W	H			
46"	49"	18"	TWJJ4649	\$2751	+\$60
46"	49"	24"	TWMJJ4649	\$2815	+\$60



Idea Island Tables, continued

SIN 711.2

Laminate Idea Island Table



Standard Includes	Required to Specify
-------------------	---------------------

- Top: laminate
- Bullnose edge profile: vinyl (PVC), black only
- Two swing shelves: cast aluminum, black only
- Four lapboards: black plastic only
- Hardware attachment kit
- Leveling glides with base: black only
- Organizer tray: black only
- Pair of T bases: black only

- 1 Style number
 - 2 Laminate color number for top
 - 3 Options, if selected (see below)
- ▶ See *Surface Materials*, page G198.

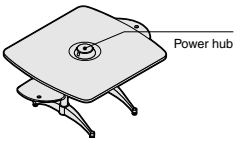

Options	Price	Required to Specify
---------	-------	---------------------

Power and Communications Center

- Power hub

+\$350

Add the suffix **P** to the style number.

Casters

- Two locking and two non-locking 2¼" diameter casters: black only

+\$100

Add the suffix **M** to the style number.

Specification Information

• Dimensions			• Style	• Base
D	W	H	Number	Price
46"	49"	18"	TLJJ4649	\$2302
46"	49"	24"	TLMJJ4649	\$2365
:	:	:	:	:



Markerboard Idea Island Table



Standard Includes	Required to Specify
-------------------	---------------------

- Top: markerboard
- Bullnose edge profile: vinyl (PVC), black only
- Two swing shelves: cast aluminum, black only
- Four lapboards: black plastic only
- Hardware attachment kit
- Leveling glides with base: black only
- Organizer tray: black only
- Pair of T bases: black only

- 1 Style number
- 2 Options, if selected (see below)
- ▶ See *Surface Materials*, page G198.

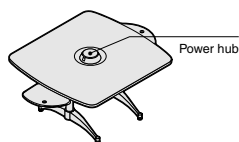

Options	Price	Required to Specify
---------	-------	---------------------

Power and Communications Center

- Power hub

+\$350

Add the suffix **P** to the style number.

Casters

- Two locking and two non-locking 2 1/4" diameter casters: black only

+\$100

Add the suffix **M** to the style number.

Specification Information				
• Dimensions			• Style	• Base
D	W	H	Number	Price

• Dimensions			• Style	• Base
D	W	H	Number	Price
46"	49"	18"	TMJJ4649	\$2476
46"	49"	24"	TMMJJ4649	\$2541



Specifying Relevant Hatchbacks and Media Carts

► For more detailed product information, see the *Relevant Systems Furniture Specification Guide* or consult your Steelcase dealer.

Hatchbacks (SIN 711.2)

G108

Media Carts (SIN 711.2)

G112

Wood Veneer Hatchbacks

SIN 711.2

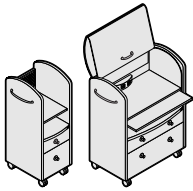

Tip: Single-wide hatchback is designed without a hood. Double-wide hatchback always includes a hood.

Standard Includes	Required to Specify
<ul style="list-style-type: none"> Hatchback: wood veneer Knob drawer pulls: black Two locking and two non-locking 3" diameter casters Diner pull on sides: black Diner pull on hood of double-wide unit: black One movable partition per box drawer: black plastic only Two movable partitions per 4"H lateral file drawer One hanging file system for front-to-back filing per file drawer (see filing options below) Lock, keyed random: 9250 Ember Chrome Power box (TPB2) with two plug-in sites and package of communication jacks Slatwall, if selected: 8044 Black Anodized Aluminum Tackboard, if selected: vertical surface fabric price group 1 Flip down tray in back for power and communications cord and cable storage and distribution 	<ol style="list-style-type: none"> Style number Wood color number for hatchback Color number for tackboard, if selected Options, if selected (see below) <p>▶ See <i>Surface Materials</i>, page G198.</p>

Options	Price	Required to Specify
Surface Materials <ul style="list-style-type: none"> Full-fill finish on worksurface only Customiz stain on wood veneer Aluminum slatwall Fabric price group 1 Fabric price group 2 Fabric price group 3 Fabric price group 4 Fabric price group 5 Fabric price group COM 	<p>Prices at right</p> <p>Prices at right</p> <p>No cost</p> <p>No cost</p> <p>+\$ 12</p> <p>+\$ 46</p> <p>+\$ 62</p> <p>+\$100</p> <p>+\$ 15</p>	<p>Specify with <i>full-fill finish</i> and select wood color number.</p> <p>▶ See <i>Surface Materials</i>, page G198.</p> <p>Specify with <i>Customiz stain</i>.</p> <p>▶ See <i>Surface Materials Reference Manual</i>.</p> <p>Specify with <i>8043 Clear Anodized Aluminum</i></p> <p>Specify fabric color number.</p> <p>Specify fabric color number.</p> <p>Specify fabric color number.</p> <p>Specify fabric color number.</p> <p>Specify fabric color number.</p> <p>▶ See <i>Surface Materials Reference Manual</i>.</p>
Drawer Pulls <p>Set 1</p> <ul style="list-style-type: none"> Knob drawer pulls: 9211 Brushed Nickel Diner side and hood pulls: color to match knobs <p>Set 2</p> <ul style="list-style-type: none"> Knob drawer pulls: 0835 Black or 9211 Brushed Nickel Dishes: black Diner side and hood pulls: color to match knobs <p>Set 3</p> <ul style="list-style-type: none"> Knob drawer pulls: 0835 Black or 9211 Brushed Nickel Dishes: 9211 Brushed Nickel Diner side and hood pulls: color to match knobs <p>Set 4</p> <ul style="list-style-type: none"> Contemporary drawer pulls: 0835 Black, 9201 Polished Chrome, or 9212 Silver Contemporary side and hood pulls: color to match drawer pulls <p>Set 5</p> <ul style="list-style-type: none"> Diner drawer pulls: 0835 Black or 9211 Brushed Nickel Diner side and hood pulls: color to match drawer pulls <p>Set 6</p> <ul style="list-style-type: none"> Loft drawer pulls: 0835 Black or 9211 Brushed Nickel Loft side and hood pulls: color to match drawer pulls 	<p>No cost</p> <p>No cost</p> <p>No cost</p> <p>No cost</p> <p>No cost</p> <p>No cost</p> <p>No cost</p>	<p>Specify with <i>E100 pulls</i> and designate color number 9211 Brushed Nickel.</p> <p>Specify with <i>E110 pulls</i> and designate color number.</p> <p>Specify with <i>E120 pulls</i> and designate color number.</p> <p>Specify with <i>E070 pulls</i> and designate color number.</p> <p>Specify with <i>E130 pulls</i> and designate color number.</p> <p>Specify with <i>E090 pulls</i> and designate color number.</p>

▶ Options continued on next page

► Options continued

Options	Price	Required to Specify
Keying	• Factory- and field-installed keying	► Page G204
Filing Hardware	• Two file bars with clips per file drawer for side-to-side or legal filing	No cost Specify with <i>TFILE</i> .

Tip: For side-to-side options including legal specify with *TFILE*.

Specification Information

Dimensions			Style Number	Base Price	Option
D	W	H			(Add \$ to Base Price)
.....
.....	Full-Fill or Customiz
.....	Stain



Single-Wide Unit with Power and Pull-Out Worksurface

With Slatwall

21¼"	16"	43"	TWHT4116	\$2265	+\$155
------	-----	-----	-----------------	--------	--------



Double-Wide Unit with Power and Pull-Out Worksurface

With Tackboard

21¼"	31⅞"	43"	TWHTTB4132	\$3785	+\$265
------	------	-----	-------------------	--------	--------

With Slatwall

21¼"	31⅞"	43"	TWHTSW4132	\$3785	+\$265
------	------	-----	-------------------	--------	--------

Drawer Pull Shapes

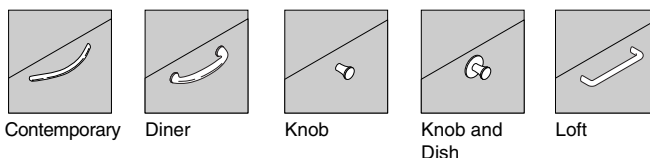

Laminate Hatchbacks

SIN 711.2

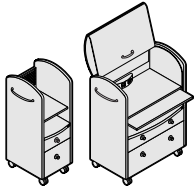

Tip: Single-wide hatchback is designed without a hood. Double-wide hatchback always includes a hood.

Tip: All laminate surfaces have a solid color default PVC edge.

► See Color Coordination List, page G200.

Standard Includes	Required to Specify
-------------------	---------------------

- Hatchback: laminate
- Drawer fronts, hood, and worksurfaces: wood veneer, if selected
- Knob drawer pulls: black
- Two locking and two non-locking 3" diameter casters
- Diner pull on sides: black
- Diner pull on hood of double-wide unit: black
- One movable partition per box drawer: black plastic only
- Two movable partitions per 4"H lateral file drawer
- One hanging file system for front-to-back filing per file drawer (see filing options below)
- Lock, keyed random: 9250 Ember Chrome
- Power box (TPB2) with two plug-in sites and package of communication jacks
- Slatwall, if selected: 8044 Black Anodized Aluminum
- Tackboard, if selected: vertical surface fabric price group 1
- Flip down tray in back for power and communications, cord and cable storage and distribution

- 1 Style number
 - 2 Laminate color number for hatchback
 - 3 Veneer color number for drawer fronts, hood, and worksurfaces.
 - 4 Color number for tackboard, if selected
 - 5 Options, if selected (see below)
- See *Surface Materials*, page G198.

Options	Price	Required to Specify
---------	-------	---------------------

Surface Materials	• Aluminum slatwall	No cost	Specify with <i>8043 Clear Anodized Aluminum</i>
	• Fabric price group 1	No cost	Specify fabric color number.
	• Fabric price group 2	+\$ 12	Specify fabric color number.
	• Fabric price group 3	+\$ 46	Specify fabric color number.
	• Fabric price group 4	+\$ 62	Specify fabric color number.
	• Fabric price group 5	+\$100	Specify fabric color number.
	• Fabric price group COM	+\$ 15	► See <i>Surface Materials Reference Manual</i> .
	• Open Line laminate	+\$ 60 plus cost of laminate	► See <i>Surface Materials Reference Manual</i> .
	• Customiz stain on wood veneer	Prices at right	Specify with <i>Customiz stain</i> . ► See <i>Surface Materials Reference Manual</i> .
Drawer Pulls	Set 1	No cost	Specify with <i>E100 pulls</i> and designate color number 9211 Brushed Nickel.
	• Knob drawer pulls: 9211 Brushed Nickel		
	• Diner side and hood pulls: color to match knobs		
	Set 2	No cost	Specify with <i>E110 pulls</i> and designate color number.
	• Knob drawer pulls: 0835 Black or 9211 Brushed Nickel		
• Dishes: black			
• Diner side and hood pulls: color to match knobs			
Set 3	No cost	Specify with <i>E120 pulls</i> and designate color number.	
• Knob drawer pulls: 0835 Black or 9211 Brushed Nickel			
• Dishes: 9211 Brushed Nickel			
• Diner side and hood pulls: color to match knobs			
Set 4	No cost	Specify with <i>E070 pulls</i> and designate color number.	
• Contemporary drawer pulls: 0835 Black, 9201 Polished Chrome, or 9212 Silver			
• Contemporary side and hood pulls: color to match drawer pulls			
Set 5	No cost	Specify with <i>E130 pulls</i> and designate color number.	
• Diner drawer pulls: 0835 Black or 9211 Brushed Nickel			
• Diner side and hood pulls: color to match drawer pulls			

► Options continued on next page

► Options continued

Options	Price	Required to Specify
Drawer Pulls, continued Set 6 <ul style="list-style-type: none"> Loft drawer pulls: 0835 Black or 9211 Brushed Nickel Loft side and hood pulls: color to match drawer pulls 	No cost	Specify with <i>E090 pulls</i> and designate color number.
Keying	<ul style="list-style-type: none"> Factory- and field-installed keying 	► Page G204
Filing Hardware	<ul style="list-style-type: none"> Two file bars with clips per file drawer for side-to-side or legal filing 	No cost
		Specify with <i>TFILE</i> .

Tip: For side-to-side options including legal specify with *TFILE*.

Specification Information

Dimensions	Style	Base	Option
D W H	Number	Price	(Add \$ to Base Price)
:	:	:	Customiz
:	:	:	Stain

Single-Wide Unit with Power and Pull-Out Worksurface

With Slatwall

21¼"	16"	43"	TLHT4116	\$1710	N.A.
:	:	:	:	:	:



Single-Wide Unit with Power and Wood Veneer Pull-Out Worksurface, Drawer Fronts, and Shelf

With Slatwall

21¼"	16"	43"	TLHT4116W	\$1980	+\$41
:	:	:	:	:	:

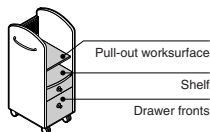

Double-Wide Unit with Power and Wood Veneer Pull-Out Worksurface, Drawer Fronts, Shelf, and Hood

With Tackboard

21¼"	31⅞"	43"	TLHTTB4132W	\$3405	+\$84
------	------	-----	--------------------	--------	-------

With Slatwall

21¼"	31⅞"	43"	TLHTSW4132W	\$3405	+\$84
:	:	:	:	:	:

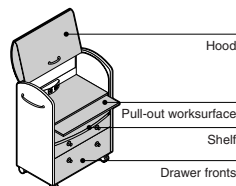

Drawer Pull Shapes

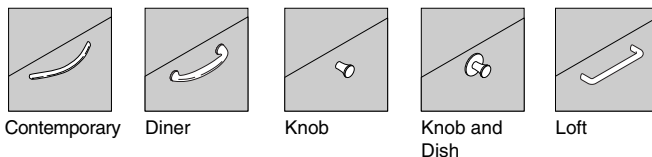

Wood Veneer Media Cart

SIN 711.2



Tip: Top shelf is adjustable in 1" increments over a 3" range.

Standard Includes	Required to Specify
<ul style="list-style-type: none"> Media cart: wood veneer Knob drawer pulls: black Two locking and two non-locking 3" diameter casters Diner pull on sides: black One movable partition per box drawer: black plastic only Two movable partitions per 4"H lateral file drawer One hanging file system for front-to-back filing per file drawer (see filing options below) Lock, keyed random: 9250 Ember Chrome Flip down tray in back for power and communications cord and cable storage and distribution Adjustable-height shelf supported by repositionable pins 	<p>1 Style number 2 Wood color number for media cart 3 Options, if selected (see below) ▶ See <i>Surface Materials</i>, page G198.</p>

Options	Price	Required to Specify
<p>Surface Materials</p> <ul style="list-style-type: none"> Full-fill finish on worksurface only Customiz stain on wood veneer 	<p>Prices at right</p> <p>Prices at right</p>	<p>Specify with <i>full-fill finish</i> and select wood color number. ▶ See <i>Surface Materials</i>, page G198. Specify with <i>Customiz stain</i>. ▶ See <i>Surface Materials Reference Manual</i>.</p>
<p>Drawer Pulls</p> <p>Set 1</p> <ul style="list-style-type: none"> Knob drawer pulls: 9211 Brushed Nickel Diner side pulls: color to match knobs 	No cost	Specify with <i>E100 pulls</i> and designate color number 9211 Brushed Nickel.
<p>Set 2</p> <ul style="list-style-type: none"> Knob drawer pulls: 0835 Black or 9211 Brushed Nickel Dishes: black Diner side pulls: color to match knobs 	No cost	Specify with <i>E110 pulls</i> and designate color number.
<p>Set 3</p> <ul style="list-style-type: none"> Knob drawer pulls: 0835 Black or 9211 Brushed Nickel Dishes: 9211 Brushed Nickel Diner side pulls: color to match knobs 	No cost	Specify with <i>E120 pulls</i> and designate color number.
<p>Set 4</p> <ul style="list-style-type: none"> Contemporary drawer pulls: 0835 Black, 9201 Polished Chrome, or 9212 Silver Contemporary side pulls: color to match drawer pulls 	No cost	Specify with <i>E070 pulls</i> and designate color number.
<p>Set 5</p> <ul style="list-style-type: none"> Diner drawer pulls: 0835 Black or 9211 Brushed Nickel Diner side pulls: color to match drawer pulls 	No cost	Specify with <i>E130 pulls</i> and designate color number.
<p>Set 6</p> <ul style="list-style-type: none"> Loft drawer pulls: 0835 Black or 9211 Brushed Nickel Loft side and hood pulls: color to match drawer pulls 	No cost	Specify with <i>E090 pulls</i> and designate color number.
<p>Keying</p> <ul style="list-style-type: none"> Factory- and field-installed keying 		▶ Page G204
<p>Power</p> <ul style="list-style-type: none"> Power box (TPB2) with two plug-in sites and package of communication jacks 	+\$150	Add the suffix P to the style number.
<p>Filing Hardware</p> <ul style="list-style-type: none"> Two file bars with clips per file drawer for side-to-side or legal filing 	No cost	Specify with <i>TFILE</i> .

Tip: For side-to-side options including legal specify with *TFILE*.

Specification Information

• Dimensions			• Style • Number	• Base • Price	• Option (Add \$ to Base Price) • Full-Fill or • Customiz • Stain
D	W	H			
21¼"	31⅞"	43"	TWMC4132	\$2225	+\$155



Drawer Pull Shapes

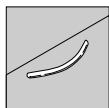

Contemporary

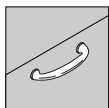

Diner

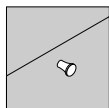

Knob

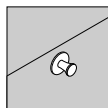

Knob and
Dish

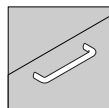

Loft

Laminate Media Cart

SIN 711.2



Tip: Top shelf is adjustable in 1" increments over a 3" range.

Tip: All laminate surfaces have a solid color default PVC edge.

▶ See Color Coordination List, page G200.

Standard Includes	Required to Specify
<ul style="list-style-type: none"> Media cart: laminate Drawer fronts and shelves: wood veneer, if selected Knob drawer pulls: black Two locking and two non-locking 3" diameter casters Diner pull on sides: black One movable partition per box drawer: black plastic only Two movable partitions per 4"H lateral file drawer One hanging file system for front-to-back filing per file drawer (see filing options below) Lock, keyed random: 9250 Ember Chrome Flip down tray in back for power and communications cord and cable storage and distribution Adjustable-height shelf supported by repositionable pins 	<ol style="list-style-type: none"> Style number Laminate color number for media cart Wood color number for drawer fronts and shelves Options, if selected (see below) <ul style="list-style-type: none"> ▶ See <i>Surface Materials</i>, page G198.

Options	Price	Required to Specify
Surface Materials <ul style="list-style-type: none"> Full-fill finish on worksurface only Customiz stain on wood veneer 	<p>Prices at right</p> <p>Prices at right</p>	<p>Specify with <i>full-fill finish</i> and select wood color number.</p> <p>▶ See <i>Surface Materials</i>, page G198.</p> <p>Specify with <i>Customiz stain</i>.</p> <p>▶ See <i>Surface Materials Reference Manual</i>.</p>
Drawer Pulls <p>Set 1</p> <ul style="list-style-type: none"> Knob drawer pulls: 9211 Brushed Nickel Diner side pulls: color to match knobs <p>Set 2</p> <ul style="list-style-type: none"> Knob drawer pulls: 0835 Black or 9211 Brushed Nickel Dishes: black Diner side pulls: color to match knobs <p>Set 3</p> <ul style="list-style-type: none"> Knob drawer pulls: 0835 Black or 9211 Brushed Nickel Dishes: 9211 Brushed Nickel Diner side pulls: color to match knobs <p>Set 4</p> <ul style="list-style-type: none"> Contemporary drawer pulls: 0835 Black, 9201 Polished Chrome, or 9212 Silver Contemporary side pulls: color to match drawer pulls <p>Set 5</p> <ul style="list-style-type: none"> Diner drawer pulls: 0835 Black or 9211 Brushed Nickel Diner side pulls: color to match drawer pulls <p>Set 6</p> <ul style="list-style-type: none"> Loft drawer pulls: 0835 Black or 9211 Brushed Nickel Loft side and hood pulls: color to match drawer pulls 	<p>No cost</p> <p>No cost</p> <p>No cost</p> <p>No cost</p> <p>No cost</p> <p>No cost</p>	<p>Specify with <i>E100 pulls</i> and designate color number 9211 Brushed Nickel.</p> <p>Specify with <i>E110 pulls</i> and designate color number.</p> <p>Specify with <i>E120 pulls</i> and designate color number.</p> <p>Specify with <i>E070 pulls</i> and designate color number.</p> <p>Specify with <i>E130 pulls</i> and designate color number.</p> <p>Specify with <i>E090 pulls</i> and designate color number.</p>
Keying <ul style="list-style-type: none"> Factory- and field-installed keying 		<p>▶ Page G204</p>
Power <ul style="list-style-type: none"> Power box (TPB2) with two plug-in sites and package of communication jacks 	<p>+\$150</p>	<p>Add the suffix P to the style number.</p>
Filing Hardware <ul style="list-style-type: none"> Two file bars with clips per file drawer for side-to-side or legal filing 	<p>No cost</p>	<p>Specify with <i>TFILE</i>.</p>

Tip: For side-to-side options including legal specify with *TFILE*.

Specification Information

• Dimensions			• Style Number	• Base Price	• Option (Add \$ to Base Price)
D	W	H			
:	:	:	:	:	: Customiz
:	:	:	:	:	: Stain

Laminate Media Cart

21¼"	31⅞"	43"	TLMC4132	\$1700	N.A.
:	:	:	:	:	:



Laminate Media Cart with Wood Veneer Drawer Fronts and Shelves

21¼"	31⅞"	43"	TLMC4132W	\$1870	+\$84
:	:	:	:	:	:

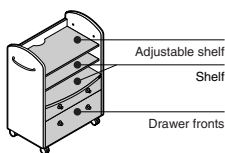

Drawer Pull Shapes

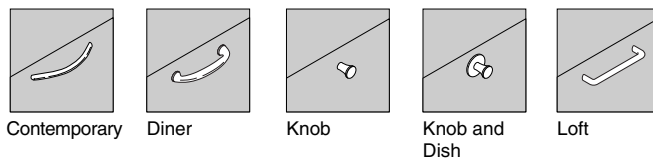



Specifying Borders

Personal Borders (SIN 711.1)

G118

Relevant

Personal Borders

SIN 711.1

Wood Veneer Personal Borders

With One Border End Panel



Tip: Side without end panel must attach to open hutch only. Do not connect it to an amenity shelf.

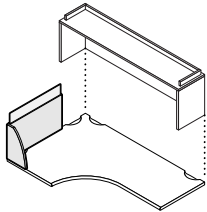

Tip: Personal border is always shorter than the supporting worksurface to allow space for a hutch.

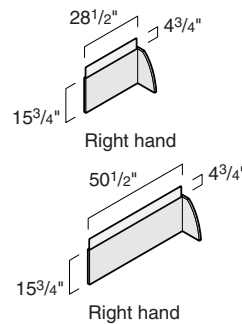
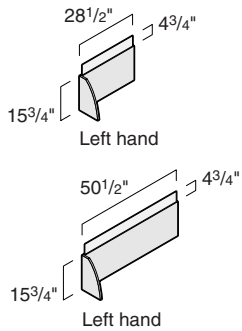

Tip: Personal borders will not work with drop top hutches, only open hutches.

Standard Includes	Required to Specify
<ul style="list-style-type: none"> Personal border: wood veneer with translucent plexiglas insert Border end panel: wood veneer Attachment hardware 	<ul style="list-style-type: none"> 1 Style number 2 Wood color number for personal border 3 Options, if selected (see below) ▶ See <i>Surface Materials</i>, page G198.

Options	Price	Required to Specify
Surface Materials <ul style="list-style-type: none"> Customiz stain on wood veneer 	Prices below	Specify with <i>Customiz stain</i> . ▶ See <i>Surface Materials Reference Manual</i> .
Related <ul style="list-style-type: none"> Tackboards Slatwall panels 		▶ Page G166 ▶ Page G176

Specification Information					
Dimensions W H	For Use On	Style Number	Base Price	Option (Add \$ to Base Price)	
				Customiz Stain	

Left-Hand Personal Borders for Use with any Corner, Extended, Transitional, or Transitional Extended Corner Worksurface

28 1/2"	20 1/2"	42" side	TWPB2029L	\$397	+\$41
50 1/2"	20 1/2"	64" side	TWPB2051L	\$517	+\$60
:	:	:	:	:	:

Right-Hand Personal Borders for Use with any Corner, Extended, Transitional, or Transitional Extended Corner Worksurface

28 1/2"	20 1/2"	42" side	TWPB2029R	\$397	+\$41
50 1/2"	20 1/2"	64" side	TWPB2051R	\$517	+\$60
:	:	:	:	:	:

Laminate Personal Borders

With One Border End Panel



Tip: Side without end panel must attach to open hutch only. Do not connect it to an amenity shelf.

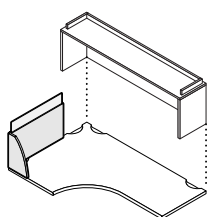

Tip: Personal border is always shorter than the supporting work surface to allow space for a hutch.

Tip: Personal borders will not work with drop top hutches, only open hutches.

Tip: All laminate surfaces have a solid color default PVC edge.

▶ See Color Coordination List, page G200.

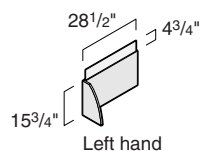

Left hand

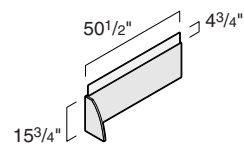

Left hand

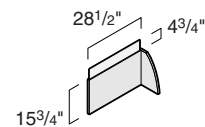

Right hand

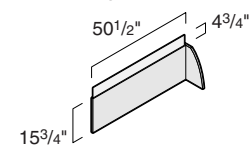

Right hand

Standard Includes	Required to Specify
-------------------	---------------------

- | | |
|--|---|
| <ul style="list-style-type: none"> Personal border: laminate with translucent plexiglas insert Border end panel: laminate Attachment hardware | <ul style="list-style-type: none"> 1 Style number 2 Laminate color number for personal border ▶ See <i>Surface Materials</i>, page G198. |
|--|---|

Related Products

- | | |
|---|--|
| <ul style="list-style-type: none"> Tackboards Slatwall panels | <ul style="list-style-type: none"> ▶ Page G166 ▶ Page G176 |
|---|--|

Specification Information					
Dimensions	For Use	Style	Price		
W	H	On	Number		

Left-Hand Personal Borders for Use with any Corner, Extended, Transitional, or Transitional Extended Corner Worksurface

28 1/2"	20 1/2"	42" side	TLPB2029L	\$302
---------	---------	----------	------------------	-------

50 1/2"	20 1/2"	64" side	TLPB2051L	\$397
---------	---------	----------	------------------	-------

:	:	:	:	:
---	---	---	---	---

Right-Hand Personal Borders for Use with any Corner, Extended, Transitional, or Transitional Extended Corner Worksurface

28 1/2"	20 1/2"	42" side	TLPB2029R	\$302
---------	---------	----------	------------------	-------

50 1/2"	20 1/2"	64" side	TLPB2051R	\$397
---------	---------	----------	------------------	-------

:	:	:	:	:
---	---	---	---	---

Personal Borders, continued

SIN 711.1

Wood Veneer Personal Border

With Two Border End Panels

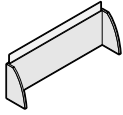

Tip: For use with rectangular, bowed front, or pier-top worksurfaces. Not for use with corner, extended corner, transitional corner, or transitional extended corner worksurfaces.

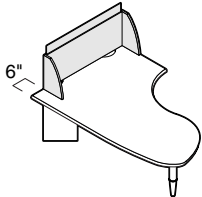

Tip: 42"W personal border can be used on 48" side of pier-top worksurface to allow 6" clear space on the visitor's side.

Standard Includes **Required to Specify**

- | | |
|---|---|
| <ul style="list-style-type: none"> • Personal border: wood veneer with translucent plexiglas insert • Two border end panels: wood veneer • Attachment hardware | <ul style="list-style-type: none"> 1 Style number 2 Wood color number for personal border 3 Options, if selected (see below) ▶ See <i>Surface Materials</i>, page G198. |
|---|---|

Options **Price** **Required to Specify**

- | | | | |
|--------------------------|---|--------------|---|
| Surface Materials | <ul style="list-style-type: none"> • Customiz stain on wood veneer | Prices below | <ul style="list-style-type: none"> Specify with <i>Customiz stain</i>. ▶ See <i>Surface Materials Reference Manual</i>. |
|--------------------------|---|--------------|---|

- | | | |
|-------------------------|---|--|
| Related Products | <ul style="list-style-type: none"> • Tackboards • Slatwall panels | <ul style="list-style-type: none"> ▶ Page G166 ▶ Page G176 |
|-------------------------|---|--|

Specification Information

Dimensions		For Use On	Style Number	Base Price	Option (Add \$ to Base Price)
W	H				
42"	20½"	42" side	TWPB2042	\$509	+\$60
64"	20½"	64" side	TWPB2064	\$688	+\$84

Laminate Personal Border

With Two Border End Panels

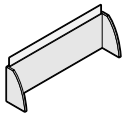

Tip: For use with rectangular, bowed front, or pier-top worksurfaces. Not for use with corner, extended corner, transitional corner, or transitional extended corner worksurfaces.

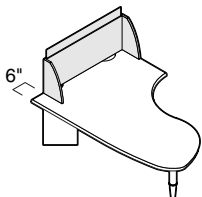

Tip: 42"W personal border can be used on 48" side of pier-top worksurface to allow 6" clear space on the visitor's side.

Standard Includes **Required to Specify**

- | | |
|---|---|
| <ul style="list-style-type: none"> • Personal border with translucent plexiglas insert: laminate • Two border end panels: laminate • Attachment hardware | <ul style="list-style-type: none"> 1 Style number 2 Laminate color number for personal border ▶ See <i>Surface Materials</i>, page G198. |
|---|---|

Related Products

- | | |
|---|--|
| <ul style="list-style-type: none"> • Tackboards • Slatwall panels | <ul style="list-style-type: none"> ▶ Page G166 ▶ Page G176 |
|---|--|

Specification Information

Dimensions		For Use On	Style Number	Price
W	H			
42"	20½"	42" side	TLPB2042	\$402
64"	20½"	64" side	TLPB2064	\$576

Specifying Relevant Storage

► For more detailed product information, see the *Relevant Systems Furniture Specification Guide* or consult your Steelcase dealer.

Storage

24"D and 30"D Pedestals (SIN 711.2)	G122
24"D and 30"D Lateral Files (SIN 711.2)	G124
24"D and 30"D Low-Boy Pedestals (SIN 711.2)	G126
24"D and 30"D Mid-Boy Pedestals (SIN 711.2)	G128
24"D and 30"D Low-Boy Lateral Files (SIN 711.2)	G130
24"D and 30"D Mid-Boy Lateral Files (SIN 711.2)	G132
Wardrobes (SIN 711.2)	G134
Tall-Boy Cabinets (SIN 711.2)	G142
Vertical Cabinets (SIN 711.2)	G150
Four-High Lateral File (SIN 711.2)	G154
Bookcases (SIN 711.2)	G158
Amenity Shelves (SIN 711.2)	G160
Open Hutches (SIN 711.2)	G161
Overhead Binder Bins (SIN 711.2)	G162
Wall-Mounted Overhead Binder Bins (SIN 711.2)	G164

Related Products

Tackboards (SIN 711.2)	G166
Markerboards (SIN 711.2)	G173
Slatwall Panels (SIN 711.2)	G176

24"D and 30"D Wood Veneer Pedestals

SIN 711.2

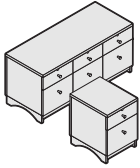

Standard Includes	Required to Specify
-------------------	---------------------

- Pedestal: wood veneer
- Knob drawer pulls: black
- One pencil tray: black plastic only
- One movable partition: black plastic only
- Two movable partitions per 4"H lateral file drawer
- One hanging file system for front-to-back filing per file drawer (see filing options below)
- Lock, keyed random: 9250 Ember Chrome
- Leveling glides: black only

- 1 Style number
 - 2 Wood color number for low-boy or mid-boy
 - 3 Options, if selected (see below)
- ▶ See *Surface Materials*, page G198.

Options	Price	Required to Specify
---------	-------	---------------------

Surface Materials	<ul style="list-style-type: none"> • Customiz stain on wood veneer 	Prices at right	Specify with <i>Customiz stain</i> . ▶ See <i>Surface Materials Reference Manual</i> .
--------------------------	---	-----------------	---

Drawer Pulls	Knob pulls		
	<ul style="list-style-type: none"> • Brushed Nickel 	No cost	Specify with 9211 <i>Brushed Nickel E100 pulls</i> .

Drawer Pulls	Knob and dish pulls		
	<ul style="list-style-type: none"> • Black knob with black dish 	No cost	Specify with 0835 <i>Black knob and E110 Black dish pulls</i> .
	<ul style="list-style-type: none"> • Black knob with Brushed Nickel dish 	No cost	Specify with 0835 <i>Black knob and E120 Brushed Nickel dish pulls</i> .
	<ul style="list-style-type: none"> • Brushed Nickel knob with black dish 	No cost	Specify with 9211 <i>Brushed Nickel knob and E110 Black dish pulls</i> .
	<ul style="list-style-type: none"> • Brushed Nickel knob with Brushed Nickel dish 	No cost	Specify with 9211 <i>Brushed Nickel knob and E120 Brushed Nickel dish pulls</i> .

Drawer Pulls	Contemporary pulls		
	<ul style="list-style-type: none"> • Black 	No cost	Specify with 0835 <i>Black E070 contemporary pulls</i> .
	<ul style="list-style-type: none"> • Polished Chrome 	No cost	Specify with 9201 <i>Polished Chrome E070 contemporary pulls</i> .

Drawer Pulls	Diner pulls		
	<ul style="list-style-type: none"> • Black • Brushed Nickel 	No cost	Specify with 0835 <i>Black E130 diner pulls</i> . Specify with 9211 <i>Brushed Nickel E130 diner pulls</i> .

Drawer Pulls	Loft pulls		
	<ul style="list-style-type: none"> • Black • Brushed Nickel 	No cost	Specify with 0835 <i>Black E090 loft pulls</i> . Specify with 9211 <i>Brushed Nickel E090 loft pulls</i> .

Keying	<ul style="list-style-type: none"> • Factory- and field-installed keying 		▶ Page G204
---------------	---	--	-------------

Filing Hardware	<ul style="list-style-type: none"> • Two file bars with clips per file drawer for side-to-side or legal filing 	No cost	Specify with <i>TFILE</i> .
------------------------	---	---------	-----------------------------

Casters	Low-boy		
	<ul style="list-style-type: none"> • Two locking and two non-locking mobile 3" diameter casters: black only 	+\$37	Add the suffix M to the style number.

Casters	Mid-boy		
	<ul style="list-style-type: none"> • Three locking and three non-locking mobile 3" diameter casters: black only 	+\$60	Add the suffix M to the style number.

Tip: For side-to-side options including legal specify with *TFILE*.

Drawer Pull Shapes



Contemporary

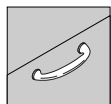

Diner

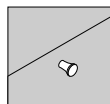

Knob

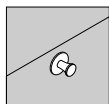

Knob and Dish

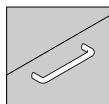

Loft

Specification Information

• Dimensions			• Style Number	• Base Price	• Option (Add \$ to Base Price)
D	W	H			
:	:	:	:	:	Customiz Stain



24"D and 30"D Low-Boy Pedestal with One Box/File Unit

20 1/16"	16"	23"	TWLB1620	\$ 979	+\$ 57
26 1/16"	16"	23"	TWLB1626	\$1086	+\$ 84
:	:	:	:	:	:

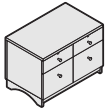

24"D and 30"D Low-Boy Pedestal with Two Box/File Units

20 1/16"	31 7/8"	23"	TWLB3220	\$1958	+\$128
26 1/16"	31 7/8"	23"	TWLB3226	\$2100	+\$181
:	:	:	:	:	:

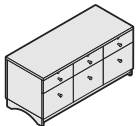

24"D and 30"D Low-Boy Pedestal with Three Box/File Units

20 1/16"	47 13/16"	23"	TWLB4820	\$2937	+\$128
26 1/16"	47 13/16"	23"	TWLB4826	\$3122	+\$212
:	:	:	:	:	:



24"D and 30"D Mid-Boy Pedestal with One Box/File Unit

20 1/16"	16"	35 1/2"	TWMB1620	\$1254	+\$128
26 1/16"	16"	35 1/2"	TWMB1626	\$1355	+\$128
:	:	:	:	:	:

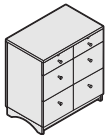

24"D and 30"D Mid-Boy Pedestal with Two Box/File Units

20 1/16"	31 7/8"	35 1/2"	TWMB3220	\$2401	+\$181
26 1/16"	31 7/8"	35 1/2"	TWMB3226	\$2597	+\$181
:	:	:	:	:	:

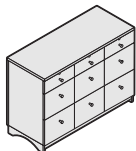

24"D and 30"D Mid-Boy Pedestal with Three Box/File Units

20 1/16"	47 13/16"	35 1/2"	TWMB4820	\$3561	+\$212
26 1/16"	47 13/16"	35 1/2"	TWMB4826	\$3830	+\$212
:	:	:	:	:	:

24"D and 30"D Wood Veneer Lateral Files

SIN 711.2

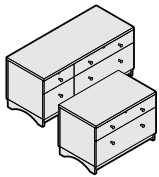

Standard Includes	Required to Specify
-------------------	---------------------

- Lateral file/pedestal: wood veneer
- Knob drawer pulls: black
- One pencil tray: black plastic only
- One movable partition: black plastic only
- Two movable partitions per 4"H lateral file drawer
- One hanging file system for front-to-back filing per file drawer (see filing options below)
- Lock, keyed random: 9250 Ember Chrome
- Leveling glides: black only

- 1 Style number
 - 2 Wood color number for low-boy or mid-boy
 - 3 Options, if selected (see below)
- ▶ See *Surface Materials*, page G198.

Options	Price	Required to Specify
---------	-------	---------------------

Surface Materials	<ul style="list-style-type: none"> • Customiz stain on wood veneer 	Prices at right	Specify with <i>Customiz stain</i> . ▶ See <i>Surface Materials Reference Manual</i> .
--------------------------	---	-----------------	---

Drawer Pulls	Knob pulls <ul style="list-style-type: none"> • Brushed Nickel 	No cost	Specify with 9211 <i>Brushed Nickel E100 pulls</i> .
---------------------	--	---------	--

	Knob and dish pulls <ul style="list-style-type: none"> • Black knob with black dish • Black knob with Brushed Nickel dish • Brushed Nickel knob with black dish • Brushed Nickel knob with Brushed Nickel dish 	No cost	Specify with 0835 <i>Black knob and E110 Black dish pulls</i> . Specify with 0835 <i>Black knob and E120 Brushed Nickel dish pulls</i> . Specify with 9211 <i>Brushed Nickel knob and E110 Black dish pulls</i> . Specify with 9211 <i>Brushed Nickel knob and E120 Brushed Nickel dish pulls</i> .
--	---	---------	--

	Contemporary pulls <ul style="list-style-type: none"> • Black • Polished Chrome • Silver 	No cost	Specify with 0835 <i>Black E070 contemporary pulls</i> . Specify with 9201 <i>Polished Chrome E070 contemporary pulls</i> . Specify with 9212 <i>Silver E070 contemporary pulls</i> .
--	--	---------	---

	Diner pulls <ul style="list-style-type: none"> • Black • Brushed Nickel 	No cost	Specify with 0835 <i>Black E130 diner pulls</i> . Specify with 9211 <i>Brushed Nickel E130 diner pulls</i> .
--	--	---------	---

	Loft pulls <ul style="list-style-type: none"> • Black • Brushed Nickel 	No cost	Specify with 0835 <i>Black E090 loft pulls</i> . Specify with 9211 <i>Brushed Nickel E090 loft pulls</i> .
--	---	---------	---

Keying	• Factory- and field-installed keying		▶ Page G204
---------------	---------------------------------------	--	-------------

Filing Hardware	• Two file bars with clips per file drawer for side-to-side or legal filing	No cost	Specify with <i>TFILE</i> .
------------------------	---	---------	-----------------------------

Casters	Low-boy <ul style="list-style-type: none"> • Two locking and two non-locking mobile 3" diameter casters: black only 	+\$37	Add the suffix M to the style number.
----------------	---	-------	--

	Mid-boy <ul style="list-style-type: none"> • Three locking and three non-locking mobile 3" diameter casters: black only 	+\$60	Add the suffix M to the style number.
--	---	-------	--

Tip: For side-to-side options including legal specify with *TFILE*.

Drawer Pull Shapes

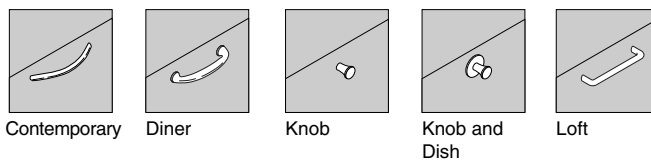

Specification Information

• Dimensions			• Style Number	• Base Price	• Option (Add \$ to Base Price)
D	W	H			
:	:	:	:	:	Customiz Stain



24"D and 30"D Low-Boy Lateral File and 4"H Drawer

20 1/16"	31 7/8"	23"	TWFB3220	\$1505	+\$128
26 1/16"	31 7/8"	23"	TWFB3226	\$1644	+\$181

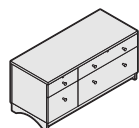

24"D and 30"D Low-Boy Lateral File, 4"H Drawer, and Box/File Unit Left

20 1/16"	47 13/16"	23"	TWFL4820	\$1993	+\$128
26 1/16"	47 13/16"	23"	TWFL4826	\$2217	+\$212

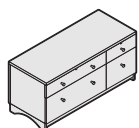

24"D and 30"D Low-Boy Lateral File, 4"H Drawer, and Box/File Unit Right

20 1/16"	47 13/16"	23"	TWFR4820	\$1993	+\$128
26 1/16"	47 13/16"	23"	TWFR4826	\$2217	+\$212

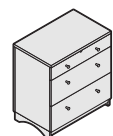

24"D and 30"D Mid-Boy Lateral File and 4"H Drawer

20 1/16"	31 7/8"	35 1/2"	TWMF3220	\$1927	+\$181
26 1/16"	31 7/8"	35 1/2"	TWMF3226	\$2087	+\$181

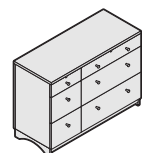

24"D and 30"D Mid-Boy Lateral File, 4"H Drawer, and Box/File Unit Left

20 1/16"	47 13/16"	35 1/2"	TWML4820	\$2602	+\$212
26 1/16"	47 13/16"	35 1/2"	TWML4826	\$2835	+\$212

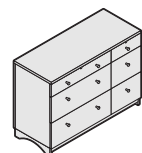

24"D and 30"D Mid-Boy Lateral File, 4"H Drawer, and Box/File Unit Right

20 1/16"	47 13/16"	35 1/2"	TWMR4820	\$2602	+\$212
26 1/16"	47 13/16"	35 1/2"	TWMR4826	\$2835	+\$212

24"D and 30"D Laminate Low-Boy Pedestals

SIN 711.2

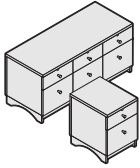

Tip: All laminate surfaces have a solid color default PVC edge.

▶ See Color Coordination List, page G200.

Standard Includes	Required to Specify
-------------------	---------------------

- Low-boy pedestal: laminate
- Drawer fronts and top: wood veneer, if selected
- Knob drawer pulls: black
- One pencil tray: black plastic only
- One movable partition: black plastic only
- One hanging file system for front-to-back filing per file drawer (see filing options below)
- Lock, keyed random: 9250 Ember Chrome
- Leveling glides: black only

- 1 Style number
 - 2 Laminate color number for low-boy
 - 3 Wood color number for drawer fronts and/or top, if selected
 - 4 Options, if selected (see below)
- ▶ See *Surface Materials*, page G198.

Options	Price	Required to Specify
---------	-------	---------------------

Surface Materials	• Customiz stain on wood veneer	Prices at right Specify with <i>Customiz stain</i> . ▶ See <i>Surface Materials Reference Manual</i> .
--------------------------	---------------------------------	--

Drawer Pulls	Knob pulls • Brushed Nickel	No cost Specify with <i>9211 Brushed Nickel E100 pulls</i> .
---------------------	---------------------------------------	---

	Knob and dish pulls • Black knob with black dish • Black knob with Brushed Nickel dish • Brushed Nickel knob with black dish • Brushed Nickel knob with Brushed Nickel dish	No cost No cost No cost No cost Specify with <i>0835 Black knob and E110 Black dish pulls</i> . Specify with <i>0835 Black knob and E120 Brushed Nickel dish pulls</i> . Specify with <i>9211 Brushed Nickel knob and E110 Black dish pulls</i> . Specify with <i>9211 Brushed Nickel knob and E120 Brushed Nickel dish pulls</i> .
--	--	--

	Contemporary pulls • Black • Polished Chrome • Silver	No cost No cost No cost Specify with <i>0835 Black E070 contemporary pulls</i> . Specify with <i>9201 Polished Chrome E070 contemporary pulls</i> . Specify with <i>9212 Silver E070 contemporary pulls</i> .
--	---	--

	Diner pulls • Black • Brushed Nickel	No cost No cost Specify with <i>0835 Black E130 diner pulls</i> . Specify with <i>9211 Brushed Nickel E130 diner pulls</i> .
--	---	---

	Loft pulls • Black • Brushed Nickel	No cost No cost Specify with <i>0835 Black E090 loft pulls</i> . Specify with <i>9211 Brushed Nickel E090 loft pulls</i> .
--	--	---

Keying	• Factory- and field-installed keying	▶ Page G204
---------------	---------------------------------------	-------------

Filing Hardware	• Two file bars with clips per file drawer for side-to-side or legal filing	No cost Specify with <i>TFILE</i> .
------------------------	---	--

Casters	• Two locking and two non-locking mobile 3" diameter casters: black only	+\$37 Add the suffix M to the style number.
----------------	--	---

Tip: For side-to-side options including legal specify with *TFILE*.

Drawer Pull Shapes

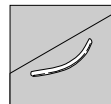

Contemporary

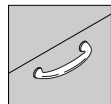

Diner

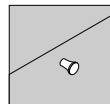

Knob

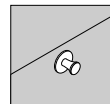

Knob and Dish

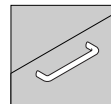

Loft

Specification Information

Dimensions			Style	Base	Option
D	W	H	Number	Price	(Add \$ to Base Price)
					Customiz
					Stain



24"D and 30"D Low-Boy Pedestal with One Box/File Unit

20 1/16"	16"	23"	TLLB1620	\$ 754	N.A.
26 1/16"	16"	23"	TLLB1626	\$ 868	N.A.

With Wood Veneer Drawer Fronts

20 1/16"	16"	23"	TLLB1620W	\$ 835	+\$24
26 1/16"	16"	23"	TLLB1626W	\$ 941	+\$41

With Wood Veneer Drawer Fronts and Top

20 1/16"	16"	23"	TLLB1620WW	\$ 872	+\$24
26 1/16"	16"	23"	TLLB1626WW	\$ 977	+\$41

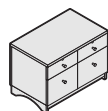

24"D and 30"D Low-Boy Pedestal with Two Box/File Units

20 1/16"	31 7/8"	23"	TLLB3220	\$1509	N.A.
26 1/16"	31 7/8"	23"	TLLB3226	\$1666	N.A.

With Wood Veneer Drawer Fronts

20 1/16"	31 7/8"	23"	TLLB3220W	\$1672	+\$24
26 1/16"	31 7/8"	23"	TLLB3226W	\$1805	+\$41

With Wood Veneer Drawer Fronts and Top

20 1/16"	31 7/8"	23"	TLLB3220WW	\$1746	+\$41
26 1/16"	31 7/8"	23"	TLLB3226WW	\$1877	+\$60

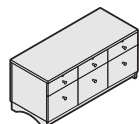

24"D and 30"D Low-Boy Pedestal with Three Box/File Units

20 1/16"	47 13/16"	23"	TLLB4820	\$2262	N.A.
26 1/16"	47 13/16"	23"	TLLB4826	\$2473	N.A.

With Wood Veneer Drawer Fronts

20 1/16"	47 13/16"	23"	TLLB4820W	\$2506	+\$41
26 1/16"	47 13/16"	23"	TLLB4826W	\$2690	+\$60

With Wood Veneer Drawer Fronts and Top

20 1/16"	47 13/16"	23"	TLLB4820WW	\$2617	+\$60
26 1/16"	47 13/16"	23"	TLLB4826WW	\$2798	+\$84

24"D and 30"D Laminate Mid-Boy Pedestals

SIN 711.2

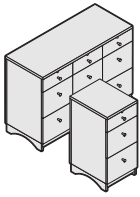

Tip: All laminate surfaces have a solid color default PVC edge.
 ▶ See Color Coordination List, page G200.

Standard Includes	Required to Specify
-------------------	---------------------

- | | |
|---|--|
| Standard Includes | Required to Specify |
| <ul style="list-style-type: none"> • Mid-boy pedestal : laminate • Drawer fronts and top: wood veneer, if selected • Knob drawer pulls: black • One pencil tray: black plastic only • One movable partition: black plastic only • One hanging file system for front-to-back filing per file drawer (see filing options below) • Lock, keyed random: 9250 Ember Chrome • Leveling glides: black only | <ol style="list-style-type: none"> 1 Style number 2 Laminate color number for mid-boy 3 Wood color number for drawer fronts and/or top, if selected 4 Options, if selected (see below) <p>▶ See <i>Surface Materials</i>, page G198.</p> |

Options	Price	Required to Specify
---------	-------	---------------------

Options	Price	Required to Specify
Surface Materials	• Customiz stain on wood veneer	Prices at right Specify with <i>Customiz stain</i> . ▶ See <i>Surface Materials Reference Manual</i> .
Drawer Pulls	Knob pulls	
	• Brushed Nickel	No cost Specify with <i>9211 Brushed Nickel E100 pulls</i> .
	Knob and dish pulls	
	• Black knob with black dish	No cost Specify with <i>0835 Black knob and E110 Black dish pulls</i> .
	• Black knob with Brushed Nickel dish	No cost Specify with <i>0835 Black knob and E120 Brushed Nickel dish pulls</i> .
	• Brushed Nickel knob with black dish	No cost Specify with <i>9211 Brushed Nickel knob and E110 Black dish pulls</i> .
• Brushed Nickel knob with Brushed Nickel dish	No cost Specify with <i>9211 Brushed Nickel knob and E120 Brushed Nickel dish pulls</i> .	
Contemporary pulls	• Black	No cost Specify with <i>0835 Black E070 contemporary pulls</i> .
	• Polished Chrome	No cost Specify with <i>9201 Polished Chrome E070 contemporary pulls</i> .
	• Silver	No cost Specify with <i>9212 Silver E070 contemporary pulls</i> .
Diner pulls	• Black	No cost Specify with <i>0835 Black E130 diner pulls</i> .
	• Brushed Nickel	No cost Specify with <i>9211 Brushed Nickel E130 diner pulls</i> .
Loft pulls	• Black	No cost Specify with <i>0835 Black E090 loft pulls</i> .
	• Brushed Nickel	No cost Specify with <i>9211 Brushed Nickel E090 loft pulls</i> .
Keying	• Factory- and field-installed keying	▶ Page G204
Filing Hardware	• Two file bars with clips per file drawer for side-to-side or legal filing	No cost Specify with <i>TFILE</i> .
Casters	• Three locking and three non-locking mobile 3" diameter casters: black only	+\$60 Add the suffix M to the style number.

Tip: For side-to-side options including legal specify with *TFILE*.

Drawer Pull Shapes

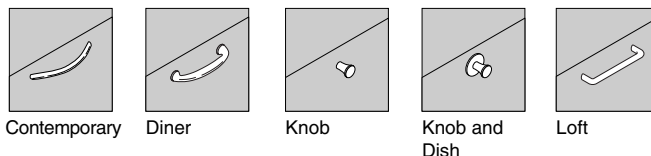

Specification Information

Dimensions			Style	Base	Option
D	W	H	Number	Price	(Add \$ to Base Price)
:	:	:	:	:	Customiz
:	:	:	:	:	Stain



24"D and 30"D Mid-Boy Pedestal with One Box/File Unit

20 1/16"	16"	35 1/2"	TLMB1620	\$1018	N.A.
26 1/16"	16"	35 1/2"	TLMB1626	\$1109	N.A.

With Wood Veneer Drawer Fronts

20 1/16"	16"	35 1/2"	TLMB1620W	\$1097	+\$41
26 1/16"	16"	35 1/2"	TLMB1626W	\$1188	+\$41

With Wood Veneer Drawer Fronts and Top

20 1/16"	16"	35 1/2"	TLMB1620WW	\$1133	+\$60
26 1/16"	16"	35 1/2"	TLMB1626WW	\$1224	+\$60

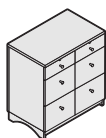

24"D and 30"D Mid-Boy Pedestal with Two Box/File Units

20 1/16"	31 7/8"	35 1/2"	TLMB3220	\$1927	N.A.
26 1/16"	31 7/8"	35 1/2"	TLMB3226	\$2090	N.A.

With Wood Veneer Drawer Fronts

20 1/16"	31 7/8"	35 1/2"	TLMB3220W	\$2085	+\$41
26 1/16"	31 7/8"	35 1/2"	TLMB3226W	\$2248	+\$41

With Wood Veneer Drawer Fronts and Top

20 1/16"	31 7/8"	35 1/2"	TLMB3220WW	\$2157	+\$60
26 1/16"	31 7/8"	35 1/2"	TLMB3226WW	\$2338	+\$60

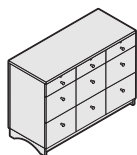

24"D and 30 "D Mid-Boy Pedestal with Three Box/File Units

20 1/16"	47 13/16"	35 1/2"	TLMB4820	\$2842	N.A.
26 1/16"	47 13/16"	35 1/2"	TLMB4826	\$3073	N.A.

With Wood Veneer Drawer Fronts

20 1/16"	47 13/16"	35 1/2"	TLMB4820W	\$3079	+\$60
26 1/16"	47 13/16"	35 1/2"	TLMB4826W	\$3300	+\$60

With Wood Veneer Drawer Fronts and Top

20 1/16"	47 13/16"	35 1/2"	TLMB4820WW	\$3187	+\$84
26 1/16"	47 13/16"	35 1/2"	TLMB4826WW	\$3408	+\$84

24"D and 30"D Laminate Low-Boy Lateral Files

SIN 711.2

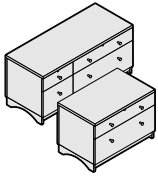

Tip: All laminate surfaces have a solid color default PVC edge.

▶ See Color Coordination List, page G200.

Standard Includes	Required to Specify
-------------------	---------------------

- Low-boy lateral files/pedestals: laminate
- Drawer fronts and top: wood veneer, if selected
- Knob drawer pulls: black
- One pencil tray: black plastic only
- One movable partition: black plastic only
- Two movable partitions per 4"H lateral file drawer
- One hanging file system for front-to-back filing per file drawer (see filing options below)
- Lock, keyed random: 9250 Ember Chrome
- Leveling glides: black only

- 1 Style number
 - 2 Laminate color number for low-boy
 - 3 Wood color number for drawer fronts and/or top, if selected
 - 4 Options, if selected (see below)
- ▶ See *Surface Materials*, page G198.

Options	Price	Required to Specify
---------	-------	---------------------

Surface Materials	<ul style="list-style-type: none"> • Customiz stain on wood veneer 	Prices at right	Specify with <i>Customiz stain</i> . ▶ See <i>Surface Materials Reference Manual</i> .
Drawer Pulls	<p>Knob pulls</p> <ul style="list-style-type: none"> • Brushed Nickel <hr/> <p>Knob and dish pulls</p> <ul style="list-style-type: none"> • Black knob with black dish • Black knob with Brushed Nickel dish • Brushed Nickel knob with black dish • Brushed Nickel knob with Brushed Nickel dish <hr/> <p>Contemporary pulls</p> <ul style="list-style-type: none"> • Black • Polished Chrome • Silver <hr/> <p>Diner pulls</p> <ul style="list-style-type: none"> • Black • Brushed Nickel <hr/> <p>Loft pulls</p> <ul style="list-style-type: none"> • Black • Brushed Nickel 	No cost	Specify with <i>9211 Brushed Nickel E100 pulls</i> . Specify with <i>0835 Black knob and E110 Black dish pulls</i> . Specify with <i>0835 Black knob and E120 Brushed Nickel dish pulls</i> . Specify with <i>9211 Brushed Nickel knob and E110 Black dish pulls</i> . Specify with <i>9211 Brushed Nickel knob and E120 Brushed Nickel dish pulls</i> . Specify with <i>0835 Black E070 contemporary pulls</i> . Specify with <i>9201 Polished Chrome E070 contemporary pulls</i> . Specify with <i>9212 Silver E070 contemporary pulls</i> . Specify with <i>0835 Black E130 diner pulls</i> . Specify with <i>9211 Brushed Nickel E130 diner pulls</i> . Specify with <i>0835 Black E090 loft pulls</i> . Specify with <i>9211 Brushed Nickel E090 loft pulls</i> .
Keying	<ul style="list-style-type: none"> • Factory- and field-installed keying 		▶ Page G204
Filing Hardware	<ul style="list-style-type: none"> • Two file bars with clips per file drawer for side-to-side or legal filing 	No cost	Specify with <i>TFILE</i> .
Casters	<ul style="list-style-type: none"> • Two locking and two non-locking mobile 3" diameter casters: black only 	+\$37	Add the suffix M to the style number.

Tip: For side-to-side options including legal specify with *TFILE*.

Drawer Pull Shapes

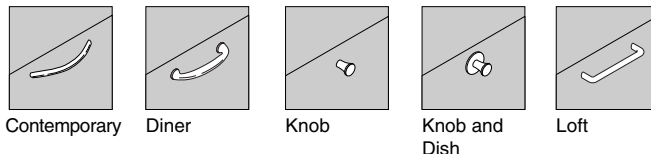

Specification Information

Dimensions			Style	Base	Option
D	W	H	Number	Price	(Add \$ to Base Price)
					Customiz
					Stain



24"D and 30"D Low-Boy Lateral File and 4"H Drawer

20 1/16"	31 7/8"	23"	TLFB3220	\$1208	N.A.
26 1/16"	31 7/8"	23"	TLFB3226	\$1350	N.A.

With Wood Veneer Drawer Fronts

20 1/16"	31 7/8"	23"	TLFB3220W	\$1284	+\$24
26 1/16"	31 7/8"	23"	TLFB3226W	\$1424	+\$41

With Wood Veneer Drawer Fronts and Top

20 1/16"	31 7/8"	23"	TLFB3220WW	\$1358	+\$41
26 1/16"	31 7/8"	23"	TLFB3226WW	\$1496	+\$60

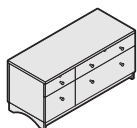

24"D and 30"D Low-Boy Lateral File, 4"H Drawer, and Box/File Unit Left

20 1/16"	47 13/16"	23"	TLFL4820	\$1674	N.A.
26 1/16"	47 13/16"	23"	TLFL4826	\$1886	N.A.

With Wood Veneer Drawer Fronts

20 1/16"	47 13/16"	23"	TLFL4820W	\$1750	+\$41
26 1/16"	47 13/16"	23"	TLFL4826W	\$1946	+\$60

With Wood Veneer Drawer Fronts and Top

20 1/16"	47 13/16"	23"	TLFL4820WW	\$1861	+\$60
26 1/16"	47 13/16"	23"	TLFL4826WW	\$2046	+\$84

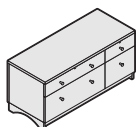

24"D and 30"D Low-Boy Lateral File, 4"H Drawer, and Box/File Unit Right

20 1/16"	47 13/16"	23"	TLFR4820	\$1674	N.A.
26 1/16"	47 13/16"	23"	TLFR4826	\$1886	N.A.

With Wood Veneer Drawer Fronts

20 1/16"	47 13/16"	23"	TLFR4820W	\$1750	+\$41
26 1/16"	47 13/16"	23"	TLFR4826W	\$1946	+\$60

With Wood Veneer Drawer Fronts and Top

20 1/16"	47 13/16"	23"	TLFR4820WW	\$1861	+\$60
26 1/16"	47 13/16"	23"	TLFR4826WW	\$2046	+\$84

Specification Information

• Dimensions			• Style	• Base	• Option
D	W	H	Number	Price	(Add \$ to Base Price)
:	:	:	:	:	Customiz
:	:	:	:	:	Stain



Mid-Boy Lateral File and 4"H Drawer

20 1/16"	31 7/8"	35 1/2"	TLMF3220	\$1593	N.A.
26 1/16"	31 7/8"	35 1/2"	TLMF3226	\$1735	N.A.

With Wood Veneer Drawer Fronts

20 1/16"	31 7/8"	35 1/2"	TLMF3220W	\$1667	+\$41
26 1/16"	31 7/8"	35 1/2"	TLMF3226W	\$1809	+\$41

With Wood Veneer Drawer Fronts and Top

20 1/16"	31 7/8"	35 1/2"	TLMF3220WW	\$1739	+\$60
26 1/16"	31 7/8"	35 1/2"	TLMF3226WW	\$1881	+\$60

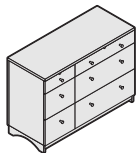

Mid-Boy Lateral File, 4"H Drawer, and Box/File Unit Left

20 1/16"	47 13/16"	35 1/2"	TLML4820	\$2221	N.A.
26 1/16"	47 13/16"	35 1/2"	TLML4826	\$2418	N.A.

With Wood Veneer Drawer Fronts

20 1/16"	47 13/16"	35 1/2"	TLML4820W	\$2295	+\$60
26 1/16"	47 13/16"	35 1/2"	TLML4826W	\$2492	+\$60

With Wood Veneer Drawer Fronts and Top

20 1/16"	47 13/16"	35 1/2"	TLML4820WW	\$2403	+\$84
26 1/16"	47 13/16"	35 1/2"	TLML4826WW	\$2589	+\$84

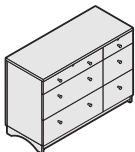

Mid-Boy Lateral File, 4"H Drawer, and Box/File Unit Right

20 1/16"	47 13/16"	35 1/2"	TLMR4820	\$2221	N.A.
26 1/16"	47 13/16"	35 1/2"	TLMR4826	\$2418	N.A.

With Wood Veneer Drawer Fronts

20 1/16"	47 13/16"	35 1/2"	TLMR4820W	\$2295	+\$60
26 1/16"	47 13/16"	35 1/2"	TLMR4826W	\$2492	+\$60

With Wood Veneer Drawer Fronts and Top

20 1/16"	47 13/16"	35 1/2"	TLMR4820WW	\$2403	+\$84
26 1/16"	47 13/16"	35 1/2"	TLMR4826WW	\$2589	+\$84

Wood Veneer Wardrobes, 8" Wide

SIN 711.2

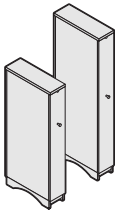

Tip: Wardrobes must be connected to or secured by adjacent tall-boy vertical cabinets, or overhead binder bin and hutch.

Standard Includes		Required to Specify
<ul style="list-style-type: none"> Wardrobe with finished back: wood veneer Knob drawer pulls: black Lock, keyed random: 9250 Ember Chrome Leveling glides: black only Ganging bracket 		1 Style number 2 Wood color number for wardrobe 3 Options, if selected (see below) ▶ See <i>Surface Materials</i> , page G198.

	Options	Price	Required to Specify
Surface Materials	<ul style="list-style-type: none"> Customiz stain on wood veneer 	Prices at right	Specify with <i>Customiz stain</i> . ▶ See <i>Surface Materials Reference Manual</i> .
Drawer Pulls	Knob pulls		
	<ul style="list-style-type: none"> Brushed Nickel 	No cost	Specify with 9211 <i>Brushed Nickel E100 pulls</i> .
	Knob and dish pulls		
	<ul style="list-style-type: none"> Black knob with black dish 	No cost	Specify with 0835 <i>Black knob and E110 Black dish pulls</i> .
	<ul style="list-style-type: none"> Black knob with Brushed Nickel dish Brushed Nickel knob with black dish Brushed Nickel knob with Brushed Nickel dish 	No cost	Specify with 0835 <i>Black knob and E120 Brushed Nickel dish pulls</i> . Specify with 9211 <i>Brushed Nickel knob and E110 Black dish pulls</i> . Specify with 9211 <i>Brushed Nickel knob and E120 Brushed Nickel dish pulls</i> .
	Contemporary pulls		
	<ul style="list-style-type: none"> Black 	No cost	Specify with 0835 <i>Black E070 contemporary pulls</i> .
	<ul style="list-style-type: none"> Polished Chrome 	No cost	Specify with 9201 <i>Polished Chrome E070 contemporary pulls</i> . Specify with 9212 <i>Silver E070 contemporary pulls</i> .
	Diner pulls		
	<ul style="list-style-type: none"> Black Brushed Nickel 	No cost No cost	Specify with 0835 <i>Black E130 diner pulls</i> . Specify with 9211 <i>Brushed Nickel E130 diner pulls</i> .
Keying	<ul style="list-style-type: none"> Factory- and field-installed keying 		▶ Page G204
Related Products	<ul style="list-style-type: none"> Tackboards Markerboards 		▶ Page G167 ▶ Page G173

Drawer Pull Shapes

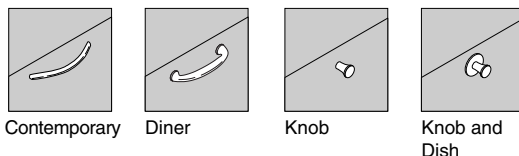

Specification Information

Dimensions			Style Number	Base Price	Option (Add \$ to Base Price)
D	W	H			
:	:	:	:	:	Customiz
:	:	:	:	:	Stain

Door Hinged on Left

24 1/8"	8"	54 3/8"	TWW548L	\$1095	+\$181
24 1/8"	8"	66 5/8"	TWW668L	\$1166	+\$181
:	:	:	:	:	:

Door Hinged on Right

24 1/8"	8"	54 3/8"	TWW548R	\$1095	+\$181
24 1/8"	8"	66 5/8"	TWW668R	\$1166	+\$181
:	:	:	:	:	:

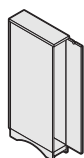
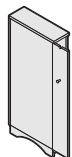

Specification Information

Dimensions			Style Number	Base Price	Option (Add \$ to Base Price)
D	W	H			
					Customiz Stain

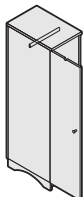

Door Hinged on Left

24 1/8"	16"	54 3/8"	TWW5416L	\$1946	+\$265
24 1/8"	16"	66 5/8"	TWW6616L	\$2022	+\$265

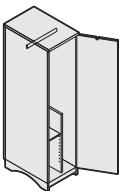

Door Hinged on Right

24 1/8"	16"	54 3/8"	TWW5416R	\$1946	+\$265
24 1/8"	16"	66 5/8"	TWW6616R	\$2022	+\$265



Specification Information

Dimensions			Style	Base	Option
D	W	H	Number	Price	(Add \$ to Base Price)
:	:	:	:	:	Customiz
:	:	:	:	:	Stain

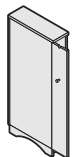

Door Hinged on Left

24 1/8"	8"	54 3/8"	TLW548L	\$ 892	N.A.
24 1/8"	8"	66 5/8"	TLW668L	\$ 947	N.A.

With Wood Veneer Door

24 1/8"	8"	54 3/8"	TLW548WL	\$ 945	+\$24
24 1/8"	8"	66 5/8"	TLW668WL	\$1015	+\$24

With Wood Veneer Door and Wood Veneer Top

24 1/8"	8"	54 3/8"	TLW548WWL	\$ 982	+\$24
24 1/8"	8"	66 5/8"	TLW668WWL	\$1052	+\$24

Door Hinged on Right

24 1/8"	8"	54 3/8"	TLW548R	\$ 892	N.A.
24 1/8"	8"	66 5/8"	TLW668R	\$ 947	N.A.

With Wood Veneer Door

24 1/8"	8"	54 3/8"	TLW548WR	\$ 945	+\$24
24 1/8"	8"	66 5/8"	TLW668WR	\$1015	+\$24

With Wood Veneer Door and Wood Veneer Top

24 1/8"	8"	54 3/8"	TLW548WWR	\$ 982	+\$24
24 1/8"	8"	66 5/8"	TLW668WWR	\$1052	+\$24

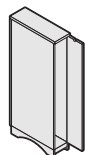

Laminate Wardrobes, 16" Wide

SIN 711.2



Tip: All laminate surfaces have a solid color default PVC edge.
 ▶ See Color Coordination List, page G200.

Tip: Pull-out storage component includes: two steel trays, one compartment divider, one pencil tray, one suspension file cradle, and one CD holder.

Standard Includes		Required to Specify	
<ul style="list-style-type: none"> Wardrobe with finished back: laminate Drawer fronts and top: wood veneer, if selected Knob drawer pulls: black Lock, keyed random: 9250 Ember Chrome Leveling glides: black only Ganging bracket One adjustable-height shelf One wardrobe coat rod 		<ol style="list-style-type: none"> Style number Laminate color number for wardrobe Wood color number for wood veneer drawer fronts and/or top, if selected Options, if selected (see below) ▶ See <i>Surface Materials</i> , page G198.	
Options	Price	Required to Specify	
Surface Materials	<ul style="list-style-type: none"> Customiz stain on wood veneer 	Prices at right	Specify with <i>Customiz stain</i> . ▶ See <i>Surface Materials Reference Manual</i> .
Drawer Pulls	<p>Knob pulls</p> <ul style="list-style-type: none"> Brushed Nickel 	No cost	Specify with 9211 <i>Brushed Nickel E100 pulls</i> .
	<p>Knob and dish pulls</p> <ul style="list-style-type: none"> Black knob with black dish Black knob with Brushed Nickel dish Brushed Nickel knob with black dish Brushed Nickel knob with Brushed Nickel dish 	No cost	Specify with 0835 <i>Black knob and E110 Black dish pulls</i> . Specify with 0835 <i>Black knob and E120 Brushed Nickel dish pulls</i> . Specify with 9211 <i>Brushed Nickel knob and E110 Black dish pulls</i> . Specify with 9211 <i>Brushed Nickel knob and E120 Brushed Nickel dish pulls</i> .
	<p>Contemporary pulls</p> <ul style="list-style-type: none"> Black Polished Chrome Silver 	No cost	Specify with 0835 <i>Black E070 contemporary pulls</i> . Specify with 9201 <i>Polished Chrome E070 contemporary pulls</i> . Specify with 9212 <i>Silver E070 contemporary pulls</i> .
	<p>Diner pulls</p> <ul style="list-style-type: none"> Black Brushed Nickel 	No cost	Specify with 0835 <i>Black E130 diner pulls</i> . Specify with 9211 <i>Brushed Nickel E130 diner pulls</i> .
	<p>Loft pulls</p> <ul style="list-style-type: none"> Black Brushed Nickel 	No cost	Specify with 0835 <i>Black E090 loft pulls</i> . Specify with 9211 <i>Brushed Nickel E090 loft pulls</i> .
Keying	<ul style="list-style-type: none"> Factory- and field-installed keying 		▶ Page G204
Storage/Door	<ul style="list-style-type: none"> Pull-out storage Mirror and tackboard Pull-out storage and mirror/tackboard 	+\$300 +\$200 +\$500	Add the suffix S to the style number. Add the suffix D to the style number. Add the suffix K to the style number.
Related Products	<ul style="list-style-type: none"> Tackboards Markerboards 		▶ Page G170 ▶ Page G174

Drawer Pull Shapes

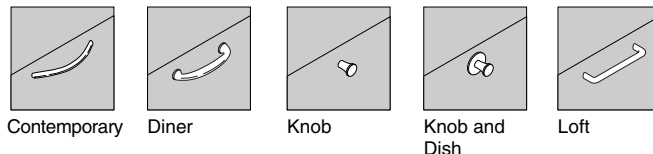

Specification Information

Dimensions			Style	Base	Option
D	W	H	Number	Price	(Add \$ to Base Price)
:	:	:	:	:	Customiz
:	:	:	:	:	Stain

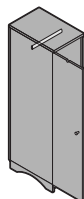

Door Hinged on Left

24 1/8"	16"	54 3/8"	TLW5416L	\$1710	N.A.
24 1/8"	16"	66 5/8"	TLW6616L	\$1778	N.A.

With Wood Veneer Door

24 1/8"	16"	54 3/8"	TLW5416WL	\$1821	+\$41
24 1/8"	16"	66 5/8"	TLW6616WL	\$1903	+\$41

With Wood Veneer Door and Wood Veneer Top

24 1/8"	16"	54 3/8"	TLW5416WWL	\$1893	+\$41
24 1/8"	16"	66 5/8"	TLW6616WWL	\$1975	+\$60

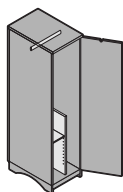

Door Hinged on Right

24 1/8"	16"	54 3/8"	TLW5416R	\$1710	N.A.
24 1/8"	16"	66 5/8"	TLW6616R	\$1778	N.A.

With Wood Veneer Door

24 1/8"	16"	54 3/8"	TLW5416WR	\$1821	+\$41
24 1/8"	16"	66 5/8"	TLW6616WR	\$1903	+\$41

With Wood Veneer Door and Wood Veneer Top

24 1/8"	16"	54 3/8"	TLW5416WWR	\$1893	+\$41
24 1/8"	16"	66 5/8"	TLW6616WWR	\$1975	+\$60

Wood Veneer Tall-Boy Cabinets with One Door and Two File Drawers

SIN 711.2

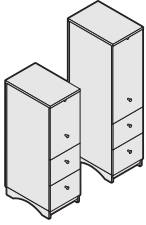

Tip: All laminate surfaces have a solid color default PVC edge.

Standard Includes	Required to Specify
-------------------	---------------------

- Tall boy with finished back: wood veneer
- Knob drawer pulls: black
- One hanging file system for front-to-back filing per file drawer (see filing options below)
- Lock, keyed random: 9250 Ember Chrome
- One adjustable shelf in 54³/₈"H cabinet
- Two adjustable shelves in 65⁵/₈"H cabinet
- Leveling glides: black only

- 1 Style number
- 2 Wood color number for tall boy
- 3 Options, if selected (see below)
- ▶ See *Surface Materials*, page G198.

Options	Price	Required to Specify
---------	-------	---------------------

Surface Materials	<ul style="list-style-type: none"> • Customiz stain on wood veneer 	Prices at right	Specify with <i>Customiz stain</i> . ▶ See <i>Surface Materials Reference Manual</i> .
Drawer Pulls	<p>Knob pulls</p> <ul style="list-style-type: none"> • Brushed Nickel 	No cost	Specify with 9211 <i>Brushed Nickel E100 pulls</i> .
	<p>Knob and dish pulls</p> <ul style="list-style-type: none"> • Black knob with black dish • Black knob with Brushed Nickel dish • Brushed Nickel knob with black dish • Brushed Nickel knob with Brushed Nickel dish 	No cost	Specify with 0835 <i>Black knob and E110 Black dish pulls</i> . Specify with 0835 <i>Black knob and E120 Brushed Nickel dish pulls</i> . Specify with 9211 <i>Brushed Nickel knob and E110 Black dish pulls</i> . Specify with 9211 <i>Brushed Nickel knob and E120 Brushed Nickel dish pulls</i> .
	<p>Contemporary pulls</p> <ul style="list-style-type: none"> • Black • Polished Chrome • Silver 	No cost	Specify with 0835 <i>Black E070 contemporary pulls</i> . Specify with 9201 <i>Polished Chrome E070 contemporary pulls</i> . Specify with 9212 <i>Silver E070 contemporary pulls</i> .
	<p>Diner pulls</p> <ul style="list-style-type: none"> • Black • Brushed Nickel 	No cost	Specify with 0835 <i>Black E130 diner pulls</i> . Specify with 9211 <i>Brushed Nickel E130 diner pulls</i> .
	<p>Loft pulls</p> <ul style="list-style-type: none"> • Black • Brushed Nickel 	No cost	Specify with 0835 <i>Black E090 loft pulls</i> . Specify with 9211 <i>Brushed Nickel E090 loft pulls</i> .
Keying	<ul style="list-style-type: none"> • Factory- and field-installed keying 		▶ Page G204
Filing Hardware	<ul style="list-style-type: none"> • Two file bars with clips per file drawer for side-to-side or legal filing 	No cost	Specify with <i>TFILE</i> .
Related Products	<ul style="list-style-type: none"> • Tackboards • Markerboards 		▶ Pages G167, G170 ▶ Pages G173–G174

Tip: For side-to-side options including legal specify with *TFILE*.

Drawer Pull Shapes

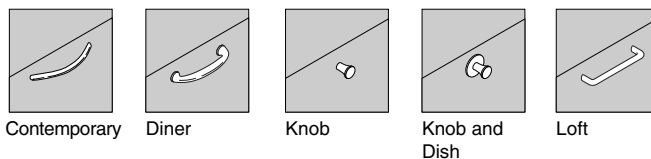

Specification Information

Dimensions			Style Number	Base Price	Option (Add \$ to Base Price)
D	W	H			
:	:	:	:	:	Customiz
:	:	:	:	:	Stain

Door Hinged on Left

24 1/8"	16"	54 3/8"	TWTB5416L	\$2231	+\$265
24 1/8"	16"	66 5/8"	TWTB6616L	\$2283	+\$265
:	:	:	:	:	:

Door Hinged on Right

24 1/8"	16"	54 3/8"	TWTB5416R	\$2231	+\$265
24 1/8"	16"	66 5/8"	TWTB6616R	\$2283	+\$265
:	:	:	:	:	:

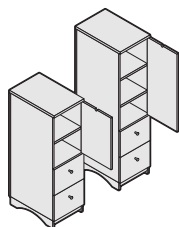
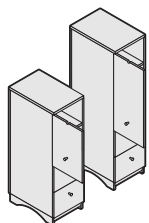

Specification Information

Dimensions			Style Number	Base Price	Option (Add \$ to Base Price)
D	W	H			
:	:	:	:	:	Customiz
:	:	:	:	:	Stain

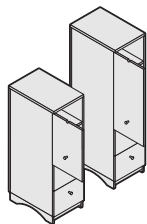

Door Hinged on Left

24 1/8"	16"	54 3/8"	TLTB5416L	\$1885	N.A.
24 1/8"	16"	66 5/8"	TLTB6616L	\$1937	N.A.

With Wood Veneer Door and Drawer Fronts

24 1/8"	16"	54 3/8"	TLTB5416WL	\$1990	+\$41
24 1/8"	16"	66 5/8"	TLTB6616WL	\$2074	+\$41

With Wood Veneer Door, Drawer Fronts, and Wood Veneer Top

24 1/8"	16"	54 3/8"	TLTB5416WWL	\$2058	+\$41
24 1/8"	16"	66 5/8"	TLTB6616WWL	\$2142	+\$60

Door Hinged on Right

24 1/8"	16"	54 3/8"	TLTB5416R	\$1885	N.A.
24 1/8"	16"	66 5/8"	TLTB6616R	\$1937	N.A.

With Wood Veneer Door and Drawer Fronts

24 1/8"	16"	54 3/8"	TLTB5416WR	\$1990	+\$41
24 1/8"	16"	66 5/8"	TLTB6616WR	\$2074	+\$41

With Wood Veneer Door, Drawer Fronts, and Wood Veneer Top

24 1/8"	16"	54 3/8"	TLTB5416WWR	\$2058	+\$41
24 1/8"	16"	66 5/8"	TLTB6616WWR	\$2142	+\$60

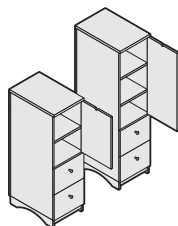

Wood Veneer Tall-Boy Cabinets with Four File Drawers

SIN 711.2



Standard Includes		Required to Specify	
<ul style="list-style-type: none"> Tall boy with finished back: wood veneer Knob drawer pulls: black One hanging file system for front-to-back filing per file drawer (see filing options below) Lock, keyed random: 9250 Ember Chrome Leveling glides: black only 		<ul style="list-style-type: none"> 1 Style number 2 Wood color number for tall boy 3 Options, if selected (see below) ▶ See <i>Surface Materials</i>, page G198. 	
Options		Price	Required to Specify
Surface Materials	<ul style="list-style-type: none"> Customiz stain on wood veneer 	Prices at right	Specify with <i>Customiz stain</i> . ▶ See <i>Surface Materials Reference Manual</i> .
Drawer Pulls	Knob pulls		
	<ul style="list-style-type: none"> Brushed Nickel 	No cost	Specify with <i>9211 Brushed Nickel E100 pulls</i> .
	Knob and dish pulls		
	<ul style="list-style-type: none"> Black knob with black dish 	No cost	Specify with <i>0835 Black knob and E110 Black dish pulls</i> .
	<ul style="list-style-type: none"> Black knob with Brushed Nickel dish 	No cost	Specify with <i>0835 Black knob and E120 Brushed Nickel dish pulls</i> .
	<ul style="list-style-type: none"> Brushed Nickel knob with black dish 	No cost	Specify with <i>9211 Brushed Nickel knob and E110 Black dish pulls</i> .
<ul style="list-style-type: none"> Brushed Nickel knob with Brushed Nickel dish 	No cost	Specify with <i>9211 Brushed Nickel knob and E120 Brushed Nickel dish pulls</i> .	
	Contemporary pulls		
	<ul style="list-style-type: none"> Black 	No cost	Specify with <i>0835 Black E070 contemporary pulls</i> .
	<ul style="list-style-type: none"> Polished Chrome 	No cost	Specify with <i>9201 Polished Chrome E070 contemporary pulls</i> .
<ul style="list-style-type: none"> Silver 	No cost	Specify with <i>9212 Silver E070 contemporary pulls</i> .	
	Diner pulls		
	<ul style="list-style-type: none"> Black 	No cost	Specify with <i>0835 Black E130 diner pulls</i> .
<ul style="list-style-type: none"> Brushed Nickel 	No cost	Specify with <i>9211 Brushed Nickel E130 diner pulls</i> .	
	Loft pulls		
	<ul style="list-style-type: none"> Black 	No cost	Specify with <i>0835 Black E090 loft pulls</i> .
<ul style="list-style-type: none"> Brushed Nickel 	No cost	Specify with <i>9211 Brushed Nickel E090 loft pulls</i> .	
Keying	<ul style="list-style-type: none"> Factory- and field-installed keying 		▶ Page G204
Filing Hardware	<ul style="list-style-type: none"> Two file bars with clips per file drawer for side-to-side or legal filing 	No cost	Specify with <i>TFILE</i> .
Related Products	<ul style="list-style-type: none"> Tackboards Markerboards 		▶ Pages G167, G170 ▶ Pages G173–G174

Tip: For side-to-side options including legal specify with TFILE.

Drawer Pull Shapes

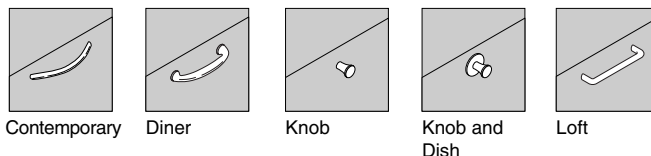

Wood Veneer Tall-Boy
Cabinets with Four
File Drawers

SIN 711.2

Specification Information

• Dimensions			• Style • Number	• Base • Price	• Option (Add \$ to Base Price) • Customiz • Stain
D	W	H			
24 ¹ / ₈ "	16"	54 ³ / ₈ "	TWVF5416	\$2875	+\$265

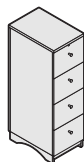

Specification Information

• Dimensions			• Style • Number	• Base • Price	• Option (Add \$ to Base Price) • Customiz • Stain
D	W	H			
24 1/8"	16"	54 3/8"	TLVF5416	\$2528	N.A.
With Wood Veneer Drawer Fronts					
24 1/8"	16"	54 3/8"	TLVF5416W	\$2633	+\$41
With Wood Veneer Drawer Fronts and Wood Veneer Top					
24 1/8"	16"	54 3/8"	TLVF5416WW	\$2701	+\$41
:	:	:	:	:	:



Wood Veneer Vertical Cabinets

SIN 711.2

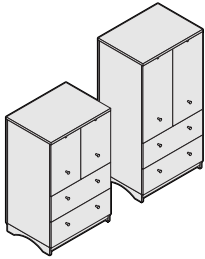

Standard Includes		Required to Specify	
<ul style="list-style-type: none"> Vertical cabinet with finished back: wood veneer Knob drawer pulls: black One hanging file system for front-to-back filing per file drawer (see filing options below) Lock, keyed random: 9250 Ember Chrome One adjustable shelf in 54³/₈"H cabinet Two adjustable shelves in 65⁵/₈"H cabinet Leveling glides: black only 		<ul style="list-style-type: none"> 1 Style number 2 Wood color number for vertical cabinet 3 Options, if selected (see below) ▶ See <i>Surface Materials</i>, page G198. 	
Options		Price	Required to Specify
Surface Materials	<ul style="list-style-type: none"> Customiz stain on wood veneer 	Prices at right	Specify with <i>Customiz stain</i> . ▶ See <i>Surface Materials Reference Manual</i> .
Drawer Pulls	<p>Knob pulls</p> <ul style="list-style-type: none"> Brushed Nickel <hr/> <p>Knob and dish pulls</p> <ul style="list-style-type: none"> Black knob with black dish Black knob with Brushed Nickel dish Brushed Nickel knob with black dish Brushed Nickel knob with Brushed Nickel dish <hr/> <p>Contemporary pulls</p> <ul style="list-style-type: none"> Black Polished Chrome Silver <hr/> <p>Diner pulls</p> <ul style="list-style-type: none"> Black Brushed Nickel <hr/> <p>Loft pulls</p> <ul style="list-style-type: none"> Black Brushed Nickel 	No cost No cost No cost No cost No cost No cost No cost No cost No cost No cost No cost	Specify with <i>9211 Brushed Nickel E100 pulls</i> . Specify with <i>0835 Black knob and E110 Black dish pulls</i> . Specify with <i>0835 Black knob and E120 Brushed Nickel dish pulls</i> . Specify with <i>9211 Brushed Nickel knob and E110 Black dish pulls</i> . Specify with <i>9211 Brushed Nickel knob and E120 Brushed Nickel dish pulls</i> . Specify with <i>0835 Black E070 contemporary pulls</i> . Specify with <i>9201 Polished Chrome E070 contemporary pulls</i> . Specify with <i>9212 Silver E070 contemporary pulls</i> . Specify with <i>0835 Black E130 diner pulls</i> . Specify with <i>9211 Brushed Nickel E130 diner pulls</i> . Specify with <i>0835 Black E090 loft pulls</i> . Specify with <i>9211 Brushed Nickel E090 loft pulls</i> .
Keying	<ul style="list-style-type: none"> Factory- and field-installed keying 		▶ Page G204
Filing Hardware	<ul style="list-style-type: none"> Two file bars with clips per file drawer for side-to-side or legal filing 	No cost	Specify with <i>TFILE</i> .
Related Products	<ul style="list-style-type: none"> Tackboards Markerboards 		▶ Pages G167, G170 ▶ Pages G173–G174

Tip: For side-to-side options including legal specify with *TFILE*.

Drawer Pull Shapes

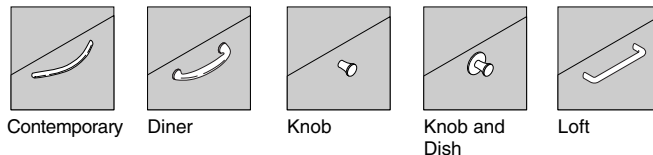

Specification Information

• Dimensions			• Style • Number	• Base • Price	• Option (Add \$ to Base Price) • Customiz • Stain
D	W	H			
24 1/8"	32"	54 3/8"	TWVC5432	\$3241	+\$316
24 1/8"	32"	66 5/8"	TWVC6632	\$3338	+\$316
.

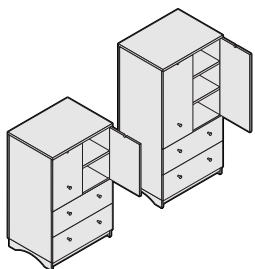

Laminate Vertical Cabinets

SIN 711.2

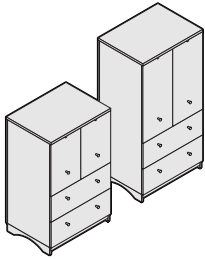

Tip: All laminate surfaces have a solid color default PVC edge.
 ▶ See Color Coordination List, page G200.

Tip: For side-to-side options including legal specify with TFILE.

Standard Includes		Required to Specify	
<ul style="list-style-type: none"> Vertical cabinet with finished back: laminate Drawer fronts and top: wood veneer, if selected Knob drawer pulls: black One hanging file system for front-to-back filing per file drawer (see filing options below) Lock, keyed random: 9250 Ember Chrome Leveling glides: black only 		<ol style="list-style-type: none"> Style number Laminate color number for vertical cabinet Wood color number for wood veneer drawer fronts and/or top, if selected Options, if selected (see below) ▶ See <i>Surface Materials</i> , page G198.	
Surface Materials	Options	Price	Required to Specify
	<ul style="list-style-type: none"> Customiz stain on wood veneer 	Prices at right	Specify with <i>Customiz stain</i> . ▶ See <i>Surface Materials Reference Manual</i> .
Drawer Pulls	Knob pulls		
	<ul style="list-style-type: none"> Brushed Nickel 	No cost	Specify with <i>9211 Brushed Nickel E100 pulls</i> .
	Knob and dish pulls		
	<ul style="list-style-type: none"> Black knob with black dish 	No cost	Specify with <i>0835 Black knob and E110 Black dish pulls</i> .
	<ul style="list-style-type: none"> Black knob with Brushed Nickel dish 	No cost	Specify with <i>0835 Black knob and E120 Brushed Nickel dish pulls</i> .
	<ul style="list-style-type: none"> Brushed Nickel knob with black dish 	No cost	Specify with <i>9211 Brushed Nickel knob and E110 Black dish pulls</i> .
	<ul style="list-style-type: none"> Brushed Nickel knob with Brushed Nickel dish 	No cost	Specify with <i>9211 Brushed Nickel knob and E120 Brushed Nickel dish pulls</i> .
	Contemporary pulls		
	<ul style="list-style-type: none"> Black 	No cost	Specify with <i>0835 Black E070 contemporary pulls</i> .
	<ul style="list-style-type: none"> Polished Chrome 	No cost	Specify with <i>9201 Polished Chrome E070 contemporary pulls</i> .
	<ul style="list-style-type: none"> Silver 	No cost	Specify with <i>9212 Silver E070 contemporary pulls</i> .
	Diner pulls		
	<ul style="list-style-type: none"> Black 	No cost	Specify with <i>0835 Black E130 diner pulls</i> .
	<ul style="list-style-type: none"> Brushed Nickel 	No cost	Specify with <i>9211 Brushed Nickel E130 diner pulls</i> .
	Loft pulls		
	<ul style="list-style-type: none"> Black 	No cost	Specify with <i>0835 Black E090 loft pulls</i> .
	<ul style="list-style-type: none"> Brushed Nickel 	No cost	Specify with <i>9211 Brushed Nickel E090 loft pulls</i> .
Keying	<ul style="list-style-type: none"> Factory- and field-installed keying 		▶ Page G204
Filing Hardware	<ul style="list-style-type: none"> Two file bars with clips per file drawer for side-to-side or legal filing 	No cost	Specify with <i>TFILE</i> .
Related Products	<ul style="list-style-type: none"> Tackboards Markerboards 		▶ Pages G167, G170 ▶ Pages G173–G174

Drawer Pull Shapes

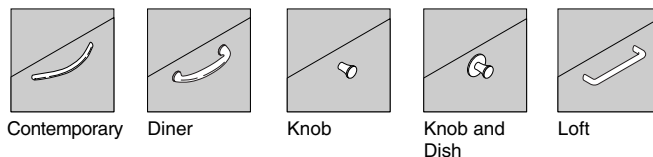

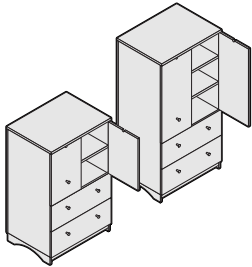

Specification Information

• Dimensions			• Style Number	• Base Price	• Option (Add \$ to Base Price)
D	W	H			
24 1/8"	32"	54 3/8"	TLVC5432	\$2674	N.A.
24 1/8"	32"	66 5/8"	TLVC6632	\$2760	N.A.
With Wood Veneer Doors and Drawer Fronts					
24 1/8"	32"	54 3/8"	TLVC5432W	\$2884	+\$ 60
24 1/8"	32"	66 5/8"	TLVC6632W	\$2970	+\$ 60
With Wood Veneer Doors, Drawer Fronts, and Wood Veneer Top					
24 1/8"	32"	54 3/8"	TLVC5432WW	\$3020	+\$ 84
24 1/8"	32"	66 5/8"	TLVC6632WW	\$3106	+\$107

Wood Veneer Four-High Lateral File

SIN 711.2

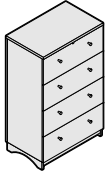

Standard Includes		Required to Specify	
<ul style="list-style-type: none"> Lateral file with finished back: wood veneer Knob drawer pulls: black One hanging file system for front-to-back filing per file drawer (see filing options below) Lock, keyed random: 9250 Ember Chrome Leveling glides: black only 		<ul style="list-style-type: none"> 1 Style number 2 Wood color number for lateral file 3 Options, if selected (see below) ▶ See <i>Surface Materials</i>, page G198. 	
Options		Price	Required to Specify
Surface Materials	<ul style="list-style-type: none"> Customiz stain on wood veneer 	Prices at right	Specify with <i>Customiz stain</i> . ▶ See <i>Surface Materials Reference Manual</i> .
Drawer Pulls	Knob pulls		
	<ul style="list-style-type: none"> Brushed Nickel 	No cost	Specify with <i>9211 Brushed Nickel E100 pulls</i> .
	Knob and dish pulls		
	<ul style="list-style-type: none"> Black knob with black dish 	No cost	Specify with <i>0835 Black knob and E110 Black dish pulls</i> .
	<ul style="list-style-type: none"> Black knob with Brushed Nickel dish 	No cost	Specify with <i>0835 Black knob and E120 Brushed Nickel dish pulls</i> .
	<ul style="list-style-type: none"> Brushed Nickel knob with black dish 	No cost	Specify with <i>9211 Brushed Nickel knob and E110 Black dish pulls</i> .
<ul style="list-style-type: none"> Brushed Nickel knob with Brushed Nickel dish 	No cost	Specify with <i>9211 Brushed Nickel knob and E120 Brushed Nickel dish pulls</i> .	
Contemporary pulls	<ul style="list-style-type: none"> Black 	No cost	Specify with <i>0835 Black E070 contemporary pulls</i> .
	<ul style="list-style-type: none"> Polished Chrome 	No cost	Specify with <i>9201 Polished Chrome E070 contemporary pulls</i> .
	<ul style="list-style-type: none"> Silver 	No cost	Specify with <i>9212 Silver E070 contemporary pulls</i> .
Diner pulls	<ul style="list-style-type: none"> Black 	No cost	Specify with <i>0835 Black E130 diner pulls</i> .
	<ul style="list-style-type: none"> Brushed Nickel 	No cost	Specify with <i>9211 Brushed Nickel E130 diner pulls</i> .
Loft pulls	<ul style="list-style-type: none"> Black 	No cost	Specify with <i>0835 Black E090 loft pulls</i> .
	<ul style="list-style-type: none"> Brushed Nickel 	No cost	Specify with <i>9211 Brushed Nickel E090 loft pulls</i> .
Keying	<ul style="list-style-type: none"> Factory- and field-installed keying 		▶ Page G204
Filing Hardware	<ul style="list-style-type: none"> Two file bars with clips per file drawer for side-to-side or legal filing 	No cost	Specify with <i>TFILE</i> .
Related Products	<ul style="list-style-type: none"> Tackboards Markerboards 		▶ Pages G167, G170 ▶ Pages G173, G174

Tip: For side-to-side options including legal specify with TFILE.

Drawer Pull Shapes

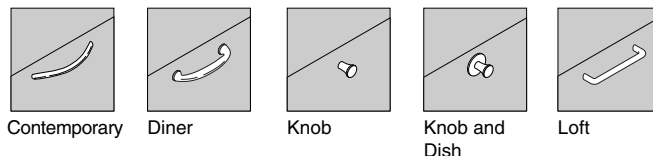

Specification Information

• Dimensions			• Style • Number	• Base • Price	• Option (Add \$ to Base Price) • Customiz • Stain
D	W	H			
24 ¹ / ₈ "	32"	54 ³ / ₈ "	TWFLF5432	\$3273	+\$212

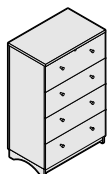

Laminate Four-High Lateral Files

SIN 711.2

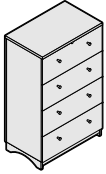

Tip: All laminate surfaces have a solid color default PVC edge.
 ▶ See *Color Coordination List*, page G200.

Tip: For side-to-side options including legal specify with TFILE.

Standard Includes		Required to Specify	
<ul style="list-style-type: none"> Lateral file with finished back: laminate Drawer fronts and top: wood veneer, if selected Knob drawer pulls: black One hanging file system for front-to-back filing per file drawer (see filing options below) Lock, keyed random: 9250 Ember Chrome Leveling glides: black only 		<ol style="list-style-type: none"> Style number Laminate color number for lateral file Wood color number for wood veneer drawer fronts, and/or tops, if selected Options, if selected (see below) ▶ See <i>Surface Materials</i> , page G198.	
Options	Price	Required to Specify	
Surface Materials	<ul style="list-style-type: none"> Customiz stain on wood veneer Prices at right	Specify with <i>Customiz stain</i> . ▶ See <i>Surface Materials Reference Manual</i> .	
Drawer Pulls	<p>Knob pulls</p> <ul style="list-style-type: none"> Brushed Nickel No cost	Specify with <i>9211 Brushed Nickel E100 pulls</i> .	
	<p>Knob and dish pulls</p> <ul style="list-style-type: none"> Black knob with black dish Black knob with Brushed Nickel dish Brushed Nickel knob with black dish Brushed Nickel knob with Brushed Nickel dish No cost	Specify with <i>0835 Black knob and E110 Black dish pulls</i> . Specify with <i>0835 Black knob and E120 Brushed Nickel dish pulls</i> . Specify with <i>9211 Brushed Nickel knob and E110 Black dish pulls</i> . Specify with <i>9211 Brushed Nickel knob and E120 Brushed Nickel dish pulls</i> .	
	<p>Contemporary pulls</p> <ul style="list-style-type: none"> Black Polished Chrome Silver No cost	Specify with <i>0835 Black E070 contemporary pulls</i> . Specify with <i>9201 Polished Chrome E070 contemporary pulls</i> . Specify with <i>9212 Silver E070 contemporary pulls</i> .	
	<p>Diner pulls</p> <ul style="list-style-type: none"> Black Brushed Nickel No cost	Specify with <i>0835 Black E130 diner pulls</i> . Specify with <i>9211 Brushed Nickel E130 diner pulls</i> .	
	<p>Loft pulls</p> <ul style="list-style-type: none"> Black Brushed Nickel No cost	Specify with <i>0835 Black E090 loft pulls</i> . Specify with <i>9211 Brushed Nickel E090 loft pulls</i> .	
Keying	<ul style="list-style-type: none"> Factory- and field-installed keying 	▶ Page G204	
Filing Hardware	<ul style="list-style-type: none"> Two file bars with clips per file drawer for side-to-side or legal filing No cost	Specify with <i>TFILE</i> .	
Related Products	<ul style="list-style-type: none"> Tackboards Markerboards 	▶ Pages G167, G170 ▶ Pages G173, G174	

Drawer Pull Shapes

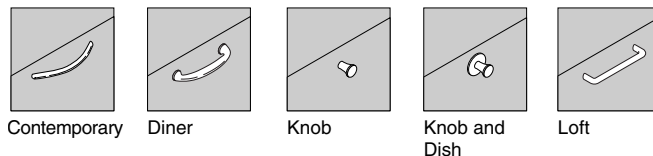

Specification Information

• Dimensions			• Style Number	• Base Price	• Option (Add \$ to Base Price) Customiz Stain
D	W	H			
24 1/8"	32"	54 3/8"	TLFLF5432	\$2706	N.A.
With Wood Veneer Drawer Fronts					
24 1/8"	32"	54 3/8"	TLFLF5432W	\$2927	+\$60
With Wood Veneer Drawer Fronts and Top					
24 1/8"	32"	54 3/8"	TLFLF5432WW	\$3063	+\$84

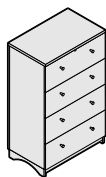

Bookcases

Wood Veneer

SIN 711.2

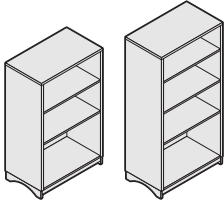

Tip: Shelf adjusts in 1" increments.

Tip: All laminate surfaces have a solid color default PVC edge.

Standard Includes	Required to Specify
-------------------	---------------------

- Bookcase with finished back: wood veneer
- Adjustable shelves
 - 54"H has one height-adjustable shelf
 - 66"H has two height-adjustable shelves
- Leveling glides: black only

- 1 Style number
- 2 Wood color number for bookcase
- 3 Options, if selected (see below)
- ▶ See *Surface Materials*, page G198.

Options	Price	Required to Specify
---------	-------	---------------------

Surface Materials

- Customiz stain on wood veneer

Prices below

Specify with *Customiz stain*.
▶ See *Surface Materials Reference Manual*.

Related Products

- Tackboards
- Markerboards

▶ Pages G167, G170
▶ Pages G173, G174

Specification Information					
Dimensions			Style Number	Base Price	Option (Add \$ to Base Price)
H	D	W			
54 ³ / ₈ "	19"	32"	TWBC5432	\$1996	+\$288
66 ⁵ / ₈ "	19"	32"	TWBC6632	\$2144	+\$288

Dimensions			Style Number	Base Price	Option (Add \$ to Base Price)
H	D	W			
54 ³ / ₈ "	19"	32"	TWBC5432	\$1996	+\$288
66 ⁵ / ₈ "	19"	32"	TWBC6632	\$2144	+\$288

54 ³ / ₈ "	19"	32"	TWBC5432	\$1996	+\$288
----------------------------------	-----	-----	-----------------	--------	--------

66 ⁵ / ₈ "	19"	32"	TWBC6632	\$2144	+\$288
----------------------------------	-----	-----	-----------------	--------	--------

Bookcases

Laminate
SIN 711.2

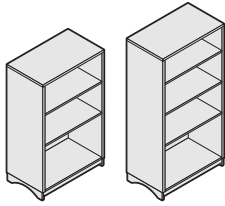

Tip: Shelf adjusts in 1" increments.

Tip: All laminate surfaces have a solid color default PVC edge.

▶ See *Color Coordination List*, page G200.

Standard Includes

- Bookcase with finished back: laminate
- Adjustable shelves
 - 54"H has one height-adjustable shelf
 - 66"H has two height-adjustable shelves
- Leveling glides: black only

Required to Specify

- 1 Style number
- 2 Laminate color number for bookcase
- ▶ See *Surface Materials*, page G198.

Related Products

- Tackboards
- Slatwall panels

- ▶ Pages G167, G170
- ▶ Page G176

Specification Information

• Dimensions			• Style	• Price
H	D	W	Number	
54 ³ / ₈ "	19"	32"	TLBC5432	\$1693
66 ⁵ / ₈ "	19"	32"	TLBC6632	\$1826

Amenity Shelves

SIN 711.2

Wood Veneer Amenity Shelves

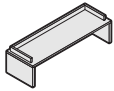

Standard Includes	Required to Specify
<ul style="list-style-type: none"> • Amenity shelf: wood veneer • Attachment hardware 	<ul style="list-style-type: none"> 1 Style number 2 Wood color number for shelf 3 Options, if selected (see below) ▶ See <i>Surface Materials</i>, page G198.

Options	Price	Required to Specify
Surface Materials <ul style="list-style-type: none"> • Customiz stain on wood veneer 	Prices below	Specify with <i>Customiz stain</i> . ▶ See <i>Surface Materials Reference Manual</i> .

Specification Information					
• Dimensions			• Style	• Base	• Option
D	W	H	Number	Price	(Add \$ to Base Price)
13½"	42"	11⅛"	TWAS4214	\$746	+\$ 50
13½"	64"	11⅛"	TWAS6414	\$746	+\$100

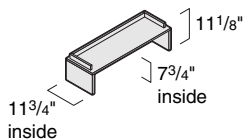

Laminate Amenity Shelves

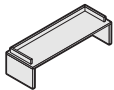

Tip: All laminate surfaces have a solid color default PVC edge.

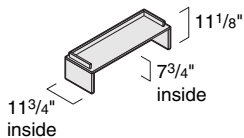

Tip: All laminate surfaces have a solid color default PVC edge.

▶ See *Color Coordination List*, page G200.

Standard Includes	Required to Specify
<ul style="list-style-type: none"> • Amenity shelf: laminate • Attachment hardware 	<ul style="list-style-type: none"> 1 Style number 2 Laminate color number for shelf ▶ See <i>Surface Materials</i>, page G198.

Specification Information				
• Dimensions			• Style	• Price
D	W	H	Number	
13½"	42"	11⅛"	TLAS4214	\$527
13½"	64"	11⅛"	TLAS6414	\$628

Open Hutches

SIN 711.2

Wood Veneer Open Hutches

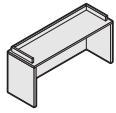

Standard Includes	Required to Specify
-------------------	---------------------

- Open hutch: wood veneer
- Attachment hardware to connect hutch to worksurface
- Wire manager: black plastic

- 1 Style number
- 2 Wood color number for hutch
- 3 Options, if selected (see below)
- ▶ See *Surface Materials*, page G198.

Options	Price	Required to Specify
---------	-------	---------------------

Surface Materials	<ul style="list-style-type: none"> • Customiz stain on wood veneer 	Prices below Specify with <i>Customiz stain</i> . ▶ See <i>Surface Materials Reference Manual</i> .
--------------------------	---	---

Related Products	<ul style="list-style-type: none"> • Tackboards • Markerboards • Slatwall panels • Task lights • Underline task lights from Details 	<ul style="list-style-type: none"> ▶ Pages G166, G168 ▶ Pages G173, G175 ▶ Page G176 ▶ Page G178 ▶ See Details electronic catalog or Details market manager to place an order.
-------------------------	--	---

Specification Information					
Dimensions			Style Number	Base Price	Option
D	W	H			(Add \$ to Base Price) Customiz Stain

13½"	42"	23 ⁷ / ₁₆ "	TWH4214	\$746	+\$ 50
13½"	64"	23 ⁷ / ₁₆ "	TWH6414	\$968	+\$100

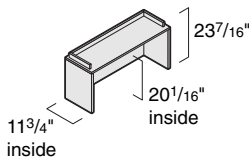

Laminate Open Hutches

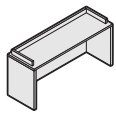

Tip: All laminate surfaces have a solid color default PVC edge.
 ▶ See *Color Coordination List*, page G200.

Standard Includes	Required to Specify
-------------------	---------------------

- Open hutch: laminate
- Attachment hardware to connect hutch to worksurface
- Wire manager: black plastic

- 1 Style number
- 2 Laminate color number for hutch
- ▶ See *Surface Materials*, page G198.

Related Products

- Tackboards
- Slatwall panels
- Task lights
- Underline task lights from Details

- ▶ Pages G166, G168
- ▶ Page G176
- ▶ Page G178
- ▶ See Details electronic catalog or Details market manager to place an order.

Specification Information					
Dimensions			Style Number	Price	
D	W	H			

13½"	42"	23 ⁷ / ₁₆ "	TLH4214	\$626	
13½"	64"	23 ⁷ / ₁₆ "	TLH6414	\$845	

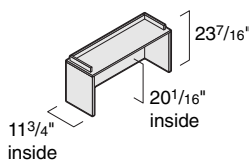

Wood Veneer Overhead Binder Bins

SIN 711.2

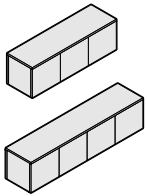

Tip: Overhead binder bin is designed to attach to a hutch. It is not intended to be wall mounted.

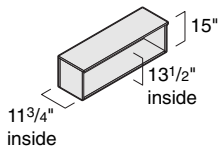

Standard Includes	Required to Specify
<ul style="list-style-type: none"> Overhead binder bin: wood veneer Attachment hardware 	<ul style="list-style-type: none"> 1 Style number 2 Wood color number for binder bin 3 Options, if selected (see below) ▶ See <i>Surface Materials</i>, page G198.

Options	Price	Required to Specify
Surface Materials <ul style="list-style-type: none"> Customiz stain on wood veneer 	Prices below	Specify with <i>Customiz stain</i> . ▶ See <i>Surface Materials Reference Manual</i> .
Related Products <ul style="list-style-type: none"> Underline task lights from Details 		▶ See Details electronic catalog or Details market manager to place an order.

Specification Information					
Dimensions			Style	Base	Option
D	W	H	Number	Price	(Add \$ to Base Price)
13½"	42"	15"	TWOB4214	\$1271	+\$79
13½"	64"	15"	TWOB6414	\$1595	+\$79
.

Laminate Overhead Binder Bins

SIN 711.2

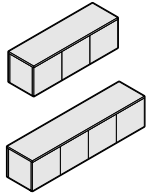

Tip: Overhead binder bin is designed to attach to a hutch. It is not intended to be wall mounted.

Tip: All laminate surfaces have a solid color default PVC edge.

▶ See Color Coordination List, page G200.

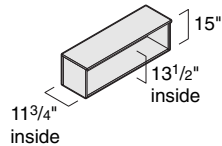

Standard Includes	Required to Specify
-------------------	---------------------

- Overhead binder bin: laminate
- Door front and top: wood veneer, if selected
- Attachment hardware

- 1 Style number
 - 2 Laminate color number for binder bin
 - 3 Wood color number for wood veneer door front and/or top, if selected
 - 4 Options, if selected (see below)
- ▶ See *Surface Materials*, page G198.

Options	Price	Required to Specify
---------	-------	---------------------

Surface Materials

- Customiz stain on wood veneer

Prices below

Specify with *Customiz stain*.
▶ See *Surface Materials Reference Manual*.

Related Products

- Underline task lights from Details

▶ See Details electronic catalog or Details market manager to place an order.

Specification Information					
• Dimensions			• Style	• Base	• Option
D	W	H	Number	Price	(Add \$ to Base Price)

D	W	H	Style Number	Base Price	Option (Add \$ to Base Price)
13 1/2"	42"	15"	TLOB4214	\$ 900	N.A.
13 1/2"	64"	15"	TLOB6414	\$1205	N.A.

With Wood Veneer Doors

13 1/2"	42"	15"	TLOB4214W	\$1026	+\$24
13 1/2"	64"	15"	TLOB6414W	\$1379	+\$41

With Wood Veneer Doors and Wood Veneer Top

13 1/2"	42"	15"	TLOB4214WW	\$1121	+\$41
13 1/2"	64"	15"	TLOB6414WW	\$1484	+\$60

Wood Veneer Wall-Mounted Overhead Binder Bins

for Use with Pathways Technology Wall (Not attachable to drywall)

SIN 711.2

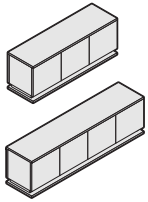

Standard Includes	Required to Specify
-------------------	---------------------

<ul style="list-style-type: none"> Overhead binder bin: wood veneer 2" organizer shelf Attachment hardware Mounting brackets and cable manager covers: black only 	<ul style="list-style-type: none"> 1 Style number 2 Wood color number for binder bin 3 Options, if selected (see below) ▶ See <i>Surface Materials</i>, page G198.
---	--

Options	Price	Required to Specify
---------	-------	---------------------

Surface Materials <ul style="list-style-type: none"> Customiz stain on wood veneer 	Prices below	Specify <i>with Customiz stain</i> . ▶ See <i>Surface Materials Reference Manual</i> .
--	--------------	---

Related Products <ul style="list-style-type: none"> Task lights Underline task lights from Details 		▶ Page G178 ▶ See Details electronic catalog or Details market manager to place an order.
---	--	--

Specification Information

• Dimensions			• Style Number	• Base Price	• Option
D	W	H			(Add \$ to Base Price)
13½"	42"	18"	TWOBS4214	\$1487	+Stain
13½"	64"	18"	TWOBS6414	\$1854	+Stain

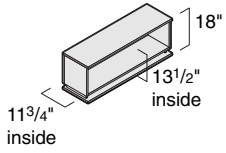

Laminate Wall-Mounted Overhead Binder Bins

Laminate Wall-Mounted
Overhead Binder Bins

for Use with Pathways Technology Wall (Not attachable to drywall)

SIN 711.2

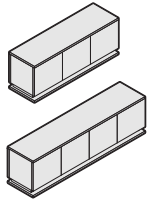

Tip: Attaches to Pathways wall. Cannot use without Technology Wall.

Tip: All laminate surfaces have a solid color default PVC edge.

▶ See Color Coordination List, page G200.

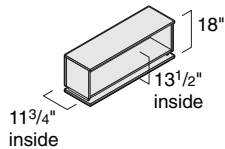

Standard Includes	Required to Specify
<ul style="list-style-type: none"> Overhead binder bin: laminate Door front and top: wood veneer, if selected 2" organizer shelf Attachment hardware Mounting brackets and cable manager covers: black only 	<ol style="list-style-type: none"> Style number Laminate color number for binder bin Wood color number for wood veneer door front and/or top, if selected Options, if selected (see below) <p>▶ See <i>Surface Materials</i>, page G198.</p>

Options	Price	Required to Specify
Surface Materials <ul style="list-style-type: none"> Customiz stain on wood veneer 	Prices below	Specify with <i>Customiz stain</i> . ▶ See <i>Surface Materials Reference Manual</i> .
Related Products <ul style="list-style-type: none"> Task lights Underline task lights from Details 		▶ Page G178 ▶ See Details electronic catalog or Details market manager to place an order.

Specification Information

• Dimensions			• Style Number	• Base Price	• Option (Add \$ to Base Price)
D	W	H			
13½"	42"	18"	TLOBS4214	\$1073	N.A.
13½"	64"	18"	TLOBS6414	\$1421	N.A.
With Wood Veneer Doors					
13½"	42"	18"	TLOBS4214W	\$1199	+\$35
13½"	64"	18"	TLOBS6414W	\$1595	+\$49
With Wood Veneer Doors and Wood Veneer Top					
13½"	42"	18"	TLOBS4214WW	\$1294	+\$52
13½"	64"	18"	TLOBS6414WW	\$1700	+\$65
...

Tackboards

SIN 711.2

Tackboards

For Use Inside Open Hutches

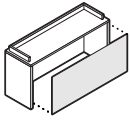

▶ See *Use of Tackboards and Markerboards* in the *Relevant Specification Guide*.

Standard Includes	Required to Specify
<ul style="list-style-type: none"> Tackboard: vertical surface fabric price group 1 Attachment hardware 	1 Style number 2 Fabric color number for tackboard ▶ See <i>Surface Materials</i> , page G198.

Surface Materials	Options	Price	Required to Specify
	<ul style="list-style-type: none"> Fabric price group 1 Fabric price group 2 Fabric price group 3 Fabric price group 4 Fabric price group 5 Fabric price group COM 	No cost +\$ 12 +\$ 46 +\$ 62 +\$100 +\$ 15	Specify fabric color number. Specify fabric color number. Specify fabric color number. Specify fabric color number. Specify fabric color number. ▶ See <i>Surface Materials Reference Manual</i> .

Related Products	Options	Required to Specify
	<ul style="list-style-type: none"> Hutches 	▶ Page G161

Specification Information

Dimensions		Style Number	Base Price
W	H		
39½"	17"	TTBH42	\$158
61½"	17"	TTBH64	\$176

Tackboards

For Use on Side of Wardrobes, Tall-Boy Cabinets, Vertical Cabinets, Four-High Lateral Files, and Bookcases

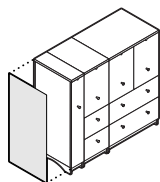

Tip: Extends full height of cabinet.

► See Use of Tackboards and Markerboards in the Relevant Specification Guide.

Standard Includes	Required to Specify
-------------------	---------------------

- Tackboard: vertical surface fabric price group 1
- Attachment hardware

- 1 Style number
- 2 Fabric color number for tackboard
- See *Surface Materials*, page G198.

Surface Materials	Options	Price	Required to Specify
-------------------	---------	-------	---------------------

- Fabric price group 1
- Fabric price group 2
- Fabric price group 3
- Fabric price group 4
- Fabric price group 5
- Fabric price group COM

- No cost
- +\$ 12
- +\$ 46
- +\$ 62
- +\$100
- +\$ 15

- Specify fabric color number.
- Specify fabric color number.
- Specify fabric color number.
- Specify fabric color number.
- Specify fabric color number.
- See *Surface Materials Reference Manual*.

Related Products

- Wardrobes
- Tall boy cabinets
- Vertical cabinets
- Four-high lateral files
- Bookcases

- Pages G134–G141
- Pages G142–G149
- Pages G150–G153
- Pages G154–G157
- Pages G158–G159

Specification Information			
Dimensions		Style Number	Base Price
W	H		

22½"	50½"	TTBS2450	\$276
22½"	62½"	TTBS2462	\$293
:	:	:	:

Tackboards, continued

SIN 711.2

Tackboards

For Use on Back of Hutches

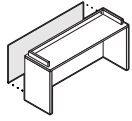

▶ See *Use of Tackboards and Markerboards* in the *Relevant Specification Guide*.

Standard Includes	Required to Specify
<ul style="list-style-type: none"> Tackboard: vertical surface fabric price group 1 Attachment hardware 	1 Style number 2 Fabric color number for tackboard ▶ See <i>Surface Materials</i> , page G198.

Options	Price	Required to Specify
Surface Materials		
<ul style="list-style-type: none"> Fabric price group 1 Fabric price group 2 Fabric price group 3 Fabric price group 3 Fabric price group 5 Fabric price group COM 	No cost +\$ 12 +\$ 46 +\$ 46 +\$100 +\$ 15	Specify fabric color number. Specify fabric color number. Specify fabric color number. Specify fabric color number. Specify fabric color number. ▶ See <i>Surface Materials Reference Manual</i> .

Related Products	<ul style="list-style-type: none"> Hutches 	▶ Page G161
-------------------------	---	-------------

Specification Information

Dimensions		Style Number	Base Price
W	H		
41½"	21"	TTBHB4220	\$254
63½"	21"	TTBHB6420	\$314

Tackboards

For Use with Personal Borders

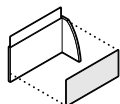

▶ See *Use of Tackboards and Markerboards* in the *Relevant Specification Guide*.

Standard Includes	Required to Specify
-------------------	---------------------

- Tackboard: vertical surface fabric price group 1
- Attachment hardware

- 1 Style number
- 2 Fabric color number for tackboard
- ▶ See *Surface Materials*, page G198.

Surface Materials	Options	Price	Required to Specify
-------------------	---------	-------	---------------------

Surface Materials	• Fabric price group 1	No cost	Specify fabric color number.
	• Fabric price group 2	+\$ 12	Specify fabric color number.
	• Fabric price group 3	+\$ 46	Specify fabric color number.
	• Fabric price group 4	+\$ 62	Specify fabric color number.
	• Fabric price group 5	+\$100	Specify fabric color number.
	• Fabric price group COM	+\$ 15	▶ See <i>Surface Materials Reference Manual</i> .

Related Products	Options	Price	Required to Specify
------------------	---------	-------	---------------------

- Personal borders
- ▶ Page G118

Specification Information

• Dimensions	• Style	• Base
W H	Number	Price

For Use with One Border End Panel

27"	12"	TTBPB2812	\$178
49"	12"	TTBPB5012	\$216

For Use with Two Border End Panels

40½"	12"	TTBPB4212	\$195
62½"	12"	TTBPB6412	\$228

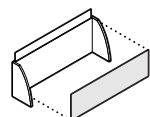
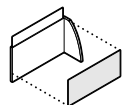

Tackboards, continued

SIN 711.2

Tackboards

For Use on Back of 16"W Wardrobes, Tall-Boy Cabinets, Vertical Cabinets, Four-High Lateral Files, and Bookcases

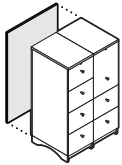

▶ See *Use of Tackboards and Markerboards* in the *Relevant Specification Guide*.

Standard Includes	Required to Specify
<ul style="list-style-type: none"> Tackboard: vertical surface fabric price group 1 Attachment hardware 	1 Style number 2 Fabric color number for tackboard ▶ See <i>Surface Materials</i> , page G198.

Options	Price	Required to Specify
Surface Materials		
<ul style="list-style-type: none"> Fabric price group 1 Fabric price group 2 Fabric price group 3 Fabric price group 4 Fabric price group 5 Fabric price group COM 	No cost +\$ 12 +\$ 46 +\$ 62 +\$100 +\$ 15	Specify fabric color number. Specify fabric color number. Specify fabric color number. Specify fabric color number. Specify fabric color number. ▶ See <i>Surface Materials Reference Manual</i> .

Related Products	Required to Specify
<ul style="list-style-type: none"> Wardrobes Tall boy cabinets Vertical cabinets Four-high lateral files Bookcases 	▶ Pages G134–G141 ▶ Pages G142–G149 ▶ Pages G150–G153 ▶ Pages G154–G157 ▶ Pages G158–G159

Specification Information

•Dimensions		•Style Number	•Base Price
W	H		
7½"	50½"	TTB850	\$178
7½"	62½"	TTB862	\$195
15½"	50½"	TTB1650	\$228
15½"	62½"	TTB1662	\$243
23¼"	50½"	TTB2450	\$276
23¼"	62½"	TTB2462	\$293
31¼"	50½"	TTB3250	\$276
31¼"	62½"	TTB3262	\$286
39¼"	50½"	TTB4050	\$308
39¼"	62½"	TTB4062	\$319

Tackboards

For Use on Back of Seated-Height Shells

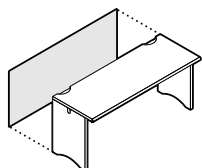

▶ See *Use of Tackboards and Markerboards* in the *Relevant Specification Guide*.

Standard Includes		Required to Specify
-------------------	--	---------------------

- Tackboard: vertical surface fabric price group 1
- Attachment hardware

- 1 Style number
- 2 Fabric color number for tackboard
- ▶ See *Surface Materials*, page G198.

Options	Price	Required to Specify
---------	-------	---------------------

Surface Materials

- | | |
|--------------------------|---------|
| • Fabric price group 1 | No cost |
| • Fabric price group 2 | +\$ 12 |
| • Fabric price group 3 | +\$ 46 |
| • Fabric price group 4 | +\$ 62 |
| • Fabric price group 5 | +\$100 |
| • Fabric price group COM | +\$ 15 |

- Specify fabric color number.
- Specify fabric color number.
- Specify fabric color number.
- Specify fabric color number.
- ▶ See *Surface Materials Reference Manual*.

Related Products

- Rectangular worksurfaces
- Bowed transition worksurfaces
- Corner worksurfaces
- Extended corner worksurfaces
- Transitional corner worksurfaces
- Transitional extended corner worksurfaces

- ▶ Pages G62–G63
- ▶ Pages G64–G65
- ▶ Pages G66–G67
- ▶ Pages G68–G69
- ▶ Pages G70–G71
- ▶ Pages G72–G73

Specification Information

Dimensions		Style Number	Base Price
W	H		
41½"	24¼"	TTB4224	\$265
63½"	24¼"	TTB6424	\$324
.	.	.	.

Tackboards, continued

SIN 711.2

Tackboards

For Use on Back of Amenity Shelf or Hutch with Overhead Binder Bin

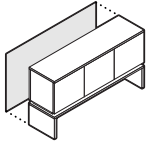

▶ See *Use of Tackboards and Markerboards* in the *Relevant Specification Guide*.

Standard Includes		Required to Specify	
<ul style="list-style-type: none"> Tackboard: vertical surface fabric price group 1 Attachment hardware 		1 Style number 2 Fabric color number for tackboard ▶ See <i>Surface Materials</i> , page G198.	
Surface Materials	Options	Price	Required to Specify
	<ul style="list-style-type: none"> Fabric price group 1 Fabric price group 2 Fabric price group 3 Fabric price group 4 Fabric price group 5 Fabric price group COM 	No cost +\$ 12 +\$ 46 +\$ 62 +\$100 +\$ 15	Specify fabric color number. Specify fabric color number. Specify fabric color number. Specify fabric color number. Specify fabric color number. ▶ See <i>Surface Materials Reference Manual</i> .
Related Products	<ul style="list-style-type: none"> Amenity shelves Hutches Overhead binder bins 		▶ Page G160 ▶ Page G161 ▶ Pages G162–G163

Specification Information			
Dimensions		Style	Base
W	H	Number	Price
For Use on Back of Amenity Shelf with Overhead Binder Bin			
41 1/2"	25 3/4"	TTB4226	\$281
63 1/2"	25 3/4"	TTB6426	\$336
For Use on Hutch with Overhead Binder Bin			
41 1/2"	38"	TTB4238	\$324
63 1/2"	38"	TTB6438	\$379
:	:	:	:

Markerboards

SIN 711.2

Markerboards

For Use on Sides of Wardrobes, Tall-Boy Cabinets, Vertical Cabinets, Four-High Lateral Files, and Bookcases

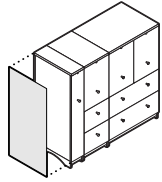

Tip: Extends full height of cabinet.

▶ See Use of Tackboards and Markerboards in the Relevant Specification Guide.

Standard Includes	Required to Specify
-------------------	---------------------

- Markerboard: white laminate only
- Attachment hardware

Style number

Related Products

- Wardrobes
- Tall boy cabinets
- Vertical cabinets
- Four-high lateral files
- Bookcases

- ▶ Pages G134–G141
- ▶ Pages G142–G149
- ▶ Pages G150–G153
- ▶ Pages G154–G157
- ▶ Pages G158–G159

Specification Information			
---------------------------	--	--	--

• Dimensions		• Style Number	• Price
W	H		
22½"	50½"	TMBS2450	\$333
22½"	62½"	TMBS2462	\$355
:	:	:	:

Markerboards

For Use on Back of Hutches

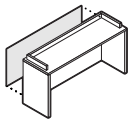

Tip: Attach to back of hutch.

▶ See Use of Tackboards and Markerboards in the Relevant Specification Guide.

Standard Includes	Required to Specify
-------------------	---------------------

- Markerboard: white laminate only
- Attachment hardware

Style number

Related Products

- Hutches

▶ Page G161

Specification Information			
---------------------------	--	--	--

• Dimensions		• Style Number	• Price
W	H		
41½"	21"	TMBHB4220	\$278
63½"	21"	TMBHB6420	\$332
:	:	:	:

Relevant

Markerboards, continued

SIN 711.2

Markerboards

For Use on Back of 16"W Wardrobes, Tall-Boy Cabinets, Vertical Cabinets, Four-High Lateral Files, and Bookcases

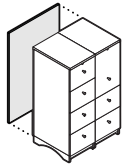

▶ See *Use of Tackboards and Markerboards* in the *Relevant Specification Guide*.

Standard Includes **Required to Specify**

- Markerboard: white laminate only
- Attachment hardware

Style number

Related Products

- Wardrobes
- Tall boy cabinets
- Vertical cabinets
- Four-high lateral files
- Bookcases

- ▶ Pages G134–G141
- ▶ Pages G142–G149
- ▶ Pages G150–G153
- ▶ Pages G154–G157
- ▶ Pages G158–G159

Specification Information

• Dimensions		• Style	• Price
W	H	Number	
15½"	50½"	TMB1650	\$267
15½"	62½"	TMB1662	\$289
23¼"	50½"	TMB2450	\$333
23¼"	62½"	TMB2462	\$355
31¼"	50½"	TMB3250	\$398
31¼"	62½"	TMB3262	\$420
39¼"	50½"	TMB4050	\$464
39¼"	62½"	TMB4062	\$486

Markerboards

For Use on Back of Amenity Shelf or Hutch with Overhead Binder Bin

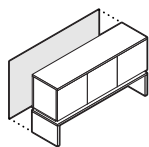

▶ See *Use of Tackboards and Markerboards* in the *Relevant Specification Guide*.

Standard Includes	Required to Specify
-------------------	---------------------

- Markerboard: white laminate only
- Attachment hardware

Style number

Related Products

- Amenity shelves
- Hutches
- Overhead binder bins

- ▶ Page G160
- ▶ Page G161
- ▶ Pages G162–G163

Specification Information			
---------------------------	--	--	--

• Dimensions		• Style	• Price
W	H	Number	

For Use on Back of Amenity Shelf with Overhead Binder Bin

41½"	25¾"	TMB4226	\$301
------	------	----------------	-------

63½"	25¾"	TMB6426	\$388
------	------	----------------	-------

For Use on Hutch with Overhead Binder Bin

41½"	38"	TMB4238	\$322
------	-----	----------------	-------

63½"	38"	TMB6438	\$410
------	-----	----------------	-------

Slatwall Panels

SIN 711.2

Slatwall Panels

For Use Inside Hutch

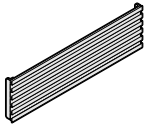

Standard Includes		Required to Specify
<ul style="list-style-type: none"> Slatwall panel: 8044 Black Anodized Aluminum Attachment hardware 		1 Style number 2 Options, if selected (see below) ▶ See Surface Materials, page G198.

Options	Price	Required to Specify
Surface Materials <ul style="list-style-type: none"> Clear anodized aluminum 	No cost	Specify with 8043 Clear Anodized Aluminum.
Related Products <ul style="list-style-type: none"> Hutches 		▶ Page G161

Specification Information			
Dimensions		Style	Price
W	H	Number	
39½"	12"	TSWH42	\$148
61½"	12"	TSWH64	\$194

Slatwall Panels

For Use with Personal Borders

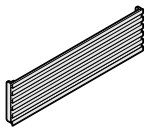

Standard Includes		Required to Specify
<ul style="list-style-type: none"> Slatwall panel: 8044 Black Anodized Aluminum Attachment hardware 		1 Style number 2 Options, if selected (see below) ▶ See Surface Materials, page G198.

Options	Price	Required to Specify
Surface Materials <ul style="list-style-type: none"> Clear anodized aluminum 	No cost	Specify with 8043 Clear Anodized Aluminum.
Related Products <ul style="list-style-type: none"> Personal borders 		▶ Page G118

Specification Information			
Dimensions		Style	Price
W	H	Number	
For Use on Personal Border with One End Panel			
27"	12"	TSWPB2812	\$131
49"	12"	TSWPB5012	\$171
For Use on Personal Border Two End Panels			
40½"	12"	TSWPB4212	\$148
62½"	12"	TSWPB6412	\$194

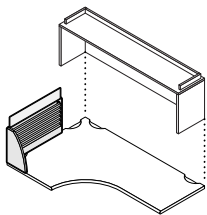

Tip: Slatwall used with personal border is always shorter than the supporting worksurface to allow space for hutch.

Specifying Relevant Wiring and Cabling

► For more detailed product information, see the *Relevant Systems Furniture Specification Guide* or consult your Steelcase dealer.

Common modular power components are available in various wiring schematics to accommodate a wide range of branch circuit configurations and power needs. The eight-wire system is available in four circuit 3+1, four circuit 2+2, and three circuit with separate neutrals. These choices are supported with a system ground and an isolated ground.

All components in an electrical distribution system must use the same wiring schematic. Components are color coded and keyed to make it impossible to connect mismatched parts.

All electrical components are listed by Underwriters Laboratory (UL) and certified by the Canadian Standards Association (CSA).

All Steelcase electrical systems are designed in compliance with the National Electrical Code (NEC) and Canadian Electrical Code (CEC) to function as a multi-wire branch circuit. Installations should be made in accordance with the NEC or CEC provisions for multi-wire branch circuits.

Local electrical codes vary. Consult a qualified electrical contractor or engineer for the proper installation of electrical equipment.

Chicago and some other locations require installations to be hardwired.

Specification Information

Task Lights (SIN 711.2)	G178
Power Communication Box (SIN 711.2)	G179
Cable Manager (SIN 711.2)	G180
Power and Communication Spheres and Port (SIN 711.2)	G181
Internode Power and Communication Components (SIN 711.2)	G183
Internode Floor Power Infeeds (SIN 711.2)	G188
Internode Multipurpose Power Infeeds (SIN 711.2)	G189
Internode Beltway Power Outfeeds (SIN 711.2)	G190
Internode Receptacles (SIN 711.2)	G191
Internode Connectors (SIN 711.2)	G192
Internode Modular Harnesses (SIN 711.2)	G194
Cabling Components (SIN 711.2)	G196

Task Lights

For Use Inside Hutches
SIN 711.2

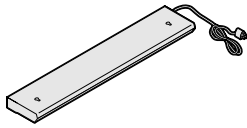

Standard Includes	Required to Specify
-------------------	---------------------

- | | |
|--|--|
| <ul style="list-style-type: none"> Light fixture housing with on-off switch on right-end : black paint 9' cord with straight plug: black vinyl only High-gloss, UV-stable reflector Standard tri-phosphor lamp Magnetic ballast or electronic ballast Attachment hardware Field-interchangeable cord Safety keyhole slots for attachment to wood surface | <ul style="list-style-type: none"> Style number |
|--|--|

Related Products

- | | |
|---|--|
| <ul style="list-style-type: none"> Open hutches Wall-mounted overhead binder bins | <ul style="list-style-type: none"> ▶ Page G161 ▶ Pages G164–G165 |
|---|--|

Specification Information				
Dimensions			Style	Price
D	W	H	Number	

With Magnetic Ballast

67/8"	24 1/4"	2"	THAL24	\$331
67/8"	36 1/4"	2"	THAL36	\$353
67/8"	48 1/4"	2"	THAL48	\$370
67/8"	57 3/4"	2"	THAL60	\$416

With Chicago Cord Including Circuit Breaker

67/8"	24 1/4"	2"	THAL24C	\$371
67/8"	36 1/4"	2"	THAL36C	\$393
67/8"	48 1/4"	2"	THAL48C	\$410
67/8"	60 1/4"	2"	THAL60C	\$456

With Electronic Ballast

67/8"	24 1/4"	2"	THAL24EB	\$297
67/8"	36 1/4"	2"	THAL36EB	\$319
67/8"	48 1/4"	2"	THAL48EB	\$336
67/8"	60 1/4"	2"	THAL60EB	\$382

With Chicago Cord Including Circuit Breaker

67/8"	24 1/4"	2"	THAL24CEB	\$337
67/8"	36 1/4"	2"	THAL36CEB	\$359
67/8"	48 1/4"	2"	THAL48CEB	\$376
67/8"	60 1/4"	2"	THAL60CEB	\$422

Task Light Mounting Kit

N.A.	N.A.	N.A.	TLKIT	\$ 20
------	------	------	--------------	-------

Tip: Task light mounting kit is used in locations with an electrical code that requires task lights to be installed and removed without tools. Exception: 57 3/4"W task lights with magnetic ballast cannot be supported with a task light mounting kit.

Power Communication Box

SIN 711.2

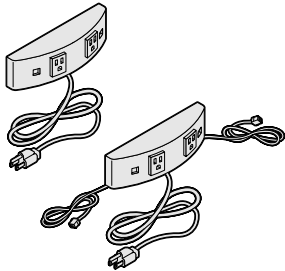

Standard Includes	Required to Specify
-------------------	---------------------

- Power communication box: black only
- Attachment hardware
- 9' power cord with plug rated at 15 amps: black only
- Metal separation between power and communications
- Adapter kit package of six communication jacks:
 - AT&T, Lucent Technologies, AMP, and Panduit category 5 adapters, and AMP and Krone category 3 adapters
 - TPB1 includes factory-installed power and adapter kit for field-installed data and communications
 - TPB2 includes factory-installed power and two factory-installed RJ45 category 5 couplers each with 9' category 5 cable
 - Adapters of both units can be removed and replaced in the field

Style number

Specification Information				
• Dimensions			• Style	• Price
D	W	H	Number	

• Dimensions			• Style	• Price
D	W	H	Number	
2 1/4"	10"	2 3/4"	TPB1	\$119
2 1/4"	10"	2 3/4"	TPB2	\$172
.

Cable Manager

SIN 711.2

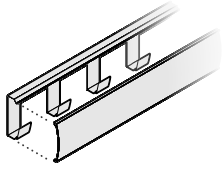

Standard Includes	Required to Specify
-------------------	---------------------

- Plastic extrusion with adhesive backer for vertical usage and attachment hardware for horizontal usage under worksurface: black only

Style number

Specification Information				
Dimensions			Style	Price
D	W	H	Number	

Dimensions			Style	Price
D	W	H	Number	

For Use with All Cabinets, Under Worksurfaces, and All End Panel Applications

1 1/8"	48"	3 1/2"	TCM48	\$74
--------	-----	--------	--------------	------

Power and Communication Spheres and Port

SIN 711.2

Power Spheres

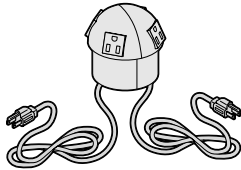

Tip: Sphere is field installed. Use 3"-diameter drill to cut mounting hole at desired location.

Standard Includes	Required to Specify
<ul style="list-style-type: none"> Sphere with four simplex electrical outlets: black plastic Two 6' power cords (each rated at 15 amps), if selected: black plastic Two 6' Greenfield conduits (each rated at 15 amps), if selected: metal 	Style number

Specification Information

• Dimensions			• Style	• Price
D	W	H	Number	

Four Electrical Outlets with Two 6' Power Cords

3 ³ / ₈ "	3 ³ / ₈ "	3"	PTDMGB1	\$164
---------------------------------	---------------------------------	----	----------------	-------

Four Electrical Outlets with Two 6' Greenfield Conduits for Hardwiring

3 ³ / ₈ "	3 ³ / ₈ "	3"	PTDMGB2	\$283
---------------------------------	---------------------------------	----	----------------	-------

Power and Communication Spheres

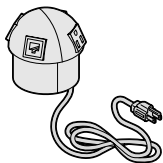

Tip: Sphere is field installed. Use 3"-diameter drill to cut mounting hole at desired location.

Tip: Face plates in sphere accommodate standard voice/data jacks. Order jacks by calling any of the manufacturers listed below:

- AMP Corporation 1.800.522.6752
- Leviton 1.800.722.2082
- Lucent 1.800.344.0223
- Krone 1.800.775.5766
- Panduit 1.800.777.3300

Standard Includes	Required to Specify
<ul style="list-style-type: none"> Sphere with two simplex electrical outlets: black plastic Face plates to accommodate two customer-supplied voice/data jacks: black plastic 6' power cord with plug rated at 15 amps, if selected: black plastic 6' Greenfield conduit for hardwiring, if selected: metal 	Style number

Specification Information

• Dimensions			• Style	• Price
D	W	H	Number	

Sphere with One 6' Power Cord

3 ³ / ₈ "	3 ³ / ₈ "	3"	PTDMGB3	\$164
---------------------------------	---------------------------------	----	----------------	-------

Sphere with One 6' Greenfield Conduit for Hardwiring

3 ³ / ₈ "	3 ³ / ₈ "	3"	PTDMGB4	\$232
---------------------------------	---------------------------------	----	----------------	-------

Power and Communication Spheres and Port, continued

SIN 711.2

Communication Sphere



Tip: Sphere is field installed. Use 3"-diameter drill to cut mounting hole at desired location.

Tip: Face plates in sphere accommodate standard voice/data jacks. Order jacks by calling any of the manufacturers listed below:

- AMP Corporation 1.800.522.6752
- Leviton 1.800.722.2082
- Lucent 1.800.344.0223
- Krone 1.800.775.5766
- Panduit 1.800.777.3300

Standard Includes	Required to Specify
<ul style="list-style-type: none"> • Sphere with face plates to accommodate four customer-supplied voice/data jacks: black plastic 	Style number

Specification Information

• Dimensions			• Style	• Price
D	W	H	Number	
3 ³ / ₈ "	3 ³ / ₈ "	3"	PTDMGB5	\$164

Round Power and Communication Port

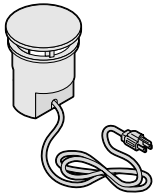

Tip: Port is field installed. Use a 3 1/2"-diameter drill to cut mounting hole at desired location.

Tip: Face plates in sphere accommodate standard voice/data jacks. Order jacks by calling any of the manufacturers listed below:

- AMP Corporation 1.800.522.6752
- Leviton 1.800.722.2082
- Lucent 1.800.344.0223
- Krone 1.800.775.5766
- Panduit 1.800.777.3300

Standard Includes	Required to Specify
<ul style="list-style-type: none"> • Round unit with two electrical outlets: black plastic • Round cap: hinged black plastic • 6' power cord with plug rated at 15 amps: black plastic • Adapters for two customer-supplied data couplers/jacks • Decorative metal cap, if selected: 9201 Polished Chrome or 9211 Nickel 	1 Style number 2 Finish color number for decorative metal cap, if selected: 9201 Polished Chrome 9211 Nickel

Specification Information

• Dimensions			• Style	• Price
D	W	H	Number	
4 ¹ / ₄ "	4 ¹ / ₄ "	4 ⁵ / ₁₆ "	PTRSGB1	\$256

Round Power and Communication Port

4 ¹ / ₄ "	4 ¹ / ₄ "	4 ⁵ / ₁₆ "	PTRSGB1	\$256
---------------------------------	---------------------------------	----------------------------------	----------------	-------

Decorative Metal Cap

4 ¹ / ₂ "	4 ¹ / ₄ "	1 ¹ / ₄ "	PTRSGBCAP	\$ 49
---------------------------------	---------------------------------	---------------------------------	------------------	-------

Internode Power and Communication Components

SIN 711.2

Power Modules

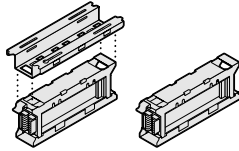

Tip: Remember to specify receptacles separately.
▶ Page G191

Standard Includes	Required to Specify
<ul style="list-style-type: none"> Power block and enclosing housing: 4793 Solar Black only Four modular receptacle attachment points Mounting bracket, if selected: 6653 Solar Black only Two covers: 6653 Solar Black only 	Style number

Related Products
<ul style="list-style-type: none"> Receptacles ▶ Page G191 Internode mounting bracket ▶ Page G184

Specification Information

Dimensions			Includes Mounting Bracket	Style Number	Price
D	W	H			

4-Circuit, 3+1

3"	10"	3½"	Yes	GFUPMBX	\$203
3"	10"	3½"	No	GFUPMX	\$176

For Use in New York City

3"	10"	3½"	Yes	GFUPMBXNYC	\$203
3"	10"	3½"	No	GFUPMXNYC	\$176

4-Circuit, 2+2

3"	10"	3½"	Yes	GFUPMBY	\$203
3"	10"	3½"	No	GFUPMY	\$176

For Use in New York City

3"	10"	3½"	Yes	GFUPMBYNYC	\$203
3"	10"	3½"	No	GFUPMYNYC	\$176

3-Circuit, Separate Neutrals

3"	10"	3½"	Yes	GFUPMBZ	\$203
3"	10"	3½"	No	GFUPMZ	\$176

For Use in New York City

3"	10"	3½"	Yes	GFUPMBZNYC	\$176
3"	10"	3½"	No	GFUPMZNYC	\$176

Tip: Internode products are included here to simplify your planning. Remember that they have different pricing terms than Steelcase Wood products.

Internode Power and Communication Components, continued

SIN 711.2

Communication Module

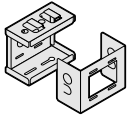

Tip: Communication modules can be supported by mounting bracket, power module, or applied directly to the underside of a worksurface.

Standard Includes	Required to Specify
<ul style="list-style-type: none"> Two-piece communication module: 4793 Solar Black only One cover, used to adapt NEMA opening to modular furniture faceplate opening 	Style number

Specification Information				
• Dimensions			• Style	• Price
D	W	H	Number	
3"	5"	4"	GFUSCM	\$41

Mounting Bracket

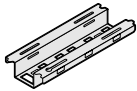

Tip: Mounting bracket supports either a communication module or a power module.

Standard Includes	Required to Specify
<ul style="list-style-type: none"> Mounting bracket: 4793 Solar Black only 	Style number

Specification Information	
• Style	• Price
Number	
GFUMB	\$27

Tip: Internode products are included here to simplify your planning. Remember that they have different pricing terms than Steelcase Wood products.

Convenience Tri-Receptacles with Modular Harness

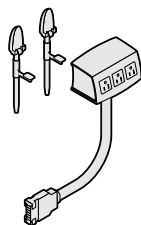

Standard Includes	Required to Specify
<ul style="list-style-type: none"> • Convenience tri-receptacle with three outlets: plastic • Harness with modular connector for attachment to end of power module • Conduit: metallic • Mounting clamp kit 	<ul style="list-style-type: none"> 1 Style number 2 Plastic color number for receptacle 3 Options, if selected (see below) ▶ See <i>Surface Materials</i>, page G198.

Options	Price	Required to Specify
Outfeed <ul style="list-style-type: none"> • Beltway power outfeed connector with cover that matches receptacle color 	+\$21	Specify <i>with beltway power outfeed connector</i> .

Specification Information

Harness Length	Line	Style Number	Base Price	Style Number	Base Price
----------------	------	--------------	------------	--------------	------------

4-Circuit, 3+1

With System Ground				With Isolated Ground	
72"	Line 1	GFUT1S72X	\$149	GFUT1G72X	\$149
	Line 2	GFUT2S72X	\$149	GFUT2G72X	\$149
	Line 3	GFUT3S72X	\$149	GFUT3G72X	\$149
	Line 4	GFUT4S72X	\$149	GFUT4G72X	\$149

4-Circuit, 2+2

With System Ground				With Isolated Ground	
72"	Line 1	GFUT1S72Y	\$149	GFUT1G72Y	\$149
	Line 2	GFUT2S72Y	\$149	GFUT2G72Y	\$149
	Line 3	GFUT3S72Y	\$149	GFUT3G72Y	\$149
	Line 4	GFUT4S72Y	\$149	GFUT4G72Y	\$149

3-Circuit, Separate Neutrals

With System Ground				With Isolated Ground	
72"	Line 1	GFUT1S72Z	\$149	GFUT1G72Z	\$149
	Line 2	GFUT2S72Z	\$149	GFUT2G72Z	\$149
	Line 3	GFUT3S72Z	\$149	GFUT3G72Z	\$149

Relevant

Tip: Internode products are included here to simplify your planning. Remember that they have different pricing terms than Steelcase Wood products.

Internode Power and Communication Components, continued

SIN 711.2

Convenience Tri-Receptacles with Power Cord and Plug



Tip: This unit does not include clamp kit.
▶ Page G187

Standard Includes **Required to Specify**

- Convenience receptacle with three outlets: plastic
- 96" power cord with grounded plug: black only

- 1 Style number
- 2 Plastic color number for receptacle
▶ See *Surface Materials*, page G198.

Related Products

- Above-worksurface clamp kit
- Below-worksurface mounting bracket

- ▶ Page G187
- ▶ Page G187

Specification Information

• Dimensions			• Style	• Price
D	W	H	Number	
2¾"	5¼"	2½"	GFUTP96	\$81

Convenience Communication Outlet Housing



Tip: This unit does not include clamp kit.
▶ Page G187

Tip: Communications convenience receptacle housing can be connected to convenience tri-receptacles side by side.

Standard Includes **Required to Specify**

- Housing for field-installed modular communications faceplate: plastic

- 1 Style number
- 2 Plastic color number for housing
▶ See *Surface Materials*, page G198.

Related Products

- Above-worksurface clamp kit
- Below-worksurface mounting bracket

- ▶ Page G187
- ▶ Page G187

Specification Information

• Dimensions			• Style	• Price
D	W	H	Number	
2¾"	5¼"	2½"	GFUCH	\$41

Tip: Internode products are included here to simplify your planning. Remember that they have different pricing terms than Steelcase Wood products.

Above-Worksurface Clamp Kit

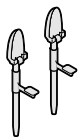

Standard Includes		Required to Specify
<ul style="list-style-type: none"> Mounting clamp to secure convenience receptacle to worksurface: 6653 Solar Black only 		Style number
Related Products		
<ul style="list-style-type: none"> Convenience tri-receptacles with modular harness Convenience tri-receptacles power cord Convenience communication outlet housing 		<ul style="list-style-type: none"> ▶ Page G185 ▶ Page G186 ▶ Page G186
Specification Information		
Style Number	Price	
GFUTMC	\$14	

Below-Worksurface Mounting Bracket

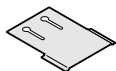

Tip: Mounting bracket supports convenience receptacles and communications outlet housing below the worksurface.

Tip: Each tri-receptacle, whether power or communications, should have its own mounting bracket for below-worksurface mounting applications.

Standard Includes		Required to Specify
<ul style="list-style-type: none"> Mounting bracket: Solar Black only 		Style number
Related Products		
<ul style="list-style-type: none"> Convenience tri-receptacles with modular harness Convenience tri-receptacles power cord Convenience communication outlet housing 		<ul style="list-style-type: none"> ▶ Page G185 ▶ Page G186 ▶ Page G186
Specification Information		
Style Number	Price	
GFUTMB	\$10	

Tip: Internode products are included here to simplify your planning. Remember that they have different pricing terms than Steelcase Wood products.

Internode Floor Power Infeeds

SIN 711.2

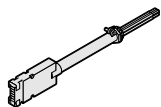

Tip: Floor power infeed cannot be used in New York City. Use a multipurpose power infeed instead.

Standard Includes	Required to Specify
-------------------	---------------------

- | | |
|--|--------------|
| <ul style="list-style-type: none"> • Junction box fittings for hardwired connection • Liquid-tight flexible conduit: black vinyl | Style number |
|--|--------------|

Specification Information		
Length	Style Number	Price

4-Circuit, 3+1

6'	GFUFFH6X	\$162
12'	GFUFFH12X	\$216
:	:	:

4-Circuit, 2+2

6'	GFUFFH6Y	\$162
12'	GFUFFH12Y	\$216
:	:	:

3-Circuit, Separate Neutrals

6'	GFUFFH6Z	\$162
12'	GFUFFH12Z	\$216
:	:	:

Tip: Internode products are included here to simplify your planning. Remember that they have different pricing terms than Steelcase Wood products.

Internode Multipurpose Power Infeeds

SIN 711.2

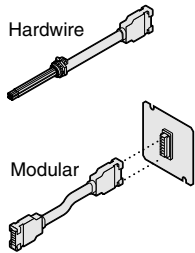

Tip: Modular connector receptacle covers a standard 4⁹/₁₆" square junction box.

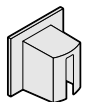

Tip: Internode products are included here to simplify your planning. Remember that they have different pricing terms than Steelcase Wood products.

Standard Includes	Required to Specify
<ul style="list-style-type: none"> • Junction box fittings for hardwired connection, if selected • Modular connector, if selected • Modular connector receptacle included with modular option • Modular infeed cover, if selected: plastic • Conduit: metal 	<ul style="list-style-type: none"> 1 Style number 2 Plastic color number for modular infeed cover, if selected <p>▶ See <i>Surface Materials</i>, page G198.</p>

Specification Information

Length and Connection	Style Number	Price
4-Circuit, 3+1		
12' Hardwire	GSGUFMH12X	\$243
12' Modular	GSGUFMM12X	\$311
24' Hardwire	GSGUFMH24X	\$352
24' Modular	GSGUFMM24X	\$419
4-Circuit, 2+2		
12' Hardwire	GSGUFMH12Y	\$243
12' Modular	GSGUFMM12Y	\$311
24' Hardwire	GSGUFMH24Y	\$352
24' Modular	GSGUFMM24Y	\$419
3-Circuit, Separate Neutrals		
12' Hardwire	GSGUFMH12Z	\$243
12' Modular	GSGUFMM12Z	\$311
24' Hardwire	GSGUFMH24Z	\$352
24' Modular	GSGUFMM24Z	\$419

Modular Infeed Cover

N.A.	GSGUFC	\$ 31
------	---------------	-------

Internode Beltway Power Outfeeds

SIN 711.2

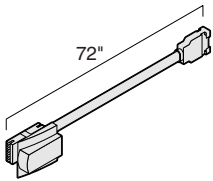

Tip: Beltway power outfeed cover and tri-receptacle are always the same color.

Standard Includes	Required to Specify
<ul style="list-style-type: none"> • 72" harness: metallic • Modular connector to attach to receptacle location in Segment beltway: plastic • Modular connector to attach to power module 	<ul style="list-style-type: none"> 1 Style number 2 Plastic color number for modular connector ▶ See <i>Surface Materials</i>, page G198.

Specification Information

•Style Number	•Price
4-Circuit, 3+1	
GFUBFM6X	\$189
•	•
4-Circuit, 2+2	
GFUBFM6Y	\$189
•	•
3-Circuit, Separate Neutrals	
GFUBFM6Z	\$189
•	•

Tip: Internode products are included here to simplify your planning. Remember that they have different pricing terms than Steelcase Wood products.

Internode Receptacles

SIN 711.2

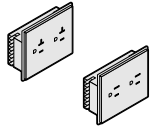

Tip: Receptacles are specified individually so you can order exactly the quantity you need.

Standard Includes	Required to Specify
-------------------	---------------------

- Individual receptacles: plastic

- 1 Style number
- 2 Plastic color number for receptacle
- ▶ See *Surface Materials*, page G198.

Specification Information				
Line	System Ground		Isolated Ground	
	Style Number	Price	Style Number	Price

4-Circuit, 3+1

15-amp Receptacles

Line 1	GSGUR1SSX	\$32	GSGUR1SGX	\$41
Line 2	GSGUR2SSX	\$32	GSGUR2SGX	\$41
Line 3	GSGUR3SSX	\$32	GSGUR3SGX	\$41
Line 4	GSGUR4SSX	\$32	GSGUR4SGX	\$41

20-amp Receptacles

Line 1	GSGUR1TSX	\$49	GSGUR1TGX	\$62
Line 2	GSGUR2TSX	\$49	GSGUR2TGX	\$62
Line 3	GSGUR3TSX	\$49	GSGUR3TGX	\$62
Line 4	GSGUR4TSX	\$49	GSGUR4TGX	\$62

4-Circuit, 2+2

15-amp Receptacles

Line 1	GSGUR1SSY	\$32	GSGUR1SGY	\$41
Line 2	GSGUR2SSY	\$32	GSGUR2SGY	\$41
Line 3	GSGUR3SSY	\$32	GSGUR3SGY	\$41
Line 4	GSGUR4SSY	\$32	GSGUR4SGY	\$41

20-amp Receptacles

Line 1	GSGUR1TSY	\$49	GSGUR1TGY	\$62
Line 2	GSGUR2TSY	\$49	GSGUR2TGY	\$62
Line 3	GSGUR3TSY	\$49	GSGUR3TGY	\$62
Line 4	GSGUR4TSY	\$49	GSGUR4TGY	\$62

3-Circuit, Separate Neutrals

15-amp Receptacles

Line 1	GSGUR1SSZ	\$32	GSGUR1SGZ	\$41
Line 2	GSGUR2SSZ	\$32	GSGUR2SGZ	\$41
Line 3	GSGUR3SSZ	\$32	GSGUR3SGZ	\$41

20-amp Receptacles

Line 1	GSGUR1TSZ	\$49	GSGUR1TGZ	\$62
Line 2	GSGUR2TSZ	\$49	GSGUR2TGZ	\$62
Line 3	GSGUR3TSZ	\$49	GSGUR3TGZ	\$62

Tip: Internode products are included here to simplify your planning. Remember that they have different pricing terms than Steelcase Wood products.

Internode Connectors

SIN 711.2

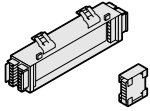

Standard Includes	Required to Specify
-------------------	---------------------

- | | |
|---|--------------|
| <ul style="list-style-type: none"> Two-sided, double-cavity power block: black plastic only Connector: black plastic only | Style number |
|---|--------------|

Specification Information		
Description	Style Number	Price

4-Circuit, 3+1

Block-to-block	GSGUBCX	\$41
Harness-to-harness	GSGUHCX	\$41
:	:	:

4-Circuit, 2+2

Block-to-block	GSGUBCY	\$41
Harness-to-harness	GSGUHCY	\$41
:	:	:

3-Circuit, Separate Neutrals

Block-to-block	GSGUBCZ	\$41
Harness-to-harness	GSGUHCZ	\$41
:	:	:

Tip: Internode products are included here to simplify your planning. Remember that they have different pricing terms than Steelcase Wood products.

Internode Modular Harnesses

SIN 711.2

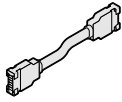

Tip: Modular-to-hardwire harnesses work on Line 1 only.

Standard Includes	Required to Specify
• Harness	Style number

Specification Information

Length	Description	Style Number	Price
--------	-------------	--------------	-------

4-Circuit, 3+1

12"		GSGUH12X	\$ 95
22"		GSGUH22X	\$ 95
28"		GSGUH28X	\$ 95
32"		GSGUH32X	\$ 95
38"		GSGUH38X	\$ 95
44"		GSGUH44X	\$108
50"		GSGUH50X	\$108
54"		GSGUH54X	\$108
64"		GSGUH64X	\$122
76"		GSGUH76X	\$135
88"		GSGUH88X	\$149
100"		GSGUH100X	\$162
120"		GSGUH120X	\$189
144"		GSGUH144X	\$216

Modular-to-Hardwire Harnesses

72"	Modular/Hardwire	GSGUHHX	\$122
-----	------------------	----------------	-------

4-Circuit, 2+2

12"		GSGUH12Y	\$ 95
22"		GSGUH22Y	\$ 95
28"		GSGUH28Y	\$ 95
32"		GSGUH32Y	\$ 95
38"		GSGUH38Y	\$ 95
44"		GSGUH44Y	\$108
50"		GSGUH50Y	\$108
54"		GSGUH54Y	\$108
64"		GSGUH64Y	\$122
76"		GSGUH76Y	\$135
88"		GSGUH88Y	\$149
100"		GSGUH100Y	\$162
120"		GSGUH120Y	\$189
144"		GSGUH144Y	\$216

Modular-to-Hardwire Harnesses

108"	Modular/Hardwire	GSGUHHY	\$122
------	------------------	----------------	-------

Tip: Internode products are included here to simplify your planning. Remember that they have different pricing terms than Steelcase Wood products.

Specification Information

Length	Description	Style Number	Price
--------	-------------	--------------	-------

3-Circuit, Separate Neutrals

12"		GSGUH12Z	\$ 95
22"		GSGUH22Z	\$ 95
28"		GSGUH28Z	\$ 95
32"		GSGUH32Z	\$ 95
38"		GSGUH38Z	\$ 95
44"		GSGUH44Z	\$108
50"		GSGUH50Z	\$108
54"		GSGUH54Z	\$108
64"		GSGUH64Z	\$122
76"		GSGUH76Z	\$135
88"		GSGUH88Z	\$149
100"		GSGUH100Z	\$162
120"		GSGUH120Z	\$189
144"		GSGUH144Z	\$216

Modular-to-Hardwire Harnesses

72"	Modular/Hardwire	GSGUHHZ	\$122
-----	------------------	----------------	-------



Cabling Components

SIN 711.2

Internode Cord and Cable Managers

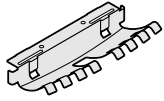

Standard Includes	Required to Specify
<ul style="list-style-type: none"> • Cord and cable manager: 6653 Solar Black only • Package of four 	Style number

Specification Information

• Dimensions			• Style	• Price
D	W	H	Number	
3½"	10"	1¾"	GFUCCM	\$81
·	·	·	·	·

Internode Harness Clips



Standard Includes	Required to Specify
<ul style="list-style-type: none"> • Package of 25 harness clips with screws: black only 	Style number

Specification Information

• Diameter	• Style	• Price
·	Number	·
1¼"	GFUCMC	\$27
·	·	·

Tip: Internode products are included here to simplify your planning. Remember that they have different pricing terms than Steelcase Wood products.

Surface Materials

Surface Materials	G198
Color Coordination List	G200
Open Line Laminate Edge Coordination Matrix	G201
Wood Grain Directions	G202

Surface Materials

This listing includes all the surface material choices that are available for the products in this specification guide.

Resources

For more information about surface materials, refer to the following resources:

Additional surface materials specification tools are available to assist you in the specification process—the Surface Materials Binders and the Surface Materials Tool Box.

Surface Materials Binders

- include:
- Surface Materials Reference Manual
 - A complete set of swatch cards for hard surfaces, vertical surface fabrics, and seating upholstery

Surface Materials Tool Box (S8150) provides 3" x 3" samples of the following surface materials:

- Vertical surface fabrics
- Seating upholstery
- Wood veneer
- Paint
- Laminate

Full-Fill Wood Finishes

This medium gloss wood finish completely fills the grain texture, yet allows the grain pattern to be seen. The wood has a lustrous, satiny look and it is smooth to the touch. This finish is available on the wood work surface or top only.

Full-fill wood choices

- 3414 Natural Cherry
- 3424 Medium Cherry
- 3534 Winter on Maple
- 3544 Blonde on Maple
- 3564 Linseed on Maple
- 3574 Amber on Maple
- 3634 Medium Oak
- 3644 Natural Oak
- 3714 Natural Walnut
- 3724 Dark Mahogany on Walnut
- 3744 Autumn Walnut
- 3774 Medium Mahogany on Walnut
- 3794 Black Walnut

Open-Pore Wood Finishes

This medium gloss finish leaves the wood grain texture visible to the eye and distinguishable to the touch.

Open-pore wood choices

- 3412 Natural Cherry
- 3422 Medium Cherry
- 3562 Linseed on Maple
- 3572 Amber on Maple
- 3582 Winter on Maple
- 3592 Blonde on Maple
- 3632 Medium Oak
- 3642 Natural Oak
- 3712 Natural Walnut
- 3722 Dark Mahogany on Walnut
- 3742 Autumn Walnut
- 3772 Medium Mahogany on Walnut
- 3792 Black Walnut

Customiz stain

Customiz stain is a service that allows you to create your own stain color on standard veneers. Customiz stain color is available on all product lines that offer wood veneer.

A one-time formulation fee of \$400 U.S. per color, per customer processing fee will apply. The fee covers the cost of formulating the Customiz finish and applies regardless of whether or not an order for product is placed. Please refer to the "Customiz Stain" option price column in your specification guide for the unit upcharge.

Customiz stains take 10 days to formulate. Consult the *Surface Materials Reference Manual* for more information. Custom veneers are also available and must be quoted by special engineering. Customiz stain on custom veneers take two to four weeks to formulate.

Requirements and information on ordering a Customiz stain color are found in the *Surface Materials Reference Manual*.

Laminate

- 2412 Natural Cherry
- 2422 Medium Cherry
- 2511 Winter on Maple
- 2592 Blonde on Maple
- 2632 Medium Oak
- 2714 Natural Walnut
- 2722 Cream
- 2729 White Sand
- 2730 Arctic White
- 2746 Black
- 2759 Warm White
- 2772 Medium Mahogany on Walnut
- 2810 Dawn
- 2811 Mist
- 2820 Coffee Speckle
- 2822 Woodrose Speckle
- 2823 Driftwood Speckle
- 2824 Smoke Speckle
- 2825 Vanadium Speckle
- 2850 Vanadium Fiber
- 2851 Rhyme Fiber
- 2852 Tungsten Fiber
- 2854 Vellum Fiber
- 2857 Stream Fiber
- 2859 Novell Fiber
- 2860 Granite Fiber
- 2870 Blonde Bronze Patina
- 2871 Blackened Bronze Patina
- 2872 Silver Plate Patina
- 2873 Instant Iron Patina

Open Line Laminate (OLL)

This service allows you to order non-standard laminate at an additional processing fee of \$60 U.S. per worksurface or storage product, plus the cost of the laminate.

Edge color for the Open Line laminate on worksurfaces or storage products must be determined by the dealer and customer before orders can be entered. Specify appropriate 2K finish number.
Tip: Standard or Accent laminates being used in the Open Line Laminate program to obtain a different edge detail will be charged the Open Line laminate upcharge; however, no additional charges for the laminate will be applied.

Laminate Approval and Material Requirements

To confirm whether a particular laminate has already been tested for use on a specific Steelcase product or to determine material square foot requirements:

- Visit www.steelcase.com
- Click on "Knowledge & Design"
- Select "Customer's Own Material"

For additional information, refer to the *Steelcase Surface Materials Reference Manual*.

Paint

- 0835 Black

Metal

- 8043 Clear Anodized Aluminum
 - 8044 Black Anodized Aluminum
 - 9201 Polished Chrome
 - 9211 Brushed Nickel
 - 9212 Silver
 - 9250 Ember Chrome
- Tip: Metal components may not be available in all colors above.*
- See specification pages for details.

Plastic

Applies to:

- Internode

- 6000 Black
- 6651 Tungsten
- 6652 Titanium
- 6653 Solar Black
- 6654 Sand (Vanadium)
- 6656 Tantalum
- 6681 Grotto

Tip: Plastic components may not be available in all colors above.

► See page G200 for an overview of the plastic colors that are available for each component.

Vertical Surface Fabric

Classics Collection

Surface materials in the Classics Collection are timeless. These materials should be available for a minimum of 10 years from the date the material is introduced into the Classics Collection. The Classics Collection includes the following fabrics in Price Groups 1 through 3:

Price Group 1

- Abacus
- Acadia
- Bariolage
- Belgrade
- BellaRose
- Boccie
- Cornice
- Embrasure

Price Group 2

- Amiranté
- Ashanti
- Ashanti Reverse
- Bouquet
- Cordial
- Firenze
- Firenze Reverse
- Fresco
- Milano
- Racquets
- Regatta
- Roulette
- Wilshire

Price Group 3

- Martinique

Designtex Graded-In Program

All Designtex Graded-In fabrics are now supported just like standard fabrics when ordered on Steelcase furniture. The Designtex Graded-In Program also includes the Environmental Impact Collection, which offers sustainable textiles in affordable price groups. For additional information and fabric samples, contact your local Designtex sales representative at 1.800.221.1540.

Designtex fabrics are graded into Steelcase Price Groups 1 through 3:

Price Group 1

Moors (Environmental Impact Collection)

Price Group 2

Acres
Bracken (Environmental Impact Collection)
Brunswick
Cut to the Chase
Gimlet
Niche
Senecal
Solitaire
Streams (Environmental Impact Collection)

Price Group 3

Apex
Dalmatian
Foxtrot
Lotto
Meringue
No Deposit No Return
Pick-Up Sticks
Rain (Environmental Impact Collection)
Sea Breeze (Environmental Impact Collection)
Six Pack
Sumo
That Straw Stuff
▶ See the *Surface Materials Reference Manual* for a listing of fabric colors.

Price Group COM (Customer's Own Material)

Fabric Approval and Yardage

To confirm whether a particular COM material has already been tested for use on a specific Steelcase product or to determine actual yardage requirements:

- Visit www.steelcase.com
- Click on "Tools & Insights"
- Select "Customer's Own Material"

For additional information regarding Customer's Own Material, call 1.888.STEELCASE.

Color Coordination List

Relevant Color Coordination List

Vinyl (PVC) edge trim color for all Relevant worksurfaces and grommets is determined by the worksurface color you select. The edge color is a default and cannot be specified.

All laminates, except woodgrain laminates, will have solid color PVC edging.

Woodgrain laminates will have woodgrain PVC edges and the grain of the edges will be horizontal. The woodgrain edge color will match the laminate color.

Laminate Color	Default PVC Color	
	For Grommets, Tables, and User's Side of Worksurfaces	For all other surfaces
2412 Natural Cherry	2792 Black	2412 Natural Cherry
2422 Medium Cherry	2792 Black	2422 Medium Cherry
2511 Natural Maple	2792 Black	2511 Natural Maple
2592 Blonde on Maple	2792 Black	2592 Blonde on Maple
2632 Medium Oak	2792 Black	2632 Medium Oak
2633 Teak	2792 Black	2633 Teak
2714 Natural Walnut	2792 Black	2714 Natural Walnut
2722 Cream	2792 Black	2722 Cream
2729 White Sand	2792 Black	2729 White Sand
2730 Arctic White	2792 Black	2730 Arctic White
2746 Black	2792 Black	2792 Black
2759 Warm White	2792 Black	2759 Warm White
2763 Light Oak	2792 Black	2763 Light Oak
2764 Dark Oak	2792 Black	2764 Dark Oak
2772 Medium Mahogany on Walnut	2792 Black	2772 Medium Mahogany on Walnut
2810 Dawn	2792 Black	2794 Dawn
2811 Mist	2792 Black	2798 Mist
2820 Coffee Speckle	2792 Black	2722 Cream
2822 Woodrose Speckle	2792 Black	2794 Dawn
2823 Driftwood Speckle	2792 Black	2722 Cream
2824 Smoke Speckle	2792 Black	2798 Mist
2825 Vanadium Speckle	2792 Black	2720 Ice
2850 Vanadium Fiber	2792 Black	2848 Sand (Vanadium)
2851 Rhyme Fiber	2792 Black	2722 Cream
2852 Tungsten Fiber	2792 Black	2798 Mist
2854 Vellum Fiber	2792 Black	2854 Vellum
2857 Stream Fiber	2792 Black	2857 Stream
2859 Novell Fiber	2792 Black	2859 Novell
2860 Granite Fiber	2792 Black	2860 Granite
2870 Blonde Bronze Patina	2792 Black	2848 Sand (Vanadium)
2871 Blackened Bronze Patina	2792 Black	2785 Grey V5
2872 Silver Plate Patina	2792 Black	2872 Silver Plate
2873 Instant Iron Patina	2792 Black	2873 Instant Iron

Open Line Laminate Edge Coordination Matrix

The color of the T-Mold and PVC edges and grommets are determined by the 2K finish number selected.

T-Mold and PVC Edges for Open Line Laminate Orders

Order Finish	Vinyl T-Mold Edge Color	PVC Edge Color	Plastic Grommet Color
2K10	6000 Black	2714 Natural Walnut	6000 Black
2K13	6000 Black	2722 Cream	6000 Black
2K14	6000 Black	2794 Dawn	6000 Black
2K16	6000 Black	2798 Mist	6000 Black
2K17	6000 Black	2759 Warm White	6000 Black
2K18	6000 Black	2729 White Sand	6000 Black
2K19	6000 Black	2730 Arctic White	6000 Black
2K21	6000 Black	2422 Medium Cherry	6000 Black
2K22	6631 Cream	2722 Cream	6000 Black
2K26	6000 Black	2720 Ice	6000 Black
2K27	6000 Black	2412 Natural Cherry	6000 Black
2K28	6000 Black	2854 Vellum Fiber	6000 Black
2K31	6000 Black	2632 Medium Oak	6000 Black
2K34	6000 Black	2859 Novell Fiber	6000 Black
2K57	6000 Black	2857 Stream Fiber	6000 Black
2K59	6655 Warm White	2759 Warm White	6000 Black
2K60	6000 Black	2860 Granite Fiber	6000 Black
2K65	6000 Black	2511 Winter on Maple	6000 Black
2K71	6000 Black	2772 Medium Mahogany on Walnut	6000 Black
2K72	6000 Black	2872 Silver Plate Patina	6000 Black
2K73	6000 Black	2873 Instant Iron Patina	6000 Black
2K85	6000 Black	2785 Grey V5	6000 Black
2K92	6000 Black	2792 Black	6000 Black
2K94	6635 Dawn	2794 Dawn	6000 Black
2K98	6636 Mist	2798 Mist	6000 Black

Wood Grain Directions

The appearance of wood veneer may change slightly depending on the angle from which it is viewed. This natural phenomenon is called polarization, and it can be seen on natural veneer, and to a lesser extent on composite veneer. Polarization is often noticed on worksurfaces installed at a 90-degree angle with each other. Please refer to the following illustrations for an understanding of grain direction on your installation.

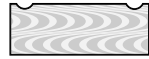

Rectangular Worksurface



Corner Worksurface

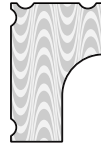

Extended Corner Worksurface



Transitional Corner Worksurface



Transitional Extended Corner Worksurface



Pier-Top Worksurface

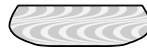

Spanner-Top Worksurface



Breadboard-Top Worksurface



Adjustable-Height Corner Worksurface



Lemon-Top Table

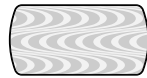

Teaming Table with Hitch

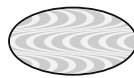

Runaround Table with Hitch

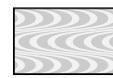

Low-Boy Pedestal

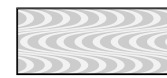

Low-Boy Lateral File

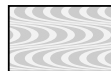

Mid-Boy Pedestal

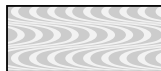

Mid-Boy Lateral File

Resources

Resources

Relevant

Lock and Keying

G204

Relevant

Lock and Keying

Relevant

All locking products are standard with factory-installed, keyed-random locks. Consecutive, specific, and random keying are available as field-installed options.

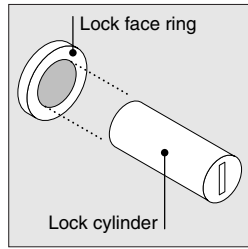

Locks consist of a factory- or field-installed lock cylinder and a factory-installed lock face ring.

Two types of locks are available—the standard keying system (FR series) and the master keying system (XF series). All the locks in the XF series can be opened with a single master key.

Factory-Installed Keying

Factory-installed locks are always key random (standard) or master key random (option). Key random means that the locks will be assigned arbitrarily at the factory with key numbers ranging from FR305 to FR454 (Master keying numbers: XF1001 to XF1150). All locks within a unit will be keyed alike.

Tip: Random keying can mean that different furniture units will have the same key

number. If you must have all locks keyed differently, you should specify field-installed, key specific or key consecutive lock cylinders.
▶ See below.

Key Random

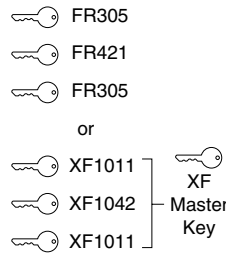

Required to Specify

Master key random +\$20 Specify with master key random.

Field-Installed Keying

Field-installed locks are only available on products that include factory-installed lock mechanisms.

Specify "plug" when specifying furniture, and the product will ship with a plastic plug in place of the lock cylinder.

Tip: For products with optional lock colors, make sure to specify the color for both the lock and lock face ring.

Front-removable lock cylinders must be specified separately. You must also order a special lock tool to install or remove lock cylinders in the field.

Tip: Lock tools are reusable. You do not need to order additional lock tools with every furniture order.

Lock cylinders will be shipped separately so that you can install the locks when you are ready.

Three keying choices are available for field installation—random (standard), specific, and consecutive. All three are also available with master keying, which means that all locks can be opened with a single master key.

Key random means that the locks will be assigned arbitrarily at the factory with key numbers ranging from FR305 to FR454 (Master keying numbers: XF1001 to XF1150).

Tip: Random keying can mean that different furniture units will have the same key number. If you must have all locks keyed differently, you should specify key specific or key consecutive lock cylinders.

Key specific means that you can specify any key number from FR305 to FR454 (Master keying numbers: XF1001 to XF1150). This option can be used to key all the furniture units in a workstation or department the same.

Tip: Designate the quantity per key number in your specification.

▶ See example at right.

Key consecutive means that you can specify lock numbers in a consecutive order to ensure that no two locks have the same key number until the key sequence repeats. You must select a beginning key number from FR305 to FR454 (Master keying numbers: XF1001 to XF1150).

Example of a typical lock cylinder specification is shown below:

10	LOCK9201FR	FR320
5	LOCK9201FR	FR350
15	LOCK9201XF	XF1100
30	Total	

1	877102003SR	standard lock tool
1	877102002SR	master lock tool

Key Random

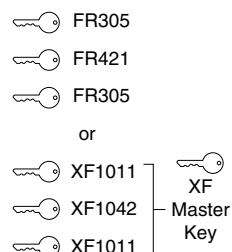

Key Specific

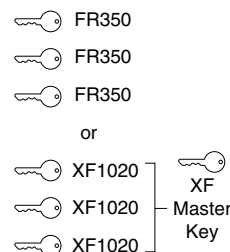

Key Consecutive

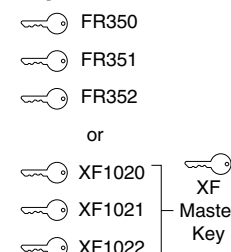

Field-Installed Lock Cylinders

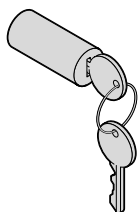

Tip: Lock price is included in price of furniture with locks.

Tip: For replacement lock cylinders, refer to Service Parts.

Tip: You can change lock cylinders in the field by using the appropriate lock tool.

Standard Includes		Required to Specify
<ul style="list-style-type: none"> Lock cylinder: 9250 Ember Chrome Two keys 		1 Style number 2 Options, if selected (see below)

Options		Required to Specify
Key specific	No cost	Select key number from FR305–FR454.
Key consecutive	No cost	Specify <i>key consecutive</i> and select beginning key number from FR305–FR454.
Master key random	+\$20 each	Specify <i>master key random</i> .
Master key specific	+\$20 each	Specify key number from XF1001–XF1150.
Master key consecutive	+\$20 each	Specify <i>master key consecutive</i> and select beginning key number from XF1001–XF1150.

Specification Information

Color	Style Number	Base Price
:	:	:

FR Series (Standard Keying System) – Lock Cylinder

Ember Chrome	LOCK9250FR	No cost
:	:	:

Standard Lock Tool

	877102003SR	\$16
:	:	:

XF Series (Master Keying System) – Lock Cylinder

Ember Chrome	LOCK9250XF	No additional cost. Price included in price of furniture with master-keyed locks.
:	:	:

Master Lock Tool

	877102002SR	\$16
:	:	:



Unison Systems Furniture



Statement of Line **H2**



Specifying Unison

Systems Worksurfaces	H23
Freestanding Worksurfaces	H57
T-Walls	H89
Storage	H93



Unison Surface Materials

Surface Materials	H123
-------------------	-------------

Unison Resources

Unison Leg Matrix	H130
Lock and Keying	H132



Unison Systems Furniture

Statement of Line

Systems Worksurfaces

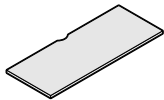

Specifying
▶ Page H24

Straight Worksurfaces

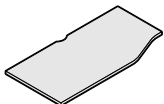
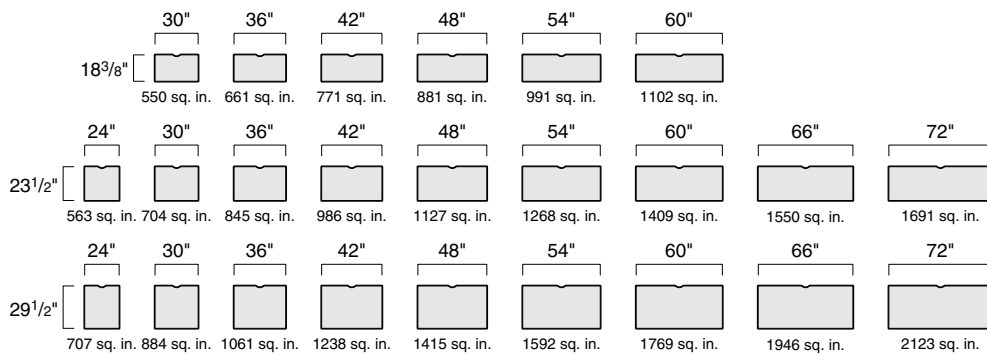

Specifying
▶ Page H25

Transition Worksurfaces*

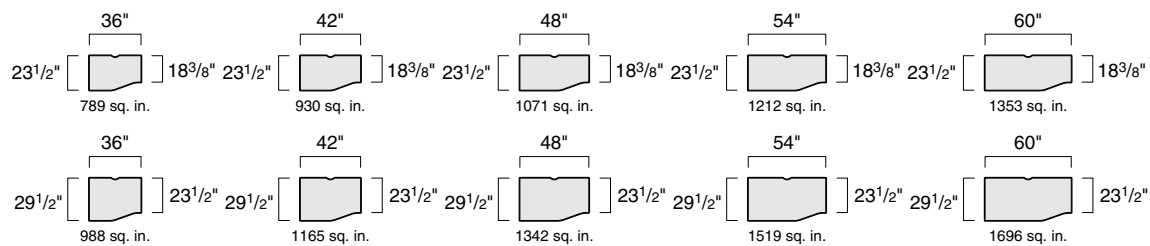

*Left-hand units shown.
Right-hand units available.

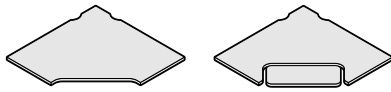

Specifying
Pages H26–H27

Corner, Straight-Front Worksurfaces

Corner, Straight-Front Worksurfaces

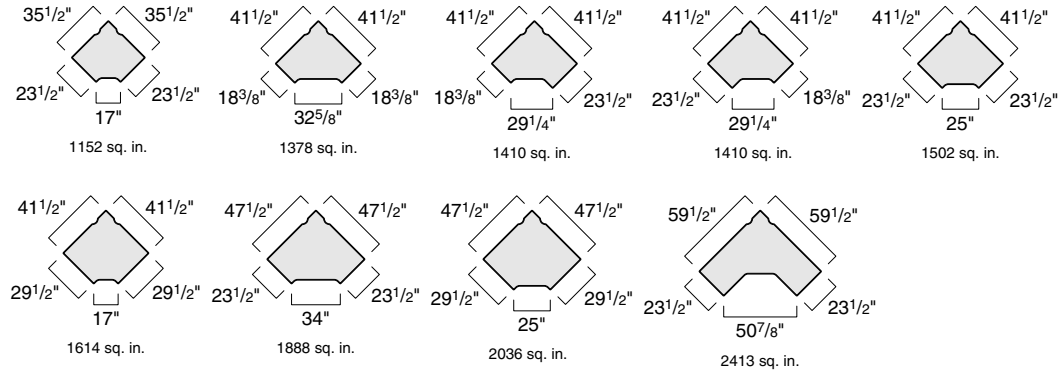

Corner, Straight-Front Worksurfaces with Adjustable Keyboard Shelf

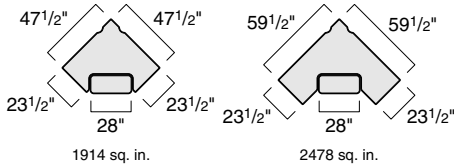

Specifying
Page H28

Corner, Curved-Front Worksurfaces

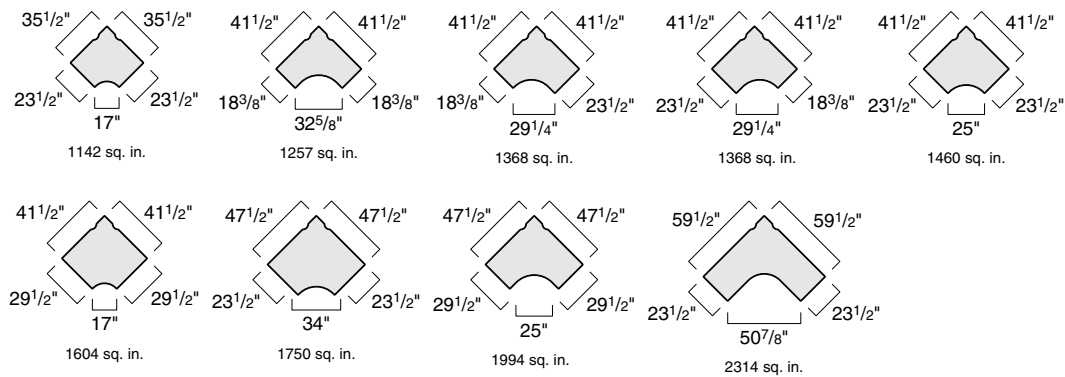

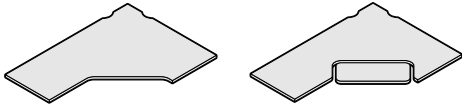

Extended Corner, Straight-Front Worksurfaces*

Extended Corner, Straight-Front Worksurfaces

*Left-hand units shown.
Right-hand units available.

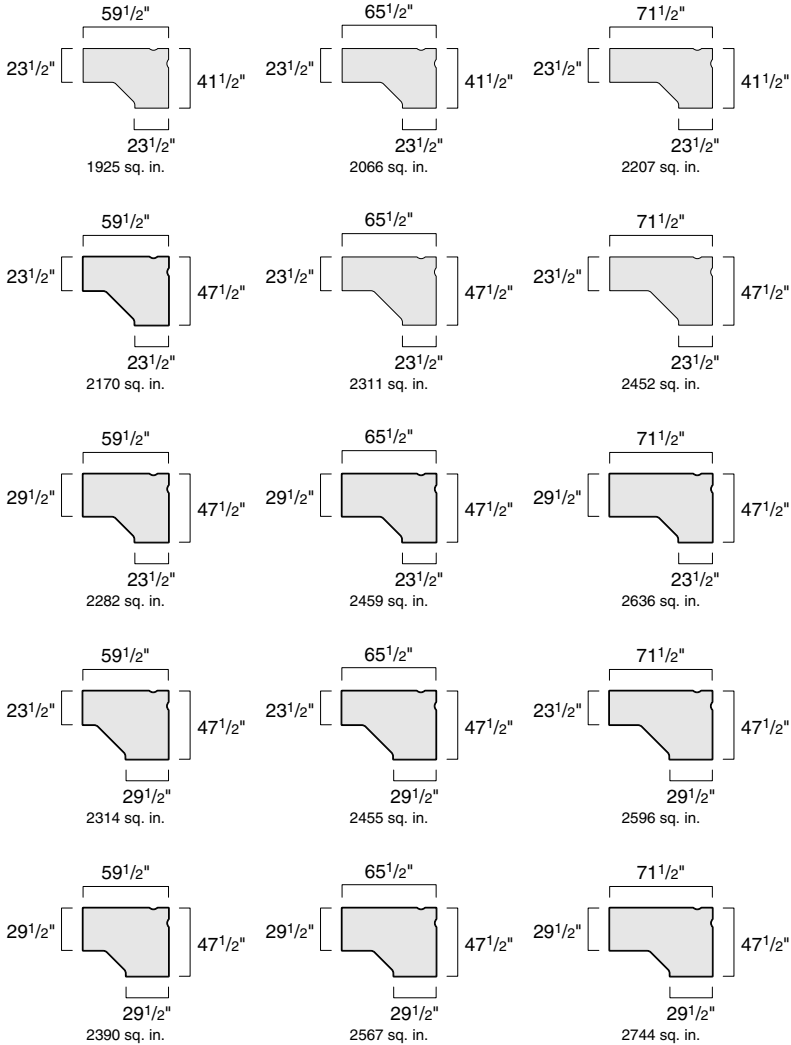

Extended Corner, Straight-Front Worksurfaces with Adjustable Keyboard Shelf

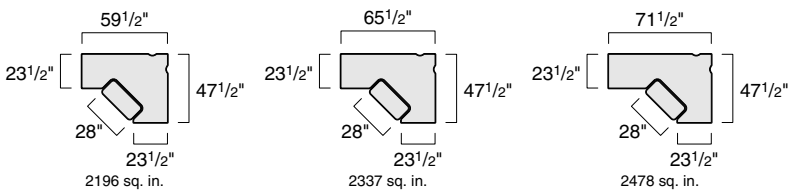



Specifying
Page H34

Extended Corner, Curved-Front Worksurfaces*

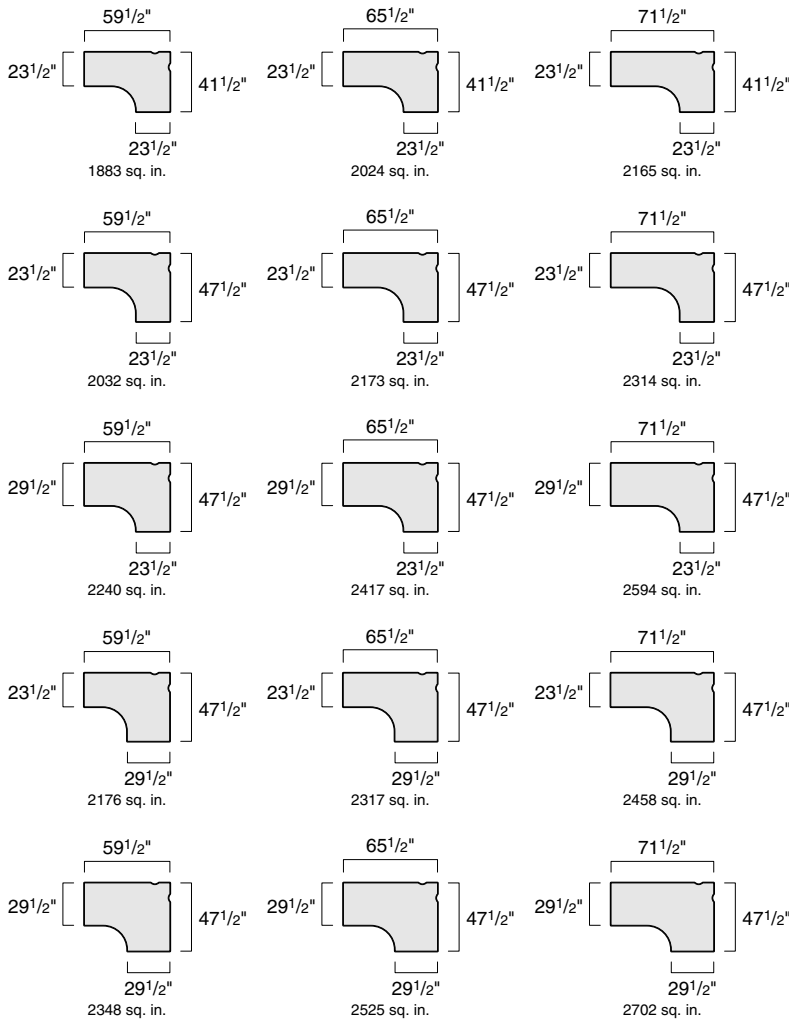

*Left-hand units shown.
Right-hand units available.



Corner, 120° Worksurfaces

Corner, 120° Worksurfaces

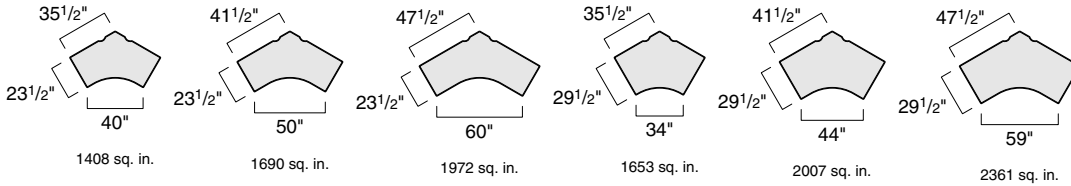

Corner, 120° Worksurfaces with Adjustable Keyboard Shelf

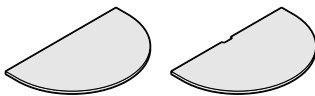
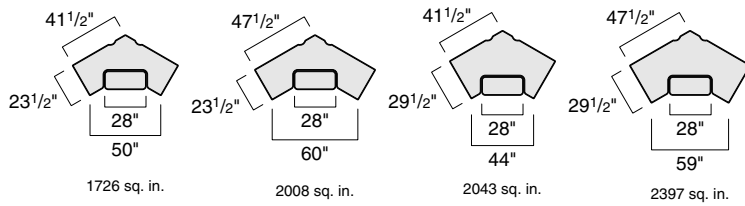

Spanner Worksurfaces

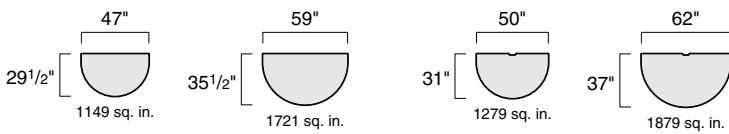

For Freestanding Applications without Panels

For use with Kick Panels

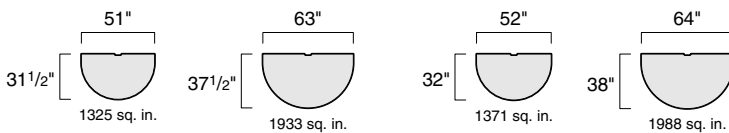

For use with Answer Panels and Montage Frames

For use with Pathways Technology Wall Panels

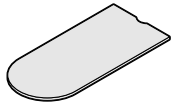

Specifying
▶ Page H39

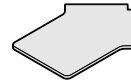

Specifying
▶ Page H40

Bullet Peninsula, Curved-Front Worksurfaces

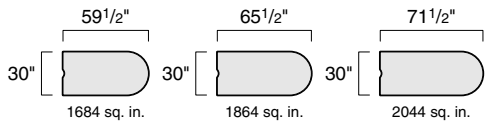

Angled Peninsula, Straight-Front Worksurfaces

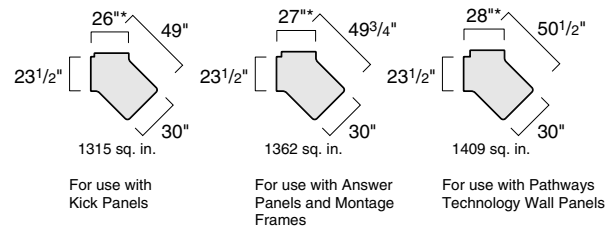

*Dimensions include notch width.



Specifying
▶ Page H41

Angled Peninsula, Curved-Front Worksurfaces

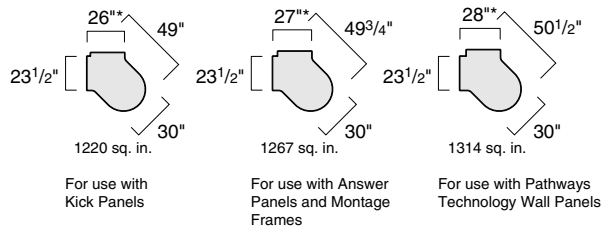

*Dimensions include notch width.

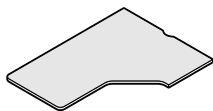

Specifying
▶ Page H42

Jetty, Straight-Front Worksurfaces*

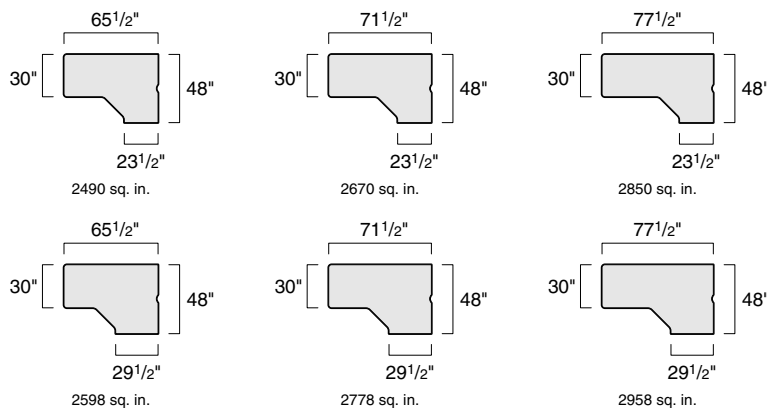

*Left-hand units shown.
Right-hand units available.



Specifying
▶ Page H43

Jetty, Curved-Front Worksurfaces*

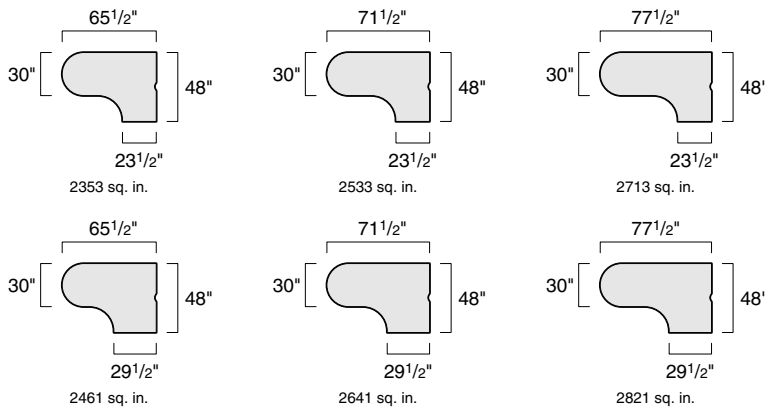

*Left-hand units shown.
Right-hand units available.

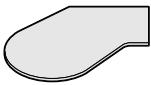

Specifying
▶ Page H44



Specifying
▶ Page H45

Bubble Jetty Worksurfaces*

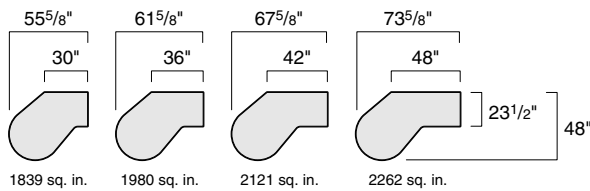

*Left-hand units shown. Right-hand units available.

Visitor, Straight-Front Worksurfaces*

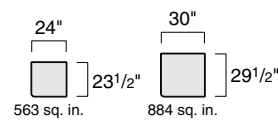

*Left-hand units shown. Right-hand units available.



Specifying
▶ Page H46

Visitor, Curved-Front Worksurfaces*

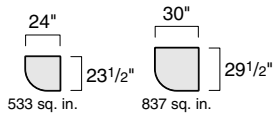

*Left-hand units shown. Right-hand units available.



Specifying
▶ Page H45

Linking, Straight-Front Worksurfaces*

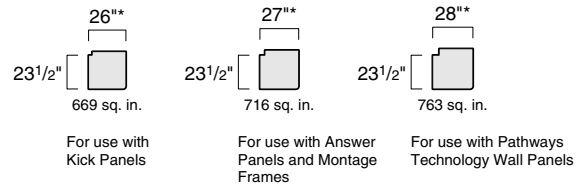

*Dimensions include notch width.



Specifying
▶ Page H46

Linking, Curved-Front Worksurfaces*

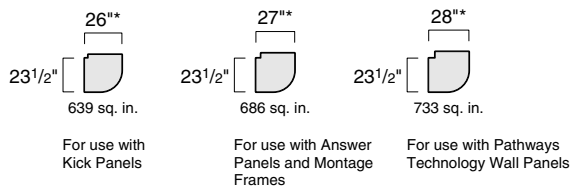

*Dimensions include notch width.

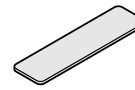

Specifying
▶ Page H47

Transaction Worksurfaces

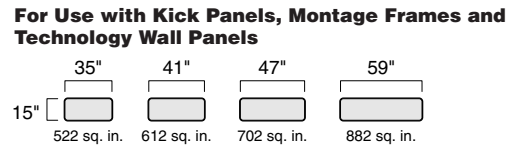
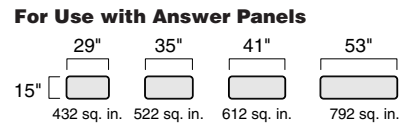

Freestanding Worksurfaces

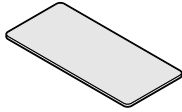

Specifying
▶ Page H58

Straight Worksurfaces

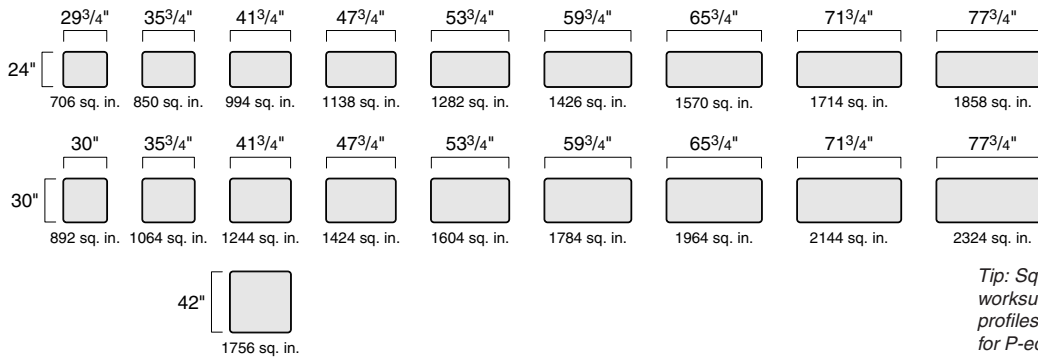

Tip: Square inch measurements are for worksurfaces with square and tapered profiles. The square inch measurements for P-edge profiles are the same as the square inch measurements for Universal Freestanding Worksurfaces.

Specifying
▶ Page H60

Transition Worksurfaces*

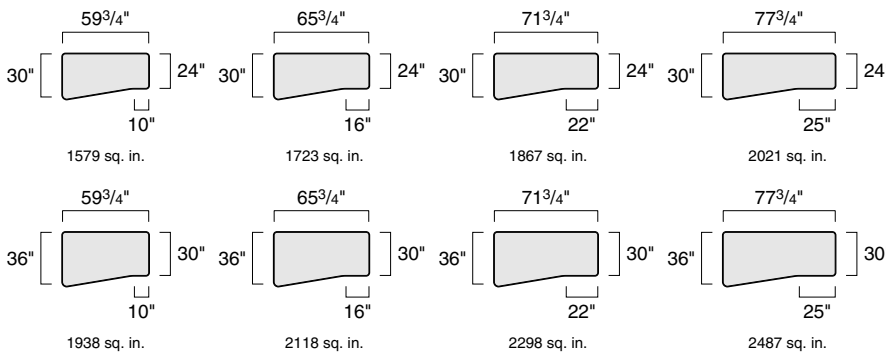

Tip: Square inch measurements are for worksurfaces with square and tapered profiles. The square inch measurements for P-edge profiles are the same as the square inch measurements for Universal Freestanding Worksurfaces.

*Left-hand units shown.
Right-hand units available.

Specifying
▶ Page H63

Corner, Straight-Front Worksurfaces

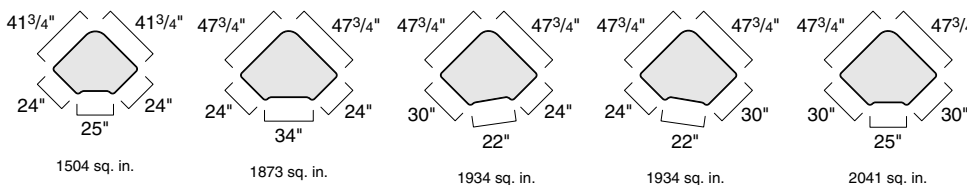

Tip: Square inch measurements are for worksurfaces with square and tapered profiles. The square inch measurements for P-edge profiles are the same as the square inch measurements for Universal Freestanding Worksurfaces.



Specifying
▶ Page H64

30" Radius Corner, Straight-Front Worksurfaces

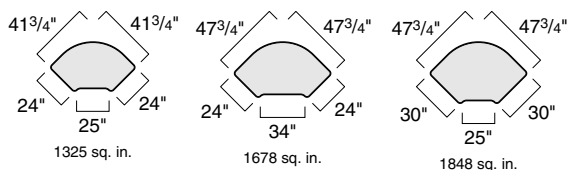

Tip: Square inch measurements are for worksurfaces with square and tapered profiles. The square inch measurements for P-edge profiles are the same as the square inch measurements for Universal Freestanding Worksurfaces.



Specifying
▶ Page H65

30" Radius Corner, Curved-Front Worksurfaces

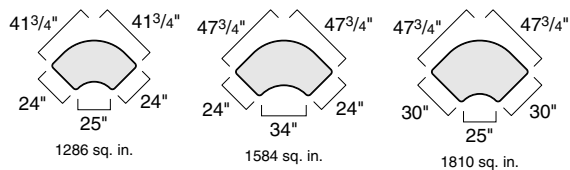

Tip: Square inch measurements are for worksurfaces with square and tapered profiles. The square inch measurements for P-edge profiles are the same as the square inch measurements for Universal Freestanding Worksurfaces.

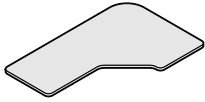

Extended Corner, Straight-Front Worksurfaces*

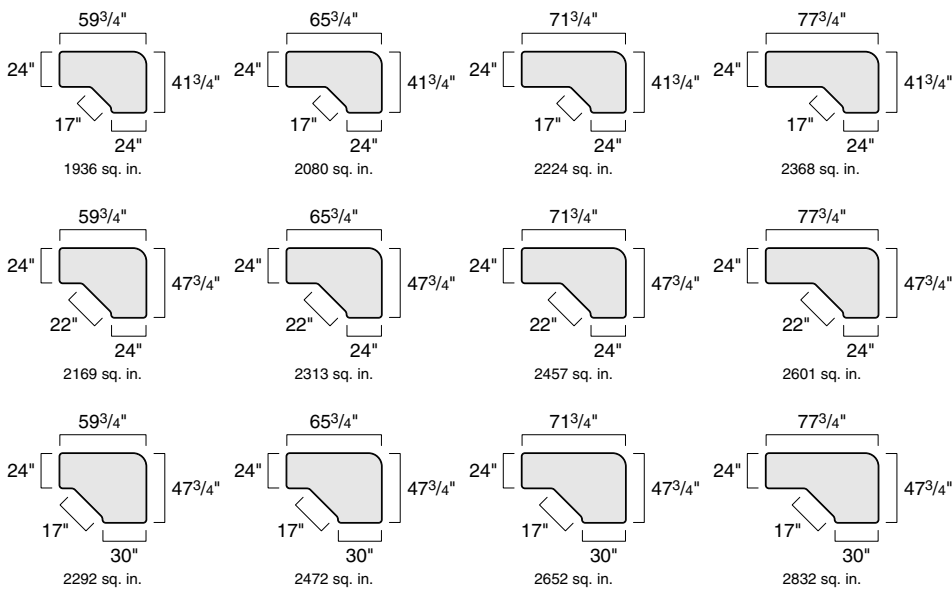

Tip: Square inch measurements are for worksurfaces with square and tapered profiles. The square inch measurements for P-edge profiles are the same as the square inch measurements for Universal Freestanding Worksurfaces.

*Left-hand units shown.
Right-hand units available.

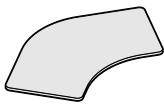

Corner, 120° Worksurfaces

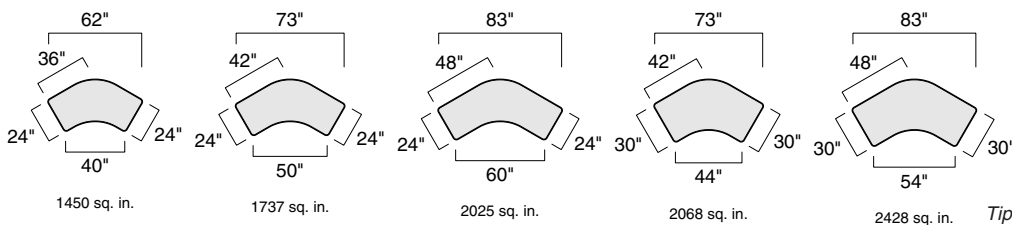

Tip: Square inch measurements are for worksurfaces with square and tapered profiles. The square inch measurements for P-edge profiles are the same as the square inch measurements for Universal Freestanding Worksurfaces.

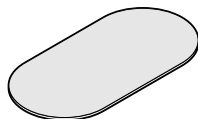

Specifying
▶ Page H71

Capsule Worksurfaces

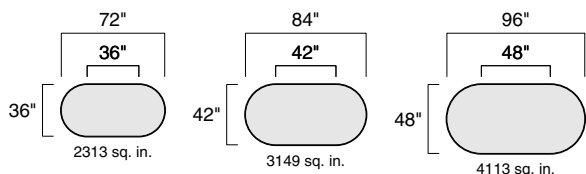

Specifying
▶ Page H72

Spanner Worksurfaces

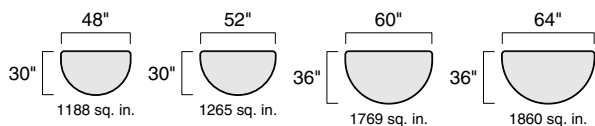

Tip: Square inch measurements are for worksurfaces with square and tapered profiles. The square inch measurements for P-edge profiles are the same as the square inch measurements for Universal Freestanding Worksurfaces.



Specifying
▶ Page H73

Peninsula Worksurfaces

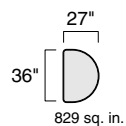

Tip: Square inch measurements are for worksurfaces with square and tapered profiles. The square inch measurements for P-edge profiles are the same as the square inch measurements for Universal Freestanding Worksurfaces.

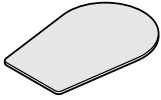

Specifying
▶ Page H74

Tapered Peninsula Worksurfaces

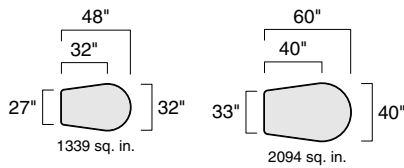

Tip: Square inch measurements are for worksurfaces with square and tapered profiles. The square inch measurements for P-edge profiles are the same as the square inch measurements for Universal Freestanding Worksurfaces.

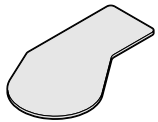

Specifying
▶ Page H76

Bubble Jetty Worksurfaces

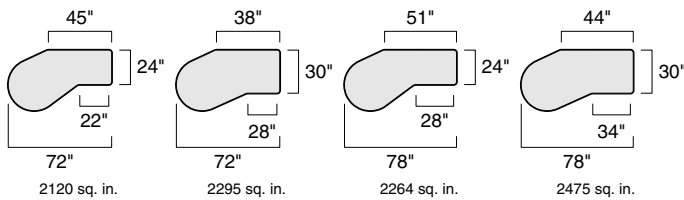

Tip: Square inch measurements are for worksurfaces with square and tapered profiles. The square inch measurements for P-edge profiles are the same as the square inch measurements for Universal Freestanding Worksurfaces.

*Left-hand units shown.
Right-hand units available.



Specifying
▶ Page H78

Round Worksurfaces

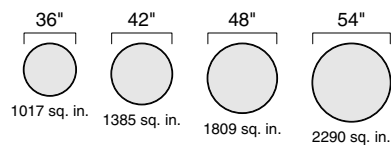



Specifying
▶ Page H79

Square Worksurfaces

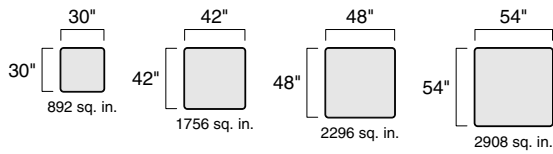

Tip: Square inch measurements are for worksurfaces with square and tapered profiles. The square inch measurements for P-edge profiles are the same as the square inch measurements for Universal Freestanding Worksurfaces.

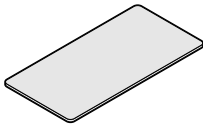

Specifying
▶ Page H80

Rectangle Worksurfaces

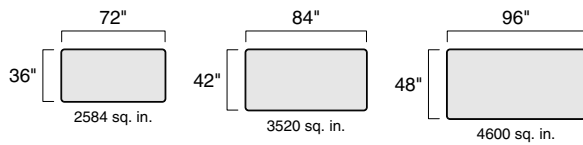

Tip: Square inch measurements are for worksurfaces with square and tapered profiles. The square inch measurements for P-edge profiles are the same as the square inch measurements for Universal Freestanding Worksurfaces.

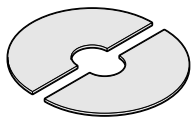

Specifying
▶ Page H81

Split-Round Worksurfaces for Use with Pathways Post and Beam

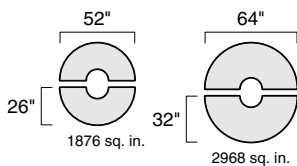

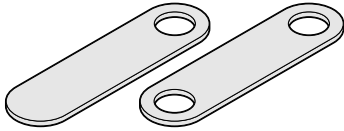

Specifying
▶ Page H82

Tethered Capsule Worksurfaces for Use with Pathways Post and Beam

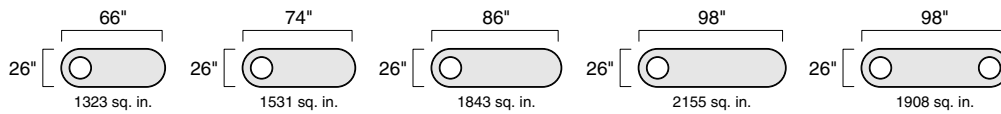

Wiring and Cabling Accessories



Field-Installed Round Grommet
Specifying
▶ Page H86



Field-Installed Triangular Grommet
Specifying
▶ Page H86

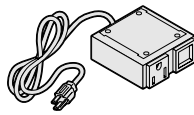

Power/Data Boxes
Specifying
▶ Page H87



Ganging Bracket for Tables
Specifying
▶ Page H87



Skeleton Bone Wire Managers
Specifying
▶ Page H88



Wire Clips
Specifying
▶ Page H88



Wire Manager
Specifying
▶ Page H88

Legs and Supports for Freestanding Worksurfaces

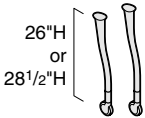

Cabby Legs
Specifying
▶ Page H85

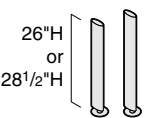

Elliptical Legs
Specifying
▶ Page H84



Pivot Hitch
Specifying
▶ Page H84



Tether Bracket
Specifying
▶ Page H85

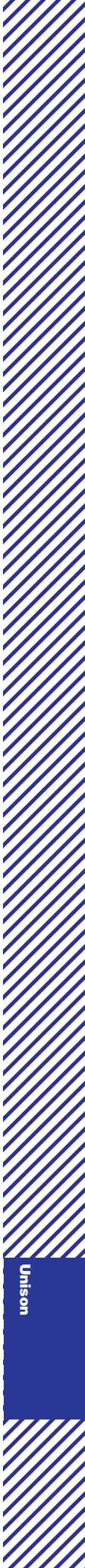

T-Walls

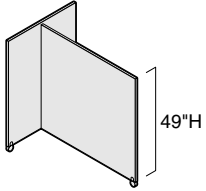

Specifying
▶ Page H90

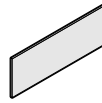

Specifying
▶ Page H91

T-Wall

	51"W
48"D	●

Tackboard

	48"W
6"H	●
18"H	●

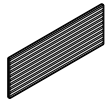

Specifying
▶ Page H91

Slatwall

	48"W
6"H	●
18"H	●

Storage

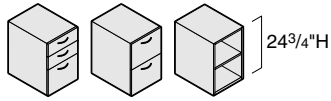

Specifying
▶ Page H94

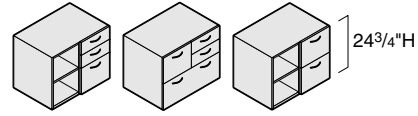

Specifying
▶ Page H96

Single-Wide Pedestals

16"W	
21 1/4"D	●
27 1/4"D	●

Double-Wide Pedestals

30"W	
21 1/4"D	●
27 1/4"D	●

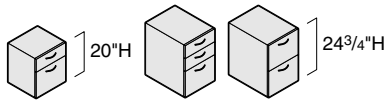

Specifying
▶ Page H98

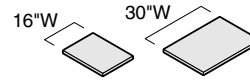

Specifying
▶ Page H100

Mobile Pedestals

16"W	
16"D	●
21 1/4"D	●
27 1/4"D	●

Pedestal Seat Cushions

	16"W	30"W
16"D	●	
21 1/4"D	●	●
27 1/4"D	●	●

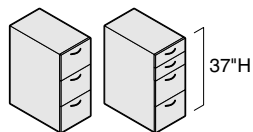

Specifying
▶ Page H102

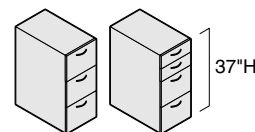

Specifying
▶ Page H104

Tall Pedestals

16"W	
21 1/4"D	●
27 1/4"D	●

Tall Mobile Pedestals

16"W	
21 1/4"D	●
27 1/4"D	●

Unison Systems Furniture
Statement of Line, continued

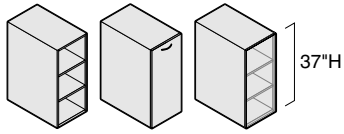

Specifying
▶ Page H106

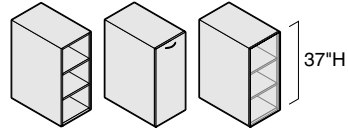

Specifying
▶ Page H108

Tall Pedestals for Use with Hedge Row Tops Only

16"W
21¼"D ●

Tall Mobile Pedestals for Use with Hedge Row Tops Only

16"W
21¼"D ●

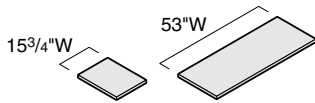

Specifying
▶ Page H110

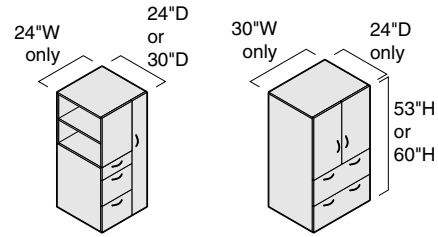

Specifying
▶ Page H112

Hedge Row Tops for Use with Tall Pedestals and Tall Mobile Pedestals

15¾"W	53"W
20½"D ●	●

Towers

24"W	30"W
24"D ●	●
30"D ●	



Specifying
▶ Page H114

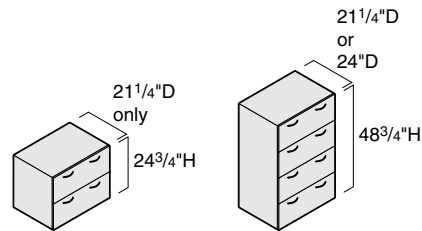

Specifying
▶ Page H116

Wood Shelves for Towers

12"W
24"D ●
30"D ●

Lateral Files

30"W	36"W
21¼"D ●	●
24"D ●	●

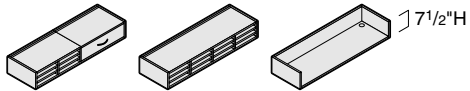

Specifying
▶ Page H118

Super Shelves for Use with Structural Walls

	36"W	48"W	60"W
15"D	●	●	●

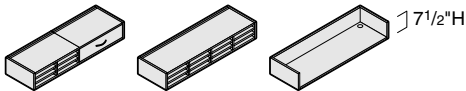

Specifying
▶ Page H120

Super Shelves for Use with T-Walls

	36"W	48"W
15"D	●	●



Specifying Systems Worksurfaces

Worksurfaces

Straight Worksurfaces (SIN 711.8)	H24
Transition Worksurfaces (SIN 711.8)	H25
Corner, Straight-Front Worksurfaces (SIN 711.8)	H26
Corner, Straight-Front Worksurfaces with Adjustable Keyboard Shelf (SIN 711.8)	H27
Corner, Curved-Front Worksurfaces (SIN 711.8)	H28
Extended Corner, Straight-Front Worksurfaces (SIN 711.8)	H30
Extended Corner, Straight-Front Worksurfaces with Adjustable Keyboard Shelf (SIN 711.8)	H32
Extended Corner, Curved-Front Worksurfaces (SIN 711.8)	H34
Corner, 120° Worksurfaces (SIN 711.8)	H36
Corner, 120° Worksurfaces with Adjustable Keyboard Shelf (SIN 711.8)	H37
Spanner Worksurfaces (SIN 711.8)	H38
Bullet Peninsula, Curved-Front Worksurfaces (SIN 711.8)	H39
Angled Peninsula, Straight-Front Worksurfaces (SIN 711.8)	H40
Angled Peninsula, Curved-Front Worksurfaces (SIN 711.8)	H41
Jetty, Straight-Front Worksurfaces (SIN 711.8)	H42
Jetty, Curved-Front Worksurfaces (SIN 711.8)	H43
Bubble Jetty Worksurfaces (SIN 711.8)	H44
Visitor and Linking, Straight-Front Worksurfaces (SIN 711.8)	H45
Visitor and Linking, Curved-Front Worksurfaces (SIN 711.8)	H46
Transaction Worksurfaces (SIN 711.8)	H47

Legs and Supports for Systems Worksurfaces (SIN 711.8)

Panel-Mounted Worksurface Supports

For Use with Answer, Kick, and Pathways Technology Wall Panels (SIN 711.8)	H49
For Use with Montage Frames (SIN 711.8)	H53

Straight Worksurfaces

Wood Veneer

SIN 711.8

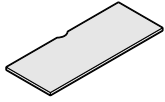

Tip: Supports for freestanding and panel-mounted applications must be specified separately.

Tip: Reinforcing channel (TS7WKSPT) is recommended to add support to worksurfaces that have 60" or more of unsupported knee-space. Must be specified separately.
▶ Page H51

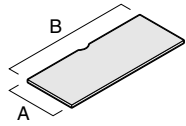

Standard Includes		Required to Specify	
	<ul style="list-style-type: none"> • Worksurface: wood veneer • Square (3 mm) edge profile on front edge: wood • Flat profile on side and back edges: matching veneer • Cable scallop on back edge 		1 Style number 2 Wood color number for worksurface 3 Options, if selected (see below) ▶ See <i>Surface Materials</i> , page H124.
Surface Materials	Options	Price	Required to Specify
	<ul style="list-style-type: none"> • Customiz stain 	Prices below	Specify with <i>Customiz stain</i> .
	<ul style="list-style-type: none"> • Full-fill finish 	Prices below	▶ See <i>Surface Materials Reference Manual</i> . Specify full-fill finish number.
Scallops	<ul style="list-style-type: none"> • Omit scallop 	No cost	Specify <i>omit scallop</i> .
Related Products	<ul style="list-style-type: none"> • Legs and supports for Systems Worksurfaces • Panel-mounted worksurface supports • Reinforcing channel 		▶ Page H48 ▶ Pages H49–H55 ▶ Page H51

Specification Information

Planning Dimensions	Style Number	Base Price	Option
A B			(Add \$ to Base Price)
			Customiz Stain or Full-Fill Finish
Square (3 mm) Edge Profile			
18"	30"	US1830SW	\$342 +\$32
18"	36"	US1836SW	\$350 +\$33
18"	42"	US1842SW	\$393 +\$37
18"	48"	US1848SW	\$423 +\$38
18"	54"	US1854SW	\$437 +\$40
18"	60"	US1860SW	\$482 +\$43
24"	24"	US2424SW	\$345 +\$32
24"	30"	US2430SW	\$355 +\$32
24"	36"	US2436SW	\$363 +\$33
24"	42"	US2442SW	\$406 +\$37
24"	48"	US2448SW	\$436 +\$38
24"	54"	US2454SW	\$450 +\$40
24"	60"	US2460SW	\$494 +\$43
24"	66"	US2466SW	\$520 +\$44
24"	72"	US2472SW	\$550 +\$46
30"	24"	US3024SW	\$401 +\$32
30"	30"	US3030SW	\$409 +\$33
30"	36"	US3036SW	\$422 +\$35
30"	42"	US3042SW	\$464 +\$38
30"	48"	US3048SW	\$494 +\$40
30"	54"	US3054SW	\$511 +\$41
30"	60"	US3060SW	\$558 +\$44
30"	66"	US3066SW	\$584 +\$46
30"	72"	US3072SW	\$613 +\$47
:	:	:	:

Corner, Straight-Front Worksurfaces

Wood Veneer

SIN 711.8



Tip: Supports must be specified separately including side support brackets for rear corner support in panel-mounted applications.

Standard Includes	Required to Specify
-------------------	---------------------

- | | |
|--|---|
| Standard Includes | Required to Specify |
| <ul style="list-style-type: none"> • Worksurface: wood veneer • Square (3 mm) edge profile on front edge: wood • Flat profile on side and back edges: matching veneer • Cable scallops on back edges | <ul style="list-style-type: none"> 1 Style number 2 Wood color number for worksurface 3 Options, if selected (see below) ▶ See <i>Surface Materials</i>, page H124. |

Options	Price	Required to Specify
---------	-------	---------------------

Surface Materials	<ul style="list-style-type: none"> • Customiz stain 	Prices below	Specify with <i>Customiz stain</i> .
	<ul style="list-style-type: none"> • Full-fill finish 	Prices below	▶ See <i>Surface Materials Reference Manual</i> . Specify full-fill finish number.
Scallops	<ul style="list-style-type: none"> • Omit scallops 	No cost	Specify <i>omit scallops</i> .
Related Products	<ul style="list-style-type: none"> • Legs and supports for Systems Worksurfaces • Panel-mounted worksurface supports 		▶ Page H48 ▶ Pages H49–H55

Specification Information

• Planning Dimensions				• Style Number	• Base Price	• Option
A	B	C	D			(Add \$ to Base Price)
						Customiz Stain or Full-Fill Finish

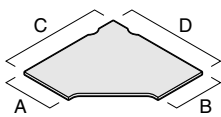

Square (3 mm) Edge Profile

18"	18"	42"	42"	UC114242SW	\$506	+\$48
18"	24"	42"	42"	UC124242SW	\$531	+\$48
24"	18"	42"	42"	UC214242SW	\$531	+\$48
24"	24"	36"	36"	UC223636SW	\$491	+\$48
24"	24"	42"	42"	UC224242SW	\$518	+\$48
24"	24"	48"	48"	UC224848SW	\$556	+\$50
30"	30"	42"	42"	UC334242SW	\$548	+\$49
30"	30"	48"	48"	UC334848SW	\$589	+\$52

Corner, Straight-Front Worksurfaces with Adjustable Keyboard Shelf

Corner, Straight-Front Worksurfaces with Adjustable Keyboard Shelf, Wood Veneer

SIN 711.8



Tip: Supports must be specified separately including side support brackets for rear corner support in panel-mounted applications.

Tip: Keyboard mechanism requires field attachment to the worksurface and keyboard shelf.

Standard Includes	Required to Specify
-------------------	---------------------

- | | |
|--|---|
| <ul style="list-style-type: none"> • Worksurface: wood veneer • Square (3 mm) edge profile on front edge of worksurface: wood • Flat profile on side and back edges: matching veneer • Cable scallops on back edges • Square (3 mm) edge profile on all edges of keyboard shelf: wood • Keyboard mechanism | <ul style="list-style-type: none"> 1 Style number 2 Wood color number for worksurface 3 Options, if selected (see below) ▶ See <i>Surface Materials</i>, page H124. |
|--|---|

Surface Materials	Options	Price	Required to Specify
-------------------	---------	-------	---------------------

- | | | | |
|--------------------------|--------------------|--------------|--|
| Surface Materials | • Customiz stain | Prices below | Specify with <i>Customiz stain</i> . |
| | • Full-fill finish | Prices below | ▶ See <i>Surface Materials Reference Manual</i> . Specify full-fill finish number. |

Scallops	• Omit scallops	No cost	Specify <i>omit scallops</i> .
-----------------	-----------------	---------	--------------------------------

- | | | | |
|-------------------------|--|--|-----------------|
| Related Products | • Legs and supports for Systems Worksurfaces | | ▶ Page H48 |
| | • Panel-mounted worksurface supports | | ▶ Pages H49–H55 |

Specification Information

• Planning Dimensions				• Style Number	• Base Price	• Option
A	B	C	D			(Add \$ to Base Price)
.....
.....	Customiz Stain or Full-Fill Finish

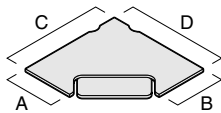

Square (3 mm) Edge Profile						
	24"	24"	48"	48"	UC224848KSW	\$996 +\$50
.....

Corner, Curved-Front Worksurfaces

Wood Veneer

SIN 711.8



Tip: Supports must be specified separately including side support brackets for rear corner support in panel-mounted applications.

Standard Includes	Required to Specify
-------------------	---------------------

- | | |
|--|---|
| Standard Includes | Required to Specify |
| <ul style="list-style-type: none"> • Worksurface: wood veneer • Square (3 mm) edge profile on front edge: wood • Flat profile on side and back edges: matching veneer • Cable scallops on back edges | <ul style="list-style-type: none"> 1 Style number 2 Wood color number for worksurface 3 Options, if selected (see below) ▶ See <i>Surface Materials</i>, page H124. |

Options	Price	Required to Specify
---------	-------	---------------------

Surface Materials	<ul style="list-style-type: none"> • Customiz stain 	Prices below	Specify with <i>Customiz stain</i> .
	<ul style="list-style-type: none"> • Full-fill finish 	Prices below	▶ See <i>Surface Materials Reference Manual</i> . Specify full-fill finish number.
Scallops	<ul style="list-style-type: none"> • Omit scallop 	No cost	Specify <i>omit scallop</i> .
Related Products	<ul style="list-style-type: none"> • Legs and supports for Systems Worksurfaces • Panel-mounted worksurface supports 		▶ Page H48 ▶ Pages H49–H55

Specification Information

• Planning Dimensions				• Style Number	• Base Price	• Option
A	B	C	D			(Add \$ to Base Price)
						Customiz Stain or Full-Fill Finish

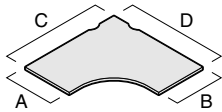

Square (3 mm) Edge Profile

18"	18"	42"	42"	UCC114242SW	\$581	+\$48
18"	24"	42"	42"	UCC124242SW	\$606	+\$48
24"	18"	42"	42"	UCC214242SW	\$606	+\$48
24"	24"	36"	36"	UCC223636SW	\$566	+\$48
24"	24"	42"	42"	UCC224242SW	\$593	+\$48
24"	24"	48"	48"	UCC224848SW	\$631	+\$50
30"	30"	42"	42"	UCC334242SW	\$623	+\$49
30"	30"	48"	48"	UCC334848SW	\$664	+\$52

Corner, Curved-Front
Worksurfaces,
Wood Veneer

SIN 711.8

Extended Corner, Straight-Front Worksurfaces

Wood Veneer

SIN 711.8



Tip: Illustration above shows a left-hand worksurface.

Tip: Supports must be specified separately including side support brackets for rear corner support in panel-mounted applications.

Tip: Reinforcing channel (TS7WKSPT) is recommended to add support to worksurfaces that have 60" or more of unsupported knee-space. Must be specified separately.

▶ Page H51

Standard Includes	Required to Specify
<ul style="list-style-type: none"> • Worksurface: wood veneer • Square (3 mm) edge profile on front edge: wood • Flat profile on side and back edges: matching veneer • Cable scallops on back edges 	<ul style="list-style-type: none"> 1 Style number 2 Wood color number for worksurface 3 Options, if selected (see below) ▶ See <i>Surface Materials</i>, page H124.

Options	Price	Required to Specify
Surface Materials <ul style="list-style-type: none"> • Customiz stain • Full-fill finish 	<ul style="list-style-type: none"> Prices at right Prices at right 	<ul style="list-style-type: none"> Specify with <i>Customiz stain</i>. ▶ See <i>Surface Materials Reference Manual</i>. Specify full-fill finish number.
Scallops <ul style="list-style-type: none"> • Omit scallops 	<ul style="list-style-type: none"> No cost 	<ul style="list-style-type: none"> Specify <i>omit scallops</i>.

Related Products <ul style="list-style-type: none"> • Legs and supports for Systems Worksurfaces • Panel-mounted worksurface supports • Reinforcing channel 	<ul style="list-style-type: none"> ▶ Page H48 ▶ Pages H49–H55 ▶ Page H51
---	---

Extended Corner, Straight-
Front Worksurfaces with
Adjustable Keyboard Shelf,
Wood Veneer

SIN 711.8

Extended Corner, Curved-Front Worksurfaces

Wood Veneer

SIN 711.8



Tip: Illustration above shows a left-hand worksurface.

Tip: Supports must be specified separately including side support brackets for rear corner support in panel-mounted applications.

Tip: Reinforcing channel (TS7WKSPT) is recommended to add support to worksurfaces that have 60" or more of unsupported knee-space. Must be specified separately.
 ▶ Page H51

Standard Includes	Required to Specify
<ul style="list-style-type: none"> • Worksurface: wood veneer • Square (3 mm) edge profile on front edge: wood • Flat profile on side and back edges: matching veneer • Cable scallops on back edges 	1 Style number 2 Wood color number for worksurface 3 Options, if selected (see below) ▶ See <i>Surface Materials</i> , page H124.

	Options	Price	Required to Specify
Surface Materials	<ul style="list-style-type: none"> • Customiz stain • Full-fill finish 	Prices at right Prices at right	Specify <i>with Customiz stain</i> . ▶ See <i>Surface Materials Reference Manual</i> . Specify full-fill finish number.
Scallops	<ul style="list-style-type: none"> • Omit scallops 	No cost	Specify <i>omit scallops</i> .

Related Products		
<ul style="list-style-type: none"> • Legs and supports for Systems Worksurfaces • Panel-mounted worksurface supports • Reinforcing channel 		▶ Page H48 ▶ Pages H49–H55 ▶ Page H51

Specification Information

Planning Dimensions				Style Number	Base Price	Option (Add \$ to Base Price)
A	B	C	D			
						Customiz Stain or Full-Fill Finish

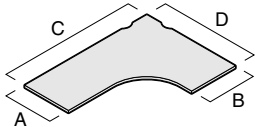

Square (3 mm) Edge Profile

Left-Hand Worksurfaces

24"	24"	60"	42"	UEC2202LSW	\$802	+\$54
24"	24"	66"	42"	UEC2262LSW	\$848	+\$68
24"	24"	72"	42"	UEC2222LSW	\$894	+\$69
24"	24"	60"	48"	UEC2208LSW	\$811	+\$68
24"	24"	66"	48"	UEC2268LSW	\$859	+\$69
24"	24"	72"	48"	UEC2228LSW	\$905	+\$71
24"	30"	60"	48"	UEC2308LSW	\$864	+\$69
24"	30"	66"	48"	UEC2368LSW	\$910	+\$71
24"	30"	72"	48"	UEC2328LSW	\$957	+\$72
30"	24"	60"	48"	UEC3208LSW	\$864	+\$69
30"	24"	66"	48"	UEC3268LSW	\$910	+\$71
30"	24"	72"	48"	UEC3228LSW	\$957	+\$72
30"	30"	60"	48"	UEC3308LSW	\$890	+\$71
30"	30"	66"	48"	UEC3368LSW	\$937	+\$72
30"	30"	72"	48"	UEC3328LSW	\$983	+\$74

Right-Hand Worksurfaces

24"	24"	42"	60"	UEC2220RSW	\$802	+\$54
24"	24"	42"	66"	UEC2226RSW	\$848	+\$68
24"	24"	42"	72"	UEC2222RSW	\$894	+\$69
24"	24"	48"	60"	UEC2280RSW	\$811	+\$68
24"	24"	48"	66"	UEC2286RSW	\$859	+\$69
24"	24"	48"	72"	UEC2282RSW	\$905	+\$71
24"	30"	48"	60"	UEC2380RSW	\$864	+\$69
24"	30"	48"	66"	UEC2386RSW	\$910	+\$71
24"	30"	48"	72"	UEC2382RSW	\$957	+\$72
30"	24"	48"	60"	UEC3280RSW	\$864	+\$69
30"	24"	48"	66"	UEC3286RSW	\$910	+\$71
30"	24"	48"	72"	UEC3282RSW	\$957	+\$72
30"	30"	48"	60"	UEC3380RSW	\$890	+\$71
30"	30"	48"	66"	UEC3386RSW	\$937	+\$72
30"	30"	48"	72"	UEC3382RSW	\$983	+\$74

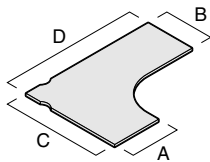

Corner, 120° Worksurfaces

Wood Veneer

SIN 711.8



Tip: Supports must be specified separately including side support brackets for rear corner support in panel-mounted applications.

Tip: Corner, 120° worksurfaces cannot be supported by Montage frames. See Montage chapter in the Specials Handbook for 120° planning.

Standard Includes	Required to Specify
-------------------	---------------------

- Worksurface: wood veneer
- Square (3 mm) edge profile on front edge: wood
- Flat profile on side and back edges: matching veneer
- Cable scallops on back edges

- 1 Style number
- 2 Wood color number for worksurface
- 3 Options, if selected (see below)
- ▶ See *Surface Materials*, page H124.

Options	Price	Required to Specify
---------	-------	---------------------

Surface Materials	• Customiz stain	Prices below	Specify with <i>Customiz stain</i> .
	• Full-fill finish	Prices below	▶ See <i>Surface Materials Reference Manual</i> . Specify full-fill finish number.
Scallops	• Omit scallop	No cost	Specify <i>omit scallop</i> .
Related Products	• Legs and supports for Systems Worksurfaces		▶ Page H48
	• Panel-mounted worksurface supports		▶ Pages H49–H55

Specification Information

• Planning Dimensions				• Style Number	• Base Price	• Option
A	B	C	D			(Add \$ to Base Price)
•	•	•	•	•	•	•
•	•	•	•	•	•	•
•	•	•	•	•	•	•
•	•	•	•	•	•	•
•	•	•	•	•	•	•

Freestanding or Panel-Mounted on Kick, Answer, and Pathways Technology Wall Panels



Square (3 mm) Edge Profile							
Height	Width	Depth	Depth	Style Number	Base Price	Option	
24"	24"	36"	36"	UB223636SW	\$785	+\$69	
24"	24"	42"	42"	UB224242SW	\$806	+\$71	
24"	24"	48"	48"	UB224848SW	\$827	+\$72	
30"	30"	36"	36"	UB333636SW	\$806	+\$71	
30"	30"	42"	42"	UB334242SW	\$827	+\$72	
30"	30"	48"	48"	UB334848SW	\$849	+\$74	
•	•	•	•	•	•	•	•

Corner, 120° Worksurfaces with Adjustable Keyboard Shelf

Wood Veneer

Corner, 120°
Worksurfaces with
Adjustable Keyboard
Shelf, Wood Veneer

SIN 711.8



Tip: Supports must be specified separately including side support brackets for rear corner support in panel-mounted applications.

Tip: Corner, 120° worksurfaces cannot be supported by Montage frames.
▶ See Montage chapter in the Specials Handbook for 120° planning.

Tip: Keyboard mechanism requires field attachment to worksurface and keyboard shelf.

Standard Includes	Required to Specify
-------------------	---------------------

- Worksurface: wood veneer
- Square (3 mm) edge profile on front edge of worksurface: wood
- Flat profile on side and back edges: matching veneer
- Cable scallops on back edges
- Square (3 mm) edge profile on all edges of keyboard shelf: wood
- Keyboard mechanism

- 1 Style number
- 2 Wood color number for worksurface
- 3 Options, if selected (see below)
- ▶ See *Surface Materials*, page H124.

Options	Price	Required to Specify
---------	-------	---------------------

Surface Materials	• Customiz stain	Prices below	Specify with <i>Customiz stain</i> .
	• Full-fill finish	Prices below	▶ See <i>Surface Materials Reference Manual</i> . Specify full-fill finish number.
Scallops	• Omit scallops	No cost	Specify <i>omit scallops</i> .
Related Products	• Legs and supports for Systems Worksurfaces		▶ Page H48
	• Panel-mounted worksurface supports		▶ Pages H49–H55

Specification Information

Planning Dimensions	Style Number	Base Price	Option
A B C D			
:	:	:	(Add \$ to Base Price)
:	:	:	Customiz Stain or Full-Fill Finish

Freestanding or Panel-Mounted on Kick, Answer, and Pathways Technology Wall Panels



Square (3 mm) Edge Profile			Style Number	Price	Option
	24"	24"	42" 42"	UB224242KSW	\$1231 +\$71
	24"	24"	48" 48"	UB224848KSW	\$1252 +\$72
	30"	30"	42" 42"	UB334242KSW	\$1327 +\$72
	30"	30"	48" 48"	UB334848KSW	\$1274 +\$74
	:	:	:	:	:

Spanner Worksurfaces

Wood Veneer

SIN 711.8

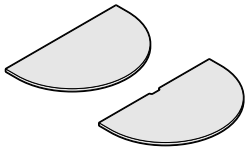

Tip: Worksurfaces for freestanding applications include alignment slots to accept four cabby or four elliptical legs.

Tip: Worksurfaces for panel-mounted and frame-supported applications include alignment slots to accept two cabby or two elliptical legs.

Tip: Supports for freestanding and panel-mounted applications must be specified separately.

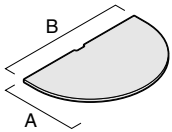
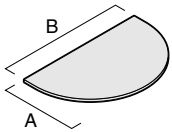

Standard Includes		Required to Specify
-------------------	--	---------------------

- Worksurface: wood veneer
- Square (3 mm) edge profile on front edge: wood
- Flat profile on back edge: matching veneer

- 1 Style number
- 2 Wood color number for worksurface
- 3 Options, if selected (see below)
- ▶ See *Surface Materials*, page H124.

Options	Price	Required to Specify
---------	-------	---------------------

Surface Materials	<ul style="list-style-type: none"> • Customiz stain 	Prices below	Specify with <i>Customiz stain</i> .
	<ul style="list-style-type: none"> • Full-fill finish 	Prices below	▶ See <i>Surface Materials Reference Manual</i> . Specify full-fill finish number.

Related Products	<ul style="list-style-type: none"> • Legs and supports for Systems Worksurfaces • Panel-mounted worksurface supports 	▶ Page H48	▶ Pages H49–H55
-------------------------	--	------------	-----------------

Specification Information

Planning Dimensions	Style Number	Base Price	Option
A B			(Add \$ to Base Price)
			Customiz Stain or Full-Fill Finish

Spanner Worksurfaces



Square (3 mm) Edge Profile

For Freestanding Applications Without Panels

29½"	47"	USPC47SW	\$571	+\$53
35½"	59"	USPC59SW	\$653	+\$57

With 2" Notch for Use with Kick Panels

31"	50"	USPC50SW	\$571	+\$53
37"	62"	USPC62SW	\$653	+\$57

With 3" Notch for Use with Answer Panels and Montage Frames

31½"	51"	USPC51SW	\$571	+\$53
37½"	63"	USPC63SW	\$653	+\$57

With 4" Notch for Use with Pathways Technology Wall Panels

32"	52"	USPC52SW	\$571	+\$53
38"	64"	USPC64SW	\$653	+\$57

Angled Peninsula, Straight-Front Worksurfaces

Wood Veneer

SIN 711.8

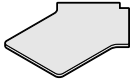

Tip: Worksurfaces for panel-mounted and frame-supported applications include alignment slots to accept two caddy or two elliptical legs.

Tip: Supports for freestanding and panel-mounted applications must be specified separately.

Tip: Angled peninsula, straight-front worksurfaces are recommended for use with other straight-front shapes such as corner, straight-front worksurfaces.

▶ Page H26

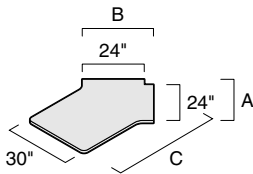

Standard Includes

- Worksurface: wood veneer
- Square (3 mm) edge profile on front edge: wood
- Flat profile on side and back edges: matching veneer

Required to Specify

- 1 Style number
 - 2 Wood color number for worksurface
 - 3 Options, if selected (see below)
- ▶ See *Surface Materials*, page H124.

Options

Surface Materials	Options	Price	Required to Specify
	• Customiz stain	Prices below	Specify with <i>Customiz stain</i> .
	• Full-fill finish	Prices below	▶ See <i>Surface Materials Reference Manual</i> . Specify full-fill finish number.

Related Products	Options	Price	Required to Specify
	• Legs and supports for Systems Worksurfaces		▶ Page H48
	• Panel-mounted worksurface supports		▶ Pages H49–H55

Specification Information

Planning Dimensions	Style Number	Base Price	Option
A B C			(Add \$ to Base Price)
·	·	·	· Customiz Stain or
·	·	·	· Full-Fill Finish

Angled Peninsula, Straight-Front Worksurfaces



Square (3 mm) Edge Profile

With 2" Notch for Use with Kick Panels

26"	27"	50"	UPA2648SW	\$717	+\$47
-----	-----	-----	------------------	-------	-------

With 3" Notch for Use with Answer Panels and Montage Frames

27"	27"	50"	UPA2748SW	\$717	+\$48
-----	-----	-----	------------------	-------	-------

With 4" Notch for Use with Pathways Technology Wall Panels

28"	28"	51"	UPA2848SW	\$717	+\$49
-----	-----	-----	------------------	-------	-------

Angled Peninsula, Curved-Front Worksurfaces

Wood Veneer

Angled Peninsula,
Curved-Front Worksurfaces,
Wood Veneer

SIN 711.8



Tip: Worksurfaces for panel-mounted and frame-supported applications include alignment slots to accept two cabby or two elliptical legs.

Tip: Supports for freestanding and panel-mounted applications must be specified separately.

Tip: Angled peninsula, curved-front worksurfaces are recommended for use with other curved-front shapes such as corner, curved-front worksurfaces.

▶ Page H28

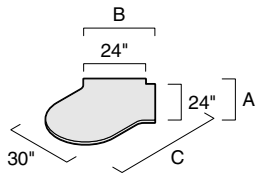

Standard Includes

- Worksurface: wood veneer
- Square (3 mm) edge profile on front edge: wood
- Flat profile on side and back edges: matching veneer

Required to Specify

- 1 Style number
 - 2 Wood color number for worksurface
 - 3 Options, if selected (see below)
- ▶ See *Surface Materials*, page H124.

Options

Options	Price	Required to Specify
Surface Materials	<ul style="list-style-type: none"> • Customiz stain 	Prices below
	<ul style="list-style-type: none"> • Full-fill finish 	Prices below
Related Products	<ul style="list-style-type: none"> • Legs and supports for Systems Worksurfaces • Panel-mounted worksurface supports 	Specify with <i>Customiz stain</i> . ▶ See <i>Surface Materials Reference Manual</i> . Specify full-fill finish number.
		▶ Page H48 ▶ Pages H49–H55

Specification Information

Planning Dimensions	Style Number	Base Price	Option
A B C			(Add \$ to Base Price)
·	·	·	· Customiz Stain or
·	·	·	· Full-Fill Finish

Angled Peninsula, Curved-Front Worksurfaces

Square (3 mm) Edge Profile					
With 2" Notch for Use with Kick Panels					
26"	26"	49"	UPAC2648SW	\$717	+\$47
With 3" Notch for Use with Answer Panels and Montage Frames					
27"	27"	50"	UPAC2748SW	\$717	+\$48
With 4" Notch for Use with Pathways Technology Wall Panels					
28"	28"	51"	UPAC2848SW	\$717	+\$49
·	·	·	·	·	·

Jetty, Curved-Front Worksurfaces

Wood Veneer

Jetty, Curved-Front Worksurfaces, Wood Veneer

SIN 711.8



Tip: Illustration above shows a left-hand worksurface.

Tip: Worksurfaces for panel-mounted and frame-supported applications include alignment slots to accept two cabby or two elliptical legs.

Tip: Supports for freestanding and panel-mounted applications must be specified separately.

Tip: Jetty, curved-front worksurfaces are recommended for use with other curved-front shapes such as corner, curved-front worksurfaces.
▶ Page H28

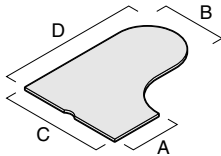
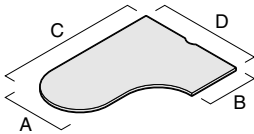

Standard Includes	Required to Specify
<ul style="list-style-type: none"> • Worksurface: wood veneer • Square (3 mm) edge profile on front edge: wood • Flat profile on side and back edges: matching veneer • Cable scallop on back edge 	1 Style number 2 Wood color number for worksurface 3 Options, if selected (see below) ▶ See <i>Surface Materials</i> , page H124.

Options	Price	Required to Specify
Surface Materials <ul style="list-style-type: none"> • Customiz stain • Full-fill finish 	Prices below Prices below	Specify <i>with Customiz stain</i> . ▶ See <i>Surface Materials Reference Manual</i> . Specify full-fill finish number.
Scallops <ul style="list-style-type: none"> • Omit scallop 	No cost	Specify <i>omit scallop</i> .
Related Products <ul style="list-style-type: none"> • Legs and supports for Systems Worksurfaces • Panel-mounted worksurface supports 		▶ Page H48 ▶ Pages H49–H55

Specification Information			
Planning Dimensions	Style Number	Base Price	Option
A B C D			(Add \$ to Base Price)
.....	Customiz Stain or Full-Fill Finish

Square (3 mm) Edge Profile

Left-Hand Worksurfaces							
Depth	Width	Depth	Width	Style Number	Base Price	Option	
30"	24"	66"	48"	UJC3268LSW	\$864	+\$68	
30"	24"	72"	48"	UJC3228LSW	\$895	+\$70	
30"	24"	78"	48"	UJC3288LSW	\$925	+\$74	
30"	30"	66"	48"	UJC3368LSW	\$884	+\$68	
30"	30"	72"	48"	UJC3328LSW	\$915	+\$70	
30"	30"	78"	48"	UJC3388LSW	\$946	+\$74	
Right-Hand Worksurfaces							
Depth	Width	Depth	Width	Style Number	Base Price	Option	
24"	30"	48"	66"	UJC2386RSW	\$864	+\$68	
24"	30"	48"	72"	UJC2382RSW	\$895	+\$70	
24"	30"	48"	78"	UJC2388RSW	\$925	+\$74	
30"	30"	48"	66"	UJC3386RSW	\$884	+\$68	
30"	30"	48"	72"	UJC3382RSW	\$915	+\$70	
30"	30"	48"	78"	UJC3388RSW	\$946	+\$74	

Bubble Jetty Worksurfaces

Wood Veneer

SIN 711.8



Tip: Illustration above shows a left-hand worksurface.

Tip: Worksurfaces for panel-mounted and frame-supported applications include alignment slots to accept two cabby or two elliptical legs.

Tip: Supports for freestanding and panel-mounted applications must be specified separately.

Standard Includes	Required to Specify
-------------------	---------------------

- Worksurface: wood veneer
- Square (3 mm) edge profile on front edge: wood
- Flat profile on side and back edges: matching veneer

- 1 Style number
- 2 Wood color number for worksurface
- 3 Options, if selected (see below)
- ▶ See *Surface Materials*, page H124.

Surface Materials	Options	Price	Required to Specify
-------------------	---------	-------	---------------------

Surface Materials	• Customiz stain	Prices below	Specify with <i>Customiz stain</i> .
	• Full-fill finish	Prices below	▶ See <i>Surface Materials Reference Manual</i> . Specify full-fill finish number.

Related Products	• Legs and supports for Systems Worksurfaces	▶ Page H48
	• Panel-mounted worksurface supports	▶ Pages H49–H55

Specification Information

Planning Dimensions	Style Number	Base Price	Option
A	B		(Add \$ to Base Price)
:	:	:	Customiz Stain or
:	:	:	Full-Fill Finish



Square (3 mm) Edge Profile

Left-Hand Worksurfaces

24"	30"	UJBC2430LSW	\$827	+\$35
24"	36"	UJBC2436LSW	\$861	+\$37
24"	42"	UJBC2442LSW	\$895	+\$41
24"	48"	UJBC2448LSW	\$929	+\$47

Right-Hand Worksurfaces

24"	30"	UJBC2430RSW	\$827	+\$35
24"	36"	UJBC2436RSW	\$861	+\$37
24"	42"	UJBC2442RSW	\$895	+\$41
24"	48"	UJBC2448RSW	\$929	+\$47

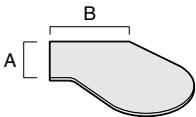
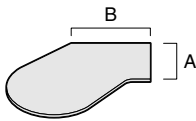

Visitor and Linking, Straight-Front Worksurfaces

Wood Veneer

Visitor and Linking,
Straight-Front Worksurfaces,
Wood Veneer

SIN 711.8

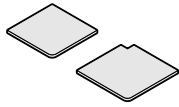

Tip: Worksurfaces for panel-mounted and frame-supported applications include alignment slots to accept one cabby or one elliptical leg.

Tip: Supports for panel-mounted applications must be specified separately.

Tip: Visitor and linking, straight-front worksurfaces are recommended for use with other straight-front shapes such as corner, straight-front worksurfaces.

▶ Page H26

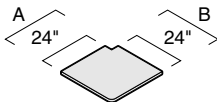
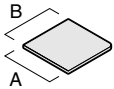
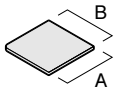

Standard Includes

- Worksurface: wood veneer
- Square (3 mm) edge profile on front edge: wood
- Flat profile on side and back edges: matching veneer

Required to Specify

- 1 Style number
 - 2 Wood color number for worksurface
 - 3 Options, if selected (see below)
- ▶ See *Surface Materials*, page H124.

Options

Options	Price	Required to Specify
Surface Materials		
• Customiz stain	+\$32	Specify with <i>Customiz stain</i> .
• Full-fill finish	+\$32	▶ See <i>Surface Materials Reference Manual</i> . Specify full-fill finish number.

Related Products		Required to Specify
• Legs and supports for Systems Worksurfaces		▶ Page H48
• Panel-mounted worksurface supports		▶ Pages H49–H55

Specification Information

Planning Dimensions	Style Number	Base Price
A B		

Visitor, Straight-Front Worksurfaces

Square (3 mm) Edge Profile			
Left-Hand Worksurfaces			
24"	24"	UV2424LSW	\$559
30"	30"	UV3030LSW	\$596
Right-Hand Worksurfaces			
24"	24"	UV2424RSW	\$559
30"	30"	UV3030RSW	\$596

Linking, Straight-Front Worksurfaces

Square (3 mm) Edge Profile			
With 2" Notch for Use with Kick Panels			
26"	26"	UL2626SW	\$646
With 3" Notch for Use with Answer Panels and Montage Frames			
27"	27"	UL2727SW	\$646
With 4" Notch for Use with Pathways Technology Wall Panels			
28"	28"	UL2828SW	\$646

Visitor and Linking, Curved-Front Worksurfaces

Wood Veneer

SIN 711.8

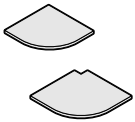

Tip: Worksurfaces for panel-mounted and frame-supported applications include alignment slots to accept one cabby or one elliptical leg.

Tip: Supports for panel-mounted applications must be specified separately.

Tip: Visitor and linking, curved-front worksurfaces are recommended for use with other curved-front shapes such as corner, curved-front worksurfaces.

▶ Page H28

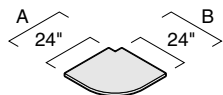
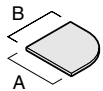
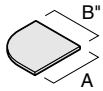

Standard Includes

- Worksurface: wood veneer
- Square (3 mm) edge profile on front edge: wood
- Flat profile on side and back edges: matching veneer

Required to Specify

- 1 Style number
 - 2 Wood color number for worksurface
 - 3 Options, if selected (see below)
- ▶ See *Surface Materials*, page H124.

Options

Options	Price	Required to Specify
Surface Materials		
• Customiz stain	+\$32	Specify with <i>Customiz stain</i> .
• Full-fill finish	+\$32	▶ See <i>Surface Materials Reference Manual</i> . Specify full-fill finish number.

Related Products	Price	Required to Specify
• Legs and supports for Systems Worksurfaces		▶ Page H48
• Panel-mounted worksurface supports		▶ Pages H49–H55

Specification Information

Planning Dimensions	Style Number	Base Price
A	B	
:	:	:

Visitor, Curved-Front Worksurfaces

Square (3 mm) Edge Profile			
Left-Hand Worksurfaces			
24"	24"	UVC2424LSW	\$559
30"	30"	UVC3030LSW	\$596
Right-Hand Worksurfaces			
24"	24"	UVC2424RSW	\$559
30"	30"	UVC3030RSW	\$596

Linking, Curved-Front Worksurfaces

Square (3 mm) Edge Profile			
With 2" Notch for Use with Kick Panels			
26"	26"	ULC2626SW	\$646
With 3" Notch for Use with Answer Panels and Montage Frames			
27"	27"	ULC2727SW	\$646
With 4" Notch for Use with Pathways Technology Wall Panels			
28"	28"	ULC2828SW	\$646

Transaction Worksurfaces

Wood Veneer

Transaction Worksurfaces,
Wood Veneer

SIN 711.8

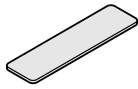

Standard Includes	Required to Specify
<ul style="list-style-type: none"> • Worksurface: wood veneer • Square (3 mm) edge profile on all edges: wood • Top caps for use with Answer panels, if selected: paint • Support brackets: black paint only 	<ol style="list-style-type: none"> 1 Style number 2 Wood color number for worksurface 3 Paint color number for top caps, if selected 4 Options, if selected (see below) <p>▶ See <i>Surface Materials</i>, page H124.</p>

Options	Price	Required to Specify
Surface Materials		
• Customiz stain	Prices below	Specify <i>with Customiz stain</i> .
• Full-fill finish	Prices below	▶ See <i>Surface Materials Reference Manual</i> . Specify full-fill finish number.
Top caps for use with Answer panels		
• Wood veneer	+\$88	Specify <i>with wood top cap</i> and select wood color number.
• Customiz stain on wood	No cost	Specify <i>with Customiz stain</i> .

Specification Information			
Planning Dimensions	Style Number	Base Price	Option
A B	:	:	:
:	:	:	:(Add \$ to Base Price)
:	:	:	: Customiz Stain or Full-Fill Finish

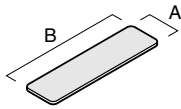

Transaction Worksurfaces

Square (3 mm) Edge Profile					
With Brackets for Use with Kick Panels					
16"	36"	UTR1636KSW	\$518	+\$41	
16"	42"	UTR1642KSW	\$537	+\$41	
16"	48"	UTR1648KSW	\$555	+\$41	
16"	60"	UTR1660KSW	\$608	+\$60	
With Brackets and Top Caps for Use with Answer Panels					
16"	36"	UTR1636ASW	\$518	+\$41	
16"	42"	UTR1642ASW	\$537	+\$41	
16"	48"	UTR1648ASW	\$555	+\$41	
16"	60"	UTR1660ASW	\$608	+\$60	
With Brackets for Use with Montage Frames					
16"	36"	UTR1636MSW	\$518	+\$41	
16"	42"	UTR1642MSW	\$537	+\$41	
16"	48"	UTR1648MSW	\$555	+\$41	
16"	60"	UTR1660MSW	\$608	+\$60	
With Brackets for Use with Pathways Technology Wall Panels					
16"	36"	UTR1636PSW	\$518	+\$41	
16"	42"	UTR1642PSW	\$537	+\$41	
16"	48"	UTR1648PSW	\$555	+\$41	
16"	60"	UTR1660PSW	\$608	+\$60	
:	:	:	:	:	:

Legs and Supports for Systems Worksurfaces

without Alignment Tab

SIN 711.8

Tip: For leg and support guidelines, refer to the Unison Leg Matrix.

▶ Page H130

Tip: Height dimensions listed are nominal and include the thickness of a worksurface.

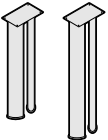
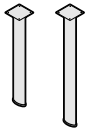

Tip: Double post legs can be used as a shared or column support in applications with other post legs.

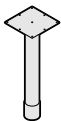
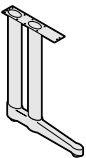

Standard Includes	Required to Specify
<ul style="list-style-type: none"> • Legs and column: paint • Attachment hardware • Caster, if selected: black plastic only 	<ul style="list-style-type: none"> 1 Style number 2 Paint color number for leg or column ▶ See <i>Surface Materials</i>, page H124.

Specification Information

• Planning Height	• Style Number	• Price

Single Post Legs

28½"	TS7SPL	\$105
------	---------------	-------

Standing Height

41½"	TS7SPLS	\$124
------	----------------	-------

Nesting Post Leg

26"	TS7NPL	\$ 97
-----	---------------	-------

Single Post Leg with Caster

28½"	TS7SPLC	\$126
------	----------------	-------

Nesting Post Leg with Caster

26"	TS7NPLC	\$118
-----	----------------	-------

Double Post Legs

28½"	TS7DPL	\$279
------	---------------	-------

Standing Height

41½"	TS7DPLS	\$328
------	----------------	-------

Double Post C-Leg

28½"	TS7CL	\$318
------	--------------	-------

Adjustable Column

28½"	ZAP	\$279
------	------------	-------

Panel-Mounted Worksurface Supports

for Use with Answer, Kick, and Pathways Technology Wall Panels

Panel-Mounted Worksurface
Supports for Use with
Answer, Kick, and Pathways
Technology Wall Panels

SIN 711.8

Cantilevers

Standard Includes	Required to Specify
<ul style="list-style-type: none"> • Cantilever: paint • Tie plate • Attachment hardware 	Style number

Specification Information

Style Number	Price

On-Module Cantilever

UCANT	\$ 85

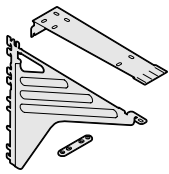

Tip: Answer panel junctions can accommodate only one cantilever at a seam.

Tip: 30" deep straight and transition worksurfaces require additional support along the front edge, such as a pedestal, post leg, or side support brackets.

Off-Module Cantilever (For Pathways Technology Wall Panel only)

UCANTOM	\$125

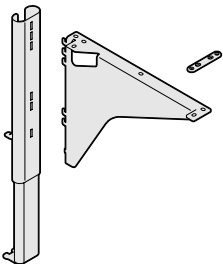

Tip: Pathways Technology Wall panel must be specified with a functional off-module rail and a segmented skin 12" above base.

Panel-Mounted Worksurface Supports, continued
for Use with Answer, Kick, and Pathways Technology Wall Panels

SIN 711.8

Side Support Brackets



Tip: Side support bracket includes a pair of handed brackets, only one of which is required for rear corner support of panel-mounted corner worksurfaces. Specify one for every two corner worksurfaces in on-module applications. Order an additional supply for off-module fin wall applications.

Standard Includes	Required to Specify
<ul style="list-style-type: none"> • Pair of handed side support brackets: black paint only • Attachment hardware 	Style number

Specification Information

Style Number	Price
USSBR	\$30

Support Plate

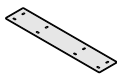

Tip: Support plate can also be used in freestanding and Montage applications.

Standard Includes	Required to Specify
<ul style="list-style-type: none"> • Support plate: black paint only • Attachment hardware 	Style number

Specification Information

Dimensions	Style Number	Price
14"D	TS714WSP	\$53
20"D	TS720WSP	\$53

Tie Plates



Standard Includes	Required to Specify
<ul style="list-style-type: none"> • Package of six tie plates: black paint only • Attachment hardware 	Style number

Specification Information

Dimensions	Style Number	Price
3¾"L	TS7TIEPLATE	\$78

Reinforcing Channel

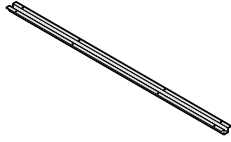

Tip: Reinforcing channel is recommended to add support to worksurfaces that have 60" or more of unsupported kneespace.

Tip: Reinforcing channel can also be used in freestanding or Montage applications.

Standard Includes	Required to Specify
<ul style="list-style-type: none"> Reinforcing channel: black paint only Attachment hardware 	Style number

Specification Information

Dimensions	Style Number	Price
57"W	TS7WKSPT	\$40

Center Support Panels

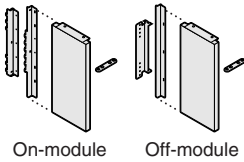

Standard Includes	Required to Specify
<ul style="list-style-type: none"> Center support panel: paint price group 1 Tie plate Attachment hardware 	1 Style number 2 Paint color number for center support panel 3 Options, if selected (see below) ▶ See <i>Surface Materials</i> , page H124.

Options	Price	Required to Specify
Surface Materials	<ul style="list-style-type: none"> Paint price group 1: No cost Paint price group 2: +\$12 Paint price group 3: +\$18 	Specify paint color number. Specify paint color number. Specify paint color number.

Specification Information

Planning Dimensions	Style Number	Base Price
D H		

On-Module Center Support Panel

11"	28½"	UCSP	\$ 95
Standing Height			
11"	41½"	UCSPS	\$112

Off-Module Center Support Panel (For Pathways Technology Wall Panel only)

11"	28½"	UCSPOM	\$ 95
Standing Height			
11"	41½"	UCSPSOM	\$112

Panel-Mounted Worksurface Supports, continued
for Use with Answer, Kick, and Pathways Technology Wall Panels

SIN 711.8

End Panels

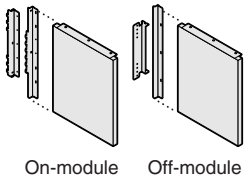

Standard Includes	Required to Specify
<ul style="list-style-type: none"> • End panel: paint price group 1 • Attachment hardware 	<ul style="list-style-type: none"> 1 Style number 2 Paint color number for end panel 3 Options, if selected (see below) ▶ See <i>Surface Materials</i>, page H124.

Options	Price	Required to Specify
Surface Materials <ul style="list-style-type: none"> • Paint price group 1 • Paint price group 2 • Paint price group 3 	No cost +\$25 +\$43	Specify paint color number. Specify paint color number. Specify paint color number.

Specification Information

Planning Dimensions	Style Number	Base Price
D H		

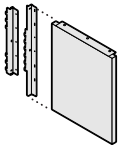

On-Module End Panel

24"	28½"	UEP24	\$305
30"	28½"	UEP30	\$345

Standing Height

24"	41½"	UEP24S	\$359
30"	41½"	UEP30S	\$405

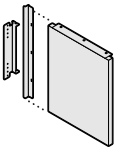

Off-Module End Panel (For Pathways Technology Wall Panel only)

24"	28½"	UEP24OM	\$305
30"	28½"	UEP30OM	\$345

Standing Height

24"	41½"	UEP24SOM	\$359
30"	41½"	UEP30SOM	\$405

Panel-Mounted Worksurface Supports

for Use with Montage Frames

Panel-Mounted
Worksurface Supports for
Use with Montage Frames

SIN 711.8

Cantilevers

Tip: All cantilevers work in on-module vertical upright situations only.

Standard Includes	Required to Specify
<ul style="list-style-type: none"> • Cantilever: paint • Attachment hardware 	1 Style number 2 Paint color number for cantilevers ▶ See <i>Surface Materials</i> , page H124.

Specification Information

Style Number	Price

On-Module Cantilevers

Non-Handed Cantilever

ZCB \$ 85

Shared Cantilever

ZCSB \$147

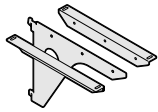
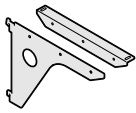

Tip: Shared cantilevers can support bubble visitor, jetty, bubble jetty, and visitor worksurfaces.

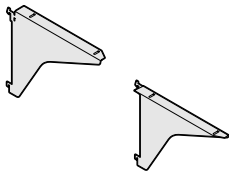

Tip: End-of-run cantilevers are used at the end of a corner worksurface.

End-of-Run Cantilevers

Left-Hand End-of-Run Cantilever

ZCEL \$ 85

Right-Hand End-of-Run Cantilever

ZCER \$ 85

Adjustable-Height Cantilevers

Left-Hand Adjustable-Height Cantilever

ZCAL \$356

Right-Hand Adjustable-Height Cantilever

ZCAR \$356

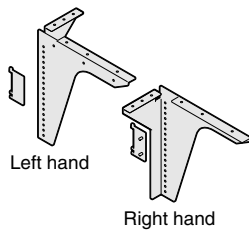

Tip: Adjustable-height cantilevers require a third cantilever to support rear of corner worksurface.

Panel-Mounted Worksurface Supports, continued
for Use with Montage Frames

SIN 711.8

Side Support Bracket

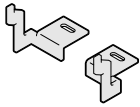

Tip: Side support bracket includes a pair of handed brackets, only one of which is required for rear corner support of panel-mounted corner worksurfaces. Specify one for every two corner worksurfaces in on-module applications. Order an additional supply for off-module fin wall applications.

Standard Includes	Required to Specify
<ul style="list-style-type: none"> • Pair of handed side support brackets: black paint only • Attachment hardware 	Style number

Specification Information

• Style Number	• Price
ZBES	\$30
•	•

Off-Module Worksurface Bracket



Tip: Brackets are used in off-module situations only.

Tip: Off-module brackets must be used in conjunction with on-module cantilevers to provide forward worksurface tip support.

Standard Includes	Required to Specify
<ul style="list-style-type: none"> • Off-module worksurface bracket: paint • Attachment hardware 	1 Style number 2 Paint color number for off-module worksurface bracket ▶ See <i>Surface Materials</i> , page H124.

Specification Information

• Style Number	• Price
ZBWOM	\$56
•	•

Off-Module Tie Plate



Tip: Tie plate is used in conjunction with an off-module worksurface bracket.

Tip: Support plate and reinforcing channel can also be used.

▶ Pages H50–H51

Standard Includes	Required to Specify
<ul style="list-style-type: none"> • Package of five tie plates: black paint only • Attachment hardware 	Style number

Specification Information

• Style Number	• Price
ZBTP	\$45
•	•

End Panels

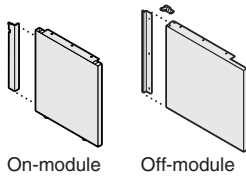

Standard Includes	Required to Specify
<ul style="list-style-type: none"> • End panel: paint price group 1 • Attachment hardware 	<ul style="list-style-type: none"> 1 Style number 2 Paint color number for end panel 3 Options, if selected (see below) ▶ See <i>Surface Materials</i>, page H124.

Options	Price	Required to Specify
Surface Materials <ul style="list-style-type: none"> • Paint price group 1 • Paint price group 2 • Paint price group 3 	No cost +\$17 +\$29	Specify paint color number. Specify paint color number. Specify paint color number.

Specification Information

Planning Dimensions	Style Number	Base Price
D H		

On-Module End Panel

Left-Hand

24"	28½"	ZEP24LH	\$305
30"	28½"	ZEP30LH	\$345

Right-Hand

24"	28½"	ZEP24RH	\$305
30"	28½"	ZEP30RH	\$345

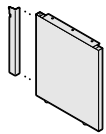

Tip: On-module end panels work in on-module vertical upright situations only.

Tip: On-module end panels can be converted to off-module end panels by ordering a panel package from Service Parts.

Off-Module End Panel

Left-Hand

24"	28½"	ZEP24LHOM	\$305
30"	28½"	ZEP30LHOM	\$345

Right-Hand

24"	28½"	ZEP24RHOM	\$305
30"	28½"	ZEP30RHOM	\$345

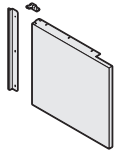

Tip: Off-module end panels work in off-module situations only.

Tip: Off-module end panels can be converted to on-module end panels by ordering a panel package from Service Parts.

Specifying Freestanding Worksurfaces

Worksurfaces

Straight Worksurfaces (SIN 711.8)	H58
Transition Worksurfaces (SIN 711.8)	H60
Corner, Straight-Front Worksurfaces (SIN 711.8)	H63
30" Radius Corner, Straight-Front Worksurfaces (SIN 711.8)	H64
30" Radius Corner, Curved-Front Worksurfaces (SIN 711.8)	H65
Extended Corner, Straight-Front Worksurfaces (SIN 711.8)	H66
Corner, 120° Worksurfaces (SIN 711.8)	H70
Capsule Worksurfaces (SIN 711.8)	H71
Spanner Worksurfaces (SIN 711.8)	H72
Peninsula Worksurfaces (SIN 711.8)	H73
Tapered Peninsula Worksurfaces (SIN 711.8)	H74
Bubble Jetty Worksurfaces (SIN 711.8)	H76
Round Worksurfaces (SIN 711.8)	H78
Square Worksurfaces (SIN 711.8)	H79
Rectangle Worksurfaces (SIN 711.8)	H80
Split-Round Worksurfaces for Use with Pathways Post and Beam (SIN 711.8)	H81
Tethered Capsule Worksurfaces for Use with Pathways Post and Beam (SIN 711.8)	H82

Legs and Supports for Freestanding Worksurfaces (SIN 711.8)

H84

Wiring and Cabling Accessories (SIN 711.8)

H86

Straight Worksurfaces

Wood Veneer

SIN 711.8

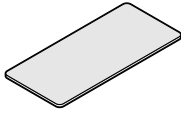

Standard Includes	Required to Specify
<ul style="list-style-type: none"> • Worksurface: wood veneer • Square (3 mm) or tapered profile on all sides, if selected: wood • Vinyl P-edge profile on all sides, if selected: 6000 Black plastic only • Reinforcing brace for worksurfaces wider than 60"W 	<ul style="list-style-type: none"> 1 Style number 2 Wood color number for worksurface 3 Options, if selected (see below) ▶ See <i>Surface Materials</i>, page H124.

Options	Price	Required to Specify
Surface Materials <ul style="list-style-type: none"> • Customiz stain • Full-fill finish 	Prices below and at right Prices below and at right	Specify <i>with Customiz stain</i> . ▶ See <i>Surface Materials Reference Manual</i> . Specify full-fill finish number.

Related Products	Options	Price	Required to Specify
<ul style="list-style-type: none"> • Legs and supports for Freestanding Worksurfaces • Pivot hitch • Tether bracket for use with Pathways Post and Beam • Wiring and Cabling • Pathways Post and Beam 			<ul style="list-style-type: none"> ▶ Page H84 ▶ Page H84 ▶ Page H85 ▶ Page H86 ▶ See <i>Pathways Post and Beam Solutions Specification Guide</i>.

Tip: Legs to support free-standing worksurfaces must be specified separately.

Tip: For leg and support guidelines, refer to the Unison Leg Matrix.
▶ Page H130

Tip: Tether brackets to attach to Pathways Post and Beam fence must be specified separately.

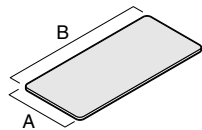

Specification Information

Planning Dimensions	Style Number	Base Price	Option
A B			(Add \$ to Base Price)
:	:	:	Customiz Stain or Full-Fill Finish

Square (3 mm) Edge Profile				
A	B	Style Number	Base Price	Option
24"	30"	BFS2430SW	\$376	+\$32
24"	36"	BFS2436SW	\$386	+\$33
24"	42"	BFS2442SW	\$431	+\$37
24"	48"	BFS2448SW	\$465	+\$38
24"	54"	BFS2454SW	\$481	+\$40
24"	60"	BFS2460SW	\$528	+\$43
24"	66"	BFS2466SW	\$557	+\$44
24"	72"	BFS2472SW	\$592	+\$46
24"	78"	BFS2478SW	\$622	+\$47
30"	36"	BFS3036SW	\$453	+\$35
30"	42"	BFS3042SW	\$498	+\$38
30"	48"	BFS3048SW	\$532	+\$40
30"	54"	BFS3054SW	\$552	+\$41
30"	60"	BFS3060SW	\$601	+\$44
30"	66"	BFS3066SW	\$631	+\$46
30"	72"	BFS3072SW	\$664	+\$47
30"	78"	BFS3078SW	\$694	+\$49
:	:	:	:	:

▶ Specification Information continued on next page

► Specification Information continued from previous page

Specification Information

Planning Dimensions		Style Number	Base Price	Option (Add \$ to Base Price) Customiz Stain or Full-Fill Finish
A	B			

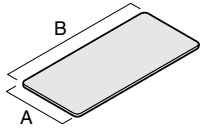

Tapered Edge Profile				
24"	30"	BFS2430BW	\$501	+\$32
24"	36"	BFS2436BW	\$511	+\$33
24"	42"	BFS2442BW	\$566	+\$37
24"	48"	BFS2448BW	\$600	+\$38
24"	54"	BFS2454BW	\$616	+\$40
24"	60"	BFS2460BW	\$673	+\$43
24"	66"	BFS2466BW	\$702	+\$44
24"	72"	BFS2472BW	\$737	+\$46
24"	78"	BFS2478BW	\$767	+\$47
30"	36"	BFS3036BW	\$578	+\$35
30"	42"	BFS3042BW	\$623	+\$38
30"	48"	BFS3048BW	\$667	+\$40
30"	54"	BFS3054BW	\$687	+\$41
30"	60"	BFS3060BW	\$736	+\$44
30"	66"	BFS3066BW	\$776	+\$46
30"	72"	BFS3072BW	\$809	+\$47
30"	78"	BFS3078BW	\$839	+\$49
:	:	:	:	:

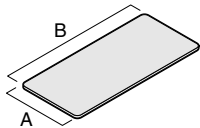

P-Edge Profile				
24"	30"	BFS2430V	\$396	+\$32
24"	36"	BFS2436V	\$406	+\$33
24"	42"	BFS2442V	\$456	+\$37
24"	48"	BFS2448V	\$490	+\$38
24"	54"	BFS2454V	\$506	+\$40
24"	60"	BFS2460V	\$558	+\$43
24"	66"	BFS2466V	\$587	+\$44
24"	72"	BFS2472V	\$622	+\$46
24"	78"	BFS2478V	\$652	+\$47
30"	36"	BFS3036V	\$473	+\$35
30"	42"	BFS3042V	\$523	+\$38
30"	48"	BFS3048V	\$557	+\$40
30"	54"	BFS3054V	\$577	+\$41
30"	60"	BFS3060V	\$631	+\$44
30"	66"	BFS3066V	\$661	+\$46
30"	72"	BFS3072V	\$694	+\$47
30"	78"	BFS3078V	\$724	+\$49
:	:	:	:	:

Transition Worksurfaces

Wood Veneer

SIN 711.8

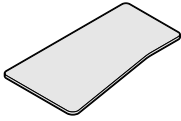

Tip: Illustration above shows a right-hand worksurface.

Tip: Legs to support free-standing worksurfaces must be specified separately.

Tip: For leg and support guidelines, refer to the Unison Leg Matrix.
▶ Page H130

Tip: Tether brackets to attach to Pathways Post and Beam fence must be specified separately.

Standard Includes	Required to Specify
<ul style="list-style-type: none"> • Worksurface: wood veneer • Square (3 mm) or tapered profile on all sides, if selected: wood • Vinyl P-edge profile on all sides, if selected: 6000 Black plastic only • Reinforcing brace for worksurfaces wider than 60"W 	<ol style="list-style-type: none"> 1 Style number 2 Wood color number for worksurface 3 Options, if selected (see below) <p>▶ See <i>Surface Materials</i>, page H124.</p>

Options	Price	Required to Specify
Surface Materials <ul style="list-style-type: none"> • Customiz stain • Full-fill finish 	Prices below and at right Prices below and at right	Specify with <i>Customiz stain</i> . ▶ See <i>Surface Materials Reference Manual</i> . Specify full-fill finish number.

Related Products	Price	Required to Specify
<ul style="list-style-type: none"> • Legs and supports for Freestanding Worksurfaces • Pivot hitch • Tether bracket for use with Pathways Post and Beam • Wiring and Cabling • Pathways Post and Beam 		▶ Page H84 ▶ Page H84 ▶ Page H85 ▶ Page H86 ▶ See <i>Pathways Post and Beam Solutions Specification Guide</i> .

Specification Information

Planning Dimensions	Style Number	Base Price	Option
A B C			(Add \$ to Base Price)
			Customiz Stain or Full-Fill Finish



Square (3 mm) Edge Profile

Left-Hand Worksurfaces

30"	24"	60"	BZC302460SW	\$777	+\$47
30"	24"	66"	BZC302466SW	\$798	+\$49
30"	24"	72"	BZC302472SW	\$818	+\$50
30"	24"	78"	BZC302478SW	\$836	+\$52
36"	30"	60"	BZC363060SW	\$836	+\$59
36"	30"	66"	BZC363066SW	\$854	+\$52
36"	30"	72"	BZC363072SW	\$873	+\$53
36"	30"	78"	BZC363078SW	\$892	+\$55

Right-Hand Worksurfaces

24"	30"	60"	BZC243060SW	\$777	+\$47
24"	30"	66"	BZC243066SW	\$798	+\$49
24"	30"	72"	BZC243072SW	\$818	+\$50
24"	30"	78"	BZC243078SW	\$836	+\$52
30"	36"	60"	BZC303660SW	\$836	+\$59
30"	36"	66"	BZC303666SW	\$854	+\$52
30"	36"	72"	BZC303672SW	\$873	+\$53
30"	36"	78"	BZC303678SW	\$892	+\$55

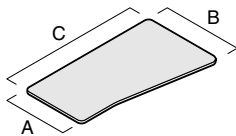
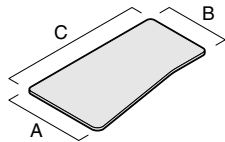

▶ Specification Information continued on next page

► Specification Information continued from previous page

Specification Information

Planning Dimensions			Style Number	Base Price	Option
A	B	C			(Add \$ to Base Price)
					Customiz Stain or Full-Fill Finish

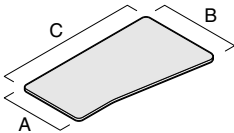
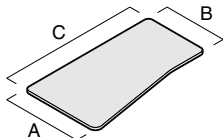

Tapered Edge Profile

Left-Hand Worksurfaces

30"	24"	60"	BZC302460BW	\$ 962	+\$47
30"	24"	66"	BZC302466BW	\$ 982	+\$49
30"	24"	72"	BZC302472BW	\$1003	+\$50
30"	24"	78"	BZC302478BW	\$1023	+\$52
36"	30"	60"	BZC363060BW	\$1023	+\$59
36"	30"	66"	BZC363066BW	\$1043	+\$52
36"	30"	72"	BZC363072BW	\$1063	+\$53
36"	30"	78"	BZC363078BW	\$1084	+\$55

Right-Hand Worksurfaces

24"	30"	60"	BZC243060BW	\$ 962	+\$47
24"	30"	66"	BZC243066BW	\$ 982	+\$49
24"	30"	72"	BZC243072BW	\$1003	+\$50
24"	30"	78"	BZC243078BW	\$1023	+\$52
30"	36"	60"	BZC303660BW	\$1023	+\$59
30"	36"	66"	BZC303666BW	\$1043	+\$52
30"	36"	72"	BZC303672BW	\$1063	+\$53
30"	36"	78"	BZC303678BW	\$1084	+\$55

► Specification Information continued on next page



Transition Worksurfaces, continued

SIN 711.8

► Specification Information continued from previous page

Specification Information

Planning Dimensions			Style Number	Base Price	Option (Add \$ to Base Price)
A	B	C			

P-Edge Profile



Left-Hand Worksurfaces

30"	24"	60"	BZC302460V	\$822	+\$47
30"	24"	66"	BZC302466V	\$842	+\$49
30"	24"	72"	BZC302472V	\$863	+\$50
30"	24"	78"	BZC302478V	\$883	+\$52
36"	30"	60"	BZC363060V	\$883	+\$59
36"	30"	66"	BZC363066V	\$903	+\$52
36"	30"	72"	BZC363072V	\$923	+\$53
36"	30"	78"	BZC363078V	\$944	+\$55

Right-Hand Worksurfaces

24"	30"	60"	BZC243060V	\$822	+\$47
24"	30"	66"	BZC243066V	\$842	+\$49
24"	30"	72"	BZC243072V	\$863	+\$50
24"	30"	78"	BZC243078V	\$883	+\$52
30"	36"	60"	BZC303660V	\$883	+\$59
30"	36"	66"	BZC303666V	\$903	+\$52
30"	36"	72"	BZC303672V	\$923	+\$53
30"	36"	78"	BZC303678V	\$944	+\$55

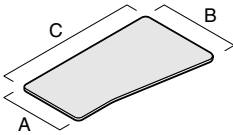
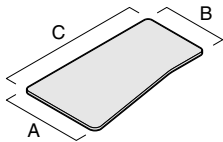

Corner, Straight-Front Worksurfaces

Wood Veneer

Corner, Straight-Front Worksurfaces, Wood Veneer

SIN 711.8



Tip: Legs to support free-standing worksurfaces must be specified separately.

Tip: For leg and support guidelines, refer to the Unison Leg Matrix.
▶ Page H130

Tip: Tether brackets to attach to Pathways Post and Beam fence must be specified separately.

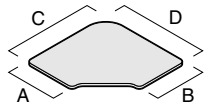

Standard Includes	Required to Specify
-------------------	---------------------

- Worksurface: wood veneer
- Square (3 mm) or tapered profile on all sides, if selected: wood
- Vinyl P-edge profile on all sides, if selected: 6000 Black plastic only

- 1 Style number
 - 2 Wood color number for worksurface
 - 3 Options, if selected (see below)
- ▶ See *Surface Materials*, page H124.

Options	Price	Required to Specify
---------	-------	---------------------

Surface Materials

- Customiz stain Prices below
- Full-fill finish Prices below

Specify with *Customiz stain*.
▶ See *Surface Materials Reference Manual*. Specify full-fill finish number.

Related Products

- Legs and supports for Freestanding Worksurfaces
- Tether bracket for use with Pathways Post and Beam
- Wiring and Cabling
- Pathways Post and Beam

- ▶ Page H84
- ▶ Page H85
- ▶ Page H86
- ▶ See *Pathways Post and Beam Solutions Specification Guide*.

Specification Information

• Planning Dimensions				• Style Number	• Base Price	• Option (Add \$ to Base Price)
A	B	C	D			Customiz Stain or Full-Fill Finish

Square (3 mm) Edge Profile						
24"	24"	42"	42"	BFC224242SW	\$537	+\$48
24"	24"	48"	48"	BFC224848SW	\$581	+\$50
30"	24"	48"	48"	BFC324848SW	\$601	+\$49
24"	30"	48"	48"	BFC234848SW	\$601	+\$49
30"	30"	48"	48"	BFC334848SW	\$619	+\$52

Tapered Edge Profile						
24"	24"	42"	42"	BFC224242BW	\$682	+\$48
24"	24"	48"	48"	BFC224848BW	\$726	+\$50
30"	24"	48"	48"	BFC324848BW	\$751	+\$49
24"	30"	48"	48"	BFC234848BW	\$751	+\$49
30"	30"	48"	48"	BFC334848BW	\$764	+\$52

P-Edge Profile						
24"	24"	42"	42"	BFC224242V	\$599	+\$48
24"	24"	48"	48"	BFC224848V	\$643	+\$50
30"	24"	48"	48"	BFC324848V	\$662	+\$49
24"	30"	48"	48"	BFC234848V	\$662	+\$49
30"	30"	48"	48"	BFC334848V	\$681	+\$52

30" Radius Corner, Straight-Front Worksurfaces

Wood Veneer

SIN 711.8



Tip: Legs to support free-standing worksurfaces must be specified separately.

Tip: For leg and support guidelines, refer to the Unison Leg Matrix.

▶ Page H130

Tip: Tether brackets to attach to Pathways Post and Beam fence must be specified separately.

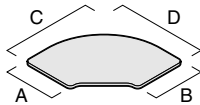

Standard Includes	Required to Specify
-------------------	---------------------

- Worksurface: wood veneer
- Square (3 mm) or tapered profile on all sides, if selected: wood
- Vinyl P-edge profile on all sides, if selected: 6000 Black plastic only

- 1 Style number
 - 2 Wood color number for worksurface
 - 3 Options, if selected (see below)
- ▶ See *Surface Materials*, page H124.

Options	Price	Required to Specify
---------	-------	---------------------

Surface Materials	• Customiz stain	Prices below	Specify <i>with Customiz stain</i> . ▶ See <i>Surface Materials Reference Manual</i> . Specify full-fill finish number.
	• Full-fill finish	Prices below	

Related Products	Price	Required to Specify
------------------	-------	---------------------

- Legs and supports for Freestanding Worksurfaces
- Tether bracket for use with Pathways Post and Beam
- Wiring and Cabling
- Pathways Post and Beam

- ▶ Page H84
▶ Page H85
- ▶ Page H86
▶ See *Pathways Post and Beam Solutions Specification Guide*.

Specification Information

Planning Dimensions	Style Number	Base Price	Option
A B C D			(Add \$ to Base Price)
:	:	:	Customiz Stain or Full-Fill Finish

Square (3 mm) Edge Profile	Style Number	Base Price	Option
----------------------------	--------------	------------	--------

24" 24" 42" 42"	BBC224242SW	\$592	+\$48
24" 24" 48" 48"	BBC224848SW	\$636	+\$50
30" 30" 48" 48"	BBC334848SW	\$674	+\$52

Tapered Edge Profile	Style Number	Base Price	Option
----------------------	--------------	------------	--------

24" 24" 42" 42"	BBC224242BW	\$707	+\$48
24" 24" 48" 48"	BBC224848BW	\$751	+\$50
30" 30" 48" 48"	BBC334848BW	\$789	+\$52

P-Edge Profile	Style Number	Base Price	Option
----------------	--------------	------------	--------

24" 24" 42" 42"	BBC224242V	\$624	+\$48
24" 24" 48" 48"	BBC224848V	\$668	+\$50
30" 30" 48" 48"	BBC334848V	\$706	+\$52

30" Radius Corner, Curved-Front Worksurfaces

Wood Veneer

30" Radius Corner,
Curved-Front Worksurfaces,
Wood Veneer

SIN 711.8



Tip: Legs to support free-standing worksurfaces must be specified separately.

Tip: For leg and support guidelines, refer to the Unison Leg Matrix.

▶ Page H130

Tip: Tether brackets to attach to Pathways Post and Beam fence must be specified separately.

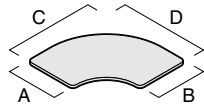

Standard Includes	Required to Specify
-------------------	---------------------

- Worksurface: wood veneer
- Square (3 mm) or tapered profile on all sides, if selected: wood
- Vinyl P-edge profile on all sides, if selected: 6000 Black plastic only

- 1 Style number
 - 2 Wood color number for worksurface
 - 3 Options, if selected (see below)
- ▶ See *Surface Materials*, page H124.

Options	Price	Required to Specify
---------	-------	---------------------

Surface Materials	• Customiz stain	Prices below	Specify with <i>Customiz stain</i> .
	• Full-fill finish	Prices below	▶ See <i>Surface Materials Reference Manual</i> . Specify full-fill finish number.

Related Products	Price	Required to Specify
------------------	-------	---------------------

- Legs and supports for Freestanding Worksurfaces
- Tether bracket for use with Pathways Post and Beam
- Wiring and Cabling
- Pathways Post and Beam

- ▶ Page H84
▶ Page H85
- ▶ Page H86
▶ See *Pathways Post and Beam Solutions Specification Guide*.

Specification Information

• Planning Dimensions				• Style Number	• Base Price	• Option (Add \$ to Base Price)
A	B	C	D			Customiz Stain or Full-Fill Finish

Square (3 mm) Edge Profile						
	24"	24"	42"	42"	BRC224242SW	\$592 +\$48
	24"	24"	48"	48"	BRC224848SW	\$636 +\$50
	30"	30"	48"	48"	BRC334848SW	\$674 +\$53

Tapered Edge Profile						
	24"	24"	42"	42"	BRC224242BW	\$707 +\$48
	24"	24"	48"	48"	BRC224848BW	\$751 +\$50
	30"	30"	48"	48"	BRC334848BW	\$789 +\$53

P-Edge Profile						
	24"	24"	42"	42"	BRC224242V	\$624 +\$48
	24"	24"	48"	48"	BRC224848V	\$668 +\$50
	30"	30"	48"	48"	BRC334848V	\$706 +\$53

Extended Corner, Straight-Front Worksurfaces

Wood Veneer

SIN 711.8

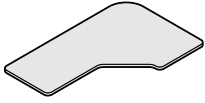

Tip: Illustration above shows a left-hand worksurface.

Tip: Legs to support free-standing worksurfaces must be specified separately.

Tip: For leg and support guidelines, refer to the Unison Leg Matrix.

▶ Page H130

Tip: Tether brackets to attach to Pathways Post and Beam fence must be specified separately.

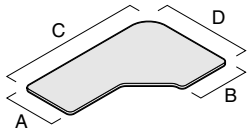

Standard Includes	Required to Specify
-------------------	---------------------

<ul style="list-style-type: none"> • Worksurface: wood veneer • Square (3 mm) or tapered profile on all sides, if selected: wood • Vinyl P-edge profile on all sides, if selected: 6000 Black plastic only • Reinforcing brace for worksurfaces wider than 60"W 	<ul style="list-style-type: none"> 1 Style number 2 Wood color number for worksurface 3 Options, if selected (see below) ▶ See <i>Surface Materials</i>, page H124.
---	---

Options	Price	Required to Specify
---------	-------	---------------------

Surface Materials <ul style="list-style-type: none"> • Customiz stain • Full-fill finish 	Prices below and at right Prices below and at right	Specify with <i>Customiz stain</i> . ▶ See <i>Surface Materials Reference Manual</i> . Specify full-fill finish number.
---	--	---

Related Products	Price	Required to Specify
------------------	-------	---------------------

<ul style="list-style-type: none"> • Legs and supports for Freestanding Worksurfaces • Pivot hitch • Tether bracket for use with Pathways Post and Beam • Wiring and Cabling • Pathways Post and Beam 	<ul style="list-style-type: none"> ▶ Page H84 ▶ Page H84 ▶ Page H85 	<ul style="list-style-type: none"> ▶ Page H86 ▶ See <i>Pathways Post and Beam Solutions Specification Guide</i>.
--	--	--

Specification Information

Planning Dimensions	Style Number	Base Price	Option
A B C D			(Add \$ to Base Price)
:	:	:	Customiz Stain or Full-Fill Finish

Square (3 mm) Edge Profile

Left-Hand Worksurfaces						
Height	Depth	Width	Depth	Style Number	Base Price	Option
24"	24"	60"	42"	BE226042LSW	\$1008	+\$54
24"	24"	66"	42"	BE226642LSW	\$1061	+\$68
24"	24"	72"	42"	BE227242LSW	\$1139	+\$69
24"	24"	78"	42"	BE227842LSW	\$1192	+\$71
24"	24"	60"	48"	BE226048LSW	\$1018	+\$68
24"	24"	66"	48"	BE226648LSW	\$1073	+\$69
24"	24"	72"	48"	BE227248LSW	\$1152	+\$71
24"	24"	78"	48"	BE227848LSW	\$1207	+\$72
30"	24"	60"	48"	BE326048LSW	\$1079	+\$69
30"	24"	66"	48"	BE326648LSW	\$1133	+\$71
30"	24"	72"	48"	BE327248LSW	\$1211	+\$72
30"	24"	78"	48"	BE327848LSW	\$1264	+\$74

▶ Specification Information continued on next page

SIN 711.8

► Specification Information continued from previous page

Specification Information

• Planning Dimensions				• Style Number	• Base Price	• Option
A	B	C	D			(Add \$ to Base Price)
:	:	:	:	:	:	:
:	:	:	:	:	:	Customiz Stain or Full-Fill Finish

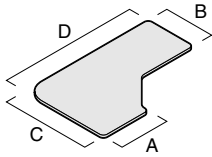

Right-Hand Worksurfaces

24"	24"	42"	60"	BE224260RSW	\$1008	+\$54
24"	24"	42"	66"	BE224266RSW	\$1061	+\$68
24"	24"	42"	72"	BE224272RSW	\$1139	+\$69
24"	24"	42"	78"	BE224278RSW	\$1192	+\$71
24"	24"	48"	60"	BE224860RSW	\$1018	+\$68
24"	24"	48"	66"	BE224866RSW	\$1073	+\$69
24"	24"	48"	72"	BE224872RSW	\$1152	+\$71
24"	24"	48"	78"	BE224878RSW	\$1207	+\$72
30"	24"	48"	60"	BE234860RSW	\$1079	+\$69
30"	24"	48"	66"	BE234866RSW	\$1133	+\$71
30"	24"	48"	72"	BE234872RSW	\$1211	+\$72
30"	24"	48"	78"	BE234878RSW	\$1264	+\$74
:	:	:	:	:	:	:

► Specification Information continued on next page

SIN 711.8

Specification Information

• Planning Dimensions				• Style Number	• Base Price	• Option (Add \$ to Base Price)
A	B	C	D			Customiz Stain or Full-Fill Finish

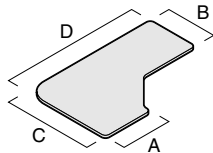
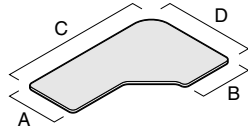

Tapered Edge Profile

Left-Hand Worksurfaces

24"	24"	60"	42"	BE226042LBW	\$1188	+\$54
24"	24"	66"	42"	BE226642LBW	\$1241	+\$68
24"	24"	72"	42"	BE227242LBW	\$1319	+\$69
24"	24"	78"	42"	BE227842LBW	\$1372	+\$71
24"	24"	60"	48"	BE226048LBW	\$1198	+\$68
24"	24"	66"	48"	BE226648LBW	\$1253	+\$69
24"	24"	72"	48"	BE227248LBW	\$1332	+\$71
24"	24"	78"	48"	BE227848LBW	\$1387	+\$72
30"	24"	60"	48"	BE326048LBW	\$1258	+\$69
30"	24"	66"	48"	BE326648LBW	\$1313	+\$71
30"	24"	72"	48"	BE327248LBW	\$1392	+\$72
30"	24"	78"	48"	BE327848LBW	\$1447	+\$74

Right-Hand Worksurfaces

24"	24"	42"	60"	BE224260RBW	\$1188	+\$54
24"	24"	42"	66"	BE224266RBW	\$1241	+\$68
24"	24"	42"	72"	BE224272RBW	\$1319	+\$69
24"	24"	42"	78"	BE224278RBW	\$1372	+\$71
24"	24"	48"	60"	BE224860RBW	\$1198	+\$68
24"	24"	48"	66"	BE224866RBW	\$1253	+\$69
24"	24"	48"	72"	BE224872RBW	\$1332	+\$71
24"	24"	48"	78"	BE224878RBW	\$1387	+\$72
30"	24"	48"	60"	BE234860RBW	\$1258	+\$69
30"	24"	48"	66"	BE234866RBW	\$1313	+\$71
30"	24"	48"	72"	BE234872RBW	\$1392	+\$72
30"	24"	48"	78"	BE234878RBW	\$1447	+\$74

► Specification Information continued on next page

► Specification Information continued from previous page

Specification Information

• Planning Dimensions				• Style Number	• Base Price	• Option
A	B	C	D			(Add \$ to Base Price)
						Customiz Stain or Full-Fill Finish

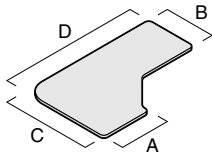
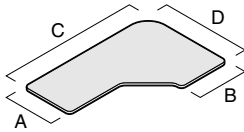

P-Edge Profile

Left-Hand Worksurfaces

24"	24"	60"	42"	BE226042LV	\$1063	+\$54
24"	24"	66"	42"	BE226642LV	\$1116	+\$68
24"	24"	72"	42"	BE227242LV	\$1194	+\$69
24"	24"	78"	42"	BE227842LV	\$1247	+\$71
24"	24"	60"	48"	BE226048LV	\$1073	+\$68
24"	24"	66"	48"	BE226648LV	\$1128	+\$69
24"	24"	72"	48"	BE227248LV	\$1207	+\$71
24"	24"	78"	48"	BE227848LV	\$1262	+\$72
30"	24"	60"	48"	BE326048LV	\$1133	+\$69
30"	24"	66"	48"	BE326648LV	\$1188	+\$71
30"	24"	72"	48"	BE327248LV	\$1267	+\$72
30"	24"	78"	48"	BE327848LV	\$1322	+\$74

Right-Hand Worksurfaces

24"	24"	42"	60"	BE224260RV	\$1063	+\$54
24"	24"	42"	66"	BE224266RV	\$1116	+\$68
24"	24"	42"	72"	BE224272RV	\$1194	+\$69
24"	24"	42"	78"	BE224278RV	\$1247	+\$71
24"	24"	48"	60"	BE224860RV	\$1073	+\$68
24"	24"	48"	66"	BE224866RV	\$1128	+\$69
24"	24"	48"	72"	BE224872RV	\$1207	+\$71
24"	24"	48"	78"	BE224878RV	\$1262	+\$72
30"	24"	48"	60"	BE234860RV	\$1133	+\$69
30"	24"	48"	66"	BE234866RV	\$1188	+\$71
30"	24"	48"	72"	BE234872RV	\$1267	+\$72
30"	24"	48"	78"	BE234878RV	\$1322	+\$74

Corner, 120° Worksurfaces

Wood Veneer

SIN 711.8



Tip: Legs to support free-standing worksurfaces must be specified separately.

Tip: For leg and support guidelines, refer to the Unison Leg Matrix.

▶ Page H130

Tip: Tether brackets to attach to Pathways Post and Beam fence must be specified separately.

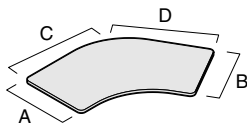

Standard Includes	Required to Specify
<ul style="list-style-type: none"> • Worksurface: wood veneer • Square (3 mm) or tapered profile on all sides, if selected: wood • Vinyl P-edge profile on all sides, if selected: 6000 Black plastic only 	<ul style="list-style-type: none"> 1 Style number 2 Wood color number for worksurface 3 Options, if selected (see below) ▶ See <i>Surface Materials</i>, page H124.

Options	Price	Required to Specify
Surface Materials <ul style="list-style-type: none"> • Customiz stain • Full-fill finish 	<ul style="list-style-type: none"> Prices below Prices below 	<ul style="list-style-type: none"> Specify <i>with Customiz stain</i>. ▶ See <i>Surface Materials Reference Manual</i>. Specify full-fill finish number.

Related Products	Price	Required to Specify
<ul style="list-style-type: none"> • Legs and supports for Freestanding Worksurfaces • Pivot hitch • Tether bracket for use with Pathways Post and Beam • Wiring and Cabling • Pathways Post and Beam 		<ul style="list-style-type: none"> ▶ Page H84 ▶ Page H84 ▶ Page H85 ▶ Page H86 ▶ See <i>Pathways Post and Beam Solutions Specification Guide</i>.

Specification Information

Planning Dimensions	Style Number	Base Price	Option
A B C D			(Add \$ to Base Price)
Square (3 mm) Edge Profile			
24" 24" 36" 36"	BFB223636SW	\$ 846	+\$69
24" 24" 42" 42"	BFB224242SW	\$ 870	+\$71
24" 24" 48" 48"	BFB224848SW	\$ 895	+\$72
30" 30" 42" 42"	BFB334242SW	\$ 895	+\$72
30" 30" 48" 48"	BFB334848SW	\$ 919	+\$74
Tapered Edge Profile			
24" 24" 36" 36"	BFB223636BW	\$1011	+\$69
24" 24" 42" 42"	BFB224242BW	\$1035	+\$71
24" 24" 48" 48"	BFB224848BW	\$1072	+\$72
30" 30" 42" 42"	BFB334242BW	\$1060	+\$72
30" 30" 48" 48"	BFB334848BW	\$1108	+\$74
P-Edge Profile			
24" 24" 36" 36"	BFB223636V	\$ 908	+\$69
24" 24" 42" 42"	BFB224242V	\$ 932	+\$71
24" 24" 48" 48"	BFB224848V	\$ 968	+\$72
30" 30" 42" 42"	BFB334242V	\$ 957	+\$72
30" 30" 48" 48"	BFB334848V	\$ 993	+\$74

Capsule Worksurfaces

Wood Veneer

SIN 711.8

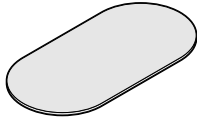

Tip: Legs to support free-standing worksurfaces must be specified separately.

Tip: For leg and support guidelines, refer to the Unison Leg Matrix.
▶ Page H130

Tip: Tether brackets to attach to Pathways Post and Beam fence must be specified separately.

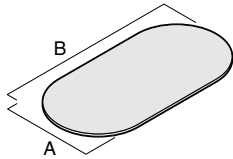

Standard Includes	Required to Specify
<ul style="list-style-type: none"> • Worksurface: wood veneer • Square (3 mm) or tapered profile on all sides, if selected: wood • Vinyl P-edge profile on all sides, if selected: 6000 Black plastic only • Reinforcing brace for worksurfaces wider than 60"W 	<ul style="list-style-type: none"> 1 Style number 2 Wood color number for worksurface 3 Options, if selected (see below) ▶ See <i>Surface Materials</i>, page H124.

Options	Price	Required to Specify
Surface Materials <ul style="list-style-type: none"> • Customiz stain • Full-fill finish 	<ul style="list-style-type: none"> Prices below Prices below 	<ul style="list-style-type: none"> Specify with <i>Customiz stain</i>. ▶ See <i>Surface Materials Reference Manual</i>. Specify full-fill finish number.

Related Products <ul style="list-style-type: none"> • Legs and supports for Freestanding Worksurfaces • Tether bracket for use with Pathways Post and Beam • Wiring and Cabling • Pathways Post and Beam 	<ul style="list-style-type: none"> ▶ Page H84 ▶ Page H85 ▶ Page H86 ▶ See <i>Pathways Post and Beam Solutions Specification Guide</i>.
---	--

Specification Information

Planning Dimensions		Style Number	Base Price	Option
A	B			(Add \$ to Base Price)
Square (3 mm) Edge Profile				
36"	72"	BFK3672SW	\$1043	+\$80
42"	84"	BFK4284SW	\$1156	+\$84
48"	96"	BFK4896SW	\$1272	+\$86
Tapered Edge Profile				
36"	72"	BFK3672BW	\$1268	+\$80
42"	84"	BFK4284BW	\$1371	+\$84
48"	96"	BFK4896BW	\$1432	+\$86
P-Edge Profile				
36"	72"	BFK3672V	\$1098	+\$80
42"	84"	BFK4284V	\$1191	+\$84
48"	96"	BFK4896V	\$1252	+\$86



Spanner Worksurfaces

Wood Veneer

SIN 711.8



Tip: Legs to support free-standing worksurfaces must be specified separately.

Tip: For leg and support guidelines, refer to the Unison Leg Matrix.

▶ Page H130

Tip: Tether brackets to attach to Pathways Post and Beam fence must be specified separately.

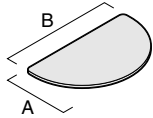

Standard Includes	Required to Specify
<ul style="list-style-type: none"> • Worksurface: wood veneer • Square (3 mm) or tapered profile on all sides, if selected: wood • Vinyl P-edge profile on all sides, if selected: 6000 Black plastic only 	<ol style="list-style-type: none"> 1 Style number 2 Wood color number for worksurface 3 Options, if selected (see below) <p>▶ See <i>Surface Materials</i>, page H124.</p>

Options	Price	Required to Specify
Surface Materials <ul style="list-style-type: none"> • Customiz stain • Full-fill finish 	Prices below Prices below	Specify <i>with Customiz stain</i> . ▶ See <i>Surface Materials Reference Manual</i> . Specify full-fill finish number.

Related Products	Price	Required to Specify
<ul style="list-style-type: none"> • Legs and supports for Freestanding Worksurfaces • Tether bracket for use with Pathways Post and Beam • Wiring and Cabling • Pathways Post and Beam 		▶ Page H84 ▶ Page H85 ▶ Page H86 ▶ See <i>Pathways Post and Beam Solutions Specification Guide</i> .

Specification Information

Planning Dimensions	Style Number	Base Price	Option
A B			(Add \$ to Base Price)
			Customiz Stain or Full-Fill Finish
■ Square (3 mm) Edge Profile			
30" 48"	BFSP48SW	\$596	+\$53
30" 52"	BFSP52SW	\$596	+\$55
36" 60"	BFSP60SW	\$740	+\$56
36" 64"	BFSP64SW	\$740	+\$57
■ Tapered Edge Profile			
30" 48"	BFSP48BW	\$810	+\$53
30" 52"	BFSP52BW	\$830	+\$55
36" 60"	BFSP60BW	\$900	+\$56
36" 64"	BFSP64BW	\$920	+\$57
■ P-Edge Profile			
30" 48"	BFSP48V	\$628	+\$53
30" 52"	BFSP52V	\$648	+\$55
36" 60"	BFSP60V	\$718	+\$56
36" 64"	BFSP64V	\$738	+\$57

Peninsula Worksurfaces

Wood Veneer

SIN 711.8



Tip: Legs to support free-standing worksurfaces must be specified separately.

Tip: For leg and support guidelines, refer to the Unison Leg Matrix.

▶ Page H130

Tip: Tether brackets to attach to Pathways Post and Beam fence must be specified separately.

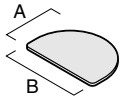

Standard Includes	Required to Specify
<ul style="list-style-type: none"> Worksurface: wood veneer Square (3 mm) or tapered profile on all sides, if selected: wood Vinyl P-edge profile on all sides, if selected: 6000 Black plastic only 	<ol style="list-style-type: none"> Style number Wood color number for worksurface Options, if selected (see below) <p>▶ See <i>Surface Materials</i>, page H124.</p>

Options	Price	Required to Specify
Surface Materials <ul style="list-style-type: none"> Customiz stain Full-fill finish 	Prices below Prices below	Specify with <i>Customiz stain</i> . ▶ See <i>Surface Materials Reference Manual</i> . Specify full-fill finish number.

Related Products <ul style="list-style-type: none"> Legs and supports for freestanding worksurfaces Tether bracket for use with Pathways Post and Beam Pathways Post and Beam 	▶ Page H84 ▶ Page H85 ▶ See <i>Pathways Post and Beam Solutions Specification Guide</i> .
---	---

Specification Information

Planning Dimensions	Style Number	Base Price	Option
A	B		(Add \$ to Base Price)
Square (3 mm) Edge Profile			
	27" 36"	BFP2736SW	\$556 +\$51
Tapered Edge Profile			
	27" 36"	BFP2736BW	\$790 +\$51
P-Edge Profile			
	27" 36"	BFP2736V	\$608 +\$51



Tapered Peninsula Worksurfaces

Wood Veneer

SIN 711.8

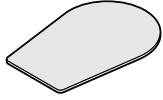

Tip: Legs to support free-standing worksurfaces must be specified separately.

Tip: For leg and support guidelines, refer to the Unison Leg Matrix.

▶ Page H130

Tip: Tether brackets to attach to Pathways Post and Beam fence must be specified separately.

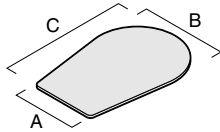



Standard Includes	Required to Specify
<ul style="list-style-type: none"> • Worksurface: wood veneer • Square (3 mm) or tapered profile on all sides, if selected: wood • Vinyl P-edge profile on all sides, if selected: 6000 Black plastic only 	<ul style="list-style-type: none"> 1 Style number 2 Wood color number for worksurface 3 Options, if selected (see below) ▶ See <i>Surface Materials</i>, page H124.

Options	Price	Required to Specify
Surface Materials <ul style="list-style-type: none"> • Customiz stain • Full-fill finish 	<ul style="list-style-type: none"> Prices below Prices below 	<ul style="list-style-type: none"> Specify with <i>Customiz stain</i>. ▶ See <i>Surface Materials Reference Manual</i>. Specify full-fill finish number.

Related Products	Price	Required to Specify
<ul style="list-style-type: none"> • Legs and supports for Freestanding Worksurfaces • Tether bracket for use with Pathways Post and Beam • Wiring and Cabling • Pathways Post and Beam 		<ul style="list-style-type: none"> ▶ Page H84 ▶ Page H85 ▶ Page H86 ▶ See <i>Pathways Post and Beam Solutions Specification Guide</i>.

Specification Information

	• Planning Dimensions			• Style Number	• Base Price	• Option (Add \$ to Base Price)
	A	B	C			
	Square (3 mm) Edge Profile					
	27"	32"	48"	BFTP48SW	\$ 752	+\$47
	33"	40"	60"	BFTP60SW	\$ 780	+\$50
	Tapered Edge Profile					
	27"	32"	48"	BFTP48BW	\$1014	+\$47
	33"	40"	60"	BFTP60BW	\$1025	+\$50
	P-Edge Profile					
	27"	32"	48"	BFTP48V	\$ 811	+\$47
	33"	40"	60"	BFTP60V	\$ 822	+\$50
	:	:	:	:	:	:

Tapered Peninsula
Worksurfaces,
Wood Veneer

SIN 711.8



Bubble Jetty Worksurfaces

Wood Veneer

SIN 711.8

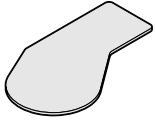

Tip: Illustration above shows a right-hand unit.

Tip: Legs to support free-standing worksurfaces must be specified separately.

Tip: For leg and support guidelines, refer to the Unison Leg Matrix.
▶ Page H130

Tip: Tether brackets to attach to Pathways Post and Beam fence must be specified separately.

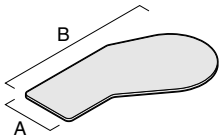
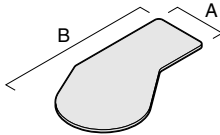

Standard Includes	Required to Specify
-------------------	---------------------

- Worksurface: wood veneer
- Square (3 mm) or tapered profile on all sides, if selected: wood
- Vinyl P-edge profile on all sides, if selected: 6000 Black plastic only

- 1 Style number
- 2 Wood color number for worksurface
- 3 Options, if selected (see below)
- ▶ See *Surface Materials*, page H124.

Surface Materials	Options	Price	Required to Specify
-------------------	---------	-------	---------------------

Surface Materials

- Customiz stain
- Full-fill finish

Prices below and at right
Prices below and at right

- Specify with *Customiz stain*.
- ▶ See *Surface Materials Reference Manual*. Specify full-fill finish number.

Related Products

- Legs and supports for Freestanding Worksurfaces
- Tether bracket for use with Pathways Post and Beam
- Wiring and Cabling
- Pathways Post and Beam

- ▶ Page H84
- ▶ Page H85
- ▶ Page H86
- ▶ See *Pathways Post and Beam Solutions Specification Guide*.

Specification Information

Planning Dimensions	Style Number	Base Price	Option
A B			(Add \$ to Base Price)
			Customiz Stain or Full-Fill Finish



Square (3 mm) Edge Profile

Left-Hand Worksurfaces

24"	72"	BFJ2472LSW	\$1058	+\$70
30"	72"	BFJ3072LSW	\$1080	+\$74
24"	78"	BFJ2478LSW	\$1130	+\$74
30"	78"	BFJ3078LSW	\$1155	+\$79

Right-Hand Worksurfaces

24"	72"	BFJ2472RSW	\$1058	+\$70
30"	72"	BFJ3072RSW	\$1080	+\$74
24"	78"	BFJ2478RSW	\$1130	+\$74
30"	78"	BFJ3078RSW	\$1155	+\$79

▶ Specification Information continued on next page

► Specification Information continued from previous page

Specification Information

• Planning Dimensions		• Style Number	• Base Price	• Option
A	B			(Add \$ to Base Price)
				Customiz Stain or Full-Fill Finish

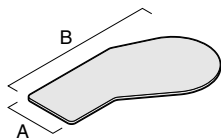
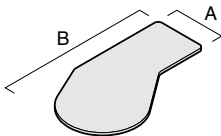
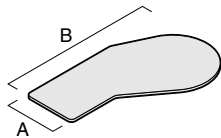
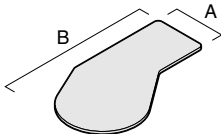

Tapered Edge Profile

Left-Hand Worksurfaces

24"	72"	BFJ2472LBW	\$1333	+\$70
30"	72"	BFJ3072LBW	\$1355	+\$74
24"	78"	BFJ2478LBW	\$1405	+\$74
30"	78"	BFJ3078LBW	\$1430	+\$79

Right-Hand Worksurfaces

24"	72"	BFJ2472RBW	\$1333	+\$70
30"	72"	BFJ3072RBW	\$1355	+\$74
24"	78"	BFJ2478RBW	\$1405	+\$74
30"	78"	BFJ3078RBW	\$1430	+\$79

P-Edge Profile

Left-Hand Worksurfaces

24"	72"	BFJ2472LV	\$1120	+\$70
30"	72"	BFJ3072LV	\$1142	+\$74
24"	78"	BFJ2478LV	\$1192	+\$74
30"	78"	BFJ3078LV	\$1217	+\$79

Right-Hand Worksurfaces

24"	72"	BFJ2472RV	\$1120	+\$70
30"	72"	BFJ3072RV	\$1142	+\$74
24"	78"	BFJ2478RV	\$1192	+\$74
30"	78"	BFJ3078RV	\$1217	+\$79

Round Worksurfaces

Wood Veneer

SIN 711.8



Standard Includes	Required to Specify
<ul style="list-style-type: none"> • Worksurface: wood veneer • Square (3 mm) or tapered profile on all sides, if selected: wood • Vinyl P-edge profile on all sides, if selected: 6000 Black plastic only 	<ul style="list-style-type: none"> 1 Style number 2 Wood color number for worksurface 3 Options, if selected (see below) ▶ See <i>Surface Materials</i>, page H124.

Options	Price	Required to Specify
Surface Materials		
• Customiz stain	Prices below	Specify <i>with Customiz stain</i> .
• Full-fill finish	Prices below	▶ See <i>Surface Materials Reference Manual</i> . Specify full-fill finish number.

Related Products	Price	Required to Specify
• Legs and supports for Freestanding Worksurfaces		▶ Page H84

Tip: Legs to support free-standing worksurfaces must be specified separately.

Tip: For leg and support guidelines, refer to the *Unison Leg Matrix*.
▶ Page H130

Specification Information			
Diameter	Style Number	Base Price	Option (Add \$ to Base Price)
•	•	•	• Customiz Stain or Full-Fill Finish
•	•	•	•
•	•	•	•
•	•	•	•
•	•	•	•

Image	Square (3 mm) Edge Profile		
	36"	BFR36SW	\$ 747 +\$38
	42"	BFR42SW	\$ 785 +\$41
	48"	BFR48SW	\$ 875 +\$46
	54"	BFR54SW	\$ 965 +\$49

Image	Tapered Edge Profile		
	36"	BFR36BW	\$ 927 +\$38
	42"	BFR42BW	\$ 965 +\$41
	48"	BFR48BW	\$1055 +\$46
	54"	BFR54BW	\$1165 +\$49

Image	P-Edge Profile		
	36"	BFR36V	\$ 777 +\$38
	42"	BFR42V	\$ 815 +\$41
	48"	BFR48V	\$ 905 +\$46
	54"	BFR54V	\$1005 +\$49
	•	•	•
	•	•	•

Square Worksurfaces

Wood Veneer

SIN 711.8



Tip: Legs to support free-standing worksurfaces must be specified separately.

Tip: For leg and support guidelines, refer to the Unison Leg Matrix.

▶ Page H130

Tip: Tether brackets to attach 24"W and 30"W worksurfaces to Pathways Post and Beam fence must be specified separately.

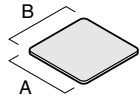

Standard Includes	Required to Specify
-------------------	---------------------

- Worksurface: wood veneer
- Square (3 mm) or tapered profile on all sides, if selected: wood
- Vinyl P-edge profile on all sides, if selected: 6000 Black plastic only

- 1 Style number
- 2 Wood color number for worksurface
- 3 Options, if selected (see below)
- ▶ See *Surface Materials*, page H124.

Options	Price	Required to Specify
---------	-------	---------------------

Surface Materials	• Customiz stain	Prices below	Specify with <i>Customiz stain</i> .
	• Full-fill finish	Prices below	▶ See <i>Surface Materials Reference Manual</i> . Specify full-fill finish number.

Related Products	• Legs and supports for Freestanding Worksurfaces	▶ Page H84
	• Tether bracket for use with Pathways Post and Beam	▶ Page H85

- Wiring and Cabling
- Pathways Post and Beam
- ▶ Page H86
- ▶ See *Pathways Post and Beam Solutions Specification Guide*.

Specification Information

• Planning Dimensions		• Style Number	• Base Price	• Option
A	B			(Add \$ to Base Price)
				Customiz Stain or Full-Fill Finish

Square (3 mm) Edge Profile				
30"	30"	BFRQ30SW	\$449	+\$33
42"	42"	BFRQ42SW	\$612	+\$41
48"	48"	BFRQ48SW	\$677	+\$46
54"	54"	BFRQ54SW	\$757	+\$49

Tapered Edge Profile				
30"	30"	BFRQ30BW	\$579	+\$33
42"	42"	BFRQ42BW	\$762	+\$41
48"	48"	BFRQ48BW	\$827	+\$46
54"	54"	BFRQ54BW	\$927	+\$49

P-Edge Profile				
30"	30"	BFRQ30V	\$469	+\$33
42"	42"	BFRQ42V	\$642	+\$41
48"	48"	BFRQ48V	\$717	+\$46
54"	54"	BFRQ54V	\$797	+\$49

Rectangle Worksurfaces

Wood Veneer

SIN 711.8

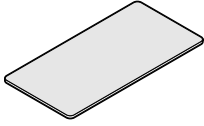

Tip: Legs to support free-standing worksurfaces must be specified separately.

Tip: For leg and support guidelines, refer to the Unison Leg Matrix.
▶ Page H130

Tip: Tether brackets to attach 36"D x 72"W rectangle worksurfaces to Pathways Post and Beam fence must be specified separately.

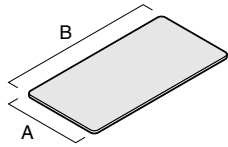

Standard Includes	Required to Specify
<ul style="list-style-type: none"> • Worksurface: wood veneer • Square (3 mm) or tapered profile on all sides, if selected: wood • Vinyl P-edge profile on all sides, if selected: 6000 Black plastic only • Reinforcing brace(s) 	<ul style="list-style-type: none"> 1 Style number 2 Wood color number for worksurface 3 Options, if selected (see below) ▶ See <i>Surface Materials</i>, page H124.

Options	Price	Required to Specify
Surface Materials <ul style="list-style-type: none"> • Customiz stain • Full-fill finish 	Prices below Prices below	Specify <i>with Customiz stain</i> . ▶ See <i>Surface Materials Reference Manual</i> . Specify full-fill finish number.

Related Products <ul style="list-style-type: none"> • Legs and supports for Freestanding Worksurfaces • Tether bracket for use with Pathways Post and Beam • Wiring and Cabling • Pathways Post and Beam 	<ul style="list-style-type: none"> ▶ Page H84 ▶ Page H85 ▶ Page H86 ▶ See <i>Pathways Post and Beam Solutions Specification Guide</i>.
---	--

Specification Information

Planning Dimensions	Style Number	Base Price	Option
A B			(Add \$ to Base Price)
			Customiz Stain or Full-Fill Finish

Square (3 mm) Edge Profile			Base Price	Option
36" 72"	BFRR3672SW	\$1078	+\$82	
42" 84"	BFRR4284SW	\$1161	+\$84	
48" 96"	BFRR4896SW	\$1192	+\$86	

Tapered Edge Profile			Base Price	Option
36" 72"	BFRR3672BW	\$1333	+\$82	
42" 84"	BFRR4284BW	\$1416	+\$84	
48" 96"	BFRR4896BW	\$1447	+\$86	

P-Edge Profile			Base Price	Option
36" 72"	BFRR3672V	\$1143	+\$82	
42" 84"	BFRR4284V	\$1226	+\$84	
48" 96"	BFRR4896V	\$1257	+\$86	

Split-Round Worksurfaces

Wood Veneer, for Use with Pathways Post and Beam

Split-Round Worksurfaces,
Wood Veneer, for Use with
Pathways Post and Beam

SIN 711.8

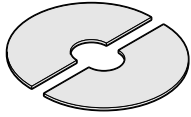

Standard Includes	Required to Specify
<ul style="list-style-type: none"> • Pair of worksurfaces: wood veneer • Square (3 mm) or tapered profile on user's side, if selected: wood • Vinyl P-edge profile on user's side, if selected: 6000 Black plastic only • Bracket kit to connect worksurfaces 	<ul style="list-style-type: none"> 1 Style number 2 Wood color number for worksurface 3 Options, if selected (see below) ▶ See <i>Surface Materials</i>, page H124.

Options	Price	Required to Specify
Surface Materials <ul style="list-style-type: none"> • Customiz stain • Full-fill finish 	Prices below Prices below	Specify with <i>Customiz stain</i> . ▶ See <i>Surface Materials Reference Manual</i> . Specify full-fill finish number.
Related Products <ul style="list-style-type: none"> • Legs and supports for Freestanding Worksurfaces • Pathways Post and Beam • Hubs 		▶ Page H84 ▶ See <i>Pathways Post and Beam Solutions Specification Guide</i> . ▶ See <i>Pathways Post and Beam Solutions Specification Guide</i> .

Tip: Legs to support free-standing worksurfaces must be specified separately.

Tip: When ordering cabby legs for split-round worksurfaces to be used with Pathways Post and Beam, specify with glides.

Tip: For leg and support guidelines, refer to the Unison Leg Matrix.
▶ Page H130

Tip: Split-round worksurfaces are specified as a pair. Bracket kit is included to connect the two worksurfaces.

Specification Information

Diameter	Style Number	Base Price	Option (Add \$ to Base Price)
.....
.....
.....

Square (3 mm) Edge Profile			
	52"	BFSPN52SW	\$1355 +\$110
	64"	BFSPN64SW	\$1507 +\$114

Tapered Edge Profile			
	52"	BFSPN52BW	\$1630 +\$110
	64"	BFSPN64BW	\$1782 +\$114

P-Edge Profile			
	52"	BFSPN52V	\$1435 +\$110
	64"	BFSPN64V	\$1587 +\$114



Tethered Capsule Worksurfaces

Wood Veneer, for Use with Pathways Post and Beam

SIN 711.8

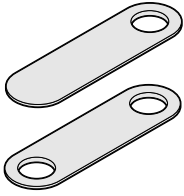

Tip: Tethered capsule work-surfaces attach to Pathways Post and Beam fence with bracket kit included. Legs do not need to be specified.

Standard Includes	Required to Specify
<ul style="list-style-type: none"> • Worksurface: wood veneer • Square (3 mm) or tapered profile on user's side, if selected: wood • Vinyl P-edge profile on user's side, if selected: 6000 Black plastic only • Bracket kit to attach to Pathways Post and Beam fence 	<ul style="list-style-type: none"> 1 Style number 2 Wood color number for worksurface 3 Options, if selected (see below) ▶ See <i>Surface Materials</i>, page H124.

	Options	Price	Required to Specify
Surface Materials	• Customiz stain	Prices at right	Specify <i>with Customiz stain</i> . ▶ See <i>Surface Materials Reference Manual</i> . Specify full-fill finish number.
	• Full-fill finish	Prices at right	
Related Products	• Pathways Post and Beam		▶ See <i>Pathways Post and Beam Solutions Specification Guide</i> .
	• Hubs		▶ See <i>Pathways Post and Beam Solutions Specification Guide</i> .

Tethered Capsule
Worksurfaces, Wood Veneer,
for Use with Pathways
Post and Beam

SIN 711.8

Tip: Width of tethered capsule
worksurfaces includes 1"
overhang on both sides of the
Pathways Post and Beam
fence.

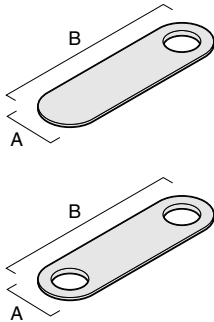

Specification Information

Planning Dimensions	Style Number	Base Price	Option
A B			(Add \$ to Base Price)
			Customiz Stain or Full-Fill Finish

Square (3 mm) Edge Profile



Square (3 mm) Edge Profile with One Cutout

26"	66"	BFFF661SW	\$ 887	+\$69
26"	74"	BFFF721SW	\$ 926	+\$74
26"	86"	BFFF841SW	\$ 995	+\$78
26"	98"	BFFF961SW	\$1064	+\$80

Square (3 mm) Edge Profile with Two Cutouts

26"	98"	BFFF962SW	\$1182	+\$80
-----	-----	------------------	--------	-------

Tapered Edge Profile



Tapered Edge Profile with One Cutout

26"	66"	BFFF661BW	\$1092	+\$69
26"	74"	BFFF721BW	\$1151	+\$74
26"	86"	BFFF841BW	\$1220	+\$78
26"	98"	BFFF961BW	\$1309	+\$80

Tapered Edge Profile with Two Cutouts

26"	98"	BFFF962BW	\$1427	+\$80
-----	-----	------------------	--------	-------

P-Edge Profile



P-Edge Profile with One Cutout

26"	66"	BFFF661V	\$ 922	+\$69
26"	74"	BFFF721V	\$ 981	+\$74
26"	86"	BFFF841V	\$1050	+\$78
26"	98"	BFFF961V	\$1139	+\$80

P-Edge Profile with Two Cutouts

26"	98"	BFFF962V	\$1257	+\$80
-----	-----	-----------------	--------	-------

Legs and Supports

for Freestanding Worksurfaces

SIN 711.8

Elliptical Legs

with Alignment Tab

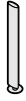

Tip: Use 26"H legs for nesting capabilities and use 28½"H legs to achieve standard height worksurfaces.

Standard Includes	Required to Specify
<ul style="list-style-type: none"> • Worksurface leg: paint or metal • Glides: paint or metal • Attachment hardware 	<ol style="list-style-type: none"> 1 Style number 2 Paint or metal color number for leg 3 Paint or metal color number for glides 4 Options, if selected (see below) <p>▶ See <i>Surface Materials</i>, page H124.</p>

Options		Price	Required to Specify
Surface Materials	Elliptical legs		
	<ul style="list-style-type: none"> • Black • Platinum • Polished Chrome 	No cost No cost +\$70	Specify with 7207 Black paint. Specify with 7604 Platinum. Specify with 9201 Polished Chrome.
	Glides		
	<ul style="list-style-type: none"> • Black • Brushed Aluminum • Polished Aluminum 	No cost No cost No cost	Specify with 7207 Black paint. Specify with 8042 Brushed Aluminum. Specify with 8046 Polished Aluminum.

Specification Information		
• Planning Height	• Style Number	• Base Price
26"	BEL25	\$140
28½"	BEL27	\$158

Tip: Height of leg includes worksurface thickness.

Pivot Hitch



Tip: For pivot hitch application rules, see *Legs and Supports for Freestanding Worksurfaces*.

▶ See *Wood Casegoods and Tables Specification Guide*.

Standard Includes	Required to Specify
<ul style="list-style-type: none"> • Metal linkage rings: black only • Attachment hardware 	Style number

Specification Information			
• Dimensions Diameter	Height	• Style Number	• Price
6"	2⅝"	BEH	\$186

Cabby Legs

with Alignment Tab

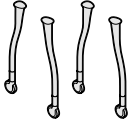

Tip: Illustration above shows legs with casters.

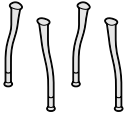

Tip: Illustration above shows legs with optional glides.

Tip: Corner worksurfaces require a leg in the back corner. Be sure to order fifth leg if specifying a package of four.

Tip: See Worksurface and Leg Combinations page for number of legs required per worksurface.

► See Wood Casegoods and Tables Specification Guide.

Tip: Height of leg includes worksurface thickness.

Standard Includes		Required to Specify	
	<ul style="list-style-type: none"> • Worksurface legs: paint or metal • Locking casters: paint or metal default • Attachment hardware 		1 Style number 2 Paint or metal color number for leg 3 Options, if selected (see below) ► See <i>Surface Materials</i> , page H124.
Options		Price	Required to Specify
Surface Materials	• Paint price group 1	No cost	Specify paint color number.
	• Paint price group 2	+\$ 17 per leg	Specify paint color number.
	• Polished Chrome	+\$104 per leg	Specify with 9201 Polished Chrome.
Casters and Glides	One cabby leg		
	• One glide	No cost	Specify with one glide.
	Package of four cabby legs		
	• Four glides	No cost	Specify with four glides.
	• Two glides and two locking casters	No cost	Specify with two glides and two locking casters.

Specification Information

• Planning Height	• Style Number	• Base Price
26"	DLNCAB26S	\$125
28½"	DLNCAB28S	\$125

One Cabby Leg

26"	DLNCAB26S	\$125
28½"	DLNCAB28S	\$125

Package of Four Cabby Legs

26"	DLNCAB264	\$500
28½"	DLNCAB284	\$500

Tether Bracket

for Use with Pathways Post and Beam



Tip: Tether brackets must be specified when tethering a worksurface to Pathways Post and Beam.

Tip: Style number is for a single bracket.

Standard Includes	Required to Specify
• Bracket: 4799 Platinum paint only	Style number

Specification Information

• Style Number	• Price
BTTB	\$77

Wiring and Cabling Accessories

SIN 711.8

Field-Installed Round Grommet



Tip: Grommet PTGRMT is for use on worksurfaces only.

Standard Includes	Required to Specify
<ul style="list-style-type: none"> Grommet: paint or metal Installation instructions 	1 Style number 2 Paint or metal color number ▶ See <i>Surface Materials</i> , page H124.

Specification Information

Dimensions		Style Number	Price
D	W		
2 1/2"	2 1/2"	PTGRMT	\$50

Field-Installed Triangular Grommet



Tip: Grommet KTGROM is for use on towers and super shelves only.

Standard Includes	Required to Specify
<ul style="list-style-type: none"> Grommet: black plastic only Installation instructions 	Style number

Specification Information

Dimensions		Style Number	Price
D	W		
2 1/8"	2 3/4"	KTGROM	\$16

Power/Data Boxes

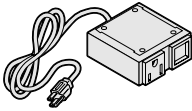

Tip: All power/data boxes ship with an adapter kit for data jacks using keystone style attachment. Choose the appropriate data jacks for each adapter kit, but for the best fit and aesthetic, keystone style data jacks are recommended. The adapter kit accommodates keystone style data jacks ordered from the following manufacturers: Panduit, Amp, Minicom, Leviton, and AT&T.

Standard Includes	Required to Specify
<ul style="list-style-type: none"> • Power/data box • Power/power box • Data/data box 	Style number

Specification Information

• Dimensions			• Style	• Price
D	W	H	Number	

Power/Data Box

3"	3"	1"	GVPDBOX	\$180

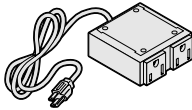

Power/Power Box

3"	3"	1"	GVPPBOX	\$180

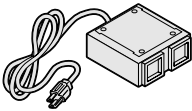

Data/Data Box

3"	3"	1"	GVDDBOX	\$180

Ganging Bracket for Tables

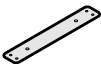

Note: This product is Turnstone, NOT Steelcase. It is included here to simplify your planning. Remember that Steelcase has different pricing terms from Turnstone products.

Standard Includes	Required to Specify
<ul style="list-style-type: none"> • Ganging bracket: black paint 	Style number

Specification Information

• Dimensions			• Style	• Price
D	W	H	Number	
1½"	9"		TS5GANGBKT	\$14

SIN 711.8

Skeleton Bone Wire Managers

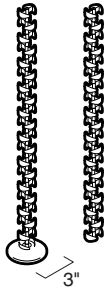

Note: This product is Turnstone, **NOT** Steelcase. It is included here to simplify your planning. Remember that Steelcase has different pricing terms than Turnstone products.

Standard Includes	Required to Specify
-------------------	---------------------

- Wire manager: black plastic
- Attachment hardware

Style number

Specification Information				
---------------------------	--	--	--	--

• Dimensions			• Style	• Price
D	W	H	Number	

Skeleton Bone Wire Manager				
----------------------------	--	--	--	--

1½"	1¾"	38"	TS5SKLBNE	\$115
-----	-----	-----	------------------	-------

Skeleton Bone Wire Manager Extension				
--------------------------------------	--	--	--	--

1½"	1¾"	36"	TS5SKEXT	\$ 98
-----	-----	-----	-----------------	-------

Wire Clips



Tip: Attaches under worksurfaces with screws or around leg.

Note: This product is Turnstone, **NOT** Steelcase. It is included here to simplify your planning. Remember that Steelcase has different pricing terms than Turnstone products.

Standard Includes	Required to Specify
-------------------	---------------------

- Package of six wire clips: velcro
- Attachment hardware

Style number

Specification Information				
---------------------------	--	--	--	--

• Dimensions			• Style	• Price
D	W	H	Number	

½"	8"	½"	TS5LEGCLP	\$33
----	----	----	------------------	------

Wire Manager

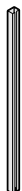

Standard Includes	Required to Specify
-------------------	---------------------

- 25" wire manager with double-sided tape: black plastic

Style number

Specification Information				
---------------------------	--	--	--	--

• Dimensions			• Style	• Price
D	W	H	Number	

1"	¾"	25"	PTWM25	\$12
----	----	-----	---------------	------

Specifying T-Walls



T-Walls

T-Wall (SIN 711.8)

H90

T-Wall Accessories (SIN 711.8)

H91

T-Wall

SIN 711.8

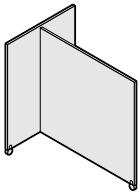

Standard Includes	Required to Specify
<ul style="list-style-type: none"> T-wall: wood Locking casters: black only Attachment hardware 	<ul style="list-style-type: none"> 1 Style number 2 Wood color number for T-wall 3 Options, if selected (see below) ▶ See <i>Surface Materials</i>, page H124.

Options	Price	Required to Specify
Surface Materials <ul style="list-style-type: none"> Customiz stain 	+\$97	Specify with <i>Customiz stain</i> . ▶ See <i>Surface Materials Reference Manual</i> .
Related Products <ul style="list-style-type: none"> T-wall accessories Super shelves 		▶ Page H91 ▶ Page H120

Specification Information				
• Dimensions			• Style	• Base
D	W	H	Number	Price
48"	51"	49"	KWALLW	\$1220

T-Wall Accessories

SIN 711.8

Tackboard

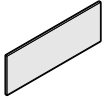

Standard Includes	Required to Specify
<ul style="list-style-type: none"> Tackboard: tackable surface Attachment hardware 	Style number

Specification Information

• Dimensions		• Style	• Price
W	H	Number	
48"	6"	KWALLTB6	\$152
48"	18"	KWALLTB18	\$278

Slatwall

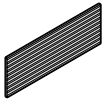

Standard Includes	Required to Specify
<ul style="list-style-type: none"> Slatwall: anodized aluminum finish Attachment hardware 	1 Style number 2 Anodized aluminum finish color: 8043 Clear Anodized aluminum 8044 Black Anodized aluminum

Specification Information

• Dimensions		• Style	• Price
W	H	Number	
48"	6"	KWALLSW6	\$152
48"	18"	KWALLSW18	\$278

Specifying Storage

Storage

Single-Wide Pedestals (SIN 711.8)	H94
Double-Wide Pedestals (SIN 711.8)	H96
Mobile Pedestals (SIN 711.8)	H98
Pedestal Seat Cushions (SIN 711.8)	H100
Tall Pedestals (SIN 711.8)	H102
Tall Mobile Pedestals (SIN 711.8)	H104
Tall Pedestals for Use with Hedge Row Tops Only (SIN 711.8)	H106
Tall Mobile Pedestals for Use with Hedge Row Tops Only (SIN 711.8)	H108
Hedge Row Tops for Use with Tall and Tall Mobile Pedestals (SIN 711.8)	H110
Towers (SIN 711.8)	H112
Wood Shelves for Towers (SIN 711.8)	H114
Lateral Files (SIN 711.8)	H116
Super Shelves for Use with Structural Walls (SIN 711.8)	H118
Super Shelves for Use with T-Walls (SIN 711.8)	H120

Single-Wide Pedestals

SIN 711.8



Tip: For interior drawer dimensions, refer to Storage Capacities.

▶ See Unison Specification Guide.

Standard Includes	Required to Specify
<ul style="list-style-type: none"> • Pedestal: wood • Contemporary, deco, or jazz pulls: paint or metal • Lock, keyed random: 9250 Ember Chrome • Rails: black only • One hanging file system for front-to-back filing per file drawer (see filing options below) • One partition per box drawer: black plastic only • One pencil tray per two box drawers: black plastic only • Leveling glides: black only 	<ol style="list-style-type: none"> 1 Style number 2 Wood color number for pedestal 3 Pulls and paint or metal color number (see below) 4 Options, if selected (see below) <p>▶ See <i>Surface Materials</i>, page H124.</p>

Options	Price	Required to Specify
Surface Materials <ul style="list-style-type: none"> • Customiz stain • Powder coat drawer fronts 	Prices at right No cost	Specify with <i>Customiz stain</i> . ▶ See <i>Surface Materials Reference Manual</i> . Specify with <i>powder coat fronts</i> and select powder coat finish color number.
Pulls		
Contemporary pulls <ul style="list-style-type: none"> • Black • Polished Chrome • Silver 	No cost No cost No cost	Specify with <i>0835 Black E070 contemporary pulls</i> . Specify with <i>9201 Polished Chrome E070 contemporary pulls</i> . Specify with <i>9212 Silver E070 contemporary pulls</i> .
Deco pulls <ul style="list-style-type: none"> • Black • Polished Chrome • Nickel 	+\$10 per pull +\$10 per pull +\$10 per pull	Specify with <i>0835 Black BPB deco pulls</i> . Specify with <i>9201 Polished Chrome BPB deco pulls</i> . Specify with <i>9211 Nickel BPB deco pulls</i> .
Jazz pulls <ul style="list-style-type: none"> • Black • Polished Chrome • Nickel 	+\$10 per pull +\$10 per pull +\$10 per pull	Specify with <i>0835 Black BPD jazz pulls</i> . Specify with <i>9201 Polished Chrome BPD jazz pulls</i> . Specify with <i>9211 Nickel BPD jazz pulls</i> .
Filing Hardware <ul style="list-style-type: none"> • Two file bars with clips per file drawer for side-to-side or legal filing 	No cost	Specify with <i>TFILE</i> .
Keying <ul style="list-style-type: none"> • Factory- and field-installed keying 		▶ Page J8
Related Products <ul style="list-style-type: none"> • Pedestal seat cushions 		▶ Page H100

Drawer Pull Shapes

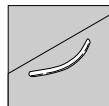

Contemporary

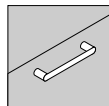

Deco

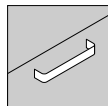

Jazz

SIN 711.8

Specification Information

Dimensions			Style Number	Base Price	Option (Add \$ to Base Price)
D	W	H			
:	:	:	:	:	Customiz
:	:	:	:	:	Stain



Single-Wide Pedestals with Box/Box/File Drawers

21 1/4"	16"	24 3/4"	KPBBF24W	\$1157	+\$57
27 1/4"	16"	24 3/4"	KPBBF30W	\$1268	+\$63
:	:	:	:	:	:



Single-Wide Pedestals with File/File Drawers

21 1/4"	16"	24 3/4"	KPFF24W	\$1105	+\$54
27 1/4"	16"	24 3/4"	KPFF30W	\$1200	+\$60
:	:	:	:	:	:



Single-Wide Pedestals with Two Open Shelves

21 1/4"	16"	24 3/4"	KPS24W	\$ 795	+\$63
27 1/4"	16"	24 3/4"	KPS30W	\$ 892	+\$72
:	:	:	:	:	:

Double-Wide Pedestals

SIN 711.8

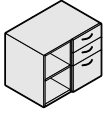

Tip: For interior drawer dimensions, refer to Storage Capacities.
 ▶ See Unison Specification Guide.

Standard Includes	Required to Specify
-------------------	---------------------

- Double pedestal: wood
- Contemporary, deco, or jazz pulls: paint or metal
- Lock, keyed random: 9250 Ember Chrome
- Rails: black only
- One hanging file system for front-to-back filing per file drawer (see filing options below)
- One partition per box drawer: black plastic only
- One pencil tray per two box drawers: black plastic only
- Leveling glides: black only

- 1 Style number
 - 2 Wood color number for double pedestal
 - 3 Pulls and paint or metal color number (see below)
 - 4 Options, if selected (see below)
- ▶ See *Surface Materials*, page H124.

Options	Price	Required to Specify
---------	-------	---------------------

Surface Materials	• Customiz stain	Prices at right	Specify with <i>Customiz stain</i> . ▶ See <i>Surface Materials Reference Manual</i> .
	• Powder coat drawer fronts	No cost	Specify with <i>powder coat fronts</i> and select powder coat finish color number.

Pulls	Contemporary pulls	Price	Required to Specify
-------	--------------------	-------	---------------------

- | | | | |
|--------------|-------------------|---------|--|
| Pulls | • Black | No cost | Specify with <i>0835 Black E070 contemporary pulls</i> . |
| | • Polished Chrome | No cost | Specify with <i>9201 Polished Chrome E070 contemporary pulls</i> . |
| | • Silver | No cost | Specify with <i>9212 Silver E070 contemporary pulls</i> . |

- | | | | |
|-------------------|-------------------|----------------|---|
| Deco pulls | • Black | +\$10 per pull | Specify with <i>0835 Black BPB deco pulls</i> . |
| | • Polished Chrome | +\$10 per pull | Specify with <i>9201 Polished Chrome BPB deco pulls</i> . |
| | • Nickel | +\$10 per pull | Specify with <i>9211 Nickel BPB deco pulls</i> . |

- | | | | |
|-------------------|-------------------|----------------|---|
| Jazz pulls | • Black | +\$10 per pull | Specify with <i>0835 Black BPD jazz pulls</i> . |
| | • Polished Chrome | +\$10 per pull | Specify with <i>9201 Polished Chrome BPD jazz pulls</i> . |
| | • Nickel | +\$10 per pull | Specify with <i>9211 Nickel BPD jazz pulls</i> . |

Filing Hardware	• Two file bars with clips per file drawer for side-to-side or legal filing	No cost	Specify with <i>TFILE</i> .
------------------------	---	---------	-----------------------------

Keying	• Factory- and field-installed keying		▶ Page J8
---------------	---------------------------------------	--	-----------

Related Products	• Pedestal seat cushions		▶ Page H100
-------------------------	--------------------------	--	-------------

Tip: Pedestal seat cushions cannot be used on double-wide pedestals with lateral file below.

Drawer Pull Shapes

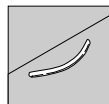

Contemporary

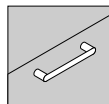

Deco

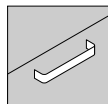

Jazz

SIN 711.8

Specification Information

Dimensions			Style	Base	Option
D	W	H	Number	Price	(Add \$ to Base Price)
:	:	:	:	:	Customiz
:	:	:	:	:	Stain

Double-Wide Pedestals with Box/Box/File Drawers

Two Open Shelves on Left

21 1/4"	30"	24 3/4"	KDBBFS24LW	\$1650	+\$138
27 1/4"	30"	24 3/4"	KDBBFS30LW	\$1865	+\$157

Two Open Shelves on Right

21 1/4"	30"	24 3/4"	KDBBFS24RW	\$1650	+\$138
27 1/4"	30"	24 3/4"	KDBBFS30RW	\$1865	+\$157

Double-Wide Pedestal Below and File Drawer on Left

21 1/4"	30"	24 3/4"	KDBBFLW24LW	\$1885	+\$ 96
27 1/4"	30"	24 3/4"	KDBBFLW30LW	\$2160	+\$110

Double-Wide Pedestal Below and File Drawer on Right

21 1/4"	30"	24 3/4"	KDBBFLW24RW	\$1885	+\$ 96
27 1/4"	30"	24 3/4"	KDBBFLW30RW	\$2160	+\$110

Double-Wide Pedestals with File/File Drawers

Two Open Shelves on Left

21 1/4"	30"	24 3/4"	KDFFS24LW	\$1586	+\$133
27 1/4"	30"	24 3/4"	KDFFS30LW	\$1801	+\$152

Two Open Shelves on Right

21 1/4"	30"	24 3/4"	KDFFS24RW	\$1586	+\$133
27 1/4"	30"	24 3/4"	KDFFS30RW	\$1801	+\$152

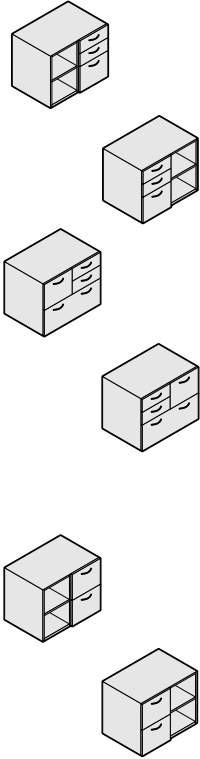

Mobile Pedestals

SIN 711.8



Tip: For interior drawer dimensions, refer to Storage Capacities.
 ▶ See Unison Specification Guide.

Standard Includes	Required to Specify
<ul style="list-style-type: none"> Mobile pedestal: wood Contemporary, deco, or jazz pulls: paint or metal One hanging file system for front-to-back filing per file drawer (see filing options below) One partition per box drawer: black plastic only One pencil tray per two box drawers: black plastic only Lock, keyed random: 9250 Ember Chrome Non-locking casters: black only 	<ol style="list-style-type: none"> Style number Wood color number for mobile pedestal Pulls and paint or metal color number (see below) Options, if selected (see below) <p>▶ See <i>Surface Materials</i>, page H124.</p>

Options	Price	Required to Specify
Surface Materials <ul style="list-style-type: none"> Customiz stain Powder coat drawer fronts 	Prices at right No cost	Specify with <i>Customiz stain</i> . ▶ See <i>Surface Materials Reference Manual</i> . Specify with <i>powder coat fronts</i> and select powder coat finish color number.
Pulls <ul style="list-style-type: none"> Contemporary pulls <ul style="list-style-type: none"> Black Polished Chrome Silver Deco pulls <ul style="list-style-type: none"> Black Polished Chrome Nickel Jazz pulls <ul style="list-style-type: none"> Black Polished Chrome Nickel 	No cost No cost No cost +\$10 per pull +\$10 per pull +\$10 per pull +\$10 per pull +\$10 per pull +\$10 per pull	Specify with <i>0835 Black E070 contemporary pulls</i> . Specify with <i>9201 Polished Chrome E070 contemporary pulls</i> . Specify with <i>9212 Silver E070 contemporary pulls</i> . Specify with <i>0835 Black BPB deco pulls</i> . Specify with <i>9201 Polished Chrome BPB deco pulls</i> . Specify with <i>9211 Nickel BPB deco pulls</i> . Specify with <i>0835 Black BPD jazz pulls</i> . Specify with <i>9201 Polished Chrome BPD jazz pulls</i> . Specify with <i>9211 Nickel BPD jazz pulls</i> .
Filing Hardware <ul style="list-style-type: none"> Two file bars with clips per file drawer for side-to-side or legal filing Tip: <i>TFILE</i> option is not available on box/file mobile pedestal. 	No cost	Specify with <i>TFILE</i> .
Keying <ul style="list-style-type: none"> Factory- and field-installed keying 		▶ Page J8
Related Products <ul style="list-style-type: none"> Pedestal seat cushions 		▶ Page H100

Drawer Pull Shapes

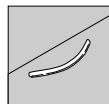

Contemporary

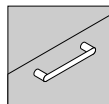

Deco

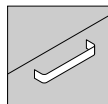

Jazz

SIN 711.8

Specification Information

Dimensions			Style Number	Base Price	Option (Add \$ to Base Price)
D	W	H			
:	:	:	:	:	Customiz
:	:	:	:	:	Stain



Mobile Pedestal with Box/File Drawers

16"	16"	20"	KPBF15MW	\$1135	+\$76
:	:	:	:	:	:



Mobile Pedestals with Box/Box/File Drawers

21 1/4"	16"	24 3/4"	KPBBF24MW	\$1214	+\$60
27 1/4"	16"	24 3/4"	KPBBF30MW	\$1324	+\$66
:	:	:	:	:	:



Mobile Pedestals with File/File Drawers

21 1/4"	16"	24 3/4"	KPFF24MW	\$1156	+\$57
27 1/4"	16"	24 3/4"	KPFF30MW	\$1256	+\$63
:	:	:	:	:	:



Pedestal Seat Cushions

Field-Installed Kit

SIN 711.8



Tip: Pedestal seat cushions cannot be used on double-wide pedestals with lateral file below.

Standard Includes	Required to Specify
<ul style="list-style-type: none"> Cushion upholstery: fabric price group 1 Installation kit 	<ol style="list-style-type: none"> Style number Fabric color number for cushion upholstery Options, if selected (see below) <p>▶ See <i>Surface Materials</i>, page H124.</p>

Options	Price	Required to Specify						
<table border="0"> <tr> <td style="vertical-align: top;">Surface Materials</td> <td> Upholstery <ul style="list-style-type: none"> Fabric price group 1 Fabric price group 2 Fabric price group 3 Fabric price group 4 Fabric price group 5 Fabric price group 6 Fabric price group 7 Fabric price group 8 Fabric price group 9 Fabric price group 10 Leather price group </td> <td> <ul style="list-style-type: none"> No cost +\$ 10 +\$ 33 +\$ 41 +\$ 50 +\$ 72 +\$ 85 +\$125 +\$160 +\$195 +\$200 </td> </tr> <tr> <td></td> <td> <ul style="list-style-type: none"> Customer's Own Material (COM) or Customer's Own Leather (COL) </td> <td> <ul style="list-style-type: none"> +\$ 15 </td> </tr> </table>	Surface Materials	Upholstery <ul style="list-style-type: none"> Fabric price group 1 Fabric price group 2 Fabric price group 3 Fabric price group 4 Fabric price group 5 Fabric price group 6 Fabric price group 7 Fabric price group 8 Fabric price group 9 Fabric price group 10 Leather price group 	<ul style="list-style-type: none"> No cost +\$ 10 +\$ 33 +\$ 41 +\$ 50 +\$ 72 +\$ 85 +\$125 +\$160 +\$195 +\$200 		<ul style="list-style-type: none"> Customer's Own Material (COM) or Customer's Own Leather (COL) 	<ul style="list-style-type: none"> +\$ 15 		<p>Specify fabric color number.</p> <p>Specify fabric color number.</p> <p>Specify fabric color number.</p> <p>Specify fabric color number.</p> <p>Specify fabric color number.</p> <p>Specify fabric color number.</p> <p>Specify fabric color number.</p> <p>Specify fabric color number.</p> <p>Specify fabric color number.</p> <p>Specify fabric color number.</p> <p>Specify fabric color number.</p> <p>Specify leather color number.</p> <p>▶ See <i>Surface Materials</i>, page H124.</p> <p>▶ See <i>Surface Materials Reference Manual</i> to specify.</p>
Surface Materials	Upholstery <ul style="list-style-type: none"> Fabric price group 1 Fabric price group 2 Fabric price group 3 Fabric price group 4 Fabric price group 5 Fabric price group 6 Fabric price group 7 Fabric price group 8 Fabric price group 9 Fabric price group 10 Leather price group 	<ul style="list-style-type: none"> No cost +\$ 10 +\$ 33 +\$ 41 +\$ 50 +\$ 72 +\$ 85 +\$125 +\$160 +\$195 +\$200 						
	<ul style="list-style-type: none"> Customer's Own Material (COM) or Customer's Own Leather (COL) 	<ul style="list-style-type: none"> +\$ 15 						

Specification Information			
• Dimensions		• Style	• Base
D	W	Number	Price

For Use with 15"W Pedestals

16"	16"	KPC1515	\$123
21¼"	16"	KPC1522	\$134
27¼"	16"	KPC1527	\$157

For Use with 30"W Pedestals

21¼"	30"	KPC3022	\$190
27¼"	30"	KPC3027	\$207

Tip: Pedestal seat cushions cannot be used on double-wide pedestals with lateral file below.

Application Information

Tip: Use the matrix below to determine the appropriate seat cushion size for your pedestal.

Pedestal Seat Cushions						
	KPC1515	KPC1522	KPC1527	KPC3022	KPC3027	
Pedestals	KPBBF24W	.	■	.	.	.
	KPBBF24MW	.	■	.	.	.
	KPBBF30W	.	.	■	.	.
	KPBBF30MW	.	.	■	.	.
	KPFF24W	.	■	.	.	.
	KPFF24MW	.	■	.	.	.
	KPFF30W	.	.	■	.	.
	KPFF30MW	.	.	■	.	.
	KPS24W	.	■	.	.	.
	KPS30W	.	.	■	.	.
	KDBBFS24LW	.	.	.	■	.
	KDBBFS24RW	.	.	.	■	.
	KDBBFS30LW	■
	KDBBFS30RW	■
	KDFFS24LW	.	.	.	■	.
	KDFFS24RW	.	.	.	■	.
	KDFFS30LW	■
	KDFFS30RW	■
	KPBF15MW	■

Legend

- = Available
- = Not available

Tall Pedestals

SIN 711.8

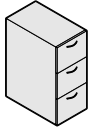

Tip: For interior drawer dimensions, refer to Storage Capacities.
 ▶ See Unison Specification Guide.

Standard Includes	Required to Specify
<ul style="list-style-type: none"> • Pedestal: wood • Contemporary, deco, or jazz pulls: paint or metal • Lock, keyed random: 9250 Ember Chrome • Rails: black only • One hanging file system for front-to-back filing per file drawer (see filing options below) • One partition per box drawer: black plastic only • One pencil tray per two box drawers: black plastic only • Leveling glides: black only 	<ol style="list-style-type: none"> 1 Style number 2 Wood color number for tall pedestal 3 Pulls and paint or metal color number (see below) 4 Options, if selected (see below) <p>▶ See <i>Surface Materials</i>, page H124.</p>

Options	Price	Required to Specify
Surface Materials <ul style="list-style-type: none"> • Customiz stain • Powder coat drawer fronts 	Prices at right No cost	Specify with <i>Customiz stain</i> . ▶ See <i>Surface Materials Reference Manual</i> . Specify with <i>powder coat fronts</i> and select powder coat finish color number.
Pulls <ul style="list-style-type: none"> Contemporary pulls <ul style="list-style-type: none"> • Black • Polished Chrome • Silver Deco pulls <ul style="list-style-type: none"> • Black • Polished Chrome • Nickel Jazz pulls <ul style="list-style-type: none"> • Black • Polished Chrome • Nickel 	No cost No cost No cost +\$10 per pull +\$10 per pull +\$10 per pull +\$10 per pull +\$10 per pull +\$10 per pull	Specify with <i>0835 Black E070 contemporary pulls</i> . Specify with <i>9201 Polished Chrome E070 contemporary pulls</i> . Specify with <i>9212 Silver E070 contemporary pulls</i> . Specify with <i>0835 Black BPB deco pulls</i> . Specify with <i>9201 Polished Chrome BPB deco pulls</i> . Specify with <i>9211 Nickel BPB deco pulls</i> . Specify with <i>0835 Black BPD jazz pulls</i> . Specify with <i>9201 Polished Chrome BPD jazz pulls</i> . Specify with <i>9211 Nickel BPD jazz pulls</i> .
Filing Hardware <ul style="list-style-type: none"> • Two file bars with clips per file drawer for side-to-side or legal filing 	No cost	Specify with <i>TFILE</i> .
Keying <ul style="list-style-type: none"> • Factory- and field-installed keying 		▶ Page J8

Drawer Pull Shapes

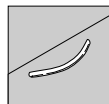

Contemporary

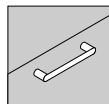

Deco

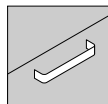

Jazz

SIN 711.8

Specification Information

Dimensions			Style Number	Base Price	Option (Add \$ to Base Price)
D	W	H			
:	:	:	:	:	Customiz
:	:	:	:	:	Stain

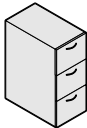

Tall Pedestals with File/File/File Drawers

21¼"	16"	37"	KPFFF3724W	\$1580	+\$80
27¼"	16"	37"	KPFFF3727W	\$1653	+\$84

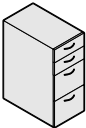

Tall Pedestals with Box/Box/File/File Drawers

21¼"	16"	37"	KPBFF3724W	\$1650	+\$84
27¼"	16"	37"	KPBFF3727W	\$1719	+\$87

Tall Mobile Pedestals

SIN 711.8

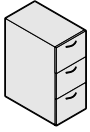

Tip: For interior drawer dimensions, refer to Storage Capacities.
 ▶ See Unison Specification Guide.

Standard Includes	Required to Specify
<ul style="list-style-type: none"> • Pedestal: wood • Contemporary, deco, or jazz pulls: paint or metal • Lock, keyed random: 9250 Ember Chrome • Rails: black only • One hanging file system for front-to-back filing per file drawer (see filing options below) • One partition per box drawer: black plastic only • One pencil tray per two box drawers: black plastic only • Non-locking casters: black only 	<ol style="list-style-type: none"> 1 Style number 2 Wood color number for tall pedestal 3 Pulls and paint or metal color number (see below) 4 Options, if selected (see below) <p>▶ See <i>Surface Materials</i>, page H124.</p>

Options	Price	Required to Specify
Surface Materials <ul style="list-style-type: none"> • Customiz stain • Powder coat drawer fronts 	Prices at right No cost	Specify with <i>Customiz stain</i> . ▶ See <i>Surface Materials Reference Manual</i> . Specify with <i>powder coat fronts</i> and select powder coat finish color number.
Pulls		
Contemporary pulls <ul style="list-style-type: none"> • Black • Polished Chrome • Silver 	No cost No cost No cost	Specify with <i>0835 Black E070 contemporary pulls</i> . Specify with <i>9201 Polished Chrome E070 contemporary pulls</i> . Specify with <i>9212 Silver E070 contemporary pulls</i> .
Deco pulls <ul style="list-style-type: none"> • Black • Polished Chrome • Nickel 	+\$10 per pull +\$10 per pull +\$10 per pull	Specify with <i>0835 Black BPB deco pulls</i> . Specify with <i>9201 Polished Chrome BPB deco pulls</i> . Specify with <i>9211 Nickel BPB deco pulls</i> .
Jazz pulls <ul style="list-style-type: none"> • Black • Polished Chrome • Nickel 	+\$10 per pull +\$10 per pull +\$10 per pull	Specify with <i>0835 Black BPD jazz pulls</i> . Specify with <i>9201 Polished Chrome BPD jazz pulls</i> . Specify with <i>9211 Nickel BPD jazz pulls</i> .
Filing Hardware <ul style="list-style-type: none"> • Two file bars with clips per file drawer for side-to-side or legal filing 	No cost	Specify with <i>TFILE</i> .
Keying <ul style="list-style-type: none"> • Factory- and field-installed keying 		▶ Page J8

Drawer Pull Shapes

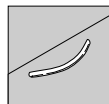

Contemporary

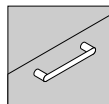

Deco

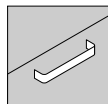

Jazz

SIN 711.8

Specification Information

Dimensions			Style	Base	Option
D	W	H	Number	Price	(Add \$ to Base Price)
:	:	:	:	:	Customiz
:	:	:	:	:	Stain



Tall Mobile Pedestals with File/File/File Drawers

21¼"	16"	37"	KPFFF3724MW	\$1637	+\$83
27¼"	16"	37"	KPFFF3727MW	\$1708	+\$87

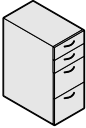

Tall Mobile Pedestals with Box/Box/File/File Drawers

21¼"	16"	37"	KPBFF3724MW	\$1709	+\$87
27¼"	16"	37"	KPBFF3727MW	\$1779	+\$90



Tall Pedestals

for Use with Hedge Row Tops Only

SIN 711.8

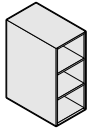

Tip: Hedge row top must be specified separately.
▶ Page H110

Tip: Tall pedestals can be used with either 15¾"W or 53"W hedge row tops.

Tip: Top of pedestal has location cutouts to affix installation kit for hedge row top attachment. Installation kit ships with tall mobile pedestals.

Tip: TFILE option is not available on mobile pedestals for use with hedge row top.

Tip: For interior drawer dimensions, refer to Storage Capacities.
▶ See Unison Specification Guide.

Standard Includes	Required to Specify
-------------------	---------------------

- Pedestal with recessed back: wood
- Wood door, if selected: wood to match pedestal
- Glass door, if selected: translucent only
- Contemporary, deco, or jazz pulls: paint or metal
- Two metal shelves and eight support pins for recessed back application: platinum paint only
- Lock, keyed random: 9250 Ember Chrome
- Rails: black only
- One hanging file system for front-to-back filing per file drawer
- Installation kit for hedge row top: platinum only
- One partition per box drawer: black plastic only
- One pencil tray per two box drawers: black plastic only
- Leveling glides: black only

- 1 Style number
 - 2 Wood color number for tall pedestal
 - 3 Pulls and paint or metal color number (see below)
 - 4 Options, if selected (see below)
- ▶ See *Surface Materials*, page H124.

Surface Materials	Options	Price	Required to Specify
-------------------	---------	-------	---------------------

- | | | | |
|--------------------------|-----------------------------|-----------------|---|
| Surface Materials | • Customiz stain | Prices at right | Specify with <i>Customiz stain</i> .
▶ See <i>Surface Materials Reference Manual</i> . |
| | • Powder coat drawer fronts | No cost | Specify with <i>powder coat fronts</i> and select powder coat finish color number. |

Pulls	Contemporary pulls	Price	Required to Specify
-------	--------------------	-------	---------------------

- | | | | |
|--------------|---------------------------|---------|--|
| Pulls | Contemporary pulls | | |
| | • Black | No cost | Specify with <i>0835 Black E070 contemporary pulls</i> . |
| | • Polished Chrome | No cost | Specify with <i>9201 Polished Chrome E070 contemporary pulls</i> . |
| | • Silver | No cost | Specify with <i>9212 Silver E070 contemporary pulls</i> . |

Deco pulls	Price	Required to Specify
------------	-------	---------------------

- | | | |
|-------------------|-----------------|---|
| Deco pulls | | |
| • Black | +\$ 10 per pull | Specify with <i>0835 Black BPB deco pulls</i> . |
| • Polished Chrome | +\$ 10 per pull | Specify with <i>9201 Polished Chrome BPB deco pulls</i> . |
| • Nickel | +\$ 10 per pull | Specify with <i>9211 Nickel BPB deco pulls</i> . |

Jazz pulls	Price	Required to Specify
------------	-------	---------------------

- | | | |
|-------------------|-----------------|---|
| Jazz pulls | | |
| • Black | +\$ 10 per pull | Specify with <i>0835 Black BPD jazz pulls</i> . |
| • Polished Chrome | +\$ 10 per pull | Specify with <i>9201 Polished Chrome BPD jazz pulls</i> . |
| • Nickel | +\$ 10 per pull | Specify with <i>9211 Nickel BPD jazz pulls</i> . |

Tackboard and Slatwall	Options	Price	Required to Specify
------------------------	---------	-------	---------------------

- | | | | |
|-------------------------------|--|--------|--|
| Tackboard and Slatwall | • Tackboard on recessed back | +\$ 80 | Specify with <i>tackboard</i> . |
| | • Tackboard (bottom) and slatwall (top) on recessed back | +\$120 | Specify with <i>slatwall top and tackboard bottom</i> and select slatwall color number 8043 Clear Anodized Aluminum or 8044 Black Anodized Aluminum. |

Keying	Options	Required to Specify
--------	---------	---------------------

- | | | |
|---------------|---------------------------------------|-----------|
| Keying | • Factory- and field-installed keying | ▶ Page J8 |
|---------------|---------------------------------------|-----------|

Related Products	Options	Required to Specify
------------------	---------	---------------------

- | | | |
|-------------------------|------------------|-------------|
| Related Products | • Hedge row tops | ▶ Page H110 |
|-------------------------|------------------|-------------|

Drawer Pull Shapes

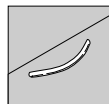

Contemporary

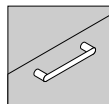

Deco

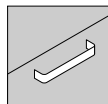

Jazz

Tip: Hedge row top must be specified separately.
▶ See page H110

Specification Information

• Dimensions			• Style Number	• Base Price	• Option (Add \$ to Base Price)
D	W	H			
:	:	:	:	:	Customiz
:	:	:	:	:	Stain

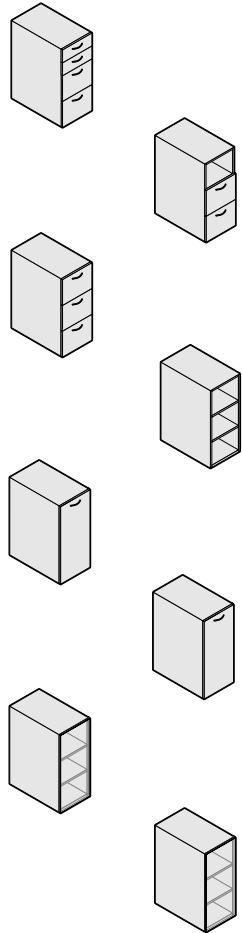

Tall Pedestal with Box/Box/File/File Drawers

21¼"	16"	37"	KPBBFF24RW	\$1845	+\$156
------	-----	-----	-------------------	--------	--------

Tall Pedestal with Open Shelf and File/File Drawers

21¼"	16"	37"	KPSFF24RW	\$1620	+\$136
------	-----	-----	------------------	--------	--------

Tall Pedestal with File/File/File Drawers

21¼"	16"	37"	KPFFF24RW	\$1779	+\$150
------	-----	-----	------------------	--------	--------

Tall Pedestal with Three Open Shelves

21¼"	16"	37"	KPSSS24RW	\$1165	+\$ 95
------	-----	-----	------------------	--------	--------

Tall Pedestal with Three Open Shelves and Wood Door Hinged on Left

21¼"	16"	37"	KPSS24RLW	\$1528	+\$127
------	-----	-----	------------------	--------	--------

Tall Pedestal with Three Open Shelves and Wood Door Hinged on Right

21¼"	16"	37"	KPSS24RRW	\$1528	+\$127
------	-----	-----	------------------	--------	--------

Tall Pedestal with Three Open Shelves and Translucent Glass Door Hinged on Left

21¼"	16"	37"	KPSS24GRLW	\$1808	+\$152
------	-----	-----	-------------------	--------	--------

Tall Pedestal with Three Open Shelves and Translucent Glass Door Hinged on Right

21¼"	16"	37"	KPSS24GRRW	\$1808	+\$152
------	-----	-----	-------------------	--------	--------

Tip: Tall pedestals with glass doors do not have pulls or locks.

Tall Mobile Pedestals

for Use with Hedge Row Tops Only

SIN 711.8

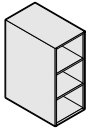

Tip: Hedge row top must be specified separately.
▶ Page H110

Tip: Tall mobile pedestals can be used with 15³/₄"W hedge row tops only.

Tip: Top of pedestal has location cutouts to affix installation kit for hedge row top attachment. Installation kit ships with tall mobile pedestals.

Tip: TFILE option is not available on mobile pedestals for use with hedge row top.

Tip: For interior drawer dimensions, refer to Storage Capacities.
▶ See Unison Specification Guide.

Standard Includes	Required to Specify
-------------------	---------------------

- Pedestal with recessed back: wood
- Wood door, if selected: wood to match pedestal
- Glass door, if selected: translucent only
- Contemporary, deco, or jazz pulls: paint or metal
- Two metal shelves and eight support pins for recessed back application: platinum paint only
- Lock, keyed random: 9250 Ember Chrome
- Rails: black only
- One hanging file system for front-to-back filing per file drawer
- Installation kit for hedge row top: platinum only
- One partition per box drawer: black plastic only
- One pencil tray per two box drawers: black plastic only
- Casters: black only

- 1 Style number
 - 2 Wood color number for tall pedestal
 - 3 Pulls and paint or metal color number (see below)
 - 4 Options, if selected (see below)
- ▶ See *Surface Materials*, page H124.

Options	Price	Required to Specify
---------	-------	---------------------

Surface Materials	• Customiz stain	Prices at right	Specify with <i>Customiz stain</i> . ▶ See <i>Surface Materials Reference Manual</i> .
	• Powder coat drawer fronts	No cost	Specify with <i>powder coat fronts</i> and select powder coat finish color number.
Pulls	Contemporary pulls		
	• Black	No cost	Specify with <i>0835 Black E070 contemporary pulls</i> .
	• Polished Chrome	No cost	Specify with <i>9201 Polished Chrome E070 contemporary pulls</i> .
	• Silver	No cost	Specify with <i>9212 Silver E070 contemporary pulls</i> .
	Deco pulls		
	• Black	+\$ 10 per pull	Specify with <i>0835 Black BPB deco pulls</i> .
	• Polished Chrome	+\$ 10 per pull	Specify with <i>9201 Polished Chrome BPB deco pulls</i> .
	• Nickel	+\$ 10 per pull	Specify with <i>9211 Nickel BPB deco pulls</i> .
	Jazz pulls		
• Black	+\$ 10 per pull	Specify with <i>0835 Black BPD jazz pulls</i> .	
• Polished Chrome	+\$ 10 per pull	Specify with <i>9201 Polished Chrome BPD jazz pulls</i> .	
• Nickel	+\$ 10 per pull	Specify with <i>9211 Nickel BPD jazz pulls</i> .	
Tackboard and Slatwall	• Tackboard on recessed back	+\$ 80	Specify with <i>tackboard</i> .
	• Tackboard (bottom) and slatwall (top) on recessed back	+\$120	Specify with <i>slatwall top and tackboard bottom</i> and select slatwall color number 8043 Clear Anodized Aluminum or 8044 Black Anodized Aluminum.
Keying	• Factory- and field-installed keying		▶ Page J8
Related Products	• Hedge row tops		▶ Page H110

Drawer Pull Shapes

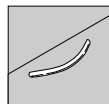

Contemporary

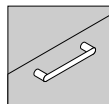

Deco

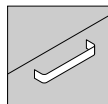

Jazz

Tip: Hedge row top must be specified separately.
▶ Page H110

Specification Information

• Dimensions			• Style Number	• Base Price	• Option (Add \$ to Base Price)
D	W	H			
:	:	:	:	:	Customiz
:	:	:	:	:	Stain

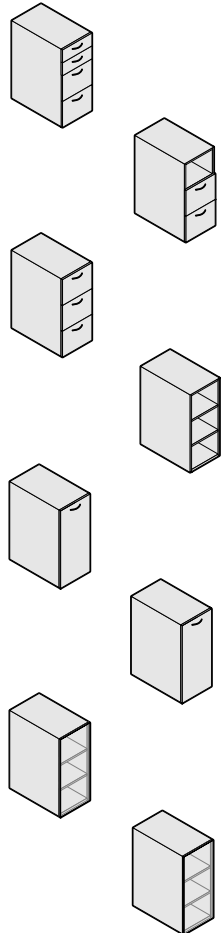

Tall Mobile Pedestal with Box/Box/File/File Drawers

21¼"	16"	37"	KPBBFF24RMW	\$1902	+\$161
------	-----	-----	--------------------	--------	--------

Tall Mobile Pedestal with Open Shelf and File/File Drawers

21¼"	16"	37"	KPSFF24RMW	\$1677	+\$141
------	-----	-----	-------------------	--------	--------

Tall Mobile Pedestal with File/File/File Drawers

21¼"	16"	37"	KPFFF24RMW	\$1836	+\$155
------	-----	-----	-------------------	--------	--------

Tall Mobile Pedestal with Three Open Shelves

21¼"	16"	37"	KPSSS24RMW	\$1222	+\$100
------	-----	-----	-------------------	--------	--------

Tall Mobile Pedestal with Three Open Shelves and Wood Door Hinged on Left

21¼"	16"	37"	KPSS24RLMW	\$1585	+\$132
------	-----	-----	-------------------	--------	--------

Tall Mobile Pedestal with Three Open Shelves and Wood Door Hinged on Right

21¼"	16"	37"	KPSS24RRMW	\$1585	+\$132
------	-----	-----	-------------------	--------	--------

Tall Mobile Pedestal with Three Open Shelves and Translucent Glass Door Hinged on Left

21¼"	16"	37"	KPSS24GRLMW	\$1865	+\$157
------	-----	-----	--------------------	--------	--------

Tall Mobile Pedestal with Three Open Shelves and Translucent Glass Door Hinged on Right

21¼"	16"	37"	KPSS24GRRMW	\$1865	+\$157
------	-----	-----	--------------------	--------	--------

Tip: Tall pedestals with glass doors do not have pulls or locks.

Hedge Row Tops

for Use with Tall Pedestals and Tall Mobile Pedestals

SIN 711.8

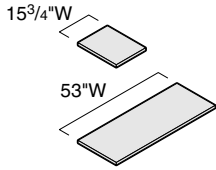

Tip: 15 3/4" W tops are for use on a single pedestal. 53" W tops are intended to span multiple pedestals, but cannot be used on mobile pedestals.

Standard Includes	Required to Specify
<ul style="list-style-type: none"> • Top: wood veneer • Square (3 mm) or tapered edge profile on front and back edges: wood • Square (3 mm) edge profile on side edges: wood 	<ul style="list-style-type: none"> 1 Style number 2 Wood color number for top 3 Options, if selected (see below) ▶ See <i>Surface Materials</i>, page H124.

Options	Price	Required to Specify
Surface Materials <ul style="list-style-type: none"> • Customiz stain 	Prices below	Specify with <i>Customiz stain</i> . ▶ See <i>Surface Materials Reference Manual</i> .

Specification Information

• Dimensions		• Style	• Base	• Option
D	W	Number	Price	(Add \$ to Base Price)
Square (3 mm) Edge Profile				
20 1/2"	15 3/4"	KSW15SW	\$372	+\$22
20 1/2"	53"	KSW54SW	\$644	+\$37
Tapered Edge Profile				
20 1/2"	15 3/4"	KSW15BW	\$428	+\$22
20 1/2"	53"	KSW54BW	\$712	+\$37
:	:	:	:	:

Hedge Row Tops
for Use with Tall Pedestals
and Tall Mobile Pedestals

SIN 711.8



Towers

SIN 711.8

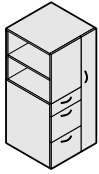

Tip: For interior drawer dimensions, refer to Storage Capacities.
 ▶ See Unison Specification Guide.

Standard Includes		Required to Specify	
<ul style="list-style-type: none"> • Tower: wood • Contemporary, deco, or jazz pulls: paint or metal • Locks, keyed random: 9250 Ember Chrome • One adjustable bookshelf: wood to match tower • One hanging file system for front-to-back filing per file drawer (see filing options below) • Coat rod • One partition per box drawer: black plastic only • One pencil tray per two box drawers: black plastic only • Leveling glides: black only 		<ol style="list-style-type: none"> 1 Style number 2 Wood color number for tower 3 Pulls and paint or metal color number (see below) 4 Options, if selected (see below) ▶ See <i>Surface Materials</i> , page H124.	
Options	Price	Required to Specify	
Surface Materials	<ul style="list-style-type: none"> • Customiz stain • Powder coat fronts 	Prices at right No cost	Specify with <i>Customiz stain</i> . ▶ See <i>Surface Materials Reference Manual</i> . Specify with <i>powder coat fronts</i> and select powder coat finish color number.
Pulls	<p>Contemporary pulls</p> <ul style="list-style-type: none"> • Black • Polished Chrome • Silver <p>Deco pulls</p> <ul style="list-style-type: none"> • Black • Polished Chrome • Nickel <p>Jazz pulls</p> <ul style="list-style-type: none"> • Black • Polished Chrome • Nickel 	No cost No cost No cost +\$10 per pull +\$10 per pull +\$10 per pull +\$10 per pull +\$10 per pull +\$10 per pull	Specify with <i>0835 Black E070 contemporary pulls</i> . Specify with <i>9201 Polished Chrome E070 contemporary pulls</i> . Specify with <i>9212 Silver E070 contemporary pulls</i> . Specify with <i>0835 Black BPB deco pulls</i> . Specify with <i>9201 Polished Chrome BPB deco pulls</i> . Specify with <i>9211 Nickel BPB deco pulls</i> . Specify with <i>0835 Black BPD jazz pulls</i> . Specify with <i>9201 Polished Chrome BPD jazz pulls</i> . Specify with <i>9211 Nickel BPD jazz pulls</i> .
Filing Hardware	<ul style="list-style-type: none"> • Two file bars with clips per file drawer for side-to-side or legal filing 	No cost	Specify with <i>TFILE</i> .
Keying	<ul style="list-style-type: none"> • Factory- and field-installed keying 		▶ Page J8
Related Products	<ul style="list-style-type: none"> • Field-installed triangular grommet • Wood shelves for towers 		▶ Page H86 ▶ Page H114

Drawer Pull Shapes

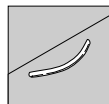

Contemporary

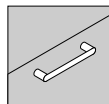

Deco

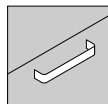

Jazz

SIN 711.8

Specification Information

Dimensions			Style Number	Base Price	Option (Add \$ to Base Price)
D	W	H			
					Customiz Stain

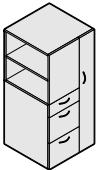

Adjustable Bookshelf on Left with Box/File/File Drawers and Door Hinged on Right

24"	24"	53"	KT5324LW	\$2725	+\$228
24"	24"	60"	KT6024LW	\$2913	+\$414
30"	24"	53"	KT5330LW	\$3104	+\$261
30"	24"	60"	KT6030LW	\$3329	+\$508

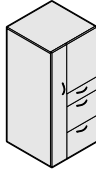

Adjustable Bookshelf on Right with Box/File/File Drawers and Door Hinged on Left

24"	24"	53"	KT5324RW	\$2725	+\$228
24"	24"	60"	KT6024RW	\$2913	+\$414
30"	24"	53"	KT5330RW	\$3104	+\$261
30"	24"	60"	KT6030RW	\$3329	+\$508

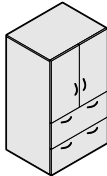

Double Doors with Adjustable Bookshelf and File/File Drawers

24"	30"	53"	KT5324DFW	\$3356	+\$285
24"	30"	60"	KT6024DFW	\$3541	+\$512



Wood Shelves for Towers

SIN 711.8



Standard Includes	Required to Specify
<ul style="list-style-type: none"> • Package of three shelves: wood • Package of twelve shelf pins 	<ul style="list-style-type: none"> 1 Style number 2 Wood color number for shelves 3 Options, if selected (see below) ▶ See <i>Surface Materials</i>, page H124.

Specification Information

• Dimensions			• Style	• Price
D	W	H	Number	
24"	12"	1"	KT1224SW	\$106
30"	12"	1"	KT1230SW	\$124
:	:	:	:	:

SIN 711.8



Lateral Files

SIN 711.8

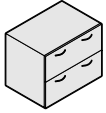

Tip: For interior drawer dimensions, refer to Storage Capacities.

▶ See *Unison Specification Guide*.

Tip: Lateral files may not be used in conjunction with the pivot hitch.

▶ See *Wood Caseworks and Tables Specification Guide* for pivot hitch application rules.

Standard Includes		Required to Specify	
<ul style="list-style-type: none"> Lateral file: wood Contemporary, deco, or jazz pulls: paint or metal Lock, keyed random: 9250 Ember Chrome Rails: black only One hanging file system for front-to-back filing per file drawer (see filing options below) Leveling glides: black only 		<ol style="list-style-type: none"> Style number Wood color number for lateral file Pulls and paint or metal color number (see below) Options, if selected (see below) <p>▶ See <i>Surface Materials</i>, page H124.</p>	
Surface Materials	Options	Price	Required to Specify
	• Customiz stain	Prices at right	Specify with <i>Customiz stain</i> .
	• Powder coat drawer fronts	No cost	▶ See <i>Surface Materials Reference Manual</i> . Specify with <i>powder coat fronts</i> and select powder coat finish color number.
Pulls	Contemporary pulls		
	• Black	No cost	Specify with <i>0835 Black E070 contemporary pulls</i> .
	• Polished Chrome	No cost	Specify with <i>9201 Polished Chrome E070 contemporary pulls</i> .
	• Silver	No cost	Specify with <i>9212 Silver E070 contemporary pulls</i> .
	Deco pulls		
	• Black	+\$10 per pull	Specify with <i>0835 Black BPB deco pulls</i> .
	• Polished Chrome	+\$10 per pull	Specify with <i>9201 Polished Chrome BPB deco pulls</i> .
	• Nickel	+\$10 per pull	Specify with <i>9211 Nickel BPB deco pulls</i> .
	Jazz pulls		
	• Black	+\$10 per pull	Specify with <i>0835 Black BPD jazz pulls</i> .
	• Polished Chrome	+\$10 per pull	Specify with <i>9201 Polished Chrome BPD jazz pulls</i> .
	• Nickel	+\$10 per pull	Specify with <i>9211 Nickel BPD jazz pulls</i> .
Filing Hardware	• Two file bars with clips per file drawer for side-to-side or legal filing	No cost	Specify with <i>TFILE</i> .
Keying	• Factory- and field-installed keying		▶ Page J8

Drawer Pull Shapes

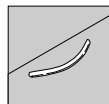

Contemporary

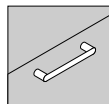

Deco

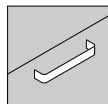

Jazz

SIN 711.8

Specification Information

Dimensions			Style Number	Base Price	Option (Add \$ to Base Price)
D	W	H			

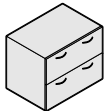

Two-High Lateral Files

21 1/4"	30"	24 3/4"	KL230W	\$1628	+\$ 82
21 1/4"	36"	24 3/4"	KL236W	\$1887	+\$ 96

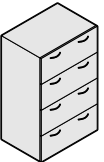

Four-High Lateral Files

21 1/4"	30"	48 3/4"	KL430W	\$2538	+\$191
21 1/4"	36"	48 3/4"	KL436W	\$2829	+\$215
24"	30"	48 3/4"	KL430XW	\$2829	+\$215
24"	36"	48 3/4"	KL436XW	\$3092	+\$235



Super Shelves

for Use with Structural Walls

SIN 711.8

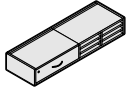

Tip: Open super shelf must be installed 38"H or higher from the floor.

Tip: For interior drawer dimensions, refer to Storage Capacities.
 ▶ See Unison Specification Guide.

Standard Includes		Required to Specify	
<ul style="list-style-type: none"> • Super shelf: wood • Contemporary, deco, or jazz pulls on workstation door: paint or metal • Paper management shelves: 4799 Platinum paint • Lock, keyed random: 9250 Ember Chrome • Attachment hardware 		<ol style="list-style-type: none"> 1 Style number 2 Wood color number for shelf 3 Paint or metal color number for pulls 4 Options, if selected (see below) ▶ See <i>Surface Materials</i> , page H124.	
Options	Price	Required to Specify	
Surface Materials	<ul style="list-style-type: none"> • Customiz stain Prices at right	Specify with <i>Customiz stain</i> . ▶ See <i>Surface Materials Reference Manual</i> .	
Pulls	Contemporary pulls		
	<ul style="list-style-type: none"> • Black No cost	Specify with <i>0835 Black E070 contemporary pulls</i> .	
	<ul style="list-style-type: none"> • Polished Chrome No cost	Specify with <i>9201 Polished Chrome E070 contemporary pulls</i> .	
	<ul style="list-style-type: none"> • Silver No cost	Specify with <i>9212 Silver E070 contemporary pulls</i> .	
	Deco pulls		
	<ul style="list-style-type: none"> • Black +\$10 per pull	Specify with <i>0835 Black BPB deco pulls</i> .	
	<ul style="list-style-type: none"> • Polished Chrome +\$10 per pull	Specify with <i>9201 Polished Chrome BPB deco pulls</i> .	
	<ul style="list-style-type: none"> • Nickel +\$10 per pull	Specify with <i>9211 Nickel BPB deco pulls</i> .	
	Jazz pulls		
	<ul style="list-style-type: none"> • Black +\$10 per pull	Specify with <i>0835 Black BPD jazz pulls</i> .	
	<ul style="list-style-type: none"> • Polished Chrome +\$10 per pull	Specify with <i>9201 Polished Chrome BPD jazz pulls</i> .	
	<ul style="list-style-type: none"> • Nickel +\$10 per pull	Specify with <i>9211 Nickel BPD jazz pulls</i> .	
Shelves	<ul style="list-style-type: none"> • Acrylic Prices at right	Specify with <i>acrylic shelves</i> .	
Keying	<ul style="list-style-type: none"> • Factory- and field-installed keying 	▶ Page J8	
Related Products	<ul style="list-style-type: none"> • Field-installed triangular grommet 	▶ Page H86	

Drawer Pull Shapes

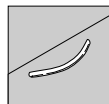

Contemporary

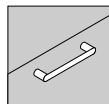

Deco

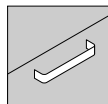

Jazz

Specification Information

• Dimensions			• Style Number	• Base Price	• Options		
D	W	H			(Add \$ to Base Price)	Customiz	Acrylic Shelves
:	:	:	:	:	:	Stain	:

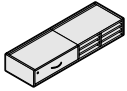

Super Shelves with Left-Hand Workstation and Paper Management Shelves

15"	36"	7½"	KSS36WLWW	\$ 927	+\$72	+\$ 40
15"	48"	7½"	KSS48WLWW	\$1058	+\$83	+\$ 80
15"	60"	7½"	KSS60WLWW	\$1217	+\$94	+\$120
:	:	:	:	:	:	:

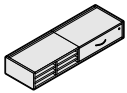

Super Shelves with Right-Hand Workstation and Paper Management Shelves

15"	36"	7½"	KSS36WRWW	\$ 927	+\$72	+\$ 40
15"	48"	7½"	KSS48WRWW	\$1058	+\$83	+\$ 80
15"	60"	7½"	KSS60WRWW	\$1217	+\$94	+\$120
:	:	:	:	:	:	:

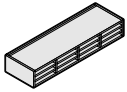

Super Shelves with Paper Management Shelves

15"	36"	7½"	KSS36PWW	\$ 983	+\$56	+\$120
15"	48"	7½"	KSS48PWW	\$1124	+\$64	+\$160
15"	60"	7½"	KSS60PWW	\$1267	+\$43	+\$200
:	:	:	:	:	:	:

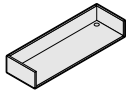

Open Super Shelves

15"	36"	7½"	KSS36SWW	\$ 685	+\$43	N.A.
15"	48"	7½"	KSS48SWW	\$ 786	+\$45	N.A.
15"	60"	7½"	KSS60SWW	\$ 894	+\$52	N.A.
:	:	:	:	:	:	:

Tip: Open super shelf must be installed 38"H or higher from the floor.

Super Shelves

for Use with T-Walls

SIN 711.8

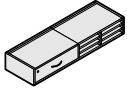

Tip: Only one super shelf can be mounted per each side of T-wall.

Tip: Open super shelf must be installed 38"H or higher from the floor.

Tip: For interior drawer dimensions, refer to Storage Capacities.

▶ See Unison Specification Guide.

Standard Includes		Required to Specify	
<ul style="list-style-type: none"> • Super shelf: wood • Contemporary, deco, or jazz pulls on workstation door: paint or metal • Paper management shelves: 4799 Platinum paint • Lock, keyed random: 9250 Ember Chrome • Attachment hardware 		<ol style="list-style-type: none"> 1 Style number 2 Wood color number for shelf 3 Paint or metal color number for pulls 4 Options, if selected (see below) <p>▶ See <i>Surface Materials</i>, page H124.</p>	
Options	Price	Required to Specify	
Surface Materials	<ul style="list-style-type: none"> • Customiz stain 	Prices at right	Specify with <i>Customiz stain</i> . ▶ See <i>Surface Materials Reference Manual</i> .
Pulls	<p>Contemporary pulls</p> <ul style="list-style-type: none"> • Black • Polished Chrome • Silver <hr/> <p>Deco pulls</p> <ul style="list-style-type: none"> • Black • Polished Chrome • Nickel <hr/> <p>Jazz pulls</p> <ul style="list-style-type: none"> • Black • Polished Chrome • Nickel 	No cost No cost No cost +\$10 per pull +\$10 per pull +\$10 per pull +\$10 per pull +\$10 per pull +\$10 per pull	Specify with <i>0835 Black E070 contemporary pulls</i> . Specify with <i>9201 Polished Chrome E070 contemporary pulls</i> . Specify with <i>9212 Silver E070 contemporary pulls</i> . Specify with <i>0835 Black BPB deco pulls</i> . Specify with <i>9201 Polished Chrome BPB deco pulls</i> . Specify with <i>9211 Nickel BPB deco pulls</i> . Specify with <i>0835 Black BPD jazz pulls</i> . Specify with <i>9201 Polished Chrome BPD jazz pulls</i> . Specify with <i>9211 Nickel BPD jazz pulls</i> .
Shelves	<ul style="list-style-type: none"> • Acrylic 	Prices at right	Specify with <i>acrylic shelves</i> .
Keying	<ul style="list-style-type: none"> • Factory- and field-installed keying 		▶ Page J8
Related Products	<ul style="list-style-type: none"> • Field-installed triangular grommet 		▶ Page H86

Drawer Pull Shapes

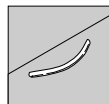

Contemporary

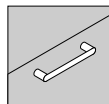

Deco

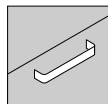

Jazz

Specification Information

• Dimensions			• Style Number	• Base Price	• Options		
D	W	H			(Add \$ to Base Price)	Customiz	Acrylic Shelves
:	:	:	:	:	:	Stain	Shelves

Super Shelves with Left-Hand Workstation and Paper Management Shelves

15"	36"	7½"	KSS36WLWT	\$ 927	+\$73	+\$ 40
15"	48"	7½"	KSS48WLWT	\$1058	+\$83	+\$ 80

Super Shelves with Right-Hand Workstation and Paper Management Shelves

15"	36"	7½"	KSS36WRWT	\$ 927	+\$73	+\$ 40
15"	48"	7½"	KSS48WRWT	\$1058	+\$83	+\$ 80

Super Shelves with Paper Management Shelves

15"	36"	7½"	KSS36PWT	\$ 983	+\$56	+\$120
15"	48"	7½"	KSS48PWT	\$1124	+\$64	+\$160

Open Super Shelves

15"	36"	7½"	KSS36SWT	\$ 685	+\$43	N.A.
15"	48"	7½"	KSS48SWT	\$ 786	+\$45	N.A.

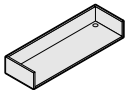
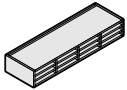
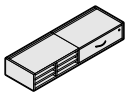
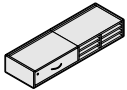

Tip: Open super shelf must be installed 38"H or higher from the floor.

Unison Surface Materials

Surface Materials	H124
Metal Color Availability Matrix	H126
Wood Grain Directions	H127

Surface Materials

This listing includes all the surface material choices that are available for the products in this specification guide.

Resources

For more information about surface materials and the categories they fall into, refer to the following resources:

Additional surface materials specification tools are available to assist you in the specification process—the Surface Materials Binders and the Surface Materials Tool Box.

Surface Materials Binders

- Surface Materials Reference Manual
- A complete set of swatch cards for hard surfaces, vertical surface fabrics, and seating upholstery

Surface Materials

Tool Box (S8150) provides 3" x 3" samples of the following surface materials:

- Vertical surface fabrics
- Seating upholstery
- Wood veneer
- Paint
- Laminate

Wood

Steelcase carefully selects veneer and solid wood or consistent color and grain structure. Wood is a natural material and variations will occur in color, grain and texture. These variations are part of the inherent natural beauty of wood and are not considered defects.

All wood products will darken with age and exposure to ultraviolet light. This is especially apparent with cherry and maple veneer. We recommend that desk accessories be rearranged periodically to insure even aging of wood surfaces.

Veneers are flat cut and are matched for proper balance and consistency.

Open-pore finish is a medium-gloss finish that leaves the wood grain texture visible to the eye and distinguishable to the touch.

Open-pore wood color choices

- 3412 Natural Cherry
- 3422 Medium Cherry
- 3562 Linseed on Maple
- 3572 Amber on Maple
- 3582 Winter on Maple
- 3592 Blonde on Maple
- 3632 Medium Oak
- 3642 Natural Oak
- 3712 Natural Walnut
- 3722 Dark Mahogany on Walnut
- 3742 Autumn Walnut
- 3772 Medium Mahogany on Walnut
- 3792 Black Walnut

Full-fill finish is a medium-gloss finish that completely fills the grain and has a lustrous, satin look and feel. This finish is available on worksurfaces and hedge row tops only.

Full-fill wood color choices

- 3414 Natural Cherry
- 3424 Medium Cherry
- 3534 Winter on Maple
- 3544 Blonde on Maple
- 3564 Linseed on Maple
- 3574 Amber on Maple
- 3634 Medium Oak
- 3644 Natural Oak
- 3714 Natural Walnut
- 3724 Dark Mahogany on Walnut
- 3744 Autumn Walnut
- 3774 Medium Mahogany on Walnut
- 3794 Black Walnut

Customiz stain is a service that allows you to create your own stain color on standard veneers. Customiz stain color is available on all product lines that offer wood veneer.

A one-time formulation fee of \$400 U.S. per color, per customer processing fee will apply. The fee covers the cost of formulating the Customiz finish and applies regardless of whether or not an order for product is placed. Please refer to the "Customiz Stain" option price column in your specification guide for the unit upcharge.

Customiz stain takes 10 days to formulate. Consult the Surface Materials Reference Manual for more information. Custom veneers are also available and must be quoted by specials engineering. Customiz stain on custom veneers take two to four weeks to formulate.

Requirements and information on ordering a Customiz stain color are found in the *Surface Materials Reference Manual*.

Paint

Applies to:

- Contemporary, deco, and jazz pulls

0835 Black

Applies to:

- Elliptical leg

4799 Platinum
7207 Black

Applies to:

- Glides

7207 Black

Applies to:

- Wood drawer fronts

Price Group 1

Textured Coating
7601 Sand
7605 Black

Price Group 2

Metallic Coating
7604 Platinum

Applies to:

- Cabby legs

Price Group 1

Textured Paint
7207 Black
7225 Sand (Vanadium)
7236 Fog
7237 Slate
7238 Fieldstone
7239 Midnight

Price Group 2

Metallic Paint
4750 Champagne
4751 Bronze
4752 Steel
4788 Gold Dust
4798 Sterling
4799 Platinum

Accent Paint

Please see the Accent Paint swatch card within the *Surface Materials Finishes Binder* for a complete list of these colorful paints.

PerfectMatch II Paint

PerfectMatch II paint is a service that allows you to create your own paint color. Refer to the *Surface Materials Reference Manual* for more information about this program.

Metal

Applies to:

- Slatwall
- Elliptical leg
- Cabby leg
- Deco pulls
- Jazz pulls
- Contemporary pulls
- Glides
- Locks

8042 Brushed Aluminum
8043 Clear Anodized Aluminum
8044 Black Anodized Aluminum
8046 Polished Aluminum
9201 Polished Chrome
9211 Nickel
9212 Silver
9250 Ember Chrome

Not every metal color is available on every metal component.

► See page H126 for an overview of the metal colors that are available for each component.

Plastic

Applies to:

- P-edge profile on worksurfaces

6000 Black

Seating

► See *Surface Materials Reference Manual* for a listing of available upholstery colors.

- Available on pedestal seat cushions only.

Classics Collection

Surface materials in the Classics Collection are timeless. These material should be available for a minimum of 10 years from the date the material is introduced into the Classics Collection. The Classics Collection includes the following fabrics in Price Groups 1 through 3:

Price Group 1

Buzz2
Jacks
Link
Sewn Vinyl

Price Group 2

Canzoné
Cavalcade
Cricket
Regis
Roulette
Spyder
Sweepstakes

Price Group 3

Hampstead
Zoe

Leather

Steelcase Leather

Designtex Graded-In Program

All Designtex Graded-In fabrics are now supported just like standard fabrics when ordered on Steelcase furniture. The Designtex Graded-In Program also includes the Environmental Impact Collection, which offers sustainable textiles in affordable price groups. For additional information and fabric samples, contact your local Designtex sales representative at 1.800.221.1540.

Designtex upholsteries are graded into Steelcase Price Groups 2 through 10:

Price Group 2

Bee (Environmental Impact Collection)

Price Group 3

Lagoon (Environmental Impact Collection)
Prairie (Environmental Impact Collection)
Reed Stripe (Environmental Impact Collection)

Price Group 4

Bowline
Closed Loop
Cord
Croquet
Domino
Montezuma
Nolita
Rook
Round About
Skittles
Tango
Tivoli
Vibe
Wobble

Price Group 5

Abex
Frisbee
Infield
Retreat
Sam

Price Group 6

Rough & Ready

Price Group 7

Ace
Firefly
Shimmy
Wool Suede Too

Price Group 8

Coppice
Delphos
Falling Leaves
Furrows
Lillian
Loseta
Meander
Packard
Rickshaw

Price Group 9

Gramercy
NoMad

Price Group 10

Plums

► See the *Surface Materials Reference Manual* for a listing of upholstery colors.

Price Group COM (Customer's Own Material)

Fabric Approval and Yardage

To confirm whether a particular COM material has already been tested for use on a specific Steelcase product or to determine actual yardage requirements:

- Visit www.steelcase.com
- Click on "Knowledge & Design"
- Select "Customer's Own Material"

For additional information regarding Customer's Own Material, call 1.888.STEELCASE.

Metal Color Availability Matrix

Not every metal color is available on every metal component. This matrix gives you an overview of which metal colors are available on each component.

		8042 Brushed Aluminum	8043 Clear Anodized Aluminum	8044 Black Anodized Aluminum	8046 Polished Aluminum	9201 Polished Chrome	9211 Nickel	9212 Silver	9250 Ember Chrome
Glides		■	•	•	■	•	•	•	•
Legs	Elliptical Leg	•	•	•	•	■	•	•	•
	Cabby Leg	•	•	•	•	■	•	•	•
Locks		•	•	•	•	•	•	•	■
Pulls	Deco Pulls	•	•	•	•	■	■	•	•
	Jazz Pulls	•	•	•	•	■	■	•	•
	Contemporary Pulls	•	•	•	•	■	•	■	•
Slatwall		•	■	■	•	•	•	•	•

Legend

- = Not available
- = Available

Wood Grain Directions

The appearance of wood veneer may change slightly depending on the angle from which it is viewed. This natural phenomenon is called polarization, and it can be seen on natural veneer, and to a lesser extent on composite veneer. Polarization is often noticed on worksurfaces installed at a 90-degree angle with each other. Please refer to the following illustrations for an understanding of grain direction on your installation.

Unison Systems Worksurfaces

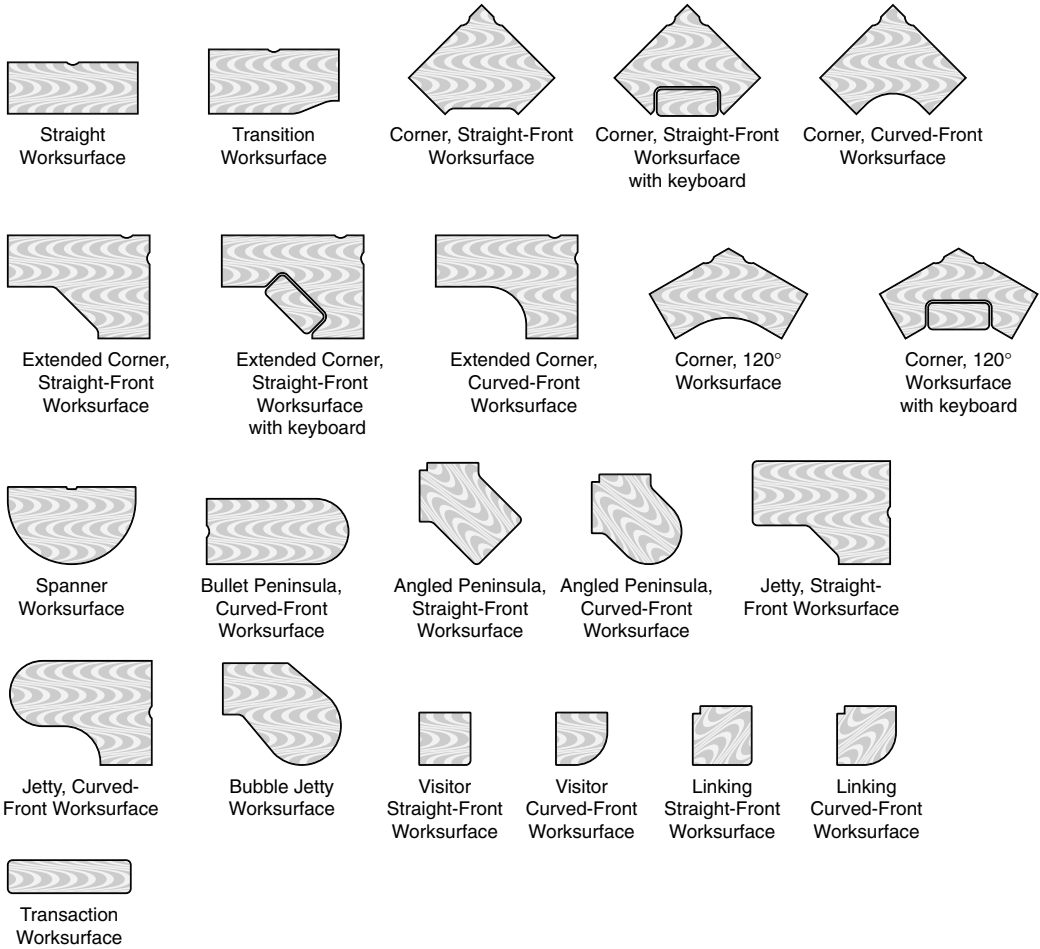

Wood Grain Directions, continued

The appearance of wood veneer may change slightly depending on the angle from which it is viewed. This natural phenomenon is called polarization, and it can be seen on natural veneer, and to a lesser extent on composite veneer. Polarization is often noticed on worksurfaces installed at a 90-degree angle with each other. Please refer to the following illustrations for an understanding of grain direction on your installation.

Unison Freestanding Worksurfaces

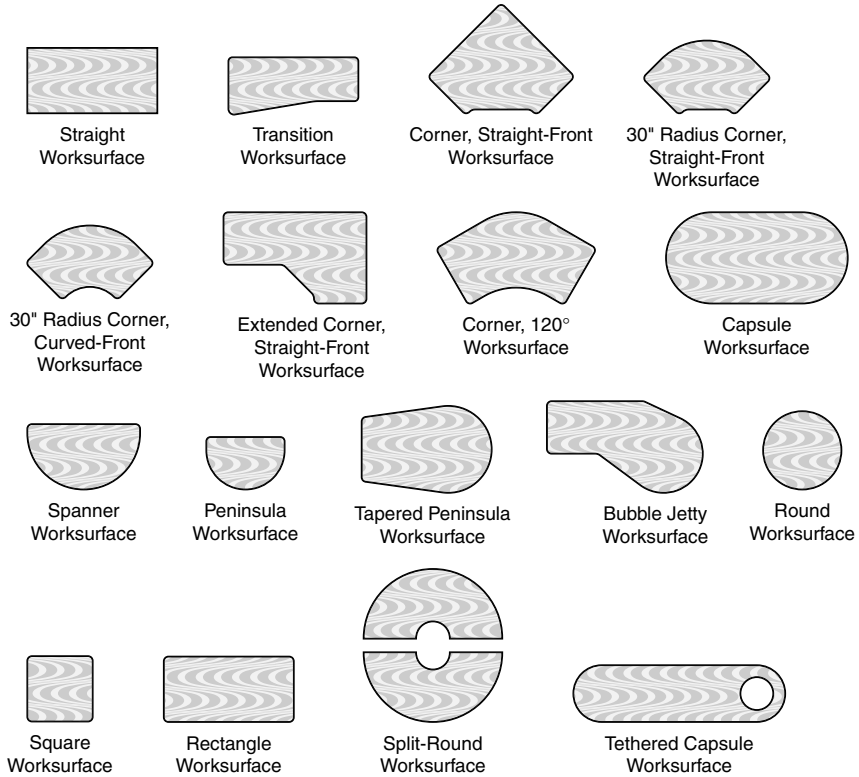

Unison Resources

Unison Leg Matrix

H130

Lock and Keying

H132

Unison Leg Matrix

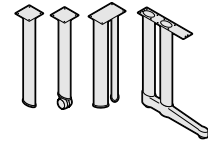
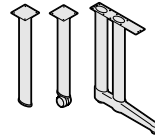

	Cabby Leg (with alignment tab) ▶ Specifying, page H85	Unison E-Leg (with alignment tab) ▶ Specifying, page H84	Post Leg Family (with alignment tab) ▶ See <i>Answer Solutions Specification Guide</i>	Post Leg Family (without alignment tab) ▶ Specifying, page H48
Unison Freestanding Worksurfaces	Recommended as the best aesthetic.	Recommended as a higher end complementary aesthetic to the post leg family.	Recommended as a lower priced alternative to the Cabby and E-legs. Double post C-leg cannot be used in shared applications.	Not recommended. (Freestanding Worksurfaces do not have pilot holes for these legs—use version with alignment tab.)
Unison Systems Worksurfaces	Can be used in limited applications as an alternative to a traditional column in order to blend seamlessly with adjacent Freestanding Worksurfaces. Alignment slots are included on the following Systems shapes: jetty, bubble jetty, visitor, linking, bullet peninsula, and angled peninsula worksurfaces.	Same as cabby leg.	Not recommended—use post legs without alignment tabs.	The recommended solution to use Systems Worksurfaces in freestanding applications.



Lock and Keying

All locking products are standard with factory-installed, keyed-random locks. Consecutive, specific, and random keying are available as field-installed options.

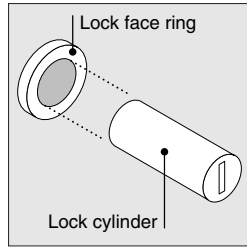

Locks consist of a factory- or field-installed lock cylinder and a factory-installed lock face ring.

Two types of locks are available—the standard keying system (FR series) and the master keying system (XF series). All the locks in the XF series can be opened with a single master key.

Factory-Installed Keying

Factory-installed locks are always key random (standard) or master key random (option). Key random means that the locks will be assigned arbitrarily at the factory with key numbers ranging from FR305 to FR454 (Master keying numbers: XF1001 to XF1150). All locks within a unit will be keyed alike.

Tip: Random keying can mean that different furniture

units will have the same key number. If you must have all locks keyed differently, you should specify field-installed, key specific or key consecutive lock cylinders.
▶ See below.

Key Random

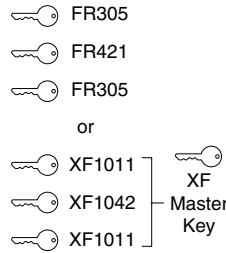

Required to Specify

Master key random	+\$20	Specify with master key random.
--------------------------	-------	---------------------------------

Field-Installed Keying

Field-installed locks are only available on products that include factory-installed lock mechanisms.

Specify "plug" when specifying furniture, and the product will ship with a plastic plug in place of the lock cylinder.

Front-removable lock cylinders must be specified separately. You must also order a special lock tool to install or remove lock cylinders in the field.
Tip: Lock tools are reusable. You do not need to order additional lock tools with every furniture order.

Lock cylinders will be shipped separately so that you can install the locks when you are ready.

Three keying choices are available for field installation—random (standard), specific, and consecutive. All three are also available with master keying, which means that all locks can be opened with a single master key.

Key random means that the locks will be assigned arbitrarily at the factory with key numbers ranging from FR305 to FR454 (Master keying numbers: XF1001 to XF1150).
Tip: Random keying can mean that different furniture units will have the same key number. If you must have all locks keyed differently, you should specify key specific or key consecutive lock cylinders.

Key specific means that you can specify any key number from FR305 to FR454 (Master keying numbers: XF1001 to XF1150). This option can be used to key all the furniture units in a workstation or department the same.
Tip: Designate the quantity per key number in your specification.
▶ See example at right.

Key consecutive means that you can specify lock numbers in a consecutive order to ensure that no two locks have the same key number until the key sequence repeats. You must select a beginning key number from FR305 to FR454 (Master keying numbers: XF1001 to XF1150).

Example of a typical lock cylinder specification is shown below:

10	LOCK9201FR	FR320
5	LOCK9201FR	FR350
15	LOCK9201XF	XF1100
30	Total	
1	877102003SR	standard lock tool
1	877102002SR	master lock tool

Key Random

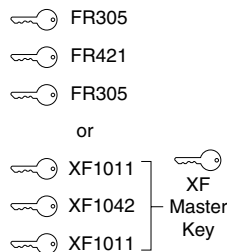

Key Specific

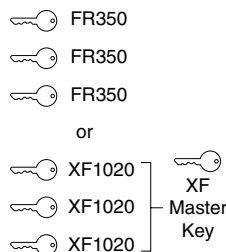

Key Consecutive

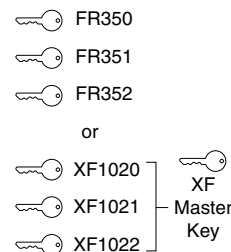

Field-Installed Lock Cylinders

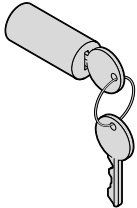

Tip: Lock price is included in price of furniture with locks.

Tip: For replacement lock cylinders, refer to Service Parts.

Standard Includes Required to Specify

- Lock cylinder: 9250 Ember Chrome
 - Two keys
- 1 Style number
2 Options, if selected (see below)

Options Price Required to Specify

Options	Price	Required to Specify
Key specific	No cost	Select key number from FR305–FR454.
Key consecutive	No cost	Specify <i>key consecutive</i> and select beginning key number from FR305–FR454.
Master key random	+\$20 each	Specify <i>master key random</i> .
Master key specific	+\$20 each	Specify key number from XF1001–XF1150.
Master key consecutive	+\$20 each	Specify <i>master key consecutive</i> and select beginning key number from XF1001–XF1150.

Specification Information

Color	Style Number	U.S. Base Price
:	:	:

FR Series (Standard Keying System) – Lock Cylinder

Ember Chrome	LOCK9250FR	No cost
:	:	:

Standard Lock Tool

	877102003SR	\$16
:	:	:

XF Series (Master Keying System) – Lock Cylinder

Ember Chrome	LOCK9250XF	No additional cost. Price included in price of furniture with master-keyed locks.
:	:	:

Master Lock Tool

	877102002SR	\$16
:	:	:

Tip: You can change lock cylinders in the field by using the appropriate lock tool.

Resources

Surface Materials for Steelcase Wood Furniture and Tables	J2
Color Availability Matrices for Steelcase Wood Furniture and Tables	J4
Lock and Keying	J6
Style Number Index	J10

Surface Materials for Steelcase Wood Furniture and Tables

This listing includes all the surface material choices that are available for the products in this specification guide.

Resources

For more information about surface materials, refer to the following resources:

Additional surface materials specification tools are available to assist you in the specification process—the Surface Materials Binders and the Surface Materials Tool Box.

Surface Materials Binders

- include:
- Surface Materials Reference Manual
 - A complete set of swatch cards for hard surfaces, vertical surface fabrics, and seating upholstery

Surface Materials

Tool Box (S8150) provides 3" x 3" samples of the following surface materials:

- Vertical surface fabrics
- Seating upholstery
- Wood veneer
- Paint
- Laminate

Wood

▶ See *Color Availability Matrices* on page J4 for color availability by product line.

Steelcase carefully selects veneer and solid wood or consistent color and grain structure. Wood is a natural material and variations will occur in color, grain and texture. These variations are part of the inherent natural beauty of wood and are not considered defects.

All wood products will darken with age and exposure to ultraviolet light. This is especially apparent with cherry and maple veneer. We recommend that desk accessories be rearranged periodically to insure even aging of wood surfaces.

Veneer

Veneers are flat cut and are matched for proper balance and consistency.

Full-fill finish is a medium-gloss finish that completely fills the grain and has a lustrous, satiny look and feel. This finish is available on worksurfaces only.

Full-fill wood color choices

- 3414 Natural Cherry
- 3424 Medium Cherry
- 3534 Winter on Maple
- 3544 Blonde on Maple
- 3564 Linseed on Maple
- 3574 Amber on Maple
- 3634 Medium Oak
- 3644 Natural Oak
- 3714 Natural Walnut
- 3724 Dark Mahogany on Walnut
- 3744 Autumn on Walnut
- 3774 Medium Mahogany on Walnut
- 3794 Black Walnut

Open-pore finish is a medium-gloss finish that leaves the wood grain texture visible to the eye and distinguishable to the touch.

Open-pore wood color choices

- 3412 Natural Cherry
- 3422 Medium Cherry
- 3562 Linseed on Maple
- 3572 Amber on Maple
- 3582 Winter on Maple
- 3592 Blonde on Maple
- 3632 Medium Oak
- 3642 Natural Oak
- 3712 Natural Walnut
- 3722 Dark Mahogany on Walnut
- 3742 Autumn on Walnut
- 3772 Medium Mahogany on Walnut
- 3792 Black Walnut

Customiz stain is a service that allows you to create your own stain color on standard veneers. Customiz stain color is available on all product lines that offer wood veneer.

A one-time formulation fee of \$400 U.S. per color, per customer processing fee will apply. The fee covers the cost of formulating the Customiz finish and applies regardless of whether or not an order for product is placed. Please refer to the "Customiz Stain" option price column in your specification guide for the unit upcharge.

Customiz stain takes 10 days to formulate. Consult the Surface Materials Reference Manual for more information. Custom veneers are also available and must be quoted by specials engineering. Customiz stain on custom veneers take two to four weeks to formulate.

Requirements and information on ordering a Customiz stain color are found in the *Surface Materials Reference Manual*.

Laminate

▶ See *Color Availability Matrices* on page J5 for color availability by product line.

- 2412 Natural Cherry
- 2422 Medium Cherry
- 2511 Winter on Maple
- 2592 Blonde on maple
- 2632 Medium Oak
- 2714 Natural Walnut
- 2722 Cream
- 2729 White Sand
- 2730 Arctic White
- 2746 Black
- 2759 Warm White
- 2772 Medium Mahogany on Walnut
- 2810 Dawn
- 2811 Mist
- 2820 Coffee Speckle
- 2822 Woodrose Speckle
- 2823 Driftwood Speckle
- 2824 Smoke Speckle
- 2825 Vanadium Speckle
- 2850 Vanadium Fiber
- 2851 Rhyme Fiber
- 2852 Tungsten Fiber
- 2854 Vellum Fiber
- 2856 Leaf Fiber
- 2857 Stream Fiber
- 2859 Novell Fiber
- 2860 Granite Fiber
- 2870 Blonde Bronze Patina
- 2871 Blackened Bronze Patina
- 2872 Silver Plate Patina
- 2873 Instant Iron Patina

Paint

Applies to:

- Furniture pulls and column

0835 Black

Applies to:

- Arbor column and base

7207 Black textured paint

Applies to:

- 8500 Series table column

Price Group 1

Textured Paint

- 7207 Black
- 7225 Sand (Vanadium)
- 7236 Fog
- 7237 Slate
- 7238 Fieldstone
- 7239 Midnight

Price Group 2

Metallic Paint

- 4750 Champagne
- 4751 Bronze
- 4752 Steel
- 4788 Gold Dust
- 4798 Sterling
- 4799 Platinum

Price Group 3

PerfectMatch II paint

PerfectMatch II paint is a service that allows you to create your own paint color through the Customiz program. Refer to the *Surface Materials Reference Manual* for more information about this program.

Applies to:

- 8500 Series table base

Price Group 1

Textured Paint

- 7207 Black
- 7225 Sand (Vanadium)
- 7236 Fog
- 7237 Slate
- 7238 Fieldstone
- 7239 Midnight

Applies to:

- Steelcase Wood Furniture table base

Price Group 1

Textured Paint

- 7207 Black

Plastic

6000 Black

Applies to: 8500 Series table edge

6000 Black
6001 Coffee
6008 Bramble
6602 Tan V2
6607 Woodrose
6608 Driftwood
6609 Smoke
6612 Grey V2
6615 Grey V5
6631 Cream
6635 Dawn
6636 Mist
6640 Brook
6642 Melba
6654 Vanadium
6655 Warm White

Plated Metal

8042 Brushed Aluminum
8044 Black Anodized Aluminum
8045 Brushed Black Aluminum
8046 Polished Aluminum
9201 Polished Chrome
9211 Nickel
9212 Silver
9213 Polished Nickel
9233 Satin Brass
9250 Ember Chrome

Applies to:

- 8500 Series table column and base
- Steelcase Wood Furniture tables

9201 Polished Chrome

Metal Coatings

Applies to:

- Steelcase Wood Furniture table base

Caldera

7331 Bronze
7332 Copper
7333 Pewter

Vertical Surface Fabric

Price Group 1

Abacus*
Acadia*
Bariolage
Belgrade
BellaRose*
Boccie**
Cornice*
Embrasure*
*Not available on 80"H panels
**Not available on panels taller than 68"H
Additional fabrics are available in this price group. Call Designtex at 1.800.221.1540 for further information about the Graded-In Program.

Price Group 2

Amiranté
Ashanti
Ashanti Reverse
Bouquet*
Cordial
Firenze
Firenze Reverse
Fresco
Milano
Racquets**
Regatta
Wilshire
*Not available on 80"H panels
**Not available on panels taller than 68"H
Additional fabrics are available in this price group. Call Designtex at 1.800.221.1540 for further information about the Graded-In Program.
▶ See *Surface Materials Reference Manual* for a listing of available fabric colors.

Price Group 3

Martinique

Designtex Graded-In Program

All Designtex Graded-In fabrics are now supported just like standard fabrics when ordered on Steelcase furniture. The Designtex Graded-In Program also includes the Environmental Impact Collection, which offers sustainable textiles in affordable price groups. For additional information and fabric samples, contact your local Designtex sales representative at 1.800.221.1540.

Designtex fabrics are graded into Steelcase Price Groups 1 through 3:

Price Group 1

Moors (Environmental Impact Collection)

Price Group 2

About Face
Acres
Bracken (Environmental Impact Collection)
Brunswick
Cut to the Chase
Niche
Senecal
Solitaire
Streams (Environmental Impact Collection)

Price Group 3

Apex
Dalmatian
Foxtrot
Lotto
Meringue
No Deposit No Return
Pick-Up-Sticks
Rain (Environmental Impact Collection)
Sea Breeze (Environmental Impact Collection)
Six Pack
Sumo
That Straw Stuff
▶ See *Surface Materials Reference Manual* for a listing of available fabric colors.

Price Group COM (Customer's Own Material)

Fabric Approval and Yardage

To confirm whether a particular COM material has already been tested for use on a specific Steelcase product or to determine actual yardage requirements:

- Visit www.steelcase.com
- Click on "Tools & Insights"
- Select "Customer's Own Material"

For additional information regarding Customer's Own Material, call 1.888.STEELCASE.

Transitional

▶ See the *Transitional Specification Guide* for a list of transitional surface materials.

Color Availability Matrices for Steelcase Wood Furniture and Tables

Wood

Available wood color choices are indicated in this matrix for each Steelcase Wood Furniture product.

	Fill Level	Arbor	Walden	Impact	8500 Series Table Tops	Convene Conference Tables and Furniture
3412 Natural Cherry	OP	■	■	■	■	■
3414 Natural Cherry	FF	■	■	■	•	■
3422 Medium Cherry	OP	■	■	■	■	■
3424 Medium Cherry	FF	■	■	■	•	■
3534 Winter on Maple	FF	■	■	■	•	■
3544 Blonde on Maple	FF	■	■	■	•	■
3562 Linseed on Maple	OP	■	■	■	■	■
3564 Linseed on Maple	FF	■	■	■	•	■
3572 Amber on Maple	OP	■	■	■	■	■
3574 Amber on Maple	FF	■	■	■	•	■
3582 Winter on Maple	OP	■	■	■	■	■
3592 Blonde on Maple	OP	■	■	■	■	■
3632 Medium Oak	OP	■	■	■	■	■
3634 Medium Oak	FF	■	■	■	•	■
3642 Natural Oak	OP	■	■	■	■	■
3644 Natural Oak	FF	■	■	■	•	■
3712 Natural Walnut	OP	■	■	■	■	■
3714 Natural Walnut	FF	■	■	■	•	■
3722 Dark Mahogany on Walnut	OP	■	■	■	■	■
3724 Dark Mahogany on Walnut	FF	■	■	■	•	■
3742 Autumn on Walnut	OP	■	■	■	■	■
3744 Autumn on Walnut	FF	■	■	■	•	■
3772 Medium Mahogany on Walnut	OP	■	■	■	■	■
3774 Medium Mahogany on Walnut	FF	■	■	■	•	■
3792 Black Walnut	OP	■	■	■	■	■
3794 Black Walnut	FF	■	■	■	•	■

Legend

- = Not available
- = Available
- = Available with exceptions

Fill Level Key

- FF = Full fill
- HR = Hand rubbed
- OP = Open pore
- ▶ For a description of fill level, see *Surface Materials Reference Manual*.

Laminate

Available laminate color choices are indicated in this matrix for each Steelcase Wood Furniture product.

	Walden	Arbor	Impact	8500 Tables	Convene Conference Tables and Furniture
2412 Natural Cherry	<input type="checkbox"/>	•	•	■	■
2422 Medium Cherry	<input type="checkbox"/>	•	•	■	■
2511 Winter on Maple	<input type="checkbox"/>	•	•	■	■
2592 Blonde on Maple	<input type="checkbox"/>	•	•	■	■
2632 Medium Oak	<input type="checkbox"/>	•	•	■	■
2714 Natural Walnut	<input type="checkbox"/>	•	•	■	■
2722 Cream	•	•	•	■	■
2729 White Sand	•	•	•	■	■
2730 Arctic White	•	•	•	■	■
2746 Black	•	•	•	■	■
2759 Warm White	•	•	•	■	■
2772 Medium Mahogany	<input type="checkbox"/>	•	•	■	■
2810 Dawn	•	•	•	■	■
2811 Mist	•	•	•	■	■
2820 Coffee Speckle	•	•	•	■	■
2822 Woodrose Speckle	•	•	•	■	■
2823 Driftwood Speckle	•	•	•	■	■
2824 Smoke Speckle	•	•	•	■	■
2825 Vanadium Speckle	•	•	•	■	■
2850 Vanadium Fiber	•	•	•	■	■
2851 Rhyme Fiber	•	•	•	■	■
2852 Tungsten Fiber	•	•	•	■	■
2854 Vellum Fiber	•	•	•	■	■
2857 Stream Fiber	•	•	•	■	■
2859 Novell Fiber	•	•	•	■	■
2860 Granite Fiber	•	•	•	■	■
2870 Blonde Bronze Patina	•	•	•	■	■
2871 Blackened Bronze Patina	•	•	•	■	■
2872 Silver Plate Patina	•	•	•	■	■
2873 Instant Iron Patina	•	•	•	■	■

Legend

- = Not available
- = Available
- = Available with exceptions

Lock and Keying

Walden

All locking products are standard with factory-installed, keyed-random locks. Consecutive, specific, and random keying are available as field-installed options.

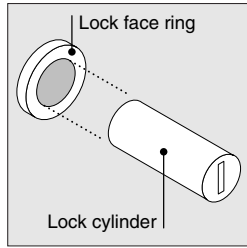

Locks consist of a factory- or field-installed lock cylinder and a factory-installed lock face ring.







Two types of locks are available—the standard keying system (NC series) and the master keying system (MK series). All the locks in the MK series can be opened with a single master key.

Factory-Installed Keying

Factory-installed locks are always key random (standard) or master key random (option). Key random means that the locks will be assigned arbitrarily at the factory with key numbers ranging from NC161 to NC231 (Master keying numbers: MK551 to MK600). All locks within a unit will be keyed alike.
Tip: Random keying can mean that different furniture

units will have the same key number. If you must have all locks keyed differently, you should specify field-installed, key specific or key consecutive lock cylinders.
▶ See below.

Key Random

-  NC305
 -  NC421
 -  NC305
 - or
 -  MK581
 -  MK596
 -  MK581
- } MK Master Key

Required to Specify

Master key random	+\$20	Specify with master key random.
--------------------------	-------	---------------------------------

Field-Installed Keying

Field-installed locks are only available on products that include factory-installed lock mechanisms.

Specify “plug” when specifying furniture, and the product will ship with a plastic plug in place of the lock cylinder.

Front-removable lock cylinders must be specified separately. You must also order a special lock tool to install or remove lock cylinders in the field.
Tip: Lock tools are reusable. You do not need to order additional lock tools with every furniture order.

Lock cylinders will be shipped separately so that you can install the locks when you are ready.

Three keying choices are available for field installation—random (standard), specific, and consecutive. All three are also available with master keying, which means that all locks can be opened with a single master key.

Key random means that the locks will be assigned arbitrarily at the factory with key numbers ranging from NC161 to NC231 (Master keying numbers: MK551 to MK600).
Tip: Random keying can mean that different furniture units will have the same key number. If you must have all locks keyed differently, you should specify key specific or key consecutive lock cylinders.







Key specific means that you can specify any key number from NC161 to NC231 (Master keying numbers: MK551 to MK600). This option can be used to key all the furniture units in a workstation or department the same.
Tip: Designate the quantity per key number in your specification.
▶ See example at right.

Key consecutive means that you can specify lock numbers in a consecutive order to ensure that no two locks have the same key number until the key sequence repeats. You must select a beginning key number from NC161 to NC231 (Master keying numbers: MK551 to MK600).







Example of a typical lock cylinder specification is shown below:

10	LOCK9250NC1	NC171
5	LOCK9250NC1	NC175
15	LOCK9250MK1	MK580
<hr/>		
30	Total	
1	N045505SR	standard lock tool
1	N045505SR	master lock tool







Key Random

-  NC305
 -  NC421
 -  NC305
 - or
 -  MK581
 -  MK596
 -  MK581
- } MK Master Key

Key Specific

-  NC350
 -  NC350
 -  NC350
 - or
 -  MK580
 -  MK580
 -  MK580
- } MK Master Key

Key Consecutive

-  NC350
 -  NC351
 -  NC352
 - or
 -  MK580
 -  MK581
 -  MK582
- } MK Master Key

Field-Installed Lock Cylinders

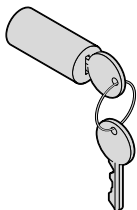

Tip: Lock price is included in price of furniture with locks.

Tip: For replacement lock cylinders, refer to Service Parts.

Standard Includes	Required to Specify
-------------------	---------------------

- | | |
|--|--|
| <ul style="list-style-type: none"> Lock cylinder, keyed random: 9250 Ember Chrome Two keys | 1 Style number
2 Options, if selected (see below) |
|--|--|

Options	Price	Required to Specify
---------	-------	---------------------

Key specific	No cost	Select key number from NC161–NC231.
Key consecutive	No cost	Specify <i>key consecutive</i> and must select beginning key number from NC161–NC231.
Master key random	+\$20 each	Specify <i>master key random</i> .
Master key specific	+\$20 each	Specify key number from MK551–MK600.
Master key consecutive	+\$20 each	Specify <i>master key consecutive</i> and must select beginning key number from MK551–MK600.

Specification Information

Style Number	Base Price

NC Series (Standard Keying System) – Lock Cylinder

LOCK9250NC1	No cost
--------------------	---------

Standard Lock Tool

N045505SR	\$16
------------------	------

MK Series (Master Keying System) – Lock Cylinder

LOCK9250MK1	No additional cost. Price included in price of furniture with master-keyed locks.
--------------------	---

Master Lock Tool

N045505SR	\$16
------------------	------

Tip: You can change lock cylinders in the field by using the appropriate lock tool.

Lock and Keying

Arbor, Impact, Convenc, and Unison

All locking products are standard with factory-installed, keyed-random locks. Consecutive, specific, and random keying are available as field-installed options.

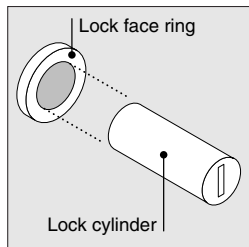

Locks consist of a factory- or field-installed lock cylinder and a factory-installed lock face ring.

Two types of locks are available—the standard keying system (FR series) and the master keying system (XF series). All the locks in the XF series can be opened with a single master key.

Factory-Installed Keying

Factory-installed locks are always key random (standard) or master key random (option). Key random means that the locks will be assigned arbitrarily at the factory with key numbers ranging from FR305 to FR454 (Master keying numbers: XF1001 to XF1150). All locks within a unit will be keyed alike. *Tip: Random keying can mean that different furniture*

units will have the same key number. If you must have all locks keyed differently, you should specify field-installed, key specific or key consecutive lock cylinders. ▶ See below.

Key Random

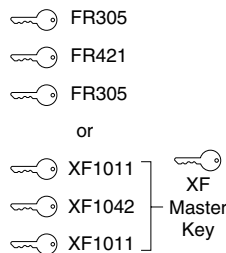

Required to Specify

Master key random	+\$20	Specify with master key random.
--------------------------	-------	---------------------------------

Field-Installed Keying

Field-installed locks are only available on products that include factory-installed lock mechanisms.

Specify "plug" when specifying furniture, and the product will ship with a plastic plug in place of the lock cylinder.

Front-removable lock cylinders must be specified separately. You must also order a special lock tool to install or remove lock cylinders in the field. *Tip: Lock tools are reusable. You do not need to order additional lock tools with every furniture order.*

Lock cylinders will be shipped separately so that you can install the locks when you are ready.

Three keying choices are available for field installation—random (standard), specific, and consecutive. All three are also available with master keying, which means that all locks can be opened with a single master key.

Key random means that the locks will be assigned arbitrarily at the factory with key numbers ranging from FR305 to FR454 (Master keying numbers: XF1001 to XF1150). *Tip: Random keying can mean that different furniture units will have the same key number. If you must have all locks keyed differently, you should specify key specific or key consecutive lock cylinders.*

Key specific means that you can specify any key number from FR305 to FR454 (Master keying numbers: XF1001 to XF1150). This option can be used to key all the furniture units in a workstation or department the same. *Tip: Designate the quantity per key number in your specification.* ▶ See example at right.

Key consecutive means that you can specify lock numbers in a consecutive order to ensure that no two locks have the same key number until the key sequence repeats. You must select a beginning key number from FR305 to FR454 (Master keying numbers: XF1001 to XF1150).

Example of a typical lock cylinder specification is shown below:

10	LOCK9201FR FR320
5	LOCK9201FR FR350
15	LOCK9201XF XF1100
30	Total
1	877102003SR standard lock tool
1	877102002SR master lock tool

Key Random

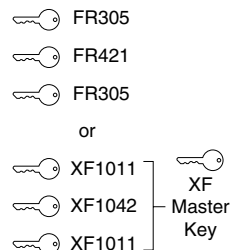

Key Specific

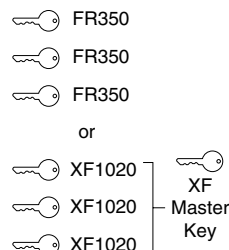

Key Consecutive

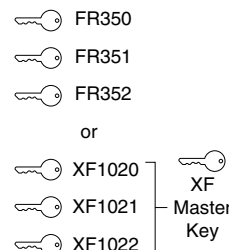

Field-Installed Lock Cylinders

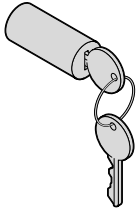

Tip: Lock price is included in price of furniture with locks.

Tip: For replacement lock cylinders, refer to Service Parts.

Standard Includes	Required to Specify
-------------------	---------------------

- | | |
|--|--|
| <ul style="list-style-type: none"> Lock cylinder, keyed random: 9201 Polished Chrome, 9230 Antique Bronze, or 9250 Ember Chrome Two keys | <ul style="list-style-type: none"> 1 Style number 2 Options, if selected (see below) |
|--|--|

Options	Price	Required to Specify
---------	-------	---------------------

Key specific	No cost	Select key number from FR305–FR454.
Key consecutive	No cost	Specify <i>key consecutive</i> and must select beginning key number from FR305–FR454.
Master key random	+\$20 each	Specify <i>master key random</i> .
Master key specific	+\$20 each	Specify key number from XF1001–XF1150.
Master key consecutive	+\$20 each	Specify <i>master key consecutive</i> and must select beginning key number from XF1001–XF1150.

Specification Information

Style Number	Base Price

FR Series (Standard Keying System) – Lock Cylinder

LOCK9201FR	No cost
LOCK9250FR	No cost

Standard Lock Tool

877102003SR	\$16

XF Series (Master Keying System) – Lock Cylinder

LOCK9201XF	No additional cost. Price included in price of furniture with master-keyed locks.
LOCK9250XF	No additional cost. Price included in price of furniture with master-keyed locks.

Master Lock Tool

877102002SR	\$16

Tip: You can change lock cylinders in the field by using the appropriate lock tool.

Style Number Index

Style Number	Page	Description
32WCP	E8	Wire Guide Clips
851204838	E5	8500 Boat Shape Table
851504838	E5	8500 Boat Shape Table
851804838	E5	8500 Boat Shape Table
853000	E4	8500 Round Table
853030	E4	8500 Square Table
853525	E5	8500 Rectangular Table
853535	E4	8500 Square Table
853600	E4	8500 Round Table
854200	E4	8500 Round Table
854530	E5	8500 Rectangular Table
854800	E4	8500 Round Table
855400	E4	8500 Round Table
856030	E5	8500 Rectangular Table
856035	E5	8500 Rectangular Table
856035S	E5	8500 Boat Shape Table
856530	E5	8500 Rectangular Table
856535	E5	8500 Rectangular Table
856535S	E5	8500 Boat Shape Table
857030	E5	8500 Rectangular Table
857035	E5	8500 Rectangular Table
857035S	E5	8500 Boat Shape Table
85723630	E5	8500 Boat Shape Table
857842	E5	8500 Oval Table
85964236	E5	8500 Boat Shape Table
859648	E5	8500 Oval Table
877102002SR	G205, H133	Master Lock Tool
877102003SR	G205, H133	Standard Lock Tool
AEG66	B12	Arbor; Tackboard
AEG72	B12	Arbor; Tackboard
AR7224KL	B27	Arbor Camber; Modular Cred Assembly
AR7224LK	B27	Arbor Camber; Modular Cred Assembly
AR7224PDP	B27	Arbor Camber; Modular Cred Assembly
AR7224PKP	B27	Arbor Camber; Modular Cred Assembly
ARB4820	B20	Arbor Camber; Bridge
ARB4820NMP	B20	Arbor Camber; Bridge
ARB4824	B20	Arbor Camber; Bridge
ARB4824NMP	B20	Arbor Camber; Bridge
ARC7236	B7	Arbor Camber; Modular Dbl-Ped Desk
ARC7236L	B11	Arbor Camber; Non-Mdlr Sgl-Ped Desk
ARC7236R	B11	Arbor Camber; Non-Mdlr Sgl-Ped Desk
ARCM7236L	B9	Arbor Camber; Modular Sgl-Ped Desk
ARCM7236R	B9	Arbor Camber; Modular Sgl-Ped Desk
ARD6630	B7	Arbor Camber; Modular Dbl-Ped Desk
ARD6630L	B11	Arbor Camber; Non-Mdlr Sgl-Ped Desk
ARD6630R	B11	Arbor Camber; Non-Mdlr Sgl-Ped Desk
ARD7236	B7	Arbor Camber; Modular Dbl-Ped Desk
ARD7236L	B11	Arbor Camber; Non-Mdlr Sgl-Ped Desk
ARD7236R	B11	Arbor Camber; Non-Mdlr Sgl-Ped Desk
ARDM6630L	B9	Arbor Camber; Modular Sgl-Ped Desk
ARDM6630R	B9	Arbor Camber; Modular Sgl-Ped Desk
ARDM7236L	B9	Arbor Camber; Modular Sgl-Ped Desk
ARDM7236R	B9	Arbor Camber; Modular Sgl-Ped Desk
ARFL432	B34	Arbor Camber; Lateral File

Style Number	Page	Description
ARG6617	B12	Arbor Camber; Transaction Worksurface
ARG7217	B12	Arbor Camber; Transaction Worksurface
ARJD3220	B19	Arbor Camber; Pedestal Substitution
ARJD3224	B19, B29	Arbor Camber; Pedestal Substitution
ARJE1620	B18	Arbor Camber; Pedestal Substitution
ARJE1624	B18, B28	Arbor Camber; Pedestal Substitution
ARJEE3220	B19	Arbor Camber; Pedestal Substitution
ARJEE3224	B19, B29	Arbor Camber; Pedestal Substitution
ARJEP3220	B19	Arbor Camber; Pedestal Substitution
ARJEP3224	B19, B29	Arbor Camber; Pedestal Substitution
ARJL3224	B29	Arbor Camber; Pedestal Substitution
ARJPE3220	B19	Arbor Camber; Pedestal Substitution
ARJPE3224	B19, B29	Arbor Camber; Pedestal Substitution
ARJPP3220	B19	Arbor Camber; Pedestal Substitution
ARJPP3224	B19, B29	Arbor Camber; Pedestal Substitution
ARKD232	B39	Arbor Camber; Bookcase
ARKD332	B39	Arbor Camber; Bookcase
ARKN232	B39	Arbor Camber; Bookcase
ARKN332	B39	Arbor Camber; Bookcase
ARKN432	B39	Arbor Camber; Bookcase
ARKN532	B39	Arbor Camber; Bookcase
ARKS332	B39	Arbor Camber; Bookcase
ARKW332	B39	Arbor Camber; Bookcase
ARMP1622	B40	Arbor Camber; Mobile Pedestal
ARPA4842L	B25	Arbor Camber; P-Shape Table
ARPA4842R	B25	Arbor Camber; P-Shape Table
ARPA6042L	B25	Arbor Camber; P-Shape Table
ARPA6042R	B25	Arbor Camber; P-Shape Table
ARPA7242L	B25	Arbor Camber; P-Shape Table
ARPA7242R	B25	Arbor Camber; P-Shape Table
ARPF7242L	B25	Arbor Camber; P-Shape Table
ARPF7242R	B25	Arbor Camber; P-Shape Table
ARR4220PL	B16	Arbor Camber; Modular LH Return
ARR4220PR	B14	Arbor Camber; Modular RH Return
ARR4224PL	B16	Arbor Camber; Modular LH Return
ARR4224PR	B14	Arbor Camber; Modular RH Return
ARR4820LL	B17	Arbor Camber; Modular LH Return
ARR4820LPL	B17	Arbor Camber; Modular LH Return
ARR4820LPR	B15	Arbor Camber; Modular RH Return
ARR4820LR	B15	Arbor Camber; Modular RH Return
ARR4824LL	B17	Arbor Camber; Modular LH Return
ARR4824LPL	B17	Arbor Camber; Modular LH Return
ARR4824LPR	B15	Arbor Camber; Modular RH Return
ARR4824LR	B15	Arbor Camber; Modular RH Return
ARR4824PL	B16	Arbor Camber; Modular LH Return
ARR4824PR	B14	Arbor Camber; Modular RH Return
ARR6020LL	B17	Arbor Camber; Modular LH Return
ARR6020LPL	B17	Arbor Camber; Modular LH Return
ARR6020LPR	B15	Arbor Camber; Modular RH Return
ARR6020LR	B15	Arbor Camber; Modular RH Return
ARR6024LL	B17	Arbor Camber; Modular LH Return
ARR6024LPL	B17	Arbor Camber; Modular LH Return
ARR6024LPR	B15	Arbor Camber; Modular RH Return
ARR6024LR	B15	Arbor Camber; Modular RH Return
ARR7220LLL	B17	Arbor Camber; Modular LH Return

Style Number	Page	Description	Style Number	Page	Description
ARR7220LLR	B15	Arbor Camber; Modular RH Return	ASD7236L	B11	Arbor Square Non-Mdlr Sgl-Ped Desk
ARR7220LPL	B17	Arbor Camber; Modular LH Return	ASD7236R	B11	Arbor Square Non-Mdlr Sgl-Ped Desk
ARR7220LPR	B15	Arbor Camber; Modular RH Return	ASDM6630L	B9	Arbor Square; Modular Sgl-Ped Desk
ARR7224LLL	B17	Arbor Camber; Modular LH Return	ASDM6630R	B9	Arbor Square; Modular Sgl-Ped Desk
ARR7224LLR	B15	Arbor Camber; Modular RH Return	ASDM7236L	B9	Arbor Square; Modular Sgl-Ped Desk
ARR7224LPL	B17	Arbor Camber; Modular LH Return	ASDM7236R	B9	Arbor Square; Modular Sgl-Ped Desk
ARR7224LPR	B15	Arbor Camber; Modular RH Return	ASFL432	B34	Arbor Square; Lateral File
ARS1660FL	B37	Arbor Camber; Storage Cabinet	ASG6617	B12	Arbor Square; Transaction Worksurface
ARS1660FR	B37	Arbor Camber; Storage Cabinet	ASG7217	B12	Arbor Square; Transaction Worksurface
ARS1672FL	B37	Arbor Camber; Storage Cabinet	ASHC1921X1	G94	Plastic Center Drwr
ARS1672FR	B37	Arbor Camber; Storage Cabinet	ASJD3220	B19	Arbor Square; Pedestal Substitution
ARS1672WL	B36	Arbor Camber; Wardrobe	ASJD3224	B19, B29	Arbor Square; Pedestal Substitution
ARS1672WR	B36	Arbor Camber; Wardrobe	ASJE1620	B18	Arbor Square; Pedestal Substitution
ARS3272L	B37	Arbor Camber; Storage Cabinet	ASJE1624	B18, B28	Arbor Square; Pedestal Substitution
ARS3272P	B37	Arbor Camber; Storage Cabinet	ASJEE3220	B19	Arbor Square; Pedestal Substitution
ARUA4830	B23	Arbor Camber; Bullet-Shape Table	ASJEE3224	B19, B29	Arbor Square; Pedestal Substitution
ARUA4836	B23	Arbor Camber; Bullet-Shape Table	ASJEP3220	B19	Arbor Square; Pedestal Substitution
ARUA6030	B23	Arbor Camber; Bullet-Shape Table	ASJEP3224	B19, B29	Arbor Square; Pedestal Substitution
ARUA6036	B23	Arbor Camber; Bullet-Shape Table	ASJL3224	B29	Arbor Square; Pedestal Substitution
ARUA7230	B23	Arbor Camber; Bullet-Shape Table	ASJPE3220	B19	Arbor Square; Pedestal Substitution
ARUA7236	B23	Arbor Camber; Bullet-Shape Table	ASJPE3224	B19, B29	Arbor Square; Pedestal Substitution
ARUF7236	B23	Arbor Camber; Bullet-Shape Table	ASJPP3220	B19	Arbor Square; Pedestal Substitution
ARV113	B33	Arbor Camber; Service Module	ASJPP3224	B19, B29	Arbor Square; Pedestal Substitution
ARV66	B33	Arbor Camber; Service Module	ASKD232	B39	Arbor Square; Bookcase
ARV72	B33	Arbor Camber; Service Module	ASKD332	B39	Arbor Square; Bookcase
ARV81	B33	Arbor Camber; Service Module	ASKN232	B39	Arbor Square; Bookcase
ARV97	B33	Arbor Camber; Service Module	ASKN332	B39	Arbor Square; Bookcase
ARX11324	B30	Arbor Camber; Straight Workcentre Cred	ASKN432	B39	Arbor Square; Bookcase
ARX11330	B30	Arbor Camber; Straight Workcentre Cred	ASKN532	B39	Arbor Square; Bookcase
ARX11330A	B30	Arbor Camber; Straight Workcentre Cred	ASKS332	B39	Arbor Square; Bookcase
ARX11348L	B31	Arbor Camber; Corner Workcentre Cred	ASKW332	B39	Arbor Square; Bookcase
ARX11348R	B31	Arbor Camber; Corner Workcentre Cred	ASMP1622	B40	Arbor Square; Mobile Pedestal
ARX9724	B30	Arbor Camber; Straight Workcentre Cred	ASPA4842L	B25	Arbor Square; P-Shape Table
ARX9730	B30	Arbor Camber; Straight Workcentre Cred	ASPA4842R	B25	Arbor Square; P-Shape Table
ARX9730A	B30	Arbor Camber; Straight Workcentre Cred	ASPA6042L	B25	Arbor Square; P-Shape Table
ARX9748L	B31	Arbor Camber; Corner Workcentre Cred	ASPA6042R	B25	Arbor Square; P-Shape Table
ARX9748R	B31	Arbor Camber; Corner Workcentre Cred	ASPA7242L	B25	Arbor Square; P-Shape Table
ARYU4824	B41	Arbor Camber; Corner Unit	ASPA7242R	B25	Arbor Square; P-Shape Table
AS7224KL	B27	Arbor Square; Modular Cred Assembly	ASPF7242L	B25	Arbor Square; P-Shape Table
AS7224LK	B27	Arbor Square; Modular Cred Assembly	ASPF7242R	B25	Arbor Square; P-Shape Table
AS7224PDP	B27	Arbor Square; Modular Cred Assembly	ASR4220PL	B16	Arbor Square; Modular LH Return
AS7224PKP	B27	Arbor Square; Modular Cred Assembly	ASR4220PR	B14	Arbor Square; Modular RH Return
ASB4820	B20	Arbor Square; Bridge	ASR4224PL	B16	Arbor Square; Modular LH Return
ASB4820NMP	B20	Arbor Square; Bridge	ASR4224PR	B14	Arbor Square; Modular RH Return
ASB4824	B20	Arbor Square; Bridge	ASR4820LL	B17	Arbor Square; Modular LH Return
ASB4824NMP	B20	Arbor Square; Bridge	ASR4820LPL	B17	Arbor Square; Modular LH Return
ASC7236	B7	Arbor Square; Modular Dbl-Ped Desk	ASR4820LPR	B15	Arbor Square; Modular RH Return
ASC7236L	B11	Arbor Square Non-Mdlr Sgl-Ped Desk	ASR4820LR	B15	Arbor Square; Modular RH Return
ASC7236R	B11	Arbor Square Non-Mdlr Sgl-Ped Desk	ASR4824LL	B17	Arbor Square; Modular LH Return
ASCM7236L	B9	Arbor Square; Modular Sgl-Ped Desk	ASR4824LPL	B17	Arbor Square; Modular LH Return
ASCM7236R	B9	Arbor Square; Modular Sgl-Ped Desk	ASR4824LPR	B15	Arbor Square; Modular RH Return
ASD6630	B7	Arbor Square; Modular Dbl-Ped Desk	ASR4824LR	B15	Arbor Square; Modular RH Return
ASD6630L	B11	Arbor Square Non-Mdlr Sgl-Ped Desk	ASR4824PL	B16	Arbor Square; Modular LH Return
ASD6630R	B11	Arbor Square Non-Mdlr Sgl-Ped Desk	ASR4824PR	B14	Arbor Square; Modular RH Return
ASD7236	B7	Arbor Square; Modular Dbl-Ped Desk	ASR6020LL	B17	Arbor Square; Modular LH Return

Style Number Index, continued

Style Number	Page	Description
ASR6020LPL	B17	Arbor Square; Modular LH Return
ASR6020LPR	B15	Arbor Square; Modular RH Return
ASR6020LR	B15	Arbor Square; Modular RH Return
ASR6024LL	B17	Arbor Square; Modular LH Return
ASR6024LPL	B17	Arbor Square; Modular LH Return
ASR6024LPR	B15	Arbor Square; Modular RH Return
ASR6024LR	B15	Arbor Square; Modular RH Return
ASR7220LLL	B17	Arbor Square; Modular LH Return
ASR7220LLR	B15	Arbor Square; Modular RH Return
ASR7220LPL	B17	Arbor Square; Modular LH Return
ASR7220LPR	B15	Arbor Square; Modular RH Return
ASR7224LLL	B17	Arbor Square; Modular LH Return
ASR7224LLR	B15	Arbor Square; Modular RH Return
ASR7224LPL	B17	Arbor Square; Modular LH Return
ASR7224LPR	B15	Arbor Square; Modular RH Return
ASS1660FL	B37	Arbor Square; Storage Cabinet
ASS1660FR	B37	Arbor Square; Storage Cabinet
ASS1672FL	B37	Arbor Square; Storage Cabinet
ASS1672FR	B37	Arbor Square; Storage Cabinet
ASS1672WL	B36	Arbor Square; Wardrobe
ASS1672WR	B36	Arbor Square; Wardrobe
ASS3272L	B37	Arbor Square; Storage Cabinet
ASS3272P	B37	Arbor Square; Storage Cabinet
ASUA4830	B23	Arbor Square; Bullet-Shape Table
ASUA4836	B23	Arbor Square; Bullet-Shape Table
ASUA6030	B23	Arbor Square; Bullet-Shape Table
ASUA6036	B23	Arbor Square; Bullet-Shape Table
ASUA7230	B23	Arbor Square; Bullet-Shape Table
ASUA7236	B23	Arbor Square; Bullet-Shape Table
ASUF7236	B23	Arbor Square; Bullet-Shape Table
ASV113	B33	Arbor Square; Service Module
ASV66	B33	Arbor Square; Service Module
ASV72	B33	Arbor Square; Service Module
ASV81	B33	Arbor Square; Service Module
ASV97	B33	Arbor Square; Service Module
ASX11324	B30	Arbor Square; Straight Workcentre Cred
ASX11330	B30	Arbor Square; Straight Workcentre Cred
ASX11330A	B30	Arbor Square; Straight Workcentre Cred
ASX11348L	B31	Arbor Square; Corner Workcentre Cred
ASX11348R	B31	Arbor Square; Corner Workcentre Cred
ASX9724	B30	Arbor Square; Straight Workcentre Cred
ASX9730	B30	Arbor Square; Straight Workcentre Cred
ASX9730A	B30	Arbor Square; Straight Workcentre Cred
ASX9748L	B31	Arbor Square; Corner Workcentre Cred
ASX9748R	B31	Arbor Square; Corner Workcentre Cred
ASYU4824	B41	Arbor Square; Corner Unit
BBC224242BW	H64	UN FS Rad Cor Wksf, Straight Front
BBC224242SW	H64	UN FS Rad Cor Wksf, Straight Front
BBC224242V	H64	UN FS Rad Cor Wksf, Straight Front
BBC224848BW	H64	UN FS Rad Cor Wksf, Straight Front
BBC224848SW	H64	UN FS Rad Cor Wksf, Straight Front
BBC224848V	H64	UN FS Rad Cor Wksf, Straight Front
BBC334848BW	H64	UN FS Rad Cor Wksf, Straight Front
BBC334848SW	H64	UN FS Rad Cor Wksf, Straight Front
BBC334848V	H64	UN FS Rad Cor Wksf, Straight Front

Style Number	Page	Description
BE224260RBW	H68	UN FS Ext Cor Wksf, Straight Front
BE224260RSW	H67	UN FS Ext Cor Wksf, Straight Front
BE224260RV	H69	UN FS Ext Cor Wksf, Straight Front
BE224266RBW	H68	UN FS Ext Cor Wksf, Straight Front
BE224266RSW	H67	UN FS Ext Cor Wksf, Straight Front
BE224266RV	H69	UN FS Ext Cor Wksf, Straight Front
BE224272RBW	H68	UN FS Ext Cor Wksf, Straight Front
BE224272RSW	H67	UN FS Ext Cor Wksf, Straight Front
BE224272RV	H69	UN FS Ext Cor Wksf, Straight Front
BE224278RBW	H68	UN FS Ext Cor Wksf, Straight Front
BE224278RSW	H67	UN FS Ext Cor Wksf, Straight Front
BE224278RV	H69	UN FS Ext Cor Wksf, Straight Front
BE224860RBW	H68	UN FS Ext Cor Wksf, Straight Front
BE224860RSW	H67	UN FS Ext Cor Wksf, Straight Front
BE224860RV	H69	UN FS Ext Cor Wksf, Straight Front
BE224866RBW	H68	UN FS Ext Cor Wksf, Straight Front
BE224866RSW	H67	UN FS Ext Cor Wksf, Straight Front
BE224866RV	H69	UN FS Ext Cor Wksf, Straight Front
BE224872RBW	H68	UN FS Ext Cor Wksf, Straight Front
BE224872RSW	H67	UN FS Ext Cor Wksf, Straight Front
BE224872RV	H69	UN FS Ext Cor Wksf, Straight Front
BE224878RBW	H68	UN FS Ext Cor Wksf, Straight Front
BE224878RSW	H67	UN FS Ext Cor Wksf, Straight Front
BE224878RV	H69	UN FS Ext Cor Wksf, Straight Front
BE226042LBW	H68	UN FS Ext Cor Wksf, Straight Front
BE226042LSW	H66	UN FS Ext Cor Wksf, Straight Front
BE226042LV	H69	UN FS Ext Cor Wksf, Straight Front
BE226048LBW	H68	UN FS Ext Cor Wksf, Straight Front
BE226048LSW	H66	UN FS Ext Cor Wksf, Straight Front
BE226048LV	H69	UN FS Ext Cor Wksf, Straight Front
BE226642LBW	H68	UN FS Ext Cor Wksf, Straight Front
BE226642LSW	H66	UN FS Ext Cor Wksf, Straight Front
BE226642LV	H69	UN FS Ext Cor Wksf, Straight Front
BE226648LBW	H68	UN FS Ext Cor Wksf, Straight Front
BE226648LSW	H66	UN FS Ext Cor Wksf, Straight Front
BE226648LV	H69	UN FS Ext Cor Wksf, Straight Front
BE227242LBW	H68	UN FS Ext Cor Wksf, Straight Front
BE227242LSW	H66	UN FS Ext Cor Wksf, Straight Front
BE227242LV	H69	UN FS Ext Cor Wksf, Straight Front
BE227248LBW	H68	UN FS Ext Cor Wksf, Straight Front
BE227248LSW	H66	UN FS Ext Cor Wksf, Straight Front
BE227248LV	H69	UN FS Ext Cor Wksf, Straight Front
BE227842LBW	H68	UN FS Ext Cor Wksf, Straight Front
BE227842LSW	H66	UN FS Ext Cor Wksf, Straight Front
BE227842LV	H69	UN FS Ext Cor Wksf, Straight Front
BE227848LBW	H68	UN FS Ext Cor Wksf, Straight Front
BE227848LSW	H66	UN FS Ext Cor Wksf, Straight Front
BE227848LV	H69	UN FS Ext Cor Wksf, Straight Front
BE234860RBW	H68	UN FS Ext Cor Wksf, Straight Front
BE234860RSW	H67	UN FS Ext Cor Wksf, Straight Front
BE234860RV	H69	UN FS Ext Cor Wksf, Straight Front
BE234866RBW	H68	UN FS Ext Cor Wksf, Straight Front
BE234866RSW	H67	UN FS Ext Cor Wksf, Straight Front
BE234866RV	H69	UN FS Ext Cor Wksf, Straight Front
BE234872RBW	H68	UN FS Ext Cor Wksf, Straight Front

Style Number	Page	Description	Style Number	Page	Description
BE234872RSW	H67	UN FS Ext Cor Wksf, Straight Front	BFFF721V	H83	UN FS Tethered Capsule Wksf
BE234872RV	H69	UN FS Ext Cor Wksf, Straight Front	BFFF841BW	H83	UN FS Tethered Capsule Wksf
BE234878RBW	H68	UN FS Ext Cor Wksf, Straight Front	BFFF841SW	H83	UN FS Tethered Capsule Wksf
BE234878RSW	H67	UN FS Ext Cor Wksf, Straight Front	BFFF841V	H83	UN FS Tethered Capsule Wksf
BE234878RV	H69	UN FS Ext Cor Wksf, Straight Front	BFFF961BW	H83	UN FS Tethered Capsule Wksf
BE326048LBW	H68	UN FS Ext Cor Wksf, Straight Front	BFFF961SW	H83	UN FS Tethered Capsule Wksf
BE326048LSW	H66	UN FS Ext Cor Wksf, Straight Front	BFFF961V	H83	UN FS Tethered Capsule Wksf
BE326048LV	H69	UN FS Ext Cor Wksf, Straight Front	BFFF962BW	H83	UN FS Tethered Capsule Wksf
BE326648LBW	H68	UN FS Ext Cor Wksf, Straight Front	BFFF962SW	H83	UN FS Tethered Capsule Wksf
BE326648LSW	H66	UN FS Ext Cor Wksf, Straight Front	BFFF962V	H83	UN FS Tethered Capsule Wksf
BE326648LV	H69	UN FS Ext Cor Wksf, Straight Front	BFJ2472LBW	H77	UN FS Bubble Jetty Wksf
BE327248LBW	H68	UN FS Ext Cor Wksf, Straight Front	BFJ2472LSW	H76	UN FS Bubble Jetty Wksf
BE327248LSW	H66	UN FS Ext Cor Wksf, Straight Front	BFJ2472LV	H77	UN FS Bubble Jetty Wksf
BE327248LV	H69	UN FS Ext Cor Wksf, Straight Front	BFJ2472RBW	H77	UN FS Bubble Jetty Wksf
BE327848LBW	H68	UN FS Ext Cor Wksf, Straight Front	BFJ2472RSW	H76	UN FS Bubble Jetty Wksf
BE327848LSW	H66	UN FS Ext Cor Wksf, Straight Front	BFJ2472RV	H77	UN FS Bubble Jetty Wksf
BE327848LV	H69	UN FS Ext Cor Wksf, Straight Front	BFJ2478LBW	H77	UN FS Bubble Jetty Wksf
BEH	H84	UN FS Pivot Hitch	BFJ2478LSW	H76	UN FS Bubble Jetty Wksf
BEL25	H84	UN FS Elliptical Leg	BFJ2478LV	H77	UN FS Bubble Jetty Wksf
BEL27	H84	UN FS Elliptical Leg	BFJ2478RBW	H77	UN FS Bubble Jetty Wksf
BFB223636BW	H70	UN FS Corner, 120° Wksf	BFJ2478RSW	H76	UN FS Bubble Jetty Wksf
BFB223636SW	H70	UN FS Corner, 120° Wksf	BFJ2478RV	H77	UN FS Bubble Jetty Wksf
BFB223636V	H70	UN FS Corner, 120° Wksf	BFJ3072LBW	H77	UN FS Bubble Jetty Wksf
BFB224242BW	H70	UN FS Corner, 120° Wksf	BFJ3072LSW	H76	UN FS Bubble Jetty Wksf
BFB224242SW	H70	UN FS Corner, 120° Wksf	BFJ3072LV	H77	UN FS Bubble Jetty Wksf
BFB224242V	H70	UN FS Corner, 120° Wksf	BFJ3072RBW	H77	UN FS Bubble Jetty Wksf
BFB224848BW	H70	UN FS Corner, 120° Wksf	BFJ3072RSW	H76	UN FS Bubble Jetty Wksf
BFB224848SW	H70	UN FS Corner, 120° Wksf	BFJ3072RV	H77	UN FS Bubble Jetty Wksf
BFB224848V	H70	UN FS Corner, 120° Wksf	BFJ3078LBW	H77	UN FS Bubble Jetty Wksf
BFB334242BW	H70	UN FS Corner, 120° Wksf	BFJ3078LSW	H76	UN FS Bubble Jetty Wksf
BFB334242SW	H70	UN FS Corner, 120° Wksf	BFJ3078LV	H77	UN FS Bubble Jetty Wksf
BFB334242V	H70	UN FS Corner, 120° Wksf	BFJ3078RBW	H77	UN FS Bubble Jetty Wksf
BFB334848BW	H70	UN FS Corner, 120° Wksf	BFJ3078RSW	H76	UN FS Bubble Jetty Wksf
BFB334848SW	H70	UN FS Corner, 120° Wksf	BFJ3078RV	H77	UN FS Bubble Jetty Wksf
BFB334848V	H70	UN FS Corner, 120° Wksf	BFK3672BW	H71	UN FS Capsule Wksf
BFC224242BW	H63	UN FS Cor Wksf, Straight Front	BFK3672SW	H71	UN FS Capsule Wksf
BFC224242SW	H63	UN FS Cor Wksf, Straight Front	BFK3672V	H71	UN FS Capsule Wksf
BFC224242V	H63	UN FS Cor Wksf, Straight Front	BFK4284BW	H71	UN FS Capsule Wksf
BFC224848BW	H63	UN FS Cor Wksf, Straight Front	BFK4284SW	H71	UN FS Capsule Wksf
BFC224848SW	H63	UN FS Cor Wksf, Straight Front	BFK4284V	H71	UN FS Capsule Wksf
BFC224848V	H63	UN FS Cor Wksf, Straight Front	BFK4896BW	H71	UN FS Capsule Wksf
BFC234848BW	H63	UN FS Cor Wksf, Straight Front	BFK4896SW	H71	UN FS Capsule Wksf
BFC234848SW	H63	UN FS Cor Wksf, Straight Front	BFK4896V	H71	UN FS Capsule Wksf
BFC234848V	H63	UN FS Cor Wksf, Straight Front	BFP2736BW	H73	UN FS Peninsula Wksf
BFC324848BW	H63	UN FS Cor Wksf, Straight Front	BFP2736SW	H73	UN FS Peninsula Wksf
BFC324848SW	H63	UN FS Cor Wksf, Straight Front	BFP2736V	H73	UN FS Peninsula Wksf
BFC324848V	H63	UN FS Cor Wksf, Straight Front	BFR36BW	H78	UN FS Round Wksf
BFC334848BW	H63	UN FS Cor Wksf, Straight Front	BFR36SW	H78	UN FS Round Wksf
BFC334848SW	H63	UN FS Cor Wksf, Straight Front	BFR36V	H78	UN FS Round Wksf
BFC334848V	H63	UN FS Cor Wksf, Straight Front	BFR42BW	H78	UN FS Round Wksf
BFFF661BW	H83	UN FS Tethered Capsule Wksf	BFR42SW	H78	UN FS Round Wksf
BFFF661SW	H83	UN FS Tethered Capsule Wksf	BFR42V	H78	UN FS Round Wksf
BFFF661V	H83	UN FS Tethered Capsule Wksf	BFR48BW	H78	UN FS Round Wksf
BFFF721BW	H83	UN FS Tethered Capsule Wksf	BFR48SW	H78	UN FS Round Wksf
BFFF721SW	H83	UN FS Tethered Capsule Wksf	BFR48V	H78	UN FS Round Wksf

Style Number Index, continued

Style Number	Page	Description
BFR54BW	H78	UN FS Round Wksf
BFR54SW	H78	UN FS Round Wksf
BFR54V	H78	UN FS Round Wksf
BFRQ30BW	H79	UN FS Square Wksf
BFRQ30SW	H79	UN FS Square Wksf
BFRQ30V	H79	UN FS Square Wksf
BFRQ42BW	H79	UN FS Square Wksf
BFRQ42SW	H79	UN FS Square Wksf
BFRQ42V	H79	UN FS Square Wksf
BFRQ48BW	H79	UN FS Square Wksf
BFRQ48SW	H79	UN FS Square Wksf
BFRQ48V	H79	UN FS Square Wksf
BFRQ54BW	H79	UN FS Square Wksf
BFRQ54SW	H79	UN FS Square Wksf
BFRQ54V	H79	UN FS Square Wksf
BFRR3672BW	H80	UN FS Rectangle Wksf
BFRR3672SW	H80	UN FS Rectangle Wksf
BFRR3672V	H80	UN FS Rectangle Wksf
BFRR4284BW	H80	UN FS Rectangle Wksf
BFRR4284SW	H80	UN FS Rectangle Wksf
BFRR4284V	H80	UN FS Rectangle Wksf
BFRR4896BW	H80	UN FS Rectangle Wksf
BFRR4896SW	H80	UN FS Rectangle Wksf
BFRR4896V	H80	UN FS Rectangle Wksf
BFS2430BW	H59	UN FS Straight Wksf
BFS2430SW	H58	UN FS Straight Wksf
BFS2430V	H59	UN FS Straight Wksf
BFS2436BW	H59	UN FS Straight Wksf
BFS2436SW	H58	UN FS Straight Wksf
BFS2436V	H59	UN FS Straight Wksf
BFS2442BW	H59	UN FS Straight Wksf
BFS2442SW	H58	UN FS Straight Wksf
BFS2442V	H59	UN FS Straight Wksf
BFS2448BW	H59	UN FS Straight Wksf
BFS2448SW	H58	UN FS Straight Wksf
BFS2448V	H59	UN FS Straight Wksf
BFS2454BW	H59	UN FS Straight Wksf
BFS2454SW	H58	UN FS Straight Wksf
BFS2454V	H59	UN FS Straight Wksf
BFS2460BW	H59	UN FS Straight Wksf
BFS2460SW	H58	UN FS Straight Wksf
BFS2460V	H59	UN FS Straight Wksf
BFS2466BW	H59	UN FS Straight Wksf
BFS2466SW	H58	UN FS Straight Wksf
BFS2466V	H59	UN FS Straight Wksf
BFS2472BW	H59	UN FS Straight Wksf
BFS2472SW	H58	UN FS Straight Wksf
BFS2472V	H59	UN FS Straight Wksf
BFS2478BW	H59	UN FS Straight Wksf
BFS2478SW	H58	UN FS Straight Wksf
BFS2478V	H59	UN FS Straight Wksf
BFS3036BW	H59	UN FS Straight Wksf
BFS3036SW	H58	UN FS Straight Wksf
BFS3036V	H59	UN FS Straight Wksf
BFS3042BW	H59	UN FS Straight Wksf

Style Number	Page	Description
BFS3042SW	H58	UN FS Straight Wksf
BFS3042V	H59	UN FS Straight Wksf
BFS3048BW	H59	UN FS Straight Wksf
BFS3048SW	H58	UN FS Straight Wksf
BFS3048V	H59	UN FS Straight Wksf
BFS3054BW	H59	UN FS Straight Wksf
BFS3054SW	H58	UN FS Straight Wksf
BFS3054V	H59	UN FS Straight Wksf
BFS3060BW	H59	UN FS Straight Wksf
BFS3060SW	H58	UN FS Straight Wksf
BFS3060V	H59	UN FS Straight Wksf
BFS3066BW	H59	UN FS Straight Wksf
BFS3066SW	H58	UN FS Straight Wksf
BFS3066V	H59	UN FS Straight Wksf
BFS3072BW	H59	UN FS Straight Wksf
BFS3072SW	H58	UN FS Straight Wksf
BFS3072V	H59	UN FS Straight Wksf
BFS3078BW	H59	UN FS Straight Wksf
BFS3078SW	H58	UN FS Straight Wksf
BFS3078V	H59	UN FS Straight Wksf
BFSP48BW	H72	UN FS Spanner Wksf
BFSP48SW	H72	UN FS Spanner Wksf
BFSP48V	H72	UN FS Spanner Wksf
BFSP52BW	H72	UN FS Spanner Wksf
BFSP52SW	H72	UN FS Spanner Wksf
BFSP52V	H72	UN FS Spanner Wksf
BFSP60BW	H72	UN FS Spanner Wksf
BFSP60SW	H72	UN FS Spanner Wksf
BFSP60V	H72	UN FS Spanner Wksf
BFSP64BW	H72	UN FS Spanner Wksf
BFSP64SW	H72	UN FS Spanner Wksf
BFSP64V	H72	UN FS Spanner Wksf
BFSPN52BW	H81	UN FS Split-Round Wksf
BFSPN52SW	H81	UN FS Split-Round Wksf
BFSPN52V	H81	UN FS Split-Round Wksf
BFSPN64BW	H81	UN FS Split-Round Wksf
BFSPN64SW	H81	UN FS Split-Round Wksf
BFSPN64V	H81	UN FS Split-Round Wksf
BFTP48BW	H74	UN FS Tapered Peninsula Wksf
BFTP48SW	H74	UN FS Tapered Peninsula Wksf
BFTP48V	H74	UN FS Tapered Peninsula Wksf
BFTP60BW	H74	UN FS Tapered Peninsula Wksf
BFTP60SW	H74	UN FS Tapered Peninsula Wksf
BFTP60V	H74	UN FS Tapered Peninsula Wksf
BRC224242BW	H65	UN FS Rad Cor Wksf, Curved Front
BRC224242SW	H65	UN FS Rad Cor Wksf, Curved Front
BRC224242V	H65	UN FS Rad Cor Wksf, Curved Front
BRC224848BW	H65	UN FS Rad Cor Wksf, Curved Front
BRC224848SW	H65	UN FS Rad Cor Wksf, Curved Front
BRC224848V	H65	UN FS Rad Cor Wksf, Curved Front
BRC334848BW	H65	UN FS Rad Cor Wksf, Curved Front
BRC334848SW	H65	UN FS Rad Cor Wksf, Curved Front
BRC334848V	H65	UN FS Rad Cor Wksf, Curved Front
BTTB	H85	UN FS Tether Bracket
BZC243060BW	H61	UN FS Transition Wksf

Style Number	Page	Description
BZC243060SW	H60	UN FS Transition Wksf
BZC243060V	H62	UN FS Transition Wksf
BZC243066BW	H61	UN FS Transition Wksf
BZC243066SW	H60	UN FS Transition Wksf
BZC243066V	H62	UN FS Transition Wksf
BZC243072BW	H61	UN FS Transition Wksf
BZC243072SW	H60	UN FS Transition Wksf
BZC243072V	H62	UN FS Transition Wksf
BZC243078BW	H61	UN FS Transition Wksf
BZC243078SW	H60	UN FS Transition Wksf
BZC243078V	H62	UN FS Transition Wksf
BZC302460BW	H61	UN FS Transition Wksf
BZC302460SW	H60	UN FS Transition Wksf
BZC302460V	H62	UN FS Transition Wksf
BZC302466BW	H61	UN FS Transition Wksf
BZC302466SW	H60	UN FS Transition Wksf
BZC302466V	H62	UN FS Transition Wksf
BZC302472BW	H61	UN FS Transition Wksf
BZC302472SW	H60	UN FS Transition Wksf
BZC302472V	H62	UN FS Transition Wksf
BZC302478BW	H61	UN FS Transition Wksf
BZC302478SW	H60	UN FS Transition Wksf
BZC302478V	H62	UN FS Transition Wksf
BZC303660BW	H61	UN FS Transition Wksf
BZC303660SW	H60	UN FS Transition Wksf
BZC303660V	H62	UN FS Transition Wksf
BZC303666BW	H61	UN FS Transition Wksf
BZC303666SW	H60	UN FS Transition Wksf
BZC303666V	H62	UN FS Transition Wksf
BZC303672BW	H61	UN FS Transition Wksf
BZC303672SW	H60	UN FS Transition Wksf
BZC303672V	H62	UN FS Transition Wksf
BZC303678BW	H61	UN FS Transition Wksf
BZC303678SW	H60	UN FS Transition Wksf
BZC303678V	H62	UN FS Transition Wksf
BZC363060BW	H61	UN FS Transition Wksf
BZC363060SW	H60	UN FS Transition Wksf
BZC363060V	H62	UN FS Transition Wksf
BZC363066BW	H61	UN FS Transition Wksf
BZC363066SW	H60	UN FS Transition Wksf
BZC363066V	H62	UN FS Transition Wksf
BZC363072BW	H61	UN FS Transition Wksf
BZC363072SW	H60	UN FS Transition Wksf
BZC363072V	H62	UN FS Transition Wksf
BZC363078BW	H61	UN FS Transition Wksf
BZC363078SW	H60	UN FS Transition Wksf
BZC363078V	H62	UN FS Transition Wksf
CFLEXT24	F36	Convене; Metal Flex Base
CFLEXT30	F36	Convене; Metal Flex Base
CFLEXX24	D36, F36	Metal Flex Base
CFLEXX30	D36, F36	Metal Flex Base
CL_B3660	F33	Convене; Boat-Shape Lam Conf Tbl Top
CL_B3666	F33	Convене; Boat-Shape Lam Conf Tbl Top
CL_B3672	F33	Convене; Boat-Shape Lam Conf Tbl Top
CL_B3684	F33	Convене; Boat-Shape Lam Conf Tbl Top

Style Number	Page	Description
CL_B42108	F33	Convене; Boat-Shape Lam Conf Tbl Top
CL_B4272	F33	Convене; Boat-Shape Lam Conf Tbl Top
CL_B4284	F33	Convене; Boat-Shape Lam Conf Tbl Top
CL_B4296	F33	Convене; Boat-Shape Lam Conf Tbl Top
CL_B48108	F33	Convене; Boat-Shape Lam Conf Tbl Top
CL_B48120	F33	Convене; Boat-Shape Lam Conf Tbl Top
CL_B48144	F33	Convене; Boat-Shape Lam Conf Tbl Top
CL_B4884	F33	Convене; Boat-Shape Lam Conf Tbl Top
CL_B4896	F33	Convене; Boat-Shape Lam Conf Tbl Top
CL_B54108	F33	Convене; Boat-Shape Lam Conf Tbl Top
CL_B54120	F33	Convене; Boat-Shape Lam Conf Tbl Top
CL_B54144	F33	Convене; Boat-Shape Lam Conf Tbl Top
CL_B54168	F33	Convене; Boat-Shape Lam Conf Tbl Top
CL_B60120	F33	Convене; Boat-Shape Lam Conf Tbl Top
CL_B60144	F33	Convене; Boat-Shape Lam Conf Tbl Top
CL_B60168	F33	Convене; Boat-Shape Lam Conf Tbl Top
CL_B60192	F33	Convене; Boat-Shape Lam Conf Tbl Top
CL_B60216	F33	Convене; Boat-Shape Lam Conf Tbl Top
CL_B66144	F33	Convене; Boat-Shape Lam Conf Tbl Top
CL_B66168	F33	Convене; Boat-Shape Lam Conf Tbl Top
CL_B66192	F33	Convене; Boat-Shape Lam Conf Tbl Top
CL_B66216	F33	Convене; Boat-Shape Lam Conf Tbl Top
CL_B72168	F33	Convене; Boat-Shape Lam Conf Tbl Top
CL_B72192	F33	Convене; Boat-Shape Lam Conf Tbl Top
CL_B72216	F33	Convене; Boat-Shape Lam Conf Tbl Top
CL_C36	F28	Convене; Cushion Lam Conf Tbl Top
CL_C42	F28	Convене; Cushion Lam Conf Tbl Top
CL_C48	F28	Convене; Cushion Lam Conf Tbl Top
CL_C54	F28	Convене; Cushion Lam Conf Tbl Top
CL_C60	F28	Convене; Cushion Lam Conf Tbl Top
CL_J3660	F29	Convене; Oval Laminate Conf Tbl Top
CL_J3666	F29	Convене; Oval Laminate Conf Tbl Top
CL_J3672	F29	Convене; Oval Laminate Conf Tbl Top
CL_J3684	F29	Convене; Oval Laminate Conf Tbl Top
CL_J42108	F29	Convене; Oval Laminate Conf Tbl Top
CL_J4272	F29	Convене; Oval Laminate Conf Tbl Top
CL_J4284	F29	Convене; Oval Laminate Conf Tbl Top
CL_J4296	F29	Convене; Oval Laminate Conf Tbl Top
CL_J48108	F29	Convене; Oval Laminate Conf Tbl Top
CL_J48120	F29	Convене; Oval Laminate Conf Tbl Top
CL_J4884	F29	Convене; Oval Laminate Conf Tbl Top
CL_J4896	F29	Convене; Oval Laminate Conf Tbl Top
CL_J54108	F29	Convене; Oval Laminate Conf Tbl Top
CL_J54120	F29	Convене; Oval Laminate Conf Tbl Top
CL_J54144	F29	Convене; Oval Laminate Conf Tbl Top
CL_J60120	F29	Convене; Oval Laminate Conf Tbl Top
CL_J60144	F29	Convене; Oval Laminate Conf Tbl Top
CL_J60168	F29	Convене; Oval Laminate Conf Tbl Top
CL_J66144	F29	Convене; Oval Laminate Conf Tbl Top
CL_J66168	F29	Convене; Oval Laminate Conf Tbl Top
CL_J66192	F29	Convене; Oval Laminate Conf Tbl Top
CL_J72168	F29	Convене; Oval Laminate Conf Tbl Top
CL_J72192	F29	Convене; Oval Laminate Conf Tbl Top
CL_J72216	F29	Convене; Oval Laminate Conf Tbl Top
CL_K3660	F35	Convене; Racetrack Lam Conf Tbl Top

Style Number	Page	Description	Style Number	Page	Description
CW_J4296	F19	Convener; Oval Wood Conf Table Top	CW_R72	F14	Convener; Round Wood Conf Table Top
CW_J48108	F19	Convener; Oval Wood Conf Table Top	CW_S36	F15	Convener; Square Wood Conf Table Top
CW_J48120	F19	Convener; Oval Wood Conf Table Top	CW_S42	F15	Convener; Square Wood Conf Table Top
CW_J4884	F19	Convener; Oval Wood Conf Table Top	CW_S48	F15	Convener; Square Wood Conf Table Top
CW_J4896	F19	Convener; Oval Wood Conf Table Top	CW_S54	F15	Convener; Square Wood Conf Table Top
CW_J54108	F19	Convener; Oval Wood Conf Table Top	CW_S60	F15	Convener; Square Wood Conf Table Top
CW_J54120	F19	Convener; Oval Wood Conf Table Top	CW_T3660	F21	Convener; Rect Wood Conf Table Top
CW_J54144	F19	Convener; Oval Wood Conf Table Top	CW_T3666	F21	Convener; Rect Wood Conf Table Top
CW_J60120	F19	Convener; Oval Wood Conf Table Top	CW_T3672	F21	Convener; Rect Wood Conf Table Top
CW_J60144	F19	Convener; Oval Wood Conf Table Top	CW_T3684	F21	Convener; Rect Wood Conf Table Top
CW_J60168	F19	Convener; Oval Wood Conf Table Top	CW_T42108	F21	Convener; Rect Wood Conf Table Top
CW_J66144	F19	Convener; Oval Wood Conf Table Top	CW_T4272	F21	Convener; Rect Wood Conf Table Top
CW_J66168	F19	Convener; Oval Wood Conf Table Top	CW_T4284	F21	Convener; Rect Wood Conf Table Top
CW_J66192	F19	Convener; Oval Wood Conf Table Top	CW_T4296	F21	Convener; Rect Wood Conf Table Top
CW_J72168	F19	Convener; Oval Wood Conf Table Top	CW_T48108	F21	Convener; Rect Wood Conf Table Top
CW_J72192	F19	Convener; Oval Wood Conf Table Top	CW_T48120	F21	Convener; Rect Wood Conf Table Top
CW_J72216	F19	Convener; Oval Wood Conf Table Top	CW_T48144	F21	Convener; Rect Wood Conf Table Top
CW_K3660	F25	Convener; Racetrack Wood Conf Tbl Top	CW_T4884	F21	Convener; Rect Wood Conf Table Top
CW_K3666	F25	Convener; Racetrack Wood Conf Tbl Top	CW_T4896	F21	Convener; Rect Wood Conf Table Top
CW_K3672	F25	Convener; Racetrack Wood Conf Tbl Top	CW_T54108	F21	Convener; Rect Wood Conf Table Top
CW_K3684	F25	Convener; Racetrack Wood Conf Tbl Top	CW_T54120	F21	Convener; Rect Wood Conf Table Top
CW_K42108	F25	Convener; Racetrack Wood Conf Tbl Top	CW_T54144	F21	Convener; Rect Wood Conf Table Top
CW_K4272	F25	Convener; Racetrack Wood Conf Tbl Top	CW_T54168	F21	Convener; Rect Wood Conf Table Top
CW_K4284	F25	Convener; Racetrack Wood Conf Tbl Top	CW_T60120	F21	Convener; Rect Wood Conf Table Top
CW_K4296	F25	Convener; Racetrack Wood Conf Tbl Top	CW_T60144	F21	Convener; Rect Wood Conf Table Top
CW_K48108	F25	Convener; Racetrack Wood Conf Tbl Top	CW_T60168	F21	Convener; Rect Wood Conf Table Top
CW_K48120	F25	Convener; Racetrack Wood Conf Tbl Top	CW_T60192	F21	Convener; Rect Wood Conf Table Top
CW_K48144	F25	Convener; Racetrack Wood Conf Tbl Top	CW_T60216	F21	Convener; Rect Wood Conf Table Top
CW_K4884	F25	Convener; Racetrack Wood Conf Tbl Top	CW_T66144	F21	Convener; Rect Wood Conf Table Top
CW_K4896	F25	Convener; Racetrack Wood Conf Tbl Top	CW_T66168	F21	Convener; Rect Wood Conf Table Top
CW_K54108	F25	Convener; Racetrack Wood Conf Tbl Top	CW_T66192	F21	Convener; Rect Wood Conf Table Top
CW_K54120	F25	Convener; Racetrack Wood Conf Tbl Top	CW_T66216	F21	Convener; Rect Wood Conf Table Top
CW_K54144	F25	Convener; Racetrack Wood Conf Tbl Top	CW_T72168	F21	Convener; Rect Wood Conf Table Top
CW_K54168	F25	Convener; Racetrack Wood Conf Tbl Top	CW_T72192	F21	Convener; Rect Wood Conf Table Top
CW_K60120	F25	Convener; Racetrack Wood Conf Tbl Top	CW_T72216	F21	Convener; Rect Wood Conf Table Top
CW_K60144	F25	Convener; Racetrack Wood Conf Tbl Top	CWADC6726	F47	Convener; Storage Credenza
CW_K60168	F25	Convener; Racetrack Wood Conf Tbl Top	CWAWLB56	F55, F63	Convener; Wallboard
CW_K60192	F25	Convener; Racetrack Wood Conf Tbl Top	CWAWLB70	F55, F63	Convener; Wallboard
CW_K60216	F25	Convener; Racetrack Wood Conf Tbl Top	CWBD_3229	F57	Convener; Storage Credenza
CW_K66144	F25	Convener; Racetrack Wood Conf Tbl Top	CWBD_3236	F59	Convener; Buffet-Height Credenza
CW_K66168	F25	Convener; Racetrack Wood Conf Tbl Top	CWBD_6429	F57	Convener; Storage Credenza
CW_K66192	F25	Convener; Racetrack Wood Conf Tbl Top	CWBD_6436	F59	Convener; Buffet-Height Credenza
CW_K66216	F25	Convener; Racetrack Wood Conf Tbl Top	CWBD_8029	F57	Convener; Storage Credenza
CW_K72168	F25	Convener; Racetrack Wood Conf Tbl Top	CWBD_8036	F59	Convener; Buffet-Height Credenza
CW_K72192	F25	Convener; Racetrack Wood Conf Tbl Top	CWCDC6726	F47	Convener; Storage Credenza
CW_K72216	F25	Convener; Racetrack Wood Conf Tbl Top	CWCIRC18	F41	Convener; Circular Drum Base
CW_LEC	F62	Convener; Lectern	CWCIRC24	F41	Convener; Circular Drum Base
CW_LECD	F62	Convener; Lectern	CWCIRC30	F41	Convener; Circular Drum Base
CW_LECT	F62	Convener; Lectern	CWCIRC36	F41	Convener; Circular Drum Base
CW_R36	F14	Convener; Round Wood Conf Table Top	CWCIRT18	F41	Convener; Circular Drum Base
CW_R42	F14	Convener; Round Wood Conf Table Top	CWCIRT24	F41	Convener; Circular Drum Base
CW_R48	F14	Convener; Round Wood Conf Table Top	CWCIRT30	F41	Convener; Circular Drum Base
CW_R54	F14	Convener; Round Wood Conf Table Top	CWCIRT36	F41	Convener; Circular Drum Base
CW_R60	F14	Convener; Round Wood Conf Table Top	CWCLEC	F54	Convener; Lectern
CW_R66	F14	Convener; Round Wood Conf Table Top	CWCLECD	F54	Convener; Lectern

Style Number Index, continued

Style Number	Page	Description
CWCLECDF	F54	Convene; Lectern
CWCLECF	F54	Convene; Lectern
CWCLECT	F54	Convene; Lectern
CWDD_3229	F57	Convene; Storage Credenza
CWDD_6429	F57	Convene; Storage Credenza
CWDD_8029	F57	Convene; Storage Credenza
CWDD_HP	F61	Convene; Hospitality Cart
CWDD_MED	F60	Convene; Media Cart
CWDDC4526	F47	Convene; Storage Credenza
CWDDC4536	F49	Convene; Buffet-Height Credenza
CWDDCHP	F53	Convene; Hospitality Cart
CWDLC4526	F47	Convene; Storage Credenza
CWDLC4536	F49	Convene; Buffet-Height Credenza
CWDLC6726	F47	Convene; Storage Credenza
CWDLC6736	F49	Convene; Buffet-Height Credenza
CWDRC4526	F47	Convene; Storage Credenza
CWDRC4536	F49	Convene; Buffet-Height Credenza
CWDRC6726	F47	Convene; Storage Credenza
CWDRC6736	F49	Convene; Buffet-Height Credenza
CWDW_HP	F61	Convene; Hospitality Cart
CWDW_MED	F60	Convene; Media Cart
CWDWC4526	F47	Convene; Storage Credenza
CWDWCHP	F53	Convene; Hospitality Cart
CWDWCMED	F51	Convene; Media Cart
CWDWCMEDF	F51	Convene; Media Cart
CWELC24	F43	Convene; Elliptical Drum Base
CWELC30	F43	Convene; Elliptical Drum Base
CWELC36	F43	Convene; Elliptical Drum Base
CWELT24	F43	Convene; Elliptical Drum Base
CWELT30	F43	Convene; Elliptical Drum Base
CWELT36	F43	Convene; Elliptical Drum Base
CWHDC18	F42	Convene; Half Drum Base
CWHDC24	F42	Convene; Half Drum Base
CWHDC30	F42	Convene; Half Drum Base
CWHDC36	F42	Convene; Half Drum Base
CWHDT18	F42	Convene; Half Drum Base
CWHDT24	F42	Convene; Half Drum Base
CWHDT30	F42	Convene; Half Drum Base
CWHDT36	F42	Convene; Half Drum Base
CWLD_6429	F57	Convene; Storage Credenza
CWLD_8029	F57	Convene; Storage Credenza
CWLF_3229	F57	Convene; Storage Credenza
CWLL_6429	F57	Convene; Storage Credenza
CWOD_3236	F59	Convene; Buffet-Height Credenza
CWOD_6436	F59	Convene; Buffet-Height Credenza
CWOD_8036	F59	Convene; Buffet-Height Credenza
CWOS_HP	F61	Convene; Hospitality Cart
CWOS_MED	F60	Convene; Media Cart
CWOSCHP	F53	Convene; Hospitality Cart
CWOSCMED	F51	Convene; Media Cart
CWOSCMEDF	F51	Convene; Media Cart
CWREC418	F38	Convene; Rectangular Base
CWREC424	F38	Convene; Rectangular Base
CWREC630	F38	Convene; Rectangular Base
CWREC636	F38	Convene; Rectangular Base

Style Number	Page	Description
CWREF418	F39	Convene; Rectangular Base
CWREF424	F39	Convene; Rectangular Base
CWREF630	F39	Convene; Rectangular Base
CWREF636	F39	Convene; Rectangular Base
CWRET418	F38	Convene; Rectangular Base
CWRET424	F38	Convene; Rectangular Base
CWRET630	F38	Convene; Rectangular Base
CWRET636	F38	Convene; Rectangular Base
CWTDC6726	F47	Convene; Storage Credenza
CWTDC6736	F49	Convene; Buffet-Height Credenza
CWUPC418	F37	Convene; U-Panel Base
CWUPC424	F37	Convene; U-Panel Base
CWUPC630	F37	Convene; U-Panel Base
CWUPC636	F37	Convene; U-Panel Base
CWXPC424	F37	Convene; X-Panel Base
CWXPC630	F37	Convene; X-Panel Base
CWXPC636	F37	Convene; X-Panel Base
D1D3066L_	D15	Impact; Single-Pedestal Desk
D1D3066R_	D15	Impact; Single-Pedestal Desk
D1D3072L_	D15	Impact; Single-Pedestal Desk
D1D3072R_	D15	Impact; Single-Pedestal Desk
D1D3666L_	D15	Impact; Single-Pedestal Desk
D1D3666R_	D15	Impact; Single-Pedestal Desk
D1D3672L_	D15	Impact; Single-Pedestal Desk
D1D3672R_	D15	Impact; Single-Pedestal Desk
D1D3678L_	D15	Impact; Single-Pedestal Desk
D1D3678R_	D15	Impact; Single-Pedestal Desk
D2D3066_	D13	Impact; Double-Pedestal Desk
D2D3072_	D13	Impact; Double-Pedestal Desk
D2D3666_	D13	Impact; Double-Pedestal Desk
D2D3672_	D13	Impact; Double-Pedestal Desk
D2D3678_	D13	Impact; Double-Pedestal Desk
D2H1554A	D59	Impact; Double-Height Overhead Strg
D2H1554B	D59	Impact; Double-Height Overhead Strg
D2H1554C	D59	Impact; Double-Height Overhead Strg
D2H1554D	D59	Impact; Double-Height Overhead Strg
D2H1560B	D59	Impact; Double-Height Overhead Strg
D2H1560D	D59	Impact; Double-Height Overhead Strg
D2H1566B	D59	Impact; Double-Height Overhead Strg
D2H1566D	D59	Impact; Double-Height Overhead Strg
D2H1572A	D59	Impact; Double-Height Overhead Strg
D2H1572B	D59	Impact; Double-Height Overhead Strg
D2H1572C	D59	Impact; Double-Height Overhead Strg
D2H1572D	D59	Impact; Double-Height Overhead Strg
D2H1578B	D59	Impact; Double-Height Overhead Strg
D2H1578D	D59	Impact; Double-Height Overhead Strg
D2H1584B	D59	Impact; Double-Height Overhead Strg
D2H1584D	D59	Impact; Double-Height Overhead Strg
D2H1590A	D59	Impact; Double-Height Overhead Strg
D2H1590B	D59	Impact; Double-Height Overhead Strg
D2H1590C	D59	Impact; Double-Height Overhead Strg
D2H1590D	D59	Impact; Double-Height Overhead Strg
D2H1596B	D59	Impact; Double-Height Overhead Strg
D2H1596D	D59	Impact; Double-Height Overhead Strg
D2TA2518	D53	Impact; 18"W Tower

Style Number	Page	Description	Style Number	Page	Description
D2TA2530	D55	Impact; 30"W Tower	DF2554	D39	Impact; Finished Back Panel
D2TA2536	D55	Impact; 36"W Tower	DF2560	D39	Impact; Finished Back Panel
D2TB2518	D53	Impact; 18"W Tower	DF2566	D39	Impact; Finished Back Panel
D2TC2512	D53	Impact; 12"W Tower	DF2572	D39	Impact; Finished Back Panel
D2TC2518	D53	Impact; 18"W Tower	DF2578	D39	Impact; Finished Back Panel
D2TD2512	D53	Impact; 12"W Tower	DF2584	D39	Impact; Finished Back Panel
D2TD2518	D53	Impact; 18"W Tower	DF2590	D39	Impact; Finished Back Panel
D2TD2530	D55	Impact; 30"W Tower	DF2596	D39	Impact; Finished Back Panel
D2TD2536	D55	Impact; 36"W Tower	DH1554A	D57	Impact; Single-Height Overhead Strg
D2TE2512	D52	Impact; 12"W Tower	DH1554B	D57	Impact; Single-Height Overhead Strg
D2TE2518	D52	Impact; 18"W Tower	DH1554D	D57	Impact; Single-Height Overhead Strg
D2TE2530	D55	Impact; 30"W Tower	DH1560B	D57	Impact; Single-Height Overhead Strg
D2TE2536	D55	Impact; 36"W Tower	DH1560D	D57	Impact; Single-Height Overhead Strg
D2TF2512	D53	Impact; 12"W Tower	DH1566B	D57	Impact; Single-Height Overhead Strg
D2TF2518	D53	Impact; 18"W Tower	DH1566D	D57	Impact; Single-Height Overhead Strg
D2TF2530	D55	Impact; 30"W Tower	DH1572A	D57	Impact; Single-Height Overhead Strg
D2TF2536	D55	Impact; 36"W Tower	DH1572B	D57	Impact; Single-Height Overhead Strg
D2TG2512	D53	Impact; 12"W Tower	DH1572D	D57	Impact; Single-Height Overhead Strg
D2TG2518	D53	Impact; 18"W Tower	DH1578B	D57	Impact; Single-Height Overhead Strg
DAA84	D65, F44	Technology Cover	DH1578D	D57	Impact; Single-Height Overhead Strg
DAB84	D65, F44	Technology Cover	DH1584B	D57	Impact; Single-Height Overhead Strg
DAC84	D65, F44	Technology Cover	DH1584D	D57	Impact; Single-Height Overhead Strg
DAX84	D65, F44	Technology Cover	DH1590A	D57	Impact; Single-Height Overhead Strg
DB3026	D63	Impact; Bookshelf	DH1590B	D57	Impact; Single-Height Overhead Strg
DBD3072L	D17	Impact; Bullet-Shape Desk	DH1590D	D57	Impact; Single-Height Overhead Strg
DBD3072R	D17	Impact; Bullet-Shape Desk	DH1596B	D57	Impact; Single-Height Overhead Strg
DBD3672L	D17	Impact; Bullet-Shape Desk	DH1596D	D57	Impact; Single-Height Overhead Strg
DBD3672R	D17	Impact; Bullet-Shape Desk	DKP121	D37	Impact; Support Panel
DBR3048	D17	Impact; Bullet-Shape Desk	DL42430	D50	Impact; Tall Lateral File
DBR3054	D17	Impact; Bullet-Shape Desk	DL42436	D50	Impact; Tall Lateral File
DBR3060	D17	Impact; Bullet-Shape Desk	DLNCAB264	H85	UN FS Cabby Leg
DBR3066	D17	Impact; Bullet-Shape Desk	DLNCAB26S	H85	UN FS Cabby Leg
DC2566	D21	Impact; Credenza	DLNCAB284	H85	UN FS Cabby Leg
DC2572	D21	Impact; Credenza	DLNCAB28S	H85	UN FS Cabby Leg
DC2L2560	D21	Impact; Credenza	DM2554	D38	Impact; Desk Modesty Panel
DC2L2572	D21	Impact; Credenza	DM2560	D38	Impact; Desk Modesty Panel
DC4848	D22	Impact; Freestanding Cnr Unit	DM2566	D38	Impact; Desk Modesty Panel
DCK2566	D21	Impact; Credenza	DM2572	D38	Impact; Desk Modesty Panel
DCK2572	D21	Impact; Credenza	DM2578	D38	Impact; Desk Modesty Panel
DCK2572L	D21	Impact; Credenza	DPA2418	D43	Impact; 18"W Pedestal
DCK2572R	D21	Impact; Credenza	DPA2430	D45	Impact; 30"W Pedestal
DCK2578L	D21	Impact; Credenza	DPA2436	D45	Impact; 36"W Pedestal
DCK2578R	D21	Impact; Credenza	DPA3018	D47	Impact; 18"W Pedestal
DCK2584L	D21	Impact; Credenza	DPA3018S	D41	Impact; 18"W Pedestal
DCK2584R	D21	Impact; Credenza	DPA3030	D47	Impact; 30"W Pedestal
DCK2590L	D21	Impact; Credenza	DPA3030S	D41	Impact; 30"W Pedestal
DCK2590R	D21	Impact; Credenza	DPB2418	D43	Impact; 18"W Pedestal
DCK2596L	D21	Impact; Credenza	DPB2418M	D49	Impact; 18"W Mobile Pedestal
DCK2596R	D21	Impact; Credenza	DPB2430	D45	Impact; 30"W Pedestal
DEP2418L	D37	Impact; Support Panel	DPB2436	D45	Impact; 36"W Pedestal
DEP2418R	D37	Impact; Support Panel	DPB3018	D47	Impact; 18"W Pedestal
DEP3018L	D37	Impact; Support Panel	DPB3018S	D41	Impact; 18"W Pedestal
DEP3018R	D37	Impact; Support Panel	DPB3030	D47	Impact; 30"W Pedestal
DF25102	D39	Impact; Finished Back Panel	DPB3030S	D41	Impact; 30"W Pedestal
DF25108	D39	Impact; Finished Back Panel	DPC2418	D43	Impact; 18"W Pedestal

Style Number Index, continued

Style Number	Page	Description
DPC2418M	D49	Impact; 18"W Mobile Pedestal
DPC2430	D45	Impact; 30"W Pedestal
DPC2436	D45	Impact; 36"W Pedestal
DPC2436M	D49	Impact; 36"W Mobile Pedestal
DPC3018	D47	Impact; 18"W Pedestal
DPC3018S	D41	Impact; 18"W Pedestal
DPC3030	D47	Impact; 30"W Pedestal
DPC3030S	D41	Impact; 30"W Pedestal
DPD2412	D43	Impact; 12"W Pedestal
DPD2418	D43	Impact; 18"W Pedestal
DPD2418M	D49	Impact; 18"W Mobile Pedestal
DPD2430	D45	Impact; 30"W Pedestal
DPD2436	D45	Impact; 36"W Pedestal
DPD2436M	D49	Impact; 36"W Mobile Pedestal
DPD3012	D46	Impact; 12"W Pedestal
DPD3012S	D40	Impact; 12"W Pedestal
DPD3018	D47	Impact; 18"W Pedestal
DPD3018S	D41	Impact; 18"W Pedestal
DPD3030	D47	Impact; 30"W Pedestal
DPD3030S	D41	Impact; 30"W Pedestal
DPE2412	D43	Impact; 12"W Pedestal
DPE2418	D43	Impact; 18"W Pedestal
DPE2430	D45	Impact; 30"W Pedestal
DPE2436	D45	Impact; 36"W Pedestal
DPE2436M	D49	Impact; 36"W Mobile Pedestal
DPE3012	D46	Impact; 12"W Pedestal
DPE3012S	D40	Impact; 12"W Pedestal
DPE3018	D47	Impact; 18"W Pedestal
DPE3018S	D41	Impact; 18"W Pedestal
DPE3030	D47	Impact; 30"W Pedestal
DPE3030S	D41	Impact; 30"W Pedestal
DPF2412	D43	Impact; 12"W Pedestal
DPF2418	D43	Impact; 18"W Pedestal
DPF3012	D46	Impact; 12"W Pedestal
DPF3012S	D40	Impact; 12"W Pedestal
DPF3018	D47	Impact; 18"W Pedestal
DPF3018S	D41	Impact; 18"W Pedestal
DPG2436	D45	Impact; 36"W Pedestal
DPG2436L	D45	Impact; 36"W Pedestal
DPG2436R	D45	Impact; 36"W Pedestal
DPG3036L	D47	Impact; 36"W Pedestal
DPG3036LS	D41	Impact; 36"W Pedestal
DPG3036R	D47	Impact; 36"W Pedestal
DPG3036RS	D41	Impact; 36"W Pedestal
DPH2436	D45	Impact; 36"W Pedestal
DPH2436L	D45	Impact; 36"W Pedestal
DPH2436M	D49	Impact; 36"W Mobile Pedestal
DPH2436R	D45	Impact; 36"W Pedestal
DPH3036L	D47	Impact; 36"W Pedestal
DPH3036LS	D41	Impact; 36"W Pedestal
DPH3036R	D47	Impact; 36"W Pedestal
DPH3036RS	D41	Impact; 36"W Pedestal
DPL2412	D43	Impact; 12"W Pedestal
DPL3012	D46	Impact; 12"W Pedestal
DPL3012S	D40	Impact; 12"W Pedestal

Style Number	Page	Description
DPR2412	D43	Impact; 12"W Pedestal
DPR3012	D46	Impact; 12"W Pedestal
DPR3012S	D40	Impact; 12"W Pedestal
DR2542L_	D19	Impact; Return
DR2542R_	D19	Impact; Return
DR2548L_	D19	Impact; Return
DR2548R_	D19	Impact; Return
DR2554L_	D19	Impact; Return
DR2554R_	D19	Impact; Return
DR2560L_	D19	Impact; Return
DR2560R_	D19	Impact; Return
DR2566L_	D19	Impact; Return
DR2566R_	D19	Impact; Return
DR2572L_	D19	Impact; Return
DR2572R_	D19	Impact; Return
DR2578L_	D19	Impact; Return
DR2578R_	D19	Impact; Return
DSB3636_	D25	Impact; Tech Center Leaf
DSC4848_	D25	Impact; Tech Center Leaf
DSE9025L_	D25	Impact; Tech Center Leaf
DSE9025LU_	D25	Impact; Tech Center Leaf
DSE9025R_	D25	Impact; Tech Center Leaf
DSE9025RU_	D25	Impact; Tech Center Leaf
DSL3621_	D25	Impact; Tech Center Leaf
DSW3630_	D23	Impact; Tech Center Worksurface
DSW3630L_	D23	Impact; Tech Center Worksurface
DT1554	D61	Impact; Hutch
DT1560	D61	Impact; Hutch
DT1566	D61	Impact; Hutch
DT1572	D61	Impact; Hutch
DT1578	D61	Impact; Hutch
DT1584	D61	Impact; Hutch
DT1590	D61	Impact; Hutch
DT1596	D61	Impact; Hutch
DT2254	D62	Impact; Tackboard
DT2260	D62	Impact; Tackboard
DT2266	D62	Impact; Tackboard
DT2272	D62	Impact; Tackboard
DT2278	D62	Impact; Tackboard
DT2284	D62	Impact; Tackboard
DT2290	D62	Impact; Tackboard
DT2296	D62	Impact; Tackboard
DTA2518	D53	Impact; 18"W Tower
DTA2530	D55	Impact; 30"W Tower
DTA2536	D55	Impact; 36"W Tower
DTB2518	D53	Impact; 18"W Tower
DTC2512	D53	Impact; 12"W Tower
DTC2518	D53	Impact; 18"W Tower
DTD2512	D53	Impact; 12"W Tower
DTD2518	D53	Impact; 18"W Tower
DTD2530	D55	Impact; 30"W Tower
DTD2536	D55	Impact; 36"W Tower
DTE2512	D52	Impact; 12"W Tower
DTE2518	D52	Impact; 18"W Tower
DTE2530	D55	Impact; 30"W Tower

Style Number	Page	Description	Style Number	Page	Description
DTE2536	D55	Impact; 36"W Tower	DWL2536L	D33	Impact; Return Worksurface
DTF2512	D53	Impact; 12"W Tower	DWL2536R	D33	Impact; Return Worksurface
DTF2518	D53	Impact; 18"W Tower	DWL2542L	D33	Impact; Return Worksurface
DTF2530	D55	Impact; 30"W Tower	DWL2542R	D33	Impact; Return Worksurface
DTF2536	D55	Impact; 36"W Tower	DWL2548L	D33	Impact; Return Worksurface
DTG2512	D53	Impact; 12"W Tower	DWL2548R	D33	Impact; Return Worksurface
DTG2518	D53	Impact; 18"W Tower	DWL2554L	D33	Impact; Return Worksurface
DWB3066	D27	Impact; Desk Worksurface	DWL2554R	D33	Impact; Return Worksurface
DWB3072	D27	Impact; Desk Worksurface	DWL2560L	D33	Impact; Return Worksurface
DWB3078	D27	Impact; Desk Worksurface	DWL2560R	D33	Impact; Return Worksurface
DWB3666	D27	Impact; Desk Worksurface	DWL2566L	D33	Impact; Return Worksurface
DWB3672	D27	Impact; Desk Worksurface	DWL2566R	D33	Impact; Return Worksurface
DWB3678	D27	Impact; Desk Worksurface	DWL2572L	D33	Impact; Return Worksurface
DWB3684	D27	Impact; Desk Worksurface	DWL2572R	D33	Impact; Return Worksurface
DWBR3048	D35	Impact; Run-Off Worksurface	DWL2578L	D33	Impact; Return Worksurface
DWBR3054	D35	Impact; Run-Off Worksurface	DWL2578R	D33	Impact; Return Worksurface
DWBR3060	D35	Impact; Run-Off Worksurface	DWL2584L	D33	Impact; Return Worksurface
DWBR3066	D35	Impact; Run-Off Worksurface	DWL2584R	D33	Impact; Return Worksurface
DWBR3072	D35	Impact; Run-Off Worksurface	DWP4272	D27	Impact; Desk Worksurface
DWBR3648	D35	Impact; Run-Off Worksurface	DWP4278	D27	Impact; Desk Worksurface
DWBR3654	D35	Impact; Run-Off Worksurface	DWP4878	D27	Impact; Desk Worksurface
DWBR3660	D35	Impact; Run-Off Worksurface	DWP4884	D27	Impact; Desk Worksurface
DWBR3666	D35	Impact; Run-Off Worksurface	DWPR4248	D35	Impact; Run-Off Worksurface
DWBR3672	D35	Impact; Run-Off Worksurface	DWPR4254	D35	Impact; Run-Off Worksurface
DWC25102	D29	Impact; Credenza Worksurface	DWPR4260	D35	Impact; Run-Off Worksurface
DWC25108	D29	Impact; Credenza Worksurface	DWPR4266	D35	Impact; Run-Off Worksurface
DWC2554	D29	Impact; Credenza Worksurface	DWPR4272	D35	Impact; Run-Off Worksurface
DWC2560	D29	Impact; Credenza Worksurface	DWPR4278	D35	Impact; Run-Off Worksurface
DWC2566	D29	Impact; Credenza Worksurface	DWS1554	D61	Impact; Hutch
DWC2572	D29	Impact; Credenza Worksurface	DWS1560	D61	Impact; Hutch
DWC2578	D29	Impact; Credenza Worksurface	DWS1566	D61	Impact; Hutch
DWC2584	D29	Impact; Credenza Worksurface	DWS1572	D61	Impact; Hutch
DWC2590	D29	Impact; Credenza Worksurface	DWS1578	D61	Impact; Hutch
DWC2596	D29	Impact; Credenza Worksurface	DWS1584	D61	Impact; Hutch
DWCC2554	D29	Impact; Credenza Worksurface	DWS1590	D61	Impact; Hutch
DWCC2560	D29	Impact; Credenza Worksurface	DWS1596	D61	Impact; Hutch
DWCC2566	D29	Impact; Credenza Worksurface	DWU2542	D31	Impact; Bridge Worksurface
DWCC2572	D29	Impact; Credenza Worksurface	DWU2548	D31	Impact; Bridge Worksurface
DWCC2578	D29	Impact; Credenza Worksurface	DWU2554	D31	Impact; Bridge Worksurface
DWCC2584	D29	Impact; Credenza Worksurface	E60014	D64	Center Drawer
DWCC2590	D29	Impact; Credenza Worksurface	EE91530	C41	Reference Shelf
DWCC2596	D29	Impact; Credenza Worksurface	GFUBFM6X	G190	Beltway Pwr Outfeed
DWD3066	D27	Impact; Desk Worksurface	GFUBFM6Y	G190	Beltway Pwr Outfeed
DWD3072	D27	Impact; Desk Worksurface	GFUBFM6Z	G190	Beltway Pwr Outfeed
DWD3078	D27	Impact; Desk Worksurface	GFUCCM	G196	Cord and Cable Mgrs
DWD3666	D27	Impact; Desk Worksurface	GFUCH	G186	Comm Outlet Housing
DWD3672	D27	Impact; Desk Worksurface	GFUCMC	G196	Harness Clips
DWD3678	D27	Impact; Desk Worksurface	GFUFFH12X	G188	Floor Power Infeed
DWD3684	D27	Impact; Desk Worksurface	GFUFFH12Y	G188	Floor Power Infeed
DWDR3060	D35	Impact; Run-Off Worksurface	GFUFFH12Z	G188	Floor Power Infeed
DWDR3066	D35	Impact; Run-Off Worksurface	GFUFFH6X	G188	Floor Power Infeed
DWDR3072	D35	Impact; Run-Off Worksurface	GFUFFH6Y	G188	Floor Power Infeed
DWDR3660	D35	Impact; Run-Off Worksurface	GFUFFH6Z	G188	Floor Power Infeed
DWDR3666	D35	Impact; Run-Off Worksurface	GFUMB	G184	Mounting Bracket
DWDR3672	D35	Impact; Run-Off Worksurface	GFUPMBX	G183	Power Module

Style Number Index, continued

Style Number	Page	Description
GFUPMBXNYC	G183	Power Module
GFUPMBY	G183	Power Module
GFUPMBYNYC	G183	Power Module
GFUPMBZ	G183	Power Module
GFUPMBZNYC	G183	Power Module
GFUPMX	G183	Power Module
GFUPMXNYC	G183	Power Module
GFUPMY	G183	Power Module
GFUPMYNYC	G183	Power Module
GFUPMZ	G183	Power Module
GFUPMZNYC	G183	Power Module
GFUSCM	G184	Comm Module
GFUT1G72X	G185	Conv Tri-Receptacle
GFUT1G72Y	G185	Conv Tri-Receptacle
GFUT1G72Z	G185	Conv Tri-Receptacle
GFUT1S72X	G185	Conv Tri-Receptacle
GFUT1S72Y	G185	Conv Tri-Receptacle
GFUT1S72Z	G185	Conv Tri-Receptacle
GFUT2G72X	G185	Conv Tri-Receptacle
GFUT2G72Y	G185	Conv Tri-Receptacle
GFUT2G72Z	G185	Conv Tri-Receptacle
GFUT2S72X	G185	Conv Tri-Receptacle
GFUT2S72Y	G185	Conv Tri-Receptacle
GFUT2S72Z	G185	Conv Tri-Receptacle
GFUT3G72X	G185	Conv Tri-Receptacle
GFUT3G72Y	G185	Conv Tri-Receptacle
GFUT3G72Z	G185	Conv Tri-Receptacle
GFUT3S72X	G185	Conv Tri-Receptacle
GFUT3S72Y	G185	Conv Tri-Receptacle
GFUT3S72Z	G185	Conv Tri-Receptacle
GFUT4G72X	G185	Conv Tri-Receptacle
GFUT4G72Y	G185	Conv Tri-Receptacle
GFUT4S72X	G185	Conv Tri-Receptacle
GFUT4S72Y	G185	Conv Tri-Receptacle
GFUTMB	G187	Below-Wksf Mtg Brkt
GFUTMC	G187	Above-Wksf Clamp Kit
GFUTP96	G186	Conv Tri-Receptacle
GSGUBCX	G192	Connector
GSGUBCY	G192	Connector
GSGUBCZ	G192	Connector
GSGUFC	G189	Mdlr Infeed Cover
GSGUFMH12X	G189	Mulpurp Pwr Infeed
GSGUFMH12Y	G189	Mulpurp Pwr Infeed
GSGUFMH12Z	G189	Mulpurp Pwr Infeed
GSGUFMH24X	G189	Mulpurp Pwr Infeed
GSGUFMH24Y	G189	Mulpurp Pwr Infeed
GSGUFMH24Z	G189	Mulpurp Pwr Infeed
GSGUFMM12X	G189	Mulpurp Pwr Infeed
GSGUFMM12Y	G189	Mulpurp Pwr Infeed
GSGUFMM12Z	G189	Mulpurp Pwr Infeed
GSGUFMM24X	G189	Mulpurp Pwr Infeed
GSGUFMM24Y	G189	Mulpurp Pwr Infeed
GSGUFMM24Z	G189	Mulpurp Pwr Infeed
GSGUH100X	G194	Modular Harness
GSGUH100Y	G194	Modular Harness

Style Number	Page	Description
GSGUH100Z	G195	Modular Harness
GSGUH120X	G194	Modular Harness
GSGUH120Y	G194	Modular Harness
GSGUH120Z	G195	Modular Harness
GSGUH12X	G194	Modular Harness
GSGUH12Y	G194	Modular Harness
GSGUH12Z	G195	Modular Harness
GSGUH144X	G194	Modular Harness
GSGUH144Y	G194	Modular Harness
GSGUH144Z	G195	Modular Harness
GSGUH22X	G194	Modular Harness
GSGUH22Y	G194	Modular Harness
GSGUH22Z	G195	Modular Harness
GSGUH28X	G194	Modular Harness
GSGUH28Y	G194	Modular Harness
GSGUH28Z	G195	Modular Harness
GSGUH32X	G194	Modular Harness
GSGUH32Y	G194	Modular Harness
GSGUH32Z	G195	Modular Harness
GSGUH38X	G194	Modular Harness
GSGUH38Y	G194	Modular Harness
GSGUH38Z	G195	Modular Harness
GSGUH44X	G194	Modular Harness
GSGUH44Y	G194	Modular Harness
GSGUH44Z	G195	Modular Harness
GSGUH50X	G194	Modular Harness
GSGUH50Y	G194	Modular Harness
GSGUH50Z	G195	Modular Harness
GSGUH54X	G194	Modular Harness
GSGUH54Y	G194	Modular Harness
GSGUH54Z	G195	Modular Harness
GSGUH64X	G194	Modular Harness
GSGUH64Y	G194	Modular Harness
GSGUH64Z	G195	Modular Harness
GSGUH76X	G194	Modular Harness
GSGUH76Y	G194	Modular Harness
GSGUH76Z	G195	Modular Harness
GSGUH88X	G194	Modular Harness
GSGUH88Y	G194	Modular Harness
GSGUH88Z	G195	Modular Harness
GSGUHCX	G192	Connector
GSGUHCY	G192	Connector
GSGUHCZ	G192	Connector
GSGUHHX	G194	RL Modular Harness
GSGUHHY	G194	RL Modular Harness
GSGUHHZ	G195	RL Modular Harness
GSGUR1SGX	G191	Receptacle
GSGUR1SGY	G191	Receptacle
GSGUR1SGZ	G191	Receptacle
GSGUR1SSX	G191	Receptacle
GSGUR1SSY	G191	Receptacle
GSGUR1SSZ	G191	Receptacle
GSGUR1TGX	G191	Receptacle
GSGUR1TGY	G191	Receptacle
GSGUR1TGZ	G191	Receptacle

Style Number	Page	Description	Style Number	Page	Description
GSGUR1TSX	G191	Receptacle	KL436XW	H117	UN Lateral File
GSGUR1TSY	G191	Receptacle	KPBFF24MW	H99	UN Mobile Pedestal
GSGUR1TSZ	G191	Receptacle	KPBFF24W	H95	UN Single-Wide Pedestal
GSGUR2SGX	G191	Receptacle	KPBFF30MW	H99	UN Mobile Pedestal
GSGUR2SGY	G191	Receptacle	KPBFF30W	H95	UN Single-Wide Pedestal
GSGUR2SGZ	G191	Receptacle	KPBFFF24RMW	H109	UN Tall Mobile Pedestal
GSGUR2SSX	G191	Receptacle	KPBFFF24RW	H107	UN Tall Pedestal
GSGUR2SSY	G191	Receptacle	KPBF15MW	H99	UN Mobile Pedestal
GSGUR2SSZ	G191	Receptacle	KPBFF3724MW	H105	UN Tall Mobile Pedestal
GSGUR2TGX	G191	Receptacle	KPBFF3724W	H103	UN Tall Pedestal
GSGUR2TGY	G191	Receptacle	KPBFF3727MW	H105	UN Tall Mobile Pedestal
GSGUR2TGZ	G191	Receptacle	KPBFF3727W	H103	UN Tall Pedestal
GSGUR2TSX	G191	Receptacle	KPC1515	H100	UN Pedestal Seat Cushion
GSGUR2TSY	G191	Receptacle	KPC1522	H100	UN Pedestal Seat Cushion
GSGUR2TSZ	G191	Receptacle	KPC1527	H100	UN Pedestal Seat Cushion
GSGUR3SGX	G191	Receptacle	KPC3022	H100	UN Pedestal Seat Cushion
GSGUR3SGY	G191	Receptacle	KPC3027	H100	UN Pedestal Seat Cushion
GSGUR3SGZ	G191	Receptacle	KPFF24MW	H99	UN Mobile Pedestal
GSGUR3SSX	G191	Receptacle	KPFF24W	H95	UN Single-Wide Pedestal
GSGUR3SSY	G191	Receptacle	KPFF30MW	H99	UN Mobile Pedestal
GSGUR3SSZ	G191	Receptacle	KPFF30W	H95	UN Single-Wide Pedestal
GSGUR3TGX	G191	Receptacle	KPFFF24RMW	H109	UN Tall Mobile Pedestal
GSGUR3TGY	G191	Receptacle	KPFFF24RW	H107	UN Tall Pedestal
GSGUR3TGZ	G191	Receptacle	KPFFF3724MW	H105	UN Tall Mobile Pedestal
GSGUR3TSX	G191	Receptacle	KPFFF3724W	H103	UN Tall Pedestal
GSGUR3TSY	G191	Receptacle	KPFFF3727MW	H105	UN Tall Mobile Pedestal
GSGUR3TSZ	G191	Receptacle	KPFFF3727W	H103	UN Tall Pedestal
GSGUR4SGX	G191	Receptacle	KPS24W	H95	UN Single-Wide Pedestal
GSGUR4SGY	G191	Receptacle	KPS30W	H95	UN Single-Wide Pedestal
GSGUR4SSX	G191	Receptacle	KPSFF24RMW	H109	UN Tall Mobile Pedestal
GSGUR4SSY	G191	Receptacle	KPSFF24RW	H107	UN Tall Pedestal
GSGUR4TGX	G191	Receptacle	KPSS24GRLMW	H109	UN Tall Mobile Pedestal
GSGUR4TGY	G191	Receptacle	KPSS24GRLW	H107	UN Tall Pedestal
GSGUR4TSX	G191	Receptacle	KPSS24GRRMW	H109	UN Tall Mobile Pedestal
GSGUR4TSY	G191	Receptacle	KPSS24GRRW	H107	UN Tall Pedestal
GVDDBOX	H87	UN FS Power/Data Box	KPSS24RLMW	H109	UN Tall Mobile Pedestal
GVPDBOX	H87	UN FS Power/Data Box	KPSS24RLW	H107	UN Tall Pedestal
GVPPOBOX	H87	UN FS Power/Data Box	KPSS24RRMW	H109	UN Tall Mobile Pedestal
KDBBFLW24LW	H97	UN Double-Wide Pedestal	KPSS24RRW	H107	UN Tall Pedestal
KDBBFLW24RW	H97	UN Double-Wide Pedestal	KPSSS24RMW	H109	UN Tall Mobile Pedestal
KDBBFLW30LW	H97	UN Double-Wide Pedestal	KPSSS24RW	H107	UN Tall Pedestal
KDBBFLW30RW	H97	UN Double-Wide Pedestal	KSS36PWT	H121	UN Super Shelf
KDBBFS24LW	H97	UN Double-Wide Pedestal	KSS36PWW	H119	UN Super Shelf
KDBBFS24RW	H97	UN Double-Wide Pedestal	KSS36SWT	H121	UN Super Shelf
KDBBFS30LW	H97	UN Double-Wide Pedestal	KSS36SWW	H119	UN Super Shelf
KDBBFS30RW	H97	UN Double-Wide Pedestal	KSS36WLWT	H121	UN Super Shelf
KDFFS24LW	H97	UN Double-Wide Pedestal	KSS36WLWW	H119	UN Super Shelf
KDFFS24RW	H97	UN Double-Wide Pedestal	KSS36WRWT	H121	UN Super Shelf
KDFFS30LW	H97	UN Double-Wide Pedestal	KSS36WRWW	H119	UN Super Shelf
KDFFS30RW	H97	UN Double-Wide Pedestal	KSS48PWT	H121	UN Super Shelf
KL230W	H117	UN Lateral File	KSS48PWW	H119	UN Super Shelf
KL236W	H117	UN Lateral File	KSS48SWT	H121	UN Super Shelf
KL430W	H117	UN Lateral File	KSS48SWW	H119	UN Super Shelf
KL430XW	H117	UN Lateral File	KSS48WLWT	H121	UN Super Shelf
KL436W	H117	UN Lateral File	KSS48WLWW	H119	UN Super Shelf

Style Number Index, continued

Style Number	Page	Description
KSS48WRWT	H121	UN Super Shelf
KSS48WRWW	H119	UN Super Shelf
KSS60PWW	H119	UN Super Shelf
KSS60SWW	H119	UN Super Shelf
KSS60WLWW	H119	UN Super Shelf
KSS60WRWW	H119	UN Super Shelf
KSW15BW	H110	UN Hedge Row Top
KSW15SW	H110	UN Hedge Row Top
KSW54BW	H110	UN Hedge Row Top
KSW54SW	H110	UN Hedge Row Top
KT1224SW	H114	UN Wood Shelf
KT1230SW	H114	UN Wood Shelf
KT5324DFFW	H113	UN Tower
KT5324LW	H113	UN Tower
KT5324RW	H113	UN Tower
KT5330LW	H113	UN Tower
KT5330RW	H113	UN Tower
KT6024DFFW	H113	UN Tower
KT6024LW	H113	UN Tower
KT6024RW	H113	UN Tower
KT6030LW	H113	UN Tower
KT6030RW	H113	UN Tower
KTGROM	H86	UN FS Triangular Grommet
KWALLSW18	H91	UN Slatwall
KWALLSW6	H91	UN Slatwall
KWALLTB18	H91	UN Tackboard
KWALLTB6	H91	UN Tackboard
KWALLW	H90	UN T-Wall
L4416630L	C9	Walden; Sgl-Pedestal Desk
L4416630R	C12	Walden; Sgl-Pedestal Desk
L4417236L	C9	Walden; Sgl-Pedestal Desk
L4417236R	C12	Walden; Sgl-Pedestal Desk
L4426030	C5	Walden; Dbl-Pedestal Desk
L4426630	C5	Walden; Dbl-Pedestal Desk
L4427236	C5	Walden; Dbl-Pedestal Desk
L44BF7236	C22	Walden; Bullet-Shape Table
L44H6620	C27	Walden; Full-Strg Credenza
L44H7220	C27	Walden; Full-Strg Credenza
L44LF3629	C36	Walden; Lateral File
L44P6620	C26	Walden; Kneespace Credenza
L44P7220	C26	Walden; Kneespace Credenza
L44PT3624	C40	Walden; VDT/Printer Table
L44U4824	C21	Walden; Bridge
L4516630L	C9	Walden; Sgl-Pedestal Desk
L4516630R	C12	Walden; Sgl-Pedestal Desk
L4517236L	C9	Walden; Sgl-Pedestal Desk
L4517236R	C12	Walden; Sgl-Pedestal Desk
L4526030	C5	Walden; Dbl-Pedestal Desk
L4526630	C5	Walden; Dbl-Pedestal Desk
L4527236	C5	Walden; Dbl-Pedestal Desk
L45BF7236	C22	Walden; Bullet-Shape Table
L45H6620	C27	Walden; Full-Strg Credenza
L45H7220	C27	Walden; Full-Strg Credenza
L45LF3629	C36	Walden; Lateral File
L45P6620	C26	Walden; Kneespace Credenza

Style Number	Page	Description
L45P7220	C26	Walden; Kneespace Credenza
L45PT3624	C40	Walden; VDT/Printer Table
L45U4824	C21	Walden; Bridge
L4616630L	C10	Walden; Sgl-Pedestal Desk
L4616630R	C13	Walden; Sgl-Pedestal Desk
L4617236L	C10	Walden; Sgl-Pedestal Desk
L4617236R	C13	Walden; Sgl-Pedestal Desk
L4626030	C6	Walden; Dbl-Pedestal Desk
L4626630	C6	Walden; Dbl-Pedestal Desk
L4627236	C6	Walden; Dbl-Pedestal Desk
L46D4824L	C17	Walden; Typing-Hgt Return
L46D4824R	C17	Walden; Typing-Hgt Return
L46F4824L	C20	Walden; Desk-Hgt Return
L46F4824R	C19	Walden; Desk-Hgt Return
L46Q7220L	C24	Walden; Kneespace Credenza
L46Q7220R	C25	Walden; Kneespace Credenza
L46Y7220L	C33	Walden; Kneespace Credenza
L46Y7220R	C33	Walden; Kneespace Credenza
L4716630L	C10	Walden; Sgl-Pedestal Desk
L4716630R	C13	Walden; Sgl-Pedestal Desk
L4717236L	C10	Walden; Sgl-Pedestal Desk
L4717236R	C13	Walden; Sgl-Pedestal Desk
L4726030	C6	Walden; Dbl-Pedestal Desk
L4726630	C6	Walden; Dbl-Pedestal Desk
L4727236	C6	Walden; Dbl-Pedestal Desk
L47D4824L	C17	Walden; Typing-Hgt Return
L47D4824R	C17	Walden; Typing-Hgt Return
L47F4824L	C20	Walden; Desk-Hgt Return
L47F4824R	C19	Walden; Desk-Hgt Return
L47Q7220L	C24	Walden; Kneespace Credenza
L47Q7220R	C25	Walden; Kneespace Credenza
L47Y7220L	C33	Walden; Kneespace Credenza
L47Y7220R	C33	Walden; Kneespace Credenza
L4816630L	C9	Walden; Sgl-Pedestal Desk
L4816630R	C12	Walden; Sgl-Pedestal Desk
L4817236L	C9	Walden; Sgl-Pedestal Desk
L4817236R	C12	Walden; Sgl-Pedestal Desk
L4826030	C5	Walden; Dbl-Pedestal Desk
L4826630	C5	Walden; Dbl-Pedestal Desk
L4827236	C5	Walden; Dbl-Pedestal Desk
L48BF7236	C22	Walden; Bullet-Shape Table
L48H6620	C27	Walden; Full-Strg Credenza
L48H7220	C27	Walden; Full-Strg Credenza
L48LF3629	C36	Walden; Lateral File
L48P6620	C26	Walden; Kneespace Credenza
L48P7220	C26	Walden; Kneespace Credenza
L48PT3624	C40	Walden; VDT/Printer Table
L48U4824	C21	Walden; Bridge
L4916630L	C10	Walden; Sgl-Pedestal Desk
L4916630R	C13	Walden; Sgl-Pedestal Desk
L4917236L	C10	Walden; Sgl-Pedestal Desk
L4917236R	C13	Walden; Sgl-Pedestal Desk
L4926030	C6	Walden; Dbl-Pedestal Desk
L4926630	C6	Walden; Dbl-Pedestal Desk
L4927236	C6	Walden; Dbl-Pedestal Desk

Style Number Index, continued

Style Number	Page	Description
TLBS42	G87	RL Back Rail
TLBS64	G87	RL Back Rail
TLBT4224L	G65	RL Bowed Trans Wksf
TLBT4224R	G65	RL Bowed Trans Wksf
TLBT6424L	G65	RL Bowed Trans Wksf
TLBT6424R	G65	RL Bowed Trans Wksf
TLBTH4224L	G36	RL Bowed Trans Shell
TLBTH4224R	G36	RL Bowed Trans Shell
TLBTH6424L	G36	RL Bowed Trans Shell
TLBTH6424R	G36	RL Bowed Trans Shell
TLC4224	G67	RL Corner Wksf
TLC4230	G67	RL Corner Wksf
TLCEP24	G86	RL Corner End Panel
TLCH4224	G43	RL Corner Shell
TLCH4230	G43	RL Corner Shell
TLEC4264L	G69	RL Ext Corner Wksf
TLEC4264R	G69	RL Ext Corner Wksf
TLECH4264L	G48	RL Ext Corner Shell
TLECH4264R	G48	RL Ext Corner Shell
TLEP24	G82, G84	RL End Panel
TLEP30	G82	RL Full-Depth End Pnl
TLFB3220	G131	RL Low-Boy Lat File
TLFB3220W	G131	RL Low-Boy Lat File
TLFB3220WW	G131	RL Low-Boy Lat File
TLFB3226	G131	RL Low-Boy Lat File
TLFB3226W	G131	RL Low-Boy Lat File
TLFB3226WW	G131	RL Low-Boy Lat File
TLFL4820	G131	RL Low-Boy Lat File
TLFL4820W	G131	RL Low-Boy Lat File
TLFL4820WW	G131	RL Low-Boy Lat File
TLFL4826	G131	RL Low-Boy Lat File
TLFL4826W	G131	RL Low-Boy Lat File
TLFL4826WW	G131	RL Low-Boy Lat File
TLFLF5432	G157	RL Four-High Lat File
TLFLF5432W	G157	RL Four-High Lat File
TLFLF5432WW	G157	RL Four-High Lat File
TLFMP4224	G91	RL Modesty Panel
TLFMP6424	G91	RL Modesty Panel
TLFR4820	G131	RL Low-Boy Lat File
TLFR4820W	G131	RL Low-Boy Lat File
TLFR4820WW	G131	RL Low-Boy Lat File
TLFR4826	G131	RL Low-Boy Lat File
TLFR4826W	G131	RL Low-Boy Lat File
TLFR4826WW	G131	RL Low-Boy Lat File
TLFSMP4236	G91	RL Modesty Panel
TLFSMP6436	G91	RL Modesty Panel
TLH4214	G161	RL Open Hutch
TLH6414	G161	RL Open Hutch
TLHAS4224	G80	RL Adj-Hgt Corner Wksf
TLHASP4224	G80	RL Adj-Hgt Corner Wksf
TLHEP24	G84	RL Half-Depth End Pnl
TLHT4116	G111	RL Hatchback
TLHT4116W	G111	RL Hatchback
TLHTSW4132W	G111	RL Hatchback
TLHTTB4132W	G111	RL Hatchback

Style Number	Page	Description
TLJJ4649	G104	RL Idea Island Table
TLKIT	G178	RL Task Light Mtg Kit
TLLB1620	G127	RL Low-Boy Pedestal
TLLB1620W	G127	RL Low-Boy Pedestal
TLLB1620WW	G127	RL Low-Boy Pedestal
TLLB1626	G127	RL Low-Boy Pedestal
TLLB1626W	G127	RL Low-Boy Pedestal
TLLB1626WW	G127	RL Low-Boy Pedestal
TLLB3220	G127	RL Low-Boy Pedestal
TLLB3220W	G127	RL Low-Boy Pedestal
TLLB3220WW	G127	RL Low-Boy Pedestal
TLLB3226	G127	RL Low-Boy Pedestal
TLLB3226W	G127	RL Low-Boy Pedestal
TLLB3226WW	G127	RL Low-Boy Pedestal
TLLB4820	G127	RL Low-Boy Pedestal
TLLB4820W	G127	RL Low-Boy Pedestal
TLLB4820WW	G127	RL Low-Boy Pedestal
TLLB4826	G127	RL Low-Boy Pedestal
TLLB4826W	G127	RL Low-Boy Pedestal
TLLB4826WW	G127	RL Low-Boy Pedestal
TLLT3226	G97	RL Lemon-Top Table
TLMB1620	G129	RL Mid-Boy Pedestal
TLMB1620W	G129	RL Mid-Boy Pedestal
TLMB1620WW	G129	RL Mid-Boy Pedestal
TLMB1626	G129	RL Mid-Boy Pedestal
TLMB1626W	G129	RL Mid-Boy Pedestal
TLMB1626WW	G129	RL Mid-Boy Pedestal
TLMB3220	G129	RL Mid-Boy Pedestal
TLMB3220W	G129	RL Mid-Boy Pedestal
TLMB3220WW	G129	RL Mid-Boy Pedestal
TLMB3226	G129	RL Mid-Boy Pedestal
TLMB3226W	G129	RL Mid-Boy Pedestal
TLMB3226WW	G129	RL Mid-Boy Pedestal
TLMB4820	G129	RL Mid-Boy Pedestal
TLMB4820W	G129	RL Mid-Boy Pedestal
TLMB4820WW	G129	RL Mid-Boy Pedestal
TLMB4826	G129	RL Mid-Boy Pedestal
TLMB4826W	G129	RL Mid-Boy Pedestal
TLMB4826WW	G129	RL Mid-Boy Pedestal
TLMC4132	G115	RL Media Cart
TLMC4132W	G115	RL Media Cart
TLMF3220	G133	RL Mid-Boy Lat File
TLMF3220W	G133	RL Mid-Boy Lat File
TLMF3220WW	G133	RL Mid-Boy Lat File
TLMF3226	G133	RL Mid-Boy Lat File
TLMF3226W	G133	RL Mid-Boy Lat File
TLMF3226WW	G133	RL Mid-Boy Lat File
TLMJJ4649	G104	RL Idea Island Table
TLML4820	G133	RL Mid-Boy Lat File
TLML4820W	G133	RL Mid-Boy Lat File
TLML4820WW	G133	RL Mid-Boy Lat File
TLML4826	G133	RL Mid-Boy Lat File
TLML4826W	G133	RL Mid-Boy Lat File
TLML4826WW	G133	RL Mid-Boy Lat File
TLMP4224	G93	RL Modesty Panel

Style Number	Page	Description	Style Number	Page	Description
TLMP6424	G93	RL Modesty Panel	TLTB5416R	G145	RL Tall-Boy Cabinet
TLMR4820	G133	RL Mid-Boy Lat File	TLTB5416WL	G145	RL Tall-Boy Cabinet
TLMR4820W	G133	RL Mid-Boy Lat File	TLTB5416WR	G145	RL Tall-Boy Cabinet
TLMR4820WW	G133	RL Mid-Boy Lat File	TLTB5416WWL	G145	RL Tall-Boy Cabinet
TLMR4826	G133	RL Mid-Boy Lat File	TLTB5416WWR	G145	RL Tall-Boy Cabinet
TLMR4826W	G133	RL Mid-Boy Lat File	TLTB6616L	G145	RL Tall-Boy Cabinet
TLMR4826WW	G133	RL Mid-Boy Lat File	TLTB6616R	G145	RL Tall-Boy Cabinet
TLOB4214	G163	RL Ovhd Binder Bin	TLTB6616WL	G145	RL Tall-Boy Cabinet
TLOB4214W	G163	RL Ovhd Binder Bin	TLTB6616WR	G145	RL Tall-Boy Cabinet
TLOB4214WW	G163	RL Ovhd Binder Bin	TLTB6616WWL	G145	RL Tall-Boy Cabinet
TLOB6414	G163	RL Ovhd Binder Bin	TLTB6616WWR	G145	RL Tall-Boy Cabinet
TLOB6414W	G163	RL Ovhd Binder Bin	TLTC4264L	G73	RL Trans Ext Cor Wksf
TLOB6414WW	G163	RL Ovhd Binder Bin	TLTC4264R	G73	RL Trans Ext Cor Wksf
TLOBS4214	G165	RL Ovhd Binder Bin	TLTC42L	G71	RL Trans Cor Wksf
TLOBS4214W	G165	RL Ovhd Binder Bin	TLTC42R	G71	RL Trans Cor Wksf
TLOBS4214WW	G165	RL Ovhd Binder Bin	TLTCH4264L	G60	RL Trans Ext Cor Shell
TLOBS6414	G165	RL Ovhd Binder Bin	TLTCH4264R	G60	RL Trans Ext Cor Shell
TLOBS6414W	G165	RL Ovhd Binder Bin	TLTCH42L	G54	RL Trans Cor Shell
TLOBS6414WW	G165	RL Ovhd Binder Bin	TLTCH42R	G54	RL Trans Cor Shell
TLPB2029L	G119	RL Personal Border	TLTT3264	G98	RL Teaming Table
TLPB2029R	G119	RL Personal Border	TLTH3264	G99	RL Teaming Table
TLPB2042	G120	RL Personal Border	TLVC5432	G153	RL Vertical Cabinet
TLPB2051L	G119	RL Personal Border	TLVC5432W	G153	RL Vertical Cabinet
TLPB2051R	G119	RL Personal Border	TLVC5432WW	G153	RL Vertical Cabinet
TLPB2064	G120	RL Personal Border	TLVC6632	G153	RL Vertical Cabinet
TLPT4872L	G75	RL Pier-Top Wksf	TLVC6632W	G153	RL Vertical Cabinet
TLPT4872R	G75	RL Pier-Top Wksf	TLVC6632WW	G153	RL Vertical Cabinet
TLPTS4872L	G75	RL Pier-Top Wksf	TLVF5416	G149	RL Tall-Boy Cabinet
TLPTS4872R	G75	RL Pier-Top Wksf	TLVF5416W	G149	RL Tall-Boy Cabinet
TLRA3260	G100	RL Runaround Table	TLVF5416WW	G149	RL Tall-Boy Cabinet
TLRAH3260	G101	RL Runaround Table	TLW5416L	G141	RL Wardrobe
TLRS4224	G63	RL Rectangular Wksf	TLW5416R	G141	RL Wardrobe
TLRS4230	G63	RL Rectangular Wksf	TLW5416WL	G141	RL Wardrobe
TLRS6424	G63	RL Rectangular Wksf	TLW5416WR	G141	RL Wardrobe
TLRS6430	G63	RL Rectangular Wksf	TLW5416WWL	G141	RL Wardrobe
TLRSH4224	G24	RL Rectangular Shell	TLW5416WWR	G141	RL Wardrobe
TLRSH4230	G30	RL Rectangular Shell	TLW548L	G139	RL Wardrobe
TLRSH6424	G24	RL Rectangular Shell	TLW548R	G139	RL Wardrobe
TLRSH6430	G30	RL Rectangular Shell	TLW548WL	G139	RL Wardrobe
TLBS42	G88	RL Back Rail	TLW548WR	G139	RL Wardrobe
TLBS64	G88	RL Back Rail	TLW548WWL	G139	RL Wardrobe
TLBSC42	G89	RL Back Rail	TLW548WWR	G139	RL Wardrobe
TLBSC64	G89	RL Back Rail	TLW6616L	G141	RL Wardrobe
TLSEP24	G85	RL Slip-Fit End Panel	TLW6616R	G141	RL Wardrobe
TLSEP30	G85	RL Slip-Fit End Panel	TLW6616WL	G141	RL Wardrobe
TLSH3224	G96	RL Shield-Top Table	TLW6616WR	G141	RL Wardrobe
TLSHCEP24	G86	RL Corner End Panel	TLW6616WWL	G141	RL Wardrobe
TLSHEP24	G82, G84	RL End Panel	TLW6616WWR	G141	RL Wardrobe
TLSHEP30	G82	RL Full-Depth End Pnl	TLW668L	G139	RL Wardrobe
TLSHHEP24	G84	RL Half-Depth End Pnl	TLW668R	G139	RL Wardrobe
TLMP64236	G93	RL Modesty Panel	TLW668WL	G139	RL Wardrobe
TLMP6436	G93	RL Modesty Panel	TLW668WR	G139	RL Wardrobe
TLST4818	G76	RL Spanner Top	TLW668WWL	G139	RL Wardrobe
TLST6023	G76	RL Spanner Top	TLW668WWR	G139	RL Wardrobe
TLTB5416L	G145	RL Tall-Boy Cabinet	TMB1650	G174	RL Markerboard

Style Number Index, continued

Style Number	Page	Description
TMB1662	G174	RL Markerboard
TMB2450	G174	RL Markerboard
TMB2462	G174	RL Markerboard
TMB3250	G174	RL Markerboard
TMB3262	G174	RL Markerboard
TMB4050	G174	RL Markerboard
TMB4062	G174	RL Markerboard
TMB4226	G175	RL Markerboard
TMB4238	G175	RL Markerboard
TMB6426	G175	RL Markerboard
TMB6438	G175	RL Markerboard
TMBHB4220	G173	RL Markerboard
TMBHB6420	G173	RL Markerboard
TMBS2450	G173	RL Markerboard
TMBS2462	G173	RL Markerboard
TMJJ4649	G105	RL Idea Island Table
TMMJJ4649	G105	RL Idea Island Table
TMP1	G94	RL Mousepad
TPB1	G179	RL Power Comm Box
TPB2	G179	RL Power Comm Box
TS5GANGBKT	H87	UN FS Ganging Bracket
TS5LEGCLP	H88	UN FS Wire Clip
TS5SKEXT	H88	UN FS Skel Wire Mgr
TS5SKLBNE	H88	UN FS Skel Wire Mgr
TS714WSP	H50	UN Sys Support Plate
TS720WSP	H50	UN Sys Support Plate
TS7CL	H48	UN Sys Double Post C-Leg
TS7DPL	H48	UN Sys Double Post Leg
TS7DPLS	H48	UN Sys Double Post Leg
TS7NPL	H48	UN Sys Nesting Post Leg
TS7NPLC	H48	UN Sys Nesting Post Leg
TS7SPL	H48	UN Sys Single Post Leg
TS7SPLC	H48	UN Sys Single Post Leg
TS7SPLS	H48	UN Sys Single Post Leg
TS7TIEPLATE	H50	UN Sys Tie Plates
TS7WKSPT	H51	UN Sys Reinforcing Channel
TSWH42	G176	RL Slatwall Panel
TSWH64	G176	RL Slatwall Panel
TSWPB2812	G176	RL Slatwall Panel
TSWPB4212	G176	RL Slatwall Panel
TSWPB5012	G176	RL Slatwall Panel
TSWPB6412	G176	RL Slatwall Panel
TTB1650	G170	RL Tackboard
TTB1662	G170	RL Tackboard
TTB2450	G170	RL Tackboard
TTB2462	G170	RL Tackboard
TTB3250	G170	RL Tackboard
TTB3262	G170	RL Tackboard
TTB4050	G170	RL Tackboard
TTB4062	G170	RL Tackboard
TTB4224	G171	RL Tackboard
TTB4226	G172	RL Tackboard
TTB4238	G172	RL Tackboard
TTB6424	G171	RL Tackboard
TTB6426	G172	RL Tackboard

Style Number	Page	Description
TTB6438	G172	RL Tackboard
TTB850	G170	RL Tackboard
TTB862	G170	RL Tackboard
TTBH42	G166	RL Tackboard
TTBH64	G166	RL Tackboard
TTBHB4220	G168	RL Tackboard
TTBHB6420	G168	RL Tackboard
TTBPB2812	G169	RL Tackboard
TTBPB4212	G169	RL Tackboard
TTBPB5012	G169	RL Tackboard
TTBPB6412	G169	RL Tackboard
TTBS2450	G167	RL Tackboard
TTBS2462	G167	RL Tackboard
TTH1	G102	RL Hitch
TWAS4214	G160	RL Amenity Shelf
TWAS6414	G160	RL Amenity Shelf
TWBB2416L	G77	RL Breadboard Wksf
TWBB2416R	G77	RL Breadboard Wksf
TWBB248L	G77	RL Breadboard Wksf
TWBB248R	G77	RL Breadboard Wksf
TWBB3023L	G77	RL Breadboard Wksf
TWBB3023R	G77	RL Breadboard Wksf
TWBBC248L	G77	RL Breadboard Wksf
TWBBC248R	G77	RL Breadboard Wksf
TWBBC3016L	G77	RL Breadboard Wksf
TWBBC3016R	G77	RL Breadboard Wksf
TWBBC3018L	G77	RL Breadboard Wksf
TWBBC3018R	G77	RL Breadboard Wksf
TWBBC308L	G77	RL Breadboard Wksf
TWBBC308R	G77	RL Breadboard Wksf
TWBC5432	G158	RL Bookcase
TWBC6632	G158	RL Bookcase
TWBS42	G87	RL Back Rail
TWBS64	G87	RL Back Rail
TWBT4224L	G64	RL Bowed Trans Wksf
TWBT4224R	G64	RL Bowed Trans Wksf
TWBT6424L	G64	RL Bowed Trans Wksf
TWBT6424R	G64	RL Bowed Trans Wksf
TWBTH4224L	G33	RL Bowed Trans Shell
TWBTH4224LL	G35	RL Bowed Trans Shell
TWBTH4224R	G33	RL Bowed Trans Shell
TWBTH4224RL	G35	RL Bowed Trans Shell
TWBTH6424L	G33	RL Bowed Trans Shell
TWBTH6424LL	G35	RL Bowed Trans Shell
TWBTH6424R	G33	RL Bowed Trans Shell
TWBTH6424RL	G35	RL Bowed Trans Shell
TWC4224	G66	RL Corner Wksf
TWC4230	G66	RL Corner Wksf
TWCEP24	G86	RL Corner End Panel
TWCH4224	G39	RL Corner Shell
TWCH4224L	G41	RL Corner Shell
TWCH4230	G39	RL Corner Shell
TWCH4230L	G41	RL Corner Shell
TWEC4264L	G68	RL Ext Corner Wksf
TWEC4264R	G68	RL Ext Corner Wksf

Style Number	Page	Description	Style Number	Page	Description
TWECH4264L	G45	RL Ext Corner Shell	TWPB2042	G120	RL Personal Border
TWECH4264LL	G47	RL Ext Corner Shell	TWPB2051L	G118	RL Personal Border
TWECH4264R	G45	RL Ext Corner Shell	TWPB2051R	G118	RL Personal Border
TWECH4264RL	G47	RL Ext Corner Shell	TWPB2064	G120	RL Personal Border
TWEP24	G81, G83	RL End Panel	TWPT4872L	G74	RL Pier-Top Wksf
TWEP30	G81	RL Full-Depth End Pnl	TWPT4872R	G74	RL Pier-Top Wksf
TWFB3220	G125	RL Low-Boy Lat File	TWPTS4872L	G74	RL Pier-Top Wksf
TWFB3226	G125	RL Low-Boy Lat File	TWPTS4872R	G74	RL Pier-Top Wksf
TWFL4820	G125	RL Low-Boy Lat File	TWRA3260	G100	RL Runaround Table
TWFL4826	G125	RL Low-Boy Lat File	TWRAH3260	G101	RL Runaround Table
TWFLF5432	G155	RL Four-High Lat File	TWRS4224	G62	RL Rectangular Wksf
TWFMP4224	G90	RL Modesty Panel	TWRS4230	G62	RL Rectangular Wksf
TWFMP6424	G90	RL Modesty Panel	TWRS6424	G62	RL Rectangular Wksf
TWFR4820	G125	RL Low-Boy Lat File	TWRS6430	G62	RL Rectangular Wksf
TWFR4826	G125	RL Low-Boy Lat File	TWRSH4224	G21	RL Rectangular Shell
TWFSMP4236	G90	RL Modesty Panel	TWRSH4224L	G23	RL Rectangular Shell
TWFSMP6436	G90	RL Modesty Panel	TWRSH4230	G27	RL Rectangular Shell
TWH4214	G161	RL Open Hutch	TWRSH4230L	G29	RL Rectangular Shell
TWH6414	G161	RL Open Hutch	TWRSH6424	G21	RL Rectangular Shell
TWHAS4224	G79	RL Adj-Hgt Corner Wksf	TWRSH6424L	G23	RL Rectangular Shell
TWHASP4224	G79	RL Adj-Hgt Corner Wksf	TWRSH6430	G27	RL Rectangular Shell
TWHEP24	G83	RL Half-Depth End Pnl	TWRSH6430L	G29	RL Rectangular Shell
TWHT4116	G109	RL Hatchback	TWSBS42	G88	RL Back Rail
TWHTSW4132	G109	RL Hatchback	TWSBS64	G88	RL Back Rail
TWHTTB4132	G109	RL Hatchback	TWSBSC42	G89	RL Back Rail
TWJJ4649	G103	RL Idea Island Table	TWSBSC64	G89	RL Back Rail
TWLB1620	G123	RL Low-Boy Pedestal	TWSEP24	G85	RL Slip-Fit End Panel
TWLB1626	G123	RL Low-Boy Pedestal	TWSEP30	G85	RL Slip-Fit End Panel
TWLB3220	G123	RL Low-Boy Pedestal	TWSH3224	G96	RL Shield-Top Table
TWLB3226	G123	RL Low-Boy Pedestal	TWSHCEP24	G86	RL Corner End Panel
TWLB4820	G123	RL Low-Boy Pedestal	TWSHEP24	G81, G83	RL End Panel
TWLB4826	G123	RL Low-Boy Pedestal	TWSHEP30	G81	RL Full-Depth End Pnl
TWLT3226	G97	RL Lemon-Top Table	TWSHHEP24	G83	RL Half-Depth End Pnl
TWMB1620	G123	RL Mid-Boy Pedestal	TWSMPP4236	G92	RL Modesty Panel
TWMB1626	G123	RL Mid-Boy Pedestal	TWSMPP6436	G92	RL Modesty Panel
TWMB3220	G123	RL Mid-Boy Pedestal	TWST4818	G76	RL Spanner Top
TWMB3226	G123	RL Mid-Boy Pedestal	TWST6023	G76	RL Spanner Top
TWMB4820	G123	RL Mid-Boy Pedestal	TWTB5416L	G143	RL Tall-Boy Cabinet
TWMB4826	G123	RL Mid-Boy Pedestal	TWTB5416R	G143	RL Tall-Boy Cabinet
TWMC4132	G113	RL Media Cart	TWTB6616L	G143	RL Tall-Boy Cabinet
TWMF3220	G125	RL Mid-Boy Lat File	TWTB6616R	G143	RL Tall-Boy Cabinet
TWMF3226	G125	RL Mid-Boy Lat File	TWTC4264L	G72	RL Trans Ext Cor Wksf
TWJJ4649	G103	RL Idea Island Table	TWTC4264R	G72	RL Trans Ext Cor Wksf
TWML4820	G125	RL Mid-Boy Lat File	TWTC42L	G70	RL Trans Cor Wksf
TWML4826	G125	RL Mid-Boy Lat File	TWTC42R	G70	RL Trans Cor Wksf
TWMPP4224	G92	RL Modesty Panel	TWTCH4264L	G57	RL Trans Ext Cor Shell
TWMPP6424	G92	RL Modesty Panel	TWTCH4264LL	G59	RL Trans Ext Cor Shell
TWMR4820	G125	RL Mid-Boy Lat File	TWTCH4264R	G57	RL Trans Ext Cor Shell
TWMR4826	G125	RL Mid-Boy Lat File	TWTCH4264RL	G59	RL Trans Ext Cor Shell
TWOB4214	G162	RL Ovhd Binder Bin	TWTCH42L	G51	RL Trans Cor Shell
TWOB6414	G162	RL Ovhd Binder Bin	TWTCH42LL	G53	RL Trans Cor Shell
TWOB54214	G164	RL Ovhd Binder Bin	TWTCH42R	G51	RL Trans Cor Shell
TWOB56414	G164	RL Ovhd Binder Bin	TWTCH42RL	G53	RL Trans Cor Shell
TWPB2029L	G118	RL Personal Border	TWTT3264	G98	RL Teaming Table
TWPB2029R	G118	RL Personal Border	TWTTH3264	G99	RL Teaming Table

Style Number Index, continued

Style Number	Page	Description
TWVC5432	G151	RL Vertical Cabinet
TWVC6632	G151	RL Vertical Cabinet
TWVF5416	G147	RL Tall-Boy Cabinet
TWW5416L	G137	RL Wardrobe
TWW5416R	G137	RL Wardrobe
TWW548L	G135	RL Wardrobe
TWW548R	G135	RL Wardrobe
TWW6616L	G137	RL Wardrobe
TWW6616R	G137	RL Wardrobe
TWW668L	G135	RL Wardrobe
TWW668R	G135	RL Wardrobe
UB223636SW	H36	UN Sys Corner, 120° Wksf
UB224242KSW	H37	UN Sys Corner, 120° Wksf
UB224242SW	H36	UN Sys Corner, 120° Wksf
UB224848KSW	H37	UN Sys Corner, 120° Wksf
UB224848SW	H36	UN Sys Corner, 120° Wksf
UB333636SW	H36	UN Sys Corner, 120° Wksf
UB334242KSW	H37	UN Sys Corner, 120° Wksf
UB334242SW	H36	UN Sys Corner, 120° Wksf
UB334848KSW	H37	UN Sys Corner, 120° Wksf
UB334848SW	H36	UN Sys Corner, 120° Wksf
UC114242SW	H26	UN Sys Cor Wksf, Straight Front
UC124242SW	H26	UN Sys Cor Wksf, Straight Front
UC214242SW	H26	UN Sys Cor Wksf, Straight Front
UC223636SW	H26	UN Sys Cor Wksf, Straight Front
UC224242SW	H26	UN Sys Cor Wksf, Straight Front
UC224848KSW	H27	UN Sys Cor Wksf, Straight Front
UC224848SW	H26	UN Sys Cor Wksf, Straight Front
UC334242SW	H26	UN Sys Cor Wksf, Straight Front
UC334848SW	H26	UN Sys Cor Wksf, Straight Front
UCANT	H49	UN Sys On-Module Cantilever
UCANTOM	H49	UN Sys Off-Module Cantilever
UCC114242SW	H28	UN Sys Cor Wksf, Curved Front
UCC124242SW	H28	UN Sys Cor Wksf, Curved Front
UCC214242SW	H28	UN Sys Cor Wksf, Curved Front
UCC223636SW	H28	UN Sys Cor Wksf, Curved Front
UCC224242SW	H28	UN Sys Cor Wksf, Curved Front
UCC224848SW	H28	UN Sys Cor Wksf, Curved Front
UCC334242SW	H28	UN Sys Cor Wksf, Curved Front
UCC334848SW	H28	UN Sys Cor Wksf, Curved Front
UCSP	H51	UN Sys On-Module Center Sprt Pnl
UCSPOM	H51	UN Sys Off-Module Center Sprt Pnl
UCSPS	H51	UN Sys On-Module Center Sprt Pnl
UCSPSOM	H51	UN Sys Off-Module Center Sprt Pnl
UE2202LSW	H31	UN Sys Ext Cor Wksf, Straight Front
UE2208KLSW	H32	UN Sys Ext Cor Wksf, Straight Front
UE2208LSW	H31	UN Sys Ext Cor Wksf, Straight Front
UE220RSW	H31	UN Sys Ext Cor Wksf, Straight Front
UE2222LSW	H31	UN Sys Ext Cor Wksf, Straight Front
UE2222RSW	H31	UN Sys Ext Cor Wksf, Straight Front
UE2226RSW	H31	UN Sys Ext Cor Wksf, Straight Front
UE2228KLSW	H32	UN Sys Ext Cor Wksf, Straight Front
UE2228LSW	H31	UN Sys Ext Cor Wksf, Straight Front
UE2262LSW	H31	UN Sys Ext Cor Wksf, Straight Front
UE2268KLSW	H32	UN Sys Ext Cor Wksf, Straight Front

Style Number	Page	Description
UE2268LSW	H31	UN Sys Ext Cor Wksf, Straight Front
UE2280KRSW	H32	UN Sys Ext Cor Wksf, Straight Front
UE2280RSW	H31	UN Sys Ext Cor Wksf, Straight Front
UE2282KRSW	H32	UN Sys Ext Cor Wksf, Straight Front
UE2282RSW	H31	UN Sys Ext Cor Wksf, Straight Front
UE2286KRSW	H32	UN Sys Ext Cor Wksf, Straight Front
UE2286RSW	H31	UN Sys Ext Cor Wksf, Straight Front
UE2308LSW	H31	UN Sys Ext Cor Wksf, Straight Front
UE2328LSW	H31	UN Sys Ext Cor Wksf, Straight Front
UE2368LSW	H31	UN Sys Ext Cor Wksf, Straight Front
UE2380RSW	H31	UN Sys Ext Cor Wksf, Straight Front
UE2382RSW	H31	UN Sys Ext Cor Wksf, Straight Front
UE2386RSW	H31	UN Sys Ext Cor Wksf, Straight Front
UE3208LSW	H31	UN Sys Ext Cor Wksf, Straight Front
UE3228LSW	H31	UN Sys Ext Cor Wksf, Straight Front
UE3268LSW	H31	UN Sys Ext Cor Wksf, Straight Front
UE3280RSW	H31	UN Sys Ext Cor Wksf, Straight Front
UE3282RSW	H31	UN Sys Ext Cor Wksf, Straight Front
UE3286RSW	H31	UN Sys Ext Cor Wksf, Straight Front
UE3308LSW	H31	UN Sys Ext Cor Wksf, Straight Front
UE3328LSW	H31	UN Sys Ext Cor Wksf, Straight Front
UE3368LSW	H31	UN Sys Ext Cor Wksf, Straight Front
UE3380RSW	H31	UN Sys Ext Cor Wksf, Straight Front
UE3382RSW	H31	UN Sys Ext Cor Wksf, Straight Front
UE3386RSW	H31	UN Sys Ext Cor Wksf, Straight Front
UEC2202LSW	H35	UN Sys Ext Cor Wksf, Curved Front
UEC2208LSW	H35	UN Sys Ext Cor Wksf, Curved Front
UEC2220RSW	H35	UN Sys Ext Cor Wksf, Curved Front
UEC2222LSW	H35	UN Sys Ext Cor Wksf, Curved Front
UEC2222RSW	H35	UN Sys Ext Cor Wksf, Curved Front
UEC2226RSW	H35	UN Sys Ext Cor Wksf, Curved Front
UEC2228LSW	H35	UN Sys Ext Cor Wksf, Curved Front
UEC2262LSW	H35	UN Sys Ext Cor Wksf, Curved Front
UEC2268LSW	H35	UN Sys Ext Cor Wksf, Curved Front
UEC2280RSW	H35	UN Sys Ext Cor Wksf, Curved Front
UEC2282RSW	H35	UN Sys Ext Cor Wksf, Curved Front
UEC2286RSW	H35	UN Sys Ext Cor Wksf, Curved Front
UEC2308LSW	H35	UN Sys Ext Cor Wksf, Curved Front
UEC2328LSW	H35	UN Sys Ext Cor Wksf, Curved Front
UEC2368LSW	H35	UN Sys Ext Cor Wksf, Curved Front
UEC2380RSW	H35	UN Sys Ext Cor Wksf, Curved Front
UEC2382RSW	H35	UN Sys Ext Cor Wksf, Curved Front
UEC2386RSW	H35	UN Sys Ext Cor Wksf, Curved Front
UEC3208LSW	H35	UN Sys Ext Cor Wksf, Curved Front
UEC3228LSW	H35	UN Sys Ext Cor Wksf, Curved Front
UEC3268LSW	H35	UN Sys Ext Cor Wksf, Curved Front
UEC3280RSW	H35	UN Sys Ext Cor Wksf, Curved Front
UEC3282RSW	H35	UN Sys Ext Cor Wksf, Curved Front
UEC3286RSW	H35	UN Sys Ext Cor Wksf, Curved Front
UEC3308LSW	H35	UN Sys Ext Cor Wksf, Curved Front
UEC3328LSW	H35	UN Sys Ext Cor Wksf, Curved Front
UEC3368LSW	H35	UN Sys Ext Cor Wksf, Curved Front
UEC3380RSW	H35	UN Sys Ext Cor Wksf, Curved Front
UEC3382RSW	H35	UN Sys Ext Cor Wksf, Curved Front
UEC3386RSW	H35	UN Sys Ext Cor Wksf, Curved Front

Style Number	Page	Description	Style Number	Page	Description
UEP24	H52	UN Sys On-Module End Panel	US1830SW	H24	UN Sys Straight Wksf
UEP240M	H52	UN Sys Off-Module End Panel	US1836SW	H24	UN Sys Straight Wksf
UEP24S	H52	UN Sys On-Module End Panel	US1842SW	H24	UN Sys Straight Wksf
UEP24SOM	H52	UN Sys Off-Module End Panel	US1848SW	H24	UN Sys Straight Wksf
UEP30	H52	UN Sys On-Module End Panel	US1854SW	H24	UN Sys Straight Wksf
UEP300M	H52	UN Sys Off-Module End Panel	US1860SW	H24	UN Sys Straight Wksf
UEP30S	H52	UN Sys On-Module End Panel	US2424SW	H24	UN Sys Straight Wksf
UEP30SOM	H52	UN Sys Off-Module End Panel	US2430SW	H24	UN Sys Straight Wksf
UJ2382RSW	H42	UN Sys Jetty Wksf, Straight Front	US2436SW	H24	UN Sys Straight Wksf
UJ2386RSW	H42	UN Sys Jetty Wksf, Straight Front	US2442SW	H24	UN Sys Straight Wksf
UJ2388RSW	H42	UN Sys Jetty Wksf, Straight Front	US2448SW	H24	UN Sys Straight Wksf
UJ3228LSW	H42	UN Sys Jetty Wksf, Straight Front	US2454SW	H24	UN Sys Straight Wksf
UJ3268LSW	H42	UN Sys Jetty Wksf, Straight Front	US2460SW	H24	UN Sys Straight Wksf
UJ3288LSW	H42	UN Sys Jetty Wksf, Straight Front	US2466SW	H24	UN Sys Straight Wksf
UJ3328LSW	H42	UN Sys Jetty Wksf, Straight Front	US2472SW	H24	UN Sys Straight Wksf
UJ3368LSW	H42	UN Sys Jetty Wksf, Straight Front	US3024SW	H24	UN Sys Straight Wksf
UJ3382RSW	H42	UN Sys Jetty Wksf, Straight Front	US3030SW	H24	UN Sys Straight Wksf
UJ3386RSW	H42	UN Sys Jetty Wksf, Straight Front	US3036SW	H24	UN Sys Straight Wksf
UJ3388LSW	H42	UN Sys Jetty Wksf, Straight Front	US3042SW	H24	UN Sys Straight Wksf
UJ3388RSW	H42	UN Sys Jetty Wksf, Straight Front	US3048SW	H24	UN Sys Straight Wksf
UJBC2430LSW	H44	UN Sys Bubble Jetty Wksf	US3054SW	H24	UN Sys Straight Wksf
UJBC2430RSW	H44	UN Sys Bubble Jetty Wksf	US3060SW	H24	UN Sys Straight Wksf
UJBC2436LSW	H44	UN Sys Bubble Jetty Wksf	US3066SW	H24	UN Sys Straight Wksf
UJBC2436RSW	H44	UN Sys Bubble Jetty Wksf	US3072SW	H24	UN Sys Straight Wksf
UJBC2442LSW	H44	UN Sys Bubble Jetty Wksf	USPC47SW	H38	UN Sys Spanner Wksf
UJBC2442RSW	H44	UN Sys Bubble Jetty Wksf	USPC50SW	H38	UN Sys Spanner Wksf
UJBC2448LSW	H44	UN Sys Bubble Jetty Wksf	USPC51SW	H38	UN Sys Spanner Wksf
UJBC2448RSW	H44	UN Sys Bubble Jetty Wksf	USPC52SW	H38	UN Sys Spanner Wksf
UJC2382RSW	H43	UN Sys Jetty Wksf, Curved Front	USPC59SW	H38	UN Sys Spanner Wksf
UJC2386RSW	H43	UN Sys Jetty Wksf, Curved Front	USPC62SW	H38	UN Sys Spanner Wksf
UJC2388RSW	H43	UN Sys Jetty Wksf, Curved Front	USPC63SW	H38	UN Sys Spanner Wksf
UJC3228LSW	H43	UN Sys Jetty Wksf, Curved Front	USPC64SW	H38	UN Sys Spanner Wksf
UJC3268LSW	H43	UN Sys Jetty Wksf, Curved Front	USSBR	H50	UN Sys Side Support Brackets
UJC3288LSW	H43	UN Sys Jetty Wksf, Curved Front	UT1236RSW	H25	UN Sys Transition Wksf
UJC3328LSW	H43	UN Sys Jetty Wksf, Curved Front	UT1242RSW	H25	UN Sys Transition Wksf
UJC3368LSW	H43	UN Sys Jetty Wksf, Curved Front	UT1248RSW	H25	UN Sys Transition Wksf
UJC3382RSW	H43	UN Sys Jetty Wksf, Curved Front	UT1254RSW	H25	UN Sys Transition Wksf
UJC3386RSW	H43	UN Sys Jetty Wksf, Curved Front	UT1260RSW	H25	UN Sys Transition Wksf
UJC3388LSW	H43	UN Sys Jetty Wksf, Curved Front	UT2136LSW	H25	UN Sys Transition Wksf
UJC3388RSW	H43	UN Sys Jetty Wksf, Curved Front	UT2142LSW	H25	UN Sys Transition Wksf
UL2626SW	H45	UN Sys Visit Link Wksf, Str Frnt	UT2148LSW	H25	UN Sys Transition Wksf
UL2727SW	H45	UN Sys Visit Link Wksf, Str Frnt	UT2154LSW	H25	UN Sys Transition Wksf
UL2828SW	H45	UN Sys Visit Link Wksf, Str Frnt	UT2160LSW	H25	UN Sys Transition Wksf
ULC2626SW	H46	UN Sys Visit Link Wksf, Crvd Frnt	UT2336RSW	H25	UN Sys Transition Wksf
ULC2727SW	H46	UN Sys Visit Link Wksf, Crvd Frnt	UT2342RSW	H25	UN Sys Transition Wksf
ULC2828SW	H46	UN Sys Visit Link Wksf, Crvd Frnt	UT2348RSW	H25	UN Sys Transition Wksf
UPA2648SW	H40	UN Sys Ang Penin Wksf, Str Front	UT2354RSW	H25	UN Sys Transition Wksf
UPA2748SW	H40	UN Sys Ang Penin Wksf, Str Front	UT2360RSW	H25	UN Sys Transition Wksf
UPA2848SW	H40	UN Sys Ang Penin Wksf, Str Front	UT3236LSW	H25	UN Sys Transition Wksf
UPAC2648SW	H41	UN Sys Ang Penin Wksf, Crvd Front	UT3242LSW	H25	UN Sys Transition Wksf
UPAC2748SW	H41	UN Sys Ang Penin Wksf, Crvd Front	UT3248LSW	H25	UN Sys Transition Wksf
UPAC2848SW	H41	UN Sys Ang Penin Wksf, Crvd Front	UT3254LSW	H25	UN Sys Transition Wksf
UPBC3060SW	H39	UN Sys Bullet Penin Wksf, Crvd Frnt	UT3260LSW	H25	UN Sys Transition Wksf
UPBC3066SW	H39	UN Sys Bullet Penin Wksf, Crvd Frnt	UTR1636ASW	H47	UN Sys Transaction Wksf
UPBC3072SW	H39	UN Sys Bullet Penin Wksf, Crvd Frnt	UTR1636KSW	H47	UN Sys Transaction Wksf

Style Number Index, continued

Style Number	Page	Description
UTR1636MSW	H47	UN Sys Transaction Wksf
UTR1636PSW	H47	UN Sys Transaction Wksf
UTR1642ASW	H47	UN Sys Transaction Wksf
UTR1642KSW	H47	UN Sys Transaction Wksf
UTR1642MSW	H47	UN Sys Transaction Wksf
UTR1642PSW	H47	UN Sys Transaction Wksf
UTR1648ASW	H47	UN Sys Transaction Wksf
UTR1648KSW	H47	UN Sys Transaction Wksf
UTR1648MSW	H47	UN Sys Transaction Wksf
UTR1648PSW	H47	UN Sys Transaction Wksf
UTR1660ASW	H47	UN Sys Transaction Wksf
UTR1660KSW	H47	UN Sys Transaction Wksf
UTR1660MSW	H47	UN Sys Transaction Wksf
UTR1660PSW	H47	UN Sys Transaction Wksf
UV2424LSW	H45	UN Sys Visit Link Wksf, Str Frnt
UV2424RSW	H45	UN Sys Visit Link Wksf, Str Frnt
UV3030LSW	H45	UN Sys Visit Link Wksf, Str Frnt
UV3030RSW	H45	UN Sys Visit Link Wksf, Str Frnt
UVC2424LSW	H46	UN Sys Visit Link Wksf, Crvd Frnt
UVC2424RSW	H46	UN Sys Visit Link Wksf, Crvd Frnt
UVC3030LSW	H46	UN Sys Visit Link Wksf, Crvd Frnt
UVC3030RSW	H46	UN Sys Visit Link Wksf, Crvd Frnt
W4416630L	C9	Walden; Sgl-Pedestal Desk
W4416630R	C12	Walden; Sgl-Pedestal Desk
W4417236L	C9	Walden; Sgl-Pedestal Desk
W4417236R	C12	Walden; Sgl-Pedestal Desk
W4426030	C5	Walden; Dbl-Pedestal Desk
W4426630	C5	Walden; Dbl-Pedestal Desk
W4427236	C5	Walden; Dbl-Pedestal Desk
W44BC1842	C38	Walden; Bookcase
W44BC3629	C38	Walden; Bookcase
W44BC3642	C38	Walden; Bookcase
W44BC3672	C39	Walden; Bookcase
W44BCD3642	C39	Walden; Bookcase
W44BF7236	C22	Walden; Bullet-Shape Table
W44H6620	C27	Walden; Full-Strg Credenza
W44H7220	C27	Walden; Full-Strg Credenza
W44LF3629	C36	Walden; Lateral File
W44P6620	C26	Walden; Kneespace Credenza
W44P7220	C26	Walden; Kneespace Credenza
W44PT3624	C40	Walden; VDT/Printer Table
W44SM66	C34	Walden; Service Module
W44SM72	C34	Walden; Service Module
W44U4824	C21	Walden; Bridge
W4516630L	C9	Walden; Sgl-Pedestal Desk
W4516630R	C12	Walden; Sgl-Pedestal Desk
W4517236L	C9	Walden; Sgl-Pedestal Desk
W4517236R	C12	Walden; Sgl-Pedestal Desk
W4526030	C5	Walden; Dbl-Pedestal Desk
W4526630	C5	Walden; Dbl-Pedestal Desk
W4527236	C5	Walden; Dbl-Pedestal Desk
W45BC1842	C38	Walden; Bookcase
W45BC3629	C38	Walden; Bookcase
W45BC3642	C38	Walden; Bookcase
W45BC3672	C39	Walden; Bookcase

Style Number	Page	Description
W45BCD3642	C39	Walden; Bookcase
W45BF7236	C22	Walden; Bullet-Shape Table
W45CTS	C42	Pullout Keyboard Shelf
W45CWD	C42	Center Drawer
W45FR	C41	Filing Rail
W45H6620	C27	Walden; Full-Strg Credenza
W45H7220	C27	Walden; Full-Strg Credenza
W45LF3629	C36	Walden; Lateral File
W45P6620	C26	Walden; Kneespace Credenza
W45P7220	C26	Walden; Kneespace Credenza
W45PT3624	C40	Walden; VDT/Printer Table
W45SM66	C34	Walden; Service Module
W45SM72	C34	Walden; Service Module
W45TB66	C35	Walden; Tackboard
W45TB72	C35	Tackboard
W45U4824	C21	Walden; Bridge
W4616630L	C10	Walden; Sgl-Pedestal Desk
W4616630R	C13	Walden; Sgl-Pedestal Desk
W4617236L	C10	Walden; Sgl-Pedestal Desk
W4617236R	C13	Walden; Sgl-Pedestal Desk
W4626030	C6	Walden; Dbl-Pedestal Desk
W4626630	C6	Walden; Dbl-Pedestal Desk
W4627236	C6	Walden; Dbl-Pedestal Desk
W46D4824L	C17	Walden; Typing-Hgt Return
W46D4824R	C17	Walden; Typing-Hgt Return
W46F4824L	C20	Walden; Desk-Hgt Return
W46F4824R	C19	Walden; Desk-Hgt Return
W46Q7220L	C24	Walden; Kneespace Credenza
W46Q7220R	C25	Walden; Kneespace Credenza
W46Y7220L	C33	Walden; Kneespace Credenza
W46Y7220R	C33	Walden; Kneespace Credenza
W4716630L	C10	Walden; Sgl-Pedestal Desk
W4716630R	C13	Walden; Sgl-Pedestal Desk
W4717236L	C10	Walden; Sgl-Pedestal Desk
W4717236R	C13	Walden; Sgl-Pedestal Desk
W4726030	C6	Walden; Dbl-Pedestal Desk
W4726630	C6	Walden; Dbl-Pedestal Desk
W4727236	C6	Walden; Dbl-Pedestal Desk
W47D4824L	C17	Walden; Typing-Hgt Return
W47D4824R	C17	Walden; Typing-Hgt Return
W47F4824L	C20	Walden; Desk-Hgt Return
W47F4824R	C19	Walden; Desk-Hgt Return
W47Q7220L	C24	Walden; Kneespace Credenza
W47Q7220R	C25	Walden; Kneespace Credenza
W47Y7220L	C33	Walden; Kneespace Credenza
W47Y7220R	C33	Walden; Kneespace Credenza
W4816630L	C9	Walden; Sgl-Pedestal Desk
W4816630R	C12	Walden; Sgl-Pedestal Desk
W4817236L	C9	Walden; Sgl-Pedestal Desk
W4817236R	C12	Walden; Sgl-Pedestal Desk
W4826030	C5	Walden; Dbl-Pedestal Desk
W4826630	C5	Walden; Dbl-Pedestal Desk
W4827236	C5	Walden; Dbl-Pedestal Desk
W48BC1842	C38	Walden; Bookcase
W48BC3629	C38	Walden; Bookcase

Style Number	Page	Description	Style Number	Page	Description
W48BC3642	C38	Walden; Bookcase	WFRF4824R	C19	Walden; Desk-Hgt Return
W48BC3672	C39	Walden; Bookcase	WFRH6620	C31	Walden; Full-Strg Credenza
W48BCD3642	C39	Walden; Bookcase	WFRH7220	C31	Walden; Full-Strg Credenza
W48BF7236	C22	Walden; Bullet-Shape Table	WFRP6620	C30	Walden; Kneespace Credenza
W48H6620	C27	Walden; Full-Strg Credenza	WFRP7220	C30	Walden; Kneespace Credenza
W48H7220	C27	Walden; Full-Strg Credenza	WFRQ7220L	C28	Walden; Kneespace Credenza
W48LF3629	C36	Walden; Lateral File	WFRQ7220R	C29	Walden; Kneespace Credenza
W48P6620	C26	Walden; Kneespace Credenza	WFS16630L	C11	Walden; Sgl-Pedestal Desk
W48P7220	C26	Walden; Kneespace Credenza	WFS16630R	C14	Walden; Sgl-Pedestal Desk
W48PT3624	C40	Walden; VDT/Printer Table	WFS17236L	C11	Walden; Sgl-Pedestal Desk
W48SM66	C34	Walden; Service Module	WFS17236R	C14	Walden; Sgl-Pedestal Desk
W48SM72	C34	Walden; Service Module	WFS26030	C7	Walden; Dbl-Pedestal Desk
W48U4824	C21	Walden; Bridge	WFS26630	C7	Walden; Dbl-Pedestal Desk
W4916630L	C10	Walden; Sgl-Pedestal Desk	WFS27236	C7	Walden; Dbl-Pedestal Desk
W4916630R	C13	Walden; Sgl-Pedestal Desk	WFSF4824L	C20	Walden; Desk-Hgt Return
W4917236L	C10	Walden; Sgl-Pedestal Desk	WFSF4824R	C19	Walden; Desk-Hgt Return
W4917236R	C13	Walden; Sgl-Pedestal Desk	WFSH6620	C31	Walden; Full-Strg Credenza
W4926030	C6	Walden; Dbl-Pedestal Desk	WFSH7220	C31	Walden; Full-Strg Credenza
W4926630	C6	Walden; Dbl-Pedestal Desk	WFSP6620	C30	Walden; Kneespace Credenza
W4927236	C6	Walden; Dbl-Pedestal Desk	WFSP7220	C30	Walden; Kneespace Credenza
W49D4824L	C17	Walden; Typing-Hgt Return	WFSQ7220L	C28	Walden; Kneespace Credenza
W49D4824R	C17	Walden; Typing-Hgt Return	WFSQ7220R	C29	Walden; Kneespace Credenza
W49F4824L	C20	Walden; Desk-Hgt Return	WRS1842WL	C39	Walden; Bookcase
W49F4824R	C19	Walden; Desk-Hgt Return	WRS1842WR	C39	Walden; Bookcase
W49Q7220L	C24	Walden; Kneespace Credenza	WSS1842WL	C39	Walden; Bookcase
W49Q7220R	C25	Walden; Kneespace Credenza	WSS1842WR	C39	Walden; Bookcase
W49Y7220L	C33	Walden; Kneespace Credenza	WWGR	B43	Round Grommet
W49Y7220R	C33	Walden; Kneespace Credenza	WWGS	B43	Square Grommet
W6GMT	C42	Grommet Package	WWS	B39	Additional Shelf
WCS1842WL	C39	Walden; Bookcase	WWYK30	B42, G94	Keyboard Shelf
WCS1842WR	C39	Walden; Bookcase	ZAP	H48	UN Sys Adjustable Column
WFC16630L	C11	Walden; Sgl-Pedestal Desk	ZBES	H54	UN Sys Side Support Bracket
WFC16630R	C14	Walden; Sgl-Pedestal Desk	ZBTP	H54	UN Sys Off-Module Tie Plate
WFC17236L	C11	Walden; Sgl-Pedestal Desk	ZBWOM	H54	UN Sys Off-Module Wksf Bracket
WFC17236R	C14	Walden; Sgl-Pedestal Desk	ZCAL	H53	UN Sys Adj-Height Cantilever
WFC26030	C7	Walden; Dbl-Pedestal Desk	ZCAR	H53	UN Sys Adj-Height Cantilever
WFC26630	C7	Walden; Dbl-Pedestal Desk	ZCB	H53	UN Sys On-Module Cantilever
WFC27236	C7	Walden; Dbl-Pedestal Desk	ZCEL	H53	UN Sys End-of-Run Cantilever
WFCD24	B42	Center Drawer	ZCER	H53	UN Sys End-of-Run Cantilever
WFCF4824L	C20	Walden; Desk-Hgt Return	ZCSB	H53	UN Sys On-Module Cantilever
WFCF4824R	C19	Walden; Desk-Hgt Return	ZEP24LH	H55	UN Sys On-Module End Panel
WFCH6620	C31	Walden; Full-Strg Credenza	ZEP24LHOM	H55	UN Sys Off-Module End Panel
WFCH7220	C31	Walden; Full-Strg Credenza	ZEP24RH	H55	UN Sys On-Module End Panel
WFCP6620	C30	Walden; Kneespace Credenza	ZEP24RHOM	H55	UN Sys Off-Module End Panel
WFCP7220	C30	Walden; Kneespace Credenza	ZEP30LH	H55	UN Sys On-Module End Panel
WFCQ7220L	C28	Walden; Kneespace Credenza	ZEP30LHOM	H55	UN Sys Off-Module End Panel
WFCQ7220R	C29	Walden; Kneespace Credenza	ZEP30RH	H55	UN Sys On-Module End Panel
WFR16630L	C11	Walden; Sgl-Pedestal Desk	ZEP30RHOM	H55	UN Sys Off-Module End Panel
WFR16630R	C14	Walden; Sgl-Pedestal Desk			
WFR17236L	C11	Walden; Sgl-Pedestal Desk			
WFR17236R	C14	Walden; Sgl-Pedestal Desk			
WFR26030	C7	Walden; Dbl-Pedestal Desk			
WFR26630	C7	Walden; Dbl-Pedestal Desk			
WFR27236	C7	Walden; Dbl-Pedestal Desk			
WFRF4824L	C20	Walden; Desk-Hgt Return			

Trademark List

- ® The following registered trademarks are used under license from Steelcase Development Corporation: Accelerate, Ally, Answer, Anthem, Arrondi, Avenir, Ballet, Bix, Brayton International Collection, Brayton Textile Collection, Breton, Canto, Chancellor, Collegium, Company, Concentrx, Context, Criterion, Crushed Can, Decorum, Designtex, Details, Drive, Elective Elements, Ellipse, Ember Chrome, Emerge, Etude, Exclamation Mark, Firstfile, Gentry, Ginkgo, Ginkgo Biloba, Hardwear, Ideo, Internode, Jersey, Kart, Kick, LaCosta, Latour, Leap, Let's B, Lucy, Lyra, Lytyn, Manhattan Product Configuration, Max-Stacker, Media Dock, Metro, Migrations, Miko, Montage, Oriana, Parade, Pathways, Perfect Match, Player, Power Pincher, Portal, Protégé, Raf System, Rally, Rapport, Relevant, Reply, Sensor, Series 9000, Springboard, Steelcase, Steelcase Design Partnership, Steelcase Workplace Performance, Stow Davis, TeamWork, Technique, Texpress, Treehouse, Trilogy, Turnstone, Vecta, Vectaflex, Werndl, Wizard, and Workflo.
- ® The following is a registered trademark of Byrne Electrical, Rockford, Michigan: Interport.
- ® The following is a registered trademark of Genlyte Thomas Company, Louisville, KY: Lightolier.
- ® The following is a registered trademark of Leviton Manufacturing Company, Little Neck, NY: Decora.
- ® The following is a registered trademark of Microsoft Corporation, Redmond, WA: Microsoft.
- ® The following is a registered trademark of Panduit Corporation, Lockport, IL: Panduit.
- ® The following is a registered trademark of Trav (Press), Cuneo, Italy: Assisa.
- ® The following is a registered trademark of Virtual Ink Corporation: mimioActive.
- ® The following registered trademarks are under license from Wilkhahn Furniture Products: Avera, Confair, Senzo, Versal, and Wilkhahn FS.

- ™ The following trademarks are used under license from Steelcase Development Corporation: 4 o'clock, à la carte, Active/Passive Shelf, Activity Products, Adia, Alcove, Alerion, Alexander Street Collection, Aliso, Allegro, Alongside, American Elect, American Tradition, Anson, Arbor, Archipelago, Archive Collection, Arriva, Ascot, Astor, Austin, Avalon, Bira, Bonn, Boomerang, Bradbury, Breadbox, Brio, Buxton, Cachet, Callahan, Camber, Canopy, Cappucino, Catalina, CbP, Chester, Chorus, Chronos, Ciao, Clarendon, Classic Rectangular, Collaboration, Collins, Cologne, Colorbox, Common (Shelf), Commons, Community, Community based Planning CbP, Convene, Convey, Cortex, Cosima, Croix, Cubby, Cubis, Cushion, Customiz, Dataduct, Datum, Deck, Dedoes, Déjà, Detour, Detriana, DNA, Domain, Donovan, Dorchester, Downspout, Drop Top Hutch, Duospace, Eastlake, Eastridge, Eco, Ella, Elsa, Emmy, Encounter, Enea, EnSync, Ensemble, Entourage, Environmental Impact Collection, Equinox, Escapade, Et Al, E-Table, Exponents, Express12, Extreme Conditions, Fillmore, Flat Top, Fling, Flip Top, Footnote, Fortuna, Frontier, Fuji, Futu, Galilei, Galveston, Garland, Ginger, Glenwood, Go Wall, Greco, Greenbrier, Grip, Groove, Groupwork, Hannah, Hatch, Hatchback, Hatteras, Health Design, Hitch, Huddleboard, Impact, Incognito, Indy, InfoWizard, InterAct, IOS, I-Solve, Jacket, Jenny, Jetty, Juice, Kendo, Kiana, L'Attitude, Lazlo, Lean Too, Lemon, Lift-N-Slide, Lotus, Lyric, M/O, Malibu, Manhattan, Mansfield, Martini, Masque, Mingle, Monterey, Montreal, MyWizard, Nadia, Nickel, Nine, Ontrak, Onyx, Outlook, Paloma, Parliament, Parts Advantage, Pasio, Passarelle, Patriarch, Patterson, Payback, Peek, Pendio, Personal Border, Pier Top, Pipe, Pisa, Playback, Portal, Progeny, Radio, Rag Top, Rei, Reunion, Rhine, Rialto, Ricetta, Riser, Rizzi Arc, Rocco, RoomWizard, Rover, Runaround, Runner, Satellite, Scribe, Shadow, Shield, Shortbed, Skinny, Sidebar, Sidewalk, Sieste, Sine, Smoke, Snug, Softwork, Spinz, Sportswear, St. Clair, Stationkits, Stiletto, Stuttgart, Super Shelf, Surprise!, Switch, Template, Terrazzo, Tessare, Theorem, Think, Topaz, Topo, Top Spin, Touchdown, Train, Trolley, T-Wall, Umbrella, Underline, Unison, Uno, Utility Bar, Venetia, Walden, Warehouse, Whittier, Windsor, Wizard WebSigns, Your Profile, Your Power, and Your Preference.
- ™ The following is a trademark of Microsoft Corporation, Redmond, WA: Windows.
- ™ The following is a trademark of Ultrafabrics, LLC, Elmsford, NY: Ultraleather.
- ™ The following trademarks are used under license from Wilkhahn Furniture: Cana, Linus, Logon, Picto, Range, Stitz, Thema, Timetable, and Tubis.