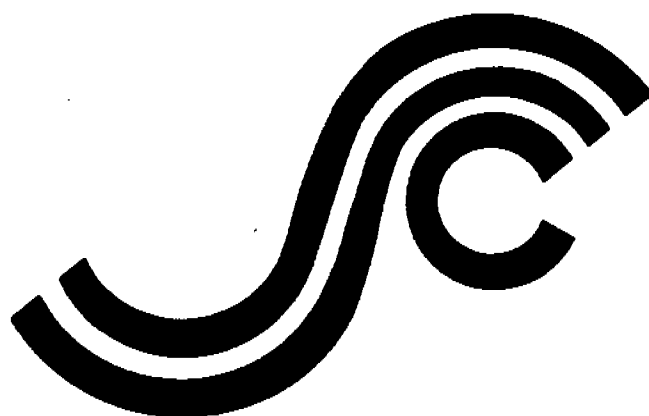


SSC-368

**PROBABILITY-BASED SHIP  
DESIGN PROCEDURES:  
A DEMONSTRATION**



This document has been approved  
for public release and sale; its  
distribution is unlimited

**SHIP STRUCTURE COMMITTEE**

**1993**

C-1 80231 (659)

3-000-2/34709 # PD 80231

707

**SSC-368 Probability Based Ship Design Procedures- A Demonstration**

**Ship Structure Committee 1993**

SPUNE  
80231  
/ 459

SPUNE

## SHIP STRUCTURE COMMITTEE

The SHIP STRUCTURE COMMITTEE is constituted to prosecute a research program to improve the hull structures of ships and other marine structures by an extension of knowledge pertaining to design, materials, and methods of construction.

RADM A. E. Henn, USCG (Chairman)  
Chief, Office of Marine Safety, Security  
and Environmental Protection  
U. S. Coast Guard

Mr. Thomas H. Peirce  
Marine Research and Development  
Coordinator  
Transportation Development Center  
Transport Canada

Mr. H. T. Haller  
Associate Administrator for Ship-  
building and Ship Operations  
Maritime Administration

Dr. Donald Liu  
Senior Vice President  
American Bureau of Shipping

Mr. Alexander Malakhoff  
Director, Structural Integrity  
Subgroup (SEA 05P)  
Naval Sea Systems Command

Mr. Thomas W. Allen  
Engineering Officer (N7)  
Military Sealift Command

Mr. Warren Nethercote  
Head, Hydronautics Section  
Defence Research Establishment-Atlantic

### EXECUTIVE DIRECTOR

CDR Stephen E. Sharpe, USCG  
Ship Structure Committee  
U. S. Coast Guard

### CONTRACTING OFFICER TECHNICAL REPRESENTATIVE

Mr. William J. Siekierka  
SEA 05P4  
Naval Sea Systems Command

## SHIP STRUCTURE SUBCOMMITTEE

The SHIP STRUCTURE SUBCOMMITTEE acts for the Ship Structure Committee on technical matters by providing technical coordination for determining the goals and objectives of the program and by evaluating and interpreting the results in terms of structural design, construction, and operation.

### AMERICAN BUREAU OF SHIPPING

Mr. Stephen G. Arntson (Chairman)  
Mr. John F. Conlon  
Mr. Phillip G. Rynn  
Mr. William Hanzelek

### NAVAL SEA SYSTEMS COMMAND

Mr. W. Thomas Packard  
Mr. Charles L. Null  
Mr. Edward Kadala  
Mr. Allen H. Engle

### TRANSPORT CANADA

Mr. John Grinstead  
Mr. Ian Bayly  
Mr. David L. Stocks  
Mr. Peter Timonin

### MILITARY SEALIFT COMMAND

Mr. Robert E. Van Jones  
Mr. Rickard A. Anderson  
Mr. Michael W. Touma  
Mr. Jeffrey E. Beach

### MARITIME ADMINISTRATION

Mr. Frederick Seibold  
Mr. Norman O. Hammer  
Mr. Chao H. Lin  
Dr. Walter M. Maclean

### U. S. COAST GUARD

CAPT T. E. Thompson  
CAPT W. E. Colburn, Jr.  
Mr. Rubin Scheinberg  
Mr. H. Paul Cojeen

### DEFENCE RESEARCH ESTABLISHMENT ATLANTIC

Dr. Neil Pegg

## SHIP STRUCTURE SUBCOMMITTEE LIAISON MEMBERS

### U. S. COAST GUARD ACADEMY

LCDR Bruce R. Mustain

### U. S. MERCHANT MARINE ACADEMY

Dr. C. B. Kim

### U. S. NAVAL ACADEMY

### NATIONAL ACADEMY OF SCIENCES - MARINE BOARD

Dr. Robert Sielski

### NATIONAL ACADEMY OF SCIENCES - COMMITTEE ON MARINE STRUCTURES

Mr. Peter M. Palermo

Member Agencies:

*United States Coast Guard  
Naval Sea Systems Command  
Maritime Administration  
American Bureau of Shipping  
Military Sealift Command  
Transport Canada*



**Ship  
Structure  
Committee**

An Interagency Advisory Committee

Address Correspondence to:

Executive Director  
Ship Structure Committee  
U. S. Coast Guard (G-M/R)  
2100 Second Street, S.W.  
Washington, D.C. 20593-0001  
PH: (202) 267-0003  
FAX: (202) 267-4677

August 13, 1993

SSC-368  
SR-1330

**PROBABILITY BASED SHIP DESIGN PROCEDURES:  
A DEMONSTRATION**

This report provides a demonstration on the use of probability based ship structural design and compares its benefits versus those of traditional methods. Relative to other traditional approaches, reliability methods hold the promise of a better understanding of engineering design. It is anticipated that in the future the use of these methods will result in a balance between reduced structure weight and life cycle cost and increased reliability. Other fields of engineering such civil engineering and offshore structures have lead the way in demonstrating the benefit of these methods.

This report gives two basic demonstrations which illustrate the development and calibration of design criteria for uniform safety over a wide range of basic parameters involved in design and applies the state of the art reliability techniques to hull girder safety analysis of existing vessels. In doing so a standardized structural reliability terminology, limit states and load extrapolation techniques are defined for future projects. The report concludes with an evaluation of benefits and drawbacks of using the method and gives recommendations for future research.

A handwritten signature in black ink that reads "A. E. HENN". The letters are cursive and somewhat stylized.

A. E. HENN  
Rear Admiral, U.S. Coast Guard  
Chairman, Ship Structure Committee

80231 (659)

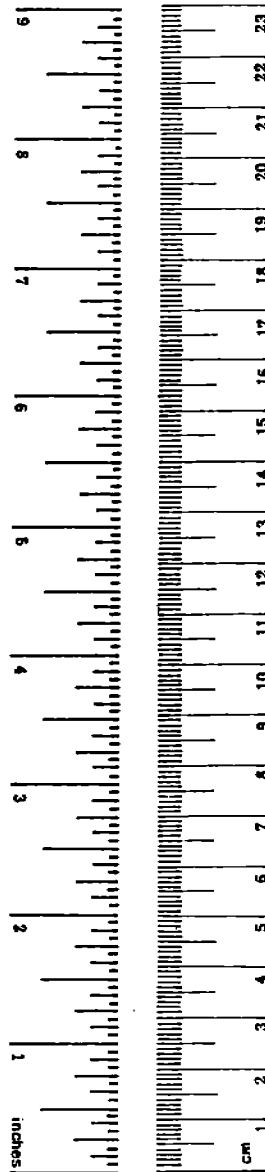
1. Report No. SSC-368		2. Government Accession No.		3. Recipient's Catalog No.	
4. Title and Subtitle <b>PROBABILITY-BASED SHIP DESIGN (PHASE 1) A DEMONSTRATION</b>				5. Report Date September 1992	
				6. Performing Organization Code	
7. Author(s) A. Mansour, M. Lin, L. Hovem, A. Thayamballi				8. Performing Organization Report No. SR-1330	
9. Performing Organization Name and Address Mansour Engineering, Inc. 14 Maybeck Twin Dr. Berkeley, CA 94708				10. Work Unit No. (TRAIS)	
				11. Contract or Grant No. DTCG23-90-C-20010	
12. Sponsoring Agency Name and Address Ship Structure Committee U.S. Coast Guard (G-M) 2100 Second Street, SW Washington, D.C. 20593				13. Type of Report and Period Covered Final Report	
				14. Sponsoring Agency Code G-M	
15. Supplementary Notes  Sponsored by the Ship Structure Committee and its Member Agencies					
16. Abstract  The report provides a demonstration on the use of probability based ship structural design methods and enumerates the benefits in comparison to traditional methods. Two basic demonstrations are provided. The first illustrates the development and calibration of design criteria that produce uniform safety over a wide range of basic parameters involved in design. The second applies state of the art reliability techniques to determine safety levels of existing vessels, taking into consideration uncertainties in loads, strength and calculation procedures. In addition, structural reliability terminology, limit states and load extrapolation techniques pertinent to ships are defined and described.					
17. Key Words  Probability Structural Reliability Ship Design			18. Distribution Statement Available from: National Technical Information Service U.S. Department of Commerce Springfield, VA 22151		
19. Security Classif. (of this report) Unclassified		20. Security Classif. (of this page) Unclassified		21. No. of Pages 111 + App.	22. Price

# METRIC CONVERSION FACTORS

## Approximate Conversions to Metric Measures

Symbol	When You Know	Multiply by	To Find	Symbol
<b>LENGTH</b>				
in	inches	2.5	centimeters	cm
ft	feet	30	centimeters	cm
yd	yards	0.9	meters	m
mi	miles	1.6	kilometers	km
<b>AREA</b>				
in <sup>2</sup>	square inches	6.5	square centimeters	cm <sup>2</sup>
ft <sup>2</sup>	square feet	0.09	square meters	m <sup>2</sup>
yd <sup>2</sup>	square yards	0.8	square meters	m <sup>2</sup>
mi <sup>2</sup>	square miles	2.6	square kilometers	km <sup>2</sup>
	acres	0.4	hectares	ha
<b>MASS (weight)</b>				
oz	ounces	28	grams	g
lb	pounds	0.45	kilograms	kg
	short tons (2000 lb)	0.9	tonnes	t
<b>VOLUME</b>				
tsp	teaspoons	5	milliliters	ml
Tbsp	tablespoons	15	milliliters	ml
fl oz	fluid ounces	30	milliliters	ml
c	cups	0.24	liters	l
pt	pints	0.47	liters	l
qt	quarts	0.95	liters	l
gal	gallons	3.8	liters	l
ft <sup>3</sup>	cubic feet	0.03	cubic meters	m <sup>3</sup>
yd <sup>3</sup>	cubic yards	0.76	cubic meters	m <sup>3</sup>
<b>TEMPERATURE (exact)</b>				
°F	Fahrenheit temperature	5/9 (after subtracting 32)	Celsius temperature	°C

\*1 in = 2.54 (exactly). For other exact conversions and more detailed tables, see NBS Misc. Publ. 286, Units of Weights and Measures, Price \$2.25, SD Catalog No. C13.10-286.



## Approximate Conversions from Metric Measures

Symbol	When You Know	Multiply by	To Find	Symbol
<b>LENGTH</b>				
mm	millimeters	0.04	inches	in
cm	centimeters	0.4	inches	in
m	meters	3.3	feet	ft
m	meters	1.1	yards	yd
km	kilometers	0.6	miles	mi
<b>AREA</b>				
cm <sup>2</sup>	square centimeters	0.16	square inches	in <sup>2</sup>
m <sup>2</sup>	square meters	1.2	square yards	yd <sup>2</sup>
km <sup>2</sup>	square kilometers	0.4	square miles	mi <sup>2</sup>
ha	hectares (10,000 m <sup>2</sup> )	2.5	acres	
<b>MASS (weight)</b>				
g	grams	0.035	ounces	oz
kg	kilograms	2.2	pounds	lb
t	tonnes (1000 kg)	1.1	short tons	
<b>VOLUME</b>				
ml	milliliters	0.03	fluid ounces	fl oz
l	liters	2.1	pints	pt
l	liters	1.06	quarts	qt
l	liters	0.26	gallons	gal
m <sup>3</sup>	cubic meters	35	cubic feet	ft <sup>3</sup>
m <sup>3</sup>	cubic meters	1.3	cubic yards	yd <sup>3</sup>
<b>TEMPERATURE (exact)</b>				
°C	Celsius temperature	9/5 (then add 32)	Fahrenheit temperature	°F

## TABLE OF CONTENTS

1. Introduction, Scope and Objectives	1
---------------------------------------	---

### PART 1 - Demonstration of Probability-Based Rule Calibration

2. Preliminary Assessment of Reliability Levels Implied in ABS Rules	5
2.1 Limit State Formulation	5
2.2 General Characteristics of "ABS Ships"	6
2.3 Strength Considerations of "ABS Ships"	6
2.3.1 Section Modulus	7
2.3.2 Yield Stress	7
2.4 Loads Applied to "ABS Ships"	8
2.4.1 Stillwater Bending Moment	10
2.4.2 Wave Bending Moment	11
2.4.3 Comments on the Ratio of Wave Bending Moment to Stillwater Bending Moment Given by ABS Rules	12
2.5 Safety Indices and Target Reliability	14
2.5.1 Reliability Analysis -- First and Second Order	14
2.6 Comments on ABS Rules Regarding Ship Section Modulus Calculation	17
3. Calibration Procedure	25
3.1 Procedure of Calculating Partial Safety Factors for "ABS Ships"	25
3.2 Redesign of "ABS Ships" and Resulting Safety Indices	26
3.3 Benefits of the Calibration	29

### PART 2 - Demonstration of Probability-Based Hull Girder Safety Analysis

4. Development of Limit States for an Example Ship	31
--	----

<b>5. Development of Load Models for the Example Ship</b>	<b>38</b>
<b>5.1 Wave Bending Moment for Ultimate Limit State</b>	<b>38</b>
<b>5.2 Stress Ranges and Number of Cycles for Fatigue Limit State</b>	<b>39</b>
<b>6. Reliability and Safety Indices of the Example Ship</b>	<b>40</b>
<b>6.1 Ultimate Limit States</b>	<b>40</b>
<b>6.1.1 Deck Initial Yield</b>	<b>41</b>
<b>6.1.2 Fully Plastic Collapse</b>	<b>42</b>
<b>6.1.3 Instability Collapse</b>	<b>42</b>
<b>6.2 Fatigue Limit State</b>	<b>43</b>
<b>6.3 Summary of Safety Indices</b>	<b>45</b>

**PART 3-Structural Reliability Process Definitions**

<b>7. Structural Reliability Terminology</b>	<b>47</b>
<b>7.1 Load Terminology</b>	<b>47</b>
<b>7.2 Strength Terminology</b>	<b>57</b>
<b>7.3 Structural Reliability Terminology</b>	<b>61</b>
<b>8. Probabilistic Extrapolation Techniques for Design Loads</b>	<b>67</b>
<b>8.1 Identification of Techniques</b>	<b>67</b>
<b>8.2 Determination of Design Loads</b>	<b>76</b>
<b>9. Serviceability Limit States</b>	<b>79</b>
<b>9.1 Serviceability Limit State for Plate Buckling</b>	<b>79</b>
<b>9.2 Serviceability Limit State for Fatigue</b>	<b>82</b>
<b>10. Limit States Associated with Lifetime Extreme Loads</b>	<b>89</b>
<b>10.1 General Hull Girder Limit States</b>	<b>89</b>
<b>10.2 Limit States Associated with Local Buckling</b>	<b>93</b>
<b>11. Conclusions and Discussion</b>	<b>105</b>
<b>11.1 Summary and Major Results</b>	<b>105</b>
<b>11.2 Benefits and Drawbacks of Using Probability-based Design Method</b>	<b>106</b>
<b>11.3 Discussion of SSC Projects in Reliability and Needs to be Addressed in</b>	<b>108</b>
<b>Future Projects</b>	



**APPENDICES**

1.  $M_{sw}$ ,  $M_w$ ,  $M_w/M_{sw}$  and SM of "ABS Ships"
2. Means and Standard Deviations of  $M_{sw}$ ,  $M_w$  and SM of "ABS Ships"
3. Calculations of Plastic Moment Capacity, Critical Buckling Stresses and Effective Section Modulus
4. Calculations of Compressive Strength Factor and the Hull Girder Instability Collapse Moment
5. Calculations of the RMS Values of the Wave Bending Moment for the Example Ship
6. Fatigue Reliability Calculations
7. Typical Input/Output File of CALREL

## *Nomenclature*

<b>B</b>	ship breadth
<b><math>C_b</math></b>	block coefficient
<b>L</b>	ship length
<b>m, C</b>	constants determined from S-N curve
<b><math>M_{sw}</math></b>	stillwater bending moment
<b><math>M_t</math></b>	total bending moment
<b><math>M_u</math></b>	ultimate moment capacity
<b><math>M_w</math></b>	wave bending moment
<b>N</b>	number of wave bending moment peaks
<b><math>P_f</math></b>	probability of failure
<b>SM</b>	section modulus
<b><math>SM_e</math></b>	elastic section modulus
<b><math>SM_{eff}</math></b>	effective section modulus
<b><math>SM_p</math></b>	plastic section modulus
<b><math>x_i</math></b>	model uncertainty associated with the variable "i"
<b><math>\beta</math></b>	safety index
<b><math>\gamma_i</math></b>	partial safety factor associated with a load variable "i"
<b><math>\Delta_F</math></b>	damage index
<b><math>\Delta S</math></b>	stress range
<b><math>\mu_i</math></b>	mean of the variable "i"
<b><math>\sigma_i</math></b>	standard deviation of variable "i"
<b><math>\sigma_{cr}</math></b>	critical stress
<b><math>\sigma_y</math></b>	yield strength
<b><math>\tau</math></b>	service life of the ship
<b><math>\phi_i</math></b>	partial safety factor associated with a resistance variable "i"
<b><math>\Omega</math></b>	stress parameter

Note : other symbols are defined where used

## **1. Introduction, Scope and Objectives**

This report, titled "Probability Based Ship Design Procedures - a Demonstration", is the second in the series of projects undertaken by the Ship Structure Committee in the thrust area of reliability based ship design. The first was the development of a comprehensive primer to structural reliability theory as applied to ships and marine structures, Ref. 6. The work in this project assumes that the reader is familiar with the various concepts and applications discussed in Ref. 6, "An Introduction to Structural Reliability Theory", SSC Report 351.

The immediate objective of this project is to provide a demonstration of the use of probability-based ship design methods and to compare the results with traditional design methods. Based on the results of the demonstration, the following conclusions and information are provided:

1. The benefits and drawbacks of the use of probability-based design methods compared to the traditional methods
2. The additional information necessary to conduct probability-based ship designs
3. A summary of the proposed probability-based method showing how it can be applied to generate new designs of uniform safety and how it can be used to assess the safety of an existing design
4. A discussion of the current and future SSC projects in reliability and loads.

Two basic demonstrations are provided in this report (Part 1 and Part 2) together with reliability process definitions (Part 3). These are summarized as follows:

1. Probability-based design procedure -- code calibration:

The objective of this part is to provide an illustration of how probability-based methods can be used to develop and calibrate a code (or design criteria) in order to produce designs with uniform safety over a wide range of the basic parameters involved in the design. For this purpose, ABS primary hull girder longitudinal strength criterion is considered. A formulation for the minimum required section modulus that satisfies this

requirement (uniform safety) is developed. A demonstration is made of how partial safety factors are determined, calibrated, and used in new designs that have uniform safety.

## 2. Probability-based ship safety analysis:

The objective of this part is to provide an illustration of how to apply state-of-the-art reliability techniques in order to determine the safety level of an existing ship or an existing design, i.e., to develop the ship safety indices taking into consideration the uncertainties associated with the environment, loads, materials and analytical models. For this purpose a tanker was selected in consultation with the Project Technical Committee (PTC) for use in an example to illustrate the safety assessment procedure. Several limit states were formulated, namely ultimate, serviceability, and fatigue limit states, and applied to the tanker. The loads corresponding to these limit states were developed and a safety index was calculated for each limit state using both first and second order reliability methods.

## 3. Structural reliability process definitions:

An extension of the work of this project (SR-1330) was approved by the PTC. The additional work is described in the following tasks:

- (a) Definition of terminology associated with structural reliability of ships and offshore structures. This includes terminology related to loads, strength and structural reliability.
- (b) Identification and description of appropriate ultimate limit states associated with lifetime extreme design loads. These include global (hull girder) initial yield, fully plastic and collapse limit states, and local ones related to column, beam/column and torsional/flexural buckling of longitudinals, and grillage buckling of longitudinals together with transverse beams.
- (c) Identification and description of serviceability limit states associated with plate buckling and fatigue.
- (d) A review of probabilistic extrapolation techniques for lifetime extreme loads. .

## A NOTE ON NOTATION

A distinction needs to be made between random variables and their characteristic or nominal values, although this may often be evident from the context. In this report, where necessary, random variables are denoted with a 'tilde' on the top, e.g.  $\tilde{\sigma}_y$  is a random variable, while  $\sigma_y$  is a nominal or characteristic value.

**PART 1**  
**Demonstration of Probability-Based Rule Calibration**

## 2. Preliminary Assessment of Reliability Levels Implied in ABS Rules

As a demonstration of a probability-based calibration procedure of a code, the safety level implied in ABS Rules for hull girder longitudinal strength is determined by calculating the reliability indices ( $\beta$ 's) for 300 ships designed according to the Rules. The range of safety ( $\beta_{\text{range}}$ ) was then calculated as the difference between the largest and smallest safety indices of all the designs considered. An average safety index ( $\beta_{\text{av}}$ ) was also calculated. The objective of the calibration process is to determine partial safety factors to be used in a modified formulation for longitudinal strength such that the resulting safety level of all designs is approximately constant with a value equal to  $\beta_{\text{av}}$  and such that the resulting safety range ( $\beta_{\text{range}}$ ) among the new designs is minimum. The details of the calibration process is illustrated in the following sections.

### 2.1 Limit State Formulation

The section modulus requirements for a ship according to ABS Rules is based on a permissible stress which is based on the yield strength of the material. For this reason, only the initial yield limit state will be formulated which is similar to ABS minimum section modulus requirement. Only vertical bending moment, composed of stillwater and wave bending moments, is considered. The initial yield limit state is expressed as:

$$g(\mathbf{X}) = \tilde{SM} \cdot \tilde{\sigma}_y - \tilde{M}_{sw} - \tilde{M}_w \quad (2.1)$$

where  $\mathbf{X}$  is a vector of the random variables, ( $\tilde{SM}$ ,  $\tilde{\sigma}_y$ ,  $\tilde{M}_{sw}$ , and  $\tilde{M}_w$ ), and

- $SM$  is the section modulus amidship,
- $\sigma_y$  is the yield stress,
- $M_{sw}$  is the stillwater bending moment, and
- $M_w$  is the wave bending moment.

These variables are taken to be random or uncertain and are assumed to be statistically independent.

## 2.2 General Characteristics of "ABS Ships"

The general characteristics of several ships designed to the minimum requirements of ABS Rules (including minimum section modulus requirements) will be determined. These ships will be called "ABS Ships". Since the initial yield limit state is the only failure mode to be considered, and the variables in Eq. 2.1 depend only on  $L$ ,  $L/B$ , and  $C_b$ , these three parameters serve as the factors on which the reliability level depends. They are specified as follows:

$L$  : from 91.5m ( 300 ft ) to 366 m ( 1200 ft )

$L/B$  : from 5.0 to 9.0

$C_b$  : from 0.60 to 0.85

These ranges cover most ships to which ABS Rules are meant to apply. The value without 'tilde' indicate deterministic characteristic values.

## 2.3 Strength Considerations of "ABS Ships"

Because of variability of properties of steel and other materials used in marine structures and because of variability in production and fabrication of their components, the strength of identical ships will not, in general, be identical. In addition, uncertainties associated with residual stresses arising from welding, the presence of small holes, etc. may affect the strength of the ship. These limitations and uncertainties indicate that a certain variability in strength or hull capacity about some mean value will result.

Additional uncertainties in the strength will arise due to uncertainties associated with the assumptions and methods of analysis used to calculate the strength. Further uncertainties are associated with possible numerical errors in the analysis. These errors may accumulate in one direction or possibly tend to cancel each other. Whatever the case, the above uncertainties have to be reflected in any reliability or failure analysis.



$$SM = C_1 \cdot C_2 \cdot L^2 \cdot B \cdot (C_b + 0.7) \text{ m-cm}^2$$

where  $C_1$  is a function of  $L$ , and  $C_2$  is a constant.

As shown in Fig. 2.1, the section modulus is assumed to be lognormally distributed with a coefficient of variation of 4 %, see Ref. 6. The section modulus calculated from the ABS rules is taken as the mean value.

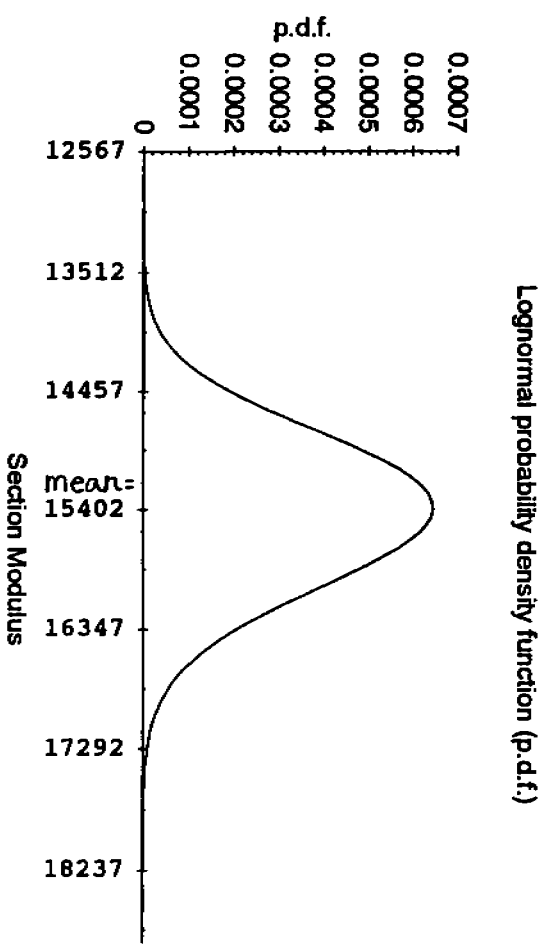


Figure 2.1 Distribution of the Section Modulus.

### 2.3.2 Yield Strength

The yield strength distribution, shown in Fig. 2.2, is assumed to be lognormal with a coefficient of variation of 7 % (Ref. 6), and with a mean value of 235 MPa (34 ksi). This

distribution gives a probability of exceeding ABS permissible stress (175MPa) equal to 99.999%. The material used is normal strength steel.

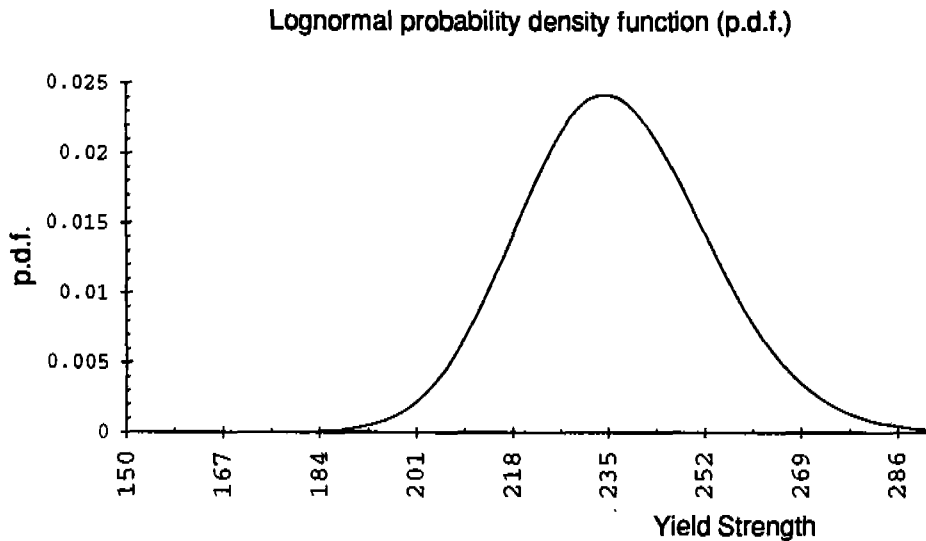


Figure 2.2 Distribution of the Yield Strength

#### 2.4 Loads Applied to "ABS Ships"

The stillwater bending moment was obtained from the 1990 Rules[2], the latest available at the time the work was conducted:

Stillwater Bending Moment:

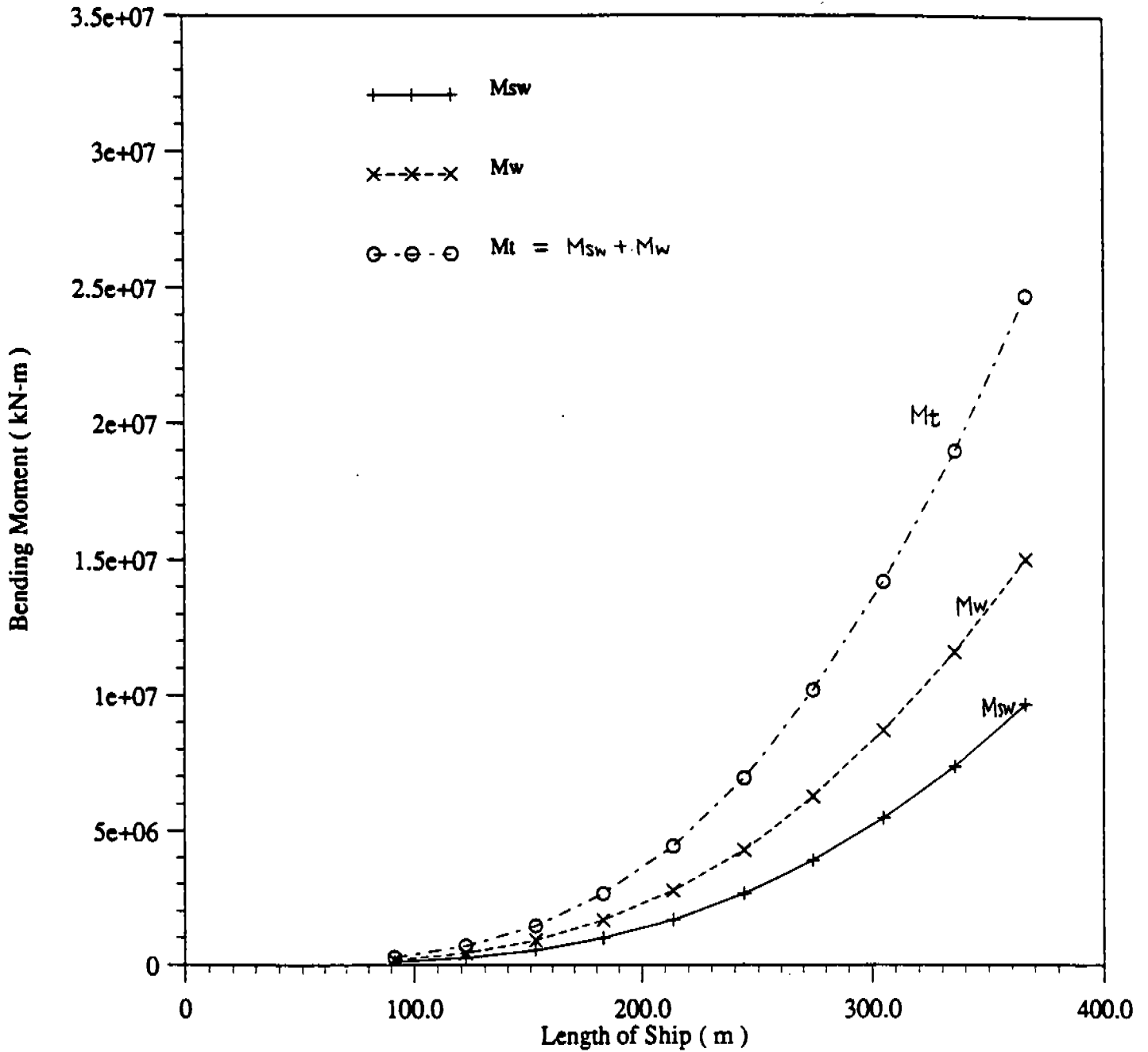
$$M_{sw} = 10^{-3} \cdot C_{st} \cdot L^{2.5} \cdot B \cdot (C_b + 0.5) \text{ kN-m ('90)}$$

Wave Bending Moment Amidship ( Sagging Moment ):

$$M_w = -k_1 \cdot C_1 \cdot L^2 \cdot B \cdot (C_b + 0.7) \cdot 10^{-3} \text{ kN-m (proposed for '91)}$$

where  $C_{st}$ ,  $k_1$ , are constant, and  $C_1$  is a function of  $L$ . Hogging moment is smaller, and so not considered.

Both stillwater and wave moments depend on length ( $L$ ), beam ( $B$ ), and block coefficient ( $C_b$ ). Fig. 2.3 shows the stillwater, wave, and total bending moment variation with ship length for a specified block coefficient and length-beam ratio as an example.



**Fig. 2.3 Total Bending Moment ( $C_b=0.6$   $L/B=5$ )**

Appendix 1 shows the values of the stillwater moment, the wave moment, the ratio of the wave to stillwater moments and the minimum section modulus, all calculated according to ABS Rules as described earlier for the selected ranges of length, length to beam ratio, and block coefficient.

#### 2.4.1 Stillwater Bending Moment Distribution

According to Soares and Moan[3], the stillwater bending moment fits to a normal distribution. In this investigation it is assumed that the value given by ABS is the maximum value with a probability of exceedance of 5 %. The large variability in the stillwater bending moment calls for a coefficient of variation of 40%[3] which gives the mean value of the distribution to be:

$$\mu_{sw} = 0.6 \cdot M_{sw,ABS} \quad (2.2)$$

where  $M_{sw,ABS}$  is the stillwater bending moment given in ABS Rules . The distribution is shown in Fig. 2.4.

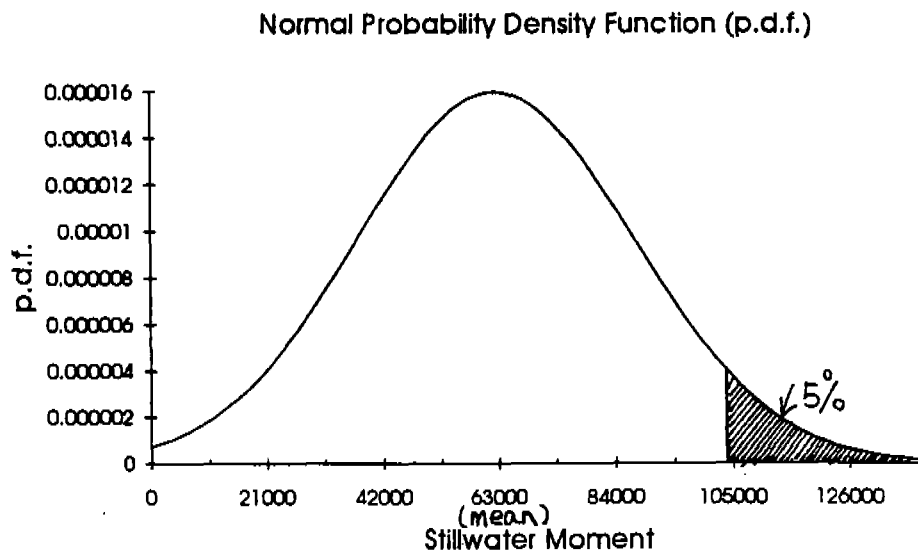


Figure 2.4. Distribution of the Still Water Bending Moment

### 2.4.2 Wave Bending Moment Distribution

If the wave loads acting on a marine structure can be represented as a stationary Gaussian process (short-term analysis), then at least four methods are available to predict the distribution of the maximum load. These methods are developed for application to marine structures and are given in more detail in [4]. In this report, extreme value distribution based on upcrossing analysis [6] is used.

The wave induced bending moment given by ABS is modeled as an extreme value following the distribution function[4]:

$$F_w(w) = \exp(-N \exp(-\frac{w^2}{2\lambda_0}))$$

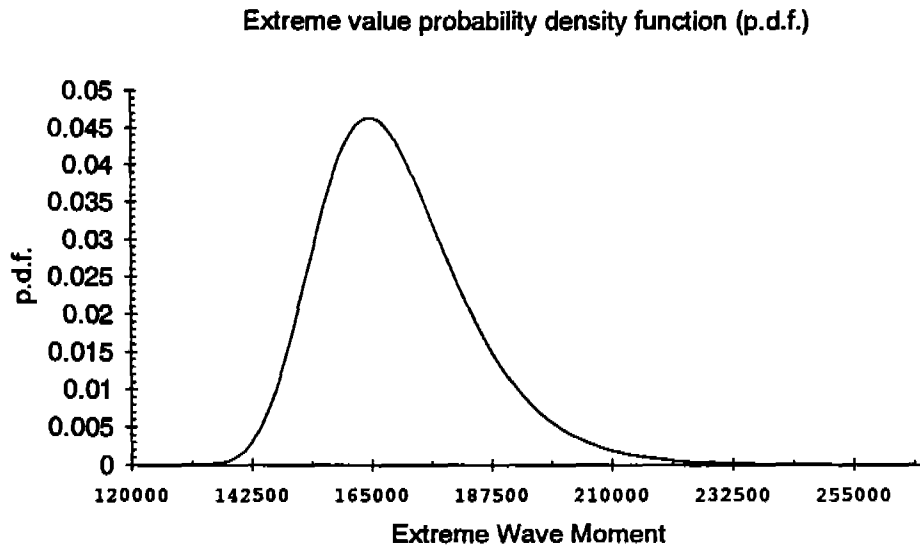
$$\mu_w = \sqrt{2\lambda_0 \ln N} + \frac{.5772}{\sqrt{2\lambda_0 \ln N}} \quad (2.3)$$

$$\sigma_w = \frac{\pi}{\sqrt{6}} \sqrt{\frac{\lambda_0}{2 \ln N}}$$

where  $\mu_w$  is the mean of the distribution and  $\sigma_w$  is the standard deviation. N is the number of wave bending moment peaks and  $\lambda_0$  is the mean square of the wave bending moment process. The value given by ABS is assumed to be the mean value of the distribution [6], and Table 2.1 shows how the coefficient of variation varies with N. Choosing N to be 1000, which is equivalent to a 3 hour storm gives a coefficient of variation of 9 %. Fig. 2.5 shows the distribution.

N	C.O.V.
500	10%
1000	9%
2000	8%

Table 2.1



**Figure 2.5 Distribution of the Extreme Wave Bending Moment**

Appendix 2 gives the calculated means and standard deviations of the stillwater moment, wave moment, and the section modulus according to the distributions described above for the selected ranges of  $L$ ,  $L/B$  and  $C_b$ .

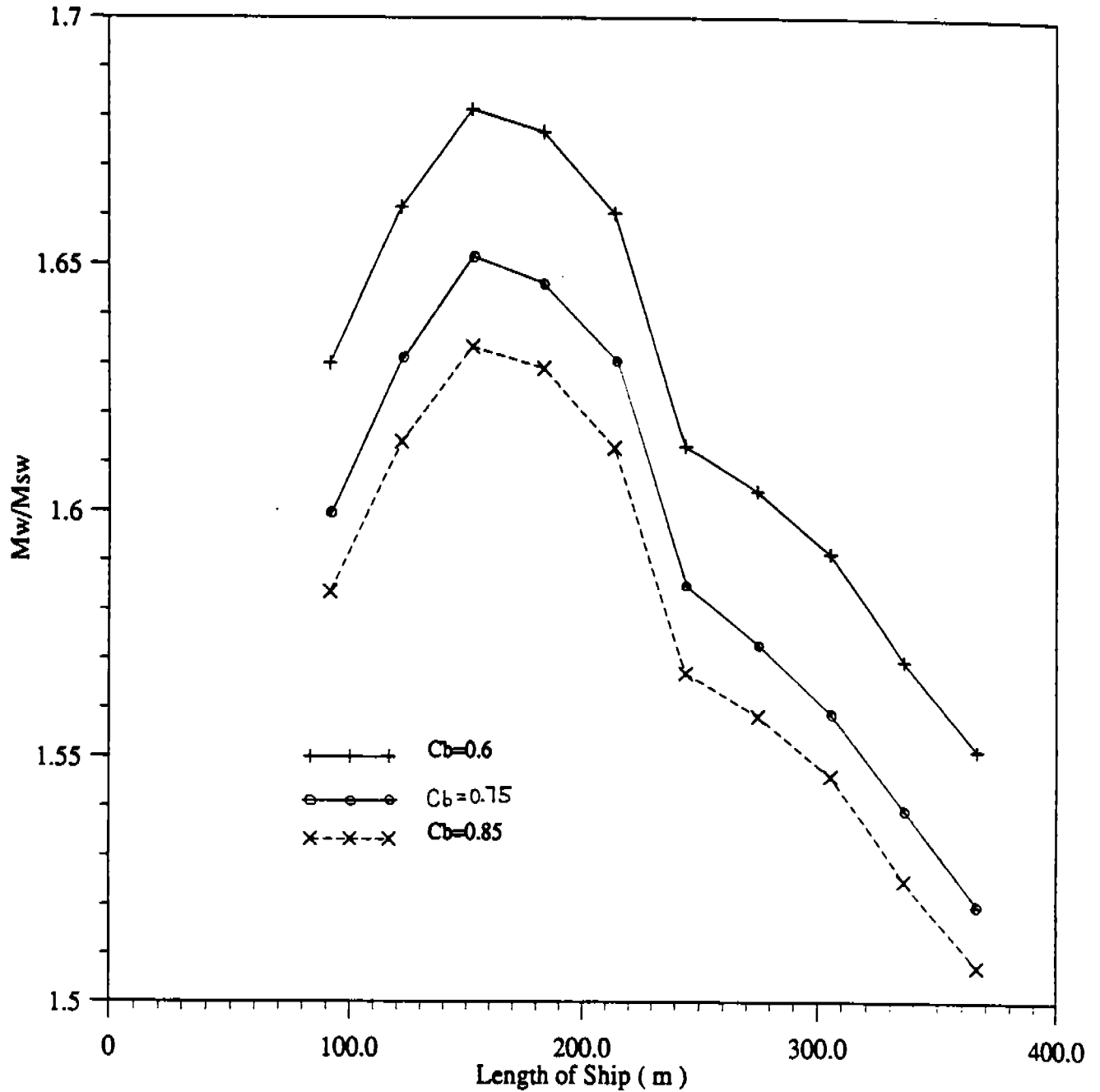
#### 2.4.3 Comments on the Ratio of Wave to Stillwater Bending Moments

Given by ABS Rules

Inspection of the calculated values of  $M_{SW}$ ,  $M_w$ , and  $M_w/M_{SW}$  according to ABS Rules (Appendix 1), leads to the following conclusions:

1.  $M_w/M_{SW}$  ratio does not depend on  $L/B$ . Hence,  $M_w/M_{SW}$  can be written as a function of  $L$  and  $C_b$  only.
2. Fig. 2.6 shows the ratio  $M_w/M_{SW}$  as a function of  $L$  for two extreme values of  $C_b$  (0.6 and 0.85). The resulting curves are more or less parallel, and each has a maximum at  $L=152.5$  m and a minimum at  $L=366.0$  m.
3. When  $L$  is held constant,  $M_w/M_{SW}$  ratio decreases monotonically as  $C_b$  increases.
4. As a result of the above observations, all  $M_{SW}/M_w$  values fall in the area bounded by

the two lines shown in Fig. 2.6. The minimum and maximum values of this ratio are 1.507 and 1.681, respectively.



**Fig. 2.6  $M_w/M_{sw}$  ( $C_b=0.6$   $C_b=0.85$ )  
as a function of length**

## 2.5 Safety Indices and Target Reliability

### 2.5.1 Reliability Analysis -- First and Second Order

The reliability analyses are carried out using the computer program CALREL [5] and first and second order methods. For a general reference of these methods see [6]. In the reliability analyses, failure is defined when the limit state function,  $g(\mathbf{X})$ , is negative or zero.  $\mathbf{X}$  is a vector of the basic random variables, i.e. load, material and geometrical properties. After transforming the basic variables into standard normal variates,  $\mathbf{U}$ , the program determines the most probable failure condition, the design point, through an iterative procedure. The design point has the coordinates  $\mathbf{U}^*$  where

$$\mathbf{U}^* = -\beta\boldsymbol{\alpha} \quad (2.4)$$

$\beta$  is the safety index and  $\boldsymbol{\alpha}$  is the unit row vector normal to the tangent plane and directed towards the failure set, see Fig. 2.7. FORM, the First Order Reliability Method, replaces the limit state surface,  $g(\mathbf{X}) = 0$ , with a tangent hyperplane at the design point in the standard normal space, while SORM, the Second Order Reliability Method, replaces the limit state surface with a hyperparaboloid fitted at the design point in the standard normal space.

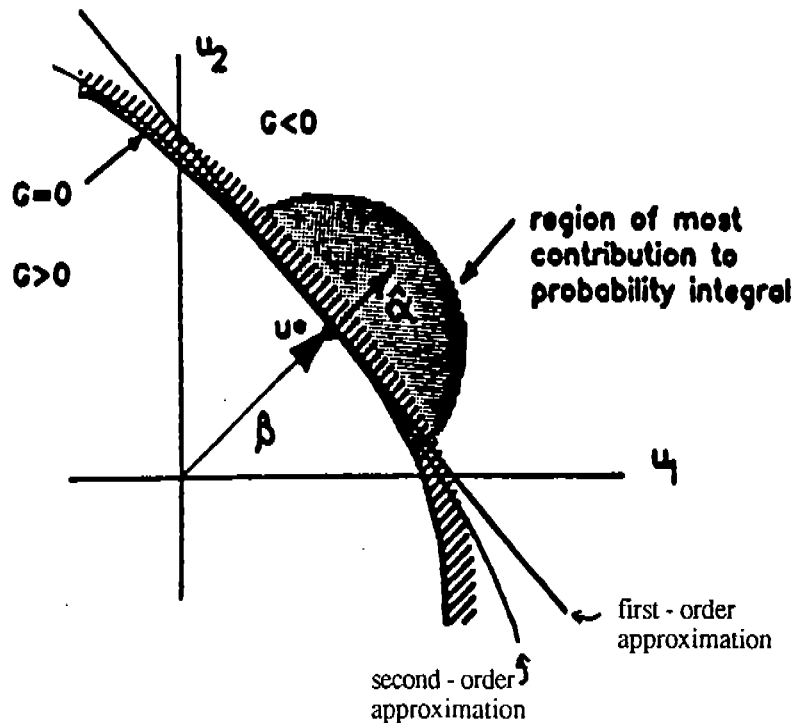


Figure 2.7 The First and Second Order Reliability Methods



The first order probability of failure,  $P_f$ , is determined from

$$P_f = \Phi(-\beta) \quad (2.5)$$

where  $\Phi$  is the standard normal distribution function. Fig. 2.8 shows the relation between  $\beta$  and  $P_f$ . ' $\beta$ ' is so called safety or reliability index. The higher the  $\beta$  value, the lower the probability of failure, and the higher the safety margin between strength and load. The relationship between  $\beta$  and  $P_f$  given in Eq. 2.5 can be determined numerically from the properties of the standard normal distribution function [15].

CALREL was used to calculate reliability indices for the "ABS ships" covering the entire range of  $L$ ,  $L/B$  and  $C_b$  described earlier. For this purpose, the limit state equation (2.1) and the probability distributions given in sections 2.3.1, 2.3.2, 2.4.1, and 2.4.2 were used in the analysis. Based on these results the following conclusions are made:

1. Holding  $L$ ,  $L/B$  fixed, and varying  $C_b$  from 0.6 to 0.85

As shown in Fig 2.9, the safety index ( $\beta$ ) decreases monotonically as the block coefficient increases.

2. Holding  $L$ ,  $C_b$  fixed, and varying  $L/B$  from 5.0 to 9.0

Fig 2.10 shows that  $\beta$  is almost constant. It suggests that the impact of  $L/B$  on  $\beta$  can be neglected.

3. Range of  $\beta$  for different  $L$

From observations 1 and 2 above, we can conclude that within our dimensions,  $\beta$  varies between the two parallel lines shown in Fig. 2.11, which shows the relation between  $\beta$  and  $L$  for the two extreme cases ( $C_b = 0.6$  and  $0.85$ ). It is also seen that these lines have the same pattern as  $M_w/M_{sw}$  lines in Fig.2.6. Fig. 2.12 and Fig. 2.13 are plotted to illustrate the relation between  $\beta$  and  $M_w/M_{sw}$ . The two lines representing the boundaries of the safety indices in Figs. 2.12 and 2.13 are plotted again in Fig. 2.14, which shows that they fall on each other. This suggests that  $\beta$  can be treated as a function of  $M_w/M_{sw}$  only.

4. Table 2.2 shows the upper and lower bounds of  $\beta$  for ship length varying from 152.5m to 366m.  $\beta$  ranges from 3.0236 to 3.3276 (see also Fig. 2.14), and its average is 3.1918.

L(m)	C <sub>b</sub>	$\beta(L/B=5.0)$	$\beta(L/B=9.0)$
91.5	0.60	3.2434	3.2434
	0.85	3.1635	3.1635
122.0	0.60	3.2953	3.3070
	0.85	3.2165	3.2165
152.5	0.60	3.3276	3.3272
	0.85	3.2490	3.2489
183.0	0.60	3.3200	3.3200
	0.85	3.2416	3.2416
213.5	0.60	3.2933	3.2933
	0.85	3.2143	3.2143
244.0	0.60	3.2148	3.2147
	0.85	3.1343	3.1343
274.5	0.60	3.1992	3.1992
	0.85	3.1185	3.1185
305.5	0.60	3.1774	3.1774
	0.85	3.0962	3.0962
355.5	0.60	3.1389	3.1389
	0.85	3.0571	3.0571
366.0	0.60	3.1060	3.1060
	0.85	3.0236	3.0236

Table 2.2 Safety Indices of ABS Ships

The safety check equation used in the calculations of  $\beta$  is given by Eq. 2.1.

## **2.6 Comments on ABS Rules Regarding Ship Section Modulus Calculation**

The following conclusions can be drawn based on the results obtained in section 2.5.1:

1. Safety implied in ABS Rules for longitudinal strength is very consistent because  $\beta$  varies within a very small range. However, the corresponding ratio of the upper and lower values of probability of failure is 2.85. This means that some room for improvement still exists.
2. The safety index depends only on the ratio of wave bending moment to stillwater bending moment. This makes the calibration procedure easier.
3. The target reliability level is set to be  $\beta = 3.20$ , which is approximately the average value of  $\beta$  determined earlier for the "ABS Ships".

# Probability of Failure vs. Safety Index, $\beta$

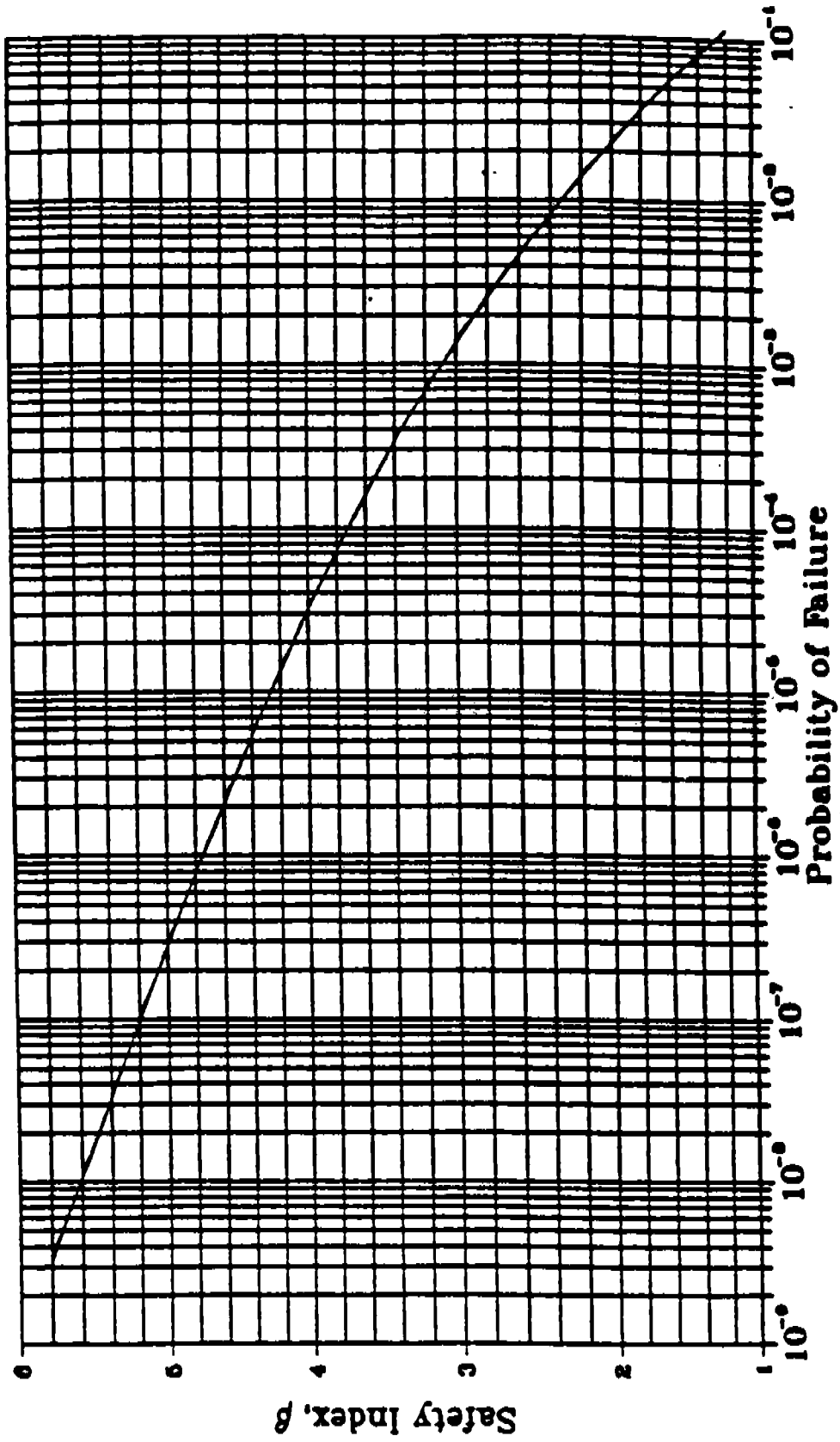
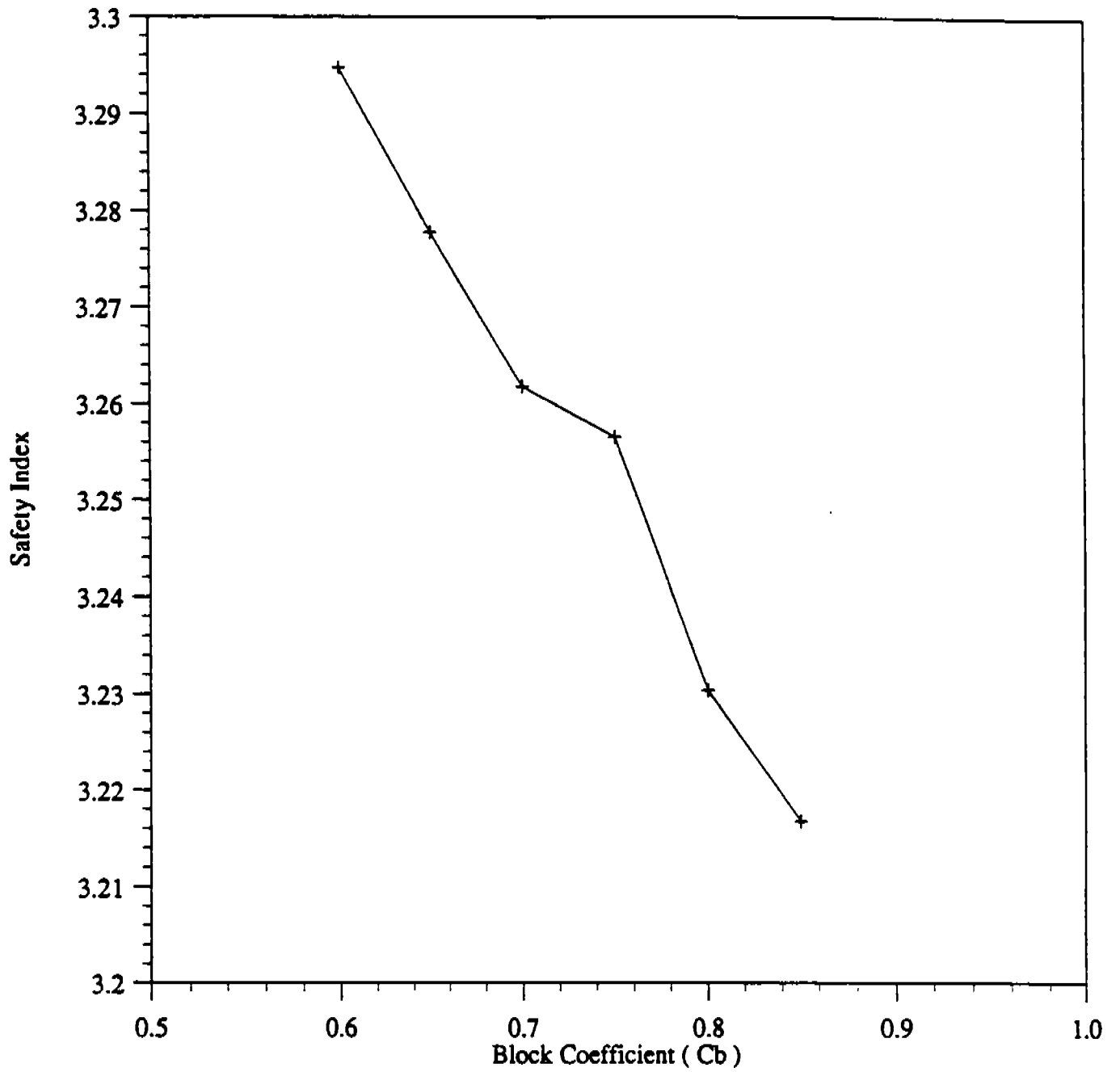
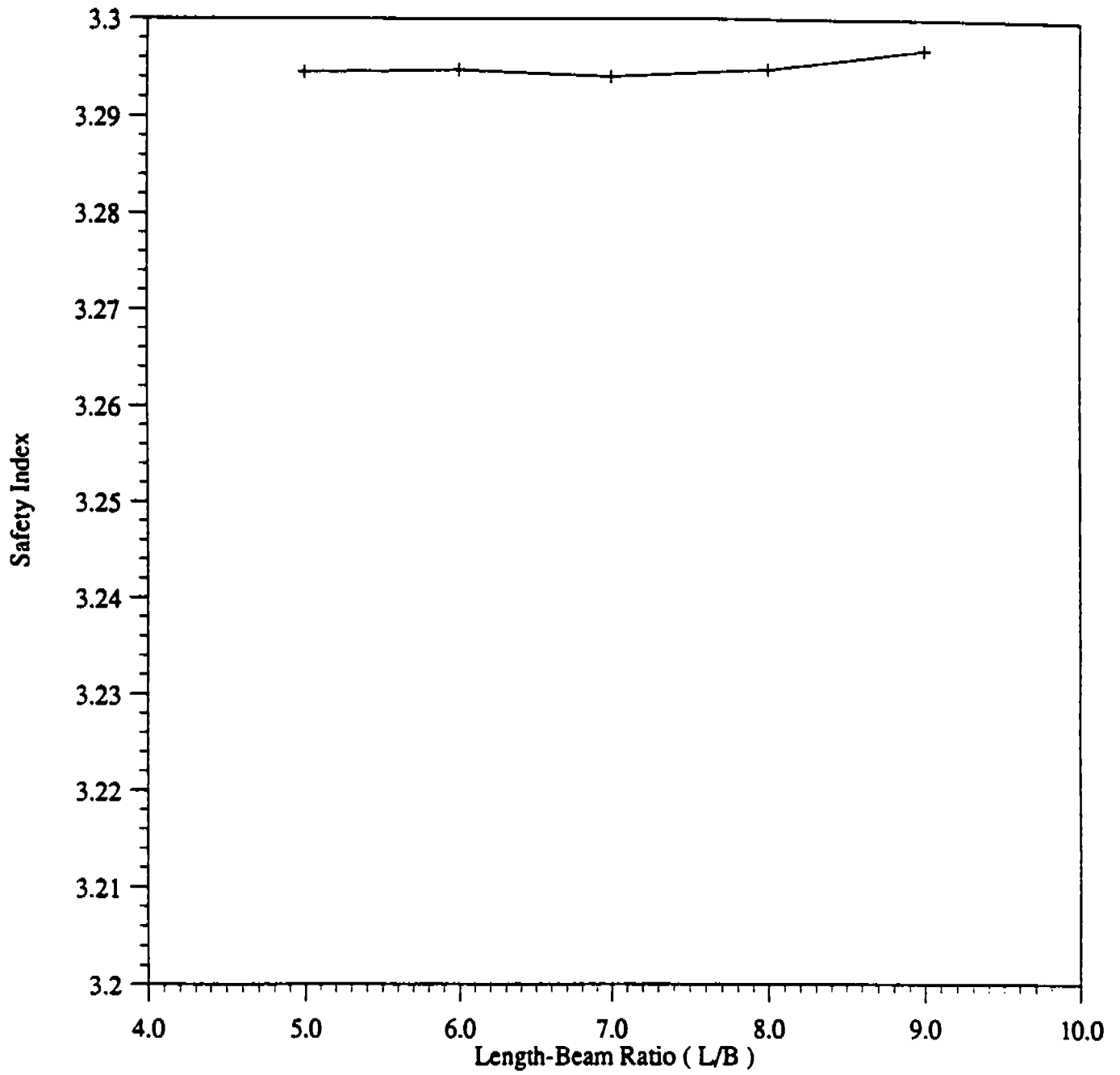


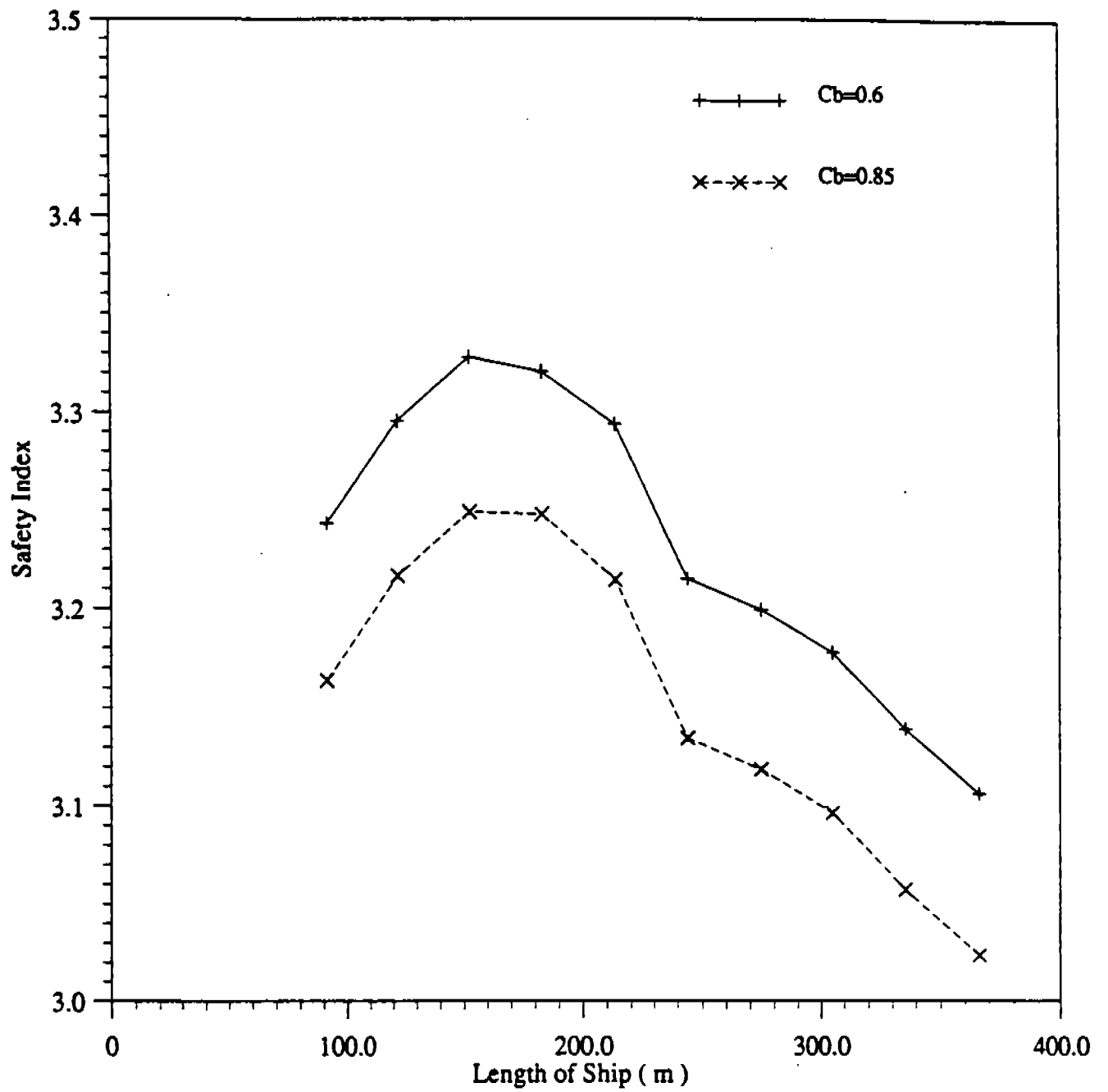
Fig.2.8 Probability of Failure versus Safety Index



**Fig. 2.9 Safety Index versus  $C_b$  ( $L=122m, L/B=6.0$ )**

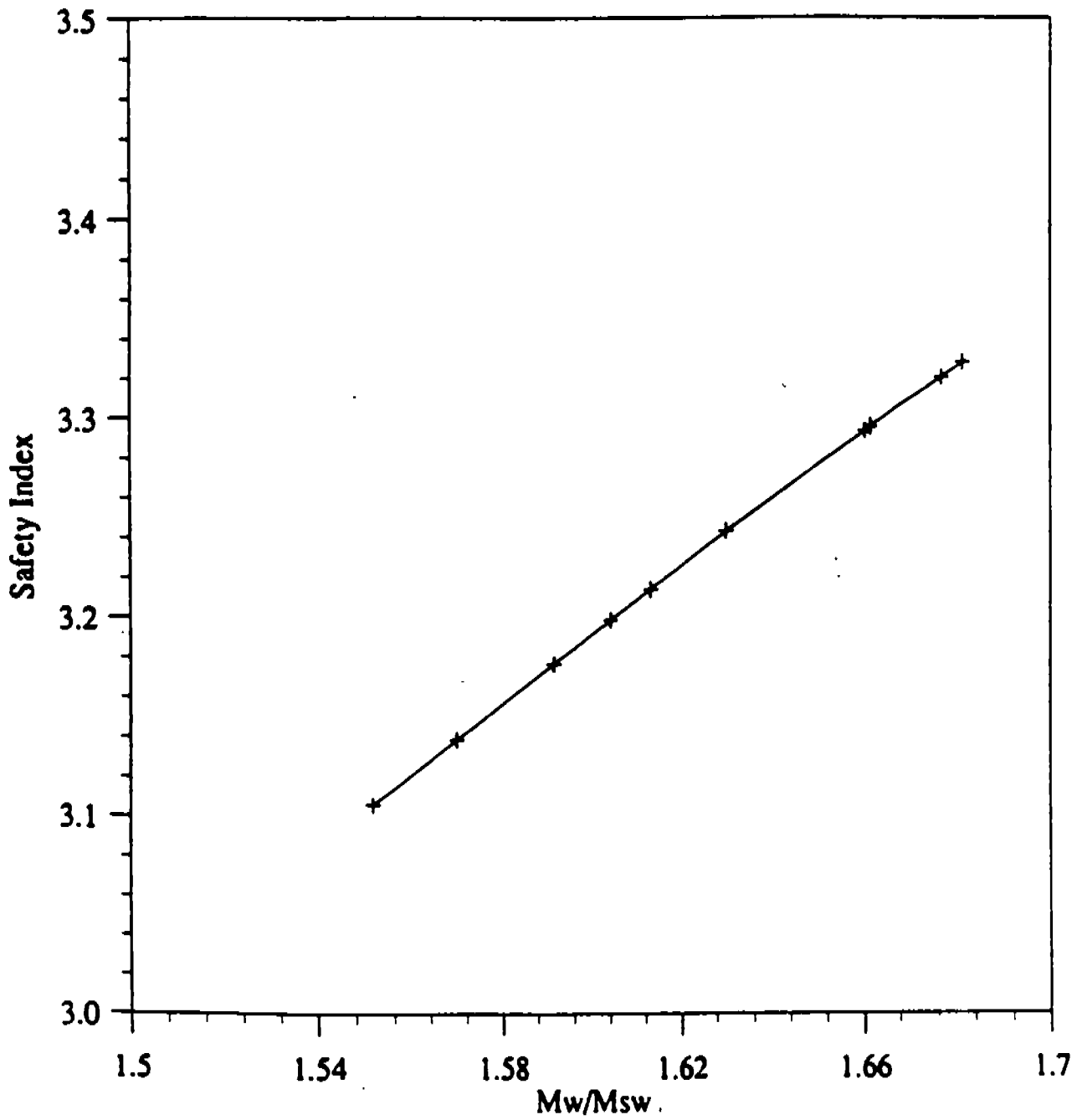


**Fig. 2.10 Safety Index versus  $L/B$  ( $L=122m, C_b=0.6$ )**



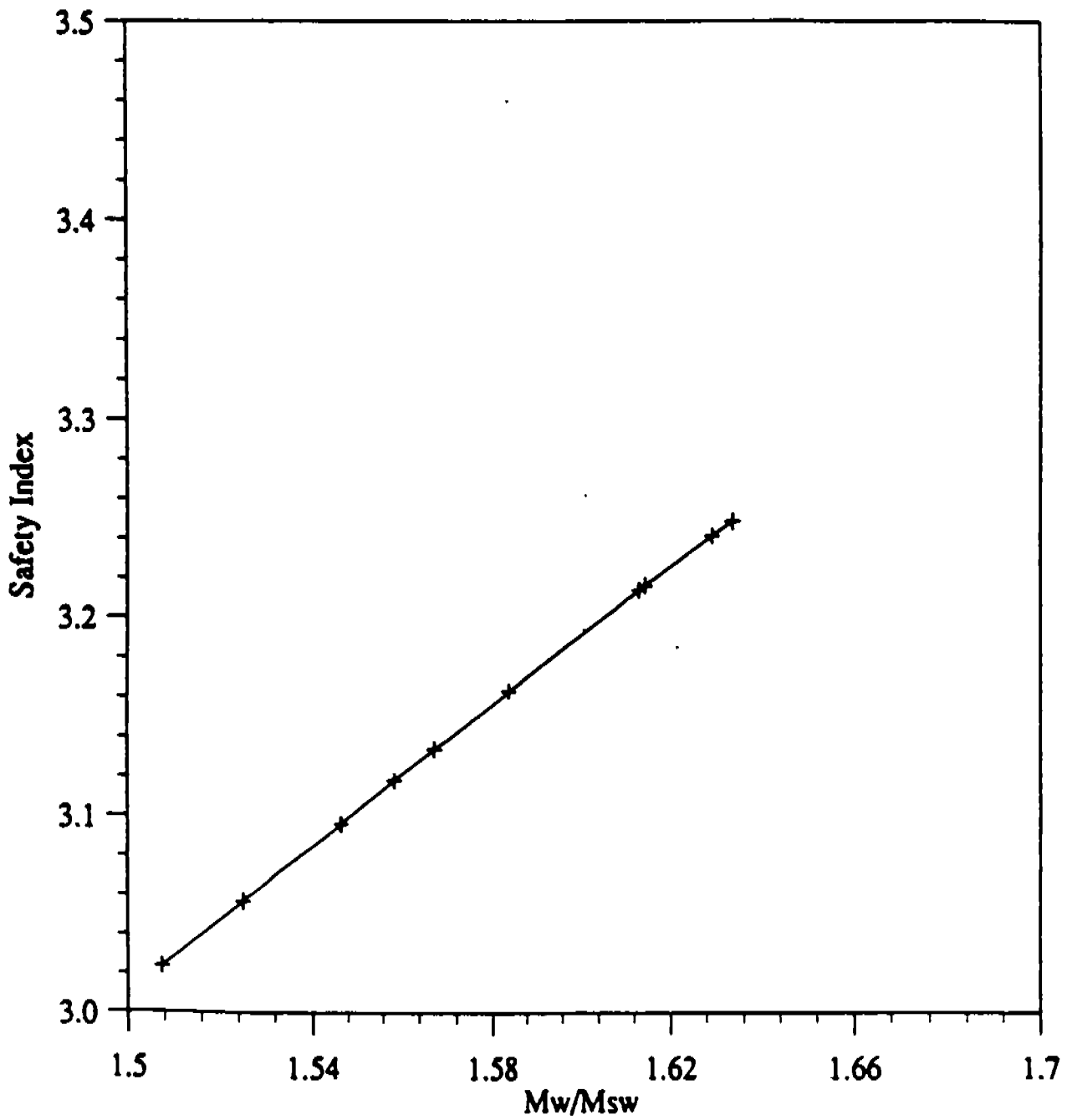
**Fig. 2.11 Safety Index (  $L/B=5$  )**

**as a function of length**

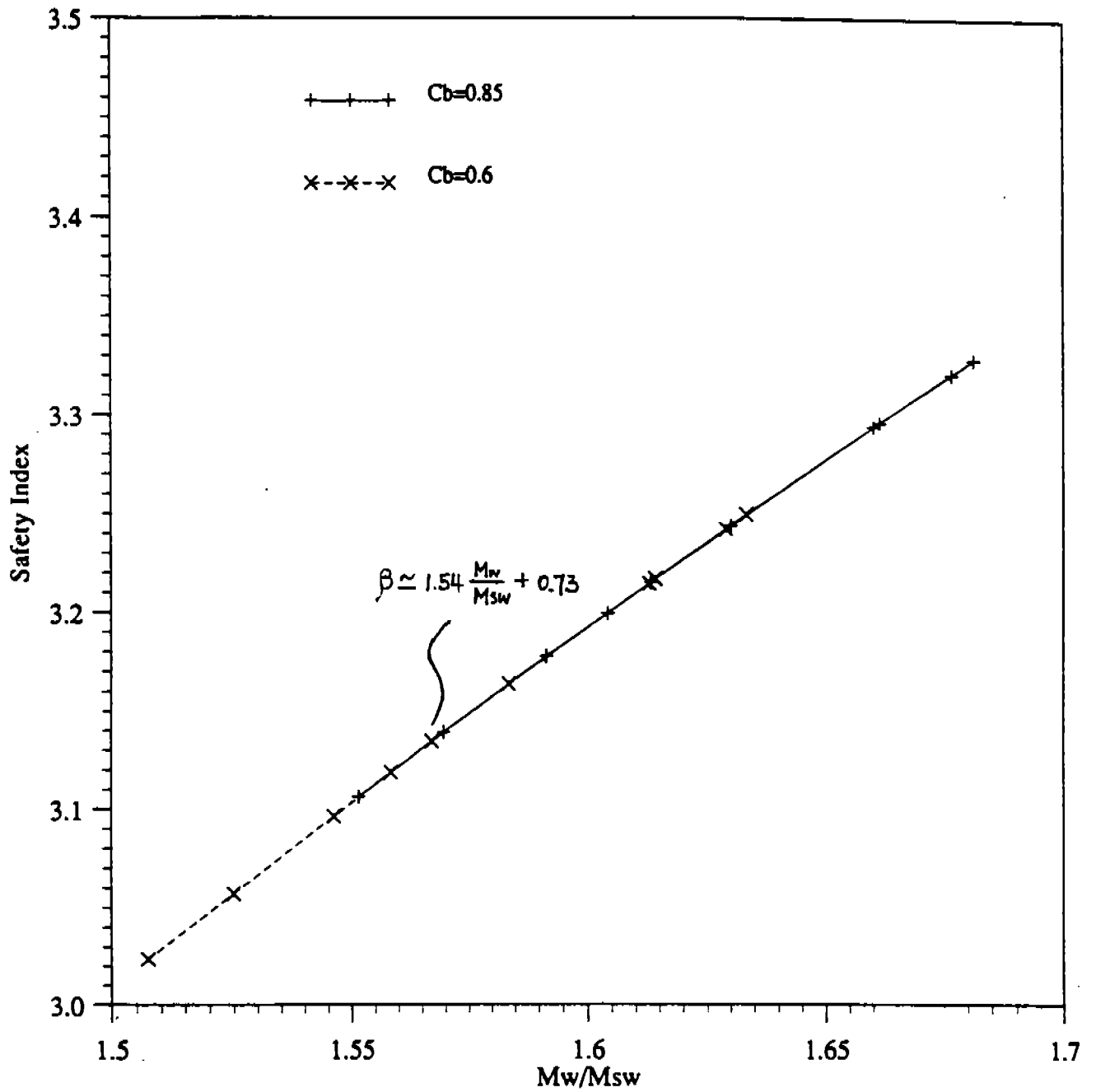


**Fig. 2.12 Safty index versus Mw/Msw ( $L/B=5.0, Cb=0.6$ )**





**Fig. 2.13 Safety index versus  $M_w/M_{sw}$  ( $L/B=5.0, C_b=0.85$ )**



**Fig. 2.14 Safty index versus Mw/Msw (L/B=5.0)**

### 3.0 Calibration Procedure

Safety factors such as those applied to yield strength and to loads are an essential part of the design process. In the probabilistic methods, this need resulted in the introduction of partial safety factors. The cumulative effect of those factors is such that the resulting design will have a certain reliability level. Thus, code developers and classification societies may determine these partial safety factors that ensure that the resulting design will have a specified reliability level. The method of determining these partial safety factors for a given safety index is discussed in Reference[6].

The objective of this section is to determine partial safety factors such that when applied to the characteristic values of stillwater moment, the wave moment and yield strength, the resulting hull girder section moduli for all ship sizes produce constant reliability index equal to the target reliability determined earlier, i.e.,  $\beta_{\text{target}}=3.2$ . This value is an average value of the computered safety indices for the ABS ships and is selected as target reliability for illustrative purposes only.

#### 3.1 Procedure of Calculating Partial Safety Factors for "ABS Ships"

As described above, partial safety factors are used in the calibration procedure to assure a specified reliability level. For the current case,

$$SM = \frac{\gamma_{sw}M_{sw} + \gamma_w M_w}{\phi_y \sigma_y} \quad (3.1)$$

where  $\gamma_{sw}$ ,  $\gamma_w$ , and  $\phi_y$  are the partial safety factors for the characteristic values  $M_{sw}$ ,  $M_w$ ,  $\sigma_y$  respectively.

The following procedure is used to determine the partial safety factors for the "ABS Ships" :

1. By trial and error determine  $\gamma$ 's and  $\phi$  in Eq. 3.1 that gives the  $\beta_{\text{target}}$ .
2. Find out for different ratios of  $M_w/M_{sw}$ , the value of  $\beta$  determined from FORM (or SORM) using the  $\gamma$ 's and  $\phi$  obtained in the first step, and check if:
  - a. the obtained  $\beta$ 's are close to the target  $\beta$ , and
  - b. the obtained  $\beta$  range is smaller than that of ABS rules.

3. If the determined  $\gamma_s$  and  $\phi$  give  $\beta$ 's close to  $\beta_{\text{target}}$  and  $\beta_{\text{range}}$  is smaller, then they can be used in the new calibrated code, otherwise make changes in them to satisfy the two criteria a. and b. above.

### 3.2 Redesign of "ABS Ships" and Resulting Safety Indices

The procedure described above can be implemented as follows. Eq. 3.1 can be rewritten as:

$$\frac{SM}{M_{sw}} = \frac{\gamma_{sw} + m\gamma_w}{\phi_y \sigma_y} \quad (3.2)$$

where  $m$  is the ratio of wave bending moment to stillwater bending moment.

It is obvious that in Eq. 3.2  $\phi_y$  is arbitrary, so we set it to be 0.86, i.e. a material or strength safety factor of 1.15. Therefore, if we can find two ships with safety indices equal to 3.20, a pair of tentative values for  $\gamma_{sw}$  and  $\gamma_w$  can be determined. One ship can be directly chosen from Table 2.2; it is the ship with  $L=274.5\text{m}$ ,  $C_b=0.6$ , and  $\beta=3.1992$ . By trial and error, another ship can be found by changing section modulus of the ship with  $L=213.5\text{m}$ ,  $C_b=0.85$  from  $166690\text{m-cm}^2$  to  $166374\text{m-cm}^2$  to make  $\beta$  equal to 3.2001. The values of  $\gamma_{sw}$  and  $\gamma_w$  can be obtained by solving the resulting two equations when the values are substituted in Eq. 3.2. The resulting  $\gamma$ 's are:

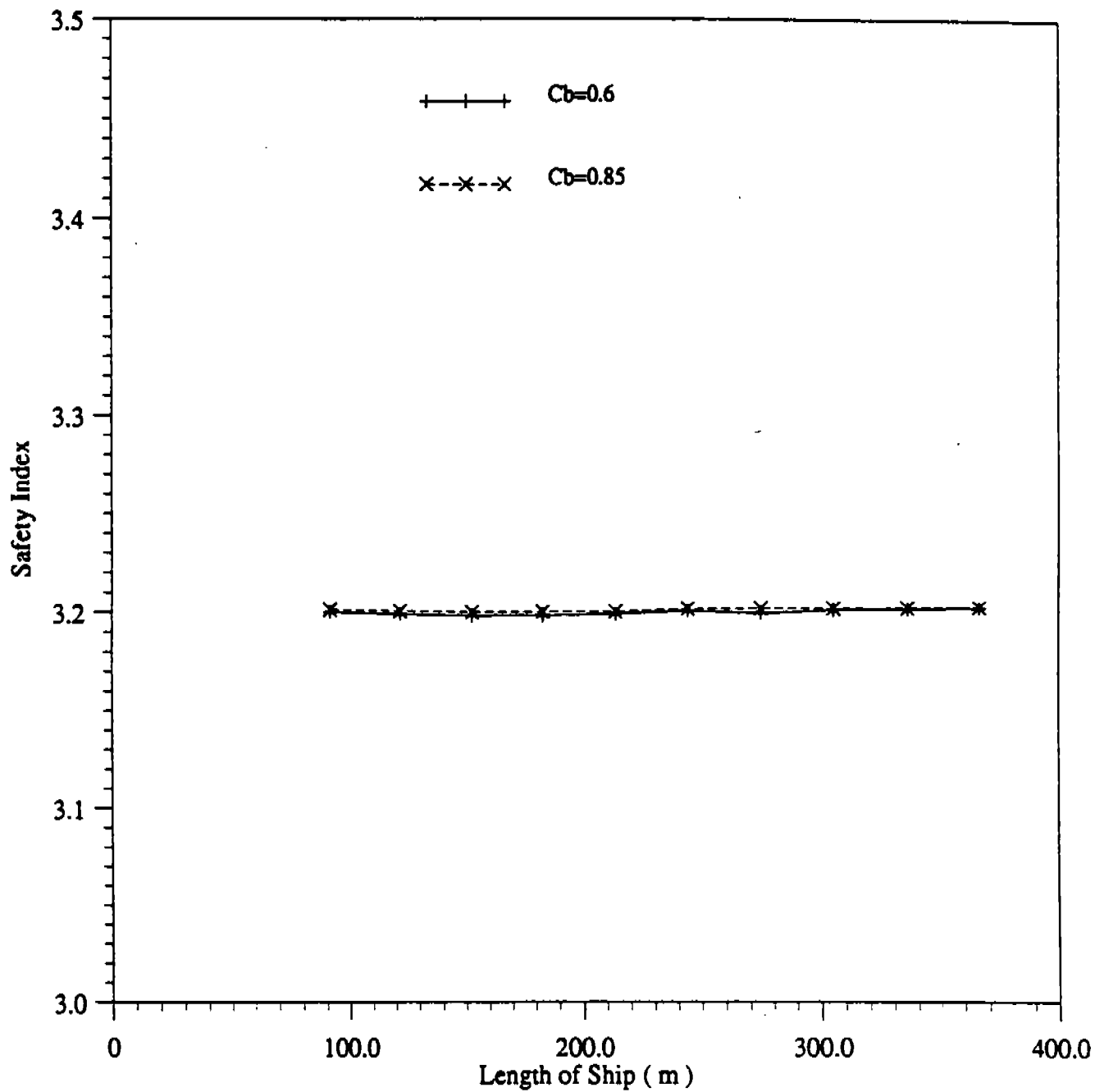
$$\begin{aligned} \gamma_{sw} &= 1.103 \\ \gamma_w &= 1.15. \end{aligned}$$

Using these partial safety factors, we can calculate new set of section moduli for which we perform reliability analysis (CALREL) to determine the safety index for every ship. The result is listed in Table 3.1 and is also plotted in Fig. 3.1. The  $\beta$ 's in Fig. 3.1 are very close to each other ( $3.1980 < \beta < 3.2022$ ), as compared to the range of  $\beta$  derived from ABS Rules. Therefore, the calibrated model for the section modulus that gives uniform safety for all ship sizes is given by Eq. 3.1 with

$$\begin{aligned} \gamma_{sw} &= 1.103 \\ \gamma_w &= 1.15 \\ \phi &= 0.86. \end{aligned}$$

L(m)	$C_b$	$\beta(L/B=5.0)$
91.5	0.60	3.1999
	0.85	3.2012
122.0	0.60	3.1988
	0.85	3.2004
152.5	0.60	3.1980
	0.85	3.1998
183.0	0.60	3.1982
	0.85	3.2000
213.5	0.60	3.1989
	0.85	3.2001
244.0	0.60	3.2005
	0.85	3.2015
274.5	0.60	3.1992
	0.85	3.2017
305.5	0.60	3.2010
	0.85	3.2018
355.5	0.60	3.2015
	0.85	3.2020
366.0	0.60	3.2018
	0.85	3.2022

Table 3.1 Safety Indices of Redesigned ABS Ships



**Fig. 3.1 Safety-index versus Ship Length**

### **3.3 Benefits of the Calibration**

The main benefit that accrues from the redesign exercise according to the new safety check format is uniform reliability and structural safety among different ship sizes, which in some cases could lead to weight savings. Code calibration exercises such as this can highlight sometimes large differences in implicit safety levels for different failure modes in a structure, a situation that can be rectified in a new generation reliability based code.

**PART 2 Demonstration of Probability-Based Hull Girder Safety Analysis**



#### 4. Development of Limit States for an Example Ship

As stated earlier, the objective of this part of the study is to demonstrate how to use reliability technology to assess the level of risk associated with an existing ship or with a "drawing board" design. For this purpose an existing tanker was selected as an example in consultation with the Project Technical Committee.

Several limit states are formulated and applied to the example ship. These are: the ultimate limit states (deck yielding, fully plastic collapse, and instability collapse), the serviceability limit state (local buckling), and the fatigue limit state for one point in the deck. Because the maximum stillwater bending moment of the example ship occurs in sagging condition, only this condition is considered for the ultimate and serviceability limit states. Details of all calculations are given in Appendices 3 through 7.

##### 4.1 Selection of the Example Ship

A tanker designed according to ABS Rules is selected as the example ship. The main characteristics are:

Displacement	149,000 tonnes
L.O.A	273.0 m. ( 895.1 ft )
L.B.P	260.0 m ( 852.5 ft )
Beam	42.0 m ( 137.7 ft )
Depth	23.5 m ( 77.0 ft )
Draft	16.0 m ( 52.5 ft )
$C_B$	0.710

The elastic section modulus at deck is  $4.657675 \cdot 10^5 \text{ m-cm}^2$  (236,851 in<sup>2</sup>-ft). The nominal yield strength of the material used is 259 MPa (37.4 ksi).

##### 4.2 Formulation of Limit States

As mentioned earlier the limit states considered in this demonstration are:

###### 1. Ultimate strength limit state

2. Serviceability limit state
3. Fatigue limit state

For ships, ultimate limit states can be decomposed into two modes of failure:

- a. Failure due to spread of plastic deformation, as can be predicted by plastic limit analysis and fully plastic moment ( initial yield and shake down moments can be also classified under this category ) [6].
- b. Failure due to instability or buckling of longitudinal stiffeners ( flexural or tripping ) or overall buckling of transverse and longitudinal stiffeners of grillage.

Serviceability limit states are associated with constraints on the ship in terms of functional requirements such as maximum deflection of a member or critical buckling loads that cause elastic buckling of a plate.

Fatigue limit states are associated with the damaging effect of repeated loading which may lead to loss of a specific function or to ultimate collapse. This particular limit state requires an independent type of analysis.

#### 4.2.1 Ultimate Strength Limit States

Three failure modes due to the combined action of wave and stillwater bending moment are considered. The ultimate limit state can be described as:

$$\tilde{M}_u - \tilde{M}_{sw} - \tilde{M}_w < 0 \quad (4.1)$$

where

$\tilde{M}_u$  is the ultimate hull girder moment capacity as determined by the critical stress of the respective failure mode and the effective section modulus.

$\tilde{M}_{sw}$  is the still-water bending moment.

$\tilde{M}_w$  is the wave bending moment.

$M_u$  is determined for each failure mode as follows:

##### Deck Initial Yield

Because buckling of the plates in the deck occurs before the deck initial yield, the effective section modulus after buckling is applied. The ratio of the effective section

modulus to the elastic section modulus is calculated to be 0.98 (see 3.3 of Appendix 3). The critical stress is then the material yield strength:

$$SM_{\text{eff}} = 4.57 \cdot 10^5 \text{ m-cm}^2$$

$$\sigma_{\text{cr}} = 259 \text{ MPa}$$

$$\sigma_y$$

### Fully Plastic Collapse

The plastic section modulus for the example ship is calculated according to [7], and the critical stress is the material yield strength. The details of the calculations are given in 3.1 of Appendix 3.

$$SM_p = 5.8376 \cdot 10^5 \text{ m-cm}^2$$

$$\sigma_{\text{cr}} = 259 \text{ MPa}$$

$$= \sigma_y$$

### Buckling Instability

The elastic section modulus is used and the critical stress is the buckling stress found by applying the approximate equations described in [8]. These equations are based on beam and plate theories for elastic and plastic buckling. The elastic section modulus of the tanker at deck is:

$$SM_e = 4.65767 \cdot 10^5 \text{ m-cm}^2$$

and the critical stress due to buckling depends on the buckling mode as follows:

#### a. Plates between stiffeners

The plates between the longitudinal stiffeners are considered as simply supported isotropic plates under uniaxial compressive load. The plate collapse stress is (see 3.2 of Appendix 3):

$$\sigma_{\text{cr}} = 238 \text{ MPa} \quad \left( \frac{\sigma_{\text{cr}}}{\sigma_y} = 0.92 \right)$$

## b. Stiffeners and effective plating

For column buckling of longitudinal stiffeners only the ultimate limit state is considered because when a column buckles it reaches its ultimate strength immediately. The effective plating is determined from buckling considerations since the plate is under edge compression. The calculations shown in 3.2 of Appendix 3 give a critical stress for pure flexural buckling as:

$$\sigma_{cr} = 248 \text{ MPa} \quad \left( \frac{\sigma_{cr}}{\sigma_y} = 0.958 \right)$$

However, coupled torsional/flexural buckling stress must be also checked. For the example tanker, deck longitudinal stiffeners have a single plane of symmetry which means that the ultimate limit state is probably governed by a combination of torsional and flexural buckling. For this condition, the critical stress is (see 3.2 of Appendix 3):

$$\sigma_{cr} = 170 \text{ MPa} \quad \left( \frac{\sigma_{cr}}{\sigma_y} = 0.656 \right)$$

## c. Cross-stiffened panels

Buckling of an entire stiffened panel, including both longitudinal and transverse stiffeners is considered assuming uniaxial compressive load. A panel between transverse and longitudinal bulkheads is shown in section 3.2 of Appendix 3 together with the buckling stress calculations according to reference[8]. The resulting critical buckling stress for the entire panel is

$$\sigma_{cr} = 259 \text{ MPa}$$

## d. Summary, Buckling Limit State Strength

Plate between stiffeners	238 MPa
Flexural buckling of stiffeners	248 MPa
Tripping of stiffeners	170 MPa
Cross stiffened panels	259 MPa

These are local modes of failure. The ultimate hull girder collapse moment is calculated in item e. below.

#### e. Hull Girder Instability Collapse

In the 1991 ISSC proceedings, report of the Committee on Applied Design[9], the following expression was used for the approximate determination of a hull girder instability collapse moment in sagging condition:

$$M_u = (-0.172 + 1.548\phi_{cp} - 0.368\phi_{cp}^2) \cdot SM_e \sigma_y$$

$\phi_{cp}$  is the compressive strength factor given by:

$$\phi_{cp} = (0.960 + 0.765\lambda^2 + 0.176B^2 + 0.131\lambda^2B^2 + 1.046\lambda^4)^{-0.5}$$

where

$\lambda$  is the column slenderness of a critical panel, and

B is the plate slenderness ratio.

Appendix 4 shows the calculations of the factor  $\phi_{cp}$  for the example tanker and the resulting ultimate moment " $M_u$ ". These values are

$$\phi_{cp} = 0.79 \text{ and}$$

$$M_u = 0.82 SM_e \cdot \sigma_y$$

#### 4.2.2 Serviceability Limit States

The serviceability limit state can be expressed in the same form as for the ultimate limit state:

$$\tilde{M}_{serv.} - \tilde{M}_{sw} - \tilde{M}_w < 0 \quad (4.2)$$

where

$\tilde{M}_{serv.}$  is the hull moment capacity as determined by the critical buckling stress in a serviceability limit state.

$\tilde{M}_{sw}$  is the stillwater bending moment.  
 $\tilde{M}_w$  is the wave bending moment.

The critical buckling stress of local plates between stiffeners is calculated for the example ship in 3.2 of Appendix 3. The elastic section modulus is applied. These values are:

$$SM_e = 4.65767 \cdot 10^5 \text{ m} \cdot \text{cm}^2$$

$$\sigma_{cr} = 227 \text{ MPa} \quad \left( \frac{\sigma_{cr}}{\sigma_y} = 0.870 \right)$$

#### 4.2.3 Fatigue Limit State

The fatigue limit state is associated with the damaging effect of repeated loading. There are two approaches to the fatigue problem, the Palmgren-Miner approach based on S-N curves, that will be used here, and the fracture mechanics approach.

The S-N curves are obtained by experiments and give the number of stress cycles to failure. Such curves are of the form:

$$N \cdot \Delta S^m = C \tag{4.3}$$

where

N is the number of cycles to failure

$\Delta S$  is the stress range

m is the inverse slope of the S-N curve

C is determined from the S-N curve by

$$\log C = \log a - 2\sigma_{\log N} \tag{4.4}$$

where

a is a constant referring to the mean S-N curve

$\sigma_{\log N}$  is the standard deviation of  $\log N$

The fatigue life calculation is determined based on the assumption of linear cumulative damage (Palmgren-Miner rule). Application of this assumption implies that

the long-term distribution of stress range is replaced by a stress histogram consisting of an equivalent set of constant amplitude stress range blocks.

The time to failure of a detail can be expressed as [10] :

$$\tilde{T} = \frac{\tilde{\Delta}_F \tilde{C}}{\tilde{B}^m \tilde{\Omega}} \quad (4.5)$$

where

$\tilde{\Delta}_F$  is the value of the Palmgren-Miner damage index at failure.

$\tilde{C}$  and  $m$  are obtained from the S-N curves.

$\tilde{B}$  is the ratio between actual and estimated stress range.

$\tilde{\Omega}$  is a stress parameter.

$T$ ,  $\Delta_F$ ,  $C$  and  $B$  are random variables. If the long-term distribution of the wave process is assumed to be a series of short-term sea states that are stationary, zero-mean, Gaussian and narrow banded, and if, in addition, the structure is linear, the stress range will follow a Rayleigh distribution and  $\Omega$  is determined from [10,11]:

$$\Omega = \frac{(2\sqrt{2})^m}{2\pi} \Gamma\left(1 + \frac{m}{2}\right) \cdot \sum_j p_j \lambda_{0j}^{(m-1)/2} \lambda_{2j}^{1/2} \quad (4.6)$$

where

$p_j$  is the probability of occurrence of the  $j$ -th sea state.

$\lambda_{0j}$ ,  $\lambda_{2j}$  are the zero and second stress spectrum moments in the  $j$ -th sea state,

respectively. Note that  $\frac{1}{2\pi} \sqrt{\frac{\lambda_{2j}}{\lambda_{0j}}}$  is the frequency of the stress process in the  $j$ -th seastate.

The fatigue limit state function is expressed as :

$$g(X) = \frac{\tilde{\Delta}_F \tilde{C}}{\tilde{B}^m \tilde{\Omega}} - \tau \quad (4.7)$$

where  $\tau$  is the service life of the ship.

## 5. Development of Load Models for the Example Ship

From the information given on the Tanker example, the maximum stillwater bending moment is  $1.9728 \cdot 10^6$  kNm and it occurs in sagging condition. The maximum allowable by ABS for this ship is  $3.022 \cdot 10^6$  kNm.

### 5.1 Wave Bending Moment for Ultimate Limit State

The r.m.s. value of the wave induced bending moment on a ship can be estimated from the seakeeping tables in [12]. Using the interpolation procedure described in that paper, the rms of the bending moment can be determined when the Froude number, the significant wave height, " $H_s$ ", the beam/draft ratio, the length/beam ratio, and the block coefficient are given. Knowing  $B/T$ ,  $L/B$ , and  $C_B$  for the example ship and assuming the ship's speed to be

12 knots for	$H_s \leq 3\text{m}$
8 knots for	$3\text{m} < H_s \leq 6\text{m}$
5 knots for	$6\text{m} < H_s$ .

The rms of the wave bending moment can be approximately determined for any sea state.

#### The Wave Bending Moment for the Ultimate Limit State

For the ultimate limit state, an extreme sea condition is of interest. The most probable extreme sea condition the ship is likely to encounter during its life time is determined from the wave data along its route. The ship is assumed to remain in this peak sea condition for three hours (which corresponds to  $N=1000$  wave peaks). A detailed procedure for this short-term analysis is described in reference[6]. The wave loads in this extreme sea condition are then determined and the corresponding safety indices for the ultimate failure modes are evaluated.

Following this procedure for the example tanker, the rms of the wave bending moment is determined for a significant wave height of 12.2 m (40 ft.). Section 5.1 of Appendix 5 shows the calculation procedure. The resulting rms value of the wave bending moment is

$$\sqrt{\lambda_0} = \text{rms} = 1.25398 \cdot 10^6 \text{ kNm} \quad (5.1)$$



Assuming that the wave bending moment follows the same distribution as described in Section 2.4.2 with  $N=1000$  peaks, the mean value is determined by Eq. 2.3 to be  $4.855 \cdot 10^6$  kNm. For comparison, the wave bending moment given by 1991 ABS for the example ship is  $4.62 \cdot 10^6$  kNm.

Note that the above calculations are for a seastate of 12.2 m (40 ft) wave height. This particular seastate is used for illustrative purposes. For design, a storm condition with specified return period should be selected including several pairs of representative significant wave heights and characteristic periods. The most critical ship response can be thus determined.

## **5.2 Stress Ranges and Number of Cycles for Fatigue Limit State**

The sea scatter diagram given in the ISSC proceedings[9] and shown in section 6.2 of Appendix 6 is applied. The rms value for every sea state is determined and the calculations and the results are included in section 5.2 of Appendix 5. The scatter diagram used is for the Osebery area of the North Sea.

## 6. Reliability and Safety Indices of the Example Ship

In this section, the reliability of the example tanker considering both the ultimate and fatigue limit states is determined. Model uncertainty will be included in all limit state formulations in order to reflect errors resulting from assumptions and deficiencies in analytical or empirical design models and equations.

### 6.1 Ultimate Limit States

The sagging condition is considered and the limit state is expressed as:

$$g(\mathbf{X}) = \tilde{x}_u \cdot \tilde{S}\tilde{M} \cdot \tilde{\sigma}_{cr} - \tilde{x}_{sw} \cdot \tilde{M}_{sw} - \tilde{x}_w \cdot \tilde{x}_s \cdot \tilde{M}_w \quad (6.1)$$

where

$\tilde{S}\tilde{M}$  is section modulus.

$\tilde{\sigma}_{cr}$  is the critical failure stress.

$\tilde{M}_{sw}$  is the stillwater bending moment.

$\tilde{M}_w$  is the wave induced bending moment.

$\tilde{x}_u$  is model uncertainty on strength.

$\tilde{x}_{sw}$  is uncertainty in the model of predicting the stillwater bending moment.

$\tilde{x}_w$  is the error in the wave bending moment due to linear seakeeping analysis.

$\tilde{x}_s$  takes into account nonlinearities in sagging.

The tilde denotes random variables.

The distribution of model uncertainty parameters are shown in Table 6.1

random variable	distribution	mean	c.o.v
$\tilde{x}_u$	N (Normal)	1.0	0.15
$\tilde{x}_{sw}$	N	1.0	0.05
$\tilde{x}_w$	N	0.9	0.15
$\tilde{x}_s$	N	1.15	0.03

Table 6.1 Distributions of Model Uncertainty Parameters

### 6.1.1 Deck Initial Yield

Two cases of the stillwater bending moment are considered:

In CASE 1, the stillwater bending moment is treated as a deterministic quantity equal to  $3.022 \cdot 10^6$  kN-m, which is the ABS maximum allowable stillwater bending moment for this ship. The effective section modulus is taken as the mean value. Table 6.2 shows the means and coefficients of variation from Ref. [6] of the random variables not shown in Table 6.1.

random variable	distribution	mean	c.o.v
$\tilde{S}_M$	Lognormal	$4.57 \cdot 10^5 \text{ m cm}^2$	0.04
$\tilde{\sigma}_{cr}$	Lognormal	25.9 kN/cm <sup>2</sup>	0.07
$\tilde{M}_w$	Extreme	$4.855 \cdot 10^6 \text{ kNm}$	0.09

Table 6.2 Distributions of Random Variables ,CASE 1

Appendix 7 shows the input/output files from CALREL printout. The safety index ( $\beta$ ) equals 1.81, which implies that if the ship, while loaded at its maximum allowable value of the stillwater bending moment, experiences a three hour storm with significant wave height of 12.2m (40 ft) the probability of failure due to deck yielding is  $P_f = 3.5 \cdot 10^{-2}$  for this severe storm.

In CASE 2, the stillwater bending moment is treated as a random variable with mean equal to  $0.6 \cdot 3.022 \cdot 10^6$  to be consistent with Eq. 2.2. Tables 6.1 and 6.3 give the random variables and their distributions. From CALREL for this case, the safety index ( $\beta$ ) equals 2.25, which implies a probability of deck yielding of  $P_f = 1.2 \cdot 10^{-2}$ .

The effect of correlation between the stillwater bending moment and the wave bending moment is investigated next. This correlation arises because of a weak dependence of the wave bending moment on the loading condition. CASE 2 is repeated with a correlation coefficient of 0.2, 0.5, and 0.8. The results are  $\beta = 2.23$ ,  $\beta = 2.18$ , and  $\beta = 2.13$ , respectively for this severe storm. This indicates that the reliability index is not very sensitive to this correlation and it is therefore neglected in the following analyses.

random variable	distribution	mean	c.o.v
$\tilde{S}M$	Lognormal	$4.57 \cdot 10^5 \text{ m cm}^2$	0.04
$\tilde{\sigma}_{cr}$	Lognormal	$25.9 \text{ kN/cm}^2$	0.07
$\tilde{M}_{sw}$	Normal	$1.813 \cdot 10^6 \text{ kNm}$	0.40
$\tilde{M}_w$	Extreme	$4.855 \cdot 10^6 \text{ kNm}$	0.09

Table 6.3. Distributions of Random Variables ,CASE 2

### 6.1.2 Fully Plastic Collapse

The random variables and their distributions for this failure mode are shown in Tables 6.1 and 6.4. The limit state developed in Section 4.2.1 and the loads determined in Section 5 are applied. The stillwater bending moment is assumed to be random. This gives a reliability  $\beta=3.15$  and a probability of failure of  $8.3 \cdot 10^{-4}$  for the severe storm condition considered.

random variable	distribution	mean	c.o.v
$\tilde{S}M$	Lognormal	$5.838 \cdot 10^5 \text{ m-cm}^2$	0.04
$\tilde{\sigma}_{cr}$	Lognormal	$25.9 \text{ kN/cm}^2$	0.07
$\tilde{M}_{sw}$	Normal	$1.813 \cdot 10^6 \text{ kNm}$	0.40
$\tilde{M}_w$	Extreme	$4.855 \cdot 10^6 \text{ kNm}$	0.09

Table 6.4. Distributions of Random Variables, Fully Plastic Collapse.

### 6.1.3 Instability Collapse

Several modes of failure are considered under instability as discussed earlier. These are:

The limit state developed for torsional/flexural buckling of the longitudinal stiffeners is applied since it is the worst mode of local stability failure. The load is as determined in Section 5, and the stillwater bending moment is assumed random. Tables 6.1 and 6.5 give the random variables and their distributions. From CALREL,  $\beta=0.57$  and  $P_f = 2.8 \cdot 10^{-1}$  for the severe storm condition considered. The conditional nature of this

probability is emphasized. It is conditioned on encountering this severe storm condition, which is small. The mode of failure is also local.

The hull girder instability collapse according to section 4.2.1.d is considered next. This gives a mean value of  $\sigma_{cr} = 212$  MPa. All other variables remain as given in Table 6.5. The resulting safety index is  $\beta = 1.49$  and  $P_f = 6.8 \cdot 10^{-2}$ , again conditional on the severe storm condition considered.

random variable	distribution	mean	c.o.v
$\tilde{S}M$	Lognormal	$4.658 \cdot 10^5$ m-cm <sup>2</sup>	0.04
$\tilde{\sigma}_{cr}$	Lognormal	17.0 kN/cm <sup>2</sup>	0.07
$\tilde{M}_{gw}$	Normal	$1.813 \cdot 10^6$ kNm	0.40
$\tilde{M}_w$	Extreme	$4.855 \cdot 10^6$ kNm	0.09

Table 6.5. Distributions of Random Variables, Instability Collapse

## 6.2 Fatigue Limit State

Figure 6.1 shows the analyzed detail, which is a welded deck longitudinal to the deck. It is classified as class D according to classification given in reference[13]. The analysis is concerned with one fatigue location. No system aspects are considered. The limit state function is given as:

$$g(X) = \frac{\tilde{\Delta}_F \tilde{C}}{\tilde{B}^m \tilde{x}_w^m \Omega} - \tau \quad (6.2)$$

$\tilde{x}_w$  is included in the limit state as a modeling uncertainty to take into account the error in wave bending moment prediction using linear analysis. The other variables are as described in Section 4.2.3. The stress parameter, calculated in section 6.1 of Appendix 6, is  $\Omega = 852$  [MN/m<sup>2</sup>]<sup>3</sup>[sec]<sup>-1</sup> and from the S-N curve, the mean value of  $C = 1.52 \cdot 10^{12}$  MN/m<sup>2</sup>.

The analysis is performed with the random variables distributed as shown in Table 6.6. The reliability index  $\beta$  equals 2.44, and the probability of failure is  $7.3 \cdot 10^{-3}$  over a lifetime of 20 years.

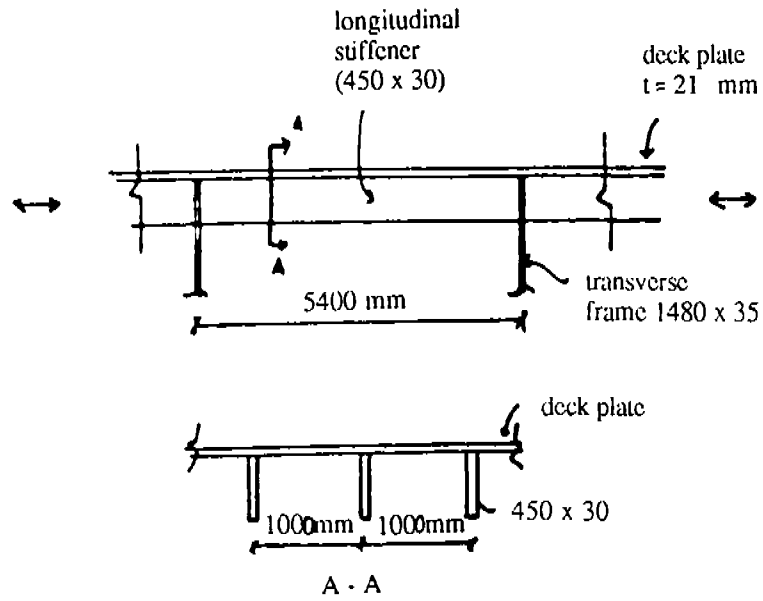


Figure 6.1 Detail Considered in the Fatigue Analysis.

random variable	distribution	mean	c.o.v
$\tilde{\Delta}_F$	Lognormal	1.44	0.15
$\tilde{C}$	Lognormal	$1.52 \cdot 10^{12}$	0.40
$\tilde{B}$	Lognormal	1.02	0.10
$\tilde{x}_w$	Normal	0.90	0.15

Table 6.6. Distributions of Random Variables, Fatigue

### 6.3 Summary of Safety Indices

The following is a summary of the calculated probabilities of failure:

- a) Deck initial yield                    0.012 (Global)
- b) Fully plastic condition            0.00083 (Global)
- c) Instability (tripping)            0.28 (Local)
- d) Hull girder ultimate moment 0.068 (Global)
  
- e) Fatigue, 20 years                    0.007 (Local)

It is to be emphasized that these values are conditional on the severe seastate assumed, in the case of items a) through d). The unconditional probabilities of failure are expected to be lower since the shown values in items "c" and "d" must be multiplied by the probability of encountering the severe storm condition used in their calculations. The fatigue (item e) is unconditional value calculated for one detail over the 20 year life of the ship.

### **PART 3 Structural Reliability Process Definition**



## 7. Terminology Associated with Structural Reliability

The aim of this chapter is to define the terminology associated with the structural reliability of ships and offshore structures. The following are considered:

- Load terminology
- Strength terminology
- Structural reliability terminology

The terminology defined addresses those terms associated with probability, statistics and reliability as used in engineering.

### 7.1 Load Terminology

The following terms are primarily used with loads, although some of the terminology is more general, and related to statistics and random processes.

#### Deterministic Process

If an experiment is performed many times under identical conditions and the records obtained are always alike, the process is said to be deterministic. For example, sinusoidal or predominantly sinusoidal time history of a measured quantity are records of a deterministic process.

#### Random Process

If the experiment is performed many times when all conditions under the control of the experimenter are kept the same, but the records (usually a time history) continually differ from one another, the process is said to be random. The degree of randomness depends on (1) understanding of the factors involved in the experiment results, (2) the ability to control them. The outcome of a random process at any given instant of time is a random variable. Time history of wave elevation and strain gage records taken aboard a ship may be considered as random processes.

#### Random Variable

Different values of a random variable have different chances (frequencies) of occurrence. A random variable thus has a probability density function. Examples of

random variables are the wave bending moment, the still water bending moment, and material yield strength.

### Probability Density Function

The probability density function defines the relative frequencies of occurrence of a random variable (e.g., wave height or wave bending moment). The function, usually denoted  $f(x)$ , where  $X$  is the random variable, has the following properties:



- 1) The probability of occurrence of fraction of the random variable  $X$  which lies between  $x$  and  $x+dx$  is  $f(x)dx$ , i.e.,

$$P[x \leq X \leq x + dx] = f(x)dx$$

- 2) The probability that a sample of the variable lies between  $a$  and  $b$  is:

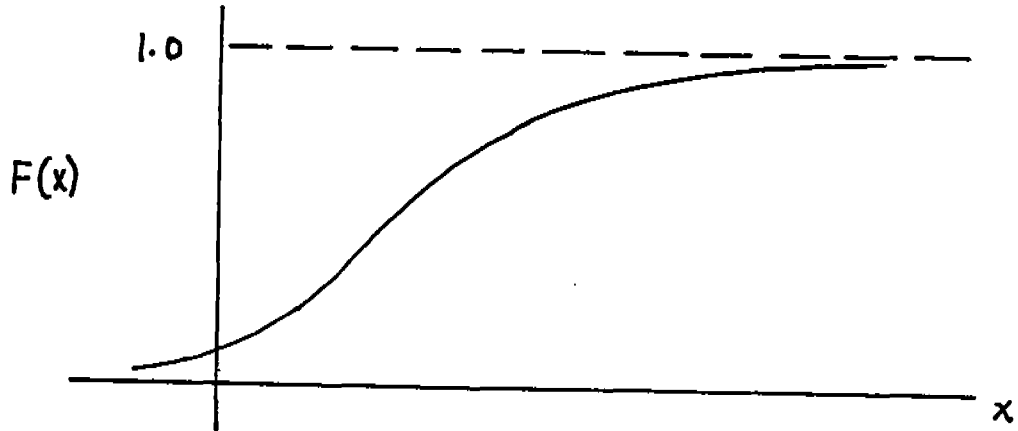
$$P[a \leq X \leq b] = \int_a^b f(x)dx$$

- 3) The probability that  $X$  lies between  $-\infty$  and  $+\infty$  is unity.
- 4)  $P[x = a] = 0$  where  $a$  is a constant.

### Probability Distribution Function

Also called the cumulative distribution function, and denoted  $F(x)$ , this defines the probability that the random variable  $X$  is less than or equal to a given value  $x$ , i.e.,

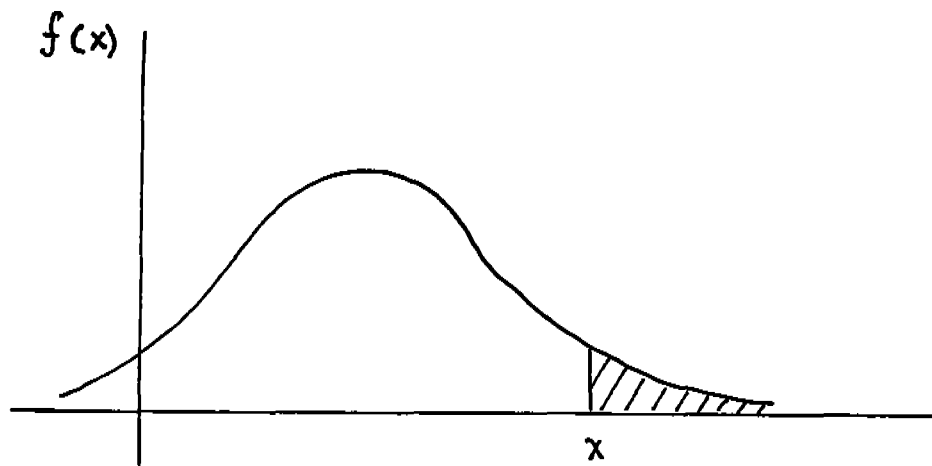
$$F(x) = -\int_{-\infty}^x f(x) dx$$



Exceedence Probability

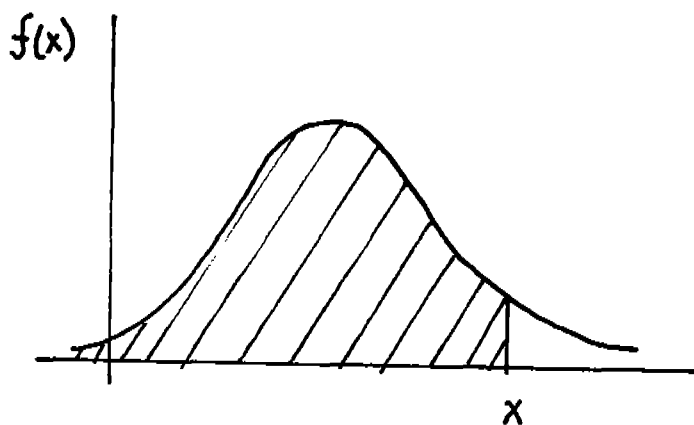
This is the probability that a random variable X (e.g., wave bending moment) exceeds a specified value x, and is given in terms of the probability distribution function as  $1 - F(x)$ , since

$$1 - F(x) = \int_x^{\infty} f(x) dx$$



## Percentile

Percentile values of a random variable  $X$  are those values corresponding to specified values of the cumulative distribution function  $F(x)$ . A 50-percentile value thus corresponds to  $x$  such that  $F(x) = 0.5$ . This particular percentile is also the median value of the random variable. A 95-percentile value is a value such that  $F(x) = 0.95$ , i.e., only 5% of the outcomes of the random variable are expected to lie above it.



## Mean, Median and Mode

For a given probability density function  $f(x)$  relating to a random variable  $X$ , the mean or average value  $\mu$  is given by

$$\mu = E(x) = \int_{-\infty}^{\infty} x f(x) dx$$

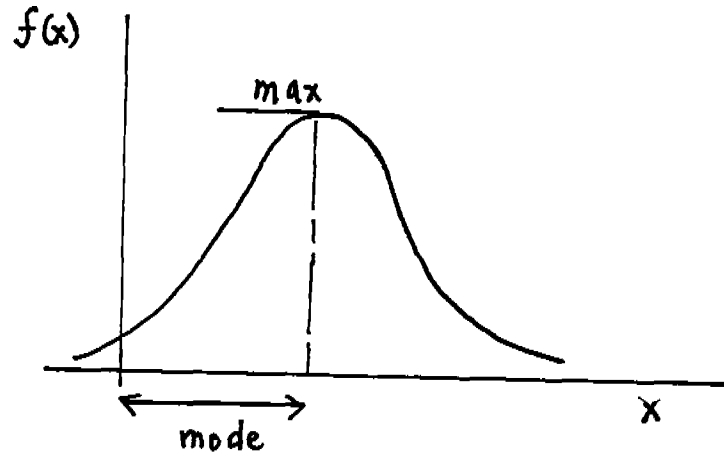
where  $E(x)$  denotes the "expected value" of  $X$ .

The median value of  $X$ , denoted  $\bar{x}$ , is defined from the cumulative distribution function  $F(x)$  as

$$\bar{x} = F^{-1}(0.5)$$

i.e., it is a value of  $X$  corresponding to a cumulative distribution function of 0.5. This implies that, on the average, 1/2 the outcomes of the random variable will lie below  $\bar{x}$  and 1/2 above it.

The mode of a random variable  $X$  is the value of  $X$  corresponding to the peak of the probability density for the random variable. The mode is also called the most probable value of the random variable (e.g., most probable wave bending moment).



### Mean Square Value

The mean square value of a random variable  $X$  is defined by

$$E(x^2) = \int_{-\infty}^{\infty} x^2 f(x) dx$$

and its root-mean-square or r.m.s. value is simply  $\sqrt{E(x^2)}$ .

### Variance and Standard Deviation

The variance of the random variable  $X$  is defined by

$$\sigma^2 = E(x - \mu_x)^2 = \int_{-\infty}^{\infty} (x - \mu_x)^2 f(x) dx = E(x^2) - \mu^2$$

The standard deviation of the random variable is  $\sigma$ . The standard deviation is a measure of spread of the random variable about the mean value. Note that for a zero mean variable, the variance and the mean square value are numerically the same. This is approximately true for both waves and wave bending moment assuming linear first order theory holds.

### Coefficient of Variation

The coefficient of variation  $\delta$  of a random variable  $X$  is defined by

$$\delta = \frac{\sigma_x}{\mu_x}$$

where  $\sigma$  and  $\mu$  are the standard deviation and the mean value. The coefficient of variation is a non-dimensional measure of the spread of the random variable outcomes about the mean value. The coefficient of variation of wave heights and wave bending moments over a long period of time is expected to be high (80-100%). The coefficient of variation of the extreme values of these quantities over a short period of time in a severe sea state is much smaller (7-20%).

### Joint Probability Density Function

The joint probability density function of two random variables  $x_1$  and  $x_2$  defines the frequency of mutual occurrence of two random variables and has the following properties:

- 1)  $P[x_1 < X_1 \leq x_1 + dx_1 \cap x_2 < X_2 \leq x_2 + dx_2] = f(x_1, x_2) dx_1 dx_2$
- 2)  $P[a_1 < X_1 \leq b_1 \cap a_2 < X_2 \leq b_2] = \int_{a_2}^{b_2} \int_{a_1}^{b_1} f(x_1, x_2) dx_1 dx_2$
- 3)  $P[-\infty < X_1 < +\infty \cap -\infty < X_2 < +\infty] = \int_{-\infty}^{+\infty} \int_{-\infty}^{+\infty} f(x_1, x_2) dx_1 dx_2 = 1$

where  $\cap$  indicates the mutual occurrence (intersection) of two events.

A related joint distribution function defining cumulative probabilities may also be defined. The definitions may be extended to more than two random variables.

The joint density and distribution functions for random variables contain the occurrence probability and also correlation information.

### Covariance

The covariance of two random variables,  $X_1$  and  $X_2$  is defined as

$$\begin{aligned}\mu_{x_1, x_2} &= E\{[x_1 - E(x_1)][x_2 - E(x_2)]\} \\ &= \int_{-\infty}^{\infty} \int_{-\infty}^{\infty} (x_1 - \mu_{x_1})(x_2 - \mu_{x_2}) f(x_1, x_2) dx_1 dx_2 \\ &= E[x_1 x_2] - \mu_{x_1} \mu_{x_2}\end{aligned}$$

where  $\mu_{x_1}$  and  $\mu_{x_2}$  are the means of the individual random variables, and  $f(x_1, x_2)$  is their joint density function.

### Independent Random Variables

Two random variables  $X_1$  and  $X_2$  are independent if their joint density function is equal to the product of their individual densities

$$f(x_1, x_2) = f(x_1) f(x_2)$$

where  $f(x_1, x_2)$  is the joint density function and  $f(x_1)$  and  $f(x_2)$  are the individual (also called marginal) density functions. The outcomes of independent random variables occur without any reference to one another. Normally in reliability analysis, strength and load are considered independent random variables.

### Dependent Random Variables

Two random variables  $X_1$  and  $X_2$  are dependent if their joint density function is not the product of the marginal densities. The outcome of any one of the random variables is dependent on the outcome of the other, i.e., there is a correlation between the realization of one random variable and realizations of the other. For  $X_1$  dependent on  $X_2$ , the following is true:

$$f(x_1 / x_2) = \frac{f_{x_1 x_2}(x_1 / x_2)}{f(x_2)}$$

where  $f(x_1/x_2)$  is the conditional density,  $f(x_2)$  is a marginal density, and  $f_{x_1 x_2}(x_1 / x_2)$  is the joint density evaluated with  $x_1$  given  $x_2$ .

### Bounded Random Variables

The definitions of probability density and distribution functions given in this section assume that random variable outcomes lie in the interval  $-\infty < X < +\infty$ . Here, the bounds on the random variable are  $-\infty$  and  $+\infty$ . For some random variables, the upper and/or lower bounds may be different. For example, material yield strength is always a positive quantity, and its lower bound is zero. An upper bound on a load is sometimes used resulting in a truncated probability density function.

### Correlation Coefficient

The correlation coefficient  $\rho_{x_1, x_2}$  for two random variables  $X_1$  and  $X_2$  is defined by

$$\rho_{x_1, x_2} = \frac{\mu_{x_1, x_2}}{\sigma_{x_1} \sigma_{x_2}}$$

where  $\mu_{x_1, x_2}$  is the covariance of  $x_1$  and  $x_2$ , and the  $\sigma$  are the standard deviations. The correlation coefficient always lies between  $-1$  and  $+1$ . If the correlation coefficient is zero, the variable outcomes are uncorrelated. The correlation coefficient is a first order measure of dependence between outcomes of two random variables. A zero correlation is a weaker condition than independence. Non-correlated random variables are not necessarily independent, but independent random variables are necessarily uncorrelated. Positive correlation means that, in general, if the outcomes of one random variable increase, the outcomes of the other will also increase. Negative correlation means that the outcomes will generally be in opposite directions.

The wave bending moment is weakly correlated to the stillwater bending moment since both depend on the weight distribution along ship length.

### Conditional Probability and Bayes Theorem

A conditional probability is denoted  $P[A/B]$  when A is one event and B is another event on whose outcome A depends on. An example of a conditional probability is a probability of structural failure calculated for a given sea state. The actual lifetime probability of failure will be different if all the sea states are considered. Bayes' Theorem applies to conditional events. By Bayes' Theorem, the probability that event A occurs conditioned on the probability that event B has already occurred is given by

$$P(A/B) = \frac{P(A \cap B)}{P(B)}$$



where A and B are the event domains and  $A \cap B$  is their intersection, i.e., the outcome space that contains both A and B at the same time (mutual occurrence).

### Stationary Random Process

A random process is stationary if the probability density function of its outcomes does not depend on time, i.e., the same probability density function is obtained for an ensemble of realizations of the random process at any given time as at any other time. This also means that statistics that are dependent on the probability density function, e.g., mean and mean-square value, are also independent of time. The second order (joint) probability density function of the outcomes at two instants of time depends on the time lag between them and not on each individually. Time history of waves or wave bending moment are usually considered stationary over a short period of time (up to 3 hours).

### Ergodic Hypothesis

This states that a single sample function is quite typical of all other sample functions representing realization of a random process. Therefore we can estimate the various statistics of interest by averaging over time using the one realization rather than averaging over an ensemble of realizations. An ergodic random process is necessarily stationary. A stationary random process is not necessarily ergodic.

### Extreme Value

The extreme value of a random process is the largest value over a period of time. Each realization of the random process will have an extreme value. Thus there is also a distribution of extreme values, i.e., the extreme value is a random variable that has its own special distribution, mean value, variance, etc. One may speak, therefore, of extreme value distribution of wave heights or wave bending moments.

### Most Probable Extreme Value

This is the value of the random variable corresponding to the peak of the extreme value density function, i.e., the mode. Thus, the most probable extreme wave bending moment is the mode value of the extreme bending moment density function, i.e., the value of the moment at the peak of the density function.

### Asymptotic Distributions of the Extreme Value

The extreme value distribution for a random process with defined probability characteristics for the outcome (e.g., a Gaussian random process) is a function of time, or equivalently, the number of peaks within the time. As time or number of peaks increase,

the distribution of the extreme value shifts to the right. The asymptotic distribution corresponds to an infinite length of time or number of peaks. The asymptotic form of the extreme value distribution depends largely on the tail behavior of the "initial" distribution of outcomes of the random process. Gumbel showed that the asymptotic distribution takes one of three forms: a double exponential form, an exponential form and an exponential form with an upper bound.

### Order Statistics

The distribution of the largest peak (e.g., largest wave bending moment) in a sequence of N peaks of a random process can be determined using order statistics, assuming that the peaks are independent and identically distributed. The cumulative distribution function of the largest peak is given by

$$\begin{aligned} F_{Z_N}(Z) &= P[\max(z_1, z_2, \dots, z_n) \leq Z] \\ &= [F_z(z, \epsilon)]^N \end{aligned}$$

where  $F_z(z, \epsilon)$  is the initial cumulative distribution function of the peaks and  $\epsilon$  is the spectral bandwidth parameter. The corresponding probability density function is given by differentiating the cumulative distribution function:

$$f_{Z_N}(z) = N[F_z(z, \epsilon)]^{N-1} \cdot f_z(z, \epsilon)$$

where  $f_z(z, \epsilon)$  is the initial p.d.f. of the peaks.

### Expected Maximum Value:

The expected value (average) of the maximum peak (e.g., wave bending moment) in a sequence of N peaks of a zero mean Gaussian random process was determined by Cartwright and Longuet-Higgins, and is approximated by

$$\frac{E[\max(z_1, z_2, \dots, z_n)]}{\sqrt{m_0}} = \left[ 2 \ln(\sqrt{1 - \epsilon^2} N) \right]^{1/2} + C \left[ 2 \ln(\sqrt{1 - \epsilon^2} N) \right]^{-1/2}$$

where  $C = 0.5772 =$  Euler's constant. Here,  $m_0$  is the area under the power spectral density, i.e., the mean square value of the process.

It should be noted that the most probable extreme value (i.e., the mode) is given by the above equation, but with the second term on the right hand side deleted.

### Narrow Band Process

This is a random process whose time realizations are such that there is one peak between every upcrossing and every downcrossing of the mean level. Process "cycles" are thus discernible. The power spectral density function of the process realization has a central tendency, i.e., it is clustered about a central frequency. The peaks of a zero mean narrow band Gaussian random process have the Rayleigh distribution function given by

$$f_p(a) = \frac{a}{m_0} e^{-\frac{a^2}{2m_0}}; \quad a \geq 0$$

where  $m_0$  is the mean square value of the process, also equal to the area under the energy spectrum for the process.

Records of waves and wave bending moments over a short period of time (3 hours) are usually considered to be narrow-band processes.

### Average of Highest 1/m-th Value

This is the average value of the highest 1/m-th peaks in a random process. For a random process whose peaks are Rayleigh distributed,

$$\text{Average of 1/3 highest values} = 2 \sqrt{m_0}$$

$$\text{Average of 1/10 highest values} = 2.55 \sqrt{m_0}$$

$$\text{Average of 1/1000 highest values} = 3.85 \sqrt{m_0}$$

where  $m_0$  is the mean square value of the process. The multipliers shown are for amplitudes rather than heights (double amplitudes). The average of 1/3 highest values is also called the significant value. These multipliers may be used for waves and wave bending moments and may err slightly on the conservative side.

## 7.2 Strength

The following terms related to strength are now defined: failure modes, limit state function, and ultimate, serviceability and fatigue limit states. Limit state exceedence probability is then defined, and contrasted to the probability of failure. Also in this section, terminology related to the classification of uncertainties is given. Some of this

terminology is general, but their use is relevant to strength variability, and illustrated with strength parameters. System failure modeling is also considered in this section.

#### Failure Mode:

A failure mode refers to a particular physical mechanism by which a structure or a part of it fails. Failure modes for ships address plastification, buckling, fatigue and fracture. As an example, buckling failure modes include plate buckling, stiffener flexural buckling, stiffener tripping, and overall buckling of the gross panel.

#### Ultimate Limit State:

The ultimate limit state considers structural performance or safety margin under extreme (typically lifetime maximum) loads. The ultimate limit state can be further decomposed into two modes of failure:

- a. Failure due to spread of plastic deformation, e.g., as predicted for beams by plastic limit analysis. The initial yield moment for a beam can also be classified under this category.
- b. Failure due to instability or buckling, e.g., of panel longitudinal stiffeners in the flexural and tripping modes, or the overall "grillage" buckling of a gross panel consisting of longitudinal and transverse stiffeners.

#### Serviceability Limit State:

The serviceability limit states are associated with constraints on the marine structure in terms of functional requirements such as the maximum deflection of a member or critical buckling loads that cause elastic buckling of plating.

#### Fatigue Limit State:

The fatigue limit state is associated with the damaging effect of repeated loading which may lead to a loss of specific function or to ultimate collapse. Fatigue limit state capacity for structural details is typically defined using S-N curves, while the demand is defined in terms of the lifetime stress range versus number of cycles histogram.

#### Limit State Function:

This is a function, often denoted  $G(\underline{X})$  where  $\underline{X}$  is a vector of basic variables, that characterizes the safety margin in a given mode of failure. A simple limit state function may be

$$G(\sigma_y, \sigma) = \sigma_y - \sigma$$

where  $\sigma_y$  is the yield strength of the material, and  $\sigma$  is the load effect (stress). Note that limit state exceedence ("failure") implies

$$G \leq 0$$

Limit state functions are traditionally formulated in this capacity minus demand form. The basic variables in the limit state equation are random because of inherent variability or model uncertainties.

### Limit State Exceedence Probability

The probability of reaching or exceeding a specified limit state is determined from

$$p_r = \int_F f_{\underline{x}}(\underline{x}) d\underline{x}$$

where  $f_{\underline{x}}(\underline{x})$  is the joint probability density function of the basic variable vector  $\underline{X}$ . The domain of integration  $F$  is over the unsafe region of the limit state function where demand exceeds capability. The integral is multi-fold. In terms of the limit state equation, the domain of integration is defined by  $G(\underline{x}) \leq 0$ . To the extent a limit state equation may address local phenomena, e.g., yield at a point, serviceability, e.g., deflections, etc. in addition to catastrophic events, interpreting the limit state exceedence probability as the probability of "failure" of the structure should be done with care.

It should also be noted that limit state exceedence probabilities calculated are often conditional on certain environmental events, e.g., occurrence of a certain severe storm.

### Probability of Failure

Although actuarially speaking, this should refer to the probability that the structure catastrophically fails, the term is generally and widely used as a substitute for limit state exceedence probability, i.e., the probability that the demand exceeds the capability in any given limit state (including exceedence of deflection and elastic buckling stress).

### Uncertainty Classification

Uncertainties which contribute to the variability of physical strength parameters may be classified as

- inherent uncertainties
- model uncertainties

They may also be classified as subjective and objective uncertainties. The classifications while illustrated here with strength parameters, are also relevant to loads and load models.

### Objective Uncertainties

These are uncertainties associated with random variables for which statistical data can be collected and examined. They can be quantified by a mean, a coefficient of variation, and a form of the probability distribution function derived from available statistical information. The variability in the yield strength of steel is an example.

### Subjective Uncertainties

These are uncertainties associated with the lack of information and knowledge. They are typically quantified on the basis of the engineer's prior experience and judgement. Examples of these include assumptions in the analysis, error in the design model, and empirical formulae. The following subjective uncertainties contribute to strength variability:

- a) Effectiveness of plating, e.g., due to shear lag
- b) Use of Navier hypothesis in calculating hull girder response
- c) Initial deformation and residual stress effects

### Inherent Uncertainties

This kind of uncertainty is inherent to the variable, and cannot be reduced because of additional information. This is a term that in many cases may involve the same sources as "objective" uncertainties. Examples are the inherent variability of wave heights, extreme wave bending moment or the variability in yield strength.

### Model Uncertainties

These uncertainties arise because of errors in the prediction models as they represent reality. They can be reduced with additional information. Model uncertainties are typically estimated based on comparing the analysis procedure with experimental data, or in some cases using professional judgement or other indirect information such as the non-occurrence of cracks in relation to expectation. Some sources of model uncertainties are described under "subjective uncertainties". The largest model uncertainty in marine

structures usually relates to loads such as slamming loads. Strength prediction techniques (e.g., for buckling strength) also have their own model uncertainties. This type of uncertainty is usually quantified in terms of a bias (i.e., actual value to predicted value ratio) and a coefficient of variation.

### Structural System Modeling

The behavior of a structure that can fail in more than one mode of failure is modeled for structural reliability evaluation purposes using structured representations of system behavior. Series, parallel or general system representations are usual. A general system representation may take the form of a cut set (parallel subsystems connected in series) representation or a link set (series subsystems connected in parallel) representation. Failure tree representations are also possible. Reference is made to [6].

#### Series System:

A series system is one that is composed of links connected in series such that failure of any one or more of these links constitute a failure of the system, i.e., "weakest link" system. In the case of the primary behavior of a ship hull, for example, occurrence of any one of a number of modes of failure will constitute failure of the hull. The multiple failure modes can then be modeled as a series system.

#### Parallel System

In a parallel system, all links along the failure path must fail for the structure to fail. An example is a multicomponent redundant structure such as a fixed offshore platform, in which a failure path is the failure of a group of members which leads to system collapse. The failure event resulting from one failure path can be modeled by a parallel system.

Since there typically are many different failure paths, each represented by a parallel system, and since failure can occur in any one of the failure paths, the entire system can be modeled as a giant series system with parallel subsystems, each representing a failure path.

## **7.3 Structural Reliability**

In this section, we consider terminology related structural reliability, reliability methods, and probabilistically based structural design codes.

### Reliability

This is the complement of the probability of failure  $p_f$ , i.e., reliability is the probability of survival, given by  $1 - p_f$ .

### Safety Margin

This is the difference between capacity and demand, or strength and load. Either mean or characteristic values may be used to determine the safety margin.

### Level I, II and III Reliability Methods

The basic concept of Level III reliability methods is that a probability of failure of a structure always exists, and may be calculated by integrating the joint probability density function of the variables involved in the load and strength aspects of the structure. The domain of integration is the unsafe region defined by the variables.

Because of the difficulties involved in determining the joint density function and in calculating the multiple integration, Level II methods for obtaining the safety index and the related probability of failure were introduced. In Level II methods, the probability content of the failure domain is obtained using approximations to the failure surface. FORM and SORM, described elsewhere, are Level II methods. Primarily because of the approximations made to the failure surface, and also because of approximations involved in the inclusion of distribution information, the probabilities of failure calculated from Level II methods are not exact. However, the methods are very efficient and usually a good approximation is obtained.

Level I refers to safety factor based design formats that are very similar to traditional design formats and safety check equations, except that the safety factor(s) are obtained on the basis of Level II methods to assure a certain target reliability level.

### Safety Index:

The safety index is a number that is inversely related to the probability of failure. The safety index  $\beta$  and the probability of failure are related by

$$p_f = \Phi(-\beta)$$

where  $\Phi$  is the standard normal distribution function. A safety index of 2.3 translates roughly to a probability of failure of 1/100, 3.1 to 1/1000, and 3.7 to 1/10000. A safety index of zero corresponds to a probability of failure of 0.5.



### Hasofer-Lind Safety Index

In the history of structural reliability theory, there have been several definitions of the safety index, some fell from favor because of a problem known as lack of invariance. By this, it is meant that mechanically different limit state functions representing the same physical failure mode resulted in different values of the safety index. The Hasofer-Lind index does not suffer from the lack of invariance problem.

### First Order Reliability Method (FORM)

The essential steps in this method of reliability analysis for the determination of the probability of failure are:

- a) The basic correlated random variables  $\underline{X}$  defining the limit state function  $G(\underline{X}) = 0$ , with prescribed probability distributions, are transformed to a set of independent standard normal variables  $\underline{U}$ .
- b) The limit state surface  $g(\underline{U})$  in the standard normal space is approximated by its tangent hyperplane at the point of the limit surface closest to the origin. This point has the highest probability density, and is called the design point or the most probable failure point.
- c) The probability content within the linearized failure domain is found as an estimate of the actual failure probability. The FORM probability of failure is

$$p_f = \Phi(-\beta)$$

where  $\beta$  is the reliability index, which is also the distance of the design point from the origin in the  $u$  space. The FORM reliability index is invariant for mechanically different limit state functions representing the same failure event.

### Rackwitz-Fiessler Transformation

In calculating the safety index, it is necessary to include information related to the form of the distribution of the basic variables. The tail of the distribution of the random variables is usually the location where most of the contribution to the probability of failure comes from. In the Rackwitz-Fiessler transformation, an equivalent normal distribution is fitted to the tail of the nonnormal distribution at the most likely failure point (design point). The method requires the cumulative distributions and the

probability density function of both the actual distribution and the normal distribution be equal at the design point.

### Second Order Reliability Methods (SORM)

In SORM, the essential steps are similar to FORM, except that the limit state surface in the standard normal "u" space is approximated by a second order approximation such as a hyperparaboloid fitted with its apex at the design point. The failure domain probability content within the second order approximation is then estimated. For hyperparaboloids, the probability content can be "exactly" estimated.

### Safety Check Equation

In structural design, the performance of the structure is checked using safety check equations. In the working stress approach for fixed offshore platforms as embodied in API RP-2A Recommended Practice, for example, the maximum or yield strength is divided by a safety factor to obtain an allowable stress. Designs are then limited so that the maximum calculated stress under extreme operating loads does not exceed the allowable value. This example safety check is of the form

$$\frac{R}{SF} \geq D + L + W + \text{other load effects}$$

where R = nominal component strength

SF = safety factor

D = nominal gravity loads on components

L = nominal live load effects on components

W = nominal environmental load effects on components

Nominal loads are all combined with factors of one, and constant safety factors 1.67 and 1.25 are used for operating and extreme loadings. There are typically many safety check equations to be satisfied in a design, each of which addresses a different failure mode or design concern.

### Partial Safety Factor Format

A safety check equation in a partial safety factor format employs multiple safety factors, which may address uncertainties in component loads, resistance, and also failure consequences, non-coincidence of peak loads from different sources, etc. Because there is more than one safety factor employed, the format is more efficient in that factors of

safety are placed in a manner more commensurate with individual demands and uncertainties. Also, the partial safety factors are usually obtained using Level II reliability methods, consistent with a required target reliability level.

A sample partial safety factor format is that recommended in the Load and Resistance Factor (LRFD) version of API RP-2A. This is given by

$$\Phi_{R_i} R_i > \gamma_D D + \gamma_L L + \gamma_W W + \dots$$

- where  $R_i$  = nominal strength or resistance of component i
- $\Phi_{R_i}$  = partial resistance factor for component i
- D = nominal gravity or dead load effect
- $\gamma_D$  = load factor for dead load
- L = nominal live load effect
- $\gamma_L$  = load factor for live load
- W = nominal environmental effect with prescribed return period
- $\gamma_W$  = load factor for environmental load

Each resistance factor  $\Phi_{R_i}$  is calculated as a product of two factors, one representing strength uncertainty, and the other taking into account the consequence of failure of the component and the structural system. The load factors  $\gamma$  are also calculated as a product of two factors, one representing uncertainty in load intensity, and the other, uncertainty in the related analysis procedures.

A partial safety factor format is a Level I reliability based format if the safety factors employed are obtained from reliability analysis with a prescribed target reliability.

#### Nominal or Characteristic Values

Traditionally in structural design, nominal or characteristic values are used for the basic design variables appearing in safety check equations. For loads, characteristic values on the high side of the mean are typically used, while for resistance, characteristic values on the low side of the mean are used. Thus for example, in ship design, safety check equations involving yield strength use the rule minimum yield, which typically is about 15% lower than the mean value. The terms "characteristic" and "nominal" are interchangeable, but an occasional distinction appears in the literature where a characteristic value refers to a nominal value that is selected on the basis of a probability. For example, the characteristic yield strength may be a 5-percentile value, i.e. there is a 95% chance that the actual yield strength is greater than the characteristic value.

### Code Calibration

This is the process of selecting a target reliability level and a corresponding set of partial safety factors for use in a probability based design code. Reliability analyses of comparable past experience (existing structures, and systematic structural designs to traditional codes) are useful in the code calibration process.

### Code Optimization

This is the process of selecting partial safety factors for use in probabilistically based safety check equations in such a manner that the scatter in the reliability of structures built to the code is minimized, and centered around the target value.

## 8. Extrapolation Techniques for Design Loads

In this chapter, extrapolation techniques for determining lifetime extreme wave loads for design are identified. For purposes of discussion, a stochastic wave load process is considered. The effective wave loads give rise to stress at a point, which include stresses arising from hull girder bending in two planes, torsion, external pressure, internal tank loads, etc. with proper accounting of phasing.

Extrapolation techniques for the wave load effect are first considered. The definition of design loads is subsequently investigated.

### 8.1 Identification of Techniques

There are two broad classes of techniques for the determination of the maximum wave induced load over the vessel design life. These are:

- a) Short term techniques, in which the short term statistical characteristics of the wave load process in a storm condition are used to obtain the distribution of the extreme load, and a characteristic design load.
- b) Long term techniques, in which the long term distribution of the wave induced load is obtained. That distribution includes within it all load peaks possible considering every seastate. A characteristic design load is then defined based on the long term distribution.

The essential difference between the two classes of methods is that in the short term approach, the extreme load distribution in a few high seastates is separately obtained for each, and the characteristic design load is typically taken as the largest among values for the various seastates, while in the long term approach, the design load corresponds to a given exceedence probability (e.g.,  $10^{-8}$ ) on the long term distribution. These two classes of techniques are now described.

#### 8.1.1 Short Term Wave Load Extrapolation

If the wave loads acting on a vessel can be represented as a stationary Gaussian random process, which is usually an adequate assumption over the duration of a seastate lasting a few hours, then at least two types of methods are available to predict the

distribution of the maximum load. These two methods, among others, are described in detail by Mansour in [6]. In the first method, the peaks are assumed to be statistically independent and identically distributed, and the distribution of the largest peak in N-peaks is determined using classical order statistics. In the second, conventional upcrossing analysis is used for determining the extreme value distribution.

#### A. Distribution of largest peak by order statistics

The distribution of the largest peak in a sequence of N-peaks can be determined using standard order statistics. Consider a sequence of random variables,  $z_1, z_2, \dots, z_n$  representing the peaks of a load on a marine structure. Assuming that these peaks are identically distributed and statistically independent, the cumulative distribution function of the largest one is given by

$$\begin{aligned} F_{z_N}(z) &= P[\max(z_1, z_2, \dots, z_n) \leq z] \\ &= [F_z(z, \epsilon)]^N \end{aligned}$$

where  $F_z(z, \epsilon)$  is the initial cumulative distribution function of the load peak (maxima) and  $\epsilon$  is the spectral bandwidth parameter defined from

$$\epsilon^2 = 1 - \frac{m_2^2}{m_0 m_4}$$

$$m_n = \int_{-\infty}^{+\infty} \omega^n S(\omega) d\omega; \quad n = 0, 2, 4$$

Here,  $\omega$  is the radian frequency. The probability density function (pdf) of the largest peak is determined by differentiating the c.d.f. with respect to  $z$ , thus

$$f_{z_N}(z) = N[F_z(z, \epsilon)]^{N-1} \cdot f_z(z, \epsilon)$$

where  $f_z(z, \epsilon)$  is the initial p.d.f. of the load peaks. For an arbitrary bandwidth process, the initial distribution of peaks within a short term seastate, considering positive maxima alone, has been derived by Ochi (J. Ship Research, 1973). For a definition of positive and negative maxima and positive and negative minima, see Figure 8.1. In the narrow banded case, the conventional Rayleigh density and distribution functions apply.

Based on the Ochi distribution and order statistics, it can be shown that the modal value, i.e., the most probable maximum load in N-peaks is approximated by

$$\frac{\tilde{E}[\max(z_1, z_2, \dots, z_n)]}{\sqrt{m_0}} = \left[ 2 \ell_n \left\{ \frac{2\sqrt{1-\epsilon^2}}{1+\sqrt{1-\epsilon^2}} N \right\} \right]^{\frac{1}{2}}$$

The approximation was derived by Ochi considering large N and  $\epsilon \leq 0.9$ . It can be shown that there is a 63% chance that the largest response will exceed the modal value. Other percentile values of the extreme value distribution were also obtained by Ochi, in terms of a "risk parameter"  $\alpha$ . He chooses a very small number,  $\alpha$  (e.g., 0.01) and obtains a non-dimensional extreme value  $\hat{\xi}_N$  such that

$$P \left[ \begin{array}{l} \text{Extreme value of maxima} \\ \text{in N peaks} \end{array} > \hat{\xi}_N \right] = \alpha$$

For  $\epsilon \leq 0.9$ , N large, and  $\alpha$  small, it can be shown that

$$\hat{\xi}_N = \sqrt{2 \ell_n \left( \frac{\sqrt{1-\epsilon^2}}{1+\sqrt{1-\epsilon^2}} \frac{2N}{\alpha} \right)}$$

The dimensional extreme value is equal to the non-dimensional extreme value multiplied by  $\sqrt{m_0}$ .

## B. Extreme value distribution based on upcrossings

The distribution of the largest peak can be determined from upcrossing analysis of a time history of a stationary random process instead of the peak analysis described above. Principles behind the upcrossing analysis are described by Mansour (Ship Structure Committee Report 351) and will not be repeated here. The essential problem is one of determining the first passage of a random process  $x(t)$  of a level "a" within a given time interval T. Based on a level crossing analysis, assuming that the individual level arrivals are independent and Poisson distributed, it can be shown that the cumulative distribution function of the largest x value, denoted Z, is

$$F_Z(a) = \exp(-v_x(a) T)$$

where  $v_x(a)$  is the expected number of level crossings per unit time. This is given by

$$v_x(a) = v_0 \exp\left(-\frac{a^2}{2m_0}\right)$$

In the above,  $v_0$  is the zero crossing rate, which for a narrow band process, is

$$v_0 = \frac{1}{2\pi} \sqrt{\frac{m_2}{m_0}}$$

The above cumulative distribution function for the largest value ignores the tendency for upcrossings to occur in clumps, because of the assumption of independence. The solution overpredicts extreme values. To consider clumping, an upper bound envelope to the given process can be constructed, and the first passage probability for the envelope process obtained. The upcrossing rate  $v_R(a)$  for the envelope of a Gaussian process is given in standard structural reliability textbooks as

$$v_R(a) = \sqrt{2\pi} \sqrt{1 - \frac{m_1^2}{m_0 m_2}} \frac{a}{\sqrt{m_0}} v_x(a)$$

In general, this upcrossing rate will not lead to a decreased bound, since the envelope may have excursions above the level without there being actual process upcrossings. Such crossings are termed "empty", while otherwise they are called "qualified" upcrossings, a terminology devised by Vanmarcke (ASME, J. Applied Mechanics, March 1975). Vanmarcke obtained an estimate of qualified excursions, which was later refined using a Slepian regression model by Ditlevsen and Lindgren (J. Sound and Vibration, 1988).

To date, the Ditlevsen and Lindgren solution is the best available. Based on it, the cumulative distribution function of the maximum value for an ergodic Gaussian narrow band wave load process becomes (Cramer and Friis Hansen, "Stochastic Modeling of the Long Term Wave Induced Responses of Ship Structures," submitted to Journal of Marine Structures):



$$F_z(a) = \left[ 1 - \exp\left(-\frac{a^2}{2m_0}\right) \right] \exp\left[ \frac{\tau_{r_v}(a) v_R(a)}{1 - \exp\left(-\frac{a^2}{2m_0}\right)} \right]$$

where  $v_R(a)$  was previously defined, "a" is the level value, and  $\tau_v(a)$  is given, for moderate spectral skewness, from

$$1 - r_v(a) = 2 \int_0^u \phi(\eta) \left[ 1 - \sqrt{2\pi} \frac{\Phi\left[\gamma_2 \pi \frac{u^2 - \eta^2}{u}\right] - \frac{1}{2}}{\gamma_2 \pi \frac{u^2 - \eta^2}{u}} \right] d\eta$$

where

$$\gamma_2 = \sqrt{\frac{m_0 m_2}{m_1^2}}; \quad u = \frac{a}{\sqrt{m_0}}$$

The extreme value analysis based on the upcrossing rate, as obtained above, provides a cumulative distribution function of the extreme value, accounting for clumping of peaks. It is derived for a narrow band ergodic Gaussian wave load process, although based on simulation comparisons, it seems applicable to relatively wide band processes also. It is worth stating that the probability density function of the maximum value has not been obtained.

### C. Calculation of the short term extreme values

Short term extreme values based on the peak or level crossing analyses are calculated seastate by seastate for several extreme wave conditions. Within a seastate, the extreme values depend on (are conditional on) vessel heading and speed. Typically in treating low frequency wave induced loads, the speed within a seastate is assumed constant and extreme values conditional on different wave headings are obtained. The extreme value for the seastate is obtained by unconditioning with respect to vessel headings, i.e., the wave load extreme values for each heading are multiplied by the heading probabilities

and added. The largest characteristic extreme load among all seastates considered may be used as a design load.

### 8.1.2 Long Term Wave Load Distributions

In the long term approach to the entire density or distribution function of the wave induced load is obtained, considering the following:

- (i) Frequency of occurrence of various sea states.
- (ii) Frequency of occurrence of various spectral shapes within each sea condition.
- (iii) Ship route and frequency of encountering each seastate and spectral shape.
- (iv) Frequency of occurrence of various vessel headings.
- (v) Frequency of occurrence of various vessel speeds.
- (vi) Frequency of occurrence of various ship loading conditions.
- (vii) The expected number of load cycles for a given sea, wave spectral shape, speed and heading.

The consideration of various spectral shapes within a seastate is characteristic of some procedures based on seastate groups, where the seastates possible in the long term are grouped into a small number of "weather groups". An example will be given later.

Taking the various factors noted into consideration, the probability density function of the load peaks applicable to the long term response can be written for each ship loading condition as:

$$f(x) = \frac{\sum_i \sum_j \sum_k \sum_l n_* P_i P_j P_k P_l f_*(x)}{\sum_i \sum_j \sum_k \sum_l n_* P_i P_j P_k P_l}$$

where  $f_*(x)$  is the probability density function for the load peaks in the short term, and  $n_*$  is the associated number of peaks per unit time. For a narrow band process,  $n_*$  is obtained based on the Rayleigh density for peaks in the short term, as

$$n_* = \frac{1}{2\pi} \sqrt{\frac{m_2}{m_0}}$$

The weighting factor  $p_i$  represents the expected occurrence probability for the sea condition,  $p_j$  for the wave spectrum shape,  $p_k$  for headings in waves in a given sea and spectrum shape, and  $p_l$  for speed in a given sea, spectrum shape and heading. The total number of responses expected during the vessel life then becomes

$$N_T = \sum_i \sum_j \sum_k \sum_l (n_* p_i p_j p_k p_l) \times T \times 60^2$$

where  $T$  is the total sea exposure time in hours. The formula for the probability density function and the total number of cycles applies to wide band short term processes also, with  $n_*$  and  $f_*(x)$  appropriately calculated. The cumulative distribution function of the wave load in the long term is also similarly obtained.

It is worth reiterating that in the long term approach, distribution and density functions in the long term are obtained by weighting and adding the short term density and distribution functions. The short term density and distribution functions corresponding to the peaks (e.g., Rayleigh distribution) are generally used. For the long term distribution thus obtained, the probability scale includes each peak or load cycle. The load corresponding to a  $1/N_T$  exceedence level is often used as the design load. If  $N_T \cong 10^8$ , as is the case in merchant ships, the exceedence level is  $10^{-8}$ , and the corresponding "10<sup>-8</sup> load" is used as a design load.

### The Weather Group Approach

In the typical long term approach, a wave scatter diagram for the long term is used. Each bin in the scatter diagram characterizes a seastate defined by a significant wave height, a spectral period, and an associated occurrence probability. In calculating the wave loads, one analytical seaspectrum such as that due to Bretschneider or ISSC, is used for each bin of the scatter diagram.

In an alternate approach, the long term wave environment is discretized into weather groups, with associated probabilities. For the average North Atlantic, Lewis in 1967 suggested the following weather groups and associated frequencies of occurrence:

$H_{1/3}^-$ , feet	% occurrence
10	84.54
20	13.30
30	2.01
40	0.14
48.2	0.01

In each weather group, more than one preselected wave spectrum (typically about 10) must be used for the short term wave load calculations. The spectral forms used are typically based on measurements, and represent a range of wave peak frequencies. The long term distribution is constructed from the short term distributions. In the process, some weather group methods may assume each spectral form within a weather group to have predefined probabilities of occurrence. Others may use additional (predefined) information on the spread of short term mean square values within a weather group.

The weather group approach may also be termed a "spectral family" approach. Spectral families for the North Atlantic, which is the design wave environment for merchantships, have also been provided by Ochi, SNAME Transactions, 1978. A weathergroup approach based on wave spectral measurements in the North Atlantic is used by the American Bureau of Shipping for vessel structural assessment for unrestricted service.

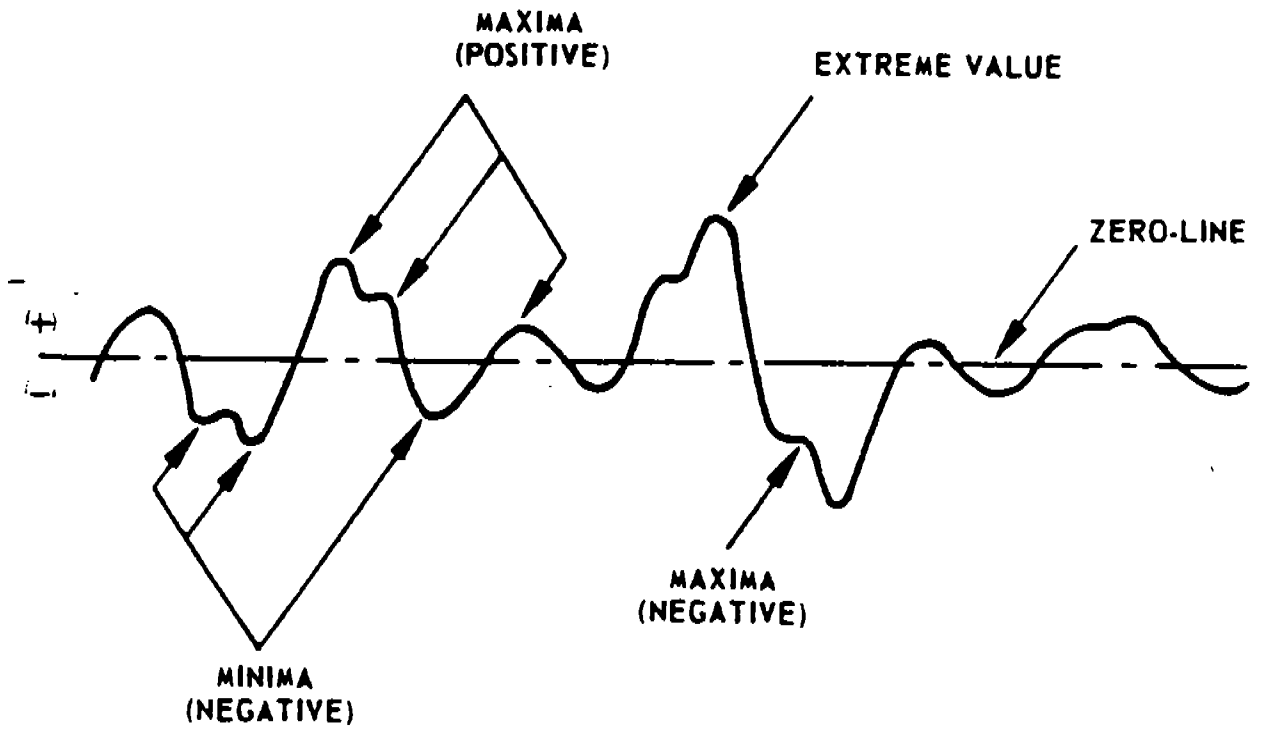


Fig. 8.1 Explanatory Sketch of a Random Process

## 8.2 Determination of Design Loads

Methods for the extrapolation of wave induced load were considered in the previous section. In this section we consider how design loads are defined. There essentially are two possible criteria for the definition of design loads. These are to

- a) Select the loads such that a certain level of exceedence is acceptable on the basis of either short or long term procedures.
- b) Select the loads such that the structural reliability level considering one or more limit states is acceptable.

We illustrate the two procedures considering a stillwater load, a wave induced load and a strength variable. The problem of treating combined loads for the same purpose of identifying design loads is an advanced one, and is in fact part of a ship structure committee research project on Load Combinations, SR-1337. Our more basic treatment considers the stillwater load, wave load and strength to be independent of one another.

### 8.2.1 Selection of Maximum Load Effect for Design

With a single wave load present, there is a one to one correspondence between the load and the load effect. In this context, the stillwater load is not specifically considered. Because it is essentially constant over voyages that last days or a month, its inclusion or consideration does not pose a difficult problem. The only question to be answered, then, is how to determine the maximum expected wave load in the lifetime of the vessel. Such load is pertinent to structural design for extreme loads.

We previously described two methods for obtaining the distribution of the largest wave load peak, either by using order statistics or by level crossing analysis. These two classes of methods apply to a short term, i.e., seastate by seastate analysis. We also described methods for the construction of the long term wave load distribution, considering every load peak in each seastate. The following are the typical ways of defining the extreme wave load for design, based on the above approaches:

#### Short Term Analysis:

In design, the largest wave load is defined considering the most probable value of the wave load distributions in each possible seastate. The number of short term wave load peaks  $N$  is computed from the zero crossing period for each seastate. The design wave

load is the largest among the set of short term most probable extreme wave loads for the selected seastates.

The seastates should be selected on the basis of an acceptable return period and/or acceptable probability of the ship encountering such seastates. The latter depends on the operational life and the route of the ship. Reference [6] describes techniques for computing probability of encountering a seastate of a specified return period, as well as techniques for determining a seastate with a specified return period based on wave data.

### Long Term Analysis

In this method, the design value is taken to be the largest wave load with an exceedence probability of  $1/N$ ,  $N$  being the total number of wave load peaks. In calculating  $N$ , and in obtaining the long term distribution, each wave load peak possible is considered. If the total number of load peaks is  $10^8$  in 20 years, for example, the design value is the  $10^{-8}$  exceedence level value from the long term distribution. This value is said to occur once in the lifetime of the vessel.

While not usual, risk parameter can also be included in the long term approach. The design value of the wave load,  $\hat{Z}_N$ , is then determined such that

$$1 - F(\hat{Z}_N) = \frac{\alpha}{N}$$

where  $\alpha$  is the risk parameter, e.g., 0.01,  $N$  is the total number of cycles (i.e., wave load peaks) in the long term, and  $F(Z_N)$  is the cumulative distribution function of the long term wave load.

### 8.2.2 Design for a Target Reliability Level

Probabilistic methods provide a mechanism for obtaining extreme design loads for a structure with the required target reliability or failure probability. The design safety check equation for the limit state may take the conceptual form

$$\phi \quad C \geq \gamma_s D_s + \gamma_w D_w$$

where  $\phi$  is the strength partial safety factor, and  $\gamma_s$  and  $\gamma_w$  are the still water and wave load partial safety factors. The  $C$ ,  $D_s$  and  $D_w$  are characteristic values of the strength, still water and wave loads. The seastate that defines  $D_w$  was previously identified. The problem is then one of determining  $\phi$ ,  $\gamma_s$  and  $\gamma_w$  considering the uncertainties in strength

and loads, such that a target reliability level is achieved. Level 1 reliability methods can be used in this process. The derivation of the partial safety factors associated with each design variable, including the loads, for a target reliability level is described in Part 1 of this report. For additional discussion of such procedures, the reader is referred to Mansour [6].



## 9. Serviceability Limitstates

This chapter pertains to identification and description of important serviceability limit states. By definition, a serviceability limit state is associated with constraints on the structure in terms of requirements such as maximum deflection of a member, critical buckling loads that cause elastic buckling of a plate element, or local cracking due to fatigue. The limit state manifestations are typically of aesthetic, functional or maintenance concern, but do not normally lead to overall collapse. The following serviceability limit states are now considered.

- (a) serviceability limit state associated with critical buckling stresses
- (b) serviceability limit state associated with fatigue

### 9.1 Serviceability Limit State for Plate Buckling

Plate elements in a ship hull, such as between longitudinals, can buckle under applied loads in either the linear elastic or inelastic range of material behavior. A plate that buckles in the linear elastic regime will essentially regain its original configuration when unloaded. On the other hand, a plate that buckles in the inelastic regime may suffer some permanent set upon unloading. The applied stress that defines the lower limit of the inelastic regime is that corresponding to the material proportional limit. Thus the so-called inelastic regime includes nonlinear elastic and plastic behavior.

Buckling of plate elements in the linear elastic regime is generally acceptable in longitudinally framed vessel hulls, although it is rare that the designer intentionally designs the structure to behave so. The major exceptions to this occur in passenger vessels and car carriers where the plating on decks above the weather deck from stress considerations alone can be relatively thin, their main function being to provide the required weather and water-tightness. In such cases, it is efficient for the designer to allow linear elastic plate buckling to occur, the result being a lighter structure than would otherwise be the case, and also less topside weight.

Depending on the philosophy of the profession and the organizations, buckling of plate elements in the inelastic regime may or may not be allowed, the primary consideration being aesthetic. From a material utilization point of view, plate thicknesses can be reduced if an amount of permanent set is allowed.

In discussing serviceability limit states involving plate buckling in longitudinally framed vessels, the following nomenclature is adopted: The plate long dimension

(length) is assumed to be parallel to the x axis, or the vessel longitudinal direction, and is labeled "a". The plate width or small dimension is taken parallel to the y axis or vessel transverse direction, and is labeled "b". The plate aspect ratio a/b is always larger than or equal to unity. The plate thickness is denoted "t". The plate element is considered under uniform inplane compression, either in the longitudinal direction (the so-called long plate case) or in the transverse direction (the so-called wide plate case). Another load case considered is the plate under uniform edge shear. The serviceability limit state is reached when the applied stress equals  $\sigma_e$  or  $\sigma_p$ , where the limit  $\sigma_e$  applies in the linear elastic range, and  $\sigma_p$  applies in the inelastic range.

### Uniform Compression

For long plate compression,

$$\sigma_{CR} = k \frac{\pi^2 E}{12(1-\nu^2)} \left(\frac{t}{b}\right)^2$$

where  $k = 4$  for simply supported edges. For other edge conditions, the buckling coefficient K can be obtained from the attached Figure 9.1. If  $\sigma_{CR} \leq \sigma_{PL}$ , the proportional limit,

$$\sigma_e = \sigma_{CR}$$

Otherwise,

$$\sigma_p = \frac{\sigma_y \sigma_{CR}^2}{\sigma_{PL} (\sigma_y - \sigma_{PL}) + \sigma_{CR}^2}$$

In the above,  $\sigma_y$  is the material yield strength.

For wide plate compression,

$$\sigma_{CR} = k \frac{\pi^2 E}{12(1-\nu^2)} \left(\frac{t}{b}\right)^2$$

where  $k = \left(1 + b^2/a^2\right)^2$  for simply supported edges. If  $\sigma_{CR} \leq \sigma_{PL}$ , the following applies.

$$\sigma_e = \sigma_{CR} .$$

Otherwise,

$$\sigma_p = \sigma_y - \frac{\sigma_{FL}(\sigma_Y - \sigma_{FL})}{\sigma_{CR}}$$

### Edge Shear

The critical buckling stress is given by

$$\tau_{CR} = k \frac{\pi^2 E}{12(1-\nu^2)} \left(\frac{t}{b}\right)^2$$

where

$$k = 5.34 + 4\left(\frac{b}{a}\right)^2$$

for simply supported edges. If the edges can be considered clamped, the buckling coefficient  $k$  takes the form

$$k = 8.98 + 5.6\left(\frac{b}{a}\right)^2$$

In the linear elastic range, that is, if  $\tau_{CR} \leq \sigma_{FL}/\sqrt{3}$ ,

$$\sigma_e = \tau_{CR}$$

Otherwise, the limit stress is

$$\sigma_p = \frac{3\tau_y \tau_{CR}^2}{\sigma_{FL}(\sigma_Y - \sigma_{FL}) + 3\tau_{CR}^2}$$

where  $\tau_y$  is the shear yield stress, equal to  $\sigma_Y/\sqrt{3}$ .

The above solutions defining the serviceability limit states under uniform edge compression or shear are based on classical buckling theory. Further reference is made to [8]. The limit stresses beyond the proportional limit are based on tangent modulus corrections due to Bleich. The interested reader is referred to Bleich's book on "Buckling Strength of Metal Structures", published by McGraw Hill, 1952. With a tangent modulus correction  $\eta$  included, the limit stress can be written in the following form:

$$\sigma_p = k \frac{\pi^2 E \eta}{12(1-\nu^2)} \left(\frac{t}{b}\right)^2$$

where  $\eta = f(E_t, E)$ ,  $E_t$  being the tangent modulus. The functional relationships defining  $\eta$  are different for the long plate, wide plate and shear cases. Hence the corresponding  $\sigma_p$  are also of different forms.

## 9.2 Serviceability Limit State for Fatigue

The fatigue limit state is associated with the damaging effect of repeated loading which may lead to loss of a specific function, maintenance costs, and in certain cases to ultimate collapse. That fatigue cracks in ships are more a maintenance than a safety concern is essentially due to the ductility of ship steels. Fatigue cracks do occur in complex structures, and design against fatigue (i.e., procedures to limit fatigue cracking to acceptable levels) is important.

There are various possible ways of computing the fatigue damage in a vessel subject to a specified long term wave environment. According to [6], the different methods may be classified as those based on

- (a) wave height history
- (b) stress range history
- (c) the entire scatter diagram

This method of classification, further explained in the attached Figure 9.2, is based on the level of detail in the treatment of the environment. Other types of classification are also possible, e.g., S-N curve based methods as opposed to fracture mechanics based methods, design stage methods in contrast to design checking methods, and so on. The formulation of the fatigue limit state will depend on the details of the method used. In this section, the formulation described is the one used in section 4.2.3 of this report.

The limit state formulation is based on S-N curves, which describe the number of constant amplitude stress cycles to failure, as a function of the fluctuating stress amplitude. The curve is written in the form

$$N \Delta S^m = C$$

where  $N$  is the number of cycles to failure,  $\Delta S$  is the constant amplitude stress range, and  $m$  and  $C$  are slope and intercept related constants. For design purposes,  $C$  is chosen so that the S-N curve forms a "lower bound" to the experimental data. One typical statistical way of defining  $C$  is

$$\log C = \log \tilde{C} - 2\sigma_{\log N}$$

where  $\tilde{C}$  corresponds to the median S-N curve, and  $\sigma_{\log N}$  is the standard deviation of  $\log N$ . Each generic structural detail type has an S-N curve. For a collection of S-N curves typical of ship structural detail situations, the reader is referred to Munse's Ship Structure Committee report SSC-318, "Fatigue Characterization of Fabricated Details for Design".

The wave environment is described completely by the set of seastates and their probabilities of occurrence as defined in a scatter diagram. For each seastate, the stress distribution can be considered Rayleigh distributed, assuming that the wave induced stress process is narrow band and zero mean Gaussian. The Rayleigh density is of the form

$$f_s(s) = \frac{s}{\lambda_{0j}} e^{-\frac{s^2}{2\lambda_{0j}}}, \quad s \geq 0$$

where  $\lambda_{0j}$  is the zero moment of the stress spectrum in seastate "j". This moment is also equal to the mean square value of the stress process. The zero-crossing frequency of the stress process in hertz (cycles/second) is given by

$$f_j = \frac{1}{2\pi} \sqrt{\frac{\lambda_{2j}}{\lambda_{0j}}}$$

where  $\lambda_{2j}$  is the second moment of the stress spectrum for the seastate. If the time spent in the seastate is  $T p_j$ , where  $T$  is the total time period and  $p_j$  is the probability of occurrence of the seastate, the number of stress cycles associated with the seastate is

$$T p_j f_j = (T P_j) \frac{1}{2\pi} \sqrt{\frac{\lambda_{2j}}{\lambda_{0j}}}$$

Also, the number of cycles associated with a stress interval  $ds$  is  $[f_s(s)ds] \cdot T p_j f_j$ .

The fatigue damage associated with the seastate "j" can then be calculated using the Miner linear cumulative damage hypothesis. The damage is given by

$$D_j = \int_0^{\infty} \frac{f_s(s) ds}{N_f(\Delta S)} T p_j f_j$$

where  $N_f(\Delta S)$  is the number of cycles to failure at the specified stress range  $\Delta S$  as determined from the S-N curve. Substituting for  $N_f(\Delta S)$ , the above equation may be rewritten as follows:

$$D_j = \frac{T p_j f_j}{C} 2^m \int_0^{\infty} s^m f(s) ds$$

$$= \frac{T p_j f_j}{C} (2\sqrt{2\lambda_{0j}})^m \Gamma\left(1 + \frac{m}{2}\right)$$

Here, the integral has been evaluated by substituting the Rayleigh density for  $f(s)$ . From this, and upon substituting for  $f_j$ , the total damage in time  $T$ , for  $j$  seastates, may be obtained as

$$D = \sum_j D_j = \frac{T}{2\pi C} (2\sqrt{2})^m \Gamma\left(1 + \frac{m}{2}\right) \sum_j p_j \lambda_{0j}^{(m-1)/2} \lambda_{2j}^{1/2}$$

The above equation defines the fatigue damage from the entire scatter diagram, for the time period  $T$ . If the Palmgren-Miner damage sum at failure is denoted  $\Delta_f$ , the time to failure may then be obtained:

$$T_f = \frac{\Delta_f C}{\frac{(2\sqrt{2})^m}{2\pi} \Gamma\left(1 + \frac{m}{2}\right) \sum_j p_j \lambda_{0j}^{(m-1)/2} \lambda_{2j}^{1/2}}$$

Equation 4.5 of the text is directly obtainable from the above equation for time to failure. That equation also includes a stress inaccuracy term  $B$  which represents the "modeling error" in the procedures used to compute the wave induced stress.

The above definition of the fatigue limit state equation in terms of the time to failure assumes that the stress process within any seastate in the scatter diagram is narrow banded. A correction for the possible wide banded nature of the process is available, see Wirsching and Light, ASCE Journal of Structural Division, Vol. 106, No. ST7, July 1980. The wide band correction was derived by Wirsching and Light using rainflow counting on simulated time histories of differing bandwidths to obtain the stress range histogram and then computing the fatigue damage, which then was compared to that predicted from the narrow band assumption. The importance of the refinement obtained

by including the correction is relatively small when compared to the inaccuracies introduced by the stress modeling error in particular. Also, the correction assumes the estimates obtained by a rainflow count based procedure to be the correct ones. Nevertheless, the rainflow correction provides a means for obtaining a fatigue damage estimate that is somewhat more realistic than that calculated using the narrow band assumptions. For typical stress time histories in ships, the effect of the correction is to reduce the calculated damage.

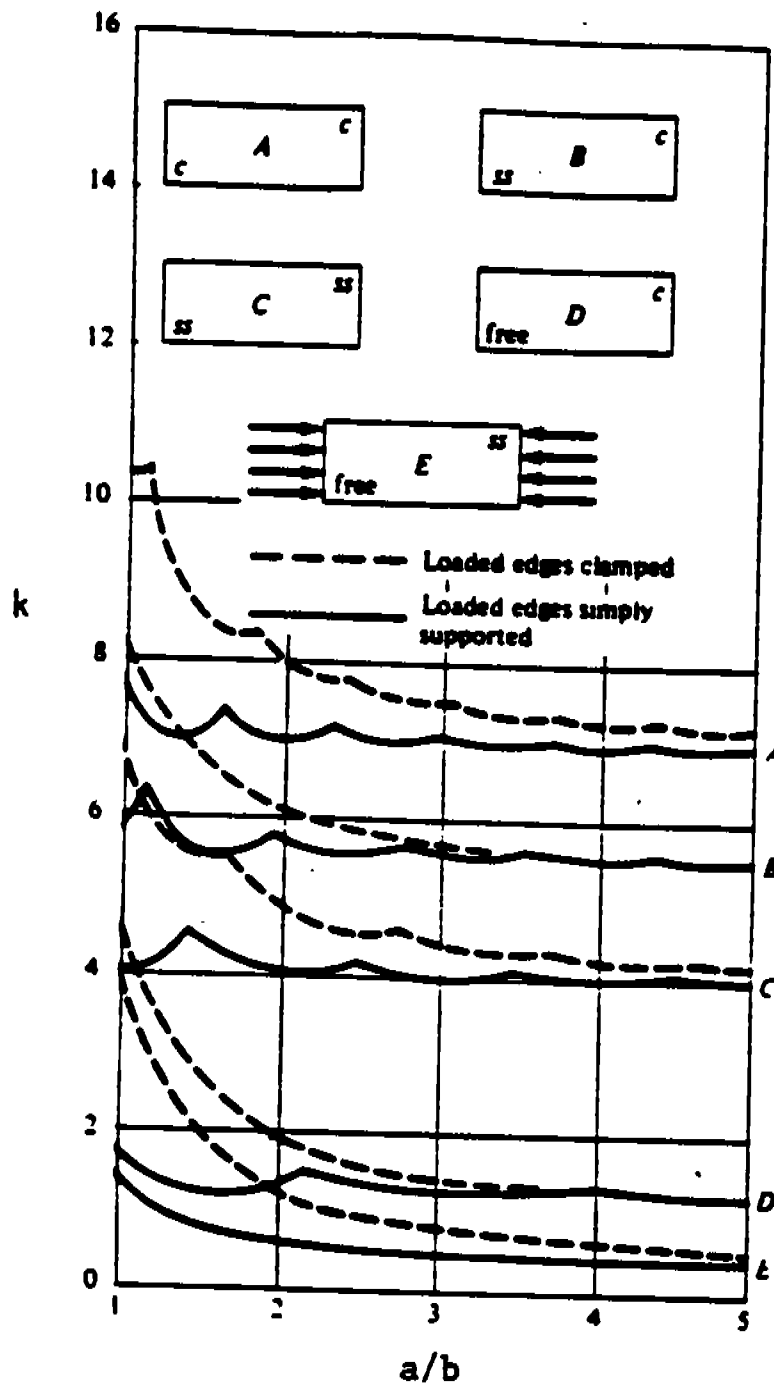


Fig. 9.1 Buckling Coefficients for Plates in Uniaxial Compression



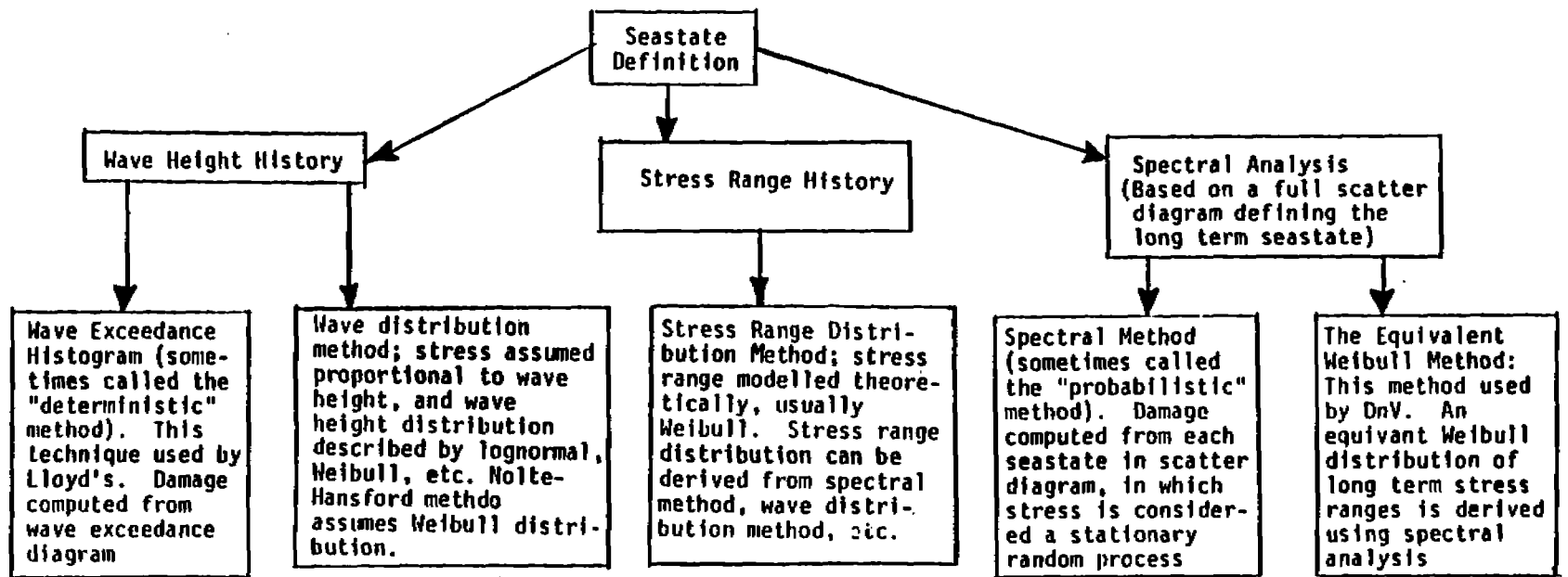


Fig. 9.2 Classification of Four Basic Methods of Computing Fatigue Damage

## 10. Limit States Associated with Lifetime Extreme Loads

The aim of this chapter is to identify and describe the appropriate limit states associated with lifetime design extreme loads. The following global limit states are considered:

- (a) Hull girder initial yield limit state
- (b) Hull girder fully plastic limit state
- (c) Hull girder collapse limit state

The strength associated with the following local buckling limit states are also considered:

- Column and beam column buckling of longitudinals
- Torsional/flexural buckling (tripping) of longitudinals
- Grillage buckling of longitudinals together with transverse beams

The global limit states apply to the hull girder as a whole. The local limit states apply to portions of the hull girder, e.g., longitudinals between transverses, longitudinals and associated flange plating between transverses, or gross panels consisting of longitudinals and transverses. Plate buckling per se is not considered, except to the extent it reduces the effective flange plate acting together with the longitudinals.

Global and local behavior are interlinked, and an argument may be made that consideration of global behavior alone is sufficient provided the consideration is detailed enough. Nevertheless, a two level approach is used because

- (a) Separate consideration of local behavior affords the designer more control over material deployment.
- (b) Local behavior is often indicative of global behavior.
- (c) A two level limit state design procedure is more consistent with present conventional design practice.

## 10.1 Hull Girder Limit States

### 10.1.1 Initial Yield Limit State

In this limit state, hull girder behavior as a beam is considered. The geometric property that characterizes hull girder behavior is its section modulus. It is assumed that under the applied extreme bending moment, the various elements of the hull cross section remain stable, i.e., no buckling occurs. The stress at any location 'y' above the neutral axis of the hull girder (see Figure 10.1) cross section is given by

$$\sigma_x = \frac{M(x)y}{I(x)}$$

where  $\sigma_x$  : the primary longitudinal bending stress at location x

y : distance from neutral axis of section to the location where the stress is computed

M(x): External bending moment at longitudinal location x

I(x) : moment of inertia of the cross section at longitudinal location x

Note that I(x)/y is the elastic section modulus, and the stress is maximum for minimum I/y, i.e., maximum 'y' distance. One can define the first yield moment for the cross section as follows (location parameter 'x' omitted):

$$M_{fy} = SM_e \sigma_y$$

where  $M_{fy}$  is the first yield moment,  $SM_e$  is the minimum elastic section modulus at the location of maximum bending moment, and  $\sigma_y$  is the material yield strength. This expression assumes elastic behavior until the stress at the extreme fibers reach yield. The first yield moment is in principle different for different longitudinal locations. At any location, the first yield moment is only realized if buckling does not occur. Nevertheless, the first yield limit state is commonly used as a convenient strength characterization parameter in ship hull design.

$$M_{ty} = SM_e \sigma_y$$

where  $SM_e$  is the minimum elastic section modulus, usually given at any cross section as  $I/y$  where  $I$  is the moment of inertia of the cross section and ' $y$ ' is the distance from the neutral axis to the extreme fiber (deck or bottom). The stress distribution is linear from the neutral axis to the location under consideration, and only the maximum stress at the extreme fiber is at yield.

In contrast, in the case of the fully plastic limit state, the entire cross section of the hull including sides has reached yield. The changes in stress distribution from the first yield to the fully plastic limit state are sketched in Figure 10.2 for an idealized box girder cross section. The following are assumed:

- a) Elastic perfectly plastic material behavior
- b) No buckling
- c) The applied external moment does not change direction

For the box girder cross section, the fully plastic moment, defined as the internal resisting moment with the entire cross section at yield, may be written as

$$M_p = \sigma_y SM_p$$

where  $\sigma_y$  is the material yield strength, and  $SM_p$  is a plastic section modulus. It can be shown that

$$SM_p = A_D g + A_B (D - g) + 2A_S \left( \frac{D}{2} - g + \frac{g^2}{D} \right)$$

where  $A_S$  = cross sectional area of one hull side, the thickness being  $t_w$

$A_B$  = cross sectional area of bottom

$A_D$  = cross sectional area of deck

$D$  = depth

$$\frac{g}{D} = \frac{A_B + 2A_S - A_D}{4A_S}$$

For more complicated cross sections and/or if more than one material is used in the hull cross section, the fully plastic moment needs to be numerically calculated, i.e., close form solutions such as that for the box girder are not available.

In general, the fully plastic limit state is not useful in a practical sense as the physical condition it represents is seldom realized because of buckling. It has been historically used, however, as a baseline value to which a buckling knockdown factor was applied in order to obtain the collapse moment for the hull cross section, particularly if the cross section is multicellular. For unicellular cross sections, a more appropriate baseline value is given by the first yield moment. In current practice, the buckling knockdown factor is applied to the initial yield moment as indicated in Part 2 of this report.

### 10.1.3 Hull Girder Collapse Limit State

The first yield limit state and the fully plastic limit state are both idealizations of hull girder behavior. In reality, as the externally applied curvature (or moment) on the hull girder is increased, strains internally will increase up to a point where either the yield strength of the material is reached, or buckling occurs depending on the slenderness of the structure. Of particular importance in longitudinally framed vessels is the buckling and post buckling behavior of longitudinals together with associated plating, and also in some cases the overall buckling of the gross panel consisting of longitudinals together with the transverse beams. When parts of the hull buckle, any additional load is "shed" to or taken by adjacent stable material, up to the point at which they also buckle or reach yield. As the externally applied curvature increases, typically the internal resisting moment calculated with accounting of buckling and yielding in parts of the cross section will increase up to a point, after which it will drop. The maximum internal resisting moment so calculated is the so-called collapse moment, 'M<sub>c</sub>'. On the tension side of the hull girder, the unloading/load shedding is slower and on the compression side, it is more rapid. A typical moment-curvature diagram for a hull cross section is illustrated in

transversely framed situations, the plate effect on collapse moment is comparatively greater.

### Calculation of Collapse Moment

There are various possible methods for calculating the collapse moment. These vary from approaches where any reserve of stiffened plate compressive strength after its maximum resistance has been reached is neglected, to nonlinear finite element calculations which include plastification and buckling in a rigorous way. The concept of downrating or knocking down the fully plastic collapse moment to account for buckling was suggested by Caldwell [16]. It has been further developed by Mansour [7], but with knock down factors to be applied to the initial yield moment. Procedures incorporating an incremental moment-curvature approach to hull collapse strength have been developed by Smith, Billingsley [17] and Adamchak [18]. Finite element calculations for ship hull collapse strength are presented in Thayamballi *et al.* [19].

It is not the intention to review the different methodologies for ship hull collapse strength calculation, but we introduce in brief here, the incremental moment curvature approach. In this method

- (i) A curvature is applied to the hull, and increased incrementally.
- (ii) For each value of curvature, the internal resisting moment is computed, accounting for the end shortening of the element resulting from internal strains, including any buckling and post buckling, as well as load limitation by plasticity. Such information is included through load-end shortening curves, an example of which is shown in Figure 10.4.
- (iii) A moment curvature relationship for the hull, such as that in Figure 10.3, is developed, and the collapse moment identified.

The most important part of the calculations is the establishment of the load-end shortening relationships for the hull members, considering the various local failure modes.

## 10.2 Limit States Associated with Local Buckling

### 10.2.1 General

As previously noted, these define the strength associated with column and beam column buckling of longitudinals together with associated plating, tripping of longitudinals, and the grillage buckling of longitudinals together with transverse beams. The strengths calculated do not account for any post buckling reserve which is typical small (but existent) in the failure modes noted. Also, the term "local" is used as a qualifier to the extent that only one component is considered in the limit state. In the real structure, there may be several such identical components under nominally identical loading.

### 10.2.2 Column and Beam Column Buckling

Column buckling refers to the flexural buckling of longitudinals together with effecting plating. The longitudinals and plating may be part of a stiffened panel between transverse beams. The panel, and hence the longitudinal and plating are considered to be under compression. In the beam-column failure mode, in addition to the axial load, there are also lateral loads present. This latter situation occurs for example in the case of longitudinals and plating at the vessel bottom. The column idealization is shown in Figure 10.5.

Column buckling strength, without consideration of lateral pressure, is given by the following (Mansour, Ref. 8):

$$\begin{aligned}\sigma_{cr} &= \frac{\pi^2 E}{(\ell_e/r)^2} && \text{if } \sigma_{cr} \leq \sigma_p \\ &= \sigma_Y - \frac{1}{C_s} && \sigma_{cr} > \sigma_p\end{aligned}$$

The first equation, valid in the range of  $0 \leq \sigma_{cr} \leq \sigma_p$ , where  $\sigma_p$  is the proportional limit stress and  $\sigma_{cr}$  is the critical buckling stress, will be recognized as the Euler elastic column strength equation. In the second equation, a correction is made, based on a factor  $C_s$ , if the calculated elastic buckling stress exceeds the proportional limit stress  $\sigma_p$ . The correction is such that the limit state strength calculated from the pair of equations given will not exceed the material yield strength.

Also, ' $l_e$ ' is the effective column length, which in continuous structures where the stiffener ends are capable of rotation, may be taken equal to the physical length between transverse supports, and ' $r$ ' is the radius of gyration of the cross section consisting of plating and stiffener. The value of  $r$  is given by:

$$r = \sqrt{\frac{I}{A}}$$

where  $I$  and  $A$  are the moment of inertia and area of the cross section, respectively. Typically, in computing these quantities, an effective plate flange assuming that the plate has buckled is used. The plate flange width may be obtained, for short edge compression, from Mansour, Ref. 8, as follows:

$$\begin{aligned} \frac{b_e}{b} &= \frac{1.9}{\beta} && \text{if } \beta \geq 3.5 \\ &= \frac{2.25}{\beta} - \frac{1.25}{\beta^2} && 1.0 < \beta < 3.5 \\ &= 1.0 && \beta \leq 1 \end{aligned}$$

where  $\beta$  is the non-dimensional plate slenderness, defined as:

$$\beta = \frac{b}{t} \sqrt{\frac{\sigma_Y}{E}}$$

where  $b$  is the width of the short edge, i.e., the spacing of longitudinals.

In the case of beam-column buckling, the lateral pressure results in a reduction in the critical stress to a value less than that obtained for the column buckling limit state. A



relatively simple approach to characterizing limit state strength for this situation is to use a linear interaction equation:

$$\frac{\sigma_a}{\sigma_{CR}} + \frac{\sigma_b}{\sigma_Y} = 1$$

where  $\sigma_{CR}$  is the column buckling strength assuming no lateral pressure, and  $\sigma_Y$  is the yield strength.  $\sigma_a$  is the axial stress and  $\sigma_b$  is the maximum bending stress over the span of the longitudinal. This interaction equation assumes that tripping of the cross section, and local buckling in the cross section (e.g., of the flange or web) are avoided.

The calculation of  $\sigma_a$  should account for any reduction in plate effectiveness because of buckling. The calculation of the bending stress should in principle account for shear lag effects, although for panels with closely spaced longitudinals, the effect may often be neglected.

### 10.2.3 Tripping of Longitudinals

In this failure mode, also called torsional/flexural buckling, failure is initiated by twisting of the stiffener in such a way that the joint between the stiffener and plate does not move laterally. A portion of the adjacent plate may participate in the twisting, and the flange of the stiffener may twist together with the web, or the two may twist differentially. Tripping is illustrated in Figure 10.5. The tripping phenomenon may occur under axial loads alone, or under axial loads in combination with lateral pressure loads.

The ultimate strength for torsional/flexural buckling under axial compressive loading may be obtained as follows (see Reference 8):

- a) Calculate the elastic tripping stress  $\sigma_t$  for the stiffener cross section rotating about an enforced axis at its toe. This is given by

$$\sigma_t = \frac{1}{I_0} \left( GJ + \frac{\pi^2 EC_w}{\ell^2} \right)$$

where  $G$  is the shear modulus for the material,  $J$  is the torsion constant, and  $C_w$  is the warping constant. The length of the longitudinal between supports is denoted ' $\ell$ '. Expressions for the torsion and warping constants as a function of cross

section shape may be found in the book by Bleich, Ref. 20.  $I_0$  is the polar moment of inertia of the cross section about an enforced axis at its toe, i.e.,

$$I_0 = I_x + I_y + A y^2$$

where  $I_x$  and  $I_y$  are the principal moments of inertia of the cross section, of area  $A$ , and  $y$  is the web depth.

- b) Obtain the elastic tripping stress  $\sigma_{tfe}$  considering interaction with column buckling, by solving the following quadratic:

$$\frac{I_c}{I_0} \sigma_{tfe}^2 - \sigma_{tfe} (\sigma_\alpha + \sigma_t) + \sigma_\alpha \sigma_t = 0$$

Here,  $I_c$  is the polar moment of inertia of the cross section of the stiffener, i.e.,  $I_x + I_y$ , and  $\sigma_\alpha$  is the limit state strength for column buckling under axial loads. If  $\sigma_{tfe} \leq \sigma_p$ , where  $\sigma_p$  is the proportional limit stress, the tripping limit stress  $\sigma_{tf} = \sigma_{tfe}$ . Otherwise,  $\sigma_{tf}$  is obtained from

$$\sigma_{tf} = \sigma_Y \left( 1 - \frac{\sigma_p \left( 1 - \frac{\sigma_p}{\sigma_Y} \right)}{\sigma_{tfe}} \right)$$

The above determination of limit state strength for tripping of longitudinals under axial loads is outlined in Mansour, Ref. 8. When lateral pressure is present, the axial tripping strength should be modified to reflect its influence. Although more detailed approaches are possible, one way to include the lateral pressure effects is to use a linear interaction formula similar to that used for the case of the beam-column limit state. Such an approach will not apply to a case where the pressure loads are the dominant ones, and additional refinements will be needed.

#### 10.2.4 Grillage Buckling

This failure mode and the limit state strength associated with it refer to the buckling of the gross panel, i.e., longitudinals and transverses, between the major support

members such as bulkheads. A portion of such a gross panel under compression is shown in Figure 10.5. This problem has been extensively studied by Mansour [21,22] using orthotropic plate theory. The following, taken from Ref. 22, may be used if the number of stiffeners in each direction is sufficiently large, e.g., 3 to 5.

For gross panels under uniaxial compression, the critical buckling stress is given from

$$\sigma_{EX} = \frac{k \pi^2 \sqrt{D_x D_y}}{h_x B^2}$$

where B is the width of the gross panel,  $h_x$  is the effective thickness resisting the compressive loads in the x direction, and k is a buckling coefficient that depends on the boundary conditions. For simply supported gross panels,

$$k = \frac{m^2}{\rho^2} + 2\eta + \frac{\rho^2}{m^2}$$

For gross panels with both loaded edges simply supported and both the other edges fixed,

$$k = \frac{m^2}{\rho^2} + 2.5\eta + 5\frac{\rho^2}{m^2}$$

where m is the number of half waves of the buckled orthotropic plate, to be chosen such that k is minimized;  $\eta$  and  $\rho$  are the virtual aspect ratio and the torsion coefficient, respectively.

The virtual aspect ratio and the torsion coefficient are given by

$$\eta = \sqrt{\frac{I_{P_x} I_{P_y}}{I_x I_y}}$$

$$\rho = \frac{L}{B} \sqrt[4]{\frac{D_y}{D_x}}$$

Here (see Figure 10.6),  $D_x$  and  $D_y$  are the flexural rigidities per unit width, given by

$$D_x = \frac{E I_x}{S_y(1-\nu^2)} \quad ; \quad D_y = \frac{E I_y}{S_x(1-\nu^2)}$$

where  $I_x$  and  $I_y$  are the moments of inertia of the stiffeners extending in the x and y directions (i.e., about the y, x axes), and  $I_{p_x}$ ,  $I_{p_y}$  are the moments of inertia of the effective plate flange alone, acting with the stiffeners in the x, y directions.  $S_x$  and  $S_y$  are the x and y stiffener spacings.

The effective plate thickness  $h_x$  is the average cross sectional area per unit width of effective plating and stiffeners in the x direction, i.e.

$$h_x = \frac{A_s + S_e t}{S_y}$$

where  $A_s$  is the stiffener area,  $t$  is the plate thickness, and  $S_e$  is the effective width of the plate flange,  $S_e \leq S_y$ .

Reference 21 by Mansour contains an extensive treatment of the behavior of orthotropic plate panels in the buckling and elastic post buckling range. Design charts are given, which address, for example, the midplane deflection, critical buckling stress, and the bending moment at midlength of the edge. The types of loading considered include combinations of normal pressure, direct inplane stresses in two directions, and edge shear stress. From the charts, prediction of large deflection behavior up to the onset of yielding is possible in a practical sense. Alternatively, in a unidirectional load situation which is a very common case, limit state strength may be obtained from the previously given close form expressions from Ref. 22. That solution is not valid beyond the linear elastic regime, unless corrections of the type made for column behavior are also made in this case.

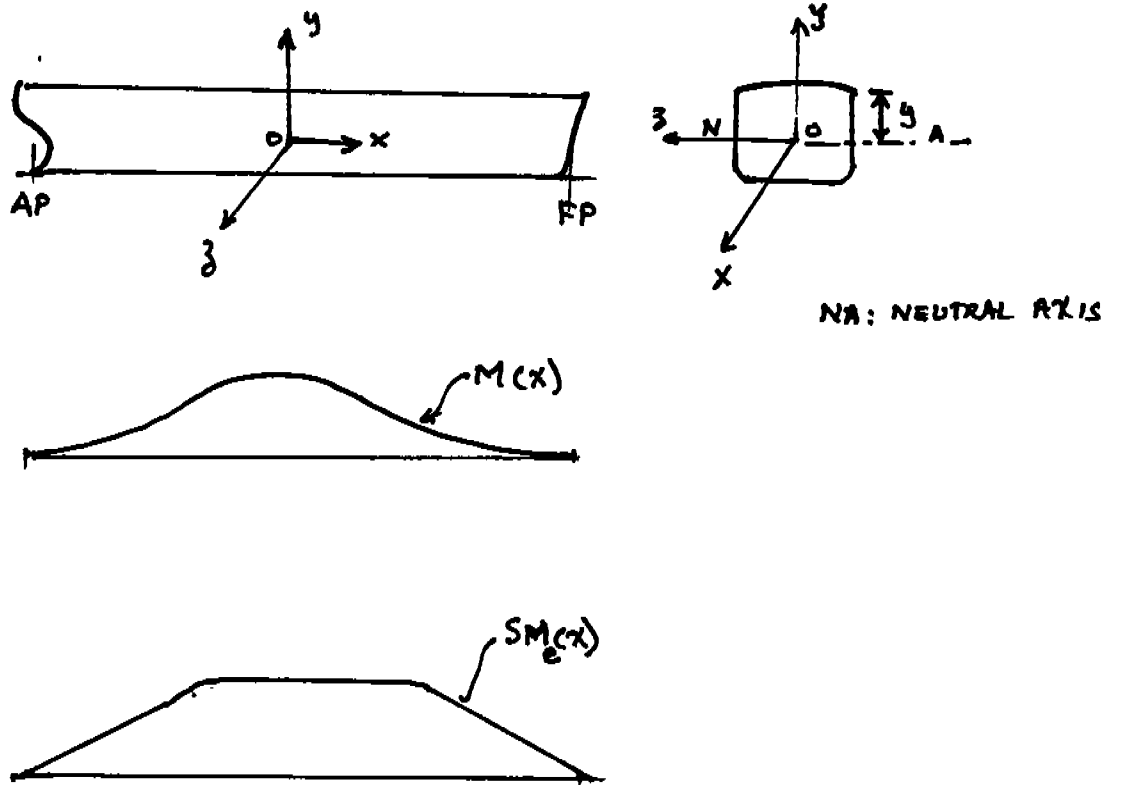


Figure 10.1 First Yield Limit State Definitions

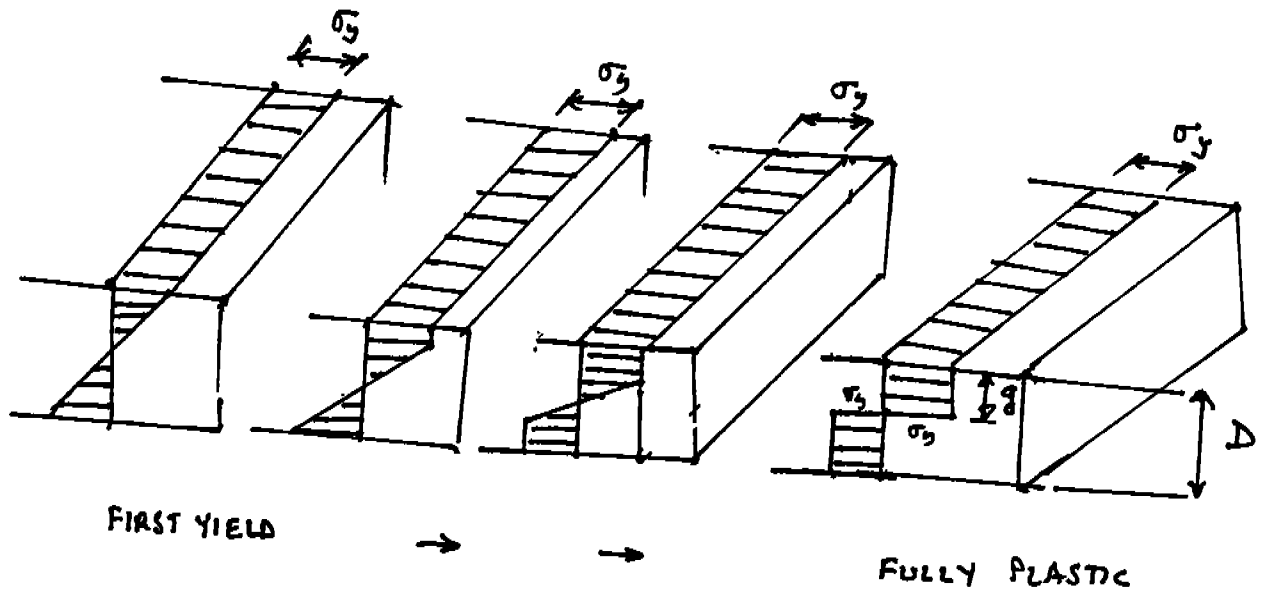


Figure 10.2 Development of the Fully Plastic Limit State

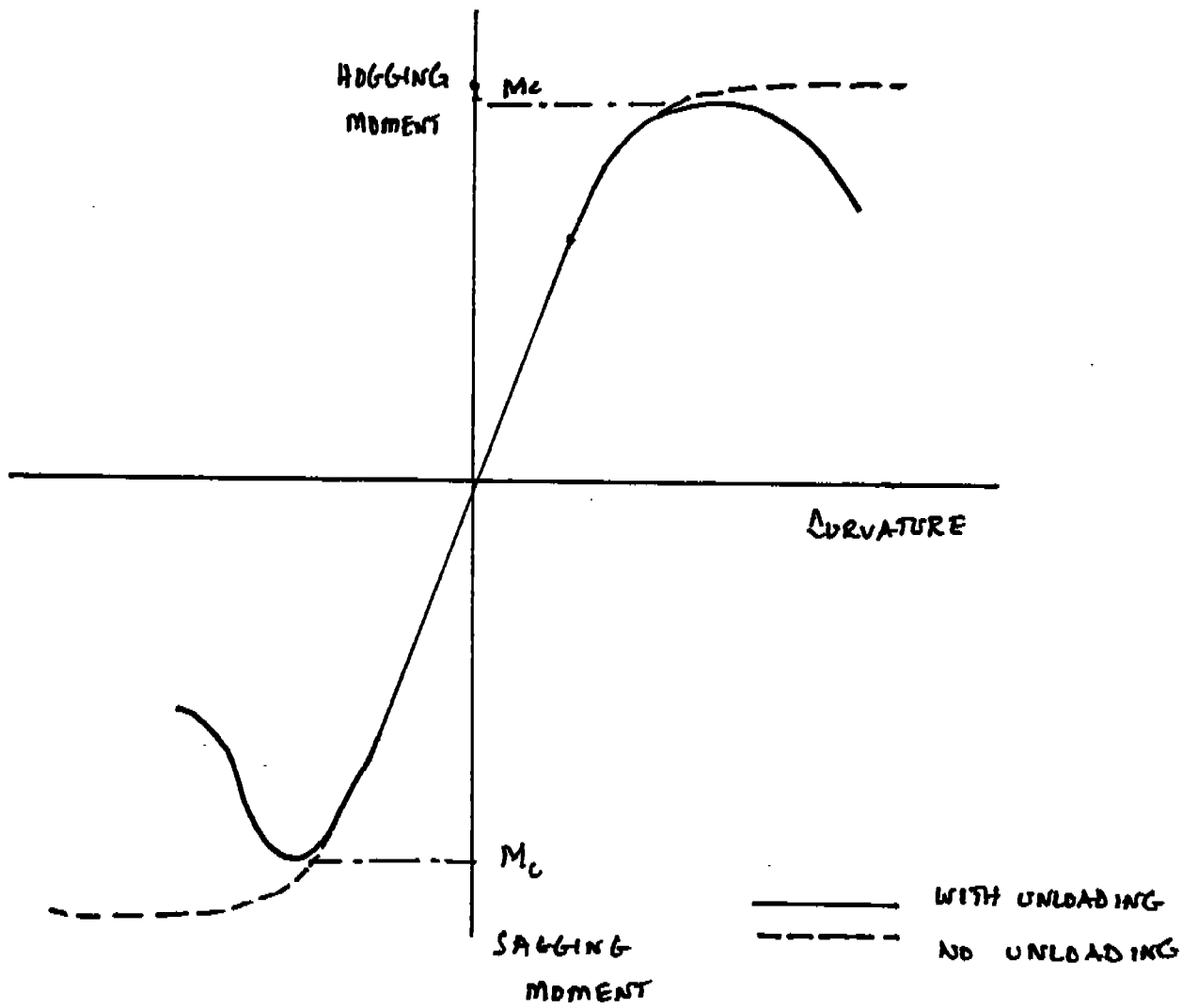


Figure 10.3 Moment-Curvature Diagrams for a Ship Hull

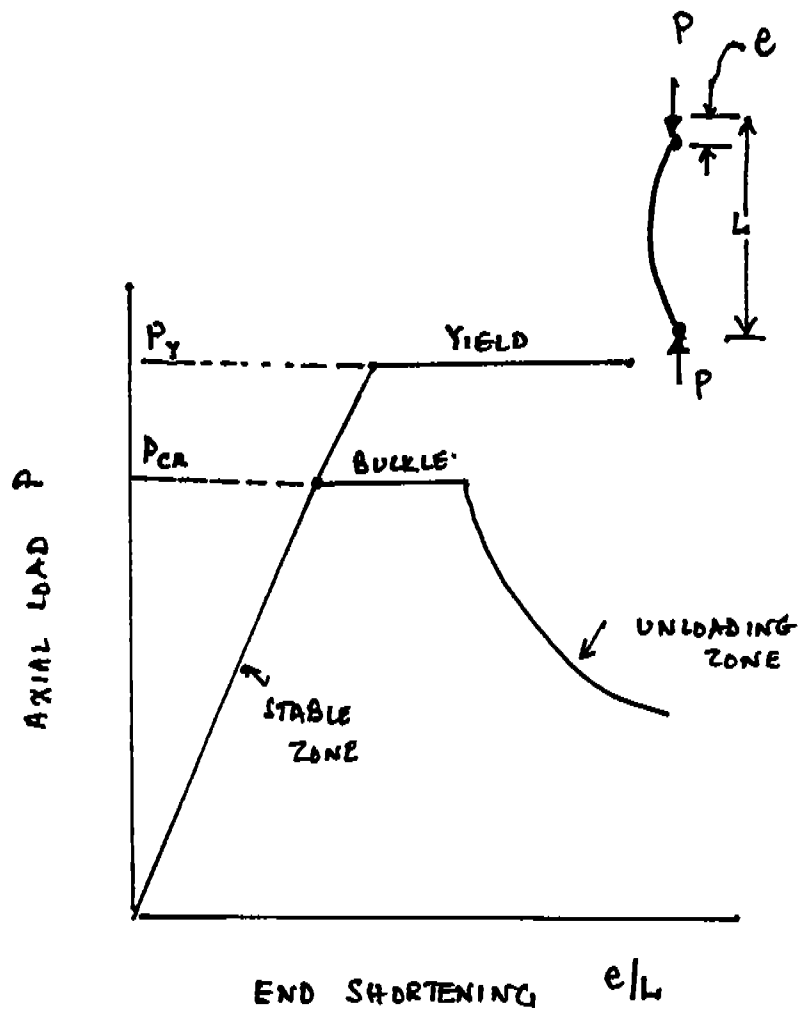


Figure 10.4 Load-End Shortening Curve for a Column



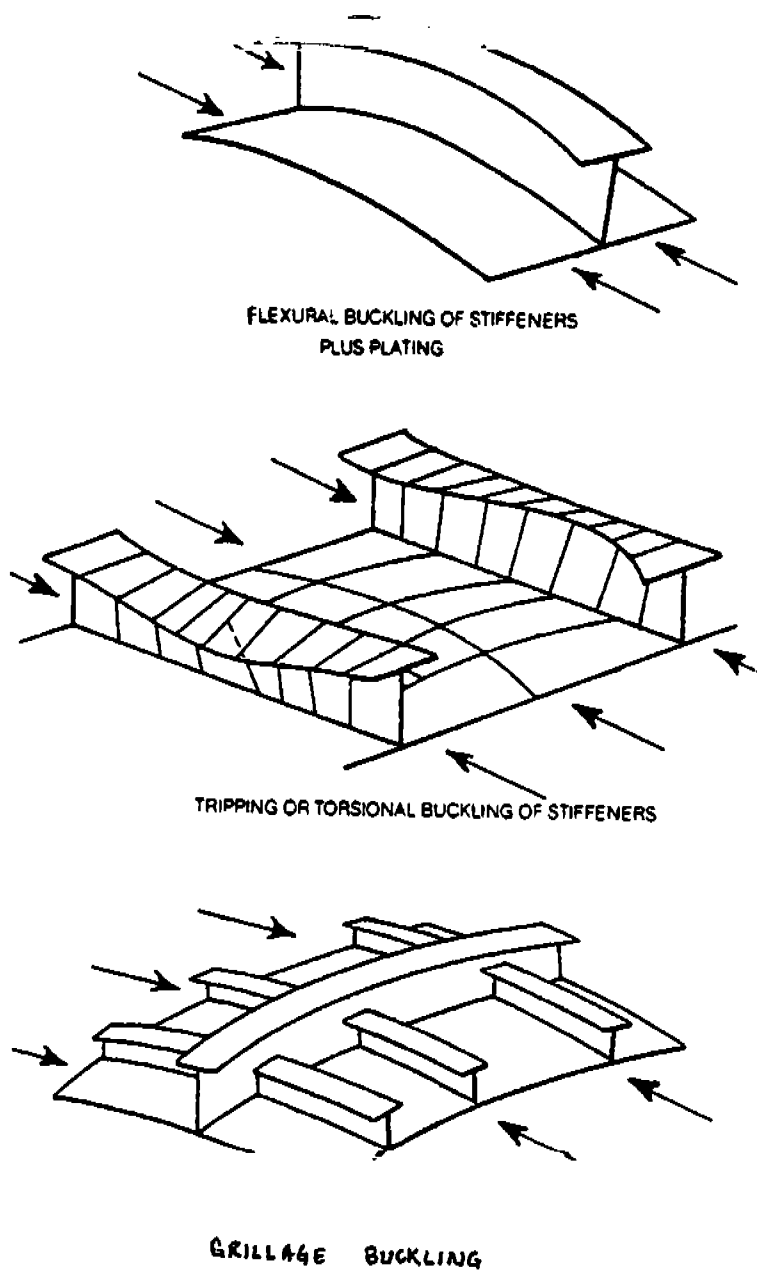


Figure 10.5 Stiffener Plate Failure Modes

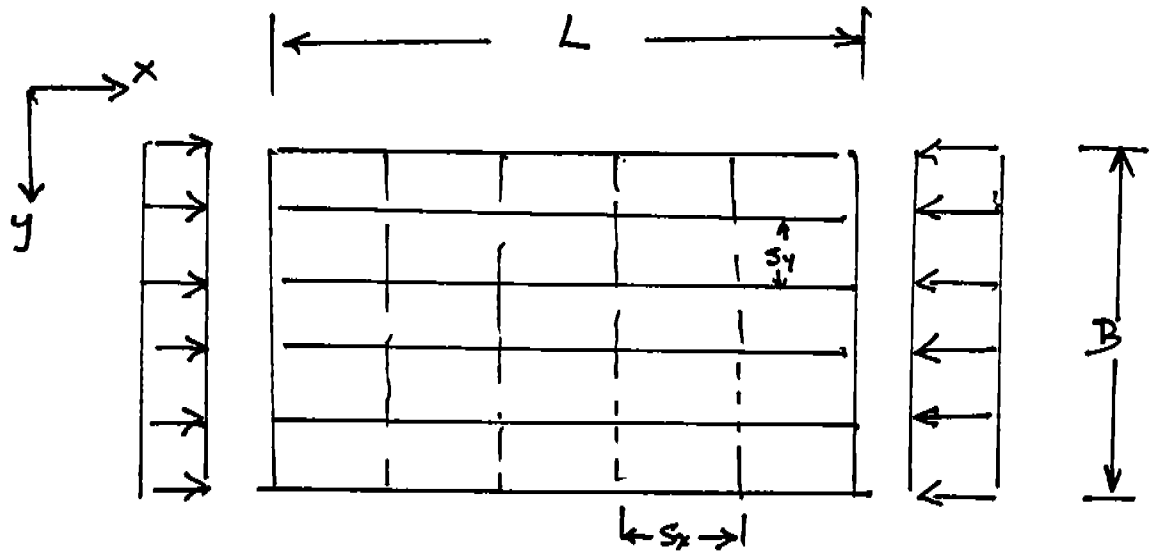


Figure 10.6 Definition Sketch for Gross Panel Buckling

## 11. Conclusions and Discussion

### 11.1 Summary and Major Results

Two demonstrations have been carried out in this project; a demonstration of probability-based Rule calibration (Part 1), and a demonstration of probability-based hull girder safety analysis (Part 2). Also, an extension to the project, Part 3 defined loads, strength and structural reliability terminology, identified ultimate and serviceability limit states, and considered procedures for load extrapolation and load definition.

In the first part, the calibration procedure was described and applied to ABS hull girder longitudinal strength formulation. For this purpose 300 "ABS Ships" are considered and the minimum required section modulus of each has been determined according to ABS Rules (see Appendices 1 and 2). The safety index  $\beta$  was then determined using first and second order reliability methods. It was found that the safety indices vary slightly and that variation depended only on the ratio of the wave bending moment to the stillwater bending moment. The range of the safety indices,  $\beta_{\text{range}} = \beta_{\text{max}} - \beta_{\text{min}}$ , was found to be 0.31. The average value of the safety indices  $\beta_{\text{av}}$  was found to be 3.2.

The aim of the calibration procedure, which is described in detail in Part 1 of the report, is to eliminate this variation in  $\beta$  in order to achieve uniform safety standard for all ship sizes. The target  $\beta$  value was taken as the average value,  $\beta_t = \beta_{\text{av}} = 3.2$ . The calibrated formulation, which is based on partial safety factor format, produced the target value of  $\beta$  and a  $\beta_{\text{range}} = 0.004$ .

It should be noted that the calibrated formulation, in as much as the initial ABS formulation, ensures only a safety level against deck yielding. For buckling considerations, the stiffening system for each of the 300 "ABS Ships" must be designed and evaluated. Buckling rule calibration is best done at the local level since the Rules control and specify stiffener spacing, section modulus and plate thickness at a local level. Similar calibration procedure to that described in Part 1 can be used to calibrate ABS formulations that give minimum required stiffener section modulus and plate thickness so as to produce uniform safety.

In Part 2 of the report a tanker was taken as an example to demonstrate the use of probability-based safety analysis, i.e., to estimate the reliability in an existing ship (or on a drawing board design). For this purpose several limit states have been developed including ultimate strength (buckling collapse, deck initial yield and fully plastic collapse), serviceability limit state (local plate buckling) and fatigue limit state. More

realistic load estimates have been developed for each limit state, based on parametric seakeeping and ship motion analysis. The wave bending moment has been calculated for the ultimate limit state with considerations given to the most probable extreme sea condition the ship is likely to encounter. For the fatigue limit state, stress ranges and number of cycles have been calculated based on a sea scatter diagram.

A reliability index  $\beta$  has been calculated using first and second order reliability methods for each limit state. Model uncertainty was included in all limit states. The resulting safety indices indicate that buckling collapse is the governing mode of failure as its safety index is well below those of deck initial yield and fully plastic collapse.

## **11.2 Benefits and Drawbacks of Using Probability-based Design Method**

Use of probabilistic methods in design can provide several benefits and some unique features. Among those are:

1. Explicit consideration and evaluation of uncertainties associated with the design variables.
2. Inclusion of all available relevant information in the design process.
3. Provides a framework of sensitivity measures.
4. Provides means for decomposition of global safety of a structure into partial safety factors associated with the individual design variables.
5. Provides means for achieving uniformity of safety within a given class of structures ( or specified nonuniformity ).
6. Minimum ambiguity when updating design criteria.
7. Provides means to weigh variables in terms of their significance.
8. Provides rationale for data gathering.
9. Provides guidance in novel design.
10. Provide the potential to reduce weight without loss of reliability, or improve reliability without increasing weight. The methods can identify and correct overly and unduly conservative designs.

In addition to the above benefits, reliability technology lends itself for certain use for which it is much more suitable than traditional design methods. In reference[14], Wirsching lists some of its use, which include:

1. To compare alternative designs, particularly in the early stages when several competing design concepts are considered.
2. To perform failure analysis of a component or a system.
3. To develop a strategy for design and maintenance of structures which age (e.g., corrosion, fatigue), and to determine inspection intervals.
4. To execute "economic value analysis" or "risk based economics" to produce a design with a minimum life cycle costs.
5. To develop a strategy for design, warranties, spare parts requirements.
6. In general, as a design tool to manage uncertainty in engineering problems.

Use and implementation of probabilistic methods are not without problems. Some of the drawbacks are:

1. Use of reliability analysis in safety and design processes requires more information on the environment, loads and the properties and characteristics of the structure than typical deterministic analyses. Often some information are not available or may require considerable time and effort to collect. Time and schedule restrictions on design are usually limiting factors on the use of such methods.
2. Application of probabilistic and reliability methods usually require some familiarity of basic concepts in probability, reliability and statistics. Practitioners and designers are gaining such familiarity through seminars, symposia and special courses. Educational institutions are also requiring more probability and statistics courses to be taken by students at the graduate and undergraduate levels. This, however, is a slow process that will take some time in order to produce the necessary "infrastructure" for a routine use of reliability and probabilistic methods in design.
3. On a more technical aspect, the reliability analysis did not deliver what it initially promised, that is, a true measure of the reliability of a structure by a "true and actual" probability of failure. Instead what it delivered is "notional probabilities" of failure and

safety indices which are good only as comparative measures. Only notional values are delivered because of the many assumptions and approximations made in the analysis producing such probabilities and indices. These approximations, deficiencies and assumptions, however are made, not only in probability-based design, but also in traditional design. Approximations are made in the determination of loads using hydrodynamics theory and in the structural analysis and response to the applied loads. When all such assumptions and deficiencies are removed from the design analysis, the resulting probabilities of failure will approach the "true" probabilities.

### **11.3 Discussion of SSC Projects in Reliability and Needs to be addressed in Further Projects**

The strategic plan of the Committee on Marine Structures (CMS) as outlined in the Marine Board report entitled "Marine Structures--Research Recommendations for FY 1992" has been reviewed. In this document, the CMS states the goals and objectives of the plan and lists a five-year research program and development which is organized under five technology areas. The technology areas are: reliability, loads and response, material criteria, fabrication and maintenance, and design methods. The five technology areas consist of 23 comprehensive and well thought-out subject areas. The projects outlined in these subject areas will undoubtedly lead towards fulfilling the goals of the plan which include improving the safety and integrity of marine structures, improving competitiveness of U.S. merchant shipping, and promoting the development of new marine systems.

Based on the work carried out in this project and the review of CMS research recommendations, the following areas are suggested for further development. Some of these areas are very specific and each need to be addressed in depth as a limited scope project. These gaps are:

1. Torsional/flexural buckling (tripping failure) of ship stiffeners with effective breadth of plating -- analysis and development of design formulation.
2. Ultimate strength of ship hull girders due to instability -- analysis to determine strength reduction factors due to instability to be used in design.

3. Experiments on hull girder ultimate strength to verify analytically calculated strength reduction factors.
4. Selection of wave spectra (or wave data) pertinent to design wave loading on ships.
5. A study leading to the determination of the ratio sag to hog wave bending moments and the bias associated with linear ship motion load prediction.
6. Design formulation for combined wave and slamming bending moments.
7. A study of shear forces and moments acting on the forward part of a ship including slamming effects.
8. A study leading to target reliabilities for each hull girder limit state based on existing ships.
9. Development of reliability procedures and target indices for local structure in ships.
10. A study to develop a reliability-based cost analysis which aims to achieve minimum life cycle costs for ships.
11. Development of a reliability-based strategy for inspection intervals and maintenance of ships.
12. Inclusion of system reliability considerations in fatigue and multiple failure modes.
13. Reliability assessment of transverse structures and lateral pressure effects.

## ACKNOWLEDGEMENT

This project has been supported by the Ship Structures Committee. The authors would like to thank the Project Technical Committee and its chairman, Mr. Norman Hammer for their advice and suggestions during the project work. Sincere thanks are expressed to Dr. James Lloyd, Exxon Productions Research Co., for the information he provided on the calibration procedures used in API guides.



## 12. References

1. ABS Report to the Technical Committee, "Proposed Change to Rules for Building and Classing Steel Vessels", American Bureau of Shipping, September, 1990
2. "Rules for Building and Classing Steel Vessels", American Bureau of Shipping, 1990
3. Soares, C.G. and Moan, T., "Statistical Analysis of Stillwater Load Effects in Ship Structures", SNAME, Trans., Vol. 96, 1988
4. Mansour, A.E., "Extreme Value Distributions of Wave Loads and their Application to Marine Structures", Proceedings of Marine Structural Reliability Symposium, Arlington, Virginia, October, 1987
5. Liu, P-L., Lin, H-Z., and Kiureghian, A.D., "CALREL User's Manual", Technical Report UCB/SEMM-89/18, Department of Civil Engineering, University of California, Berkeley, 1989
6. Mansour, A.E., "An Introduction to Structural Reliability Theory", Ship Structure Committee Report, SSC-351, December, 1990
7. Mansour, A.E. and Thayamballi, A., "Ultimate Strength of a Ship's Hull Girder in Plastic and Buckling Modes", Ship Structure Committee Report, SSC-299, July, 1980
8. Mansour, A.E., "Approximate Formulae for Preliminary Design of Stiffened Plates", Proceedings, Fifth International Symposium and Exhibition on Offshore Mechanics and Arctic Engineering, Tokyo, Japan, April, 1986, pp.427-434
9. Proceedings of the 11th ISSC, Report of Committee, Vol. 1, "Applied Design", Wuxi, China, 1991
10. Wirsching, P.H. and Chen, Y.N., "Fatigue Design Criteria for TLP Tendons", Journal of Structural Engineering, 113(7), July, 1987
11. Ximenes, Maria Celia C., "System Fatigue Reliability: A Study of Tension Leg Platform Tendon System", Ph.D. Dissertation, Naval Architecture and Offshore Engineering Department, University of California, Berkeley, November, 1990
12. Loukakis, T.A. and Chryssostomidis, C., "Seakeeping Series for Cruiser-Stern Ships", SNAME, Trans., 1975
13. Gurney, T.R., "Fatigue of Welded Structures", Cambridge University Press, 1979
14. Private Communication with P.H. Wirsching dated November 26, 1991
15. Steel, R.G.D. and Torrie, J. H., "Principles and Procedures of Statistics", McGraw Hill, New York, 1980
16. Caldwell, J.B. (1965) "Ultimate Longitudinal Strength", Trans. RINA, 1965
17. Billingsley, D. (1980), "Hull Girder Response to Extreme Bending Moments", Proc., SNAME STAR Symposium, Colorado, CA 1980

18. Adamchak, J.C. (1982), "ULTSTR: A Program for Estimating the Collapse Moment of a Ship's Hull Girder Longitudinal Bending", DTNSRDC Report, October 1982
19. Thayamballi, A.K., Kutt, L.M. and Chen, Y.N. (1986) "Advanced Strength and Structural Reliability Assessment of the Ship's Hull Girder", Proc. Symposium on Advances in Marine Structures", Admiralty Research Establishment, Elsevier Applied Science Publishers, London, 1986
20. Bleich, F. (1952) "Buckling Strength and Metal Structures" McGraw Hill
21. Mansour, A. (1976) "Charts for the Postbuckling Analysis of Stiffened Plates under Combined Loads" SNAME T&R Bulletin 2-22, July 1976
22. Mansour, A. (1977) "Gross Panel Strength under Combined Loading" Ship Structure Committee Report SSC-270, 1977

## **APPENDIX 1**

Msw, Mw, Mw/Msw, and SM of "ABS Ships"

9/11/21  
11:53:47

Appendix-1

L(m)	L/B	Cb	Msw (kN-m)	Mw (kN-m)	Mw/Msw	SM (m-cm-cm)	L(m)	L/B	Cb	Msw (kN-m)	Mw (kN-m)
91.5	5.0	0.60	104026.36700	169564.21900	1.63001	15414.92970	152.5	5.0	0.75	614201.93800	1013540.75000
91.5	5.0	0.65	108754.02800	176085.90600	1.61911	16007.81060	152.5	5.0	0.80	638770.00000	1048490.38000
91.5	5.0	0.70	113483.31300	182607.62500	1.60911	16600.69340	152.5	5.0	0.85	663338.06300	1083440.00000
91.5	5.0	0.75	118211.77300	189129.34400	1.59992	17193.57620	152.5	6.0	0.60	450414.75000	757243.06300
91.5	5.0	0.80	122940.23400	195651.03100	1.59143	17786.45700	152.5	6.0	0.65	470888.15600	786367.75000
91.5	5.0	0.85	127668.72700	202172.71900	1.58357	18379.33990	152.5	6.0	0.70	491361.53100	815492.50000
91.5	6.0	0.60	86688.64060	141303.51600	1.63001	12845.77440	152.5	6.0	0.75	511834.93800	844617.31300
91.5	6.0	0.65	90629.02340	146738.26600	1.61911	13339.84280	152.5	6.0	0.80	532308.31300	873742.00000
91.5	6.0	0.70	94569.42970	152173.03100	1.60911	13833.91110	152.5	6.0	0.85	552781.75000	902866.68800
91.5	6.0	0.75	98509.81250	157607.78100	1.59992	14327.98050	152.5	7.0	0.60	386069.78100	649065.50000
91.5	6.0	0.80	102450.19500	163042.53100	1.59143	14822.04790	152.5	7.0	0.65	403618.40600	674029.50000
91.5	6.0	0.85	106390.60200	168477.26600	1.58357	15316.11620	152.5	7.0	0.70	421167.03100	698993.56300
91.5	7.0	0.60	74304.54690	121117.30500	1.63001	11010.66410	152.5	7.0	0.75	438715.65600	723957.68800
91.5	7.0	0.65	77682.02340	125775.65600	1.61911	11434.15040	152.5	7.0	0.80	456264.25000	748921.68800
91.5	7.0	0.70	81059.50780	130434.02300	1.60911	11857.63870	152.5	7.0	0.85	473812.90600	773885.75000
91.5	7.0	0.75	84436.98440	135092.39100	1.59992	12281.12600	152.5	8.0	0.60	337811.06300	567932.31300
91.5	7.0	0.80	87814.45310	139750.73400	1.59143	12704.61230	152.5	8.0	0.65	353166.12500	589775.81300
91.5	7.0	0.85	91191.94530	144409.09400	1.58357	13128.09960	152.5	8.0	0.70	368521.15600	611619.37500
91.5	8.0	0.60	65016.48050	105977.64100	1.63001	9634.33105	152.5	8.0	0.75	383876.18800	633463.00000
91.5	8.0	0.65	67971.76560	110053.69500	1.61911	10004.88180	152.5	8.0	0.80	399231.21900	655306.50000
91.5	8.0	0.70	70927.07030	114129.76600	1.60911	10375.43360	152.5	8.0	0.85	414586.31300	677150.00000
91.5	8.0	0.75	73882.35940	118205.84400	1.59992	10745.98540	152.5	9.0	0.60	300276.50000	504828.68800
91.5	8.0	0.80	76837.64840	122281.89800	1.59143	11116.53610	152.5	9.0	0.65	313925.43800	524245.15600
91.5	8.0	0.85	79792.95310	126357.95300	1.58357	11487.08690	152.5	9.0	0.70	327574.34400	543661.68800
91.5	9.0	0.60	57792.42580	94202.34370	1.63001	8563.84961	152.5	9.0	0.75	341223.28100	563078.18800
91.5	9.0	0.65	60419.34770	97825.50780	1.61911	8893.22851	152.5	9.0	0.80	354872.21900	582494.68800
91.5	9.0	0.70	63046.28520	101448.68000	1.60911	9222.60742	152.5	9.0	0.85	368521.15600	601911.12500
91.5	9.0	0.75	65673.21090	105071.85900	1.59992	9551.98730	183.0	5.0	0.60	991459.25000	1662384.63000
91.5	9.0	0.80	68300.13280	108695.01600	1.59143	9881.36523	183.0	5.0	0.65	1036525.44000	1726322.50000
91.5	9.0	0.85	70927.07030	112318.18000	1.58357	10210.74410	183.0	5.0	0.70	1081591.88000	1790260.38000
122.0	5.0	0.60	261790.68800	434950.56300	1.66144	39540.95700	183.0	5.0	0.75	1126658.13000	1854198.38000
122.0	5.0	0.65	273690.25000	451679.37500	1.65033	41061.76170	183.0	5.0	0.80	1171724.50000	1918136.38000
122.0	5.0	0.70	285589.84400	468408.28100	1.64014	42582.57030	183.0	5.0	0.85	1216790.88000	1982074.00000
122.0	5.0	0.75	297489.40600	485137.21900	1.63077	44103.37890	183.0	6.0	0.60	826216.00000	1385320.50000
122.0	5.0	0.80	309388.96900	501866.03100	1.62212	45624.17970	183.0	6.0	0.65	863771.25000	1438602.13000
122.0	5.0	0.85	321288.56300	518594.87500	1.61411	47144.98830	183.0	6.0	0.70	901326.56300	1491883.75000
122.0	6.0	0.60	218158.90600	362458.78100	1.66144	32950.79690	183.0	6.0	0.75	938881.81300	1545165.25000
122.0	6.0	0.65	228075.20300	376399.50000	1.65033	34218.13670	183.0	6.0	0.80	976437.06300	1598446.88000
122.0	6.0	0.70	237991.95100	390340.21900	1.64014	35485.47270	183.0	6.0	0.85	1013992.38000	1651728.38000
122.0	6.0	0.75	247907.84400	404281.00000	1.63077	36752.81640	183.0	7.0	0.60	708185.18800	1187417.63000
122.0	6.0	0.80	257824.15600	418221.68800	1.62212	38020.15240	183.0	7.0	0.65	740375.31300	1233087.50000
122.0	6.0	0.85	267740.46900	432162.37500	1.61411	39287.48830	183.0	7.0	0.70	772565.62500	1278757.50000
122.0	7.0	0.60	186993.35900	310678.96900	1.66144	28243.54100	183.0	7.0	0.75	804755.81300	1324427.38000
122.0	7.0	0.65	195493.03100	322628.12500	1.65033	29329.83010	183.0	7.0	0.80	836946.06300	1370097.38000
122.0	7.0	0.70	203992.73400	334577.34400	1.64014	30416.12110	183.0	7.0	0.85	869136.31300	1415767.13000
122.0	7.0	0.75	212492.43800	346526.56300	1.63077	31502.41210	183.0	8.0	0.60	619662.00000	1038990.38000
122.0	7.0	0.80	220992.12500	358475.75000	1.62212	32588.70120	183.0	8.0	0.65	647828.43800	1078951.50000
122.0	7.0	0.85	229491.84400	370424.90600	1.61411	33674.99220	183.0	8.0	0.70	675994.93800	1118912.75000
122.0	8.0	0.60	163619.18800	271844.09400	1.66144	24713.09770	183.0	8.0	0.75	704161.37500	1158874.00000
122.0	8.0	0.65	171056.40600	282299.62500	1.65033	25663.60160	183.0	8.0	0.80	732327.81300	1198835.25000
122.0	8.0	0.70	178493.64100	292755.15600	1.64014	26614.10550	183.0	8.0	0.85	760494.25000	1238796.25000
122.0	8.0	0.75	185930.87500	303210.75000	1.63077	27564.61130	183.0	9.0	0.60	550810.68800	923547.00000
122.0	8.0	0.80	193368.10900	313666.28100	1.62212	28515.11330	183.0	9.0	0.65	575847.50000	959068.06300
122.0	8.0	0.85	200805.35900	324121.78100	1.61411	29465.61720	183.0	9.0	0.70	600884.37500	994589.12500
122.0	9.0	0.60	145439.28100	241639.20300	1.66144	21967.19730	183.0	9.0	0.75	625921.18800	1030110.19000
122.0	9.0	0.65	152050.14100	250932.98400	1.65033	22812.08990	183.0	9.0	0.80	650958.06300	1065631.25000
122.0	9.0	0.70	158661.01600	260226.81300	1.64014	23656.98240	183.0	9.0	0.85	675994.93800	1101152.25000
122.0	9.0	0.75	165271.89100	269520.65600	1.63077	24501.87700	213.5	5.0	0.60	1667410.25000	2768129.50000
122.0	9.0	0.80	171882.76600	278814.46900	1.62212	25346.76760	213.5	5.0	0.65	1743201.50000	2874595.75000
122.0	9.0	0.85	178493.65600	288108.25000	1.61411	26191.66020	213.5	5.0	0.70	1818993.00000	2981062.50000
152.5	5.0	0.60	540497.68800	908691.68800	1.68121	82608.33590	213.5	5.0	0.75	1894784.25000	3087529.25000
152.5	5.0	0.65	565065.75000	943641.31300	1.66997	85785.57810	213.5	5.0	0.80	1970575.63000	3193995.75000
152.5	5.0	0.70	589633.81300	978591.00000	1.65966	88962.82810	213.5	5.0	0.85	2046367.13000	3300462.00000

Appendix-1

L/B	L(m)	Cb	Msw (kN-m)	Mw (kN-m)	Mw/Msw	SM (m-cm-cm)	L/B	Cb	Msw (kN-m)	Mw (kN-m)	Mw/Msw	SM (m-cm-cm)
91.5	5.0	0.60	104026.36700	169564.21900	1.63001	15414.92970	5.0	0.75	614201.93800	1013540.75000	1.65018	92140.07030
91.5	5.0	0.65	108754.82800	176085.90600	1.63011	16007.90160	5.0	0.80	638770.00000	1048490.38000	1.65142	95317.31250
91.5	5.0	0.70	113483.31300	182607.62500	1.60911	16600.69340	5.0	0.85	663338.06300	1083440.00000	1.63331	98494.55470
91.5	5.0	0.75	118211.77900	189129.34400	1.59992	17193.57620	6.0	0.60	450414.75000	757243.06300	1.68121	68840.28120
91.5	5.0	0.80	122940.23400	195651.03100	1.59143	17786.45700	6.0	0.65	470888.15600	786367.75000	1.65997	71487.97650
91.5	5.0	0.85	127668.72700	202172.71900	1.58357	18379.33990	6.0	0.70	491361.53100	815492.50000	1.65966	74135.68750
91.5	6.0	0.60	86688.64060	141303.51600	1.63001	12845.77440	6.0	0.75	511834.93600	844617.31300	1.65018	76783.39060
91.5	6.0	0.65	90629.02340	146738.26600	1.61911	13339.84280	6.0	0.80	532308.31300	873742.00000	1.64142	79431.09370
91.5	6.0	0.70	94569.42970	152173.03100	1.60911	13833.91110	6.0	0.85	552781.75000	902856.68800	1.63331	82078.79690
91.5	6.0	0.75	98509.81250	157607.78100	1.59992	14327.98050	7.0	0.60	386069.78100	649065.50000	1.68121	59005.95700
91.5	6.0	0.80	102450.19500	163042.53100	1.59143	14822.04790	7.0	0.65	403617.40600	674029.50000	1.65997	61275.41020
91.5	6.0	0.85	106390.60300	168477.26600	1.58357	15316.11620	7.0	0.70	421167.93100	698993.56300	1.65966	63544.87500
91.5	7.0	0.60	74304.54690	121117.50500	1.63001	11010.66410	7.0	0.75	436715.65600	723957.68800	1.65018	65814.33590
91.5	7.0	0.65	77682.02340	125775.65600	1.61911	11434.15040	7.0	0.80	452624.25000	748921.68800	1.64142	68083.79690
91.5	7.0	0.70	81059.50780	130434.02300	1.60911	11857.63870	7.0	0.85	473812.90600	773885.75000	1.63331	70353.25780
91.5	7.0	0.75	84436.98440	135092.39100	1.59992	12281.12600	8.0	0.60	337811.06300	567932.31300	1.68121	51630.21100
91.5	7.0	0.80	87814.45310	139750.73400	1.59143	12704.61230	8.0	0.65	353166.17500	589775.81300	1.65997	53615.98440
91.5	7.0	0.85	91191.94530	144409.09400	1.58357	13128.09960	8.0	0.70	368521.15600	611619.37500	1.65966	55601.76560
91.5	8.0	0.60	65016.40050	105977.64100	1.63001	9634.33105	8.0	0.75	383876.18800	633463.00000	1.65018	57587.54300
91.5	8.0	0.65	67971.76560	110053.69500	1.61911	10004.88180	8.0	0.80	399231.21800	655306.50000	1.64142	59573.32030
91.5	8.0	0.70	70927.07030	114129.76600	1.60911	10375.43360	8.0	0.85	414586.31300	677150.00000	1.63331	61559.09770
91.5	8.0	0.75	73882.35940	118205.84400	1.59992	10745.98540	9.0	0.60	300276.50000	504828.68800	1.68121	45893.51950
91.5	8.0	0.80	76837.64840	122281.89800	1.59143	11116.53610	9.0	0.65	313925.43800	524245.15600	1.65997	47658.65240
91.5	8.0	0.85	79792.95310	126357.95300	1.58357	11487.08690	9.0	0.70	327574.34400	543661.68800	1.65966	49423.79300
91.5	9.0	0.60	57792.42580	94202.34370	1.63001	8863.84961	9.0	0.65	391459.25000	1662384.63000	1.67670	151125.87500
91.5	9.0	0.65	60419.34770	97825.50780	1.61911	8893.22850	9.0	0.70	408159.18800	1728322.50000	1.66549	156938.40600
91.5	9.0	0.70	63046.28520	101448.68000	1.60911	9222.80742	9.0	0.75	412233.28100	1790260.38000	1.65521	162750.93800
91.5	9.0	0.75	65673.21090	105071.85900	1.59992	9531.96730	9.0	0.80	42582.57030	1854198.38000	1.64575	168563.48400
91.5	9.0	0.80	68300.13280	108695.01600	1.59143	9881.36523	9.0	0.85	44103.37890	1918136.38000	1.63702	174376.01600
122.0	5.0	0.60	261790.68800	434950.56300	1.66144	39540.95700	5.0	0.60	826216.00000	1385320.50000	1.66549	125938.22700
122.0	5.0	0.65	273690.25000	451679.37500	1.65033	41061.76170	5.0	0.70	863771.25000	1438662.13000	1.67671	130782.00000
122.0	5.0	0.70	285589.84400	468408.28100	1.64014	42582.57030	5.0	0.75	901326.36300	1491883.75000	1.65521	135625.78100
122.0	5.0	0.75	297489.40600	485137.21900	1.63077	44103.37890	5.0	0.80	930881.81300	1545165.25000	1.64575	140489.37800
122.0	5.0	0.80	309388.96900	501866.03100	1.62212	45624.17970	5.0	0.85	96081.06300	159846.88800	1.63702	145313.34400
122.0	5.0	0.85	321288.56300	518594.87500	1.61411	47144.98830	6.0	0.60	301326.36300	1370097.38000	1.65521	120402.49200
122.0	6.0	0.60	218158.90600	362458.78100	1.66144	32950.79690	6.0	0.65	330881.81300	159846.88800	1.67671	168563.48400
122.0	6.0	0.65	228075.20300	376399.50000	1.65033	34218.13670	6.0	0.70	35485.47270	1651728.38000	1.66549	125938.22700
122.0	6.0	0.70	237991.53100	390340.21900	1.64014	35485.47270	6.0	0.75	378185.18800	1728322.50000	1.63702	145313.34400
122.0	6.0	0.75	247907.84400	404281.00000	1.63077	36524.81640	6.0	0.80	408159.18800	1854198.38000	1.67671	168563.48400
122.0	6.0	0.80	257824.15600	418221.68800	1.62212	38020.15240	6.0	0.85	42582.57030	1918136.38000	1.65521	135625.78100
122.0	6.0	0.85	267740.46900	432162.37500	1.61411	39287.48830	6.0	0.90	44103.37890	20074.00000	1.64575	140489.37800
122.0	7.0	0.60	186993.35900	310678.96900	1.66144	28443.54100	7.0	0.60	619662.00000	1038990.38000	1.67671	168563.48400
122.0	7.0	0.65	195893.03100	322628.12500	1.65033	29229.83010	7.0	0.65	647826.43800	1078951.50000	1.65521	135625.78100
122.0	7.0	0.70	203992.73400	334577.34400	1.64014	30416.12110	7.0	0.70	675994.93800	1118912.75000	1.64575	140489.37800
122.0	7.0	0.75	212492.43800	346526.56300	1.63077	30416.12110	7.0	0.75	704327.81300	1158874.00000	1.63702	145313.34400
122.0	7.0	0.80	220992.12500	358475.75000	1.62212	32566.70120	7.0	0.80	727565.62500	1228796.25000	1.67671	168563.48400
122.0	7.0	0.85	229491.84400	370424.90600	1.61411	33674.99220	7.0	0.85	748185.18800	1278757.50000	1.65521	135625.78100
122.0	8.0	0.60	163619.18800	271844.09400	1.66144	24713.09770	8.0	0.60	494755.81300	1324427.38000	1.67671	168563.48400
122.0	8.0	0.65	171056.40600	282229.62500	1.65033	25663.60160	8.0	0.65	518106.88800	1370097.38000	1.65521	135625.78100
122.0	8.0	0.70	178493.64100	292755.15600	1.64014	26614.10550	8.0	0.70	542427.38000	1424427.38000	1.64575	140489.37800
122.0	8.0	0.75	185930.87500	303210.75000	1.63077	27564.61130	8.0	0.75	569136.31300	1481578.13000	1.63702	145313.34400
122.0	8.0	0.80	193368.10900	313666.28100	1.62212	28515.11330	8.0	0.80	596106.88800	1538796.25000	1.67671	168563.48400
122.0	8.0	0.85	200805.35900	324121.78100	1.61411	29465.61720	8.0	0.85	623327.81300	1598874.00000	1.65521	135625.78100
122.0	9.0	0.60	145439.28100	241639.20300	1.66144	21967.19730	9.0	0.60	408884.37500	994589.12500	1.67671	168563.48400
122.0	9.0	0.65	152050.14100	250932.98400	1.65033	22812.08590	9.0	0.65	436958.06300	1055631.25000	1.65521	135625.78100
122.0	9.0	0.70	158661.01600	260226.81300	1.64014	23656.98240	9.0	0.70	465958.06300	1101152.25000	1.64575	140489.37800
122.0	9.0	0.75	165271.89100	269520.85600	1.63077	24501.87700	9.0	0.75	494755.81300	1158874.00000	1.63702	145313.34400
122.0	9.0	0.80	171882.76600	278814.46900	1.62212	25346.76760	9.0	0.80	524276.43800	1218912.75000	1.67671	168563.48400
122.0	9.0	0.85	178493.65600	288106.25000	1.61411	26191.66020	9.0	0.85	55316.11620	1278796.25000	1.65521	135625.78100
152.5	5.0	0.60	540497.68800	908691.68800	1.68121	82608.33590	5.0	0.60	1667410.25000	2760129.50000	1.66014	251648.12500
152.5	5.0	0.65	565065.75000	943641.31300	1.66997	85785.57810	5.0	0.65	1743201.50000	2874595.75000	1.64903	261326.90800
152.5	5.0	0.70	589633.81300	978591.00000	1.65966	88962.82810	5.0	0.70	181878.63000	3087529.25000	1.62949	280684.46900
152.5	5.0	0.75	614201.93800	1013540.75000	1.65018	92140.07030	5.0	0.75	1907575.63000	3193995.75000	1.62084	290363.21900
152.5	5.0	0.80	638770.00000	1048490.38000	1.64142	95317.31250	5.0	0.80	20074.00000	3300462.00000	1.61284	300042.00000

Appendix-1

L(m)	L/B	Cb	Msw (kN-m)	Mw (kN-m)	Mw/Msw	SM (m-cm-cm)	L(m)	L/B	Cb	Msw (kN-m)	Mw (kN-m)	Mw/Msw	SM (m-cm-cm)
213.5	6.0	0.60	1389508.50000	2306774.50000	1.66014	209706.76600	274.5	6.0	0.75	3709205.25000	5839980.50000	1.57446	530907.25000
213.5	6.0	0.65	1452667.80000	2395496.50000	1.64903	217772.42200	274.5	6.0	0.80	3857573.50000	6041359.00000	1.56610	549214.37500
213.5	6.0	0.70	1515827.50000	2484218.75000	1.63885	225838.06300	274.5	6.0	0.85	4005942.00000	6242737.50000	1.55837	567521.50000
213.5	6.0	0.75	1578986.88000	2572941.00000	1.62949	233903.73400	274.5	7.0	0.60	2797800.50000	4487866.50000	1.60407	407987.81300
213.5	6.0	0.80	1642146.25000	2661663.00000	1.62084	241969.35900	274.5	7.0	0.65	2924973.25000	4660476.50000	1.59334	423679.65600
213.5	6.0	0.85	1705306.00000	2750385.00000	1.61284	250035.00000	274.5	7.0	0.70	3052146.00000	4833087.00000	1.58350	439371.50000
213.5	7.0	0.60	1191007.25000	1977235.25000	1.66014	179740.65600	274.5	7.0	0.75	3179310.75000	5005697.50000	1.57446	455063.34400
213.5	7.0	0.65	1245143.88000	2053282.63000	1.64903	186662.07800	274.5	7.0	0.80	3306491.50000	5178307.50000	1.56610	470755.18800
213.5	7.0	0.70	1299280.75000	2129330.25000	1.63885	193575.48400	274.5	7.0	0.85	3433664.50000	5350918.00000	1.55837	486447.00000
213.5	7.0	0.75	1353417.25000	2205378.00000	1.62949	200488.90600	274.5	8.0	0.60	2448075.50000	3926883.00000	1.60407	356989.34400
213.5	7.0	0.80	1407554.00000	2281425.50000	1.62084	207402.29700	274.5	8.0	0.65	2559351.50000	4077917.00000	1.59334	370719.68800
213.5	7.0	0.85	1461690.75000	2357472.75000	1.61284	214315.71900	274.5	8.0	0.70	2670627.75000	4226951.00000	1.58350	384450.06300
213.5	8.0	0.60	1042131.38000	1730080.88000	1.66014	157280.07800	274.5	8.0	0.75	2781903.75000	4379985.50000	1.57446	398180.43800
213.5	8.0	0.65	1089500.88000	1796622.38000	1.64903	163329.31300	274.5	8.0	0.80	2893180.25000	4531019.50000	1.56610	411910.78100
213.5	8.0	0.70	1136870.63000	1863164.00000	1.63885	169378.54700	274.5	8.0	0.85	3004456.50000	4682053.00000	1.55837	425641.12500
213.5	8.0	0.75	1184240.13000	1929705.75000	1.62949	175427.79700	274.5	9.0	0.60	2176067.25000	3490562.75000	1.60407	317323.87500
213.5	8.0	0.80	1231609.75000	1996247.25000	1.62084	181477.01600	274.5	9.0	0.65	2274979.25000	3624815.00000	1.59334	329526.62500
213.5	8.0	0.85	1278979.50000	2062788.75000	1.61284	187526.25000	274.5	9.0	0.70	2373891.50000	3759067.50000	1.58350	341733.37500
213.5	9.0	0.60	926339.00000	1537849.63000	1.66014	139804.51600	274.5	9.0	0.75	2472803.50000	3893320.25000	1.57446	353938.15600
213.5	9.0	0.65	968445.25000	1596997.63000	1.64903	145181.60900	274.5	9.0	0.80	2571715.75000	4027572.75000	1.56610	366142.90600
213.5	9.0	0.70	1010551.69000	1656145.75000	1.63885	150558.70300	274.5	9.0	0.85	2670628.00000	4161825.00000	1.55837	376447.65600
213.5	9.0	0.75	1052657.88000	1715294.00000	1.62949	155935.81300	305.0	5.0	0.60	5481061.00000	8723164.00000	1.59151	793014.81300
213.5	9.0	0.80	1094764.25000	1774442.00000	1.62084	161312.90600	305.0	5.0	0.65	5730200.00000	9058669.00000	1.58086	823515.37500
213.5	9.0	0.85	1136870.63000	1833590.00000	1.61284	166690.00000	305.0	5.0	0.70	5979339.50000	9394176.00000	1.57111	854015.87500
244.0	5.0	0.60	2660812.50000	4292152.50000	1.61310	390195.62500	305.0	5.0	0.75	6228478.50000	9729683.00000	1.56213	884516.62500
244.0	5.0	0.65	2781758.50000	4457235.00000	1.60231	405203.15600	305.0	5.0	0.80	6477617.50000	10065188.00000	1.55384	915017.12500
244.0	5.0	0.70	2902704.75000	4622318.00000	1.59242	420210.68800	305.0	5.0	0.85	6726757.00000	10400694.00000	1.54617	945517.62500
244.0	5.0	0.75	3023650.50000	4787401.00000	1.58332	435218.25000	305.0	6.0	0.60	4567551.00000	7269303.00000	1.59151	660845.68800
244.0	5.0	0.80	3144596.50000	4952483.50000	1.57492	450225.75000	305.0	6.0	0.65	4775166.50000	7548891.00000	1.58086	686262.81300
244.0	5.0	0.85	3265542.75000	5117566.00000	1.56714	465233.25000	305.0	6.0	0.70	4982783.00000	7828480.00000	1.57111	711679.93800
244.0	6.0	0.60	2217343.75000	3576793.75000	1.61310	325163.03100	305.0	6.0	0.75	5190398.50000	8108069.00000	1.56213	737097.18800
244.0	6.0	0.65	2318132.00000	3714362.25000	1.60231	337669.28100	305.0	6.0	0.80	5398014.50000	8387657.00000	1.55384	762514.25000
244.0	6.0	0.70	2418920.50000	3851931.75000	1.59242	350175.59400	305.0	6.0	0.85	5605630.50000	8667245.00000	1.54617	787931.31300
244.0	6.0	0.75	2519708.75000	3989501.00000	1.58332	362681.87500	305.0	7.0	0.60	3915043.75000	6230831.00000	1.59151	566439.12500
244.0	6.0	0.80	2620497.00000	4127069.50000	1.57492	375188.12500	305.0	7.0	0.65	4093000.00000	6470478.00000	1.58086	588225.25000
244.0	6.0	0.85	2721285.75000	4264638.50000	1.56714	387694.37500	305.0	7.0	0.70	4270957.00000	6710125.50000	1.57111	610011.37500
244.0	7.0	0.60	1900580.38000	3065823.25000	1.61310	278711.15600	305.0	7.0	0.75	4448913.00000	6949773.50000	1.56213	631797.56300
244.0	7.0	0.65	1986970.38000	3183739.25000	1.60231	289430.81300	305.0	7.0	0.80	4626869.50000	7189420.50000	1.55384	653583.62500
244.0	7.0	0.70	2073360.50000	3301655.75000	1.59242	300150.50000	305.0	7.0	0.85	4804826.50000	7429067.50000	1.54617	675369.68800
244.0	7.0	0.75	2159750.50000	3419572.25000	1.58332	310870.18800	305.0	8.0	0.60	3425663.25000	5451977.00000	1.59151	495634.25000
244.0	7.0	0.80	2246140.25000	3537488.25000	1.57492	321589.81300	305.0	8.0	0.65	3581375.00000	5661668.50000	1.58086	514697.09400
244.0	7.0	0.85	2332530.50000	3655404.50000	1.56714	332309.46900	305.0	8.0	0.70	3737087.25000	5871360.00000	1.57111	533759.93800
244.0	8.0	0.60	1663007.88000	2682595.25000	1.61310	243872.26600	305.0	8.0	0.75	3892799.00000	6081051.50000	1.56213	552822.87500
244.0	8.0	0.65	1738599.00000	2785771.75000	1.60231	253251.96900	305.0	8.0	0.80	4048511.00000	6290743.00000	1.55384	571885.68800
244.0	8.0	0.70	1814190.50000	2888948.75000	1.59242	262631.68800	305.0	8.0	0.85	4204223.00000	6500434.00000	1.54617	590948.50000
244.0	8.0	0.75	1889781.63000	2992125.75000	1.58332	272011.40600	305.0	9.0	0.60	3045034.00000	4846202.00000	1.59151	440563.78100
244.0	8.0	0.80	1965372.75000	3095302.25000	1.57492	281391.09400	305.0	9.0	0.65	3183444.50000	5032594.00000	1.58086	457508.53100
244.0	8.0	0.85	2040964.25000	3198478.75000	1.56714	290770.78100	305.0	9.0	0.70	3321855.25000	5218986.50000	1.57111	474453.28100
244.0	9.0	0.60	1478229.25000	2384529.25000	1.61310	216775.34400	305.0	9.0	0.75	3460265.75000	5405379.00000	1.56213	491398.12500
244.0	9.0	0.65	1545421.38000	2476241.50000	1.60231	225112.85900	305.0	9.0	0.80	3598676.50000	5591771.50000	1.55384	508342.84400
244.0	9.0	0.70	1612613.75000	2567954.50000	1.59242	233450.39100	305.0	9.0	0.85	3737087.00000	5778163.50000	1.54617	525287.56300
244.0	9.0	0.75	1679805.88000	2659667.25000	1.58332	241787.92200	335.5	5.0	0.60	7396485.50000	11610330.00000	1.56974	1055502.75000
244.0	9.0	0.80	1746998.00000	2751379.75000	1.57492	250125.42200	335.5	5.0	0.65	7732689.50000	12057089.00000	1.55924	1096098.88000
244.0	9.0	0.85	1814190.38000	2843092.25000	1.56714	258462.92200	335.5	5.0	0.70	8068894.00000	12503648.00000	1.54961	1136695.25000
274.5	5.0	0.60	3916920.75000	6283013.00000	1.60407	571182.93800	335.5	5.0	0.75	8405098.00000	12950208.00000	1.54076	1177291.63000
274.5	5.0	0.65	4094962.50000	6524667.00000	1.59334	593151.50000	335.5	5.0	0.80	8741301.00000	13396766.00000	1.53258	1217887.75000
274.5	5.0	0.70	4273004.50000	6766321.50000	1.58350	615120.12500	335.5	5.0	0.85	9077505.00000	13843325.00000	1.52501	1258484.00000
274.5	5.0	0.75	4451046.00000	7007976.50000	1.57446	637088.68800	335.5	6.0	0.60	6163738.00000	9675441.00000	1.56974	879585.56300
274.5	5.0	0.80	4629088.50000	7249631.00000	1.56610	659057.25000	335.5	6.0	0.65	6443988.00000	10047574.00000	1.55924	913415.75000
274.5	5.0	0.85	4807130.50000	7491285.00000	1.55837	681025.81300	335.5	6.0	0.70	6724078.50000	10419707.00000	1.54961	947246.06300
274.5	6.0	0.60	3264100.75000	5235844.00000	1.60407	475985.78100	335.5	6.0	0.75	7004248.00000	10791840.00000	1.54076	981076.31300
274.5	6.0	0.65	3412468.75000	5437222.50000	1.59334	494292.90600	335.5	6.0	0.80	7284418.00000	11163972.00000	1.53258	1014906.50000
274.5	6.0	0.70	3560837.00000	5638601.50000	1.58350	512600.09400	335.5	6.0	0.85	7564587.50000	11536104.00000	1.52501	1048736.63000

L (m)	L/B	Cb	Msw (kN-m)	Mw (kN-m)	Mw/Msw	SM (m-cm-cm)
213.5	6.0	0.60	1389508.50000	2306774.50000	1.66014	209706.76600
213.5	6.0	0.65	1452667.88000	2395496.50000	1.64903	217772.42200
213.5	6.0	0.70	1515827.50000	2484218.75000	1.63885	225830.06300
213.5	6.0	0.75	1578986.88000	2572941.00000	1.62949	233903.73400
213.5	6.0	0.80	1642146.25000	2661663.00000	1.62084	241969.35900
213.5	6.0	0.85	1705306.00000	2750385.00000	1.61284	250035.00000
213.5	7.0	0.60	1191007.25000	1977235.25000	1.66014	179748.65600
213.5	7.0	0.65	1245143.88000	2053282.63000	1.64903	186662.07800
213.5	7.0	0.70	1299280.75000	2129330.25000	1.63885	193575.48400
213.5	7.0	0.75	1353417.25000	2205378.00000	1.62949	200488.90600
213.5	7.0	0.80	1407554.00000	2281425.50000	1.62084	207402.29700
213.5	7.0	0.85	1461690.75000	2357472.75000	1.61284	214315.71900
213.5	8.0	0.60	1042131.38000	1730080.88000	1.66014	157280.07800
213.5	8.0	0.65	1089500.88000	1796622.38000	1.64903	163329.31300
213.5	8.0	0.70	1136870.63000	1863164.00000	1.63885	169378.54700
213.5	8.0	0.75	1184240.13000	1929705.75000	1.62949	175427.79700
213.5	8.0	0.80	1231609.75000	1996247.25000	1.62084	181477.01600
213.5	8.0	0.85	1278979.50000	2062788.75000	1.61284	187526.25000
213.5	9.0	0.60	926339.00000	1537849.63000	1.66014	139804.51600
213.5	9.0	0.65	968445.25000	1596997.63000	1.64903	145181.60900
213.5	9.0	0.70	1010551.69000	1656145.75000	1.63885	150558.70300
213.5	9.0	0.75	1052657.88000	1715294.00000	1.62949	155935.81300
213.5	9.0	0.80	1094764.25000	1774442.00000	1.62084	161312.90600
213.5	9.0	0.85	1136870.63000	1833590.00000	1.61284	166690.00000
244.0	5.0	0.60	2660812.50000	4292152.50000	1.61310	390195.62500
244.0	5.0	0.65	2781758.50000	4457235.00000	1.60231	405203.15600
244.0	5.0	0.70	2902704.75000	4622318.00000	1.59242	420210.68800
244.0	5.0	0.75	3023650.50000	4787401.00000	1.58332	435218.25000
244.0	5.0	0.80	3144596.50000	4952483.50000	1.57492	450225.75000
244.0	5.0	0.85	3265542.75000	5117566.00000	1.56714	465232.25000
244.0	6.0	0.60	2217343.75000	3576793.75000	1.61310	325163.03100
244.0	6.0	0.65	2318132.00000	3714362.25000	1.60231	337669.28100
244.0	6.0	0.70	2418920.50000	3851931.75000	1.59242	350175.59400
244.0	6.0	0.75	2519708.75000	3989501.00000	1.58332	362681.87500
244.0	6.0	0.80	2620497.00000	4127069.50000	1.57492	375188.12500
244.0	6.0	0.85	2721285.75000	4264638.50000	1.56714	387694.37500
244.0	7.0	0.60	1900580.38000	3065823.25000	1.61310	278711.15600
244.0	7.0	0.65	1986970.38000	3183739.25000	1.60231	289430.81300
244.0	7.0	0.70	2073360.50000	3301655.75000	1.59242	300150.50000
244.0	7.0	0.75	2159750.50000	3419572.25000	1.58332	310870.18800
244.0	7.0	0.80	2246140.25000	3537488.25000	1.57492	321589.81300
244.0	7.0	0.85	2332530.50000	3655404.50000	1.56714	332309.46900
244.0	8.0	0.60	1663807.88000	2682595.25000	1.61310	243872.26600
244.0	8.0	0.65	1738599.00000	2785771.75000	1.60231	253251.96900
244.0	8.0	0.70	1814190.50000	2888948.75000	1.59242	262631.68800
244.0	8.0	0.75	1889781.63000	2992125.75000	1.58332	272011.40600
244.0	8.0	0.80	1965372.75000	3095302.25000	1.57492	281391.09400
244.0	8.0	0.85	2040964.25000	3198478.75000	1.56714	290770.78100
244.0	9.0	0.60	1478229.25000	2384529.25000	1.61310	216775.34400
244.0	9.0	0.65	1545421.38000	2476241.50000	1.60231	225112.85900
244.0	9.0	0.70	1612613.75000	2567954.50000	1.59242	233450.39100
244.0	9.0	0.75	1679805.88000	2659667.25000	1.58332	241787.92200
244.0	9.0	0.80	1746998.00000	2751379.75000	1.57492	250125.42200
244.0	9.0	0.85	1814190.38000	2843092.25000	1.56714	258462.92200
274.5	5.0	0.60	3916920.75000	6283013.00000	1.60407	571182.93800
274.5	5.0	0.65	4094962.50000	6524667.00000	1.59334	593151.50000
274.5	5.0	0.70	4273004.50000	6766321.50000	1.58350	615120.12500
274.5	5.0	0.75	4451046.00000	7007976.50000	1.57446	637088.68800
274.5	5.0	0.80	4629088.50000	7249631.00000	1.56610	659057.25000
274.5	5.0	0.85	4807130.50000	7491285.00000	1.55837	681025.81300
274.5	6.0	0.60	3264100.75000	5235844.00000	1.60407	475985.78100
274.5	6.0	0.65	3412468.75000	5437222.50000	1.59334	494222.90600
274.5	6.0	0.70	3560837.00000	5638601.50000	1.58350	512600.09400

L (m)	L/B	Cb	Msw (kN-m)	Mw (kN-m)	Mw/Msw	SM (m-cm-cm)
274.5	6.0	0.75	3709205.25000	5839980.50000	1.57446	530907.25000
274.5	6.0	0.80	3857573.50000	6041359.00000	1.56610	549214.37500
274.5	6.0	0.85	4005942.00000	6242737.50000	1.55837	567521.50000
274.5	7.0	0.60	2797800.50000	4487866.50000	1.60407	407987.81300
274.5	7.0	0.65	2924973.25000	4660476.50000	1.59334	423679.65600
274.5	7.0	0.70	3052146.00000	4833087.00000	1.58350	439371.50000
274.5	7.0	0.75	3179318.75000	5005697.50000	1.57446	455063.34400
274.5	7.0	0.80	3306491.50000	5178307.50000	1.56610	470755.18800
274.5	7.0	0.85	3433664.50000	5350918.00000	1.55837	486447.00000
274.5	8.0	0.60	2448075.50000	3926883.00000	1.60407	356989.34400
274.5	8.0	0.65	2559351.50000	4077917.00000	1.59334	370719.68800
274.5	8.0	0.70	2670627.75000	4228951.00000	1.58350	384450.06300
274.5	8.0	0.75	2781903.75000	4379985.50000	1.57446	398180.43800
274.5	8.0	0.80	2893180.25000	4531019.50000	1.56610	411910.78100
274.5	8.0	0.85	3004456.50000	4682053.00000	1.55837	425641.12500
274.5	9.0	0.60	2176067.25000	3490562.75000	1.60407	317323.87500
274.5	9.0	0.65	2274979.25000	3624815.00000	1.59334	329528.62500
274.5	9.0	0.70	2373891.50000	3759067.50000	1.58350	341733.37500
274.5	9.0	0.75	2472803.50000	3893320.25000	1.57446	353938.15600
274.5	9.0	0.80	2571715.75000	4027572.75000	1.56610	366142.90600
274.5	9.0	0.85	2670628.00000	4161825.00000	1.55837	378347.65600
305.0	5.0	0.60	5481061.00000	8723164.00000	1.59151	793014.81300
305.0	5.0	0.65	5730200.00000	9058669.00000	1.58086	823515.37500
305.0	5.0	0.70	5979339.50000	9394176.00000	1.57111	854015.87500
305.0	5.0	0.75	6228478.50000	9729683.00000	1.56213	884516.62500
305.0	5.0	0.80	6477617.50000	10065188.00000	1.55384	915017.12500
305.0	5.0	0.85	6726757.00000	10400694.00000	1.54617	945517.62500
305.0	6.0	0.60	4567551.00000	7269303.00000	1.59151	660845.68800
305.0	6.0	0.65	4775166.50000	7548891.00000	1.58086	686262.81300
305.0	6.0	0.70	4982783.00000	7828480.00000	1.57111	711679.93800
305.0	6.0	0.75	5190398.50000	8108069.00000	1.56213	737097.18800
305.0	6.0	0.80	5398014.50000	8387657.00000	1.55384	762514.25000
305.0	6.0	0.85	5605630.50000	8667245.00000	1.54617	787931.31300
305.0	7.0	0.60	3915043.75000	6230831.00000	1.59151	566439.12500
305.0	7.0	0.65	4093000.00000	6470478.00000	1.58086	588225.25000
305.0	7.0	0.70	4270957.00000	6710125.50000	1.57111	610011.37500
305.0	7.0	0.75	4448913.00000	6949773.50000	1.56213	631797.56300
305.0	7.0	0.80	4626869.50000	7189420.50000	1.55384	653583.62500
305.0	7.0	0.85	4804826.50000	7429067.50000	1.54617	675369.68800
305.0	8.0	0.60	3426663.25000	5451977.00000	1.59151	495634.25000
305.0	8.0	0.65	3581375.00000	5661668.50000	1.58086	514697.09400
305.0	8.0	0.70	3737087.25000	5871360.00000	1.57111	533759.93800
305.0	8.0	0.75	3892799.00000	6081051.50000	1.56213	552822.87500
305.0	8.0	0.80	4048511.00000	6290743.00000	1.55384	571885.68800
305.0	8.0	0.85	4204223.00000	6500434.00000	1.54617	590948.50000
305.0	9.0	0.60	3045034.00000	4846202.00000	1.59151	440563.78100
305.0	9.0	0.65	3183444.50000	5032594.00000	1.58086	457508.53100
305.0	9.0	0.70	3321855.25000	5218986.50000	1.57111	474453.28100
305.0	9.0	0.75	3460265.75000	5405379.00000	1.56213	491398.12500
305.0	9.0	0.80	3598676.50000	5591771.50000	1.55384	508342.84400
305.0	9.0	0.85	3737087.00000	5778163.50000	1.54617	525287.56300
335.5	5.0	0.60	7396485.50000	11610530.00000	1.56974	1055502.75000
335.5	5.0	0.65	7732689.50000	12057089.00000	1.55924	1096098.88000
335.5	5.0	0.70	8068894.00000	12503648.00000	1.54961	1136695.25000
335.5	5.0	0.75	8405098.00000	12950208.00000	1.54076	1177291.63000
335.5	5.0	0.80	8741301.00000	13396766.00000	1.53258	1217887.75000
335.5	5.0	0.85	9077505.00000	13843325.00000	1.52501	1258484.00000
335.5	6.0	0.60	6163738.00000	9675441.00000	1.56974	879585.56300
335.5	6.0	0.65	6443908.00000	10047574.00000	1.55924	913415.75000
335.5	6.0	0.70	6724078.50000	10419707.00000	1.54961	947246.06300
335.5	6.0	0.75	7004248.00000	10791840.00000	1.54076	981076.31300
335.5	6.0	0.80	7284418.00000	11163972.00000	1.53258	1014906.50000
335.5	6.0	0.85	7564587.50000	11		

Appendix-1

I (m)	L/B	Cb	Msw (kN-m)	Mw (kN-m)	Mw (kN-m)	Mw/MSW	SN (m-cm-cm)
335.5	7.0	0.60	5283204.00000	8293235.50000	1.56974	753930.50000	
335.5	7.0	0.65	5523349.50000	8612206.00000	1.55924	762927.81300	
335.5	7.0	0.70	5763495.50000	8931177.00000	1.54961	811925.18800	
335.5	7.0	0.75	6003641.00000	9250148.00000	1.54076	840922.56300	
335.5	7.0	0.80	6243787.00000	9569119.00000	1.53258	869919.87500	
335.5	7.0	0.85	6483932.50000	9888089.00000	1.52501	898917.12500	
335.5	8.0	0.60	4622803.50000	7256581.00000	1.56974	659689.18800	
335.5	8.0	0.65	4832931.00000	7535680.50000	1.55924	685061.81300	
335.5	8.0	0.70	5043058.50000	7814780.00000	1.54961	710434.56300	
335.5	8.0	0.75	5253186.00000	8093880.00000	1.54076	735807.25000	
335.5	8.0	0.80	5463313.50000	8372978.50000	1.53258	761179.87500	
335.5	8.0	0.85	5673441.00000	8652078.00000	1.52501	786552.50000	
335.5	9.0	0.60	4109158.750000	6450294.50000	1.56974	586390.37500	
335.5	9.0	0.65	4295938.50000	6698382.50000	1.55924	608943.81300	
335.5	9.0	0.70	4482719.00000	6946471.00000	1.54961	631497.37500	
335.5	9.0	0.75	4669498.50000	7194560.00000	1.54076	654050.87500	
335.5	9.0	0.80	4856278.50000	7442647.50000	1.53258	676604.31300	
335.5	9.0	0.85	5043058.50000	7690736.00000	1.52501	699157.75000	
366.0	5.0	0.60	9684023.00000	15024778.00000	1.55150	1365888.88000	
366.0	5.0	0.65	10124206.00000	15602654.00000	1.54112	1418423.00000	
366.0	5.0	0.70	10564389.00000	16180530.00000	1.53161	1470957.25000	
366.0	5.0	0.75	11004572.00000	16758407.00000	1.52286	1523491.63000	
366.0	5.0	0.80	11444754.00000	17336282.00000	1.51478	1576025.75000	
366.0	5.0	0.85	11884937.00000	17914158.00000	1.50730	1628559.75000	
366.0	6.0	0.60	8070019.00000	12520649.00000	1.55150	1138240.75000	
366.0	6.0	0.65	8436838.00000	13002211.00000	1.54112	1182019.13000	
366.0	6.0	0.70	8803658.00000	13483775.00000	1.53161	1225797.75000	
366.0	6.0	0.75	9170476.00000	13965339.00000	1.52286	1269576.38000	
366.0	6.0	0.80	9537293.00000	14446902.00000	1.51478	1313354.75000	
366.0	6.0	0.85	9904114.00000	14928465.00000	1.50730	1357133.13000	
366.0	7.0	0.60	6917159.00000	10731985.00000	1.55150	975634.93800	
366.0	7.0	0.65	7231576.00000	11144753.00000	1.54112	1013159.31000	
366.0	7.0	0.70	7545992.50000	11557522.00000	1.53161	1050683.75000	
366.0	7.0	0.75	7860408.50000	11970291.00000	1.52286	1088208.25000	
366.0	7.0	0.80	8174824.50000	12383059.00000	1.51478	1125732.63000	
366.0	7.0	0.85	8489241.00000	12795827.00000	1.50730	1163257.00000	
366.0	8.0	0.60	6052514.50000	9390487.00000	1.55150	853680.56300	
366.0	8.0	0.65	6327629.00000	9751658.00000	1.54112	886514.37500	
366.0	8.0	0.70	6602743.50000	10112831.00000	1.53161	919348.31300	
366.0	8.0	0.75	6877857.50000	10474004.00000	1.52286	952182.25000	
366.0	8.0	0.80	7152971.50000	10835176.00000	1.51478	985016.06300	
366.0	8.0	0.85	7428086.00000	11196348.00000	1.50730	1017849.88000	
366.0	9.0	0.60	5360012.50000	8347099.00000	1.55150	758827.18800	
366.0	9.0	0.65	5624559.00000	8668141.00000	1.54112	788012.75000	
366.0	9.0	0.70	5869105.00000	8989184.00000	1.53161	817198.50000	
366.0	9.0	0.75	6113651.00000	9310226.00000	1.52286	846384.25000	
366.0	9.0	0.80	6358196.50000	9631268.00000	1.51478	875569.81300	
366.0	9.0	0.85	6602743.00000	9952310.00000	1.50730	904755.43800	

9/11/21 11:53:47



Appendix-I

9/11/21  
11:53:47

L (m)	L/B	Cb	MSW (kN-m)	MW (kN-m)	MW (kN-m)	MW/Msw	SM (m-cm-cm)
335.5	7.0	0.60	5283204.00000	8293235.50000	1.56974	753930.50000	
335.5	7.0	0.65	5523349.50000	8612206.00000	1.55924	782927.81300	
335.5	7.0	0.70	5763495.50000	8931177.00000	1.54961	811925.18800	
335.5	7.0	0.75	6003641.00000	9250148.00000	1.54076	840922.56300	
335.5	7.0	0.80	6243787.00000	9569119.00000	1.53258	869919.87500	
335.5	8.0	0.85	6483932.50000	9888089.00000	1.52501	898917.12500	
335.5	8.0	0.90	6724078.00000	10207069.00000	1.51744	927914.47500	
335.5	8.0	0.95	6964224.00000	10526049.00000	1.51033	956911.82500	
335.5	9.0	1.00	7204370.00000	10845029.00000	1.50373	985909.17500	
335.5	9.0	1.05	7444516.00000	11164009.00000	1.49762	1014888.52500	
335.5	9.0	1.10	7684662.00000	11482989.00000	1.49196	1043777.87500	
335.5	9.0	1.15	7924808.00000	11801969.00000	1.48685	1072667.22500	
335.5	9.0	1.20	8164954.00000	12120949.00000	1.48228	1101556.57500	
335.5	9.0	1.25	8405100.00000	12440929.00000	1.47825	1130446.02500	
335.5	9.0	1.30	8645246.00000	12760909.00000	1.47470	1159335.47500	
335.5	9.0	1.35	8885392.00000	13080889.00000	1.47162	1188224.92500	
335.5	9.0	1.40	9125538.00000	13400869.00000	1.46901	1217114.37500	
335.5	9.0	1.45	9365684.00000	13720849.00000	1.46686	1246003.82500	
335.5	9.0	1.50	9605830.00000	14040829.00000	1.46516	1274893.27500	
335.5	9.0	1.55	9845976.00000	14360809.00000	1.46390	1303782.72500	
335.5	9.0	1.60	10086122.00000	14680789.00000	1.46307	1332672.17500	
335.5	9.0	1.65	10326268.00000	15000769.00000	1.46258	1361561.62500	
335.5	9.0	1.70	10566414.00000	15320749.00000	1.46242	1390451.07500	
335.5	9.0	1.75	10806560.00000	15640729.00000	1.46247	1419340.52500	
335.5	9.0	1.80	11046706.00000	15960709.00000	1.46263	1448229.97500	
335.5	9.0	1.85	11286852.00000	16280689.00000	1.46290	1477119.42500	
335.5	9.0	1.90	11526998.00000	16600669.00000	1.46327	1506008.87500	
335.5	9.0	1.95	11767144.00000	16920649.00000	1.46375	1534898.32500	
335.5	9.0	2.00	12007290.00000	17240629.00000	1.46433	1563787.77500	
335.5	9.0	2.05	12247436.00000	17560609.00000	1.46499	1592677.22500	
335.5	9.0	2.10	12487582.00000	17880589.00000	1.46573	1621566.67500	
335.5	9.0	2.15	12727728.00000	18200569.00000	1.46653	1650456.12500	
335.5	9.0	2.20	12967874.00000	18520549.00000	1.46739	1679345.57500	
335.5	9.0	2.25	13208020.00000	18840529.00000	1.46831	1708235.02500	
335.5	9.0	2.30	13448166.00000	19160509.00000	1.46928	1737124.47500	
335.5	9.0	2.35	13688312.00000	19480489.00000	1.47030	1766013.92500	
335.5	9.0	2.40	13928458.00000	19800469.00000	1.47137	1794903.37500	
335.5	9.0	2.45	14168604.00000	20120449.00000	1.47248	1823792.82500	
335.5	9.0	2.50	14408750.00000	20440429.00000	1.47363	1852682.27500	
335.5	9.0	2.55	14648896.00000	20760409.00000	1.47482	1881571.72500	
335.5	9.0	2.60	14889042.00000	21080389.00000	1.47605	1910461.17500	
335.5	9.0	2.65	15129188.00000	21400369.00000	1.47731	1939350.62500	
335.5	9.0	2.70	15369334.00000	21720349.00000	1.47859	1968240.07500	
335.5	9.0	2.75	15609480.00000	22040329.00000	1.47989	1997129.52500	
335.5	9.0	2.80	15849626.00000	22360309.00000	1.48120	2026018.97500	
335.5	9.0	2.85	16089772.00000	22680289.00000	1.48253	2054908.42500	
335.5	9.0	2.90	16329918.00000	23000269.00000	1.48387	2083797.87500	
335.5	9.0	2.95	16570064.00000	23320249.00000	1.48522	2112687.32500	
335.5	9.0	3.00	16810210.00000	23640229.00000	1.48658	2141576.77500	
335.5	9.0	3.05	17050356.00000	23960209.00000	1.48794	2170466.22500	
335.5	9.0	3.10	17290502.00000	24280189.00000	1.48931	2199355.67500	
335.5	9.0	3.15	17530648.00000	24600169.00000	1.49068	2228245.12500	
335.5	9.0	3.20	17770794.00000	24920149.00000	1.49206	2257134.57500	
335.5	9.0	3.25	18010940.00000	25240129.00000	1.49344	2286024.02500	
335.5	9.0	3.30	18251086.00000	25560109.00000	1.49482	2314913.47500	
335.5	9.0	3.35	18491232.00000	25880089.00000	1.49621	2343802.92500	
335.5	9.0	3.40	18731378.00000	26200069.00000	1.49760	2372692.37500	
335.5	9.0	3.45	18971524.00000	26520049.00000	1.49899	2401581.82500	
335.5	9.0	3.50	19211670.00000	26840029.00000	1.49999	2430471.27500	
335.5	9.0	3.55	19451816.00000	27160009.00000	1.50099	2459360.72500	
335.5	9.0	3.60	19691962.00000	27480989.00000	1.50199	2488250.17500	
335.5	9.0	3.65	19932108.00000	27800969.00000	1.50299	2517139.62500	
335.5	9.0	3.70	20172254.00000	28120949.00000	1.50399	2546029.07500	
335.5	9.0	3.75	20412400.00000	28440929.00000	1.50499	2574918.52500	
335.5	9.0	3.80	20652546.00000	28760909.00000	1.50599	2603807.97500	
335.5	9.0	3.85	20892692.00000	29080889.00000	1.50699	2632697.42500	
335.5	9.0	3.90	21132838.00000	29400869.00000	1.50799	2661586.87500	
335.5	9.0	3.95	21372984.00000	29720849.00000	1.50899	2690476.32500	
335.5	9.0	4.00	21613130.00000	30040829.00000	1.50999	2719365.77500	
335.5	9.0	4.05	21853276.00000	30360809.00000	1.51099	2748255.22500	
335.5	9.0	4.10	22093422.00000	30680789.00000	1.51199	2777144.67500	
335.5	9.0	4.15	22333568.00000	31000769.00000	1.51299	2806034.12500	
335.5	9.0	4.20	22573714.00000	31320749.00000	1.51399	2834923.57500	
335.5	9.0	4.25	22813860.00000	31640729.00000	1.51499	2863813.02500	
335.5	9.0	4.30	23054006.00000	31960709.00000	1.51599	2892702.47500	
335.5	9.0	4.35	23294152.00000	32280689.00000	1.51699	2921591.92500	
335.5	9.0	4.40	23534298.00000	32600669.00000	1.51799	2950481.37500	
335.5	9.0	4.45	23774444.00000	32920649.00000	1.51899	2979370.82500	
335.5	9.0	4.50	24014590.00000	33240629.00000	1.51999	3008260.27500	
335.5	9.0	4.55	24254736.00000	33560609.00000	1.52099	3037149.72500	
335.5	9.0	4.60	24494882.00000	33880589.00000	1.52199	3066039.17500	
335.5	9.0	4.65	24735028.00000	34200569.00000	1.52299	3094928.62500	
335.5	9.0	4.70	24975174.00000	34520549.00000	1.52399	3123818.07500	
335.5	9.0	4.75	25215320.00000	34840529.00000	1.52499	3152707.52500	
335.5	9.0	4.80	25455466.00000	35160509.00000	1.52599	3181596.97500	
335.5	9.0	4.85	25695612.00000	35480489.00000	1.52699	3210486.42500	
335.5	9.0	4.90	25935758.00000	35800469.00000	1.52799	3239375.87500	
335.5	9.0	4.95	26175904.00000	36120449.00000	1.52899	3268265.32500	
335.5	9.0	5.00	26416050.00000	36440429.00000	1.52999	3297154.77500	
335.5	9.0	5.05	26656196.00000	36760409.00000	1.53099	3326044.22500	
335.5	9.0	5.10	26896342.00000	37080389.00000	1.53199	3354933.67500	
335.5	9.0	5.15	27136488.00000	37400369.00000	1.53299	3383823.12500	
335.5	9.0	5.20	27376634.00000	37720349.00000	1.53399	3412712.57500	
335.5	9.0	5.25	27616780.00000	38040329.00000	1.53499	3441602.02500	
335.5	9.0	5.30	27856926.00000	38360309.00000	1.53599	3470491.47500	
335.5	9.0	5.35	28097072.00000	38680289.00000	1.53699	3499380.92500	
335.5	9.0	5.40	28337218.00000	39000269.00000	1.53799	3528270.37500	
335.5	9.0	5.45	28577364.00000	39320249.00000	1.53899	3557159.82500	
335.5	9.0	5.50	28817510.00000	39640229.00000	1.53999	3586049.27500	
335.5	9.0	5.55	29057656.00000	39960209.00000	1.54099	3614938.72500	
335.5	9.0	5.60	29297802.00000	40280189.00000	1.54199	3643828.17500	
335.5	9.0	5.65	29537948.00000	40600169.00000	1.54299	3672717.62500	
335.5	9.0	5.70	29778094.00000	40920149.00000	1.54399	3701607.07500	
335.5	9.0	5.75	30018240.00000	41240129.00000	1.54499	3730496.52500	
335.5	9.0	5.80	30258386.00000	41560109.00000	1.54599	3759385.97500	
335.5	9.0	5.85	30498532.00000	41880089.00000	1.54699	3788275.42500	
335.5	9.0	5.90	30738678.00000	42200069.00000	1.54799	3817164.87500	
335.5	9.0	5.95	30978824.00000	42520049.00000	1.54899	3846054.32500	
335.5	9.0	6.00	31218970.00000	42840029.00000	1.54999	3874943.77500	
335.5	9.0	6.05	31459116.00000	43160009.00000	1.55099	3903833.22500	
335.5	9.0	6.10	31699262.00000	43480989.00000	1.55199	3932722.67500	
335.5	9.0	6.15	31939408.00000	43800969.00000	1.55299	3961612.12500	
335.5	9.0	6.20	32179554.00000	44120949.00000	1.55399	3990501.57500	
335.5	9.0	6.25	32419700.00000	44440929.00000	1.55499	4019391.02500	
335.5	9.0	6.30	32659846.00000	44760909.00000	1.55599	4048280.47500	
335.5	9.0	6.35	32899992.00000	45080889.00000	1.55699	4077169.92500	
335.5	9.0	6.40	33140138.00000	45400869.00000	1.55799	4106059.37500	
335.5	9.0	6.45	33380284.00000	45720849.00000	1.55899	4134948.82500	
335.5	9.0	6.50	33620430.00000	46040829.00000	1.55999	4163838.27500	
335.5	9.0	6.55	33860576.00000	46360809.00000	1.56099	4192727.72500	
335.5	9.0	6.60	34100722.00000	46680789.00000	1.56199	4221617.17500	
335.5	9.0	6.					

## **APPENDIX 2**

**Means and Standard Deviations of Msw, Mw, and SM of "ABS  
Ships"**

9/11/21  
11:52:25

1

Appendix-2

L	L/B	Ch	Msw (mean)	Msw (sd)	Mw (mean)	Mw (sd)	SM (mean)	SM (sd)
91.5	5.0	0.60	62416.	24966.	169564.	15261.	15415.	616.60
91.5	5.0	0.65	65253.	26102.	176086.	15848.	16008.	640.31
91.5	5.0	0.70	68090.	27236.	182608.	16435.	16601.	664.03
91.5	5.0	0.75	70927.	28371.	189129.	17022.	17194.	687.74
91.5	5.0	0.80	73764.	29506.	195651.	17609.	17786.	711.46
91.5	5.0	0.85	76601.	30640.	202173.	18196.	18379.	735.17
91.5	6.0	0.60	52013.	20805.	141304.	12717.	12846.	513.83
91.5	6.0	0.65	54377.	21751.	146738.	13206.	13340.	533.59
91.5	6.0	0.70	56742.	22697.	152173.	13696.	13834.	553.36
91.5	6.0	0.75	59106.	23642.	157608.	14185.	14328.	573.12
91.5	6.0	0.80	61470.	24588.	163043.	14674.	14822.	592.88
91.5	6.0	0.85	63834.	25534.	168477.	15163.	15316.	612.64
91.5	7.0	0.60	44583.	17833.	121117.	10901.	11011.	440.43
91.5	7.0	0.65	46609.	18644.	125776.	11320.	11434.	457.37
91.5	7.0	0.70	48636.	19454.	130434.	11739.	11858.	474.31
91.5	7.0	0.75	50662.	20265.	135092.	12158.	12281.	491.25
91.5	7.0	0.80	52689.	21075.	139751.	12578.	12705.	508.18
91.5	7.0	0.85	54715.	21886.	144409.	12997.	13120.	525.12
91.5	8.0	0.60	39010.	15604.	105978.	9538.	9634.	385.37
91.5	8.0	0.65	40783.	16313.	110054.	9905.	10005.	400.20
91.5	8.0	0.70	42556.	17022.	114130.	10272.	10375.	415.02
91.5	8.0	0.75	44329.	17732.	118206.	10639.	10746.	429.84
91.5	8.0	0.80	46103.	18441.	122278.	11005.	11117.	444.66
91.5	8.0	0.85	47876.	19150.	126358.	11372.	11487.	459.48
91.5	9.0	0.60	34675.	13870.	94202.	8478.	8564.	342.55
91.5	9.0	0.65	36252.	14501.	97826.	8804.	8893.	355.73
91.5	9.0	0.70	37828.	15131.	101449.	9130.	9223.	368.90
91.5	9.0	0.75	39404.	15762.	105072.	9456.	9552.	382.08
91.5	9.0	0.80	40980.	16392.	108695.	9783.	9881.	395.25
91.5	9.0	0.85	42556.	17022.	112318.	10109.	10211.	408.43
122.0	5.0	0.60	157074.	62830.	434951.	39146.	39541.	1581.64
122.0	5.0	0.65	164214.	65686.	451679.	40651.	41062.	1642.47
122.0	5.0	0.70	171354.	68542.	468408.	42157.	42583.	1703.30
122.0	5.0	0.75	178494.	71397.	485137.	43662.	44103.	1764.14
122.0	5.0	0.80	185633.	74253.	501866.	45168.	45624.	1824.97
122.0	5.0	0.85	192773.	77109.	518595.	46674.	47145.	1885.80
122.0	6.0	0.60	130895.	52358.	362459.	32621.	32951.	1318.03
122.0	6.0	0.65	136845.	54738.	376400.	33876.	34218.	1368.73
122.0	6.0	0.70	142795.	57118.	390340.	35131.	35485.	1419.42
122.0	6.0	0.75	148745.	59498.	404281.	36385.	36753.	1470.11
122.0	6.0	0.80	154695.	61878.	418222.	37640.	38020.	1520.81
122.0	6.0	0.85	160644.	64258.	432162.	38895.	39287.	1571.50
122.0	7.0	0.60	112196.	44878.	310679.	27961.	28244.	1129.74
122.0	7.0	0.65	117296.	46918.	322628.	29037.	29330.	1173.19
122.0	7.0	0.70	122396.	48958.	334577.	30112.	30416.	1216.64
122.0	7.0	0.75	127495.	50998.	346527.	31187.	31502.	1260.10
122.0	7.0	0.80	132595.	53038.	358476.	32263.	32589.	1303.55
122.0	7.0	0.85	137695.	55078.	370425.	33338.	33675.	1347.00
122.0	8.0	0.60	98172.	39269.	271844.	24466.	24713.	980.52
122.0	8.0	0.65	102634.	41054.	282300.	25407.	25664.	1026.54
122.0	8.0	0.70	107096.	42838.	292755.	26348.	26614.	1064.56
122.0	8.0	0.75	111559.	44623.	303211.	27289.	27565.	1102.58
122.0	8.0	0.80	116021.	46408.	313666.	28230.	28515.	1140.60
122.0	8.0	0.85	120483.	48193.	324122.	29171.	29466.	1178.62
122.0	9.0	0.60	87264.	34905.	241639.	21748.	21967.	878.69
122.0	9.0	0.65	91230.	36492.	250933.	22584.	22812.	912.48
122.0	9.0	0.70	95197.	38079.	260227.	23420.	23657.	946.28
122.0	9.0	0.75	99163.	39665.	269521.	24257.	24502.	980.08
122.0	9.0	0.80	103130.	41252.	278814.	25093.	25347.	1013.87
122.0	9.0	0.85	107096.	42838.	288108.	25930.	26192.	1047.67
152.5	5.0	0.60	124299.	129719.	408692.	81782.	82608.	3104.33
152.5	5.0	0.65	133939.	135616.	441641.	84928.	85786.	3431.42

L	L/B	Ch	Msw (mean)	Msw (sd)	Mw (mean)	Mw (sd)	SM (mean)	SM (sd)
152.5	5.0	0.70	353780.	141512.	978591.	88073.	88963.	3558.51
152.5	5.0	0.75	368521.	147408.	1013541.	91219.	92140.	3685.60
152.5	5.0	0.80	383262.	153305.	1048490.	94364.	95317.	3812.69
152.5	5.0	0.85	398003.	159201.	1083440.	97510.	98495.	3939.78
152.5	6.0	0.60	270249.	108100.	757243.	68152.	68840.	2753.61
152.5	6.0	0.65	282533.	113013.	786368.	70773.	71488.	2859.52
152.5	6.0	0.70	294817.	117927.	815493.	73394.	74136.	2965.43
152.5	6.0	0.75	307101.	122840.	844617.	76016.	76783.	3071.34
152.5	6.0	0.80	319385.	127754.	873742.	78637.	79431.	3177.24
152.5	6.0	0.85	331669.	132668.	902867.	81258.	82079.	3283.15
152.5	7.0	0.60	231642.	92657.	649066.	58416.	59006.	2360.24
152.5	7.0	0.65	242171.	96868.	674030.	60663.	61275.	2451.02
152.5	7.0	0.70	252700.	101080.	698994.	62909.	63545.	2541.79
152.5	7.0	0.75	263229.	105292.	723958.	65156.	65814.	2632.57
152.5	7.0	0.80	273759.	109503.	748922.	67403.	68084.	2723.35
152.5	7.0	0.85	284288.	113715.	773886.	69650.	70353.	2814.13
152.5	8.0	0.60	202687.	81075.	567932.	51114.	51630.	2065.21
152.5	8.0	0.65	211900.	84760.	589776.	53080.	53616.	2144.64
152.5	8.0	0.70	221113.	88445.	611619.	55046.	55602.	2224.07
152.5	8.0	0.75	230326.	92130.	633463.	57012.	57588.	2303.50
152.5	8.0	0.80	239539.	95815.	655307.	58978.	59573.	2382.93
152.5	8.0	0.85	248752.	99501.	677150.	60944.	61559.	2462.36
152.5	9.0	0.60	180166.	72066.	504829.	45435.	45894.	1835.74
152.5	9.0	0.65	188355.	75342.	524245.	47182.	47659.	1906.35
152.5	9.0	0.70	196545.	78618.	543662.	48930.	49424.	1976.95
152.5	9.0	0.75	204734.	81894.	563078.	50677.	51189.	2047.56
152.5	9.0	0.80	212923.	85169.	582495.	52425.	52954.	2118.16
152.5	9.0	0.85	221113.	88445.	601911.	54172.	54719.	2188.77
183.0	5.0	0.60	594876.	237950.	1662385.	149615.	151126.	6045.03
183.0	5.0	0.65	621915.	248766.	1726323.	155369.	156938.	6277.54
183.0	5.0	0.70	648955.	259582.	1790260.	161123.	162751.	6510.04
183.0	5.0	0.75	675995.	270398.	1854198.	166878.	168563.	6742.54
183.0	5.0	0.80	703035.	281214.	1918136.	172632.	174376.	6975.04
183.0	5.0	0.85	730075.	292030.	1982074.	178387.	180189.	7207.54
183.0	6.0	0.60	495730.	198292.	1385321.	124679.	125938.	5037.53
183.0	6.0	0.65	518263.	207305.	1438602.	129474.	130782.	5231.28
183.0	6.0	0.70	540796.	216318.	1491884.	134270.	135626.	5425.03
183.0	6.0	0.75	563329.	225332.	1545165.	139065.	140470.	5618.78
183.0	6.0	0.80	585862.	234345.	1598447.	143860.	145313.	5812.53
183.0	6.0	0.85	608395.	243358.	1651728.	148656.	150157.	6006.28
183.0	7.0	0.60	424911.	169964.	1187418.	106868.	107947.	4317.88
183.0	7.0	0.65	444225.	177690.	1233088.	110978.	112099.	4483.95
183.0	7.0	0.70	463539.	185416.	1278758.	115088.	116251.	4650.03
183.0	7.0	0.75	482854.	193141.	1324427.	119198.	120402.	4816.10
183.0	7.0	0.80	502168.	200867.	1370097.	123309.	124554.	4982.17
183.0	7.0	0.85	521482.	208593.	1415767.	127419.	128706.	5148.24
183.0	8.0	0.60	371797.	148719.	1038990.	93509.	94454.	3778.15
183.0	8.0	0.65	388697.	155479.	1078952.	97106.	98087.	3923.46
183.0	8.0	0.70	405597.	162239.	1118913.	100702.	101719.	4068.77
183.0	8.0	0.75	422497.	168999.	1158874.	104299.	105352.	4214.09
183.0	8.0	0.80	439397.	175759.	1198835.	107895.	108985.	4359.40
183.0	8.0	0.85	456297.	182519.	1238796.	111492.	112618.	4504.71
183.0	9.0	0.60	330486.	132195.	923547.	83119.	83959.	3358.35
183.0	9.0	0.65	345509.	138203.	959068.	86316.	87188.	3487.52
183.0	9.0	0.70	360531.	144212.	994589.	89513.	90417.	3616.69
183.0	9.0	0.75	375553.	150221.	1030110.	92710.	93646.	3745.86
183.0	9.0	0.80	390575.	156230.	1065631.	95907.	96876.	3875.02
183.0	9.0	0.85	405597.	162239.	1101152.	99104.	100105.	4004.19
213.5	5.0	0.60	1000446.	400178.	2768102.	249132.	251648.	10065.92
213.5	5.0	0.65	1045921.	418368.	2874596.	258714.	261327.	10453.08
213.5	5.0	0.70	1091396.	436558.	2981063.	268296.	271006.	10840.23
213.5	5.0	0.75	1136871.	454748.	3087529.	277878.	280684.	11227.38

Appendix-2



L	L/B	Cb	Msw (mean)	Msw (sd)	Mw (mean)	Mw (sd)	SM (mean)	SM (sd)
91.5	5.0	0.60	62416.	24966.	169564.	15261.	15415.	616.60
91.5	5.0	0.65	65253.	26101.	176086.	15848.	16008.	640.31
91.5	5.0	0.70	68090.	27236.	182608.	16435.	16601.	664.03
91.5	5.0	0.75	70927.	28371.	189129.	17022.	17194.	687.74
91.5	5.0	0.80	73764.	29506.	195651.	17609.	17786.	711.46
91.5	5.0	0.85	76601.	30640.	202173.	18196.	18379.	735.17
91.5	6.0	0.60	52013.	20805.	141304.	12717.	12846.	513.83
91.5	6.0	0.65	54377.	21751.	146738.	13206.	13340.	533.59
91.5	6.0	0.70	56742.	22697.	152173.	13696.	13834.	553.36
91.5	6.0	0.75	59106.	23642.	157608.	14185.	14328.	573.12
91.5	6.0	0.80	61470.	24588.	163043.	14674.	14822.	592.88
91.5	6.0	0.85	63834.	25534.	168477.	15163.	15316.	612.64
91.5	7.0	0.60	44583.	17833.	121117.	10901.	11011.	440.43
91.5	7.0	0.65	46609.	18644.	125776.	11320.	11434.	457.37
91.5	7.0	0.70	48636.	19454.	130434.	11739.	11858.	474.31
91.5	7.0	0.75	50662.	20265.	135092.	12158.	12281.	491.25
91.5	7.0	0.80	52689.	21075.	139751.	12578.	12705.	508.18
91.5	7.0	0.85	54715.	21886.	144409.	12997.	13128.	525.12
91.5	8.0	0.60	39010.	15604.	105978.	9538.	9634.	385.37
91.5	8.0	0.65	40783.	16313.	110054.	9905.	10005.	400.20
91.5	8.0	0.70	42556.	17022.	114130.	10375.	10475.	415.02
91.5	8.0	0.75	44329.	17732.	118206.	10639.	10746.	429.84
91.5	8.0	0.80	46103.	18441.	122274.	11005.	11117.	444.66
91.5	8.0	0.85	47876.	19150.	126338.	11372.	11487.	459.48
91.5	9.0	0.60	34675.	13870.	94202.	8478.	8564.	342.55
91.5	9.0	0.65	36252.	14501.	97826.	8804.	8893.	355.73
91.5	9.0	0.70	37828.	15131.	101449.	9130.	9223.	368.90
91.5	9.0	0.75	39404.	15762.	105072.	9456.	9552.	382.08
91.5	9.0	0.80	40980.	16392.	108695.	9783.	9881.	395.25
91.5	9.0	0.85	42556.	17022.	112318.	10109.	10211.	408.43
122.0	5.0	0.60	157074.	62830.	434951.	39146.	39541.	1581.64
122.0	5.0	0.65	164214.	65686.	451679.	40651.	41062.	1642.47
122.0	5.0	0.70	171354.	68542.	468408.	42157.	42583.	1703.30
122.0	5.0	0.75	178494.	71397.	485137.	43662.	44103.	1764.14
122.0	5.0	0.80	185633.	74253.	501866.	45168.	45624.	1824.97
122.0	5.0	0.85	192773.	77109.	518595.	46674.	47145.	1885.80
122.0	6.0	0.60	130895.	52358.	362459.	32621.	32951.	1318.03
122.0	6.0	0.65	136845.	54738.	376400.	33876.	34218.	1368.73
122.0	6.0	0.70	142795.	57118.	390340.	35131.	35485.	1419.42
122.0	6.0	0.75	148745.	59498.	404281.	36385.	36753.	1470.11
122.0	6.0	0.80	154695.	61878.	418222.	37640.	38020.	1520.81
122.0	6.0	0.85	160644.	64258.	432162.	38895.	39287.	1571.50
122.0	7.0	0.60	112196.	44878.	310679.	27961.	28244.	1129.74
122.0	7.0	0.65	117296.	46918.	322628.	29037.	29330.	1173.19
122.0	7.0	0.70	122396.	48958.	334577.	30112.	30416.	1216.64
122.0	7.0	0.75	127495.	50998.	346527.	31187.	31502.	1260.10
122.0	7.0	0.80	132595.	53038.	358476.	32263.	32589.	1303.55
122.0	7.0	0.85	137695.	55078.	370425.	33338.	33675.	1347.00
122.0	8.0	0.60	98172.	39269.	271844.	24466.	24713.	988.52
122.0	8.0	0.65	102634.	41054.	282300.	25407.	25664.	1026.54
122.0	8.0	0.70	107096.	42838.	292755.	26348.	26614.	1064.56
122.0	8.0	0.75	111559.	44623.	303211.	27289.	27565.	1102.58
122.0	8.0	0.80	116021.	46408.	313666.	28230.	28515.	1140.60
122.0	8.0	0.85	120483.	48193.	324122.	29171.	29466.	1178.62
122.0	9.0	0.60	87264.	34905.	241639.	21748.	21967.	878.69
122.0	9.0	0.65	91230.	36492.	250933.	22584.	22812.	912.48
122.0	9.0	0.70	95197.	38079.	260227.	23420.	23657.	946.28
122.0	9.0	0.75	99163.	39665.	269521.	24257.	24502.	980.08
122.0	9.0	0.80	103130.	41252.	278814.	25093.	25347.	1013.87
122.0	9.0	0.85	107096.	42838.	288108.	25930.	26192.	1047.67
152.5	5.0	0.60	324299.	129719.	908692.	81782.	82608.	3104.33
152.5	5.0	0.65	339039.	135616.	943641.	84928.	85786.	3411.42

L	L/B	Cb	Msw (mean)	Msw (sd)	Mw (mean)	Mw (sd)	SM (mean)	SM (sd)
152.5	5.0	0.70	353780.	141512.	978591.	88073.	88963.	3558.51
152.5	5.0	0.75	368521.	147408.	1013541.	91219.	92140.	3685.60
152.5	5.0	0.80	383262.	153305.	1048490.	94364.	95317.	3812.69
152.5	5.0	0.85	398003.	159201.	1083440.	97510.	98495.	3939.78
152.5	6.0	0.60	270249.	108100.	757243.	68152.	68840.	2753.61
152.5	6.0	0.65	282533.	113013.	786368.	70773.	71488.	2859.52
152.5	6.0	0.70	294817.	117927.	815493.	73394.	74136.	2965.43
152.5	6.0	0.75	307101.	122840.	844617.	76016.	76783.	3071.34
152.5	6.0	0.80	319385.	127754.	873742.	78637.	79431.	3177.24
152.5	6.0	0.85	331669.	132668.	902867.	81258.	82079.	3283.15
152.5	7.0	0.60	231642.	92657.	649066.	58416.	59006.	2360.24
152.5	7.0	0.65	242171.	96868.	674030.	60663.	61275.	2451.02
152.5	7.0	0.70	252700.	101080.	698994.	62909.	63545.	2541.79
152.5	7.0	0.75	263229.	105292.	723958.	65156.	65814.	2632.57
152.5	7.0	0.80	273759.	109503.	748922.	67403.	68084.	2723.35
152.5	7.0	0.85	284288.	113715.	773886.	69650.	70353.	2814.13
152.5	8.0	0.60	202687.	81075.	567932.	51114.	51630.	2065.21
152.5	8.0	0.65	211900.	84760.	589776.	53080.	53616.	2144.64
152.5	8.0	0.70	221113.	88445.	611619.	55046.	55602.	2224.07
152.5	8.0	0.75	230326.	92130.	633463.	57012.	57588.	2303.50
152.5	8.0	0.80	239539.	95815.	655307.	58978.	59573.	2382.93
152.5	8.0	0.85	248752.	99501.	677150.	60944.	61559.	2462.36
152.5	9.0	0.60	180166.	72066.	504829.	45435.	45894.	1835.74
152.5	9.0	0.65	188355.	75342.	524245.	47182.	47659.	1906.35
152.5	9.0	0.70	196545.	78618.	543662.	48930.	49424.	1976.95
152.5	9.0	0.75	204734.	81894.	563078.	50677.	51189.	2047.56
152.5	9.0	0.80	212923.	85169.	582495.	52425.	52954.	2118.16
152.5	9.0	0.85	221113.	88445.	601911.	54172.	54719.	2188.77
183.0	5.0	0.60	594876.	237950.	1662385.	149615.	151126.	6045.03
183.0	5.0	0.65	621915.	248766.	1726323.	155369.	156938.	6277.54
183.0	5.0	0.70	648955.	259582.	1790260.	161123.	162751.	6510.04
183.0	5.0	0.75	675995.	270398.	1854198.	166878.	168563.	6742.54
183.0	5.0	0.80	703035.	281214.	1918136.	172632.	174376.	6975.04
183.0	5.0	0.85	730075.	292030.	1982074.	178387.	180189.	7207.54
183.0	6.0	0.60	495730.	198292.	1365321.	124679.	125938.	5037.53
183.0	6.0	0.65	518263.	207305.	1438602.	129474.	130782.	5231.28
183.0	6.0	0.70	540796.	216318.	1491884.	134270.	135626.	5425.03
183.0	6.0	0.75	563329.	225332.	1545165.	139065.	140470.	5618.78
183.0	6.0	0.80	585862.	234345.	1598447.	143860.	145313.	5812.53
183.0	6.0	0.85	608395.	243358.	1651728.	148656.	150157.	6006.28
183.0	7.0	0.60	424911.	169964.	1187418.	106868.	107947.	4317.88
183.0	7.0	0.65	444225.	177690.	1233088.	110978.	112099.	4483.95
183.0	7.0	0.70	463539.	185416.	1278758.	115088.	116251.	4650.03
183.0	7.0	0.75	482854.	193141.	1324427.	119198.	120402.	4816.10
183.0	7.0	0.80	502168.	200867.	1370097.	123309.	124554.	4982.17
183.0	7.0	0.85	521482.	208593.	1415767.	127419.	128706.	5148.24
183.0	8.0	0.60	371797.	148719.	1038990.	93509.	94454.	3778.15
183.0	8.0	0.65	388697.	155479.	1078952.	97106.	98087.	3923.46
183.0	8.0	0.70	405597.	162239.	1118913.	100702.	101719.	4068.77
183.0	8.0	0.75	422497.	168999.	1158874.	104299.	105352.	4214.09
183.0	8.0	0.80	439397.	175759.	1198835.	107895.	108985.	4359.40
183.0	8.0	0.85	456297.	182519.	1238796.	111492.	112618.	4504.71
183.0	9.0	0.60	330486.	132195.	923547.	83119.	83959.	3358.35
183.0	9.0	0.65	345509.	138203.	959068.	86316.	87188.	3487.52
183.0	9.0	0.70	360531.	144212.	994589.	89513.	90417.	3616.69
183.0	9.0	0.75	375553.	150221.	1030110.	92710.	93646.	3745.86
183.0	9.0	0.80	390575.	156230.	1065631.	95907.	96876.	3875.02
183.0	9.0	0.85	405597.	162239.	1101152.	99104.	100105.	4004.19
213.5	5.0	0.60	1000446.	400178.	2768130.	249132.	251648.	10065.92
213.5	5.0	0.65	1045921.	418368.	2874596.	258714.	261327.	10451.08
213.5	5.0	0.70	1091396.	436558.	2981063.	268296.	271006.	10840.23
213.5	5.0	0.75	1136871.	454748.	3087529.	277878.	280684.	11227.38

Appendix-2

L	L/B	Cb	Msw (mean)	Msw (sd)	Mw (mean)	Mw (sd)	SM (mean)	SM (sd)
213.5	5.0	0.80	1182345.	472938.	3193996.	287460.	290363.	11614.53
213.5	5.0	0.85	1227820.	491128.	3300462.	297042.	300042.	12001.60
213.5	6.0	0.60	833705.	333482.	2306775.	207610.	209707.	8388.27
213.5	6.0	0.65	871601.	348640.	2395497.	215595.	217772.	8710.90
213.5	6.0	0.70	909497.	363799.	2484219.	223580.	225838.	9033.52
213.5	6.0	0.75	947392.	378957.	2572941.	231565.	233904.	9356.15
213.5	6.0	0.80	985288.	394115.	2661663.	239550.	241969.	9678.77
213.5	6.0	0.85	1023184.	409273.	2750385.	247535.	250035.	10001.40
213.5	7.0	0.60	714604.	285842.	1977235.	177951.	179749.	7189.95
213.5	7.0	0.65	747086.	298835.	2053283.	184795.	186662.	7466.48
213.5	7.0	0.70	779569.	311827.	2129330.	191640.	193575.	7743.02
213.5	7.0	0.75	812050.	324820.	2205378.	198484.	200489.	8019.56
213.5	7.0	0.80	844532.	337813.	2281426.	205328.	207402.	8296.09
213.5	7.0	0.85	877015.	350806.	2357473.	212173.	214316.	8572.63
213.5	8.0	0.60	625279.	250112.	1730081.	155707.	157280.	6291.20
213.5	8.0	0.65	653701.	261480.	1796622.	161696.	163329.	6533.17
213.5	8.0	0.70	682122.	272849.	1863164.	167685.	169379.	6775.14
213.5	8.0	0.75	710544.	284218.	1929706.	173674.	175428.	7017.11
213.5	8.0	0.80	738966.	295586.	1996247.	179662.	181477.	7259.08
213.5	8.0	0.85	767388.	306955.	2062789.	185651.	187526.	7501.05
213.5	9.0	0.60	555803.	222321.	1537850.	138406.	139805.	5592.10
213.5	9.0	0.65	581067.	232427.	1596998.	143730.	145182.	5807.26
213.5	9.0	0.70	606331.	242532.	1656146.	149053.	150559.	6022.35
213.5	9.0	0.75	631595.	252638.	1715294.	154376.	155936.	6237.43
213.5	9.0	0.80	656859.	262743.	1774442.	161313.	16452.52	
213.5	9.0	0.85	682122.	272849.	1833590.	165023.	166690.	6667.60
244.0	5.0	0.60	1596488.	638595.	4292153.	386294.	390196.	15607.82
244.0	5.0	0.65	1669055.	667622.	4457235.	401151.	405203.	16208.13
244.0	5.0	0.70	1741623.	696649.	4622318.	416009.	420211.	16808.43
244.0	5.0	0.75	1814190.	725676.	4787401.	430866.	435218.	17408.73
244.0	5.0	0.80	1886758.	754703.	4952484.	445724.	450226.	18009.03
244.0	5.0	0.85	1959326.	783730.	5117566.	460581.	465233.	18609.33
244.0	6.0	0.60	1330406.	532163.	3576794.	321911.	325163.	13006.52
244.0	6.0	0.65	1390879.	556352.	3714362.	334293.	337669.	13506.77
244.0	6.0	0.70	1451352.	580541.	3851932.	346674.	350176.	14007.02
244.0	6.0	0.75	1511825.	604730.	3989501.	359055.	362682.	14507.27
244.0	6.0	0.80	1572298.	628919.	4127070.	371436.	375188.	15007.52
244.0	6.0	0.85	1632772.	653109.	4264639.	383817.	387694.	15507.77
244.0	7.0	0.60	1140348.	456139.	3065823.	275924.	278711.	11148.45
244.0	7.0	0.65	1192182.	476873.	3183739.	286537.	289431.	11577.23
244.0	7.0	0.70	1244016.	497607.	3301656.	297149.	300151.	12006.02
244.0	7.0	0.75	1295850.	518340.	3419572.	307762.	310870.	12434.81
244.0	7.0	0.80	1347684.	539074.	3537488.	318374.	321590.	12863.59
244.0	7.0	0.85	1399510.	559807.	3655405.	328986.	332309.	13292.38
244.0	8.0	0.60	997805.	399122.	2682595.	241434.	243872.	9754.89
244.0	8.0	0.65	1043159.	417264.	2785772.	250719.	253252.	10130.08
244.0	8.0	0.70	1088514.	435406.	2888949.	260005.	262632.	10505.27
244.0	8.0	0.75	1133869.	453548.	2992126.	269291.	272011.	10880.46
244.0	8.0	0.80	1179224.	471690.	3095302.	278577.	281391.	11255.64
244.0	8.0	0.85	1224579.	489831.	3198479.	287863.	290771.	11630.83
244.0	9.0	0.60	886938.	354775.	2384529.	214608.	216775.	8671.01
244.0	9.0	0.65	927253.	370901.	2476242.	222862.	225113.	9004.51
244.0	9.0	0.70	967568.	387027.	2567955.	231116.	233450.	9338.02
244.0	9.0	0.75	1007884.	403153.	2659667.	239370.	241788.	9671.52
244.0	9.0	0.80	1048199.	419280.	2751380.	247624.	250125.	10002.02
244.0	9.0	0.85	1088514.	435406.	2843092.	255878.	258463.	10338.52
274.5	5.0	0.60	2350153.	940061.	6283013.	565471.	571183.	22847.32
274.5	5.0	0.65	2456978.	982791.	6524667.	587220.	593152.	23726.06
274.5	5.0	0.70	2563803.	1025521.	6766322.	608969.	615120.	24764.80
274.5	5.0	0.75	2670620.	1068251.	7007977.	630718.	637089.	25483.55
274.5	5.0	0.80	2777453.	1110981.	7249631.	652467.	659057.	26362.29
274.5	5.0	0.85	2884279.	1153711.	7491285.	674216.	681026.	27241.03

L	L/B	Cb	Msw (mean)	Msw (sd)	Mw (mean)	Mw (sd)	SM (mean)	SM (sd)
274.5	6.0	0.60	1958461.	783384.	5235844.	471226.	475986.	19039.43
274.5	6.0	0.65	2047481.	818993.	5437223.	489350.	494293.	19771.71
274.5	6.0	0.70	2136502.	854601.	5638602.	507474.	512600.	20504.00
274.5	6.0	0.75	2225523.	890209.	5839981.	525598.	530907.	21236.29
274.5	6.0	0.80	2314544.	925818.	6041359.	543722.	549214.	21968.57
274.5	6.0	0.85	2403565.	961426.	6242738.	561846.	567522.	22700.86
274.5	7.0	0.60	1678680.	671472.	4487867.	403908.	407988.	16319.51
274.5	7.0	0.65	1754984.	701994.	4660477.	419443.	423680.	16947.19
274.5	7.0	0.70	1831288.	732515.	4833087.	434978.	439372.	17574.86
274.5	7.0	0.75	1907591.	763037.	5005698.	450513.	455063.	18202.53
274.5	7.0	0.80	1983895.	793558.	5178308.	466048.	470755.	18830.21
274.5	7.0	0.85	2060199.	824080.	5350918.	481583.	486447.	19457.88
274.5	8.0	0.60	1468845.	587538.	3926883.	353419.	356989.	14279.57
274.5	8.0	0.65	1535611.	614244.	4077917.	367013.	370720.	14828.79
274.5	8.0	0.70	1602377.	640951.	4228951.	380606.	384450.	15378.00
274.5	8.0	0.75	1669142.	667657.	4379986.	394199.	398180.	15927.22
274.5	8.0	0.80	1735908.	694363.	4531020.	407792.	411911.	16476.43
274.5	8.0	0.85	1802674.	721070.	4682053.	421385.	425641.	17025.64
274.5	9.0	0.60	1305640.	522256.	3490563.	314151.	317324.	12692.96
274.5	9.0	0.65	1364988.	545995.	3624815.	326233.	329529.	13181.14
274.5	9.0	0.70	1424335.	569734.	3759068.	338316.	341733.	13669.33
274.5	9.0	0.75	1483682.	593473.	3893320.	350399.	353938.	14157.53
274.5	9.0	0.80	1543030.	617212.	4027573.	362482.	366143.	14645.72
274.5	9.0	0.85	1602377.	640951.	4161825.	374564.	378348.	15133.91
305.0	5.0	0.60	3288637.	1315455.	8723164.	785085.	793015.	31720.59
305.0	5.0	0.65	3438120.	1375240.	9058669.	815280.	823515.	32940.61
305.0	5.0	0.70	3587604.	1435042.	9394176.	845476.	854016.	34160.63
305.0	5.0	0.75	3737087.	1494835.	9729683.	875672.	884517.	35380.66
305.0	5.0	0.80	3886571.	1554628.	10065188.	905867.	915017.	36600.68
305.0	5.0	0.85	4036054.	1614422.	10400694.	936063.	945518.	37820.70
305.0	6.0	0.60	2740531.	1096212.	7269303.	654237.	660846.	26433.83
305.0	6.0	0.65	2865100.	1146040.	7548891.	679400.	686263.	27450.51
305.0	6.0	0.70	2989670.	1195868.	7828480.	704563.	711680.	28467.20
305.0	6.0	0.75	3114239.	1245696.	8108069.	729726.	737097.	29483.89
305.0	6.0	0.80	3238809.	1295524.	8387657.	754889.	762514.	30500.57
305.0	6.0	0.85	3363379.	1345351.	8667245.	780052.	787931.	31517.25
305.0	7.0	0.60	2349026.	939611.	6230831.	560775.	566439.	22657.56
305.0	7.0	0.65	2455800.	982320.	6470478.	582343.	588225.	23529.01
305.0	7.0	0.70	2562574.	1025030.	6710126.	603911.	610011.	24400.46
305.0	7.0	0.75	2669348.	1067739.	6949774.	625480.	631798.	25321.90
305.0	7.0	0.80	2776122.	1110449.	7189421.	647048.	653584.	26143.34
305.0	7.0	0.85	2882896.	1153158.	7429068.	668616.	675370.	27014.79
305.0	8.0	0.60	2055398.	822159.	5451977.	490678.	495634.	19825.37
305.0	8.0	0.65	2148825.	859530.	5661669.	509550.	514697.	20587.88
305.0	8.0	0.70	2242253.	896901.	5871360.	528422.	533760.	21350.40
305.0	8.0	0.75	2335680.	934272.	6081052.	547295.	552823.	22112.91
305.0	8.0	0.80	2429107.	971643.	6290743.	566167.	571886.	22875.43
305.0	8.0	0.85	2522534.	1009014.	6500434.	585039.	590949.	23637.94
305.0	9.0	0.60	1827021.	730808.	4846202.	436158.	440564.	17622.55
305.0	9.0	0.65	1910067.	764027.	5032594.	452933.	457509.	18300.34
305.0	9.0	0.70	1993113.	797245.	5218987.	469709.	474453.	18978.13
305.0	9.0	0.75	2076160.	830464.	5405379.	486484.	491398.	19655.92
305.0	9.0	0.80	2159206.	863682.	5591772.	503259.	508343.	20333.71
305.0	9.0	0.85	2242252.	896901.	5778164.	520035.	525288.	21011.50
335.5	5.0	0.60	4437892.	1775157.	11610530.	1044948.	1055503.	42220.11
335.5	5.0	0.65	4639614.	1855846.	12057089.	1085		

Appendix-2

L	L/B	Cb	Msw (mean)	Msw (sd)	Mw (mean)	Mw (sd)	SM (mean)	SM (sd)
213.5	5.0	0.80	1182345.	472938.	3193996.	287460.	290363.	11614.53
213.5	5.0	0.85	1227820.	491128.	3300462.	297042.	300042.	12001.68
213.5	6.0	0.60	833705.	333482.	2306775.	207610.	209707.	8388.27
213.5	6.0	0.65	871601.	348640.	2395497.	215595.	217772.	8710.90
213.5	6.0	0.70	909497.	363799.	2484219.	223580.	225838.	9033.52
213.5	6.0	0.75	947392.	378957.	2572941.	231565.	233904.	9356.15
213.5	6.0	0.80	985288.	394115.	2661663.	239550.	241969.	9678.77
213.5	6.0	0.85	1023184.	409273.	2750385.	247535.	250035.	10001.40
213.5	7.0	0.60	714604.	285842.	1977235.	177951.	179749.	7189.95
213.5	7.0	0.65	747086.	298835.	2053283.	184795.	186662.	7466.48
213.5	7.0	0.70	779569.	311827.	2129330.	191640.	193575.	7743.02
213.5	7.0	0.75	812050.	324820.	2205378.	198484.	200489.	8019.56
213.5	7.0	0.80	844532.	337813.	2281426.	205328.	207402.	8296.09
213.5	7.0	0.85	877015.	350806.	2357473.	212173.	214316.	8572.63
213.5	8.0	0.60	625279.	250112.	1730081.	155707.	157280.	6291.20
213.5	8.0	0.65	653701.	261480.	1796622.	161696.	163329.	6533.17
213.5	8.0	0.70	682122.	272849.	1863164.	167685.	169379.	6775.14
213.5	8.0	0.75	710544.	284218.	1929706.	173674.	175428.	7017.11
213.5	8.0	0.80	738966.	295886.	1996247.	179662.	181477.	7259.08
213.5	8.0	0.85	767388.	306955.	2062789.	185651.	187526.	7501.05
213.5	9.0	0.60	555803.	222321.	1537850.	138406.	139805.	5592.18
213.5	9.0	0.65	581067.	232427.	1596998.	143730.	145182.	5807.26
213.5	9.0	0.70	606331.	242532.	1656146.	149053.	150559.	6022.35
213.5	9.0	0.75	631595.	252638.	1715294.	154376.	155936.	6237.43
213.5	9.0	0.80	656859.	262743.	1774442.	159700.	161313.	6452.52
213.5	9.0	0.85	682122.	272849.	1833590.	165023.	166690.	6667.60
244.0	5.0	0.60	1596488.	638595.	4292153.	386294.	390196.	15607.82
244.0	5.0	0.65	1669055.	667622.	4457235.	401151.	405203.	16208.13
244.0	5.0	0.70	1741623.	696649.	4622318.	416009.	420211.	16808.43
244.0	5.0	0.75	1814190.	725676.	4787401.	430866.	435218.	17408.73
244.0	5.0	0.80	1886758.	754703.	4952484.	445724.	450226.	18009.03
244.0	5.0	0.85	1959326.	783730.	5117566.	460581.	465233.	18609.33
244.0	6.0	0.60	1330406.	532163.	3576794.	321911.	325163.	13006.52
244.0	6.0	0.65	1390879.	556352.	3714362.	334293.	337669.	13506.77
244.0	6.0	0.70	1451352.	580541.	3851932.	346674.	350176.	14007.02
244.0	6.0	0.75	1511825.	604730.	3989501.	359055.	362682.	14507.27
244.0	6.0	0.80	1572298.	628919.	4127070.	371436.	375188.	15007.52
244.0	6.0	0.85	1632772.	653109.	4264639.	383817.	387694.	15507.77
244.0	7.0	0.60	1140348.	456139.	3065823.	275924.	278711.	11148.45
244.0	7.0	0.65	1192182.	476873.	3183739.	286537.	289431.	11577.23
244.0	7.0	0.70	1244016.	497607.	3301656.	297149.	300151.	12006.02
244.0	7.0	0.75	1295850.	518340.	3419572.	307762.	310870.	12434.81
244.0	7.0	0.80	1347684.	539074.	3537488.	318374.	321590.	12863.59
244.0	7.0	0.85	1399518.	559807.	3655405.	328986.	332309.	13292.38
244.0	8.0	0.60	997805.	399122.	2682595.	241434.	243872.	9754.89
244.0	8.0	0.65	1043159.	417264.	2785772.	250719.	253252.	10130.08
244.0	8.0	0.70	1088514.	435406.	2888949.	260005.	262632.	10505.27
244.0	8.0	0.75	1133869.	453548.	2992126.	269291.	272011.	10880.46
244.0	8.0	0.80	1179224.	471690.	3095302.	278577.	281391.	11255.64
244.0	8.0	0.85	1224579.	489831.	3198479.	287863.	290771.	11630.83
244.0	9.0	0.60	886938.	354775.	2384529.	214608.	216775.	8671.01
244.0	9.0	0.65	927253.	370901.	2476242.	222862.	225113.	9004.51
244.0	9.0	0.70	967568.	387027.	2567955.	231116.	233450.	9338.02
244.0	9.0	0.75	1007884.	403153.	2659667.	239370.	241788.	9671.52
244.0	9.0	0.80	1048199.	419280.	2751380.	247624.	250125.	10005.02
244.0	9.0	0.85	1088514.	435406.	2843092.	255878.	258463.	10338.52
274.5	5.0	0.60	2350153.	940061.	6283013.	565471.	571183.	22847.32
274.5	5.0	0.65	2456978.	982791.	6524667.	587220.	593152.	23726.06
274.5	5.0	0.70	2563803.	1025521.	6766322.	608969.	615120.	24604.80
274.5	5.0	0.75	2670628.	1060251.	7007977.	630718.	637089.	25483.55
274.5	5.0	0.80	2777453.	1110981.	7249631.	652467.	659057.	26362.29
274.5	5.0	0.85	2884279.	1153711.	7491285.	674216.	681026.	27241.03

L	L/B	Cb	Msw (mean)	Msw (sd)	Mw (mean)	Mw (sd)	SM (mean)	SM (sd)
274.5	6.0	0.60	1958461.	783384.	5235844.	471226.	475986.	19039.43
274.5	6.0	0.65	2047481.	818993.	5437223.	489350.	494293.	19771.71
274.5	6.0	0.70	2136502.	854601.	5638602.	507474.	512600.	20504.00
274.5	6.0	0.75	2225523.	890209.	5839981.	525598.	530907.	21236.29
274.5	6.0	0.80	2314544.	925818.	6041359.	543722.	549214.	21966.57
274.5	6.0	0.85	2403565.	961426.	6242738.	561846.	567522.	22700.86
274.5	7.0	0.60	1678680.	671472.	4487867.	403908.	407988.	16319.51
274.5	7.0	0.65	1754984.	701994.	4660477.	419443.	423680.	16947.19
274.5	7.0	0.70	1831288.	732515.	4833087.	434978.	439372.	17574.86
274.5	7.0	0.75	1907591.	763037.	5005698.	450513.	455063.	18202.53
274.5	7.0	0.80	1983895.	793558.	5178308.	466048.	470755.	18830.21
274.5	7.0	0.85	2060199.	824080.	5350918.	481583.	486447.	19457.88
274.5	8.0	0.60	1468845.	587538.	3926883.	353419.	359989.	14279.57
274.5	8.0	0.65	1535611.	614244.	4077917.	367013.	370720.	14828.79
274.5	8.0	0.70	1602377.	640951.	4228951.	380606.	384450.	15378.00
274.5	8.0	0.75	1669142.	667657.	4379986.	394199.	398180.	15927.22
274.5	8.0	0.80	1735908.	694363.	4531020.	407792.	411911.	16476.43
274.5	8.0	0.85	1802674.	721707.	4682053.	421385.	425641.	17025.64
274.5	9.0	0.60	1305640.	522256.	3490563.	314151.	317324.	12692.96
274.5	9.0	0.65	1364988.	545995.	3624815.	326233.	329529.	13181.14
274.5	9.0	0.70	1424335.	569734.	3759068.	338316.	341733.	13669.33
274.5	9.0	0.75	1483682.	593473.	3893320.	350399.	353938.	14157.53
274.5	9.0	0.80	1543030.	617212.	4027573.	362482.	366143.	14645.72
274.5	9.0	0.85	1602377.	640951.	4161825.	374564.	378348.	15133.91
305.0	5.0	0.60	3288637.	1315455.	8723164.	785085.	793015.	31720.59
305.0	5.0	0.65	3438120.	1375248.	9058669.	815280.	823515.	32940.61
305.0	5.0	0.70	3587604.	1435042.	9394176.	845476.	854016.	34160.63
305.0	5.0	0.75	3737087.	1494835.	9729683.	875672.	884517.	35380.66
305.0	5.0	0.80	3886571.	1554628.	10065188.	905867.	915017.	36600.68
305.0	5.0	0.85	4036054.	1614422.	10400694.	936063.	945518.	37820.70
305.0	6.0	0.60	2740531.	1096212.	7269303.	654237.	660846.	26433.83
305.0	6.0	0.65	2865100.	1146400.	7548891.	679400.	686263.	27450.51
305.0	6.0	0.70	2989670.	1195868.	7828480.	704563.	711680.	28467.20
305.0	6.0	0.75	3114239.	1245696.	8108069.	729726.	737097.	29483.89
305.0	6.0	0.80	3238809.	1295524.	8387657.	754889.	762514.	30500.57
305.0	6.0	0.85	3363379.	1345351.	8667245.	780052.	787931.	31517.25
305.0	7.0	0.60	2349026.	939611.	6230831.	560775.	566439.	22657.56
305.0	7.0	0.65	2455800.	982320.	6470478.	582343.	588225.	23259.01
305.0	7.0	0.70	2522574.	1025030.	6710126.	603911.	610011.	24400.46
305.0	7.0	0.75	2669348.	1067739.	6949774.	625480.	631798.	25271.90
305.0	7.0	0.80	2776122.	1110449.	7189421.	647048.	653584.	26143.34
305.0	7.0	0.85	2882896.	1153158.	7429068.	668616.	675370.	27014.79
305.0	8.0	0.60	2055398.	822159.	5451977.	490678.	495634.	19825.37
305.0	8.0	0.65	2148825.	859530.	5661669.	509550.	514697.	20587.88
305.0	8.0	0.70	2242253.	896901.	5871360.	528422.	533760.	21350.40
305.0	8.0	0.75	2335680.	934272.	6081052.	547295.	552823.	22112.91
305.0	8.0	0.80	2429107.	971643.	6290743.	566167.	571886.	22875.43
305.0	8.0	0.85	2522534.	1009014.	6500434.	585039.	590949.	23637.94
305.0	9.0	0.60	1827021.	730808.	4846202.	436158.	440564.	17622.55
305.0	9.0	0.65	1910067.	764027.	5032594.	452933.	457509.	18300.34
305.0	9.0	0.70	1993113.	797245.	5218987.	469709.	474453.	18978.13
305.0	9.0	0.75	2076160.	830464.	5405379.	486484.	491398.	19655.92
305.0	9.0	0.80	2159206.	863682.	5591772.	503259.	508343.	20333.71
305.0	9.0	0.85	2242252.	896901.	5778164.	520035.	525286.	21011.50
335.5	5.0	0.60	4437892.	1775157.	11610530.	1044948.	1055503.	42220.11
335.5	5.0	0.65	4639614.	1855846.	12057089.</			

Appendix-2

9/11/21  
11:02:25

L	L/B	Cb	Msw	(mean)	Msw	(sd)	Mw	(mean)	Mw	(sd)	SM	(mean)	SM	(sd)
335.5	6.0	0.70	4034447.	1613779.	10419707.	937774.	947246.	37889.84						
335.5	6.0	0.75	4202548.	1681020.	10791840.	971266.	981076.	39243.05						
335.5	6.0	0.80	4370651.	1748260.	11163972.	1004758.	1014907.	40596.26						
335.5	6.0	0.85	4538753.	1815501.	11536104.	1036249.	1048737.	41949.46						
335.5	7.0	0.60	3169923.	1267969.	8293236.	746391.	753931.	30157.22						
335.5	7.0	0.65	3314010.	1325604.	8612906.	775099.	782928.	31317.11						
335.5	7.0	0.70	3458098.	1383239.	8931177.	803806.	811925.	32477.01						
335.5	7.0	0.75	3602185.	1440874.	9250148.	832513.	840923.	33636.90						
335.5	7.0	0.80	3746272.	1498509.	9569119.	861221.	869920.	34796.79						
335.5	7.0	0.85	3890360.	1556144.	9888089.	889928.	898917.	35956.68						
335.5	8.0	0.60	2773662.	1109473.	7256581.	653092.	659689.	26387.57						
335.5	8.0	0.65	2899759.	1159904.	7535681.	678211.	685062.	27402.47						
335.5	8.0	0.70	3025835.	1210334.	7814780.	703330.	710435.	28417.38						
335.5	8.0	0.75	3151912.	1260765.	8093880.	728449.	735807.	29432.29						
335.5	8.0	0.80	3277988.	1311195.	8372979.	753566.	761180.	30447.19						
335.5	8.0	0.85	3404065.	1361626.	8652078.	778687.	786553.	31462.10						
335.5	9.0	0.60	2465495.	986198.	6450295.	580527.	586390.	23455.62						
335.5	9.0	0.65	2577563.	1031025.	6698383.	602854.	608944.	24357.75						
335.5	9.0	0.70	2689632.	1075853.	6946471.	625182.	631497.	25259.89						
335.5	9.0	0.75	2801699.	1120680.	7194560.	647510.	654051.	26162.04						
335.5	9.0	0.80	2913767.	1165507.	7442648.	669838.	676604.	27064.17						
335.5	9.0	0.85	3025835.	1210334.	7690736.	692166.	699158.	27966.31						
366.0	5.0	0.60	5810414.	2324166.	15024778.	1352230.	1365889.	54635.55						
366.0	5.0	0.65	6074524.	2429810.	15602654.	1404239.	1418423.	56736.92						
366.0	5.0	0.70	6338634.	2535454.	16180530.	1456248.	1470957.	58838.29						
366.0	5.0	0.75	6602744.	2641098.	16758407.	1508257.	1523492.	60939.66						
366.0	5.0	0.80	6866853.	2746741.	17336282.	1560266.	1576026.	63041.03						
366.0	5.0	0.85	7130963.	2852385.	17914158.	1612274.	1628560.	65142.39						
366.0	6.0	0.60	4842012.	1936805.	12520649.	1126859.	1138241.	45529.63						
366.0	6.0	0.65	5062103.	2024841.	13002211.	1170199.	1182019.	47280.77						
366.0	6.0	0.70	528195.	2112878.	13483775.	1213540.	1225798.	49031.91						
366.0	6.0	0.75	5502286.	2200915.	13965339.	1256881.	1269576.	50783.05						
366.0	6.0	0.80	5722377.	2288951.	14446902.	1300221.	1313355.	52534.19						
366.0	6.0	0.85	5942469.	2376988.	14928465.	1343562.	1357133.	54285.32						
366.0	7.0	0.60	4150296.	1660118.	10731985.	965879.	975635.	39025.40						
366.0	7.0	0.65	4338946.	1735378.	11144753.	1003028.	1013159.	40526.37						
366.0	7.0	0.70	4527596.	1811038.	11575522.	1040177.	1050684.	42027.35						
366.0	7.0	0.75	4716246.	1886498.	11970291.	1077326.	1088208.	43528.33						
366.0	7.0	0.80	4904895.	1961958.	12383059.	1114475.	1125733.	45029.30						
366.0	7.0	0.85	5093545.	2037418.	12795827.	1151625.	1163257.	46530.28						
366.0	8.0	0.60	3631509.	1452604.	9390487.	845144.	853681.	34147.22						
366.0	8.0	0.65	3796578.	1518631.	9751658.	877649.	886514.	35460.57						
366.0	8.0	0.70	3961646.	1584659.	10112831.	910155.	919348.	36773.93						
366.0	8.0	0.75	4126715.	1650686.	10474004.	942660.	952182.	38087.29						
366.0	8.0	0.80	4291783.	1716713.	10835176.	975166.	985016.	39400.64						
366.0	8.0	0.85	4456852.	1782741.	11196348.	1007671.	1017850.	40713.99						
366.0	9.0	0.60	3280008.	1291203.	8347099.	751239.	758827.	30353.09						
366.0	9.0	0.65	3374736.	1349894.	8668141.	780133.	788013.	31520.51						
366.0	9.0	0.70	3521463.	1408585.	8989184.	809027.	817199.	32687.94						
366.0	9.0	0.75	3668191.	1467276.	9310226.	837920.	846384.	33855.37						
366.0	9.0	0.80	3814918.	1525967.	9631268.	866814.	875570.	35022.79						
366.0	9.0	0.85	3961616.	1584658.	9952310.	895708.	904755.	36190.21						

141

01/11/21  
11:52:25

Appendix-2

L	L/B	Cb	Msw (mean)	Msw (sd)	Mw (mean)	Mw (sd)	SM (mean)	SM (sd)
335.5	6.0	0.70	4034447.	1613779.	10419707.	937774.	947246.	37889.84
335.5	6.0	0.75	4202549.	1681020.	10791840.	971266.	981076.	39243.05
335.5	6.0	0.80	4370651.	1748260.	11163972.	1004758.	1014907.	40596.26
335.5	6.0	0.85	4538753.	1815501.	11536104.	1038249.	1048737.	41949.46
335.5	7.0	0.60	3169923.	1267969.	8293236.	746391.	753931.	30157.22
335.5	7.0	0.65	3314010.	1325604.	8612206.	775099.	782928.	31317.11
335.5	7.0	0.70	3458098.	1383239.	8931177.	803806.	811925.	32477.01
335.5	7.0	0.75	3602185.	1440874.	9250148.	832513.	840923.	33636.90
335.5	7.0	0.80	3746272.	1498509.	9569119.	861221.	869920.	34796.79
335.5	7.0	0.85	3890360.	1556144.	9888089.	889928.	898917.	35956.68
335.5	8.0	0.60	2773682.	1109473.	7256581.	653092.	659689.	26387.57
335.5	8.0	0.65	2899759.	1159904.	7535681.	678211.	685062.	27402.47
335.5	8.0	0.70	3025835.	1210334.	7814780.	703330.	710435.	28417.38
335.5	8.0	0.75	3151912.	1260765.	8093880.	728449.	735807.	29432.29
335.5	8.0	0.80	3277988.	1311195.	8372979.	753568.	761180.	30447.19
335.5	8.0	0.85	3404065.	1361626.	8652078.	778687.	786553.	31462.10
335.5	9.0	0.60	2465495.	986198.	6450295.	580527.	586390.	23455.62
335.5	9.0	0.65	2577563.	1031025.	6698383.	602854.	608944.	24357.75
335.5	9.0	0.70	2689632.	1075853.	6946471.	625182.	631497.	25259.89
335.5	9.0	0.75	2801699.	1120680.	7194560.	647510.	654051.	26162.04
335.5	9.0	0.80	2913767.	1165507.	7442648.	669838.	676604.	27064.17
335.5	9.0	0.85	3025835.	1210334.	7690736.	692166.	699158.	27966.31
366.0	5.0	0.60	5810414.	2324166.	15024778.	1352230.	1365889.	54635.55
366.0	5.0	0.65	6074524.	2429810.	15602654.	1404239.	1418423.	56736.92
366.0	5.0	0.70	6338634.	2535454.	16180530.	1456248.	1470957.	58838.29
366.0	5.0	0.75	6602744.	2641098.	16758407.	1508257.	1523492.	60939.66
366.0	5.0	0.80	6866853.	2746741.	17336282.	1560266.	1576026.	63041.03
366.0	5.0	0.85	7130963.	2852385.	17914158.	1612274.	1628560.	65142.39
366.0	6.0	0.60	4842012.	1936805.	12520649.	1126859.	1138241.	45529.63
366.0	6.0	0.65	5062103.	2024841.	13002211.	1170199.	1182019.	47280.77
366.0	6.0	0.70	5282195.	2112878.	13483775.	1213540.	1225798.	49031.91
366.0	6.0	0.75	5502286.	2200915.	13965339.	1256881.	1269576.	50783.05
366.0	6.0	0.80	5722377.	2288951.	14446902.	1300221.	1313355.	52534.19
366.0	6.0	0.85	5942469.	2376988.	14928465.	1343562.	1357133.	54285.32
366.0	7.0	0.60	4150296.	1660118.	10731985.	965879.	975635.	39025.40
366.0	7.0	0.65	4338946.	1735578.	11144753.	1003028.	1013159.	40526.37
366.0	7.0	0.70	4527596.	1811038.	11557522.	1040177.	1050684.	42027.35
366.0	7.0	0.75	4716246.	1886498.	11970291.	1077326.	1088208.	43528.33
366.0	7.0	0.80	4904895.	1961958.	12383059.	1114475.	1125733.	45029.30
366.0	7.0	0.85	5093545.	2037418.	12795827.	1151625.	1163257.	46530.28
366.0	8.0	0.60	3631509.	1452604.	9390487.	845144.	853681.	34147.22
366.0	8.0	0.65	3796578.	1518631.	9751658.	877649.	886514.	35460.57
366.0	8.0	0.70	3961646.	1584659.	10112831.	910155.	919348.	36773.93
366.0	8.0	0.75	4126715.	1650686.	10474004.	942660.	952182.	38087.29
366.0	8.0	0.80	4291783.	1716713.	10835176.	975166.	985016.	39400.64
366.0	8.0	0.85	4456852.	1782741.	11196348.	1007671.	1017850.	40713.99
366.0	9.0	0.60	3228008.	1291203.	8347099.	751239.	758827.	30353.09
366.0	9.0	0.65	3374736.	1349894.	8668141.	780133.	788013.	31520.51
366.0	9.0	0.70	3521463.	1408585.	8989184.	809027.	817199.	32687.94
366.0	9.0	0.75	3668191.	1467276.	9310226.	837920.	846384.	33855.37
366.0	9.0	0.80	3814918.	1525967.	9631268.	866814.	875570.	35022.79
366.0	9.0	0.85	3961646.	1584658.	9952310.	895708.	904755.	36190.21



## **APPENDIX 3**

- 3.1 Calculation of Plastic Moment Capacity
- 3.2 Calculation of Critical Buckling Stresses
- 3.3 Calculation of Effective Section Modulus after Buckling

### 3.1 FULLY PLASTIC MOMENT CAPACITY

$$M_p = \text{fully plastic moment} = (SM)_p \cdot f_y$$

$$f_y = \text{yield strength of the material} = 259 \text{ N/mm}^2 (37.6 \text{ ksi})$$

$$(SM)_p = \text{plastic section modulus}$$

From SSC 219 "Ultimate Strength of a Ship's Hull Girder in Plastic and Buckling Modes":

$$(SM)_p = A_D g + 2(A_S + A_{BLK}) \left( \frac{D}{2} - g + \frac{g^2}{D} \right) + A_B (D - g)$$

$$\frac{g}{D} = \frac{A_B + 2(A_S + A_{BLK}) - A_D}{4A_S} = 0.591$$

$$D = 24 \text{ m} \Rightarrow g = 14.181 \text{ m.}$$

$$(SM)_p = 5.8376 \cdot 10^5 \text{ m cm}^2$$

Ratio between plastic section modulus and the elastic section modulus:

$$\frac{(SM)_p}{(SM)_c} = \frac{5.8376 \cdot 10^5}{4.65767 \cdot 10^5} = 1.25$$

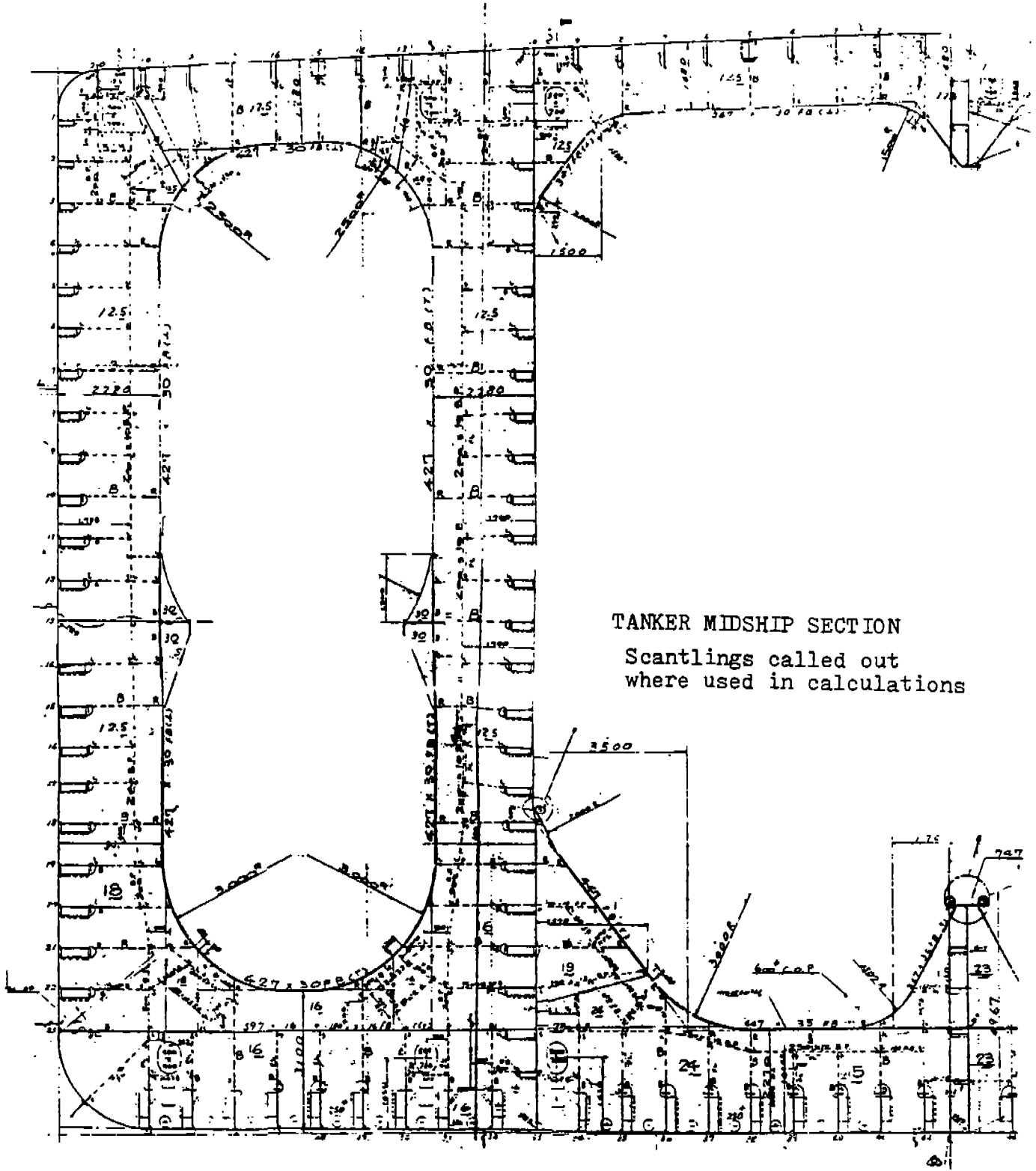
Also,

$$A_D = 1.4645 \cdot 10^6 \text{ mm}^2$$

$$A_B = 1.9934 \cdot 10^6 \text{ mm}^2$$

$$A_S = 7.9654 \cdot 10^5 \text{ mm}^2$$

$$A_{BLK} = 6.5830 \cdot 10^5 \text{ mm}^2$$



TANKER MIDSHIP SECTION

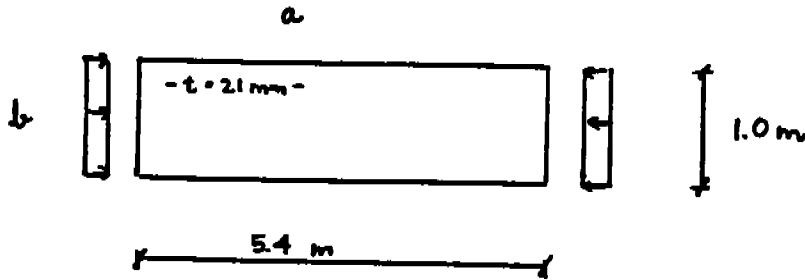
Scantlings called out  
where used in calculations

### 3.2 CRITICAL BUCKLING STRESSES

Calculations follow Ref. [8]

#### I. Plates Between Stiffeners

Considering only vertical bending moment, so uniaxial compressive stress:



$$E = 2.1 \cdot 10^5 \text{ N/mm}^2$$

$$\sigma_0 = 259 \text{ N/mm}^2$$

$$\sigma_p = 0.6(259) = 155.4 \text{ N/mm}^2$$

$$a/b > 1$$

#### Ultimate Limit State

$$\left(\frac{\sigma_{cr}}{\sigma_0}\right)^{1/2}$$

$$\text{if } \beta \geq 3.5$$

$$\frac{\sigma_{ul}}{\sigma_0} = \frac{2.25}{\beta} - \frac{1.25}{\beta^2}$$

$$1.0 < \beta < 3.5$$

$$1.0$$

$$\beta \leq 1.0$$

$$\beta = \frac{b}{t} \sqrt{\frac{\sigma_0}{E}} = \frac{1000}{21} \sqrt{\frac{235}{2.1 \cdot 10^5}} = 1.593$$

$$\frac{\sigma_{ul}}{\sigma_0} = \frac{2.25}{1.593} - \frac{1.25}{(1.593)^2} = 0.92$$

$$\sigma_{ul} = 0.92 \cdot 259 = 238.3 \frac{\text{N}}{\text{mm}^2}$$

### Serviceability Limit State

$$\sigma_{cr} = \begin{cases} K_c \frac{\pi^2 E}{12(1-\nu^2)} \left(\frac{t}{b}\right)^2 & \text{if } \sigma_{cr} \leq \sigma_p \\ \frac{C_l \sigma_o}{C_l + 1} & \sigma_{cr} > \sigma_p \end{cases}$$

$$C_l = \frac{\sigma_1^2}{\sigma_p(\sigma_o - \sigma_p)} \quad \sigma_{cr} = \frac{4\pi E}{12(1-\nu^2)} \left(\frac{t}{b}\right)^2 = \frac{4 \cdot \pi^2 \cdot 2.1 \cdot 10^5}{12(1-0.3^2)} \left(\frac{21}{1000}\right)^2 = 334.8 \frac{\text{N}}{\text{mm}^2}$$

$$C_l = \frac{334.8^2}{155.4(259-155.4)} = 6.96$$

$$\sigma_{cr} = 334.8 \frac{\text{N}}{\text{mm}^2} > \sigma_p = 155.4 \frac{\text{N}}{\text{mm}^2}$$

$$\Rightarrow \boxed{\sigma_{cr} = \frac{6.96(259)}{6.96+1} = 226.46 \frac{\text{N}}{\text{mm}^2}}$$

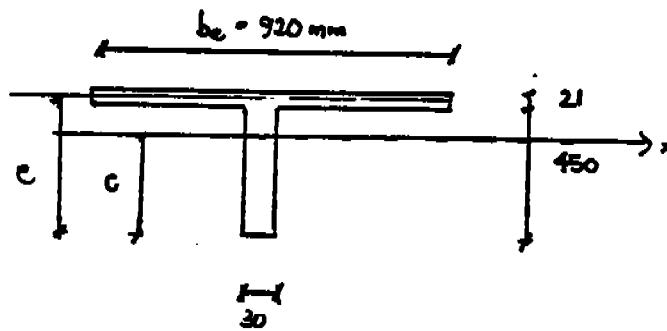
### II. Stiffeners and Effective Plating

The compressive strength of the stiffeners together with effective plating is considered. Only ultimate limit state is considered, because when a column buckles it reaches immediately its ultimate strength.

The effective plating under edge compression is determined from:

$$b_c = b \left( \frac{\sigma_{ul}}{\sigma_o} \right) = 1000 \cdot 0.92 = 920 \text{ mm}$$

Column Buckling – Ultimate Limit State:



$$C = 363.6 \text{ mm}$$

$$I_x = 6.692 \cdot 10^8 \text{ mm}^4$$

$$A = 3.2816 \cdot 10^4 \text{ mm}^2$$

$$r = \sqrt{\frac{I}{A}} = 142.8$$

$$l = 5400 \text{ mm}$$

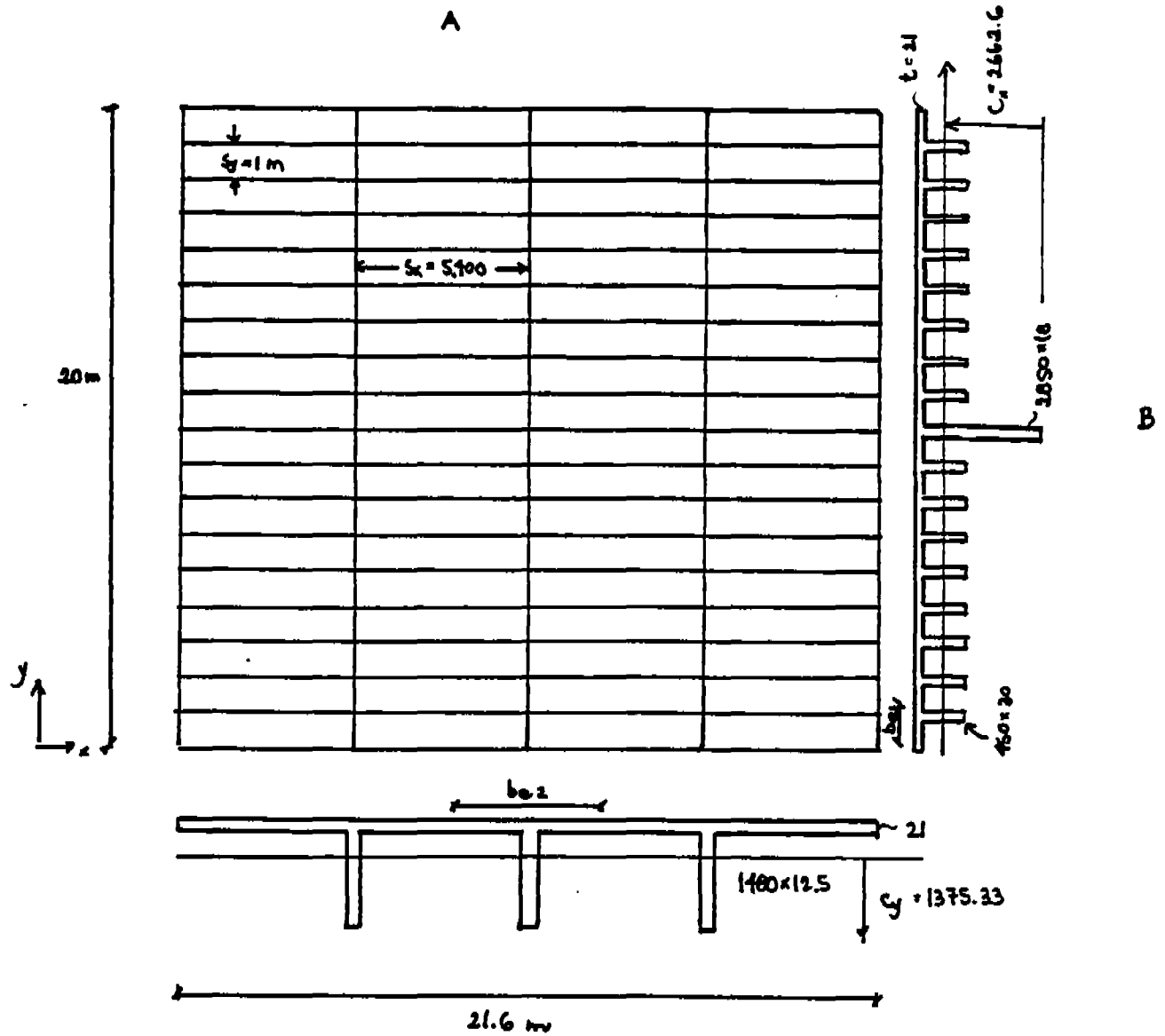
$$\sigma_{cr} = \begin{cases} \frac{\pi^2 E}{(l/r)^2} & \text{if } \sigma_{cr} \leq \sigma_p \\ \sigma_o - \frac{1}{C_s} & \sigma_{cr} > \sigma_p \end{cases}$$

$$C_s = \frac{\sigma_s}{\sigma_p(\sigma_o - \sigma_p)}$$

$$\sigma_s = \frac{\pi^2 E}{(l/r)^2}$$

$$\sigma_{cr} = 248 \frac{\text{N}}{\text{mm}^2}$$

### III. Gross Stiffened Panels



$$b_{e1} = b \left( \frac{\sigma_{ul}}{\sigma_0} \right) = 920 \text{ mm} \quad (\text{from previous calculations})$$

$$b_{e2} \text{ (from buckling considerations) } = 0.221(5400) = 1193 \text{ mm}$$

$$b_{e2} \text{ (from shear lag analysis) } = 0.9(5400) = 4860 \text{ mm}$$

### Torsional/Flexural Buckling – Ultimate Limit State

$$A = 3.2816 \cdot 10^4 \text{ mm}^2$$

$$I_x = 3.2816 \cdot 10^8 \text{ mm}^4$$

$$I_y = 1.363 \cdot 10^9 \text{ mm}^4$$

$$e = 450.5 \quad \text{distance from neutral axis to shear center } y_o = 96.9 \text{ mm}$$

$$I_o = I_x + I_y + Ay^2 = 2.34 \cdot 10^9 \text{ mm}^4$$

$$I_c = I_x + I_y = 2.035 \cdot 10^9 \text{ mm}^4$$

$$J = \text{torsional const} = \frac{920 \cdot 21^3 + \left(450 + \frac{21}{2}\right) \cdot 30^3}{3} = 7.08 \cdot 10^6 \text{ mm}^4$$

$$C_w = \text{warping constant} = \frac{21 \cdot 450^2}{12} \frac{920^3 \cdot 30^3}{920^3 + 30^3} = 9.567 \cdot 10^9$$

$$G = \frac{E}{2(1+\nu)} = \frac{2.1 \cdot 10^5}{2.6} = 8.077 \cdot 10^4 \frac{\text{N}}{\text{mm}^2}$$

$$\sigma_t = \frac{1}{I_o} \left( GJ + \frac{\pi^2 EC_w}{l^2} \right) = 244 \frac{\text{N}}{\text{mm}^2}$$

$$\sigma_{cr} = 248 \frac{\text{N}}{\text{mm}^2}$$

- i) Elastic Range: Consider interaction with flexural buckling.

$$\frac{I_c}{I_o} \cdot \sigma_{tfe}^2 - \sigma_{tfe} (\sigma_{cr} + \sigma_t) + \sigma_{cr} \cdot \sigma_t = 0 \quad \sigma_{tfe} = 181 \frac{\text{N}}{\text{mm}^2}$$



ii) Plastic Range:

$$\sigma_{tfp} = \sigma_o \left( 1 - \frac{\sigma_p \left( 1 - \frac{\sigma_p}{\sigma_o} \right)}{\sigma_{tfe}} \right) = \boxed{170 \frac{N}{mm^2}}$$

Uniaxial Compressive Load – Serviceability Limit State

$$C_x = 2662.6 \text{ mm}$$

$$I_x = 1.4386 \cdot 10^{10} + 4.44 \cdot 10^9 + 1.133 \cdot 10^{11} = 1.3213 \cdot 10^{11} \text{ mm}^4$$

$$I_{px} = 1.4386 \cdot 10^{10} \text{ mm}^4$$

For the calculation of  $I_y$  and  $I_{py}$  an effective breadth of 4860 is used:

$$C_y = 1357.33 \text{ mm}$$

$$I_y = 4.072 \cdot 10^9 + 3.25 \cdot 10^{10} = 3.6572 \cdot 10^{10} \text{ mm}^4$$

$$I_{py} = 4.072 \cdot 10^9 \text{ mm}^4$$

$$S_y = 1000 \text{ mm}$$

$$S_x = 5400 \text{ mm}$$

$t_x$  = equivalent thickness of plate and stiffeners extending in x-direction

$$= \frac{450 \cdot 30 \cdot 18 + 2850 \cdot 18}{20000} + 21 = 35.715 \text{ mm}$$

$$D_x = \frac{EI_x}{S_y(1 - \nu^2)} = 3.049 \cdot 10^{13} \quad A/B = 1.08$$

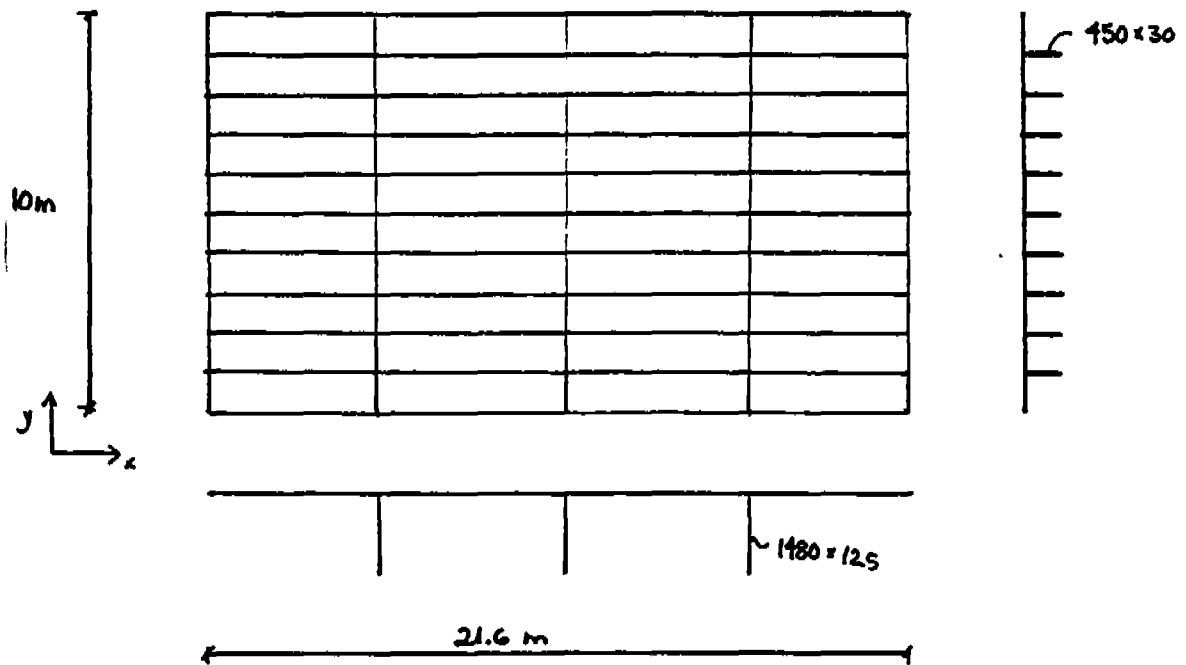
$$D_y = \frac{EI_y}{S_x(1 - \nu^2)} = 1.563 \cdot 10^{12} \quad \nu = 0.3$$

$$4 \cdot \frac{\pi^2 \sqrt{3.049 \cdot 10^{13} \cdot 1.563 \cdot 10^{12}}}{35.715 \cdot 20000^2} = 19076 \frac{\text{N}}{\text{mm}^2} > \sigma_p$$

$$\sigma_{cr} = \frac{\frac{19076^2}{155.4(259 - 155.4)} \cdot 259}{\frac{19076^2}{155.4(259 - 155.4)} + 1} = \boxed{259 \frac{\text{N}}{\text{mm}^2}}$$

**Gross Stiffened Panel** (considering only half the panel)

Uniaxial Compressive Load – Serviceability Limit State



$$C_x = 363.6$$

$$C_y = 1375.3$$

$$I_x = 9(6.692) \cdot 10^8 \text{ mm}^4 = 6.0228 \cdot 10^9 \text{ mm}^4$$

$$I_y = 3.6572 \cdot 10^{10} \text{ mm}^4$$

$$S_y = 1000 \text{ mm}$$

$$S_x = 5400 \text{ mm}$$

$$t_x = \frac{450 \cdot 30 \cdot 9}{10000} + 21 = 33.15 \text{ mm}$$

$$D_x = \frac{EI_x}{S_y \sqrt{1 - \nu^2}} = 1.39 \cdot 10^{12}$$

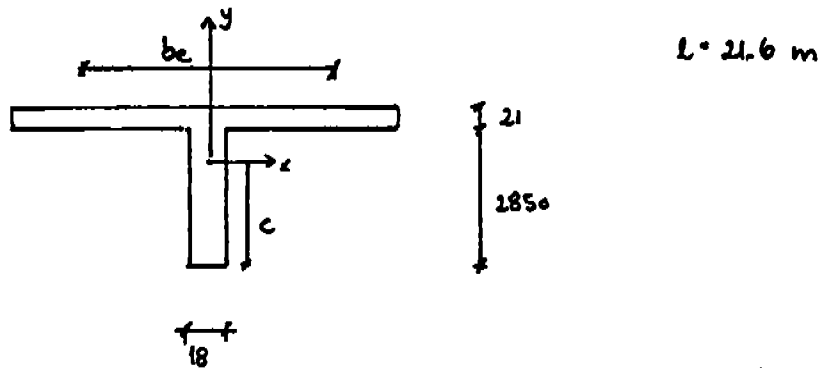
$$D_y = \frac{EI_y}{S_x (1 - \nu^2)} = 1.563 \cdot 10^{12}$$

$$\sigma_{cr} = \frac{4 \cdot \pi^2 \sqrt{1.39 \cdot 10^{12} \cdot 1.563 \cdot 10^{12}}}{33.15 \cdot 10000^2} = 17288.9 \frac{\text{N}}{\text{mm}^2} > \sigma_p$$

$$\sigma_{cr} =$$

$$\boxed{259 \frac{\text{N}}{\text{mm}^2}}$$

### Column Buckling of Larger Longitudinal Stiffener



From buckling considerations  $b_c = 0.0597 \cdot 20 = 1193 \text{ mm}$

$$A = 7.635 \cdot 10^4 \text{ mm}^2$$

$$C = 1896.1 \text{ mm}$$

$$I_x = 6.94 \cdot 10^{10} \text{ mm}^4$$

$$r = \sqrt{\frac{I}{A}} = 953.4$$

$$\frac{\pi^2 E}{(\ell/r)^2} = 4038.6 \frac{\text{N}}{\text{mm}^2} > \sigma_p$$

$$\sigma_{cr} =$$

$$259 - \frac{155.4(259 - 155.4)}{4038.6} = \boxed{255.0 \frac{\text{N}}{\text{mm}^2}}$$

### 3.3 EFFECTIVE SECTION MODULUS AFTER BUCKLING IN DECK

$$b = 92\% \text{ of original width}$$

$$SM_{\text{eff}} = \frac{1}{C} \left( I - \left( \frac{bh^3}{12} + C^2bh \right)_{\text{deck}} + \left( \frac{b_{\text{eff}} h^3}{12} + C^2 b_{\text{eff}} \cdot h \right)_{\text{deck}} \right)$$

$$C = \text{distance from local neutral axis to global neutral axis}$$

$$I = 4.657675 \cdot 10^{10} \text{ mm} \cdot 12950 = 6.0137 \cdot 10^{14} \text{ mm}^4$$

$$SM_{\text{eff}} = \frac{1}{12950} [6.0137 \cdot 10^{14} - 40 \cdot 2.8244 \cdot 10^{11}] = 4.570443 \cdot 10^{10} \text{ mm}^3$$

$$\boxed{SM_{\text{eff}} = 4.570443 \cdot 10^5 \text{ m cm}^2} \quad \text{reduced 1.9\%}$$

## **APPENDIX 4**

**Calculations of Compressive Strength Factor and the Hull Girder Instability  
Collapse Moment**

The Compressive Strength Factor for the Critical Panel of the Example Ship  
(ISSC Formula)

$$\phi_{cp} = (0.960 + 0.765 \lambda^2 + 0.176 \beta^2 + 0.131 \lambda^2 \beta^2 + 1.064 \lambda^4)^{-0.5}$$

$$\lambda = \frac{\ell}{\pi} \sqrt{\frac{f_y}{E}} = \frac{5400}{142.8 \cdot \pi} \sqrt{\frac{235}{2.1 \cdot 10^5}} = 0.403$$

$$\beta = \frac{b}{t} \sqrt{\frac{f_y}{E}} = \frac{1000}{21} \sqrt{\frac{235}{2.1 \cdot 10^5}} = 1.593$$

$$\phi_{cp} = \underline{0.787}$$

For the sagging condition, we then have

$$\begin{aligned} M_u &= (-0.172 + 1.548 \phi_{cp} - 0.368 \phi_{cp}^2) SM \cdot f_y \\ &= \underline{0.819 SM \cdot f_y} \end{aligned}$$

4-3

160

## **APPENDIX 5**

### **Calculations of the RMS Values of the Wave Bending Moment for the Example Ship**

5.1 Ultimate Limit State

5.2 Fatigue Limit State



## 5.1 RMS OF EXTREME WAVE BENDING MOMENT (ULTIMATE LIMIT STATE)

### VESSEL AND SEA STATE DATA

$$C_B = 0.71$$

$$H_S = 12.2 \text{ m (40 ft)}$$

$$L/B = 6.19$$

$$S = H_S/L = 0.047$$

$$B/T = 2.62$$

$$F_n = 0.05 \text{ (will use } F_n = 0.1)$$

### CALCULATION PROCEDURE

Calculations are made according to seakeeping tables of Ref. 6. From the seakeeping table (see sample interpolation chart on the next page),

$$\text{rms} = 272.7$$

This value is made dimensional by multiplying it with:  $\rho g L^4$

where  $\rho$  = specific density of seawater =  $1025 \text{ kg/m}^3$

$g$  = acceleration of gravity =  $9.81 \text{ m/s}^2$

$L$  = length of ship =  $260 \text{ m}$ .

$$\text{Dimensional rms} = 1.25398 \cdot 10^6 \text{ kNm}$$

This value may be overestimated a few percent because a Froude number of 0.1 is applied instead of the value 0.05.

The seakeeping tables are not tabulated for values of  $F_n$  lower than 0.1.

INTERPOLATION TABLE 10	$H_s = 12.2 \text{ m}$																											
COLUMN 6	272.9 RESPONSE																											
COLUMN 5	270.7												281.9															
COLUMN 4	(CB) <sup>-</sup>						(CB) <sup>+</sup>						(CB) <sup>-</sup>						(CB) <sup>+</sup>									
COLUMN 3	292.5				245.0				303.5				292.5				245.0				303.5				292.5			
COLUMN 2	(L/B) <sup>-</sup>				(L/B) <sup>+</sup>				(L/B) <sup>-</sup>				(L/B) <sup>+</sup>				(L/B) <sup>-</sup>				(L/B) <sup>+</sup>							
COLUMN 1	281.6		302.2		241.6		247.1		287		313.6		281.6		302.2		241.6		247.1		287		313.6		281.6		302.2	
COLUMN 1	(B/T) <sup>-</sup>		(B/T) <sup>+</sup>		(B/T) <sup>-</sup>		(B/T) <sup>+</sup>		(B/T) <sup>-</sup>		(B/T) <sup>+</sup>		(B/T) <sup>-</sup>		(B/T) <sup>+</sup>		(B/T) <sup>-</sup>		(B/T) <sup>+</sup>		(B/T) <sup>-</sup>		(B/T) <sup>+</sup>		(B/T) <sup>-</sup>		(B/T) <sup>+</sup>	
COLUMN 1	248		296		270		316		216		252		224		257		252		302		280		328		222		222	
COLUMN 1	S <sup>-</sup>		S <sup>+</sup>		S <sup>-</sup>		S <sup>+</sup>		S <sup>-</sup>		S <sup>+</sup>		S <sup>-</sup>		S <sup>+</sup>		S <sup>-</sup>		S <sup>+</sup>		S <sup>-</sup>		S <sup>+</sup>		S <sup>-</sup>		S <sup>+</sup>	
COLUMN 1	F <sup>-</sup>		F <sup>+</sup>		F <sup>-</sup>		F <sup>+</sup>		F <sup>-</sup>		F <sup>+</sup>		F <sup>-</sup>		F <sup>+</sup>		F <sup>-</sup>		F <sup>+</sup>		F <sup>-</sup>		F <sup>+</sup>		F <sup>-</sup>		F <sup>+</sup>	
COLUMN 1	1	2	3	4	5	6	7	8	9	10	11	12	13	14	15	16	17	18	19	20	21	22	23	24	25	26	27	28

Interpolation chart

Seakeeping Standard Series for Cruiser-Stern Ships

104

## 5.2 RMS VALUE FOR WAVE BENDING MOMENT (FATIGUE LIMIT STATE)

Hs [m]	rms [kNm]
0.5	$3.1705 \cdot 10^4$
1.5	$9.6541 \cdot 10^4$
2.5	$1.6639 \cdot 10^5$
3.5	$2.1385 \cdot 10^5$
4.5	$3.3420 \cdot 10^5$
5.5	$4.8565 \cdot 10^5$
6.5	$6.2111 \cdot 10^5$
7.5	$7.4853 \cdot 10^5$
8.5	$7.9416 \cdot 10^5$
9.5	$9.5985 \cdot 10^5$
10.5	$1.0340 \cdot 10^6$
11.5	$1.1082 \cdot 10^6$
12.5	$1.1686 \cdot 10^6$
13.5	$1.2404 \cdot 10^6$

The above results are for the sea scatter diagram used in the fatigue analysis and shown in Appendix F. The interpolation charts using the seakeeping tables of Ref. 6 are omitted for brevity, but each calculation is similar to that previously shown for the rms of extreme wave bending moment.

## **APPENDIX 6**

### **Fatigue Reliability Calculations**

#### **6.1 Fatigue Reliability Analysis of Deck Detail**

#### **6.2 Sea Scatter Diagrams**

## 6.1 FATIGUE RELIABILITY ANALYSIS OF DECK DETAIL

The detail is shown in Figure 6.1 and classified as belonging to class D [13]. The long term statistics of sea states is from the Oseberg Area of the North Sea. It is shown elsewhere in this section.

The class D gives the S-N curves:

$$\begin{aligned}\log N &= \log a - 2 \log s - m \log \Delta S \\ &= 11.7525 - 2 \cdot 0.1793 - 3 \cdot \log \Delta S\end{aligned}$$

N = number of cycles  
 $\Delta S$  = stress range

$$\therefore C = N \Delta S^m = 10^{(12.6007 - 2 \cdot 0.4190)} = 1.52 \cdot 10^{12} \text{ N/mm}^2$$

The limit state function is

$$g(X) = \frac{\Delta_F \cdot C}{B^m \cdot X_m \cdot \Omega} - T$$

T is the service life of the ship = 20 years.

$\Omega$  is the stress parameter which is given below:

$$\Omega = \frac{(2\sqrt{2})^m}{2\pi} \Gamma\left(1 + \frac{m}{2}\right) \sum_j P_j \lambda_{oj}^{(m-1)/2} \cdot \lambda_{2j}^{1/2} \quad (1)$$

where

m = fixed = 3 (from SN-curve)

$$\lambda_{2j} = \left(\frac{2\pi}{T_z}\right)^2 \lambda_{oj}$$

$\lambda_{oj}$ ,  $\lambda_{2j}$  are zero and second stress spectrum moment in j-th sea state.

From the seakeeping tables [6], the rms for the wave bending moment is obtained. The relation between the zero stress spectrum moment and zero wave b.m spectrum moment is:

$$\lambda_o^{\text{stress}} = \left( \frac{1}{SM} \cdot \frac{\text{distance from NA to fatigue crack}}{\text{distance from NA to deck}} \right)^2 \lambda_o^{\text{WBM}}$$

For the example ship:

$$\lambda_o^{\text{stress}} = (4.2948 \cdot 10^{-4} [\text{m}^6]^{-1}) \lambda_o^{\text{WBM}} \quad (2)$$

and

$$\sum_j P_j \lambda_{oj}^{(m-1)/2} \cdot \lambda_{2j}^{1/2} = 2.009 \cdot 10^{16} [\text{kNm}]^3 [\text{sec}]^{-1} \quad (3)$$

when the  $\lambda_{oj}$  and  $\lambda_{2j}$  are for the wave bending moment obtained in Appendix E.

Equations (1), (2) and (3) give  $\Omega$ , the stress parameter:

$$\Omega = \frac{(2\sqrt{2})^3}{2\pi} \Gamma\left(\frac{5}{2}\right) \cdot (4.2948 \cdot 10^{-4})^{3/2} \cdot 2.009 \cdot 10^{16} \left(\frac{\text{kN}}{\text{m}^2}\right)^3 [\text{sec}]^{-1}$$

$$\Rightarrow \Omega = 852 \left(\frac{\text{MN}}{\text{m}^2}\right)^3 [\text{sec}]^{-1}$$

		$T_e$ (Sec)														
		0-1	1-2	2-3	3-4	4-5	5-6	6-7	7-8	8-9	9-10	10-11	11-12	12-13	13-14	Sum
MEMO (H)	0-1	0,0	0,002	0,102	1,962	3,562	1,703	0,522	0,302	0,233	0,110	0,025	0,020	0,010	0,0	6,633
	1-2	0,0	0,0	0,040	3,210	10,066	9,630	4,847	2,253	1,067	0,640	0,244	0,101	0,041	0,0	32,195
	2-3	0,0	0,0	0,004	0,165	2,780	9,877	7,438	3,642	1,346	0,338	0,161	0,023	0,011	0	29,793
	3-4	0	0	0	0,003	0,151	2,059	7,426	3,866	1,390	0,364	0,115	0,050	0,016	0,002	15,442
	4-5		0	0	0	0,002	0,147	2,372	4,357	1,571	0,507	0,076	0,057	0,023	0,004	9,116
	5-6			0	0	0	0,012	0,165	2,431	1,550	0,500	0,112	0,044	0,016	0,000	4,830
	6-7			0	0	0	0	0,008	0,310	1,408	0,394	0,149	0,042	0,013	0,007	2,331
	7-8				0	0	0	0	0,025	0,486	0,365	0,093	0,042	0,013	0,004	1,020
	8-9					0	0	0	0,002	0,047	0,279	0,054	0,023	0,012	0,004	0,421
	9-10						0	0	0	0,006	0,080	0,050	0,011	0,003	0,001	0,199
	10-11							0	0	0,001	0,006	0,016	0,012	0,004	0,001	0,058
	11-12								0	0	0,002	0,009	0,007	0,001	0,000	0,019
	12-13									0	0	0,001	0,004	0,001	0	0,006
	13-14										0	0	0,001	0,0	0,0	0,001
		0,002	0,146	5,348	16,569	23,436	22,770	17,260	9,105	3,593	1,125	0,437	0,162	0,031	1000	

Table 2 Long term statistics of sea states for Oseberg area

## **APPENDIX 7**

### **Typical Input/Output File of CALREL**

#### **7.1 User Defined Subroutine for Limit State Function and Wave Bending Moment Distribution**

#### **7.2 Input Data File**

#### **7.3 Output File**



```
CALRel nrx=8 ntp=1
DATA
TITL nline title
1
example ship reliability analysis -- deck initial yield, case1
FLAG icl,igr
1 0
OPTI iop,ni1,ni2,tol,op1,op2,op3
1,20,4,0.001
STAT igt(i),nge,ngm nv,ids,ex,sg,p3,p4,x0
1 8
sm 1,2,4.57e5,1.828e4
fp 2,2,25.9,1.813
sw 3,1,3.022e6,1.0
mw 4,-51,4.855e6,4.3695e5,0.0,0.0,4.855e6
xu 5,1,1.0,0.15
xsw 6,1,1.0,0.05
xw 7,1,0.9,0.135
xs 8,1,1.15,0.0345
END
FORM
SENS
SORM
EXIT
```

```
implicit real*8 (a-h,o-z)
dimension x(1),tp(1)
g = x(5)*x(1)*x(2)-x(6)*x(3)-x(7)*x(8)*x(4)
return
end
```

```
subroutine udgx(dgx,x,tp,ig)
implicit real*8 (a-h,o-z)
dimension x(1),dgx(1),tp(1)
return
end
```

```
subroutine udd(x,par,sg,ids,cdf,pdf,bnd,ib)
implicit real*8 (a-h,o-z)
dimension x(1),par(4),bnd(2)
pi=3.1415926
fact1=(sqrt(6)/pi)*par(1)*par(2)-(0.5772*6/pi**2)*(par(2)**2)
fact2=dexp(0.5*((pi/sqrt(6))*(par(1)/par(2))-0.5772))
cdf=dexp(-fact2*dexp(-(x(4)**2)/(2*fact1)))
pdf=(x(4)/fact1)*fact2*dexp(-(x(4)**2)/(2*fact1))*cdf
bnd(1)=0.0d0
ib=1
sg=par(2)
return
end
```

```

*****
*      University of California      *
*      Department of Civil Engineering *
*                                     *
*      C A L R E L                   *
*      CAL-REliability program       *
*      Developed by                   *
*      P.-L. Liu, H.-Z. Lin and A. Der Kiureghian *
*                                     *
*      Last Revision:  January 1990  *
*      Copyright © 1990               *
*****

```

WARNING 2: command not available

>>>> NEW PROBLEM <<<<

```

number of limit-state functions.....ngf=      1
number of independent variable groups ...nig=    1
total number of random variables .....nrx=     8
number of limit-state parameters .....ntp=     1

```

>>>> INPUT DATA <<<<

```

example ship reliability analysis -- deck initial yield, case1
type of system .....icl=      1
  icl=1 .....component
  icl=2 .....series system
  icl=3 .....general system
flag for gradient computation .....igr=      0
  igr=0 .....finite difference
  igr=1 .....formulas provided by user

```

```

optimization scheme used .....iop=      1
  iop=1 .....HL-RF method
  iop=2 .....modified HL-RF method
  iop=3 .....gradient projection method
  iop=4 .....sequential quadratic method
maximum number of iteration cycles .....nil=    20
maximum steps in line search .....ni2=      4
convergence tolerance .....tol= 1.000E-03
optimization parameter 1 .....op1= 1.000E+00
optimization parameter 2 .....op2= 0.000E+00
optimization parameter 3 .....op3= 0.000E+00

```

```

statistical data of basic variables:
available probability distributions:
determinitic .....ids=0
normal .....ids=1
lognormal .....ids=2
gamma .....ids=3
shifted exponential .....ids=4
shifted rayleigh .....ids=5
uniform .....ids=6
beta .....ids=7
type i largest value .....ids=11
type i smallest value ....ids=12
type ii largest value ....ids=13
weibull .....ids=14
user defined .....ids>50

```

group no.:	1	group type:				1	param3	param4	init. pt
var	ids	mean	st. dev.	param1	param2				
sm	2	4.57E+05	1.83E+04	1.30E+01	4.00E-02			0.00E+00	
fp	2	2.59E+01	1.81E+00	3.25E+00	6.99E-02			0.00E+00	
sw	1	3.02E+06	1.00E+00	3.02E+06	1.00E+00			0.00E+00	
mw	51		4.37E+05	4.86E+06	4.37E+05	0.00E+00	0.00E+00	4.86E+06	
xu	1	1.00E+00	1.50E-01	1.00E+00	1.50E-01			0.00E+00	
xsw	1	1.00E+00	5.00E-02	1.00E+00	5.00E-02			0.00E+00	
xw	1	9.00E-01	1.35E-01	9.00E-01	1.35E-01			0.00E+00	
xs	1	1.15E+00	3.45E-02	1.15E+00	3.45E-02			0.00E+00	

```

*****
* University of California *
* Department of Civil Engineering *
*
* C A L R E L *
* CAL-RELIability program *
* Developed by *
* P.-L. Liu, H.-Z. Lin and A. Der Kiureghian *
*
* Last Revision: January 1990 *
* Copyright © 1990 *
*****

```

WARNING 2: command not available

>>>> NEW PROBLEM <<<<

```

number of limit-state functions.....ngf=      1
number of independent variable groups ...nig=      1
total number of random variables .....nrx=      8
number of limit-state parameters .....ntp=      1

```

>>>> INPUT DATA <<<<

```

example ship reliability analysis -- deck initial yield, case1
type of system .....icl=      1
  icl=1 .....component
  icl=2 .....series system
  icl=3 .....general system
flag for gradient computation .....igr=      0
  igr=0 .....finite difference
  igr=1 .....formulas provided by user

```

```

optimization scheme used .....iop=      1
  iop=1 .....HL-RF method
  iop=2 .....modified HL-RF method
  iop=3 .....gradient projection method
  iop=4 .....sequential quadratic method
maximum number of iteration cycles .....ni1=     20
maximum steps in line search .....ni2=      4
convergence tolerance .....tol= 1.000E-03
optimization parameter 1 .....op1= 1.000E+00
optimization parameter 2 .....op2= 0.000E+00
optimization parameter 3 .....op3= 0.000E+00

```

```

statistical data of basic variables:
available probability distributions:
determinitic .....ids=0
normal .....ids=1
lognormal .....ids=2
gamma .....ids=3
shifted exponential .....ids=4
shifted rayleigh .....ids=5
uniform .....ids=6
beta .....ids=7
type i largest value .....ids=11
type i smallest value .....ids=12
type ii largest value .....ids=13
weibull .....ids=14
user defined .....ids>50

```

group no.:	1	group type:		1					
var	ids	mean	st. dev.	param1	param2	param3	param4	init.	pt
sm	2	4.57E+05	1.83E+04	1.30E+01	4.00E-02			0.00E+00	
fp	2	2.59E+01	1.81E+00	3.25E+00	6.99E-02			0.00E+00	
sw	1	3.02E+06	1.00E+00	3.02E+06	1.00E+00			0.00E+00	
mw	51		4.37E+05	4.86E+06	4.37E+05	0.00E+00	0.00E+00	4.86E+06	
xu	1	1.00E+00	1.50E-01	1.00E+00	1.50E-01			0.00E+00	
xsw	1	1.00E+00	5.00E-02	1.00E+00	5.00E-02			0.00E+00	
xw	1	9.00E-01	1.35E-01	9.00E-01	1.35E-01			0.00E+00	
xs	1	1.15E+00	3.45E-02	1.15E+00	3.45E-02			0.00E+00	

```

print interval .....npr=      0
npr<0 .....no first order results are printed
npr=0 .....print the final step of FORM results
npr>0 .....print the results of every npr steps
initialization flag .....ini=    0
ini=0 .....start from mean point
ini=1 .....start from point specified by user
ini=-1 ....start from previous linearization point
restart flag .....ist=          0
ist=0 .....analyze a new problem
ist=1 .....continue an unconverged problem

```

limit-state function 1

```

-----
iteration number .....iter=      7
value of limit-state function..g(x)=-2.805E-05
reliability index .....beta=    1.8118
probability .....Pf1= 3.501E-02
var      design point      sensitivity vectors
      x*      u*      alpha      gamma      delta      eta
sm      4.511E+05      -3.076E-01      -.1698      -.1698      .1722      -.0590
fp      2.488E+01      -5.378E-01      -.2969      -.2969      .3098      -.1800
sw      3.022E+06      8.876E-07      .0000      .0000      .0000      .0000
mw      4.959E+06      4.358E-01      .2406      .2406      .0000      .0000
xu      7.773E-01      -1.484E+00      -.8193      -.8193      .8193      -1.2163
xsw     1.007E+00      1.332E-01      .0735      .0735      -.0735      -.0098
xw      9.920E-01      6.818E-01      .3763      .3763      -.3763      -.2566
xs      1.155E+00      1.496E-01      .0826      .0826      -.0826      -.0124
-----

```

>>>> SENSITIVITY ANALYSIS AT COMPONENT LEVEL <<<<

```

type of parameters for sensitivity analysis
.....isv=      0
isv=1 .....distribution parameters
isv=2 .....limit-state fcn parameters
isv=0 ..distribution and limit-state fcn parameters

```

sensitivity with respect to distribution parameters

limit-state function 1

```

-----
d(beta)/d(parameter) :
var      mean      std dev      par 1      par 2      par 3      par 4
sm      9.420E-06      -3.225E-06      4.246E+00      -1.306E+00
fp      1.709E-01      -9.927E-02      4.246E+00      -2.284E+00
sw      -4.899E-07      -4.349E-13      -4.899E-07      -4.349E-13
mw      .....      .....      -5.588E-07      -1.201E-07      0.000E+00      0.000E+00
xu      5.462E+00      -8.109E+00      5.462E+00      -8.109E+00
xsw     -1.471E+00      -1.959E-01      -1.471E+00      -1.959E-01
xw      -2.788E+00      -1.901E+00      -2.788E+00      -1.901E+00
xs      -2.394E+00      -3.582E-01      -2.394E+00      -3.582E-01

```

```

d(Pf1)/d(parameter) :
var      mean      std dev      par 1      par 2      par 3      par 4
sm      -7.281E-07      2.493E-07      -3.282E-01      1.009E-01
fp      -1.321E-02      7.673E-03      -3.282E-01      1.765E-01
sw      3.787E-08      3.361E-14      3.787E-08      3.361E-14
mw      .....      .....      4.319E-08      9.283E-09      0.000E+00      0.000E+00
xu      -4.222E-01      6.267E-01      -4.222E-01      6.267E-01
xsw     1.137E-01      1.515E-02      1.137E-01      1.515E-02
xw      2.155E-01      1.469E-01      2.155E-01      1.469E-01
xs      1.850E-01      2.769E-02      1.850E-01      2.769E-02
-----

```

sensitivity with respect to limit-state function parameters

limit-state function 1

```

-----
par      d(beta)/d(parameter)      d(Pf1)/d(parameter)
1      0.000E+00      0.000E+00
-----

```

```

print interval .....npr= 0
npr<0 .....no first order results are printed
npr=0 .....print the final step of FORM results
npr>0 .....print the results of every npr steps
initialization flag .....ini= 0
ini=0 .....start from mean point
ini=1 .....start from point specified by user
ini=-1 ....start from previous linearization point
restart flag .....ist= 0
ist=0 .....analyze a new problem
ist=1 .....continue an unconverged problem

```

7-5

limit-state function 1

```

-----
iteration number .....iter= 7
value of limit-state function..g(x)=-2.805E-05
reliability index .....beta= 1.8118
probability .....Pf1= 3.501E-02
var          design point          sensitivity vectors
          x*          u*          alpha      gamma      delta      eta
sm      4.511E+05    -3.076E-01    -.1698     -.1698     .1722     -.0590
fp      2.488E+01    -5.378E-01    -.2969     -.2969     .3098     -.1800
sw      3.022E+06     8.876E-07     .0000     .0000     .0000     .0000
mw      4.959E+06     4.358E-01     .2406     .2406     .0000     .0000
xu      7.773E-01    -1.484E+00    -.8193     -.8193     .8193     -1.2163
xsw     1.007E+00     1.332E-01     .0735     .0735     -.0735     -.0098
xw      9.920E-01     6.818E-01     .3763     .3763     -.3763     -.2566
xs      1.155E+00     1.496E-01     .0826     .0826     -.0826     -.0124
-----

```

>>>> SENSITIVITY ANALYSIS AT COMPONENT LEVEL <<<<

```

type of parameters for sensitivity analysis
.....isv= 0
isv=1 .....distribution parameters
isv=2 .....limit-state fcn parameters
isv=0 ..distribution and limit-state fcn parameters

```

sensitivity with respect to distribution parameters

limit-state function 1

```

-----
d(beta)/d(parameter) :
var      mean      std dev      par 1      par 2      par 3      par 4
sm      9.420E-06  -3.225E-06  4.246E+00  -1.306E+00
fp      1.709E-01  -9.927E-02  4.246E+00  -2.284E+00
sw      -4.899E-07  -4.349E-13  -4.899E-07  -4.349E-13
mw      5.462E+00  -8.109E+00  -5.588E-07  -1.201E-07  0.000E+00  0.000E+00
xu      5.462E+00  -8.109E+00  5.462E+00  -8.109E+00
xsw     -1.471E+00  -1.959E-01  -1.471E+00  -1.959E-01
xw      -2.788E+00  -1.901E+00  -2.788E+00  -1.901E+00
xs      -2.394E+00  -3.582E-01  -2.394E+00  -3.582E-01
-----

```

```

d(Pf1)/d(parameter) :
var      mean      std dev      par 1      par 2      par 3      par 4
sm      -7.281E-07  2.493E-07  -3.282E-01  1.009E-01
fp      -1.321E-02  7.673E-03  -3.282E-01  1.765E-01
sw      3.787E-08  3.361E-14  3.787E-08  3.361E-14
mw      4.319E-08  9.283E-09  0.000E+00  0.000E+00
xu      -4.222E-01  6.267E-01  -4.222E-01  6.267E-01
xsw     1.137E-01  1.515E-02  1.137E-01  1.515E-02
xw      2.155E-01  1.469E-01  2.155E-01  1.469E-01
xs      1.850E-01  2.769E-02  1.850E-01  2.769E-02
-----

```

sensitivity with respect to limit-state function parameters

limit-state function 1

```

-----
par      d(beta)/d(parameter)      d(Pf1)/d(parameter)
1          0.000E+00          0.000E+00
-----

```

95%

178

```

type of integration scheme used .....=
itg=1 .....improved Breitung formula
itg=2 .....improved Breitung formula
.....& Tvedt's exact integral
max. number of iterations for each fitting point ..inp= 4

```

7-6

limit-state function 1

-----  
coordinates and ave. main curvatures of fitting points in rotated space

axis	u'i	u'n	G(u)	u'i	u'n	G(u)	a'i
1	1.810	1.814	-4.040E-03	-1.810	1.814	-2.416E-03	6.4993E-04
2	1.811	1.812	-1.017E-04	-1.811	1.812	-8.243E-05	1.0947E-04
3	1.812	1.812	-2.953E-07	-1.812	1.812	-2.201E-07	-3.7914E-12
4	1.812	1.750	1.491E-04	-1.812	1.758	2.554E-04	-1.7551E-02
5	1.812	1.731	1.514E-04	-1.812	1.737	6.208E-04	-2.3695E-02
6	1.811	1.812	-1.408E-04	-1.811	1.812	-1.296E-04	1.3290E-04
7	1.792	1.831	-2.968E-01	-1.790	1.833	-1.760E-01	6.2968E-03

```

generalized reliability index betag = improved Breitung Tvedt's EI
probability Pf2 = 1.7753 1.7760
3.792E-02 3.786E-02
-----

```

Stop - Program terminated.

Imp.

179

116

## SHIP STRUCTURE COMMITTEE PUBLICATIONS

- SSC-351 An Introduction to Structural Reliability Theory by Alaa E. Mansour  
1990
- SSC-352 Marine Structural Steel Toughness Data Bank by J. G. Kaufman and  
M. Prager 1990
- SSC-353 Analysis of Wave Characteristics in Extreme Seas by William H. Buckley  
1989
- SSC-354 Structural Redundancy for Discrete and Continuous Systems by P. K.  
Das and J. F. Garside 1990
- SSC-355 Relation of Inspection Findings to Fatigue Reliability by M. Shinozuka  
1989
- SSC-356 Fatigue Performance Under Multiaxial Load by Karl A. Stambaugh,  
Paul R. Van Mater, Jr., and William H. Munse 1990
- SSC-357 Carbon Equivalence and Weldability of Microalloyed Steels by C. D.  
Lundin, T. P. S. Gill, C. Y. P. Qiao, Y. Wang, and K. K. Kang 1990
- SSC-358 Structural Behavior After Fatigue by Brian N. Leis 1987
- SSC-359 Hydrodynamic Hull Damping (Phase I) by V. Ankudinov 1987
- SSC-360 Use of Fiber Reinforced Plastic in Marine Structures by Eric Greene  
1990
- SSC-361 Hull Strapping of Ships by Nedret S. Basar and Roderick B. Hulla 1990
- SSC-362 Shipboard Wave Height Sensor by R. Atwater 1990
- SSC-363 Uncertainties in Stress Analysis on Marine Structures by E. Nikolaidis  
and P. Kaplan 1991
- SSC-364 Inelastic Deformation of Plate Panels by Eric Jennings, Kim Grubbs,  
Charles Zanis, and Louis Raymond 1991
- SSC-365 Marine Structural Integrity Programs (MSIP) by Robert G. Bea 1992
- SSC-366 Threshold Corrosion Fatigue of Welded Shipbuilding Steels by G. H.  
Reynolds and J. A. Todd 1992
- SSC-367 Fatigue Technology Assessment and Strategies for Fatigue Avoidance in  
Marine Structures by C. C. Capanoglu
- None Ship Structure Committee Publications – A Special Bibliography

C-4 80231  
459



**COMMITTEE ON MARINE STRUCTURES**

**Commission on Engineering and Technical Systems**

**National Academy of Sciences – National Research Council**

**The COMMITTEE ON MARINE STRUCTURES has technical cognizance over the interagency Ship Structure Committee's research program.**

**Peter M. Palermo Chairman, Alexandria, VA  
Mark Y. Berman, Amoco Production Company, Tulsa, OK  
Subrata K. Chakrabarti, Chicago Bridge and Iron, Plainfield, IL  
Rolf D. Glasfeld, General Dynamics Corporation, Groton, CT  
William H. Hartt, Florida Atlantic University, Boca Raton, FL  
Robert Sielski, National Research Council, Washington, DC  
Robert G. Loewy, NAE, Rensselaer Polytechnic Institute, Troy, NY  
Stephen E. Sharpe, Ship Structure Committee, Washington, DC**

**LOADS WORK GROUP**

**Subrata K. Chakrabarti Chairman, Chicago Bridge and Iron Company, Plainfield, IL  
Howard M. Bunch, University of Michigan, Ann Arbor, MI  
Peter A. Gale, John J. McMullen Associates, Arlington, VA  
Hsien Yun Jan, Martech Incorporated, Neshanic Station, NJ  
Naresh Maniar, M. Rosenblatt & Son, Incorporated, New York, NY  
Solomon C. S. Yim, Oregon State University, Corvallis, OR**

**MATERIALS WORK GROUP**

**William H. Hartt Chairman, Florida Atlantic University, Boca Raton, FL  
Santiago Ibarra, Jr., Amoco Corporation, Naperville, IL  
John Landes, University of Tennessee, Knoxville, TN  
Barbara A. Shaw, Pennsylvania State University, University Park, PA  
James M. Sawhill, Jr., Newport News Shipbuilding, Newport News, VA  
Bruce R. Somers, Lehigh University, Bethlehem, PA  
Jerry G. Williams, Conoco, Inc., Ponca City, OK**

*C-3 80231 (659)*