

THE NEW 1976 COLOR TV RECEIVERS

Popular Electronics®

WORLD'S LARGEST-SELLING ELECTRONICS MAGAZINE FEBRUARY 1976/75c

A **PE TESTED** FIRST!

Build the "TV DAZZLER"

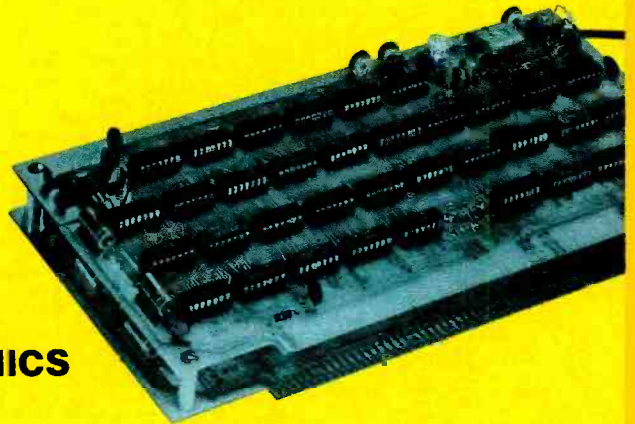

COMPUTER ACCESSORY FOR PLAYING ACTION TV GAMES, DISPLAYING GRAPHICS AND ALPHANUMERICS ON COLOR TV

Light-Beam Communication Experiments

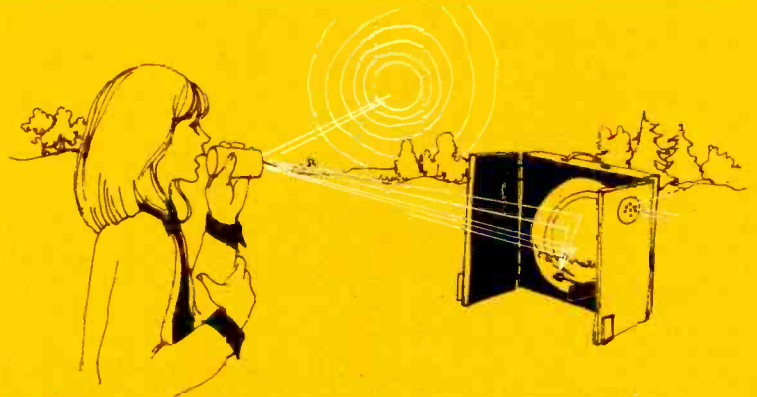

IT STARTED WITH ALEXANDER GRAHAM BELL

\$15 Temperature Meter

DO YOUR
TRANSISTORS
RUN TOO HOT?

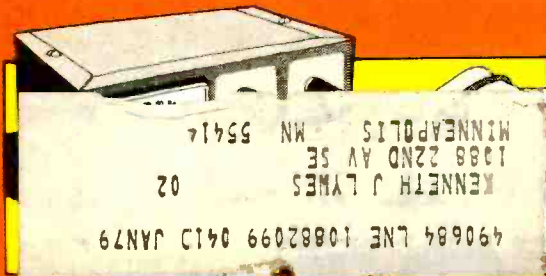

OTHER PROJECTS:

A High-Power Mobile Stereo Amp for Auto, Camper or Boat

Multi-Battery Charger Handles Four Cell Types Simultaneously

TEST REPORTS:

Dual Stereo Cassette Deck

Jensen Bookshelf Speaker System

Browning "Golden Eagle" CB Base Station

Triplett "Safety" VOM





We don't just talk quality

We build quality. That's why Cobra CB radios are engineered and built to operate at peak performance under all conditions. But we don't stop there. Our concern for quality assures you of performance that makes using your CB more enjoyable. And our dealers and distributors are concerned about customer service.

All this—because, like you, we're serious about CB.



Cobra
Products of Dynascan

1801 W. Belle Plaine Ave., Chicago, Illinois 60613 (312) 327-7270

CIRCLE NO. 13 ON FREE INFORMATION CARD

www.americanradiohistory.com

The new Mallory CA3 Intrusion Alarm.

Reliable.

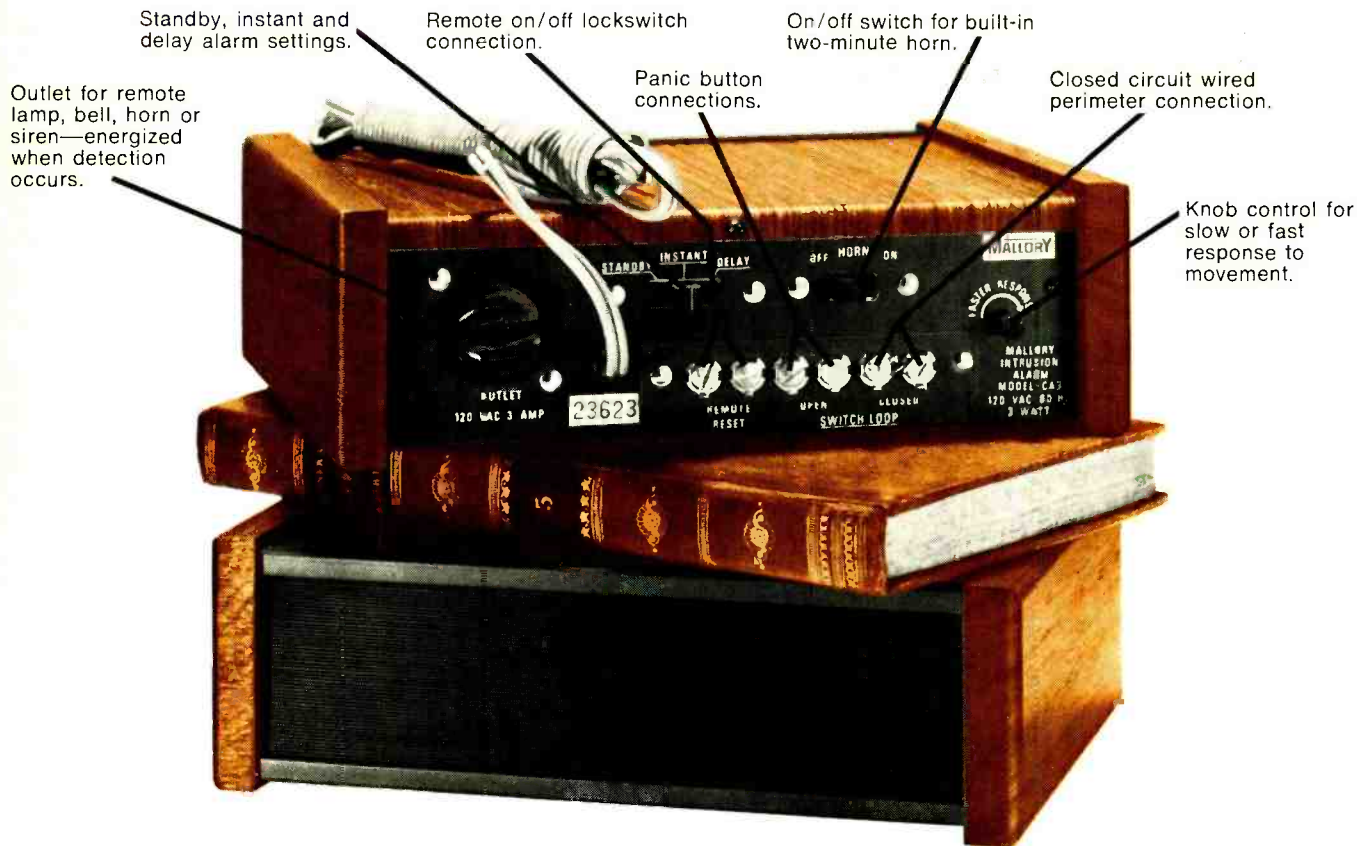

(And inconspicuous.)

This area-and-perimeter device creates and transmits an ultrasonic wavelength field for detection up to a distance of 20 feet. And because of its modern design and walnut-grain finish, the CA3 is attractive and inconspicuous enough to pass as a radio or stereo tuner.

Virtually any movement by an intruder (or a break in the perimeter circuit) activates the built-in horn and the remote outlet for two minutes. An automatic

reset handles the possibility of a new or renewed intrusion. And special CA3 circuitry guards against false alarms from line transients and insects. A variety of companion indoor or outdoor accessory devices is available.

The Mallory CA3 Ultrasonic Intrusion Alarm. From the manufacturer of the most complete line of do-it-yourself security products. Another sound reason to see your Mallory distributor today.

MALLORY

MALLORY DISTRIBUTOR PRODUCTS COMPANY

a division of P. R. MALLORY & CO. INC.

Box 1284, Indianapolis, Indiana 46206; Telephone: 317-856-3731

Batteries • Capacitors • Controls • Security Products • DURATAPE® • Resistors • Semiconductors • SONALERT® • Switches • Timing Devices and Motors

OURACELL® OURATAPE® and SONALERT® are registered trademarks of P. R. Mallory & Co. Inc.

FEBRUARY 1976

CIRCLE NO. 32 ON FREE INFORMATION CARD

1

TO: JOE RIDGE
WINEGARD SALES MANAGER

FIRST REPORTS FROM FIELD REALLY FANTASTIC!
INSTALLERS SAY WE HAVE A REAL WINNER IN
CHROMSTAR--MORE POWERFUL PERFORMANCE, ESPECIALLY
UHF--STRONGEST ANTENNA EVER BUILT--EASIER
INSTALLATION. ACCEPTANCE AND DEMAND HIGH AND
GROWING . . . KEEP 'EM COMING!

DISTRIBUTORS PLEASED WITH DEALER REACTION, AND
HAPPY WITH NEW, COMPACT CARTON SIZES. SET
OWNERS GETTING CLEARER PICTURES, BETTER COLOR
FROM ALL STATIONS IN RANGE. AM SENDING YOU
ACTUAL DEALER STATEMENTS.

LEO RIDDLE
DISTRICT MANAGER



Dealers Everywhere Welcome CHROMSTAR™ First New TV Antennas In Years.

Response has been totally enthusiastic because of the many far-ahead features built into Chromstar models!

- New Standard of Excellence In Construction and Performance.
- Anodized and Ruggedized for Weather Protection, Long Life.
- New Tri-Linear UHF Director System Increases Gain Up To 30%
- Models To Solve Every Reception Problem.

GET ALL THE FACTS FROM YOUR WINEGARD DISTRIBUTOR.
FREE SPEC CHARTS ON ALL MODELS. CASH IN WITH
CHROMSTAR SALES AND INSTALLATIONS!

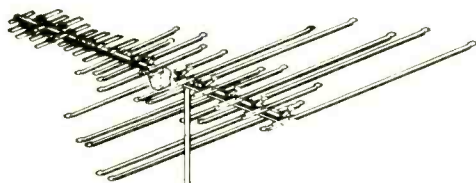

CH-7080
VHF-UHF-FM

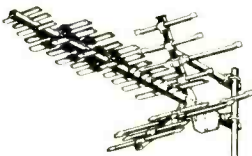

CH-9085
UHF only

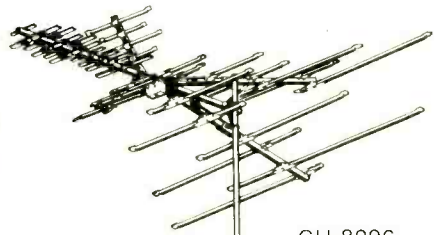

CH-8096
VHF-UHF-FM



WINEGARD®
C O M P A N Y
3000 Kirkwood • Burlington, Iowa 52601

TV ANTENNAS MORE PEOPLE LOOK UP TO.

Popular Electronics®

WORLD'S LARGEST SELLING ELECTRONICS MAGAZINE

FEATURE ARTICLES

THE NEW 1976 COLOR TV RECEIVERS	Art Margolis	41
<i>Serviceability and automatic color controls are emphasized.</i>		
TALK OVER A SUNBEAM WITH A "PHOTOPHONE"	Forrest M. Mims	54
<i>A communication system that modulates light to convey information.</i>		
ELECTRONIC SWITCHING WITH TRANSMISSION GATES	Robert D. Pascoe	62
<i>CMOS device provides "bounceless" switching at speeds to 10 MHz.</i>		
DUMMY ANTENNAS FOR HAMS AND CB'ERS	John T. Frye	65
<i>How and why dummy loads are used to test transmitters.</i>		
WHAT DO YOU KNOW ABOUT DIODES?	Robert P. Balin	73

CONSTRUCTION ARTICLES

BUILD THE TV DAZZLER	Walker, Melen, Garland, & Hall	31
<i>Unique computer accessory provides alphanumeric and graphics in color.</i>		
A HIGH-POWER MOBILE STEREO AMPLIFIER	Edgar Braden	50
<i>Produces 15 watts per channel audio from a 12-V dc source.</i>		
BUILD THE BATTERY MULTI-CHARGER	Ralph Tenny	67
<i>Inexpensive circuit rejuvenates four types of carbon-zinc cells.</i>		
BUILD A LOW-COST TEMPERATURE METER	William A. Russo	70
<i>Identifies hot spots in electronic equipment.</i>		

COLUMNS

STEREO SCENE	Ralph Hodges	22
<i>Looking to the Future.</i>		
TEST EQUIPMENT SCENE	Leslie Solomon	91
<i>Can Test Equipment Be Wrong?</i>		
SOLID STATE	Lou Garner	92
<i>A Dandy Circuit.</i>		
CB SCENE	Ray Newhall	96
<i>The FCC and CB'ers.</i>		
EXPERIMENTER'S CORNER	Forrest Mims	101
<i>TTL Sequence Generator.</i>		

PRODUCT TEST REPORTS

DUAL STEREO CASSETTE DECK	78
JENSEN MODEL OPC-21 SPEAKER SYSTEM	80
BROWNING GOLDEN EAGLE MARK III AM/SSB CB BASE STATION	82
TRIPLETT MODEL 60 MULTIMETER	88
JERROLD MODEL TRC-12 VHF TV REMOTE CONTROL ACCESSORY	89

DEPARTMENTS

EDITORIAL	Art Salsberg	4
<i>Good News For Mail-Order Buyers.</i>		
LETTERS	6	
OUT OF TUNE	7	
<i>"Build a Preregulated Power Supply" (Nov. 1975)</i>		
NEW PRODUCTS	12	
NEW LITERATURE	16	
NEWS HIGHLIGHTS	28	
OPERATION ASSIST	98	
TIPS & TECHNIQUES	99	
ELECTRONICS LIBRARY	100	
ADVERTISERS INDEX	119	

POPULAR ELECTRONICS, February 1976, Volume 9, Number 2. Published monthly at One Park Avenue, New York, NY 10016. One year subscription rate for U.S., \$6.98; U.S. Possessions and Canada, \$7.98; all other countries, \$8.98. Second Class postage paid at New York-NY and at additional mailing offices. Authorized as second class mail by the Post Office Department, Ottawa, Canada and for payment of postage in cash. Subscription service and Forms 3579, P. O. Box 2774, Boulder, CO 80302. POPULAR ELECTRONICS including ELECTRONICS WORLD, Trade Mark Registered. Indexed in the Reader's Guide to Periodical Literature. COPYRIGHT © 1976 BY ZIFF-DAVIS PUBLISHING COMPANY. ALL RIGHTS RESERVED.

Ziff-Davis also publishes Boating, Car and Driver, Cycle, Flying, Modern Bride, Popular Photography, Skiing and Stereo Review.
Editorial correspondence: POPULAR ELECTRONICS, 1 Park Ave., New York, NY 10016. Editorial contributions must be accompanied by return postage and will be handled with reasonable care; however, publisher assumes no responsibility for return or safety of manuscripts, art work, or models.
Forms 3579 and all subscription correspondence: POPULAR ELECTRONICS, Circulation Dept., P. O. Box 2774, Boulder, CO 80302. Please allow at least eight weeks for change of address. Include your old address, enclosing, if possible, an address label from a recent issue.

EDGAR W. HOPPER
Publisher

ARTHUR P. SALSBERG
Editorial Director

LESLIE SOLOMON
Technical Editor

JOHN R. RIGGS
Managing Editor

ALEXANDER W. BURAWA
Feature Editor

EDWARD I. BUXBAUM
Art Director

JOHN McVEIGH
Assistant Editor

ANDRE DUZANT
Technical Illustrator

PATRICIA BROWN
Editorial Assistant

LOU GARNER
GLENN HAUSER
JULIAN D. HIRSCH
RALPH HODGES
ART MARGOLIS
FORREST MIMS
JERRY OGDIN
WILFRED M. SCHERER
Contributing Editors

JOSEPH E. HALLORAN
Advertising Director

JOHN J. CORTON
Advertising Sales

LINDA BLUM
Advertising Service Manager

PEGI McENEANEY
Executive Assistant

STANLEY NEUFELD
Associate Publisher

ZIFF-DAVIS PUBLISHING COMPANY
Popular Electronics
Editorial and Executive Offices
One Park Avenue New York, New York 10016
212-725-3500
Hershel B. Sarbin, President
Furman Hebb, Executive Vice President
Vincent Perry, Financial Vice President and Treasurer
Phillip T. Heffernan, Senior Vice President, Marketing
Edward D. Muhlfeld, Senior Vice President, Sports Division
Philip Sine, Senior Vice President
Frank Pomerantz, Vice President, Creative Services
Arthur W. Butzow, Vice President, Production
Lawrence Sporn, Vice President, Circulation
George Morrissey, Vice President
Sydney H. Rogers, Vice President
Sidney Holtz, Vice President
Al Traina, Vice President
Philip Korsant, Vice President
Paul H. Chook, Vice President, Market Planning
Charles B. Seton, Secretary
Edgar W. Hopper, Vice President, Electronics Div.
William Ziff, Chairman
W. Bradford Briggs, Vice Chairman

Midwestern Office
The Pattis Group, 4761 West Touhy Ave.,
Lincolnwood, Illinois 60644, 312 679-1100
GERALD E. WOLFE, THOMAS HOCKNEY

Western Office
9025 Wilshire Boulevard, Beverly Hills, CA 90211
213 273-8050; BRadshaw 2-1161
Western Advertising Manager, BUD DEAN

Japan: James Yagi
Oji Palace Aoyama: 6-25, Minami Aoyama
6 Chome, Minato-Ku, Tokyo 407-1930/6821,
582-2851



The publisher has no knowledge of any proprietary rights which will be violated by the making or using of any items disclosed in this issue.



Editorial

GOOD NEWS FOR MAIL-ORDER BUYERS

I have recently observed a growing number of complaints about mail-order purchases—some of them legitimate, some not. Most of them are concerned with shipping delays, with the seller neither acknowledging an order nor notifying the purchaser that there would be a delay. Without doubt, these represent fair expressions of discontent when the buyer has waited perhaps eight weeks with no word from the seller.

Lamentably, some mail-order sellers do not follow good business practices in these matters. We have tried to exert pressure on behalf of complainants, meeting with reasonable success. In one case, a company president listened well and hired a person just to handle this type of correspondence. In other cases, however, the seller simply oiled the squeaky wheel—a shortsighted approach, of course. To be fair, though, most mail-order companies who advertise in PE provide service in four days to three weeks.

Now the government has stepped into the picture! The Federal Trade Commission has set down an amendment to commercial practice rules for Mail Order Merchandise, effective February 2, 1976. In essence, it says that if no shipment time is clearly and conspicuously indicated in a solicitation (such as an advertisement), shipment must be made within 30 days after receipt of a properly completed order. Furthermore, the seller must have a reasonable basis at the time of solicitation to expect that shipment will be made within 30 days (or alternate stated shipping date) of receipt of order.

One assumes, therefore, that (as an example) a legitimate reason for not meeting a shipping date would be the receipt of a larger number of orders than anticipated. In such cases, the seller must inform the buyer of a revised shipping date or that a date cannot be determined—for whatever reason. This must be done within a reasonable time after the seller first becomes aware of the delay. Moreover, the seller must offer the buyer an option either to consent to a shipping delay or to cancel his order and receive a prompt refund. If cancellation is not received on or before a revised shipping date (30 days or less delay), it is assumed that the buyer consented to the delay. If stated delay is more than 30 days or indefinite, the order will be automatically deemed cancelled if not shipped within 30 days or unless the seller receives a response within 30 days specifically consenting to the delay. When the delay is indefinite, the buyer has a continuing right to cancel prior to a shipment.

If a notice of further delay is issued, the same rules above apply, but the seller must send the buyer a business reply envelope or prepaid postage to exercise the new option.

Prompt refund, by the way, means a refund by first-class mail within seven days of receipt of such a request or within one billing cycle in the case of cancelling a renewed option. Part of the new rules does not apply to subscriptions (such as magazine sales ordered for serial delivery).

In the recent past, I haven't looked kindly upon many new government regulations. But I do feel that this is a welcome one. In any event, to speed fulfillment of an order by mail, buyers should use a money order or credit card. Sending a personal check sometimes causes the seller to wait weeks for the check to clear before shipping.

Art Salsberg



II'nd only to the III.

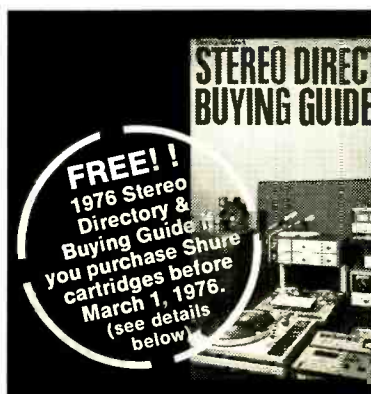

The new Shure M95ED phono cartridge combines an ultra-flat 20-20,000 Hz frequency response and extraordinary trackability with an utterly affordable price tag! To achieve this remarkable feat, the same hi-fi engineering team that perfected the incomparable Shure V-15 Type III cartridge spent five years developing a revolutionary all-new interior pole piece structure for reducing magnetic losses. The trackability of the M95ED is second only to the Shure V-15 Type III. In fact, it is the new "Number 2" cartridge in *all* respects and surpasses much higher priced units that were considered "state of the art" only a few years ago. Where a temporary austerity budget is a pressing and practical consideration, the M95ED can deliver more performance per dollar than anything you've heard to date.

Shure Brothers Inc.
222 Hartrey Ave., Evanston, IL 60204
In Canada: A. C. Simmonds & Sons Limitec



FREE! 1976 Stereo Directory & Buying Guide with the purchase of a Shure V-15 Type III, or the M95 series, M75 Type II or M91 series of cartridges. Simply send us your warranty card with the notation "Send Free Buying Guide" before March 1, 1976. (Offer subject to supply and may be withdrawn at any time.)

the greatest distance between the two curves, representing the best S/N obtainable with a specific tape on a given deck. The sensitivity of the VU meters can next be set to 0 dB for the corresponding 1000-Hz signal level that yields the maximum allowable THD. Only after the bias current has been set can the recording equalization be adjusted to give a correct frequency response at playback. This can be done by taking the overall record/playback curve at a safe recording level (e.g. -20 dB).

It cannot be overemphasized that the bias oscillator must be as clean as possible from the odd harmonics.—*J.P. Van Dormael, Temse, Belgium*

PRO'S AND CON'S OF METRICATION

The November 1975 editorial, titled "The Metrication Waiting Game," was certainly appropriate. Phono cartridges are an interesting case—tracking force in grams, stylus overhang in millimeters, reference velocity in cm/s . . . and a mounting center dimension of 1/2".

Because we deal in both English and metric units, we are interested in the metrication cause.—*Fred W. Nichols, Marketing Manager, Audio-Technica U.S., Inc., Fairlawn, Ohio*

The November 1975 Editorial states that "there is no serious move in our schools to teach upcoming generations the system of

weights and measures that must ultimately be adopted." I don't know what your criterion of "serious" is, but when the metric system is taught and used in every chemistry, biology, and physics class I ever knew about or visited in the past 38 years of science teaching, I think that you must admit that there is a definite effort to teach a large segment of upcoming generations something about the metric system.—*Paul R. Doe, Hyde Park, N.Y.*

What do you mean by *defeated* U.S. Metrication Bill? Metrication Bill HR 8674 has passed the House, had hearings in a Senate subcommittee on October 8 and 9, and is now waiting to be voted on in the Senate.—*LeRoy Taraba, Portland, Ore.*

Elementary and secondary schools provide only cursory coverage of the metric system, quickly returning to the English system. Unless a student is studying science or technology, his chances of getting

involved with metrics are remote.

The reference to the defeated bill was to an earlier attempt to pass some legislation. At the time we went to press with the Editorial, HR 8674 still hadn't passed the House. And as of this writing, the Senate has not yet voted on it.

Out of Tune

In "Build a Preregulated Power Supply," p 58, November 1975, the component placement guide is shown from the component side of the board, not the foil side. The foil pattern on the component placement guide is correct. A corrected half-size etching and drilling guide is shown below. Arrows point to areas where changes are necessary.

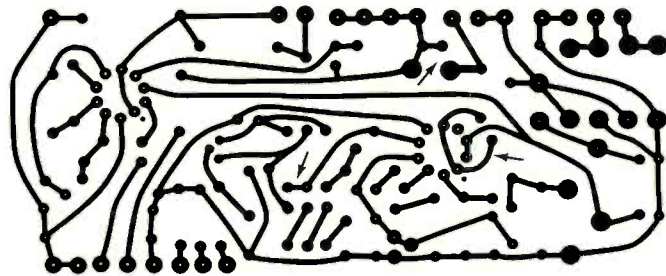

You don't have to buy a new car to get an electronic ignition.

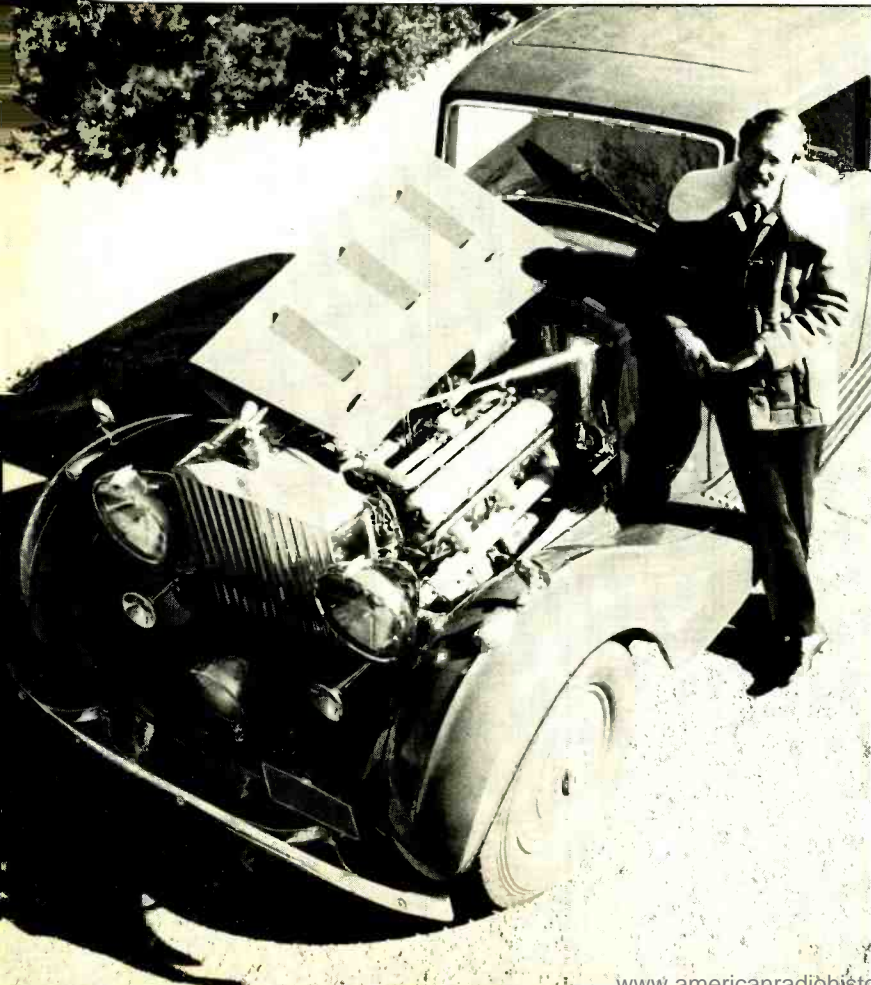

Let's face it. After 37 years, even a Phantom III can use a lift. That's why I put a Delta Mark Ten B Capacitive Discharge Ignition on my Phantom . . . to give her a spark I'd pit against any '75 model car. I went to Delta because they aren't Johnny-come-latelys. Delta's been making electronic ignition systems for over a decade.

Whatever kind of car you drive, you can give it the same great Delta performance I gave mine.

- Mark Ten B Capacitive Discharge Ignition Systems are manufactured by Delta Products, Inc., a company with a conscience, and with a proven record of reliability both in product and in customer relations.
- The Mark Ten B really does save money by eliminating the need for 2 out of 3 tune-ups. Figure it out for yourself. The first tune-up or two saved pays for the unit, the rest is money in your pocket. No bunk!
- Because the Mark Ten B keeps your car in better tune, you actually can save on expensive gasoline.
- With a Mark Ten B, spark plugs stay clean and last longer . . . fouling is virtually eliminated.



I want to know more about Mark Ten B CDI's. Send me complete no-nonsense information on how they can improve the performance of my car.

Name _____
 Address _____
 City _____ State _____ Zip _____



DELTA PRODUCTS, INC.

P.O. Box 1147, Dept. PE, Grand Junction, Colo. 81501
 303-242-9000

Mark Ten B, assembled	\$64.95 ppd	Standard Mark Ten, assembled	\$49.95 ppd
Mark Ten B, kit	\$49.95 ppd	Deltakit®	\$34.95 ppd

CIRCLE NO. 14 ON FREE INFORMATION CARD

Prepare for a high-paying career in Complete Communications

Including equipment installation,
and maintenance...in actual practice

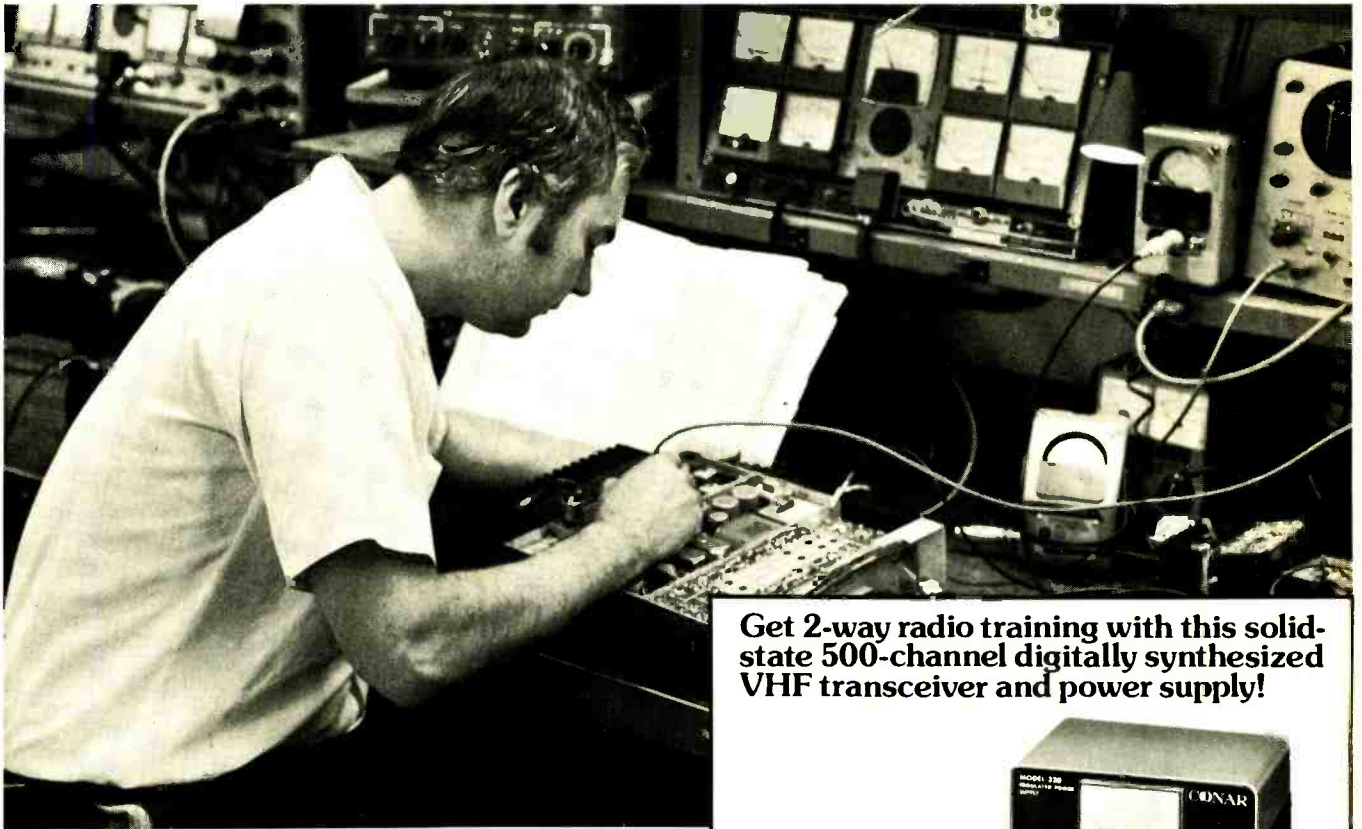

The field of communications is bursting out all over. In Citizens Band alone, estimates predict a growth in equipment sales from \$514 million in 1973 to \$1.2 billion dollars in 1982! That means a lot of openings in service and maintenance jobs. NRI can train you at home to fill one of those openings . . . including your FCC license and solid-state 2-way radio service.

NRI's Complete Communications Course will qualify you for a First Class Commercial License within 6 months after graduation or you get your money back! It covers AM and FM transmission systems, teletype, radar principles, marine electronics, mobile communications, and aircraft electronics.

You will learn to service and adjust communications equipment . . . using your own 500 channel VHF transceiver and AC power supply for hands-on experience as well as your own personal use.

With NRI's training program, you can learn this important skill easily, at home in your spare time. You get 10 training kits, including an

Get 2-way radio training with this solid-state 500-channel digitally synthesized VHF transceiver and power supply!



Your communications/CB training will be up-to-the-minute when you experiment with this solid-state transceiver. Mount it in your car or use it with your AC power supply as a base station. You get "hands-on" experience that puts your course theory into practice the practical way.

Antenna Applications Lab, CMOS frequency counter and optical digital transmission systems. You'll learn from bite-size lessons, progressing at your own speed to your FCC license and then into the communications field of your choice.



Only NRI offers you five TV/Audio Servicing Courses



NRI can train you at home to service TV equipment and audio systems. You can choose from 5 courses, starting with a

48-lesson basic course, up to a Master Color TV/Audio Course, complete with 25" diagonal solid state color TV and a 4-speaker SQ® Quadraphonic Audio System. NRI gives you both TV and Audio servicing for less than you'd pay for either course at the next leading home study school!

All courses are available with low down payment and convenient monthly payments. All courses provide professional tools and "Power-On" equipment along with NRI kits engineered for training. With the Master Course, for instance, you build your own 5" wide-band triggered sweep solid state oscilloscope, digital color TV pattern generator, CMOS digital frequency counter, and NRI "Discovery" electronics lab.



® Trademark of CBS, Inc.

NRI's complete computer electronics course gives you real digital training

Digital electronics is the career area of the future . . . and the best way to learn is with NRI's Complete Computer Electronics Course. NRI's programmable digital computer goes far beyond any "logic trainer" in preparing you to become a computer or digital technician. With the IC's in its new Memory Kit, you get the only home training in machine language programming . . . experience essential to trouble shooting digital computers. And the NRI programmable computer is just one of ten kits you receive, including a TVOM and NRI's exclusive "Discovery" Lab. It's the quickest and best way to learn digital logic and computer operation.

You pay less for NRI training and you get more for your money

NRI employs no salesmen, pays no commissions. We pass the savings on to you in reduced tuitions and extras in the way of professional equipment, testing instruments, etc. You can pay more, but you can't get better training.

More than one million students in 62 years have learned at home the NRI way.

Mail the insert card and discover for yourself why NRI is the recognized leader in home training. No salesman will call. Do it today and get started on that new career.



APPROVED FOR CAREER TRAINING UNDER GI BILL
Check box on card for details.

MAIL THE INSERT CARD FOR YOUR FREE NRI CATALOG No salesman will call



NRI SCHOOLS
McGraw-Hill Continuing Education Center
3939 Wisconsin Avenue,
Washington, D.C. 20016

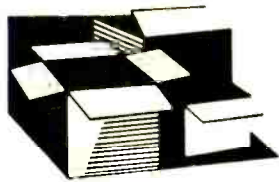

New Products

Additional information on new products covered in this section is available from the manufacturers. Either circle the item's code number on the Reader Service Card inside the back cover or write to the manufacturer at the address given.

SANSUI AM/STEREO FM RECEIVER

The Sansui Model 331 AM/stereo FM receiver, designed for "budget" audio systems, is rated at 12 watts rms per channel minimum output, both channels driven



into 8 ohms loads with 1% maximum THD and power bandwidth 40 to 20,000 Hz. Frequency response at 1 watt overall is 25 to 30,000 Hz +2 dB, -3 dB. Other specifications are: IHF sensitivity, 2.5 microvolts; S/N, 65 dB; selectivity, 60 dB; and capture ratio, 1.5 dB. The receiver has a frequency-linear variable capacitor, MOSFET front end, two bi-resonator ceramic filters and high-density IC's. \$200.00

CIRCLE NO. 85 ON FREE INFORMATION CARD

HEATHKIT MODULES FOR AUDIO SYSTEMS

The heart of Heath's new "Modulus" line of audio modules is the AN-2016 Digital AM/Stereo FM Control Center. This is a tuner with digital frequency readout and a built-in stereo/quadrasonic preamp. A matching power amplifier (35 watts rms per channel or 60 watts rms per channel) may be added for stereo and a second unit for 4-channel use. Preamp specifications include: frequency response, 10 to 30,000 Hz, +0, -0.5 dB; THD, 0.05%; input sensitivities, 2 mV and 6 mV; hum and noise, -80 dB; high filters, -3 dB at 7 kHz \pm 1 kHz; low filters, -3 dB at 30 Hz \pm 2 Hz. For the FM section: sensitivity (mono) 1.7 μ V IHF, (stereo) 35 μ V for 50 dB S/N; separation, 40 dB at 1 kHz; selectivity, greater than 100 dB; capture ratio, 1.3 dB. It features peak-

MIDLAND MOBILE/PORTABLE CB RIG

Midland's new Model 13-861 is a 23-channel CB transceiver for mobile or portable applications. It comes with a battery pack, carrying case, and antenna for portable use. In this mode up to 3.1 watts of r-f output are available. When high power is not needed, a high/low power switch reduces transmitter output and extends battery life. The receiver section features dual-conversion superhet circuitry, agc, and anl. A three-way meter monitors r-f output, received signal strength, and battery condition. A PTT speaker/microphone is included, along with a charger jack and telescoping antenna. In mobile operation, the antenna and battery pack are disconnected, and r-f output appears at an antenna jack. A mobile mounting bracket accepts the transceiver in or out of its case, which contains the battery pack (holding 10 NiCd "AA" or 8 penlight cells). The case also has an adjustable shoulder strap and belt loop. Measures 7 $\frac{7}{8}$ " D \times 4 $\frac{5}{8}$ " W \times 3 $\frac{1}{4}$ " H (17.8 \times 11.8 \times 8.3 cm). \$164.95.

CIRCLE NO. 86 ON FREE INFORMATION CARD

HUFCO FREQUENCY COUNTERS

Two frequency counters, Models TWS-300 (3 digits) and TWS-600 (6 digits), have been announced by Hufco TWS Labs. Both counters are said to have 300-mV sensitivity and they operate through 250 MHz. They are equipped with 115-volt power supplies, but will work with 12-V dc through a dropping resistor. The TWS-300 is \$99.95 in kit form and \$117.95 assembled; TWS-600 is \$119.95 kit and \$139.95 assembled.

CIRCLE NO. 87 ON FREE INFORMATION CARD

MULTI-TESTER WITH TEMPERATURE RANGE

The SP144 multi-tester from A.W. Sperry Instruments features a -20 to +300°F temperature range. Other standard

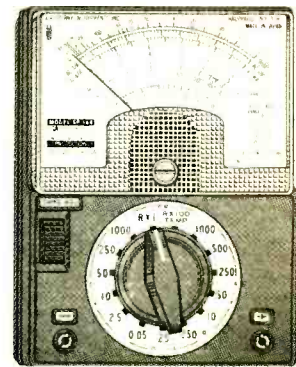

scales include 10/50/250/500/1000 V ac; 2.5/10/50/250/1000 V dc; .05/25/250 mA dc; 4000 and 400,000 ohms with 35-ohm mid-scale; and -20 to +62 dB. Sensitivity is 20,000 ohms/V dc and 10,000 ohms/V ac. Includes fuse, battery and test leads. Measures 4 $\frac{3}{4}$ " H \times 3 $\frac{1}{4}$ " W \times 1 $\frac{1}{16}$ " D (12 \times 8 \times 4 cm) and weighs 9 oz.

CIRCLE NO. 88 ON FREE INFORMATION CARD

TELEPHONICS STEREO HEADPHONE

The Telephonics Stereo-50 headphone features an ear cushion that has an inner, open-air supra-aural section and an outer closed-air circum-aural portion. The combination is said to provide an unusual stereo effect. A channel blend control can be adjusted by the listener. Specifications



include: frequency range, 16 to 22,000 Hz; THD, less than 0.2% at 100 dB SPL; power handling capability, 400 mW per channel. Weighs 12 oz. \$50.00.

CIRCLE NO. 89 ON FREE INFORMATION CARD

UNGAR TEMPERATURE-CONTROLLED SOLDERING STATION

The "Ungarmatic" has preset thread-in heaters rated and controlled at 600, 700, or 800°F. A closed-loop control maintains the idling temperature during soldering. A bench-top power supply provides 24 volts to reduce the effect of ac line voltage surges. During idling, the iron rests in a stainless steel holder to control heat loss. Heavy-duty plug-in tips are available in

POPULAR ELECTRONICS



CIRCLE NO. 90 ON FREE INFORMATION CARD

Solder less. Design more.



The soldering iron. As a design tool, it's obsolete.

Whether you're a full-time engineer or spare-time hobbyist, there are only so many hours a day you can spend designing and building circuits. So why not make the most of your time?

Design circuits literally as fast as you can think. Instead of starting your next project with a soldering iron, save time by starting with our Design Mate™ 1. In a compact (7½"W x 6¾"D x 3¼"H) case with a convenient sloping top, it offers solderless breadboarding at its best: 790 terminals; a continuously-adjustable regulated 5-15 VDC 600 mA supply; and a DC voltmeter to monitor the internal supply or

test your operating circuit.

With Design Mate 1, hooking up (or changing) a circuit is as simple as pushing leads into holes on the breadboard. Rugged 5-point contacts insure reliable, low-resistance connections between resistors, capacitors, transistors... even IC's in TO-5 or DIP packages. And short lengths of solid #22 AWG wire make interconnections easy wherever you need them.

At \$49.95* complete, it's not only a time-saver, it's a money-saver, too.

Larger capacity? Smaller capacity? Have it your way.

Whatever your breadboarding needs,

Proto-Board 103 2250 solderless terminals save you time on every circuit you design.

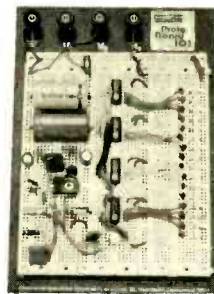

we can fill them. For larger capacity, save time with our Proto-Board® series—660 to 3060 terminal points, with or without built-in regulated power supplies. For smaller applica-



Test DIP's with power on and hands off—even on the most crowded circuit board with our Proto-Clip™ series.

tions, use 1 or more of our handy QT Sockets and Bus Strips, locking them together for infinite expandability, as you need it. Starting at \$2.00.

Other ways to save time and money. Proto-

Boards, QT Sockets and Bus Strips are just the beginning of the many ways we can help make your life more enjoyable: how about a foolproof, shortproof way to test DIP IC's—even in operating circuits—for just \$4.50*? A full-featured, precision function generator for \$64.95*? A professional R/C bridge for \$54.95*? A way to

instantly see and monitor logic levels in an operating IC, without expensive scopes or elaborate procedures. And more, to save you time, money and aggravation.

Time is money:

Start saving it. Ask your CSC dealer to show you how to solder less, design more and take the drudgery out of your electronic life. Or send for our free catalog and dealer list.

*Manufacturer's recommended retail.



Design Mate 2: versatile function generator, only \$64.95*

Design Mate 3: Precision R/C bridge, just \$54.95*

CONTINENTAL SPECIALTIES CORPORATION



44 Kendall Street, Box 1942
New Haven, CT 06509 • 203-624-3103 TWX: 710-465-1227
West Coast office: Box 7809, San Francisco, CA
94119 • 415-421-8872 TWX: 910-372-7992
Canada: Len Finkler Ltd., Ontario

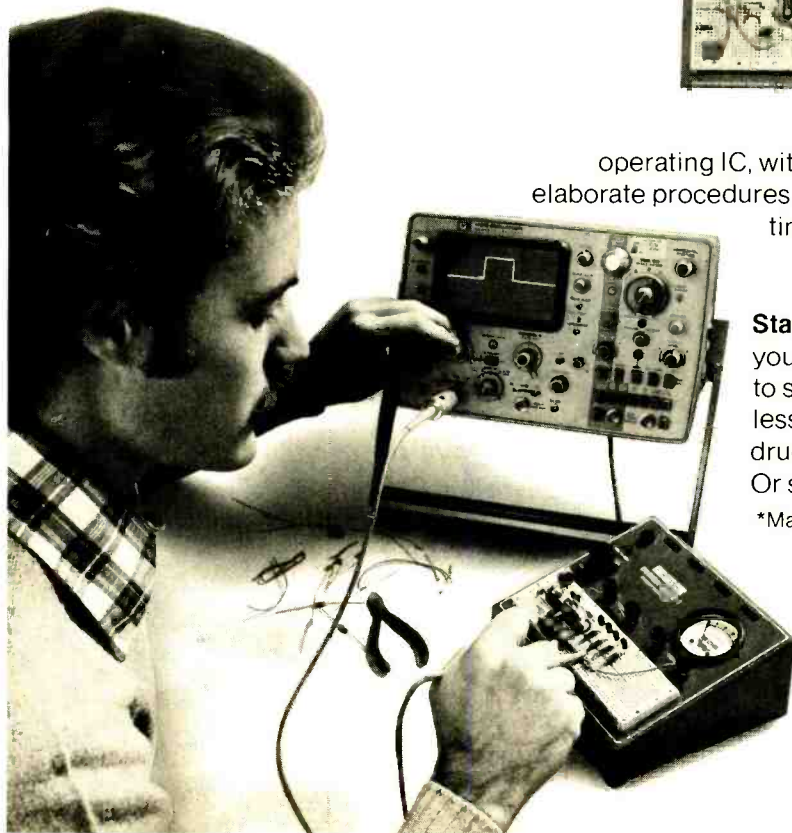

The \$300 alternative.

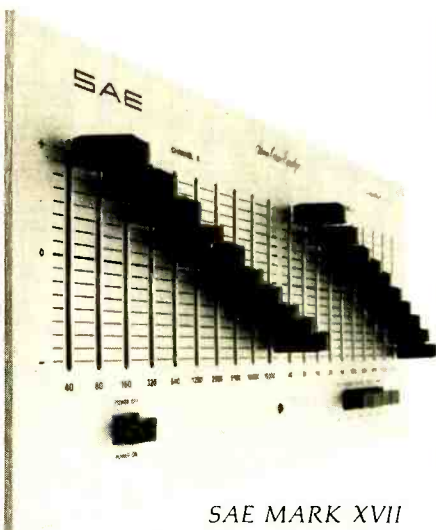

SAE MARK XVII
Dual-Channel Equalizer

Your tone controls are just not designed to compensate for

- Room acoustics
- Speaker placement
- Old or bad recordings

We built the Mark XVII Equalizer to solve these problems and more. These are some of the ways:

- Individual Octave Control for each channel
- Long throw, oil-damped linear slide pots for greater accuracy
- Dual range operation (controls operate over either $\pm 8\text{dB}$ or $\pm 16\text{dB}$)

Plus

- Capable of driving any system
- Low distortion—less than 0.03% THD and IM
- Low noise—greater than 90dB
- 5-year parts and labor service contract
- SAE's reputation as the finest manufacturer in the audio field

You'd have to look a long time to find an EQ that delivers this much value. SAE innovation has done it.

Components for the connoisseur.



Scientific Audio Electronics, Inc. PE-2-76
P.O. Box 60271, Terminal Annex
Los Angeles, California 90060
Please send me the reasons (including available literature) why the SAE MARK XVII Dual-Channel Equalizer is the "\$300 Alternative."

NAME _____
ADDRESS _____
CITY _____ STATE _____ ZIP _____

CIRCLE NO. 44 ON FREE INFORMATION CARD

nine shapes, and a special tip adapter allows the use of all 19 Ungar $\frac{1}{8}$ " thread-in triplets and nibs. Tip cleaning is achieved on a sponge and tray, detachable from the power supply.

CIRCLE NO. 91 ON FREE INFORMATION CARD

SHARP CB AM MOBILE TRANSCEIVER

The Sharp CB-550 is a solid-state, 23-channel, mobile AM transceiver. It has squelch control, automatic noise limiting,



delta tuning, and dual conversion receiver design. \$119.50. A \$29.95 base station adapter (AD 111) permits the unit to be used on ac.

CIRCLE NO. 92 ON FREE INFORMATION CARD

FONE-A-LERT SIGNALING DEVICE

The Fone-A-Lert, from Floyd Bell Assoc., produces a loud signal synchronized to the ringing of a phone or doorbell. A transducer is attached by means of a suction cup (no wiring connection) to the frame of telephone or doorbell. The transducer is connected by 40 feet of wire to the signaling unit, which can be located outside or where ambient noise would otherwise obscure the original sound. The system is powered by a 9-volt battery. \$14.95. Address: Floyd Bell Assoc., Inc., 555 Marion Rd., Columbus, OH 43207.

COVE-CRAFT CRYSTAL TESTER

The condition of oscillator crystals rated from 1 MHz to the uhf range can be checked with the tester made by Cove-Craft, Inc. Crystal is plugged into a socket

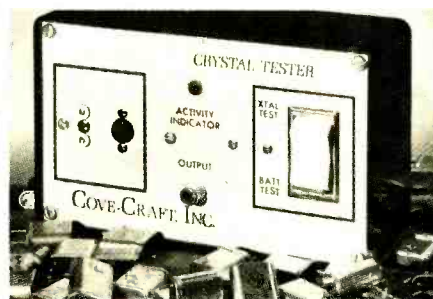

on the front of the tester and an LED indicates whether it is oscillating or not. An output socket is also available for connecting to a scope or meter for frequency check. No tuning is necessary. Operates from a 9-V battery and has a battery check position. Measures $6\frac{1}{4}$ " \times $3\frac{3}{4}$ " \times $2\frac{1}{4}$ " (16 \times 10 \times 6 cm). \$56.

CIRCLE NO. 93 ON FREE INFORMATION CARD

DIGITAL FIELD-STRENGTH METER

With a frequency range of 2 to 1100 MHz, Infinite's FS-20 field strength meter can be used to check the output power performance of communication transmitters. Radiated power is monitored and there are no connections necessary to the transmitter. Readout is a 6-digit LED. Operates on battery or external power. Measures $5\frac{1}{2}$ "L \times 3"W \times $1\frac{1}{4}$ "H (14 \times 7.6 \times 3.3 cm) and weighs 6 oz (170 g). \$75.00. Address: Infinite Inc., Box 906, 151 Center St., Cape Canaveral, FL 32920.

RCA VHF/UHF SCANNER

RCA's new Model 16S400 scanning monitor has 10-channel capability, and covers 30-50, 150-174, 450-470, and 470-512 MHz. Additional features are two-speed scanning, varactor tuning, a scan delay control adjustable from 0 to 4 seconds, separate lockout switches for each channel, and a channel selector switch for manual scanning. Two power cords are provided for 12-V dc and 117-V ac operation. Also included are an external speaker jack, a mounting bracket, and separate telescoping antennas for vhf and uhf. Measures $8\frac{1}{2}$ " D \times $7\frac{3}{8}$ " W \times $2\frac{5}{8}$ " H (22 \times 20 \times 7 cm) and weighs 4 lb, 5 oz (1.96 kg). \$184.95

CIRCLE NO. 94 ON FREE INFORMATION CARD

BASIX 4-CHANNEL SCOPE ACCESSORY

The Mode 4 accessory, from Basix, permits display of up to four simultaneous analog and/or digital signals on any single- or dual-channel oscilloscope. Modification of the scope is not required. The user selects parallel or serial multiplex modes. Individual gain of each channel is X0.01 to

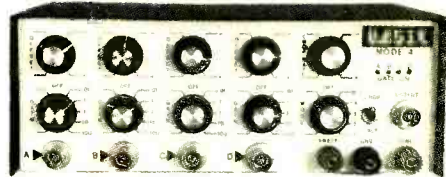

X100 in decade steps. Digital signals are processed as analog waveforms. The instrument is said to be compatible with all logic families, including TTL and CMOS. \$189.

CIRCLE NO. 95 ON FREE INFORMATION CARD

AMTRONCRAFT EQUIPMENT CABINETS

A new series of six aluminum equipment cabinets in kit form has been announced by Amtroncraft Kits, Ltd. They range in sizes from $9\frac{1}{4}$ "W \times $5\frac{7}{8}$ "D \times $5\frac{1}{8}$ "H (23.5 \times 15 \times 13 cm) to $11\frac{1}{8}$ "W \times $7\frac{7}{8}$ "D \times $5\frac{1}{8}$ "H (29.5 \times 20 \times 13 cm) and $9\frac{1}{4}$ "W \times $5\frac{7}{8}$ "D \times $3\frac{3}{4}$ "H (23.5 \times 15 \times 9.5 cm) to $11\frac{1}{8}$ "W \times $7\frac{7}{8}$ "D \times $3\frac{3}{4}$ "H (29.5 \times 20 \times 9.5 cm). Prices are from \$12.50 to \$17.50. The front panels are of brushed aluminum with shock-proof plastic escutcheons. Removable tilt stands and plastic feet are included.

CIRCLE NO. 96 ON FREE INFORMATION CARD

PASS TO VICTORY

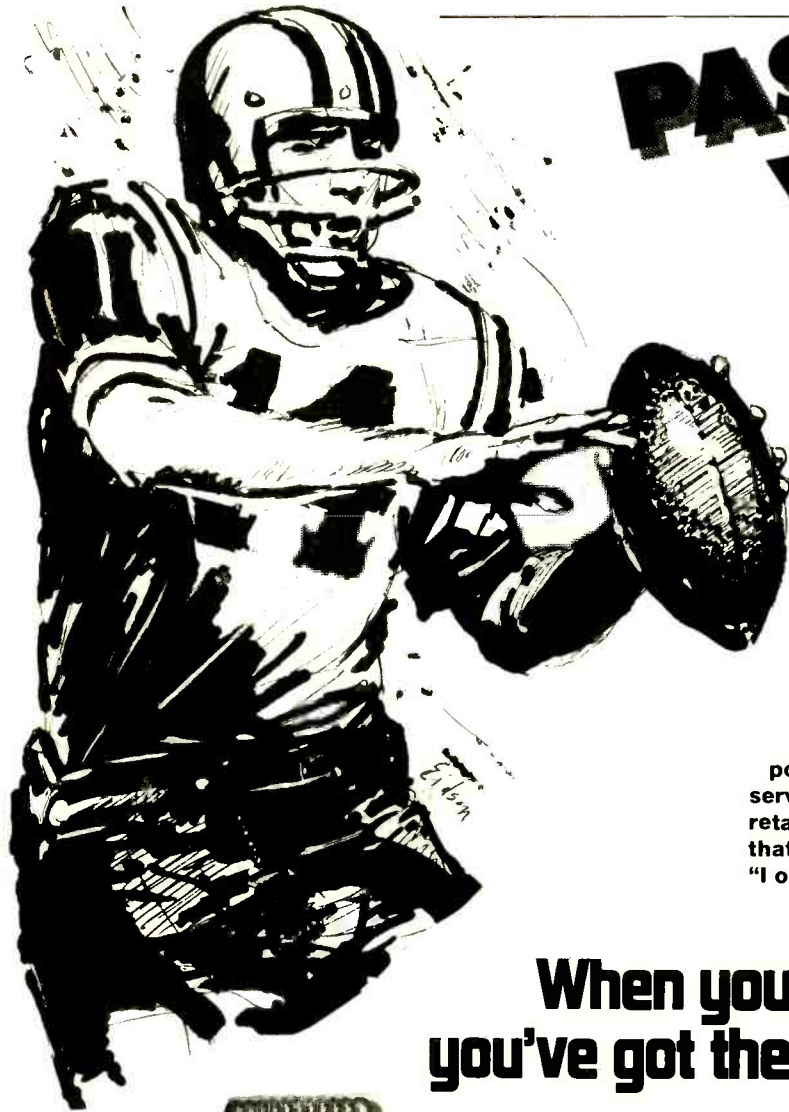

The quarterback is picking just the right spot to call a screen pass. He passes. The running back carries the ball to a touchdown. Victory!

Pick yourself the right CB radio. No problems to tackle when you own a PACE CB radio. They're designed to carry your conversations with clarity and high performance. The quarterback gets total support from his team on the field. In the same manner will you get total Pace support in the field. From our experienced service centers coast to coast. From our retailers and distributors. Grant yourself that victorious feeling and pass along, "I own a PACE CB."

When you've got a Pace, you've got the world by the ears.

CB 145

**((p))
PACE**



See Your Dealer Now. Get this super deluxe model to transmit and receive messages while driving the wintery highways. Pickup the weather information you need. *Let others know.*
Suggested list price \$209.95.

((p)) PATHCOM INC. PACE TWO-WAY RADIO PRODUCTS

02102

24049 S. Frampton Ave., Harbor City, CA. 90710

Available in Canada from Superior Electronics Inc.
Export (all other parts of the world): 2200 Shames Dr., Westbury, N.Y. 11590



New Literature

MODULAR POWER SUPPLY CATALOG

Calex offers a new 12-page Power Supply Catalog describing its line of modular, en-

capsulated power supplies. Described are single, dual and triple supplies with voltages of 5 V to ± 15 V dc, with current ratings up to 1 A. The supplies are designed for operational-amplifier, function-module, and data-conversion applications. Address: Calex Mfg. Co., 3305 Vincent Road, Pleasant Hill, CA 94523.

CTS CRYSTAL SELECTION GUIDE

A 72-page guide to crystal selection lists all standard CB, synthesized CB, monitor and 2-meter amateur crystals available from CTS Knights, Inc. Includes general information about each crystal type, as well as

CB cross-reference charts, monitor and 2-meter equipment vs CTS part number listings, and frequency charts for standard and synthesized CB crystals. Available for \$1.00. Address: Distributor Sales Manager, CTS Knights, Inc. Sandwich, IL 60548.

VIDEO CASSETTE NEWS LETTER

SCAN is a four-page newsletter published quarterly by Memorex for video tape users. The spring issue discusses proper handling of the video cassette, storage procedures, and the importance of cleaning both tape and machine. It also covers the adjustments a VTR user must make to match tape and machine for optimum performance. Address: SCAN, Memorex Corp., Box 420, Santa Clara, CA 95052

VECTOR ELECTRONICS CATALOG

Vector Electronic's 16-page catalog lists its 398 most preferred packaging products. Organized alphabetically, it gives features and specifications for circuit boards, cages, card cases, sockets, terninals, Vectorboards and tools. Also listed are a variety of breadboarding kits, patchboards, turrets, positive photosensitized boards and developer. Address: Vector Electronic Co., Inc. 12460 Gladstone Avenue, Sylmar, CA 91342.

FOUR-CHANNEL AND CALCULATOR BROCHURES

Two new brochures on four-channel sound and electronic calculators have been added to the Electronic Industries Association/Consumer Electronics Group consumer information program series. The complete line of brochures includes "Tips on Television Sets," "Tips on Audio Products," "Tips on Tape Recorders & players," "Tips on Electronic Calculators," "Tips on Four-Channel Sound," and "Television Safety Tips." Copies available on request. Specify desired title(s). Address: EIA/CEG, Box 19369, Washington, DC 20006.

ALARM EQUIPMENT CATALOG

Mountain West Alarm Supply Co.'s new catalog A-76 highlights available equipment and includes an alarm equipment application guide. Covered are a general alarm system discussion, installation procedures, and connection diagrams. Over 500 products are listed, ranging from relatively simple kits to the latest ultrasonic, radar, and infrared intrusion detectors. Product categories include fire and burglar systems, detectors, control instruments, remote controls, signalling devices, telephone dialers, lock specialties, tools and books. Applications, principles of operation, specifications, and connection diagrams are given. Address: Mountain West Alarm Supply Co., 4215 N. 16th St., Phoenix, AZ 85106.



You can build a better organ than you can buy!

A magnificent Schober Electronic Organ

What a marvelous way to put *your* special talents to work! With our Schober Electronic Organ Kits and your skill, you can build yourself some very special satisfaction, and a lifetime of great music!

Schober Organs are literally far superior to comparably-priced "ready-made" units. You could actually pay twice as much and get no better organ...and miss the fun of assembling it yourself. A PC board at a time, component by component, you'll assemble your own "king of instruments." And when you're done, you'll wish there was more to do. And there is! For then, Schober will help you learn to play, even

if you've never played a note before!

Schober Organ Kits range from \$650 to \$2850, and you can purchase in sections to spread costs out...or have two-year time payments. Combine the incomparable quality of Schober components with your talent...and produce a far better organ than you can buy! Thousands of others have, ever since 1955.

You can have all the details, without cost or obligation. Just send the coupon for the fascinating Schober color catalog (or enclose \$1 for a record that lets you hear as well as see Schober quality.) Why not clip it right now, before you forget?

<p>THE <i>Schober</i> ORGAN CORP. DEPT. PE-64 43 West 61st Street New York, N.Y. 10023</p>	<input type="checkbox"/> Please send me Schober Organ Catalog.	<input type="checkbox"/> Enclosed please find \$1.00 for 12-inch L.P. record of Schober Organ music.	
	NAME _____		
	ADDRESS _____		
	CITY _____	STATE _____	ZIP _____

CIRCLE NO. 47 ON FREE INFORMATION CARD

Sleeper!

The Realistic® STA-90 Will Change Your Ideas About Who's #1 in Hi-Fi Features, Value and Style!

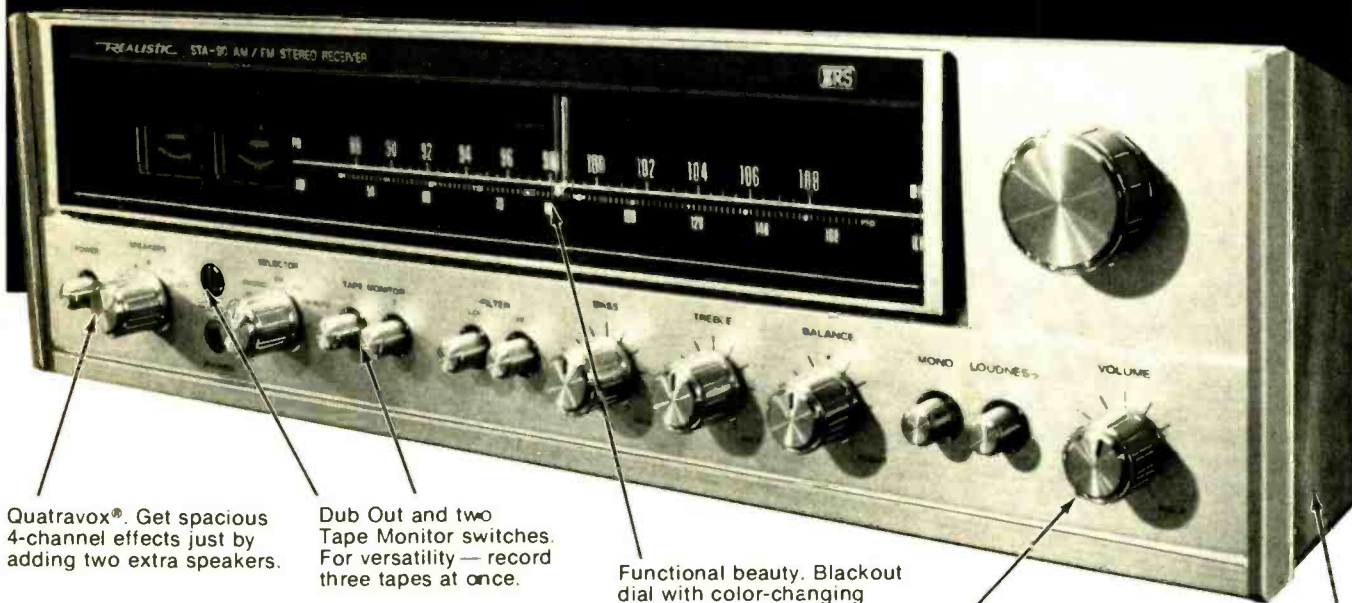

Quatravox®. Get spacious 4-channel effects just by adding two extra speakers.

Dub Out and two Tape Monitor switches. For versatility — record three tapes at once.

Functional beauty. Blackout dial with color-changing pointer/FM stereo indicator.

Solid metal knobs.

Walnut veneer case.

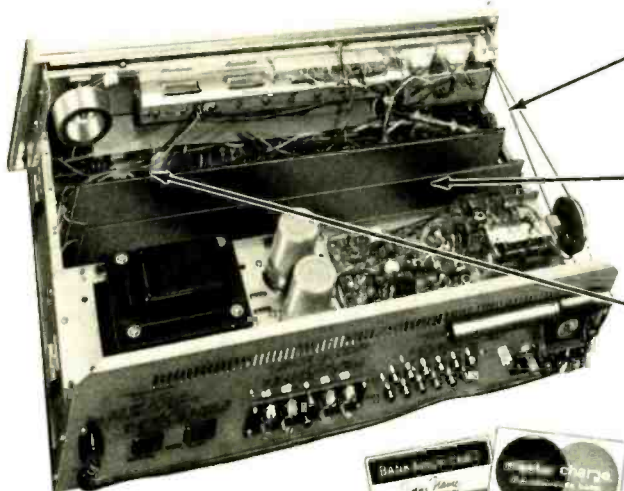

Dual-Gate MOSFET FM. Gets weak stations and still resists overload. Superior to FET designs.

Phase-locked loop FM stereo demodulator. For wider channel separation, almost zero distortion.

Direct-coupled amplifiers for powerful bass even at 20 Hz. 44 watts per channel, minimum RMS at 8 ohms from 20-20,000 Hz, with no more than 0.5% total harmonic distortion.

Amplifier Specs

Power Bandwidth: 17-35,000 Hz
 Response: 20-20,000 Hz ± 2 dB
 IM Distortion: 0.3% at 30W
 Phono Overload: 150 mV
 Hum and Noise (dB):
 Phono 1, -60
 Aux 1, -75

FM Tuner Specs

Sensitivity: 2.0 μ V IHF
 S/N Ratio: 65 dB
 Separation: 35 dB at 1 kHz
 Total Harm. Dist.: 0.8%
 Capture Ratio: 2 dB
 Selectivity: 60 dB

Only 359.95 at participating stores and dealers. Prices may vary at individual stores. U.L. listed. Ask for 31-2063. See what a Sleeper looks like — today!

SOLD ONLY WHERE YOU SEE THIS SIGN:

Radio Shack®

A TANDY CORPORATION COMPANY
 OVER 4000 STORES • 50 STATES • 8 COUNTRIES

FREE 164-Page Catalog Write to Radio Shack, P.O. Box 1052, Dept. 665, Ft. Worth, TX 76101

Demand for electronics technicians will continue to grow year after year, according to responsible projections, not only in broadcast control (shown here), but in hospitals...industry...offices...schools. Electronics is the field for tomorrow.



16 WAYS TO MOVE AHEAD IN

Choose the one that's right for you, now. The one that can make your future more rewarding, more secure, more enjoyable. These steps to your better tomorrow are available from Electronics Technical Institute...the finest in electronics home study courses and programs!

"Building" is a key word at Electronics Technical Institute. Whether your goal is to get into TV Repair and Service, get your FCC license, move into computers, advance in your present job through learning solid-state technology, or become an electronics draftsman, you build a solid future where the action has to come.

You build that future on a foundation of learning that is useful...practical...step-by-step...hands-on.

You build it from the beginning by a special, simplified, building-block teaching system called *Autotext* (exclusive with Electronics Technical Institute) that makes learning fun. You keep building, combining hands-mind-equipment in the most practical way, so you can "talk shop" or present an idea effectively, and you *can also do the job!* You've learned by doing, and you gain all the confidence that comes with it.

You build with the concerned personal help of a licensed instructor who knows the subject and wants to know you. You build with the reputation of the school that began as the Marconi Institute back in 1909.

In many phases of building your technical know-how, you use specially developed Project Kits that move in a logical sequence, hands-on, from the first step through completion of basic units. There is no surer way to build solid electronics knowledge and your own confidence in what you can do.

Choose your future...here, and now!

Fundamental Electronics

Get a solid foundation for entering the fast-moving world of electronics where today is great, and tomorrow will be greater. Learn it the simple, easy, step-by-step, programmed way called *Autotext*, exclusive with ETI!

Electronics Drafting

Learn a vitally needed specialty that translates new tech-

ELECTRONICS

nological concepts and developments to the practical drawing board. Become a specialist-in-demand, through ETI's training. Learn it at home...get your future moving now!

Color TV Servicing

There's a real future waiting for the established color television technician. You become that technician through this program that takes you step-by-step to *theoretical and practical* mastery of color TV. Get your tomorrow started today!

Master TV/Radio Servicing

Here is true "master" preparation for a career that can take you as far as you want to go into radio and television servicing, both black and white, and color. The helpful, practical ETI way can be your way to more money, security, success!

Communications

ETI's communications program opens up a whole range of career development possibilities in electronics. Solid-state receivers, solid-state audio equipment, communications equipment, CATV, as well as preparation for FCC-licensed positions in commercial broadcasting and mobile communications. You can find a real future here!



Industrial Electronics

You open great career opportunities through this program, as instrumentation technician, electronic equipment maintenance technician, electronic calculating machine technician and audio technician. It also prepares you to move into and up in communications, automation and industrial electronics!



Digital Technology

Join the digital revolution which is radically altering our lives today and tomorrow. Get solidly trained in the new digital specialties that can lead to a real future as a digital control technician, electronic calculating machine technician, field representative, manufacturer's representative.

Electronics Technology

Learn electronics across the board! You'll be ready for real career advancement with training that can lead to technical positions in communication, automation and industrial electronics, and can also help you in sales positions, management and administration.

Computers

ETI offers training opportunities in Computer Technology and Computer Programming. Learn at home, and get ready to enter a field where incredible developments are sure to continue. It's practical, useful—the step-by-step ETI way!

Advanced Electronics

Want greater challenges and career advancement? This course is for you. It can be valuable preparation not only for a technical career, but also for the fields of sales, management and administration. Make your move now!

Digital Electronics—Advanced

Here's a special course for those already in the field of digital electronics, ready to move into more advanced areas. This is how to move up in sales, management and administration. Here's your tomorrow!

Black and White TV Servicing—Advanced

This can be your own "advance" source to black-and-white TV competence from A to Z. You'll construct a receiver yourself, if you wish. A key to life-time success!

Industrial Instrumentation—Advanced

Move up in the world...the wonderful electronics world! This course opens up a whole range of careers in the industrial field, as instrumentation technician, laboratory technician, process control technician or electronic calculating machine technician. Get ready...and go!

Color TV Servicing—Advanced

Here is the "graduate" course in color TV for those who already know television fundamentals. You'll learn color TV from top to bottom, build your own set if you choose. A great way to build your future!



Solid-State Electronics—Advanced

Applications of transistors are increasing all the time and the

transistor may be a breakthrough comparable in importance to the development of nuclear energy. Solid-state can mean your solid career development, too, through ETI!

FCC License Preparation

Here is real down-to-earth practical preparation to take your 3rd, 2nd, or 1st class Federal Communication Commission Radio-telephone License examinations. Get yourself ready now for any of the FCC-licensed positions involving broadcasting, mobile communications, microwave communications links, marine communications equipment or in many other positions in solid-state, communications, CATV. Get ready for tomorrow...today!

And it's simple to check it all out right now, with no obligation—and no salesman will call. All it takes to get the colorful new 48-page ETI Career Book is a card or coupon. If you like electronics, you'll enjoy reading about it. You owe it to yourself to get the facts.

The Career Book itself may be worth real money to you, as you make plans for your future and consider the many opportunities open to you through 16 different courses and



programs in electronics.

To build a future in electronics, the first step is to send for your free ETI Career Book today!

Electronics Technical Institute

Division of Technical Home Study Schools

Electronics Technical Institute, Dept. 2-473-026
Little Falls, New Jersey 07424

Send me the Electronics Technical Institute Career Book.

Tell me how I can get ahead in Electronics through ETI. I've checked the fields of special interest to me

<input type="checkbox"/> TV/Audio Servicing	<input type="checkbox"/> Communications	<input type="checkbox"/> Computers	<input type="checkbox"/> Business and Engineering
Black and White	FCC License	Digital Electronics	Electronics Fundamentals
Color	Aircraft	Computer Technology	Electronics Drafting
Solid-State	Marine	Computer Programming	Industrial Electronics
CATV	Mobile Two-Way		Advanced Electronics
Closed Circuit	Microwave		Industrial Instrumentation
Video Recorders			Electronics Technology
Radio			Medical Electronics
Hi-Fi Stereo			

Check here for Veterans information.

Name _____ (please print)
Address _____
City _____ State _____ Zip _____



Stereo Scene

By Ralph Hodges

LOOKING TO THE FUTURE

THE 52nd convention of the Audio Engineering Society got off to a flying start with a number of exceptionally interesting papers on disc recording. CBS Technology Center's Dan Gravereaux assured us (with the significant assistance of Jim White) that the mechanical aspects of certain widely used disc-cutting lathes are at least adequate for their intended task. Steve Temmer of Gotham Audio suggested that the electroplating process (by which the products of the lathe are turned into molds for phonograph records) may not be. And Mr. S. K. Khanna of RCA Records demonstrated, as exhaustively as he could in the time allotted, that the vinylite material from which phonograph records are molded is a difficult

medium that is little understood, particularly in terms of its flow properties, its elasticity, and the effect of temperature on both these characteristics.

I consider these papers important because they point out where we should and shouldn't be looking for problems encountered in records we routinely buy from stores. But the paper that really brought the house down was given by Tomlinson Holman (Advent Corporation) on the subject of phono preamplifiers.

Phono Preamplifiers. As you're no doubt aware, a phono preamplifier is a gain and equalization stage present in every receiver or amplifier intended to be used with a magnetic phono cartridge. It receives the output of such a

cartridge directly (through an interconnecting cable of course) and attempts to turn it into a signal comparable to what would be received from a typical high-level program source, such as a tuner or a tape deck with electronics. Usually it's a simple device, involving as few as two bipolar transistors per channel and a small handful of capacitors and resistors. Ordinarily, nobody thinks too much about it, as witnessed by the way most specification sheets give an S/N figure for the phono preamplifier but nothing else. When you see distortion values for any electronic audio component you can depend upon the fact (unless specifically stated otherwise) that the phono preamplifier stage has been bypassed and is not included in the total. In short, the preamp is an unknown quantity.

Lest this begin to sound like the scandal of the year, let me say that most phono preamplifier sections are reasonably good by most measurement standards. You won't find too many of them that test out at 0.01% total harmonic distortion, but the days in which you could see 5% THD at certain frequencies (with input levels that should be acceptable) are pretty much past. Still, in the opinion of many people, some phono preamplifiers definitely sound different from others, and the reasons for their doing so are evidently not crystal clear.

As one who shares this opinion, I found Mr. Holman's data quite arresting, especially since his subjective impressions of these audible differences seem to correspond so well with my own. He speaks of them as sounding like frequency-response errors,

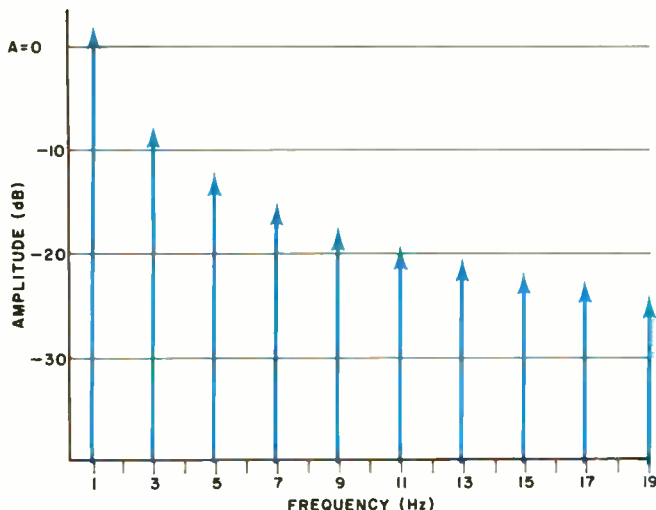
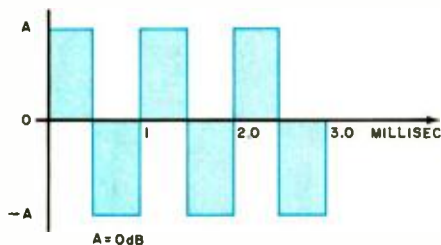

Fig. 1. In spectrum analysis of 1-kHz square wave (top), no even overtones are present.

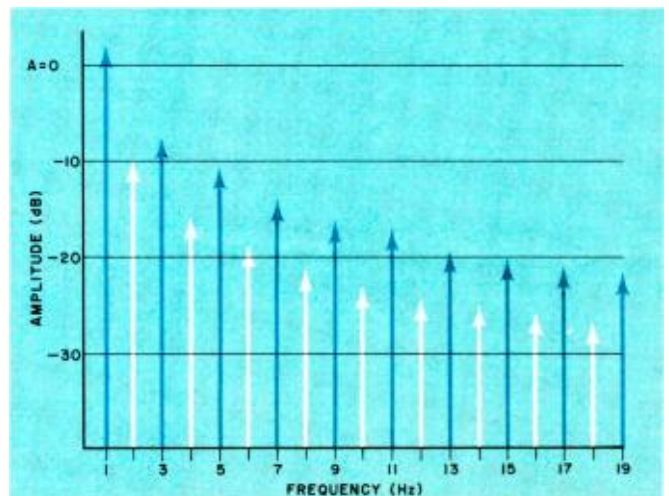

Fig. 2. In a poor preamplifier, second-harmonic distortion is only 13 dB below fundamental (borne out by listening tests).

The Black Watch kit

At \$29.95, it's

★**practical**—easily built by anyone in an evening's straightforward assembly.

★**complete**—right down to strap and batteries.

★**guaranteed.** A correctly-assembled watch is guaranteed for a year. It works as soon as you put the batteries in. On a built watch we guarantee an accuracy within a second a day—but building it yourself you may be able to adjust the trimmer to achieve an accuracy within a second a week.



The Black Watch by Sinclair is unique. Controlled by a quartz crystal . . . powered by two hearing aid batteries . . . it's also styled in the cool prestige Sinclair fashion: no knobs, no buttons, no flash . . . just touch the front of the case to show hours and minutes and minutes and seconds in bright red LEDs.

The Black Watch kit is unique, too. It's rational—Sinclair have reduced the separate components to just four.

It's simple—anybody who can use a soldering iron can assemble a Black Watch without difficulty. From opening the kit to wearing the watch is a couple of hours' work.

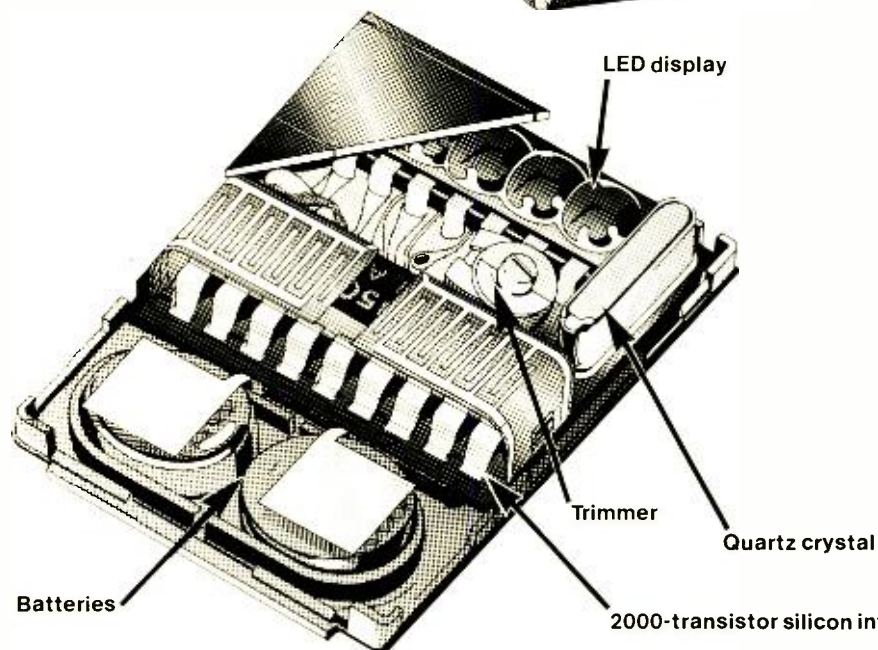

Complete kit \$29.95!

The kit contains

1. printed circuit board
2. unique Sinclair-designed IC
3. encapsulated quartz crystal
4. trimmer
5. capacitor
6. LED display
7. 2-part case with window in position
8. batteries
9. battery-clip
10. black strap (black stainless-steel bracelet optional extra—see order form)
11. full instructions for building and use.

All you provide is a fine soldering iron and a pair of cutters.

Take advantage of this no-risks, money-back offer today!

The Sinclair Black Watch is fully guaranteed. Return your kit within 10 days and we'll refund your money without question.

sinclair

SINCLAIR RADIONICS

375 Park Avenue
New York, N.Y. 10022
Tel. 212-688-6623

Please send me _____ Sinclair Black Watch kit(s) at \$29.95 (Plus \$2.50 per unit, shipping and handling). Stainless steel band \$4.00.

Enclosed is my check for _____

Name _____

Address _____

City _____

State _____ Zip Code _____

Mail to: Sinclair Radionics Inc., 375 Park Ave., New York, N.Y. 10022
N.Y. Residents add sales tax.

“...most often having the quality of ‘brighter’ vs ‘duller.’” If they were frequency-response errors they would presumably be amenable to simple tone-control correction. But I don’t find them always to be so; and apparently Mr. Holman agrees.

In fact, he notes that it is sometimes possible to run a frequency-response test on one of the bright-sounding preamplifiers (taking care to include all the relevant characteristics of the phono cartridge in the measurement) and find that it actually has a subdued high end compared with another preamplifier that doesn’t sound as bright—a phenomenon that I have also encountered.

The first part of Holman’s paper essentially dealt with matters that are pretty much accepted: the complex interface of preamplifier and cartridge (which is mentioned in more and more equipment test reports of late); the cartridge as a noise source (again an interface-related factor); and the potentially harmful effects of permitting subsonic frequencies (from record warps and vibration sources) to lie within the passband of the preamplifier. In the second part of the paper, Holman discussed a test devised to rank phono preamplifiers in terms of listener preference.

The test assumes that all the above interface factors have been properly attended to. Then, through a cartridge-simulating network, an RIAA pre-equalized 1,000-Hz square wave is introduced into the amplifier and the output studied with a spectrum analyzer (Fig. 1). What Holman observed after doing this with a variety of preamplifiers was (aside from the expected sequence of odd-order harmonics) significant even-order harmonics that were not present in the input signal. In the worst case, second harmonic distortion, down 67 dB in the input, was down only 13 dB in the output of the preamplifier (Fig. 2). Holman also reports that the preferences of listeners auditioning the preamplifiers under controlled conditions correlated almost perfectly with the absence of these spurious harmonics.

The interpretation of this test in terms of circuit design was questioned by a number of people in the convention audience. (In fact, Holman’s paper notes several possible causes for the problem without citing any one as being prevalent in the products he evaluated.) Some were

openly critical of the test as being no more than a trivial demonstration of the various preamplifiers’ overload characteristics, carried out with a test signal that is not adequately representative of a real phono cartridge’s output. I can understand such sincere reservations, but I am becoming a little frustrated with the audio industry’s reluctance to look harder at new and sometimes unconventional test procedures, particularly when they apparently correlate meaningfully with listener reactions. In many areas, evidence is mounting that static sine-wave tests are not unconditionally representative of the performances of a device that will have to handle music signals. We do not have any really agreed-upon standards for dynamic test signals and probably won’t for some time. But I don’t think this is an excuse to ignore the whole matter.

It is becoming rather fashionable to say, without further investigation, that any dissimilarities one hears between preamp A and preamp B have to be the result of minute frequency-response and level differences. This is a convenient attitude to take because we know that such differences can have profound subjective effects, and because if we look hard enough we can always find *some* slight response difference between two preamplifiers to bear all the blame. Undoubtedly this is the correct explanation in many instances, but people like Holman don’t believe it holds true always; and I feel they deserve a better hearing.

Listening to Light. Wireless microphones and headsets are certainly not new, but so far they have failed to perform up to the standards of the serious audio buff. That situation may have changed materially if spokesmen for Beyer (Revox Corp. in the U.S.) and Sennheiser are correct. The development responsible for this is an LED that, radiating exclusively in the infrared region, makes beam-of-light transmission of audio signals practical and relatively inexpensive. Both the aforementioned companies offer very compact transmitters and even smaller receivers in pocket-size modules or built into light-weight headsets. The Beyer setup costs just under \$100 for the transmitter and about \$75 for a battery-powered receiving module. The Sennheiser system will ultimately be made available in stereo at a somewhat higher price. Apparently such devices have become popular as

built-in accessories for TV sets in Europe, although their first U.S. appearance in commercial form was at the AES convention.

The especially interesting thing about the technique is that it is reportedly interference-free as long as reasonable distance and line-of-sight conditions are maintained, along with suitable lighting in the environment (illumination that is heavy—particularly near the infrared spectrum—can evidently saturate the receiving sensors). Multipath effects could not be induced during my brief trial of the device, and small infrared sources such as lighted cigarettes and pipes did not seem to affect it.

In a typical configuration (Sennheiser), the baseband audio frequency modulates a subcarrier which amplitude-modulates a 95-kHz sub-carrier that in turn amplitude-modulates the infrared source. Adding additional sub-carriers permits multi-channel transmissions. Naturally, since the FCC is mute on the subject of infrared transmissions, there are as yet no restrictions on bandwidth and dynamic range, nor are there likely to be any. Given this and the freedom from interference, it might just be possible—with the right electronics—to get a true high-fidelity signal from here to there on a light beam as readily as we do today with an audio cable.

Teac and DBX. Late word has it that the Teac/Tascam group has become the first equipment licensee for the DBX compander-type noise-reduction system. The first consumer tape machine to contain the system should be available before you read this. The marriage was apparently made possible by the emergence of the DBX circuitry in IC form.

This looks to be a promising development, since several people have indicated to me that the excellent results they’ve gotten with the DBX system has rejuvenated their interest in live recording. Of course, the Dolby B system so widely used in cassette recording was received with similar accolades some years ago, and it is also a compander technique. However, the Dolby designers wished to maintain some degree of compatibility with tape machines not equipped to decode Dolbyized tapes, and thus restricted the action of the compression-expansion cycle to frequencies above 2000 Hz. By contrast, the DBX

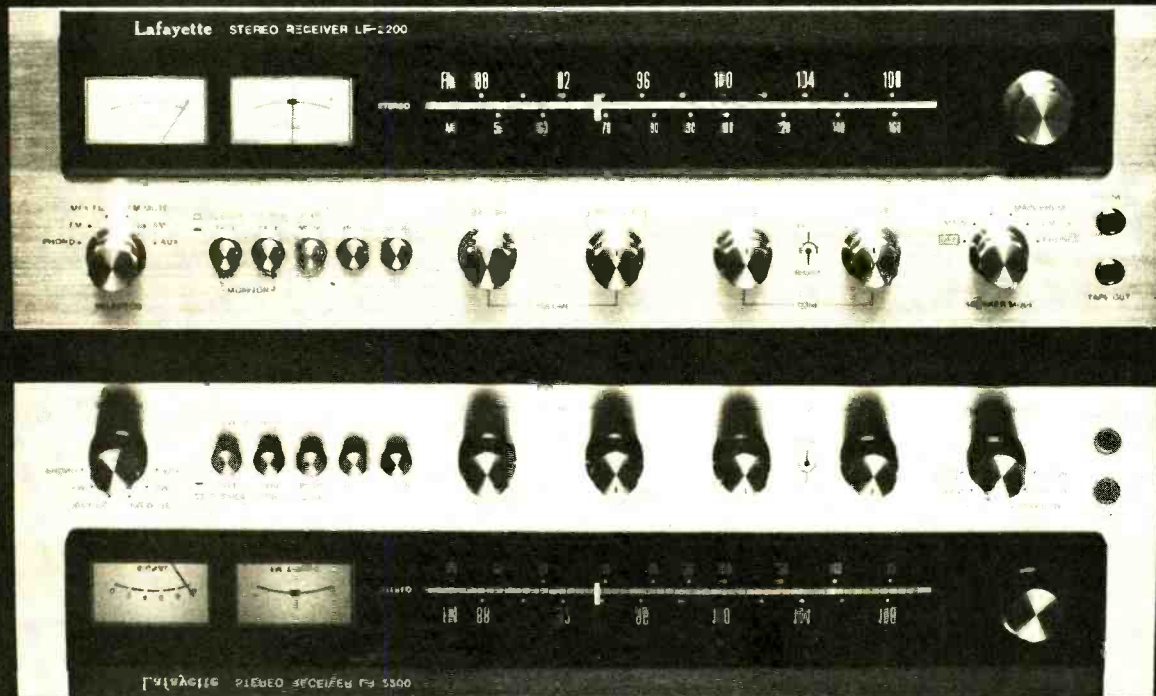

The Image of Performance

The new Lafayette LR-2200 has the look of performance many receivers try to achieve. But real performance comes from within. That's where the LR-2200 stands out.

This serious receiver performs to the highest standards with advanced circuitry, a most selective AM/FM stereo FM receiver, full music controls including two tuning meters, dual tape monitoring jacks and derived four channel matrix. The sensitive performance of the LR-2200 comes across powerfully through 27 watts per channel, minimum RMS. Both stereo channels are driven at 8 ohms from 20-20,000 Hz, with no more than 0.5% total harmonic distortion.

The Lafayette audio designers performed in the creation of the LR-2200. Lafayette put the most features, the cleanest specifications, the most power for any receiver Lafayette has ever offered for this price. \$29.95.

Because Lafayette performed in the creation of this receiver it will perform for you. For years.

See it, hear it at a Lafayette store. It gives quite a performance.

Like to see more of the performers? Visit any of the Lafayette stores coast to coast. Or write for our free catalog.

Electronically Speaking,
Who Knows Better Than

Lafayette
Radio Electronics & Shopping Centers

The problem solver



DC300A

The Crown DC-300A power amplifier is at least worth its weight in aspirin as a problem-solver for commercial sound installers.

Crown rates the DC-300A at 155 watts per channel RMS into 8 ohms (1Hz to 20KHz). Or 310 watts per channel into 4 ohms.* Or 500 watts per channel into 2.5 ohms.* Or 600 watts in the mono mode into 8 ohms. You can drive a 70 volt line directly.

Which solves the power problem.

The DC-300A front end long ago set standards of low distortion and noise that have not yet been surpassed.

Which solves the clarity problem.

The Crown DC-300A will drive any speaker load — even totally reactive ones — with no spikes, thumps or fly-backs. Each channel has separate controls and circuitry. It acts like two separate mono amps.

Which goes a long way towards solving the design problem.

The output protection circuitry prevents damage from shorts, mismatched loads and overheating. Its proven reliability record is a little short of awesome.

Which solves a service problem.

Price? Again, no problem. We still think the DC-300A always has been audio's best performance value.

Do you have some special problems on current bids? Call us at 219/294-5571. Our real-life problem solvers might be able to help.

*(Single channel operating; sine wave test signal into resistive load; extended operation or limited ventilation may require forced air cooling to maintain levels described.)

When listening
becomes an art,
crown

Box 1000, Elkhart, IN 46514

CIRCLE NO 12 ON FREE INFORMATION CARD

system acts on all frequencies to such a radical extent that DBX-encoded material is unlistenable unless properly decoded during playback.

Intrigued by the reports of DBX's effectiveness, I duly presented myself at the DBX demonstration room at AES and was again taken aback by the huge, undistorted sounds that can emerge from an uncannily quiet background when this processor is used. The DBX staff had brought along a tape or two made by enthusiastic amateurs in their basements and other unlikely settings, and the technical excellence of these efforts surpassed anything in my experience and all my expectations.

Department of Misunderstandings.

In the August 1975 "Letters" column, a well-informed communication from Mr. M. Howard Lieberman argued, among other things, for the importance of maintaining interchannel phase integrity when adjusting the azimuth of tape heads. My reply, which appeared with the letter, declared that in this context I didn't think phase was very important at all. After this incautious remark I really got the works from a number of readers, who took me to task for everything from advocacy of random phase reversal to ignorance of the principles of stereo. I am not guilty, I hope, but I perceive there is a misunderstanding afoot. An amplification of my statements (which were edited to save space) may clear things up.

To paraphrase Mr. Lieberman's comment: a tape head that has been aligned for the best maximum-output compromise between the two channels with a 10,000-Hz test signal may still introduce a phase shift of 180 degrees or more between the channels at that frequency. As far as I know, this is exactly right, but it is not as serious as it sounds. A 180-degree phase shift (indicating a completely out-of-phase condition between channels) means, in effect, that one tape-head gap leads or lags the other on the tape by one half wavelength, which (at 10,000 Hz and 7½ ips) is a displacement of 0.000375 inch. But at 1000 Hz the same displacement results in a phase shift of only 18 degrees, and at lower frequencies, where wavelengths get longer, the phase shift becomes smaller and smaller. This is not, in other words, a situation in which the tape machine's channels can be described as being out of phase.

Another way of looking at it is to consider the gap displacement as a time displacement between channels; one channel's speaker emits its output one twenty-thousandth of a second later than the other, so that 10,000-Hz signals from the speakers arrive at a point equidistant between them out of phase. Now 10,000 Hz has a wavelength of roughly an inch in air. If we move the listening position an appropriate distance closer to the lagging speaker and away from the leading speaker, their outputs will fall into phase and all will be well. In this case, depending on the geometry of the listening layout, the required position shift would be on the order of one quarter of an inch. But be sure not to let your head nod so much as one quarter inch to either side as you sit there, or you'll be out of phase at 10,000 Hz again.

I don't want to pooh-pooh the significance of such phase shifts. Obviously, when you're just listening to a stereo tape through speakers, they are trivial, and even uncontrollable. But if you had it in mind to *mix* identical tape tracks on a machine with this kind of phase shift you'd run into deep frequency-response troubles. And in the professional sphere—particularly today, when it's necessary to maintain precise phase relationships in the mixing of matrix four-channel tape masters—phase considerations are vital (and studio tape speeds of 15 ips make them easier to deal with.)

Actually, it would be ideal if consumer tape machines were designed so that an azimuth adjustment that brought the channels exactly into phase also resulted in optimum frequency response for all channels. Unfortunately, it doesn't turn out that way as a rule. With current manufacturing techniques, it is supremely difficult to keep the several gaps in a tape head perfectly lined up. Also, as I understand it, there can be some ambiguity as to where the magnetic gaps (as opposed to the physical gaps) really are. And then there are also tape-motion problems.

A spokesman for Tandberg, a company known for its scrupulous attention to head alignment, states that, up to now, they have not been able to take much account of phase in adjusting their machines. However, he notes that a new head going into production should be close enough in manufacturing tolerances to permit phase and response to match up. ♦

For a limited time only, you can own an Altair® 8800 Computer kit with 4,096 words of memory, new Altair multi-port interface, and revolutionary Altair BASIC language software, for just \$695. A savings of up to \$114!*



Computer. The Altair 8800 is the best-selling general-purpose computer in the world today. It is a parallel 8-bit word/16-bit address computer with an instruction cycle time of 2 microseconds. It was designed for almost unlimited peripheral and memory expansion, using a bus system where all input/output connections merge into a common line. The Altair 8800 is capable of addressing up to 65,536 words (bytes) of memory. *Regularly priced at \$439 for a kit and \$621 assembled.*

Memory. The Altair 4K Memory Board provides 4,096 words of dynamic random-access-memory for the Altair 8800. Contains memory protect circuitry, and address selection circuitry for any one of 16 starting address locations in increments of 4K. Access time is 200-300 nanoseconds. The entire 4,096 words of memory on the board can be protected by switching to PROTECT. *Regularly priced at \$195 for kit and \$275 assembled.*

Interface. Your choice—either the new Altair 88-2SIO serial interface or the new Altair 88-4PIO parallel interface. The serial interface can be ordered with either one or two ports and the parallel interface can be ordered with up to four ports. *Add \$24 for an additional 88-2SIO port kit. Add \$30 for each additional 88-4PIO port kit.*

Each port of the new serial interface board is user-selectable for RS232C, 110, or 20 milliamp current loop (teletype). The 88-2SIO with two ports can interface two serial I/O devices, each running at a different baud rate and each using a different electrical interconnect. For example, the 88-2SIO could be interfaced to an RS232C CRT terminal running at 9600 baud and a teletype running at 110 baud. An on-board, crystal-controlled clock allows each port to be set for one of 12 baud rates. *The 88-2SIO is regularly priced at \$115 kit and \$144 assembled.*

Each port of the new parallel interface board provides 16 data lines and four controllable interrupt lines. Each of the data lines can be used as an input or output so that a single port can interface a terminal requiring 8 lines in and 8 lines out. All data lines are TTL compatible. *The 88-4PIO regularly sells for \$86 kit and \$112 assembled.*

Software. Altair 4K BASIC leaves approximately 725 bytes in a 4K Altair for programming which can be increased by deleting the math functions (SIN, SQR, RND). This powerful BASIC has

16 statements (IF, GOTO, THEN, GOTO, GOSUB, RETURN, FOR, NEXT, READ, INPUT, END, DATA, LET, DIM, REM, RESTORE, PRINT and STOP) in addition to 4 commands (LIST, RUN, CLEAR, NEW) and 6 functions (RND, SQR, SIN, ABS, INT, TAB, and SGN). Other features include: direct execution of any statement except INPUT; an "@" symbol that deletes a whole line and a "←" that deletes the last character; two-character error code and line number printed when error occurs. Control C which is used to interrupt a program; maximum line number of 65,529; and all results calculated to seven decimal digits of precision. *Altair 4K BASIC is regularly priced at \$60 for purchasers of an Altair 8800, 4K of Altair memory, and an Altair I/O board. Please specify paper tape or cassette tape when ordering.*

***Savings depends upon which interface board you choose. An Altair 4K BASIC language system kit with an 88-2SIO interface regularly sells for \$809. With an 88-4PIO interface, this system sells for \$780.**

NOTE: Offer expires on March 30, 1976.

MIT S
"Creative Electronics"

MIT S/6328 Linn N.E., Albuquerque, NM 87108 505/265-7553 or 262-1951

MAIL THIS COUPON TODAY!

- Enclosed is check for \$_____
- BankAmericard # _____ or Master Charge # _____
- Altair BASIC System Special 4PIO interface 2SIO interface
- Cassette tape or paper tape
- Extra SIO port _____ Extra 4PIO ports
- Add \$8 for postage and handling.
- Please send free literature

NAME _____

ADDRESS _____

CITY _____ STATE & ZIP _____

NOTE: Personal checks take 2-3 weeks for clearance. For immediate processing send money order or use charge card. Delivery 30 days. Prices, specifications and delivery subject to change.

NEWS HIGHLIGHTS

Stereo By Satellite

The first intercontinental stereo relay to the UK took place in late Spring when BBC Radio 3 carried the final concert of the BBC Symphony Orchestra's tour of Japan. The live program was transmitted first to a Japanese earth station near the southern tip of the main island of Honshu, then to the Intelsat IV satellite which is in a geostationary orbit about 35,000 km (21,700 miles) above the Indian Ocean. Signals were beamed from the satellite to a British Post Office earth station in Cornwall, and ultimately through the BBC's pulse code modulation (PCM) system to the Radio 3 transmitter network. Reception was reported to be excellent.

1976 Student Computer Fair

The 1976 National Student Computer Conference will sponsor its NCC Student Computer Fair during its June 7-10 meeting in New York City. Elementary, middle, and high school students are eligible to enter projects in the fair. The deadline for submittal of application forms is April 1, 1976. It is hoped that students will concentrate on the social situations they know best. The entry categories are being broadened this year to include computer art and music, short stories, science fiction, and poetry. Elementary students, for example, may submit drawings of a computer. Of course, such projects as computer games, and computer tools for home or school use are also welcome. First Prize is an Altair 8800 Computer Kit, plus a two-year subscription to *Creative Computing* magazine. For entry rules, application forms, etc., write to: 1976 NCC Student Computer Fair, C.U.N.Y., 33 W 42nd Street, New York, NY 10036

SCA Services For The Blind

To provide blind people with "talking book" entertainment, groups in 11 cities are now using SCA (Subsidiary Communications Authority) subchannels of FM broadcast stations. For example, Radio Information Center for the Blind (919 Walnut St., Philadelphia, PA 19107), operates an SCA service for the sightless within WUHY-FM's 90.9-MHz allocation. Programming totals 88 hours per week, running from 10 a.m. to 11 p.m. Monday through Saturday, and 1 p.m. to 11 p.m. on Sunday. RICB reports that it has distributed, free of charge, over 1300 crystal-controlled receivers (tuned exactly to the subchannel) to blind people in the WUHY service area.

Interestingly, each night from 10 to 11 p.m., Monday through Friday, RICB has an "Adult Book Hour" when books dealing with sexual themes are read. This is done in response to listener requests, as they want access to the whole range of literature that other adults have. The FCC's obscenity regulations do not apply to these programs, as they are not available to the general public and are not literally "broadcast."

Such programming is available in a number of other cities, including Columbia, SC; Washington, DC; Seattle; St. Paul (this group operates 5 transmitters across Minnesota); E. Lansing, MI; Belleville, IL; Lawrence,

KS; Oklahoma City; and Erie and Lancaster, PA. Other groups are planning similar SCA services in San Diego, Madison, WI, Salt Lake City, Boston, New York, Harrisburg, Pittsburg, Knoxville, and Nashville.

14 Hours On Cassette

Answerline Associates, Mt. Vernon, N.Y., using a tape speed of $\frac{3}{8}$ ips and a "Magnapulse" recording head, has produced a cassette recorder (Model LP5A) that will record up to 14 hours of material on a standard C-180 high-energy cassette. The recorder is expected to be applied to voice and data recording, physiological information storage, etc. An optional voice actuator with a 75-ms start time is also offered.

Computer Museum

The Bicentennial Commission of Pennsylvania has recognized the Computer Museum to be established at the U. of Pennsylvania as an official bicentennial project. It will be housed in Penn's Moore School of Electrical Engineering, site of the development of ENIAC, the first large-scale electronic digital computer, which was dedicated on February 15, 1946. Components of ENIAC, on loan from the Smithsonian Institution, will hold a key spot in the exhibition area. Also on display will be a mechanical differential analyzer developed at the Moore School in 1935, as well as parts or replicas of other early computers developed there. Visitors will also see an operating modern computer, the Univac 70/46, and will be able to use a hands-on terminal to play simple games, experiment with displays such as the structure of atoms, and ask questions about Museum exhibits. ENIAC employed 18,000 vacuum tubes, 500,000 soldered joints, 10,000 capacitors, and 70,000 resistors. It weighed more than 30 tons (272,400 kg), occupied 1,500 square feet (139 m²) of floor space, and could perform 5,000 calculations per second—spectacular for its time.

The Audio Accessories Market

Americans are expected to have spent over \$415 million at retail outlets in 1975 for audio accessories, according to a Zenith Radio Corp. spokesman. Some \$286 million of the total went for blank 8-track and cassette tapes. Audiophiles who want to keep their sounds to themselves spent \$58.5 million for two- and four-channel headphones. Expenditures of \$3.25 million were made for such items as cable connectors and cables, chemicals for tape-head cleaning, etc., and speaker wire. External FM antenna sales added up to \$1.3 million.

Joint Group Studies AM Stereo

This Fall, a study was undertaken by three industry organizations to determine the best method AM radio stations may use to broadcast stereo programming. The National Association of Broadcasters, the Electronic Industries Association, and the IEEE have set up the National AM Stereophonic Radio Committee at the request of the FCC, to which findings will be reported.

SBE OPTI/SCAN.

The scanner that's only a light beam away from 16,000 frequencies.

OPTI/SCAN is, without question, the world's most advanced scanning receiver. It is the only crystal-less scanner that optically scans any station in the nation by the use of programmed cards with permanent memory. Simply program and insert the card, OPTI/SCAN does the rest. You can change cards even while driving without taking your eyes off the road. Built-in AC/DC operation.

Who needs a system as advanced as OPTI/SCAN? Anyone anywhere who wants a digital scanning receiver that will be ahead of all the others for years to come.



Better Communications through Creative Technology

For information write: SBE, Inc., 220 Airport Blvd., Watsonville, CA 95076

INTERNATIONAL OFFICES: E. S. Gould Marketing Co. Ltd. 109 Montee de Liesse, Montreal, Quebec, Canada H4T 1S9 • Linear Systems S.A. 5 Rue des Alpes, P.O. Box 163, 1211 Geneva 1, Switzerland

CIRCLE NO. 45 ON FREE INFORMATION CARD
www.americanradiohistory.com



The component look. By design.

Rather than adapt one transport design to fit another need, we produced a completely new, highly streamlined mechanism. From the inside out. It's called the A-400.

Twin rotary levers control the transport functions with smooth, positive cam action. Which means unnecessary mechanical linkages have been eliminated. You get peace of mind instead, because fewer moving parts assure greater reliability and long term dependability.

Since the cassette loads vertically into the A-400, the adverse effect of gravity on the cassette package itself is eliminated. So tape jams are prevented and smooth, even tape packs are predictable.

If new design concepts superbly executed appeal to you, put an A-400 through its paces. Just call (800) 447-4700* toll free for the name and location of your nearest TEAC retailer. You'll find that the A-400 delivers definitive TEAC performance with the added convenience of a front load component. All by design. * In Illinois, call (800) 322-4400.

A-400

TEAC® The leader. Always has been.

TEAC Corporation of America
7733 Telegraph Road, Montebello, Calif. 90640
©TEAC 1975

BY TERRY WALKER,
ROGER MELEN,
HARRY GARLAND
ED HALL

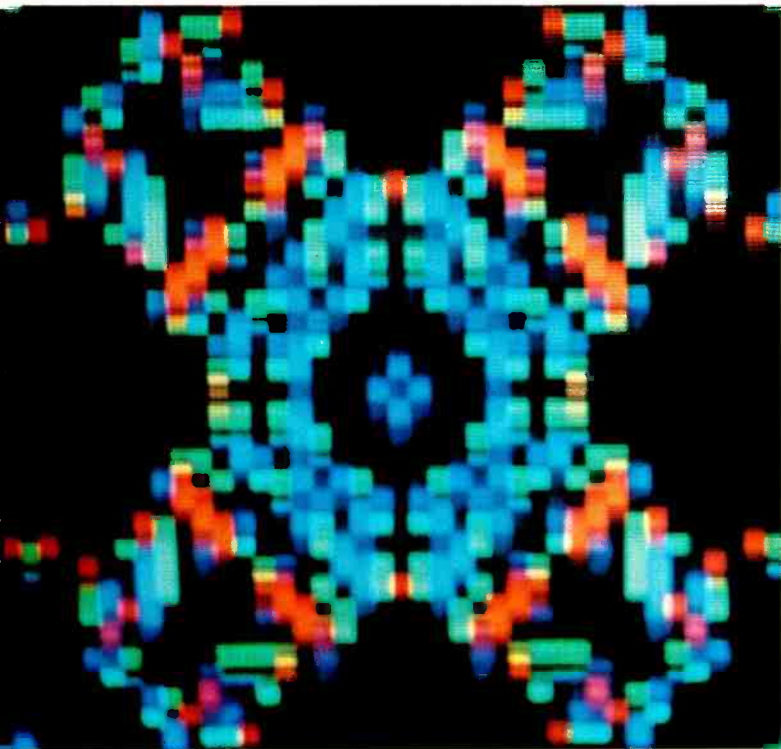
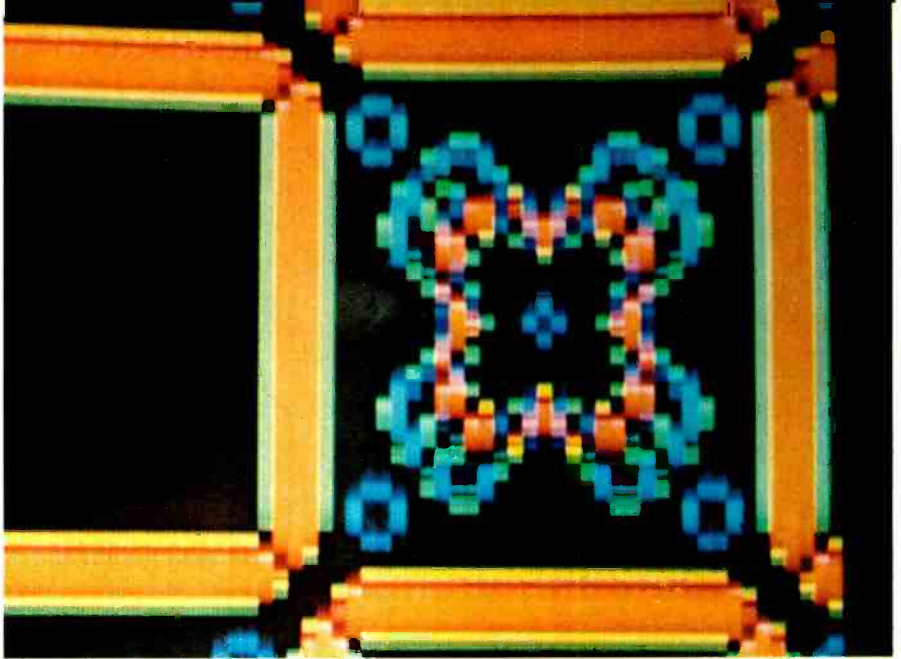

BUILD THE

TV DAZZLER

*Unique computer accessory
provides alphanumerics
and graphics in full color.*



THE TV DAZZLER provides versatile electronic coupling between a small home computer and a color TV set. It can be used to generate action games, animated displays, educational learning drills, graphs, even light shows—all in *full color!* The Dazzler is designed to plug directly into the Altair 8800 computer (POPULAR ELECTRONICS, Jan. 1975); however, since it uses direct memory access (DMA) to scan the computer memory, it can easily be used with many other computers. If a Teletypewriter is your only communications link with your computer, here is a chance to build this new concept in computer peripherals at less than the

It takes more learn about

Bell & Howell Schools introduces three fascinating learn-at-home programs featuring some of the finest equipment available as your "teachers." Choose the program you prefer—then mail card for more details today!

Experience is the best teacher, without a doubt. And when it comes to learning electronics, we feel it's hands-on experience with state-of-the-art equipment that counts the most. That's why with Bell & Howell Schools' learn-at-home programs you work with some of the most up-to-date equipment. Equipment that's being used today—and will be used tomorrow. So the skills and knowledge you acquire will be useful for years to come.

Of course, with all our learn-at-home programs you'll have plenty of lab manuals and basic principles to work with. And you'll also get exciting "teachers" to help make electronics come alive...

Lab Starter Kit gives you hands-on experience with the very first lesson.

We get you started with the basics in an exciting way! At the very beginning you get a fully-assembled volt-ohm meter as well as design panels, modular connectors, experimental parts and battery. So you don't just read about electronics principles, you actually see them at work!

You build your own Electro-Lab® electronics training system.

Whatever program you choose, you get your own home laboratory including oscilloscope, digital multimeter and design console to give you actual experience in wiring, soldering, assembling, testing, trouble-shooting and circuit analyzing.

I. Learn new skills in the field of Home Entertainment Electronics including building the new generation color TV.

What better or more exciting way to learn digital electronics! Once you have the basics under your belt and get into color theory and service, you'll build a 25" diagonal color TV and probe into the digital technology behind digital channel numbers that flash on the screen... a digital clock that flashes the time to the second and an automatic channel selector.

As you put the set together, you'll discover how advanced integrated circuitry works, how to trouble-shoot it and much more. Upon completion of the program you'll have gained the specialized occupational skills to service color TV's plus the principles that you can apply to repair a variety of home electronic equipment. And you'll have the foundation to understand and work with new product applications as they're developed, too!

II. Use professional communications equipment as you delve into Communication Electronics .

Here's how to pick up skills in the vital field of two-way radio, widely used in public safety, marine, industrial and transportation areas. Bell & Howell Schools Communication Electronics Program can help prepare you for the FCC licensing exam, right through to 1st class radiotelephone operator. And teach you skills in two-way radio, radar or commercial broadcasting.

For a refundable deposit, you get to use the special two-way radio equipment lab featuring an FM transceiver, frequency meter, and modulation meter. All regular, first-rate commercial grade test equipment.



"Electro-Lab®" is a registered trademark of the Bell & Howell Company.
Simulated TV Test Pattern

than books to electronics.

III. Digital Trainer helps you learn the latest in Industrial Digital Electronics.

Digital technology is setting new standards of accuracy and beginning a revolution in industry. For example, more precise control in refining, manufacturing plants, food processing and transportation. And now you can learn about this technology with Bell & Howell Schools' unique Digital Trainer. You'll analyze and experiment with various types of

integrated circuits so you'll have a solid background in modern digital electronics and its applications to industry.

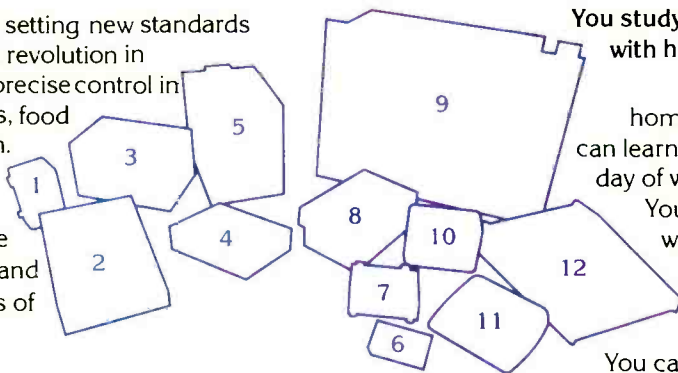

You study at home in your spare time . . . with help as close as the telephone.

Because these are home study programs, you can learn electronics without missing a day of work or a single paycheck.

You study at your convenience—without being a classroom captive. If you ever have any questions, you can call our toll-free number for help.

You can also meet and talk shop with fellow students and instructors at "help sessions" held in 50 cities at various times throughout the year. Bell & Howell Schools tries to give you more personal attention than any other learn-at-home program.

Decide which exciting program you're interested in . . . you can check more than one. Then mail postage-paid card today for full information!

Taken for vocational purposes, these courses are approved by the state approval agency for Veterans' Benefits. Please check box on card for more information. Naturally, we cannot offer assurance of income opportunities.

1. Power Output Meter
2. Design Console
3. Modulation Meter
4. Digital Multimeter
5. Triggered Sweep Oscilloscope
6. Lab Starter Kit
7. Frequency Meter
8. FM Transceiver
9. 25" Diagonal Color TV
10. Alignment Generator
11. Lesson Tape Player
12. Digital Trainer



724R3

If card has been removed, please write to:

An Electronics Home Study School
DeVRY INSTITUTE OF TECHNOLOGY
ONE OF THE



BELL & HOWELL SCHOOLS

414-1 Belmont, Chicago, Illinois 60641

"Breaker . . . Breaker . . ."

Break-through with **BREAKER!**

The New Freedom Line of CB Mobile and Base Antennas and Accessories made in the U.S.A. for communications between people.

A wide selection of "revolutionary" new CB High Efficiency communications antennas of superior strength, electronically and physically, for all the talk power your CB rig will deliver—coming and going in the 27 Megahertz frequency band.

Mobile Breaker antennas for cars, trucks, trailers, sports cars, station wagons, motorcycles, boats. Breaker base station antennas to communicate with mobiles and hand helds . . . all designed specifically for the outstanding transmission and reception of CB signals.

The high quality and materials of the Breaker CB antennas and accessories assure you the maximum in performance for many years and at reasonable cost. Performance-tested Breaker CB antennas offer you these advantages plus more:

- ★ Easily adjust for lowest VSWR
- ★ Long-life stainless steel and fiberglass whips
- ★ Highest quality coaxial cable with solderless connections
- ★ Innovative engineering designs
- ★ Packaged for quick, easy installation to get you on the air fast, complete with cables and hardware

All Breaker antennas are American made in Arlington, Texas. In keeping with the tradition of the Bi-Centennial they are proudly named after our revolutionary heroes and places. Red, white and blue are also the colors of Breaker. Chosen because we too are very proud of our heritage and contribution to making exciting products for use by people communicating with people. See and buy the Freedom line of Breaker antennas and accessories at your nearest electronic distributor. Look for the red, white and blue packaging.

WRITE FOR FREE CATALOG.

GEORGE WASHINGTON

**West Coast Mirror Mount
Dual Truck, RV Antennas
Model 10-200**

Weather resistant dual 57" stainless steel whip antennas with static arrestor tips. Secure horizontal or vertical mounting to West Coast side view truck type mirrors. Twin antennas co-phased for more directional power and easily adjustable for fine tuning. Hermetically sealed, white oversized ABS center load. Dual 18' low-loss coaxial phasing harnesses with solderless connectors and quick disconnect PL-259 plugs. Complete with corrosion resistant mounting hardware.

INDEPENDENCE

**Gutter Mount Antenna
Model 10-245**

Low-profile 21" stainless steel whip antenna with static arrestor and flex-matic shock spring. Fits practically any vehicle rain gutter. No interference with door opening or passenger exit. Heavy-duty molded clamp bracket insulates and supports antenna. Center loaded ABS laced coil for excellent transmission and reception. 12' coaxial cable with solderless connector and quick-disconnect PL-259 plug. Complete with corrosion resistant mounting hardware.

THE PATRIOT

**Omni-directional
¼-Wave Base Antenna
Model 11-101**

High in quality, performance and efficiency, low in cost. Has three 108" quarter wave tubular aluminum radials plus a quarter-wave radiator (vertical element). Heavy-duty U-clamp fits mast up to 1½" diameter. Built-in lightning protector. SO-239 style connector mount. Mates with PL-259 plug. Shunt loaded coil. Heavy duty insulated molded clamp bracket. Easy to assemble and dis-assemble. Fixed construction.

PAUL REVERE

**Roof Mount Antenna
Model 10-215**

Special "power-plus" 42" base-loaded roof mount with long-life stainless steel whip, rugged stainless steel shock spring and high-quality 16-ft. shielded coax cable and solderless connections for fast "on-the-air" installation. Named after the famed communicator and hero of revolutionary era.

THE MINUTEMAN

Trunk Mount Antenna Model 10-230

Sturdy, durable, no-hole required in trunk of vehicle. Super 44" stainless steel whip, base loaded low-profile antenna with stainless shock absorbing spring, chrome plated brass bell housing, 78-foot shielded coaxial cable and solderless connections.

"Just say it with Breaker!"

BREAKER
CORPORATION

1101 Great Southwest Parkway
Arlington, Texas 76011

CIRCLE NO. 63 ON FREE INFORMATION CARD

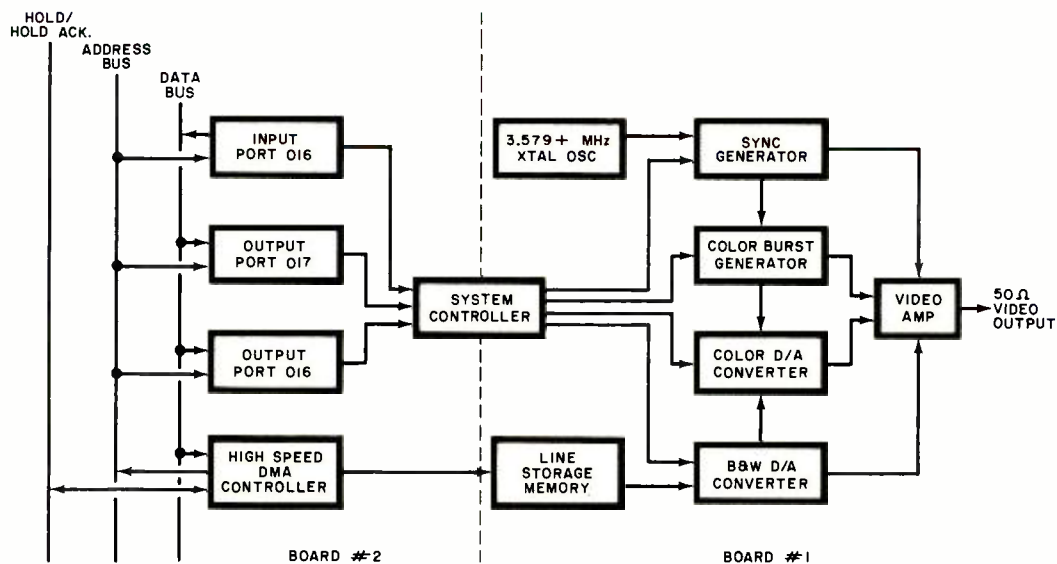

PARTS LIST

C1 through C9, C18 through C25—0.1- μ F disc ceramic capacitor
 C10, C11, C26, C27—47- μ F, 20-volt tantalum capacitor
 C12—330-pF disc capacitor
 C13—680-pF disc capacitor
 C14, C15, C16—470-pF disc capacitor
 C17—9-35-pF variable capacitor
 D1—IN914 silicon diode
 D2—IN5242B, 12-volt zener diode
 IC1, IC37—LM340-5.0, 5-volt regulator
 IC2, IC16, IC17, IC18—SN7410N triple 3-input positive NAND gate
 IC3, IC10—SN7473N dual J-K master-slave flip-flop
 IC4, IC21, IC56—SN7432N quad 2-input OR gate
 IC5, IC30—SN7430N 8-input positive NAND gate
 IC6, IC23, IC42, IC43—SN7474N dual D-type edge-triggered flip-flop
 IC7, IC19, IC35, IC40, IC48—SN7404N hex inverter
 IC8, IC22, IC25, IC39, IC51—SN7408N quadruple 2-input positive AND gate
 IC9, IC14, IC15, IC28—SN7400N quadruple 2-input NAND gate
 IC11, IC12, IC31, IC32, IC49, IC50, IC52—SN7493N 4-bit binary counter
 IC13, IC27, IC33, IC45—SN74157N quadruple 2-input data selector
 IC20, IC29—SN7420N dual 4-input positive NAND gate

IC24—F3342DC 64 x 4 MOS shift register (Fairchild)
 IC26—SN74151N 8-line to 1-line data selector
 IC34, IC46, IC54—SN74175N quadruple D-type edge-triggered flip-flop
 IC36, IC53, IC55, IC61, IC63, IC64—SN7475N quadruple bistable latch
 IC38—SN7402N quadruple 2-input positive OR gate
 IC41—SN74LS10N triple 3-input positive NAND gate
 IC44—SN74LS30N 8-input positive NAND gate
 IC47—SN74LS08N quadruple 2-input positive AND gate
 IC57—SN7495N 4-bit universal shift register
 IC58, IC59, IC65, IC72, IC73—SN74LS04N register
 IC60, IC62—SN7483N 4-bit binary full adder
 IC66, IC67, IC74—SN7405N hex inverter with open collector
 IC68, IC69, IC70, IC71—SN74367 hex tri-state buffer
 Q1—2N3904 transistor
 Q2, Q3—2N3906 transistor
 Following resistors are 5%, 1/4 watt:
 R1—150 ohms
 R2, R3—1000 ohms
 R4—470 ohms
 R5, R6, R7, R29—1200 ohms

R8, R10—9100 ohms
 R9—18,000 ohms
 R11—7500 ohms
 R12—15,000 ohms
 R13—62,000 ohms
 R14—30,000 ohms
 R15 through R20—13,000 ohms
 R21—820 ohms
 R22—1500 ohms
 R23—330 ohms
 R24—220 ohms
 R25—51 ohms
 R26—100 ohms
 R27—22 ohms
 R28—680 ohms
 R30, R31, R32—500-ohm trimmer potentiometers
 XTAL—3.579545 MHz
 Misc.—IC sockets (74), heat sinks (2), mounting hardware
 Note: The following are available from Cromemco, 1 First St., Los Altos, CA 94022: complete set of parts less IC sockets at \$195; with IC sockets at \$215, assembled and tested Dazzler for \$350. California residents please include sales tax. Prices include postage for orders shipped within the U.S. Partial kits are not available. The schematic and foil patterns are available *free of charge* by sending a stamped (for 3 oz.) self-addressed 9" by 12" envelope to Cromemco, 1 First St., Los Altos, CA. 94022.

Fig. 1. Board 1 of the Dazzler contains an NTSC color TV signal generator with output through a 50-ohm line. Board 2 communicates with the computer and modulates the TV signal.

cost of a black-and-white terminal; and you do not need an RS-232 interface. The Dazzler can be built for less than \$200.

If you use your computer for business or accounting, the Dazzler can display multi-colored graphs of stored data. It can also be used to display a

picture produced by the Cyclops solid-state camera (POPULAR ELECTRONICS, February 1975). With the Cyclops picture either processed or unprocessed, the system can be used for security purposes, pattern recognition tests, and measurement and control of processes.

How It Works. A block diagram of the Dazzler is shown in Fig. 1. Most of the components on board #1 are used to generate a conventional NTSC (National Television Standards Committee) color video signal. The circuit is terminated in a 50-ohm, 1-volt output. This signal can be used to drive the

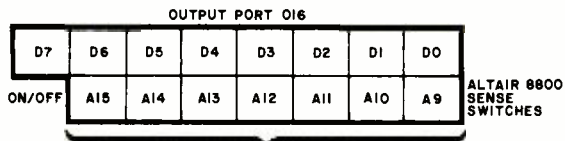

Fig. 2. Configuration of the data bits at output port 016.

video amplifier of a color set or to modulate a class-1 TV device connected to the set's antenna terminals (using a locally unoccupied channel).

The components on board #2 are used to communicate with the computer, with a high-speed DMA controller

as the basis. The controller issues a "hold" command when it is ready to access the computer memory. When the computer is ready, it issues a "hold acknowledge" command and the DMA begins operation.

Communication between the Daz-

Output Port 017

D7 - not used

D6 { 1 Resolution X4. Color and intensity set by D4 through D0.
0 Normal resolution (32 x 32 for 512 bytes, 64 x 64 for 2K bytes). Color and intensity set by 4-bit words in computer memory.

D5 { 1 Picture in 2K bytes of memory
0 Picture in 512 bytes of memory

D4 { 1 Color picture
0 Black-and-white picture

D3 { 1 High intensity color }
0 Low intensity color } ----- Most significant bit of 4-bit B/W intensity

D2 { 1 Blue *
0 No blue

D1 { 1 Green *
0 No green

D0 { 1 Red
0 No red } Least significant bit

Fig. 3. The states of seven data bits at output port 017 determine resolution of TV picture and either chroma or monochrome parameters.

Memory Location	Memory Contents	Comments
000 000	076	Move immediate into
000 001	200	the accumulator.
000 002	323	Output to port
000 003	016	number 016.
000 004	333	Input
000 005	377	from sense switches.
000 006	323	Output to port
000 007	017	number 017.
000 010	303	Jump to
000 011	000	memory location 000
000 012	000	000.

Fig. 4. A test program to be used on the TV Dazzler.

zler and the host computer is through output ports 016 and 017 and input port 016. One bit of output port 016 is used to turn the Dazzler on and off, and the remaining seven bits are used to set the starting address of the picture in the computer memory. The organization of output port 016 is shown in Fig. 2.

Output port 017, whose organization is shown in Fig. 3, is used to set the format of the TV picture. Note that bit D7 is not used. Bit D6 is used to set normal resolution (32 x 32 for 512 bytes or 64 x 64 for 2K bytes) or 4X resolution (64 x 64 for 512 bytes or 128 x 128 for 2K bytes). Bit D5 sets the amount of computer memory, starting at the location given to output port 016, allocated to the picture. When 512 bytes are selected, the computer memory must have an access time of at least one microsecond. When 2K bytes are used, the memory must have an access time of at least 500 nanoseconds.

Bit D4 is used to select either a black-and-white or color display. In the 4X resolution mode (D6 at a 1), bits D3 to D0 are used to set the color of the display when in the color mode or the intensity when D4 is in the black-and-white mode. Bits D3 to D0 are not used in the normal resolution mode.

Only two bits of input port 016 are used. When bit D7 is a 1 (high), it indicates that the Dazzler is enabled (bit D7 of output port 016 actually performs the enabling), while bit D6 goes low to indicate an end of frame. This latter bit is useful when changing frames in rapid succession.

To generate a TV picture with the Dazzler, the information that the Dazzler reads from the computer memory must be properly formatted. In the 4X resolution (output port 017, bit D6 high), each point on the TV screen is controlled by just one bit in the computer memory. This bit turns its corresponding point in the picture on or off. The color or intensity of that frame of the picture is set by bits D3 through D0 of the control word at output port 017. To get full color in the 4X mode, multiple frames of different colors must be interleaved.

In the normal resolution mode (output port 017, bit D6 low), the color and intensity of each point on the screen is controlled by a four-bit "nybble" in the computer memory. Two points of the picture are thus encoded in each byte of the computer memory. For this reason, a 64 x 64 picture requires 2K of

THE GAME OF LIFE

One of the most fascinating uses of the Dazzler is in playing what is known as "The Game of Life." (See *Scientific American*, October 1970, p 120; February 1971, p 112; April 1971, p 116.) The game is started by entering the program shown below. (A paper tape of the program is available for \$15 from Cromemco, 1 First St., Los Altos, CA 94022.) Then a colony of cells is entered to appear on the TV screen on a 64 x 64 grid.

Each cell in the colony has eight possible neighbors, as shown at right. The evolution of the colony proceeds according to a fixed set of rules invented by John Conway at the University of Cambridge. Every cell with two or three neighbors will survive to the next generation. Every cell with four or more neighbors dies from over-population. Every cell with one neighbor or no neighbors dies from isolation. Every cell with exactly three neighbors is a birth cell—a new cell is born here in the subsequent generation.

In the Dazzler version of The Game of Life, blue represents life; birth generates a green cell; and death is shown in red. There are many surprises to be found in the game. Some colonies survive and prosper; others reach a stable state—neither grow-

ing nor lessening. Other colonies fade from existence. Some colonies, known as "gliders" sail across the screen and can be devoured by other colonies in the process.

The full-color illustrations on the first page of this article are actual photos of a TV screen several generations into a Life program.

The initial colony of cells is drawn on the TV screen using ASCII keyboard inputs as controls. Control A deposits a cell of life on the screen. Controls N, O, P, and H step the cursor up, down, right, and left, respectively. Once the initial colony is complete, Control D is initiated to start the game.

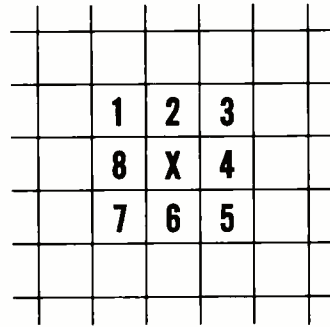

Each cell has 8 possible neighbors.

Program for Game of Life is below.

DAZZLE-LIFE PR0GRAM (L0ADS BEGINNING 000 000, RUNS FR0M 000 000)

0CTAL-LISTING (000 000 = 061, 000 001 = 000, 000 002 = 010 ETC.)

```

061 000 010 315 265 001 315 335 001 315 175 000 315 142 000 315
222 000 315 142 000 333 377 027 332 125 000 027 332 106 000 303
111 000 311 002 002 002 002 002 002 002 002 002 002 002 002
002 002 002 002 002 002 002 002 002 002 002 002 311 001 000 000
315 324 000 076 100 014 271 302 200 000 016 000 004 270 302 200
000 311 001 000 000 315 064 001 376 011 302 245 000 076 000 315
105 001 303 257 000 376 012 302 257 000 076 004 315 105 001 076
100 014 271 302 225 000 016 000 004 270 302 225 000 311 041 000
010 021 000 370 006 000 076 000 272 302 316 000 273 310 160 023
043 303 310 000 305 076 000 271 302 354 000 015 315 034 001 062
164 002 301 305 315 034 001 062 165 002 301 305 014 315 034 001
041 165 002 106 167 200 053 116 160 201 127 301 310 325 315 064
001 321 376 000 312 023 001 172 376 003 310 376 004 310 076 011
303 105 001 172 376 003 300 076 012 303 105 001 005 303 176 002
004 315 052 001 004 315 052 001 172 311 325 315 064 001 321 376
000 303 206 002 315 141 001 176 332 076 001 346 017 311 346 360
007 007 007 007 311 346 017 365 315 141 001 321 332 125 001 176
346 360 202 167 311 172 007 007 007 007 127 176 346 017 202 167
311 041 000 010 170 346 040 312 156 001 021 000 002 031 171 346
040 312 170 001 021 000 004 031 171 346 037 007 007 007 027 137
076 000 027 127 031 170 037 365 346 017 137 026 000 031 361 311
333 000 346 040 300 014 302 220 001 004 302 220 001 311 333 000
346 002 312 236 001 170 323 001 311 106 076 000 270 310 315 236
001 043 303 251 001 315 276 000 076 204 323 016 076 260 323 017
041 163 002 315 251 001 315 220 001 312 306 001 333 001 107 315
236 001 346 177 376 131 310 043 163 002 303 236 001 043 163 002
315 236 001 303 214 002 315 102 002 303 166 002 127 227 276 312
346 001 172 276 312 375 001 043 043 043 303 355 001 043 136 043
126 353 315 010 002 303 346 001 351 001 062 002 002 071 002 004
050 002 010 100 002 011 067 002 017 060 002 013 052 002 015 056
002 016 076 002 000 000 000 000 301 311 021 000 000 311 006 000
014 311 076 017 315 105 001 004 311 076 000 303 064 002 015 311
005 311 315 064 001 365 305 076 014 315 105 001 021 370 370 315
220 001 302 157 002 301 305 076 000 315 105 001 021 370 370 315
220 001 301 312 106 002 361 315 105 001 333 001 323 001 311 301
303 146 002 000 000 000 041 011 002 346 177 303 354 001 026 000
315 052 001 303 040 001 310 376 012 310 024 311 315 276 000 021
000 000 303 346 001 000 000 000 000 000 000 000 000 000 000
    
```

memory storage. The lowest order (D0) bit determines if the display is red, D1 is green, D2 is blue, and D3 determines either a high- or low-intensity color. In black and white, these four bits are used to determine one of 16 shades of gray.

Construction. The Dazzler consists of two adjoining pc boards that plug directly into the Altair-8800 bus connectors. The video output is taken from a pad on board #1. The schematics, etching and drilling guide and component placement diagram for the boards are too large for reproduction here. They can be obtained FREE by sending a stamped, self-addressed 9" by 12" envelope to Cromemco, 1 First St., Los Altos, CA 94022. (These items are also included with each kit as mentioned in the Parts List.)

In assembling the pc boards, note that all components are mounted on one side of the board, with all soldering on the opposite side. The sides to be soldered are those on which the foil marking can be properly read. Plated-through holes assure contact on the component side. If desired, sockets can be used for mounting the IC's. When soldering, use a low-wattage iron and fine solder. Inspect your work to make sure you have no solder bridges.

Because portions of the Dazzler operate at very high frequencies, it is important that all components be mounted close to the pc board. Be sure to use components that meet the required specifications—some untested IC's may not have the required switching speeds.

There are 36 IC's on board 1, plus the color crystal oscillator, and associated passive components. A heat sink is used for IC1, the 5-volt regulator on board #1. When mounting the color-burst crystal, use a small length of wire soldered from the metal case of the crystal to the ground foil immediately above the case. This reduces noise pickup.

One of the center dual in-line positions in the bottom row of board #1 is used for board-to-board interconnections rather than an IC.

There are 37 IC's on board #2. One dual in-line position is left open for interconnections. To connect the two boards, use sixteen 8" lengths of insulated wire (or a 16-conductor flat cable).

The two boards are attached using 5/8" spacers at each corner hole, with

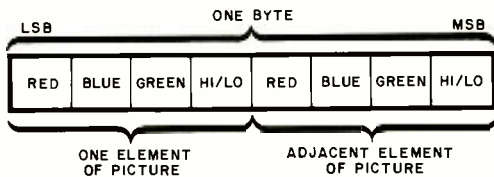
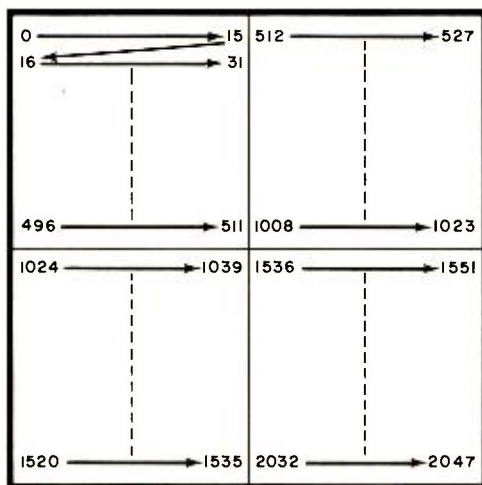

Fig. 5. In low-resolution mode, four bits of computer memory are used for each picture element.

Fig. 6. Memory map of the Dazzler picture. Only first quadrant is displayed in the 512-byte display. All four are displayed in 2K-byte picture.



the component side of one facing the soldered side of the other. The two are separated by exactly the same distance as two adjacent connectors on the Altair bus.

Check-Out. Check for solder bridges and proper component orientation. Facing the component side of a board, pin 1 of each IC should be at the lower left. Check the interconnections between the boards.

Turn off the power to the Altair and then insert the Dazzler into adjacent sockets on the bus line. Using a length of coaxial cable, connect the Dazzler video output (ground the coax braid to

the adjacent ground foil) to the video input and signal ground of your color TV receiver. The connection can usually be made at the input to the video amplifier, with a switch to select the normal input or the Dazzler input.

Tune-Up. The Dazzler is activated and deactivated by software control. The simple program shown in Fig. 4 will turn the Dazzler on and display a picture that is stored starting at location zero in memory (D0 through D6 of output port 016 at zero). This short program also allows sense switch control of the word sent to output port 017. The sense switches are labelled

A8 through A15 on the front panel of the Altair.

Load from the program in Fig. 4 into the Altair from the front panel, examine zero and run the program beginning at location zero in memory. (Be sure all sense switches are down.)

With the color TV set operating and the Altair "running", raise sense switch A12 and note that a colorful quilt-like pattern appears on the screen. Potentiometer R30 (bias) on board 1 of the Dazzler acts as a horizontal hold control and should be adjusted to obtain a stable picture.

Raise sense switches A10 and A11, and adjust capacitor C17 on board #1 for the most saturated blue on the screen. Now put A10 down, raise A9, and adjust R32 for the most saturated green color. Finally, set A9 down, raise A8, and adjust R32 for the most saturated red color.

Dazzler Software. When writing programs for the Dazzler, it is important to remember that the TV picture is stored as a specially coded sequence in the computer memory. The Dazzler simply interprets this code to form the TV image.

Two different codes are used depending on whether the Dazzler is in the low-resolution or high-resolution mode. This is determined by the control word at output port 017. In the low-resolution mode, four bits of computer memory are used to code each element of the picture (Fig. 5). Either a 32 x 32 or 64 x 64 element picture can be displayed. The latter is organized as quadrants within the computer memory as shown in Fig. 6.

In the high-resolution mode, each bit of memory is used either to turn on



Fig. 7. In high-resolution mode, each memory byte is used to represent 8 picture elements.

(bit=1) or off (bit=0) a single memory element. The control word output to port 017 is used to set the picture color. Figure 7 shows how one byte of memory is divided up to control eight elements of the picture. In this mode, either a 64 x 64 element picture using 512 bytes or a 128 x 128 element picture using 2K bytes can be displayed on the screen. ♦

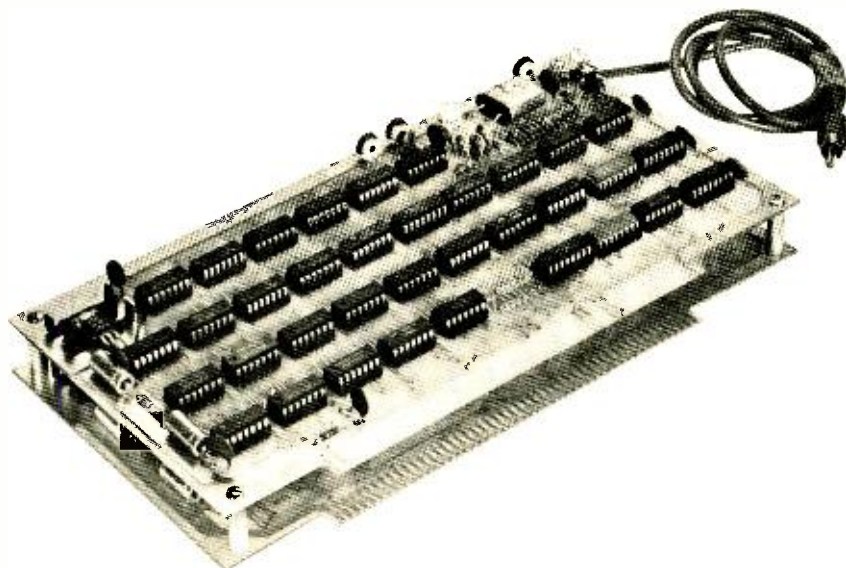

The Dazzler fits in two slots on the Altair bus. Output is video and can be fed to amplifier of TV set or an FCC-approved class-1 r-f device.

THE NEW 1976 COLOR TV RECEIVERS

Serviceability and automatic color controls are emphasized in most lines.

BY ART MARGOLIS

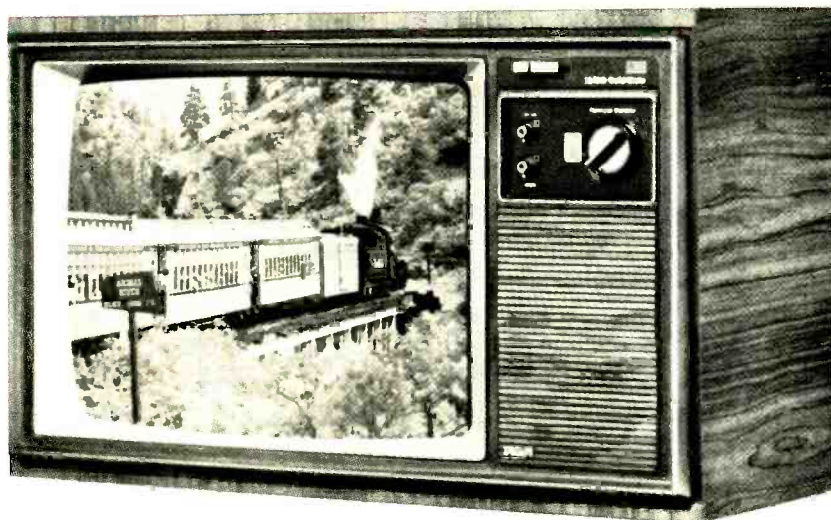
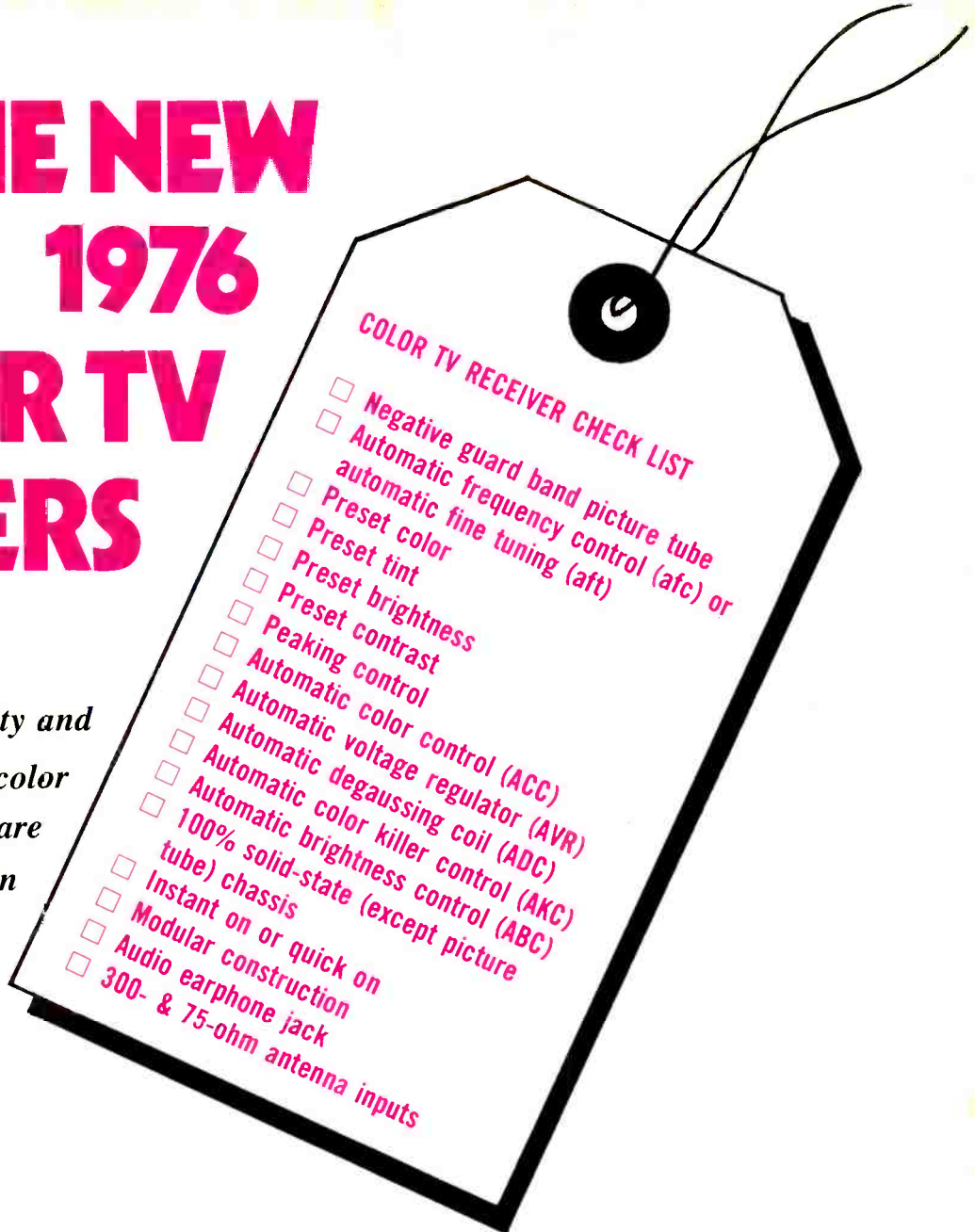

The RCA line of XL-100 receivers features ColorTrak, a remote Control Center which operates all primary controls.

In the 30 years since television first became a serious entertainment medium, TV receiver design has come full circle. Some TV receivers started out in modular form and now most of them have come back to this practical method of assembly, prompted mainly by a need for simple, efficient servicing. High on the list of desirable features for modern TV receivers are modular circuit assemblies, featuring, in many cases, active components that plug in and out for easy replacement.

Just as the auto industry has become accustomed to introducing new model cars each year, TV receiver manufacturers think in the same terms. Each year sees new features incorporated into existing models and completely new models coming on the market. An example of the former is

the constant refinements in picture tuning systems to make them as automatic as possible. The latest systems automatically adjust most picture parameters (brightness, contrast, color, and tint) with the press of a button.

Here are some details of what the major color TV receiver manufacturers are offering for 1976.

Zenith. A vertical chassis that contains a number of Dura-Modules[®] has been introduced by Zenith. The modules carry about 75% of the receiver circuitry. In addition, many of the IC's and transistors on the modules are plug-ins for easy replacement when only the device and not the entire module needs to be replaced.

Zenith's hot new item is a zoom feature that blows up the action at the center of the screen for a close-up view. You press a button on the

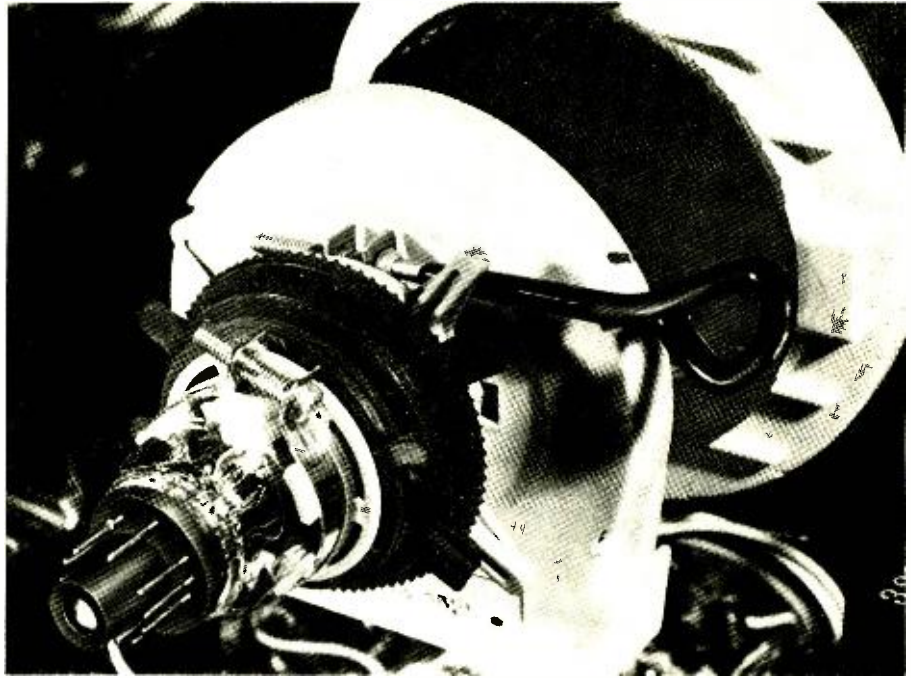

Semi-toroid deflection yoke is used in Quasar's QMX-1 self-converging system to improve efficiency and reduce weight.

hand-held Space Commander 1000 remote control transmitter, and the center-screen action blows up by 50%. (The zoom feature is accomplished by overscanning during beam deflection.) When the zoom is on, an indicator on the receiver lights up. When you press the ZOOM button on the remote control transmitter again, the picture returns to normal and the indicator extinguishes.

The electronic Space Commander 1000 remote control transmitter is a "first" for Zenith. In the past, Zenith's remote-control transmitters used mechanical ultrasonic transducers.

GTE Sylvania. GT-Matic[™] tuning is featured in the new line of color TV receivers from Sylvania. Automatic adjustments are built in to cure problems involving the horizontal line, a rolling picture, poor contrast, lack of color, and incorrect tint. Since almost everything is automatic, the front panel of the Sylvania receiver contains only three controls: a combined power on/off and volume control and the vhf and uhf channel selectors.

The GT-Matic system is preset at the factory for a "normal" optimized picture. If you don't like what you see, a key provided with the receiver can be used to open a hidden panel to provide access to the BRIGHTNESS, CONTRAST, COLOR INTENSITY, and TINT controls. You can set these controls as desired and then lock the panel to keep others from disturbing the picture settings.

An afc circuit keeps the tuner from drifting off frequency, while a Perma Tint circuit acts as a monitor to maintain correct color levels. When the Perma Tint circuit is activated, the demodulation angle between the B-Y and R-Y signals is increased to provide a wider range of phase angles for determining the actual color of the flesh tones.

The usual vertical-hold control has been replaced with a vertical countdown IC. In the past, the vertical countdown circuit required too many components. However, in IC form, the



The Magnacox STAR system provides random-access, one-button tuning.



When the ZOOM button is pressed on Zenith's Space Command remote control models, the picture is enlarged 50%.

COLOR TV RECEIVER HIGHLIGHTS FOR 1976

Company	Chassis Series	Type of Tuner	Channel Indicator	Special Features
Zenith	GC	Varactor	Digital	Zoom (enlarges center-screen action)
Sylvania	GT-Matic	Varactor	Digital	Key-locked picture control panel
Sony	KV	Detent	Tuner dial	Optional accessories
Sharp	C	Varactor & Detent	Digital & Tuner dial	Flat contacts on tuner for longer life
RCA	CTC 68	Varactor	Digital	ColorTrak automatic color control
Quasar	QXM-1 & QS 3000	Detent	Digital	Slumber Sentry (automatic shut-off); Power Saver switch
Philco	BOSS	Detent	Tuner dial	Power Guard for greater reliability and longer life
Panasonic	CT552 & GP-3000	Detent	Tuner dial	Mini color TV receiver with 4½" picture tube
Magnavox	STAR	Varactor	Digital	On-screen channel numbers; STAR control panel on receiver
Hitachi	CT & CB	Detent	Tuner dial	Extra Strong warranty
GE	MB-2, MC-2, YA & YC	Varactor	Digital	
Admiral	M25	Detent	Tuner dial	

TV receiver model is complete and well illustrated.

All kinds of optional accessories for portable receivers are offered by Sony. They include car battery cords, sun glare filters, rechargeable battery packs, earphones, and mobile, boat, and home antennas.

Sharp. The Sharp Linytron-Plus in-line, one-gun picture tube is being aggressively promoted. It has good overall performance characteristics.

The detented vhf tuner has a feature that Sharp claims reduces wear and tear to provide longer life. Instead of using the traditional hemispherical contacts, they are flat so that, as the tuner knob is rotated, the contacts on the tuner "turret" press against flat stationary contacts. The electrical connections cover a much larger area than the point-contact hemispherical contacts

The Linytron picture tube is equipped with a fast-start heater. When the receiver is turned on from a cold start, you get sound instantly, followed four seconds later by the picture.

An LDR gives the Sharp receivers an "Optimatic" light-sensing feature that serves as an automatic brightness-level control system. There are a number of remote-control receiver models in the company's line, plus a 12-pushbutton variable-capacitance (Varactor) tuner model that eliminates moving parts.

RCA. This year, RCA is continuing to market its XL-100 series of color TV

circuit is practicable and the picture is locked in even when there are noise pulses that would knock the vertical out of sync with ordinary vertical-hold circuits.

The Sylvania receivers also contain circuits that deal with airplane flutter, line voltage variations, and even transmitter-caused problems. Another circuit automatically adjusts the horizontal hold to maintain a stable picture.

Sylvania uses a modular chassis approach that features plug-in transistors in practically all circuits.

Sony. This company is progressing with its line of high-quality table-model color TV receivers. The CRT sizes keep getting larger and the 19" (48.3-cm) Trinitron picture tube features a single cathode. It has a 114° deflection angle, which permits the receiver cabinet to have a depth of only 15½" (40 cm). The shorter neck of the tube also diminishes the distance electrons have to travel from the "gun" to the screen, which means an

increase in picture brightness.

Service consideration is a major Sony goal. Much time and money have been spent in documenting service notes, and the service manual for each

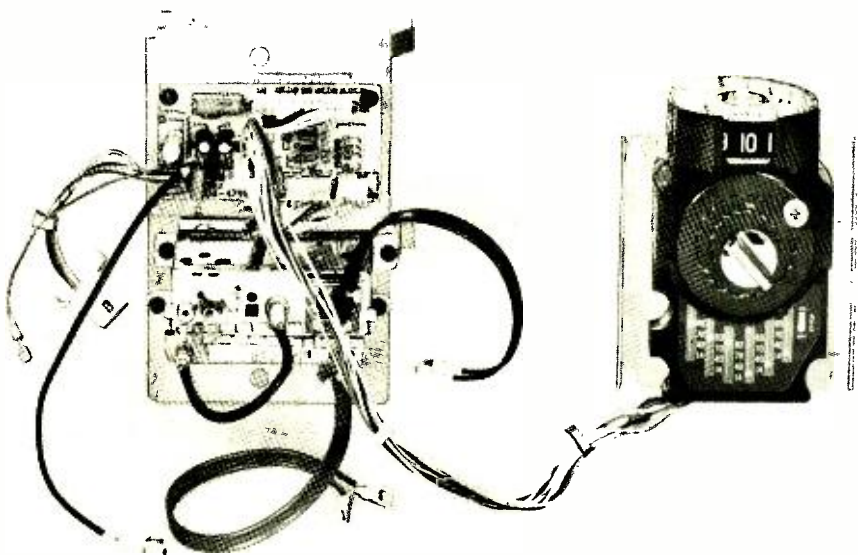

No moving parts are used in Zenith's 18-position tuning system. Vhf is set at factory with six positions for customer tuning of uhf.

receiver chassis. The XL-100 is 100% solid-state, and the bottom-of-the-line hybrid (tube/transistor) receivers have been phased out.

Ten of the XL-100 receivers (19" and 25" diagonal) now have a color control system called ColorTrak which relies on a new solid-state chassis and a new picture tube employing filtered phosphors. The latter are said to reduce the reflection from ambient light, producing clearer blacks and more vivid colors. XL-100 consoles with ColorTrak also have a new remote Control Center which operates all of the primary controls and provides for display of the time of day and channel number on the screen.

More wood (less plastic) is emphasized in the 1976 line, which includes five main screen sizes: 15", 17", 19", 21", and 25" (38, 43.2, 48.3, 53.3, and 63.5 cm), measured diagonally. The 21" and 25" models have CTC68 chassis and 31-kV high-voltage power supplies.

RCA also concentrates on ease of servicing. Twelve small plug-in modules and five IC's are used in the circuit design. The modules are upgraded as repetitive field troubles are discovered. For instance, if a particular transistor repeatedly fails in the field, its circuit is redesigned to correct the condition. Care is taken to keep the same plug contacts on the modules during upgrading.

With 12 modules in the receiver, each module's cost is relatively lower

than a receiver in which fewer modules are used. Thus, the value of a module approaches a throw-away status which greatly simplifies servicing.

Low power consumption is a continuing RCA aim, and the company claims that its new console receivers require some 48% less power than comparable tube-type receivers.

Quasar. Quasar is now owned by Matsushita, which also produces the Panasonic line of TV receivers. However, the two brands are produced by independent operations.

A new QMX-1 color TV receiver chassis is featured in the 13" and 15" (35 and 38 cm) models. This is not a "works in a drawer" chassis. It has an in-line picture tube with a semi-toroid yoke, which eliminates the need for dynamic convergence adjustments, though static convergence, purity, and gray-scale adjustments must still be performed. No dot/crosshatch generator is needed for making the required adjustments. The service technician who sets up the receiver can "eyeball" all color adjustments, which reduces the cost of the service bill.

Quasar is using the Panasonic Quin-trix in-line black-matrix picture tube in its chassis. The tube has an extra pre-focus electrode for sharper pictures. Since the deflection yoke is not cemented to the neck of the tube, if the yoke fails, only it has to be replaced, not the entire assembly.

Quasar places a lot of emphasis on its Super Insta-Matic automatic brightness control feature. In essence, this system uses an LDR circuit to adapt the brightness of the picture to room lighting.

The QMX-1 chassis contains only three modules. Two of them plug into the chassis in the conventional manner. The third includes the picture-tube cap; to remove it, the cap must be disconnected from the tube.

The QS 3000 "Works in a Drawer" TV receiver is being upgraded to include an energy-saver switch that disconnects the picture tube's filaments to defeat the instant-on feature. (Otherwise, the filaments consume 4 watts of power.) Remote-controlled receivers feature a Slumber Sentry system that automatically shuts off receiver power within 20 seconds after a station goes off the air. The Slumber Sentry detects the absence of vertical sync pulses to trigger the shut-off mechanism.

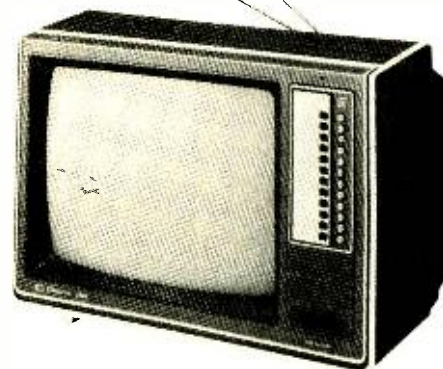

Sharp's 19" model has 12-button Varactor tuner with one-button color tuning system. Solid-state modular chassis are used.

Philco. Until recently owned by the Ford Motor Company, Philco is now a part of GTE Sylvania. However, the Sylvania and Philco TV receiver divisions are autonomous.

The 1976 color TV receiver line from Philco contains four portable and 10 large-screen models. In the portable lineup are one 19", two 17", and one 15" receivers. Each features an all solid-state BOSS chassis, Philco's Automatic Lock Channel Tuning (ACT), 70-position click-stop uhf tuner, in-line picture tube, and plug-in transistors for ease of servicing.

All large-screen Philco receivers have 25" black matrix picture tubes. There are seven consoles, one table model, and two home-entertainment center receivers in the line. (The home entertainment centers are color receiver and stereo system combinations.) Each large-screen receiver has the same features as the portables, plus modular chassis, lighted channel indicators, and the Philco Power-Guard System that provides improved reliability and longer chassis life.

Panasonic. New to the Panasonic line this year is the 4½" (11.4-cm) diagonal-measurement Model CT-552 color TV receiver. Not a toy, this sophisticated receiver has Panasonic's Q-Lock II automatic tint and color circuit and a tube that gives pictures in 4 seconds. It retails for about \$480. The circuit design is all solid-state and employs several IC's. The receiver can be line-powered or operated from a car or boat (12-volt dc) electrical system or its own re-

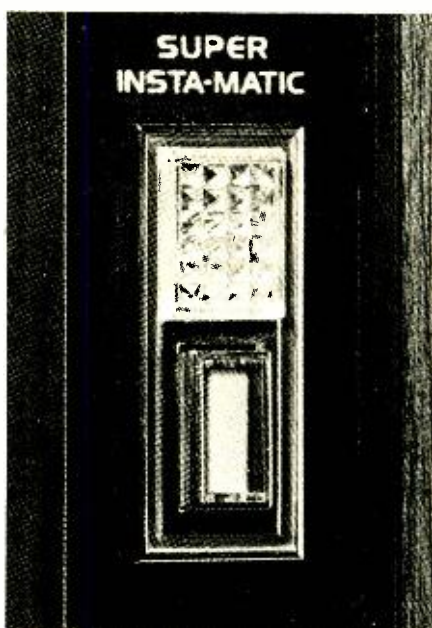

In Quasar color control, room brightness is sensed by an LDR behind honeycomb lens. Picture power is adjusted automatically.

**TYPICAL ENERGY USE
vs WEIGHT
FOR SOLID-STATE
COLOR TV RECEIVERS**

Screen Size	Power Consumption (watts)	Receiver Weight (in pounds)
4"	25	15
9"	60	25
13"	85	40
15"	85	50
17"	95	55
19"	100	65
21"	110	120
25"	130	135

chargeable battery pack. When powered from the ac line, it consumes only 22 watts. The receiver even has a system that automatically switches over to its internal battery pack should ac line power fail. Available accessories include earphones, rechargeable batteries, and glare-proof tinted screen.

There are also two new Panacolor receiver models available, measuring 12" and 19" diagonally. Both use the Quinrix picture tube and a new GP-3000 chassis. The number of components on the chassis has been cut by a full third when compared to previous models. The total wiring length has also been reduced from 46' to only 14'.

Power consumption is down in the Panasonic TV receivers. The high-voltage level in the 12" model is 24.5 kV, with power consumption at 103 watts. The 19" model requires 30 kV from the high-voltage supply and consumes 120 watts of power.

Magnavox. Last year, Magnavox made a big splash with its STAR (Selective Tuning At Random) remote-control tuning in its top-of-the-line receivers. This year, the STAR system is appearing in lower-priced large-screen and some 19" receivers as well. (STAR permits instant precision selection of any one of the 82 vhf and uhf channels at random and out of sequence. The system goes directly to the selected channel without having to cycle through a lot of intermediate channels.)

Last year's 15-button STAR control panel was available on only the handheld remote control transmitter. This year, it's also on the TV receiver.

With the STAR system, when a channel is selected, its number is displayed

in 5" (12.7-cm) high numerals at the top of the picture. The numerals are displayed for about three seconds, after which they blank out. The system never needs fine tuning.

Magnavox is attempting to provide high-fidelity sound from its receivers. To this end, larger than average dual-cone 9" (22.7-cm) speakers, separate transducers, and speaker pairing are used.

Hitachi. Although it is primarily in the portable TV business, Hitachi also has a consolette with a 21" diagonal measurement picture tube. Hitachi receivers start with a 9" model that operates on ac line power or from a 12-volt dc car/boat electrical system. Also in the line are 13", 15", 17", and 19" portable TV receivers.

The Hitachi TV system is called SMAGC, which stands for Seven-Merit Automatic Gain Control. One of the seven merits, APS (Automatic Picture Setting), performs the usual preset control functions for color, tint, brightness, and contrast. However, it is combined with a tint stabilizer and the Automatic Color Control (ACC) to maintain correct tint and color intensity when changing channels or when a camera switch is made during a program.

Hitachi has an "Extra Strong" warranty. It covers transistors for 10 years and all other parts, including the picture tube, for two years.



Portable, model from Panasonic has a 4½" diagonal screen.

GI

th

Th

cl

tu

o

ε

from,

new YC chassis

and 19" color TV

screen models continue

10HE chassis.

The only major design change

GE receivers is in the modular

series. Last year, the high voltage w

produced by a 7.5-kV flyback transformer and quadrupler rectifier that

brought it up to 30 kV. This year, the

flyback circuit develops about 10 kV,

while a tripler rectifier is used to do the

boosting to the required 30 kV.

The GE modules continue to undergo

constant updating. For instance, the

chroma and vertical modules have been

changed but inputs, outputs, and plug-pin

configurations remain the same.

The YC chassis has a 29.5-kV supply

(higher than that used in the older YA

chassis) and top and bottom pincushion

correction circuits.

A caddy-size symptom/repair manual

is available for recent GE chassis.

Each trouble symptom is listed with a

"most likely cause."

Admiral. In Admiral's IM30 chassis,

the power transformer has stable voltage

regulation. The ac line voltage can vary

from about 90 to 130 volts without seriously

affecting the picture. The power transformer

is tuned to the 60-Hz line by a 3.5-μF

filter capacitor across its secondary. The

inductance of the secondary combines

with the capacitor to form a tuned LC

system.

The transformer is wound in a special

configuration so that the tuned secondary

produces fixed-amplitude square waves,

with the transformer operated in saturation.

When the input is 117 volts ac, the output

is clipped to a square wave of fixed amplitude.

As the line voltage varies, any changes

produce inverse changes in the clipping

action. The voltage output level, however,

remains the same.

Summing Up. Color TV receivers of

all makes are reaching a high state of

excellence. They are capable of producing

near-perfect pictures, lasting longer,

and requiring less service than previous

models. ♦

Learning with CIE is



Electronics no picnic.

**It takes work.
And a few
sacrifices.
But
it's worth it!**

The minute you start your CIE course you'll see why CIE is different than other home-study schools.

Because as a CIE student you'll get the kind of electronics training that prepares you for a career, not just a job. We'll give you a meaningful, well-rounded foundation in electronics theory and practice. And with our special Auto-Programmed® Lessons, we'll make sure you grasp the key theories and methods of modern Electronics. No "fun and games" frills. No time-wasting, superficial lesson material. No "snap" exams.

We'll challenge your thinking.

We have to. Because after you graduate, employers will expect you to really know how to analyze and troubleshoot virtually all kinds of electronics equipment. Some employers of electronics personnel have told us that our graduates have what it takes.

That's why we're so thorough. We've got a 40-year reputation to uphold and we're going to keep it by giving our students the best *independent home-study* training we can.

Sure, some of our weaker students drop out. (Learning Electronics with CIE is no free ride.) But you can bet on this... the ones who do make it are ready! Ready to go out and make it in the rewarding world of Electronics. And that's the reason you want to learn, isn't it?

You can have attractive job opportunities

There have already been many exciting developments and breakthroughs in

Electronics and some people might assume there will be no new frontiers... no new worlds to conquer. Not so.

Electronics is still growing. In nearly every one of the new and exciting fields of the Seventies you'll find electronics skills and knowledge in demand. Computers and data processing. Air traffic control. Medical technology. Pollution control. Broadcasting and communications.

Importance of an FCC License

If you want to work in commercial broadcasting... television or AM or FM broadcasting... as a broadcast engineer, federal law requires you to have a First Class Radiotelephone License. Or if you plan to operate or to maintain mobile two-way communications systems, microwave relay stations or radar and signaling devices, a Second Class FCC License is required.

But even if you aren't planning a career which involves radio transmission of any kind, an FCC "ticket" is valuable to have as Government certification of certain technical skills. It's a job credential recognized by some employers as evidence that you know your stuff.

A good way to prepare for your FCC License exam is to take one of the CIE career courses which include FCC License preparation. We are confident you can successfully earn your license, if you're willing to put forth an effort,

because the vast majority of CIE students have. In fact, based on continuing surveys, close to 9 out of 10 CIE graduates have passed their FCC exams!

So if you are serious about getting ahead in Electronics... if you are willing to put in the extra work... get in touch with us.

We have many *career* courses for you to select from. If you already have some electronics training, you may want to skip our beginner-level courses and enroll in an intermediate program. Or, if you're really hot, there's a tough, college-level course called "Electronics Engineering" that can make you even better.

Send today for FREE school catalog

Send today for our FREE school catalog and complete package of *independent home-study* career information. For your convenience, we will try to have a representative call to assist in course selection. Mail reply card or coupon to CIE... or write: Cleveland Institute of Electronics, Inc., 1776 East 17th Street, Cleveland, Ohio 44114.

Do it TODAY.

G.I. Bill Benefits

All CIE career courses are approved for educational benefits under the G.I. Bill. If you are a Veteran or in service now, check box for G.I. Bill information.

CIE Cleveland Institute of Electronics, Inc.

1776 East 17th Street, Cleveland, Ohio 44114
Accredited Member National Home Study Council

Yes, I want your FREE school catalog and career information package today.

I am especially interested in:

- | | | |
|--|--|------|
| <input type="checkbox"/> Electronics Technology | <input type="checkbox"/> Industrial Electronics | PE92 |
| <input type="checkbox"/> FCC License Preparation | <input type="checkbox"/> Electronics Engineering | |
| <input type="checkbox"/> Color TV Maintenance | <input type="checkbox"/> Other _____ | |
| <input type="checkbox"/> Mobile Communications | | |

Print Name _____

Address _____

Apt. _____

City _____

State _____

Zip _____

Age _____

Check box for G.I. Bill information. Veteran On Active Duty

CIRCLE NO. 9 ON FREE INFORMATION CARD



CONSTRUCTION

A HIGH-POWER MOBILE STEREO AMPLIFIER

Provides clean, 15-W/channel audio from a 12-V dc source.

BY EDGAR BRADEN

TRYING to get high-fidelity sound in a mobile environment presents very difficult problems. First of all, ambient (road and motor) noise must be overcome. But the direct-coupled, complementary output stages of many tape players and radios cannot produce more than a few watts of power. Output transformers could boost the power, but serious drawbacks such as bulkiness and high cost make them impractical.

In the face of these limitations, many camper, sports car, and boat owners still ask, "How can I get an appreciable amount of clean audio output using solid-state circuitry operating from a +12-V dc source?" This article provides the answer with the Mobile Stereo Power Amplifier.

The amplifier will provide 15 W rms/channel of low-distortion audio into 8-ohm loads (enough to drive even low-efficiency speakers). Only a +12-volt dc supply is required, and with slight modifications, it will operate from 6-volt supplies. Also, the amplifier sections for the two channels can be "bridged" (driven out of phase) to provide 30 watts monaural into a 16-ohm speaker, or paralleled for a 4-ohm load. Parts cost for the amplifier is about \$25. Of course, two such units can be operated independently in the bridged or parallel mode to provide 30 watts per channel for stereo.

Among the amplifier's features are direct-coupled output circuitry, a high-frequency (20,000-Hz) dc-to-dc

converter, and a low-distortion IC audio driver. The converter offers high efficiency and compact size as a result of its operating frequency. What's more, core (magnetostriction) and pickup noise lie beyond the audible spectrum. Above all, both the power converter and audio amplifier are easy to build!

About the Circuit. The dc-to-dc converter shown in Fig. 1 is a fairly standard design. Its frequency of operation is governed by saturating-core transformer *T1*. The winding (points 5 and 6) connected to the bases of transistors *Q3* and *Q4* is phased to provide positive feedback, which sustains oscillations. Thus a 12-volt, 20,000-Hz square wave is applied to the primary

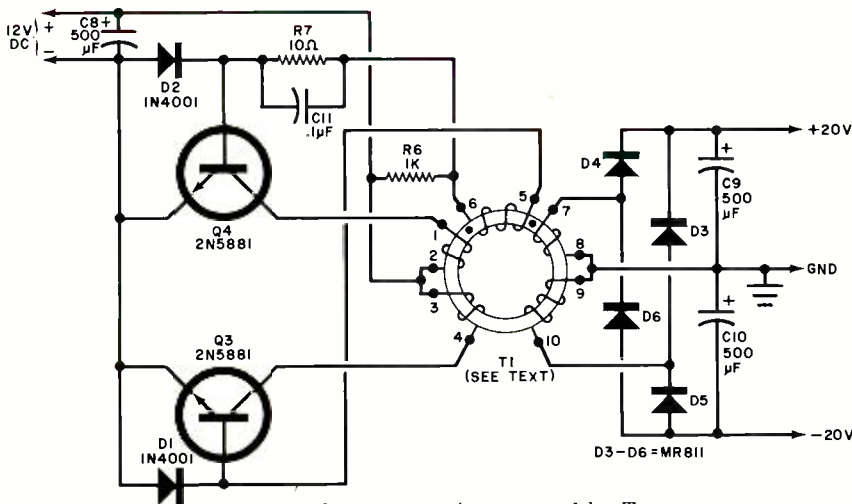

Fig. 1. Frequency of dc-to-dc converter is governed by T1.

POWER SUPPLY PARTS LIST

C8,C9,C10—500-µF, 25-volt electrolytic capacitor
 C11—0.1-µF paper or Mylar capacitor
 D1,D2—IN4001 rectifier
 D3 through D6—MR811 (Motorola) or IN4933 fast-recovery diodes. (See the text)
 F2—10-ampere slow-blow fuse
 Q3,Q4—2N5881 (Motorola) npn power transistor—(do not substitute)
 R7—10-ohm, 2-watt resistor

R6—1000-ohm, ½-watt resistor
 S1—Spst switch
 T1—See text. Requires a Ferroxcube No. 846T250-3E2A toroid core.
 Note: an etched and drilled circuit board is available from EBCO, 10 Sherwood Drive, Nashua, NH 03060 for \$4.50. The Ferroxcube toroidal core is available from Elna Ferrite Laboratories, Inc., Box 395, Woodstock, NY 12498, for \$1.75 (first class postage paid).

of T1 (points 1 and 4) via the collector leads. The stepped-up output of T1 is rectified by the full-wave bridge D3-D6 and filtered by C9 and C10. A bipolar (±20 V, referenced to ground) output is obtained.

A ferrite toroid is used as the core of T1 because of its high permeability and residual magnetization (remnance), which aids the switching between the transistors. Further, the toroid's form factor keeps core losses low as there is a minimum of magnetic material for a large power-handling capability. Toroids are self shielding—all magnetic flux remains in the core. This isolates the switching circuit from the power amplifier. Also, fewer turns are required, so heavier gauge wire can be used, resulting in lower I²R losses. And, practically speaking, the toroid is much easier to wind by hand than the bobbin of a laminated-iron core!

A Signetics NE540 integrated circuit acts as the power amplifier's input stage and supplies base drive to power transistors Q1 and Q2, which form a complementary-symmetry output stage (Fig. 2). It also controls the transistors' bias current to minimize crossover distortion.

The 540 IC is a high-fidelity device, having a bandwidth exceeding

100,000 Hz. Its output stage can drive a 600-ohm load to 3 dB below maximum, with a typical distortion figure of 0.5% at 40 dB gain. The circuit config-

uration shown in Fig 2 has a gain of 34 dB, which should reduce distortion to about 0.25% for high-fidelity listening. Note that only one channel (Channel A) is shown.

Construction. The task of winding T1 is not really difficult, but care must be exercised to keep track of the start and finish ends of each winding to assure proper phasing so the circuit will oscillate.

Use No. 20 enameled magnet wire for both the primary and secondary windings. (No. 22 wire can be substituted.) Fold in half a 5' (1.52-m) length of the wire and wind this around the toroid for a total of 14 turns. Distribute the wire as evenly as possible all the way around the core. Bend the wire sharply around the corners of the core to make tight windings. When you are finished, label the two free ends with pieces of tape numbered 1 and 3. Snip through the fold loop. Then use an ohmmeter to determine which of the newly cut ends has continuity with lead 1; label the unmarked end lead 2. Then label the remaining unmarked lead with a 4. (It should have continuity with lead 3).

Next, wind the feedback winding. This consists of five turns of No. 22 or No. 24 wire, evenly distributed around the core. Start and finish the winding

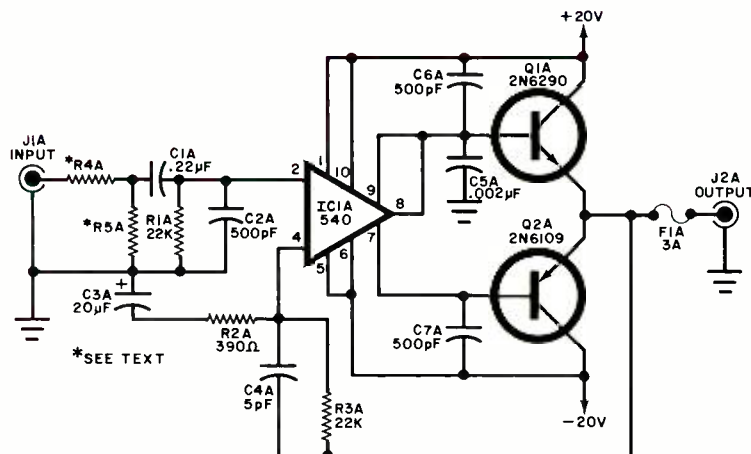

Fig. 2. First stage of amplifier is an integrated circuit.

AMPLIFIER PARTS LIST

C1—0.22-µF Mylar capacitor
 C2,C6,C7—500-pF disc capacitor
 C3—20-µF, 15-volt electrolytic capacitor
 C4—5-pF silver mica or ceramic capacitor
 C5—2000-pF (0.002-µF) disc capacitor
 F1—3-ampere fast-blow fuse
 IC1—NE540 or SE540 integrated circuit (see text)
 J1,J2—Phono jack
 Q1—2N6290 npn power transistor
 Q2—2N6109 pnp power transistor
 R1,R3—22,000-ohm, ½-watt resistor

R2—390-ohm, ½-watt resistor
 RA,RB—Input attenuator resistors (see text).
 Misc.—Printed circuit board; fuse holders (3); heat sink or chassis box; 22,000-ohm, ½-watt resistor for bridge hookup (see text); spacers (4); mica and plastic-film insulators for transistors; silicone heat sink paste; magnet wire for T1; silicone adhesive; machine hardware; hookup wire; solder; etc.

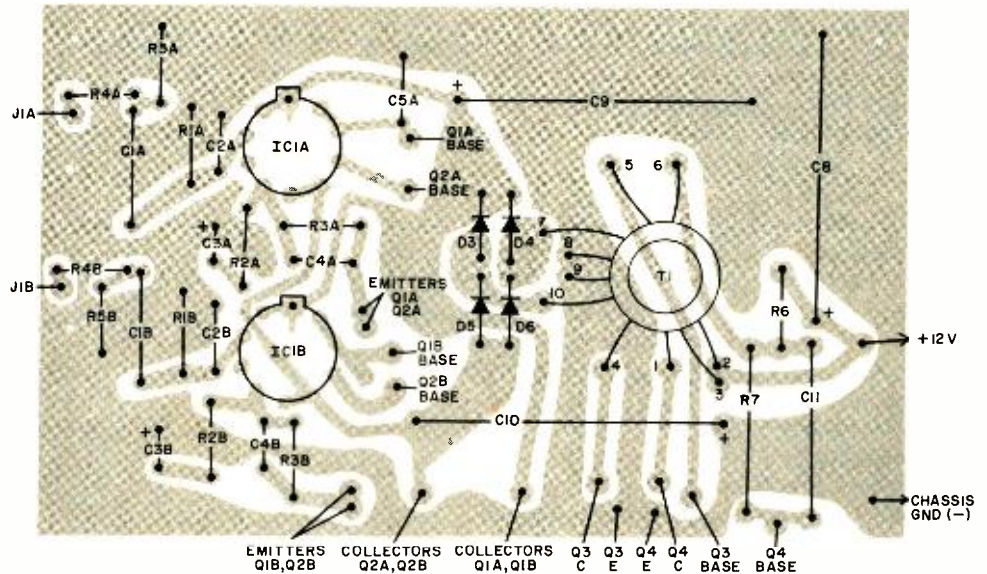

Fig. 3. Actual-size etching and drilling guide for pc board is shown above with component layout at right.

on the opposite side of the core from the primary leads 1 and 4 to facilitate matching the leads with their pads on the pc board. Label the ends of the feedback winding 5 and 6, taking careful note that current flowing from 5 to 6 should pass through the hole in the core in the same direction as current flowing from 1 to 2 or from 3 to 4 in the primary winding.

The secondary winding comes next. As with the primary, the secondary must be bifilar wound to provide tight coupling between the two halves of the winding. It also makes the job of winding easier. Fold in half a 6' (1.83-m) length of No. 20 or No. 22 enameled magnet wire and wind 21 turns of the double strand around the core. Evenly distribute the turns

around the core and press them tightly around the edges to allow sufficient room within the core's hole for the entire winding. When all 21 turns are on the core, label the two free ends 7 and 8. When all 21 turns are on the core, label the two free ends 7 and 8. Label the remaining unmarked lead 10. The direction in which the secondary is wound is not important.

(Note: For 6-volt electrical systems, reduce the number of primary windings to seven bifilar turns and the feedback winding to three turns.)

An actual-size etching and drilling guide for the pc board is shown in Fig. 3. After preparing the board, proceed with circuit assembly. Start by mounting T1 in place as shown in the com-

ponent guide (also shown in Fig 3). Do not forget to remove the enamel coating on the ends of the leads so they can be soldered to the copper pads on the circuit board. The leads will normally hold the transformer solidly against the top of the board, but it's a good idea to use a dab of silicone adhesive between board and transformer since the project will be subjected to vibration and other stresses. Taking care to observe polarities and IC pin basing, mount and solder into place the remaining components.

All transistors must be mounted on a heat sink that has at least 10 sq in. (6.54 sq cm) of radiating area. Standard 1/16" (1.6-mm) thick aluminum plate will do for the 15-W/channel stereo version of the amplifier if cut to

the same size as the pc board. After machining the heat sink, mount the transistors, using mica or plastic film insulators, silicone heat-sink compound, and insulating shoulder washers under the mounting screws for the board.

Solder C6 and C7 directly to the leads of transistors Q1 and Q2, respectively. Similarly, solder diodes D1 and D2 directly to the leads of transistors Q3 and Q4, respectively. Or, if preferred, the capacitors and diodes can be soldered to the appropriate pads on the foil side of the pc board. When this is done, solder interconnecting hookup wire between the transistor leads and the appropriate points on the pc board.

Now, using 3/4" to 1" (19-25.4-cm) spacers and machine hardware, sandwich the pc board and heat-sink assemblies together. The transistors must be on the side of the aluminum plate that is opposite the pc board to provide shielding between the transistors and amplifier inputs.

If desired, connect an SPST switch (S1) in series between the +12-volt supply and the appropriate pad on the pc board. However, the vehicle's ignition switch can be used in place of S1. It is also advisable to insert F2, a 10-ampere, slow-blow fuse between the supply and S1.

If you plan to use a box to house the amplifier, select one that measures 6"L x 4"W x 1 1/2"D (15 x 10 x 3.8 cm). Mount the transistors on the top of the box, cases outward and secure the circuit board assembly with spacers and machine hardware. Don't forget to mount the fuse blocks where they will be easily accessible. When you mount the project inside your vehicle, bear in mind that the transistor cases are electrically "hot." So, take care that they do not short out against the project or vehicle chassis. Insulate them with a layer of electrical tape or a cardboard shield. Note that we assume a negative-ground 12-volt source. A positive-ground supply can also be used, but make sure that the amplifier pc board "ground" is not connected to the vehicle's chassis ground.

A word about rectifiers D3 through D6 is in order here. These are MR811, fast-recovery devices. If you expect full sustained output power from the amplifier, do not substitute devices. Power supply transistors Q3 and Q4 must be high-frequency devices with an f_T of at least 4 MHz. They should

have a beta of at least 20 at 6-A collector current. Lower frequency transistors have a tendency to overheat at the switching frequency employed.

Getting More Power. The amplifier can provide 30 watts of output power into a *monaural* load for 4- or 16-ohm speakers. For 4-ohm speakers, simply parallel the inputs and outputs. For 16-ohm speakers, a bridge configuration can be used as shown in the simplified schematic of Fig 4. Note that a 22,000-ohm resistor must be connected from pin 4 of the channel B driver IC to the junction of C4 and R3 in the channel A circuit. Also, channel B's input must be grounded at the input jack J1B. Connect a 16-ohm speaker directly across the "hot" sides of jacks J2 of both channels.

With the system wired as shown in Fig. 4., the second amplifier channel is driven out-of-phase with the IC1 channel. This doubles the voltage across the speaker load, and thus

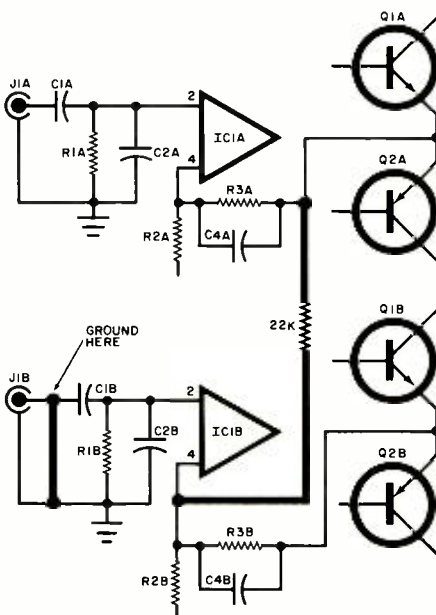

Fig. 4. Additional connection shown in bold will drive the amplifier, in bridged mode, giving 30 W rms (monaural) into 16 ohms.

quadruples the power into the load. However, the output transistors cannot handle this much power. By doubling the load impedance to 16 ohms, however, power is merely doubled to 30 watts. This is well within the power rating of the audio transistors.

Output power from each channel in this OTL (output-transformerless) circuit is limited by the maximum supply

potential rating of ± 22 volts for the NE540 IC. However, if you can obtain the SE540 version of this IC, you can raise the clipping power level by about 15%. To do this, the supply voltage must be increased to ± 27 volts by adding four turns to the secondary winding of T1.

Using the Amplifier. The low-level outputs of most tape decks and tuners can directly drive the amplifying system. However, if you tap the signal at the speaker output jack, the attenuator network consisting of R4 and R5 must be used on each input to reduce signal amplitude to a reasonable level. A good choice of values for R4 and R5 would be 10,000 and 1000 ohms, respectively. These values can be varied according to the output level of the tape player or radio used.

If the driving signal is taken from across a volume control, the attenuator network can be eliminated altogether. But if the attenuator is used in this situation, put a coupling capacitor in the input line to avoid placing too heavy a dc load on the source and to prevent upsetting bias levels.

The pc board for the amplifier (Fig. 2) has provisions for installing R4 and R5. If you do not need the attenuator, connect the input line directly to one of the free holes on the board common with C1.

Because the amplifier uses feedback, it is possible that "parasitic" oscillations may occur at a few hundred kilohertz. Although they are inaudible, these oscillations can affect quiescent bias conditions, and thus increase distortion. If you suspect the amplifier is oscillating, install a suppressor (a single layer of No. 24 wire wrapped on a 10-ohm, 1-watt resistor) between the emitters of the complementary pair, Q1 and Q2, and the fuseholder for F1. The suppressor will not affect audio response in any way.

Much ignition noise pickup can be eliminated by bolting the amplifier right to the radio receiver or vehicle chassis. This will also prevent ground-loop currents from getting into the amplifier; but it will probably not be necessary if a high-level input is fed to the attenuator network. When used with an AM receiver, the amplifier must be shielded or located several feet away from the receiver. Otherwise harmonics of the switching frequency of the power supply will get into the receiver's i-f section. ♦



TALK OVER A SUNBEAM WITH A "PHOTOPHONE"

Modernized version of Alexander Graham Bell's sunlight communicator provides some 1880 electronics nostalgia—that works.

A LITTLE-KNOWN fact about the inventor of the telephone is that Alexander Graham Bell considered an electro-optical communicator he called a "Photophone" to be his greatest invention, greater even than his telephone. In 1880, Bell and Sumner Tainter communicated by voice over a beam of reflected sunlight. This was 19 years before A. Frederick Collins conducted the first feeble voice transmissions over a distance of three blocks in Narberth, Pennsylvania. So, the first "wireless" voice transmissions were *not* by radio, as history would have us believe.

Compared to the power-hungry radiotelephone medium developed 25 years after Bell's discovery, the Photophone was an elegantly simple technological marvel.

Bell and Tainter succeeded in developing more than 50 ways of voice-modulating a beam of light, including variable-polarization schemes used today in sophisticated laser communication systems.

Photophone Details. The simplest of Bell's and Tainter's modulators

consisted of a small flat mirror cemented to a hollow cylinder. Voice energy directed into the open end of the cylinder caused the surface of the mirror to flex in step with the speech patterns. By shining a continuous beam of light onto the mirror's surface, a variable beam impressed with the voice modulation was produced.

Most of the light-beam receivers used with the Photophone employed selenium detectors. (In 1873, it was discovered that the resistance of bulk selenium changed in response to varying light intensity.) It was after Bell had read about selenium experiments that, in 1878, he conceived his Photophone idea.

One of Bell's detectors consisted of a circular array, while another consisted of a cylindrical array of selenium cells. The first was designed to be used with a collector lens, while the latter was designed to be used with a parabolic reflector. Both detectors were connected in series with a battery and a telephone receiver to make up the receiving equipment for the Photophone.

On April 1, 1880, Tainter voice-

modulated a beam of sunlight from a mirror and talked to Bell over a 699-ft (213-m) range. After this, Bell made optimistic predictions about the future of his Photophone, none of which materialized during his lifetime. In fact, shortly after Bell's death, in 1921, the Photophone was used mainly in a few military applications. Bell was criticized and even mocked for his opinions and predictions. Today, as we are poised on the threshold of large-scale light-beam communication, the inventor has been vindicated. In short, his predictions after all these years are finally materializing.

Build a Photophone. Bell's sunlight communication experiments can easily be bettered and duplicated with modern solar cells and audio amplifier modules. You can start with Bell's simple mirror-and-cylinder transmitter. An excellent choice for this purpose is the \$1.65 Cat. No. 30,626 mirror from Edmund Scientific Co. (300 Edscorp Bldg., Barrington, NJ 08007). This mirror measures 25 mm in diameter and nicely mates with a 1" (25.4-mm) diameter tube.

Cut the tube to a length of about 2" (50.8-mm). Then, use white glue to cement the mirror to one end of the tube. Make certain that the aluminized surface of the mirror is facing outward to obtain best results. (You can determine which is the mirror's aluminized surface by touching both surfaces with the point of a pencil and observing the reflections. The side that shows no gap between the real and image points is the aluminized surface of the mirror.) True, the uncoated surface of the mirror is more resistant to scratches and abrasion, but if this surface faced outward, 5% less light would be reflected, which means you would have a shorter communication range.

The Photophone receiver can be as simple as a single silicon solar cell connected across the input of an inexpensive audio amplifier module (see Fig. 1). Of course, the larger the active area of the cell the better the results.

A convenient housing for a basic receiver can be had by modifying a flashlight, such as the Burgess "Dolphin."

BILL OF MATERIALS

Transmitter:

- 1—25-mm diameter mirror (see text)
- 1—2"-3" length of 1" outer-diameter rigid tubing
- White glue

Receiver

- 1—16" diameter parabolic mirror (see text)
- 1—Audio amplifier module (Radio Shack No. 277-1240 or similar)
- 1—Miniature 8-ohm loudspeaker
- 1—10,000-ohm potentiometer with spst switch
- 1—2 × 2-cm silicon solar cell
- 1—9-volt battery
- 1—Miniature phone plug and jack
- 1—17" × 17" piece of 1/2" plywood (rear panel)
- 2—17" × 3" pieces of 1/2" plywood (side panels)
- 2—16" × 3" pieces of 1/2" plywood (top and bottom panels)
- 2—3" lengths of 3/4" × 3/4" pine (cabinet feet)
- 2—3" × 1 1/2" pieces of 1/2" plywood (door legs)
- 1—12" length of 1 1/2" × 3/8" piece of hardwood lumber (detector arm)
- 1—3" length of 1 1/2" × 3/8" piece of hardwood lumber (detector arm)
- 1—1 1/2" length of 1 1/2" × 3/8" piece of hardwood lumber (detector arm)
- 1—6" length of 1" × 1" pine (door-opener block and mirror retainers)
- 1—16" length of 1/4"-diameter hardwood dowel (door opener and solar cell)
- 5—Metal hinges (doors and detector arm)
- 1—Drawer pull (cabinet handle)
- 1—Hasp and lock or hook and eye
- Misc.—Flat black and white enamel paint; resilient foamed plastic; white glue; #6 machine hardware; 1" finishing nails; vinyl electrical tape; battery clip and battery holder; metal spacers (4); stranded hookup wire; solder; etc.

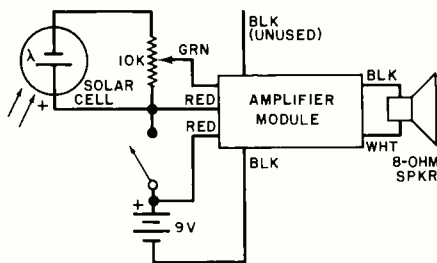

Fig. 1. Schematic diagram of a simple Photophone receiver.

This flashlight's built-in reflector is an ideal place for mounting a pair of solar cells because it would reflect far more light onto the cells than would be possible if the cells were used by themselves.

Mount two solar cells, back-to-back and connected in series with each other, by their leads with their plane lying along the axis of the reflector. Focus the detector by adjusting the mounting leads while observing their reflections. When the dark surfaces of the two cells fill the entire area in the reflection, the cell detector is properly aligned.

Getting Greater Range. The Photophone receiver described above will have a range of up to 550' (168 m). For really long-range communication by sunlight, you can use a large Fresnel lens or parabolic mirror to increase the optical gain of the receiver's detector. A 16" (40.2-cm) reflector—complete with detector, amplifier, battery, and loudspeaker—is shown in a plywood cabinet in Fig. 2. This receiver can pick up good-quality voice and music from as far away as a half mile. Increasing the transmitter's mirror as well, will increase the communication range even more.

You can duplicate this receiver by following the construction details given in Figs. 3 and 4. Make the cabinet from 1/2" (1.27-cm) thick plywood, but don't install the doors until later. Paint all inside surfaces of the cabinet flat black and all outside surfaces white enamel. The black in the interior reduces stray light reflections, while the white exterior makes for good visibility during alignment.

The 16" parabolic mirror is available from Edmund Scientific for \$14.25 as Cat. No. 80,097. It is aluminized on its rear surface, which prevents it from being a perfect reflector. But its 1/2" circle of reflected light at the focal point is about the same size as the

photocell, which at least partially makes up for the shortcoming.

Four wood retainers hold the mirror in place inside the cabinet. After cutting these retainers to size, use white glue to cement strips of resilient foamed plastic along one entire narrow face of each. Then, while the glue is setting, locate and drill the mounting holes for the retainers. By this time, the glue should have set. Paint each retainer block—not the foamed plastic—flat black and let them dry.

Meanwhile, mount a pair of pine legs on the bottom of the cabinet. Install the carrying handle on the top of the cabinet, and use white glue to cement a 1"-square piece of resilient foamed plastic in the center of the inside rear wall of the box.

Mount the hinges on the cabinet's doors. Carefully align the doors with the front edges of the side, top, and bottom panels, and mark the locations of the remaining hinge holes. Remove and set aside the doors and drill the holes at the points indicated.

Now, lifting the mirror only by its edges, carefully position it in the cabinet. Mount the four retainer blocks in place with their foamed surfaces against the mirror's edge. The foamed plastic should be lightly compressed, holding the mirror firmly but gently in place, when all four retainers are fastened down with machine hardware. Once the mirror is in place, exercise care when working around it. Always place a thick bath towel or a blanket over the mirror when you are working on the cabinet.

The detector used in this receiver should be a single 2 × 2-cm silicon solar cell mounted at the end of a hardwood dowel (see Fig. 4) that plugs into a two-section arm made from

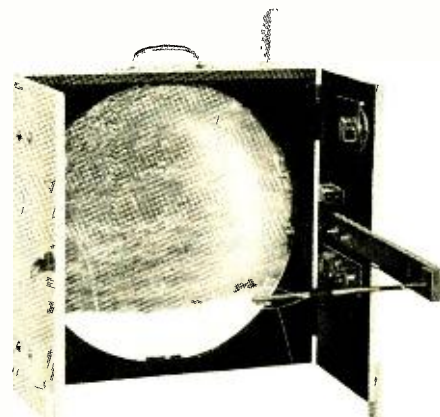
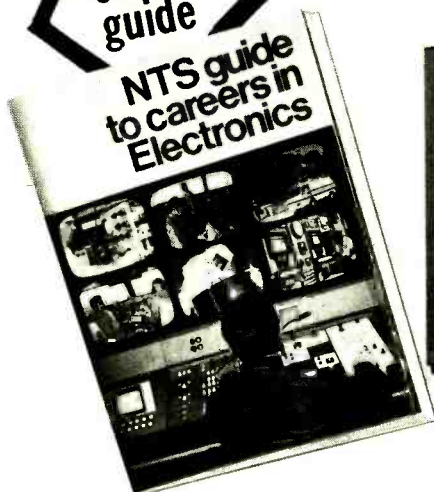

Fig. 2. This receiver can pick up good signals as far as 1/2 mile.

The better the training the better you'll

Send for
FREE
illustrated
career
guide



IN-CIRCUIT TRANSISTOR TESTER
TROUBLESHOOTER
VOM

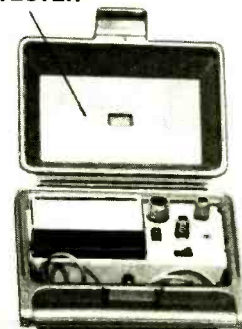
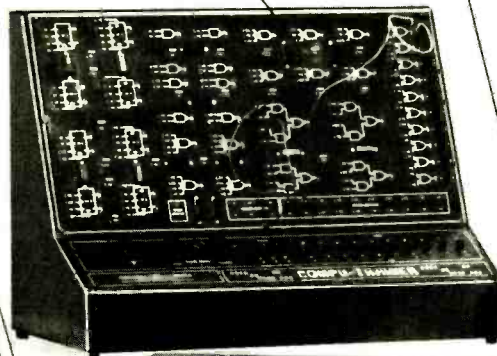

SOLID-STATE
OSCILLOSCOPE

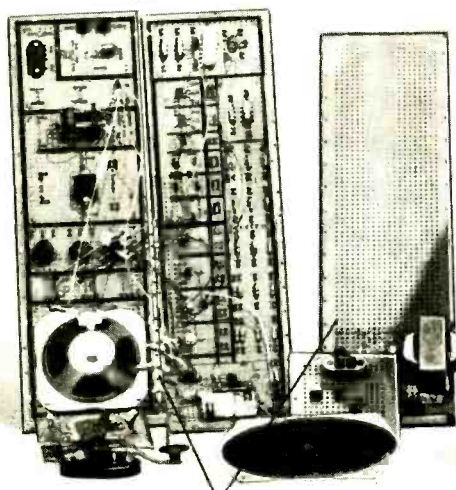

ELECTRO-LAB

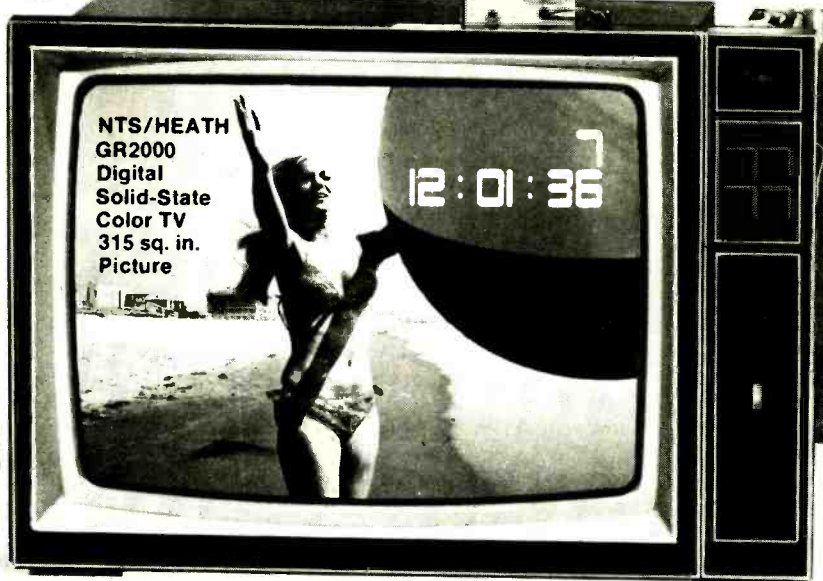

(Simulated TV Reception)

As an NTS student you'll acquire the know-how that comes with first-hand training on NTS professional equipment. **Equipment you'll build and keep.** Our courses include equipment like the **NTS/Heath Digital GR-2000 Solid State color TV** with first-ever features like silent varactor diode tuning; digital channel selection, (with optional digital clock), and big 315 sq. in. ultra-rectangular screen.

Also pictured above are other units — 5" solid state oscilloscope, vector monitor scope, solid-state stereo AM-FM receiver with twin speakers, digital multimeter, and more. It's the kind of better equipment that gets you better equipped for the electronics industry.

This electronic gear is not only designed for training; it's field-type — like you'll meet on the job, or when you're making service calls. And with NTS easy-to-read, profusely illustrated lessons you learn the theory behind these tools of the trade.

Choose from 12 NTS courses covering a wide range of fields in electronics, each complete with equipment, lessons, and manuals to make your training more practical and interesting.

Compare our training; compare our lower tuition. We employ no salesmen, pay no commissions. You receive all home-study information by mail only. All Kits, lessons, and experiments are described in full color. Most liberal refund policy and cancella-

and the equipment be equipped.

**COMPARE OUR
KITS AND LESSONS.
COMPARE OUR
TUITION.**

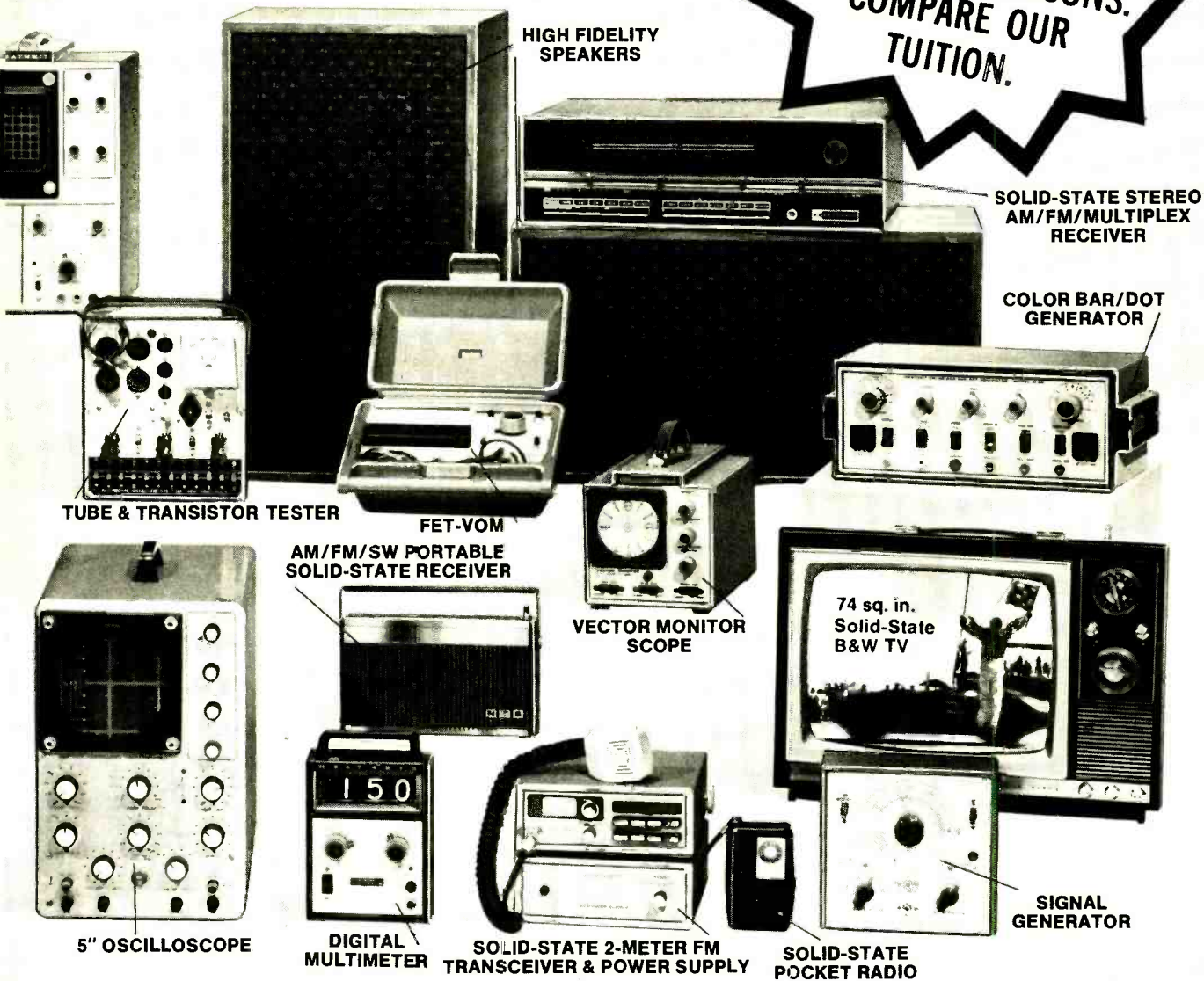

tion privileges spelled out. Make your own comparisons, your own decision. Mail card today, or clip coupon if card is missing.

NO OBLIGATION. NO SALESMAN WILL CALL

APPROVED FOR VETERAN TRAINING

Get facts on new 2-year extension

NATIONAL TECHNICAL SCHOOLS

TECHNICAL-TRADE TRAINING SINCE 1905
Resident and Home-Study Schools
4000 So. Figueroa St., Los Angeles, Calif. 90037

NATIONAL TECHNICAL SCHOOLS Dept. 205-026
4000 South Figueroa St., Los Angeles, Calif. 90037
Please send FREE Color Catalog and Sample Lesson.
NO OBLIGATION. NO SALESMAN WILL CALL.

Color TV Servicing
 B & W TV and Radio Servicing
 Electronic Communications
 FCC License Course

Electronics Technology
 Computer Electronics
 Basic Electronics
 Audio Electronics Servicing

NAME _____ AGE _____

ADDRESS _____ APT # _____

CITY _____ STATE _____

Please fill in Zip Code for fast service _____

Check if interested in G.I. Bill information.
 Check if interested ONLY in classroom training in Los Angeles.

hardwood stock and hinged at the joint. (The arm is in two sections so that it can be folded to permit the doors to close without obstruction.)

Strike a pencil line down the length of the long arm section, centering it on the wide side. Then strike cross lines 1" from one end, and three more lines spaced 1 1/4" (32 mm), 2" (51 mm), and 3 1/4" (83 mm) from the first cross line. At each line crossing, drill a 3/16" (4.76-mm) hole through the wood. Then use a router, coping saw, or wood chisel to remove all the wood between the first and second and third and fourth holes, making the slots only as wide as the diameter of the original holes.

Butt together the two arm pieces as shown and mount a small hinge at the joint. Use glue and finishing nails to mount a square wood block at the free end of the short arm section. Paint the entire arm assembly flat black. When the paint has dried, drill a hole through the block and arm section, connect 12" (30-cm) lengths of stranded hookup wire to the lugs of a miniature phone jack, and mount the jack in the hole.

After painting an 8 1/4" long by 1/4" diameter (21 cm x 6.35 mm) hardwood dowel flat black and allowing it to dry, mount the 2 x 2-cm silicon solar cell at one end with white glue. Solder stranded hookup wires to the cell's contacts at one end, and connect and solder the free ends of the wires to the lugs on a miniature phone

plug. Cut a groove in the side of the dowel to permit the plug's plastic cap to slide over the wire leads. Remove enough wood from the dowel at the end opposite the cell to permit it to be force-fitted into the end of the plug's cap. With a little care, the dowel will be locked into place when the cap is screwed onto the plug. Use black electrical tape to bind the wires to the dowel in a couple of places.

Mount the dowel-and-block assembly that holds the door open at the top of the right door. Position it so that it will not interfere with door closure, and use glue and finishing nails, the

Fig. 4. Construction of final section of detector arm, which is folded to permit door closing.

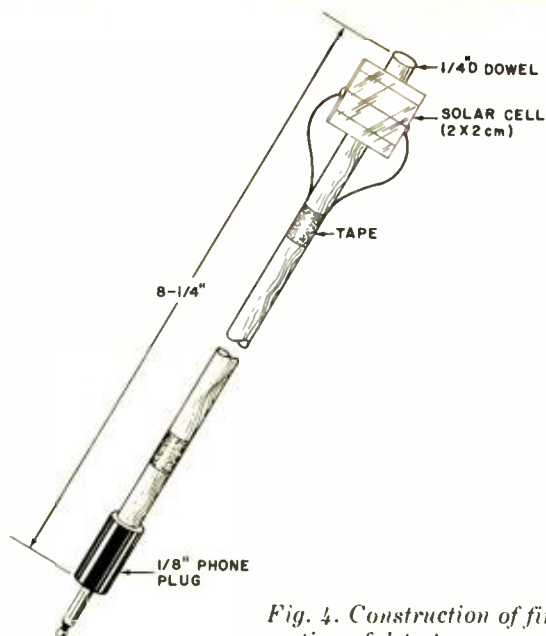

latter driven through the door panel into the block. Make sure the nails do not interfere with free movement of the dowel and the dowel moves freely in the block.

Locate and drill the holes for the detector arm as follows: First, strike a line across the panel midway between the top and bottom of the panel. Mount the door on the cabinet via its hinges. Slide the dowel in the block forward to lock the door open. Direct a strong beam of light on the mirror's surface. Now, plug the detector dowel assembly into the arm assembly and place the arm against the door panel. Center the slots in the arm over the line on the door. Standing out of the way of the light beam, move the arm closer to or farther from the mirror until the reflected light from the mirror just fills the detector cell's active surface area. Indicate on the door panel's line the points that mark the centers of the slots in the arm. Remove the arm, unplug the detector dowel assembly, and set both aside. Finally, drill a hole at each location indicated. Make the holes just large enough to require that you use a screwdriver to drive a pair of No. 6 x 1 1/2" screws into the holes.

Remove the door panel from the cabinet. Mount plywood legs on the front of both door panels. Then paint the panels, flat black on their inside surfaces and white enamel on their outside surfaces. When the paint has thoroughly dried, drill perforations for the speaker grille, and mount the speaker on the inside of the panel. Use a metal L bracket for the switched potentiometer and spacers for the

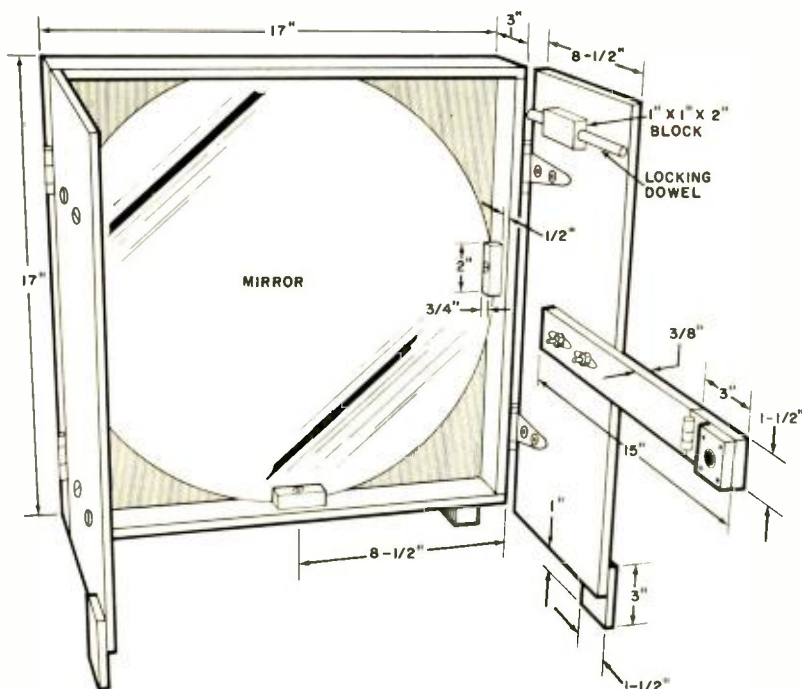

Fig. 3. Dimensions of the plywood cabinet for the Photophone. Mirror is held in place by wood blocks.

amplifier module when mounting them in place. Then refer back to Fig. 1 and interconnect all components.

Anchor the detector arm to the door with large flat washers and wing nuts. (The wing nuts will facilitate easy focusing of the receiver during field operation.) Bolt the doors to the cabinet with No. 6 machine hardware. Use large flat washers under all screw heads and nuts. Finally, install a hook and eye or lock and hasp on the doors to keep them closed when the receiver is not in use.

Range Testing. Start your testing by fastening the transmitter mirror assembly directly over the speaker of a small portable radio receiver. Aim the beam from the transmitter down a range of several thousand feet where it will not be obstructed. Take the receiver several hundred feet down-range and align its mirror with the transmitter's reflected beam. Plug the detector dowel assembly into the arm on the door and adjust the focusing for the best possible received signal. With proper beam alignment and receiver focusing, you should be able to

hear good-quality voice and music.

Continue to move the receiver away from the transmitter and make reception tests every 50' (15 m) or 100' (30 m) until the signal becomes too weak to "copy." Bear in mind that the earth's rotation will cause the sunlight reflected from the transmitter's mirror to move away from your original alignment point. So, you will occasionally have to adjust the transmitter's orientation to assure proper receiver/transmitter alignment. It helps if you can recruit one or two friends for the alignment procedure as distances can become quite great.

The maximum range of your system is dependent on the areas of the transmitter's and receiver's mirrors, overall gain of the receiver's amplifier, atmospheric condition, and angle of the sun in the sky. The last is of particular importance because high angles yield far more light intensity than do low angles. Offsetting this is the fact that at high angles, less of the transmitter's mirror surface is utilized than at the lower angles. Consequently, there is no way of predicting,

with absolute assurance, what the range of your system will actually be.

Some Modifications. The Photophone can be modified in a number of ways to make it perform better. For example, you can increase sensitivity by using light shields and baffles to cut out extraneous light reflections, or you can use a preamplifier to boost the signal level from the solar cell. A large Fresnel lens can also considerably improve receiver operation. Edmund Scientific's No. 70,717 (\$32.00) 24¾" × 19¼" (63 × 49 cm) lens has more than twice the collecting area and yields a smaller blur circle of light at its focus than does the 16" mirror.

By using an amplifier module, microphone, and 49-mm-square mirror (Edmund Scientific No. 41,619 at \$1.50 each) cemented to the cone of a 2" miniature speaker with white glue, you can put together an excellent voice transmitter that will greatly increase the range of your system.

There are many more possible modifications you can use. With a little ingenuity, you can push the range of your system out to several miles. ♦

From:

Systems Research, Inc.

A MODULAR MICROCOMPUTER SYSTEM THAT
EVERYONE CAN AFFORD!!!
— THE SRI-500 SERIES —

SRI-F8 Microprocessor Board (Complete with 1K Words, RAM TTY Interface, and a special DEBUG program in ROM called FAIRBUG)	\$ 325
SRI-PWR Power Supply (+5V., +12V., -12V. Regulated)	\$ 55
SRI-CAS Cassette Interface Board	\$ 45
SRI-SER-C RS-232, Keyboard Interface and System Control Board	\$ 35
SER-VI-A Video Interface Board (32 char. x 16 lines, R. F. and Video out)	\$ 175
SER-KBD Keyboard Assembly	\$ 100
SER-RAM-2 2K Words RAM Board (Additional Memory)	\$ 100
SRI-ENC Enclosure (Complete with main board, switches and rear panel connectors)	\$ 100

NOT A KIT - COMPLETELY ASSEMBLED AND TESTED

We supply complete software support and offer many options . . .

CALL OR WRITE FOR FREE INFORMATION

(801) 942-1093

Systems Research, Inc.

P.O. Box 151280 · Salt Lake City, Utah 84115 · (801) 942-1093

CIRCLE NO 56 ON FREE INFORMATION CARD

ELECTRONIC SWITCHING WITH TRANSMISSION GATES

CMOS device provides "bouncelless" switching at speeds to 10 MHz.

BY ROBERT D. PASCOE

LOW-LEVEL analog or digital signals must often be switched between various circuits at high speed.

In such cases, a simple electromechanical switch, such as a relay or reed switch, must generally be

avoided because of the inherent contact bounce and long switching time.

The practical answer to electronic switching requirements can be found in the type 4016 "bilateral switch" or transmission gate (TG). This is a unique form of logic found only in the CMOS family of devices. A high-speed, solid-state electronic spst switch, it can transfer ac or dc voltages or currents in either direction. It can switch at speeds up to 10 MHz, which is compatible with most modern digital systems. Although the TG's "on" resistance (300 ohms) is not the ideal short-circuit condition, its "off" resistance is extremely high. With a characteristic input resistance of 10^{12} ohms, it will not load down the switching source.

Theory. The symbol for a transmission gate is shown in Fig. 1A, while Fig. 1B illustrates the basic action of the device, similar to a relay contact which is closed when the CONTROL

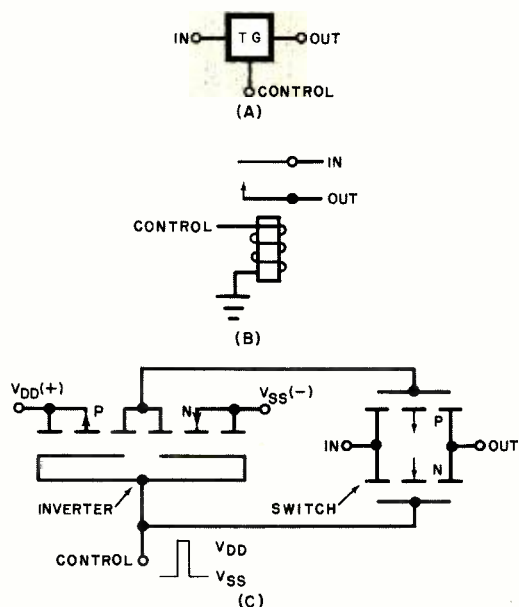

Fig. 1. Symbol (A), mechanical analog (B), and schematic (C) of a transmission gate. When control input is high, switch is turned on.

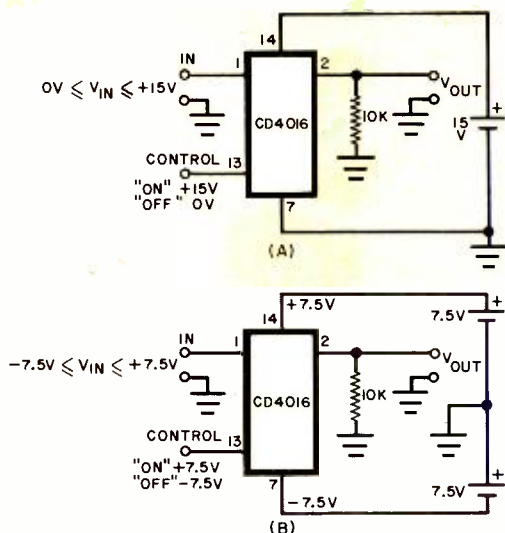

Fig. 2. The TG can switch positive dc signals (A) or bipolar signals (B), depending on power supply used.

input is high. The actual circuit for the TG, using enhancement FET's, is shown in Fig. 1C.

Note in Fig. 1C that, between the input and output terminals of the TG, there are an n-channel and a p-channel MOSFET. The gates of these MOSFET's are connected to the input and the output of an inverter. To turn on the TG, the CONTROL voltage should approximately equal V_{DD} . Conversely, to turn off the TG, the CONTROL voltage should be approximately V_{SS} .

The 4016 contains, in a 14-pin DIP assembly, four spst-type switches. Each switch has an "on" resistance of about 300 ohms over a 15-volt input-signal range, dependent on the values of V_{DD} and V_{SS} . The leakage current when the switch is off is about 10 pA, which is a result of its very high "off" resistance. The 4016 has an allowable control (clock) rate of 10 MHz, with a turn-on time of approximately 20 ns. As the recommended dc supply voltage is 3 to 15 volts, the input signal level must not exceed these values.

The 4016 can be used to switch positive dc or bipolar voltages as shown in Fig. 2. A peak potential of 15 volts (maximum) can be switched by the circuit shown in Fig. 2A. In this circuit, a single supply is required, with the V_{SS} terminal connected to ground. The Fig. 2B circuit illustrates how bipolar signals can be switched. Here, a split supply is used with the V_{DD} terminal at +7.5 volts and the V_{SS} terminal at -7.5 volts. In this case, the maximum input signal level can be 15 volts peak-to-peak. Note that in both circuits of Fig. 2, the control voltage is equal to V_{DD} for the "on" condition

and to V_{SS} for the "off" condition. For most applications, the load resistance should be 10,000 ohms or greater. A maximum input signal frequency response of 40 MHz is attainable with V_{DD} at +5 volts and V_{SS} at -5 volts.

Switch Configurations. Because the 4016 contains four independent bilateral switches in one package, the individual switches can be arranged to function as a variety of switch types similar to the electromechanical switches for which they can be substi-

tuted. Two such arrangements are shown in Fig. 3. A pair of TG's can be wired to form a spdt switch as in Fig. 3A. Two such switches can be obtained from a single 4016. The control signals are out of phase as denoted by the line over one. This permits a conventional flip-flop to drive the switches.

The diagram in Fig. 3B illustrates how four TG's can be arranged to act as a dpdt switch. Again, the control inputs are driven out-of-phase in pairs, permitting the same flip-flop hookup.

Dual-Trace Converter. A dual-trace adapter for single-trace oscilloscopes is shown in Fig. 4. Besides the TG's, the circuit employs a 4001 quad-NOR IC as a multivibrator and phase inverter and a 536 operational amplifier IC.

This is a version of the principle of "time division multiplexing" in which each input of a two-channel system is coupled to the common output for a specific period of time, with the other channel shut off. The two channels alternate in supplying the output depending on the rate of the two-phase clock driving the multiplexer.

The op amp in this circuit is arranged as a summing amplifier. When one pair of TG's is on, it sums both the signal and the dc level determined by

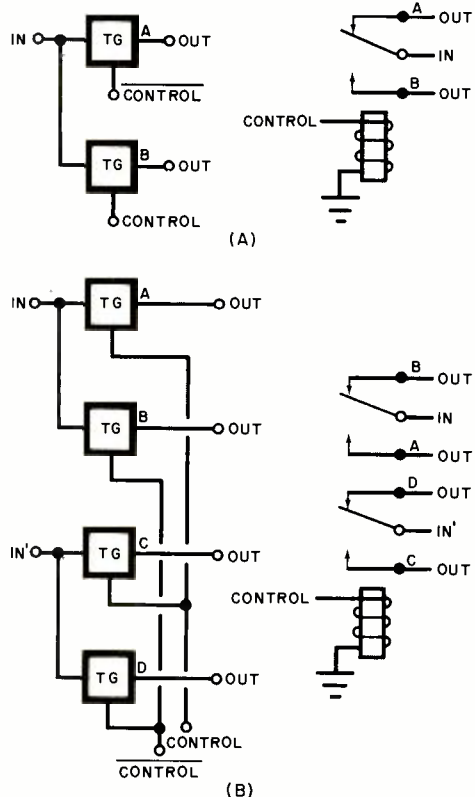

Fig. 3. Spst gates can be ganged for more complex switching circuits, such as spdt (A) or dpdt (B).

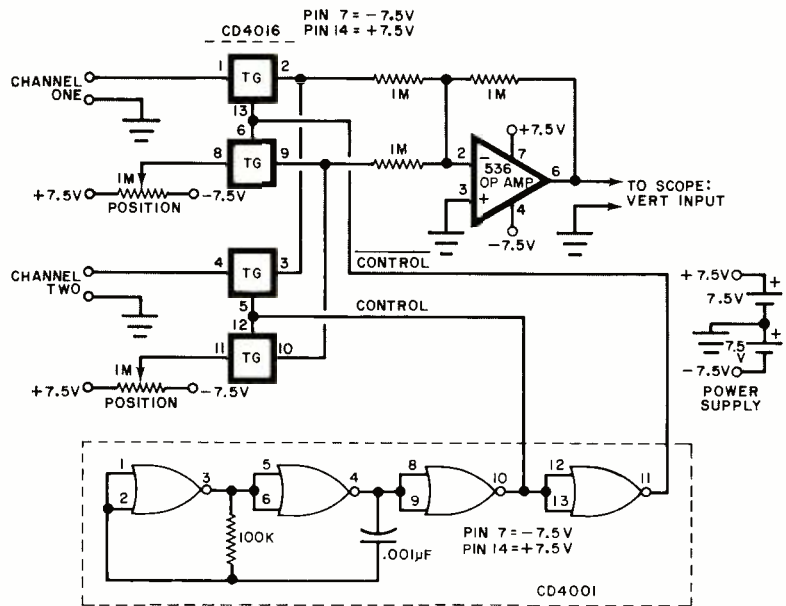

Fig. 4. TG's driven by a 2-phase clock time-multiplex vertical input.

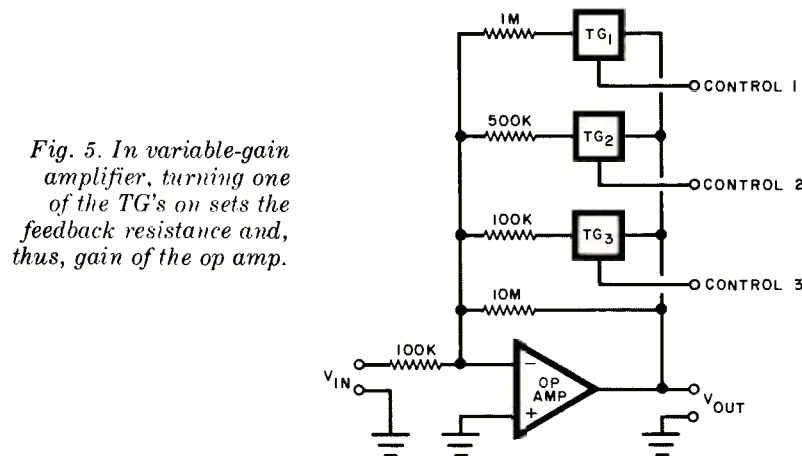

Fig. 5. In variable-gain amplifier, turning one of the TG's on sets the feedback resistance and, thus, gain of the op amp.

the POSITION control. This level determines where on the face of the scope's CRT that particular trace will be displayed. This basic approach is very similar to that used in commercial dual-trace scopes. You can vary the frequency of the clock oscillator so that it is not related to that of the input signal, thus avoiding a broken pattern.

Variable Gain Amplifier. Another application for the bilateral switch is shown in Fig. 5. The circuit is a basic op amp whose gain is determined by the ratio of the feedback to the input resistance. With none of the TG's on, the only feedback is through the 10-megohm resistor, to provide a gain of 100. (Note: This circuit is a phase inverter.)

If TG1 is on and TG2 and TG3 are off, the total feedback resistance is 10 megohms paralleled by 1 megohm, producing a gain of 10. With TG2 on

and TG1 and TG3 off, the total feedback resistance of 500,000 ohms produces a gain of 5. Hence, the gain of

the op amp is determined by which TG's are on and which are off.

Squelch Circuit. A simple squelch circuit can be built with the aid of the bilateral switch as shown in Fig. 6. The audio input signal is peak detected by D1, whose output drives a voltage-follower op amp. The output of the follower is averaged by the parallel RC circuit (5 µF and the 1-megohm potentiometer) and drives the noninverting (+) input of the second op amp connected as a comparator.

The level of the squelch is determined by the setting of the SQUELCH ADJUST potentiometer. If the voltage at the inverting (-) input of the comparator is greater than the voltage on the noninverting input, the comparator's output is almost at the maximum negative supply voltage. This signal keeps the TG off so that the audio input signal will not pass through to the audio amplifier.

If the averaged signal produces a voltage at the noninverting input of the comparator greater than that supplied to the inverting input, the output of the comparator swings to the maximum positive power supply level. This action turns on the TG and allows the received audio to pass to the amplifier. The off delay (up to several seconds) is determined by the time constant of the RC circuit.

Closing Comment. In this article, we have covered only a very small fraction of the possible applications for the versatile transmission gate. With a knowledge of what the TG can do, you can create many new applications for this unique solid-state switch. ♦

Fig. 6. A sufficiently strong signal in squelch circuit will cause the comparator to turn on the TG, to drive amplifier.

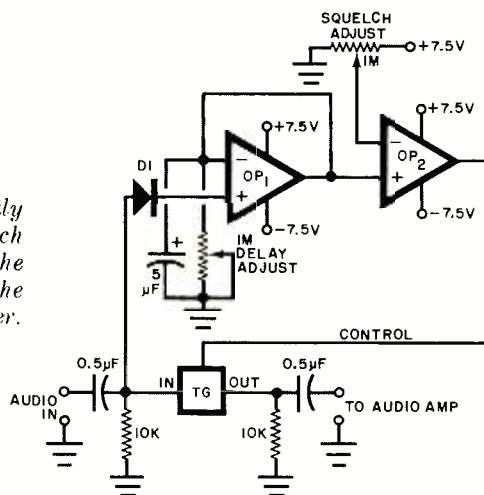



MAC'S SERVICE SHOP

DUMMY ANTENNAS FOR HAMS AND CB'ERS

By John T. Frye, W9EGV

"HEY, boss, what are you doing with that crazy paint bucket?" asked Barney as Mac came through the door of the service department carrying a shiny black gallon bucket with printing, a diagram, and a chart emblazoned in white on the side.

"Watch your tongue," Mac said; "you're speaking of my new, almost-finished Heathkit 'Cantenna,' Model HN-31, RF Load Resistor."

"Pardon me!" Barney replied with exaggerated contriteness, "but I thought you used a foot-long, war-surplus, noninductive resistor for a dummy load."

"I do, but I'm already overloading it with just the hundred-watt key-down output from my ham SSB exciter. I don't dare put the output of the linear amplifier, which runs about seven times that, to the resistor. It would go up in smoke. This cantenna, however, is rated at a kilowatt ICAS and will take the 700 watts continuously for fifteen minutes—plenty long enough to melt down the final tubes in a SSB transmitter. Any owner of a SSB transmitter who sits on the key for even a tenth of that time is just plain stupid."

"You really think a dummy antenna is needed, huh?"

"Do!! I believe no ham or CB operator should be issued a license unless he possesses and uses a dummy antenna to load up his transmitter for testing. Putting an unmodulated carrier on the air for minutes at a time or performing unidentified testing is not only illegal but it stamps the

perpetrator as a 'lid of the first water,' who has a total disregard for others."

Why Use a Dummy Load? "There are other sound reasons for using a nonradiating load resistor. For one thing, almost all service literature requires that the transmitter be connected to a good dummy antenna at the proper impedance when testing. Results obtained with a mismatched or reactive load are at best meaningless and, at worst, quite likely to cause damage. Moreover, with a good dummy antenna you can establish a reference standard of performance. As soon as I finish the Cantenna, I plan to feed it with the exciter barefoot and then through the linear amplifier at a selected logged frequency on each band. In each case, I'll tune for maximum output and then log grid current, plate current, tank and load capacitor settings and relative voltage reading as indicated by the Cantenna's monitor circuit, which I'll discuss later. If I question performance at some future date, I can compare new readings with those I logged to see if anything has changed. If it has, I'll have some very helpful clues as to where the trouble lies."

"What makes a good dummy antenna?"

"First, it should present an accurate, unchanging, purely resistive load—usually 50 ohms—to the transmitter under a wide range of frequencies and power outputs. The load resistor should be shielded to prevent radiation, and capable of absorbing the maximum output of the transmitter at 100% duty cycle for a reasonable length of time. AM and full-power tune-up represent 100% duty cycle; CW, 50%; SSB, 33%. The dummy antenna should connect to the transmitter through coaxial cable and a coaxial antenna switch so the transmitter can be switched quickly from the antenna to the dummy load, and vice versa. Finally, it's helpful if the dummy antenna incorporates some method of indicating at least relative r-f input. Ideally, it will indicate actual wattage

being absorbed and dissipated by the resistor."

"Those requirements eliminate a lot of things," Barney observed. "For instance, a 100-watt incandescent bulb can take a full 100 watts of r-f indefinitely and translate it into radiated light and heat, but its resistance changes from 10 ohms when cold to about 144 ohms at its normal operating temperature. You can imagine what happens to the resistance when you're pumping an SSB signal into the filament. Carbon resistors are very limited in the power they can absorb without damage. Wirewound resistors have inductance. But hey, how about giving me a peek at that granddaddy kilowatt resistor inside the bucket? I don't think I ever saw anything bigger than a couple of hundred watts wirebound."

Smiling, Mac pried up the bucket lid with a screwdriver and set it upside down on the bench. Barney saw a 5" x 11½" aluminum tube fastened vertically to the bottom of the lid with two brackets that held the top of the tube about 1½" (3.8 cm) below the bottom of the lid. Inside the tube was a 5" (2.7 cm) film-type resistor on a hollow ceramic form ¾" (1.9 cm) in diameter. Silver-plated copper contact straps were bolted around the silvered ends of this resistor, which was centered in the bottom of the tube by four triple-nutted brass bolts. The bolts also made firm contact with the bottom strap. The top strap clamped the open ends of a U-shaped silver-plated bracket against the silvered contact surface. The center of this bracket was connected to a porcelain feed-through insulator that went through the lid into a metal box on the top.

"You mean to tell me that little resistor can dissipate a kilowatt?" Barney asked in disbelief.

"It can and will when I fill this bucket with non-conducting, high-temperature transformer oil. Much of the heat of the resistor will be transferred to the oil circulating around and through the resistor, effectively increasing the dissipation capacity at least a hundred fold."

"Why is the resistor inside the metal tube?"

"Two reasons: first, the diameter of the tube is proportioned to the diameter of the resistor so the combination submerged in oil has a surge impedance equal to that of a 50-ohm coax line. What we then have is a continuation of the coaxial cable with the resis-



Heathkit Cantenna presents a 50-ohm resistive load to the transmitter.

tor serving as the center conductor of the last five inches of the cable. Incidentally, if this were a solid bar instead of a film type resistor, the r-f resistance would increase with frequency because the current would concentrate on the surface. That's why film resistors are used almost exclusively in dummy loads.

"The second reason for the resistor-in-a-tube combination is that it forms a 'thermal siphon' in the oil. Oil heated by the resistor expands, rises, and flows out the top of the tube. This pulls cool oil from the bottom of the bucket into the bottom of the tube. Heated oil rising to the surface spreads out radially and contacts the air-cooled walls of the bucket, where it gives up some of its heat and sinks to the bottom. All this creates a "closed-loop fountain" in the oil that aids in cooling the resistor."

"What's in that little box on the lid?"

"It carries the fitting for attaching the coax cable from the transmitter and also houses the components of the relative voltage monitoring circuit shown on this diagram on the side of

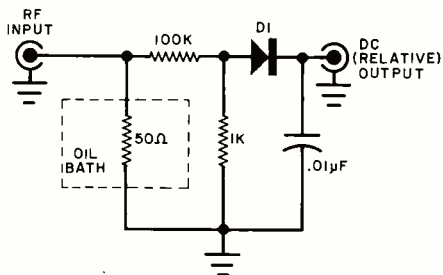

Power is dissipated by resistor in oil bath, while other components form a dc sampling circuit.

the bucket. A voltage divider across the r-f load resistor feeds a small fraction of the r-f voltage to a germanium diode for rectification. The 0.01- μ F capacitor smooths the rectified signal which can then be measured with a VTVM or other high-impedance meter connected to the phono jack on the end of the box. Any change in r-f across the load resistor is reflected as a change in dc output. This permits a transmitter to be tuned for maximum output."

Output Wattage. "Can't you calculate transmitter output wattage from the meter reading?"

"No, because the resistive voltage divider is frequency sensitive. The reading goes up with frequency. This occurs because the carbon composi-

tion resistors in the divider tend to exhibit stray reactance. A capacitive divider, on the other hand, remains purely capacitive for a wide frequency range, and most Bird Termaline[®] wattmeters are designed with capacitive dividers."

"How did the birds get into this conversation?"

"The Bird Electronic Corporation of Cleveland is a leading manufacturer of coaxial load resistors, r-f absorption and directional wattmeters. Their dummy antennas, called Termaline Coaxial Load Resistors, come in sizes all the way from 2 watts to 50 kilowatts. These are precision, laboratory-grade instruments and are priced accordingly. While the low-cost Cantenna—which I consider adequate for most ham and CB use—is claimed to have a VSWR of less than 1.5 up to 300 MHz and less than 2.0 up to 400 MHz, a comparable air-cooled, liquid-dielectric Bird unit rated at 1 kW *continuous duty*, has a VSWR of 1.1 up to 1 GHz and only 1.25 up to 2.5 GHz."

"How does Bird do it?"

"They start with a special high-precision film resistor that will maintain its 50-ohm value through all rated temperatures and frequencies. Instead of being a cylinder, the resistor shell tapers in a logarithmic fashion from the full diameter of the line at the top to only the diameter of the resistor at the bottom, where the two meet. A wave traveling down the line sees 50 ohms at the top of the resistor, 25 ohms at the center, and 0 ohms at the bottom. To insure a frequency-

independent termination, the shell must be matched to the resistor at any point along its length. The shell is filled with a heat-conducting dielectric and is equipped with external heat-radiating fins. By combining a form of r-f voltmeter calibrated directly in watts with a coaxial load resistor, Bird forms their series of Termaline R-F Absorption Wattmeters.

"Bird makes load resistors that are dry-air cooled, air cooled with a liquid dielectric, cooled with forced air, and water cooled. Their absorption wattmeters operate from 2 to 500 MHz. They have Thruline[®] directional wattmeters that will read forward and reflected power at any point in a feed line.

"Now let me tell you how you can measure transmitter output with a Cantenna or similar dummy load. Connect the vertical deflection plates of a scope (already calibrated in peak-to-peak volts per inch deflection) across the line feeding the dummy load. Once you know the sine-wave p-p volts across the dummy load, convert this to rms volts by multiplying by 0.3535. Square this, and divide by 50 ohms to get the power in watts. For example, my exciter gives me 200 volts p-p, or 70.7 volts rms. The square of this is 4998—let's call it 5,000—and 5,000 divided by 50 is 100 watts. It's no coincidence this is the rated output of the exciter."

"I've just reached a conclusion," Barney announced with a sigh; "there's nothing dumb about dummy antennas!"

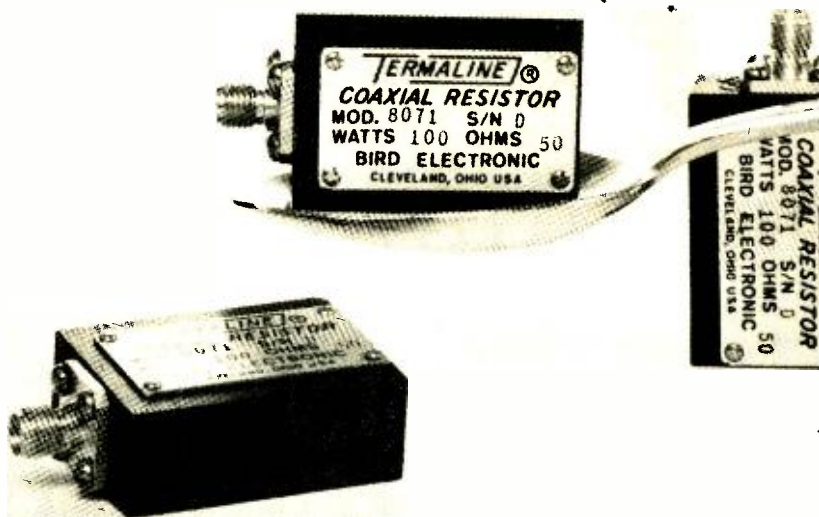

Bird's small dummy load can handle up to 100 watts from dc to 2 GHz, when heat-sunked to equipment panel.

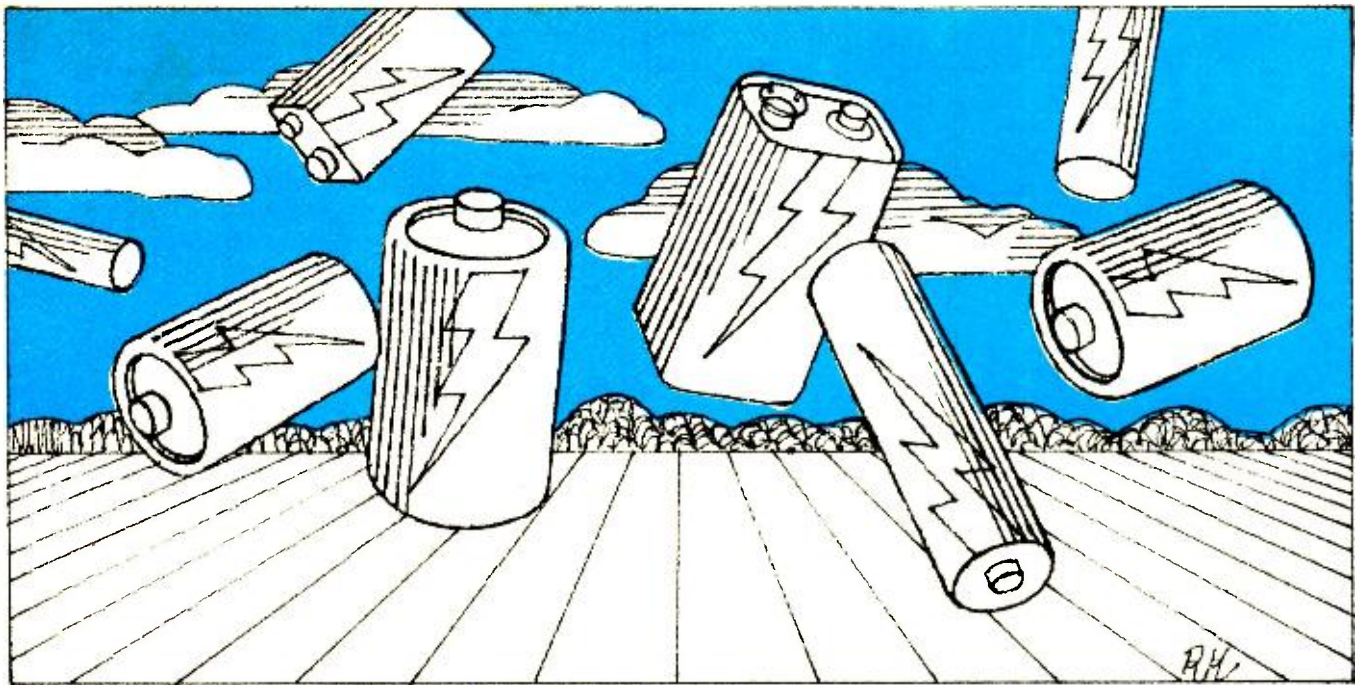

BUILD THE BATTERY MULTI-CHARGER

Inexpensive circuit rejuvenates four types of carbon-zinc cells simultaneously.

BY RALPH TENNY

THE Multi-Charger described here can often rejuvenate carbon-zinc batteries used in radios and flashlights. It handles between one and six cells charging four *different* types simultaneously.

The rejuvenating process used is not recharging in the strict sense. Though there is a very limited amount of reversible electrochemical activity (such as occurs in nickle-cadmium and lead-acid storage batteries), the action is primarily one of driving hydrogen bubbles from the anode rod. In this way, interrial cell resistance (the common cause of cell "failure") is reduced and operating lifetime is extended.

About the Circuit. The Multi-Charger consists of a bridge rectifier, two silicon diodes, six resistors, a

potentiometer, and a monolithic transistor array. The heart of the circuit is a constant-current source, two versions of which are shown in Fig. 1. Assume that a constant dc voltage is applied to the V+ bus (Fig. 1A). Current flows through D1, D2, and R2, generating a reference voltage at point X. Since the magnitude of this voltage is less than that at V+, Q1 is forward biased and collector current flows through the milliammeter. The amount of current can be set by potentiometer R1 to bias Q1 in an equilibrium condition. If the gain of Q1 is very high, this current will be well-regulated. So, if a potentiometer is placed between Q1 and the milliammeter, a more or less constant current will flow, regardless of the potentiometer's setting.

A similar constant current source is

shown in Fig. 1B. If a reference current (I_{REF}) is applied to the base and collector of Q2, it will flow through this transistor and R3, establishing a voltage drop across R3 and the base-emitter

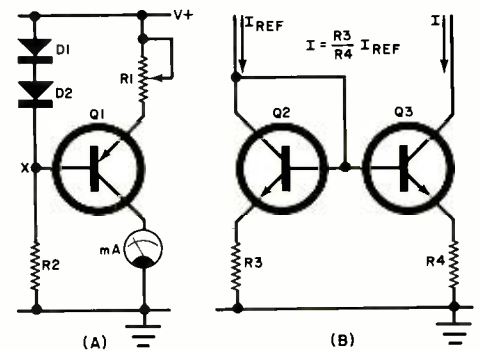
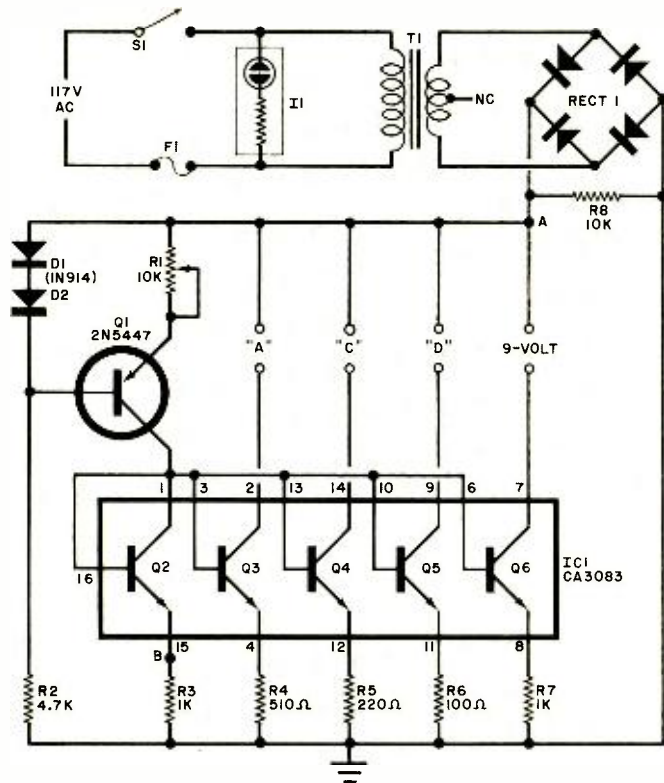

Fig. 1. In (A) reference voltage at X produces constant current in Q1. In (B) output I depends on reference current, R3, and R4.



PARTS LIST

D1, D2—Silicon signal diodes (1N914) or equivalent)
 F1—¼-amp fuse
 I1—Neon panel lamp assembly (Radio Shack 272-705 or equivalent)
 IC1—CA 3083 monolithic transistor array (RCA)
 Q1—2N5447, HEP S0019, or equivalent
 R1—10,000-ohm linear taper potentiometer
 R2—4700-ohm resistor
 R3, R7—1000-ohm resistor

R4—510-ohm resistor
 R5—220-ohm resistor
 R6—100-ohm resistor
 R8—10,000-ohm resistor
 RECT1—1-amp, 50-PIV full-wave bridge rectifier (Radio Shack 276-1151, HEP R0801 or equivalent)
 S1—Spst power switch
 T1—12.6-volt center tapped, 100-mA transformer
 Misc—Printed circuit or perforated board, hookup wire, solder, suitable enclosure, mounting hardware, fuseholder, machine hardware, etc.

Fig. 2. Circuits in Fig. 1 are combined in the charger.

junction of Q2. This voltage serves as a reference voltage like that at point A in Fig. 1A. Assuming that Q2 and Q3 are closely matched, as transistors formed on a monolithic block of silicon would be, and that R4 is one-half the value of R3, then Q3 will source a current (I) twice that of I_{ref} . If we employ a five-transistor array, four such current sources can be set up, with their outputs governed by the ratios of their emitter resistors. This is exactly what the Multi-Charger is. Its current sources can handle the four common ("A," "C," "D," and 9-volt transistor) cells.

In the actual circuit, whose schematic is shown in Fig. 2, the dc source is not a constant value, but rather the unfiltered output (at point A) of a full-wave bridge. Its waveform is shown in Fig. 3A. Accordingly, D1 and D2 don't conduct all the time, so Q1's collector

current will have a "clipped" waveform. Reference current for Q2, and the charging current outputs of Q3, Q4, Q5, and Q6 will pulsate in the same manner. Emitter current (at Point B in Fig. 2) of Q2 is shown in Fig. 3B. Since the output and reference currents in a circuit like that in Fig. 1A (or the transistor array Q2, Q3, etc. in Fig. 2) are alike when R3 and R4 are equal, the circuit is called a "current mirror" or "current reflector."

The Multi-Charger will work simultaneously with any number of each type of cell, up to 9 volts total. Readily available battery holders for two, four, or six cells can be used across each set of charging terminals.

Construction & Use. Fairly simple circuitry allows flexibility in assembling the Multi-Charger. Printed circuit board, perfboard, or wire-wrap

techniques can be used. If battery packs are used, bring out the charging terminals through the case (using grommets) for quick connection.

When construction is complete, set potentiometer R1 for maximum resistance and attach a milliammeter across the 9-volt transistor battery terminals and set R1 so that 1 mA flows through the meter. Then check the other output terminals—charging currents should be 2 mA ("A" cells), 5 mA ("C" cells), 10 mA ("D" cells). Observe the 9-volt limit when using battery packs. Although an 8-cell pack (12 volts) will not damage the Multi-Charger, the charge rate would be prohibitively slow.

Since the required charging time will vary with cell usage, keep a record of the charging time compared to operating time. Make it a practice to check cell voltage, and recharge before it drops too low. A good recharge point is 1.4 volts per cell for "A," "C," and "D" cells, and about 8.8 volts for 9-volt transistor batteries. Mark each battery (scratch the case paint) each time you charge it to keep track of the number of charging cycles. Examine each cell carefully before a new cycle, to make sure that the case is not deteriorating. After a while, your records will enable you to predict the end of useful life for cells from each manufacturer.

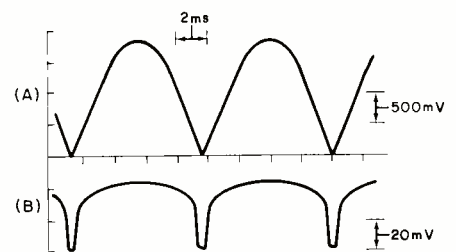

Fig. 3. Waveform (A) is output of a full-wave bridge rectifier. Outputs of Q2 through Q6 pulsate as shown by waveform at (B).

Finally, keep these ideas in mind when using the Multi-Charger:

- Use only good-quality batteries with heavy metal cases. It's false economy to buy cheap cells that will probably damage the appliance through electrolyte leakage.

- Never leave run-down batteries in any appliance.

- Avoid leaving cells with several completed charging cycles in any device, since the charging process accelerates any tendency of the cells to leak.

THINKING ABOUT A "6800" TYPE COMPUTER?

It seems that a great many people came to the same conclusion that we did here at SwTPC. The M6800 is an outstanding processor and makes a great computer – "BUT" – Not all computers using the M6800 processor are the same. May we suggest that you consider the following features when you make your choice.

IT IS A COMPLETE 6800 SYSTEM?

You cannot get all of the advantages of the 6800 system with only the processor chip. Unless the whole 6800 family of chips is used you cannot possibly get all of the versatility and superior performance that the system is capable of providing. If for instance the design does not use the MC6820 parallel and the MC6850 serial integrated circuits for interfacing, you lose the programmable interface feature that makes it so easy to interconnect the computer system with outside devices such as terminals, printers, disks, etc.

IS THE SOFTWARE COMPATABLE OR UNIQUE?

If the design does not use the "Motorola" Mikbug[®] ROM, then the software and programs that will run on the system are probably unique to

that particular brand of computer. SwTPC uses the standard Motorola MCM6830L7 ROM. This provides automatic loading and an operating system that is compatible with other systems using the standard widely sold Motorola evaluation set. As an owner of our 6800 computer system, you are eligible for membership in the Motorola Users Group. If you join you have access to a library of programs that will run on your system. Editor and assembler programs are available directly from SwTPC.

CAN THE SYSTEM BE EXPANDED AT A REASONABLE COST?

Some of the limited systems being offered at lower prices can be expanded only with difficulty. Check the amount of memory that can be added and at what cost. How many additional interfaces can be added, if any. How much of the above can be run off of the power supply provided with the system? The SwTPC 6800 can be expanded up to 16K words of memory in the standard cabinet and with the power supply provided. It may also be expanded up to eight interface (I/O) boards for external devices by simply plugging in the cards. Memory is \$125.00 for each 4,096 words of expansion and inter-

face cards are only \$35.00 for serial or parallel types.

Memory expansion will be essential if you ever intend to use a resident assembler, or higher level languages such as APL or BASIC on your system. Assembler programs typically require a minimum of 4,096 words of memory and higher level languages require even more.

HOW DO YOU ENTER AND READ DATA?

Let's hope it is by way of a TTY, or video terminal. No one with a serious computer application would consider attempting to enter data from a switch and status light console. These may be educational, but they sure aren't practical. Calculator keypads and digital readouts are not much better. There is no substitute for a full alphanumeric keyboard and terminal system display for serious work.

Mikbug[®] is a registered trademark of Motorola Inc.

SWTPC 6800

**Computer System
with serial interface and 2,048 Words
of memory \$450.00**



Enclosed is \$450 for my SwTPC Computer Kit Send Data

or BAC _____ # _____

or MC _____ Ex Date _____

NAME _____

ADDRESS _____

CITY _____ STATE _____ ZIP _____

Southwest Technical Products Corp., Box 32040, San Antonio, Texas 78284

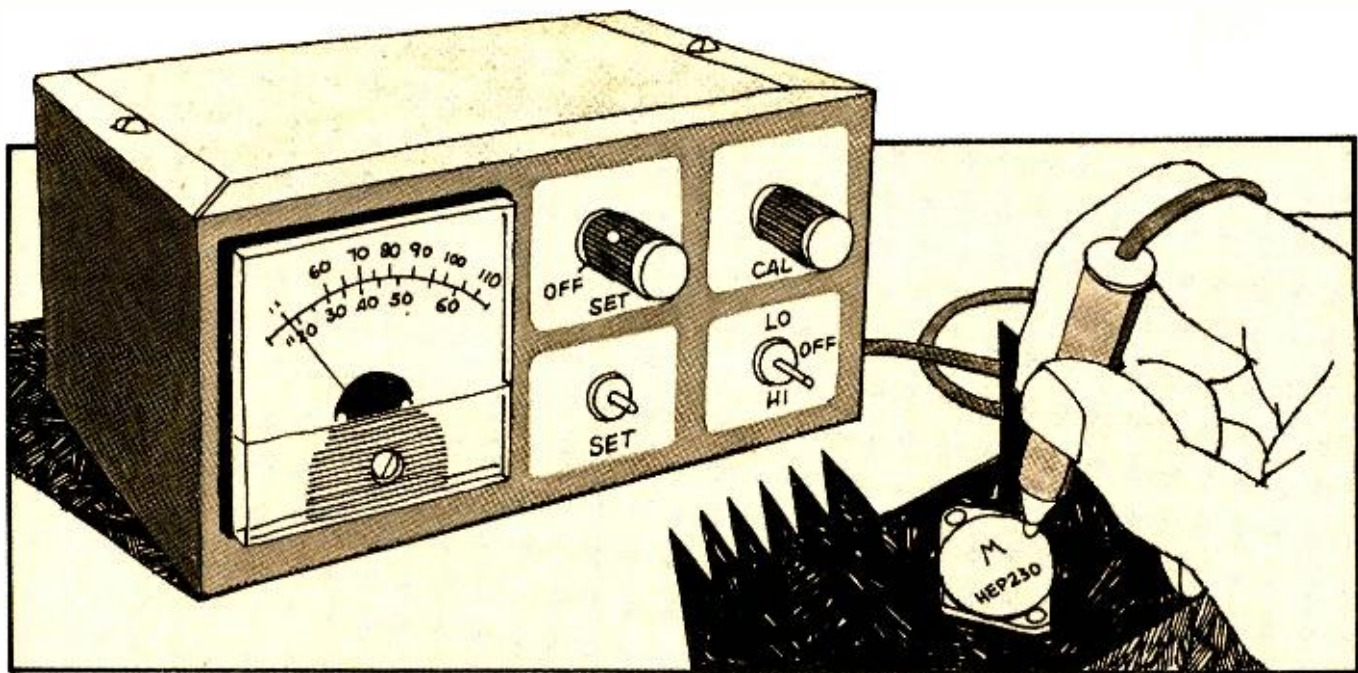

BUILD A LOW-COST TEMPERATURE METER

Identifies hot spots in your electronic equipment.

BY WILLIAM A. RUSSO

SOLID-STATE devices are notoriously heat sensitive. They tend to self-destruct if certain operating temperatures are exceeded for even a short time. Hence, keeping tabs on component temperatures can often be critical. The only way to distinguish accurately between a power transistor operating at a relatively cool 90° C and one ready to destruct at 120° C is with a fast-acting thermometer. The electronic thermometer described here, which you can build for about \$15 worth of parts, fills the bill nicely.

The thermometer is useful for a number of different temperature-measuring applications. Aside from keeping tabs on component temperatures, it will measure the thermal resistance of a heat sink and tell you how well thermal grease improves the heat transfer from a component to the sink. Furthermore, it can tell you if the movement of the air inside the chassis of an expensive project you just built is sufficient to maintain the temperature below the recommended 70° C commercial limit.

As designed, the electronic thermometer can measure the temperatures of noncorrosive liquids and gases as well as the surface temperatures of solids. It has an approximate measurement range of 20° C to 110° C (in two switch-selectable ranges) and an accuracy of roughly $\pm 5^\circ$ C. The temperature probe has a low thermal mass to assure virtually instantaneous metering indication. Finally, the project is battery powered for both bench and field use and to eliminate the danger of electric shocks.

About the Circuit. The schematic diagram of the thermometer is shown in Fig. 1. It consists essentially of a resistor (thermistor) connected in series with a meter movement (M1) across battery B1. As the resistance of the thermistor, RT, varies with changes in temperature, the current through the meter varies in step with it, changing pointer deflection. With the thermistor specified, as temperature increases, RT's resistance decreases and more current goes

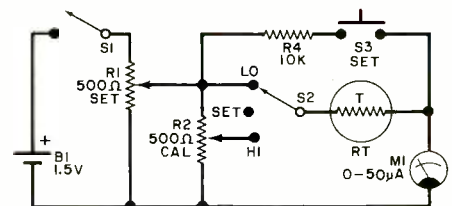

Fig. 1. Probe RT senses temperature.

PARTS LIST

- B1—1.5-volt D cell
 - M1—0-to-50- μ A dc meter movement (Radio Shack No. 22-051 or similar)
 - R1—500-ohm linear-taper potentiometer
 - R2—500-ohm trimmer potentiometer
 - RT—Thermistor (50,000 ohms at room temperature)
 - S1—Spst switch (part of R1)
 - S2—Spdt switch (center off)
 - S3—Normally open spst pushbutton switch
 - Misc.—Suitable box (6¼" × 3¾" × 2") with cover; battery holder; cable for probe; terminal strips; control knob; mounting hardware; heat-shrinkable tubing; hookup wire; solder; etc.
- Note: The thermistor is available from Delta Electronics, P.O. Box 1, Lynn, MA 01903 as part No. B5160 for 50¢ each. Minimum order is \$5.00. Also, a complete insulated probe assembly with 5' of cable is available for \$3.75 (post-paid USA) from William A. Russo, 5 Main St., Acton, MA 01720.

TRANSISTORS AND HEAT

High junction temperature is the main culprit in the premature failure of semiconductor diodes and transistors. Since the semiconductor case is sealed, the actual junction temperature cannot be measured directly, but you can measure the case temperature T_C . This can then be related to junction temperature T_J using the formula

$$T_J - T_C = P_T \theta_{JC}$$

where P_T is the power dissipated in watts and θ_{JC} is the junction-to-case thermal resistance in degrees C/watt. The former is roughly equal to $I_C \times V_{CE}$ (dc or the rms ac values) for a transistor. You can find θ_{JC} listed on manufacturers' data sheets either explicitly or in the form of a dissipation derating curve such as that shown in Fig. 3 (which is for a 2N3789). In the curve, θ_{JC} is equal to the magnitude of the curve's slope from the knee (at 25 degrees C here) to the point at which $P_T = 0$ (200 degrees here.) Thus $\theta_{JC} = 175 \text{ degrees} \div 150 \text{ watts} = 1.17 \text{ degrees/watt}$. Another way to present this data is in words. The 2N3789 data sheet, for example, says: "Continuous device dissipation at or below 25 degrees C case temperature = 150 W; derate linearly to 200 degrees C case temperature at the rate of 0.855 W/deg." The figure "0.855 W/deg" is the reciprocal of θ_{JC} .

Do not confuse θ_{JC} with θ_{JA} . The latter is the junction-to-ambient thermal resistance and is always much lower than θ_{JC} . It is useful for calculating T_J when no heat sink is used:

$$T_J - T_A = P_T \theta_{JA}$$

When a heat sink is used, the

above formula applies with θ_{JA} replaced by $\theta_{JC} + \theta_{C-HS} + \theta_{HS-A}$ where the last two terms characterize heat sink performance and are specified by heat sink makers. These heat sink parameters, however, are very dependent on heat sink orientation and air flow, and the most useful data in any particular usage can best be obtained from direct temperature measurement.

Suppose you are using a 2N3789 in a voltage regulator circuit with $V_{CE} = 8 \text{ volts rms}$, with $I_C = 5 \text{ amps}$. The metal front panel of your case is doubling as a heat sink. Is it adequate? To find out, first establish thermal equilibrium at full load current and measure T_C . If equilibrium can't be reached (the temperature just keeps rising) the heat sink is too small. Assume we measure $T_C = 100 \text{ degrees}$ and $T_A = 25 \text{ degrees}$ at equilibrium. Calculate $P_T = 8V \times 5A = 40 \text{ watts}$. Referring to the curve, P_T (max) at 100 degrees case temperature is around 85 watts, more than double the power we're using, so we know the heat sink is OK. It is easy to find θ_{CA} too:

$$\theta_{CA} = (T_C - T_A) / P_T = (100 - 25) / 40 = 1.875^\circ\text{C/W}$$

which can be filed for future reference and used for finding T_C in projects using the same heat sink.

In this example, we assumed a T_A of 25 degrees C on both sides of the heat sink, but this is not always the case. The temperature on one side may be much higher due to component heating inside the cabinet. This will be reflected in a higher T_C .

For maximum reliability, transistor and rectifier case temperatures should not exceed 100 degrees C for silicon devices and 75 degrees C for germanium units.

through $M1$ to produce an up-scale pointer deflection.

Potentiometer $R1$ is used during initial setup to compensate for variations in battery voltage due to aging and power consumption. Potentiometer $R2$ is used to set the proper scale factor for the HI temperature range. Switch $S3$ and resistor $R4$ substitute for RT ($S2$ in SET position) when adjusting $R1$. Long life can be expected from $B1$ because the drain is on the order of only 6 mA or less.

Construction. With the exception of the thermistor, the entire circuit can be quickly point-to-point wired inside a small box. Access to trimmer potentiometer $R2$ is required only during initial setup. Switched potentiometer $R1/S1$, switches $S2$ and $S3$, and meter $M1$ mount on one wall of the box.

Exercise care when preparing the probe assembly because excessive soldering heat or mechanical stresses on the thermistor can permanently damage it. At the thermistor end of a 6'

(about 2 meters) length of thin, flexible two-conductor cable (such as the type used for intercoms), slit and remove about a 2" (5-cm) length of the cable's plastic jacket. Save the removed piece. Next, cut off 1" (2.5 cm) of one of the cable's wires and strip 1" of insulation from the longer wire and 1/2" (1.27 cm) from the shorter wire.

If you examine the body of the thermistor, you will note that the end containing the thermistor is sealed with a metal cap and the other end looks like the point of a ballpoint pen. It is to this latter end that the cable leads will be soldered. Use a sharp knife to carefully scrape the solder coating around the tip. Then use the knife to clean a shiny band about 1/4" (6.4 cm) wide and about 1/4" down from the tip on the main shank (near the indented bands).

Wrap the stripped end of the cable's longer wire around the cleaned band on the shank and the shorter wire around the tip of the thermistor. *Do not twist the probe tip!* Bend the cable to the desired cable/probe angle. Now, using a cleaned, hot, tinned, low-wattage soldering iron and fine solder, quickly but carefully solder the cables to the probe.

To give it more mechanical strength, wrap around the probe's soldered joints the piece of reserved plastic jacket. Slip a 2" long length of heat-shrinkable insulation over the assembly and shrink it into place.

At the free end of the cable, prepare the ends of both conductors and solder them to the appropriate points in the circuit. The cable can enter the box through a small hole lined with a rubber grommet.

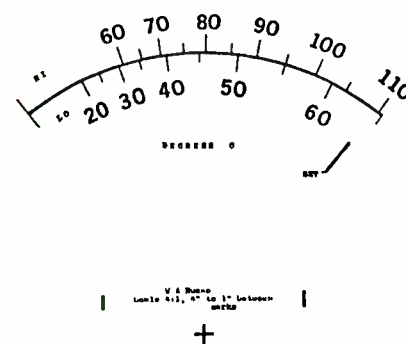

Fig. 2. Use this scale with the meter specified in Parts List to obtain an accuracy within 5°C.

Setup and Use. With an ohmmeter, you should measure about 50,000 ohms across the circuit ends of the probe cable. (The measurement will

NO Strings attached



NEW Weller® CORDLESS SOLDERING IRON... GOES ANYWHERE

Weller's WC-100... the professional quality, feather-light cordless. Lets you make connections anywhere. Without AC cord and outlet.

Fingertip touch on exclusive sliding safety switch activates long-life, nickel-cadmium battery. Heats tip to over 700°F in 6 sec. Locks in "off" position to prevent accidental discharge in use or while restoring energy with fast-power recharger (UL listed).

Simple, instant change to any of 4 tips... for any job. Built-in light focuses on tip and work area.

Get this! It's at your dealer or distributor now... waiting for you. Need more info first? Request literature.

Weller-Xcelite Electronics Division



The Cooper Group

P. O. BOX 728,
APEX, NORTH CAROLINA 27502

be slightly lower if the probe has just been handled.) An ohmmeter reading that differs sharply from this may mean that the thermistor has been permanently damaged during assembly. If the reading is infinity, don't jump to the immediate conclusion that the thermistor is at fault, however. First check the cable and soldered connections at both ends to determine if the circuit is complete. On the other hand, if the thermistor yields a low-resistance reading at all times, it must be replaced.

Install *B1* in its holder. Place *S2* in the LO position and rotate *R1* until *S1* closes. Adjust *R1* until the meter's pointer deflects about half way up-scale. If the meter operates erratically, dirty or poorly adjusted battery holder contacts are usually the blame. Rectify the problem before proceeding by cleaning and/or bending inward the battery contacts.

Temporarily connect a 2000-ohm, 5% tolerance resistor (or any resistor whose value is between 1900 and 2000 ohms) across the thermistor cable. Set *S2* to HI and adjust *R2* for full-scale pointer deflection. Set *S2* to SET, depress and hold down *S3*, and adjust *R1* for a full-scale meter pointer deflection. Release *S3*. (Repeat the adjustment of *R1* and *R2* until there is negligible error in either the HI or SET positions of *S2*.) Remove the 2000-ohm resistor from across the cable. Trimmer pot *R2* is now properly adjusted and should not have to be disturbed again.

From this point on, before each use, switch *S2* to SET, depress *S3*, and adjust *R1* for a full-scale meter deflection.

For initial calibration, set *S2* to LO. Insert a mercury thermometer whose accuracy is known and about 1/2" of the probe tip into a container of cold water. Once the mercury thermometer has stabilized, you can make a table of °C versus meter scale indications. Calibrate the LO scale from 20° C to 60° C and the HI scale from 60° C to 110° C in 5° intervals, setting *S2* to the proper range as necessary. If you prefer, you can use the scale shown in Fig. 2 with the meter specified in the Parts List to obtain an accuracy within 5° C of the reading indicated by the meter's pointer.

To use, first adjust *R1* as described above. Then, after selecting the high or low meter range, touch the probe tip to the component whose temperature is to be measured. Allow

a few seconds for the probe tip to come up to temperature. Then read the temperature directly off the meter. For added accuracy, coat the tip of the probe with heat-sink grease to promote heat conduction. *Do not attempt to measure temperatures greater than 150° C or you will destroy the thermistor.* Note also that you must wait a few seconds when measuring air temperatures for equilibrium to be reached.

For liquid temperature measurements, immerse about 1/2" of the probe's tip in the liquid. The meter's response will be almost instantaneous because of the high-efficiency heat-transfer characteristics of a liquid medium.

When probing around in an electronic circuit, keep in mind that the probe's tip is metal and must be handled in the same manner as you would handle any other probe. With a little experience, you will develop a "feel" for the correct operating temperatures of various components, which you can mark on schematic diagrams for future reference. (See Fig. 3 for typical transistor case temperature versus device's continuous power

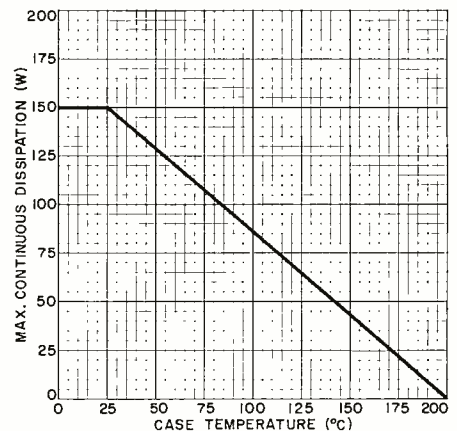

Fig. 3. Temperature vs power dissipation for 2N3789 transistor.

dissipation.) As a starter, many silicon devices (not thyristors) frequently are operated at temperatures in excess of 100° C, as are many power resistors. For best results, germanium and silicon thyristors should be operated at temperatures below 100° C. In well-designed circuits, passive components and IC's should be operated so that they generate maximum temperatures of about 70° C.

When transporting the electronic thermometer, it is a good idea to set *S2* to HI to damp the meter movement and prevent pointer damage. ♦

WHAT DO YOU KNOW ABOUT DIODES?

BY ROBERT P. BALIN

Diodes are deceptively simple electronic components. Even though they consist of just two elements (anode and cathode), their proper application requires a good understanding of how they work. See how many of the following questions you can answer. Numbers of questions refer to numbers on diagrams. Answers are below.

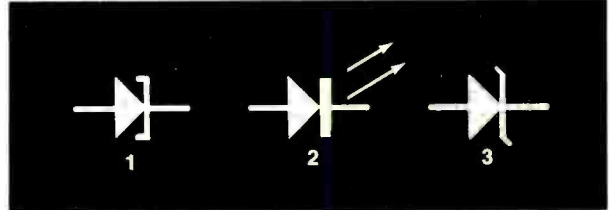

1, 2, 3. What types of diodes do these symbols represent?

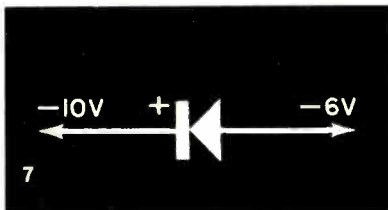
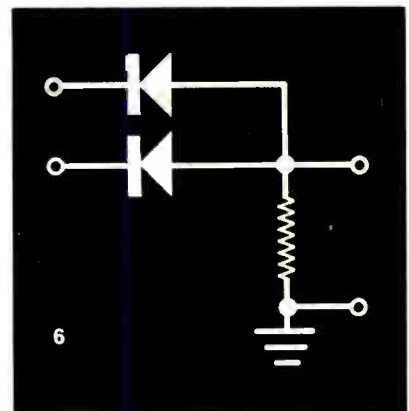
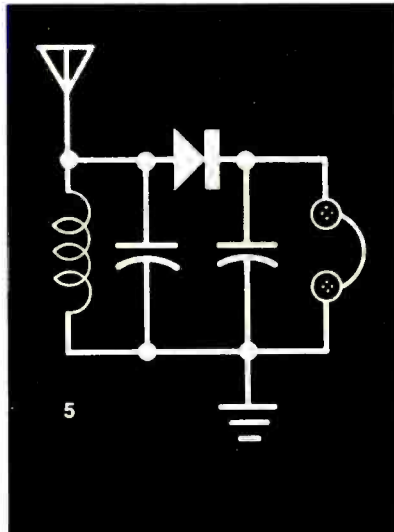
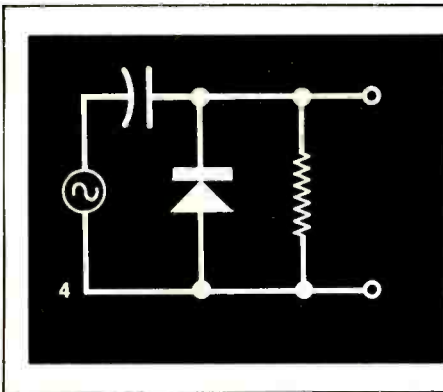

7. Is this diode forward or reverse biased?

4, 5, 6. What are the functions of the diodes in these circuits?

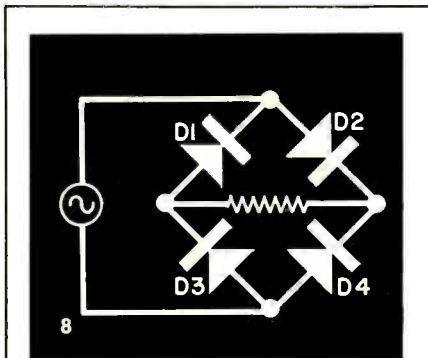

8. Which of the diodes in this full-wave bridge has been wired incorrectly.

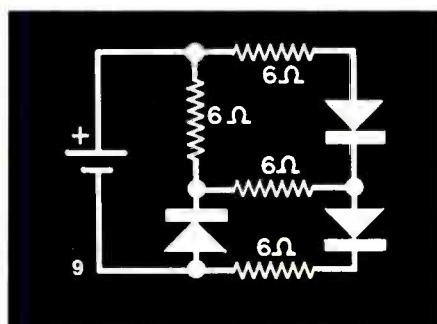

9. What is the total resistance across the battery if the diodes have zero forward resistance and infinite reverse resistance.

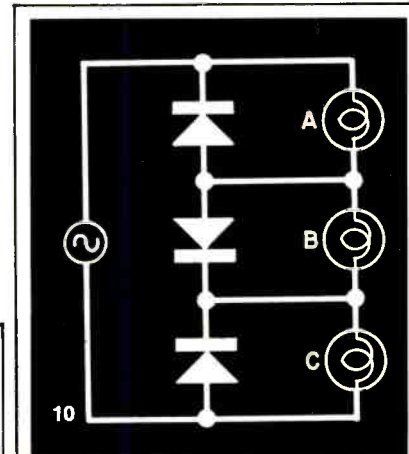

10. Which lamp will be the brightest?

Answers: 1. Tunnel; 2. Light-emitting; 3. Zener; 4. receives full line voltage.) half cycle, lamps A and C are shorted out and B receive half of the line voltage. On the negative half cycle, lamps A and C in series each D3, 9, 10 ohms; 10. B; On the positive half cycles, lamp B is shorted out and A and C in series each receives full line voltage.)

Engineers design electronic circuits —so can you!

**Only CREI offers you a choice
of 18 home study programs
in electronics with circuit design,
plus special arrangements
for engineering degrees**

Circuit design is perhaps the one qualification that distinguishes advanced technical personnel and engineers from the average electronics technician.

If you can design electronic circuits, you can more readily understand the circuitry of all types of electronic equipment. Thus you can more easily handle the repair and maintenance of such equipment, as well as assist in the development of new electronic systems.

The ability to design electronic circuits to solve practical engineering problems is one of the most valuable skills you can possess. Those with this ability are sought after and command positions of far greater responsibility, prestige and pay than the average technician.

If you are going to have a worthwhile career in the field of electronics, the ability to design circuits is a skill you will want to acquire.

Circuit design in all CREI programs

CREI covers circuit design in its home study programs in electronics. This is one of the factors that makes CREI training different from most other home study schools. CREI programs, of course, are college level—the same level of training you will find in any college or university offering programs in electronic engineering technology.

CREI training, however, is designed for home study. The programs give you effective, step-by-step training to help you move up in your career in electronics by using your spare time for technical self improvement.

Unique Design Lab

CREI gives you both theory and practical experience in circuit design with its Electronic Design Laboratory Program. The professional equipment included in this program allows you to construct, test out and correct the circuits you design until you have an effective circuit.

This Lab Program helps you understand advanced electronics. It also gives you practical experience in many other important areas of electronics, as in prototype construction, breadboarding, test and measurement procedures, circuit operation and behavior, characteristics of electronic components and how to apply integrated circuits.

Career Training at Home

Only CREI offers this unique Lab Program. It is a complete college lab and, we believe, better than you will find in most colleges. The "Lab" is one of the factors that makes CREI training interesting and effective. And the professional equipment in this program becomes yours to keep and use throughout your professional career after you complete the training.

Engineering Degree

CREI offers you special arrangements for earning engineering degrees at certain colleges and universities as part of your home study training program. An important advantage in these arrangements is that you can continue your full time job while "going to college" with CREI. This also means you can apply your CREI training in your work and get practical experience to qualify for career advancement.

Wide Program Choice

CREI gives you a choice of specialization in 14 areas of electronics. You can select exactly the area of electronics best for your career field. You can specialize in such areas as computer electronics, communications engineering, microwave, CATV, television (broadcast) engineering and many other areas of modern electronics.

FREE Book

In the brief space here, there isn't room to give you all of the facts about CREI college-level, home study programs in electronics. So we invite you to send for our free catalog (if you are qualified to take a CREI program). The catalog has over 80, fully illustrated pages describing your opportunities in advanced electronics and the details of CREI home study programs.

Qualifications

You may be eligible to take a CREI college-level program in electronics if you are a high school graduate (or the true equivalent) and have previous training or experience in electronics. Program arrangements are available depending upon whether you have extensive or minimum experience in electronics.

Send for this **FREE** Book describing your opportunities and CREI college-level programs in electronics

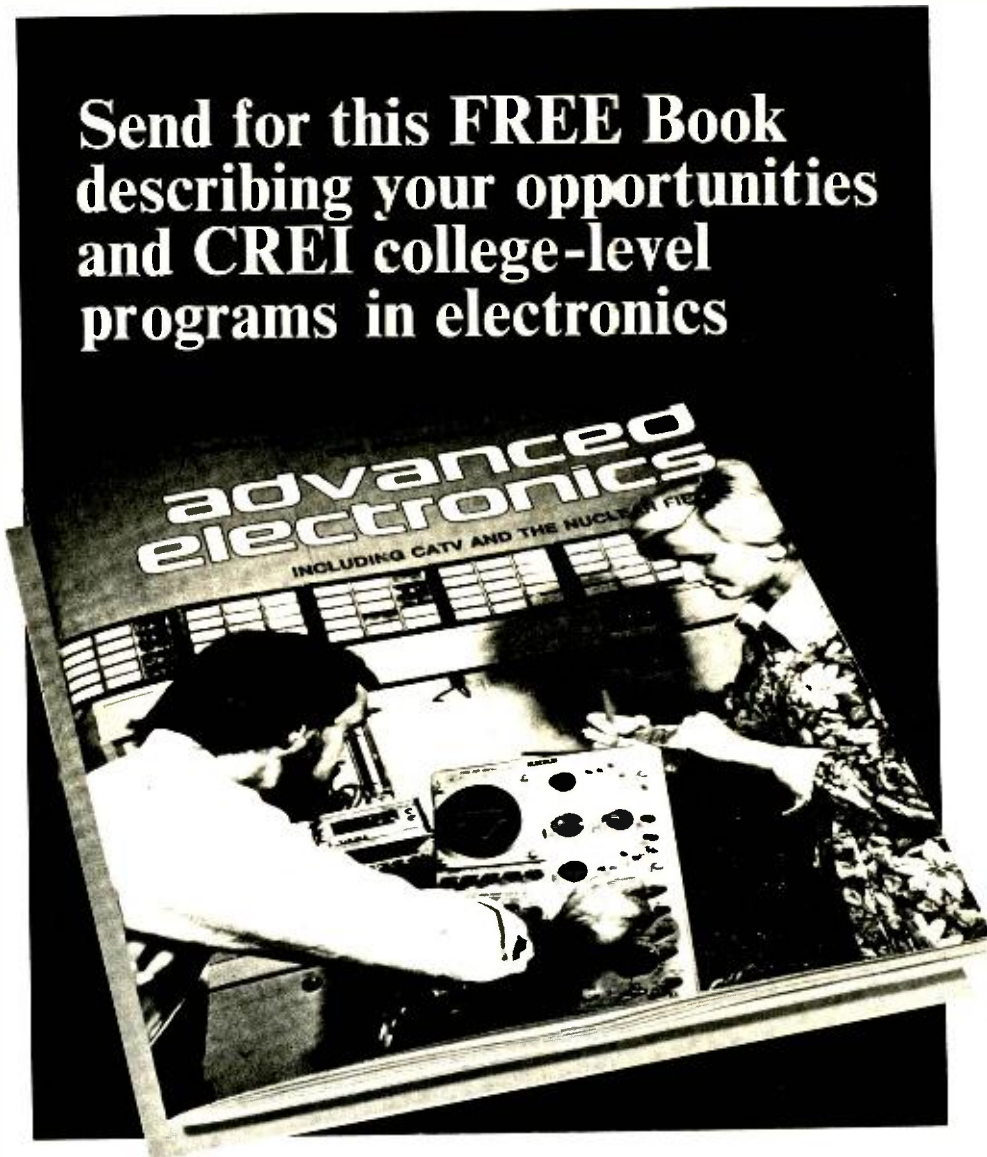

Mail card or write describing qualifications to

CREI **CAPITOL
RADIO
ENGINEERING
INSTITUTE**

**McGraw-Hill Continuing Education Center
3939 Wisconsin Avenue Northwest
Washington, D.C. 20016**

Accredited Member National Home Study Council

GI Bill

CREI programs are approved for training of veterans and servicemen under the G.I. Bill.





Product Test Reports

ABOUT THIS MONTH'S HI-FI PRODUCTS

Dual's new cassette deck combines the convenience of auto-reverse playback and bi-directional recording with excellent flutter and signal-to-noise characteristics. The designers (probably utilizing their experience with record players) have introduced a viscous-damped cassette cover to eliminate the "pop-up toaster" effect found in many cassette ejection systems. Best of all, the quality of the performance matches the novelty of the design at a price competitive with other deluxe cassette decks.

There would seem to be little that could be done in the way of innovations in the design of small bookshelf speaker systems. However, Jensen Sound Laboratories has managed to make a small system that looks unlike its many competitors (without using bizarre styling) and sounds unlike them as well. The Jensen OPC 21 is as easy to look at as it is to hear—with a \$70 price tag.

—Julian D. Hirsch

DUAL DELUXE CASSETTE DECK

Features bi-directional recording and automatic playback reversing.

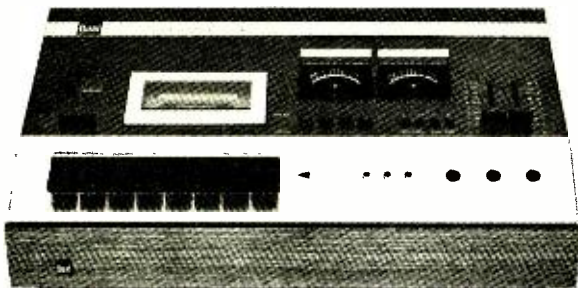

The Dual name, long associated with record players, now appears on a deluxe stereo cassette recorder. The bi-directional deck is designed to record and play back in both directions without requiring the user to turn over the cassette at the half-way point. Reverse operation is automatic during playback and the deck can be set to repeat indefinitely.

The single-motor transport uses the same motor that powers the company's Model 1229Q record player. A heavy flywheel filters out the pulsations of motor torque that could cause flutter, and two separately driven belts turn the capstan and tape hubs. The piano-key operating controls can be

pressed in any sequence without risking tape damage.

The deck features a walnut finished base. Its overall dimensions are 16½"W × 11¹³/₁₆"D × 4½"H (42 × 30 × 11.4 cm), and its weight is 15¼ pounds (7 kg). Retail price is \$450.

General Description. The recorder is basically a horizontal, top-loading deck. However, it can also be operated vertically when used with mounting legs furnished with it. Pressing the EJECT key causes the cassette cover to swing open slowly. The cover retains the cassette under light pressure to prevent it from falling out when the deck is operated vertically.

A switch is provided for optimizing both bias and equalization for STD (ferric-oxide) and CrO₂ (chromium-

dioxide) tape formulations. Normally, this switch is left in the STD position, although it can be manually moved to CrO₂ at any time. If a CrO₂ cassette has the appropriate edge notch in its case, the tape switch will automatically go to the CrO₂ position when the cassette is inserted into the deck.

The piano-key operating controls appear to be conventional, but there are a few more of them than usual. The key functions are: STOP, CONT PLAY (the only one that mechanically latches and must be pressed a second time to unlatch), RECORD (identified by a red bar), normal and fast speeds in both directions, and PAUSE. Arrows illuminated in red indicate the direction of tape travel. Small signal lights indicate momentary recording levels that exceed +3 dB, RECORD status, and DOLBY operation. A headphone jack for low-impedance (8-to-16-ohm) phones and two ¼" microphone jacks for low- to medium-impedance dynamic microphones are also provided. There is no separate power switch. To apply power, the user simply presses one of the operating keys. Power shuts off completely when the tape ends or the STOP key is pressed.

Two illuminated level meters that can lie flat or be angled upward about 30° for better visibility from the front of the deck are calibrated from -20 to 0 dB in black for normal operating levels and in red from 0 to +5 dB for higher levels. The Dolby trademark symbol is positioned on the meter scales at the +3-dB point, which corresponds to the normal Dolby calibration of 200 nanowebers/meter. (The deck's internal calibration system produces a 0-dB playback indication from its test tone.) The movements are designed to have the ballistic response of a true VU meter.

Four small black pushbuttons in front of the meters are for MONO recording (paralleling the two channels), automatic level control (ALC), switching in and out the Dolby circuits, and injecting a test tone for calibration of the Dolby system. Four screwdriver controls on top of the deck are provided for making calibration adjustments, separately for each channel and STD and CrO₂ tapes.

Slide-type controls are used for setting recording levels. Playback from the deck is at a fixed level. Phono jacks for the LINE inputs and outputs are located on the rear of the deck, as is a DIN socket. When a microphone is plugged into one of the MIC jacks, the

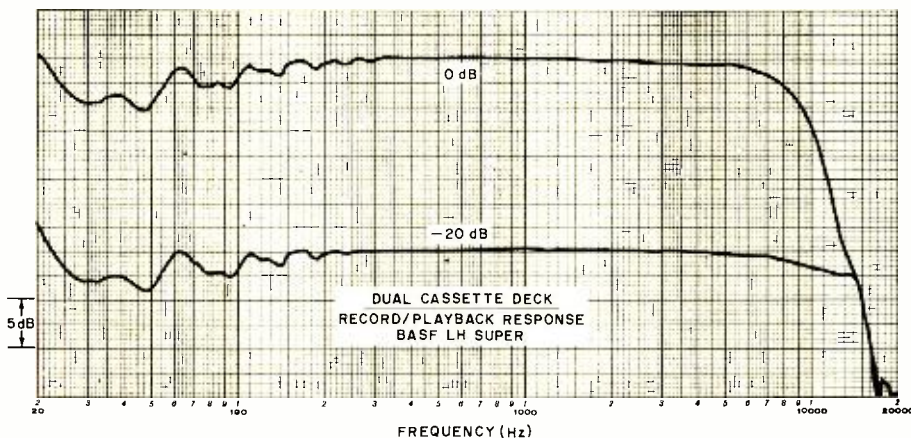
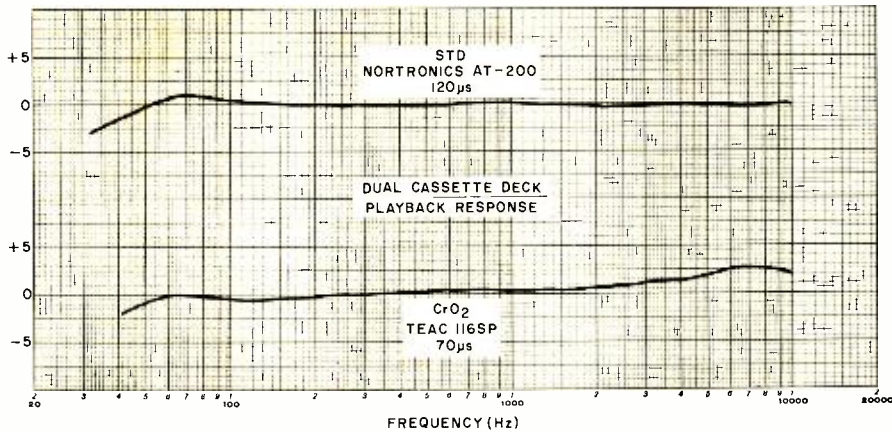

corresponding LINE input is disabled and replaced by the microphone.

Laboratory Measurements. We measured the playback frequency response of the deck with Nortronics AT200 tape for the STD (120- μ s) and Teac 116SP tape for the CrO₂ (70- μ s) equalization. The STD response was within +1.5/-3 dB from 31.5 to 10,000 Hz. It was a very flat ± 0.5 dB from 100 to 10,000 Hz. The CrO₂ response was within +3/-2 dB from 40 to 10,000 Hz.

The overall record/playback response was measured with BASF LH Super tape (for which the deck was biased) and TDK KR tape for the CrO₂ bias. At a -20-dB level, both tapes gave essentially the same response, within ± 2.5 dB from 20 to 14,000 Hz. The useful response extended to the lowest audio frequencies. In fact, it reached a maximum at 20 Hz. The response was the same in both directions of tape movement.

We tried several other high-quality ferric-oxide (and ferrichrome) tapes on the deck and found little difference between them. For example, TDK ED and SA tapes gave almost exactly the same results as the BASF LH and TDK KR tapes. (The output from the SA tape was about 3 dB greater.) Maxell

UDXL tape gave an extraordinarily flat high-frequency response, almost ruler-flat to beyond 15,000 Hz before dropping off, while Scotch Classic, a ferrichrome tape, gave a slight peak at 15,000 Hz. All the tapes were within the deck's ± 2.5 -dB tolerance over the specified frequency range.

A standard Dolby-level tape produced a +4-dB meter reading (1 dB above the Dolby mark on the meter scale) on playback. The tracking of the Dolby circuits, between the recording and playback characteristics, was excellent at -20 and -30 dB, with less than 1 dB of change in frequency response when the Dolby circuits were switched in and out.

A 70-mV LINE or 0.2-mV MIC input was required to record at a 0-dB level. The resulting playback output was 0.78 volt with CrO₂ tape and 0.85 volt with STD tape, corresponding to meter readings of +0.5 and +1.5 dB.

The playback THD at a 0-dB level was 1.3%. To reach the standard 3% THD reference level, the input level had to be increased to +7.5 dB with STD and +5.5 dB with CrO₂ tape. The unweighted S/N, referred to the 3% level, was 54.5 dB with both tapes. It increased to 60 dB with IEC "A" weighting. With the Dolby system

switched in, the weighted S/N was an outstanding 67.5 dB with standard and 66 dB with chromium-dioxide tapes. The noise level increased by 11 dB through the MIC inputs at maximum gain, but the increase at normal settings was slight.

The PEAK indicator began to come on at +2 dB. As claimed, the meter ballistics matched professional VU-meter standards. The meters indicated 100% of their steady-state values on 0.3-second tone bursts.

When the ALC switch is pressed, the normal gain controls are disabled. The gain is rapidly reduced when a signal appears at the deck's input. It increases very gradually when the level drops off. It is impossible to force the meter to deflect beyond the +3-dB mark, even momentarily, when using ALC. Most of the time, the pointers stay well below the 0-dB point. Because of this, it is impossible to make a distorted recording with ALC, but the audible compression and slow "breathing" as the gain changes make this feature usable only for voice recording.

The operating speed of the transport was within 0.1% of the nominal 1 $\frac{7}{8}$ ips (4.7 cm/s). The unweighted rms flutter was unusually low at 0.1% residual of our test instruments and tapes. The results were identical in both directions of tape movement. The fast speeds were really *fast*, passing a C-60 cassette from end to end in only 49 seconds.

User Comment. In its basic recording and playback functions, this deck is on a par with the best of today's fine cassette decks. Its bi-directional recording and playback capability gives it a large measure of added utility.

The deck has some distinctive operating characteristics that must be learned by the user. For example, to prevent accidental erasure of previously recorded material, tape reversal must be initiated manually in the record mode. The safety tab on a cassette, which must usually be removed to protect each side of the cassette against unwanted recording, blocks the recording function in both directions. The same applies if only one tab is removed. Hence, both tabs must be on the cassette to restore the recording function.

Automatic reversal of the tape's motion is a great convenience during playback, especially with a cassette that has a program that continues

onto the next side. However, it cannot be disabled. As a result, some people might find an unwanted side being played before they can react and shut off the deck. The reversal action is so smooth and rapid that it can easily be missed if one is not listening carefully. The automatic tape bias feature, likewise very convenient, depends on whether or not the cassette has the specially notched back edge (for CrO₂ tapes). Most cassettes have this notch, but many older ones do not.

The transport controls operated very smoothly and positively. The keys do not remain locked down, with the result that one learns to depend on the highly visible indicator lights on the deck to keep tabs on the operating mode and direction of tape movement. Because of the proximity of the control keys to each other and lack of visual distinction between them, we deem it advisable to look at the keys when operating them. On the other hand, one can go directly from one

speed and direction to any other speed and direction without first having to operate the STOP key. Fast cueing is accomplished by holding down the STOP and fast-movement keys simultaneously. The tape then stops instantly when the fast key is released.

The deck's low noise and flutter are excellent, which, with its exceptional operating versatility, makes the Dual cassette deck worthy of consideration for discriminating audiophiles.

CIRCLE NO. 80 ON FREE INFORMATION CARD

JENSEN MODEL OPC 21 SPEAKER SYSTEM

Smooth-sounding \$70 bookshelf speaker system.



With a fresh new styling approach, Jensen Sound Laboratories has designed a line

of loudspeaker systems with what it calls an "Optimum Performance Concept," or OPC for short. Jensen claims that the OPC speaker systems have a higher power-handling capability than previous systems of comparable size. The lowest-cost speaker system in the OPC line is the two-way Model OPC 21, with a suggested retail price of \$69.95. It measures 18 $\frac{3}{8}$ "H \times 11"W \times 8 $\frac{3}{4}$ "D (46.7 \times 28 \times 21.3 cm) and weighs only 14 pounds (6.4 kg), which qualifies it as a true "bookshelf" speaker system.

The cabinet is covered with wood-grained vinyl with a perforated plastic grille in contrasting light and dark brown shades. Diagonally across the grille is a translucent brown plastic strip, behind which is a knob for tweeter level control. Access to it is provided by lifting off the plastic strip.

The entire grille can be removed to reveal an 8" (20.3-cm) woofer with flexible plastic surround and a 2 $\frac{3}{4}$ " (7-cm) cone-type tweeter. A foam plastic ring surrounding the tweeter ap-

parently serves to smooth the response. Recessed into the rear of the cabinet are the insulated spring-loaded connectors for hookup to the cable coming from the driving amplifier.

Laboratory Measurements. The frequency response of the speaker system above 1500 Hz was exceptionally smooth, varying by only ± 1.5 dB up to 16,000 Hz. There was a "jog" in the response curve at about 1000 Hz, with a variation of about ± 3 dB within the 750-to-1500-Hz octave. At lower frequencies, the output dropped slightly to a minimum at 250 Hz and rose to a maximum at 85 Hz and then dropped off at a 12-dB/octave rate as the frequency lowered.

The high-frequency level control was able to cut off the tweeter completely. Its effect began at about 2000 Hz, which we judge to be the crossover frequency between tweeter and woofer. The bass distortion characteristics of the speaker system were very good for this size/price range. From 100 down to 55 Hz, at a 1-watt drive level, the THD was less than 1%. It rose at lower frequencies to 5% at 40 Hz and 7.5% at 35 Hz. At 10 watts input,

the distortion was about 2.5% in the 80-to-100-Hz range, increasing to 8% at 50 Hz and to 14.5% at 35 Hz. We also measured the distortion with the drive level adjusted to maintain a constant 90-dB sound-pressure level (SPL) at a distance of 1 meter from the speaker system. It was similar to the 1-watt drive curve down to 70 Hz, where it rose more rapidly at lower frequencies—to 2.1% at 60 Hz and 6.6% at 50 Hz.

The system's impedance was just slightly less than 5 ohms at 20 Hz and in the 100-to-200-Hz range; and it measured between 5 and 16 ohms from 200 to 20,000 Hz. At the 73-Hz bass-resonance peak, the impedance reached a maximum of about 28 ohms.

As with many acoustic-suspension speaker systems, the Model OPC 21's efficiency was quite low. With a 1-watt power input in the midrange, the SPL at 1 meter away measured 89 dB. The tone-burst response was generally good, with only a moderate transient at the beginning and end of each burst and no sustained ringing.

User Comment. In our simulated live-versus-recorded listening test, the speaker system acquitted itself admirably. Having listened to it for some time prior to the laboratory tests, we were not surprised at this. It was obvious from the outset that its sound was essentially musical and well-balanced. The extreme "top end," above 10,000 Hz, where many speaker systems are deficient, was strong and produced the necessary "edge" on wire brush and other sounds in that frequency range. The midrange irregularity could be detected as a slight coloration that we could not completely eliminate with our octave band equalizer. However, it was noticeable

IMSAI

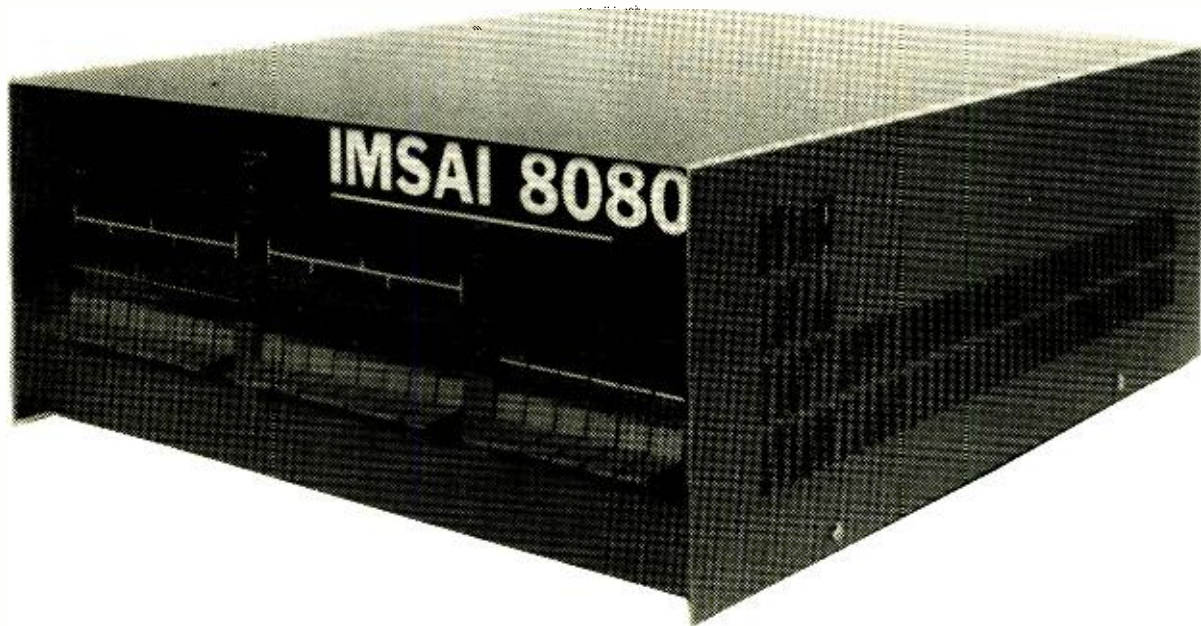

A POWERFUL SUPERIOR GRADE 8080 BASED MICROCOMPUTER SYSTEM REASONABLY PRICED.

QUALITY FEATURES INCLUDE:

- A commercial grade cabinet, made of heavy gauge aluminum, custom designed for this specific product. Rack mounting is available as a special option.
- Lucite display panel with a photographically reproduced legend and LED display mask. In addition to standard lights and switches, the heavy duty front panel has an extra 8 program controlled LED's.
- Rugged commercial grade paddle switches backed up by reliable debouncing circuits.
- Gold plated contacts on board edge connectors to assure corrosion free contact at all locations.
- A heavy duty power supply to handle lots of extra cards, the power supply delivers up to 20 amperes at 8 volts, and 3 amps each at +16 and -16 volts.
- A sturdy card cage to properly support up to 22 printed circuit boards.
- Plug removable front panel board that eliminates the normal wiring harness between front panel and back plane. For special dedicated uses, the front panel board may be removed from the unit altogether and used only when program changes are desired.
- A full line of peripheral devices to build truly powerful and complete systems.
- An exclusive shared memory facility from the company that pioneered shared memory microprocessing. Shared memory facilities allow multiple microprocessors in the same cabinet to share the same memory, yet run different programs in parallel with each other.
- A full complement of board options.

BASIC COMPUTER INCLUDES: 8080A Processor Board, Front Panel Control Board, lights and switches, power supply, Expander Board, Cabinet, . . . and . . . Software (Assembler, Monitor, & Text Editor).

PRICES: KIT . . . \$439 ASSEMBLED . . . \$931 BASIC 8080 WITH 1K RAM KIT . . . \$499 ASSEMBLED . . . \$699

OPTIONS: Rack mount, RAM & PROM Boards, Parallel & Serial I/O Boards, an 8 level Priority Interrupt/Clock Board, Shared Memory Boards, Interface Boards.

PERIPHERALS: Floppy Disk Drives, 32 Column/125 LPM Printer, 80 Column/300 LPM Printer, 50 Megabyte Disk Drive, 30 character per second Printer with Plotting Mode.

COMING SOON: Free BASIC and extended BASIC for registered IMSAI 8080 owners.

TERMS: Check or Money Order, BankAmericard, Master Charge, 25% deposit on COD orders. On all orders under \$1,000, add 5% postage and handling. California residents add 6% tax.

SEND FOR FREE CATALOG OF IMSAI MICROCOMPUTER PRODUCTS

DEALER INQUIRIES INVITED

SPECIAL NOTICE TO ALTAIR 8800 OWNERS:

If you would like to step-up to the superior quality of an IMSAI 8080, you will be pleased to know that your ALTAIR 8800 boards are "plug-in" usable—without modification—in the IMSAI 8080 cabinet. Furthermore, by acquiring IMSAI's unique Memory Sharing Facility, your ALTAIR MPU board and IMSAI MPU board can co-exist in the same cabinet, operate in parallel with each other, and share all memory in common. This is the technology that laid the foundation for IMSAI's powerful HYPERCUBE Computer and Intelligent Disk systems (recently featured in Computerworld, Datamation and Electronics magazines).

IMS ASSOCIATES, INC., 1922 REPUBLIC AVENUE SAN LEANDRO, CA 94577

(415) 483-2093

only during our A-B comparison with the original sound.

Listening to a variety of program material, we were constantly impressed with the smoothness and balance of the system. In fact, the OPC 21 is a feather-weight speaker system that moves into the middleweight class when it comes to sheer sound quality. Of course, one cannot expect a speaker system of the Model OPC 21's size and price to reproduce a deep and powerful bass, nor does it. By slightly reducing the level of the

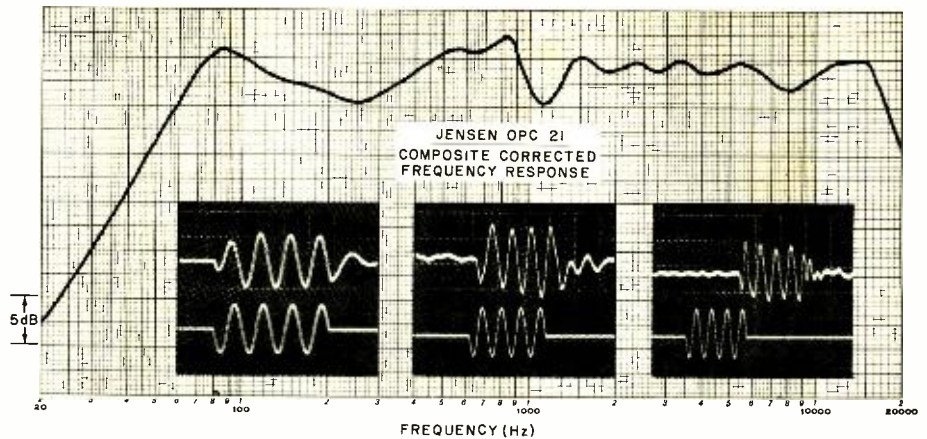

Tone-burst responses are for 100, 800, and 5000 Hz (left to right).

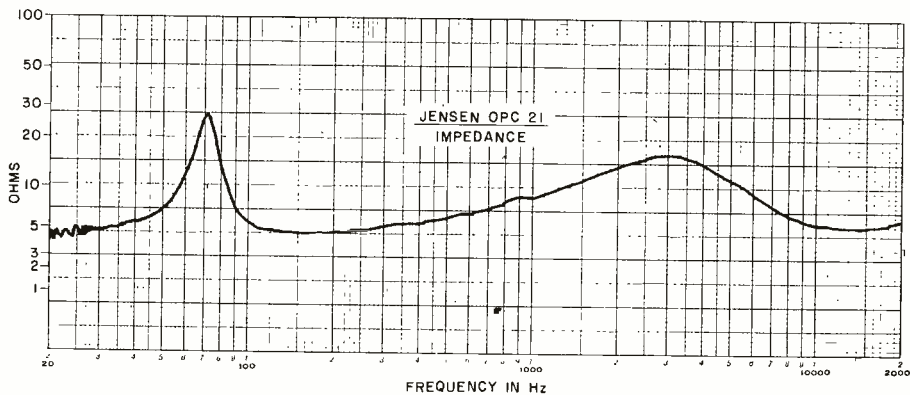

tweeter, however, the balance can be adjusted to avoid a "thin" sound.

Although the Model OPC 21 has no protective fuse and no power recommendations are provided, we feel that it can be used successfully and safely with any receiver or power amplifier that delivers up to about 40 watts/channel of output power. However, fuses are recommended if higher power levels are planned.

The Model OPC is among the more "listenable" small speaker systems.

CIRCLE NO. 81 ON FREE INFORMATION CARD

BROWNING GOLDEN EAGLE MARK III AM/SSB CB BASE STATION

Highly versatile system with separate transmitter and receiver.

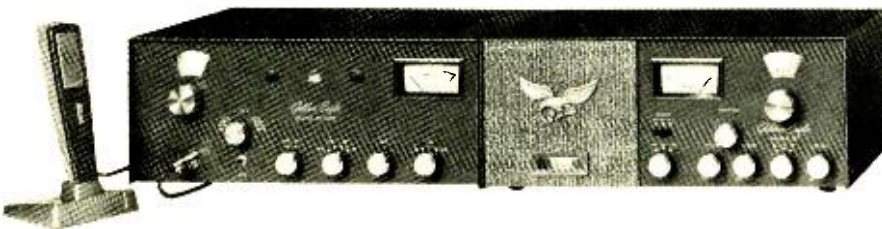

THE Browning Golden Eagle Mark III is a sophisticated high-quality CB base station with separate transmitter and receiver packages. Both sections employ vacuum-tube technology and are designed to provide complete AM/SSB communication on all Class D CB channels. Separate power supplies for 117-volt ac line operation are built into the transmitter and receiver, permitting either to be used independently of the other if desired. The transmitter is rated at 4 watts output power on AM and 12 watts PEP (peak envelope power) on SSB.

Both the transmitter and the receiver are housed inside the same-size cabinets that each measure 15¼"W × 9"D × 6¼"H (39 × 23 × 16 cm). The

transmitter retails for \$410 and the receiver for \$285.

General Details. The continuously tunable receiver employs double conversion and has one crystal-controlled channel. Standard features include BANDSPREAD tuning, SQUELCH, S meter, switchable AM noise limiter (anl) and fixed SSB anl, AM/LSB/USB selector, RF GAIN control, front-facing speaker, and external headphone/speaker jack. Two unusual features are an AGC disabling switch and a switch that allows selection of internal speaker only, external speaker only, or both speakers simultaneously. There is also a large ON THE AIR light that comes on when the transmitter is keyed.

The transmitter is crystal-controlled on all channels. It has a fine-tune control, selector for AM/LSB/USB operation (with separate indicator lamps for each mode), frequency spotter, and meter with selector switch for monitoring plate current, modulation level in all modes, forward power, and reflected power. The last two are for determining output power and SWR. A detachable desk-stand crystal microphone and all cables for connecting the transmitter to the receiver are included.

The Receiver. The first i-f of 4435 to 4145 kHz is obtained in the receiver by heterodyning the CB signal with a 31.4-MHz crystal oscillator signal. The second conversion to the 455-kHz i-f is obtained by mixing the first i-f with a 4600-to-4890-kHz signal from the tunable variable-frequency oscillator (vfo). Since the vfo operates at a relatively low frequency, a high degree of stability can be achieved. Augmenting this is built-in temperature compensation. In our tests, the stability held within an average of 200 Hz/hr starting

at 75° F (24° C) ambient temperatures. The single-channel crystal (not supplied) is used in place of the vfo.

Two Nuvistor triodes in a cascode circuit make up the r-f amplifier. This type of circuit is often used in vhf and uhf communication equipment to ensure stability with high sensitivity and low noise, which are also enhanced by the use of triode mixers. That this approach pays off well is indicated by our sensitivity measurements of 0.25 μ V on AM at 30% modulation with a 1000-Hz test signal and less than 0.1 μ V on SSB for 10 dB (S+N)/N.

Selectivity is obtained through the use of a 455-kHz tuned bandpass filter. On AM, this allowed an overall 6-dB response of nominally 300 to 3000 Hz and an adjacent-channel rejection of 50 dB. On SSB, the 6-dB response was nominally 240 to 2400 Hz, and unwanted-sideband suppression was 20 dB at 1000 Hz.

Three pentode i-f stages precede a diode envelope detector for AM, and a pentode product detector is used for SSB. The latter also functions as a self-excited bfo for carrier reinsertion. A series-gate anl is used on AM, while a pulse-diode anl is used on SSB. A triode audio amplifier stage drives a pentode power amplifier output stage that delivered 2 watts at 6% distortion with a 1000-Hz test signal into 8 ohms at the start of negative-peak clipping.

The receiver's triode squelch circuit is agc-activated. It could be set for thresholds of 0.1 to 10,000 μ V. The agc held the audio output to within 9.5 dB with an 80-dB r-f input change at 1 to 10,000 μ V. The meter registered S9 with a 32- μ V input signal.

Other measurements indicated image, i-f, and other spurious-signal rejection figures of 78, 87, and 45 dB, respectively.

The Transmitter. Frequency control for the transmitter is obtained with the aid of 23 crystals in the 16.270-to-16.560-MHz range. On any given channel, the main crystal frequency is mixed with another 5.0485-, 5.047-, or 5.050-MHz crystal-controlled signal for AM, LSB, or USB operation. The mixing process produces a signal of about 21.6085 MHz. The new signal then goes to a transmitter mixer, where the on-channel signal is obtained by combining it with a 5.6465, 5.648-, or 5.645-MHz crystal signal for AM, LSB, or USB operation. A fine-tune control is included for this oscillator frequency.

FEBRUARY 1976

A 12BY7 tube is used as the driver and a 7558 tube as the power amplifier. The power-amplifier stage automatically goes into class C operation on AM or becomes linear (class AB) on SSB. The output circuit is a multi-pi section. A trough-line printed-circuit sensor at the antenna feed is built in to provide the power/SWR functions.

For AM, a dual-triode speech amplifier precedes a dual-triode a-f clipper/driver, followed by a low-pass a-f filter. For SSB, a suppressed-carrier, double-sideband signal is generated by a diode-type balanced modulator and converted to one sideband by a 5.64-MHz crystal filter that precedes the transmitter mixer. A transistorized amplified automatic-level-control (alc) system is used for this mode.

Powering the transmitter from the standard 117-volt ac line, we measured a 4.5-watt AM carrier output at 10% distortion with a 1000-Hz sine-wave signal at 100% modulation. The distortion rose to 18% and heavy negative-peak clipping and carrier breakup occurred when the a-f input was increased by 6 dB. Adjacent-channel splatter was down 50 and 45 dB using 1000- and 2500-Hz test tones, respectively. Otherwise, the audio response was 400 to 4000 Hz.

On SSB the PEP output measured 12 watts with voice signals. The response was nominally 300 to 2800 Hz. Third-order distortion products with the two-tone tests were 34 to 35 dB below the maximum PEP, which was better by at least 10 dB than is usually the case with solid-state transmitters. The alc readily prevented flat-topping that would deteriorate signal quality.

The carrier suppression figure measured 70 dB, while sideband suppression at 1000 Hz was 60 dB. The transmitter's frequency tolerance at the extremes of the fine-tuning control (-vfo+) was within 0.003% on AM and 0.004% on SSB.

User Comment. The system's control knobs are large and easy to grasp and rotate, but their index marks don't extend to the fronts of the knobs, which can make settings difficult to determine under certain lighting and viewing conditions. On the other hand, the illuminated meters and channel dials are large and exceptionally readable under all lighting conditions.

The dial for the receiver includes

ALLISON 'OPTO-ELECTRIC' The BEST...the ULTIMATE of ALL Ignition Systems!



● (We challenge ANYONE to dispute this Fact)



Never wears out or needs any Maintenance!



● gives you Maximum Power with continuous PEAK PERFORMANCE while reducing Maintenance and Operating Costs!



★ The Allison OPTO-ELECTRIC System eliminates the Points and Condenser, replacing them with an OPTO-ELECTRONIC TRIGGER, using a Light-Emitting Diode and Photo transistor. The System operates on a beam of Light. As there are NO moving parts in rubbing contact, "Friction-wear" is completely eliminated. Timing adjustments are PERMANENT.

● Gives 40-Times more Timing accuracy than ANY system using "Mechanical Breaker-Points!" UNLIMITED RPM!
"Electronically-Controlled" DWELL automatically supplies HIGHEST Performance at both Low and High speeds. Spark strength does not fall off at high RPM. POSITIVE SPARK helps eliminate "Misture" for faster acceleration and improved Engine Performance. Sparkplugs LAST 3 to 10-Times LONGER.

● Easier Starting under any condition! Smoother running... (NO TIMING FLUCTUATION as with Magnetic Impulse Units)
All SOLID-STATE Components UNAFFECTED BY Temperature, Moisture, or Vibration! Only Highest grade materials used. Guarantees you Solid, Dependable Performance!

● PERFECT TIMING INCREASES Engine Efficiency and Gas Mileage. SAVES Precious Fuel! Allison gives you MAXIMUM Engine Efficiency 100% of the Time and that's the name of the game for the BEST in GAS MILEAGE AND ECONOMY.

★ Perfect Timing and Dwell never change.

● Pays for itself! Eliminates ignition Tune-Ups forever!
"INFINITE LIFE" Once installed Never needs replacing!



★ PROVEN RELIABILITY!

Each Unit Tested to 15,000 RPM.

● Road and Race Proven.

(Opto-Electric Systems won at INDY Two years in a row!)



You CAN install the ALLISON System in ALL the U.S. made & Foreign Cars! (4, 6, or 8-Cylinder)

"EASIEST-TO-INSTALL" UNIT ON THE MARKET.
(Not necessary to dismantle Distributor as with other systems)

★ If you want the BEST, and SAVE! This is IT!

ORDER with CONFIDENCE
SATISFACTION GUARANTEED
or Full Refund
10-YEAR FACTORY WARRANTY!
(Free Repair or Replacement)

● Send Check or M/D

State Make, Year, Engine Size (Calif. Res. add Tax)

★ (So New...it's Sold ONLY FROM FACTORY DIRECT)

● You may use your MASTER CHARGE or BANKAMERICARD
Send us (1) Your Number, (2) Interbank No., (3) Exp. Date

★ Before buying any other Type ignition system...

Send Postcard for our FREE BROCHURE.

★ If you have already installed a C-D ignition system, Modernize and Increase its Efficiency...
CONVERT YOUR "C-D" UNIT TO BREAKERLESS!
Opto-Electric "TRIGGER UNIT"...Only \$34.95

● Our BEST Salesmen are the users of our ALLISON System!

● America's Oldest and Largest Mfg. of Opto-Electronic Ignition Systems.



ALLISON
AUTOMOTIVE COMPANY

1267-P, East EDNA PL., COVINA, CAL. 91722

CIRCLE NO. 3 ON FREE INFORMATION CARD

Why live with

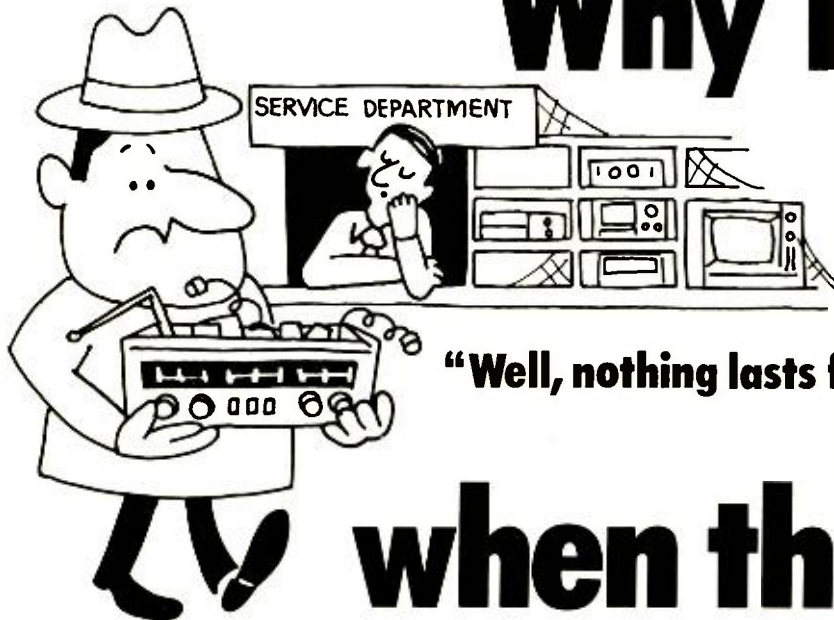

"Well, nothing lasts forever..." *

when the cure is

* How often have you heard that sighed remark? Or maybe even said it yourself...and been willing to accept the fact that you've been a victim of poor design or shabby component quality...or accepted mediocrity because you've been told that "it happens to everybody."

Well, it doesn't happen to

everybody. And it especially doesn't have to happen to you. Because now you can have a hand in deciding how much care goes into the assembly of over 400 electronic kit products.

Order your free Heathkit Catalog today and learn how you can assemble everything from hi-fi components to test equipment to color TV's to automotive accessories to much,

much more. And since you build it yourself, you can service it yourself...even if you've never built a kit before.

You'll learn how the famous Heathkit assembly manuals help you do it yourself...and that's your best hedge against someone else's built-in obsolescence. Don't be satisfied with less than the best.

See these exciting new Heathkit Products



Laboratory breadboard



4-band QRP transceiver

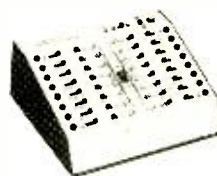

Digital IC Tester



Matching stereo preamp & equalizer



10 MHz dual-trace 'scope

...and over 400 other do-it-yourself kits in this big,

- Test & service equipment
- Color TV
- Stereo & 4-Channel
- Automotive tune-up gear & accessories
- Digital time, weather and date monitors

built-in obsolescence

in this book?...and it's

FREE!

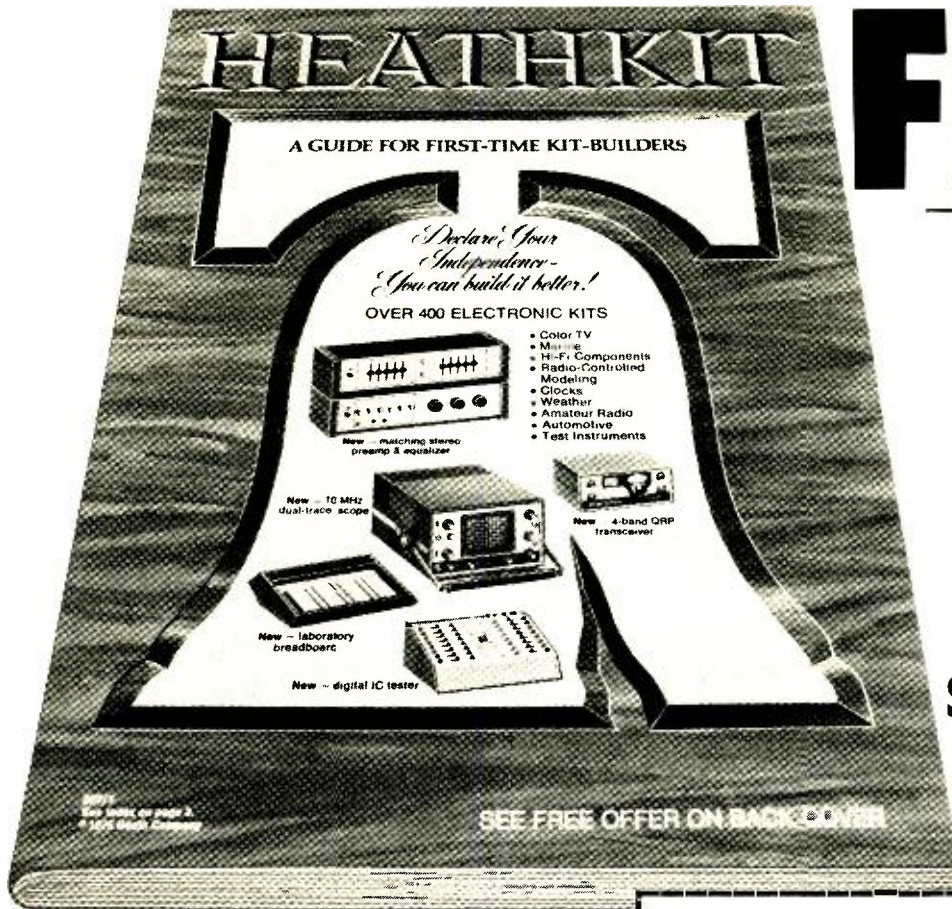

Send this coupon
for your free
Heathkit Catalog

new Heathkit Catalog.

• Amateur radio & shortwave • Marine & fishing equipment • R/C modeling gear • Home security systems • Educational programs

Heath Company, Dept. 10-14
Benton Harbor, Michigan 49022

HEATH

Schlumberger

Please send my free Heathkit Catalog.

Name _____

Address _____

City _____

State _____

Zip _____

CL-588

FREE EICO CATALOG

346 Ways To Save On Instruments, Burglar Alarms, Automotive & Hobby Electronics!

The more you know about electronics, the more you'll appreciate EICO. We have a wide range of products for you to choose from, each designed to provide you with the most pleasure and quality performance for your money. The fact that more than 3 million EICO products are in use attests to their quality and performance.

"Build-it-Yourself" and save up to 50% with our famous electronic kits.

For latest EICO Catalog on Test Instruments, Automotive and Hobby Electronics, Eicocraft Project kits, Burglar-Fire Alarm Systems and name of nearest EICO Distributor, check reader service card or send 50¢ for fast first class mail service.

**EICO—283 Malta Street,
Brooklyn, N.Y. 11207**

*Leadership in creative electronics
since 1945.*



CIRCLE NO. 17 ON FREE INFORMATION CARD

settings for the radio-control channels (marked RC). Setting the TUNING control to HF enables the receiver to tune in 32 additional channels in the 27,285-to-27,595-kHz range, calibrated on the tuning dial. The dial is accurately calibrated. AM signals appear at the center of the channel numerals, while on SSB, the dial must be moved slightly to one or the other side of the numeral, depending on the sideband in use.

The AM anl was highly effective. It was also good on SSB, but not as noticeably so because SSB's resistance to impulse noise is inherently greater than AM's. The operation of

the squelch was very smooth.

The exceptionally high receiver sensitivity enables weak AM and SSB signals to be copied easily.

The agc action on strong SSB signals was good. Reducing the setting of the RF GAIN control when strong signals are present can reduce overloading and minimize distortion. Disabling the agc at the same time can also improve sideband suppression under dynamic conditions.

The high quality and performance of the Mark III system make it an ideal base-station setup. Its versatility should make it a CB'er's delight.

CIRCLE NO. 82 ON FREE INFORMATION CARD

TRIPLETT MODEL 60 MULTIMETER

General-purpose VOM emphasizes ruggedness and safety.

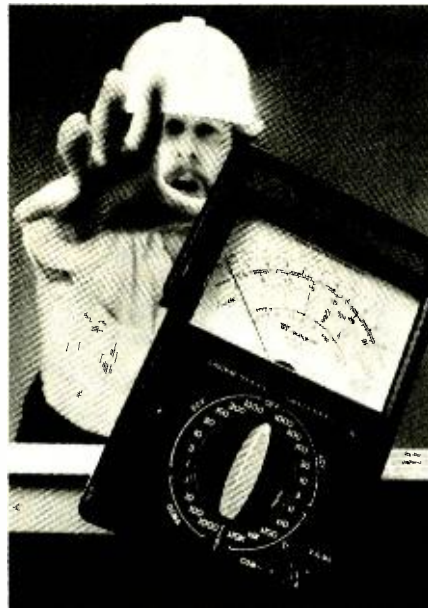

distinguished by a number of refinements. For example, its high-impact plastic case and ruggedized meter movement suspension permit the VOM to withstand severe physical shock, such as dropping it onto a hard floor from a 5' (1.5-m) height, without degrading measuring accuracy. Moreover, accidental burnout of internal components and the meter movement due to incorrect function and/or range setting is virtually eliminated by several internal protection devices. Among these are 1/8- and 1-ampere, 250-volt fuses for normal overload conditions and a 2-ampere, 1000-volt fuse and two zener diodes as backup protection under extreme conditions.

The instrument's ruggedized 45- μ A meter boasts a 4 1/2" (11.4-cm) scale length. The movement and scales are contained in a separate protective housing, which in effect physically isolates them from the main instrument case.

In addition to promised longevity, the user obtains a number of welcome operator safety features with the new multimeter. The instrument is completely insulated. Test leads have protective "boots" over the alligator clips that slip onto the basic test probe tips. The test probes themselves are needle sharp for easy penetration of insulation and making good contact with pc board conductors. As mentioned earlier, a 2-ampere fuse offers protection against high-energy faults.

There are eight dc voltage ranges from 0.3 to 1000 volts full-scale in a 1-3 format. (The 0-to-0.3-V dc scale is ob-

Triplett's new Model 60 multimeter is a battery-powered, general-purpose instrument designed to withstand the rigors of heavy use and misuse. In addition, it offers a high degree of protection against electrical-shock hazards. It has ranges for ac and dc voltage, direct current, resistance, and decibels.

The instrument measures 7 1/4"H \times 5 1/4"W \times 3 1/4"D (18.4 \times 13.3 \times 8.3 cm) and weighs 2 1/2 pounds (about 2 kg) with one 9- and one 1.5-volt battery installed. Price is \$90.

Features. Most service technicians and hobbyists are familiar with the Model 60's pedigree. It evolved from a long line of 20,000-ohms/(dc) volt multimeters. The model 60, however, is

tained with the selector switch in the 0.1 DCMA position.) Measurement accuracy at full scale is $\pm 2\%$, and sensitivity is 20,000 ohms/volt. For ac, there are six voltage ranges, in the same 1-3 format, with full-scale ranges of 3 to 1000 volts. Accuracy on these ranges is $\pm 3\%$ full-scale, while sensitivity is 5000 ohms/volt. The four direct-current ranges provide full-scale measurements of 0.1, 10, 100, and 1000 dc mA. There are also five resistance ranges, in decade steps, covering a range from $\times 1$ to $\times 10k$. When measuring decibels, the range available is from -20 to $+52$ dB.

A TEST position on the range/function switch allows the user to check the instrument's accuracy and an OFF position protects the meter when not in use. There are only two remaining controls. One is the ohms-adjust potentiometer, and the other is a slide-type switch for selecting polarity.

User Comment. This super-safe, ultra-rugged multimeter will be welcomed by electrical and TV service people who work an instrument "hard" and test a wide variety of electrical and electronic products. With a single combined range/function switch, a single pair of test lead inputs, and a large meter face with red and black scales, the Model 60 VOM is a pleasure to use. A further convenience is its carrying handle, which can also be used as a tilt stand on a workbench.

In the event anything ever goes wrong with the multimeter, the user will find it unusually easy to disassemble for servicing. Removing only eight screws completely disassembles the modular-constructed tester. The tester's "guts" are entirely exposed, and everything is accessible for test, troubleshooting, and repair.

Since the VOM doesn't incorporate a dc-blocking capacitor, it's necessary to insert one in series with the test lead

to measure ac voltages when a dc component is present. Aside from this, the Model 60 is about as complete a general-purpose multimeter as one could hope for. Of course, its 20,000 ohms/volt impedance does limit its use in very low-voltage solid-state circuits because of loading effects. Also, it cannot measure ac signals in the millivolt range commonly found in small-signal circuits. However, if you do a lot of work on low-resistance circuits where circuit resistance is less than one-fifth of the meter's resistance, and you require portability, ruggedness, and a high degree of operator safety, you should seriously consider the Model 60 multimeter. This is especially true if high-voltage probes and clamp-on alternating-current measuring accessories—both available for use with the multimeter—are desirable for service work.

CIRCLE NO. 83 ON FREE INFORMATION CARD

JERROLD MODEL TRC-12 VHF TV REMOTE CONTROL ACCESSORY

Attaches to TV set's antenna terminals for remote electronic channel changing.

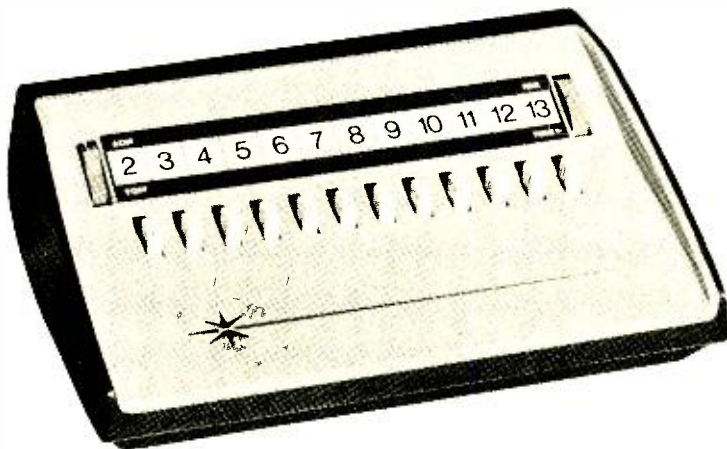

JERROLD Electronics' Model TRC-12 accessory provides TV receiver owners with an opportunity to add remote control of power, channel selection (vhf TV channels 2 through 13 only), and fine tuning without making internal circuit modifications or connections. The solid-state accessory operates without motors, gears, cams, belts, or any other mechanical parts at distances up to 25 ft (6.4 m) from any monochrome or color TV receiver to which it is connected.

The R/C system consists of a converter that attaches to a TV receiver's antenna terminals and an attractive brown-and-tan control unit connected to the converter by a 25' long control

line. The TV antenna lead-in cable and receiver's ac power cord connect to the converter's input and switched convenience outlet, respectively. Price is \$100.

General Description. To obtain channel changing and fine tuning functions without using mechanical parts, the accessory employs a voltage-variable capacitance (Varactor®) diode oscillator. The oscillator's frequency is changed by depressing one of 12 push-button channel-selector switches, each of which selects a precise dc bias voltage for a given channel. The incoming vhf channel signals are instantly con-

verted to an unused channel in the user's viewing area (usually channel 2 or channel 3). Since the output of the converter is fixed-tuned to one of the unused channels, two models are available: The Model TRC-12-2 is for channel 2, while the Model TRC-12-3 is for channel 3.

The fine-tuning control has a range of about ± 1.5 MHz around the nominal TV channel frequency selected. It enables the operator to make minute changes in the Varactor diode's biasing voltage to tune in a clear, sharp picture.

Incoming vhf signals to the converter are filtered. This signal then beats with the variable oscillator's output in a mixer stage to produce an intermediate frequency, which is fed to a second mixer and an i-f amplifier. Beating with a fixed oscillator's output, the signal is down-converted to TV channel 2 or 3 and fed to a final amplifier stage. The output of this stage is fed to the TV receiver's external vhf antenna terminals.

The power supply for the converter and remote-switch control box is in the converter that plugs into a standard 117-volt ac power outlet. The maximum voltage carried to and from the converter and remote-control box is 20 V dc to avoid shock.

The Grabbers!

(30MHz Kit)
\$ **69**.95

(250MHz Kit)
\$ **119**.95

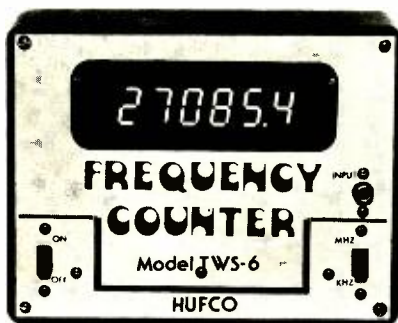

Six Digit Frequency Counters

For: HAMS, CBers, SERVICE TECHS, EXPERIMENTERS!

- 6 Digits
- 100Hz READOUT
- 1Hz OPTIONAL
- Wired & Tested add \$20
- HAM, CB & Commercial Bands
- Crystal Time-Base
- M. Chg/B. Americard OK
- Add \$2 Shipping

We have a whole wonderful line of unbelievable counters starting at \$45.95! Drop us a line or give us a call today.

P.O. Box 357 Dept. 15 Provo, Utah 84601

(801) 375-8566

Hufco

CIRCLE NO. 23 ON FREE INFORMATION CARD

FREE McIntosh CATALOG and FM DIRECTORY

Get all the newest and latest information on the new McIntosh Solid State equipment in the McIntosh catalog. In addition you will receive an FM station directory that covers all of North America.



MX 113

FM/FM STEREO - AM TUNER AND PREAMPLIFIER

SEND TODAY!

McIntosh Laboratory, Inc.
East Side Station P.O. Box 96
Binghamton, N.Y. 13904
Dept. PE

NAME _____
ADDRESS _____
CITY _____ STATE _____ ZIP _____

If you are in a hurry for your catalog please send the coupon to McIntosh.
For non rush service send the *Reader Service Card* to the magazine.

CIRCLE NO. 30 ON FREE INFORMATION CARD

The system's specifications include a 54-to-216-MHz input passband, 6-MHz (± 1 dB flatness) output channel bandwidth, 4.5-dB minimum and 11 dB maximum gain, and 13-dB nominal noise figure. Power consumption is about 8 watts. The control unit measures 8½" x 5½" x 2½" (21.6 x 14 x 6.4 cm).

User Comment. Installing the Model TRC-12 remote-control system couldn't be simpler. The only tool needed is a screwdriver. Since the converter has 75-ohm input and output impedances, we had to use an inexpensive matching transformer to accommodate our antenna's 300-ohm twin-lead cable. Then we tucked the cord linking converter and control box behind a sofa to keep it out of our traffic area.

After setting the receiver's and converter's fine tuning controls so that picture and sound were adjusted to the centers of their ranges, the fine-tuning control wasn't needed when switching from one channel to another. This is the result of the high stability inherent in Varactor oscillators.

Unlike mechanical remote-control systems, the Model TRC-12 can directly tune to any selected channel in any sequence without having to cycle through intermediate channels.

To turn on and off the TV receiver, it must be plugged into the accessory's convenience outlet and have its power switch set to on. If your receiver has an "instant-on" feature, using it with the remote-control system negates this feature. Hence, there will be a slight delay until the filaments warm up before the picture comes on. Also, the converter is not designed to operate on uhf-TV channels. So, if uhf is important in your reception area, you will have to manually tune these channels at the receiver itself.

The remote-control system did not degrade TV reception. In reality, the boosted signal appeared to improve picture quality on color programs and, from time to time, an out-of-town channel could be received with some "snow," but conditions were still viewable.

In sum, the Jerrold Model TRC-12 remote-control system can be the answer to all those TV receiver owners who bought manual-tune TV receivers and have always wished for remote-control operation.

CIRCLE NO. 84 ON FREE INFORMATION CARD

POPULAR ELECTRONICS



Test Equipment Scene

By Leslie Solomon

CAN TEST EQUIPMENT BE WRONG?

IT OFTEN happens that a circuit or a piece of equipment has a problem but test gear normally used to locate its source isn't any help. Here are three actual problems we have encountered in which the pertinent test equipment told us everything was OK, but there was a real problem in the circuit operation.

Magnets to the Rescue. While final-testing a vacuum-tube TV receiver, we noted a strange effect on the left half of the screen. We had seen this phenomenon before—it has the appearance of a stream of water running down the screen. Sometimes it looks like just a trickle, other times, it's a regular waterfall. The question is what type of test equipment can be used to locate the origin of this effect, and could the equipment tell us how to eliminate the trouble.

The first thing we did, of course, was to test all the tubes, particularly those in the sweep section. They all tested OK. All the voltages and waveforms were within specified limits; and, except for the waterfall, the picture looked good. So, as far as the test equipment was concerned, everything was fine—but our eyes knew better.

In this case, the problem was caused by the electrons "playing games" inside the horizontal sweep output tube. There is no available test equipment to locate this effect (called Barkhausen oscillation). It doesn't show up on a tube tester.

About the only thing to do is change the horizontal output tube and see if the waterfall goes away. If a replacement for the tube is not available, or if a new tube doesn't clear up the trouble, there is one solution. Call on our old friend, the magnet.

In the past, we have mentioned that a magnet is a potential troublemaker around color TV sets, but in this case the magnet becomes a friend instead of an enemy. Obtain a small magnet, and being very careful to avoid high

voltages and temperatures, place the magnet against the wall of the horizontal output tube. Move the magnet around until the waterfall either disappears or is reduced until it is no longer conspicuous.

Once the "magic" spot is located, use some form of nonmagnetic holder to keep the magnet against the wall of the tube. Don't use conventional tape as the high bulb temperature will cause the tape to curl up and die.

Invisible Components. Strange things can also happen in the process of checking out homebuilt equipment—especially that of the digital variety. Here again, the standard test equipment won't indicate any trouble. All of the semiconductors are in good shape, the resistors and capacitors are within limits, and the IC chips are getting the required supply of dc. Unfortunately, no matter what the test equipment says, the circuit can still produce some strange readouts—as if there were an invisible circuit component teasing us.

As an example, we had one piece of homemade digital test equipment that we were asked to check out for a friend. Everything tested perfect, but there were all kinds of errors in the display. In this particular case, it turned out that, on the beautiful foil pattern drawn up by the builder, a slender (too thin) foil trace was interwoven around the board to supply the +5 volts to all of the TTL chips. As each IC changed states, current spikes were dashing around this common lead, which was nothing more than a long resistor with taps here and there. The spikes along this line looked like signals to some of the IC's, and they responded to the signals.

After redrawing the foil pattern to thicken the 5-volt line (lowering the resistance and thus the spike level) and including a bypass capacitor between each IC's power input pin

and ground (right at the IC), the instrument worked properly. Of course, this same problem could have occurred if the ground line had been too long and thin. The same thing can also happen in point-to-point wiring if a single thin lead is used to supply power (or as a ground).

As another example of invisible components, stray capacitance and its effect on frequency-sensitive circuits should always be kept in mind. Stray capacitance can be present in circuit wiring as well as in tubes and semiconductors.

Half-Bad Transistors. You can't always take the word of test equipment that says a semiconductor is "bad." It may be only "half-bad" and can be used to advantage in many circuits. For example, a transient-damaged high-PRV rectifier diode may be a washout at high voltages, but will work fine as a low-voltage rectifier (if the junction has not been destroyed).

Then there is the case of a transistor with just one bad junction. With a little luck, these half-bad units can be used as conventional diodes, rectifiers, or even good-quality zeners. We have even used some of these one-junction transistors as voltage-variable capacitors. If you happen to have a collection of one-junction silicon power transistors, consider using them as power rectifiers. There is no reason why you shouldn't make use of the one good diode.

While on the subject of transistors, I would like to point out some important facts about physical handling of them. Many people assume that these tough little plastic or metal cans are pretty rugged. Well, they are, but only to a point. One major semiconductor manufacturer claims that a 4½" drop to a hardwood bench produces an acceleration of a few hundred G's; a 30" drop to a cement floor means several thousand G's; and even clipping the leads with a pair of dykes can notch up hundreds of G's. We cannot recall a single case of a failure attributable to the G force. However, since we learned of this possible problem, we have been a little more careful in handling transistors and IC's. Of course, we all know about keeping MOS devices (both transistors and IC's) plugged into conducting foam (usually black) when they are not in a circuit. Don't use ordinary styrofoam (usually white) for this job. ♦



Solid State

A DANDY CIRCUIT

By Lou Garner

IN CASE you are wondering, that word "DANDY" in the title is my own acronym for Discretes Are Not Dead Yet. Although many of today's experimenter and hobbyist projects use integrated circuits, there are hundreds, if not thousands, of exciting and interesting circuits that still use discrete devices (i.e. individual diodes, transistors, and other semiconductor components). There are, in fact, a number of serious experimenters who actually *prefer* to work with discrete devices, feeling that such designs offer more of a challenge to their skills than those using IC's. As one reader expressed it, "I feel I'm *really* assembling a circuit when I work with discretes. Using IC's, except in fairly complex projects, is much like stringing a bunch of black boxes together." Thus, the circuit illustrated in Fig. 1 should provide an interesting (and useful) challenge. It is a voltage-tuned FM broadcast band front end for use with a conventional 10.7-MHz i-f strip. It is also an excellent example of a design using discrete devices. From an engineering applications note from Signetics Corporation (811 East Arques Ave., Sunnyvale, CA 94086), the tuner features a pair of DMOS field-effect transistors and several Varactor diodes. According to the notes, the prototype had a measured sensitivity of better than 1.5 μ V for 30-dB quiet-

ing, a 50-dB agc range (with an agc voltage of 0 to +10 volts), and an average gain of between 30 and 34 dB, depending on frequency. In tests, the complete FM broadcast band (88 to 108 MHz) was covered as the dc tuning control voltage was varied from about 1.2 to 8.7 volts.

Although similar to conventional MOSFET's, Signetics' DMOS transistors are fabricated with a relatively narrow effective gate channel which reduces parasitic capacitance and raises the drain breakdown voltage. The types specified for the FM tuner are silicon n-channel enhancement-mode devices with integral zener diodes between their gates and substrates. The diodes bypass voltage transients and thus protect the devices against damage during handling and soldering. Half of a double dual-gate DMOS FET (SD6000) is used as an r-f amplifier, with the other half employed as a mixer. A second FET (SD211DE) serves as the local oscillator. The antenna, r-f, and local oscillator coils, *L1*, *L2* and *L3*, respectively, are tuned by individual fixed and variable trimmer capacitors shunted by dual Varactor diodes in back-to-back configurations. The Varactors' dc control voltage is applied to each pair through separate 82,000-ohm isolation resistors, with a 0.005- μ F capacitor serving as a common bypass. As

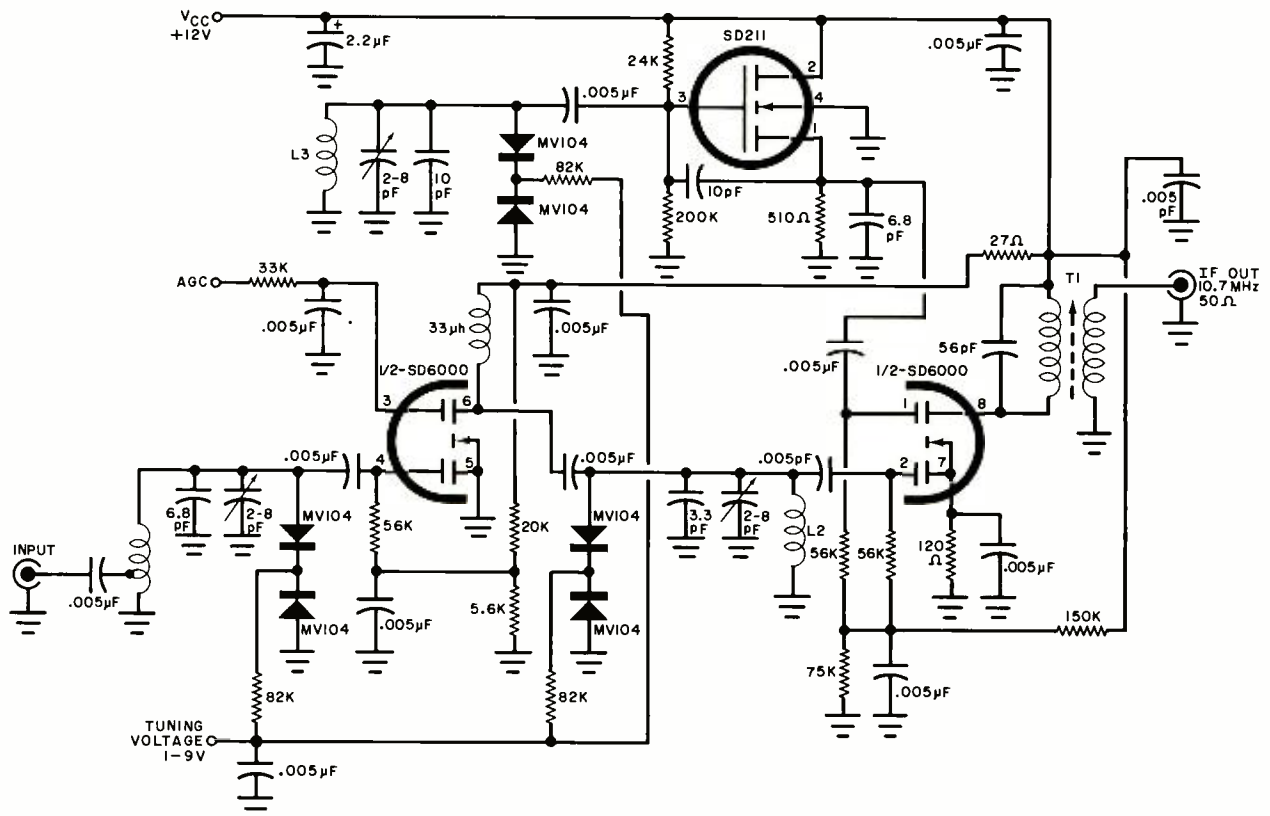

Fig. 1. A voltage-tuned FM broadcast-band front end using discrete devices.

the dc voltage across the diodes is varied, their effective capacitances change, thus tuning their respective circuits to different frequencies. The minimum capacitances, hence the highest frequencies, occur with the higher control voltages, and vice versa. An agc voltage is applied to the r-f amplifier's second gate through a 33,000-ohm resistor, bypassed by a 0.005- μ F capacitor. Maximum gain is achieved when the agc voltage is at its maximum (about 10 volts), minimum gain is reached as the voltage approaches zero. Finally, in the mixer stage, one gate is used for the amplified r-f input, the second for the local oscillator's output signal, with both coupled to the mixer through 0.005- μ F capacitors.

Except for the hand-wound r-f coils, and i-f transformer, standard components are used throughout the design. The varactor diodes are type MV104. Coils *L1*, *L2* and *L3* are all wound with No. 22 gauge enamelled wire on type T37-12 cores, with *L1* consisting of 5 turns, tapped one turn from the ground end, *L2* consisting of 5 turns, and *L3* 4 turns. The i-f transformer, *T1*, is wound with No. 26 gauge enamelled wire on a *Cambion* type 533-3652-003 form, with the primary consisting of 30 turns, the secondary 2 turns. A 33- μ H choke serves as the r-f amplifier's drain load. Capacitors, except for the 2.2- μ F electrolytic used as a power supply bypass, should be high-quality ceramic, mica, or plastic film types.

Intended for operation on a 12-volt dc source, the FM tuner can be assembled on a printed circuit board or, with care, on perf board. However, since high-frequency operation is involved, layout may be critical and good technical practice must be observed, with all leads kept short, direct and isolated, and distributed wiring capacitance kept at a minimum. When connected to a standard 10.7-MHz i-f amplifier/discriminator strip, the tuner can be aligned using conventional techniques.

Reader's Circuit. In the majority of metronome circuits using simple R-C timing networks, the tempo (frequency) adjustment has most of its control "squeezed" near one end of the operating range. Seeking to minimize this problem, reader Richard K. Brush (1965 East 3375 South, Salt Lake City, UT 84106) decided to develop his own design for a metronome. His circuit (Fig. 2) features a nearly linear tempo control, loudspeaker output, and, interestingly, discrete devices rather than an IC.

Richard's major improvement is a shift from a voltage variable to a current-controlled charging source for the timing capacitor. Transistor *Q1A* provides temperature compensation for a voltage divider network consisting of *R2*, tempo control *R3* and *R4*. The tempo control's adjustment determines the base bias applied to *Q1B* which, in conjunction with limiting resistor *R1*, serves as a current source for timing capacitor *C1* in the UJT relaxation oscillator. The pulse oscillator's output, developed across base load *R6*, drives the power amplifier, *Q2*, which, in turn, delivers an output signal to a PM loudspeaker. The loudspeaker's voice coil is shunted by *D1*, to dissipate transient voltage peaks developed by sharp current pulses.

To keep costs low, inexpensive components are used. Dual transistor *Q1* is a Poly Paks type 14A 653 or type 2N1132, the UJT is type TIS43, and the output amplifier is a general-purpose npn power transistor, (Radio Shack No. 276-636 or similar). The damping diode, *D1*, is a general-purpose rectifier with a 1-A rating. Timing capacitor *C1* is a 15- or 20-volt electrolytic. An 8-ohm, 3" PM loudspeaker

Bugbook III: A Blow for Microprocessor Independence.



Bugbooks are dedicated to the proposition that all men should be electronically independent and creative . . . that you should be able to conceive and execute your own circuit designs . . . that the Bugbooks will enable you to participate in one of the most exciting of all technological revolutions: the micro-electronics revolution.

Bugbooks I and II set forth the fundamental truths of digital circuitry. Bugbook IIa explores asynchronous serial interfacing of data transmission. But now there is a new one: Bugbook III. It expands and builds on the pioneering simplicity. It's a forthright approach to microcomputer/microprocessor use and design.

Bugbook III focuses on microprocessor system design, using an 8080 based system for microcomputer interfacing. Typical subjects: microcomputer programming and I/O; breadboarding the Micro-Designer™; clock cycles and timing loops; and more.

All practical. All clear. In 592 pages, with a glossary of 200 microcomputer terms. And, most important of all, 60 self-teaching experiments designed to make you independent and creative.

Strike a blow for independence — your independence. Bugbook III is available now for \$14.95 from the people who are revolutionizing the way digital electronics is learned.

YES! I want to strike a blow for independence! Send me Bugbook III for \$14.95, postage included.

Also send me, at
\$16.95 the pair, Bugbook I, Bugbook II,
\$ 4.95 each, Bugbook IIa

Name _____

Company _____

Address _____

Enclose Check/MO

CIRCUIT DESIGN, INC.

Division of E&L Instruments
P.O. Box 24
Shelton, Conn. 06484

CIRCLE NO. 66 ON FREE INFORMATION CARD

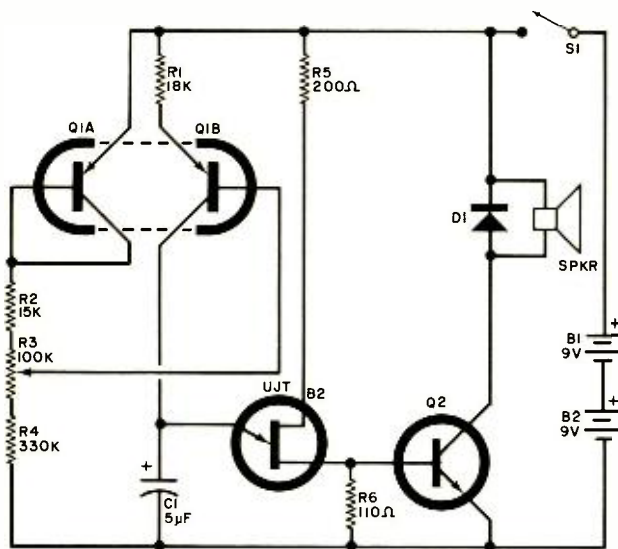

Fig. 2. Metronome circuit has a nearly linear tempo control and loudspeaker output.

was used in the original model, but larger units can be used if preferred. Finally, B1 and B2 are standard 9-volt transistor batteries.

Any construction technique can be used for duplicating the circuit. The completed unit, after check-out, can be calibrated using another metronome or a stopwatch.

Richard writes that his original model has a range of 30 to 220 beats per minute, but this may vary with component tolerances. The range can be shifted by using different values for R1 and R2. Current limiting resistor R1's value determines the overall tempo, while R2's value establishes the minimum-to-maximum ratio. The use of a UJT type other than the one specified may require different values for R5 and R6.

Device/Product News. A pair of logic interface IC's designed to drive 48-volt telephone relays without special protection is available from the National Semiconductor Corporation (2900 Semiconductor Drive, Santa Clara, CA 95051). Identified as types DS3686, a positive-voltage driver, and DS3687, for negative-voltage relays, both convert standard bipolar and CMOS logic signals to the high-voltage, high-current outputs needed by telephone relays. The devices employ pnp input transistors, providing not only compatibility with TTL, DTL, and CMOS logic, but also a high input impedance for low input loading. In addition, both devices incorporate an internal reference which prevents the type of output-breakdown latching common to ordinary relay drivers and eliminates the need for an external clamping diode to guard against inductive transient voltages. The outputs are Darlington transistors rated at 65 volts and capable of sinking 300 mA per channel.

Not too long ago, you could have safely said that all MOSFET's are low-power devices. That's not true today, for Siliconix, Inc. (2201 Laurelwood Rd., Santa Clara, CA 95054) has introduced the first of a new family of high-power MOSFET's capable of competing with bipolar transistors in both linear and power switching applications. The initial offering in the new "Mospower" family is the VMP-1, a MOSFET with a maximum current rating of 2 A and a power dissipation capability of 60 W. An n-channel device, the VMP-1 is supplied in a TO-3 package, and has a maximum gate voltage rating of 10 V, with a source-to-

drain breakdown specification of 60 V. Featuring a minimum transconductance of 200 μ mhos and gate threshold levels of from 0.8 to 1.8 volts, the device can be switched directly with standard 5-volt logic signals. The VMP-1's unique power handling capability is made possible by a new fabrication technique employing a V-shaped vertical structure called VMOS.

A new charge-coupled analog shift register that has a variety of applications in video and communications equipment has been announced by the Fairchild Camera and Instrument Corporation (Integrated Circuits Group, 464 Ellis Street, Mountain View, CA 94042). The new device, type CCD311, is a 130/260-bit integrated circuit which performs the function of a wide-range variable analog delay line. Delay is determined solely by the frequency of an external clock signal. Utilizing Fairchild's buried-channel charge-coupled technology, the CCD311 eliminates the need to convert analog signals to digital form for delay within a digital delay system and the subsequent reconversion to analog form. An analog signal voltage can be fed into two charge-injection ports directly to two 130-bit analog shift registers. At the user's option, the CCD311 can be operated either as a single 130-bit unit or, by using multiplexing techniques, as a 260-bit device. The input ports transform the input signals into charge packets which are shifted through the registers by external clock signals. Information in charge packets from the registers is fed into an on-chip output gate, preamplifier and compensation amplifier and the output is a video signal. Capable of operating from frequencies as low as 10 kHz to video rates as high as 15 MHz, the CCD311 can provide delay times from 20 μ s to 25 ms simply by varying the clock rate.

An inexpensive monolithic sinewave tone generator suitable for use in radio pagers, data transmission equip-

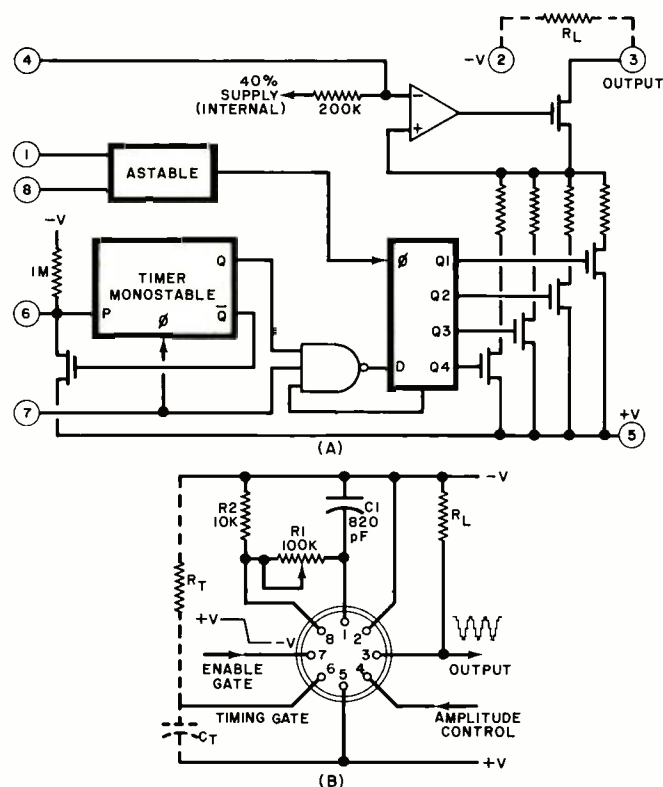

Fig. 3. (A) Block diagram of FX-205. (B) Typical circuit connections for device.

ment, telephone systems, etc., is now available from the Consumer Microcircuits of America, Inc. (114 East Simmons St., Galesburg, IL 61401). Designated type FX-205, the device's block diagram is given in Fig. 3A, while typical circuit connections are shown in Fig. 3B. The device generates sinewave signals by digital synthesis, using weighted current steps to form the output waveshape. Its frequency is adjustable between 30 Hz and 5 kHz, using an external resistor and capacitor. Output amplitude can be adjusted and the FX-205 also will accept an external pulse signal, converting it to a sine-wave output of corresponding frequency stability. The FX-205 is in an 8-pin TO-99 case. For a limited time, the manufacturer is offering a development kit consisting of two FX-205's and a matching PC board for \$10.00 on direct order.

An intriguing display device which should spark the imagination of hobbyists and experimenters has been introduced by Industrial Electronic Engineers, Inc. (7740 Lemona Ave., Van Nuys, CA 91405). Identified as type 301R, the new unit is a gallium-arsenide phosphide 10-dot LED indicator assembled as a linear array in a 12-pin DIP. With a common cathode connection, the device requires 1.6 volts dc at, nominally, 5 mA per dot, delivering an emission brightness (per dot) of 120 μ Cd. Suitable for use in a variety of displays, including bar graphs, the 301R is compatible with most TTL and DTL circuitry.

Texas Instruments, Inc. (P.O. Box 5474, Dallas, TX 75222) has announced a new micro/minicomputer family with the unique capability of operating with the same "software language." This feature makes it possible for users to expand or upgrade their computer systems without discarding software developed for the initial installation. The new compatible family includes the TMS9900 *microprocessor*, the Model 990/4, a complete *microcomputer* on a single printed circuit board, and the general-purpose Model 990/10 *minicomputer*. All members of the family use 16-bit words. The 990/4 microcomputer uses the single-chip 9900 microprocessor as its central processing unit, and is designed for use in a variety of industrial control and data communications applications. The 990/4 also can be used as the central processor for larger computer systems.

Teledyne Semiconductor has announced their 836 quad op amp, which replaces and outperforms the old workhorse, the 741. Small signal bandwidth has been raised to 1.5 MHz (unity gain) and power bandwidth to 20 kHz. Corresponding to this is a typical slew rate of 1.2 V/ μ s, as compared with 0.5 V/ μ s for 741-type op amps. Class AB output circuitry is used to eliminate the crossover distortion inherent in class B operation. At maximum output, signal voltage remains symmetrical about ground and swings to within 1 volt of either supply.

The 836's input common-mode voltage range is -15 V to +13.5 V. Since this includes the negative supply, fewer external components are required for biasing in single-supply applications. At ± 15 -volt supply voltage and 700 μ A per amplifier, total dissipation per package is 84 mW, or only 21 mW per amplifier. The amplifiers are internally compensated, have differential inputs, and share a common bias network and supply inputs. Minimum voltage gain is 25,000. The quad package operates on single-ended supplies from 3 to 30 V, or on split supplies from ± 1.5 V to ± 15 V. Outputs are short-circuit protected. Three versions are offered: the 836C in a 14-pin ceramic or plastic DIP for 0°C to 70°C environments, and the 836B ceramic mil-spec DIP.

THE COMPLETE DVM



\$348

FOR FASTER, MORE RELIABLE MEASUREMENTS

A NEW STANDARD IS BORN

High accuracy you can trust . . .
Versatile measuring capabilities . . .
An efficient, easy to operate meter . . .
All at an affordable price . . .
That's the DVM38 . . . The complete DVM that sets new performance standards in 4 key areas.

A NEW ACCURACY STANDARD

The 3 $\frac{1}{2}$ digit, .1% accuracy is backed by a 15 meg Ω input impedance, compared to 10 meg Ω input of conventional DVM's, which guarantees up to 50% greater accuracy with 1/3 less circuit loading on every measurement for high accuracy you can trust.

A STANDARD IN CAPABILITIES

The DVM38 is more accurate in MORE circuits with these versatile ranges: 100 μ V to 2000V DC, 1KV AC; .01 Ω to 20 meg Ω ; 0.1 μ A to 2A . . . Plus

HI and LO ohms and a 50KVDC range with accessory Hv probe.

A NEW STANDARD IN SPEED AND EASE OF OPERATION

Large pushbuttons and callouts — no need to hunt and peck. Large .4" L.E.D.'s with direct readout, down to V and mV indicators. SINGLE STEP AUTO-RANGING for maximum resolution and efficiency. 2KV DC protection minimizes downtime.

THE AFFORDABLE STANDARD

There are few .1% DVM's less expensive — there are none as complete in this price range, plus backed by a LIFETIME guarantee against factory workmanship errors.

THE DVM38 A NEW STANDARD IN DVM's FOR SPEED, VERSATILITY AND ACCURACY.

DVM38 BACKED BY SENCORE'S 100% MADE RIGHT LIFETIME GUARANTEE

SENCORE 3200 Sencore Drive, Sioux Falls, S.D. 57107
Phone: 1 605 339 0100 TWX: 910-660 0300

CIRCLE NO. 48 ON FREE INFORMATION CARD

COMING UP IN THE MARCH

Popular Electronics®

HOW TO MINIMIZE SCOPE-PROBE
COMBINATOR ERRORS
CARE AND FEEDING OF NICKLE-CADMIUM
BATTERIES
THEFT ALARM FOR HAND-HELD CALCULATORS
BUILD THE "PENNYWHISTLE" MODEM
LED-READOUT AUDIO POWER METER

PRODUCT TEST REPORTS:

ONKYO TX-220 AM/STEREO FM RECEIVER
MARANTZ 5220 STEREO CASSETTE DECK
MIDLAND CB AT MOBILE TRANSCEIVER
HEATHKIT GB-1201 7-FUNCTION STOP WATCH

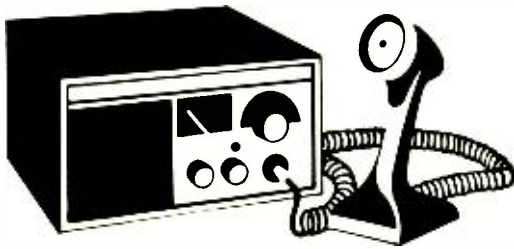

CB Scene

By Ray Newhall

THE FCC AND THE CB'ER

TO AN old-time CB'er who has used more than a dozen rigs since 1959, it's been very interesting to note an important shift in the FCC's attitude toward the Citizen's Radio Service. Evidence of this is obvious; in early 1975, antenna height regulations were eased; in September, restrictions on hobby use were lifted, and inter-station communications were permitted on 21 "free" channels.

At this point, it seems safe to say that the FCC is finally meeting the CB'er at the half-way point. The troublesome, unenforceable regulations have been nearly eliminated from Part 95, and constructive rules have been strengthened to improve the service. Let's briefly review these changes to the Rules and Regulations.

Relaxed Rules.

- Omnidirectional antennas can be raised to 60 feet above ground. All other antenna restrictions remain unchanged. Note these cover receiving as well as transmitting antennas.

- All channels except channels 9 and 11 can be used for communications between units of different stations.

- Non-substantive (hobby) use is permitted on all "free" channels.

- Only *your* call letters need be broadcast at the beginning and end of each transmission. Handles (Chief Frog, etc.) can be used additionally for ID purposes, but are not substitutes for call letters.

- The 5-year license fee has been reduced from \$20 to \$4.

- Communications are still limited to 5 minutes duration, but waiting time between communications has been reduced to one minute. CB'ers can now relay messages for other operators up to a total distance of 150 miles.

- Uses of channel 9 which provide assistance to travellers have been clarified to include boats, aircraft, etc.

Added Or Reinforced Reg's.

- Channel 11 has been designated a "Call and Switch" channel, which can be used as a common hailing channel. Once contact is established, the operators must switch to another channel.

- Each CB'er must transmit his own call letters at the beginning and end of each transmission. There is a strong indication that failure to use call letters will be considered evidence that the operator is not licensed. Stringent enforcement of station ID is expected, with intensive efforts made to identify and prosecute unlicensed operators.

- No linear amplifiers can be manufactured, sold, or used. The presence of a linear on the premises will be considered "de facto" evidence of its use. No modulation boosting devices (mike amplifiers) can be used if they are capable of driving the transmitter beyond 100% modulation. Note that all type-accepted transmitters built since May 1974 must contain modulation limiting devices, and must not modulate the carrier with audio information extending above 3000 Hz.

- CB radio must not be used in any connection with acts contrary to any Federal, state, or local law or ordinance.

- No CB communications can contain obscene, indecent, or profane words, language, or meaning. No music, whistling, or audio tones (other than tone bursts for selective squelch) can be transmitted. No modulated or unmodulated carrier or SSB signal can be transmitted with the intention or effect of "jamming" the frequency or attracting attention (such as "Goony birds"). It is illegal to intentionally interfere in any way with the communications of another station.

- Never transmit the word "MAY-DAY" or any other international distress signal unless there is a confirmed, "grave and imminent danger to life or property." Penalties for false distress signals range from heavy fines to severe jail sentences, or both!

For about 18 years many CB'ers

Our new cartridges will turn your good record player into a great record player.

Perhaps you've tried to track your records at the lowest advertised setting for your elliptical stylus. In the hopes of optimizing performance and reducing record wear. But every footstep threatens to bounce the stylus out of the groove. And big crescendos are simply *fuzzy*. Should you get a better player? No. Get a better stylus.

We have a sensible new approach. A stylus shape that contacts more of the groove wall, to spread tracking force over a greater vertical area. The Shibata

stylus. It safely tracks your records at up to 2 grams while maintaining response to 45,000 Hz, offering great stereo separation, and *reducing* record wear... even compared with an elliptical stylus at less than a gram.

Put an Audio-Technica Dual Magnet UNIVERSAL cartridge with genuine Shibata stylus in your good old record player today. It's a great combination for better sound today and tomorrow, and tomorrow.



AT12S



AT14Sa



AT15Sa
AT20SLa



audio-technica® INNOVATION / PRECISION / INTEGRITY

© AUDIO-TECHNICA U.S., INC., Dept. 26P, 33 Shilawasse Ave., Fairlawn, Ohio 44313
Available in Canada from Superior Electronics, Inc.

have questioned the motives for the restrictive provisions of Part 95. But now (at last!) we have a set of relaxed rules we can live with.

These rules are also just in that they provide a legal basis to protect the majority of us who want to use the Citizens Band legitimately. They will make life difficult for the few rude operators who claim solitary possession of the channels for their personal pleasure. The "don'ts" have been clearly defined. We all must admit that these restrictions are aimed only at curbing the gross abuses of the CB pirates who tend to make the band offensive and useless.

By simplifying the rules, the FCC seems to be saying that it intends to enforce them as completely as possible. One major area of concentration will be illegal linears and mike boosters. Every day, both we and the FCC monitors can hear splatter, distortion, and bleedover caused by the use of such devices. Persons who use them obviously have no concern for others. Nor do they have the knowledge (in my opinion) that every word they say can be heard on at least three, seven, or in extreme cases, all 23 channels. Not to mention their neighbors' radios, TV receivers, etc.!

All legitimate CB'ers should applaud these efforts to clear up the band. I, for one, will keep my Congressman and Senators aware of the Commission's need for adequate funding of the enforcement program. I hope you'll do the same!

Is There More to Come? Yes, there is. There are possibilities of nearly doubling the number of Class D channels, although some of the new channels may be restricted to SSB only.

But equally important are the most recent proposals for an additional class of the Citizens Radio Service in the vhf region, around 200 MHz. It would be an FM band with an authorized transmitter power output between 10 and 25 watts, not unlike the vhf/FM marine band now in use.

The EIA first suggested a "Class E" Citizen's Band in 1968, and petitioned the FCC to authorize 80 channels on frequencies which are part of the then little-used 220-to-225 MHz amateur band. This service would enjoy the benefits of FM operations—noise immunity and capture effect (the tendency of an FM receiver to "lock on" to the most powerful signal on channel and reject all others).

The nature of vhf signal propagation would restrict most communications to a 15-to-20 mile "line-of-sight" range. Over these distances, 25 watts of output power would provide reliable communications at almost any time of the day, season of the year, or point in the 11-year sunspot cycle.

However, the Commission has not acted on the Class E proposal for nearly seven years, due in part to the objections of radio amateurs. During that time amateurs successfully established many repeater networks on the band under the theory of "protection of property." In 1975, the FCC finally issued a counterproposal to the EIA petition, suggesting a 40-channel band just below 220 MHz.

However, no such service has actually been set up. In 1975, the Office of

Telecommunication Policy, a White House agency set up in recent years, requested that the FCC act quickly to establish the Class E band. Unfortunately, the Commission has not yet made any firm decisions on the Class E proposal for a variety of reasons. Of major importance is the fact that Canada and Mexico have not agreed to the change thus far. Are both D and E needed? Yes, most definitely—at least for the next several years. Class D is a popular, low-cost service, especially useful for the protection and safety of those using the interstate highways, as well as small boat users. Most of all, Class D is an established service, a known quantity.

Class E, on the other hand, will be at an initial disadvantage. Vhf transceivers will probably cost about twice as

The Defender

stands guard over super CB performance

- Connects to base station rig
- Constant control of SWR
- Constant check on power output
- Constant check on modulation
- Easy to use and install—coax connections only



Shakespeare

Shakespeare Antenna Group, P. O. Box 246, Columbia, S. C. 29202
In Canada: Len Finkler, Ltd., Ontario

CIRCLE NO. 49 ON FREE INFORMATION CARD

the PROFITMETER



**AUTO ZERO/POLARITY
3½ DIGIT MULTIMETER KIT
WITH BRIGHT RED LED DISPLAY**

On the Service Bench or in the Field. Wherever and whatever the job, you'll need its battery operated portability and its high accuracy: .1% DCV & OHMS, 1% Current and ACV.

\$79.95 +2.95 P & H
LESS TEST LEADS
& BATTERIES



ALPHA ELECTRONICS
DEPT 1 PO BOX 1005
MERRITT ISLAND, FLA. 32952

TO ORDER OR FOR INFORMATION
CALL TOLL FREE
800 - 327 - 2084

DIXIE SAVE ON Brand Name Audio Components

BY MAIL

Write Today for Our
FREE Audio Catalog

DIXIE is one of the oldest and largest audio component mail order houses in the country. Our prices on brand name components are actually **LOWER** than "Discounters". See our new catalog or call us for a price quote. Everything shipped factory-sealed with full manufacturer's warranty.



DIXIE HI-FIDELITY PE-2

5600 Second St., N. E., Washington, D. C. 20011
Phone: 1-202-635-4900

Please rush me your **FREE** Audio Catalog and complete information. I understand there is no obligation.

Name _____
Address _____
City _____
State _____ Zip _____

much as those for the 11-meter band with similar features. At first, the band will be empty. Despite higher initial cost, vhf rigs will yield far more reliable "point-to-point" communications than their hf counterparts. The very emptiness of the band will stimulate interest.

About ten years after its introduction, Class E may well overtake the Class D band. As hf equipment wears out, much of it will likely be replaced with vhf gear. Many will join the move to vhf to escape ignition noise, skip, and other types of interference.

The Citizens Radio Service today represents by far the greatest number of two-way radio users outside of government agencies. Yet it is allocated only a small fraction of the radio spectrum as compared to others. So I hope that events in 1976 will build on what has happened for the good in 1975. This includes finalizing Class D expansion, adopting Class E, speeding issuance of licenses (perhaps at point-of-sale), and controlling violators of Part 95 rules. For the latter, perhaps a CB counterpart of the hams' official observer program could be instituted to clean up our own house.

Your comments, both pro and con, are most welcome. ◆



12 REASONS YOUR CAR NEEDS TIGER CDI

Instant starting in any weather - Eliminates tune-ups - Increases gas mileage - Increases horsepower 15% - Improves acceleration and performance - Spark plugs last up to 70,000 miles - Reduces engine maintenance expense - Amplifies spark plug voltage to 45,000 volts - Maintains spark plug voltage to 10,000 RPM - Reduces exhaust emissions - Dual ignition switch - An Unconditional **LIFETIME GUARANTEE** Installs in 10 minutes on any car with 12 volt negative ground - No rewiring - Most powerful, efficient and reliable Solid State Ignition made.

SATISFACTION GUARANTEED or money back

TIGER 500 assembled \$53.95
TIGER SST assembled \$42.95
Post Paid in U.S.A.

Send check or money order with order to:

Tri-Star Corporation
P. O. Box 1727 C
Grand Junction, Colorado 81501

DEALER INQUIRIES INVITED
CIRCLE NO. 57 ON FREE INFORMATION CARD

free BA 1976 catalog

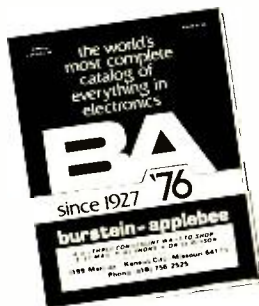

**244 PAGE
RADIO, TV &
ELECTRONICS
CATALOG**

Your buying guide for Everything in Electronics ... Stereo, Hi-Fi, TV's, Radios, Tape Recorders, CB, Kits, Tools, Books and Electronic Parts.

**WRITE FOR YOUR
FREE COPY NOW!**

burstein-applebee

DEPT. PE-2 3199 MERCIER ST.
KANSAS CITY, MO. 64111

NAME _____
ADDRESS _____
CITY _____
STATE _____ ZIP _____

Operation Assist

If you need information on outdated or rare equipment—a schematic, parts list, etc.—another reader might be able to assist! Simply send a postcard to Operation Assist, POPULAR ELECTRONICS, 1 Park Ave., New York, NY 10016. For those who can help readers please respond directly to them. They'll appreciate it. (Only those items regarding equipment not available from normal sources are published.)

Rogers batteryless receiver type R-563-E, serial no. 5221E, by Rodgers-Majestic Corp., Ltd., Toronto. Early 1940's. Schematic, manual, or any information. William G. Carew, No. 5, 6147 Buckthorn Rd. N.W., Calgary, Alberta, Canada T2K 2Z2.

Paco Model C 25 in-circuit capacitor tester. Schematic. S. Goldhor. 1014 B St., Hayward, CA 94541.

Mood Master Model 201 recorder by Conley Electronics Corp., Skokie, IL. Need transformer or data, and source for same. Schematic also. Henry W. Roeben, Rte. 1, Box 5, Lancaster, WI 53813.

Grundig-Volltransistor-Konzertgerat 8053 stereo receiver, schematic and/or service notes. **Heath** roll and/or chart for Model TC-2. Robert Caylor, 40 W. Free Rd., Anderson, IN 46012.

Delco or **Motorola** 2N1970 and **GE** 2N2106 transistors or source for same. K. R. Gustafson, 1604 9th St., Marinette, WI 54143.

Guya Tone Model GA-950 guitar amp. by Tokyo Sound Co. Ltd. Schematic. Ron Holmes, 5545 Canehill, Lakewood, CA 90713.

Knight r-f and a-f signal generator manufactured by Allied 1955-65. Schematic or construction manual. Leonard Watkins, Jr., 126 S. Gordy, El Dorado, KS 67042.

National Model NC 125 four-band general-coverage receiver. Any available information. Daryl Rybotycki, 46 Morris Dr., Saskatoon, Sask., Canada, S7L 3T9.



FOR THE MAN IN ELECTRONICS

SEE TRIGGER'S GREAT SELECTIONS

Send for this reliable buying guide to carefully selected:
Amateur Gear • Stereo Hi-Fi • Electronic Kits • CB Radio • Tape Recording • Electronic Parts • Antennas • Tubes • Transistors • Tools • Books • Test Gear

Count on TRIGGER for the best in electronics. Write for this Free Catalog today!

A MONEY-SAVER

SEND FOR IT TODAY! **FREE Catalog**

TRIGGER Electronics, Dept. 12-FE
7361 North Ave., River Forest, Ill. 60305

Send **FREE TRIGGER** Catalog

Name _____
PLEASE PRINT
Address _____
City _____ State _____ Zip _____

CIRCLE NO. 58 ON FREE INFORMATION CARD
POPULAR ELECTRONICS

WHAT CREATURE CAN:

- Make outer space sounds for rock musicians?
- Demonstrate principles of music & acoustics for educators?
- Create sound effects for theatre companies?
- Provide rhythmic pulses and tones for modern dance groups?
- Be one of the neatest toys in the world for an audiophile?

PAIA'S GNOME,



of course!

The 1st Micro-Synthesizer...
under \$50 in kit form.

FOR DETAILS AND PHOTOGRAPHS OF THE GNOME, AS WELL AS DOZENS OF OTHER KITS FEATURING INNOVATION RATHER THAN IMITATION, WRITE TO US FOR A

FREE CATALOG

PAIA Electronics, Dept. 2-P,
Box 14359, Oklahoma City, OK 73114

CIRCLE NO. 39 ON FREE INFORMATION CARD

CB

where the ACTION'S at

Millions of 2-way CB radios are in use—millions of new ones are being sold annually to new CBers and for replacing old units—what a market for repair service. It's the biggest thing in electronics since color TV. There's only one thing wrong with CB growth—the lack of technicians capable of servicing CB radios. That's why many TV shops are expanding into CB and why new CB shops are opening up all over the country. Going CB servicing rates run from \$12 to \$24 per hour.

To get into CB radio servicing, full-time or part-time, you need test equipment, an FCC operator license and to learn how. To learn how, you can buy the **CB RADIO REPAIR COURSE** for cash, on a monthly payment plan, or charge the cost to your BankAmericard or Master Charge account.

To make it easy to study, this 70-lesson course employs the **PROGRAMMED** teaching technique and sticks to the target—CB radio. Study at your own pace as you receive the self-examining lessons. We can't guarantee that you will become a CB expert since that depends on you. We promise nothing except information. To get the facts about this course, write a letter or card or mail the coupon below today. No salesman will call.

CB RADIO REPAIR COURSE, INC.

Dept. P-26

531 N. Ann Arbor
Oklahoma City, OK 73127

Please send information about your Course to:

Name _____
Address _____
City _____ State _____ Zip _____

CIRCLE NO. 61 ON FREE INFORMATION CARD



Tips & Techniques

DOG-BONE WRENCH IS RIGHT TOOL FOR FRONT-PANEL COMPONENTS

Rotary switches, potentiometers, and other components that mount on panels must be securely tightened. Most experimenters and hobbyists, unfamiliar with proper shop practices or too much in a hurry to get the job done, reach for ordinary pliers to tighten the nuts holding these components. The result is that the pliers often slip and gouge the panel. The obvious moral is to use the right tool for the job. But what is the right tool in this case? The answer is the inexpensive "dogbone" wrench. It has hex openings sized to accommodate all common locknut sizes.

—Raymond F. Arthur

MEDICAL/DENTAL TOOLS

Some medical and dental tools can be put to good use on an electronics workbench. As a typical example, the dental inspection mirror is just as handy in inspecting electronic equipment chassis as they are for inspecting teeth. Need a hands-free heat sink when soldering a component into place in a circuit? Almost made-to-order for heat-sinking jobs like this is the medical hemostat or clamp. Equipped with a positive locking action that keeps its jaws clamped shut, the hemostat also comes in handy as a general holding tool. Such tools are available from certain electronics parts outlets, but if you can't find them locally, try your local medical/dental supply house.

—Michael Rosentfield

MASKING TAPE MAKES HANDY NUT HOLDER

When assembling a kit, it can be very difficult to start a screw when a nut must be held on the other side of a chassis. Using a 3- or 4-inch (7.5- or 10-cm) piece of masking tape can simplify matters. Wrap the tape (adhesive side out) around the tip of the index finger. Place the nut on the adhesive side of the tape and hold it behind the hole.

—Harry Gondo

HAND DRILL SIMPLIFIES MAKING TWISTED-PAIR CABLE

If you have ever tried to make by hand a twisted-pair cable more than a few inches long, you know how tedious the job can be. It needn't be. The next time you need twisted-pair cable, cut two pieces of hookup wire to the same length, clamp one end of each in a vise, and chuck the other ends into a hand (not electric power) drill. Then just crank away on the drill. In a matter of minutes, you can make several feet of twisted-pair cable.

—John Bretthauer



LISTEN!

We're one of the country's largest Mail Order Houses of Stereo Equipment

Our volume buying power enables us to pass the savings on to you. Listen to us ... You can't go wrong.

Fill out this coupon and mail to address below for our latest Free Catalogs.

Name _____

Address _____

City _____

State _____ Zip _____

AUDIO CATALOG

PE-2

STEREO DISCOUNTERS

7A AYLESBURY ROAD □ TIMONIUM, MD. 21093

[301] 252-6880

CIRCLE NO. 55 ON FREE INFORMATION CARD

SAVE!

MONEY • TIME • FREIGHT

QUALITY STEREO EQUIPMENT AT LOWEST PRICES.

YOUR REQUEST FOR QUOTATION RETURNED SAME DAY.

FACTORY SEALED CARTONS—GUARANTEED AND INSURED.

SAVE ON NAME BRANDS LIKE:

A.D.C.	KLH
A.R.	SHURE
DYNACO	KOSS
SONY	FISHER

PIONEER

AND MORE THAN 50 OTHERS

BUY THE MODERN WAY

BY MAIL—FROM



Department 217S

12 East Delaware

Chicago, Illinois 60611

312-664-0020

CIRCLE NO. 26 ON FREE INFORMATION CARD

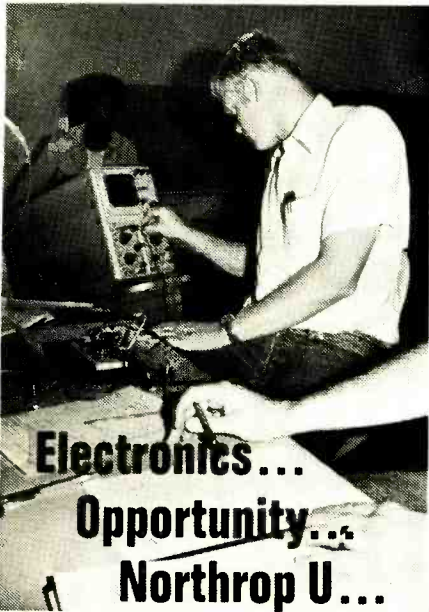

**Electronics...
Opportunity...
Northrop U...**

Want a career in electronics? Like to attend a university with a world-wide reputation in engineering education? Northrop University offers a small-class environment where learning really happens. The faculty, many have wide industry experience, are always there to help. The facilities are top-notch and graduate placement continues to be outstanding. Many EE students belong to the student chapter of the Institute of Electrical and Electronic Engineers, a national professional society.

These students know . . . opportunities in electronics, begin at Northrop U.

For information, complete and mail the coupon below. There's no obligation, of course.

**NORTHROP
UNIVERSITY**

1123 W. Arbor Vitae Street
Inglewood, California 90306

An independent, accredited, coeducational senior institution offering undergraduate and graduate programs in engineering, math, science, technology, computer science and management.

Northrop University 1122
1123 W. Arbor Vitae St., Inglewood, CA 90306

Please send me more information, I am interested in:

- Undergraduate Graduate
 Colleges of: Engineering, Technology, Science & Humanities
 College of Business & Management
 Institute of Technology (A & P)
 School of Law (Graduate)

H.S. Grad. Date _____ 19 _____

Name _____ Age _____

Address _____

City _____

State _____ Zip _____

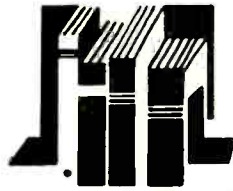

Electronics Library

GUIDE TO HIGH FIDELITY

This book (prepared by The Institute of High Fidelity) presents the advantages of component high-fidelity systems (stereo and 4-channel) and some points to consider when shopping for such equipment. Popular program sources, including discs; cassette, cartridge, and open-reel tapes, and FM radio, are discussed. Various aspects of preamplifier and power amplifier operation are explained—including equalization, impedances, power output, amplifier controls and specifications. Separate chapters are devoted to loudspeakers and headphones. The final chapter explains how to assemble a hi-fi system from components. Appendices include typical component specifications and a glossary of high-fidelity terms.

Published by Howard W. Sams & Co., 4300 W. 62nd St., Indianapolis, IN 46206. 174 pages. \$4.50.

**GE POWER TRANSISTORS USERS GUIDE,
SECOND EDITION**

This updated book contains practical information on circuit applications, handling and mounting, and reliability prediction. Covered is GE's line of power semiconductors, which includes complementary pairs, Darlingtons, and high-voltage transistors, in both metal and plastic cases. General information is given on pellet construction, critical parameters, thermal considerations and operational cycling.

Published by General Electric Corp., Semiconductor Products Dept., Syracuse, NY 13201. 120 pages (8½" x 11"). Soft cover.

SERVICING MAGNAVOX FOR 1974-1975

by Stan Prentiss

This latest addition to Audel's servicing series covers Magnavox's consumer electronics line for the appropriate years. Included are color and monochrome television receivers, with separate chapters devoted to TV portables, radios and the Odyssey TV game simulator, and tape players/recorders and amplifiers. Special servicing information is contained in two chapters. One shows the wide range of tests possible with an oscilloscope, and the other gives troubleshooting tips and waveforms for the new T995 TV receiver.

Published by Theodore Audel & Co., Div. of Howard W. Sams & Co., 4300 W. 62nd St., Indianapolis, IN 46206. 473 pages (8½" x 11"), not including foldouts. \$12.95 soft cover.

**INTRODUCING
VDM-1**



VIDEO DISPLAY MODULE

- ultra high-speed intelligent display
- generates 16, 64 character lines of alpha-numeric data
- displays upper and lower case characters
- full 128 ascii characters
- single printed circuit card
- standard video output

The VDM-1 is an ultra high-speed intelligent display on a single printed circuit card. The new card generates 16, 64 character lines of Alpha-numeric data in upper and lower case characters from a 1K Byte memory.

The VDM-1 configuration allows you to build a powerful terminal, with a standard video output into your Altair Processor.

Price: \$160.00

**SPECIAL
FREE OFFER!**

**Scientific Notation Software
Package with Formatted Output**

With the purchase of (1) VDM-1 and (1) 4KRA Memory:

Just \$299.00

(Offer expires 2-1-76)

The floating point math package features 12 decimal digits with exponents from +127 to -127; handles assigned and unassigned numbers. With it is a 5 function calculator package; + - X ÷ & square root. It includes 3 storage and 3 operating memories and will handle chain and column calculations.

For more details on these and other 8800 plug-in compatible modules, write to:

Processor Technology
2465 Fourth Street
Berkeley, Ca. 94710

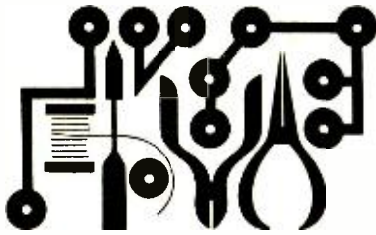

Experimenter's Corner

By Forrest M. Mims

TTL SEQUENCE GENERATOR

BUILDING a TTL sequence generator is an excellent way to learn more about digital logic IC's. Besides being a valuable teaching tool, this handy circuit has dozens of practical applications, ranging from a programmable square-wave generator to an unusual LED flasher. You can also

is also a single transistor at each output to provide interface buffering.

Now that you know how the sequence generator works, take a look at the complete circuit diagram in Fig. 2. The clock is a 555 timer IC connected as an astable (free-running) multivibrator. You can use a unijunc-

show the two simplest operating modes of the sequencer. In Fig. 3, the timing pulses from the 555 clock are shown in the top trace, and the output from one of the ten 7441 outputs is shown in the bottom trace. Note how one 7441 pulse occurs for every ten clock pulses. In Fig. 4, two outputs from the 7441 (pins 16 and 8) have been shorted together to give two output pulses separated by a single clock period. By shorting pin 15 to pins 16 and 8, a third pulse will be produced between the existing two. The result will be a single pulse having a total width of three clock periods.

Different Outputs. Most of you are probably way ahead of me by now and realize you can short various combinations of output pins to produce dif-

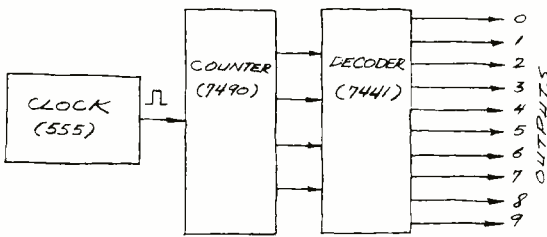
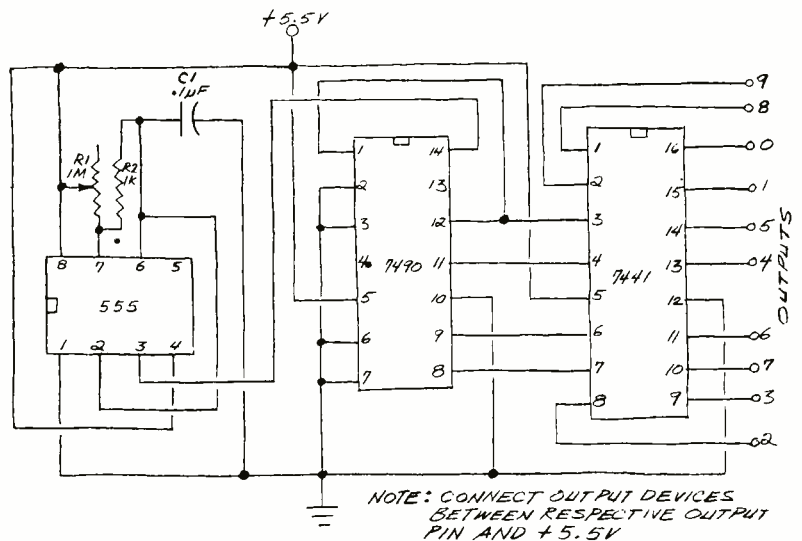

Fig. 1. Block diagram of sequence generator.

Fig. 2. A 555 timer is the clock and two 7400 IC's count and decode its output.



program a sequence generator to synthesize electronic music or to turn lights and radios on and off at "random" when you are away. The operation is versatile enough to fool potential burglars into thinking someone is home.

Figure 1 is the block diagram for a basic ten step (0-9) sequencer which uses a simple clock and a couple of TTL chips. All three chips for the sequencer can be purchased for well under \$2.50 from many of the parts suppliers who advertise in the back of this magazine.

Operation of the sequencer is straightforward. The clock delivers a string of pulses to a 7490 decade counter which counts the incoming pulses and supplies a running total in binary form (often called binary coded decimal or simply BCD) to a 7441 BCD to decimal decoder. The 7490 contains four cascaded flip-flops. Only one of the ten outputs of the 7441 is activated for each of the BCD equivalents of 0-9. The 7441 does all this with 7 gates containing a total of 17 transistors, 26 diodes, and 29 resistors. There

tion transistor oscillator or a simple TTL clock made from inverters, but the 555 provides a very wide range of timing periods and is ideally suited for use in a sequence generator. Note that both the 7490 and 7441 are self-contained chips which don't require any external components.

The scope photos in Figs. 3 and 4

ferent square-wave outputs.

To convert the basic sequencer into an odd-sequence LED flasher (guaranteed to attract attention) just connect two or more LED's to various outputs or combinations of outputs. Connect the anode leads of the LED's to the positive supply through 370-ohm resistors (to limit current and pro-

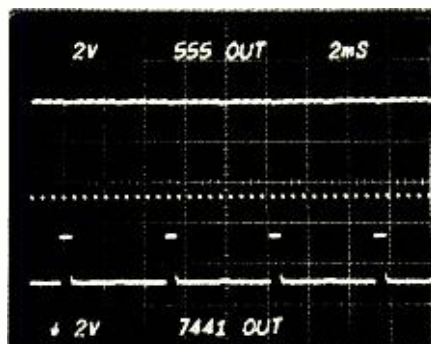

Fig. 3. 555 clock pulses and single output from the 7441.

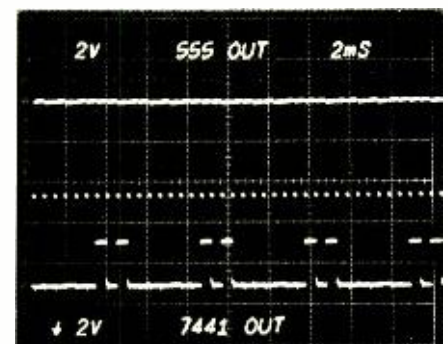

Fig. 4. Clock pulses (top) and output from two pins of 7441.

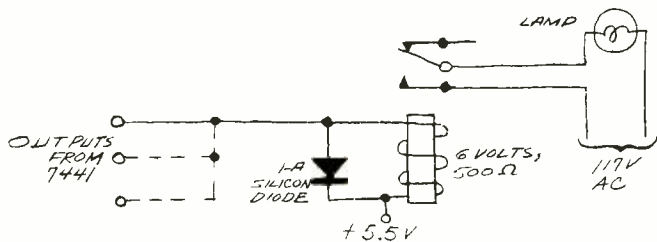

Fig. 5. As many as 10 relays can be used to control various home appliances.

tect the LED's) and the cathode leads to the appropriate output pins. Increase $C1$ (Fig. 2) to about $5\ \mu\text{F}$ to slow down the clock and make the individual flashes visible.

For easy programming, use one or

more rotary switches to short various outputs together. You can make interesting effects by mounting the LED's in a geometric shape or outline. Try arrows, circles, and zig-zags for best results. Incidentally, this circuit

delivers about 10 mA to each LED. If more current is needed for your LED's, use 185-ohm series resistors for 20 milliamperes.

Burglar Deceiver. Now that you know how to build both a programmable square-wave generator and a fairly fancy LED flasher, how do you "randomly" switch your house lights and perhaps a radio on and off to keep the burglars away? Simply increase $C1$ to $50\ \mu\text{F}$ and $R1$ to 10 megohms to get a clock cycle of about ten minutes for a total timing period of 100 minutes. Then connect outputs from the 7441 to suitable relays whose contacts control lamps or radios in various rooms of your house. Install a 1-A rectifier diode across each relay coil as shown in Fig. 5.

Here's a table for a possible deception arrangement you can adapt to your own use:

Timing Cycle	7441 Pins	Appliance(s)
0	16	Kitchen Light
1	15	Kitchen Light
2	8	Living Room Lamp/Radio
3	9	Living Room Lamp/Radio
4	13	Living Room Lamp/Radio
5	14	Bedroom Lamp
6	11	Bedroom Lamp
7	10	Bathroom Lamp
8	1	Bedroom Lamp/Radio
9	2	Bedroom Lamp/Radio

(Repeat)

Make sure the relays you choose are properly rated or your burglar deceiver will fool no one but you! For example, let's assume you use relays with contacts rated for 1 ampere at 117 volts. Most household appliances are rated according to power consumption, so you will have to determine what power level these contacts can safely handle. Since $P=EI$, this relay will switch up to 117×1 or 117 watts. Of course, if you want to use solid-state switching, the 7441 outputs can drive triacs, but be sure to observe current and PIV ratings.

If you like this burglar deceiver, don't be afraid to experiment with the timing cycles and sequences. For example, try increasing $C1$ to get longer timing cycles. Also, consider using a light-activated relay to turn the circuit on at night and off in the daytime. Finally, be sure to install the circuit in a case along with a 5.5-volt power supply (more about this topic in a future column). Use good wiring between the relays and the appliances they control or you may have a fire hazard. ♦

You're known by the company you keep!



Owners of Citizens Band radios represent a unique consumer group whose word-of-mouth product opinions are voiced using the product itself! These users, who "tell it like it is," have established Browning as the industry's quality leader, in the status-conscious CB fraternity, owning a Browning Golden Eagle means owning the very best—a fact that has been substantiated by actual user resale prices for the past ten years.

As pioneer in the electronics industry for over half a century, Browning has established a heritage of craftsmanship that CBers know and trust. Be it base station or mobile, every Browning unit is backed by an outstanding service policy unequalled in the industry.

For further information about Browning, talk to any of the more than 4,000,000 licensees or write for your free full-color brochure of all Browning products from

browning
laboratories inc.

LACONIA, N.H. 03246
(603) 524-5454

Poly Pak's



SALE



EXCLUSIVE 'BARREL'

THE BIGGEST INFLATION-FIGHTING VALUE EVER! TEST 'EM YOURSELF 'N SAVE!

Every kit carries money back guarantee.

BUY 'EM FROM THE "BARREL"

BARREL KIT #1 5N7400 DIP IC'S 75 for \$1.98 Marked 14 and/or with 10 pin dips, may include gates, registers, flip flops, counters. Who knows! GUARANTEED SATISFACTION! Cat. No. 2415 Untested.	BARREL KIT #2 LINEAR OP AMPS, DIPS 75 for \$1.98 You tested 709's, 741's, 703's, 640 series, 645 included, marked and unmarked. Cat. No. 2416	BARREL KIT #3 1N4148/914 SWITCHING DIODES 100 for \$1.98 You never saw this before. Imagine famous switching diodes at these prices! Cat. No. 2418 Untested.	BARREL KIT #4 "4000" RECTIFIERS 100 for \$1.98 These are the famous micro miniature rectifiers of the UN1000 series. May include 25, 50, 100, 200, 300, 600, 800 and 1000 voltages. Cat. 2417 Untested.	BARREL KIT #5 SCRs, TRIACS, QUADRACS 40 for \$1.98 All the famous plastic power tab type. Raw factory stocks! All the 10 amp types. Cat. No. 2419 Untested.	BARREL KIT #7 VOLUME CONTROL BONANZAS! 40 for \$1.98 100% good Singles, duals, variety of values, styles, big ones — small ones. Cat. No. 2421	BARREL KIT #8 SUBMINIATURE IF TRANSFORMERS 60 for \$1.98 100% good. Amazing, includes 455Kcs, 05K, antennas who knows! From transistor radio manufacturers. No. 2422
BARREL KIT #10 ROMS-REGISTERS 50 for \$1.98 Untested 28 to 40 pin devices, marked, internal factory numbers, etc. No. 2424	BARREL KIT #11 POWER TAB TRANSISTORS 40 for \$1.98 NPN, plastic TO220 type. Assorted 2N numbers. Cat. No. 2425 Untested.	BARREL KIT #12 POWER TAB TRANSISTORS 40 for \$1.98 PNP, plastic TO220 type. Assorted 2N numbers. Cat. No. 2426 Untested.	BARREL KIT #13 RESISTOR NETWORKS 40 for \$1.98 Untested. By Corning Glass in 14-pin dip packs. Cat. No. 2427	BARREL KIT #14 PRECISION RESISTORS 200 for \$1.98 100% good Marked and unmarked 1/4, 1/2, 2 watts. No. 2428	BARREL KIT #15 MOSFET TRANSISTORS 60 for \$1.98 100% good All 4 leaders TO-18 case, includes DUTY transistors too! Cat. 2429 Untested.	BARREL KIT #16 DISC CAPACITORS 200 for \$1.98 Marked and unmarked. Red case type ass't. values. Cat. No. 2430 100% good.
BARREL KIT #17 LINEAR & 7400 DIPS 100 for \$1.98 Untested Marked and unmarked, internal numbers of raw factory stock. No. 2431	BARREL KIT #18 ZENER-RECTIFIER MIX 100 for \$1.98 Subminiature, DO7's, includes ass't. zeners and rectifiers. It's mixed at the factory, we cannot separate. Untested. Cat. 2432	BARREL KIT #19 DIPPED MYLARS 60 for \$1.98 100% good. Finest capacitor made, shiny finish. Imagine factory dumping 'em in barrels. Cat. No. 2597 100% good.	BARREL KIT #20 LONG LEAD DISCS 100 for \$1.98 100% good. Factory distributor stock "auction sale". Prime, marked only. Long leads. Cat. No. 2598 100% good.	BARREL KIT #23 "RTL" IC'S 75 for \$1.98 100% good. All in TO-5 cases, brand new. May include 90M, 91F, 91Z, 91S, etc. Cat. 2601	BARREL KIT #24 HIGH VOLTAGE RECTIFIERS 60 for \$1.98 Untested. Up to 12,000 volts, 4 mils. epoxy, axial leads. Cat. No. 2602	BARREL KIT #25 METAL CAN TRANSISTORS 100 for \$1.98 Untested. Includes TO-5, TO-18, etc., assorted 2N numbers, unmarked etc. Cat. No. 2603
BARREL KIT #26 PLASTIC TRANSISTORS 100 for \$1.98 Untested. Type TO-92 (TO-18), all manufacturers, variety of 2N's. Cat. No. 2604	BARREL KIT #27 PREFORMED DISCS 100 for \$1.98 100% good. Hi-Fi mfr's shelf inventory but he dumped 'em in barrels. Preformed, for PC use. Mixed values too! Cat. No. 2605 100% good.	BARREL KIT #28 CERAMIC CAPACITORS 200 for \$1.98 100% good. Not only do the barrels contain dogbones, but factories dumped. Eric Central, molded types too! Cat. No. 2606 100% good.	BARREL KIT #29 VITAMIN Q CAPS 100 for \$1.98 100% good. Every type of oil-impregnated caps, some worth \$2. But the "oil barrel" sale gives you the bargain-of-a-lifetime. Cat. No. 2607	BARREL KIT #30 PREFORMED RESISTORS 200 for \$1.98 100% good. We got barrels of 1/4 and 1/2 wattors for pc use. You'll get even amount 100 1/4, 100 1/2 wattors. Cat. No. 2608 100% good.	BARREL KIT #31 METALLIC RESISTORS 100 for \$1.98 100% good. Made mostly by Corning, the finest resistor made. Mostly 1/2 wattors, 1% to 5% tol & a barrel of values 100% good. No. 2609	BARREL KIT #32 TRANSISTORS WITH A HOLE IN IT 50 for \$1.98 Untested. Can't name factory but we bought barrels of 25 wattors with tiny hole in middle. PNP's and NPN's. Cat. No. 2610 Untested.
BARREL KIT #34 TUBE SOCKETS 100 for \$1.98 100% good. Good old tube sockets still in demand! Barrels and barrels: 4's, 5's, 7, 8, 9, even computer types. Cat. No. 2612 100% good.	BARREL KIT #35 NEON LAMPS 40 for \$1.98 100% good. Famous NE-2's. All prime, but factory made millions and barrels 'em, your advantage. Cat. 2613	BARREL KIT #36 GERMANIUM DIODES 200 for \$1.98 100% good. Famous maker, popular item. Never grows old. But this is the way the RECTIFIERS buy 'em from the factories. Untested. Cat. 2614	BARREL KIT #37 1 AMP "BULLET" RECTIFIERS 100 for \$1.98 100% good. Famous style, ass't. voltages, silicon, axial includes all types of voltages to 1KV. Untested. Cat. No. 2615	BARREL KIT #38 2 AMP RECTIFIERS 75 for \$1.98 Untested. "CYLINDER" type, silicon. Mallory, includes all voltages up to 1KV. Axial leads. Cat. No. 2616	BARREL KIT #39 2N3055 HOBBY TRANSISTORS 15 for \$1.98 100% good. From factory to you, these fallouts of the famous 2N3055. We have 10 barrels. Cat. No. 2617	BARREL KIT #40 PNP HIGH-POWER TRANSISTORS 20 for \$1.98 100% good. Popular germanium TO-3 case units, now available at "good ole barrel" prices. Cat. No. 2618 100% good.
BARREL KIT #41 TO-66 SCRS 30 for \$1.98 Untested. IMAGINE! These popular TO-66 case (mini TO-3), scrs, made up to barrel kit. Values to 600 volts. Silicon. Cat. No. 2619	BARREL KIT #42 100 IFT "GLASS 4000" RECTIFIERS 100 for \$1.98 Untested. Just in! 1N4000 silicon rectifiers in epoxy, now in glass, encased at barrel prices to 1000 volt. Cat. No. 2620	BARREL KIT #44 BILATERAL "POWER" SWITCHES 100 for \$1.98 100% good. The "TOP HAT" of dimmer circuits. Acts like an scr, includes many 200 PHV units. Cat. No. 2622	BARREL KIT #46 G.E. 3.5 WATT AMPLIFIERS 25 for \$1.98 100% good. Hobby type, factory fallouts, we purchased them in barrels. These are unknown. No. 2624 Untested.	BARREL KIT #49 QUADS! QUADS! 50 for \$1.98 100% good. Untested! 4 mirror on amps in one package. Why the factory barreled these we don't know. Cat. No. 2627	BARREL KIT #50 SIGNAL SILICON DIODES 200 for \$1.98 100% good. Includes many, many types of switching, signal silicon types, all axial leads. Some may be zeners. Cat. No. 2628 Untested.	BARREL KIT #51 HOBBY OPTO COUPLERS 30 for \$1.98 100% good. We got 1,000's unknown momentaries, etc. Tremendous number of couplers, but we DON'T KNOW! We don't know the types, 1600V isolation. No. 2629 Untested.
BARREL KIT #52 DISCS! 500 for \$1.98 100% good. No. 2630 The bargain of a lifetime! First time ever offered by Poly Pak's for the economy-minded bargain hunters.	BARREL KIT #53 JUMBO RESISTOR PAK 100-pc. \$1.98 100% good. Assorted metal films, precision, carbons, metal oxide powders, from 1/4 watt to 7 watts. Color coded & 100% good. Worth \$10.	BARREL KIT #54 9 DIGIT READOUTS 10 for \$1.98 Untested. Bargain of a lifetime! All we got was 1 barrel — the "blisidor digit" types. Multi-plexed. Cat. No. 2722	BARREL KIT #55 3 DIGIT READOUTS 15 for \$1.98 100% good. National cleaned its warehouse, now we have barrels of NSN-33 type. Untested. Cat. No. 2723	BARREL KIT #57 HI-POWER RECTIFIERS 15 for \$1.98 100% good. 50-Amp studs; 6, 12, 24, 48V, 100% material. Factory rectifier "line" rejects. Cat. No. 2725 100% good.	BARREL KIT #58 SLIDE SWITCHES 30 for \$1.98 100% good. All shapes, sizes, spst, dpdt, momentaries, etc. Tremendous shop pak for 100's of switching projects. Cat. No. 2726 100% good.	BARREL KIT #59 POWER TRANSISTORS 40 for \$1.98 100% good. 15 watt Bendix B-5000 pnp transistors, non, all good, purchased from a pretreater, have millions of 100% good. Cat. No. 2727
BARREL KIT #60 DTL IC'S 75 for \$1.98 Untested. This is prime barrel material. Who wants DTL's? 930, 936, 946's. Your gain is our loss. They're marked too. Cat. No. 2728	BARREL KIT #61 POLYSTYRENE CAPS 100 for \$1.98 100% good. Finest caps made. As a gamble we bought 10 barrels from factory, mixed values; all good. Cat. No. 2729	BARREL KIT #62 MIXED IC'S 100 for \$1.98 100% good. All shapes: 7400 Series, 8000, 9000, ROMs, RTL's, DTL's, linears of all kinds. What a mix! Have fun — all good. Cat. No. 2730 Untested.	BARREL KIT #64 6-DIGIT ARRAYS 20 for \$1.98 100% good. Here's a bargain! This is a National "dump" — inflation is stopped here! Cat. No. 2732 Untested.	BARREL KIT #65 MIXED READOUTS 30 for \$1.98 100% good. Factory returns — such numbers as MAN-4's, MAN-7's, MAN-3's, 11 barrels & no time to separate. Cat. No. 2733 Untested.	BARREL KIT #67 2-WATT AMPLIFIERS 50 for \$1.98 100% good. Buy from the barrel 'n save! LM-380 types in dip packs. Are they good? We don't want to find out. We got millions. Cat. No. 2734	BARREL KIT #68 2 WATERS 100 for \$1.98 100% good. Nobody seems to want 'em! So many suppliers don't count, but throw 'em in the barrel. It's a 100% gold mine! All marked. Cat. No. 2735
BARREL KIT #71 CAPACITOR SPECIAL 100 pcs. \$1.98 100% good. Emptied stockrooms into barrels of mylars, poly's, mica's, molded's, plastics, ceramics, discs, etc. Nifty 100% good. Cat. 2736	BARREL KIT #72 TERMINALS, RECEPTACLES 150 for \$1.98 100% good. Maker of these dumped into barrels. You get 2, 4, 6 strips & receptacles. What a buy! Cat. No. 2739	BARREL KIT #73 TRANSISTOR ELECTROS 50 for \$1.98 100% good. It bugs us why the factories dump 'em in barrels. We don't wish to separate wide ass't. voltages & values up to 300 mf. No. 2747	BARREL KIT #75 400MW ZENERS 100 for \$1.98 100% good. Factory out of biz! Amazing offer: 6, 8, 10, 12 to 15V. You test. Hermetically sealed glass pak. Double plug. Cat. No. 2740 Untested.	BARREL KIT #76 4-WATT ZENERS 100 for \$1.98 Untested. Factory same as 100-mw's. Never-to-see-again offer: 6, 8, 10, 12, 15V, under glass. Double plug. Cat. No. 2741	BARREL KIT #78 "RED" BODY TRANSISTORS 40 for \$1.98 100% good. G-E D-40 series: has hv. voltage, Darlingtons, hi-current, npn's. Factory line discontinued. Power tabs. Cat. No. 2742 Untested.	BARREL KIT #79 DARLINGTON POWER TABS 25 for \$1.98 Untested. Production line stopped. Barrels of mylars, oils, tubulars, but unmarked with all kinds of sizes. All good, you test. Cat. No. 2744
BARREL KIT #82 8000 SERIES IC'S 50 for \$1.98 100% good. By National. From factory to you. Assortment of popular series factory fallouts, overruns. Untested. Cat. No. 2634	BARREL KIT #83 LM-340T UNTESTED VOLTAGE REGULATORS 15 for \$1.98 100% good. Factory rejected them for length of leads. May include 6, 8, 12, 15, 18, 24 volts. Power tab. No. 2635	BARREL KIT #84 UNTESTED MAN-3 "THE CLAW" 25 for \$1.98 100% good. LED hobby or experimental use; for understanding the working of "mini" or calculator readouts. A segment may be missing. No. 2679	BARREL KIT #86 HOBBY LEDS 40 for \$1.98 100% good. Wow! A Litronics dump of all kinds of mixed discrete LEDS, shapes, colors, good, poor, etc. Cat. 2859	BARREL KIT #87 NATIONAL IC BONANZA 100 for \$1.98 100% good. Factory dumps into barrels. Types: 8000, 7400 series, DTLs, ROMs, registers, clock & calc. chips, linears, etc. Cat. No. 2860 Untested.	TWIN PAK #1 LED READOUTS 20 for \$1.98 100% good. 10 Man-3's, 10 Man-7's, 6, 8, 10, 12 to 15V. Cat. No. 2826	TWIN PAK #4 ZENERS 100 for \$1.98 100% good. 60 400-mw, 60 1-watt, 60 1-watt, 6, 8, 10, 12 to 15V. Cat. No. 2829
BARREL KIT #80 HOBBY CAPS 200 for \$1.98 100% good. Production line stopped. Barrels of mylars, oils, tubulars, but unmarked with all kinds of sizes. All good, you test. Cat. No. 2745	BARREL KIT #81 SUBMINI RESISTORS 100 for \$1.98 100% good. PC, upright type, color coded, 1/4 watt. Ass't. values. Come to us in a barrel. Cat. No. 2746	BARREL KIT #88 HOBBY LEDS 40 for \$1.98 100% good. Wow! A Litronics dump of all kinds of mixed discrete LEDS, shapes, colors, good, poor, etc. Cat. 2859	BARREL KIT #89 NATIONAL IC BONANZA 100 for \$1.98 100% good. Factory dumps into barrels. Types: 8000, 7400 series, DTLs, ROMs, registers, clock & calc. chips, linears, etc. Cat. No. 2860 Untested.	TWIN PAK #10 POWER RESISTORS 70 for \$1.98 100% good. 40 Oxide 2-wattors, 30 Oxide 7-wattors. Cat. No. 2835	TWIN PAK #9 6 & 8-DIGIT READOUTS 15 for \$1.98 100% good. Hobby types, from calculator makers' closeouts. Cat. No. 2834	

Terms: Add postage. Rated: net 30
 Phone: Wakefield, Mass. (617) 245-3829
 Retail: 16-18 Del Carmine St., Wakefield,
 (off Water Street) C.O.D.'S MAY BE PHONED

POLY PAKS
 P.O. BOX 942E-2,
 LYNNFIELD, MASS. 01940

20¢ CATALOG on Fiber Optics, 'IC's', Semi's, Parts

MINIMUM ORDER — \$4.00

CIRCLE NO 41 ON FREE INFORMATION CARD

ELECTRONICS MARKET PLACE

NON-DISPLAY CLASSIFIED: COMMERCIAL RATE: For firms or individuals offering commercial products or services, \$2.00 per word (including name and address). Minimum order \$30.00. Payment must accompany copy except when ads are placed by accredited advertising agencies. Frequency discount; 5% for 6 months; 10% for 12 months paid in advance. **READER RATE:** For individuals with a personal item to buy or sell, \$.120 per word (including name and address.) No minimum! Payment must accompany copy. **DISPLAY CLASSIFIED:** 1" by 1 column (2-1/4" wide), \$230.00. 2" by 1 column, \$460.00. 3" by 1 column, \$690.00. Advertiser to supply film positives. For frequency rates, please inquire.

GENERAL INFORMATION: First word in all ads set in caps at no extra charge. All copy subject to publisher's approval. All advertisers using Post Office Boxes in their addresses **MUST** supply publisher with permanent address and telephone number before ad can be run. Advertisements will not be published which advertise or promote the use of devices for the surreptitious interception of communications. Ads are not acknowledged. They will appear in first issue to go to press after closing date. Closing Date: 1st of the 2nd month preceding cover date (for example, March issue closes January 1st. Send order and remittance to **POPULAR ELECTRONICS**, One Park Avenue, New York, New York 10016, Attention: Hal Cymes.

FOR SALE

FREE! Bargain Catalog—IC's, LED's, readouts, fiber optics, calculators parts & kits, semiconductors, parts. Poly Paks, Box 942PE, Lynnfield, Mass. 01940.

GOVERNMENT Surplus Receivers, Transmitters, Sniperscopes, Radios, Parts, Picture Catalog 25 cents. Meshna, Nahant, Mass. 01908.

LOWEST Prices Electronic Parts, Confidential Catalog Free. KNAPP, 3174 8th Ave. S.W. Largo, Fla. 33540.

ELECTRONIC PARTS, semiconductors, kits, FREE FLYER Large catalog \$1.00 deposit BIGELOW ELECTRONICS, Bluffton, Ohio 45817.

RADIO—T V Tubes—36 cents each Send for free catalog, Cornell, 4213 University, San Diego, Calif 92105

AMATEUR SCIENTISTS, Electronics Experimenters, Science Fair Students Construction plans—Complete, including drawings, schematics, parts list with prices and sources Robot Man — Psychedelic shows — Lasers — Emotion/Lie Detector — Touch Tone Dial — Quadraphonic Adapter — Transistorized Ignition — Burglar Alarm — Sound Meter over 60 items. Send 50 cents coin (no stamps) for complete catalog Technical Writers Group, Box 5994, University Station, Raleigh, N.C. 27607.

METERS—Surplus, new used, panel or portable Send for list, Hanchett, Box 5577, Riverside, CA 92507.

MECHANICAL, ELECTRONIC devices catalog 10 cents, Greatest Values — Lowest Prices, Fertik's, 5249 "D", Philadelphia, Pa. 19120.

SOUND SYNTHESIZER KITS—Surf \$12.95, Wind \$12.95, Wind Chimes \$17.95, Electronic Songbird \$6.95, Musical Accessories, many more. Catalog free. PAIA Electronics, Box J14359, Oklahoma City, OK 73114

BUGGED??? New locator finds them fast. Write, Clifton, 11500-L N.W. 7th Avenue, Miami, Florida 33168.

DISCOUNT PRICES
B&K, SENCORE, LEADER, RCA
EICO, FLUKE, HICKOK, SIMPSON
Test Equipment
 ICC/Servicecenter, RCA and Raytheon Tubes
 Complete line of electronic supplies
Free Catalog
FORDHAM RADIO SUPPLY CO., INC.
 558 Morris Ave., Bronx, N.Y. 10451 (212) 585-0330

YOU WILL SAVE BIG MONEY! Surplus, Clearouts, Bankruptcy, Inventory, Deals, Catalog \$1 (redeemable), ETCOA Electronics, Box 741, Montreal, H3C 2V2 U.S. Inquiries

TELEPHONE "BUGGED"? Countermeasures Brochure \$1.00, Negeye, Drawer 547, Pennsboro, W. VA 26415.

HEAR POLICE/FIRE Dispatchers! Catalog shows exclusive directories of "confidential" channels, receivers, Send 10 cent stamp, Communications, Box 56-PE, Commack, N.Y. 11725

CD IGNITIONS, VHF/UHF monitors, crystals, CB radios, Southland, Box 3591-B, Baytown, Texas 77520.

ALPHA/THETA BRAINWAVE biofeedback instruments, Analog instruments from \$125; digital processing systems from \$225, BioScan, Box 14168-E, Houston, Texas 77021.

SURPRISE! Build inexpensively, the most Unusual Test Instruments, Futuristic Gadgets using Numerical Readouts! Catalogue Free! GBS, Box 100A, Green Bank, West Virginia 24944.

LEARN DESIGN TECHNIQUES Electronics Design Newsletter, Digital, linear construction projects, design theory and procedures, Annual subscription \$6.00, sample copy \$1.00, Valley West, Box 2119-B, Sunnyvale, California 94087

TELEPHONES UNLIMITED, equipment, supplies, Catalog 50 cents, Box 1654E, Costa Mesa, Calif. 92626.

DIGITAL ELECTRONICS! Highly effective course brings immediate results, \$10.00. Satisfaction or \$11.00 refunded! Plans, Projects, Free Literature, DYNASIGN, Box 60A7, Wayland, Mass. 01778.

UNSCRAMBLERS: Fits any scanner or monitor, easily adjusts to all scrambled frequencies. Only 4" square \$29.95, fully guaranteed, Dealer inquiries welcomed, PDQ Electronics, Box 841, North Little Rock, Arkansas 72115.

SURPRISE! SURPRISE! Digital Piano Tuning Device tunes musical instruments Accurately! Perfectly! Inexpensively! Construction-Instruction-Plans Complete \$12.95 Airmailed Postpaid! Moonlighting quickly repays \$40 electronics investment! GBS, Box 100P, Green Bank, West Virginia 24944.

PYROTECHNICAL chemicals, casings, fuse, tools, literature, supplies, Catalog \$1.00, with samples — \$2.00, Westech, Logan, Utah 84321.

RECONDITIONED Test Equipment, \$0.50 for catalog, Walter's Test Equipment, 2697 Nickel, San Pablo, CA 94806.

FREE giant bargain electronic catalog listing thousands of components, tubes, transistors, IC's, kits, test equipment, EDLIE'S, 2700-PL Hempstead Tpke., Levittown, N.Y. 11756.



**WORLD'S SMALLEST
 ELECTRONIC
 CALCULATOR...\$19.95!**
Does Everything Big Ones Do

Small but mighty! 8-digit, 4-function electronic calculator even has automatic % key . . . for only \$19.95. Take it anywhere. Carry it in your pocket or purse — it's 2/3 the size of a pack of cigarettes. This 3 1/2-ounce dynamo features floating decimal, constant key, lead zero depression, clear entry, more! At Edmund's low price, the unit comes with a Ni-Cad rechargeable battery pack that can plug into any AC outlet. No need for special recharging adapters. Calculator overall is just 2 x 3 1/2 x 1/8" with plenty of room for most fingers. *Another Edmund first with advanced technology.* **\$19.95** ppd.
STOCK NO. 1945 AVC Only

GIANT FREE CATALOG!
 NEW 164Pages Over 4,500 Unusual Bargains for Hobbyists, Schools, Industry

JUST CHECK COUPON!
EDMUND SCIENTIFIC CO.
 300 EDSCORP BUILDING
 Barrington, N. J. 08007
America's Greatest Science • Optics • Hobby Mart

COMPLETE AND MAIL COUPON NOW

EDMUND SCIENTIFIC CO. 300 Edscorp Bldg., Barrington, N. J. 08007

SEND FREE 172 PAGE CATALOG "AVC" Charge my BankAmericard Charge my Master Charge Interbank No _____ Card No _____ Expiration Date _____

30-DAY MONEY-BACK GUARANTEE. You must be satisfied or return any purchase in 30 days for full refund

Send me: _____ ELECTRONIC CALCULATOR(S) @ \$19.95 ea. (No. 1945 AVC) \$_____ Service and handling charge \$_____ \$1.00 Enlosed is check, m.o. in amount of \$_____ Signature _____ Name _____ Please print Address _____ City _____ State _____ Zip _____

wanted Citizens Band **DEALER-DISTRIBUTORS**
 Send this ad with Letterhead to:
PAL ELECTRONICS CO.
 2962 W. WELDON - PHOENIX, ARIZ. 85017

FOR A New Electronic Experience, learn to control your brainwaves. Aquarius Electronics, Box 962E, Albion, CA 95410.

AUDIO PROGRAM CONTROL CENTER

\$14.95 PPD. USA
 10 inputs, 4 outputs, Switch TV, Short-Wave, Ham, FM to Stereo Amplifier & Recorder. Listen & Record.
POWERCOM CORPORATION
 Box 454 Dept 4 Troy, N. Y. USA 12181

POLICE, Fire monitors, scanners, crystals discount priced. New crystal-less scanners. Box 19224, Denver, CO 80219.

YOU WANT TO BUILD IT: WE WANT TO HELP. WE SELL CONSTRUCTION PLANS with an Engineering Service. TELEPHONE: Answering Machines, Speakerphones, Car-phones, Phonevision, Touch Button Dialers. TELEVISION: VTR, 1" Color TV Set, PONG, \$25.00 Camera. COLOR PROJECTION TV. HOBBYIST: Electron Microscope, \$75 software programmable computer. BROADCAST: Special Effects Generator, Chroma Key, Audio Board, DA's. COURSES: Telephone Engineering \$52.00, Detective Electronics \$29.50, IC Engineering \$65.00, PLUS MUCH MORE. NEW Super Hobby Catalog PLUS year's subscription to Electronic News Letter AIR MAILED \$1.00. Don Britton Enterprises, 6200 Wilshire Blvd., Los Angeles, Calif. 90048.

S. D. SALES CO.

6 Digit Digital Clock Kit

We wanted our word to mean something to you. When we first introduced our clock we used such words as "impossible", "unbelievable bargain", "prime quality", and "unconditional money back guarantee." We anticipated selling several hundred kits. Your response to our clock has been fantastic. Now several thousand kits later, we hear such comments as "outstanding value", "exceptional service", "I can't believe it", etc. One enthusiastic customer even wrote saying it was "the best thing since bottled beer."

Here's What The Kit Includes:

- 1 - MM5314 National Clock Chip with socket
 - 6 - Common Cathode Led Readouts (.25 in. char.)
 - 13 - NPN and PNP Driver Transistors
 - 2 - Push Button Switches for time set
 - 1 - Switch for Time Hold
 - 1 - Filter Cap
 - 4 - IN4001 Rectifiers
 - 1 - IN914 Diode
 - 2 - .01 Disc. Caps
 - 9 - Carbon Resistors
- \$9⁹⁵** (KIT)
WITH SPECS.
 Transformer **POSTPAID**
\$1.50
P.C. BOARD FOR ABOVE
\$3.00 each

INTEL 1702A 2K ERASEABLE PROM'S \$6.95

We tell it like it is. We could have said these were factory new, but here is the straight scoop. We bought a load of new computer gear that contained a quantity of 1702A's in sockets. We carefully removed the parts, verified their quality, and are offering them on one heck of a deal. First come, first served. Satisfaction guaranteed.

PROFESSIONAL QUALITY STEREO HEADPHONES

Here is the kind of super deal that S. D. is famous for. Treat your ears to a super sound at a super price. Soft padded ear cushions, lightweight, fully adjustable headband, long coiled cord, wide response. **\$6 Post Paid - NEW IN ORIGINAL FACTORY BOXES**

SALE ON CUT LEAD SEMICONDUCTORS

Leads were cut for PCB insertion. Still very useable.
 IN4148 Diode - 40/\$1 2N3904 (House #Transistor) - 25/\$1

INSTRUMENT KNOBS

Black with brushed aluminum insert. Medium size, very attractive style. **SPECIAL 5 FOR \$1**

DUAL 741 (5558)

Another S. D. "SPECIAL" — 2 — 741V in one MINI DIP Package. These units were bought from Xerox Corporation on another of our super buys. They are house numbered, but guaranteed prime. They feature: No frequency compensation required. Short circuit protection. Low power consumption. No latch-up.

S. D. SPECIAL INTRODUCTORY PRICE

4/\$1.00

1AMP 1000 PIV SILICON RECTIFIERS

IN4007. Factory prime devices. 10 for \$1.00

741C OP AMPS

Prime, factory tested and marked. Full spec on all parameters. Not re-tested, functional only, units as sold by others.
 741 CH -TO-5 8 Lead Metal Can . . . 3/\$1
 741CV - 8 Lead Mini Dip 4/\$1

DL747 JUMBO LED READOUTS

By Litronix. .65 inch character. Common anode. Outperforms SLA-3, perfect for giant digital clocks. Only 20 MA. per segment. Special - \$2.50 ea. (Not Class II)

SUBMINIATURE TRIMMER CAPS

Ultra stable. Range: 3.5 to 18 PF. 2 for \$1

FILTER CAPS

Dual section, 2000 MFD and 1500 MFD at 30 WVDC Twist Lock. 79c ea. 3 For \$2

NATIONAL VOLTAGE REGULATOR

Like 7805. 5VDC - 1 AMP output. Has TO-220 plastic power tab - 99c

IN4148 COMPUTER DIODES

Same as IN914. Factory prime. 20 for \$1

FULL WAVE BRIDGE

By G. I. 1.5 AMP 800PIV - 75c

2N706A 400MHZ. TRANSISTORS

Silicon NPN. 1 WATT. TO-18 Case. 5 For \$1

LARGE SIZE LED LAMPS

Similar to MV5024. Prime factory tested units. We include plastic mounting clips which are very hard to come by. **Special 5 for \$1**

MOTOROLA NEG. VOLTAGE REG

MC1469R. TO-66 9 Lead package. For 3 TO 30V Outputs. Provides 600 MA direct output or more by using an external power transistor. Reg. catalog \$4 ea. With specs \$1.95 ea.

VERNIER DIAL

From a close out of metal detector manufacturer. 1/2 Turn, 8 to 1 ratio. Internal stops easily removed to make unit multi-turn.

LIMITED QUANTITY - \$.99 EACH

DO YOU NEED A LARGE COMMON ANODE READOUT AT A FANTASTIC PRICE!

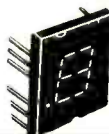

S. D. presents the MAN-64 by Monsanto - .40 inch character. All LED construction - not reflective bar type, fits 14 pin DIP. Brand new and factory prime. Left D.P.

\$1.59 ea. 6 for \$7.50

2102 1K RAM's - 8 FOR \$12.95

New units by National. We bought a load on a super deal, hence this fantastic price.

Units tested for 500NS Speed.

FET'S BY TEXAS INSTRUMENTS

#TIS-75 but with an internal house number. TO-92 plastic case. N Channel, Junction type FET.

SPECIAL 5 FOR \$1

FAIRCHILD LED READOUTS - 69c

FND-70. Common cathode. Right hand decimal point. .25 inch character. Prime new units. Perfect for clocks, frequency counters, etc. 69c 10 For \$6
 Best Readout Buy in USA!



DRIVER TRANSISTORS
 2N3904 - NPN
 2N3906 - PNP
 8 for \$1

FAIRCHILD BIG LED READOUTS

A big .50 inch easy to read character. Now available in either common anode or common cathode. Take your pick. Super low current drain, only 5 MA per segment typical.

FND - 510 Common Anode
 FND - 503 Common Cathode

YOUR CHOICE
\$2 ea.

H.P. IS BACK!

No Rejects or Rerests here — You Want Quality? You have it with this popular 0.3" L.E.D. by Hewlett Packard. Fits Standard I.C. Socket. Right hand DP.
 5082-7740 — Common Cathode \$1.25

6 for \$6.00



SIGNETICS 1K P-ROM

82S129. 256 X 4. Bipolar, much faster than MOS devices. 50 NS. Tri-state outputs TTL compatible. Field programmable, and features on chip address decoding. Perfect for microprogramming applications. 16 pin DIP. With specs. \$2.95 ea.

LM324 - QUAD 741 OP AMP - 99c

NE555 - Timers - 49c
 709CH - OP AMPS - 4 For \$1

GE SCR C106B1
 4 AMP 200PIV. Sensitive Gate. 59c

8T97B

Signetics, TRI-State Hex Buffer. MOS and TTL interface to TRI-State Logic. Special: \$1.

MOTOROLA POWER DARLINGTON \$1.99

MJ3001 - NPN - 80 Volts - 10 Amps - HFE 6000 typ. To-3 Case. Ideal for power supplies, etc. We include a free 723 regulator w/schematic for power supply with purchase of the MJ3001. You get the two key parts for a DC supply for only \$1.99. Regular catalog price for the MJ3001 is \$3.82

MOTOROLA NEGATIVE VOLTAGE REG

MC1463R - Like our 1469R, except for negative voltage. Reg. catalog \$5. Our price \$1.95.

We do not sell junk. Money back guarantee on every item. WE PAY POSTAGE. Orders under \$10 add 75c handling. No C.O.D. Texas Res. add 5% tax.

S. D. SALES CO.

P.O. BOX 28810
 DALLAS, TEXAS 75228

FEBRUARY SPECIALS

ALARM CLOCK CHIP

MM5375AA 4-6 digit, 12 hour, 60Hz vnooze alarm, brightness control capability, alarm tone output 24 pin DIP **\$4.95**

8038 FUNCTION GENERATOR

Voltage controlled oscillator — sine, square, triangular output. 16 pin DIP with data **\$3.95**

7001 CLOCK CHIP

4-6 digit, 12-24 hr. alarm, timer and date circuits — with data **\$6.95**

DVM CHIP 4 1/2 DIGIT

MM5330 — P channel device provides all logic for 4 1/2 digit volt meter, 16 pin DIP with data **\$14.95**

TTL'S

7441	.75	7448	.79
7442	.59	7483	.65
7443	.69	7485	.79
7445	.69	7496	.59
7446	.75	74123	.69

LINEARS

308	mDIP	.69
310	mDIP	.89
319	DIP	.92
320T-5v	TO-220	1.39
320T-12v	TO-220	1.39

MEMORIES

1702A	14.95
3102	2.95
2102-1	3.25
2102-2	3.25
F93410	
256 bit RAM	2.19

AFTER CHRISTMAS SPECIAL PULTRON V.I.P. QUARTZ REGULATED LED WATCH

MEN'S 5 function—hours, minutes, month, day and seconds
Latest slim-line design (prox. 1/2" thick)
Four year calendar—requires setting only on February 29th.
One year warranty against all defects in material and workmanship.
Built-in phototransistor adjusts intensity of display.
Gold tone—with adjustable mesh strap.



\$79.50

-\$1.50 Shipping & Handling

USUAL DISCOUNT APPLIES

POCKET CALCULATOR

5 function plus constant — addressable memory with individual recall — 8 digit display plus overflow — battery saver — uses standard or rechargeable batteries — all necessary parts in ready to assemble form — instructions included.
Kit with AC adaptor included
Set of Alkaline batteries (disposable)



\$14.95
\$ 2.50

UNIVERSAL BREADBOARD

Silver plated copper circuit board 3-3/16" x 5-1/16". 2 rows of 27 holes for DIP IC's — space for transistors, resistors & capacitors. Versatile and simple for breadboarding IC circuitry **\$1.50 ea.**
50 pcs. 1.00 ea.

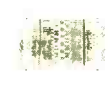

ALARM CLOCK KIT

4 Large Digits — AM-PM. Complete kit includes 1M5 8034 chip — green fluorescent panel with 5 1/2 digits — PC board — alarm speaker — all necessary components — case — schematic and instructions.
Shipped UPS or Parcel Post.



\$31.95

NEW ITEM — EXCLUSIVE WITH IEU RESISTOR ASSORTMENTS

Supplied with convenient storage unit designed for experimenters, technicians and schools. Replacements available at low cost by mail from IEU.

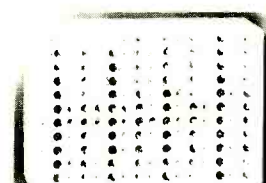

Rohm
QUALITY RELIABILITY

USUAL DISCOUNT APPLIES

RS 10-25 \$99.50
AN ASSORTMENT OF 2725 RESISTORS, 170 VALUES FROM .51 OHMS TO 5.6M OHMS QUANTITIES DETERMINED BY TYPICAL USAGE 1/2 WATT 5% CARBON FILM

RS 11-25 \$114.50
AN ASSORTMENT OF 4000 RESISTORS, 106 EACH OF 40 STANDARD VALUES 1 OHM TO 3.3M OHM 1/2 WATT 5% CARBON FILM

RS 11-50 \$69.50
AN ASSORTMENT OF 2000 RESISTORS, 50 EACH OF 40 STANDARD VALUES 1 OHM TO 3.3M OHMS 1/2 WATT 5% CARBON FILM

\$1.00 SHIPPING & HANDLING — SHIPPED UPS OR PARCEL POST

TTL

7400	.14	7491	.97
7401	.16	7492	.71
7402	.15	7493	.60
7403	.16	7494	.94
7404	.19	7495	.79
7405	.19	74100	1.30
7406	.35	74105	.44
7407	.35	74107	.40
7408	.18	74121	.42
7409	.19	74122	.45
7410	.16	74123	.85
7411	.25	74124	.94
7412	.35	74125	.63
7413	.35	74126	.64
7414	.35	74127	1.04
7415	.35	74128	1.04
7416	.35	74129	.97
7417	.35	74130	.97
7418	.35	74131	.79
7419	.35	74132	.99
7420	.26	74133	1.25
7421	.26	74134	1.25
7422	.26	74135	1.07
7423	.26	74136	1.07
7424	.26	74137	.97
7425	.26	74138	.97
7426	.26	74139	1.39
7427	.26	74140	1.39
7428	.26	74141	1.39
7429	.26	74142	1.39
7430	.26	74143	1.39
7431	.26	74144	1.39
7432	.26	74145	1.39
7433	.26	74146	1.39
7434	.26	74147	1.39
7435	.26	74148	1.39
7436	.26	74149	1.39
7437	.26	74150	1.39
7438	.26	74151	1.39
7439	.26	74152	1.39
7440	.26	74153	1.39
7441	.26	74154	1.39
7442	.26	74155	1.39
7443	.26	74156	1.39
7444	.26	74157	1.39
7445	.26	74158	1.39
7446	.26	74159	1.39
7447	.26	74160	1.39
7448	.26	74161	1.39
7449	.26	74162	1.39
7450	.26	74163	1.39
7451	.26	74164	1.39
7452	.26	74165	1.39
7453	.26	74166	1.39
7454	.26	74167	1.39
7455	.26	74168	1.39
7456	.26	74169	1.39
7457	.26	74170	1.39
7458	.26	74171	1.39
7459	.26	74172	1.39
7460	.26	74173	1.39
7461	.26	74174	1.39
7462	.26	74175	1.39
7463	.26	74176	1.39
7464	.26	74177	1.39
7465	.26	74178	1.39
7466	.26	74179	1.39
7467	.26	74180	1.39
7468	.26	74181	1.39
7469	.26	74182	1.39
7470	.26	74183	1.39
7471	.26	74184	1.39
7472	.26	74185	1.39
7473	.26	74186	1.39
7474	.26	74187	1.39
7475	.26	74188	1.39
7476	.26	74189	1.39
7477	.26	74190	1.39
7478	.26	74191	1.39
7479	.26	74192	1.39
7480	.26	74193	1.39
7481	.26	74194	1.39
7482	.26	74195	1.39
7483	.26	74196	1.39
7484	.26	74197	1.39
7485	.26	74198	1.39
7486	.26	74199	1.39
7487	.26	74200	1.39
7488	.26	74201	1.39
7489	.26	74202	1.39
7490	.26	74203	1.39

Data included with orders on request. Add \$1.50 to cover shipping and handling for orders under \$15.00. Add \$1.50 for each extra order.

Satisfaction guaranteed. Shipment will be made via first class mail within 14 days from receipt of order. Add \$1.50 to cover shipping and handling for orders under \$25.00. Minimum order \$5.00. California residents add sales tax.

INTERNATIONAL ELECTRONICS UNLIMITED
P.O. BOX 1708/ MONTEREY, CA. 93940 USA
PHONE (408) 659-3171

5% OFF ON ORDERS OVER \$50.00
10% OFF ON ORDERS OVER \$100.00
15% OFF ON ORDERS OVER \$250.00

LINEAR CIRCUITS

300	Pos V Reg (super 723)	TO-5	\$.71
301	Hi perf op amp	mDIP	.29
407	Op AMP (super 741)	mDIP	.26
408	Micro Pwr Op Amp	mDIP	.89
101K	5V 1A regulator	TO-1	1.15
310	V Follower Op Amp	mDIP	1.07
311	Hi perf V Comp	mDIP	.95
319	Hi Speed Dual Comp	DIP	1.13
320	Neq Reg 5.2, 12, 15	TO-1	1.04
324	Quad Op Amp	DIP	1.52
339	Quad Comparator	DIP	1.58
340K	Pos. V reg. (5V, 6V, 8V, 12V, 15V, 18V, 24V)	TO-1	1.69
340T	Pos. V reg. (5V, 6V, 8V, 12V, 15V, 18V, 24V)	TO-220	1.49
370	AGC/Squelch AMP	DIP	.71
372	AF-IF Strip Detector	DIP	2.93
373	AM/FM SSB Strip	DIP	.53
376	Pos. V Reg	mDIP	2.42
380	2w Audio Amp	DIP	1.13
380-8	Jw Audio Amp	mDIP	1.52
381	Lo Noise Dual preamp	DIP	1.52
550	Pre V Reg	DIP	.89
555	Timer	mDIP	.89
556A	Dual 555 Times	DIP	1.49
560	Phase Locked Loop	DIP	2.48
562	Phase Locked Loop	DIP	2.48
565	Phase Locked Loop	DIP	2.18
566	Function Gen	mDIP	2.25
567	Tone Decoder	mDIP	2.66
704	Operational AMPL	DIP	.26
710	Hi Speed Volt Comp	DIP	.62
723	V Reg	DIP	1.07
739	Dual Hi Perf Op Amp	DIP	1.07
741	Comp Op Amp	mDIP	.32
747	Dual 741 Op Amp	DIP	.71
748	Freq Adj 741	mDIP	.35
1104	FM Mulp Stereo Demod	DIP	1.07
1307	FM Mulp Stereo Demod	DIP	.62
1458	Dual Comp Op Amp	mDIP	.62
1800	Stereo multiplexer	DIP	2.48
1900	Quad Amplifier	DIP	.15
8038	V contr. ost	DIP	4.95
8064	9 DIG LED Cath Drive	DIP	2.25
75150	Dual Line Driver	DIP	1.95
75451	Dual Peripheral Driver	mDIP	.35
75452	Dual Peripheral Driver	mDIP	.35
75451	(351) Dual Periph. Driver	mDIP	.35
75491	Quad Sqg Driver for LED	DIP	.71
75492	Hex Digit Driver	DIP	.80

MEMORIES

1101	256 bit RAM MOS	\$ 1.50
1103	1024 bit RAM MOS	1.95
2102	1024 bit static RAM	5.55
5203	2048 bit UV eras PROM	17.95
5260	1024 bit RAM	2.49
5261	1024 bit RAM	2.69
5262	2048 bit RAM	5.95
7489	4 bit ROM TTL	2.48
8223	Programmable ROM	3.69
74200	256 bit RAM tri-state	5.90

CALCULATOR & CLOCK CHIPS

5001	12 DIG 4 funct chip dec	\$3.45
5002	Same as 5001 exc btry pwr	1.95
5005	12 DIG 4 funct w/mem	4.95
MM5725	8 DIG 4 funct chain & dec	1.98
MM5736	18 pin 8 DIG 4 funct 1	4.45
MM5738	8 DIG 5 funct & 8 mem	5.35
MM5739	9 DIG 4 funct 1 (btry sur)	3.35
MM5311	28 pin BCD 6 dig mux	4.45
MM5312	24 pin 1 pps BCD 4 dig mux	3.95
MM5313	28 pin 1 pps BCD 6 dig mux	4.45
MM5314	24 pin 6 dig mux	4.45
MM5316	40 pin alarm 4 dig	5.39

LED'S

MV10B	Red TO 18	\$.22
MV10	Axial leads	.18
MV5020	Jumbo Vis. Red (Red Dome)	.22
	Jumbo Vis. Red (Clear Dome)	.22
	Insta red diff. dome	.54
MAN1	Red 7 seg. .270"	2.19
MAN2	Red alpha num. .12"	1.39
MAN4	Red 7 seg. .190"	4.95
MAN5	Green 7 seg. .270"	3.45
MAN6	6" high solid seg.	4.25
MAN7	Red 7 seg. .270"	1.19
MAN8	4" high solid seg.	1.45
MAN9	4" high solid seg.	2.95
MAN6b	6" high spaced seg	1.75
MCT2	Opto-isol transistor	.61

CMOS

4015A	1.49	4049A	.59
4016A	.56	4050A	.59
4017A	1.19	4064A	.89
4001A	.25	4020A	1.39
4002A	.25	4021A	1.39
4003A	1.15	4022A	1.10
4007A	.26	4023A	.25
4008A	1.79	4024A	.89
4009A	.57	4025A	.25
4010A	.54	4027A	.39
4011A	.29	4028A	.98
4012A	.25	4030A	.44
4013A	.45	4035A	1.27
4014A	1.49	4042A	1.47
		4585A	2.10

NEW • UNEQUALLED • VALUE
MINATURE SOLID STATE

VIDEO CAMERA KIT

A UNIQUE CAMERA KIT
FEATURING A... 100 X 100 BIT
SELF SCANNING CHARGED
COUPLED DEVICE

INCLUDES THE FOLLOWING UNIQUE FEATURES... FOUND IN FAR MORE EXPENSIVE CAMERAS IF AVAILABLE

- LOW VOLTAGE SUPPLY (OR BATTERIES) + 5 AND ± 15 VOLTS
- SENSITIVE TO INFRARED AS WELL AS VISIBLE LIGHT
- MAY BE USED FOR IR SURVEILLANCE WITH AN IR LIGHT SOURCE
- EXCELLENT FOR STANDARD SURVEILLANCE WORK BECAUSE OF ITS LIGHT WEIGHT AND SMALL SIZE
- ALL COMPONENTS MOUNTED ON TWO PARALLEL 3" X 5" SINGLE SIDED BOARDS TOTAL WEIGHT UNDER 2 LBS
- MAY BE WIRED BY PERSON WITH SOME TECHNICAL EXPERIENCE IN 4-6 HRS

MAY BE USED WITH AMATEUR RADIO FOR VIDEO

USED FOR CHARACTER RECOGNITION FOR COMPUTERS WITH EXTERNAL CIRCUITS

MAY BE USED IN A VACUUM, UNDER WATER, HIGH ALTITUDE, AND IN MAGNETIC ENVIRONMENT BECAUSE THERE IS NO HIGH VOLTAGE OR MAGNETIC DEFLECTION

WE SUPPLY ALL SEMICONDUCTORS, BOARDS, DATA SHEETS, DIAGRAMS, RESISTORS AND CAPACITORS

SOBRY, WE DO NOT SUPPLY THE CASE BATTERIES (OR SUPPLY) AND THE LENSES

(OPTIONAL)



SUPER UNBELIEVABLE

\$225.00

ONLY ADD \$2.00 POSTAGE AND HANDLING PLUS \$6.00 FOR ALL IC SOCKETS



SOLID STATE SALES

P.O. BOX 74
SOMERVILLE, MASS 02143
TEL (617) 547-7053

CIRCLE NO. 52 ON FREE INFORMATION CARD

BUILD THAT ELECTRONIC ORGAN YOU ALWAYS WANTED AT A PRICE YOU CAN AFF

Altaj Electronic Bargains

PRICES SLASHED! WE WANT YOUR BUSINESS. SATISFACTION GUARANTEED ON EVERY ITEM



LM309K
TO-3 Case, 1 AMP 5 VDC Voltage Regulator. Brand New By National \$1.19



3 DIGIT LED READOUT ARRAY
Like Litronix DL-33 3 MAN-3 style readouts in one package. Factory new units Designed for calculators. Special — \$1.39 (3 Digits)



LITRONIX DL707 READOUTS
.30 IN. CHAR. Common Anode. SPECIAL — \$1.19

CALCULATOR CHIP BONANZA PRICES SLASHED!

The newest and easiest to use chips available today. Made by famous US mfg. All are 28 pin DIP. Features: direct LED segment drive, low power consumption, internal keyboard debounce, internal clock oscillator, single supply voltage, internal keyboard encoding, and floating decimal point. Does not require many external components as do older types like CT5001, 5002, 5005, etc. We offer the most sophisticated functions for the lowest price anywhere.
Chip #1 — 8 Digit, Constat, Six Function (+, -, x, +, %,) — \$2.49

MOTOROLA MJE 3055

Plastic version of 2N3055. NPN Silicon. 90 Watts 15 Amps. SPECIAL — 69c

8008 MICROPROCESSOR

Computer on a chip. 8 Bit Parallel CPU. Can address 16k x 8 bits of memory. With specs. Factory tested units.
\$24.95

2102-1K RAM's for above — \$4.95 or 8 For \$30

TTL SUPER SPECIAL

74121 — ONE SHOT 4/\$1

LINEAR IC SPECIALS

555V-75c 567V-\$1.95 723CH-59c
741CV-25c LM324 by National — Quad
741CV in one DIP — \$1.19

12VDC REED RELAY

Coil is 500 OHM. SPST-No.
\$1.49 Sub-Mini.

PRIME TTL DIP IC'S

7400-16c	7448-89c	74151-75c
7402-16c	7453-16c	74153-89c
7404-16c	7473-37c	74154-95c
7406-24c	7474-37c	74157-99c
7808-16c	7475-65c	74161-99c
7410-16c	7476-39c	74163-1.19
7413-49c	7483-85c	74164-1.89
7420-16c	7490-69c	74165-1.49
7427-24c	7492-75c	74174-1.29
7430-16c	7493-75c	74175-1.39
7437-39c	7495-75c	74181-2.75
7438-35c	7496-75c	74192-1.25
7440-16c	74121-38c	74193-1.25
7442-69c	74123-75c	74195-79c
7447-89c	74150-70c	74197-79c

COMPUTER BOARD BONANZA

We bought over 4 tons of assorted boards. Contains TTL, diodes, transistors, etc. 5 board assmt. with 150 to 250 IC's — \$3.95.

DIGITAL ALARM CLOCK IC

The newest and easiest to use alarm chip on the market today. Features:

1. Single supply voltage.
2. LED intensity control
3. Simple time set.
4. 4 or 6 Digit LED Display
5. AM-PM Indication
6. 24 Hr. Alarm.
7. 10 minute snooze.
8. Outperforms MM5316

Order #70250 — \$4.99

MM5314

NATIONAL CLOCK CHIP

The most popular clock chip around. We made a huge special purchase of factory fresh, prime units. Lowest price in USA. 24 Pin DIP. 4 or 6 Digits. With Specs. \$3.95

DOUBLE DIGIT JUMBO READOUTS

New. Litronix 727. Dual. Perfect for giant clocks, etc.
\$3.95 each (2 DIGITS)

JUMBO LED READOUT

Twice the size of regular readouts. .65 inches. Like Litronix DL747. Outperforms and easier to read than SLA-3, only 20 MA per segment. Our best readout for digital clocks.
\$2.95 ea. (6 FOR \$15) Common Anode

FILTER CAPS

1000 MFD 16VDC upright style.
4 FOR \$1

8038 FUNCTION GENERATOR

Brand new. Voltage controlled oscillator. Has sine, square wave, and triangular outputs. \$4.95 each.

IN4148 DIODES

Brand New Units. Same as IN914. Full Leads.
25 For \$1

MONSANTO COLORED READOUTS

.27 IN. Character. Common Anode.
MAN5 — GREEN — \$1.29
MAN8 — YELLOW — \$1.29

PHASE LOCKED LOOP

565A by Signetics. Extremely stable. High linearity, wide frequency range. TTL compatible. Perfect for tone decoders, FSK, SCA receivers, frequency multiplication and division — 99c
WITH SPECS

FLOURESCENT READOUT TUBES

7 Segments. Blue-Green in color. Mfg. by ISE. #DG8F. The most popular display used in many imported clocks and calculators. Perfect for use with MM5316 clock chips.

SUPER SPECIAL 69c ea.
12 For \$5.95

GE TRANSISTOR ASSORTMENT

One of the best mixed transistor lots we have seen. TO-98 Plastic cased. Includes Darlingtons, SCR's, PNP, NPN, etc. Untested sample test shows very high yield. Satisfaction assured. 50 for 99c
SPECIAL: 6 BAGS FOR \$5.

COLOR ORGAN CONTROL MODULE

Completely self-contained. Has SCR circuitry, AC line cord, etc. From a close out by a mfg. of color organs. New, unused.
\$1.49

MOTOROLA SCR

2N4443 8 Amp 400PN, Plastic Power Case. 69c

GE POWER DARLINGTON

NPN, Plastic Power Tab Case. VCEO-30 HFE-30,000 TYP. Brand new units, but leads are slightly trimmed for P.C.B.
#D40C1 — SPECIAL 4 For \$1

RCA PHOTO DETECTOR — POWER AMP. IC

RCA CA3062 for photoelectric applications. The IC with a window. Contains photosensitive section, amplifier, and high current output pair of transistors. Has 100 MA output. Useful for intrusion alarms, counters, position sensors, etc. with complete spec sheets. Reg. \$4.84.
SPECIAL — \$1.99

LOOK MOS 4 DIGIT COUNTER

An ALTAJ exclusive. These are the latest state of the art, MOS chips. By a famous US mfg. Contains a complete 4 digit counter, including 4 decade counters, latches, multiplexing circuits, display decoders, etc. Features: 5VDC operation, 25 MW power consumption, both 7 segment and BCD outputs. Perfect for making DVM's frequency meters, tachometers, stopwatches, or any other device requiring 4 or more digits. Complete with specs 28 PIN DIP. QTY Limited.
SPECIAL — \$12.50
BACK IN STOCK!

LED DRIVER IC'S

75491 Quad segment dr. — 29c
75492 Hex digit dr. — 39c

RCA CA3043 — FM IC

Used in FM stereos. Contains IF Amp, Limiter, FM Detector, and an Audio Preamp and Driver all in one 12 lead TO-5 package. With Spec Sheets.
A \$3.00 Value — 99c

4 DIGIT ALARM CLOCK KIT

Features the only LED direct drive clock chip on the market. Kit includes all parts (except X fmr) for a 4 Digit alarm clock kit. Uses .25 inch LED readouts.
SPECIAL: \$15.95 (with PC Board)



6 DIGIT LED READOUTS

Brand new arrays by T. I. Common cathode, properly multiplexed. Six digits plus a negative sign. Perfect for calculators, mini-clocks, stop watches, etc.
SUPER SPECIAL \$1.29 ea 3 for \$3

U.V. ERASEABLE PROMS

New Prime units by National
MM5203 2K \$14.95
MM5204 4K \$19.95

TRANSISTOR BAKER'S DOZEN SALE!

2 million pieces bought for this sale. New house numbered units by T.I. All prime first quality at a give-away price.
NPN 2N3904-13 For \$1
PNP 2N3906-13 For \$1

In4004 RECTIFIERS

1 AMP 400PIV SPECIAL 15/\$1

7805 STYLE REGULATORS

TO-220 Plastic Case 5VDC Regulator. Brand New by National — 99c

FACTORY NEW LED'S

Jumbo Red-Like MV5024-8/\$1
Jumbo Green-Like MV5222-5/\$1
Jumbo Yellow-5/\$1
Mini Red-Like MV50-10/\$1

FORD SOLID STATE MODULES

Mfg. by Conralab for Ford car radios. Each module contains 2 transistors plus other components. These modules were used as audio pre amps. We include specs. — 4 For \$1

TTL IC ASSORTMENT

Various types. Most are marked. Our best selling assortment. Untested but includes many useable devices.
200 PCS FOR \$3.95

FM TRANSFORMERS

We bought a load of coils and transformers that were used in Ford AM-FM car radios. Includes 19KHZ, 38KHZ, OSC. Coils, etc. All New. Perfect for experimenters or repairmen. 10 Pc Assmt. — 99c

TANTALUM CAPS

By Sprague. 4.7 MFD 10 VDC. Axial Leads. Perfect for timers.
10 For \$1

TRANSFORMER SPECIAL #1

Miniature size. Primary 115V AC Secondary 11V AC No Load. 8V AC with 400 MA Load. Perfect for clocks or calculators or small power supply. 99c

Altaj Electronics

P.O. Box 38544
Dallas, Texas 75238

TERMS: Check or money order. No. COD. Add 10% Pstg. and Hdg. Tex Res. add 5%.

C-MOS

CD400024	CD4015 1.19	CD4026 1.49	CD4044 . . .59
CD400124	CD4016 . .59	CD4027 . .59	CD4047 . . .59
CD400224	CD4017 1.29	CD4028 . .99	CD4049 . . .59
CD40061.49	CD4018 1.49	CD4029 1.39	CD4050 . . .59
CD400724	CD4019 . .59	CD4030 . .49	CD4066 . . .99
CD40081.15	CD4020 1.59	CD4032 . .24	CD4077 . . .39
CD400959	CD4021 1.49	CD4033 1.49	74C02 . . .29
CD401124	CD4022 1.19	CD4035 1.39	74C04 . . .29
CD401224	CD4023 . .24	CD4040 1.59	74C107 1.29
CD401359	CD4024 . .99	CD4041 . .89	
CD40141.49	CD4025 . .24	CD4042 . .79	

CIRCLE NO. 4 ON FREE INFORMATION CARD

7400N TTL

SN7400N	13	SN7445N	27	SN74151N	125
SN7401N	16	SN7445N	27	SN74152N	130
SN7402N	21	SN7445N	21	SN74154N	125
SN7403N	16	SN7445N	25	SN74155N	125
SN7404N	16	SN7460N	22	SN74156N	130
SN7405N	24	SN7470N	45	SN74157N	130
SN7406N	16	SN7472N	39	SN74158N	130
SN7407N	45	SN7473N	37	SN74161N	145
SN7408N	25	SN7474N	32	SN74163N	135
SN7409N	25	SN7475N	59	SN74166N	165
SN7410N	16	SN7476N	30	SN74168N	170
SN7411N	30	SN7480N	50	SN74169N	50
SN7412N	42	SN7482N	175	SN74170N	300
SN7413N	85	SN7483N	115	SN74172N	180
SN7414N	70	SN7485N	112	SN74173N	180
SN7415N	43	SN7486N	45	SN74174N	190
SN7417N	43	SN7488N	350	SN74174N	195
SN7418N	25	SN7489N	300	SN74175N	195
SN7420N	21	SN7490N	49	SN74176N	90
SN7421N	39	SN7491N	120	SN74177N	90
SN7422N	37	SN7492N	82	SN74180N	325
SN7425N	43	SN7493N	57	SN74181N	355
SN7426N	31	SN7494N	91	SN74182N	95
SN7427N	37	SN7495N	91	SN74183N	230
SN7429N	42	SN7496N	91	SN74187N	220
SN7430N	26	SN74100N	100	SN74187N	630
SN7432N	31	SN74107N	49	SN74190N	150
SN7437N	47	SN74121N	45	SN74191N	150
SN7438N	40	SN74122N	49	SN74192N	150
SN7439N	25	SN74123N	30	SN74193N	95
SN7440N	21	SN74125N	60	SN74194N	95
SN7441N	110	SN74126N	81	SN74195N	100
SN7442N	108	SN74132N	300	SN74196N	125
SN7443N	105	SN74141N	115	SN74197N	110
SN7444N	110	SN74142N	400	SN74198N	325
SN7445N	110	SN74143N	450	SN74199N	225
SN7446N	115	SN74144N	450	SN74200N	700
SN7447N	79	SN74145N	115	SN7421N	250
SN7448N	99	SN74148N	250	SN7424N	600
SN7450N	26	SN74150N	110	SN74285N	600

JAMES FEBRUARY SPECIALS

Astrisk Denotes items On Special For This Month

Special Requested Items

RC4194	1/2" Trk V Reg	\$ 5.95	H8797	\$ 3.00	MKS007\$10.95	MC20M4	4.50	
RC4195	1/2" Trk V Reg	3.25	4024P	2.25	8263	5.95	LM3909	2.25
F9368	Decoder	3.95	2513	11.00	8267	2.75	MM5320	19.95
LD110:111	Duo Chip Set	28.00	2518	7.00	8288	1.15	74279	90
CA3130	Super CMOS Op Amp	1.49	2524	3.50	8826	3.00	4072AE	45
MC1408L7	Aid	9.95	2525	6.00	8800	1.35	4511AE	2.50
F341	FIFO	8.95	2527	5.00	7497	5.00	4136	2.50

WE'LL BE HAPPY TO QUOTE ON YOUR SPECIAL PARTS —

OPTO ELECTRONICS

DISCRETE LEDs

R - RED
G - GREEN
Y - YELLOW
O - ORANGE

XC209R	5/S1	XC526R	4/S1	XC111R	5/S1
XC209G	3/S1	XC266G	4/S1	XC111G	4/S1
XC209Y	4/S1	XC528Y	4/S1	XC111Y	4/S1
XC209O	3/S1	XC526O	4/S1		

125" dia. 185" dia. 190" dia.

XC22R	5/S1	XC556R	5/S1	MV50	085" dia. Micro
XC22G	4/S1	XC556G	4/S1		red led
XC22Y	4/S1	XC556Y	4/S1		6/S1
XC22O	4/S1	XC556O	4/S1		

200" dia. 200" dia. 085" dia.

DISPLAY LEDs

FND70 DL707 MAN2 MAN3 MAN7 DL747 DL338

TYPE	POLARITY	HT	PRICE	TYPE	POLARITY	HT	PRICE
MAN 1	COMMON ANODE	300	3.95	MAN 7	COMMON CATHODE	300	\$1.50
MAN 2	5 x 7 DOT MATRIX	300	3.95	DL707	COMMON ANODE*	300	\$1.50
MAN 3	COMMON CATHODE	125	39	DL747	COMMON ANODE*	300	1.95
MAN 4	COMMON CATHODE	167	2.50	DL750	COMMON CATHODE	600	2.49
MAN 7	COMMON ANODE	300	2.50	DL338	COMMON CATHODE	110	1.95
MAN 7G	COMMON ANODE-GREEN	300	2.50	FND70	COMMON CATHODE	250	50
MAN 7Y	COMMON ANODE-YELLOW	300	2.50	FND503	COMMON CATHODE	500	1.75
MAN 7Z	COMMON ANODE	300	1.50	FND507	COMMON ANODE	500	1.75

IC SOLDERTAIL — LOW PROFILE (TIN) SOCKETS

8 pin	\$1.16	15	15	24 pin	\$3.38	37	36
14 pin	20	19	18	28 pin	45	44	43
16 pin	22	21	20	36 pin	60	59	58
18 pin	29	28	27	40 pin	63	62	61
22 pin	37	36	35				

SOLDERTAIL STANDARD (TIN)

14 pin	\$2.27	25	24	28 pin	\$ 99	90	81
16 pin	30	27	25	36 pin	1.39	1.26	1.15
18 pin	35	32	30	40 pin	1.59	1.45	1.30
24 pin	49	45	42				

SOLDERTAIL STANDARD (GOLD)

8 pin	\$3.20	27	24	24 pin	\$ 70	63	57
14 pin	35	32	29	28 pin	1.10	1.00	90
16 pin	38	35	32	36 pin	1.75	1.40	1.26
				40 pin	1.75	1.59	1.45

WIRE WRAP SOCKETS (GOLD) LEVEL #3

10 pin	\$4.55	41	37	24 pin	\$1.05	95	85
14 pin	39	38	37	28 pin	1.40	1.25	1.10
16 pin	43	42	41	36 pin	1.59	1.45	1.30
18 pin	75	68	62	40 pin	1.75	1.55	1.40

50 PCS. RESISTOR ASSORTMENTS \$1.75 PER ASST.

ASST. 1	5 ea.	10 OHM	12 OHM	15 OHM	18 OHM	22 OHM	50 PCS.
		27 OHM	33 OHM	39 OHM	47 OHM	56 OHM	1/4 WATT 5%
ASST. 2	5 ea.	68 OHM	82 OHM	100 OHM	120 OHM	150 OHM	50 PCS.
		180 OHM	220 OHM	270 OHM	330 OHM	390 OHM	1/4 WATT 5%
ASST. 3	5 ea.	470 OHM	560 OHM	680 OHM	820 OHM	1k	1/4 WATT 5%
		1.2k	1.5k	1.8k	2.2k	2.7k	50 PCS.
ASST. 4	5 ea.	3.3k	3.9k	4.7k	5.6k	6.8k	1/4 WATT 5%
		8.2k	10k	12k	15k	18k	50 PCS.
ASST. 5	5 ea.	22k	27k	33k	39k	47k	1/4 WATT 5%
		56k	68k	82k	100k	120k	50 PCS.
ASST. 6	5 ea.	150k	180k	220k	270k	330k	1/4 WATT 5%
		390k	470k	560k	680k	800k	50 PCS.
ASST. 7	5 ea.	1M	1.2M	1.5M	1.8M	2.2M	1/4 WATT 5%
		2.7M	3.3M	3.9M	4.7M	5.6M	50 PCS.

ALL OTHER RESISTORS FROM 2.2 OHMS 5.6M AVAILABLE IN MULTIPLES OF 5 ea.
5-25 PCS. .05 ea. 30-95 PCS. 04 ea. 100-495 PCS. 03 ea. 500-995 027 ea.

14 PCS. POTENTIOMETER ASSORTMENTS

ASST. A	2 ea.	10 OHM 20 OHM 50 OHM 100 OHM 200 OHM 500 OHM 500 OHM	\$9.95
ASST. B	2 ea.	1K 2K 7.5K 10K 20K 25K 50K	\$9.95
ASST. C	2 ea.	50K 100K 200K 250K 500K 1M	\$9.95

Each assortment contains 14 pcs of 10 turn pots. All pots are available in single and quantity. \$9.95 ea.

JAMES

Satisfaction Guaranteed. \$5.00 Min. Order. U.S. Funds.
California Residents — Add 6% Sales Tax
Write for FREE 1976 Catalog — Data Sheets .25¢ each

P.O. BOX 822, BELMONT, CA. 94002
PHONE ORDERS — (415) 592-8097

74LS00 TTL

74LS00	39	74LS05	39	74LS151	155
74LS02	39	74LS73	65	74LS153	189
74LS03	39	74LS74	65	74LS157	155
74LS04	45	74LS75	70	74LS162	225
74LS05	45	74LS76	65	74LS163	225
74LS08	39	74LS83	219	74LS164	225
74LS10	39	74LS86	65	74LS181	369
74LS13	79	74LS90	125	74LS190	285
74LS14	219	74LS92	125	74LS191	285
74LS20	39	74LS93	125	74LS192	285
74LS26	49	74LS95	125	74LS193	285
74LS27	45	74LS96	189	74LS194	225
74LS28	49	74LS97	125	74LS195	225
74LS30	39	74LS112	65	74LS257	189
74LS32	45	74LS132	155	74LS260	55
74LS40	49	74LS136	65	74LS279	79
74LS51	39	74LS138	189	74LS670	595

DPST C & K ROCKER SWITCH

Dim: 1" x 1" x 1/2"

They are rated at 125 Vac @ 5A.
They are excellent in applications such as Microcomputer Panel Switches. **\$6.99**

DPST	ON	OFF	ON	221	2.08	2.08	1.87	1.70
	ON	NC/NC	ON	223	2.08	2.08	1.87	1.81
	ON	OFF	ON	131	2.08	1.95	1.43	1.30
	ON	NC/NC	ON	133	2.08	1.85	1.21	1.10

PUSH BUTTON

Model 1 Quantity net prices
Number Each 29 10 29 30 99

PB-123 \$2.35 \$1.95 \$1.47 \$1.30

THUMBWHEEL SWITCHES

Part No.	Description	Price	Part No.	Description	Price
SR EP	End Plate (pair)	\$ 5.50	SR EP	End Plate (pair)	\$ 5.50
SR DP	Driver Plate (each)	40	SR DP	Driver Plate (each)	40
SR BB	Blank Body (each)	40	SR BB	Blank Body (each)	40
SR HB	Hall Body (each)	40	SR HB	Hall Body (each)	40

8 POSITION ROTARY SWITCH

These switches are a 7 position, one position open, rotary switch enclosed in a 10 D x 5 mm. They have a standard 8 pin configuration and will mount perfectly on printed circuit board. **\$9.95**

ZENERS—DIODES—RECTIFIERS

TYPE	VOLTS	W	PRICE	TYPE	VOLTS	W	PRICE
1N4733	3.3	300m	1.10	1N4003	200 PIV	1 AMP	12/100
1N4734	5.1	300m	1.10	1N4004	400 PIV	1 AMP	12/100
1N4735	5.6	300m	1.10	1N3600	50	200m	6/100
1N4736	6.2	300m	1.10	1N4148	75	10m	15/100
1N4737	6.8	300m	1.10	1N4154	35	10m	17/100
1N4738	7.5	300m	1.10	1N4174	5	10m	17/100
1N4739	8.2	300m	1.10	1N4235	6.2	10m	28
1N4740	9.1	300m	1.10	1N4236	6.8	10m	28
1N4741	10	300m	1.10	1N4238	8.2	10m	28
1N4742	11	300m	1.10	1N4243	12	10m	28
1N4743	12	300m	1.10	1N4245	15	10m	28
1N4744	13	300m	1.10	1N1181	50 PIV	35 AMP	1.60
1N4745	15	300m	1.10	1N1184	100 PIV	35 AMP	1.60
1N4746	18	300m	1.10	1N1188	200 PIV	35 AMP	1.60
1N4747	20	300m	1.10	1N1189	300 PIV	35 AMP	1.60
1N4748	22	300m	1.10				
1N4749	24	300m	1.10				
1N4750	27	300m	1.10				
1N4751	30	300m	1.10				
1N4752	33	300m	1.10				
1N4753	36	300m	1.10				
1N4754	39	300m	1.10				
1N4755	43	300m	1.10				
1N4756	47	300m	1.10				
1N4757	51	300m	1.10				
1N4758	56	300m	1.10				
1N4759	62	300m	1.10				
1N4760	68	300m	1.10				
1N4761	75	300m	1.10				
1N4762	82	300m	1.10				
1N4763	91	300m	1.10				
1N4764	100	300m	1.10				
1N4765	110	300m	1.10				
1N4766	120	300m	1.10				
1N4767	130	300m	1.10				
1N4768	150	300m	1.10				
1N4769	180	300m	1.10				
1N4770	220	300m	1.10				
1N4771	270	300m	1.10				
1N4772	330	300m	1.10				
1N4773	390	300m	1.10				
1N4774	470	300m	1.10				
1N4775	560	300m	1.10				
1N4776	680	300m	1.10				
1N4777	820	300m	1.10				
1N4778</							

CRYSTALS

Part #	Frequency	Case Style	Price
CY1A	1.000 MHz	HC33/U	\$4.95
CY2A	2.000 MHz	HC33/U	\$4.95
CY3A	4.000 MHz	HC18/U	\$4.95
CY1A	5.000 MHz	HC18/U	\$4.95
CY12A	10.000 MHz	HC18/U	\$4.95
CY19A	18.000 MHz	HC18/U	\$4.95
CY22A	20.000 MHz	HC18/U	\$4.95
CY30B	32.000 MHz	HC18/U	\$4.95

AVAILABLE IN THESE FREQUENCIES ONLY

CLOCK CASES

Nicely styled cases complete with red bezel for use in such applications as desk clocks, car clocks, alarm clocks, instrument cases.

DIMENSIONS: W-4" L-4 1/4" H-2"

\$5.95

MULTIPURPOSE KEYBOARDS

MULTIPURPOSE KEYBOARDS
26 Keys - Touch Tone

No scheming needed. Calculator use or alternate (pop off) keycaps. For touch tone use any control application. This unit may be used for simple units.

\$2.95

This unit was originally intended for calculator type applications but can be adapted to a variety of other types of units, such as microcomputer interface, digital counter/demultiplexer, digital clock, etc. Frequency sensitive units will have touch tone applications. The unit is composed of 18 very low bounce wire or the SPST type, and contains a push switch. Numbers are white. Clear and black are blue and all other keys are orange on a black background.

\$2.49

CALCULATOR CHIPS AND DRIVERS

MM5725	8 DIGIT 4 FUNCTION	\$1.98
DM75491	SEGMENT DRIVER	.79
MM5736	6 DIGIT 4 FUNCTION	1.95
DM75492	DRIVER FOR 5736	.89
MM5738	8 DIGIT 5 FUNCTION	2.95
DM8864	DRIVER TYPE 1	2.00
DM8865	DRIVER TYPE 2	1.00

CLOCK CHIPS

MM5311	6 DIGIT W/BCD	\$4.95
MM5312	4 DIGIT W/BCD	4.95
MM5313	6 DIGIT W/BCD	4.95
MM5314	6 DIGIT CLOCK	3.95
MM5316	ALARM CLOCK	4.95
CT7001	CALC-CLOCK CHIP	5.95

DIGITAL WATCH READOUT

FOR USE WITH WATCHES, DVMS, COUNTERS, ETC.

\$1.95

HP-5082-7300

HP 5082-7300
3" Dnt Matrix type numeric readouts with decoder/diver/flash built on the chip. Only 8 pins (BCD in, DP Latch, +5v, ground)

\$5.95

HP 5082 7300
+1 version of 7300

4.95

1 1/4" x 1 1/2" XFEMERS

PC Mount

That were designed for clock type applications. 110 Vac primary @ 60 Hz. Secondaries: 8-10 Vac @ 30 mA-50 mA. 50 Vac @ 30 mA-50 mA. 1" tall for miniature power supplies & gas discharge displays.

SPECIAL \$7.99

1/16 VECTOR BOARD

0.1" Hole Spacing P Pattern

Part No.	Length	Width	1-19	20-49	
PHENOLIC	64P44 062XXXP	4.50	6.50	1.72	1.54
	169P44 02XXXP	4.50	17.00	3.69	3.32
EPOXY GLASS	64P44 062	4.50	6.50	2.07	1.86
	64P44 062	4.50	8.50	2.56	2.31
	169P44 062	4.50	17.00	5.04	4.53
	169P44 062	8.50	17.00	9.23	8.26
EPOXY GLASS COPPER CLAD	169P44 062C1	4.50	17.00	6.80	6.12

VECTOR WRITING PENCIL

Vector Writing Pencil P173 consists of a hand held featherweight (under one ounce) tool which is used to guide and wrap insulated wire, fed off a self-contained replaceable bobbin, onto component leads or terminals installed on pre-punched "P" Pattern Vectorboard™. Connections between the wrapped wire and component leads, parts or terminals are made by soldering. Complete with 250 FT of red wire.

\$9.50 ea.

REPLACEMENT WIRE - BOBBINS FOR WRITING PENCIL

W36 3-A-Pkg. 3	(Green)	\$2.40
W36 3-B-Pkg. 3	(Red)	\$2.40
W36 3-C-Pkg. 3	(Clear)	\$2.40
W36 3-D-Pkg. 3	(Blue)	\$2.40

9V BATTERY CLIP STANDARD CLIP

FOR USE WITH 9V TRANSISTOR BATTERIES WITH 4" LEADS

9/.99

TERMINAL STRIPS

THREE TERMINAL STRIPS WITH CENTER TERMINAL. USED FOR MOUNTING

15/\$1.00

AMP TERMINAL PINS

TERMINAL PINS FOR MOUNTING COMPONENTS ALSO PERFECT FOR USE WITH BOARD CONNECTORS AND SUBASSEMBLIES

\$1.00/100 PCS.

MICROPROCESSOR COMPONENTS

8080A \$39.95

8080 AND 8088 SUPPORT COMPONENTS

8224 CLOCK GENERATOR USED TO GENERATE TWO PHASE 8008 STATE LINES INTO 8 USEABLE LINES FOR ADDRESS LATCHING **\$12.95**

74LS138 DECODER PERFECT FOR DECODING THE THREE 8008 STATE LINES INTO 8 USEABLE LINES FOR ADDRESS LATCHING **\$3.98**

8228 SYSTEM CONTROLLER GENERATES A SYSTEM DATA BUS AND CONTROL SIGNALS FOR MEMORY **\$21.25**

CPU'S		RAM'S			
8008	8 BIT CPU	\$19.95	1101	256K1	STATIC \$2.25
8080	SUPER 8008	39.95	1103	1024X1	DYNAMIC 6.95
4040	4 BIT 8080	39.95	2101	256X1	STATIC 2.95
			2102	1024X1	STATIC 2.95
2504	1024 DYNAMIC	\$9.00	2107	4096X1	DYNAMIC 19.95
2518	HEX 32 BIT	7.00	2111	256X3	STATIC 7.95
2519	HEX 40 BIT	4.00	7010	1024X1	MNOS 29.95
2524	512 DYNAMIC	3.50	7489	16X4	STATIC 2.49
2525	1024 DYNAMIC	6.00	8101	256X4	STATIC 7.95
2527	DUAL 256 BIT	3.95	8111	256X4	STATIC 7.95
2529	DUAL 512 BIT	4.00	8599	16X4	STATIC 3.49
2532	QUAD 80 BIT	3.95	91102	1024X1	STATIC 2.95
2533	1024 STATIC	7.95	74200	1024X1	STATIC 6.95
3341	FHD	6.95	93410	256X1	STATIC 1.75
74LS670	16X4 REG	3.95	5262	2048X1	DYNAMIC 2.95
AV-5-1013	UART'S	\$6.95	17074	3048	FAMOS 15.95
			5202	2048	FAMOS 14.95
2513	CHAR GEN	11.00	8223	32X8	BIPOLAR 3.00
7488	RANDOM BITS	3.50	74S287	1024	STATIC 7.95

JOLT 159.95

ACCESSORIES

CPU 159.95 KIT

RAM 199.95 KIT

The JOLT system consists of a set of modular microcomputer boards which can be used singly or tied together to produce any desired microcomputer system configuration. The minimum system is one CPU board, which alone constitutes a viable computer system complete with central processor I/O, interrupts, timer, read-write memory, and a complete software debug monitor in read-only memory.

JOLT INCLUDES SOFTWARE, HARDWARE AND ASSEMBLY MANUALS. AVAILABLE FOR IMMEDIATE SHIPMENT \$159.95 in kit form. \$249 assembled.

JOLT SYSTEM DESCRIPTION

JOLT RAM Card — Fully static 4,096 bytes of RAM with 1 microsecond access time and on-board decoding. Hardware and assembly manuals included. AVAILABLE FOR IMMEDIATE SHIPMENT \$199.95 kit. \$285 assembled.

JOLT Power Supply — Operates at +5, -12 and 10 voltages. Supports JOLT CPU, 4k bytes of RAM and JOLT I/O card — or CPU and 8 I/O cards. Manuals included. AVAILABLE FOR IMMEDIATE SHIPMENT \$99.95 kit. \$145 assembled.

JOLT Accessory Bag — Contains enough hardware to connect one JOLT card to another. Such necessary items as flat cable, connectors, cord spacers, hardware, etc. AVAILABLE FOR IMMEDIATE SHIPMENT \$39.95

64 KEY BOARD

These are high quality keyboards which were originally made by Digital Equipment Corporation. Each keyboard has 64 keys, which are brought out on unpopulated pins. They utilize magnetic reed line switches, and are new in appearance.

\$29.95

HD10165 Keyboard Encoder ROM **\$7.95**

WIRE WRAP WIRE

AWG	COLOR	25 FT MIN	50 FT	100 FT	1000 FT
30 AWG	WHITE	\$2.10	\$2.75	\$3.50	\$24.00
30 AWG	YELLOW	2.10	2.75	3.50	24.00
30 AWG	RED	2.10	2.75	3.50	24.00
30 AWG	GREEN	2.10	2.75	3.50	24.00
30 AWG	BL/UE	2.10	2.75	3.50	24.00
30 AWG	BLACK	2.10	2.75	3.50	24.00

RIBBON CABLE

Conductors	1-9H/ft	10-24H/ft	25-99H/ft	100R
10	39	29	25	23
20	59	49	45	43
30	79	69	65	62
40	99	89	85	80
50	119	109	105	100

6' 2 CONDUCTOR POWER CORDS 125V @ 5A

THREE CONDUCTOR POWER SUPPLY CORDS

NUMBER	LENGTH	AWG	O.O.	RATING	COLOR	PRICE
17236	6'	18(41X34)	265	1250W	BLACK	Special 99 ea
17237	6'	18(41X35)	253	1250W	GREY	1.25
17238	6'	18(41X34)	265	1250W	BLACK	Special 99 ea
17239	6'	18(41X34)	253	1250W	GREY	1.30
17000	4'	18(41X34)	253	1250W	BLACK	59

Satisfaction Guaranteed. \$5.00 Min. Order. U.S. Funds. California Residents - Add 6% Sales Tax. Write for FREE 1976 Catalog - Data Sheets .25¢ each

JAMES

P.O. BOX 822, BELMONT, CA. 94002

PHONE ORDERS - (415) 592-8097

JE SERIES KITS

JE801 DVM

The JE801 is a three and one half digit, auto polarity digital voltmeter, in a kit form. It features several options not available in any commercial digital voltmeter. Its low cost is perhaps the most important feature, which is achieved by offering it in a kit form. A kit allows the unit to be used by small OEM's where cost effectiveness is an important factor, and by the hobbyist who has to be concerned with cost. The unit also features on-car regulators, allowing it to be operated off a single plus and minus fifteen volt, unregulated power supply. The unit has a small size of three inches width, three and three quarters of an inch height, and one and a quarter inch height.

\$39.95 Per Kit printed circuit board

JE803 PROBE

The Logic Probe is a unit which is for the most part indispensable in trouble shooting logic families TTL, DTL, RTL, CMOS. It derives the power it needs to operate directly off of the circuit under test drawing a scant 10 mA max. It uses a MAX9 readout to indicate any of the following states by these symbols: H (1), L (LOW), 0 (PULSE), P. The Probe can detect high frequency pulses to 45 MHz. It can be used at MOS levels on-circuit damage will result.

\$7.95 Per Kit SPECIAL printed circuit board

JE700 CLOCK

The JE700 is a low cost digital clock, but is a very high quality unit. The unit features a simulated walnut case with dimensions of 6" x 2 1/2" x 1 1/2". It utilizes a MAM72 high brightness readout, and the MM5314 clock chip.

12 or 24 Hour
115 VAC
\$19.95 per kit.

JOYSTICK

These joysticks feature four 100K potentiometers, that vary resistance proportional to the angle of the stick. Sturdy metal construction with plastic components only at the movable joint. Perfect for electronic games and instrumentation.

\$9.95 ea.

ELECTRONIC ROULETTE

Complete kit with all components case and transformer.

\$29.95 Per Kit

115 VAC

6 1/2 x 6 1/2 x 1 1/2

ELECTRONIC CRAPS

Complete kit with all components case and transformer.

\$19.95 Per Kit

6 1/2 x 3 1/2 x 1 1/2

CONTINENTAL SPECIALTIES

\$15.95

PROTO BOARD 6
The PB-6 lets the user test and build circuits without soldering or patch cords. All interconnections between components are made with common #22 AWG hookup wire. This quality breadboarding kit includes 630 component tie points at less than 2.5¢ each. It measures 6" long by 4" wide. Designed especially to breadboard Microprocessor Circuits **\$15.95**

PROTO BOARD 100

A low cost, big 100 IC capacity breadboard kit with all the quality of QT sockets and the best of the Proto Board series. Complete down to the last nut, bolt and screw. Includes 2 CT-35S Sockets, 1 OT-35B Bus Strip, 2.5-winding binding posts, 4 rubber feet, screws, nuts, bolts, and easy assembly instructions **\$19.95**

Bring IC leads from pc board for fast signal tracing and troubleshooting. Inject signals. Wire unused circuits into boards. Scope probes and test leads lock onto Dynagrip inset (see circle) for hands-off testing. Plastic construction eliminates springs, pivots. Non-corrosive nickel-silver contacts for simultaneous low resistance connections.

PC-14, 14 pin Proto Chip **\$4.50 ea.**
PC-16, 16 pin Proto Chip **\$4.75 ea.**
PC-24, 24 pin Proto Chips **\$8.50 ea.**

BINAURAL SOUND...

a remarkable listening experience for stereo headphone owners!



Created specifically for playback through stereo headphones, this unique record presents the listener with sound of unsurpassed realism. It recreates at each of the listener's ears the precise sound that each ear would have heard — independently — at the original scene.

Binaural recording re-creates the directions, distances, and even the elevations of sounds better than any other recording method. The super-realism of binaural recording is accomplished by recording the acoustical input for each ear separately, and then playing it back through stereo headphones. Thus the sound intended for the left ear cannot mix with the sound for the right ear, and vice versa.

Binaural recording offers the listener the identical acoustical perspective and instrument spread of the original. The sound reaching each ear is exactly the same as would have been heard at the live scene.

"MAX" — GENIE OF BINAURAL RECORDING.

"Max," is a specially constructed dummy head, cast in silicone rubber, which duplicates the role of the human head as an acoustical absorber and reflector of sound. Super-precision capacitor microphones were installed in Max's ears so that each microphone would pick up exactly what each human ear would hear. The result is a demonstration of phenomenal recorded sound.

STARTLING REALITY. The Binaural Demonstration Record offers 45 minutes of sound and music of startling reality.

You'll marvel at the eerie accuracy with which direction and elevation are re-created as you embark on a street tour in binaural sound—Sounds Of The City... Trains, Planes & Ships... A Basketball Game, a Street Parade, a Steel Fabrication Plant, The Bird House at the Zoo—all demonstrating the incredible realism of binaural sound reproduction.

MUSIC IN BINAURAL. The musical performances presented on the Binaural Demonstration Record transport you to the concert hall for a demonstration of a wide variety of music. Selections total 23 minutes, and include examples of jazz, rock, organ, and chamber music.

The Stereo Review Binaural Demonstration Record is the ultimate in sound reproduction. It has been made without compromise for the owner of stereo headphones. If you own stereo headphones, this record is a must.

CHARGE YOUR ORDER TO YOUR AMERICAN EXPRESS, BANKAMERICARD, MASTER CHARGE OR DINERS CLUB ACCOUNT.

Ziff-Davis Service Division, Dept. R, 595 Broadway, New York, N.Y. 10012. PE-276

Please send the Binaural Demonstration Record @ \$9.98, postpaid (\$8 outside U.S.A.).

Enclosed is \$_____ (Residents of Calif., Col., Fla., Ill., Mich., Mo., N.Y. State, D.C. and Tex. add applicable sales tax.)

CHARGE: BankAmericard Master Charge American Express Diners Club

Account # _____ Exp. Date _____

Master Charge Interbank # _____ (4 numbers over your name)

Signature _____

Print Name _____

Address _____

City _____ State _____ Zip _____

FREE CATALOG Ultrasonic Devices, LEDs, Transistors, IC's, Keyboards, Digital Thermometers, Unique Components. Chaney S. Box 15431, Lakewood, Colo. 80215

SEMICONDUCTOR AND PARTS Catalogue from the semiconductor specialists J & J Electronics, Box 1437, Winnipeg, Manitoba, Canada. U.S. Inquiries.

ELECTRONIC Ignition: Sparkless, Transistor, Capacitor, Vapor Inductors, Auburn Sparkplugs. Information 10 cents. Anderson Engineering, Epsom, N.H. 03234

TV PING PONG game. Plays through your set's antenna terminals. Plans \$3.25. ARS SYSTEMS, Box 1922, Sunnyvale, CA 94088.

6 MHZ CRYSTALS including schematic and info to generate 60 hz-12VAC to make your digital clock run on batteries. \$10.50 pp in US. Eastern Sales, Box 510, Raleigh, N.C. 27602.

FREE CATALOG Kits and components. ELS Electronics, Box 581, Westbury, N.Y. 11590.

BUILD YOUR OWN TV CAMERA!
— Ideal for home & business —

THE ECONOMICAL ANSWER TO HOME MONITORING OF BUSINESSES, ENTRANCES, DRIVEWAYS, BUSINESS and SURVEILLANCE...TV...AMATEUR TV PLUS HUNDREDS OF OTHER APPLICATIONS. MODEL AT-1A, SERIES D - KIT FORM \$185. ASSEMBLED \$275. SOLID-STATE, WORKS ON ANY TV SET. OPTIONAL SOUND KIT \$28.95. PHONE or WRITE for catalog. Dial 402-967-2771

1301 BROADWAY ATV Research DAKOTA CITY, NE 68731

DESCRAMBLERS: Several Professional Models that work with all Scanners, Tone Encoders/Decoders, Scanmate AAPP, Radar Detectors, Big Ears, Alarms, Books, Kits, parts. Catalog 25 cents. KRYSTAL KITS, Box 445, Bentonville, Ark. 72712.

4K 8080 COMPUTER, 3 I/O Ports \$395 assembled. Kits from \$35. Details \$2.00 (refundable). VACOMP, Box 4733, Arlington, Virginia 22204.

UNIVERSAL TTL/DTL/GMOS IC TESTER Set Programming Switches, Plug In, Press To Test, Errors Displayed. Tests 16/14 pin IC's! Easy Circuit Construction with TTL Illustrated Info/Plans \$2.00. NORTHSTAR ENGINEERING, 3617 North Crede Drive, Charleston, WV 25302.

CB RADIO

\$9

CB RADIO

Oldest and largest CB Radio Magazine in the U.S.

Covers: **CB NEWS**
SCANNERS
CB PRODUCTS
FCC REGULATIONS

SEND \$8.50 for one year subscription (12 issues) and receive a free 24 book of official FCC Part 95 CB regulations.

\$9 / CB Radio 14 Vandeventer Ave., Port Washington, NY 11050

Do you need a terminal for your **ALTAIR 8800?**

Our VIDEO board has the ability to display GRAPHICS as well as text. Graphics and text can even be displayed together on the same screen—great for games and displays—FEATURES:

- 16 lines of 32 characters on a standard TV monitor or modified TV (expandable to 64 characters with optional memory for use with high resolution monitors)
- 128 characters (7 x 9 font) incl. upper and lower case
- 48 x 64 dot matrix for graphics (48 x 128 with memory option)
- The display may be written or read in less than 20msec
- 8 bit keyboard input port provided on board
- Complete cursor, text editing and plotting software incl. PRICES: \$160 kit, \$230 assem, memory option \$25

Interface your computer to the analog world with our A/D D/A interface board—FEATURING:

- 1 or 2 analog outputs with 10 bit resolution
- 8 Analog inputs—software controlled A/D conversion
- 50-500µs conversion time depending on software
- 6 Digital outputs for control functions

Use for CRT graphics display plots up to 20K lines/sec. PRICES: 1 D/A \$135 kit, \$175 assem.; 2 D/A's \$185 kit, \$235 assem, bipolar option \$8 (\$12 with 2 D/A's)

Both boards are fully Altair 8800 plug compatible. Each is on a single double-sided board with plated through holes and gold plated contacts. Application notes, assembly instructions (kit version), and software is included with each board.

CALIFORNIA RESIDENTS PLEASE ADD SALES TAX
POLYMORPHIC SYSTEMS
P. O. Box 2207 Goleta, CA 93018
MASTERCHARGE ACCEPTED

COMPUTER, 8 bit serial, complete. \$225. Scope display generator, 128 characters, parallel input, \$85. Brochure 10 cents. RAECO, Box 14, Readville, Mass. 02137.

KEYBOARDS, for synthesizers, organs. Three octave, two buss. \$65. Brinkwood Electronics, Box 26, Sandy Spring, MD 20860.

UNBEATABLE—2N5296 NPN 36W audio power transistor 3/\$1.00. MPSA70 PNP general purpose 10/\$1.00. 200/16V axial capacitor 7/\$1.00. 5.50 handling. Winebrenner, 612 S. Ijams, Garrett, IN 46738.

ALTAIR 8800 assembled and tested \$450 ppd. E. Wong, 1027 West 34th Street, Los Angeles, Calif. 90007.

"BASIC TELEPHONE WIRING" Unique report gives complete details. \$3.50 postpaid. Queens Village Telephone Supply, Box 29002-R, Queens Village, NY 11429.

SPECIAL! Pin Photo Detector HP5082-4203... \$1.99. Catalog Electronic Parts. BDJ Electronics, 33 Howard, Orangeburg, New York 10962.

TV TECHNICIANS, SERVICEMEN, HOBBYISTS—Vista Model 740 Digital Crosshatch Generator. Compact crystal divider for lowest-priced ultra-stable 5x7 crosshatch or 56 dot patterns. AC powered. \$31.95 complete kit; \$41.95 assembled. Postpaid in USA. Canada. Information available free. Photolum Corporation, Dept. PE-26, 118 East 28th Street, New York, New York 10016.

AMAZING cordless electric lawnmower. FREE information. No waiting plans \$10.00. Amonics, P.O. Box 1045, Norman, Oklahoma 73069.

MEMORY SYP21LO2A Synertek 1K Static Rams \$2.75. 4.5" x 6.5" 4K card. Inquire: Wm. Witherspoon, 3558 Stony Point Road, Grand Island, N.Y. 14072.

WHOLESALE C.B. Scanners, Antennas, Crystals. Special cut. \$4.95. Monitor \$3.95. Send make, model, frequency. Catalog 25 cents. G Enterprises, Box 461P, Clearfield, UT 84015.

CARBON FILM RESISTORS. Brand new as low as 1.7 cents discounts of 20%. Prompt delivery. FREE samples/specifications. COMPONENTS CENTER, Box 134P, N.Y., N.Y. 10038.

SONAR VHF FM Business Radio. Pagers, Scanners, Amateur, Marine. L.C. McCann Co., Oley, PA 19547.

GODBOUT

BILL GODBOUT ELECTRONICS
BOX 2355, OAKLAND AIRPORT, CA 94614

12 VOLTS, 8A!

Remember the 12V, 6A supply in the Dec 74 Popular Electronics? This IMPROVED version offers an 8 amp continuous rating, adjustable output 11-14V, total short circuit protection, and much more. For powering mobile equipment, tape players, bench supply, or whatever. Kit complete, but less chassis and hardware...\$22.50 plus shipping for 7 pounds.

EXPERIMENTER'S SUPPLY: VARIABLE (+) AND (-)

This kit provides dual tracking, regulated voltages from ±1V to over ±18V, at up to 200 ma per side. Short circuit protected, thermal limiting. Kit (less case & hardware) \$10.95 + 2 lbs shipping.

BOBBINS, too!

OK, all you wire pencil fanatics, here's replacement wire: 3 bobbins/\$2.40. Specify RED, GREEN, BLUE, or CLEAR.

TERMS: Add 50c to orders under \$10; add shipping where shown. Cal add tax. No COD. BankAmericard®/Mastercharge® call (415) 357-7007, 24 hrs.

CIRCLE THE READER SERVICE # FOR OUR FLYER (IT'S FREE!)

5370 \$4.50
THE SECOND GENERATION ALARM CLOCK IC: Multiplexed digits make it much easier to apply than the 5316. Hrs + mins, snooze, alarm out, more.

2102 \$1.95
THE SPECIAL CONTINUES with our guaranteed under 750 ns. 2102s; qty discounts, too...

5203 \$9.95
2K EPROM; erases with UV light. Programmable and versatile memory.

PARTS

CONTINENTAL SPECIALTIES

PROTO BOARDS

Build & test circuits as fast as you think!
PB100 10 IC cap breadboard kit, 4.5 x 6.0 x 1.35" \$19.95
PB101 10 14-DIP cap, 5-way post, 940 solderless tie points, 5.8 x 4.5" \$29.95
PB102 12 14-DIP cap, like PB101 with 2,240 tie points, 7.0 x 4.5" \$39.95
PB103 24 14-DIP cap., 4 5-way posts, 2,240 tie points, 6.0 x 9.0" \$59.95
PB104 32 14-DIP cap., 3060 solderless tie points, 8.0 x 9.76" \$79.95

PROTO-CLIP

For power-on/hands-off signal tracing. Bring IC leads up from PC board surface for fast trouble-shooting.
PC14 14 pin \$4.50
PC16 16 pin \$4.75

LOGIC MONITOR

Simultaneously displays static and dynamic logic states of DTL, TTL, HTL or CMOS DIP IC's. Pocket size. \$84.95.

SOCKETS & BUS STRIPS

Plug-in, wire, test, modify or expand without patch cords or solder. Snap together to form breadboard networks.

PN/Description	L. Hole-to-Hole	Term's	Price
OT59S Socket	6.5"	6.2"	118 \$12.50
OT59B Bus	6.5"	6.2"	20 2.50
OT47S Socket	5.3"	5.0"	94 10.00
OT47B Bus	5.3"	5.0"	16 2.25
OT35S Socket	4.1"	3.8"	70 8.50
OT35B Bus	4.1"	3.8"	12 2.00
OT18S Socket	2.4"	2.1"	34 3.75
OT18B Bus	2.4"	2.1"	5 1.25
OT8S Socket	1.4"	1.1"	16 3.25
OT8B Bus	1.3"	1.0"	14 3.00

7400N TTL

7400N \$1.12	7442N \$8.00	74797N 5.00	74164N 1.10
7401N .16	7443N .74	74100N 1.00	74165N 1.10
7402N .14	7444N .73	74100N 1.20	74166N 1.27
7403N .16	7445N .75	74105N .50	74170N 1.58
7404N .19	7446N .75	74107N .33	74173N 1.29
7405N .19	7447N .72	74109N .74	74174N 1.14
7406N .29	7448N .80	74110N .72	74175N .98
7407N .29	7449N .14	74111N 1.20	74176N 1.25
7408N .19	7450N .14	74112N 2.00	74177N 1.40
7409N .10	7451N .14	74121N .36	74178N 1.42
7410N .18	7454N .14	74122N .38	74179N 3.60
7411N .26	7459N .20	74123N .71	74180N .75
7412N .33	7460N .14	74125N .46	74181N 2.39
7413N .44	7470N .65	74126N .59	74182N .67
7414N 1.05	7472N .26	74128N .84	74184N 1.84
7416N .28	7473N .37	74132N 1.10	74185N 2.20
7417N .33	7474N .32	74136N .95	74188N 4.75
7418N .30	7475N .50	74141N 1.20	74189N 1.17
7419N .13	7476N .32	74145N .89	74191N 1.17
7421N .33	7480N .59	74147N 2.40	74192N 1.08
7422N .50	7481N 1.30	74148N 2.00	74193N 1.02
7423N .49	7482N .89	74150N 1.00	74194N 1.05
7426N .23	7483N .65	74151N 8.00	74195N 1.74
7427N .25	7485N .90	74152N 1.40	74196N .99
7428N .33	7486N .34	74153N .79	74197N .76
7430N .20	7489N 2.12	74154N 1.40	74198N 1.61
7431N .24	7490N .78	74155N 1.00	74199N 1.50
7433N .36	7491N .78	74156N .69	74200N 5.60
7437N .29	7492N .49	74157N .69	74221N 1.50
7438N .29	7493N .49	74158N 1.52	74251N 1.40
7439N .39	7494N .49	74160N .98	74278N 2.45
7440N .16	7495N .80	74161N .98	74279N 2.45
7441N .83	7496N .67	74162N .98	74293N 1.00
		74163N .99	74298N 1.98

HIGH SPEED TTL

74H00N .33	74H20N .33	74H52N .36	74H73N .80
74H01N .25	74H21N .33	74H53N .36	74H74N .80
74H04N .33	74H22N .33	74H54N .36	74H76N .75
74H05N .33	74H23N .33	74H55N .36	74H102N .75
74H08N .40	74H40N .36	74H60N .36	74H103N .90
74H10N .33	74H41N .36	74H61N .36	74H108N .95
74H11N .33	74H42N .36	74H72N .75	

LOW POWER TTL

74L00N .24	74L10N .24	74L51N .34	74L90N 1.62
74L02N .24	74L20N .24	74L52N .34	74L93N 1.74
74L03N .39	74L42N 1.49	74L74N .90	74L95N 1.62
74L04N .33			

74LS

74LS00 .42	74LS27 .47	74LS112 .65	74LS170 5.80
74LS01 .58	74LS30 .42	74LS113 .92	74LS174 2.25
74LS02 .42	74LS32 .47	74LS114 .60	74LS175 2.42
74LS03 .50	74LS38 .53	74LS138 1.94	74LS181 7.00
74LS04 .47	74LS51 .60	74LS139 2.06	74LS194 2.40
74LS08 .42	74LS54 .48	74LS151 1.92	74LS195A 2.40
74LS09 .58	74LS55 .58	74LS153 1.92	74LS196 2.76
74LS10 .42	74LS73 .65	74LS157 1.68	74LS251 2.06
74LS11 .42	74LS74 .65	74LS158 1.68	74LS252 2.42
74LS15 .58	74LS76 .92	74LS160 3.06	74LS257 2.06
74LS20 .42	74LS78 .92	74LS161 3.06	74LS258 2.06
74LS21 .58	74LS79 .92	74LS162 3.06	74LS260 .58
74LS22 .58	74LS109 .92	74LS163 2.90	

SCHOTTKY TTL

74S00 .44	74S32 .80	74S113 1.50	74S174 3.30
74S01 .76	74S40 .65	74S114 1.20	74S175 2.90
74S02 .60	74S50 .76	74S133 .80	74S181 6.00
74S03 .75	74S51 .80	74S138 2.20	74S189 4.40
74S04 .55	74S60 .80	74S139 2.20	74S194 3.30
74S05 .75	74S65 .80	74S140 .80	74S195 3.30
74S08 .80	74S65 .80	74S151 2.20	74S251 2.20
74S09 .76	74S74 .90	74S153 3.40	74S253 2.40
74S10 .55	74S76 1.15	74S157 2.40	74S257 2.40
74S11 .65	74S78 1.15	74S158 2.00	74S258 2.40
74S15 .76	74S79 1.15	74S160 3.06	74S260 2.00
74S20 .65	74S86 2.50	74S161 4.70	74S280 5.70
74S21 .76	74S112 1.00	74S172 6.00	74S289 4.00

9300 SERIES

9300PC \$1.00	9318PC 2.30	9366PC 1.75	9318 3.50
9301PC 1.20	9321PC 1.20	93L00 1.50	9321 1.50
9304PC 1.50	9322PC 1.80	93L01 1.50	9322 1.50
9306PC 6.90	9324PC 2.00	93L08 3.20	9324 2.80
9308PC 2.60	9328PC 2.50	93L09 1.80	9328 3.70
9309PC 1.60	9334PC 2.95	93L10 2.80	9334 3.40
9310PC 1.31	9335PC 3.10	93L11 4.20	9335 4.20
9311PC 2.30	9340PC 5.00	93L12 1.80	9340 6.50
9312PC 1.20	9341PC 4.10	93L14 1.70	9341 6.50
9314PC 1.30	9342PC 1.15	93L16 3.20	93L60 3.00
9316PC 1.50	9360PC 1.75	93L18 3.50	93L66 2.70

AUDIO AMPS

TYPE	V	W	Ω	PRICE
LM352	6-15	1.15	8	1.60
TA861B12	6-15	1.15	8	1.60
TA862A12	6-15	1.40	8	2.00
TA864B11	6-15	2.20	4	3.00
TBA800	5-30	4.70	8	2.20
TBA810A	4-20	2.50	4	3.00
TBA820	3-16	1.70	4	2.00
TCA830	5-20	4.00	4	2.20
TCA940	6-24	6.50	8	4.40



LINEAR IC'S

H-T-O-S	N-DIP	M-MINI-DIP	D-CER-DIP	K-T-O-3	
LM105H	3.90	LM311H	1.20	LM710CH	.90
LM108H	4.90	LM311D	.90	LM710CN	.90
LM114H	3.00	LM311M	1.75	LM711CH	.90
LM300H	1.20	LM312N	2.75	LM711CN	.90
LM300M	1.20	LM312P	1.50	LM715CH	.60
LM301AH	.50	LM318M	1.40	LM715CD	.60
LM301AM	.80	LM324N	1.90	LM723CH	.60
LM301AN	1.10	LM331N	1.25	LM723CN	.65
LM301M	.95	LM336K	2.40	LM725CH	1.50
LM302H	1.30	LM339	1.30	LM725CD	5.00
LM302H	1.40	LM320-5K	2.90	LM733CH	1.40
LM304H	1.20	LM320-5T	2.50	LM733CD	3.50
LM305H	.85	LM320-12K	2.60	LM733CN	1.30
LM305AH	1.05	LM320-12T	2.50	LM741CH	.40
LM305M	1.00	LM340-5K	5.00	LM741CD	1.25
LM306N	.95	LM340-6K	2.60	LM741CM	.39
LM307H	.60	LM340-8K	2.60	LM747CH	.75
LM307M	1.50	LM340-12K	2.60	LM747CN	.90
LM308H	.85	LM340-15K	2.60	LM748CM	.55
LM308AH	5.00	LM340-18K	2.60	LM777CH	2.15
LM308M	1.00	LM340-24K	2.60	LM777CN	2.10
LM309H	1.75	LM555CM	.70	LM3046CN	.95
LM309M	1.00	LM556CM	1.30	LM3056CN	1.50
LM310H	1.50	LM567C	1.70	SG4501T	2.40
LM310M	1.80	LM709CN	.75	SG4501N	2.40
		LM709CN	.75	LM5000K	7.50

C-MOS

P/N	1-9 10 up	P/N	1-9 10 up	P/N	1-9 10 up
4000AE	.22 .21	4027AE	.50 .49	4070AE	.60 .59
4001AE	.23 .22	4028AE	.84 .83	4071AE	.22 .21
4002AE	.23 .22	4029AE	1.23 1.22	4072AE	.40 .39
4003AE	0.99	4030AE	3.33	4073AE	.33 .32
4006AE	1.16 1.15	4033AE	1.95 1.94	4075AE	.50 .49
4007AE	.22 .21	4035AE	1.08 1.07	4076AE	1.24 1.23
4008AE	1.79 1.78	4040AE	1.24 1.23	4077AE	.70 .69
4009AE	.61 .50	4041AE	1.82 1.81	4078AE	.50 .49
4010AE	.46 .45	4042AE	.78 .77	4081AE	.22 .21
4011AE	.24 .23	4043AE	.78 .77	4082AE	.50 .49
4012AE	.21 .20	4044AE	.78 .77	4085AE	2.00 1.99
4013AE	.38 .37	4047AE	2.75 2.74	4088AE	1.30 1.29
4014AE	1.24 1.23	4048AE	1.12 1.11	4089AE	2.80 2.79
4015AE	1.24 1.23	4049AE	.49 .48	4507AE	.60 .55
4016AE	.46 .45	4050AE	.49 .48	4508AE	2.20 2.19
4017AE	1.01 1.00	4051AE	1.49 1.48	4510AE	1.24 1.23
4018AE	2.21 2.20	4052AE	1.49 1.48	4511AE	3.50 3.49
4019AE	.49 .48	4053AE	1.49 1.48	4515AE	0.90 0.89
4020AE	1.24 1.23	4055AE	1.99 1.98	4516AE	1.75 1.74
4021AE	1.24 1.23	4056AE	1.99 1.98	4518AE	1.28 .98
4022AE	.94 .93	4060AE	1.98 1.97	4520AE	1.28 .98
4023AE	.23 .22	4063AE	2.50 2.49	4521AE	3.36 3.35
4024AE	.75 .74	4066AE	.75 .75	4585AE	1.78 1.77
4025AE	.23 .22	4068AE	.50 .49	4901AE	.43 .36
4026AE	1.90 1.89	4069AE	.35 .34	4911AE	.43 .36

PREMIUM QUALITY COMPONENTS

We've been buying and selling top quality components for nearly ten years. Our annual volume exceeds \$3 million. We handle only original parts, from the world's leading manufacturers and our customers include some of the largest and most quality-conscious companies. Now you can take advantage of our component buying skills and power and select from a broad range of advanced circuits.

FIRST QUALITY ONLY

WAVEFORM GENERATOR KIT

Here's a highly versatile lab instrument at a fraction of the cost of conventional unit. Kit includes 2 XR205 IC's, data & applications, PC board, latched and drilled, ready for assembly! Detailed instructions.

EXAR XR

SILENT SECRETARY starts tape recorder when you lift phone, connects anywhere on line. plans \$3.00. KM Products. 5971 W. 217. Cleveland, OH 44126.

FREE FLYER of electronic parts, semiconductors, printed circuit boards, kits, etc. Write to: R & L PHOTO-ELECTRONICS, P.O. Box 1432, Redsea, CA 91335.

THE AUDIO AMATEUR — A quarterly publication for the serious audio constructor. Free prospectus. The Audio Amateur, Box 1762, Peterborough, N.H. 03458.

ALTAIR 8800 OWNERS—Fantastic Games and centerfold pictures are now available. Send \$1 for samples catalog Scientific Research, P.O. Box 83, Marcy, NY 13403.

SUBSCRIBE NOW!
LEARN THE SECRETS OF YOUR TELEPHONE

FACTS NEVER BEFORE PUBLISHED FOR THE PUBLIC
ONE YEAR SUBSCRIPTION ONLY \$6.00

TELEPHONE COMPANY OF AMERICA
P.O. BOX 200
LOS ANGELES, CA 90008

MEMORIES—IC

RAMS | PROMS

2102-1 | 82S23/82S123

1.75 EA | 1.95 EA

Guaranteed to DATA SHEETS

ELTRON—P.O. Box 2542
Sunnyvale, CA. 94087

Min. Order \$10.00—Add \$1.00 P&H

COMPUTER HOBBYISTS! Bargain hunt and sell via ON-LINE 18 issues/year — \$3.75. Free sample issue from ON-LINE. 24695 Santa Cruz Hwy., Los Gatos, CA 95030

4-RANGE DIGITAL READOUT INTERVAL TIMER KIT

E-207

100.00 VALUE

SPECIAL 19.99

- 4 time functions: 1.99 Sec., 1.99 Sec., 1.99 Min., 1.99 Min., 1/2" High Voltage Tube Readouts
- For darkroom use as both processing & enlarging processes
- As a timer for sport & contest events (Stop watch)
- Provides timed 120V AC outlet and S.P. NO contact to trigger buzzer alarm or visual signals
- Full Wiring Instructions included — No Cabinet Or Case Available For Timer

24-KEY DESK CALCULATOR KEYBOARD

E-208

1.99 3/5.50

• Touch tone type contacts • Computer on circuit board • 4-line memory and 4-stage switches • 7 1/2" x 3 1/2" x 1 1/2" (height) • 100% • 1/2" (width) • 100% • Shipping at 1.10

12 VOLT DC SPOT MINIMATURE COAXIAL RELAY

S-196

• 75 Ohm coil • Designed for efficient transfer of RF energy at extremely low loss.

2.88

INDOOR/OUTDOOR LOW VOLTAGE LIGHTING TRANSFORMER

G-1

• Made for fluorescent, halogen incandescent, outdoor lighting of low voltage. No safety of high voltage. • Provides 100 watts and 100 watt series. • Many taps for the typical or unusual low voltage applications. • Includes the full complement of parts. • Includes 1/2" x 1/2" x 1/2" (height) • 100% • 100% • Shipping at 1.10

99c

SPERRY 9-DIGIT SP-425-09 PLANAR PLASMA DISPLAY

E-208

1.19 3/3.00

Features: Character height 0.25 inch • Brightness 70 foot lamberts • Viewing distance: 15 feet.

12-VOLT CASSETTE MOTOR

G-345

1.49 3/4.00

- Made For Low Voltage Cassette Players
- Measures 1 3/8" x 1 3/4" Dia.
- Pulley Shaft Extends 3/8" Above Motor

POWER SUPPLY ALUMINUM ELECTROLYTICS

G-345

Your Choice 1.49 3/4.20 10/13.00

• Especially suitable for measurement circuit where high capacitance is required

SIMPSON MODEL 318-SR

Dual Trace Conversion Instrument: Convert Your Old Oscilloscope To Dual Trace

Simpson Regular Suggested Price... \$189.95

29.99

SOLID STATE SPECIALS (ALL PRIME MERCHANDISE)

1N4003	Pkg. of 10	.65/Pkg
1N5707	Pkg. of 10	.65/Pkg
TTL-7440E		.17 ea.
TTL-7448		.89 ea.
OE-CX138		.25 10/2.50
LM-390	2W Audio Amp	.99
741	Op Amp	.39 3/1.00
747	Dual 741	.89
LM-565	Pinbase Lock Loop	1.49 3/3.80
LM309K	5V 1A Regulator	.89
ML-741CS	Mini-Dip Op Amp	.49
TTL-7447		.89
258473	(HEP442)G0616 (ECO-131 SR3052)	1.29 10/2.00

Send for free catalog - satisfaction guaranteed
Min. Order \$3.00 - Allow For Postage
Ill. Residents Add 5% Sales Tax
Prices good thru March 31, 1976 or while stocks last.

ELECTRONIC DISTRIBUTORS, INC.

DEPT. PE 1-4900 ELSTON CHICAGO, ILL. 60630

Tel: 312 283-4800

CIRCLE NO. 20 ON FREE INFORMATION CARD

"HOLD-A-CALL" Hold button for single line phones (rotary or touch tone). Single line. \$29.95, double line \$39.95 with music on hold \$10.00 additional. Money back guarantee, catalog 25 cents. PCS. 92 Marcus Avenue, New Hyde Park, N.Y. 11040.

HEAT SINKS for electronics. Catalog 25 cents. Amtech, 50 Boxwood, Buffalo, N.Y. 14227.

COMPUTER HOBBYISTS! Learn how to program. Complete self-taught programming course. Details \$1.00. Creative Computer, Box 52, Palo Alto, CA 94302.

PERSONALS

MAKE FRIENDS WORLDWIDE through international correspondence. Illustrated brochure free. Hermes, Berlin 11, Box 110660/ZD, Germany

Ph.D.'s MASTER'S BACHELOR'S — official nonresident College Degrees easily acquired through mailorder Universities. Revealing Directory — \$2. Counseling Connection, 5495 Claremont, No. BSG, Oakland, CA 94618.

NEW LUXURY CAR without costs! Free details. CODEX-DD, Box 6073, Toledo, Ohio 43614.

QUALITY ELECTRONIC COMPONENTS

— SAME DAY SERVICE —

NEW DISCOUNT SCHEDULE SAVES YOU EVEN MORE!

8080A \$49.95 **2102 \$2.65**

MICROPROCESSOR 1024 Bit Random Access Memory
0-70°C 480 ns Clock Period 500 ns Typical, 1000 ns Max Access Time

INTEGRATED CIRCUITS — TTL, CMOS, LINEAR & MOS

7400	21	7473	.30	74174	.98	4001	.23	4073	.23
7401	21	7474	.30	74175	.93	4002	.23	4075	.23
7402	21	7475	.49	74176	.79	4006	1.23	4081	.23
7403	21	7476	.32	74177	.99	4025	.22	4082	.23
7404	21	7480	.70	74180	.70	4008	.79	4502	.79
7405	21	7482	.70	74181	2.15	4009	.44	4510	1.14
7406	25	7483	.70	74182	.79	4010	.44	4511	1.05
7407	25	7485	.89	74184	2.19	4011	.22	4514	2.80
7408	21	7486	.28	74185	2.19	4012	.23	4515	2.80
7409	21	7489	2.19	74188	3.50	4013	.40	4516	1.23
7410	21	7490	.44	74189	3.50	4014	.96	4518	1.14
7411	21	7491	.70	74190	1.23	4015	.96	4520	1.14
7412	21	7492	.44	74191	1.23	4016	.40	4527	1.68
7413	25	7493	.44	74192	.88	4017	1.05	4528	.88
7414	89	7494	.70	74193	1.09	4018	1.05	4529	1.23
7416	25	7495	.70	74194	.88	4019	.23	LM309K	1.80
7417	25	7496	.70	74195	.88	4020	1.14	LM324N	1.28
7420	21	74100	1.28	74196	.88	4021	1.14	LM3401-5	1.25
7421	25	74101	.25	74197	.88	4022	1.14	LM3402	1.25
7423	35	74109	.33	74198	.49	4023	.23	LM3401-8	1.25
7425	35	74121	.35	74199	.49	4024	.84	LM3401-12	1.25
7426	25	74122	.44	74201	1.09	4025	.23	LM3401-15	1.25
7427	33	74123	.61	74229	.58	4026	1.68	LM3401-18	1.25
7428	28	74125	.40	74365	.67	4027	.40	LM3401-24	1.25
7430	21	74126	.40	74366	.67	4028	.89	LM3909K	.88
7432	25	74132	.70	74367	.67	4029	1.14	NE5267	3.24
7433	30	74141	.88	74368	.67	4030	.23	NE40L	2.04
7437	25	74145	.70	75150	1.31	4033	1.51	NE55V	.48
7438	25	74147	1.63	75450	.88	4034	3.50	NE556A	.88
7440	21	74401	1.30	75451	.61	4035	1.14	NE556B	3.83
7441	88	74150	1.16	75452	.61	4040	1.14	NE561B	3.83
7442	53	74151	.70	75453	.61	4041	.79	NE562B	3.83
7443	63	74153	.65	75454	.61	4042	.79	NE565A	1.25
7444	63	74154	1.63	75491	.11	4043	.70	NE564V	.28
7445	70	74155	.70	75492	.84	4044	.70	NE567V	1.36
7446	70	74156	.70	75493	1.09	4046	1.86	uA709CV	.44
7447	70	74157	.70	75494	1.19	4049	.40	uA710CA	.44
7448	70	74160	.88	8093	.40	4050	.40	uA711CA	.53
7450	21	74161	.88	8094	.40	4051	1.26	uA723CA	.60
7453	21	74162	.88	8095	.67	4052	1.26	uA741CV	.44
7454	21	74163	.88	8096	.67	4053	.72	uA742CA	.70
7460	21	74164	.88	8097	.67	4060	1.58	uA748CV	.49
7470	30	74166	1.26	8098	.67	4066	.79	MC1458V	.53
7472	30	74170	2.64	82525	2.19	4071	.23	2102	2.65
		74173	1.42	4000	.23	4072	.23	8080A	49.95

AP SUPER STRIP II—Universal Breadboarding

Element with 840 Solderless Plug-in Tie-Points

\$17.00

IC TEST CLIPS

14 pin TC-14 \$4.30 24 pin TC-24 \$13.85

16 pin TC-16 \$4.75

We carry AP's Patch Cords, Terminal Strips, Distribution Strips and ACE's tool

BISHOP GRAPHICS Printed Circuit Drafting

Aids are now available from Dig-Key

ROCKWELL CALCULATORS

We stock a complete line from \$16.88 through \$99.95.

Scientific Slide Rule \$89.95 with Case and Battery Charger

- 4-pin, low-profile DIP
- Lends on standard .10" (2.54 mm) grid
- 1 Amp at 40°C (104°F)

DIB DUAL IN-LINE BRIDGE

An integrated bridge rectifier in a miniature dual in-line package

CMOS DATABOOK \$1.50

Specifications and pin-outs for 80 different 4000 series parts

LED DISPLAYS

Your Choice of RED, GREEN or YELLOW

0.3" High... \$1.90 ea. 0.6" High... \$3.50 ea.

XAN72	RED	C.A.	XAN672	RED	C.A.
XAN52	GREEN	C.A.	XAN652	GREEN	C.A.
XAN82	YELLOW	C.A.	XAN642	YELLOW	C.A.
XAN74	RED	C.C.	XAN674	RED	C.C.
XAN54	GREEN	C.C.	XAN654	GREEN	C.C.
XAN84	YELLOW	C.C.	XAN644	YELLOW	C.C.

SILICON TRANSISTORS

MPS1918, MPS930, MPS2222A, MPS2369A, MPS2712, MPS2907A, MPS3392, MPS3393, MPS3394, MPS3395, MPS3363, MPS3365, MPS3368, MPS3369A, MPS3369B, MPS3369C, MPS3369D, MPS3369E, MPS3369F, MPS3369G, MPS3369H, MPS3369I, MPS3369J, MPS3369K, MPS3369L, MPS3369M, MPS3369N, MPS3369O, MPS3369P, MPS3369Q, MPS3369R, MPS3369S, MPS3369T, MPS3369U, MPS3369V, MPS3369W, MPS3369X, MPS3369Y, MPS3369Z, PN1537, PN1538, PN1539, PN1540, PN1541, PN1542, PN1543, PN1544, PN1545, PN1546, PN1547, PN1548, PN1549, PN1550, PN1551, PN1552, PN1553, PN1554, PN1555, PN1556, PN1557, PN1558, PN1559, PN1560, PN1561, PN1562, PN1563, PN1564, PN1565, PN1566, PN1567, PN1568, PN1569, PN1570, PN1571, PN1572, PN1573, PN1574, PN1575, PN1576, PN1577, PN1578, PN1579, PN1580, PN1581, PN1582, PN1583, PN1584, PN1585, PN1586, PN1587, PN1588, PN1589, PN1590, PN1591, PN1592, PN1593, PN1594, PN1595, PN1596, PN1597, PN1598, PN1599, PN1600, PN1601, PN1602, PN1603, PN1604, PN1605, PN1606, PN1607, PN1608, PN1609, PN1610, PN1611, PN1612, PN1613, PN1614, PN1615, PN1616, PN1617, PN1618, PN1619, PN1620, PN1621, PN1622, PN1623, PN1624, PN1625, PN1626, PN1627, PN1628, PN1629, PN1630, PN1631, PN1632, PN1633, PN1634, PN1635, PN1636, PN1637, PN1638, PN1639, PN1640, PN1641, PN1642, PN1643, PN1644, PN1645, PN1646, PN1647, PN1648, PN1649, PN1650, PN1651, PN1652, PN1653, PN1654, PN1655, PN1656, PN1657, PN1658, PN1659, PN1660, PN1661, PN1662, PN1663, PN1664, PN1665, PN1666, PN1667, PN1668, PN1669, PN1670, PN1671, PN1672, PN1673, PN1674, PN1675, PN1676, PN1677, PN1678, PN1679, PN1680, PN1681, PN1682, PN1683, PN1684, PN1685, PN1686, PN1687, PN1688, PN1689, PN1690, PN1691, PN1692, PN1693, PN1694, PN1695, PN1696, PN1697, PN1698, PN1699, PN1700, PN1701, PN1702, PN1703, PN1704, PN1705, PN1706, PN1707, PN1708, PN1709, PN1710, PN1711, PN1712, PN1713, PN1714, PN1715, PN1716, PN1717, PN1718, PN1719, PN1720, PN1721, PN1722, PN1723, PN1724, PN1725, PN1726, PN1727, PN1728, PN1729, PN1730, PN1731, PN1732, PN1733, PN1734, PN1735, PN1736, PN1737, PN1738, PN1739, PN1740, PN1741, PN1742, PN1743, PN1744, PN1745, PN1746, PN1747, PN1748, PN1749, PN1750, PN1751, PN1752, PN1753, PN1754, PN1755, PN1756, PN1757, PN1758, PN1759, PN1760, PN1761, PN1762, PN1763, PN1764, PN1765, PN1766, PN1767, PN1768, PN1769, PN1770, PN1771, PN1772, PN1773, PN1774, PN1775, PN1776, PN1777, PN1778, PN1779, PN1780, PN1781, PN1782, PN1783, PN1784, PN1785, PN1786, PN1787, PN1788, PN1789, PN1790, PN1791, PN1792, PN1793, PN1794, PN1795, PN1796, PN1797, PN1798, PN1799, PN1800, PN1801, PN1802, PN1803, PN1804, PN1805, PN1806, PN1807, PN1808, PN1809, PN1810, PN1811, PN1812, PN1813, PN1814, PN1815, PN1816, PN1817, PN1818, PN1819, PN1820, PN1821, PN1822, PN1823, PN1824, PN1825, PN1826, PN1827, PN1828, PN1829, PN1830, PN1831, PN1832, PN1833, PN1834, PN1835, PN1836, PN1837, PN1838, PN1839, PN1840, PN1841, PN1842, PN1843, PN1844, PN1845, PN1846, PN1847, PN1848, PN1849, PN1850, PN1851, PN1852, PN1853, PN1854, PN1855, PN1856, PN1857, PN1858, PN1859, PN1860, PN1861, PN1862, PN1863, PN1864, PN1865, PN1866, PN1867, PN1868, PN1869, PN1870, PN1871, PN1872, PN1873, PN1874, PN1875, PN1876, PN1877, PN1878, PN1879, PN1880, PN1881, PN1882, PN1883, PN1884, PN1885, PN1886, PN1887, PN1888, PN1889, PN1890, PN1891, PN1892, PN1893, PN1894, PN1895, PN1896, PN1897, PN1898, PN1899, PN1900, PN1901, PN1902, PN1903, PN1904, PN1905, PN1906, PN1907, PN1908, PN1909, PN1910, PN1911, PN1912, PN1913, PN1914, PN1915, PN1916, PN1917, PN1918, PN1919, PN1920, PN1921, PN1922, PN1923, PN1924, PN1925, PN1926, PN1927, PN1928, PN1929, PN1930, PN1931, PN1932, PN1933, PN1934, PN1935, PN1936, PN1937, PN1938, PN1939, PN1940, PN1941, PN1942, PN1943, PN1944, PN1945, PN1946, PN1947, PN1948, PN1949, PN1950, PN1951, PN1952, PN1953, PN1954, PN1955, PN1956, PN1957, PN1958, PN1959, PN1960, PN1961, PN1962, PN1963, PN1964, PN1965, PN1966, PN1967, PN1968, PN1969, PN1970, PN1971, PN1972, PN1973, PN1974, PN1975, PN1976, PN1977, PN1978, PN1979, PN1980, PN1981, PN1982, PN1983, PN1984, PN1985, PN1986, PN1987, PN1988, PN1989, PN1990, PN1991, PN1992, PN1993, PN1994, PN1995, PN1996, PN1997, PN1998, PN1999, PN2000, PN2001, PN2002, PN2003, PN2004, PN2005, PN2006, PN2007, PN2008, PN2009, PN2010, PN2011, PN2012, PN2013, PN2014, PN2015, PN2016, PN2017, PN2018, PN2019, PN2020, PN2021, PN2022, PN2023, PN2024, PN2025, PN2026, PN2027, PN2028, PN2029, PN2030, PN2031, PN2032, PN2033, PN2034, PN2035, PN2036, PN2037, PN2038, PN2039, PN2040, PN2041, PN2042, PN2043, PN2044, PN2045, PN2046, PN2047, PN2048, PN2049, PN2050, PN2051, PN2052, PN2053, PN2054, PN2055, PN2056, PN2057, PN2058, PN2059, PN2060, PN2061, PN2062, PN2063, PN2064, PN2065, PN2066, PN2067, PN2068, PN2069, PN2070, PN2071, PN2072, PN2073, PN2074, PN2075, PN2076, PN2077, PN2078, PN2079, PN2080, PN2081, PN2082, PN2083, PN2084, PN2085, PN2086, PN2087, PN2088, PN2089, PN2090, PN2091, PN2092, PN2093, PN2094, PN2095, PN2096, PN2097, PN2098, PN2099, PN2100, PN2101, PN2102, PN2103, PN2104, PN2105, PN2106, PN2107, PN2108, PN2109, PN2110, PN2111, PN2112, PN2113, PN2114, PN2115, PN2116, PN2117, PN2118, PN2119, PN2120, PN2121, PN2122, PN2123, PN2124, PN2125, PN2126, PN2127, PN2128, PN2129, PN2130, PN2131, PN2132, PN2

TAPE AND RECORDERS

RENT 4-Track open reel tapes—all major labels—3,000 different — free brochure Stereo-Parti, 55 St. James Drive, Santa Rosa, Ca. 95401

1930-1962 Radio Programs, Reels, \$1.00 Hour! Cassettes, \$1.00 Show! Mammoth Catalog, \$1.25, AM Treasures, Box 192PE, Babylon, N.Y. 11702.

RECORDS—TAPES! Discounts to 73%. All labels, no purchase obligations; newsletter; discount dividend certificates; 100% guarantees. Free details. Discount Music Club, 650 Main St., Dept. 5-26, New Rochelle, New York, N.Y. 10801.

CLASSICAL CASSETTES! FREE CATALOG! Better quality 50% less cost than records! CCC Box 506PE, Saddle River, N.J. 07458

EXTRA LONG PLAY SANYO CASSETTE RECORDER. Records over 8 hours on standard cassette. Excellent voice fidelity, electret mike, digital counter, only \$99.95 pp. Money back guarantee. catalog 25 cents. Phont Control Systems, 92 Marcus Avenue, New Hyde Park, N.Y. 11040.

GOVERNMENT SURPLUS

GOVERNMENT Surplus How and Where to Buy in Your Area. Send \$2.00 Surplus 30177-PE Headquarters Bldg., Washington, D.C. 20014

MANUALS for Govt Surplus radios, test sets, scopes. List 50 cents (coin). Books, 7218 Roanne Drive, Washington, D.C. 20021

TREASURE FINDERS

FREE FACT-FILLED CATALOG! World's largest selection! Metal detectors starting at \$79.50. Two year guarantee! Three factories, U.S.-Canada, 1,200 dealers - Service Centers nationwide. Finest instruments at any price! Budget Terms. Dealer inquiries invited. Write: White's Electronics, Inc. Dept. PD6P, 1011 Pleasant Valley Road, Sweet Home, Oregon 97386.

TREASURE FINDER locates buried gold, silver, coins, treasures, 6 powerful models. Instant financing available. Write or call for free catalog. Phone (713) 682-2728 day or night. Dealer inquiries invited. Relco, Dept. AA20, Box 10839, Houston, Texas 77018.

BURGLAR ALARMS

BURGLAR ALARM dialing unit automatically calls police \$29.95. Free literature. S&S Systems, 5619-C St. John, Kansas City, MO 64123.

PRESSURE sensitive miniature cable for burglar alarm systems. Place under carpet in any contour for intrusion detection or secret switching. \$4.95 for twenty feet. Cable Switch Corp., Box 72-PE, West Long Branch, NJ 07764.

BURGLAR-FIRE alarm supplies and information. Free catalog. Protecto Alarm Sales, Box 357-G, Birch Run, Michigan 48415.

CALCULATORS

TEXAS INSTRUMENTS CALCULATORS DISCOUNT HOT LINE Toll Free (800) 638-8906. Phone us long distance free for the low discount price on the Texas Instruments Calculator of your choice. SR-50A, SR-51A, SR-161I, TI-2500II, TI-1500, TI-2550II, TI-5050. All of the great new Texas Instruments models. Capital Calculator Company, 701 East Guide Drive, Rockville, Maryland 20850. The discount super market for top brand name calculators. Mail and phone orders accepted. BankAmericard and Master Charge accepted.

MUSICAL INSTRUMENTS

UP TO 60% DISCOUNT! Name brand instruments catalog. Freeport Music, 455N Route 110, Melville, N.Y. 11746.

WHOLESALE! Professional Guitars, PA Systems, Aitec Speakers, 240W RMS Amplifiers. Free Catalog, Carvin, Escondido, Calif. 92028.

30% TO 50% DISCOUNT! Guitars, Amps, Drums. Free Catalog! Warehouse PE-4, Box 11449, Ft. Worth, TX 76109.

EMPLOYMENT OPPORTUNITIES

ELECTRONICS/AVIONICS EMPLOYMENT OPPORTUNITIES. Report on jobs now open. Details FREE. Aviation Employment Information Service, Box 240E, Northport, New York 11768.

CALIFORNIA companies hiring Engineers and Technicians. Current openings bulleting \$3. Dynamics, Box 1867-K, Covina, Calif. 91722.

HIGH FIDELITY

DIAMOND NEEDLES and Stereo Cartridges at Discount prices for Shure, Pickering, Stanton, Empire, Grado and ADC. Send for free catalog LYLE CARTRIDGES, Dept. P, Box 69, Kensington Station, Brooklyn, New York 11218.

SAVE 50%. Build your own speaker systems featuring Norelco, Eminence and CTS. Famous brands from world's largest speaker factories at lowest wholesale prices. Write for free catalog of speakers and electronic accessories. McGee Radio & Electronic Corp., 1901 McGee Street, Kansas City, Missouri 64108.

WANTED

QUICKSILVER, Platinum, Silver, Gold, Ores Analyzed. Free Circular, Mercury Terminal, Norwood, Mass. 02062.

ALTAIR owners, want to sell yours? Call (312) 357-3021 at 10pm or write Cook, 25 W. 178-39th St., Naperville, Ill. 60540.

TUBES

RADIO & T.V. Tubes—36 cents each. Send for free Catalog, Cornell, 4213 University, San Diego, Calif. 92105.

TUBES receiving, factory boxed, low prices, free price list. Transletronic, Inc., 1365 39th Street, Brooklyn, N.Y. 11218A, Telephone 212-633-2800.

TUBES "Oldies" latest. Lists free. Steinmetz, 7519 Maplewood, Hammond, Indiana 46324.

TUBES Send 10 cents for large conclusive list. Low Prices. T-J Specialties, Box 43, Bradley Beach, New Jersey 07720.

ELECTRICAL SUPPLIES & EQUIPMENT

PLATING Equipment, Portable Platers, Supplies and "Know-How." Build your own tanks for nickel, chrome, etc. Easy-to-install PVC liners. Rectifier components—all sizes. Schematics, parts lists, formulas, operating instructions for all plating. Guaranteed to save you 25%-75%. Some good used units for sale. Write for details. Platers Service Company, 1511-PE Esperanza, Los Angeles, Calif. 90023.

INTEL 8080 CPU \$39.00 8008 BIT MICRO PROCESSING CHIP (w/In Data Book) \$19.00 2102-2 1024 BIT RAM \$2.95 5202A UV PROM \$12.50 M15203 UV PROM \$12.50 5204-4K PROM \$24.95 1702A-UV PROM \$12.95	TRANSISTOR SPECIALS 2N3585 NPN Si TO-66 \$.95 2N3772 NPN Si TO-3 \$1.80 2N4901 PNP Si TO-3 \$.85 2N6517 NPN Si TO-92 4 \$1.00 2N5086 PNP Si TO-92 4 \$1.00 2N4898 PNP TO-66 \$.60 2N104 PNP GE TO-5 5 \$1.00 2N3919 NPN Si TO-3 RF \$1.50 MPSA13 NPN Si TO-92 3 \$1.00 2N3767 NPN Si TO-66 \$.70 2N2222 NPN Si TO-18 5 \$1.00 2N3055 NPN Si TO-3 \$.80 2N3904 NPN Si TO-92 5 \$1.00 2N3906 PNP Si TO-92 5 \$1.00 2N5296 NPN Si TO-220 \$.50 2N6109 PNP Si TO-220 \$.55 2N3866 NPN Si TO-5 SIF \$.75 2N3638 NPN Si TO-5 5 \$1.00 2N218A NPN Si TO-5 4 \$1.00	C/MOS (DIODE CLAMPED) 74C02—26 4012—24 4025—24 74C10—30 4013—45 4026—1.90 74C157—1.75 4015—1.24 4027—55 4001—24 4016—50 4028—95 4002—24 4017—1.15 4030—49 4006—1.35 4018—1.24 4035—1.50 4007—24 4019—50 4042—75 4009—50 4022—1.24 4046—2.75 4010—50 4023—24 4047—3.50 4011—24 4024—95 4050—49 4055—1.95 FCD 810 OPTO ISOLATOR \$.80
MINIATURE TRIM POTS BOURNS 3009 5K, 10K, 50K, 100K, 200K 100, 500 \$.75 ea. 3/\$2.00	MULTI-TURN TRIM POTS Similar to Bourns 3010 style 316" x 1/4" 1/4" 50, 100, 2000, 10,000 ohms \$1.50	7 POLE SINGLE THROW TO-5 MINIATURE ROTARY SWITCH \$1.15
LIGHT ACTIVATED SCR's TO-18 200V 1A \$1.75	PRINTED CIRCUIT BOARD 4 1/2" x 6 1/2" single sided epoxy board, 1/16" thick, unetched \$.50 ea. 5/\$2.20	CAPACITORS 35V at 47 UF TANT 5/\$1.00 35V at 6.8 UF TANT 3/\$1.00 25V at 33 UF TANT \$.40 35V at 68 UF TANT 5/\$1.00 20V at 150 UF TANT \$.40 6V 30 UF TANT 5/\$1.00 200V 4.7 UF ELECT \$.30
VECTOR BOARD 1" SPACING 4.5" x 6" SHEET \$1.50	2N5460 P FET \$.45 2N5457 N FET \$.45 2N4891 UJT \$.45 TIS 43 UJT \$.35 ER900 TRIGGER DIODES 4/\$1.00 2N6028 PROG. UJT \$.50	DO-33 A 3 DIG. LED ARRAY READOUT \$1.35 MAN-1 READOUT \$1.75 MAN-3 READOUT \$1.00 MAN-4 READOUT \$1.30 MAN-7 READOUT \$1.25 DL747 \$3.50
VERIPAX PC BOARD This board is a 1/16" single sided paper epoxy board, 4 1/2" x 6 1/2" DRILLED and ETCHED which will hold up to 21 single 14 pin IC's or 8, 16 or LSI DIP IC's with bussess for power supply connector. \$5.25	MM MOS SERIES MM1402-3.20 MM5055-4.00 MM5061-4.95 MM1403-3.20 MM5056-4.00 MM5210-1.95 MM1404-2.50 MM5057-4.00 MM5260-2.95 MM5013-7.75 MM5058-4.95 MM5555-6.25 MM5016-3.50 MM5060-4.95 MM5556-6.25 MM5017-4.75	Full Wave Bridges PRV 2A 6A 25A 200 95 1.25 \$3.00 400 115 1.50 \$4.00 600 135 1.75 \$5.00
8 PIN MINI/DIP SOCKETS 8 PIN MINI/DIP SOCKETS \$.30	8 PIN MINI/DIP SOCKETS 8 PIN MINI/DIP SOCKETS \$.30	4 WATT IR LASER DIODE CD 110 LINEAR 256 X1 BIT SELF SCANNING CHARGED COUPLED DEVICE, WITH DATA TA \$125.00
1 WATT ZENERS 3.9 4.7 12 18 OR 22V \$.75 EA. 1 WATT ZENERS 4.7 5.6 10 12 15 18 OR 22V \$.25 EA.	Silicon Power Rectifiers PRV 1A 3A 12A 50A 125A 100 06 14 30 80 200 .07 .20 35 1.15 4.25 400 .09 .25 50 1.40 6.50 600 11 .30 70 1.80 8.50 800 15 .35 90 2.30 10.50 1000 20 .45 1.10 2.75 12.50	SANKEN AUDIO POWER AMPS Si 1010 G 10 WATTS \$ 6.90 Si 1020 G 20 WATTS \$3.95 Si 1050 G 50 WATTS \$24.95
CT7001 CALENDAR ALARM CLOCK CHIP \$5.75	REGULATED MODULAR POWER SUPPLIES —15VDC AT 100ma 115VAC INPUT \$24.95 5VDC AT 1A, 115VAC INPUT \$24.95 12V 5A \$24.95 IN 4148 (IN914) 15/\$1.00 1103 1024 bit RAM \$2.75 NEC 6003 2048 bit RAM \$6.00 1101 256 bit RAM \$1.40 7489 RAM \$2.30	LINEAR CIRCUITS LM 309K 5V 1A REGULATOR \$1.20 723—40—40V REGULATOR \$.54 301748—4 Per Up Amp \$.28 307 OP AMP \$.28 CA 3047—HI PERFORM OP AMP \$.95 CA 3089 FM IF SYSTEM \$3.25 LM 320T 5, 12, 15 OR 24V NEG. REGULATOR 741A or 741C OP. AMP \$.31 709C OPER. AMP \$.25 340T-5 8 12 15 18 24V 101 OPER. AMP HI PERFORM \$1.20 747—DUAL 731 \$.65 556—DUAL TIMER \$.75 540-70W POWER DRIVER \$2.50 LM 3800—QUAD OP AMP \$.45 LM 324—QUAD 741 560—PHASE LOCK LOOP \$1.50 561—PHASE LOCK LOOP \$2.00 565—PHASE LOCK LOOP \$1.75 566 FUNCTION GEN \$2.00 567—TONE DECODER \$1.75 LM1310N STEREO DEMOD \$2.75 LM 370—AGC SQUELCH AMP \$.70 555—2 us 2 HR TIMER \$.33 553 QUAD TIMER \$3.50 FCD 810 OPTO-ISOLATOR \$.80 1458 DUAL OP AMP \$.65 LM 389—2W AUDIO AMP \$.95 LM 387—2W STEREO AUDIO AMP \$2.50 LM 381—STEREO PREAMP \$1.15 LM 382—DUAL AUDIO PREAMP \$1.15 LM 311—HI PER COMP. COMP. \$.95 LM 319—Dual Hi Speed Comp \$1.10 LM 338—QUAD COMP. \$1.25 8038C IC VOLT CONT. OSC \$3.90
HP COMMON CATHODE 7740 3" RED DISPLAY \$1.75	TTL IC SERIES 74100—26 7476—35 7400—14 7480—48 7401—15 7483—75 7402—15 7485—1.05 7403—15 7486—34 7404—18 7490—49 7405—18 7491—79 7406—35 7492—49 7407—33 7493—49 7408—18 7495—74 7409—18 7496—79 7410—15 74107—34 7411—25 74121—38 7412—30 74123—74 7413—45 74125—54 7414—15 74126—54 7416—33 74130—92 7417—33 74151—69 7420—15 74153—79 7425—27 74154—1.05 7426—24 74155—1.05 7427—27 74157—75 7430—15 74161—95 7432—24 74163—95 7437—29 74164—1.10 7438—29 74165—1.10 7440—15 74173—1.35 7441—95 74175—95 7442—59 74177—75 7445—79 74181—2.90 7446—87 74182—1.10 7447—87 74193—1.10 7448—85 74194—1.15 7472—28 74195—74 7473—34 74196—95 7474—35 7532A—1.75 7475—49 75491—1.10	TRIACS PRV 1A 10A 25A 1.5A 6A 35A 100 .40 .70 1.30 .40 .50 1.20 200 .70 1.10 1.75 .60 .70 1.60 400 1.10 1.60 2.60 1.00 1.20 2.70 800 1.70 2.30 3.60 1.40 3.00
ALCO MINIATURE TOGGLE SWITCHES MTA 106 SPDT \$.95 MTA 206 DPDT \$1.45	ALCO MINIATURE TOGGLE SWITCHES MTA 106 SPDT \$.95 MTA 206 DPDT \$1.45	SCR's

Terms: FOB Cambridge, Mass.
Send Check or Money Order.
Include Postage. Minimum
Order \$5.00. COD's \$20.00.



SOLID STATE SALES
P.O. BOX 74A
SOMERVILLE, MASS. 02143 TEL. (617) 547-4005

WE SHIP OVER 95%
OF OUR ORDERS THE
DAY WE RECEIVE THEM

Olson[®] ELECTRONIC PARTS AND ACCESSORIES



500-ft. Hookup Wire Kit	WW-579	1.69
3-6V DC Mini Hobby Motor, Kit/5	MO-333	.55
3-6V DC Midi Hobby Motor, Kit/4	MO-334	.79
3-6V DC Ass'd. Hobby Motor, Kit/4	MO-335	.99
1 Amp. 200 PIV. Diode, Kit/50	DI-051	.69
1M4148 Switch Diode, Kit/10	XM-382	.59
1/4 - 12 - 1 Watt Resistors 1 lb. Kit	RS-239	.99
PNP Audio Transistors Kit/10	TR-445	.39
NPN Audio Transistors Kit/10	TR-444	.39
C-60 Cassettes, Kit/3	TA-879	.99
8 Tr. 40-Min. Blank, Each	TA-854	.99
8 Tr. 80-Min. Blank, Each	TA-855	.99
1M4001 1A. 50 PIV Diode, Kit/5	DI-028	.39
1M4002 1A. 100 PIV Diode, Kit/5	DI-029	.39
1M4003 1A. 200 PIV Diode, Kit/5	DI-030	.39
1M4004 1A. 400 PIV Diode, Kit/5	DI-031	.39
SCR Assortment, Unbiased Kit/25	TR-446	.99
7A. Pwr. Trans. NPN-like SK3034, Each		1.49
1A. 50 PIV Epoxy Diodes, Kit/50		1.00
5 Volt 1 Amp Regulator, Each		1.20
6.2 Volt Zener Diode, HEP 103		1.00
6500KV Color TV Rectifier		3 for 1.95
Colorburst Quartz Crystals		2 for 1.89
10 Ass'td. Diodes 1N34-1N60-1N64 Etc.		1.00

SILICON POWER RECTIFIERS

PRV	1 Amp.	3 Amp.	12 Amp.	50 Amp.
100	.06	14	30	.80
200	.07	20	35	1.15
400	.09	25	50	1.40
600	.11	30	70	1.80
800	.15	35	90	2.30
1000	.20	45	110	2.75

TRIACS

PRV	1 Amp.	10 Amp.	25 Amp.
100	.40	.70	1.30
200	.70	1.10	1.75
400	1.10	1.60	2.50
600	1.70	2.30	3.00

SCRS

PRV	1.5 Amp.	6 Amp.	35 Amp.
100	.40	.50	1.20
200	.60	.70	1.60
400	1.00	1.20	2.00
600	1.40	1.70	2.30

LM 703 CN Linear OP Amp	.45
LM 709 H Linear OP Amp	.29
LM 708 N Linear OP Amp	.29
LM 710 N Linear OP Amp	.75
LM 711 N Linear OP Amp	.39
LM 723 N Linear OP Amp	.55
LM 723 H Linear OP Amp	.55
Mini Numeric Nixie 170V DC, XM-107	.80
3 1/2 Digit Liquid Crystal Display, XM-371	6.00
Fairchild 914 Type IC, Kit/2, TR-297	.60
Fairchild 717 Type IC, TR-294	.30
200 Bit Shift Register Kit/5, TR-295	.60
Fairchild 909 Type IC, RE-131	.60
6-12 Amp Stud Rectifiers, Pkg. of 3, TR-443	.60
Low Voltage Electrolytics, Pkg. of 50, CD-407	2.70
DGBR Numeric Indicator Tube, XM-338	1.20

DUAL IN-LINE IC'S

Made in U.S. These IC's are guaranteed against defects. With diagram. Shpg. wt. 1/4 lb.

LOW AS	29c
Type 7400 Quad 2-Input Pos. NAND Gate. High speed, diode-clamped inputs	29c
TR-431	
Type 7402 Quad 2-Input Pos. NOR Gate. Low-noise Propagation delay, 12 ns.	29c
TR-432	
Type 7404 Hex Inverter. Low noise, low power dissipation.	29c
TR-433	
Type 7410 Triple 3-Input Pos. NAND Gate. Low output impedance, diode-clamped inputs	29c
TR-434	
Type 7447 BCD to 7-Seg. ment Decoder/Driver. With common anode displays	59c
TR-435	
Type 7473 Dual J-K Master/Slave Flip-Flop.	39c
TR-436	
Type 7474 Dual D-Type Edge Triggered Flip-Flop.	39c
TR-438	
Type 7475 4-Bit Latch. Temp. stores binary coded info.	79c
TR-437	
Type 7490 Decode Counter. Binary coded decimal counter with symmetrical divide	79c
TR-439	

FREE Olson Catalogs

59c LED'S 2V 10 mA
Gallium phosphide. Large red, high quality LED
Wt. 1/4 lb.
PL-233.

ORDER TODAY! Send to Olson Electronics, 260 S. Forge St., Akron, Ohio 44327. Allow for postage. C.O.D. 20% Deposit. Ohio Residents Add 4% Sales Tax.

Olson electronics
Dept. IQ, 260 S. Forge St., Akron, Ohio 44327

NAME _____
ADDRESS _____
CITY _____
STATE _____ ZIP _____

PLANS AND KITS

FREE CATALOGUE KITS COMPONENTS Audio equipment, Sinclair Kits, radio parts Gladstone Electronics, 1736 Avenue RD, Toronto, Canada, M5M 3Y7, U.S. Inquiries

NEW Capacitance Meter reads picofarads like ohmmeter reads ohms. Two I.C. battery circuit. Schematic details \$2.00 C. Hall, Box 692, Addison, Texas 75001.

ELECTRONIC ROULETTE "Wheel of Fortune" shown in October's Popular Electronics. Complete kits, \$24.95 with same day shipments from Hostelt Electronics, 224 Opal Blvd., Steubenville, Ohio 43952

AMAZING ELECTRONIC PRODUCTS

LASERS SUPER POWERED RIFLE, PISTOL, POCKET SEE IN DARK PYRO, TECHNICAL DE BUGGING UNCRAMBLERS, GIANT TESTA STUNWARD TV DISRUPTER, ENERGY PRODUCING SCIENTIFIC DETECTOR, ELECTRIFYING CHEMICAL, ULTRASONIC, CB, AERO, AUTO AND MECH DEVICES, HUNDREDS MORE - ALL NEW PLUS INFO UNLTD PARTS SERVICE.

INFORMATION unlimited
CATALOG \$1 Box 626 Lord Jeffrey PZ • Amherst, N.H. 03031

ELECTRONIC Game Kits. Components. PC board front panel. Send stamp. NBL-E, Box 1115, Richardson, Texas 75080

At Last A New Amazingly Simple

HIGH FREQUENCY

(1HZ-30MHZ) COUNTER

BUILD FROM EASY-TO-FOLLOW

"PLANS WITH CIRCUIT BOARDS"

PRICE: \$37.00

FREE BULLETIN describes precision laboratory quality, extraordinary performance, unique features and simplicity of design. Write for prompt reply

SINCLAIR LABORATORIES 500 Caroline St. Bellingham, Wash 98225 OR SINCLAIR LABORATORIES 1030 Hamilton, Suite 4 Vancouver, B.C. V6B 2S1



PLANS! Useful, inexpensive—Telephone Burglar Alarm, Telephone Answering Device, Automatic Recorder, Continuous Caller, "Unlisted" Caller, Telephone Intercom Plans \$2.25 each — Complete list furnished with order. Emergency Alarms, P.O. Box 944, Hartselle, AL 35640

ACCURATELY measure and control temperatures from -300 to 1200 F. Complete kits \$59.95. Send SASE for free plans. Dage Scientific Instruments, 1931 Tobruk, Livermore, CA 94550

CONVERT TV TO

NEW! 16 FT. WIDE SCREEN!

Easy Do-It-Yourself Kit

Project a giant 5'x6' picture onto wall or screen. B&W/Color. Kit contains detailed plans, Inst., and Precision Lens System. Only \$15.95 ppd., or write for Free illustrated details.

The Macrocoma Co., Dept. DB
Washington Crossing, PA 18977

ETCH IT YOURSELF printed circuit kit. Everything you need to produce your own circuit boards. Including positive acting photosensitized glass epoxy, artwork supplies, chemicals, and tray \$16.95 ppd. Excel Circuits, 116 Delaware, Detroit, Michigan 48202

INVENTIONS WANTED

INVENTORS Protect your ideas! Free Recommended Procedure. Washington Inventors Service, 422T Washington Building, Washington, D.C. 20005

Inventors Wanted

RECOGNITION, FINANCIAL REWARD, OR CREDIT for "inventing it first" may be yours! We'll develop your idea, introduce it to industry, publicize it, negotiate for Cash Sale or Royalty Licensing.

Send for **FREE INVENTORS KIT** Includes • Vital Information on Protection, Development, Marketing of your Invention • Important "Invention Record Form" • Directory of 500 Corporations Seeking New Products

RAYMOND LEE ORGANIZATION
230 Park Ave. No., New York, NY 10017
Please rush **FREE INVENTORS KIT A-139**

Name _____
Address _____
City _____ State _____ Zip _____

FREE PAMPHLET: "Tips on Marketing Your Invention" Write: United States Inventors Service Company, Dept. T, 1435 G Street NW, Washington, D.C. 20005

New, Fantastic Lower Prices on Minicomputer Components and Kits

8008 CPU	9.95
8080 CPU	32.95
8080A CPU	37.95
M6800 CPU	49.95

ALL COMPONENTS PRIME- NO SURPLUS, SECONDS, REBRANDS

MEMORIES

2102	1000 ns	\$1.79
2102-1	500 ns	\$2.95
91L02	500 ns	\$3.49

Low power version, direct substitute, fully tested to MIL 883 specs.

IN STOCK: 8224, system clock; 8228, system controller; 8212, latch; 6820, (PIA); 6850, (ACIA); 6860, (Modem); 6830 (Mik-bug ROM). Write for prices.

Altair 8800 Components

Viking 100 Pin Connectors for bus \$9.95
100 Pin wire wrap connectors \$6.95
Write for price list of our 1976 line of Altair interfaces.

UARTS - pin for pin with industry standard, requires only 5 volt supply REG \$9.95, SPECIAL \$7.95

COMPLETE DEC-built LSI-11 Mini-computer, 4K X 16 memory \$849.

C-MOD 8080A or C-MOD 6800 CPU System, Complete Board, with all components Reg. 129.95 SPECIAL 99.95 until 2-28-76

4 1/2 by 6 board, fully compatible with all C-Mod 8/80 boards, complete with the newest, most sophisticated interface components.

RM6800 or RM8080A SPECIAL w/ 4K Memory and RM Terminal, less printer or display unit SPECIAL \$399.50

Boards and components, less TERMINAL \$319.95 SPECIAL. Offer expires 2-28-76.



MiniMicroMart

1618 James Street
Syracuse, New York 13203
(315) 422-4467

CIRCLE NO. 34 ON FREE INFORMATION CARD
POPULAR ELECTRONICS

Planning to move?

Let us know 8 weeks in advance so that you won't miss a single issue of **POPULAR ELECTRONICS**.

Attach old label where indicated and print new address in space provided. Also include your mailing label whenever you write concerning your subscription. It helps us serve you promptly.

Write to: P.O. Box 2774, Boulder, CO 80302, giving the following information:

- Change address only.
- Extend subscription. Enter new subscription.
- 1 year \$6.98
- Payment enclosed (1 extra BONUS issue)
- Bill me later

AFFIX LABEL

If you have no label handy, print OLD address here.

name <small>please print</small>	address	city	state
name <small>please print</small>	address	city	state

zip code

Add'l postage per year: Add \$1 for Canada; \$2 for all other countries outside the U.S.

For faster service

USE ZIP CODE

on all mail

HEAVY DUTY POWER SUPPLIES



These heavy duty power supplies are ideal as a general purpose lab supply, micro-computer supply, etc. All have constant volt-

age transformers and large 18,000 mfd 35v. elec. filter caps for filtering. In addition, the + and - 10v and -3.6v outputs have separate semiconductor regulators, which are voltage adjustable. Each is 22 1/2" long, 6 1/2" wide, 6" high. Shipping weight 26 lbs.

P5313....Outputs at -30v @ 1.5 amp, +30v @ .5 amp, -10v @ 1.5 amp, +10v @ .5 amp, and -3.6v @ 1.5 amp. 85 watts.
STOCK NO. P5313 \$24.50 each

P5314....Outputs at -30v @ 1 amp, +30v @ .5 amp, -10v @ 1 amp, and +10v @ .5 amp. 60 watts total.
STOCK NO. P5314 \$19.50 each

P5342....Outputs at -30v @ 1.5 amp, +30v @ .5 amp, -10v @ 1.5 amp, and +10v @ .5 amp. 80 watts total.
STOCK NO. P5342 \$22.50 each

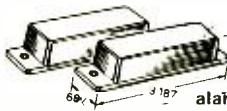

PROXIMITY REED SWITCHES FOR BURGLAR ALARMS

These small magnetic proximity reed switches are ideal for all types of burglar alarms. One case contains an Alnico magnet, which actuates a Normally Open reed switch in the other case within a distance of 1". Mount on windows & doors, on the back of valuable equipment, etc. Protect your home, car, and shop.

STOCK NO. P5351 \$1.75/set, 4 sets/6.00, 10 sets/12.50

MINIMUM ORDER \$5.00. Include sufficient postage, excess refunded. Send for new 88 page Catalog 15, bigger than ever.



BANKAMERICARD and MASTERCHARGE now accepted, minimum charge \$15.00. Please include all numbers. Phone orders accepted.



DELTA ELECTRONICS CO.

BOX 1, LYNN, MASSACHUSETTS 01903
Phone (617) 388-4705

CIRCLE NO. 10 ON FREE INFORMATION CARD

CB SPECIALS—R.F. DRIVERS—R.F. POWER OUTPUTS—FETS

2SC481	1.85	2SC767	15.75	2SC866	5.85	2SC1449-1	1.60	40081	1.50
2SC482	1.75	2SC773	.85	2SC013	.50	2SC475	1.50	40082	3.00
2SC495	1.10	2SC774	1.75	2SC1014	1.50	2SC1678	5.50	2SC608	7.90
2SC502	3.75	2SC775	2.75	2SC1017	1.50	2SC1679	4.75	SK3046	2.15
2SC517	4.75	2SC776	5.00	2SC1018	1.50	2SC1728	2.15	SK3047	3.75
2SC614	3.80	2SC777	4.75	2SC1173	1.25	2SC1760	2.15	SK2095	3.50
2SC615	3.90	2SC778	3.25	2SC1226A	1.25	2SC1816	5.50	SK3048	3.25
2SC616	4.15	2SC797	2.50	2SC1237	4.50	2SC1908	.70	SK3054	1.25
2SC617	4.25	2SC798	3.10	2SC1239	3.50	2SC1957	1.50		
2SC699	4.75	2SC781	3.00	2SC1243	1.50	2SF8	3.00	2SK19	1.75
2SC710	.70	2SC789	1.00	2SC1306	4.75	HEP-S3001	3.25	2SK30	1.00
2SC711	.70	2SC796	3.15	2SC1306	1.40	2SD235	1.00	2SK33	1.20
2SC735	.70	2SC799	4.25	2SC1307	5.75	MRF8004	3.00		
2SC756	3.00	2SC802	3.75	2SC1307	16.00	4004	3.00	3SK40	2.75
2SC765	9.50	2SC803	4.00	2SC1377	5.50	4005	3.00	3SK45	2.75
2SC766	10.15	2SC839	.85	2SC1449	1.30	40080	1.25	3SK49	2.75

JAPANESE TRANSISTORS

2SA52	.60	2SB187	.60	2SC458	.70	2SC815	.75	2SC1569	1.25
2SA316	.75	2SB235	1.75	2SC460	.70	2SC828	.75	2SC1756	1.25
2SA473	.75	2SB303	.65	2SC478	.80	2SC829	.75		
2SA483	1.95	2SB324	1.00	2SC491	2.50	2SC830	1.60	2SD30	.95
2SA489	.80	2SB337	2.10	2SC497	1.60	2SC839	.85	2SD45	2.00
2SA490	.70	2SB367	1.60	2SC515	.80	2SC945	.65	2SD65	.75
2SA505	.70	2SB370	.65	2SC535	.75	2SC1010	.80	2SD68	.90
2SA564	.50	2SB405	.85	2SC536	.65	2SC1012	.80	2SD72	1.00
2SA628	.65	2SB407	1.65	2SC537	.70	2SC1051	2.50	2SD88	1.50
2SA643	.85	2SB415	.85	2SC563	2.50	2SC1061	1.65	2SD151	2.25
2SA647	2.75	2SB461	1.25	2SC605	1.00	2SC1079	3.75	2SD170	2.00
2SA673	.85	2SB463	1.65	2SC620	.80	2SC1096	1.20	2SD180	2.75
2SA679	3.75	2SB471	1.75	2SC627	1.75	2SC1098	1.15	2SD201	1.95
2SA682	.85	2SB474	1.50	2SC642	3.50	2SC1115	2.75	2SD218	4.75
2SA699	1.30	2SB476	1.25	2SC643	3.75	2SC1166	.70	2SD300	2.50
2SA699A	1.75	2SB481	2.10	2SC644	.70	2SC1170	4.00	2SD313	1.10
2SA705	.55	2SB492	1.25	2SC681	2.50	2SC1172B	4.25	2SD315	.75
2SA815	.85	2SB495	.95	2SC684	2.10	2SC1209	.55	2SD318	.95
2SA816	.85	2SB507	.90	2SC687	2.50	2SC1213	.75	2SD341	.95
		2SB511	.70	2SC696	2.35	2SC1226	1.25	2SD350	3.25
2SB22	.65			2SC712	.70	2SC1243	1.50	2SD352	.80
2SB54	.70	2SC206	1.00	2SC713	.70	2SC1293	.85	2SD380	5.70
2SB56	.70	2SC240	1.10	2SC732	.70	2SC1308	4.75	2SD389	.90
2SB77	.70	2SC261	.65	2SC733	.70	2SC1347	.80	2SD390	.75
2SB128	2.25	2SC291	.65	2SC739	.70	2SC1383	.75	2SD437	5.50
2SB135	.95	2SC320	2.00	2SC715	1.75	2SC1409	1.25		
2SB152	4.50	2SC352	.75	2SC762	1.90	2SC1410	1.25	C106B1	.50
2SB173	.55	2SC353	.75	2SC783	1.00	2SC1447	1.25		
2SB175	.55	2SC371	.70	2SC784	.70	2SC1448	1.25		
2SB178	1.00	2SC372	.70	2SC785	1.00	2SC1507	1.25		
2SB186	.60	2SC394	.70	2SC793	2.50	2SC1509	1.25		

POWER TRANSISTORS HIGH-VOLT. TV. TYPE

BU204	1300V	3.90	BU207	1300V	5.40	2SC1172B	1100V	4.25
BU205	1500V	4.70	BU208	1500V	6.25	2SC308	1100V	4.95
BU206	1700V	5.90	2SC1170	1100V	4.00	2SC1325	1100V	4.95

OEM SPECIALS

1N270	.10	2N960	.55	2N2219A	.30	2N2913	.75	2N3740	1.00	2N4401	.20
1N914	.10	2N962	.40	2N2221	.25	2N2914	1.20	2N3771	1.75	2N4402	.20
		2N967	.50	2N2221A	.30	2N2916A	3.65	2N3732	1.90	2N4403	.20
2N173	1.75	2N1136	1.35	2N2222	.25	2N3019	.50	2N3773	3.00	2N4409	.20
2N178	.90	2N1142	2.25	2N2222A	.30	2N3053	.30	2N3819	.32	2N4410	.25
2N327A	1.15	2N1302	.25	2N2270	.40	2N3054	.70	2N3823	.70	2N4416	.75
2N334	1.20	2N1305	.30	2N2322	1.00	2N3055	.75	2N3856	.20	2N4441	.85
2N336	.90	2N1377	.75	2N2323	1.00	2N3227	1.00	2N3866	.85	2N4442	.90
2N338A	1.05	2N1420	.20	2N2324	1.35	2N3247	3.40	2N3903	.20	2N4443	1.20
2N398B	.90	2N1483	.95	2N2325	2.00	2N3250	.50	2N3904	.20	2N4852	.55
2N404	.30	2N1540	.90	2N2326	2.85	2N3375	6.50	2N3905	.20	2N5061	.30
2N443	1.75	2N1543	2.70	2N2327	3.80	2N3393	.20	2N3906	.25	2N5064	.50
2N456	1.10	2N1544	.80	2N2328	4.20	2N3394	.17	2N3925	3.75	2N5130	.20
2N501A	3.00	2N1549	1.25	2N2329	4.75	2N3414	.17	2N3954	3.50	2N5133	.15
2N508A	.45	2N1551	2.50	2N2368	.25	2N3415	.18	2N3954A	3.75	2N5138	.15
2N555	.45	2N1552	3.25	2N2369	.25	2N3416	.19	2N3955	2.45	2N5198	3.75
2N652A	.85	2N1554	1.25	2N2484	.32	2N3417	.20	2N3957	1.25	2N5294	.50
2N677C	6.00	2N557	.15	2N2712	.18	2N3442	1.85	2N3958	1.20	2N5296	.50
2N706	.25	2N1560	2.80	2N2894	.40	2N3553	1.50	2N4037	.60	2N5306	.20
2N706B	.40	2N1605	.35	2N2903	3.30	2N3563	.20	2N4093	.85	2N5354	.20
2N711	.50	2N1613	.30	2N2904	.25	2N3565	.20	2N4124	.20	2N5369	.20
2N711B	.60	2N1711	.30	2N2904A	.30	2N3638	.20	2N4126	.20	2N5400	.40
2N718	.25	2N1707	4.10	2N2905	.25	2N3642	.20	2N4141	.20	2N5401	.50
2N718A	.30	2N2060	1.85	2N2905A	.30	2N3643	.15	2N4142	.20	2N5457	.35
2N720A	.50	2N2102	.40	2N2906	.25	2N3645	.15	2N4143	.20	C103Y	.25
2N918	.35	2N2218	.25	2N2906A	.30	2N3646	.14	2N4220A	.45	C103D	.40
2N930	.25	2N2218A	.30	2N2907	.25	2N3730	1.50	2N4234	.95	C106B1	.50
2N956	.30	2N2219	.25	2N2907A	.30	2N3731	2.75	2N4400	.20	C106D1	.75

SILICON UNIJUNCTIONS

INTEGRATED CIRC.

RECTIFIERS

2N2646	.50	2N2160	.65	UA703C	.40		10	100
2N2647	.60	2N4870	.50	709C OP. AMP.	.25			
2N6027	.55	2N4871	.50	741C OP. AMP.	.25	IN4001	.60	5.00
2N6028	.70	2N4891	.50	7400	.15	IN4002	.70	6.00
D5E37	.25	2N4892	.50	7404N	.18	IN4003	.80	7.00
		2N4893	.50	7430N	.19	IN4004	.90	8.00
		2N4894	.50	7430N	.19	IN4005	1.00	9.00
		MU10	.40	74L00J	.35	IN4006	1.10	10.00
				74H55N	.35	IN4007	1.20	11.00



New-Tone Electronics
P.O. Box 1738 A
Bloomfield, N.J. 07003
Phone: (201) 762-9020

ALL PARTS GUARANTEED AND TESTED ON PREMISES.

N.J. residents add 5% sales tax. Minimum order \$5.00. All orders add \$1.00 postage. Dealers write or phone for discount prices.



POTTER BRUMFIELD

Type KHP Relay
4 PDT 3A Contacts
24 VDC (650 coil) \$1.50 EA.
120 VAC (10.5 MA coil) \$1.75 EA.

Similar to National LH0021. General purpose 1 amp operational amplifier. TO-3 package.
Each \$ 6.95
5 for \$30.00



DIP TRIMMER

-12 turn trimpoos which also into a DIP socket
-5K and 200K
-1/4" x 1/4" x 1/4"
-4 leads spaced .3" x .2"

Each \$.65 10 for \$4.95

1 Amp OP AMP

Power transistor: PD-115W; VCE-60V; HFE-50; FT-30K; Case TO-3
Each \$.90 19 for \$6.95

NATIONAL MOS TO-5

Dynamic shift registers TO-5
MM502 dual 50 Bit.. \$.75
MM506 dual 100 Bit.. 1.75
MM506 dual 100 Bit.. 1.50
MM5013 1024 Bit.. 2.25
MM5016 512 Bit.. 1.00

Static shift registers
MM504 dual 16 Bit.. \$1.50
MM505 dual 32 Bit.. 1.75
MM550 dual differential analog switch 2.50

410 (RCA) 200V: 10A.
Each \$1.75 10 for \$15.00

Memories

BRAND NEW--
93410 - 256 X 4 RAM
(256 WORD X 1 BIT)
FULLY DECODED: HIGH SPEED (40 NS): OPEN COLLECTOR OUTPUT: 16 PIN DIP WITH DATA FROM FAIRCHILD
ONLY \$2.25 10/\$18.95

1702 - 2048 BIT PROM
2K STATIC UNITS, ULTRA-VIOLET LIGHT ERASABLE. \$9.95 EACH
A85129 - 1024 BIT ROM
(256X4 PROM): 50 NS: POWER DISSIPATION .5 MW/IT: TRI-STATE OUTPUT. \$5.00 EA. 8 - \$34.95

2102-2 MOS 1024 BIT MEMORY (DIP)
FULLY DECODED STATIC RANDOM ACCESS MEMORY DIRECTLY TTL COMPATIBLE INPUTS AND OUTPUT SINGLE 5V SUPPLY - NO CLOCKS OR RESET
\$3.00 EACH 10 FOR \$27.95

DIODE ARRAY

10 - 1N914 Silicon Signal Diodes in one package. 20 leads spaced .1"; no common connections. Each \$.25 10 for \$2.25

Space Age Clock Kit

12 or 24 hour format. All instructions incl. Four digit clock kit includes all parts for complete clock: size 3 1/2 x 2 -FNO-70 readouts
-MM5314 clock chip and all transistors, etc.
-extruded aluminum case
-cord with transformer plug



SPECIAL 8223 PROM

8 BIT 32 WORD MEMORY \$3.00 EA. 10 - \$29 WE PROGRAM FOR \$5 EACH

RECTIFIER SPECIAL! 1N4007 - 1 AMP - 1000 volt PRV \$.13 each 10 for \$1.00

All IC's are new and fully tested. Leads are plated with gold or solder. Due to increased costs, orders under \$7.00 add \$1.00 postage and handling. Residents of California add sales tax. TWX: 910-367-1521 \$10 minimum on C.O.D.'s.

SEND FOR FREE FLYER

Phone (916) 334-2161
Mail orders to: P.O. Box 41779 Sacramento, CA 95841

BABYLON ELECTRONICS

CIRCLE NO. 7 ON FREE INFORMATION CARD

REAL ESTATE

BIG SPRING '76 CATALOG Free! Over 2,600 top values coast to coast! UNITED FARM AGENCY. 612-EP West 47th, Kansas City. MO 64112

RECORDS

OLDIES 45rpm. Free Catalog Corry's Record Shop. Box 166TC, Mason, Ohio 45040

FREE RECORD COLLECTION Reviewers wanted Anyone qualifies. We ship you new records to review. You pay postage. Records are free. Applicants accepted "first come" basis. Write: Research PE. 6162 Washington Circle, Milwaukee, Wisconsin 53213

RUBBER STAMPS

RUBBER ADDRESS STAMPS. Free Catalog. 45 type styles. Jackson's, Dept. K, Brownsville Rd., Mt. Vernon, Ill 62864.

118

INSTRUCTION

LEARN ELECTRONIC ORGAN SERVICING at home all makes including transistor. Experimental kit--trouble-shooting Accredited NHC Free Booklet NILES BRYANT SCHOOL. 3631 Stockton, Dept. A, Sacramento, Calif 95820

LEARN WHILE ASLEEP. Hypnotize! Strange catalog free. Auto-suggestion. Box 24-2D, Olympia, Washington 98501

DEGREE IN ELECTRONICS through correspondence. Free catalog. Grantham, 2000 Stoner Avenue, Los Angeles, California 90025

INTENSIVE 5 week course for Broadcast Engineers F C C First Class license. Radio Engineering Incorporated, 61 N Pineapple Ave., Sarasota, Florida 33577 and 2402 Tidelwater Trail, Fredericksburg, VA 22401

SCORE high on F C C Exams Over 300 questions and answers Covers 3rd, 2nd, 1st and even Radar Third and Second Test \$14.50. First Class Test. \$15.00 All tests. \$26.50 R E I Inc. Box 806, Sarasota, Fla 33577.

UNIVERSITY DEGREES BY MAIL! Bachelors. Masters. Ph.D. Free revealing details. Counseling. Box 1162-PE2, Tustin, California 92680

SELF-STUDY CB RADIO REPAIR COURSE THERE'S MONEY TO BE MADE REPAIRING CB RADIOS This easy-to-learn course can prepare you for a career in electronics enabling you to earn as much as \$16.00 an hour in your spare time. For more information write CB RADIO REPAIR COURSE, Dept PE026, 531 N Ann Arbor, Oklahoma City, Okla 73127

FREE Educational Electronics Catalog Home study courses Write to Edukits Workshop, Department 714D, Hewlett NY 11557

TELEVISION repair course Learn how to service televisions from master technicians. Send \$6.00 for first lesson and details to Guardian, 20 E. Main, Ramsey, NJ

NO FCC LICENSE? Tried every way but the right way? It's time for Genn Tech Home Study Free Catalog 5540 Hollywood Blvd Los Angeles, Calif 90028

FCC LICENSE STUDY GUIDE new, 377 pages, includes 1465 FCC-type questions, with answers and discussions, covering third, second, and first class radiotelephone exams \$8.95 postpaid GSE, 2000 Stoner Avenue, Los Angeles, Calif 90025

LEARN TO BUILD AND TEST ELECTRONIC CIRCUITS FOR FUN AND PROFIT Complete Details Free Chapel Company, 1154 West 27th Street, Erie, Pennsylvania 16508

LEARN BASIC Digital Troubleshooting by correspondence Information Free Educational Technologies, Box 224, Reynoldsburg, Ohio 43068

DRAFTING -Blueprint Reading (Mechanical, Electronic, Architectural) Home Courses \$25.00 Send \$2.00 first lesson. Prior, inc., 23-09 169th Street, Whitestone, NY 11357

POPULAR ELECTRONICS INDEXES Detailed and complete subject indexes available to magazine years 1974, 1973, and 1972 Hundreds of subject references to help you quickly find that special project article or product test. 1972, 1973 and 1974 editions \$1.50 each All three editions only \$4.00. INDEX, Box 2228, Falls Church, Va 22042.

BOOKS AND MAGAZINES

FREE CATALOG Aviation and Space Books, Aero Pub lishers, 329PE West Aviation, Fallbrook, California 92028

ELECTRONIC MUSIC, SYNAPSE: A new synthesizer magazine. For details write P O Box 359, No. Hollywood, Calif 91603

FREE book prophet Elijah coming before Christ. Wonderful bible edition. Megiddo Mission, Dept. 64, 481 Thurston Rd., Rochester, NY 14619

HYPNOTISM

SLEEP learning Hypnotic method, 92% effective. Details free. ASR Foundation, Box 23429EG, Fort Lauderdale, Florida 33307.

FREE Hypnotism, Self-Hypnosis, Sleep Learning Catalog! Drawer H400, Ruidoso, New Mexico 88345.

AMAZING self-hypnosis record releases fantastic mental power. Instant results! Free trial. Write Forum (AA2), 333 North Michigan, Chicago 60601.

FREE DATA SHEETS WITH EVERY ITEM. IC OR FET'S WITH \$5 & \$10 ORDERS.*

- MONEY-BACK GUARANTEE
- 24-HOUR SHIPMENT
- ALL TESTED AND GUARANTEED

TRANSISTORS (NPN)

2N918 TYPE RF Amp & Oscillator to 1 GHz 3/51.00
2N3583 TYPE RF Amp & Osc to 1 GHz (pl. 2N918) 5/51.00
2N3585 TYPE GP, Purpose Gain (TO-92/106) 5/51.00
2N3641 TYPE RF & GP Amp & Sw to 500 mA & 30 MHz 5/51.00
2N3666 TYPE RF Power Amp 1.5 W @ 450 MHz 81.50
2N3903 TYPE GP Amp & Sw to 100 mA and 30 MHz 6/51.00
2N3904 TYPE GP Amp & Sw to 100 mA hFE 100 6/51.00
2N3919 TYPE RF Power Amp 10-25 W @ 3-30 MHz 13.00
2N4274 TYPE Ultra-High Speed Switch 12 ns 5/51.00
2N5108 TYPE RF Power Amp 2 W @ 450, 1 W @ 1 GHz 52.50
MPS6515 TYPE High-Gain Amplifier hFE 250 3/51.00
Assort. NPN GP TYPES, e.g. 2N3694, 2N3903, etc. (15) 52.00
2N3638 TYPE (PNP) GP Amp & Sw to 300 mA 5/51.00
2N3906 TYPE (PNP) GP Amp & Sw to 30 MHz 5/51.00
2N4249 TYPE (PNP) Low-Noise Amp 1µA to 50 mA 4/51.00

FET's:

N-CHANNEL (LOW-NOISE)
2N4091 TYPE RF Amp & Switch (TO-18/106) 3/51.00
2N4416 TYPE RF Amplifier to 450 MHz (TO-72) 2/51.00
2N5183 TYPE GP, Purpose Amp & Sw (TO-106) 3/51.00
2N5486 TYPE RF Amp to 450 MHz (plastic 2N4416) 2/51.00
E100 TYPE Low-Cost Audio Amplifier 4/51.00
ITE4868 TYPE Ultra-Low Noise Audio Amp 2/51.00
TIS74 TYPE High-Speed Switch 402 3/51.00
Assort. RF & GP FET's, e.g. 2N5183, MPF102, etc. (8) 52.00
P-CHANNEL
2N4369 TYPE GP, Purpose Amp & Sw (TO-106) 3/51.00
E175 TYPE High-Speed Switch 125Ω (TO-106) 3/51.00

FEBRUARY SPECIALS:

2N2222 NPN TRANSISTOR GP Amp & Switch 6/51.00
2N2907 PNP TRANSISTOR GP Amp & Switch 6/51.00
2N3552 RF Power Amp 5 W @ 150 MHz, 2 W @ 50 MHz \$2.00
E101 N-CHANNEL FET Low Current, Low Vp Amp/Sw 3/51.00
MPF102 N-CHANNEL FET RF Amp 200 MHz 3/51.00
556 DUAL 555 TIMER 1 µsec to 1 hour (DIP) \$1.00
723 VOLT. REGULATOR 3-30 V @ 1-200 mA (DIP/TO-5) 2/51.00
741 Op Amp, Freq. Comp., LM 741, µA741, etc. (MINI-DIP) 4/51.00
2740 FET Op Amp, Like NE536 and µA740 (TO-5) \$2.40
µA7805 VOLTAGE REGULATOR 5 V @ 1 A (TO-220) 11.25
8038 WAVEFORM GENERATOR Wave w/ccts \$4.50
1N4001 RECTIFIER 50 V PIV. 1A 1/51.00
1N4154 DIODE 30 V/10mA-1N914 except 30 V 2/51.00
BR1 BRIDGE RECTIFIER 50 V PIV. 500 mA (DIP) 3/51.00
MM5314 DIGITAL CLOCK CHIP With Specs/Schematics \$4.95

LINEAR IC's:

308 Micro-Power Op Amp (TO-5/MINI-DIP) \$1.00
309K Voltage Regulator 5 V @ 1 A (TO-3) \$1.25
324 Quad 741 Op Amp, Compensated (DIP) \$1.50
340T Volt. Reg. 1 Amp-Specify 5, 6, 12, 15 or 24 V-w/ccts \$1.75
380 2-5 Watt Audio Amplifier 34 dB (DIP) \$1.29
555 Timer 1 µs to 1 hr. NE555, LM555, etc. (MINI-DIP) \$.29
709 Popular Op Amp (DIP/TO-5) \$.75
739 Dual Low-Noise Audio Preamp/Op Amp (DIP) \$1.00
1458 Dual 741 Op Amp (MINI-DIP) \$.65
741 Freq. Comp. Op Amp (DIP/TO-5) 3/51.00

DIODES:

ZENERS-Specify Voltage 3.3, 3.9, 4.3, 5.1, 5.8, 8.2 400mW 4/51.00
8.1, 10, 12, 15, 16, 18, 20, 22, 24, 27, or 33V (±10%) 1 Watt 3/51.00
1N914 or 1N4148 TYPE General Purpose 100V/10mA 15/51.00
1N3893 TYPE RECTIFIER Stud Mount 400 V/12 A 2/51.00
05 VARACTOR 5-50 W Output @ 30-250 MHz, 7-70 pF \$5.00
F7 VARACTOR 1-3 W Output @ 100-500 MHz, 5-30 pF \$1.00
*MAIL NOW! FREE DATA SHEETS supplied with every item from this ad. FREE ON REQUEST-741 Op Amp with every order of \$5 or more; 749 Dual Op Amp or two E100 FET's with every order of \$10 or more, postmarked prior to 4/30/76. One free item per order.
ORDER TODAY - All items subject to prior sale and prices subject to change without notice. All items are new surplus parts - 100% functionally tested.
WRITE FOR FREE CATALOG #7510 offering over 350 semiconductors carried in stock. Send 13¢ stamp.
TERMS: Send check or money order (U.S. funds) with order. We pay 1st Class postage to U.S., Canada and Mexico. \$1.00 handling charge on orders under \$10. Calif. residents add 8% sales tax. Foreign orders add postage. COD orders - add \$1.00 service charge.

ADVA ELECTRONICS

BOX 4181 BH, WOODSIDE, CA 94062
Tel. (415) 851-0455

CIRCLE NO. 2 ON FREE INFORMATION CARD

DO-IT-YOURSELF

TELEPHONES. All Types. Equipment. Supplies. Keyed. Regular. Decorator. Catalog, 50 cents. Box 1654J, Costa Mesa, California 92626.

PRO SPORTS ACTION FILMS

SPEND YOUR CHRISTMAS \$\$\$ ON SPORTS FILMS! February Special! NFL Super Bowl 1972 (Dolphins/Cowboys). Super 8. B&W. 200'. \$6.95 each PPD—you save \$2.00 a reel. Also 69 Super Bowl (Jets/Cowboys), Super 8, B&W, \$7.95 each PPD—you save a dollar. World Cup Soccer, 200' reels, Super 8, B&W, choice of three official films - Italy/Germany, England/Germany; Brazil (Pete) / Italy - \$6.95 each PPD - limited offer while quantities last. Castle, Columbia or Sportlite films catalogs - 3 for a dollar or 35 cents each - be sure to include coins or stamps, please. SPORTLITE, Elect-2, Box 24-500, Speedway, Indiana 46224.

POPULAR ELECTRONICS

ADVERTISERS INDEX

READER SERVICE NO.	ADVERTISER	PAGE NUMBER
1	A P Products, Inc	6
2	Adva Electronics	118
3	Allison Automotive Company	83
	Alpha Electronics	97
4	Altaj Electronics	109
6	Ancrona Corp	113
	Audio Technica U.S.A. Inc	96
7	Babylon Electronics	118
	Bell & Howell Schools	32,33,34,35
63	Breaker Corporation	36
8	Browning Labs	102
	Burnstein-Applebee	98
61	CB Radio Repair	99
	CREI Capitor Radio Engineering Institute	74,75,76,77
66	Circuit Design, Inc	93
9	Cleveland Institute of Electronics	46,47,48,49
13	Cobra, Product of Dynascan	SECOND COVER
11	Continental Specialties Corporation	13
12	Crown	26
10	Delta Electronics Co.	117
	Delta Products, Inc.	7
16	Digi-Key Corporation	114
	Dixie Hi-Fidelity	98
17	EICO	88
18	Edmund Scientific Co.	106
19	Edmund Scientific Co.	120
20	Electronic Distributors, Inc	114
21	Electronics Technical Institute	18,19,20,21
22	Godbout Electronics, Bill	112
	Heath Company	84,85,86,87
23	Hufco	90
24	IMS Associates Inc	81
25	IMS Associates Inc	119
26	Illinois Audio	99
27	International Electronics Unlimited	108
28	James	110,111
33	Johnson Co., E F	FOURTH COVER
29	Lafayette Radio Electronics	25
30	McIntosh Laboratory, Inc	90
31	MITS	27
32	Mallory & Co., Inc., P.R.	1
34	Mini-Micro Mart	116
	NRI Schools	8,9,10,11
	National Technical Schools	56,57,58,59
35	New-Tone	117
37	Northrop University	100
38	Olson Electronics	116
39	PAIA Electronics	99
40	Pathcom Inc	15
41	Poly Paks	105
42	Processor Technology	100
43	Radio Shack	17
44	S A E	14
45	SBE, Inc	29
46	S.D. Sales Co.	107
47	Schober Organ Corp., The	16
48	Sencore	95
49	Shakespeare Antenna Group	97
50	Shure Brothers Inc	5
51	Sinclair Radionics Inc	23
52	Solid State Sales	108
64	Solid State Sales	115
65	Southwest Technical Products Corp	69
53	Sphere Corporation	6
54	Stanton Magnetics, Inc.	THIRD COVER
55	Stereo Discounters	99
	Surplus Center	119
56	Systems Research, Inc	61
	TEAC Corporation	30
57	Tri-Star Corporation	98
58	Trigger Electronics	98
59	Weller-Xcelite Electronics Division	72
60	Winegard Company	2

CLASSIFIED ADVERTISING:

106,108,112,114,115,116,118,119

BUSINESS OPPORTUNITIES

I MADE \$40,000.00 Year by Mailorder! Helped others make money! Free Proof Torrey, Box 318-NN, Ypsilanti, Michigan 48197.

FREE CATALOGS Repair air conditioning, refrigeration, Tools, supplies, full instructions. Doolin, 2016 Canton, Dallas, Texas 75201.

MAILORDER MILLIONAIRE helps beginners make \$500 weekly! Free report reveals secret plan! Executive (1K2), 333 North Michigan, Chicago 60601

PIANO TUNING LEARNED QUICKLY AT HOME! Musical knowledge unnecessary. Free Information, Empire School, Box 450327, Miami 33145

\$200.00 DAILY in Your Mailbox! Your opportunity to do what mail-order experts do. Free details Associates, Box 136-J, Holland, Michigan 49423

FREE BOOK "2042 unique proven enterprises" Work home! Hayling-B, Carlsbad, CA 92008

wanted P-2
Citizens Band
DEALER-DISTRIBUTORS
Send this ad with Letterhead to:
PAL ELECTRONICS CO.
2962 W. WELDON - PHOENIX, ARIZ. 85017

GET RICH with Secret Law that smashes debts and brings you \$500 to \$5 Million cash. Free report! Credit 4K2, 333 North Michigan, Chicago 60601.

PROPRIETORSHIP-Partnership-Corporation Which is right for your new Business and how to go about forming it. \$5.00 ISSCO, Box 4009, Irving, Texas 75061.

HIGHLY PROFITABLE ONE-MAN ELECTRONIC FACTORY
Investment unnecessary, knowledge not required, sales handled by professionals. Postcard brings facts about this unusual opportunity. Write today! Barta-DB, Box 248, Walnut Creek, CA 94597.

FM RADIO STATION Start your own. Fantastic income. Frequencies still available. Complete information \$3.00. Concept, Box 106, Lawrence, N.Y. 11559.

MAGNETS

PERMANENT MAGNET MOTION Foucault Drives. Virtual Perpetual Motion. Details \$3.00. MAGNETRIKS, 6064 N Paulina, Chicago, IL 60660.

MISCELLANEOUS

WINEMAKERS Free illustrated catalog yeasts, equipment. Semplex, Box 12276P, Minneapolis, Minn. 55412.

EXPERT SERVICE. PC Boards, Assemblies, etc. assembled and soldered. Professional Quality at low rates. Your components or ours. Write for quote. Quality Enterprises, Route 1, Box 15A5, Stockholm, NJ 07460.

DISCOUNTERS of Stained Glass Supplies. Send \$1.00 for catalog. Nervo Distributors, 650 University Ave., Berkeley, CA 94710.

FREE! CONSUMER SERVICE DIVISION CATALOG
Includes a wide variety of products associated with the special interests of readers of Ziff-Davis magazines — Psychology Today, Popular Photography, Stereo Review, Popular Electronics, Boating, Flying, Car and Driver, Cycle, Skiing.
Send for your free catalog today.
Consumer Service Division, 595 Broadway, New York, N.Y. 10012

IMSAI AND ALTAIR OWNERS!!
IMSAI 8080 COMPUTER
(ALL BOARDS COMPLETELY "PLUG COMPATIBLE" WITH ALTAIR 8800)
BASIC COMPUTER INCLUDES CPU, FRONT PANEL CONTROL BOARD, LIGHTS AND SWITCHES, POWER SUPPLY, EXPANDER BOARD AND CASE. \$439 KIT \$521 ASSEMBLED
SEE FULL PAGE AD IN THIS ISSUE FOR DETAILS
INTERCHANGEABLE CPU, MEMORY, & I/O BOARDS
FULL IMSAI 8080/ALTAIR 8800 COMPATIBILITY. NO HARDWARE OR SOFTWARE MODIFICATIONS REQUIRED. JUST PLUG IN!!!!

PART #	DESCRIPTION	KIT	ASSEMBLED
CPU A	8080 CPU BOARD	\$181.00	\$208.00
RAM 4-4	4K RAM ON 4K BOARD	\$165.00	\$195.00
RAM 4-1	1K RAM ON 4K BOARD	\$69.00	\$99.00
PROM 4-2	2K EPROM ON 4K BOARD	\$175.00	\$195.00
EXT-C	EXTENDER CARD	\$29.00	\$39.00
PIC-8	COMB. VECT. INT. & R.T. CLK.	\$119.00	\$138.00

PARALLEL I/O BOARDS, 8 BIT PORTS!!
PIO 4-1 1 BYTE IN, 1 BYTE OUT, PLUS STROBES, INTERRUPT PROVISION FOR LED'S ON EACH OUTPUT BIT, AND EXPANDABLE TO 4 BYTES IN, 4 BYTES OUT. \$89 KIT \$109 ASSEMBLED
PIO 4-4 SAME AS PIO 4-1, BUT 4 BYTES IN, 4 BYTES OUT. \$149 KIT \$199 ASSEMBLED
SERIAL I/O BOARDS: HANDLE BOTH SYNCH AND ASYNCH COMM. IRS 232 PLUS CONTROL LINES PLUS TTL PLUS TTY!
SIO 2-1 ONE I/O CHANNEL \$119.00 \$138 ASSEMBLED
SIO 2-2 TWO I/O CHANNELS \$149 KIT \$199 ASSEMBLED

NEW... UNIVERSAL CASSETTE RECORDER INTERFACE
JUMPER SELECT BETWEEN PE HITS SYSTEM AND NEW KANSAS CITY STANDARD. ALL ON ONE BOARD. FOR BOTH THE IMSAI 8080 AND THE ALTAIR 8800
KIT \$49 ASSEMBLED AND TESTED \$79

THE INTEL DATA BOOK
CONTAINS COMPLETE SPECIFICATIONS AND DATA SHEETS ON INTEL 8080A AND ALL ASSOCIATED INTEL MEMORY AND PERIPHERAL CHIPS. ALSO INCLUDES PRELIMINARY SPECS ON "COMING" INTEL CHIPS. 157 pages \$5.00

THE TTL DATA BOOK
CONTAINS COMPLETE ELECTRICAL SPECIFICATIONS FOR ALL 7400 SERIES TTL. THIS IS THE TTL "BIBLE". 640 pages \$10.00

THE PINOUT HANDBOOK
COVERS ENTIRE 5400/7400 SERIES D.P.I.C.S. PIN CONNECTIONS, FUNCTIONAL SPECS, CROSS REFERENCE. \$3.95

IMS ASSOCIATES INC. 1922 REPUBLIC AVE. SAN LEANDRO, CALIF. 94577
TERMS: CHECK OR M.O., BANK AMERICAN, MASTERCARD. 25% DEPOSIT ON C.O.D.
ADD 5% POSTAGE AND HANDLING. (415) 483 2003. PRICES SUBJECT TO CHANGE WITHOUT NOTICE.
CALIF. RESIDENTS: ADD 6.5% SALES TAX. **IMSAI** CIRCLE 25 ON READER SERVICE CARD

GOV'T SURPLUS Electronic "Super-Buys"

- Nationally Known-World Famous SURPLUS CENTER offers finest, Government Surplus electronic units and components at a fraction of their original acquisition cost.

STANDARD DIAL TELEPHONE
• (ITEM #715) -- Std. commercial telephone. Some as used throughout U.S.A. like new condition. Polished black. Use as extension phone or connect several phones together for local intercom system. Full instructions furnished. Wt. 9 lbs.
Original Cost \$24.50
\$7.39

STEP-BY-STEP TELEPHONE SWITCH
• (ITEM #738) -- Amazing selector switch makes great experimental item. When used with 2-wire telephone dial it will select any number from 0 to 100. Make private phone or intercom system, turn on remote lights, motors, etc. Complete with contact bank 13" x 6" x 5" (16 lbs.)
\$7.81 Cost Over \$90.00

• (ITEM #700) -- Telephone Dial for use with #738 switch **\$1.38**

SPECIAL SALE Correspondence Course In ELECTRICAL ENGINEERING
\$11.79 PREPAID IN USA
\$12.79 PREPAID OUTSIDE USA

• (ITEM #9-181) -- Technical training at low cost! Lincoln Engineering School suspended its Correspondence Courses because of rising costs. Limited number of Electrical Engineering courses (without examination grading service) available. Course consists of 15 lesson books with associated exams and standard answers. Home Experimental Lab Bench book included FREE!

BUILD ELECTRIC CARTS WITH UNIQUE MOTORIZED DRIVE WHEEL
• (ITEM #5-936) -- Permanent magnet field motor drives wheel through gear box for high torque. Operates on 6 or 12-volt storage battery. Reversible. 65 to 125 RPM. Swivels for steering. 4 1/2" diam. rubber tire wheel. Instructions. **\$9.98**

ALL ITEMS F.O.B. LINCOLN, NEBR.
Write For Catalogs Order Direct From Ad.
SURPLUS CENTER
DEPT. PE-26 LINCOLN, NE. 68501

LIVE IN THE WORLD OF TOMORROW... TODAY!

And our FREE 164 PAGE CATALOG is packed with exciting and unusual values in electronic, hobby and science items — plus 4,500 finds for fun, study or profit... for every member of the family.

A BETTER LIFE STARTS HERE

FUEL MISER RECLAIMS HEAT

Save your 40% wasted heat to warm a basement, garage or rec room at no extra cost! Instead of going "up the chimney" it goes where you want it. Remove part of furnace exhaust pipe, slip Heat Exchanger in. At 125° fan automat. forces clean air through unit which heats to over 200°F., can be ducted to 20 ft. from unit. 110v AC. Instructions.



- No. 19,194V (5" DIA.) Shpg. 17 lb. \$106.00 FOB
- No. 19,195AV (6" DIA.) Shpg. 17 lb. \$106.00 FOB
- No. 19-198AV (7" DIA.) Shpg. 17 lb. \$106.00 FOB

SUPER POWER FOR ANY RADIO

New antenna assist turns a tiny transistor into a tiger, has pulled in stations up to 1000' miles away! Just set beside radio (no wires, clips, grounding) and fine-tune Select-A-Tenna's dial to same frequency — "gangbusters"! Great for clearing weak signals in radio depressed areas, off-coast islands, crowded frequency stations. Solid state—uses no electricity, batts., tubes.



- Stock No. 72,095AV \$15.95 Ppd.
- ULTRA SELECT-A-TENNA
- No. 72,147AV (*OVER 1000 MI.) \$22.95 Ppd.

ELEC. DIG. STOPWATCH: \$49.95

The price alone obsoletes your wind-up timer and it's ±0.002% accurate! Hand-held, you start, stop, reset compact 6-ounce w/one hand; times to 59 mins, 59.9 secs in 1/10 increments. Failsafe design (cannot be accidentally reset), solid-state electronics! Incl. neckstrap, repl. batts.



- No. 1671AV (5-DIGIT LED DISPLAY) \$49.95 Ppd.
- SPLIT ACTION W/NICADS, RECHARGER
- No. 1669AV (5-DIGIT LED DISPLAY) \$79.95 Ppd.
- DELUXE SPLIT ACTION BATTERY MODEL
- No. 1653AV (6-DIGIT NEON DISPLAY) \$149.95 Ppd.

SEE MUSIC IN PULSATING COLOR

New 3-Channel Color Organ adds to music listening pleasure, lets you modulate 3 independent strings of colored lamps with intensity of your music to create an audio "light show." They flash, vary in brightness related to music's rhythm, pitch, volume—pulsating lighting performance to music! Fully assembled & priced half that of others, the Edmund Sound To Light Control is a terrific value. Plug in, turn on!



- No. 42,309AV... (ASSEMBLED) \$17.95 Ppd.
- No. 42,336AV... (UNASSEMBLED) \$13.95 Ppd.

MAIL COUPON FOR GIANT FREE CATALOG!

172 PAGES • MORE THAN 4500 UNUSUAL BARGAINS

Completely new 1976 edition. New items, categories, illustrations. Dozens of electrical and electromagnetic parts, accessories. Enormous selection of Astronomical Telescopes. Unique lighting and ecological items. Microscopes, Binoculars, Magnifiers, Magnets, Lenses, Prisms. Hard-to-get-surplus bargains. Ingenious scientific tools. 1000's of components.

EDMUND SCIENTIFIC CO.
300 Edscorp Building, Barrington, N. J. 08007
Please Free Giant Catalog "AV"

Name _____
Address _____
City _____ State _____ Zip _____

COMPLETE & MAIL WITH CHECK OR M.O.

EDMUND SCIENTIFIC CO. 300 Edscorp Building, Barrington, N.J. 08007

How Many	Stock No.	Description	Price Each	Total
<input type="checkbox"/>		PLEASE SEND GIANT FREE CATALOG "AV"		
<input type="checkbox"/>		Charge my BankAmericard		
<input type="checkbox"/>		Charge my Master Charge*		
Interbank No. _____			Add Handling and Service Charge \$1.00	
My Card No. Is _____			I enclose <input type="checkbox"/> check <input type="checkbox"/> money order for TOTAL \$ _____	
Card Expiration Date _____			Signature _____	
30-DAY MONEY-BACK GUARANTEE. You must be satisfied or return any purchase in 30 days for full refund. *\$15.00 minimum			Name _____ Address _____ City _____ State _____ Zip _____	

WHEN YOU COME TO PHILADELPHIA BE SURE TO SEE
FREE BICENTENNIAL LIGHT SHOW
IN BARRINGTON, N. J. ONLY 10 MINUTES AWAY AT
EDMUND FACTORY STORE

PLUG IN 200,000 CANDLEPOWER!



Powerful 12v emergency light projects big straight beam visible for 2 miles. Plugs into car's cigarette lighter; only 3½ lbs. Great for motorists, outdoorsmen, emergency crews, security men, campers. Super bright 200,000 candlepower G.E. aircraft landing light in a rugged weatherproof steel housing with baked enamel finish, steel lens grate, polished chrome-plated reflector, on/off switch. 15 ft. extension cord; 6¼ dia. x 11¼". Keep it handy!

- Stock No. 72,093 AV \$22.95 Ppd.

CAN'T SLEEP, RELAX? TRY THIS!

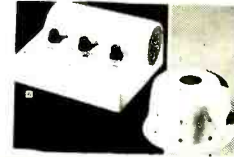

Electronic sound conditioner simulates 4 kinds of soothing sounds of ocean surf and rain. "White sound" helps mask unwanted noise, adds restful, intriguing background sound. Program the solid-state unit to your own need: 2 surf, 2 rain; or "white sound", proven by medical tests to have analgesic effects. Great for meditation, restlessness, sleeplessness psychology

- (A)-No. 71,997AV... (7½ x 7 x 3½") 110V AC \$89.95 Ppd.
- (B)-AS ABOVE, BUT "WHITE SOUND" ONLY
- No. 71,980AV... (6" Rd. x 3½" Hi) \$28.00 Ppd.

KNOW YOUR ALPHA FROM THETA!



For greater relaxation, concentration, listen to your Alpha-Theta brainwaves. Ultra-sensitive electrode headband slips on/off in seconds—eliminates need for messy creams, etc. Atch'd to amplifier, filters brainwaves, signals beep for ea. Alpha or Theta wave passed. Monitoring button stimulates Alpha sound; audio & visual (L. E. D.) feedback. Reliable, easy-to-use unit comparable to costlier models. Completely safe. Comprehensive instruction booklet.

- No. 1635AV (8 • 3 • 4"; 24 oz.) \$149.50 Ppd.
- DELUXE "ON" TIME MONITOR—Measures and records %
- No. 1652AV... (15 • 10 • 6") \$299.50 Ppd.
- No. 71809AV LOW COST "STARTER" UNIT \$55.00 Ppd.
- DO-IT-YOURSELF KIT... No. 61,069AV \$34.95 Ppd.

LOW COST 7X INFRA-RED VIEWER



For infra-red crime detection surveillance, security system alignment, I.R. detection, laser checking, nite wildlife study, any work req. I.R. detection & conv. to visible spectrum. Self cont. scope w/everything incl I.R. light source.

- No. 1659AV (11 x 14¼ x 3") \$285.00 Ppd.
- WITHOUT LIGHT SOURCE
- No. 1663AV \$225.00 Ppd.

4¼" ASTRONOMICAL TELESCOPE



See moon craters, rings of Saturn, double stars. New equatorial mount. f/10, 1/4 wave mirror (Pyrex). Gives theoretical limit of resolution. Rack & pinion focusing. Aluminum tube, 6X finder. 1" F.L. 45X Kellner achromatic eyepiece and Barlow lens to double & triple power up to 135X. Free Star Chart plus 2 Books.

- Stock No. 85,105AV (Shipping Wt. 42 lbs.) \$159.50 FOB
- 4¼" WITH CLOCK DRIVE No. 85,107AV \$199.50 FOB
- 6" REFLECTOR TELESCOPE (48X to 360X) No. 85,187AV \$249.50 FOB
- 6" WITH CLOCK DRIVE No. 85,086AV \$285.00 FOB
- 3" DELUXE REFLECTOR (30X to 90X) No. 8D,162AV \$ 89.95 Ppd.
- STANDARD 3" REFLECTOR No. 85,240AV \$ 59.95 Ppd.

Disco use challenges a cartridge... that's why Stanton is the overwhelming first choice of disco pros

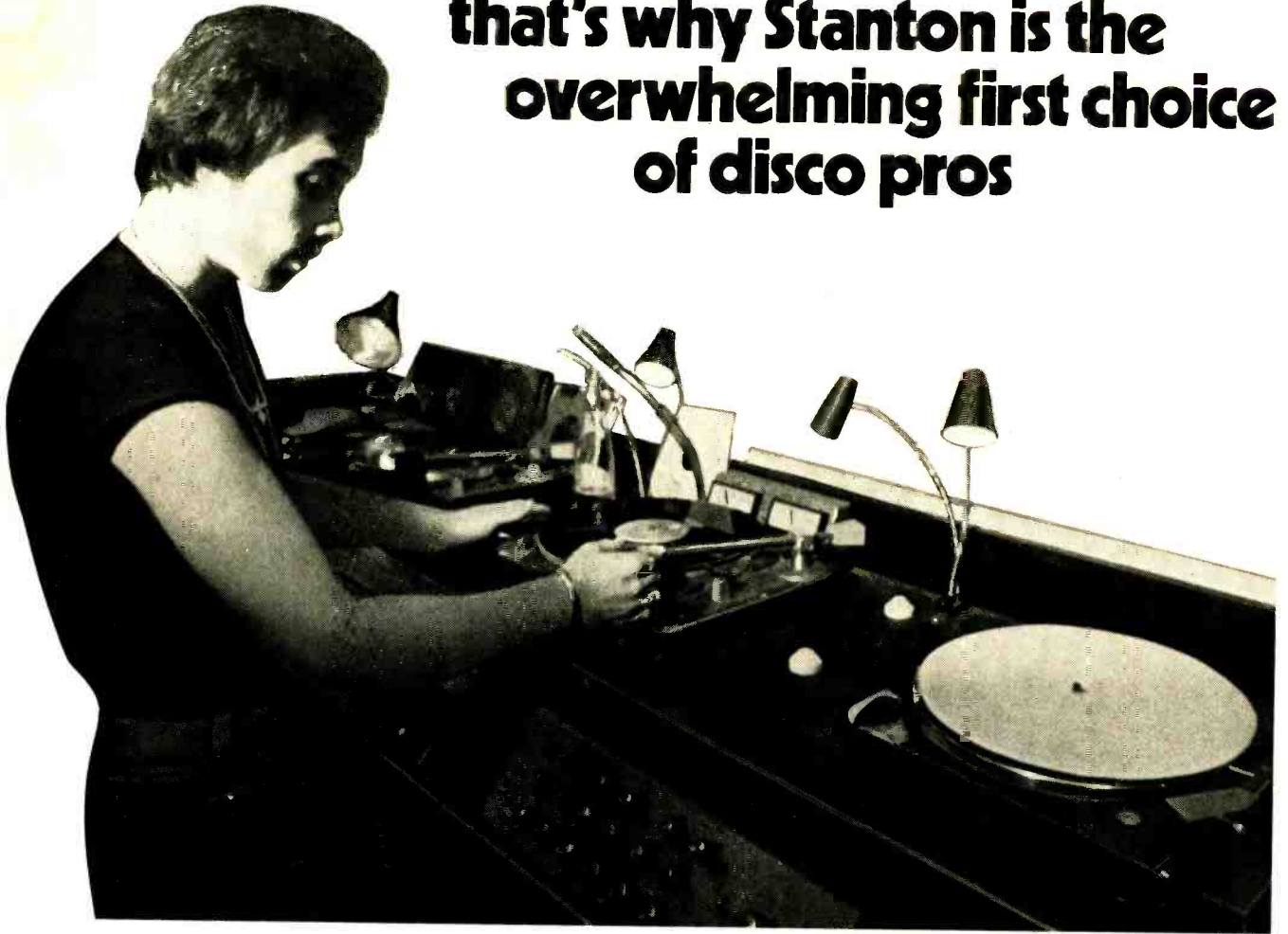

Richie Kaczor, Disc Jockey at Hollywood Disco, New York City.

Discotheques represent one of the most grueling professional situations for a pickup that can be imagined. Not only must the cartridge achieve a particular high level of sound excellence, it must do so in the "live" environment of back cueing, slip cueing, heavy tracking forces, vibration and potential mishandling... where a damaged stylus means much more than lost music, it means lost business.

The Discotheque is a commercial venture. It must have as little "down time" as possible... that is why disco operators look for durability and reliability in their equipment. And, that is why leading dealers and professional distributors recommend the Stanton product for this purpose.

Stanton has two cartridges eminently suited to Discotheques, both designed with optimum ratios of vertical stylus force, compliance, stylus shank strength... the calibrated 681SE, which possesses superb audio performance, and the more modest 500AL. Both are tough. Both perform beautifully, and dependably. And that's what a Discotheque needs.

Whether your usage involves recording... broadcasting... disco or home entertainment, your choice should be the choice of the Professionals... STANTON.

For further information write:
Stanton Magnetics, Inc.
Terminal Drive,
Plainview, New York 11803.



Ronnie Soares, Disc Jockey at Ipenema.



Two Views of the Action at the Ipenema Disco, New York City.



What the music can do.

CIRCLE NO. 54 ON FREE INFORMATION CARD

www.americanradiohistory.com

New Horizons In CB Performance

The Johnson solid-state meter.



Clearly an improvement! Bright ruby red LED readouts let you read signal strength, transmitter power and modulation precisely ... at a glance! All solid-state, it's completely reliable regardless of temperature, dust or humidity. Solid-state metering — exclusive in the Messenger 123SJ.

Engineer's triumph ... Operator's dream.

Improving what is already the best is the ultimate challenge for the engineer. And the ultimate reward for the CB operator. Now you can experience the incredible interference rejection of the only dual cascaded crystal filtering system in CB — plus a new fully automatic noise limiter and RF-type noise blanker. It's a dream rig you can own! Messenger 323A.



Johnson sideband. Again!



Nearly 10 years ago we introduced the first CB sideband radio ... now Johnson offers the most advanced SSB performance on-the-air! With color-keyed lights for USB/LSB/AM modes, individual controls for every function, and famous Johnson quality, performance, warranty and service. Viking 352.

Write for free catalog



JOHNSON

E. F. JOHNSON COMPANY, WASECA, MINNESOTA 56033

In Canada: A. C. Simmonds & Sons, Ltd.

CIRCLE NO. 33 ON FREE INFORMATION CARD

www.americanradiohistory.com