

















Seal Source Inc.

	RA	J	2
	RA/N	J	10
	RA/E	J	15
	RC	J	20
	621 TECH. DETAILS	J	29
	RE	J	30
	RH	J	31
	RR	J	32
	RV	J	37
	RX	J	40
	RZ	J	42
	R5	J	46
	R8	J	47
	R12	J	48
	R14	J	49
	R19	J	50
	R20	J	51

METRIC SIZE
ROD SEALS



Tel.: 1-888-609-SEAL
Fax: 1-888-717-SEAL



www.sealsourceinc.com

RA - Rod Seals Polyurethane AU 94A

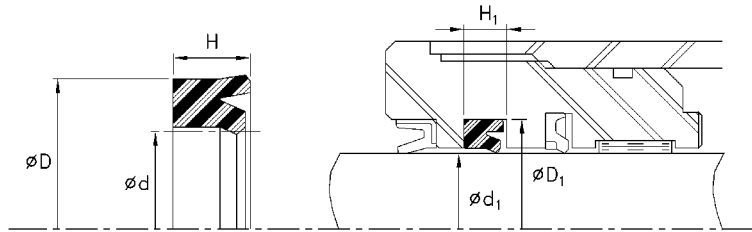
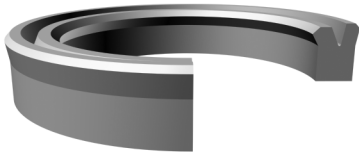

Temperature: -31/212F [-35/100C]

Pressure: 6000 PSI [415 Bar]

Ref.Number	Rod diameter		Nominal Seal Dimensions			Housing Dimensions					\$	
		Tol.	d	D	H	d1	Tol.	D1	Tol.	H1		Tol.
R008016050RA*	8.00	+0.00 / -0.04	8.00	16.00	5.00	8.00	+0.00 / -0.04	16.00	+0.07 / -0.00	5.70	+0.30 / -0.00	0/R
R008018060RA*	8.00	+0.00 / -0.04	8.00	18.00	6.00	8.00	+0.00 / -0.04	18.00	+0.07 / -0.00	7.00	+0.30 / -0.00	0/R
R008018075RA*	8.00	+0.00 / -0.04	8.00	18.00	7.50	8.00	+0.00 / -0.04	18.00	+0.07 / -0.00	8.50	+0.30 / -0.00	0/R
R009017050RA*	9.00	+0.00 / -0.04	9.00	17.00	5.00	9.00	+0.00 / -0.04	17.00	+0.07 / -0.00	5.70	+0.30 / -0.00	0/R
R009019060RA*	9.00	+0.00 / -0.04	9.00	19.00	6.00	9.00	+0.00 / -0.04	19.00	+0.08 / -0.00	7.00	+0.30 / -0.00	0/R
R009019075RA*	9.00	+0.00 / -0.04	9.00	19.00	7.50	9.00	+0.00 / -0.04	19.00	+0.08 / -0.00	8.50	+0.30 / -0.00	0/R
R009019080RA*	9.00	+0.00 / -0.04	9.00	19.00	8.00	9.00	+0.00 / -0.04	19.00	+0.08 / -0.00	9.00	+0.30 / -0.00	0/R
R010018050RA*	10.00	+0.00 / -0.04	10.00	18.00	5.00	10.00	+0.00 / -0.04	18.00	+0.07 / -0.00	5.70	+0.30 / -0.00	0/R
R010020060RA*	10.00	+0.00 / -0.04	10.00	20.00	6.00	10.00	+0.00 / -0.04	20.00	+0.08 / -0.00	7.00	+0.30 / -0.00	0/R
R010020075RA*	10.00	+0.00 / -0.04	10.00	20.00	7.50	10.00	+0.00 / -0.04	20.00	+0.08 / -0.00	8.50	+0.30 / -0.00	0/R
R010020080RA*	10.00	+0.00 / -0.04	10.00	20.00	8.00	10.00	+0.00 / -0.04	20.00	+0.08 / -0.00	9.00	+0.30 / -0.00	0/R
R014020048RA*	14.00	+0.00 / -0.04	14.00	20.00	4.80	14.00	+0.00 / -0.04	20.00	+0.08 / -0.00	5.50	+0.30 / -0.00	0/R
R014022050RA*	14.00	+0.00 / -0.04	14.00	22.00	5.00	14.00	+0.00 / -0.04	22.00	+0.08 / -0.00	5.70	+0.30 / -0.00	0/R
R014022110RA*	14.00	+0.00 / -0.04	14.00	22.00	11.00	14.00	+0.00 / -0.04	22.00	+0.08 / -0.00	12.00	+0.30 / -0.00	0/R
R014024060RA*	14.00	+0.00 / -0.04	14.00	24.00	6.00	14.00	+0.00 / -0.04	24.00	+0.08 / -0.00	7.00	+0.30 / -0.00	0/R
R014024075RA*	14.00	+0.00 / -0.04	14.00	24.00	7.50	14.00	+0.00 / -0.04	24.00	+0.08 / -0.00	8.50	+0.30 / -0.00	0/R
R014024080RA*	14.00	+0.00 / -0.04	14.00	24.00	8.00	14.00	+0.00 / -0.04	24.00	+0.08 / -0.00	9.00	+0.30 / -0.00	0/R
R015023050RA*	15.00	+0.00 / -0.04	15.00	23.00	5.00	15.00	+0.00 / -0.04	23.00	+0.08 / -0.00	5.70	+0.30 / -0.00	0/R
R015025060RA*	15.00	+0.00 / -0.04	15.00	25.00	6.00	15.00	+0.00 / -0.04	25.00	+0.08 / -0.00	7.00	+0.30 / -0.00	0/R
R015025080RA*	15.00	+0.00 / -0.04	15.00	25.00	8.00	15.00	+0.00 / -0.04	25.00	+0.08 / -0.00	9.00	+0.30 / -0.00	0/R
R015028080RA*	15.00	+0.00 / -0.04	15.00	28.00	8.00	15.00	+0.00 / -0.04	28.00	+0.08 / -0.00	9.00	+0.30 / -0.00	0/R
R015028100RA*	15.00	+0.00 / -0.04	15.00	28.00	10.00	15.00	+0.00 / -0.04	28.00	+0.08 / -0.00	11.00	+0.30 / -0.00	0/R
R016024050RA*	16.00	+0.00 / -0.04	16.00	24.00	5.00	16.00	+0.00 / -0.04	24.00	+0.08 / -0.00	5.70	+0.30 / -0.00	0/R
R016026060RA*	16.00	+0.00 / -0.04	16.00	26.00	6.00	16.00	+0.00 / -0.04	26.00	+0.08 / -0.00	7.00	+0.30 / -0.00	0/R
R016026075RA*	16.00	+0.00 / -0.04	16.00	26.00	7.50	16.00	+0.00 / -0.04	26.00	+0.08 / -0.00	8.50	+0.30 / -0.00	0/R
R016026080RA*	16.00	+0.00 / -0.04	16.00	26.00	8.00	16.00	+0.00 / -0.04	26.00	+0.08 / -0.00	9.00	+0.30 / -0.00	0/R
R018026050RA*	18.00	+0.00 / -0.04	18.00	26.00	5.00	18.00	+0.00 / -0.04	26.00	+0.08 / -0.00	5.70	+0.30 / -0.00	0/R
R018028060RA*	18.00	+0.00 / -0.04	18.00	28.00	6.00	18.00	+0.00 / -0.04	28.00	+0.08 / -0.00	7.00	+0.30 / -0.00	0/R
R018028080RA*	18.00	+0.00 / -0.04	18.00	28.00	8.00	18.00	+0.00 / -0.04	28.00	+0.08 / -0.00	9.00	+0.30 / -0.00	0/R
R018031100RA	18.00	+0.00 / -0.04	18.00	31.00	10.00	18.00	+0.00 / -0.04	31.00	+0.10 / -0.00	11.00	+0.30 / -0.00	6.28
R019027050RA*	19.00	+0.00 / -0.04	19.00	27.00	5.00	19.00	+0.00 / -0.04	27.00	+0.08 / -0.00	5.70	+0.30 / -0.00	0/R
R020025050RA*	20.00	+0.00 / -0.04	20.00	25.00	5.00	20.00	+0.00 / -0.04	25.00	+0.08 / -0.00	5.70	+0.30 / -0.00	0/R
R020028057RA*	20.00	+0.00 / -0.04	20.00	28.00	5.70	20.00	+0.00 / -0.04	28.00	+0.08 / -0.00	6.30	+0.30 / -0.00	0/R
R020033080RA*	20.00	+0.00 / -0.04	20.00	33.00	8.00	20.00	+0.00 / -0.04	33.00	+0.10 / -0.00	9.00	+0.30 / -0.00	0/R
R020033100RA*	20.00	+0.00 / -0.04	20.00	33.00	10.00	20.00	+0.00 / -0.04	33.00	+0.10 / -0.00	11.00	+0.30 / -0.00	0/R
R022030070RA*	22.00	+0.00 / -0.04	22.00	30.00	7.00	22.00	+0.00 / -0.04	30.00	+0.08 / -0.00	8.00	+0.30 / -0.00	0/R

*: GENERALLY NOT STOCKED BUT AVAILABLE - CHECK WITH C/SER

Seal Source Inc.

RA SERIES - AU 94A

Ref.Number	Rod diameter		Nominal Seal Dimensions			Housing Dimensions					\$	
		Tol.	d	D	H	d1	Tol.	D1	Tol.	H1		Tol.
R022035100RA*	22.00	+0.00 / -0.04	22.00	35.00	10.00	22.00	+0.00 / -0.04	35.00	+0.10 / -0.00	11.00	+0.30 / -0.00	O/R
R024034060RA*	24.00	+0.00 / -0.04	24.00	34.00	6.00	24.00	+0.00 / -0.04	34.00	+0.10 / -0.00	7.00	+0.30 / -0.00	O/R
R025033050RA	25.00	+0.00 / -0.04	25.00	33.00	5.00	25.00	+0.00 / -0.04	33.00	+0.10 / -0.00	5.70	+0.30 / -0.00	7.74
R025035050RA*	25.00	+0.00 / -0.04	25.00	35.00	5.00	25.00	+0.00 / -0.04	35.00	+0.10 / -0.00	5.70	+0.30 / -0.00	O/R
R025035080RA*	25.00	+0.00 / -0.04	25.00	35.00	8.00	25.00	+0.00 / -0.04	35.00	+0.10 / -0.00	9.00	+0.30 / -0.00	O/R
R025035090RA*	25.00	+0.00 / -0.04	25.00	35.00	9.00	25.00	+0.00 / -0.04	35.00	+0.10 / -0.00	10.00	+0.30 / -0.00	O/R
R025038080RA*	25.00	+0.00 / -0.04	25.00	38.00	8.00	25.00	+0.00 / -0.04	38.00	+0.10 / -0.00	9.00	+0.30 / -0.00	O/R
R025038100RA*	25.00	+0.00 / -0.04	25.00	38.00	10.00	25.00	+0.00 / -0.04	38.00	+0.10 / -0.00	11.00	+0.30 / -0.00	O/R
R025040090RA*	25.00	+0.00 / -0.04	25.00	40.00	9.00	25.00	+0.00 / -0.04	40.00	+0.10 / -0.00	10.00	+0.30 / -0.00	O/R
R025040100RA*	25.00	+0.00 / -0.04	25.00	40.00	10.00	25.00	+0.00 / -0.04	40.00	+0.10 / -0.00	11.00	+0.30 / -0.00	O/R
R026036080RA*	26.00	+0.00 / -0.04	26.00	36.00	8.00	26.00	+0.00 / -0.04	36.00	+0.10 / -0.00	9.00	+0.30 / -0.00	O/R
R027040100RA*	27.00	+0.00 / -0.04	27.00	40.00	10.00	27.00	+0.00 / -0.04	40.00	+0.10 / -0.00	11.00	+0.30 / -0.00	O/R
R028034040RA*	28.00	+0.00 / -0.04	28.00	34.00	4.00	28.00	+0.00 / -0.04	34.00	+0.10 / -0.00	4.70	+0.30 / -0.00	O/R
R028036050RA*	28.00	+0.00 / -0.04	28.00	36.00	5.00	28.00	+0.00 / -0.04	36.00	+0.10 / -0.00	5.70	+0.30 / -0.00	O/R
R028038060RA*	28.00	+0.00 / -0.04	28.00	38.00	6.00	28.00	+0.00 / -0.04	38.00	+0.10 / -0.00	7.00	+0.30 / -0.00	O/R
R028038080RA*	28.00	+0.00 / -0.04	28.00	38.00	8.00	28.00	+0.00 / -0.04	38.00	+0.10 / -0.00	9.00	+0.30 / -0.00	O/R
R028041080RA*	28.00	+0.00 / -0.04	28.00	41.00	8.00	28.00	+0.00 / -0.04	41.00	+0.10 / -0.00	9.00	+0.30 / -0.00	O/R
R028041100RA*	28.00	+0.00 / -0.04	28.00	41.00	10.00	28.00	+0.00 / -0.04	41.00	+0.10 / -0.00	11.00	+0.30 / -0.00	O/R
R028043090RA*	28.00	+0.00 / -0.04	28.00	43.00	9.00	28.00	+0.00 / -0.04	43.00	+0.10 / -0.00	10.00	+0.30 / -0.00	O/R
R028043100RA*	28.00	+0.00 / -0.04	28.00	43.00	10.00	28.00	+0.00 / -0.04	43.00	+0.10 / -0.00	11.00	+0.30 / -0.00	O/R
R030036040RA*	30.00	+0.00 / -0.04	30.00	36.00	4.00	30.00	+0.00 / -0.04	36.00	+0.10 / -0.00	4.70	+0.30 / -0.00	O/R
R030037060RA*	30.00	+0.00 / -0.04	30.00	37.00	6.00	30.00	+0.00 / -0.04	37.00	+0.10 / -0.00	7.00	+0.30 / -0.00	O/R
R030038050RA*	30.00	+0.00 / -0.04	30.00	38.00	5.00	30.00	+0.00 / -0.04	38.00	+0.10 / -0.00	5.70	+0.30 / -0.00	O/R
R030040080RA*	30.00	+0.00 / -0.04	30.00	40.00	8.00	30.00	+0.00 / -0.04	40.00	+0.10 / -0.00	9.00	+0.30 / -0.00	O/R
R030043100RA	30.00	+0.00 / -0.04	30.00	43.00	10.00	30.00	+0.00 / -0.04	43.00	+0.10 / -0.00	11.00	+0.30 / -0.00	7.21
R030045090RA	30.00	+0.00 / -0.04	30.00	45.00	9.00	30.00	+0.00 / -0.04	45.00	+0.10 / -0.00	10.00	+0.30 / -0.00	9.17
R030045100RA*	30.00	+0.00 / -0.04	30.00	45.00	10.00	30.00	+0.00 / -0.04	45.00	+0.10 / -0.00	11.00	+0.30 / -0.00	O/R
R032042060RA*	32.00	+0.00 / -0.04	32.00	42.00	6.00	32.00	+0.00 / -0.04	42.00	+0.10 / -0.00	7.00	+0.30 / -0.00	O/R
R034040040RA*	34.00	+0.00 / -0.04	34.00	40.00	4.00	34.00	+0.00 / -0.04	40.00	+0.10 / -0.00	4.70	+0.30 / -0.00	O/R
R034043060RA*	34.00	+0.00 / -0.04	34.00	43.00	6.00	34.00	+0.00 / -0.04	43.00	+0.10 / -0.00	7.00	+0.30 / -0.00	O/R
R034044060RA*	34.00	+0.00 / -0.04	34.00	44.00	6.00	34.00	+0.00 / -0.04	44.00	+0.10 / -0.00	7.00	+0.30 / -0.00	O/R
R034050120RA*	34.00	+0.00 / -0.04	34.00	50.00	12.00	34.00	+0.00 / -0.04	50.00	+0.10 / -0.00	13.00	+0.30 / -0.00	O/R
R035041040RA*	35.00	+0.00 / -0.04	35.00	41.00	4.00	35.00	+0.00 / -0.04	41.00	+0.10 / -0.00	4.70	+0.30 / -0.00	O/R
R035043050RA*	35.00	+0.00 / -0.04	35.00	43.00	5.00	35.00	+0.00 / -0.04	43.00	+0.10 / -0.00	5.70	+0.30 / -0.00	O/R
R035045060RA	35.00	+0.00 / -0.04	35.00	45.00	6.00	35.00	+0.00 / -0.04	45.00	+0.10 / -0.00	7.00	+0.30 / -0.00	9.06
R035045070RA*	35.00	+0.00 / -0.04	35.00	45.00	7.00	35.00	+0.00 / -0.04	45.00	+0.10 / -0.00	8.00	+0.30 / -0.00	O/R
R035045080RA*	35.00	+0.00 / -0.04	35.00	45.00	8.00	35.00	+0.00 / -0.04	45.00	+0.10 / -0.00	9.00	+0.30 / -0.00	O/R
R035050090RA*	35.00	+0.00 / -0.04	35.00	50.00	9.00	35.00	+0.00 / -0.04	50.00	+0.10 / -0.00	10.00	+0.30 / -0.00	O/R
R035050100RA*	35.00	+0.00 / -0.04	35.00	50.00	10.00	35.00	+0.00 / -0.04	50.00	+0.10 / -0.00	11.00	+0.30 / -0.00	O/R
R036051100RA*	36.00	+0.00 / -0.04	36.00	51.00	10.00	36.00	+0.00 / -0.04	51.00	+0.12 / -0.00	11.00	+0.30 / -0.00	O/R
R038047060RA*	38.00	+0.00 / -0.04	38.00	47.00	6.00	38.00	+0.00 / -0.04	47.00	+0.10 / -0.00	7.00	+0.30 / -0.00	O/R
R038048060RA*	38.00	+0.00 / -0.04	38.00	48.00	6.00	38.00	+0.00 / -0.04	48.00	+0.10 / -0.00	7.00	+0.30 / -0.00	O/R
R039048060RA*	39.00	+0.00 / -0.05	39.00	48.00	6.00	39.00	+0.00 / -0.05	48.00	+0.10 / -0.00	7.00	+0.30 / -0.00	O/R
R040048060RA	40.00	+0.00 / -0.05	40.00	48.00	6.00	40.00	+0.00 / -0.05	48.00	+0.10 / -0.00	7.00	+0.30 / -0.00	17.06
R040050060RA	40.00	+0.00 / -0.05	40.00	50.00	6.00	40.00	+0.00 / -0.05	50.00	+0.10 / -0.00	7.00	+0.30 / -0.00	9.93
R040050070RA	40.00	+0.00 / -0.05	40.00	50.00	7.00	40.00	+0.00 / -0.05	50.00	+0.10 / -0.00	8.00	+0.30 / -0.00	10.78
R040055090RA	40.00	+0.00 / -0.05	40.00	55.00	9.00	40.00	+0.00 / -0.05	55.00	+0.12 / -0.00	10.00	+0.30 / -0.00	11.07

*: GENERALLY NOT STOCKED BUT AVAILABLE - CHECK WITH C/SER

Tel.: 1-888-609-SEAL
Fax: 1-888-717-SEAL

J 3

www.sealsourceinc.com

**METRIC SIZE
ROD SEALS**



Seal Source Inc.

METRIC SIZE
ROD SEALS

RA SERIES - AU 94A

Ref.Number	Rod diameter		Nominal Seal Dimensions			Housing Dimensions					\$	
		Tol.	d	D	H	d1	Tol.	D1	Tol.	H1		Tol.
R040055100RA	40.00	+0.00/-0.05	40.00	55.00	10.00	40.00	+0.00/-0.05	55.00	+0.12/-0.00	11.00	+0.30/-0.00	11.98
R040056100RA*	40.00	+0.00/-0.05	40.00	56.00	10.00	40.00	+0.00/-0.05	56.00	+0.12/-0.00	11.00	+0.30/-0.00	O/R
R040056120RA*	40.00	+0.00/-0.05	40.00	56.00	12.00	40.00	+0.00/-0.05	56.00	+0.12/-0.00	13.00	+0.30/-0.00	O/R
R041051060RA*	41.00	+0.00/-0.05	41.00	51.00	6.00	41.00	+0.00/-0.05	51.00	+0.12/-0.00	7.00	+0.30/-0.00	O/R
R042050050RA*	42.00	+0.00/-0.05	42.00	50.00	5.00	42.00	+0.00/-0.05	50.00	+0.10/-0.00	5.70	+0.30/-0.00	O/R
R042056100RA*	42.00	+0.00/-0.05	42.00	56.00	10.00	42.00	+0.00/-0.05	56.00	+0.12/-0.00	11.00	+0.30/-0.00	O/R
R043053060RA*	43.00	+0.00/-0.05	43.00	53.00	6.00	43.00	+0.00/-0.05	53.00	+0.12/-0.00	7.00	+0.30/-0.00	O/R
R045055060RA	45.00	+0.00/-0.05	45.00	55.00	6.00	45.00	+0.00/-0.05	55.00	+0.12/-0.00	7.00	+0.30/-0.00	11.72
R045055070RA	45.00	+0.00/-0.05	45.00	55.00	7.00	45.00	+0.00/-0.05	55.00	+0.12/-0.00	8.00	+0.30/-0.00	11.03
R045055080RA*	45.00	+0.00/-0.05	45.00	55.00	8.00	45.00	+0.00/-0.05	55.00	+0.12/-0.00	9.00	+0.30/-0.00	O/R
R045060090RA	45.00	+0.00/-0.05	45.00	60.00	9.00	45.00	+0.00/-0.05	60.00	+0.12/-0.00	10.00	+0.30/-0.00	13.95
R045060100RA	45.00	+0.00/-0.05	45.00	60.00	10.00	45.00	+0.00/-0.05	60.00	+0.12/-0.00	11.00	+0.30/-0.00	13.95
R045061100RA*	45.00	+0.00/-0.05	45.00	61.00	10.00	45.00	+0.00/-0.05	61.00	+0.12/-0.00	11.00	+0.30/-0.00	O/R
R045061120RA	45.00	+0.00/-0.05	45.00	61.00	12.00	45.00	+0.00/-0.05	61.00	+0.12/-0.00	13.00	+0.30/-0.00	10.95
R047063120RA*	47.00	+0.00/-0.05	47.00	63.00	12.00	47.00	+0.00/-0.05	63.00	+0.12/-0.00	13.00	+0.30/-0.00	O/R
R048058060RA*	48.00	+0.00/-0.05	48.00	58.00	6.00	48.00	+0.00/-0.05	58.00	+0.12/-0.00	7.00	+0.30/-0.00	O/R
R049059060RA*	49.00	+0.00/-0.05	49.00	59.00	6.00	49.00	+0.00/-0.05	59.00	+0.12/-0.00	7.00	+0.30/-0.00	O/R
R050060060RA	50.00	+0.00/-0.05	50.00	60.00	6.00	50.00	+0.00/-0.05	60.00	+0.12/-0.00	7.00	+0.30/-0.00	14.29
R050060080RA	50.00	+0.00/-0.05	50.00	60.00	8.00	50.00	+0.00/-0.05	60.00	+0.12/-0.00	9.00	+0.30/-0.00	14.29
R050063100RA	50.00	+0.00/-0.05	50.00	63.00	10.00	50.00	+0.00/-0.05	63.00	+0.12/-0.00	11.00	+0.30/-0.00	14.05
R050065090RA	50.00	+0.00/-0.05	50.00	65.00	9.00	50.00	+0.00/-0.05	65.00	+0.12/-0.00	10.00	+0.30/-0.00	14.19
R050065100RA	50.00	+0.00/-0.05	50.00	65.00	10.00	50.00	+0.00/-0.05	65.00	+0.12/-0.00	11.00	+0.30/-0.00	14.19
R050066100RA*	50.00	+0.00/-0.05	50.00	66.00	10.00	50.00	+0.00/-0.05	66.00	+0.12/-0.00	11.00	+0.30/-0.00	O/R
R050066120RA	50.00	+0.00/-0.05	50.00	66.00	12.00	50.00	+0.00/-0.05	66.00	+0.12/-0.00	13.00	+0.30/-0.00	9.95
R050070120RA*	50.00	+0.00/-0.05	50.00	70.00	12.00	50.00	+0.00/-0.05	70.00	+0.12/-0.00	13.00	+0.30/-0.00	14.29
R052062060RA*	52.00	+0.00/-0.05	52.00	62.00	6.00	52.00	+0.00/-0.05	62.00	+0.12/-0.00	7.00	+0.30/-0.00	O/R
R053063060RA*	53.00	+0.00/-0.05	53.00	63.00	6.00	53.00	+0.00/-0.05	63.00	+0.12/-0.00	7.00	+0.30/-0.00	O/R
R053063080RA*	53.00	+0.00/-0.05	53.00	63.00	8.00	53.00	+0.00/-0.05	63.00	+0.12/-0.00	9.00	+0.30/-0.00	O/R
R055065060RA	55.00	+0.00/-0.05	55.00	65.00	6.00	55.00	+0.00/-0.05	65.00	+0.12/-0.00	7.00	+0.30/-0.00	17.40
R055065080RA*	55.00	+0.00/-0.05	55.00	65.00	8.00	55.00	+0.00/-0.05	65.00	+0.12/-0.00	9.00	+0.30/-0.00	O/R
R055068100RA	55.00	+0.00/-0.05	55.00	68.00	10.00	55.00	+0.00/-0.05	68.00	+0.12/-0.00	11.00	+0.30/-0.00	17.53
R055070090RA	55.00	+0.00/-0.05	55.00	70.00	9.00	55.00	+0.00/-0.05	70.00	+0.12/-0.00	10.00	+0.30/-0.00	16.16
R055070100RA	55.00	+0.00/-0.05	55.00	70.00	10.00	55.00	+0.00/-0.05	70.00	+0.12/-0.00	11.00	+0.30/-0.00	16.16
R055071100RA*	55.00	+0.00/-0.05	55.00	71.00	10.00	55.00	+0.00/-0.05	71.00	+0.12/-0.00	11.00	+0.30/-0.00	O/R
R055075120RA*	55.00	+0.00/-0.05	55.00	75.00	12.00	55.00	+0.00/-0.05	75.00	+0.12/-0.00	13.00	+0.30/-0.00	O/R
R056066060RA	56.00	+0.00/-0.05	56.00	66.00	6.00	56.00	+0.00/-0.05	66.00	+0.12/-0.00	7.00	+0.30/-0.00	17.78
R056068060RA*	56.00	+0.00/-0.05	56.00	68.00	6.00	56.00	+0.00/-0.05	68.00	+0.12/-0.00	7.00	+0.30/-0.00	O/R
R056071090RA*	56.00	+0.00/-0.05	56.00	71.00	9.00	56.00	+0.00/-0.05	71.00	+0.12/-0.00	10.00	+0.30/-0.00	O/R
R056071100RA*	56.00	+0.00/-0.05	56.00	71.00	10.00	56.00	+0.00/-0.05	71.00	+0.12/-0.00	11.00	+0.30/-0.00	O/R
R056072100RA*	56.00	+0.00/-0.05	56.00	72.00	10.00	56.00	+0.00/-0.05	72.00	+0.12/-0.00	11.00	+0.30/-0.00	O/R
R056076120RA*	56.00	+0.00/-0.05	56.00	76.00	12.00	56.00	+0.00/-0.05	76.00	+0.12/-0.00	13.00	+0.30/-0.00	O/R
R057065050RA*	57.00	+0.00/-0.05	57.00	65.00	5.00	57.00	+0.00/-0.05	65.00	+0.12/-0.00	5.70	+0.30/-0.00	O/R
R058068060RA*	58.00	+0.00/-0.05	58.00	68.00	6.00	58.00	+0.00/-0.05	68.00	+0.12/-0.00	7.00	+0.30/-0.00	O/R
R058070065RA*	58.00	+0.00/-0.05	58.00	70.00	6.50	58.00	+0.00/-0.05	70.00	+0.12/-0.00	7.50	+0.30/-0.00	O/R
R060070060RA	60.00	+0.00/-0.05	60.00	70.00	6.00	60.00	+0.00/-0.05	70.00	+0.12/-0.00	7.00	+0.30/-0.00	18.34
R060070080RA*	60.00	+0.00/-0.05	60.00	70.00	8.00	60.00	+0.00/-0.05	70.00	+0.12/-0.00	9.00	+0.30/-0.00	O/R
R060071070RA*	60.00	+0.00/-0.05	60.00	71.00	7.00	60.00	+0.00/-0.05	71.00	+0.12/-0.00	8.00	+0.30/-0.00	O/R

*: GENERALLY NOT STOCKED BUT AVAILABLE - CHECK WITH C/SER

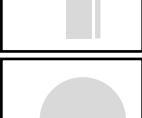
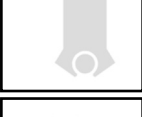

M

Seal Source Inc.

**METRIC SIZE
ROD SEALS**

RA SERIES - AU 94A

Ref.Number	Rod diameter	Nominal Seal Dimensions			Housing Dimensions					\$	
	Tol.	d	D	H	d1	Tol.	D1	Tol.	H1		Tol.
R075090090RA	75.00 +0.00 / -0.06	75.00	90.00	9.00	75.00	+0.00 / -0.06	90.00	+0.14 / -0.00	10.00	+0.30 / -0.00	19.31
R075090100RA	75.00 +0.00 / -0.06	75.00	90.00	10.00	75.00	+0.00 / -0.06	90.00	+0.14 / -0.00	11.00	+0.30 / -0.00	21.23
R075095120RA	75.00 +0.00 / -0.06	75.00	95.00	12.00	75.00	+0.00 / -0.06	95.00	+0.14 / -0.00	13.00	+0.30 / -0.00	21.23
R075095150RA*	75.00 +0.00 / -0.06	75.00	95.00	15.00	75.00	+0.00 / -0.06	95.00	+0.14 / -0.00	16.00	+0.30 / -0.00	O/R
R076088055RA*	76.00 +0.00 / -0.06	76.00	88.00	5.50	76.00	+0.00 / -0.06	88.00	+0.14 / -0.00	6.50	+0.30 / -0.00	O/R
R080090060RA	80.00 +0.00 / -0.09	80.00	90.00	6.00	80.00	+0.00 / -0.09	90.00	+0.14 / -0.00	7.00	+0.30 / -0.00	20.34
R080090080RA	80.00 +0.00 / -0.09	80.00	90.00	8.00	80.00	+0.00 / -0.09	90.00	+0.14 / -0.00	9.00	+0.30 / -0.00	O/R
R080093090RA*	80.00 +0.00 / -0.09	80.00	93.00	9.00	80.00	+0.00 / -0.09	93.00	+0.14 / -0.00	10.00	+0.30 / -0.00	O/R
R080093100RA	80.00 +0.00 / -0.09	80.00	93.00	10.00	80.00	+0.00 / -0.09	93.00	+0.14 / -0.00	11.00	+0.30 / -0.00	21.50
R080095090RA	80.00 +0.00 / -0.09	80.00	95.00	9.00	80.00	+0.00 / -0.09	95.00	+0.14 / -0.00	10.00	+0.30 / -0.00	21.50
R080095100RA	80.00 +0.00 / -0.09	80.00	95.00	10.00	80.00	+0.00 / -0.09	95.00	+0.14 / -0.00	11.00	+0.30 / -0.00	22.16
R080095120RA*	80.00 +0.00 / -0.09	80.00	95.00	12.00	80.00	+0.00 / -0.09	95.00	+0.14 / -0.00	13.00	+0.30 / -0.00	O/R
R080100120RA	80.00 +0.00 / -0.09	80.00	100.00	12.00	80.00	+0.00 / -0.09	100.00	+0.14 / -0.00	13.00	+0.30 / -0.00	23.35
R080100150RA*	80.00 +0.00 / -0.09	80.00	100.00	15.00	80.00	+0.00 / -0.09	100.00	+0.14 / -0.00	16.00	+0.30 / -0.00	O/R
R085100090RA	85.00 +0.00 / -0.09	85.00	100.00	9.00	85.00	+0.00 / -0.09	100.00	+0.14 / -0.00	10.00	+0.30 / -0.00	23.35
R085100100RA	85.00 +0.00 / -0.09	85.00	100.00	10.00	85.00	+0.00 / -0.09	100.00	+0.14 / -0.00	11.00	+0.30 / -0.00	23.43
R085105150RA*	85.00 +0.00 / -0.09	85.00	105.00	15.00	85.00	+0.00 / -0.09	105.00	+0.14 / -0.00	16.00	+0.30 / -0.00	O/R
R086096060RA	86.00 +0.00 / -0.09	86.00	96.00	6.00	86.00	+0.00 / -0.09	96.00	+0.14 / -0.00	7.00	+0.30 / -0.00	20.34
R090100060RA	90.00 +0.00 / -0.09	90.00	100.00	6.00	90.00	+0.00 / -0.09	100.00	+0.14 / -0.00	7.00	+0.30 / -0.00	20.34
R090105090RA	90.00 +0.00 / -0.09	90.00	105.00	9.00	90.00	+0.00 / -0.09	105.00	+0.14 / -0.00	10.00	+0.30 / -0.00	24.58
R090105100RA	90.00 +0.00 / -0.09	90.00	105.00	10.00	90.00	+0.00 / -0.09	105.00	+0.14 / -0.00	11.00	+0.30 / -0.00	24.85
R090110120RA	90.00 +0.00 / -0.09	90.00	110.00	12.00	90.00	+0.00 / -0.09	110.00	+0.14 / -0.00	13.00	+0.30 / -0.00	16.77
R090110130RA*	90.00 +0.00 / -0.09	90.00	110.00	13.00	90.00	+0.00 / -0.09	110.00	+0.14 / -0.00	14.00	+0.30 / -0.00	O/R
R090110150RA*	90.00 +0.00 / -0.09	90.00	110.00	15.00	90.00	+0.00 / -0.09	110.00	+0.14 / -0.00	16.00	+0.30 / -0.00	O/R
R092107090RA*	92.00 +0.00 / -0.09	92.00	107.00	9.00	92.00	+0.00 / -0.09	107.00	+0.14 / -0.00	10.00	+0.30 / -0.00	O/R
R093108090RA*	93.00 +0.00 / -0.09	93.00	108.00	9.00	93.00	+0.00 / -0.09	108.00	+0.14 / -0.00	10.00	+0.30 / -0.00	O/R
R095105120RA*	95.00 +0.00 / -0.09	95.00	105.00	12.00	95.00	+0.00 / -0.09	105.00	+0.14 / -0.00	13.00	+0.30 / -0.00	O/R
R095110090RA	95.00 +0.00 / -0.09	95.00	110.00	9.00	95.00	+0.00 / -0.09	110.00	+0.14 / -0.00	10.00	+0.30 / -0.00	26.01
R095110100RA	95.00 +0.00 / -0.09	95.00	110.00	10.00	95.00	+0.00 / -0.09	110.00	+0.14 / -0.00	11.00	+0.30 / -0.00	26.01
R095115120RA	95.00 +0.00 / -0.09	95.00	115.00	12.00	95.00	+0.00 / -0.09	115.00	+0.14 / -0.00	13.00	+0.30 / -0.00	26.24
R095115150RA*	95.00 +0.00 / -0.09	95.00	115.00	15.00	95.00	+0.00 / -0.09	115.00	+0.14 / -0.00	16.00	+0.30 / -0.00	O/R
R097112090RA*	97.00 +0.00 / -0.09	97.00	112.00	9.00	97.00	+0.00 / -0.09	112.00	+0.14 / -0.00	10.00	+0.30 / -0.00	O/R
R098112085RA*	98.00 +0.00 / -0.09	98.00	112.00	8.50	98.00	+0.00 / -0.09	112.00	+0.14 / -0.00	9.50	+0.30 / -0.00	O/R
R098113090RA*	98.00 +0.00 / -0.09	98.00	113.00	9.00	98.00	+0.00 / -0.09	113.00	+0.14 / -0.00	10.00	+0.30 / -0.00	O/R
R100110060RA*	100.00 +0.00 / -0.09	100.00	110.00	6.00	100.00	+0.00 / -0.09	110.00	+0.14 / -0.00	7.00	+0.30 / -0.00	O/R
R100115090RA	100.00 +0.00 / -0.09	100.00	115.00	9.00	100.00	+0.00 / -0.09	115.00	+0.14 / -0.00	10.00	+0.30 / -0.00	30.01
R100115100RA	100.00 +0.00 / -0.09	100.00	115.00	10.00	100.00	+0.00 / -0.09	115.00	+0.14 / -0.00	11.00	+0.30 / -0.00	19.88
R100115120RA	100.00 +0.00 / -0.09	100.00	115.00	12.00	100.00	+0.00 / -0.09	115.00	+0.14 / -0.00	13.00	+0.30 / -0.00	48.31
R100120120RA	100.00 +0.00 / -0.09	100.00	120.00	12.00	100.00	+0.00 / -0.09	120.00	+0.14 / -0.00	13.00	+0.30 / -0.00	28.45
R100120130RA	100.00 +0.00 / -0.09	100.00	120.00	13.00	100.00	+0.00 / -0.09	120.00	+0.14 / -0.00	14.00	+0.30 / -0.00	24.10
R100120150RA*	100.00 +0.00 / -0.09	100.00	120.00	15.00	100.00	+0.00 / -0.09	120.00	+0.14 / -0.00	16.00	+0.30 / -0.00	24.10
R102117100RA*	102.00 +0.00 / -0.09	102.00	117.00	10.00	102.00	+0.00 / -0.09	117.00	+0.14 / -0.00	11.00	+0.30 / -0.00	O/R
R105120090RA	105.00 +0.00 / -0.13	105.00	120.00	9.00	105.00	+0.00 / -0.13	120.00	+0.14 / -0.00	10.00	+0.30 / -0.00	31.46
R105120100RA	105.00 +0.00 / -0.13	105.00	120.00	10.00	105.00	+0.00 / -0.13	120.00	+0.14 / -0.00	11.00	+0.30 / -0.00	32.56
R105125120RA	105.00 +0.00 / -0.13	105.00	125.00	12.00	105.00	+0.00 / -0.13	125.00	+0.16 / -0.00	13.00	+0.30 / -0.00	35.33
R105125150RA	105.00 +0.00 / -0.13	105.00	125.00	15.00	105.00	+0.00 / -0.13	125.00	+0.16 / -0.00	16.00	+0.30 / -0.00	34.20
R105125160RA*	105.00 +0.00 / -0.13	105.00	125.00	16.00	105.00	+0.00 / -0.13	125.00	+0.16 / -0.00	17.00	+0.30 / -0.00	O/R

*: GENERALLY NOT STOCKED BUT AVAILABLE - CHECK WITH C/SER

M

RA SERIES - AU 94A

Ref.Number	Rod diameter		Nominal Seal Dimensions			Housing Dimensions					\$	
		Tol.	d	D	H	d1	Tol.	D1	Tol.	H1		Tol.
R106120085RA*	106.00	+0.00 / -0.13	106.00	120.00	8.50	106.00	+0.00 / -0.13	120.00	+0.14 / -0.00	9.50	+0.30 / -0.00	O/R
R106121090RA*	106.00	+0.00 / -0.13	106.00	121.00	9.00	106.00	+0.00 / -0.13	121.00	+0.16 / -0.00	10.00	+0.30 / -0.00	O/R
R106121100RA*	106.00	+0.00 / -0.13	106.00	121.00	10.00	106.00	+0.00 / -0.13	121.00	+0.16 / -0.00	11.00	+0.30 / -0.00	O/R
R106126150RA*	106.00	+0.00 / -0.13	106.00	126.00	15.00	106.00	+0.00 / -0.13	126.00	+0.16 / -0.00	16.00	+0.30 / -0.00	O/R
R106126160RA*	106.00	+0.00 / -0.13	106.00	126.00	16.00	106.00	+0.00 / -0.13	126.00	+0.16 / -0.00	17.00	+0.30 / -0.00	O/R
R107122100RA*	107.00	+0.00 / -0.13	107.00	122.00	10.00	107.00	+0.00 / -0.13	122.00	+0.16 / -0.00	11.00	+0.30 / -0.00	O/R
R110120065RA*	110.00	+0.00 / -0.13	110.00	120.00	6.50	110.00	+0.00 / -0.13	120.00	+0.14 / -0.00	7.50	+0.30 / -0.00	O/R
R110120070RA*	110.00	+0.00 / -0.13	110.00	120.00	7.00	110.00	+0.00 / -0.13	120.00	+0.14 / -0.00	8.00	+0.30 / -0.00	O/R
R110125090RA	110.00	+0.00 / -0.13	110.00	125.00	9.00	110.00	+0.00 / -0.13	125.00	+0.16 / -0.00	10.00	+0.30 / -0.00	36.14
R110125100RA	110.00	+0.00 / -0.13	110.00	125.00	10.00	110.00	+0.00 / -0.13	125.00	+0.16 / -0.00	11.00	+0.30 / -0.00	36.79
R110130100RA	110.00	+0.00 / -0.13	110.00	130.00	10.00	110.00	+0.00 / -0.13	130.00	+0.16 / -0.00	11.00	+0.30 / -0.00	37.49
R110130120RA	110.00	+0.00 / -0.13	110.00	130.00	12.00	110.00	+0.00 / -0.13	130.00	+0.16 / -0.00	13.00	+0.30 / -0.00	37.96
R110130130RA*	110.00	+0.00 / -0.13	110.00	130.00	13.00	110.00	+0.00 / -0.13	130.00	+0.16 / -0.00	14.00	+0.30 / -0.00	O/R
R110130150RA*	110.00	+0.00 / -0.13	110.00	130.00	15.00	110.00	+0.00 / -0.13	130.00	+0.16 / -0.00	16.00	+0.30 / -0.00	O/R
R110130160RA*	110.00	+0.00 / -0.13	110.00	130.00	16.00	110.00	+0.00 / -0.13	130.00	+0.16 / -0.00	17.00	+0.30 / -0.00	O/R
R111121060RA*	111.00	+0.00 / -0.13	111.00	121.00	6.00	111.00	+0.00 / -0.13	121.00	+0.16 / -0.00	7.00	+0.30 / -0.00	O/R
R111126090RA*	111.00	+0.00 / -0.13	111.00	126.00	9.00	111.00	+0.00 / -0.13	126.00	+0.16 / -0.00	10.00	+0.30 / -0.00	O/R
R112125090RA*	112.00	+0.00 / -0.13	112.00	125.00	9.00	112.00	+0.00 / -0.13	125.00	+0.16 / -0.00	10.00	+0.30 / -0.00	O/R
R112127090RA*	112.00	+0.00 / -0.13	112.00	127.00	9.00	112.00	+0.00 / -0.13	127.00	+0.16 / -0.00	10.00	+0.30 / -0.00	O/R
R112127100RA*	112.00	+0.00 / -0.13	112.00	127.00	10.00	112.00	+0.00 / -0.13	127.00	+0.16 / -0.00	11.00	+0.30 / -0.00	O/R
R112132150RA*	112.00	+0.00 / -0.13	112.00	132.00	15.00	112.00	+0.00 / -0.13	132.00	+0.16 / -0.00	16.00	+0.30 / -0.00	41.48
R112132160RA*	112.00	+0.00 / -0.13	112.00	132.00	16.00	112.00	+0.00 / -0.13	132.00	+0.16 / -0.00	17.00	+0.30 / -0.00	34.01
R112135150RA*	112.00	+0.00 / -0.13	112.00	135.00	15.00	112.00	+0.00 / -0.13	135.00	+0.16 / -0.00	16.00	+0.30 / -0.00	O/R
R115130090RA	115.00	+0.00 / -0.13	115.00	130.00	9.00	115.00	+0.00 / -0.13	130.00	+0.16 / -0.00	10.00	+0.30 / -0.00	39.51
R115130100RA*	115.00	+0.00 / -0.13	115.00	130.00	10.00	115.00	+0.00 / -0.13	130.00	+0.16 / -0.00	11.00	+0.30 / -0.00	O/R
R115135120RA	115.00	+0.00 / -0.13	115.00	135.00	12.00	115.00	+0.00 / -0.13	135.00	+0.16 / -0.00	13.00	+0.30 / -0.00	O/R
R115135160RA*	115.00	+0.00 / -0.13	115.00	135.00	16.00	115.00	+0.00 / -0.13	135.00	+0.16 / -0.00	17.00	+0.30 / -0.00	O/R
R116131090RA*	116.00	+0.00 / -0.13	116.00	131.00	9.00	116.00	+0.00 / -0.13	131.00	+0.16 / -0.00	10.00	+0.30 / -0.00	O/R
R117133085RA*	117.00	+0.00 / -0.13	117.00	133.00	8.50	117.00	+0.00 / -0.13	133.00	+0.16 / -0.00	9.50	+0.30 / -0.00	O/R
R118128060RA*	118.00	+0.00 / -0.13	118.00	128.00	6.00	118.00	+0.00 / -0.13	128.00	+0.16 / -0.00	7.00	+0.30 / -0.00	O/R
R118133090RA	118.00	+0.00 / -0.13	118.00	133.00	9.00	118.00	+0.00 / -0.13	133.00	+0.16 / -0.00	10.00	+0.30 / -0.00	43.54
R118133100RA*	118.00	+0.00 / -0.13	118.00	133.00	10.00	118.00	+0.00 / -0.13	133.00	+0.16 / -0.00	11.00	+0.30 / -0.00	O/R
R118138150RA*	118.00	+0.00 / -0.13	118.00	138.00	15.00	118.00	+0.00 / -0.13	138.00	+0.16 / -0.00	16.00	+0.30 / -0.00	O/R
R118138160RA*	118.00	+0.00 / -0.13	118.00	138.00	16.00	118.00	+0.00 / -0.13	138.00	+0.16 / -0.00	17.00	+0.30 / -0.00	O/R
R120135090RA	120.00	+0.00 / -0.13	120.00	135.00	9.00	120.00	+0.00 / -0.13	135.00	+0.16 / -0.00	10.00	+0.30 / -0.00	40.43
R120135100RA*	120.00	+0.00 / -0.13	120.00	135.00	10.00	120.00	+0.00 / -0.13	135.00	+0.16 / -0.00	11.00	+0.30 / -0.00	44.42
R120140100RA	120.00	+0.00 / -0.13	120.00	140.00	10.00	120.00	+0.00 / -0.13	140.00	+0.16 / -0.00	11.00	+0.30 / -0.00	41.84
R120140120RA	120.00	+0.00 / -0.13	120.00	140.00	12.00	120.00	+0.00 / -0.13	140.00	+0.16 / -0.00	13.00	+0.30 / -0.00	44.07
R120140130RA*	120.00	+0.00 / -0.13	120.00	140.00	13.00	120.00	+0.00 / -0.13	140.00	+0.16 / -0.00	14.00	+0.30 / -0.00	O/R
R120140150RA*	120.00	+0.00 / -0.13	120.00	140.00	15.00	120.00	+0.00 / -0.13	140.00	+0.16 / -0.00	16.00	+0.30 / -0.00	O/R
R120140160RA*	120.00	+0.00 / -0.13	120.00	140.00	16.00	120.00	+0.00 / -0.13	140.00	+0.16 / -0.00	17.00	+0.30 / -0.00	O/R
R125135060RA*	125.00	+0.00 / -0.13	125.00	135.00	6.00	125.00	+0.00 / -0.13	135.00	+0.16 / -0.00	7.00	+0.30 / -0.00	O/R
R125140100RA	125.00	+0.00 / -0.13	125.00	140.00	10.00	125.00	+0.00 / -0.13	140.00	+0.16 / -0.00	11.00	+0.30 / -0.00	34.01
R125145120RA	125.00	+0.00 / -0.13	125.00	145.00	12.00	125.00	+0.00 / -0.13	145.00	+0.16 / -0.00	13.00	+0.30 / -0.00	26.87
R125145160RA*	125.00	+0.00 / -0.13	125.00	145.00	16.00	125.00	+0.00 / -0.13	145.00	+0.16 / -0.00	17.00	+0.30 / -0.00	O/R
R125150190RA*	125.00	+0.00 / -0.13	125.00	150.00	19.00	125.00	+0.00 / -0.13	150.00	+0.16 / -0.00	20.00	+0.30 / -0.00	O/R
R125150200RA*	125.00	+0.00 / -0.13	125.00	150.00	20.00	125.00	+0.00 / -0.13	150.00	+0.16 / -0.00	21.00	+0.30 / -0.00	O/R

*: GENERALLY NOT STOCKED BUT AVAILABLE - CHECK WITH C/SER

Tel.: 1-888-609-SEAL
Fax: 1-888-717-SEAL



www.sealsourceinc.com

**METRIC SIZE
ROD SEALS**



Seal Source Inc.

RA SERIES - AU 94A

METRIC SIZE
ROD SEALS

Ref.Number	Rod diameter		Nominal Seal Dimensions			Housing Dimensions					\$	
		Tol.	d	D	H	d1	Tol.	D1	Tol.	H1		Tol.
R130140060RA*	130.00	+0.00 / -0.13	130.00	140.00	6.00	130.00	+0.00 / -0.13	140.00	+0.16 / -0.00	7.00	+0.30 / -0.00	O/R
R130145090RA	130.00	+0.00 / -0.13	130.00	145.00	9.00	130.00	+0.00 / -0.13	145.00	+0.16 / -0.00	10.00	+0.30 / -0.00	35.91
R130145100RA	130.00	+0.00 / -0.13	130.00	145.00	10.00	130.00	+0.00 / -0.13	145.00	+0.16 / -0.00	11.00	+0.30 / -0.00	55.48
R130150090RA*	130.00	+0.00 / -0.13	130.00	150.00	9.00	130.00	+0.00 / -0.13	150.00	+0.16 / -0.00	10.00	+0.30 / -0.00	O/R
R130150120RA	130.00	+0.00 / -0.13	130.00	150.00	12.00	130.00	+0.00 / -0.13	150.00	+0.16 / -0.00	13.00	+0.30 / -0.00	41.82
R130150130RA*	130.00	+0.00 / -0.13	130.00	150.00	13.00	130.00	+0.00 / -0.13	150.00	+0.16 / -0.00	14.00	+0.30 / -0.00	O/R
R130150160RA*	130.00	+0.00 / -0.13	130.00	150.00	16.00	130.00	+0.00 / -0.13	150.00	+0.16 / -0.00	17.00	+0.30 / -0.00	O/R
R130155195RA*	130.00	+0.00 / -0.13	130.00	155.00	19.50	130.00	+0.00 / -0.13	155.00	+0.16 / -0.00	20.50	+0.30 / -0.00	O/R
R132157200RA*	132.00	+0.00 / -0.13	132.00	157.00	20.00	132.00	+0.00 / -0.13	157.00	+0.16 / -0.00	21.00	+0.30 / -0.00	O/R
R135150130RA*	135.00	+0.00 / -0.13	135.00	150.00	13.00	135.00	+0.00 / -0.13	150.00	+0.16 / -0.00	14.00	+0.30 / -0.00	O/R
R135155120RA*	135.00	+0.00 / -0.13	135.00	155.00	12.00	135.00	+0.00 / -0.13	155.00	+0.16 / -0.00	13.00	+0.30 / -0.00	O/R
R135155150RA*	135.00	+0.00 / -0.13	135.00	155.00	15.00	135.00	+0.00 / -0.13	155.00	+0.16 / -0.00	16.00	+0.30 / -0.00	O/R
R135155160RA*	135.00	+0.00 / -0.13	135.00	155.00	16.00	135.00	+0.00 / -0.13	155.00	+0.16 / -0.00	17.00	+0.30 / -0.00	O/R
R135160190RA*	135.00	+0.00 / -0.13	135.00	160.00	19.00	135.00	+0.00 / -0.13	160.00	+0.16 / -0.00	20.00	+0.30 / -0.00	O/R
R136150085RA*	136.00	+0.00 / -0.13	136.00	150.00	8.50	136.00	+0.00 / -0.13	150.00	+0.16 / -0.00	9.50	+0.30 / -0.00	O/R
R140150060RA*	140.00	+0.00 / -0.13	140.00	150.00	6.00	140.00	+0.00 / -0.13	150.00	+0.16 / -0.00	7.00	+0.30 / -0.00	O/R
R140150070RA*	140.00	+0.00 / -0.13	140.00	150.00	7.00	140.00	+0.00 / -0.13	150.00	+0.16 / -0.00	8.00	+0.30 / -0.00	O/R
R140155090RA	140.00	+0.00 / -0.13	140.00	155.00	9.00	140.00	+0.00 / -0.13	155.00	+0.16 / -0.00	10.00	+0.30 / -0.00	30.10
R140155100RA	140.00	+0.00 / -0.13	140.00	155.00	10.00	140.00	+0.00 / -0.13	155.00	+0.16 / -0.00	11.00	+0.30 / -0.00	50.82
R140160090RA*	140.00	+0.00 / -0.13	140.00	160.00	9.00	140.00	+0.00 / -0.13	160.00	+0.16 / -0.00	10.00	+0.30 / -0.00	O/R
R140160120RA	140.00	+0.00 / -0.13	140.00	160.00	12.00	140.00	+0.00 / -0.13	160.00	+0.16 / -0.00	13.00	+0.30 / -0.00	47.38
R140160130RA	140.00	+0.00 / -0.13	140.00	160.00	13.00	140.00	+0.00 / -0.13	160.00	+0.16 / -0.00	14.00	+0.30 / -0.00	55.34
R140160160RA	140.00	+0.00 / -0.13	140.00	160.00	16.00	140.00	+0.00 / -0.13	160.00	+0.16 / -0.00	17.00	+0.30 / -0.00	55.34
R140165120RA*	140.00	+0.00 / -0.13	140.00	165.00	12.00	140.00	+0.00 / -0.13	165.00	+0.16 / -0.00	13.00	+0.30 / -0.00	O/R
R140165190RA*	140.00	+0.00 / -0.13	140.00	165.00	19.00	140.00	+0.00 / -0.13	165.00	+0.16 / -0.00	20.00	+0.30 / -0.00	O/R
R140165200RA*	140.00	+0.00 / -0.13	140.00	165.00	20.00	140.00	+0.00 / -0.13	165.00	+0.16 / -0.00	21.00	+0.30 / -0.00	O/R
R143157090RA*	143.00	+0.00 / -0.13	143.00	157.00	9.00	143.00	+0.00 / -0.13	157.00	+0.16 / -0.00	10.00	+0.30 / -0.00	O/R
R143158090RA*	143.00	+0.00 / -0.13	143.00	158.00	9.00	143.00	+0.00 / -0.13	158.00	+0.16 / -0.00	10.00	+0.30 / -0.00	O/R
R145160090RA*	145.00	+0.00 / -0.13	145.00	160.00	9.00	145.00	+0.00 / -0.13	160.00	+0.16 / -0.00	10.00	+0.30 / -0.00	82.47
R145170190RA*	145.00	+0.00 / -0.13	145.00	170.00	19.00	145.00	+0.00 / -0.13	170.00	+0.16 / -0.00	20.00	+0.30 / -0.00	O/R
R145170200RA*	145.00	+0.00 / -0.13	145.00	170.00	20.00	145.00	+0.00 / -0.13	170.00	+0.16 / -0.00	21.00	+0.30 / -0.00	O/R
R150165090RA	150.00	+0.00 / -0.13	150.00	165.00	9.00	150.00	+0.00 / -0.13	165.00	+0.16 / -0.00	10.00	+0.30 / -0.00	101.81
R150165100RA	150.00	+0.00 / -0.13	150.00	165.00	10.00	150.00	+0.00 / -0.13	165.00	+0.16 / -0.00	11.00	+0.30 / -0.00	69.63
R150170120RA	150.00	+0.00 / -0.13	150.00	170.00	12.00	150.00	+0.00 / -0.13	170.00	+0.16 / -0.00	13.00	+0.30 / -0.00	55.68
R150170160RA*	150.00	+0.00 / -0.13	150.00	170.00	16.00	150.00	+0.00 / -0.13	170.00	+0.16 / -0.00	17.00	+0.30 / -0.00	O/R
R150175160RA*	150.00	+0.00 / -0.13	150.00	175.00	16.00	150.00	+0.00 / -0.13	175.00	+0.16 / -0.00	17.00	+0.30 / -0.00	71.59
R150175200RA*	150.00	+0.00 / -0.13	150.00	175.00	20.00	150.00	+0.00 / -0.13	175.00	+0.16 / -0.00	21.00	+0.30 / -0.00	O/R
R155165060RA*	155.00	+0.00 / -0.13	155.00	165.00	6.00	155.00	+0.00 / -0.13	165.00	+0.16 / -0.00	7.00	+0.30 / -0.00	O/R
R155170090RA*	155.00	+0.00 / -0.13	155.00	170.00	9.00	155.00	+0.00 / -0.13	170.00	+0.16 / -0.00	10.00	+0.30 / -0.00	94.42
R155175090RA*	155.00	+0.00 / -0.13	155.00	175.00	9.00	155.00	+0.00 / -0.13	175.00	+0.16 / -0.00	10.00	+0.30 / -0.00	O/R
R155180190RA*	155.00	+0.00 / -0.13	155.00	180.00	19.00	155.00	+0.00 / -0.13	180.00	+0.16 / -0.00	20.00	+0.30 / -0.00	131.67
R157175100RA*	157.00	+0.00 / -0.13	157.00	175.00	10.00	157.00	+0.00 / -0.13	175.00	+0.16 / -0.00	11.00	+0.30 / -0.00	O/R
R160175090RA*	160.00	+0.00 / -0.13	160.00	175.00	9.00	160.00	+0.00 / -0.13	175.00	+0.16 / -0.00	10.00	+0.30 / -0.00	O/R
R160175100RA*	160.00	+0.00 / -0.13	160.00	175.00	10.00	160.00	+0.00 / -0.13	175.00	+0.16 / -0.00	11.00	+0.30 / -0.00	O/R
R160180120RA	160.00	+0.00 / -0.13	160.00	180.00	12.00	160.00	+0.00 / -0.13	180.00	+0.16 / -0.00	13.00	+0.30 / -0.00	66.36
R160180160RA*	160.00	+0.00 / -0.13	160.00	180.00	16.00	160.00	+0.00 / -0.13	180.00	+0.16 / -0.00	17.00	+0.30 / -0.00	68.11
R160185160RA	160.00	+0.00 / -0.13	160.00	185.00	16.00	160.00	+0.00 / -0.13	185.00	+0.18 / -0.00	17.00	+0.30 / -0.00	68.11

*: GENERALLY NOT STOCKED BUT AVAILABLE - CHECK WITH C/SER

Seal Source Inc.

RA SERIES - AU 94A

Ref.Number	Rod diameter		Nominal Seal Dimensions			Housing Dimensions					\$	
		Tol.	d	D	H	d1	Tol.	D1	Tol.	H1		Tol.
R160185190RA*	160.00	+0.00 / -0.13	160.00	185.00	19.00	160.00	+0.00 / -0.13	185.00	+0.18 / -0.00	20.00	+0.30 / -0.00	O/R
R160185200RA*	160.00	+0.00 / -0.13	160.00	185.00	20.00	160.00	+0.00 / -0.13	185.00	+0.18 / -0.00	21.00	+0.30 / -0.00	O/R
R165180090RA*	165.00	+0.00 / -0.13	165.00	180.00	9.00	165.00	+0.00 / -0.13	180.00	+0.16 / -0.00	10.00	+0.30 / -0.00	O/R
R170180060RA*	170.00	+0.00 / -0.13	170.00	180.00	6.00	170.00	+0.00 / -0.13	180.00	+0.16 / -0.00	7.00	+0.30 / -0.00	O/R
R170185090RA*	170.00	+0.00 / -0.13	170.00	185.00	9.00	170.00	+0.00 / -0.13	185.00	+0.18 / -0.00	10.00	+0.30 / -0.00	100.86
R170185100RA*	170.00	+0.00 / -0.13	170.00	185.00	10.00	170.00	+0.00 / -0.13	185.00	+0.18 / -0.00	11.00	+0.30 / -0.00	108.04
R170190120RA	170.00	+0.00 / -0.13	170.00	190.00	12.00	170.00	+0.00 / -0.13	190.00	+0.18 / -0.00	13.00	+0.30 / -0.00	100.86
R170190160RA	170.00	+0.00 / -0.13	170.00	190.00	16.00	170.00	+0.00 / -0.13	190.00	+0.18 / -0.00	17.00	+0.30 / -0.00	108.04
R170195090RA	170.00	+0.00 / -0.13	170.00	195.00	9.00	170.00	+0.00 / -0.13	195.00	+0.18 / -0.00	10.00	+0.30 / -0.00	108.04
R170195160RA	170.00	+0.00 / -0.13	170.00	195.00	16.00	170.00	+0.00 / -0.13	195.00	+0.18 / -0.00	17.00	+0.30 / -0.00	65.22
R170195200RA*	170.00	+0.00 / -0.13	170.00	195.00	20.00	170.00	+0.00 / -0.13	195.00	+0.18 / -0.00	21.00	+0.30 / -0.00	O/R
R175190090RA	175.00	+0.00 / -0.13	175.00	190.00	9.00	175.00	+0.00 / -0.13	190.00	+0.18 / -0.00	10.00	+0.30 / -0.00	107.24
R175200120RA*	175.00	+0.00 / -0.13	175.00	200.00	12.00	175.00	+0.00 / -0.13	200.00	+0.18 / -0.00	13.00	+0.30 / -0.00	O/R
R175200190RA*	175.00	+0.00 / -0.13	175.00	200.00	19.00	175.00	+0.00 / -0.13	200.00	+0.18 / -0.00	20.00	+0.30 / -0.00	108.04
R180200120RA*	180.00	+0.00 / -0.13	180.00	200.00	12.00	180.00	+0.00 / -0.13	200.00	+0.18 / -0.00	13.00	+0.30 / -0.00	O/R
R180200160RA*	180.00	+0.00 / -0.13	180.00	200.00	16.00	180.00	+0.00 / -0.13	200.00	+0.18 / -0.00	17.00	+0.30 / -0.00	112.39
R180205160RA	180.00	+0.00 / -0.13	180.00	205.00	16.00	180.00	+0.00 / -0.13	205.00	+0.18 / -0.00	17.00	+0.30 / -0.00	83.04
R180205190RA*	180.00	+0.00 / -0.13	180.00	205.00	19.00	180.00	+0.00 / -0.13	205.00	+0.18 / -0.00	20.00	+0.30 / -0.00	O/R
R180205200RA*	180.00	+0.00 / -0.13	180.00	205.00	20.00	180.00	+0.00 / -0.13	205.00	+0.18 / -0.00	21.00	+0.30 / -0.00	O/R
R190210120RA	190.00	+0.00 / -0.13	190.00	210.00	12.00	190.00	+0.00 / -0.13	210.00	+0.18 / -0.00	13.00	+0.30 / -0.00	O/R
R190210150RA*	190.00	+0.00 / -0.13	190.00	210.00	15.00	190.00	+0.00 / -0.13	210.00	+0.18 / -0.00	16.00	+0.30 / -0.00	O/R
R190210160RA*	190.00	+0.00 / -0.13	190.00	210.00	16.00	190.00	+0.00 / -0.13	210.00	+0.18 / -0.00	17.00	+0.30 / -0.00	O/R
R190215160RA*	190.00	+0.00 / -0.13	190.00	215.00	16.00	190.00	+0.00 / -0.13	215.00	+0.18 / -0.00	17.00	+0.30 / -0.00	O/R
R190215200RA*	190.00	+0.00 / -0.13	190.00	215.00	20.00	190.00	+0.00 / -0.13	215.00	+0.18 / -0.00	21.00	+0.30 / -0.00	O/R
R200220120RA*	200.00	+0.00 / -0.13	200.00	220.00	12.00	200.00	+0.00 / -0.13	220.00	+0.18 / -0.00	13.00	+0.30 / -0.00	145.59
R200220160RA*	200.00	+0.00 / -0.13	200.00	220.00	16.00	200.00	+0.00 / -0.13	220.00	+0.18 / -0.00	17.00	+0.30 / -0.00	O/R
R200225160RA	200.00	+0.00 / -0.13	200.00	225.00	16.00	200.00	+0.00 / -0.13	225.00	+0.18 / -0.00	17.00	+0.30 / -0.00	145.59
R200225190RA*	200.00	+0.00 / -0.13	200.00	225.00	19.00	200.00	+0.00 / -0.13	225.00	+0.18 / -0.00	20.00	+0.30 / -0.00	138.25
R200225200RA*	200.00	+0.00 / -0.13	200.00	225.00	20.00	200.00	+0.00 / -0.13	225.00	+0.18 / -0.00	21.00	+0.30 / -0.00	138.25
R210220065RA*	210.00	+0.00 / -0.13	210.00	220.00	6.50	210.00	+0.00 / -0.13	220.00	+0.18 / -0.00	7.50	+0.30 / -0.00	O/R
R210235160RA*	210.00	+0.00 / -0.13	210.00	235.00	16.00	210.00	+0.00 / -0.13	235.00	+0.18 / -0.00	17.00	+0.30 / -0.00	O/R
R210235190RA*	210.00	+0.00 / -0.13	210.00	235.00	19.00	210.00	+0.00 / -0.13	235.00	+0.18 / -0.00	20.00	+0.30 / -0.00	O/R
R210235200RA*	210.00	+0.00 / -0.13	210.00	235.00	20.00	210.00	+0.00 / -0.13	235.00	+0.18 / -0.00	21.00	+0.30 / -0.00	O/R
R220240120RA*	220.00	+0.00 / -0.13	220.00	240.00	12.00	220.00	+0.00 / -0.13	240.00	+0.18 / -0.00	13.00	+0.30 / -0.00	159.53
R220240160RA*	220.00	+0.00 / -0.13	220.00	240.00	16.00	220.00	+0.00 / -0.13	240.00	+0.18 / -0.00	17.00	+0.30 / -0.00	O/R
R220240190RA*	220.00	+0.00 / -0.13	220.00	240.00	19.00	220.00	+0.00 / -0.13	240.00	+0.18 / -0.00	20.00	+0.30 / -0.00	O/R
R220240200RA*	220.00	+0.00 / -0.13	220.00	240.00	20.00	220.00	+0.00 / -0.13	240.00	+0.18 / -0.00	21.00	+0.30 / -0.00	O/R
R220245160RA	220.00	+0.00 / -0.13	220.00	245.00	16.00	220.00	+0.00 / -0.13	245.00	+0.18 / -0.00	17.00	+0.30 / -0.00	160.48
R220245190RA*	220.00	+0.00 / -0.13	220.00	245.00	19.00	220.00	+0.00 / -0.13	245.00	+0.18 / -0.00	20.00	+0.30 / -0.00	O/R
R220245200RA*	220.00	+0.00 / -0.13	220.00	245.00	20.00	220.00	+0.00 / -0.13	245.00	+0.18 / -0.00	21.00	+0.30 / -0.00	O/R
R225245120RA*	225.00	+0.00 / -0.13	225.00	245.00	12.00	225.00	+0.00 / -0.13	245.00	+0.18 / -0.00	13.00	+0.30 / -0.00	O/R
R225245160RA*	225.00	+0.00 / -0.13	225.00	245.00	16.00	225.00	+0.00 / -0.13	245.00	+0.18 / -0.00	17.00	+0.30 / -0.00	O/R
R225250160RA*	225.00	+0.00 / -0.13	225.00	250.00	16.00	225.00	+0.00 / -0.13	250.00	+0.18 / -0.00	17.00	+0.30 / -0.00	O/R
R225250190RA*	225.00	+0.00 / -0.13	225.00	250.00	19.00	225.00	+0.00 / -0.13	250.00	+0.18 / -0.00	20.00	+0.30 / -0.00	O/R
R225250200RA*	225.00	+0.00 / -0.13	225.00	250.00	20.00	225.00	+0.00 / -0.13	250.00	+0.21 / -0.00	21.00	+0.30 / -0.00	O/R
R230250120RA*	230.00	+0.00 / -0.13	230.00	250.00	12.00	230.00	+0.00 / -0.13	250.00	+0.18 / -0.00	13.00	+0.30 / -0.00	O/R
R230250160RA*	230.00	+0.00 / -0.13	230.00	250.00	16.00	230.00	+0.00 / -0.13	250.00	+0.18 / -0.00	17.00	+0.30 / -0.00	O/R

*: GENERALLY NOT STOCKED BUT AVAILABLE - CHECK WITH C/SER

Tel.: 1-888-609-SEAL
Fax: 1-888-717-SEAL



www.sealsourceinc.com

**METRIC SIZE
ROD SEALS**

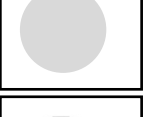
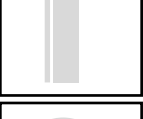

Seal Source Inc.

METRIC SIZE
ROD SEALS

RA SERIES - AU 94A

Ref.Number	Rod diameter		Nominal Seal Dimensions			Housing Dimensions					\$	
		Tol.	d	D	H	d1	Tol.	D1	Tol.	H1		Tol.
R230255150RA*	230.00	+0.00 / -0.13	230.00	255.00	15.00	230.00	+0.00 / -0.13	255.00	+0.21 / -0.00	16.00	+0.30 / -0.00	O/R
R230255160RA*	230.00	+0.00 / -0.13	230.00	255.00	16.00	230.00	+0.00 / -0.13	255.00	+0.21 / -0.00	17.00	+0.30 / -0.00	O/R
R230255190RA*	230.00	+0.00 / -0.13	230.00	255.00	19.00	230.00	+0.00 / -0.13	255.00	+0.21 / -0.00	20.00	+0.30 / -0.00	186.92
R230255200RA*	230.00	+0.00 / -0.13	230.00	255.00	20.00	230.00	+0.00 / -0.13	255.00	+0.21 / -0.00	21.00	+0.30 / -0.00	O/R
R230260190RA*	230.00	+0.00 / -0.13	230.00	260.00	19.00	230.00	+0.00 / -0.13	260.00	+0.21 / -0.00	20.00	+0.30 / -0.00	346.47
R240260120RA*	240.00	+0.00 / -0.13	240.00	260.00	12.00	240.00	+0.00 / -0.13	260.00	+0.21 / -0.00	13.00	+0.30 / -0.00	O/R
R240260160RA*	240.00	+0.00 / -0.13	240.00	260.00	16.00	240.00	+0.00 / -0.13	260.00	+0.21 / -0.00	17.00	+0.30 / -0.00	O/R
R240265160RA*	240.00	+0.00 / -0.13	240.00	265.00	16.00	240.00	+0.00 / -0.13	265.00	+0.21 / -0.00	17.00	+0.30 / -0.00	O/R
R240265190RA*	240.00	+0.00 / -0.13	240.00	265.00	19.00	240.00	+0.00 / -0.13	265.00	+0.21 / -0.00	20.00	+0.30 / -0.00	O/R
R240265200RA*	240.00	+0.00 / -0.13	240.00	265.00	20.00	240.00	+0.00 / -0.13	265.00	+0.21 / -0.00	21.00	+0.30 / -0.00	O/R
R250270120RA*	250.00	+0.00 / -0.13	250.00	270.00	12.00	250.00	+0.00 / -0.13	270.00	+0.21 / -0.00	13.00	+0.30 / -0.00	O/R
R250270160RA*	250.00	+0.00 / -0.13	250.00	270.00	16.00	250.00	+0.00 / -0.13	270.00	+0.21 / -0.00	17.00	+0.30 / -0.00	O/R
R250275160RA*	250.00	+0.00 / -0.13	250.00	275.00	16.00	250.00	+0.00 / -0.13	275.00	+0.21 / -0.00	17.00	+0.30 / -0.00	O/R
R250275190RA*	250.00	+0.00 / -0.13	250.00	275.00	19.00	250.00	+0.00 / -0.13	275.00	+0.21 / -0.00	20.00	+0.30 / -0.00	O/R
R250275200RA*	250.00	+0.00 / -0.13	250.00	275.00	20.00	250.00	+0.00 / -0.13	275.00	+0.21 / -0.00	21.00	+0.30 / -0.00	O/R
R300330190RA	300.00	+0.00 / -0.13	300.00	330.00	19.00	300.00	+0.00 / -0.13	330.00	+0.21 / -0.00	20.00	+0.30 / -0.00	428.62

RA/N - Rod Seals

Nitrile NBR 85A

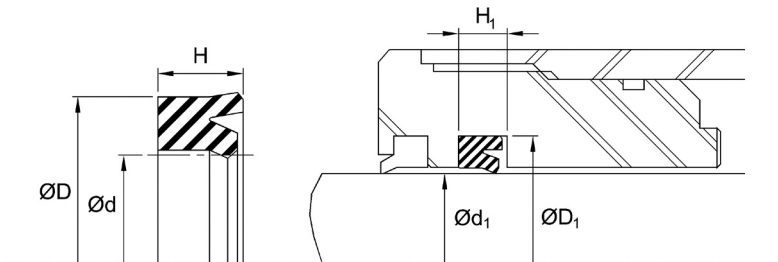
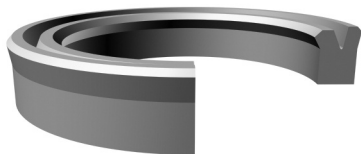

Temperature: -40/212F [-40/100C]

Pressure: 2300 PSI [160 Bar]

Ref.Number	Rod diameter		Nominal Seal Dimensions			Housing Dimensions					\$	
		Tol.	d	D	H	d1	Tol.	D1	Tol.	H1		Tol.
R002004017RA/N*	2.00	+0.00 / -0.04	2.00	4.50	1.70	2.00	+0.00 / -0.04	4.50	+0.09 / -0.00	2.20	+0.20 / -0.00	1.52
R002007035RA/N*	2.00	+0.00 / -0.04	2.00	7.00	3.50	2.00	+0.00 / -0.04	7.00	+0.09 / -0.00	4.00	+0.20 / -0.00	1.52
R002005017RA/N*	2.50	+0.00 / -0.04	2.50	5.00	1.70	2.50	+0.00 / -0.04	5.00	+0.09 / -0.00	2.20	+0.20 / -0.00	1.62
R003007030RA/N*	3.00	+0.00 / -0.04	3.00	7.00	3.00	3.00	+0.00 / -0.04	7.00	+0.09 / -0.00	3.50	+0.20 / -0.00	1.62
R004008030RA/N*	4.00	+0.00 / -0.04	4.00	8.00	3.00	4.00	+0.00 / -0.04	8.00	+0.09 / -0.00	3.50	+0.20 / -0.00	1.71
R004009035RA/N*	4.00	+0.00 / -0.04	4.00	9.00	3.50	4.00	+0.00 / -0.04	9.00	+0.09 / -0.00	4.00	+0.20 / -0.00	1.71
R004010042RA/N*	4.00	+0.00 / -0.04	4.00	10.00	4.20	4.00	+0.00 / -0.04	10.00	+0.09 / -0.00	4.70	+0.20 / -0.00	1.71
R004012045RA/N*	4.00	+0.00 / -0.04	4.00	12.00	4.50	4.00	+0.00 / -0.04	12.00	+0.09 / -0.00	5.00	+0.20 / -0.00	1.81
R004012055RA/N	4.00	+0.00 / -0.04	4.00	12.00	5.50	4.00	+0.00 / -0.04	12.00	+0.09 / -0.00	6.00	+0.20 / -0.00	1.90
R005009025RA/N*	5.00	+0.00 / -0.04	5.00	9.00	2.50	5.00	+0.00 / -0.04	9.00	+0.09 / -0.00	3.00	+0.20 / -0.00	2.00
R005010040RA/N	5.00	+0.00 / -0.04	5.00	10.00	4.00	5.00	+0.00 / -0.04	10.00	+0.09 / -0.00	4.50	+0.20 / -0.00	2.09
R005012045RA/N	5.00	+0.00 / -0.04	5.00	12.00	4.50	5.00	+0.00 / -0.04	12.00	+0.11 / -0.00	5.00	+0.20 / -0.00	2.00

*: GENERALLY NOT STOCKED BUT AVAILABLE - CHECK WITH C/SER

Seal Source Inc.

RA/N SERIES - NBR 85A

Ref.Number	Rod diameter	Nominal Seal Dimensions			Housing Dimensions						\$
	Tol.	d	D	H	d1	Tol.	D1	Tol.	H1	Tol.	
R006010030RA/N*	6.00 +0.00 / -0.04	6.00	10.00	3.00	6.00	+0.00 / -0.04	10.00	+0.09 / -0.00	3.50	+0.20 / -0.00	2.19
R006011032RA/N	6.00 +0.00 / -0.04	6.00	11.50	3.20	6.00	+0.00 / -0.04	11.50	+0.09 / -0.00	4.20	+0.20 / -0.00	7.03
R006012040RA/N*	6.00 +0.00 / -0.04	6.00	12.00	4.00	6.00	+0.00 / -0.04	12.00	+0.11 / -0.00	4.50	+0.20 / -0.00	2.19
R006012042RA/N	6.00 +0.00 / -0.04	6.00	12.00	4.20	6.00	+0.00 / -0.04	12.00	+0.11 / -0.00	4.70	+0.20 / -0.00	2.19
R006013055RA/N*	6.00 +0.00 / -0.04	6.00	13.00	5.50	6.00	+0.00 / -0.04	13.00	+0.11 / -0.00	6.00	+0.20 / -0.00	2.19
R008014040RA/N	8.00 +0.00 / -0.04	8.00	14.00	4.00	8.00	+0.00 / -0.04	14.00	+0.11 / -0.00	4.50	+0.20 / -0.00	2.28
R008014045RA/N*	8.00 +0.00 / -0.04	8.00	14.50	4.50	8.00	+0.00 / -0.04	14.50	+0.11 / -0.00	5.00	+0.20 / -0.00	2.38
R008016055RA/N	8.00 +0.00 / -0.04	8.00	16.00	5.50	8.00	+0.00 / -0.04	16.00	+0.11 / -0.00	6.00	+0.20 / -0.00	2.38
R008016060RA/N*	8.00 +0.00 / -0.04	8.00	16.00	6.00	8.00	+0.00 / -0.04	16.00	+0.11 / -0.00	6.50	+0.20 / -0.00	2.47
R008018080RA/N*	8.00 +0.00 / -0.04	8.00	18.00	8.00	8.00	+0.00 / -0.04	18.00	+0.11 / -0.00	8.50	+0.20 / -0.00	2.57
R010013023RA/N	10.00 +0.00 / -0.04	10.00	13.60	2.30	10.00	+0.00 / -0.04	13.60	+0.11 / -0.00	2.70	+0.20 / -0.00	2.76
R010015035RA/N*	10.00 +0.00 / -0.04	10.00	15.00	3.50	10.00	+0.00 / -0.04	15.00	+0.11 / -0.00	4.00	+0.20 / -0.00	2.76
R010016045RA/N	10.00 +0.00 / -0.04	10.00	16.00	4.50	10.00	+0.00 / -0.04	16.00	+0.11 / -0.00	5.00	+0.20 / -0.00	2.66
R010016060RA/N	10.00 +0.00 / -0.04	10.00	16.00	6.00	10.00	+0.00 / -0.04	16.00	+0.11 / -0.00	6.50	+0.20 / -0.00	2.76
R010018055RA/N*	10.00 +0.00 / -0.04	10.00	18.00	5.50	10.00	+0.00 / -0.04	18.00	+0.11 / -0.00	6.00	+0.20 / -0.00	2.76
R011018045RA/N*	11.00 +0.00 / -0.04	11.00	18.00	4.50	11.00	+0.00 / -0.04	18.00	+0.11 / -0.00	5.00	+0.20 / -0.00	2.76
R012018045RA/N	12.00 +0.00 / -0.04	12.00	18.00	4.50	12.00	+0.00 / -0.04	18.00	+0.11 / -0.00	5.00	+0.20 / -0.00	2.76
R012019045RA/N*	12.00 +0.00 / -0.04	12.00	19.00	4.50	12.00	+0.00 / -0.04	19.00	+0.13 / -0.00	5.00	+0.20 / -0.00	2.85
R012020055RA/N*	12.00 +0.00 / -0.04	12.00	20.00	5.50	12.00	+0.00 / -0.04	20.00	+0.13 / -0.00	6.00	+0.20 / -0.00	2.76
R012022075RA/N*	12.00 +0.00 / -0.04	12.00	22.00	7.50	12.00	+0.00 / -0.04	22.00	+0.13 / -0.00	8.00	+0.20 / -0.00	2.76
R014022050RA/N*	14.00 +0.00 / -0.04	14.00	22.00	5.00	14.00	+0.00 / -0.04	22.00	+0.13 / -0.00	5.50	+0.20 / -0.00	3.23
R014022055RA/N	14.00 +0.00 / -0.04	14.00	22.00	5.50	14.00	+0.00 / -0.04	22.00	+0.13 / -0.00	6.00	+0.20 / -0.00	2.95
R014025080RA/N	14.00 +0.00 / -0.04	14.00	25.00	8.00	14.00	+0.00 / -0.04	25.00	+0.13 / -0.00	8.50	+0.20 / -0.00	3.23
R015022050RA/N	15.00 +0.00 / -0.04	15.00	22.00	5.00	15.00	+0.00 / -0.04	22.00	+0.13 / -0.00	5.50	+0.20 / -0.00	3.23
R015023060RA/N*	15.00 +0.00 / -0.04	15.00	23.00	6.00	15.00	+0.00 / -0.04	23.00	+0.13 / -0.00	6.50	+0.20 / -0.00	3.23
R016020050RA/N*	16.00 +0.00 / -0.04	16.00	20.50	5.00	16.00	+0.00 / -0.04	20.50	+0.13 / -0.00	5.50	+0.20 / -0.00	3.23
R016022040RA/N	16.00 +0.00 / -0.04	16.00	22.00	4.00	16.00	+0.00 / -0.04	22.00	+0.13 / -0.00	4.50	+0.20 / -0.00	3.23
R016022055RA/N*	16.00 +0.00 / -0.04	16.00	22.00	5.50	16.00	+0.00 / -0.04	22.00	+0.13 / -0.00	6.00	+0.20 / -0.00	3.23
R016022045RA/N*	16.00 +0.00 / -0.04	16.00	22.50	4.50	16.00	+0.00 / -0.04	22.50	+0.13 / -0.00	5.00	+0.20 / -0.00	3.23
R016023055RA/N*	16.00 +0.00 / -0.04	16.00	23.00	5.50	16.00	+0.00 / -0.04	23.00	+0.13 / -0.00	6.00	+0.20 / -0.00	3.23
R016024055RA/N	16.00 +0.00 / -0.04	16.00	24.00	5.50	16.00	+0.00 / -0.04	24.00	+0.13 / -0.00	6.00	+0.20 / -0.00	3.23
R016026070RA/N*	16.00 +0.00 / -0.04	16.00	26.00	7.00	16.00	+0.00 / -0.04	26.00	+0.13 / -0.00	7.50	+0.20 / -0.00	3.23
R016026075RA/N*	16.00 +0.00 / -0.04	16.00	26.00	7.50	16.00	+0.00 / -0.04	26.00	+0.13 / -0.00	8.00	+0.20 / -0.00	3.42
R017025055RA/N	17.00 +0.00 / -0.04	17.00	25.00	5.50	17.00	+0.00 / -0.04	25.00	+0.13 / -0.00	6.00	+0.20 / -0.00	3.42
R018024040RA/N*	18.00 +0.00 / -0.04	18.00	24.00	4.00	18.00	+0.00 / -0.04	24.00	+0.13 / -0.00	4.50	+0.20 / -0.00	3.52
R018025045RA/N*	18.00 +0.00 / -0.04	18.00	25.00	4.50	18.00	+0.00 / -0.04	25.00	+0.13 / -0.00	5.00	+0.20 / -0.00	3.52
R018025055RA/N*	18.00 +0.00 / -0.04	18.00	25.00	5.50	18.00	+0.00 / -0.04	25.00	+0.13 / -0.00	6.00	+0.20 / -0.00	3.52
R018026055RA/N	18.00 +0.00 / -0.04	18.00	26.00	5.50	18.00	+0.00 / -0.04	26.00	+0.13 / -0.00	6.00	+0.20 / -0.00	3.52
R018025055RA/N-1*	18.50 +0.00 / -0.04	18.50	25.50	5.50	18.50	+0.00 / -0.04	25.50	+0.13 / -0.00	6.00	+0.20 / -0.00	3.52
R020026048RA/N	20.00 +0.00 / -0.04	20.00	26.00	4.80	20.00	+0.00 / -0.04	26.00	+0.13 / -0.00	5.30	+0.20 / -0.00	3.80
R020028055RA/N	20.00 +0.00 / -0.04	20.00	28.00	5.50	20.00	+0.00 / -0.04	28.00	+0.13 / -0.00	6.00	+0.20 / -0.00	3.52
R020030060RA/N*	20.00 +0.00 / -0.04	20.00	30.00	6.00	20.00	+0.00 / -0.04	30.00	+0.13 / -0.00	6.50	+0.20 / -0.00	3.52
R020030075RA/N*	20.00 +0.00 / -0.04	20.00	30.00	7.50	20.00	+0.00 / -0.04	30.00	+0.13 / -0.00	8.00	+0.20 / -0.00	3.52
R020030100RA/N*	20.00 +0.00 / -0.04	20.00	30.00	10.00	20.00	+0.00 / -0.04	30.00	+0.13 / -0.00	11.00	+0.20 / -0.00	3.61
R020032060RA/N*	20.00 +0.00 / -0.04	20.00	32.00	6.00	20.00	+0.00 / -0.04	32.00	+0.16 / -0.00	6.50	+0.20 / -0.00	3.71
R020032070RA/N*	20.00 +0.00 / -0.04	20.00	32.00	7.00	20.00	+0.00 / -0.04	32.00	+0.16 / -0.00	7.50	+0.20 / -0.00	3.71
R020032075RA/N*	20.00 +0.00 / -0.04	20.00	32.00	7.50	20.00	+0.00 / -0.04	32.00	+0.16 / -0.00	8.00	+0.20 / -0.00	3.80

*: GENERALLY NOT STOCKED BUT AVAILABLE - CHECK WITH C/SER

METRIC SIZE
ROD SEALS

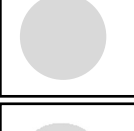
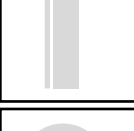
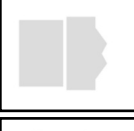

Tel.: 1-888-609-SEAL
Fax: 1-888-717-SEAL

J

11

www.sealsourceinc.com

Seal Source Inc.

RA/N SERIES - NBR 85A

METRIC SIZE
ROD SEALS

Ref.Number	Rod diameter		Nominal Seal Dimensions			Housing Dimensions					\$	
		Tol.	d	D	H	d1	Tol.	D1	Tol.	H1		Tol.
R022029055RA/N	22.00	+0.00 / -0.04	22.00	29.00	5.50	22.00	+0.00 / -0.04	29.00	+0.13 / -0.00	6.00	+0.20 / -0.00	3.80
R022030055RA/N	22.00	+0.00 / -0.04	22.00	30.00	5.50	22.00	+0.00 / -0.04	30.00	+0.13 / -0.00	6.00	+0.20 / -0.00	3.80
R022030070RA/N*	22.00	+0.00 / -0.04	22.00	30.00	7.00	22.00	+0.00 / -0.04	30.00	+0.13 / -0.00	7.50	+0.20 / -0.00	3.80
R022032060RA/N*	22.00	+0.00 / -0.04	22.00	32.00	6.00	22.00	+0.00 / -0.04	32.00	+0.16 / -0.00	6.50	+0.20 / -0.00	3.80
R022032070RA/N*	22.00	+0.00 / -0.04	22.00	32.00	7.00	22.00	+0.00 / -0.04	32.00	+0.16 / -0.00	7.50	+0.20 / -0.00	3.80
R022032080RA/N*	22.00	+0.00 / -0.04	22.00	32.00	8.00	22.00	+0.00 / -0.04	32.00	+0.16 / -0.00	8.50	+0.20 / -0.00	3.80
R023031055RA/N*	23.00	+0.00 / -0.04	23.00	31.00	5.50	23.00	+0.00 / -0.04	31.00	+0.16 / -0.00	6.00	+0.20 / -0.00	3.80
R024032055RA/N*	24.00	+0.00 / -0.04	24.00	32.00	5.50	24.00	+0.00 / -0.04	32.00	+0.16 / -0.00	6.00	+0.20 / -0.00	3.80
R025032055RA/N*	25.00	+0.00 / -0.04	25.00	32.00	5.50	25.00	+0.00 / -0.04	32.00	+0.16 / -0.00	6.00	+0.20 / -0.00	4.56
R025032060RA/N*	25.00	+0.00 / -0.04	25.00	32.00	6.00	25.00	+0.00 / -0.04	32.00	+0.16 / -0.00	6.50	+0.20 / -0.00	3.80
R025033055RA/N	25.00	+0.00 / -0.04	25.00	33.00	5.50	25.00	+0.00 / -0.04	33.00	+0.16 / -0.00	6.00	+0.20 / -0.00	3.80
R025033100RA/N*	25.00	+0.00 / -0.04	25.00	33.00	10.00	25.00	+0.00 / -0.04	33.00	+0.16 / -0.00	11.00	+0.20 / -0.00	3.80
R025035060RA/N*	25.00	+0.00 / -0.04	25.00	35.00	6.00	25.00	+0.00 / -0.04	35.00	+0.16 / -0.00	6.50	+0.20 / -0.00	3.80
R025035070RA/N	25.00	+0.00 / -0.04	25.00	35.00	7.00	25.00	+0.00 / -0.04	35.00	+0.16 / -0.00	7.50	+0.20 / -0.00	3.80
R025035075RA/N*	25.00	+0.00 / -0.04	25.00	35.00	7.50	25.00	+0.00 / -0.04	35.00	+0.16 / -0.00	8.00	+0.20 / -0.00	3.80
R025035080RA/N*	25.00	+0.00 / -0.04	25.00	35.00	8.00	25.00	+0.00 / -0.04	35.00	+0.16 / -0.00	8.50	+0.20 / -0.00	4.09
R025035100RA/N*	25.00	+0.00 / -0.04	25.00	35.00	10.00	25.00	+0.00 / -0.04	35.00	+0.16 / -0.00	11.00	+0.20 / -0.00	4.47
R025037060RA/N*	25.00	+0.00 / -0.04	25.00	37.00	6.00	25.00	+0.00 / -0.04	37.00	+0.16 / -0.00	6.50	+0.20 / -0.00	4.56
R025040100RA/N*	25.00	+0.00 / -0.04	25.00	40.00	10.00	25.00	+0.00 / -0.04	40.00	+0.16 / -0.00	11.00	+0.20 / -0.00	4.56
R026036070RA/N*	26.00	+0.00 / -0.04	26.00	36.00	7.00	26.00	+0.00 / -0.04	36.00	+0.16 / -0.00	7.50	+0.20 / -0.00	4.66
R028036055RA/N*	28.00	+0.00 / -0.04	28.00	36.00	5.50	28.00	+0.00 / -0.04	36.00	+0.16 / -0.00	6.00	+0.20 / -0.00	4.75
R028036057RA/N*	28.00	+0.00 / -0.04	28.00	36.00	5.70	28.00	+0.00 / -0.04	36.00	+0.16 / -0.00	6.20	+0.20 / -0.00	4.85
R028038060RA/N*	28.00	+0.00 / -0.04	28.00	38.00	6.00	28.00	+0.00 / -0.04	38.00	+0.16 / -0.00	6.50	+0.20 / -0.00	4.85
R028038070RA/N	28.00	+0.00 / -0.04	28.00	38.00	7.00	28.00	+0.00 / -0.04	38.00	+0.16 / -0.00	7.50	+0.20 / -0.00	4.85
R028038080RA/N*	28.00	+0.00 / -0.04	28.00	38.00	8.00	28.00	+0.00 / -0.04	38.00	+0.16 / -0.00	8.50	+0.20 / -0.00	4.85
R028038100RA/N*	28.00	+0.00 / -0.04	28.00	38.00	10.00	28.00	+0.00 / -0.04	38.00	+0.16 / -0.00	11.00	+0.20 / -0.00	5.13
R030038055RA/N	30.00	+0.00 / -0.04	30.00	38.00	5.50	30.00	+0.00 / -0.04	38.00	+0.16 / -0.00	6.00	+0.20 / -0.00	5.13
R030038063RA/N*	30.00	+0.00 / -0.04	30.00	38.00	6.30	30.00	+0.00 / -0.04	38.00	+0.16 / -0.00	6.80	+0.20 / -0.00	5.13
R030038080RA/N	30.00	+0.00 / -0.04	30.00	38.00	8.00	30.00	+0.00 / -0.04	38.00	+0.16 / -0.00	8.50	+0.20 / -0.00	5.13
R030040060RA/N*	30.00	+0.00 / -0.04	30.00	40.00	6.00	30.00	+0.00 / -0.04	40.00	+0.16 / -0.00	6.50	+0.20 / -0.00	5.23
R030040070RA/N	30.00	+0.00 / -0.04	30.00	40.00	7.00	30.00	+0.00 / -0.04	40.00	+0.16 / -0.00	7.50	+0.20 / -0.00	5.23
R030040080RA/N*	30.00	+0.00 / -0.04	30.00	40.00	8.00	30.00	+0.00 / -0.04	40.00	+0.16 / -0.00	8.50	+0.20 / -0.00	5.23
R030042085RA/N	30.00	+0.00 / -0.04	30.00	42.00	8.50	30.00	+0.00 / -0.04	42.00	+0.16 / -0.00	9.50	+0.20 / -0.00	5.32
R032040055RA/N*	32.00	+0.00 / -0.04	32.00	40.00	5.50	32.00	+0.00 / -0.04	40.00	+0.16 / -0.00	6.00	+0.20 / -0.00	5.42
R032042070RA/N*	32.00	+0.00 / -0.04	32.00	42.00	7.00	32.00	+0.00 / -0.04	42.00	+0.16 / -0.00	7.50	+0.20 / -0.00	5.42
R032045100RA/N	32.00	+0.00 / -0.04	32.00	45.00	10.00	32.00	+0.00 / -0.04	45.00	+0.16 / -0.00	11.00	+0.20 / -0.00	5.42
R032048080RA/N*	32.00	+0.00 / -0.04	32.00	48.00	8.00	32.00	+0.00 / -0.04	48.00	+0.16 / -0.00	8.50	+0.20 / -0.00	5.42
R033043070RA/N*	33.00	+0.00 / -0.04	33.00	43.00	7.00	33.00	+0.00 / -0.04	43.00	+0.16 / -0.00	7.50	+0.20 / -0.00	5.89
R034044070RA/N*	34.00	+0.00 / -0.04	34.00	44.00	7.00	34.00	+0.00 / -0.04	44.00	+0.16 / -0.00	7.50	+0.20 / -0.00	5.89
R035043080RA/N*	35.00	+0.00 / -0.04	35.00	43.00	8.00	35.00	+0.00 / -0.04	43.00	+0.16 / -0.00	8.50	+0.20 / -0.00	5.89
R035045060RA/N*	35.00	+0.00 / -0.04	35.00	45.00	6.00	35.00	+0.00 / -0.04	45.00	+0.16 / -0.00	6.50	+0.20 / -0.00	5.89
R035045070RA/N	35.00	+0.00 / -0.04	35.00	45.00	7.00	35.00	+0.00 / -0.04	45.00	+0.16 / -0.00	7.50	+0.20 / -0.00	5.89
R035045080RA/N*	35.00	+0.00 / -0.04	35.00	45.00	8.00	35.00	+0.00 / -0.04	45.00	+0.16 / -0.00	8.50	+0.20 / -0.00	6.08
R035050080RA/N*	35.00	+0.00 / -0.04	35.00	50.00	8.00	35.00	+0.00 / -0.04	50.00	+0.16 / -0.00	8.50	+0.20 / -0.00	6.27
R036046070RA/N*	36.00	+0.00 / -0.04	36.00	46.00	7.00	36.00	+0.00 / -0.04	46.00	+0.16 / -0.00	7.50	+0.20 / -0.00	6.27
R036046080RA/N*	36.00	+0.00 / -0.04	36.00	46.00	8.00	36.00	+0.00 / -0.04	46.00	+0.16 / -0.00	8.50	+0.20 / -0.00	6.27
R036046100RA/N*	36.00	+0.00 / -0.04	36.00	46.00	10.00	36.00	+0.00 / -0.04	46.00	+0.16 / -0.00	11.00	+0.20 / -0.00	6.46

*: GENERALLY NOT STOCKED BUT AVAILABLE - CHECK WITH C/SER

Seal Source Inc.

RA/N SERIES - NBR 85A

Ref.Number	Rod diameter		Nominal Seal Dimensions			Housing Dimensions					\$	
		Tol.	d	D	H	d1	Tol.	D1	Tol.	H1		Tol.
R036050100RA/N*	36.00	+0.00 / -0.04	36.00	50.00	10.00	36.00	+0.00 / -0.04	50.00	+0.16 / -0.00	11.00	+0.20 / -0.00	6.46
R038048070RA/N	38.00	+0.00 / -0.04	38.00	48.00	7.00	38.00	+0.00 / -0.04	48.00	+0.16 / -0.00	7.50	+0.20 / -0.00	6.56
R040048055RA/N*	40.00	+0.00 / -0.05	40.00	48.00	5.50	40.00	+0.00 / -0.05	48.00	+0.16 / -0.00	6.00	+0.20 / -0.00	6.56
R040048080RA/N*	40.00	+0.00 / -0.05	40.00	48.00	8.00	40.00	+0.00 / -0.05	48.00	+0.16 / -0.00	8.50	+0.20 / -0.00	6.75
R040050070RA/N	40.00	+0.00 / -0.05	40.00	50.00	7.00	40.00	+0.00 / -0.05	50.00	+0.16 / -0.00	7.50	+0.20 / -0.00	6.84
R040050080RA/N*	40.00	+0.00 / -0.05	40.00	50.00	8.00	40.00	+0.00 / -0.05	50.00	+0.16 / -0.00	8.50	+0.20 / -0.00	6.84
R040050100RA/N*	40.00	+0.00 / -0.05	40.00	50.00	10.00	40.00	+0.00 / -0.05	50.00	+0.16 / -0.00	11.00	+0.20 / -0.00	6.84
R040055100RA/N*	40.00	+0.00 / -0.05	40.00	55.00	10.00	40.00	+0.00 / -0.05	55.00	+0.19 / -0.00	11.00	+0.20 / -0.00	7.03
R042052070RA/N*	42.00	+0.00 / -0.05	42.00	52.00	7.00	42.00	+0.00 / -0.05	52.00	+0.19 / -0.00	7.50	+0.20 / -0.00	7.03
R045055070RA/N	45.00	+0.00 / -0.05	45.00	55.00	7.00	45.00	+0.00 / -0.05	55.00	+0.19 / -0.00	7.50	+0.20 / -0.00	7.70
R045055100RA/N*	45.00	+0.00 / -0.05	45.00	55.00	10.00	45.00	+0.00 / -0.05	55.00	+0.19 / -0.00	11.00	+0.20 / -0.00	9.12
R045060100RA/N*	45.00	+0.00 / -0.05	45.00	60.00	10.00	45.00	+0.00 / -0.05	60.00	+0.19 / -0.00	11.00	+0.20 / -0.00	9.60
R045061120RA/N*	45.00	+0.00 / -0.05	45.00	61.00	12.00	45.00	+0.00 / -0.05	61.00	+0.19 / -0.00	13.00	+0.20 / -0.00	9.60
R047057070RA/N*	47.00	+0.00 / -0.05	47.00	57.00	7.00	47.00	+0.00 / -0.05	57.00	+0.19 / -0.00	7.50	+0.20 / -0.00	9.79
R048058070RA/N	48.00	+0.00 / -0.05	48.00	58.00	7.00	48.00	+0.00 / -0.05	58.00	+0.19 / -0.00	7.50	+0.20 / -0.00	10.07
R050058080RA/N*	50.00	+0.00 / -0.05	50.00	58.00	8.00	50.00	+0.00 / -0.05	58.00	+0.19 / -0.00	8.50	+0.20 / -0.00	15.49
R050060060RA/N*	50.00	+0.00 / -0.05	50.00	60.00	6.00	50.00	+0.00 / -0.05	60.00	+0.19 / -0.00	6.50	+0.20 / -0.00	11.40
R050060070RA/N	50.00	+0.00 / -0.05	50.00	60.00	7.00	50.00	+0.00 / -0.05	60.00	+0.19 / -0.00	7.50	+0.20 / -0.00	13.78
R050060100RA/N*	50.00	+0.00 / -0.05	50.00	60.00	10.00	50.00	+0.00 / -0.05	60.00	+0.19 / -0.00	11.00	+0.20 / -0.00	15.30
R050063085RA/N*	50.00	+0.00 / -0.05	50.00	63.00	8.50	50.00	+0.00 / -0.05	63.00	+0.19 / -0.00	9.50	+0.20 / -0.00	15.77
R050063120RA/N	50.00	+0.00 / -0.05	50.00	63.00	12.00	50.00	+0.00 / -0.05	63.00	+0.19 / -0.00	13.00	+0.20 / -0.00	14.22
R054064070RA/N*	54.00	+0.00 / -0.05	54.00	64.00	7.00	54.00	+0.00 / -0.05	64.00	+0.19 / -0.00	7.50	+0.20 / -0.00	18.96
R055065070RA/N*	55.00	+0.00 / -0.05	55.00	65.00	7.00	55.00	+0.00 / -0.05	65.00	+0.19 / -0.00	7.50	+0.20 / -0.00	22.86
R055070100RA/N*	55.00	+0.00 / -0.05	55.00	70.00	10.00	55.00	+0.00 / -0.05	70.00	+0.19 / -0.00	11.00	+0.20 / -0.00	25.38
R056068085RA/N*	56.00	+0.00 / -0.05	56.00	68.00	8.50	56.00	+0.00 / -0.05	68.00	+0.19 / -0.00	9.50	+0.20 / -0.00	30.84
R060070085RA/N*	60.00	+0.00 / -0.05	60.00	70.00	8.50	60.00	+0.00 / -0.05	70.00	+0.19 / -0.00	9.50	+0.20 / -0.00	42.72
R060070100RA/N*	60.00	+0.00 / -0.05	60.00	70.00	10.00	60.00	+0.00 / -0.05	70.00	+0.19 / -0.00	11.00	+0.20 / -0.00	32.74
R060072085RA/N*	60.00	+0.00 / -0.05	60.00	72.00	8.50	60.00	+0.00 / -0.05	72.00	+0.19 / -0.00	9.50	+0.20 / -0.00	23.89
R060074080RA/N*	60.00	+0.00 / -0.05	60.00	74.00	8.00	60.00	+0.00 / -0.05	74.00	+0.19 / -0.00	8.50	+0.20 / -0.00	33.80
R060075120RA/N*	60.00	+0.00 / -0.05	60.00	75.00	12.00	60.00	+0.00 / -0.05	75.00	+0.19 / -0.00	13.00	+0.20 / -0.00	34.86
R060080140RA/N*	60.00	+0.00 / -0.05	60.00	80.00	14.00	60.00	+0.00 / -0.05	80.00	+0.19 / -0.00	15.00	+0.20 / -0.00	70.71
R063073070RA/N	63.00	+0.00 / -0.05	63.00	73.00	7.00	63.00	+0.00 / -0.05	73.00	+0.19 / -0.00	7.50	+0.20 / -0.00	17.83
R063075085RA/N*	63.00	+0.00 / -0.05	63.00	75.00	8.50	63.00	+0.00 / -0.05	75.00	+0.19 / -0.00	9.50	+0.20 / -0.00	25.46
R063080160RA/N*	63.00	+0.00 / -0.05	63.00	80.00	16.00	63.00	+0.00 / -0.05	80.00	+0.19 / -0.00	17.00	+0.20 / -0.00	31.73
R065075100RA/N*	65.00	+0.00 / -0.06	65.00	75.00	10.00	65.00	+0.00 / -0.06	75.00	+0.19 / -0.00	11.00	+0.20 / -0.00	34.86
R065077085RA/N*	65.00	+0.00 / -0.06	65.00	77.00	8.50	65.00	+0.00 / -0.06	77.00	+0.19 / -0.00	9.50	+0.20 / -0.00	16.75
R068080085RA/N	68.00	+0.00 / -0.06	68.00	80.00	8.50	68.00	+0.00 / -0.06	80.00	+0.19 / -0.00	9.50	+0.20 / -0.00	27.78
R070080120RA/N*	70.00	+0.00 / -0.06	70.00	80.00	12.00	70.00	+0.00 / -0.06	80.00	+0.19 / -0.00	13.00	+0.20 / -0.00	38.03
R070082085RA/N*	70.00	+0.00 / -0.06	70.00	82.00	8.50	70.00	+0.00 / -0.06	82.00	+0.22 / -0.00	9.50	+0.20 / -0.00	38.03
R070085100RA/N*	70.00	+0.00 / -0.06	70.00	85.00	10.00	70.00	+0.00 / -0.06	85.00	+0.22 / -0.00	11.00	+0.20 / -0.00	42.25
R075085120RA/N*	75.00	+0.00 / -0.06	75.00	85.00	12.00	75.00	+0.00 / -0.06	85.00	+0.22 / -0.00	13.00	+0.20 / -0.00	42.25
R080090070RA/N	80.00	+0.00 / -0.09	80.00	90.00	7.00	80.00	+0.00 / -0.09	90.00	+0.22 / -0.00	7.50	+0.20 / -0.00	40.22
R080090120RA/N*	80.00	+0.00 / -0.09	80.00	90.00	12.00	80.00	+0.00 / -0.09	90.00	+0.22 / -0.00	13.00	+0.20 / -0.00	45.42
R080092075RA/N*	80.00	+0.00 / -0.09	80.00	92.00	7.50	80.00	+0.00 / -0.09	92.00	+0.22 / -0.00	8.00	+0.20 / -0.00	54.35
R080092085RA/N*	80.00	+0.00 / -0.09	80.00	92.00	8.50	80.00	+0.00 / -0.09	92.00	+0.22 / -0.00	9.50	+0.20 / -0.00	24.74
R085095070RA/N*	85.00	+0.00 / -0.09	85.00	95.00	7.00	85.00	+0.00 / -0.09	95.00	+0.22 / -0.00	7.50	+0.20 / -0.00	33.18
R085095120RA/N*	85.00	+0.00 / -0.09	85.00	95.00	12.00	85.00	+0.00 / -0.09	95.00	+0.22 / -0.00	13.00	+0.20 / -0.00	47.53

*: GENERALLY NOT STOCKED BUT AVAILABLE - CHECK WITH C/SER

**METRIC SIZE
ROD SEALS**

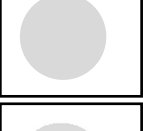
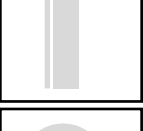

Tel.: 1-888-609-SEAL
Fax: 1-888-717-SEAL

J 13

www.sealsourceinc.com

Seal Source Inc.

RA/N SERIES - NBR 85A

METRIC SIZE
ROD SEALS

Ref.Number	Rod diameter		Nominal Seal Dimensions			Housing Dimensions					\$	
		Tol.	d	D	H	d1	Tol.	D1	Tol.	H1		Tol.
R085100100RA/N*	85.00	+0.00 / -0.09	85.00	100.00	10.00	85.00	+0.00 / -0.09	100.00	+0.22 / -0.00	11.00	+0.20 / -0.00	52.53
R088100085RA/N*	88.00	+0.00 / -0.09	88.00	100.00	8.50	88.00	+0.00 / -0.09	100.00	+0.22 / -0.00	9.50	+0.20 / -0.00	55.07
R090100120RA/N*	90.00	+0.00 / -0.09	90.00	100.00	12.00	90.00	+0.00 / -0.09	100.00	+0.22 / -0.00	13.00	+0.20 / -0.00	48.59
R090102085RA/N*	90.00	+0.00 / -0.09	90.00	102.00	8.50	90.00	+0.00 / -0.09	102.00	+0.22 / -0.00	9.50	+0.20 / -0.00	10.94
R095105120RA/N*	95.00	+0.00 / -0.09	95.00	105.00	12.00	95.00	+0.00 / -0.09	105.00	+0.22 / -0.00	13.00	+0.20 / -0.00	35.91
R100110070RA/N*	100.00	+0.00 / -0.09	100.00	110.00	7.00	100.00	+0.00 / -0.09	110.00	+0.22 / -0.00	7.50	+0.20 / -0.00	23.21
R100115100RA/N*	100.00	+0.00 / -0.09	100.00	115.00	10.00	100.00	+0.00 / -0.09	115.00	+0.22 / -0.00	11.00	+0.20 / -0.00	23.18
R105120100RA/N*	105.00	+0.00 / -0.13	105.00	120.00	10.00	105.00	+0.00 / -0.13	120.00	+0.22 / -0.00	11.00	+0.20 / -0.00	31.47
R105120120RA/N*	105.00	+0.00 / -0.13	105.00	120.00	12.00	105.00	+0.00 / -0.13	120.00	+0.22 / -0.00	13.00	+0.20 / -0.00	20.32
R110125100RA/N	110.00	+0.00 / -0.13	110.00	125.00	10.00	110.00	+0.00 / -0.13	125.00	+0.25 / -0.00	11.00	+0.20 / -0.00	42.25
R110130140RA/N*	110.00	+0.00 / -0.13	110.00	130.00	14.00	110.00	+0.00 / -0.13	130.00	+0.25 / -0.00	15.00	+0.20 / -0.00	23.99
R115125120RA/N*	115.00	+0.00 / -0.13	115.00	125.00	12.00	115.00	+0.00 / -0.13	125.00	+0.25 / -0.00	13.00	+0.20 / -0.00	31.48
R115130100RA/N*	115.00	+0.00 / -0.13	115.00	130.00	10.00	115.00	+0.00 / -0.13	130.00	+0.25 / -0.00	11.00	+0.20 / -0.00	36.22
R120135095RA/N*	120.00	+0.00 / -0.13	120.00	135.00	9.50	120.00	+0.00 / -0.13	135.00	+0.25 / -0.00	10.50	+0.20 / -0.00	47.18
R125140100RA/N*	125.00	+0.00 / -0.13	125.00	140.00	10.00	125.00	+0.00 / -0.13	140.00	+0.25 / -0.00	11.00	+0.20 / -0.00	43.02
R125145140RA/N*	125.00	+0.00 / -0.13	125.00	145.00	14.00	125.00	+0.00 / -0.13	145.00	+0.25 / -0.00	15.00	+0.20 / -0.00	30.34
R135145120RA/N*	135.00	+0.00 / -0.13	135.00	145.00	12.00	135.00	+0.00 / -0.13	145.00	+0.25 / -0.00	13.00	+0.20 / -0.00	45.07
R140160140RA/N*	140.00	+0.00 / -0.13	140.00	160.00	14.00	140.00	+0.00 / -0.13	160.00	+0.25 / -0.00	15.00	+0.20 / -0.00	14.74
R150170140RA/N*	150.00	+0.00 / -0.13	150.00	170.00	14.00	150.00	+0.00 / -0.13	170.00	+0.25 / -0.00	15.00	+0.20 / -0.00	35.52
R155165120RA/N*	155.00	+0.00 / -0.13	155.00	165.00	12.00	155.00	+0.00 / -0.13	165.00	+0.25 / -0.00	13.00	+0.20 / -0.00	57.75
R155170100RA/N*	155.00	+0.00 / -0.13	155.00	170.00	10.00	155.00	+0.00 / -0.13	170.00	+0.25 / -0.00	11.00	+0.20 / -0.00	164.38
R160170120RA/N*	160.00	+0.00 / -0.13	160.00	170.00	12.00	160.00	+0.00 / -0.13	170.00	+0.25 / -0.00	13.00	+0.20 / -0.00	73.94
R160180140RA/N*	160.00	+0.00 / -0.13	160.00	180.00	14.00	160.00	+0.00 / -0.13	180.00	+0.25 / -0.00	15.00	+0.20 / -0.00	53.36
R160184150RA/N*	160.00	+0.00 / -0.13	160.00	184.00	15.00	160.00	+0.00 / -0.13	184.00	+0.29 / -0.00	16.00	+0.20 / -0.00	44.47
R170190140RA/N*	170.00	+0.00 / -0.13	170.00	190.00	14.00	170.00	+0.00 / -0.13	190.00	+0.29 / -0.00	15.00	+0.20 / -0.00	66.31
R180200140RA/N*	180.00	+0.00 / -0.13	180.00	200.00	14.00	180.00	+0.00 / -0.13	200.00	+0.29 / -0.00	15.00	+0.20 / -0.00	75.93
R185195120RA/N*	185.00	+0.00 / -0.13	185.00	195.00	12.00	185.00	+0.00 / -0.13	195.00	+0.29 / -0.00	13.00	+0.20 / -0.00	31.69
R185215200RA/N*	185.00	+0.00 / -0.13	185.00	215.00	20.00	185.00	+0.00 / -0.13	215.00	+0.29 / -0.00	21.00	+0.20 / -0.00	184.81
R210240280RA/N*	210.00	+0.00 / -0.13	210.00	240.00	28.00	210.00	+0.00 / -0.13	240.00	+0.29 / -0.00	29.00	+0.20 / -0.00	138.60
R215225120RA/N*	215.00	+0.00 / -0.13	215.00	225.00	12.00	215.00	+0.00 / -0.13	225.00	+0.29 / -0.00	13.00	+0.20 / -0.00	50.70
R220250200RA/N*	220.00	+0.00 / -0.13	220.00	250.00	20.00	220.00	+0.00 / -0.13	250.00	+0.29 / -0.00	21.00	+0.20 / -0.00	39.95

*: GENERALLY NOT STOCKED BUT AVAILABLE - CHECK WITH C/SER

M

RA-E - Rod Seals Polyurethane AU 94A

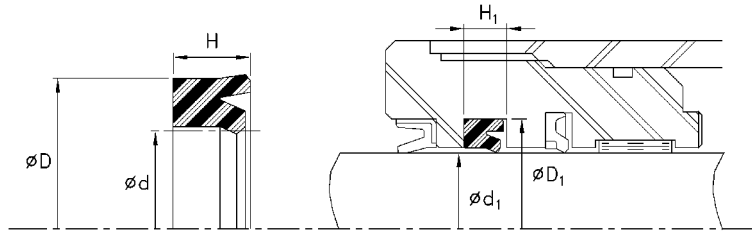
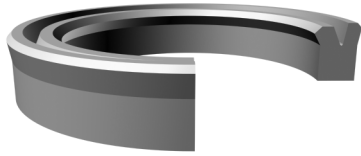

Temperature: -22/212F [-30/100C]

Pressure: 5800 PSI [400 Bar]

Ref.Number	Rod diameter	Nominal Seal Dimensions			Housing Dimensions					\$		
	Tol.	d	D	H	d1	Tol.	D1	Tol.	H1		Tol.	
R006010030RA-E*	6.00	+0.00 / -0.04	6.00	10.00	3.00	6.00	+0.00 / -0.04	10.00	+0.07 / -0.00	3.50	+0.30 / -0.00	3.08
R006012040RA-E*	6.00	+0.00 / -0.04	6.00	12.00	4.00	6.00	+0.00 / -0.04	12.00	+0.07 / -0.00	4.50	+0.30 / -0.00	3.08
R006013050RA-E*	6.00	+0.00 / -0.04	6.00	13.00	5.00	6.00	+0.00 / -0.04	13.00	+0.07 / -0.00	6.00	+0.30 / -0.00	3.08
R006014058RA-E*	6.00	+0.00 / -0.04	6.00	14.00	5.80	6.00	+0.00 / -0.04	14.00	+0.07 / -0.00	6.80	+0.30 / -0.00	3.08
R008014032RA-E	8.00	+0.00 / -0.04	8.00	14.00	3.20	8.00	+0.00 / -0.04	14.00	+0.07 / -0.00	4.00	+0.30 / -0.00	3.08
R008014040RA-E*	8.00	+0.00 / -0.04	8.00	14.00	4.00	8.00	+0.00 / -0.04	14.00	+0.07 / -0.00	4.50	+0.30 / -0.00	3.08
R008018080RA-E	8.00	+0.00 / -0.04	8.00	18.00	8.00	8.00	+0.00 / -0.04	18.00	+0.07 / -0.00	9.00	+0.30 / -0.00	3.64
R010014040RA-E*	10.00	+0.00 / -0.04	10.00	14.00	4.00	10.00	+0.00 / -0.04	14.00	+0.07 / -0.00	4.50	+0.30 / -0.00	3.64
R010016045RA-E*	10.00	+0.00 / -0.04	10.00	16.00	4.50	10.00	+0.00 / -0.04	16.00	+0.07 / -0.00	5.00	+0.30 / -0.00	3.78
R010018057RA-E	10.00	+0.00 / -0.04	10.00	18.00	5.70	10.00	+0.00 / -0.04	18.00	+0.07 / -0.00	6.30	+0.30 / -0.00	3.78
R010020045RA-E*	10.00	+0.00 / -0.04	10.00	20.00	4.50	10.00	+0.00 / -0.04	20.00	+0.07 / -0.00	5.00	+0.30 / -0.00	4.62
R012016030RA-E*	12.00	+0.00 / -0.04	12.00	16.00	3.00	12.00	+0.00 / -0.04	16.00	+0.08 / -0.00	3.50	+0.30 / -0.00	3.78
R012017037RA-E*	12.00	+0.00 / -0.04	12.00	17.00	3.70	12.00	+0.00 / -0.04	17.00	+0.08 / -0.00	4.20	+0.30 / -0.00	3.78
R012020055RA-E*	12.00	+0.00 / -0.04	12.00	20.00	5.50	12.00	+0.00 / -0.04	20.00	+0.08 / -0.00	6.50	+0.30 / -0.00	3.74
R012022050RA-E*	12.00	+0.00 / -0.04	12.00	22.00	5.00	12.00	+0.00 / -0.04	22.00	+0.08 / -0.00	6.00	+0.30 / -0.00	4.62
R012022075RA-E*	12.00	+0.00 / -0.04	12.00	22.00	7.50	12.00	+0.00 / -0.04	22.00	+0.08 / -0.00	8.50	+0.30 / -0.00	4.62
R012022080RA-E*	12.00	+0.00 / -0.04	12.00	22.00	8.00	12.00	+0.00 / -0.04	22.00	+0.08 / -0.00	9.00	+0.30 / -0.00	4.62
R014024080RA-E*	14.00	+0.00 / -0.04	14.00	24.00	8.00	14.00	+0.00 / -0.04	24.00	+0.08 / -0.00	9.00	+0.30 / -0.00	4.75
R015023060RA-E*	15.00	+0.00 / -0.04	15.00	23.00	6.00	15.00	+0.00 / -0.04	23.00	+0.08 / -0.00	7.00	+0.30 / -0.00	4.90
R016022050RA-E*	16.00	+0.00 / -0.04	16.00	22.00	5.00	16.00	+0.00 / -0.04	22.00	+0.08 / -0.00	6.00	+0.30 / -0.00	4.90
R016023055RA-E*	16.00	+0.00 / -0.04	16.00	23.00	5.50	16.00	+0.00 / -0.04	23.00	+0.08 / -0.00	6.50	+0.30 / -0.00	4.90
R016024050RA-E*	16.00	+0.00 / -0.04	16.00	24.00	5.00	16.00	+0.00 / -0.04	24.00	+0.08 / -0.00	6.00	+0.30 / -0.00	5.04
R016024065RA-E*	16.00	+0.00 / -0.04	16.00	24.00	6.50	16.00	+0.00 / -0.04	24.00	+0.08 / -0.00	7.50	+0.30 / -0.00	4.90
R016026050RA-E*	16.00	+0.00 / -0.04	16.00	26.00	5.00	16.00	+0.00 / -0.04	26.00	+0.08 / -0.00	6.00	+0.30 / -0.00	4.90
R016026070RA-E*	16.00	+0.00 / -0.04	16.00	26.00	7.00	16.00	+0.00 / -0.04	26.00	+0.08 / -0.00	8.00	+0.30 / -0.00	4.90
R018024050RA-E*	18.00	+0.00 / -0.04	18.00	24.00	5.00	18.00	+0.00 / -0.04	24.00	+0.08 / -0.00	6.00	+0.30 / -0.00	3.62
R018025050RA-E*	18.00	+0.00 / -0.04	18.00	25.00	5.00	18.00	+0.00 / -0.04	25.00	+0.08 / -0.00	6.00	+0.30 / -0.00	4.90
R018026045RA-E*	18.00	+0.00 / -0.04	18.00	26.00	4.50	18.00	+0.00 / -0.04	26.00	+0.08 / -0.00	5.50	+0.30 / -0.00	5.04
R018028070RA-E*	18.00	+0.00 / -0.04	18.00	28.00	7.00	18.00	+0.00 / -0.04	28.00	+0.08 / -0.00	8.00	+0.30 / -0.00	5.18
R020028057RA-E	20.00	+0.00 / -0.04	20.00	28.00	5.70	20.00	+0.00 / -0.04	28.00	+0.08 / -0.00	6.30	+0.30 / -0.00	5.18
R020028070RA-E	20.00	+0.00 / -0.04	20.00	28.00	7.00	20.00	+0.00 / -0.04	28.00	+0.08 / -0.00	8.00	+0.30 / -0.00	5.18
R020030060RA-E	20.00	+0.00 / -0.04	20.00	30.00	6.00	20.00	+0.00 / -0.04	30.00	+0.08 / -0.00	7.00	+0.30 / -0.00	5.60
R020030072RA-E	20.00	+0.00 / -0.04	20.00	30.00	7.20	20.00	+0.00 / -0.04	30.00	+0.08 / -0.00	8.00	+0.30 / -0.00	5.18
R020030080RA-E*	20.00	+0.00 / -0.04	20.00	30.00	8.00	20.00	+0.00 / -0.04	30.00	+0.08 / -0.00	9.00	+0.30 / -0.00	5.88
R020030100RA-E*	20.00	+0.00 / -0.04	20.00	30.00	10.00	20.00	+0.00 / -0.04	30.00	+0.08 / -0.00	11.00	+0.30 / -0.00	6.16
R020032060RA-E*	20.00	+0.00 / -0.04	20.00	32.00	6.00	20.00	+0.00 / -0.04	32.00	+0.08 / -0.00	7.00	+0.30 / -0.00	5.74

*: GENERALLY NOT STOCKED BUT AVAILABLE - CHECK WITH C/SER

METRIC SIZE
ROD SEALS



Tel.: 1-888-609-SEAL
Fax: 1-888-717-SEAL

J

15

www.sealsourceinc.com

Seal Source Inc.

RA/E SERIES - AU 94A

METRIC SIZE
ROD SEALS

Ref.Number	Rod diameter		Nominal Seal Dimensions			Housing Dimensions					\$	
		Tol.	d	D	H	d1	Tol.	D1	Tol.	H1		Tol.
R020032075RA-E*	20.00	+0.00/-0.04	20.00	32.00	7.50	20.00	+0.00/-0.04	32.00	+0.08/-0.00	8.50	+0.30/-0.00	5.60
R022030050RA-E	22.00	+0.00/-0.04	22.00	30.00	5.00	22.00	+0.00/-0.04	30.00	+0.08/-0.00	5.70	+0.30/-0.00	4.50
R022030070RA-E*	22.00	+0.00/-0.04	22.00	30.00	7.00	22.00	+0.00/-0.04	30.00	+0.08/-0.00	8.00	+0.30/-0.00	5.60
R022030080RA-E*	22.00	+0.00/-0.04	22.00	30.00	8.00	22.00	+0.00/-0.04	30.00	+0.08/-0.00	9.00	+0.30/-0.00	5.60
R025032057RA-E	25.00	+0.00/-0.04	25.00	32.00	5.70	25.00	+0.00/-0.04	32.00	+0.10/-0.00	6.30	+0.30/-0.00	5.60
R025033100RA-E	25.00	+0.00/-0.04	25.00	33.00	10.00	25.00	+0.00/-0.04	33.00	+0.10/-0.00	11.00	+0.30/-0.00	4.50
R025035060RA-E	25.00	+0.00/-0.04	25.00	35.00	6.00	25.00	+0.00/-0.04	35.00	+0.10/-0.00	7.00	+0.30/-0.00	6.16
R025035080RA-E*	25.00	+0.00/-0.04	25.00	35.00	8.00	25.00	+0.00/-0.04	35.00	+0.10/-0.00	9.00	+0.30/-0.00	6.16
R025035100RA-E*	25.00	+0.00/-0.04	25.00	35.00	10.00	25.00	+0.00/-0.04	35.00	+0.10/-0.00	11.00	+0.30/-0.00	4.85
R025037060RA-E*	25.00	+0.00/-0.04	25.00	37.00	6.00	25.00	+0.00/-0.04	37.00	+0.10/-0.00	7.00	+0.30/-0.00	6.16
R025040100RA-E*	25.00	+0.00/-0.04	25.00	40.00	10.00	25.00	+0.00/-0.04	40.00	+0.10/-0.00	11.00	+0.30/-0.00	5.30
R028035070RA-E*	28.00	+0.00/-0.04	28.00	35.00	7.00	28.00	+0.00/-0.04	35.00	+0.10/-0.00	8.00	+0.30/-0.00	6.16
R028036057RA-E*	28.00	+0.00/-0.04	28.00	36.00	5.70	28.00	+0.00/-0.04	36.00	+0.10/-0.00	6.70	+0.30/-0.00	6.16
R028036080RA-E*	28.00	+0.00/-0.04	28.00	36.00	8.00	28.00	+0.00/-0.04	36.00	+0.10/-0.00	9.00	+0.30/-0.00	6.16
R028038060RA-E*	28.00	+0.00/-0.04	28.00	38.00	6.00	28.00	+0.00/-0.04	38.00	+0.10/-0.00	7.00	+0.30/-0.00	6.16
R028038070RA-E*	28.00	+0.00/-0.04	28.00	38.00	7.00	28.00	+0.00/-0.04	38.00	+0.10/-0.00	8.00	+0.30/-0.00	6.16
R028038080RA-E*	28.00	+0.00/-0.04	28.00	38.00	8.00	28.00	+0.00/-0.04	38.00	+0.10/-0.00	9.00	+0.30/-0.00	6.16
R028038100RA-E*	28.00	+0.00/-0.04	28.00	38.00	10.00	28.00	+0.00/-0.04	38.00	+0.10/-0.00	11.00	+0.30/-0.00	6.16
R030038057RA-E*	30.00	+0.00/-0.04	30.00	38.00	5.70	30.00	+0.00/-0.04	38.00	+0.10/-0.00	6.70	+0.30/-0.00	4.95
R030038060RA-E*	30.00	+0.00/-0.04	30.00	38.00	6.00	30.00	+0.00/-0.04	38.00	+0.10/-0.00	7.00	+0.30/-0.00	6.16
R030038080RA-E	30.00	+0.00/-0.04	30.00	38.00	8.00	30.00	+0.00/-0.04	38.00	+0.10/-0.00	9.00	+0.30/-0.00	4.95
R030040057RA-E	30.00	+0.00/-0.04	30.00	40.00	5.70	30.00	+0.00/-0.04	40.00	+0.10/-0.00	6.30	+0.30/-0.00	6.60
R030040060RA-E	30.00	+0.00/-0.04	30.00	40.00	6.00	30.00	+0.00/-0.04	40.00	+0.10/-0.00	7.00	+0.30/-0.00	6.44
R030040070RA-E*	30.00	+0.00/-0.04	30.00	40.00	7.00	30.00	+0.00/-0.04	40.00	+0.10/-0.00	8.00	+0.30/-0.00	6.44
R030040080RA-E*	30.00	+0.00/-0.04	30.00	40.00	8.00	30.00	+0.00/-0.04	40.00	+0.10/-0.00	9.00	+0.30/-0.00	6.44
R030040100RA-E	30.00	+0.00/-0.04	30.00	40.00	10.00	30.00	+0.00/-0.04	40.00	+0.10/-0.00	11.00	+0.30/-0.00	6.43
R030042085RA-E*	30.00	+0.00/-0.04	30.00	42.00	8.50	30.00	+0.00/-0.04	42.00	+0.10/-0.00	9.50	+0.30/-0.00	6.38
R032042070RA-E*	32.00	+0.00/-0.04	32.00	42.00	7.00	32.00	+0.00/-0.04	42.00	+0.10/-0.00	8.00	+0.30/-0.00	5.42
R032042100RA-E	32.00	+0.00/-0.04	32.00	42.00	10.00	32.00	+0.00/-0.04	42.00	+0.10/-0.00	11.00	+0.30/-0.00	5.68
R032048080RA-E*	32.00	+0.00/-0.04	32.00	48.00	8.00	32.00	+0.00/-0.04	48.00	+0.10/-0.00	9.00	+0.30/-0.00	6.83
R032048100RA-E	32.00	+0.00/-0.04	32.00	48.00	10.00	32.00	+0.00/-0.04	48.00	+0.10/-0.00	11.00	+0.30/-0.00	7.21
R033043100RA-E	33.00	+0.00/-0.04	33.00	43.00	10.00	33.00	+0.00/-0.04	43.00	+0.10/-0.00	11.00	+0.30/-0.00	6.54
R035043057RA-E	35.00	+0.00/-0.04	35.00	43.00	5.70	35.00	+0.00/-0.04	43.00	+0.10/-0.00	6.30	+0.30/-0.00	6.16
R035043080RA-E*	35.00	+0.00/-0.04	35.00	43.00	8.00	35.00	+0.00/-0.04	43.00	+0.10/-0.00	9.00	+0.30/-0.00	6.16
R035045060RA-E*	35.00	+0.00/-0.04	35.00	45.00	6.00	35.00	+0.00/-0.04	45.00	+0.10/-0.00	7.00	+0.30/-0.00	6.38
R035045070RA-E	35.00	+0.00/-0.04	35.00	45.00	7.00	35.00	+0.00/-0.04	45.00	+0.10/-0.00	8.00	+0.30/-0.00	6.38
R035045080RA-E*	35.00	+0.00/-0.04	35.00	45.00	8.00	35.00	+0.00/-0.04	45.00	+0.10/-0.00	9.00	+0.30/-0.00	6.38
R035045100RA-E	35.00	+0.00/-0.04	35.00	45.00	10.00	35.00	+0.00/-0.04	45.00	+0.10/-0.00	11.00	+0.30/-0.00	6.50
R035050080RA-E*	35.00	+0.00/-0.04	35.00	50.00	8.00	35.00	+0.00/-0.04	50.00	+0.10/-0.00	9.00	+0.30/-0.00	6.72
R036046060RA-E*	36.00	+0.00/-0.04	36.00	46.00	6.00	36.00	+0.00/-0.04	46.00	+0.10/-0.00	7.00	+0.30/-0.00	6.72
R036046080RA-E*	36.00	+0.00/-0.04	36.00	46.00	8.00	36.00	+0.00/-0.04	46.00	+0.10/-0.00	9.00	+0.30/-0.00	6.38
R036046100RA-E*	36.00	+0.00/-0.04	36.00	46.00	10.00	36.00	+0.00/-0.04	46.00	+0.10/-0.00	11.00	+0.30/-0.00	6.38
R036051100RA-E*	36.00	+0.00/-0.04	36.00	51.00	10.00	36.00	+0.00/-0.04	51.00	+0.12/-0.00	11.00	+0.30/-0.00	6.72
R040048057RA-E	40.00	+0.00/-0.05	40.00	48.00	5.70	40.00	+0.00/-0.05	48.00	+0.10/-0.00	6.30	+0.30/-0.00	6.16
R040048080RA-E*	40.00	+0.00/-0.05	40.00	48.00	8.00	40.00	+0.00/-0.05	48.00	+0.10/-0.00	9.00	+0.30/-0.00	6.72
R040050072RA-E	40.00	+0.00/-0.05	40.00	50.00	7.20	40.00	+0.00/-0.05	50.00	+0.10/-0.00	8.00	+0.30/-0.00	6.72
R040050080RA-E	40.00	+0.00/-0.05	40.00	50.00	8.00	40.00	+0.00/-0.05	50.00	+0.10/-0.00	9.00	+0.30/-0.00	6.72

*: GENERALLY NOT STOCKED BUT AVAILABLE - CHECK WITH C/SER

RA/E SERIES - AU 94A

Ref.Number	Rod diameter		Nominal Seal Dimensions			Housing Dimensions					\$	
		Tol.	d	D	H	d1	Tol.	D1	Tol.	H1		Tol.
R040050100RA-E	40.00	+0.00 / -0.05	40.00	50.00	10.00	40.00	+0.00 / -0.05	50.00	+0.10 / -0.00	11.00	+0.30 / -0.00	6.72
R040055100RA-E	40.00	+0.00 / -0.05	40.00	55.00	10.00	40.00	+0.00 / -0.05	55.00	+0.12 / -0.00	11.00	+0.30 / -0.00	6.72
R040060120RA-E	40.00	+0.00 / -0.05	40.00	60.00	12.00	40.00	+0.00 / -0.05	60.00	+0.12 / -0.00	13.00	+0.30 / -0.00	7.39
R042052070RA-E*	42.00	+0.00 / -0.05	42.00	52.00	7.00	42.00	+0.00 / -0.05	52.00	+0.12 / -0.00	8.00	+0.30 / -0.00	6.94
R045055070RA-E	45.00	+0.00 / -0.05	45.00	55.00	7.00	45.00	+0.00 / -0.05	55.00	+0.12 / -0.00	8.00	+0.30 / -0.00	7.17
R045055100RA-E	45.00	+0.00 / -0.05	45.00	55.00	10.00	45.00	+0.00 / -0.05	55.00	+0.12 / -0.00	11.00	+0.30 / -0.00	7.17
R045060090RA-E*	45.00	+0.00 / -0.05	45.00	60.00	9.00	45.00	+0.00 / -0.05	60.00	+0.12 / -0.00	10.00	+0.30 / -0.00	7.28
R045061120RA-E*	45.00	+0.00 / -0.05	45.00	61.00	12.00	45.00	+0.00 / -0.05	61.00	+0.12 / -0.00	13.00	+0.30 / -0.00	7.39
R045065100RA-E*	45.00	+0.00 / -0.05	45.00	65.00	10.00	45.00	+0.00 / -0.05	65.00	+0.12 / -0.00	11.00	+0.30 / -0.00	7.39
R050060060RA-E	50.00	+0.00 / -0.05	50.00	60.00	6.00	50.00	+0.00 / -0.05	60.00	+0.12 / -0.00	7.00	+0.30 / -0.00	7.39
R050060080RA-E	50.00	+0.00 / -0.05	50.00	60.00	8.00	50.00	+0.00 / -0.05	60.00	+0.12 / -0.00	9.00	+0.30 / -0.00	7.50
R050060100RA-E*	50.00	+0.00 / -0.05	50.00	60.00	10.00	50.00	+0.00 / -0.05	60.00	+0.12 / -0.00	11.00	+0.30 / -0.00	7.39
R050062080RA-E*	50.00	+0.00 / -0.05	50.00	62.00	8.00	50.00	+0.00 / -0.05	62.00	+0.12 / -0.00	9.00	+0.30 / -0.00	7.39
R050063080RA-E	50.00	+0.00 / -0.05	50.00	63.00	8.00	50.00	+0.00 / -0.05	63.00	+0.12 / -0.00	9.00	+0.30 / -0.00	8.66
R050065100RA-E*	50.00	+0.00 / -0.05	50.00	65.00	10.00	50.00	+0.00 / -0.05	65.00	+0.12 / -0.00	11.00	+0.30 / -0.00	7.50
R055065073RA-E*	55.00	+0.00 / -0.05	55.00	65.00	7.30	55.00	+0.00 / -0.05	65.00	+0.12 / -0.00	8.30	+0.30 / -0.00	7.39
R055065100RA-E*	55.00	+0.00 / -0.05	55.00	65.00	10.00	55.00	+0.00 / -0.05	65.00	+0.12 / -0.00	11.00	+0.30 / -0.00	7.50
R055071120RA-E	55.00	+0.00 / -0.05	55.00	71.00	12.00	55.00	+0.00 / -0.05	71.00	+0.12 / -0.00	13.00	+0.30 / -0.00	7.73
R056066100RA-E*	56.00	+0.00 / -0.05	56.00	66.00	10.00	56.00	+0.00 / -0.05	66.00	+0.12 / -0.00	11.00	+0.30 / -0.00	8.18
R056068085RA-E*	56.00	+0.00 / -0.05	56.00	68.00	8.50	56.00	+0.00 / -0.05	68.00	+0.12 / -0.00	9.50	+0.30 / -0.00	7.50
R060070085RA-E*	60.00	+0.00 / -0.05	60.00	70.00	8.50	60.00	+0.00 / -0.05	70.00	+0.12 / -0.00	9.50	+0.30 / -0.00	7.73
R060070100RA-E*	60.00	+0.00 / -0.05	60.00	70.00	10.00	60.00	+0.00 / -0.05	70.00	+0.12 / -0.00	11.00	+0.30 / -0.00	7.95
R060070120RA-E*	60.00	+0.00 / -0.05	60.00	70.00	12.00	60.00	+0.00 / -0.05	70.00	+0.12 / -0.00	13.00	+0.30 / -0.00	8.18
R060072085RA-E*	60.00	+0.00 / -0.05	60.00	72.00	8.50	60.00	+0.00 / -0.05	72.00	+0.12 / -0.00	9.50	+0.30 / -0.00	7.95
R060074080RA-E*	60.00	+0.00 / -0.05	60.00	74.00	8.00	60.00	+0.00 / -0.05	74.00	+0.12 / -0.00	9.00	+0.30 / -0.00	7.95
R060075120RA-E*	60.00	+0.00 / -0.05	60.00	75.00	12.00	60.00	+0.00 / -0.05	75.00	+0.12 / -0.00	13.00	+0.30 / -0.00	8.51
R063073065RA-E*	63.00	+0.00 / -0.05	63.00	73.00	6.50	63.00	+0.00 / -0.05	73.00	+0.12 / -0.00	7.50	+0.30 / -0.00	8.18
R063073120RA-E*	63.00	+0.00 / -0.05	63.00	73.00	12.00	63.00	+0.00 / -0.05	73.00	+0.12 / -0.00	13.00	+0.30 / -0.00	8.62
R063075085RA-E*	63.00	+0.00 / -0.05	63.00	75.00	8.50	63.00	+0.00 / -0.05	75.00	+0.12 / -0.00	9.50	+0.30 / -0.00	8.40
R063078100RA-E*	63.00	+0.00 / -0.05	63.00	78.00	10.00	63.00	+0.00 / -0.05	78.00	+0.12 / -0.00	11.00	+0.30 / -0.00	9.13
R065075100RA-E*	65.00	+0.00 / -0.06	65.00	75.00	10.00	65.00	+0.00 / -0.06	75.00	+0.12 / -0.00	11.00	+0.30 / -0.00	8.18
R065078100RA-E	65.00	+0.00 / -0.06	65.00	78.00	10.00	65.00	+0.00 / -0.06	78.00	+0.12 / -0.00	11.00	+0.30 / -0.00	8.54
R065080100RA-E	65.00	+0.00 / -0.06	65.00	80.00	10.00	65.00	+0.00 / -0.06	80.00	+0.12 / -0.00	11.00	+0.30 / -0.00	10.06
R070080120RA-E*	70.00	+0.00 / -0.06	70.00	80.00	12.00	70.00	+0.00 / -0.06	80.00	+0.12 / -0.00	13.00	+0.30 / -0.00	8.74
R070085100RA-E*	70.00	+0.00 / -0.06	70.00	85.00	10.00	70.00	+0.00 / -0.06	85.00	+0.12 / -0.00	11.00	+0.30 / -0.00	8.96
R070085115RA-E*	70.00	+0.00 / -0.06	70.00	85.00	11.50	70.00	+0.00 / -0.06	85.00	+0.12 / -0.00	12.50	+0.30 / -0.00	9.18
R070090135RA-E*	70.00	+0.00 / -0.06	70.00	90.00	13.50	70.00	+0.00 / -0.06	90.00	+0.12 / -0.00	14.50	+0.30 / -0.00	8.29
R075085072RA-E	75.00	+0.00 / -0.06	75.00	85.00	7.20	75.00	+0.00 / -0.06	85.00	+0.14 / -0.00	8.00	+0.30 / -0.00	7.48
R075085120RA-E*	75.00	+0.00 / -0.06	75.00	85.00	12.00	75.00	+0.00 / -0.06	85.00	+0.14 / -0.00	13.00	+0.30 / -0.00	7.78
R075095120RA-E*	75.00	+0.00 / -0.06	75.00	95.00	12.00	75.00	+0.00 / -0.06	95.00	+0.14 / -0.00	13.00	+0.30 / -0.00	9.07
R080090120RA-E*	80.00	+0.00 / -0.09	80.00	90.00	12.00	80.00	+0.00 / -0.09	90.00	+0.14 / -0.00	13.00	+0.30 / -0.00	9.41
R080093100RA-E	80.00	+0.00 / -0.09	80.00	93.00	10.00	80.00	+0.00 / -0.09	93.00	+0.14 / -0.00	11.00	+0.30 / -0.00	9.88
R080095100RA-E	80.00	+0.00 / -0.09	80.00	95.00	10.00	80.00	+0.00 / -0.09	95.00	+0.14 / -0.00	11.00	+0.30 / -0.00	9.74
R080100135RA-E*	80.00	+0.00 / -0.09	80.00	100.00	13.50	80.00	+0.00 / -0.09	100.00	+0.14 / -0.00	14.50	+0.30 / -0.00	11.20
R085095070RA-E*	85.00	+0.00 / -0.09	85.00	95.00	7.00	85.00	+0.00 / -0.09	95.00	+0.14 / -0.00	8.00	+0.30 / -0.00	9.63
R085095120RA-E*	85.00	+0.00 / -0.09	85.00	95.00	12.00	85.00	+0.00 / -0.09	95.00	+0.14 / -0.00	13.00	+0.30 / -0.00	9.74
R085105120RA-E	85.00	+0.00 / -0.09	85.00	105.00	12.00	85.00	+0.00 / -0.09	105.00	+0.14 / -0.00	13.00	+0.30 / -0.00	9.74

*: GENERALLY NOT STOCKED BUT AVAILABLE - CHECK WITH C/SER

METRIC SIZE
ROD SEALS



Tel.: 1-888-609-SEAL
Fax: 1-888-717-SEAL

J

17

www.sealsourceinc.com

Seal Source Inc.

**METRIC SIZE
ROD SEALS**

RA/E SERIES - AU 94A

Ref.Number	Rod diameter		Nominal Seal Dimensions			Housing Dimensions					\$	
		Tol.	d	D	H	d1	Tol.	D1	Tol.	H1		Tol.
R090100120RA-E*	90.00	+0.00 / -0.09	90.00	100.00	12.00	90.00	+0.00 / -0.09	100.00	+0.14 / -0.00	13.00	+0.30 / -0.00	9.74
R090102090RA-E	90.00	+0.00 / -0.09	90.00	102.00	9.00	90.00	+0.00 / -0.09	102.00	+0.14 / -0.00	10.00	+0.30 / -0.00	8.85
R090105114RA-E*	90.00	+0.00 / -0.09	90.00	105.00	11.40	90.00	+0.00 / -0.09	105.00	+0.14 / -0.00	12.40	+0.30 / -0.00	8.37
R090110115RA-E*	90.00	+0.00 / -0.09	90.00	110.00	11.50	90.00	+0.00 / -0.09	110.00	+0.14 / -0.00	12.50	+0.30 / -0.00	8.85
R095105120RA-E*	95.00	+0.00 / -0.09	95.00	105.00	12.00	95.00	+0.00 / -0.09	105.00	+0.14 / -0.00	13.00	+0.30 / -0.00	9.74
R095110120RA-E*	95.00	+0.00 / -0.09	95.00	110.00	12.00	95.00	+0.00 / -0.09	110.00	+0.14 / -0.00	13.00	+0.30 / -0.00	10.75
R100110140RA-E*	100.00	+0.00 / -0.09	100.00	110.00	14.00	100.00	+0.00 / -0.09	110.00	+0.14 / -0.00	15.00	+0.30 / -0.00	12.32
R100115090RA-E*	100.00	+0.00 / -0.09	100.00	115.00	9.00	100.00	+0.00 / -0.09	115.00	+0.14 / -0.00	10.00	+0.30 / -0.00	12.32
R100115120RA-E*	100.00	+0.00 / -0.09	100.00	115.00	12.00	100.00	+0.00 / -0.09	115.00	+0.14 / -0.00	13.00	+0.30 / -0.00	10.59
R100120135RA-E*	100.00	+0.00 / -0.09	100.00	120.00	13.50	100.00	+0.00 / -0.09	120.00	+0.14 / -0.00	14.50	+0.30 / -0.00	14.00
R100120145RA-E*	100.00	+0.00 / -0.09	100.00	120.00	14.50	100.00	+0.00 / -0.09	120.00	+0.14 / -0.00	15.50	+0.30 / -0.00	10.73
R105120120RA-E*	105.00	+0.00 / -0.09	105.00	120.00	12.00	105.00	+0.00 / -0.09	120.00	+0.14 / -0.00	13.00	+0.30 / -0.00	13.44
R105125120RA-E*	105.00	+0.00 / -0.09	105.00	125.00	12.00	105.00	+0.00 / -0.09	125.00	+0.14 / -0.00	13.00	+0.30 / -0.00	14.22
R110130115RA-E*	110.00	+0.00 / -0.09	110.00	130.00	11.50	110.00	+0.00 / -0.09	130.00	+0.14 / -0.00	12.50	+0.30 / -0.00	13.89
R115125120RA-E*	115.00	+0.00 / -0.09	115.00	125.00	12.00	115.00	+0.00 / -0.09	125.00	+0.14 / -0.00	13.00	+0.30 / -0.00	12.88
R120135095RA-E*	120.00	+0.00 / -0.09	120.00	135.00	9.50	120.00	+0.00 / -0.09	135.00	+0.14 / -0.00	10.50	+0.30 / -0.00	14.22
R120135145RA-E*	120.00	+0.00 / -0.09	120.00	135.00	14.50	120.00	+0.00 / -0.09	135.00	+0.14 / -0.00	15.50	+0.30 / -0.00	16.46
R120140115RA-E*	120.00	+0.00 / -0.09	120.00	140.00	11.50	120.00	+0.00 / -0.09	140.00	+0.14 / -0.00	12.50	+0.30 / -0.00	15.68
R120140146RA-E*	120.00	+0.00 / -0.09	120.00	140.00	14.60	120.00	+0.00 / -0.09	140.00	+0.14 / -0.00	15.60	+0.30 / -0.00	16.46
R125135135RA-E*	125.00	+0.00 / -0.13	125.00	135.00	13.50	125.00	+0.00 / -0.13	135.00	+0.16 / -0.00	14.50	+0.30 / -0.00	16.24
R125140090RA-E	125.00	+0.00 / -0.13	125.00	140.00	9.00	125.00	+0.00 / -0.13	140.00	+0.16 / -0.00	10.00	+0.30 / -0.00	27.53
R125145120RA-E*	125.00	+0.00 / -0.13	125.00	145.00	12.00	125.00	+0.00 / -0.13	145.00	+0.16 / -0.00	13.00	+0.30 / -0.00	14.21
R128140100RA-E*	128.00	+0.00 / -0.13	128.00	140.00	10.00	128.00	+0.00 / -0.13	140.00	+0.16 / -0.00	11.00	+0.30 / -0.00	16.76
R130140135RA-E*	130.00	+0.00 / -0.13	130.00	140.00	13.50	130.00	+0.00 / -0.13	140.00	+0.16 / -0.00	14.50	+0.30 / -0.00	12.74
R130150150RA-E*	130.00	+0.00 / -0.13	130.00	150.00	15.00	130.00	+0.00 / -0.13	150.00	+0.16 / -0.00	16.00	+0.30 / -0.00	16.76
R132142060RA-E*	132.00	+0.00 / -0.13	132.00	142.00	6.00	132.00	+0.00 / -0.13	142.00	+0.16 / -0.00	7.00	+0.30 / -0.00	11.17
R135145120RA-E*	135.00	+0.00 / -0.13	135.00	145.00	12.00	135.00	+0.00 / -0.13	145.00	+0.16 / -0.00	13.00	+0.30 / -0.00	12.84
R150160135RA-E*	150.00	+0.00 / -0.13	150.00	160.00	13.50	150.00	+0.00 / -0.13	160.00	+0.16 / -0.00	14.50	+0.30 / -0.00	16.76
R150165090RA-E*	150.00	+0.00 / -0.13	150.00	165.00	9.00	150.00	+0.00 / -0.13	165.00	+0.16 / -0.00	10.00	+0.30 / -0.00	17.35
R150170135RA-E*	150.00	+0.00 / -0.13	150.00	170.00	13.50	150.00	+0.00 / -0.13	170.00	+0.16 / -0.00	14.50	+0.30 / -0.00	19.60
R150170150RA-E*	150.00	+0.00 / -0.13	150.00	170.00	15.00	150.00	+0.00 / -0.13	170.00	+0.16 / -0.00	16.00	+0.30 / -0.00	19.60
R155165120RA-E*	155.00	+0.00 / -0.13	155.00	165.00	12.00	155.00	+0.00 / -0.13	165.00	+0.16 / -0.00	13.00	+0.30 / -0.00	16.95
R160170120RA-E*	160.00	+0.00 / -0.13	160.00	170.00	12.00	160.00	+0.00 / -0.13	170.00	+0.16 / -0.00	13.00	+0.30 / -0.00	18.33
R160180120RA-E*	160.00	+0.00 / -0.13	160.00	180.00	12.00	160.00	+0.00 / -0.13	180.00	+0.16 / -0.00	13.00	+0.30 / -0.00	24.11
R160180150RA-E*	160.00	+0.00 / -0.13	160.00	180.00	15.00	160.00	+0.00 / -0.13	180.00	+0.16 / -0.00	16.00	+0.30 / -0.00	24.11
R165180110RA-E*	165.00	+0.00 / -0.13	165.00	180.00	11.00	165.00	+0.00 / -0.13	180.00	+0.16 / -0.00	12.00	+0.30 / -0.00	18.72
R170180145RA-E*	170.00	+0.00 / -0.13	170.00	180.00	14.50	170.00	+0.00 / -0.13	180.00	+0.16 / -0.00	15.50	+0.30 / -0.00	19.60
R170190150RA-E*	170.00	+0.00 / -0.13	170.00	190.00	15.00	170.00	+0.00 / -0.13	190.00	+0.16 / -0.00	16.00	+0.30 / -0.00	16.90
R180190110RA-E*	180.00	+0.00 / -0.13	180.00	190.00	11.00	180.00	+0.00 / -0.13	190.00	+0.18 / -0.00	12.00	+0.30 / -0.00	26.95
R180192100RA-E*	180.00	+0.00 / -0.13	180.00	192.00	10.00	180.00	+0.00 / -0.13	192.00	+0.18 / -0.00	11.00	+0.30 / -0.00	33.78
R180195125RA-E*	180.00	+0.00 / -0.13	180.00	195.00	12.50	180.00	+0.00 / -0.13	195.00	+0.18 / -0.00	13.50	+0.30 / -0.00	30.97
R180200120RA-E*	180.00	+0.00 / -0.13	180.00	200.00	12.00	180.00	+0.00 / -0.13	200.00	+0.18 / -0.00	13.00	+0.30 / -0.00	26.95
R180200150RA-E	180.00	+0.00 / -0.13	180.00	200.00	15.00	180.00	+0.00 / -0.13	200.00	+0.18 / -0.00	16.00	+0.30 / -0.00	26.95
R185195120RA-E*	185.00	+0.00 / -0.13	185.00	195.00	12.00	185.00	+0.00 / -0.13	195.00	+0.18 / -0.00	13.00	+0.30 / -0.00	30.77
R200220150RA-E*	200.00	+0.00 / -0.13	200.00	220.00	15.00	200.00	+0.00 / -0.13	220.00	+0.18 / -0.00	16.00	+0.30 / -0.00	44.10
R200225150RA-E*	200.00	+0.00 / -0.13	200.00	225.00	15.00	200.00	+0.00 / -0.13	225.00	+0.18 / -0.00	16.00	+0.30 / -0.00	46.06
R210230120RA-E*	210.00	+0.00 / -0.13	210.00	230.00	12.00	210.00	+0.00 / -0.13	230.00	+0.18 / -0.00	13.00	+0.30 / -0.00	93.44

*: GENERALLY NOT STOCKED BUT AVAILABLE - CHECK WITH C/SER

RA/E SERIES - AU 94A

Ref.Number	Rod diameter		Nominal Seal Dimensions			Housing Dimensions					\$	
		Tol.	d	D	H	d1	Tol.	D1	Tol.	H1		Tol.
R210230160RA-E	210.00	+0.00 / -0.13	210.00	230.00	16.00	210.00	+0.00 / -0.13	230.00	+0.18 / -0.00	17.00	+0.30 / -0.00	95.22
R210240280RA-E*	210.00	+0.00 / -0.13	210.00	240.00	28.00	210.00	+0.00 / -0.13	240.00	+0.18 / -0.00	29.00	+0.30 / -0.00	85.55
R212224100RA-E*	212.00	+0.00 / -0.13	212.00	224.00	10.00	212.00	+0.00 / -0.13	224.00	+0.18 / -0.00	11.00	+0.30 / -0.00	35.38
R215225120RA-E*	215.00	+0.00 / -0.13	215.00	225.00	12.00	215.00	+0.00 / -0.13	225.00	+0.18 / -0.00	13.00	+0.30 / -0.00	35.38
R220240150RA-E*	220.00	+0.00 / -0.13	220.00	240.00	15.00	220.00	+0.00 / -0.13	240.00	+0.18 / -0.00	16.00	+0.30 / -0.00	46.75
R220245190RA-E*	220.00	+0.00 / -0.13	220.00	245.00	19.00	220.00	+0.00 / -0.13	245.00	+0.18 / -0.00	20.00	+0.30 / -0.00	52.33
R220250227RA-E*	220.00	+0.00 / -0.13	220.00	250.00	22.70	220.00	+0.00 / -0.13	250.00	+0.18 / -0.00	23.70	+0.30 / -0.00	59.09
R240250120RA-E*	240.00	+0.00 / -0.13	240.00	250.00	12.00	240.00	+0.00 / -0.13	250.00	+0.18 / -0.00	13.00	+0.30 / -0.00	52.82
R240260150RA-E*	240.00	+0.00 / -0.13	240.00	260.00	15.00	240.00	+0.00 / -0.13	260.00	+0.18 / -0.00	16.00	+0.30 / -0.00	68.40
R240270180RA-E*	240.00	+0.00 / -0.13	240.00	270.00	18.00	240.00	+0.00 / -0.13	270.00	+0.18 / -0.00	19.00	+0.30 / -0.00	64.09
R250270150RA-E*	250.00	+0.00 / -0.13	250.00	270.00	15.00	250.00	+0.00 / -0.13	270.00	+0.21 / -0.00	16.00	+0.30 / -0.00	73.99
R280300150RA-E*	280.00	+0.00 / -0.13	280.00	300.00	15.00	280.00	+0.00 / -0.13	300.00	+0.21 / -0.00	16.00	+0.30 / -0.00	79.58
R280310190RA-E	280.00	+0.00 / -0.13	280.00	310.00	19.00	280.00	+0.00 / -0.13	310.00	+0.21 / -0.00	20.00	+0.30 / -0.00	144.22
R300360228RA-E*	300.00	+0.00 / -0.13	300.00	360.00	22.80	300.00	+0.00 / -0.13	360.00	+0.21 / -0.00	23.80	+0.30 / -0.00	106.82

METRIC SIZE
ROD SEALS



*: GENERALLY NOT STOCKED BUT AVAILABLE - CHECK WITH C/SER

Tel.: 1-888-609-SEAL
Fax: 1-888-717-SEAL

J

19

www.sealsourceinc.com



Seal Source Inc.

METRIC SIZE
ROD SEALS

RC - Rod Seals Polyurethane AU 93A

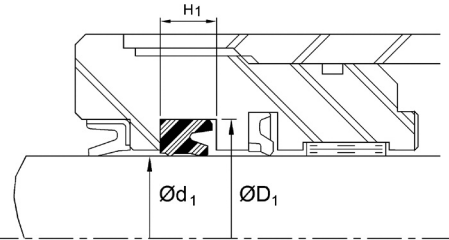
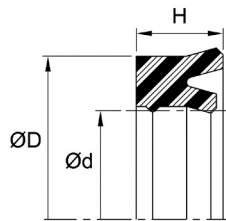
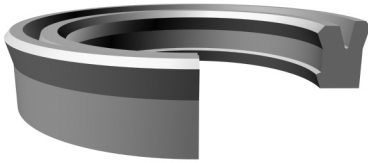

Temperature: -31/212F [-35/100C]

Pressure: 5800 PSI [400 Bar]

Ref.Number	Rod diameter		Nominal Seal Dimensions			Housing Dimensions					\$	
		Tol.	d	D	H	d1	Tol.	D1	Tol.	H1		Tol.
R008016057RC*	8.00	+0.00 / -0.04	8.00	16.00	5.70	8.00	+0.00 / -0.04	16.00	+0.11 / -0.00	6.30	+0.25 / -0.00	8.93
R008018070RC*	8.00	+0.00 / -0.04	8.00	18.00	7.00	8.00	+0.00 / -0.04	18.00	+0.11 / -0.00	8.00	+0.25 / -0.00	8.09
R010015036RC	10.00	+0.00 / -0.04	10.00	15.00	3.60	10.00	+0.00 / -0.04	15.00	+0.11 / -0.00	4.00	+0.25 / -0.00	7.62
R010016045RC*	10.00	+0.00 / -0.04	10.00	16.00	4.50	10.00	+0.00 / -0.04	16.00	+0.11 / -0.00	5.30	+0.25 / -0.00	9.67
R010018057RC*	10.00	+0.00 / -0.04	10.00	18.00	5.70	10.00	+0.00 / -0.04	18.00	+0.11 / -0.00	6.30	+0.25 / -0.00	6.99
R012018040RC*	12.00	+0.00 / -0.04	12.00	18.00	4.00	12.00	+0.00 / -0.04	18.00	+0.13 / -0.00	4.50	+0.25 / -0.00	8.15
R012018055RC*	12.70	+0.00 / -0.04	12.70	18.00	5.50	12.70	+0.00 / -0.04	18.00	+0.13 / -0.00	6.00	+0.25 / -0.00	7.96
R012018057RC	12.00	+0.00 / -0.04	12.00	18.00	5.70	12.00	+0.00 / -0.04	18.00	+0.13 / -0.00	6.30	+0.25 / -0.00	6.94
R012019045RC*	12.00	+0.00 / -0.04	12.00	19.00	4.50	12.00	+0.00 / -0.04	19.00	+0.13 / -0.00	5.00	+0.25 / -0.00	7.62
R012019050RC*	12.00	+0.00 / -0.04	12.00	19.00	5.00	12.00	+0.00 / -0.04	19.00	+0.13 / -0.00	5.60	+0.25 / -0.00	5.37
R012020057RC	12.00	+0.00 / -0.04	12.00	20.00	5.70	12.00	+0.00 / -0.04	20.00	+0.13 / -0.00	6.30	+0.25 / -0.00	7.01
R012022077RC	12.00	+0.00 / -0.04	12.00	22.00	7.70	12.00	+0.00 / -0.04	22.00	+0.13 / -0.00	9.00	+0.25 / -0.00	7.96
R013020045RC	13.00	+0.00 / -0.04	13.00	20.00	4.50	13.00	+0.00 / -0.04	20.00	+0.13 / -0.00	5.00	+0.25 / -0.00	7.62
R014022057RC	14.00	+0.00 / -0.04	14.00	22.00	5.70	14.00	+0.00 / -0.04	22.00	+0.13 / -0.00	6.30	+0.25 / -0.00	7.96
R014024073RC*	14.00	+0.00 / -0.04	14.00	24.00	7.30	14.00	+0.00 / -0.04	24.00	+0.13 / -0.00	8.00	+0.25 / -0.00	7.96
R016022045RC	16.00	+0.00 / -0.04	16.00	22.00	4.50	16.00	+0.00 / -0.04	22.00	+0.13 / -0.00	5.00	+0.25 / -0.00	7.62
R016022050RC	16.00	+0.00 / -0.04	16.00	22.00	5.00	16.00	+0.00 / -0.04	22.00	+0.13 / -0.00	6.00	+0.25 / -0.00	8.65
R016024057RC	16.00	+0.00 / -0.04	16.00	24.00	5.70	16.00	+0.00 / -0.04	24.00	+0.13 / -0.00	6.30	+0.25 / -0.00	8.53
R016024063RC*	16.00	+0.00 / -0.04	16.00	24.00	6.30	16.00	+0.00 / -0.04	24.00	+0.13 / -0.00	7.00	+0.25 / -0.00	9.07
R016026073RC*	16.00	+0.00 / -0.04	16.00	26.00	7.30	16.00	+0.00 / -0.04	26.00	+0.13 / -0.00	8.00	+0.25 / -0.00	11.08
R016026077RC	16.00	+0.00 / -0.04	16.00	26.00	7.70	16.00	+0.00 / -0.04	26.00	+0.13 / -0.00	9.00	+0.25 / -0.00	7.52
R018025050RC	18.00	+0.00 / -0.04	18.00	25.00	5.00	18.00	+0.00 / -0.04	25.00	+0.13 / -0.00	6.00	+0.25 / -0.00	7.89
R018026050RC	18.00	+0.00 / -0.04	18.00	26.00	5.00	18.00	+0.00 / -0.04	26.00	+0.13 / -0.00	5.70	+0.25 / -0.00	7.96
R018026057RC	18.00	+0.00 / -0.04	18.00	26.00	5.70	18.00	+0.00 / -0.04	26.00	+0.13 / -0.00	6.30	+0.25 / -0.00	7.96
R018026060RC	18.00	+0.00 / -0.04	18.00	26.00	6.00	18.00	+0.00 / -0.04	26.00	+0.13 / -0.00	7.00	+0.25 / -0.00	8.78
R018028077RC*	18.00	+0.00 / -0.04	18.00	28.00	7.70	18.00	+0.00 / -0.04	28.00	+0.13 / -0.00	9.00	+0.25 / -0.00	7.62
R020025032RC	20.00	+0.00 / -0.04	20.00	25.00	3.20	20.00	+0.00 / -0.04	25.00	+0.13 / -0.00	3.50	+0.25 / -0.00	7.62
R020026050RC	20.00	+0.00 / -0.04	20.00	26.00	5.00	20.00	+0.00 / -0.04	26.00	+0.13 / -0.00	5.50	+0.25 / -0.00	6.25
R020028050RC	20.00	+0.00 / -0.04	20.00	28.00	5.00	20.00	+0.00 / -0.04	28.00	+0.13 / -0.00	5.70	+0.25 / -0.00	8.31
R020028057RC	20.00	+0.00 / -0.04	20.00	28.00	5.70	20.00	+0.00 / -0.04	28.00	+0.13 / -0.00	6.30	+0.25 / -0.00	7.15
R020030060RC	20.00	+0.00 / -0.04	20.00	30.00	6.00	20.00	+0.00 / -0.04	30.00	+0.13 / -0.00	7.00	+0.25 / -0.00	8.31
R020030073RC*	20.00	+0.00 / -0.04	20.00	30.00	7.30	20.00	+0.00 / -0.04	30.00	+0.13 / -0.00	8.00	+0.25 / -0.00	11.90
R020030077RC	20.00	+0.00 / -0.04	20.00	30.00	7.70	20.00	+0.00 / -0.04	30.00	+0.13 / -0.00	9.00	+0.25 / -0.00	7.50
R020030080RC	20.00	+0.00 / -0.04	20.00	30.00	8.00	20.00	+0.00 / -0.04	30.00	+0.13 / -0.00	9.00	+0.25 / -0.00	8.21
R020030100RC	20.00	+0.00 / -0.04	20.00	30.00	10.00	20.00	+0.00 / -0.04	30.00	+0.13 / -0.00	11.00	+0.25 / -0.00	8.65
R022030050RC	22.40	+0.00 / -0.04	22.40	30.00	5.00	22.40	+0.00 / -0.04	30.00	+0.16 / -0.00	5.70	+0.25 / -0.00	7.96

*: GENERALLY NOT STOCKED BUT AVAILABLE - CHECK WITH C/SER

Seal Source Inc.

RC SERIES - AU 93A

Ref.Number	Rod diameter		Nominal Seal Dimensions			Housing Dimensions					\$	
		Tol.	d	D	H	d1	Tol.	D1	Tol.	H1		Tol.
R022030057RC	22.00	+0.00 / -0.04	22.00	30.00	5.70	22.00	+0.00 / -0.04	30.00	+0.16 / -0.00	6.30	+0.25 / -0.00	6.86
R022030073RC	22.00	+0.00 / -0.04	22.00	30.00	7.30	22.00	+0.00 / -0.04	30.00	+0.16 / -0.00	8.00	+0.25 / -0.00	8.31
R022032073RC	22.00	+0.00 / -0.04	22.00	32.00	7.30	22.00	+0.00 / -0.04	32.00	+0.16 / -0.00	8.00	+0.25 / -0.00	7.15
R022032080RC*	22.40	+0.00 / -0.04	22.40	32.40	8.00	22.40	+0.00 / -0.04	32.40	+0.16 / -0.00	9.00	+0.25 / -0.00	9.74
R022032100RC	22.00	+0.00 / -0.04	22.00	32.00	10.00	22.00	+0.00 / -0.04	32.00	+0.16 / -0.00	11.00	+0.25 / -0.00	7.96
R022033038RC	22.00	+0.00 / -0.04	22.00	33.00	3.80	22.00	+0.00 / -0.04	33.00	+0.16 / -0.00	4.30	+0.25 / -0.00	5.38
R025033050RC	25.00	+0.00 / -0.04	25.00	33.00	5.00	25.00	+0.00 / -0.04	33.00	+0.16 / -0.00	5.70	+0.25 / -0.00	7.96
R025033057RC	25.00	+0.00 / -0.04	25.00	33.00	5.70	25.00	+0.00 / -0.04	33.00	+0.16 / -0.00	6.30	+0.25 / -0.00	6.86
R025033063RC*	25.00	+0.00 / -0.04	25.00	33.00	6.30	25.00	+0.00 / -0.04	33.00	+0.16 / -0.00	7.00	+0.25 / -0.00	7.95
R025033065RC*	25.00	+0.00 / -0.04	25.00	33.00	6.50	25.00	+0.00 / -0.04	33.00	+0.16 / -0.00	7.30	+0.25 / -0.00	7.95
R025033068RC	25.00	+0.00 / -0.04	25.00	33.00	6.80	25.00	+0.00 / -0.04	33.00	+0.16 / -0.00	7.50	+0.25 / -0.00	8.31
R025033100RC	25.00	+0.00 / -0.04	25.00	33.00	10.00	25.00	+0.00 / -0.04	33.00	+0.16 / -0.00	11.00	+0.25 / -0.00	8.31
R025035073RC	25.00	+0.00 / -0.04	25.00	35.00	7.30	25.00	+0.00 / -0.04	35.00	+0.16 / -0.00	8.00	+0.25 / -0.00	8.62
R025035077RC	25.00	+0.00 / -0.04	25.00	35.00	7.70	25.00	+0.00 / -0.04	35.00	+0.16 / -0.00	9.00	+0.25 / -0.00	7.55
R025035080RC*	25.00	+0.00 / -0.04	25.00	35.00	8.00	25.00	+0.00 / -0.04	35.00	+0.16 / -0.00	9.00	+0.25 / -0.00	10.59
R025035100RC	25.00	+0.00 / -0.04	25.00	35.00	10.00	25.00	+0.00 / -0.04	35.00	+0.16 / -0.00	11.00	+0.25 / -0.00	7.55
R025037100RC*	25.00	+0.00 / -0.04	25.00	37.00	10.00	25.00	+0.00 / -0.04	37.00	+0.16 / -0.00	11.00	+0.25 / -0.00	10.03
R025040100RC	25.00	+0.00 / -0.04	25.00	40.00	10.00	25.00	+0.00 / -0.04	40.00	+0.16 / -0.00	11.00	+0.25 / -0.00	10.03
R026036070RC*	26.00	+0.00 / -0.04	26.00	36.00	7.00	26.00	+0.00 / -0.04	36.00	+0.16 / -0.00	8.00	+0.25 / -0.00	8.65
R028035050RC	28.00	+0.00 / -0.04	28.00	35.50	5.00	28.00	+0.00 / -0.04	35.50	+0.16 / -0.00	5.70	+0.25 / -0.00	7.14
R028036057RC*	28.00	+0.00 / -0.04	28.00	36.00	5.70	28.00	+0.00 / -0.04	36.00	+0.16 / -0.00	6.30	+0.25 / -0.00	5.70
R028036070RC	28.00	+0.00 / -0.04	28.00	36.00	7.00	28.00	+0.00 / -0.04	36.00	+0.16 / -0.00	8.00	+0.25 / -0.00	8.57
R028038073RC-1	28.00	+0.00 / -0.04	28.00	38.00	7.30	28.00	+0.00 / -0.04	38.00	+0.16 / -0.00	8.00	+0.25 / -0.00	7.55
R028038073RC	28.00	+0.00 / -0.04	28.00	38.00	7.30	28.00	+0.00 / -0.04	38.00	+0.16 / -0.00	8.00	+0.25 / -0.00	8.65
R028043114RC*	28.00	+0.00 / -0.04	28.00	43.00	11.40	28.00	+0.00 / -0.04	43.00	+0.16 / -0.00	12.50	+0.25 / -0.00	7.55
R030038057RC*	30.00	+0.00 / -0.04	30.00	38.00	5.70	30.00	+0.00 / -0.04	38.00	+0.16 / -0.00	6.30	+0.25 / -0.00	10.07
R030038063RC	30.00	+0.00 / -0.04	30.00	38.00	6.30	30.00	+0.00 / -0.04	38.00	+0.16 / -0.00	7.00	+0.25 / -0.00	7.55
R030040060RC	30.00	+0.00 / -0.04	30.00	40.00	6.00	30.00	+0.00 / -0.04	40.00	+0.16 / -0.00	7.00	+0.25 / -0.00	7.80
R030040070RC	30.00	+0.00 / -0.04	30.00	40.00	7.00	30.00	+0.00 / -0.04	40.00	+0.16 / -0.00	7.70	+0.25 / -0.00	9.48
R030040073RC	30.00	+0.00 / -0.04	30.00	40.00	7.30	30.00	+0.00 / -0.04	40.00	+0.16 / -0.00	8.00	+0.25 / -0.00	7.89
R030040100RC	30.00	+0.00 / -0.04	30.00	40.00	10.00	30.00	+0.00 / -0.04	40.00	+0.16 / -0.00	11.00	+0.25 / -0.00	7.83
R030042109RC	30.00	+0.00 / -0.04	30.00	42.00	10.90	30.00	+0.00 / -0.04	42.00	+0.16 / -0.00	12.00	+0.25 / -0.00	10.73
R030050100RC*	30.00	+0.00 / -0.04	30.00	50.00	10.00	30.00	+0.00 / -0.04	50.00	+0.16 / -0.00	11.00	+0.25 / -0.00	11.09
R032040060RC	32.00	+0.00 / -0.04	32.00	40.00	6.00	32.00	+0.00 / -0.04	40.00	+0.16 / -0.00	7.00	+0.25 / -0.00	6.54
R032040067RC	32.00	+0.00 / -0.04	32.00	40.00	6.70	32.00	+0.00 / -0.04	40.00	+0.16 / -0.00	7.70	+0.25 / -0.00	8.31
R032040077RC	32.00	+0.00 / -0.04	32.00	40.00	7.70	32.00	+0.00 / -0.04	40.00	+0.16 / -0.00	9.00	+0.25 / -0.00	7.57
R032040080RC*	32.00	+0.00 / -0.04	32.00	40.00	8.00	32.00	+0.00 / -0.04	40.00	+0.16 / -0.00	9.00	+0.25 / -0.00	8.19
R032041079RC	32.00	+0.00 / -0.04	32.00	41.50	7.90	32.00	+0.00 / -0.04	41.50	+0.16 / -0.00	8.90	+0.25 / -0.00	8.65
R032042057RC	32.00	+0.00 / -0.04	32.00	42.00	5.70	32.00	+0.00 / -0.04	42.00	+0.16 / -0.00	6.30	+0.25 / -0.00	7.15
R032042073RC	32.00	+0.00 / -0.04	32.00	42.00	7.30	32.00	+0.00 / -0.04	42.00	+0.16 / -0.00	8.00	+0.25 / -0.00	8.35
R032042100RC	32.00	+0.00 / -0.04	32.00	42.00	10.00	32.00	+0.00 / -0.04	42.00	+0.16 / -0.00	11.00	+0.25 / -0.00	8.35
R032045100RC	32.00	+0.00 / -0.04	32.00	45.00	10.00	32.00	+0.00 / -0.04	45.00	+0.16 / -0.00	11.00	+0.25 / -0.00	10.86
R032047091RC*	32.00	+0.00 / -0.04	32.00	47.00	9.10	32.00	+0.00 / -0.04	47.00	+0.16 / -0.00	10.00	+0.25 / -0.00	8.65
R032047100RC	32.00	+0.00 / -0.04	32.00	47.00	10.00	32.00	+0.00 / -0.04	47.00	+0.16 / -0.00	11.00	+0.25 / -0.00	8.65
R032048100RC	32.00	+0.00 / -0.04	32.00	48.00	10.00	32.00	+0.00 / -0.04	48.00	+0.16 / -0.00	11.00	+0.25 / -0.00	10.12
R035043063RC	35.00	+0.00 / -0.04	35.00	43.00	6.30	35.00	+0.00 / -0.04	43.00	+0.16 / -0.00	7.00	+0.25 / -0.00	7.55
R035043082RC	35.00	+0.00 / -0.04	35.00	43.00	8.20	35.00	+0.00 / -0.04	43.00	+0.16 / -0.00	9.00	+0.25 / -0.00	7.55

*: GENERALLY NOT STOCKED BUT AVAILABLE - CHECK WITH C/SER

**METRIC SIZE
ROD SEALS**



**Tel.: 1-888-609-SEAL
Fax: 1-888-717-SEAL**

M

Seal Source Inc.

RC SERIES - AU 93A

METRIC SIZE
ROD SEALS

Ref.Number	Rod diameter		Nominal Seal Dimensions			Housing Dimensions					\$	
		Tol.	d	D	H	d1	Tol.	D1	Tol.	H1		Tol.
R035045060RC	35.00	+0.00 / -0.04	35.00	45.00	6.00	35.00	+0.00 / -0.04	45.00	+0.16 / -0.00	7.00	+0.25 / -0.00	8.19
R035045060RC	35.50	+0.00 / -0.04	35.50	45.00	6.00	35.50	+0.00 / -0.04	45.00	+0.16 / -0.00	7.00	+0.25 / -0.00	10.73
R035045073RC	35.00	+0.00 / -0.04	35.00	45.00	7.30	35.00	+0.00 / -0.04	45.00	+0.16 / -0.00	8.00	+0.25 / -0.00	9.11
R035045077RC	35.00	+0.00 / -0.04	35.00	45.00	7.70	35.00	+0.00 / -0.04	45.00	+0.16 / -0.00	9.00	+0.25 / -0.00	8.15
R035045100RC	35.00	+0.00 / -0.04	35.00	45.00	10.00	35.00	+0.00 / -0.04	45.00	+0.16 / -0.00	11.00	+0.25 / -0.00	7.55
R035050090RC	35.00	+0.00 / -0.04	35.00	50.00	9.00	35.00	+0.00 / -0.04	50.00	+0.16 / -0.00	10.00	+0.25 / -0.00	9.18
R035050100RC	35.00	+0.00 / -0.04	35.00	50.00	10.00	35.00	+0.00 / -0.04	50.00	+0.16 / -0.00	11.00	+0.25 / -0.00	8.94
R035050100RC-1	35.50	+0.00 / -0.04	35.50	50.50	10.00	35.50	+0.00 / -0.04	50.50	+0.16 / -0.00	11.00	+0.25 / -0.00	10.73
R036044058RC	36.00	+0.00 / -0.04	36.00	44.00	5.80	36.00	+0.00 / -0.04	44.00	+0.16 / -0.00	6.30	+0.25 / -0.00	7.71
R036044064RC	36.00	+0.00 / -0.04	36.00	44.00	6.40	36.00	+0.00 / -0.04	44.00	+0.16 / -0.00	7.50	+0.25 / -0.00	7.15
R036044082RC	36.00	+0.00 / -0.04	36.00	44.00	8.20	36.00	+0.00 / -0.04	44.00	+0.16 / -0.00	9.00	+0.25 / -0.00	7.65
R036046057RC*	36.00	+0.00 / -0.04	36.00	46.00	5.70	36.00	+0.00 / -0.04	46.00	+0.16 / -0.00	6.30	+0.25 / -0.00	8.65
R036046073RC	36.00	+0.00 / -0.04	36.00	46.00	7.30	36.00	+0.00 / -0.04	46.00	+0.16 / -0.00	8.00	+0.25 / -0.00	7.48
R036046100RC	36.00	+0.00 / -0.04	36.00	46.00	10.00	36.00	+0.00 / -0.04	46.00	+0.16 / -0.00	11.00	+0.25 / -0.00	8.35
R037047080RC	37.00	+0.00 / -0.04	37.00	47.00	8.00	37.00	+0.00 / -0.04	47.00	+0.16 / -0.00	9.00	+0.25 / -0.00	8.42
R037047100RC*	37.00	+0.00 / -0.04	37.00	47.00	10.00	37.00	+0.00 / -0.04	47.00	+0.16 / -0.00	11.00	+0.25 / -0.00	12.26
R038048100RC	38.00	+0.00 / -0.04	38.00	48.00	10.00	38.00	+0.00 / -0.04	48.00	+0.16 / -0.00	11.00	+0.25 / -0.00	10.21
R038050085RC*	38.00	+0.00 / -0.04	38.00	50.00	8.50	38.00	+0.00 / -0.04	50.00	+0.16 / -0.00	9.50	+0.25 / -0.00	8.82
R038050100RC	38.00	+0.00 / -0.04	38.00	50.00	10.00	38.00	+0.00 / -0.04	50.00	+0.16 / -0.00	11.00	+0.25 / -0.00	11.17
R038053100RC	38.00	+0.00 / -0.04	38.00	53.00	10.00	38.00	+0.00 / -0.04	53.00	+0.16 / -0.00	11.00	+0.25 / -0.00	10.59
R040048082RC	40.00	+0.00 / -0.05	40.00	48.00	8.20	40.00	+0.00 / -0.05	48.00	+0.16 / -0.00	9.00	+0.25 / -0.00	8.35
R040049095RC	40.00	+0.00 / -0.05	40.00	49.50	9.50	40.00	+0.00 / -0.05	49.50	+0.16 / -0.00	10.50	+0.25 / -0.00	9.69
R040050060RC	40.00	+0.00 / -0.05	40.00	50.00	6.00	40.00	+0.00 / -0.05	50.00	+0.16 / -0.00	7.00	+0.25 / -0.00	9.69
R040050070RC	40.00	+0.00 / -0.05	40.00	50.00	7.00	40.00	+0.00 / -0.05	50.00	+0.16 / -0.00	8.00	+0.25 / -0.00	10.36
R040050073RC	40.00	+0.00 / -0.05	40.00	50.00	7.30	40.00	+0.00 / -0.05	50.00	+0.16 / -0.00	8.00	+0.25 / -0.00	9.69
R040050100RC	40.00	+0.00 / -0.05	40.00	50.00	10.00	40.00	+0.00 / -0.05	50.00	+0.16 / -0.00	11.00	+0.25 / -0.00	11.76
R040052109RC	40.00	+0.00 / -0.05	40.00	52.00	10.90	40.00	+0.00 / -0.05	52.00	+0.16 / -0.00	12.00	+0.25 / -0.00	11.74
R040055090RC	40.00	+0.00 / -0.05	40.00	55.00	9.00	40.00	+0.00 / -0.05	55.00	+0.16 / -0.00	10.00	+0.25 / -0.00	11.74
R040055100RC	40.00	+0.00 / -0.05	40.00	55.00	10.00	40.00	+0.00 / -0.05	55.00	+0.16 / -0.00	11.00	+0.25 / -0.00	10.17
R040060100RC*	40.00	+0.00 / -0.05	40.00	60.00	10.00	40.00	+0.00 / -0.05	60.00	+0.16 / -0.00	11.00	+0.25 / -0.00	11.07
R042050075RC	42.00	+0.00 / -0.05	42.00	50.00	7.50	42.00	+0.00 / -0.05	50.00	+0.19 / -0.00	8.00	+0.25 / -0.00	8.65
R042052100RC	42.00	+0.00 / -0.05	42.00	52.00	10.00	42.00	+0.00 / -0.05	52.00	+0.19 / -0.00	11.00	+0.25 / -0.00	9.69
R045053056RC	45.00	+0.00 / -0.05	45.00	53.00	5.60	45.00	+0.00 / -0.05	53.00	+0.19 / -0.00	6.30	+0.25 / -0.00	10.50
R045053080RC*	45.00	+0.00 / -0.05	45.00	53.00	8.00	45.00	+0.00 / -0.05	53.00	+0.19 / -0.00	9.00	+0.25 / -0.00	11.07
R045053081RC	45.00	+0.00 / -0.05	45.00	53.00	8.10	45.00	+0.00 / -0.05	53.00	+0.19 / -0.00	9.00	+0.25 / -0.00	8.35
R045053118RC*	45.00	+0.00 / -0.05	45.00	53.00	11.80	45.00	+0.00 / -0.05	53.00	+0.19 / -0.00	13.00	+0.25 / -0.00	9.69
R045055056RC	45.00	+0.00 / -0.05	45.00	55.00	5.60	45.00	+0.00 / -0.05	55.00	+0.19 / -0.00	6.30	+0.25 / -0.00	9.69
R045055060RC	45.00	+0.00 / -0.05	45.00	55.00	6.00	45.00	+0.00 / -0.05	55.00	+0.19 / -0.00	7.00	+0.25 / -0.00	9.69
R045055073RC	45.00	+0.00 / -0.05	45.00	55.00	7.30	45.00	+0.00 / -0.05	55.00	+0.19 / -0.00	8.00	+0.25 / -0.00	8.35
R045055080RC*	45.00	+0.00 / -0.05	45.00	55.00	8.00	45.00	+0.00 / -0.05	55.00	+0.19 / -0.00	9.00	+0.25 / -0.00	8.35
R045055100RC	45.00	+0.00 / -0.05	45.00	55.00	10.00	45.00	+0.00 / -0.05	55.00	+0.19 / -0.00	11.00	+0.25 / -0.00	11.65
R045055114RC*	45.00	+0.00 / -0.05	45.00	55.00	11.40	45.00	+0.00 / -0.05	55.00	+0.19 / -0.00	12.50	+0.25 / -0.00	11.07
R045057095RC	45.00	+0.00 / -0.05	45.00	57.70	9.50	45.00	+0.00 / -0.05	57.70	+0.19 / -0.00	10.50	+0.25 / -0.00	10.39
R045060100RC	45.00	+0.00 / -0.05	45.00	60.00	10.00	45.00	+0.00 / -0.05	60.00	+0.19 / -0.00	11.00	+0.25 / -0.00	9.25
R045060115RC*	45.00	+0.00 / -0.05	45.00	60.00	11.50	45.00	+0.00 / -0.05	60.00	+0.19 / -0.00	12.50	+0.25 / -0.00	9.25
R045065100RC	45.00	+0.00 / -0.05	45.00	65.00	10.00	45.00	+0.00 / -0.05	65.00	+0.19 / -0.00	11.00	+0.25 / -0.00	15.80
R048060100RC	48.00	+0.00 / -0.05	48.00	60.00	10.00	48.00	+0.00 / -0.05	60.00	+0.19 / -0.00	11.00	+0.25 / -0.00	11.01

*: GENERALLY NOT STOCKED BUT AVAILABLE - CHECK WITH C/SER



M

Seal Source Inc.

RC SERIES - AU 93A

Ref.Number	Rod diameter		Nominal Seal Dimensions			Housing Dimensions					\$	
		Tol.	d	D	H	d1	Tol.	D1	Tol.	H1		Tol.
R050057100RC	50.00	+0.00 / -0.05	50.00	57.00	10.00	50.00	+0.00 / -0.05	57.00	+0.19 / -0.00	11.00	+0.25 / -0.00	11.07
R050058080RC*	50.00	+0.00 / -0.05	50.00	58.00	8.00	50.00	+0.00 / -0.05	58.00	+0.19 / -0.00	9.00	+0.25 / -0.00	11.37
R050058114RC*	50.00	+0.00 / -0.05	50.00	58.00	11.40	50.00	+0.00 / -0.05	58.00	+0.19 / -0.00	12.50	+0.25 / -0.00	11.37
R050060060RC	50.00	+0.00 / -0.05	50.00	60.00	6.00	50.00	+0.00 / -0.05	60.00	+0.19 / -0.00	7.00	+0.25 / -0.00	10.03
R050060073RC	50.00	+0.00 / -0.05	50.00	60.00	7.30	50.00	+0.00 / -0.05	60.00	+0.19 / -0.00	8.00	+0.25 / -0.00	11.07
R050060080RC*	50.00	+0.00 / -0.05	50.00	60.00	8.00	50.00	+0.00 / -0.05	60.00	+0.19 / -0.00	9.00	+0.25 / -0.00	12.34
R050060100RC	50.00	+0.00 / -0.05	50.00	60.00	10.00	50.00	+0.00 / -0.05	60.00	+0.19 / -0.00	11.00	+0.25 / -0.00	12.34
R050060118RC*	50.00	+0.00 / -0.05	50.00	60.00	11.80	50.00	+0.00 / -0.05	60.00	+0.19 / -0.00	13.00	+0.25 / -0.00	8.94
R050060120RC*	50.00	+0.00 / -0.05	50.00	60.00	12.00	50.00	+0.00 / -0.05	60.00	+0.19 / -0.00	13.00	+0.25 / -0.00	8.94
R050062095RC	50.00	+0.00 / -0.05	50.00	62.70	9.50	50.00	+0.00 / -0.05	62.70	+0.19 / -0.00	10.50	+0.25 / -0.00	11.53
R050065090RC	50.00	+0.00 / -0.05	50.00	65.00	9.00	50.00	+0.00 / -0.05	65.00	+0.19 / -0.00	10.00	+0.25 / -0.00	11.53
R050065095RC	50.00	+0.00 / -0.05	50.00	65.00	9.50	50.00	+0.00 / -0.05	65.00	+0.19 / -0.00	10.50	+0.25 / -0.00	11.32
R050065100RC	50.00	+0.00 / -0.05	50.00	65.00	10.00	50.00	+0.00 / -0.05	65.00	+0.19 / -0.00	11.00	+0.25 / -0.00	9.47
R050065109RC	50.00	+0.00 / -0.05	50.00	65.00	10.90	50.00	+0.00 / -0.05	65.00	+0.19 / -0.00	12.00	+0.25 / -0.00	13.85
R050065114RC	50.00	+0.00 / -0.05	50.00	65.00	11.40	50.00	+0.00 / -0.05	65.00	+0.19 / -0.00	12.50	+0.25 / -0.00	19.56
R050065145RC	50.00	+0.00 / -0.05	50.00	65.00	14.50	50.00	+0.00 / -0.05	65.00	+0.19 / -0.00	16.00	+0.25 / -0.00	9.01
R050070120RC	50.00	+0.00 / -0.05	50.00	70.00	12.00	50.00	+0.00 / -0.05	70.00	+0.19 / -0.00	13.00	+0.25 / -0.00	16.24
R052062100RC*	52.00	+0.00 / -0.05	52.00	62.00	10.00	52.00	+0.00 / -0.05	62.00	+0.19 / -0.00	11.00	+0.25 / -0.00	14.56
R053065090RC*	53.00	+0.00 / -0.05	53.00	65.00	9.00	53.00	+0.00 / -0.05	65.00	+0.19 / -0.00	10.00	+0.25 / -0.00	11.09
R055063080RC	55.00	+0.00 / -0.05	55.00	63.00	8.00	55.00	+0.00 / -0.05	63.00	+0.19 / -0.00	9.00	+0.25 / -0.00	15.18
R055063114RC*	55.00	+0.00 / -0.05	55.00	63.00	11.40	55.00	+0.00 / -0.05	63.00	+0.19 / -0.00	12.50	+0.25 / -0.00	15.18
R055065060RC*	55.00	+0.00 / -0.05	55.00	65.00	6.00	55.00	+0.00 / -0.05	65.00	+0.19 / -0.00	7.00	+0.25 / -0.00	10.39
R055065073RC	55.00	+0.00 / -0.05	55.00	65.00	7.30	55.00	+0.00 / -0.05	65.00	+0.19 / -0.00	8.00	+0.25 / -0.00	13.04
R055065082RC	55.00	+0.00 / -0.05	55.00	65.00	8.20	55.00	+0.00 / -0.05	65.00	+0.19 / -0.00	9.00	+0.25 / -0.00	10.39
R055065100RC	55.00	+0.00 / -0.05	55.00	65.00	10.00	55.00	+0.00 / -0.05	65.00	+0.19 / -0.00	11.00	+0.25 / -0.00	8.94
R055065118RC	55.00	+0.00 / -0.05	55.00	65.00	11.80	55.00	+0.00 / -0.05	65.00	+0.19 / -0.00	13.00	+0.25 / -0.00	10.73
R055067100RC*	55.00	+0.00 / -0.05	55.00	67.00	10.00	55.00	+0.00 / -0.05	67.00	+0.19 / -0.00	11.00	+0.25 / -0.00	19.88
R055068100RC	55.00	+0.00 / -0.05	55.00	68.00	10.00	55.00	+0.00 / -0.05	68.00	+0.19 / -0.00	11.00	+0.25 / -0.00	12.84
R055070090RC	55.00	+0.00 / -0.05	55.00	70.00	9.00	55.00	+0.00 / -0.05	70.00	+0.19 / -0.00	10.00	+0.25 / -0.00	13.49
R055070118RC*	55.00	+0.00 / -0.05	55.00	70.00	11.80	55.00	+0.00 / -0.05	70.00	+0.19 / -0.00	13.00	+0.25 / -0.00	11.62
R055075120RC	55.00	+0.00 / -0.05	55.00	75.00	12.00	55.00	+0.00 / -0.05	75.00	+0.19 / -0.00	13.00	+0.25 / -0.00	16.30
R056066065RC*	56.00	+0.00 / -0.05	56.00	66.00	6.50	56.00	+0.00 / -0.05	66.00	+0.19 / -0.00	7.50	+0.25 / -0.00	12.82
R056066080RC*	56.00	+0.00 / -0.05	56.00	66.00	8.00	56.00	+0.00 / -0.05	66.00	+0.19 / -0.00	9.00	+0.25 / -0.00	12.82
R056066100RC	56.00	+0.00 / -0.05	56.00	66.00	10.00	56.00	+0.00 / -0.05	66.00	+0.19 / -0.00	11.00	+0.25 / -0.00	12.82
R056071100RC	56.00	+0.00 / -0.05	56.00	71.00	10.00	56.00	+0.00 / -0.05	71.00	+0.19 / -0.00	11.00	+0.25 / -0.00	11.04
R056071114RC	56.00	+0.00 / -0.05	56.00	71.00	11.40	56.00	+0.00 / -0.05	71.00	+0.19 / -0.00	12.50	+0.25 / -0.00	14.86
R060070060RC	60.00	+0.00 / -0.05	60.00	70.00	6.00	60.00	+0.00 / -0.05	70.00	+0.19 / -0.00	7.00	+0.25 / -0.00	9.87
R060070100RC	60.00	+0.00 / -0.05	60.00	70.00	10.00	60.00	+0.00 / -0.05	70.00	+0.19 / -0.00	11.00	+0.25 / -0.00	14.31
R060070114RC*	60.00	+0.00 / -0.05	60.00	70.00	11.40	60.00	+0.00 / -0.05	70.00	+0.19 / -0.00	12.50	+0.25 / -0.00	12.29
R060070118RC	60.00	+0.00 / -0.05	60.00	70.00	11.80	60.00	+0.00 / -0.05	70.00	+0.19 / -0.00	13.00	+0.25 / -0.00	10.43
R060070120RC*	60.00	+0.00 / -0.05	60.00	70.00	12.00	60.00	+0.00 / -0.05	70.00	+0.19 / -0.00	13.00	+0.25 / -0.00	12.29
R060072100RC	60.00	+0.00 / -0.05	60.00	72.00	10.00	60.00	+0.00 / -0.05	72.00	+0.19 / -0.00	11.00	+0.25 / -0.00	10.43
R060073100RC*	60.00	+0.00 / -0.05	60.00	73.00	10.00	60.00	+0.00 / -0.05	73.00	+0.19 / -0.00	11.00	+0.25 / -0.00	11.04
R060075090RC	60.00	+0.00 / -0.05	60.00	75.00	9.00	60.00	+0.00 / -0.05	75.00	+0.19 / -0.00	10.00	+0.25 / -0.00	13.49
R060075100RC	60.00	+0.00 / -0.05	60.00	75.00	10.00	60.00	+0.00 / -0.05	75.00	+0.19 / -0.00	11.00	+0.25 / -0.00	15.04
R060075114RC*	60.00	+0.00 / -0.05	60.00	75.00	11.40	60.00	+0.00 / -0.05	75.00	+0.19 / -0.00	12.50	+0.25 / -0.00	12.65
R060075118RC	60.00	+0.00 / -0.05	60.00	75.00	11.80	60.00	+0.00 / -0.05	75.00	+0.19 / -0.00	13.00	+0.25 / -0.00	16.02

*: GENERALLY NOT STOCKED BUT AVAILABLE - CHECK WITH C/SER

Tel.: 1-888-609-SEAL
Fax: 1-888-717-SEAL

J

23

www.sealsourceinc.com

METRIC SIZE
ROD SEALS



Seal Source Inc.

RC SERIES - AU 93A

METRIC SIZE
ROD SEALS

Ref.Number	Rod diameter		Nominal Seal Dimensions			Housing Dimensions					\$	
		Tol.	d	D	H	d1	Tol.	D1	Tol.	H1		Tol.
R060075120RC*	60.00	+0.00 / -0.05	60.00	75.00	12.00	60.00	+0.00 / -0.05	75.00	+0.19 / -0.00	13.00	+0.25 / -0.00	13.27
R060075205RC*	60.00	+0.00 / -0.05	60.00	75.00	20.50	60.00	+0.00 / -0.05	75.00	+0.19 / -0.00	22.50	+0.25 / -0.00	22.11
R060080114RC*	60.00	+0.00 / -0.05	60.00	80.00	11.40	60.00	+0.00 / -0.05	80.00	+0.19 / -0.00	12.50	+0.25 / -0.00	18.54
R060080120RC	60.00	+0.00 / -0.05	60.00	80.00	12.00	60.00	+0.00 / -0.05	80.00	+0.19 / -0.00	13.00	+0.25 / -0.00	18.25
R063071080RC*	63.00	+0.00 / -0.05	63.00	71.00	8.00	63.00	+0.00 / -0.05	71.00	+0.19 / -0.00	9.00	+0.25 / -0.00	18.64
R063073060RC	63.00	+0.00 / -0.05	63.00	73.00	6.00	63.00	+0.00 / -0.05	73.00	+0.19 / -0.00	7.00	+0.25 / -0.00	12.11
R063073100RC*	63.00	+0.00 / -0.05	63.00	73.00	10.00	63.00	+0.00 / -0.05	73.00	+0.19 / -0.00	11.00	+0.25 / -0.00	12.11
R063073118RC	63.00	+0.00 / -0.05	63.00	73.00	11.80	63.00	+0.00 / -0.05	73.00	+0.19 / -0.00	13.00	+0.25 / -0.00	12.11
R063073120RC*	63.00	+0.00 / -0.05	63.00	73.00	12.00	63.00	+0.00 / -0.05	73.00	+0.19 / -0.00	13.00	+0.25 / -0.00	14.46
R063075120RC	63.00	+0.00 / -0.05	63.00	75.00	12.00	63.00	+0.00 / -0.05	75.00	+0.19 / -0.00	13.00	+0.25 / -0.00	13.27
R063078100RC	63.00	+0.00 / -0.05	63.00	78.00	10.00	63.00	+0.00 / -0.05	78.00	+0.19 / -0.00	11.00	+0.25 / -0.00	11.62
R063078114RC	63.00	+0.00 / -0.05	63.00	78.00	11.40	63.00	+0.00 / -0.05	78.00	+0.19 / -0.00	12.50	+0.25 / -0.00	16.83
R063083120RC	63.00	+0.00 / -0.05	63.00	83.00	12.00	63.00	+0.00 / -0.05	83.00	+0.19 / -0.00	13.00	+0.25 / -0.00	13.27
R063083135RC*	63.00	+0.00 / -0.05	63.00	83.00	13.50	63.00	+0.00 / -0.05	83.00	+0.19 / -0.00	14.50	+0.25 / -0.00	13.27
R063083150RC*	63.00	+0.00 / -0.05	63.00	83.00	15.00	63.00	+0.00 / -0.05	83.00	+0.19 / -0.00	16.00	+0.25 / -0.00	13.27
R065075060RC*	65.00	+0.00 / -0.06	65.00	75.00	6.00	65.00	+0.00 / -0.06	75.00	+0.19 / -0.00	7.00	+0.25 / -0.00	10.73
R065075077RC	65.00	+0.00 / -0.06	65.00	75.00	7.70	65.00	+0.00 / -0.06	75.00	+0.19 / -0.00	9.00	+0.25 / -0.00	10.73
R065075100RC	65.00	+0.00 / -0.06	65.00	75.00	10.00	65.00	+0.00 / -0.06	75.00	+0.19 / -0.00	11.00	+0.25 / -0.00	11.62
R065075114RC*	65.00	+0.00 / -0.06	65.00	75.00	11.40	65.00	+0.00 / -0.06	75.00	+0.19 / -0.00	12.50	+0.25 / -0.00	13.27
R065075118RC	65.00	+0.00 / -0.06	65.00	75.00	11.80	65.00	+0.00 / -0.06	75.00	+0.19 / -0.00	13.00	+0.25 / -0.00	10.15
R065075120RC*	65.00	+0.00 / -0.06	65.00	75.00	12.00	65.00	+0.00 / -0.06	75.00	+0.19 / -0.00	13.00	+0.25 / -0.00	22.69
R065077095RC	65.00	+0.00 / -0.06	65.00	77.70	9.50	65.00	+0.00 / -0.06	77.70	+0.19 / -0.00	10.50	+0.25 / -0.00	12.44
R065078100RC	65.00	+0.00 / -0.06	65.00	78.00	10.00	65.00	+0.00 / -0.06	78.00	+0.19 / -0.00	11.00	+0.25 / -0.00	14.36
R065080090RC	65.00	+0.00 / -0.06	65.00	80.00	9.00	65.00	+0.00 / -0.06	80.00	+0.19 / -0.00	10.00	+0.25 / -0.00	20.41
R065080118RC	65.00	+0.00 / -0.06	65.00	80.00	11.80	65.00	+0.00 / -0.06	80.00	+0.19 / -0.00	13.00	+0.25 / -0.00	20.41
R065085120RC	65.00	+0.00 / -0.06	65.00	85.00	12.00	65.00	+0.00 / -0.06	85.00	+0.19 / -0.00	13.00	+0.25 / -0.00	23.07
R067077060RC	67.00	+0.00 / -0.06	67.00	77.00	6.00	67.00	+0.00 / -0.06	77.00	+0.19 / -0.00	7.00	+0.25 / -0.00	12.44
R068078120RC	68.00	+0.00 / -0.06	68.00	78.00	12.00	68.00	+0.00 / -0.06	78.00	+0.19 / -0.00	13.00	+0.25 / -0.00	17.64
R070078080RC*	70.00	+0.00 / -0.06	70.00	78.00	8.00	70.00	+0.00 / -0.06	78.00	+0.19 / -0.00	9.00	+0.25 / -0.00	13.88
R070078114RC*	70.00	+0.00 / -0.06	70.00	78.00	11.40	70.00	+0.00 / -0.06	78.00	+0.19 / -0.00	12.50	+0.25 / -0.00	13.88
R070080060RC*	70.00	+0.00 / -0.06	70.00	80.00	6.00	70.00	+0.00 / -0.06	80.00	+0.22 / -0.00	7.00	+0.25 / -0.00	13.88
R070080080RC	70.00	+0.00 / -0.06	70.00	80.00	8.00	70.00	+0.00 / -0.06	80.00	+0.22 / -0.00	9.00	+0.25 / -0.00	13.88
R070080114RC*	70.00	+0.00 / -0.06	70.00	80.00	11.40	70.00	+0.00 / -0.06	80.00	+0.22 / -0.00	12.50	+0.25 / -0.00	13.88
R070080118RC	70.00	+0.00 / -0.06	70.00	80.00	11.80	70.00	+0.00 / -0.06	80.00	+0.22 / -0.00	13.00	+0.25 / -0.00	13.14
R070080120RC*	70.00	+0.00 / -0.06	70.00	80.00	12.00	70.00	+0.00 / -0.06	80.00	+0.22 / -0.00	13.00	+0.25 / -0.00	17.04
R070082087RC*	70.00	+0.00 / -0.06	70.00	82.00	8.70	70.00	+0.00 / -0.06	82.00	+0.22 / -0.00	9.60	+0.25 / -0.00	13.14
R070082100RC	70.00	+0.00 / -0.06	70.00	82.00	10.00	70.00	+0.00 / -0.06	82.00	+0.22 / -0.00	11.00	+0.25 / -0.00	13.14
R070083100RC	70.00	+0.00 / -0.06	70.00	83.00	10.00	70.00	+0.00 / -0.06	83.00	+0.22 / -0.00	11.00	+0.25 / -0.00	11.51
R070085090RC	70.00	+0.00 / -0.06	70.00	85.00	9.00	70.00	+0.00 / -0.06	85.00	+0.22 / -0.00	10.00	+0.25 / -0.00	13.82
R070085100RC	70.00	+0.00 / -0.06	70.00	85.00	10.00	70.00	+0.00 / -0.06	85.00	+0.22 / -0.00	11.00	+0.25 / -0.00	12.95
R070085114RC	70.00	+0.00 / -0.06	70.00	85.00	11.40	70.00	+0.00 / -0.06	85.00	+0.22 / -0.00	12.50	+0.25 / -0.00	12.95
R070085120RC	70.00	+0.00 / -0.06	70.00	85.00	12.00	70.00	+0.00 / -0.06	85.00	+0.22 / -0.00	13.00	+0.25 / -0.00	11.51
R070085205RC	70.00	+0.00 / -0.06	70.00	85.00	20.50	70.00	+0.00 / -0.06	85.00	+0.22 / -0.00	22.50	+0.25 / -0.00	14.86
R070090120RC	70.00	+0.00 / -0.06	70.00	90.00	12.00	70.00	+0.00 / -0.06	90.00	+0.22 / -0.00	13.00	+0.25 / -0.00	18.83
R075083115RC*	75.00	+0.00 / -0.06	75.00	83.00	11.50	75.00	+0.00 / -0.06	83.00	+0.22 / -0.00	12.50	+0.25 / -0.00	9.36
R075085060RC*	75.00	+0.00 / -0.06	75.00	85.00	6.00	75.00	+0.00 / -0.06	85.00	+0.22 / -0.00	7.00	+0.25 / -0.00	9.36
R075085087RC*	75.00	+0.00 / -0.06	75.00	85.00	8.70	75.00	+0.00 / -0.06	85.00	+0.22 / -0.00	9.50	+0.25 / -0.00	13.88

*: GENERALLY NOT STOCKED BUT AVAILABLE - CHECK WITH C/SER

M

Seal Source Inc.

RC SERIES - AU 93A

Ref.Number	Rod diameter		Nominal Seal Dimensions			Housing Dimensions					\$	
		Tol.	d	D	H	d1	Tol.	D1	Tol.	H1		Tol.
R075085114RC*	75.00	+0.00 / -0.06	75.00	85.00	11.40	75.00	+0.00 / -0.06	85.00	+0.22 / -0.00	12.50	+0.25 / -0.00	13.88
R075085118RC	75.00	+0.00 / -0.06	75.00	85.00	11.80	75.00	+0.00 / -0.06	85.00	+0.22 / -0.00	13.00	+0.25 / -0.00	11.62
R075085120RC*	75.00	+0.00 / -0.06	75.00	85.00	12.00	75.00	+0.00 / -0.06	85.00	+0.22 / -0.00	13.00	+0.25 / -0.00	13.88
R075088100RC	75.00	+0.00 / -0.06	75.00	88.00	10.00	75.00	+0.00 / -0.06	88.00	+0.22 / -0.00	11.00	+0.25 / -0.00	12.77
R075090090RC	75.00	+0.00 / -0.06	75.00	90.00	9.00	75.00	+0.00 / -0.06	90.00	+0.22 / -0.00	10.00	+0.25 / -0.00	14.61
R075090114RC*	75.00	+0.00 / -0.06	75.00	90.00	11.40	75.00	+0.00 / -0.06	90.00	+0.22 / -0.00	12.50	+0.25 / -0.00	13.88
R075095120RC	75.00	+0.00 / -0.06	75.00	95.00	12.00	75.00	+0.00 / -0.06	95.00	+0.22 / -0.00	13.00	+0.25 / -0.00	19.34
R077087120RC*	77.00	+0.00 / -0.09	77.00	87.00	12.00	77.00	+0.00 / -0.09	87.00	+0.22 / -0.00	13.00	+0.25 / -0.00	19.31
R078086085RC*	78.00	+0.00 / -0.09	78.00	86.00	8.50	78.00	+0.00 / -0.09	86.00	+0.22 / -0.00	9.50	+0.25 / -0.00	14.55
R078086114RC*	78.00	+0.00 / -0.09	78.00	86.00	11.40	78.00	+0.00 / -0.09	86.00	+0.22 / -0.00	12.50	+0.25 / -0.00	14.55
R080088114RC*	80.00	+0.00 / -0.09	80.00	88.00	11.40	80.00	+0.00 / -0.09	88.00	+0.22 / -0.00	12.50	+0.25 / -0.00	14.55
R080090060RC*	80.00	+0.00 / -0.09	80.00	90.00	6.00	80.00	+0.00 / -0.09	90.00	+0.22 / -0.00	7.00	+0.25 / -0.00	10.20
R080090090RC*	80.00	+0.00 / -0.09	80.00	90.00	9.00	80.00	+0.00 / -0.09	90.00	+0.22 / -0.00	10.00	+0.25 / -0.00	10.20
R080090100RC	80.00	+0.00 / -0.09	80.00	90.00	10.00	80.00	+0.00 / -0.09	90.00	+0.22 / -0.00	11.00	+0.25 / -0.00	13.19
R080090118RC	80.00	+0.00 / -0.09	80.00	90.00	11.80	80.00	+0.00 / -0.09	90.00	+0.22 / -0.00	13.00	+0.25 / -0.00	15.28
R080090120RC*	80.00	+0.00 / -0.09	80.00	90.00	12.00	80.00	+0.00 / -0.09	90.00	+0.22 / -0.00	13.00	+0.25 / -0.00	17.68
R080092087RC	80.00	+0.00 / -0.09	80.00	92.00	8.70	80.00	+0.00 / -0.09	92.00	+0.22 / -0.00	9.60	+0.25 / -0.00	15.44
R080093100RC	80.00	+0.00 / -0.09	80.00	93.00	10.00	80.00	+0.00 / -0.09	93.00	+0.22 / -0.00	11.00	+0.25 / -0.00	15.10
R080095090RC	80.00	+0.00 / -0.09	80.00	95.00	9.00	80.00	+0.00 / -0.09	95.00	+0.22 / -0.00	10.00	+0.25 / -0.00	16.46
R080095100RC	80.00	+0.00 / -0.09	80.00	95.00	10.00	80.00	+0.00 / -0.09	95.00	+0.22 / -0.00	11.00	+0.25 / -0.00	15.54
R080095114RC	80.00	+0.00 / -0.09	80.00	95.00	11.40	80.00	+0.00 / -0.09	95.00	+0.22 / -0.00	12.50	+0.25 / -0.00	26.21
R080095118RC	80.00	+0.00 / -0.09	80.00	95.00	11.80	80.00	+0.00 / -0.09	95.00	+0.22 / -0.00	13.00	+0.25 / -0.00	17.29
R080095120RC	80.00	+0.00 / -0.09	80.00	95.00	12.00	80.00	+0.00 / -0.09	95.00	+0.22 / -0.00	13.00	+0.25 / -0.00	22.67
R080100100RC*	80.00	+0.00 / -0.09	80.00	100.00	10.00	80.00	+0.00 / -0.09	100.00	+0.22 / -0.00	11.00	+0.25 / -0.00	10.08
R080100120RC	80.00	+0.00 / -0.09	80.00	100.00	12.00	80.00	+0.00 / -0.09	100.00	+0.22 / -0.00	13.00	+0.25 / -0.00	22.33
R080100145RC	80.00	+0.00 / -0.09	80.00	100.00	14.50	80.00	+0.00 / -0.09	100.00	+0.22 / -0.00	16.00	+0.25 / -0.00	22.04
R080100150RC*	80.00	+0.00 / -0.09	80.00	100.00	15.00	80.00	+0.00 / -0.09	100.00	+0.22 / -0.00	16.00	+0.25 / -0.00	33.43
R080110164RC	80.00	+0.00 / -0.09	80.00	110.00	16.40	80.00	+0.00 / -0.09	110.00	+0.22 / -0.00	18.00	+0.25 / -0.00	37.96
R085093100RC	85.00	+0.00 / -0.09	85.00	93.00	10.00	85.00	+0.00 / -0.09	93.00	+0.22 / -0.00	11.00	+0.25 / -0.00	12.44
R085093115RC*	85.00	+0.00 / -0.09	85.00	93.00	11.50	85.00	+0.00 / -0.09	93.00	+0.22 / -0.00	12.50	+0.25 / -0.00	23.14
R085093120RC*	85.00	+0.00 / -0.09	85.00	93.00	12.00	85.00	+0.00 / -0.09	93.00	+0.22 / -0.00	13.00	+0.25 / -0.00	12.44
R085095120RC*	85.00	+0.00 / -0.09	85.00	95.00	12.00	85.00	+0.00 / -0.09	95.00	+0.22 / -0.00	13.00	+0.25 / -0.00	12.44
R085100090RC	85.00	+0.00 / -0.09	85.00	100.00	9.00	85.00	+0.00 / -0.09	100.00	+0.22 / -0.00	10.00	+0.25 / -0.00	21.93
R085100118RC	85.00	+0.00 / -0.09	85.00	100.00	11.80	85.00	+0.00 / -0.09	100.00	+0.22 / -0.00	13.00	+0.25 / -0.00	19.45
R085100120RC*	85.00	+0.00 / -0.09	85.00	100.00	12.00	85.00	+0.00 / -0.09	100.00	+0.22 / -0.00	13.00	+0.25 / -0.00	26.87
R085105120RC*	85.00	+0.00 / -0.09	85.00	105.00	12.00	85.00	+0.00 / -0.09	105.00	+0.22 / -0.00	13.00	+0.25 / -0.00	20.41
R090098080RC*	90.00	+0.00 / -0.09	90.00	98.00	8.00	90.00	+0.00 / -0.09	98.00	+0.22 / -0.00	9.00	+0.25 / -0.00	11.80
R090098109RC*	90.00	+0.00 / -0.09	90.00	98.00	10.90	90.00	+0.00 / -0.09	98.00	+0.22 / -0.00	12.00	+0.25 / -0.00	11.80
R090098115RC*	90.00	+0.00 / -0.09	90.00	98.00	11.50	90.00	+0.00 / -0.09	98.00	+0.22 / -0.00	12.50	+0.25 / -0.00	11.80
R090100068RC	90.00	+0.00 / -0.09	90.00	100.00	6.80	90.00	+0.00 / -0.09	100.00	+0.22 / -0.00	7.50	+0.25 / -0.00	17.29
R090100090RC	90.00	+0.00 / -0.09	90.00	100.00	9.00	90.00	+0.00 / -0.09	100.00	+0.22 / -0.00	10.00	+0.25 / -0.00	17.29
R090100100RC*	90.00	+0.00 / -0.09	90.00	100.00	10.00	90.00	+0.00 / -0.09	100.00	+0.22 / -0.00	11.00	+0.25 / -0.00	11.80
R090100115RC*	90.00	+0.00 / -0.09	90.00	100.00	11.50	90.00	+0.00 / -0.09	100.00	+0.22 / -0.00	12.50	+0.25 / -0.00	15.80
R090100118RC	90.00	+0.00 / -0.09	90.00	100.00	11.80	90.00	+0.00 / -0.09	100.00	+0.22 / -0.00	13.00	+0.25 / -0.00	17.29
R090102087RC	90.00	+0.00 / -0.09	90.00	102.00	8.70	90.00	+0.00 / -0.09	102.00	+0.22 / -0.00	9.60	+0.25 / -0.00	17.49
R090105090RC	90.00	+0.00 / -0.09	90.00	105.00	9.00	90.00	+0.00 / -0.09	105.00	+0.22 / -0.00	10.00	+0.25 / -0.00	16.41
R090105100RC	90.00	+0.00 / -0.09	90.00	105.00	10.00	90.00	+0.00 / -0.09	105.00	+0.22 / -0.00	11.00	+0.25 / -0.00	18.59

*: GENERALLY NOT STOCKED BUT AVAILABLE - CHECK WITH C/SER

**METRIC SIZE
ROD SEALS**

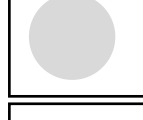

Tel.: 1-888-609-SEAL
Fax: 1-888-717-SEAL

J

25

www.sealsourceinc.com

Seal Source Inc.

RC SERIES - AU 93A

METRIC SIZE
ROD SEALS

Ref.Number	Rod diameter		Nominal Seal Dimensions			Housing Dimensions					\$	
		Tol.	d	D	H	d1	Tol.	D1	Tol.	H1		Tol.
R090105114RC	90.00	+0.00 / -0.09	90.00	105.00	11.40	90.00	+0.00 / -0.09	105.00	+0.22 / -0.00	12.50	+0.25 / -0.00	16.06
R090105115RC*	90.00	+0.00 / -0.09	90.00	105.00	11.50	90.00	+0.00 / -0.09	105.00	+0.22 / -0.00	12.50	+0.25 / -0.00	18.76
R090105120RC*	90.00	+0.00 / -0.09	90.00	105.00	12.00	90.00	+0.00 / -0.09	105.00	+0.22 / -0.00	13.00	+0.25 / -0.00	12.10
R090110100RC*	90.00	+0.00 / -0.09	90.00	110.00	10.00	90.00	+0.00 / -0.09	110.00	+0.22 / -0.00	11.00	+0.25 / -0.00	12.10
R090110120RC	90.00	+0.00 / -0.09	90.00	110.00	12.00	90.00	+0.00 / -0.09	110.00	+0.22 / -0.00	13.00	+0.25 / -0.00	18.96
R090110130RC*	90.00	+0.00 / -0.09	90.00	110.00	13.00	90.00	+0.00 / -0.09	110.00	+0.22 / -0.00	13.00	+0.25 / -0.00	12.45
R090110150RC*	90.00	+0.00 / -0.09	90.00	110.00	15.00	90.00	+0.00 / -0.09	110.00	+0.22 / -0.00	15.00	+0.25 / -0.00	12.45
R092107114RC*	92.00	+0.00 / -0.09	92.00	107.00	11.50	92.00	+0.00 / -0.09	107.00	+0.22 / -0.00	12.50	+0.25 / -0.00	27.56
R095105085RC*	95.00	+0.00 / -0.09	95.00	105.00	8.50	95.00	+0.00 / -0.09	105.00	+0.22 / -0.00	9.50	+0.25 / -0.00	21.52
R095105120RC*	95.00	+0.00 / -0.09	95.00	105.00	12.00	95.00	+0.00 / -0.09	105.00	+0.22 / -0.00	13.00	+0.25 / -0.00	12.45
R095110090RC	95.00	+0.00 / -0.09	95.00	110.00	9.00	95.00	+0.00 / -0.09	110.00	+0.22 / -0.00	10.00	+0.25 / -0.00	18.96
R095110100RC	95.00	+0.00 / -0.09	95.00	110.00	10.00	95.00	+0.00 / -0.09	110.00	+0.22 / -0.00	11.00	+0.25 / -0.00	18.96
R095110120RC*	95.00	+0.00 / -0.09	95.00	110.00	12.00	95.00	+0.00 / -0.09	110.00	+0.22 / -0.00	13.00	+0.25 / -0.00	14.96
R095115120RC	95.00	+0.00 / -0.09	95.00	115.00	12.00	95.00	+0.00 / -0.09	115.00	+0.22 / -0.00	13.00	+0.25 / -0.00	17.80
R096104109RC*	96.00	+0.00 / -0.09	96.00	104.00	10.90	96.00	+0.00 / -0.09	104.00	+0.22 / -0.00	12.00	+0.25 / -0.00	17.99
R100110109RC	100.00	+0.00 / -0.09	100.00	110.00	10.90	100.00	+0.00 / -0.09	110.00	+0.22 / -0.00	12.50	+0.25 / -0.00	18.42
R100110115RC*	100.00	+0.00 / -0.09	100.00	110.00	11.50	100.00	+0.00 / -0.09	110.00	+0.22 / -0.00	12.50	+0.25 / -0.00	20.28
R100115090RC	100.00	+0.00 / -0.09	100.00	115.00	9.00	100.00	+0.00 / -0.09	115.00	+0.22 / -0.00	10.00	+0.25 / -0.00	20.33
R100115118RC	100.00	+0.00 / -0.09	100.00	115.00	11.80	100.00	+0.00 / -0.09	115.00	+0.22 / -0.00	13.00	+0.25 / -0.00	21.56
R100115120RC	100.00	+0.00 / -0.09	100.00	115.00	12.00	100.00	+0.00 / -0.09	115.00	+0.22 / -0.00	13.00	+0.25 / -0.00	20.33
R100120115RC*	100.00	+0.00 / -0.09	100.00	120.00	11.50	100.00	+0.00 / -0.09	120.00	+0.22 / -0.00	12.50	+0.25 / -0.00	14.83
R100120118RC	100.00	+0.00 / -0.09	100.00	120.00	11.80	100.00	+0.00 / -0.09	120.00	+0.22 / -0.00	13.00	+0.25 / -0.00	27.15
R100120120RC	100.00	+0.00 / -0.09	100.00	120.00	12.00	100.00	+0.00 / -0.09	120.00	+0.22 / -0.00	13.00	+0.25 / -0.00	32.42
R100120145RC	100.00	+0.00 / -0.09	100.00	120.00	14.50	100.00	+0.00 / -0.09	120.00	+0.22 / -0.00	16.00	+0.25 / -0.00	27.15
R100120150RC*	100.00	+0.00 / -0.09	100.00	120.00	15.00	100.00	+0.00 / -0.09	120.00	+0.22 / -0.00	16.00	+0.25 / -0.00	31.64
R105113100RC*	105.00	+0.00 / -0.13	105.00	113.00	10.00	105.00	+0.00 / -0.13	113.00	+0.22 / -0.00	11.00	+0.25 / -0.00	24.18
R105113115RC*	105.00	+0.00 / -0.13	105.00	113.00	11.50	105.00	+0.00 / -0.13	113.00	+0.22 / -0.00	12.50	+0.25 / -0.00	26.09
R105115115RC	105.00	+0.00 / -0.13	105.00	115.00	11.50	105.00	+0.00 / -0.13	115.00	+0.22 / -0.00	12.50	+0.25 / -0.00	19.40
R105115132RC*	105.00	+0.00 / -0.13	105.00	115.00	13.20	105.00	+0.00 / -0.13	115.00	+0.22 / -0.00	14.50	+0.25 / -0.00	20.87
R105120100RC*	105.00	+0.00 / -0.13	105.00	120.00	10.00	105.00	+0.00 / -0.13	120.00	+0.22 / -0.00	11.00	+0.25 / -0.00	14.83
R105120145RC	105.00	+0.00 / -0.13	105.00	120.00	14.50	105.00	+0.00 / -0.13	120.00	+0.22 / -0.00	16.00	+0.25 / -0.00	24.00
R108123109RC*	108.00	+0.00 / -0.13	108.00	123.00	10.90	108.00	+0.00 / -0.13	123.00	+0.22 / -0.00	12.00	+0.25 / -0.00	25.88
R110118115RC*	110.00	+0.00 / -0.13	110.00	118.00	11.50	110.00	+0.00 / -0.13	118.00	+0.22 / -0.00	12.50	+0.25 / -0.00	24.70
R110125090RC	110.00	+0.00 / -0.13	110.00	125.00	9.00	110.00	+0.00 / -0.13	125.00	+0.22 / -0.00	10.00	+0.25 / -0.00	26.01
R110125120RC*	110.00	+0.00 / -0.13	110.00	125.00	12.00	110.00	+0.00 / -0.13	125.00	+0.22 / -0.00	13.00	+0.25 / -0.00	12.21
R110125145RC	110.00	+0.00 / -0.13	110.00	125.00	14.50	110.00	+0.00 / -0.13	125.00	+0.22 / -0.00	16.00	+0.25 / -0.00	33.54
R110130118RC	110.00	+0.00 / -0.13	110.00	130.00	11.80	110.00	+0.00 / -0.13	130.00	+0.22 / -0.00	13.00	+0.25 / -0.00	37.12
R110130145RC	110.00	+0.00 / -0.13	110.00	130.00	14.50	110.00	+0.00 / -0.13	130.00	+0.22 / -0.00	16.00	+0.25 / -0.00	37.12
R110130150RC*	110.00	+0.00 / -0.13	110.00	130.00	15.00	110.00	+0.00 / -0.13	130.00	+0.22 / -0.00	16.00	+0.25 / -0.00	44.41
R110135145RC	110.00	+0.00 / -0.13	110.00	135.00	14.50	110.00	+0.00 / -0.13	135.00	+0.22 / -0.00	16.00	+0.25 / -0.00	45.79
R112125090RC*	112.00	+0.00 / -0.13	112.00	125.00	9.00	112.00	+0.00 / -0.13	125.00	+0.25 / -0.00	10.00	+0.25 / -0.00	24.71
R113123085RC*	113.00	+0.00 / -0.13	113.00	123.00	8.50	113.00	+0.00 / -0.13	123.00	+0.25 / -0.00	9.50	+0.25 / -0.00	28.55
R115125120RC*	115.00	+0.00 / -0.13	115.00	125.00	12.00	115.00	+0.00 / -0.13	125.00	+0.25 / -0.00	13.00	+0.25 / -0.00	12.65
R115125140RC	115.00	+0.00 / -0.13	115.00	125.00	14.00	115.00	+0.00 / -0.13	125.00	+0.25 / -0.00	15.00	+0.25 / -0.00	31.31
R115130090RC	115.00	+0.00 / -0.13	115.00	130.00	9.00	115.00	+0.00 / -0.13	130.00	+0.25 / -0.00	10.00	+0.25 / -0.00	30.51
R115130109RC	115.00	+0.00 / -0.13	115.00	130.00	10.90	115.00	+0.00 / -0.13	130.00	+0.25 / -0.00	12.00	+0.25 / -0.00	30.51
R115130145RC	115.00	+0.00 / -0.13	115.00	130.00	14.50	115.00	+0.00 / -0.13	130.00	+0.25 / -0.00	16.00	+0.25 / -0.00	30.51

*: GENERALLY NOT STOCKED BUT AVAILABLE - CHECK WITH C/SER

Seal Source Inc.

RC SERIES - AU 93A

Ref.Number	Rod diameter		Nominal Seal Dimensions			Housing Dimensions					\$	
		Tol.	d	D	H	d1	Tol.	D1	Tol.	H1		Tol.
R160180120RC	160.00	+0.00 / -0.13	160.00	180.00	12.00	160.00	+0.00 / -0.13	180.00	+0.25 / -0.00	13.00	+0.25 / -0.00	59.96
R160180145RC	160.00	+0.00 / -0.13	160.00	180.00	14.50	160.00	+0.00 / -0.13	180.00	+0.25 / -0.00	16.00	+0.25 / -0.00	51.87
R160180150RC*	160.00	+0.00 / -0.13	160.00	180.00	15.00	160.00	+0.00 / -0.13	180.00	+0.25 / -0.00	16.00	+0.25 / -0.00	34.43
R160185150RC*	160.00	+0.00 / -0.13	160.00	185.00	15.00	160.00	+0.00 / -0.13	185.00	+0.25 / -0.00	16.00	+0.25 / -0.00	30.03
R160185182RC	160.00	+0.00 / -0.13	160.00	185.00	18.20	160.00	+0.00 / -0.13	185.00	+0.25 / -0.00	20.00	+0.25 / -0.00	107.20
R165175120RC*	165.00	+0.00 / -0.13	165.00	175.00	12.00	165.00	+0.00 / -0.13	175.00	+0.25 / -0.00	13.00	+0.25 / -0.00	25.85
R165184130RC*	165.00	+0.00 / -0.13	165.00	184.00	13.00	165.00	+0.00 / -0.13	184.00	+0.29 / -0.00	14.00	+0.25 / -0.00	59.98
R170178115RC*	170.00	+0.00 / -0.13	170.00	178.00	11.50	170.00	+0.00 / -0.13	178.00	+0.29 / -0.00	12.50	+0.25 / -0.00	34.72
R170190145RC*	170.00	+0.00 / -0.13	170.00	190.00	14.50	170.00	+0.00 / -0.13	190.00	+0.29 / -0.00	16.00	+0.25 / -0.00	63.31
R170200180RC*	170.00	+0.00 / -0.13	170.00	200.00	18.00	170.00	+0.00 / -0.13	200.00	+0.29 / -0.00	19.00	+0.25 / -0.00	86.46
R180195115RC*	180.00	+0.00 / -0.13	180.00	195.00	11.50	180.00	+0.00 / -0.13	195.00	+0.29 / -0.00	12.50	+0.25 / -0.00	54.59
R180200118RC	180.00	+0.00 / -0.13	180.00	200.00	11.80	180.00	+0.00 / -0.13	200.00	+0.29 / -0.00	13.00	+0.25 / -0.00	65.03
R180200150RC*	180.00	+0.00 / -0.13	180.00	200.00	15.00	180.00	+0.00 / -0.13	200.00	+0.29 / -0.00	16.00	+0.25 / -0.00	33.99
R180210180RC*	180.00	+0.00 / -0.13	180.00	210.00	18.00	180.00	+0.00 / -0.13	210.00	+0.29 / -0.00	19.00	+0.25 / -0.00	62.06
R185195120RC*	185.00	+0.00 / -0.13	185.00	195.00	12.00	185.00	+0.00 / -0.13	195.00	+0.29 / -0.00	13.00	+0.25 / -0.00	30.03
R185200109RC*	185.00	+0.00 / -0.13	185.00	200.00	10.90	185.00	+0.00 / -0.13	200.00	+0.29 / -0.00	12.00	+0.25 / -0.00	65.03
R190210150RC*	190.00	+0.00 / -0.13	190.00	210.00	15.00	190.00	+0.00 / -0.13	210.00	+0.29 / -0.00	16.00	+0.25 / -0.00	39.16
R200220120RC*	200.00	+0.00 / -0.13	200.00	220.00	12.00	200.00	+0.00 / -0.13	220.00	+0.29 / -0.00	13.00	+0.25 / -0.00	70.70
R200220145RC	200.00	+0.00 / -0.13	200.00	220.00	14.50	200.00	+0.00 / -0.13	220.00	+0.29 / -0.00	16.00	+0.25 / -0.00	70.70
R200225182RC*	200.00	+0.00 / -0.13	200.00	225.00	18.20	200.00	+0.00 / -0.13	225.00	+0.29 / -0.00	20.00	+0.25 / -0.00	99.96
R205220125RC*	205.00	+0.00 / -0.13	205.00	220.00	12.50	205.00	+0.00 / -0.13	220.00	+0.29 / -0.00	13.50	+0.25 / -0.00	74.70
R220240145RC*	220.00	+0.00 / -0.13	220.00	240.00	14.50	220.00	+0.00 / -0.13	240.00	+0.29 / -0.00	16.00	+0.25 / -0.00	77.37
R220250180RC*	220.00	+0.00 / -0.13	220.00	250.00	18.00	220.00	+0.00 / -0.13	250.00	+0.29 / -0.00	20.00	+0.25 / -0.00	71.83
R220250227RC*	220.00	+0.00 / -0.13	220.00	250.00	22.70	220.00	+0.00 / -0.13	250.00	+0.29 / -0.00	25.00	+0.25 / -0.00	121.91
R230260180RC*	230.00	+0.00 / -0.13	230.00	260.00	18.00	230.00	+0.00 / -0.13	260.00	+0.32 / -0.00	20.00	+0.25 / -0.00	72.49
R230260227RC*	230.00	+0.00 / -0.13	230.00	260.00	22.70	230.00	+0.00 / -0.13	260.00	+0.32 / -0.00	25.00	+0.25 / -0.00	181.58
R280310180RC*	280.00	+0.00 / -0.13	280.00	310.00	18.00	280.00	+0.00 / -0.13	310.00	+0.32 / -0.00	20.00	+0.25 / -0.00	76.45
R330350180RC*	330.00	+0.00 / -0.13	330.00	350.00	18.00	330.00	+0.00 / -0.13	350.00	+0.32 / -0.00	20.00	+0.25 / -0.00	298.06

*: GENERALLY NOT STOCKED BUT AVAILABLE - CHECK WITH C/SER

METRIC SIZE
ROD SEALS





Rod seals

Hallite



METRIC SIZE
ROD SEALS

621

TECHNICAL DETAILS		METRIC	INCH			
OPERATING CONDITIONS						
MAXIMUM SPEED	1.0 m/sec	3.0 ft/sec				
TEMPERATURE RANGE	-45°C + 110°C	-50°F + 230°F				
MAXIMUM PRESSURE	700 bar	10,000 p.s.i.				
MAXIMUM EXTRUSION GAP						
PRESSURE bar	160	250	400	500	700	
MAXIMUM GAP mm	1.0	0.8	0.6	0.4	0.25	
PRESSURE p.s.i.	2400	3750	6000	7500	10,000	
MAXIMUM GAP in	0.040	0.032	0.024	0.016	0.010	
SURFACE ROUGHNESS						
DYNAMIC SEALING FACE ϕd_1	μmRa	μmRt	$\mu inCLA$	$\mu inRMS$		
STATIC SEALING FACE ϕD_1	0.1	0.4	4 max	4	16	
STATIC HOUSING FACES L_1	1.8 max	10 max	63 max	70 max	140 max	
	3.2 max	16 max	125 max	140 max		
CHAMFERS & RADII						
GROOVE SECTION S mm	4.0	5.0	7.5	10.0	12.5	15.0
MIN CHAMFER C mm	3.0	3.5	5.0	6.5	7.0	8.0
MAX FILLET RAD r_1 mm	0.2	0.4	0.8	0.8	1.2	1.6
MAX FILLET RAD r_2 mm	0.4	0.8	1.2	1.2	1.6	2.4
GROOVE SECTION S in	0.125	0.187	0.250	0.312	0.375	0.500
MIN CHAMFER C in	0.093	0.093	0.125	0.156	0.187	0.217
MAX FILLET RAD r_1 in	0.008	0.008	0.016	0.016	0.032	0.032
MAX FILLET RAD r_2 in	0.016	0.016	0.032	0.032	0.047	0.047
TOLERANCES						
ϕd_1	ϕD_1	L_1 mm	L_1 in			
∓ 9	Js11	+0.25 -0	+0.010 -0			

Figures show the maximum permissible gap all on one side using minimum rod ϕ and maximum clearance ϕ .

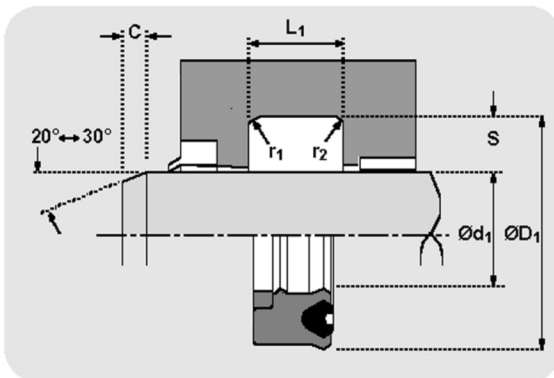

DESIGN

The Hallite 621 is a top of the range high pressure rod seal. The design of the seal incorporates a unique profiled NBR energiser to ensure complete lip actuation under all pressure conditions and to cushion the seal against shock loadings.

The shell is moulded in Hallite's high performance polyurethane Hythane 181, ensuring flexibility for installation and performance at low temperatures. The Hallite 621 also benefits from Hallite's twin lip profile for dry rod sealing.

FEATURES

- HIGH PRESSURE/SHOCK LOAD CAPABILITY
- TWIN LIP DESIGN OFFERING:
 - LOWER FRICTION
 - IMPROVED SEALING
 - PRIMARY LIP PROTECTION
 - INCREASED SEAL STABILITY
- POLYACETAL ANTI-EXTRUSION RING.

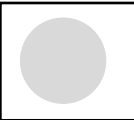

RE - Rod Seals

Polyurethane/Polyacetal/Nitrile

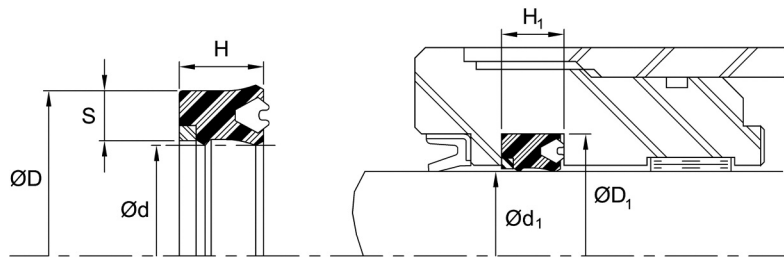
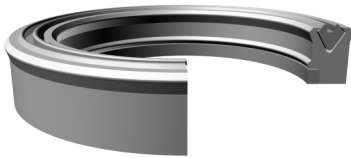

Temperature: -50/230F [-46/110C]

Pressure: 5000 PSI [345 Bar]

Ref.Number	Rod diameter		Nominal Seal Dimensions			Housing Dimensions					\$	
		Tol.	d	D	H	d1	Tol.	D1	Tol.	H1		Tol.
R030040073RE	30.00	+0.00 / -0.04	30.00	40.00	7.30	30.00	+0.00 / -0.04	40.00	+0.10 / -0.00	8.00	+0.30 / -0.00	15.38
R035050095RE	35.00	+0.00 / -0.04	35.00	50.00	9.50	35.00	+0.00 / -0.04	50.00	+0.10 / -0.00	10.50	+0.30 / -0.00	28.88
R036046073RE	36.00	+0.00 / -0.04	36.00	46.00	7.30	36.00	+0.00 / -0.04	46.00	+0.10 / -0.00	8.00	+0.30 / -0.00	28.88
R040050073RE	40.00	+0.00 / -0.04	40.00	50.00	7.30	40.00	+0.00 / -0.04	50.00	+0.10 / -0.00	8.00	+0.30 / -0.00	30.75
R040050100RE	40.00	+0.00 / -0.04	40.00	50.00	10.00	40.00	+0.00 / -0.04	50.00	+0.10 / -0.00	11.00	+0.30 / -0.00	32.51
R045055073RE	45.00	+0.00 / -0.04	45.00	55.00	7.30	45.00	+0.00 / -0.04	55.00	+0.12 / -0.00	8.00	+0.30 / -0.00	33.32
R045060114RE	45.00	+0.00 / -0.04	45.00	60.00	11.40	45.00	+0.00 / -0.04	60.00	+0.12 / -0.00	12.50	+0.30 / -0.00	34.21
R050060073RE	50.00	+0.00 / -0.04	50.00	60.00	7.30	50.00	+0.00 / -0.04	60.00	+0.12 / -0.00	8.00	+0.30 / -0.00	35.80
R050065100RE	50.00	+0.00 / -0.04	50.00	65.00	10.00	50.00	+0.00 / -0.04	65.00	+0.12 / -0.00	11.00	+0.30 / -0.00	36.51
R050065114RE	50.00	+0.00 / -0.04	50.00	65.00	11.40	50.00	+0.00 / -0.04	65.00	+0.12 / -0.00	12.50	+0.30 / -0.00	36.86
R055070114RE	55.00	+0.00 / -0.04	55.00	70.00	11.40	55.00	+0.00 / -0.04	70.00	+0.12 / -0.00	12.50	+0.30 / -0.00	38.12
R056071114RE	56.00	+0.00 / -0.04	56.00	71.00	11.40	56.00	+0.00 / -0.04	71.00	+0.12 / -0.00	12.50	+0.30 / -0.00	38.65
R060073130RE	60.00	+0.00 / -0.04	60.00	73.00	13.00	60.00	+0.00 / -0.04	73.00	+0.12 / -0.00	14.00	+0.30 / -0.00	34.21
R060075114RE	60.00	+0.00 / -0.04	60.00	75.00	11.40	60.00	+0.00 / -0.04	75.00	+0.12 / -0.00	12.50	+0.30 / -0.00	40.69
R063078114RE	63.00	+0.00 / -0.04	63.00	78.00	11.40	63.00	+0.00 / -0.04	78.00	+0.12 / -0.00	12.50	+0.30 / -0.00	42.18
R063083118RE	63.00	+0.00 / -0.04	63.00	83.00	11.80	63.00	+0.00 / -0.04	83.00	+0.14 / -0.00	13.00	+0.30 / -0.00	43.16
R065075100RE	65.00	+0.00 / -0.04	65.00	75.00	10.00	65.00	+0.00 / -0.04	75.00	+0.14 / -0.00	11.00	+0.30 / -0.00	43.89
R065080100RE	65.00	+0.00 / -0.04	65.00	80.00	10.00	65.00	+0.00 / -0.04	80.00	+0.14 / -0.00	11.00	+0.30 / -0.00	44.11
R065080114RE	65.00	+0.00 / -0.04	65.00	80.00	11.40	65.00	+0.00 / -0.04	80.00	+0.14 / -0.00	12.50	+0.30 / -0.00	45.22
R070085114RE	70.00	+0.00 / -0.04	70.00	85.00	11.40	70.00	+0.00 / -0.04	85.00	+0.14 / -0.00	12.50	+0.30 / -0.00	45.80
R075088130RE	75.00	+0.00 / -0.04	75.00	88.00	13.00	75.00	+0.00 / -0.04	88.00	+0.14 / -0.00	14.00	+0.30 / -0.00	37.42
R075090130RE	75.00	+0.00 / -0.04	75.00	90.00	13.00	75.00	+0.00 / -0.04	90.00	+0.14 / -0.00	14.00	+0.30 / -0.00	42.50
R080095114RE	80.00	+0.00 / -0.04	80.00	95.00	11.40	80.00	+0.00 / -0.04	95.00	+0.14 / -0.00	12.50	+0.30 / -0.00	50.62
R080095130RE	80.00	+0.00 / -0.04	80.00	95.00	13.00	80.00	+0.00 / -0.04	95.00	+0.14 / -0.00	14.00	+0.30 / -0.00	54.73
R085100118RE	85.00	+0.00 / -0.04	85.00	100.00	11.80	85.00	+0.00 / -0.04	100.00	+0.14 / -0.00	13.00	+0.30 / -0.00	40.84
R085100130RE	85.00	+0.00 / -0.04	85.00	100.00	13.00	85.00	+0.00 / -0.04	100.00	+0.14 / -0.00	14.00	+0.30 / -0.00	41.43
R090105114RE	90.00	+0.00 / -0.04	90.00	105.00	11.40	90.00	+0.00 / -0.04	105.00	+0.14 / -0.00	12.50	+0.30 / -0.00	55.42
R090105130RE	90.00	+0.00 / -0.04	90.00	105.00	13.00	90.00	+0.00 / -0.04	105.00	+0.14 / -0.00	14.00	+0.30 / -0.00	44.59
R095110130RE	95.00	+0.00 / -0.04	95.00	110.00	13.00	95.00	+0.00 / -0.04	110.00	+0.14 / -0.00	14.00	+0.30 / -0.00	45.55
R100115130RE	100.00	+0.00 / -0.04	100.00	115.00	13.00	100.00	+0.00 / -0.04	115.00	+0.14 / -0.00	14.00	+0.30 / -0.00	46.76
R100120146RE	100.00	+0.00 / -0.04	100.00	120.00	14.60	100.00	+0.00 / -0.04	120.00	+0.14 / -0.00	16.00	+0.30 / -0.00	60.52
R110130130RE	110.00	+0.00 / -0.04	110.00	130.00	13.00	110.00	+0.00 / -0.04	130.00	+0.14 / -0.00	14.00	+0.30 / -0.00	49.70
R110130146RE	110.00	+0.00 / -0.04	110.00	130.00	14.60	110.00	+0.00 / -0.04	130.00	+0.16 / -0.00	16.00	+0.30 / -0.00	65.34
R115135146RE	115.00	+0.00 / -0.04	115.00	135.00	14.60	115.00	+0.00 / -0.04	135.00	+0.16 / -0.00	16.00	+0.30 / -0.00	68.99
R120135146RE	120.00	+0.00 / -0.04	120.00	135.00	14.60	120.00	+0.00 / -0.04	135.00	+0.16 / -0.00	16.00	+0.30 / -0.00	70.37
R120140130RE	120.00	+0.00 / -0.04	120.00	140.00	13.00	120.00	+0.00 / -0.04	140.00	+0.16 / -0.00	14.00	+0.30 / -0.00	51.57

*: GENERALLY NOT STOCKED BUT AVAILABLE - CHECK WITH C/SER

RE SERIES - AU/POM/NBR

Ref.Number	Rod diameter		Nominal Seal Dimensions			Housing Dimensions					\$	
		Tol.	d	D	H	d1	Tol.	D1	Tol.	H1		Tol.
R120140146RE	120.00	+0.00 / -0.04	120.00	140.00	14.60	120.00	+0.00 / -0.04	140.00	+0.16 / -0.00	16.00	+0.30 / -0.00	53.60
R125145146RE	125.00	+0.00 / -0.04	125.00	145.00	14.60	125.00	+0.00 / -0.04	145.00	+0.16 / -0.00	16.00	+0.30 / -0.00	50.52
R130150146RE	130.00	+0.00 / -0.04	130.00	150.00	14.60	130.00	+0.00 / -0.04	150.00	+0.16 / -0.00	16.00	+0.30 / -0.00	82.62
R140160130RE	140.00	+0.00 / -0.04	140.00	160.00	13.00	140.00	+0.00 / -0.04	160.00	+0.16 / -0.00	14.00	+0.30 / -0.00	57.58
R140160146RE	140.00	+0.00 / -0.04	140.00	160.00	14.60	140.00	+0.00 / -0.04	160.00	+0.16 / -0.00	16.00	+0.30 / -0.00	55.65
R150170146RE	150.00	+0.00 / -0.04	150.00	170.00	14.60	150.00	+0.00 / -0.04	170.00	+0.16 / -0.00	16.00	+0.30 / -0.00	61.40
R160180146RE	160.00	+0.00 / -0.04	160.00	180.00	14.60	160.00	+0.00 / -0.04	180.00	+0.16 / -0.00	16.00	+0.30 / -0.00	62.54
R160185145RE	160.00	+0.00 / -0.04	160.00	185.00	14.50	160.00	+0.00 / -0.04	185.00	+0.16 / -0.00	16.00	+0.30 / -0.00	91.86
R180200146RE	180.00	+0.00 / -0.04	180.00	200.00	14.60	180.00	+0.00 / -0.04	200.00	+0.16 / -0.00	16.00	+0.30 / -0.00	69.44
R200220146RE	200.00	+0.00 / -0.04	200.00	220.00	14.60	200.00	+0.00 / -0.04	220.00	+0.16 / -0.00	16.00	+0.30 / -0.00	76.33
R215235146RE	215.00	+0.00 / -0.04	215.00	235.00	14.60	215.00	+0.00 / -0.04	235.00	+0.16 / -0.00	16.00	+0.30 / -0.00	124.13

METRIC SIZE
ROD SEALS

RH - Buffer Seals Polyurethane AU 94A/Polyacetal

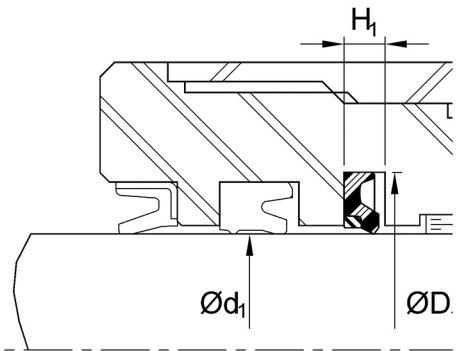
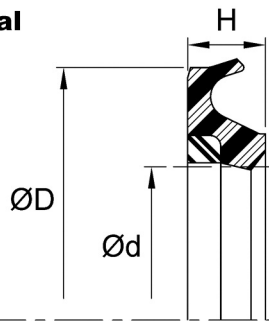

Temperature: -31/212F [-35/100C]

Pressure: 8500 PSI [584 Bar]

Ref.Number	Rod diameter		Nominal Seal Dimensions			Housing Dimensions					\$	
		Tol.	d	D	H	d1	Tol.	D1	Tol.	H1		Tol.
R035051060RH*	35.50	+0.00 / -0.05	35.50	51.00	6.00	35.50	+0.00 / -0.05	50.00	+0.20 / -0.00	6.30	+0.20 / -0.00	15.56
R040055060RH	40.00	+0.00 / -0.05	40.00	55.50	6.00	40.00	+0.00 / -0.05	55.50	+0.20 / -0.00	6.30	+0.20 / -0.00	7.58
R045060060RH	45.00	+0.00 / -0.05	45.00	60.50	6.00	45.00	+0.00 / -0.05	60.50	+0.20 / -0.00	6.30	+0.20 / -0.00	8.05
R050065060RH	50.00	+0.00 / -0.05	50.00	65.50	6.00	50.00	+0.00 / -0.05	65.50	+0.20 / -0.00	6.30	+0.20 / -0.00	15.46
R055070060RH	55.00	+0.00 / -0.05	55.00	70.50	6.00	55.00	+0.00 / -0.05	70.50	+0.20 / -0.00	6.30	+0.20 / -0.00	15.54
R056071060RH	56.00	+0.00 / -0.05	56.00	71.50	6.00	55.00	+0.00 / -0.05	71.50	+0.20 / -0.00	6.30	+0.20 / -0.00	26.72
R060075060RH	60.00	+0.00 / -0.05	60.00	75.50	6.00	60.00	+0.00 / -0.05	75.50	+0.20 / -0.00	6.30	+0.20 / -0.00	22.09
R063078060RH	63.00	+0.00 / -0.05	63.00	78.50	6.00	63.00	+0.00 / -0.05	78.50	+0.20 / -0.00	6.30	+0.20 / -0.00	17.29
R065080060RH	65.00	+0.00 / -0.06	65.00	80.50	6.00	65.00	+0.00 / -0.06	80.50	+0.20 / -0.00	6.30	+0.20 / -0.00	26.27
R070085060RH	70.00	+0.00 / -0.06	70.00	85.50	6.00	70.00	+0.00 / -0.06	85.50	+0.20 / -0.00	6.30	+0.20 / -0.00	28.67
R075090060RH	75.00	+0.00 / -0.06	75.00	90.50	6.00	75.00	+0.00 / -0.06	90.50	+0.20 / -0.00	6.30	+0.20 / -0.00	30.47
R080095060RH	80.00	+0.00 / -0.09	80.00	95.50	6.00	80.00	+0.00 / -0.09	95.50	+0.20 / -0.00	6.30	+0.20 / -0.00	32.27
R085100060RH	85.00	+0.00 / -0.09	85.00	100.50	6.00	85.00	+0.00 / -0.09	100.50	+0.20 / -0.00	6.30	+0.20 / -0.00	34.63
R090105060RH	90.00	+0.00 / -0.09	90.00	105.50	6.00	90.00	+0.00 / -0.09	105.50	+0.20 / -0.00	6.30	+0.20 / -0.00	41.80
R095110060RH	95.00	+0.00 / -0.09	95.00	110.50	6.00	95.00	+0.00 / -0.09	110.50	+0.20 / -0.00	6.30	+0.20 / -0.00	44.13
R100115060RH	100.00	+0.00 / -0.09	100.00	115.50	6.00	100.00	+0.00 / -0.09	115.50	+0.20 / -0.00	6.30	+0.20 / -0.00	45.41
R105120060RH	105.00	+0.00 / -0.13	105.00	120.50	6.00	105.00	+0.00 / -0.13	120.50	+0.20 / -0.00	6.30	+0.20 / -0.00	47.05
R110125060RH	110.00	+0.00 / -0.13	110.00	125.50	6.00	110.00	+0.00 / -0.13	125.50	+0.20 / -0.00	6.30	+0.20 / -0.00	48.98

*: GENERALLY NOT STOCKED BUT AVAILABLE - CHECK WITH C/SER

Tel.: 1-888-609-SEAL
Fax: 1-888-717-SEAL

J

31

www.sealsourceinc.com



RH SERIES - AU 94A/POM

Ref.Number	Rod diameter		Nominal Seal Dimensions			Housing Dimensions					\$	
		Tol.	d	D	H	d1	Tol.	D1	Tol.	H1		Tol.
R115130060RH	115.00	+0.00 / -0.13	115.00	130.50	6.00	115.00	+0.00 / -0.13	130.50	+0.20 / -0.00	6.30	+0.20 / -0.00	27.02
R120135060RH	120.00	+0.00 / -0.13	120.00	135.50	6.00	120.00	+0.00 / -0.13	135.50	+0.20 / -0.00	6.30	+0.20 / -0.00	53.18
R125140060RH	125.00	+0.00 / -0.13	125.00	140.50	6.00	125.00	+0.00 / -0.13	140.50	+0.20 / -0.00	6.30	+0.20 / -0.00	26.70
R130145060RH	130.00	+0.00 / -0.13	130.00	145.50	6.00	130.00	+0.00 / -0.13	145.50	+0.20 / -0.00	6.30	+0.20 / -0.00	82.55
R132147060RH*	132.00	+0.00 / -0.13	132.00	147.50	6.00	132.00	+0.00 / -0.13	147.50	+0.20 / -0.00	6.30	+0.20 / -0.00	98.99
R135150060RH*	135.00	+0.00 / -0.13	135.00	150.50	6.00	135.00	+0.00 / -0.13	150.50	+0.20 / -0.00	6.30	+0.20 / -0.00	99.61
R140155060RH	140.00	+0.00 / -0.13	140.00	155.50	6.00	140.00	+0.00 / -0.13	155.50	+0.20 / -0.00	6.30	+0.20 / -0.00	134.40
R145160060RH*	145.00	+0.00 / -0.13	145.00	160.50	6.00	145.00	+0.00 / -0.13	160.50	+0.20 / -0.00	6.30	+0.20 / -0.00	99.78
R150165060RH	150.00	+0.00 / -0.13	150.00	165.50	6.00	150.00	+0.00 / -0.13	165.50	+0.20 / -0.00	6.30	+0.20 / -0.00	88.10
R155170060RH	155.00	+0.00 / -0.13	155.00	170.50	6.00	155.00	+0.00 / -0.13	170.50	+0.20 / -0.00	6.30	+0.20 / -0.00	90.23
R160175060RH	160.00	+0.00 / -0.13	160.00	175.50	6.00	160.00	+0.00 / -0.13	175.50	+0.20 / -0.00	6.30	+0.20 / -0.00	135.10
R165180060RH*	165.00	+0.00 / -0.13	165.00	180.50	6.00	165.00	+0.00 / -0.13	180.50	+0.20 / -0.00	6.30	+0.20 / -0.00	143.80
R170185060RH	170.00	+0.00 / -0.13	170.00	185.50	6.00	170.00	+0.00 / -0.13	185.50	+0.20 / -0.00	6.30	+0.20 / -0.00	190.49
R180195060RH	180.00	+0.00 / -0.13	180.00	195.50	6.00	180.00	+0.00 / -0.13	195.50	+0.20 / -0.00	6.30	+0.20 / -0.00	265.84
R190205060RH*	190.00	+0.00 / -0.13	190.00	205.50	6.00	190.00	+0.00 / -0.13	205.50	+0.20 / -0.00	6.30	+0.20 / -0.00	149.90
R200220081RH	200.00	+0.00 / -0.13	200.00	215.50	7.70	200.00	+0.00 / -0.13	220.50	+0.20 / -0.00	8.10	+0.20 / -0.00	253.33
R210225081RH*	210.00	+0.00 / -0.13	210.00	225.50	7.70	210.00	+0.00 / -0.13	225.50	+0.20 / -0.00	8.10	+0.20 / -0.00	266.44

RR - Series NBR - Fabric - POM

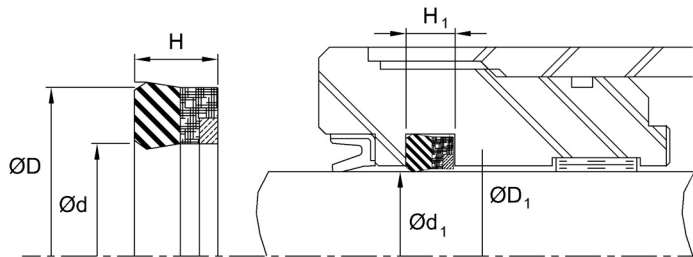

Temperature: -22/105F [-30/105C]

Pressure: 5800 PSI [400 Bar]

Ref.Number	Rod diameter		Nominal Seal Dimensions			Housing Dimensions					\$	
		Tol.	d	D	H	d1	Tol.	D1	Tol.	H1		Tol.
R012023072RR*	12.00	+0.00 / -0.04	12.00	23.00	7.20	12.00	+0.00 / -0.04	23.00	+0.04 / -0.00	7.50	+0.25 / -0.00	5.60
R015027067RR*	15.00	+0.00 / -0.04	15.00	27.00	6.70	15.00	+0.00 / -0.04	27.00	+0.04 / -0.00	7.00	+0.25 / -0.00	6.61
R016028072RR*	16.00	+0.00 / -0.04	16.00	28.00	7.20	16.00	+0.00 / -0.04	28.00	+0.04 / -0.00	7.50	+0.25 / -0.00	6.61
R016024067RR*	16.00	+0.00 / -0.04	16.00	24.00	6.70	16.00	+0.00 / -0.04	24.00	+0.04 / -0.00	7.00	+0.25 / -0.00	3.36
R018026061RR*	18.00	+0.00 / -0.04	18.00	26.00	6.10	18.00	+0.00 / -0.04	26.00	+0.04 / -0.00	6.40	+0.25 / -0.00	6.61
R018028060RR*	18.00	+0.00 / -0.04	18.00	28.00	6.00	18.00	+0.00 / -0.04	28.00	+0.04 / -0.00	6.30	+0.25 / -0.00	6.83
R018030072RR*	18.00	+0.00 / -0.04	18.00	30.00	7.20	18.00	+0.00 / -0.04	30.00	+0.04 / -0.00	7.50	+0.25 / -0.00	7.17
R020030077RR*	20.00	+0.00 / -0.04	20.00	30.00	7.70	20.00	+0.00 / -0.04	30.00	+0.05 / -0.00	8.00	+0.25 / -0.00	6.94
R020027057RR*	20.00	+0.00 / -0.04	20.00	27.00	5.70	20.00	+0.00 / -0.04	27.00	+0.05 / -0.00	6.00	+0.25 / -0.00	6.94
R020028060RR*	20.00	+0.00 / -0.04	20.00	28.00	6.00	20.00	+0.00 / -0.04	28.00	+0.05 / -0.00	6.30	+0.25 / -0.00	6.94
R020028067RR*	20.00	+0.00 / -0.04	20.00	28.00	6.70	20.00	+0.00 / -0.04	28.00	+0.05 / -0.00	7.00	+0.25 / -0.00	7.28
R020030082RR*	20.00	+0.00 / -0.04	20.00	30.00	8.20	20.00	+0.00 / -0.04	30.00	+0.05 / -0.00	8.50	+0.25 / -0.00	6.94

*: GENERALLY NOT STOCKED BUT AVAILABLE - CHECK WITH C/SER

RR SERIES - NBR/FABRIC/POM

Ref.Number	Rod diameter		Nominal Seal Dimensions			Housing Dimensions					\$	
		Tol.	d	D	H	d1	Tol.	D1	Tol.	H1		Tol.
R02203207RR*	22.00	+0.00 / -0.04	22.00	32.00	7.20	22.00	+0.00 / -0.04	32.00	+0.05 / -0.00	7.50	+0.25 / -0.00	7.50
R022029047RR*	22.00	+0.00 / -0.04	22.00	29.00	4.70	22.00	+0.00 / -0.04	29.00	+0.05 / -0.00	5.00	+0.25 / -0.00	6.94
R022030067RR*	22.00	+0.00 / -0.04	22.00	30.00	6.70	22.00	+0.00 / -0.04	30.00	+0.05 / -0.00	7.00	+0.25 / -0.00	7.28
R022032097RR*	22.00	+0.00 / -0.04	22.00	32.00	9.70	22.00	+0.00 / -0.04	32.00	+0.05 / -0.00	10.00	+0.25 / -0.00	7.50
R022034092RR*	22.00	+0.00 / -0.04	22.00	34.00	9.20	22.00	+0.00 / -0.04	34.00	+0.05 / -0.00	9.50	+0.25 / -0.00	7.84
R022035097RR*	22.00	+0.00 / -0.04	22.00	35.00	9.70	22.00	+0.00 / -0.04	35.00	+0.05 / -0.00	10.00	+0.25 / -0.00	7.84
R025038092RR*	25.00	+0.00 / -0.04	25.00	38.00	9.20	25.00	+0.00 / -0.04	38.00	+0.05 / -0.00	9.50	+0.25 / -0.00	7.84
R025033057RR*	25.00	+0.00 / -0.04	25.00	33.00	5.70	25.00	+0.00 / -0.04	33.00	+0.05 / -0.00	6.00	+0.25 / -0.00	6.94
R025035077RR*	25.00	+0.00 / -0.04	25.00	35.00	7.70	25.00	+0.00 / -0.04	35.00	+0.05 / -0.00	8.00	+0.25 / -0.00	7.62
R025033061RR*	25.00	+0.00 / -0.04	25.00	33.00	6.10	25.00	+0.00 / -0.04	33.00	+0.05 / -0.00	6.40	+0.25 / -0.00	6.94
R025035087RR*	25.00	+0.00 / -0.04	25.00	35.00	8.70	25.00	+0.00 / -0.04	35.00	+0.05 / -0.00	9.00	+0.25 / -0.00	7.62
R025038097RR*	25.00	+0.00 / -0.04	25.00	38.00	9.70	25.00	+0.00 / -0.04	38.00	+0.05 / -0.00	10.00	+0.25 / -0.00	7.84
R025033067RR*	25.00	+0.00 / -0.04	25.00	33.00	6.70	25.00	+0.00 / -0.04	33.00	+0.05 / -0.00	7.00	+0.25 / -0.00	7.06
R028038077RR*	28.00	+0.00 / -0.04	28.00	38.00	7.70	28.00	+0.00 / -0.04	38.00	+0.05 / -0.00	8.00	+0.25 / -0.00	7.84
R028014092RR*	28.00	+0.00 / -0.04	28.00	14.00	9.20	28.00	+0.00 / -0.04	14.00	+0.05 / -0.00	9.50	+0.25 / -0.00	9.30
R028036061RR*	28.00	+0.00 / -0.04	28.00	36.00	6.10	28.00	+0.00 / -0.04	36.00	+0.05 / -0.00	6.40	+0.25 / -0.00	7.62
R028040092RR	28.00	+0.00 / -0.04	28.00	40.00	9.20	28.00	+0.00 / -0.04	40.00	+0.05 / -0.00	9.50	+0.25 / -0.00	8.40
R028041097RR*	28.00	+0.00 / -0.04	28.00	41.00	9.70	28.00	+0.00 / -0.04	41.00	+0.05 / -0.00	10.00	+0.25 / -0.00	8.62
R030040102RR*	30.00	+0.00 / -0.04	30.00	40.00	10.20	30.00	+0.00 / -0.04	40.00	+0.05 / -0.00	10.50	+0.25 / -0.00	8.62
R030038062RR*	30.00	+0.00 / -0.04	30.00	38.00	6.20	30.00	+0.00 / -0.04	38.00	+0.05 / -0.00	6.50	+0.25 / -0.00	7.84
R030040067RR*	30.00	+0.00 / -0.04	30.00	40.00	6.70	30.00	+0.00 / -0.04	40.00	+0.05 / -0.00	7.00	+0.25 / -0.00	8.18
R030040072RR*	30.00	+0.00 / -0.04	30.00	40.00	7.20	30.00	+0.00 / -0.04	40.00	+0.05 / -0.00	7.50	+0.25 / -0.00	8.18
R030045087RR*	30.00	+0.00 / -0.04	30.00	45.00	8.70	30.00	+0.00 / -0.04	45.00	+0.05 / -0.00	9.00	+0.25 / -0.00	10.08
R030050142RR*	30.00	+0.00 / -0.04	30.00	50.00	14.20	30.00	+0.00 / -0.04	50.00	+0.05 / -0.00	14.50	+0.25 / -0.00	12.32
R032040087RR*	32.00	+0.00 / -0.04	32.00	40.00	8.70	32.00	+0.00 / -0.04	40.00	+0.06 / -0.00	9.00	+0.25 / -0.00	8.62
R032042107RR*	32.00	+0.00 / -0.04	32.00	42.00	10.70	32.00	+0.00 / -0.04	42.00	+0.06 / -0.00	11.00	+0.25 / -0.00	9.18
R032045097RR*	32.00	+0.00 / -0.04	32.00	45.00	9.70	32.00	+0.00 / -0.04	45.00	+0.06 / -0.00	10.00	+0.25 / -0.00	9.74
R032040047RR*	32.00	+0.00 / -0.04	32.00	40.00	4.70	32.00	+0.00 / -0.04	40.00	+0.06 / -0.00	5.00	+0.25 / -0.00	7.86
R035045102RR*	35.00	+0.00 / -0.04	35.00	45.00	10.20	35.00	+0.00 / -0.04	45.00	+0.06 / -0.00	10.50	+0.25 / -0.00	10.30
R035050102RR*	35.00	+0.00 / -0.04	35.00	50.00	10.20	35.00	+0.00 / -0.04	50.00	+0.06 / -0.00	10.50	+0.25 / -0.00	10.30
R035045097RR*	35.00	+0.00 / -0.04	35.00	45.00	9.70	35.00	+0.00 / -0.04	45.00	+0.06 / -0.00	10.00	+0.25 / -0.00	10.30
R035050112RR*	35.00	+0.00 / -0.04	35.00	50.00	11.20	35.00	+0.00 / -0.04	50.00	+0.06 / -0.00	11.50	+0.25 / -0.00	10.30
R035043057RR*	35.00	+0.00 / -0.04	35.00	43.00	5.70	35.00	+0.00 / -0.04	43.00	+0.06 / -0.00	6.00	+0.25 / -0.00	10.08
R036043062RR*	36.00	+0.00 / -0.04	36.00	43.00	6.20	36.00	+0.00 / -0.04	43.00	+0.06 / -0.00	6.50	+0.25 / -0.00	10.08
R036044061RR*	36.00	+0.00 / -0.04	36.00	44.00	6.10	36.00	+0.00 / -0.04	44.00	+0.06 / -0.00	6.40	+0.25 / -0.00	10.08
R036046082RR*	36.00	+0.00 / -0.04	36.00	46.00	8.20	36.00	+0.00 / -0.04	46.00	+0.06 / -0.00	8.50	+0.25 / -0.00	10.30
R036048117RR*	36.00	+0.00 / -0.04	36.00	48.00	11.70	36.00	+0.00 / -0.04	48.00	+0.06 / -0.00	12.00	+0.25 / -0.00	10.75
R036048092RR*	36.00	+0.00 / -0.04	36.00	48.00	9.20	36.00	+0.00 / -0.04	48.00	+0.06 / -0.00	9.50	+0.25 / -0.00	10.30
R038055102RR*	38.00	+0.00 / -0.04	38.00	55.00	10.20	38.00	+0.00 / -0.04	55.00	+0.06 / -0.00	10.50	+0.25 / -0.00	10.30
R040050102RR	40.00	+0.00 / -0.05	40.00	50.00	10.20	40.00	+0.00 / -0.05	50.00	+0.06 / -0.00	10.50	+0.25 / -0.00	10.30
R040055102RR*	40.00	+0.00 / -0.05	40.00	55.00	10.20	40.00	+0.00 / -0.05	55.00	+0.06 / -0.00	10.50	+0.25 / -0.00	10.30
R040050107RR*	40.00	+0.00 / -0.05	40.00	50.00	10.70	40.00	+0.00 / -0.05	50.00	+0.06 / -0.00	11.00	+0.25 / -0.00	10.30
R040048062RR*	40.00	+0.00 / -0.05	40.00	48.00	6.20	40.00	+0.00 / -0.05	48.00	+0.06 / -0.00	6.50	+0.25 / -0.00	9.18
R040055107RR*	40.00	+0.00 / -0.05	40.00	55.00	10.70	40.00	+0.00 / -0.05	55.00	+0.06 / -0.00	11.00	+0.25 / -0.00	10.30
R040050097RR*	40.00	+0.00 / -0.05	40.00	50.00	9.70	40.00	+0.00 / -0.05	50.00	+0.06 / -0.00	10.00	+0.25 / -0.00	10.30
R040050077RR*	40.00	+0.00 / -0.05	40.00	50.00	7.70	40.00	+0.00 / -0.05	50.00	+0.06 / -0.00	8.00	+0.25 / -0.00	10.30
R040055077RR*	40.00	+0.00 / -0.05	40.00	55.00	7.70	40.00	+0.00 / -0.05	55.00	+0.06 / -0.00	8.00	+0.25 / -0.00	10.30

*: GENERALLY NOT STOCKED BUT AVAILABLE - CHECK WITH C/SER

Tel.: 1-888-609-SEAL
Fax: 1-888-717-SEAL

J

33

www.sealsourceinc.com

**METRIC SIZE
ROD SEALS**

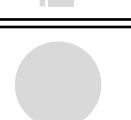
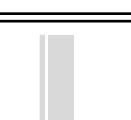

M

Seal Source Inc.

**METRIC SIZE
ROD SEALS**

RR SERIES - NBR/FABRIC/POM

Ref.Number	Rod diameter		Nominal Seal Dimensions			Housing Dimensions					\$	
		Tol.	d	D	H	d1	Tol.	D1	Tol.	H1		Tol.
R040060142RR*	40.00	+0.00 / -0.05	40.00	60.00	14.20	40.00	+0.00 / -0.05	60.00	+0.06 / -0.00	14.50	+0.25 / -0.00	11.87
R042052087RR*	42.00	+0.00 / -0.05	42.00	52.00	8.70	42.00	+0.00 / -0.05	52.00	+0.06 / -0.00	9.00	+0.25 / -0.00	10.30
R045055102RR*	45.00	+0.00 / -0.05	45.00	55.00	10.20	45.00	+0.00 / -0.05	55.00	+0.06 / -0.00	10.50	+0.25 / -0.00	10.30
R045060102RR	45.00	+0.00 / -0.05	45.00	60.00	10.20	45.00	+0.00 / -0.05	60.00	+0.06 / -0.00	10.50	+0.25 / -0.00	11.09
R045055107RR*	45.00	+0.00 / -0.05	45.00	55.00	10.70	45.00	+0.00 / -0.05	55.00	+0.06 / -0.00	11.00	+0.25 / -0.00	10.30
R045055077RR*	45.00	+0.00 / -0.05	45.00	55.00	7.70	45.00	+0.00 / -0.05	55.00	+0.06 / -0.00	8.00	+0.25 / -0.00	10.30
R045055072RR*	45.00	+0.00 / -0.05	45.00	55.00	7.20	45.00	+0.00 / -0.05	55.00	+0.06 / -0.00	7.50	+0.25 / -0.00	10.30
R045057097RR*	45.00	+0.00 / -0.05	45.00	57.00	9.70	45.00	+0.00 / -0.05	57.00	+0.06 / -0.00	10.00	+0.25 / -0.00	10.53
R045065142RR	45.00	+0.00 / -0.05	45.00	65.00	14.20	45.00	+0.00 / -0.05	65.00	+0.06 / -0.00	14.50	+0.25 / -0.00	12.21
R050065102RR*	50.00	+0.00 / -0.05	50.00	65.00	10.20	50.00	+0.00 / -0.05	65.00	+0.06 / -0.00	10.50	+0.25 / -0.00	11.09
R050062097RR*	50.00	+0.00 / -0.05	50.00	62.00	9.70	50.00	+0.00 / -0.05	62.00	+0.06 / -0.00	10.00	+0.25 / -0.00	10.75
R050060102RR*	50.00	+0.00 / -0.05	50.00	60.00	10.20	50.00	+0.00 / -0.05	60.00	+0.06 / -0.00	10.50	+0.25 / -0.00	10.42
R050060097RR*	50.00	+0.00 / -0.05	50.00	60.00	9.70	50.00	+0.00 / -0.05	60.00	+0.06 / -0.00	10.00	+0.25 / -0.00	10.75
R050065107RR*	50.00	+0.00 / -0.05	50.00	65.00	10.70	50.00	+0.00 / -0.05	65.00	+0.06 / -0.00	11.00	+0.25 / -0.00	11.09
R050062077RR*	50.00	+0.00 / -0.05	50.00	62.00	7.70	50.00	+0.00 / -0.05	62.00	+0.06 / -0.00	8.00	+0.25 / -0.00	10.75
R050070137RR*	50.00	+0.00 / -0.05	50.00	70.00	13.70	50.00	+0.00 / -0.05	70.00	+0.06 / -0.00	14.00	+0.25 / -0.00	12.32
R050060072RR*	50.00	+0.00 / -0.05	50.00	60.00	7.20	50.00	+0.00 / -0.05	60.00	+0.06 / -0.00	7.50	+0.25 / -0.00	10.42
R050060077RR*	50.00	+0.00 / -0.05	50.00	60.00	7.70	50.00	+0.00 / -0.05	60.00	+0.06 / -0.00	8.00	+0.25 / -0.00	10.42
R050070142RR*	50.00	+0.00 / -0.05	50.00	70.00	14.20	50.00	+0.00 / -0.05	70.00	+0.06 / -0.00	14.50	+0.25 / -0.00	12.32
R054066092RR*	54.00	+0.00 / -0.05	54.00	66.00	9.20	54.00	+0.00 / -0.05	66.00	+0.07 / -0.00	9.50	+0.25 / -0.00	11.31
R055065102RR*	55.00	+0.00 / -0.05	55.00	65.00	10.20	55.00	+0.00 / -0.05	65.00	+0.07 / -0.00	10.50	+0.25 / -0.00	11.09
R055065117RR*	55.00	+0.00 / -0.05	55.00	65.00	11.70	55.00	+0.00 / -0.05	65.00	+0.07 / -0.00	12.00	+0.25 / -0.00	11.31
R055065107RR*	55.00	+0.00 / -0.05	55.00	65.00	10.70	55.00	+0.00 / -0.05	65.00	+0.07 / -0.00	11.00	+0.25 / -0.00	11.20
R055075137RR*	55.00	+0.00 / -0.05	55.00	75.00	13.70	55.00	+0.00 / -0.05	75.00	+0.07 / -0.00	14.00	+0.25 / -0.00	12.32
R055065077RR*	55.00	+0.00 / -0.05	55.00	65.00	7.70	55.00	+0.00 / -0.05	65.00	+0.07 / -0.00	8.00	+0.25 / -0.00	11.31
R055070102RR*	55.00	+0.00 / -0.05	55.00	70.00	10.20	55.00	+0.00 / -0.05	70.00	+0.07 / -0.00	10.50	+0.25 / -0.00	12.32
R055075142RR*	55.00	+0.00 / -0.05	55.00	75.00	14.20	55.00	+0.00 / -0.05	75.00	+0.07 / -0.00	14.50	+0.25 / -0.00	12.32
R056066102RR*	56.00	+0.00 / -0.05	56.00	66.00	10.20	56.00	+0.00 / -0.05	66.00	+0.07 / -0.00	10.50	+0.25 / -0.00	11.09
R056071102RR*	56.00	+0.00 / -0.05	56.00	71.00	10.20	56.00	+0.00 / -0.05	71.00	+0.07 / -0.00	10.50	+0.25 / -0.00	12.32
R056076142RR*	56.00	+0.00 / -0.05	56.00	76.00	14.20	56.00	+0.00 / -0.05	76.00	+0.07 / -0.00	14.50	+0.25 / -0.00	12.32
R060070102RR*	60.00	+0.00 / -0.05	60.00	70.00	10.20	60.00	+0.00 / -0.05	70.00	+0.07 / -0.00	10.50	+0.25 / -0.00	11.76
R060070122RR*	60.00	+0.00 / -0.05	60.00	70.00	12.20	60.00	+0.00 / -0.05	70.00	+0.07 / -0.00	12.50	+0.25 / -0.00	11.76
R060075127RR*	60.00	+0.00 / -0.05	60.00	75.00	12.70	60.00	+0.00 / -0.05	75.00	+0.07 / -0.00	13.00	+0.25 / -0.00	13.10
R060080142RR*	60.00	+0.00 / -0.05	60.00	80.00	14.20	60.00	+0.00 / -0.05	80.00	+0.07 / -0.00	14.50	+0.25 / -0.00	14.45
R060080137RR*	60.00	+0.00 / -0.05	60.00	80.00	13.70	60.00	+0.00 / -0.05	80.00	+0.07 / -0.00	14.00	+0.25 / -0.00	14.45
R060075127RR*	60.00	+0.00 / -0.05	60.00	75.00	12.70	60.00	+0.00 / -0.05	75.00	+0.07 / -0.00	13.00	+0.25 / -0.00	13.10
R060075122RR*	60.00	+0.00 / -0.05	60.00	75.00	12.20	60.00	+0.00 / -0.05	75.00	+0.07 / -0.00	12.50	+0.25 / -0.00	13.10
R060070107RR*	60.00	+0.00 / -0.05	60.00	70.00	10.70	60.00	+0.00 / -0.05	70.00	+0.07 / -0.00	11.00	+0.25 / -0.00	12.32
R060070077RR*	60.00	+0.00 / -0.05	60.00	70.00	7.70	60.00	+0.00 / -0.05	70.00	+0.07 / -0.00	8.00	+0.25 / -0.00	11.76
R060070127RR*	60.00	+0.00 / -0.05	60.00	70.00	12.70	60.00	+0.00 / -0.05	70.00	+0.07 / -0.00	13.00	+0.25 / -0.00	11.76
R060072097RR*	60.00	+0.00 / -0.05	60.00	72.00	9.70	60.00	+0.00 / -0.05	72.00	+0.07 / -0.00	10.00	+0.25 / -0.00	11.98
R063071087RR*	63.00	+0.00 / -0.05	63.00	71.00	8.70	63.00	+0.00 / -0.05	71.00	+0.07 / -0.00	9.00	+0.25 / -0.00	12.88
R063075107RR*	63.00	+0.00 / -0.05	63.00	75.00	10.70	63.00	+0.00 / -0.05	75.00	+0.07 / -0.00	11.00	+0.25 / -0.00	12.66
R063078122RR*	63.00	+0.00 / -0.05	63.00	78.00	12.20	63.00	+0.00 / -0.05	78.00	+0.07 / -0.00	12.50	+0.25 / -0.00	13.10
R063083142RR*	63.00	+0.00 / -0.05	63.00	83.00	14.20	63.00	+0.00 / -0.05	83.00	+0.07 / -0.00	14.50	+0.25 / -0.00	14.45
R065080122RR*	65.00	+0.00 / -0.06	65.00	80.00	12.20	65.00	+0.00 / -0.06	80.00	+0.07 / -0.00	12.50	+0.25 / -0.00	14.00
R065075122RR*	65.00	+0.00 / -0.06	65.00	75.00	12.20	65.00	+0.00 / -0.06	75.00	+0.07 / -0.00	12.50	+0.25 / -0.00	11.76

*: GENERALLY NOT STOCKED BUT AVAILABLE - CHECK WITH C/SER

RR SERIES - NBR/FABRIC/POM

Ref.Number	Rod diameter		Nominal Seal Dimensions			Housing Dimensions					\$	
		Tol.	d	D	H	d1	Tol.	D1	Tol.	H1		Tol.
R065075132RR*	65.00	+0.00 / -0.06	65.00	75.00	13.20	65.00	+0.00 / -0.06	75.00	+0.07 / -0.00	13.50	+0.25 / -0.00	11.76
R065077093RR*	65.00	+0.00 / -0.06	65.00	77.00	9.30	65.00	+0.00 / -0.06	77.00	+0.07 / -0.00	9.60	+0.25 / -0.00	12.32
R065080112RR*	65.00	+0.00 / -0.06	65.00	80.00	11.20	65.00	+0.00 / -0.06	80.00	+0.07 / -0.00	11.50	+0.25 / -0.00	14.00
R070080122RR*	70.00	+0.00 / -0.06	70.00	80.00	12.20	70.00	+0.00 / -0.06	80.00	+0.07 / -0.00	12.50	+0.25 / -0.00	14.00
R070085117RR*	70.00	+0.00 / -0.06	70.00	85.00	11.70	70.00	+0.00 / -0.06	85.00	+0.07 / -0.00	12.00	+0.25 / -0.00	14.90
R070085122RR	70.00	+0.00 / -0.06	70.00	85.00	12.20	70.00	+0.00 / -0.06	85.00	+0.07 / -0.00	12.50	+0.25 / -0.00	14.90
R070090137RR*	70.00	+0.00 / -0.06	70.00	90.00	13.70	70.00	+0.00 / -0.06	90.00	+0.07 / -0.00	14.00	+0.25 / -0.00	15.79
R070080077RR*	70.00	+0.00 / -0.06	70.00	80.00	7.70	70.00	+0.00 / -0.06	80.00	+0.07 / -0.00	8.00	+0.25 / -0.00	13.66
R070080127RR*	70.00	+0.00 / -0.06	70.00	80.00	12.70	70.00	+0.00 / -0.06	80.00	+0.07 / -0.00	13.00	+0.25 / -0.00	14.00
R070082102RR*	70.00	+0.00 / -0.06	70.00	82.00	10.20	70.00	+0.00 / -0.06	82.00	+0.07 / -0.00	10.50	+0.25 / -0.00	14.00
R070084122RR*	70.00	+0.00 / -0.06	70.00	84.00	12.20	70.00	+0.00 / -0.06	84.00	+0.07 / -0.00	12.50	+0.25 / -0.00	14.90
R075085122RR*	75.00	+0.00 / -0.06	75.00	85.00	12.20	75.00	+0.00 / -0.06	85.00	+0.07 / -0.00	12.50	+0.25 / -0.00	15.01
R075090107RR*	75.00	+0.00 / -0.06	75.00	90.00	10.70	75.00	+0.00 / -0.06	90.00	+0.07 / -0.00	11.00	+0.25 / -0.00	14.90
R075085107RR*	75.00	+0.00 / -0.06	75.00	85.00	10.70	75.00	+0.00 / -0.06	85.00	+0.07 / -0.00	11.00	+0.25 / -0.00	15.01
R075090112RR*	75.00	+0.00 / -0.06	75.00	90.00	11.20	75.00	+0.00 / -0.06	90.00	+0.07 / -0.00	11.50	+0.25 / -0.00	14.90
R075090125RR*	75.00	+0.00 / -0.06	75.00	90.00	12.50	75.00	+0.00 / -0.06	90.00	+0.07 / -0.00	12.80	+0.25 / -0.00	15.01
R075095142RR*	75.00	+0.00 / -0.06	75.00	95.00	14.20	75.00	+0.00 / -0.06	95.00	+0.07 / -0.00	14.50	+0.25 / -0.00	16.24
R080090122RR*	80.00	+0.00 / -0.09	80.00	90.00	12.20	80.00	+0.00 / -0.09	90.00	+0.07 / -0.00	12.50	+0.25 / -0.00	15.01
R080100122RR*	80.00	+0.00 / -0.09	80.00	100.00	12.20	80.00	+0.00 / -0.09	100.00	+0.07 / -0.00	12.50	+0.25 / -0.00	15.46
R080100137RR*	80.00	+0.00 / -0.09	80.00	100.00	13.70	80.00	+0.00 / -0.09	100.00	+0.07 / -0.00	14.00	+0.25 / -0.00	16.02
R080095117RR*	80.00	+0.00 / -0.09	80.00	95.00	11.70	80.00	+0.00 / -0.09	95.00	+0.07 / -0.00	12.00	+0.25 / -0.00	15.23
R080093142RR*	80.00	+0.00 / -0.09	80.00	93.00	14.20	80.00	+0.00 / -0.09	93.00	+0.07 / -0.00	14.50	+0.25 / -0.00	15.01
R080096102RR*	80.00	+0.00 / -0.09	80.00	96.00	10.20	80.00	+0.00 / -0.09	96.00	+0.07 / -0.00	10.50	+0.25 / -0.00	15.23
R080100117RR*	80.00	+0.00 / -0.09	80.00	100.00	11.70	80.00	+0.00 / -0.09	100.00	+0.07 / -0.00	12.00	+0.25 / -0.00	15.46
R080100142RR	80.00	+0.00 / -0.09	80.00	100.00	14.20	80.00	+0.00 / -0.09	100.00	+0.07 / -0.00	14.50	+0.25 / -0.00	16.02
R080095097RR*	80.00	+0.00 / -0.09	80.00	95.00	9.70	80.00	+0.00 / -0.09	95.00	+0.07 / -0.00	10.00	+0.25 / -0.00	14.90
R085100122RR*	85.00	+0.00 / -0.09	85.00	100.00	12.20	85.00	+0.00 / -0.09	100.00	+0.09 / -0.00	12.50	+0.25 / -0.00	15.46
R085095077RR*	85.00	+0.00 / -0.09	85.00	95.00	7.70	85.00	+0.00 / -0.09	95.00	+0.09 / -0.00	8.00	+0.25 / -0.00	15.01
R085100122RR*	85.00	+0.00 / -0.09	85.00	100.00	12.20	85.00	+0.00 / -0.09	100.00	+0.09 / -0.00	12.50	+0.25 / -0.00	15.46
R085105142RR	85.00	+0.00 / -0.09	85.00	105.00	14.20	85.00	+0.00 / -0.09	105.00	+0.09 / -0.00	14.50	+0.25 / -0.00	16.02
R090105122RR*	90.00	+0.00 / -0.09	90.00	105.00	12.20	90.00	+0.00 / -0.09	105.00	+0.09 / -0.00	12.50	+0.25 / -0.00	15.46
R090110122RR*	90.00	+0.00 / -0.09	90.00	110.00	12.20	90.00	+0.00 / -0.09	110.00	+0.09 / -0.00	12.50	+0.25 / -0.00	16.69
R090105092RR*	90.00	+0.00 / -0.09	90.00	105.00	9.20	90.00	+0.00 / -0.09	105.00	+0.09 / -0.00	9.50	+0.25 / -0.00	15.46
R090110117RR*	90.00	+0.00 / -0.09	90.00	110.00	11.70	90.00	+0.00 / -0.09	110.00	+0.09 / -0.00	12.00	+0.25 / -0.00	13.33
R095105107RR*	95.00	+0.00 / -0.09	95.00	105.00	10.70	95.00	+0.00 / -0.09	105.00	+0.09 / -0.00	11.00	+0.25 / -0.00	15.46
R095112117RR*	95.00	+0.00 / -0.09	95.00	112.00	11.70	95.00	+0.00 / -0.09	112.00	+0.09 / -0.00	12.00	+0.25 / -0.00	16.69
R095115142RR*	95.00	+0.00 / -0.09	95.00	115.00	14.20	95.00	+0.00 / -0.09	115.00	+0.09 / -0.00	14.50	+0.25 / -0.00	16.69
R095110117RR*	95.00	+0.00 / -0.09	95.00	110.00	11.70	95.00	+0.00 / -0.09	110.00	+0.09 / -0.00	12.00	+0.25 / -0.00	16.46
R095115117RR*	95.00	+0.00 / -0.09	95.00	115.00	11.70	95.00	+0.00 / -0.09	115.00	+0.09 / -0.00	12.00	+0.25 / -0.00	16.58
R100115122RR*	100.00	+0.00 / -0.09	100.00	115.00	12.20	100.00	+0.00 / -0.09	115.00	+0.09 / -0.00	12.50	+0.25 / -0.00	16.69
R100120137RR*	100.00	+0.00 / -0.09	100.00	120.00	13.70	100.00	+0.00 / -0.09	120.00	+0.09 / -0.00	14.00	+0.25 / -0.00	18.82
R100125197RR*	100.00	+0.00 / -0.09	100.00	125.00	19.70	100.00	+0.00 / -0.09	125.00	+0.09 / -0.00	20.00	+0.25 / -0.00	25.65
R100120242RR*	100.00	+0.00 / -0.09	100.00	120.00	24.20	100.00	+0.00 / -0.09	120.00	+0.09 / -0.00	24.50	+0.25 / -0.00	25.76
R100115112RR*	100.00	+0.00 / -0.09	100.00	115.00	11.20	100.00	+0.00 / -0.09	115.00	+0.09 / -0.00	11.50	+0.25 / -0.00	16.69
R100120117RR*	100.00	+0.00 / -0.09	100.00	120.00	11.70	100.00	+0.00 / -0.09	120.00	+0.09 / -0.00	12.00	+0.25 / -0.00	18.82
R100120142RR*	100.00	+0.00 / -0.09	100.00	120.00	14.20	100.00	+0.00 / -0.09	120.00	+0.09 / -0.00	14.50	+0.25 / -0.00	19.26
R105115107RR*	105.00	+0.00 / -0.13	105.00	115.00	10.70	105.00	+0.00 / -0.13	115.00	+0.09 / -0.00	11.00	+0.25 / -0.00	15.68

*: GENERALLY NOT STOCKED BUT AVAILABLE - CHECK WITH C/SER

Tel.: 1-888-609-SEAL
Fax: 1-888-717-SEAL

J

35

www.sealsourceinc.com

**METRIC SIZE
ROD SEALS**

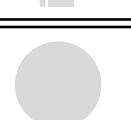
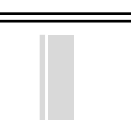

Seal Source Inc.

**METRIC SIZE
ROD SEALS**

RR SERIES - NBR/FABRIC/POM

Ref.Number	Rod diameter		Nominal Seal Dimensions			Housing Dimensions					\$	
		Tol.	d	D	H	d1	Tol.	D1	Tol.	H1		Tol.
R105125122RR*	105.00	+0.00 / -0.13	105.00	125.00	12.20	105.00	+0.00 / -0.13	125.00	+0.09 / -0.00	12.50	+0.25 / -0.00	18.82
R110130122RR*	110.00	+0.00 / -0.13	110.00	130.00	12.20	110.00	+0.00 / -0.13	130.00	+0.09 / -0.00	12.50	+0.25 / -0.00	19.26
R110125117RR*	110.00	+0.00 / -0.13	110.00	125.00	11.70	110.00	+0.00 / -0.13	125.00	+0.09 / -0.00	12.00	+0.25 / -0.00	16.69
R110135152RR*	110.00	+0.00 / -0.13	110.00	135.00	15.20	110.00	+0.00 / -0.13	135.00	+0.09 / -0.00	15.50	+0.25 / -0.00	20.27
R120130102RR*	120.00	+0.00 / -0.13	120.00	130.00	10.20	120.00	+0.00 / -0.13	130.00	+0.09 / -0.00	10.50	+0.25 / -0.00	17.36
R120135122RR*	120.00	+0.00 / -0.13	120.00	135.00	12.20	120.00	+0.00 / -0.13	135.00	+0.09 / -0.00	12.50	+0.25 / -0.00	17.36
R120140122RR	120.00	+0.00 / -0.13	120.00	140.00	12.20	120.00	+0.00 / -0.13	140.00	+0.09 / -0.00	12.50	+0.25 / -0.00	25.20
R120145185RR*	120.00	+0.00 / -0.13	120.00	145.00	18.50	120.00	+0.00 / -0.13	145.00	+0.09 / -0.00	18.80	+0.25 / -0.00	27.78
R125150137RR*	125.00	+0.00 / -0.13	125.00	150.00	13.70	125.00	+0.00 / -0.13	150.00	+0.10 / -0.00	14.00	+0.25 / -0.00	30.80
R125150142RR*	125.00	+0.00 / -0.13	125.00	150.00	14.20	125.00	+0.00 / -0.13	150.00	+0.10 / -0.00	14.50	+0.25 / -0.00	27.78
R130145127RR*	130.00	+0.00 / -0.13	130.00	145.00	12.70	130.00	+0.00 / -0.13	145.00	+0.10 / -0.00	13.00	+0.25 / -0.00	25.31
R130145147RR*	130.00	+0.00 / -0.13	130.00	145.00	14.70	130.00	+0.00 / -0.13	145.00	+0.10 / -0.00	15.00	+0.25 / -0.00	25.54
R130150167RR*	130.00	+0.00 / -0.13	130.00	150.00	16.70	130.00	+0.00 / -0.13	150.00	+0.10 / -0.00	16.00	+0.25 / -0.00	25.54
R135150137RR*	135.00	+0.00 / -0.13	135.00	150.00	13.70	135.00	+0.00 / -0.13	150.00	+0.10 / -0.00	14.00	+0.25 / -0.00	27.78
R135160137RR*	135.00	+0.00 / -0.13	135.00	160.00	13.70	135.00	+0.00 / -0.13	160.00	+0.10 / -0.00	14.00	+0.25 / -0.00	30.80
R140160117RR*	140.00	+0.00 / -0.13	140.00	160.00	11.70	140.00	+0.00 / -0.13	160.00	+0.10 / -0.00	12.00	+0.25 / -0.00	29.34
R140155127RR*	140.00	+0.00 / -0.13	140.00	155.00	12.70	140.00	+0.00 / -0.13	155.00	+0.10 / -0.00	13.00	+0.25 / -0.00	25.98
R140160142RR*	140.00	+0.00 / -0.13	140.00	160.00	14.20	140.00	+0.00 / -0.13	160.00	+0.10 / -0.00	14.50	+0.25 / -0.00	26.77
R140160122RR*	140.00	+0.00 / -0.13	140.00	160.00	12.20	140.00	+0.00 / -0.13	160.00	+0.10 / -0.00	12.50	+0.25 / -0.00	26.77
R140170225RR*	140.00	+0.00 / -0.13	140.00	170.00	22.50	140.00	+0.00 / -0.13	170.00	+0.10 / -0.00	22.80	+0.25 / -0.00	30.80
R150170137RR*	150.00	+0.00 / -0.13	150.00	170.00	13.70	150.00	+0.00 / -0.13	170.00	+0.10 / -0.00	14.00	+0.25 / -0.00	34.27
R150170142RR*	150.00	+0.00 / -0.13	150.00	170.00	14.20	150.00	+0.00 / -0.13	170.00	+0.10 / -0.00	14.50	+0.25 / -0.00	34.27
R160175167RR*	160.00	+0.00 / -0.13	160.00	175.00	16.70	160.00	+0.00 / -0.13	175.00	+0.10 / -0.00	16.00	+0.25 / -0.00	34.27
R160180142RR*	160.00	+0.00 / -0.13	160.00	180.00	14.20	160.00	+0.00 / -0.13	180.00	+0.10 / -0.00	14.50	+0.25 / -0.00	34.27
R175200227RR*	175.00	+0.00 / -0.13	175.00	200.00	22.70	175.00	+0.00 / -0.13	200.00	+0.10 / -0.00	23.00	+0.25 / -0.00	44.46
R180200142RR*	180.00	+0.00 / -0.13	180.00	200.00	14.20	180.00	+0.00 / -0.13	200.00	+0.10 / -0.00	14.50	+0.25 / -0.00	45.70
R180210202RR*	180.00	+0.00 / -0.13	180.00	210.00	20.20	180.00	+0.00 / -0.13	210.00	+0.10 / -0.00	20.50	+0.25 / -0.00	47.94
R190210142RR*	190.00	+0.00 / -0.13	190.00	210.00	14.20	190.00	+0.00 / -0.13	210.00	+0.12 / -0.00	14.50	+0.25 / -0.00	48.72
R198208117RR*	198.00	+0.00 / -0.13	198.00	208.00	11.70	198.00	+0.00 / -0.13	208.00	+0.12 / -0.00	12.00	+0.25 / -0.00	45.70
R200220142RR*	200.00	+0.00 / -0.13	200.00	220.00	14.20	200.00	+0.00 / -0.13	220.00	+0.12 / -0.00	14.50	+0.25 / -0.00	55.44
R210240202RR*	210.00	+0.00 / -0.13	210.00	240.00	20.20	210.00	+0.00 / -0.13	240.00	+0.12 / -0.00	22.50	+0.25 / -0.00	81.54
R220250202RR*	220.00	+0.00 / -0.13	220.00	250.00	20.20	220.00	+0.00 / -0.13	250.00	+0.12 / -0.00	20.50	+0.25 / -0.00	98.00
R230260202RR*	230.00	+0.00 / -0.13	230.00	260.00	20.20	230.00	+0.00 / -0.13	260.00	+0.12 / -0.00	20.50	+0.25 / -0.00	O/R

*: GENERALLY NOT STOCKED BUT AVAILABLE - CHECK WITH C/SER

M

RV - Rod Seals

Nitrile/Neofab/Polyacetal

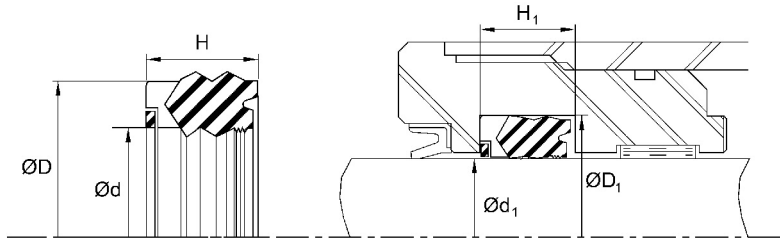

Temperature: -22/212F [-30/100C]

Pressure: 10 000 PSI [700 Bar]

Ref.Number	Rod diameter		Nominal Seal Dimensions			Housing Dimensions					\$	
		Tol.	d	D	H	d1	Tol.	D1	Tol.	H1		Tol.
R015027200RV*	15.00	+0.00 / -0.04	15.00	27.00	20.00	15.00	+0.00 / -0.04	27.00	+0.10 / -0.00	20.00	+0.25 / -0.00	7.97
R020033200RV*	20.00	+0.00 / -0.04	20.00	33.00	20.00	20.00	+0.00 / -0.04	33.00	+0.10 / -0.00	20.00	+0.25 / -0.00	7.97
R022035200RV*	22.00	+0.00 / -0.04	22.00	35.00	20.00	22.00	+0.00 / -0.04	35.00	+0.10 / -0.00	20.00	+0.25 / -0.00	7.97
R025037225RV*	25.00	+0.00 / -0.04	25.00	37.00	22.50	25.00	+0.00 / -0.04	37.00	+0.10 / -0.00	22.50	+0.25 / -0.00	14.62
R025038200RV*	25.00	+0.00 / -0.04	25.00	38.00	20.00	25.00	+0.00 / -0.04	38.00	+0.10 / -0.00	20.00	+0.25 / -0.00	7.97
R028041200RV*	28.00	+0.00 / -0.04	28.00	41.00	20.00	28.00	+0.00 / -0.04	41.00	+0.10 / -0.00	20.00	+0.25 / -0.00	10.64
R030043200RV*	30.00	+0.00 / -0.04	30.00	43.00	20.00	30.00	+0.00 / -0.04	43.00	+0.10 / -0.00	20.00	+0.25 / -0.00	10.64
R032047225RV*	32.00	+0.00 / -0.04	32.00	47.00	22.50	32.00	+0.00 / -0.04	47.00	+0.10 / -0.00	22.50	+0.25 / -0.00	13.82
R035045256RV*	35.00	+0.00 / -0.04	35.00	45.00	25.50	35.00	+0.00 / -0.04	45.00	+0.10 / -0.00	25.50	+0.25 / -0.00	11.15
R035047225RV*	35.00	+0.00 / -0.04	35.00	47.00	22.50	35.00	+0.00 / -0.04	47.00	+0.10 / -0.00	22.50	+0.25 / -0.00	11.15
R035050225RV*	35.00	+0.00 / -0.04	35.00	50.00	22.50	35.00	+0.00 / -0.04	50.00	+0.10 / -0.00	22.50	+0.25 / -0.00	10.64
R036051225RV*	36.00	+0.00 / -0.05	36.00	51.00	22.50	36.00	+0.00 / -0.05	51.00	+0.10 / -0.00	22.50	+0.25 / -0.00	10.64
R040050173RV*	40.00	+0.00 / -0.05	40.00	50.00	17.50	40.00	+0.00 / -0.05	50.00	+0.10 / -0.00	17.50	+0.25 / -0.00	13.08
R040052225RV*	40.00	+0.00 / -0.05	40.00	52.00	22.50	40.00	+0.00 / -0.05	52.00	+0.12 / -0.00	22.50	+0.25 / -0.00	11.68
R040055225RV	40.00	+0.00 / -0.05	40.00	55.00	22.50	40.00	+0.00 / -0.05	55.00	+0.12 / -0.00	22.50	+0.25 / -0.00	12.97
R040060300RV*	40.00	+0.00 / -0.05	40.00	60.00	30.00	40.00	+0.00 / -0.05	60.00	+0.12 / -0.00	30.00	+0.25 / -0.00	12.57
R045060225RV	45.00	+0.00 / -0.05	45.00	60.00	22.50	45.00	+0.00 / -0.05	60.00	+0.12 / -0.00	22.50	+0.25 / -0.00	17.97
R045065280RV*	45.00	+0.00 / -0.05	45.00	65.00	28.00	45.00	+0.00 / -0.05	65.00	+0.12 / -0.00	28.00	+0.25 / -0.00	20.55
R050063200RV*	50.00	+0.00 / -0.05	50.00	63.00	20.00	50.00	+0.00 / -0.05	63.00	+0.12 / -0.00	20.00	+0.25 / -0.00	12.87
R050065225RV	50.00	+0.00 / -0.05	50.00	65.00	22.50	50.00	+0.00 / -0.05	65.00	+0.12 / -0.00	22.50	+0.25 / -0.00	15.32
R050065245RV	50.00	+0.00 / -0.05	50.00	65.00	24.50	50.00	+0.00 / -0.05	65.00	+0.12 / -0.00	24.50	+0.25 / -0.00	18.24
R050070300RV*	50.00	+0.00 / -0.05	50.00	70.00	30.00	50.00	+0.00 / -0.05	70.00	+0.12 / -0.00	30.00	+0.25 / -0.00	13.30
R050070319RV*	50.00	+0.00 / -0.05	50.00	70.00	31.90	50.00	+0.00 / -0.05	70.00	+0.12 / -0.00	31.90	+0.25 / -0.00	13.30
R055070225RV*	55.00	+0.00 / -0.05	55.00	70.00	22.50	55.00	+0.00 / -0.05	70.00	+0.12 / -0.00	22.50	+0.25 / -0.00	32.16
R055070250RV*	55.00	+0.00 / -0.05	55.00	70.00	25.00	55.00	+0.00 / -0.05	70.00	+0.12 / -0.00	25.00	+0.25 / -0.00	15.52
R055075300RV*	55.00	+0.00 / -0.05	55.00	75.00	30.00	55.00	+0.00 / -0.05	75.00	+0.12 / -0.00	30.00	+0.25 / -0.00	15.95
R055075320RV*	55.00	+0.00 / -0.05	55.00	75.00	32.00	55.00	+0.00 / -0.05	75.00	+0.12 / -0.00	32.00	+0.25 / -0.00	15.95
R056071225RV*	56.00	+0.00 / -0.05	56.00	71.00	22.50	56.00	+0.00 / -0.05	71.00	+0.12 / -0.00	22.50	+0.25 / -0.00	15.95
R056071250RV*	56.00	+0.00 / -0.05	56.00	71.00	25.00	56.00	+0.00 / -0.05	71.00	+0.12 / -0.00	25.00	+0.25 / -0.00	16.74
R056076280RV*	56.00	+0.00 / -0.05	56.00	76.00	28.00	56.00	+0.00 / -0.05	76.00	+0.12 / -0.00	28.00	+0.25 / -0.00	15.95
R060075225RV	60.00	+0.00 / -0.05	60.00	75.00	22.50	60.00	+0.00 / -0.05	75.00	+0.12 / -0.00	22.50	+0.25 / -0.00	16.39
R060075250RV*	60.00	+0.00 / -0.05	60.00	75.00	25.00	60.00	+0.00 / -0.05	75.00	+0.12 / -0.00	25.00	+0.25 / -0.00	14.63
R060077270RV*	60.00	+0.00 / -0.05	60.00	77.00	27.00	60.00	+0.00 / -0.05	77.00	+0.12 / -0.00	27.00	+0.25 / -0.00	14.63
R060080270RV*	60.00	+0.00 / -0.05	60.00	80.00	27.00	60.00	+0.00 / -0.05	80.00	+0.12 / -0.00	27.00	+0.25 / -0.00	15.95
R060080300RV*	60.00	+0.00 / -0.05	60.00	80.00	30.00	60.00	+0.00 / -0.05	80.00	+0.12 / -0.00	30.00	+0.25 / -0.00	16.60
R060080320RV*	60.00	+0.00 / -0.05	60.00	80.00	32.00	60.00	+0.00 / -0.05	80.00	+0.12 / -0.00	32.00	+0.25 / -0.00	16.74

*: GENERALLY NOT STOCKED BUT AVAILABLE - CHECK WITH C/SER

Tel.: 1-888-609-SEAL
Fax: 1-888-717-SEAL

J

37

www.sealsourceinc.com

METRIC SIZE
ROD SEALS

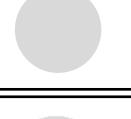
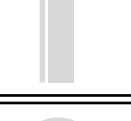

M

Seal Source Inc.

RV SERIES - NBR/NEO/POM

METRIC SIZE
ROD SEALS

Ref.Number	Rod diameter		Nominal Seal Dimensions			Housing Dimensions					\$	
		Tol.	d	D	H	d1	Tol.	D1	Tol.	H1		Tol.
R060080349RV*	60.00	+0.00 / -0.05	60.00	80.00	34.90	60.00	+0.00 / -0.05	80.00	+0.12 / -0.00	34.90	+0.25 / -0.00	15.95
R063083270RV*	63.00	+0.00 / -0.05	63.00	83.00	28.00	63.00	+0.00 / -0.05	83.00	+0.14 / -0.00	28.00	+0.25 / -0.00	40.89
R063083290RV*	63.00	+0.00 / -0.05	63.00	83.00	29.00	63.00	+0.00 / -0.05	83.00	+0.14 / -0.00	29.00	+0.25 / -0.00	15.95
R063083300RV*	63.00	+0.00 / -0.05	63.00	83.00	30.00	63.00	+0.00 / -0.05	83.00	+0.14 / -0.00	30.00	+0.25 / -0.00	20.44
R065085290RV*	65.00	+0.00 / -0.05	65.00	85.00	29.00	65.00	+0.00 / -0.05	85.00	+0.14 / -0.00	29.00	+0.25 / -0.00	33.65
R070083250RV*	70.00	+0.00 / -0.06	70.00	83.00	25.00	70.00	+0.00 / -0.06	83.00	+0.14 / -0.00	25.00	+0.25 / -0.00	18.33
R070085225RV	70.00	+0.00 / -0.06	70.00	85.00	22.50	70.00	+0.00 / -0.06	85.00	+0.14 / -0.00	22.50	+0.25 / -0.00	19.07
R070085250RV*	70.00	+0.00 / -0.06	70.00	85.00	25.00	70.00	+0.00 / -0.06	85.00	+0.14 / -0.00	25.00	+0.25 / -0.00	15.95
R070090300RV	70.00	+0.00 / -0.06	70.00	90.00	30.00	70.00	+0.00 / -0.06	90.00	+0.14 / -0.00	30.00	+0.25 / -0.00	27.34
R070090319RV*	70.00	+0.00 / -0.06	70.00	90.00	31.90	70.00	+0.00 / -0.06	90.00	+0.14 / -0.00	31.90	+0.25 / -0.00	17.28
R075095280RV	75.00	+0.00 / -0.06	75.00	95.00	28.00	75.00	+0.00 / -0.06	95.00	+0.14 / -0.00	28.00	+0.25 / -0.00	18.61
R075095300RV*	75.00	+0.00 / -0.06	75.00	95.00	30.00	75.00	+0.00 / -0.06	95.00	+0.14 / -0.00	30.00	+0.25 / -0.00	36.34
R080095225RV*	80.00	+0.00 / -0.09	80.00	95.00	22.50	80.00	+0.00 / -0.09	95.00	+0.14 / -0.00	22.50	+0.25 / -0.00	58.08
R080100300RV	80.00	+0.00 / -0.09	80.00	100.00	30.00	80.00	+0.00 / -0.09	100.00	+0.14 / -0.00	30.00	+0.25 / -0.00	28.70
R085095225RV*	85.00	+0.00 / -0.09	85.00	95.00	22.50	85.00	+0.00 / -0.09	95.00	+0.14 / -0.00	22.50	+0.25 / -0.00	27.70
R085100225RV	85.00	+0.00 / -0.09	85.00	100.00	22.50	85.00	+0.00 / -0.09	100.00	+0.14 / -0.00	22.50	+0.25 / -0.00	33.49
R085105220RV*	85.00	+0.00 / -0.09	85.00	105.00	22.00	85.00	+0.00 / -0.09	105.00	+0.14 / -0.00	22.00	+0.25 / -0.00	18.61
R085105300RV*	85.00	+0.00 / -0.09	85.00	105.00	30.00	85.00	+0.00 / -0.09	105.00	+0.14 / -0.00	30.00	+0.25 / -0.00	18.61
R090105225RV*	90.00	+0.00 / -0.09	90.00	105.00	22.50	90.00	+0.00 / -0.09	105.00	+0.14 / -0.00	22.50	+0.25 / -0.00	19.94
R090105250RV*	90.00	+0.00 / -0.09	90.00	105.00	25.00	90.00	+0.00 / -0.09	105.00	+0.14 / -0.00	25.00	+0.25 / -0.00	19.94
R090105335RV*	90.00	+0.00 / -0.09	90.00	105.00	33.50	90.00	+0.00 / -0.09	105.00	+0.14 / -0.00	33.50	+0.25 / -0.00	19.94
R090110300RV	90.00	+0.00 / -0.09	90.00	110.00	30.00	90.00	+0.00 / -0.09	110.00	+0.14 / -0.00	30.00	+0.25 / -0.00	29.35
R090110325RV*	90.00	+0.00 / -0.09	90.00	110.00	32.50	90.00	+0.00 / -0.09	110.00	+0.14 / -0.00	32.50	+0.25 / -0.00	19.94
R095110225RV*	95.00	+0.00 / -0.09	95.00	110.00	22.50	95.00	+0.00 / -0.09	110.00	+0.14 / -0.00	22.50	+0.25 / -0.00	21.84
R095115280RV*	95.00	+0.00 / -0.09	95.00	115.00	28.00	95.00	+0.00 / -0.09	115.00	+0.14 / -0.00	28.00	+0.25 / -0.00	22.32
R100114242RV*	100.00	+0.00 / -0.09	100.00	114.30	24.20	100.00	+0.00 / -0.09	114.30	+0.14 / -0.00	24.20	+0.25 / -0.00	21.26
R100120300RV*	100.00	+0.00 / -0.09	100.00	120.00	30.00	100.00	+0.00 / -0.09	120.00	+0.14 / -0.00	30.00	+0.25 / -0.00	25.70
R105118250RV*	105.00	+0.00 / -0.13	105.00	118.00	25.00	105.00	+0.00 / -0.13	118.00	+0.16 / -0.00	25.00	+0.25 / -0.00	22.23
R105120340RV*	105.00	+0.00 / -0.13	105.00	120.00	34.00	105.00	+0.00 / -0.13	120.00	+0.16 / -0.00	34.00	+0.25 / -0.00	22.23
R105125300RV*	105.00	+0.00 / -0.13	105.00	125.00	30.00	105.00	+0.00 / -0.13	125.00	+0.16 / -0.00	30.00	+0.25 / -0.00	31.07
R110125225RV*	110.00	+0.00 / -0.13	110.00	125.00	22.50	110.00	+0.00 / -0.13	125.00	+0.16 / -0.00	22.50	+0.25 / -0.00	34.24
R110130300RV*	110.00	+0.00 / -0.13	110.00	130.00	30.00	110.00	+0.00 / -0.13	130.00	+0.16 / -0.00	30.00	+0.25 / -0.00	44.15
R110130325RV*	110.00	+0.00 / -0.13	110.00	130.00	32.50	110.00	+0.00 / -0.13	130.00	+0.16 / -0.00	32.50	+0.25 / -0.00	27.79
R110132365RV*	110.00	+0.00 / -0.13	110.00	132.00	36.50	110.00	+0.00 / -0.13	132.00	+0.16 / -0.00	36.50	+0.25 / -0.00	27.79
R114130190RV*	114.00	+0.00 / -0.13	114.00	130.00	19.00	114.00	+0.00 / -0.13	130.00	+0.16 / -0.00	19.00	+0.25 / -0.00	37.03
R115125225RV*	115.00	+0.00 / -0.13	115.00	125.00	22.50	115.00	+0.00 / -0.13	125.00	+0.16 / -0.00	22.50	+0.25 / -0.00	39.84
R115130225RV*	115.00	+0.00 / -0.13	115.00	130.00	22.50	115.00	+0.00 / -0.13	130.00	+0.16 / -0.00	22.50	+0.25 / -0.00	34.24
R115130300RV*	115.00	+0.00 / -0.13	115.00	130.00	30.00	115.00	+0.00 / -0.13	130.00	+0.16 / -0.00	30.00	+0.25 / -0.00	27.79
R120140300RV*	120.00	+0.00 / -0.13	120.00	140.00	30.00	120.00	+0.00 / -0.13	140.00	+0.16 / -0.00	30.00	+0.25 / -0.00	27.79
R125140225RV*	125.00	+0.00 / -0.13	125.00	140.00	22.50	125.00	+0.00 / -0.13	140.00	+0.16 / -0.00	22.50	+0.25 / -0.00	37.59
R125145300RV*	125.00	+0.00 / -0.13	125.00	145.00	30.00	125.00	+0.00 / -0.13	145.00	+0.16 / -0.00	30.00	+0.25 / -0.00	29.15
R127142225RV*	127.00	+0.00 / -0.13	127.00	142.00	22.50	127.00	+0.00 / -0.13	142.00	+0.16 / -0.00	22.50	+0.25 / -0.00	37.59
R130150300RV	130.00	+0.00 / -0.13	130.00	150.00	30.00	130.00	+0.00 / -0.13	150.00	+0.16 / -0.00	30.00	+0.25 / -0.00	30.58
R135150225RV*	135.00	+0.00 / -0.13	135.00	150.00	22.50	135.00	+0.00 / -0.13	150.00	+0.16 / -0.00	22.50	+0.25 / -0.00	39.26
R135155280RV*	135.00	+0.00 / -0.13	135.00	155.00	28.00	135.00	+0.00 / -0.13	155.00	+0.16 / -0.00	28.00	+0.25 / -0.00	32.53
R140155225RV*	140.00	+0.00 / -0.13	140.00	155.00	22.50	140.00	+0.00 / -0.13	155.00	+0.16 / -0.00	22.50	+0.25 / -0.00	46.26
R140160190RV*	140.00	+0.00 / -0.13	140.00	160.00	19.00	140.00	+0.00 / -0.13	160.00	+0.16 / -0.00	19.00	+0.25 / -0.00	34.74

*: GENERALLY NOT STOCKED BUT AVAILABLE - CHECK WITH C/SER

Seal Source Inc.

RV SERIES - NBR/NEO/POM

Ref.Number	Rod diameter		Nominal Seal Dimensions			Housing Dimensions					\$	
		Tol.	d	D	H	d1	Tol.	D1	Tol.	H1		Tol.
R140160225RV*	140.00	+0.00 / -0.13	140.00	160.00	22.50	140.00	+0.00 / -0.13	160.00	+0.16 / -0.00	22.50	+0.25 / -0.00	44.47
R140160280RV*	140.00	+0.00 / -0.13	140.00	160.00	28.00	140.00	+0.00 / -0.13	160.00	+0.16 / -0.00	28.00	+0.25 / -0.00	34.74
R140160300RV*	140.00	+0.00 / -0.13	140.00	160.00	30.00	140.00	+0.00 / -0.13	160.00	+0.16 / -0.00	30.00	+0.25 / -0.00	63.59
R145165225RV*	145.00	+0.00 / -0.13	145.00	165.00	22.50	145.00	+0.00 / -0.13	165.00	+0.16 / -0.00	22.50	+0.25 / -0.00	47.82
R150170280RV*	150.00	+0.00 / -0.13	150.00	170.00	28.00	150.00	+0.00 / -0.13	170.00	+0.16 / -0.00	28.00	+0.25 / -0.00	34.74
R155175225RV*	155.00	+0.00 / -0.13	155.00	175.00	22.50	155.00	+0.00 / -0.13	175.00	+0.16 / -0.00	22.50	+0.25 / -0.00	54.70
R155175280RV*	155.00	+0.00 / -0.13	155.00	175.00	28.00	155.00	+0.00 / -0.13	175.00	+0.16 / -0.00	28.00	+0.25 / -0.00	48.65
R160180280RV*	160.00	+0.00 / -0.13	160.00	180.00	28.00	160.00	+0.00 / -0.13	180.00	+0.16 / -0.00	28.00	+0.25 / -0.00	31.69
R165185300RV*	165.00	+0.00 / -0.13	165.00	185.00	30.00	165.00	+0.00 / -0.13	185.00	+0.16 / -0.00	30.00	+0.25 / -0.00	48.65
R170185225RV*	170.00	+0.00 / -0.13	170.00	185.00	22.50	170.00	+0.00 / -0.13	185.00	+0.16 / -0.00	22.50	+0.25 / -0.00	56.38
R170195350RV*	170.00	+0.00 / -0.13	170.00	195.00	35.00	170.00	+0.00 / -0.13	195.00	+0.16 / -0.00	35.00	+0.25 / -0.00	55.60
R175195225RV*	175.00	+0.00 / -0.13	175.00	195.00	22.50	175.00	+0.00 / -0.13	195.00	+0.16 / -0.00	22.50	+0.25 / -0.00	61.59
R175195300RV*	175.00	+0.00 / -0.13	175.00	195.00	30.00	175.00	+0.00 / -0.13	195.00	+0.16 / -0.00	30.00	+0.25 / -0.00	68.29
R175200350RV*	175.00	+0.00 / -0.13	175.00	200.00	35.00	175.00	+0.00 / -0.13	200.00	+0.16 / -0.00	35.00	+0.25 / -0.00	55.60
R177192225RV*	177.00	+0.00 / -0.13	177.00	192.00	22.50	177.00	+0.00 / -0.13	192.00	+0.16 / -0.00	22.50	+0.25 / -0.00	64.94
R180205350RV	180.00	+0.00 / -0.13	180.00	205.00	35.00	180.00	+0.00 / -0.13	205.00	+0.18 / -0.00	35.00	+0.25 / -0.00	56.87
R185200225RV*	185.00	+0.00 / -0.13	185.00	200.00	22.50	185.00	+0.00 / -0.13	200.00	+0.18 / -0.00	22.50	+0.25 / -0.00	68.29
R185210350RV*	185.00	+0.00 / -0.13	185.00	210.00	35.00	185.00	+0.00 / -0.13	210.00	+0.18 / -0.00	35.00	+0.25 / -0.00	62.55
R187202225RV*	187.00	+0.00 / -0.13	187.00	202.00	22.50	187.00	+0.00 / -0.13	202.00	+0.18 / -0.00	22.50	+0.25 / -0.00	68.29
R190215350RV*	190.00	+0.00 / -0.13	190.00	215.00	35.00	190.00	+0.00 / -0.13	215.00	+0.18 / -0.00	35.00	+0.25 / -0.00	62.55
R192210225RV*	192.00	+0.00 / -0.13	192.00	210.00	22.50	192.00	+0.00 / -0.13	210.00	+0.18 / -0.00	22.50	+0.25 / -0.00	68.29
R195210225RV*	195.00	+0.00 / -0.13	195.00	210.00	22.50	195.00	+0.00 / -0.13	210.00	+0.18 / -0.00	22.50	+0.25 / -0.00	68.29
R195220350RV*	195.00	+0.00 / -0.13	195.00	220.00	35.00	195.00	+0.00 / -0.13	220.00	+0.18 / -0.00	35.00	+0.25 / -0.00	69.48
R200215225RV*	200.00	+0.00 / -0.13	200.00	215.00	22.50	200.00	+0.00 / -0.13	215.00	+0.18 / -0.00	22.50	+0.25 / -0.00	71.64
R200225350RV	200.00	+0.00 / -0.13	200.00	225.00	35.00	200.00	+0.00 / -0.13	225.00	+0.18 / -0.00	35.00	+0.25 / -0.00	85.37
R205230350RV*	205.00	+0.00 / -0.13	205.00	230.00	35.00	205.00	+0.00 / -0.13	230.00	+0.18 / -0.00	35.00	+0.25 / -0.00	109.22
R207225225RV*	207.00	+0.00 / -0.13	207.00	225.00	22.50	207.00	+0.00 / -0.13	225.00	+0.18 / -0.00	22.50	+0.25 / -0.00	71.64
R210235300RV*	210.00	+0.00 / -0.13	210.00	235.00	30.00	210.00	+0.00 / -0.13	235.00	+0.18 / -0.00	30.00	+0.25 / -0.00	90.34
R210235350RV*	210.00	+0.00 / -0.13	210.00	235.00	35.00	210.00	+0.00 / -0.13	235.00	+0.18 / -0.00	35.00	+0.25 / -0.00	121.32
R212230225RV*	212.00	+0.00 / -0.13	212.00	230.00	22.50	212.00	+0.00 / -0.13	230.00	+0.18 / -0.00	22.50	+0.25 / -0.00	75.17
R215240350RV*	215.00	+0.00 / -0.13	215.00	240.00	35.00	215.00	+0.00 / -0.13	240.00	+0.18 / -0.00	35.00	+0.25 / -0.00	90.34
R220240225RV*	220.00	+0.00 / -0.13	220.00	240.00	22.50	220.00	+0.00 / -0.13	240.00	+0.18 / -0.00	22.50	+0.25 / -0.00	88.75
R220245350RV	220.00	+0.00 / -0.13	220.00	245.00	35.00	220.00	+0.00 / -0.13	245.00	+0.18 / -0.00	35.00	+0.25 / -0.00	90.34
R225240225RV*	225.00	+0.00 / -0.13	225.00	240.00	22.50	225.00	+0.00 / -0.13	240.00	+0.18 / -0.00	22.50	+0.25 / -0.00	88.75
R225250350RV*	225.00	+0.00 / -0.13	225.00	250.00	35.00	225.00	+0.00 / -0.13	250.00	+0.18 / -0.00	35.00	+0.25 / -0.00	97.29
R230250225RV*	230.00	+0.00 / -0.13	230.00	250.00	22.50	230.00	+0.00 / -0.13	250.00	+0.18 / -0.00	22.50	+0.25 / -0.00	102.34
R230255350RV*	230.00	+0.00 / -0.13	230.00	255.00	35.00	230.00	+0.00 / -0.13	255.00	+0.18 / -0.00	35.00	+0.25 / -0.00	97.29
R235255225RV*	235.00	+0.00 / -0.13	235.00	255.00	22.50	235.00	+0.00 / -0.13	255.00	+0.18 / -0.00	22.50	+0.25 / -0.00	109.22
R240265350RV*	240.00	+0.00 / -0.13	240.00	265.00	35.00	240.00	+0.00 / -0.13	265.00	+0.18 / -0.00	35.00	+0.25 / -0.00	97.29
R250275350RV*	250.00	+0.00 / -0.13	250.00	275.00	35.00	250.00	+0.00 / -0.13	275.00	+0.18 / -0.00	35.00	+0.25 / -0.00	111.17
R260280225RV*	260.00	+0.00 / -0.13	260.00	280.00	22.50	260.00	+0.00 / -0.13	280.00	+0.18 / -0.00	22.50	+0.25 / -0.00	143.46
R265290350RV*	265.00	+0.00 / -0.13	265.00	290.00	35.00	265.00	+0.00 / -0.13	290.00	+0.18 / -0.00	35.00	+0.25 / -0.00	125.08
R275300350RV*	275.00	+0.00 / -0.13	275.00	300.00	35.00	275.00	+0.00 / -0.13	300.00	+0.18 / -0.00	35.00	+0.25 / -0.00	125.08
R280305350RV*	280.00	+0.00 / -0.13	280.00	305.00	35.00	280.00	+0.00 / -0.13	305.00	+0.18 / -0.00	35.00	+0.25 / -0.00	125.08
R283303225RV*	283.00	+0.00 / -0.13	283.00	303.00	22.50	283.00	+0.00 / -0.13	303.00	+0.18 / -0.00	22.50	+0.25 / -0.00	150.16
R300325350RV*	300.00	+0.00 / -0.13	300.00	325.00	35.00	300.00	+0.00 / -0.13	325.00	+0.18 / -0.00	35.00	+0.25 / -0.00	138.98
R335360350RV*	335.00	+0.00 / -0.13	335.00	360.00	35.00	335.00	+0.00 / -0.13	360.00	+0.18 / -0.00	35.00	+0.25 / -0.00	166.77

*: GENERALLY NOT STOCKED BUT AVAILABLE - CHECK WITH C/SER

**METRIC SIZE
ROD SEALS**

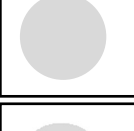
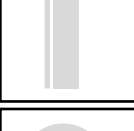

Tel.: 1-888-609-SEAL
Fax: 1-888-717-SEAL

J

39

www.sealsourceinc.com

Seal Source Inc.

METRIC SIZE
ROD SEALS

RX - Buffer Seals 40% BR. PTFE/NBR

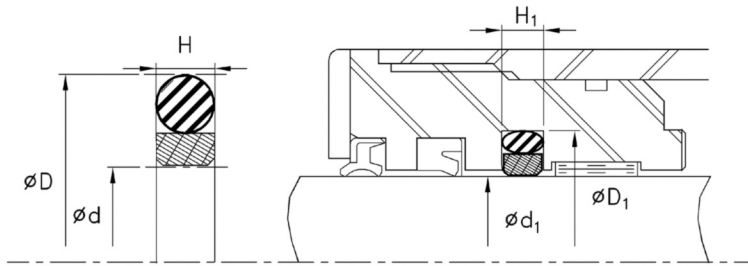
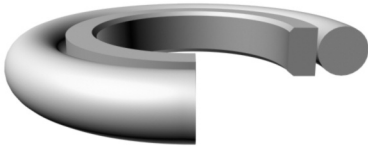

Temperature: -30/250F [-34/121C]

Pressure: 5800 PSI [400 Bar]

Ref.Number	Rod diameter		Nominal Seal Dimensions				Housing Dimensions				\$
		Tol.	d	D	H	EXP.	D1	Tol.	H1	Tol.	
R004008020RX	4.00	+0.00 / -0.04					8.90	+0.04 / -0.00	2.20	+0.20 / -0.00	10.14
R005009020RX	5.00	+0.00 / -0.04					9.90	+0.04 / -0.00	2.20	+0.20 / -0.00	10.14
R006010020RX	6.00	+0.00 / -0.04					10.90	+0.04 / -0.00	2.20	+0.20 / -0.00	10.14
R007011020RX	7.00	+0.00 / -0.04					11.90	+0.04 / -0.00	2.20	+0.20 / -0.00	10.14
R008012020RX	8.00	+0.00 / -0.04					12.90	+0.04 / -0.00	2.20	+0.20 / -0.00	10.14
R008015029RX	8.00	+0.00 / -0.04					15.30	+0.04 / -0.00	3.20	+0.20 / -0.00	10.14
R010014020RX	10.00	+0.00 / -0.04					14.90	+0.04 / -0.00	2.20	+0.20 / -0.00	10.30
R010017029RX	10.00	+0.00 / -0.04					17.30	+0.04 / -0.00	3.20	+0.20 / -0.00	10.30
R012016020RX	12.00	+0.00 / -0.04					16.90	+0.04 / -0.00	2.20	+0.20 / -0.00	10.30
R012019029RX	12.00	+0.00 / -0.04					19.30	+0.04 / -0.00	3.20	+0.20 / -0.00	10.30
R014018020RX	14.00	+0.00 / -0.04					18.90	+0.04 / -0.00	2.20	+0.20 / -0.00	10.30
R014021029RX	14.00	+0.00 / -0.04					21.30	+0.04 / -0.00	3.20	+0.20 / -0.00	10.30
R015022029RX	15.00	+0.00 / -0.04					22.30	+0.04 / -0.00	3.20	+0.20 / -0.00	10.30
R016020020RX	16.00	+0.00 / -0.04					20.90	+0.04 / -0.00	2.20	+0.20 / -0.00	10.30
R016023029RX	16.00	+0.00 / -0.04					23.30	+0.04 / -0.00	3.20	+0.20 / -0.00	10.45
R018022020RX	18.00	+0.00 / -0.04					22.90	+0.04 / -0.00	2.20	+0.20 / -0.00	10.45
R018025029RX	18.00	+0.00 / -0.04					25.30	+0.04 / -0.00	3.20	+0.20 / -0.00	10.45
R020027029RX	20.00	+0.00 / -0.04					27.30	+0.05 / -0.00	3.20	+0.20 / -0.00	10.45
R020030039RX	20.00	+0.00 / -0.04					30.70	+0.05 / -0.00	4.20	+0.20 / -0.00	10.45
R022029029RX	22.00	+0.00 / -0.04					29.30	+0.05 / -0.00	3.20	+0.20 / -0.00	10.45
R022032039RX	22.00	+0.00 / -0.04					32.70	+0.05 / -0.00	4.20	+0.20 / -0.00	10.45
R025032029RX	25.00	+0.00 / -0.04					32.30	+0.05 / -0.00	3.20	+0.20 / -0.00	10.45
R025035039RX	25.00	+0.00 / -0.04					35.70	+0.05 / -0.00	4.20	+0.20 / -0.00	10.45
R028038039RX	28.00	+0.00 / -0.04					38.70	+0.05 / -0.00	4.20	+0.20 / -0.00	10.85
R030037029RX	30.00	+0.00 / -0.04					37.30	+0.05 / -0.00	3.20	+0.20 / -0.00	10.85
R030040039RX	30.00	+0.00 / -0.04					40.70	+0.05 / -0.00	4.20	+0.20 / -0.00	10.85
R032039029RX	32.00	+0.00 / -0.04					39.30	+0.05 / -0.00	3.20	+0.20 / -0.00	10.85
R032042039RX	32.00	+0.00 / -0.04					42.70	+0.06 / -0.00	4.20	+0.20 / -0.00	10.85
R035045039RX	35.00	+0.00 / -0.04					45.70	+0.06 / -0.00	4.20	+0.20 / -0.00	10.99
R036043029RX	36.00	+0.00 / -0.04					43.30	+0.06 / -0.00	3.20	+0.20 / -0.00	10.99
R036046039RX	36.00	+0.00 / -0.04					46.70	+0.06 / -0.00	4.20	+0.20 / -0.00	10.99
R040050039RX	40.00	+0.00 / -0.05					50.70	+0.06 / -0.00	4.20	+0.20 / -0.00	10.99
R040055059RX	40.00	+0.00 / -0.05					55.10	+0.06 / -0.00	6.30	+0.20 / -0.00	10.57
R042057059RX	42.00	+0.00 / -0.05					57.10	+0.06 / -0.00	6.30	+0.20 / -0.00	33.31
R045055039RX	45.00	+0.00 / -0.05					55.70	+0.06 / -0.00	4.20	+0.20 / -0.00	13.40
R045060059RX	45.00	+0.00 / -0.05					60.10	+0.06 / -0.00	6.30	+0.20 / -0.00	13.40

*: GENERALLY NOT STOCKED BUT AVAILABLE - CHECK WITH C/SER

Seal Source Inc.

RX SERIES - 40% BR.PTFE/NBR

Ref.Number	Rod diameter		Nominal Seal Dimensions				Housing Dimensions				\$
		Tol.	d	D	H	EXP.	D1	Tol.	H1	Tol.	
R048063059RX	48.00	+0.00 / -0.05					63.10	+0.06 / -0.00	6.30	+0.20 / -0.00	33.31
R050060039RX	50.00	+0.00 / -0.05					60.70	+0.06 / -0.00	4.20	+0.20 / -0.00	13.40
R050065059RX	50.00	+0.00 / -0.05					65.10	+0.06 / -0.00	6.30	+0.20 / -0.00	24.71
R052067059RX	52.00	+0.00 / -0.05					67.10	+0.07 / -0.00	6.30	+0.20 / -0.00	37.79
R055070059RX	55.00	+0.00 / -0.05					70.10	+0.07 / -0.00	6.30	+0.20 / -0.00	22.35
R056066039RX	56.00	+0.00 / -0.05					66.70	+0.07 / -0.00	4.20	+0.20 / -0.00	32.17
R056071059RX	56.00	+0.00 / -0.05					71.10	+0.07 / -0.00	6.30	+0.20 / -0.00	14.61
R060070039RX	60.00	+0.00 / -0.05					70.70	+0.07 / -0.00	4.20	+0.20 / -0.00	17.03
R060075059RX	60.00	+0.00 / -0.05					75.10	+0.07 / -0.00	6.30	+0.20 / -0.00	22.35
R063078059RX	63.00	+0.00 / -0.05					78.10	+0.07 / -0.00	6.30	+0.20 / -0.00	18.44
R065080059RX	65.00	+0.00 / -0.06					80.10	+0.07 / -0.00	6.30	+0.20 / -0.00	21.55
R070085059RX	70.00	+0.00 / -0.06					85.10	+0.07 / -0.00	6.30	+0.20 / -0.00	25.03
R075090059RX	75.00	+0.00 / -0.06					90.10	+0.07 / -0.00	6.30	+0.20 / -0.00	26.69
R080095059RX	80.00	+0.00 / -0.09					95.10	+0.07 / -0.00	6.30	+0.20 / -0.00	28.78
R085100059RX	85.00	+0.00 / -0.09					100.10	+0.09 / -0.00	6.30	+0.20 / -0.00	28.42
R090105059RX	90.00	+0.00 / -0.09					105.10	+0.09 / -0.00	6.30	+0.20 / -0.00	31.24
R095110059RX	95.00	+0.00 / -0.09					110.10	+0.09 / -0.00	6.30	+0.20 / -0.00	32.25
R100115059RX	100.00	+0.00 / -0.09					115.10	+0.09 / -0.00	6.30	+0.20 / -0.00	32.76
R105120059RX	105.00	+0.00 / -0.13					120.10	+0.09 / -0.00	6.30	+0.20 / -0.00	37.26
R110125059RX	110.00	+0.00 / -0.13					125.10	+0.09 / -0.00	6.30	+0.20 / -0.00	38.90
R115130059RX	115.00	+0.00 / -0.13					130.10	+0.09 / -0.00	6.30	+0.20 / -0.00	38.79
R120135059RX	120.00	+0.00 / -0.13					135.10	+0.09 / -0.00	6.30	+0.20 / -0.00	38.98
R125140059RX	125.00	+0.00 / -0.13					140.10	+0.10 / -0.00	6.30	+0.20 / -0.00	39.42
R130145059RX	130.00	+0.00 / -0.13					145.10	+0.10 / -0.00	6.30	+0.20 / -0.00	39.73
R135150059RX	135.00	+0.00 / -0.13					150.10	+0.10 / -0.00	6.30	+0.20 / -0.00	54.05
R140155059RX	140.00	+0.00 / -0.13					155.10	+0.10 / -0.00	6.30	+0.20 / -0.00	40.12
R145160059RX	145.00	+0.00 / -0.13					160.10	+0.10 / -0.00	6.30	+0.20 / -0.00	55.64
R150165059RX	150.00	+0.00 / -0.13					165.10	+0.10 / -0.00	6.30	+0.20 / -0.00	42.34
R155170059RX	155.00	+0.00 / -0.13					170.10	+0.10 / -0.00	6.30	+0.20 / -0.00	57.10
R160175059RX	160.00	+0.00 / -0.13					175.10	+0.10 / -0.00	6.30	+0.20 / -0.00	43.58
R165180059RX	165.00	+0.00 / -0.13					180.10	+0.10 / -0.00	6.30	+0.20 / -0.00	78.30
R170185059RX	170.00	+0.00 / -0.13					185.10	+0.10 / -0.00	6.30	+0.20 / -0.00	53.55
R180195059RX	180.00	+0.00 / -0.13					195.10	+0.10 / -0.00	6.30	+0.20 / -0.00	89.91
R180200076RX	180.00	+0.00 / -0.13					200.50	+0.10 / -0.00	8.10	+0.20 / -0.00	91.61
R190205059RX	190.00	+0.00 / -0.13					205.10	+0.12 / -0.00	6.30	+0.20 / -0.00	94.40
R200220076RX	200.00	+0.00 / -0.13					220.50	+0.12 / -0.00	8.10	+0.20 / -0.00	96.24
R210230076RX	210.00	+0.00 / -0.13					230.50	+0.12 / -0.00	8.10	+0.20 / -0.00	105.31
R220240076RX	220.00	+0.00 / -0.13					240.50	+0.12 / -0.00	8.10	+0.20 / -0.00	105.54
R230250076RX	230.00	+0.00 / -0.13					250.50	+0.12 / -0.00	8.10	+0.20 / -0.00	110.04
R240260076RX	240.00	+0.00 / -0.13					260.50	+0.12 / -0.00	8.10	+0.20 / -0.00	118.65
R250270076RX	250.00	+0.00 / -0.13					270.50	+0.12 / -0.00	8.10	+0.20 / -0.00	143.59
R260284076RX	260.00	+0.00 / -0.13					284.00	+0.13 / -0.00	8.10	+0.20 / -0.00	152.48
R260287089RX	260.00	+0.00 / -0.13					287.30	+0.13 / -0.00	9.50	+0.20 / -0.00	175.10
R270294076RX	270.00	+0.00 / -0.13					294.00	+0.13 / -0.00	8.10	+0.20 / -0.00	161.36
R280304076RX	280.00	+0.00 / -0.13					304.00	+0.13 / -0.00	8.10	+0.20 / -0.00	161.71
R290314076RX	290.00	+0.00 / -0.13					314.00	+0.13 / -0.00	8.10	+0.20 / -0.00	O/R
R300324076RX	300.00	+0.00 / -0.13					324.00	+0.13 / -0.00	8.10	+0.20 / -0.00	O/R

*: GENERALLY NOT STOCKED BUT AVAILABLE - CHECK WITH C/SER

METRIC SIZE
ROD SEALS

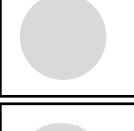
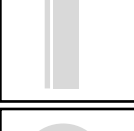

Tel.: 1-888-609-SEAL
Fax: 1-888-717-SEAL

J 41

www.sealsourceinc.com

Seal Source Inc.

METRIC SIZE
ROD SEALS

RX SERIES - 40% BR.PTFE/NBR

Ref.Number	Rod diameter		Nominal Seal Dimensions				Housing Dimensions				\$
		Tol.	d	D	H	EXP.	D1	Tol.	H1	Tol.	
R310334076RX	310.00	+0.00 / -0.13					334.00	+0.14 / -0.00	8.10	+0.20 / -0.00	O/R
R320344076RX	320.00	+0.00 / -0.13					344.00	+0.14 / -0.00	8.10	+0.20 / -0.00	O/R
R330354076RX	330.00	+0.00 / -0.13					354.00	+0.14 / -0.00	8.10	+0.20 / -0.00	O/R
R340364076RX	340.00	+0.00 / -0.13					364.00	+0.14 / -0.00	8.10	+0.20 / -0.00	O/R
R350374076RX	350.00	+0.00 / -0.13					374.00	+0.14 / -0.00	8.10	+0.20 / -0.00	O/R
R360384076RX	360.00	+0.00 / -0.13					384.00	+0.14 / -0.00	8.10	+0.20 / -0.00	O/R
R370394076RX	370.00	+0.00 / -0.13					394.00	+0.14 / -0.00	8.10	+0.20 / -0.00	O/R
R380404076RX	380.00	+0.00 / -0.13					404.00	+0.14 / -0.00	8.10	+0.20 / -0.00	O/R
R390414076RX	390.00	+0.00 / -0.13					414.00	+0.14 / -0.00	8.10	+0.20 / -0.00	O/R
R400424076RX	400.00	+0.00 / -0.13					424.00	+0.14 / -0.00	8.10	+0.20 / -0.00	O/R
R410434076RX	410.00	+0.00 / -0.13					434.00	+0.16 / -0.00	8.10	+0.20 / -0.00	O/R
R420444076RX	420.00	+0.00 / -0.13					444.00	+0.16 / -0.00	8.10	+0.20 / -0.00	O/R
R430454076RX	430.00	+0.00 / -0.13					454.00	+0.16 / -0.00	8.10	+0.20 / -0.00	O/R
R440464076RX	440.00	+0.00 / -0.13					464.00	+0.16 / -0.00	8.10	+0.20 / -0.00	O/R
R450474076RX	450.00	+0.00 / -0.13					474.00	+0.16 / -0.00	8.10	+0.20 / -0.00	O/R
R460484076RX	460.00	+0.00 / -0.13					484.00	+0.16 / -0.00	8.10	+0.20 / -0.00	O/R
R470494076RX	470.00	+0.00 / -0.13					494.00	+0.16 / -0.00	8.10	+0.20 / -0.00	O/R
R480504076RX	480.00	+0.00 / -0.13					504.00	+0.16 / -0.00	8.10	+0.20 / -0.00	O/R
R490514076RX	490.00	+0.00 / -0.13					514.00	+0.16 / -0.00	8.10	+0.20 / -0.00	O/R
R500524076RX	500.00	+0.00 / -0.13					524.00	+0.16 / -0.00	8.10	+0.20 / -0.00	O/R

RZ - Buffer Seals 40% BR. PTFE/NBR

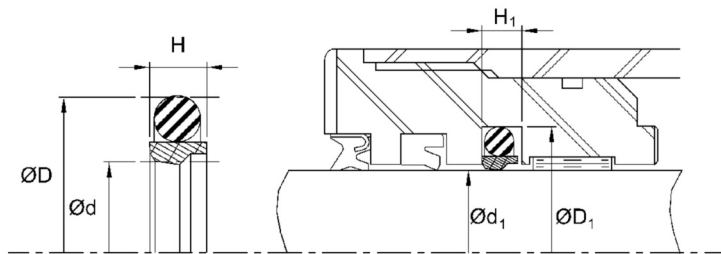
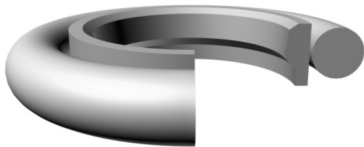

Temperature: -30/250F [-34/121C]

Pressure: 5800 PSI [400 Bar]

Ref.Number	Rod diameter		Nominal Seal Dimensions				Housing Dimensions				\$
		Tol.	d	D	H	EXP.	D1	Tol.	H1	Tol.	
R004008020RZ*	4.00	+0.00 / -0.04					8.90	+0.04 / -0.00	2.20	+0.20 / -0.00	10.86
R005009020RZ*	5.00	+0.00 / -0.04					9.90	+0.04 / -0.00	2.20	+0.20 / -0.00	10.86
R006010020RZ*	6.00	+0.00 / -0.04					10.90	+0.04 / -0.00	2.20	+0.20 / -0.00	3.48
R007011020RZ*	7.00	+0.00 / -0.04					11.90	+0.04 / -0.00	2.20	+0.20 / -0.00	10.86
R008012020RZ*	8.00	+0.00 / -0.04					12.90	+0.04 / -0.00	2.20	+0.20 / -0.00	9.46
R008015029RZ*	8.00	+0.00 / -0.04					15.30	+0.04 / -0.00	3.20	+0.20 / -0.00	9.35
R010014020RZ	10.00	+0.00 / -0.04					14.90	+0.04 / -0.00	2.20	+0.20 / -0.00	11.04
R010017029RZ	10.00	+0.00 / -0.04					17.30	+0.04 / -0.00	3.20	+0.20 / -0.00	11.04
R012016020RZ	12.00	+0.00 / -0.04					16.90	+0.04 / -0.00	2.20	+0.20 / -0.00	4.14

*: GENERALLY NOT STOCKED BUT AVAILABLE - CHECK WITH C/SER

Seal Source Inc.

RZ SERIES - 40% BR.PTFE/NBR

Ref.Number	Rod diameter		Nominal Seal Dimensions				Housing Dimensions				\$
		Tol.	d	D	H	EXP.	D1	Tol.	H1	Tol.	
R012019029RZ	12.00	+0.00 / -0.04					19.30	+0.04 / -0.00	3.20	+0.20 / -0.00	8.58
R014018020RZ	14.00	+0.00 / -0.04					18.90	+0.04 / -0.00	2.20	+0.20 / -0.00	4.14
R014021029RZ	14.00	+0.00 / -0.04					21.30	+0.04 / -0.00	3.20	+0.20 / -0.00	11.04
R015022029RZ	15.00	+0.00 / -0.04					22.30	+0.04 / -0.00	3.20	+0.20 / -0.00	8.58
R016020020RZ	16.00	+0.00 / -0.04					20.90	+0.04 / -0.00	2.20	+0.20 / -0.00	11.04
R016023029RZ	16.00	+0.00 / -0.04					23.30	+0.04 / -0.00	3.20	+0.20 / -0.00	4.14
R018022020RZ	18.00	+0.00 / -0.04					22.90	+0.04 / -0.00	2.20	+0.20 / -0.00	8.04
R018025029RZ	18.00	+0.00 / -0.04					25.30	+0.04 / -0.00	3.20	+0.20 / -0.00	4.35
R020027029RZ	20.00	+0.00 / -0.04					27.30	+0.05 / -0.00	3.20	+0.20 / -0.00	6.09
R020030039RZ	20.00	+0.00 / -0.04					30.70	+0.05 / -0.00	4.20	+0.20 / -0.00	6.09
R022029029RZ	22.00	+0.00 / -0.04					29.30	+0.05 / -0.00	3.20	+0.20 / -0.00	6.20
R022032039RZ	22.00	+0.00 / -0.04					32.70	+0.05 / -0.00	4.20	+0.20 / -0.00	6.20
R025032029RZ	25.00	+0.00 / -0.04					32.30	+0.05 / -0.00	3.20	+0.20 / -0.00	6.32
R025035039RZ	25.00	+0.00 / -0.04					35.70	+0.05 / -0.00	4.20	+0.20 / -0.00	16.07
R028038039RZ	28.00	+0.00 / -0.04					38.70	+0.05 / -0.00	4.20	+0.20 / -0.00	11.62
R030037029RZ	30.00	+0.00 / -0.04					37.30	+0.05 / -0.00	3.20	+0.20 / -0.00	11.62
R030040039RZ	30.00	+0.00 / -0.04					40.70	+0.05 / -0.00	4.20	+0.20 / -0.00	20.27
R032039029RZ	32.00	+0.00 / -0.04					39.30	+0.05 / -0.00	3.20	+0.20 / -0.00	13.48
R032042039RZ	32.00	+0.00 / -0.04					42.70	+0.06 / -0.00	4.20	+0.20 / -0.00	6.75
R035045039RZ	35.00	+0.00 / -0.04					45.70	+0.06 / -0.00	4.20	+0.20 / -0.00	7.28
R036043029RZ	36.00	+0.00 / -0.04					43.30	+0.06 / -0.00	3.20	+0.20 / -0.00	7.37
R036046039RZ	36.00	+0.00 / -0.04					46.70	+0.06 / -0.00	4.20	+0.20 / -0.00	7.28
R040050039RZ	40.00	+0.00 / -0.05					50.70	+0.06 / -0.00	4.20	+0.20 / -0.00	11.87
R040052039RZ	40.00	+0.00 / -0.05					52.60	+0.06 / -0.00	4.20	+0.20 / -0.00	20.53
R040055059RZ	40.00	+0.00 / -0.05					55.10	+0.06 / -0.00	6.30	+0.20 / -0.00	20.46
R042057059RZ	42.00	+0.00 / -0.05					57.10	+0.06 / -0.00	6.30	+0.20 / -0.00	35.69
R045055039RZ	45.00	+0.00 / -0.05					55.70	+0.06 / -0.00	4.20	+0.20 / -0.00	14.46
R045058042RZ	45.00	+0.00 / -0.05					57.60	+0.06 / -0.00	4.20	+0.20 / -0.00	19.71
R045060059RZ	45.00	+0.00 / -0.05					60.10	+0.06 / -0.00	6.30	+0.20 / -0.00	14.46
R048063059RZ	48.00	+0.00 / -0.05					63.10	+0.06 / -0.00	6.30	+0.20 / -0.00	35.69
R050060039RZ	50.00	+0.00 / -0.05					60.70	+0.06 / -0.00	4.20	+0.20 / -0.00	14.46
R050062042RZ	50.00	+0.00 / -0.05					62.60	+0.06 / -0.00	4.50	+0.20 / -0.00	24.06
R050065059RZ	50.00	+0.00 / -0.05					65.10	+0.06 / -0.00	6.30	+0.20 / -0.00	14.46
R050065059RZ/U	50.00	+0.00 / -0.05					65.10	+0.06 / -0.00	6.30	+0.20 / -0.00	65.97
R052067059RZ	52.00	+0.00 / -0.05					67.10	+0.07 / -0.00	6.30	+0.20 / -0.00	40.49
R055070059RZ	55.00	+0.00 / -0.05					70.10	+0.07 / -0.00	6.30	+0.20 / -0.00	24.12
R056066039RZ	56.00	+0.00 / -0.05					66.70	+0.07 / -0.00	4.20	+0.20 / -0.00	34.46
R056068042RZ	56.00	+0.00 / -0.05					68.60	+0.07 / -0.00	4.50	+0.20 / -0.00	24.12
R056071059RZ	56.00	+0.00 / -0.05					71.10	+0.07 / -0.00	6.30	+0.20 / -0.00	17.40
R060070039RZ	60.00	+0.00 / -0.05					70.70	+0.07 / -0.00	4.20	+0.20 / -0.00	18.38
R060075059RZ	60.00	+0.00 / -0.05					75.10	+0.07 / -0.00	6.30	+0.20 / -0.00	24.12
R063078059RZ	63.00	+0.00 / -0.05					78.10	+0.07 / -0.00	6.30	+0.20 / -0.00	19.91
R065075039RZ	65.00	+0.00 / -0.05					75.70	+0.07 / -0.00	4.20	+0.20 / -0.00	20.27
R065080059RZ	65.00	+0.00 / -0.06					80.10	+0.07 / -0.00	6.30	+0.20 / -0.00	23.25
R070085059RZ	70.00	+0.00 / -0.06					85.10	+0.07 / -0.00	6.30	+0.20 / -0.00	27.02
R075090059RZ	75.00	+0.00 / -0.06					90.10	+0.07 / -0.00	6.30	+0.20 / -0.00	28.82
R080095059RZ	80.00	+0.00 / -0.09					95.10	+0.07 / -0.00	6.30	+0.20 / -0.00	31.06

*: GENERALLY NOT STOCKED BUT AVAILABLE - CHECK WITH C/SER

METRIC SIZE
ROD SEALS

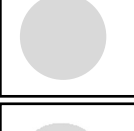
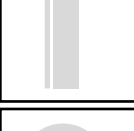
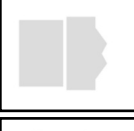

Tel.: 1-888-609-SEAL
Fax: 1-888-717-SEAL

J

43

www.sealsourceinc.com

Seal Source Inc.

RZ SERIES - 40% BR.PTFE/NBR

METRIC SIZE
ROD SEALS

Ref.Number	Rod diameter		Nominal Seal Dimensions				Housing Dimensions				\$
		Tol.	d	D	H	EXP.	D1	Tol.	H1	Tol.	
R085100059RZ	85.00	+0.00 / -0.09					100.10	+0.09 / -0.00	6.30	+0.20 / -0.00	30.67
R085100059RZ/U	85.00	+0.00 / -0.09					100.10	+0.09 / -0.00	6.30	+0.20 / -0.00	75.35
R090105059RZ	90.00	+0.00 / -0.09					105.10	+0.09 / -0.00	6.30	+0.20 / -0.00	33.74
R090105059RZ/U	90.00	+0.00 / -0.09					105.10	+0.09 / -0.00	6.30	+0.20 / -0.00	75.48
R095110059RZ	95.00	+0.00 / -0.09					110.10	+0.09 / -0.00	6.30	+0.20 / -0.00	34.82
R100115059RZ	100.00	+0.00 / -0.09					115.10	+0.09 / -0.00	6.30	+0.20 / -0.00	35.36
R105120059RZ	105.00	+0.00 / -0.13					120.10	+0.09 / -0.00	6.30	+0.20 / -0.00	40.24
R105120059RZ/U*	105.00	+0.00 / -0.13					120.10	+0.09 / -0.00	6.30	+0.20 / -0.00	78.24
R105125076RZ	105.00	+0.00 / -0.13					125.50	+0.09 / -0.00	8.10	+0.20 / -0.00	49.46
R110125059RZ	110.00	+0.00 / -0.13					125.10	+0.09 / -0.00	6.30	+0.20 / -0.00	42.00
R110125059RZ/U	110.00	+0.00 / -0.13					125.10	+0.09 / -0.00	6.30	+0.20 / -0.00	84.24
R110134076RZ	110.00	+0.00 / -0.13					130.50	+0.09 / -0.00	8.10	+0.20 / -0.00	75.43
R115130059RZ	115.00	+0.00 / -0.13					130.10	+0.09 / -0.00	6.30	+0.20 / -0.00	41.89
R120135059RZ	120.00	+0.00 / -0.13					135.10	+0.09 / -0.00	6.30	+0.20 / -0.00	42.08
R125140059RZ	125.00	+0.00 / -0.13					140.10	+0.10 / -0.00	6.30	+0.20 / -0.00	42.55
R125146076RZ	125.00	+0.00 / -0.13					146.00	+0.10 / -0.00	8.10	+0.20 / -0.00	59.96
R130145059RZ	130.00	+0.00 / -0.13					145.10	+0.10 / -0.00	6.30	+0.20 / -0.00	42.86
R130151076RZ	130.00	+0.00 / -0.13					151.00	+0.10 / -0.00	8.10	+0.20 / -0.00	56.81
R135150059RZ	135.00	+0.00 / -0.13					150.10	+0.10 / -0.00	6.30	+0.20 / -0.00	57.91
R140155059RZ	140.00	+0.00 / -0.13					155.10	+0.10 / -0.00	6.30	+0.20 / -0.00	42.98
R145160059RZ	145.00	+0.00 / -0.13					160.10	+0.10 / -0.00	6.30	+0.20 / -0.00	59.61
R150165059RZ	150.00	+0.00 / -0.13					165.10	+0.10 / -0.00	6.30	+0.20 / -0.00	45.72
R150171076RZ	150.00	+0.00 / -0.13					171.00	+0.10 / -0.00	8.10	+0.20 / -0.00	70.17
R155170059RZ	155.00	+0.00 / -0.13					170.10	+0.10 / -0.00	6.30	+0.20 / -0.00	61.18
R160175059RZ	160.00	+0.00 / -0.13					175.10	+0.10 / -0.00	6.30	+0.20 / -0.00	47.05
R160181076RZ	160.00	+0.00 / -0.13					181.00	+0.10 / -0.00	8.10	+0.20 / -0.00	83.79
R165180059RZ	165.00	+0.00 / -0.13					180.10	+0.10 / -0.00	6.30	+0.20 / -0.00	83.90
R170185059RZ	170.00	+0.00 / -0.13					185.10	+0.10 / -0.00	6.30	+0.20 / -0.00	57.84
R170190076RZ	170.00	+0.00 / -0.13					190.50	+0.10 / -0.00	8.10	+0.20 / -0.00	90.24
R180195059RZ	180.00	+0.00 / -0.13					195.10	+0.10 / -0.00	6.30	+0.20 / -0.00	96.34
R190205059RZ	190.00	+0.00 / -0.13					205.10	+0.12 / -0.00	6.30	+0.20 / -0.00	101.14
R200220076RZ	200.00	+0.00 / -0.13					220.50	+0.12 / -0.00	8.10	+0.20 / -0.00	103.11
R210230076RZ	210.00	+0.00 / -0.13					230.50	+0.12 / -0.00	8.10	+0.20 / -0.00	112.83
R220240076RZ	220.00	+0.00 / -0.13					240.50	+0.12 / -0.00	8.10	+0.20 / -0.00	113.08
R230250076RZ	230.00	+0.00 / -0.13					250.50	+0.12 / -0.00	8.10	+0.20 / -0.00	117.90
R240260076RZ	240.00	+0.00 / -0.13					260.50	+0.12 / -0.00	8.10	+0.20 / -0.00	127.12
R250270076RZ	250.00	+0.00 / -0.13					270.50	+0.12 / -0.00	8.10	+0.20 / -0.00	153.84
R260284076RZ	260.00	+0.00 / -0.13					284.00	+0.13 / -0.00	8.10	+0.20 / -0.00	163.37
R270294076RZ	270.00	+0.00 / -0.13					294.00	+0.13 / -0.00	8.10	+0.20 / -0.00	172.88
R280304076RZ	280.00	+0.00 / -0.13					304.00	+0.13 / -0.00	8.10	+0.20 / -0.00	173.26
R290314076RZ	290.00	+0.00 / -0.13					314.00	+0.13 / -0.00	8.10	+0.20 / -0.00	180.59
R300324076RZ	300.00	+0.00 / -0.13					324.00	+0.13 / -0.00	8.10	+0.20 / -0.00	187.51
R300324076RZ/N	300.00	+0.00 / -0.13					324.00	+0.13 / -0.00	8.10	+0.20 / -0.00	96.92
R310334076RZ	310.00	+0.00 / -0.13					334.00	+0.14 / -0.00	8.10	+0.20 / -0.00	218.20
R320344076RZ	320.00	+0.00 / -0.13					344.00	+0.14 / -0.00	8.10	+0.20 / -0.00	229.79
R330354076RZ	330.00	+0.00 / -0.13					354.00	+0.14 / -0.00	8.10	+0.20 / -0.00	236.48
R340364076RZ	340.00	+0.00 / -0.13					364.00	+0.14 / -0.00	8.10	+0.20 / -0.00	249.60

*: GENERALLY NOT STOCKED BUT AVAILABLE - CHECK WITH C/SER

RZ SERIES - 40% BR.PTFE/NBR

Ref.Number	Rod diameter		Nominal Seal Dimensions				Housing Dimensions				\$
		Tol.	d	D	H	EXP.	D1	Tol.	H1	Tol.	
R350374076RZ	350.00	+0.00 / -0.13					374.00	+0.14 / -0.00	8.10	+0.20 / -0.00	258.66
R360384076RZ	360.00	+0.00 / -0.13					384.00	+0.14 / -0.00	8.10	+0.20 / -0.00	268.35
R370394076RZ	370.00	+0.00 / -0.13					394.00	+0.14 / -0.00	8.10	+0.20 / -0.00	276.52
R380404076RZ	380.00	+0.00 / -0.13					404.00	+0.14 / -0.00	8.10	+0.20 / -0.00	279.11
R390414076RZ	390.00	+0.00 / -0.13					414.00	+0.14 / -0.00	8.10	+0.20 / -0.00	286.47
R400424076RZ	400.00	+0.00 / -0.13					424.00	+0.14 / -0.00	8.10	+0.20 / -0.00	299.28
R410434076RZ	410.00	+0.00 / -0.13					434.00	+0.16 / -0.00	8.10	+0.20 / -0.00	307.22
R420444076RZ	420.00	+0.00 / -0.13					444.00	+0.16 / -0.00	8.10	+0.20 / -0.00	318.94
R430454076RZ	430.00	+0.00 / -0.13					454.00	+0.16 / -0.00	8.10	+0.20 / -0.00	326.37
R440464076RZ	440.00	+0.00 / -0.13					464.00	+0.16 / -0.00	8.10	+0.20 / -0.00	332.41
R450474076RZ	450.00	+0.00 / -0.13					474.00	+0.16 / -0.00	8.10	+0.20 / -0.00	333.98
R460484076RZ	460.00	+0.00 / -0.13					484.00	+0.16 / -0.00	8.10	+0.20 / -0.00	334.78
R470494076RZ	470.00	+0.00 / -0.13					494.00	+0.16 / -0.00	8.10	+0.20 / -0.00	369.53
R480504076RZ	480.00	+0.00 / -0.13					504.00	+0.16 / -0.00	8.10	+0.20 / -0.00	398.99
R490514076RZ	490.00	+0.00 / -0.13					514.00	+0.16 / -0.00	8.10	+0.20 / -0.00	436.48
R500524076RZ	500.00	+0.00 / -0.13					524.00	+0.16 / -0.00	8.10	+0.20 / -0.00	449.99
R520544076RZ	520.00	+0.00 / -0.13					544.00	+0.16 / -0.00	8.10	+0.20 / -0.00	452.93

METRIC SIZE
ROD SEALS

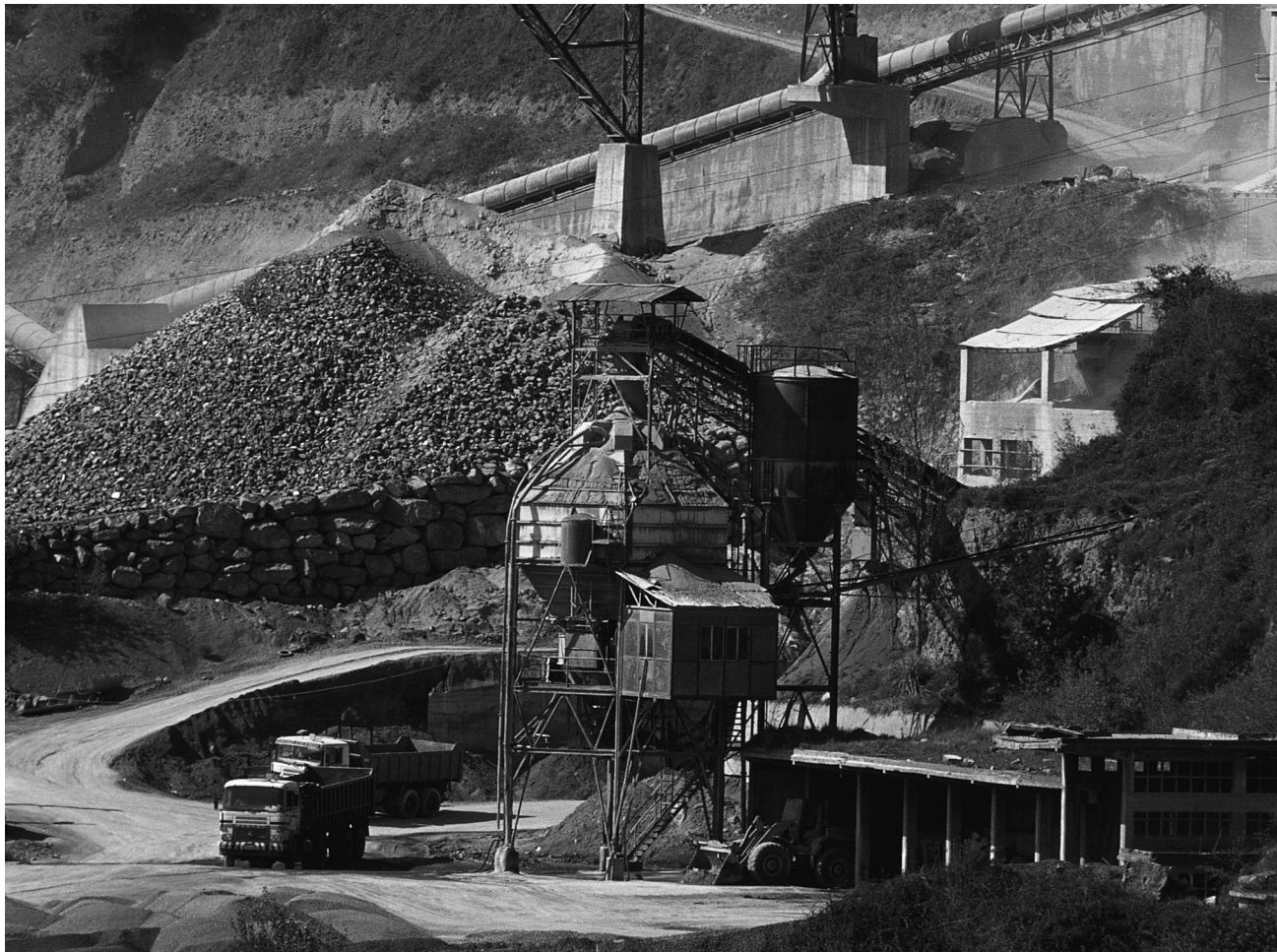

*: GENERALLY NOT STOCKED BUT AVAILABLE - CHECK WITH C/SER

Tel.: 1-888-609-SEAL
Fax: 1-888-717-SEAL

J

45

www.sealsourceinc.com

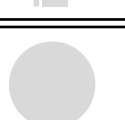

Seal Source Inc.

METRIC SIZE
ROD SEALS

R5 - Cushion Seals

Nitrile NBR 89A

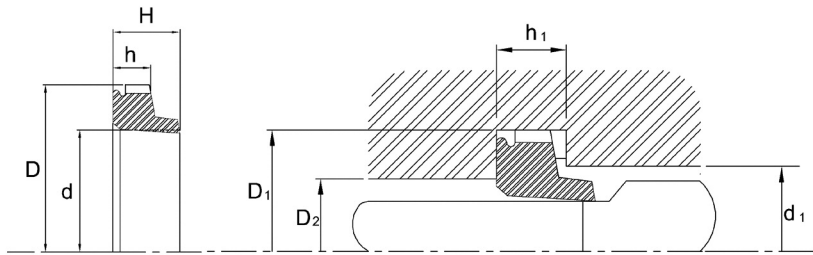

Temperature: -4/176F [-20/80C]

Pressure: 232 PSI [16 Bar]

Ref.Number	Rod diameter	Nominal Seal Dimensions				Housing Dimensions						\$
	Tol.	d	D	h	H	d1	Tol.	D1	Tol.	D2	Tol.	
R004008026R5*	4.50 +0.00 / -0.04	4.50	8.00	2.60	3.50	6.50 +0.07 / -0.00	8.00 +0.09 / -0.00	5.00 +0.08 / -0.00	3.10 +0.10 / -0.10	0/R		
R005009032R5*	5.00 +0.00 / -0.04	5.00	9.00	3.20	4.10	7.00 +0.07 / -0.00	9.00 +0.09 / -0.00	5.50 +0.08 / -0.00	3.70 +0.10 / -0.10	0/R		
R006010032R5*	6.00 +0.00 / -0.04	6.00	10.00	3.20	4.10	8.00 +0.09 / -0.00	10.00 +0.09 / -0.00	6.50 +0.09 / -0.00	3.70 +0.10 / -0.10	5.94		
R008011028R5*	8.00 +0.00 / -0.04	8.00	11.60	2.80	3.50	10.00 +0.09 / -0.00	11.60 +0.09 / -0.00	8.50 +0.09 / -0.00	3.30 +0.10 / -0.10	6.12		
R009015037R5*	9.50 +0.00 / -0.04	9.50	15.00	3.70	4.60	12.00 +0.09 / -0.00	15.00 +0.09 / -0.00	10.00 +0.11 / -0.00	4.50 +0.10 / -0.10	6.31		
R010018063R5*	10.00 +0.00 / -0.04	10.00	18.00	6.30	7.80	13.00 +0.11 / -0.00	18.00 +0.11 / -0.00	10.50 +0.11 / -0.00	7.00 +0.10 / -0.10	6.61		
R012018041R5*	12.00 +0.00 / -0.04	12.00	18.00	4.10	5.00	15.50 +0.11 / -0.00	18.00 +0.11 / -0.00	13.00 +0.11 / -0.00	4.80 +0.10 / -0.10	6.98		
R012020063R5*	12.00 +0.00 / -0.04	12.00	20.00	6.30	7.80	17.00 +0.11 / -0.00	20.00 +0.11 / -0.00	13.00 +0.11 / -0.00	7.00 +0.10 / -0.10	7.16		
R014022045R5*	14.00 +0.00 / -0.04	14.00	22.00	4.50	5.50	18.50 +0.11 / -0.00	22.00 +0.11 / -0.00	15.00 +0.11 / -0.00	5.20 +0.10 / -0.10	0/R		
R014022063R5*	14.00 +0.00 / -0.04	14.00	22.00	6.30	7.80	19.00 +0.11 / -0.00	22.00 +0.11 / -0.00	15.00 +0.11 / -0.00	7.00 +0.10 / -0.10	7.47		
R016022045R5*	16.00 +0.00 / -0.04	16.00	22.00	4.50	5.50	19.50 +0.11 / -0.00	22.00 +0.11 / -0.00	17.00 +0.11 / -0.00	5.20 +0.10 / -0.10	7.59		
R016024063R5*	16.00 +0.00 / -0.04	16.00	24.00	6.30	7.80	21.00 +0.11 / -0.00	24.00 +0.11 / -0.00	17.00 +0.11 / -0.00	7.00 +0.10 / -0.10	7.78		
R018026063R5*	18.00 +0.00 / -0.04	18.00	26.00	6.30	7.80	23.00 +0.13 / -0.00	26.00 +0.13 / -0.00	19.00 +0.13 / -0.00	7.00 +0.10 / -0.10	8.14		
R020028063R5*	20.00 +0.00 / -0.04	20.00	28.00	6.30	7.80	24.00 +0.13 / -0.00	28.00 +0.13 / -0.00	21.00 +0.13 / -0.00	7.00 +0.10 / -0.10	8.51		
R022030063R5*	22.00 +0.00 / -0.04	22.00	30.00	6.30	7.80	26.00 +0.13 / -0.00	30.00 +0.13 / -0.00	23.00 +0.13 / -0.00	7.00 +0.10 / -0.10	9.06		
R025033063R5*	25.00 +0.00 / -0.04	25.00	33.00	6.30	7.80	29.00 +0.13 / -0.00	33.00 +0.13 / -0.00	26.00 +0.13 / -0.00	7.00 +0.10 / -0.10	9.37		
R028036063R5*	28.00 +0.00 / -0.04	28.00	36.00	6.30	7.80	32.00 +0.13 / -0.00	36.00 +0.13 / -0.00	29.00 +0.13 / -0.00	7.00 +0.10 / -0.10	10.17		
R030040062R5*	30.00 +0.00 / -0.04	30.00	40.00	6.20	7.80	35.00 +0.16 / -0.00	40.00 +0.16 / -0.00	31.50 +0.16 / -0.00	7.00 +0.10 / -0.10	10.41		
R032042062R5*	32.00 +0.00 / -0.04	32.00	42.00	6.20	7.80	37.00 +0.16 / -0.00	42.00 +0.16 / -0.00	33.50 +0.16 / -0.00	7.00 +0.10 / -0.10	10.90		
R036046062R5*	36.00 +0.00 / -0.04	36.00	46.00	6.20	7.80	41.00 +0.16 / -0.00	46.00 +0.16 / -0.00	37.50 +0.16 / -0.00	7.00 +0.10 / -0.10	11.76		
R040050062R5*	40.00 +0.00 / -0.05	40.00	50.00	6.20	7.80	45.00 +0.16 / -0.00	50.00 +0.16 / -0.00	41.50 +0.16 / -0.00	7.00 +0.10 / -0.10	12.25		
R050060062R5*	50.00 +0.00 / -0.05	50.00	60.00	6.20	7.80	55.00 +0.16 / -0.00	60.00 +0.16 / -0.00	51.50 +0.19 / -0.00	7.00 +0.10 / -0.10	12.80		
R050067110R5*	50.00 +0.00 / -0.05	50.00	67.00	11.00	11.00	58.00 +0.16 / -0.00	67.00 +0.19 / -0.00	53.00 +0.19 / -0.00	12.50 +0.10 / -0.10	0/R		
R057074110R5*	57.00 +0.00 / -0.05	57.00	74.00	11.00	11.00	65.00 +0.19 / -0.00	74.00 +0.19 / -0.00	60.00 +0.19 / -0.00	12.50 +0.10 / -0.10	20.21		
R070087110R5*	70.00 +0.00 / -0.06	70.00	87.00	11.00	11.00	78.00 +0.19 / -0.00	87.00 +0.19 / -0.00	73.00 +0.19 / -0.00	12.50 +0.10 / -0.10	0/R		
R078095110R5*	78.00 +0.00 / -0.09	78.00	95.00	11.00	11.00	86.00 +0.22 / -0.00	95.00 +0.22 / -0.00	81.00 +0.22 / -0.00	12.50 +0.10 / -0.10	45.25		

*: GENERALLY NOT STOCKED BUT AVAILABLE - CHECK WITH C/SER

R8 - Cushion Seals

Polyurethane

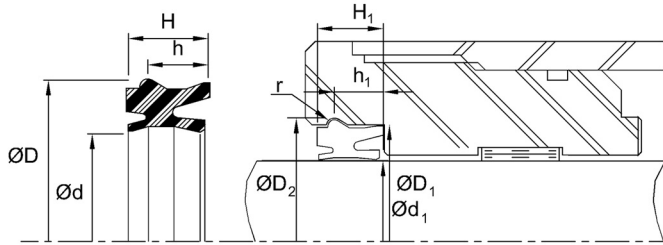

Temperature: -52/176F [-30/105C]

Pressure: 232 PSI [16 Bar]

Ref.Number	Rod diameter	Nominal Seal Dimensions				Housing Dimensions							\$		
	Tol.	d	D	h	H	D1	Tol.	D2	Tol.	H1	Tol.	h2		Tol.	Rad
R012022104R8*	12.00 +0.00 / -0.04	12.00	22.00	7.00	10.40	22.00	+0.10 / -0.10	24.20	+0.10 / -0.10	13.00	+0.50 / -0.00	7.50	+0.25 / -0.00	1.10	6.29
R016026104R8*	16.00 +0.00 / -0.04	16.00	26.00	7.00	10.40	26.00	+0.10 / -0.10	28.20	+0.10 / -0.10	13.00	+0.50 / -0.00	7.50	+0.25 / -0.00	1.10	6.43
R018028104R8	18.00 +0.00 / -0.04	18.00	28.00	7.00	10.40	28.00	+0.10 / -0.10	30.00	+0.10 / -0.10	13.00	+0.50 / -0.00	7.50	+0.25 / -0.00	1.10	6.62
R020030104R8*	20.00 +0.00 / -0.04	20.00	30.00	7.00	10.40	30.00	+0.10 / -0.10	32.20	+0.10 / -0.10	13.00	+0.50 / -0.00	7.50	+0.25 / -0.00	1.10	7.21
R025035104R8*	25.00 +0.00 / -0.04	25.00	35.00	7.30	10.40	35.00	+0.10 / -0.10	37.80	+0.10 / -0.10	13.00	+0.50 / -0.00	8.00	+0.25 / -0.00	1.40	7.70
R032042104R8*	32.00 +0.00 / -0.04	32.00	42.00	7.30	10.40	42.00	+0.10 / -0.10	44.80	+0.10 / -0.10	13.00	+0.50 / -0.00	8.00	+0.25 / -0.00	1.40	8.41
R040050104R8*	40.00 +0.00 / -0.04	40.00	50.00	7.30	10.40	50.00	+0.10 / -0.10	52.80	+0.10 / -0.10	13.00	+0.50 / -0.00	8.00	+0.25 / -0.00	1.40	11.55
R050060104R8*	50.00 +0.00 / -0.04	50.00	60.00	7.70	10.40	60.00	+0.10 / -0.10	63.60	+0.10 / -0.10	13.00	+0.50 / -0.00	8.50	+0.25 / -0.00	1.78	12.60

METRIC SIZE
ROD SEALS



*: GENERALLY NOT STOCKED BUT AVAILABLE - CHECK WITH C/SER

Tel.: 1-888-609-SEAL
Fax: 1-888-717-SEAL

J **47**

www.sealsourceinc.com

R12 - Buffer Seals

Nylon/PTFE/Nitrile

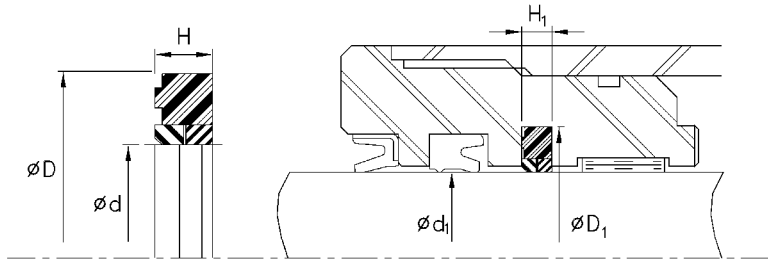
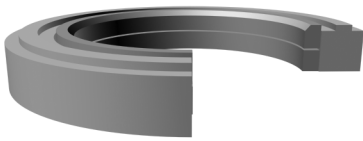

Temperature: -40/220F [-40/104C]

Pressure: 5000 PSI [345 Bar]

Ref.Number	Rod diameter		Nominal Seal Dimensions			Housing Dimensions					\$	
		Tol.	d	D	H	d1	Tol.	D1	Tol.	H1		Tol.
R040055059R12*	40.00	+0.00 / -0.05	40.00	55.50	5.90	40.00	+0.00 / -0.05	55.50	+0.19 / -0.00	6.30	+0.20 / -0.00	24.20
R045060059R12*	45.00	+0.00 / -0.05	45.00	60.50	5.90	45.00	+0.00 / -0.05	60.50	+0.19 / -0.00	6.30	+0.20 / -0.00	25.99
R050065059R12*	50.00	+0.00 / -0.05	50.00	65.50	5.90	50.00	+0.00 / -0.05	65.50	+0.19 / -0.00	6.30	+0.20 / -0.00	27.02
R055070059R12*	55.00	+0.00 / -0.05	55.00	70.50	5.90	55.00	+0.00 / -0.05	70.50	+0.19 / -0.00	6.30	+0.20 / -0.00	28.02
R060075059R12*	60.00	+0.00 / -0.05	60.00	75.50	5.90	60.00	+0.00 / -0.05	75.50	+0.19 / -0.00	6.30	+0.20 / -0.00	30.19
R065080059R12*	65.00	+0.00 / -0.06	65.00	80.50	5.90	65.00	+0.00 / -0.06	80.50	+0.22 / -0.00	6.30	+0.20 / -0.00	32.32
R070085059R12*	70.00	+0.00 / -0.06	70.00	85.50	5.90	70.00	+0.00 / -0.06	85.50	+0.22 / -0.00	6.30	+0.20 / -0.00	34.46
R075090059R12*	75.00	+0.00 / -0.06	75.00	90.50	5.90	75.00	+0.00 / -0.06	90.50	+0.22 / -0.00	6.30	+0.20 / -0.00	36.62
R080095059R12*	80.00	+0.00 / -0.09	80.00	95.50	5.90	80.00	+0.00 / -0.09	95.50	+0.22 / -0.00	6.30	+0.20 / -0.00	38.80
R085100059R12*	85.00	+0.00 / -0.09	85.00	100.50	5.90	85.00	+0.00 / -0.09	100.50	+0.22 / -0.00	6.30	+0.20 / -0.00	40.94
R090105059R12*	90.00	+0.00 / -0.09	90.00	105.50	5.90	90.00	+0.00 / -0.09	105.50	+0.22 / -0.00	6.30	+0.20 / -0.00	43.09
R095110059R12*	95.00	+0.00 / -0.09	95.00	110.50	5.90	95.00	+0.00 / -0.09	110.50	+0.22 / -0.00	6.30	+0.20 / -0.00	45.22
R100115059R12*	100.00	+0.00 / -0.09	100.00	115.50	5.90	100.00	+0.00 / -0.09	115.50	+0.22 / -0.00	6.30	+0.20 / -0.00	49.53
R105120059R12*	105.00	+0.00 / -0.13	105.00	120.50	5.90	105.00	+0.00 / -0.13	120.50	+0.25 / -0.00	6.30	+0.20 / -0.00	51.68
R110125059R12*	110.00	+0.00 / -0.13	110.00	125.50	5.90	110.00	+0.00 / -0.13	125.50	+0.25 / -0.00	6.30	+0.20 / -0.00	53.88
R115130059R12*	115.00	+0.00 / -0.13	115.00	130.50	5.90	115.00	+0.00 / -0.13	130.50	+0.25 / -0.00	6.30	+0.20 / -0.00	56.01
R120135059R12*	120.00	+0.00 / -0.13	120.00	135.50	5.90	120.00	+0.00 / -0.13	135.50	+0.25 / -0.00	6.30	+0.20 / -0.00	59.30
R125140059R12*	125.00	+0.00 / -0.13	125.00	140.50	5.90	125.00	+0.00 / -0.13	140.50	+0.25 / -0.00	6.30	+0.20 / -0.00	59.53
R130145059R12*	130.00	+0.00 / -0.13	130.00	145.50	5.90	130.00	+0.00 / -0.13	145.50	+0.25 / -0.00	6.30	+0.20 / -0.00	65.23
R135150059R12*	135.00	+0.00 / -0.13	135.00	150.50	5.90	135.00	+0.00 / -0.13	150.50	+0.25 / -0.00	6.30	+0.20 / -0.00	69.55
R140155059R12*	140.00	+0.00 / -0.13	140.00	155.50	5.90	140.00	+0.00 / -0.13	155.50	+0.25 / -0.00	6.30	+0.20 / -0.00	75.40
R150165059R12*	150.00	+0.00 / -0.13	150.00	165.50	5.90	150.00	+0.00 / -0.13	165.50	+0.25 / -0.00	6.30	+0.20 / -0.00	69.99
R160175059R12*	160.00	+0.00 / -0.13	160.00	175.50	5.90	160.00	+0.00 / -0.13	175.50	+0.25 / -0.00	6.30	+0.20 / -0.00	76.46
R170185059R12*	170.00	+0.00 / -0.13	170.00	185.50	5.90	170.00	+0.00 / -0.13	185.50	+0.29 / -0.00	6.30	+0.20 / -0.00	82.30
R180195059R12*	180.00	+0.00 / -0.13	180.00	195.50	5.90	180.00	+0.00 / -0.13	195.50	+0.29 / -0.00	6.30	+0.20 / -0.00	90.23

*: GENERALLY NOT STOCKED BUT AVAILABLE - CHECK WITH C/SER

R14 - Buffer Seals

Nylon/Nitrile

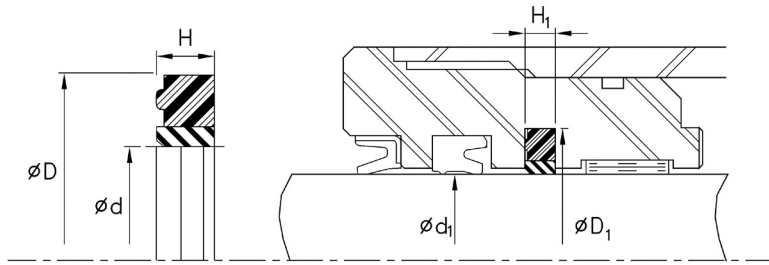
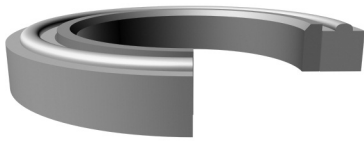

Temperature: -40/220F [-40/104C]

Pressure: 5000 PSI [345 Bar]

Ref.Number	Rod diameter		Nominal Seal Dimensions			Housing Dimensions					\$	
		Tol.	d	D	H	d1	Tol.	D1	Tol.	H1		Tol.
R040055059R14*	40.00	+0.00 / -0.05	40.00	55.50	5.90	40.00	+0.00 / -0.05	55.50	+0.19 / -0.00	6.30	+0.20 / -0.00	9.54
R045060059R14*	45.00	+0.00 / -0.05	45.00	60.50	5.90	45.00	+0.00 / -0.05	60.50	+0.19 / -0.00	6.30	+0.20 / -0.00	10.28
R050065059R14*	50.00	+0.00 / -0.05	50.00	65.50	5.90	50.00	+0.00 / -0.05	65.50	+0.19 / -0.00	6.30	+0.20 / -0.00	15.22
R055070059R14*	55.00	+0.00 / -0.05	55.00	70.50	5.90	55.00	+0.00 / -0.05	70.50	+0.19 / -0.00	6.30	+0.20 / -0.00	19.45
R060075059R14*	60.00	+0.00 / -0.05	60.00	75.50	5.90	60.00	+0.00 / -0.05	75.50	+0.19 / -0.00	6.30	+0.20 / -0.00	21.02
R065080059R14*	65.00	+0.00 / -0.06	65.00	80.50	5.90	65.00	+0.00 / -0.06	80.50	+0.22 / -0.00	6.30	+0.20 / -0.00	22.50
R070085059R14*	70.00	+0.00 / -0.06	70.00	85.50	5.90	70.00	+0.00 / -0.06	85.50	+0.22 / -0.00	6.30	+0.20 / -0.00	24.02
R075090059R14*	75.00	+0.00 / -0.06	75.00	90.50	5.90	75.00	+0.00 / -0.06	90.50	+0.22 / -0.00	6.30	+0.20 / -0.00	25.54
R080095059R14*	80.00	+0.00 / -0.09	80.00	95.50	5.90	80.00	+0.00 / -0.09	95.50	+0.22 / -0.00	6.30	+0.20 / -0.00	27.02
R085100059R14*	85.00	+0.00 / -0.09	85.00	100.50	5.90	85.00	+0.00 / -0.09	100.50	+0.22 / -0.00	6.30	+0.20 / -0.00	28.51
R090105059R14*	90.00	+0.00 / -0.09	90.00	105.50	5.90	90.00	+0.00 / -0.09	105.50	+0.22 / -0.00	6.30	+0.20 / -0.00	30.01
R095110059R14*	95.00	+0.00 / -0.09	95.00	110.50	5.90	95.00	+0.00 / -0.09	110.50	+0.22 / -0.00	6.30	+0.20 / -0.00	31.55
R100115059R14*	100.00	+0.00 / -0.09	100.00	115.50	5.90	100.00	+0.00 / -0.09	115.50	+0.22 / -0.00	6.30	+0.20 / -0.00	34.52
R105120059R14*	105.00	+0.00 / -0.13	105.00	120.50	5.90	105.00	+0.00 / -0.13	120.50	+0.25 / -0.00	6.30	+0.20 / -0.00	36.06
R110125059R14*	110.00	+0.00 / -0.13	110.00	125.50	5.90	110.00	+0.00 / -0.13	125.50	+0.25 / -0.00	6.30	+0.20 / -0.00	37.56
R115130059R14*	115.00	+0.00 / -0.13	115.00	130.50	5.90	115.00	+0.00 / -0.13	130.50	+0.25 / -0.00	6.30	+0.20 / -0.00	24.17
R120135059R14*	120.00	+0.00 / -0.13	120.00	135.50	5.90	120.00	+0.00 / -0.13	135.50	+0.25 / -0.00	6.30	+0.20 / -0.00	39.05
R125140059R14*	125.00	+0.00 / -0.13	125.00	140.50	5.90	125.00	+0.00 / -0.13	140.50	+0.25 / -0.00	6.30	+0.20 / -0.00	26.55
R130145059R14	130.00	+0.00 / -0.13	130.00	145.50	5.90	130.00	+0.00 / -0.13	145.50	+0.25 / -0.00	6.30	+0.20 / -0.00	27.18
R135150059R14*	135.00	+0.00 / -0.13	135.00	150.50	5.90	135.00	+0.00 / -0.13	150.50	+0.25 / -0.00	6.30	+0.20 / -0.00	33.55
R140155059R14	140.00	+0.00 / -0.13	140.00	155.50	5.90	140.00	+0.00 / -0.13	155.50	+0.25 / -0.00	6.30	+0.20 / -0.00	171.05
R145160059R14*	145.00	+0.00 / -0.13	145.00	160.50	5.90	145.00	+0.00 / -0.13	160.50	+0.25 / -0.00	6.30	+0.20 / -0.00	178.55
R150165059R14*	150.00	+0.00 / -0.13	150.00	165.50	5.90	150.00	+0.00 / -0.13	165.50	+0.25 / -0.00	6.30	+0.20 / -0.00	183.88
R155170059R14*	155.00	+0.00 / -0.13	155.00	170.50	5.90	155.00	+0.00 / -0.13	170.50	+0.25 / -0.00	6.30	+0.20 / -0.00	189.22
R160175059R14	160.00	+0.00 / -0.13	160.00	175.50	5.90	160.00	+0.00 / -0.13	175.50	+0.25 / -0.00	6.30	+0.20 / -0.00	193.05
R165180059R14*	165.00	+0.00 / -0.13	165.00	180.50	5.90	165.00	+0.00 / -0.13	180.50	+0.29 / -0.00	6.30	+0.20 / -0.00	199.15
R170185059R14*	170.00	+0.00 / -0.13	170.00	185.50	5.90	170.00	+0.00 / -0.13	185.50	+0.29 / -0.00	6.30	+0.20 / -0.00	207.43
R180200076R14	180.00	+0.00 / -0.13	180.00	200.00	7.60	180.00	+0.00 / -0.13	200.50	+0.29 / -0.00	8.10	+0.20 / -0.00	220.55
R200220076R14	200.00	+0.00 / -0.13	200.00	220.00	7.60	200.00	+0.00 / -0.13	220.50	+0.29 / -0.00	8.10	+0.20 / -0.00	242.55
R220240076R14	220.00	+0.00 / -0.13	220.00	240.00	7.60	220.00	+0.00 / -0.13	240.50	+0.29 / -0.00	8.10	+0.20 / -0.00	264.55
R230250076R14	230.00	+0.00 / -0.13	230.00	250.00	7.60	230.00	+0.00 / -0.13	250.50	+0.29 / -0.00	8.10	+0.20 / -0.00	275.55
R260287089R14	260.00	+0.00 / -0.13	260.00	287.30	8.90	260.00	+0.00 / -0.13	287.30	+0.29 / -0.00	9.50	+0.20 / -0.00	316.03

*: GENERALLY NOT STOCKED BUT AVAILABLE - CHECK WITH C/SER

Tel.: 1-888-609-SEAL
Fax: 1-888-717-SEAL

J

49

www.sealsourceinc.com

METRIC SIZE
ROD SEALS

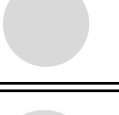
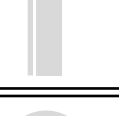

Seal Source Inc.

METRIC SIZE
ROD SEALS

R19 - Rod Seals

Polyurethane AU 94A

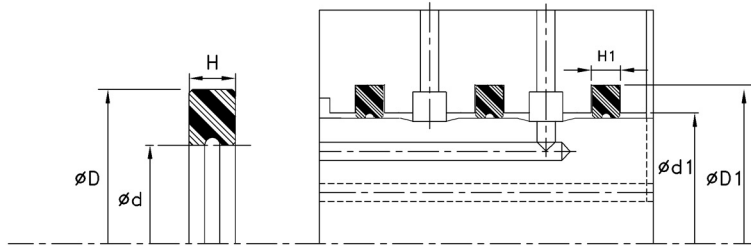

Temperature: -31/212F [-35/100C]

Pressure: 5000 PSI [343 Bar]

Ref.Number	Rod diameter		Nominal Seal Dimensions			Housing Dimensions					\$	
		Tol.	d	D	H	d1	Tol.	D1	Tol.	H1		Tol.
R060070053R19*	60.00	+0.00 / -0.05	60.00	70.00	4.90	60.00	+0.00 / -0.05	70.00	+0.12 / -0.00	5.30	+0.30 / -0.00	0/R
R070080053R19*	70.00	+0.00 / -0.06	70.50	81.00	4.90	70.00	+0.00 / -0.06	80.00	+0.12 / -0.00	5.30	+0.30 / -0.00	27.23
R075085053R19*	75.00	+0.00 / -0.06	75.30	85.80	4.90	75.00	+0.00 / -0.06	85.00	+0.14 / -0.00	5.30	+0.30 / -0.00	28.45
R080091053R19*	80.00	+0.00 / -0.09	80.50	91.00	4.90	80.00	+0.00 / -0.09	90.00	+0.14 / -0.00	5.30	+0.30 / -0.00	28.06
R085096053R19*	85.00	+0.00 / -0.09	85.50	96.00	4.90	85.00	+0.00 / -0.09	95.00	+0.14 / -0.00	5.30	+0.30 / -0.00	30.97
R090101053R19	90.00	+0.00 / -0.09	90.50	101.00	4.90	90.00	+0.00 / -0.09	100.00	+0.14 / -0.00	5.30	+0.30 / -0.00	33.00
R095106053R19*	95.00	+0.00 / -0.09	95.50	106.00	4.90	95.00	+0.00 / -0.09	105.00	+0.14 / -0.00	5.30	+0.30 / -0.00	33.34
R100111053R19	100.00	+0.00 / -0.09	100.50	111.00	4.90	100.00	+0.00 / -0.09	110.00	+0.14 / -0.00	5.30	+0.30 / -0.00	39.81
R105116053R19*	105.00	+0.00 / -0.13	105.50	116.00	4.90	105.00	+0.00 / -0.13	115.00	+0.14 / -0.00	5.30	+0.30 / -0.00	34.51
R110121053R19*	110.00	+0.00 / -0.13	110.50	121.00	4.90	110.00	+0.00 / -0.13	120.00	+0.14 / -0.00	5.30	+0.30 / -0.00	34.17
R115126053R19*	115.00	+0.00 / -0.13	115.50	126.00	4.90	115.00	+0.00 / -0.13	125.00	+0.16 / -0.00	5.30	+0.30 / -0.00	34.46
R120131053R19	120.00	+0.00 / -0.13	120.50	131.00	4.90	120.00	+0.00 / -0.13	130.00	+0.16 / -0.00	5.30	+0.30 / -0.00	34.77
R125136053R19	125.00	+0.00 / -0.13	125.50	136.00	4.90	125.00	+0.00 / -0.13	135.00	+0.16 / -0.00	5.30	+0.30 / -0.00	43.68
R130141053R19*	130.00	+0.00 / -0.13	131.10	141.60	4.90	130.00	+0.00 / -0.13	140.00	+0.16 / -0.00	5.30	+0.30 / -0.00	45.28
R135146053R19*	135.00	+0.00 / -0.13	136.10	146.60	4.90	135.00	+0.00 / -0.13	145.00	+0.16 / -0.00	5.30	+0.30 / -0.00	47.05
R140151053R19*	140.00	+0.00 / -0.13	141.10	151.60	4.90	140.00	+0.00 / -0.13	150.00	+0.16 / -0.00	5.30	+0.30 / -0.00	50.32
R145156053R19*	145.00	+0.00 / -0.13	146.10	156.60	4.90	145.00	+0.00 / -0.13	155.00	+0.16 / -0.00	5.30	+0.30 / -0.00	51.75
R150161053R19*	150.00	+0.00 / -0.13	151.10	161.60	4.90	150.00	+0.00 / -0.13	160.00	+0.16 / -0.00	5.30	+0.30 / -0.00	53.69
R155166053R19*	155.00	+0.00 / -0.13	156.10	166.60	4.90	155.00	+0.00 / -0.13	165.00	+0.16 / -0.00	5.30	+0.30 / -0.00	55.07
R160171053R19*	160.00	+0.00 / -0.13	161.10	171.60	4.90	160.00	+0.00 / -0.13	170.00	+0.16 / -0.00	5.30	+0.30 / -0.00	56.96

*: GENERALLY NOT STOCKED BUT AVAILABLE - CHECK WITH C/SER

R20 - Rod Seals

Polyurethane AU 92A

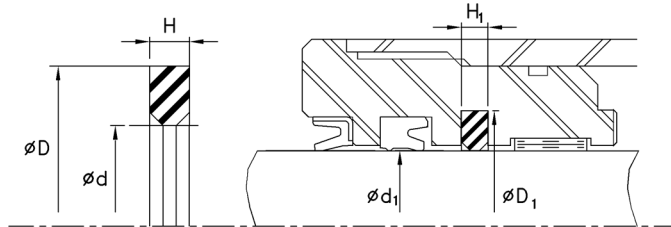
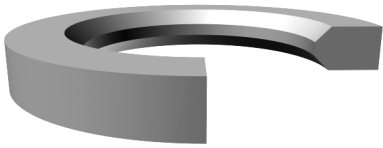

Temperature: -40/250F [-40/121C]

Pressure: 5000 PSI [343 Bar]

Ref.Number	Rod diameter	Nominal Seal Dimensions			Housing Dimensions					\$	
	Tol.	d	D	H	d1	Tol.	D1	Tol.	H1		Tol.
R025033023R20*	25.00	25.00	33.60	2.30							14.72
R030041029R20*	30.00	30.00	41.00	2.90							15.80
R035046029R20*	35.00	35.00	46.00	2.90							14.30
R035048030R20*	35.00	35.00	48.00	3.00							14.86
R040048030R20	40.00	40.00	48.00	3.00							14.43
R050058029R20	50.00	50.00	58.00	2.90							14.80
R050062030R20*	50.00	50.00	62.00	3.00							15.75
R050063040R20*	50.00	50.00	62.60	4.00							15.78
R056068040R20*	56.00	56.00	68.60	4.00							20.12
R056070030R20	56.00	56.00	70.00	3.00							18.89
R056073048R20	56.00	56.00	73.00	4.80							20.77
R063080047R20	63.00	63.00	80.00	4.70							22.32
R065078040R20*	65.00	65.00	78.00	4.00							21.69
R070083040R20*	70.00	70.00	83.00	4.00							23.04
R070084030R20*	70.00	70.00	84.00	3.00							19.45
R075088040R20*	75.00	75.00	88.00	4.00							20.71
R080093040R20*	80.00	80.00	93.00	4.00							22.53
R090104040R20*	90.00	90.00	104.00	4.00							22.60
R100113040R20*	100.00	100.00	113.00	4.00							24.86

METRIC SIZE
ROD SEALS

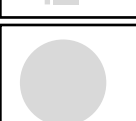

*: GENERALLY NOT STOCKED BUT AVAILABLE - CHECK WITH C/SER

Tel.: 1-888-609-SEAL
Fax: 1-888-717-SEAL

J

51

www.sealsourceinc.com

Seal Source Inc.

METRIC SIZE
ROD SEALS

