

100V N-Channel Enhancement Mode MOSFET

Description

The NP2N10VR uses advanced trench technology to provide excellent $R_{DS(ON)}$, low gate charge and high density cell Design for ultra low on-resistance. This device is suitable for use as a load switch or in PWM applications.

General Features

- ◆ $V_{DS} = 100V$, $I_D = 2A$
 $R_{DS(ON)}(Typ.) = 200m\Omega$ @ $V_{GS} = 10V$
 $R_{DS(ON)}(Typ.) = 220m\Omega$ @ $V_{GS} = 4.5V$
- ◆ High power and current handling capability
- ◆ Lead free product is acquired
- ◆ Surface mount package

Application

- ◆ PWM applications
- ◆ Load switch

Package

- ◆ SOT23



Schematic diagram

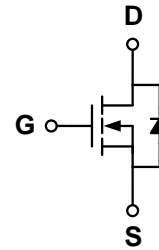

Marking and pin assignment

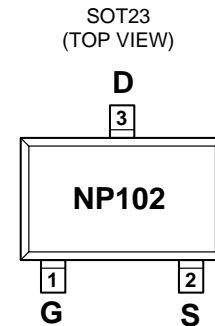

Ordering Information

Part Number	Storage Temperature	Package	Devices Per Reel
NP2N10VR-G	-55°C to +150°C	SOT-23-3L	3000

Absolute Maximum Ratings (TA=25°C unless otherwise noted)

parameter	symbol	limit	unit	
Drain-source voltage	V_{DS}	100	V	
Gate-source voltage	V_{GS}	±20	V	
Continuous Drain Current (TJ = 150 °C)	I_D	$T_C = 25^\circ C$	2	A
		$T_C = 70^\circ C$	1.7	
		$T_A = 25^\circ C$	1.6 ^{b,c}	
		$T_A = 70^\circ C$	1.3 ^{b,c}	
Continuous Source-Drain Diode Current	I_S	$T_C = 25^\circ C$	2.1	
		$T_A = 25^\circ C$	1 ^{b,c}	
Pulsed Drain Current (t = 300 μs)	I_{DM}	5		

Maximum power dissipation	$T_C=25^{\circ}\text{C}$	P_D	2.5	W
	$T_C=70^{\circ}\text{C}$		1.6	
	$T_A=25^{\circ}\text{C}$		1.25 ^{b,c}	
	$T_A=70^{\circ}\text{C}$		0.8 ^{b,c}	
Operating Junction and Storage Temperature Range		T_J, T_{STG}	-55—150	$^{\circ}\text{C}$

Thermal Characteristics

Parameter		Symbol	Typical	Maximum	Unit
Maximum Junction-to-Ambient ^{b, d}	$t \leq 5 \text{ s}$	$R_{\theta JA}$	100	130	$^{\circ}\text{C/W}$
Maximum Junction-to-Foot (Drain)	Steady State	$R_{\theta JF}$	60	75	

Notes:

a: $T_C = 25^{\circ}\text{C}$. b: Surface mounted on 1" x 1" FR4 board.

c: $t = 5 \text{ s}$. d: Maximum under steady state conditions is 175°C/W .

Electrical Characteristics ($T_A=25^{\circ}\text{C}$ unless otherwise noted)

Parameter	Symbol	Condition	Min	Typ	Max	Unit
OFF Characteristics						
Drain-source breakdown voltage	BV_{DSS}	$V_{GS}=0\text{V}, I_D=250\mu\text{A}$	100	-	-	V
Zero gate voltage drain current	I_{DSS}	$V_{DS}=100\text{V}, V_{GS}=0\text{V}$	-	-	1	μA
Gate-body leakage	I_{GSS}	$V_{DS}=0\text{V}, V_{GS}=\pm 20\text{V}$	-	-	± 100	nA
ON Characteristics						
Gate threshold voltage	$V_{GS(th)}$	$V_{DS}=V_{GS}, I_D=250\mu\text{A}$	1.2	1.9	2.5	V
Drain-source on-state resistance	$R_{DS(ON)}$	$V_{GS}=10\text{V}, I_D=2\text{A}$	-	200	220	m Ω
		$V_{GS}=4.5\text{V}, I_D=2\text{A}$	-	220	260	
Forward transconductance	g_{fs}	$V_{DS}=5\text{V}, I_D=1\text{A}$	1	-	-	S
Dynamic Characteristics						
Input capacitance	C_{ISS}	$V_{DS}=50\text{V}, V_{GS}=0\text{V}$ $f=1.0\text{MHz}$	-	423	-	pF
Output capacitance	C_{OSS}		-	17	-	
Reverse transfer capacitance	C_{RSS}		-	14	-	
Switching Characteristics						
Turn-on delay time	$t_{D(ON)}$	$V_{DD}=50\text{V}$ $R_L=39 \text{ ohm}$ $V_{GS}=10\text{V}$ $R_G=1 \text{ ohm}$	-	6	-	ns
Rise time	t_r		-	10	-	
Turn-off delay time	$t_{D(OFF)}$		-	10	-	
Fall time	t_f		-	6	-	
Total gate charge	Q_g	$V_{DS}=50\text{V}$ $I_D=2\text{A}$ $V_{GS}=10\text{V}$	-	6.73	-	nC
Gate-source charge	Q_{gs}		-	2.06	-	
Gate-drain charge	Q_{gd}		-	2.69	-	
DRAIN-SOURCE DIODE CHARACTERISTICS						
Diode forward voltage	V_{SD}	$V_{GS}=0\text{V}, I_S=2\text{A}$	-	0.76	1.16	V

Typical Performance Characteristics

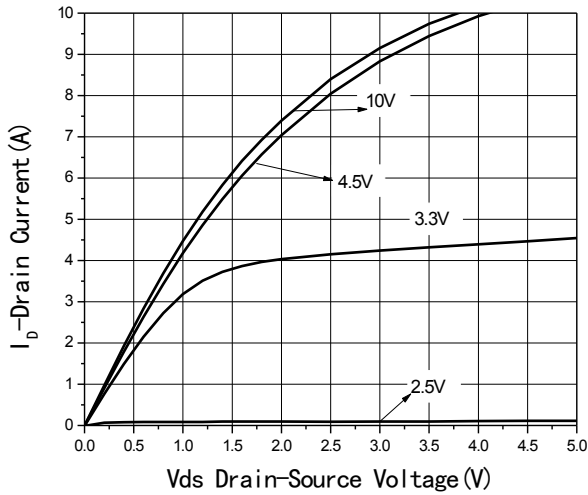

Fig1 Output Characteristics

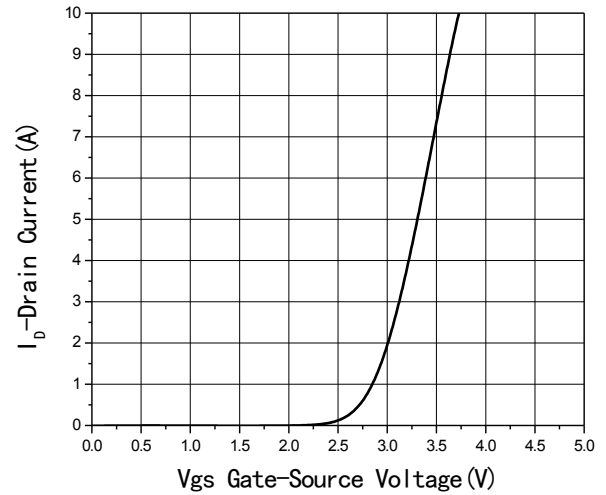

Fig2 Transfer Characteristics

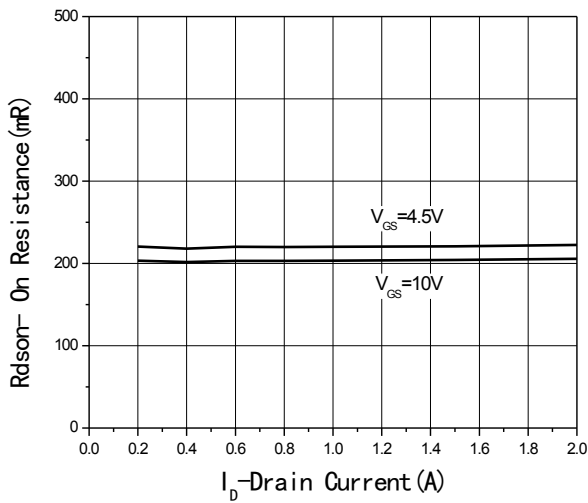

Fig3 $R_{DS(on)}$ -Drain current

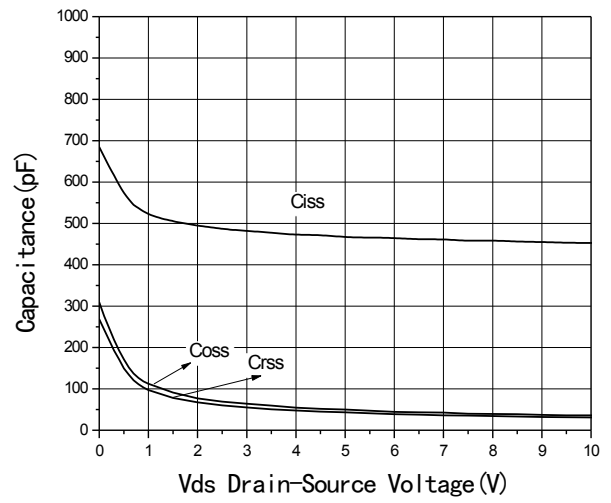

Fig4 Capacitance vs V_{DS}

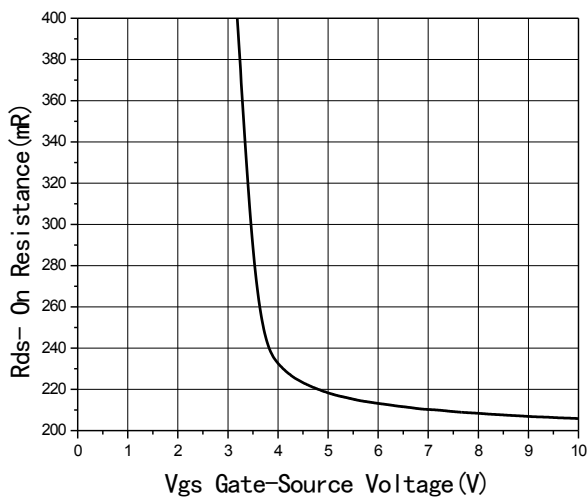

Fig5 $R_{DS(on)}$ -Gate Drain voltage

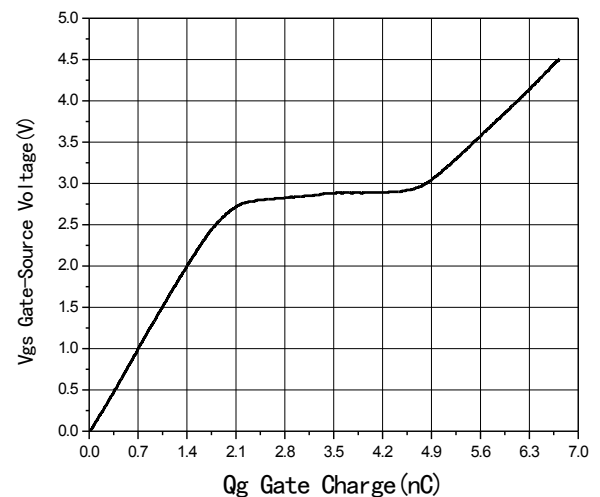

Fig6 Gate Charge

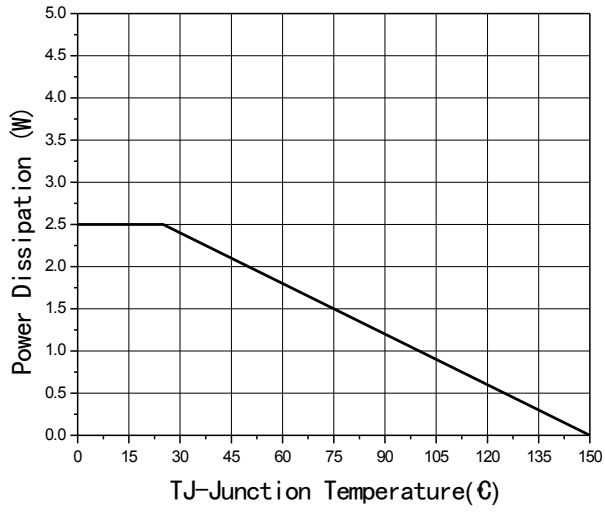

Fig7 Power De-rating

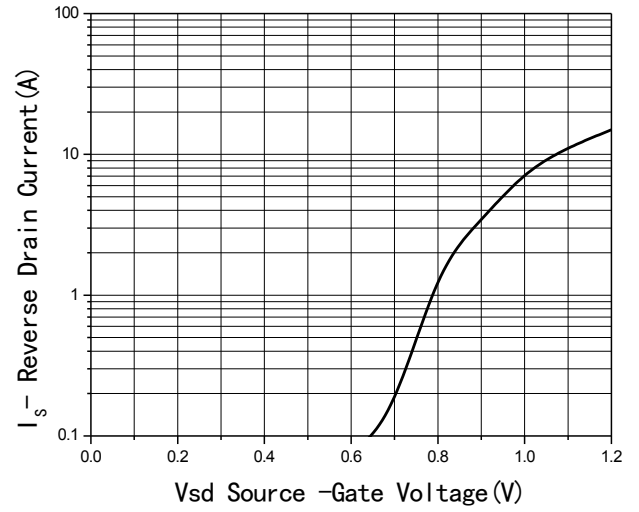
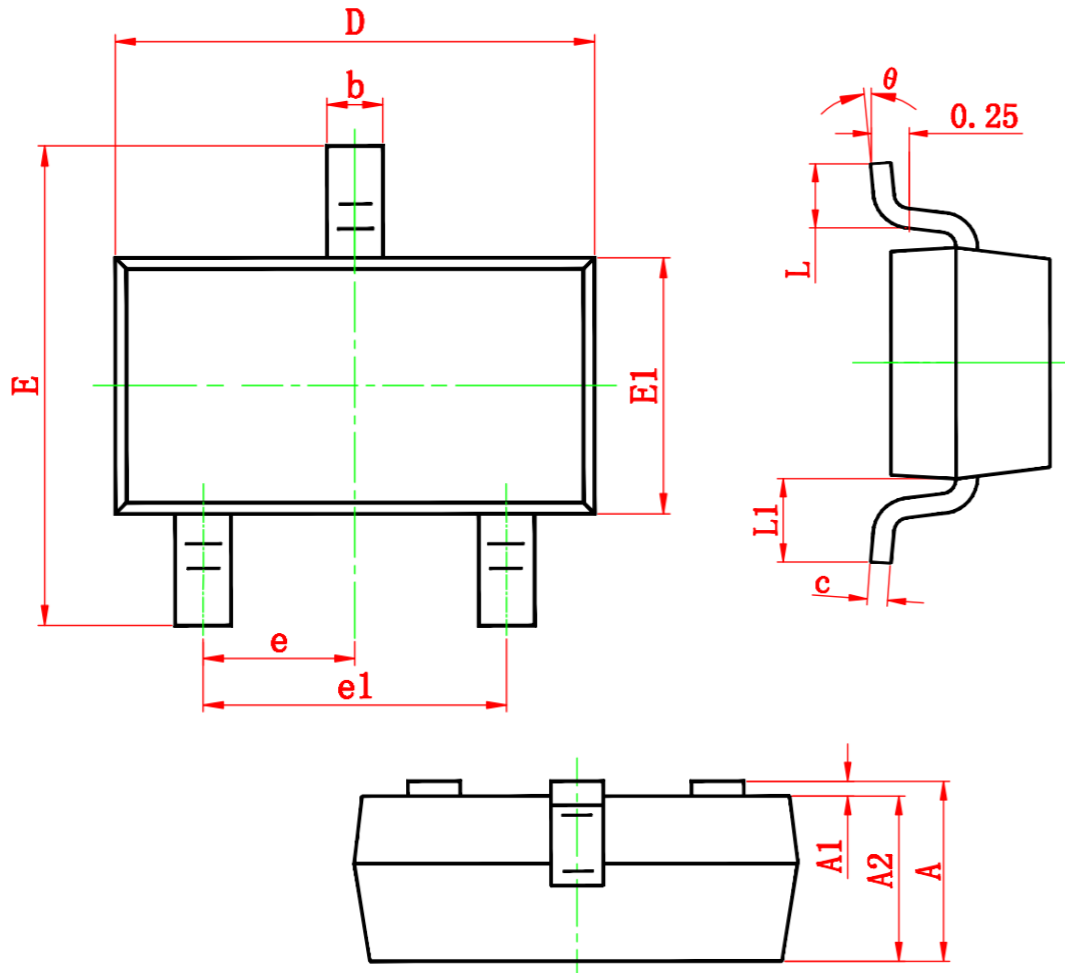

Fig8 Source-Drain Diode Forward

Package Information

- SOT-23



Symbol	Dimensions In Millimeters		Dimensions In Inches	
	Min.	Max.	Min.	Max.
A	0.900	1.150	0.035	0.045
A1	0.000	0.100	0.000	0.004
A2	0.900	1.050	0.035	0.041
b	0.300	0.500	0.012	0.020
c	0.080	0.150	0.003	0.006
D	2.800	3.000	0.110	0.118
E	2.250	2.550	0.089	0.100
E1	1.200	1.400	0.047	0.055
e	0.950 TYP.		0.037 TYP.	
e1	1.800	2.000	0.071	0.079
L	0.300	0.500	0.012	0.020
L1	0.550 REF.		0.022 REF.	
θ	0°	8°	0°	8°