

HOWE

RACING ENTERPRISES



ORIGINAL RACING PRODUCTS

26TH EDITION CATALOG

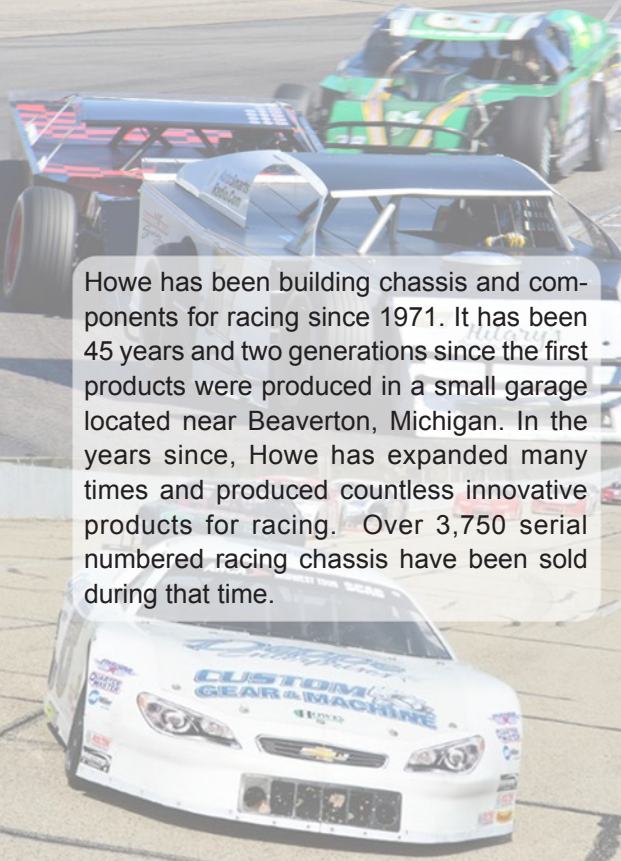

Howe has been building chassis and components for racing since 1971. It has been 45 years and two generations since the first products were produced in a small garage located near Beaverton, Michigan. In the years since, Howe has expanded many times and produced countless innovative products for racing. Over 3,750 serial numbered racing chassis have been sold during that time.

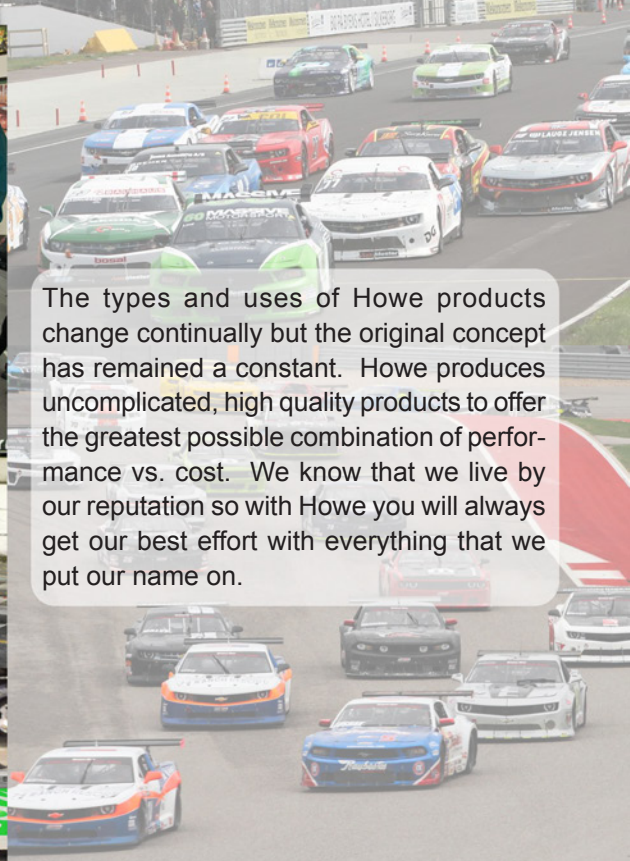

The types and uses of Howe products change continually but the original concept has remained a constant. Howe produces uncomplicated, high quality products to offer the greatest possible combination of performance vs. cost. We know that we live by our reputation so with Howe you will always get our best effort with everything that we put our name on.

TERMS AND POLICIES

PAYMENT

All prices are F.O.B. our plant. Unless otherwise approved Orders must be prepaid or C.O.D. with Certified check or Visa / Mastercard. Prices are subject to change without notice. Customers checks returned N.S.F. will be charged \$25.00. Drop ships require a \$4.00 drop ship fee.

ORDERING

All orders should include quantity and part number. All orders should include the customers name, address, zip code and phone or fax number. When using a credit card; provide card number, expiration, cvv code, and cc billing address.

EXPORT AND EXPRESS ORDERS

To offset preparation expenses a \$4.00 export charge is added to shipments outside of the US. \$5.00 is added to orders sent Fed Ex Express, U.P.S. red, blue and 3 day service.

RETURN POLICY

1. A return authorization number is required on all returns. The number can be obtained by calling prior to shipping the product.
2. A copy of the invoice must accompany the part(s) when being returned.
3. A minimum 10% restocking fee will be deducted from the credit given for the part(s). Higher restocking fees will be determined per the condition of the part(s). Exceptions to this rule will be: a)Parts sent in error, b)Parts defective, c) Exchange parts.
4. There will be no credit given for items purchased more than one year prior to the date of return, or special order items. Freight on all returns must be prepaid.

QUALITY POLICY

Howe Racing Enterprises, Inc. will repair or replace any Howe products found upon our inspection to be defective in material or workmanship beyond normal wear within one year from the date of purchase for the original purchaser. Neither the seller nor Howe Racing Ent., Inc. will be responsible for any loss, damage or injury from any cause including defects of Howe Racing Ent., Inc. products. Under no circumstance shall H.R.E. be responsible for incidental or consequential damages with respect to economic loss or injury to persons or property, whether as a result of breach of expressed or implied warranty, negligence, or otherwise. Howe Racing Ent., Inc. products are not approved or intended for street use. Purchase and/or use of Howe Racing Ent., Inc. products implies recognition and acceptance of this entire warranty and disclaimer by consumer.

DEPOSITS

Frame assembly orders require a 20% minimum deposit. More complete cars require a 50% minimum deposit. These deposits are refundable only in merchandise. Unique or special order chassis may require larger deposits or complete prepayment.

PARTS PICK UP

We encourage all customers to buy from our dealers rather than direct, as the prices and technical support are the same. All orders picked up at our plant should be called in prior to pickup by dealers or racers. Our hours are 8:00 AM to 5:00 PM, Monday through Friday. **Most orders are shipped the same day if ordered by 3:00 P.M. E.S.T.; red and blue label by 3:30. Common freight (truck) orders ship within 3 working days.**

CHASSIS REPAIR

Chassis may be repaired or modified at our facility by appointment on a first call first serve basis. No frame repair work will be scheduled to start on a Friday though it may be finished from the previous day. From November through March chassis repairs are scheduled for the last five working days of each month. Prior to bringing a chassis or frame for work the following steps should be taken to avoid additional labor.

1. Remove the fuel cell and drain the fuel lines
2. Remove all grease, oil, rubber and body work from repair area.
3. Remove engine, suspension and ballast below the frame.

NEW CATALOG ORGANIZATION:

You will notice these three different colored car silhouettes throughout this catalog. To save you time, each silhouette identifies the type of car that certain products will fit; Late Model, Modified or Road Race. Products that do not have any silhouette are for non specific applications or for other types of racing.



LATE MODEL



MODIFIED



ROAD RACE

HOWE CHASSIS

The current line of Howe chassis fall into one of three asphalt racing groups. Late Models or Modifieds for oval racing in North America and Road Racing Chassis for competing on road circuits worldwide.



LATE MODEL

Late model chassis go back to the founding of our company, we take great pride in our current design carrying on the winning tradition. Our offset Late model chassis can be configured to meet the specification for many different tracks and regions in North America. The chassis are intended for use with Template bodies using either Crate or Built V8 engines. Our current Late Model is an updated and lighter version of the very successful 101 design. The 101 is built to take advantage of our most current suspension. The Howe Late model chassis has become the preferred choice for selective Late Model customers.

- 10702N Frame & Cage - "101"
- 35301 Mid Section - Offset
- 36609 101 / SS Template Tail - 9" Shock
- 366097 101 / SS Template Tail - 7" Shock
- 35394 Mid Section - Perimeter
- 36606P ES Template Tail - Underslung
- 36602 Overaxle Perimeter Tail



MODIFIED

Howe Modified chassis have a proven record of success across the USA. These chassis have been built using either the 68-72 Chevelle or the "Big Metric" Impala. Due to scarcity of these frames Howe has new policies regarding modified chassis. Customers ordering a modified chassis with a factory frame must provide a core frame. Due to quality issues Howe will also no longer build chassis with offshore reproduction frames. Howe modified chassis with fabricated frames can be ordered without delay and at lower prices. At the time of print, several tracks in the country allow the Howe fabricated frame as an alternative. We are expecting that number to increase.

- 10702M* Frame & Cage - Impala Mod
- 10702CM* Frame & Cage - Chevelle Mod
- 35397 Mid Section - Asphalt Mod
- 358AMOD* Impala Mod Front Frame
- 358CMOD* Chevelle Mod Front Frame
- 35809 Fabricated Impala Frame
- 358091 Fab Impala, No Upper Mounts
- 35810 Fabricated Chevelle Frame
- 358101 Fab Chevelle, No Upper Mounts
- 36610 Asphalt Mod Tail



IMPALA MODIFIED CHASSIS

*Requires a core frame for factory front frame.



ROAD RACE

Howe introduced a new class of road race cars in 2010 with the Scandinavian based Camaro Cup. In the time since, nearly 200 of these chassis have been produced between North America, Europe, Central America and Australia. Howe has benefited from the input of marquee drivers including Pete Halsmer, Cameron Lawrence, Adam Andretti, Tommy Archer, Nic Jonsson, Tommy Kendall, Wally Dallenbach and Jan Magnussen. The most prominent growth in the USA has been in TA2 and GT2 classes. All but three TA2 races and every championship has been won in a Howe built car. See website for current brochure and detailed options.

- 10702R Frame & Cage - Road Race
- 35303 Mid Section - Euro
- 35304 Mid Section - USA / TA2
- 366CCR Tail Section Road Race



TA2 / GT2 CHASSIS

For more specific technical and pricing details on any of our chassis please contact us to request a chassis brochure or a price quotation on a chassis built to your exact needs.

FRONT LOOP KITS

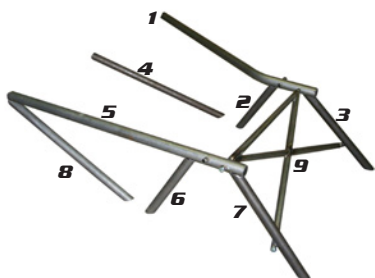

A Howe front loop kit can be used to tie together your own frame project or for repair. Kits are pre-notched and contain the same basic materials; a main structure with diagonal bracing of 1-3/4" x .065 D.O.M. tubing, additional loop supports out of 1-1/2" x .083 and 1" x .083, shock mounts, a bolt in over engine bar and engine bay braces. For proper fit please specify the front frame and mid section that you are using when you order. dimensions vary by application.

35293

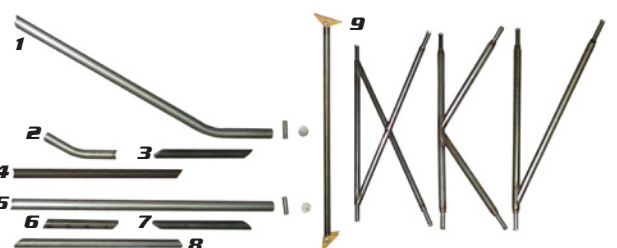

FRONT FRAME SECTIONS

101 FRONT FRAME 2011-CURRENT

The 101 is designed to race skimming off the track with the latest set-up technology. With standard components the width at hub face is 64" with wide 5 and 5x5 hubs. Requires a specific rack and pinion. Made to be adaptable to all current set-up trends. Accepts 101 suspension packages.

- 358131-2** 1" Offset, 2" Set Back - Ford Crate, Ford & Chevy Dry Sump
358131-4 1" Offset, 4" Set Back - Chevy Crate Engine

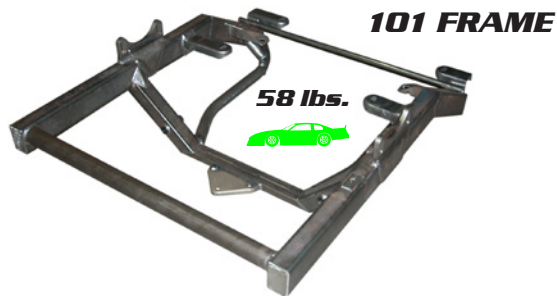

SS & ES FAMILY OF FRAMES

The SS design frame was developed specifically for "soft spring" set ups without bump stops.

SS - ORIGINAL & CROSS SHAFT

The popular "SS" design remains available in two popular configurations. The "Original" style feature slotted double shear mounts for adjustable upper a-frames. The "Cross Shaft" style features tower type mounts that use keys and spacers to adjust caster & camber. Tread width at hub face is 64" with wide 5 and 63" with 5x5 with standard components.

- 357SS125** 1" Offset, 2" Set Back - 11" Crank, Adj Inner Pivots - Original
358SS1-2 1" Offset, 2" Set Back - 11" Crank - Cross Shaft

ES EQUAL LENGTH LOWERS

Originally made for ACT rules that require equal length lowers but has since been used in many other applications as well. A "strut" style front end with coilover springs and rack & pinion steering. The main frame rails are made with 2" x 3" x .083 wall tubing.

- 358ES1-0** 1" Offset, 0" Setback - Cross Shaft



OPTIONS FOR SS AND ES:

- OP-07** Fixed Sway Bar Mount Tube - fixed mounted tube for sway bar.
OP-08 Conventional Coil - Mounts for 5" conventional coil springs are added.
OP-31 Wide Radiator - Front rails are dog legged from 29" to 31-1/2" for racing in the South West.

LLM - LIMITED LATE MODEL

The LLM front frame is made to directly replace the stock F-car front frame that we are no longer able to locate. Made with tough 2" x 4" tubing main rails to retain the durability of a stock frame. Accepts stock lowers & steering, conventional springs and a 3rd design sway bar. Engine mounts are slotted for 0" to 1" of set back. Inspection tags are welded to the top of the rails (shown in red).

- 358-8-01** LLM Frame
358-8R-01 LLM Frame w/ Rack Plate.
358-8-03 LLM Frame, 2x3 Rails
358-8R-03 LLM Frame, 2x3 w/ Rack Plate



FABRICATED IMPALA & CHEVELLE

The Howe fabricated replacement frames are made to replace the popular 77-85 Impala / Caprice GM OEM frame along with the 68-72 Chevelle that have become standards for the modified classes.

A fabricated frame eliminates the shortage and saves time and cost without making existing bolt on parts obsolete.

Cost - The fabricated frame sells for less than a reworked OEM frame, if you can find one. A surviving stock frame that is not crashed or rusted out must be sandblasted, stripped, straightened and modified to be ready to install. The fabricated frame installs faster lowering the labor cost of both new cars and repairs.

Compatibility - Fits existing components including lower a-frames, spindles, steering and springs. Frame rails are made long enough to fit existing nerf bars.

Weight - Integral ballast mounts equalize any weight advantage during a transition from factory to fabricated frames. The new Howe frames are 86 lbs. compared the factory frames, which are 145 lbs. for the Impala and 120 lbs. for the Chevelle. Weight may be added to each side to make the frames equal.

Tech - To identify the frame a CNC cut part number tag is welded on each frame. In addition a trademarked Howe "H" logo is stamped into each side of the frame rail. Howe will also supply tracks a tech inspectors drawing to allow critical dimensions to be checked.

FABRICATED IMPALA FRAME

- 35809** Fab Impala Front Frame
358091 Fab Impala Front Frame, No Upper A-frame Mounts

FABRICATED CHEVELLE FRAME

- 35810** Fab Chevelle Front Frame
358101 Fab Chevelle Front Frame, No Upper A-frame Mounts

ADJUSTABLE CROSS MEMBER KIT

Install in place of standard fixed mounts to allow adjustment of the lower control arm mounting height. Purchasable as an update kit or pre-installed on chassis or front frames.



RT ROAD RACE

Our road racing front frames are made with more robust suspension mounts to better handle the harsh curbs and stiffer suspensions. The different versions of this frame are made for various engines and specific application. The upper a-frame mounts allow for roll center and anti dive adjustment using Howe offset keys (see page 6). Sway bar mount accepts standard splined bars or Howe square end bars (see page 18).

- 35803** 17" Wheels / European
35804 15" Wheels / TA2 - 2014 & Earlier
35805 Chevy / Dodge - 15" Wheels / TA2 - 2015 & Newer
35806 Ford - 15" Wheels / TA2 - 2015 & Newer

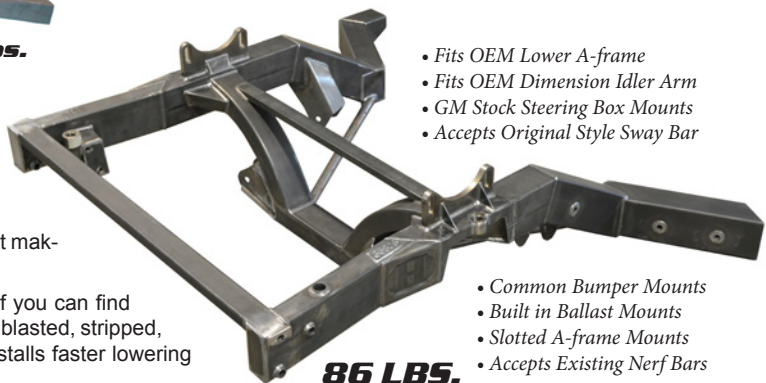

BUMPERS

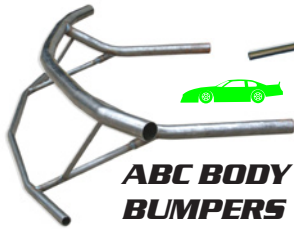

ABC BODY BUMPERS

Bumper kits sent FedEx are in pre-fitted sub sections and should be assembled on the car. The main bumper pipes are made with 1-3/4" in the front and 1-1/2" in the rear. They allow easy replacement.

Note: Bumper kits shipped FedEx are sent with the bumper tube not welded to the side supports.



ROAD RACE BUMPERS

Note: Road Race bumpers come in two configurations, Euro (Narrow) and US (Wide), to match the body styles.

Body Style	Assembly	Bumper Tube	Main Support	Lower Support	Side Support	Upper Support
ABC - Front	82120MABC	82437MABC	N/A	82101MABC	82204	82103
ABC - Rear	82220MABC	82438T	82205	82205	----	----

Body Style	Front (Euro)	Front (US)	Rear (Euro)	Rear (US)
Gen 5 Camaro	82120CAM	82120CTA2	82220CAM	82220CAM
Gen 5 Mustang	82120MN	82120M	82220M	82220M
Gen 5 Challenger	82120D	82120D	82220D	82220D
Gen 6 Camaro	82120101	82120201	82220101	82220201
Gen 6 Mustang	82120102	82120202	82220102	82220202

BOLT ON RIGHT SIDE DOOR BARS

All of our offset chassis are built with provisions for a bolt on right side door bar. Cars with welded on door bars can change to a bolt on bar by welding on the mounting tabs.

- 9198 SS Template 01-10 (A)
- 9198-101 2011+ SS / 101 Template Chassis (Not Pictured)
- 9199 SS Template Kit 01-10 (Non-welded for Shipping)
- 9199-101 SS / 101 Template Kit 11+ (Non-welded for Shipping)
- 9198P Perimeter (Not Pictured)

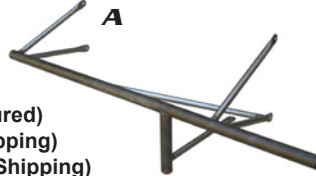

DOOR BARS & RUB RAILS

FUEL CELL CAGES

A variety of cell mounts to meet your rules and requirements. Made from 2" strap with 1" tubing mounts. Made to fit a variety of cell sizes and with or without protective plates.



ASPHALT MOD BUMPERS & NERF BARS

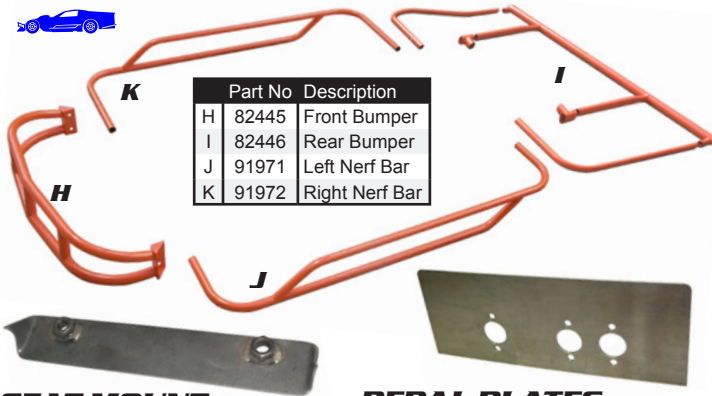

Part No	Description
H 82445	Front Bumper
I 82446	Rear Bumper
J 91971	Left Nerf Bar
K 91972	Right Nerf Bar

CHASSIS BRACKETS AND MOUNTS

SEAT MOUNT

Used in all Howe chassis. Welds to the underside of the back cross bar to mount the back of your seat to.

330690 Rear Seat Mount

PEDAL PLATES

Sheared 1/8" thick Hot roll and punched to fit standard floor pedals.

- 913 Offset Pedal Plate
- 913P Perimeter Plate
- 913FLM FL Chassis

BODY MOUNT

Small 3/4" I.D. mount with a notch in the bottom to weld to round tubing. Drilled & tapped to fit a 1/4"-20 x 1" allen head cap screw. Great for various braces and supports.

9021 Body Mount



BATTERY BOXES

Light weight battery box fits standard size batteries. Includes hold down assembly.

UB603011 Light Battery Box

Popular 12-1/4" x 12" battery box fits Optima and most other standard size batteries. Includes hold down assembly.

9116 Battery Box

Small battery box for where space is a premium and no extra weight is needed. Light weight and able to mount in a variety of places. Tray is 6-1/2" wide by 10" long.

9119 Battery Box, Small



RACK & PINION FRAME MOUNT

1/8" thick pressed HR steel mount welds to the front of the crossmember. Has more clearance for the pinion housing & ribs to eliminate need for a gusset.

R2109 Rack Plate

SHOCK MOUNTS

Part No.	Description
A CO920	Bolt on for 92-94 (1-3/4")
B CO391	Flat Back
C CO3902	Coilover Mnt. 2" w/ hardware
C CO3903	Coilover Mnt. 3" w/ hardware
C CO3904	Coilover Mnt. 4" w/ hardware



WEIGHT TRAY

The 1/2" holes are 5" apart and fit 11" long bars. Weld to the side of the frame rail flush with the bottom.

91935

CHASSIS TABS

1/8" thick weld on tabs with a 1/2" hole. Used for: Ballast, Fuel Cell Mounts, Seat Belt Anchors, Bolt On Door Bars, and Hood Pin Mounts.

- 9193 Folded
- 91930 Flat



CELL MOUNT

We use this 1/8" thick mount for the fuel cell to allow 3" of ground height adjustment.

91938 Package of 4



SADDLE GUSSET

Saddle gussets are used in critical strength areas of the roll cage and chassis. .060" thick. Fits 1-1/2" or 1-3/4" tubing.

AA315A Saddle Gusset



IGNITION PLATE MOUNT

Made for mounting the ignition in the chassis. Provides a compact and clean look for your ignition system.

UB55-9005 Pair



SHOCK SPACERS

- CO327 3/4" O.D. x 1/2" I.D.
- CO328 3/4" O.D. x 1/2"-13 thread



T-ARM MOUNTS

Part No	Description
E 31893	Mod, RS
F 31895	Mod, LS
G 94000	Road Race



CONSTRUCTION MATERIAL

TUBING



Part No	Description	Thickness
12165	1/2" Round	16ga. - .065
12160	1/2" Square	16ga. - .065
34120	3/4" Round	12ga. - .109
34180	3/4" Round	18ga. - .049
34160	3/4" Square	16ga. - .065
11200	1" Round	12ga. - .109
11400	1" Round	14ga. - .083
11800	1" Round	18ga. - .049
11600	1" Square	16ga. - .065
12110	1" x 2"	11ga. - .120
12140	1" x 2"	14ga. - .083
112065	1-1/2" Round Alum	16ga. - .065
11211	1-1/2" Round	11ga. - .120
12083	1-1/2" Round DOM	14ga. - .083
134316	1-3/4" Round	3/16"
13495	1-3/4" Round DOM	13ga. - .095
134083	1-3/4" Round Alum	14ga. - .083
13483	1-3/4" Round DOM	14ga. - .083
13416	1-3/4" Round Moly	16ga. - .065
13465	1-3/4" Round	16ga. - .065
2211	2" Square	11ga. - .120
221400	2" Square	14ga. - .083
2114	2" x 1"	14ga. - .083
23120	2" x 3"	11ga. - .120
23083	2" x 3"	14ga. - .083
2411	2" x 4"	11ga. - .120
21214	2-1/2" Square	14ga. - .083
30650	3" Round Alum	16ga. - .065
34011	3" x 4"	11ga. - .120
34014	3" x 4"	14ga. - .083

ALUMINUM SHEET

Part No	Thick	W x L	Color
06020	.060	2' x 4'	Aluminum
11181	1/8"	1' x 4'	Aluminum
11182	1/8"	2' x 4'	Aluminum
30001	.032	4' x 10'	White
30000	.040	4' x 10'	White
30000BK	.040	4' x 10'	Black*
30001MB	.040	4' x 10'	Matte Black*
30001M	.040	4' x 10'	Mill*
30001DG	.040	4' x 10'	Dark Grey*
30001BL	.040	4' x 10'	Chevron Blue*
30001PB	.040	4' x 10'	Pepsi Blue*
30001HB	.040	4' x 10'	Huron Blue*
30001R	.040	4' x 10'	Red*
30001O	.040	4' x 10'	Orange*
30001Y	.040	4' x 10'	Yellow*
30001G	.040	4' x 10'	Kelly Green*

* Colored Aluminum 1 Side Only

DUCT TAPE



Color	Part No
Black	8820B
Blue	8820BL
Green	8820G
Orange	8820O
Red	8820R
Silver	8820S
White	8820W
Yellow	8820Y

WELD ON CAPS

1/8" thick weld on caps are handy for welding on the end of pipes.

C134 1-3/4"
C112 1-1/2"

CHASSIS GUSSET

Common weld in chassis gusset stamped from .090 hot roll steel.
25000 Each

SCREEN

Stainless steel screen is tough stuff sold in 1' x 4' pieces.

64003 1/8" Square

ADEL CLIPS

Great for lines, wires and hoses.



Part No	Size
32601	1/4"
32602	3/8"
32603	1/2"
32604	5/8"
32605	3/4"
32606	1"

RIVETS

Aluminum rivets with a steel nail so they draw tight. Sold per box of 250.

Color	Small Head	Large Head
Plain	66264	66266
Black	66264BK	66266BK
Pepsi Blue	66264BL	66266BL
Chevron Blue	66264BLC	66266BLC
Red	66264RD	66266RD
White	66264WT	66266WT
Yellow	66264YL	66266YL
Orange	66264OR	66266OR



Part No.	Description
66065	Small Head Sealed End
66063	Small Head Double Grip
66067	Double Head Alum/Alum
6644BSLF	1/8"x1/4" Alum/Stl Lrg Head
66ADSBS	7/8" "Xploding" Alum Rivet

RIVET WASHERS

66010 Box of 500

CLECOS & PLIERS

A must for body & interior work. Work best if you drill your holes just under 3/16" and then open them up when ready to rivet.

490 Clecos, Ea.
491 Pliers



THREADED WELD

IN SLEEVES

3/4"-16RH threaded I.D. inserts come in several different lengths.

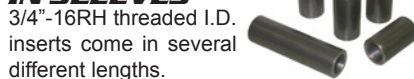

CHASSIS INTERIORS

Interior kits are available in all .040 aluminum or all .024 steel or a combination of both. Kits come pre-cut, bent, bead rolled, and numbered for installation. Notching for bars and drilling for rivets is up to you. Steel pieces are unpainted and aluminum comes white standard. Colored interiors built on request, available in; black, blue, red, yellow, and dark grey (colored one side only). Replacement pieces may be ordered individually by number. Please specify rules when ordering interiors.

LBR098 Labor To Install Alum Interior
LBR099 Labor To Install Steel Interior

Part #	Chassis	Model	Material	Kit Type
B891T	Offset	SS, 101	Alum	Complete
B892T	Offset	SS, 101	Alum	Tub Only
B894	Modified	Asphalt	Alum	Complete
B895	Perimeter	XL-ES	Alum	Complete
B895S	Perimeter	XL-ES	Steel	Complete
B888	Perimeter	Road Race	Alum	Complete

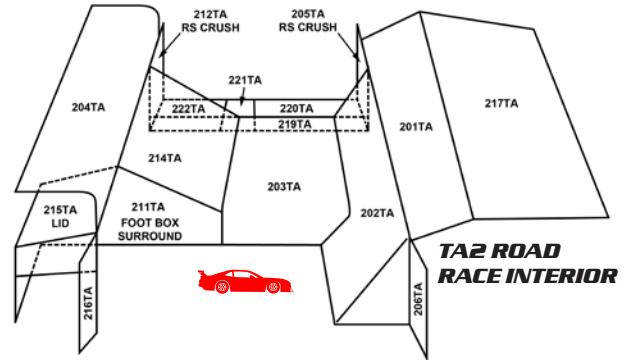
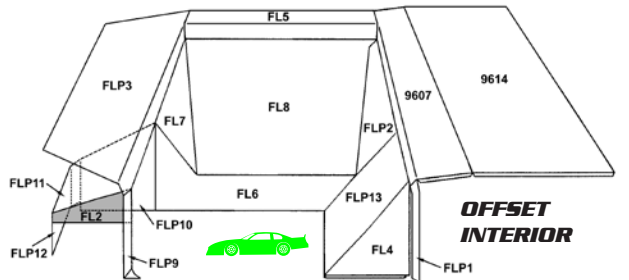
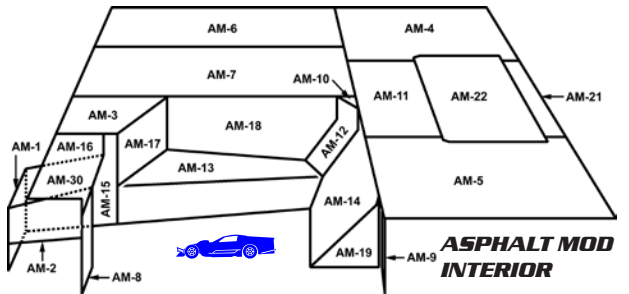

BOLT KITS

Includes all necessary bolts to assemble standard suspension pieces onto each type of Howe chassis listed.

Part No.	Length
307A134	1-3/4"
307A15	1-1/2"
307A2	2"
307A214	2-1/4"
307A212	2-1/2"
307A3	3"
307A35	3-1/2"

Part No	Description
31492	Road Race
31493	2000+ Late Model
31495	SS/ES Chassis
31497	Asphalt Modified





Howe precision max a-frames offer the low drag and low friction of other Howe precision products. Sealed dual row ball bearings allow bind free movement under severe braking conditions or even if the a-frame becomes damaged. Easily removable cross shafts for use with tower mounts, are replaceable, and available in three different styles. Reinforced ball joint mounting ring prevents flex and distortion of the ball joint housing. Available in a variety of lengths, mount with 1/2" bolts.

APPLICATION REFERENCE CHART

This is an easy reference of popular Howe A-frames and the applications they fit.

Application	Part No.
101 Template	2214215 2213807
SS Template	2213815 2213407
ES Perimeter	2214207 2213607
TA2 Perimeter	2213407
Fab Impala Mod	2215115 221380702
Fab Chevelle Mod	2214315 2213407
Hamke Offset	221392002HA 221401202HA
Pierce Modified	221281205H 221301205H 221400706H



Part No.	Shaft	Angle
7.25"		
2202900	Alum Hole	0
2202907	Alum Hole	7
2212900	Slot & Key	0
2212907	Slot & Key	7
2212900H	Steel Hole	0
2212907H	Steel Hole	7
7.50"		
2203000	Alum Hole	0
2203007	Alum Hole	7
2203015	Alum Hole	15
2213000	Slot & Key	0
2213007	Slot & Key	7
2213015	Slot & Key	15
2213000H	Steel Hole	0
2213007H	Steel Hole	7
2213015H	Steel Hole	15
7.75"		
2203100	Alum Hole	0
2203107	Alum Hole	7
2203115	Alum Hole	15
2213100	Slot & Key	0
2213107	Slot & Key	7
2213115	Slot & Key	15
2213100H	Steel Hole	0
2213107H	Steel Hole	7
2213115H	Steel Hole	15

Part No.	Shaft	Angle
8"		
2203200	Alum Hole	0
2203207	Alum Hole	7
2203215	Alum Hole	15
2213200	Slot & Key	0
2213207	Slot & Key	7
2213215	Slot & Key	15
2213200H	Steel Hole	0
2213207H	Steel Hole	7
2213215H	Steel Hole	15
8.25"		
2203300	Alum Hole	0
2203307	Alum Hole	7
2203315	Alum Hole	15
2213300	Slot & Key	0
2213307	Slot & Key	7
2213315	Slot & Key	15
2213300H	Steel Hole	0
2213307H	Steel Hole	7
2213315H	Steel Hole	15
8.50"		
2203400	Alum Hole	0
2203407	Alum Hole	7
2203415	Alum Hole	15
2213400	Slot & Key	0
2213407	Slot & Key	7
2213415	Slot & Key	15
2213420	Slot & Key	20
2213400H	Steel Hole	0
2213407H	Steel Hole	7
2213415H	Steel Hole	15
8.75"		
2203500	Alum Hole	0
2203507	Alum Hole	7
2203515	Alum Hole	15
2213500	Slot & Key	0
2213507	Slot & Key	7
2213515	Slot & Key	15
2213500H	Steel Hole	0
2213507H	Steel Hole	7
2213515H	Steel Hole	15

Part No.	Shaft	Angle
9"		
2203600	Alum Hole	0
2203607	Alum Hole	7
2203615	Alum Hole	15
2213600	Slot & Key	0
2213607	Slot & Key	7
2213615	Slot & Key	15
2213600H	Steel Hole	0
2213607H	Steel Hole	7
2213615H	Steel Hole	15
9.25"		
2203700	Alum Hole	0
2203707	Alum Hole	7
2203715	Alum Hole	15
2213700	Slot & Key	0
2213707	Slot & Key	7
2213715	Slot & Key	15
2213700H	Steel Hole	0
2213707H	Steel Hole	7
2213715H	Steel Hole	15
9.50"		
2203800	Alum Hole	0
2203807	Alum Hole	7
2203815	Alum Hole	15
2213800	Slot & Key	0
2213807	Slot & Key	7
2213815	Slot & Key	15
2213800H	Steel Hole	0
2213807H	Steel Hole	7
2213815H	Steel Hole	15
9.75"		
2203900	Alum Hole	0
2203907	Alum Hole	7
2203915	Alum Hole	15
2213900	Slot & Key	0
2213907	Slot & Key	7
2213915	Slot & Key	15
2213920	Slot & Key	20
2213900H	Steel Hole	0
2213907H	Steel Hole	7
2213915H	Steel Hole	15

Part No.	Shaft	Angle
10"		
2204000	Alum Hole	0
2204007	Alum Hole	7
2204015	Alum Hole	15
2214000	Slot & Key	0
2214007	Slot & Key	7
2214015	Slot & Key	15
2214000H	Steel Hole	0
2214007H	Steel Hole	7
2214015H	Steel Hole	15
10.25"		
2204100	Alum Hole	0
2204107	Alum Hole	7
2204115	Alum Hole	15
2214100	Slot & Key	0
2214107	Slot & Key	7
2214115	Slot & Key	15
2214120	Slot & Key	20
2214100H	Steel Hole	0
2214107H	Steel Hole	7
2214115H	Steel Hole	15
10.50"		
2204200	Alum Hole	0
2204207	Alum Hole	7
2204215	Alum Hole	15
2214200	Slot & Key	0
2214207	Slot & Key	7
2214215	Slot & Key	15
2214220	Slot & Key	20
2214200H	Steel Hole	0
2214207H	Steel Hole	7
2214215H	Steel Hole	15
10.75"		
2204300	Alum Hole	0
2204307	Alum Hole	7
2204315	Alum Hole	15
2214300	Slot & Key	0
2214307	Slot & Key	7
2214315	Slot & Key	15
2214300H	Steel Hole	0
2214307H	Steel Hole	7
2214315H	Steel Hole	15

PRECISION MAX UPPER A-FRAMES



EXCLUSIVE A-FRAMES*

* The Howe A-frames that are produced specifically for a chassis builders can only be purchased through those dealers.

Rocket: (304) 592-3200

Bloomquist: (423) 921-3231

Swartz: (740) 820-2341

	Part No.	Shaft	Angle	Offset	Clearance	
	9.50"	221380702	Slot & Key	7	0.50"	Std
	9.75"	221392002HA	Slot & Key	20	0.50"	High
	10"	221401202HA	Slot & Key	12	0.50"	High
	10.50"	221421503	Slot & Key	15	0.75"	Std
		221420706H	Steel Hole	7	1.50"	Std
	11"	221441502	Slot & Key	15	0.50"	Std

Part No.	Shaft	Angle
11"		
2204400	Alum Hole	0
2204407	Alum Hole	7
2204415	Alum Hole	15
2214400	Slot & Key	0
2214407	Slot & Key	7
2214415	Slot & Key	15
2214420	Slot & Key	20
2214400H	Steel Hole	0
2214407H	Steel Hole	7
2214415H	Steel Hole	15
11.25"		
2204500	Alum Hole	0
2204507	Alum Hole	7
2204515	Alum Hole	15
2214500	Slot & Key	0
2214507	Slot & Key	7
2214515	Slot & Key	15
2214500H	Steel Hole	0
2214507H	Steel Hole	7
2214515H	Steel Hole	15
11.50"		
2204600	Alum Hole	0
2204607	Alum Hole	7
2204615	Alum Hole	15
2214600	Slot & Key	0
2214607	Slot & Key	7
2214615	Slot & Key	15
2214600H	Steel Hole	0
2214607H	Steel Hole	7
2214615H	Steel Hole	15
11.75"		
2204700	Alum Hole	0
2204707	Alum Hole	7
2204715	Alum Hole	15
2214700	Slot & Key	0
2214707	Slot & Key	7
2214715	Slot & Key	15
2214700H	Steel Hole	0
2214707H	Steel Hole	7
2214715H	Steel Hole	15
12.75"		
2215115	Slot & Key	15

CUSTOM SHAFT KIT

This kit allows you to custom fabricate your own steel cross shaft a-frame. Available with slot & key shaft or with two holes.

221000 Shaft Kit, Slot & Key

221000H Shaft Kit, Holes



REPLACEMENT PARTS

22240A Alum. Shaft

22240S Steel Shaft

22240SK Slot & Key Shaft

222998 Alum Cap - Blue

222999 Steel Cap - Clear

22240B Bearing

22240BH Bearing Housing

22240R Retaining Ring

22240V V-Seal

22328 Grease Zerk

TOWER MOUNTS

These tower a-frame mounts are slotted and inset to accept different position keys allowing for simple upper a-frame adjustment. Standard on "101" and "RT" front frames and as an alternative option for "SS" and "ES" frames. Shim plates are used for adjusting the camber. 6" hole centers. Keys interchange with a-frame keys.



22605 Upper A-frame Tower Mount - Standard

22615 Upper A-frame Tower Mount - +1" Taller Double Hole

22616 Upper A-frame Tower Mount - +1" Taller

22606 Key for Tower Mount (Requires 2)

60203 1/8" Shim Plate

60205 1/4" Shim Plate

INDIVIDUAL KEYS

22601 Open

22602 0

22603 1/16"

22606 1/8"

22607 3/16"

22608 1/4"

22609 5/16"

22610 3/8"

22611 7/16"

22612 1/2"



A-FRAME KEY SET

This key set includes 10 different keys for adjusting your slot & key a-frames. The keys are in 1/16" increments from 0 (centered) to 1/2" offset as well as a slotted key. Made for use with 1/2" bolts

22001 Key Set (of 10) for Slot & Key Style

PRECISION MAX U-FRAMES

Application	Left Side	Right Side	
Howe 101	2224215	2223807	
Howe TA2	2223407	2223407	
Howe Fab Impala	2225115	222380702	
Howe Fab Chevelle	2224315	2223407	



These new u-frames eliminate the weight of the ball joint housing. With the stud fitting directly into the u-frame. A unique, secure cap retainer hold the unit together. Integral type a-frames are not as strong as the traditional style Precision Max a-frame but are adequate for applications where light weight takes priority over durability.

INTERNAL HARDWARE

Slide the 1/2" fine thread block inside the upper a-frame mount for easy caster and camber adjustment.

2286 Standard
INDIVIDUAL PIECES
 222861 Set Screw
 22861 Threaded Block Only



Length	Alum. Shaft	Steel Shaft
7"	222370	---
7-1/4"	222372	221372
7-1/2"	222375	---
8"	222380	221380
8-1/4"	222382	---
8-1/2"	222385	221385
8-3/4"	222387	221387
9"	222390	221390
9-1/2"	222395	221395
10-1/2"	---	221315

CHASSIS MOUNTS

Universal design uses 2286 internal hardware.

22688 Universal Mount

CROSS SHAFT BASIC A-FRAME

These basic a-frames do not have low friction bearings and are not as rugged as the precision max, but are one third of the cost. They are made with 11 ga. DOM tubing and have been used successfully for many years.



ADJUSTABLE DESIGN A-FRAME MOUNTS

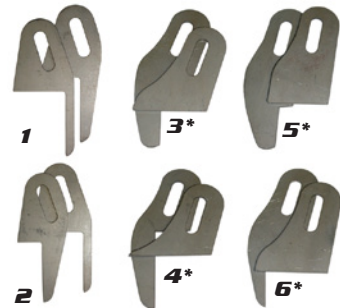

Part No.	Adjustable Design Mounts	Chassis
1	22662 Right SS Inner	SS
	22663 Right SS Outer	SS
2	22662 Left SS Inner	SS
	22673 Left SS Outer	SS
3	22642* Right Mod, Front - Outer*	MOD
	22643* Right Mod, Front - Inner*	MOD
4	22640* Left Mod, Front - Outer*	MOD
	22641* Left Mod, Front - Inner*	MOD
5	22646* Right Mod, Rear - Inner*	MOD
	22647* Right Mod, Rear - Outer	MOD
6	22644* Left Mod, Rear - Inner*	MOD
	22645* Left Mod, Rear - Outer*	MOD

* Are for Impala style asphalt modified only.

HOWE ADJUSTABLE DESIGN

Designed for use with early SS design and Howe modifieds. Eliminates the cross shaft for additional spring clearance and easier spring changes. Aluminum hex or swagged steel sleeves allow for easy adjustment. 5/8" rod end bearings allow for bind-free movement.

	Side	Alum	Steel	Plate	Front Sleeve	Rear Sleeve	
Early SS Design	Left	222965	----	10°	4.5"	4.5"	
	Right	22297	----	5°	5.25"	5.25"	
Asphalt Modified	Left	----	222991	5°	4"	4"	
	Right	----	222992	10°	5.5"	5.5"	



HOWE MODIFIED STYLE A-FRAME

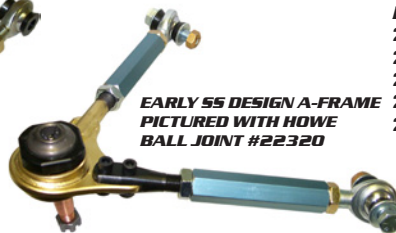

EARLY SS DESIGN A-FRAME PICTURED WITH HOWE BALL JOINT #22320

BALL JOINT PLATES

22291 5° - Gold
 222915 10° - Silver
 222919 15° - Black
 222912 Asphalt Mod RS
 222920 20° - Black

INDIVIDUAL PARTS

R33155 5.25" Sleeve Only - Alum.
 R33158 5.5" Sleeve Only - Alum.
 R33145 4.5" Sleeve Only - Alum.
 R33147 4.75" Sleeve Only - Alum.
 SS5140 4.0" Sleeve Only - Steel
 SS5145 4.5" Sleeve Only - Steel
 SS5155 5.5" Sleeve Only - Steel
 22292 A-Frame Clevis Only - 5/8"
 22293 Rod End Spacers
 22865 Bolt Kit for "M" Design Upper

LOWER CONTROL ARMS

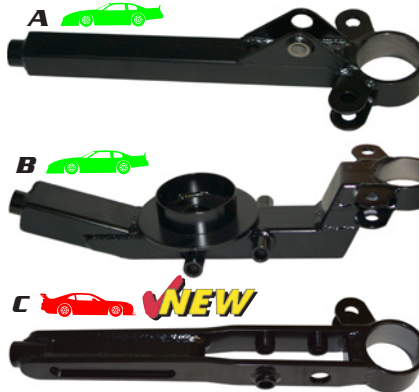

STRUT STYLE

All Howe strut lower control arms are designed to be as durable as possible but still bend before the frame. Different styles suit a variety of applications.

- [A] Our most current lower fits coilover chassis that use a solid rod end strut rod.
- [B] For 5" coil spring with solid rod end style strut. Will bolt directly to tubing cross member.
- [C] Designed for high demands of the 2015+ TA2 Chassis. *Specify Right or Left with an R or L suffix.

Length	[A] 93 & Up Strut Lower w/ Heim	[A] 93 & Up Strut Lower No Heim	[B] 5" Coil Threaded No Heim	[A] Screw In Ball Joint No Heim	[A] Screw In Ball Joint w/ Heim	[C] TA2 Lower No Heim*
13.6	---	---	---	229613	229623	---
14.6	22824	22834	---	229614	229624	---
15.6	22825	22835	22855	229615	229625	
16.6	22826	22836	22856	229616	229626	22916R / L*
17.6	22827	22837	22857	229617	229627	---
18.6	22828	22838	---	229618	229628	---
NO BALL JOINT, ACCEPTS PRESS IN			NO BALL JOINT, ACCEPTS SCREW IN			



STRUT RODS

Fits Howe lower control arms 93 and newer. Available with standard or aircraft grade rod ends. Includes: solid end (22943, 22949, 229492), two jam nuts, rod end bearing, and sleeve.

STRUT & CONTROL ARM COMBOS

Chassis / Lower	Struts			Lower Control Arms		Length	Application
	Assembly - Standard	Assembly - Aircraft	Sleeve	Screw In Ball No Heim	Screw In Ball w/ Heim		
"SS" / Left	22947-16	22947A-16	16"	229613	229623	13.6"	
"SS" / Right	22947-18	22947A-18	18"	229616	229626	16.6"	
"ES" / Both	22947-17	22947A-17	17"	229615	229625	15.6"	
"101" / Left	----	22947A-20	20"	229615	229625	15.6"	
"101" / Right	----	22947A-22	22"	2296180	2296280	18"	
"TA2" / Both Pre 2015	----	22945A-18	18"	229616C	229626C	16.6"	
"TA2" / Left 2015+	----	22942A-18	18"	229916L	----	16.6"	
"TA2" / Right 2015+	----	22942A-18	18"	229916R	----	16.6"	

SOLID STRUT ENDS

22943 Straight -3/4"
 22949 5° - 3/4"
 229492 2.5° - 3/4"
 22948 5° - 5/8"

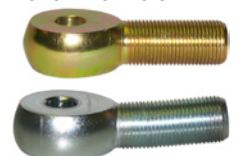

OEM LOWER A FRAMES

OEM STYLE - CAMARO

Built from remanufactured OEM lowers. The ball joint hole is opened to accept the stronger mid size Impala ball joint.

Length	Side	Nylon Bushing	No Bushing
17"	Left	22934	22926
	Right	22935	22927
		Fits Press In	Fits Screw In



OEM STYLE - CHEVELLE

Brand new steel stampings of 64-72 Chevelle lower a-frames. Meet all of the original OEM specifications and dimensions. Fits Asphalt and dirt modifieds. Bushings and ball joint sold separately. Fits Press In ball joint.

Length	Side	No Bushing No Ball Joint
17"	Left	KRC8804
	Right	KRC8803



OEM STYLE - WIDE FORD

We remanufacture these OEM Ford lowers as well as sell new steel stampings to fit our Impala frame asphalt modifieds. Fits Press In ball joint.

Length	Style	No Bushing No Ball Joint
18"	OEM - L	22938
	OEM - R	22937
18"	NEW - L	22956
	NEW - R	22957





COILOVER OEM REPLACEMENT

Fabricated with 1-1/4" round tubing to fit 70-81 Camaro based frames. Does not include ball joint. Press in version uses Howe 22413. Screw in version uses Howe 22410.

Width	Side	Nylon Bushing	Monoball Bushing
15.5"	Left	23050L	22961
	Right	-----	-----
17"	Left	23054L	-----
	Right	23050R	-----
		Fits Press In	Fits Screw In



BALL JOINT AND BUSHING APPLICATIONS

Model	OEM Ball Joint	Howe Ball Joint	OEM Bushings	Howe Bushings	Howe Bolts ea.	Applications
70-81 Camaro - Upsize Press In	K6141	22413	K6109	22915	2294	LLM, Street Stocks, and Other 70-81 Camaro Based Frames. 
70-81 Camaro - Upsize Screw In	n/a	22410	K6109	22915	2294	
70-81 Camaro - Stock	K6145	22420	K6109	22915	2294	
80-94 Ford - Impala Stud	n/a	22406,07	K8297	22920	2294	Impala Modifieds and Other 77-85 Big Metric GM Based Frames. 
80-94 Ford - Stock	K8259	n/a	K8297	22930	2295	
64-72 Chevelle - Stock	K5103	22421	K5149	22901	2296	Chevelle Modified and Other 68-72 Chevelle Based Frames. 
64-72 Chevelle - Pinto Spindle	n/a	22414, 14V	K5149	22901	2296	

PRECISION LOWER A-FRAME BUSHINGS

22901



COMMON

22900

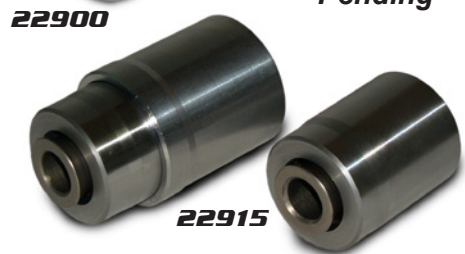

Patent Pending



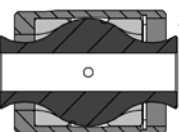

22915



SHOWN FOR DETAIL

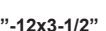

Howe bushings eliminate the bind & drag of rubber bushings while offering superior performance, durability, and low friction. They can be lubricated without disassembly and the bearing is one piece for easy installation, unlike monoballs which require spacers and must be disassembled to lubricate. Available to fit popular racing OEM lower a-frames. Detailed installation instructions are included. Each set includes two bushings for one a-frame.

Model	OEM Reference	Bushing Kit Description	Bushing Kit Part No.	Required Bolts
70-81 Camaro / Firebird	K6109	x2 Round x1 Sleeve	22915	2294 (x2) 
83-94 Ford Crown Vic, Grand Marq, 80-94 Town Car, 80-82 LTD	K297	x2 Round x1 Sleeve	22930	2295 (x2) 
OEM Ford on Impala Frame	K8297	x2 Round x1 Sleeve	22920	2294 (x2) 
New Steel Stamping Ford on Impala Frame	-----	x1 Big Round x1 Small Round x1 Sleeve	22924	2294 (x2) 
65-70 Bonneville/ Catalina, 69-72 Grand Prix, 65-70 Ventura, Any 66-72 "A" Body w/ OEM Replacement Lowers	K5149	x1 Small Round x1 Oval	22900	2296 (x2) 
67-72 Chevelle, 68-74 Nova, 67-70 Camaro, 68-74 Chevy II, 67-69 Firebird, 66-72 Buick Special, 67-72 El Camino, 70-72 Monte Carlo	K6076	x1 Small Round x1 Big Round	22901	2296 (x2) 
78-87 Mid Size GM Metric	K6177	x1 Round Narrow x1 Round Wide	22925	2294 (x1) 2295 (x1)

Note: Please check your lower a-frame bushing holes to ensure proper bushing needs before ordering a precision bushing kit.



2294 Grease Bolt, 9/16"-12x3-1/2"
2295 Grease Bolt, 9/16"-12x4"
2296 Grease Bolt, 1/2"-13x3-1/2"

HOWE Precision BALL JOINTS

U.S. Patents no. 8,662,783 B2, 7,927,035 B2, 6,908,251 B2
Additional Patents Pending



Taper Dimensions

Tapers are listed by the number of inches per foot but there are also differences in the base diameter, the length of the taper and the threads.

Howe Precision Ball Joints are the choice of top teams and car builders due to their superior durability and performance. They provide very low resistance and a captured ball to maintain precise front end alignment. A proprietary process allows the studs to bend while the ball resist wear. Howe ball joints offer the largest selection of interchangeable stud sizes and are made with fewer pieces for fewer problem with no plastic internal parts. Made in the USA for consistent quality.

NASCAR APPROVED / IMCA LEGAL
With Steel Cap

Torque Specifications		
1/2" - 55 ft/lbs.	9/16" - 80 ft/lbs.	5/8" - 110 ft/lbs.

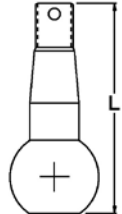

All Ball joints come standard with a "0" length stud that is equal to stock length unless stated otherwise.

SCREW IN UPPERS

Howe 22308 - Fits K704

Cap	Make	Reference	Racing
Alum	Chrysler	60-76 Valiant, 63-76 Dart, 64-69 Cuda, 71-76 Scamp, 70-76 Duster, 71-72 Demon, 61-62 Lancer	Nostalgia Classes
Less Stud	Taper Ball Size		
223089	2" 1.25		

Available Studs for 22308

Change	Part #	Dim, L
0	223080	3.308"

1/2-20 Thread



Howe 22320 - Fits K772



Cap	Make	Reference	Racing
Alum	Chrysler	65-89 Chrysler, Dodge, Plymouth	All Asphalt Late Models, TA2 Cars, Dirtworks, Troyer Ford steering uppers. Also fits Pinto upper taper.
Less Stud	Taper Ball Size		
22329	1.5 1.437		

The XD housing is 300% stronger in end of travel load testing. The added strength is in the mil-spec alloy housing. The cap is held securely in place with a hex lock and snap ring.

Available Studs for 22320

Change	Part #	Dim, L	ID
-.3"	2233103	3.04"	C
-.2"	2233102	3.14"	B
-.1"	2233101	3.24"	A
0	22330	3.34"	None
+.1"	22331	3.44"	1
+.2"	22332	3.54"	2
+.3"	22333	3.64"	3
+.4"	22334	3.74"	4
+.5"	22335	3.84"	5
+.75"	223375	4.09"	7
+1.0"	223310	4.34"	Z



Variations

Complete	Variation	Less Stud
22320S	Steel Cap	22329S
22320X	XD	22329X
22320XV	XD +1/2"	22329X
22320SV	+1/2" Steel Cap	22329S
22320V	+1/2" Aluminum Cap	22329

Howe 22310 - Fits K778

Cap	Make	Reference	Racing
Alum	Chrysler	Full Size Chrysler & Dakota Trucks	1992-2013 Dodge Viper
Less Stud	Taper Ball Size		
22450	1.69" 1.625"		

Available Studs for 22310

Change	Part #	Dim, L
-.5"	2231005	2.84"
-.4"	2231004	2.94"
-.3"	2231003	3.04"
-.2"	2231002	3.14"
-.1"	2231001	3.24"
0	223100	3.34"
+.1"	223101	3.44"
+.2"	223102	3.54"
+.3"	223103	3.64"
+.4"	223104	3.74"
+.5"	223105	3.84"

5/8-18 Thread



Howe 22306 - HYBRID K5208 / K772

Cap	Make	Reference	Racing
Alum	GM / Chrysler	71-94 Impala, 70-81 Camaro, 73-88 Chevelle & Monte Spindle w/ Chrysler Housing	Small Metric Frame Modified with Racing A-frame.
Less Stud	Taper Ball Size		
22329	2" 1.437"		

Available Studs for 22306

Change	Part #	Dim, L
0	22360	3.30"
+.1"	22361	3.46"
+.2"	22362	3.56"
+.3"	22363	3.66"
+.4"	22364	3.76"
+.5"	22365	3.86"
+.9"	22369A	4.26"



Howe 22314 - Hybrid K8212 / K772

Cap	Make	Reference	Racing
Alum	Ford / Chrysler	72-79 Torino, 74-78 Mustang, 71-80 Pinto, 67-79 T-Bird, 70-79 Lincoln Spindle with 65-89 Chrysler Housing.	Nostalgia Classes
Less Stud	Taper Ball Size		
22329	1.5" 1.437"		

Available Studs for 22314

Change	Part #	Dim, L
0	22370	3.52"
+.1"	22371	3.62"
+.2"	22372	3.72"
+.3"	22373	3.82"
+.4"	22374	3.92"
+.5"	22375	4.02"

1/2-20 Thread



4 BOLT GM UPPERS

Howe 22300 - Fits K6024

Cap	Make	Ref.	Racing
Alum	GM	63-71 GM Truck	Most Late Models Asphalt and Dirt, shorter variation, also fits Pinto upper
Less Stud	Taper Ball Size		
22309	1.5"	1.437"	

Available Studs for 22300

Change	Part #	Dim, L
-3"	2233103	3.04"
-2"	2233102	3.14"
-1"	2233101	3.24"
0	22330	3.34"
+1"	22331	3.44"
+2"	22332	3.54"
+3"	22333	3.64"
+4"	22334	3.74"
+5"	22335	3.84"
+.75"	223375	4.09"
+1.0"	223310	4.34"



1/2-20 Thread

Variations

Complete	Variation	Less Stud
22300S	Steel Cap	22309S
22309S	Less Stud	22309S

Howe 22301 - Fits K6136

Cap	Make	Ref.	Racing
Alum	GM	73-95 Chevy Blazer and GM Truck	IMCA Mod, Street Stock w/ aftermarket a-frame
Less Stud	Taper Ball Size		
22309	2.04"	1.437"	

Available Studs for 22301

Change	Part #	Dim, L
0	22350	3.63"
+1"	22351	3.73"
+2"	22352	3.83"
+3"	22353	3.93"
+4"	22354	4.03"
+5"	22355	4.13"



1/2-20 Thread

Variations

Complete	Variation	Less Stud
22301S	Steel Cap	22309S

Howe 22302 - Fits K5208

Cap	Make	Reference	Racing
Alum	GM	71-94 Impala, 70-81 Camaro, 73-88 Chevelle & Monte Carlo	Street Stock, Sportsman & Modifieds w/ stock a-frame
Less Stud	Taper Ball Size		
22339	2.04"	1.437"	

Available Studs for 22302

Change	Part #	Dim, L
0	22360	3.30"
+1"	22361	3.46"
+2"	22362	3.56"
+3"	22363	3.66"
+4"	22364	3.76"
+5"	22365	3.86"
+9"	22369A	4.26"



1/2-20 Thread

Variations

Complete	Variation	Less Stud
22302S	Steel Cap	22339S

Howe 22303 - Fits K5108

Cap	Make	Ref.	Racing
Alum	GM	68-72 Chevelle, Nova, 67-69 Camaro	Street Stock with stock a-frame
Less Stud	Taper Ball Size		
22339	1.5"	1.437"	

Available Studs for 22303

Change	Part #	Dim, L
0	22380	3.15"
+1"	22381	3.25"
+2"	22382	3.35"
+3"	22383	3.45"
+4"	22384	3.55"
+5"	22385	3.65"
+9"	22389A	4.05"



1/2-20 Thread

Variations

Complete	Variation	Less Stud
22303S	Steel Cap	22339S

Howe 22307 - Fits K6024+

Cap	Make	Ref.	Racing
Alum	GM	63-71 GM Truck	Some Late Models Asphalt and Dirt, taller variation, Fits Rayburn
Less Stud	Taper Ball Size		
22309	1.5"	1.437"	

Available Studs for 22307

Change	Part #	Dim, L
-.2"	2230702	3.14"
0	223070	3.34"
+1"	223071	3.44"
+2"	223072	3.54"
+3"	223073	3.64"
+4"	223074	3.74"
+5"	223075	3.84"



1/2-20 Thread

3 BOLT UPPER

Howe 22304 - Fits K6034

Cap	Make	Ref.	Racing
Alum.	Chevy	55-70 Impala, 63-82 Vette	Nostalgia Classes
Less Stud	Taper Ball Size		
22359	1.5"	1.437"	

Available Studs for 22304

Change	Part #	Dim, L
0	22380	3.15"
+1"	22381	3.25"
+2"	22382	3.35"
+3"	22383	3.45"
+4"	22384	3.55"
+5"	22385	3.65"
+9"	22389A	4.05"



1/2-20 Thread

HYBRID SCREW IN GM LOWER

Howe 22410 - Hybrid K6141/ K727

Cap	Make	Reference	Racing
Alum	GM	71-76 Impala Spindle w/ 60-66 Imperial Housing	Howe LM & TA2, Rayburn, GRT, Warrior, Hamke, FLF, Port City, most popular LM, Most wide type dirt cars.
Less Stud	Taper Ball Size		
22450	2"	1.625"	

Variations

Complete	Variation	Less Stud
22410S	Steel Cap	22450S
22410X	XD Housing	22450X
22410V	+1/2" Alum Cap	22450
22410SV	+1/2" Steel Cap	22450S



Original

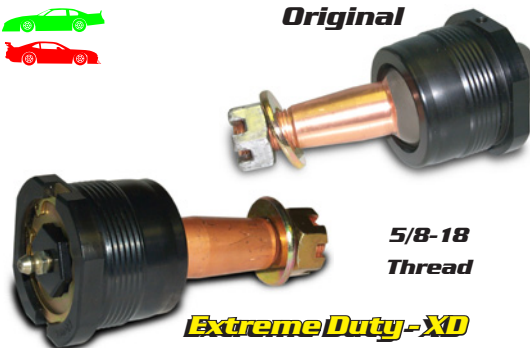

5/8-18 Thread

Extreme Duty-XD

Available Studs for 22410

Change	Part #	Dim, L	ID
-.3"	2243103	3.04"	C
-.2"	2243102	3.14"	B
-.1"	2243101	3.24"	A
0	22430	3.34"	None
+1"	22431	3.44"	1
+2"	22432	3.54"	2
+3"	22433	3.64"	3
+4"	22434	3.74"	4
+5"	22435	3.84"	5
+1.0"	224310	4.34"	Z

This ball joint is a hybrid of a 71-76 Chevy Impala (K6141) with a Chrysler Imperial (K727) threaded housing

The 22410 is the most common asphalt late model lower ball joint.

HYBRID SCREW IN GM

Howe 22436 - Hybrid K6117/ K727

Cap	Make	Reference	Racing
Alum	GM / Chrysler	71-95 1/2 Ton GM Truck Lower Stud w/ 60-66 Imperial Lower Housing	Some IMCA Mods & Street Stocks w/ Fabricated Lowers or 22411 Threaded Adapter
Less Stud	Taper	Ball Size	
22450	2"	1.625"	

Available Studs for 22436

Change	Part #	Dim. L	ID
- .7"	2246105	3.61"	G
0	22460	4.31"	None
+ .1"	22461	4.41"	1
+ .2"	22462	4.51"	2
+ .3"	22463	4.61"	3
+ .4"	22464	4.71"	4
+ .5"	22465	4.81"	5
+ 1.0"	224610	5.31"	Z

5/8-18
Thread

This ball joint is a hybrid of a 71-95 1/2 Ton GM Truck (K6117) with a Chrysler Imperial (K727) threaded housing

Howe 22418 - Fits K719

Cap	Make	Reference	Racing
Alum	Chrysler	75-79 Cordoba, 73-76 Coronet, 73-78 Charger, 78-79 Magnum, 73-79 Road Runner, 75-78 Fury, 76-80 Aspen, 79-80 Duster	Modifieds, all Troyer Lowers, Troyer Sweet steering uppers. Stacy Mod.
Less Stud	Taper	Ball Size	
22329	1.5"	1.475"	

Available Studs for 22418

Change	Part #	Dim. L
0	22451	3.63"
+ .1"	22452	3.73"
+ .2"	22453	3.83"
+ .3"	22454	3.93"
+ .4"	22455	4.03"
+ .5"	22456	4.13"

5/8-18
Thread



Variations

Complete	Variation	Less Stud
22418S	Steel Cap	22339S
22418V	+1/2"	22339

PRESS IN GM LOWERS

Howe 22413 - Fits K6141

Cap	Make	Reference	Racing App.
Alum	GM	71-76 Impala #2	Howe, Rayburn, GRT, Warrior, Hamke, FLF, Port City, most popular LM, Most wide type dirt cars.
Less Stud	Taper	Ball Size	
22491	2"	1.625"	

Available Studs for 22413

Change	Part #	Dim. L
- .3"	2243103	3.27"
- .2"	2243102	3.37"
- .1"	2243101	3.47"
0	22430	3.57"
+ .1"	22431	3.67"
+ .2"	22432	3.77"
+ .3"	22433	3.87"
+ .4"	22434	3.97"
+ .5"	22435	4.07"
+ 1.0"	224310	4.17"



2.185" O.D.

5/8-18
Thread

Variations

Complete	Variation	Less Stud
22413S	Steel Cap	22491S

SCREW IN CHRYSLER LOWERS

Howe 22412 - Fits K727

Cap	Make	Reference	Racing
Alum	Chrysler	60-66 Imperial	Large LM, Most Late Model Stocks, some Dirt Late Models, Grand National, ARCA and Cup cars.
Less Stud	Taper	Ball Size	
22450	1.5"	1.625"	

Original



Standard Studs for 22412

Change	Part #	Dim. L	ID
- .5"	2244105	3.32"	E
- .4"	2244104	3.42"	D
- .3"	2244103	3.52"	C
- .2"	2244102	3.62"	B
- .1"	2244101	3.72"	A
0	22440	3.82"	None
+ .1"	22441	3.92"	1
+ .2"	22442	4.02"	2
+ .3"	22443	4.12"	3
+ .4"	22444	4.22"	4
+ .5"	22445	4.32"	5
+ 1.0"	224410	4.82"	Z
+ 1.5"	2244150	5.32"	X



Extreme Duty - XD

The XD housing is 300% stronger in end of travel load testing. The added strength is in the mil-spec alloy housing. The cap is held securely in place with a hex lock and snap ring.

5/8-18
Thread

Variations

Complete	Variation	Less Stud
22412S	Steel Cap	22450S
22412V	+1/2"	22450S
22412SV	Steel Cap, +1/2"	22450S
22412X	XD	22250X

HIGH MISALIGNMENT STUD

HM - High Misalignment Studs have been tapered down at the neck for additional misalignment. Allows 2.40" more travel than our standard stud. The extra misalignment allows for approximately .55" of additional suspension travel.

Change	Part #	Dim. L
0	22440HM	3.815"
+ .1"	22441HM	3.915"
+ .2"	22442HM	4.015"
+ .3"	22443HM	4.115"
+ .4"	22444HM	4.215"
+ .5"	22445HM	4.315"



High Misalignment Studs are standard in 22412 XD

COMPACT CHRYSLER LOWER

Howe 22412SB - Hybrid K727/ K772

Cap	Make	Reference	Racing
Steel	Chrysler	60-66 Imperial Lower Stud with 65-89 Chrysler upper housing.	Grand National and Cup cars with small housing lower a-frames.
Less Stud	Taper	Ball Size	
22329S	1.5"	1.475"	

SB - Small Ball studs are made with the smaller 1-7/16" ball used on upper ball joint. This allows a smaller compact housing for added rotor clearance. Available in standard and XD.

5/8-18
Thread

Available Studs for 22412SB

Change	Part #	Dim. L
0	22440SB	3.815"
+ .1"	22441SB	3.915"
+ .2"	22442SB	4.015"
+ .3"	22443SB	4.115"
+ .4"	22444SB	4.215"
+ .5"	22445SB	4.315"



Variations

Complete	Variation	Less Stud
22412SBX	XD Housing	22329X

MORE PRESS IN GM LOWERS

Howe 22419 - Fits K6117

Cap	Make	Reference	Racing
Alum	GM	71-95 1/2 Ton GM Trucks	Some IMCA Mods & Street Stocks
Less Stud	Taper Ball Size		
22493	2" 1.625"		

Available Studs for 22419

Change	Part #	Dim, L
-7"	2446107	3.61"
0	22460	4.31"
+1"	22461	4.41"
+2"	22462	4.51"
+3"	22463	4.61"
+4"	22464	4.71"
+5"	22465	4.81"
+1.0"	224610	5.31"



Variations

Complete	Variation	Less Stud
22419S	Steel Cap	22493S

See 22436 on Page 11 for Hybrid version with screw in housing

Howe 22420 - Fits K6145

Cap	Make	Reference	Racing
Alum	GM	77-89 Impala,	Mini Stocks
Less Stud	Taper Ball Size	70-81 Camaro, 73-88 Chevelle & Malibu	
22494	2" 1.437"		

Available Studs for 22420

Change	Part #	Dim, L
-2"	2247102	3.21"
-1"	2247101	3.31"
0	22470	3.41"
+1"	22471	3.51"
+2"	22472	3.61"
+3"	22473	3.71"
+4"	22474	3.81"
+5"	22475	3.91"
+75"	22429S	4.16"

2.085" O.D.



Variations

Complete	Variation	Less Stud
22420S	Steel Cap	22494S
22429	+3/4"	22494

Howe 22421 - Fits K5103

Cap	Make	Ref.	Racing
Alum	GM	64-72 Chevelle, 67-69 Camaro	Some IMCA Type Mods, Dirtworks
Less Stud	Taper Ball Size		
22495	1.6" 1.437"		

Available Studs for 22421

Change	Part #	Dim, L
0	22480	3.16"
+1"	22481	3.26"
+2"	22482	3.36"
+3"	22483	3.46"
+4"	22484	3.56"
+5"	22485	3.66"

2.015" O.D.



Variations

Complete	Variation	Less Stud
22421S	Steel Cap	22495S

Howe 22424 - Fits K6345

Cap	Make	Reference	Racing
Alum	GM	1984-96 Corvette	Road Racing, Auto Cross
Less Stud	Taper Ball Size		
224249	2" 1.437"		

Available Studs for 22424

Change	Part #	Dim, L
0	224240	3.41"
+5"	224245	3.91"



PRESS IN CHRYSLER LOWERS

Howe 22408 - Fits Viper

Cap	Make	Ref.	Racing
Alum	Chrysler	1992-2008 Dodge Viper	Viper Road Racing
Less Stud	Taper Ball Size		
22496	1.48" 1.625"		

Available Studs for 22408

Change	Part #	Dim, L
0	224080	3.41"
+1"	224081	3.51"
+2"	224082	3.61"
+3"	224083	3.71"
+4"	224084	3.81"
+5"	224085	3.91"



Howe 22422 - Fits K7025

Cap	Make	Ref.	Racing
Alum	Chrysler	70-92 Dodge Truck	Off Road Trucks
Less Stud	Taper Ball Size		
224229	1.48" 1.625"		

Available Studs for 22422

Change	Part #	Dim, L
0	224900	3.41"
+1"	224901	3.51"
+2"	224902	3.61"
+3"	224903	3.71"
+4"	224904	3.81"
+5"	224905	3.91"

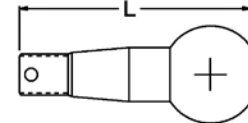

Howe 22426 - Fits K8259

Cap	Make	Reference	Racing
Alum	Ford	79-93 Mustang, 83-94 Crown Vic, 80-94 Town Car	Mods or Sportsman with Stock Ford Lower and Spindles
Less Stud	Taper Ball Size		
22457	1.69" 1.625"		

Available Studs for 22426

Change	Part #	Dim, L
-5"	2248005	3.50"
-4"	2248004	3.60"
-3"	2248003	3.70"
-2"	2248002	3.80"
-1"	2248001	3.90"
0	224800	4.00"
+1"	224801	4.10"
+2"	224802	4.20"
+3"	224803	4.30"
+4"	224804	4.40"
+5"	224805	4.50"



PRESS IN FORD LOWERS

Howe 22401 - Fits K9908

Cap	Make	Ref.	Exclusive Dealer
Alum	Mazda	91-05 Miata	V8 Roadster 813-532-2786
Less Stud	Taper Ball Size		
N/A	1.47" 1.125"		

Available Studs for 22401

Change	Part #	Dim, L
0	224010	2.68"

7/16-20 Thread



Howe 22400 - Fits K8749

Cap	Make	Ref.
Alum	Ford	1999-2004 Mustang & Cobra
Less Stud	Taper Ball Size	
N/A	0" 1.25"	

Available Studs for 22400

Change	Part #	Dim, L
0	224000	N/A

No Thread



PRESS IN HYBRID LOWERS

Howe 22414 - Hybrid K8209/ K5103

Cap	Make	OEM Spindle	OEM A-Frame	Racing	
Alum	GM/Ford	74-80 Pinto, 74-78 Mustang II	Aftermarket 64-72 Chevelle, 67-69 Camaro	Howe & Popular Mods with Chevelle Frames	
Less Stud	Taper				Ball Size
22458	1.5"				1.625"

Available Studs for 22414

Change	Part #	Dim, L
-.2"	2241402	3.16"
0	224140	3.36"
+.1"	224141	3.46"
+.2"	224142	3.56"
+.3"	224143	3.66"
+.4"	224144	3.76"
+.5"	224145	3.86"
+1.0"	2241410	4.36"



Howe 22406 & 22407 - Fits K6145 / K8259

Cap	Make	OEM Spindle	OEM A-Frame	Racing	
Alum	GM	71-76 Impala #2	79-93 Mustang, 83-94 Crown Vic, 80-94 Town Car	Howe Impala Mod 22406 Left 22407 Right	
Less Stud	Taper				Ball Size
22437	2"				1.437"

Available Studs for 22406 & 22407

22406 Change	22407 Change	Part #	Dim, L
-.7"	-.2"	224702	3.21"
-.6"	-.1"	224701	3.31"
-.5"	0	22470	3.41"
-.4"	+.1"	22471	3.51"
-.3"	+.2"	22472	3.61"
-.2"	+.3"	22473	3.71"
-.1"	+.4"	22474	3.81"
0"	+.5"	22475	3.91"
+.25"	+.75"	22429S	4.16"



Howe 22429 - Hybrid K6145

Cap	Make	Stock A-Frame	Racing
Alum	GM	77-89 Impala, 70-81 Camaro, 73-88 Chevelle & Malibu	Small Metric Modified
Less Stud	Taper	Ball Size	
22494	2"	1.437"	

Available Studs for 22429

Change	Part #	Dim, L
0	22429S	4.16"

9/16-18 Thread



Howe 22423 - Hybrid K6141 / K6145

Cap	Make	OEM Spindle	OEM A-Frame	Racing	
Alum	GM	71-76 Impala #2	77-89 Impala, 70-81 Camaro, 73-88 Chevelle or Malibu	Racing Spindle on a "Small Metric" chas- sis.	
Less Stud	Taper				Ball Size
22494	2"				1.437"

Howe 22416 - Hybrid K6141 / K8259

Cap	Make	OEM Spindle	OEM A-Frame	Racing	
Alum	GM/Ford	71-76 Impala	79-93 Mustang, 83-94 Crown Vic, 80-94 Town Car	Left Ford Lower w/ Racing Spindle	
Less Stud	Taper				Ball Size
22437	2"				1.437"

Howe 22425 - Hybrid K6141 / K8259

Cap	Make	OEM Spindle	OEM A-Frame	Racing	
Alum	GM/Ford	71-76 Impala	79-93 Mustang, 83-94 Crown Vic, 80-94 Town Car	Right Ford Lower w/ Racing Spindle	
Less Stud	Taper				Ball Size
22437	2"				1.437"

Available Studs for 22416, 22423, 22425

22416 Change	22423 Change	22425 Change	Part #	Dim, L
-.5"	0	0	22438	3.15"
-.4"	+.1"	+.1"	224381	3.25"
-.3"	+.2"	+.2"	224382	3.35"
-.2"	+.3"	+.3"	224383	3.45"
-.1"	+.4"	+.4"	224384	3.55"
0"	+.5"	+.5"	224385	3.65"
+.5"	+.10"	+.10"	2243810	4.15"



Howe 22498

Cap	Make	Racing
Alum	GM	Left Side Shaw ARGO Spindle w/ Aftermarket Chevelle Lower
Less Stud	Taper	Ball Size
22458	2"	1.625"

Available Studs for 22498

Change	Part #	Dim, L
0	224980	2.993"

5/8-18 Thread

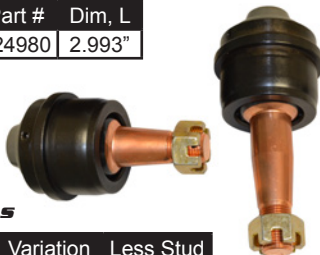

Variations

Complete	Variation	Less Stud
22498S	Steel Cap	22458S
22499S	Steel Cap	22458S

5/8-18 Thread

Howe 22499

Cap	Make	Racing
Alum	GM	Right Side Shaw ARGO Spindle w/ Aftermarket Chevelle Lower
Less Stud	Taper	Ball Size
22458	2"	1.625"

Available Studs for 22499

Change	Part #	Dim, L
-.7"	2243103	3.27"
-.6"	2243102	3.37"
-.5"	2243101	3.47"
-.4"	22430	3.57"
-.3"	22431	3.67"
-.2"	22432	3.77"
-.1"	22433	3.87"
0"	22434	3.97"
+.1"	22435	4.07"
+.6"	224310	4.57"

Howe 2243902A

Cap	Make	Racing
Alum	GM	Pinto Spindle with OEM Chevelle Lower
Less Stud	Taper	Ball Size
22495	2"	1.437"

1/2-20 Thread

Available Studs for 2243902A

Change	Part #	Dim, L
0	2230702	3.14"
+.2"	223070	3.34"
+.3"	223071	3.44"
+.4"	223072	3.54"
+.5"	223073	3.64"
+.6"	223074	3.74"
+.7"	223075	3.84"

Howe 2241402A

Cap	Make	Racing
Alum	GM	Pinto Spindle with Aftermarket Chevelle Lower
Less Stud	Taper	Ball Size
22458	2"	1.437"

1/2-20 Thread

Available Studs for 2243902A

Change	Part #	Dim, L
0	2241402	3.16"
+.2"	224140	3.36"
+.3"	224141	3.46"
+.4"	224142	3.56"
+.5"	224143	3.66"
+.6"	224144	3.76"
+.7"	224145	3.86"
+1.2"	2241410	4.36"

BALL JOINT PARTS AND TOOLS

BALL JOINT BOOT

These boots fit all styles of our screw in and press in upper and lower ball joint housings. Viton boot available for harsher conditions.

- 22399 Precision Boot
- 22399V Viton Boot, High Temp



4 BOLT BALL JOINT BOOT

Designed to fit our four bolt upper ball joint housings this boot forms a tight seal to keep out dirt and grime.

- 223991 Ball Joint Boot, 4 Bolt



PRECISION BALL JOINT HOUSINGS

Housing	Howe App.	OEM Replacement	Style	Make	Ball Size
223220	22300 22301 22307	K6024, K6136 10185, 10269	4 Bolt, lg	GM	1.437"
22322	22306 22418 22320	K719, K772 10162, 10163	Screw In	Chrysler	1.437"
22322X	22320X				
223221	22302 22303	K5208, K5108 10195, 10268	4 Bolt, sm	GM	1.437"
223222	22305	K8212, 10262	3 Bolt	Ford	1.437"
223223	22304	K6034, 10203	3 Bolt	GM	1.437"
22446	22406 22407 22416 22425	N/A	Press In	Ford	1.437"
22417	22410 22412	K727, 10171N	Screw In	Chrysler	1.625"
22417X	22412X				
22459	22426	K8259	Press In	Ford	1.625"
22490	22413	K6141, 10267	Press In	GM	1.625"
22458	22414		Press In	GM	1.625"
22492	22419	K6117, 10264	Press In	GM	1.625"
224170	22420 22423 22429	K6145, 10277	Press In	GM Metric	1.437"
224906	22421	K5103, 10197	Press In	Chevy	1.437"
22489	22422	K7025, 10226	Press In	Chrysler	1.625"

PRESS IN THREADED ADAPTER

22411 threaded adapter allows the use of any ball joint the has the 60-66 Chrysler lower threaded housing to press into lower a-frames made to accept the 71-76 Impala press in ball joint.

- 22411 Adapter



SOCKET FOR SCREW IN BALL JOINTS

These sockets fit our screw in upper & lower ball joints. Maximum torque capacity for the sockets is 150 ft/lbs. Ball Joints should be torqued to 100 ft/lbs. when installed.

- 2152 Socket - Upper
- 2153 Socket - Lower



NOTE: Never Install a Ball Joint with an Impact Wrench! Only Install with a Socket Turning the Housing.

SPINDLE TAPER MACHINE REAM

Standard reams are designed to be used by hand and fail quickly if used in a drill or other machine. These are specially designed for machine use featuring a left helical right cutting design. They are available for 1.5" per foot and 2.0" per foot tapers.

- 84015 Spindle Ream - 1.5"/ft.
- 84020 Spindle Ream - 2.0"/ft.



BALL JOINT SPREADER

Place the tool between the upper and lower ball joint stud with the nut removed from one ball joint, then turn the tool to push the ball joint from the spindle, add the extension for taller spindles.

- 2154 Spreader
- 2155 Extension



SERVICE PARTS

- 22325 Set Screw
- 22326 O-Ring for 22321 Caps
- 22328 Grease Zerk
- 22311 Hex Retainer, 1.437" Ball Housing
- 22312 Retainer Snap Ring, Small Housing
- 22427 Hex Retainer, 1.625 Ball Housing
- 22428 Retainer Snap Ring, Large Housing



BALL JOINT CAPS



Part No.	Material	Housing Size
22321	Aluminum	1.437 Ball
22321S	Steel	1.437 Ball
22321X	XD Steel	1.437 Ball
22415	Aluminum	1.625 Ball
22415S	Steel	1.625 Ball
22415X	XD Steel	1.625 Ball
224006	Aluminum	1.250 Ball

PRECISION BALL JOINT INSPECTION GAUGES



Fit	Gauge	Taper	Ball Joint	Fits
A	22500	1.5"	22412	K727H
B	22501	2"	22410 22413 22416 22423 22425	K6141
C	22502	1.5"	22320 22300	K772H
D	22503	1.5"	OEM	K727
E	22504	1.5"	OEM OEM	K772 K6024
F	22505	1.52"	22418	K719
G	22506	1.6"	22421	K5103
H	22507	2"	22406 22407 22420 22429 22343P	K6145
I	22508	2.04"	22302 22306 22341P 22342P	K5208
M	22514	2.04"	22301	K6136
N	22515	1.5"	22303 22304	K5108 K6034
O	22516	1.53"	22305	K8212
P	22517	1.5"	22307 22414 2243902A 22499	K6024
Q	22518	2"	22308	K704
R	22519	1.69"	22310 22426	K778 K8259
S	22520	1.47"	22401	
T	22521	2.03	22402 22424	K6346
U	22522	1.48"	22408	
V	22523	2"	22419	K6117
W	22524	1.48"	22422	K7025
X	22525		22400	

BALL JOINT MOUNTING RINGS

These are the same ball joint mounting rings that we use to manufacture our own upper a-frame and lower control arms. The upper is threaded to accept the 65-89 Chrysler thread ball joints. The lower fit ball joints using the 60-66 Chrysler Imperial thread.

- 22340 Upper
- 22960 Lower



THREADED SLEEVE

Howe aluminum trailing arm sleeves are extruded with the correct tap diameter. Grooves on one side for counting turns. Available in bulk lengths. Steel trailing arm sleeves use a thin wall tube swaged on each end to the correct thread size.

LENGTH	HEX ALUM	SWEDGE STEEL- 3/4"	SWEDGE STEEL- 5/8"
4"	----	----	SS5140
4.5"	----	----	SS5145
5.5"	----	----	SS5155
9"	----	----	SS509
10"	30610	----	----
11"	30611	----	SS511
12"	30612	----	SS512
13"	30613	SS113	SS513
14"	30614	SS114	SS514
15"	30615	SS115	SS515
16"	30616	SS116	SS516
17"	30617	SS117	SS517
18"	30618	SS118	SS518
19"	30619	SS119	SS519
20"	30620	SS120	----
21"	30621	SS121	----
22"	30622	SS122	----
23"	30623	SS123	----
23-3/4"	30623	SS123	----
24"	30624	SS124	----
25"	30625	SS125	----
26"	30626	----	----
26-1/4"	30626	SS126	----
28"	30628	SS128	----
30"	30630	----	----
34"	30634	----	----
35"	30635	----	----



AXLE MOUNT

Weldable cast steel bracket has 50% greater clamping force than aluminum. Two mounts 1.5" apart allow changes in spring stance for easy roll rate adjustment. T-arm holes are threaded 3/4-10 and shock mounts are 1/2-13. Fits 3" axle tube.

- 31991 Complete Mount
- 319910 Cap Only
- 319911 Bottom Half Only

TRAILING ARM ADAPTER

Adapts 31991 3/4" trailing arm brackets to accept 5/8" trailing arm hardware.

- 31910 Adapter

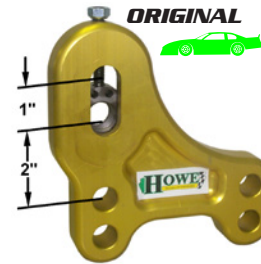
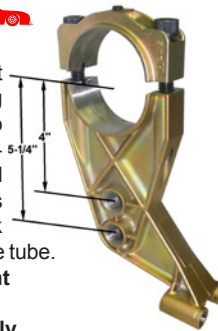

ORIGINAL

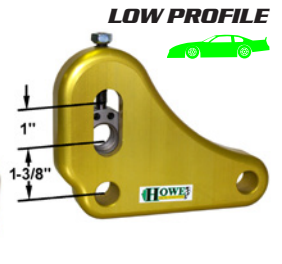

LOW PROFILE

TRAILING ARM EASY ADJUSTERS

Make changes easily by loosening the 3/4" trailing arm bolt and simply turning the fine adjuster up or down 1/16" per turn. Mount attaches with two 5/8" bolts.

- 318927R Right Side - Original
- 318927L Left Side - Original
- 318928R Right Side - Low Profile
- 318928L Left Side - Low Profile
- 31860 1/4" Spacer Only
- 318920 Slide Nut 3/4" - 11



31899

2" long 5/8" fine thread bushings weld into the frame rail 4" apart.

- 31899 5/8 Threaded Bushing



TRAILING ARM ASSEMBLIES

	Late Model	Modified	TA2
Side Assy.	Both 31993	Both 31993A	Both 31997
Rod End	3/4" Std	3/4" Aircraft	5/8" Aircraft
Axle Mnt.	31991	31991	31991
Sleeve PN	30623	30623	SS519
Sleeve Length	23" - 3/4 Alum	23" - 3/4 Alum	19" - 5/8 Steel
			22" - 3/4 Steel

See Page 3 for weld on t-arm chassis mounts.



EXTRA ADJUSTMENT T-ARM MOUNT



Allows a 2" greater range of vertical adjustment by moving the adjuster ahead two inches.

- 318926R Extended Adj. T-arm Mount - RS

STANDARD 10.96 lbs.

HOWE STEEL BIRD CAGES

Steel bird cages with inner bearings at a minimum weight. Developed with the input of dirt modified racers and builders. Three different styles allow rear suspension choices and adjustability. Fits many brands of chassis.

Basic - An uncomplicated bird cage made for use with suspensions that have a separate shock mount on the swing arm or axle.

- 31984 Basic Steel Bird Cage Assembly

Standard - Includes an integral shock mount without the added weight of the Lock Down version. Adjustable shock mount position to adapt to different mount locations. Optional high travel shock mount allows it to turn and prevent the shock from binding.

- 31999 Standard Steel Bird Cage Assembly

Lock Down - Offers provisions to lock the shock mount and bird cage or just the shock mount. Connect the axle clamp to the shock mount to stop it from moving with the bird cage independent or attached. Uses same shock mounts as the standard model.

- 31992 Lock Down Steel Bird Cage Assembly

- Optional High Travel Shock Mount
- Bolt In Mount Block for CO393
- Replacement Top Plate
- Replacement Shock Plate



LOCK DOWN 15.38 lbs.

CO393

- CO393
- CO394
- 31999LP
- 31999SP

EXTRA TALL NEW T-ARM MOUNT



BASIC 4.85 lbs.

Lowest adjustment is 3/8" taller than the original design but it has 2-5/8" of adjustment available.

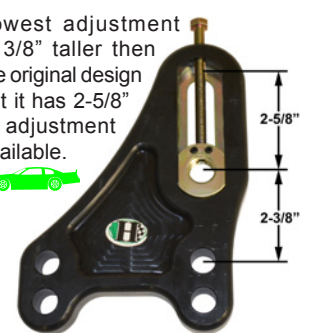

- 318925R Tall Adj. Mount - RS
- 318925L Tall Adj. Mount - LS

RUBBER BUSHINGS & ROD ENDS

ROD END BEARINGS

We have sold Aurora brand rod end bearings for over 40 years and have yet to find a better steel bearing. Aurora aircraft grade bearings have no "play" and exceed the tensile strength of the parts they are installed in.



AURORA

STEERING SHAFT ROD END AU-CM12-12 3/4" Male RH

See Page 23 for jam nuts.

Size	Type	Aurora Standard	Aurora Aircraft	Econo
1/4"	RH Male	AU-CM4	----	----
	LH Male	AU-CB4	----	----
5/16"	RH Female	AU-CW5	----	----
1/2"	RH Male	AU-CM8	----	----
	LH Male	AU-CB8	AU-AB8T	----
	RH Female	AU-CW8	----	----
5/8"	RH Male	----	AU-AM10T	CM10
	LH Male	----	AU-AB10T	EML10
3/4"	RH Male	AU-CM12	AU-AM12T	----
	LH Male	AU-CB12	AU-AB12T	----
	RH Female	AU-CW12	AU-AW12T	----
	LH Female	AU-CG12	----	----

RUBBER BUSHINGS

Patterned after OEM chassis bushings, ours are made with a firmer durometer rating. OEM bushings lose resilience even after limited use. Oversized cupped steel washer prevents bolt from pulling through.

- 3171 Bushing w/ Boss
- 3172 Bushing w/o Boss
- 3176 Steel Washer



Use in place of rod end bearings to cushion suspension forces or induce rear steer. Also an option to mono balls where rod ends aren't allowed. 2.4" wide with 3/4" hole.

- 31865 3/4-16RH, Straight
- 31865L 3/4-16LH, Straight



THIRD LINKS FOR QC REARS

3 HOLE FOR QUICK CHANGE



32003 3 Hole Bracket - Each
32095 Assembly for TA2

Made of heat treated 1/8" thick aluminum, the formed edges make them as strong as brackets weighing almost twice as much. The 3/4" holes are at 8-3/4", 10" and 11-1/4" from the center of the axle and will accommodate rubber bushings, rod end bearings or a spring link. (Not for use with 3201).

2 HOLE FOR QUICK CHANGE

Holes are flared to 1" I.D. to accept the 3201 pivot assembly and are 8-3/4" and 11-1/4" from the center of the axle. Complete assembly comes with a 3201 pivot assembly, 18" aluminum sleeve, jam nuts and a 3/4" LH male rod end bearing.

32002 2 Hole Bracket, Alum - Ea
32006 2 Hole Bracket, Steel - Ea
3208 Assy for LM Chassis (18")
32094 Assembly for Mod (Steel)

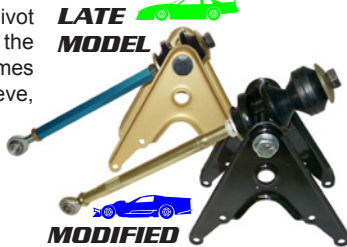

LATE MODEL 



MODIFIED 

PIVOT ASSEMBLY

Pivot assembly cushions both acceleration and braking. Bushings should be preloaded 5 turns when installed.

3201 Pivot Assembly - Standard 
3202 Pivot Housing
3203 Pivot Assembly - Asphalt Mod 
3204 Pivot Slider Assy. - For Lift Bar 



THIRD LINKS FOR 9" FORD

WELD ON 9" FORD

Welds directly to steel 9" Ford housing. Holes are at 8-3/4" and 11-1/4" from the center of axle. Flared to accommodate 3201 pivot assembly.

32004 Bracket Only
32096 Assy, Steel 9" Ford - Mod
Includes: 32004, SS114, 3203, AU-CB12, 310, 3102 & 2 spacers.



CARRIER MOUNT 9" FORD



Fits Winters aluminum 9" Ford housing. Bolts on with the carrier providing a sturdy three link suspension rear end mount.

32009 Carrier Mount



HOUSING MOUNT WINTERS ALUMINUM 9" FORD

Bolts to the 3rd member bolts on a Winters 9" Ford housing. Rear of bracket attaches to the ribs by drilling holes. Use with W5243, Winters 9" Ford aluminum center section.

32005 Housing Mount  



3/4" SPACERS



TAPERED 3RD LINK SPACERS

Kit contains 4 different aluminum spacers that can be arranged to create 16 different possible configurations. Made to fit standard width quick change mounts and most chassis.

32164 3rd Link Spacer Kit*
32160 1.875" Tapered Spacer
32161 1" Tapered Spacer
32162 1.25" Straight Spacer
32163 1" Straight Spacer

***Kit Contains:**
2 - 1.875" Cone Spacers
2 - 1.0" Cone Spacers
1 - 1.0" Straight Spacer
1 - 1.25" Straight Spacer

3/4" STEEL SPACERS



Part No.	Length	Part No.	Length
321125	1/8"	321140	1-1/4"
321114	1/4"	321138	1-3/8"
321375	3/8"	321112	1-1/2"
321112	1/2"	32158	1-5/8"
32134	3/4"	321134	1-3/4"
32111	1"	321238	2-3/8"
32118	1-1/8"	321300	3"

PANHARD FRAME MOUNTS

CAST CLAMP MOUNT

Tough cast steel mount is half the material of a billet aluminum mount with more than twice the strength at only 2.1 lbs. and is IMCA legal. Captured end to never strip threads and only needs one of each wrench. Clamps to 1-3/4" O.D. tubing. Use for any 3/4" bolt application.

30780 Cast Clamp Frame Mount

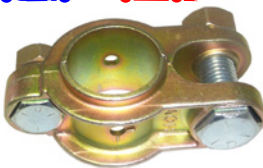

SQUARE TUBE PANHARD CLEVIS

CNC machined from steel to be IMCA legal and weighs just over 2 lbs.. Finished with black anodize. Available for 1-1/2" or for 2", square or rectangular tubing. Threaded holes on each side for quick and easy panhard changes.

30781 IMCA Panhard Clevis - 2"
30782 IMCA Panhard Clevis - 1-1/2"



HOWE WATTS LINK

WATTS LINK

Designed for the TA2 style chassis the watts link assembly attaches to the pinion of a quick change rear end and to brackets welded to the frame rails of the chassis. Provides adjustment with three holes spaced 1.25" apart.

30799 Watts Link Complete Assy - TA2
31175 Watts Pinion Mount Assy

NEW

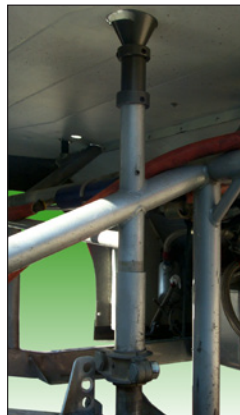

QUICK ADJUST PANHARD MOUNT



307752 Pictured Above with **30780** Panhard Mount



307753

Welds to the frame of any underslung chassis, attach your clevis to its normal height and you will have 1.5" adjustment in either direction. Move the clamp for larger adjustments. Use 3/8" drive extension to adjust the sleeve. Weighs 5.5 lbs. Accepts 1-3/4" panhard clevis. 8" version for tight spaces.
307752 Panhard Mount - 21" (can be shortened up to 2")
307753 Panhard Mount - 8"
307754 Screw Detent for 307752



PANHARD MOUNT & BARS

REAR

Rear mounted panhard bar package comes with aluminum hex or swaged steel sleeve, two 3/4" aircraft grade rod end bearings and jam nuts.

Part No.	Description	Sleeve	Applications
30789	Panhard Bar, Mod (Steel)	23"	MOD 
30791	Panhard Bar, SS	23"	SS 

RETAINER CLAMPS

Used to restrict lateral movement of any axle tube bracket, such as on either side of the panhard mount to prevent movement while adjusting height.

31990 2 Piece - 3"



Made long enough so that the panhard bar clears the quick change cover. Clamps to any 3" axle tube. 13" from the center of the axle to center of 3/4" rod end bearing.

31190 13" Mount, 3/4"



Fits 3" O.D. axle tube. Used on the front of a quick change or either side of a non-QC or 9" Ford. 8" from the center of the axle to the center of the rod end bearing.







31180 8" Mount, 3/4"
31180D 8" Mount, 5/8"
31184 7-1/4" Mount, 3/4"



FRONT



Allows clearance over the drive shaft and under the upper link. Assembly comes with aircraft grade rod end bearings. Length is measured from eye to eye on assem-

Part No.	Description	Length	Applications
30795	Front Bar, Assembly	31.5"	LM QC 
30794	Front Bar Only	25.5"	LM QC 
307942	Front Bar, +1" Each End	28.375"	LM 9" 
			Mod QC 
30793	Front Bar, Assembly	29.75"	TA2 QC 
307941	Front Bar Only	23.75"	TA2 QC 
307943	Front Bar Only	27.125"	TA2 9"

blies and from end to end on the bars only. Use with axle mount 31180.

AXLE MOUNTS

Fits a 3" O.D. axle tube. Designed for mounting the panhard bar on an angle off the main roll bar tube. Measures 8" from center of the axle to the center of the 3/4" rod end bearing. Fits 101 design chassis and newer modifieds.

31183 8" Angle Mount, 3/4"



STABILIZER - ANTI SWAY BARS

ORIGINAL HOWE DESIGN SWAY BARS

Design originated on Howe chassis in the early 70's as a modified stock GM sway bar. The current tubular version is a lighter replacement, available in five rates. Fits asphalt modified.

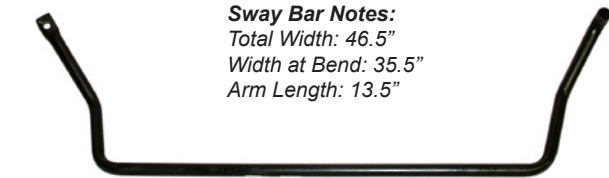

Sway Bar Notes:
Total Width: 46.5"
Width at Bend: 35.5"
Arm Length: 13.5"

Part No.	Description
238	Frame Tube
239	Standard Adjuster Bolt
240	Adjuster Nut
242	Attaching Bolt Assy.
23973	Mod.Sway Bar Eye, LS

Modified Left Side INDIVIDUAL HARDWARE
Adjuster eyes are available with solid shafts. They weigh 1.74 lbs. each. Fits up to 1-3/8" sway bar.

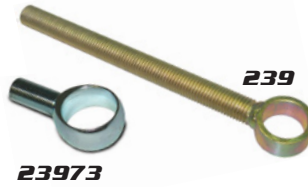

Bar Size	Rate	Bar Only	Impala Mod Kit	Chevelle Mod Kit
1"	176 lbs.	23711	----	----
1-1/8"	266 lbs.	23718	23618M	23618CM
1-1/4"	385 lbs.	23714	23614M	23614CM
1-3/8"	534 lbs.	23719	----	----
1-1/2"	718 lbs.	23720	----	----

1 PIECE ADJ. RATE SWAY BARS - OVAL, XL, M, SS, ES

INDIVIDUAL HARDWARE PIECES

- 236961 Wear Blocks, Old Road Race Adapter Kit (No Threads)
- 236971 Wear Blocks Kit - One Car
- 23698 Sway Bar Frame Mount & Bolts
- 23697 Wear Block Only - 5/16
- 236973 Wear Block Only - 3/8
- 23699 Cap Only for 23698



- 2397 Swaybar Eye, 1"- 1-1/4" Bars
- 23972 Swaybar Eye, 1-3/8" - 1-1/2" Bars
- 23978 Swaybar Eye, 1-3/8" - 1-1/2" Bars w/ Sleeve

An adjustable rate sway bar allows for infinite adjustment of the front to rear roll stiffness relationship, or "roll couple".



Bar Size	Bar Rate	Bar Only	Hardware	Adjuster
1-1/8" - 45.5" Wide	266 to 400 lbs.	23793	23694	2397
1-1/4" - 45.5" Wide	385 to 578 lbs.	23794	23694	2397
1-3/8" - 45.5" Wide	534 to 802 lbs.	23795	23692	23972
1-1/2" - 45.5" Wide	718 to 1078 lbs.	23796	23692	23972



SPLINED SWAY BAR - OVAL, XL, M, SS, ES

Fits XL, M, SS, and ES design chassis. May move on the frame to adjust arm length and rate. Bent arms allow greater ground clearance, keeps eyes from dragging, and the tie rods from hitting when on jack stands.

Bar Size	Bar Rate	Bar Only	Bar Assy.	Mount*	Adj. Eye*	Left Arm	Right Arm
1-3/8"	534 to 802 lbs.	SC1449HW138	23655	23650*	23980*	SP617-3-49	RF2700H
1-1/2"	718 to 1078 lbs.	SC1449HW112	23657				

*Are sold individually, need 2 per bar.

3 PIECE STABILIZER BARS

SPLINED SWAY BAR - OVAL, 101

Designed for the 101 suspension package it offers the same features of the "SS" kit with a few changes. EZ adjuster allows for simple bar preload adjustments. A straight left arm is used instead of the offset arm.

Bar Size	Bar Rate	Bar Only	Bar Assy.	Left Mount	Right Mount	Left Eye	Right Eye	Nylon Spacer*	Left Arm	Right Arm
1-3/8"	534 to 802 lbs.	SC1449HW138	23672	23650	23691	23980	23951	23985	RF2779	239275
1-1/2"	718 to 1078 lbs.	SC1449HW112	23673							

*Are sold individually, need 2 per bar.

Standard Arms - Arms with the splined insert will fit a standard Schroeder type bar with a 1-1/4" x 49 spline or the new square end bars.

RF2779 101 Oval Track, Left 239275 101 Oval Track, Right (Pictured)

NEW



101 JS KIT

All splined bars are 37-1/2" long with 1-1/4" x 49 spline, .600 I.D.

FIXED SPLINED SWAY BAR - ROAD RACE, TA2, V8TC

Non-adjustable arms feature an effective arm length of 12" and have threaded 1/2"-13 holes for attaching to the suspension with a 1/2" rod end bearings.

Bar Size	Bar Rate	Bar Only	Bushing*	Left Arm	Right Arm
1-3/8"	931 lbs.	SC1449HW138			
1-1/2"	1279 lbs.	SC1449HW112	23925*	23926	23927
1-5/8"	1736 lbs.	SC1449HW158			
1-5/8"	1885 lbs.	SC134HW158			
1-3/4"	2448 lbs.	SC134HW134	239251*	239261	239271
2"	4000 lbs.	SC134HW2		239262**	239272**

*Are sold individually, need 2 per bar.

**For 2015 Front Suspension.



Weld on fixed sway bar mount 357144. OP-07 installed on clip see page 2 for front frames.

Standard Arms - Arms with the splined insert will fit a standard Schroeder type bar with a 1-1/4" x 49 spline.

Large Bar Arms - These arms do not have an insert and fit the larger Schroeder type bar with a 1-3/4" x 48 spline. Arms are available for road racing applications.

Side	[A] Pre-2015, 1.50" Original Lower	[B] Pre-2015, 1.75" Original Lower	[C] 2015, 1.75" New Lower	Pre-2015, 1.75" New Lower
Left	23926	239261	239262	239264
Right	23927	239271	239272	239274

SQUARE END BARS

Large splined sway bar arms are hard to install on the sway bar due to the pinch retainer always remaining distorted and when you do get them on they can easily be one tooth off. The new square end arms slide right on. The square bar ends are held in-line in a fixture while the tube is welded so they are always in line. The thin heat treated tube saves as much as seven pounds over standard splined bars. Currently available in popular rates. New rates are being added on the website.

Bar Size	Bar Rate	Bar Only	Bushing*	Left Arm	Right Arm
1.500	1279 lbs.	2373150	239257*	239263	239273
2.080	1885 lbs.	2373158			
2.170	2448 lbs.	2373134	239257*	239267	239277
2.250	4000 lbs.	23732			

Square End Bar Arms - Feature the large square drive that is rotated in the arm to differentiate them from the splined insert bars as well as provide a beefier cross section to deal with the heavier bar loads.

NEW

Side	Pre-2015, Orig. Lower	Pre-2015, New Lower	2015, New Lower
Left	239263	239266	239267
Right	239273	239276	239277

FRAME MOUNTED REAR SWAY BAR



Our rear sway bar is 3/4" diameter with arm mounts at 14", 15" and 16" giving you a choice of 32.5, 35 or 37 pounds. Designed to mount in front or behind the rear end with room for a quick change.

- 23610 Complete Assembly
- 23710 Sway Bar Only
- 23651 Axle Mount
- 23652 Eyelet / Clamp
- 35461045 Split Collar Clamp



23610

STABILIZER - ANTI SWAY BAR ADJUSTERS

QUICK CHANGE SWAY BAR ADJUSTER

Unique quick-change coupling allows you to detach the eye for easy sway bar changes.

Accepts up to a 1-3/8" bar, is lined with a replaceable polymer bushing and hard coat anodized for durability. Comes with a 7/8"-9 threaded steel bung to weld to the frame. Weighs less than half of a standard adjuster and with the frame bung it is still only 1.24 lbs..

23951

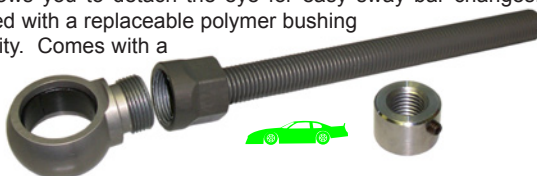

SWAY BAR CLAMP

Clamp these to the inside of each sway bar mounting bolt to prevent the bar from shifting and causing changes in rate and preload. Made from anodized billet aluminum.

- 23701 1" I.D. Each
- 23706 1-1/16" I.D. Each
- 23700 1-1/8" I.D. Each
- 23704 1-1/4" I.D. Each
- 23705 1-3/8" I.D. Each
- 23702 1-1/2" I.D. Each



STABILIZER - ANTI SWAY BAR ADJUSTERS

EASY ADJUSTERS

Simple to install and use on oval track chassis. To adjust, use a 3/8" drive wrench on the top and simply turn in or out to pre-load. Thread drag adjuster prevents it from moving on its own. Fits up to 1-1/2" bars.

VERTICAL EZ ADJUSTER

Mounts on the sides of standard 2"x3" frame rail. Vertical design takes up less space allowing the adjuster to be in closer to the frame. Adjust the rate by moving ahead and back. Adapts to many chassis. Complete assembly includes 24097 & 23691.

- 23990 Complete Assy. - Coarse
- 23990F Complete Assy. - Fine
- 23691 Vert EZ Adj. Mount - Coarse
- 23691F Vert EZ Adj. Mount - Fine



FOR ORIGINAL STYLE HOWE BARS



Just slide it in and weld the threaded bushing in place.

- 23997 Complete Assy w/ Bushing - Coarse
- 23997F Complete Assy w/ Bushing - Fine
- 23996 Bushing Only - Coarse
- 23996F Bushing Only - Fine
- 24097 Bolt & Eye Assy - Coarse
- 24097F Bolt & Eye Assy - Fine
- 24098 3/8 Cap Screw for Eye
- 24099 7/8 threaded Shaft
- 23994 Plastic Ball
- 23995 Set Screw



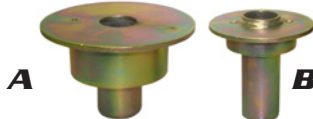

UPPER SPRING CUPS

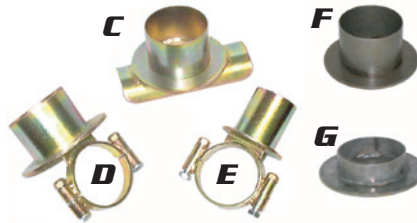

- A. 304 Fits 5 or 5.5" Spring 
- B. 304SP Fits 2-1/2" Spring 



LOWER SPRING CUPS

- C. 303 Fits 5 or 5.5" Spring on Axle
- D. 30391 Fits 5" or 5.5" Spring on 31991 
- E. 30392 Fits 2-1/2" Spring on 31991 
- F. 30300 Spring Cup Without Center
- G. 30310 Weld On Lower Spring Cup

COILOVER WEDGE BOLT ADJUSTER

Used for making quick adjustments to wedge with a simple turn of the wrench. Requires 1"-14 fine threaded mounting to the car.

- 30150 Wedge Bolt Adjuster
- 30151 Weld-on Mount

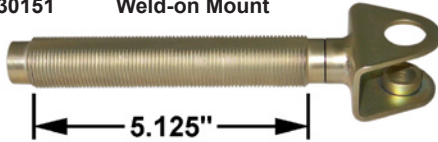

FINE THREADED LOAD BOLT

Fine threaded load bolts allow more precise adjustments. They feature a 1"-14 thread, a 3/8" broach, available 8" or 10.75" long.

- 30152 Sleeve Only - Fine Thread
- 30051 8" Fine Load Bolt
- 3005 10.75" Fine Load Bolt



STANDARD LOAD BOLTS

Threaded 1"-8 coarse thread, cadmium plated, and broached on one end to accept a 3/8" drive wrench. Available in 8" and 11".

- 300 8" Load Bolt 
- 3003 11" Load Bolt



FRONT MOUNT

Fits between the upper a-frame mounts to convert coilover frames to conventional coil. Made of sturdy 1/2" H.R. steel plate with a 1"-8 thread.

- 30193 Weight Jack Plate

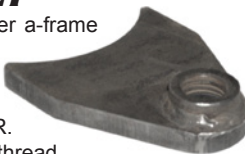

LOAD BOLT PLATE

Used on all types of stock frames from Camaro to IMCA modifieds. Just cut out the top spring seat and weld the 5" round load bolt plate to the frame. Uses 1"-8 coarse thread.

- 301 Weight Jack Plate



ADJUSTABLE SPRING CUP

Use inside the frame to conceal spring adjustment where load bolts are not allowed.

- 30400



HOWE SPRING SLIDERS - COIL OVER ELIMINATORS

ALL STEEL IMCA LEGAL



Slider Notes:

- 13" Slider Uses 11" Spring, has 10" Body
- 14" Slider Uses 13" Spring, has 11" Body
- 13" Centers Travel From 13" to 21"
- 14" Centers Travel From 14" to 22-1/2"

Note: Length Measured Eye to Eye While Centered in Travel.

LINEAR BEARING SLIDERS

Our low fraction sliders have a linear ball bearing. Comes with two 1/2" rod ends and spring cups. Fit 5" conventional coil springs.

- 30253 13" with Cups
- 30254 14" with Cups
- 30243 13" Slider Less Cups
- 30244 14" Slider Less Cups

LINEAR SLIDER PARTS

- 30200 Slotted Cup Only
- 30201 Shaft End Cup Only
- 302002 Adjuster Nut
- 302005 Body Cap
- 302347 Stop Bolt

Length	Body	Shaft
13"	302336	302335
14"	302346	302345

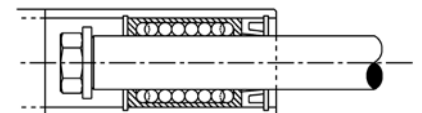

- 302348 Flat Washer
- 302349 Snap Ring, Inner
- 302350 Linear Bearing Slider
- 302351 Seal
- 302352 Snap Ring, Outer

CONVENTIONAL COIL & COILOVER SPRINGS



(NOTE: Alternate spring manufacturers may be offered when Hypercoil is unavailable.)

2.5" COILOVER-OVAL TRACK

RATE	12" P/N	14" P/N
80	----	080-14
90	----	090-14
100	----	100-14
110	----	110-14
125	----	125-14
150	150-12	150-14
165	----	165-14
175	175-12	175-14
185	185-12	185-14
200	200-12	200-14
225	225-12	225-14
250	250-12	250-14
275	275-12	275-14
300	300-12	300-14
325	325-12	----
350	350-12	----
375	375-12	----
400	400-12	----
425	425-12	----
450	450-12	----
475	475-12	----



2.5" COILOVER-ROAD RACE

RATE	Part No.	Length
225	225-10	10"
250	250-10	10"
275	275-10	10"
300	300-10	10"
350	350-10	10"
900	900-08	8"
1000	1000-08	8"
1100	1100-08	8"
1200	1200-08	8"

2.5" COILOVER-ROAD RACE SPRING TENDER

Use with stiffer rate non-preloaded springs to keep spring seated when the car is off the ground.

CS600 Tender, Spring
18DS100 Tender, Ring



CONVENTIONAL COIL - 5", 5.5"

Rear Springs

Front Springs

Rate	5" x 11"	5" x 13"
150	S15011	S15013
175	S17511	S17513
200	S20011	S20013
225	S22511	S22513
250	S25011	S25013
275	S27511	----
300	S30011	----
325	S32511	----
350	S35011	----
375	S37511	----

Rate	5.5" x 9.5"	5" x 9.5"
450	S4509	S45059
500	S5009	S50059
550	S5509	S55059
600	S6009	S60059
650	S6509	S65059
700	S7009	S70059
750	S7509	S75059
800	S8009	S80059
850	S8509	S85059
900	S9009	S90059
950	S9509	----
1000	S10009	----
1050	S10509	----
1100	S11009	----
1150	S11509	----
1200	S12009	----
1300	S13009	----
1500	S15009	----

5" COILOVER ADAPTER

Adapters work with coilover hardware to easily fit a 5" coil spring. Compatible with hardware kits from many manufacturers. Designed to be strong, light weight and sharp looking. Powder coated and only 1.30 lbs per pair.



30205 5" C/O Adapter - Pair
30203 5" C/O Adapter - Single

SPRING CAGE **NEW**

Aluminum spring cage allows you to preload a 3" x 10" coilover spring independently of the shock for softer rates and more grip. This also allows for quick and easy shock and spring changes.

30209 Spring Cage

3" COILOVER-OVAL TRACK **NEW**

These 3" diameter by 10" long springs are required for use with the spring cage to quickly and easily preload springs independently from the shock.

Rate	Hypercoil	Eibach
100	10E0100	1000.300.0100S
150	10E0150	1000.300.0150S
200	10E0200	1000.300.0200S
300	10E0300	1000.300.0300S

RACING SPRING RUBBERS

Fit 2.5", 5", and 5.5" diameter springs for quick, precise spring rate changes. Made in soft, medium, and hard rate Polyurethane that out lasts rubber 4 to 1.

Maintains 95% of rate at 180 degrees. 5" & 5.5" coil spring rubbers come in 1.25" & 1.75" height.



Rate	2.5"	5", 5.5" - 1.25"	5", 5.5" - 1.75"
Soft	SA4310	SA1310	TSAML175189
Med	SA4915	----	TSAML175237
Hard	SA5720	SA1620	TSAML175283

2.5" ULTRA HIGH TRAVEL

Ultra High Travel (UHT) Hypercoils are designed specifically for light rate/ high travel applications. UHT remain consistent in free length and installed height. Larger "body bulge" over standard OBD designs allows additional deflection and resistance to bowing. Available in select rates at 14" and 15" lengths.

2.5" UHT		
RATE	Part No.	Length
110	15B0110UHT	15"
125	14B0125UHT	14"
140	14B0140UHT	14"
150	14B0150UHT	14"
165	14B0165UHT	14"
175	14B0175UHT	14"
185	14B0185UHT	14"
200	14B0200UHT	14"
225	14B0225UHT	14"
250	14B0250UHT	14"



ESSENTIAL FOR SOFT SPRING SET-UPS.

SPRING ACCESSORIES

HOWE PRELOAD RING KITS

Quickly change heavily preloaded springs by installing retainer rods before jacking up the car, then raise car and easily remove the spring. Install spring already preloaded, set the car down, and remove rods. Must have on cars using "big bar / soft spring" packages with 2.5" I.D. or Swift barrel style springs.

86900 Preload Ring Kit, Std 2.5" ID Springs
86901 Preload Ring Kit, Swift Springs



SHOCK TRAVEL INDICATORS

Determine the travel of the shock from ride height. Simple design allows it to be used with any shock. Great for calculating spring and bump stop loads.

84030 Shock Travel Indicator

SPRING BEARING

5/32" thin roller bearing fits between the spring and the shock greatly reducing the effort and time needed preloading springs.

7A166 Coilover Bearing for 2.5" ID
7A167 Coilover Bearing for 3" ID



SPRING PRELOAD SPACER

When heavily preloading springs, threaded body shocks may run out of adjustment. This 2" spacer gives you added adjustment.

31030120-2 Shock Preload Spacer



High quality and relatively easy to revalve and repair. Some have external adjustments, but large changes must be made internally. All Penske's are mono tube type shocks with a variety of piston, shaft, and valving choices.

7150 SERIES STEEL





Simplified design, advanced coatings and materials, provide for a cost effective shock without losing the high-quality components, consistency, reliability, and tuning options found in any Penske shock. IMCA late model and modified approved.*

PK7157 Steel 7" Stroke

PK7159 Steel 9" Stroke

*Can upgrade with the addition of an adjustable rebound shaft.

ADJUSTABLE SHOCK CAP

Designed by Howe to fit Penske shocks this cap offers the ability to adjust the shocks' length 1.25" total eye to eye. Allows quick adjustments when setting ride height and bump stop travel and load. Eliminates chassis mounted screw adjusters  

PK9000 Cap - 7500 Series

PK9300P Cap - 8300 Series



7500 SERIES



The 7500 series is the most popular shock option with an aluminum body and nitrogen separator piston. Available in 7", 8", and 9" lengths. Coilover Ready. Call for valving specifications when ordering.

PS7547 7" Stroke

PS7548 8" Stroke

PS7547RA 7" Rebound Adjustable

PS7548RA 8" Rebound Adjustable

Part No.	Description
A PIHF12005	High Flow Piston 1 / 2
PIHF14005	High Flow Piston 1 / 4
PIHF21005	High Flow Piston 2 / 1
PIHF22005	High Flow Piston 2 / 2
PIHF24005	High Flow Piston 2 / 4
B PK6018-06	Eyelet - Standard

8300 SERIES

Available with or without rebound adjustable shaft. The rebound adjuster has 25 sweeps of bleed adjustment and the compression adjuster has 20 clicks of adjustment. This is accomplished by a parabolic needle valve that adjusts a fluid bypass past a standard shim stack. Call for valving specs when ordering.

PK8347 7" Stroke

PK8349 9" Stroke

PK8347RA 7" Rebound Adjustable

PK8349RA 9" Rebound Adjustable



PENSKE HARDWARE

PK6036-04 Ride Height Adjuster Nut

PK6038-50 Penske Spring Retainer

PK6016BX Revalve Kit

PKWB6031 Wrench, Penske

PK6003-32 Shock Oil, 1 qt.

PK6013-10 Regulator



SHOCK DYNO & CUSTOM VALVING SERVICES

Howe Racing offers a full line of shock services. Custom valvings can be tailored to your application. We have full shock dyno service as well as preloading machines for setting bump stops.



Comp	Reb	Stroke	WB -Steel	TA - Steel	AC - Alum
3	3	7	----	PRTA7300	PRAC730B
3	3	9	PRWB93	PRTA9300	PRAC930B
3	5	7	PRWB735	PRTA7350	----
3	5	9	PRWB935	----	----
4	4	7	PRWB74	PRTA7400	PRAC740B
4	4	9	PRWB94	PRTA9400	PRAC940B
4	6	7	PRWB746	----	----
4	6	9	PRWB946	PRTA9460	PRAC946B
4.5	4.5	9	----	----	PRAC94.5B
5	3	7	PRWB753	----	----
5	3	9	PRWB953	----	----
5	5	7	PRWB75	PRTA7500	PRAC750B
5	5	9	PRWB95	PRTA9500	PRAC950B
6	3	7	PRWB763	----	----
6	6	7	PRWB76	PRTA7600	PRAC760B
6	6	9	----	PRTA9600	PRAC960B
7	7	7	PRWB77	PRTA7700	PRAC770B
9	1	7	PRWB791	----	----

Comp	Reb	Stroke	AC - Alum. Reb Adj.	AC - Alum. Dbl Adj.
3-7	3-8	7	----	PRAC737/38B
4	3-8	9	PRAC943-8B	----
5	3-8	7	PRAC753-8B	----
6	3-8	7	PRAC763-8B	----

PRO SHOCKS

Pro shocks compression and rebound are rated on a scale of 1 to 14 with the lower numbers being softer and higher numbers stiffer.

WB - STEEL

A good racing shock for the budget minded. The Pro welded bearing steel shock features a non-rebuildable design. Comes as shown. Can **NOT** be used as coilovers!



TA - STEEL

Good digressive racing shock for the money. Utilizes take apart design that allows them to be rebuilt and revalved. Requires two 1/2" bearing shock eyes that are sold separately (PN: PRB200).



AC - ALUMINUM

Lighter than the steel shock and has a threaded body. Digressive but made to closer tolerances than steel and can be sent in to be rebuilt. Fluid pressurized, but they do not have gas pressure. Includes 1/2" bearing shock eye.



AC - ALUM. ADJUSTABLE

Available in both rebound adjustable as well as double adjustable (pictured above) configurations. Includes 1/2" bearing shock eye.



ADJUSTABLE REBOUND SHOCKS:

Pro adjustable rebound shocks are identified by the "dash" between the last two digits. The number before the dash is the lower limit and after is the upper limit.

HARDWARE KITS

PRC300 Hardware Kit for Steel
PRC320 Hardware Kit for Aluminum
PRB200 1/2" Bearing Shock Eye
PRZ902 Spanner Wrench - 2" Shock

BUMP STOPS



HOWE BUMP STOP 101 SYSTEM

Bump stops are complicated but you can get everything you need in a simple kit with this system. Several different rates and shapes can be used with 3 different thickness shims to get the rate and length combination for any track.

101-4000 Complete Kit A selection of bump stops, washers, and spacers for tuning your bump stop set up.

101-2000 Left Front Kit Each Corner kit Includes: 2 stops with (3) washers, (1) 1/2" shims, (2) 1/4" shim and (4) 1/8" shims.

101-W125 Washer Only, 1/8"
101-5000 Road Race Kit Complete kit for running bump stops on the front of a TA2 style chassis. Includes bumps, washers and shims.

BUMP STOP TECH

DVD produced by Tony Blanchard of Race 101. It is the first of a series to help you understand the basic principals and fundamentals of using bump stop set-ups.

89010 Bump Stop Tech, Vol. 1



101 BUMP RUBBERS

Rate	1/2 Round	Flat	Tall 1/2 Round
Soft	101-3379	---	101-3390
Medium	101-3380	101-3383	101-3391
M Hard	101-33805	---	101-3392
Hard	101-3384	101-3381	---
X Hard	101-3385	101-3382	101-3394
XX Hard	101-3386	---	---

PACKER SHIMS

Thickness	P/N
1/8"	101-P125
1/4"	101-P250
1/2"	101-P500
1/8" Washer	101-W125

FABRICATED SPINDLES

Part No.	Hub	Steering Arm	Brake Type	Brake Pos.	Side	Drop
345L*	W5	Threaded	GM	Front	Left	3.5"
34605	5x5	Threaded	GM	Front	Right	3.5"
34605L	5x5	Threaded	GM	Front	Left	3.5"
34605LA	5x5	Adjustable	GM	Front	Left	3.5"
34645L	5x5	Threaded	4P	Front	Left	3.5"
34645RR	5x5	Threaded	4P	Rear	Right	3.5"
34605LR	5x5	Threaded	GM	Rear	Left	3.5"
34605RR	5x5	Threaded	GM	Rear	Right	3.5"

* 1/2" Narrower than standard

5TH DESIGN & LLM

10 degree spindles that fit 3rd-5th Howe chassis as well as stock & LLM clip cars. All are 8.75" tall with a 3.5" pin height and 1.25" thick 11.75" rotors. 64.25" with Howe 5x5 hubs on a Camaro or LLM clip with stock length lowers. W5 hubs add 1".

WIDE 5 GM FRONT MOUNT BRAKE



5X5 4 PISTON REAR MOUNT BRAKE WITH GM BRAKE ADAPTER

GM BRAKE ADAPTERS

With the Howe GM Brake Adapters you can choose to purchase your spindles with a 4 piston mount and have the option to use either type of brakes. See page 42.



STRUT SPINDLES

Stocked in four different pin heights for different ride heights and tire sizes. Using taller ball joint pins allows you to make height adjustments. Built to accept 1.25" thick 11.75" rotors.

- 4.5" Drop** - For 101 suspension package. Requires slug for upper taper.
- 4" Drop** - For all SS chassis with right side tires larger than 85".
- 3.5" Drop** - For XL, M and ES chassis with right side tires 85"+
- 2.5" Drop** - For SS or ES chassis with right side tires smaller than 85".

WIDE 5 4 PISTON REAR MOUNT BRAKE

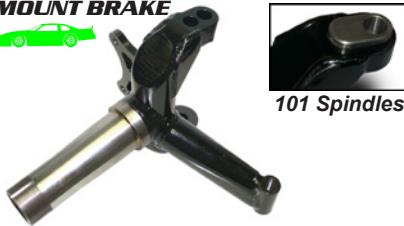

101 Spindles

Design	Part No.	Hub	Steering Arm	Brake Type	Brake Pos.	Side	Drop	Height
101 Slugs Required	34612L4A	5x5	Adjustable	4P	Rear	Left	4.5"	9.25"
	34612	5x5	Threaded	4P	Rear	Right	4.5"	9.25"
	34712L4A	W5	Adjustable	4P	Rear	Left	4.5"	9.25"
	34712	W5	Threaded	4P	Rear	Right	4.5"	9.25"
SS 85"+ Tires	347074	W5	Threaded	4P	Rear	Right	4.0"	7.75"
	34707L4A	W5	Adjustable	4P	Rear	Left	4.0"	7.75"
XL M ES 85"+ Tires	346944	5x5	Threaded	4P	Rear	Right	3.5"	7.75"
	34694L4A	5x5	Adjustable	4P	Rear	Left	3.5"	7.75"
	346074	5x5	Threaded	4P	Rear	Right	3.5"	7.75"
	34607L4A	5x5	Adjustable	4P	Rear	Left	3.5"	7.75"
	347944	W5	Threaded	4P	Rear	Right	3.5"	7.75"
	34794L4	W5	Threaded	4P	Rear	Left	3.5"	7.75"
SS -85" Tires ES -85" Tires	34794L4A	W5	Adjustable	4P	Rear	Left	3.5"	7.75"
	34794LA	W5	Adjustable	GM	Front	Left	3.5"	7.75"
	346254	5x5	Threaded	4P	Rear	Right	2.5"	7.75"
	34725	W5	Threaded	GM	Rear	Right	2.5"	7.75"
	34725LA	W5	Adjustable	GM	Rear	Left	2.5"	7.75"
	347254	W5	Threaded	4P	Rear	Right	2.5"	7.75"
	34725L4A	W5	Adjustable	4P	Rear	Left	2.5"	7.75"

ROAD RACE SPINDLES

V8TC / GT2 / TA2 / CTCC

A 7.75" spindle with short equal length non-adjustable steering arm. Built to accept 12.19" brake rotors. MK2 design utilizes a slug style upper taper for versatility.

- 34610L4 Left - MK1, 5-10"**
- 346104 Right - MK1, 5-10"**
- 34611L4 Left - MK2, Slug Type**
- 346114 Right - MK2, Slug Type**



WILWOOD TA2/ GT2 SPINDLES

Special spindles with relocated caliper mount are required for the Wilwood GN6R caliper (page 41). Also requires a Wilwood specific rotor.

- 34611LW Left - MK2**
- 34611W Right - MK2**

SPINDLE REPAIR / CHECK POLICY

We **do not** repair or modify spindles as they often have hidden damage. We check fabricated spindles for a fee of \$15.00 per spindle. Allow 7 working days from when we receive them. Customer is responsible for shipping charges to and from Howe Racing. Damaged spindles will be discarded unless specified otherwise.

HOWE CAST SPINDLES

MODIFIED SPINDLES

Howe Cast - Tough 4140 heat treated steel spindle works great when rules prohibit tubular spindles. It is 8.75" tall with a 3.5" pin height. Steering arms have tapered holes for tie rod ends can be drilled for use with a 5/8" hiem. Threaded to accept a fabricated Howe brake bracket or interchanges with 1969 Olds 442 caliper bracket. Fits hubs for 74-81 C10 Truck or 70-73 Impala & Cadillac. Raybestos #5006 or equivalent.

- 344GN Right
- 344GNL Left
- 339L Brake Mount - Left
- 339R Brake Mount - Right

Kit	Bearing	Race
A3	M12649	M12610
A5	LM48548	LM48510

Chevelle Modified - Howe Chevelle modified chassis uses this new after market Pinto type spindle that accepts a (SWS203-852) Granada style hub or the Howe replacement hub (204345). It is 7.5" tall with a 2.25" pin height. Ball joint tapers come reamed 1.5" per foot upper, 2.0" per foot lower.

- SWS1043901 Left - Chevelle Mod
- SWS1043921 Right - Chevelle Mod

IMPALA Modified - Steering arms of stock spindles can vary. Our reconditioned OEM spindles are pressed in a fixture for consistency with bump steer and akerman. They are a full size GM spindle that accepts the 3370 caliper with a OEM style (PQP60476) hub or the Howe replacement (204346) hub.

- 3448B Left - Impala Mod
- 3449B Right - Impala Mod

SPINDLE SLUGS

Upper taper slugs are required for 101 and MK2 spindles. Available in 0°, +/-1°, and +/- 2°.

- 347DET00 0° Slug
- 347DET01 +/- 1° Slug
- 347DET02 +/- 2° Slug



STEERING SPACERS

5/8-18 RH thread bolt fits threaded spindles and racks. Shims are used between the rod end and the rack or spindle to set bump steer.

- R356 Bolt and Spacer
- R357 .300 Spacer
- R358 .050 Spacer
- R359 2-1/4" Bolt
- R360 .125 Spacer
- R361 .025 Spacer



JAM NUTS



Size	Thread	Part No.
7/8-9	RH	240
3/4-16	RH	310
	LH	3102
5/8-18	RH	R352R
	LH	R352L
Nylock	RH	N1137136
	LH	3104
3/8-24	RH	N38J
5/16-24	RH	N516JAMNC

EXTENDED QUICK BUMP STUD

Extended an extra 1" to allow a nylock nut. Shoulder allows spacer to reinforce the stud with a spacer when extended.

- 2329610 Stud Only, Extended +1"
- R367 Cut to Length Spacer

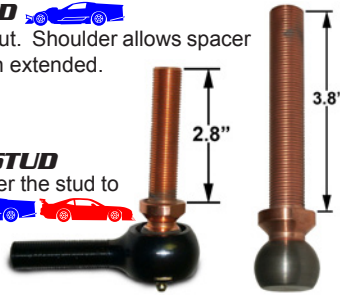

SHOULDERED QUICK BUMP STUD

Shoulder allows a spacer to be used over the stud to make it stronger when extended.

- 23284 Complete RH
- 23283 Complete LH
- 23296 Stud Only

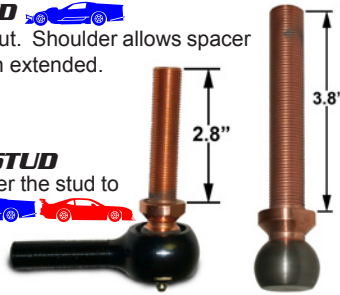

SERRATED NUT

For installing Quick Bump tie rods on adjustable steering arm spindles.

- 23299 Serrated Nut



REPLACEMENT PARTS

- A 23236 Cap, XD - Steel, No Zerk
- B 23237 XD Cap Retainer
- C 23238 XD Cap Snap Ring
- D 23242 O-Ring - fits all Tie Rods
- E 23243 Race

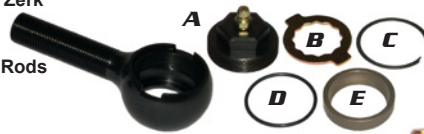

TAPERED TIE ROD END STUDS

Tie Rod PN	Std.	+100	+200	+300	+400	+500
23220	23200	23201	23202	23203	23204	23205
23240	23290	23291	23292	23293	23294	23295
23270	23210	23211	23212	23213	23214	23215



TAPERED TIE ROD GAUGES

Used to check tapered tie rod ends for damage. Use the table below to select the correct gauge for your tie rod taper.

Part No.	Taper	Gauge	Stud
22509	1.69"	J	23200
22512	1.50"	K	23210
22513	1.50"	L	23290



COMPLETE HOUSINGS, LESS STUD

- 23244 Complete, Less Stud - 23220, 23240
- 23245 Complete, Less Stud - 23230, 23250
- 23247 Complete, Less Stud - 23270
- 23248 Complete, Less Stud - 23280
- 23249 Complete, Less Stud - 23278

HOWE QUICK BUMP TIE ROD ENDS

All of the advantages of our precision tie rod ends plus the ability to quickly and easily adjust bump steer. They eliminate bump steer shims and offer 8° more misalignment than rod ends. Studs are threaded 5/8"x18 RH to screw directly into the rack or spindle and are held in position with a jam nut. Bump steer adjustments are made quickly and easily with a 3/8" allen wrench.

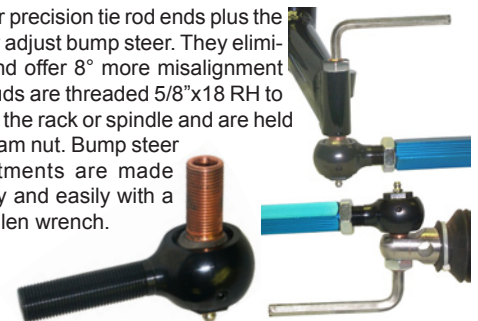
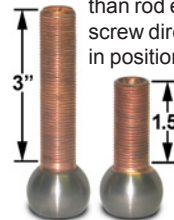

Part No.	Housing Style	Stud Style	Housing	Stud
23283	5/8"x18 LH Thread	3.00" (long shouldered)	23247	23296
23284	5/8"x18 RH Thread	3.00" (long shouldered)	23248	23296
23285	5/8"x18 LH Thread	1.50" (short, rack end)	23247	23297
23286	5/8"x18 RH Thread	1.50" (short, rack end)	23248	23298
23287	5/8"x18 LH Thread	3.00" (long, spindle end)	23247	23298

Note: EZ Bump tie rod assemblies require a threaded style rack.

HOWE PRECISION TIE ROD ENDS

PATENTED: US Patent No. 6,908,251 B2. Additional Patents Pending.

IMPROVED HOUSING



Features the same advantages as our Precision Ball Joints; Easily rebuildable and adjustable. Alloy steel ball studs are process coated for low friction and long wear. Stronger than any other tie rod end tested with superior misalignment compared to rod end bearings. Standard studs are dimensionally the same as OEM with longer studs available. Interchangeable studs and housings.

Howe	Replaces	Thread	Taper per ft.	Racing Application	Complete Less Stud	Stud	Gauge
23220	ES150R	3/4"x16 RH	1.69"	Grand National Chassis w/ Large Taper	23244	23200	J
23230	ES150L	3/4"x16 LH			23245		
23240	ES2847R	3/4"x16 RH	1.5"	Most Grand National Chassis	23244	23290	L
23250	ES2848L	3/4"x16 LH			23245		
23270	ES370L	5/8"x18 LH	1.5"	Interchanges with 5/8" Rod End	23247	23210	K
23280	ES370R	5/8"x18 RH			23248		

TIE ROD ASSEMBLIES



Chassis Design	Rack Style	Left Sleeve	Right Sleeve	Inner End	Left Assy.	Right Assy.
Camaro Frame Stock Lowers	Threaded 18.25"	R3313 - 13"	R3314 - 14"	5/8" Hiem	R35013	R35014
SS Design	Threaded 17.25" EZ Bump 17.25"	R33112 - 12"	R33116 - 16" R33115 - 15"	5/8" Hiem 23285	R35012 R35112	R35016 R35116
ES Design	Threaded 17.25" EZ Bump 17.25"	R3313 - 13"	R3314 - 14" R3313 - 13"	5/8 Hiem 23285	R35013 R35113	R35014 R35113
Road Race						
101 Design	Clevis 18.25"	R3311 - 11"	R3314 - 14"	5/8 Hiem*	R35111	R35114

*Hiems are included with new Woodward clevis end rack & pinions.

TIE ROD SLEEVES

Howe tie rod sleeves are made from aluminum that has the correct tap diameter without machining. The tubes have a hexagon O.D. for a 15/16" wrench. They are also available in bulk lengths. The steel sleeve are 7/8" diameter with swaged down ends.

R331M Aluminum Per Foot

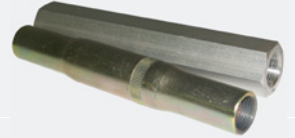

HOWE STOCK STEERING REPLACEMENT KITS

Each packages is made to provide the best possible steering for each application. Kits includes stock replacement racing centerlink, billet pitman arm, billet idler arm, and quick bump tie rod assemblies. These packages optimize the bump steer, allow quick adjustments and a precision feel. Designed for racing applications, not intended for street car applications!

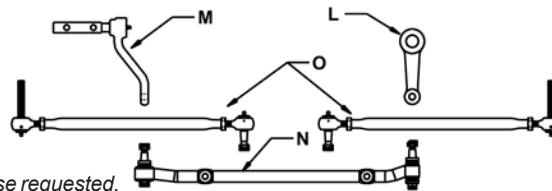

Note: All tie rod kits come w/ EZ Bump outer ends unless otherwise requested.

Style	Complete Kit	[L] Billet Pitman	[N] Centerlink	[M] Billet Idler	Spacer	[O] Tie Rod Assy.	Bump Steer Spacer Kit
OEM Chevelle Modified	23501	2345	233973	23428	----	R354150	R366
New Chevelle Modified	23500	2345	233973	23428	32165	R354150	R366
OEM Chevelle	23502	*N/A	23397	23428	----	N/A	N/A
OEM Chevelle w/ Camaro Pitman	23507	2349	233974	23428	----	N/A	N/A
Impala Modified	23503	23475	23380	23431	----	R35416	N/A
Camaro, Racing	23504	2349	23396	23421	----	R35413 / R35414	N/A

Length	Aluminum	Steel
4"	----	SS5140
4.5"	R33145	SS5145
5.25"	R33155	----
5.5"	R33158	SS5155
7"	R3317	SS517
8"	R3318	SS518
9"	R3319	SS519
10"	R3310	----
11"	R3311	SS511
12"	R3312	SS512
13"	R3313	SS513
14"	R3314	SS514
15"	R3315	SS515
16"	R33116	SS516
17"	R33117	SS517
18"	R33118	SS518
19"	----	SS519

New Chevelle Modified - This package was developed for Chevelle modifieds with new reproduction frames that vary from stock. Complete packages are made for both the OEM and new frames. An OEM idler arm will work on a OEM frame but requires a offset bracket if used on a reproduction frame.

HOWE STOCK STEERING REPLACEMENT PARTS

STOCK STEERING TIE ROD ASSY.



Application	Side	Inner	Outer	Sleeve	Assy.
Camaro Clip	Left	23270	23284	SS513	R35413
Camaro Clip	Right	23270	23284	SS514	R35414
Impala Mod	Both	23270	23284	SS516	R35416
Chevelle Mod	Both	23270	23284	SS513	R354150

HOWE BILLET PITMAN ARMS

Replaces stock 1970-80's GM parts that are out of production. Comes pre-bent for proper ackerman & bump steer when used with Howe centerlink & idler arm. Fits power GM boxes with 1-1/8"-32 spline.



Part No	Application	Length	Offset	Taper
2349	70-81 Camaro	5"	0.5"	1.5"
23475	Impala Mod	4.5"	1.5"	1.5"
2345	Chevelle Mod	5"	0"	1.5"

STOCK REPLACEMENT RACING CENTERLINKS

Howe centerlinks are made to replace popular stock models that have been adopted for racing. Made with provisions for simple bump steer adjustment. All feature 1.50" tapers.

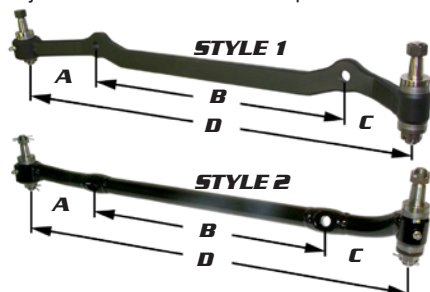

Part #	Replace	Application	[A]	[B]	[C]	[D]
1	23396 DS830	Camaro - 70-73 manual (350HP) for racing. Will not work with stock 7" pitman arm. Not for stock or street applications.	6"	15"	3.5"	24.375"
	23397 DS749	Chevelle - 68-72 with stock spindles. Does Not Drop for oil pan clearance!	5.75"	15.25"	3.25"	23.75"
	233974 DS749	Chevelle Hybrid - 68-72 w/ stock spindles & Camaro pitman arm.	5.75"	15.25"	3.25"	23.75"
2	233973 N/A	Chevelle Modified - Corrected bump steer on 68-72 frames with Pinto spindles & 2345 pitman.	2.75"	19.25"	1.375"	23.75"
	23380 DS899	Big Metric - 77-96 Caprice & Impala, 77-85 Delta 88, 85-90 Riviera, 77-81 Bonneville.	5.625"	14.625"	4"	23.875"
	23399 DS909	Small Metric - 78-87 Monte Carlo, Grand Prix, Cutlass, El Camino.	5.25"	13"	3.875"	21.75"

HOWE BILLET IDLER ARMS



Part #	Application	Length	Offset	Taper
23421	Camaro, OEM Tie Rod	6.0"	0"	1.5"
23422	Camaro, Threaded Sleeves, OEM Bar	5.5"	0"	1.5"
23427	Hybrid, Chevelle Shaft / Impala Arm	5.375"	1.25"	1.5"
23428	Chevelle	4.5"	0"	1.5"
23431	Impala	5.375"	1.25"	1.5"
23432	Small Metric	6.25"	1.125"	1.5"

Our billet idlers are tough enough to last and easy to adjust height for bump steer. If damaged it can be rebuilt. Available for Camaro, Impala, Chevelle and Small Metric. To adjust the arm height loosen pinch bolt and turn adjusting nut.

OEM IDLER BRACKET
Corrects mounting location of OEM idler arms on reproduction Chevelle frames. **912340 Chevelle Mount Bracket**



REPLACEMENT PARTS
 234211 Shaft only for 23421
 234212 Arm Only for 23421
 234213 Camaro Spacer
 234281 Shaft Only for 23428
 234282 Arm Only for 23428

32165
 234311 Arm Only for 23431
 234321 Arm Only for 23432
 234322 Shaft Only for 23431 & 23432
 23433 Bearing
 32165 Chevelle Spacers

STEERING QUICKENERS



STEALTH HD STEERING QUICKENER
 BY HOWE RACING ENTERPRISES
PATENTED
 US Patent No. 7134981
BILLET HOUSING

Stealth HD steering quickener uses patented multiple gear design to increase tooth contact for strength & durability superior to any other quickener. Unlike other quickeners, the input and output shafts are inline for reduced gear load. Only 2 lbs., low friction and small 2.75" diameter. Features .735-36 spline.



TOUGHEST
 2.0 lbs.

522B2 2 to 1 Unit

MOUNTING BOLT

The 3/8" mounting bolts come with lock washers and in corresponding lengths.

5226 Bolts for Basic
5227 Bolts for Stealth
5228 Bolts for Original



HOWE BASIC

The Howe Basic Quickeners meet the requirements of the job and keep cost down. Has undergone extensive cycle and load testing to assure durability. Not as tough as the Stealth HD but alloy steel gears and unique tooth design are far stronger and more durable than other small body quickeners on the market. .735-36 spline.



TOUGH

2.0 lbs.

5224 2 to 1 Howe Basic
5225 1.5 to 1 Howe Basic

Note: Howe steering quickener mounting holes are 1.75" spacing.

SPLINED COUPLER

Fits all of our steering quickeners. Features a .735-36 spline on one side and 3/4" bore for steering shaft on the other.

5221 .735-36 Splined Coupler



STEERING WHEELS AND RELEASES

DRIVEN STEERING WHEELS

Inspired by racers for Racers, Driven was formed to provide quality and affordable racing steering wheels for every form of racing.

DR01 13.5" Dished
DR02 12.9" Flat
DR03 15" Dished
DRA Wheel Adapter



WOODWARD SPLINED

Snaps in place by pushing it on. Releases by pulling back on the collar ring. Available in aluminum or steel.

WQRS Steel - 0.97 lbs.
WQRA Aluminum - 0.78 lbs.



HOWE HEX

Lightest available at .58 lbs.. Slips together snug and is very affordable.

51366 Complete
5137 Coupler Only



WARNING! It is the responsibility of the driver to check any steering coupler for full engagement before starting the car. Remember to apply anti-seize to steering coupler pins to maintain smooth operation and easy release.

DELUXE COLLAPSIBLE COLUMN

Supported at each end with a roller bearing in a rigid case. Allows 8" of collapse. Splined for Woodward .750-20 spline. Specify steel or aluminum steering quick release. Available in two lengths. No u-joints.

SCA827 Column - 18.75"
SCA827LM Column - 17"



CENTER PAD

Dense foam filled pad covered by thick vinyl. Fits three spoke wheels.

5215



FIREWALL BEARING

Holds a 3/4" steering shaft bind free to the firewall.

9192



TELESCOPING SPLINE COLUMN

Allows 6" of collapse. Splined for Woodward .750-20 spline.

SCA500 Column, No U-joints



CLAMP ON - 1 PIECE

Strong, lightweight mount weighs only 1.2 lbs. Precision monoball machined to accept 3/4" steering shaft. Wheel position easily adjusted by loosening clamp.

91997 1-3/4"
91998 1-1/2"
91995 1-3/4" Heim Type
91996 1-1/2" Heim Type



EXTENSION

1-1/2" tubing extension allows the mount to move back up to 12" when used with clamp on steering shaft mounts. Made with .049 HREW tubing.

91900 - Standard



WELD ON

Welds to dash bar and slot allows for 1-1/2" of movement from right to left. Made for 3/4" male rod end bearing p/n: AU-CM12-12. See page 15 for rod end.
AA350A



U-JOINTS & COUPLERS

3/4" BORE SPLINED COUPLERS

P/N	Spline	Application
C101	.750-48	Sweet Rack, Old Woodward
5221	.735-36	Old GM Manual, Mustang Pwr
C103	.720-30	New GM Power, Appleton
C104	.820-36	Old GM Power, Sweet Servo
C201	.750-20	New Woodward Rack / Servo



U-JOINTS

We carry Woodward U-joints. They offer superior quality to any other steering u-joints that we have used.

3/4" BORE ONE END U-JOINTS

P/N	Spline	Application	Chassis
UA100	3/4" Bore	Mid Steering Shaft	All
UA101	.750-48	Sweet Rack, Old Woodward	LM
UA102	.735-36	Old GM Manual, Howe Quickener	MOD
UA103	.720-30	New GM Power OEM, Appleton	LM, MOD
UA104	.820-36	Old GM Power, Sweet Servo	LM, MOD
UA201	.750-20	New Woodward Rack and Servo	LM, RR

WOODWARD POWER RACK AND PINIONS

Woodward racks are the most rugged available. Made in one piece with a beefy 1.25" diameter shaft and full contact teeth. Uses .750-20 splined universal. Racks for road racing applications come with travel limiter plates installed.

App.	Design	Length	Rack Ends	Ratio	Cylinder		Servo Type	Part No.	
					Bore	Travel Limit			
Late Model	XL, M, SS	17.25"	Threaded	2.36"	1.25"	No	No	GE236CC1725	
		18.25"	Clevis	2.36"	1.25"	No	No	GEC236CB1825	
		18.25"	Clevis	2.62"	1.25"	No	No	GEC262CB1825	
Road Race	V8TC	17.25"	Threaded	2.36"	1.375"	Yes	.210	HE236	
		TA2 / GT2	18.25"	Threaded	2.62"	1.25"	Yes	No	GE262CB1825
			18.25"	Threaded	2.36"	1.375"	Yes	No	GE236CC1825
			18.25"	Threaded	2.62"	1.375"	Yes	No	GE262CC1825
			18.25"	Threaded	2.36"	1.375"	Yes	.210	HE236-1825

14.5 lbs.

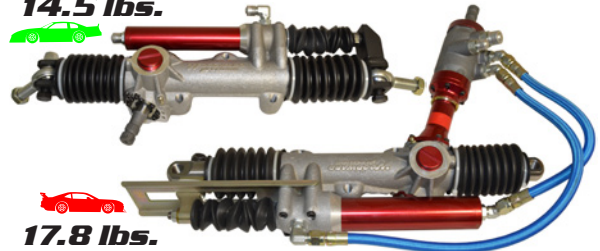

17.8 lbs.

Woodward integral racks feature the 900 series servo and a big bore cylinder on the rack allowing it to handle over 2000 psi and flow over 10 gpm. Road racing racks use attached servo when space allows.

REPLACEMENT PARTS

Description	Part No	Description	Part No
Rack Bushing	E101	Pinion O-ring 3/4" ID	E322
Rack Snubber	E102	Pinion O-ring 7/8" ID	E323
Snubber Adj, Screw	E104	Rack Bearing	E340
Snubber O-ring	EW103	Bearing Retainer Plug	E341
Set Screw & Ball	E105	Boot for Power	E360G
Grease Fitting	E106	Cylinder Assembly	G150B
Pinion Bushing 7/8" ID	E321	Boot for PS Cylinder	G361

RACK TRAVEL LIMITER

Replaces spacer between cylinder and arms for road racing to keep tires from hitting the frame and boots from splitting.

R2107 Rack Travel Limiter



POWER STEERING

WOODWARD POWER SERVOS

Using a 5/32 Allen wrench, the valve torsion bar may be easily changed to get the feel of steering that you desire. We stock the complete units in three popular rates. Can be mounted anywhere in the shaft with or without a mounting bracket.

FB25 Mounting Bracket

Size	Servo	Bar Only
.210*	VA955X210	TB210
.215	----	TB215
.220*	VA955X220	TB220
.230	----	TB230
.240	VA955X240	TB240



Note: Woodward torque specs must be followed when unit is reassembled.

FLUID TANKS

Made of .083 wall aluminum. Internal baffles help to reduce aeration and "channelling" of the fluid.

PS500 Tank & Bracket
PS551 Tank Bracket
PS552 Clamp Mount
PS553 Vented Cap



Designed for the TA2 chassis these tanks feature either a #6 or #8 AN return fitting and a #10 AN lower fitting and a clamp for 1.5" tubing.

PS501 Tank #6
PS5012 Tank #8
PS5015 Tank #8 Low Mnt



POWER STEERING COOLER

12" long by 5" wide and 3/4" thick. Weighs only 8.6 oz. Features two #6 or #8 A.N. fittings.

PS401 PS Cooler #6
PS402 PS Cooler #8
PS8300 Cooler Hose Kit



OEM STEERING BOX

Affordable newly remanufactured OEM box is used with a quickener. Available in 16:1 ratios. Fits 80-92 Camaro, Caprice Impala, and Malibu. **2359 16:1 OEM**

Fits 1-1/8"-32 Spline Pitman Arms



KRC PRO SERIES ALUMINUM PUMP

KRC teamed with Woodward to design and build "The Evolution" pump as a racing only component. Features a 9000 RPM max and a max flow capacity of 4.2 gallons per minute. Comes standard with a "C" flow valve.

3.0 lbs.
KRC29116811 KRC Aluminum Pump
KRC20015000 Pulley, 4.2" Serpentine
KRC25308000 Flow Valve, Alum - #6 AN
KRC25408000 Flow Valve, Steel - #6 AN
KRC60212000 Inlet Fitting, #10 AN

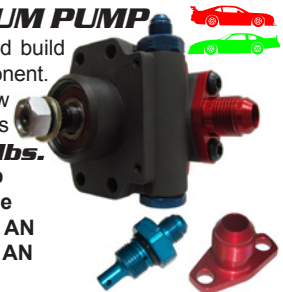

FLUID

We have found no better power steering fluid than GM brand. Many "racing" fluids are the same stuff with a new label.
PS105 16 oz.



STEEL PUMP

Very durable pump with a long standing reputation. Volume is marginal for cars with over 3" of caster. Feature a hard anodized aluminum pulley. Inlet fitting is #10 and #6 outlet. Relief valve set for 1050 psi at 900 RPM at 2.6 gallons per minute.
PS100 Pump and Pulley



HOSE KITS

Four different hose kits to fit varied applications. Each has extra high pressure braided hose and all the steel AN fittings you will need for your system.

PS800 LM w/ Rack
PS8100 LM w/ Box
PS8301* RR w/ Remote Servo
PS8303* RR w/ Integral Servo
PS8400 Asphalt Modified

* Includes Cooler

See Page 46 for Individual Fittings.





HEADERS, MUFFLERS, PIPES & ELBOWS



IRON LUNG HEADER

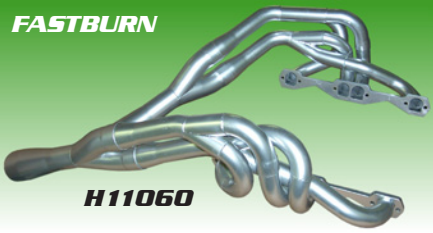

The Howe Iron Lung was designed to improve the performance of unported or restricted flow heads. Offers the greatest advantage in restricted applications such as no porting or small carburetors. Should not be used with less than 10 to 1 compression or with a baffled muffler. Used in combination with a 2 into 1 muffler, increases of up to 25 hp and 15 ft/lbs. of torque are not uncommon when peak rpms are under 7000. These are a firing order header and should not be installed backwards on the dyno, or modified for use on non-Chevy engines. Use 3.5" collector for more torque and better average horse power, use 3" for greater peak horse power. Built with 3/8" thick CNC flanges.

H20281 Y-pipe Collector only for 3-1/2" collector
H202813 Y-pipe Collector only for 3" collector
Note: Y-pipe collectors come included with iron lung headers

Part No.	Port Style	Primary	Collector	Finish
H8105	Chevy 23	1.75"	3.5"	Paint
H8105C	Chevy 23	1.75"	3.5"	Coated
H81050	Chevy 23	1.625"	3.5"	Paint
H11060	Chevy Fast Burn	1.75"	3.5"	Paint
H11060C	Chevy Fast Burn	1.75"	3.5"	Coated
H110603	Chevy Fast Burn	1.75"	3"	Paint
H110623	Chevy Fast Burn	1.625"	3"	Paint
H110623C	Chevy Fast Burn	1.625"	3"	Coated

CROSS OVER HEADERS

Crossover headers provide the best combination of performance and fit where allowed. Many primary sizes and combinations to suit your preference for power versus torque and rpm range. Final 4" of the 36" primaries are made in parallel to allow changing the length before attaching the slip-on collector. Each exhaust system segment works in combination with the engine package so it is important to select the best combination of header, muffler and collectors. All crossover headers have 3/8" thick CNC flanges. All crossover headers can be ordered with Stinger collectors on request.



Part No.	Port Style	Chassis	1st Dia.	2nd Dia.	3rd Dia.	Collector	Finish
H110501	Chevy 23	LM	1.75"	1.875"	---	3.5"	Paint
H110501C	Chevy 23	LM	1.75"	1.875"	---	3.5"	Coated
H11050	Chevy 23	LM	1.625"	1.75"	---	3.5"	Paint
H110503	Chevy 23	LM	1.625"	1.75"	---	3"	Paint
H110513	Chevy 23	LM	1.625"	---	---	3"	Paint
H11052	Chevy 23	LM	1.625"	1.875"	---	3.5"	Paint
H11054	Chevy 23	LM	1.75"	2"	---	3.5"	Paint
H11056	Chevy 23	Mod	1.75"	1.875"	---	3.5"	Paint
H11057	Chevy 23	LM	1.75"	1.875"	2"	3.5"	Paint
H11059	Chevy Fast Burn	LM	1.75"	1.875"	---	3.5"	Paint
H11061	Chevy Fast Burn	LM	1.625"	1.75"	---	3.5"	Paint
H110SB2	SB2	LM	1.875"	2"	---	3.5"	Paint
H11209	Chevy LS1	LM	1.75"	1.875"	---	3.5"	Paint
H11209C	Chevy LS1	LM	1.75"	1.875"	---	3.5"	Coated
H11157	Chevy "A.C.E." Spec	LM	1.625"	1.75"	1.875"	3.5"	Paint
H71058	Chevy 18	LM	1.875"	2"	---	3.5"	Paint
H41055	Ford "N" Head	LM	1.75"	1.875"	---	3.5"	Paint
H4200	Ford Crate	LM	1.75"	1.875"	---	3.5"	Paint
H4300	Ford McGunegill	LM	1.75"	1.875"	---	3.5"	Paint

ASPHALT MODIFIED

Our finished header sets fit both Howe asphalt modified chassis. Come complete with gaskets, bolts, weld-on tabs.





FINISHED HEADER SETS

Part No.	Engine	App.	Type.	1st Dia.	2nd Dia.	Collector	Finish
H11056	Chevy 23	Asphalt Mod	Cross Over	1.75"	1.875"	3.5"	Paint
H9106	Chevy 23	Asphalt Mod	Dual	1.75"	1.875"	3.5"	Paint
H9106C	Chevy 23	Asphalt Mod	Dual	1.75"	1.875"	3.5"	Coated
H9108	Chevy 18	Asphalt Mod	Dual	1.75"	1.875"	3.5"	Paint
H9108C	Chevy 18	Asphalt Mod	Dual	1.75"	1.875"	3.5"	Coated

GASKETS

Application	Gasket
A Chevy Standard	H9950
B Chevy Fast Burn	H9953

CHASSIS HEADERS

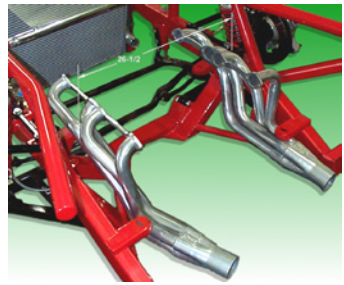

Originally made for the Nascar LMS division but now used anywhere that calls for under chassis headers. Made with CNC cut flanges. Used with a 2 into 1 pipe or dual outlets. 1.625" primaries with 3" collectors.

H116513 23°
H116514 Fastburn
OUTLET PIPES

Component	Part No.	Dia.	Length
Exhaust Elbow	H2104	3"	45"
2 to 1 Pipe	H2023	3" to 3.5"	19"
Outlet for 2 to 1	H1003	3.5"	36"

COATED PARTS

Headers and collectors that are coated are done by Component Coatings using Metallic Ceramic. The standard color is glossy grey. Proven to lower cockpit temperature, extend header life and increase horse power.

TA2 / GT2 EXHAUST SYSTEM

Developed for our TA2 / GT2 legal chassis. Incorporates coated Howe Headers with custom collectors, and coated exhaust pipes that exit the door through an aluminum exhaust flange. Headers are currently available for the Chevy LS, Katech LS, Carbureted Ford and the Dodge engine packages; other headers will be available as other engine options are developed.

Part No.	Engine	1st Dia.	2nd Dia.	3rd Dia.	Collector	Finish
H11213C	Chevy LS	1.75"	1.875"	---	3.5"	Coated
H11240C	Katech LS	1.625"	1.75"	1.875"	3"	Coated
H4400	Ford	1.75"	1.875"	---	3.5"	Coated
H6200	Dodge	1.75"	1.875"	---	3.5"	Coated



- EXHAUST SYSTEM PARTS**
- H2193C Tail Pipe Bend, Outer
 - H2192C Tail Pipe Bend, Inner
 - B9291 Exhaust Flange, Camaro Gen 5
 - B9292 Exhaust Flange, Katech Camaro Gen 5
 - B9291D Exhaust Flange, Challenger
 - B9291M Exhaust Flange, Mustang Gen 5

Y-PIPES



The Y-pipe is the key to the performance of a 2 into 1 exhaust system. The length and taper of each stage is critical. A Howe Y-pipe will maximize the benefit of your exhaust system.

Part No.	Inlet	Outlet
H2021	3.5"	5"
H2021C	3.5"	5"
H2022	3"	5"
H2023	3"	3.5"
H4022	3"	4"



POWER X



Made differently than most X-pipes with four separate transitions allowing the same smooth transitions used in a merge collector. Can use with mufflers but works great without. Emits a noticeably higher pitch.

H20200 3.5"

H20203 3"

Balances exhaust pulses to improve power output on dual pipe systems.



STINGER COLLECTORS



The Howe Stinger is half the price of similar merge type collectors with equal performance. On a 355 c.u. 9:1 compression engine, engine builders have found increases from 4-7 h.p. with peak horsepower achieved at a lower r.p.m.. Available painted or high temperature coated.

Part No.	Inlet	Outlet	Finish
H1082	2"	3.5"	Paint
H1082C	2"	3.5"	Coated
H1087	1.875"	3.5"	Paint
H1087C	1.875"	3.5"	Coated



STANDARD COLLECTORS

Standard collectors are cost effective and durable. Available in a variety of inlet and outlet combinations.

Part No.	Inlet	Outlet	Type
H10007	1.75"	3.5"	V8
H10008	1.875"	3.5"	V8
H10009	1.75"	3"	V8



MUFFLER FOR DUAL EXHAUST

The 3-1/2" Louvered Muffler is easy to fit and very light. Louvered core is wrapped with fiberglass mat to help deaden sound. All dual mufflers come with a 3.5" tail pipe.

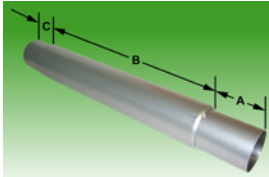

Part No.	A	B	C	Overall	DB @100'	Weight
H3001	1.75"	5"	1.625"	8.375"	101+	2.04 lbs.
H3002	4.5"	22.25"	3"	30"	98	9.06 lbs.
H3004	9"	12"	3"	24"	100	6.98 lbs.
H3008	2.25"	8.25"	1.5"	12"	101+	3.62 lbs.

2 INTO 1 MUFFLER



Straight through design produces the same power and torque as straight pipe. Use in combination with the Y-pipe to see significant increases in torque over fixed baffle mufflers. Keep bends to a minimum after the muffler for best performance. Sound will vary with outlet location.

Part No.	Baffle	Length	DB @100'	Weight	Dia.
H3010	Ceramic	10"	100	8.32 lbs.	5"
H3015	Ceramic	15"	98	11.51 lbs.	5"
H3015S	Stainless	15"	98	11.02 lbs.	5"
H3018	Ceramic	18"	95	13.21 lbs.	5"
H3018S	Stainless	18"	95	12.41 lbs.	5"
H3047	Stainless	10"	100	5.35 lbs.	4"



Our 15" and 18" mufflers are available with **Stainless Steel** packing. Stainless Steel will outlast **Ceramic Fiber** more than 3 to 1.

H3000 **Ceramic Fiber Muffler Repack Kit for 18" and Less**
H3007 **Stainless Steel Fiber Repack Kit for 18" and Less**

SEALING CLAMPS

Made of thin stainless steel that when installed and tightened conforms to the shape of the exhaust connection. A great way to eliminate air leaks without having to permanently weld pieces together.

HPFC300 3" Clamp
HPFC350 3.5" Clamp
HPFC500 5" Clamp



DOUBLE BARREL MUFFLER



Produced with an oval case for greater durability. Costs less than dual mufflers, similar power to 2 to 1 systems 94-96 DB. At 3.5" in and 3.5" out it fits the rule in places where a 5" system won't. Performs the same as an X-pipe, only quieter.

H3044 **Double Barrel Muffler**

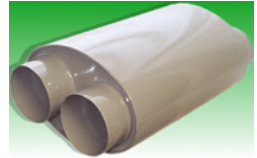

EXHAUST MOUNTS



H3030 **Muffler Mount, Dual Exhaust (above right)**
H3029 **Muffler Mounting Kit, 2 Into 1 (above left)**

MERGE MUFFLER



Two inlets come together with a smooth transition to balance exhaust pulses. Muffler core placement takes advantage of sound cancellation and is wrapped with ceramic fiber for 95-97 DB. Muffler core expands out at the exit to improve scavange. Use the 29" for max performance or the 21" to reduce weight and length.

H3098 **Merge Muffler 3.5" to 5", 7" Case - 29"**
H3099 **Merge Muffler 3.5" to 5", 7" Case - 21"**
H3100 **Merge Muffler 3" to 5", 7" Case - 21"**



BENDS & PIPES

	Part #	Dia.	Size / Bend
Elbows	H2108	3.5"	Small 45°
	H2118	3.5"	Large 45°
	H2128	3.5"	20°
	H21905	5"	90°
Pipes	H1003	3.5"	3"
	H10031	5"	16"
	H10032	3.5"	3' (x2)
	Turn Downs	H2005	5"
H20051		5"	60°
H3240		3.5"	9" 45°
H3241		3.5"	11.5" 45°



ADAPTERS

Part #	Inlet	Outlet
H3235	3.5"	3"
H3236	3.5"	5"

HARDWARE



H100 3/8-16 Header Bolt, 7/16 Head
H120 Exhaust Tab

ELBOW KITS

Component	Part No.	Dia.
Elbow, Short 90°	H2191	3.5"
Elbow, Long 90°	H2193	3.5"
Elbow Kit, CARB	H2100	3.5"
Elbow Kit, Coated	H2100C	3.5"
Elbow Kit	H2103	3.5"



H2100 contains (1) H2108 and (2) H2128



HOWE

RACING RADIATORS

COOL PERFORMANCE

RACING & CUSTOM

ALUMINUM RADIATORS

Howe radiators feature billet filler necks and crimped & welded tanks that are hand fitted to each core. Howe radiators are 100% TIG welded by experienced craftsmen for exceptional quality & appearance. Each radiator is pressure tested & guaranteed against manufacturing defects.

WATER FLOWS INSIDE & OUT

ONLY 1.5 LBS.

- Has a burst strength in excess of all competitors.
- Nearly one gallon per hour greater flow rate prevents horsepower loss.
- Straight oil channels allow flushing for reuse.

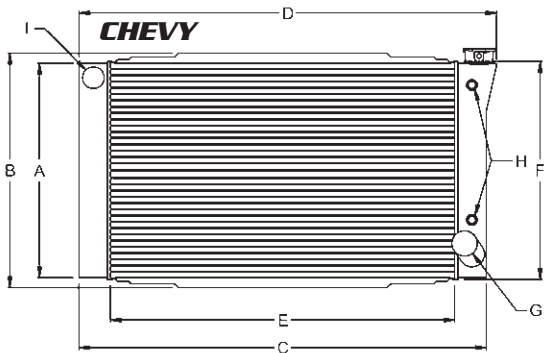

- A - TANK HEIGHT
- B - TOTAL HEIGHT
- C - TOTAL WIDTH - BOTTOM
- D - TOTAL WIDTH - TOP
- E - CORE WIDTH
- F - CORE HEIGHT
- G - WATER OUTLET
- H - HEAT EXCHANGER
- I - WATER INLET

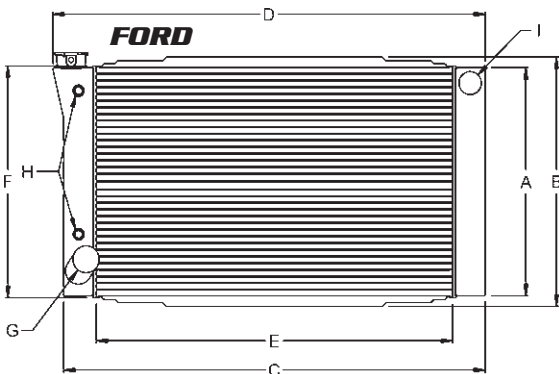

Since 1984 Howe has remained a trusted name for dependable performance and quality workmanship. Our radiators are Epoxy free with 100% tube to fin contact for maximum heat transfer. More than 7% cooler than a flux bonded aluminum cores and 15% cooler than copper & brass.



34127C

CROSSFLOW WITH COOLER

Part No.	Fit	A	B	C	D	E	F	G	H	I
34120C	Chevy	18-1/4"	19"	20-1/4"	21-1/4"	16"	18-1/2"	1-3/4"	1/2 pipe	1-1/2"
34122C	Chevy	21-1/4"	23"	21-1/2"	21-1/2"	17"	21-1/2"	1-3/4"	1/2 pipe	1-1/2"
34123C	Chevy	18-1/4"	20"	22-1/4"	23-1/4"	18"	18-1/2"	1-3/4"	1/2 pipe	1-1/2"
34125C	Chevy	18-1/4"	19-1/4"	24-1/4"	25-1/4"	20"	18-1/2"	1-3/4"	1/2 pipe	1-1/2"
34125F	Ford	18-1/4"	19-1/4"	24-1/4"	25-1/4"	20"	18-1/2"	1-3/4"	1/2 pipe	1-1/2"
34125FNF	Ford	18-1/4"	18-1/4"	24-1/4"	25-1/4"	20"	18-1/2"	1-3/4"	1/2 pipe	1-1/2"
34127C	Chevy	18-1/4"	20"	26-3/4"	27-3/4"	22-1/2"	18-1/2"	1-3/4"	1/2 pipe	1-1/2"
34127C12	Chevy	18-1/4"	20"	26-3/4"	27-3/4"	22-1/2"	18-1/2"	1-3/4"	#12	1-1/2"
34127C1216	Chevy	18-1/4"	20"	26-3/4"	27-3/4"	22-1/2"	18-1/2"	1-3/4"	#12	#16
34127C1216NF	Chevy	18-1/4"	20"	26-3/4"	26-3/4"	22-1/2"	18-1/2"	1-3/4"	#12	#16
34127C1220	Chevy	18-1/4"	20"	26-3/4"	27-3/4"	22-1/2"	18-1/2"	1-3/4"	#12	#20
34127C16	Chevy	18-1/4"	20"	26-3/4"	27-3/4"	22-1/2"	18-1/2"	1-3/4"	1/2 pipe	#16
34127C16NF	Chevy	18-1/4"	20"	26-3/4"	26-3/4"	22-1/2"	18-1/2"	1-3/4"	1/2 pipe	#16
34127C20	Chevy	18-1/4"	20"	26-3/4"	27-3/4"	22-1/2"	18-1/2"	1-3/4"	1/2 pipe	#20
34127CL1216	Chevy	18-1/4"	20"	26-3/4"	27-3/4"	22-1/2"	18-1/2"	1-3/4"	#12	#16
34127CNF	Chevy	18-1/4"	20"	26-3/4"	26-3/4"	22-1/2"	18-1/2"	1-3/4"	1/2 pipe	1-1/2"
34127F	Ford	18-1/4"	20"	26-3/4"	27-3/4"	22-1/2"	18-1/2"	1-3/4"	1/2 pipe	1-1/2"
34127F12	Ford	18-1/4"	20"	26-3/4"	27-3/4"	22-1/2"	18-1/2"	1-3/4"	#12	1-1/2"
34127F1216	Ford	18-1/4"	20"	26-3/4"	27-3/4"	22-1/2"	18-1/2"	1-3/4"	#12	#16
34127F16	Ford	18-1/4"	20"	26-3/4"	27-3/4"	22-1/2"	18-1/2"	1-3/4"	1/2 pipe	#16
34128C	Chevy	14-3/4"	16-1/4"	28-3/8"	29-3/8"	24"	15"	1-3/4"	1/2 pipe	1-1/2"
34128C12	Chevy	14-3/4"	16-1/4"	28-3/8"	29-3/8"	24"	15"	1-3/4"	#12	1-1/2"
34128F	Ford	14-3/4"	16-1/4"	28-3/8"	29-3/8"	24"	15"	1-3/4"	1/2 pipe	1-1/2"
34129C	Chevy	18-1/4"	19-3/4"	28-3/4"	29-3/4"	24-1/2"	18-1/2"	1-3/4"	1/2 pipe	1-1/2"
34129C10	Chevy	18-1/4"	19-3/4"	28-3/4"	29-3/4"	24-1/2"	18-1/2"	1-3/4"	#10	1-1/2"
34129C12	Chevy	18-1/4"	19-3/4"	28-3/4"	29-3/4"	24-1/2"	18-1/2"	1-3/4"	#12	1-1/2"
34129C1216	Chevy	18-1/4"	19-3/4"	28-3/4"	29-3/4"	24-1/2"	18-1/2"	1-3/4"	#12	#16
34129C1216NF	Chevy	18-1/4"	19-3/4"	28-3/4"	28-3/4"	24-1/2"	18-1/2"	1-3/4"	#12	#16
34129C12NF	Chevy	18-1/4"	19-3/4"	28-3/4"	28-3/4"	24-1/2"	18-1/2"	1-3/4"	#12	1-1/2"
34129C16	Chevy	18-1/4"	19-3/4"	28-3/4"	29-3/4"	24-1/2"	18-1/2"	1-3/4"	1/2 pipe	#16
34129C16NF	Chevy	18-1/4"	19-3/4"	28-3/4"	28-3/4"	24-1/2"	18-1/2"	1-3/4"	1/2 pipe	#16
34129CNF	Chevy	18-1/4"	19-3/4"	28-3/4"	28-3/4"	24-1/2"	18-1/2"	1-3/4"	1/2 pipe	1-1/2"
34129F	Ford	18-1/4"	19-3/4"	28-3/4"	29-3/4"	24-1/2"	18-1/2"	1-3/4"	1/2 pipe	1-1/2"
34129F1212	Ford	18-1/4"	19-3/4"	28-3/4"	29-3/4"	24-1/2"	18-1/2"	1-3/4"	#12	#12 x2
34129F1216	Ford	18-1/4"	19-3/4"	28-3/4"	29-3/4"	24-1/2"	18-1/2"	1-3/4"	#12	#16
34129F16NF	Ford	18-1/4"	19-3/4"	28-3/4"	28-3/4"	24-1/2"	18-1/2"	1-3/4"	1/2 pipe	#16
34132C	Chevy	18-1/4"	20"	31-3/4"	32-3/4"	27-1/2"	18-1/2"	1-3/4"	1/2 pipe	1-1/2"
34132C12	Chevy	18-1/4"	20"	31-3/4"	32-3/4"	27-1/2"	18-1/2"	1-3/4"	#12	1-1/2"
34132C1216	Chevy	18-1/4"	20"	31-3/4"	32-3/4"	27-1/2"	18-1/2"	1-3/4"	#12	#16
34132C12NF	Chevy	18-1/4"	20"	31-3/4"	31-3/4"	27-1/2"	18-1/2"	1-3/4"	#12	1-1/2"
34132C16	Chevy	18-1/4"	20"	31-3/4"	32-3/4"	27-1/2"	18-1/2"	1-3/4"	1/2 pipe	#16
34132CNF	Chevy	18-1/4"	20"	31-3/4"	31-3/4"	27-1/2"	18-1/2"	1-3/4"	1/2 pipe	1-1/2"
34132F	Ford	18-1/4"	20"	31-3/4"	32-3/4"	27-1/2"	18-1/2"	1-3/4"	1/2 pipe	1-1/2"

CROSSFLOW

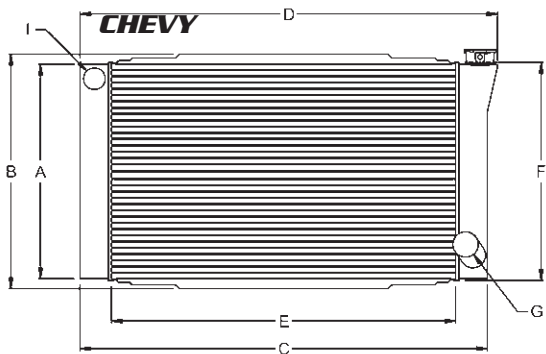

A - TANK HEIGHT
B - TOTAL HEIGHT
C - TOTAL WIDTH - BOTTOM
D - TOTAL WIDTH - TOP
E - CORE WIDTH
F - CORE HEIGHT
G - WATER OUTLET
I - WATER INLET

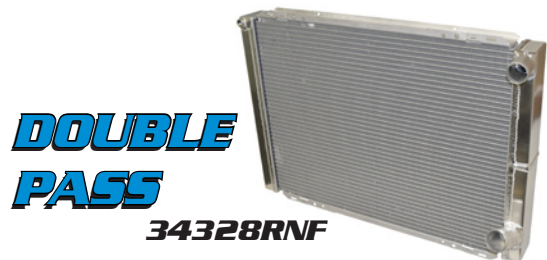
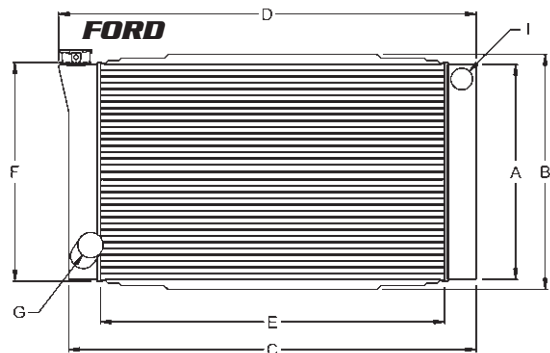

DOUBLE PASS

34328RNF

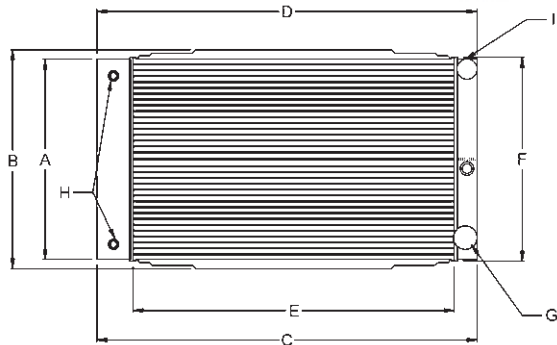

A - TANK HEIGHT
B - TOTAL HEIGHT
C - TOTAL WIDTH - BOTTOM
D - TOTAL WIDTH - TOP
E - CORE WIDTH
F - CORE HEIGHT
G - WATER OUTLET
H - HEAT EXCHANGER
I - WATER INLET

Part No.	A	B	C	D	E	F	G	I	Fins
34224	18-1/4"	19-1/4"	23-1/4"	24-1/4"	20"	18-1/2"	1-3/4"	1-1/2"	14
34224F	18-1/4"	19-1/4"	23-1/4"	24-1/4"	20"	18-1/2"	1-3/4"	1-1/2"	14
342A	18-1/4"	20"	25-3/4"	26-3/4"	22-1/2"	18-1/2"	1-3/4"	1-1/2"	14
342A16	18-1/4"	20"	25-3/4"	26-3/4"	22-1/2"	18-1/2"	1-3/4"	#16	14
342ANF	18-1/4"	20"	25-3/4"	25-3/4"	22-1/2"	18-1/2"	1-3/4"	1-1/2"	14
342AF	18-1/4"	20"	25-3/4"	25-3/4"	22-1/2"	18-1/2"	1-3/4"	1-1/2"	14
342AFNF	18-1/4"	20"	25-3/4"	25-3/4"	22-1/2"	18-1/2"	1-3/4"	1-1/2"	14
342A28	18-1/4"	19-1/2"	27-3/4"	28-3/4"	24-1/2"	18-1/2"	1-3/4"	1-1/2"	14
342A2816	18-1/4"	19-1/2"	27-3/4"	28-3/4"	24-1/2"	18-1/2"	1-3/4"	#16	14
342A2816NF	18-1/4"	19-1/2"	27-3/4"	27-3/4"	24-1/2"	18-1/2"	1-3/4"	#16	14
342A2816NFLS	18-1/4"	19-1/2"	27-3/4"	27-3/4"	24-1/2"	18-1/2"	1-3/4"L	#16	14
342A28NF	18-1/4"	19-1/2"	27-3/4"	27-3/4"	24-1/2"	18-1/2"	1-3/4"	1-1/2"	14
342A28F	18-1/4"	19-1/2"	27-3/4"	28-3/4"	24-1/2"	18-1/2"	1-3/4"	1-1/2"	14
342A28F12	18-1/4"	19-1/2"	27-3/4"	28-3/4"	24-1/2"	18-1/2"	1-3/4"	#12x2	14
342A28F16NF	18-1/4"	19-1/2"	27-3/4"	27-3/4"	24-1/2"	18-1/2"	1-3/4"	#16	14
342A28FNF	18-1/4"	19-1/2"	27-3/4"	27-3/4"	24-1/2"	18-1/2"	1-3/4"	1-1/2"	14
342AA	14-3/4"	16-1/4"	27-3/8"	28-3/8"	24"	15"	1-3/4"	1-1/2"	14
342AANF	14-3/4"	16-1/4"	27-3/8"	27-3/8"	24"	15"	1-3/4"	1-1/2"	14
342AAF	14-3/4"	16-1/4"	27-3/8"	28-3/8"	24"	15"	1-3/4"	1-1/2"	14
342AAFNF	14-3/4"	16-1/4"	27-3/8"	27-3/8"	24"	15"	1-3/4"	1-1/2"	14
342B	18-1/4"	20"	21-1/4"	22-1/4"	18"	18-1/2"	1-3/4"	1-1/2"	14
342BNF	18-1/4"	20"	21-1/4"	21-1/4"	18"	18-1/2"	1-3/4"	1-1/2"	14
342BF	18-1/4"	20"	21-1/4"	22-1/4"	18"	18-1/2"	1-3/4"	1-1/2"	14
342BM	15-3/4"	15-3/4"	23"	23"	18"	14-3/4"	1-3/4"	1-1/2"	14
342C	21-3/8"	23"	23-1/2"	23-1/2"	20"	21-1/2"	1-3/4"	1-1/2"	15
342D	21-3/8"	23"	20-3/4"	20-3/4"	17-1/4"	21-1/2"	1-3/4"	1-1/2"	10
342E	18-1/4"	20"	30-3/4"	31-3/4"	27-1/2"	18-1/2"	1-3/4"	1-1/2"	12
342E16	18-1/4"	20"	30-3/4"	31-3/4"	27-1/2"	18-1/2"	1-3/4"	#16	12
342ENF	18-1/4"	20"	30-3/4"	30-3/4"	27-1/2"	18-1/2"	1-3/4"	1-1/2"	12
342EF	18-1/4"	20"	30-3/4"	31-3/4"	27-1/2"	18-1/2"	1-3/4"	1-1/2"	12
342EFNF	18-1/4"	20"	30-3/4"	30-3/4"	27-1/2"	18-1/2"	1-3/4"	1-1/2"	12
342J	17"	18-1/2"	35-1/4"	36-1/4"	32"	17"	1-3/4"	1-1/2"	10
342JF	17"	18-1/2"	35-1/4"	36-1/4"	32"	17"	1-3/4"	1-1/2"	10
342R*	18-1/4"	20"	26"	27"	22-1/2"	18-1/2"	1-3/4"	1-1/2"	15
342W	18-1/4"	19-1/4"	31-1/2"	32-1/2"	28-1/2"	18-1/2"	1-3/4"	1-1/2"	17

***Single Row Radiator**

Note: Core fin count & dimensions may occasionally vary slightly due to manufacturers.

Most part numbered radiators are in stock or built within one week. See the custom radiator section for applications not shown.

Part No.	A	B	C	D	E	F	G	H	I
34326R	18-1/4"	20"	25-3/4"	26-3/4"	22-1/2"	18-1/2"	1-3/4"	NONE	1-1/2"
34326R16	18-1/4"	20"	25-3/4"	26-3/4"	22-1/2"	18-1/2"	1-3/4"	#16	1-1/2"
34326R16NF	18-1/4"	20"	25-3/4"	25-3/4"	22-1/2"	18-1/2"	1-3/4"	#16	1-1/2"
34326RNF	18-1/4"	20"	25-3/4"	25-3/4"	22-1/2"	18-1/2"	1-3/4"	NONE	1-1/2"
34327RNF	14-3/4"	16-1/4"	27-3/8"	27-3/8"	24"	15"	1-3/4"	NONE	1-1/2"
34328F12**	18-1/4"	20"	27-3/4"	27-3/4"	24-1/2"	18-1/2"	1-3/4"	NONE	#12x2
34328R	18-1/4"	20"	27-3/4"	28-3/4"	24-1/2"	18-1/2"	1-3/4"	NONE	1-1/2"
34328R10NF	18-1/4"	20"	27-3/4"	27-3/4"	24-1/2"	18-1/2"	1-3/4"	NONE	#10
34328R16	18-1/4"	20"	27-3/4"	28-3/4"	24-1/2"	18-1/2"	1-3/4"	NONE	#16
34328R16NF	18-1/4"	20"	27-3/4"	27-3/4"	24-1/2"	18-1/2"	1-3/4"	NONE	#16
34328RNF	18-1/4"	20"	27-3/4"	27-3/4"	24-1/2"	18-1/2"	1-3/4"	NONE	1-1/2"
34329RNF	14-3/4"	16-1/4"	27-3/8"	27-3/8"	24"	15"	1-3/4"	NONE	1-1/2"
34329RNF10*	14-3/4"	16-1/4"	28-3/8"	28-3/8"	24"	15"	1-3/4"	#10	1-1/2"
34329RNF12	14-3/4"	16-1/4"	28-3/8"	28-3/8"	24"	15"	1-3/4"	#12	1-1/2"
34331L	18-1/4"	20"	30-3/4"	31-3/4"	27-1/2"	18-1/2"	1-3/4"	NONE	1-1/2"
34331LNF	18-1/4"	20"	30-3/4"	30-3/4"	27-1/2"	18-1/2"	1-3/4"	NONE	1-1/2"
34331R	18-1/4"	20"	30-3/4"	31-3/4"	27-1/2"	18-1/2"	1-3/4"	NONE	1-1/2"
34331R16	18-1/4"	20"	30-3/4"	31-3/4"	27-1/2"	18-1/2"	1-3/4"	NONE	#16
34331RNF	18-1/4"	20"	30-3/4"	30-3/4"	27-1/2"	18-1/2"	1-3/4"	NONE	1-1/2"

* For LS1 Engine

** Features 1/2" Bung & 3/8" Bung

Year	Application	Howe Part # Manual Trans	Howe Part # Auto Trans	Stock Core Size
55-57	Chevy 6 Cyl mounts	342G06	342G07	
60-68	Belair, Biscayne, Caprice, Impala	342G10	342G11	16-1/8 x 25 x 2
69-70	Belair, Biscayne, Caprice, Impala			17-3/8 x 25 x 2
71-78	Belair, Biscayne, Caprice, Impala	342G26	342G27	20-3/4 x 17 x 1-1/4
71-78	Belair, Biscayne, Caprice, Impala	342G08	342G09	26-3/8 x 17 x 2-5/8
71-78	Belair, Biscayne, Caprice, Impala	342G32	342G33	28-3/8 x 17 x 2
79	Caprice, Impala	342G32	342G33	28-3/8 x 17 x 1-1/4
80-87	Caprice, Impala	342G26	342G27	20-3/4 x 17 x 1-1/4
80-87	Caprice, Impala	342G08	342G09	26-3/8 x 17 x 1-5/8
67-69	Camaro	342G20	342G21	20-3/4 x 17 x 2
67-69	Camaro, w/ electric fan shroud	342G24	342G25	
67-69	Camaro	342G38	N/A	23" Core
70-81	Camaro	342G26	342G27	20-3/4 x 17 x 2
70-81	Camaro	342G08	342G09	26-3/4 x 17 x 1-1/4
82-92	Camaro	342G12	342G13	26-3/8 x 17 x 1-5/8
93-99	Camaro V8	342G14	342G15	24-3/4 x 17-1/4 x 1-3/8
93-99	Camaro V6	342G16	342G17	24-3/4 x 17-1/4 x 7/8
64-67	Chevelle	342G10	342G11	16-1/8 x 25 x 2
66	Chevelle	342G03		18-1/2 x 16-1/2 x 2-5/8
68-71	Chevelle, Monte Carlo, Nova	342G26	342G27	20-3/4 x 17 x 2
68-71	Chevelle, Monte Carlo	342G32	342G33	28-3/8 x 17 x 2-5/8
72-77	Chevelle, Malibu, Nova	342G26	342G27	20-3/8 x 17 x 2
72-77	Chevelle, Malibu, Monte Carlo, Nova (76-77)	342G08	342G09	26-3/4 x 17 x 2
72-77	Chevelle, Malibu, Monte Carlo	342G32	342G33	28-3/8 x 17 x 2
73-74	Nova			23 x 17 x 2
78-88	Malibu, Monte Carlo, Nova (78-79)	342G26	342G27	20-3/4 x 17 x 2
78-88	Malibu, Monte Carlo, Nova (78-79)	342G08	342G09	26-3/8 x 17 x 2
63-72	Corvette	342G03		18-1/2 x 16-1/2 x 2-5/8
69-72	Corvette Big Block	342G40	342G41	
74-76	Corvette			27-1/2 x 17 x 2-5/8
77-82	Corvette	342G18	342G19	26-3/8 x 17 x 2-5/8
84-89	Corvette	342G28	342G29	23-5/8 x 15-1/4 x 1-3/8
90-96	Corvette	342G04	342G05	23-5/8 x 17 x 1-3/8
97-04	Corvette	342G22	342G23	
67-72	GM Truck	342G34	342G35	
81-87	GM Truck w/ 454	342G30	342G31	28-1/4 x 17 x 1-5/8
82-87	GM Truck w/ 6.2L Diesel	342G42	342G43	
65	Cobra Replicar	342F13	N/A	
67-69	Mustang	342F03	342F04	
68-70	Mustang	342F15	342F16	
76-78	Mustang	342F01	342F02	16-1/2 x 23 x 2-1/4
80-93	Mustang	342F05	342F06	
70-79	F100 Truck	342F07	342F08	18 x 24-1/8 x 1-1/4
2001+	Ford F-Series	342F11	342F12	
50	Chrysler w/ Ford 300 CID	342C17	342C18	
64	Dodge Coronet 44 CID	342C15	342C16	
65	Dodge Van	342C13	342C14	
66	Dodge Van	342C11	342C12	
90	Dodge 350 w/ 5.9L Cummins	342C09	342C10	
	*Viper I	342C01	N/A	
	*Viper II	342C02	N/A	
68	Jeep CJ5	342C07	342C08	
87-91	Jeep Wrangler	342C05	342C06	
91	BMW Z1	342B04	342B03	
95-98	BMW M3	342B02	342B01	21-5/8 x 17-1/4 x 1-1/4
80-82	Ferrari Testarossa 308	342FE01	342FE02	
92-95	Honda Civic	342H00	N/A	
61-63	*Jaguar 3.8L Standard Tank	342J03	N/A	
64-67	*Jaguar 4.1L	342J01	N/A	
68-71	*Jaguar 3.8L Machined Tank	342J00	N/A	
68-71	*Jaguar E type	342J02	342J02C	
72-75	*Jaguar E type V12 5.4L	342J04	342J05	
86	Maserati	342MAS	N/A	
62-79	MGV 4cyl & V8	342MG1		
69	MGC6	342MG2		
75-78	Datsun 280Z	342N07	N/A	
90-96	*Nissan 300ZX Turbo	342N01	N/A	19-3/8 x 18 x 1
90-96	*Nissan 300ZX non-Turbo	342N03	N/A	
90-96	*Nissan 300ZX Turbo w/ Intercooler	342N05	N/A	
	*Nissan 350Z	342N09	N/A	
78-86	*Porsche 928	342P00	342P01	00 LS Cooler, 01 Dbl Cooler
78-86	*Porsche 928	342P10	342P11	10 None, 11 RS Cooler
87-95	*Porsche 928	342P02	342P03	02 None, 03 RS Cooler
87-98	*Porsche 928	342P08	342P09	08 LS Cooler, 09 Dbl Cooler
06	*Pontiac Solstice - LS2 V8 Conversion	342SOL	N/A	
06	*Pontiac Solstice - Stock Replacement	342SOL1	N/A	
85-92	Volkswagon Gulf	342V01	342V02	
88-95	Toyota 4 Runner	342T00	342T01	

DROP INS

Howe "Drop In" radiators are custom quality radiators that we can build without a sample or drawing. They directly replace stock radiators in many popular applications. These radiators require little to no additional work to install into stock vehicles. This allows these high quality radiators to come to you for an easy "Drop In" installation. We are continuously developing new radiators for other applications.



342G21

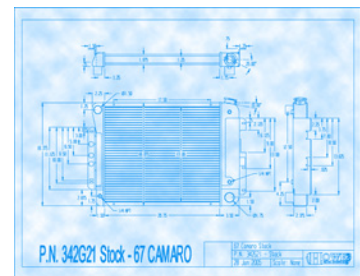

* Notes models that are stocked and sold by an exclusive Howe distributor. Call for referral to stocking dealers.



***342J00**



342G09

RADIATOR ACCESSORIES

SURGE TANKS

Built to fit congested engine bays, raises the fill neck to create a high point in the system.

A). Vertical tank features two 1/4" NPT fittings, tapered tank bottom to 3/8" NPT fitting, and billet clamp for 1.75" pipe. **B).** Horizontal tank features one 1/4" NPT fitting on each end, and 3/8" NPT fitting in the bottom of the tank. **C).** Vertical tank features two 1/8" NPT fittings, tapered tank to 3/4" O.D. hose neck, and billet clamp for 1.75" pipe.

- A** 342410 Billet Clamp Style - Vertical
B 3424 Radiator Surge Tank - Horizontal
C 342411 Billet Clamp - Vertical, Road Race

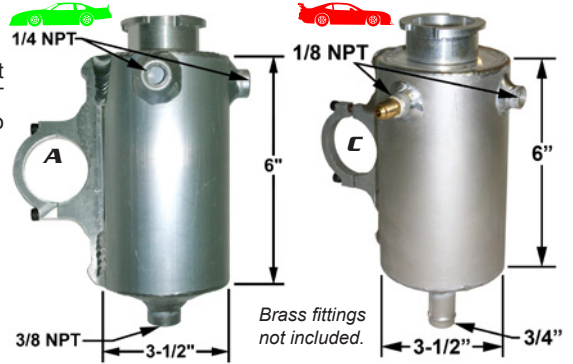
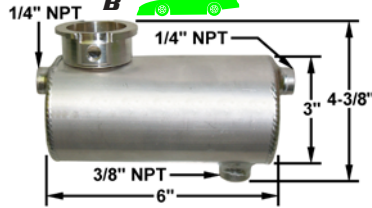

ALUMINUM FILLER NECKS

Show quality billet necks are very affordable, and much more durable than a stamped filler. Overflow hole is 1/8" NPT for a replaceable hose barb.

- E** 34301 Billet Filler
F 3434 Filler Overflow Fitting
G 343025 Small Filler



ALUMINUM A.N. BUNGS

CNC machined from weldable aluminum to original Army/Navy (AN) specs. Used on power steering, breather tanks, radiators, oil systems, etc.



Part No.	Size
AN2006	#6
AN2008	#8
AN2010	#10
AN2012	#12
AN2016	#16
AN2020	#20

HOWE BILLET WATER NECK

Made from hard-coated finish aluminum and features reusable o-ring seal. Replaces standard thermostat housing with a #16 A.N. neck. 3/8" thick flange bolts directly to the manifold or used in combination with a riser. Will not accommodate a thermostat.

- 343411 #16 Water Neck**



INLINE ACCESSORIES



- A** 3436 In-line Temp Sensor Housing, 1.75"
B 3423 Radiator Inline Filler, 1.50"

RADIATOR MOUNTS

- D** 342024 Lower Mount
C 342025 Upper Clamp - Alum
34203 Mount Kit, (2) D & (1) C



ABA HOSE CLAMP

Entirely made of 316 stainless steel. Pressed worm housing increases the strength by 30%. 1/2" band width, rolled edges, and tamped threads leave inside of the clamp smooth allowing it to seal completely over 360° and preventing hose damage. **SS12050 Fit 1-1/2" to 2"**



ALUMINUM OVERFLOW TANK

Made from 6061 aluminum with a 2 quart capacity. Features a 4.5" x 3.625" universal mount to attach to any vertical surface. Filtered vent at the top and drain at the bottom. Overflow inlet is 1/4 NPT. See page 45 for filters.

- 342415 Overflow Tank**
B103647 Petcock
KN62-1370 Filter

Petcock not included.

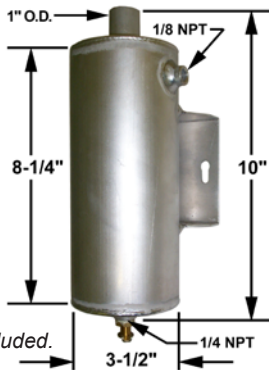

STEEL MECHANICAL

Durable six bladed steel fans move more air than an electric or flex fan. 17" weighs 4.3 lbs. and 15" weighs 3.4 lbs.

- E112 17"**
E1120 15"



ELECTRIC FANS

Maradyne are the lowest profile, high performance, reversible electric fans on the market. Quiet reversible S-blade design works as a puller or a pusher. 130 watt sealed motor and all glass-filled nylon construction.

- M103 10" - 950 CFM @ 7.9 Amps**
M142K 14" - 1975 CFM @ 17.2 Amps
M162K 16" - 2170 CFM @ 17.7 Amps
MFA102 Fan Harness w/ Sender
MFA104 Fan Bracket Kit



ACCESSORIES

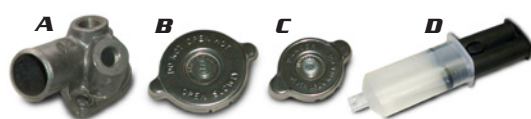

- A** 3425 Radiator Thermostat Housing
B 3427 Radiator Cap, 22-24 lbs.
C 342797 Radiator Cap for 343025, 14-15 lbs.
B 34272 Radiator Cap, 29-31 lbs.
B 34273 Radiator Cap, 13-15 lbs.
D 34211 Radiator Repair Kit, Aluminum

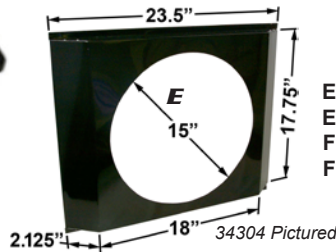

FAN SHROUDS

- E** 34304 Vert. Mount 24" - Black
E 34304M Vert. Mount 24" - Mill
F 34306 Angle Mount 26"
F 34307 Angle Mount 31"

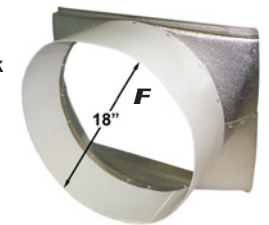

- G** 342150 Radiator Hose, Upper 1.50", 19.25" Long
H 342175 Radiator Hose, Lower 1.75", 18.75" Long
I HRP45150 Silicone Hose 1.50", 45°
J HRP90150 Silicone Hose 1.50", 90° (Not Pictured)
I HRP45175 Silicone Hose 1.75", 45° (Not Pictured)
J HRP90175 Silicone Hose 1.75", 90°

COOL TUBE



- E2000 Per Foot (Specify)**
E20026 26" Pre-Threaded
E2003 3' Pre-Threaded

Howe oil cooler tubes replace braided oil line to transfer heat into the surrounding air. Fin design increases the surface area 5 times over straight tubing. Aluminum conducts heat, while braided line is actually an insulator. The outside diameter is 1.75" diameter allowing it to be bent in a standard tubing bender. Inside diameter is sized for 3/4" Pipe thread. May adapt to #10, #12 or #16 oil lines. Sold in pre-threaded and chamfered lengths or in bulk up to 9'.

- E2004 4' Pre-Threaded**
E2005 5' Pre-Threaded
E2006 6' Pre-Threaded

HOWE CUSTOM RADIATORS



MAY MOTORSPORTS



CUSTOM SUPER MODIFIED

ORDER INFORMATION

Standard listed radiators are available at Howe and Howe dealers nationwide. Call for the dealer nearest you. Custom radiators may be ordered with a Howe custom radiator form, a complete drawing, a stock sample, or a sketch. Custom radiators require a minimum of five working days before shipping. We will fax or mail you a custom radiator form on request.

3195 LYLE ROAD • BEAVERTON, MICHIGAN 48612
PHONE: (989) 435-7080 • FAX: (888) 484-3946

Find Your Howe Dealer at: www.howeracing.com

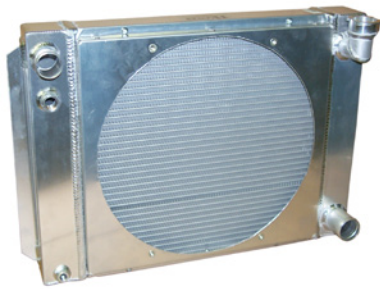

**CUSTOM STREET ROD RADIATOR W/ SHROUD
 BUILT FROM CUSTOM PRINT**

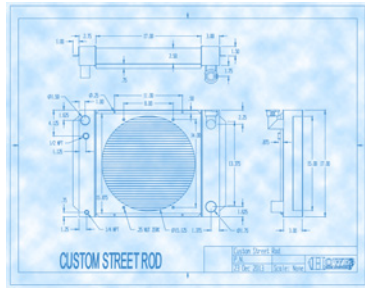

**'25 FORD STREET ROD CUSTOM
 RADIATOR BUILT TO STOCK SAMPLE**



**CUSTOM DOUBLE PASS
 FOR SAND RAIL**



**'37 OLDS
 CUSTOM RADIATOR**



Part No.	Rows	Height	Width	Fins/ In.*
3429A	2	18-1/2"	22-1/2"	14
3429AA	2	15"	24"	14
3429A28	2	18-1/2"	24-1/2"	14
3429B	2	18-1/2"	18"	14
3429C	2	21"	20"	15
3429D	2	21-1/2"	17"	10
3429E	2	18-1/2"	27-1/2"	12
3429F	2	27-5/8"	16"	16
3429G	2	18"	20"	16
3429H	2	14-3/4"	20-1/8"	16
3429I	2	18-1/2"	16"	19
3429J	2	17"	32"	10
3429L	2	19"	26-1/4"	19
3429S	2	20-3/4"	34"	14
3429W	2	18-1/2"	28-1/4"	17
342924	2	18-1/2"	20"	14
3429Q	1	18-1/2"	27-1/2"	23
3429R	1	18-1/2"	22-1/2"	15
3429Y	1	18-1/2"	18"	13

CORES

Every Howe radiator starts with one of more than 16 different size cores. Each core features the highest tube to fin bond rating of any aftermarket radiator. It is that bond that determines the efficiency of heat transfer from the water to the air. You select the core dimensions that best fit your application.

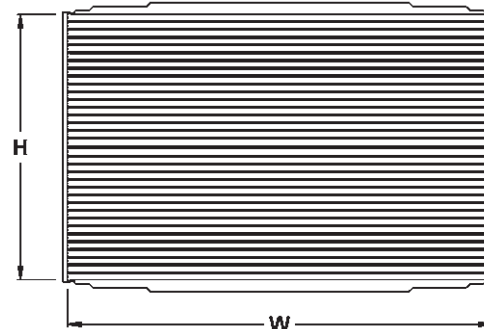

Width measured from the inside edges of the headers. Height measured from the top of the first row of fins to the bottom of the last row of fins.

*Core fin count & dimensions may occasionally vary slightly due to manufacturers.

INSTRUMENTS AND WIRING

NOTE: Graphics On Panels May Vary From Those Pictured.



ASSEMBLED GAUGE PANELS

Gauges	Part No.	Style
Oil Press., Water Temp.	E4400	Auto Meter Std
With Tachometer	E4400T	Auto Meter Std
Oil Press., Water Temp., Oil Temp.	E4407	Auto Meter Std
With Tachometer	E4407T	Auto Meter Std
Oil Pres., Water Temp., Fuel Pres., Oil Temp., Tach.	E4408T	Auto Meter Std
Oil Pres., Water Temp., Fuel Pres., Oil Temp., Tach.	E44085T	AM Liquid Fill
Mini Brake Bias	E4409M	Auto Meter Std

INDIVIDUAL GAUGES

- E149 Fuel Pressure
- E150 Oil Temperature
- E151 Oil Pressure
- E152 Water Temperature

SENDERS

- E1250 Water Temp Sender
- E1251 Oil Temp Sender
- E1252 Oil Pressure Sender
- E2245 Fuel Level Sender

FUEL GAUGES

- E3316 Level, Small Sweep
- E3310 Level, Large Sweep
- E3561 Pressure, 0-15 - No Regulator Req.
- E3563 Pressure, 10-100 - Regulator

NOTE: All Fuel Pressure Gauges Have Isolators.



IGNITION PANEL

Carbon fiber look aluminum switch panel designed for the ignition, engine fan, brake fan, master disconnect, and starter button.

B9000 Howe Ignition Panel Works well with # 84520 Multi-Bracket.



SWITCH PANELS

For Standard Ignition or Mag

- E4480 Switch Panel Electronic
- E4482 Switch Panel w/ Acc. Switch

Individual Parts

- E126 Toggle Switch Only
- E127 Starter Button Only
- M-626-02 HD Starter Button



WIRING ACCESSORIES

E5480 - STD CABLE KIT

Qty	Part #	Description
14'	E5492	Battery Cable
1	E5491	Ground Strap
1	E5494	Starter Cable End
1	E5493	Battery End
8	32602	Adel Clips

Individual Parts

- A. E5490 Shut Off Switch
- B. E5491 Ground Strap
- C. E5492 Battery Cable per Foot

E5481 - KIT W/ SHUT OFF

Qty	Part #	Description
14'	E5492	Battery Cable
1	E5490	Shut Off Switch
1	E5491	Ground Strap
3	E5494	Starter Cable End
1	E5493	Battery End
8	32602	Adel Clips

- D. E5493 Battery End
- E. E5494 Starter End
- F. E5495 Shut Off Switch, 4 Post

HD MASTER POWER DISCONNECT

Can support two circuits or disconnect both the positive and negative. Provides superior vibration and shock resistance as well as 500A continuous rating. Four M12 x 25mm studs.

44057 **NEW**



TOTAL POWER BATTERY

Provide superior vibration and shock resistance in a non-spillable / maintenance free design. Delivers 1200 cranking amps and is capable of being mounted in virtually any position. Only 24 lbs.

TP1200



This instrument panel houses all the gauges and accessory switches that you could need. Features: oil pressure, water temp., oil temp., tach w/ recall, fuel pressure, fuel level, ignition, master disconnect, directional, wipers, brake blowers, defrost, running lights, engine fan, fuse box, and Howe Racing graphics. Gauges not included in dash panels.

- B902D** GT2 / TA2 Dash - Analog
- B902F** GT2 / TA2 Dash - Digital Ready

AIM MXL2 DATA LOGGING SYSTEM



MXL2 is the new AIM dashlogger providing all the info needed by professional racers. MXL2 acquires and displays data coming from your ECU, the internal accelerometer and gyro, as well as from the GPS module included in the kit. You can add up to eight expansion modules. The MXL2 display features a high contrast LCD, an ambient light sensor keeps the backlight at optimum brightness. Six different alarm LEDs let you choose the conditions, the colors and the flashing frequency. Includes a 10 LED shift light array. Thanks to the SD Card, Memory Module can record all your data in a file that can be downloaded on your PC for post-analysis. Memory Module, with 16Gb capability, can be connected via CAN-Bus to MXL2 and to all AIM loggers.

E45000 Aim Data System - Digital

REAR VIEW CENTER MIRRORS

We offer four different mirrors. The standard flat mirror requires a chassis mount for a 1/4" stud. Five Star mirrors come with mounting brackets.

- 8451** Standard 5" x 8" Mirror
- FS820** 5 Star Mirror 17.7" x 3" - Curved
- FS820F** 5 Star Mirror 17.7" x 3" - Flat
- 22534** Mirror 14" x 2.75" - Curved

See Body Page 54 for Camaro & Mustang Mirrors



OPTIMA BATTERY

Sealed zero maintenance battery design eliminates vibration failures and recharges quickly. 12 volt with 800 cranking amps. 7-13/16" tall, 9-15/16" long & 6-3/4" wide. Weighs 39 lbs.

OT800S



Complete 5 Point Harness w/ 2 Piece Shoulder Belts



5 OR 6 POINT HARNESS

Harness includes 3" Lap and shoulder belts with an aircraft style latch system. Most rules require 5 point, we recommend 6 when possible. Universal 6 point mount bolts to the floor pan for proper mounting of 6 point harness sub-strap. Restraint brand varies by availability.

Style	Complete Belts	Sub Strap
5 Point	M96555-12BA	----
6 Point	M96566-12BA	M652122

Note: Do not use 33075 6 point mount with floor pans less than 1/8" thick.



33075 Six Point Harness Mount

WEBBED STRAP

Black 1" nylon strap web nets are 17.5" tall by 22" wide and accept standard mounting hardware.

4001

MESH

Stronger, improves visibility, and is more escapable during a fire than strap style. Used on our road race cars with partially opening doors. 22" wide by 24" tall.

4005 Mesh Net - TA2

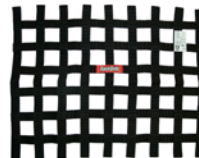

WINDOW NET MOUNTS



Upper latch bar is solid 3/16" x 1" with aircraft style latch. Chassis mount kit comes with a 1/2" diameter tube. Weld in mounts are 1/8" x 1."

40025 Latch bar Assembly
40020 Chassis Mount - Tube



6 POINT HARNESS

We use these belts with the Sparco Pro 2000 seat. These belts are six point adjustable and Hans Device friendly with 3" straps with 2" over the shoulders. Pull down to tighten type, cam lock latch system. Eyebolt style mount system. FIA Approved. Restraint brand varies by availability.

902217 RR 6 P Harness

HIGH IMPACT BAR PADDING

BSCI padding is far more effective at absorbing impact energy than standard foam padding. Comes in lengths of 3', has adhesive backing, and is far more flame retardant than standard padding.

65030 Black 1/2 Round
BSC155601 FIA Type A



RIGHT SIDE HEAD RESTRAINT

Designed to fit our GT2 / TA2 chassis it connects to the chassis at three points to provide driver protection in case of a side impact and meets SCCA Pro Racing requirements. Features a sturdy kevlar strap that allows it to be drawn tight.

4007 Right Side Restraint



SPARCO PRO 2000

Has been used to win every major touring and sports car championship in the world. So popular it is used by the top factory sports car and rally teams. Features special adjustable lateral lumbar supports. Fiberglass construction with side mounting only.

330480

Sparco Seat Mounts

330481 Sparco Seat Brackets
330482 Sparco Adj. Slider



RACETECH 119 SERIES

Used by many professional teams at both national and international level. There are three sizes available; standard, tall and wide-tall. Customize your seat further with low base cushions or add side cushions for support in the thigh area. The 119 series seats are compliant with FIA 8855-1999 standards when back mounted to the roll cage at shoulder height.



Size	Part No.
Standard	RT4119HRW
Tall	RT4119THRW
Wide-Tall	RT4119WTHR

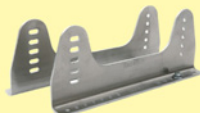

Racetech Seat Mounts
RTB1009M Racetech Side Brackets

MOUNTING BRACKETS

Made from 1/8" hot roll steel. 7" mounts withstand greater impacts without deforming the seat. Made to fasten to the chassis and seat with 3/8" bolts.



330687 Complete Set, V Back - 7"

Part #	Description
A 330617	Welds to Floor
B 330637	Bottom Seat Mount, Bolt to A
C 330627	Top Seat Mount, Bolt to Chassis
D 330647	Top Seat Mount, Bolt to C

SEATS

RICHARDSON MILLENNIUM

Millennium seats are all special order and built to fit like a custom driving suit. The same double wall hand formed seats that are used by Cup and Grand National drivers. To order, please call and request a custom seat order form and we will mail, e-mail or fax it to you on request. Allow 3 to 4 weeks for delivery.

R09000 Millennium



RICHARDSON SPORTSMAN

Made of 1/8" aluminum that is formed to size with a welded bottom. Features dual rib supports and 5 point belt slots. Very close to a Millennium seat without the double wall, the custom fit or the custom price. Includes a snap in cloth cover. Standard seats are black with red and blue available by request. Pictured with optional add on supports available below.

Size	Style	Complete
15"	2 Hole	330450
17"	2 Hole	330470



ADD ON SUPPORTS

Part No	Description
A 3305R	Head Rest - R
A 3305L	Head Rest - L
B 3308R	Leg - R
B 3307R	Leg - L
C 3309	Shoulder - R
C 3309L	Shoulder - L



FIRE SYSTEMS

FIRE BOTTLE

Pick push or pull to activate whatever is natural to you. Once activated it completely discharges 5 lbs. of 1211 halon. 1211 is a clear liquid vapor that quickly blankets discharge area, eliminating combustion. System weighs 10 lbs. and the bottle is 11" long and 4.25" dia.. All bottles are rechargeable.



Part No.		System Pieces
Pull	355	35502 5# Bottle Only - Long 35504 Push Release Valve Only
Push	355P	35505 Pull Release Valve Only 35506 Aluminum Tubing Only

HEAT ACTIVATED FIRE BOTTLE

Offers the same protection as a standard firebottle system but features a remote automatic trigger. Remote temperature sensor / spray nozzle is set to auto release at 170° Fahrenheit. Can still be triggered manually with a pull release. **AMRC500 5 lb. Pull / Automatic Firebottle**



ADHESIVE HEAT INSULATION MATERIAL

Top surface has a bonded radiant heat shield. Base material is Poron, a high tech silicone elastomeric foam. Withstands temperatures in excess of 1000°. Only 1/4" thick, flexible, adhesive backing, and easy to fit. We like to seal the edges with common heat duct foil tape. Sold by the foot off of a 3' Roll with a minimum order of 1 foot.

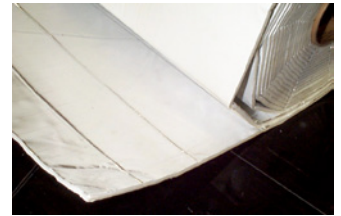

RF125A High Temp x 3'
Medium temperature insulation is a lower cost alternative that can be used in areas away from the exhaust under 300 degrees.
RF126A Medium Temp x 5'

NOMEX SHIFT BOOT





12 oz. Nomex material is used as a primary or a secondary shift boot cover over existing rubber boot. **SIM36010 Nomex Shift Boot**



PEDALS

GAS PEDALS

The safety throttle has become so common that it has been taken for granted. We offer different versions to fit varied mounting applications.

Part No	Application
A 523	Std Tunnel 
B 5236	Asphalt Mod 
C 5239	Angled Mount 
D 523FLM	SS, FL 

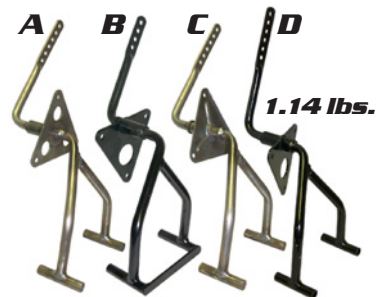

EFI THROTTLE CABLE KIT

This throttle cable is made from a thicker gauge than most and comes in a durable wear resistant sleeve. Feature a quickly detachable clevis. **NEW**

52500 Cable Kit
52502 Cable Engine Mount



CRANK STYLE

Easier to keep track of turns than knob type. 526A has 10" and the 5260A has 14" of spiral wound steel flex cable. Threaded 3/8-24 to attach to most balance bar assemblies.

526A 28" Adjuster
5260A 34" Adjuster



PRO BRAKE PEDAL

Unique aluminum pedal developed with top oval and road racing drivers. Pad can be adjusted in height and installed as 6:1 or 7:1 ratio. Complete pedal includes adjustable return stop to eliminate play in the master cylinder. Pedal arm fits the same base and mounts as the 52692 Howe brake pedal.

52696 Complete Assy.
526961 Pedal Arm Only



HOWE FLOOR MOUNT PEDALS

BRAKE

1.8 lbs.

CLUTCH

1.25 lbs.

BALANCE BAR

52613



Howe floor pedals are strong, light and affordable. Made of cast aluminum with black finish. The brake uses a clevis type balance bar for bias adjustment. Pedals have a 6 to 1 ratio and accept standard master cylinder bolt spacing. Accepts 5/16 master cylinder rods.

52692 Brake Pedal
52613 Balance Bar and Clevis for Howe Pedals
52992 Clutch Pedal
52994 Clevis for Clutch Pedal (52992)

TA2 GAS PEDAL

We developed this pedal for use in late model type chassis in road racing applications. Allows for "heel-toe" driving. Includes pad for throttle stop.

5235 TA2 Gas Pedal
5237 V8TC Gas Pedal

CARBURETOR THROTTLE LINKAGE KIT

Throttle linkage kits include: 26" of 3/8" hydraulic tubing, two 5/16 x 1" bolts, two jam nuts and two 5/16" RH female rod end bearings. Bending, cutting and welding is required.

525 Kit



HOWE HANGING PEDALS

Weigh only 4.8 lbs. with aluminum frame and sturdy steel pedals. Accommodates dual brake and clutch master cylinders. Mounts with four 5/16" bolts. 7 to 1 leverage ratio.

5262 Pedal Assembly
Individual Parts
52621 Pedal Clevis
52623 Pedal Only - Clutch
52624 Pedal Only - Brake
52623 Frame Only for 5262



90° elbow allows you to reroute the bias adjuster to move your floor pedals closer together. **72560**

Wilwood firewall mount adjuster takes up little room and is simple to install. **WW340-4990**



DIAL DISPLAY BIAS ADJUSTER

See at a glance exactly where the bias is set. After setting zero, the number of turns in either direction is indicated by the number on the dial. Includes two decals to indicate direction determined by master cylinder location. Assembly includes 48" of flex cable and sheathing. **NEW**

52620 Complete Assembly
52615 Adjuster Only (no cable)
526151 Weld On Mount Bracket

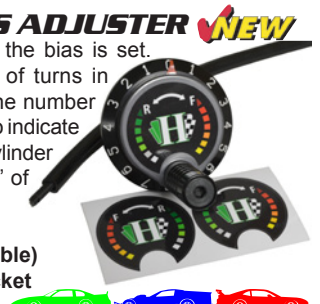

HOWE G3 RACING MASTER CYLINDERS



**ONLY
0.85 LBS.**

A.

INDIVIDUAL PARTS

- 524354 Shield Only
- 524350 Cap Only
- 524351 Tank Only
- 524352 Bellows - Standard
- 524357 Bellows - Rough Track



Optional stainless steel shield protects against rocks and heat.

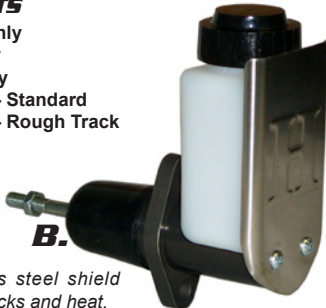

B.

COMPACT DESIGN - The next generation design moves the fluid ports away from the piston seal. This allows the size and weight to be substantially less.

EXTREME DURABILITY - Conventional master cylinders are made with piston seals passing over the fluid intake port slowly eating away the seal. The G3 eliminates this problem drastically extending seal life.

NO PAD DRAG - Calipers release completely due to the open return port design eliminating pad drag.

VERSATILE - Accepts a remote or directly attached fluid reservoir requiring only 4 ounces of fluid from new to worn out pads.

RUGGED - Optional shield may be attached to increase protection from rocks and heat. Tough Billet housing is guaranteed not to leak.

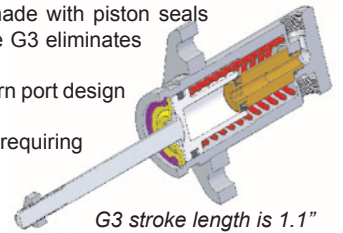

G3 stroke length is 1.1"

Bore	[A] Attached	[B] Shielded	[C] Bare	[D] Remote
3/4"	524412	524412SK	524312	524512
13/16"	524413	524413SK	524313	524513
7/8"	524414	524414SK	524314	524514
15/16"	524415	524415SK	524315	524515
1"	524416	524416SK	524316	524516



C.



D.

Fluid reservoir is available with single or double outlet. It has integral mounting bosses and a screw on lid.

Kit Includes: Master, Reservoir, Hose, Hose Clips

REBUILD KIT

- 524312K 3/4" Seal Kit
- 524313K 13/16" Seal Kit
- 524314K 7/8" Seal Kit
- 524315K 15/16" Seal Kit
- 524316K 1" Seal Kit

Kit Includes: 3 seals and a packet of lube

NOTE: With the correct clean fluid you may never need to replace the seals in a G3.



- CP0805420 Dual Port Reservoir
- CP0805424 Single Port Reservoir
- CP2293-48 Bellows for Remote
- 524353 Remote Res. Fitting
- AU12685 Brake Hose Clamp
- 524802 Hose & Clips



WARNING: Howe master cylinder seals are not compatible with silicone based fluids. Castrol SRF fluid has been found to reduce seal life. If SRF is used seals should be replaced annually.

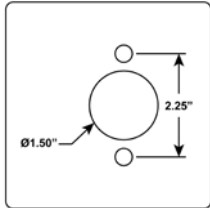

NOTE: Diagram shows pedal plate hole requirements to fit G3 Master cylinders.

BILLET BRAKE RESERVOIRS **NEW**

Designed to replace plastic reservoirs that are prone to leaks. Fits the same mounts as other popular remote reservoirs. Ports are threaded 1/8" NPT to accept the barb or fitting of your choice.

- 524360 Billet - Single Port
- 524361 Billet - Dual Port
- 524371 Cap, Plastic
- 524373 Cap, Aluminum



HOWE ORIGINAL STYLE PARTS

- Replacement Parts**
- 524B Rubber Dust Boot
 - 524G Gasket for Lid
 - 524L Lid Only
 - 524R Push Rod Only
 - 524W Wire for Lid

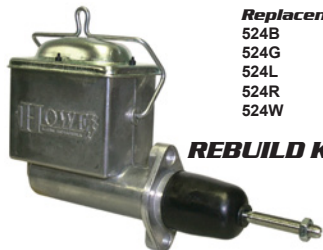

REBUILD KITS

Bore	Part No.
3/4"	524-12K
7/8"	524-14K
1"	524-16K

Note: The G3 master cylinder made earlier designs obsolete. Original style Howe master cylinder was produced from 1979 to 2009. We will stock replacement parts only as long as there is sufficient demand.

LONG G3 PUSH RODS

Extended length push rods for applications with a lot of brake wear. Helps maintain proper pedal position. 1/2" longer than standard. 5/16-24 Thread.

- 524356 Long Push Rod - 4"
- 524343 Original Push Rod - 3.5"



WILWOOD RESIDUAL VALVE

Use in applications with G3 Master Cylinders and floated rotors or any time to trade increased rotor drag for less pedal travel.

- WW260-13706 2 lb. Residual Valve



FLOW RESTRICTOR

Most often used as a diagnostic tool to identify faulty caliper mounts or air traps in the lines. Creates restriction for the G3 similar to other master cylinders.

- 52460 Restrictor Valve



1/8-27 NPT Thread

A brake system is only as good as its weakest link, which is often the fluid. We sell a variety of fluids because each type has advantages and disadvantages.

A. Wilwood 570 is most affordable and adequate for the average user.

B. AP600 and Motul are both very good fluids that are moderately priced with good resistance to boiling and are easy on seals.

C. AP PRF and the Castrol SRF fluids have an extremely high wet boiling point but are expensive and can cause swelling of the master cylinder and caliper seals.

D. StopTech STR-660 fluid is comparable in performance to AP600 or Motul but in a sealed metal can for 25% longer shelf life.



BRAKE FLUID

Dry	Wet	Brand	OZs	Part No.
550°	284°	Wilwood 570	12	532
622°	404°	StopTech STR-660	16.9	STP50100002
572°	410°	AP600	16.9	AP600
585°	421°	Motul	16.9	5332
608°	518°	AP PRF	16.9	CP15601608
590°	518°	Castrol SRF	33.8	T80-9450-1

NOTE: Dry boiling rating is in laboratory conditions. In your car the actual boiling point is at the wet rating or less.

BRAKE ROTORS

STANDARD ROTORS

All of the rotors that we sell are cast iron with a 7.00" bolt circle. Lighter rotors such as .810's should be used only in less demanding applications such as the rear of asphalt cars or in the front under mild braking conditions. Aside from circulating more air, curved rotor vanes help to prevent cracking by not following potential crack lines.

MOST AFFORDABLE

Part No.	Thick	Vanes	Bolt	LBS.	Dia.
21580	1.25"	Curved, Left	8	11.15	11.75"
21585	1.25"	Curved, Right	8	11.15	11.75"
21591	.810"	Straight	8	8.1	11.75"

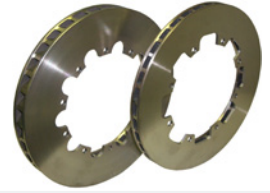



AP J-HOOK ROTORS

J-hook design offer advantages over grooved rotors; greater initial bite, superior pad cleaning, faster pad release and reduced thickness variation. This provides faster reaction, less susceptibility to glazing, brake drag, and pad build up. Inner diameter slightly larger than other rotors to prevent heat distortion. 12.19" dia. rotors are well suited for heavy brake applications.

BEST VALUE



Style	Part No.	Thick	Vanes	Bolt	LBS.	Dia.
 J-Hook	CP1901722	1.25"	60 Vane, Right	8	10.68	11.75"
	CP1901723	1.25"	60 Vane Left	8	10.68	11.75"
	CP1901726	1.25"	60 Vane, Right	8	11.00	12.19"
	CP1901727	1.25"	60 Vane Left	8	11.00	12.19"
 Standard AP	CP1901780	1.25"	28 Vane, Right	8	9.90	11.75"
	CP1901781	1.25"	28 Vane, Left	8	9.90	11.75"
	CP1901782	.810"	28 Vane, Right	8	8.76	11.75"
	CP1901783	.810"	28 Vane, Left	8	8.76	11.75"

STOP TECH ROTORS

The newest choice in high performance racing rotors. Stop Tech calipers and rotors are the choice of some top TA2 series drivers. Made by California based Centric Parts.

MOST DURABLE

HAT HARDWARE

Part No.	Description
PSYH432229250	Rotor Hat, 12 Bolt
BOT100002	Bobbin, EA
HAE100248	Washer, EA
SCT100107	Screw, EA
BRT100575	Bracket Kit



PRE-BURNISHED

Part No.	Thick	Vanes	Bolt	LBS.	Dia.
ROR12191254823	1.25"	48 Vane, Left	Hat	13.90	12.19"
ROR12191254824	1.25"	48 Vane, Right	Hat	13.90	12.19"
STP31G3B0171	1.25"	48 Vane, Left	Hat	11.80	11.75"
STP31G3B0172	1.25"	48 Vane, Right	Hat	11.80	11.75"

ROTOR BOLTS

Kits both contains 8 grade 8 allen head bolts. Lock washers for W5. Washers, lock nuts for 5x5.

21515 W5, Set of 8
21518 5x5, Set of 8



STOCK STYLE HUBS

HOWE STOCK REPLACEMENT HUBS

Cast 5x5 hubs made in two versions to replace stock hub and rotor assemblies used on Modified and other stock divisions. OEM aftermarket hubs can not tolerate hard use without breaking. Howe hubs are much stronger and separate the hub from the rotor. You can use any popular 8 bolt racing rotor. Impala features an added .600" width built into the hub face to reduce the need for wheel spacers.



Style	Assy.	Hub	Bearings	Seal	Lbs.
Granada	205350	205345	20567 Kit	21257	10.85
Impala	205351	205346	LM67048 M12649	8871	11.15

GRANADA HUB & ROTOR ASSY

Fits Pinto spindles for use on Chevelle modifieds. 5X5 bolt pattern 11" x .810" rotors meet all OEM specs and dimensions. Requires bearing and seal kit.

SWS203-852 Granada Hub & Rotor Assy.
SWS201449 Cap & Nut for Granada Hub
SWS201450 Bearing Kit for Granada Hub **20 lbs.**



IMPALA MOD FRONT HUB/ROTOR

Impala modified front hub and rotors measure 11-13/16" diameter. Has extra long wheel studs to accommodate the 1" wheel spacer.

205376 Hub/Rotor w/ Kit - Impala Mod
Kit Includes: Hub/Rotor, Bearings, Seal, Spindle Washer & Nut, Dust Cap, and Wheel Spacer
PQP60476 Hub/Rotor Only - Impala Mod
ALL44123 Spacer Only, 1"



29 lbs.

HOWE HUBS - MACHINED & ASSEMBLED IN THE U.S.A.

SMALL FIVE HUB

Howe 5x5 hubs are so popular that they are the short track standard for 5x5 hub design. Designed not only for strength but to minimize heat transfer from the rotor to the bearings. We recommend aluminum where allowed except for the right front on cars over 3000 lbs..

STEEL
9.68 lbs.



Part No.	Description	Bolts
Steel 205300	Hub & Kit	8
5x5 36568	Hub Only	8

SMALL FIVE PARTS

Part #	Description
20569	Hub Bearing Kit, 5x5, 5x4.75
20589	Hub Bearing, 5x5 or 5x4.75
20599	Hub Bearing Race, 5x5 Howe
21250	Hub Snap Ring Seal Retainer
21255	Hub Seal, All But Old Mag W5

ALUMINUM
6.01 lbs.



Part No.	Description	Bolts
Aluminum 205100	Hub & Kit	8
5x5 36558	Hub Only	8

Note: Aluminum 5x5 hubs should not be subjected to extended use on the right front on asphalt tracks with more than 25 degrees of banking. These applications are within the limits of a new aluminum hub, but may exceed that of older ones. In these applications we recommend steel on the right front. Torque bearings to 60 ft./lbs. aluminum 5x5 hubs and 40 ft./lbs. steel.

HOWE HUBS - MACHINED & ASSEMBLED IN THE U.S.A.

HOWE GT HUBS

For applications where extreme brake performance is required. Utilizes aluminum hat style rotor mount that can fit any 7" I.D. 8 bolt rotor. Rotor can be mounted solid to the hat or floated with an additional hardware kit. Aluminum dust caps can be removed without removing the rotor hat. No special caliper mounts are required, rotor location remains the same as any 2" bearing 5x5 hubs. Available in steel or aluminum in 5x5 and 5x4.75 bolt patterns. The 5x5 version has 5/8" course studs while the 5x4.75 version comes with 1/2" fine studs. All 5x5 versions of the GT hub feature Timken bearings.

ROAD RACE

5x5 Wide	Part No.	Description
Steel	205800	Hub & Kit
	36569	Hub Only
Aluminum	205900	Hub & Kit
	36569A	Hub Only

*Kit includes bearings, seal, snap ring, spindle nut, lock ring, inner washer, screws and lug nuts.

5x4.75 Wide	Part No.	Description
Steel	36571	Hub Only
Aluminum	36571A	Hub Only

- 20537 GT Dust Cap, Bullet
- 20536 GT Dust Cap, Low Profile
- 20574 GT Rotor Hat - 5x5
- 20573 GT Rotor Hat - 5x4.75
- 36574 Replacement T-nut for GT hub
- 36575 T-nut & Bolt Hardware Kit for Hat
- 36573G Tabs for AP Rotor (8 per pkg)



OVAL TRACK

5x5 Narrow	Part No.	Description
Steel	205800N	Hub & Kit
	36569N	Hub Only
Aluminum	205900N	Hub & Kit
	36569AN	Hub Only

*Kit includes bearings, seal, snap ring, bullet dust cap, dust cap screws, spindle nut, lock ring, inner washer, screws and lug nuts.

- 20537N Narrow GT Dust Cap, Bullet
- 20574N Narrow GT Rotor Hat - 5x5
- 36574N Replacement T-nut for GT hub
- 36575N T-nut & Bolt Hardware Kit for Hat



Hat style rotor mounts dramatically reduce thermal transfer of rotor heat. Lower temperatures extend the life of grease and wheel bearings. This reduces thermal expansion of the hub allowing bearing preload to be reduced by 50%, and less frequent maintenance. Allows rotor to expand without "coining" for better pad contact, and pad wear. Results are improved performance and durability.



GT HUB DRIVE FLANGES

Drive flange for Road Racing applications where you want the advantages of the hat type rotor on the rear. Allows the axle to be removed without removing the hat. Features a bullet shape for easily locating wheels. Requires rear rotor hat to match drive flange shape. For wide configuration GT 5x5 Hubs only.

- 20545 GT Straight Drive Flange
- 20579 Rear GT Rotor Hat 
- 20546 GT Cambered Drive Flange



W5 FLOATED ROTOR ADAPTER

Unique design maintains original rotor location. Simply bolt the rotor to the adapter using the Howe t-nuts, then bolt the adapter solid to the hub.

Larger t-nut contact surface distribute braking forces more evenly than other floated designs allowing more uniform expansion and no binding that creates vibration. Floated mounts allow the rotor to expand when hot without distorting resulting in improved pad wear and rotor life.

Improved rotor to pad contact by maintaining a flat surface and lower temperatures. Race tested at harsh braking tracks. Fit any common 8 bolt on 7" circle racing rotor.

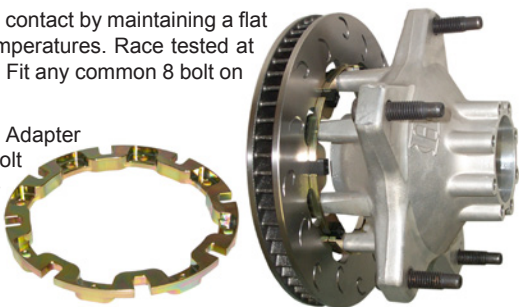

Each hub requires an Adapter (20577), a T-Nut & Bolt Kit (36575N) to secure the rotor to the adapter, and bolts to secure the adapter to the hub.

- 20577 W5 Floated Rotor Adapter
- 36575N Narrow T-Nut & Bolt Kit



FLOATED ROTOR APPLICATION TABLE

Find the floated rotor options by your application below. Divided by chassis type as well as hub type. Find the components that you need to fit your application.

Applications	HUB	HAT / Adapter	T-Nut (ea)	Bolt (Kit of 8)	Drive Flange / Dust Cap	App
LM - 5x5 Narrow	36569N	20574N	36574N	ARP300-0802	20537N	
LM - W5	20465	20577	36574N	ARP300-0802	207	
TA2 - 5x5 Front	36569	20574	36574	ARP300-0802	20537	
TA2 - 5x5 Rear	36569	20545	36574	ARP300-0802	20579	
V8TC 5x4.75	36571	20573	36574	ARP300-0802	20536	

SPINDLE NUTS

The reusable lock ring of this spindle nut is held securely in place with two 10/32 allen head screws. They fit both wide five and Howe 5x5 spindle pins.

- 2143 Spindle Nut Assembly Nut w/ Threaded Holes
- 214 Spindle Nut Lock Ring
- 21430 Spindle Nut Washer
- 21431 Spindle Nut Screw
- 21432



SPINDLE NUT SOCKET

Handy socket to install and remove the oversized spindle nuts. Made of billet aluminum and hard coat anodized. Broached to fit a 1/2" drive wrench.

- 2142 Spindle Nut Wrench - Alum.



WHEEL STUDS

The studs are tapered with an easy lead on thread for quick changes without cross threading. The 206C is made of heat treated 4140 steel and forged to fit a 21/32" dia. hole.

- 206C 5/8" Coarse
- ALL4419 5/8"-11 x 3.75"
- 20612 1/2" Fine



WHEEL NUTS



COARSE THREAD

- 2082 5/8" Heat Treated
- 2085 5/8" Aluminum
- 208C 5/8" Standard Grade

FINE THREAD

- 2081 1/2" Standard Grade
- 2083 7/16" Standard Grade
- 208F 5/8" Standard Grade

HOWE HUBS - MACHINED & ASSEMBLED IN THE U.S.A.

WIDE FIVE - CONTENDER III

When you see the Howe "H" logo you don't have to worry if it is the super trick version that is going to break; all Howe wide 5 hubs are proven tough enough to use anywhere. Howe hubs have always been designed to be as lightweight as possible without compromising strength. Each spoke is internally reinforced for strength. It is 4-7/8" from the wheel surface to the far side of a 1-1/4" rotor.

- 20445 Hub and Kit* - 8 Bolt
- 20465 Hub Only - 8 Bolt

THE STRONGEST WIDE 5 RACING HUB ON EARTH!

In 2009 we subjected the Howe Contender 3 and other popular Wide 5 hubs to extensive strength testing. The Howe hub is second to none. The Contender 3 is **approved by NASCAR** for the demanding Modified division at Bristol.



Part No.	Description
20570	Hub Bearing Kit*, Howe W5
18690	Hub Outer Bearing, W5 Howe
WW370-0315	Hub Outer Race, W5Howe
209	Hub Inner Race, W5 Howe
211	Hub Inner Bearing, W5 Howe
212	Hub Seal, Original Mag W5 Howe
21250	Hub Snap Ring Seal Retainer
21255	Hub Seal, All but Old Mag W5
21256	Low Drag Seal, All but Old Mag W5

Note: Wide 5 hubs do not require bearing preload. When installing tighten the spindle nut to seat the bearings then back off the nut to zero preload.



*Kit includes bearings, seal, snap ring, spindle nut, and rotor bolts.

Howe Hubs are cast and machined in the USA. To be sold competitively all complete hub kits come standard with bearings that are imported. U.S. made bearings are available on request at a higher price.

W5 WHEEL SPACER

Spacers add 1/4" of width to wide 5 hub and are threaded 5/8-11. 20571



DUST COVERS & DRIVE FLANGES

W5 DUST CAP

If weight is priority, there is nothing lighter or more simple than our stamped aluminum wide five dust cover. 207

2.6 oz.



WIDE FIVE CAMBERED
Contains a crown cut gear for cambered axle tubes. 

RT2000DRFL Cambered W5 Flange
1.7 lbs.

WIDE 5 DRIVE FLANGE

At one pound the Howe wide five drive flange is as light as an aluminum flange and as durable as steel.

- 205832 Drive Flange, - Steel
- 205840 Bolt Kit for Wide 5 Drive Flange



1.0 lbs.

WIDE 5 HUB GASKETS

These Wide 5 hub gaskets are available in standard paper & premium grades. Premium gaskets are durable coated steel allowing them to be used repeatedly.

- 205833 Paper W5 Gasket
- 205834 Premium W5 Gasket

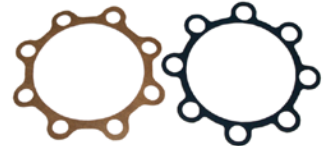

5X5 DUST CAPS

Machined from an aluminum casting, our 5x5 cover keeps crud out of the bearings while the tapered design helps quickly align the wheel and studs.

- 20539 5X5 or 4-3/4 Dust Cover 9.6 oz.
- 20540 Screw for 5x5 Dust Cover



3.2 oz.

Billet aluminum dust cover for small centered wheels or where weight is a premium. 20538

SMALL CENTER DRIVE FLANGE

These drive flanges were developed to fit both 5x5 and 5x4.75 hubs. For use with stock style wheels that have a smaller center hole.

- 20547 Small Center Flange

2.35 lbs.



WHEEL BEARING GREASE

Schaeffers stands up to extreme friction and severe heat. It is unaffected by moisture & reduces bearing temperatures. Bearings should be packed from 100 to 500 laps determined by application.

- 2381 Schaeffers Grease   

Note: Latex gloves are recommended when using this grease. It does not come off bearings or your hands.



DRILLED DRIVE PLATE BOLTS

These 7/16 UNC drive plate bolts are 1.5" long and drilled to allow safety wire to be ran through them to assure they will not try to back themselves out during competition.

- ARP200-3401 Drilled Drive Plate Bolts



3.7 lbs.

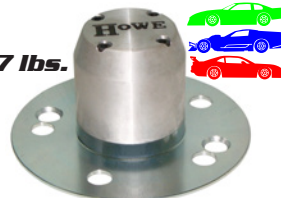

5X5 DRIVE FLANGE

The 5x5 flange is made with a steel spline and an aluminum cap.

- 20549 Drive Flange for 5X5 Alum.
- 205492 Drive Flange Cap for 5X5 & 4.75
- 205495 Drive Flange O-Ring 5X5 & 4.75
- 205496 Drive Flange for Steel 5x5 & 4.75
- 20550 Gasket for 5X5, 5X4-3/4 Drive Flange
- 20551 Drive Flange Screw

4.1 lbs.

QUARTERMASTER 5X5 CAMBERED

A crown cut flange is required when using a cambered axle tube greater than 1°.

- QM176400 Cambered Flange

Note: QuarterMaster drive flange is NOT compatible with Howe GT hubs.



HOWE D52 SINGLE PISTON

Replaces the D52 GM caliper. Two piston sizes offered for proper brake bias with 1" master cylinders. "No Name" version available for where they are better off unnoticed. Fits "D" shape pad.

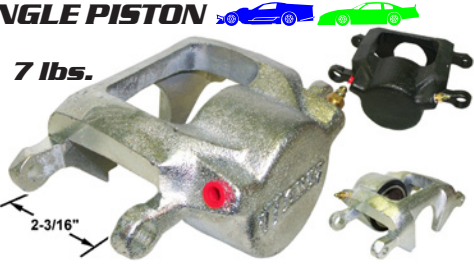

Piston Size	Howe	No Name	Piston	O-Ring Kit (4)	Dust Boot	Pad
2.937	337	3370	3367	3376	3377	D
2.625	33658	33705	3365	33761	33771	D

CALIPER SPACERS

Allows you to use calipers made for 1.25" thick rotors with lighter .750" or .810" rotors.



33712 3/8" Alum. Spacer Plate, GM

Disclaimer: Howe brake products are made for racing on a closed course and are NOT intended for highway use!

HOWE DOUBLE PISTON

Dual piston calipers provide maximum braking at a reduced weight in a GM D52 mount caliper. 2 piston design applies even pressure to the pad reducing uneven wear. Meets or exceeds the clamping pressure of any short track caliper. Fits "D" Shape Pad.



Piston Size	1.25" Rotor	O-Ring Kit (4)	Piston	Pad
2.125"	33701	33706	3366218	
1.875"	----	33707	3366178	D
1.625"	33703	33708	3366158	

HOWE METRIC SINGLE PISTON

Nearly a pound lighter than common OEM version. More open bridge improves cooling and is available in two piston sizes. The casting marks are the same as an OEM caliper. Slightly wider than most metric calipers to work with either 1" or 1-1/4" rotors. Fits "C" shape pad.

Piston Size	No Name	Piston	O-Ring Kit (4)	Dust Boot	Pad
2.75	3368	3366	33762	33772	C
2.625	3369	3365	33763	33773	C

Note: All Howe calipers require 1/8 NPT fitting and bleeders. Each caliper will fit either side.



FSLI4



5.2 lbs.

The FSLI4 (Forged Superlite Internal 4) and the FSLI (Forged Superlite Internal) feature a stress-flow forged body and bridge bolt for rigidity with easy pad changes. Excellent on the front of pavement cars with 1.75-1.88 pistons with 1.38" or 1.12" piston calipers in the rear. 3.5" lug style mounts.



5.2 lbs.

Forged Superlite 6R Radial Mount caliper has been redesigned with internal fluid ports eliminating the external cross-over tubes. Fits standard superlite style pad (B). We recommend these with a 12-3/16" rotor for a high demand package while still fitting in a 15" wheel. Stocked with Thermlock piston upgrade. Uses a 3.5" center mount bracket kit.



5.4 lbs.

WW250-6309 Radial Mount to 3.5" Bracket for FSL6R



8.2 lbs.

Grand National GN6R are forged aluminum six-piston radial mount calipers. High-strength forged aluminum body in nickel plate finish, Thermlock® pistons, uses .80" thick pads, and is compatible with rotors 1.25" to 1.38" thick and 12.19" to 13.06" diameters. Uses 3.5" or 6.0" center mount bracket kits.

NEW Mount Bracket WW250-14046 Radial Mount to 3.5" Bracket for GN6R

WILWOOD CALIPERS

Type	Application	Pos.	Side	Part No.	Pistons	Rotor	Pad
FSLI4	Front Asphalt Ovals	Trail	Left	WW120-11330	1.88 / 1.75	1.25	
			Right	WW120-11329			
FSLI	Rear Asphalt Ovals	Lead	Both	WW120-11130	1.38 / 1.38	1.25	B
			Both	WW120-11128			
			Both	WW120-11126			
FSL6R	Front High Demand O & RR	Trail	Left	WW120-13236TL	1.62 / 1.12	1.25	
			Right	WW120-13235TL			
GN6R	Front High Demand Road Racing	Trail	Left	WW120-13949-N	1.75 / 1.38	1.25	F
			Right	WW120-13948-N			

Replacement Parts

- WW130-2427 O-Ring Kit, SL3 & SL4, 1.75 / 1.88
- WW130-2479 O-Ring Kit 1.25 (4)
- WW130-2655 O-Ring Kit, 1.75 (4)
- WW130-2658 O-Ring Kit, 1.38 (4)
- WW130-2579 O-Ring Kit, 1.12 (4)
- WW190-4743 Cross Over Tube, 1-1/4 All

AP calipers have a high quality aluminum alloy body with cast in protection for the bleeders and stainless steel cross over lines. Thin wall stainless steel pistons for low heat transfer. Fits "B" shape pad.

Side	Part No.	Piston Size	Rotor	Pad
Right / Trail	CP1902800	1.87 / 1.75	1.25	B
Left / Trail	CP1902801	1.87 / 1.75	1.25	
Left / Lead	CP1902810	1.25 / 1.25	.810	
Right / Lead	CP1902811	1.25 / 1.25	.810	

- Parts**
- CP04004 Fitting, #3 to 3/8-24
 - CP177002 Crush Washer for Fitting
 - CP591972 Fitting, #4 to 3/8-24
 - CP0804690 Seal - 1.125"
 - CP0804691 Seal - 1.250"

- CP0804703 Seal - 1.375"
- CP0804710 Seal - 1.750"
- CP0804715 Seal - 1.875"
- CP1903070 Piston - 1.875"
- CP1903071 Piston - 1.75"
- CP1903015 AP Caliper Bleeder

4.8 lbs.



StopTech STR calipers are radial mount forged calipers. Claimed to provide a 20-percent reduction in weight without sacrificing stiffness or performance.

- Parts**
- BLW100106 Bleed Screw, M10x1
 - BRE06371020 Caliper Inlet Fitting
 - BRT.100575 Caliper Bracket w/ Hardware
 - EAR650103 Banjo Fitting #3-3/8 Adapter
 - EAR997503 Bolt, 3/8 Banjo-8MM
 - PSY111 O-ring Lube
 - PSY2149 Fitting Gasket
 - PSYSFCS Front Caliper Shim Kit
 - STP421000108 Abutment Plate STR43
 - STP75323411B 32MM Pressure Seal
 - STP75399004B 38MM Pressure Seal
 - STP75399007B 44MM Pressure Seal
 - XRP420133 #3 to M10x1 Seal Adapter





STOPTECH CALIPERS

Part No.	Position	Piston Size	Rotor	Pad
STP379332231	Left Rear	1.25 / 1.25	1.25"	B
STP379332232	Right Rear	1.25 / 1.25	1.25"	
STP3793358233	Left Front	1.50 / 1.75	1.25"	
STP3793358234	Right Front	1.50 / 1.75	1.25"	

CALIPER MOUNTS

FABRICATED

D52 and metric caliper mounts are pressed out of High Form 3/16" steel with threaded buttons. Clamp to 3" tube. Fabricated mounts should be tack welded or bolted to the axle tube.

Style	Clamp On	Weld On	App
GM D52	34029	A 340	B 
GM Metric	34031	C 34032	-- 

GM D52



GM METRIC

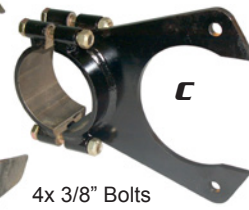

4x 3/8" Bolts

SUPERLITE 3.5"

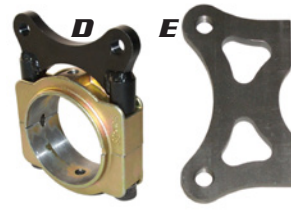

4P TO GM BRAKE ADAPTER BRACKET

Adapts a 4 piston brake application to GM D52 calipers. Allows you the flexibility to meet the various rules of different tracks. Superior in strength to the standard folded style GM brake bracket.

- 34050 4P to GM Adapter, W5 Only - Gold .100 Offset
- 34051 4P to GM Adapter, 5x5 Only - Silver .250 Offset



CALIPER MOUNT FOR CAMBERED BOLT ON PINS

These steel caliper mounts fit the plates on cambered pins on a Tiger style rear end.

34089 Each



4 & 6 piston Wilwood and AP calipers attach to the car with these 2-1/4" long 7/16-20 grade 8 shoulder bolts.

B716SHCS Bolts Each

PINTO / MUSTANG II CALIPER MOUNTS

Our new billet caliper mounts fit the popular 74-80 Pinto and 74-78 Mustang II spindles. These allow you to use a GM D52 or Metric caliper with an 11-3/4" racing brake rotor mounted to our new Howe Pinto Racing Hub. See page 38.

- 34052 GM - D52 Caliper Mount, Right & Left
- 34055 Metric Caliper Mount, Right & Left

Shown with: Howe 337 Caliper, SWS1043921 Spindle, CP1901781 Rotor, 205345 Hub

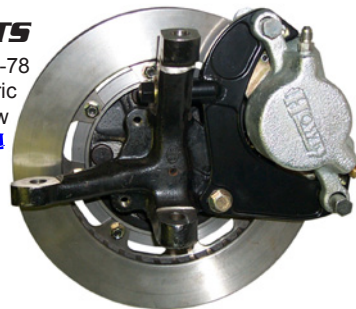

CALIPER BOLTS

Our caliper bolts have a built in shoulder with the heads machined for a 5/8" socket. The hardened bolts will take more abuse without bending.

- 337B Standard GM, pair - Silver
- 337BH Hardened GM, pair - Gold

BRAKE PADS



HAWK

PAGID







WILWOOD



Use the information in the table to select a pad that is right for you. Ratings represent 1 being the least and 10 being the most in each category. Comparisons are based on our testing and the opinions of trusted customers under racing conditions.

Note: Even though the pads themselves do not require break in, they should be properly bedded to the rotors for peak performance. One short practice session of heavy braking is usually sufficient. The next time out they should be race ready.

Brand	Part No.	Design	Material	Cold Stopping (300-800° F)	Hot Stopping (500-1600° F)	Rotor Wear	Pad Shape
	HB101C	SL 4.75"	Black	6	5	5	A
	HB101E800	SL 4.75"	9012	7	7	5	A
	HB101U800	SL 4.75" F	DTC-70	8	9	8	A
	HB521U800	SL 4.75" R	DTC-70	8	9	8	B
	HB119C	GM Metric	Black	6	5	5	C
	HB119L	GM Metric	MT4	8	9	8	C
	HB119U594	GM Metric	DTC-70	8	9	8	C
	HB131C	GM Magnum	Black	6	5	5	D
	HB131L595	GM Magnum	MT4	8	9	8	D
	HB131U595	GM Magnum	DTC-70	8	9	8	D
	PAG2205RS52	SL 4.75" F	RS 52	8	10	7	B
	PAG2205RS53	SL 4.75" R	RS 53	8	10	7	B
	PAG2206RST01B	SL 4.75" F	RST 1	8	10	7	B
	WW150-12245K-B	SL 4.75"	BP-40	8	9	--	B
	WW150-12246K-B	GN 6"	BP-40	8	9	--	F

BRAKE FITTING & LINES



Style	Part No.	Inlet Size	Outlet Size	Angle	Material
A	FBM2581	1/8 Pipe Male	#3	45 Deg.	Steel
	33709	1/8 Pipe Male	#4	45 Deg.	Steel
B	3379	1/8 Pipe Male	#4	90 Deg. - Long	Steel
C	33790	1/8 Pipe Male	#4	90 Deg. - Short	Steel
	33791	1/8 Pipe Male	#3	90 Deg. - Short	Steel
D	3380	1/8 Pipe Male	#4	Straight	Steel
	FBM2511	1/8 Pipe Male	#3	Straight	Steel
	BR10825	1/8 Pipe Female	#4	Straight	Brass
E	BR11078	1/8 Pipe Male	3/16 Brake Line	90 deg.	Brass
F	BR11112	1/8 Pipe Male	3/16 Brake Line	Straight	Brass
G	BR11811	3/16 Brake Line	3/16 Brake Line	T	Brass
H	3381	3/16 Brake Line	#4	Bulkhead	Steel
	FBM2936	3/16 Brake Line	#3	Bulkhead	Steel
I	3382	Clip for Bulkhead			
J	3374	1/8" NPT Bleeder			



Part No.	Size	Length	Ends
33824	#4	24"	Straight
33826	#4	26"	Straight
3384189	#4	18" w/ 90°	Str / 90°
338306	#3	6"	Straight
338318	#3	18"	Straight
338322	#3	22"	Straight
338324	#3	24"	Straight
338326	#3	26"	Straight
3383219	#3	21" w/ 90°	Str / 90°
338E	#4	22"	Straight
E1513E	#4	36"	Straight
E1514E	#4	48"	Straight

AIR DUCTS



Part No.	Color	Hole
RE200	Clear	1

SPINDLE DUCTS

We have five different styles of spindle ducts.

- (A) Fit 7-3/4" standard Howe rear caliper spindles.
- (B) Fit 8-1/4" rear caliper spindles.
- (C) Fit 7-3/4" spindles with 4" pin height.
- (D) Fits 7-3/4" spindles with 3.5" pin height and 12-3/16" rotors.
- (E) Fits 101 suspension package spindles.

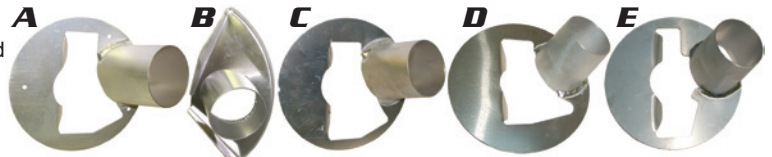

TWO TENTS BRAKE

Made to oppose the angle of the lower air dam so that it doesn't point into the ground and is stepped to accept 3" or 4" hose.

RE305 4" x 6" Inlet



ASSORTED

Part No.	Size	Hole
RE205	4" x 6"	1
RE206	3" x 7.7"	1
RE207	3" x 7.7"	2

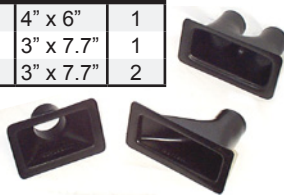

HOSE - 300°

High heat duct hose comes in 10' lengths in 3" diameter and 18" lengths in 4.5" diameter.

RE2031 3" x 10'

RE2034 4.5" x 18"



SRS BRAKE BLOWER FAN

Designed specifically for cooling brake systems on race cars. They move over 250 CFM of air. Inlet side is 4.5" and the outlet is 3".

SRS400 Brake Blower Fan

B939 Mounting Tab

B941L Mount, Left

B941R Mount, Right



HIGH PERFORMANCE

BRAKE BLOWER FAN

Bilge style blower fan mounts in 3" brake ducts or defroster. Fits 3" diameter hose.

RE195 Brake Blower Fan



LOW COST

BRAKE HOSE REDUCER

This adapter drops you from 4.5" brake hose to 3" hose. This can create enough pressure in some applications to not require a blower fan.

RE1910 Brake Hose Reducer



BRAKE DUCT DIFFUSER

Stainless steel brake duct diffuser is placed between the rotor and hub. When used in a brake duct system the diffuser forces more air to travel through the rotor slots providing improved rotor cooling.

RE211 Brake Diffuser, 11.75" Rotor

RE2110 Brake Diffuser, 12.19" Rotor



CALIPER COOLER MOUNT

Highly effective at cooling the brake system. Mounts on 4 piston type caliper bolt to aim air directly onto the caliper itself. Fits 3" brake hose.

B931



PRIMARY BRAKE COOLER KIT

This kit is installed to take air pressure off of the nose and force it into the center of the brake rotors. This is enough cooling for most applications.

RE199 Brake Cooler Kit
Includes: 1 - RE2031, 1 - RE209L, 1 - RE209R, 2 - RE305

RE199



TA2 BRAKE COOLING KIT

This kit includes two sets of hoses for extreme braking applications. Starts with a large 4.5" hose and reduces to 3.5" through a powerful fan that boosts the air blown onto the top of the caliper where the fluid is most likely to boil. The other 3.5" hose blows into the spindle ducts.

RE193 TA2/ V8TC Brake Cooling Kit

RE193



LINES AND FITTINGS

BRAKE DUCT MOUNTS

Allows an auxiliary source for air separate from the main duct work. Highly useful when you don't want to steal any air flow from the main cooling area. Fits 3" brake hose.



Description	Right	Left
Camaro, Gen 5 3" 4.5" Inlet	RE306	RE306L
4.5" for 2015 Duct	RE308	RE308L
Mustang, Gen 5*	RE315	RE315L
Challenger*	RE307	RE307L
Camaro, Gen 6	RE309	RE309L
Mustang, Gen 6	RE31000	RE31000L
	RE31001	RE31001L

*Requires RE3071DET1 and features attachments for both 3" and 4.5" hose.

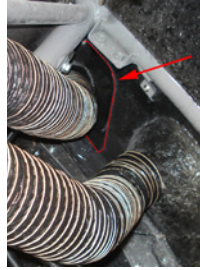

B PILLAR DUCT MOUNT

Developed to fit our TA2 B pillars it provides two air inlets that run to the driver cooling system and to the rear end cooler. Fits 3" diameter hose.

- RE304 Camaro - Gen 5
- RE304M Mustang - Gen 5
- RE304D Challenger
- RE31100 Camaro - Gen 6
- RE31101 Mustang - Gen 6



FAST COOL SUIT SYSTEM

System provides cool, filtered, fresh air to the drivers helmet as well as a liquid cooled "cool suit" to keep the driver comfortable and focused in the seat. Stocked with XL shirt, other sizes ordered on request. Helmet not included.

FA216W FAST Cool Suit System



DRY SUMP TANKS

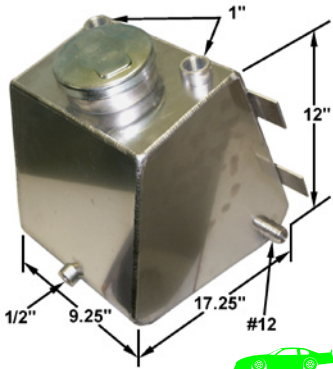

HOWE BEHIND DRIVER

This tank fits tight behind the driver to leave more room for the panhard bar, battery and power steering. We rounded the two bottom corners to eliminate stalled oil in the corners. Fitting locations are optimized from dyno testing for minimum aeration. Holds 10 quarts and is made from 1/8" aluminum. Standard vent and return fittings are 1" pipe. The pick-up is #12 and drain is 1/2" pipe. Sight hole is 1/4" pipe thread. Custom fittings available on request (allow 3 days).

- E1596 Tank
- E1980 Baffle

Use E15901 Breather Tank.



- E2001 Cap for Howe Tanks
- 4078-1 Weld On Neck

SETRAB OIL COOLERS

A superior combination of durability, performance, flow, and universal 22mm ports. We offer three sizes of oil coolers for different applications. The smallest we use as a rear end and transmission cooler. The mid-size cooler we use as an option if the small coolers capacity is exceeded. The large cooler we use as an engine oil cooler.

- 50-110-7612 Cooler - 8.27"W x 3"H
- 50-616-7612 Cooler - 13"W x 4.8"H
- 50-625-7612 Cooler - 13"W x 7.6"H

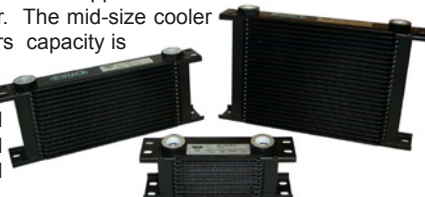

BREATHER TANKS



Howe breather tanks are made to clamp to 1-3/4" chassis bars. They vent engine pressure and accumulate oil vapor that may be drained or plumbed back to the tank. Part # listed is for bare tank without filter.

	Inlet 1	Inlet 2	Inlet 3	Vent	Drain	Part No.	Filter	Application
A	#10	#12	---	1.50"	3/8 NPT	E15901	KN62-1460	Rear LM
B	---	---	---	1.50"	#8 AN	E15908	KN62-1460	Rear End Vent
C	#6	#6	#12	1.50"	#6 AN	E15910	KN62-1460	Front V8TC
D	#12	#12	#12	1.50"	#6 AN	E15911	KN62-1460	Front TA2
E	---	---	---	1.0"	3/8 NPT	E15914	KN62-1370	Trans Vent

OIL FILTER ADAPTER



CAN22580

Remote Oil Filter Adapter is for SBC with 1/2" N.P.T. ports. Designed for wet sump systems where a remote filter is desired.

Oil Filter Adapter Block

REMOTE OIL FILTER MOUNT



Billet aluminum remote filter mount fits Ford type spin-on filters (3/4"-16). Designed for high performance applications. Includes two 1/2" NPT inlets and two 1/2" NPT outlets. Can be plumbed right to left or left to right.

CAN22625

Remote Oil Filter Mount



VENT BREATHERS

Breathers for venting valve covers, breather tanks, rear end, transmission or fuel cell. The fabric element lets fumes and gases out without letting dust and crud in.



	Part No.	Size	Design
A	TN95540	1/4 Pipe I.D. 1-3/8" O.D.	1-3/4" Clamp On
B	KN62-1370	1" Female	No Shield
C	KN62-1460	1-1/2" Female	No Shield
D	KNERD-710	2-1/2" Female	No Shield

LS ENGINE OIL FILTER ADAPTER

Installs in place of the oil filter on an LS engine. It features a sleeve that matches the stock oil filter stud and two #10 AN fittings that allow you to run lines to a remote oil filter.

E1597 LS Oil Filter Adapter



DRY SUMP HOSE & FITTING KITS

FBM999

Oval, Howe Dry Sump - Rear



Qty	Part No.	Description
10	FBA1600	#16 Line
24	FBA1200	#12 Line
1	FBM1036	#16, 90 Degree
1	FBM1035	#12, 90 Degree
1	FBM1015	#12, Straight
1	FCM2075	#12 Bulkhead Union
1	FCM2076	#16 Bulkhead Union
1	FCM2105	#12 Nut
1	FCM2106	#16 Nut

E3000 Road Race, Wet Sump



FBM997

Road Race, Dry Sump - Front

Qty	Part No.	Description
4	FBA1600	#16 Oil Line
13	FBA1000	#10 Oil Line
2	04510	#10 45 Degree
4	00010	#10 Straight
4	09010	#10 90 Degree
4	81610	#10 to 1/2" NPT
1	E1514E	#4 Line - 48"
1	3380	1/8" NPT to #4
1	33790	90° Caliper Fitting
1	82210A	#10 to 1/2" NPT 90°
1	82410	#10 Alum Tee

Qty	Part No.	Description
6	FBA1200	#12 Oil Line
3	FBA1000	#10 Oil Line
3	09012	#12 90 Degree
1	01212	#12 120 Degree
1	09010	#10 90 Degree
1	01210	#10 120 Degree
1	00010	#10 Straight
1	81610	#10 to 1/2" Pipe

ALUMINUM HOSE FITTINGS

Angle	Econo	Size
Straight	00006	#6
	00008	#8
	00010	#10
	00012	#12
	00016	#16
45°	04506	#6
	04508	#8
	04510	#10
	04512	#12
	04516	#16
90°	09006	#6
	09008	#8
	09010	#10
	09012	#12
	09016	#16
120°	01206	#6
	01208	#8
	01210	#10
	01212	#12
	01216	#16



RACING HOSE

(Per Foot)

Size	PN
-4	20004
-6	FBA0600
-8	FBA0800
-10	FBA1000
-12	FBA1200
-16	FBA1600



FIRESLEEVE

(Per Foot)

Size	Fit	PN
.50	-4	FBS0800
.62	-6	FBS1000
.75	-8	FBS1200
1.0	-12	FBS1600



WELD ON ALUM. A.N. BUNGS

CNC machined from weldable aluminum to original Army/Navy (AN) specs.

Part No.	Size
AN2006	-6
AN2008	-8
AN2010	-10
AN2012	-12
AN2016	-16
AN2020	-20



PREMIUM OIL LINE KITS

These kits are pre-assembled crimped line kits made to our specifications. Designed to fit popular TA2 engine packages. Full details of kits is not available at time of print, please see the Howe website for further information.

FBM996 Katech Chevy EFI, Front

FBM995 Katech Ford EFI, Front



PREMIUM OIL SUCTION LINE

A cheap oil suction line can be the most expensive thing on your car if it kinks or collapses. We had this critical #12 line made using the highest rated material that we could find with Aramid braid and a PTFE liner, crimped ends and factory tested. Made to fit Howe TA2 / GT2 chassis with a forward mounted oil tank.

GH004 Premium Oil Suction Line, TA2

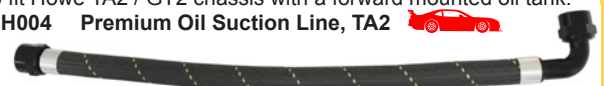

ATL FUEL CELLS

ATL Super Cell fuel pickups are twin 1/2" and #8 A.N. fittings plus a dip stick for checking fuel level. The anti surge foam is removable for cleaning. The bladder is designed for gasoline and can not be used with alcohol. Can is made with 20 gauge steel and powder coated. Comes with a five year limited warranty.

100 SERIES

100 series super cells are equipped with lower-cost FT3 three layer rubberized bladders. Rated at 450 NTS (nominal tensile strength).

SPORT CELL

Best built non-fabric cell available. Has the same 6" x 10" opening and anti-surge foam as the super cell. Filler has a flap valve with an aircraft cap and a vent ball valve. Twin 1/2" and #8 AN pickup fittings. 20 gauge steel powder coated container. Sport Cell is resistant to methanol as well as gas, however the foam must be removed for use with methanol. Five year limited warranty is included. Rated at 450 NTS.



SU122RR
Includes electric fuel pump for LS engine.



Part No.	Description	Capacity	Size
FB270	Bladder Only	22 Gal.	32"x17.75"x10"
SU122FS	100 Series	22 Gal.	32"x17.75"x10"
SU122FSFV*	100 Series	22 Gal.	32"x17.75"x10"
SU122RR* **	100 Series	22 Gal.	32"x17.75"x10"
SU22H	100 Series	22 Gal.	34"x18"x10"
SP115	Sport Cell	15 Gal.	24.3"x17.6"x9.25"
TF147ATL	Gasket 4.75		
TF217ATL	Gasket 6x10		

* Includes optional quick fill valve & roll over valve.

** For Road Racing applications.

Note: All quick fill vents require 1-1/2" I.D. hose.

PYROTECT FUEL CELLS

The PyroCell from PYROTECT is approved for use by ALL major racing sanctioning bodies and designed to Howe Racing specs. For use with: Pump Gasoline, Racing Gasoline, AVGAS and Gasohol

(Not for Nitro or Alcohol Use!). Comes in an aluminum container with ultra durable double coated urethane fabric bladder, full foam baffling, aircraft style nut ring, gasket, pick-up assembly, vent check valve, modular fill plate with rollover check valve, #8 AN vent, fuel level sending unit, and a 5 year bladder warranty. EFI cells include an internal electric fuel pump, #6 AN pick up, return, and 2-1/4" 45° remote fill neck. Carburetor cells include #8 AN fuel pick up and 3-1/2" threaded fill cap.

PE124VC



App	Part No.	Description	Size
	PE124LC	Carb, 24gal	34"x16"x12"
	PE124LS	EFI, 24gal	34"x16"x12"
	PE124VC	Carb, Vert 24g	34"x12"x16"
	PE124VS	EFI, Vert 24gal	34"x12"x16"

PG1340H

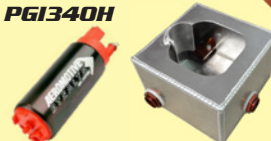

FUEL HOSE & FILTERS

BILLET FENDER FILLER

A simple billet cap that installs in the quarter panel to allow easy access to refueling the car. Accepts 2-1/4" clear hose. 



13202 Billet Filler

CLEAR HOSE

RF115	5/8" I.D.
RE125	1-1/4" I.D.
RE126	1-1/4" Reinforced
RE127	1-1/2" I.D.
RF102	2-1/4" I.D.
FSCFH225W	2-1/4" Reinforced



INLINE ALUMINUM FILTER

Lightweight aluminum filters clamp directly to a 1-1/2" or 1-3/4" bar with no welding. Male #8 AN fitting on each end. Filter is 8.5" long.



1 lb.

Part No.	Mount	HP1100	Filter Element
HP100	1-3/4"	HP1116	Bracket - 1-1/2"
HP1000	None	HP1117	Bracket - 1-3/4"

BRASS LINE FITTINGS

RD11691	1/2" Hose to 1/2" Female Swivel
RD11689	3/8" Hose to 3/8" Female Swivel
RD11682	3/8" Hose to 3/8" Pipe Male
RD11576	1/4" Hose to 1/4" Female Swivel
RD11690	3/8" Hose to 3/8" JIC (For ATL Cells)



LS3 FUEL FILTER

Required for use with the LS3 EFI engines it serves as a fuel filter and a pressure regulator. #6 AN fittings. HP2010 LS3 Fuel Filter

BRAIDED RUBBER HOSE

RD108	1/4" I.D.	RD138	3/8" I.D.
RD110	1/2" I.D.	RD109	5/16" I.D.



FUEL LINE KITS - LESS FILTER

Handy kits so you get everything needed for each application without a lot of wasted material or trips to the parts store.

RF210	Late Model Kit (right) 
RF211	Mod Kit 
RF212	Road Race Kit 



POWER STEERING LINES & FITTINGS

POWER STEERING STEEL FITTINGS

Angle	Size	Part No.
Straight	#6	FCM1103
45°	#6	FCM1112
90°	#6	FCM1122
Straight	#10	FBM1234



HOSE PER FOOT

Size	Part No.	Description
#6	FBC0600	TFE Racing Hose
#10	FBV1000	AQP Socketless



See page 26 for power steering hose kits.

CHEVY EFI AIR FILTER HOUSING

This plastic housing attaches to the top of the radiator air duct for cars using fuel injected engines such as the Schwanke sealed engine package. 

21044	Housing Lid
E147	Housing Base TA2
E144	Lid Clamp



CARB TOTES

Throw away old cardboard box and protect your valuable carb from damage with the Howe polypropylene carb tote. Fits 2 or 4 barrel Holley carbs. 8610 Black





Fabricated from 1/4" HR steel to fit to existing frame mounts and made in two styles. Tall rear mounts bolt between the block and the bell housing. Shorter rear mounts bolt on the back side of a Quarter Master bell housing. Both fit either right or left.

- 36401 Quarter Master Rear
- 36410 Standard Tall Rear



CHEVY GEN 2 BLOCK

Howe motor mounts fit most stock car racing chassis. Made from 1/4" HR steel. All holes are punched at once with a single die to insure a perfect fit. Rear mount can be mounted between the block and bell, or behind the bell.

Car	Rear - L	Rear - R	Front Ea.
LM	3611	3611	362
Mod	3612	3611	362
RR, Carb	3611	3613	362
RR, EFI	3611	3613	36298

3612 is used as the left rear mount of asphalt modifieds due to the tight area around the driver foot box. 3613 is used on the right rear of LS based engines as the upper hole of a 3611 is not used.

CHEVY LS GEN3 BLOCK



Used in combination with standard rear SBC mounts will allow the LS engine to fit into racing chassis mounts. Sold individually.

- 36298 Front Block Mount

PRESSED FRAME MOUNTS

Mounts are pressed out of 1/8" thick steel. Flared edge adds strength to allow weight to be kept to a minimum.

- 359375 3.75"
- 359562 5.62"
- 359625 6.25"
- 35987 6.75"



SPACERS

Light aluminum spacers work great for spacing up motors or upper a-frames.



Part No.	Description
R100	1/2" Hole x 1/4" Thick
R1005	1/2" Hole x 1/2" Thick

THROW OUT BEARINGS

STOCK THROWOUT BEARING SPACER



Spacer fits between the bearing and housing providing an extra 1/8" clearance for the lines and fittings. Available separately or assembled on a bearing. Increases the overall compressed and extended lengths by .125".

- 828723 Spacer Only
- 828724 Bearing & Spacer

Bearing face is 2.675" O.D. & 1.795" I.D.



HYDRAULIC BEARING FOR STOCK CLUTCHES

Designed for racing classes that require a stock type clutch. Installs by replacing one bolt on the front of the transmission. Conical shims are provided for proper fit. Made to work with Saginaw, T-10, Muncie and Jerico transmissions but has been used on others with the same diameter bearing retainer. The I.D. of the throw out bearing is 1.379", make sure your transmission will accept this. Compressed it is 1.688" thick and extended it reaches 2.375" providing .688" of travel. A 3/4" bore master cylinder and a minimum 6:1 ratio pedal is recommended for comfortable operation. Pressure exceeding 1,500 psi. can damage the O-rings.

82870 Stock Clutch Throw Out Bearing

- Service Parts**
- 82871 O-Ring Kit - Old Style (Pre '07)
 - 828715 O-Ring Kit - New Style
 - 82872 Replacement Bearing
 - 82873 Shim Kit
 - 82874 5/16" - 18 Stud
 - 82875 3/8" - 16 Stud
 - 82877 Line Fitting - 1/8" NPT
 - 82878 Bleeder Fitting



Master Diameter	Bearing Travel with 1" stroke	Bearing Travel with 1-3/8" stroke
3/4"	.43	.59
7/8"	.58	.688*
1"	.688*	.688*

*.688 is the maximum travel of the unit.

82870 Does not fit T-5 transmission without modification to the bearing retainer (nose cone). For T5 use part number 82876. Works with OEM and OEM replacement clutches.

HYDRAULIC BEARING FOR T-5 TRANS WITH STOCK CLUTCH

Our T-5 throw out bearing has all of the same features and is based on the same design as our model number 82870. The base of the T-5 bearing is machined to fit the bearing retainer of the T-5 transmission. The compressed thickness is 1.513" and 2.048" fully extended for .536" of travel. The inner diameter of the throw out bearing is 1.379". Does not fit Ford with 1.441 O.D. bearing retainer.

- 82876 T5 Throw Out Bearing

Notes: Never use petroleum or mineral base fluids; only DOT 3 or equivalent non-silicone brake fluid.

HYDRAULIC HARDWARE

Attaches to either style hydraulic throw out bearing in place of the existing bleeder. Allows you to bleed the bearing from outside of the bell housing.

Includes: E1513E 36" Line, 338E 22" Line, 33709 45° fitting, 3379 90° fitting, BR10825 1/8 NPT female to #4, 3380 1/8 NPT male to #4.

- 8289 Remote Bleed Kit for 8288

- 8287 Remote Bleed Kit for 82870

Includes: E1513E, 82879, ALL48183

- 82879 Bleeder Assy Only for 8287

(Adapts #4 to bleeder hose)



HYDRAULIC QUICK COUPLER

Allows you to remove and reinstall the engine or throw out bearing without rebleeding or losing fluid. 1/8 NPT, rated for 4000 p.s.i.

- 8290 Coupler Assembly

- 82901 Male End Only

- 82902 Female End Only



HYDRAULIC BEARING FOR RACING CLUTCHES

At only 1.8 lbs. this Howe hydraulic throw out bearing is the lightest available. Compatible with most reduced diameter racing clutches including QuarterMaster and Tilton. The unit installs by simply replacing two of the bearing retainer bolts with the provided studs. The optional remote bleeder kit (8289) allows for easy bleeding of the system outside of the bell housing. This throw out bearing will not work with a stock clutch or Ram coupler. Fully compressed the unit is 2-3/8" thick and will need at least .060 working clearance. Fully extended it is 2-3/4" thick extended providing 3/8" throw.

8288 Racing Throw Out Bearing

- Service Parts**
- 82881 O-Ring Kit
 - 82882 Replacement Bearing Only
 - 82883 Bolt Kit Only
 - 82884 Bearing Snap Ring
 - 82885 Thrust Washer



Works with: Tilton & QuarterMaster 7.25" & 5.5" clutches. Ram Assault Weapon 2 & 3 Disc 1996 & newer.

CLUTCH MASTER CYLINDER

The girling design of this master cylinder allows it to be made more compact. The volume may not be suited for brakes, but it works well for the clutch. 3/4" bore.

834 Master
FBM2927 Fitting
Service Parts
8342 Clevis Only

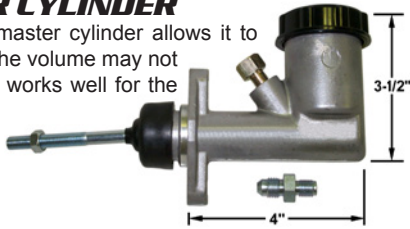

CLUTCH SLAVE CYLINDER

The pull cylinder normally attaches to the chassis and pulls on the clutch fork. Works best with 3/4" master cylinder. Has .88" bore with 1.125" of stroke; requires .99 c.i. for fluid for full travel. Bleeder and #4 line fitting included.

829 Pull

Service Parts
8291 Rebuild Kit



QUARTERMASTER CLUTCH COMPONENTS

CLUTCH ASSEMBLIES

The best clutch for you will be determined by your application. An 8.48 lb. 2 disc 7.25" clutch is tough enough to withstand almost any short track racing application. A 10.99 lb. 7.25" 3 disc will last longer but is only really needed in extreme traction and power applications. The 7.24 lb. 5.5" 3 disc clutch will handle the same applications as the larger 2 disc but with less total weight and a smaller rotating diameter.



PRO SERIES CLUTCHES

The Quarter Master Pro-Series clutches are known for their years of reliable performance and service. These clutches are driven by the outer housing or "ring". They are available in 5.5" and 7.25" styles.

5.5"
7.2 lbs.



7.25"
8.5 lbs.



PACK REFERENCE

You should replace your discs when they reach .090" thick in a 2 disc clutch or .094" thick in a 3 disc clutch.



Size	Disc	Spline	Disc Packs	Pressure Plate	Floater Plate	Housing	Cover Only	Clutch Assy. Only	*Weight	Application
7.25"	2 Disc	1-1/8" - 10 Coarse 1-5/32" - 26 Fine	QM226080 QM226090	QM209501	QM509506	QM209503	QM309500	QM299000 QM299050	8.48 lbs	
	3 Disc	1-1/8" - 10 Coarse 1-5/32" - 26 Fine	QM309390 QM309395	QM309501	QM509506	QM309503	QM309500	QM399000 QM399050	10.99 lbs	
5.5"	3 Disc	1-1/8" - 10 Coarse	QM325080	QM105501	QM105506	QM305503	QM105504	QM395080	7.24 lbs	
		1-5/32" - 26 Fine	QM325090				QM395090			

V DRIVE RALLY CLUTCH

*Weights are clutch less flywheel and bolts.

7.25"

V-drive clutches have precise balance and even force distribution. We have combined the 3 disc V-drive housing with two thick "rally" discs specifically for road racing. The rally discs provide longer wear and tolerate slipping for using a raceable first gear.



9.6 lbs.

Style	Disc	Spline	Disc Pack	Pressure Plate	Floater Plate	Cover	Clutch Assy.	*Weight
7.25" V-Drive	Rally 2	1-5/32" - 26 Fine	QM226090RY	QM108502	QM508506	QM308500	QM398158RY	9.6 lbs.

COMPLETE REVERSE PACKAGES

One piece aluminum/magnesium alloy bell housing with bottom contoured closely around the 9-1/4" starter ring gear for max ground clearance. Back of bell is machined flat to accept Howe style motor mounts. Rear mount starter location provides unlimited oil pan and increased header clearance. Transmission flange is machined to accept transmissions with GM bolt pattern.

Make	Clutch	Spline	Part No.	App.
Chevy Crate	5.5" 3 Disc	1-5/32" x 26 Fine	QM10039590ZZ	
Chevy LS RR	5.5" Rally	1-5/32" x 26 Fine	QM10029891RYLS	

FLYWHEELS

QM505170 Chevy Button - 5.5" Standard
QM505171SCZZ Chevy Button - 5.5" Crate Engine
QM509110 Chevy Button - 7.25" Reverse
QM509127 Chevy Button - 7.25" LS1

Flywheel Bolt Kits

QM505001 Crank Bolts for Ford or Chevy
QM505007 Metric Flywheel Bolt Kit for LS1
QM305508 Housing Bolts for 5.5 Clutch
QM309508 Housing Bolts for 7.25 Clutch



BELL HOUSING

Quarter Master's reverse mount bell housings are engineered for durability and weight savings.

QM110100 Reverse Start BH

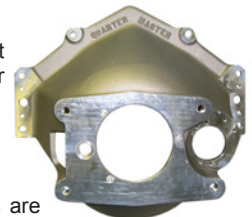

STARTERS

Quarter Master Ultra-Duty starters are gear reduction with ball bearing construction. Heavy duty solenoid allow them to tolerate high temperatures.

QM114260 Reverse
Starter Service Parts
QM114262 Starter Drive - Reverse



CLUTCH SPLINE ALIGNMENT TOOL

Align splines for transmission installation easily. 1-5/32"-26 spline for fine and 1-1/8"-10 spline for coarse spline clutch packs.

QM660090 1-5/32"-26 Fine Spline
QM660080 1-1/8"-10 Coarse Spline



STARTER RING GEARS

QM110010 Rev. Start Ring Gear - 7.25"
QM110018 Rev. Start Ring Gear - 5.5"

TRANSMISSIONS

JERICO 2 SPEED

The Jerico two speed allows you to shift under power for flawless restarts. Low gear ratios are available from 1.71 to 1.04. We recommend the 1:18 for the fast restarts. Drag type restarts may call for a 1:29. With the recommended synthetic lubricant, these 52 lb. transmissions take everything thrown at them. Available with a modified Hurst shifter from Jerico. Additional ratios available on request.

JSN4211 Jerico Two Speed - 1.18
J499-877-2SP Jerico Special Hurst Shifter

ASPHALT OVAL



ROAD RACE

CUSTOM G-FORCE 4 SPEED

The G-Force 4 speed is custom built to our specifications. It is plumbed for an external pump and weighs 80 lbs. Comes without a shifter.

G101A G-Force 4 Speed **BEST VALUE**



CUSTOM MID-VALLEY 4 SPEED

This premium transmission features an enclosed Shur Shift shifting mechanism & splined shift lever. Includes internal mechanical pump and small dog rings for easier shifting. Weighs 83 lbs.

MVE-NC500 Mid-Valley 4 Speed



LONG 4 SPEED H PATTERN SHIFTER

The Long HT4000 shifter features extra heavy duty construction with an internal rail design. This combination gives you smooth shifts for the most demanding applications whether short track oval or road race. Has a reverse lock out feature. Fits T-101, Jerico, Richmond Super T-10, EMCO, and some G-Force transmissions.

HT4000 Long 4 Speed Shifter

THUNDER CAR SHIFT KIT **NEW**

This shift kit upgrade was originally developed in Sweden in the V8 Thunder Car series. Moves the shift lever up closer to the steering wheel while creating shorter shifts. Delrin shift knob prevents heat transfer. Includes: Knob, Lever, Trans Mount, Trans Arms & Rods.

3264 Thunder Car Shift Kit



TRANSMISSION COOLING

PUMP

Rugged 12 volt pump moves 1-2 gpm and draws 2-3 amps with a 50 psi working pressure. Built for hi oil temp applications.

TIL40-524



COOLER

Compact cooler used for transmissions or rear ends. Connects with #6 A.N. fittings.

50-110-7612



TEMP. SWITCH

Set to engage when the temperature reaches 180 degrees. Can be connected to a pump or a warning light.

15721



GEAR TOTE

These handy totes are essential for anyone with a quick change and a collection of valuable gear sets.

32386 Tote Box



QUICKCHANGE SPUR GEARS

We stock high quality Quartermaster quick change gears. To order use the prefix QM911 with the part number suffix below.

 • TA2/GT2 ratios typically range from 2.95 to 4:11 and use a 4:11 ring & pinion.

 • Late Models and Mod ratios for built engines typically range from 4.86 to 6.76 with a 4:86 ring & pinion.

 • Late Model ratios for crate engines typically range from 3.50 to 5.49. with a 4:86 ring & pinion.



SET#	PN Suffix	4:11 Ring Low	4:11 Ring High	4:86 Ring Low	4:86 Ring High
1	000	4.11	4.11	4.86	4.86
2	037	4.26	3.96	5.04	4.68
5	045	4.30	3.93	5.08	4.65
15	053	4.33	3.91	5.10	4.63
26	074	4.42	3.83	5:22	4.52
6	091	4.48	3.77	5.30	4.45
6Q	095	4.50	3.75	5.32	4.44
25	105	4:54	3.72	5:37	4.39
12	115	4.59	3.69	5.42	4.35
7	130	4.65	3.64	5.49	4.30
7Q	143	4.70	3.60	5.55	4.25
17	160	4.77	3.54	5.63	4.19
8Q	174	4.83	3.50	5.70	4.14
8	182	4.86	3.48	5.74	4.11
19	190	4.89	3.45	5.78	4.08
9Q	200	4.93	3.43	5.83	4.05
9	211	4.98	3.40	5.88	4.01
11	227	5.05	3.35	5.96	3.96
3	238	5.09	3.32	6.01	3.92
13	250	5.14	3.29	6.07	3.89
18	261	5.18	3.26	6.12	3.85
18Q	273	5.23	3.23	6.18	3.82
4Q	278	5.25	3.22	6.21	3.80
20Q	286	5.29	3.20	6.24	3.78
4	292	5.31	3.18	6.27	3.76
20	304	5.36	3.15	6.34	3.72
22	318	5.42	3.12	6.40	3.68
16	333	5.48	3.08	6.48	3.64
10	350	5.55	3.05	6.56	3.60
14	391	5.72	2.95	6.76	3.49
32	421	5.84	2.89	6.90	3.42
24	450	5.96	2.84	7.04	3.35
36	471	6.05	2.80	7.14	3.30
23	500	6.17	2.74	7.29	3.24
21	524	6.26	2.70	7.40	3.19
27	550	6.37	2.65	7.53	3.13
43	563	6.42	2.63	7.59	3.11
28	579	6.49	2.60	7.67	3.08
29	600	6.58	2.57	7.77	3.04
39	611	6.62	2.55	7.83	3.01

ALUMINUM SHAFT YOKES



QM188535
QM188545
369
329-10

3&4 Speed Muncie
T-10, Jerico
Precision U-Joint
U-Bolts - 2 Per Pack

DRIVE SHAFTS - ALL DRIVE SHAFTS SPECIAL ORDER

STEEL

Steel shafts are machine welded and balanced. Yoke is sold separately.



243100 31" Driveshaft, No Yoke, 2.5" OD - Asphalt Modified
243950 39.5" Driveshaft, No Yoke, 3" OD - TA2

ALUMINUM - QUARTERMASTER

Forged aluminum yokes attached by monobolt fasteners. Special ordered to length from Quartermaster. Length measured from center to center of the joints. Yoke sold separately.



QM188___ Specify Length
Example: QM188380 would be 38" and fit a 102" wheelbase w/ Jerico transmission

QUICK CHANGE REAR ENDS

Note: Rear ends are assembled, set-up, then broken down to ship. Axles not included in Complete packages, must order separately.

TIGER QUICK CHANGE REAR END

The most popular quick change that we sell due to its reliability and low friction. It has more internal support around the bearings to help hold set-up tolerance and add to the overall ruggedness of the rear end. Every rear end comes standard with 6 rib bells, HD gear cover, heat treated shaft, pinion nose roller bearing, posi-lock nut assembly and a durable Viton yoke seal. Flush cover nuts to prevent punctures of the fuel cell. Options include lightened EDM cut ring gear, tube seal, Detroit Locker or Gleason. Made in the USA.



TIGER PACKAGES

TG2000 5x5 Impala Asphalt Modified 24.75" left, 31.50" right, steel tubes, 6 web bells, aluminum spool. 4:86

TG2010 W5 SS & 101 Chassis w/ Cambered Tubes 26.25" left, 32.25" right, steel tubes, 6 web bells, low drag, EDM, Detroit Locker, tube seal. 4:86

TG20100 W5 SS & 101 Chassis w/ Bolt on Snouts 26.25" left, 32.25" right, steel tubes, 6 web bells, low drag, EDM, Detroit Locker, tube seal. 4:86

TG20101 5x5 TA2 Chassis w/ Bolt on Snouts 27.25" left & right, steel tubes, 6 web bells, low drag, EDM, Detroit Locker, tube seals, cooling pump. 4:11

TG20102 5x5 TA2 Chassis w/ Bolt on Snouts 27.25" left & right, steel tubes, 6 web bells, low drag, EDM, Gleason, tube seals, cooling pump. 4:11

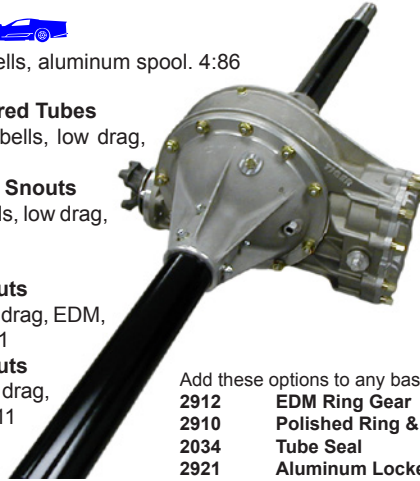

TIGER PARTS

- TG1000 Cooler Bracket
- TG2043 4:86 Low Drag Pinion
- TG2054 Ring Gear Bolt Set
- TG2302 Bearing, QC Cover
- TG2704 Yoke Seal



TIGER COOLING PUMP OPTION

Cooling pump kit is recommended for endurance application. This will extend the life of all moving parts in the rear end.

Includes: pump, cooler, cover, hex drive pinion, lines and fittings.



- | | | |
|---|-------------|----------------------------------|
| Add these options to any base Tiger quick change: | 2922 | Gundrilled HT Lower Shaft |
| 2912 EDM Ring Gear | 2923 | 4:12 Ring & Pinion |
| 2910 Polished Ring & Pinion | 2932 | Cromoly Tubes - W5 |
| 2034 Tube Seal | 2934 | Cromoly Tubes - 5x5 |
| 2921 Aluminum Locker | 2944 | Bolt on Snouts |

WINTERS QUICK CHANGE REAR END

The Winters Sprint quick change is a good combination of weight, durability and price. We stock Winters Sprint quick change centers with 6 rib bells. We can install your combination of tube types and components to suit your application. Choose a package or custom order to your specs. All of our Sprints include: posi-lock pinion, heat treated lower shaft, heavy duty gear cover, pinion nose roller bearings, and a high nickel ring & pinion gear. 4:86 is standard in quick changes but 4:11 is available.



Note: When changing axle tubes, bells should be heated to 270-300 degree F.

WINTERS PACKAGES

32404 W5 SS / 101 Chassis - Base Sprint 26.25" left, 32.25" right, steel tubes, aluminum spool, 6 rib bells.

32415 W5 SS / 101 Chassis - Sprint w/ Locker 32404 with Detroit Locker, tube seal.

32416 W5 SS / 101 Chassis - Sprint Complete 32404 with hubs, .810" rotors, and drive flanges.

32417 W5 SS / 101 Chassis - Complete w/ Locker 32416 with Detroit Locker, tube seal.

32396 5x5 - Impala Asphalt Modified 24.75" left, 31.50" right, steel tubes, aluminum spool, 6 rib bells.

32397 5x5 - Chevelle Asphalt Modified 22.75" left, 29.50" right, steel tubes, aluminum spool, 6 rib bells.

AXLE TUBES

STRAIGHT TUBES

Hub	Total Length	Steel	Apps
W5	26.25"	325262	
	27.25"	325272	
	27.75"	325277	
	28.25	325282	
	30.25"	325202	
	31.25"	325312	
	32.25"	325320	
	5x5	22.75"	
23.75"		326237	
24.75"		326247	
25.75"		326257	
27.25"		326272	
27.75"		326277	
28.5"		326285	
29.5"		326295	
29.75"		326297	
31.5"		326315	



8 BOLT AXLE TUBES

Winters PN	Tiger PN	No Pin	W5	5x5
W1400-19	TG2067-2625	19"	26.25	23.5
<i>W1400A-20</i>	-----	20"	27.25	24.5
	TG2067-2725	22.75"	30	27.25
W1400-23	-----	23"	30.25	27.5
<i>W1400A</i>	-----	24"	31.25	28.5
W1400-24	TG2067-3125	24"	31.25	28.5
-----	TG2067-32	27.75"	35	32.25
W1400-25	TG2067-3225	25"	32.25	29.5
<i>W1400A-25</i>	-----	25"	32.25	29.5

Note: *Italic Part Numbers denote Aluminum Tubes.*

AXLE PINS

Weld in axle pins and Winters 8 bolt. Available in straight or cambered.



Camber	Wide 5		Howe 5x5	
	Winters	Tiger	Winters	Tiger
0°	W6620HT	TG2839 TG2840**	W1384	TG2853 TG2853BB*
.5°	W6620C-05HT	-----	-----	-----
1.5°	W6620-15HT	TG2843	-----	TG2856

*For Bolt on Brake Bracket, See Page 42

**Heat Treated

Weld On Axle Pin

3254 Straight Weld In Pin - 5x5

Bolts For Pins

W7970 5/16-24X3/4" Bolt (Cambered Pin)

POPULAR HOWE AXLE & TUBE APPLICATIONS

Car Design	Hub Type	Left Tube	Right Tube	Left Axle	Right Axle
101	W5 5x5	26.25 23.75	32.25 29.75	32 29.5	38 36
SS	W5 5x5	26.25 23.75	32.25 29.75	32 29.5	38 36
ES	W5 5x5	27.75 25.75	29.75 27.75	33.5 32	36 34
XL	W5 5x5	27.25 24.75	30.25 27.75	33 31	36 34
M	W5 5x5	27.25 24.75	31.25 28.5	33 31	37 35
LLM, FL Tail	W5	27.25	31.25	33	37
LLM, Wide Tail	W5	28.25	30.25	34	36
Impala Mod	5x5	24.75	31.5	31.5	38
Chevelle Mod	5x5	22.75	29.5	29	36
TA2 Locker	5x5	27.25	27.25	34	34
TA2 Gleason	5x5	27.25	27.25	33.5	33.5

RING & PINION

Ring & Pinion sets come with the pinion bearings installed on the pinion.

W5401-8104 4:86

W5715-8104 4:11

Ring Bolt Kit

W7868 QC & Non QC

Tiger Low Drag Pinion

TG2043 4:86

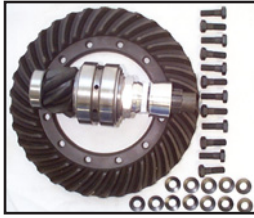

SPOOL

The 5.7 lb. standard spool and the 5.1 lb. Ultralight spool are both 31 spline. The only difference is the weight and the price.

W5034-11A Standard
W5034-11UL Ultralight



GLEASON

DIFFERENTIAL

A worm gear style differential. Weighs 26.7 lbs. Requires regular inspection for wear & maintenance.

TG2400

NEW



DETROIT LOCKER

The most consistent and affordable differential. Standard locker weighs 14.1 lbs. and light locker weighs 10.6 lbs. Change springs annually, we recommend the extra heavy rate purple (2 required).

TG2403 Standard
TG2430 Springs Purple
TG2429 Light Weight Locker

Note: If using a LW Locker subtract 1-1/4" from the left axle and add 1-1/4" to the right.

QUICK CHANGE TOOLS

The ring & pinion inspection plug fits the new 6 Rib side bells. Use the aluminum combination wrench 2-7/8" / 1-3/8".

W5290 Plug

W2104 Wrench

W3153 Socket (not shown)



LOCK UP PLUG

Use this plug or a longer axle, to lock up differentials.

SCP-QT31



AXLE SHAFTS



All of the axles we stock are 31 spline reliable and strong gundrilled axles. The outer end is a 24 spline. Shaft diameter for seals is 1.170.

Solid - .32 lbs. per in.

Gundrilled - .22 lbs. in.

Titanium - .19 lbs. per in.

Length	Gundrilled
27.25"	83327
28"	83328
29.5"	833295
30"	83329
30.5"	83330
31"	83331
31.5"	833315
32"	83332
32.5"	W5067G-325
33"	83333
33.5"	833335
34"	83334
35"	83335
36"	83336
37"	83337
38"	83338
38.5"	W5067G-385

Note: Add 1/2" to axle length when using cambered drive flanges. See table to the Left on page 50 for axle applications.

QUICK CHANGE SERVICE PARTS

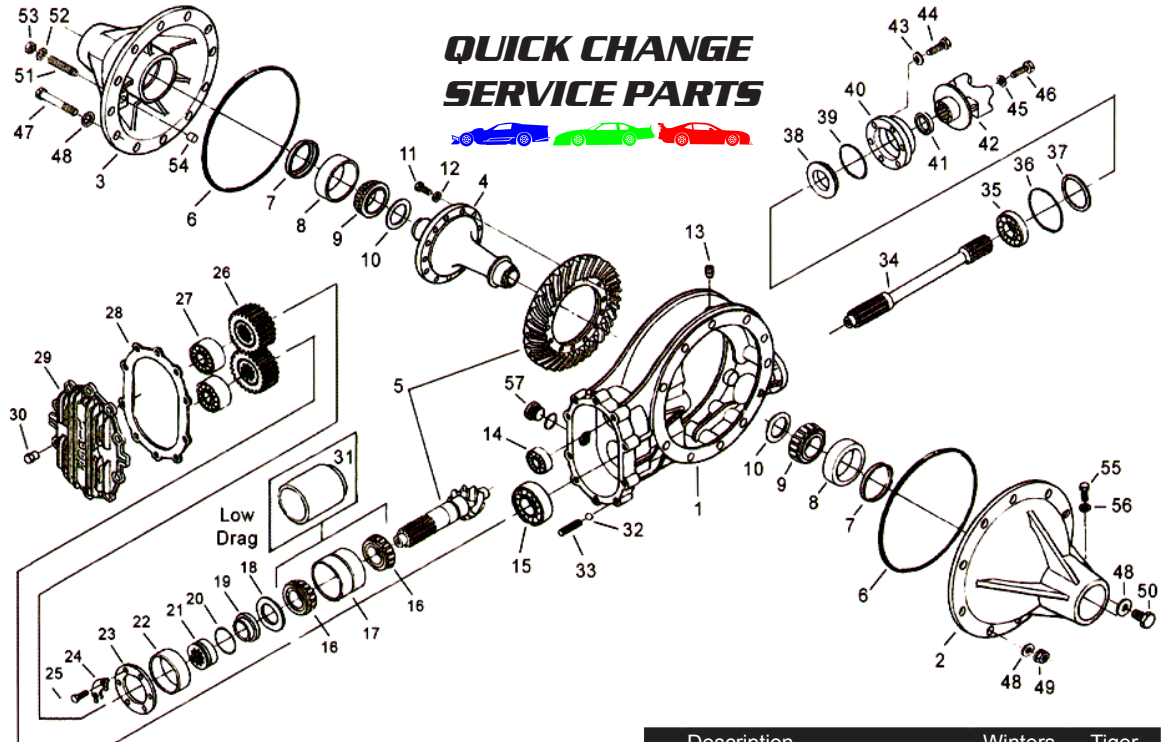

Description	Winters	Tiger
1 Aluminum Sprint Center	W5840	TG2101
2 6 Rib Bell - Right, Aluminum	W1663-01B	TG2201
8 Rib Bell - Right, Aluminum	W5016-01	TG2226
3 6 Rib Bell - Left, Aluminum	W1663-02	TG2202
8 Rib Bell - Left, Aluminum	W5016-02	TG2227
4 Spool	W5034-11A	TG2401
5 Ring & Pinion - 4:86	W5401-8104	TG2601
Ring & Pinion - 4:11	W5715-8104	TG2602
6 Side Bell O-ring, Thin - 4&6 Rib	W7403T	TG2203
Side Bell O-ring, Thick - 8 Rib	W7403	TG2217
7 Carrier Seal, Side Bell	W7205	TG2204
8 Side Bell Bearing Race	W7310	TG2206
9 Al. Spool Bearing Cones	W7340	TG2406
10 Carrier Shim Kit (AL. Spool)	W5295	TG2408
11 Ring gear Bolts	W7868	TG2055
14 Pinion Bearing	W7312	TG2606
27 Gear Cover Bearing	W7332	TG2302
28 Cover Gasket	W6729	TG2313
29 Cover	WK6508	TG2039

Description	Winters	Tiger
30 Alum. Nut & Stud Kit x 10 ea.	W6390A	TG2075
34 Heat Treated Lower Shaft	W5003	TG2503
35 Lower Shaft Front Bearing	W7390	TG2504
36 O-Ring, Seal Plate	W7413	TG2701
38 Yoke Seal	W7204	TG2704
39 Inner Seal Plate O-Ring	--	TG2713
40 Seal Plate, Aluminum	W5018	TG2705
41 Yoke Spacer	--	TG2708
42 Drive Yoke, Steel	W5038	TG2709
43 Drive Yoke Washer	W5037	TG2706
44 3/8-16x1.25 Seal Plate Bolt	--	TG2707
45 Drive Yoke Retainer Washer	--	TG2711
46 3/8-24x1.25 Drive Yoke Bolt	--	TG2712
51 1/2-13 Adjusting Screw	--	TG2624
52 Aluminum Flat Washer	W5157-6	TG2626
53 1/2-13 Jam Nut	--	TG2627
54 Thrust Block	W5010	TG2628
55 Bolt, Axle Tube to Bell	W7109S	TG2211
57 Inspection Plug with O-Ring	--	TG2102

REAR END ACCESSORIES



GEAR LUBE FILLER

This filler tank is flanged to mount in the trunk or interior or may be attached to a chassis bar with a power steering tank mount (PS550). The outlet is a #10 AN male bung welded to the bottom of the tank to attach.

3251 Filler & Cap



HOWE SYNTHETIC GEAR LUBE

75W-90 synthetic blend specifically made for racing. Outstanding thermal stability to minimize oxidative sludge and varnish. High film strength and good foam resistance.

8232 1 Gallon

PHENIX REAR END FILTER

This in-line filter installed with a #8 a.n. line in and a #6 a.n. line out. The coarse filter screen is specifically for use with drive line cooling systems to extend pump life.

HP2000 Phenix Filter



9" FORD REAR END HOUSINGS



ALL STEEL

Our 9" Ford housings are made in close tolerance fixtures and brand new 3/16" wall 3" tubes. The three 1/2" pipe thread bungs are welded in for the vent, fill and drain.

Hub Type	Part No.	Width @ Hub Face	Width @ Bearing Shoulder	Pinion Offset to Left	Axle Shaft Lengths
Howe 5x5	40610	60"	54.7"	0"	30" / 34"
	40614	64"	58.7"	1"	31" / 37"
	40638	65.75"	60.45"	2.375"	31.5" / 38"

Note: Other widths available on request.



AXLE TUBE SEALS

Seals are a must in a 9" Ford and not a bad idea in a quick change. Made with an aluminum housing and rubber seals. The best tube seals available. Fit 2-5/8" ID tubes.

32258 Tube Seal, Shouldered (Silver)
TT4625 Tube Seal, No Shoulder (Red)



Note: When changing axle tubes, housing should be heated to 270-300° F.

ALUMINUM WINTERS

Much lighter than steel housings and tubes are replaceable. Big inspection plug allows for checking gear condition. Accepts all 3" I.D. axle tubes. See the diagram to the right and select tubes from page 50, or call us with your requirements and we can figure it for you.

W5243 Aluminum Housing
LBR065 Labor to Install Tubes



Note: Seals must be installed between tube mounting bolts in tube!

DIMENSIONAL DATA

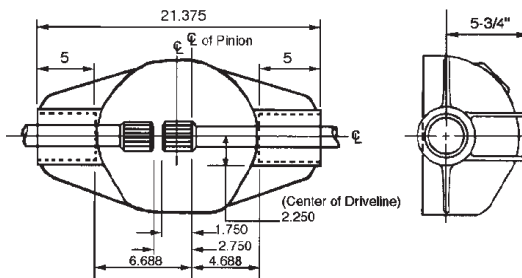

RACING WHEELS

BASSETT



SX5

WIDE 5

SX5
8" Silver Spun

Bassett wheels stocked in black and Diamonds wheels stocked in silver.

MODIFIED WHEELS

Chassis	Side	Bassett	lbs.	Diamond	lbs.	Offset	Width
Impala	Right	B58553B	16	W083055	18.5	3"	8"
	Left	B58555B	16	W085055	18.5	5"	8"
Chevelle	Right	B58552B	16	W082055	18.5	2"	8"
	Left	B58553B	16	W083055	18.5	3"	8"

LATE MODEL WHEELS

Chassis	Side	Bassett	lbs.	Diamond	lbs.	Offset	Width
101 @ 66" W5	Both	W1050MB	17	W1050M	19	5"	10"
SS @ 66" W5	Right	W1040MB	17	W1040M	19	4"	10"
	Left	W1050MB	17	W1050M	19	5"	10"
ES @ ACT 5x5	Both	B58554B	16	W084055	18.5	4"	8"

ROAD RACE WHEELS

Chassis	Color	Bassett	Diamond	lbs.	Offset	Width
TA2	Black	B50L55	----	21	5"	10"
5x5	Chrome	B50L55CH	----	21	5"	10"
	Silver	B50L55S	W105055	21	5"	10"

DIAMOND



WIDE 5

SX5

10" Pro Spun

8" Challenger

Chrome available in both brands - Specify when ordering. Must be ordered from manufacturer



TIE DOWN STRAPS

Part No.	Description
A H80138	D-Ring
B H80849	Recessed D-Ring
C H80978	Axle Strap 21"
D H83350	Ratchet Strap

VALVE STEMS



Tough reliable brass valve stems that will last for years and can take a beating without leaking.

8670 Each

HOWE CAMARO NOSE PANELS



B722 Top B824 Bottom C922W White C925B Black C925W White B422W White B422B Black



MODIFIED DUCT WORK SYSTEM

Made in three separate pieces that can be used individually or in combination. Made to fit GM Metric and 70-72 Chevelle. Made with flexible polypropylene.

The **Base Pan** is a replacement for the time consuming and easily damaged custom fabricated aluminum ducts. Black Only.

The **Inlet Valance** is made to be functional and good looking. The molded grill opening can be cut out and a screen installed from the back side or air can be taken from underneath.

The **Duct Lid** fits the Base Pan or can be used independently. The lid ties in the space between the Inlet and the hood. Intake indentation molded in the center provides an optional second inlet.

Description	Asphalt Mod
Rocker Panel	4174
Hood Scoop	4172
Sail Panel - R	4190
Sail Panel - L	4189
Quarter Panel - R	4170
Quarter Panel - L	4171
QTR Rocker - R	4177
QTR Rocker - L	4178
A Pillar - R	4192
A Pillar - L	4191
Door - R	4180
Door - L	4181
Roof - Fiberglass	4LU4450
Hood Filler - R	4184
Hood Filler - L	4183
Tail Panel	41410
Spoiler	4197
L left Door Filler	4175

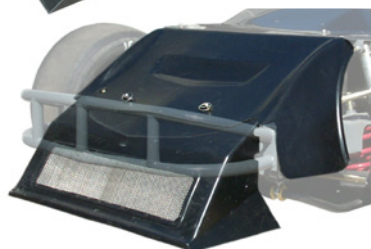

ASPHALT MODIFIED BODY

COMPLETE BODY LESS DUCT WORK

Asphalt Mod Body, no spoiler 4405



TA2 REAR WING
TA2 Wing 92550

NEW
TA2 WING MOUNT KIT
Complete Mount Kit 92515

DOWNFORCE ACCESSORIES

- SPLITTER MOUNT NEW**
- B9185 Splitter Mount
 - B91800 Camaro Gen 5 Improved
 - B91801 Mustang Gen 5 Improved
 - B91802 Challenger Improved
 - B91803 5 Star Camaro & Mustang



BASIC SPLITTER BRACES
Splitter Braces B918

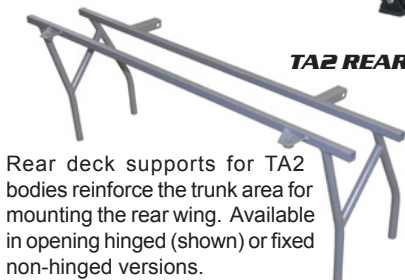

TA2 REAR DECK SUPPORTS

Rear deck supports for TA2 bodies reinforce the trunk area for mounting the rear wing. Available in opening hinged (shown) or fixed non-hinged versions.

Description	Hinged	Non-Hinged
Camaro, Gen 5	B93600	B93700
Mustang, Gen 5	B93601	B93701
Challenger	B93602	B93702
Camaro, Gen 6	B93603	B93703
Mustang, Gen 6	B93604	B93704

TALL WING MOUNTS
Dual Elem Right 92500
Dual Elem Left 92500L



DUAL ELEMENT REAR WING
Dual Element Wing AS105552



HOOD LOUVERS NEW
Pair w/ Rivets B940

The Howe Generation 5 muscle car bodies are designed to fit our popular road race chassis. They are available in two tread widths a 64-65" Wide package used in the USA and Australia the 60-61" Narrow package used in Europe.

Description	Gen 5 Camaro		Gen 5 Mustang		2014 Challenger	
	Narrow	Wide	Narrow	Wide	Narrow	Wide
Nose	B422W (Plastic)		4045MN	4045M	4045DN	4045D
Hood	4011CAM		4011M		4011D	
Trunk Lid	4015CAM		4015M		4015D	
Quarter Panel - R	4040CAM	4048CAM	4040M	4048M	4040D	4048D
Quarter Panel - L	4041CAM	4047CAM	4041M	4047M	4041D	4047D
Tail Panel - R	4042CAM		4042M		4042D	
Tail Panel - L	4043CAM		4043M		4043D	
Rear Diffuser	4044CAM		4044M		4044D	
Fender - R	4072CAM	4078CAM	4072M	4078M	4072D	4078D
Fender - L	4073CAM	4079CAM	4073M	4079M	4073D	4079D
Door - R	4080CAM		4080M		4080D	
Door - L	40810CAM	4081CAM	40810M	4081M	40810D	4081D
Roof Front	40820CAM		4082M		4082D	
Roof Rear	4082CAM		40820M		40820D	
Windshield	B8019		B8019M		B8019D	
Mirror Bracket - L	B919		B919M		B919D	
Mirror Bracket - R	B920		B920M		B920D	
Qtr Window - R	B921		B921M		B921D	
Qtr Window - L	B922		B922M		B922D	
Rear Window	B923		B923M		B923D	
Qtr Panel Brace	B924		B924		B924	
Taillight Bracket	B925		B925		B925	
Brake Hose Mount	B926		B926		B926	
Jack Post Plate	B927		B927		B927	
Window Brace Brkt	B928		B928M		B928D	
Exhaust Exit Plate	B929		B929M	B9291M	B929D	B9291D
Ignition Plate	B930		B930		B930	



CAMARO GEN 5

COMPLETE BODY 60-61" NARROW TREAD WIDTH
2011 Camaro Body Package 4409

COMPLETE BODY 64-65" WIDE TREAD WIDTH
2011 Camaro Body Package 4402

CAMARO SIDE MIRRORS

Complete GM mirrors to complete the Gen 5 Camaro body package.

B9195C Left
B9205C Right



CAMARO GRILL INSERT
B9500 Grill Insert Kit



CAMARO DECALS

CAMHLD Headlight Decal
CAMTLD Taillight Decal



CAMARO SPLITTER

B917 Splitter, Narrow
B9170 Splitter, Wide
B9175 Splitter, Magnum
B9171 Pinch Plate



MUSTANG GEN 5

COMPLETE BODY 60-61" NARROW TREAD WIDTH
Mustang Body Package 4403

COMPLETE BODY 64-65" WIDE TREAD WIDTH
Mustang Body Package 4401

MUSTANG SIDE MIRRORS

Complete side mirrors to finish out the Mustang body package.

15175-A32 Left
15175-A31 Right



MUSHLD Headlight & Grill Decal
MUSTLD Taillight Decal

MUSTANG SPLITTER

B917M Splitter, Narrow
B9170M Splitter, Wide
B9175M Splitter, Magnum
B9171M Pinch Plate



CHALLENGER

COMPLETE BODY 60-61" NARROW TREAD WIDTH
Challenger Body Package 4409

COMPLETE BODY 64-65" WIDE TREAD WIDTH
Challenger Body Package 4402

CHALLENGER SIDE MIRRORS

Complete side mirrors to finish out the Challenger body package.

B9195D Left
B9205D Right



CHALLENGER DECALS

CHAHLD Headlight & Grill Decal
CHATLD Taillight Decal

CHALLENGER SPLITTER

B917D Splitter, Narrow
B9170D Splitter, Wide
B9175D Splitter, Magnum
B9171D Pinch Plate



Gen 6 Camaro and Mustang are in development at time of printing. See Howe website for current information.

We stock the most popular Five Star body parts and complete bodies. You may place your order with us using Five Star numbers directly from their catalog using a "FS" prefix.

For a complete online catalog of Five Star products visit them at www.fivestarbodies.com



ORDERING FIVE STAR BODY PACKAGES

When ordering your complete body package you have the choice of black or white nose and bumper cover, style of windows and the angle of the spoiler; 45, 55, 70, or 90 Degrees. Complete bodies come with a 55 degree spoiler, clear windows, white nose and bumper cover unless specified otherwise.

ABC OFFSET

Standard fiberglass bodies are offset style, meaning the roof is mounted as much as two inches to the left of center. Made for 48" roof and up to 65" tread width chassis. These bodies are used on short tracks throughout North America. Fiberglass roofs are standard.

Individual Panels:

- Quarters
- Doors
- Fenders
- Deck Filler
- Deck Lid
- Roof
- Aluminum Spoiler
- Bumper Cover
- Nose Panel
- Headlight Decals - All
- Hood



PLASTIC PRIMER

Five Star plastic primer is made to bond to polypropylene to allow enamel paint to stick to the nose and tail panel.

FS842 13oz.

HOOD HINGE KIT

FS000-33H



ABC CHEVY

5 STAR ABC LEGAL CHEVY

FS663-142* Package C ABC Offset

ABC FUSION

FIVE STAR ABC LEGAL

FS583-132* Package C ABC Offset

Package C includes a molded windshield.

*ABC bodies come with 661-6737 spoiler. it is 70° 2 piece 1/4" polycarbonate blade with 2 piece aluminum brackets. Measures 6-1/2"x60".



TA2 MUSTANG GEN 6 NEW

 5 STAR TA2 LEGAL
FS81321-106* Complete Body TA2

TA2 CAMARO GEN 6 NEW

 5 STAR TA2 LEGAL
FS81131-106* Complete Body TA2

*Includes molded windshield & windows.



 NEW

BODY ACCESSORIES

HOOD PINS

Kit includes: 2 Pins, 2 Clips, Nuts and Plates.

B1017 Chrome
B1017A Aluminum

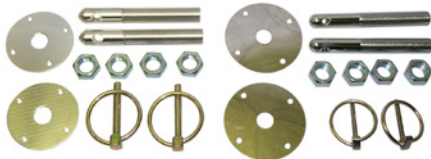

READY-MADE BODY MOUNT

Made with thin wall steel hydraulic tubing and adjust from 17" out to 28". Use on spoilers or anywhere an adjustable support is needed.

9018 Each



COWL

MOUNTS

Supports Body Cowl & Dash as well as providing mounts for hinged hood and windshield wipers.



Description	Non-Hinged (G)		Hinged (F)	
	Left	Right	Left	Right
Camaro, Gen 5	B932L	B932	B933L	B933
Mustang, Gen 5	B932ML	B932M	B933ML	B933M
Challenger	B932DL	B932D	B933DL	B933D
Camaro, Gen 6	B93200L	B93200	B93300L	B93300
Mustang, Gen 6	B93201L	B93201	B93301L	B93301

WINDSHIELD BRACES

Our kits will save you time and money. Made with 1" x 1" x .060 aluminum that is anodized flat black. It comes with the high density foam already installed. The kits include 10/32 round head Allen bolts.

B800 3 x 31" Braces

Description	Front	Rear
Camaro, Gen 5	B800C	B800CR
Mustang, Gen 5	B800M	B800MR
Challenger	B800D	B800DR
Camaro, Gen 6	B80000	B81000
Mustang, Gen 6	B80001	B81001



TOW HOOKS

9020 Bolt On



OPENING DOOR HARDWARE

Made to be compatible with our TA2 road race chassis and bodies. Allows the upper portion the drivers door to open allowing for easier entry and exit of the chassis.

Description	Part No.
A Door Latch	40029
B Inner Panel, Per Body Model	40033__
C Door Handle	40032
D Door Support	CAMDRS
E Hinge Assembly	CAMDRH





HOODIES & SWEAT SHIRTS

Made with a 50/50 cotton blend these thick sweat shirts come in green, black, blue, and micro-fleece green. *Specify adult sizes M, L, XL, 2X or 3X.

- | | | | |
|--------|----------------------|---------|----------------------------|
| 6015G* | Green - Adult Crew | 6014BL* | Blue - Adult Hoodie |
| 6015B* | Black - Adult Crew | 6016* | Micro-Fleece Green - Adult |
| 6014G* | Green - Adult Hoodie | | |



JACKET NEW

Modern style jacket with a 86% polyester/ 14% spandex blend. Wind and waterproof outer layer with a breathable, bonded to mesh lining for warmth & mobility. Full-length zipper with storm flap, zippered pockets, and the embroidered Howe Hornet logo. Available in sizes: S-3X.

- 6011 Adult - S, M, L, XL, 2X, 3X



T-SHIRTS

Made with a 50/50 cotton blend and come in green, black and white with a pocket on the left chest across from the Howe hornet logo and a large Howe Racing logo on the back. Also available are the retro styled white, the charcoal gray H logo, and the long sleeve black. *Specify adult sizes S, M, L, XL, 2X, or 3X.

- | | | | | | |
|---|-------|-----------------------|---|-------|-----------------------------|
| A | 601G* | Green - Adult T-shirt | B | 601R* | Retro White - Adult T-shirt |
| A | 601B* | Black - Adult T-shirt | C | 6019* | Charcoal - Adult T-shirt |
| A | 601W* | White - Adult T-shirt | D | 6017* | Black Long Sleeve T-shirt |



POLO STYLE

Collared two button shirts feature the Howe Hornet embroidered on the left chest. Available in black and forest green. *Specify S, M, L, XL, 2X, or 3X.

- 6012G* Green Polo
6012* Black Polo



HATS

- Up to date style hats available in 4 designs.
- | | | | |
|------|--------------|------|-------------|
| 604G | Gray "Force" | 604M | "H" Logo |
| 604H | Olive Hornet | 604C | Camo Hornet |

BUTTON UP

Comfortable 100% cotton with double needle stitching throughout. Adjustable cuffs, tuck-in tail, button down collar, pocket, and the Howe Hornet logo. Available in sizes: S-3X.

- 6018B* Denim Blue
6018BK* Black



DECALS



- | | | |
|-----|-------------|---------------|
| 606 | 2.625"x9.5" | Howe Racing |
| 608 | 4.75"x18" | Howe Racing |
| 609 | 3"x9.375" | Howe Radiator |
| 610 | 3.5"x10.5" | Howe Exhaust |
| 613 | 2"x4.5" | Uniform Patch |

HOWE RACING BANNER



- 602 2' x 4' Banner

INDEX

In recent years racing has lost a pair of short track legends and long time friends of Howe Racing. It has been a privilege to have had the opportunity to work with these two men of exceptional talent and great personal character. All of us at Howe Racing are grateful for having known both of them and they will be truly missed.

A-frame, Upper.....	5-7	Clutch Throw Out Bearing.....	47	Mid Sections.....	1	Spring Rubbers.....	20
A-frame Hardware.....	6, 7	Cool Tube.....	32	Mid-Valley Transmission.....	49	Spring Sliders.....	19
A-frame Keys, Upper.....	6	Coil Over Adapters, 5".....	20	Mirrors.....	34, 54	Spur Gears.....	49
A-frame Mounts, Upper.....	6, 7	Coil Over Eliminators.....	19	Modified Body.....	53	Stabilizer Adjusters.....	17, 18, 19
A-frame, Lower.....	7, 8	Coil Over Wedge Adj.....	19	Motor Mounts.....	47	Stabilizer Bars.....	17, 18
A-frame Bushings, Lower.....	8	Collectors.....	28	Mufflers.....	28	Seat Belts.....	35
AiM Data Logger.....	34	Control Arms, Lower.....	7, 8	Mustang Bodies.....	54, 55	Seats.....	35
Air Ducts.....	43-44	Dashes.....	34	Nerf Bars.....	3	Seat Mounts.....	35
Air Filter Housing.....	46	Data Logger, AiM.....	34	Nose Panels.....	53, 54	Steering Boxes.....	26
Aluminum Sheet.....	4	Decals.....	54, 56	Oil Coolers.....	44	Steering Column Mount.....	25
AP Brakes.....	41	Detroit Locker.....	51	Oil Tanks.....	44	Steering Mounts.....	25
Apparel.....	56	Diamond Wheels.....	52	Pagid Brake Pads.....	42	Steering Quickener.....	25
ATL.....	46	Door Bars.....	3	Paint, Plastic Primer.....	55	Steering Wheels.....	25
Axle Shafts.....	51	Drive Flanges.....	39, 40	Panhard Axle Mounts.....	17	Steering Wheel Release.....	25
Axle Tubes.....	50	Drive Shafts.....	49	Panhard Mounts.....	16	Stock Steering Packages.....	24
Axle Tube Seals.....	52	Driver Cool Suit.....	44	Panhard Rods.....	17	Stoptech Brake Calipers.....	41
Ball Joints, Precision.....	9-13	Driver Restraints.....	35	Pedals, Brake, Clutch & Gas.....	36	Strut Rods.....	7
Ball Joint Accessories.....	14	Driver Seats.....	35	Pedal Plates.....	3	Surge Tanks.....	32
Banners.....	56	Driver Seat Mounts.....	35	Penske Shocks.....	21	Sway Bar Adjusters.....	17, 18, 19
Bassett Wheels.....	52	Dry Sump Fittings.....	45	Pitman Arm, Steering.....	24	Sway Bars.....	17, 18
Batteries.....	34	Dry Sump Hose.....	45	Plastic Primer.....	55	Switches.....	34
Battery Accessories.....	34	Dry Sump Tanks.....	44	Plastic Nose Panels.....	53		
Battery Boxes.....	3	Duct Tape.....	4	Power Steering Cooler.....	26		
Bellhousings.....	48	Duct Work.....	44	Power Steering Fittings.....	56		
Bird Cage.....	15	Dust Covers.....	39, 40	Power Steering Fluid.....	26		
Bodies.....	53-55	Exhaust.....	27-28	Power Steering Hose.....	26, 56		
Bodies, Late Model.....	55	Exhaust Clamps.....	28	Power Steering Pumps.....	26		
Bodies, Modified.....	53	Exhaust Manifolds.....	32	Power Steering Servos.....	26		
Bodies, Road Race.....	54, 55	Fan, Cooling.....	32	Power Steering Tanks.....	26		
Body Mounts.....	3, 55	Fire Extinguishers.....	36	Precision A-frames.....	5-6		
Bolt Kits.....	4	Firewall Bearing.....	25	Precision Ball Joints.....	9-13		
Braided Hose.....	43	Fittings, Braided Line.....	45	Precision Bushings.....	8		
Brake Bias Adjuster.....	36	Fittings, Brass.....	46	Precision Tie Rods.....	23		
Brake Blowers.....	43	Fittings, Power Steering.....	46	Pro Shocks.....	21		
Brake Calipers.....	41	Five Star Bodies.....	55	Pyroprotect Fuel Cell.....	46		
Brake Ducts.....	43	Floated Rotors.....	39	Quarter Master.....	40, 48, 49		
Brake Fans.....	43	Flywheels.....	48	Quick Change Gears.....	49		
Brake Fittings.....	43	Ford Rear Ends.....	52	Quick Change Rear End.....	50		
Brake Fluid.....	37	Front Frames.....	1-2	Quick Change Parts.....	51		
Brake Lines.....	43	Front Loop Kits.....	1	Rack & Pinions.....	26		
Brake Master Cylinders.....	37	Fuel Cells.....	46	Rack Plate.....	3		
Brake Pads.....	42	Fuel Cell Mounts.....	3	Radiators.....	29-33		
Brake Rotors.....	38	Fuel Fillers.....	46	Radiator Accessories.....	32		
Breather Tank.....	45	Fuel Filters.....	46	Radiator Cores.....	33		
Bumpers.....	3	Fuel Hose.....	46	Radiators, Custom.....	33		
Bump Stops.....	22	Fuel Line.....	46	Radiators, Drop In.....	31		
Caliper Mounts.....	42	Gauges, Panels.....	34	Rear End Housing, Ford 9".....	52		
Camaro Body.....	54, 55	Gear Lube.....	52	Rear End Filter.....	52		
Caps, Weld On.....	4	G-force Transmission.....	49	Ring & Pinions.....	51		
Carb Tote.....	46	Gleason Differential.....	51	Rivets.....	4		
Center Link, Steering.....	24	Grease, Wheel Bearing.....	40	Rivet Gun.....	4		
Challenger Body.....	54	Gussets, Chassis.....	3, 4	Rod End Bearings.....	15		
Chassis, Modified.....	1	Hats.....	56	Roll Bar Padding.....	35		
Chassis, Late Model.....	1	Hawk Brake Pads.....	42	Rotors.....	38		
Chassis, Road Race.....	1	Headers.....	27	Rub Rails.....	3		
Chassis Tabs.....	3	Heat Insulation.....	36	Rubber Bushings.....	15		
Clecos.....	4	Hiem Joints.....	15	Screen, Stainless.....	4		
Clips, Adel Line.....	4	Hood Hinges.....	55	Shifters.....	49		
Clutches.....	48	Hood Pins.....	55	Shirts.....	56		
Clutch Slave Cylinder.....	48	Hose Clamps.....	32	Shocks, Pro.....	21		
		Hubs, GT.....	39	Shocks, Penske.....	21		
		Hubs, Stock Replacement.....	38	Shock Mounts.....	3		
		Hubs, 5x5.....	38	Slave Cylinder.....	48		
		Hubs, Wide 5.....	39	Spindles.....	22, 23		
		Idle Arm, Billet.....	25	Spindle Ducts.....	43		
		Interior Kits.....	4	Spindle Nuts.....	39		
		Jackets.....	56	Spindle Nut Socket.....	39		
		Jacking Bolts.....	19	Spindle Slugs.....	23		
		Jam Nuts.....	23	Splined Coupler.....	25, 26		
		Jerico Transmission.....	49	Splitters.....	54		
		Load Bolts.....	19	Spools.....	51		
		Louvers.....	53	Springs, Coilover.....	20		
		Lower Bushings.....	8	Springs, Coil.....	20		
		Master Cylinders, Clutch.....	37, 48	Spring Cage.....	20		
		Master Cylinders, Howe.....	37	Spring Cups.....	19		



Jim Sauter 1943-2014

Jim was a rare and honorable person with great intelligence, a quick smile and clever wit.

Denny Nyari 1943-2015
Denny was a tough, no nonsense racer, keenly insightful and straight talking.





HOWE RACING ENTERPRISES



3195 LYLE ROAD BEAVERTON, MICHIGAN 48612

PHONE: (989) 435-7080

TOLL FREE FAX: (888) 484-3946

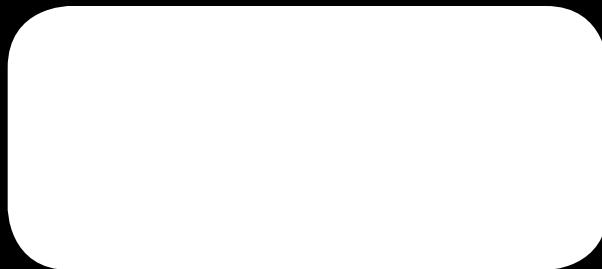

"RACING IS OUR MIDDLE NAME"