

# HOT

PRODUCTS

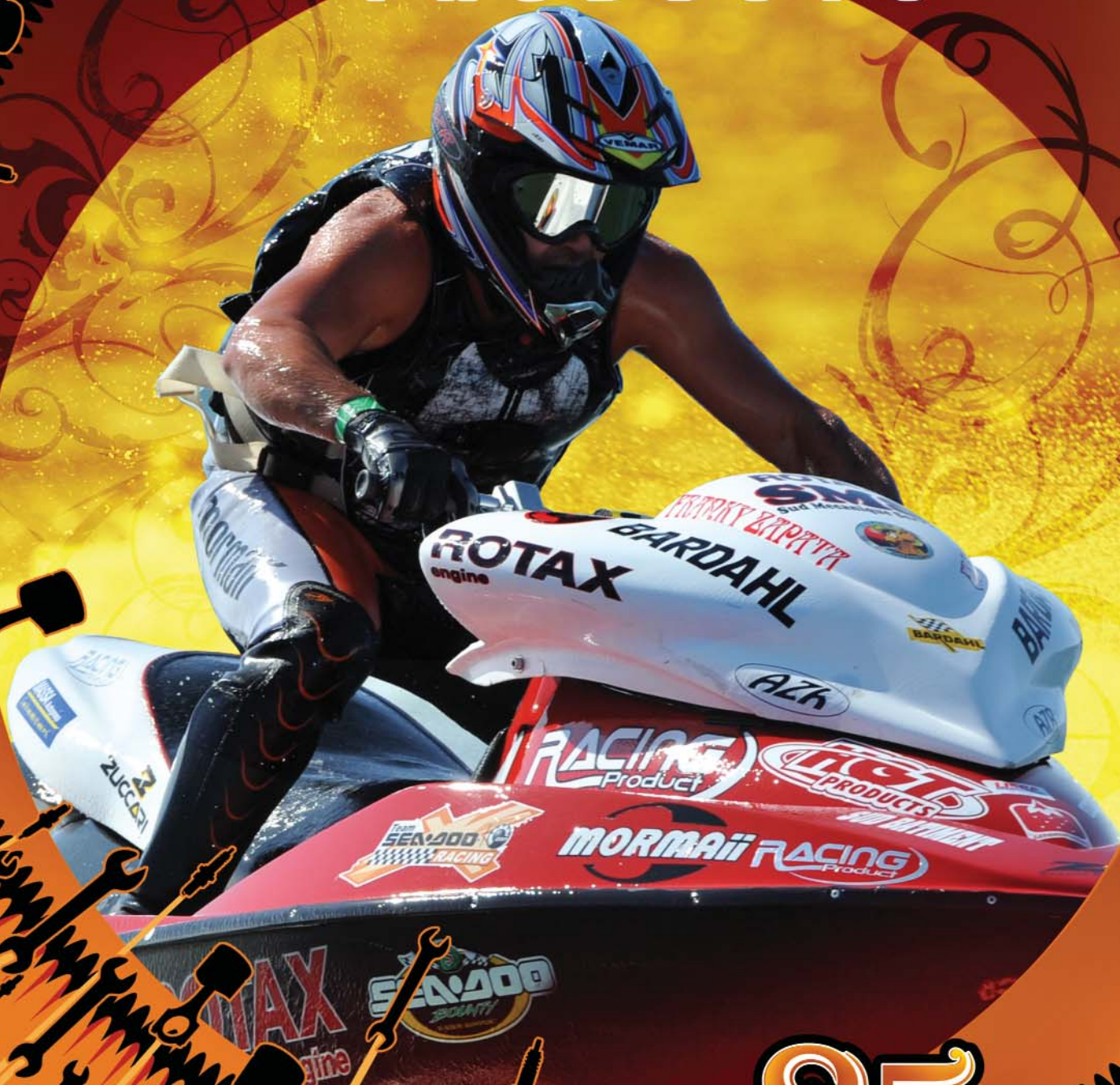

25<sup>TH</sup>  
ANNIVERSARY

2009  
CATALOG

**Dear Hot Products Customers,**

We are pleased to present to you the 25th Anniversary Hot Products High Performance Racing and Repair Parts catalog for the 2009 season.

With the new and rapidly growing Four Stroke Parts and Accessories market we have developed three new sections that feature the most up to date information and parts available on the first 45 pages of the 2009 catalog. To support this expanding market we have organized the new parts and information by the newest and most popular Sea Doo, Yamaha and Kawasaki models available. Due to the complexity and unique performance benefits of the four stroke parts available compared to the two stroke performance parts of the past, the four stroke parts and accessories sections of the catalog offers the most current parts detail and explanations as possible at the time of publication.

We know racers are always striving to make their PWC faster and looking for newest ways to improve their PWC. The aftermarket parts manufacturers are following this trend by introducing new and improved performance products to support this growing market. These new Four Stroke Parts and Accessories will be introduced and released in to the market through out the the entire 2009 season. To support the new items we will be producing new product catalog supplements throughout the entire 2009 season as the parts become available.

The Hot Products goal is to be your #1 information source and supplier for every part and accessory available for the PWC Performance and Repair Industry.

25 years is long time... Hot Products has always strived to contribute and grow the Personal Watercraft Industry and we will always be incorporate this as part of our business plan.

The Hot Products staff, Racers and I would like to send our appreciation to all of our customers and vendors that have been part of the our great business for last 25 years.

**Scott Saito • Hot Products Founder and President**



**— TO CONTACT US —**



**ADDRESS**

8830 Rehco Road, #F  
San Diego, CA 92121

**PHONE**

**1-858-453-4454**



**FAX**

**1-858-453-2045** (International Orders)  
**1-858-453-2046** (Domestic Orders)



**HOURS**

**9:00am - 4:30pm**  
Pacific Standard Time, Monday - Friday



**E-MAIL:**

**scott@hotproductsusa.com**  
(International Orders)

**ken@hotproductsusa.com**  
(Domestic Orders)



**ORDERS AND CUSTOMER SERVICE**

**Stock orders are processed and shipped within 24 hours.**

Most orders placed by 2:00pm PST Monday-Friday are shipped via ground service by United Parcel Service "UPS". Upon your request we will upgrade your shipment to Next Day Air, Second Day Air, or Three Day Select, additional shipping fees will apply.

**We are ready to help you.** Hot Products is committed to becoming your #1 Watercraft Industry parts and information source. Please call us, we are here waiting to help.

**Order minimum/COD Fees.** Hot Products minimum parts order is \$50.00. Also any order under \$200.00 that is shipped COD will incur a \$9.50 COD service charge (the actual UPS COD fee.) If the order payment is made via Visa or Mastercard the \$9.50 fee does not apply.

**PAYMENT METHODS**

**C.O.D.** All orders will be shipped COD unless previously arranged.

**Charge.** We accept payments via Visa & Mastercard.



**EXPORT SERVICES**

The parent company of Hot Products, Exceed International Inc. has over 20 years of export experience and the ability to purchase from all aftermarket watercraft industry manufacturers for export. All export orders are processed and packaged for one easy and convenient shipment to expedite the shipment and save on shipping/export fees.

Cover Photograph by Jin Omura  
2008-09 Hot Products Sponsored Rider, Franky Zapata

**VISIT OUR WEBSITE AND SIGN UP TO RECEIVE THE HOT PRODUCTS NEWSLETTER**

**www.HotProductsUSA.com**



**Hot Products is a proud sponsor and supporting member of these 2009 racing events.**

Hot Products has signed on as the title sponsor of the **APBA Junior (JR) Star Program** for the 2009 season. The Juniors are the future of our sport and Hot Products is pleased to be able to support the **APBA JR Star Program**. The support of the **JR Star program** and the APBA gives the APBA an opportunity to support the industry and the network of dealers across the United States.



Hot Products has signed to be the title sponsor for the 2010 APBA Mark Hahn Memorial Havasu 300. Hot Products would like to invite all of the customers and racers to participate in the great event next year.



FOUR STROKE	INTAKE SYSTEMS	ENGINE/GASKETS	EXHAUST	DRIVE LINE HANDLING	ELECTRICAL	WATERLINE /BILGE	STEERING & CONTROLS	BODY	ACCESSORIES	SERVICE TOOLS	CHEMICAL
-------------	----------------	----------------	---------	---------------------	------------	------------------	---------------------	------	-------------	---------------	----------

# SEA DOO RXP RXP-X RXT RXT-X • INTAKE

SEA DOO  
4 STROKE  
INTAKE  
SYSTEMS  
ENGINE/  
GASKETS  
EXHAUST  
DRIVE LINE  
HANDLING  
ELECTRICAL  
WATERLINE  
/BILGE  
STEERING  
& CONTROLS  
BODY  
ACCESSORIES  
SERVICE TOOLS  
/HARDWARE  
CHEMICAL



## R&D RXT, GTX155/185/215 FILTER KIT

The R&D RXT high performance "supercharger" air intake/filter kit will eliminate power robbing air intake restriction caused by a long intake tube design and promote

a noticeable bolt of low and mid range acceleration and boost top end performance 1 - 1.5 mph! The kit features are the short intake tube design and the huge (largest in the industry) filter element. The "supercharger" power plenum filter is coupled up to a rubber mounted, precision CNC formed 60/61 aluminum constructed short intake track runner tube. The new R&D "supercharger" filter kit will allow your 1500 cc Sea Doo 4Tec "supercharged" rev up an additional 100 plus RPM's. The filter kit installs very easily in 10-20 minutes, and has provisions in the filter to install the OEM crankcase ventilator.

Sea Doo	Part No.
RXT (For 185 & 215 HP Engine), GTX Supercharged	203-95003
GTX 4-TEC N.A. (155 HP Engine)	203-95002



## R&D SEA DOO RXP 215 POWER PLENUM FILTER KIT

A hot rod should run and sound like a hot rod! The new

R&D RXP Power Plenum Air Filter Kit will get the job done with definite noticeable increase in throttle response and acceleration, as well as increase RPM's between 50 and 100! R&D Power Plenum Filter Kits have been dyno tested and race proven to add 3 to 5 horsepower on stock four stroke 1500 cc engines! High performance four stroke guru's have dyno tested the R&D Power Plenum Air Filters to over 280 horsepower! The R&D RXP Power Plenum Filter Kit gives the RXP 215's engine a high performance racing look, sound, and performance without sacrificing an ounce of reliability!

Sea Doo	Part No.
Sea Doo RXP (215 HP Engine)	203-00215



## R&D RXP-X/RXT-X 255 POWER PLENUM FILTER KIT

The R&D RXP-X and RXT-X High Performance Power Plenum Air Filter Kit was designed and developed exclusively for the new Sea Doo RXP-X and RXT-X 255 H.P. 4Tecs new high

flow intake system design. The R&D filter kit will unleash restricted low-end, mid-range and peak horsepower trapped in the O.E.M. air filtration system and intake ducting by relieving the air intakes main restriction. The new R&D Filter Kit installs in place of the O.E.M. main air box plenums restrictive air intake cover. Replacing the O.E.M. air box intake cover with the R&D Filter offers a very economical way to improve airflow CFM at a fraction of the cost compared to other aftermarket kits. Sounds good, looks great, saves cash and will install in minutes. The R&D Filter Kit is easy to remove for dealer maintenance visits.

Sea Doo	Part No.
R&D RXP-X/RXT-X 255 Power Plenum Filter Kit	203-00255

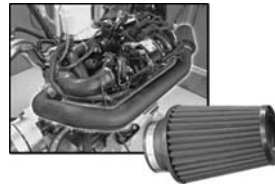

## RIVA RXP/RXP-X RXT/RXT-X/GTX-SC POWER FILTER KIT

Delivers greatly improved acceleration and a 1-2 mph (150-200 rpm) top speed

increase by replacing the restrictive stock intake system. The Power Filter feeds your supercharger with a steady diet of cool air via a 3" diameter intake duct and oversized K&N filter element. Ducting is precision formed from a race proven composite that will not conduct heat to incoming air. Installs securely via a silicone coupler and sturdy bracket. Includes pre-filter element.

*NOTE: It will be necessary to upgrade your stock pump impeller to a steeper pitch when using our Power Filter Kit. Sea Doo and RIVA both strongly recommend the use of premium octane (91+) pump fuel in your Supercharged watercraft.*

Sea Doo	Part No.
Power Filter Kit, SD RXP/RXT (04-07), RXP-X/RXT-X 255, GTX-SC,	RS13050-06
Power Filter Kit, SD (03) GTX-SC only	RS13050-03
Power Filter only, for RS 13050-03/06	RS13050-2



## RIVA RXP PRO-SERIES POWER FILTER KIT

The Pro-Series Power Filter is

a race-bred air intake system that draws cool air from outside your engine compartment delivering incredible performance and eliminating power-robbing heat intake. Air enters the system under seat through a billet aluminum intake flange equipped with a water-repellent pre-filter. Precision formed ducting attaches to supercharger via a large 4" adapter. Kit includes a complete oil catch can/breather system that keeps hot oil vapor and crankcase fumes from entering your engine's air intake. Also contains two Flow-Rite® water-repellent vents for improved ventilation of engine compartment through engine cowling.

*NOTE: This product is not designed for heavy surf use due to possibility of water ingestion. We recommend RIVA Power Filter part#RS13050-YEAR for this application.*

Sea Doo	Part No.
Power Filter Kit, Pro-Series Sea Doo RXP 215, RXP-X 255*	RS13056
Pre-Filter Assembly only, For RS13056	RS13056-PF
OEM Intercooler	RS17080-ICUK
Upgrade Kit RXP-X 255 HP, RXT-X 255 HP	

*\*NOTE: Relocation of the stock intercooler is required with Part #RS17080-ICUK (Page 6)*



## RIVA INTAKE MANIFOLD UPGRADE KIT (255HP)

This Intake Manifold Upgrade Kit enables your engine to produce more horsepower through increased boost pressure (+1lb). Supplied hole cutting tool allows easy removal of restrictive screen element from inside of intake manifold. Special o-ringed, billet block-off plug with integrated fitting for aftermarket boost pressure gauge fills opening left after removal of screen element. Includes detailed installation instructions.

Sea Doo	Part No.
RIVA Intake Manifold Kit RXP-X/RXT-X 255	RS12080-IMUK

# SEA DOO RXP RXP-X RXT RXT-X • INTAKE • FUEL • ENGINE



## RIVA RXP STAINLESS BRAIDED VENT HOSE KIT

Riva's custom Stainless Braided Vent Hoses directly replace the inferior plastic vent hoses that are prone to fading, cracking and distorting over time.

**Sea Doo**

RIVA RXP 215/RXP-X 255  
Stainless Braided Vent Hose Kit

**Part No.**

RS5-0100



## RIVA RXP HIGH FLOW HOOD KIT

Riva's lightweight High Flow Hood Kit directly replaces the OEM storage compartment lid on your RXP utilizing the original hinge & latch. Integrated ducting delivers

increased air to engine compartment improving performance and keeps water out. Easy installation requires elimination of front storage compartment bucket. Available in paint ready finish only.

**Sea Doo**

RIVA RXP 215/RXP-X 255 High Flow Hood Kit

**Part No.**

RS5-0050



## SEA DOO POWERSHOT ADJUSTABLE FUEL TUNER

The R&D Powershot fuel injection tuner will deliver increased horsepower, acceleration, and stronger mid-range performance by delivering a higher performing air to fuel ratio (A.F.R.) to the engine. Many of today's

high performance fuel injected four stroke muscle craft have a lean A.F.R. R&D Performance has tested, documented, and analyzed the O.E.M. fuel maps on every current fuel injected four stroke watercraft, and pre-programmed and coded the new R&D Powershot fuel injection control module to safely alter the O.E.M. fuel map to a higher performing and safer A.F.R. (richer). More horsepower, greater acceleration and stronger mid-range are the result when the proper A.F.R. is achieved and is tuned for optimum performance.

The R&D Powershot is fully adjustable on the fly (with the engine running, observed and tuned while riding), and will accommodate a wide range of adjustability to properly performance tune the A.F.R. for any combination of aftermarket parts. The R&D Powershot will add horsepower, reliability, and adjustability to any electronic fuel injected two or four stroke watercraft engine.

**Description**

R&D RXP/RXT 215HP Powershot Adj. Fuel Tuner **803-95002**  
R&D RXP-X/RXT-X 255HP Powershot Adj. Fuel Tuner **803-95003**

**Part No.**



## RIVA PRO-SERIES SEA DOO FUEL INJECTORS

Riva's high performance fuel injectors supply modified Sea Doo engines with additional fuel. 50lb injectors are for use with RIVA Racing ECU

for correct calibration. Available in three piece kit or sold individually.

**Description**

RIVA Pro-Series SD Fuel Injectors (3-pc kit) **RS12050-I-KIT-50**  
215HP RXP/RXT/05-08 GTX-SC Ltd., RXP-X/RXT-X 255HP  
RIVA Pro-Series SD Fuel Injectors (Single Injector) **RS12050-I-50**  
215HP RXP/RXT/05-08 GTX-SC Ltd., RXP-X/RXT-X 255HP

**Part No.**



2006 & Newer Models



2005 & Older Models



## RXP/RXT CATCH CAN/OIL BREATHER SYSTEM

Easy to install catch can/oil breather eliminates power-robbing crankcase fumes and oil vapor from your engine's air intake. Increases horsepower by removing the engine's requirement to burn relatively non-combustible oil. Also improves intercooler efficiency by preventing the oil sludge coating that lowers thermal efficiency. Excess oil vapor is routed to our translucent catch can where it condenses and collects for occasional draining via integrated petcock valve. Kit included K&N breather and Sea Doo mounting bracket along with all necessary hardware & installation instructions.

**Sea Doo**

Breather, Catch Can Kit, SD RXP215,  
RXT 215, RXP-X 255, RXT-X 255 & GTX 4-TEC

**Part No.**

RS19050-BCC



## R&D SEA DOO RXP CRANKCASE BREATHER KIT

The R&D Crankcase Breather Kit eliminates power-robbing crankcase fumes from the engines main air intake. Cleaner mass air equals more power!

**Sea Doo**

Sea Doo RXP/RXT 215 HP, GTX 4-Tec  
Crankcase Breather Kit

**Part No.**

203-00216

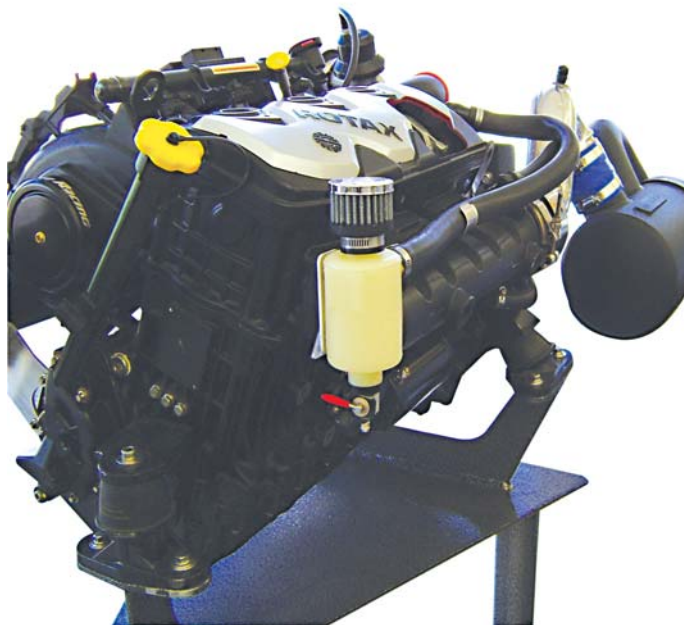

SEA DOO  
4 STROKE

INTAKE  
SYSTEMS

ENGINE/  
GASKETS

EXHAUST

DRIVE LINE  
HANDLING

ELECTRICAL

WATERLINE  
/BILGE

STEERING  
& CONTROLS

BODY

ACCESSORIES  
& HARDWARE

SERVICE TOOLS

CHEMICAL

# SEA DOO RXP RXP-X RXT RXT-X • EXHAUST

SEA DOO  
4 STROKE

INTAKE  
SYSTEMS

ENGINE/  
GASKETS

EXHAUST

DRIVE LINE  
HANDLING

ELECTRICAL

WATERLINE  
/BILGE

STEERING  
& CONTROLS

BODY

ACCESSORIES

SERVICE TOOLS  
/HARDWARE

CHEMICAL



## RIVA RXP / RXT REAR EXHAUST KIT WITH STOCK INTERCOOLER SYSTEM

Kit allows removal of restrictive suppression system located between waterbox and hull exit. Improves engine performance by reducing back pressure and restriction. Strategically placed fitting injects water just before exhaust exit to suppress sound level. Includes custom molded exhaust tube, billet through-hull exhaust outlet and OE exhaust block-off along with all necessary mounting hardware and installation instructions. Removal of O.P.A.S. and installation of RIVA Performance O.P.A.S. Block-off Kit (part # RS29050-1) is necessary to accommodate installation of RIVA Rear Exhaust Kit for all models (page 12).

Description	Part No.
Rear Exhaust Kit RXP/RXT 215, GTX-SC (04-07), <b>RXP-X/RXT-X 255*</b>	<b>RS15050-1</b>
Performance Kit, OPAS Removal RXP/RXT 215, GTX, RXT 215/RXT-X 255	<b>RS29050-1</b>
OEM Intercooler Upgrade Kit RXP-X/RXT-X 255 HP	<b>RS17080-ICUK</b>

\*NOTE: RXP-X/RXT-X 255 models require use of OEM Intercooler Upgrade Kit (RS17080-ICUK • page 6) along with OPAS Block-off kit (RS29050-1 • page 12).



## RIVA REAR EXHAUST OUTLET KIT FOR

### AFTERMARKET INTERCOOLER OR WATERBOX

Kit allows you to relocate exhaust outlet to rear of craft when using aftermarket intercooler systems or water boxes. Includes billet through-hull exhaust outlet and OE exhaust outlet block-off along with all necessary mounting hardware. Fits all RXP/RXT/GTX/RXP-X/RXT-X Supercharged models.

Description	Part No.
Rear Exhaust Outlet Kit Sea Doo 215 & 255 Models	<b>RS15050-ET</b>



## R&D BILLET EXHAUST OUTLET

The new R&D Billet Exhaust Outlet.

Description	Part No.
3" Diameter R&D Billet Exhaust Outlet	<b>331-30000</b>
2.75" Diameter R&D Billet Exhaust Outlet	<b>331-32750</b>



## R&D HIGH TEMPERATURE SILICON COUPLINGS

Description	Part No.
3"-3" High Temp Silicon Couplings	<b>061-30030</b>
3"-2" Reducer High Temp Silicon Couplings	<b>061-32500</b>
2.75"-2.5" Reducer High Temp Silicon Couplings	<b>061-32501</b>
3"-2.75" Reducer High Temp Silicon Couplings	<b>061-32750</b>



## RIVA PRO-SERIES SEA DOO 215/255 HP WATER BOX

Riva's Pro-Series Sea Doo Water Boxes deliver increased horsepower and performance by reducing exhaust restriction and back pressure. Developed on a flow bench, our water boxes feature radiused exhaust tubes and end caps for optimum exhaust flow. Innovative short design allows easy servicing of supercharger without removal of exhaust system. High strength aluminum construction & precision welds will survive backfires & overheating. Powder coated to prevent corrosion. Includes detailed installation instructions.

*Note: Requires use of RIVA O.P.A.S. Block-off Kit (Performance RS209050-1 • page 12 or Pro-Series RS29950/RS29985 • page 12) as well as RIVA Rear Exhaust Outlet Kit (part# RS15050-ET). Will directly replace and upgrade RIVA Rear Exhaust Kit (part# RS15050-1) utilizing existing rear exhaust outlet installation.*

Description	Part No.
Waterbox Sea Doo 215/255HP '08 & newer except IS models	<b>RS16081</b>
Waterbox Sea Doo 215HP '07 and older models	<b>RS16082</b>
Rear Exhaust Outlet Kit Sea Doo 215 & 255 Models for aftermarket intercooler systems or waterbox	<b>RS15050-ET</b>
Pro-Series O.P.A.S. Block off RXP, RXP-X	<b>RS29950</b>
Pro-Series O.P.A.S. Block off RXT, RXT-X	<b>RS29985</b>
RXP/RXT Performance Block off	<b>RS29050-1</b>



## RXP-X WATER BOX HOSE CLAMP KIT

The new R&D Water Box Hose Clamp Kit has superior clamping force over the OEM hose clamps which often fail, allowing the exhaust hose to leak or slip completely off. 2 clamps per kit.

Description	Part No.
R&D RXP-X Water Box Hose Clamp Kit (2 clamps/kit)	<b>333-80150</b>

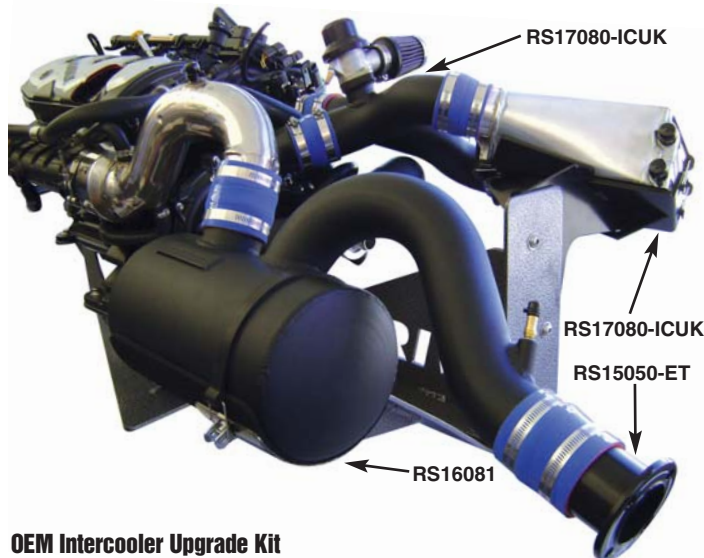

### OEM Intercooler Upgrade Kit

Installation example of RS17080-ICUK, Rear Exhaust Outlet Kit RS15050-ET and Pro-Series Waterbox RS16081

# SEA DOO RXP RXP-X RXT RXT-X • EXHAUST



## RIVA FREE FLOW EXHAUST KITS



RS16050-01-04/07, RXP  
RS16055-01-05/07, RXT



RS16080  
RXP-X/RXT-X



RS16055

Replaces the restrictive sound suppression system located between the water box and hull exit on your watercraft. Improves engine performance by reducing back pressure and harmful detonation. Includes mandrel bent aluminum tubing that is powder coated to prevent corrosion, high-temp silicone replacement coupler and installation instructions.

Description	Part No.
Free-Flow Exhaust Kit GTX-SC 03	RS16055
Free-Flow Exhaust Kit RXP-X/RXT-X	RS16080
Free-Flow Exhaust Kit RXP 04-06	RS16050-01-04
Free-Flow Exhaust Kit RXP 07-08	RS16050-01-07
Free-Flow Exhaust Kit RXT 05-06	RS16055-01-05
Free-Flow Exhaust Kit RXT 07-08	RS16055-01-07



#265 PERRY FIELD

3X BRITISH CHAMPION • 1X EUROPEAN CHAMPION  
2ND PLACE 2008 WORLD FINALS PRO-AM RUNABOUT LIMITED  
2ND PLACE 2006 WORLD FINALS PRO-AM RUNABOUT STOCK  
PHOTO COURTESY OF JIN OMURA



## R&D RXP-X/RXT-X 255HP MODEL FREE-FLOW EXHAUST

The new R&D Free-Flow Exhaust Kit eliminates the power robbing sound suppression system allowing the exhaust to travel out of the water box with zero restriction and back pressure. Improves acceleration and top speed.

Description	Part No.
R&D RXP-X/RXT-X 255HP Model Free-Flow Exhaust	333-80255



## R&D EXHAUST MANIFOLD X-TENDER KIT

The R&D Exhaust X-Tender Kit allows the exhaust to be extended 1.5 inches which will move the water muffler back 1.5 inches creating enough room to be able to change out a supercharger (Hot) in 5 minutes. No more hassling with extremely hot exhaust pipes, water mufflers and V-band clamps! The X-TENDER kit installs easily using an additional V-band clamp. Install the R&D Exhaust X-TENDER kit in place and never hassle a supercharger change out again. Once installed and used you will wonder why the factory didn't build it this way! The R&D kit will install directly to all RXT/RXP/GTX supercharged model Sea Doo's using O.E.M. BRP hardware.

Description	Part No.
Exhaust Manifold X-Tender Kit RXP, RXT 215HP	613-95004



## R&D RXP-X EXHAUST MANIFOLD X-TENDER / O2 SENSOR MOUNT KIT

The R&D High Performance Exhaust Manifold X-Tender with O2 Sensor Mount Kit is a creative and unique product that was designed and developed while testing the R&D Superclutch and new R&D High Performance Compressor Wheels. The Sea Doo supercharger and exhaust systems parts and "J" pipe are extremely difficult to get to and handle when they are extremely hot, and the exhaust systems "J" pipe that must be removed can be tricky on a cold engine. R&D needed to be able to remove and replace the supercharger in five minutes to be able to test products back to back in a timely manner, as well as the same day for accurate testing data. The R&D Exhaust X-Tender Kit allows the exhaust to be extended 2 inches which will move the water muffler back 2 inches creating enough room to be able to change out a supercharger (Hot) in 5 minutes. No more hassling with extremely hot exhaust pipes, water mufflers and V-band clamps! An additional bonus is the oxygen sensor mount incorporated into the X-Tender, allowing quick and easy installation of an AFR Gauge (Air/Fuel Ratio) for properly tuning the X power plant. The X-Tender kit installs easily using an additional OEM V-band clamp. Install the R&D Exhaust X-Tender kit in place and never hassle a supercharger change out again. Once installed and used you will wonder why the factory didn't build it this way! The R&D X-Tender is manufactured from the highest grade stainless steel exhaust material available. The R&D kit will install directly to all Sea Doo X supercharged models using O.E.M. BRP hardware. You will need to purchase an extra OEM V band clamp. One is not provided.

Description	Part No.
R&D Exhaust Manifold X-Tender / O2 Sensor Mount Kit	333-80155

SEA DOO 4 STROKE	INATKE SYSTEMS	ENGINE/ GASKETS	EXHAUST	DRIVE LINE HANDLING	ELECTRICAL	WATERLINE /BILGE	STEERING & CONTROLS	BODY	ACCESSORIES SERVICE TOOLS /HARDWARE	CHEMICAL
---------------------	-------------------	--------------------	---------	------------------------	------------	---------------------	------------------------	------	---	----------

# SEA DOO RXP RXP-X RXT RXT-X • INTERCOOLER

**GEN-II**



## RIVA POWER COOLER KIT 215HP

Presenting the ultimate aftermarket intercooler system for the Sea Doo 215hp engine! The RIVA 'GEN-2' Power Cooler is our next generation intercooler system featuring a new "double wide" cooler element for maximum efficiency. Delivers an increase of 18 peak horse-

power over original intercooler providing arm-wrenching results on the water. The 'GEN-2' Power Cooler features a large, unrestricted core that exhibits minimal pressure loss. The cooling element is dramatically more efficient than the stock unit with exit temperatures averaging 50°F cooler than stock. This delivers cooler, denser air for increased performance throughout the RPM range. Includes integrated blow-off valve mount that will accept RIVA Blow-Off Valve kits (sold separately) for improved supercharger reliability and performance. Use of Blow-Off Valve also reduces supercharger clutch wear and eliminates heat soak in discharge tube or the buyer has the choice to purchase the RIVA Blow-Off Valve Block-off kit. Power Cooler Kit contains all necessary mounting hardware and installation instructions.

Requires use of RIVA Rear Exhaust Kit (RS15050-ET, RS15050-1) and RIVA O.P.A.S. Block-off Kit (Performance or Pro-Series • RS29950, RS29985, RS29050-1).

RIVA Blow-off Valve Kit Application Chart:

- 215hp Sea Doo Stage I & II: RIVA Performance Blow-Off Valve Kit (RS17080-BV-PF)
- 215hp Sea Doo Stage III & above: RIVA Pro-Series Blow-Off Valve Kit (RS17080-BV-PS)
- RIVA Blow-Off Valve Block-off Kit (RS1750-BVBO)

<b>Description</b>	<b>Part No.</b>
RIVA GEN-II Power Cooler Kit	RS1751-PC



## RIVA OEM INTERCOOLER UPGRADE KIT (255HP)

Riva intercooler Upgrade Kit for the new RXP-X & RXT-X relocates the original intercooler and

significantly improves efficiency of the system with upgraded components. Key benefits include:

- Relocation of original intercooler: By strategically moving original intercooler, we have greatly improved access to engine compartment. **Relocation also allows installation of key performance parts including RIVA Rear Exhaust Kit (RS15050-1) & RIVA Pro-Series Power Filter Kit (RS13056).**
- Precision formed aluminum tubing: Our high strength aluminum tubes are shorter than original to minimize boost loss. Also, the rigid aluminum will not swell under pressure like original soft rubber hoses providing improved throttle response.
- Integrated blow-off valve mount: **Intercooler tubing includes mount for RIVA Pro-Series Blow-Off Valve Kit (RS17080-BV-PS) or RIVA Blow-Off Valve Block-off Kit (RS17050-BVBO); both sold separately.** Kit includes sturdy aluminum intercooler mounting bracket, high strength mandrel bent aluminum tubing and all necessary mounting hardware & installation instructions. **Requires installation of RIVA Rear Exhaust Kit (RS15050-1) and RIVA Performance OPAS Block-off Kit (RS29050-1).**

<b>Description</b>	<b>Part No.</b>
RXP-X/RXT-X Stock Intercooler Upgrade Kit	RS17080-ICUK



## RIVA PRO-SERIES BLOW-OFF VALVE KIT

For use with RS17080-ICUK or RS1751-PC Kits installed on 255hp Sea Doo Stage I & above or 215hp Sea Doo Stage III & above.

<b>Description</b>	<b>Part No.</b>
Riva Pro-Series Blow-Off Valve Kit	RS17080-BV-PS



## RIVA PERFORMANCE BLOW-OFF VALVE KIT

For use with RS17080-ICUK or RS1751-PC Kits installed on 215hp Sea Doo Stage I & II

<b>Description</b>	<b>Part No.</b>
RIVA Performance Blow-Off Valve Kit	RS17080-BV-PF



## RIVA SD 215/255 BLOCK-OFF KIT, SD BLOW-OFF VALVE

For use with RS17080-ICUK or RS1751-PC Kits.

<b>Description</b>	<b>Part No.</b>
Riva SD 215/255 Block-off Kit, SD Blow-off Valve	RS1750-BVBO



## RIVA SD SUPERCHARGER BLOW-OFF VALVE KIT

Our Blow-off Valve Kit improves supercharger reliability and performance by relieving unwanted pressure during off-throttle operation. Reduces supercharger clutch wear and eliminates heat soak in discharge tube. High-strength silicone hose with integrated blow-off valve installs easily in place of OEM elbow joint. Includes K&N filter to prevent debris from entering valve outlet. A simple and cost effective upgrade for both stock and modified supercharged engines. Includes all necessary mounting hardware and installation instructions.

<b>Description</b>	<b>Part No.</b>
Blow-off Valve Kit, SD S/C, RXP/RXT/GTX-SC	RS1750-BV



## RIVA SEA DOO BVIC INTAKE BLOCK-OFF

Made from billet aluminum, our block-off plate fills the opening in the 215 intake manifold left when the stock intercooler is removed. Integrated fitting allows for use of aftermarket boost gauge. Includes Viton o-ring and is anodized to prevent corrosion.

<b>Description</b>	<b>Part No.</b>
RIVA Sea Doo BVIC Intake Block-off	RS1750-PC-ABBO



# SEA DOO RXP RXP-X RXT RXT-X • INTERCOOLER



## R&D RXP/RXP-X/RXT/RXT-X GTX-SC SUPERCHARGER SURGE PROTECTOR KIT

The R&D Surge Protector Kit will significantly improve supercharger clutch and compressor wheel performance and reliability by eliminating compressor surge. Compressor surge is defined as the negative charge of pressure that causes turbulence in the supercharger that occurs during aggressive

of off-throttle operations. When the throttle valve is abruptly closed at high rpms, the engine decelerates quickly down from 8,000 rpms, however the supercharger is compressing air (creating boost) as the supercharger has to decelerate from 42,000 rpms. This turbulence is the primary cause of undue stress on the supercharger clutch system and its components. The R&D surge protection kit utilizes an automotive vacuum assisted Bosch pressure blow off valve that automatically releases the unwanted intake pressure between the closed throttle valve and the supercharger. As soon as the throttle valve is opened, the blow off valve immediately closes and the compressor can supply its full boost potentials to the engine.

Manufactured from high-temperature silicone hose with an integrated molded riser for the blow off valve to function without hindering intake flow or velocity. The R&D kit installs easily in place of the OEM rubber intake elbow joint. This kit is a very necessary and cost effective up-grade for all Sea Doo supercharged watercraft. Kit comes completely assembled with silicone elbow, blow off valve, R&D B.O.V. filter, mounting hardware and instructions.

Description	Part No.
A. R&D RXP 215, RXT 215, GTX-SC SC Surge Protector Kit	613-95003
B. R&D RXP-X 255, RXT-X 255 SC Surge Protector Kit	613-95255



## R&D RXP-X/RXT-X 255 SILICONE INTAKE HOSE KIT

The R&D Supercharger High Performance Hose Kit was developed while testing the R&D Monster Compressor Wheel Kits. Higher boost pressures create higher intake air temperatures of up to 235 degrees. The O.E.M. standard black rubber hose and standard hose clamps just do not hold up to the pressures and heat like high quality, high temperature silicone hose and high strength stainless steel style hose clamps. The R&D "Blue Hose" is manufactured from high performance, turbo charger quality high-temperature silicone.

Sea Doo	Part No.
R&D RXP-X/RXT-X 255 Silicone Intake Hose Kit	613-95256



## R&D RXP-X/RXT-X BILLET SURGE PROTECTOR VALVE & FILTER KIT

The R&D Billet Surge Protector Valve and Filter Kit is now available. The billet aluminum

CNC machined valve is an optional bolt-on replacement for the plastic Bosch valve used in the R&D and other aftermarket surge protection systems. The o-ring sealed billet design offers improved consistency and performance in higher boost pressure applications.

Description	Part No.
R&D Billet Surge Protector Valve & Filter Kit	613-95260
RXP-X/RXT-X 255	



## RIVA GEN-2 SUPERCHARGER IMPELLER 215HP

Presenting the ultimate (drop-in) performance supercharger impeller for the Sea Doo 215hp engine! Working closely with Vortech

Engineers, we developed the next generation high-performance replacement impeller that delivers 9lbs of boost @ 8,100rpm in RIVA Stage II applications. Produces more horsepower and torque throughout the RPM range resulting in excellent acceleration & top speed. Investment cast from an extremely strong, lightweight proprietary aluminum and CNC machined to ensure exact tolerances. All new blade design is optimized aerodynamically and precision balanced to deliver smooth operation. Installs easily into stock supercharger housing with no additional modifications required. Includes replacement mounting nut and detailed installation instructions.

Description	Part No.
SC Impeller, all RXP 215/RXT 215/GTX-SC	RS1750-001B
Nut, Supercharger Impeller, RIVA	RS1750-001A-N



## RIVA PRO-SERIES SD SUPERCHARGER HOUSING & IMPELLER 215HP

Our high performance impeller & housing combo deliver a significant increase in boost pressure and horsepower due through increased impeller blade surface area and larger interior housing volume. Produces 10.5 lbs of boost at 8,400 RPM when run with our recommended Stage III components. Impeller features a sophisticated Vortech blade design that is precision balanced to deliver smooth operation. Housing and impeller install easily onto stock supercharger base plate with no additional modifications required.

Description	Part No.
Supercharger Housing & Impeller	RS1750-2M011
SD RXP 215/RXT 215/05-07 GTX-SC Ltd.	



## RIVA X-CHARGER PRO-SERIES IMPELLER AND HOUSING 255HP

Our X-Charger Impeller & Housing delivers a 20% increase in boost pressure at 8,000rpm producing arm wrenching acceleration and increased top speed. High performance impeller & housing combo increase horsepower through superior impeller blade design and larger interior housing volume. Impeller features a sophisticated Vortech® blade design that is precision balanced to deliver smooth operation. Housing and impeller install easily onto stock supercharger base plate with no additional modifications required. Includes installation instructions.

*\*NOTE: Requires use of RIVA 50lb Fuel Injector Kit (part# RS12050-I-KIT-50 • page 3) with stock ECU or RIVA Racing ECU (page 11) FOR COMPETITION USE ONLY.*

Description	Part No.
Impeller and Housing, X-Charger, SD 255	RS17080-2M061

SEA DOO 4 STROKE	INATKE SYSTEMS	ENGINE/ GASKETS	EXHAUST	DRIVE LINE HANDLING	ELECTRICAL	WATERLINE /BILGE	STEERING & CONTROLS	BODY	ACCESSORIES	SERVICE TOOLS /HARDWARE	CHEMICAL
------------------	----------------	-----------------	---------	---------------------	------------	------------------	---------------------	------	-------------	-------------------------	----------

# SEA DOO RXP RXP-X RXT RXT-X • SUPERCHARGER

SEA DOO  
4 STROKE  
INTAKE  
SYSTEMS  
ENGINE/  
GASKETS  
EXHAUST  
DRIVE LINE  
HANDLING  
ELECTRICAL  
WATERLINE  
/BILGE  
STEERING  
& CONTROLS  
BODY  
ACCESSORIES  
SERVICE TOOLS  
/HARDWARE  
CHEMICAL



## RXP-X/RXT-X 255HP MONSTER POWER SUPERCHARGER IMPELLER WHEEL

The R&D engineering staff has developed a complete line of supercharger impeller wheels. Each Monster Impeller wheel will come complete with a statistical data sheet graphing the RPM/boost pressures that the wheel produces, eliminating the mystery behind the supercharger.

### BALANCING INFORMATION

R&D Monster Compressor Wheels for 255 H.P. 4 Tec engines have been precision mass center balanced in the preliminary casting/machining operations process, and precision two plane balanced after the final machining processes. The balance tolerances on the R&D Monster Wheels are held to a much stricter and tighter tolerance over O.E.M. or aftermarket wheels. The R&D precision two plane balanced compressor wheels will perform perfectly and smoothly at 180,000-200,000 rpm's as the wheels have been blueprinted and balanced to stringent turbocharger specifications, even though the wheel will only spin at 46-48,000 rpm's in the Rotax engine at 8,000 crankshaft rpm's. R&D's higher balancing standards will add significantly to the service life and performance of Rotax's vulnerable and temperamental clutch system and will significantly increase bearing life, promote better clutch performance, extend clutch life through decreased clutch slippage, and increase horsepower performance. **Available summer of 2009.**

Description	Part No.
R&D C1 Monster Charger Wheel	613-94012
R&D C2 Monster Charger Wheel	613-94014



## R&D SUPERCHARGER REBUILD TOOL KIT

R&D has designed a custom tool kit that is essential in the rebuilding process of the Sea Doo Supercharger. All tools are specific in application and are cnc machined to ensure a precision job.

Description	Part No.
185 Horsepower Tool Kit*	613-96001
215 Horsepower Tool Kit*	613-96002
A. Supercharger Holder Tool	613-96005
B. Bearing Puller/Installer Tool	613-96006
C. 4-Pin Socket	613-96007
D. Seal/Bearing Retainer Torx Wrench	613-96008
E. 215HP 16 Tooth Drive Gear Tool	613-96016
E. 185HP 17 Tooth Drive Gear Tool	613-96017
F. 185HP Clutch drive / Lock Washer Tool	613-96018
F. 215HP Clutch drive / Lock Washer Tool	613-96019

\*NOTE: Kit comes with a S/C holder, bearing puller/installer tool, drive gear tool and clutch drive/lock washer tool.



## RIVA SEA DOO SUPERCHARGER SHAFT HOLDER TOOL

Servicing your supercharger in a snap. Ergonomically designed billet handle, heat treated tool-grade steel to resist wear and to prevent flexing.

Description	Part No.
RIVA Sea Doo Supercharger Shaft Holder Tool	RS1750-ISH-949



## RACE TECH RXP-X/RXT-X 255HP 137MM BILLET SC IMPELLER WITH 3MM SPACER

Engine-Tech supercharger impeller with spacer for the Sea Doo 255 hp X models. This CNC machined impeller makes 12.5+ lbs of boost at 8100 rpm and an incredible 13.5+ lbs at 8500 rpm! No other drop in impeller even comes close. It is made from heat treated 7075 aluminum and hard anodized for strength and corrosion resistance.

Description	Part No.
137MM+3drop in SC Impeller with Spacer	ET137+3SCI



## RACE TECH 68/140 EXTREME SUPERCHARGER

E-Tec 68/140 Supercharger. This is the most powerful supercharger available today. 15.5 to 16 lbs of boost @ 8700 rpm. This is a ready to use complete charger for all Seadoo 4 tec supercharged watercraft. Includes billet 140mm E-Tec impeller with spacer, CNC machined housings, 2008 shaft kit with BT Tech 86000 rpm bearings and titanium carbonite coated clutch washers. Assembled with preset clutch slippage.

Description	Part No.
Race Tech 68/140 Extreme Supercharger	ET68/140SC







## RACE TECH 4" AIR INTAKE BILLET VELOCITY STACK

Race Tech's new billet velocity stack for the seadoo superchargers that allows the user to adapt a larger 4" air intake.



Description	Part No.
Race Tech 4" Air Intake Billet Velocity Stack	ET-VSS

# SEA DOO RXP RXP-X RXT RXT-X • SUPERCHARGER

R&D's C1, C2 and C3 Monster Compressor Wheel for all Sea Doo 215 4 Tec engines will deliver "horsepower you can feel" with instant throttle response, improved mid range acceleration, and increased top end performance. The R&D Monster Wheel replaces the stock wheels inefficient long inducer, 6 blade design, with a modern low profile, high flow 8 blade w/splitter design.

			
	R&D KIT/MODEL	STAGE C1	STAGE C2
<b>Part Number</b>	<b>613-94001</b>	<b>613-94002</b>	<b>613-94003</b>
Description Application	C1 Monster Charger Wheel RXP/RXT/GTX 215	C2 Monster Charger Wheel RXP/RXT/GTX 215	C3 Monster Charger Wheel RXP/RXT/GTX 215
Compressor Housing Compressor Case Spacer	OEM, No modification None	OEM, No modification .040"	OEM, No modification .080"
Boost Pressure	2.5-3 over stock @8200rpm	2.5-3 over stock @8200rpm	3-4 over stock @8200rpm
Airflow	2 pound per minute gain	2.5 pounds per minute gain	2.5-3 pound per minute gain
Horse Power	20-25hp increase 2mph gain	25hp plus increase 2mph gain	25-30hp plus increase 2mph plus gain
Intercooler	Utilize OEM Intercooler	Utilize OEM Intercooler	Utilize OEM Intercooler
Gasoline	91 Octane Pump Gas	91 Octane Pump Gas	91 Octane Pump Gas

R&D's C4 & C5 Monster Compressor Wheel Kit for all Sea Doo 215 4 Tec engines will deliver 35-40 "X" type horsepower to the 2004-2008 RXT/RXP Sea Doo's to significantly increase overall performance. The R&D Monster Wheel Kit replaces the stock wheels inefficient long inducer, 6 blade design, with a modern low profile, high flow 8 blade w/splitter design with a 2mm larger inducer and increased blade tip height.

		
	R&D KIT/MODEL	STAGE C4
<b>Part Number</b>	<b>613-94004</b>	<b>613-94005</b>
Description Application	C4 Monster Charger Wheel & Housing RXP/RXT/GTX 215	C5 Monster Charger Wheel & Housing RXP/RXT/GTX 215
Compressor Housing Compressor Case Spacer	"X" OEM Front Compressor Housing .060"	"X" OEM Front Compressor Housing .080"
Boost Pressure	3-4 over stock @8200rpm	4-5 over stock @\$8200rpm
Airflow	3.5-3.75 pound per minute gain	4 pound per minute gain
Horse Power	35hp plus increase 3mph plus gain	40hp plus increase 3mph plus gain
Intercooler	Utilize OEM "X" or Aftermarket Intercooler Kit	Utilize OEM "X" or Aftermarket Intercooler Kit
Gasoline	91 Octane Pump Gas	91 Octane Pump Gas

**\* For both the Stage C4 and Stage C5 kits:**

R&D suggests that the "X" or aftermarket intercooler kits be used as high boost pressures and high air volumes can dead head into the O.E.M. intercooler causing compressor surge. For closed course or endurance racing use using the rotax racing E.C.U. where rpms are between 8250 and 8500, R&D recommends the use of the X model or aftermarket intercooler system. Tests have proven the O.E.M. intercooler to have restrictions at 23.5 pounds of air, or 9.5 pounds of boost at sea level and 60-80 degrees.

SEA DOO  
4 STROKE  
INATKE  
SYSTEMS  
ENGINE/  
GASKETS  
EXHAUST  
DRIVE LINE  
HANDLING  
ELECTRICAL  
WATERLINE  
/BLIGE  
& CONTROLS  
BODY  
ACCESSORIES  
SERVICE TOOLS  
/HARDWARE  
CHEMICAL

# SEA DOO RXP RXP-X RXT RXT-X • SUPERCHARGER

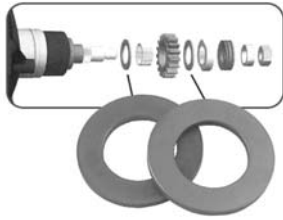

## RIVA HEAVY-DUTY 04-07 RXP/RXT/GTX SC SUPERCHARGER CLUTCH WASHERS

These are direct replacements for the original clutch washers that are prone to fail on modified engines. Precision machined from tool grade steel to increase durability. Will not break up and damage engine at end of service life.

Description	Part No.
Riva Clutch Washers '04-05 RXP/RXT/GTX SC	RS1751-HDW-945
Riva Clutch Washers '06-07 RXP/RXT/GTX SC	RS1751-HDW-946*

*\*Note: RS1751-HDW-946 must be used with 2006 style Sea Doo OEM Supercharger shaft Part #420881946*



## RIVA HEAVY-DUTY 08 RXP-X/RXT-X 255HP 08 RXP/RXT/GTX-SC 215HP SUPERCHARGER CLUTCH WASHERS

These are direct replacements for the original clutch washers that are prone to fail on modified engines. Precision machined from tool grade steel to increase durability. Will not break up and damage engine at end of service life.

**NOTE: BRP recommends that you replace the Supercharger shaft/clutch assembly when servicing your supercharger. Order part# 420881100 ('08 spec). Requires '08 spec Heavy-duty Clutch Washers (part# RS1751-HDW-948).**

Description	Part No.
Riva Clutch Washers '08 255hp RXP-X/RXT-X & 215hp RXP/RXT/GTX-SC	RS1751-HDW-948



## R&D SUPERCHARGER HIGH PERFORMANCE CLUTCH WASHER KIT

The R&D High Performance Supercharger Clutch Washer Kit is a direct replacement upgrade for the very fragile factory BRP O.E.M. ceramic clutch washers that are and prone to fracture and disintegrate, which can result in costly engine damages. The R&D High Performance Clutch Kit is manufactured from a high strength, wear resistant bronze alloy material that has a yield strength of 32,000 psi plus, and a Rockwell hardness of B95. The R&D Superclutch was designed to improve reliability without disintegrating under the Sea Doo superchargers high rpms, heat and is designed to not only but also increase boost by decreasing clutch slippage.

Description	Part No.
R&D Clutch Washer Kit 06-07 RXP/RXT 215*	613-95001

*\*NOTE: (or any supercharger rebuilt or warranted with a BRP rebuild kit part #420881946 or #420881947) NOTE: BRP#420881946 is for 215 engines, and #420881947 is for 185 engines.*

R&D Clutch Washer Kit 03-04 GTX 185 S/C 04-05 RXP 215, 05 RXT 215	613-95002
--	-----------

*\*NOTE: BRP supercharger rebuilt kit installed, upgraded, or warranty updated with the BRP rebuild kits #420881947 (for 185) or #420881946 (for 215), these upgraded superchargers will require R&D PART # 613-95001*

R&D Clutch Washer Kit 08 RXP/RXT 215HP & RXP-X/RXT-X 255HP	613-95006
---	-----------

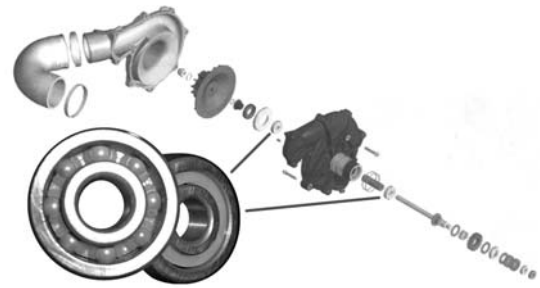

## RIVA CERAMIC SEA DOO SUPERCHARGER BEARINGS

These precision-built Ceramic S/C Bearings provide greatly reduced heat build up and less rolling resistance. Superior surface finish of the ceramic balls reduces friction and significantly increases bearing life. These are a great upgrade when replacing your clutch washers or rebuilding your supercharger. Set includes two bearings & complete installation instructions. Made in the USA.

Description	Part No.
Riva Supercharger Bearings All 185HP & 215HP Sea Doo Supercharged Engines	RS1750-CB-420



## RXP-X/RXT-X SUPERCHARGER BEARING KIT

The R&D Supercharger Bearing kit is a precision OEM replacement bearing. Bearing changes are recommended when rebuilding the supercharger or changing the clutch washers. **Available summer of 2009.**

Description	Part No.
R&D RXP-X/RXT-X Supercharger Bearing Kit	613-95010



## RXP-X/RXT-X SUPERCHARGER 16 TOOTH GEAR

Normal clutch wear with OEM and aftermarket Steel clutch washers will typically have unwanted galling on the clutch surfaces of the gear. The new R&D OEM Replacement supercharger gear (not available from Sea Doo) enables the supercharger clutch assembly to be rebuilt to OEM specifications without the expensive purchase of the entire Sea Doo supercharger shaft assembly rebuild Kit. All that is needed to rebuild the supercharger clutch back to new condition is the R&D High Performance clutch Washer Kit and the R&D 16 tooth Gear. **Available summer of 2009.**

Description	Part No.
R&D RXP-X/RXT-X Supercharger 16 Tooth Gear	613-95016



## R&D RXP SUPERCHARGER SLEEVE

The sleeving up of the diameter of the Supercharger enables a 3.5" or 4" intake filter system to be utilized. The larger intake increases cubic air volume as well as decreases air inlet restriction. A win win, supercharge your supercharger and give it more air! Available in 3.5" and 4" diameters.

Description	Part No.
RXP Supercharger Sleeve 3 1/2" Diameter	613-95035
RXP Supercharger Sleeve 4" Diameter	613-95040

SEA DOO  
4 STROKE

INTAKE  
SYSTEMS

ENGINE/  
GASKETS

EXHAUST

DRIVE LINE  
HANDLING

ELECTRICAL

WATERLINE  
/BILGE

STEERING  
& CONTROLS

BODY

ACCESSORIES

SERVICE TOOLS  
/HARDWARE

CHEMICAL

# SEA DOO RXP RXP-X RXT RXT-X • ENGINE



## RIVA SEA DOO VALVE TRAIN UPGRADE KIT

Our Valve Train Upgrade Kit increases the reliability of your modified engine by reducing the possibility of valve float at high rpm. Includes lightweight, precision-machined titanium valve retainers, racing valve springs, base washers and OE rocker arm shaft bolts that must be replaced during installation.

**Description** Upgrade Kit, Valve Train, SD RXP/RXT/GTX **Part No.** RS19050-VTU



## RIVA SEA DOO PRO-SERIES ECU

Our Pro-Series Racing ECU delivers a huge performance advantage to the Sea Doo 255 & 215 Supercharged Intercooled engines. ECU is calibrated for Stage II & III applications and must be used with RIVA Pro-Series 50lb Fuel Injector Kit, RIVA Valve Train Upgrade Kit and 91+ octane pump fuel. Plugs directly into factory wiring harness in place of stock ECU. Key benefits include:

- \* **Performance Fuel Mapping:** Delivers optimal fuel required for your specific level of modification (Stage II or III) based on boost pressure.
- \* **Performance Timing Curves:** Special racing curves produce more power throughout the RPM range. Timing is automatically adjusted based on sensor input.
- \* **Rev Limiter Increase:** Stock rev limit has been increased from 8,300 to 8,650 RPM. With our recommended pump combination, engine RPM can be run higher producing more boost pressure and horsepower.
- \* **Practice Key:** In addition to normal "full power" key, a 60 MPH "practice" key can be programmed by BRP dealer BUDS system to limit speed for race-course practice. ECU does not support original "learning" key mode.

\* **Retains Engine Diagnostic & Primary Safety Functions:**

- 1) Provides diagnostic information displayed on dash instrumentation along with more detailed data through BRP dealer B.U.D.S. system.
- 2) Sensor input is monitored for abnormal readings and will react by triggering warnings and/or limp mode.

*\*NOTE: This product is for competition use only. Must be used with RIVA Pro-Series 50lb Fuel Injector Kit (part #RS12050-I-KIT-50 • page 3), RIVA Valve Train Upgrade Kit and 91+ octane pump fuel. Unit must be activated in watercraft by an authorized BRP dealer using BUDS system. Activation by RIVA Racing available with customer supplied throttle body. Installation of this racing product will void BRP factory warranty.*

Description	Part No.
ECU, Pro-Series, SD 04-05 RXP/RXT	RS11850-01-A
ECU, Pro-Series, SD 06 RXP/RXT	RS11850-01-B
ECU, Pro-Series, SD 08 255 RXP-X/RXT-X, 07-08 215 RXP/RXT	RS11850-01-C
Injector Kit, Pro-Series, 50lb, SD 255/215	RS12050-I-KIT-50
Valve Train Upgrade Kit SD 4-TEC all	RS19050-VTU

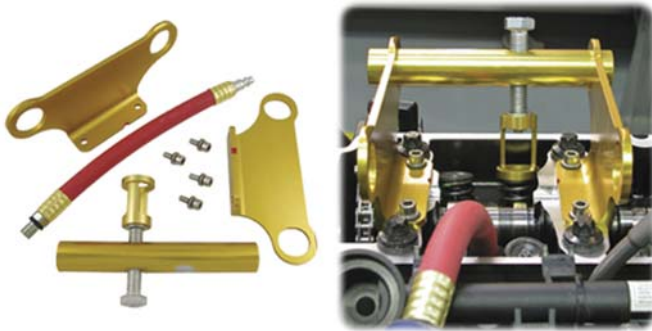

## VALVE COMPRESSION, TOOL SD 4-TEC

Our overhead Valve Compression Tool allows easy removal of valve springs and keepers without removing cylinder head. Includes compression adapter to pressurize cylinder keeping valves in place during removal of stock springs and keepers.

**Description** Tool, Valve Compression, SD 4-TEC **Part No.** RS19050-VCT



## RIVA RXP/RXT/GTX THERMOSTAT KIT

Our cool running Thermostat Kit reduces the operating temperature of your modified 4-Tec® engine by 30°F for maximum reliability and performance. Kit includes replacement thermostat, billet coolant inlet flange, stock thermostat removal tool, Oetiker® clamps, Oetiker® pliers and detailed installation instructions.

*\*NOTE: Thermostat housing (shown above) not included.*  
**Description** Thermostat Kit, SD RXP/RXT/GTX **Part No.** RS1015

SEA DOO 4 STROKE	INATKE SYSTEMS	ENGINE/ GASKETS	EXHAUST	DRIVE LINE HANDLING	ELECTRICAL	WATERLINE /BILGE	STEERING & CONTROLS	BODY	ACCESSORIES	SERVICE TOOLS /HARDWARE	CHEMICAL
------------------	----------------	-----------------	---------	---------------------	------------	------------------	---------------------	------	-------------	-------------------------	----------

# SEA DOO RXP RXP-X RXT RXT-X • CONTROL



## R&D SEA DOO AQUAVEIN SCOOP GRATE

R&D's new Aquavein Scoop Grate kit that is now available for Sea

Doo's new supercharged model is an absolute necessity to tame the cavitation that is created by Sea Doo's new supercharged 1500cc 185hp beast of an engine! Zero cavitation and quicker acceleration from 0-30mph is what you can expect from R&D's new 2 bar, full winged design. Improved low and high speed cornering, greater straight line stability, and an increase of .50mph in the speed department! The new R&D 4TEC Aquavein Grate installs easily in minutes and has been tested extensively with both the OEM impeller and the new R&D/Skat-Trak 16/21 3 blade impeller. The R&D/Skat-Trak impeller and Aquavein combination nets a bolt on performance boost of a full 1.5mph gain in top speed!

Description	Part No.
Sea Doo RXT Aquavein Scoop Grate	113-95000
RXP 215	113-95001
RXP 215 Pro Aquavein & Girdle Kit	113-95002



## R&D SEA DOO RXP AQUAVEIN GIRDLE KIT

The R&D RXP Aquavein Girdle Kit was designed and developed to add two extra 6mm bolts to the back end of either an R&D Aquavein or OEM grate for a much higher degree of security against pulling inserts out of the OEM PVC plastic pump shoe! A must for competition use!

Description	Part No.
Sea Doo RXP Aquavein Girdle Kit	123-10010



## R&D RXP-X, RXT-X AQUAVEIN INTAKE GRATE

R&D's exclusive dual patented technology that's incorporated into the revolutionary Aquavein will enhance the X beast. Blow through low and high-speed turns with confidence and chew up rough water conditions with a new found 3 mph top speed gain. Quicker acceleration and straight-line stability are also maximized. The new X Sea Doo, equipped with an R&D Aquavein cracks the glass on the fun meter!

Description	Part No.
R&D RXP-X/RXT-X Aquavein Stock/Recreation	113-95004
R&D RXP-X/RXT-X Aquavein Off-Shore/Closed Course	113-95007



## WORX MAXILOADER INTAKE GRATE

The WORX Maxiloader is the first mod anyone should do to their PWC. Among the benefits you'll receive are; reduced porpoising, no or minimal top speed loss (up to 3mph gain in choppy conditions!) and greater control & turning capability.

Description	Part No.
GTX 4Tec 02-05/GTX SC 03-04, RXT 215 (05-08) Intake Grate	WR221
Worx RXP 215 (04-08) Intake Grate	WR223
Worx RXP-X/RXT-X 255HP Intake Grate	WR229



## RIVA TOP-LOADER INTAKE GRATES

The Riva top-loader intake grate features a unique tapered wing design that eliminates prop spin and cavitation while delivering enhanced acceleration and 2mph additional top-speed. Deep side rails improve stability and handling. Durable black race coating protects from corrosion. Race Legal.

Description	Part No.
RXP 215 (04-08)	RS22050
RXT 215 (05-08)/GTX-SC (03-04)	RS22055
RXP-X 255/RXT-X 255HP	RS22080
GTI 4-Tec 06 & Newer	RS22060



## O.P.A.S. PERFORMANCE BLOCK-OFF KIT

Improves handling characteristics for competition use. Necessary to accommodate Riva Rear Exhaust Kit (RS15050-1, see page 4). Also designed to cleanly and easily cover the openings left when O.P.A.S. is removed preventing water from entering the hull. Made from billet aluminum utilizing o-ring seals. Anodized to prevent corrosion.

Description	Part No.
SD RXP/RXT/GTX 03 and newer models	RS29050-1



## RIVA PRO-SERIES OPAS BLOCK-OFF KIT

Optimizes the handling characteristics. Extensions fill voids dramatically improving handling and reducing porpoising.

For competition use only.

Description	Part No.
RXP 215/RXP-X 255	RS29950
RXT 215/RXT-X 255	RS29985



## R&D O.P.A.S. BLOCK OFF KIT

Designed for closed course competition to cover the openings left when O.P.A.S. is removed

preventing water from entering the hull. Made from billet aluminum and anodized to prevent corrosion.

Description	Part No.
R&D O.P.A.S. Block Off Kit	123-95002
RXP/RXT 215, RXP-X/RXT-X 255	

# SEA DOO RXP RXP-X RXT RXT-X • CONTROL



## R&D RXP/RXP-X RXT/RXT-X/GTX PRO SERIES SPONSON KIT

The new R&D Sea Doo Pro Series Sponson Kit was designed and developed to deliver lots of handling performance with adjustability options, which allows you to setup your Sea Doo "your way" with 2-position backing plate and 3-position sponson blade adjustability. The R&D Sponson Kit will deliver a much smoother ride and low speed and high-speed turns are a breeze with new found control! There is also a higher end recreational/race setting with enough grip for the best of pro's!

**Description** Part No.  
RXP/RXP-X/RXT/RXT-X/GTX Pro Series Sponson Kit **123-95101**



## RIVA RACING RXP/RXP-X RXT/RXT-X/GTX PRO-SERIES SPONSON KIT

Riva's race proven Pro-Series Sponsons will dramatically improve the handling of your craft with their superior blade & backing plate design. Includes a bulletproof mounting system that features a solid backing plate and five anchor points with billet inserts in sponson fins. Sponson depth is adjustable to control the amount of influence they have on the craft.

**Description** Part No.  
Sponson Kit, Pro-Series, **RS26050**  
SD RXP/RXP-X/RXT/RXT-X/GTX



## WORX RACING SEA DOO SPONSONS

Unbelievable cornering, better control in the rough and predictable inline tracking while towing wakeboards or waterskiers. WORX sponsons are easy to fit, look great and bolt right into stock mounting holes.

**Description** Part No.  
05 onwards all GTX/RXP/RXT, 06 on GTI **WR534**  
02 thru 04 all GTX, 04 only RXP **WR526**  
RXP-X/RXT-X **WR540**



## RIVA COMPETITION O.P.A.S. KIT

Provides more predictable handling characteristics while retaining the benefits of the off-throttle O.P.A.S. system. Precision-machined composite collars prevent the O.P.A.S. fins from dropping when pump is out of the water in

choppy conditions. Installs quickly and easily without tools.

**Description** Part No.  
SD RXP 215/RXP-X 255/RXT 215 **RS-29055**  
RXT-X 255/GTX Competition O.P.A.S. Kit



## GTX 4-TEC

RXP

## SEA DOO RXT 2.5 DEGREE NOZZLE WEDGE KIT

The R&D 2.5 degree reduction nozzle wedge kit for the new Sea Doo 4-TEC was designed, developed and tested extensively in all types of flat and rough water conditions to ensure that there would be no handling performance compromises. Most brands of watercraft have some form of V.T.S. (variable trim system) including other model Sea Doo's. Why the

4-TEC doesn't have a trim system is a mystery. Extensive testing has led our development team to wedge the reduction nozzle up 2.5 degrees which will inexpensively give your 4-TEC better handling everywhere and provide a boost of 1 to 2 mph in top speed performance. The billet aluminum CNC machined 2.5 degree reduction nozzle wedge kit was designed to work with the OEM O.P.A.S. system and installs easily in 15 to 20 minutes with R&D's "easy install" directions.

**Description** Part No.  
02-03 GTX 4-TEC SC / 03-05 GTX 4-TEC NA **143-95002**  
2.5 Degree Pump Wedge/Cable Extension Kit  
RXT 215/(04-05) GTX 4-TEC **143-95004**  
2.5 Degree Pump Wedge/Cable Extender Kit  
RXT-X 255 2.5 Degree Pump Wedge/Adjustable Trim **143-95005**  
Rod/Cable Extender Kit  
RXP-X 255 1.0 Degree Pump Wedge/Adjustable Trim **143-95006**  
Rod/Cable Extender Kit



## RIVA RXP/RXP-X, RXT/RXT-X, GTX-SC BILLET PUMP WEDGE

2 Degree wedge trims up your pump nozzle raising the bow of your craft for less drag and more control.

**Description** Part No.  
RXP, RXP-X, RXT, RXT-X, **RS23050**  
GTX-SC 2-Degree Pump Wedge



## RIVA RXP/RXP-X/RXT-X VTS EXTENSION ROD

Our precision-machined VTS Extension Rod allows maximum "nozzle down" adjustment after installation of RIVA Pump Wedge. Necessary on modified craft to keep bow down during initial acceleration while still providing maximum top speed advantage when trimmed up. Adjustable design comes preset for RIVA 2° Pump Wedge (part# RS23050).

**Description** Part No.  
RXP/RXP-X/RXT-X VTS Extension Rod **RS23050-1-ER**

SEA DOO  
4 STROKE

INATKE  
SYSTEMS

ENGINE/  
GASKETS

EXHAUST

DRIVE LINE  
HANDLING

ELECTRICAL

WATERLINE  
/BILGE

STEERING  
& CONTROLS

BODY

ACCESSORIES

SERVICE TOOLS  
/HARDWARE

CHEMICAL

# SEA DOO RXP RXP-X RXT RXT-X • CONTROL

SEA DOO  
4 STROKE

INTAKE  
SYSTEMS

ENGINE/  
GASKETS

EXHAUST

DRIVE LINE  
HANDLING

ELECTRICAL

WATERLINE  
/BILGE

STEERING  
& CONTROLS

BODY

ACCESSORIES

SERVICE TOOLS  
/HARDWARE

CHEMICAL



## R&D SEA DOO RXP/RXT 215/255 AUTO TRIM KIT

The R&D RXP/RXT 215/255 Auto Trim Kit was developed to override the OEM VTS System with a fully adjustable and fully automatic trim system. The R&D Auto Trim automatically drops a rider preferred adjustable 2-8 degrees. For long

straight rides install the R&D VTS/Holeshot Driver Rod (Pt. #163-21503), which works in conjunction with the R&D Auto Trim to electronically override the Auto Trim back to the OEM VTS Nozzle angle trim settings! The combination allows the best of both worlds for recreational and closed course riding!

Description	Part No.
Sea Doo RXP 215 Auto Trim Kit	163-21502
Sea Doo RXT 215/GTX 4-TEC Auto Trim Kit	163-95003
Sea Doo RXP-X 255/RXT-X 255 Auto Trim Kit	163-25500



## R&D RXP/RXT 215/255 HOLESHOT ROD

The R&D Holeshot Rod is designed to work in conjunction with the R&D Auto Trim Kit. The Holeshot Rod mounts to the VTS system and allows maximum

nozzle drop when the nozzle is straight for improved holeshots.

Description	Part No.
R&D RXP/RXT/RXP-X/RXT-X Holeshot Rod	163-21503



## RXP PRO STEERING NOZZLE

The R&D RXP 215/255 Pro Series Steering Nozzle was developed to replace the OEM steering nozzles oval and stepped inner design shape with a race proven high performance round Venturi design. Improved acceleration, cornering,

and top speed performance! The new R&D RXP 215/255 Nozzle also incorporates a cast in boss for the R&D Auto Trim Kit Option.

Description	Part No.
Sea Doo RXP 215/RXP-X 255/RXT 215/RXP-X 255 Pro Steering Nozzle (+15mm)	163-21500



## R&D RXP-X/RXT-X 84MM REDUCTION NOZZLE KIT

The R&D RXP-X/RXT-X 84mm Pump Reduction cone will reduce the venturi size from a short O.E.M. 87mm large bore design to a plus .750 over stock venturi length with a final venturi size of 84mm. Increased hook up, stronger

acceleration and mid range, improved top speed performance.

Description	Part No.
R&D RXP-X/RXT-X 84mm Reduction Nozzle Kit	173-25584



## RXP/RXT PRO-SERIES REDUCTION NOZZLE

Our Pro-Series Reduction Nozzle is ideal for tuning your Sea Doo pump combination to maximize performance.

Nozzle exit diameter can be easily

changed via interchangeable ring system. Nozzle includes three precision-machined stainless steel rings in 81, 82 and 83mm.

Additional ring sizes available (RS23050-NR-SIZE) 80, 81.5, 82.5 and 84mm.

Description	Part No.
Venturi Nozzle w/3 Rings, SD RXP 215/RXP-X 255	RS23050-N
Venturi Nozzle w/3 Rings, SD RXT/05-07 GTX-SC	RS23051-N



## THROTTLE CONVERSION KIT, ALL 4-TEC 4-STROKE RXP - RXT - GTX - GTI

Quickly and easily transform your Sea Doo thumb throttle into a more natural finger throttle with our Throttle Conversion Kit. Aluminum extensions insert directly into bar ends adding 1-3/4" to each side providing more turning leverage and a more natural riding position. Molded

steering pad end cap mates to finger throttle for a clean factory look. No modifications to existing handlebars necessary and minimal downtime.

Description	Part No.
For stock grips. All 4-TEC 4 stroke 02-07 RXP/RXT/GTX/All GTI 4-TEC	RS2455



## RIVA RACING BILLET FINGER THROTTLE FOR SEADOO

Specifically designed to match throttle travel of SeaDoo 4-Stroke PWC.

Direct replacement for bulky OEM throttle on X-Models and can be used with aftermarket bars on other 4-tec applica-

tions. Adjustable throttle angle & unique trigger design keeps the trigger at the tip of your finger throughout the throttle range for reduced arm pump & superb throttle control. Delrin bushings eliminate play common in OEM throttles and provide smooth actuation. All stainless hardware at hinge point eliminates corrosion and play. No "C" clips used. Use with OEM adapter on X-Models or use aftermarket adapter (sold separately) for other 4-Tec applications.

Description	Part No.
Riva Racing Billet Finger Throttle for SeaDoo	RS24010P
*available in clear polished finish only	

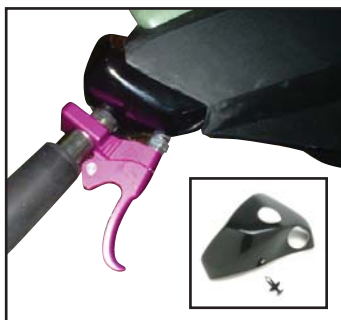

## HANDLEBAR COVER CAP FOR SEA DOO 4-TEC - RXP RXT - GTX - GTI

Description	Part No.
Handlebar Cvr Cap	FB001-SD



# SEA DOO RXP RXP-X RXT RXT-X • CONTROL



## UMI TOP STOP BILLET STEERING

Top stop steering for positive control and extraordinary strength. Improved handling by shifting weight to correct point on watercraft. Available for most sport and runabout models.

<b>Description</b>	<b>Part No.</b>
GSX/GTX/GTI/GTS/GSI/GS 96+, RX, RXP, RXP-X, RXT, RXT-X	58-6321



## HOT PRODUCTS HANDLE BARS

Models	Surface	Pad Size	Part No.
Sea Doo GTS/GTX, XP97-98, RXP, RXT	Silver	Large	HJR-02

Handle Bar Specs: 30.5 width • 3" Rise • 1.5" Pull Back



## STAR BAR RUNABOUT FAT BARS

Handlebar Type	Colors	Part No.
Fat Runabout Bars	Titan (Dark Grey)	SB1007BOOSTTIT

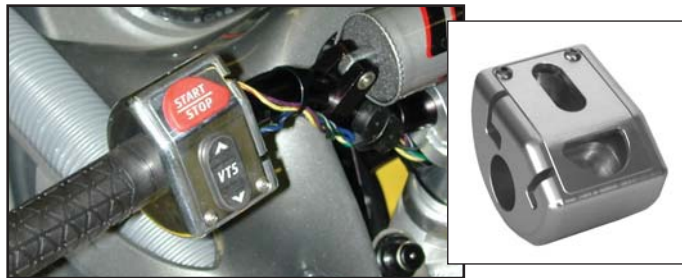

## UMI RXP TRIM/SWITCH HOUSING

U.M.I.'s trim/switch housing is machined from 6061-T6 billet aluminum, replacing the stock plastic housing. Trim/switch housing uses the factory variable trim switch and start/stop switch. This housing must be used with the U.M.I. GSX/RXP (P/#58-6321) steering system, aftermarket bars and finger throttle.

<b>Sea Doo</b>	<b>Part No.</b>
RXP Silver	SD-01600-CLR



## SPEED MAGIC "X-MOUNT" STEERING HEAD

The Speed Magic "X-Mount" for the RXP-X and RXT-X improves handling by lowering the steering head 85mm lower than the stock position and moves the rider forward for a more aggressive position. Regular and Fat Bar applications.

<b>Description</b>	<b>Part No.</b>
Speed Magic Steering Head (Standard Handlebars)	SE-027015
Speed Magic Steering Head (Fat Bars)	SE-027015F



## DO SPEED SPACER AND MOUNTING KIT FOR UMI RXP-X/RXT-X STEERING SYSTEMS

Do Speed has developed this spacer and mounting bracket specifically to be used in combination with a UMI steering system on a RXP-X or RXT-X. The spacer prevents water from entering the engine compartment and the bracket creates a clean and safe installation of the OEM Sea Doo warning system signal.



<b>Description</b>	<b>Part No.</b>
DO Speed Spacer and Mount Kit for UMI RXP-X/RXT-X Steering System	D-X-P

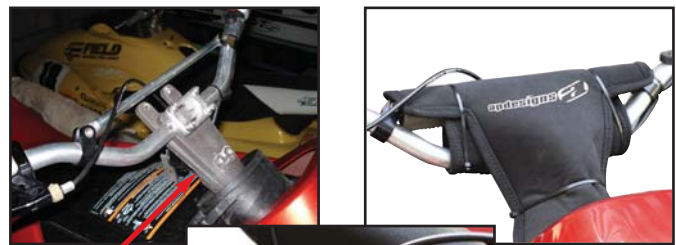

Aftermarket Bars Installed - OEM Protective Cover No Longer Fits



Safety Switch Mounting Bracket

## HANDLE BAR STEERING MOUNT COVER AND SAFETY SWITCH BRACKET

When you install aftermarket handlebars on your Sea Doo using the OEM steering system the OEM pad cover will no longer fit. AP Designs has developed this new pad to allow for the bars to fit properly and protect you while riding your Sea Doo as well as to cover the ugly cast steering system. Also developed in conjunction with this cover is a safety switch mounting bracket.

<b>Sea Doo</b>	<b>Part No.</b>
Handlebar Mount Cover for	SD-HCV
Sea Doo RXP, RXT, RX, GSX, GTX, GTI, GTS, GSI, GS 96+	
Safety Switch Mounting Bracket	N-SDSWMT

SEA DOO 4 STROKE	INATKE SYSTEMS	ENGINE/GASKETS	EXHAUST	DRIVE LINE HANDLING	ELECTRICAL	WATERLINE /BLIGE	STEERING & CONTROLS	BODY	ACCESSORIES	SERVICE TOOLS /HARDWARE	CHEMICAL
------------------	----------------	----------------	---------	---------------------	------------	------------------	---------------------	------	-------------	-------------------------	----------

# SEA DOO RXP RXP-X RXT RXT-X • PUMP



**Skat-Trak** USA  
PERFORMANCE PRODUCTS

## SKAT TRAK IMPELLERS FOR SEA DOO PWC

Increased acceleration and top speed gains are only a few of the advantages of upgrading to a Skat-Trak impeller.

**On the New 3-Blade Swirl Super Pro Impeller**

**Skat Trak recommends:**

- 13/17 for a Stock RXT application
- 13/17 for a RXT Stock Stage 1 application
- 13/18 for a RXT-X Stock Stage 1 application
- 13/18 for a RXT Stage 2 application
- 13/18 for a RXP Stock Stage 1 application
- 14/19 for a RXP-X Stock Stage 1 application
- 14/19 for a RXP Stage 2 application
- 14/20 for a RXP Stage 3 application
- 15/20 for a RXP 300hp and up application
- 15.5/21.5 for a RXP 315hp and up application

*Skat Trak Impellers do not include a seal, Hot Products recommends SLA012 sold separately.*

159-83-28 3-Blade Swirl Super Pro		
Description		Part. No.
13/17	3-Blade Swirl Super Pro	SS598328SW31317
13/18	3-Blade Swirl Super Pro	SS598328SW31318
14/19	3-Blade Swirl Super Pro	SS598328SW31419
14/20	3-Blade Swirl Super Pro	SS598328SW31420
15/18	3-Blade Swirl Super Pro	SS598328SW31518
15/19	3-Blade Swirl Super Pro	SS598328SW31519
15/20	3-Blade Swirl Super Pro	SS598328SW31520
15.5/21.5	3-Blade Swirl Super Pro	SS5983283155215
Aluminum Billet Impeller Seal for 3-Blade Super Pro		SLA012

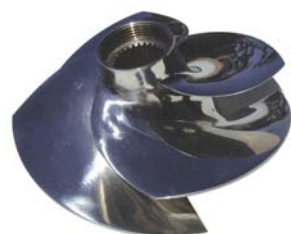

**SOLAS**  
Where speed begins

## SOLAS IMPELLERS

Increased acceleration and top speed gains are only a few of the advantages of upgrading to a Solas impeller.

Description	Part. No.
RXP Stock/Limited	SRX-CD-1419
RXP Modified	SRX-CD-1520
RXP-X Stock	SRX-CD-1521
RXT Stock/Limited	SRX-CD-1318
RXT Modified	SRX-CD-1520
GTX-SC Stock/Limited	SR-CD-1220

## SOLAS BILLET IMPELLER SEAL

The new generation of the SOLAS Impeller seal is made with billet aluminum. They are very suitable for high power applications. Fits Solas Concord and Skat Trak 3-Blade Super Pro impellers.



Description	Part No.
Aluminum Billet Impeller Seal for Concord Impellers	SLA012



## RIVA R-SERIES PUMP IMPELLERS



R-Series Pump Impellers are precision tuned to Riva's specifications using a fixture called a Pitch Block. This delivers a higher level of consistency and performance when matched with Riva Performance Kits. Includes a Billet Impeller Nose Cone for increased durability and performance.

Description	Part No.
13/19 R-Series Solas Concord Impeller	SRX-CD-13/19R
14/17 R-Series Solas Concord Impeller	SRX-CD-14/17R
14/19 R-Series Solas Concord Impeller	SRX-CD-14/19R
15/20 R-Series Solas Concord Impeller	SRX-CD-15/20R
15/22 R-Series Solas Concord Impeller	SRX-CD-15/22R

*NOTE: R-Series Impellers must be used with Riva's Pro-Series Reduction Nozzle (Part# RS23050-N for RXP/RXP-X) or (Part# RS23051-N for RXT) page 14.*

**Riva Performance Kit Pump Impellers Recommend Chart:**

Model	Stock	Stage I	Stage II
RXP-X	N/A	SRX-CD-15/22R	TBA
RXT-X	N/A	SRX-CD-15/22R	TBA
RXP	SRX-CD-13/18R	SRX-CD-14/19R	SRX-CD-15/20R
RXT	SRX-CD-14/17R	SRX-CD-14/17R	SRX-CD-13/19R

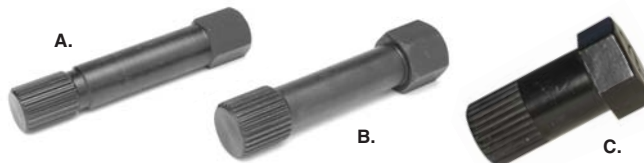

## IMPELLER HOLDER TOOL

Description	Part No.
A. GTX 4Tec Super Charged	DS#70
B. RXP/RXT 27mm	DS#71
C. Solas RXP/RXT 27mm	WR012-SRX

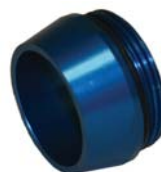

## R&D RXP PUMP CONE KIT

The R&D RXP Pump Cone Kit is an inexpensive and creative bolt on part that adds extended length over the O.E.M. plastic pump cones length, which will reduce cavitation while adding additional pump thrust. Spacing the pump cones length will add to top speed while keeping the engine rpm's stable and out of the rev limiter! Precision cast aluminum, CNC machined, and o-ring sealed for leak free pump bearing protection.

Description	Part No.
RXP Pump Cone Kit	133-02550

# SEA DOO RXP RXP-X RXT RXT-X • PUMP



## RIVA PUMP EXTENSION KIT FOR RXP & RXP-X

Riva's race bred pump extension kit increases top speed (1~2mph), hook-up and drive in all riding conditions. Billet aluminum spacer installs between transom plate and pump housing extending the intake tract 50mm delivering greatly improved pump efficiency. Precision machined extended stainless steel wear ring provides improved performance through tighter tolerance and increased durability. Supplied extended billet drive shaft is CNC machined to exact tolerances and heat treated to increase strength. Includes extended VTS Rod, stainless steel steering and reverse cable extensions, and detailed installation instructions. This modification is a must for all forms of competition including closed course, off shore and drag racing.

Description	Part No.
RIVA Pump Extension Kit for RXP/RXP-X	RS33080-PEK-50
RIVA Pump Extension Kit for RXT/RXT-X	RS33085-PEK-50



163-95350  
Sea Doo Pump Cone Spacer

## R&D ANTI-CAVITATION CONE FOR SEA DOO

The unique patent pending design balances the bowl pressure in the last stage of the pump to eliminate detectable cavitation. Improve bottom and punch midrange pull and overall performance.

Sea Doo	Part No.
RXP 215/RXT 215/RXP-X 255/RXT-X 255/GTX	163-95001
RXP 215/RXT 215/RXP-X 255/RXT-X 255	163-95200
GTX 4-TEC Anti-Cavitation Pump Cone Spacer .200 (02-05)	
RXP 215/RXT 215/RXP-X 255/RXT-X 255	163-95350
GTX 4-TEC Anti-Cavitation Pump Cone Spacer .350 (02-05)	



## RAD 4 RACING SEA DOO RXP THRU HULL FITTING

Replace the stock carbon seal with this RAD 4 Racing reliable bearing carrier. Includes drive shaft skim for perfect installation. For All RXP and RXP-X.

Sea Doo	Part No.
Rad 4 Racing SD RXP Thru Hull Fitting	R4RTHUHULL



## RIVA STAINLESS STEEL REPLACEMENT WEAR RING

100% stainless steel wear rings/impeller liners are the perfect replacement for your damaged original unit. Replaces original plastic unit on RXP, RXT, 07 GTX Wake Edition and GTC-SC Ltd. models with easy press in installation. Durable stainless steel resists debris damage and saltwater corrosion. Provides increased durability and performance due to precision machined clearance between wear ring and impeller. 159mm

Description	Part No.
RIVA Stainless Steel Replacement Wear Ring	RS33-159-SRX



## WSM REPLACEMENT PUMP WEAR RINGS FOR SEA DOO

Description	OEM#	Part No.
1998 Up including 4-Tech (Non-SC)	271-000-653	003-503
4-Tech Supercharged 03-04	267-000-104	003-502
RXP/RXT (159mm)	267-000-105	003-499



## WSM REPLACEMENT PUMP WEAR RINGS WITH STAINLESS STEEL LINER

Description	OEM#	Part No.
1998 Up including 4-Tech (Non-SC)	271-000-653	003-503S
4-Tech Supercharged 03-04	267-000-104	003-502S
RXP/RXT (159mm)	267-000-105	003-499S



## SAND & DEBRIS FILTER .75IN

Our Water Filters/Strainers protect your engine from damage due to water-borne debris such as seaweed, sand, grass and pebbles that are sucked into the cooling system. Filters mount inline with the inlet cooling hose to your watercraft's engine. Filter cup is clear to provide easy visual inspection, threaded for quick removal and seals with a durable rubber o-ring.

Description	Part No.
Sand & Debris Filter .75in	56-9004

SEA DOO  
4 STROKE

INATKE  
SYSTEMS

ENGINE/  
GASKETS

EXHAUST

DRIVE LINE  
HANDLING

ELECTRICAL

WATERLINE  
/BILGE

STEERING  
& CONTROLS

BODY

ACCESSORIES

SERVICE TOOLS  
/HARDWARE

CHEMICAL

# SEA DOO RXP RXP-X RXT RXT-X • BODY



RXP - A. Black/Silver/Black



RXP - A. Black/Yellow/Black

## AP DESIGNS SEAT COVERS

Description	Color	Part No.
A. Ultra Grip Top	Black/Silver/Black	USDRXP-BK/SL/BK
A. Sure Grip Top	Black/Silver/Black	SSDRXP-BK/SL/BK
B. Ultra Grip Top	Black/Yellow/Black	USDRXP-BK/YW/BK
B. Sure Grip Top	Black/Yellow/Black	SSDRXP-BK/YW/BK

4-TEC GTX RXT - A. Black/Silver/Rust



4-TEC GTX RXT - B. Black/Silver/Black

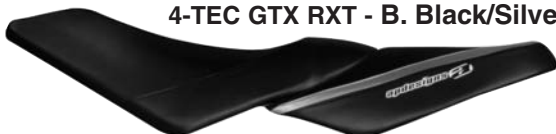

Description	Color	Part No.
A. Ultra Grip Top	Black/Silver/Rust	USDGTX-BK/SL/RU
A. Sure Grip Top	Black/Silver/Rust	SSDGTX-BK/SL/RU
B. Ultra Grip Top	Black/Silver/Black	USDGTX-BK/SL/BK
B. Sure Grip Top	Black/Silver/Black	SSDGTX-BK/SL/BK

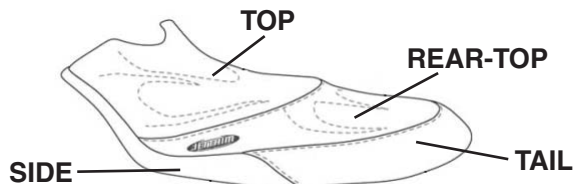

## JETTRIM CUSTOM SEAT COVER

Jet Trim seats covers are developed to the highest performance standards and design trends for the PWC industry.

*The upholstery outline for your custom designed seat cover is available at [www.jettrim.com](http://www.jettrim.com)*

Description	Part No.
Jettrim RXP Custom Designed Seat Cover	SDRXP101
Jettrim RXP-X Custom Designed Seat Cover	SDRXPX101
Jettrim RXT Custom Designed Seat Cover	SDRXT101
Jettrim RXP-X Custom Designed Hump Seat Cover	SDRXPX101H



## HYDRO TURF SEAT COVER

All Hydro Turf Seat covers are custom made to order. Hydro Turf offers a wide variety of colors and materials types to fit any application.

*The upholstery outline for your custom designed seat cover is available at [www.hydroturf.com](http://www.hydroturf.com)*

Description	Part No.
Hydro Turf RXP (04-08) Custom Designed Seat Cover	SEW89
Hydro Turf RXT (04-08), RXT-X Custom Designed Seat Cover	SEW88

## HYDRO-TURF MATS

Description	Part No.
GTX DI (02), 4-TEC (02), RXT 05, GTX (03-06) RXP	HT88-BLK HT89-BLK



## COVERCRAFT COVERS

Premium custom-patterned covers provide maximum protection and are loaded with features

that make the covers easy to use. Covercraft covers protect against ultraviolet (UV) damage, bird droppings, tree sap and air pollutants - elements that can ruin the finish of an expensive watercraft. Designed for use while trailering.

Description	Part No.
RXP (04-06)	XW868BL
GTX 4-TEC (02-05), GTX 4-TEC Ltd (03-05), GTX 4-TEC VTCE (03-05), GTX DI (02-03)	XW860BL
RXT (05-06)	XW860BL
RXP/RXP-X (07-08)	XW880BL
RXT/RXT-X (07-08)	XW879BL



## AQUA PERFORMANCE "AQUA STEPS"

The spring-loaded stainless steel step stays in the upward position until needed for added safety benefits. The step features a soft marine foam covering for your non-slip protection and grip. It

comes completely assembled with all stainless steel hardware.

Description	Part No.
RXP (04-08), RXP-X (08), RXT (04-07) RXT-X (08)	2004RXP-BLK 2008RXT-BLK



## OEM REPLACEMENT AFTERMARKET OIL FILTERS

Description	OEM#	Part No.
K&N Filter - All Sea Doo 4-stroke	420950741	<b>KN556</b>
A. WSM Filter - All Sea Doo 4-stroke		<b>006-560</b>
B. WSM Filter - All Sea Doo 4-stroke Oil Filter Cap		<b>006-562</b>



## MOELLER MARINE PRODUCTS FLUID EXTRACTOR

- Empties oil in 15 pumps or less
- Extracts warm or cold oil
- Single-hand-ease effortless operation
- Tethered cap
- Pressure relief valve allows easy transportation and storage
- Delivers gulp-free, mess-free performance
- Complete adapter kit is included featuring three extraction tubes

Description	Part No.
Moeller Oil Extractor (6.5 Liter Fluid Extractor)	<b>MR07398</b>

*\*Note: Not for use with gasoline.*

USA Patent #5450924 Germany Patent #29500683.8 U.K. Patent #2272948  
Australia Patent #674469 Taiwan Patent #113238 China Patent #ZL92241981.7



## HYDRO-TURF OIL EXTRACTOR

The unit uses a small vacuum system, which pumps fluid through a hose to the 6-liter reservoir. It also includes a pour spout to aid in emptying the reservoir. Pump is removable for easy storage.

Description	Part No.
Hydro-Turf Oil Extractor	<b>OIL01</b>



## RULE FLAT TANK ELECTRIC OIL EXTRACTOR

Eliminate those costly yard service fees with the new quick, clean, compact electric oil extractor. Includes a 3-1/2 gallon compact self-priming diaphragm pump for extraction and an easy pour spout for oil transfer.

- 3.5 gallon (13 liter) leak proof container
- Designed for ease of carrying
- Empties and stows easily
- Complete with dipstick, suction tube & battery clamps

- Self-priming, dry running, 12 or 24 volt diaphragm pump

Description	Part No.
Electric Oil Extractor	<b>17860-0012</b>



## NGK SPARK PLUG

Since 1936 NGK has lead the industry in technology, innovation and world class design of its entire product line. You can depend on NGK for quality and reliability.

- Triple-Gasket Sealing Process
- Consistent Performance
- Plug of Choice in Millions of Vehicles

Description	Part No.
NGK Plug for Sea Doo GTX 4-TEC (10 plugs per box)	<b>DCPR-8E</b>



## TORX® SOCKET SET FOR SEA DOO

Special Star Sockets for Sea Doo 4-TEC& DI engine bolts are made from heat-treated vanadium steel and black oxide coated for

durability. Supplied in a convenient vinyl holder.

- Four 3/8" Drive Sockets (T10, T12, T14, T16)
- Three 1/4" Drive Sockets (T6, T7, T8)

Description	Part No.
Torx Socket Set	<b>LS26750</b>



Fits the rear drain on Sea Doo and Kawasaki 4 stroke engines.

ON & OFF Water Lever

Connects to your waterhose

## SNAP CONNECT & FLOW CONTROL

This flush kit includes a quick disconnect that features a on/off water valve to make flushing the watercraft a simple and easy process. \*The adapter is a direct to fit to the rear drain line on Sea Doo and Kawasaki 4 stroke watercraft.

Description	Part No.
Snap Connect and Flow Control	<b>SC-2900</b>
Flush Kit Adapter	<b>SC-2905</b>

SEA DOO  
4 STROKE

INATKE  
SYSTEMS

ENGINE/  
GASKETS

EXHAUST

DRIVE LINE  
HANDLING

ELECTRICAL

WATERLINE  
/BILGE

STEERING  
& CONTROLS

BODY

ACCESSORIES

SERVICE TOOLS  
/HARDWARE

CHEMICAL

# SEA DOO FOUR STROKE • PERFORMANCE PART KITS & RPM KITS



## RXP 215 STAGE I KIT

Kit Part # RS-RPM-RXP-1  
Stock 67-68 mph  
RPM Kit 72 mph @ 8,100 RPM

Description	Quantity	Part No.
RIVA RXP Power Filter Kit	1	RS13050-06
RIVA RXP Pump Wedge	1	RS23050
RIVA RXP Top Loader Intake Grate	1	RS22050
Solas Concord Impeller	1	SRX-CD-14/19R

## RXP 215 STAGE II KIT

Kit Part # RS-RPM-RXP-2  
Stock 67-68 mph  
RPM Kit 75 mph @ 8,100 RPM

Description	Quantity	Part No.
RIVA RXP Power Filter Kit	1	RS13050-06
RIVA RXP Supercharger Impeller	1	RS1750-001A
RIVA RXP Power Cooler Kit	1	RS1750-PC
RIVA RXP Rear Exhaust Kit	1	RS15050-1
RIVA RXP Top Loader Intake Grate	1	RS22050
Solas Concord Impeller	1	SRX-CD-15/20R
RIVA RXP Pump Wedge (2-degree)	1	RS23050
RIVA RXP Pro-Series Sponson Kit	1	RS26050
RIVA O.P.A.S. Performance Block-off Kit	1	RS29050-1

## RXP STAGE III KIT

Kit Part # RS-RPM-RXP-3  
Stock 67-68 mph  
RPM Kit 80+ mph @ 8,400 RPM

Description	Quantity	Part No.
RIVA RXP Power Filter Kit	1	RS13050-06
RIVA RXP Pro-Series Supercharger Housing & Impeller	1	RS1750-2M011
RIVA RXP Power Cooler Kit with Pro-Series Blow-off Valve	1	RS1750-PC-001
RIVA RXP Pro-Series Fuel Injector Kit	1	RS12050-I-KIT
RIVA RXP Rear Exhaust Kit	1	RS15050-1
RIVA Pro-Series ECU*	1	RS11850-01-YEAR*
*2004-05 = A • 2006 = B • 2007 = C		
RIVA RXP Thermostat Kit	1	RS1015
RIVA RXP Valve Spring Retainer Kit	1	RS19050-VTU
RIVA RXP Heavy Duty Supercharger Clutch Washers	1	RS1750-HDW-946
RIVA RXP Top Loader Intake Grate	1	RS22050
RIVA/Skat-Trak Swirl Impeller with Billet Nose Cone	1	SP-IMP-159-15-19R
RIVA RXP Pump Wedge (2-degree)	1	RS23050
RIVA RXP VTS Extension Rod	1	RS23050-ER
RIVA RXP Pro-Series Reduction Nozzle	1	RS23050-N
RIVA RXP Pro-Series Sponson Kit	1	RS26050
RIVA O.P.A.S. Performance Block-off Kit	1	RS29950

## RXT STAGE I KIT - RXT 215/05-06 GTX SC-LTD

Kit Part # RS-RPM-RXT-1  
Stock 64-65 mph  
RPM Kit 68-69 mph @ 8,100 RPM

Description	Quantity	Part No.
RIVA RXT Power Filter Kit	1	RS13050-06
RIVA RXT Pump Wedge	1	RS23050
RIVA RXT Top Loader Intake Grate	1	RS22055
Solas Concord Impeller	1	SRX-CD-14/17R
RIVA O.P.A.S. Competition Kit	1	RS29055

## RXT STAGE II KIT - RXT 215/05-06 GTX SC-LTD

Kit Part # RS-RPM-RXT-2  
Stock 64-65 mph  
RPM Kit 71-72 mph @ 8,100 RPM

Description	Quantity	Part No.
RIVA RXT Power Filter Kit	1	RS13050-06
RIVA RXT Supercharger Impeller	1	RS1750-001A
RIVA RXT Power Cooler Kit	1	RS1750-PC
RIVA RXT Rear Exhaust Kit	1	RS15050-1
RIVA RXT Top Loader Intake Grate	1	RS22055
Solas Concord Impeller	1	SRX-CD-13/19R
RIVA RXT Pump Wedge (2-degree)	1	RS23050
RIVA RXT Pro-Series Sponson Kit	1	RS26050
RIVA O.P.A.S. Performance Block-off Kit	1	RS29050-1

## RXP STAGE III KIT

Stock 64-65 mph • RPM Kit 74-75 mph @ 8,400 RPM

Description	Quantity	Part No.
RIVA RXT Power Filter Kit	1	RS-RPM-RXT-3*

\* Call for details, Stage III Kit Parts List and Pricing

## RIVA RXP-X 255 STAGE I KIT

Kit Part # RS-RPM-RXPX-1  
Stock 68 MPH @ 8,000RPM  
Stage 1 Kit 74 MPH @ 8,000RPM

Description	Quantity	Part No.
RIVA Performance Power Filter Kit	1	RS13050-06
RIVA Top-Loader Intake Grate	1	RS22080
Solas Concord Impeller	1	SRX-CD-15/22R
RIVA 2 Pump Wedge	1	RS23050
RIVA VTS Extension Rod	1	RS23050-1-ER
RIVA Pro-Series Reduction Nozzle	1	RS23050-N

## RIVA RXT-X 255 STAGE I KIT

Kit Part # RS-RPM-RXTX-1  
Stock 67 MPH @ 8,000RPM  
Stage 1 Kit 73 MPH @ 8,000RPM

Description	Quantity	Part No.
RIVA Performance Power Filter Kit	1	RS13050-06
RIVA Top-Loader Intake Grate	1	RS22080
Solas Concord Impeller	1	SRX-CD-15/22R
RIVA 2 Pump Wedge	1	RS23050
RIVA VTS Extension Rod	1	RS23050-1-ER
RIVA Pro-Series Reduction Nozzle	1	RS23050-N
RIVA Competition O.P.A.S. Kit	1	RS29055

\*When ordering the Riva Pro-Series ECU you must specify the year of the Sea Doo RXP or RXT.

# YAMAHA FX-SHO & FX CRUISER SHO • INTAKE • SUPERCHARGER



## RIVA PERFORMANCE YAMAHA FX-SHO/FZR/FZS POWER FILTER KIT

The Riva Power Filter feeds your SHO or FZR a steady diet of cool air delivering greatly improved acceleration and rpm. Replaces restrictive stock air box with a high-volume, precision-formed intake duct that attaches to the supercharger via a large 4" adapter. Cool air enters the system via an oversized K&N filter element. Includes water-repellent pre-filter.

**Description** Part No.  
Riva FX-SHO/FZR/FZS Performance Power Filter Kit RY13040

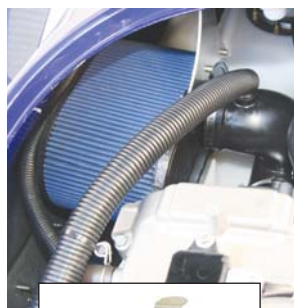

## R&D PERFORMANCE POWER PLENUM AIR FILTER KIT

The R&D High Performance Power Plenum Air Filter Kit was designed, developed and dyno tested exclusively for the new Yamaha SHO/FZR supercharged intake system to unleash low-end, mid-range, and peak horsepower trapped in the restrictive stock air box. The exclusive lightweight filter design couples to the OEM supercharger hose and is engineered with a large 6"x10"x6" plenum to deliver massive cubic air volume and improved air speed to the supercharger. Replacing the O.E.M. air box with the R&D Filter kit offers an economical way

to improve performance, looks, and sound at a fraction of the cost of other aftermarket kits. Kit comes complete with all necessary hardware and installs in minutes.

**Description** Part No.  
R&D FX-SHO/FZR/FZS Performance Power Plenum Air Filter Kit 200-01801



## R&D FX-SHO/FZR/FZS POWER PLENUM FLAME ARRESTER FOR STOCK AIR BOX

The R&D High Flow Filter design replaces the restrictive stock filter inside the stock air box, allowing improved air flow. Why? Because more air flow means more power and improved performance. The washable and reusable design means this will be the last filter you will ever have to buy.

**Description** Part No.  
R&D FX-SHO/FZR/FZS Power Plenum Flame Arrester 200-01800



FOR INTAKE MANIFOLD



FOR INTERCOOLER

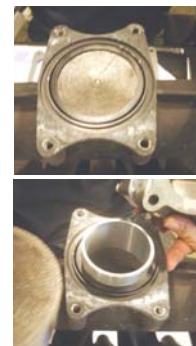

OEM

R&D

## R&D SHO POWER CORE INTAKE MANIFOLD/INTERCOOLER CFM KIT

The R&D FX-SHO/FZR/FZS Power Intake Manifold and Intercooler CFM Kit was developed to increase airflow into and through the intake system by relieving restrictions. The R&D FX-SHO/FZR/FZS intake manifold ribbon remover sleeve will unlock a 40 CFM (cubic feet per minute) air flow restriction by replacing the intake manifold ribbon with the R&D billet venturi sleeve. The R&D Intercooler Spacer will unlock a 30-35 CFM restriction in the intercooler. The R&D FX-SHO/FZR/FZS Intake Kit will add low end and mid range throttle response, and a full 100 plus rpms to top end performance to a stock FX-SHO/FZR/FZS. The R&D FX-SHO/FZR/FZS Intake Kit is an absolute must have parts kit to remove intake restrictions before contemplating power adding compressor booster wheels or turbo charger kits to the FX-SHO/FZR/FZS engine. True horsepower gains on the FX-SHO/FZR/FZS start right here with the R&D Intake Kit. More airflow will equal more power, and there is no other way around the fact that restricted is restricted power.

**Description** Part No.  
R&D FX-SHO/FZR/FZS Power Core Billet Intake Manifold Sleeve & Intercooler Spacer CFM Kit 612-18000  
R&D FX-SHO/FZR/FZS Intercooler CFM Spacer Only 612-17999



## RIVA FX-SHO/FZR/FZS INTAKE MANIFOLD UPGRADE KIT

Upgrade your engine to produce more horsepower through increased boost pressure (+1lb). Supplied hole cutting tool allows easy removal of restrictive

screen element from inside of intake manifold. Special o-ringed, billet block-off plug with integrated fitting for aftermarket boost pressure gauge fills opening left after removal of screen element. Includes detailed installation instructions. *NOTE: Testing has determined the stock ECU will compensate for the increased boost provided by our Intake Manifold Upgrade Kit.*

**Description** Part No.  
Riva FX-SHO/FZR/FZS Intake Manifold Upgrade Kit RY12040-IMUK



4 STROKE	YAMAHA
SYSTEMS	INTAKE
GASKETS	ENGINE/
EXHAUST	EXHAUST
DRIVE LINE	DRIVE LINE
ELECTRICAL	ELECTRICAL
WATERLINE	WATERLINE
BLIGE	BLIGE
STEERING	STEERING
CONTROLS	CONTROLS
BODY	BODY
ACCESSORIES	ACCESSORIES
SERVICE TOOLS	SERVICE TOOLS
HARDWARE	HARDWARE
CHEMICAL	CHEMICAL

YAMAHA  
4 STROKE

INTAKE  
SYSTEMS

ENGINE/  
GASKETS

EXHAUST

DRIVE LINE  
HANDLING

ELECTRICAL

WATERLINE  
/BILGE

STEERING  
& CONTROLS

BODY

ACCESSORIES

SERVICE TOOLS  
/HARDWARE

CHEMICAL



## R&D FX-SHO/FZR/FZS C1 MONSTER CHARGER WHEEL

R&D's new C1 11 Blade Series Monster Compressor Wheel Kit for Yamaha SHO/FZS/FZR engines is new and improved to deliver "horsepower you can feel" with instant throttle response,

improved mid range acceleration, and increased top end performance. The R&D Monster Wheel replaces the stock wheels inefficient 5 blade design with an all new modern low profile, high flow, 11 blade high tech design. Fits directly into the O.E.M. stock compressor housing with no modifications. The C1-11 Monster works with the OEM intercooler, OEM fuel injectors, OEM ignition system and the R&D Intake CFM Kit. Kit performs well on 91 octane pump gasoline. Boost rated 7/8.5 P.S.I. (7 @ 7500 and 8.5 @ 7700) Horsepower increases were professionally documented by MOTEC AUSTRALIA.

- Increased boost pressure ( 3-3.5 over stock @ 7700 rpm)
- Increased airflow (1.5-2 pound per minute gain)
- 25-30 Horsepower increase and 2 MPH Gain (with OEM ignition)
- 70 Horsepower increase (with Motec ECU, CFM kit, 91 pump gas)
- Precision balanced (turbo specs .012-.027 gram inches)
- Better throttle response, increased horsepower • Ultra easy installation
- 91 octane pump gas friendly • Inexpensive horsepower upgrade

The C1 Wheel Kit works excellent for recreational use applications retaining the OEM ignition, fuel system, injectors, and intercooler. R&D has data logged and documented the A.F.R. (air to fuel ratio) to be a conservative and safe 11.8-12.0 with the C1 wheel kit. R&D recommends that the R&D Power Core Intake Manifold and intercooler CFM kit or the R&D Stage 1 Intercooler Kit be used with the C1 wheel.

Description	Part No.
R&D FX-SHO/FZR/FZS C1 Monster Charger Wheel	612-25001

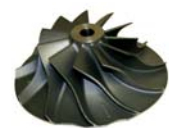

## R&D FX-SHO/FZR/FZS C3 MONSTER CHARGER WHEEL

R&D's new C3-11 Blade Series Racing Monster Compressor Wheel Kit for Yamaha SHO/FZS/FZR engines is an exciting new racing product that will deliver "horsepower you can feel" with instant throttle response, aggressively improved low and mid range acceleration, and increased top end performance. The

R&D Monster Wheel replaces the stock wheels low performing 5 blade design with a modern low profile, high flow 11 blade high tech design with a larger exducer diameter to move more air flow at lower rpm's producing better holeshot horsepower. The R&D C3 Monster Wheel and R&D Exducer Seal Plate Kit will install directly into the O.E.M. stock compressor housing with no modifications. The C3 Racing Monster will require the R&D High Performance Intercooler Kit, and an R&D Impellor upgrade. The C3-11 performs well on 91 octane pump gasoline. Boost rated 10/13 P.S.I. (10 @ 7700 and 13@8300) The new R&D 11 blade series compressor wheels offer the highest levels of airflow and horsepower gains available for the 1.8 Yamaha engine using the stock E.C.U.

- Increased boost pressure ( 5 P.S.I. over stock @ 7700 rpm)
- Increased airflow ( 2.5-3 pound per minute gain)
- 35+ Horsepower increase and 2 MPH Gain (with stock ECU)
- 300+ Horsepower using aftermarket ECU (MOTEC)
- Precision balanced (turbo specs .012-.027 gram inches)
- Utilizes O.E.M. ignition system with R&D Impellor Upgrade
- Utilizes O.E.M. fuel injectors • 91 octane pump gas friendly

*NOTE: The C3 Monster Wheel Kit will require impellor upgrades over the C1 impellor suggestions. Contact R&D for intercooler suggestions, and impellor pitch/nozzle combination that will be best for your performance level or application. R&D stocks the largest selection of custom impellors for the SHO/FZ/FZR.*

Description	Part No.
R&D FX-SHO/FZR/FZS C3 Monster Charger Wheel	612-25003



## RIVA PRO-SERIES SUPERCHARGER IMPELLER

Presenting the ultimate (drop-in) performance supercharger impeller for the Yamaha 1.8 liter Supercharged Engine! Working closely with Vortech Engineers, we developed a high-performance replacement impeller that delivers 14 lbs of boost @

8,000rpm in RIVA Stage II applications. Produces more horsepower and torque throughout the RPM range resulting in excellent acceleration & top speed. Investment cast from an extremely strong, lightweight proprietary aluminum and CNC machined to ensure exact tolerances. All new blade design is optimized aerodynamically and precision balanced to deliver smooth operation. Installs easily into stock supercharger housing with no additional modifications required. Includes detailed installation instructions.

*NOTE: This impeller requires use of RIVA Pro-Series ECU & Injector Kit for proper engine management calibration and premium 91+ octane fuel is required.*

Description	Part No.
Riva FX-SHO/FZR/FZS Pro-Series S/C Impeller	RY17040-SCI-1



## R&D FX-SHO/FZR/FZS SILICONE INTAKE HOSE KIT

The R&D Yamaha FX-SHO/FZR/FZS Supercharger High Performance Hose Kit was developed while testing the R&D Monster Compressor Wheel Kits. Higher boost pressures create higher intake air temperatures of up to 235 degrees. The O.E.M. standard black rubber hose and standard hose clamps just do not hold up to the pressures and heat like high quality, high temperature silicone hose and high strength stainless steel T-bolt style hose clamps. The R&D "Blue Hose" is manufactured from high performance, turbo charger quality high-temperature silicone. The R&D silicone hose installs easily in place of the OEM rubber elbow hose, and T-bolt clamps will keep the hose secure for the longest of endurance races.

Description	Part No.
R&D FX-SHO/FZR/FZS Silicone Intake Hose Kit	612-18007





## R&D FX-SHO/FZR/FZS STAGE 1 INTERCOOLER CORE KIT

The R&D Yamaha FX SHO/FZR Stage 1 Intercooler Core Kit was developed to replace the over restrictive OEM intercooler with an inexpensive direct replacement core that will bolt in to the OEM stock location with all stock hardware. The R&D Intercooler Core reduces the deadhead air restriction (similar to the R&D Intake Core Kit) that is created when installing a C1 Monster compressor wheel with a 3-4 pound boost pressure gain. The R&D Intercooler offers better cooling efficiency with an aluminum 8 core design over the stock cooper 6 core design. The R&D core will flow more air, offer better cooling efficiency, and allow the C1 Monster Wheel to live up to its airflow volume potential.

The R&D core will flow more air, offer better cooling efficiency, and allow the C1 Monster Wheel to live up to its airflow volume potential.

- Flows 40 CFM more than stock
- 3 pounds lighter than stock
- Improves cooling efficiency
- Bolts directly into stock location
- Increases horsepower by reducing restrictions
- Works great with C1 compressor wheels
- Retains O.E.M. flushing system for maintenance

**Description** R&D FX-SHO/FZR/FZS Stage 1 Intercooler Core Kit **Part No.** 612-18001



## R&D FX-SHO/FZR/FZS 300+ HP INTERCOOLER KIT

The new R&D Intercooler System will efficiently

decrease superheated air temperatures produced by high performance Superchargers. Designed for 300+ horsepower applications.

**Description** R&D FX-SHO/FZR/FZS Stage 1 Intercooler Core Kit **Part No.** 612-18002



## RIVA FX-SHO/FZR/FZS POWER COOLER

The RIVA Power Cooler intercooler system features a huge Vortech cooler element for maximum efficiency. Delivers an increase of 15 peak horsepower over original intercooler providing arm-wrenching results on the water. The RIVA Power Cooler features a large, unrestricted core that exhibits minimal pressure loss. The

cooling element is dramatically more efficient than the stock unit with exit temperatures averaging 50°F cooler than stock. This delivers cooler, denser air for increased performance throughout the RPM range. Innovative design allows easy disassembly of cooler element & ducting for maintenance and cleaning. Installs securely with shock absorbing rubber mounting system and stainless steel hardware. Power Cooler Kit contains all necessary hardware and detailed installation instructions.

**Description** Riva FX-SHO/FZR/FZS Power Cooler **Part No.** RY17040-PC



## R&D FX-SHO/FZR/FZS SURGE PROTECTOR KIT

The R&D Yamaha FX-SHO/FZR/FZS Surge Protector Kit will significantly improve supercharger clutch and compressor wheel performance

and reliability by eliminating damaging compressor surge. The R&D Yamaha FX-SHO/FZR/FZS Surge Protection Kit utilizes an automotive vacuum assisted Bosch pressure blow off valve that releases the unwanted intake pressure between the throttle valve and the supercharger thus keeping the pressures in P1 and P2 equal. As soon as the throttle valve is opened, the blow off valve immediately closes and the compressor can supply its full boost potentials to the engine. The R&D surge hose is manufactured from high performance, high-temperature silicone with an integrated molded riser for the blow off valve to function without hindering intake flow or velocity. The R&D kit installs easily in place of the OEM rubber elbow joint with no modifications. The R&D Pressure Port installs between the MAP sensor and the MAP sensor bracket with a "bolt on" part. The R&D Surge Protection Kit is a necessary and cost effective upgrade for the Yamaha SHO supercharged engine. The R&D kit comes completely assembled with silicone elbow, blow off valve, R&D B.O.V. filter, mounting hardware and instructions.

**Description** R&D Surge Protector Kit **Part No.** 612-18008



## R&D FX-SHO/FZR/FZS BILLET SURGE PROTECTOR VALVE & FILTER KIT

The R&D Billet Surge Protector Valve and Filter Kit is now available. The billet aluminum CNC machined valve

is an optional bolt-on replacement for the plastic Bosch valve used in the R&D and other aftermarket surge protection systems. The o-ring sealed billet design offers improved consistency and performance in higher boost pressure applications.

**Description** R&D Billet Surge Protector Valve & Filter Kit **Part No.** 613-95260

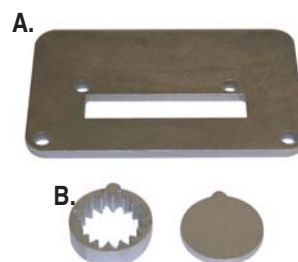

## SPECIALTY SUPERCHARGER TOOLS

R&D has designed a custom tool kit that is essential in the rebuilding process of the Yamaha Supercharger. All tools are specific in application and are cnc machined to ensure a precision job.

**Description** A. Supercharger Housing Holder Bracket Tool **Part No.** 612-92010  
B. Shaft/Gear Holding Tool **Part No.** 612-92011

4 STROKE	YAMAHA
SYSTEMS	INTAKE
GASKETS	ENGINE/
	GASKETS
	EXHAUST
HANDLING	DRIVE LINE
	ELECTRICAL
	WATERLINE
	/BLIGE
	STEERING
	& CONTROLS
	BODY
	ACCESSORIES
	SERVICE TOOLS
	/HARDWARE
	CHEMICAL



## R&D FX-SHO/FZR/FZS INTERCOOLER COOLING KIT

The R&D Yamaha FX-SHO/FZR/FZS Intercooler Temperature Control system was developed to offer an inexpensive complete bolt on kit that will allow the full

performance and cooling potential the O.E.M. intercooler has to offer for recreational applications. Intercooler core water temperatures have a range of affect on the supercharged air temperatures that enter into the engine. The Yamaha SHO Intercooler operates on a single low pressure (10 P.S.I.) line of lake temperature water to cool the intercooler. R&D has found that by adding an additional intercooler water in line, and adding an additional water out line and bypass fitting, there will be double the water flow volume at 20 P.S.I. Reduced intercooler core temperatures can add a noticeable increase in low end and midrange power along with reduced detonation. R&D offers a range of machined flow control fittings to allow water volume control tuning for intercooler temperature adjustments for warm lake water and extreme hot air conditions. R&D also offers a pressure relief blowoff valve kit for high water volume flow rates on higher boost Stage 1 and up engine kits. The R&D Kit will allow temperature tuning that will deliver surprising results. Unlock hidden performance and power potential in the OEM stock intercooler or aftermarket intercooler system by reducing intercooler core temperatures.

- More horsepower with cooler intake air temperatures
- Increased acceleration and mid range performance
- Reduces detonation in hot weather conditions
- Temperature control tuneability
- An inexpensive recreational performance addition
- Pressure relief valve options
- Easy installation instruction

Description	Part No.
R&D FX-SHO/FZR/FZS Intercooler Cooling Kit	660-18000



## R&D FX-SHO/FZR/FZS INTERCOOLER TEMPERATURE CONTROL PRESSURE RELIEF VALVE KIT

R&D also offers a pressure relief blowoff valve kit for high water

volume flow rates on higher boost Stage 1 and up engine kits. The R&D kit will allow temperature tuning that will deliver surprising results. Unlock hidden performance and power potential in the OEM stock intercooler or aftermarket intercooler system by reducing intercooler core temperatures.

Description	Part No.
R&D FX-SHO/FZR/FZS Intercooler Temperature Control Pressure Relief Valve Kit	660-82511



## R&D FX-SHO/FZR/FZS O2 SENSOR MOUNT KIT

The new R&D O2 sensor mount kit makes installing an AFR gauge a breeze on the Yamaha FX-SHO, FZR, FZS, FX140, HO, GPR, and VX110. It simply replaces the OEM

plug and installs directly into the OEM pipe without any modifications. Kit comes complete with installation tool. AFR gauge sold separately.

Description	Part No.
FX-SHO/FZR/FZS/FX140/HO/GPR/VX110 O2 Sensor Mount Kit	332-18010



## R&D FX-SHO/FZR/FZS HIGH FLOW EXHAUST KIT

The R&D SHO High Flow Exhaust Kit will add a noticeable low end and mid range power feel as well as add top end performance! The

R&D High Flow Exhaust Kit will add a great performance sound to the SHO while maintaining a safe and under IJSBA and Coast Guard approved 86 db!

Description	Part No.
FX-SHO/FZR/FZS High Flow Exhaust Kit	332-18000



## RIVA FX SHO/FZR FREE FLOW EXHAUST KIT

Replaces the restrictive sound suppression system located between the

water box and hull exit on your watercraft. Improves engine performance by reducing back pressure and harmful detonation. Includes mandrel bent aluminum tubing that is powder coated to prevent corrosion, high-temp silicon replacement coupler and installation instructions.

Description	Part No.
Riva FX-SHO/FZR/FZS Free Flow Exhaust Kit	RY16040



## R&D BILLET EXHAUST OUTLET

The new R&D Billet Exhaust Outlet.

Description	Part No.
3" Diameter R&D Billet Exhaust Outlet	331-30000
2.75" Diameter R&D Billet Exhaust Outlet	331-32750



## R&D HIGH TEMPERATURE SILICON COUPLINGS

Description	Part No.
3"-3" High Temp Silicon Couplings	061-30030
3"-2" Reducer High Temp Silicon Couplings	061-32500
2.75"-2.5" Reducer High Temp Silicon Couplings	061-32501
3"-2.75" Reducer High Temp Silicon Couplings	061-32750

# YAMAHA FX-SHO & FX CRUISER SHO • FUEL SYSTEM



## R&D FX-SHO/FZR/FZS FUEL PRESSURE REGULATOR KIT

R&D offers a Yamaha FX-SHO/FZR/FZS model specific fuel pressure regulator system allowing custom fuel pressure tuning to the EFI fuel systems fuel pressures. The R&D Fuel Pressure Regulator System offers a wide range of setup possibilities. Base fuel pressure is adjustable from 5 to 60 PSI. The R&D fuel pressure regulator can also be set up to allow "rising rate" fuel pressure at a 1 to 1 ratio (One pound of fuel pressure gain over base for every pound of boost gain). R&D offers two types of fuel pressure regulator set ups. Part #802-00080 will come completely assembled and ready to install. The R&D Pro System is 100 percent complete, installs directly to the top of the fuel tank, and connects directly to the fuel rail with OEM security lock connectors with no modifications. For the R&D Fuel Pressure Regulator only use part #801-25010, which comes complete with 90 degree barbed brass fittings for use with push on type hose and Oetiker style clamps for security. R&D offers high performance fuel hose that can be purchased by the foot, as well as the Oetiker style clamps. The R&D bypass style regulator system is capable of handling any fuel pump up to 250 GPH. Replace "Deadhead" regulator performance and experience the full flow volume and rock steady fuel pressure that only a dynamic R&D fuel pressure regulator kit can produce.

- Fuel pressure will rise on a 1:1 ratio when boost referenced
- All ports are 3/8" NPT, with one inlet, 3 outlets, and one return port on the bottom
- Beautiful type II bright dip anodized finish
- Bypass design produces the ultimate, dynamic fuel delivery system
- 3/8 pipe tapped for standard or AN fitting ready
- R&D offers pre-assembled #4 AN hose to finish off a return system
- R&D offers fuel hose by the foot for custom routing

<b>Description</b>	<b>Part No.</b>
R&D FX-SHO/FZR/FZS Fuel Pressure Regulator Kit	802-00080



## R&D FX SHO/FZR IN-TANK FUEL PRESSURE REGULATOR BLOCK OFF KIT

R&D offers a Fuel Pressure Regulator Block Off Kit which will allow the OEM stock in tank fuel pressure regulator to be removed, blocked off, and replaced with a billet part which is mandatory when installing an aftermarket externally adjustable fuel pressure regulator system. The OEM in tank fuel pressure regulator is fixed to maintain 40-43 pounds of fuel pressure at all times. For high performance applications where horsepower is boosted, it is necessary to install larger flowing fuel injectors and be able to tune the fuel pressure up or down as needed. Most factory race teams are running 65 plus pounds of fuel pressure along with higher flowing fuel injectors and externally adjustable pressure regulators. The R&D has a complete line up of fuel pumps, fuel injectors, fuel pressure regulators, fuel gauge, and fuel hose accessories all designed specifically for the Yamaha SHO. All R&D fuel injection parts and products meet Coast Guard, I.J.S.B.A., and APBA approval.

<b>Description</b>	<b>Part No.</b>
R&D FX-SHO/FZR/FZS In-Tank Fuel Pressure Regulator Block Off Kit	812-35257



## R&D FX-SHO/FZR/FZS HIGH PERFORMANCE FUEL INJECTOR KIT

When boosting the horsepower on the FX-SHO/FZR/FZS four stroke fuel injected engine, whether using high compression pistons, cams, or higher ratio supercharger compressor wheels, it will be necessary to increase the fuel flow delivery. The OEM Yamaha SHO injectors have been precision flow rate tested to be 80 percent peaked on stock units at sea level without modifications. R&D offers high performance fuel injectors with a higher atomization spray pattern that are easily capable of delivering fuel flow specifications to accommodate up to 400 horsepower! R&D has flow rate tested the O.E.M. Yamaha SHO injectors and verified them to flow 396 cc at 43 PSI of fuel pressure, which rates them to flow 30 pounds of fuel per hour. The R&D High Performance Fuel Injectors have precision flow rate tested to 525 cc at 43 PSI of fuel pressure, and 625 cc at 70 PSI of fuel pressure, which rates them to flow as much as 62 pounds of fuel per hour. R&D High Performance Injectors have been flow rate tested to perform excellent, delivering precise fuel at fuel pressure ratings ranging from 40 to 80 PSI. Each R&D High Performance Fuel Injector Kit will come packaged with vital flow test rating information that will be broken down specifically in five pound increments in fuel pressure to give the fuel flow delivery information that will help in tuning fuel pressure to match the engines fuel flow needs based on horsepower gains over stock. R&D offers only the highest quality fuel injectors, fuel pressure regulators, and fuel management accessories, for all your engine management needs.

<b>Description</b>	<b>Part No.</b>
R&D FX-SHO/FZR/FZS High Perf. Fuel Injector Kit	812-18000



## RIVA FX SHO/FZR PRO-SERIES FUEL INJECTOR KIT

Riva's high performance fuel injector kit supplies modified Yamaha 1.8 liter Supercharged engines with additional fuel for RIVA Stage II & III applications. These 95lb injectors are designed for use with RIVA Pro-Series ECU (RY11840-01-C, page 7) for correct calibration. Injector sets are flow-matched for optimum idle quality and peak performance.

<b>Description</b>	<b>Part No.</b>
Riva FX-SHO/FZR/FZS Pro-Series Fuel Injector Kit	RY12040-I-KIT



## R&D #4 & #6 FUEL RETURN LINE KIT

R&D has developed a two larger fuel return line kits for the FX-SHO/FZR/FZS. Increasing the diameter of the fuel return line to #4 or #6, decreases line pressure and increases fuel volume, yielding increased tuning ability in high heat and higher performance applications.

<b>Description</b>	<b>Part No.</b>
R&D #4 Fuel Return Line	612-00082
R&D #6 Fuel Return Line	612-00083

4 STROKE	YAMAHA
SYSTEMS	INATKE
GASKETS	ENGINE/
EXHAUST	EXHAUST
DRIVE LINE HANDLING	DRIVE LINE HANDLING
ELECTRICAL	ELECTRICAL
WATERLINE /BILGE	WATERLINE /BILGE
STEERING & CONTROLS	STEERING & CONTROLS
BODY	BODY
ACCESSORIES	ACCESSORIES
SERVICE TOOLS /HARDWARE	SERVICE TOOLS /HARDWARE
CHEMICAL	CHEMICAL

# YAMAHA FX-SHO & FX CRUISER SHO • FUEL SYSTEM

YAMAHA  
4 STROKE

INTAKE  
SYSTEMS

ENGINE/  
GASKETS

EXHAUST

DRIVE LINE  
HANDLING

ELECTRICAL

WATERLINE  
/BILGE

STEERING  
& CONTROLS

BODY

ACCESSORIES

SERVICE TOOLS  
/HARDWARE

CHEMICAL



## RIVA FX-SHO/FZR/FZS PRO-SERIES ECU

The Riva Pro-Series Racing ECU delivers a huge performance

advantage to the Yamaha 1.8 liter Supercharged Engine. ECU is calibrated for Stage II & III applications and must be used with RIVA Pro-Series Fuel Injector Kit (RY12040-I-KIT, page 6) and 91+ octane pump fuel. Plugs directly into factory wiring harness in place of stock ECU. Key benefits include:

- Performance Fuel Mapping: Delivers optimal fuel required for your specific level of modification (Stage II or III) based on boost pressure.
- Performance Timing Curves: Special racing curves produce more power throughout the RPM range. Timing is automatically adjusted based on sensor input.
- Rev Limiter Increase: Stock rev limit has been increased from 7550 to 8300 RPM. With our recommended pump combination, engine RPM can be run higher producing more boost pressure and horsepower.
- Retains dash Display, Engine Diagnostic & Primary Engine Safety

Functions:

- 1) All original dash function are retained.
- 2) Provides diagnostic information that can be displayed via computer interface.
- 3) Sensor input is monitored for abnormal readings and will react by triggering warnings and/or limp mode.

*NOTE: RIVA Pro-Series ECU is for competition use only.  
Available Summer 2009.*

Description	Part No.
Riva FX-SHO/FZR/FZS Pro-Series ECU	RY11840-01-C



## R&D FX-SHO/FZR/FZS MULTI-PRESSURE PORT BOOST GAUGE/SURGE/RRFPS ADAPTOR KIT

The R&D Yamaha FX-SHO/FZR/FZS Multi-Pressure Port Adaptor Kit will allow quick and easy hook up of digital or manual boost gauges with the R&D Multi-port billet adaptor. The R&D Pressure Port Adaptor installs between the MAP sensor and the MAP sensor bracket as a "bolt on" part with no modifications. Operate a vacuum/boost gauge, check plenum air temperatures, and operate a surge protection valve at the same time, or run a boost gauge, surge protection device, and operate a boost referenced fuel pressure regulator (RRFPR) at the same time with one simple part. The R&D Pressure Port Adaptor Kit comes complete with longer MAP sensor mounting screws, o-ring seals, nylon cable ties, all mounting hardware and instruction.

Description	Part No.
R&D FX-SHO/FZR/FZS Multi-Pressure Port Boost Gauge/Surge/RRFPS Adaptor Kit	612-92005



## R&D YAMAHA 2008/2009 SHO/FZ/FZR POWERSHOT FUEL INJECTION/ENGINE TUNER ENGINES

The new R&D Powershot Fuel

Injection/Engine Tuning module for the YAMAHA SHO/FZR will deliver increased acceleration, stronger mid-range, and increased top speed performance by delivering a higher performing air to fuel ratio (A.F.R.) and allowing higher mass air/boost pressure levels to be utilized. R&D Performance has data logged and analyzed the O.E.M. fuel map and Fly By Wire functions on the new YAMAHA SHO/ FZR four stroke engine and has determined that one of the main horsepower and performance holdbacks in Yamaha's Fly by Wire E.C.U. system is the mass air or boost limitation that is controlled by the Fly by Wire Throttle System. The Yamaha E.C.U. manipulates and controls the mass air or boost pressure levels by closing the throttle plate which limits peak horsepower performance. The R&D Powershot interfaces with the E.C.U., fuel injectors, and sensors to unlock, take over, and control mass air or boost limitations. The R&D Powershot will allow the R&D C1 and C3 Monster Supercharger Wheels to perform to their full potential by defending against unwanted codes and internal E.C.U. limitations. The R&D Powershot comes pre-programmed and coded to safely alter the fuel map, intercept and recondition sensor voltage signals allowing up to 10 P.S.I. of boost pressure without throttle limitation or regulation. The R&D Powershot allows custom fuel tuning to cruise, acceleration, and top end zones. Top end fuel mixtures can be custom tuned from 13.5:1 (lean) to 11.5:1 (rich) on the fly. Quicker acceleration, stronger mid-range, and increased top speed performance is the result when the A.F.R. is tuned for optimum performance. The R&D Powershot is fully adjustable to accommodate and properly performance tune the A.F.R. for any combination of aftermarket parts. *No more Boost Limiter!*

Description	Part No.
08/09 SHO/FZ/FZR Powershot Fuel Injection/Engine Tuner	802-18000

## R&D FX-SHO/FZR/FZS HIGH PERFORMANCE HIGH VOLUME FUEL PUMP KITS

R&D Performance carries a complete line up of high performance replacement fuel pumps that are machined specifically to fit the Yamaha FX-SHO/FZR/FZS fuel pump housing and are offered in a variety of flow ratings to facilitate from basic low cost replacement to an all out 500 H.P. race machine. All R&D FX-SHO/FZR/FZS fuel pumps have been precision flow rate tested and charted in (LPH) liters per hour. R&D FX-SHO/FZR/FZS fuel pumps arrive complete with Yamaha FX-SHO/FZR/FZS model specific installation instructions complete with detailed photos that will help make the fuel pump installation quick and easy.

*NOTE: There are no modifications necessary to install the R&D fuel pump therefore switching back to the O.E.M. fuel pump assembly is quick and easy as well.*

Description	Part No.
R&D FX-SHO/FZR/FZS 190 LPH OEM Replacement Fuel Pump Kit	812-35190
R&D FX-SHO/FZR/FZS 255 LPH Low Pressure Fuel Pump Kit	812-35255
R&D FX-SHO/FZR/FZS 255 LPH High Pressure Fuel Pump Kit	812-35256

# YAMAHA FX-SHO & FX CRUISER SHO • RPM KITS • ENGINE



## RIVA RACING RPM KIT • FX-SHO PART #RY-RPM-FXSHO

STOCK FX-SHO AVG. SPEED • 65 MPH @ 7,450 RPM  
RPM KIT • 68 MPH @ 7,500 RPM  
ALL TESTING WAS PERFORMED WITH 1/3 TANK OF FUEL.

Description	Quantity	Part No.
RIVA FX-SHO Performance Power Filter Kit	1	RY13040
RIVA FX-SHO Free Flow Exhaust Kit	1	RY16040
RIVA FX-SHO Top-Loader Intake Grate	1	RY22040
RIVA FX-SHO Performance Ride Plate	1	RY21040
RIVA FX-SHO Pro-Series Sponson Kit	1	RY2625

Additional Performance Upgrades available:

Description	Quantity	Part No.
RIVA Intake Manifold Upgrade Kit	1	RY12040-IMUK

\*Riva Racing Stage 1 Kit Coming Soon



## SCEPTER FLEXIBLE FUNNEL

Scepter's flexible funnel is perfect for all your PWC uses and really helps perform those difficult maintenance and repair applications. Manufactured from quality, high density polymers: the funnel won't rust, dent, or crack. This means no drips and leaks for you to clean up after your done. The funnel length is 18".

Description	Part No.
Scepter 18" Flexible Funnel	MRO3603



## NGK SPECIAL SPARK PLUGS FOR FOUR STROKE ENGINES

Description	Part No.
Yamaha FX SHO/FX Cruiser SHO/FZR (10 plugs per box)	LFR6A



## PERFORMANCE GOLD OIL FILTER

- 1-inch nut easy-on/easy wrench-off
- Drilled safety wire holes for racing
- Heavy-duty construction
- Premium filter media provides outstanding filtration at high-flow rates

Description	OEM#	Part No.
All Yamaha Four Stroke	59H-1344-0-00-00	KN303



## MOELLER MARINE PRODUCTS FLUID EXTRACTOR

- Empties oil in 15 pumps or less
- Extracts warm or cold oil
- Single-hand-ease effortless operation
- Tethered cap
- Pressure relief valve allows easy transportation and storage
- Delivers gulp-free, mess-free performance
- Complete adapter kit is included featuring three extraction tubes

Description	Part No.
Moeller Oil Extractor (6.5 Liter Fluid Extractor)	MR07398

\*Note: Not for use with gasoline.

USA Patent #5450924 Germany Patent #29500683.8 U.K. Patent #2272948  
Australia Patent #674469 Taiwan Patent #113238 China Patent #ZL92241981.7



## FX-SHO/FZR/FZS ENGINE SHIMS

Engine shims are essential for precise engine alignment. R&D Engine Shims have a tab that provides easy insertion and removal. Shims are made of stainless steel and have etched numbers to identify thickness. Shims available in thickness of .010", .020", .050", .100"

Description	Thickness	Part No.
FX-SHO/FZR/FZS Engine Shims	.010"	050-00010
FX-SHO/FZR/FZS Engine Shims	.020"	050-00020
FX-SHO/FZR/FZS Engine Shims	.050"	050-00050
FX-SHO/FZR/FZS Engine Shims	.100"	050-00100

YAMAHA  
4 STROKE  
INATKE SYSTEMS  
ENGINE/GASKETS  
EXHAUST  
DRIVE LINE HANDLING  
ELECTRICAL  
WATERLINE /BILGE  
STEERING & CONTROLS  
BODY  
ACCESSORIES  
SERVICE TOOLS /HARDWARE  
CHEMICAL

# YAMAHA FX-SHO & FX CRUISER SHO • CONTROL

YAMAHA  
4 STROKE

INTAKE  
SYSTEMS

ENGINE/  
GASKETS

EXHAUST

DRIVE LINE  
HANDLING

ELECTRICAL

WATERLINE  
/BILGE

STEERING  
& CONTROLS

BODY

ACCESSORIES

SERVICE TOOLS  
/HARDWARE

CHEMICAL



FX SHO  
112-18000



FZR  
112-18001

## R&D FX SHO & FZR AQUAVEIN INTAKE GRATE

Description	Part No.
R&D Yamaha FX SHO Aquavein Intake Grate	112-18000
R&D Yamaha FZR Aquavein Intake Grate	112-18001



## RIVA YAMAHA FX-SHO FZR/FZS INTAKE GRATE

Riva's Top-Loader intake grate improves hook up and handling in rough conditions. Center wing eliminates prop spin and cavitation found with the stock grate along with the SHO's tendency to drop on its nose

when the throttle is let off at high speeds. Powder coated to prevent corrosion.

Description	Part No.
Riva Yamaha FX-SHO Intake Grate	RY22040
Riva Yamaha FZR/FZS Intake Grate	RY22050



FX SHO  
122-18000

## R&D HIGH PERFORMANCE RIDE PLATE

The new R&D SHO Pro Series Ride Plate will meet the demands in performance whether being used for weekend recreational riding, closed course racing, or offshore competition. Increased top speed performance of .50 to 1 MPH over stock, and compromises nothing when turned loose in rough water conditions. Bow search with full fuel loads is alleviated completely.

- 1 MPH top speed improvement
- Improved straight line stability
- Reduced chine walking on high speed sweepers
- Drives through chop with superior stability
- Retains reverse gate mounting and operation
- Unique multi-step concept
- Significantly improved cornering

Description	Part No.
R&D FX SHO High Performance Ride Plate	122-18000
R&D FZR High Performance Ride Plate	122-18001



## WORX RACING YAMAHA SPONSONS

Fitting WORX sponsons provide unbelievable cornering, better control in the rough and predictable inline tracking while towing wakeboards or waterskiers. WORX sponsons are easy to fit, look great and bolt right into stock mounting holes.

Description	Part No.
Worx Yamaha FX SHO Sponsons Kit	WR542
Worx Yamaha FZR/FZS Sponsons Kit	WR543



## RIVA YAMAHA FX-SHO PERFORMANCE RIDE PLATE

Our Performance Ride Plate for the new SHO improves top speed and reduces porpoising.

Unique design provides quicker planing and improved handling. Compatible with OEM speedo sender. Power coated to prevent corrosion.

Description	Part No.
Riva Yamaha FX-SHO Performance Ride Plate	RY21040



## R&D YAMAHA FX-SHO/FZR/FZS SPONSON KIT

The new R&D Yamaha SHO Pro Series Sponson Kit was designed and developed with all new generation performance concepts in

mind to deliver a whole new level of handling and speed performance with offshore and closed course race proven adjustability options. The R&D Pro Series Sponson Kits have been extensively offshore, race track, and 1 and 2 up recreational tested to guarantee a comfortable setting for any riding style or condition! The R&D Sponson Kit will deliver higher top speed performance and a much smoother and more predictable ride over O.E.M. sponsons. Low speed and high-speed turns are a breeze with new found control. The secret to R&D's new generation concept is in the backing plate design with an after-market first, low pressure, low friction concept that breaks up and relieves speed robbing drag within the sponson's backing plate channel. The new R&D design staggers the sponson blades fins water trapping area to pick up less water in the front and more in the back. The stagger/step-up concept greatly reduces chine walk in high speed corners, while allowing more rear end grip. There is also a higher end recreational/race setting with enough grip for the best of pro's! Finally there is an aftermarket sponson kit that really does it all! More top speed due to less drag, less chine walking, racer preferred rear end grip, and unmatched straight line stability.

Description	Part No.
R&D FX-SHO Sponson Kit	122-01800
R&D FX FZR/FZS Sponson Kit	122-01801



## RIVA YAMAHA FX-SHO/FZR/FZS/VX SPONSON KIT

Unique blade design provides a significant improvement to the handling characteristics. Reduces rough water hunting and rolling sometimes experienced with stock

sponsons. Sponson depth is adjustable to control the amount of influence they have on craft. Easily installs to stock mounting points with our bulletproof mounting system that features billet inserts in sponson fins. Fits all Yamaha FX-SHO, FZR, FZS & VX models.

Description	Part No.
Riva Yamaha FX-SHO/FZR/FZS/VX Sponsons Kit	RY2625

# YAMAHA FX-SHO & FX CRUISER SHO • CONTROL



## R&D SHO PUMP SEAL KIT

R&D's new pump seal kit for the SHO stuffs up all the unwanted cavities in the pump shoe that aid in producing cavitation. This kit offers a way to seal the pump shoe, which will reduce cavitation and

increase pump efficiency and performance.

Description	Part No.
R&D FX SHO Pump Seal Kit for OEM Intake Grate	162-00003
R&D FX SHO Pump Seal Kit for Riva Racing Intake Grate	162-00004
R&D FX SHO Pump Seal Kit for R&D Aquavein Intake Grate	162-00005
R&D FZR Pump Seal Kit for OEM Intake Grate	162-00006
R&D FZR Pump Seal Kit for R&D Aquavein Intake Grate	162-00007

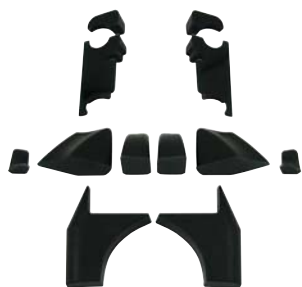

## RIVA FX-SHO PUMP SEAL KIT

Dramatically reduce cavitation and prop spin with our easy to install Pump Seal Kit. Location specific, molded inserts fill the voids in intake grate that can bleed air into pump causing cavitation. Specifically designed for craft using RIVA FX-SHO intake grate (part# RY22040). Includes detailed installation instructions.

Description	Part No.
Riva FX-SHO Pump Seal Kit for Riva Intake Grate	RY25040
Riva FZR/FZS Pump Seal Kit for Riva Intake Grate	RY25050



## R&D FX-SHO/FZR/FZS ANTI-CAVITATION CONE

The R&D FX-SHO/FZR/FZS Anti-Cavitation Pump Cone Kit will reduce overall internal pump cavitation within the Yamaha's offset reduction/compression nozzle design. The O.E.M. reduction/compression nozzle is offset, while the O.E.M. pump cone/bearing cap remains straight which causes uneven pressures within the pump

and reduction nozzle. The R&D Anti-Cavitation Pump Cone is offset and reshaped to match the O.E.M. reduction nozzle offset promoting even pressures, which will substantially reduce cavitation, increase pump hook up, boost acceleration, and increase top speed performance.

Description	Part No.
R&D FX-SHO/FZR/FZS Anti-Cavitation Cone	162-18000



## FX-SHO/FZR/FZS IMPELLER SHAFT HOLDER TOOL

Developed specifically for the FX-SHO/FZR/FZS watercraft, this tool is required to change the impeller.

Description	Part No.
FX-SHO/FZR/FZS Impeller Tool	TOOL #53



## R&D FX-SHO/FZR/FZS AUTO TRIM NOZZLE KIT

The R&D FX-SHO/FZR/FZS Auto Trim Kit was developed to accommodate the O.E.M. VTS Quick Shift System with a fully adjustable and fully automatic trim system! The R&D Auto Trim automatically

drops a rider preferred and adjustable 2-8 degrees. Drive from turn to turn never worrying whether the trim is in the best position for perfect turn negotiation! The R&D Auto Trim allows you to set the trim up your way to carve perfect turn every time! For long straight rides the R&D Auto Trim System works in conjunction with O.E.M VTS, so stock trim settings are retained, while the R&D Auto Trim takes over in the turns. The combination allows the best of both worlds for recreational and closed course riding!

Description	Part No.
R&D FX-SHO/FZR/FZS Auto Trim Nozzle Kit	162-18020



## R&D FX-SHO/FZR/FZS HYDRO FORCE STEERING NOZZLE

R&D's new Hydro Force Steering Nozzle for the FX-SHO/FZR/FZS is a direct replacement nozzle. The new lengthened design delivers a full 1 MPH speed gain over stock.

The adjustable pivot position improves the turning radius allowing you to carve tighter turns with a more positive feel. Improved performance through speed, acceleration and handling.

Description	Part No.
R&D FX-SHO/FZR/FZS Hydro Force Steering Nozzle	162-14000



## R&D FX-SHO/FZR/FZS VTS QUICK SHIFT CAM KIT

The R&D FX-SHO/FZR/FZS VTS Trim Driver Cam is a cam device that installs directly in

place of the O.E.M. plastic VTS trim driver cam. The R&D cam is designed to recalibrate the trim position amount from an O.E.M. 7 to 8 degree per shift to a finer and speed friendly 4 degree per shift. The O.E.M. SHO neutral position setting is 85 degree or 5 degree up from horizontal zero. The new recalibrated position with the new R&D Trim Cam is 87.5 degrees or 2.5 degree up from horizontal zero. The R&D Trim Cam will deliver a more positive group of adjustments that will allow much better turning capabilities, as well as finer adjustments for rough water conditions. The R&D Trim Cam will work with the O.E.M. trim nozzle assembly, or the R&D Auto Trim Kit.

Description	Part No.
R&D FX-SHO/FZR/FZS VTS Trim Driver Cam Kit	162-18010

## FX SHO SKAT TRAK IMPELLERS 155-75-25 SWIRL W/BILLET NOSE BOOT

11/19 for a stock SHO application  
12/20 for a stock stage 1 application  
13/23 for a SHO stage 2

Imp. Pitch	Part No.	Imp. Pitch	Part No.
11/19	SY557525SW1119	13/23	SY557525SW1323
12/20	SY557525SW1220	13/24	SY557525SW1324
13/21	SY557525SW1321	13/25	SY557525SW1325
13/22	SY557525SW1322		

4 STROKE	YAMAHA
SYSTEMS	INATKE
GASKETS	ENGINE/
	EXHAUST
HANDLING	DRIVE LINE
ELECTRICAL	ELECTRICAL
WATERLINE	WATERLINE
& CONTROLS	STEERING
BODY	BODY
ACCESSORIES	ACCESSORIES
SERVICE TOOLS	SERVICE TOOLS
HARDWARE	HARDWARE
CHEMICAL	CHEMICAL

# YAMAHA FX-SHO & FX CRUISER SHO • ENGINE PERFORMANCE KITS

## R&D FZR/SHO PERFORMER ENGINE KIT PARTS RECOMMENDATION

Stock 67 mph @ 7600rpm  
R&D Performer Engine Kit 70-71 mph @ 7700 rpm / 8.5lbs boost @ 7700

### R&D FZR/SHO Performer Engine Kit Includes:

R&D Power Plenum Filter Pt# 200-01801  
R&D C1 Monster Wheel Pt# 612-25001  
R&D Intercooler CFM Kit Pt# 612-17999  
R&D Intercooler Cooling Kit Pt# 660-18000  
13/24 Pitch Prop Pt# SY557525SW1324 for FZR\* or 13/23 Pitch Prop Pt#SY557525SW1323 for the SHO

The R&D FZR/SHO Performer Engine Kit was specifically developed to produce low end horsepower and increase top speed performance while maintaining 100% reliability using 91 octane pump gas and the stock ECU and fuel system. This kit delivers power and speed you are looking for, without difficult and expensive aftermarket ECU and valve train up-grades. The results are impressive, the increased boost pressure added by the popular R&D C1-11 Monster Compressor Wheel delivers improved acceleration and top speed performance. The Power Plenum Air filter ensures that a massive amount of unrestricted filtered air is delivered to the C1-11 Compressor Wheel. The R&D Power Core intake sleeve and Intercooler CFM Kit will allow the increased air flow and boost into the intake system with less restriction. The R&D Intercooler Cooling Kit adds cooling capability through more water flow to the OEM intercooler. Decreasing intake air temperature improves horsepower. \* The 13/24 Pitch prop is specifically designed to deliver maximum hook up while keeping increased RPM's at safe and reliable levels for FZR applications. At R&D, reliability is always important. At our test center we have been developing and testing this kit for about 1 year. We felt it was time to prove the Performer Kits reliability. So we entered it in the 2009 Mark Hahn 300 Mile Endurance Race. The race conditions were grueling and continuous for 6 straight hours. We are proud to announce that not only did the Performer Kit finish the race, it also took first in class. If pump gas performance at an economic price is what you are in the market for, look no further. Dollar for dollar no other kit compares to the R&D Performer Engine kit.

- 3-4 mph Speed Gain
- 8.5 lbs boost @ 7700rpm
- Endurance Race Tested
- 30 Horsepower Gain
- Dollar for Dollar Best Performance

NOTE: The R&D Performer Kit data, and speed information posted was data logged on the water after an initial warm-up to stabilize engine temperatures. All testing was performed exclusively with Chevron 91 octane pump gasoline at 500 feet above sea level. Ambient air temperature during testing was 90-100 degrees, with under seat temp. of 150 degrees.

### Optional Performance parts:

Powershot - Enables fuel tuning and overrides boost limiter Pt# 802-18050  
Performance Intercooler Power Core Kit - Increases intercooler cooling capability Pt# 612-18001  
R&D Aquavein Intake Grate Pt# 112-18000 for SHO - Pt# 112-18001 for FZR  
R&D Pump Shoe Seal Kit Pt# 162-00004 for SHO - Pt# 162-00007 for FZR  
R&D Ride Plate Pt# 122-18000 for SHO - Pt# 122-18001 for FZR  
R&D Anti-cavitation Cone Pt# 162-18000  
R&D Auto Trim Nozzle Pt# 162-18010  
R&D Sponsons Pt# 122-01800 for SHO  
- Pt# 122-01801 for FZR

## R&D FZR/SHO STAGE 1 ENGINE KIT PARTS RECOMMENDATION

Stock 67 mph @ 7600rpm  
R&D Stage 1 Engine Kit 71-72 mph @ 7700rpm / 10lbs boost @ 7700

### R&D FZR/SHO Stage 1 Engine Kit Includes:

R&D Power Plenum Filter Pt# 200-01801  
R&D C3 Monster Wheel Pt# 612-25003  
R&D High Performance R4 Intercooler kit with Surge BOV Pt# 612-18002  
R&D Powershot Fuel tuner & Boost Override Pt# 802-18000  
13/25 Pitch Prop Pt# SY557525SW1325  
R&D Multi- pressure Port Boost Gauge Adaptor Pt#612-92005

The R&D FZR/SHO Stage 1 Engine Kit was specifically developed to produce low end horsepower and increase top speed performance while maintaining 100% reliability using 91 octane pump gas and the stock ECU and fuel system. This kit delivers the maximum power and speed that the OEM ECU will allow, without difficult and expensive aftermarket ECU and valve train up-grades. The results are extremely impressive for a bolt-on kit. The increased boost pressure added by the R&D C3-11 Monster Compressor Wheel delivers massive acceleration and top speed performance. The R&D Power Plenum Air Filter was designed and developed exclusively for the new Yamaha supercharged intake system. Engineered with an oversized 6"x10"x6" plenum to deliver the cubic air volume needed to the R&D C3-11 Monster Compressor Wheel. The R&D High Performance R4 Intercooler Cooling Kit delivers the cooling and CFM capability to produce maximum horsepower with the C3-11 Compressor Wheel Kit. Decreasing intake air temperature and removing intake air restrictions improves horsepower. The R&D Powershot Fuel tuner will enable precise fuel tuning while interfacing with the ECU to allow the C3 Monster Supercharger Wheel to perform to full boost potential by defending against unwanted codes and internal E.C.U. limitations. The R&D 13/25 Pro Pitch prop is specifically designed to deliver maximum hook up while keeping increased RPM's at safe and reliable levels. The R&D Multi-pressure Port Boost Adaptor will enable bolt-on installation of a boost gauge and also provide an easy install to operate the surge blow off valve on the R4 Intercooler.

- 4-5 mph Speed Gain
- 10 lbs boost @ 7700rpm
- Endurance Race Tested (Mark Hahn 300)
- 50 Horsepower Gain

NOTE: The R&D Performer Kit data, and speed information posted was data logged on the water after an initial warm-up to stabilize engine temperatures. All testing was performed exclusively with Chevron 91 octane pump gasoline at 500 feet above sea level. Ambient air temperature during testing was 90-100 degrees, with under seat temp. of 150 degrees.

### Optional Performance parts:

R&D Aquavein Intake Grate Pt# 112-18000 for SHO - Pt# 112-18001 for FZR  
R&D Pump Shoe Seal Kit Pt# 162-00004 for SHO - Pt# 162-00007 for FZR  
R&D Ride Plate Pt# 122-18000 for SHO - Pt# 122-18001 for FZR  
R&D Anti-cavitation cone Pt# 162-18000  
R&D Sponsons Pt# 122-01800 for SHO - Pt# 122-01801 for FZR  
R&D Auto Trim Nozzle Pt# 162-18010  
R&D Free Flow Exhaust Kit Pt# 332-18000



YAMAHA  
4 STROKE  
INTAKE  
SYSTEMS  
ENGINE/  
GASKETS  
EXHAUST  
DRIVE LINE  
HANDLING  
ELECTRICAL  
WATERLINE  
/BILGE  
STEERING  
& CONTROLS  
BODY  
ACCESSORIES  
SERVICE TOOLS  
/HARDWARE  
CHEMICAL



# YAMAHA FX-SHO & FX CRUISER SHO • SEAT COVERS • MATS



**FX SHO**  
Part # SEWFX1

**FX SHO Cruiser**  
Part # SEWFX1C



**FX FZR**  
Part # SEWFZR



**FX FZS**  
Part # SEWFZS

## HYDROTURF FX SHO, FZR & FZS SEAT COVER

Nice clean lines. Looks great in a simple Dark Gray Carbon Fiber and Black Vinyl combination or you can use our pattern to create your own color scheme. Choose from all our vinyl, carbon fiber, non-slip and metallic fabrics. Note: All seat covers are custom made. There are no refunds or exchanges on any upholstery items. Color swatches will be sent to you upon request prior to placing your order.

Description	Part No.
Hydroturf Yamaha FX SHO Seat Cover	SEWFX1
Hydroturf Yamaha FX SHO Cruiser Seat Cover	SEWFX1C
Hydroturf Yamaha FX FZR (09) Seat Cover	SEWFZR
Hydroturf Yamaha FX FZS (09) Seat Cover	SEWFZS



## HYDROTURF MAT KIT FOR YAMAHA FZR, FZS & FX SHO

Description	Part No.
Hydroturf Mat FX SHO (08) FX Cruiser (08), FZR (09), FZS (09)	HTFX1

08-09 FX SHO Part # YSHO101



08 FX SHO Part # YSHO101



09 FZR Spike Design Part # YFZR101



09 FZR Retro Design Part # YFZR102



09 FZS Retro Design  
Part # YFZS101



09 FZS Spike Design  
Part # YFZS102

## JETTRIM YAMAHA SEAT COVER

Jet Trim seats covers are developed to the highest performance standards and design trends for the PWC industry.

Description	Part No.
Jettrim Yamaha FX SHO Custom Seat Cover	YSHO101
Jettrim Yamaha FZR Spike Design Custom Seat Cover	YFZR101
Jettrim Yamaha FZR Spike Retro Custom Seat Cover	YFZR102
Jettrim Yamaha FZS Spike Retro Custom Seat Cover	YFZS101
Jettrim Yamaha FZS Spike Design Custom Seat Cover	YFZS102

\*Note: Jet Trim Seat cover for FX SHO Cruiser is currently not available.



4 STROKE	YAMAHA
INATKE SYSTEMS	INATKE
GASKETS	ENGINE/ GASKETS
EXHAUST	EXHAUST
HANDLING	DRIVE LINE HANDLING
ELECTRICAL	ELECTRICAL
WATERLINE /BILGE	WATERLINE /BILGE
STEERING & CONTROLS	STEERING & CONTROLS
BODY	BODY
ACCESSORIES	ACCESSORIES
SERVICE TOOLS /HARDWARE	SERVICE TOOLS /HARDWARE
CHEMICAL	CHEMICAL

# ULTRA 250X/260X • AIR INTAKE SYSTEMS



## R&D KAWASAKI ULTRA 250X HIGH PERFORMANCE AIR INTAKE SYSTEMS

The R&D high performance Air Filter Kit will improve acceleration and top speed performance by increasing air flow and reducing air temperatures that enter directly into the Ultra 250X's air plenum box area. The O.E.M. air plenum box on the Ultra 250X is a great design that will flow plenty of air. However, the air that feeds the plenum box is heated by the engine. R&D has created an easy to install "flat filter" that installs directly in place of the large center access inspection cover located directly under the main glove box. The R&D Flat Air Filter insert will allow unrestricted fresh and cool air to enter the air plenum box area which will add power you can feel and a nice high performance tone. The R&D Performance Filter Kit also features

two filters, one for each of the surge and blowoff protections valves. The O.E.M. surge valve recycles compressed hot air back into the air box plenum at idle and under deceleration conditions. The R&D surge and blowoff valve filter kit removes the air recycling hoses which will keep the hot air from entering the air plenum box reducing the engines intake air temperatures. The R&D Ultra 250X Air Filter Kit offers great performance tips on how to remove the restrictive air vent hoses which will further reduce the under seat ambient air temperatures. The R&D Filter system does not remove or alter the O.E.M. plenum box in any way, therefore there are no questions to be answered regarding water ingestion!

The R&D Filter Kit is easy to install with no modifications required to the O.E.M. parts. IJSBA legal for all classes.

Description	Part No.
R&D Ultra 250X Cool Air Intake Kit (A & B)	215-25000
<i>This kit consists of one of each 215-25001 &amp; 215-24999</i>	
R&D Ultra 250X Surge and Blowoff (A) Valve Air Filter Kit Only (2 pieces)	215-25001
R&D Ultra 250X Cool Air Intake Flat Filter Only (B)	215-24999

## RIVA RACING KAWASAKI ULTRA 250X HIGH PERFORMANCE AIR INTAKE SYSTEMS



① Replacement Glove Tray      ② Power Filter Cover

## RIVA ULTRA 250X PRO-SERIES POWER FILTER KIT

Ultra 250X Pro-Series Power Filter Kit is a race-bred air intake system that draws cool air from outside your engine compartment delivering awesome performance and eliminating power-robbing heat intake. Air enters the system under the glove box area through an oversized K&N air filter that is protected by a composite cover to prevent water intrusion. Air is fed to the supercharger via a large 4" diameter intake duct. Ducting is precision formed from a race proven composite that will not conduct heat into incoming air. Includes replacement glove box tray & water-repellent pre-filter. Not stock legal with IJSBA or APBA.

Description	Part No.
Riva Racing Ultra 250X Pro-service Power Filter Kit	RK13096



## RIVA ULTRA 250X PERFORMANCE POWER FILTER KIT

ULTRA 250X Performance Power Filter Kit:  
Delivers greatly improved acceleration and increased top speed by replacing the restrictive stock intake system. The Power Filter feeds your supercharger with an increased volume of air via a large 4" diameter intake duct and oversized K&N filter element. Ducting is precision formed from a race proven composite that will not conduct heat to incoming air. Includes water-repellent pre-filter. IJSBA legal for all classes.

Description	Part No.
Riva Racing Ultra 250X Performance Power Filter Kit	RK13090



## RIVA ULTRA 250X BYPASS UPGRADE KIT

Easy to install Bypass Upgrade Kit contains all parts necessary to redirect hot air from the engine's bypass valves and crankcase vent; eliminating power-robbing engine emissions from entering your air intake system. Kit includes fitted K&N filters for bypass & blow-off valves and crankcase vent. Designed to work with both RIVA Pro-Series & Performance Power Filter Kits for Ultra 250X.

Description	Part No.
Riva Racing Ultra 250X Bypass Upgrade Kit	RK1750-BPUK



## R&D ULTRA 250X ENGINE PERFORMER KIT PART #611-24349

STOCK ULTRA 250X AVG. SPEED • 65.5-66 MPH @ 7600-7700 RPM  
STAGE 1 PERFORMANCE KIT • 72-72.5 MPH @ 8050-8100 RPM

The R&D Performer Engine Kit Option will add a great boost in overall power. Increased low end and mid range response and acceleration, as well as a solid 2 MPH gain in top speed performance. The R&D Performer Engine Kit will deliver more horsepower reliably with the properly matched fuel control component parts only available through R&D. The R&D Performer Engine Kit will perform excellent in all recreational riding conditions using 91 octane pump gasoline.

The R&D Performer Engine Kit consists of:

Description	Page	Part No.
R&D Tensioner Wheel	6	611-25000
R&D 1 to 1 Supercharger Wheel	6	611-25011
R&D Powershot	3	801-25000
R&D 255 Low Pressure Fuel Pump	5	811-25255
R&D Fuel Pump Installation Tool	5	811-25257



## R&D ULTRA 250X POWERSHOT ADJUSTABLE FUEL TUNER

Ultra 250 PowerShot Adjustable Fuel Tuner: The R&D Powershot fuel injection tuner will deliver increased horsepower, acceleration,

and stronger mid-range performance by delivering a higher performing Air to Fuel Ratio (A.F.R.) to engine. Many of today's high performance fuel injected four stroke muscle craft have a lean A.F.R. R&D Performance has tested, documented, and analyzed the O.E.M fuel maps on every current fuel injected four stroke watercraft, and pre-programmed and coded the new R&D Powershot fuel injection control module to safely alter the O.E.M. fuel map to a higher performing and safer A.F.R. (richer). More horsepower, greater acceleration and stronger mid-range are the result when the proper A.F.R. is achieved and is tuned for optimum performance.

The R&D Powershot is fully adjustable on the fly (with the engine running, observed and tuned while riding), and will accommodate a wide range of adjustability to properly performance tune the A.F.R. for any combination of aftermarket parts. The R&D Powershot will add horsepower, reliability, and adjustability to any electronic fuel injected two or four stroke personal watercraft engine.

Description	Part No.
R&D Ultra 250X Powershot Adjustable Fuel Tuner	801-25000



## R&D ULTRA 250X ENGINE STAGE 1 PERFORMANCE KIT PART #611-24350

STOCK ULTRA 250X AVG. SPEED • 65.5-66 mph @ 7600-7700 RPM  
STAGE 1 PERFORMANCE KIT • 73 mph @ 8100-8150 RPM

The R&D Stage 1 Engine Kit will massively increase low end, mid range response and acceleration with a top speed performance of 73 mph (combined with a R&D Performer kit). The R&D Stage 1 Engine Kit will deliver more horsepower reliably with the properly matched fuel control component parts only available through R&D. The R&D Stage 1 Engine Kit will perform excellent in all recreational riding conditions using 91 octane pump gasoline.

The R&D Performer Engine Kit consists of:

Description	Page	Part No.
R&D Tensioner Wheel	6	611-25000
R&D 1 to 1 Supercharger Wheel*	6	611-25011
<i>*Recommend to use with 611-25001 Billet Hub Kit</i>		
R&D Fuel Rail Fitting	4	611-27500
R&D Bulkhead Fitting	4	611-27501
R&D Fuel Line Rail to Regulator	4	611-27513
R&D Fuel Line Regulator to Tank	4	611-27514
R&D Fuel Pressure Gauge Adapter	4	611-27517
R&D Powershot	3	801-25000
R&D Fuel Pressure Regulator	4	801-25010
R&D Fuel Pressure Regulator	4	801-25011
Mounting Bracket		
R&D 625cc High Flow Fuel Injector Kit *Use with the stock OEM fuel pump		811-25000**

\*\*The R&D 625cc High Flow Fuel Pump #811-25000 is not sold separately - it is only available in Performance Kit #611-24350

KAWASAKI  
4 STROKE

INATKE  
SYSTEMS

ENGINE/  
GASKETS

EXHAUST

DRIVE LINE  
HANDLING

ELECTRICAL

WATERLINE  
/BILGE

STEERING  
& CONTROLS

BODY

ACCESSORIES

SERVICE TOOLS  
/HARDWARE

CHEMICAL

KAWASAKI  
4 STROKE

INTAKE  
SYSTEMS

ENGINE/  
GASKETS

EXHAUST

DRIVE LINE  
HANDLING

ELECTRICAL

WATERLINE  
/BILGE

STEERING  
& CONTROLS

BODY

ACCESSORIES

SERVICE TOOLS  
/HARDWARE

CHEMICAL

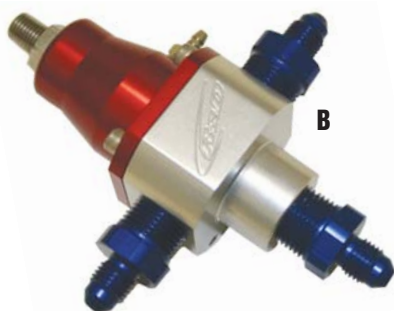

## R&D UNIVERSAL FUEL PRESSURE REGULATOR

Universal bypass fuel pressure regulator for carbureted or EFI fuel systems applications. Base fuel pressure is adjustable from 20 to 60 PSI with high pressure spring

(installed). Ideal for carbureted and EFI bypass applications where more flow and superior pressure control are desired. R&D offers two types of fuel pressure regulator set ups. Part #801-25010 will come completely assembled with #4 fittings ready for R&D custom hoses with #4 AN fittings for a nice high performance hot rod look. Part #801-25009 will have brass 3/8" to 1/4" barb 90 degree fittings installed for use with push on type hose and Otekiei style clamps for security. R&D offers a high performance Coast Guard approved fuel hose that can be purchased by the foot (Part #611-27502), as well as the Otekiei style clamps (Part #611-27518).

The universal type bypass style regulator is capable of handling any fuel pump up to 250 GPH. Replace "Deadhead" regulator performance and experience full flow volume and steady fuel pressure.

R&D offers a mounting bracket (Part #801-25011) that specifically mounts the fuel pressure regulator on top of the inner cooler. This location allows the R&D custom fuel lines to route perfectly.

Description	Part No.
A. R&D Fuel Pressure Regulator Barb Style	801-25009
B. R&D Fuel Pressure Regulator AN Style (pictured above)	801-25010
C. R&D Ultra 250X Mounting Bracket for Fuel Pressure Regulator	801-25011



## R&D ULTRA 250X FUEL LINE KITS

R&D fuel lines are produced using high performance billet anodized AN fittings coupled to Type A SAE J 1527 US Coast Guard Approved fuel line. All Ultra 250 fuel lines are cut to

specific length and pre-assembled to ensure a perfect seal, custom fit, and that awesome hot rod look.

Description	Part No.
Rail to Regulator	611-27513
Regulator to Tank w/Standard Tank Bulkhead Fitting Kit	611-27514
Regulator to Tank w/ Standard Tank Vent Fitting	611-27515
Regulator to Fuel Gauge	611-27516
Type A SAE J 1527 US Coast Guard Approved	611-27502
1/4" Fuel Line - Sold per foot.	
1/2" Otekiei Style Clamps	611-27518



## R&D ULTRA 250X FUEL GAUGE ADAPTER FOR TESTING AND TUNING

R&D Fuel Gauge Adapter allows you to mount the fuel pressure gauge directly to the fuel pressure regulator.

Description	Part No.
R&D Ultra 250X Fuel Gauge Adapter <i>*Sold by the set only</i>	611-27517

### BARB STYLE



611-27499

### AN STYLE



611-27500

## R&D ULTRA 250X FUEL RAIL RETURN LINE ADAPTER FITTING

R&D offers a unique Fuel Rail Return Line Adapter fitting which will allow quick and easy connections of high performance fuel pressure regulators or fuel pressure gauges. The R&D Fuel Rail Fitting has the O.E.M. tapered metric thread pitch for easy bolt on assembly (no tapping required) installation. The R&D Fitting is available in two types, part number 611-27499 for barb type push on hose connections, and part number 611-27500 for #4 AN type connections. R&D has complete line up of fuel pressure regulators, fuel gauge and fuel hose accessories, all that meet I.J.S.B.A. and APBA

Description	Part No.
Barb Style (Fuel rail fitting)	611-27499
AN Style (Fuel rail fitting)	611-27500



## R&D UNIVERSAL #4 AN FUEL RETURN LINE FITTING ADAPTER KIT

The R&D Universal Fuel Return Line Adapter Fitting can be installed into the top of any fuel tap assembly by finding a clear area on top of the fuel tap system large enough to install the fitting. Drill a 15/32 or #56 (.468) drill size hole and install the fitting using the kit supplied aluminum seal washer on each side of the fitting. The R&D universal fuel return fitting kit is the safest and cleanest way to properly install a fuel return to the top of any make or model fuel tap assembly. Kit comes with one #4 AN bulkhead fitting, one #4 AN bulkhead nut, and two #4 AN 7/16" Aluminum washers.

Description	Part No.
R&D Universal #4 AN Style Fuel Return Line Adapter Kit	611-27501



## R&D ULTRA 250X DEEP FUEL PICKUP



The R&D Deep Fuel Pickup is designed to maximize fuel volume. The stock fuel pickup is located horizontally in the gas tank three inches above the bottom of the tank. This leaves approximately 5 gallons of unusable fuel in the bottom of the tank. The R&D Deep Fuel Pickup

relocates the stock fuel pickup to the bottom of the tank in a vertical position. The new positioning allows for 24 percent more riding time per tank of gas. The deep fuel pickup is an absolute must for offshore racing.

Description	Part No.
R&D Ultra 250X/LX Deep Fuel Pick Up	801-25100

# ULTRA 250X/260X • FUEL PUMP



## R&D UNIVERSAL HIGH PERFORMANCE HIGH VOLUME FUEL PUMP KITS FOR ULTRA 250X

All R&D fuel pumps have been precision flow rate tested and charted in (LPH) liters per hour. R&D fuel pumps

arrive complete with terminal connectors for both the new high performance pumps quick connect installation, as well as extra terminal connector parts for the O.E.M. pump for use when converting back to stock. The R&D quick connect terminals help make fuel pump testing easy when switching from a low pressure to a high pressure fuel pump.

Description	Part No.
R&D 190 LPH (Liter Per Hour) Low Pressure Fuel Pump Kit (O.E.M. Replacement)	811-25190
R&D 255 LPH (Liter Per Hour) Low Pressure Fuel Pump Kit (Performer Kit)	811-25255
R&D 255 LPH (Liter Per Hour) High Pressure Fuel Pump Kit (400hp aftermarket supercharger)	811-25256
R&D Fuel Pump Swedge Tool*	811-25257

\*NOTE: R&D High Performance fuel pumps are .040 larger than O.E.M. Mitsubishi fuel pumps on Yamaha's and Kawasaki's, therefore it may be necessary to use the R&D Fuel Pump swedge tool to enlarge the fuel pump housing for easy installation.



## R&D ULTRA 250X AIR/FUEL RATIO KIT

Professionally tune your engine with complete confidence. The LC-1 is more accurate than conventional designs, and its self-calibrating circuitry can compensate for changes in temperature,

altitude and sensor condition. The LC-1 is ideal for applications such as Dynos, Data Acquisition, Standalone ECUs, piggyback fuel controllers, OBD-II software or chip programmers, and gauges. This Innovate kit comes complete with the patented award-winning LC-1 Wideband Controller with a sealed cable, DB-Blue digital Gauge, Bosch 5-wire Wideband O2 Sensor, Bung/Plug Kit, Software CD, and quick start guide.

Description	Part No.
R&D Ultra 250X Air/Fuel Ratio Kit	900-04378



## R&D ULTRA 250X FUEL PRESSURE GAUGE

R&D offers the Autogage fuel pressure gauge gives the best reference in verifying and monitoring fuel pressure precisely on any supercharged or boosted engine. 0 to 100 psi.

Description	Part No.
R&D Ultra 250X Fuel Pressure Gauge	900-02180



## R&D AUTOMETER 0-35 PSI UNIVERSAL BOOST GAUGE

R&D offers the Autometer Ultra-Lite Series 2" mechanical boost gauge to give the best reference in verifying and monitoring boost levels precisely.

Installing a precision boost gauge is the only way to know exactly what boost level the compressor is producing. Check and verify constant boost conditions and verify Sea-Doo clutch conditions and true boost level gains when installing aftermarket compressors, compressor wheels, and overdrive compressor drive wheels. The Autometer Gauge kit comes complete with all the necessary hardware, and 10 feet of nylon tubing to install on any watercraft.

Description	Part No.
R&D Autometer Universal Boost Gauge	900-04304

\*NOTE: It will be necessary to order an R&D Boost Gauge Adaptor Kit for the specific make and model of engine. See Ultra 250 Boost Gauge Adapter part #611-26002



## R&D AUTOMETER DASH BEZEL FOR FUEL PRESSURE GAUGE

The R&D Autometer Fuel Pressure Gauge Bezel is necessary for adapting and installing the small

Autometer fuel pressure gauge into an instrument panel. R&D has created a unique and clean method to install a small fuel rail gauge in a dash or console. By using a small fuel pressure gauge and creating a barrel bezel for the perimeter of the gauge, it is possible to have 3 gauges in a small compact area.

Description	Part No.
R&D Autometer Dash Bezel for Fuel Pressure Gauge	900-04379

## RIVA RACING STAGE 1 KIT • 2007 ULTRA 250X PART #RK-RPM-UL250X-1

STOCK ULTRA 250X AVG. SPEED • 65 MPH @ 7700 RPM  
STAGE 1 PERFORMANCE KIT • 69 MPH @ 7850 RPM

Description	Quantity	Part No.
RIVA Ultra 250X Performance Power Filter Kit	1	RK13090
RIVA Ultra 250X Valve Cover Block-off Kit	1	RK19090-VCB
RIVA Ultra 250X Free Flow Exhaust Kit	1	RK16090
RIVA Ultra 250X Top-Loader Intake Grate	1	RK22090
RIVA Ultra 250X Performance Ride Plate	1	RK21090
RIVA Ultra 250X Pro-Series Sponson Kit	1	RK26090

\*Note: Stage 1 Kit for Competition Use Only

Additional Performance Upgrades available:

Description	Quantity	Part No.
RIVA Ultra 250X Pro-Series Power Filter Kit	1	RK13096*
RIVA Ultra 250X Bypass Upgrade Kit	1	RK1750-BPUK*

\*Note: These items are not included in the Riva Racing Stage 1 Kit

## RIVA RACING STAGE 1 KIT • 2008 ULTRA 250X PART #RK-RPM-UL250X-1-08

STOCK ULTRA 250X AVG. SPEED • 65 MPH @ 7700 RPM  
STAGE 1 PERFORMANCE KIT • 70 MPH @ 7850 RPM

Description	Quantity	Part No.
RIVA Ultra 250X Performance Power Filter Kit	1	RK13090
RIVA Ultra 250X Pro-Series Water Box	1	RK16091
RIVA Ultra 250X Free Flow Exhaust Kit (08 Model)	1	RK16090-08
RIVA Ultra 250X Top-Loader Intake Grate	1	RK22090
RIVA Ultra 250X Performance Ride Plate	1	RK21090
RIVA Ultra 250X Pro-Series Sponson Kit	1	RK26090

\*Note: Stage 1 Kit for Competition Use Only

Additional Performance Upgrades available:

Description	Quantity	Part No.
RIVA Ultra 250X Pro-Series Power Filter Kit	1	RK13096*
RIVA Ultra 250X Bypass Upgrade Kit	1	RK1750-BPUK*

\*Note: These items are not included in the Riva Racing Stage 1 Kit

4 STROKE  
 KAWASAKI  
 NATK  
 SYSTEMS  
 ENGINE/  
 GASKETS  
 EXHAUST  
 DRIVE LINE  
 HANDLING  
 ELECTRICAL  
 WATERLINE  
 /BILGE  
 STEERING  
 & CONTROLS  
 BODY  
 ACCESSORIES  
 SERVICE TOOLS  
 /HARDWARE  
 CHEMICAL



## R&D ULTRA 250X CRANKCASE VENTILATION/OIL & VAPOR SEPARATOR KIT

The R&D Ultra 250X Crankcase ventilation system was developed to offer a complete bolt on breather expansion kit which will substantially reduce crankcase pressures on Kawasaki Ultra 250X's supercharged engines. High performance engines (especially supercharged) need as much crankcase ventilation as possible. The R&D system doubles the volume of the O.E.M. crankcase breather and triple baffles the oil and vapor pressures within the O.E.M. breather case. The R&D system relieves excess crankcase pressures in the oil breather case and vents high pressures and fuel vapors into a piggyback vapor/oil catch can reservoir. The R&D vapor/oil reservoir mounts and connects directly to the O.E.M. oil separator system puts an end to oil blow by messes in the engine compartment by relieving excess crankcase pressures and trapping excess fuel vapors, condensation and blow by oil into the R&D oil/vapor separator.

Description	Part No.
R&D Ultra 250X Crankcase Ventilation/Oil and Vapor Separator Kit	215-25002



## R&D ULTRA 250X BILLET BLOW OFF VALVE KIT

The R&D Billet Blow Off Valve Kit replaces the OEM plastic valve that is prone to leaking and is unreliable. The R&D Billet Blow Off Valve allows for precise pressure adjustments

and has an operating range from 5lbs to 21lbs of boost.

Description	Part No.
R&D Billet Blow Off Valve Kit	611-25210



## ULTRA 250X/260X BILLET DRIVE COUPLERS

Billet aluminum drive coupler set for the Kawasaki 250X & 260X. The crank side coupler with the pulley is 1.24lbs lighter than the stock steel coupler. The pulley diameter is the same as stock. Uses the stock

rubber dampner. Clear anodized for protection against saltwater corrosion.

Description	Part No.
Ultra 250X/260X Billet Drive Coupler Set	31-700590



## R&D ULTRA 250X SUPERCHARGER PULLEYS

The new R&D Racing Supercharger Pulley Wheel will deliver a noticeable and impressive boost in torque and overall horsepower. Designed and manufactured from high quality billet aluminum and precision hard anodized for superi-

or belt wear resistance. The R&D Pulley is 3/4 lb lighter than the O.E.M. steel pulley, and delivers 2.5 to 3.5 lbs of additional boost pressure along with 30 plus well fed ponies. The holeshot acceleration is a solid 1.5-2 boat lengths over stock with a top speed gain of 1 to 2 mph over stock. Impressive results! The R&D Pulley comes completely assembled with a new high performance bearing, all necessary hardware and installation instructions.

R&D strongly recommends the use of the R&D Powershot Fuel Tuner and R&D High Output Fuel Injectors to increase fuel flow delivery when using the R&D Supercharger Wheel. Not using the recommended R&D Powershot and R&D High Output Fuel Injector Kit and High Volume Fuel Pump Kit with the R&D Supercharger wheel, can result in engine damage due to a lean air fuel ratio.

Description	Part No.
R&D Supercharger Pulley Wheel 1 to 1 (entry level)	611-25011
R&D Supercharger Pulley Wheel 1.05 to 1	611-25105
R&D Supercharger Pulley Wheel 1.1 to 1	611-25110
OEM Replacement Supercharger Pulley	611-25010

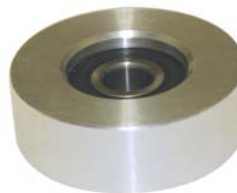

## R&D ULTRA 250X SUPERCHARGER BELT TENSIONER WHEEL

R&D has significantly improved the Kawasaki Ultra 250X's serpentine belt tensioning wheel system by redesigning and precision machining a new tensioner

wheel with a larger O.D. The new R&D Tensioner Wheel offers a wider adjustment range and helps to reduce belt slippage via more surface area for belt contact. Wheel comes complete with precision bearing installed.

Description	Part No.
R&D Ultra 250X Supercharger Belt Tensioner Wheel	611-25000



## R&D ULTRA 250X BEARING REBUILD KIT

R&D recommends the inspection of the R&D Supercharger and Tensioner wheel bearings after 15 hours and replacing them after 20 hours.

Description	Part No.
R&D Ultra 250X Bearing Rebuild Kit	611-25009

# ULTRA 250X/260X • SUPERCHARGER COMPONENTS & TOOLS



## R&D ULTRA 250X SUPERCHARGER GEAR OIL

R&D's new Supercharger Gear Oil is specifically formulated to perform in ultra high temperatures and provide maximum gear lubrication with minimum drag. Sold by the quart.

**Description** R&D Ultra 250X Supercharger Gear Oil **Part No.** 611-27000



## R&D ULTRA 250X SUPERCHARGER WHEEL PULLER TOOL

The R&D wheel puller tool makes it fast and easy to remove a supercharger wheel without the removal of the inter-cooler system or the water muffler assembly. The R&D Supercharger drive

wheel puller will save at least an hour on a pulley removal and replacement. A must have tool.

**Description** R&D Ultra 250X Supercharger Wheel Puller Tool **Part No.** 611-26004



## R&D ULTRA 250X DRIVER WHEEL HOLDER TOOL

The R&D Holding Tool makes it fast and easy to remove and re-install a supercharger wheel without damaging or breaking the wheel hub. Use the holding tool to properly torque the drive bolts and main spline drive bolt. A must have tool.

**Description** Ultra 250X Driver Wheel Holder Tool **Part No.** 611-26003



## R&D ULTRA 250X WASTE GATE BLOCK-OFF KIT

The new R&D Waste Gate Block-Off kit is designed to block-off the inconsistent OEM waste gate. The CNC machined part allows the supercharger to deliver its boost without premature pressure loss from a leaking waste gate. Kit comes complete with gaskets and hardware.

**Description** R&D Ultra 250X Waste Gate Block-Off Kit **Part No.** 611-26001



## R&D ULTRA 250X BOOSTGAUGE ADAPTER

The R&D Boost Adapter installs between the supercharger and the waste gate and allows the ability to mount a boost gauge to it via 1/8" fitting. This will enable an accurate measurement of boost the supercharger is delivering. Kit comes with gaskets and hardware.

**Description** R&D Ultra 250X Boost Gauge Adapter **Part No.** 611-26002



## R&D ULTRA 250X SUPERCHARGER WHEEL BILLET HUB KIT

The R&D Supercharger Hub Kit will replace the O.E.M.'s vulnerable part with a redesigned and beefed up precision CNC Machined 6061 billet aluminum part that is much stronger than stock. The new R&D design also offers pulley wheel alignment adjustments with a CNC machined Shim Kit that allows for precision serpentine belt cog alignment. The R&D kit comes complete with a special tool that will indicate the perfect alignment of the crank drive and compressor pulleys. At 8,000 RPM, horsepower and belt life can be greatly sacrificed through misaligned pulleys! The R&D kit offers superior strength, precision pulley alignment, and extended serpentine belt life. The all adds up to a powerful gain.

**Description** A & B. R&D Ultra 250X Supercharger Wheel Hub Kit **Part No.** 611-25001  
B. Pulley Alignment Tool Only **611-26000**



## R&D ULTRA 250X BELT HOLDER KIT

The R&D Ultra 250X Belt Holder Kit was developed to make repairs and performance upgrades easier and faster.

**Description** Ultra 250X Belt Holder Kit **Part No.** 611-25200



## R&D TEMP. SENSOR INTERFACER

R&D Performance offers a unique supercharger air temp sensor interfacer which may be necessary on some Ultra 250X units. There have been some Ultra 250X models that will default into "limp home mode" if the charger temperature sensor is peaked prematurely. Any Ultra 250 which as this default occur on long rides on hot (115 degree) days should install the R&D Supercharger Temp Interfacer Kit. The Interfacer is an inexpensive fix for this randomly occurring problem on random boats.

**Description** R&D Temp. Sensor Interfacer **Part No.** 801-25008



## R&D ULTRA 250X INTERCOOLER TEMPERATURE CONTROL UPGRADE KIT

The R&D Ultra 250X Intercooler Temperature Control system was developed to offer an inexpensive complete bolt on kit that will allow the full performance and cooling potential the O.E.M. intercooler has to offer for recreational applications.

**Description** 250X Intercooler Temperature Control Upgrade Kit **Part No.** 660-82500

KAWASAKI  
4 STROKE

INATKE  
SYSTEMS

ENGINE/  
GASKETS

EXHAUST

DRIVE LINE  
HANDLING

ELECTRICAL

WATERLINE  
/BILGE

STEERING  
& CONTROLS

BODY

ACCESSORIES

SERVICE TOOLS  
/HARDWARE

CHEMICAL

KAWASAKI  
4 STROKE  
INTAKE  
SYSTEMS  
ENGINE/  
GASKETS  
EXHAUST  
DRIVE LINE  
HANDLING  
ELECTRICAL  
WATERLINE  
/BILGE  
STEERING  
& CONTROLS  
BODY  
ACCESSORIES  
SERVICE TOOLS  
/HARDWARE  
CHEMICAL



## RIVA RACING BLOCK-OFF VALVE COVER KAW 4-STROKE ENGINE ULTRA 250X/LX; STX-15F/12F

The Ultra 250X Valve Cover Block-off Kit is designed to seal off the ports on the valve cover when removing the emission control system for racing applications. There are two major benefits to removing the factory emissions system:

- 1) For racing applications it is recommended to remove all necessary equipment from your craft for increased reliability and reduced maintenance. This also cleans up plumbing in the engine compartment providing a clean look.
- 2) To accurately monitor air/fuel ratio for tuning purposes you must remove the emissions system. The OEM system pumps fresh air into the exhaust stream throwing off air/fuel ratio.

Plates are precision machined from billet aluminum and anodized to prevent corrosion. Includes two block-off plates and installation instructions.

Description	Part No.
Riva Racing Ultra 250X (07)/LX (07), STX-15F, STX-12F Exhaust Emissions Block-off Kit	<b>RK19090-VCB</b>
R&D Ultra 250X (07)/LX (07), STX-15F, STX-12F Exhaust Emission Block-off Kit	<b>331-25000</b>
TBM Ultra Ultra 250X (07) Valve Cover Block Offs	<b>TBM137</b>



## RIVA EXHAUST KIT, FREE FLOW ULTRA 250X

Enables you to bypass or remove secondary muffler (weight savings of +10lbs) improving engine performance by reducing backpressure and harmful detonation. Formed aluminum exhaust tube is lightweight and powder coated to resist corrosion. Included billet exhaust tip (also sold separately) with laser-etched graphics is anodized to prevent corrosion. High temperature silicone couplers included with detailed installation instructions.

Description	Part No.
Riva Racing Free Flow Exhaust Kit Ultra 250X (07)/LX (07)	<b>RK16090</b>
Riva Racing Free Flow Exhaust Kit Ultra 250X (08)	<b>RK16090-08*</b>

\*Note: Must use with Part # RS16091 Riva Racing Waterbox



## RIVA PRO-SERIES ULTRA 250X WATER BOX

The Riva Racing Pro-Series Water Box delivers increased horsepower and performance by reducing exhaust restriction and back pressure. Feature lightweight aluminum construction and precise fit.

07 Models: Direct replacement for original water box. Use with RIVA Free Flow Exhaust Kit RK16090.

08 Models: Direct replacement for original water box. Features larger outlet (2-1/4") compared to stock water box (1-3/4"). Must be used with RIVA Free Flow Exhaust Kit RK16090-08.

Description	Part No.
RIVA Ultra 250X Pro-Series Water Box	<b>RK16091</b>



## TBM RACING ULTRA 250X VALVE COVER VENT BLOCK OFF PLATE

Complete the valve cover dress up with our Valve Cover Vent Block off Plate. This is the last piece to give your engine compartment the ultra trick look.

Description	Part No.
TBM Ultra 250X Valve Cover Vent Block off Plate	<b>TBM138</b>



## RIVA RACING BILLET ALUMINUM EXHAUST TIP FOR ULTRA 250X/LX, STX- 15F/12F

Quickly and easily add style to your craft with this direct replacement for the stock, plastic exhaust tip. Made from billet aluminum with laser etched graphics. Anodized to prevent corrosion.

Description	Part No.
Riva Racing Billet Aluminum Exhaust Tip Ultra 250X/LX, STX-15F, STX-12F	<b>RK16086</b>
Riva Racing Billet Aluminum Exhaust Outlet Ultra 250X/LX, STX-15F, STX-12F	<b>RK16090-EO</b>



## R&D BILLET EXHAUST OUTLET

The new R&D Billet Exhaust Outlet. The exhaust outlet has four holes for the Kawasaki Ultra 250 and 260.

Description	Part No.
3" Diameter R&D Billet Exhaust Outlet	<b>331-25300</b>
2.75" Diameter R&D Billet Exhaust Outlet	<b>331-25275</b>



# ULTRA 250X/260X • CONTROL SYSTEMS & HANDLING



## UMI RACING BILLET STEERING SYSTEM ULTRA 250X/LX

Complete precision machined steering systems feature a watertight o-ring bearing box and adjustable quick-turn steering. These systems are significantly stronger than the stock units. Includes off-throttle steering sensor bracket.

**Description** **Part No.**  
UMI Racing Ultra 250X/LX Steering System **KA-04608-250X**



## MACC RACING ULTRA 250X STEERING MOUNT 1/2 STYLE

The Macc Racing Ultra 250x steering wheel mount is a stronger and more aggressive alternative to the OEM Kawasaki steering system, made with the highest quality material improve the handling and overall feel of your 250x.

**Description** **Part No.**  
Macc Racing Ultra 250X/LX Steering Mount **MR-0087**



## RIVA ULTRA 250X/LX STEERING COLUMN COVER

This lightweight cover fills the large void left when the stock steering system is removed. Designed for use with UMI Steering System and highly recommend when using RIVA Pro-Series Power Filter Kit (part# RK13096).

**Description** **Part No.**  
RIVA Ultra 250X/LX Steering Column Cover **RK5-SCC-090**



## UMI RACING RUNABOUT HANDLEBARS

**Handlebars & Clamps** **Part No.**  
UMI Racing Handle Bar Silver **X2-01200POL**  
UMI Racing Handle Bar Black **X2-01200BKA**



## STAR BAR RUNABOUT BARS & FAT BARS

Models	Colors	Reg Bar Part No.	Fat Bar Part No.
Runabout	Titan (Dark Grey)	<b>SB1006TTT</b>	<b>SB1007BOOSTTIT</b>



## SKAT TRAK HEAVY ARMOR ULTRA 250X STEERING CABLE

The Skat-Trak "Heavy-Armor" steering cable directly replaces the stock steering cable that is prone to failure on modified Kawasaki Ultra 250X's. At twice the thickness, this heavy-duty steering cable is more durable and reliable when compared to the stock steering cable. Comes complete with stainless steel ball joint cable ends for easy installation and adjustment.

**Description** **Part No.**  
Skat Trak Heavy Armor Ultra 250X Steering Cable **PRSTKAWU250A**



## TBM RACING ULTRA 250X/LX ADJUSTABLE OFFSHORE STEERING SYSTEM

TBM Racing set out to build the ultimate offshore steering system incorporating several unique features to enhance the ergonomics of your Ultra. The fully adjustable design features a dual tubular steering head for rigidity and function. Almost 2" of vertical adjustment and four handlebar positions allow you to truly tailor your cockpit to your personal preference. In the fully extended position with standard rise bars our steering is 4.5" taller than stock and positions the rider reward on the ski lightening the nose. TBM designed the bar clamps to accommodate any popular 1 1/8" bulge (fat) bars to offer superior strength during offshore competition. The upper steering head utilizes the OEM lower pivot making installation a breeze and saving the expense of an elaborate lower assembly.

**Description** **Part No.**  
TBM Ultra 250X/LX Adjustable Offshore Steering System with Standard Long Tubes (Upper Steering Head)\* **TBM136**  
TBM Ultra 250X/LX Offshore Steering System with Closed Course Tubes **TBM136-CC**  
TBM Ultra 250X/LX Closed Course Tubes only **TBM136-CCT**  
TBM Ultra 250X/LX Offshore Tubes only **TBM136-OST**  
*\*Steering System Not Included*  
*\*Steering System Not Included*  
*\*Must use with Fat Bar #SB1007BOOSTTIT (see left column)*



## TBM RACING ULTRA 250X SEALED BEARING STEERING SYSTEM BASE ASSEMBLY

(Compatible with the TBM Adjustable Offshore Steering System)

Several unique features are incorporated into the TBM Steering System: An interlocking bearing housing that is bolted rather than welded into place eliminating any concentricity issues, angular roller bearings with pressed in races. These bearings are similar to those used in high strength steering assemblies on street and dirt motorcycles. Proper preload can be obtained without causing the bearings to bind or become notchy. Also used is an actual seal in place of an o-ring to keep water and sand from penetrating the bearings. An adjustable linkage arm gives you an infinite amount of steering ratios to meet your personal preference. The off power steering sensor is obtained. The lower steering assembly is designed to be used with the TBM adjustable upper steering head to provide a durable and functional steering system.

**Description** **Part No.**  
TBM Racing Sealed Bearing Steering System **TBM136-LA**  
(To be used with the TBM-136 Steering Head Assembly)

4 STROKE  
KAWASAKI

SYSTEMS  
NATKIE

GASKETS  
ENGINE/

EXHAUST

HANDLING  
DRIVE LINE

ELECTRICAL

WATERLINE  
/BULGE

STEERING  
& CONTROLS

BODY

ACCESSORIES

SERVICE TOOLS  
/HARDWARE

CHEMICAL

KAWASAKI  
4 STROKE

INTAKE  
SYSTEMS

ENGINE/  
GASKETS

EXHAUST

DRIVE LINE  
HANDLING

ELECTRICAL

WATERLINE  
/BILGE

STEERING  
& CONTROLS

BODY

SERVICE TOOLS  
ACCESSORIES

SERVICE TOOLS  
/HARDWARE

CHEMICAL



## R&D ULTRA 250X/LX AQUAVEIN SCOOP GRATE

The new R&D Kawasaki Ultra 250 Aquavein Intake Grate Kit has been designed and developed with all new

performance concepts in mind to deliver the ultimate handling and speed performance in recreational, offshore, and closed course race conditions. The new R&D Ultra 250 Aquavein has been extensively offshore, race track, and 1 and 2 up recreational tested to guarantee reduced cavitation and maximum pump hook up in any condition. The R&D Ultra 250 Aquavein will deliver quicker acceleration, higher top speed performance and a much smoother and more predictable ride over the O.E.M. intake grate in rough water conditions. Low speed and high-speed turns are a breeze with new found control.

Description	Part No.
R&D Ultra 250X/LX Aquavein Scoop Grate	111-25000



## R&D ULTRA 250X/LX ALUMINUM PERFORMANCE OFFSHORE RIDE PLATE

The R&D Kawasaki Ultra 250X Ride Plate has been fashioned after our GP-1200R & Kawasaki 15-F plate designs with a few new tricks. The Ultra 250X ride plate is extended 30mm and re-angled over stock to reduce porposing while the new R&D stepper concept will add top speed. R&D's Ride Plate concepts are the only aftermarket designs to dominate in Offshore, National, and World Championships, and to be used and endorsed by Factory Yamaha and Kawasaki racing teams! The new Ultra 250X ride plate from R&D is "The Perfect Ride plate" with a great balance of speed and handling with no compromises.

Description	Part No.
R&D Ultra 250X/LX Cast Aluminum Ride Plate	121-25000



## RIVA RACING ULTRA 250X/LX TOP-LOADER INTAKE GRATE

Our top-loader intake grate features a unique tapered wing design that eliminates prop spin and cavitation while delivering enhanced acceleration

and top-speed. Deep side rails improve stability and handling. Durable black race coating protects from corrosion. Race Legal.

Description	Part No.
RIVA Racing Top-Loader Intake Grate	RK22090

## R&D ULTRA 250X/LX CARBON CLOSED COURSE RACING RIDE PLATE

The R&D Ultra 250 Carbon Fiber Ride Plate Design was developed for close course racing to offer a light weight ride plate that delivers more aggressive turning ability and straightline hookup.

Description	Part No.
R&D Ultra 250X/LX Carbon Fiber Ride Plate	121-25003



## TBM RACING ULTRA 250X TUNABLE SUPER SCOOP

A fully tunable scoop grate that allows the rider an multiple handling options. The center foil has three positions or can be removed entirely. In flat water

conditions you can raise the center foil to the highest position and gain .5mph. The deeper center bars and removable rear inlet chip vastly improves handling and hook up.

Description	Part No.
Ultra 250X Tunable Super Scoop	TBM100-UL



## RIVA RACING ULTRA 250X/LX PERFORMANCE RIDE PLATE

The new Riva Racing Ultra 250X/LX Performance Ride Plate design allows craft to plane faster increasing acceleration & top-speed as well as improving handling in all types of water conditions.

Description	Part No.
RIVA Racing Ultra 250X/LX Performance Ride Plate	RK21090



## WORX RACING ULTRA 250X/LX INTAKE GRATE

The Ultra 250 boats hook up pretty good in the calm but really benefit from our intake grate in choppy to rough water, the Worx grate will not cost you

any top speed in the calm but will give you heaps better hook-up and drive in the rough water and around the track for closed course racing. This grate features two bars running the full length of the boat to stop the back of the boat from sliding out, the center blade of the grate does most of the work in the straights and the side wings keep the pump fully loaded and eliminates cavitation. The pick-up point at the rear of the intake grate has also been shifted forward to improve rough water hook-up.

Description	Part No.
Worx Racing Ultra 250X/LX Maxiloader Intake Grate	WR227



## TBM RACING KAWASAKI ULTRA 250X/LX TUNABLE RIDE PLATE

TBM's Ultra 250X ride plate is truly "Tunable" with a built in trim tab that automatically drops when you turn the handlebars. The neutral position is tunable by adjusting the trim tab linkage with a simple turn of a

wrench. You no longer have to choose between a ride plate designed for top speed that doesn't turn well, or a plate that compromises speed for handling. The plate gives you the highest top speed possible (over 2mph on a stock Ultra) with the precise handling of a Pro caliber race ski. A separate handlebar mounted trim lever override is available to activate the trim tab manually when desired.

Description	Part No.
TBM Ultra 250X/LX Tunable Ride Plate	TBM123-ULT
TBM Handlebar Mounted Lever Override Kit	TBM140



## RIVA RACING ULTRA 250X/LX PRO-SERIES SPONSON KIT

Delivers a significant improvement over the stock sponsons with superior blade design and backing plate. Includes a bulletproof mounting system that features three anchor points with billet inserts in sponson fins. Backing plate is precision machined from high strength billet aluminum that is anodized to prevent corrosion. Sponson depth is adjustable to control the amount of influence they have on the craft. Easy installation requires no drilling.

**Description** RIVA Racing Ultra 250X/LX Pro-Series Sponson Kit  
**Part No.** RK26090



## R&D ULTRA 250X/LX SPONSON KIT

The R&D Ultra 250 Sponson Kit will deliver higher top speed performance and a much smoother and more predictable ride over O.E.M. sponsons. Low speed and

high-speed turns are a breeze with new found control. The secret to R&D's new generation concept is in the backing plate design with an aftermarket first, low pressure, low friction concept that breaks up and relieves speed robbing drag within the sponson's backing plate channel. The new R&D design staggers the sponson blades fins water trapping area to pick up less water in the front and more in the back. The stagger/step-up concept greatly reduces chine walk in high speed corners, while allowing more rear end grip. There is also a higher end recreational/race setting with enough grip for the best of pro's! More top speed due to less drag, less chine walking, racer preferred rear end grip, and unmatched straight line stability.

**Description** R&D Ultra 250X/LX Sponson Kit  
**Part No.** 121-25001



## WORX RACING ULTRA 250X/LX

Developed as always with countless hours of testing, Worx sponsons allow you to fine tune your skis cornering and handling characteristics to suit your riding style - from mild to aggressive while providing a more

predictable 'feel' in straight line tracking.

**Description** Worx Racing Ultra 250X/LX Sponson Kit  
**Part No.** WR536



## TBM RACING ULTRA 250X/LX REAR SPONSONS

Introducing the most adjustable rear sponsons on the market for your Kawasaki Ultra 250X or Ultra LX. Several unique design features separate our sponsons from the competition. The back-

ing plate is a two piece design constructed of 6061 billet aluminum and allows you to adjust the sponson closer, or further away from the hull dramatically affecting the handling characteristics. The backing plates are not just a mounting pad for the sponson blade, they are designed to create lift and reduce friction once up on plane with our stepped design which increases speed and gives the blade more bite in the corners. The blades also incorporate a stepped design and have 12 different mounting positions giving you multiple adjustment positions. A race inspired billet aluminum washer prevents the sponson blade from flexing under the most extreme conditions.

**Description** Ultra 250X/LX Rear Sponsons  
**Part No.** TBM101-UL



## DCR ULTRA 250X/260X AFTERMARKET BILLET HANDLEBAR ADAPTER

DCR has developed this billet aluminum handlebar adapter to allow a rider the ability to install aftermarket handlebars on the Kawasaki Ultra 250X and 260X. This simple conversion will greatly improve steering and control.

**Description** DCR Billet Handlebar Adapter  
**Part No.** DC-HA-KU



Angelo Bertozzi - Italy  
Craft: Kawasaki 2008 Ultra 250X

4 STROKE	KAWASAKI
SYSTEMS	INATKE
GASKETS	ENGINE/
EXHAUST	
HANDLING	DRIVE LINE
ELECTRICAL	
WATERLINE	/BILGE
STEERING	& CONTROLS
BODY	
ACCESSORIES	
SERVICE TOOLS	/HARDWARE
CHEMICAL	

KAWASAKI  
4 STROKE

INTAKE  
SYSTEMS

ENGINE/  
GASKETS

EXHAUST

DRIVE LINE  
HANDLING

ELECTRICAL

WATERLINE  
/BILGE

STEERING  
& CONTROLS

BODY

ACCESSORIES

SERVICE TOOLS  
/HARDWARE

CHEMICAL



## R&D ULTRA 250X/LX PUMP SHOE SEAL KIT

The R&D Pump Shoe Seal kit for the Ultra 250 is now available. The three piece Seal Kit stuffs up the unwanted cavities in the pump shoe and the oem intake grate that aid in producing cavitation. This kit allows you to seal

up the area between the intake grate and pump shoe, which will reduce cavitation and increase pump efficiency and performance.

**Description** **Part No.**  
R&D Ultra 250X/LX Pump Shoe Seal Kit **161-25000**



## R&D ULTRA 250X/LX 1 DEGREE NOZZLE WEDGE KIT

The R&D 1 Degree Reduction Nozzle Wedge Kit for the Ultra 250X/LX will add quicker acceleration and top speed performance as well as allow the bow to ride slightly higher which will significantly reduce annoying bow spray

promoting a much dryer ride. Extensive testing has led our development team to wedge the reduction nozzle up 1 full degree which will inexpensively give better handling everywhere and provide a boost of up to 1 mph in top speed performance. The billet aluminum CNC machined 1 degree reduction nozzle wedge kit was specifically designed to work without compromising or removing the O.E.M. reverse gate. The R&D Pump Wedge Kit comes complete with all the necessary hardware and instructions for easy installation.

**Description** **Part No.**  
R&D Ultra 250X/LX One Degree Nozzle Wedge Kit **141-25001**



## R&D ULTRA 250X/LX DRIVESHAFT SHIM KIT

The R&D driveshaft shims install into the prop snout and removes the unwanted play or float the driveshaft has in the prop/pump assembly. Properly shimming the driveshaft will keep the driveshaft couplers fully engaged eliminating premature rubber dampner wear and failure.

**Description** **Part No.**  
R&D Ultra 250X/LX Driveshaft Shim Kit **161-00810**



## R&D ULTRA 250X/LX ANTI-CAVITATION PUMP CONE KIT

The R&D Anti-Cavitation Pump Cone Kit was developed to reduce overall internal pump cavitation within the Ultra 250's offset reduction/compression nozzle design. The O.E.M.

Reduction/Compression nozzle is offset 5 degrees, while the pump cone/bearing cap remains straight which causes uneven pressures within the pump and reduction nozzle. The R&D Anti-Cavitation Pump Cone is offset 5 degrees and reshaped to match the O.E.M. reduction nozzle offset promoting even pressures, which will substantially reduce cavitation, increase pump hook up, boost acceleration, and increase top speed performance.

**Description** **Part No.**  
R&D Ultra 250X/LX Anti-Cavitation Pump Cone Kit **161-25010**



## SKAT-TRAK ULTRA 250X MAGNUM PUMPS

Skat-Trak now offers a variety of Magnum Pumps and Nozzle Kits for the Ultra 250X. We offer the Kawasaki E-75 (155 mm), Kawasaki

E+-75 (158 mm), and Kawasaki E++75 (160 mm) in a 6 Vane Standard, 8 Vane Standard, 12 Vane Standard or Set Back, and 14 Vane Standard or Set Back stainless steel stator configurations. The variety of magnum pumps allows you to customize a Magnum Pump system for your racing application and horsepower needs.

For replacement pumps on a stock runabout or for off-shore endurance racing, Skat-Trak recommends running 6 Vane or 8 Vane stator sections. The 6 and 8 vane stator configurations work very well on top speed performance. The stainless steel stator vane sections will give you the durability and reliability the stock OEM aluminum pump housings can not. If you are running a modified Kawasaki watercraft, the Magnum Pumps are a must.

For the closed course racing enthusiast, 12 Vane and 14 Vane Magnum Pumps will provide you with the hook up and acceleration needed for rough water and buoy to buoy performance. Acceleration is everything in closed course racing. It has been proven in the past that the rider with the quickest watercraft will beat the rider with the fastest watercraft in closed course racing.

The 12 Vane and 14 Vane stator sections are available in Standard or Set Back applications. The Standard Magnum Pumps locate the impeller and stator vane section in the stock or "standard" position. The stock OEM drive shaft is compatible with the Standard Magnum Pumps.

The Set Back feature moves the impeller and stator vane section back internally in the pump housing. This requires you to run an extended drive shaft or a Long Nose Magnum Swirl impeller to make up the distance the impeller and stator vane section are "Set Back". Extended drive shafts and Long Nose Magnum Swirls are not available for the Ultra 250X. Testing has shown that the 12 and 14 Vane Set Back Magnum Pumps are faster on top speed with compared to the 12 and 14 Vane Standard Magnum Pumps.

### Description

- All Magnum Pumps are custom made and require a 2 to 3 week manufacturing time.
- Hot Products does not inventory Skat-Trak Magnum Pumps.
- Pricing is available upon request and verification of the Magnum Pump specifications and configuration.

### Racing Configurations:

*The current preferred setup being used for the Ultra 250X at this time by racers world wide is:*

*12 Vane 155mm E83 with a 16/22 long nose Skat Trak impeller*

*with*

*6 Vane 155mm nozzle with siphon 83/84mm rings 90/91mm steering rings and auto and manual*

# ULTRA 250X/260X • PUMP & IMPELLER



**Skat-Trak**  
Performance Products USA

**SOLAS**<sup>®</sup>  
Where speed begins



## SKAT-TRAK IMPELLERS

Model	Engine Mods	Pitch	Part No.
Ultra250X	Stock	13/18	SK557520SW1318
Ultra250X	Limited	13/19	SK557520SW1319
Ultra250X	Modified	14/20	SK557520SW1420

## SOLAS IMPELLERS

Model	Engine Mods	Pitch	Part No.
Ultra250X	Stock	16/21	KX-CD-16/21
Ultra250LX	Stock	12/18	KX-CD-12/18



# ULTRA 250X/260X • BODY



## TBM ULTRA 250X RACE BUMPERS

Introducing the easiest way to enhance the handling of your PWC simply by replacing your stock bumper with this adhesive backed bumper.

Description	Part No.
TBM Racing Ultra 250X/STXR/15F/12F	TBM117-STXR



## JSU-STXR-BUMPER



## ULTRA 250X/LX RAIL MOLDING KITS

Directly replaces the bulky, sharp-edged stock rails saving weight as well as your hands! Reduces corner drag on Ultra models.

Description	Part No.
Riva Ultra 250X/LX Rail Molding Kits (Includes rivets)RK5-RMK-085	
JSU Runabout Side Molding Kit	JSU-STXR-BUMPER



## RIVA RACING ULTRA 250X/LX MIRROR BLOCKOFF KIT

Lightweight anodized aluminum plates cover openings left in hood when mirrors and reverse lever are removed for competition. Easy installation requires no special tools.

Description	Part No.
Riva Racing Ultra 250X/LX Mirror Blockoff Kit	RK5-U250X-MB



COOL AIR INDUCTION

## MACC RACING ULTRA 250X RACING CARBON FIBER REAR SEAT

Macc Racing has developed a Carbon Racing seat for the Ultra 250. The rear seat is about 15lbs lighter than stock and features a cool air induction intake while keeping water out of the engine compartment.

Description	Part No.
Macc Racing Ultra 250X Carbon Racing Rear Seat	MR-ULTRASEAT

*\*Note: The Macc Racing Carbon Racing Rear seat is intended for a performance advantage and is not intended to be used as a seat for a passenger.*

4 STROKE	KAWASAKI
SYSTEMS	INATKE
GASKETS	ENGINE/
	EXHAUST
HANDLING	DRIVE LINE
ELECTRICAL	
WATERLINE	/BILGE
STEERING	& CONTROLS
BODY	
ACCESSORIES	SERVICE TOOLS
	/HARDWARE
CHEMICAL	

# ULTRA 250X/260X • SEAT COVERS



## AP DESIGNS 250X SEAT COVER

Recreational Riders - Ultra Grip (UG)  
Racers/Aggressive Riders - Sure Grip\* (SG)



Black/Red/White • Black/Red/Silver

Type	Colors	Part No.
UG	Blk, Red, White	UKAU250-BK/RD/W
SG*	Blk, Red, White	SKAU250-BK/RD/W
UG	Blk, Red, Silver	UKAU250-BK/RD/S
SG*	Blk, Red, Silver	SKAU250-BK/RD/S

\*Wetsuits are recommended for Sure Grip Seats



Black/Blue/White • Black/Blue/Silver

Type	Colors	Part No.
UG	Blk, Blue, White	UKAU250-BK/BU/W
SG*	Blk, Blue, White	SKAU250-BK/BU/W
UG	Blk, Blue, Silver	UKAU250-BK/BU/S
SG*	Blk, Blue, Silver	SKAU250-BK/BU/S

\*Wetsuits are recommended for Sure Grip Seats



Black/Green/White • Black/Green/Silver

Type	Colors	Part No.
UG	Blk, Green, White	UKAU250-BK/GN/W
SG*	Blk, Green, White	SKAU250-BK/GN/W
UG	Blk, Green, Silver	UKAU250-BK/GN/S
SG*	Blk, Green, Silver	SKAU250-BK/GN/S

\*Wetsuits are recommended for Sure Grip Seats



Side Mat with Lifter



Ultra 250X/LX • Black/Black

## AP DESIGNS SURE GRIP MAT SET & SIDE LIFTER

The OEM mat does not offer the durability and traction for racing. AP Designs has developed their mat kits to be a perfect fit and replacement to the OEM mats featuring superior traction and durability.

Description	Part No.
AP Designs Ultra 250X/LX Side Mat w/Lifter	KAU250SM-BLK/BLK
AP Designs Ultra 250X/LX Mat Kit	KAU250MT-BLK/BLK



## JET TRIM ULTRA 250X/LX CUSTOM SEAT COVERS

Jet Trim seats covers are developed to the highest performance standards and design trends for the PWC industry.

Kawasaki	Part No.
Jettrim Ultra 250X/LX Custom Designed Seat Cover	KU250X101



## HYDRO TURF ULTRA 250X/LX CUSTOM SEAT COVERS

All Hydro Turf Seat covers are custom made to order. Hydro Turf offers a wide variety of colors and materials types to fit any application.

Kawasaki	Part No.
Hydro Turf Ultra 250X/LX Custom Designed Seat Cover	SEW62

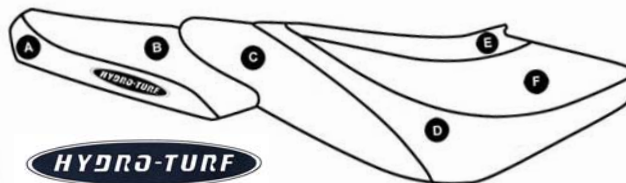

The upholstery outline for your custom designed seat cover is available at [www.hydroturf.com](http://www.hydroturf.com) and [www.jettrim.com](http://www.jettrim.com)

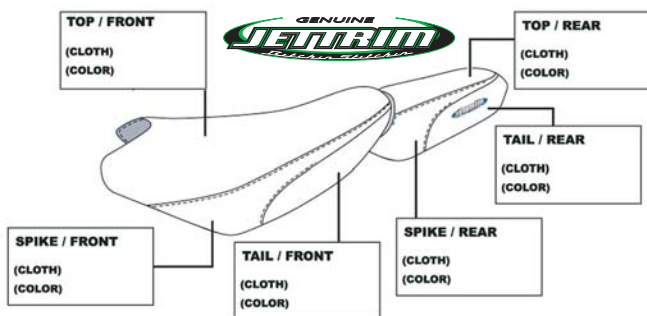

## HYDRO TURF ULTRA 250X/LX MAT KIT

Freshen up those mats on the Ultra 250X/LX with these grooved mats. Available in all Hydro-Turf colors. Provides additional traction and a great new look.

Description	Part No.
Hydro Turf Ultra 250X/LX Mat Kit	HT62



## NGK SPECIAL SPARK PLUGS FOR 4 STROKE ENGINES

NGK Spark Plugs offer excellent ignitability and durability. NGK is the OEM plug on the Kawasaki Ultra 250X and LX.

Spark Plug Size	Part No.
NGK OEM Repl. Platinum Spark Plugs *Sold in Pk/4	<b>PMR9B</b>
NGK Standard Metal Spark Plugs *Sold in Pk/10	<b>CR9EK</b>



## NGK IRIDIUM IX SPARK PLUGS

Iridium is significantly stronger than any metal used in spark plugs today. The ignitability and durability is better than platinum. Sold in packs of four.

Spark Plug Size	Reach	Part No.
10mm	3/4"	<b>CR9EIX</b>



## BILLET QUICK DRAIN

Mounts to the transom of your Kawasaki Personal Watercraft with billet aluminum mounting plate.

Description	Part No.
Billet Drain System	<b>57-4065</b>



## VERSIPLUG DRAIN SYSTEM

Versiplug is a self-bailing drain plug system produced using aircraft grade aluminum, water resistant plastic and stainless steel. Installation is simple, quick and easy. The kit will completely drain four PWC without you having to do anything.

Description	Part No.
Versiplug Drain System	<b>PD1300</b>



## TBM ULTRA 250 BILLET OIL CAP

Complete the dress up of your engine compartment with our billet aluminum oil filler cap.

Description	Part No.
TBM Ultra 250 Billet Oil Cap	<b>TBM139</b>



## K&N PERFORMANCE GOLD OIL FILTER

- 1-inch nut easy-on/easy wrench-off
- Heavy-duty construction
- Premium filter media provides outstanding filtration at high-flow rates.
- Drilled safety wire holes for racing

Description	OEM#	Part No.
All Kawasaki Four Stroke PWC	16099-004	<b>KN204</b>

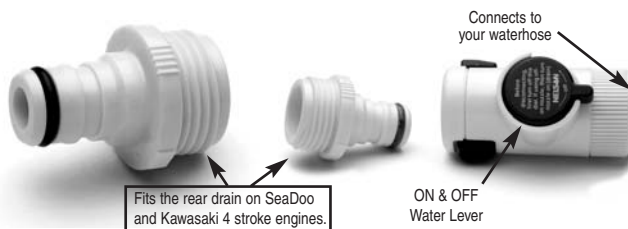

## FLUSH KIT ADAPTER

Flush Kit Adapter for adapting overseas special size hose to connect flush kit. This adapter is a direct to fit to the rear drain line on SeaDoo and Kawasaki 4 stroke watercraft.

Description	Part No.
Flush Kit Adapter	<b>SC-2905</b>

## SNAP CONNECT AND FLOW CONTROL

This flush kit includes adapter SC-2905 listed to the left and also includes a quick disconnect that features a on/off water valve to make flushing the watercraft a simple and easy process.

\*The adapter is a direct to fit to the rear drain line on SeaDoo and Kawasaki 4 stroke watercraft.

Description	Part No.
Snap Connect and Flow Control	<b>SC-2900</b>

## 2007 KAWASAKI ULTRA 250X ENGINE DIAGRAM

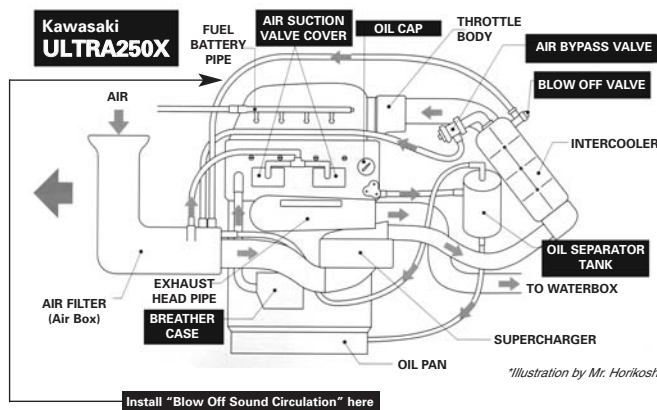

## ULTRA 250X/260X BLOW OFF SOUND CIRCULATION

The blow off circulation is installed into the air hose located back of the seat. This small piece fits in the blow off return line hose. When you let off the throttle and the blow off valve opens the part will create a racing performance sound from the part.

Description	Part No.
Blow Off Sound Circulation	<b>DC-BSS</b>

KAWASAKI  
4 STROKE

WATERCRAFT  
SYSTEMS

ENGINE/  
GASKETS

EXHAUST

DRIVE LINE  
HANDLING

ELECTRICAL

WATERLINE  
/BILGE

STEERING  
& CONTROLS

BODY

ACCESSORIES

SERVICE TOOLS  
/HARDWARE

CHEMICAL



# MIKUNI CARBURETORS

## HI-PERFORMANCE SUPER BN

### Extended Throttle Shaft Without Choke Shaft



**38MM**

Part # **53-2050**  
Mikuni # BN38-34-8113



**44MM**

Part # **53-2060S**  
Mikuni # BN44-40-8067



**44MM**

Part # **53-2060**  
Mikuni # BN44-40-8052



**46MM**

Part # **53-2065**  
Mikuni # BN46-42-8002



# OEM REPLACEMENT SUPER BN

## Regular Throttle Shaft With Choke Shaft

**\*\*\* Direct replacement of OEM Carburetors at a fraction of OEM cost. \*\*\***

**MAG-SIDE**



**40MM - I-SERIES**

**MAG-SIDE (FRONT)**

Part # **53-2085** Mikuni # BN40I-38-26

**PTO-SIDE (REAR)**

Part # **53-2090** Mikuni # BN40I-38-27

Sea Doo 720 GTI, GTS, GS, GSI '98, 800 GTX, GSX '96-'00, 800 SPX 97-99, 800 XP '95-'99, 951 GSX LTD '97

**PTO-SIDE**

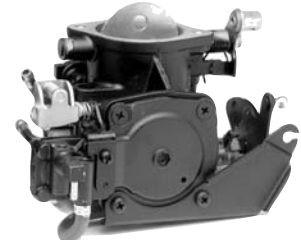

**38MM**

Part # **53-2063**  
Mikuni # BN34-28-8010

Yamaha,  
Wave Runner 500 88-89  
Wave Jammer 500 88-89



**44MM - I-SERIES**

Part # **53-2080**  
Mikuni # BN40I-38-24

Sea Doo 720,  
GTI, GTS, GS, GSI, '97



**44MM**

Part # **53-2062**  
Mikuni # BN44-40-43

Yamaha Superjet,  
Wave Blaster, Tigershark

## DUAL CARBURETOR SET

**46MM - I-SERIES**

Part # **53-2095**  
Mikuni # BN461-42-B4

SeaDoo 951 - GSX, GTX, XP-LTD, '98-01, XP'00, RX, LRV

*Note: Sold as a fully assembled dual carburetor set.*



FOUR  
STROKE

INTAKE  
SYSTEMS

ENGINE/  
GASKETS

EXHAUST

DRIVE LINE  
HANDLING

ELECTRICAL

WATERLINE  
/BILGE

STEERING  
& CONTROLS

BODY

ACCESSORIES

SERVICE TOOLS  
/HARDWARE

CHEMICAL





# MIKUNI

## GENUINE CARBURETOR REBUILD KITS

Kits include all necessary gaskets, diaphragms, and hardware required to disassemble and rebuild Mikuni carburetor.

Mikuni	Diaphragm Cover	Part No.
<b>Super BN 38mm, 44mm, 46mm</b> I Series 38/40 *Sea Doo Pre 97, Kawasaki 750 98-02, 800 SX-R 03-08 and ALL Mikuni Performance Super BN Square Body 38mm, 44mm and 46mm carbs.	Square	53-2114
<b>I Series 46mm</b> *Sea Doo 951 98 and newer	Square	53-2115
<b>I Series 44mm</b> *Yamaha GP800 98-99, GP 800R 00-05, XL 800 01, XLT 800 02-04, GP 1200R 00-02, XL1200 Limited 99-00 and XLT 1200 01-05	Square	53-2117
<b>BN 38mm, 44mm</b> *BN carbs are "Old Style/Round Body" with round diaphragm covers	Round	53-2110

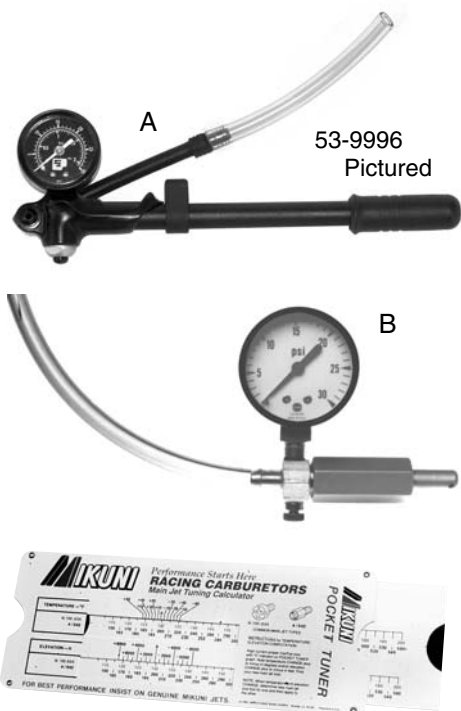

### POP-OFF GAUGE

For Accurate adjustment of pop off pressure levels.

Description	Part No.
<b>A</b> Mikuni Gauge 30 Lbs. 53-9996 60 Lbs. 53-9996-60 100 Lbs. 53-9996-100	
<b>B</b> Aftermarket Thumb Operated Gauge	53-9995



### MIKUNI TOOL KIT

This handy little kit contains all the tools necessary to make jetting change, perform normal maintenance as well as disassemble and rebuild any Mikuni carburetor.

### MIKUNI POCKET TUNER

A handy pocket-size slide calculator which can be used to determine required jetting changes in Mikuni carburetors due to ambient temperature, altitude or both.

Description	Part No.
Mikuni Pocket Tuner	53-9988

Description	Part No.
Mikuni Tool Kit	53-9989

## MIKUNI SUPER BN SPECIFICATIONS

Hot Products Part #	Carb.	Low Speed Jet	High Speed Jet	Needle Valve	Arm Spring (grams)	Low Speed Adjuster	High Speed Adjuster	Choke or Primer	Color
53-2050	BN38-34-8113	65	107.5	2.0	115 gr.	1.0	1.5	Primer	Silver
53-2060	BN44-40-8052	100	125	2.3	65 gr.	1.0	1.5	Primer	Black
53-2060S	BN44-40-8067	120	140	2.5	80 gr.	1.0	1.5	Primer	Silver
53-2065	BN46-42-8002	120	150	2.5	80 gr.	1.0	1.5	Primer	Silver
53-2062	BN44-40-43	120	115	1.5	115 gr.	1.0	.75	Choke	Black
53-2063	BN34-28-8010	77.5	80	1.5	65 gr.			Choke	Black
53-2080	BN40I-38-24	70	167.5	1.5	95 gr.	1.25	closed	Choke	Black
53-2085	BN40I-38-26	67.5	140	1.5	95 gr.	1.25	closed	Choke	Black
53-2090	BN40I-38-27	67.5	142.5	1.5	95 gr.	1.25	closed	Choke	Black
53-2095	BN46I-42-B4	77.5	162.5	2.0	95 gr.	1.25	closed	Choke	Black

FOUR STROKE  
INTAKE SYSTEMS  
ENGINE/GASKETS  
EXHAUST  
DRIVE LINE HANDLING  
ELECTRICAL  
WATERLINE /BILGE  
STEERING & CONTROLS  
BODY  
ACCESSORIES SERVICE TOOLS /HARDWARE  
CHEMICAL



# SUPER BN 44/46

## Socket Bolt Kit

**59-9131**

See bottom of page

- \* Super BN38 and Late Super BN44
- \*\* Early Super BN44

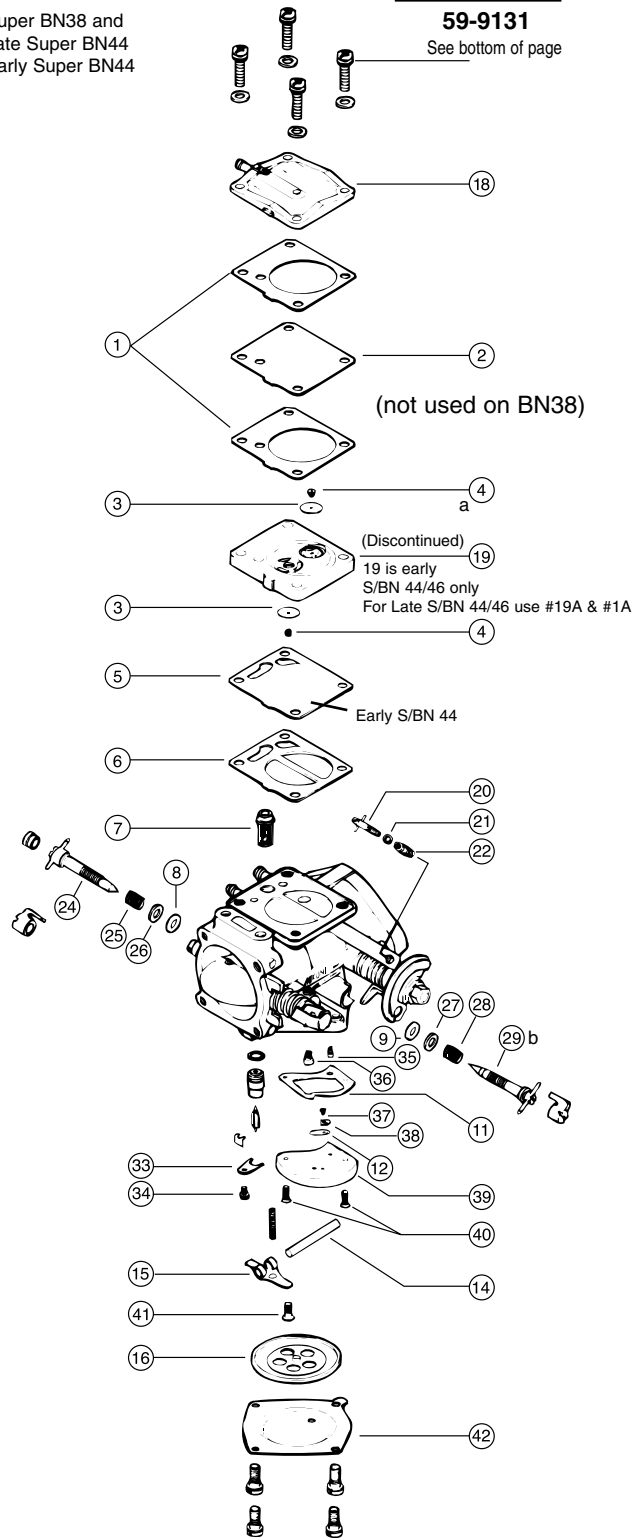

## MIKUNI GENUINE PARTS SUPER BN38 / BN44 / BN46

Diagram No.	Description	Mikuni Part No.
1.	Gasket Pump (2)	BN38/547
1a.	O-Ring*	.616-72001
2.	Diaphragm, Pump (Clear)	BN34/97
3.	Check Valve (2) (Clear)	BN34/124
4.	Grommet, Check Valve (2)	BN34/125
5.	Diaphragm, Damper (large hole)**	BN34/100
5a.	Diaphragm, Damper (small hole)*	BN34/129
6.	Gasket, Damper**	BN34/101
6a.	O-Ring*	.616-92007
7.	Filter	BN44/146
8.	O-Ring, Hi Speed	B30/305
9.	O-Ring, Low Speed	MD12/16
11.	Gasket Valve Body	BN34/123
12.	Check Valve (Clear)	BN34/107
14.	Pin, Arm	VM30/97
15.	Arm (Stainless)	BN38/534
16.	Diaphragm Assembly	BN44/145
18.	Cover Pump	BN34/95B
19a.	Body Assembly Pump* (Must use w/O-Ring 1A)	BN34/128
20.	Stop Screw, Idle**	BN44/109
20a.	Stop Screw, Idle*	BN34/82
21.	Washer (Aluminum - Same as #26)	BN38/39
22.	Spring, Idle**	BN38/341
22a.	Spring, Idle (Same as #25)*	BN38/344
24.	Adjuster, Hi Speed (with Cross Bar)	BN44/167
25.	Spring, Hi Speed (Same as #22a)	BN38/344
26.	Washer, Hi Speed (Aluminum - Same as #21)	BN38/39
27.	Washer, Low Speed (Aluminum)	BN38/172
28.	Spring, Low Speed	BN38/343
29a.	Adjuster, Low Speed (with Cross Bar) 38mm	BN38/477
29b.	Adjuster, Low Speed (with Cross Bar) 44mm	BN38/166
33.	Plate, N.V. Retainer	BN34/117-GG
34.	Screw with washer	CW2-0307-G
35.	Low Jet, 30-160 in increments of 5 (See page 50)	N100.606-SIZE
36.	Main Jet, 30-260 in increments of 5 (See page 50)	N102.221-SIZE
37.	Screw	BV15/121-05-GG
38.	Plate, Valve	BN34/108-GG
39.	Valve Body Assembly	BN44/165
40.	Screw (2 pcs)	C5-0414-G
41.	Screw	C6-0308-G
42.	Cover (Stainless)	BN44/147

\* Super BN38 and Late Super BN44  
\*\* Early Super BN44



## SUPER BN CARBURETOR TUNING MANUAL

For the watercraft tuner working with Super BN series carburetors.

Description	Part No.
Mikuni Manual	53-9999



## CARBURETOR SOCKET BOLT KIT

Replace the stock phillips bolts on carbs with stainless steel socket head bolts.

Description	Part No.
Mikuni Super BN	59-9131

FOUR STROKE  
INTAKE SYSTEMS  
ENGINE/GASKETS  
EXHAUST  
DRIVE LINE HANDLING  
ELECTRICAL  
WATERLINE /BILGE  
STEERING & CONTROLS  
BODY  
SERVICE TOOLS ACCESSORIES /HARDWARE  
CHEMICAL

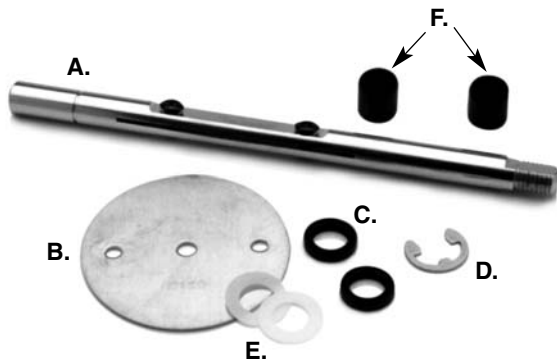

## THROTTLE VALVE KIT

Description	Part No.	Mikuni Part No.
Throttle valve (#120) kit for 44mm	45	MK-BN/044 TV
Throttle valve (#120) kit for 46mm	46	MK-BN/046 TV
Throttle valve (#150) kit for 38mm	47	MK-BN/038 TV

## THROTTLE SHAFTS AND VALVES

Description	Part No.	Mikuni Part No.
A. Super BN 44mm Throttle Shaft (Extended)	THS-4446	703-89004
B. Super BN 44mm #120 Throttle Valve	V44-120	BN44/06-120
B. Super BN 46mm #120 Throttle Valve	V46-120	818-46009-120
C. Super BN 38/44/46mm Throttle Shaft Seal	THSS	N167.126
D. Super BN 38/44/46mm Throttle Shaft Clip (Standard)	THSC	BN38/566
D. Super BN 38/44/46mm Throttle Shaft Clip (Heavy Duty)	THSCHD	MK-BN/005
E. Super BN 38/44/46mm Throttle Shaft Washer (Nylon)	THSW	N114.077
F. Super BN 38/44/46mm Throttle Shaft Bushing	49	BN38/569
Super BN 38/44/46mm Throttle Shaft Screw	THVS	

**Super BN 38**  
Also used in late style Super BN 44

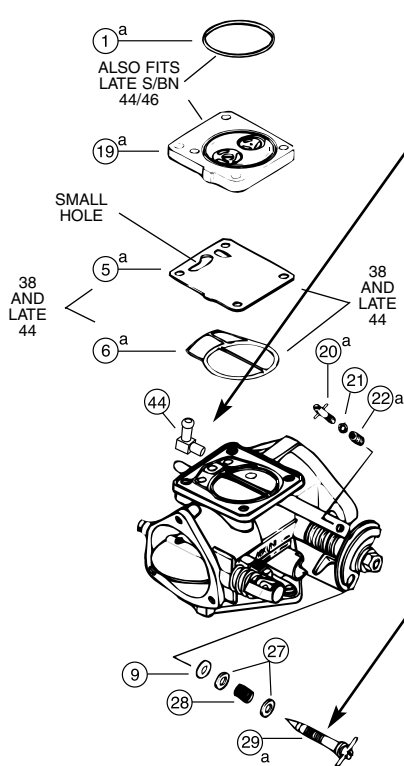

### 90° FUEL INLET FITTING (PRESS IN)

Description	Diag. #	Part No.
90° Fuel Inlet Fitting	44	DF44-2/70



### ADJUSTER WITH CROSS BAR

Description	Diag. #	Part No.
High Speed 38/44	24	BN44/167
Low Speed 38	29a	BN38/477
Low Speed 44	29b	BN38/166

(Does not fit Yam OEM 44mm carb)

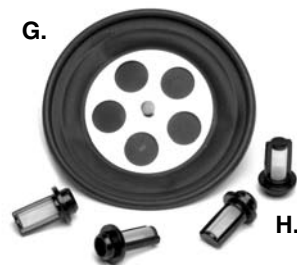

### DIAPHRAGM AND FILTER

Description	Diag. #	Part No.
G. Diaphragm Assembly	16.	BN44/145
H. Super BN Filter	7.	BN44/146



### ULTIMATE CARB GASKETS

Thick "Green" gaskets.

Mikuni	Part No.
38mm	9230
40mm "I" Series	9235
44mm	9240
46mm	9250
48mm	9252
50mm	9257
48mm SD951 I Series	6740

FOUR  
STROKE

INTAKE  
SYSTEMS

ENGINE/  
GASKETS

EXHAUST

DRIVE LINE  
HANDLING

ELECTRICAL

WATERLINE  
/BILGE

STEERING  
& CONTROLS

BODY

ACCESSORIES

SERVICE TOOLS  
/HARDWARE

CHEMICAL



**PARTS STAMPING** This marking on a jetting part is your quality assurance guarantee it is a genuine Mikuni component. **DO NOT ACCEPT SUBSTITUTES.**



### GENUINE MIKUNI CARB COMPARTMENT KIT

Description	Part No.
Dealer Compartment Kit*	53-2120
Compartment only	53-2122

\* Dealer Compartment Kit consists of:  
**4 Each of Needle and Seat** 1.5/2.0/2.3/2.5  
**4 Each of Arm Spring** 65/80/95/115gm  
**5 Each of Low Jets** 67.5/70/72.5/75/77.5  
 87.5/90/92.5/95/97.5/100/102.5/105/107.5/110  
**5 Each of Main Jets** 105/110/115/120/125  
 130/135/140/145/150/155/160

#### CARBURETOR JETS Mikuni Low Jets P/# (N100.606-size)

Size:	30	95
	32.5	97.5
	35	100
	37.5	102.5
	40	105
	42.5	107.5
	45	110
	47.5	112.5
	50	115
	52.5	117.5
	55	120
	57.5	122.5
	60	125
	62.5	127.5
	65	130
	67.5	132.5
	70	135
	72.5	137.5
	75	140
	77.5	142.5
	80	145
	82.5	147.5
	85	150
	87.5	155
	90	160
	92.5	

#### CARBURETOR JETS Mikuni Main Jets P/# (N102.221-size)

Size:	30	95	160
	32.5	97.5	162.5
	35	100	165
	37.5	102.5	167.5
	40	105	170
	42.5	107.5	172.5
	45	110	175
	47.5	112.5	177.5
	50	115	180
	52.5	117.5	182.5
	55	120	185
	57.5	122.5	187.5
	60	125	190
	62.5	127.5	195
	65	130	200
	67.5	132.5	205
	70	135	210
	72.5	137.5	215
	75	140	220
	77.5	142.5	230
	80	145	240
	82.5	147.5	
	85	150	
	87.5	152.5	
	90	155	
	92.5	157.5	

### OLD TYPE NEEDLES & SEATS

#### ROUND DIAPHRAGM COVER STANDARD BN OLD TYPE, STANDARD METAL TIP

— Screw in Type —



Description	Part No.	Mikuni No.
1.5	53-2500	VM26/26-1.5
2.0	53-2501	VM26/26-2.0
2.3	53-2502	VM26/26-2.3
2.5	53-2503	VM26/26-2.5
2.8	53-2504	VM26/26-2.8

### NEW TYPE NEEDLES & SEATS

#### SQUARE DIAPHRAGM COVER SUPER BN (NEW TYPE)

— Push in Type —



#### VITON TIP

Recommended for Gas Fuel Applications

Description	Part No.	Mikuni No.
1.2	—	—
1.5	53-2600	786-35015-1.5
1.8	53-2608	786-35015-1.8
2.0	53-2601	786-35015-2.0
2.3	53-2602	786-35015-2.3
2.5	53-2603	786-35015-2.5

#### STANDARD METAL TIP

Recommended for Alcohol Fuel Applications

Description	Part No.	Mikuni No.
1.2	53-2599	786-35018-1.2
1.5	53-2598	786-35018-1.5
1.8	53-2597	786-35018-1.8
2.0	53-2596	786-35018-2.0
2.3	53-2595	786-35018-2.3
2.5	53-2594	786-35018-2.5

### MIKUNI ARM SPRINGS

Description	Part No.	Mikuni No.
65gm	53-2614	730-03030
80gm	53-2613	730-03033
95gm*	53-2615	730-03034
*This 95gm spring is for Sea Doo BN 46l Carbs Only!		
95gm	53-2612	730-03027-T
115gm	53-2611	730-03027

### POP-OFF PRESSURE CHART

Part No.	53-2611	53-2612	53-2613	53-2614
Arm Springs	115 grams	95 grams	80 grams	65 grams
Needle Valve Size	1.5	55 p.s.i.	43 p.s.i.	38 p.s.i.
	2.0	32 p.s.i.	25 p.s.i.	21 p.s.i.
	2.3	22 p.s.i.	20 p.s.i.	17 p.s.i.
	2.5	19 p.s.i.	17 p.s.i.	14 p.s.i.
Color	Platinum*	Dull Silver	Black	Shiny Silver

\*The new color "platinum" color is due to increasing emission regulations in Japan. The new treatment process of the springs creates the new color.



# MIKUNI GENUINE PARTS SUPER BN 46 "I"



## SUPER BN 46 "I" TYPE CARB

Diagram No.	Description	Mikuni Part No.
4.	Grommet, Check Valve (2)	BN34/125
7.	Filter	BN44/146
8.	O-Ring, Hi Speed (2)	BN30/305
9.	O-Ring, Low Speed (2)	MD12/16
11.	Gasket Valve Body	BN34/123
12.	Check Valve (Clear)	BN34/107
14.	Pin, Arm	VM30/97
15.	Arm (Stainless)	BN38/534
16.	Diaphragm Assembly	BN44/145
61.	Gasket, Pump	BN46/13
62.	Diaphragm, Pump (Clear)	BN46/14
63.	O-Ring	616-73002
64.	Check Valve (2)	BN46/11
66.	Diaphragm, Damper	BN46/34
67.	Diaphragm, Damper (clear)	BN46/15
68.	O-Ring	616-73003
69.	O-Ring, Needle Valve	KV/10

### 53-2115 BN46 I Rebuild Kit

21.	Washer, Aluminum (3)	BN38/39
25.	Spring (2)	BN38/344
27.	Washer, Aluminum (2)	BN38/172
28.	Spring, Low Speed	BN38/343
29b.	Adjuster, Low Speed	BN38/166
33.	Plate, Needle Valve Retainer	BN34/177-GG
34.	Screw with Washer	CW2-0307-G
37.	Screw	BV15/121-05-GG
38.	Plate, Valve	BN34/108-GG
39.	Valve Body Assembly	BN44/165
40.	Screw (2)	C5-0414-G
41.	Screw	C6-0308-G
42.	Cover (Stainless)	BN44/147
70.	Screw with 2 Washers (4)	BN34/120-35
73.	Stop Screw, Idle	BN38/140
76.	Screw (4)	C2S=0514
77.	Diaphragm, Accelerator. Pump	BN40/22
79.	Body Assembly, Pump	BN46/49



### ADJUSTER WITH CROSS BAR

This allows simple tuning adjustments, which is not possible with oem screw.

**"I" series 44/46, OEM Yam GP800 & SD 951** Part No.  
High Speed cross bar screw SA-100

**OEM Yamaha Carb, XL1200LTD, XLT1200, GP1200R** Part No.  
Low Speed cross bar screw SA-200  
High Speed cross bar screw SA-300

**OEM Kawasaki Carb, Kawasaki 800SX-R** Part No.  
Low Speed cross bar screw SA-500  
High Speed cross bar screw SA-100

**OEM Yamaha Carb, Superjet 2004+** Part No.  
Low Speed cross bar screw\* SA-700  
High Speed cross bar screw\* SA-800

\*Choke must be removed to install SA-700 and SA-800

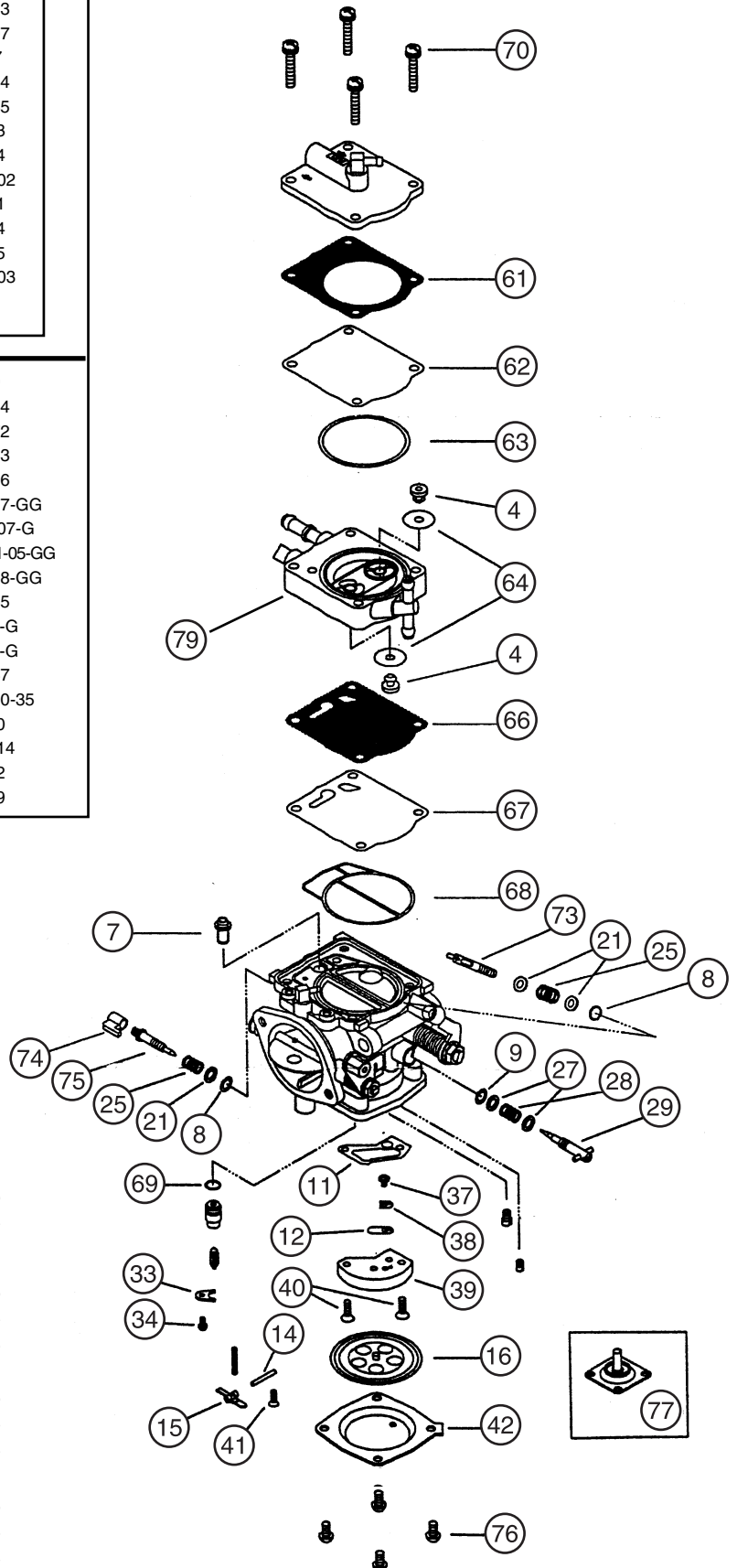

FOUR STROKE
INTAKE SYSTEMS
ENGINE/GASKETS
EXHAUST
DRIVE LINE HANDLING
ELECTRICAL
WATERLINE /BILGE
STEERING & CONTROLS
BODY
ACCESSORIES SERVICE TOOLS /HARDWARE
CHEMICAL

# KEIHIN RACING CARBURETOR

FOUR STROKE  
INTAKE SYSTEMS  
ENGINE/GASKETS  
EXHAUST  
DRIVE LINE HANDLING  
ELECTRICAL  
WATERLINE /BILGE  
STEERING & CONTROLS  
BODY  
ACCESSORIES  
SERVICE TOOLS /HARDWARE  
CHEMICAL



## KEIHIN OEM REPLACEMENT CARBURETOR

Polaris Hurricane 700  
1996-97  
39 mm

Description	Part No.
OEM Replacement	53-2030

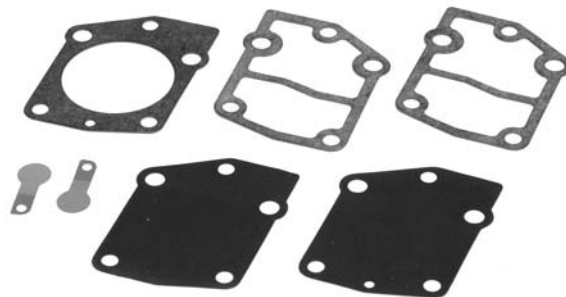

## KEIHIN FUEL PUMP REBUILD KIT

Includes all parts necessary to rebuild the Keihin fuel pump. Fits Kawasaki 650SX 1986-91, 650X2 1989-91.

Description	Part No.
Fuel Pump Rebuild Kit	53-2105

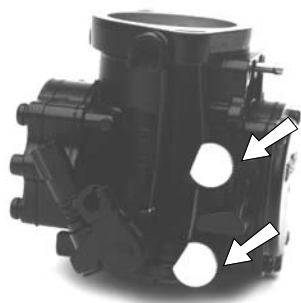

## KEIHIN CARB MIXTURE ADJUSTMENT KNOBS

Billet aluminum, knurled outer, anodized knobs with index reference mark fit on the existing adjustment screws of Keihin 38/40mm carbs to make mixture adjustment easy.

Description	Part No.
Carburetor Adjustment Knobs	53-9993
Fits 38/40mm OEM Type only (does not fit 42mm)	



## ULTIMATE CARB GASKETS

Thick "Green" gaskets.

Keihin	Part No.
38mm	9200
40mm	9205
42mm	9220



## CARB SCREW ADJUSTING TOOL

A special 90-degree screwdriver, designed to adjust carburetors of triple-cylinder watercraft.

Description	Part No.
Carb Screw Adjusting Tool	53-9994

## CARBURETOR JETS

Keihin Low Jets		Keihin Main Jets	Keihin Main Jets	
P/# (N424-35-size)	P/# (N424-27-size)		P/# (N424-36-size)	
40	88	150	100	148
42	90	155	102	150
45	92	160	105	152
48	95	165	108	155
50	98	170	110	158
52	100	175	112	160
55	102	180	115	162
58	105	185	118	165
60	108	190	120	168
62	110	195	122	170
65	112	200	125	172
68	115	(for CDCV)	128	175
70	118		130	178
72	120		132	180
75			135	182
78			138	185
80			140	190
82			142	195
85			145	200

**WHEN ORDERING SPECIFY TYPE AND SIZE. PART NUMBER IS NOT NECESSARY**



2008 OLERON FRANCE  
ZBIGNIEW STANCZYK • POLAND

**GENUINE KEIHIN  
CARBURETOR PARTS**



Description	Diagram	Keihin Part No.
Screw	102	N114-03060
Adjust Screw (Main)	103	Z014-0660
Adjust Screw (Slow)	107	Z014-0670
Check Valve	110	1242-809-2000
Gasket	111	1202-823-2000
Cover	113	1230-827-2000
Diaphragm	114	1201-813-2100
Screw	115	93500-04008-1H
Coil Spring	116 A	1290-966-2000
Coil Spring	116 B	1290-947-2000
Screw	117	4114-001-1200
Arm Pin	118	16152-KG8-9010M1
Float Arm	119	1054-823-2000
Needle Valve	120	1062-818-2000
Gasket	121	1202-822-2000
U-Ring	123	0903-809-6000
Lever Pin	126	1480-049-2004
O-Ring	128	0901-055-6000
Screen	130	2009-811-2100
Diaphragm	134	1201-825-2000
O-Ring	137	0901-841-6000
Gasket	139	1202-851-2000

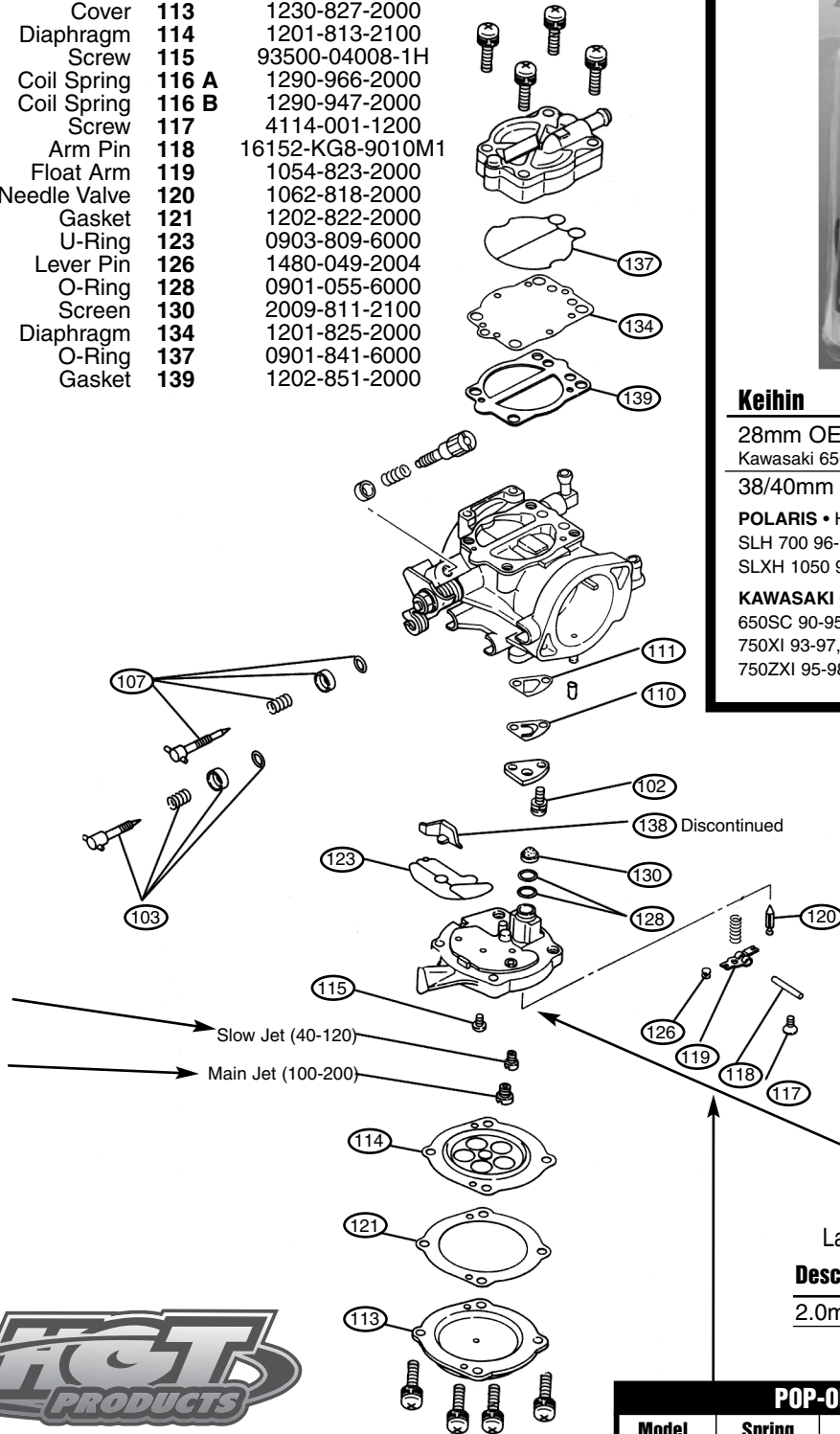

**KEIHIN COIL SPRINGS**

Description	Part No.
42mm 40 grm	1290-966-2000
42mm 70 grm	1290-947-2000
40mm 40 grm	1290-992-2000
40mm 70 grm	1290-961-2000

**KEIHIN GENUINE  
CARBURETOR REBUILD KITS**

Kits include all necessary gaskets, diaphragms, and hardware required to disassemble and rebuild Keihin carburetor.



Keihin	Part No.
28mm OEM Type Kawasaki 650 SX 1986-91 & 650 X-2 1986-91	53-2100
38/40mm OEM Type & 42mm CDKII	53-2103
<b>POLARIS</b> • Hurricane 700 96-97, SL/SLT 700 96-97, SLH 700 96-97, SL900 96-97, SL/SLTX 1050 96-00, SLXH 1050 98-99, Genesis 99-00, 1200Pro 00, Virage/TX 00	
<b>KAWASAKI</b> • JS440 91-92, JS550SX 91-95, 650TS 89-96, 650SC 90-95, 750SX 92-95, 750SXI 95, 750SS 92-98, 750XI 93-97, 750XIR 94, 750ST 94-95, 750STS 95-97, 750ZXI 95-98, 900ZXI 95-97, 900STX 97-99, 1100ZXI 96-97	



**KEIHIN METERING BLOCK  
ASSEMBLIES**

Large high flow needle valve seat assembly.

Description	Part No.
2.0mm	53-2609

**POP-OFF PRESSURE CHART**

Model	Spring Force	Spring Length	Part Number	Needle Size	Valve Size	Size
CDK II	70gr.(std)	11mm	116B	1.6(std)	1.8	2.0
	40gr.	9.17mm	116A	15psi	13psi	11psi
40mm mid range & 42mm Accp.	70gr.(std)	8.7mm	116D	N/A	N/A	N/A
	40gr.	7.4mm	116C	N/A	N/A	N/A

- FOUR STROKE
- INTAKE SYSTEMS
- ENGINE/ GASKETS
- EXHAUST
- DRIVE LINE HANDLING
- ELECTRICAL
- WATERLINE /BILGE
- STEERING & CONTROLS
- BODY
- ACCESSORIES
- SERVICE TOOLS /HARDWARE
- CHEMICAL

## NOVI-TEC PERFORMANCE INTRODUCES NEW PWC CARBURETOR WITH GEN III SONIC BOOSTER TECHNOLOGY

Novi-TEC Performance® is taking their carburetor expertise to a new platform. From the company's on going research and development, Novi-TEC has recently introduced the next evolution of high performance watercraft carburetors with new Generation III booster technology.

After more than a year of testing and race proven results, the new Novi-TEC Generation III booster venturi is ready for release. It is designed to create the most precise high-flow air/fuel delivery system available. The Novi-TEC Generation III design optimally meters air and fuel flowing into the combustion chambers to produce maximum power at all throttle ranges; virtually eliminating hesitation and bogging, while maximizing combustion efficiency.

The new Novi-TEC Generation III booster design offers precise and consistent tuning in all atmospheric conditions and minimizes sonic wave reverse fueling effects. The new design offers maximum performance by maintaining a high flow capacity for today's large displacement engines.

The new Novi-TEC PWC carburetor with Generation III booster technology is virtually a mechanical "Smart Carb".

Novi-TEC Performance is based in Palm Bay, Florida and specializes in the development, testing, and marketing of fuel and engine management perfection for all forms of high-performance recreational vehicles. Novi-TEC Performance was founded by Tim Vaughn bringing over 35 years of successful high performance experience.

*All Novi-Tec Carburetor Kits are custom made on a special order basis.*

**Freestyle** **Part No.**  
 Freestyle Single 48mm Carb Only - Flange Mount **48XRF-FS**

**Yamaha** **Part No.**  
 Yamaha 701/760 Dual 46XR **DY-46XRF-S/S**  
 Yamaha 701/760 Dual 48XR **DY-48XRF-S/S**

**Kawasaki** **Part No.**  
 Kawasaki 750/800 Dual 46XR **DK-46XRF-S/S**  
 Kawasaki 750/800 Dual 48XR **DK-48XRF-S/S**

**Sea Doo** **Part No.**  
 Sea Doo 951 Dual 48XR **DS-48XR-P**

## RIVA YAMAHA RACING CARBURETOR WITH POWER BOMB FUEL ATOMIZER



Riva Yamaha new racing carburetors feature a short threaded air bell that tapers from a massive 70mm to a true 48mm throttle plate. Starting with proven Mikuni Super-BN carburetors, each one is hand assembled with top shelf components. At the heart of carburetor is Riva's exclusive "Power Bomb" fuel atomizer, providing peak performance under all conditions. Hesitation and bogging are eliminated while delivering explosive acceleration and extreme top speed. Available individually with flange mounting applications..

**Description** **Part No.**  
 48mm Flange Mount **RY1200R-48-IF**  
 Butterfly Rebuild Kit **RY12-TSRK**

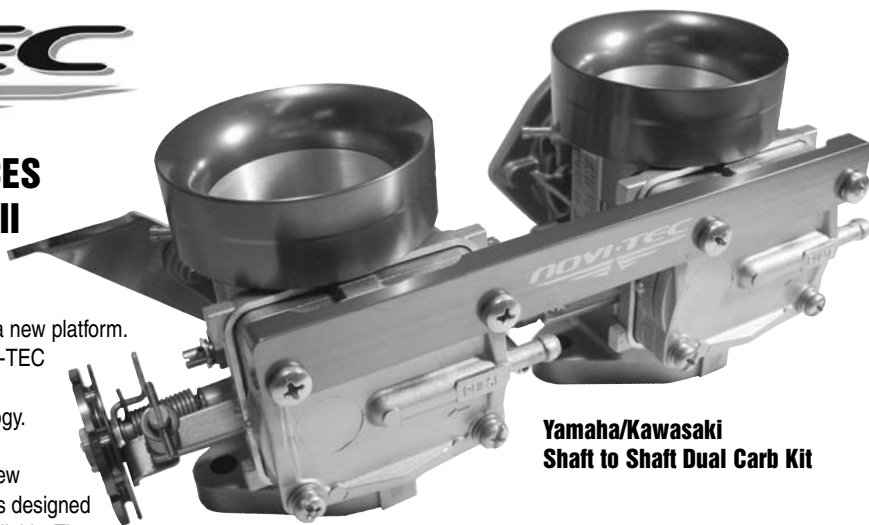

**Yamaha/Kawasaki Shaft to Shaft Dual Carb Kit**



**Novi-TEC Generation III booster design**



**Sea Doo 951 Dual Carburetor Kit Part# DS-48XR-P**

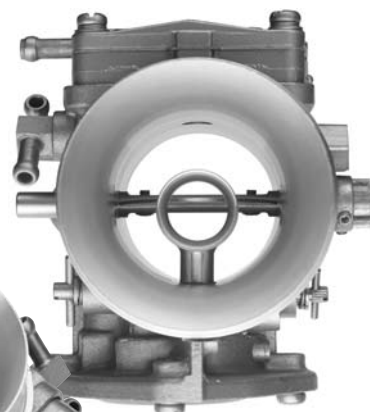

FOUR STROKE
INTAKE SYSTEMS
ENGINE/GASKETS
EXHAUST
DRIVE LINE HANDLING
ELECTRICAL
WATERLINE /BILGE
STEERING & CONTROLS
BODY
ACCESSORIES
SERVICE TOOLS /HARDWARE
CHEMICAL





## HOT PRODUCTS SEADOO DUAL CARBURETOR KITS

Sea Doo	Carb	Flame Arrestor	Part No.
720	Mikuni 44mm	K&N	53-0915
720	Mikuni 46mm	K&N	53-0916
800	Mikuni 44mm	K&N	53-0925
800	Mikuni 46mm	K&N	53-0926

720 Kits also fit 650 & 580 Engines. Please specify for proper jetting.

*All carburetor kits are assembled with the above listed K&N Filters or Tau Ceti Pro Series II Flame Arrestors, the filter size and shape is the best fit based on the watercraft model.*



## HOT PRODUCTS YAMAHA AND KAWASAKI DUAL MIKUNI CARBURETOR KITS

Yamaha	Carb	Flame Arrestor	Part No.
701 W/Rdr / 760 (62T)	Mikuni 44mm	K&N	53-0975
701 W/Rdr / 760 (62T)	Mikuni 46mm	K&N	53-0974
1100/1200	Mikuni 44mm	K&N	53-0980
1100/1200	Mikuni 46mm	K&N	53-0992

\* See page 13 for crankcase application chart

Kawasaki	Carb	Flame Arrestor	Part No.
750	Mikuni 44mm	K&N	53-0830
750	Mikuni 46mm	K&N	53-0840

*All carburetor kits are assembled with the above listed K&N Filters or Tau Ceti Pro Series II Flame Arrestors, the filter size and shape is the best fit based on the watercraft model.*



## HOT PRODUCTS KAWASAKI SINGLE MIKUNI CARBURETOR KITS

Kawasaki	Carb	Flame Arrestor	Part No.
750 All	Mikuni 44mm	K&N	53-0820
750 All	Mikuni 46mm	K&N	53-0825

*All carburetor kits are assembled with the above listed K&N Filters or Tau Ceti Pro Series II Flame Arrestors, the filter size and shape is the best fit based on the watercraft model.*

## SINGLE INTAKE MANIFOLDS

FITS MIKUNI 44/46 MM



Kawasaki	Part No.	Yamaha	Part No.
750 All	53-0827	701/760 (62T/64X)	RY126M



2008 WORLD FINALS FREESTYLE • LAKE HAVASU, AZ

DERRICK "LIL D" KEMNITZ JR. • USA

PHOTO COURTESY OF JIN OMURA

FOUR  
STROKE

INTAKE  
SYSTEMS

ENGINE/  
GASKETS

EXHAUST

DRIVE LINE  
HANDLING

ELECTRICAL

WATERLINE  
/BILGE

STEERING  
& CONTROLS

BODY

ACCESSORIES  
& HARDWARE

SERVICE TOOLS

CHEMICAL

# DUAL INTAKE MANIFOLDS FOR SEA DOO

FITS MIKUNI 44/46MM AND KEIHIN\*



R&D

**SEA DOO** Part No.  
580/650/720 53-0923



R&D

**SEA DOO** Part No.  
XP800 Direct Flow 223-80001



R&D

**SEA DOO** Part No.  
951 223-95000

Must use with part number 273-95000 R&D Stuffers



2008 WORLD FINALS  
LAKE HAVASU, AZ

AKIS MALOUCOS • GREECE



# DUAL / TRIPLE INTAKE MANIFOLDS FOR YAMAHA

FITS MIKUNI 44/46MM

## BOYESEN EXTREME VELOCITY INTAKE KIT & RAD VALVES

IMK-001

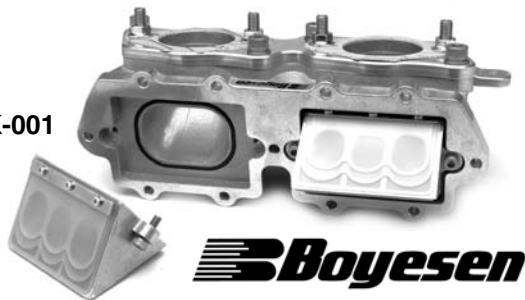

**Boyesen**



Yamaha	Part No.
701 Superjet 96-08, Extreme Velocity Intake Kit*	<b>IMK-001</b>
Extreme Velocity Intake Manifold Only	<b>IM-001</b>
"EV" RAD Valves Kit (2 Valves per Kit)	<b>RAD-131A</b>
Replacement RAD Reed for RAD-131A	<b>PSR-131A</b>
Replacement Gasket for RAD-131A	<b>2830</b>

Yamaha	Part No.
701(62T) W/Rdr/760 With Billet Carb. Plate for <b>OEM Reed</b>	<b>222-76000</b>
701(62T) W/Rdr/760 With Billet Carb. Plate for <b>Moto Tassinari Reed</b>	<b>222-76100</b>
Mounting Plate Gasket	<b>12-0010</b>
Center to center 120 mm	

## Yamaha Crankcase Application Chart

<b>6M6</b>	650LX, VXR, Wave Runner III, Super Jet 90-93
<b>61X</b>	Pro VXR, Wave Runner III, GP, Super Jet 94-95, Fx-1, Wave Blaster 93-95, Raider 701 96-97
<b>62T</b>	Super Jet 96-01, Blaster II
<b>64X</b>	Wave Blaster 96-97, GP760, Raider 701/Deluxe/760 94-95, Venture 701/760, XL700/760
<b>63M</b>	Raider 1100, Venture 1100
<b>66E</b>	GP800 Power Valve
<b>65U</b>	GP1200, XL1200, SUV1200
<b>66V</b>	GP1200R, XL1200 LTD/XLT, 99-01 Power Valve



**PRO-TEC**

**Yamaha** Part No.  
Y701 (62T), Wave Raider/760 **13-2109**



**R&D**

**Yamaha** Part No.  
1100/1200 (63M/65U) **232-11000**



**R&D**

**Yamaha** Part No.  
GP800 with stuffers **222-80000**

# DUAL / TRIPLE INTAKE MANIFOLDS FOR KAWASAKI

FITS MIKUNI 44/46MM



**Kawasaki** Part No.  
800SX-R **231-75146**  
With Billet Carb. Plate  
for OEM Reed  
Mounting Plate Gasket **12-0010**  
Center to center 120mm



**Kawasaki** Part No.  
800SX-R **231-75148**  
With Billet Carb. Plate  
for MOTO TASSINARI reed  
Mounting Plate Gasket **12-0010**  
Center to center 120mm



**JetWorks**  
**Kawasaki** Part No.  
Ultra 150/STX-R **53-0887**  
\*Sold separately \*Use with OEM reed

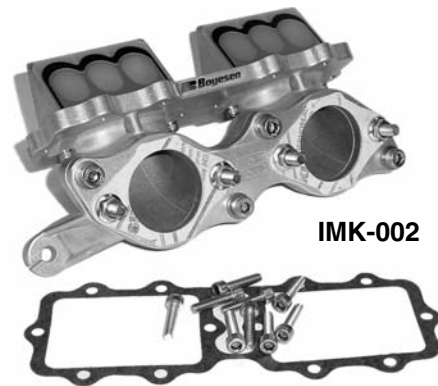

**IMK-002**

## BOYESEN EXTREME VELOCITY INTAKE KIT & RAD VALVES

<b>Kawasaki</b>	<b>Part No.</b>
800SX-R 03-08, Extreme Velocity Intake Kit*	<b>IMK-002</b>
Extreme Velocity Intake Manifold Only	<b>IM-002</b>
"EV" RAD Valves Kit (Single Valve)	<b>RAD-113</b>
Replacement RAD Reed for RAD-113	<b>PSR-131A</b>
Replacement Gasket for RAD-113	<b>IMG-001</b>

\*Kit includes (1) precision cast aluminum intake manifold, (2) "EV" RAD valves, (1) carb adapter plate and all necessary installation hardware.



**R&D**

For Mikuni SBN 44, 46 or 48mm Spigot Mount Carb Applications

<b>Kawasaki</b>	<b>Part No.</b>
Ultra 150/STX-R Kit	<b>231-15000</b>
*Use with M-16 reed only	

FOUR STROKE	INTAKE SYSTEMS	ENGINE/GASKETS	EXHAUST	DRIVE LINE HANDLING	ELECTRICAL	WATERLINE /BILGE	STEERING & CONTROLS	BODY	ACCESSORIES	SERVICE TOOLS /HARDWARE	CHEMICAL
-------------	----------------	----------------	---------	---------------------	------------	------------------	---------------------	------	-------------	-------------------------	----------



### CARBURETORS LINKAGE

Linkage Kit	Part No.
Mikuni	53-0622



### MIKUNI DUAL CARBURETORS LINKAGE KIT

Description	Part No.
Mikuni Dual Linkage Kit	MK-BN/001



### TBM CARBURETOR SHAFT COLLARS

Designed to replace the e-clips that commonly break allowing the carburetor shaft to vibrate side to side damaging the butterfly's and carburetor bodies. Manufactured from stainless steel for corrosion prevention, the two-piece design allows installation without disassembling the carburetors.

Description	Part No.
Carburetor shaft collars	TBM108



### CARBURETORS LINKAGE SLEEVES

Sleeve Only		Part No.
5/8"	16mm	53-9905
3/4"	19mm	53-9906
1"	25mm	53-9916
2-3/16"	56mm	53-9917
6"	152mm	53-9918



### LINKAGE INSTALLATION TOOL FOR OEM CARB.

Description	Part No.
Linkage Installation Tool	53-0434



### JETWORKS LINKAGE

Using 120mm center to center aftermarket dual S/BN carburetor applications. It is made to have zero backlashes and will not compress after age.

Description	Part No.
120 mm center to center	LK-2

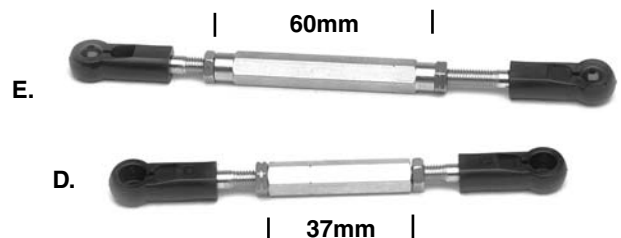

### MIKUNI GENUINE OEM STYLE LINKAGE RODS

Description	Part No.
D. Sea Doo XP800	53-0615
E. Sea Doo 951	53-0616



2008 WORLD FINALS  
LAKE HAVASU, AZ

VASILIS MORAITIS • GREECE



# THROTTLE CABLE DRUM FOR MIKUNI

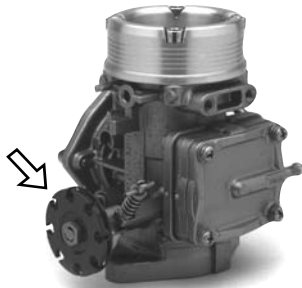

Hot Products original billet throttle drum for Mikuni carburetors allows the use of any throttle cable and bracket on Mikuni carburetors. 9 positions, 18mm throw.

Description	Part No.
Hot Products Cable Drum 18mm Throw	53-2622

PJS Drums features a center web thin enough to allow use of nut with lock washer. "D" slot match the throttle shaft for a perfect fit. 12 positions and available in 20mm or 25mm throws

Description	Part No.
Standard Size (20mm throw)	53-2625
Oversized (25mm throw) For Oil injection and stock carburetors of Yamaha GP/XL	53-2627



# THROTTLE CABLE BRACKETS FOR MIKUNI



## Diaphragm Cover Mount Throttle Cable Bracket

Recommend for use with Hot Products Cable Drum Part #53-2622 8mm hole.

RY12-TCB	8mm
THRTL-BRKT	10mm
290-00200	10mm



## Body Mount Throttle Cable Bracket

53-3310



## Kawasaki / Polaris / Tigershark - 10mm Hole

53-3317



## Sea Doo / Yamaha / WetJet - 8mm Hole

53-3318



## MOTOINE SOFT SPRING FOR MIKUNI CARBS

New Motoine Mikuni spring is 2/3 softer than original spring and reduces thumb and/or finger throttle fatigue.

Description	Part No.
Motoine Soft Spring	MR-00013



## ADA RACING CABLE BRACKET FOR OEM CARBS

Kawasaki 750/800 throttle cable/choke cable bracket. For use with stock carbs when using the ADA Racing billet girdle head kit. This bracket has the throttle cable mount moved up, so it does not interfere with the girdle bracket.

Description	Part No.
ADA Bracket	KA800BRK-CARB



THAILAND JET SKI RACING TEAM

FOUR STROKE	INTAKE SYSTEMS	ENGINE/GASKETS	EXHAUST	DRIVE LINE HANDLING	ELECTRICAL	WATERLINE /BILGE	STEERING & CONTROLS	BODY	ACCESSORIES	SERVICE TOOLS /HARDWARE	CHEMICAL
-------------	----------------	----------------	---------	---------------------	------------	------------------	---------------------	------	-------------	-------------------------	----------



### FUEL PICKUP FOR ZXI/STX-R

Provides maximum fuel flow to triple carbs

Description	Part No.
Kawasaki ZXI/STX-R	53-9957



### ADA PICKUP FOR ULTRA

Description	Part No.
Kawasaki Ultra	KUPP



### BLOWSION FUEL FILLER FOR YAMAHA SUPERJET AND POLARIS OCTANE

Description	Part No.
Billet Dual Pick Up	01-02-502
Billet Single Pick Up	01-02-501



### BLOWSION FUEL FILLER FOR KAWASAKI SX/SXI/SXI-PRO/SX-R

Description	Part No.
Billet Dual Pick Up	01-02-506



### BLOWSION RACING FUEL PICKUP FOR KAWASAKI SX/SXI/SXI-PRO/SX-R

Description	Part No.
Billet Dual Pick Up	01-02-507



### ONE WAY CHECK VALVE

One way vent valve allows fuel to travel in one direction only. 1/4" Fuel Line.

Description	Part No.
One Way Check Valve	53-9941

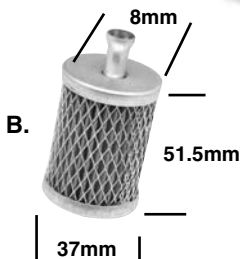
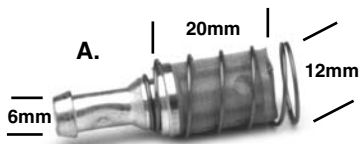

### FUEL TANK FILTER

Description	Part No.
A. Universal Fuel Tank Filter (Replaces Sea Doo #275-500-005)	53-9946
B. Universal Fuel Tank Filter (Replaces Yamaha #8H5-224560-00)	006-516
C. Sea Doo Fuel Filter Tank Filter (Replaces Sea Doo #275-500-089)	006-510



### R&D ULTRA 250X DEEP FUEL PICKUP

The R&D Deep Fuel Pickup is designed to maximize fuel volume. The stock fuel pickup is located horizontally in the gas tank three inches above the bottom of the tank. This leaves approximately 5 gallons of unusable fuel in the bottom of the tank. The R&D Deep Fuel Pickup relocates the stock fuel pickup to the bottom of the tank in a vertical position. The new positioning allows for 24 percent more riding time per tank of gas. The deep fuel pickup is an absolute must for offshore racing.

Description	Part No.
R&D Ultra 250X/LX Deep Fuel Pick Up	801-25100



## RIVA HIGH VOLUME FILTER

3/8" Fuel Line.

Description	Part No.
3/8" Riva High Volume Filter	<b>RY-0503</b>



## 2" SLIMLINE WITH BRONZE ELEMENT

Clear nylon housing and bronze 75 Micron Element. 2" length. 1/4" Fuel Line.

Description	Part No.
2" Slimline with bronze	<b>53-9952</b>
Retail sales display card with 20 filters	<b>53-9952D</b>



## 3" SLIMLINE WITH POLYESTER ELEMENT

Lightweight high flow 90 Micron Polyester Element. 3" length. 1/4" Fuel Line.

Description	Part No.
3" Slimline with polyester	<b>53-9953</b>
Retail sales display card with 20 filters	<b>53-9953D</b>



## IN-LINE OIL FILTER

75 Micron Stainless Steel Element. 1.3" diameter, 1/4" Fuel Line. This filter works with fuel and oils. Perfect protection for oil pumps and oil injection engines.

Description	Part No.
Stainless Steel filter	<b>53-9943</b>
Retail sales display card with 20 filters	<b>53-9943D</b>



## HIGH-CAPACITY HIGH FLOW FILTER

80 Micron Paper Element. 1.6" diameter, 1/4" Fuel Line.

Description	Part No.
High Flow Paper Filter	<b>53-9945</b>
Retail sales display card with 20 filters	<b>53-9945D</b>



## HIGH PERFORMANCE CATALYTIC FILTER

A Fuel filter made of high impact nylon. Clean burning engines, better throttle response and some increase in power and fuel efficiency.

Description	Part No.
Catalytic Filter	<b>53-9948</b>



## QUICK DISCONNECT RESTRICTOR

Mikuni main jets thread into the billet part of the restrictor. This kit is used on the return lines of carburetors to fine tune fuel pump pressures.

Description	Part No.
Quick Disconnect Restrictor 1/4"	<b>QD-14</b>



### Recommended Main Jets:

Stock Carbs for 1200 (66V)	105
Novi Carbs for 1200 (66V)	100-120
Novi Carbs for 701 (61X)	100-120

## FUEL RETURN LINE RESTRICTOR 1/4" LINE

Designed to improve throttle response and reduce lean conditions in power band, our new Fuel Return Line Restrictor installs into fuel return line between carburetors and fuel tank, restricting fuel return rate, increasing pressure to carburetors. Precision-machined billet restrictor is threaded to accept a Mikuni Main Jet (not included) to match your application. For use with OEM and aftermarket carburetors.

Description	Part No.
Fuel Return Line Restrictor	<b>RY12-RLR-14</b>



## RIVA FUEL FILTERS

OE replacements fit stock mounting bracket in all Yamaha watercraft these fuel filters also serve as a water separator protecting the motor from water damage

Description	Part No.
OE Replacement filter (all except 66V/E)	<b>RY-0501</b>
OE Replacement filter 66V/E	<b>RY-0502</b>

FOUR STROKE

INTAKE SYSTEMS

ENGINE/GASKETS

EXHAUST

DRIVE LINE HANDLING

ELECTRICAL

WATERLINE /BILGE

STEERING & CONTROLS

BODY

ACCESSORIES

SERVICE TOOLS /HARDWARE

CHEMICAL

FOUR STROKE  
INTAKE SYSTEMS  
ENGINE/GASKETS  
EXHAUST  
DRIVE LINE HANDLING  
ELECTRICAL  
WATERLINE /BILGE  
STEERING & CONTROLS  
BODY  
ACCESSORIES  
SERVICE TOOLS /HARDWARE  
CHEMICAL



## 1/4" FUEL LINE & 1/8" PRIMER LINE

Our fuel and primer line is made from a thick walled polyurethane tubing. Both the fuel and primer line is clear blue. Sold per foot or 25 feet packages.

Description	Part No.
Fuel (1/4") per foot	53-9970
Fuel (1/4") - 25 foot package	53-9970-25
Primer Line (1/8") per foot	53-9980
Primer Line (1/8") per foot - 25 foot package	53-9980-25

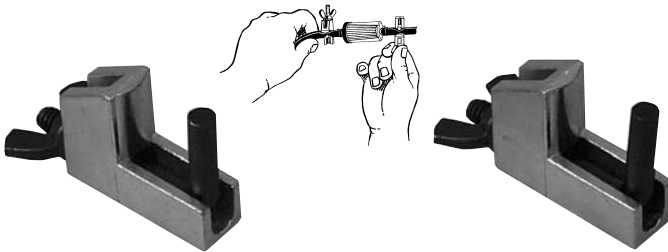

## HOSE PINCHERS

Quick, easy way to pinch off fuel lines, etc, without damaging the fuel line. Sold two per set.

Description	Part No.
Hose Pinchers	LS22850



## HOSE SHEARS

Simply Scissor-action cutter for hose. Cuts clean, straight and no damaged hose ends. A must have tool for every toolbox.

Description	Part No.
Hose Shears	59-4020

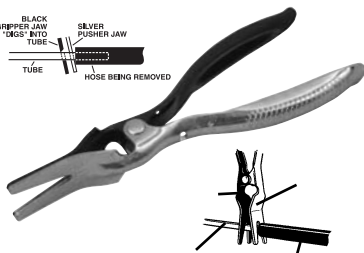
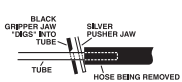

## HOSE REMOVAL PLIERS

For easy removal of 5/32" to 1/2" (4mm to 14mm) hoses. Engage the tube (line) with the black jaw. This sharpened jaw actually "digs" into the tube to grip it! Squeeze, and the hose is easily pushed off by the silver jaw.

Description	Part No.
Hose Removal Pliers	LS47900



## FUEL LINE Q/D W/SHUT-OFF VALVE for 1/4" fuel line

Description	Part No.
Fuel Line Q/D w/Shut-off Valve	53-9951



## HOSE PINCHER

Clamps and holds hoses up to 3/4" inside diameter. Angled jaws close to create a complete seal every time. Jaws are offset for hard-to-reach areas. The handles lock firmly to hold the jaws in closed position.

Description	Part No.
Hose Pinchers	LS23000



Pincer Tool Part # 59-4015

## Fast, Easy, Strong and Secure Installation

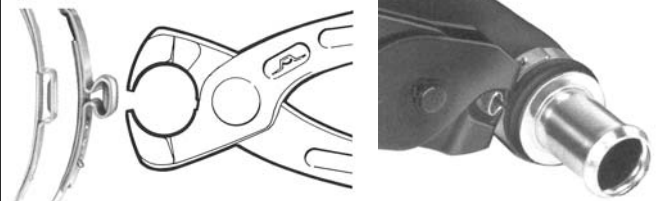

## Fast & Easy Removal

## SQUEEZE ON STAINLESS STEEL LOW PROFILE CLAMPS

Oetiker Stepless Ear Clamps, due to the reinforcing 'dimple' in the ear, hold against pressure and vibration or hose shrinkage due to temperature changes. A built-in spring action permits the clamp to "breathe" without loosening, the need to retighten is eliminated. Once installed, any tampering is easily visible, making this an excellent clamp for service or security applications.

Description	Clamp Size	Part No.
Pincer Tool	-	59-4015
Clamp for 1/4" Hose (10 pcs/pk)	9/16	59-4016
Clamp for 3/8" Water Line (10 pcs/pk)	11/16	59-4017
Clamp for 1/2" Water Line (10 pcs/pk)	13/16	59-4018

100 Clamp Packs	Clamp Size	Part No.
Clamp for 1/4" Hose (100 pcs/pk)	9/16	59-4016-100
Clamp for 3/8" Water Line (100 pcs/pk)	11/16	59-4017-100
Clamp for 1/2" Water Line (100 pcs/pk)	13/16	59-4018-100





### PRIMER KITS

A cure for hard-starting motors. Draws fuel from the fuel line to give the carburetor a blast of fuel for easy starting. Eliminates chokes and adds to battery life. A must on high-performance modified carburetors with eliminated chokes. Hot Products primers are assembled with top-quality materials and include 9 feet of 1/8" blue primer hose to fit sit down craft. USA made top-quality plunger, brass "T" fittings, spigot, caps and zip ties.

Plunger Primer Kit	Part No.
Mikuni Primer Kit Single	53-9920
Mikuni Primer Kit Dual	53-9928
Mikuni Primer Kit Triple	53-9922
Keihin Primer Kit Single	53-9925
Keihin Primer Kit Dual	53-9929
Keihin Primer Kit Triple	53-9924



Spigot & Plug Kit

Brass T Fitting

Parts Only	Part No.
G. Mikuni Brass Spigot & Plug Kit	53-9921
Mikuni Brass Plug Only	53-9921B
H. Keihin Brass Spigot & Plug Kit	53-9926
Keihin Brass Plug Only	53-9926B
I. Brass T for Dual 1/8 x 1/8 x 1/8	64-0015
J. Brass T for Primer 1/4 x 1/4 x 1/8	64-0017
Primer Line 1/8 (Sold per foot)	53-9980

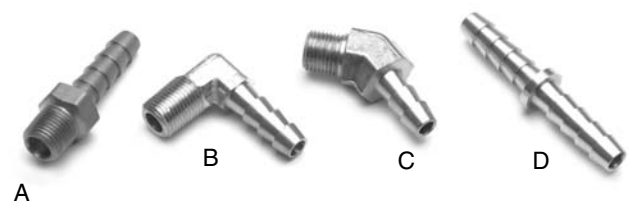

### 1/4" HOSE BRASS FITTINGS

Description	Part No.
A. Straight: 1/8" Thread 1/4" Hose	64-0001
B. 90 Degree: 1/8" Thread 1/4" Hose	64-0010
C. 45 Degree: 1/8" Thread 1/4" Hose	64-0065
D. Barb Connector 1/4" I.D.-1/4" I.D.	64-0057



### PRIMER ADD ON KITS

Mikuni and Keihin primer add on kits for use with dual and triple carb kits. One add on kit needed for duals, two needed for triples. Kit includes spigot and cap, T-fitting, 6" of 1/8" blue primer hose and zip ties.

Description	Part No.
Mikuni Primer Add On	53-9923
Keihin Primer Add On	53-9927



53-9915

53-9910A

Plunger Body Only	Part No.
Plunger Primer Only	53-9910A
Button Primer Only	53-9915



### PRESS IN NIPPLE

Description	Part No.
1/8" Straight	53-9936
1/4" Straight	53-9937



### PLASTIC "Y" FITTINGS

Description	Part No.
1/4" X 1/4" X 1/4" (White)	64-0046
1/4" X 1/4" X 1/4" (Black)	64-0047



### MIKUNI HIGH VOLUME FUEL PUMP

16 gallons/61 Liters per hour

<b>Description</b>	<b>Part No.</b>
Fuel Pump	53-3328
Fuel Pump Repair Kit	53-3328RP

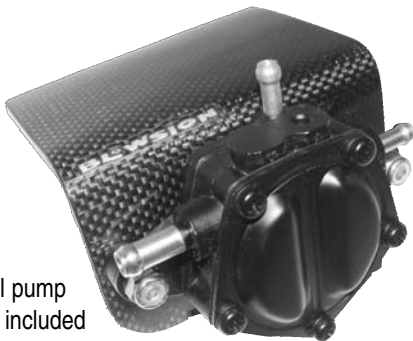

\*\*Fuel pump is not included

### CARBON REMOTE FUEL PUMP BRACKET

Use this ultra sano 100% carbon fuel pump bracket when adding remote fuel pumps. Lightweight and burly, this is the key to your mounting problems without adding weight or stress to the engine compartment.

<b>Description</b>	<b>Part No.</b>
Fuel Pump Bracket	01-02-556



### SEA DOO DUAL FUEL PUMP UPGRADE KIT

A must for high performance engines with the OEM dual carbs with a single fuel pump. Kit adds a fuel pump to the rear carb, eliminating fuel starvation in the rear carb at high RPM. Includes pulse fitting and hose.

<b>Description</b>	<b>Part No.</b>
Sea Doo Fuel Pump Kit	53-3325



#48 GOLD BAND

#53 BLACK BAND

### SPIGOT MOUNT FLANGE FOR MIKUNI CARBURETOR

For easier removal and installation of carburetor for jetting and maintenance. Recommended to use with side draft manifold only.

<b>Description</b>	<b>Part No.</b>
M-VM40-200K (Gold Band)	48
I-VM44-200-1 For Sea Doo 951 (Black band)	53

Part NUMBER	8.5MM BOLT HOLE	CARB BORE SIZE	CARB SPIGOT DIAMETER	FLANGE THROAT DEPTH	TYPICAL CARB SIZE
M-VM40-200K	75	46	52	32	40-44
I-VM44-200-1	84	46	52	26	40-44



### KEIHIN CARBURETOR ADAPTERS FOR MIKUNI CARBURETOR MANIFOLDS

<b>Description</b>	<b>Part No.</b>
A. This adapter allows mounting of Keihin CDKII 38, 42 carburetor to any popular O.E. or aftermarket 44mm Mikuni intake manifold.	53-3305

\*The carb will stand straight up when using this adapter - the carb is just rotated a few degrees to clear the adapter mounting bolts.

<b>Description</b>	<b>Part No.</b>
B. This adapter is designed to mount to the Keihin CDKII 38, 42 carburetor at an angle specifically for the Kawasaki JS440/550 piston port engine.	53-3308

\*A short air filter is required for to prevent rubbing on the inside of the hood



### MIKUNI FUEL PUMP BLOCK OFF

Sold individually. One block off and the four mounting bolts per kit.

<b>Description</b>	<b>Part No.</b>
Mikuni Fuel Pump Block Off	53-3330



### BLOWSION FUEL PUMP BLOCK OFF

New for 2009 Blowson has created these sanitary anodized and engraved Blowson logo carb block offs. A necessity when using a remote fuel pump. Fits all Mikuni carbs. Billet aluminum and includes all stainless hardware.

<b>Description</b>	<b>Part No.</b>
Blowson Mikuni Fuel Pump Block Off	01-02-557



### BILLET ALUMINUM OIL INJECTION BLOCK OFF



<b>Sea Doo</b>	<b>Part No.</b>
580/650/720 All	50-9504



<b>Sea Doo</b>	<b>Part No.</b>
800/951	50-9506



<b>Polaris</b>	<b>Part No.</b>
SL700/SLT700/Hurricane SL900/SLTX/1050	50-9509



<b>Yamaha</b>	<b>Part No.</b>
650/701/760	50-9500



<b>Yamaha</b>	<b>Part No.</b>
1100/1200/ GPR	50-9501

<b>Kawasaki</b>	<b>Part No.</b>
650/750	50-9500

<b>Kawasaki</b>	<b>Part No.</b>
900/1100	50-9503



### PLASTIC CAPS

The plastic caps have many uses on a PWC. Use the caps to cap the primer fittings, fuel fittings and any other item you need to cap will performing repairs or performing routine maintenance. Caps are sold in packs of 10.

<b>Description</b>	<b>Part No.</b>
Small 1/8" - Oil Primer Nipple	50-9500P
Large 3/8" - Carb/Fuel Nipple	50-9504P



### CASE BLOCK OFF

<b>Kawasaki</b>	<b>Part No.</b>
650/750	50-9505

\*Case Block off not applicable for 800SX-R

FOUR STROKE	INTAKE SYSTEMS	ENGINE/ GASKETS	EXHAUST	DRIVE LINE HANDLING	ELECTRICAL	WATERLINE /BILGE	STEERING & CONTROLS	BODY	ACCESSORIES SERVICE TOOLS /HARDWARE	CHEMICAL
-------------	----------------	-----------------	---------	---------------------	------------	------------------	---------------------	------	-------------------------------------	----------

# ROTARY VALVE PARTS

FOUR STROKE  
INTAKE SYSTEMS  
ENGINE/GASKETS  
EXHAUST  
DRIVE LINE HANDLING  
ELECTRICAL  
WATERLINE /BILGE  
STEERING & CONTROLS  
BODY  
ACCESSORIES  
SERVICE TOOLS /HARDWARE  
CHEMICAL

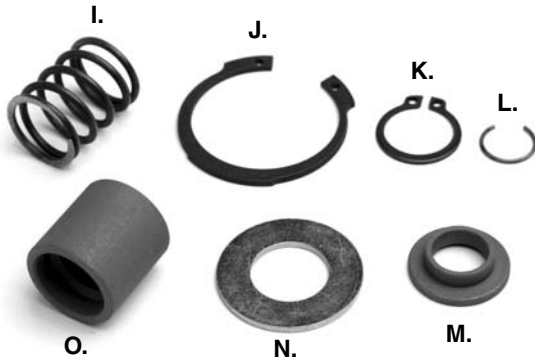
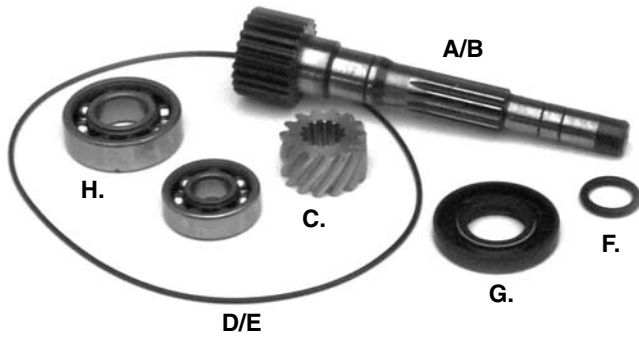

## ROTARY VALVE TIMING WHEEL

**Sea Doo** Part No. 012-170  
Rotary Valve Timing Wheel



## ROTARY SHAFT PULLER

Special rotary shaft puller tool for Sea Doo PWC.  
Fits: Most 580cc, 650cc, 720cc, and 800cc Sea Doo engines.  
(6mm thru bolt included)  
*\*Lubrication of all areas is required before using this tool*

**Sea Doo** Part No. B-204  
Rotary Shaft Puller

# SEA DOO ROTARY VALVE SHAFT AND PARTS

Descriptions	OEM#	Part No.
A. Rotary Valve Shaft 580/650/720	293-837-251	010-455
B. Rotary Valve Shaft 800	290-837-351	010-457
C. Rotary Valve Shaft Gear only (14 teeth) 580/650/720/800 (89-up)	420-935-735	010-450
D. Rotary Cover O-Ring 580/650/720	293-300-023	6250
E. Rotary Cover O-Ring 800	290-831-765	6628
F. Rotary Shaft O-Ring 580/650/720/800	293-300-024	6260
G. Rotary Shaft Oil Seal 580/650/720/800	290-930-580	009-779
H. Rotary Shaft Bearing 580/650/720/800	290-932-032 290-932-797	010-225 010-226

Descriptions	OEM#	Part No.
I. Rotary Shaft Spring 580/650/720/800	290-938-810	010-453
J. Rotary Shaft Snap Ring - Large 580/650/720/800	290-845-260	010-483
K. Rotary Shaft Snap Ring - Small 580/650/720/800	290-932-032	010-482
L. Rotary Shaft C-Clips 580/650/720/800	290-845-160	010-454
M. Rotary Spring Holder 580/650/720/800	420-827-430	010-484-01
N. Rotary Bearing Washer 580/650/720/800	420-227-439	010-459
O. Rotary Shaft Barrel 580/650/720/800	290-847-282	010-484

## STAINLESS STEEL ROTARY VALVES

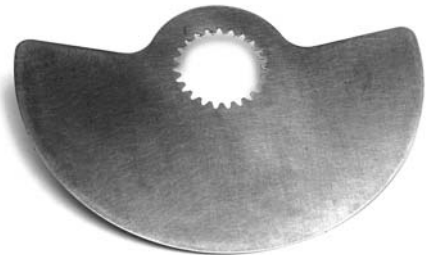

Model	Year	Opening Duration	Part No.
580 All	94-96	147°	006-147
650 All	94-95	159°	006-159
720	95-02	159°	006-159
785	95-02	159°	006-159



2008 HYDRO-TURF APBA WATERCROSS NATIONAL TOUR  
HARBOR BEACH, MICHIGAN



## MOTO TASSANARI V-FORCE3 THE FEATURES AND BENEFITS OF VFORCE TECHNOLOGY

The VForce3 Reed Valve System incorporates features you won't find with other system on the market. With such features as twice the reed tip surface, radius cage surface, snap-together construction, proprietary carbon fiber recipes and more. By doubling the reed tip surface the petals now only need to open half as far to have the same flow as a stock style cage. This is a significant advantage when you factor in that a reed petal opens and closes 133 times per second at 8,000 rpm. The petals are only traveling half the distance of a stock style cage, so now fatigue to the petal has been greatly reduced, increasing petal life. This design also enables the valve to drastically improve the entire powerband with a significant boost in the bottom and mid. Instant throttle response is an understatement! The petals now sit on a radius surface to create a "pre-loading" effect that improves an already snappy acceleration. Our new cage design now allows the reed petal tips to be recessed into the cage itself. This allows for a cushioning of the reed tips and also discourages the possibility of any back-flow.

### SYMMETRICAL REED PETALS:

The VForce3 now uses symmetrical reed petals for both the inner and outer reed petals. No longer will you need to be concerned with having both "inner" and "outer" reed petals.

### SNAP-TOGETHER CONSTRUCTION:

The VForce3 Reed Valve System incorporates the industry's first and only patented snap together reed valve design. The entire assembly is completely screw free, meaning that when reed petals need changing the job is now literally a "SNAP".

### CUSTOM AIR-GUIDES:

Custom air guides specific to each individual application ensure the maximum airflow and performance benefits of the VForce3 reed valve system in your pwc.

### PROPRIETARY CARBON LAY-UP:

Moto Tassinari continues to test and develop new "recipes" for our carbon fiber used in the VForce3 Reed Valve system. In fact Moto Tassinari specs our own exclusive recipes for all the carbon fiber we use, you can be assured

# NEW

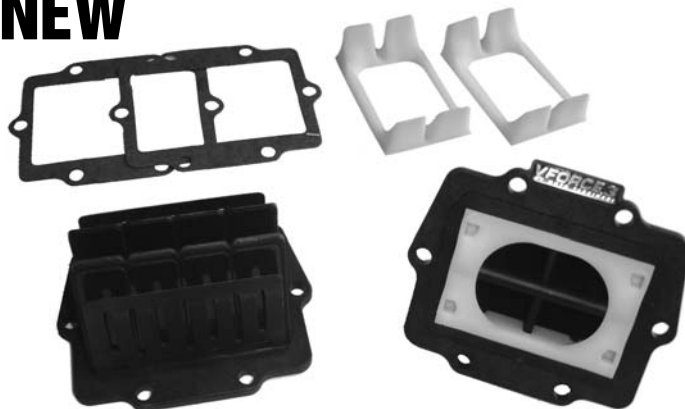

you'll never get "generic" carbon fiber designed for somebody and something else, when you buy VForce.

### TWICE THE REED TIP SURFACE:

The unique and proven design of the VForce3 Reed Valve System doubles the available reed tip surface over a conventional reed valve design. By doubling the effective reed tip surface it enables the engine to get more air with less effort. The number one rule in two-stroke motor modification is More Air = More Horsepower.

### AIRFOIL TECHNOLOGY:

The new reed cage design on the VForce3 Reed Valve system incorporates airfoil shaped (flat on bottom/curved on top) reed tip surfaces which in turn increases the velocity of the fuel/air mixture as it passes through and over, creating the optimum fuel atomization.



Yamaha	V-Force 3	V-Force 3 Repl. Pedal
All Triples*	V3140-794-3	3P794A
All Twins*	V3140-794-2	3P794A

*\*Not compatible for older WaveBlasters and GPR (Power valve cylinders) applications*

Kawasaki	V-Force 3	V-Force 3 Repl. Pedal
All Triples	V3150-794-3	3P794A
All Twins	V3150-794-2	3P794A

Polaris	V-Force 3	V-Force 3 Repl. Pedal
Octane 777	V3130-794A-2	3P794A



## V-FORCE DELTA 2



- Sold as complete system per engine.
- Replacement pedals and gasket: sold one set for each reed valve.

Sea Doo	Delta 2	Delta 2 Repl. Pedal	Delta 1 Repl. Pedal (97-99)	Repl. Gasket
GSX/GTX/XP 951**	V2W121-2	2P127-1	DP120-1	6755

Polaris	Delta 2	Delta 2 Repl. Pedal	Delta 1 Repl. Pedal (97-99)	Repl. Gasket
SL650,SL/SLT750				
SLX780/785 Pro	V2W131-3	2P117-1		4050
SL900/SLTX1050	V2W132-3	2P117-1		4050

Yamaha	Delta 2	Delta 2 Repl. Pedal	Delta 1 Repl. Pedal (97-99)	Repl. Gasket
All Triples	V2W140-3	2P127-1	DP120-1	4430
All Twins***	V2W140-2	2P127-1	DP120-1	2830

Kawasaki	Delta 2	Delta 2 Repl. Pedal	Delta 1 Repl. Pedal (97-99)	Repl. Gasket
All Triples	V2W150-3	2P127-1	DP120-1	MT6150
All Twins	V2W150-2	2P127-1	DP120-1	MT6150

*\*\*Must use with part #53-0939 R&D Manifold*

*\*\*\*Except older Blasters*

FOUR STROKE  
INTAKE SYSTEMS  
ENGINE/GASKETS  
EXHAUST  
DRIVE LINE HANDLING  
ELECTRICAL  
WATERLINE /BILGE  
STEERING & CONTROLS  
BODY  
ACCESSORIES  
SERVICE TOOLS /HARDWARE  
CHEMICAL



# Carbon Tech



FOUR  
STROKE

INTAKE  
SYSTEMS

ENGINE/  
GASKETS

EXHAUST

DRIVE LINE  
HANDLING

ELECTRICAL

WATERLINE  
/BILGE

STEERING  
& CONTROLS

BODY

ACCESSORIES

SERVICE TOOLS  
/HARDWARE

CHEMICAL

## Sea Doo

CC	Model	Year	Performance Info	Part No.
951	All 951 models	97-06	Better mid & top end for stock, limited and superstock motors: +4hp midrange,+2 top 206HT Highly modified motors for top end only	206SS or 206HT

## Polaris

CC	Model	Year	Performance Info	Part No.
650	All 650 models	92-95	Better low to mid	317LT
700	All 700 models	96-04	Better bottom and midrange	275LT
750	All 750 models	93-95	Better mid (used by factory riders)	317LT
777	Octane	02-04	Better low to mid/stock, limited	275LT
	Virage I	02-04	Better mid to top for superstock	275MT
780	All 780 models	96-97	Better low to mid	317LT
780	SLX Pro 785	97-00	Best low to mid	317LT
			Best mid to top end: most durable	317HT
900	SL900	96-97	Increased rpm for higher top spd.	318LT
1050	All 1050 models	96-99	Increased rpm for higher top spd.	318LT
1165	All 1200 models	99-04	318LT More low end response	318LT or
			318HT Mid to top end: most durable	318HT
1192	MSX 140	03-04	More low end response	318LT
			Mid to top end: most durable	318HT

## Yamaha

CC	Model	Year	Performance Info	Part No.
650	All 650 models	89-96	Smoother powerband	223LT
701	Wave blaster	93-95	225LT Stock cylinder, single carb.	225LT
	Superjet	94-95	225HT Sock cylinder, dual carbs	225HT
61X	FXI	94-95		or
CASE	PROVXR	93-94	225M Ported motors, single carb.	225M
	Waverunner III	94-95,97	225SS Ported motors, dual carbs	225SS
	Waveraider	96-97		
701	Waveraider	94-95		
	Waveblaster	96	202LT +3HP in midrange: for limited and stock motors	202LT
62T	Superjet	96-09		or
CASE	Wave Venture	95-98	202SSKT Special kit for superstock applications	202SSKT
	XL 700	99-04		
760	All 760 Models	96-00	202LT +3 HP in mid, +2HP top end for limited and non-ported rec boats	202LT
			202HT Best choice for 760 superstock motors or fuel injected 701 motors	202HT
800	GP800	98-00	Better midrange & top end for stock	266HT
	GP800R	01-05	Limited & superstock motors: Gives 100 RPM=1 MPH	
	XL/XLT 800	00-04	(tested by Pro-Tec)	
1100	All 1100 models	95-97	Better midrange	302LT
1131	GP1200	97-99	*+3 HP mid to top: limited racing	338LT
	XL1200	98-99	Superstock & recreational motors	338SS
	SUV1200	99-04	Top end: only choice for fuel Ing.	338HT
1176	XL1200ltd	99-00	Stock motors, single pipe motors	366HT
	XLT1200	01-05	Single pipe, limited triple pipe	366SS
	GPI1200R	00-02	Ported triple pipe motors	366R
1296	GP1300R	03-08	Stock motors, single pipe motors	366HT
			Single pipe, limited triple pipe	366SS
			Ported triple pipe motors	366R

## Kawasaki

CC	Model	Year	Performance Info	Part No.
550	ALL	91-95	Smoother powerband	239LT
650	ALL	86-96	Improved low to midrange	212LT
743	ALL	92-02	Better low & mid: stock & limiteds	238LT
			Superstock & ported motors	238SS
			High RPM, stroked or fuel injected	238HT
782	800 Motor	03-09	Better low & mid: stock & limiteds	238LT
			Superstock & ported motors	238SS
			High RPM stroked or fuel injected	238HT
891	ALL 900 MOTORS	95-06	Better midrange and bottom end	338LT
			Superstock & ported motors	338SS
1071	ALL 1100 MOTORS	96-04	Better low & mid: stock & limiteds	338LT
			Superstock & ported motors	338SS
			High RPM, stroked or fuel injected	338HT
1176	Ultra 150 1200STXR	99-05 04-05		338LT, 338SS or 338HT

# Boyesen



## BOYESEN POWER REEDS

- The unique dual-petal design
- Quicker acceleration, throttle response and speed.
- Dual-flex epoxy fiber material for maximum longevity and reliability.

Yamaha	Part No.
500 All	022
650 Super Jet	023
650 Wave Runner (All)	023
700 Wave Raider (All)	024
701 FX1 (94-95)	024
701 Pro-VXR (93-94)	024
701 Super Jet (94-95)	024
Wave Blaster (93-95)	024
Wave Raider (Single Carb) (96)	024
Wave Runner III (94-97)	024
701 Super Jet (96-09)	026
Wave Blaster (96)	026
Wave Raider (94-96)	026
Wave Raider DLX (95-96)	026
Wave Runner XL (99-04)	026
Wave Venture (95-98)	026
GP760(97-00), 760 Waves All (95-99)	029
1100 All (95-97)	028
GP1200(97-99), SUV1200(99-04)	033
XL1200(98)	033

Kawasaki	Part No.
550SX (91-95)	014
650SX/X2/SC/SS/ST/TS (All)	012
750SX/SXI/SXI-Pro (All)	013
750SS/STS/XI/ZXI (All)	013
800 SX-R (03-09)	013
900ZXI (-97), STX (97-01), STS (01)	020
1100ZXI/STX (96-03)	021
Ultra 130 (01-04)	036
STX-R 1200 (02-05), Ultra 150 (99-05)	021

Polaris	Part No.
650 All (92-95)	016
SL750 (93-95), SLT750 (94-95)	016
SL780 (96-97), SLT780 (96-97)	016
SLT780 (96-97), SLX780 (96)	016
SLX785 Pro (97-01)	016
700 All (-02)	013
Octane (02-04)	013
800 DI (02-04)	013
Hurricane (96-97)	013
SL900 (96-97)	030
SL1050 (97), SLTX1050 (96-99)	031
SLX1050 (98)	031
Pro/SLX/Virage TX 1200 (00-02)	031
Genesis 1200/FFI (99-01)	031
MSX 140 (03-04)	031

Tigershark	Part No.
640 All (93-99), 770 All (96-99)	018
900 (95-96)	019
1000 All (97-98), TS1100 (99)	019



## BOYESEN PRO SERIES REEDS

- Quicker acceleration for that all important holeshoot.
- Crisper mid-range allowing you to pull that extra boat length.
- Carries RPMs further past peak allowing you to run that steeper pitched impeller for increased top end.
- Easy starting and smoother idling for those dreaded no-wake zones.
- Increased life over traditional carbon fiber reeds.

Yamaha	Stock Unlimited	Hi-Performance
700 Wave Raider (All)	PRO-34	PRO-35
701 FX1 (94-95)	PRO-34	PRO-35
701 Pro-VXR (93-94)	PRO-34	PRO-35
701 Super Jet (94-95)	PRO-34	PRO-35
701 Super Jet (96-08)	PRO-36	PRO-37
Wave Blaster (93-95)	PRO-36	PRO-37
Wave Blaster (96)	PRO-36	PRO-37
Wave Raider (94-96)	PRO-36	PRO-37
Wave Raider, Single Carb (96)	PRO-34	PRO-35
Wave Raider DLX (95-96)	PRO-36	PRO-37
Wave Runner III (94-97)	PRO-34	PRO-35
Wave Runner XL (99-04)	PRO-36	PRO-37
Wave Venture (95-98)	PRO-36	PRO-37
GP760 (97-00)	PRO-38	PRO-39
760 Waves All (96-99)	PRO-38	PRO-39
1100 All (95-97)	PRO-40	PRO-41
GP1200 (97-99), GP1200R (99)	PRO-77	PRO-78
SUV1200 (99-04), XL1200 (98)	PRO-77	PRO-78

Kawasaki	Stock Unlimited	Hi-Performance
750 All	PRO-24	PRO-25
800 SX-R (03-08)	PRO-24	PRO-25
900 All (-96)	PRO-76	—
1100 All (96-03)	PRO-57	—
Ultra 150/STX-R1200 (99-05)	PRO-57	—

Polaris	Stock Unlimited	Hi-Performance
700 All (thru 04)	PRO-26	PRO-27
Octane (02-04)	PRO-26	PRO-27
750 All (93-95)	PRO-28	PRO-29
780 All (98-97)	PRO-30	PRO-31
785 SLX Pro (97-01)	PRO-30	PRO-31



FOUR STROKE  
INTAKE SYSTEMS  
ENGINE/GASKETS  
EXHAUST  
DRIVE LINE HANDLING  
ELECTRICAL  
WATERLINE /BILGE  
STEERING & CONTROLS  
BODY  
ACCESSORIES  
SERVICE TOOLS /HARDWARE  
CHEMICAL



## BOYESEN REED VALVE STUFFER KIT

Kit includes a complete engine set of Boyesen 3D Reed Valve Stuffers and Boyesen PRO Series reeds.

<b>Yamaha</b>	<b>Part No.</b>
GP1200R (00-02), XL/XLT 1200 (99-05), GP1300R (03-08)	<b>RSK-306</b>
Replacement Reed *Must use with Boyesen Stuffer	<b>PRO-128</b>



## RAD VALVES FOR YAMAHA WATERCRAFT

Fits Yamaha Engines:  
701(62T) (94-08), 760(64X),  
1100(63M) and 1200(65U)

Yamaha	Rad Valve	Replacement Rad Reed	Gasket
Stock Intake	<b>RAD-131*</b>	<b>PRO-131</b>	<b>2830</b>
Manifold in Stock applications			
Riva or R&D	<b>RAD-131R*</b>	<b>PRO-131R</b>	<b>2830</b>
Twin or Triple Intake Manifold			

\* Order one set per cylinder, 2 valves for twin, 3 valves for triple cylinders.

## BOYESEN EXTREME VELOCITY INTAKE KIT & RAD VALVES



<b>Yamaha</b>	<b>Part No.</b>
701 Superjet 96-09, Extreme Velocity Intake Kit*	<b>IMK-001</b>
Extreme Velocity Intake Manifold Only	<b>IM-001</b>
"EV" RAD Valves Kit (2 Valves per Kit)	<b>RAD-131A</b>
Replacement RAD Reed for RAD-131A	<b>PSR-131A</b>
Replacement Gasket for RAD-131A	<b>2830</b>



<b>Kawasaki</b>	<b>Part No.</b>
800SX-R 03-09, Extreme Velocity Intake Kit*	<b>IMK-002</b>
Extreme Velocity Intake Manifold Only	<b>IM-002</b>
"EV" RAD Valves Kit (Single Valve)	<b>RAD-113</b>
Replacement RAD Reed for RAD-113	<b>PSR-131A</b>
Replacement Gasket for RAD-113	<b>IMG-001</b>

\*Kit includes (1) precision cast aluminum intake manifold, (2) "EV" RAD valves, (1) carb adapter plate and all necessary installation hardware.

## REED VALVE STUFFERS

- Improves Airflow • Quicker Throttle Response
- Easy Installation

R&D Reed Value Stuffers significantly increase low-speed air velocity. This dramatically improves low/mid range throttle response and also top end performance. Exclusive internal wing design increases overall velocity through reed assembly.



<b>Sea Doo</b>	<b>Part No.</b>
98GS/XL/XPL/GTXL	<b>273-95000</b>
*Excluded 97GS/XL	
951 Used with R&D Manifold 223-95000	



<b>Yamaha</b>	<b>Part No.</b>
GP 1200R/GP1300R	<b>272-12000</b>
OEM Manifold	



<b>Yamaha</b>	<b>Part No.</b>
94-95 701 Raider	<b>272-70301</b>
760 Raider 96 701 Venture, 96 Blaster / Blaster2 96+ Super Jet OEM Manifold	



<b>Kawasaki</b>	<b>Part No.</b>
750/800SX-R	<b>271-75001</b>
OEM Manifold	
750/800SX-R	<b>271-75000</b>
R&D Manifold	



## RIVA/BOYESEN REED STUFFERS



Riva precision aluminum reed stuffers were designed to increase fuel/air velocity through the intake tract, resulting in increased throttle response and acceleration. These stuffers fit

your stock reed cages and match perfectly with the original intake manifold. Will not warp or loose shape like traditional plastic stuffers. A very economical bolt-on performance modification.

<b>Yamaha</b>	<b>Part No.</b>
701 (62T) 2 pcs.	<b>RY1402</b>



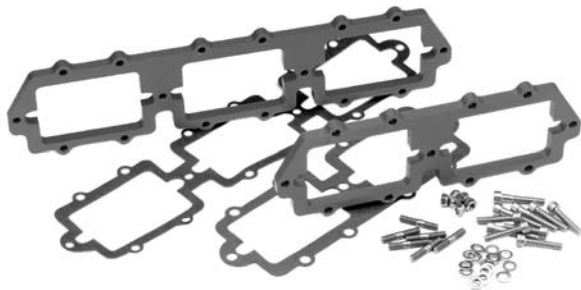

## REED VALVE SPACER BOOSTERS

Yamaha	Part No.
701/760 (62T/64X) Case	RY124M-S
701/760 Spacer Gasket	53-5235-GSK
1100/1200 (63M/65U) Case	RY128M-S
1100/1200 Spacer Gasket	53-5236-GSK



## JSU ANGLED REED SPACER

Angled to direct intake airflow up into the transfer ports on cylinder. This reed spacer kit is the easiest way to bolt on a 3 HP gain. Kit comes complete with all the hardware and gasket needed for installation.

Kawasaki	Part No.
K750/800SX-R Angled Reed Spacer	JSU 800-RSK



2008 WORLD FINALS • LAKE HAVASU, AZ  
PHOTO COURTESY OF RAY CORRAL OF MSD



## R&D REED VALVE SPACERS

Yamaha	Part No.
701/760 (62T/64X) Reed Spacer Angled	262-70101



\*Hardware not included.

Kawasaki	Part No.
750/800 Spacer	251-75010
750/800 Spacer Angled	251-80000
Reed Gasket	7050
6x50mm Stainless Steel Studs (Sold Each)	62-3050

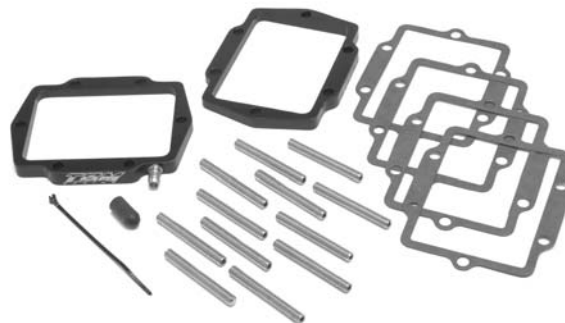

## TBM ANGLED REED SPACER

TBM angled reed spacers position the reed cages in the optimal position for fuel atomization. Key features include a full 3 degrees of angle, an integrated pulse fitting, which allows you to add a second pulse line without drilling your crankcase. Compatible with stock, or aftermarket cages these spacers come complete with all necessary hardware and gaskets.

Kawasaki	Part No.
K750/800SX-R Angled Reed Spacer	TBM106

FOUR STROKE	INTAKE SYSTEMS	ENGINE/ GASKETS	EXHAUST	DRIVE LINE HANDLING	ELECTRICAL	WATERLINE /BILGE	STEERING & CONTROLS	BODY	ACCESSORIES	SERVICE TOOLS /HARDWARE	CHEMICAL
-------------	----------------	-----------------	---------	---------------------	------------	------------------	---------------------	------	-------------	-------------------------	----------



# RACING FLAME ARRESTORS (without Cotton Media)

Experience increased horsepower and engine protection with K&N Personal Watercraft flame arrestors for both normal and race applications. K&N "RACING ONLY" flame arrestors have an epoxied screen filter that does not have the cotton media.

K&N flame arrestors replace the restrictive factory airbox. In most cases an adapter is required (for adapters see pages 30 & 31) to mount the flame arrestor onto the carburetor. Some watercraft may require a slight adjustment to the carburetor's fuel circuits to allow for optimum performance.

## 4" Tall



59-2040R  
STAINLESS TOP

59-2040RK  
COMPOSITE TOP

Height	Top Color	Part No.
4"	Black Composite	59-2040RK
4"	Stainless Steel	59-2040R
Water Repellent Pre-Filter		WR145-10-4DT

## 2-1/2" Tall



59-2042RK  
CHROME TOP

59-2042R  
COMPOSITE TOP

Height	Top Color	Part No.
2-1/2"	Black Composite	59-2042RK
2-1/2"	Chrome	59-2042R
Water Repellent Pre-Filter		WR145-115-25DT

## 2" Tall



Height	Top Color	Part No.
2"	Black Composite	59-2046
Water Repellent Pre-Filter		WR125-2DT



2008 WORLD FINALS • LAKE HAVASU, AZ  
FRANKY ZAPATA • 2008 GP RUNABOUT WORLD CHAMPION  
PHOTO COURTESY OF JIN OMURA

# K&N REGULAR FLAME ARRESTORS (with Cotton Media)

Regular K&N flame arrestors come with K&N's oiled cotton media sandwiched between screen material.

K&N flame arrestors replace the restrictive factory airbox. In most cases an adapter is required (for adapters see pages 30 & 31) to mount the flame arrestor onto the carburetor. Some watercraft may require a slight adjustment to the carburetor's fuel circuits to allow for optimum performance.



## SINGLE 4-1/2" X 7" OVAL

Height	Part No.
3" Tall (40 degree/Tapered)	59-2015
2" Mikuni Wet Suite	25-5911

## DUAL 5-1/2" X 9" OVAL

Height	Center to Center	Part No.
2-1/2" Tall	3-13/16"	59-2910

\*For information on Outwears Water Repellent Pre Filters please see page 73

# HOT PRODUCTS RACING POWER FILTERS

by Tau Ceti

Tau Ceti's new Pro Series II Flame Arrestors are constructed from top quality materials such as aircraft grade aluminum, stainless steel, and a superior quality rubber base. This Flame Arrestor is designed with both duration and superior performance in mind. Using an extremely light anodized aluminum top in Silver, Black, Blue, Green and Red and a stainless steel mesh, this product is 100% corrosion resistant. With our free flowing, **stainless steel mesh**, we achieved an increase in acceleration and a much better throttle response. The universal rubber mount will fit any personal watercraft with a stock carburetor using the appropriate adapter (for adapters see pages 30 & 31). No re-jetting is necessary on stock boats.



Description	Part No.
Round Filter 2" Silver	53-4272-SIL
Round Filter 2" Black	53-4272-BLK
Round Filter 2" Blue	53-4272-BLU
Round Filter 2" Green	53-4272-GRN
Round Filter 2" Red	53-4272-RED
Water Repellent Pre-Filter	WR125-2DT

Description	Part No.
Round Filter 1.5" Silver	53-4270-SIL
Round Filter 1.5" Black	53-4270-BLK
Round Filter 1.5" Blue	53-4270-BLU
Round Filter 1.5" Green	53-4270-GRN
Round Filter 1.5" Red	53-4270-RED
Water Repellent Pre-Filter	WR125-15DT

**Please see pages 74 & 75 for our complete line of air filter adapters required for most applications**



## MIKUNI WETSUIT FOR K&N 2" OVAL FILTERS



Silicone treated foam filter wrap designed to repel water without restricting the air flow to the engine. This cover is a great solution for keeping your filter dry while your riding.

Description	Part No.
Mikuni Wetsuit Color is Blue	25-5911

## Outerwears Racing Accessories

The Outerwears Pre-filter is an excellent solution to prevent water from entering into the engine without restricting air flow or causing a loss in performance. An Outerwears Pre-Filter is designed to be water repellent and will reduce the risk of water entering through an air intake system. Outerwears offers water repellent pre-filters for K&N, Tau Ceti, ProK and R&D performance air filters and flame arrestors.

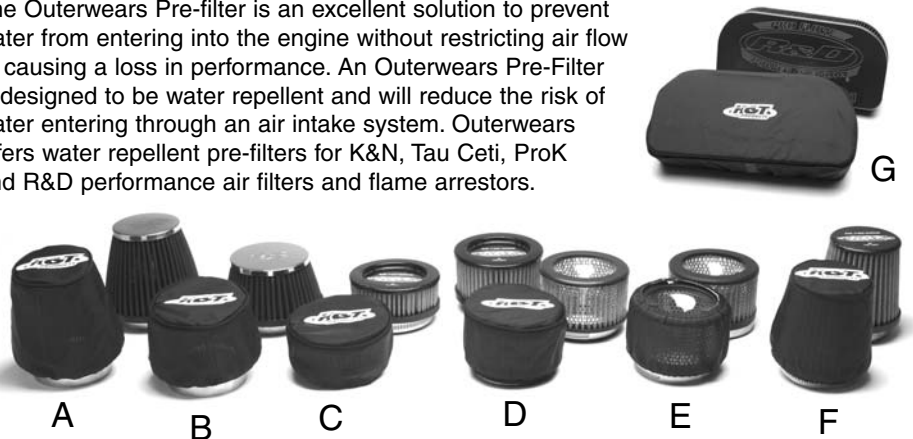

Description	Flame Arrestor Type	Part No.
A. 4.25" x 3" Taper/4" Tall	K&N 59-2040R/RK	WR145-10-4DT
B. 4.25" x 3.5" Taper/2.5" Tall	K&N 59-2042R/RK	WR145-115-25DT
C. 4" dia/1.75" Tall	Tau Ceti 53-4270	WR125-15DT
D. 4" dia/2.25" Tall	Tau Ceti 53-4272, ProK	WR125-2DT
E. 4" dia/2.25" Tall (Open Top)	Tau Ceti 53-4272, ProK	WR125-225
F. 4" x 3" Taper/3.5" Tall	Tau Ceti 53-4275	WR125-10-35DT
G. Pro-Lock SD951/2.5" Tall	R&D 203-95000	WR30-25DTPRO

FOUR STROKE  
INTAKE SYSTEMS  
ENGINE/GASKETS  
EXHAUST  
DRIVE LINE HANDLING  
ELECTRICAL  
WATERLINE /BILGE  
STEERING & CONTROLS  
BODY  
ACCESSORIES  
SERVICE TOOLS /HARDWARE  
CHEMICAL



# ALUMINUM AIR FILTER ADAPTERS FOR MIKUNI CARBURETORS. SOLD EACH.



Mikuni		Part No.
38mm	38mm Bore	53-4460
44mm	46mm Bore	53-4480
46mm	48mm Bore	53-4490



Mikuni		Part No.
38mm	w/oil injection only	53-4462
44mm	w/oil injection only	53-4482



Mikuni	Part No.
OEM 40mm "I" Series (48mm Bore) Sea Doo HX/XP, K750 SXI 96-02, K800SX-R 03-08	53-4465



Mikuni		Part No.
OEM Carb Yamaha		53-4466
GPR Series (57mm Bore)		



## OIL INJECTION SPACER PLATES

Description	Part No.
Mikuni 44mm	53-4485
Mikuni 46mm	53-4495
Press in Nipple (1/8") only	53-9936



## K&N FILTERS AND ADAPTER FOR GO-PED®

Description	Part No.
Adapter for K&N	20-1001



2008 WORLD FINALS • LAKE HAVASU, AZ

FRANKY ZAPATA • 2008 WORLD CHAMPION

PHOTO COURTESY OF JIN OMURA

## REPLACEMENT THROTTLE CABLES



Sea Doo	OEM#	Part No.
720 XP 95, 800 SPX 97-99, 800 SP 95-96	277-000-468	002-039-03
580XP 91, 580GT 90-91	277-000-098	002-037
Yamaha		
500WR '87-'93, 650SJ '90-'93, 650 WR/WRIII/LX/WR VXR '90-'96	EUO-U7252-01	58-3501
701 SJ '90-'95, WR701 '96-'97, W/B701 '93-'95, 701WRII GP '94-'95, 701 WR Pro VXR '93-'94, 701 WRII '97		
701 WR DX 95, 701 WV 95-96 1100 WR 95-96, 1100 WV 96	GJ1-U7252-00	002-057
Kawasaki		
440 '77-'86, 550 '82-'86	54012-3001	58-3121

FOUR STROKE  
INTAKE SYSTEMS  
ENGINE/GASKETS  
EXHAUST  
DRIVE LINE HANDLING  
ELECTRICAL  
WATERLINE /BILGE  
STEERING & CONTROLS  
BODY  
ACCESSORIES  
SERVICE TOOLS /HARDWARE  
CHEMICAL

# PERFORMANCE FILTER KITS FOR TWO STROKE MOTORS

FOUR STROKE  
INTAKE SYSTEMS  
ENGINE/GASKETS  
EXHAUST  
DRIVE LINE HANDLING  
ELECTRICAL  
WATERLINE /BILGE  
STEERING & CONTROLS  
BODY  
SERVICE TOOLS ACCESSORIES  
SERVICE TOOLS /HARDWARE  
CHEMICAL



**Kawasaki** **Part No.**  
1200STXR Stock Carb/Stock Pipe **200-01240**



**Kawasaki** **Part No.**  
800SX-R Stock Carb (I Series Adapters Included) **200-00800**  
800SX-R Aftermarket Carb **200-00120**  
120mm center to center (Adapter not included)



SD 951  
#203-95000

**Sea Doo** **Part No.**  
951 All **203-95000**



**Yamaha** **Part No.**  
GP1300R Stock **200-13143**  
Fuel Injection  
GP1200R/XLL/XLT1200 **200-00142**



Ultra 150 #200-00140

**Kawasaki** **Part No.**  
Ultra 150 1200cc **200-00140**  
Stock Carbs



## GP 1300R POWER STACK AIR FILTER KIT

The R&D GP 1300R Power Stack Air Filter Kit is designed to assemble on to the front of the OEM air plenum box. The R&D Power stack adds bottom and mid range power performance while increasing engine RPM's.

**Yamaha** **Part No.**  
GP 1300R for Stock Box **200-13100**



## RIVA POWER FILTER FOR GP1300R

Power filter fits directly onto OEM air box assembly. Kit comes with water repellent filter.

**Yamaha** **Part No.**  
Flame Arrestor, Power Filter Kit GP1300R (60T) **RY1312**

# PERFORMANCE FILTER KITS FOR FOUR STROKE MOTORS

## FOR ADDITIONAL 4-STROKE PRODUCTS SEE THE FOUR STROKE SECTION



### R&D POWER PLENUM HIGH PERFORMANCE FLAME ARRESTOR KIT

The new R&D F12 / F 15 Power Plenum Air Filter kit delivers a noticeable increase in throttle response and acceleration, as well as increase RPM's between 50 and 100.

**Kawasaki** **Part No.**  
STX-12F/15F **215-15010**



### R&D REPLACEMENT PERFORMANCE FILTER

The new R&D Replacement Performance Filter replaces the stock restrictive perforated filter plate and allows for improved airflow. Amounts directly into the stock filter box and retains the OEM look. The improved airflow increases throttle response, RPM, and top speed.

**Kawasaki** **Part No.**  
STX-12F/15F **215-15000**



### RIVA ULTRA LX/STX-F PERF. POWER FILTER KIT

- Increases airflow and power.
- Installs easily.
- Mounts directly onto stock throttle body.
- Built to our specifications by K&N.
- Includes two smaller K&N filters for engine breather hoses and water repellent pre-filter cover for primary filter.

**Kawasaki** **Part No.**  
Performance Power Filter **RK13085**



### R&D POWER PLENUM FLAME ARRESTER

The R&D High Flow Power Plenum replaces the restrictive stock flame arrester allowing more improved airflow, why? Because more air flow with less restriction means more power!

**Yamaha** **Part No.**  
FX 140/Cruiser **200-00144**  
FX HO/Cruiser



### R&D HIGH FLOW POWER PLENUM AIR BREATHER

The R&D High flow breather is a direct replacement for the stock breather in the OEM air box. Water tested to deliver improved throttle response, acceleration and top speed with 50-100 RPM increase.

**Yamaha** **Part No.**  
FX 140/Cruiser **200-00143**  
FX HO/Cruiser



### VELOCITY STACK KIT

The R&D Velocity Stack Kit is a direct bolt-on kit that replaces the restrictive OEM stacks. Designed to increase air velocity into the throttle bodies producing improved throttle response and top end speed. Easily installs with OEM hardware.

**Yamaha** **Part No.**  
FX 140/Cruiser **206-00140**  
FX HO/Cruiser



### VX110 PERFORMANCE AIR FILTER KIT

The new R&D Performance Air Filter for the VX 110 is now available. The R&D High Flow Filter design replaces the restrictive stock filter inside the stock air box, allowing improved air flow. Why? Because more air flow means more power and improved performance.

**Yamaha** **Part No.**  
VX110 for Stock Carb Air Box **200-00110**



### VX110 POWER FILTER KIT

Screen-type filter element replaces restrictive stock air filter. Extended intake tube draws cooler air into engine significantly improving performance. Includes pre-filter.

**Yamaha** **Part No.**  
VX110 Power Filter Kit **RY13030**



### HONDA F15 POWER PLENUM FLAME ARRESTER

The R&D High Flow Filter design replaces the restrictive stock filter inside the OEM air box. This is the only performance filter that utilizes the water resistant OEM air box, allowing improved air flow creating more power and improved performance. The filter is washable and features reusable design.

**Honda** **Part No.**  
F15 **200-51500**

FOUR  
STROKE

INTAKE  
SYSTEMS

ENGINE/  
GASKETS

EXHAUST

DRIVE LINE  
HANDLING

ELECTRICAL

WATERLINE  
/BILGE

STEERING  
& CONTROLS

BODY

ACCESSORIES

SERVICE TOOLS  
/HARDWARE

CHEMICAL



A complete line of motor mounts designed specifically for heavy duty watercraft applications. Monkey Grip Motor Mounts are designed to be stronger than OEM mounts, yet able to dampen and isolate vibration far better than performance mounts currently available. This combination of durability and performance make Monkey Grip the right choice. Monkey Grip Motor Mounts are available for all popular watercraft.

FOUR STROKE  
INTAKE SYSTEMS  
ENGINE/GASKETS  
EXHAUST  
DRIVE LINE HANDLING  
ELECTRICAL  
WATERLINE /BILGE  
STEERING & CONTROLS  
BODY  
ACCESSORIES  
SERVICE TOOLS /HARDWARE  
CHEMICAL



**Sea Doo** Part No.  
580/650/720 All 57-1182



**Sea Doo** Part No.  
800/951 Front (1 required) 57-1183F



**Sea Doo** Part No.  
800/951 Rear (2 required) 57-1183R



**Part No. 57-1152**

Yamaha Wave Runner 500	All Years
Yamaha 650 VXR	91-95
Yamaha 650LX	90-93
Yamaha 650 Wave Runner III	90-96
Yamaha 701 VXR	93-94
Yamaha 701 Wave Runner	93-00
Yamaha Wave Runner III GP	84-95
Yamaha 701 Pro VXR	93-94
Yamaha Wave Runner III 650	90-96
Yamaha Wave Raider 700	94-97
Yamaha Wave Runner III 700	97
Yamaha XL 700	99-04
Yamaha GP 800	98-00
Yamaha XL 800	00-01
Yamaha XLT 800	02-04
Yamaha GP 1200	97-99
Yamaha XL 1200	98



**Part No. 57-1172**

Yamaha Wave Blaster	93-96
Yamaha Wave Blaster II	96-97
Yamaha 700 Venture	95-96
Yamaha 701 FX	94-95
Yamaha 760 GP	97-00
Yamaha 701 Wave Raider	96
Yamaha 760 XL	98-99
Yamaha Wave Venture	97
Yamaha Wave Raider 1100	95-96
Yamaha Wave Venture 1100	96-97
Yamaha 1200 SUV	99-04



**Part No. 57-1162**

Yamaha 650 Super Jet	All Years
Yamaha 701 Super Jet	All Years



**Part No. 57-1173**

Yamaha 1200R GPR	00-01
Yamaha 1300 GP	04-06
Yamaha FX 140	02-04
Yamaha FX 1100	04-06
Yamaha VX 1100	05-06
Yamaha FX CRUISER	04-06



**Part No. 57-1174**

Yamaha 1200 XL LTD.	99-00
Yamaha 1200 XLT	01-05





**Kawasaki** **Part No.**  
650/750 (Except ZXI) **57-1142**  
800SX-R (03-08)

**Kawasaki** **Part No.**  
750/900/1100 ZXI, **57-1143**  
Ultra 150 Rear (2 required)



**Kawasaki** **Part No.**  
450/550 All **57-1122**



**Part No. 57-1196**  
Polaris SL650 **92-93**  
Polaris SL750 **93**  
Polaris 650 SL **94-95**  
Polaris 750 SL **94**  
Polaris 780 **All**



**Part No. 57-1197**  
Polaris 700/900/1050 **All**  
All SMC Hulls **Late Models**



**Kawasaki** **Part No.**  
Ultra 150 Front **57-1144**



**Tiger Shark** **Part No.**  
All Models 93-95, **57-1175**  
Montego 96, Monte  
Carlo 640/900 96



### ENGINE SHIMS

Engine shims are essential for precise engine alignment. R&D Engine Shims have a tab that provides easy insertion and removal. Shims are made of stainless steel and have etched numbers to identify thickness. Shims available in thickness of .010", .020", .050", .100"

Description	Thickness	Part No.
Engine Shims	.010"	050-00010
Engine Shims	.020"	050-00020
Engine Shims	.050"	050-00050
Engine Shims	.100"	050-00100



01-07-511 Installation Shown



### BLOWSION ENGINE KEEPERS JOE KENNEY DESIGN

Kenney Keepers are a must have for any hardcore surf or flat-water invert artist. Each set contains a left and right side front mount retainer and extended stainless hardware for install. Our unique close tolerance design retains the front, "top heavy" weight of the engine block from being flexed or thrown forward during flat out and invert maneuvers. Since this is a common occurrence (even in flat water racing action), we have also found them to be excellent insurance against ever having to replace expensive engine mounts again.

Description	Part No.
Yamaha SJ 96+	01-03-802
Kawasaki 750SXI/800SXR	01-03-801

FOUR STROKE
INTAKE SYSTEMS
ENGINE/GASKETS
EXHAUST
DRIVE LINE HANDLING
ELECTRICAL
WATERLINE /BILGE
STEERING & CONTROLS
BODY
ACCESSORIES
SERVICE TOOLS /HARDWARE
CHEMICAL



FOUR STROKE  
INTAKE SYSTEMS  
ENGINE/GASKETS  
EXHAUST  
DRIVE LINE HANDLING  
ELECTRICAL  
WATERLINE /BILGE  
STEERING & CONTROLS  
BODY  
ACCESSORIES  
SERVICE TOOLS /HARDWARE  
CHEMICAL

R&D Pro Series Cast CNC Machined heads are an economical alternative to the remachining of the Stock OEM Head, which many times crack and don't seal or cool properly after being modified. Pro Series Heads incorporate larger water volumes, improved circulation for superb cooling and O-Ring design for maximum sealing.

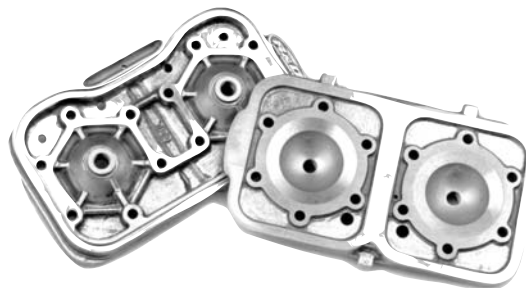

**Sea Doo 800**

**Sea Doo** **Part No.**  
800 Limited/Recreational pump gas spec. 43cc **413-80043**



**Yamaha 701 Ltd**

**Yamaha** **Part No.**  
701 Limited/Recreational 35cc **412-70035**  
701/760 O-Ring set of 2 **080-76000**



**Sea Doo 951**

Sea Doo	Head Kit	Repl. Dome	O-Ring
951 Limited 46cc	<b>413-90046</b>	<b>413-90146</b>	<b>080-95000</b>
951 Recreational 49cc	<b>413-90049</b>	<b>413-90149</b>	<b>080-95000</b>

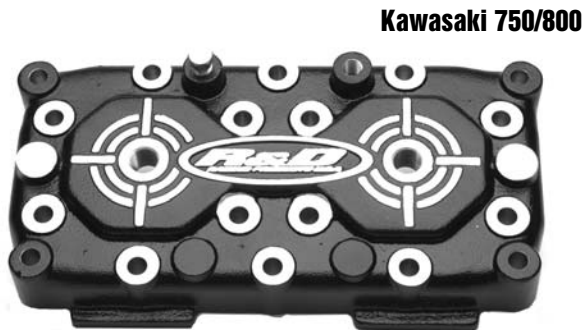

**Kawasaki 750/800**

**Kawasaki** **Part No.**

750/800 23cc	<b>411-75023</b>
750/800 25cc	<b>411-75025</b>
750/800 26cc	<b>411-75026</b>
750/800 27cc	<b>411-75027</b>
750 O-Ring Set of 2	<b>080-75000</b>
800 SXR 28cc	<b>411-80028</b>
800 SXR 29cc	<b>411-80029</b>
800 O-Ring Set of 2	<b>080-80000</b>
750/800 Girdle Hardware Kit	<b>411-75000</b>

\*Girdle kit is optional



**Yamaha GP1300R**

**Yamaha** **Part No.**

GP1300R Head Kit 45cc	<b>412-13045</b>
GP1200R/XLL1200 41cc	<b>412-20041</b>
GPR Head Girdle Hardware Kit	<b>412-12000</b>

\*Girdle kit is optional



**Kawasaki** **Part No.**

Ultra 150/STX-R 1200 Recreational 42cc	<b>411-15042</b>
Ultra Head Girdle Hardware Kit	<b>411-15000</b>



## TBM RACING KAWASAKI 800SXR BILLET HEAD



### Kawasaki SX-R Head with Girdle Kit TBM107-G

This head utilizes a three-piece design that has water flow control not possible with a one-piece head. No gaskets or messy silicone needed as it's completely sealed by o-rings. Other key features are an integrated rear pipe mount for the Factory Pipe and a girdle design that eliminates the need to machine your cylinder.

Domes are manufactured from 7057 aluminum alloy and hard anodized for even heat dissipation and corrosion protection. Domes feature a unique bowl design that is not your typical spherical configuration. Team Kawasaki has proved this design for the past two seasons.



Head without Girdle TBM107

#### Description

Description	Part No.
Kawasaki SX-R Head Kit with Girdle	TBM107-G
Kawasaki SX-R Head Kit without Girdle	TBM107
Replacement O-Rings for Head Kit	TBM107-O
Girdle Head Factory Dry Pipe Hardware Kit	TBM107-FP
Dome 22cc Super Stock 220 psi+	TBM022
Dome 24cc Limited/Super Stock 215 psi+	TBM024
Dome 26cc Limited/Super Stock 210 psi+	TBM026
Dome 27cc Limited/Super Stock 195 psi+	TBM027

\* Domes Sold Individually

When the 2005 IJSBA rulebook allowed the use of up to a .060" base gasket in the limited class we went right to work designing a dome that will accommodate this change. The difference between these domes is the increased step in the squish band. A .050" step optimizes the piston clearance when using a .060" base gasket. If a thinner gasket is used the dome will require machining to avoid piston to head contact.

#### Description

Description	Part No.
Limited Spec. Dome 22cc (+.050")	TBM022-L
Limited Spec. Dome 24cc (+.050")	TBM024-L
Limited Spec. Dome 26cc (+.050")	TBM026-L
Limited Spec. Dome 27cc (+.050")	TBM027-L
Limited Spec. Dome 28cc (+.050")	TBM028-L
Limited Spec. Dome 29cc (+.050")	TBM029-L
Limited Spec. Dome 30cc (+.050")	TBM030-L
Limited Metal Core Base Gasket (0.60")	TBM125-060

\* Domes Sold Individually



## KOMMANDER INDUSTRIES 800 SXR BILLET HEAD AND DOME

Kommander Industries new billet girdle head is without a doubt the most complete cylinder head package available on the market. The body and lid are machined from 6061-T6 aluminum and then anodized with our corrosion protection coating.

Kommander Industries billet aluminum domes are made for racing. Utilizing a custom dome architecture for maximum fuel burn and horsepower gains, these domes are ready for the races.

Kommander Industries Domes Specifications:

82MM: 22cc, 24cc, 26cc, 27cc, 28cc, 29cc, & 32cc

85MM: 28cc, 30cc & 32cc

Limited Spec with .030" (0.76cm) step: 22cc, 26cc, 27cc, & 29cc

Limited Spec with .050" (1.27cm) step: 25cc, 27cc, & 29cc



#### Description

Description	Part No.
Kommander 800 SXR Girdle Billet Head Kit	KOM-101
Kommander 800 SXR Non-Girdle Billet Head Kit	KOM-102
Kommander Girdle Hardware Kit	KOM-101-HARD
Kommander O-Ring Kit	KOM-101-O
Kommander 800 SXR Domes	KOM-DOME-SIZES

\* Domes Sold Individually

FOUR STROKE	ENGINE/GASKETS	EXHAUST	DRIVE LINE HANDLING	ELECTRICAL	WATERLINE /BILGE	STEERING & CONTROLS	BODY	ACCESSORIES	SERVICE TOOLS /HARDWARE	CHEMICAL
-------------	----------------	---------	---------------------	------------	------------------	---------------------	------	-------------	-------------------------	----------



FOUR STROKE  
INTAKE SYSTEMS  
ENGINE/GASKETS  
EXHAUST  
DRIVE LINE HANDLING  
ELECTRICAL  
WATERLINE /BILGE  
STEERING & CONTROLS  
BODY  
ACCESSORIES  
SERVICE TOOLS /HARDWARE  
CHEMICAL



**ADA Girdle Head Shell**

**Yamaha 701/760**



**ADA Girdle Hardware Kit**



**ADA Non-Girdle Head Shell**



**ADA YAMAHA 701/760 BILLET HEAD**

Yamaha	Part No.
Y701/760 Girdle Billet Head Shell**	YA701M
** Girdle Kit is not included in Head Kit	
Girdle Kit (6 pcs.) for Girdle Head **	YA701G6
Y701/760 Non-Girdle Billet Head Shell	YA701L
701-81mm 33cc (200Lbs/105 Octane)	YA2133L
701-81mm 35cc (185Lbs/92 Octane) *	YA2135L
* 35cc Dome for 100 Octane with Dry Pipe	
701-81mm 37cc (170Lbs/92 Octane)	YA2137L
760-84mm 31cc (230Lbs/115 Octane)	YA7631L
760-84mm 33cc (215Lbs/110 Octane)	YA7633L
760-84mm 35cc (200Lbs/105 Octane)	YA7635L
760-84mm 38cc (180Lbs/98 Octane)	YA7638L
760-84mm 40cc (165Lbs/91 Octane)	YA7640L
Flat Top Dome –	
4° w/.015" Relief@86mm	30cc YAK8630L15
Flat Top Dome –	
4° w/.015" Relief@86mm	28cc YAK8628L15
Flat Top Dome –	
4° w/.015" Relief@86mm	26cc YAK8626L15
Flat Top Dome –	
4° w/.015" Relief@86mm	24cc YAK8624L15
Flat Top Dome –	
4° w/.015" Relief@86mm	22cc YAK8622L15
Dome for Flat Top Kawasaki Piston @ 82mm	24cc KD1224
Exhaust Pipe Mount Bracket	YEXBRKT-2M
O-Ring Kit	ORKIT-YA701M

\*\*\*All ADA Domes are sold individually

**ADA SUPER BORE HEAD**

Yamaha	Part No.
Super Bore Non-Girdle Head Shell	YA760SB
Super Bore Girdle Head Shell	YA760SBM
Super Bore 38cc Dome Yamaha	SD9538

\*ADA Super Bore Head Shells and Domes are Special Order Only. Hot Products does not inventory these Super Bore items.

\*\*\*All ADA Domes are sold individually

**Sea Doo 720/800**



**ADA SD720 AND 800 BILLET HEAD**

Sea Doo	Part No.
Sea Doo 720 Billet Head Shell	SD720
Sea Doo 720 34cc Dome (190 Lbs 105 oct.)	SD7234
Sea Doo 720 36cc Dome (175 Lbs 100 oct.)	SD7236
Sea Doo 800 Billet Head Shell	SD800
Sea Doo 800 39cc Dome (205 Lbs 105 oct.)	SD8039
Sea Doo 800 41cc Dome (190 Lbs 98 oct.)	SD8041
Sea Doo 800 43cc Dome (175 Lbs 91 oct.)	SD8043

\*\*\*All ADA Domes are sold individually

The ADA Sea Doo 720 & 800 domes are interchangeable but the head billet shells are engine size specific.



**Sea Doo 951**

**ADA SD951 BILLET HEAD**

Sea Doo	Part No.
Sea Doo 951 Billet Head Shell	SD951
Sea Doo 951 46cc Dome (183 lbs-105 oct.)	SD9546
Sea Doo 951 48cc Dome (175 lbs-98 oct.)	SD9548
Sea Doo 951 50cc Dome (165 lbs-91 oct.)	SD9550
O-Ring Kit	ORKIT-SD951

\*\*\*All ADA Domes are sold individually

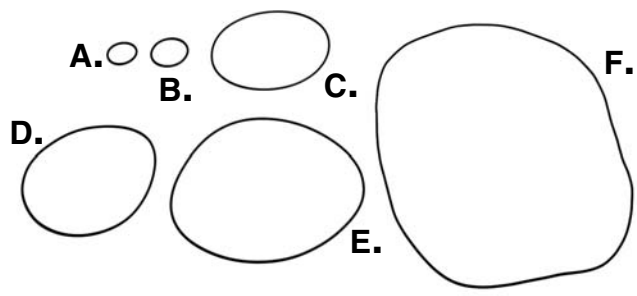

**ADA INDIVIDUAL O-RING**

Descriptions	Part No.
A. O-Ring, Dome Top Around Spark Plug Hole	OR020
B. O-Ring Head Shell to Dome	OR024
C. Compression O-Ring Ultra 150, All Yamaha	OR043
D. Compression O-Ring SD 951	OR044
E. Outer Water O-Ring Ultra 150 (3 req.)	OR049
F. Outer Water O-Ring Y701/760	ORYA701
Compression O-Ring K750/800	OR042



KA800G

KA800M  
KAWASAKI  
800SXR/750  
GIRDLE HEAD SHELL



ADA 800SXR/750  
Throttle/Choke Cable Bracket

KA750  
KAWASAKI  
800SX-R/750  
NON-GIRDLE BILLET  
HEAD SHELL

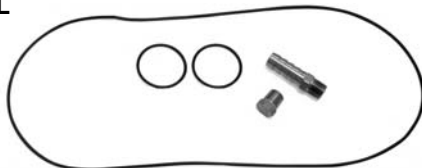

KU150  
KAWASAKI  
ULTRA 150/STX-R  
NON GIRDLE  
HEAD SHELL



KA1200M  
KAWASAKI  
ULTRA 150/STX-R  
GIRDLE HEAD SHELL KIT

\*DOMES SOLD SEPARATELY



## ADA KAWASAKI 800SXR BILLET GIRDLE HEAD

This head uses the stock head bolts and is completely sealed by O-rings, no head gasket required. Dual water outlets for additional cooling. This head will work with Factory Pipe's 800 dry pipe.

Kawasaki	Part No.
ADA 800SXR/750 Girdle Head Shell**	KA800M
ADA 800SXR Girdle Kit	KA800G
ADA 800SXR Dome 22cc (225 lbs.-114 Octane)	KA8022
ADA 800SXR Dome 24cc (216 lbs.-110 Octane)	KA8024
ADA 800SXR Dome 26cc (208 lbs.-105 Octane)	KA8026
ADA 800SXR Dome 28cc (200 lbs.-98 Octane)	KA8028
ADA 800SXR Dome 30cc (190 lbs.-95 Octane)	KA8030
ADA 800SXR Dome 32cc (180 lbs.-91 Octane)	KA8032
ADA 800SXR/750 Throttle/Choke Cable Bracket	KA800BRK-CARB
to use with stock carburetors with ADA Billet Girdle Head	
ADA 800SXR O-Ring Kit	ORKITK750

\*\*\*All ADA Domes are sold individually

## ADA KAWASAKI 800SXR BIG BORE DOME - BILLET HEAD

Billet girdled big bore head kit for the Kawasaki 750/800. Domes will fit up to an 85mm bore size and they are notched to fit around the head studs to allow for a larger compression sealing oring than the ADA standard domes.

Big bore domes feature a squish relief of .010" @ 85mm with a 4 degree angle. Available in 22-34cc domes in 2cc increments.

Kawasaki	Part No.
ADA 800SXR/750 Big Bore Head Shell	KA800BB
ADA 800SXR/750 Big Bore Girdled Head Shell	KA800M-BB
ADA 800SXR/750 Big Bore Domes	KA85XX10*

\*XX in the part represent the dome size = 22, 24, 26, 28, 30, 32, 34

## ADA KAWASAKI 750 BILLET HEAD

Kawasaki	Part No.
ADA 800SXR/750 Girdle Head Shell**	KA800M
ADA 800SXR Girdle Kit	KA800G
ADA 800SXR/750 Non-Girdle Billet Head Shell	KA750
ADA K750 24cc Dome (195 lbs.-100 Octane)	KA7524
ADA K750 26cc Dome (180 lbs.-92 Octane)	KA7526
ADA K750 28cc Dome (165 lbs.-91 Octane)	KA7528
ADA K750 30cc Dome (150 lbs.-89 Octane)	KA7530

\*\*ADA 800SXR Girdle and Non-Girdle Head Shell also fits Kawasaki 750 but must use the ADA 750 Domes.

\*\*\*All ADA Domes are sold individually

## ADA KAWASAKI ULTRA 150/STX-R BILLET GIRDLE HEAD KIT

Kawasaki	Part No.
Ultra 150/STX-R Billet Head Shell (Non Girdle Head)	KU150
Ultra 150/STX-R Billet Girdle Head with Girdle Hardware	KA1200M
44cc Dome +10 Lbs 91 Oct.	KU1544
42cc Dome +20 lbs 91 Oct.	KU1542
40cc Dome +30 lbs 98 Oct.	KU1540
38cc Dome +40 lbs 105 Oct.	KU1538
Ultra 150/STX-R O-Ring Kit	ORKIT-KU150

\*\*\*All ADA Domes are sold individually

## RIVA RACING HEAD O-RING KIT

Head O-Ring Kit	Part No.
2 Cylinder (701/760)	RY10026-O
3 Cylinder (63M/65U)	RY10028-O
GP800 (66E)	RY100277-O
GP1200R (For RY100288B/100289A1)	RY100288-O

FOUR STROKE  
INTAKE SYSTEMS  
ENGINE/GASKETS  
EXHAUST  
DRIVE LINE HANDLING  
ELECTRICAL  
WATERLINE /BILGE  
STEERING & CONTROLS  
BODY  
ACCESSORIES SERVICE TOOLS /HARDWARE  
CHEMICAL

## PERSONAL WATERCRAFT KITS

All pistons are high quality forged alloy and include rings, taper wall wrist pins and circlips.

L.A. Sleeve produces a complete watercraft line of two stroke centrifugally spun iron cylinder sleeves. LASCO sleeves with exact port specifications, chrome-moly iron alloy, high tensile strength material provide the rebuilder with ease of installation, trouble free boring and a lasting long life engine.



The ★ column, next to the sleeve part number, will help the rebuilder identify the cylinder that is to be sleeved. The ★ column designation will also help the rebuilder to determine the proper installation procedure.

### ★ Column Code Explanations:

- AC** – Original cylinder bore is alloy-chrome plated, Nikasil, or electrofused. The cylinder must be bored to accept the new cylinder sleeve.
- CS** – Original block has a cast-in sleeve liner in the cylinder. The cylinder must be bored out to accept the new cylinder sleeve. The cast-in liner will be bored completely out of the cylinder. Do not try to push out the cast-in liner, cylinder damage may be the result.
- CI** – Original block has a cast-in liner in the cylinder. The cylinder must be bored to accept the new cylinder sleeve. When using a CI style sleeve the cast-in liner will not be completely removed. The sleeve is designed to insert into the iron lined cylinder.
- RS** – Original block has a replacement sleeve. Heat the cylinder to remove the sleeve. Reheat the cylinder to install the new cylinder sleeve.
- CC** – Original barrel is cast-iron. The cylinder must be bored to accept the new cylinder sleeve.



**Piston Wrist Pin Bearing**



**Crank Side/End Rod Bearing**

				L.A. SLEEVE										WISECO		Piston Wrist Pin Bearing	Crank Side/End Rod Bearing
Model	SEA DOO	Cyl. I.D.	★	Piston Style	Piston Kit	Bore Size mm	Over Size mm	CC	Ring Set	Circlip	Wrist Pin						
Sea Doo 580 (Long Finger Port)	1988	76mm	RS	FL-5102	E Coated	734M07600	76.00	STD	580	2992TD	CW18	S477	50-4185	01319			
Sea Doo 580 (Short Finger Port)	1989-96	76mm	RS	FL-5125		734M07650	76.50	0.50	588	3012TD							
						734M07700	77.00	1.00	595	3032TD							
						734M07750	77.50	1.50	602	3051TD							
XP, SPI, GTX, SPX-650 (657cc)	1993-95	78mm	RS	FL-5244	L Ring STOCK STYLE	663M07800	78.00	STD	650	3071LK	CW20	S512	50-4184 (1993)	01319			
						663M07850	78.50	0.50	658	3091LK			50-4182 (94-95)				
						663M07900	79.00	1.00	666	3110LK							
						663M08000	80.00	1.50	674	3150LK							
XP, GTI, HX, SPX, GTS, GS, GSI-750 (718cc)	1995-97	82mm	RS	FL-5268	L Ring IJSPA Ltd. Class Legal	775M08200	82.00	STD	718	8200LF	CW20	S461	50-4184	01321			
						775M08250	82.50	0.50	726	8250LF							
						775M08300	83.00	1.00	735	8300LF							
						775M08350	83.50	1.50	744	8350LF							
						775M08400	84.00	2.00	754	8400LF							
XP, SPX, GSX, GTX-785 Rave GTX RFI, GSX RFI-785 Rave	1995-00	82mm	RS	FL-5290	L Ring IJSPA Ltd. Class Legal	779M08200	82.00	STD	780	8200LF	CW20	S461	50-4184	01323			
						779M08210	82.10	0.10	782	8210LF							
						779M08250	82.50	0.50	791	8250LF							
						779M08296	82.96	0.96	800	*8300LF							
						779M08300	83.00	1.00	801	8300LF							
						779M08350	83.50	1.50	810	8350LF							
						779M08400	84.00	2.00	820	8400LF							
GSX LTD, XP LTD, GTX LTD-951 LRV, RX	1997-00	88mm	RS	FL-5322		716M08800	88.00	STD	951	3464KD	CW21	S568	01242	B1065			
						716M08850	88.50	0.50	960	3484KD							
						716M08900	89.00	1.00	971	3503KD							
						716M08940	89.40	1.40	982	3520KD							
						716M09000	90.00	2.00	993	3544KD							
						716M09100	91.00	3.00	1017	3584KD							

\* Must gap rings

\* Cylinder Sleeving and Crankcase cleanup required for 91mm bore.

\*\*Special Head Gasket Required Part #6700BB (91.25mm)



Model	YAMAHA	Cyl. I.D.	★	L.A. SLEEVE	Piston Style	Piston Kit	Bore Size mm	Over Size mm	CC	Ring Set	Circlip	Wrist Pin	Piston Wrist Pin Bearing	Crank Side/End Rod Bearing
WaveJammer, WaveRunner (496cc)	1987-92	72mm	RS	YA-5025		586M07200 586M07250 586M07300 586M07350	72.00 72.50 73.00 73.50	STD 0.50 1.00 1.50	496 503 509 517	2835CD 2854CD 2874CD 2894CD	CW20	S478	50-4184	01325
Super Jet 1990-93, WaveRunner III 1996, WaveRunner VXR 1992-95 (from 817001)	(633cc) Twin	77mm	RS	YA-5139		602M07700 602M07750 602M07800 602M07850 602M07900	77.00 77.50 78.00 78.50 79.00	STD 0.50 1.00 1.50 2.00	633 641 649 658 667	3032TD 3051TD 3071TD 3091TD 3110TD	CW20	S423	50-3302	01325
WaveRunner 91-92, WaveRunner LX 93, WaveRunner III 1990-95, WaveRunner VXR (from 816999) 91-92	(633cc) Twin	77mm	RS	YA-5176										
Super Jet, WaveRunner III GP, WaveBlaster, WaveRunner II, WaveRunner Pro VXR, FX700, WaveRaider (701cc) Twin	93-00	81mm	RS	YA-5187		790M08100 790M08150 790M08200 790M08250 790M08300 790M08400	81.00 81.50 82.00 82.50 83.00 84.00	STD 0.50 1.00 1.50 2.00 3.00	701 710 718 726 735 753	3189KD 3209KD 3228KD 3248KD 3268KD 3307KD	CW20	S512	50-3483	01325
WaveRaider, WaveRaider DX, WaveVenture, WaveVenture XL700 (701cc) Twin	1994-95 95-00	81mm	RS	YA-5284										
Super Jet, WaveRunner III GP, WaveBlaster, WaveRunner II, WaveRunner Pro VXR, FX700, WaveRaider (Big Bore to 789cc) Twin	93-00	84mm		YA-5187B		757M08400 757M08450 757M08500 757M08550 757M08600	84.00 84.50 85.00 85.50 86.00	STD 0.50 1.00 1.50 2.00	754 763 771 780 789	3307KD 3327KD 3347KD 3368KD 3386KD	CW20	S512	50-3483	01325
WaveBlaster, WaveBlaster II, WaveRaider, WaveRunner GP760, WaveVenture, XL760 (754cc) Twin	1996-00	84mm	RS	YA-5304										
WaveRunner GP800, WaveRunner XL800 (784cc) Twin	1998-00 2000	80mm	AC	YA-5356		758M08000	80.00	STD	784	3150KD	CW22	S640	01343	
WaveRaider 1100, WaveVenture 1100 (1051cc) Triple	1995-97	81mm	RS	YA-5282		791M08100 791M08150 791M08200 791M08250 791M08300	81.00 81.50 82.00 82.50 83.00	STD 0.50 1.00 1.50 2.00	1051 1064 1077 1090 1104	3189KD 3209KD 3228KD 3248KD 3268KD	CW20	S512	50-3483	01325
WaveRunner GP1200, SUV1200, XL1200 (1131cc) Triple	1997-99 1999-00 1998	84mm	RS	YA-5349		757M08400 757M08450 757M08500 757M08550 757M08600	84.00 84.50 85.00 85.50 86.00	STD 0.50 1.00 1.50 2.00	1131 1142 1156 1169 1184	3307KD 3327KD 3347KD 3366KD 3386KD	CW20	S631	50-3483	01325
XL 1200 LTD, GP1200R (1176cc) Triple	1998-00 2000	80mm	AC	YA-5469		758M08000	80.00	STD	1176	3150KD	CW22	S640	01343	

FOUR STROKE  
INTAKE SYSTEMS  
ENGINE/GASKETS  
EXHAUST  
DRIVE LINE HANDLING  
ELECTRICAL  
WATERLINE /BILGE  
STEERING & CONTROLS  
BODY  
ACCESSORIES  
SERVICE TOOLS /HARDWARE  
CHEMICAL

### General Rules for Sleeve Installation:

These tips are intended to be a guide for installing sleeves into cylinders. There are always exceptions to the rule and care must be taken on special applications.

**ALWAYS WAIT UNTIL THE SLEEVE ARRIVES BEFORE BEGINNING ANY MACHINE WORK. NEVER ASSUME THAT THE STATED MODEL AND YEAR OF THE CYLINDER IS CORRECT. ALWAYS CHECK TO SEE IF THE SLEEVE PORTS MATCH THE CYLINDER PORTS.**

1. Interference fit for cylinder sleeve to aluminum bore is .004.
2. Interference fit for cylinder sleeve to a cast iron bore is .002 to .003.
3. Installation of flanged type sleeves follow the same rules, but the top of the cylinder must have a countersink to the correct depth to accept the flanged sleeve. .000 to .001 interference fit on the flange diameter is recommended.
4. Heating the cylinder for 45 minutes to one hour at 350 degrees to 450 degrees is preferable.
5. The sleeve should slide in very easily when the cylinder is properly heated. Freeze shrinking the sleeve is not necessary. (Some machinists believe this assists installation of the sleeve.)
6. **REMEMBER:** Rap or press the sleeve down while the cylinder is cooling down. Use a hydraulic press for this procedure.
7. Milling the top deck of the cylinder always adds a quality touch. A caution here, some cylinders may not be able to have the top surface decked.
8. For two-stroke cylinders, blending or matching the aluminum cylinder to the sleeve ports is recommended for proper fuel flow.

FOUR STROKE  
INTAKE SYSTEMS  
ENGINE/GASKETS  
EXHAUST  
DRIVE LINE HANDLING  
ELECTRICAL  
WATERLINE /BILGE  
STEERING & CONTROLS  
BODY  
ACCESSORIES  
SERVICE TOOLS /HARDWARE  
CHEMICAL

Model <b>KAWASAKI</b> Cyl. I.D. ★				L.A. SLEEVE	WISECO							Piston Wrist Pin Bearing	Crank Side/End Rod Bearing
Model	Cyl. I.D.	★		Piston Style	Piston Kit	Bore Size mm	Over Size mm	CC	Ring Set	Circlip	Wrist Pin		
JS-550 Iron Cylinder 1986-90	75mm	CC	KA-5033		516M07500	75.00	STD	531	2953TC	CW16	S259	50-3122	
					516M07550	75.50	0.50	537	2973TC				
					516M07600	76.00	1.00	544	2992TC				
JS-550SX Reed 1991-95	75mm	CI	KA-5135		608M07500	75.00	STD	531	2953TD	CW16	S259	50-3122	
					608M07550	75.50	0.50	537	2973TD				
					608M07600	76.00	1.00	544	2992TD				
JS, JL, JF-650 1986-96	76mm	CS	KA-999		549M07600	76.00	STD	635	2992TD	CW18	S513	50-3272	01315
					549M07650	76.50	0.50	643	3012TD				
					549M07700	77.00	1.00	657	3032TD				
JS-750SX, SS, ST, XiR Supersport Xi 1992-95 1993-95 Special Heavy O.D. Sleeve 3.600" * Crankcase cleanup and cylinder sleeving required for 83mm thru 85.5mm bore.	80mm	CI	KA-5166		813M08000	80.00	STD	743	3150KD	CW20	S650 (20mm)	50-3302	01317
					813M08050	80.50	0.50	752	3169KD				
					813M08100	81.00	1.00	760	3189KD				
					813M08150	81.50	1.50	771	3209KD				
					813M08200	82.00	2.00	779	3228KD				
					813M08300	83.00	3.00	496	3268KD				
					813M08500	85.00	5.00	840	3347KD				
813M08550	85.50	5.50	849	3367KD									
JS-750 SXi, ZXi STX, STS, SXi Pro, Xi Sport Supersport Xi 1995-00 1996-97 Special Heavy O.D. Sleeve 3.600" * Crankcase cleanup and cylinder sleeving required for 83mm thru 84.5mm bore.	80mm	CI	KA-5280		809M08000	80.00	STD	743	3150KD	CW22	S662 (22mm)	50-3304	B1065
					809M08050	80.50	0.50	752	3169KD				
					809M08100	81.00	1.00	760	3189KD				
					809M08150	81.50	1.50	771	3209KD				
					809M08200	82.00	2.00	779	3228KD				
					809M08300	83.00	3.00	795	3268KD				
					809M08400	84.00	4.00	820	3307KD				
809M08450	84.50	4.50	830	3327KD									
JS-750 SXi, SXi pro 1996-02 SX800R 2003 * These racing pistons feature a cutaway skirt, boost port feed hole, and thinner rings. Kawasaki factory race part	80mm			E Coated	810M08250	82.50	2.50	791	8250KB	CW22	S640	50-3304	B1065
					810M08296	82.96	2.96	800	8300KB				
SX800R 2003	82mm		KA-5496		837M08200	82.00	STD	782	3228KD	CW22	S662	50-3304	B1065
					837M08250	82.50	0.50	791	3248KD				
					837M08296	82.96	0.96	800	3268KD				
JH-900 ZXi, JT-900 STX (891cc) 1995-00 triple cylinder	73mm	CS	KA-5283		659M07300	73.00	STD	891	2874CD	CW20	S512	50-3302	01317
					659M07350	73.50	0.50	903	2894CD				
					659M07400	74.00	1.00	915	2913CD				
JH-1100 ZXi, JT-1100 STX (1071cc) 1996-00 triple cylinder Not for 1100DI	80mm		KA-5303		809M08000	80.00	STD	1071	3150KD	CW22	S662	50-3304	01317
					809M08050	80.50	0.50	1083	3169KD				
					809M08100	81.00	1.00	1097	3189KD				
					809M08150	81.50	1.50	1106	3209KD				
					809M08200	82.00	2.00	1125	3228KD				
JH-1100 ZXi, JT-1100 STX Big Bore to 1193cc 1996-00			KA-5303B		809M08300	83.00	3.00	1151	3268KD	CW22	S662	50-3304	01317
					809M08400	84.00	4.00	1179	3307KD				
					809M08450	84.50	4.50	1193	3327KD				
Ultra 150 (1176cc) triple cylinder 1999-00	80mm	AC	KA-5415		749M08000	80.00	STD	1176	3150TD	CW24	S598	50-4186	
				749M08050	80.50	0.50	1191	3169TD					
				749M08100	81.00	1.00	1205	3189TD					

**SJ Flat Top Piston**  
85.0 mm for SJ 771CC  
85.5 mm for SJ 780CC  
Piston skirt must be modified to match sleeve

Model <b>POLARIS</b> Cyl. I.D. ★				L.A. SLEEVE	WISECO							Piston Wrist Pin Bearing	Crank Side/End Rod Bearing
Model	Cyl. I.D.	★		Piston Style	Piston Kit	Bore Size mm	Over Size mm	CC	Ring Set	Circlip	Wrist Pin		
SL-650 1992-95	65mm	CI	FL-5191		624M06500	65.00	STD	647	2559CD	CW18	S280	50-3496	01329
					624M06550	65.50	0.50	656	2579CD				
					624M06600	66.00	1.00	665	2598CD				
					624M06650	66.50	1.50	675	2618CD				
					624M06700	67.00	2.00	685	2638CD				
Hurricane 700 SL, SLT-700 SLH, SLTH-700, Virage (5+) (700cc) twin Freedom 1996-97 1996-97 1998-02 2002	81mm	RS	FL-5300		700M08100	81.00	STD	700	3189TD	CW20	S512	50-4182	
					700M08150	81.50	0.50	710	3209TD				
					700M08200	82.00	1.00	718	3228TD				
					700M08250	82.50	1.50	726	3248TD				
					700M08300	83.00	2.00	734	3268TD				
SL, SLT-750 1993-95 Special Heavy O.D. 80.60mm	69.75mm	CI	FL-5239		633M06975	69.75	STD	744	2746CD	CW18	S343	50-3496	01329
					633M07025	70.25	0.50	755	2766CD				
					633M07075	70.75	1.00	766	2786CD				
					633M07125	71.25	1.50	777	2805CD				
					633M07150	71.50	1.75	783	2815CD				
SL, SLT, SLX-780 triple cylinder 1995-97	71.3mm		FL-5302		633M07200	72.00	2.25	795	2835CD	CW18	S343	50-3496	01329
					633M07150	71.50	STD	783	2815CD				
					633M07200	72.00	0.71	794	2835CD				



Model		POLARIS	Cyl. I.D. ★	L.A. SLEEVE	Piston Style	Piston Kit	Bore Size mm	Over Size mm	CC	Ring Set	Circlip	Wrist Pin	Piston Wrist Pin Bearing	Crank Side/End Rod Bearing
SLX Pro 785 (779cc) triple cylinder		1997-00	69.72mm		FL-5342	XPS E-Coated	722M06970	69.70	STD	799	2746CD	CW18	S343	
<i>* Nikasil Bore – Cylinder Sleevling or Replating Required for Oversizes.</i>														
Octane 777 Virage I		2002	84mm		FL-5416	E-Coated	811M08400	84.00	STD	775.8	8400KB	CW22	S662	
<i>Low Dome Race Part. (Flat Top) Head Modifications required.</i>							811M08450	84.50	.050	785.1	8450KB			
							811M08500	85.00	1.00	794.4	8500KB			
							811M08525	85.25	1.25	779.1	8520KB			
							812M08500	85.00	1.00	794.4	8500KB			
SL-900 triple cylinder		1996-97	74.5mm	RS	FL-5305		687M07450	74.50	STD	889	2933TD	CW20	S512	50-4182
SL, SLX, SLTC, SLXH-1050 (1051cc) triple cylinder		1996-99	81mm		FL-5297		687M07500	75.00	0.50	901	2953TD			
							687M07550	75.50	1.00	913	2973TD			
							687M07600	76.00	1.50	925	2992TD			
							687M07650	76.50	2.00	937	3012TD			
Pro1200, Virage TX Virage TXI, SLX Genesis all Models X45		2000-01 99-02 1999	84mm		FL-5416		811M08400	84.00	STD	775.8	8400KB	CW22	S662	
Pro1200, Virage TX Virage TXI		2001-02	85mm				811M08450	84.50	0.50	785.1	8450KB			
							811M08500	85.00	1.00	794.4	8500KB			
							811M08525	85.25	1.25	799.1	8525KB			
							812M08500	85.00	1.00	794.4	8500KB			
							812M08525	85.25	1.25	799.1	8525KB	CW22	S662	
<i>Low Dome Race Part. (Flat Top) Head Modifications required.</i>														

MODEL	L.A. SLEEVE	CUBIC DISPLACEMENT	CYLINDER I.D.	CODE	PART NO.
<b>Sea Doo</b>					
580 (Long Finger Port) 1988		580cc	76mm	RS	FL-5102
580 (Short Finger Port) 1989-96		580cc	76mm	RS	FL-5125
XP/SPI, GTX, SPX 1993-95		650cc	78mm	RS	FL-5244
GTI, HX, SPX, XP, GTS, GS, GSI		718cc	82mm	RS	FL-5268
XP/SPX/GTX RFI-785 Rave 1995-02		782cc	82mm	RS	FL-5290
GSX/XP/GTX-951 LTD RX 1997-02		951cc	88mm	RS	FL-5322
785DI		782cc	82mm	RS	FL-5583
951DI		951cc	88mm	RS	FL-5578
<b>Polaris</b>					
SL-650 1992-95		647cc	65mm	CI	FL-5191
SL-750 1993-95		744cc	69.7mm	CI	FL-5239
SLX Pro 785 1997-01			69.72mm	AC	FL-5342
SL-900 1996-97		889cc	74.5mm	RS	FL-5305
SLTX/SLXH-1051 1996-99		1051cc	81mm		FL-5297
Virage, Octane 777 2002		777cc	84mm	RS	FL-5416
Genesis 1200 (99-02), SLX, X-45 1200, Pro 1200, Virage TX & TXI 1999-02		1165cc	84mm	RS	FL-5416
<b>Yamaha</b>					
Wave Jammer, Wave Runner 1987-92		496cc	72mm	RS	YA-5025
Wave Runner, Super Jet thru 1993		633cc	77mm	RS	YA-5139
Wave Runner LXII VXR 1991-96		633cc	77mm	RS	YA-5176
61X Wave Blaster, WRIII, FX, Pro VXR, Superjet (93-07)		701cc	81mm	RS	YA-5187
Super Jet, Wave Blaster Big Bore to 62T 701 Wave Raider (94-95), Wave Venture XL 700 (95-02)		789cc	84mm		YA-5187B
Wave Raider, WBII, GP 760/Wave Blaster (96-00)		701cc	81mm	RS	YA-5284
Wave Runner GP-800 (98-02), XL/XLT 800 (00-02)		754cc	84mm	RS	YA-5304
1100Wave Raider (95-96), Wave Venture (96-97)		784cc	80mm	AC	YA-5356
GP1200( 97-99)/XL 1200 (98)		1051cc	81mm	RS	YA-5282
XL1200 Ltd/GP1200R		1131cc	84mm	RS	YA-5349
GP1300R (03-07)		1176cc	80mm	AC	YA-5469
		1296cc	84mm	AC	YA-5502
<b>Kawasaki</b>					
JS-550 Iron Cylinder 1986-90		531cc	75mm	CC	KA-5033
JS-550 SX Reed 1991-95		531cc	75mm	CI	KA-5135
JS, JF-650 1986-96		635cc	76mm	CS	KA-999
JS-750 SX/SS (92-95)		743cc	80mm	CI	KA-5166
JS-750 SX/SS (92-95) Special Heavy OD Sleeve 3.600"		743cc	80mm	CS	KA-5166H
JS-750 SXI, ZXI (96-97), ST (94-95) SXI Pro		743cc	80mm	CI	KA-5280
JS-750 SX, ZXI (95-97), ST (94-95), SXI Pro Special Heavy OD Sleeve 3.600"		743cc	80mm	CS	KA-5280H
JS-900 ZXI, STX (95-06)		891cc	73mm	CS	KA-5283
JS1100ZXI, STX (96-02)		1071cc	80mm	CI	KA-5303
JS-1100 ZXI, STX (96-02) Big Bore to 800 SXR 2003-07		1180cc	83mm		KA-5303B
Ultra 150 1999-00			82mm		KA-5496
			80mm	AC	KA-5415

FOUR STROKE  
INTAKE SYSTEMS  
ENGINE/GASKETS  
EXHAUST  
DRIVE LINE HANDLING  
ELECTRICAL  
WATERLINE /BILGE  
STEERING & CONTROLS  
BODY  
ACCESSORIES  
SERVICE TOOLS /HARDWARE  
CHEMICAL

# PRO-X

## PRO-X PISTON KITS

Pro-X Piston Kits are manufactured in Japan and are designed to be an O.E.M. replacement. The aluminum alloy used in the manufacturing of Pro-X pistons maintains or exceeds the factory specifications. Additional oversizes are available in .010 increments up to .080 (2.00 mm).



\* - Rings are available for all pistons. For Rings Part Number, put "R" after piston part number.

		STD	.010	.020	.030	.040	.050	.060	.070	.080	TOP END BEARINGS
<b>SEA DOO</b>	Std. Bore	STD	.25mm	.50mm	.75mm	1mm	1.25mm	1.5mm	1.75mm	2mm	
580 All thru 1996	76.00	P8020	P8021	P8022	P8023	P8024		P8026			50-4185
720 HX, XP, GTS, GS SPX, GTI, GSI '1995-02	82.00	P8040	P8041	P8042	P8043	P8044		P8046			50-4184
800 XP GSX, GTX, RFI SPX 1995-02	82.00	P8050	P8051	P8052	P8053	P8054		P8056			50-4184
951 XPL, GSXL, GTXL, RX, LRV 1997-07	88.00	P8060	P8061	P8062	P8063	P8064					01242
RXP (04-08), RXT (05-08) RXP-X (08)		01.5594.000		01.5594.050		01.5594.100					

		STD	.010	.020	.030	.040	.050	.060	.070	.080	TOP END BEARINGS
<b>YAMAHA</b>	Std. Bore	STD	.25mm	.50mm	.75mm	1mm	1.25mm	1.5mm	1.75mm	2mm	
650 All Thru 1996	77.00						P7105	P7106			50-3302
701 All Thru 2007	81.00	P7090	P7091	P7092	P7093	P7094		P7096		P7098	50-3483
760 All Thru 1998	84.00	P7110	P7111	P7112	P7113	P7114		P7116		P7118	50-3483
1200/GP1200All thru '98	84.00	P7110	P7111	P7112	P7113	P7114		P7116			50-3483
800 All thru 2002 GP1200 R 2000-02 XL1200 LTD 1998-00 XLT1200 2001-02	79.90 79.91 79.92	P7170A P7170B P7170C									01343
GP1300 R 2003-07	83.90 83.91 83.92	P7190A P7190B P7190C									

		STD	.010	.020	.030	.040	.050	.060	.070	.080	TOP END BEARINGS
<b>KAWASAKI</b>	Std. Bore	STD	.25mm	.50mm	.75mm	1mm	1.25mm	1.5mm	1.75mm	2mm	
JS-550 1982-90	75.00						P4465		P4467	P4468	50-3122
JS, JF-650 1986-96	76.00	P4470	P4471	P4472		P4474	P4475		P4477	P4478	50-3272
JS-750 SS, XS, Xi 1993-97	80.00	P4480	P4481	P4482	P4483	P4484		P4486	P4487	P4488	50-3302
JS-750 ZXi, SXi '95-98	80.00	P4490	P4491	P4492		P4494		P4496			50-3304
800SX-R 2003-07	82.00	P4510	P4511	P4512	P4513	P4514					50-3304
JS-900 ZXi, STX 1995-06	80.00	P4500	P4501	P4502	P4503	P4504	P4505	P4506			50-3302
JS-1100 ZXi 1996-98	73.00	P4490	P4491	P4492		P4494		P4496			50-3304
Ultra 150 99-05 STX-R1200 2002-05	79.87 79.88 79.89	P4520A P4520B P4520C									50-4186



## TOP END (WRIST PIN) BEARINGS

Kawasaki	OEM No.	Size	Part No.	
300	1986-93	13033-1010	18x22x24	50-3272
440	1977-92	13033-3005	16x20x22.5	50-3122
550	1982-95	13033-3005	16x20x22.5	50-3122

650 SX,X2,TS,SC  
1986-96 13033-1010 18x22x24 50-3272

750 ST,SX,SS,XiR,Supersport Xi  
1992-95 13033-3702 20x25x25 50-3302

900 ZXI,STX 1995-06 13033-3702 20x25x25 50-3302

750 ZXI,STX,SXi,STS,Xi Sport,SXi Pro,Supersport Xi  
1996-02 13033-3703 22x27x24.7 50-3304

800 SXR 2003-07 22x27x24.7 50-3304

1100 ZXI,STX 1996-02 13033-3703 22x27x24.7 50-3304

Ultra 150,STX-R 13033-3704 24x29x25 50-4186

**Polaris** OEM No. Size Part No.

650 1987-92 3083216 18x23x21.5 50-3496

750 1987-92 3083216 18x23x21.5 50-3496

780 1987-92 3083216 18x23x21.5 50-3496

700 1995-97 3584001 20x25x21.7 50-4182

900 1997-02 3584001 20x25x21.7 50-4182

1050 1998-02 3584001 20x25x21.7 50-4182

**Tiger Shark** Size Part No.

640/900/1000 1993-99 20X26X24 B1024

**Sea Doo** OEM No. Size Part No.

580 1988-96 290.832.320 18x22x22 50-4185

650 1993 290.832.440 20x24x23 50-4184

650 1994-95 20x25x21.7 50-4182

720 1995-02 290.832.420 20x24x23 50-4184

785 1995-02 290.832.420 20x24x23 50-4184

951 1997-02 290.832.550 21x25x24 01242

**Yamaha** OEM No. Size Part No.

500 1987-92 20x24x23 50-4184

650 thru 1996 933310-320U200 20x25x25 50-3302

701, 760 thru 2002 20x25x24 50-3483

1100 1995-97 20x25x24 50-3483

1200 (65U) 1997-02 20x25x24 50-3483

800 1998-02 22x27x23 01343

1200 (66V) 1998-02 22x27x23 01343

## BIG END (CRANK PIN) BEARINGS

**Sea Doo** Size Part No.

720 26 x 33 x 18 01321

785 28 x 35 x 18 01323

**Yamaha** Size Part No.

650, 701, 760, 1100 25 x 32 x 20 01325



**Kawasaki** Size Part No.

JS/JF-650 24 x 32 x 20 01315

JS750 93-95 26 x 34 x 20 01317

JS750 96-02 28 x 36 x 20 B1065

JS900ZXI 24 x 34 x 20 01317

JS1100ZXI 24 x 34 x 20 01317

**Polaris** Size Part No.

650, 750, 780 24 x 32 x 16 01329

## HOT ROD THRUST WASHERS

Determine part number by size. Refer to Dimension Chart on Page 52.

ID Size	Thickness	Part No.
24mm X	1mm	W106
25mm X	1mm	W111
26mm X	1mm	W113
27mm X	1.5mm	W115
28mm X	1mm	W116
32mm X	1mm	W118



## THRUST WASHERS

Determine part number by size. Refer to Dimension Chart on Page 52.

ID Size	Thickness	Part No.
24mm X	1mm (coated)	TW4942
25mm X	1mm	TW4968



## PRO-X SEA DOO PERFORMANCE STAINLESS STEEL VALVES

Pro-X has developed these valves for Sea-Doo GTX-4TEC '03-08 + RXP/RXT '04-08. These valves are manufactured from stainless steel.

ID Size	Thickness	Part No.
Pro-X Sea Doo Exhaust Valves		28.5594-1
Pro-X Sea Doo Intake Valves		28.5594-2

\*Pro-X Sea Doo Performance Valves are sold piece.

FOUR  
STROKE

INTAKE  
SYSTEMS

ENGINE/  
GASKETS

EXHAUST

DRIVE LINE  
HANDLING

ELECTRICAL

WATERLINE  
/BILGE

STEERING  
& CONTROLS

BODY

ACCESSORIES

SERVICE TOOLS  
/HARDWARE

CHEMICAL

# HOT PRODUCTS CONNECTING RODS

Heavy duty replacement rods are used in many racing applications because of proven reliability. Kits are complete with top and bottom roller bearings, pin and shims. Made in Japan.

Sea Doo	Part No.
580	50-3520
720 (PTO)	50-3522
720 (MAG)	50-3523
785	50-3524
951	50-3525

Yamaha	Part No.
500	50-3480
650/701/760/1100/1200 (97-98)	50-3490
GP800R/XL800/GP1200R/XL1200*	50-3495

\*Crank pins are not included in kit 50-3495

Kawasaki	Part No.
450/550 All	50-3120
650 All	50-3270
750 1992-95, 900ZXI	50-3280
750ZXI/SXI/STS/STX/SS/XI 1996-02	50-3281
800 SX-R	50-3281
1100 ZXI/STX 1995-98	50-3282



## PERSONAL WATERCRAFT CONNECTING ROD DIMENSIONS

Watercraft Model	CENTER TO CENTER MM	SMALL END BORE MM	BIG END BORE MM	SMALL END WIDTH MM	BIG END WIDTH MM	PIN DIAMETER MM	PIN LENGTH MM	SMALL END BEARING MM	BIG END BEARING MM	WASHER THICKNESS MM
<b>KAWASAKI</b>										
JS 440/550	110	20	30.6	18	15	24.6	49	16X20X23	24.6X30.6X15	1
JS/JF 650	133	22	32	22	20	24	59	18X22X24	24X32X20	1
JS 750 (93-96) 20mm wrist pin	133	25	34	22	20	26	59	20X25X25	26X34X20	1
JS 750 (95-00) 22mm wrist pin	133	27	36	22	20	28	58	22X27X25	28X36X20	1
JS 900 ZXI	133	25	34	22	20	26	59	20X25X25	26X34X20	1
JS 1100 ZXI, SXI (95-00)	135	27	34	22	20	26	59	22X27X25	26X34X20	1
Ultra 150	140	29	40	22	20	32	62	24X29x25	32x40x20	1
<b>POLARIS</b>										
650/750/780 SL MAG/center	120	23	32.3	16	16	24.3	51	18X23X22	24.3X32.3X16	1
650/750/780 SL PTO	120	23	32.3	16	16	24.3	54	18X23X22	24.3X32.3X16	1
700/900/1050	136	25	35	16	16	28	60	20X25X22	28X35X16	1
<b>SEA DOO</b>										
580 thru (96)	125	22	31	17	17	24	52	18X22X22	24X31X17	1
650 thru (97)	125	25	31	17	17	24	52	20X25X22	24X31X17	1
720 XP, HX MAG (95-00)	125	24	33	18	18	26	53	20X24X22	26X33X18	1
720 XP, HX PTO (95-00)	125	24	33	18	18	26	55	20X24X24	26X33X18	1
785 XP RAVE (all)	140	24	35	18	18	28	55	20X24X23	28X35X18	1
951 RAVE (98-00)	140	25	36	20	20	28	57	21X25X24	28X36X20	1
<b>YAMAHA</b>										
650/901/760/1100 (all)	125	25	32	20	20	25	60	20X25X24	25X32X20	1
GP800, GP1200R	135	27	34	21	21	27	69	22x27x23	29x34x21	1.5

**NEW**



## RACETEMP® SAVING MOTORS EVERYWHERE!

Detect overheating and monitor engine components with the Racetemps® temperature monitoring device. Racetemps® is a small visible strip that enables machine operators to quickly and accurately determine the temperature of vital components such as: radiator, cylinder, rear shock body, clutch housings and more. This product aids in vehicle maintenance, monitoring and troubleshooting.

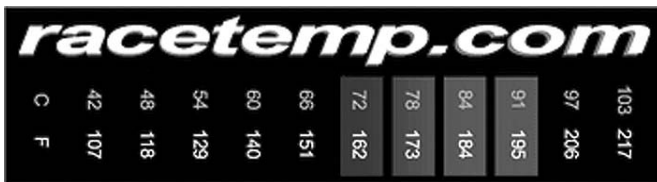

Temperature ranges of 107-217 & 138-248 degrees fahrenheit

Accurate within 1-2 degrees

Reversible thermometer with long lasting adhesive

Aids in maintenance and diagnosis

**Know it before you blow it!**

Description	Part No.
Race Engine Thermometer	RT138-248
Pack of three + decal <b>138-248 degrees</b>	
Race Engine Thermometer	RT107-217
Pack of Three and Decal <b>107-217 degrees</b>	

# HOT RODS CONNECTING RODS



Sea Doo	Part No.
580 1990-96	HR8166
650 1997	HR8117
720 1995-02 MAG	HR8116
720 1995-02 PTO	HR8168
785	HR8123
951 1998-05	HR8601
951 Direct Injection	HR8628

Hot Rods are double forged to improve grain flow and maintain dimensional consistency.

Polaris	Part No.
700/900/1050	HR8122

Yamaha	Part No.
650/701/760/1100/1200 (97-98)	HR8169
GP800/GP1200R	HR8606

Kawasaki	Part No.
650 All	HR8113
750 (92-95), 900 ZXI	HR8114
750 (96-02), 800 03-07	HR8131
1100ZXI (95-00),STX	HR8138
Ultra 150 (99-05), STX R (02-05)	HR8607



## CRANK SHAFT REPLACEMENT BEARINGS

Sea Doo	FRONT MAG. #1	FRONT MAG. #2	INNER #1	INNER #2	REAR PTO#1	REAR PTO#2
580 87-94	6206NR	6206NR	6305NR	6206NR	6207NC4	6207NC4
580 95-96	6206NC4	6206NC4	6305NR	6206NR	6207NC4	6207NC4
650 93	6206NR	6206NR	6206NC4	6206NC4	6207NC4	6207NC4
650 94-96	6206NC4	6206NC4	6206NC4	6206NC4	6207NC4	6207NC4
720 all	6206NC4	6206NC4	6206NC4	6206NC4	6207NC4	6207NC4
800 all	6207NC4	6207NC4	6207NC4	6207NC4	6306NR	6207NC4
951 all	6208NC4	6208NC4	6306NC4	6208NC4	6208NC4	6208NC4

Yamaha						
650/701/760	83B207		6207YR	6207YR		
1100/1200	83B207		6207YR	6207YR		

  

Kawasaki						
440/550	6206NR		6305N	6305N	6206N	
650/750	6306C3		6306C3	6306NR	6306C3	
900/1100/Ultra	5207-1LT		6207NLT	83A844A (3)	83A948	

Polaris						
650/701/780	6207NC4	6207NC4	6207NC4(2)	6307NR		
700/900/1050	6207NC4	6207NC4	6207NC4	6207NC4	6207NC4	6207NC4

## CRANKSHAFT PARTS FOR SEA DOO

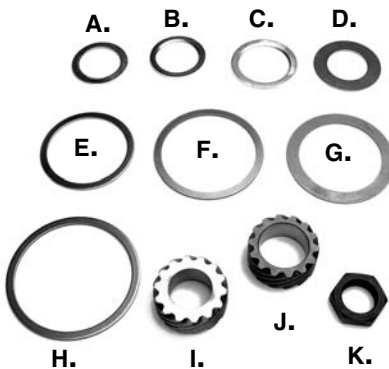

Descriptions	Models	OEM No.	Part No.
A. Distance Ring	720 Mag side – 1.5mm thick	290-827-447	010-474
B. Distance Ring	580/650 Mag side – 2mm thick	290-827-440	010-472
C. Distance Ring	580/650/720 Pto side		
	800 Mat & Pto – 2mm thick	290-827-760	010-473
D. Flat Bearing Washer	580/650 (Small)	420-827-715	010-475
E. Retainer Shim	720 (Small)	420-827-050	010-476
F. Retainer Shim	720 (Medium)	420-827-050	010-477
G. PTO Seal Retaining Ring	580/650/720/800 (Large)	420-827-715	010-479
H. Thrust Washer	951		010-470
I. Crank Center Gear	580		010-471-01
J. Crank Center Gear	650/720/800		010-471
K. Flywheel Nut	All Models	420-842-230	010-480

FOUR STROKE

INTAKE SYSTEMS

ENGINE/GASKETS

EXHAUST

DRIVE LINE HANDLING

ELECTRICAL

WATERLINE /BILGE

STEERING & CONTROLS

BODY

ACCESSORIES

SERVICE TOOLS /HARDWARE

CHEMICAL



## HOT RODS NEW COMPLETE CRANKSHAFT ASSEMBLIES

All new assembly. Crankshafts are sold complete with Hot Rods Connecting rods, main bearings and inner crankshaft webs. Trued to within .001. Crankshafts are completely rebuildable.

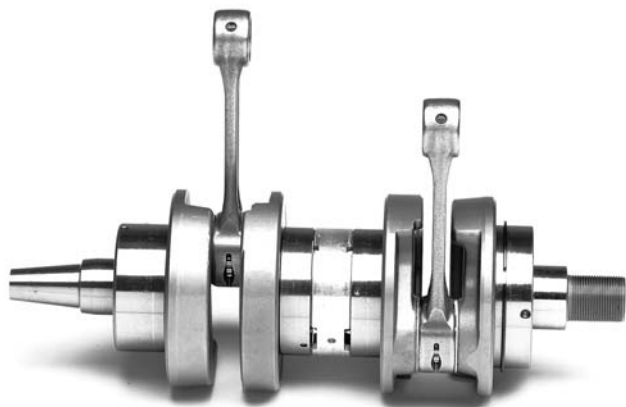

Sea Doo	Crank Assy.
580 All	HR4008
720 All	HR4009
785 1996-04 (will not fit fuel injection models)	HR4010
951 All Carburetor Models	HR4051
951 All Injection Models	HR4052

Yamaha	Crank Assy.
650/701/760 All	HR4003
800 GPR	HR4072
1100 Triple (63M)	HR4104
1200 Triple (65U) (No mag end bearing)	HR4004
1200 Triple (66V)	HR4069

Kawasaki	Crank Assy.
750 96-02, 800 SX-R 03-07	HR4061



### CRANKSHAFT WEBS

OEM Kawasaki 650/750 and Yamaha cranks are non-rebuildable. In order to rebuild these crankshafts the crankshaft webs must be replaced.

Yamaha	Part No.
650/701/760/1100/1200	HR201

Kawasaki	Part No.
750 93-94 (26mm Crank Pin)	HR202
650	HR203
750ZXI/SXI (28mm Crank Pin)	HR205
900 All, 1100 97-98	HR206

\*Web Kit contains 2 webs without crank pin.



### CRANKSHAFT OIL SEAL KIT

Hot Products has researched and tested these crank case seal kits to ensure the highest of quality and durable seals on the market. These seals are a direct replacements for the OEM seals. Why risk an engine failure or a short seal life with low cost seals when Hot Products has these seals in stock and ready for installation in your customers engine.

Sea Doo	Part No.
580	51-0068
650/720	51-0069
785	51-0072
951 Outer Seals Only	51-0073
951 Inner Seals Only	51-0073B

Polaris	Part No.
650/750/780/785	51-0074

Yamaha	Part No.
500 87-90	51-0048
650/701/760/1100/1200	51-0054
800	51-0057
GP1200R	51-0058

Kawasaki	Part No.
440 73-80 (Full Circle)	51-0014
440 81-91/550JS/550SX	51-0015
650/750/800	51-0027
900/1100	51-0029

2008 HYDRO-TURF  
APBA WATERCROSS NATIONAL TOUR  
PARKER, ARIZONA



# HOT PRODUCTS GASKET SETS

Hot Products gasket sets consist of superior quality gaskets for engine rebuilders and the hi-performance personal watercraft market.

Hot Products offers top end and complete gaskets sets.  
Made in the USA.



Sea Doo	Top	Complete
580 -91 Yellow Eng.SP/XP/GT	6400	6425
580 92+ White Eng.SP/SPI/XP/GTS	6440	6465
650 GTX/XP/XPI/SPX	6480	6500
720 SPX/GTI/HX	6600	6610
785 XP/GSX/GTX	6620	6640
800 DI	6855	6860
951 97 GSX LTD White Eng.	6825	6830
951 98 XP LTD, GSX LTD Silver Eng	6840	6842
951 DI.	6875	6880

Polaris	Top	Complete
650	4200	4210
750	4220	4230
700 Hurricane, Virage, Freedom	4375	4378
Octane 777		4860
780	4235	4240
785/Pro	4250	4260
900	4380	4383
1050	4385	4390
1200 Genesis	4394	4395

Yamaha	Top	Complete
WJ/WR500	-	51-4803
SJ/WRIII/VXR650 (90-93)	2600	2650
LX650 (90-93)	-	51-5703
701SJ-95, BLST-95, 701W/Raider 96+	2700	2750
701SJ 96+, BLST 96+	2550	2555
701W/RDR 94-95/Venture 95+	2950	2980
760W/RDR 96+/BLST II 96+/XL760	2990	2992
800 GP 98+	3520	3530
1100Raider/Venture	4520	4530
1200 GP, XL1200	4680	4685
GP1200R, XL1200LTD	3730	3740
GP1300R	3800	3810

Kawasaki	Top	Complete
440 77-80	-	51-1203
440 81-92	-	51-1503
550 82-85	5550	5560
550 86-90	5570	5580
550SX 91-95	-	51-2403
650 All	-	5940
650 X2, TS	-	5960
750 All/800SXR	7200	-
750 SX/SXI/SXI Pro	7200	7210
750 SS/XI	7200	7220
750 SS 92-93	7200	7240
750 XIR	7200	7230
750 95 STS	7200	7225
750 ZXI 95+	7200	7245
800 SXR 03-07	7300	7310
900 ZXI 95+	7500	7520
1100 ZXI 96-98	7670	7680
Ultra 150 99+	7830	7835

Tiger Shark	Top	Complete
639	3100	3110
644	3100	3120

**\*\* Hot Products Complete Gasket Sets do not include bottom end engine seals.**

## INDIVIDUAL GASKETS FOR SEA DOO

### 580 PRE '92 SP/XP/GT (Yellow Engine)

YELLOW ENGINE	OEM No.	Part No.
Top Kit	Yellow Engine	6400
Complete Kit	Yellow Engine	6425
Head Cover O-Ring	290-950-050	6200*
Spark Plug O-Ring (2 required)	290-430-782	6220*
Cylinder O-Ring (2 required)	290-850-540	6170*
Water Jacket O-Ring (2 required)	290-850-040	6230*
Base Gasket	290-931-160	6000*
Carb Gasket 38mm (2 required)	290-842-040	6100*
Exhaust Gasket (2 required)	290-850-630	6050*
Headpipe Gasket	290-950-250	6140*
Starter Gasket	290-950-905	6120
Water Dist	290-831-612	6110
Water Mani O-Ring (2 required)	290-430-460	6240*
Flywheel Housing	290-850-600	6125
Rotary Valve Shaft O-Ring	290-831-500	6260
Rotary Valve Cover O-Ring	290-831-360	6250
Manifold O-Ring (2 carb)	290-831-705	6270
Manifold O-Ring (1 carb)	290-850-160	6275
Flywheel Cover O-Ring	290-950-130	6280

### 580 '92+ SP/SPI/XP/GTS (WHITE ENGINE)

WHITE ENGINE	OEM No.	Part No.
Top Kit	White Engine	6440
Complete Kit	White Engine	6465
Head Cover O-Ring	290-950-360	6205*
Spark Plug O-Ring (2 required)	290-430-782	6220*
Cylinder O-Ring (2 required)	293-300-026	6170*
Water Jacket O-Ring (2 required)	290-850-040	6230*
Base Gasket	290-931-161	6020.3*
Carb Gasket 38mm (2 required)	290-850-373	6100*
Carb Gasket 39mm (2 required)	270-000-114	6105*
Exhaust Gasket (2 required)	290-850-635	6060*
Headpipe Gasket	290-950-251	6150*
Starter O-Ring	278-000-694	6152
Flywheel Housing	290-850-605	6130
Rotary Valve Shaft O-Ring	293-300-023	6250
Rotary Valve Cover O-Ring	293-300-024	6260
Manifold O-Ring (2 carb)	290-831-705	6270
Flywheel Cover O-Ring	290-831-555	6278

**\* Denotes when the gasket is included in the Top End Gasket Set.**

FOUR STROKE  
INTAKE SYSTEMS  
ENGINE/GASKETS  
EXHAUST  
DRIVE LINE HANDLING  
ELECTRICAL  
WATERLINE /BILGE  
STEERING & CONTROLS  
BODY  
ACCESSORIES  
SERVICE TOOLS /HARDWARE  
CHEMICAL

# INDIVIDUAL GASKETS FOR SEA DOO

## 951 97+ GSX LTD, XP LTD

### 650 GTX/XP/XPI/SPX

	OEM No.	Part No.
Top Kit		6480
Complete Kit		6500
Head Cover O-Ring	290-950-320	6210*
Spark Plug O-Ring (2 required)	290-430-782	6220*
Cylinder O-Ring (2 required)	290-931-220	6180*
Water Jacket O-Ring (2 required)	290-850-045	6235*
Base Gasket (.012/0.3mm)	290-931-161	6020.3
Base Gasket (.017/0.4mm)	290-931-162	6020.4
Base Gasket (.020/0.5mm)	290-931-163	6020.5*
Base Gasket (.024/0.6mm)	290-931-164	6020.6
Base Gasket (.030/0.8mm)	290-931-165	6020.8
Carb Gasket 38mm (2 required)	290-850-373	6100*
Exhaust Gasket (2 required)	290-850-637	6080*
Headpipe Gasket	290-950-251	6150*
Starter O-Ring	278-000-694	6152
Flywheel Housing	290-850-605	6130
Rotary Valve Cover O-Ring	293-300-023	6250
Rotary Valve O-Ring	293-300-024	6260
Manifold O-Ring (2 carb)	290-831-705	6270
Flywheel Cover O-Ring	290-831-555	6278

### 720 SPX/GTI/HX/GTS/GS

	OEM No.	Part No.
Top Kit		6600
Complete Kit		6610
Head Cover O-Ring	290-950-360	6205*
Spark Plug O-Ring (2 required)	290-430-782	6220*
Cylinder O-Ring (2 required)	290-931-410	6185*
Water Jacket O-Ring (2 required)	290-850-045	6235*
Base Gasket (.012/0.3mm)	290-931-400	6025.3
Base Gasket (.017/0.4mm)	290-931-401	6025.4
Base Gasket (.020/0.5mm)	290-931-402	6025.5*
Base Gasket (.024/0.6mm)	290-931-403	6025.6
Base Gasket (.030/0.8mm)	290-931-404	6025.8
Carb Gasket 41mm (2 required)	293-250-042	6107*
Exhaust Gasket (2 required)	290-850-637	6080*
Headpipe Gasket	290-950-251	6150*
Starter O-Ring	278-000-694	6152
Flywheel Housing	290-850-605	6130
Rotary Valve Cover O-Ring	293-300-023	6250
Rotary Valve Shaft O-Ring	293-300-024	6260
Flywheel Cover O-Ring	290-831-555	6278

### 785 XP/GSX/GTX/SPX

	OEM No.	Part No.
Top Kit		6620
Complete Kit		6640
Head Cover O-Ring	290-831-550	6612*
Spark Plug O-Ring (2 required)	290-430-782	6220*
Cylinder O-Ring (2 required)	290-931-410	6185*
Water Jacket O-Ring (2 required)	290-931-420	6614*
Base Gasket (.012/0.3mm)	290-931-720	6035.3
Base Gasket (.017/0.4mm)	290-931-721	6035.4
Base Gasket (.020/0.5mm)	270-931-722	6035.5*
Base Gasket (.024/0.6mm)	290-931-723	6035.6
Base Gasket (.030/0.8mm)	290-931-724	6035.8
Carb Gasket 41mm (2 required)	293-250-042	6107*
Power Valve Gasket (2 required)	290-931-540	6618
Power Valve O-Ring (2 required)	290-430-110	6622
Exhaust Gasket	290-931-480	6082*
Head Pipe Gasket	290-931-500	6155*
Balance Shaft O-Ring	290-230-300	6624
Manifold O-Ring	290-831-765	6628
Rotary Valve Shaft O-Ring	293-300-024	6260
Starter O-Ring	278-000-694	6152
Flywheel Housing Gasket	290-931-470	6045
Flywheel Cover O-Ring	290-950-360	6632
Oil Pump O-Ring	293-300-018	6255
P.T.O. O-Ring	290430-782	6220

	OEM No.	Part No.
Top Kit 951 '97	White Engine	6825
Complete Kit 951 '97	White Engine	6830
Top Kit 951 '98	Silver Engine	6840
Complete Kit 951 '98	Silver Engine	6842
Head Gasket	290-931-700	6700*
Head Gasket (91.25)		6700BB
Base Gasket '97	290-931-680	6730.3*
Base Gasket '97	290-931-681	6730.4*
Base Gasket '97	290-931-682	6730.6*
Base Gasket '98	290-931-685.5	6732.5*
Base Gasket '98	290-931-686.6	6732.6*
Base Gasket '98	290-931-687.8	6732.8*
Carb Gasket 48mm (2 required)	270-500-384	6740*
Power Valve O-Ring (2 required)	290-430-110	6622*
Power Valve Housing O-Ring	290-931-670	6750*
Exhaust Gasket (2 required)	293-250-081	6760*
Headpipe Gasket 97	290-931-487	6770*
Headpipe Gasket 98	429-931-488	6775*
Stud O-Ring	290-850-460	6780
Balance Shaft O-Ring	290-230-300	6624
Starter O-Ring	278-001-159	6790
Flywheel Housing	290-931-690	6795
Oil Pump O-Ring	293-300-018	6255

### SEA DOO 800 DI

	OEM No.	Part No.
800 DI Top Kit	*	6850
800 DI Complete Kit	ALL	6855
Head Cover O-Ring	420-831-550	6612*
Spark Plug O-Ring (2 Req'd)	420-430-782	6220*
Cylinder O-Ring (2 Req'd)	420-931-410	6185*
Water Jacket O-Ring (2 Req'd)	420-931-420	6614*
Base (3 Hole 0.12)	420-931-728	6035.3
Base (4 Hole 0.16)	420-931-728	6035.4*
Base (6 Hole 0.24)	420-931-728	6035.6
Power Valve O-Ring (2 Req'd)	290-931-765	6622
Power Valve Housing O-Ring	290-931-670	6750
Exhaust	290-931-481	6082*
Headpipe	420-931-503	6155*
Balance Shaft O-Ring	290-230-300	6624
Manifold O-Ring	290-831-767	6628
Rotary Valve Shaft O-Ring	293-300-024	6260
Starter O-Ring	278-000-694	6152
Flywheel Housing Gasket	290-931-470	6045
Flywheel Cover O-Ring	290-950-360	6632
Oil Pump O-Ring	293-300-018	6255
Case Plug O-Ring	290-250-890	6650
Intake Manifold O-Ring	420-850-520	6655
Rectifier Cover O-Ring	420-850-390	6784
Bearing Cover O-Ring	420-230-300	6624
Sump Cover O-Ring	420-950-360	6205

### SEA DOO 950 DI

	OEM No.	Part No.
950 DI Top Kit	2000+	6875
950 DI Complete Kit	2000+	6880
Head	420-931-706	6705*
Base (3 Hole 0.12)	420-931-905.3	6734.3*
Base (4 Hole 0.16)	420-931-905.4	6734.4*
Base (6 Hole 0.24)	420-931-905.6	6734.6*
Reed (Not Req'd w/Stock Reeds)		6745
Power Valve O-Ring (2 Req'd)	290-850-460	6622*
Power Valve Housing O-Ring	290-931-670	6750*
Exhaust (2 Req'd)	293-250-081	6760*
Headpipe	420-931-990	6870*
Balance Shaft O-Ring	290-230-300	6624
Starter O-Ring	278-001-159	6790
Flywheel Cover	290-931-690	6795
Oil Pump O-Ring	293-300-018	6255
Engine Bottom Cover O-Ring	420-931-880	6782
Rectifier Cover O-Ring	420-850-390	6784
Compressor	420-230-300	6624
Compressor Gasket	420-931-870	6850
O-Ring	293-300-054	6862
O-Ring	293-300-076	6865
O-Ring	293-300-070	6868





## INDIVIDUAL GASKETS FOR YAMAHA

### WAVE JAMMER, WAVE RUNNER 500

	OEM No.	Part No.
Complete Kit		51-4803
Head	6K8-1181	2000
Carb	6K8-13556	2010
Thermostat Cover	655-12414	2020
Reed	6K8-13621	2030
Oil Seal Housing	6K8-15369	2040
Flywheel Cover	6K8-81365	2050
Flame Arrestor	6K8-13674	2060
Exhaust Cover #1	6K8-41124	2070
Exhaust Cover #2	6K8-41122	2080
Exhaust Cover Inner	6K8-41112	2090
Exhaust Cover Outer	6K8-41114	2100
Muffler Damper #1	6K8-14739	2110
Muffler Damper #2	6K8-14749	2120
Silencer	6K8-14755	2130
Upper Case	6K8-45113	2140

### 650 SUPERJET 90-93, WRIII 90-93

	OEM No.	Part No.
Top Kit		2600
Complete Kit		2650
Head 77mm .050	6R7-11181	2205*
Base	6M6-11351	2220*
Carb (2 required)	6M6-13556	2230*
Top Manifold	6M6-13563	2240*
Lower Manifold	6M6-13566	2260*
Reed (2 required)	6M6-13621	2280*
Exhaust	6M6-14613	2310*
Oil Pump	6R8-13116	2340
Air Cleaner (2 required)	6M6-13674	2350
Flywheel Cover	6M6-81365	2360
Head Pipe	6R7-14755	2370
Outer Cover	6R7-41114	2380
Damper	6R7-14749	2390
Exhaust Pipe (2 required)	6M6-14739	2400
Head Cover	6M6-11193	2410

### 701 SUPERJET 94-95, BLASTER 93-95 WAVE RAIDER 96, WRIII 94-95

	OEM No.	Part No.
Top Kit		2700
Complete Kit		2750
Head 82mm .050	61X-11181A	2215*
Base	6M6-11351	2220*
Carb (2 required)	6M6-13556	2230*
Top Manifold	61X-13563	2250*
Lower Manifold	61X-13566	2270*
Reed (2 required)	61X-13621	2290*
Exhaust Green	61X-14613	2330*
Oil Pump	6R8-13116	2340
Flame Arrestor (2 required)	6M6-13674	2350
Flywheel Cover	6M6-81365	2360
Silencer (aka Head Pipe)	6R7-14755	2370
Outer Cover	6R7-41114	2380
Damper	6R7-14749	2390
Exhaust Pipe	6M6-14739	2400
Head Cover	6M6-11193	2410

\* Denotes when the gasket is included in the Top End Gasket Set.

### 701 SUPERJET 96-99, WAVE BLASTER 96

	OEM No.	Part No.
Top Kit		2550
Complete Kit		2555
Head 82mm	62T-11181	2215*
Base	6M611351	2220*
Reed (2 required)	62T-13566	2830*
Carb Manifold	62T13556	2820*
Carb Base (2 required)	-	5460
Exhaust Green	61X-14613	2330*
Oil Pump	6R8-13116	2340
Arrestor (2 required)	62T-13674	2825
Flywheel Cover	6M6-81365	2360
Head Pipe	6R7-17455	2370
Outer Cover	6R741114	2380
Damper	6R7-14749	2390
Exhaust Pipe	6M6-14739	2400

### 701 WAVE RAIDER 94-95, WAVE VENTURE 95+

	OEM No.	Part No.
Top Kit		2950
Complete Kit		2980
Head Green	62T-11181	2810*
Base	6M6-11351	2220*
Carb Base	62T-14398	5030*
Carb Manifold	62T-13556	2820*
Air Cover	62T-13674	2825
Flywheel Cover	6M6-81365	2360
Reed (2 required)	62T-13566	2830*
Exhaust Green	62T-14613	2850*
Muffler Damper 1	62T-14739	2860
Head Pipe	62T-14749	2870
Exhaust Outer Cover #1	62T-41114	2880
Exhaust Inner Cover	62T-41122	2890
Exhaust Outer Cover #2	62T-41124	2900
Oil Pump	6R8-13116	2340
Ignition Box Cover	6M6-81921	2116A

### 760 WAVE RAIDER 96+, BLASTER II 96+, XL760W

	OEM No.	Part No.
Top Kit		2990
Complete Kit		2992
Head .025 Stainless	64X-11181	3200*
Head .050 86mm	Ultimate	3210
Base	6M6-11351-A2	3205*
Carb Base (2 required)	62T-14398	5460*
Carb Manifold	64X-13556	3220*
Arrestor (2 required)	64X-13674	3230*
Reed (2 required)	62T-13566	2830*
Exhaust Green	62T-14613	2850*
Flywheel Cover	6M6-81365	2360
Head Pipe	64X-14749	2870
Exhaust Outer Cover #1	62T-41114	2880
Exhaust Inner Cover	62T-41122	3240
Outer Cover Exhaust	62T-41124	3250
Oil Pump	6R8-13116	2340

### GP800 98+

	OEM No.	Part No.
Top Kit		3520
Complete Kit		3530
Head .025 Stainless		3400*
Head .050 82mm	Ultimate	3410
Base (2 required)		3420*
Carb Base		5460
Carb Manifold		3430*
Exhaust Green		3450*
Head Pipe		3460
Power Valve (2 required)		3470
Exhaust Section		3480
Oil Pump		2340

FOUR  
STROKE

INTAKE  
SYSTEMS

ENGINE/  
GASKETS

EXHAUST

DRIVE LINE  
HANDLING

ELECTRICAL

WATERLINE  
/BILGE

STEERING  
& CONTROLS

BODY

ACCESSORIES

SERVICE TOOLS  
/HARDWARE

CHEMICAL

# INDIVIDUAL GASKETS FOR YAMAHA

## 1100 WAVE VENTURE / WAVE RAIDER

	OEM No.	Part No.
Top Kit		4520
Complete Kit		4530
Head .050 82mm	63M-11181	4400*
Base	63M-11351	4415*
Carb Base	63M-14398	5030
Carb Manifold	63M-13556	4420*
Reed (2 required)	63M-13566	4430*
Exhaust	63M-14613	4450*
Muffler Damper 1	63M-14739	4455
Muffler Damper 2	63M-14749	4460
Exhaust Outer Cover (2 required)	63M-41114	4470
Exhaust Inner Cover	63M-41122	4480
Head Cover	63M-11193	4500
Flywheel Cover	63M-81365	4505
Oil Pump	63M-13116	4510

## YAMAHA GP 1200, XL 1200 98+

	OEM No.	Part No.
Top Kit		4680
Complete Kit		4685
Head .025 86mm	65U-11181	4600*
Head .050 86mm Green	Ultimate	4610
Base	65U-11351	4615*
Carb Base XL 1200 W	65U-13556	5460
Carb Manifold	64X-14162	4620*
Spark Arrester	-	4630
Reed (2 required)	65U-13566	4430*
Exhaust	65U-14613	4650*
Muffler Damper 1	63M-14739	4455
Head Pipe	63M-14749	4460
Exhaust Outer Cover (2 required)	63M-41114	4470
Exhaust Inner Cover	63M-41122	4480
Head Cover	63M-11193	4500
Flywheel Cover	63M-81365	4505
Oil Pump	63M-13116	4510

## YAMAHA GP 1200R, XL 1200LTD

	OEM No.	Part No.
Top Kit		3730
Complete Kit		3740
Head .025 Stainless Steel	66V-11181	3600*
Base (3 Required)	66E-11351	3420*
Carb Base (3 Required)	66E-14398	3425*
Carb Manifold	66V-13558	3620*
Reed	-	3435
Reed Center	-	3440
Power Valve (3 Required)	66E-1131B-0	3470
Exhaust Green	66V-14613	3650
Head Pipe	66V-14739	3660
Chamber	66V-14749	3670
Outer Cover #1	66V-41114	3680
Outer Cover #2	66V-41124	3690
Tail Cone	66V-14623	3700
Starter O-Ring	1FK-81847	3490
Oil Pump	63M-13116	2340
Head Cover	66V-11193	3610

★ Denotes when the gasket is included in the Top End Gasket Set.

## YAMAHA 1300 GPR

	OEM No.	Part No.
1300 Top Kit		3800
1300 Complete Kit		3810
Head .025 Stainless Steel	66V-11181	3605*
Base (3 Req'd)	66E-11351	3420*
Manifold		3620*
Reed	NOE	3435
Reed Center	NOE	3440
Power Valve (3 Req'd)	66E-1131B-01	3470
Exhaust	66V-14613	3650
Head Pipe	66V-14739	3660
Chamber	66V-14749	3670
Outer Cover #1	66V-41114	3680
Outer Cover #2	66V-41124	3690
Tail Cone	66V-14623	3700
Starter O-Ring	1FK-81847	3490
Oil Pump	63M-13116	2340



## INDIVIDUAL GASKETS FOR KAWASAKI

### 440 ALL

	OEM No.	Part No.
Complete Kit 77-80		51-1203
Complete Kit 81-92		51-1503
Head	11004-3707	5200
Base	11009-505	5240
Intake	11009-3785	5250
Carb Base 38mm	11009-3786	5030
Housing Pre 82	92065-515	5270
Exhaust	11009-3779	5280
Headpipe Green	11060-3710	5290
Arrester 38mm	11060-3702	5080

### 550 1982-85, 1986-90

	OEM No.	Part No.
Top Kit 1982-85		5550
Complete Kit 1982-85		5560
Top Kit 1986-90		5570
Complete Kit 1986-90		5580
Head All	11004-3709	5400*
Base	11009-3782	5430*
Intake (2 required)	11009-3785	5250*
Carb Base 38mm Pre 86	11009-3786	5030*
Carb Base 44mm 86-90	11060-3743	5460*
Exhaust	11009-3779	5280*
Headpipe Pre-86	11009-3051	5480
Conn Pipe Lower Pre 86	11060-3730	5490
Headpipe	11060-3726	5500
Conn Pipe 86-90	11060-3727	5510
Chamber 86-90	11060-3278	5520
Arrester 38mm Pre 86	11060-3702	5080
Arrester 44mm 86-90	11060-3744	5540



## INDIVIDUAL GASKETS FOR KAWASAKI

### 550sx 1991-95

	OEM No.	Part No.
Complete Kit		51-2403
Head .010 Stainless	11004-3706	51-2409
Head .047 Green		5610
Base .010 Stainless	11009-3780	5630
Base .020 Fiber		5635
Reed	11009-3787	5640
Intake	11009-3788	5650
Keihin 38mm	11060-3716	5660
Exhaust	11009-3779	5280
Headpipe	11060-3726	5500
Conn Pipe	11060-3727	5510
Chamber	11009-2446	5520

### KAWASAKI 650, X2/TS/SC

	OEM No.	Part No.
650 Complete		5940
650 X2, TS Complete		5960
Head .010 Stainless	11004-3710	5800
Head .040 Green	Ultimate	5830
Base	11009-3775	5850
Reed	11009-3731	5860
Keihin 28mm Carb Base	11009-3747	5870
Keihin 38mm Carb Base	11060-3716	5660
Exhaust	11009-3722	5880
Head Pipe	11009-3752	5890
Head Pipe 46mm ID Green	11009-3752	5900
Muffler TS	11060-3718	7120
X-2 Conn Pipe	11009-3724	5910
Control Valve All	11060-3723	7150

### 750SX, SXI, SXI PRO

	OEM No.	Part No.
Top Kit	All 750	7200
Complete Kit	SX/SXI	7210
Head .010 Stainless	11004-3714	7000*
Head .020 Head Copper	Copper	7010
Base	11060-3711	7040*
Reed A SX(4pcs) SXI(2pcs)	11060-3717	7050*
Reed B SXI(2pcs)	11060-3757	7430*
40mm Carb	11060-3716	7060*
40mm Carb SXI 96+	11060-3761	7065*
Exhaust (2 required)	11060-3759	7070*
Head Pipe SX, SXI	11060-3712	7080
Upper Muffler SX, SXI	11060-3713	7090
Muffler SX, SXI	11060-3714	7140
Control Valve All	11060-3723	7150

\* Denotes when the gasket is included in the Top End Gasket Set.

### 750 SS, XI, XIR

	OEM No.	Part No.
Top Kit	All 750	7200
Complete Kit	SS/XI	7220
Complete Kit	SS 92-93	7240
Complete Kit	XIR	7230
Head .010 Stainless	11004-3714	7000*
Base All	11060-2711	7040*
Reed (4pcs) SS92+, XI93-95, XI	11060-3717	7050*
Reed A XI 96 (2 pcs)	11060-3717	7050*
Reed B XI 96 (2 pcs)	11060-3757	7430*
40mm Carb SS, XI, XIR	11060-3716	7060*
40mm Carb XI 96	11060-3758	7060*
Exhaust All	11060-3721	7070
Head Pipe SS 92-93	11060-3720	7100
Head Pipe SS 94+, ST, XI 93+	11060-3732	7110
Head Pipe (XIR)	11009-3752	5900
Muffler XI, SS	11060-3718	7120
Control Valve All	11060-3723	7150

### 750 STS, ZXI

	OEM No.	Part No.
Top Kit	ALL 750	7200
750 Complete	95 STS	7225
750 Complete	ZXI 95+	7245
Head .010 Stainless	11004-3714	7000*
Base All	11060-3711	7040*
Reed A ZXI, STS (2), ST (4)	11060-3717	7050*
Reed B ZXI, STS (2)	11060-3757	7430*
40mm Carb ZXI, STS (2)	11060-3758	7060*
Exhaust STS 95-96, ZXI (2)	11060-3721	7070*
Headpipe 95 STS	11060-3732	7110
Headpipe 96 STS	11060-3771	7115
Headpipe ZXI 95-96	11060-3754	7470
Muffler 1 95 STS	11060-3718	7120
Exhaust Joint STS 96	11060-3763	7125
Muffler 1 96 STS	11060-3766	7135
Muffler 2 96 STS	11060-3770	7145
Muffler ZXI 95-96	11060-3755	7480
Control Valve All	11060-3723	7150

### KAWASAKI 800 SXR

	OEM No.	Part No.
800 Top Kit		7300
800 Complete Kit		7310
Head Stainless Steel .010	11004-3720	7005*
Base SXR	11060-3711	7040*
Reed SXR (4 required)	11060-3717	7050*
Reed SXR (2 required)	11060-3757	7430*
40mm Carb SXR (2 required)	11060-3761	7067*
Exhaust SXR (2 required)	11060-3759	7075*
Headpipe SXR	11060-3712	7080
Upper Muffler SXR	11060-3713	7090
Muffler SXR	11060-3714	7140

### KAWASAKI 900 ZXI 95+

	OEM No.	Part No.
Top Kit		7500
Complete Kit		7520
Head .010 Stainless	11004-3713	7400*
Head .040 Fiber		7410
Base	11060-3752	7420*
Reed Engine (3 required)	11060-3717	7050*
Reed Carb (3 required)	11060-3757	7430*
Exhaust (3 required)	11060-3756	7450*
Carb Base	11060-3753	7460
Headpipe	11060-3754	7470
Muffler	11060-3755	7480

FOUR STROKE  
INTAKE SYSTEMS  
ENGINE/GASKETS  
EXHAUST  
DRIVE LINE HANDLING  
ELECTRICAL  
WATERLINE /BILGE  
STEERING & CONTROLS  
BODY  
ACCESSORIES  
SERVICE TOOLS /HARDWARE  
CHEMICAL

## KAWASAKI 1100ZXI 96-98

	OEM No.	Part No.
Top Kit		7670
Complete Kit		7680
Head .010 Stainless	11004-3715	7600
Head .040 Fiber		7605
Base	11060-3760	7615
Reed Engine	11060-3717	7050
Reed Carb	11060-3757	7630
Exhaust	11060-3767	7650
Carb	11060-3775	7652
Carb	11060-3776	7655
Headpipe	11060-3768	7660
Muffler	11060-3769	7665

## KAWASAKI ULTRA 150 99+

	OEM No.	Part No.
Top Kit		7830
Complete Kit		7835
Head Stainless Steel .010*	11004-3717	7700*
Base	11060-3783	7715*
Water Pipe	11060-3785	7720
Reed (3 Req'd)	11060-3717	7050*
Reed Carb (3 Req'd)	11060-3757	7630*
Exhaust (3 Req'd)	11060-3785	7750*
Carb (3 Req'd)	11060-3788	7760
Head Pipe	11060-3786	7770
Exhaust Body	11060-3787	7780
Flywheel Cover	11060-3803	7790

## INDIVIDUAL GASKETS FOR POLARIS

### 700 HURRICANE, VIRAGE, FREEDOM

	OEM No.	Part No.
Top Kit		4375
Complete Kit		4378
Head O-Ring (2 required)	5410931	4300*
Cylinder O-Ring (2 required)	5410932	4305*
Spark Plug O-Ring (2 required)	5410917	4310*
Base (2 required)	5811057	4315*
Base Virage-Freedom (2 required)	5811784	4805*
Reed Engine Side	N.O.E	4317
Reed Carb Side	N.O.E	4319
Carb (2 required)	5830043	4320*
Arrestor	5830062	4325
Exhaust (2 required)	5811045	4330*
Headpipe (2 required)	5830051	4335*
Flywheel Cover	5811145	4337
Water Manifold (2 required)	5830061	4339
Oil Pump O-Ring	5411056	4340
Thermostat Housing	5410860	4353
Crank O-Ring	5410613	4356
Starter O-Ring (2 required)	3240114	4359

### POLARIS 650/750

	OEM No.	Part No.
650 Top Kit		4200
650 Complete Kit		4210
750 Top Kit		4220
750 Complete Kit		4230
Head 650 .010 Stainless (3 req'd)	3240057	4000*
Head 750 .040 Stainless (3 req'd)	3240213	4010*
Head 650 .040 Fiber	Ultimate	4020
Base .020 (3 required)	3240055	4040*
Reed(6 required)	3084148	4050*
Carb (6 required)	3240128	5030*
Arrestor	5830013	4065
Exhaust (3 required)	5211489	4070*
Headpipe	5830038	4080*
Water Manifold (3 required)	3082937	4100
Thermostat Housing	5410781	4110
Oil Pump O-Ring	3083127	4112
Starter O-Ring (2 required)	3240114	4359

## POLARIS 780, 785 PRO

	OEM No.	Part No.
Head 780 Stainless (3 required)	3240251	4035*
Head 785 Stainless (3 required)	3240305	4037*
Base (3 required)	3240249	4040*
Reed (3 required)	3084148	4050*
Carb (3 required)	3240128	5030*
Carb 785 (3 required)	3240358	9240*
Arrestor (3 required)	5830013	4065*
Arrestor 785 (3 required)	5830115	5540*
Exhaust	5211623	4077*
Exhaust 785	5211725	4078
Exhaust 785 O-Ring (6 required)	5411311	4079
Head Pipe	5830038	4080*
Power Valve 785 (3 required)	3240313	4085
Water Manifold	3082937	4100
Oil Pump O-Ring	3083127	4112
Thermostat Housing	5410781	4110
Starter O-Ring	3240114	4359

## POLARIS 900/1050

	OEM No.	Part No.
Top Kit 900		4380
Complete Kit 900		4383
Top Kit 1050		4385
Complete Kit 1050		4390
Head O-Ring (3 required)	5410931	4300*
900 Cylinder O-Ring (3 required)	5411044	4303*
1050 Cylinder O-Ring (3 required)	5410932	4305*
Spark Plug O-Ring (3 required)	5410917	4310*
Base 900 (3 required)	5811057	4315*
Base 1050 (3 required)	5830123	4316
Reed		4318
Carb (3 required)	5830043	4320
Arrestor	5830062	4325
Exhaust (3 required)	5811045	4330*
Headpipe	5830051	4335
Flywheel Cover	5811145	4337
Water Manifold	5830061	4339
Oil Pump O-Ring	5411056	4340
Thermostat Housing	5410860	4353
Crank O-Ring	5410613	4356
Starter O-Ring	3240114	4359

## INDIVIDUAL GASKETS FOR TIGER SHARK

### TIGER SHARK 639, 644

	OEM No.	Part No.
Top Kit 639/644		3100
639 Complete Kit		3110
644 Complete Kit		3120
Head	3008-174	3000*
Head 639,644 77MM .040	Ultimate	3010
Base	3008-050	3030*
Reed (4 required)	3008-076	3040*
Carb Base 44mm	3008-057	5460*
Exhaust (2 required)	3008-080	3060*
Head Pipe	3008-081	3070
Connector Pipe 644 only	3008-082	3080
Air Cleaner	3008-058	3090

★ Denotes when the gasket is included in the Top End Gasket Set.

# INDIVIDUAL GASKETS BY SECTION

## HEAD GASKETS



Head gaskets for all applications including high performance racing applications. All gaskets meet or exceed the OEM manufacturers specifications.

Head gaskets are available in:  
Metal, Copper, and "Ultimate" Green fiber.

Sea Doo Cylinder	Type	Part No.
O ring set 580 92+	O-Ring	6170
O ring set 650	O-Ring	6180
O ring set 720/785	O-Ring	6185
951 (carb) 97+	Metal 88-90mm	6700
951 (carb) 97+	Metal 91.25mm	6700BB
951 DI	Metal 88-90mm	6705

Sea Doo Head Cover	Type	Part No.
O ring 580 Yellow Engine	O-Ring	6200
O-Ring 580 White Engine/720	O-Ring	6205
O ring 650	O-Ring	6210
O ring 785	O-Ring	6612

Polaris	Thickness	Type		Part No.
650	0.040	Green	(3 Required)	4020
750	0.040	Green	(3 Required)	4030
650	0.010	Metal	(3 Required)	4000
750	0.010	Metal	(3 Required)	4010
780	0.010	Metal	(3 Required)	4035
785	0.010	Metal	(3 Required)	4037

Polaris Head O-Ring	Part No.
700 Hurricane/900/1050	4300

Polaris Cylinder O-Ring	Part No.
700 Hurricane/1050	4305
900	4303

Yamaha	Thickness	Type	Part No.
500 All	0.040	Fiber	2000
500 All	0.050	Green	2005
650 All 77mm	0.050	Green	2205
701 All 82mm	0.050	Green	2215
701 W/Raider	0.050	Green	2810
760 86mm	0.050	Green	3210
GP800	0.050	Green	3410
1100 82mm	0.050	Green	4400
1200 86mm	0.050	Green	4610
760 86mm	0.025	Metal	3200
GP800	0.050	Metal	3400
1200 86mm	0.025	Metal	4600
GP1200R,XL1200LTD	0.025	Metal	3600

Kawasaki	Thickness	Type	Part No.
440 77-80	0.040	Fiber	51-1206
440 81-92	0.040	Fiber	5200
550 82-90	0.040	Fiber	5400
550 91-95	0.047	Green	5610
650 84MM	0.040	Fiber	51-2707
650 All	0.040	Green	5830
750 All	0.040	Green	7020
900 ZXI	0.040	Green	7410
1100 ZXI	0.040	Green	7605
550 91-	0.010	Metal	51-2409
650 All	0.010	Metal	5800
750 All	0.010	Metal	7000
900 ZXI	0.010	Metal	7400
1100 ZXI	0.010	Metal	7600
550 91-	0.020	Copper	51-2410
750 All	0.020	Copper	7010
800 SX-R	0.010	Metal	7005
800 SX-R	.005	Copper	TBM125-H-COP

# ThreeBond



1211 (White)



1207 D (Black)

## THREE BOND SILICON GASKET

### #1211 (White) Silicon Liquid Gasket

High grade silicon liquid gasket used by many OEM's in aluminum case assembly. 1211 is tack free in 90 minutes and fully cured in 24 hours.

### #1207D (Black) Quick Dry Silicon Gasket

Crankcase sealer for large gaps, sheet metal, tough to seal areas, and vertical applications. 1207D is tack free in 5 minutes and fully cured in 24 hours.

Descriptions	Part No.
Silicon Liquid Gasket (White)	1211AT100
Quick Dry Silicon Liquid Gasket (Black)	1207B100G

FOUR STROKE  
INTAKE SYSTEMS  
ENGINE/GASKETS  
EXHAUST  
DRIVE LINE HANDLING  
ELECTRICAL  
WATERLINE /BILGE  
STEERING & CONTROLS  
BODY  
ACCESSORIES SERVICE TOOLS /HARDWARE  
CHEMICAL

# INDIVIDUAL GASKETS BY SECTION

## INTAKE & REED GASKETS (Intake Manifold to Cylinder or Cases)

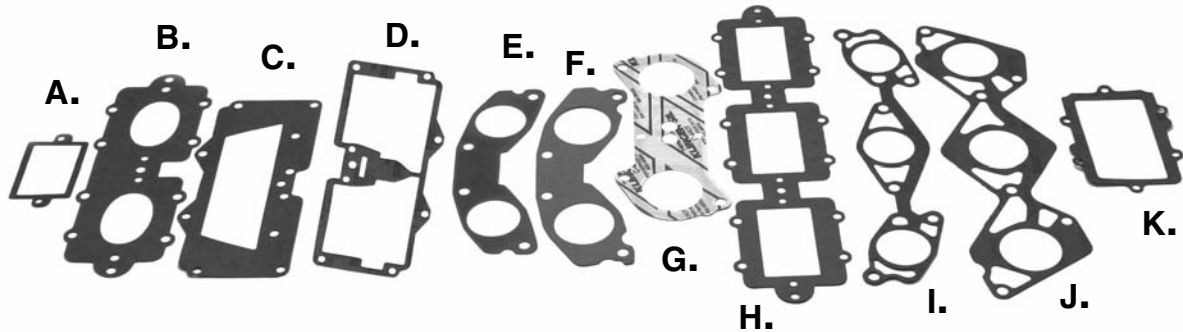

	Yamaha	OEM#	Part No.
A.	701 Reed	61X-13621	2290
B.	760 W/Rdr Reed/701 96+	62T-13566	2830
C.	701 Top Manifold	61X-13563	2250
D.	701 Lower Manifold	61X-13566	2270
E.	SJ,W/Blster 701 96+/WRdr 701	62T-13556	2820
F.	760 Carb Manifold	64X-13556	3220
G.	800 Carb Manifold	64E-13556	3430
H.	1100/1200 Reed	63M-13566	4430
I.	1100 Carb Manifold	64M-13556	4420
J.	1200 Carb Manifold	64X-14162	4620
K.	GP1200R/XLL1200 Reed		3435

	Yamaha	OEM#	Part No.
	500 Reed	6K8-13261	2030
	650 All Reed	6M6-13621	2280
	650 Top Intake	6M6-13563	2240
	650 Bottom Intake	6M6-13566	2260

	Kawasaki	OEM#	Part No.
	440/550 Intake	11009-3785	5250
	550SX Intake	11009-3788	5650
	550SX Reed	11009-3787	5640
	650 All Reed	11060-3703	5860
	750/900/1100 Engine	11060-3717	7050
	750/900/1100 Reed Carb	11060-3757	7430

	Polaris	OEM#	Part No.
	650/750/780/785 Reed	308448	4050
	900/1050/Reed		4318
	700/Hurricane Reed Engine Side		4317
	700/Hurricane Reed Carb Side		4319



## EXHAUST HEAD PIPE GASKETS (Manifold to Pipe)

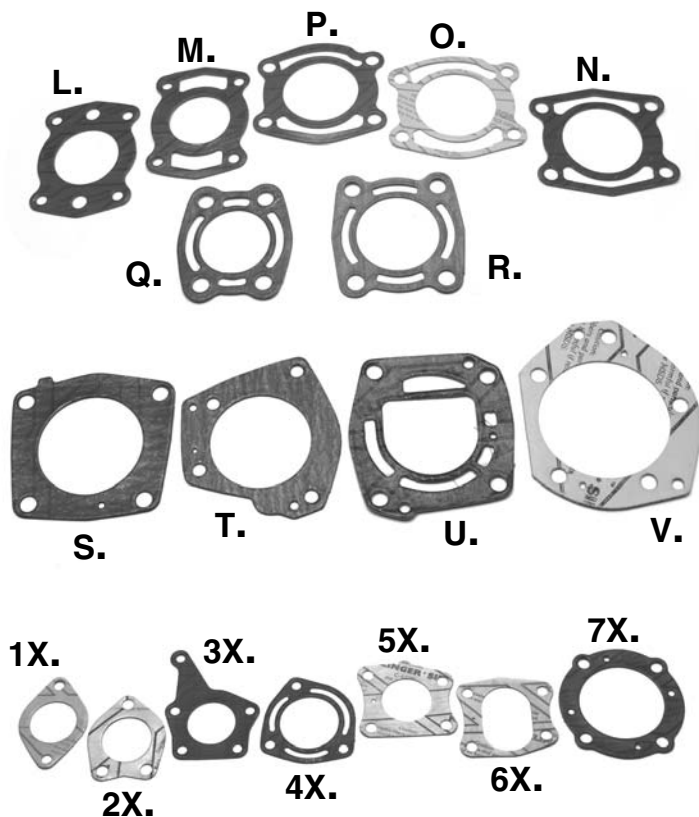

	Sea Doo	OEM#	Part No.
L.	580 -92	290-950-250	6140
M.	580 92+/650/720	290-950-251	6150
N.	785	290-931-500	6155
O.	951 97	290-931-487	6770
P.	951 98+	290-250-080	6775

	Polaris	OEM#	Part No.
Q.	650/750/780/785	5830038	4080
R.	700/Hurricane/900/1050	5830051	4335

	Yamaha	OEM#	Part No.
S.	650/701	6R7-14755	2370
T.	701 WRD 94-95	62T-14749	2870
T.	760	64X-14749	2870
U.	1100/1200	63M-14749	4460
V.	800	66E-14749	3460

	Kawasaki	OEM#	Part No.
1X.	440/550	11009-3051	5290
2X.	650 All (46mm ID)	11009-3752	5900
3X.	750 SX/SX1	11060-3712	7080
4X.	750 SX/SX1 Front	11060-3713	7090
5X.	750 SS 92-95	11060-3720	7100
6X.	750 X1 93-96	11060-3732	7110
7X.	900	11060-3755	7480
	1100	11060-3769	7665

# INDIVIDUAL GASKETS BY SECTION (Cylinder to Manifold)

## EXHAUST MANIFOLD GASKETS

(cylinder to manifold)

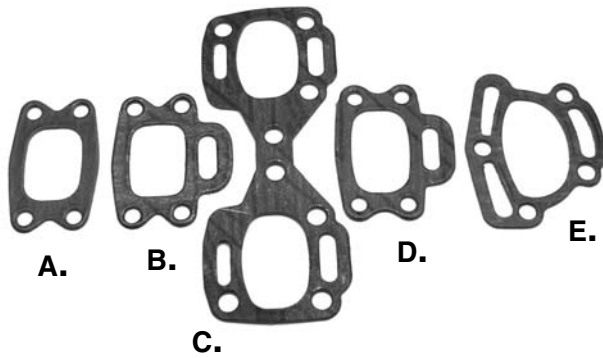

Sea Doo	OEM#	Part No.
A. 580 All -91	420-850-632	6050
B. 580 All 92+	290-850-635	6060
C. 785	290-931-480	6082
D. 650/720	290-850-637	6080
E. 951	290-250-081	6760

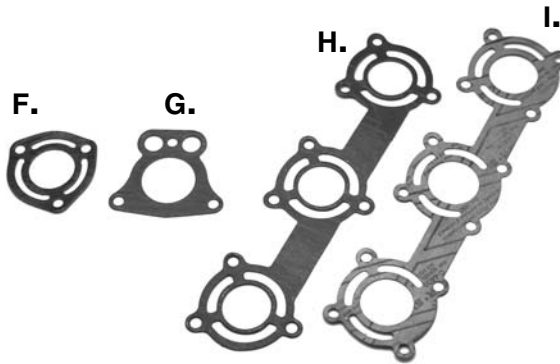

Polaris	OEM#	Part No.
F. 650/750	5211489	4070
G. 700/Hurricane/900/1050	5811045	4330
H. 780	5211623	4077
I. 785	5211725	4078

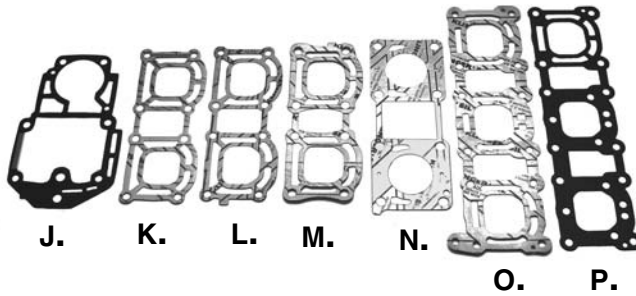

Yamaha	OEM#	Part No.
J. 500	6K8-45113	2140
K. 650 All	6M6-14613	2310
L. 701	61X-14613	2330
M. 701/760 W/Rdr	62T-14613	2850
N. 800	66E-14613	3450
O. 1100	63M-14613	4450
P. 1200	65W-14613	4650

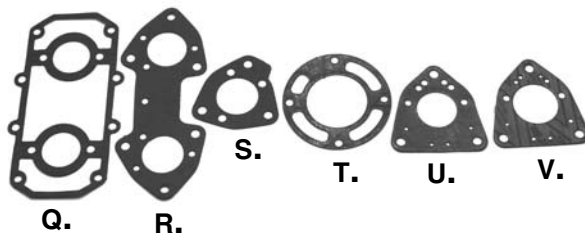

Kawasaki	OEM#	Part No.
Q. 440/550	11009-3779	5280
R. 650 (86-90)	11060-3739	5880
S. 650/750 (2 required)	11060-3759	7070
T. 750 SS-X1	11060-3718	7120
U. 900	11060-3756	7450
V. 1100	11060-3767	7650

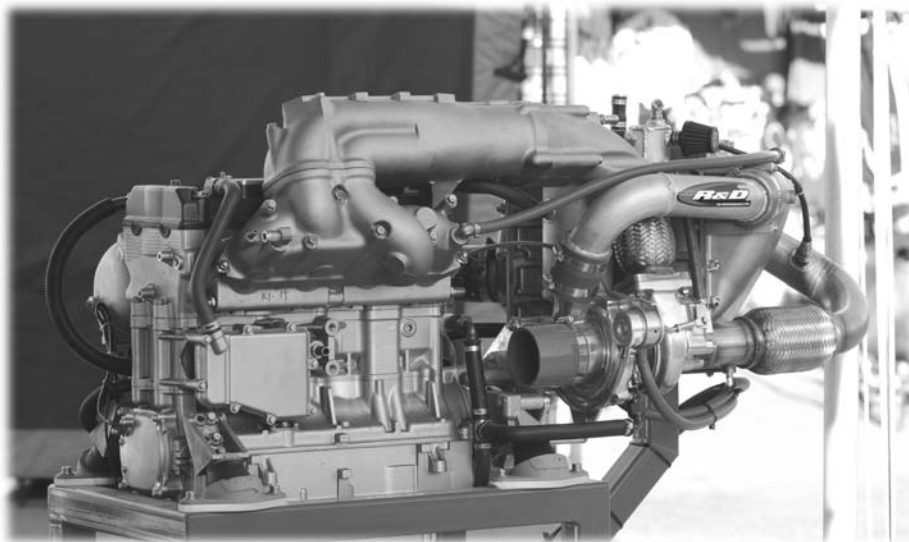

R&D PERFORMANCE  
PROTOTYPE KAWASAKI  
ULTRA 250 TURBO ENGINE

2008 WORLD FINALS  
LAKE HAVASU, AZ  
PHOTO COURTESY OF  
JIN OMURA

FOUR STROKE	INTAKE SYSTEMS	ENGINE/GASKETS	EXHAUST	DRIVE LINE HANDLING	ELECTRICAL	WATERLINE /BILGE	STEERING & CONTROLS	BODY	ACCESSORIES	SERVICE TOOLS /HARDWARE	CHEMICAL
-------------	----------------	----------------	---------	---------------------	------------	------------------	---------------------	------	-------------	-------------------------	----------

# INDIVIDUAL GASKETS BY SECTION



## BASE GASKETS

Sea Doo	OEM#	Part No.
580 -91	290-850-775	6000
580 92+/650	290-931-161	6020.3
580 92+/650	290-931-162	6020.4
580 92+/650	290-931-163	6020.5
580 92+/650	290-931-164	6020.6
580 92+/650	290-931-165	6020.8
720 0.3mm	290-931-400	6025.3
720 0.4mm	290-931-401	6025.4
720 0.5mm	290-931-402	6025.5
720 0.6mm	290-931-403	6025.6
720 0.8mm	290-931-404	6025.8
785 0.3mm	290-931-720	6035.3
785 0.4mm	290-931-721	6035.4
785 0.5mm	290-931-722	6035.5
785 0.6mm	290-931-723	6035.6
785 0.8mm	290-931-724	6035.8
951 97	290-931-680	6730.3
951 97	290-931-681	6730.4
951 97	290-931-682	6730.6
951 98+	290-931-685.5	6732.5
951 98+	290-931-686.6	6732.6
951 98+	290-931-687.8	6732.8

Polaris	Part No.
650/750/780/785	4040
700/Hurricane/900/1050	4315

Yamaha	OEM#	Part No.
760	6M6-11351-A200	3205
650/701 All		2220
GP800	66E-11351-0000	3420
1100/1200	63M-11351-010	4415

Kawasaki	OEM#	Part No.
440 All		5240
550 80-90	11009-3782	5430
550 91-93	11009-3780	5635
550 91-93 Copper	—	51-2417
650 All	11009-3775	5850
750 All	11060-3711	7040
900	11060-3752	7420
1100	11060-3760	7615



## HEAD PIPE GASKET FOR AFTERMARKET

Pipe	Part No.
Riva WaveRaider (3 Hole)	9070
Riva All Others (3 Hole)	9060
R&D 3 Bolt	9080
R&D 4 Bolt	9090
Factory Pipe All (46mm ID)	5900
Factory Pipe 785 (Spec 1)	6155
Factory Pipe 785 (Spec 2)	6158
Factory Pipe Sea Doo 650/720	9010
Factory Pipe Kaw 550 LTD	9000
Coffman Pipe 550 Climax	9020
Coffman 750 SX Rocket Mod	9030
Coffman 750 SS, XI, ST Rocket	7100A
Coffman 750 XI (Hurricane)	7105



## R&D Dominator Base Gaskets

Yamaha	Thickness	Part No.
Superjet	.020 - 0.5mm	070-00020
Superjet	.040 - 1.0mm	070-00040
Superjet	.060 - 1.5mm	070-00060
Kaw 750/800	.060 - 1.5mm	071-00060



## HIGH PERFORMANCE BASE GASKETS

Kawasaki	Thickness	Part No.
800 SXR	.020 - 0.5mm*	B0075020C
800 SXR	.030 - 0.75mm**	7040C
800 SXR	.040 - 1.00mm**	7040D
800 SXR	.050 - 1.25mm**	7040E
800 SXR	.060 - 1.50mm**	7040F

\*Metal Gasket \*\*Fiber gasket with a metal core



## CARBURETOR BASE GASKETS

Description	Fiber	Green
Mikuni 38mm	5030	9230
Mikuni 40mm	6107	9235
Mikuni 44mm	5460	9240
Mikuni 46mm	9245	9250
Mikuni 48mm		9252
Mikuni 48mm (SD951 I Series)		6740
Mikuni 50mm		9257
Keihin 42mm	9210	9220
Keihin 38mm	5660	9200
Keihin 40mm	7060	9205



## TBM 800 SXR COPPERBASE GASKETS

Boost your stock SX-R 800 compression between 10psi to 20psi over stock with these copper base gaskets without sacrificing reliability. Test results confirm an increase in acceleration and midrange power without losing peak RPM.

**2006 Stock Class legal.**

Kawasaki 800 SX-R	Part No.
Copper Base Gasket .005	TBM125-005
Copper Base Gasket .002	TBM125-002

## TBM 800 SXR POLY BASE GASKETS

.010" poly base gasket gives you an alternative to the TBM .005" copper base gasket if you would like to run higher port timing. Some tuners will prefer this gasket over the copper depending on the variations in port heights in the stock cylinders.

**2006 Stock Class legal.**

Kawasaki 800 SX-R	Part No.
Poly Base Gasket .010	TBM125-010

## TBM 750/800 SXR METAL CORE BASE GASKET (.060")

.060" metal core base gasket is a must when competing in the **800 Limited Class**. Significant gains (150-200rpm) in peak RPM translate to more speed when using this gasket. TBM highly recommends using a TBM head with Limited Domes to optimize the benefit of this upgrade. When using the .060" base gasket in conjunction with the Orecommended head and domes you will net a broader powerband and 2-3 mph in top speed depending on set up.

Kawasaki 800 SX-R	Part No.
Metal Core Base Gasket .060	TBM125-060







## OEM REPLACEMENT AFTERMARKET OIL FILTERS

Sea Doo	Part No.
A. All Sea Doo Four Stroke	006-560
B. All Sea Doo Four Stroke Oil Filter Cap	006-562

Yamaha	Part No.
All Yamaha Four Stroke OEM #594-13440-00-00	006-563



## HYDRO-TURF OIL EXTRACTOR

The unit uses a small vacuum system, which pumps fluid through a hose to the 6-liter reservoir. It also includes a pour spout to aid in emptying the reservoir. Pump is removable for easy storage.

Description	Part No.
Hydro-Turf Oil Extractor	OIL01



## SCEPTER FLEXIBLE FUNNEL

Scepter's flexible funnel is perfect for all your PWC uses and really helps perform those difficult maintenance and repair applications. Manufactured from quality, high density polymers: the funnel won't rust, dent, or crack. This means no drips and leaks for you to clean up after your done. The funnel length is 18".

Description	Part No.
Scepter 18" Flexible Funnel	MR03603

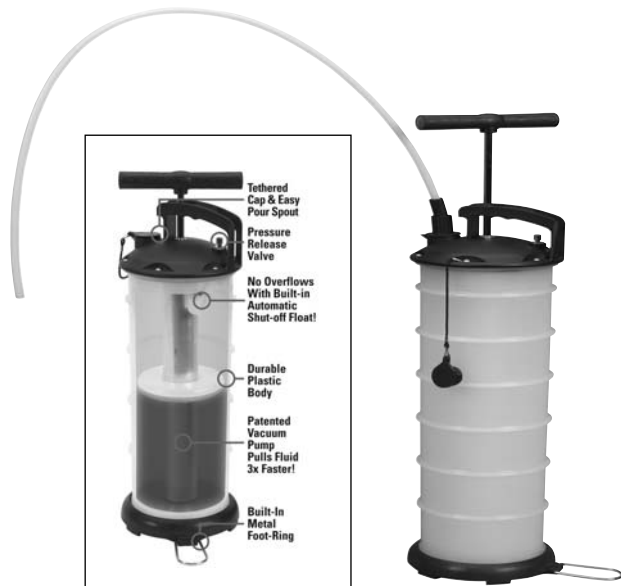

KN204

KN303



## PERFORMANCE GOLD OIL FILTER

- 1-inch nut easy-on/easy wrench-off
- Drilled safety wire holes for racing
- Heavy-duty construction
- Premium filter media provides outstanding filtration at high-flow rates

Sea Doo	OEM#	Part No.
All Sea Doo 4-stroke	420950741	KN556

Yamaha	OEM#	Part No.
All Yamaha Four Stroke	59H-1344-0-00-00	KN303

Kawasaki	OEM#	Part No.
All Kawasaki Four Stroke	16097-004	KN204

Honda	OEM#	Part No.
All Honda Four Stroke	15410-NCJ-003	KN204



## RULE FLAT TANK ELECTRIC OIL EXTRACTOR

Eliminate those costly yard service fees with the new quick, clean, compact electric oil extractor. Includes a 3-1/2 gallon compact self-priming diaphragm pump for extraction and an easy pour spout for oil transfer.

- 3.5 gallon (13 liter) leak proof container
- Designed for ease of carrying
- Complete with dipstick, suction tube & battery clamps
- Empties and stows easily
- Self-priming, dry running, 12 or 24 volt diaphragm pump

Description	Part No.
Electric Oil Extractor	17860-0012

## MOELLER MARINE PRODUCTS FLUID EXTRACTOR

- Empties oil in 15 pumps or less
- Extracts warm or cold oil
- Pressure relief valve allows easy transportation and storage
- Single-hand-ease effortless operation
- Feathered cap
- Delivers gulp-free, mess-free performance
- Complete adapter kit is included featuring three extraction tubes

Description	Part No.
Moeller Oil Extractor (6.5 Liter Fluid Extractor)	MR07398
Moeller Fluid Extractor Tube Replacement Kit	MR08032

*\*Note: Not for use with gasoline.*



**Adapter Kit Included!**

USA Patent #5450924 - Germany Patent #29500683.8 - U.K. Patent #2272948  
Australia Patent #674469 - Taiwan Patent #113238 - China Patent #ZL92241981.7

FOUR STROKE  
INTAKE SYSTEMS  
ENGINE/GASKETS  
EXHAUST  
DRIVE LINE HANDLING  
ELECTRICAL  
WATERLINE /BILGE  
STEERING & CONTROLS  
BODY  
ACCESSORIES  
SERVICE TOOLS /HARDWARE  
CHEMICAL

## FACTORY PIPE GENUINE REPLACEMENT PARTS



ID	LENGTH	PART NO.
1-3/4"	5"	COMHOS0074
2"	2-1/2"	COMHOS0080
2-1/2"	2-3/4"	COMHOS0085
3-1/2"	2-1/16"	COMHOS0090
3"	2-1/2"	COMHOS0091
2-1/4"	2"	COMHOS0092
3-1/2"	2-3/16"	COMHOS0093
2-1/2"	2-1/2"	COMHOS0094
4"	1-15/16"	COMHOS0101
4"	2-1/16"	COMHOS0100
5"	1-15/16"	COMHOS0111
5"	2-3/8"	COMHOS0110
5-1/2"	3"	COMHOS0150
3-3/4"	2"	COMHOS0701



MOD Blaster	COMHOS0130
96 701SJ LTD	COMHOS0135



5-1/2"	#600 COMCLP0080
5"	#88 COMCLP0030
4"	COMCLP0050
3-1/2" (High Torque)	#400 COMCLP0045
2"	#32 COMCLP0020
2" (High Torque)	#250 COMCLP0021

TYPE	COUPLER	CLAMP	MOUNT
<b>SEA DOO</b>			
580 SP 94-LATER	COMHOS0110 (5")	COMCLP0030	COMMNT0050
650 XP 93 & 95/96 SPX	COMHOS0110 (5")	COMCLP0030	COMMNT0050
650 GTX 94/95 & 96 580 GTS	COMHOS0110 (5")	COMCLP0030	COMMNT0050
650 & 720 XP 94/95	COMHOS0110 (5")	COMCLP0030	COMMNT0050
720 HX	COMHOS0110 (5")	COMCLP0030	COMMNT0050
720 GTI	COMHOS0110 (5")	COMCLP0030	COMMNT0050
785 XP/GSX/GTX SPEC I 95/96	COMHOS0150 (5.5")	COMCLP0080	
785 XP/GSX/GTX SPEED II 95/96	COMHOS0150 (5.5")	COMCLP0080	
785 GSX/GTX/SPX SPEC I 97	COMHOS0150 (5.5")	COMCLP0080	
785 GSX/GTX/SPX SPEC II 97	COMHOS0150 (5.5")	COMCLP0080	
785 XP ONLY SPEC I 1997	COMHOS0150 (5.5")	COMCLP0080	
785 XP ONLY SPEC II 1997	COMHOS0150 (5.5")	COMCLP0080	
951XP / RX	COMHOS0701 (3.75")	—	COMMNT0052/54
<b>YAMAHA</b>			
650 SUPER JET	COMHOS0100 (4")	COMCLP0050	
650 WAVERUNNER III	COMHOS0100 (4")	COMCLP0050	
	COMHOS0085 (2.5")	—	
701 SUPER JET LIMITED 96-UP	COMHOS0100 (4")	COMCLP0050	
	COMHOS0135	—	
701 SUPER JET LIMITED	COMHOS0100 (4")	COMCLP0050	
701 SUPER JET MOD	COMHOS0100 (4")	COMCLP0050	
701 SUPER JET LTD/SS DRY PIPE	COMHOS0093 (3.5")	COMCLP0045	COMMNT0050/52
701 SUPER JET TYPE 8 DRY PIPE	COMHOS0093 (3.5")	COMCLP0045	COMMNT0052
701 SUPER JET TYPE 9 DRY PIPE	COMHOS0093 (3.5")	COMCLP0045	COMMNT0052
	COMHOS0080 (2.5")	COMCLP0021	
	COMHOS0092 (2.25")		
701 FX1	COMHOS0100 (4")	COMCLP0050	
701 WAVERUNNER III	COMHOS0100 (4")	COMCLP0050	
	COMHOS0080 (2")	COMCLP0020	
701 WAVEBLASTER LIMITED	COMHOS0100 (4")	COMCLP0050	COMMNT0050
	COMHOS0080 (2")	COMCLP0020	COMMNT0030
701 WAVEBLASTER MOD	COMHOS0100 (4")	COMCLP0050	COMMNT0030
	COMHOS0130	COMCLP0020	COMMNT0040
701 WAVERAIDER	COMHOS0100 (4")	COMCLP0050	COMMNT0030
	COMHOS0080 (2")	COMCLP0020	COMMNT0040
760 GP/WAVEBLASTER II	COMHOS0090 (3.5")	COMCLP0040	COMMNT0030
800 GP TWIN	COMHOS0111 (5")	COMCLP0030	COMMNT0050/52
1200 GP TRIPLE	COMHOS0101 (4")	COMCLP0050	COMMNT0050/30
	COMHOS0111 (5")	COMCLP0030	COMMNT0052
1200 XL LTD/GP1200R TRIPLE			COMMNT0050/30
			COMMNT0052
<b>KAWASAKI</b>			
550 LIMITED 86/90	COMHOS0074 (1.75")	—	COMMNT0040
	COMHOS0100 (4")	COMCLP0050	
550 LIMITED 91/96	COMHOS0074 (1.75")	—	COMMNT0040
	COMHOS0100 (4")	COMCLP0050	
650 SX/X2 LIMITED	COMHOS0100 (4")	COMCLP0050	
650 SX/X2 MOD	COMHOS0100 (4")	COMCLP0050	
750 SS/XI	COMHOS0090 (3.5")	COMCLP0040	COMMNT0060
		COMCLP0020	
750 XIR	COMHOS0080 (2")	COMCLP0020	COMMNT0040
	COMHOS0100 (4")	COMCLP0050	
750 SX/SXI LIMITED	COMHOS0080 (2")	COMCLP0020	COMMNT0040
	COMHOS0100 (4")	COMCLP0050	
750 SX/SXI MOD	COMHOS0080 (2")	COMCLP0020	COMMNT0040
	COMHOS0100 (4")	COMCLP0050	
750 SXI DRY PIPE	COMHOS0701 (3.75")	—	COMMNT0052
800SXR DRY PIPE	COMHOS0701 (3.75")		COMMNT0052
	COMHOS0094 (2.5")		
800SXR WET PIPE	COMHOS0100 (4")	COMCLP0050	
1200 ULTRA/STX-R DRY PIPE	COMHOS0091 (3")	COMCLP0021	COMMNT0052
			COMMNT0030
<b>POLARIS</b>			
1050 SLTX TRIPLE	COMHOS0101 (4")	COMCLP0050	COMMNT0050/52

For information on parts of Factory pipe,  
visit [www.factorypipe.com](http://www.factorypipe.com)  
► Products ► Technical ► Instructions

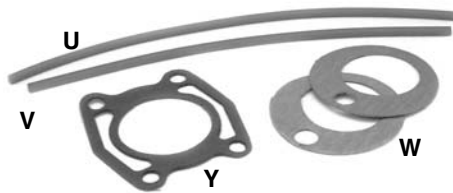
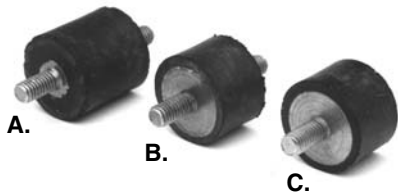

## FACTORY PIPE REPLACEMENT GASKETS AND O-RINGS

<b>A.</b> Blstr LTD/SeaDoo #168	<b>COMMNT0050</b>
<b>B.</b> K750SX/Blstr/Rdr #123	<b>COMMNT0040</b>
<b>C.</b> Blstr/Rdr #177	<b>COMMNT0030</b>
SJ Dry GP1200, 800SXR	<b>COMMNT0052</b>
SD951	<b>COMMNT0054</b>

<b>U.</b> 14" Silicon Ring Chamber	(SD 580/650/720)	<b>COMGAS0005</b>
<b>V.</b> 13" Silicon Ring Headpipe	(SD 580/650/720)	<b>COMGAS0006</b>
<b>W.</b> Manifold/Headpipe Gasket	(SD 580/650/720)	<b>COMGAS0070</b>
Headpipe/Manifold Gasket	SD785 Spec II	<b>COMGAS0120</b>
<b>Y.</b> Headpipe/Manifold Gasket	SD785 Spec I	<b>COMGAS0110</b>
246 Viton O-Ring	GP800	<b>COMGAS0170</b>
337 Buna O-Ring	Super Jet Dry	<b>COMGAS0235</b>

## FACTORY PIPE O-RING APPLICATION CHART

TYPE	O-RING NUMBER	O-RING DESCRIPTION	QTY
<b>SEA DOO</b>			
580/650/720 ALL MODELS	COMGAS0005	14" SILICON RING	1
	COMGAS0006	13" SILICON RING	1
951 XP/XPL	COMGAS0235	337 BUNA O-RING (M)	2
	COMGAS0330	341 BUNA O-RING (L)	2
	COMGAS0340	344 BUNA O-RING (S)	2
<b>YAMAHA</b>			
701 SUPERJET DRY Type 4,8,9	COMGAS0235	337 BUNA O-RING	1
760 GP / WAVEBLASTER II	COMGAS0100	333 BUNA O-RING	2
800 GP TWIN	COMGAS0180	329 VITON O-RING	6
	COMGAS0170	246 VITON O-RING	1
1200 GP TRIPLE	COMGAS0180	329 VITON O-RING	9
	COMGAS0160	<b>DISCONTINUED</b>	2
	COMGAS0170	246 VITON O-RING	1
1200XL LTD / GP1200R TRIPLE	COMGAS0180	329 VITON O-RING	9
	COMGAS0150	7.5" GRAPHITE/KEVLAR	3
<b>KAWASAKI</b>			
750SX DRY PIPE	COMGAS0235	337 BUNA O-RING (M)	1
800SXR DRY PIPE	COMGAS0330	341 BUNA O-RING (L)	1
	COMGAS0340	344 BUNA O-RING (S)	1
STX-R TRIPLE	COMGAS0350	330 VITON O-RING	9
<b>POLARIS</b>			
1050 SLXH TRIPLE	COMGAS0180	329 VITON O-RING	9
1050 SLTX TRIPLE	COMGAS0180	329 VITON O-RING	9
<b>MISCELLANEOUS</b>			
ECWI FILTER BLOCK ASSY.	COMGAS0130	AS568A DASH#122	1



### Factory Pipe Part No.

- D.** 1/8X1/4" Spray Nozzle (Head Pipe) **COMFTG0015**
- E.** 1/8X3/8" Spray Nozzle (ECWI) **COMFTG0025**
- F.** #10-32 Water Screw S/S **COMFAS0013**
- G.** #10-32 Nuts S/S **COMFAS0014**
- H.** 10mmX1.25X40 Bolt **COMFAS0050**
- I.** 10mmX1.25X50 Bolt **COMFAS0060**
- J.** 10mmX1.5X30 Bolt S/S **COMFAS0260**
- K.** 3/8"-16 S/S Nut **COMFAS0095**

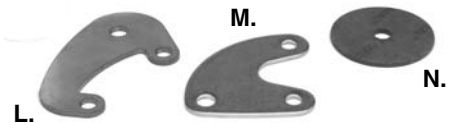

## EXHAUST SILICON COUPLER 36" LENGTH



36" = 91.44cm

### Inside Diameter 36" Length

1-3/4"	<b>52-9004</b>
2"	<b>52-9005</b>
2-1/4"	<b>52-9008</b>
2-1/2"	<b>52-9010</b>
3"	<b>52-9006</b>
3-1/2"	<b>52-9015</b>
4"	<b>52-9011</b>
4-1/2"	<b>52-9012</b>
5"	<b>52-9014</b>
5-1/2"	<b>52-9017</b>
6"	<b>52-9018</b>

### Factory Pipe Part No.

- L.** SJ Type 9 Head Bracket **COMBRK0223**
- M.** KAW 800SXR Dry Pipe Head Bracket **COMBRK0228**
- N.** Fiber Insulating Washer **COMFAS0200**
- O.** Kaw 800SXR Inline Filter **COMFTG0036**
- P.** Kaw 800SXR Wet Pipe Air Temp. Bypass Connector **COMIGN0016**

FOUR  
STROKE

INTAKE  
SYSTEMS

ENGINE/  
GASKETS

EXHAUST

DRIVE LINE  
HANDLING

ELECTRICAL

WATERLINE  
/BLIGE

STEERING  
& CONTROLS

BODY

ACCESSORIES  
SERVICE TOOLS

HARDWARE

CHEMICAL



# R&D EXHAUST SYSTEM REPLACEMENT PARTS

FOUR STROKE  
INTAKE SYSTEMS  
ENGINE/GASKETS  
EXHAUST  
DRIVE LINE HANDLING  
ELECTRICAL  
WATERLINE /BILGE  
STEERING & CONTROLS  
BODY  
SERVICE TOOLS ACCESSORIES  
/HARDWARE  
CHEMICAL

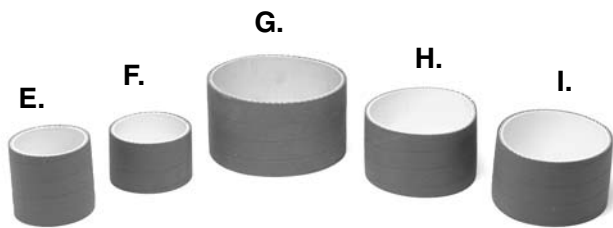

Silicon Hose Coupler	Part No.
E. 2.5" id x 2.75" L	060-25027
F. 2.75" id x 2" L Kaw/Yam Headpipe	060-27520
G. 5" id x 3" L (Sea Doo 785)	060-05003
H. 5" id x 5" L	060-05005
I. 4.25" id x 2.5" L (Super Jet Dry Pipe)	060-41425



## REPLACEMENT EXHAUST HOSE FOR YAMAHA

Yamaha	OEM No.	Part No.
701 Wave Venture 95-96	63N-14752-30	011-500



## REPLACEMENT EXHAUST DIFFUSER FOR KAWASAKI

Kawasaki	OEM No.	Part No.
N. 650SX (87-93), X2 (87-94)	92059-3767	011-508
O. 650SX (87-93), X2 (87-94)	92059-3706	011-509
P. 650TS (89-96), 750XI (98-99)	92190-3712	011-510
750SS (92-97), 750 SXI (93-97)		
Q. 650TS (89-96), 650 SC (91-95)	92093-3732	011-511
750 SS (92-97)	92093-3738	011-519
750 SXXI (93-97)		
750 XI (98-99)		
750 ST (94-95)		
750 STS 95		
750 STS (96-97)	92191-3733	011-517
750 STX (98)		
750 STS (97-98)	92093-3744	011-518
750 STX (98)		
900 STX (97-98)	92191-3811	011-512
900 STX (97-98)	92093-3751	011-513



J. Super Jet Pipe O-Ring Set (2)	080-70101
K. Lord Mount	080-70102



## EXHAUST BUSHINGS FOR SEA DOO

Sea Doo	OEM No.	Part No.
L. Exhaust Bushings. Sold in pairs	293-830-031	011-515
M. Exhaust Bushing	274-000-114	011-516

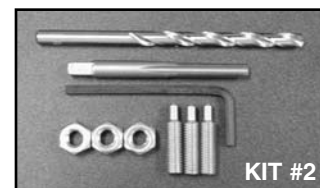
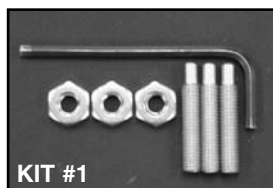

## HEADPIPE SCREW KIT FOR FACTORY PIPE

This kit is designed to replace the water adjustment set screws supplied with Factory Pipe products exhaust systems utilizing their tunable headpipe. The Stainless Steel set screws are machined to the same dimensions as the screws available from Factory Pipe.. This kit will directly replace all three #10-32 set screws in the headpipe. This kit will fit exhaust systems: Yamaha B Pipe for Super Jets and Blasters, Kawasaki 750SX, 650SX, and X2.

Description	Part No.
Headpipe Screw Kit	JPE-KIT#1
Headpipe Screw Repair Kit	JPE-KIT#2



## T-BOLT CLAMPS

T-BOLT Clamps supply the maximum clamping pressure and are superior to the standard hose clamps used in most watercraft applications. Stainless steel with a nylux nut.

Size	Clamp Width	Part No.
3"	3/4" 19mm	64-0080
3-1/4"	3/4" 19mm	64-0081
4-1/2"	3/4" 19mm	64-0082
5"	3/4" 19mm	64-0084
5-1/4"	3/4" 19mm	64-0085
5-1/2"	3/4" 19mm	64-0086

## RIVA FREE FLOW EXHAUST KITS



RY1613



RY1625



RY1619-1

RY1620



Replaces the restrictive sound suppression system on GPR and XLT models. Provides reduced back-pressure that improves engine's performance and reduces harmful detonation. Easy installation with noticeable results. IJSBA Superstock legal.

Yamaha	Part No.
Free-Flow Exhaust Kit, XL800/1200	RY1619-1
Free-Flow Exhaust Kit, GP800R/1200R	RY1620
Free-Flow Exhaust Kit GP1300R	RY1613
Free-Flow Exhaust Kit FX/FXHO (All Models)	RY1625



## RIVA CAT TEMP SENSOR CHIP FOR GPR

RIVA Cat Temp Sensor Chip is a must when removing the OEM catalytic converter on Yamaha

1200 & 1300 Powervalve engines. The circuit is designed to mimic the signal sent to the OEM CDI by the catalytic converter's temperature probe preventing CDI, flutters, warning devices and engine shut downs due to cat removal. Can be used with stock or modified OEM CDI's. Plugs directly into factory wire harness.

Description	Part No.
Cat Temp Sensor Chip Yamaha 1200/1300 Powervalve (66V/66T)	RY115-20



## R&D FX-SHO/FZR/FZS O2 SENSOR MOUNT KIT

The new R&D O2 sensor mount kit makes installing an AFR gauge a breeze on the Yamaha FX-SHO,

FZR, FZS, FX140, HO, GPR, and VX110. It simply replaces the OEM plug and installs directly into the OEM pipe without any modifications. Kit comes complete with installation tool. AFR gauge sold separately.

Description	Part No.
FX-SHO/FZR/FZS/FX140/HO/GPR/VX110 O2 Sensor Mount Kit	332-18010



## R&D SOUND SUPPRESSION REMOVAL TUBE

R&D is now producing the new Sound Suppression Removal Tube for the GPR. This modification allows the exhaust to free flow out of the water box adding bottom end punch and overall performance. Replacing of the stock plastic sound box with the R&D Sound Tube will eliminate potential melting failures in limited and superstock modified applications. Easily installs, no cutting of hoses necessary.

Description	Part No.
GP1200R/1300R Sound Suppression Removal Tube	332-12001

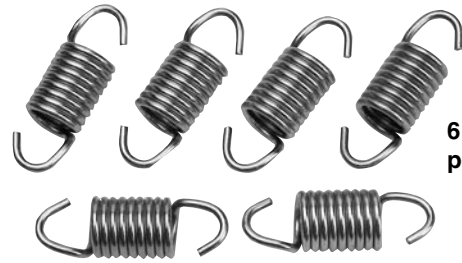

6 springs per kit

## RIVA HEAVY-DUTY EXHAUST SPRING KIT

Our Heavy-Duty Exhaust Spring Kits for Factory Pie twin & triple exhaust systems hold pipes tightly into exhaust manifolds, reducing movement that robs horsepower and wears o-rings and o-rings cord. Kit includes 6 springs.

Description	Part No.
HD Spring Kit for Triple/Twin Exhaust	RY15-HD-SPRING



## R&D D-PLATE FOR YAMAHA GP1200R/GP1300R, XLL/XLT1200

The new R&D D-Plate takes the place of the stock catalytic converter and delivers the best overall low, mid, peak and overall horsepower. The benefits include reducing engine compartment temperatures created by the catalytic converter and reliability of the complete stock exhaust assembly.

Description	Part No.
R&D D-Plate	332-12000



## CATALYTIC CONVERTER REMOVAL PLATE FOR YAMAHA GP1200R/GP1300R, XLL/XLT1200

This plate allows you to remove the catalytic converter easily and fills the gap where the catalytic converter mounts on the OEM exhaust system. Benefits include a cooler running exhaust system and ability to run any kinds of two-stroke oil. The plate features a centrally located outlet designed to give some beneficial back pressure but with much better exhaust gas flow compared to an offset or cutout plate. This gives better response and acceleration throughout the power band.

**FOR COMPETITION USE ONLY.**

Description	Part No.
JetWorks Catalytic Converter Removal Plate	YE-155P

FOUR STROKE	INTAKE SYSTEMS	ENGINE/GASKETS	EXHAUST	DRIVE LINE HANDLING	ELECTRICAL	WATERLINE /BLIGE	STEERING & CONTROLS	BODY	ACCESSORIES	SERVICE TOOLS /HARDWARE	CHEMICAL
-------------	----------------	----------------	---------	---------------------	------------	------------------	---------------------	------	-------------	-------------------------	----------

# PROGRAMMABLE PULSE WIDTH MODULATED WATER INJECTION

Stock and performance exhaust systems are designed for maximum power at a specific rpm. It's not really something you can change during a race, and we know that compromises power at other rpm. Racers don't like to compromise, so MSD offers a new Programmable Water Injection system so you can tune your exhaust to match any rpm!

By injecting water into the exhaust chamber at lower rpm, the density of the exhaust pulse is increased, which slows it down. This has the same effect as lengthening the chamber to increase low to mid-range torque and power! The Programmable Water Injection system uses MSD's Pro-Data+ Windows based software so you can easily program how much water and at what RPM it gets injected into the pipe. The programming features allow you to inject water from 0 to 100 percent anywhere from 500 rpm to 12,000 rpm.

The kit comes complete with spray nozzles, solenoid, heat resistant hose, programmable controller and software.



7550



42590

Description	Part No.
Programmable Pulse Width Modulated Water Injection Complete Kit	42590
Hand Held Programmer / Monitor	7550



## SOLENOID

The electronic Switch that pulses the water to the spray nozzle.

Part No.	M4340
----------	-------



## WATER FILTER

A clear bowl & removable filter screen allow easy inspection & cleaning. 3/8" Inlet.

Part No.	56-9011
----------	---------



## REMOTE MOUNT SPRAY NOZZLE

The brass 1/16" NPT spray nozzle that attaches to an 1/8" hose from the solenoid.

Part No.	4341
----------	------



## REMOTE MOUNT SPRAY NOZZLE

The brass 1/8" NPT spray nozzle that mounts to the solenoid.

Part No.	43411
----------	-------



## FUEL TANK BRACKET FOR SJ96+

This bracket attached on Super Jet Fuel Tanks utilizing OEM Fuel Tank Rubber Strap. Bracket holds MSD Water Control system (pre-drilled), Micro Touch Water Injection System and etc.

Yamaha	Part No.
Yamaha Fuel Tank Bracket	115849



## WATER SOLENOIDS

Water fittings not included.

Description	Part No.
Poded Sealed Solenoids (Waterproof)	PSOL-10



## TDR WATER BOX

Compact, strong, quiet, super power capabilities.



Yamaha	Waterbox Type	Part No.
Y1100 Right Water Box*	Standard	02-0028B
Elbow Pipe*		02-0026
*Can replace both or one box (Left)+Elbow		
Polaris		Part No.
SL900/1050/SLT-X1100	Power Spray	02-0033PS



## BLOWSION FREESTYLE DUAL EXHAUST KIT

Unload that exhaust during tail stands! Kit includes all necessary hoses, clamps, exhaust splitter, aluminum outlet and detailed installation instructions. Our kits are ultra sano and feature a show quality polished outlet and pre bent hoses. Do not settle for cobbed together "universal" hoses and outlets. Absolutely necessary for the stand up purist.

Description	Part No.
Yamaha SuperJet 96+	01-01-553
Kawasaki 800 SXR	01-01-507



## BLOWSION FREESTYLE YAMAHA EXHAUST AND SIDE EXHAUST OUTLET

Unload that exhaust during tail stands! Kit includes all necessary hoses, clamps, exhaust splitter, aluminum outlet and detailed installation instructions. Our kits are ultra sano and feature a show quality polished outlet and pre bent hoses. Do not settle for cobbed together "universal" hoses and outlets. Absolutely necessary for the stand up purist.

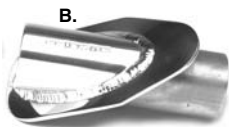

Description	Part No.
A. Yamaha Exhaust Splitter Only	01-01-555
B. Yamaha Side Exhaust Outlet	01-01-554



## R&D KAWASAKI 800 SXR EXHAUST POWER SLEEVE

The new R&D billet aluminum Exhaust power Sleeve is designed to insert into the stinger of the stock exhaust to reduce the stinger size thereby increasing back pressure. This is a simple installation that will increase top speed and add 100 RPM.

Description	Part No.
Kawasaki 800 SXR	331-80000



## YAMAHA GP 1300R EXHAUST POWER SLEEVE

The R&D GP 1300R Exhaust Power Sleeve will add a serious boost to low end and mid range horsepower and performance! The R&D Exhaust Power Sleeve installs between the exhaust chamber and the catalytic housing to increase sonic wave energy! The R&D

Exhaust power Sleeve will add the Y.P.V.S. (power valve) feel to the 2005 Yamaha's non-power valve engine!

Description	Part No.
Yamaha GP 1300R Exhaust Power Sleeve	332-13001

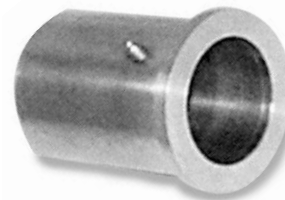

## SEA DOO 951 EXHAUST END STINGER

Simple exhaust end modification provides power gain.

Description	Part No.
Sea Doo 951 Exhaust End Stinger	52-3089

## MICRO TOUCH SINGLE OUTPUT WATER CONTROLLER FOR 2-CYLINDER WATERCRAFT

### REGULAR UNIT (Features include:)

- Adjustable Output for 1 Water Injection Solenoid — 16 ON Settings from 1,500 to 3,000 RPM; 16 OFF settings from 5,750 to 7,250 RPM.
- Senses Engine RPM from Spark Plug Wire

### RACER UNIT

- CNC-Machined Billet Aluminum Case.
- Adjustable Output for 1 Water Injection Solenoid — 16 ON and OFF Settings Programmed to Customer Specifications.
- Senses Engine RPM from Digital Tach Output on OEM or MSD Ignition.
- Replaceable Microchip for Future Upgrades and Reconfiguration.

Description	Part No.
Regular Single Output Water Controller	MT-16x2-2

## MICRO TOUCH DUAL OUTPUT WATER CONTROLLER FOR 2-CYLINDER WATERCRAFT

For injecting water into pipe and waterbox (or stinger) independently. Improve acceleration. Additional exhaust back pressure can increase top end power without sacrificing bottom end. Features Include:

- Adjustable Output for 2 Water Injection Solenoid —
  - #1: 4 ON Settings from 1,500 to 3,000 RPM; 16 OFF settings from 4,000 to 7,000 RPM.
  - #2: 4 ON Settings from 5,000 to 7,000 RPM, OFF at 10,000.
- Senses Engine RPM from Spark Plug Wire

Description	Part No.
Dual Output Water Controller	MT-DUAL-2



MT-16x2-2



MT-DUAL-2

FOUR STROKE	INTAKE SYSTEMS	ENGINE/GASKETS	EXHAUST	DRIVE LINE HANDLING	ELECTRICAL	WATERLINE /BLIGE	STEERING & CONTROLS	BODY	ACCESSORIES	SERVICE TOOLS /HARDWARE	CHEMICAL
-------------	----------------	----------------	---------	---------------------	------------	------------------	---------------------	------	-------------	-------------------------	----------



## JETWORKS FLOW CONTROL VALVE

The Flow Control Valve provides improved throttle response and much quicker starts by drying out your waterbox at low rpm and idle speeds. Tests have shown an average acceleration improvement of 10 feet over a non-equipped model in the first 50 feet. The Flow Control Valve allows unrestricted water flow to the Stinger for better top speed. Yet it controls the amount of water at low speeds for better response. It also allows for an easier tuning of the Carburetors. It does not interfere with normal engine or exhaust pipe cooling and is compatible with all electronic water injection systems. Race Legal for All Classes. Two Models are available. Both are adjustable. The Standard Flow Control Valve is preset at 3.5 p.s.i. and is adjusted by adding the supplied stainless steel shims to increase the spring tension. The Pro-Series is externally adjustable by turning the outer housing by hand. Pressure can be tested with pop off gauge. All PWC w/OEM or aftermarket exhaust systems (except Yamaha's w/OEM exhaust)

Description		Part No.
Standard Flow Control Valve	3/8"	52-3118
Pro Flow Control Valve	3/8"	52-3119
Pro Flow Control Valve	1/4"	52-3122



## JETWORKS QUICK DISCONNECT WATER RESTRICTOR

QD-38 comes with 4/3/2mm restrictor inserts used for controlling water flow through exit passes, stinger, head pipes, etc. QD-14 is for use with Mikuni Jets (not included), and allows quick change in small increments of water flow.

Description	Part No.
Quick Disconnect Water Restrictor 3/8"	QD-38
Quick Disconnect Water Restrictor 1/4"	QD-14



## RIVA EXHAUST STINGER WATER FILTER/RESTRICTOR

Features fine mesh stainless filter screen that is threaded to accept Mikuni main jet (not included) for water restriction. Allows removal of restrictive filter screen in water distribution manifold of single, twin and triple exhaust systems, providing increased cooling water to motor.

Description	Part No.
Exhaust Stinger Water Filter/Restrictor 3/8"	RY15-SF38

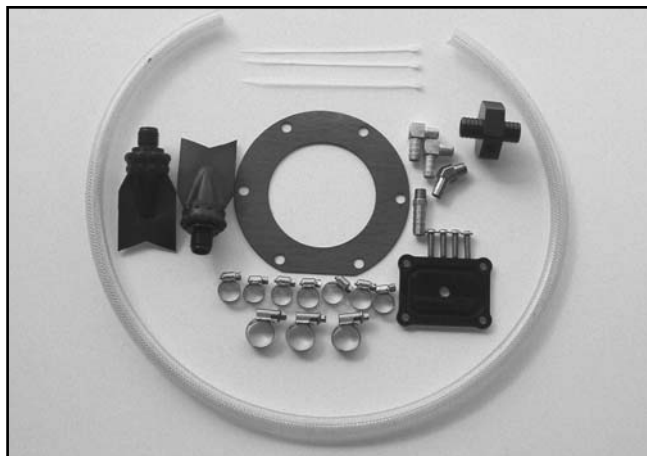

## JETWORKS GP1200R/XL1200LTD FLOW CONTROL ADAPTER KIT

Our adapter kit is designed to improve bottom end response and get the craft into high speed quickly and gives more acceleration out of turns.

By allowing the craft to get up on a plane quicker, less time is spent pushing or plowing the craft through the water. This is especially true on the XL models. The quicker you get the craft up and on the water, the quicker the boat will accelerate because you can use or free up the horsepower that is being used up to displace or push aside the water. The water drag - frictional loss of the wetted surface - is reduced and this is when the craft actually starts to really accelerate.

One of the main reasons the GPR and XL are sluggish or experience a lag on acceleration is due to the large amounts of water that enter the water box. This water backs up in the water box to be purged or blown out upon acceleration. The water box can hold a considerable amount of water. This can not be purged or blown out since the hoses and resonators are located at a higher level than the water box. The water must be pushed upwards and through the resonators. Since the water box is fairly large it can hold a good amount of water. It is not until all this water is blown out that the exhaust can be free flowing. During all this time the craft is trying to get on a plane which causes more load on the engine and further lengthens the process.

What we do is to block the water reaching the original spray orifices and use a water pressure sensitive flow control valve to control when water is injected through the OEM stinger outlet. By using this kit, you can reset the RPM when you want the water to start flowing. By setting the RPM point to 3400 RPM, you have eliminated the water flow at idle and in a sense have a dry water box upon acceleration. The craft can now get on a plane quicker and accelerate much much quicker. We don't need water flow below these RPM's mostly because the firing pulsations are too weak and too far apart to create any considerable heat at this location (too far away). This also increases acceleration in the mid-range to upper mid-range and greatly improves acceleration coming out of turns. This is accomplished primarily because we also have completely shut down the water flow through the orifices in the OEM stinger outlet at the moment of deceleration.

(NOTE: This kit is designed to be used on watercraft that have a catalytic converter removed and also using a straight tube in place of the plastic sound suppression resonators.)

There are two kits available:

The 155-SPK kit requires the removal of the cooling system overheat sensor. The 155-SPK-TS kit retains the overheat sensor but requires you to drill and tap the water jacket of the exhaust system and install a calibrated bypass fitting on the craft. This kit comes complete with all the bypass fittings, hoses, tees and clamps.

Yamaha	Part No.
Flow Control Adapter Kit	155-SPK
Flow Control Adapter Kit	155-SPK-TS





## R&D BILLET EXHAUST VALVES FOR GPR

The new R&D Billet Exhaust Valves reduce the clearance between the valve and piston. This reduced clearance improves the seal which boosts the valve down compressions ratio delivering greater bottom and mid-range power. Directly replace OEM YPVS valve units.

Yamaha	Part No.
GP800/GP1200R Exhaust Valve Kit (each)	332-12002
Exhaust Valve Arm Only	332-12003
GP1300R Exhaust Valve Kit (each)	332-13000



## BILLET EXHAUST NOZZLE FOR 800SXR

This is one ultra sano nozzle. Function and fit are Blowsion perfect. Vanity rules on these beauties. Blowsion logo engraved into the extruded design. Available in clear, green, red or black.

Kawasaki	Part No.
Clear	04-03-208
Green	04-03-204
Red	04-03-207
Black	04-03-201



## TBM BILLET EXHAUST FLANGE FOR 800SXR

The flange is a complete replacement of the stock flange. A slim design allows the addition of rear hull extensions if you prefer. Offered in black anodized or polished finish.

Kawasaki	Part No.
Black	TBM110
Polished	TBM110P

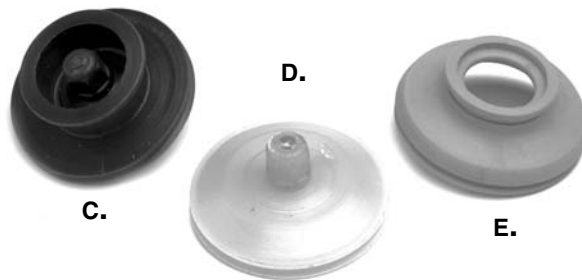

## REPLACEMENT EXHAUST VALVE PARTS FOR SEA DOO

Sea Doo	OEM No.	Part No.
C. Exhaust Valve Piston	420-253-255	010-495-15
D. Exhaust Valve Piston	420-854-449	010-495-10
E. Exhaust Valve Bellow	290-260-723	010-495-05



## BILLET EXHAUST NOZZLE FOR SUPERJET 96+

This is one ultra sano nozzle. Function and fit are Blowsion perfect. Vanity rules on these beauties. Blowsion logo engraved into the extruded design. Available in clear, blue, black or 2004 Superjet red.

Yamaha	Part No.
Clear	04-03-258
Blue	04-03-252
Red	04-03-257
Black	04-03-251



## RIVA STX-F BILLET EXHAUST TIP

Replaces plastic exhaust outlet cover. Made from billet aluminum. Anodized to prevent corrosion.

Kawasaki	Part No.
STX-12F/15F	RK16086

FOUR STROKE	INTAKE SYSTEMS	ENGINE/GASKETS	EXHAUST	DRIVE LINE HANDLING	ELECTRICAL	WATERLINE /BILGE	STEERING & CONTROLS	BODY	ACCESSORIES SERVICE TOOLS /HARDWARE	CHEMICAL
-------------	----------------	----------------	---------	---------------------	------------	------------------	---------------------	------	-------------------------------------	----------

## RECOMMENDED SKAT-TRAK IMPELLER

	Model	Year	Engine	Orig. Imp.	Pump Dia.	Stock Engine	Limited Engine	Modified Engine
FOUR STROKE	LRV DI	02-04	951	n/a	155.5mm	SS583SW1418	SS583SW1319	SS583SW1320
	LRV	00-01	951	n/a	155.5mm	SS583SW1418	SS583SW1319	SS583SW1320
	3D DI	06-07	951	n/a	155.5mm	SS583SW1319	Call for application	Call for application
INTAKE SYSTEMS	3D Base	2005	800	n/a	155.5mm	SS583SW1016	Call for application	Call for application
	3D Premium	2005	800	n/a	155.5mm	SS583SW1016	Call for application	Call for application
	RXP 215	04-09	1494 SC	n/a	159.8mm	See Special Applications Page 113	See Special Applications Page 113	See Special Applications Page 113
ENGINE/GASKETS	RXP-X 255	08-09	1494 SC	n/a	159.8mm	See Special Applications Page 113	See Special Applications Page 113	See Special Applications Page 113
	RXT 215	05-09	1494 SC	n/a	159.8mm	See Special Applications Page 113	See Special Applications Page 113	See Special Applications Page 113
	RXT-X 255	08-09	1494 SC	n/a	159.8mm	See Special Applications Page 113	See Special Applications Page 113	See Special Applications Page 113
EXHAUST	RXX	01	951	16/23 D-75 Mag	148mm	SSD75SW1623	Call for application	Call for application
	RX Di	00-04	951	n/a	155.5mm	SS583SW1319	SS583SW1320	SS583SW1321
	RX	00-02	951	n/a	155.5mm	SS583SW1319	SS583SW1320	SS583SW1321
DRIVE LINE HANDLING	XP Di	03-04	951	n/a	155.5mm	SS583SW1320	SS583SW1321	Call for application
	XP Ltd.	98-02	951	13/21	155.5mm	SS583SW1321	SS583SW1321	SS5831322
	XP 800	97	800	16/23	140mm	*SSSW1722 or SSSS1726**	*SSSW1723 or SSSS1726**	*SSSW1724B or SSSS17.527**
ELECTRICAL		95-96	800	17/25	140mm	*SSSW1722 or SSSS1726**	*SSSW1723 or SSSS1726**	*SSSW1724B or SSSS17.527**
	XP	95	720	10/22	140mm	*SSSW1621 or SSSL1520**	SSSW14.522.5	SSSW1722 to SSSW1724B
		94	650	16/24	140mm	*SSSW1520 or SSSL1419**	*SSSW1520 or SSSL1419**	*SSSW1621 or SSSL1520**
WATERLINE /BILGE		93	650	15/20.5	140mm	*SSSW1419 or SSSL1318**	*SSSW1520 or SSSL1419**	*SSSW1621 or SSSL1520**
		91-92	580	19	140mm	SSSL1318	*SSSL1318 or SSSL1419**	SSSL1419 to SSSL1621
	GSX Ltd.	98-99	951	16/21	155.5mm	SS583SW1320	SS583SW1320	SS583SW1321
STEERING & CONTROLS		97 1/2	951	n/a	155.5mm	SS583SW1418	SS583SW1418	SS583SW1419
	GSX RFI	99-01	800	12/25	140mm	SS4075SW1621	SS4075SW1622	SS4075SW1623
	GSX	96-97	800	17/24, 16/23	140mm	*SSSW1722 or SSSS1625**	*SSSW1723 or SSSS1726**	*SSSW1724B or SSSS17.527**
BODY	Gsi	97	720	11/22	140mm	*SSSW1621 or SSSL1520**	SSSW14.522.5	SSSW1722 to SSSW1724B
	GS	98-01	720	11/22, 14/21	140mm	SSSW1520	SSSW1621	SSSW14.522.5
		97	720	10/35 al	140mm	*SSSW1621 or SSSL1520**	SSSW14.522.5	SSSW1722 to SSSW1724B
SERVICE TOOLS /HARDWARE	HX	95-97	720	10/22, 11/24	140mm	*SSSW1621 or SSSL1520**	SSSW14.522.5	SSSW1722 to SSSW1724B
	SPX	97-99	800	16/24, 16/23	140mm	*SSSW1722 or SSSS1726**	SSSW1723/SSSS1726	*SSSW1724B or SSSS17.527
		96	720	11/24	140mm	*SSSW1621 or SSSL1520**	SSSW14.522.5	SSSW1722 to SSSW1724B
CHEMICAL		95	650	11/21	140mm	*SSSW1520 or SSSL1419**	*SSSW1520 or SSSL1419**	*SSSW1621 or SSSL1520**
		94	650	14/21.5	140mm	*SSSW1419 or SSSL1318**	*SSSW1520 or SSSL1419**	*SSSW1621 or SSSL1520**
		93	580	16/20.5	140mm	SSSL1318	*SSSL1318 or SSSL1419**	SSSL1419 to SSSL1621
	SPi	94-96	580	14/21	140mm	SSSL1318	*SSSL1318 or SSSL1419**	SSSL1419 to SSSL1621
		93	580	17.7	140mm	SSSL1318	*SSSL1318 or SSSL1419**	SSSL1419 to SSSL1621
	SP	97	720	16/35 al	140mm	SSSW1520/SSSL1419	SSSW14.522.5	SSSW1722 to SSSW1724B
	88-96	580	18.8 al	140mm	SSSL1318	*SSSL1318 or SSSL1419**	SSSL1419 to SSSL1621	

\* Suggested for maximum bottom-to-mid range acceleration gains. \*\* Suggested for maximum top speed gains. NOTE: 17/24B is NOT as aggressive as the original 17/24 swirl impeller. Refer to the USBA Rulebook for a more detailed definition of "stock, Limited, and Modified."

## SKAT TRAK IMPELLER DESIGNS AND PITCHES AVAILABLE

### SWIRL

PITCH	PART NUMBER
12/17	SSSW1217
13/18	SSSW1318
14/19	SSSW1419
15/20	SSSW1520
16/21	SSSW1621
14.5/22.5	SSSW14.522.5
16/23	SSSW1623
16/24	SSSW1624
16/25	SSSW1625
17/22	SSSW1722
17/23	SSSW1723
17/24B	SSSW1724B
17/24	SSSW1724

### 140/75 SWIRL

PITCH	PART NUMBER
16/21	SS4075SW1621
16/22	SS4075SW1622
16/23	SS4075SW1623

### SLIM LINE

PITCH	PART NUMBER
12/17	SSSL1217
13/18	SSSL1318
14/19	SSSL1419
15/20	SSSL1520
16/21	SSSL1621
17/22	SSSL1722

### SSL

PITCH	PART NUMBER
16/25	SSSS1625
17/26	SSSS1726
17.5/27	SSSS17.527

### 155/83/23 SWIRL

PITCH	PART NUMBER
15/20	SS58323SW1520
16/21	SS58323SW1621

### 155-83-23-33 SWIRL

WITH BILLET 22-33 NOSE BOOT

PITCH	PART NUMBER
12/15	SS583233SW1215
13/17.5	SS583233SW13175

### 155/83 SWIRL

PITCH	PART NUMBER
10/16	SS583SW1016
11/17	SS583SW1117
13/18	SS583SW1318
13/19	SS583SW1319
13/20	SS583SW1320
13/21	SS583SW1321
13/22	SS583SW1322
14/18	SS583SW1418

### 155/83 SSL

PITCH	PART NUMBER
13/19	SS583SS1319
13/20	SS583SS1320
13/21	SS583SS1321

### 155 SSL

PITCH	PART NUMBER
14/18	SS583SS1418
14/19	SS583SS1419

## RECOMMENDED SKAT-TRAK IMPELLER

Model	Year	Engine	Orig. Imp.	Pump Dia.	Stock Engine	Limited Engine	Modified Engine
GTX 4-Tec	02-04	1494	n/a	155.8mm	SS558323SW1520	SS558323SW1621	Call for application
4-Tec SC	03-04	1494 SC	n/a	155.8mm	SS558323SW1621	Call for application	Call for application
4-Tec Tow	03-04	1494	n/a	155.8mm	SS558323SW1520	SS558323SW1621	Call for application
WAKE 155	05-09	1494	n/a	155.8mm	SS558323SW1520	Call for application	Call for application
WAKE 215	07-09	1494 SC	n/a	159.8mm	SS598328SW31317	Call for application	Call for application
GTX DI	00-03	951	n/a	155.5mm	*SS5583SW1319 or SS5583SW1418**	SS5583SW1320	SS5583SW1321
GTX Ltd. 215	05-08	1494 SC	n/a	159.8mm	SS59832831317	Call for application	Call for application
GTX Ltd.	98-02	951	13/21	155.5mm	SS5583SW1319	SS5983SW1319	SS5583SW1321
GTX RFI	98-02	800	16/24, 12/25	140mm	SS4075SW1622	SS4075SW1623	SS4075SW1623
GTX 255	2009	1494 SC	n/a	159.8mm	Call for application	Call for application	Call for application
GTX SC 215	05-09	1494 SC	n/a	159.8	SS5983283SW31317	Call for application	Call for application
GTX 155	05-09	1494	n/a	155.8mm	SS558323SW1520	Call for application	Call for application
	96-97	800	17/25, 12/24	140mm	*SSSW1722 or SSSS1625**	*SSSW1723 or SSSS1726	*SSSW1724B or SSSS17.527**
	95	650	10/22	140mm	*SSSW1520 or SSSL1419**	*SSSW1520 or SSSL1419	*SSSW1621 or SSSL1520**
	94	650	15/20	140mm	*SSSW1419 or SSSL1318**	*SSSW1520 or SSSL1419	*SSSW1621 or SSSL1520**
	92-93	580	18.3	140mm	SSSL1318	*SSSL1318 or SSSL1419	*SSSL1419 or SSSL1621**
GTS	01-02	720	n/a	155.5mm	SS5583SW1016	*SS5583SW1016 or SS5583SW1117**	Call for application
Gti LE RFI	03-04	800	n/a	155.5mm	SS5583SW1016	SS5583SW1117	Call for application
Gti LE	02-05	720	n/a	155.5 mm	SS5583SW1016	*SS5583SW1016 or SS5583SW1117**	Call for application
Gti RFI	04-05	800	n/a	155.5mm	SS5583SW1016	SS5583SW1117	Call for application
Gti SE 130	06-09	1494	n/a	155.8mm	SS55832333SW1215	Call for application	Call for application
Gti 130	06-09	1494	n/a	155.8mm	SS55832333SW1215	Call for application	Call for application
Gti SE 155	07-09	1494	n/a	155.8mm	SS55832333SW1215	Call for application	Call for application
Gti	02-05	720	n/a	155.5 mm	SS5583SW1016	*SS5583SW1016 or SS5583SW1117**	Call for application
	99-01	720	n/a	140mm	SS4075SW1621	SS4075SW1622	Call for application
	96-98	720	11/24, 11/22	140mm	*SSSW1621 or SSSL1520**	SSSW14.522.5	SSSW1722 to SSSW1724B
GTS	01-02	720	n/a	155.5mm	SS5583SW1016	SS5583SW1117	Call for application
	97-00	720	11/22	140mm	*SSSW1621 or SSSL1520**	SSSW14.522.5	SSSW1722 to SSSW1724B
	94-96	580	14/21, 15/21, 10/25	140mm	SSSL1318	*SSSL1318 or SSSL1419**	SSSL1419 to SSSL1621
	92-93	580	17	140mm	SSSL1318	*SSSL1318 or SSSL1419**	SSSL1419 to SSSL1621
GT	90-91	580	17 al	140mm	SSSL1318	*SSSL1318 or SSSL1419**	SSSL1419 to SSSL1621

\* Suggested for maximum bottom-to-mid range acceleration gains. \*\* Suggested for maximum top speed gains. NOTE: 17/24B is **NOT** as aggressive as the original 17/24 swirl impeller. Refer to the USBA Rulebook for a more detailed definition of "stock, Limited, and Modified."

# 1977-2006 HONDA WATERCRAFT IMPELLER APPLICATIONS GUIDE

## RECOMMENDED SKAT-TRAK IMPELLER

Model	Year	Engine	Orig. Imp.	Pump Dia	Stock Engine	Limited Engine	Modified
Aquatrax F-12	03-04	1235	n/a	155mm	SH5580SW1221	Call for application	Call for application
Aquatrax F-12	05-06	1235	n/a	147mm	SH4775SW1523	Call for application	Call for application
Aquatrax F-12X Turbo	03-06	1235	n/a	155mm	SH5580SW1728	Call for application	Call for application
Aquatrax F-12X GPScape	05-06	1235	n/a	155mm	SH5580SW1728	Call for application	Call for application
Aquatrax R-12	04-06	1235	n/a	155mm	SH5580SW1221	Call for application	Call for application
Aquatrax R-12X Turbo	03-06	1235	n/a	155mm	SH5580SW1728	Call for application	Call for application

### RXP AND RXT APPLICATIONS

**New 3-Blade Swirl Super Pro Impeller Skat-Trak recommends:**

- 13/17 for a Stock RXT application
- 13/17 for a RXT Stock Stage 1 application
- 13/18 for a RXT-X Stock Stage 1 application
- 13/18 for a RXT Stage 2 application
- 13/18 for a RXP Stock Stage 1 application
- 14/19 for a RXP-X Stock Stage 1 application
- 14/19 for a RXP Stage 2 application
- 14/20 for a RXP Stage 3 application
- 15/20 for a RXP 300hp and up application
- 15.5/21.5 for a RXP 315hp and up application

Description	159-83-28 3-Blade Swirl Super Pro	Part No.
13/17	3-Blade Swirl Super Pro	SS598328SW31317
13/18	3-Blade Swirl Super Pro	SS598328SW31318
14/19	3-Blade Swirl Super Pro	SS598328SW31419
14/20	3-Blade Swirl Super Pro	SS598328SW31420
15/18	3-Blade Swirl Super Pro	SS598328SW31518
15/19	3-Blade Swirl Super Pro	SS598328SW31519
15/20	3-Blade Swirl Super Pro	SS598328SW31520
15.5/21.5	3-Blade Swirl Super Pro	SS5983283155215

Skat-Trak Impellers do not include a seal, Hot Products recommends SLA012 sold separately.

### SKAT-TRAK REPLACEMENT NOSE BOOT AND O-RING



Description	Part No.
1. SJ/FX	SK-NB6
2. KAW/SD/YAM/SWIRL	SK-NB7
3. YAM GPR.XL-L	SK-NB155XL
4. SD SUPER SLIM LINE	SK-NBSSL
5. O-RING KAWASAKI	SK-KAW-O
6. 750/900 PLUG O-RING	SK-750P
7. O-RING SEA DOO	SK-SD-O

## RECOMMENDED SKAT-TRAK IMPELLER

Model	Year	Engine	Orig. Imp.	Pump Dia.	Stock Engine	Limited Engine	Modified Engine
SUV 1200	99-04	1131	15.2	155mm	SY55XLSW1218R	*SY55XLSW1218R or SY55XLSW1319R**	SY55XLSW1319R
FZR	2009	1812	n/a	155mm	Call for application	Call for application	Call for application
FZS	2009	1812	n/a	155mm	Call for application	Call for application	Call for application
VX 110	05-09	1052	n/a	155mm	SY55KYSW1624	Call for application	Call for application
VX 110 Delux	05-09	1052	21.2	155mm	SY55KYSW1523	Call for application	Call for application
VX 110 Sport	05-09	1052	21.2	155mm	SY55KYSW1523	Call for application	Call for application
FX SHO	08-09	1812	n/a	155mm	SY557525SW119	SY557525SW1220	SY557525SW1323
FX Cruiser SHO	08-09	1812	n/a	155mm	Call for application	Call for application	Call for application
FX H.O.	04-09	1052	16.8	155mm	SY55XLSW1824	Call for application	Call for application
FX-140	02-08	998	16.3	155mm	SY55XLSW1319R	*SY55XLSW1319R or SY55XLSW1420R**	Call for application
FX Cruiser H.O. 50th	2006	1052	n/a	155mm	SY55XLSW1824	Call for application	Call for application
FX Cruiser H.O.	04-09	1052	16.8	155mm	SY55XLSW1824	Call for application	Call for application
FX Cruiser	03-08	998	17	155mm	SY55XLSW1319R	*SY55XLSW1319R or SY55XLSW1420R*	Call for application
FX	02-08	998	n/a	155mm	SY55XLSW1319R	Call for application	Call for application
GP 1200	97-99	1131	16.5/19, 15.2	155mm	*SY55SW1419 or SY55SSL1319**	*SY55XLSW1419 or SY55SSL1420**	SY55SSL14.521
GP 1300R	03-04	1296	n/a	155mm	*SY55XLSW1319R or SY55SW1321R**	*SY55XLSW1319R or SY55XLSW1420R**	SY55XLSW1319R
GP 1300R	05-08	1296	n/a	155mm	SY55XLSW1319R	SY55XLSW1320R	SY55XLSW1321R
GP 1200R	99-02	1131	16/19	155mm	SY55XLSW1319R	*SY55XLSW1319R or SY55XLSW1420R**	SY55XLSW1420R
GP 800	98-00	784	15/21, 17/1	144mm	SY44SS1420	SY44SS1422	SY44SS1422
GP 800R	01-05	784	13.2	155mm	SY55XLSW0714	Call for application	Call for application
GP 760	97-00	754	17/20	144mm	SY44SS1420	SY44SS1420	SY44SS1422
Raider 1100	95-96	1100	16/19	155mm	*SY55SW1419 or SY55SSL1420**	*SY55SW1419 or SY55SSL1420**	SY55SSL14.521
Raider 760	96	760	17/20	144mm	SY44SS1420	SY44SS1420	SY44SS1422
Raider 701	94-95	701	17/20	144mm	SY44SS14.518.5	SY44SS1519	SY44SS1420
	96-97	701	13/16 al	144mm	SY44SS1418	SY44SS14.518.5	SY44SS1420 to SY44SS1519
Raider DLX	95	701	17/20	144mm	SY44SS14.518.5	SY44SS1519	SY44SS1420
XLT 1200 Ltd.	99-05	1176	15.2, 15.6	155mm	SY55XLSW1218R	*SY55XLSW1218R or SY55XLSW1319R**	SY55XLSW1420R
XL 1200	98-99	1176	13/19	155mm	SY55SW1217	SY55SW1318	SY55SW1318
Venture 1100	96-97	1100	16/19	155mm	*SY55SW1419 or SY55SSL1319**	*SY55SW1419 or SY55SSL1420**	SY55SSL14.521
XLT 800	00-04	784	n/a	155mm	SY55XLSW1016	Call for application	Call for application
XL 760	98-00	754	11/14	155mm	SY55SW0714	Call for application	Call for application
XL 700	99-04	701	11/14	155mm	SY55SW0712	SY55SW0714	Call for application
Venture 760	97	760	11/14	155mm	SY55SW0714	SY55SW0714	Call for application
Venture 700	98	701	11/14	155mm	SY55SW0712	SY55SW0714	Call for application
	95-96	701	17/20	144mm	SY44SS14.518.5	SY44SS1519	SY44SS1420
Blaster 2	96-97	760	13/16	155mm	SY55SW0714	SY55SW0714	Call for application
Blaster	93-96	701	15/18	144mm	SY44SS1418	SY44SS14.518.5	SY44SS1420 to SY44SS1519
Pro VXR	93-94	701	15/18	144mm	SY44SL1419	SY44SL1419	SY44SL1419 to SY44SL1520
VXR	91-95	650	14/19 al	144mm	SY44SL1318	SY44SL1419	SY44SL1419 to SY44SL1520
Wave 3 GP	94-95	701	15/18	144mm	*SY44SL1318 or SY44SL1419**	SY44SL1419	SY44SL1419 to SY44SL1520
Wave 3	97	701	13/16 al	144mm	SY44SL1318	SY44SL1318 to SY44SL1419	SY44SL1419 to SY44SL1520
	91-96	650	13/16 al	144mm	SY44SL1318	SY44SL1318 to SY44SL1419	SY44SL1419 to SY44SL1520
Super Jet	94-09	701	13/16	144mm	SY44SS1418	SY44SS14.518.5	SY44SS1420 to SY44SS1519
	90-93	650	14/19 al	144mm	SY44SS1418	SY44SS14.518.5	SY44SS1420 to SY44SS1519
SJ Free Style	all	all	n/a	144mm	SY44SW1217/SY44SW1317/SY44SW1318	SY44SW1419/SY44SW1520	SY44SS1519/SY44SW1520/SY44SW1621
FX-1	94-95	701	21/27 al	n/a	SYFX1SL1924	SYFX1SL1924	SYFX1SL2025
LX 650	all	650	17 al	n/a	SYLX1619	SYLX1619	SYLX1720
Wave 500	all	500	16 al	n/a	SY500WR1316	SY500WR1316	SY500WR1417

\* Suggested for maximum bottom-to-mid range acceleration gains. \*\* Suggested for maximum top speed gains.  
Refer to the USBA Rulebook for a more detailed definition of "Stock, Limited, and Modified."

### IMPELLER DESIGNS AND PITCHES

#### 155-75-22 SWIRL 155-61-22 SWIRL

PITCH	PART NUMBER	PITCH	PART NUMBER
13/19	SY55XLSW1319	7/12	SY55XLSW0712
13/19R	SY55XLSW1319R	7/14	SY55XLSW0714
13/20	SY55XLSW1320	10/16	SY55XLSW1016
13/20R	SY55XLSW1320R	12/18R	SY55XLSW1218R
13/21	SY55XLSW1321	13/18	SY55XLSW1318
13/21R	SY55XLSW1321R	13/19	SY55XLSW1319
18/23	SY55XLSW1823	13/19R	SY55XLSW1319R
18/23R	SY55XLSW1823R	14/19	SY55XLSW1419
18/24	SY55XLSW1824	14/20	SY55XLSW1420
18/24R	SY55XLSW1824R	14/20R	SY55XLSW1420R
18/25	SY55XLSW1825	14/22	SY55XLSW1422
18/25R	SY55XLSW1825R	15/20	SY55XLSW1520

#### 155-75-20 YAM SWIRL

PITCH	PART NUMBER
15/23	SY55KYSW1523
16/24	SY55KYSW1624

#### 155-61-20 SSL

PITCH	PART NUMBER
14/18	SY55SSL1319
14.5/21	SY55SSL14.521
14/20	SY55SSL1420

† Super Slim Line

#### 155-61-20 SWIRL

PITCH	PART NUMBER
7/12	SY55SW0712
7/14	SY55SW0714
12/17	SY55SW1217
13/18	SY55SW1318
14/19	SY55SW1419
15/20	SY55SW1520
16/21	SY55SW1621

#### 144 SWIRL

PITCH	PART NUMBER
12/17	SY44SW1217
13/17	SY44SW1317
13/18	SY44SW1318
14/19	SY44SW1419
15/19	SY44SW1519
15/20	SY44SW1520
16/21	SY44SW1621

#### 144 SSL

#### 144 SLIM LINE

PITCH	PART NUMBER
13/18	SY44SL1318
14/19	SY44SL1419
15/20	SY44SL1520
16/21	SY44SL1621

PITCH	PART NUMBER
14/18	SY44SS1418
14.5/18.5	SY44SS14.518.5
14/20	SY44SS1420
14/22	SY44SS1422
15/19	SY44SS1519

## RECOMMENDED SKAT-TRAK IMPELLER

Model	Year	Orig. Imp.	Pump Dia.	Stock Engine	Limited Engine	Modified Engine
Ultra 250 X	07-08	n/a	155mm	SK557520SW1318	SK557520SW1318 or SK557520SW1319	SK557520SW1319 or SK557520SW1420
Ultra 260 X	2009	n/a	155mm	Call for application	Call for application	Call for application
Ultra 260 LX	2009	n/a	155mm	Call for application	Call for application	Call for application
Ultra LX	07-08	n/a	155mm	Call for application	Call for application	Call for application
Ultra 130 Di	01-04	n/a	Tapered	SK150SW1419	SK150SW1520	SK150SW1421/SK150SW1422/SK150SW1423
Ultra 150	99-05	n/a	Tapered	SK150SW1419	SK150SW1420	SK150SW1421/SK150SW1422/SK150SW1423
STX 12-F	04-08	n/a	148mm	*SK1100SW1319 or SK1100SW1319R**	SK1100SW1420	Call for application
STX 15-F	04-09	n/a	148mm	*SK1100SW1319 or SK1100SW1319R**	Call for application	Call for application
Ultra STX	2009	n/a	148mm	Call for application	Call for application	Call for application
1200 STX-R	02-05	n/a	148mm	*SK1100SW1424 or SK1100SW1424R**	*SK1100SW1424 or SK1100SW1424R**	*SK1100SW1424 or SK1100SW1424R**
1100 STX DI	00-03	n/a	148mm	SK1100SW1319R	SK1100SW1420	SK1100SW1420
1100 STX	97-99	8/22	148mm	SK1100SW1318	SK1100SW1318 to SK1100SW1319	SK1100SW1420 to SK1100SW1424
900 STX	01-06	12/17	148mm	SK1100SW1217	SK1100SW1318	SK1100SW1419
	97-00	10/24	140mm	*SK900SW1419 or SK900SL1520**	*SK900SW1419 or SK900SL1621**	*SK900SW1520 or SK900SL1722**
1100 ZXi	99-03	7/20	148mm	SK1100SW1318	*SK1100SW1318 or SK1100SW1319**	SK1100SW1420 to SK1100SW1424
900 ZXi	95-97	14/22	140mm	*SK900SW1419 or SK900SL1520**	*SK900SW1419 or SK900SL1621**	*SK900SW1520 or SK900SL1722**
900 STS	01-02	n/a	140mm	SK900SL1621	SK900SL1722	SK900SL1723
750 ZXi	95-97	14/22	140mm	SK900SW1318	SK900SW1318 to SK900SW1419	SK900SW1419 to SK900SW1520
750 Xi Sport	98-99	13/18	140mm	*SK900SW1217 or SK750ST1018**	*SK900SW1217 or SK750ST1119**	*SK900SW1318 or SK900SL1318**
750 Xi	96-97	13/18	140mm	*SK900SW1217 or SK750ST1018**	*SK900SW1217 or SK750ST1119**	*SK900SW1318 or SK900SL1318**
	93-95	8/16 5-blade	140mm	SK750ST1018	SK750ST1119	*SK900SW1318 or SK900SL1318**
800 SX-R	03-09	n/a	140mm	SK4075SW1318	SK4075SW1419	SK4075SW1520
750 Sxi Pro	98-02	9/17	140mm	*SK750ST0917 or SK750ST1018**	*SK900SW1217 or SK750ST1018**	*SK900SW1318 or SK900SL1318**
750 SKi	95-96	9/17	140mm	*SK750ST0917 or SK750ST1018**	*SK900SW1217 or SK750ST1018**	*SK900SW1318 or SK900SL1318**
750 SX	92-95	14/19 alum.	140mm	SK750ST0917	SK750ST0917 to SK750ST1018	*SK900SW1318 or SK900SL1318**
750 SS	96-97	12/17	140mm	SK750ST0917	SK750ST0917 to SK750ST1018	*SK900SW1318 or SK900SL1318**
	92-95	14/19 alum.	140mm	SK750ST0917	SK750ST0917 to SK750ST1018	*SK900SW1318 or SK900SL1318**
750 XIR	94	9/17	140mm	SK750ST0917	SK750ST0917 to SK750ST1018	*SK900SW1318 or SK900SL1318**
750 STX	98	12/17	140mm	*SK900SW1217 or SK750ST1018**	SK900SW1318	SK900SW1419
750 STS	96-97	12/17	140mm	*SK900SW1217 or SK750ST1018**	*SK900SW1217 or SK750ST1119**	*SK900SW1318 or SK900SL1318**
	95	13/18	140mm	*SK900SW1217 or SK750ST1018**	*SK900SW1217 or SK750ST1119**	*SK900SW1318 or SK900SL1318**
750 ST	95	13/21	140mm	SK750ST0917	SK750ST0917 to SK750ST1018	*SK900SW1318 or SK900SL1318**
	93-94	10/18 alum. 5-bl.	140mm	SK750ST0917	SK750ST0917 to SK750ST1018	*SK900SW1318 or SK900SL1318**
650 TS	89-96	16.5 alum.	140mm	SK650ST0917	SK650ST0917 to SK650ST1018	SK650ST1119
650 SX	86-93	15 alum.	140mm	SK650ST0816	SK650ST0917	SK650ST1018 to SK650ST1119
650 X-2	86-95	18 alum.	140mm	SK650ST0816	SK650ST0917	SK650ST1018 to SK650ST1119
650 SC	91-95	16.5 alum.	140mm	SK650ST0917	SK650ST0917 to SK650ST1018	SK650ST1119
650 JM	91-92	15 alum.	140mm	SK650ST0917	SK650ST0917 to SK650ST1018	SK650ST1119
550 SX	90-95	17.5 alum.	Tapered	SK550SX1316	SK550SX1316	SK550SX1417
550 JS	82-89	16 alum.	Tapered	SK550ST1316	SK550ST1316	SK550ST1417
440 JS	77-94	15 alum.	121.7mm	SK440ST1316	SK440ST1316	SK440ST1417
300 SX	87-91	15 alum.	121.7mm	SK440ST1316	SK440ST1316	SK440ST1417
300 JS	86-88	15 alum.	121.7mm	SK440ST1316	SK440ST1316	SK440ST1417

\* Suggested for maximum bottom-to-mid range acceleration gains. \*\* Suggested for maximum top speed gains. Refer to the USBA Rulebook for a more detailed definition of "Stock, Limited, and Modified."

### 550 JS

PITCH	PART NUMBER
13/16	SK550ST1316
14/17	SK550ST1417
15/18	SK550ST1518
15	SK550ST15.0
15.5	SK550ST15.5
16	SK550ST16.0
16.5	SK550ST16.5
17	SK550ST17.0
17.5	SK550ST17.5

### 550 SX

PITCH	PART NUMBER
13/16	SK550SX1316
14/17	SK550SX1417
15/18	SK550SX1518
15	SK550SX15.0
15.5	SK550SX15.5
16	SK550SX16.0
16.5	SK550SX16.5
17	SK550SX17.0
17.5	SK550SX17.5

### 650 STANDARD

PITCH	PART NUMBER
8/16	SK650ST0816
9/17	SK650ST0917
10/18	SK650ST1018
11/19	SK650ST1119
12/20	SK650ST1220
15	SK650ST15.0
15.5	SK650ST15.5
16	SK650ST16.0
16.5	SK650ST16.5
17	SK650ST17.0

### 140-75 SWIRL

PITCH	PART NUMBER
9/17	SK4075SW0917
10/18	SK4075SW1018
13/18	SK4075SW1318
14/18	SK4075SW1418
14/19	SK4075SW1419
15/20	SK4075SW1520

### 155-75-20 SWIRL

PITCH	PART NUMBER
12/19	SK557520SW1219
12/20	SK557520SW1220
13/18	SK557520SW1318
13/19	SK557520SW1319
13/21	SK557520SW1321
14/20	SK557520SW1420

### 750/900 SWIRL

PITCH	PART NUMBER
12/17	SK900SW1217
13/18	SK900SW1318
14/19	SK900SW1419
15/20	SK900SW1520
16/21	SK900SW1621
17/22	SK900SW1722

### ULTRA 150 SWIRL

PITCH	PART NUMBER
14/19	SK150SW1419
14/20	SK150SW1420
14/21	SK150SW1421
14/22	SK150SW1422
14/23	SK150SW1423
14/24	SK150SW1424

### 1100/1200 SWIRL

PITCH	PART NUMBER
12/17	SK1100SW1217
13/18	SK1100SW1318
13/19	SK1100SW1319
13/19R	SK1100SW1319R
14/19	SK1100SW1419
14/20	SK1100SW1420
14/23	SK1100SW1423
14/24	SK1100SW1424
14/24R	SK1100SW1424R
14/25	SK1100SW1425
14/25R	SK1100SW1425R
16/25	SK1100SW1625

### 750/900 SLIM LINE

PITCH	PART NUMBER
12/17	SK900SL1217
13/18	SK900SL1318
14/19	SK900SL1419
15/20	SK900SL1520
16/21	SK900SL1621
17/22	SK900SL1722
18/23	SK900SL1823

### 750 STANDARD

PITCH	PART NUMBER
8/16	SK750ST0816
9/17	SK750ST0917
10/18	SK750ST1018
11/19	SK750ST1119
12/20	SK750ST1220

FOUR STROKE  
INTAKE SYSTEMS  
ENGINE/GASKETS  
EXHAUST  
DRIVE LINE HANDLING  
ELECTRICAL  
WATERLINE /BILGE  
STEERING & CONTROLS  
BODY  
ACCESSORIES  
SERVICE TOOLS /HARDWARE  
CHEMICAL

# 1977-2009 KAWASAKI WATERCRAFT

Model	Year	Orig. Impeller	Pump Diameter	Stock Engine	Limited Engine	Modified Engine	Seal	Wrench
Ultra 250 X	07-08		155mm	KX-CD-1621	KX-CD-1621		SL-089	WR001
Ultra 250 LX	07-08		155mm	KX-CD-1218	KX-CD-1218		SL-089	WR001
STX-15F	04-09		148mm	KG-CD-1421	KG-CD-1421	KG-CD-1521	SL009/SLA009*	WR00
STX-12F	03-08	8/22	148mm	KG-CD-1218	KG-CD-1218	KG-CD-1319	SL009/SLA009*	WR001
1200 STX-R	02-05	13/23	148mm	KG-CD-1521	KG-CD-1521	KG-CD-1622	SL009/SLA009*	WR001
Ultra 150	99-05	13/18	Mixed	KH-DF-1620	KH-DF-1620	KH-DF-1721	SL007	WR001
1100 STX DI	00-03	8/23	148mm	KG-CD-1319	KG-CD-1319	KG-CD-1420	SL009/SLA009*	WR001
1100 STX	97-99	8/22	148mm	KG-CD-1319	KG-CD-1319	KG-CD-1420	SL009/SLA009*	WR001
1100 Zxi	99-03	7/20	148mm	KG-CD-1319	KG-CD-1319	KG-CD-1420	SL009/SLA009*	WR001
800 SXR	03-09	13/18	140mm	KP-DF-1322	KP-DF-1423	KP-DF-1524	SL009	WR001
750 Zxi	95-97	14/22	140mm	KE-CD-1116	KE-CD-1218	KE-CD-1218	SL009	WR001
750 Xi Sport	98-99	13/18	140mm	KE-CD-1116	KE-CD-1218	KE-CD-1218	SL009	WR001
750 Xi	96-97	13/18	140mm	KE-CD-1116	KE-CD-1218	KE-CD-1218		
	93-95	8/16 5-blade	140mm	KE-CD-1116	KE-CD-1218	KE-CD-1218		
750 Sxi Pro	98-02	9/17	140mm	KE-CD-0915	KE-CD-1116	KE-CD-1218	SL009	WR001
750 Sxi	95-96	9/17	140mm	KE-CD-0915	KE-CD-1116	KE-CD-1218	SL009	WR001
750 SX	92-95	14/19 alum	140mm	KE-CD-0915	KE-CD-1116	KE-CD-1218	SL009	WR001
750 SS	96-97	12/17	140mm	KE-CD-0915	KE-CD-1116	KE-CD-1116	SL009	WR001
	92-95	14/19 alum	140mm	KE-CD-0915	KE-CD-1116	KE-CD-1116	SL009	WR001
750 XIR	94	9/17	140mm	KE-CD-1116	KE-CD-1218	KE-CD-1218	SL009	WR001
750 STX	98	12/17	140mm	KE-CD-1116	KE-CD-1218	KE-CD-1218		
750 STS	96-97	12/17	140mm	KE-CD-1116	KE-CD-1218	KE-CD-1218	SL009	WR001
	95	13/18	140mm	KE-CD-1116	KE-CD-1218	KE-CD-1218	SL009	WR001
750 ST	95	12/21	140mm	KE-CD-0915	KE-CD-1116	KE-CD-1218	SL009	WR001
	93-94	10/18 alum 5-blade	140mm	KE-CD-0915	KE-CD-1116	KE-CD-1218	SL009	WR001

## KH DYNAFLY

\*SL009 is an optional part compatible with Xprop & IJK Series impellers for earlier models.

PITCH	PART NUMBER
16/20	KH-DF-1620
17/21	KH-DF-1721

## KG CONCORD

PITCH	PART NUMBER
12/18	KG-CD-1218
13/19	KG-CD-1319
14/20	KG-CD-1420
14/21	KG-CD-1421
15/21	KG-CD-1521
16/22	KG-CD-1622

## KE CONCORD

PITCH	PART NUMBER
09/15	KE-CD-0915
11/16	KE-CD-1116
12/18	KE-CD-1218
13/19	KE-CD-1320

## KP DYNAFLY

PITCH	PART NUMBER
13/22	KP-DF-1322
14/23	KP-DF-1423
15/24	KP-DF-1524

## KX CONCORD

PITCH	PART NUMBER
10-16	KX-CD-1016
12/18	KX-CD-1218
16/21	KX-CD-1621

# 1988-2006 SEA DOO WATERCRAFT

Model	Year	Eng. Size	Orig. Imp.	Pump Diam.	Stock Engine	Limited Engine	Modified Engine	Seal	Wrench
RXT 215	05-09	1494	n/a	159.8mm	SRX-CD-1318	SRX-CD-1419	SRX-CD-1520	SLA012	WR012
RXT-X 255	08-09	1494	n/a	159.8mm	SRX-CD-1318			SLA012	WR012
RXP 215	04-09	1494	n/a	159.8mm	SRX-CD-1419	SRX-CD-1419	SRX-CD-1520	SLA012	WR012
RXP-X 255	08-09	1494	n/a	159.8mm	SRX-CD-1521			SLA012	WR012
GTI 130	06-09	1494	n/a	155.8mm	SR-CD-1018	SR-CD-1119	SR-CD-1220	SLA011/SLA011A	WR001
GTI 130 SE	06-09	1494	n/a	155.8mm	SR-CD-1018	SR-CD-1119	SR-CD-1220	SLA011/SLA011A	WR001
GTX 4-Tec Ltd SC 185	2004	1494	4-bi SS	159mm	SR-CD-1220	SR-CD 1321	SRX-CD-1321	SLA011/SLA011A	WR001
GTX 4-Tec SC 185	03-06	1494	4-bi SS	159mm	SR-CD-1220	SR-CD-1220	SRX-CD-1321	SLA011/SLA011A	WR001
GTX 4-Tec Wake 115	05-09	1494	4-bi SS	159mm	SR-CD-1119	SR-CD-1220	SR-CD-1220	SLA011/SLA011A	WR001
GTX 4-Tec	02-04	1494	4-bi SS	159mm	SR-CD-1119	SR-CD-1220	SR-CD-1220	SLA011/SLA011A	WR001
RX-DI	01-03	951	14/21	155.5mm	ST-DF-1319	ST-CD-1520 or ST-DF-1319	ST-DF-1420 or ST-CD-1722	SL007	WR001
RX	00-02	951	14/21	155.5mm	ST-DF-1319	ST-CD-1520 or ST-DF-1319	ST-DF-1420 or ST-CD-1722	SL007	WR001
XP DI	03-04	951	14/21	155.5mm	ST-DF-1319	ST-CD-1520 or ST-DF-1319	ST-DF-1420 or ST-CD-1722	SL007	WR001
XP	00-02	951	14/21	155.5mm	ST-DF-1319	ST-CD-1620 or ST-DF-1319	ST-DF-1420 or ST-CD-1722	SL007	WR001
XP Ltd	98-99	951	13/21	155.5mm	ST-CD-1520	ST-CD-1520	ST-CD-1621	SL007	WR001
LRV/LRV DI	00-03	951	14/21	155.5mm	ST-CD-1419	ST-CD-1419	ST-DF-1520	SL007	WR001
GTX	00-03	951	14/21	155.5mm	ST-DF-1319	ST-CD-1520 or ST-DF-1319	ST-DF-1420 or ST-CD-1621	SL007	WR001
GTX DI	00-02	951	14/21	155.5mm	ST-DF-1319	ST-CD-1520 or ST-DF-1319	ST-DF-1420 or ST-CD-1621	SL007	WR001
GTX Ltd	98-99	951	13/21	155.5mm	ST-CD-1520	ST-CD-1520	ST-CD-1621	SL007	WR001
RXX	01-02	951		148mm	KG-CD-1521	KG-CD-1622	KG-CD-1622	SL007	WR001

## SRX CONCORD

PITCH	PART NUMBER
13/18	SRX-CD-1318
14/19	SRX-CD-1419
15/20	SRX-CD-1520
15/21	SRX-CD-1521

## SR CONCORD

PITCH	PART NUMBER
10/18	SR-CD-1018
11/19	SR-CD-1119
12/20	SR-CD-1220
13/21	SR-CD-1321

## ST CONCORD

PITCH	PART NUMBER
14/19	ST-CD-1419
15/20	ST-CD-1520
16/21	ST-CD-1621
17/22	ST-CD-1722

## ST DYNAFLY

PITCH	PART NUMBER
12/18	ST-DF-1218
13/19	ST-DF-1319
14/20	ST-DF-1420

# 1987-2009 YAMAHA WATERCRAFT

Model	Year	Eng. Size	Orig. Imp.	Pump Diam.	Stock Engine	Limited Engine	Modified Engine	Seal	Wrench	Holder
VX110	05-09	1052	N/A	155mm	YH-CD-1822	YH-CD-1822		SLA009	WR001/WR007	N/A
FX Cruiser	03-08	998	N/A	155mm	YF-CD-1218	YF-CD-1319	YF-CD-1319	SLA009	WR007	WR007H
FX Cruiser H.O.	04-09	1052	N/A	155mm	YG-DF-1420	YG-DF-1420		SLA009	WR007	WR007H
FX-140	02-08	998	N/A	155mm	YF-CD-1218	YF-CD-1319	YF-CD-1319	SLA009	WR007	WR007H
FX-140 H.O.	04-09	1052	N/A	155mm	YG-DF-1420	YG-DF-1420		SLA009	WR007	WR007H
SUV 1200	99-04	1131	15.2	155mm	YF-CD-1218	YF-CD-1218		SLA009	WR007	WR007H
XLT 1200	01-04	1176	15.6	155mm	YF-CD-1218	YF-CD-1319	YF-CD-1420	SLA009	WR007	WR007H
XL 1200 Ltd.	99-05	1176	15.2	155mm	YF-CD-1218	YF-CD-1319	YF-CD-1420			
XL 1200	98-99	1176	13/19	155mm	YD-CD-1218	YD-CD-1218	YD-CD-1319	SLA009	WR007	WR007H
XLT 800	00-04	784	13.4	155mm	YF-CD-1114	YF-CD-1114		SLA009	WR001/WR007	WR007H
XL 800	00-01	784	13.4	155mm	YF-CD-1114	YF-CD-1114		SLA009	WR001/WR007	WR007H
GP 1300R	05-08	1296	16.3	155mm	YG-DF-1420	YG-DF-1420		SLA009	WR007	WR007H
GP 1300R	03-04	1296	16.3	155mm	YF-CD-1319	YF-CD-1319	YF-CD-1420	SLA009	WR007	WR007H
GP 1200R	00-02	1176	15.6	155mm	YF-CD-1319	YF-CD-1319	YF-CD-1420	SLA009	WR007	WR007H
GP 1200	97-99	1131	16.5/19, 15.2	155mm	YD-CD-1319	YD-CD 1319	YD-CD-1420	SLA008/SLA009A	WR004/WR007	WR004H
Raider 1100	95-96	1100	16/19	144mm	YD-CD-1218	YD-CD-1218	YD-CD-1319	SLA008/SLA009A	WR004/WR007	WR004H
GP 800R	01-05	784	13.2	144mm	YF-CD-1114	YF-CD-1114		SLA009	WR001/WR007	WR007H
GP 800	98-00	784	15/21, 17.1	144mm	YB-CD-1418 or XO	YB-CD-1519 or XO	YB-CD-1619 or XI	SL008/SL008A	WR004	WR004H
GP 760	97-00	754	17/20	155mm	YB-CD-1317 or X	YB-CD-1418 or XO	YB-CD-1519 or XI	SL008/SLA008	WR004	WR004H
Raider 760	96	760	7/20	144mm	YB-SC-I	YB-SC-I	YB-SC-J	SLA008	WR004	WR004H
Raider 701	94-95	701	17/20	144mm	YB-CD-1317, J	YB-CD-1418 or K	YB-CD-1519 or K	SL008A/SLA008	WR004	WR004H
	96-97	701	13/16 al	144mm	YB-CD-1317 or I	YB-CD-1317 or J	YB-CD-1418 or K	SL008A/SLA008	WR004	WR004H
Raider DLX	95	701	17/20	144mm	YB-CD-1317 or J	YB-CD-1418	YB-CD-1519 or K	SL008A/SLA008	WR004	WR004H
Venture 700	95-96	701	17/20	144mm	YB-CD-1317, J	YB-CD-1317, K	YB-CD-1418, K	SL008A/SLA008	WR004	WR004H
Blaster	93-96	701	15/18	144mm	YB-CD-1317, I	YB-CD-1317 or J	YB-CD-1418 or K	SL008A/SLA008	WR004	WR004H
Pro VXR	93-94	701	15/18	144mm	YB-CD-1317, I	YB-CD-1317 or J	YB-CD-1418 or K	SL008A/SLA008	WR004	WR004H
Super Jet	94-09	701	13/16 al	144mm	YB-CD-1317, I	YB-CD-1317 or J	YB-CD-1418 or K	SL008A/SLA008	WR004	WR004H
	90-93	650	14/19 al	144mm	YB-SC-I	YB-SC-J	YB-SC-K	SL008A/SLA008	WR004	WR004H

## YB CONCORD

PITCH	PART NUMBER
13/17	YB-CD-1317
14/18	YB-CD-1418
15/19	YB-CD-1519
16/20	YB-CD-1620

## YB X-PROP

PITCH	PART NUMBER
15/18	YB-SC-X
16/19	YB-SC-XI

## YF CONCORD

PITCH	PART NUMBER
11/14	YF-CD-1114
12/18	YF-CD-1218
13/19	YF-CD-1319
14/20	YF-CD-1420

## YD CONCORD

PITCH	PART NUMBER
12/18	YD-CD-1218
13/19	YD-CD-1319
14/20	YD-CD-1420

## YB SUPER CAMBER

PITCH	PART NUMBER
14.5/18	YB-SC-I
14.7/18.5	YB-SC-J
15/19	YB-SC-K

## YH CONCORD

PITCH	PART NUMBER
18/22	YH-CD-1822

## YG DYNAPLY

PITCH	PART NUMBER
13/19	YG-DF-1319
14/20	YG-DF-1420

## YD SUPER CAMBER

PITCH	PART NUMBER
16/19	YD-SC-XO



## WATCON IMPELLER PITCH GAUGES

It's a known fact; not all impellers are created equal. Sometimes when impellers are mass produced, there are subtle differences that can affect performance. Use this simple tool to measure the pitch angle and blade length of each blade throughout its circumference. This enables you to make adjustments to the pitch where needed. Great for fine tuning, making minor changes or verifying pitch when sending impellers off for repair.

Race Class	Description	Part No.
140-142mm Impeller		IMP-142
144-148mm Impellers		IMP-148
155 Impellers		IMP-155
158-160mm Impellers		IMP-160

FOUR STROKE  
INTAKE SYSTEMS  
ENGINE/GASKETS  
EXHAUST  
DRIVE LINE HANDLING  
ELECTRICAL  
WATERLINE /BILGE  
STEERING & CONTROLS  
BODY  
ACCESSORIES  
SERVICE TOOLS /HARDWARE  
CHEMICAL



## IMPROS CUSTOM MODIFIED SOLAS IMPELLERS

Impros is a qualified, full service impeller modification facility with more than 20 years in the PWC impeller business. Providing custom performance impellers to reputable engine builders, world class racers, and companies seeking to maximize the pump performance for their customers. Impros is recognized as the "Only" Factory Authorized Solas Service Center. Now available to you from Hot Products.

### KAWASAKI 800 SXR IMPROS CUSTOM SOLAS SET BACK IMPELLERS

Hot Products Set Back impellers are custom pitched to maximize performance & engine rpm for specific applications. These Solas Dynafly impellers are machined -5mm to set them closer to the pump vanes, which maximizes pump hook up. The impellers fit right into stock SXR pump, with & without the TBM Super Pump Cone.

Race Class	Description	Part No.
Freestyle	13/19 Solas Dynafly -5mm	KPDF1319SB
Stock	13/21 Solas Dynafly -5mm	KPDF1321SB
Limited	13/23 Solas Dynafly -5mm	KPDF1323SB
Modified	14/24 Solas Dynafly -5mm	KPDF1424SB



### IMPROS PRO-CONE

*Improve pump efficiency and increase performance!*

Made of durable 6061-T6 Billet aluminum, the PRO-CONE improves efficiency, performance and is quicker & easier to install than the rubber

versions. The Yamaha Pro-Cone utilizes a stainless steel nyloc set screw, and comes with a free allen wrench for ease of installation. The new Kawasaki Pro-Cone is designed with an o-ring seal for the shaft splines and an o-ring that snaps it into the impeller so it stays in place.

The durable new Pro-Cone is a must-have with the new high horsepower watercraft creating extreme pump pressures. Rubber impeller cones tear off creating an inefficient pump, and performance loss.

Description	Part No.
Solas Yamaha YB/YD models (GP1200, Raider, Blaster, GP 800)	PC-YB
Solas Kawasaki KH, KG, KF & KE Impellers (Ultra 150, ZXI/STX 1100/900/750, SXi)	PC-KH



### YAMAHA SUPERJET FREESTYLE IMPROS CUSTOM SOLAS SET BACK IMPELLERS

Hot Products set back custom pitched impellers are modified to maximize bottom end acceleration & hook up for your SuperJet. These Solas Concord impellers are set back -3mm & pitched to give your SJ explosive bottom end response, so you can get the most air out of your ski! These impellers work with the stock pump, with & without the TBM Super Pump Cone.

Race Class	Description	Part No.
Freestyle	13/15 Solas Concord -3mm	YBCD1315SB
Stock/Ltd.	13/15 Solas Concord -3mm	YBCD1315SB
Modified	13/16 Solas Concord -3mm	YBCD1316SB

### YAMAHA HOOKER IMPELLERS

Impros Hooker impellers have specifically developed to offer the maximum performance gains from the Yamaha 701 engine platform in conjunction with the 144mm pump.

#### Part No. IMY144915

9/15 Impros Yamaha 144 SB Hooker impeller for anything from a stock 701 to a strong limited setup. This is the most popular for people who want to maximize bottom end.

#### Part No. IMY1441016

10/16 Impros Yamaha 144 SB Hooker impeller for the more healthy version of a limited with porting, big carbs, etc. This pitch will transfer a bit more to the top end.

#### Part No. IMY1441117

11/17 Impros Yamaha 144 SB Hooker impeller for the maximum hookup and added HP. This is used by closed course racers. Very popular and an excellent upgrade on the 2008-09 Superjet with a pipe.

### YAMAHA 1200GPR/1300GPR IMPROS CUSTOM SOLAS SET BACK IMPELLERS

#### GP1200R (00-02) and GP1300R (03-04)

Race Class	Description	Part No.
Stock/Ltd.	13/20 Solas Concord -3mm	YF-CD-1320SB
Ltd/Modified	14/22 Solas Concord -3mm	YF-CD-1422SB

#### GP1300R (05-08)

Race Class	Description	Part No.
Stock/Ltd.	14/20 Solas Dynafly -1mm	YG-DF-1420SB
Ltd/Modified	14/22 Solas Dynafly -1mm	YG-DF-1422SB
	14/24 Solas Dynafly -1mm	YG-DF-1424SB



**SEA-DOO**

MODEL	YEAR	ENGINE C.C.	O.D. (mm)	STOCK (Bone stock)	LIMITED (Add bolt-on parts)	MODIFIED (Major modifications)
LRV DI	02-04	951	155	SD-B6.0L	SD-B6.0L / SD-B6.5L	SD-B6.5L
LRV	00-01	951	155	SD-B6.0L	SD-B6.0L / SD-B6.5L	SD-B6.5L
GTx 4-TEC	02	1500	155	N/A	N/A	N/A
GTx DI	00-02	951	155	SD-B5.7L / SD-B6.0L	SD-B6.0L / SD-B6.5L	SD-B6.5L
GTx / GTx Ltd.	98-01	951	155	SD-B6.0L	SD-B6.0L / SD-B6.5L	SD-B6.5L
GTx RFI	98-02	782	140	SD-A6.2L	SD-A6.2L	-
GTx	96-97	782	140	SD-A6.0 / SD-A6.1	SD-A6.0 / SD-A6.1	SD-A6.5
GTx	02	951	155	SD-B6.0L	SD-B6.0L	SD-B6.5L
RX DI	00-04	951	155	SD-B6.0L	SD-B6.0L	SD-B6.5L
RX	00-01	951	155	SD-B6.0L	SD-B6.0L / SD-B6.5L	SD-B6.5L
GSX RFI	99-00	782	140	SD-A6.2L	SD-A6.2L	-
GSX Ltd.	98-99	951	155	SD-B6.0L	SD-B6.0L / SD-B6.5L	SD-B6.5L
GSX Ltd.	97.5	951	155	SD-B5.0	SD-B5.0 / SD-B5.5	SD-B5.5
GSX	96-97	782	140	SD-A6.0 / SD-A6.1	SD-A6.0 / SD-A6.1	SD-A6.5
XP / XP Ltd.	98-02	951	155	SD-B6.0L	SD-B6.0L / SD-B6.5L	SD-B6.5L
XP	96-97	782	140	SD-A6.0 / SD-A6.1	SD-A6.0 / SD-A6.1	SD-A6.5
XP	95	718	140	SD-A5.5	SD-A5.5	SD-A6.0 / SD-A6.1
Gti / Gti LE	02	718	155	SD-B5.7L	SD-B6.0L	SD-B6.5L
Gti	01	718	155	SD-B5.7L	SD-B6.0L	SD-B6.5L
Gti	96-00	718	140	SD-A5.5	SD-A5.5	SD-A6.0 / SD-A6.1
GTS	01	718	155	N/A	N/A	SD-B6.0L
GTS	97-00	718	140	SD-A5.5	SD-A5.5	SD-A6.0 / SD-A6.1
GTS	92-96	580	140	N/A	N/A	N/A
Gsi	97	718	140	SD-A5.5	SD-A5.5	SD-A6.0 / SD-A6.1
GS	97-01	718	140	SD-A5.5	SD-A5.5	SD-A6.0 / SD-A6.1
HX	95-97	718	140	SD-A5.5	SD-A5.5	SD-A6.0 / SD-A6.1
SPX	99	782	140	SD-A6.2L	SD-A6.2L	-
SPX	97-98	782	140	SD-A6.0 / SD-A6.1	SD-A6.0 / SD-A6.1	SD-A6.5
SPX	96	718	140	SD-A5.5	SD-A5.5	SD-A6.0 / SD-A6.1
SPi	93-94	580	140	N/A	N/A	N/A
SP	97	718	140	SD-A5.5	SD-A5.5	SD-A6.0 / SD-A6.1
SP	88-96	580	140	N/A	N/A	N/A

**YAMAHA**

FX 140	02-08	1000	155	N/A	N/A	N/A
SUV 1200	99-04	1200	155	YM-B5.5	YM-B5.5 / YM-B6.0	YM-B6.0
SUV 1200	00-04	1200	155	YM-C6.0	YM-C6.0 / YM-C6.5	YM-C6.5
GP 1200	97-99	1200	155	YM-B5.5 / YM-B6.0	YM-B6.0 / YM-B6.5	YM-B6.5
GP 1200R	00-02	1200	155	YM-C6.0	YM-C6.0 / YM-C6.5	YM-C6.5
GP 800	98-00	800	144	YM-A5.0	YM-A5.0 / YM-A5.5	YM-A6.0
GP 800R	01-05	800	155	—	YM-C5.5 / YM-C6.0	YM-C6.0
GP 760	97-00	760	144	YM-A5.0	YM-A5.0 / YM-A5.5	YM-A6.0
XLT 1200	00-02	1200	155	YM-C6.0	YM-C6.0 / YM-C6.5	YM-C6.5
XL 1200	98-99	1200	155	YM-B5.5 / YM-B6.0	YM-B6.0 / YM-B6.5	YM-B6.5
XL 1200 Ltd	99-00	1200	155	YM-C6.0	YM-C6.0 / YM-C6.5	YM-C6.5
XLT	02	800	155	—	YM-C6.0	YM-C6.5
XL 800	00-01	800	155	—	YM-C6.0	YM-C6.0
XL 760	98-99	760	155	YM-B5.0	YM-B5.0 / YM-B5.5	YM-B5.5
XL 700	00-04	700	155	YM-B5.0	YM-B5.0 / YM-B5.5	YM-B5.5
WaveBlaster II	96-97	760	155	YM-B5.0	YM-B5.0 / YM-B5.5	YM-B5.5
WaveBlaster 701	96-97	701	144	YM-A5.0	YM-A5.0 / YM-A5.5	YM-A5.5
WaveBlaster 701/650	95 & earlier	701	144	—	YM-A5.0	YM-A5.5
WaveRaider 1100	95-96	1100	155	YM-B5.5	YM-B5.5 / YM-B6.0	YM-B6.0
WaveRaider 760	96 & earlier	760	144	YM-A5.5	YM-A5.5 / YM-A6.0	YM-A6.0
WaveRaider 701	96-97	701	144	YM-A5.0	YM-A5.0 / YM-A5.5	YM-A5.5
WaveRaider 701	95 & earlier	701	144	YM-A5.5	YM-A5.5 / YM-A6.0	YM-A6.0
WaveVenture 1100	96-97	1100	155	YM-B5.0 / YM-B5.5	YM-B5.5	YM-B6.0
WaveVenture 760	97	760	155	YM-B5.0	YM-B5.0 / YM-B5.5	YM-B5.5
WaveVenture 701	95-98	701	144	YM-A5.0	YM-A5.0 / YM-A5.5	YM-A5.5
SuperJet 701 / Ltd.	96-08	701	144	YM-A5.0	YM-A5.0 / YM-A5.5	YM-A5.5
SuperJet 701/650	95 & earlier	701/650	144	—	YM-A5.0	YM-A5.5
WaveRunner III 701	97 (65hp)	701	144	—	YM-A5.0	YM-A5.0

**KAWASAKI**

Ultra 150	99-05	1176	136-157	KW-D6.0	KW-D6.0	-
Ultra 130 DI	01-04	1071	136-157	KW-D6.0	KW-D6.0	-
STX 1200R	02-05	1176	148	KW-C5.0	KW-C5.5	KW-C5.5
STX 1100	97-99	1071	148	KW-C5.0	KW-C5.0	KW-C5.5
STX 1100 DI	00-03	1071	148	KW-C5.0	KW-C5.0	KW-C5.5
STX 900	01-02	891	148	—	KW-C5.0	KW-C5.5
STX 900	97-00	891	140	KW-B5.0	KW-B5.0 / KW-B5.5	KW-B5.5
STS 900	01-02	891	140	KW-B5.0	KW-B5.0 / KW-B5.5	KW-B5.5
STX 750	98	743	140	KW-A5.0	KW-A5.0 / KW-A5.5	KW-A5.5
ZXi 1100	96-02	1071	148	KW-C5.0	KW-C5.5	KW-C5.5
ZXi 900	96-97	891	140	KW-B5.0	KW-B5.0 / KW-B5.5	KW-B5.5
ZXi 750	95-97	743	140	KW-A5.0 / KW-A5.5	KW-A5.5 / KW-A6.0	KW-A6.0
STS 750	95-97	743	140	KW-A5.0	KW-A5.0 / KW-A5.5	KW-A5.5
SS 750	92-97	743	140	—	KW-A5.0	KW-A5.0
SI 750	93-95	743	140	—	KW-A5.0	KW-A5.0
Xi Sport 750	98	743	140	KW-A5.0	KW-A5.0 / KW-A5.5	KW-A5.5
Xi 750	93-97	743	140	KW-A5.0	KW-A5.0 / KW-A5.5	KW-A5.5
SXi Pro 750	98-02	743	140	KW-A5.0	KW-A5.0 / KW-A5.5	KW-A5.5
SXi 750	95-96	743	140	KW-A5.0	KW-A5.0 / KW-A5.5	KW-A5.5
SX 750	92-96	743	140	—	KW-A5.0	KW-A5.0

**TIGERSHARK**

TS1100L	99	1100	148	TS-B6.5	TS-B6.5	-
TS1100R	99	1100	148	TS-B5.5	TS-B5.5	-
Daytona 1000	97-98	1000	146	TS-A6.0	TS-A6.0	-
Monte Carlo 1000	97-98	1000	146	TS-A6.0	TS-A6.0	-
Daytona 770	96-99	770	146	TS-A5.5	TS-A5.5	TS-A6.0
Monte Carlo 770	96-99	770	146	TS-A5.5	TS-A5.5	TS-A6.0
TS770	98-99	770	146	TS-A5.5	TS-A5.5	TS-A6.0
Monte Carlo 640	97-98	640	146	TS-A5.0	TS-A5.0	TS-A5.5
Montego 640	97-98	640	146	TS-A5.0	TS-A5.0	TS-A5.5
Montego Deluxe 640	97-99	640	146	TS-A5.0	TS-A5.0	TS-A5.5



**NuJet DESTROYER  
STAINLESS STEEL IMPELLER**

The Destroyer has a unique 3-D blade design with a super-progressive pitch and minimal blade overlap. Minimizing the amount of overlap increases the efficiency of the Destroyer giving harder acceleration throughout the power band and higher top speeds and reduced cavitation for better performance in all water conditions.



**SEA DOO**

SD-A5.5	SD-A6.1
SD-B5.0	SD-A6.2L
SD-B5.5	SD-A6.5
SD-B5.7L	SD-B6.5L
SD-A6.0	
SD-B6.0L	

**YAMAHA**

YM-A5.0	YM-B6.0
YM-A5.5	YM-C6.0
YM-B5.0	YM-B6.5
YM-B5.5	YM-C6.5
YM-A6.0	

**KAWASAKI**

KW-A5.0	KW-A6.0
KW-B5.0	KW-D6.0
KW-C5.0	
KW-A5.5	
KW-B5.5	
KW-C5.5	

**TIGERSHARK**

TS-A5.0	TS-B6.5
TS-A5.5	
TS-B5.5	
TS-A6.0	

FOUR  
STROKE

INTAKE  
SYSTEMS

ENGINE/  
GASKETS

EXHAUST

DRIVE LINE  
HANDLING

ELECTRICAL

WATERLINE  
/BILGE

STEERING  
& CONTROLS

BODY

ACCESSORIES

SERVICE TOOLS  
/HARDWARE

CHEMICAL

FOUR STROKE  
INTAKE SYSTEMS  
ENGINE/GASKETS  
EXHAUST  
DRIVE LINE HANDLING  
ELECTRICAL  
WATERLINE /BILGE  
STEERING & CONTROLS  
BODY  
ACCESSORIES  
SERVICE TOOLS /HARDWARE  
CHEMICAL

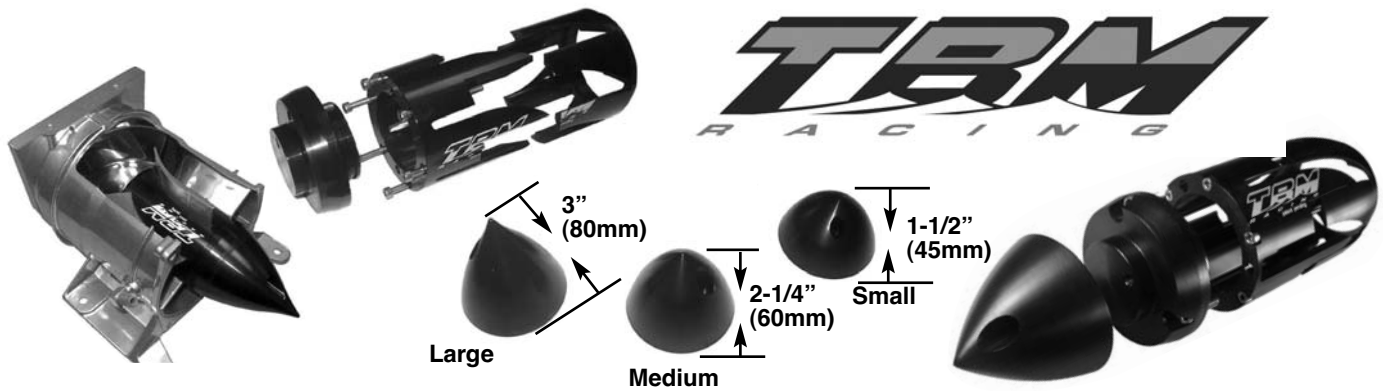

## TBM RACING SUPER PUMP CONE "PRO" KAWASAKI 750/800

We have increased the hub diameter of the OEM pump, which creates an increase in pump pressure keeping the pump "loaded" in rough water conditions. The increased efficiency adds amazing acceleration, improved handling and top speed. The Super Pump Cone is designed to be used with the OEM, Solas Dynafly, or C-75 Skat-Trak impellers in standard, or a 5mm set back. Installation is as simple as changing an impeller and can be performed with standard tools. Fits '92-'07s Kawasaki 750/800 stand ups.

Included with our "Pro" kit is the Super Pump Cone insert, a tail cone base that seals the pump and three different length tail cone tips. The cone tips can be changed by simply removing one M6 bolt and replacing the tip with a different length to optimize your impeller and nozzle combination. The short cone works for Freestyle, Freeride and tight Closed Courses, while the medium and long tail cone works excellent for rough water hook up and amazing top speed.

<b>Kawasaki</b>	<b>Part No.</b>
Super Pump Cone (Kawasaki)	<b>TBM120</b>

## TBM RACING YAMAHA SUPER PUMP CONE

Our Yamaha Super Pump Cone will transform your inefficient OEM pump into a high performance large diameter hub race pump. It is not necessary to run a large hub impeller, so there is no need to purchase a new impeller to benefit from our Yamaha Super Pump Cone. We have designed our Yamaha Super Pump Cone to accommodate any diameter hub impeller. An OEM, standard aftermarket, or C-75 Magnum impeller will work with this set up.

Three sizes of our interchangeable tail cone tips are included with this kit. Outstanding for racing, freestyle or freeride applications. The Yamaha Super Pump Cone will work on any year Yamaha Super Jet, Wave Blaster and any other Yamaha watercraft models that utilize a Yamaha 144mm pump housing.

<b>Yamaha</b>	<b>Part No.</b>
Super Pump Cone (Yamaha)	<b>TBM120-YAM</b>

## SUPER PUMP CONE IMPELLER REFERENCE CHART FOR KAWASAKI 800 SX-R

Hot Products Set Back impellers are custom pitched to maximize performance and engine rpm for specific applications. These Solas Dynafly impellers are machined -5mm to set them closer to the pump vanes, which maximizes pump hook up. The impellers fit right into the stock SXR pump, with and without the TBM Super Pump Cone.

	<b>Rider Weight 100-150 Lbs. (4.5-68 Kg)</b>	<b>Rider Weight 150-200 Lbs. (68-91 Kg)</b>	<b>Rider Weight 200-250 Lbs. (91-114 Kg)</b>
<b>Stock Class Impeller</b>	SK4075SW0917 or KP-DF-1321SB*	SK4075SW0917 or KP-DF-1321SB*	SK4075SW0917 or KP-DF-1321SB*
<b>Stock Class Nozzle</b>	OEM 76mm	OEM 76mm	OEM 76mm
<b>Stock Class Closed Course</b>	Medium or Large	Medium or Large	Small or Medium
<b>Tail Cone Tip</b>			
<b>Limited Class Impeller</b>	SK4075SW1419 or KP-DF-1323SB*	SK4075SW1419 or KP-DF-1323SB*	SK4075SW1419 or KP-DF-1323SB*
<b>Limited Class Nozzle</b>	80mm	80.5mm	81mm
<b>Limited Class Closed Course</b>	Medium or Large	Medium or Large	Small or Medium
<b>Tail Cone Tip</b>			
<b>Open Class Impeller</b>	KP-DF-1424SB*	KP-DF-1424SB*	KP-DF-1424SB*
<b>Open Class Nozzle</b>	81.5 mm	82mm	82.5mm
<b>Open Class Closed Course</b>	Medium or Large	Medium or Large	Small or Medium
<b>Tail Cone Tip</b>			
<b>Free Style Impeller</b>	KP-DF-1319SB*	KP-DF-1319SB*	KP-DF-1319SB*
<b>Tail Cone Tip</b>	Small	Small	Small

\* Indicates Impros -5mm set back Solas Dynafly impeller

## YAMAHA SUPERJET FREESTYLE IMPROS CUSTOM SOLAS SET BACK IMPELLERS

Hot Products Set Back custom pitched impellers are modified to maximize bottom end acceleration and hook up for your SuperJet. These Solas Concord impellers are set back -3mm and pitched to give your SJ explosive bottom end response, so you can get the most air out of your ski! These impellers work with the stock pump, with and without the TBM Super Pump Cone.

<b>Part No.</b>	<b>Description</b>
Stock/Ltd.	13/15 Solas Concord -3mm <b>YBCD1315SB</b>
Modified	13/16 Solas Concord -3mm <b>YBCD1316SB</b>



## ADJUST-A-THRUST

The only Automatic Transmission for PWC Jet Pumps Maximize Your Performance



In low gear the shuttle lets a large volume of water be moved to accelerate the craft.



As speed and pump pressure increase, the shuttle is forced out into the exit nozzle, reducing its size and increasing water velocity. This increases top speed.

Kawasaki	Part No.
1100 ZXI/STX, STXR, STX12F/15F	<b>KAW 1</b>
All 650-800, SXI, SXI Pro, SXR 800	<b>KAW 3</b>

Skat Trak Magnum Pump	Part No.
Skat Trak, Yamaha, Polaris Octane	<b>SKT1</b>
Skat Trak, Kawasaki/Sea Doo (75mm hub)	<b>SK27</b>



Sea Doo



Yamaha

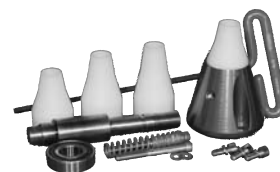

Kawasaki



Skat Trak SK 27

Sea Doo	Part No.
XP LTD, GSX LTD, GTX LTD, RX	<b>SEA 2</b>
4 Tec NA/SC (01-04), RXP, RXT	<b>SEA 4</b>

Yamaha	Part No.
SJ (90-04), WRIII (91-97), GP700	<b>YAM 1</b>
VXR/VXR Pro, Blaster, B2, All Raider	
GP1200 (97-99), Venture 1100, XL1200 (98-99)	<b>YAM 2</b>
GPR 1200 (99-02), XLT 1200 (99-92)	<b>YAM 3</b>
FX140, GPR1300 (03-04), GP760, GP800	
FX160/GP1300R (05-08)	<b>YAM 3</b>

## WET WOLF FREESTYLE CONE

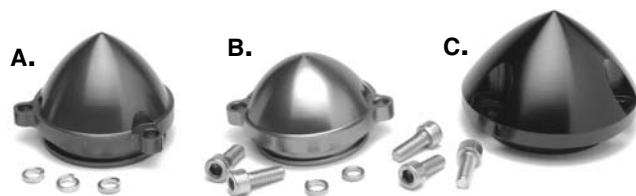

Freestyle cones are specially designed to maximize low end performance. The small design of the cone also lets the engine rev faster for a more powerful midrange hit. Perfect for Freestyle/Freeride, increases throttle response. CNC machined and Tuff-Coat anodized for superior corrosion resistance.

Yamaha	Part No.
A. Super Jet	<b>FSYAM</b>

Kawasaki	Part No.
B. 800 SXR, 750SX, SXI-Pro	<b>FSKW3</b>
C. Polaris Octane, Yamaha Magnum Pump	<b>FSSKT1</b>



## INTERCHANGEABLE PUMP CONE ROD FOR YAMAHA

Change the diameter of your exit nozzle with one easy turn of a bolt, you can adjust your exit nozzle diameter by interchanging the various rod sizes.

Description	Part No.
Yamaha SJ, Wave Blaster, 701 Raider	<b>54-3351</b>

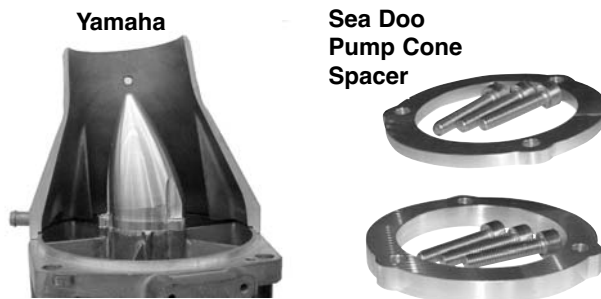

## R&D ANTI-CAVITATION CONE

The unique patent pending design balances the bowl pressure in the last stage of the pump to eliminate detectable cavitation. Improve bottom and punch midrange pull and overall performance.

Yamaha	Part No.
FX140 GP800R/GP1200R/ GP1300R (all except 05)	<b>162-12002</b>
XL1200LTD, XLT800/1200	<b>162-12003</b>
H.O./2005 GP1300R, VX110	<b>162-16000</b>

Sea Doo	Part No.
GTX/RXT/RXP 185/215 HP (04-07)	<b>163-95001</b>
RXP-X, RXT-X	
GTX 4-Tec/RXT Anti-Cavitation Pump Cone Spacer .200 (02-05)	<b>163-95200</b>
GTX 4-Tec RXT Anti-Cavitation Pump Cone Spacer .350 (02-05)	<b>163-95350</b>

Kawasaki	Part No.
Ultra 250X	<b>161-25010</b>

FOUR STROKE  
INTAKE SYSTEMS  
ENGINE/GASKETS  
EXHAUST  
DRIVE LINE HANDLING  
ELECTRICAL  
WATERLINE /BILGE  
STEERING & CONTROLS  
BODY  
ACCESSORIES  
SERVICE TOOLS /HARDWARE  
CHEMICAL



## R&D RXP / RXT PRO-SERIES REDUCTION NOZZLE

Our Pro-Series Reduction Nozzle is ideal for tuning your Sea Doo pump combination to maximize performance. Nozzle exit diameter can be easily changed via interchangeable ring system. Looking for more RPM or acceleration power? Insert a larger diameter ring. Want more top speed? Install a smaller diameter ring. Nozzle includes three precision-machined stainless steel rings (81/82/83mm) in graduated sizes. Additional ring sizes available.

Description	Part No.
SD RXP 215/RXP-X 255	RS23050-N
SD RXT (05-06), GTX-SC Ltd.	RS23051-N



## ADJUSTABLE EXIT NOZZLE AND NOZZLE RING KITS FOR SEA DOO 650/720/800

Our variety of interchangeable billet machined rings offer to find the maximum performance of the boat. Large ring for bottom-end acceleration and Small ring for top-end. Kit includes 83/85/87 mm rings.

Sea Doo	Part No.
Exit Nozzle with Billet Machined Nozzle Rings 83/85/87mm	54-3313



GTX 4-Tec



RXP

## R&D 2.5 DEGREE PUMP WEDGE KIT FOR SEA DOO

R&D 2.5 degree Pump Nozzle Wedge Kit will inexpensively give 4tc better handling everywhere and provide a boost of 1 to 2m mph in top speed performance. This kit works with the OEM O.P.A.S. system.

Sea Doo	Part No.
02-03 GTX 4-Tec SC / 03-05 GTX 4-Tec NA	143-95002
2.5 Degree Pump Wedge/Cable Extension Kit	
RXT/(04-05) GTX 4-Tec (185 & 215 HP Motor)	143-95004
Pump Wedge/Cable Extender Kit	
RXP Holeshoot Rod for use with R&D Auto Trim Nozzle part # 163-21502	163-21503

## GPR PERFORMANCE EXIT NOZZLE

The new R&D GPR 87mm 6 vein 5 degree Exit Nozzle is now available. The water straightening veins inside the nozzle drastically reduce cavitation and increase nozzle head pressure and velocity. The 5 degree positive angle lightens the nose and adds top speed over any other nozzle. Specifically designed to maximize performance with a 13-19 or 14-20 prop.

Description	Part No.
GP1200R/GP1300R Performance Exit Nozzle	162-13587



## R&D ULTRA 250X/LX 1 DEGREE NOZZLE WEDGE KIT

The R&D 1 Degree Reduction Nozzle Wedge Kit for the Ultra 250X/LX will add quicker acceleration and top speed performance as well as allow the bow to ride slightly higher which will significantly reduce annoying bow spray promoting a much dryer ride. Extensive testing has led our development team to wedge the reduction nozzle up 1 full degree which will inexpensively give better handling everywhere and provide a boost of up to 1 mph in top speed performance. The billet aluminum CNC machined 1 degree reduction nozzle wedge kit was specifically designed to work without compromising or removing the O.E.M. reverse gate. The R&D Pump Wedge Kit comes complete with all the necessary hardware and instructions for easy installation.

Description	Part No.
R&D Ultra 250X/LX 1° Nozzle Wedge Kit	141-25001



## RIVA RXP/RXT/GTX-SC BILLET PUMP WEDGE

2-Degree wedge trims up your pump nozzle raising the bow of your craft for less drag and more control.

Sea Doo	Part No.
RXP RXP-X, RXT, RXT-X, GTX-SC 2-Degree Pump Wedge	RS23050
RXP VTS Extension Rod	RS23050-ER



## RIVA RXP/RXP-X/RXT-X VTS EXTENSION ROD

Riva's precision-machined VTS Extension Rod allows maximum "nozzle down" adjustment after installation of RIVA Pump Wedge. Necessary on modified craft to keep bow down during initial acceleration while still providing maximum top speed advantage when trimmed up. Adjustable design comes preset for RIVA 2° Pump Wedge (part# RS23050).

Description	Part No.
RXP/RXP-X/RXT-X VTS Extension Rod	RS23050-1-ER



## RIVA TOP LOADER INTAKE GRATE



Our top-loader intake grates for the RXP and GTX 4-TEC SC feature a unique tapered wing design that eliminates prop spin and cavitation while delivering enhanced acceleration and top-speed. Deep side rails improve stability and handling. Durable black race coating protects from corrosion. Race Legal.

Sea Doo	Part No.
RXP 215	RS22050
GTX 4-TEC, GTX 4-TEC SC, RXT 215	RS22055
RXP-X 255, RXT-X 255	RS22080

Yamaha	Part No.
FX140, FXHO	RY22325
FX SHO, FX SHO CRUISER	RY22040

Kawasaki	Part No.
Ultra 250/260X, 250/260LX	RK22090



02-02-432



JD #36

## ALUMINUM PUMP SHOES FOR YAMAHA SUPERJET

Aluminum pump shoes are designed to replace the stock plastic unit which is prone to fail with a winged intake grate. These aluminum pump shoes have a completely redesigned front entrance compared to the OEM plastic pump shoe allowing water to feed into the pump more efficiently. Improves hook-up, cornering, stability, rough water speed and overall handling.

Description	Part No.
Blowson Yamaha	02-02-432
Super Jet 96+ Pump Intake Shoe	
Jet Dynamics	JD #36
Superjet 96+, OEM Replacement Aluminum Pump Ring	



TBM100-HS



TBM100

## TBM RACING SUPER SCOOP™

It's designed to enhance the handling characteristics of the SX-R and correct its one inefficiency, which is keeping the pump hooked up in hard corners. The Super Scoop™ keeps the pump loaded when the ski is on edge as is the case in hard cornering. Each intake is coated with a corrosion resistant coating.

Kawasaki	Part No.
800 SXR Super Scoop	TBM100

Hydrospace	Part No.
Hydrospace Super Scoop	TBM100-HS



## TBM RACING ULTRA 250X TUNABLE SUPER SCOOP

A fully tunable scoop grate that allows the rider an multiple handling options. The center foil has three positions or can be removed entirely. In flat water conditions you can raise the center foil to the highest position and gain .5mph. The deeper center bars and removable rear inlet chip vastly improves handling and hook up.

Description	Part No.
Ultra 250X Tunable Super Scoop	TBM100-UL



Ultra 150 (#51)

## JET DYNAMICS SHAFT SHIELDING TOP LOADER (SST)

Kawasaki	Part No.
Ultra 150	Standard (#51) 54-6500



## SCOOP GRATES FOR KAWASAKI 440/550

Hot Products offers two open style intake grates for Kawasaki 440/550. Both designed to reduce drag and turbulence as water enters the pump area. These grates also improve turning. Available standard and deep.

Sea Doo	Part No.
K440/550	Deep Polished 54-6035

FOUR STROKE	INTAKE SYSTEMS	ENGINE/GASKETS	EXHAUST	DRIVE LINE HANDLING	ELECTRICAL	WATERLINE /BILGE	STEERING & CONTROLS	BODY	ACCESSORIES	SERVICE TOOLS /HARDWARE	CHEMICAL
-------------	----------------	----------------	---------	---------------------	------------	------------------	---------------------	------	-------------	-------------------------	----------



FOUR STROKE  
INTAKE SYSTEMS  
ENGINE/GASKETS  
EXHAUST  
DRIVE LINE HANDLING  
ELECTRICAL  
WATERLINE /BILGE  
STEERING & CONTROLS  
BODY  
ACCESSORIES  
SERVICE TOOLS /HARDWARE  
CHEMICAL

Sea Doo	Part No.
ALL Sp/SPX/SPI/GT/91-96 XP/94 XPI/ 92-95 GTX/92-00 GTS/96 GTI	113-00000
HX 95-97	113-72700
HX 95-97 PRO 2	113-72710
96-97 GSX/96-97 GTX/97 GSI/97-01 GS/ 97-01 GS/97-00 GTI/98-02 GTX RFI/99-00 GSX RFI	113-80400
97-99 GSX LTD/98-99 GTX LTD/ 00-02 GTX/00-01 GTX DI/00-01 LRV/02 LRV DI XP97	113-80401
98-99 XP LTD/00-02 XP/00-02 RX/ 00-03 RX DI/RXX/03+ XP DI	113-00001
98-99 XP LTD/00-02 XP/00-02 RX/ 00-03 RX DI/RXX/03+ XP DI	113-00002
*for use with R&D Ride Plate pt# 123-80620 (Aquavein has extended tabs that lock into the R&D Ride Plate to remove stress from stock inserts).	



112-70106

**Super Jet Limited Race**

Increased pickup area of the lowered rear chip. The lowered chip area also produces down force to the nose of the craft to reduce porpoising. The R&D Stuffer #112-70203 is also compatible with this design to add 1 1/2 to 2 mph additional speed.

Yamaha	Part No.
Super Jet (96-07)	112-70102
Super Jet (96-07) Double Deep PRO 2	112-70105
Super Jet (96-07) Limited Race	112-70106
Super Jet (2008)	112-70108
GP1200R/GP1300R (single bar)	112-12100
701 & 760 WaveRds/Rds Deluxe 701/Venture 95-96	112-70300
1100 WaveRdr/Venture, 97 760 Wave Venture, 98 Venture 701	112-11300



111-80001

**Kawasaki 800SXR STEALTH**

The new R&D SXR 800 Stealth Aquavein delivers the ultimate in performance with maximum hookup, unmatched high speed stability, increased cornering (lean in angle) capabilities, and improved off-throttle braking performance.

Kawasaki	Part No.
440/550 all years	111-55100
650 SX/X2	111-65100
750 SX/SXI	111-75101
750 SXI Pro 98-02	111-75102
750/900/1100ZXI (99 only STX/pre 00-1100 STX)	111-75500
Ultra 150 All	111-15000
1200 STXR /15F Pro 2	111-12100
*for use with R&D Ride Plate #121-12001	
15F/12F/STXR/STXR DI	111-15001
*for use with stock or R&D Ride Plate pt#121-15100	
800 SXR STEALTH series	111-80001
Ultra 250X/LX (07-08), 260X/LX (09)	111-25000



113-95001  
113-95002

**Sea Doo RXP 215**

Blow through low and high-speed turns with confidence and chew up rough water conditions with new found top speed averages. Quicker acceleration and straightline stability are also increased.

Sea Doo	Part No.
98-99 XP LTD/00-02 XP/00-02 RX/00-03 RX DI/ RXX/03+ XP DI	113-00003
*for use with stock ride plate.	
01 GTS/01-05 GTI/02-05 GTI LE/ 04 GTI LE RFI/04-05GTI RFI/04-05 3D	113-00003
*for use with stock ride plate.	
02-05 GTX 4-TEC ALL MODELS	113-95000
02-03 GTX/951 DI, RXT	
RXP 215	113-95001
RXP 215 PRO 2 AQUAVEIN & GIRDLE KIT	113-95002
RXP 215 GIRDLE KIT Only	123-10010
RXP-X 255, RXT-X 255	113-95004
GTI 06-07	113-95003



112-70105

**Super Jet Double Deep**

Designed to work with the R&D Stuffer and aluminum pump shoe. See page #86 (#112-70203)

Yamaha	Part No.
GP1200 97-99, XL 700/760. XL 1200 98	112-12000
GP760/800 98-00	112-70301
XL1200 LTD/XL 800/SUV/XLT 800 & 1200	112-12001
GP1200R/GP 1300R all	112-12002
GP800R All	112-00800
FX140/FX H.O.	112-14000
VX110	112-00110
FX SHO, FX SHO CRUISER	112-18000
FZR, FZS	112-18001



112-14000

*Aquavein will significantly reduce cavitation, increase acceleration, add up to 1 mph on top end performance, and keep the H/O pump loaded and hooked up!*



115-12002  
115-12003

**Honda**

Aquavein Scoop Grate will reduce cavitation while increasing overall handling, straight-line stability and top speed performance. The R&D Aquavein will add 3 to 4 mph top speed average in choppy water conditions over the O.E.M. grate.

Honda	Part No.
R12X 1200 T2	115-12002
F12X 1200 T3	115-12003

Polaris	Part No.
All (Except 750/Hurricane)	114-65100
SL/SLT 50/Hurricane	114-75100

Hydrospace	Part No.
Hydrospace S4	116-00100

# WORX RACING COMPONENTS

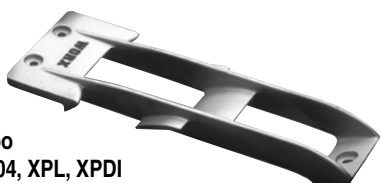

**WR211**  
Sea Doo  
XP 97-04, XPL, XPDI

The Work grate gives the pump excellent loading in all water conditions, it will not cost you speed in the calm and make a night and day difference in choppy to rough conditions.

Sea Doo	Part No.
HX, GTS 93-01, GTX 93-95, GTI 93-97	<b>WR206</b>
SP/SPI/xp 92-96/SPX 96-97	<b>WR207</b>
GS, GSI, GSX, GTI 97-01, GTX 96-97, GTX RFI	<b>WR208</b>
XP 97-04, XPL, XP DI	<b>WR211</b>

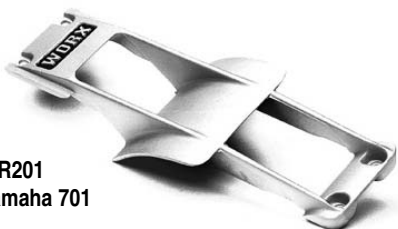

**WR201**  
Yamaha 701

Improves hook-up and turning dramatically, it is a great rough water and surf riding intake grate because the pick-up area is wide and deep. It not only loads the pump, but it also allows you to ride hard up to a turn buoy. When you come off the throttle, the grate acts like a brake to slow you into a turn.

Yamaha	Part No.
701 Super Jet (Pre 08), W/Blaster I/II	<b>WR201</b>
701 Super Jet (Pre 08) Pro Series (less aggressive than W201)	<b>WR205</b>
701 Super Jet (Pre 08) Dominator Stuffer	<b>WR205D</b>
Raider 701/760, Venture 701, GP760/800	<b>WR213</b>

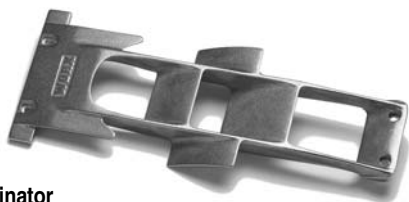

**WR225**  
Kawasaki  
800 SXR Dominator

The "NEW" WORX WR225 intake grate has twin central pickup vanes as well as the proven WORX side wings. This grate also has a wider and deeper pickup area at the back. The combined effect is more efficient pump loading in all water conditions and better hook-up and drive out of turns.

Kawasaki	Part No.
1200 STXR 00-04, STX12F 03, STX15F 04	<b>WR219</b>
800SXR 03-05	<b>WR222</b>
800 SXR 03-05 Dominator	<b>WR225</b>
Ultra 250X/LX	<b>WR227</b>

Polaris	Part No.
All (Except Hurricane/Genesis)	<b>WR210</b>
Octane 02-04	<b>WR220</b>

# WORX RACING MAXILOADER



**WR223**  
Sea Doo  
RXP 04-06

These boats hook up pretty well in the calm but really benefit from our intake grate in choppy to rough water. The worx grate will not cost you any top speed in the calm but will give you heaps better hook-up and drive in the rough and around the track for closed course racing. Similar to the WR221, this grate also has two bars running the full length of the boat that hang down and stop the back of the boat from sliding out, the centre blade of the grate does most of the work in the straights and the side wings come into play in the corners to keep the pump fully loaded and driving.

Sea Doo	Part No.
GSX LTD, GTX 98-01, GTX DI 01, GTX LTD	<b>WR212</b>
RX, GTS 01, GTI 02-04	<b>WR217</b>
GTX 4Tec 02-05, GTX Supercharged 03-04,	<b>WR221</b>
RXT/RXP 04-06 GTI,	<b>WR223</b>
GTI SE 06-08, GTI 06-08	<b>WR226</b>
RXP-X, RXT-X	<b>WR229</b>



**WR205**  
Yamaha  
701 Super jet Pro Series

This is a similar grate to the WR 201, only it is less aggressive and gives 1-2 MPH higher top speed but does not have the same braking effect that some people prefer. If you want top speed and usually ride in calmer water, this is the one for you.

Yamaha	Part No.
GP/XL1200, Raider 1100, Venture 760/1100	<b>WR214</b>
XL1200LTD, XLT 01	<b>WR216</b>
GP1200R/GP800R 00-03, GP1300R 03-04	<b>WR218</b>
FX140, FXHO	<b>WR224</b>
701 Super Jet (2008)	<b>WR228</b>
FX SHO	<b>WR233</b>
FZR, FZS	<b>WR234</b>



**WR219**  
Kawasaki  
STXR, 12F, 15F

The Worx intake grate gives a lot better hook-up in all conditions:

- No top speed loss
- Better pump loading in rough water
- Holds the boat on the water better, giving better control
- Better cornering as the Worx grate has two rails running the full length that hang down 12mm below the pump cavity and stop the boat sliding out

Kawasaki	Part No.
650 SX/X2	<b>WR202</b>
750 SX/SXI	<b>WR203</b>
750 SXI Pro	<b>WR203D</b>
440/550	<b>WR204</b>
All ZXI, STX 1100 98-99, STX 900 99	<b>WR209</b>
ULTRA 150, 130, DI	<b>WR215</b>

FOUR STROKE	INTAKE SYSTEMS	ENGINE/ GASKETS	EXHAUST	DRIVE LINE HANDLING	ELECTRICAL	WATERLINE /BILGE	STEERING & CONTROLS	BODY	ACCESSORIES	SERVICE TOOLS /HARDWARE	CHEMICAL
-------------	----------------	-----------------	---------	---------------------	------------	------------------	---------------------	------	-------------	-------------------------	----------



122-70102

### SUPERJET 96+ RUIS RIDE PLATE

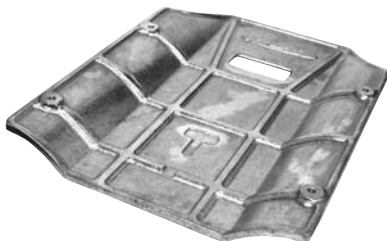

121-80000

### KAWASAKI 800SXR LIMITED RIDE PLATE

This Ride Plate features a redesigned bottom for improving straight line stability and superior cornering. The cast aluminum design offers a negative plain angle that lightens the nose for up to 1 mph speed gain.



122-13001

### YAMAHA GP1200R/ GP1300R/ GP800R RIDE PLATE TRIM PADS

The Ride Plate Trim Pad design will promote smoother and quicker planing under aggressive 0-30 mph acceleration, produce an overall more stable ride, and has proven to have better top speed averages!

Yamaha	Part No.
FX SHO/SHO Cruiser	122-18000
FZR/FZS	122-18001



122-13000

### GP1300R RIDE PLATE

The plate mounting surface has been raised and re-angled, producing quicker and more stable planing from 0-30 mph and smoother cruising at 50-60 mph. There is also more positive straight line stability and better high speed cornering.

\* Requires a slight and simple modification to the reduction nozzle.



121-80001

### KAWASAKI 800SXR PRO SERIES RIDE PLATE

This Ride Plate has a lower planing surface and an improved rear contour shape, reduced porpoising, increased high speed stability, improved traction and cornering. It also integrates with aftermarket pumps and drop nozzle systems.

Yamaha	Part No.
Super Jet 90-95	122-70100
Super Jet 96-07	122-70101
Super Jet 96-07 Ruis Ride Plate	122-70102
Superjet 08-09	122-70108
GP 760/800/1200	122-12000
GP1200R/800R speed plate	122-12001
XLL 1200, XLT1200, XL800	122-12004
GP1300R speed plate	122-13000
GPR Ride Plate Trim Pad	122-13001
FX 140 02-04	122-14000
05+ FX, FX140/ FXHO	122-16000

Sea Doo	Part No.
XP 800 97, XP-LTD 98+, RX, RXX	123-80620
3D Ride Plate	123-80621
580/650 X-Tender (except 3 seater)	123-00000
95 720/800 XP X-Tender Kit (with wings)	123-72600
96 800 XP/96-97SPX X-Tender Kit (with wings)	123-80600
96 800 XP/96-97 SPX X-Tender Plate	123-80610
95-96 720/800 XP Trim Wing (3 degrees only)	123-72621



121-25000

### R&D ULTRA 250X/LX ALUMINUM PERFORMANCE OFFSHORE RIDE PLATE

The Ultra 250X ride plate is extended 30mm and re-angled over stock to reduce porpoising while the new R&D stepper concept will add top speed.



121-15100  
121-15011



### KAWASAKI F15/F12 SPEED PLATE / OPTIONAL REVERSE GATE BRACKET

This Ride Plate improves handling and adds up to 3 mph on top end speed. Optional reverse gate hardware kit available.

Kawasaki	Part No.
750 SX/SXI 92-97 Pro Series Plate	121-75101
750/900/1100ZXI Pro Series Plate	121-75500
750SXI Pro 98-02 Pro Series Plate	121-75102
800 SXR 03-07 LTD Series Plate	121-80000
800SXR Pro Series Superstock Plate	121-80001
1200 STXR/1100	121-12000
STX DI/1200 STXF (for use with stock grate)	
1200 STXR/1100 STX DI/	121-12001
1200 STXF (for use with R&D Aquavein #111-12100	
F15/F12 Speed Plate (optional reverse gate bracket available)	121-15100
F15/F12 Reverse Gate Bracket Kit (for use with part #121-15100)	121-15011
Ultra 150, X-Tender Plate	121-15000
Ultra 250X Offshore Ride Plate	121-25000

Polaris	Part No.
650/700/750/780SL	124-00100



# WORX DOMINATOR "D" CUT-OUT RIDE PLATES

Not just for looks! The "D" cut makes a big difference in the handling in several ways.

1. It helps to hold the boat flatter in rough water and under initial acceleration, as the bow lifts the "D" cut out bites into the water pulling the boat back down which lets the pump get better hook-up and drive.
2. When you are cornering hard the "D" cut out keeps the boat more stable by allowing water to travel over the top of the plate through the cut-out.

## WORX Extended Length Ride Plates

Extended length ride plates hold the boat a lot flatter to the water and with the hard chine lines on the edges of the plate makes it a lot easier to carve those really tight turns while allowing more complete rider control.

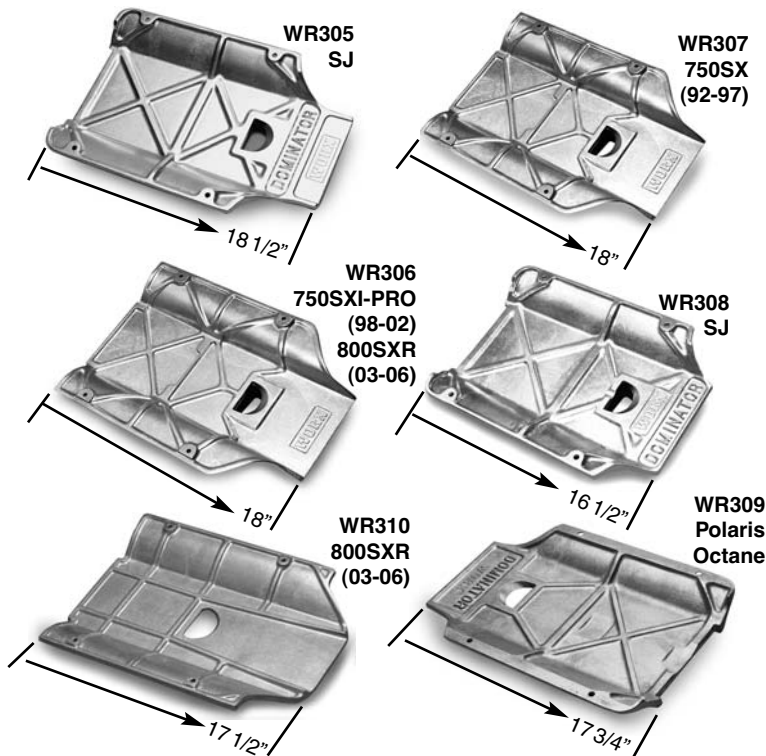

## NEW DOUBLE CONCAVE DESIGN FOR THE KAWASAKI 800SXR

Combine all three features:

1. Wider rear section
  2. Double concave
  3. The "D" cut-out
- and you have the very best ride plate for your SX-R 800 through the longest turns.

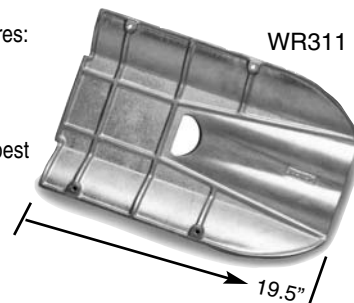

Yamaha	Length	Part No.
Wave Blaster I (93-97) & II (96-97)	16 3/4"	WR301
Super Jet Dominator, Long	18 1/2"	WR305
Super Jet Free Style, Short	16 1/2"	WR308
Super Jet (08-09)	16"	WR312

Kawasaki	Part No.
750 SXI-Pro 98-02/800SXR 03-07	18" WR306
750 SX/SX 92-97 Extended	18" WR307
800SXR 03-07	17 1/2" WR310
800SXR 03-07 - Double Concave Design	WR311

Polaris	Part No.
Octane 02-04	17 3/4" WR309



## TBM RACING

### "SIGNATURE SERIES" RIDE PLATE

Slightly longer than stock, our plate eliminates porpoising without sacrificing turning prowess. We've gone to great lengths to make our plate ideal for the Novice Stock class racer to the Seasoned Pro, inspiring the confidence to carry more speed into and out of corners.

Kawasaki	Part No.
800SXR, Powder Coated - Race	TBM123
800 SXR, Without Powder Coat - Standard	TBM123-S

Hydrospace	Part No.
Hydrospace Ride Plate	TBM123-HS

Yamaha	Part No.
SJ 96-07	TBM123-Y
SJ 08-09	TBM123-Y08

### TBM RACING KAWASAKI ULTRA 250X/LX TUNABLE RIDE PLATE

TBM's Ultra 250X ride plate is truly "Tunable" with a built in trim tab that automatically drops when you turn the handlebars. The neutral position is tunable by adjusting the trim tab linkage with a simple turn of a wrench. You no longer have to choose between a ride plate designed for top speed that doesn't turn well, or a plate that compromises speed for handling. Our plate gives you the highest top speed possible (over 2mph on a stock Ultra) with the precise handling of a Pro caliber race ski. A separate handlebar mounted trim lever override is available to activate the trim tab manually when desired. TBM Ultra 250X/LX ride plate is also available without the trim tab.

Kawasaki	Part No.
TBM Ultra 250X/LX Tunable Ride Plate	TBM123-UL
Handlebar Mounted Lever Override Kit	TBM140

FOUR STROKE  
INTAKE SYSTEMS  
ENGINE/GASKETS  
EXHAUST  
DRIVE LINE HANDLING  
ELECTRICAL  
WATERLINE /BILGE  
STEERING & CONTROLS  
BODY  
ACCESSORIES  
SERVICE TOOLS /HARDWARE  
CHEMICAL

# BLOWSION



## BLOWSION CARBON RIDE PLATE KENNEY LIP RIPPER

Designed with feedback exclusively from Joe, Taylor Curtis and Clay Cullen this is quite simply the coolest ride plate for surf shredding available.

Unique reverse "D" cutout generates wave carving turns to die for.

Yamaha	Part No.
SuperJet 96-07	02-01-245
Kawasaki	Part No.
800 SXR	02-01-209



## RIDE PLATE - CARBON 2008+ SJ RACE

Unreal. All we can say. Tested and updated for the unique 2008 SJ's. This dual channel recessed bottom design race plate is set up in full length for racing with the 2008

Super Jet. The new Riva Racing Ultra 250X/LX Performance Ride Plate design allows craft to plane faster increasing acceleration & top-speed as well as improving handling in all types of water conditions.

Description	Part No.
Blowsion Ride Plate - Carbon 2008+ SJ Race	02-01-242



## RIDE PLATE - CARBON 2008+ SJ "MIDI"

Tested and updated for the unique 2008 SJ's. This dual channel recessed bottom design race plate is set up in mid length for all around recreational and freestyle riding with the 2008 Super Jet.

Description	Part No.
Ride Plate - Carbon 2008+ SJ "Midi"	02-01-243



## BLOWSION SJ CARBON RIDE PLATE- SICKERLING WINGER

Introducing the ultimate ride plate for those who must have flat-water aerial performance, coupled with surf

freeride performance. Using his Porsche and Audi Team Racing technology, Norbert Weber, the Blowsion crew and Blowsion Team rider Marc Sickerling have created a winged ride plate design that allows rider to create a set up wake for flat-water moves, yet allows rider to remain hooked up at speed for surf launches. The channel and wing design uses Bernoulli's principle of flow to create down force and hook up when water flows through the twin tunnel and over the wing. These dramatic results are executed using different wing angles depending on rider size and weight. Each plate includes new (required) custom exit nozzle and specific mounting hardware. Fits 93-07 Super Jet. *Coming soon for the 2008+ Super Jet.*

Description	Part No.
Blowsion SJ Carbon Ride Plate- Sickerling Winger	02-01-247



54-7476 Ultra 150



54-7462 Yamaha Superjet

## JET DYNAMICS CONCAVE RIDE PLATES

U.S. PATENT NO. 335.484

Yamaha	Jet Dynamics	Part No.
701 Super Jet Extra Long	(#DD-RP)	54-7462
Kawasaki		Part No.
750 SXI Pro/800SXR Extra Long	(#TT-RP)	54-7474
Ultra 150	(#U-RP)	54-7476



## RIVA RACING ULTRA 250X/LX PERFORMANCE RIDE PLATE

The new Riva Racing Ultra

250X/LX Performance Ride Plate design allows craft to plane faster increasing acceleration & top-speed as well as improving handling in all types of water conditions.

Description	Part No.
RIVA Ultra 250X/LX Performance Ride Plate	RK21090



## MACC RACING 800 SX-R RIDE PLATE

Named "the Hooker" because no other ride plate hooks turns better. Designed and tested by The Mac himself, this is the rideplate of choice for the 800 SX-R. Specifically on Fast Limited and Superstock race boats.

Yamaha	Part No.
Macc Racing "The Hooker" Ride Plate	MR-0002



## REPLACEMENT HULL INSERTS

Replacement for damaged or missing hull inserts that hold ride plates and intake grates in place.

Description	Part No.
Repair Kit (4)	54-7900



## Yamaha R&D PUMP PLUG KIT

Pump stuffer kit stuffs up all those unwanted cavities in the pump shoe that aid in producing cavitation. Reducing cavitation equals greater performance.

Yamaha	Part No.
GP1200R, GP800R, GP1300R	162-00000
XL1200LTD, XLT800/1200	162-00001
FX140, FX140 H.O. (160 HP)	162-00002
VX110 for Stock Intake Grate Applications	162-00110
VX110 for R&D Intake Grate Applications	162-00111
FX SHO Pump Shoe Seal Kit (OEM Scoop Grate)	162-00003
FX SHO Pump Shoe Seal Kit (Riva Scoop Grate)	162-00004
FX SHO Pump Shoe Seal Kit (R&D Scoop Grate)	162-00005
FZR/FZS Pump Shoe Seal Kit (OEM Scoop Grate)	162-00006
FZR/FZS Pump Shoe Seal Kit (R&D Scoop Grate)	162-00007

Kawasaki	Part No.
750/800 Stand-up	161-80000
Ultra 250	161-25000

Honda	Part No.
R12X 1200 T2	165-00002
R12X 1200 T3	165-00003



## TBM RACING ULTRA 250X/LX REAR ADJUSTABLE SPONSONS

Introducing the TBM Racing adjustable rear sponsons for

your Kawasaki Ultra 250X or Ultra LX. Several unique design features separate our sponsons from the competition. The backing plate is a two piece design constructed of 6061 billet aluminum and allows you to adjust the sponson closer, or further away from the hull dramatically affecting the handling characteristics. The backing plates are not just a mounting pad for the sponson blade, they are designed to create lift and reduce friction once up on plane with our stepped design which increases speed and gives the blade more bite in the corners. The blades also incorporate a stepped design and have 12 different mounting positions giving you multiple adjustment positions. A race inspired billet aluminum washer prevents the sponson blade from flexing under the most extreme conditions.

Description	Part No.
Ultra 250X/LX Rear Sponsons	TBM101-UL



## TBM 800 SXR REAR SPONSONS

TBM Racing SX-R 800 Rear Sponsons are the original sponsons used by Team Kawasaki for the 2003 World Finals and throughout the 2004 season.

Kawasaki	Part No.
800 SXR	TBM101

Hydrospace	Part No.
Hydrospace Rear Sponsons	TBM101-HS

## R&D HULL INSERTS KIT FOR GPR

These inserts are fixed together by an aluminum strap to insure they do not spin upon installation or removal of the ride plate or pump shoe. Simply silicone them in place and mount the ride plate or pump shoe.

Yamaha	Part No.
GP 1200R Ride Plate Insert	122-10000
GP 1200R Pump Shoe Insert	122-10010



PRO SKI OPEN WORLD FINALS CHAMPION • ALBERTO MONTI  
2008 WORLD FINALS • LAKE HAVASU, AZ



## WAVE S.R.L. FRONT SPONSONS

New full material molding - compressed polyurethane. These front sponsons allow for faster turns, no submarining in turns, better and easier control in race conditions. Used by some of the top Pro Racers on Kawasaki SXR's and Hydrospace S4's: Alberto

Monti, Renaud Urbain, Alessia Ida, Macc, Goodchild, Bossche and many other Pro Racers.

These sponsons will change and improve the handling of the SX-R and Hydrospace dramatically! Made in Italy.

Kawasaki	Part No.
Wave S.R.L. Front Sponsons	FFS101

FOUR  
STROKE

INTAKE  
SYSTEMS

ENGINE/  
GASKETS

EXHAUST

DRIVE LINE  
HANDLING

ELECTRICAL

WATERLINE  
/BILGE

STEERING  
& CONTROLS

BODY

ACCESSORIES  
SERVICE TOOLS

HARDWARE

CHEMICAL



FOUR  
STROKE

INTAKE  
SYSTEMS

ENGINE/  
GASKETS

EXHAUST

DRIVE LINE  
HANDLING

ELECTRICAL

WATERLINE  
/BILGE

STEERING  
& CONTROLS

BODY

SERVICE TOOLS  
ACCESSORIES

/HARDWARE

CHEMICAL

## R&D G-FORCE SPONSONS

R&D designed and tested to deliver superior cornering, unmatched speed, and improved straight line stability. R&D Pro Series Sponson Kits main feature includes an ultra strong cast aluminum CNC machined backing plate, which is far superior over plastic backing plates with furniture inserts for threads! The R&D Pro Series Sponson Kits offer a adjustability, smoother more predictable ride with much better low and high speed turning capabilities!



2-position back plate (forward or backward) and 3-position (depth) sponson blade adjustability. \*(GP1300R 3-position and 6-position depth backplate)

Yamaha	Part No.
GP1200R, GP800R	122-12100
GPR1300R	122-13100
FX140/FX H.O.	122-00140



Kawasaki	Part No.
800SXR, 750 92+ Rear Sponsons	121-00800



Kawasaki	Part No.
1200 STXR/STX/STX DI	121-12100
STX-12F/15F	121-21500
Ultra 250X/LX	121-25001



2-position back plate (forward or backward) and 3-position (depth) sponson blade adjustability.

Sea Doo	Part No.
RXP/GTX-4TEC 03-04	123-95100
05 GTX, GTI/RXT/RXP 06	123-95101
RXP-X, RXT-X, GTI 06	



Yamaha	Part No.
FX SHO, FX SHO Cruiser	121-01800
FX FZR, FZS	121-01801



Honda	Part No.
R12X 1200 T2	125-21200
F12X 1200 T3	125-31200

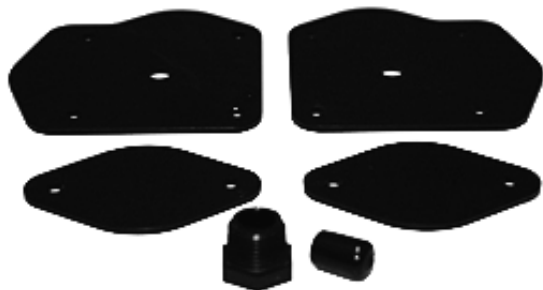

## R&D O.P.A.S. BLOCK OFF KIT

Designed for closed course competition to cover the openings left when O.P.A.S. is removed preventing water from entering the hull. Made from billet aluminum and anodized to prevent corrosion.

Description	Part No.
RXP/RXT 215, RXP-X/RXT-X 255 O.P.A.S. Block Off Kit	123-95002



## R&D O.P.A.S. RECREATIONAL OFFSHORE KIT

The R&D O.P.A.S. offshore kit was designed and developed for those who ride in extreme rough water or ocean conditions and want to stop the Sea-Doo O.P.A.S. system from dropping down while the hull or pump is out of the water! The R&D O.P.A.S. offshore kit is designed to hold the

O.P.A.S. system open or constantly in the up position to improve safety and handling in rough water conditions! When the O.P.A.S. system is held in the up position, the O.P.A.S. directional fins function exactly as stock (i.e. the fins still function to steer the craft)! The R&D O.P.A.S. kit is a must have part for offshore racing use! Also, if your O.P.A.S. system's water lines or passages are clogged with debris or sand, the O.P.A.S. system will not work properly and will stay in the down position until repairs are made. The R&D O.P.A.S. kit can be installed or removed very easily in minutes. Install the R&D O.P.A.S. kit today and never worry about a clogged, disfunctioning O.P.A.S. system again!

NOTE: R&D Performance strongly suggests that periodic maintenance should include checking for proper operation of the O.P.A.S. system! The R&D O.P.A.S. kit is a great addition to your OEM tool pouch for occasions where the O.P.A.S. system is not functioning! Installation of the R&D O.P.A.S. kit will get you up and away quickly and safely!

Pt. # 123-95000 2003 Models Only

Description	Part No.
GTX 4-TEC 2003 O.P.A.S. Recreational/Offshore	123-95000





# RIVA RACING SPONSONS



**RY2620-1  
GP1200R**

**Yamaha**  
GP800R/GP1200R/GP1300R

**Part No.**  
**RY2620-1**



**Kawasaki**  
STX-12-F/15F Pro Series  
Ultra 250X/LX Pro Series

**Part No.**  
**RK26085**  
**RK26090**



**Sea Doo**  
RXP/RXP-X/RXT/RXT-X/GTX

**Part No.**  
**RS26050**



## RIVA YAMAHA FX-SHO/FZR/FZS/VX SPONSON KIT

Unique blade design provides a significant improvement to the handling characteristics. Reduces rough water hunting and rolling sometimes experienced with stock sponsons. Sponson depth is adjustable to control the amount of influence they have on craft. Easily installs to stock mounting points with our bullet-proof mounting system that features billet inserts in sponson fins. Fits all Yamaha FX-SHO, FZR, FZS & VX models.

**Description**  
Riva Yamaha FX-SHO/FZR/FZS/VX Sponsons Kit

**Part No.**  
**RY2625**



## O.P.A.S. PERFORMANCE BLOCK-OFF KIT

Improves handling characteristics for competition use. Necessary to accommodate Riva Rear Exhaust Kit (RS15050-1). Also designed to cleanly and easily cover the openings left when O.P.A.S. is removed preventing water from entering the hull. Made from billet aluminum utilizing o-ring seals. Anodized to prevent corrosion.

**Description**  
SD RXP/RXT/GTX 03 and newer models

**Part No.**  
**RS29050-1**



## RXP PRO-SERIES OPAS BLOCK-OFF KIT

Optimizes RXP's handling characteristics. Extensions fill voids dramatically improving handling and reducing porpoising. For competition use only.

**Sea Doo**  
RXP/RXP-X/GTX 03  
RXT/RXT-X

**Part No.**  
**RS29950**  
**RS29985**



KAWASAKI ULTRA 250X  
ANGELO BERTOZZI - ITALY

FOUR STROKE
INTAKE SYSTEMS
ENGINE/GASKETS
EXHAUST
DRIVE LINE HANDLING
ELECTRICAL
WATERLINE /BILGE
STEERING & CONTROLS
BODY
ACCESSORIES
SERVICE TOOLS /HARDWARE
CHEMICAL

# WORX

## RACING COMPONENTS

Fitting WORX sponsors to your PWC is like fitting extra wide tires to your road car. Unbelievable cornering, better control in the rough and predictable inline tracking while towing wakeboards or waterskiers. WORX sponsors are easy to fit, look great and bolt right into stock mounting holes.

### WORX SPONSORS

Sea Doo	Part No.
GS, GSI, GSX, GSX LTD, GSX RFI	WR505
HX All	WR506
SP 92-96, SPI, XP, SPX 96-97 Pro Race	WR510
XP 97-04, XP LTD, XP DI, 3D	WR515
GTX 97-01, GTX LTD, GTX RFI, GTI 96-01	WR517
GTX 93-95, GTS 96-01	WR518
ALL RX, RXX, RX DI	WR521
GTX 4Tec 02-04, GTX S/C 03-04, RXP 04	WR526
GTI 06+, GTX, RXP, RXP-X, RXT, RXT-X	WR534
RXP-X, RXT-X Professional Series	WR540
Less Aggressive than WR534	
Polaris	Part No.
All except Hurricane SLX/Pro, Genesis, MSX	WR509
All SLX 785 Pro	WR516
Honda	Part No.
R-12, R-12X	WR530
F-12, F-12X, F-12 GP Scape	WR531
R-15X 2009	WR541



WR515



WR533



WR527



WR534

Yamaha	Part No.
Wave Raider (all)	WR507
GP760/800/1200	WR511
Wave Venture 96-98, XL1200 98, XL700/760 98-03	WR514
XL1200 LTD 99-00, XL800 00-01	WR520
GP800R/GP1200R 00-04, GP1300R 03-04	WR522
XLT1200 01-03, XL800 02-03	WR524
FX 140, FX 140 H.O., FX160, VX110	WR529
GP1300R 2005	WR533

Kawasaki	Part No.
ZXI 750/900/1100 (all)	WR508
750/900 STX 99, 1100 STX 98-99	WR513
Ultra 150, 130 DI	WR519
STX 1100 00 & up	WR523
1200 STXR All	WR525
STX 900/1100 DI, STX 12F/15F	WR527
800 SXR All, 750SX, 750 SXI, 750 SXI Pro	WR528
Ultra 250X/LX	WR536

## BLOWSION



### BLOWSION TUBBIE SPONSORS

This Race Model Tubbie Two (Part # AWC0213) grips better in turning and is more stable in straight line high speed riding. The Rec/Freeride model (Part#AWC0212) is very stable, but has some nose wandering at mid throttle due to the curved chine riding back and forth on the bow wave. This is very beneficial in freeriding as the ski is able to be more forgiving and reacts better to a variety of directions and water flow angles.

Description	Part No.
A. Tubbie 1 – Rec-Surf-Freeride-Freestyle	02-01-002
B. Tubbie 2 – Race/Rec Model Only	02-01-003
Tubbie 3 - Race (08-09 Superjet)	02-01-004
Tubbie 3 - Freeride (08-09 Superjet)	02-01-005

### BLOWSION TUBBIE DESTROYER SPONSORS

New removable Tubbie Destroyer front sporsors from Blowsion. They are composite front and back (not foam backed) and built specifically shaped to each model of standup we offer them for. They are a 3 bolt ten minute a side install. No more time-consuming installs permanent screws and glue like the Tubbie I, II, and III. Patent Pending

Destroyer Front Sporsors	Part No.
C. Kawasaki SX-R & Hydrospace	02-01-010
D. 2008-09 Yamaha Superjet	02-01-012
1996-07 Yamaha Superjet	02-01-013

Sea Doo	6 A.M. SPONSONS	Color
BH101-B	SPX 94-99, SP/SPI 93-98, XP 93-96	Black
BH102-B	GT/GTI 92-96, GTS 94-00, GTX 94-95	Black
BH102-W	GT/GTI 92-96, GTS 94-00, GTX 94-95	White
BH104-B	XP/XPL 97-02	Black
BH105-W	GTXL, GTX DI 01, GTX RFI 98-02, GTX 96-02 (not 4-Tec), GTI, GTI LE 97-01	White
BH106-B	RX, RX DI, RXX	Black
Yamaha	6 A.M. SPONSONS	Color
BH205-B	XLT1200L 01-early 02, XL/XLT 800 01-early 02	Black
Polaris	6 A.M. SPONSONS	Color
BH402-B	Pro 785 99-01, SLX Pro 98/SL785 Pro 97, Pro 1200 -01	Black

Kawasaki	6 A.M. SPONSONS	Color
BH301-W	STX750 97-98, XI 95-99, XIR 94-95, STS 96-97	White
BH302-B	ZXI 95-97, STX1100 97-99, STX750 99	Black
BH303-W	900STS 01-02, 900STX 97-00, 1100ZXI 98-02	White
BH304-B	Ultra150 99-02, Ultra130 DI 02	Black
BH305-W	STX900 01-02, STX1100 DI 00-02, 12F 03-06, 15F 03-06	White
BH306-W	STX-R 02-05	White
Tigershark	6 A.M. SPONSONS	Color
BH502-B	TS770R 99, TS100R 99	Black
BH502-W	TS770R 99, TS100R 99	White

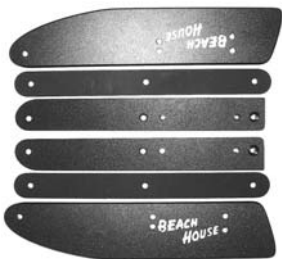

BH104-B

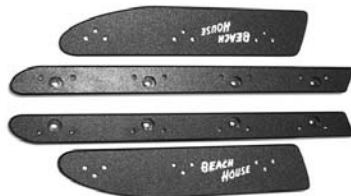

BH304-B

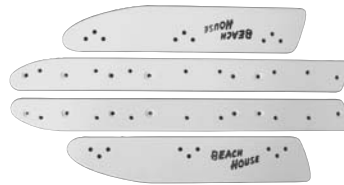

BH306-W



### BEACH HOUSE LARGE WASHER



Developed to assist in preventing cracking or sponson failure by distributing the extreme pressure to a larger surface area developed when cornering. The washers are compatible with all model sponsons made by Beachhouse and the other manufacturers.

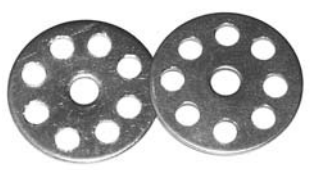

Description	Part No.
Stainless Steel Large Washer (Sold individually)	<b>NO1</b> * Sold Each. Thickness 1.5 mm



Drilling Required

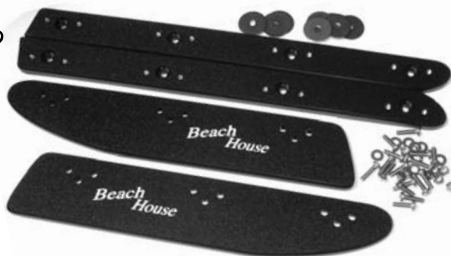

### STIX BEACH HOUSE SPONSONS

Designed by racers and made for racing. Installation does not use the OEM mounting holes if applicable and requires drilling of new mounting holes.

Yamaha	Part No.
GP760/800/1200 97-00	SX202-W (White)
Pro Slalom Series With Short Face Plates*	SX202-B (Black)

These sponsons perform the best in smooth water conditions

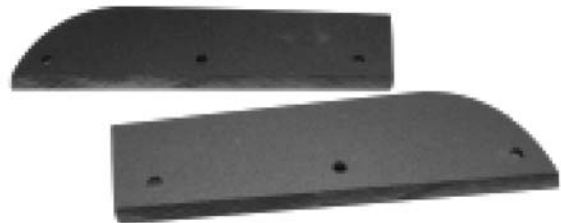

### TRIM TABS FOR SEA DOO

- No more porpoising. • Super lightweight but durable.
- Slightly textured for optimum water flow.

Sea Doo	Part No.
XP 96, SPX 97-99	BH-901

FOUR STROKE	INTAKE SYSTEMS	ENGINE/GASKETS	EXHAUST	DRIVE LINE HANDLING	ELECTRICAL	WATERLINE /BILGE	STEERING & CONTROLS	BODY	ACCESSORIES	SERVICE TOOLS /HARDWARE	CHEMICAL
-------------	----------------	----------------	---------	---------------------	------------	------------------	---------------------	------	-------------	-------------------------	----------

# DRIVELINE PARTS FOR SEA DOO



A.



B.

## SEAL HOUSING CARRIER

Sea Doo	Part No.
A. 580/650 All OEM#272-000-024	003-115
B. 720/800 All OEM#272-000-012	003-116



SEA DOO DRIVESHAFT SEAL



## PUMP HOUSING BEARINGS AND SEALS FOR SEA DOO

Sea Doo	Description	OEM No.	Part No.
All Models	PTO/Front Seal	293-200-025	009-730
All Models	Driveshaft/Rear Seal	293-200-012	009-730
580/650/720 All	All Seal Carrier Bearing	293-350-007	54-3135



C.



D.

## SEAL CARRIER COMPLETE ASSEMBLIES

Comes with bearings and seals installed.

Sea Doo	Part No.
C. 560/650 All	003-115-01
D. 720/800 All	003-116-01

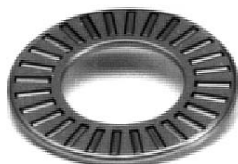

SEA DOO THRUST BEARINGS



## PUMP HOUSING BEARINGS AND SEALS

Sea Doo	Description	OEM No.	Part No.
580/650/720/800	Pump Seal	293-200-025	009-730
580/650/720/800	Pump Shaft Needle Bearings	293-350-001	54-3130
580/650/951 (1997)	Thrust Bearings	293-350-002	010-228-01
720/800/951 (98-01)	Thrust Bearings	293-350-019	010-228-02
951 Late	Thrust Bearings	213-350-022	010-228-03
580/650	Pump Seal & Bearings Repair Kit		003-640
720/800	Pump Seal & Bearings Repair Kit		003-641
580/650/720/800	Pump O-Ring	293-300-011	008-641
		293-300-013	008-642



## SEA DOO COUPLER RETAINER

Hot Products precision machined thermal fit coupler retainer, holds coupler in casing and prevents shaft damage.

Sea Doo	Coupler	Part No.
HX 96+	Front	54-1152
XP 97	Front/Rear	54-1152



## CARBONE RING

Sea Doo	Part No.
720 HX 95, All Models 96-97 OEM#272-000-042	003-110



## THRU HULL REPAIR FITTING FOR SEA DOO IMPELLER SHAFT



54-3140

## REPLACEMENT PUMPSHAFT

Sea Doo	Description	Part No.
580/650/720/800	271-000-291	54-3140
951 97-98	271-000-886	003-108
951 99-01*	271-000-965	003-111

\*033-111 Length=5 3/4" Thread O.D.=11/16"  
Uses Larger I.D. Thrust Washer  
(010-228-03)



## IMPELLER SHAFT THRUST WASHER

Sea Doo	Part No.	Sea Doo	Part No.
580/650/720 All OEM#293-350-003	003-099	All Models OEM#292-000-075	011-112





003-500



003-503

### REPLACEMENT PUMP WEAR RINGS

Sea Doo	Part No.
580/650/720/800 Wear Ring OEM# 271-000-291	<b>003-500</b>
951 98+ OEM# 271-000-563	<b>003-503</b>
4-Tec/4-Tec SC OEM#267-000-104 (155 mm)	<b>003-502</b>
RXP/RXT OEM#267-000-105 (159 mm)	<b>003-499</b>



### RIVA RXP/RXT SS REPLACEMENT WEAR RING

Replaces original plastic unit with easy press in installation. Durable stainless steel resists debris damage and saltwater corrosion.  
.159mm SRX Series

Sea Doo	Part No.
Replacement Wear Ring	<b>RS33-159-SRX</b>



### PUMP WEAR RING WITH STAINLESS SLEEVE

Sea Doo	Part No.
2-Stroke before '98 Sea Doo 580/650/720/800	<b>003-500S</b>
4-Tec/SC (155 mm)	<b>003-502S</b>
RXP/RXT (159 mm)	<b>003-499S</b>



003-125-02



003-129

### SEA DOO PTO ENDS

Sea Doo	Part No.
Lightweight 580/650/720	<b>003-125-02</b>
951	<b>003-129</b>



### DRIVE SHAFT BOOT

Sea Doo	Part No.
720HX 95, All Models 96-97 OEM#272-000-041	<b>003-105</b>
580/650 All to 95	<b>003-102</b>
GTX 4-Tec, RXT OEM# 272-000-183	<b>003-104</b>
GTI/GTX 02-05, RX 02-03, 3D RFI 05-06	<b>003-104-01</b>
OEM# 272-000-184	



### DRIVE SHAFT BUMPERS

Sea Doo	Part No.
560/650/720 All (sold in pairs) OEM#292-000-019	<b>003-350</b>



### PTO BOOT

Sea Doo	Part No.
All Models OEM#272-000-001	<b>003-100</b>



003-152



003-154



003-159



003-163



003-168



### REPLACEMENT DRIVE SHAFTS FOR SEA DOO

Sea Doo	Year	OEM#	Part No.
580 GTS, SP, SPI, 720 GTI, GTS	96	272-000-073	<b>003-154</b>
720 SP	97	272-000-073	<b>003-154</b>
720 SPX	96	272-000-073	<b>003-154</b>
800 GSX	96-97	272-000-096	<b>003-152</b>
800 GSX (RFI)	99-01	272-000-096	<b>003-152</b>
800 SPX	97	272-000-096	<b>003-152</b>
800 XP	96	272-000-096	<b>003-152</b>
800 XP	97	272-000-009	<b>003-163</b>
951 GTX LTD	98-99	272-000-160	<b>003-168</b>
951 GTX, GTX DI, LRV	00-01	272-000-160	<b>003-168</b>
951 RX, RX DI	00-01	272-000-151	<b>003-159</b>

FOUR STROKE
INTAKE SYSTEMS
ENGINE/GASKETS
EXHAUST
DRIVE LINE HANDLING
ELECTRICAL
WATERLINE /BILGE
STEERING & CONTROLS
BODY
ACCESSORIES
SERVICE TOOLS /HARDWARE
CHEMICAL



## DRIVE LINE PARTS FOR YAMAHA



Yamaha	Part No.
650 Super Jet 90-93	003-507
650 VXR 91-95	003-507
701 Super Jet 95-01	003-507
701 Wave Blaster 93-96	003-507
650 Wave Runner 92-93, 96	003-506
701 Wave Runner III GP 94-95	003-506
701 Wave Raider 94-97	003-506
701 Wave Raider DX 95	003-506
701 Wave Runner III 97	003-506

Yamaha	Part No.
701 Wave Venture 95-96	003-506
760 GP 97-00	003-506
760 Wave Raider 96	003-506
800 GP 98-00	003-506
701 Wave Venture 98	003-505
701 Wave Venture XL 99-01	003-505
760 Wave Venture 97	003-505
800 GP 01	003-508
800 XL 00-01	003-508
1100 Wave Venture 96-97	003-505
1100 Wave Raider 95-96	003-505
1200 GP 97-99	003-505
1200 GP 00-01	003-508
1200 SUV 99-01	003-508
1200 XL 98	003-505
1200 XL 99-01	003-508

Replacement Rings (sold each)	Part No.
Fits 003-506 and 003-507 (144mm)	003-521
Fits 003-505 (155mm)	003-520
Fits 003-508	003-522



003-250



003-251



DS# 61-5

DS# 60-3

## YAMAHA COUPLER SHAFT

## DRIVE COUPLER WRENCH

## BILLET DRIVE COUPLER SET

Yamaha	Part No.
A. ADA All Yamaha (except 63M/66E/66V) "Kawasaki Dampener Type"	34-700190
A. R&D Yamaha Coupler "Kawasaki Dampener Type"	612-70300
B. GP1200R, XLL1200	612-12000

Yamaha	Part No.
650 SJ, VXR 9109	003-250
701 Blaster 93-96, 650 WR III	003-250
701 SJ 95-03, 701 VXR 93-94	003-250
701 Venture 95-96, 98	003-251
701 XL 99, 01	003-251
760 Venture 97	003-251
760 XL 98-00	003-251

Yamaha	Part No.
144mm Pump	DS#60-3
155mm Pump	DS#61-5



## REPLACEMENT DRIVE SHAFTS FOR YAMAHA



003-170



003-174



003-175



003-178

Yamaha	Year	OEM#	Part No.
650 SJ	90-93	6R7-45511-01-00	003-170
701 Raider/Wave Runner III	94-97	6R8-45511-00-00	003-174
701 SJ	96-06	6R7-45511-01-00	003-170
701 Wave Venture	95-96	6R8-45511-00-00	003-174
701 Wave Venture	98	65R-45511-00-00	003-175
701 XL	99-04	65R-45511-00-00	003-175
760 Wave Raider	96	6R8-45511-00-00	003-174
760 Wave Venture	97	65R-45511-00-00	003-175
760 XL	98	65R-45511-00-00	003-175
800 XL	00-01	66V-45511-00-00	003-178
1200 GP	00-01	66V-45511-00-00	003-178
1200 SUV	99-01	66V-45511-00-00	003-178
1200 XL	99-00	66V-45511-00-00	003-178
1300GP	03-04	66V-45511-00-00	003-178
1300SUV	03-04	66V-45511-00-00	003-178

# SHAFT HOUSING BEARINGS AND SEALS FOR KAWASAKI



003-107



003-109



550SX, 650SX, 750SX, 900ZXI, 1100ZXI

## REPLACEMENT PUMPSHAFT

Kawasaki	OEM No.	Part No.
All 650 (Except ZXI)	13107-3721	<b>003-107</b>
750/900/1100 ZXI 12F/15F/900STX/STXR	13107-3737	<b>003-109</b>

## SHAFT HOUSE BEARINGS AND SEALS FOR KAWASAKI

Kawasaki	Description	OEM No.	Part No.
440/550-90	Driveshaft Seal (4pieces/pk)	92050-501	<b>54-3203</b>
440/550-90	Driveshaft Bearings		<b>54-3103</b>
440/550-90	Driveshaft Seal & Bearings Repair Kit		<b>54-3003</b>
550SX 91-95	Driveshaft Seal		<b>54-3227</b>
650/750/900/1100 All			
550SX 91-95	Driveshaft Bearings		<b>54-3127</b>
650/750/900/1100 All			
550SX 91-95	Driveshaft Seal & Bearings Repair Kit		<b>54-3027</b>
650/750/900/1100 All			
440	Pump Seal Kit	92050-502/503	<b>54-9203</b>
750/800	Jet Pump Repair Kit		<b>54-8000</b>

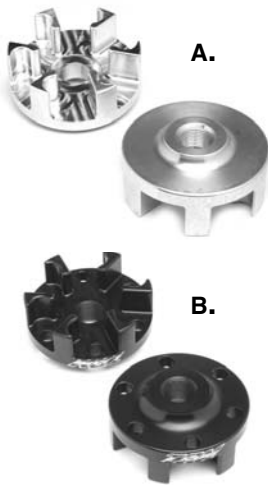

## BILLET DRIVE COUPLER SET

Kawasaki	Part No.
A. 750SS 94-97, XI 93-97, ZXI 95-97 SXI 95-97, 800SXR	<b>KA800DCS</b>
B. TBM 800SXR Light Weight	<b>TBM103</b>
STXR/Ultra 150/STX/12F/15F	<b>611-12000</b>



**WSM OEM REPLACEMENT  
DRIVE SHAFTS  
FOR KAWASAKI PWC**



003-405

## DRIVE SHAFT BEARING HOUSING

Kawasaki	Part No.
Driveshaft Beating Housing only for 550SX 91-95, 650/750/900/1100/All	OEM# 13280-3730 <b>003-405</b>
Complete Assembly with Bearing for 550SX 91-95, 650/750/900/1100/All	<b>003-405-01</b>



003-161-01



003-161-02

Kawasaki	Year	OEM#	Part No.
750 SS	94-97	39159-3717	<b>003-161-01</b>
750 SSXI	93-97	39159-3717	<b>003-161-01</b>
750 ST	94-95	39159-3717	<b>003-161-01</b>
750 STS	95-97	39159-3717	<b>003-161-01</b>
750 XI Sport	98-99	39159-3717	<b>003-161-01</b>
900 STS	00-01	39159-3732	<b>003-161-02</b>
900 STX	02-06	39159-3732	<b>003-161-02</b>
1100 STX DI	00-03	39159-3732	<b>003-101-02</b>
1200 STXR	02-05	39159-3732	<b>003-101-02</b>

FOUR STROKE  
INTAKE SYSTEMS  
ENGINE/GASKETS  
EXHAUST  
DRIVE LINE HANDLING  
ELECTRICAL  
WATERLINE /BILGE  
STEERING & CONTROLS  
BODY  
ACCESSORIES  
SERVICE TOOLS /HARDWARE  
CHEMICAL

# MSD<sup>TM</sup> POWERSPORTS



## MULTI-CHANNEL RACING IGNITION SYSTEMS

Precise ignition timing is essential to produce maximum horsepower. However, one timing setting is not ideal for an engine's entire rpm range. The dynamics of air and fuel flow into the engine as well as the speed that the piston travels through the combustion stroke all affect the ideal timing setting. Fortunately, the Programmable MSD Ignition lets you tune in a custom timing curve to match your engine's requirements.

There are three settings that you program to create a timing curve. First you set where you want the initial timing, or idle timing. Next you set the rpm

point to begin the curve, followed by the amount you want it to retard (up to 30°) through the high rpm limit. All the adjustments are made with dip switches built into the ignition.

This Ignition delivers a powerful capacitive discharge spark from idle to top end. This improved output results in complete combustion for performance through the entire rpm range of your engine.

Kit Part No.	Description	Ignition Unit	Trigger Plates	Trigger(s)	Coil (w/Bracket)	Wire Set	Flywheel/Magnet Wheels
42460	Sea Doo 951 Total Loss	42351	43283	(2) 4316	(2) 42921	31009	*43232
42380	Yamaha 650/701/760 Total Loss	42351	4311	(2) 4316	(2) 42921	31009	43032
42410	Yamaha 800	42351	43114	(2) 43161	(2) 42921	31009	43035
42350	Yamaha 1200 Powervalve	42351	43115	(3) 43161	(3) 42921	31039	43035
42370	Kawasaki 650/750 Total Loss	42351	43122	(2) 4316	(2) 42921	31009	43022
42351	Multi Channel Ignition Unit Only (Replacement Ignition Unit)						

\* Magnet Wheel Only. Utilize OEM Flywheel.

### 1-REV CONTROL

The MSD's adjustable rev limiter allows you to program an rpm limit that the engine will not rev past. This is a great feature that will save your engine from over rev damage caused by parts failure or if the craft's drive mechanism comes out of the water. When your limit is reached, the ignitions adjusts the spark output quickly to stay below the rpm. This produces a smooth rev limiting action.

### 2-HOLESHOT

Thanks to the rev limiting circuit of the Ignition, MSD engineers developed a feature that will give you great holeshots. By installing a handlebar operated switch, you can activate a lower rpm limit that will hold an engine under 3,000 rpm. This way you can hold the throttle wide open and concentrate on the rubberband snapping. When it does, you release the button, the engine revs to full power and you launch out in front! (See page 107. Hole shot control switch)

### 3-EASY STARTS

When you increase the compression ratio of your engine, it also puts more presume on your starter to crank the engine over. The MSD Programmable Ignition has two features that can help ease cranking pressure and improve the start up of our watercraft.

**Retard:** When activated, this feature retards the timing 20° to ease cranking. When the engine starts, the timing returns to the initial setting.

**Delay for Electric Starters:** When activated, this mode will not produce a spark for the first several rotations of the engine. This helps build momentum in the engine, resulting in easier starting.



One of the advantages of the MSD Multi-Channel Ignition system is the individual trigger pickups for each cylinder. This way you can make up for the variations in fuel flow dynamics to each cylinder, exhaust characteristics or carb synchronization by altering the timing of each cylinder,

### MSD TRIGGER PICKUP PLATE

Description	Part No.
Sea Doo 800	43281
Sea Doo 951	43283
Sea Doo 800/951 Magnet Ring	43232
Yamaha 650/701/760	4311
Yamaha 800	43114
Yamaha 1200 Powervalve	43115
Kawasaki 650/750	43122

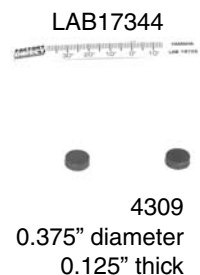

### MSD TOTAL LOSS PICK UP

Description	Part No.
Pick Up Total Loss Universal	4316
Pick Up Yamaha 800/1100/1200	43161
Pick Up Shim Kit	4318
Timing Tape, Sea Doo	LAB17344
Timing Tape, Yamaha 1200/800	LAB19722
Magnets, Round 2 pcs/set	4309

# MSD<sup>TM</sup> POWERSPORTS



## MSD COILS

Description	Part No.
A. Single Tower Pro Coil	42921
B. Stock Improved Coil for start-up	4294



## Mini Stripper-Crimper

Designed to be in a vise and with a single-edge razor blade to strip spark plug wires without damaging the core and to crimp a terminal. Inexpensive too!

Description	Part No.
Mini Stripper-Crimper	3503

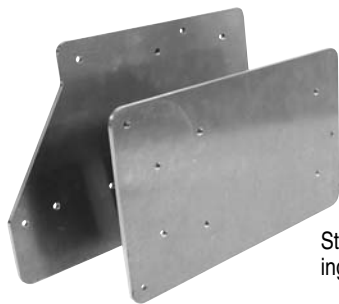

## MOUNTING BRACKETS

Sturdy aluminum brackets with mounting holes for MSD Ignitions!

Description	Part No.
Yamaha 650/701	4396

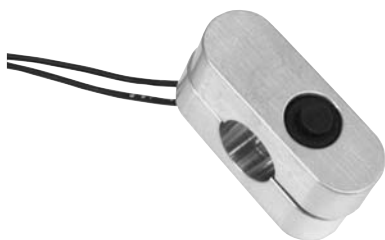

## HOLESHOT CONTROL SWITCH

This is a momentary push-button switch encased in a CNC machined aluminum housing that clamps around the handle bar. It comes with a 6-foot wire harness that should reach almost anywhere on your watercraft. Use this switch to activate any MSD feature.

Description	Part No.
Holeshot Control Switch	4372



## 8.5MM SUPER CONDUCTOR SPARK PLUG WIRE

Spark plug wires have two main objectives; transfer the spark energy and suppress the Electro Magnetic interference (EMI) that the spark voltage creates. The MSD 8.5mm Super conductor delivers the best of both worlds. MSD uses a special copper conductor keeping resistance under 50 ohms per foot! Even with this low resistance, the wire retains high EMI suppression capabilities. By wrapping the conductor tightly around a ferro-magnetic impregnated center core and EMI choke is created, keeping any interference inside the wire.

Description	Part No.
Two Cylinder Wire Set	31009
One Cylinder Wire Set	31019
Three Cylinder Wire Set	31039
Bulk Wire 25 feet - Red	34019
Bulk Wire 25 feet - Black	34013



## MSD SPARK PLUG BOOT RETAINERS

There's no excuse for losing a race due to a plug wire popping off when you run MSD's Boot Retainers. These handy clamps are molded from heat resistant nylon material and will lock the boot to the spark plug.

Description	Part No.
A. Boot Retainer, 90° Spark Plug Boots & Terminal	3340
B. 90° Spark Plug Boots & Terminal Only (2 pcs.)	3311



## DUAL WIRE SEPARATORS

These handy separators will secure two wires and keep them away from the exhaust or moving parts. Each wire can be moved easily and clipped right back in! Sold in a pack of 16.

Description	Part No.
Dual Wire Separator (pack of 16)	8841

FOUR  
STROKE  
INTAKE  
SYSTEMS  
ENGINE/  
GASKETS  
EXHAUST  
DRIVE LINE  
HANDLING  
ELECTRICAL  
WATERLINE  
/BILGE  
STEERING  
& CONTROLS  
BODY  
ACCESSORIES  
SERVICE TOOLS  
/HARDWARE  
CHEMICAL

# MSD™ POWERSPORTS



4253

## YAMAHA 650/701 ENHANCER

At lower rpm you'll notice incredible acceleration and throttle response due to advancing the timing. Then as the rpm increases, the timing is retarded to the factory setting to prevent detonation and engine damage. For racers, there is also a lower rpm limit that you can activate for quick and consistent holeshots. By activating a switch (see page 95) mounted on the handle bar the rpm will limit at approximately 3,000 rpm. The instant the button is released, the rpm revs up just as normal and you rocket off. Everything you need to install the Yamaha Enhancer is supplied along with factory connectors for a direct plug-in installation!

*Not compatible with Yamaha 760 engine applications.*

Description	Part No.
Yamaha 650/701	4253



4251

## KAWASAKI 750 ENHANCER

There are two versions of the Kawasaki 750 Enhancer. Both models feature the increased spark energy you expect from MSD plus they have an adjustable rev limiter and holeshot rpm limit. The rev limit is adjusted with a potential on the back of the ignition housing. The holeshot feature lets you activate a lower rpm limit that is best to use for quick starts at the beginning of a race. Also, these ignitions can be connected to the factory overheat sensor. With this feature, if the water temperature gets too high, the Enhancer will limit the rpm to a safe value to avoid any engine damage. Note: Enhancer will not work on 1996Zxi.

Description	Part No.
Kawasaki 750 SS/XI/XIR	4250
Kawasaki 750 SX/SXI/95ZXI	4251

## ENHANCER IGNITIONS

Each Enhancer is a direct plug in unit and is designed to fit in the stock location. The Enhancer Ignition gives the racer an edge due to the powerful spark energy and adjustable rev-limiter. The Enhancer Ignitions produce a much more powerful spark, as much as four times more spark energy, to insure complete combustion of the fuel mixture. This complete combustion results in improved performance including quick throttle response, improved pulling power and top end, plus will reduce spark plug fouling. Whether your watercraft is stock or if you've added other modifications such as a better flowing intake or exhaust modifications, the Enhance ignitions will improve the performance.



4255

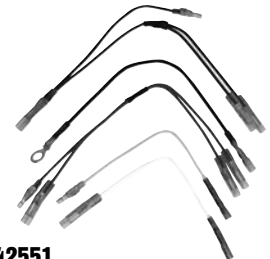

42551

## SEA-DOO 800 ENHANCER

The Enhance Ignition for the Sea Doo® 800 (also the '95, '96, XP and GSX) uses a high speed RISC microprocessor to control all of the timer and rev limiter functions. This opens the door for programming, giving you the ability to set two rev limits and a timing curve through a series of dip switches built into the Enhancer. Being able to control the ignition curve lets you match the timing specifically to your engine and its modifications. The Digital Enhancer produces a series of sparks through 3,000 rpm rather than just a single spark. This feature delivers incredible throttle response, acceleration and keeps the idle clean and smooth. Note: This modification will eliminate the factory DSS security system and the handlebar kill feature.

Description	Part No.
Sea Doo 800 '95-96	4255
Sea Doo 800 '97-98 SPX, GTX	42551
Harness Only	



## TIMING ADVANCE PLATE

The timing advance plate is recommended for all Kawasaki 750 engines running the Enhancer Ignition. This plate advances the timing 7° for a boost in low to mid range performance. Note: If you are running excessive compression or low octane fuel it is recommended that you run the retard module listed. Must be used with PN 4251 on SXi, XiR, and ZXi.

Description	Part No.
Timing Advance Plate for Kawasaki	4332



## ENHANCER RETARD MODULE

The Enhancer Retard Module is designed to retard the timing of the Enhancer Ignition by 5°. On racing and high performance engines with extremely high compression using the Enhancer and Timing Advance Plate, this module is recommended.

Description	Part No.
Enhancer Retard Module for Kawasaki	4331



42590



7550

## PROGRAMMABLE PULSE WIDTH MODULATED WATER INJECTION

Stock and performance exhaust systems are designed for maximum power at a specific rpm. It's not really something you can change during a race, and we know that compromises power at other rpm. Racers don't like to compromise, so MSD offers a new Programmable Water Injection system so you can tune your exhaust to match any rpm!

By injecting water into the exhaust chamber at lower rpm, the density of the exhaust pulse is increased, which slows it down. This has the same effect as lengthening the chamber to increase low to mid-range torque and power! The Programmable Water Injection system uses MSD's Pro-Data+ Windows based software so you can easily program how much water and at what RPM it gets injected into the pipe. The programming features allow you to inject water from 0 to 100 percent anywhere from 500 rpm to 12,000 rpm.

The kit comes complete with spray nozzles, solenoid, heat resistant hose, programmable controller and software.

Description	Part No.
Programmable Water Injection Control System	42590
Water Injection Solenoid Only	M4340
Hand held Programmer/Monitor	7550



## MSD EXTERNAL STARTER RELAY

This 12 volt relay is a heavy duty unit designed to mount outside the electrical box. It's made with material that locks out moisture and chemicals. The large copper terminals assure good solid contact with your wiring. The stainless steel base plate allows the relay to be mounted in any position. Rated at 65 amps.

Description	Part No.
MSD External Starter Relay	M4390



## MSD TIMING LIGHT

MSD offers a heavy duty top quality timing light. This timing light is supplied in a heavy duty metal housing and features a high output Linear Xenon strobe with a focused fresnel lens that produces a light that's bright enough to use outdoors. It is equipped with a 6 foot lead and uses a metal inductive pickup that clamps to the spark plug wire.

Description	Part No.
MSD Timing Light	8990

Grey Deutsch



Weathertight

## MSD WEATHERTIGHT & DEUTSCH CONNECTORS

Description	Part No.
Weathertight 6 pin connectors	8170
Weathertight 4 pin connectors	8171
Weathertight 3 pin connectors	8172
Weathertight 2 pin connectors	8173
Grey Deutsch 8 pin connectors	8185
Grey Deutsch 6 pin connectors	8180
Grey Deutsch 4 pin connectors	8181
Grey Deutsch 2 pin connectors	8183



## PERMA-SEAL CONNECTION KIT

Maximum ignition reliability can only be obtained by using high quality connectors and the Perma-Seal Connector Kit fits the bill! The tin coated copper terminals prevent corrosion and increase the connector's strength. To seal the connection, each connector has a special heat shrinkable outer sleeve that bonds and seals to the wire when heat is applied to it.

Description	Part No.
MSD Perma-Seal Connector Kit	4377



## PRO-CRIMP TOOL

To do a job right, it is important to have the right tools. If you custom build a lot of plug wires, the Pro-Crimp is the right tool for you! The Pro-Crimp features a hardened steel frame, molded hand grips and built-in ratchet action that is also adjustable. The tool is supplied with jaws to fit MSD's Super Conductor Spark Plug wires and can be removed to use additional jaws (not supplied) for crimping common wiring terminals.

Description	Part No.
MSD Pro-Crimp Tool	3505
Spark Plug Dies	3508
Amp Pins	3506
Amp Lug Dies	3507
Weathertight Dies	3509
Deutsch Terminal Dies	3510

FOUR STROKE  
INTAKE SYSTEMS  
ENGINE/GASKETS  
EXHAUST  
DRIVE LINE HANDLING  
ELECTRICAL  
WATERLINE /BILGE  
STEERING & CONTROLS  
BODY  
ACCESSORIES  
SERVICE TOOLS /HARDWARE  
CHEMICAL

FOUR  
STROKEINTAKE  
SYSTEMSENGINE/  
GASKETS

EXHAUST

DRIVE LINE  
HANDLING

ELECTRICAL

WATERLINE  
/BILGESTEERING  
& CONTROLS

BODY

ACCESSORIES

SERVICE TOOLS  
/HARDWARE

CHEMICAL

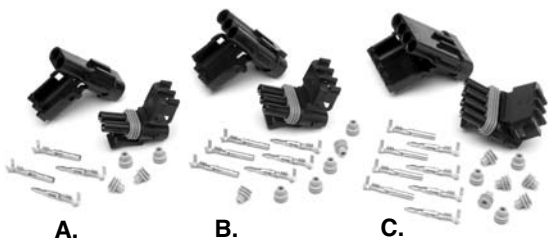

A.

B.

C.

F.

D.

F.

F.

E.

## HOT PRODUCTS WEATHER PACK CONNECTORS

Ideal for use in harsh environments. Positive snap-action locking. Secondary locking helps terminal retention and provides access to the terminals for service.

Description	Part No.
A. 2 Way Housing Kit	55-2060
B. 3 Way Housing Kit	55-2061
C. 4 Way Housing Kit	55-2062
D. Female Terminal Only 100 pcs/pk	55-2070
E. Male Terminal Only 100 pcs/pk	55-2071
F. Cavity Seals Only 100 pcs.	55-2072



59-0254

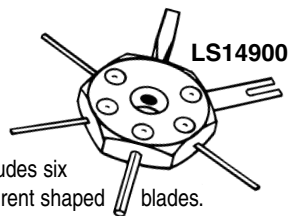

LS14900

Includes six  
different shaped  
blades.

## TERMINAL DETENT TOOL

The hollow barrel allows you to depress the tab on the terminal end and to remove the wire from the connector without damaging its ends.

Description	Part No.
Terminal Detent Tool	59-0254
Terminal Removal Tool	LS14900



## ADHESIVE LINED HEAT SHRINK BUTT CONNECTORS

Best used where moisture and corrosion is a problem. After crimping these terminals to wire, heat is applied enabling the adhesive within each shrunk tube terminal to melt and flow evenly to seal the connection against the harshest environment.

Description	Wire Range	Part No.
10pcs/pk Pink	22-18 (0.3-0.8mm)	55-2040
100pcs/pk Pink	22-18 (0.3-0.8mm)	55-2041
10pcs/pk Blue	16-14 (1-2mm)	55-2042
100pcs/pk Blue	16-14 (1-2mm)	55-2043



## WATERPROOF TERMINAL KIT

Japanese OEM type connector Kit.

Description	Part No.
2-Pin Terminal Kit	55-2050
3-Pin Terminal Kit	55-2051
4-Pin Terminal Kit	55-2052



## JAPANESE OEM STYLE CONNECTOR

Description	Part No.
OEM Style Electric Connector Kit 5pcs/pk	55-2035
Dealer Kit 20pcs/pk	55-2037



## MALE/FEMALE TERMINAL KIT

This kit includes 30 of both the male and female terminals and plastic sleeves/covers. The terminals are tin plated to prevent corrosion. The terminal kit is provided in a handy plastic case.

Description	Part No.
Male/Female Terminal Kit	16-601



## IGNITION SYSTEM SPARK TESTER

This ignition system tester checks the integrity and strength of your system by gauging your systems spark.

Description	Part No.
Ignition System Spark Tester	59-0253





## MICRO TOUCH REV-LIMITER FOR SEA DOO

Description	Part No.
ALL SEA DOO 89-91 16 Rev (6500-8900rpm)	<b>MT-REV-SD89-91</b>
580/650/720 92-97 8Rev (7250-8400rpm)	<b>MT-REV-SD92-97</b>
XP800 95 2Rev (7500&7900rpm)	<b>MT-REV-SDRAVE95</b>
785 RAVE 96 2Rev (7500&7900rpm)	<b>MT-REV-SDRAVE96</b>
785/951 RAVE 97-98 4Rev (7500&8250rpm)	<b>MT-REV-SD97-98</b>

## MICRO TOUCH MICROPROCESSOR BASED IGNITION CONTROLLERS FOR SEA DOO

Features Include:

- 25% More Spark Energy
- 4 Rev Limits from 7500 to 8250 RPM
- 4 Timing Curves
- Initial Timing Correction Adjustment
- 4 Timing Retard Rates
- On-board Output Water Injection Controller
- Compatible with OEM Throttle Position sensor

Description	Part No.
785-951 RAVE w/Single Coil 96-98	<b>MT-IGN-REV96-98</b>
951 RAVE w/Twin Coil 99-02	<b>MT-IGN-REV99-02</b>



MT-16x2-2

## MICRO TOUCH SINGLE OUTPUT WATER CONTROLLER FOR 2-CYLINDER WATERCRAFT

### REGULAR UNIT

Features include:

- Adjustable Output for 1 Water Injection Solenoid — 16 **ON** Settings from 1,500 to 3,000 RPM; 16 **OFF** settings from 5,750 to 7,250 RPM.
- Senses Engine RPM from Spark Plug Wire

### RACER UNIT

- CNC-Machined Billet Aluminum Case.
- Adjustable Output for 1 Water Injection Solenoid — 16 **ON** and **OFF** Settings Programmed to Customer Specifications.
- Senses Engine RPM from Digital Tach Output on OEM or MSD Ignition.
- Replaceable Microchip for Future Upgrades and Reconfiguration.

Description	Part No.
Regular Single Output Water Controller	<b>MT-16x2-2</b>



MT-DUAL-2

## MICRO TOUCH DUAL OUTPUT WATER CONTROLLER FOR 2-CYLINDER WATERCRAFT

For injecting water into **pipe** and **waterbox** (or **stinger**) independently. Improve acceleration. Additional exhaust back pressure can increase top end power without sacrificing bottom end.

Features Include:

- Adjustable Output for 2 Water Injection Solenoid —
  - #1: 4 **ON** Settings from 1,500 to 3,000 RPM; 16 **OFF** settings from 4,000 to 7,000 RPM.
  - #2: 4 **ON** Settings from 5,000 to 7,000 RPM, **OFF** at 10,000.
- Senses Engine RPM from Spark Plug Wire

Description	Part No.
Dual Output Water Controller	<b>MT-DUAL-2</b>

FOUR STROKE	INTAKE SYSTEMS	ENGINE/GASKETS	EXHAUST	DRIVE LINE HANDLING	ELECTRICAL	WATERLINE /BLIGE	STEERING & CONTROLS	BODY	ACCESSORIES	SERVICE TOOLS /HARDWARE	CHEMICAL
-------------	----------------	----------------	---------	---------------------	------------	------------------	---------------------	------	-------------	-------------------------	----------



## POWERSHOT ADJUSTABLE FUEL TUNER



The all new R&D Powershot fuel injection tuner will deliver increased horsepower, acceleration, and stronger mid-range performance by delivering a higher performing air to fuel ratio (A.F.R.) to the engine. Many of today's high performance fuel injected four stroke muscle craft have a conservative A.R.R., which allows manufacturers to meet C.A.R.B.'s O.E.M emission standards and regulations. R&D Performance has tested, documented, and analyzed the O.E.M. fuel map or curve, on every current fuel injected four stroke watercraft. The pre-programmed and coded R&D Powershot fuel injection control module safely alters the O.E.M. fuel map to a higher performing and safer A.F.R. (richer). More horsepower, greater acceleration and stronger mid-range are the result when the proper A.F.R. is achieved and is tuned for optimum performance. The R&D Powershot is pre-coded, pre-tuned, preset and ready to install easily in minutes with R&D's comprehensive installation and tuning instruction.

The R&D Powershot is fully adjustable on the fly (with the engine running, observed and tuned while riding), and will accommodate a wide range of adjustability to properly performance tune the A.F.R. for any combination of aftermarket parts, i.e. aftermarket supercharger modifications, camshafts or valve train modifications, head modifications, exhaust system modifications, and high compression piston kits. The R&D Powershot will add horsepower, reliability, and adjustability to any electronic fuel injected two or four stroke watercraft engine.

R&D has a Powershot unit for virtually every watercraft application! Available for all two and four stroke fuel injected Sea-Doo, Yamaha, Kawasaki and Honda Watercraft. The R&D Powershot is a must have part on supercharged Sea-Doo's using Vortech high boost compressor wheels, and Kawasaki 15Fs with offshore kits!

### Description

### Part No.

KAW 12F/15F Powershot Fuel Tuner	<b>801-15000</b>
KAW Ultra 250X/250LX Powershot Fuel Tuner	<b>801-25000</b>
YAM VX110 Powershot Fuel Tuner	<b>802-00110</b>
YAM FX H.O. Powershot Fuel Tuner	<b>802-16000</b>
YAM FX SHO/FZR/FZS Powershot Fuel Tuner	<b>802-18000</b>
YAM GP 1300R Powershot Fuel Tuner	<b>802-13001</b>
S-D GTX/GTI 4-TEC N.A. Powershot Fuel Tuner	<b>803-95000</b>
S-D GTX 4-TEC SC (185 HP) Powershot Fuel Tuner	<b>803-95001</b>
S-D RXP/RXT/GTX 4-TEC (215 HP) Powershot Fuel Tuner	<b>803-95002</b>
S-D RXP-X/RXT-X (255HP) Powershot Fuel Tuner	<b>803-95003</b>
Hydrospace Powershot Fuel Tuner	<b>806-10000</b>



## IGNI-PRO PROGRAMMABLE IGNITION 800 SX-R

Igni-Pro Programmable Ignition 800 SX-R (all years) - Best is getting better! NEW UPDATED, ignition does not require power when the engine is not running eliminating the battery draw down in the past units. 2008 Igni-Pro is a high power ignition only for racing, which can be adjusted fully online with your PC at home or with Laptop directly on the water. (USB). This allows you to react at changes at your Kawasaki SX-R 800 configuration. The conversion from the OEM ignition system to Igni-Pro is very simple. Programming software is supplied for Windows 2000 and XP. Operates as a total loss system on all Superstock and GP engines. The unit fits perfectly in the OEM Kawasaki sealed ignition box protecting the unit from possible water damage!

### Description

Igni-Pro Programmable Ignition 800 SX-R

### Part No.

**IGNI-SXR**

## RIVA PRO-SERIES E.F.I. CONTROL UNIT

If you plan to modify your Yamaha GP1300R our Pro-Series EFI Control Unit is a must. This easy-to-use control unit plugs directly into the OEM wiring harness between the ignition and fuel injection system providing control of the engines fuel management system. Key benefits include:

- Allows addition of fuel required with engine modifications without upsetting stock fuel map.
- Integrated dials provide easy adjustment and fine-tuning of fuel delivery curve without external programming devices.
- LED lights indicate fuel delivery settings while tuning.
- Won't interfere with craft's stock sensors and inputs.



### Yamaha

Control Unit, EFI GP1300R (60T), Plug-in

### Part No.

**RY11913**

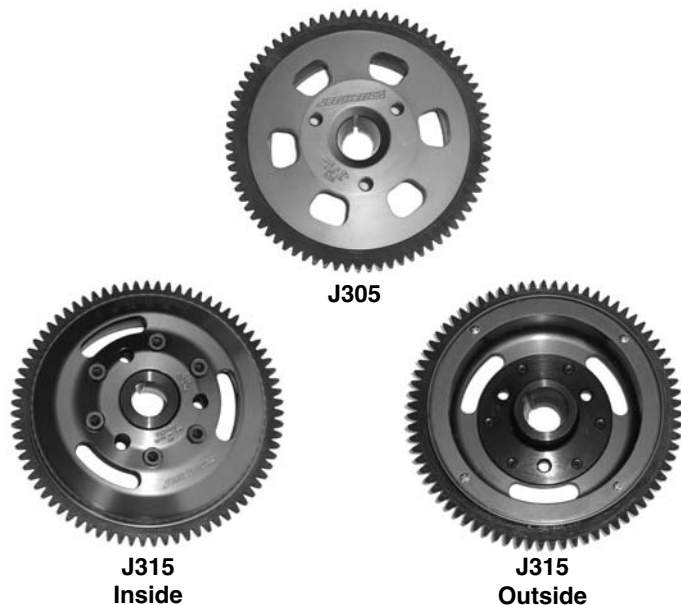

## JETINETICS CHARGING FLYWHEEL

Lightweight, high strength aluminum fly-wheels offer a dramatic increase in acceleration, throttle response and horsepower throughout the entire RPM range.

Every flywheel comes with precision engraved degree marks, allowing for simple and precise ignition timing adjustments.

Description	Part No.
Yamaha 701 (62T/64X)	J315
Kawasaki 750/800	J305

\* For Sea Doo, Yamaha GPR Flywheel, See page 106. Rad Flywheel



## MACC RACING KAWASAKI ULTRA 250X TIMING ADVANCE COVER

Macc Racing and Speed Magic have developed this billet timing advance cover to allow the timing to be advanced up to 6 degrees on the Kawasaki Ultra 250X.

Description	Part No.
Macc Racing Ultra 250X Timing Advance Cover	MR-0085



## TBM RACING KAWASAKI SX-R 800 LIGHTWEIGHT FLYWHEEL

TBM's new flywheel is compatible with the stock ignition in 2004-2006 800 SX-R models and any aftermarket ignition system. 2003 SX-R's require the use of any aftermarket ignition system. The flywheel operates as a total loss system (does not recharge the battery). The flywheel has a weight savings of over 3lbs. vs the stock flywheel. I deal for racing, freestyle and freeride, the TBM flywheel will give you amazing throttle response and acceleration without jeopardizing reliability.

Description	Part No.
Kawasaki 800 SX-R Total Loss Flywheel	TBM124



## TBM RACING YAMAHA 701 LIGHTWEIGHT CHARGING FLYWHEEL

Introducing the TBM Racing Yamaha 701 Lightweight Charging Flywheel. As soon as TBM released the SX-R Total Loss Flywheel they began getting calls asking them when they would make Yamaha charging flywheels. Manufactured from the highest grade aircraft aluminum available and an engineered design that will withstand the most powerful engines and abusive riding. Weighing in at 2.0 pounds this is by far the lightest Yamaha charging flywheel on the market.

Description	Part No.
Yamaha 701 Lightweight Charging Flywheel	TBM124-YAM



## TBM RACING KAWASAKI 750/800 LIGHTWEIGHT CHARGING FLYWHEEL

Introducing the TBM Racing TBM Racing Kawasaki 750/800 Lightweight Charging Flywheel. As soon as TBM released the SX-R Total Loss Flywheel they began getting calls asking them when they would make a charging flywheel. Manufactured from the highest grade aircraft aluminum available and an engineered design that will withstand the most powerful engines and abusive riding. Weighing in at 2.2 pounds this is by far the lightest Kawasaki charging flywheel on the market.

Description	Part No.
Kawasaki 750/800 Lightweight Charging Flywheel	TBM124-KAW

FOUR STROKE	INTAKE SYSTEMS	ENGINE/GASKETS	EXHAUST	DRIVE LINE HANDLING	ELECTRICAL	WATERLINE /BILGE	STEERING & CONTROLS	BODY	ACCESSORIES	SERVICE TOOLS /HARDWARE	CHEMICAL
-------------	----------------	----------------	---------	---------------------	------------	------------------	---------------------	------	-------------	-------------------------	----------

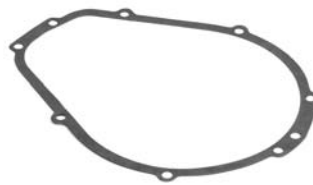

## FLYWHEEL COVER & HOUSING GASKETS, O-RINGS & OIL SEALS

FOUR STROKE

### FLYWHEEL PULLER

Sea Doo	Part No.
800/951 38mm x 1.5	MP#42
Kawasaki	Part No.
900/1100 35mm x 1.5	DS#29

Yamaha	Part No.
580/650/Pre 94 701	DS#37
12 Hole Disc 8mm Bolts	
701/760/800/1100/1200	DS#37
12 Hole Disc 8mm Bolts	

Sea Doo	OEM#	Part No.
---------	------	----------

Flywheel Cover O-Rings		
580 (88-91)	290-950-130	6280
580/650/720 (92-98)	290-831-555	6278
800 (95-99)	420-950-360	6632
950 (98-99)	290-931-690	6795

INTAKE SYSTEMS

### MAGNETO FLYWHEEL PULLER

Sea Doo	Part No.
580/650/720	DS#34
3 Hole Disc 8mm Bolts	

Kawasaki	Part No.
300/440/550/650	DS#37
12 Hole Disc 8mm Bolts	
750/800	MP#18
Special 18mm x 1.5 Right Hand Bolt	

Flywheel Housing Gaskets		
580/650/720	290-850-605	6130
800	290-931-470	6045

ENGINE/GASKETS

Polaris	Part No.
Polaris All & Universal	DS#37
Universal 12 Hole Disc 8mm Bolts	

Yamaha	OEM#	Part No.
650/701/760	6M6-81365	2360
1100/1200	63M-81365	4505
1200XLL/GP1200R/1300R (Oil Seal)	93102-35M57	3710

EXHAUST

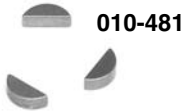

010-480

010-481

### SEA DOO FLYWHEEL NUT & WOODRUFF KEY

Sea Doo	OEM#	Part No.
Flywheel Nut Sea Doo All	420-842-230	010-480
Woodruff Key Sea Doo All	420-246-055	010-481

DRIVE LINE HANDLING

ELECTRICAL

### FLYWHEEL BOLTS & KEY

Kawasaki	OEM Number	Part No.
Flywheel Bolts All Models	92150-381	010-491
Flywheel Key All Models	92038-001	010-481-01

Yamaha	OEM Number	Part No.
Flywheel Bolts All Models	90109-10M44-00	010-492
Flywheel Key All Models	90280-16053-00	010-481-02

WATERLINE /BILGE

STEERING & CONTROLS

BODY

ACCESSORIES

SERVICE TOOLS /HARDWARE

CHEMICAL



### MSD TIMING ADVANCE PLATE

The timing advance plate is recommended for all Kawasaki 750 engines running the Enhancer Ignition. This plate advances the timing 7° for a boost in low to mid range performance. Note: If you are running excessive compression or low octane fuel it is recommended that you run the retard module listed. Must be used with PN 4251 on SXi, XiR, and ZXi.

Description	Part No.
MSD Timing Advance Plate for Kawasaki	4332

### R&D KAWASAKI 750 & 800 SX-R TIMING ADVANCE KIT



The R&D SX-R 800 Timing kit produces a substantial performance gain with the OEM ignition system. By relocating the pickup trigger on the ignition cover a full six degrees of ignition timing is available. Initial ignition timing from 0-2000 rpm boosted from 14 to 20 degrees, mid 3000-5000 rpm from 20 to 26 degrees and overall 6500 rpm + from 12 to 18 degrees.

Description	Part No.
R&D 750/800 Timing Advance Kit	441-75001
Replacement Timing Cover Gasket Only	8050



### ADA RACING TIMING ADVANCE PLATE KAWASAKI 12F AND 15F

This is a stock timing trigger plate that is machined with additional locations for timing advance. Has the stock position, +3, +4, and +5 degrees. This fits the Kawasaki STX-15F and STX-12F four stroke watercraft.

Description	Part No.
ADA Racing Timing Advance Plate	31-250100



# NEW MES AQUA TORQUE STARTERS AND STARTER DRIVES



MES "High Torque" models and OEM equivalent models.  
All starters meet or exceed OEM specification.



S1090MHT  
S1090M



S1091MHT • S1091M  
\*Complete as shown with  
mounting bracket



S1096MHT-9  
S1096M-9  
\*9 Tooth Bendix



S1098MHT  
S1098M



S1102M

Sea Doo Model	OEM#	High Torque Starter	OEM Replacement Starter	Drive Gear Idle Gear
GT, SP, XP580 89-91	278-000-316	S1090MHT	S1090M	3275M/3276M
SP, SPL, SPX580 91-94	278-000-316	S1090MHT	S1090M	3275M/3276M
XP650 91-94(all)	278-000-316	S1090MHT	S1090M	3275M/3276M
580/650/720 94-00(all)	278-000-485	S1091MHT	S1091M	3275M/3276M
XP800 95, XP/GSX/GTX96	278-000-577	S1096MHT-9	S1096M-9	3275M/3276M
951(all)	278-000-98Z	S1098MHT	S1098M	3270M
4 Tec (4Stroke)	290-888-999		S1102M	Not Required
97-2003 GSX, SPX, GTX RFI, GSX RFI & 2003 GTI RFI	278-001-497/278-001-038 278-001-301	S1096MHT-8	S1096M-8	Not Required



S1095MHT  
S1095M



S1099MHT  
S1099M



S1103M



S1101M



S1097MHT

## Yamaha

500 88-89				3274M
650/701 (all)	6M6-81800-10-00	S1095MHT	S1095M	3270M
760	64X-81800-00-00	S1105MHT	S1105M	3270M
800/1100/1200 (all)	63M-81800-00-00	S1099MHT	S1099M	3270M
FX140 (4Stroke)	60E-81800-00-00	S1103MHT	S1103M	Not Required
VX1100	6D3-81800-00	S1107MHT	S1107	

## Honda

F12/F12X 1200cc Aqua Trax	31200-HW1-671		S1101M	Not Required
---------------------------	---------------	--	--------	--------------

## Tigershark

640/650/770/900/1000 (92-99)	3008/093/327/536	S1097MHT		3270M
------------------------------	------------------	----------	--	-------



S1094MHT  
S1094M



S1092MHT  
S1092M



S1100M



S1093MHT  
S1093M

## Kawasaki

440/550/550SX (all)	21163-3710	S1094MHT	S1094M	3273M
650/750/900/1100 (all)	21163-3712	S1092MHT	S1092M	3270M
ULTRA150, STX-R	21163-3715		S1100M	Not Required

## Polaris

650/750/785/900/1050 (all)	324-01100	S1093MHT	S1093M	3270M
All Late Model w/ext battery stud	406-0118	S1104MHT	S1104M	3270M



3270M  
(19 tooth)



3273M  
(9 tooth)



3274M  
(11 tooth)



3275M  
9 Tooth  
(OEM 9 Tooth)



3276M  
8 Tooth  
(High Torque Unit)

**Manufacturer's Warranty Policy:** All MES products (excluding MES Economy Starters), when properly installed, are warranted by MES against defects in materials and workmanship for a period of one year from the date of sale to the original purchaser. For MES to accurately inspect defective items for warranty consideration, we ask that all returns reach our facility within the warranty period with an RA#, along with a copy of the original invoice and a brief explanation of the product's alleged malfunction.

**Non-Covered Warranty Issues:** Our warranty is limited to the replacement of defective units only and does not cover labor or any other expenses. This warranty extends to the application under normal use, and does not apply to any of the following: submersion, deliberate abuse, broken drive-gears, that are broken or tampered with during installation, or involved in attempted improper installations. Any tampering or dismantling, grinding, drilling, removing or addition of parts, or any action that alters the original design of the unit, will immediately render this warranty null and void.

FOUR  
STROKE

INTAKE  
SYSTEMS

ENGINE/  
GASKETS

EXHAUST

DRIVE LINE  
HANDLING

ELECTRICAL

WATERLINE  
/BILGE

STEERING  
& CONTROLS

BODY

ACCESSORIES

SERVICE TOOLS  
/HARDWARE

CHEMICAL

# MES ECONOMY STARTERS



Sea Doo Model	OEM#	Economy Starter	Drive Gear/Idle Gear
GT, SP, XP580 89-91	278-000-316	C1090-NA	3275M/3276M
SP, SPL, SPX580 91-94	278-000-316	C1090-NA	3275M/3276M
XP650 91-94(all)	278-000-316	C1090-NA	3275M/3276M
580/650/720 94-00(all)	278-000-485	C1091-NA	3275M/3276M
XP800 95, XP/GSX/GTX96	278-000-577	C1096-9-NA	3275M/3276M
951(all)	278-000-98Z	C1098-NA	3270M
4 Tec (4Stroke)	290-888-999	C1102-NA	Not Required
97-2003 GSX, SPX, GTX RFI, GSX RFI & 2003 GTI RFI	278-001-497/278-001-038 278-001-301	C1096-8-NA	Not Required



Yamaha Model	OEM#	Economy Starter	Drive Gear/Idle Gear
650/701 (all)	6M6-81800-10-00	C1095-NA	3270M
800/1100/1200 (all)	63M-81800-00-00	C1099-NA	3270M

Tigershark Model	OEM#	Economy Starter	Drive Gear/Idle Gear
640/650/770/900/1000 (92-99)	3008/093/327/536	C1097-NA	3270M



Kawasaki Model	OEM#	Economy Starter	Drive Gear/Idle Gear
650/750/900/1100 (all)	21163-3712	C1092-NA	3270M
ULTRA150, STX-R	21163-3715	C1100-NA	Not Required

Polaris Model	OEM#	Economy Starter	Drive Gear/Idle Gear
650/750/785/900/1050 (all)	324-01100	C1093-NA	3270M

**Manufacturer's Warranty Policy:** All MES Economy Starters, when properly installed, are warranted by MES against defects in materials and workmanship for a period of 90 days from the date of sale to the original purchaser. For MES to accurately inspect defective items for warranty consideration, we ask that all returns reach our facility within the warranty period with an RA#, along with a copy of the original invoice and a brief explanation of the product's alleged malfunction.

**Non-Covered Warranty Issues:** Our warranty is limited to the replacement of defective units only and does not cover labor or any other expenses. This warranty extends to the application under normal use, and does not apply to any of the following: submersion, deliberate abuse, broken drive-gears, that are broken or tampered with during installation, or involved in attempted improper installations. Any tampering or dismantling, grinding, drilling, removing or addition of parts, or any action that alters the original design of the unit, will immediately render this warranty null and void.

## PERSONAL WATERCRAFT REPLACEMENT STARTER SOLENOIDS AND SOLENOID POSTS



### SEA DOO

Fits Late Sea Doo Models:  
Replaces Sea Doo OEM #278-001-802  
**Part Number SL4000**



### YAMAHA

Fits 1987-2001 Yamaha Models:  
Replaces Yamaha OEM #6G1-81941-10  
**Part Number SL4001**



### MSD EXTERNAL STARTER RELAY

This 12 volt relay is a heavy duty unit designed to mount outside the electrical box. Moisture and chemicals resistant. The large copper terminals assure good solid contacts. The stainless steel base plate allows the relay to be mounted in any position. Rated at 65 amps.

Description	Part No.
MSD External Starter Relay	M4390



### SEA DOO

Fits Sea Doo 580 GT, SP, XP, GTS, GTX (90-93):  
Replaces Sea Doo OEM #278-000-342  
**Part Number 004-120**



### YAMAHA

Fits 2002-2007 Yamaha Models:  
Replaces Yamaha OEM #68N-81940-00  
**Part Number SL4002**



### KAWASAKI SOLENOID POST

Replace corroded, stripped or broken posts without replacing the solenoid on all Kawasaki Jet Ski's with small electrical box.

Description	Part No.
Solenoid Post (2 per package)	55-3350



# OEM REPLACEMENT COILS



## STATOR COILS / CHARGE COILS

Sea Doo (Generating Coil)	OEM No.	Part No.
580 1988-90	290-866-635	004-170
580 GT 1990-91, XP/SP 1991	299-866-635	004-170
650 XP 1993-95	410-912-000	004-170

Yamaha	OEM No.	Part No.
All 650 1990-95	6M6-85520-00	004-155
All 701 1993-95	6M6-05S20-00	004-155
Wave Raider	62T-85520-00	004-148

Kawasaki (Individual Coil For Stator Assy)	OEM No.	Part No.
440 1984-92	59031-3002	004-161
550 1982-95	59031-3002	004-161
All 650 1986-95	21003-3707/12/16	004-165



## STATOR COILS / PULSING COILS

Yamaha	OEM No.	Part No.
Wave Jammer 500 1987-88	6GO-85580-70	004-154
Wave Runner 500 1987-89	6GO-85580-70	004-154
SJ/WR/WRA 650 1990-93	6M6-85580-00	004-153
WRB 650VXR 1991-95	6M6-85580-00	004-153
WB701 1993	6M6-85580-00	004-153
WRB Pro VXR 701 1993	6M6-85580-00	004-153

Kawasaki	OEM No.	Part No.
440 1984-92	59026-3008	004-163
550 1982-95	59026-3008	004-163



## STATOR COILS / EXCITER COILS

Kawasaki	OEM No.	Part No.
440 1984-92	21049-3007	004-162
550 1982-95	21049-3007	004-162
All 650 1986-95	21003-3719	004-166



## IGNITION COILS OEM Replacement

Sea Doo	OEM No.	Part No.
580GT 1988-91	290-866-607	004-175

Yamaha	OEM No.	Part No.
Wave Jammer 500 1987-90	6K8-85570-010	004-150
Wave Runner 500 1987-93	6K8-85570-010	004-150
SJ650 1990-93	6R8-85570-00	004-157
WR650/III/LXR 1990-95	6R8-85570-00	004-157
FX/SJ/WB/WR/WV701 1994-95	6R8-85570-00	004-157
1100 All	63M-85570-00	004-193

Kawasaki	OEM No.	Part No.
750SX 92-94, SXI 95	21121-3705	004-157
900/1100 All	21121-3708/9/10	004-192



## STATOR COILS / LIGHTING COILS

Yamaha	OEM No.	Part No.
Wave Jammer 500 1987-90	6K8-0103-40	004-152
Wave Runner 500 1987-93	6K8-0103-40	004-152
All 650 1990-96	6M6-85533-00	004-156
All 701 1993-95 except Raider	6K8-8103-40	004-156
Wave Raider	62T-85533-00	004-147

FOUR STROKE  
INTAKE SYSTEMS  
ENGINE/GASKETS  
EXHAUST  
DRIVE LINE HANDLING  
ELECTRICAL  
WATERLINE /BILGE  
STEERING & CONTROLS  
BODY  
ACCESSORIES  
SERVICE TOOLS  
HARDWARE  
CHEMICAL



# OPPAMA



*\*All Tachometers featured are for Two Stroke Engine applications only.*



## PET-2100DX TACHOMETERS

This measures engine rpm, maximum rpm, total cumulative operating time, resetable cumulative operating time. This has a dual display system for either current rpm alone or current & maximum rpm, and also has two maximum rpm memories for comparison. 2 stroke 1-4 cylinder. Made in Japan.

## WATERPROOF DELUXE TACHOMETER

Features include: Tachometer with RPM memory, Hour meter, Stopwatch with 10-data memory, clock, Power save off switch, and over-run (red line) alarm, For 2 or 3 cylinder. Made in Japan.

Description	Part No.
PET-2100DX Tachometer	PET-2100DX

Description	Part No.
PET-2500 Deluxe Tachometer	PET-2500



## TINY TACH

Hourmeter and Tachometer powered by internal battery. Sealed for moisture resistance.

## HOUR/TACH METER

Has same features as hour meter plus tachometer feature. Works on any gas engine up to 2 cylinders and 9000 RPM.

- Firing pattern 1 spark = 1 RPM
- Resolution 10 RPMs
- Maximum RPMs 9000
- Suitable for all single and twin, two or four cycle gasoline engines operating within specified tachometer firing pattern.

Description	Part No.
Digital Tiny Tach (2-Cylinder)	59-0550
Digital Tiny Tach (3-Cylinder)*	59-0552



Description	Part No.
Hour/Tach Meter	HR-8061

\*Resetable hourmeter



## MAINTAINER MODEL #CU2602

Total Amps: 0.5  
Battery System: 12Volt



## CHARGER MODEL #CU2606A

Total Amps: 6  
Battery System: 12Volt

## MAINTAINER MODEL #CU2603

Total Amps: 3  
Battery System: 12Volt



## CHARGER MODEL #CU2612A

Total Amps: 10  
Battery System: 12Volt



## GUEST 12 VOLT MAINTAINERS AND PORTABLE BATTERY CHARGERS

AMPS	TYPE	PART/MODEL #	TERMINATION	DIMENSIONS	CHARGING CABLE LENGTH	AC/WALL CABLE LENGTH	WEIGHT
.5	Maintainer	CU2602	Alligator Clips	1.5" x 3.0" x 2.0"	4'	6' w/Standard Plug	.5LBs
3	Charger	CU2603	Alligator Clips	3.1" x 3.5" x 2.34"	4'	6' w/Standard Plug	1LBs
6	Portable	CU2606A	Alligator Clips	5.5" x 5.0" x 2.4"	4'	6' w/Standard Plug	3.5LBs
10	Portable	CU2612A	Alligator Clips	7.5" x 5.0" x 2.4"	4'	6' w/Standard Plug	4.5LBs





2008 WORLD FINALS • LAKE HAVASU, AZ  
 FRANKY ZAPATA • 2008 GP RUNABOUT WORLD CHAMPION  
 PHOTO COURTESY OF JIN OMURA

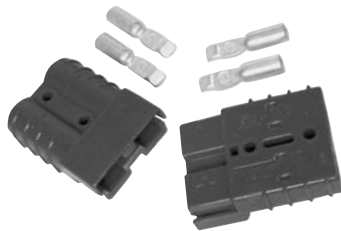

### BATTERY QUICK DISCONNECT

Racers will appreciate this Quick Disconnect Battery Connector because it allows for easy removal of the battery. The connectors grip together to form a vibration proof connection but can easily be disconnected for quick removal for charging of the battery.

Description	Part No.
Battery Quick Disconnect	4376



### JUMPER CABLES

8 feet long heavy duty 8 gauge copper jumper cables are big on charging power, yet stow conveniently in the 9 x 9 inch nylon bag.

Description	Part No.
Jumper Cables	59-0530



### JET WORKS GEL-FILLED BATTERIES

Premature failures in conventional batteries are a direct result of vibration, constant use and neglect. Jet Works Gel-Filled batteries have been designed and tested to the extremes, making our batteries specially resistant to vibration and long term abuse.

Description	L	W	H	Part No.
Jet Works Gel-Filled Battery	7"	2-7/8"	6-1/2"	KB35

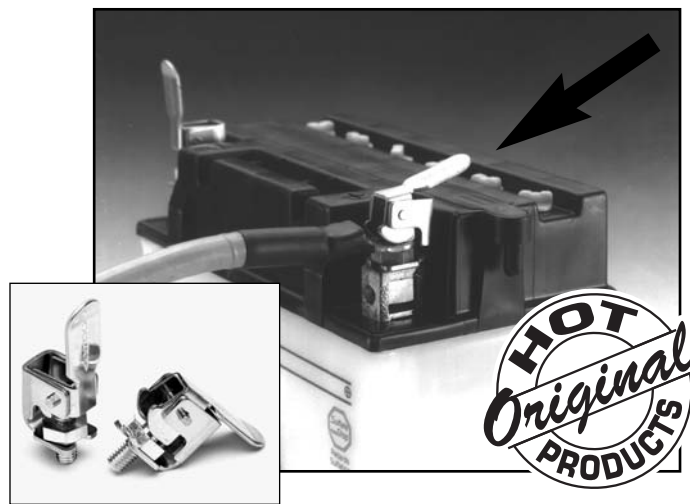

### QUICK SNAPS

Battery cable Quick Snaps remove your battery in 10 seconds. Quick snaps are easy to install in any style watercraft or motorcycle battery. Once installed no tools are required for battery removal. Made of stainless steel.

Descriptions	Part No.
Quick Snap (2 pcs/set)	59-0527



### QUALITY BATTERY CONNECTION

Broken cable end, no problem. High quality replacement cable end, crimp on.

Descriptions	Part No.
Battery Cable Ends (2pcs/set)	55-2031

FOUR STROKE	INTAKE SYSTEMS	ENGINE/GASKETS	EXHAUST	DRIVE LINE HANDLING	ELECTRICAL	WATERLINE /BILGE	STEERING & CONTROLS	BODY	ACCESSORIES	SERVICE TOOLS /HARDWARE	CHEMICAL
-------------	----------------	----------------	---------	---------------------	------------	------------------	---------------------	------	-------------	-------------------------	----------

# NO MORE SEARCHING REQUIRED! HOT PRODUCTS HAS THE SWITCH FOR YOUR APPLICATION

## Hot Products PWC Waterproof Switches Imported Exclusively from



**HOT PRODUCTS  
EXCLUSIVE**

### 3-WAY PANEL MOUNT ROTARY SWITCHES

Connects to two electronic accessories for power control. Allows the operation of one or both accessories to run at the same time. Suggested uses: Second Bilge, Ignition, etc. 12Volt/5Amp.



**Left Hand  
On Position**  
Use: Blue &  
Red Wires

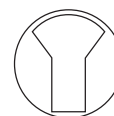

**Center Off  
Position**

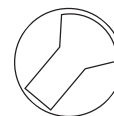

**Right Hand  
On Position**  
Use: White &  
Red Wires



JP7043



JP7044

### UNIVERSAL HANDLEBAR MOUNT SWITCHES

Mounts to handlebar or mounts to underside of most aftermarket throttle levers. Complete with 9" wire lead.

Description	Part No.	Description	Part No.
Handlebar Mount Switch	JP7043	Handlebar Mount Switch	JP7044
12Volt/6Amp push on/off switch		12Volt/5Amp 3 way rotary switch	

Description	Part No.
Panel Mount Switch	57-3020



### ROTARY SWITCH COVER

Protect your ultra sano BULLETPROOF Blowsion rotary bilge switch with this sanitary powder coated black aluminum switch shield. No more broken off knobs between your toes during aerials. All mounting hardware included. (Rotary Switch is sold separately)

Description	Part No.
Rotary Switch Cover	06-01-310



### MSD HOLESHOT CONTROL SWITCH

This is a momentary push-button switch encased in a CNC machined aluminum housing that clamps around the handle bar. It comes with a 6-foot wire harness that should reach almost anywhere on your watercraft. Use this switch to activate any MSD feature.

Description	Part No.
Holeshot Control Switch	4372



### CPI WATERPROOF SWITCH ONLY

This replacement safety switch fits Sea Doo's and other manufacturers.

Description	Part No.
Replacement Safety Switch (Sea Doo & other manufacturers)	57-3011

## WATERPROOF SWITCHES AND BRACKETS

- Features waterproof on/off switch that is available with machined aluminum clamp-on or switch mounted bracket. Allows totally reliable and easy control of bilge pump operation.
- Mounting bracket is machined from billet alloy and is anodized black to prevent corrosion. Available for clamp-on bar mounting or bolts to the bottom of the OEM on/off switch assembly.
- All of the switches have a 9 ft. high grade wire lead.



**Yamaha** Part No. 57-3017  
All

**UNIVERSAL**



**Description** Part No. 57-3006  
Universal Handle Bar Mount



**Kawasaki** Part No. 57-3015  
All 650's / 750SS-95 / XI-93



**Kawasaki** Part No. 57-3003  
440 / 550 / 750SX / 750SXI / 800SX-R

**Description** Part No. 57-3009  
Standard Switch with 9 feet of wire (No bracket included)



### BILLET 3 SWITCH HOLDER For Aftermarket Handlebar

Description	Color	Part No.
SeaDoo	Polished	58-2004



### BILLET STOP SWITCH HOLDER For Aftermarket Handlebar

Description	Color	Part No.
SeaDoo	Polished	58-2003

**EPOXY LINED ON THE INSIDE OF THE TUBING**



### EPOXY LINED HEAT SHRINK TUBING

High performance epoxy lined 1/2" id heat shrink. Just splice your wires, heat until the epoxy liquifies and your worries of possible water damage/corrosion are over! Heat shrink tubing color is Black.

Description	Part No.
Epoxy Lined Heat Shrink Tubing (4' length, 1/2" ID)	55-2032

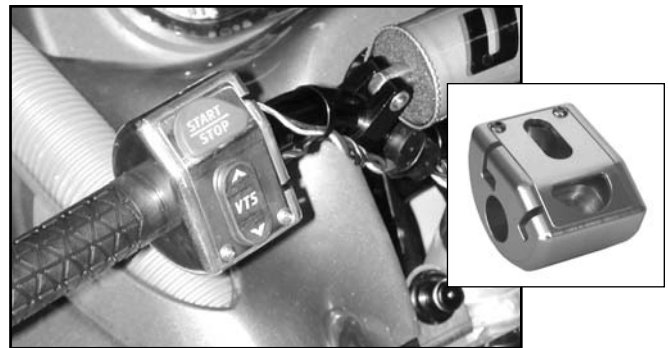

### UMI RXP TRIM/SWITCH HOUSING

U.M.I.'s trim/switch housing is machined from 6061-T6 billet aluminum, replacing the stock plastic housing. Trim/switch housing uses the factory variable trim switch and start/stop switch. This housing must be used with the U.M.I. GSX/RXP (P/#58-6321) steering system, aftermarket bars and finger throttle.

Sea Doo	Part No.
RXP Silver	SD-01600-CLR



**CORROSION BLOCK**

### CORROSION BLOCK MULTI-PURPOSE GREASE

Liquid grease is ideal for use in electrical applications requiring grease.

Description	Part No.
Corrosion Block Liquid 1oz. Bottle	CB-20001

FOUR  
STROKE

INTAKE  
SYSTEMS

ENGINE/  
GASKETS

EXHAUST

DRIVE LINE  
HANDLING

ELECTRICAL

WATERLINE  
/BILGE

STEERING  
& CONTROLS

BODY

ACCESSORIES  
& HARDWARE

SERVICE TOOLS

CHEMICAL

# NGK SPARK PLUGS



## STANDARD PLUGS

- B7ES
- B7HS
- B8ES
- B8HS
- B9ES

*Sold Pk/10*



(Ceramic can be removed)

## RESISTOR PLUGS

- BPR7ES
- BR7ES
- BR7HS
- BPR8ES
- BPR9ES
- BR8ES
- BR8HS
- BR9ES
- BR9HS

*Sold Pk/10*



## SOLID RESISTOR PLUGS

- BR8ES-SOLID
- BR8HS-SOLID
- BR9ES-SOLID
- BR8ES-11
- (For Yam GPR)
- CR9EB

*Sold Pk/10*



*Solid Terminal (Non separable)*

\*Solid Terminal Nut

### YAMAHA

			YEAR	REG PLUG	IRIDIUM PLUG
1300	WaveRunner GP	GP1300	2004-2003	BR8ES-11*	---
1200	WaveRunner III GP	GP1200	1999-1997	BR8HS	BR8HX
	WaveRunner III GP	GP1200R	2002-2000	BR8ES-11*	---
	WaveRunner	SUV1200	2004-1999	BR8HS	BR8HX
	WaveRunner	XA1200	1998	BR8ES	BR8EIX
	WaveRunner	XL1200	1998	BR8HS	BR8HX
	WaveRunner	XL1200	2000-1999	BR8ES-11*	---
	WaveRunner	XL1200	2004-2001	BR8ES-11*	---
1100	FX160	FX160	2004	CR9EB*	---
	WaveRaider II	RA1100	1996-1995	BR8HS	BR8HX
	WaveVenture	WV1100	1997-1996	BR8HS	BR8HX
1000	WaveRunner	FX140	2004-2002	CR9EB*	---
800	WaveRunner	GP800	2004-1998	BR8ES*	BR8EIX
	WaveRunner	XL800	2001-2000	BR8ES*	BR8EIX
	WaveRunner	XL1800	2004-2002	BR8ES*	BR8EIX
760	WaveRunner III GP	GP760	2000-1997	BR8HS	BR8HX
	WaveRaider	RA760	1996	BR8HS	BR8HX
	WaveBlaster II	WB760	1997-1996	BR8HS	BR8HX
	WaveVenture	WV760	1997	BR8HS	BR8HX
	WaveRunner	XL760	1999-1998	BR8HS	BR8HX
700	FX1	FX700	1996-1994	B8HS	BR8HX
	WaveRaider	RA700	1996-1994	BR8HS	BR8HX
	WaveRaider	RA700B	1997	B7HS	BR7HX
	Wave Raider Deluxe	RA700B	1996	B8HS	BR8HX
	SuperJet	SJ700	1996-1994	B8HS	BR8HX
	SuperJet	SJ700	2001-1997	BR7HS	BR7HX
	SuperJet	SJ700	2004-2002	BR8HS	BR8HX
	WaveBlaster	WB700	1996-1993	BR8HS	BR8HX
	WaveRunner III	WRA700	1997-1995	BR8HS	BR8HX
	WaveRunner Pro VXR	WRB700	1994-1993	BR8HS	BR8HX
	WaveVenture	WV700	1998-1995	BR8HS	BR8HX
	Wave Runner	XL700	2004-1990	BR8HS	BR8HX
650	SuperJet	SJ650	1992-1990	B8HS	BR8HX
	WaveRunner	WR650	1992-1990	B8HS	BR8HX
	WaveRunner III	WRA650	1995-1991	BR8HS	BR8HX
	WaveRunner VXR	WRB6	1995-1991	B8HS	BR8HX
500	WaveJammer	WJ500	1990-1978	B7HS	BR7HX
	WaveRunner	WR500	1993-1987	B7HS	BR7HX

### POLARIS

			YEAR	REG PLUG	IRIDIUM PLUG
	MX140		2004	PZFR6H	---
1200	Genesis		2001-1999	BR9ES*	---
	Genesis I		2002-1999	PZFR6H	---
	Pro 1200		2002-2000	BPR8ES	---
	SLX		2001-2000	BPR8ES	---
	Virage TX		2001-2000	BR9ES*	BR9EIX
	Virage TXI		2002-2001	---	---
1050	SLX		1999	BPR8ES	---
	SLTX		1999-1996	BPR8ES	---
	SL 1050		1998-1997	BPR8ES	---
900	SL 900		1997-1996	BPR8ES	---
780	SL 780		1997-1996	BPR8ES	---
	SLT 780		1997-1996	BPR8ES	---
	SLX 780		1997-1996	BPR8ES	---
785	SLX Pro 785		2000-1998	BR9ES*	BR9EIX
777	Virage I		2002	---	---
	Octane		2002	---	---
	Octane		2002	BR9ES*	BR9EIX
750	SL 750		1995-1994	BPR7ES	---
	SLT 750		1995	BPR7ES	---
700	Virage		2002-2000	BPR8ES	---
	SLTH		1999	BPR8ES	---
	SLH		2001-1999	BPR8ES	---
	Freedom		2002	BPR8ES	---
	SL 700		1998-1997	BPR8ES	---
	SL 700 Deluxe		1998-1996	BPR7ES	---
	Hurricane		1997-1996	BPR8ES	---
650	SL 650		1995-1994	BPR7ES	---

### HONDA

			YEAR	IRIDIUM PLUG
1235	Aqua Trax F-12X		2002-2004	IMR9D-9H
	Aqua Trax F-12		2002-2004	IMR9D-9H
1200	Aqua Trax R-12		2002-2004	IMR9D-9H
	Aqua Trax R-12X		2002-2004	IMR9D-9H

### KAWASAKI (Jet-Ski)

			YEAR	REG PLUG	IRIDIUM PLUG
1500	STX-15F	JT1500-C	2004	CR9EK	CR9EIX
1200	Ultra 150 (A2)	JH1200-A	2002-2000	BR9ES*	BR9EIX
	Ultra 150 (A1)	JH1200-A	1999	R6918C-9*	---
	STX-R	JT1200-A	2003-2002	BR9ES*	BR9EIX
	STX-12F	JT1200-B	2004-2003	CR9EK	CR9EIX
	Ultra 150	JH1200-B	2004-2003	BR9ES*	BR9EIX
	STX-R	JT1200-C	2004	BR9ES*	BR9EIX
1100	ZXi	JH1100-A	2003-1996	BR9ES*	BR9EIX
	Ultra 130 DI	JH1100-B	2004-2001	PZFR7G-G	---
	STX	JT1100-A	1997	BR9ES*	BR9EIX
	STX	JT1100-B	1999-1998	BR9ES*	BR9EIX
	STX	JT1100-C	2000	PZFR7G-G	---
	STX D1	JT1100-F	2002-2001	PZFR7G-G	---
	STX D1	JT1100-G	2003	PZFR7G-G	---
900	ZXi	JH900-A	1997-1995	BR9ES*	BR9EIX
	STX	JT900-A	1999-1997	BR9ES*	BR9EIX
	STX	JT900-B	2002-2001	BR9ES*	BR9EIX
	STX	JT900-B	2000-1999	BR9ES*	BR9EIX
	STX	JT900-C	2002-2001	BR9ES*	BR9EIX
	STX	JT900-D	2003	BR9ES*	BR9EIX
	STX	JT900-E	2004	BR9ES*	BR9EIX
800	800SXR	800SXR	2004-2003	BR8ES*	BR9EIX
	800SXR	JS800-A	2004-2003	BR8ES*	BR9EIX
750	Super Sport	JH750-A	1994-1992	BR8ES*	BR9EIX
	Super Sport Xi	JH750-B	1995-1993	BR8ES*	BR9EIX
	ZXi	JH750-C	1997-1995	BR8ES*	BR9EIX
	XiR	JH750-D	1994	BR8ES*	BR9EIX
	Super Sport	JH750-E	1997-1996	BR8ES*	BR9EIX
	Super Sport Xi	JH750-F	1997-1996	BR8ES*	BR9EIX
	Super Sport Xi	JH750-G	1999-1998	BR8ES*	BR9EIX
	SX	JS750-A	1994-1992	BR8ES*	BR9EIX
	SX	JS750-B	1997-1995	BR8ES*	BR9EIX
	SXi Pro	JS750-C	2002-1998	BR8ES*	BR9EIX
	ST	JT750-A	1994	BR8ES*	BR9EIX
	STS	JT750-B	1997-1995	BR8ES*	BR9EIX
	STS	JT750-C	1999-1998	BR8ES*	BR9EIX
650	Jet Mate	JB650	1992-1989	BR7ES*	BR7EIX
	X2	JF650-A	1995-1986	BR7ES*	BR7EIX
	TS	JF650-B	1996-1989	BR7ES*	BR7EIX
	SC	JL650	1995-1991	BR7ES*	BR7EIX
	650SX	JS650	1995-1991	BR7ES*	BR7EIX
	650SX	JS650	1990-1987	BR7ES*	---
550	550SX (C2)	JS550	1995-1982	BR8ES*	BR8EIX
440	440SX	JS440	1992-1976	BR7ES*	BR7EIX
400	400SX	JS400	1975-1974	B7ES	---

### BOMBARDIER (Sea-Doo)

			YEAR	REG PLUG	IRIDIUM PLUG
1500	GTX 4-TEC, 4-TEC S/C		2003-2002	DCPR8E	---
950	GSX Limited		1999-1997	BR8ES*	BR8EIX
	GTX		2002-1999	BR8ES*	BR8EIX
	GTX DI		2003-2000	ZFR4F-11	---
	LRV DI		2003-2002	ZFR4F-11	---
	RX		2002-2000	BR8ES*	BR8EIX
	RX DI		2003-2000	ZFR4F-11	BR8EIX
	RXX		2002-2001	BR8ES*	BR8EIX
	XP		2002-1999	BR8ES*	BR8EIX
780	GSX		2000-1996	BR8ES*	BR8EIX
	GTX		2000-1996	BR8ES*	BR8EIX
	GTX RFI		2002-1999	BR8ES*	BR8EIX
	SPX		1999-1997	BR8ES*	BR8EIX
	XP		2000-1995	BR8ES*	BR8EIX
720	GS		2001-1997	BR8ES*	BR8EIX
	GSI		1998-1997	BR8ES*	BR8EIX
	GTH		2003-1996	BR8ES*	BR8EIX
	GTS		2001-1997	BR8ES*	BR8EIX
	HX		1997-1995	BR8ES*	BR8EIX
	SP		1998-1997	BR8ES*	BR8EIX
	SPX		1997-1996	BR8ES*	BR8EIX
650	GTX		1995-1994	BR8ES*	BR8EIX
	SPX		1995-1994	BR8ES*	BR8EIX
	XP		1994-1993	BR8ES*	BR8EIX
580	SP		1990-1988	BR7ES	BR7EIX
	GT		1991-1990	BR7ES	BR7EIX
	GTS		1997-1992	BR7ES	BR7EIX
	GTX		1993-1992	BR7ES	BR7EIX
	SP		1996-1991	BR7ES	BR7EIX
	SPI		1997-1993	BR7ES	BR7EIX
	SPX		1993	BR7ES	BR7EIX
	XP		1993-1991	BR7ES	BR7EIX



## NGK Iridium IX SPARK PLUGS

Iridium is significantly stronger than any metal used in spark plugs today. The ignitability and durability is better than platinum. Sold pk/4.

### Part No.

<b>BR8EIX</b>	<b>BKR7EIX-11</b>
<b>BR9EIX</b>	<b>BPR8EIX</b>
<b>BR8HIX</b>	<b>BPR9EIX</b>
<b>CR9EIX</b>	<b>BR8HVX</b>
	<b>DCPR8EIX</b>

*\*All Iridium Plugs are 4 per Package*



## NGK RACING CABLE

High performance red silicon outer shell for maximum heat resistance and durability. Ceramic resistor (5ohm) enhances protection against RFI.

Description	Part No.
90° Resistor cover 100cm, solid	<b>CR6</b>



## SPARK PLUG WIRE TESTER

Now you can check spark plug wires without piercing the wires. Light flashes indicating sound wire.

Description	Part No.
Spark Plug Wire Tester	<b>LS26900</b>
Replacement Bulb Assembly	<b>LS26970</b>



## NGK SPECIAL SPARK PLUGS FOR 4 STROKE ENGINES

Description	Part No.
K1100 STX-DI, Ultra 130 DI (PK/4)	<b>*PZRF7G-G</b>
Sea Doo GTX-4TEC (PK/10)	<b>DCPR-8E</b>
Sea Doo GTX-DI, LRV-DI, RX-DI (PK/4)	<b>ZFR4F-11</b>
Yamaha FX 140/160, VX110 (PK/10)	<b>CR9EB</b>
Kawasaki STX 12F/15F (PK/10)	<b>CR9EK</b>
Kawasaki Ultra 250 (PK/4)	<b>PMR9B</b>
Polaris M140, Genesis (PK/4)	<b>DZFR6H</b>
Hydrospace S4 (PK/4)	<b>BKR7EIX-11</b>
Honda 4 Stroke (PK/4)p	<b>IMR90-9H</b>
FX SHO, FZR, FZS (PK/10)	<b>LFR6A</b>



## 8.5MM SUPER CONDUCTOR SPARK PLUG WIRE

See page 99 for details

Description	Part No.
Two Cylinder Wire Set	<b>31009</b>
One Cylinder Wire Set	<b>31019</b>
Three Cylinder Wire Set	<b>31039</b>
Bulk Wire 25 feet - Red	<b>34019</b>
Bulk Wire 25 feet - Black	<b>34013</b>

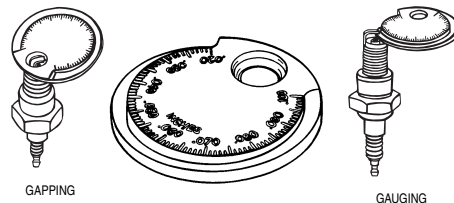

## STANDARD/HIGH ENERGY SPARK PLUG GAUGE & GAPPER

Gauge and gap all types of spark plugs from .020" to .110 (.50mm to 2.53mm).

Description	Part No.
Spark Plug Gauge and Gapper	<b>LS67870</b>



## NGK RESISTOR COVER

Waterproof spark plug resistor covers for use with resistor spark plugs.

Description	Part No.
(5K OHM) 90 "T" 14mm plugs with terminal nut	<b>TB05EM</b>



## MSD SPARK PLUG BOOT RETAINERS

There's no excuse for losing a race due to a plug wire popping off when you run MSD's Boot Retainers. These handy clamps are molded from heat resistant nylon material and will lock the boot to the spark plug.

Description	Part No.
A. Boot Retainer, 90° Spark Plug Boots & Terminal	<b>3340</b>
B. 90° Spark Plug Boots & Terminal Only (2 pcs.)	<b>3311</b>

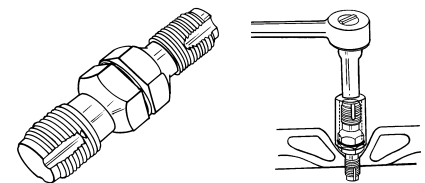

## SPARK PLUG HOLE THREAD CHASER

Cleans threads in spark plug hole. Use with 13/16" spark plug socket. Double-ended for both 14mm and 18mm threads.

Description	Part No.
Spark Plug Hole Thread Chaser	<b>LS20200</b>



## SPARK PLUG TOOLS

Description	Part No.
Ratchet Plug Wrench	<b>59-0539</b>

FOUR STROKE

INTAKE SYSTEMS

ENGINE/GASKETS

EXHAUST

DRIVE LINE HANDLING

ELECTRICAL

WATERLINE /BILGE

STEERING & CONTROLS

BODY

ACCESSORIES

SERVICE TOOLS /HARDWARE

CHEMICAL

# Atlantis

## ATLANTIS FLUSH KITS

FOUR STROKE  
INTAKE SYSTEMS  
ENGINE/GASKETS  
EXHAUST  
DRIVE LINE HANDLING  
ELECTRICAL  
WATERLINE /BILGE  
STEERING & CONTROLS  
BODY  
ACCESSORIES  
SERVICE TOOLS /HARDWARE  
CHEMICAL



**Sea Doo** **Part No.**  
93-02 All Non-Rear Drain Pipe Models **A7001**



**Sea Doo** **Part No.**  
95-06 Long Version of Rear Drain Pipe Model **A7003**



**Sea Doo** **Part No.**  
96-06 Short Version of Rear Drain Pipe Model & 95-97 Sportster/challenger Jet Boat (Single Engine) **A7004**



**Sea Doo** **Part No.**  
95-06 All with Rear Drain Pipe **A7006**



**Yamaha** **Part No.**  
87-98 Long Yamaha All non-factory installed flush kits (Except 760/800/1200) **A8588**



**Yamaha** **Part No.**  
87-98 Long Yamaha All non-factory installed flush kits (Except 760/800/1200) Quick Snap Type **A8589**



**Yamaha** **Part No.**  
95-02 Factory replacement GP760/1100/1200 & Jet Boat **A8582**



**Tigershark** **Part No.**  
All Model 94-99 **A5000**



**Kawasaki** **Part No.**  
03-05 4-Stroke Easy way to flush your new Kawasaki Jet Ski. Just screw on the fitting and leave it. Attach a quick-snap fitting to a garden hose and you are ready to flush. **A2628**



**Kawasaki** **Part No.**  
89-91 Jet Ski, Ultra 150 **A2520**



**Kawasaki** **Part No.**  
92-02 Jet Ski Except ZXI/STX/Ultra 150 **A2521**



**Kawasaki** **Part No.**  
95-02 ZXI, STX, Ultra 130 **A2522**



**Universal** **Part No.**  
A. Male Quick Snap Adapter Only for replacement **A2690**  
B. Universal 3/8" **A2505**



**Polaris** **Part No.**  
90-04 (Except Direct Injection) **A6000**



**Polaris** **Part No.**  
01-04 Direct Injection **A6001**



**Honda** **Part No.**  
All except 08 F-15X/15 GPScope **A5200**  
08 F-15X/15 GPScope **A5201**

# BLOWSION

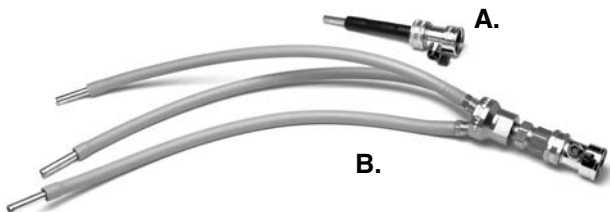

## BLOWSION ENGINE FLUSH KITS

A must for salt water riders! All metal construction - easy to use - just push into aftermarket water bypass. No tools, clamps or extra hoses necessary. Back flushes entire cooling system instead of forcing salt and sand into cooling jackets. Use in conjunction with our salt terminator kit. Simple and effective.

Description	Part No.
A. Standard Flush Tool	06-04-001
B. SX-R Flush Tool-Triple	06-04-002

\*Salt Terminator: See Chemical Section



Fits the rear drain on Sea Doo and Kawasaki 4 stroke engines.

Connects to your waterhose

ON & OFF Water Lever

### FLUSH KIT ADAPTER

Flush Kit Adapter for adapting overseas special size hose to connect flush kit. This adapter is a direct to fit to the rear drain line on Sea Doo and Kawasaki 4 stroke watercraft.

Description	Part No.
Flush Kit Adapter	SC-2905

### SNAP CONNECT AND FLOW CONTROL

This flush kit includes adapter SC-2905 listed to the left and also includes a quick disconnect that features a on/off water valve to make flushing the watercraft a simple and easy process.

\*The adapter is a direct to fit to the rear drain line on Sea Doo and Kawasaki 4 stroke watercraft.

Description	Part No.
Snap Connect and Flow Control	SC-2900

### PLASTIC GARDEN HOSE ADAPTER

Description	Part No.
Garden Hose Adapter Cap	64-0029



### Barb Connector

1/4" I.D. Hose-1/4" I.D. Hose	Part No.
3/8" I.D. Hose-3/8" I.D. Hose	64-0058
1/2" I.D. Hose-1/2" I.D. Hose	64-0059

### QUICK CONNECT

The ultimate in waterline connections, the fittings are fool proof. These fittings are safe for high temperatures and high pressure.

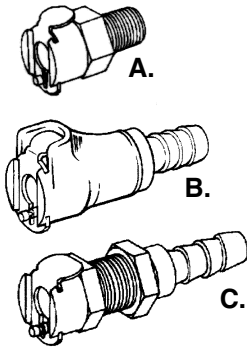

Description	Part No.
<i>Female</i>	
A. 1/4" Pipe Thread	64-0100
B. 3/8" In Line	64-0103
C. 3/8" Panel Mount	64-0106

### BRASS FITTINGS



Straight Hose Barbed	Part No.
1/8" Thread 1/4" Hose	64-0001
1/8" Thread 3/8" Hose	64-0003
1/4" Thread 1/2" Hose	64-0005



90 Degree	Part No.
1/8" Pipe thread 3/8" Hose	64-0007
1/4" Pipe thread 1/2" Hose	64-0009
1/8" Pipe thread 1/4" Hose	64-0010



Garden Hose Adapter	Part No.
3/8"	64-0012
1/2"	64-0014

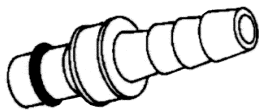

Description	Part No.
<i>Male (Barbed)</i>	
3/8" With shut off	64-0107
3/8" Without shut off	64-0109



45 Degree	Part No.
1/8" Pipe thread 1/4" Hose	64-0065
1/8" Pipe thread 3/8" Hose	64-0066
1/4" Pipe thread 1/2" Hose	64-0067



Brass Fitting	Part No.
1/8" Pipe threaded junction	64-0011
1/8" to 1/4" Adapter	64-0013
9mm Yamaha Flush Adapter	64-0004

### PLASTIC FITTINGS



Plastic T Fitting	Part No.
3/8" x 3/8" x 3/8"	64-0025
1/2" x 1/2" x 1/2"	64-0027

Plastic Y Fitting	Part No.
3/8" x 3/8" x 3/8" (white)	64-0045
1/4" x 1/4" x 1/4" (white)	64-0046
1/4" x 1/4" x 1/4" (black)	64-0047



Description	Part No.
1/2" Female in line	64-0117
1/2" Male in line	64-0115



T-Fitting	Part No.
Primer Fitting 1/8" x 1/8" x 1/8"	64-0015
Primer 1/4" x 1/4" x 1/8"	64-0017
Fuel Line 1/4" x 1/4" x 1/4"	64-0019

FOUR STROKE  
INTAKE SYSTEMS  
ENGINE/GASKETS  
EXHAUST  
DRIVE LINE HANDLING  
ELECTRICAL  
WATERLINE /BLIGE  
& CONTROLS  
BODY  
ACCESSORIES  
SERVICE TOOLS /HARDWARE  
CHEMICAL



## WATER LINE HOSE

Goodyear hose has been replacing rubber hose or metal tubing designs. Goodyear hose and tubing offers customers a number of benefits, including flexibility, durability, abrasion resistance, lighter weight materials, superior chemical resistance, high pressure capability, and extended product performance. Waterline is sold per foot.

Description	Part No.
3/8" Blue	56-8000
1/2" Blue	56-8004
3/8" Clear Vinyl*	56-8007

\*Clear vinyl hose is not manufactured by Goodyear.

500 foot reel 3/8" blue hose available and  
400 foot reel 1/2" blue hose available

**Call for special pricing on reel purchases.**



## GP1300R 1/2" X 1/2" BULKHEAD FITTINGS

The R&D Billet Aluminum Fitting allows for easy installation for extra cooling lines through the bulk head.

Description	Part No.
1/2" x 1/2" Bulkhead Fittings	660-00012



## GP1300R/GP1200R 1/2" INLINE WATER FILTER

The R&D Billet Inline Water Filter utilizes a screw in stainless steel mesh screen to stop small particles of sand from entering the water way of the engine.

Description	Part No.
1/2" Inline Water Filter	660-00013



## STAINLESS STEEL HOSE CLAMPS

Description	Part No.
#5 Clamps (for waterline)	64-0030



## WATER LINE HOSE

Flex-Tech multi purpose hose is more flexible and bendable for those complicated water routing requirements. This waterline is highly recommended for Factory and TBM Dry Pipe installations. Waterline is sold per foot.

Description	Part No.
3/8" Light Blue	56-8010



## 90 BYPASS FITTING

Water bypass fittings increase engine performance by diverting water from the cylinder head to the bypass fitting, rather than forcing all of the water thru the exhaust system, thus drying out the exhaust. These machined bypass fittings are angled at 90 degrees.

Description	Hose	Part No.
Silver	3/8"	56-2010
Black	3/8"	56-2012
Purple	3/8"	56-2019
Silver	1/2"	5085-POL
Black	1/2"	5085-BLK



TREY FRAME • TEAM BLACKSTAR  
PRO-AM 800 OPEN  
2ND PLACE OVERALL NATIONAL RANKING



## 45° BYPASS FITTING

Water bypass fittings increase engine performance by diverting water from the cylinder head to the bypass fitting, rather than forcing all of the water thru the exhaust system, thus drying out the exhaust. These machined bypass fittings are angled at 45 degrees.

Description	Hose	Part No.
Silver	3/8"	56-2020
Black	3/8"	56-2028
Silver	1/2"	J5087
Black	1/2"	J5088
Silver UMI	3/8"	JS-02001CLR
Black UMI	3/8"	JS-02001BKA

## Fast, Easy, Strong and Secure Installation



## SQUEEZE ON STAINLESS STEEL LOW PROFILE CLAMPS

Oetiker Stepless Ear Clamps, due to the reinforcing 'dimple' in the ear, hold against pressure and vibration or hose shrinkage due to temperature changes. A built-in spring action permits the clamp to "breathe" without loosening, the need to retighten is eliminated. Once installed, any tampering is easily visible, making this an excellent clamp for service or security applications.

Description	Clamp Size	Part No.
Pincer Tool	-	59-4015
Clamp for 1/4" Hose (10 pcs/pk)	9/16	59-4016
Clamp for 3/8" Water Line (10 pcs/pk)	11/16	59-4017
Clamp for 1/2" Water Line (10 pcs/pk)	13/16	59-4018

100 Clamp Packs	Clamp Size	Part No.
Clamp for 1/4" Hose (100 pcs/pk)	9/16	59-4016-100
Clamp for 3/8" Water Line (100 pcs/pk)	11/16	59-4017-100
Clamp for 1/2" Water Line (100 pcs/pk)	13/16	59-4018-100





## WATER STRAINER

The **Water Strainer** is a must to trap all sand, shell, and vegetation particles.  
**No more clogged water lines!!**  
 Height=2" (51mm)  
 Footprint= 2-1/2" (64mm) - Round

Description	Part No.
3/4" Water Line Strainer for Sea Doo 4-Stroke	56-9004
1/2" Water Line Strainer	56-9005
3/8" Water Line Strainer	56-9006
#20 Mesh Replacement	20420020
#40 Mesh Replacement	20420040

(#40 Mesh is finer than #20 Mesh)



## JET WORKS QUICK DISCONNECT WATER RESTRICTOR

QD-38 comes with 4/3/2mm restrictor inserts used for controlling water flow through exit passes, stinger, head pipes, etc. QD-14 is for use with Mikuni Jets (not included), and allows quick change in small increments of water flow.

Description	Part No.
Quick Disconnect Water Restrictor 3/8"	QD-38
Quick Disconnect Water Restrictor 1/4"	QD-14



## RIVA EXHAUST STINGER WATER FILTER/RESTRICTOR

Features fine mesh stainless filter screen that is threaded to accept Mikuni main jet (not included) for water restriction. Allows removal of restrictive filter screen in water distribution manifold of single, twin and triple exhaust systems, providing increased cooling water to motor.

Description	Part No.
Exhaust Stinger Water Filter/Restrictor 3/8"	RY15-SF38



## LOW PROFILE WATER STRAINERS

Smaller water strainers. Ideal for using with water injection or tight space.  
 Height: 2-3/8" (60mm)  
 Footprint: 1-3/8" (35mm) - Round

Description	Part No.
1/2" Water Line Strainer	56-9010
3/8" Water Line Strainer	56-9011
#20 Mesh Replacement	10486
#40 Mesh Replacement	10485

(#40 is finer than #20)



## JET WORKS FLOW CONTROL VALVE

The Flow Control Valve provides improved throttle response and much quicker starts by drying out your waterbox at low rpm and idle speeds. Tests have shown an average acceleration improvement of 10 feet over a non-equipped model in the first 50 feet. The Flow Control Valve allows unrestricted water flow to the Stinger for better top speed. Yet it controls the amount of water at low speeds for better response. It also allows for an easier tuning of the Carburetors. It does not interfere with normal engine or exhaust pipe cooling and is compatible with all electronic water injection systems. Race Legal for All Classes. Two Models are available. Both are adjustable. The Standard Flow Control Valve is preset at 3.5 p.s.i. and is adjusted by adding the supplied stainless steel shims to increase the spring tension. The Pro-Series is externally adjustable by turning the outer housing by hand. Pressure can be tested with pop off gauge. All PWC w/OEM or aftermarket exhaust systems (except Yamaha's w/OEM exhaust)

Description	Part No.
Standard Flow Control Valve 3/8"	52-3118
Pro Flow Control Valve 3/8"	52-3119
Pro Flow Control Valve 1/4"	52-3122

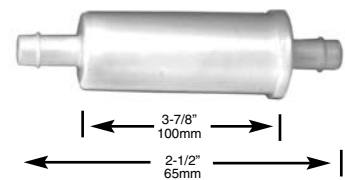

## FOR FACTORY PIPE CHAMBER WATERLINE

Description	Part No.
Waterline Inline Filter	COMFTG0036



## JET WORKS ADJUSTABLE WATER RESTRICTOR

Allows user to adjust flow on any 3/8" ID waterline. A great product for fine tuning engine/exhaust temperature for maximum power.

Description	Part No.
Adjustable Water Restrictor	JWR-01



## RIVA RACING ALUMINUM THRU HULL CONNECTORS

Riva Racing's aluminum thru hull fittings are anodized to prevent corrosion. Available in 3/8" and 1/2" waterline applications.

Description	Part No.
3/8" Thru Hull Connector	RY1013-TH-3/8
1/2" Thru Hull Connector	RY1013-TH-1/2



2006 WORLD FINALS • LAKE HAVASU, AZ  
 PHOTO COURTESY OF JIN OMURA

FOUR STROKE  
 INTAKE SYSTEMS  
 ENGINE/ GASKETS  
 EXHAUST  
 DRIVE LINE HANDLING  
 ELECTRICAL  
 WATERLINE /BLGE  
 STEERING & CONTROLS  
 BODY  
 ACCESSORIES  
 SERVICE TOOLS /HARDWARE  
 CHEMICAL



## RULE BILGE PUMP



Description	Hose	Height	Part No.
500 GPH	3/4"	3-1/2" (89mm)	25D
800 GPH	3/4"	3-3/4" (96mm)	20R

Description	Hose	Height	Part No.
1100 GPH	1-1/8"	4-1/4" (108mm)	27D



## PWC AUTOMATIC 500 GPH PUMP

Automatically removes water from engine compartment. Cycles every 20 seconds to check for water. Equipped with gasoline resistant strainer base and 72" wire leads.

Description	Height	Part No.
500 GPH	4" (102mm)	25S-6WC



## RULE STRAINER BASE & S/S DEBRIS STRAINER

Description	Part No.
Blue Plastic Strainer Base	57-4006
Gas Resistant Strainer Base	57-4007
Stainless Steel Debris Strainer	57-4025



## PLASTIC HOSES AND FITTINGS

Description	Part No.
3/4" Hose 12" Length	57-4008
1-1/8" Hose 12" Length	57-4009



## RULE-MATE FULLY AUTOMATED BILGE PUMP

All in one pump and switch system. Extra long life Heavy Duty Motor. Non-contact, mercury free float switch.

Description	Hose	Height	Part No.
500GPH	3/4"	4" (102mm)	RM500
750GPH	3/4"	4" (102mm)	RM750
1100GPH	1-1/8"	4" (102mm)	RM1100



## STRAIGHT BILGE FITTING

Aluminum through hull outlet fittings.

Description	Part No.
3/4" Silver	57-4012
3/4" Black	57-4015
1-1/8" Silver	57-4018
1-1/8" Black	57-4020



## 45 DEGREE BILGE FITTING

Description	Hose	Part No.
3/4"	Silver	57-4021
3/4"	Black	57-4023



PHOTO COURTESY OF JEFF HAIN



## SX-R 800 RULE BRIDGE MOUNT BRACKET

The R&D Bilge Pump Mount Bracket bolts securely to the hull developing a secure surface to hold the Bilge pump in place.

<b>Kawasaki</b>	<b>Part No.</b>
800SX-R	660-80000



## BILGE PUMP BRACKETS

<b>Yamaha</b>	<b>Part No.</b>
A. WaveBlaster/701 Super Jet 95+	57-3029
<b>Kawasaki</b>	<b>Part No.</b>
B. 440/550	57-3023
C. 650SX/X2, 550SX, 750SX, SXI	57-3024
D. 750SS/XI/ST/STS	57-3025



## DUAL BILGE PUMP MOUNTING BRACKET

<b>Description</b>	<b>Part No.</b>
Kawasaki 800SX-R	06-01-101
Superjet 96+	06-01-153

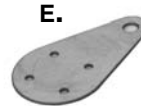

<b>Sea Doo</b>	<b>Part No.</b>
E. HX	SE-044013

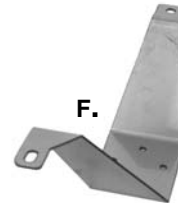

<b>Polaris</b>	<b>Part No.</b>
F. Polaris -98	SE044011

<b>Yamaha</b>	<b>Part No.</b>
F. Wave Raider	SE-044011



## WATERPROOF TERMINAL KIT

Japanese OEM type connector Kit.

<b>Description</b>	<b>Part No.</b>
2-Pin Terminal Kit	55-2050
3-Pin Terminal Kit	55-2051
4-Pin Terminal Kit	55-2052



## BILGE ELECTRICAL PARTS KIT

Kit contains waterproof fuse holder, 6amp fuse, ring terminal, shrink tubing.

<b>Description</b>	<b>Part No.</b>
Bilge Electrical Parts Kit	57-3030



## JAPANESE OEM STYLE CONNECTOR

<b>Description</b>	<b>Part No.</b>
OEM Style Electric Connector Kit 5pcs/pk	55-2035
Dealer Kit 20pcs/pk	55-2037



## ADHESIVE LINED HEAT SHRINK BUTT CONNECTORS

Best used where moisture and corrosion is a problem. After crimping these terminals to wire, heat is applied enabling the adhesive within each shrunk tube terminal to melt and flow evenly to seal the connection against the harshest environment.

<b>Description</b>	<b>Wire Range</b>	<b>Part No.</b>
10pcs/pk Pink	22-18 (0.3-0.8mm)	55-2040
100pcs/pk Pink	22-18 (0.3-0.8mm)	55-2041
10pcs/pk Blue	16-14 (1-2mm)	55-2042
100pcs/pk Blue	16-14 (1-2mm)	55-2043

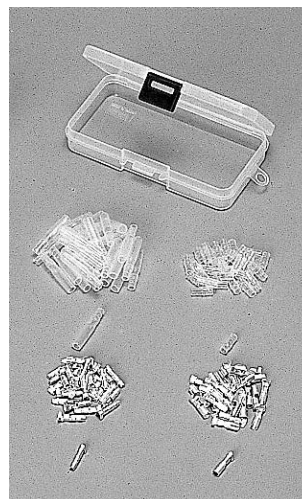

## MALE/FEMALE TERMINAL KIT

This kit includes 30 of both the male and female terminals and plastic sleeves/covers. The terminals are tin plated to prevent corrosion. The terminal kit is provided in a handy plastic case.

<b>Description</b>	<b>Part No.</b>
Male/Female Terminal Kit	16-601

FOUR STROKE  
INTAKE SYSTEMS  
ENGINE/GASKETS  
EXHAUST  
DRIVE LINE HANDLING  
ELECTRICAL  
WATERLINE /BILGE  
& CONTROLS  
STEERING  
BODY  
ACCESSORIES  
SERVICE TOOLS /HARDWARE  
CHEMICAL

## WATERPROOF SWITCHES AND BRACKETS

- Features waterproof on/off switch that is available with machined aluminum clamp-on or switch mounted bracket. Allows totally reliable and easy control of bilge pump operation.
- Mounting bracket is machined from billet alloy and is anodized black to prevent corrosion. Available for clamp-on bar mounting or bolts to the bottom of the OEM on/off switch assembly.
- All of the switches have a 9 ft. high grade wire lead.



**Yamaha** Part No. 57-3017  
All



**UNIVERSAL**

**Description** Part No.  
Universal Handle Bar Mount 57-3006



**Kawasaki** Part No. 57-3015  
All 650's / 750SS-95 / XI-93



**Kawasaki** Part No. 57-3003  
440 / 550 / 750SX / 750SXI / 800SX-R



**Description** Part No.  
Standard Switch with 9 feet of wire (No bracket included) 57-3009

## Hot Products PWC Waterproof Switches Imported Exclusively from



57-3020

**HOT PRODUCTS EXCLUSIVE**

### 3-WAY PANEL MOUNT ROTARY SWITCHES

Connects to two electronic accessories for power control. Allows the operation of one or both accessories to run at the same time. Suggested uses: Second Bilge, Ignition, etc. 12Volt/5Amp.



**Left Hand On Position**  
Use: Blue & Red Wires

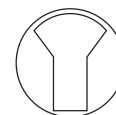

**Center Off Position**

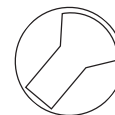

**Right Hand On Position**  
Use: White & Red Wires



JP7043



JP7044

## UNIVERSAL HANDLEBAR MOUNT SWITCHES

Mounts to handlebar or mounts to underside of most aftermarket throttle levers. Complete with 9" wire lead.

Description	Part No.	Description	Part No.
Handlebar Mount Switch	JP7043	Handlebar Mount Switch	JP7044
12Volt/6Amp push on/off switch		12Volt/5Amp 3 way rotary switch	

Description	Part No.
Panel Mount Switch	57-3020

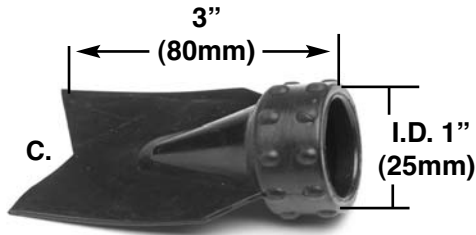
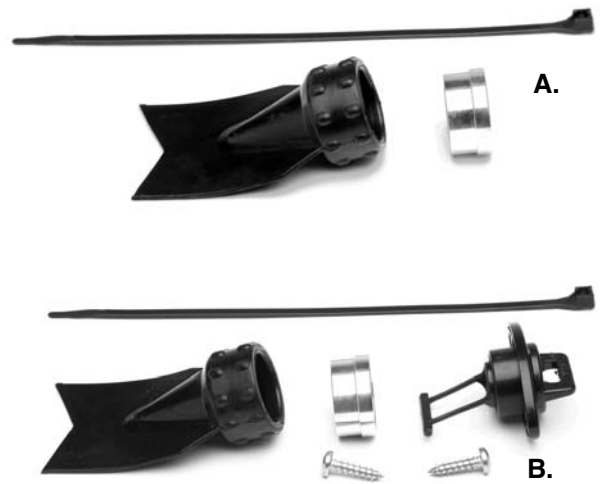

## DUCK BILL DRAIN SYSTEM

Simple and clean, drains water from hull under acceleration.

- A. Add to your current drain plug or
- B. Purchase entire system kit.

Description	Part No.
A. All SeaDoo (Except XP) All Sit down Yamaha / Kawasaki*	57-4050
B. Universal (Complete System)	57-4060
C. Duck Bill Flapper only	57-4055

\*Kawasaki models require slight modification



## DRAIN PLUG

The replacement drain plug at a fraction of manufacturer's prices. Our floating drain plug is oil and fuel resistant. Just flip or twist to install.

Description	Part No.
D. Sea Doo & Polaris	57-4058
E. Pre 95 Sea Doo & Polaris	A2385



## BILLET QUICK DRAIN FOR KAWASAKI

Mounts to the transom of your Kawasaki 1200 STX-R or SX-R 800 watercraft with billet aluminum mounting plate.

Kawasaki	Part No.
1200 STX-R, 800 SX-R	57-4065



## UNIVERSAL BILLET QUICK DRAIN

Mounts to the transom of any watercraft with billet aluminum mounting plate.

Description	Part No.
Billet Quick Drain Kit	57-4059



## DUCK BILL DRAIN ADAPTER PLUG

Unscrew stock drain plug and screw our duck bill drain plugs in place. Keep your stock plug if you ever need to change!

Description	Part No.
Kawasaki	Z471
Yamaha	Z472



## BILGE SPONGE

This Viscose-Covered sponge will pick-up and hold an amazing 32 ounces (512gm) of water without leaking. With grommet and hand cord.

Description	Part No.
Bilge Sponge	57-4070



2007 WORLD FINALS • LAKE HAVASU, AZ  
PHOTO COURTESY OF JIN OMURA

FOUR STROKE	EXHAUST	DRIVE LINE HANDLING	ELECTRICAL	WATERLINE /BILGE	STEERING & CONTROLS	BODY	ACCESSORIES	SERVICE TOOLS /HARDWARE	CHEMICAL
-------------	---------	---------------------	------------	------------------	---------------------	------	-------------	-------------------------	----------

## VERSIPLUG DRAIN SYSTEM

The reliable self-bailing drain plug made specifically for the PWC industry.

With Versiplug you will never have to put the plugs in or take the plugs out... Because the Versiplug is the automatic drain solution.

Versiplugins are simple to install and once you install them you will never have to think about the drain plug again.

Versiplug is available in three options:

- 1. Versiplug** (The original) fits Yamaha, Kawasaki, Sea Doo, Honda and Polaris.
- 2. Versiplug-R** - Developed for the serious PWC enthusiast and racers  
Higher flowing and lighter weight than the original Versiplug
- 3. Versiplug Max** - The rugged solution for leaky flap scuppers  
Created for freestyle to create a reliable fix to scupper setups that had leaking issues when not moving.

### VERSIPLUG

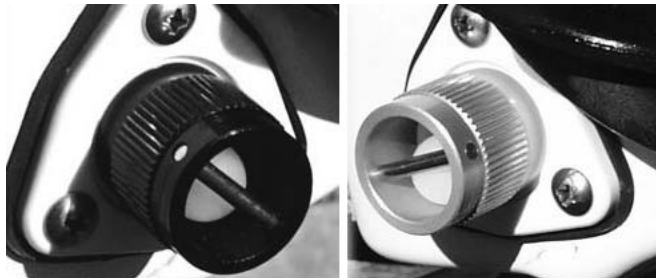

Description	Color	Part No.
Versiplug Original - Yamaha	Silver	PD1200
Versiplug Original - Yamaha	Black	PD1201
Versiplug Original - Kawasaki	Silver	PD1300
Versiplug Original - Kawasaki	Black	PD1301
Versiplug Original - Sea Doo/Honda/Polaris	Silver	PD1400
Versiplug Original - Sea Doo/Honda/Polaris	Black	PD1401
Versiplug Original - Hydrospace	Silver	PD1500
Versiplug Original - Hydrospace	Black	PD1501



### BLOWSION CAS BILLET ALUMINUM ONE WAY VALVE SCUPPER

The new 2009 CAS flow valve design prevents water getting in during tail stands, wave jumping, or all out buoy shredding. The new billet flange assembly is the premium design setup and allows use of the Blowision billet exhaust outlet so vain riders can sanitize both sides of the rear of their watercraft. The aluminum, rubber, and injection molded construction of the Blowision one-way valve assembly along w/ the recessed internal mounting results in a bulletproof set-up. Fits all years Super Jet, Kawasaki 650, 750 and SXR 800 and Polaris Octane. Each pre-assembled kit includes explicitly detailed instructions, two Blowision molded glue able urethane bulkhead and ski flanges for leak less sealing, recessed one-way flow valve, special flex tubing (allows for off center mounting unlike straight PVC tube scupper systems) mounting epoxy and stainless fasteners.

Description	Part No.
Blowision CAS Aluminum One Way Valve Scupper	06-01-022
Blowision CAS Billet Aluminum Flange Only	06-01-023

NOTE: Recommend Blowision 2 part mixing foam pint kit with install (PART # AWMA100).

### VERSIPLUG-R

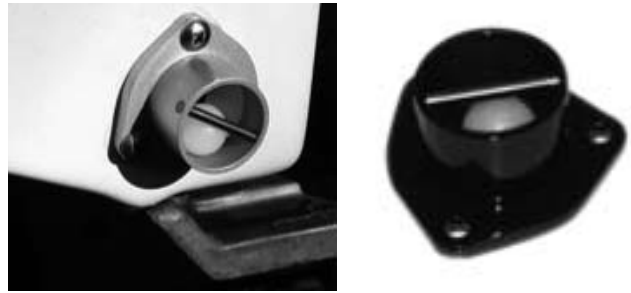

Description	Part No.
Versiplug-R - Silver	PD1500
Versiplug-R - Black	PD1600

### VERSIPLUG MAX!



Description	Color	Part No.
Versiplug Max	Silver	PD1700
Versiplug Max	Black	PD1701



### SCUPPER VALVE ASSEMBLY

Ski Clinic drain valve has an aluminum flap, that does not bend or warp,

greatly improving the seal. *For Freestyle use only.*

Description	Part No.
Scupper Valve Assembly (Silver)	SCVL
Scupper Valve Assembly (Black)	SCVL-B

### BLOWSION



### ONE WAY VALVE

Unlike scupper valves that mount on the exposed exterior of your ski, our one way valve kits install "into" the rear 1/4 of your PWC end caps. This keeps continual water pressure on the inside of the tube, keeping the valve shut when the ski is floating.

Description	Part No.
800SX-R	05-04-321
Superjet, Kawasaki 750, Polaris Octane	05-04-312
Pro Finish Kit	05-04-314

# WSM REPLACEMENT STEERING CABLES

MODEL	YEAR	OE NO.	PART NO.
<b>SEA DOO</b>			
580 GT	90-91	277-000-152	002-045
580 GTS	92	277-000-152	002-045
580 GTS	93	277-000-229	002-045
580 GTS	94	277-000-261	002-045-01
580 GTS	95-96	271-000-436	002-045-02
580 GTX	92	277-000-152	002-045
580 GTX	93	277-000-229	002-045
580 SP	92	277-000-151	002-045-06
580 SP	89-91	277-000-228	002-046
580 SP	94-96	277-000-289	002-048-01
580 SPI	93	277-000-228	002-046
580 SPI	94-96	277-000-289	002-048-01
580 SPX	93	277-000-228	002-046
580 XP	91	277-000-228	002-046
580 XP	92	277-000-151	002-045-06
650 GTX	94	277-000-261	002-045-01
650 GTX	95	271-000-436	002-045-02
650 SPX	94-95	277-000-289	002-048-01
650 XP	93	277-000-267	002-048-02
650 XP	94	277-000-289	002-048-01
650 XPI	94	277-000-289	002-048-01
720 GS	97-01	271-000-436	002-045-02
720 GSI	97	271-000-436	002-045-02
720 GTI	96	271-000-436	002-045-02
720 GTI	97-00	277-000-526	002-048-04
720 GTI	01-04	277-001-010	002-045-08
720 GTI LE	02-04	277-001-010	002-045-08
720 GTS	97-00	271-000-436	002-045-02
720 GTS	2001	277-001-010	002-045-08
720 HX	95-97	277-000-051	002-045-03
720 SP	97	277-000-289	002-048-01
720 SPX	96-97	277-000-289	002-048-01
720 XP	95	277-000-467	002-048-03
800 GSX	96-97	271-000-436	002-045-02
800 GSX RFI	99	271-000-841	N/A
800 GSX RFI	2000	277-000-841	002-046-02
800 GTI RFI	2004	277-001-010	002-045-08
800 GTI LE RFI	03-04	277-001-010	002-045-08
800 GTX	96-97	277-000-526	002-045-06
800 GTX RFI	98	277-000-769	N/A
800 GTX RFI	99-00	277-000-842	002-046-03
800 GTX RFI	01-02	277-001-009	N/A
800 SPX	98-99	277-000-289	002-048-01
951 GSX LTD	98	271-000-436	002-045-02951
GSX LTD	99	271-000-841	N/A
951 GTX LTD	98	277-000-526	002-045-06
951 GTX	2000	277-000-843	002-046-04
951 GTX	01-02	277-001-010	002-045-08
951 GTX DI	2000	277-000-842	002-046-03
951 GTX DI	02-03	277-000-949	002-046-05
951 GTX DI	2001	277-001-009	N/A
951 GTX LTD	99	277-000-843	002-046-04
951 RX	01-02	277-001-011	002-045-05
951 RX DI	2000	277-000-841	002-046-02
951 RX X	2001	289-100-070	N/A
951 XP	2000	277-000-889	N/A
951 XP	01-02	277-001-008	002-045-04
951 XP DI	03-04	277-001-008	002-045-04
951 XP LTD	98-99	277-000-773	002-046-01
4-TEC GTX	02-04	277-000-949	002-046-05
4-TEC GTX LTD SC	03-04	277-000-949	002-046-05
4-TEC GTX SC	03-04	277-000-949	002-046-05
4-TEC GTX WAKE BOARD	03-04	277-000-949	002-046-05

MODEL	YEAR	OE NO.	PART NO.
<b>KAWASAKI</b>			
300 SX	86-88	59406-3001	002-069
400 SX	76-79	59406-3001	002-069
440 SX	77-92	59406-3001	002-069
550 SX	82-95	59406-3001	002-069
650 SC	91-95	59406-3724	002-074-03
650 SX	87-90	59406-3705	002-074
650 SX	91-93	59406-3720	002-043
650 TS	89-96	59406-3714	002-040
650 X2	88-95	59406-3711	002-074-01

MODEL	YEAR	OE NO.	PART NO.
<b>KAWASAKI CONTINUED...</b>			
650 X2	88-95	59406-3712	002-073
650 X2	86-87	59406-3723	002-070
750 SS	92-97	59406-3728	002-044-01
750 SSXI	93-97	59406-3732	002-044
750 ST	94-95	59406-3729	N/A
750 STS	95-97	59406-3736	002-042-01
750 STX	98	59406-3736	002-042-01
750 SX	92-95	59406-3726	002-041
750 SXI	95-96	59406-3726	002-041
750 SXI PRO	98-02	59406-3726	002-041
750 XI	98-99	59406-3728	002-044-01
750 XIR	94	59406-3738	N/A
750 ZXI	95	59406-3746	002-042-02
800 SX-R	03-06	59406-3776	N/A
900 STS	01-02	59406-3748	002-042-03
900 STX	97-98	59406-3736	002-042-01
900 STX	99-02	59406-3748	002-042-03
900 STX	03-06	59406-3778	002-040-02
900 ZXI	95	59406-3746	002-042-02
1100 STX	97-99	59406-3748	002-042-03
1100 STX D.I.	00-02	59406-3748	002-042-03
1100 STX D.I.	2003	59406-3778	002-040-02
1100 ULTRA 130	01-04	59406-3771	002-042-04
1100 ZXI	96-03	59406-3757	002-040-01
1200 STX	03-04	59406-3778	002-040-02
1200 STX-F	05-06	59406-3778	002-040-02
1200 STX-R	02-03	59406-3748	002-042-03
1200 STX-R	04-05	59406-3778	002-040-02
1200 ULTRA 150	99-05	594063-3771	002-042-04
1500 STX-F	04-06	59406-3778	002-040-02

MODEL	YEAR	OE NO.	PART NO.
<b>YAMAHA</b>			
500 LX	93	EU0-U1481-00	002-051
500 WAVE JAMMER	89-90	EW3-61481-02	002-050
500 WAVE RUNNER	89, 92-93	EU0-U1481-00	002-051
650 SUPER JET	90-93	EW2-61481-00	002-059
650 WAVE RUNNER III	90-96	FJ0-61481-00	002-049
650 WAVE RUNNER VXR	91-95	FN8-U1481-00	002-042
701 FX	94-95	FX1-61481-00	N/A
701 RAIDER	94	GH1-61481-02	002-059-01
701 RAIDER	95-97	GH6-U1481-00	002-051-04
701 SUPER JET	95	EW2-U1481-00	N/A
701 SUPER JET	96-04	GM6-61481-00	002-059-03
701 VXR PRO	93-94	FN8-U1481-00	002-042
701 WAVE VENTURE	98	GP3-61480-00	N/A
701 WAVEBLASTER	93-96	GA7-61481-00	002-058
701 WAVE RUNNER III	97	FJ0-61481-00	002-049
701 WV	95-96	GJ3-U1481-00	002-059-02
701 XL	99-01	GU2-U1481-10	002-059-05
760 GP	99-00	GP7-U1481-00	002-051-05
760 RAIDER	96	GH6-U1481-00	002-051-04
760 WAVEBLASTER	96	GK5-61480-00	N/A
760 WAVE RUNNER	97-98	GP7-U1481-00	002-051-05
760 WAVE VENTURE	97	GP3-61480-00	N/A
760 XL	99	GU2-U1481-01	002-059-05
800 GP	98-00	GP7-U1481-00	002-051-05
800 GP	01-02	F0X-U1481-00	002-051-02
800 GP	2003	F0X-U1481-10	002-051-02
800 GP	2004	F0W-61481-01	N/A
800 XA	2004	F0D-U1481-10	002-051-01
800 XL	02-04	F0D-U1481-10	002-051-01
1000 FX/HIGH OUTPUT	2004	F1B-61481-02	N/A
1100 RAIDER	95-96	GJ1-U1481-00	002-058-01
1100 WAVE VENTURE	96-97	GH3-61480-00	002-051-03
1200 GP	97-99	GP8-U1481-00	002-059-04
1200 GP	00-02	F0X-U1481-00	002-051-02
1200 XA	2004	F0D-U1481-10	002-051-01
1200 XL	98	GU2-U1481-10	002-059-05
1200 XLT	03-04	F0D-U1481-10	002-051-01
1300 GP R	2004	F1G-61481-02	N/A
1400 FX	02-03	F1B-61481-01	N/A

FOUR  
STROKE  
INTAKE  
SYSTEMS  
ENGINE/  
GASKETS  
EXHAUST  
DRIVE LINE  
HANDLING  
ELECTRICAL  
WATERLINE  
/BILGE  
STEERING  
& CONTROLS  
BODY  
ACCESSORIES  
SERVICE TOOLS  
/HARDWARE  
CHEMICAL



## RICK ROY PRODUCTS ADJUSTABLE HANDLEPOLE

- Extra strong design using 6061 T6 aluminum tube.
- Quickly adjustable from +2 inches to -10 inches.
- Comes with Kawasaki or Yamaha bushing.
- Optional pole bracket enables installation of two 2 1/5" air intakes (engine breathes from top of pole).
- Requires Superjet Pole Pad Cover.
- Ships in 24 x 6 x 10 inch box.

Description	Part No.
Kawasaki SX-R	HP-KAW
Yamaha Super Jet	HP-YAM
Hydrospace	HP-HY-SP*

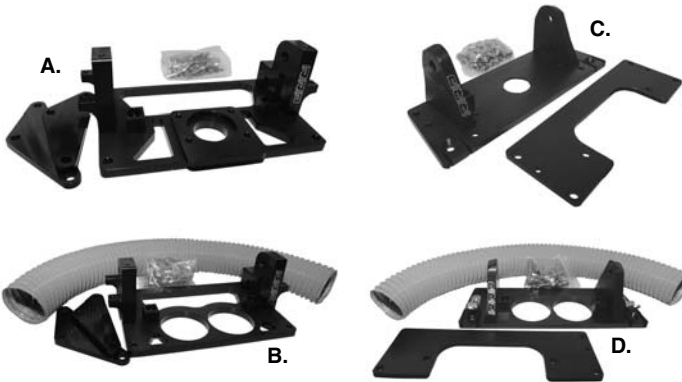

Kawasaki pole bracket with under plate.

Yamaha pole bracket with under plate.

Kawasaki 800 SX-R	Part No.	Yamaha SJ 96+	Part No.
A. 1 Hole	BR-KAW-1H	C. 1 Hole Low	BR-YAM-L-1H
B. 2 Hole	BR-KAW-2H*	D. 2 Holes Low	BR-YAM-L-2H*

RRP Handlepole Brackets B and D include 2 breather hoses.



High flow breather air tube.

**Flex Hose only** Part No.  
2.5"OD x 24" length FL-HO-24  
\*Sold one piece each



This quick steering adapter fits the stock superjet nozzle. It will give you the option to play with the quickness of the steering from really aggressive to really smooth. It will also give you a lot more turning ratio for free style. Comes in Red or Black.

Yamaha Quick Steering Adapter	Part No.
Black	QU-ST-YAM-BL
Red	QU-ST-YAM-RD



\*For Kawasaki 800SXR Handle Pole Conversion, please see Steps 1-2-3 on pages 168 and 169.  
(RRP Handle Poles include the items in Step 1)  
Select Step 2 & Step 3

Set-Up	HP-KAW	HP-YAM
OEM Turn Plate with OEM Mount	NO	YES
Aftermarket Turn Plate with UMI Mount	YES	YES

\*Note: You may have to a minimal amount of fitting to create the proper hood clearance. You must use the RRP Chin Pad and RRP Steering System and Steering Stopper.

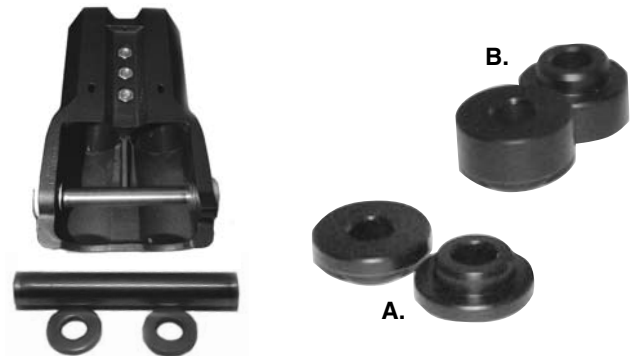

For the rider that rides with a very tight pivot bolt. This spacer will prevent the casting from breaking.

Handle Pole Bushing	Part No.
A. Yamaha	BU-YAM
B. Kawasaki	BU-KAW

Description	Part No.
Yam / Kaw	FS-BC-SPC

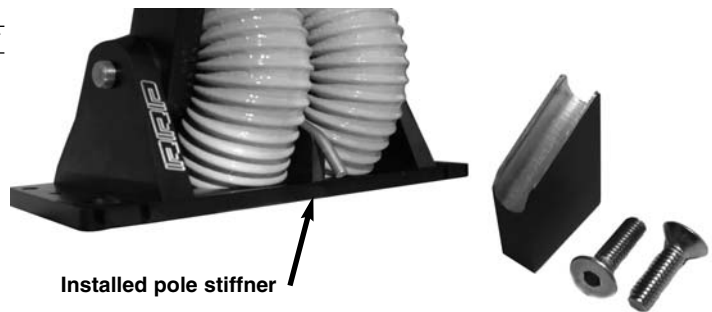

## RRP POLE SPRING STIFFNER

This RRP developed part has been designed to make your handlepole spring stiffer creating a lighter feeling handlepole. Easy to install. This bracket will fit both the one hole and two hole RRP handlepole brackets.

\*If you use a 2 hole air inlet bracket BR-YAM-L-2H or a BR-KAW-2H and want to run the OEM handlepole spring you must use this part. This part only fits the RRP bracket system.

Description	Part No.
RRP Yamaha Pole Spring Stiffner	SP-BL-YAM
RRP Kawasaki Pole Spring Stiffner	SP-BL-KAW





## RRP CARBON CHIN PAD

The most innovative pad design. The only chin pad that really matches the lines of the RRP Handlepole. Comes with number plate. (Numbers are not included)

Description	Part No.
RRP Chin Pad with White Stripping	RRP-PAD-WHITE
RRP Chin Pad with Green Stripping	RRP-PAD-GREEN
RRP Chin Pad with Orange Stripping	RRP-PAD-ORANGE
RRP Chin Pad with Blue Stripping	RRP-PAD-BLUE

\*Note: You must use with ST-STOP-BL-10 or ST-STOP-RD-10



## RRP CARBON "AIR FORCED" CHIN PAD

The New RRP "Air Forced" chin pad is designed to increase air flow by forcing air thru the handle pole tubes into the engine compartment. The fresh air pressureized engine compartment will improve the overall performance of the engine.

Description	Part No.
RRP "Air Forced" Chin Pad with Blue Stripping	RRP-PAD-BU
RRP "Air Forced" Chin Pad with Red Stripping	RRP-PAD-RED
RRP "Air Forced" Chin Pad with Green Stripping	RRP-PAD-GREEN

\*Note: Works in conjunction with RRP Handle pole bracket with breathing tube or also with the stock Hydro-space bracket.



## RRP CHIN PAD SUPPORT & STEERING STOP

This steering stopper will also prevent the pole pad from crushing or getting ripped out from the handel pole. Comes in red or black.

Yamaha OEM Chin Pad	Part No.
RRP Chin Pad Support and Steering Stop - Black	ST-STOP-BL
RRP Chin Pad Support and Steering Stop - Red	ST-STOP-RD

RRP Chin Pad (10mm Shorter Unit for RRP Chin Pad)	Part No.
RRP Chin Pad Support and Steering Stop - Black	ST-STOP-BL-10
RRP Chin Pad Support and Steering Stop - Red	ST-STOP-RD-10



System Installed

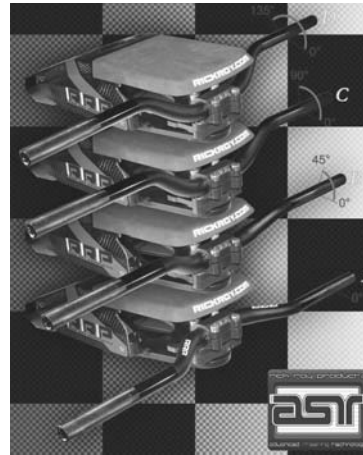

## RRP AST STEERING SYSTEM FOR 28.6MM FAT BARS

This RRP AST (Advanced Steering Technology) steering system has been designed for all types of riding from Freestyle to racing and from freeride to the recreational rider. Each rider will find benefits in this new concept.

The concept behind this steering system has many features:

- To bring the rider closer to the pivot point
- Less movement to turn the bars (quicker steering)
- Lowers the center of gravity
- Multiple bar position allowing the rider to perfect his riding style
- Fits all stand up watercraft due to the moveable steering cable arm
- Slotted mounting for the steering cable ball for maximum adjustment.
- Utilizes the fat bar 28.6 mm technology for better clamping surface
- The system uses bearings and is o-rings sealed
- Grease Zerk fitting to grease the bearing system for easy maintenance
- 100% Compatible with RRP carbon pole pads (both models)

Description	Part No.
RRP AST "Fat" Bar Steering System	STR-SYS-UNIV-F

\*Note: This system will work with other chin pads but will require fit modification to clear the steering when riding. Riders using the straight 28.6 bars will need to use the extended base clamp if not the controls will hit the pad before the turn plate hits the steering stopper.

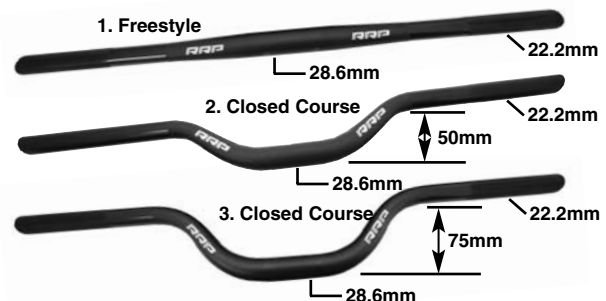

## RRP "FAT" PERFORMANCE HANDLEBARS

Brand new for 2008, RRP has developed these "Fat" bars to be extremely strong for freestyle and racing. All RRP handlebars are "Fat" bars and are 28.6mm at the clamping area.

Description	Part No.
1. Straight Freestyle Bars	ST-B-F*
2. Closed Course Bars - 50mm Bend	50-B-F
3. Closed Course Bars - 75mm Bend	75-B-F

\*Note: Riders using the straight 28,6 bars will need to use the extended base clamp if not the controls will hit the pad before the turn plate hits the steering stopper. Extended Base Clamps Part# EXT-BS-PLT

FOUR STROKE	INTAKE SYSTEMS	ENGINE/GASKETS	EXHAUST	DRIVE LINE HANDLING	ELECTRICAL	WATERLINE /BILGE	STEERING & CONTROLS	BODY	ACCESSORIES	SERVICE TOOLS /HARDWARE	CHEMICAL
-------------	----------------	----------------	---------	---------------------	------------	------------------	---------------------	------	-------------	-------------------------	----------

FOUR STROKE  
INTAKE SYSTEMS  
ENGINE/GASKETS  
EXHAUST  
DRIVE LINE HANDLING  
ELECTRICAL  
WATERLINE /BILGE  
STEERING & CONTROLS  
BODY  
ACCESSORIES  
SERVICE TOOLS /HARDWARE  
CHEMICAL

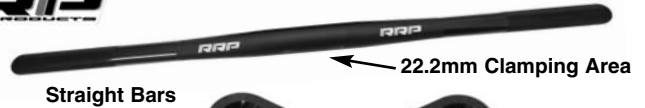

## RRP UNIVERSAL STEERING SYSTEM

Designed to match and compliment the RRP Turn Plate, this steering system improves the steering feel, eliminates steering slop and is much stronger than the OEM steering systems on standup watercraft. This kit will fit most aftermarket turn plates.

Description	Part No.
RRP Bearing Steering System	STR-SYST-UNIV



## RRP PRECISION TURN PLATE

The RRP Turn Plate is one inch shorter than the OEM turn plate moving the rider up in the tray. Fits Kawasaki, Yamaha, Polaris and Hydro-Space. The steering arm can be mounted either side, allowing this turn plate to fit any ski. The steering arm is slotted to allow for extremely precise steering ratio adjustments. RRP has also integrated a grease fitting on the turn plate that allows the rider to fully grease your steering system in only few seconds. The turn plate will accept V bars and straight bars and fits most after market steering systems.

Description	Part No.
RRP -1" Precision Turn Plate	TRN-PLT-UNIV
RRP Straight Standup Bars 22.2mm	ST-B*

\*Note: Big advantage of using the straight bars it brings the rider closer to the pivot point, less movement going left and right with the bars more stability in the turn because the bars are staying closer to the rider.



## RRP ADJUSTABLE BINDING SYSTEM

This is a revolutionnary product, the AB (Adjustable Binding) System was developed from the same system that is used on the RICKTER FS-1.

This system allows you install the RRP Adjustable Binding System on any Super-Jet with a limited amount of modifications to fit the custom binding system box to your watercraft.

This system is a must for any freestyle or free rider.

Description	Part No.
RRP Adjustable Binding System	RRP-AB-SYST

## KAWASAKI 800 SX-R HANDLE POLE CONVERSION Three Easy STEPS 1 - 2 - 3

### Step 1

You must have a set of handlepole bushings that fit the OEM Kawasaki handlepole pivot mount. You will also need to have an steering cable extension mounting bracket, you have a choice of a Blowsion or UMI bracket shown below.

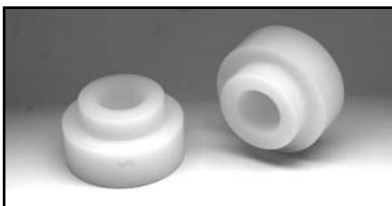

**BLWSION**

### SXR PIVOT BOLT BUSHING FOR OEM BRACKET

UMI Handle Pole conversion for OEM SX-R bracket or AC Handlepole conversion for OEM SX-R Bracket.

KAWASAKI SX-R	Part No.
For UMI Handlepole	03-04-101
For AC Handlepole	03-04-102



**UMI Racing USA**  
...For The Uncommon®

### UMI HANDLE POLE KIT FOR KAWASAKI 800SXR

This kit adapts the UMI Racing Super Jet Handle Pole to Kawasaki 800SXR. This kit includes handle pole bushings, steering cable bracket and retainer.

Description	Part No.
800SXR Handle Pole Kit	JS-09200
800 SXR Pivot Bolt Bushing only. Sold 1 pc. (2 pcs. required)	KA-24104



**BLWSION**

### SXR STEERING CABLE EXTENSION BRACKET

For SX-R handle pole conversion with UMI handle pole.

KAWASAKI SX-R	Part No.
Steering Cable Extension Bracket	03-04-021

## Step 2

Now that you have completed Step #1 you will need to purchase a UMI sealed Bearing Steering System (shown to the right). You have a choice of turn plates to install in conjunction with the UMI Steering system. A steering stop is not required for UMI handlepole because the UMI handlepole is supplied with the stop when the handle pole is purchased. OEM Kawasaki turn plates and mount systems will not fit on a Superjet type handlepole.



### STEERING STOP

Steering stop with nut for AC and OEM Yamaha handle poles. Required with Kawasaki SX-R conversion. UMI Handle Pole includes steering stop. For RRP Handle Pole, use RRP pad support and steering stopper (QU-Stop)

Kawasaki SX-R	Part No.
Steering Stop with Nut	03-04-131



### TBM SEALED BEARING STEERING SYSTEM

Description	Part No.
Kaw/Yam/Pol Sealed Bearing Steering System	TBM126



### UMI SEALED BEARING STEERING SYSTEM

Description	Part No.
Mounting System	JS-04103

BLWSION



### STANDARD SX-R TURN PLATE

Standard length steering turn plate with UMI handle pole and UMI bearing system for SX-R.

\*Use with UMI Part#JS-04103

Kawasaki SX-R	Part No.
Blowsion Standard Length Turn Plate	03-05-042
UMI Standard Length Turn Plate	JS-04105-CLR

UMI Racing USA  
...For The Uncommon®



BLWSION



### -1" SX-R TURN PLATE

Moves the normal rider position forward approximately 1 inch. Helps to reduce hull porpoising and dramatically improves handling. For SX-R with UMI handle pole and UMI bearing system.

\*Use with UMI Part#JS-04103

Kawasaki SX-R	Part No.
Blowsion -1" SX-R Turn Plate	03-05-04
TBM -1" SX-R Turn Plate	TBM102

TBM RACING



## Step 3

Kawasaki OEM Chin Pads will not fit on the Superjet type Handlepoles. You must purchase a Yamaha Superjet Type Chin Pad and you have a choice of a 24-7 or Blowsion Yamaha Type Chin Pad as shown below.



### CARBON FIBER CHIN PAD

This system solves all inherent problems with stock pole pads. Carbon, Glass and Aluminum design adds strength and rigidity. Pole brace is incorporated into the system (Pad will not interfere with steering system). Hydro-Turfing will not water log. System includes all mounting hardware. Fits 1996 & newer Yamaha Superjets.

Description	Part No.
Carbon Fiber Chin Pad	CP-001



### CARBON CHIN PAD

Lightweight construction with unbreakable carbon construction. Fits 96+ Superjet and UMI 800SXR handlepole conversion system. Chin Pad cover black top/green side only.

Description	Part No.
Black/Green	04-01-205
Black/Black	04-01-202

FOUR  
STROKE

INTAKE  
SYSTEMS

ENGINE/  
GASKETS

EXHAUST

DRIVE LINE  
HANDLING

ELECTRICAL

WATERLINE  
/BILGE

STEERING  
& CONTROLS

BODY

ACCESSORIES

SERVICE TOOLS  
/HARDWARE

CHEMICAL



### AC RACING ALUMINUM HANDLE POLE

Yamaha	Polish
Super Jet 701 96+	58-6019P



UMI



BLOWSION

### HANDLE POLE EXTENSION LIMITING ROPE

This pole limiting rope is to STOP pole from extending approx 2-3" from total max extension. This prevents the forward motion of the pole. Fits all stand up Yamaha Super Jet, Polaris Octane, Kawasaki SXR 800, 750 SX & all JS models. A must for ocean or big wave riders



Description	Part No.
UMI Limiting Rope Kit (picture shown)	YA-09100
Blowsion Limiting Rope Kit	03-04-151



### SXR BILLET HOOD BUMPER

Direct replacement for OEM bumper. Includes pre-cut foam and hardware. For Kawasaki 800SXR/750SXI.

Description	Part No.
Hood Bumper Clear	04-04-201
Hood Bumper Green	04-04-202
Hood Bumper Red	04-04-203

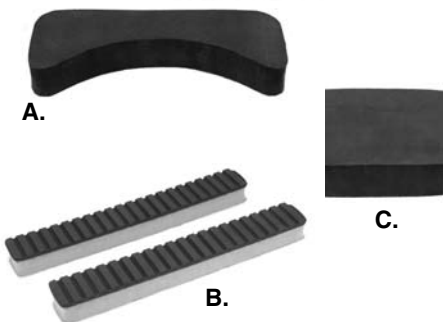

### POLE SHOCK PADS

Protects engine hood from damage when handlepole is dropped. Color: Black only

Description	Part No.
A. Kawasaki 750SX/SXI/800SXR (1)	TS401
B. Kawasaki JS440/550 (2)	TS41
C. Yamaha Super Jet (1)	TS421

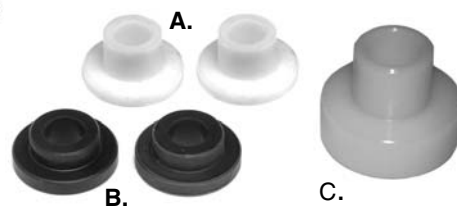

### HANDLE POLE BUSHINGS

Description	Part No.
A. Bushing for OEM Kawasaki 440/550 Handle Pole	58-5995
Bushing for OEM Kawasaki 750/800 Handle Pole	58-5998
B. AC Handle Pole Bushings	03-3300
C. Kawasaki 800SXR UMI Handle Pole Pivot Bushing only sold per one piece (Required 2 pcs.)	KA-24104
Yamaha UMI Handle Pole Pivot Bushing only sold per one piece (Required 2 pcs.)	PO-24103



2008 WORLD FINALS  
LAKE HAVASU, AZ

FRANKY ZAPATA  
2008 GP SKI 3RD PLACE

PHOTO COURTESY OF JIN OMURA



A.

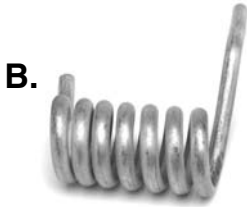

B.

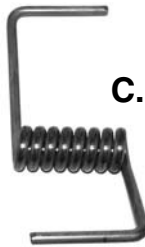

C.

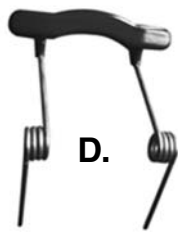

D.



## HANDLE POLE SPRINGS

Greatly reduces weight of stock handle pole up to 75% and reduces rider arm and shoulder fatigue.

Yamaha	Part No.
A. Super Jet Pre 95	UYA05010
B. Super Jet 96+	YAMAL050

Kawasaki	Part No.
C. 800SXR	KA800AC
D. 300/440/550/550SX Dual Coil Spring	RM5500



## KOMMANDER 800SXR SPRING TENSIONER

Available in two height options:  
 -TALL, for an extra light handle pole  
 -SHORT, for a little extra lightness depending on handlepole application (varies)

Kawasaki	Part No.
Kommander Tensioner Tall	KOM-104T
Kommander Tensioner Short	KOM-104S



## R&D SPRING TENSIONER KAWASAKI 800SXR

The R&D adjustable spring tensioner allows you to adjust and tune to find the best tension for you.

Kawasaki	Part No.
800SXR	521-80000



## R&D TWIN HANDLEPOLE SPRING SHIM

The R&D Spring Shim adds preload to the handlepole which reduces the handlepole weight 50%. The lighter handlepole reduces back, shoulder and arm fatigue. The stainless steel constructed shim installs in less than 5 minutes with basic tools.

Kawasaki	Part No.
Twin Handlepole Spring Shim	521-75100



E.



F.

## TBM RACING TENSIONER KAWASAKI 800SXR

TBM billet spring tensioner is available in two heights to optimize your comfort. The standard height is recommended for the stock handlepole, while the short height is designed for the aftermarket aluminum handle poles on the market.

Kawasaki	Part No.
E. 800SXR Short	TBM104-S
F. 800SXR Tall	TBM104-T



## HOT PRODUCTS CAST HANDLE POLE PIVOT MOUNT

OEM replacement and is properly engineered from 356b alloy aluminum and heat treated to a T-6 condition to withstand the most abusive conditions.

Description	Part No.
SJ96+	58-5922
FX1	58-5922-FX1

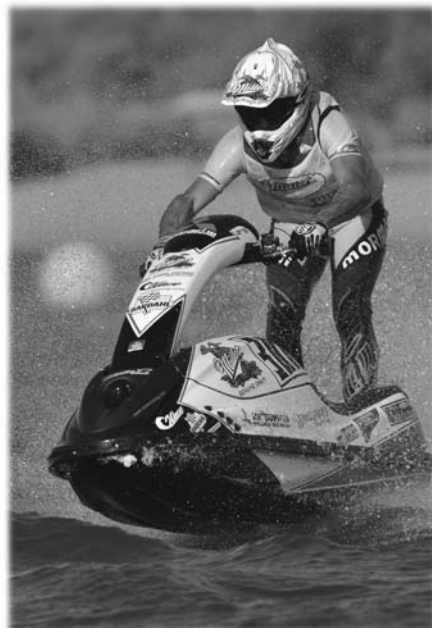

2008 WORLD FINALS • LAKE HAVASU, AZ  
 ALBERTO MONTI  
 2008 PRO SKI OPEN WORLD CHAMPION  
 PHOTO COURTESY OF JIN OMURA

FOUR  
STROKE

INTAKE  
SYSTEMS

ENGINE/  
GASKETS

EXHAUST

DRIVE LINE  
HANDLING

ELECTRICAL

WATERLINE  
/BILGE

STEERING  
& CONTROLS

BODY

ACCESSORIES  
SERVICE TOOLS

/HARDWARE

CHEMICAL

FOUR STROKE  
INTAKE SYSTEMS  
ENGINE/GASKETS  
EXHAUST  
DRIVE LINE HANDLING  
ELECTRICAL  
WATERLINE /BILGE  
STEERING & CONTROLS  
BODY  
SERVICE TOOLS ACCESSORIES  
SERVICE TOOLS /HARDWARE  
CHEMICAL

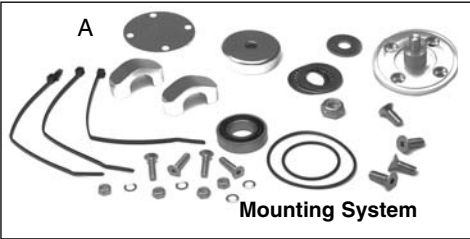

Mounting System

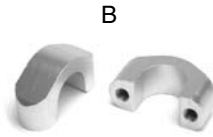

SJ 96+ Handlebar Pad Cover



Replacement Bearing Kit

## SEALED BEARING POWER TURN PLATE STEERING SYSTEM

Description	Part No.
A. Super Jet/Kawasaki 800SXR* Mounting System	JS-04103
B. Set of Clamps (silver)	58-8970
C. Yamaha Super Jet Turn Plate	YA-04104-CLR
D. Kawasaki 800SXR Turn Plate*	JS-04105-CLR
E. Super Jet 96+ Handlebar pad cover	YA-04109
F. Replacement Bearing Kit	58-8434

\* Kawasaki 800SXR: This mounting system and turn plate only fits the UMI Handle Pole. *This kit does not fit on Kawasaki OEM Handle Pole.*

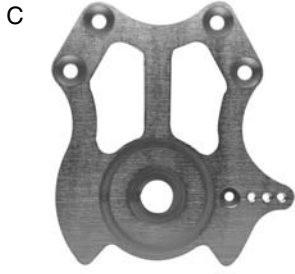

Yamaha Superjet

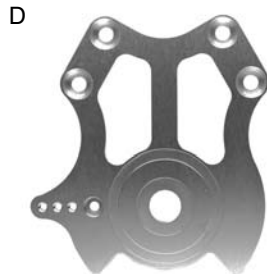

Kawasaki 800 SXR



### -1" SHORT TURN PLATE

Moves the normal rider position forward approximately 1 inch. Helps to reduce hull porposing and dramatically improves handling. For SX-R with UMI handle pole and UMI bearing system. \*Use with UMI Part#JS-04103

Description	Part No.
-1" Kaw SX-R Turn Plate	03-05-041
-1" Yam Superjet Turn Plate	03-05-043

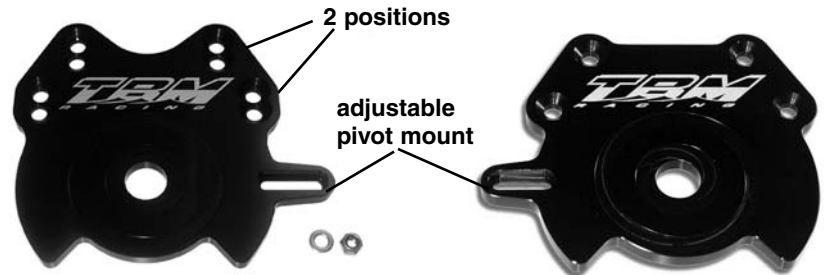

### TBM YAMAHA SHORTENED TURN PLATE

Designed for the aggressive racer, freestyler, or freerider, the Turn Plate positions the rider forward of the ski for more control and maneuverability. TBM Turn Plate has two sets of handlebar mounting holes, enabling the rider to choose between -1", or -1.5" from the stock location.

Yamaha Super Jet 96+ Shortened Turn Plate	Part No.
	TBM102-YAM

### TBM KAWASAKI SHORTENED TURN PLATE

Introducing a simple yet effective part designed to move the rider forward in the tray for a more aggressive riding position. If you are tired of having to choose from three steering pivot positions, we've got your fix providing an infinite amount of adjustment from subtle to aggressive and anything in between.

Kawasaki SX-R -1" SX-R Turn Plate	Part No.
	TBM102



### TBM SEALED BEARING STEERING SYSTEM

Designed for a Kawasaki/Yamaha/Polaris stand-up. We utilize two high quality thrust bearings and Quattro Seal to eliminate friction and slop while keeping the elements from contaminating the bearings.

Description	Part No.
Kaw/Yam/Polaris Sealed Bearing Steering System	TBM126
Bearing Replacement Kit	TBM126-B
Steering System Locknut only	TBM126-N



### DOO SPEED OEM TYPE STEERING SYSTEM

If you like the Yamaha OEM Steering with an after-market Turn Plate, this is the solution. Utilizing the OEM washers, this system makes smooth turns at a fraction of the cost. Slight modifications to the washer is required. Made in Japan.

Description	Part No.
Turn Plate Stud Mount	DO-TP



### BLOWSION BILLET STEERING SYSTEM - SEALED BEARING WITH KROK LOCK NUT

Description	Part No.
Blowsion Billet Steering System - Yamaha SJ, Kawasaki Conversion, Octane	03-05-001
Blowsion Krok Collar	03-05-019

## UMI TOP STOP BILLET STEERING

Top stop steering for positive control and extraordinary strength. Improved handling by shifting weight to correct point on watercraft. Available for most sport and runabout models.



Sea Doo RXP, RX & GSX



Sea Doo XP97+

Kawasaki Ultra 250



Yamaha GP1200R



Kawasaki STX-R



### Sea Doo

### Billet Steering Part No.

XP 93-96, SP/SPI/SPX 94-98	58-6317
GSX/GTX/GTI/GTS/GSI/GS 96+, RX, RXP, RXT	58-6321
XP 800 97-98, XP-LTD 951 98+	58-6324

### Yamaha

### Billet Steering Part No.

XL800-1200LTD/SUV, XLT1200	58-6326
GP1200R/GP1300R	58-6327

### Kawasaki

### Part No.

STXR/STX-15F**	58-6329
Ultra 250*	KA-04608-250X

\* Includes Off Throttle Steering Sensor Bracket

\*\* Reverse does not work



## 800SXR RAPID RATIO STEERING PLATE AND SUBSHAFT

The R&D SXR 800 Rapid Ratio Steering Plate was designed to increase steering nozzle turning ratio using three adjustable steering cable ball pivot positions (Stock plus 8 mm, and 16 mm). The R&D Steering Plate also has a redesigned stop system, which will allow the steering plate to be relocated 1 inch forward. Must use the R&D Steering Subshaft for 1 inch shorter handle pole length.

Description	Part No.
H. R&D Rapid Ratio Steering Plate	521-80010
I. R&D Steering Subshaft	521-80020



## TBM RACING KAWASAKI OEM REPLACEMENT TURN PLATE

(Compatible with '92 - '02 750SX/SXI/SX1 Pro and '03 - '05 SX-R 800) Introducing our OEM replacement turn plate for the 750 and 800 Kawasaki stand-ups. Our turn plate has many unique features including two handlebar positions giving the rider an option depending on conditions and riding style. In addition you have the option of using our replacement stud that allows you to relocate the turn plate an inch forward from the stock location. Combining the two options gives you a slightly over 1.5" forward from stock.

Description	Part No.
Kawasaki OEM Replacement Turnplate	TBM102-OE
Turn Plate Stud	TBM102-S



## REPLACEMENT BEARING KIT FOR UMI STEERING SYSTEMS

Description	Part No.
Replacement Bearing Kit For all Steering Systems except XP97+ (requires 2 kits)	58-6300



## RIVA ULTRA 250X/LX STEERING COLUMN COVER

This lightweight cover fills the large void left when the stock steering system is removed; preventing water from entering the hull and reducing engine noise. Designed for use with UMI Steering System and highly recommend when using RIVA Pro-Series Power Filter Kit (part# RK13096).

Description	Part No.
RIVA Ultra 250X/LX Steering Column Cover	RK5-SCC-090



## DO SPEED SPACER AND MOUNTING KIT FOR UMI RXP-X/RXT-X STEERING SYSTEMS

Do Speed has developed this spacer and mounting bracket specifically to be used in combination with a UMI steering system on a RXP-X or RXT-X. The spacer prevents water from entering the engine compartment and the bracket creates a clean and safe installation of the OEM Sea Doo warning system signal.



Description	Part No.
DO Speed Spacer and Mount Kit for UMI RXP-X/RXT-X Steering System	D-X-P

FOUR STROKE	INTAKE SYSTEMS	ENGINE/GASKETS	EXHAUST	DRIVE LINE HANDLING	ELECTRICAL	WATERLINE /BILGE	STEERING & CONTROLS	BODY	ACCESSORIES	SERVICE TOOLS /HARDWARE	CHEMICAL
-------------	----------------	----------------	---------	---------------------	------------	------------------	---------------------	------	-------------	-------------------------	----------

FOUR STROKE  
 INTAKE SYSTEMS  
 ENGINE/GASKETS  
 EXHAUST  
 DRIVE LINE HANDLING  
 ELECTRICAL  
 WATERLINE /BILGE  
 STEERING & CONTROLS  
 BODY  
 ACCESSORIES  
 SERVICE TOOLS /HARDWARE  
 CHEMICAL



## TBM RACING ULTRA 250X/LX ADJUSTABLE OFFSHORE STEERING SYSTEM

TBM Racing set out to build the ultimate offshore steering system incorporating several unique features to enhance the ergonomics of your Ultra. The fully adjustable design features a dual tubular steering head for rigidity and function. Almost 2" of vertical adjustment and four handlebar positions allow you to truly tailor your cockpit to your personal preference. In the fully extended position with standard rise bars our steering is 4.5" taller than stock and positions the rider reward on the ski lightening the nose. TBM designed the bar clamps to accommodate any popular 1 1/8" bulge (fat) bars to offer superior strength during offshore competition. The upper steering head utilizes the OEM lower pivot making installation a breeze and saving the expense of an elaborate lower assembly.

Description	Part No.
TBM Ultra 250X/LX Adjustable Offshore Steering System with Standard Long Tubes (Upper Steering Head)*	TBM136
TBM Ultra 250X/LX Steering System with Closed Course Tubes	TBM136-CC
TBM Ultra 250X/LX Closed Course Tubes only *Steering System Not Included	TBM136-CCT
TBM Ultra 250X/LX Offshore Tubes only *Steering System Not Included	TBM136-OST
*Must use with Fat Bar #SB1007BOOSTTIT (see left column)	



## TBM RACING ULTRA 250X SEALED BEARING STEERING SYSTEM BASE ASSEMBLY

(Compatible with the TBM Adjustable Offshore Steering System)

Several unique features are incorporated into the TBM Steering System: An interlocking bearing housing that is bolted rather than welded into place eliminating any concentricity issues, angular roller bearings with pressed in races. These bearings are similar to those used in high strength steering assemblies on street and dirt motorcycles. Proper preload can be obtained without causing the bearings to bind or become notchy. Also used is an actual seal in place of an o-ring to keep water and sand from penetrating the bearings. An adjustable linkage arm gives you an infinite amount of steering ratios to meet your personal preference. The off power steering sensor is obtained. The lower steering assembly is designed to be used with the TBM adjustable upper steering head to provide a durable and functional steering system.

Description	Part No.
TBM Racing Sealed Bearing Steering System (To be used with the TBM-136 Steering Head Assembly)	TBM136-LA



## SPEED MAGIC "X-MOUNT" STEERING HEAD

Speed Magic has developed the "X-Mount" for the RXP-X and RXT-X that improves handling by lowering the steering head 85mm lower than the stock position and also moves the rider forward for a more aggressive position. Available for regular and Fat Bar applications.

Description	Part No.
Speed Magic Steering Head (Standard Handlebars)	SE-027015
Speed Magic Steering Head (Fat Bars)	SE-027015F



## DCR ULTRA 250X/260X AFTERMARKET HANDLEBAR ADAPTER

DCR has developed this billet aluminum handlebar adapter to allow a rider the ability to install aftermarket handlebars on the Kawasaki Ultra 250X and 260X. This simple conversion will greatly improve steering and control.

Description	Part No.
DCR Billet Handlebar Adapter	DC-HA-KU



## SKAT TRAK HEAVY ARMOR ULTRA 250X STEERING CABLE

The Skat-Trak "Heavy-Armor" steering cable directly replaces the stock steering cable that is prone to failure on modified Kawasaki Ultra 250X's. At twice the thickness, this heavy-duty steering cable is more durable and reliable when compared to the stock steering cable. Comes complete with stainless steel ball joint cable ends for easy installation and adjustment.

Description	Part No.
Skat Trak Heavy Armor Ultra 250X Steering Cable	PRSTKAWU250A
Skat Trak Heavy Armor Kaw STX-R, STX-15F	PRSTKAWSTXRA



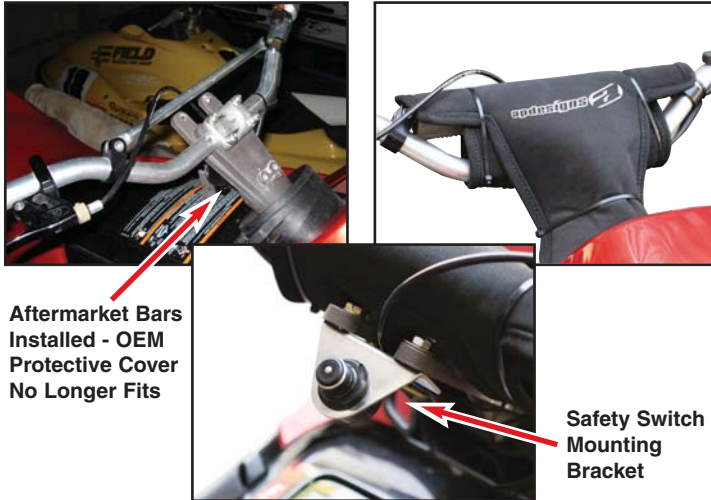

Aftermarket Bars Installed - OEM Protective Cover No Longer Fits

Safety Switch Mounting Bracket

## HANDLE BAR STEERING MOUNT COVER AND SAFETY SWITCH BRACKET

When you install aftermarket handlebars on your SeaDoo using the OEM steering system the OEM pad cover will no longer fit. AP Designs has developed this new pad to allow for the bars to fit properly and protect you will riding your Sea Doo as well as to hide the ugly cast steering system. Also developed in conjunction with this cover is a safety switch mounting bracket.

<b>SeaDoo</b>	<b>Part No.</b>
Handlebar Mount Cover for SeaDoo RXP, RXT, RX, GSX, GTX, GTI, GTS, GSI, GS 96+	SD-HCV
Safety Switch Mounting Bracket	N-SDSWMT

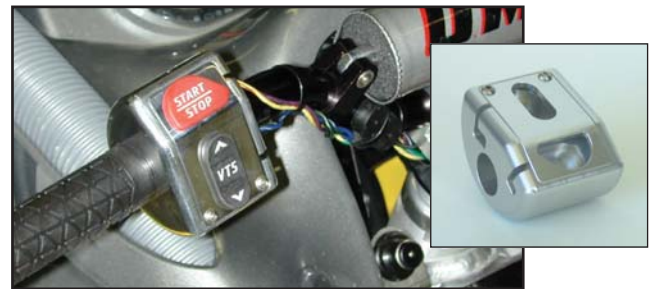

## UMI RXP TRIM/SWITCH HOUSING

U.M.I.'s trim/switch housing is machined from 6061-T6 billet aluminum, replacing the stock plastic housing. Trim/switch housing uses the factory variable trim switch and start/stop switch. This housing must be used with the U.M.I GSX/RXP (P/#58-6321) steering system, aftermarket bars and finger throttle.

<b>Sea Doo</b>	<b>Part No.</b>
RXP Silver	SD-01600-CLR



## BILLET STOP SWITCH HOLDER

For Aftermarket Handlebars

Description	Color	Part No.
SeaDoo	Polished	58-2003



## BILLET 3 SWITCH HOLDER

For Aftermarket Handlebar

Description	Color	Part No.
SeaDoo	Polished	58-2004

## 2009 APBA MARK HAHN MEMORIAL HAVASU 300 • LAKE HAVASU CITY, ARIZONA

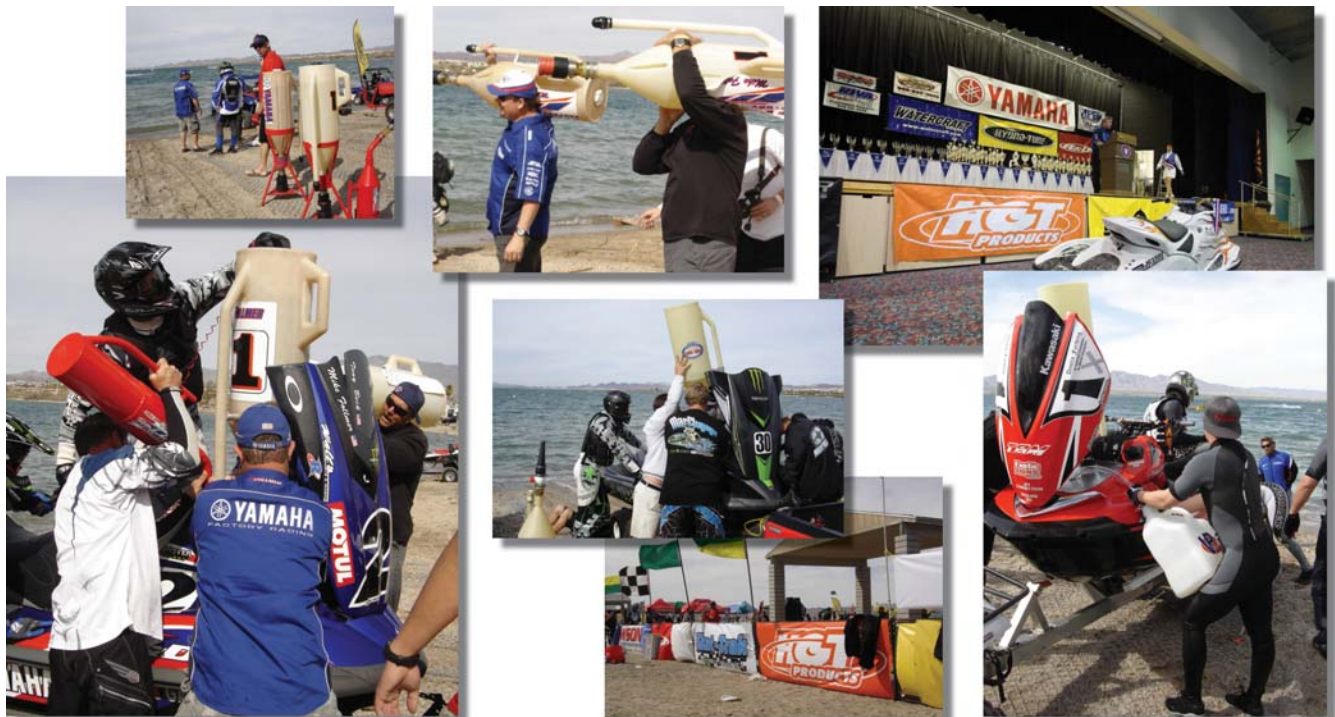

Hot Products has signed to be the title sponsor for the 2010 APBA Mark Hahn Memorial Havasu 300. Hot Products would like to invite all of the customers and racers to participate in the great event next year.

FOUR STROKE	INTAKE SYSTEMS	ENGINE/GASKETS	EXHAUST	DRIVE LINE HANDLING	ELECTRICAL	WATERLINE /BILGE	STEERING & CONTROLS	BODY	ACCESSORIES	SERVICE TOOLS /HARDWARE	CHEMICAL
-------------	----------------	----------------	---------	---------------------	------------	------------------	---------------------	------	-------------	-------------------------	----------

# Hot Products

FOUR STROKE  
INTAKE SYSTEMS  
ENGINE/GASKETS  
EXHAUST  
DRIVE LINE HANDLING  
ELECTRICAL  
WATERLINE /BILGE  
STEERING & CONTROLS  
BODY  
ACCESSORIES  
SERVICE TOOLS /HARDWARE  
CHEMICAL

- Available in clear and black anodized finish with a 0 degree or 4 degree bend

- 7/8" (22mm) external diameter to fit most standard sized handlebar clamps

- High grade aluminum, which Hot Products has extensively tested for the manufacturing of these handlebars.

- Lightweight, super-strength, durable and excellent vibration dampening for freestyle and rough surf riders



## RUNABOUT RACE HANDLEBARS

Width 775mm Rise 75mm Pull Back 30mm

Description	Part No.
Runabout Handlebars Silver	HJR-02
Runabout Handlebars Black	HJR-02BK

- The handlebar surface has been shot peened to help assist in prevent fatigue or failure

- Knurling – Grip end only – increases bonding between bar and grip

- Anodized finish forms an integral coating giving protection against corrosion

- A Hot Products crossbar pad is included with every handlebar.



## STAND UP PERFORMANCE HANDLEBARS

Description	Part No.
Yamaha/Kawasaki Handlebars 0 degree Silver	HJF-00
Yamaha/Kawasaki Handlebars 0 degree Black	HJF-00BK
Yamaha/Kawasaki Handlebars 4 degree Silver	HJF-04
Yamaha/Kawasaki Handlebars 4 degree Black	HJF-04BK



## UNIVERSAL FAT BAR ADAPTERS

Hot Products has designed these billet adapters to be compatible with UMI steering and other manufacturing steering systems and allows for use of "Fat Bars" for that added strength and clamping pressure needed for todays high performance applications. Both the one piece kit and two piece set come laser etched with the Hot Products logo.

Description	Part No.
One Piece Billet Adapter Kit	HJCL-01
Two Piece Billet Adapter Set	HJCL-02



## MOTOINE ADJUSTABLE HANDLEBAR

Utilizing handlebar clamp holes, this Motorcycle Road Racing type handlebar allows you to adjust the handlebar position from -4 degrees to +16 degrees.

Kawasaki	Part No.
Adjustable Handlebar for 800SXR	MR-SXR-012



## STAR BAR RUNABOUT FAT BARS

Handlebar Type	Colors	Part No.
Fat Runabout Bars	Titan (Dark Grey)	SB1007BOOSTTIT



## UMI RACE HANDLE BARS

Models	Surface	Pad Size	Part No.
Polaris (use with UMI Steering System only)	Polish	Large	PS-01500POL
Yam W/Raider, Blaster II, Venture, GP760/1200,XL1200,SUV, XL800	Polish	Small	YA-01301POL
Yam W/Raider, Blaster II, Venture, GP760/1200,XL1200,SUV, XL800	Black	Small	YA-01301BKA
Kawasaki 750SS/XI/XIR	Black	Medium	KA-01100BKA
Kawasaki X2/ZXI/STXR/Ultra 150	Polish	X-Large	X2-01200POL
Kawasaki X2/ZXI/STXR/Ultra 150	Black	X-Large	X2-01200BKA

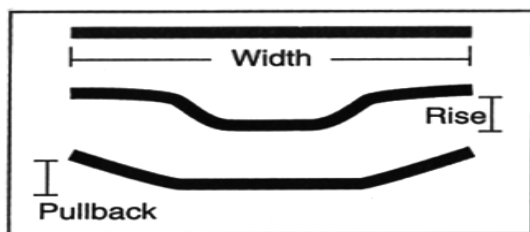

Part No.	Models	Width	Rise	Pullback
PS-01500	Polaris	28.75"	4.00"	2.25"
YA-01301	GP/GPR	28.75"	2.00"	1.50"
KA-01100	750SS/XI	27.50"	3.00"	1.25"
X2-01200	STXR/ULTRA	29.50"	4.00"	2.00"



### Description

Blowsion Kommand Handlebars 0-Degree W/Crossbar & Pad- Extended	Clear	03-05-141
Blowsion Kommand Handlebars 0-Degree W/Crossbar & Pad- Extended	Black	03-05-142
Blowsion Kommand Handlebars 4-Degree W/Crossbar & Pad- Extended	Clear	03-05-143
Blowsion Kommand Handlebars 4-Degree W/Crossbar & Pad- Extended	Black	03-05-144
Blowsion Kommand Handlebars Fat-Bar Straight	Black	03-05-145
Blowsion Kommand Handlebars Fat V Bar Riser	Black	03-05-146
Blowsion Kommand Sport/Runabout Handlebars - 28"	Black	03-05-150
Blowsion Kommand Runabout Handlebars - 32"	Black	03-05-152
Blowsion Kommand Runabout Handlebars - 32"	Clear	03-05-153
Blowsion Crossbar Assy with Pad	Silver	03-05-159
Blowsion Billet Crossbar Clamp Set	Black	03-05-160



## UMI HANDLEBAR PAD COVERS

Large: GSX and Polaris Bars - 7 3/4"  
X-Large: X2/Ultra Bars - 9 1/2"

Description	Color	Part No.
Large	Blue	PG-83251-BL
Large	Silver/Purple	PG-83251-PUR
Extra Large	Blue	PG-83252-BL

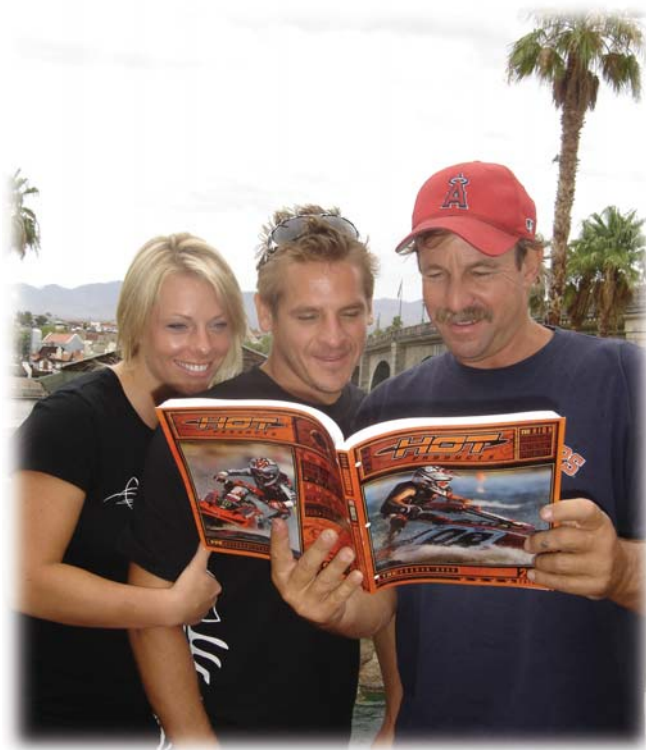

Color	Part No.
Clear	03-05-141
Black	03-05-142
Clear	03-05-143
Black	03-05-144
Black	03-05-145
Black	03-05-146
Black	03-05-150
Black	03-05-152
Clear	03-05-153
Silver	03-05-159
Black	03-05-160

FOUR STROKE  
INTAKE SYSTEMS  
ENGINE/GASKETS  
EXHAUST  
DRIVE LINE HANDLING  
ELECTRICAL  
WATERLINE /BILGE  
STEERING & CONTROLS  
BODY  
ACCESSORIES  
SERVICE TOOLS /HARDWARE  
CHEMICAL



# R&D AUTO DROP NOZZLE KITS

FOUR STROKE  
INTAKE SYSTEMS  
ENGINE/GASKETS  
EXHAUST  
DRIVE LINE HANDLING  
ELECTRICAL  
WATERLINE /BILGE  
STEERING & CONTROLS  
BODY  
ACCESSORIES  
SERVICE TOOLS /HARDWARE  
CHEMICAL

## Yamaha GP1200R



The R&D VTS/Auto Drop Nozzle is the first manually activated VTS nozzle with Auto Drop functions! When riding with the VTS adjusted in the neutral position the nozzle will drop 5 degrees in the turns allowing for a much smoother high speed turn to be made. When the steering reaches the straight position the nozzle returns back to the straight position. When riding with a full tank the best VTS setting is usually in the click up position and stays

there. With the R&D VTS Nozzle Kit you can ride 1 click up (5 degrees up) and when you turn the nozzle will drop 5 degrees which is back to zero or straight position. When steering returns back to straight the nozzle resumes the one click up (5 degrees up) position.

Yamaha	Part No.
GP1200R VTS Auto Drop Nozzle Kit	162-12001
GP1300R VTS Auto Drop Nozzle Kit	162-13000
FX SHO/FZR/FZS VTS Auto Drop Nozzle Kit	162-18010

## Sea Doo RXP



The R&D RXP Auto Trim Kit was developed to override the OEM VTS System with a fully adjustable and fully automatic trim system! The R&D Auto Trim automatically drops a rider preferred adjustable 2-8 degrees. Drive from turn to turn never worrying whether the trim is in the best position for perfect turn negotiation! For long straight rides install the R&D VTS/Holeshot Driver Rod (Pt.#

163-21503), which works in conjunction with the R&D Auto Trim to electronically override the Auto Trim back to the OEM VTS Nozzle angle trim settings!

Sea Doo	Part No.
RXP	163-21502
RXP Holeshot Rod for use with #163-21502	163-21503
GTX 4-Tech/RXT Auto Trim Kit	163-95003

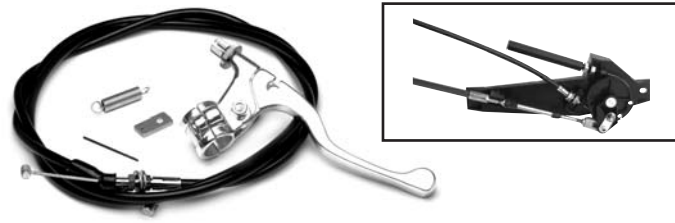

## RIVA DROP NOZZLE KIT

Convert your twist style Quick Shift trim system (QSTS) into a spring loaded, lever actuated system that instantly drop steering nozzle down when pulled.

Yamaha	Part No.
GP1300R/GP1200R/GP800R	RY2420



## YAMAHA GPR/FX140 BILLET TRIM RING

The R&D Billet Trim Ring PT# 162-12101 was made to replace the OEM trim ring for those individuals that want to install the R&D Auto Trim Nozzle system without modifying the OEM trim ring. It makes the installation of the R&D Auto Trim System a bolt-on set up.

Description	Part No.
GPR/FX140 Billet Trim Ring	162-12101

## QUICK STEERING ADAPTER

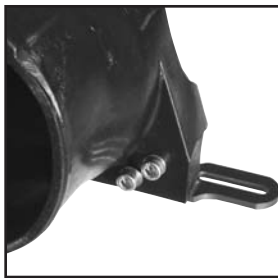

This quick steering adapter fits the stock superjet nozzle. It will give you the option to play with the quickness of the steering from really

aggressive to really smooth. It will also give you a lot more turning ratio for free style.

Available in Red or Black.

Description	Part No.
Black	QU-ST-YAM-BL
Red	QU-ST-YAM-RD

## SATO ENGINEERING DROP NOZZLE KIT FOR 800SXR



- Inner Venturi design with fins improve performance.
- Steering nozzle is 20mm longer than Stock for better control.
- Exit pump nozzle size is changeable with rings.
- Ring size is available: 76/77/78/79/80/81/82mm.
- Steering nozzle size is fixed with 83mm

Kawasaki	Part No.
Drop Nozzle Kit 800SXR	SE-013014
Cable Only (141"Long) <i>*Barrel Nipple Cable Top &amp; Barrel Nipple Cable End</i>	SE-013014-CABLE*
Ring Only	SE-013014-SIZE**

\*\*When ordering you must specify the ring size from the list above



SE-013015-R



SE-013020-R

## SATO ENGINEERING FLIP NOZZLE KIT

You must have this Flip Nozzle Kit for the trick of "Back Flips" and "Barrel Rolls." This kit allows the nozzle to move upwards up to 20 degrees. Steering nozzle is 30mm longer than stock. Exit nozzle size is changeable with ring. (76-82mm)

Description	Part No.
Kawasaki 800SXR Flip Nozzle Kit	SE-013015-R
Super Jet Flip Nozzle Kit	SE-013020-R
Kawasaki 800SXR Flip Nozzle Cable Only	SE-013014-CABLE*
<i>*Barrel Nipple Cable Top &amp; Barrel Nipple Cable End Bottom</i>	
Super Jet Flip Nozzle Cable Only	SE-013020-CABLE**
<i>**Barrel Nipple Cable Top &amp; Threaded Stud Cable End Bottom</i>	



## SATO ENGINEERING FREESTYLE UPSTEERING NOZZLE

Sato Super Jet steering nozzle has adjustable angles between 0 to 5 degrees for rider's preference.

Description	Part No.
Super Jet 0-5 Degree Adjustable Up Nozzle	SE-013103



Kaw Ultra 150



Sea Doo RXP



Yamaha  
GP1200R/GP1300R

## R&D HYDRO FORCE STEERING NOZZLE

The new lengthened design delivers a full 1 MPH speed gain over stock. The pivot point position improves the turning radius allowing you to carve tighter turns with a more positive feel. Improved performance through speed, acceleration and handling.

Sea Doo	Part No.
RXP (+15mm)	163-21500
Yamaha	
GP 1200R / 1300R	162-12000
FX140 / FX H.O./FX SHO/FZR/FZS	162-14000
Kawasaki	
Ultra 150	161-15000



## BLOWSION IZZNELL TWISTER NOZZLE

Available for all years Yamaha SuperJets. Allows additional throw on steering nozzle and multiplies the turning radius exponentially. A surf and freeride necessity!

Yamaha	Part No.
Izznell Twister Nozzle Bracket only	YASJAC666



## SKAT TRAK DROP NOZZLE KIT

A must if you race your Kawasaki 800 SX-R closed course at a professional level. It allows you to drop or trim the steering nozzle with a manually operated, handlebar mounted lever. Our new Kawasaki SX-R 800 Drop Nozzle Kit is compatible with the OEM 140mm pump and our Skat-Trak Magnum Pump System. The kit includes an aluminum extended Steering Nozzle, a manual Trim Cable, and all the hardware for mounting. (Lever sold separately.)

\*Recommend Stock 80/83, LTD 81/84 or 82/85, s/s 83/86.

\*\*Aftermarket ride plates may require modification when used with the Skat Trak Nozzle Kit.

Kawasaki 800 SXR	Part No.
Drop Nozzle Kit 80/83	PRNKAW800SXR80
Drop Nozzle Kit 81/84	PRNKAW800SXR81
Drop Nozzle Kit 82/85	PRNKAW800SXR82
Drop Nozzle Kit 83/86	PRNKAW800SXR83
Replacement Trim Cable only	PRSTKAWSXRT
Kawasaki Sitdown and Standup	



## SLOP FREE STEERING CABLE ENDS

Direct replacement for the O.E.M. steering cable that quickly wear and become sloppy. Eliminate all free-play in your steering by installing our slop free steering cable ends. Incorporating CNC machined delrin washers that adjust to capture the ball joint and prevent friction and wear. Fits all Kawasaki Jet Skis and every other manufacturer's craft that uses a 9mm ball joint.

Description	Part No.
Slop Free Steering Cable Ends	TBM112

## UMI TRIM LEVERS

Billet Aluminum Trim Lever for Trim Tab and Quick Trim Nozzle.

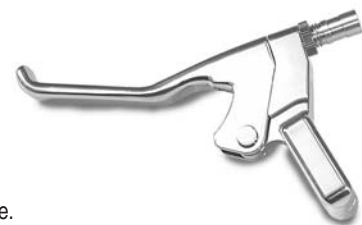

Description	Part No.
Umi Trim Lever	KA-01525-CLR



## BLOWSION BILLET ALUMINUM TRIM LEVERS

Blowision Trim Lever - Left hand operated trim lever for pump tilt or trim systems. Anodized clear.

Description	Part No.
Blowision Trim Lever - Clear	03-05-230

FOUR STROKE	INTAKE SYSTEMS	ENGINE/GASKETS	EXHAUST	DRIVE LINE HANDLING	ELECTRICAL	WATERLINE /BILGE	STEERING & CONTROLS	BODY	ACCESSORIES	SERVICE TOOLS /HARDWARE	CHEMICAL
-------------	----------------	----------------	---------	---------------------	------------	------------------	---------------------	------	-------------	-------------------------	----------



### UMI BILLET FINGER THROTTLE

Lever perch is machined at an angle which makes the lever pull at a downward sloping angle. This motion keeps the lever at the tip of your finger throughout the throttle range greatly reducing arm pump and providing superb throttle control. Also available in traditional straight pull. Teflon bushings eliminate the play common in other throttles and provides a smoother throttle pull. Stainless steel pin and C-Clip eliminates corrosion at hinge point. Available for all models. Also available in anodized black. Some models require throttle cable adapter.

3 Cable Throw Positions

Nylon Cable Roller

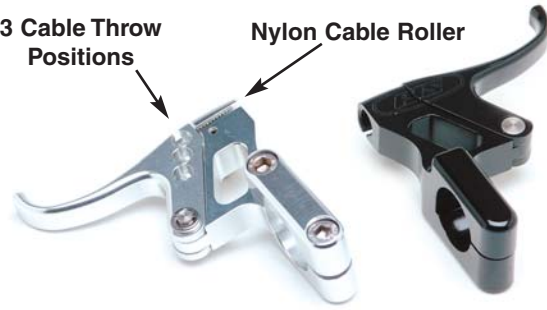

### PJS BILLET THROTTLE LEVER

Billet constructed throttle features nylon cable roller, nylon bushing and thrust washers, 3 cable throw positions, 6mm stainless steel bolts. This lever is specially designed to contour around your index finger. The narrow lining allows you to gain quicker response on hole shots without your middle finger getting in the way of a full pull.

Description	Part No.
Silver	58-0981
Black	58-0982



Description	Part No.	Description	Part No.
Silver Straight	58-0965	Silver Regular	58-0960
Black Straight	58-0966	Black Regular	58-0961



### HOT PRODUCTS ALUMINUM TRIGGER THROTTLE LEVERS

Fits 86-95 Kawasaki & Polaris.  
10mm Throttle Cable Kawasaki 550 (86-95), 650 (86-95),  
750 SX-SS-SXI (92-95), 750 ST (94-95).

An adapter is required for:  
Sea Doo, Yamaha and Kawasaki Pre 86 & 96+.

Description	Part No.
Silver	58-0970
Black	58-0971



### TBM HI PERFORMANCE ADJUSTABLE FINGER THROTTLE

Precision machined from aircraft grade aluminum featuring a bushing pivot, fully adjustable perch and ergonomically correct to reduce hand fatigue. Fully rebuildable design allows you to replace the pivot bearing extending the life of the throttle lever. Also available with a needle bearing pivot for the ultimate in precision ergonomics.

Description	Model	Part No.
Polished	Bushing	TBM118B-CLR
Black	Bushing	TBM118B-BLK
Polished	Bearing	TBM118BB-CLR
Black	Bearing	TBM118BB-BLK



## BLOWSION BILLET THROTTLE LEVER

Machined with the stand-up rider comfort at a premium, the new Blowsion straight pull finger throttle levers are ergonomically designed for premium fit and feel whether you are on the waves or on the buoys. Lever angle is situated to reduce hand

and arm fatigue. Delrin bushings eliminate the play common in OEM throttle levers and provides a smooth throttle pull action. All stainless hardware at the hinge point eliminates corrosion and play 100%. No "C" clips are used in the throttle lever assembly.

Description	Part No.
Clear	03-05-208
Black	03-05-201
Green	03-05-204



## THROTTLE CONVERSION KIT, ALL 4-TEC 4-STROKE - RXP - RXT - GTX - GTI

Quickly and easily transform your Sea Doo thumb throttle into a more natural finger throttle with our Throttle Conversion Kit. Aluminum extensions insert directly into bar ends adding 1-3/4" to each side providing more turning leverage and a more natural riding position. Molded steering pad end cap mates to finger throttle for a clean factory look. No modifications to existing handlebars necessary and minimal downtime. Available for RXP and GTX 4-TEC 4-stroke models with stock and aftermarket grips. Includes drill bit, tap, stainless steel bolt (to secure throttle trigger to handlebars) and complete installation instructions.

Sea Doo	Part No.
For stock grips. All 4-TEC 4 stroke	RS2455

## RIVA RACING SEADOO BILLET FINGER THROTTLE



Specifically designed to match throttle travel of SeaDoo 4-Stroke PWC. Direct replacement for bulky OEM throttle on X-Models and can be used with aftermarket bars on other 4-tec applications. Adjustable throttle angle & unique trigger design keeps the trigger at the

tip of your finger throughout the throttle range for reduced arm pump & superb throttle control. Delrin bushings eliminate play common in OEM throttles and provide smooth actuation. All stainless hardware at hinge point eliminates corrosion and play. No "C" clips used. Use with OEM adapter on X-Models or use aftermarket adapter (sold separately) for other 4-Tec applications.

Description	Part No.
Riva Racing Billet Finger Throttle for Sea Doo	RS24010P
*available in clear polished finish only	



## THROTTLE CABLE ADAPTERS

Description	Part No.
Cable Adapter for All Sea Doo Models	58-1996

Description	Part No.
Cable Adapter for Kawasaki Pre-86, Yamaha & All Wet Jet 6mm Throttle Cable Kawasaki 440 (76-86), 550 (82-85), Yamaha All Models (87-00)	58-0990

Description	Part No.
Cable Adapter for Kawasaki 96+ 8mm Throttle Cable Kawasaki 750 SS-XI-SXI (96-00), 750 STS (95-97), ZXI (95-00), STX (97-00)	58-0991

Description	Part No.
UMI Racing Cable PWC Adapter for All Sea Doo	SD-01530

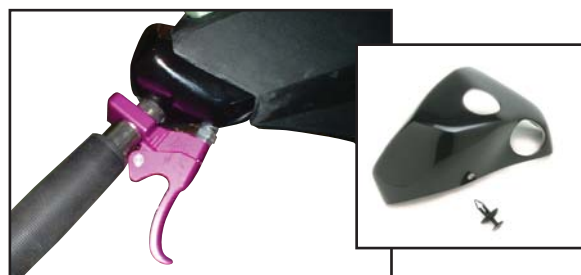

## HANDLEBAR COVER CAP FOR SEA DOO 4-TEC - RXP - RXT - GTX - GTI

Description	Part No.
Handlebar Cover Cap	FB001-SD



## BILLET COVERS FOR SEA DOO OEM HANDLEBARS

Description	Color	Part No.
Billet Cover for Sea Doo	Silver	58-1994-POL

## RIVA RACING YAMAHA & KAWASAKI BILLET FINGER THROTTLE



Introducing the ultimate billet throttle lever. Ergonomically designed for premium fit and feel whether you are on the waves or turning buoys. Lever angle is fully adjustable to reduce hand and arm fatigue. Delrin

bushings eliminate play common in OEM throttles and provide smooth actuation. All stainless hardware at hinge point eliminates corrosion and play. No "C" clips used. Available in anodized Clear or Black. Throttle cable adapter sold separately.

Description	Part No.
Clear Billet Finger Throttle for Yam/Kaw	RY24010P
Black Billet Finger Throttle for Yam/Kaw	RY24010B

FOUR STROKE  
INTAKE SYSTEMS  
ENGINE/GASKETS  
EXHAUST  
DRIVE LINE HANDLING  
ELECTRICAL  
WATERLINE /BILGE  
STEERING & CONTROLS  
BODY  
ACCESSORIES  
SERVICE TOOLS /HARDWARE  
CHEMICAL



# ATI TWO PLY GRIPS

Two ply construction. Inner core harder. Outer Layer is softer to help reduce vibration and hand fatigue.

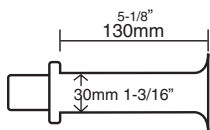

**Hard**

## 955 FLAME

Big Flange	Part No.
Blue	58-4077

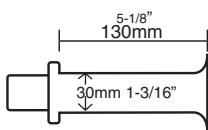

**Medium Soft**

## JACKSON

Big Flange	Part No.
Red	58-4046
Blue	58-4047

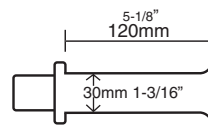

**Medium Soft**

## SCHWARTZ

Big Flange	Part No.
Black	58-4070
Red	58-4071
Blue	58-4072



DREW ROUSH  
BLACK STAR RACING TEAM  
AMATUER 800 OPEN & LIMITED  
NATIONAL TOUR & WORLD CHAMPION

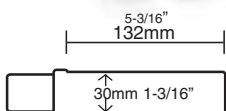

**Medium Soft**

## JACKSON

No Flange	Part No.
Black	58-4050
Grey	58-4053

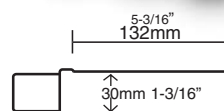

**Medium Soft**

## SCHWARTZ

No Flange	Part No.
Black	58-4055
Red	58-4056
Blue	58-4057

# ATI SINGLE PLY GRIPS

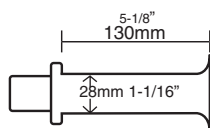

**Soft Slim**

## SPIKE ISO

Big Flange	Part No.
Red	58-4040
Yellow	58-4041

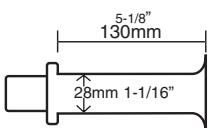

**Soft Slim**

## POS-A-TRAC

Big Flange	Part No.
Red	58-4042
Yellow	58-4043

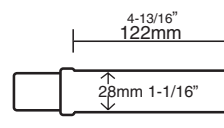

**Soft Slim**

## NEWTRON

No Flange	Part No.
Black	58-4065
Clear	58-4066



# NEW SLIM LINE SPIDER GRIPS

New slim line Spider Grips are specially made for watercraft. These Grips are available with or without a flange. The diamond pattern sheds water as well as dampening out vibrations.

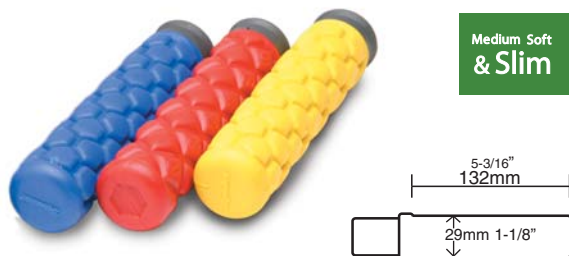

## WATERCRAFT FLANGELESS GRIP

Description	Part No.
Blue	A3-BL
Red	A3-R
Yellow	A3-Y



## WATERCRAFT FLANGE GRIP

Description	Part No.
Red w/Black	SLT R/B
Blue w/Black	SLT BL/B
Green w/Black	SLT K/B



## AME WATERCRAFT GRIPS

Description	Part No.
Blue	58-4002
Yellow	58-4006
Purple	58-4000



## AME TRI STAR PWC GRIPS

Description	Part No.
Blue	58-4012
Red	58-4013



## GRIP-IT, INSTANT GRIP GLUE

10 to 25 second adhesive

Description	Part No.
1 oz. (28.4g) bottle	58-4094
12 bottles with POP display	58-4095

## ThreeBond 3BOND GRIP LOCK

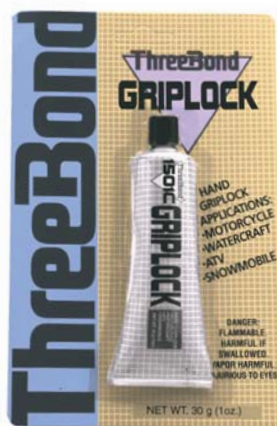

A high strength adhesive specially formulated to keep grips in place without damaging the rubber. Ideal for Snowmobile, Motorcycle, ATV and Personal Watercraft

Description	Part No.
ThreeBond Grip Lock 30gm (Dealer)	TB1501C
ThreeBond Grip Lock 10gm (Individual)	TB1501CX



## MOTOGRIPTM TRAINER

- Strengthen grip and forearm muscles anywhere in your car, desk, walking, etc.
- Helpful for all forms of riding: PWC, MX, off road, trail, ATV, road and snowmobiles

- When routinely used in 3 sets of 30 to 100 reps, MotoGrip™ Trainer noticeably improves finger-hand-forearm strength and endurance
- Built for high repetition endurance training
- Available in three different resistance levels 30, 40 and 50lbs

Description	Part No.
MotoGrip Trainer Green 30lb max resistance	17-0001
MotoGrip Trainer Black 40lb max resistance	17-0002
MotoGrip Trainer Red 50lb max resistance	17-0003



FOUR STROKE  
INTAKE SYSTEMS  
ENGINE/GASKETS  
EXHAUST  
DRIVE LINE HANDLING  
ELECTRICAL  
WATERLINE /BILGE  
STEERING & CONTROLS  
BODY  
ACCESSORIES  
SERVICE TOOLS /HARDWARE  
CHEMICAL



# Easy Installation No Grip Glue Required

## Revolutionary Non-Slip Technology for the Wettest Environments on Earth

- Lock-On Grip System eliminates grip twisting and slippage without the need for ties or glues.
- Replaceable aluminum Lock Jaw clamps lock grip onto bars like a vise to prevent slippage.
- New 3/4 Flange helps keep hands from slipping without interfering with thumb throttle systems.
- Fits on aftermarket handlebars such as UMI, etc.

Aluminum Lock Jaw clamps grips onto bars like a vise to prevent slipping.

Soft and tacky outer layer cushions hands and provides optimal traction.

New aluminum bar and snap cap.

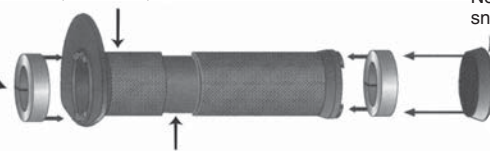

Durable inner sleeve allows grip to easily slide onto bars.

### ODI ROGUE LOCK-ON GRIPS

- Thick raised pads for maximum shock absorption
- Texture surface pattern for better control
- Elevated thread pattern channels water off the grip

Soft



Description	Part No.
Rogue, Thumb Throttle, 120mm, with 3/4 Flange	L30RG

Soft



Description	Part No.
Rogue, No Flange, 130mm	L31RGS

### BLOWSION LOCK RING CAP SET

Blowsion integrated the outside lock ring and the end cap into one piece for that special look. Each package contains two lock rings and two lock ring end caps.



Description	Part No.
Grip Lock Ring End Caps set-Billet-Black	03-05-341
Grip Lock Ring End Caps set-Billet-Blue	03-05-342
Grip Lock Ring End Caps set-Billet-Clear	03-05-343
Grip Lock Ring End Caps set-Billet-Gold	03-05-344
Grip Lock Ring End Caps set-Billet-Green	03-05-345
Grip Lock Ring End Caps set-Billet-Orange	03-05-346
Grip Lock Ring End Caps set-Billet-Purple	03-05-347
Grip Lock Ring End Caps set-Billet-Red	03-05-348
Grip Lock Ring End Caps set-Billet-Yellow	03-05-349

### ODI RUFFIAN LOCK-ON GRIPS

- Extra narrow diameter
- Diamondized surface for excellent traction

Medium Soft & Slim



Description	Part No.
Ruffian, Thumb Throttle, 120mm, with 3/4 Flange	L30RF

Medium Soft & Slim



Description	Color	Part No.
Ruffian, No Flange, 130mm	Black	L31RFS
Ruffian, No Flange, 130mm	White	L31RFW-B

NEW FOR 2009  
WHITE GRIPS  
NOW AVAILABLE



### ANODIZED ALUMINUM LOCK RING

Anodized aluminum lock ring for ODI grips. Lock-on system grips package's contains 4 lock rings each.

Description	Part No.
Griplock Lock Ring Anodized Yellow	03-05-339
Griplock Lock Ring Anodized Green	03-05-335
Griplock Lock Ring Anodized Purple	03-05-337
Griplock Lock Ring Anodized Orange	03-05-336
Griplock Lock Ring Anodized Gold	03-05-334



## Experience the Ultimate in Watercraft Control

These grips features a raised diamond plate pattern that offers additional comfort as well as control across the length of the grip. ODI has also included our exclusive "pre-cut" style flange which is just large enough to easily reference your hand position, while also being small enough to stay out of the way when you are trying to access thumb-throttles or other handlebar components.

### X-Treme Elements Lock-On Grip

Medium Soft



Black  
L30XTB-B

Medium Soft



Graphite  
L30XTH-G

Description	Part No.
X-Treme Pre-Cut Flange, 130mm, Graphite	L30XTH-G
X-Treme Pre-Cut Flange, 130mm, Black	L30XTB-B

### ODI LOCK JAW CLAMPS AND CAPS

- Sturdy one-piece machined aluminum design
- Replacement set includes 2.5mm bolts
- Available in anodized Black, Blue, Gray, Red & Silver



Description	Part No.
Lock Jaw Clamps and Caps, Black	L70LJB
Lock Jaw Clamps and Caps, Silver	L70LJS
Lock Jaw Clamps and Caps, Blue	L70LJU
Lock Jaw Clamps and Caps, Red	L70LJR
Lock Jaw Clamps and Caps, Gray	L70LJG
Lock Jaw Clamps and Caps, Green	L70LJN

### ODI RUFFIAN MX LOCK-ON GRIPS

NEW! The Ruffian MX Grip combines an ultra narrow knurled Ruffian surface pattern combined with a motocross inspired half-waffle pattern for a great all around grip.

Medium Soft & Slim



Description	Part No.
Ruffian MX, No Flange, 130mm	L32RFB-S

### ODI CROSS TRAINER LOCK-ON GRIPS

Medium Soft & Slim



Description	Part No.
Cross Trainer, No Flange, 130mm	L30CTB-B

### BILLET ALUMINUM END PLUG



Protect your bars and grips with ODI Aluminum End Plugs.

Constructed of sturdy 6061 aluminum, these plugs are designed to take the brunt of whatever you can throw at them. Product Features: Sturdy 6061 Aluminum, Fits most sized bars, Triple-Core Design Holds Plugs Inside Bars, Sold in pairs

Description	Color	Part No.
Aluminum Bar End Plug	Black	L71APB
Aluminum Bar End Plug	Blue	L71APU
Aluminum Bar End Plug	Red	L71APR
Aluminum Bar End Plug	Silver	L71APS

### ODI LOCK JAW REPLACEMENT BOLTS



5 Bolts per pack

These bolts are replacements for the specially designed allen bolts used with Lock Jaws and eliminates the need to buy an entire new set of clamps just to replace the bolts.

Description	Part No.
Lock Jaw Replacement Bolt Set	F7ORSB

FOUR STROKE	INTAKE SYSTEMS	ENGINE/GASKETS	EXHAUST	DRIVE LINE HANDLING	ELECTRICAL	WATERLINE /BILGE	STEERING & CONTROLS	BODY	ACCESSORIES	SERVICE TOOLS /HARDWARE	CHEMICAL
-------------	----------------	----------------	---------	---------------------	------------	------------------	---------------------	------	-------------	-------------------------	----------



### LIZARD SKINS CHARGER GRIPS

Charger Lock-On

Your favorite grip now available as a lock-on grip. Small diameter, 130mm, 117.9g/0.26lbs pair

Description	Color	Part No.
Lizard Skins Charger Grips	Black	LOCD100
Lizard Skins Charger Grips	White	LOCD200
Lizard Skins Charger Grips	Green	LOCD700



### LIZARD SKINS PEATY GRIPS

Steve Peat inspired signature grip. White grips come with anodized red and blue rings and graphite grips come with anodized red rings. Small diameter, 130mm, 113.3g/0.25lbs pair

Description	Color	Part No.
Lizard Skins Peaty Grips	Graphite	LOPDS300
Lizard Skins Peaty Grips	White	LOPDS200



New Color



New Color

### LIZARD SKINS LOGO GRIPS

Our lock-on grips are manufactured here in the USA by ODI. Their patented design restricts unwanted movement, maximizing the rider's control and comfort. All Lizard Skins lock-on grips are compatible with ODI clamps. Available in black only. Comes in a bonus pack, which includes grips and clamps. This is our most popular lock-on grip.

Description	Color	Part No.
Lizard Skins Logo Grips	Black	LOLDS100
Lizard Skins Logo Grips	Red	LOLDS500
Lizard Skins Logo Grips	Green	LOLDS700



### LIZARD SKINS FLANGE LOGO GRIPS

Our lock-on grips are manufactured here in the USA by ODI. Their patented design restricts unwanted movement, maximizing the rider's control and comfort. (Flange can be cut so that the grips may be used with rapid-fire shifters) All Lizard Skins lock-on grips are compatible with ODI clamps. Available in black only. Comes in a bonus pack, which includes grips and clamps. Great for people with medium sized hands.

Description	Color	Part No.
Lizard Skins Flange Logo Grips	Black	LOFDS100
Lizard Skins Flange Logo Grips	White	LOFDS200

### LIZARD SKINS NORTHSHORE GRIPS

Our lock-on grips are manufactured here in the USA by ODI. Their patented design restricts unwanted movement, maximizing the rider's control and comfort. All Lizard Skins lock-on grips are compatible with ODI clamps. Comes in a bonus pack, which includes grips and clamps. This grip is great for people with large hands.

Description	Color	Part No.
Lizard Skins Northshore Grips	Black	LONDS100
Lizard Skins Northshore Grips	Red	LONDS500

FOUR STROKE  
 INTAKE SYSTEMS  
 ENGINE/GASKETS  
 EXHAUST  
 DRIVE LINE HANDLING  
 ELECTRICAL  
 WATERLINE /BILGE  
 STEERING & CONTROLS  
 BODY  
 ACCESSORIES  
 SERVICE TOOLS /HARDWARE  
 CHEMICAL



## AP DESIGNS CHIN PAD COVERS AND MATS FOR YAMAHA SUPER JET

SUPER JET 96+



Black/Black

<b>Yamaha</b>	<b>Part No.</b>
Chin Pad	<b>YASJ96CP</b>

SUPER JET 96+



<b>Yamaha</b>	<b>Flame-Red</b>	<b>Part No.</b>
Super Chin Pad		<b>YASJ96CP-FLME-B</b>

SUPER JET 96+



Yellow/White

<b>Yamaha</b>	<b>Part No.</b>
Super Chin Pad Hot Products Special Design	<b>YASJ96CP-YLW/WH</b>

SUPER JET 96+



<b>Yamaha</b>	<b>Part No.</b>
Side Mat	<b>YASJ96SM</b>

SUPER JET 96+



<b>Yamaha</b>	<b>Part No.</b>
Side Mat with Lifter 10" Side Mat with Lifter 15"	<b>YASJ96SM-LFT</b> <b>YASJ96SM-LFT15</b>

SUPER JET 96+



<b>Yamaha</b>	<b>Part No.</b>
Bottom Mat	<b>YASJ96BM</b>

## AP DESIGNS CHIN PAD COVERS AND MATS FOR KAWASAKI

750 SX/SXI/SXI PRO & 800 SX-R



Black/Black

<b>Kawasaki</b>	<b>Part No.</b>
750 Chin Pad	<b>KA750SXCP</b>
800 Chin Pad	<b>KA800SXRCP</b>

750 SX/SXI/SXI PRO & 800 SX-R

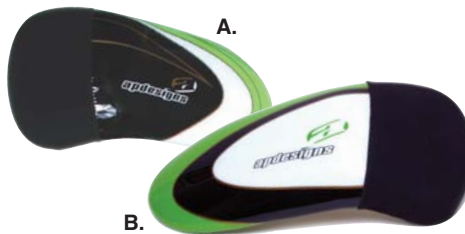

<b>Kawasaki</b>	<b>Part No.</b>
A. 750 Chin Pad	<b>KA750SXCP-GRN/W</b>
B. 800 Chin Pad	<b>KA800SXRCP-SUPE</b>

800 SX-R



<b>Kawasaki</b>	<b>Part No.</b>
Super Chin Pad	<b>KA800SXRCP-FL-RD</b>

750 SX/SXI



<b>Kawasaki</b>	<b>Part No.</b>
Side Mat	<b>KA750SXSM</b>
Side Mat with Lifter 10"	<b>KA750SXSM-LFT</b>
Side Mat with Lifter 15"	<b>KA750SXSM-LFT15</b>
Bottom Mat	<b>KA750SXBM</b>

800 SXR



<b>Kawasaki</b>	<b>Part No.</b>
Side Mat	<b>KA800SXSM</b>
Side Mat w/Lifter 10"	<b>KA800SXSM-LFT</b>
Side Mat w/Lifter 15"	<b>KA800SXSM-LFT1</b>
Bottom Mat	<b>KA800SXRBM</b>

800 SXR



<b>Kawasaki</b>	<b>Part No.</b>
Side Mat with Lifter	<b>KA800SXSMRC</b>

\* This Side Mat is specially designed for wrapping onto Rail Cap #KASRUP402.

FOUR STROKE  
 INTAKE SYSTEMS  
 ENGINE/GASKETS  
 EXHAUST  
 DRIVE LINE HANDLING  
 ELECTRICAL  
 WATERLINE /BILGE  
 STEERING & CONTROLS  
 BODY  
 ACCESSORIES  
 SERVICE TOOLS /HARDWARE  
 CHEMICAL

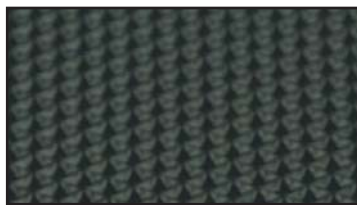

Ultra Grip Material

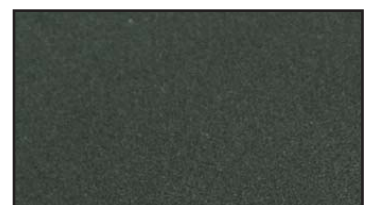

Sure Grip Material

## ULTRA GRIP SEAT COVERS & SURE GRIP SEAT COVERS

**ULTRA GRIP** — The Ultra Grip material is a rubberized, waffle patterned material designed for the recreational and racing enthusiast. It provides exceptional grip without sacrificing rider comfort. Because of its rubberized nature, the rider can ride comfortably in swim trunks and still expect exceptional traction.

**SURE GRIP** — Our Sure Grip material is an aggressive material designed for watercraft racers. It is extremely durable and provides exceptional grip for racing applications. We recommend that riders wear a wetsuit when using a Sure Grip seat cover.

### YAMAHA

GP800R/1200R/1300R



Black/White/Silver

VX110



Black/White/Silver

GP1200



Black/Silver/White

Yamaha	Part No.
Ultra Grip Top	UYAGPR-BK/WT/SL
Sure Grip Top	SYAGPR-BK/WT/SL

Yamaha	Part No.
Ultra Grip Top	UYAVX110-B/W/S
Sure Grip Top	SYAVX110-B/W/S

Yamaha	Part No.
Ultra Grip Top	UYAGP-BK/SL/WT
Sure Grip Top	SYAGP-BK/SL/WT

### SEA DOO

RXP



A. Black/Silver/Black

4-TEC GTX RXT



A. Black/Silver/Rust

XP/XPL (97-02)



A. Black/Silver/Yellow



B. Black/Yellow/Silver



B. Black/Silver/Black

Sea Doo	Part No.
A. Ultra Grip Top	USDRXP-BK/SL/BK
A. Sure Grip Top	SSDRXP-BK/SL/BK
B. Ultra Grip Top	USDRXP-BK/SL/BK
B. Sure Grip Top	SSDRXP-BK/SL/BK

Sea Doo	Part No.
A. Ultra Grip Top	USDGTX-BK/SL/RU
A. Sure Grip Top	SSDGTX-BK/SL/RU
B. Ultra Grip Top	USDRXP-BK/SL/BK
B. Sure Grip Top	SSDGTX-BK/SL/BK

Sea Doo	Part No.
A. Ultra Grip Top	USDXP97-BK/SL/YW
A. Sure Grip Top	SSDXP97-BK/SL/YW
Ultra Grip Top	USDXP97-BLK/BLK
Sure Grip Top	SSDXP97-BLK/BLK

### KAWASAKI

ULTRA 250



Black/Red/White  
Black/Red/Silver

ULTRA 250



Black/Blue/White  
Black/Blue/Silver

ULTRA 250



Black/Green/White  
Black/Green/Silver

Kawasaki	Part No.
Ultra Grip Top	UKAU250-BK/RD/W
Sure Grip Top	SKAU250-BK/RD/W
Ultra Grip Top	UKAU250-BK/RD/S
Sure Grip Top	SKAU250-BK/RD/S

Kawasaki	Part No.
Ultra Grip Top	UKAU250-BK/BU/W
Sure Grip Top	SKAU250-BK/BU/W
Ultra Grip Top	UKAU250-BK/BU/S
Sure Grip Top	SKAU250-BK/BU/S

Kawasaki	Part No.
Ultra Grip Top	UKAU250-BK/GN/W
Sure Grip Top	SKAU250-BK/GN/W
Ultra Grip Top	UKAU250-BK/GN/S
Sure Grip Top	SKAU250-BK/GN/S

# KAWASAKI

12F/15F 2006



Black/Silver/Green/Black  
Black/Silver/Red/Black

Kawasaki	Part No.
Ultra Grip Top	UKASTX06-B/S/G/
Sure Grip Top	SKASTX06-B/S/G/
Ultra Grip Top	UKASTX06-B/S/R/
Sure Grip Top	SKASTX06-B/S/R/

STX-R/12F/15F



A. Black/Green/Silver/Carbon



B. Black/Red/Black/White

Kawasaki	Part No.
A. Ultra Grip Top	UKASTX-B/G/S/C
A. Sure Grip Top	SKASTX-B/G/S/C
B. Ultra Grip Top	UKASTX-B/R/B/W/
B. Sure Grip Top	SKASTX-B/R/B/W/

ULTRA 150/ULTRA 130 DI



A. Black/Silver/Blue



B. Black/Silver/Red

Kawasaki	Part No.
A. Ultra Grip Top	UKAULT-BK/SL/BL
A. Sure Grip Top	SKAULT-BK/SL/BL
B. Ultra Grip Top	UKAULT-BK/SL/RD
B. Sure Grip Top	SKAULT-BK/SL/RD

## AP DESIGNS SURE GRIP MAT SETS

YAMAHA GP 800R/  
1200R/1300R



Black/Black

Yamaha	Part No.
Yamaha GP 800R / 1200R / 1300R	YAGPRMT-BLK/BLK

KAWASAKI ULTRA 150, 250  
1200 STX-R, 15F



Black/Black

Kawasaki	Part No.
Ultra150	KAULTMT-BLK/BLK
STXR, 12F, 15F	KASTXR-BLK/BLK
Ultra250	KAU250MT-BLK/BL

SEA DOO RXP



Black/Black

Sea Doo	Part No.
RXP	SDGTXTMT-BLK/BLK

SEA DOO GTX DI (02-03),  
4-TEC (02-05), RXT



Black/Black

Sea Doo	Part No.
RXT	SDRXTMT-BLK/BLK

KAWASAKI STX-R / ULTRA 250  
SIDE MAT WITH LIFTER REPLICA



Black/Black

Kawasaki	Part No.
1200STX-R	KASTXRSM-BLK/BL
Ultra 250	KAU250SM-BLK/BLK

HYDROSPACE MATS



Black/Black  
With 15"  
Side Lifter

HydroSpace	Part No.
Bottom Mat	HYDROSPACEBM
Side Mat	HYDROSPACEBM
Bottom for Kick Tail	HYDROSPACEBMKT



Aftermarket Bars  
Installed - OEM  
Protective Cover  
No Longer Fits

Safety Switch  
Mounting Bracket

## HANDLE BAR STEERING MOUNT COVER AND SAFETY SWITCH BRACKET

When you install aftermarket handlebars on your Sea Doo using the OEM steering system the OEM pad cover will no longer fit. AP Designs has developed this new pad to allow for the bars to fit properly and protect you while riding your Sea Doo as well as to hide the ugly cast steering system. Also developed in conjunction with this cover is a safety switch mounting bracket.

Sea Doo	Part No.
Handlebar Mount Cover for Sea Doo RXP, RXT, RX, GSX, GTX, GTI, GTS, GSI, GS 96+	SD-HCV
Safety Switch Mounting Bracket	N-SDSWMT

FOUR STROKE  
INTAKE SYSTEMS  
ENGINE/GASKETS  
EXHAUST  
DRIVE LINE HANDLING  
ELECTRICAL  
WATERLINE /BILGE  
STEERING & CONTROLS  
BODY  
ACCESSORIES  
SERVICE TOOLS /HARDWARE  
CHEMICAL



# JET TRIM SEATCOVER

Jet Trim's handcrafted seat covers are hand cut, hand sewn, and specifically fitted to each individual year and model. Whether you're a recreational or pro-level rider, we can custom tailor each seat cover to your requirements. Call today for a template for your custom designed seat cover.

*Pricing, manufacturing and shipping time varies.  
Please call for details and pricing based on your customized design.*

FOUR STROKE  
INTAKE SYSTEMS  
ENGINE/GASKETS  
EXHAUST  
DRIVE LINE HANDLING  
ELECTRICAL  
WATERLINE /BILGE  
STEERING & CONTROLS  
BODY  
ACCESSORIES  
SERVICE TOOLS /HARDWARE  
CHEMICAL



**SEA DOO RXP**

Sea Doo Part No. SDRXP101  
SeaDoo RXP Seat Cover



**SEA DOO 4-TEC/RXT**

Sea Doo Part No. SDRXT101  
SD 4-TEC/RXT Seat Cover



**SEA DOO XP/XP-L**

Sea Doo Part No. SDXP101  
SeaDoo XP/XP-L Seat Cover



FOUR STROKE  
INTAKE SYSTEMS  
ENGINE/GASKETS  
EXHAUST  
DRIVE LINE HANDLING  
ELECTRICAL  
WATERLINE /BILGE  
STEERING & CONTROLS  
BODY  
ACCESSORIES  
SERVICE TOOLS /HARDWARE  
CHEMICAL



**YAMAHA FX SHO (09)**

Yamaha Part No.  
Yamaha FX SHO (08-09) **YSHO101**



**YAMAHA FZR (09)**

Yamaha Part No.  
Yamaha FZR Spike Design (09) **YFZR101**



**YAMAHA FZS (09)**

Yamaha Part No.  
Yamaha FZS Retro Design (09) **YFZS101**



**YAMAHA FX SHO (08)**

Yamaha Part No.  
Yamaha FX SHO (08) **YSHO101**



**YAMAHA FZR (09)**

Yamaha Part No.  
Yamaha FZR Retro Design (09) **YFZR102**



**YAMAHA FZS (09)**

Yamaha Part No.  
Yamaha FZS Spike Design (09) **YFZS102**



**YAMAHA FX-140/160**

Yamaha Part No.  
Yamaha FX 140/160 **YFX140101**



**YAMAHA GPR**

Yamaha Part No.  
Yamaha GPR **YGPR101**



**YAMAHA GP**

Yamaha Part No.  
Yamaha GP **YGP101**



**KAW ULTRA 250X/LX**

Kawasaki Part No.  
Jet Trim Ultra 250X/LX **KU250X101**



**KAW STX 00+/12F/15F 06+**

Kawasaki Part No.  
Kaw STX (00+//12F/15F (06+) **K15F101**



**KAW STX-R/15F - 02-05**

Kawasaki Part No.  
Kaw STX-R/15F (02-05) **KSTXR101**



## HYDRO-TURF MATS

Hydro-Turf® is a leading manufacturer of performance traction mats and seat covers. Hydroturf offers some of the best looking, best gripping ride mats on the market. Superior traction grooves and excellent durability are the choice for amateur and professional riders looking to upgrade or replace their existing traction mats. Our jetski and personal watercraft upholstery kits are designed to replace worn or damaged seats and provide the rider superior traction and resistance to elements.

Yamaha	Part No.	Stocked Available Colors
Wave Runner	HT70	BLK
FX1	HT71	BLK, PUR
SUV	HT72	BLK, GRA
Wave Runner III	HT73	BLK, PUR
Wave Blaster	HT74	BLK, BW
Wave Blaster II	HT741	BLK
Wave Blaster 800	HT742	BLK
Super Jet 90-95	HT75	BLK, PUR
Super Jet 96-08	HT751	BLK, PUR
Wave Raider	HT76	BLK, ROY
VXR, VXR-Pro	HT77	BLK
Wave Venture/XL1200(98)/XL700 & 760 (98-04)	HT78	BLK, DG
XL1200 LTD 99-01/ XL800/ XLT1200/XLT800	HT784	BLK, DP
GP/GP1200R (99)	HT79	BLK, BW
GP1300R/GP1200R(00-02)		
GP800R(01-05)	HT791	BLK, GRY, TRI
FX140, FX Cruiser, FXHO (02-08), FX SHO (08), FX Cruiser SHO (08), FZR (09), FZS (09)	HTFX	BLK
VX110 (05)	HTVX	BLK
FX SHO (08)	HTFX1	BLK
FX Cruiser SHO (08)		

Hydrospace	Part No.	Stocked Available Color
Hydrospace S4 with 2" Kick Tail	HT100	BLK

Sea Doo	Part No.	Stocked Available Colors
GTI (06-08)	HT824	BLK
XP-93, SP Family -94	HT80	BLK, PUR
GT Family 90-95,		
GTI 96, GTS 96-00	HT82	BLK, PUR
GTX 96-02, GTI 97-00	HT821	BLK, BW
GTS (01)/GTI (01-05)	HT823	BLK
XP 93-96, SP Family 94-99	HT83	BLK, PUR
GS Family	HT831	BLK, BW
XP 97-04	HT84	BLK, TRI
LRV	HT85	BLK, GRA
RX / RXX	HT86	BLK
HX 95-97	HT87	BLK, PUR
GTX DI (02) & 4-TEC (02), RXT, GTX (03-06)	HT88	BLK
RXP	HT89	BLK
3D	HT3D	BLK
RXT-IS/GTX Limited (09)	HT882	BLK

Kawasaki	Part No.	Stocked Available Colors
JS300/440/550	HT20	BLK, PUR, ROY
JF650X2	HT40	BLK, PUR, ROY
JS550SX	HT55	BLK, ROY
ZXI	HT60	BLK, PUR
ULTRA 150, Ultra 130	HT61	BLK
Ultra 250X, Ultra 250 LX (07-08)	HT62	BLK
ST/STS/750STX&900STX(pre 99)	HT63	BLK, PUR, ROY
STX1100 97-99		
STX900 99-00, 900STS(01-02)	HT631	BLK, PUR
STX1100DI (00-02), All STX(01-06), 12F, 15F, STXR	HT64	BLK
JF650SX	HT65	BLK, PUR, ROY
750SS/XI/XIR	HT66	BLK
JF750SX/SXI	HT67	BLK, PUR, ROY
800 SX-R	HT68	BLK, PUR, ROY
800 SX-R with Kick Tail (1")	HT68K	BLK

Honda	Part No.	Stocked Available Color
F-12/F-12X	HT05	BLK
R-12/R-12X	HT06	BLK
F-15X (08)	HT07	BLK

Polaris	Part No.	Stocked Available Colors
SL/SLX-99, 785Pro 99-01	HT90	BLK, PUR, ROY
Hurricane	HT91	BLK, BW
SLXH(98), SLH, SLX(99)	HT92	BLK
SLH/SLX/Pro (00-01)	HT921	BLK
SLT, SLTX, X-45	HT93	BLK
Virage, Freedom	HT94	BLK
Genesis	HT95	BLK
Octane (Bottom Mat only)	HT96	BLK

\*When ordering, add color code to Part Number.

## COLOR CODE

Color	Code	Color	Code	Color	Code	Color	Code	Color	Code
Black	BLK	Dark Purple	DP	Lime Green	LGN	Red	RED	Tri-Color	TRI
Black/White Marble	BW	Deep Blue	DB	Orange	ONG	Royal Blue	ROY	White	WHT
Camouflage	CAM	Granite	GRA	Pink	PK	Royal Marble	RM	Yellow	YLW
Dark Gray	DGY	Light Blue	LBL	Purple	PUR	Tan	TAN	Yellow Camo	YLWCAM
Dark Green	DG	Light Gray	LGY	Purple Marble	PM	Teal	TEL		

# HYDRO-TURF SPECIAL MATS FOR KAWASAKI 750 & 800



\*All special mats only available in black.

Kawasaki	Part No.
750SXI Mats for use with "Digger" Footholds	HT67F
800 SXR Mats for use with "Kicker" Footholds and Blowision Rail Caps	HT68BF
800 SXR Mats with 1" kick tail for use with Blowision Rail Caps	HT68RC
Blowision Dawson "Digger" Footholds	AWCO124
Blowision "Kicker" Footholds	AWCO125
Blowision Composite Rail Caps	KASRUP402

# HYDRO-TURF SPECIAL MATS FOR YAMAHA SUPER JET



\*All special mats only available in black.

Yamaha	Part No.
Super Jet (96-08) Mats for use with Wamilton Footholds	HT751F
Super Jet (96-08) Mats for use with Blowision "Digger" Footholds	HT751FD
Super Jet (96-08) Mats for use with Blowision "Kicker" Footholds	HT751BF
Bumper Rail Strips/Mats for (all stand up models) brands	TS50
Wamilton "Ricker" Foothold	FHWAM



SD01



Mats displayed on boat.

# HYDRO-TURF MATS FOR JET BOAT FLOORING

◆ Non Inventory Items: Special Order Only ◆

Yamaha	Part No.
Exciter (All years)	Y01
LS2000 / LX2000 (99)	Y02A
LS2000 / LX2000 (2000+)	Y02
LS210 / LX210 / AR210 (-05)	Y021
XR 1800	Y03
SR230 / SX230 / AR230 (05-06)	Y04
SR210 / SX210 / AR210 / 2102 (06-08)	Y05
SR230 / SX230 / AR230 / 232 (07-08)	Y06

\*When ordering, add color code to Part No.

Sea Doo	Part No.
Speedster (94-95)	SD01
Speedster (96) / Sportster (96-99)	SD02
Challenger (96-00) / Speedster (97)	SD04
Challenger 1800 (97-04)	SD05
Sportster 1800 (98-00)	SD06
Speedster SK (99)	SD07
Speedster (98-99)	SD08
Challenger 2000 (00-04) / X (02-04)	SD09
Challenger X (03-05)	SD091
Islandia (00-08) "Available Flat Only"	SD10
Utopia 185 (01-05)	SD11
Speedster (00-03) / Speedster 160 (04)	SD12
Challenger (01) / Sportster (01-05)	SD13
Utopia 205 (02-08) / SE (07)	SD14
Sportster 4-Tec (03-05) / SCIC (05-06)	SD15
Speedster 200 (05-08) / Wake (06-08)	SD16
Speedster (07-08)	
Challenger 180 (05-06)	SD17
Challenger 180 (07-08)	SD171
Challenger 230 / SE (07-08) 13 piece set	SD18
Challenger 230 / SE (07-08) 2 piece set	SD18R

\*When ordering, add color code to Part Number

◆ Mats are available only in colors listed. When ordering, add color code to Part No. ◆ Color swatch kit available upon request



FOUR STROKE  
INTAKE SYSTEMS  
ENGINE/GASKETS  
EXHAUST  
DRIVE LINE HANDLING  
ELECTRICAL  
WATERLINE /BILGE  
STEERING & CONTROLS  
BODY  
ACCESSORIES  
SERVICE TOOLS /HARDWARE  
CHEMICAL

# HYDRO-TURF

FOUR STROKE  
INTAKE SYSTEMS  
ENGINE/GASKETS  
EXHAUST  
DRIVE LINE HANDLING  
ELECTRICAL  
WATERLINE /BILGE  
STEERING & CONTROLS  
BODY  
ACCESSORIES  
SERVICE TOOLS /HARDWARE  
CHEMICAL

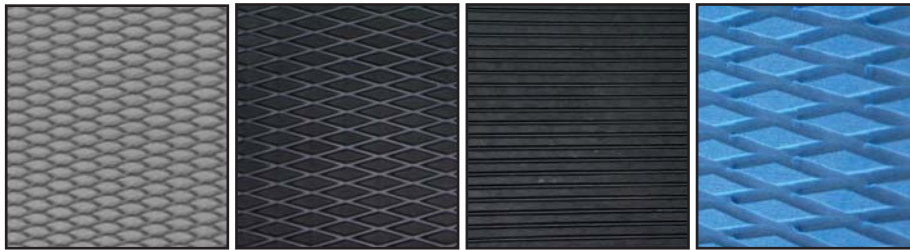

SHT40MD-DGY      SHT40MD-BLK      SHT40MG-BLK      SHT40CD

Hydro-Turf Sheet Only 40" x 62"	Part No.
40" x 62" Cut Groove (all colors) (Grooves are 62" long)	SHT40CG
40" x 62" Cut Diamond (all colors)	SHT40CD
40" x 62" Molded Groove (Grooves are 62" long) - Black	SHT40MG-BLK
40" x 62" Molded Diamond - Black	SHT40MD-BLK
40" x 62" Molded Diamond - Dark Gray	SHT40MD-DGY

*\*Note: Hydro-Turf grooved mat sheets may not always come with a precise clean edges or corners due to the manufacturing process.*



Hydro-Turf Underpad Sheet 39" x 78"	Part No.
39x78 Underpad 3/4" (20mm) thick	SHTUPAD20
39x78 Underpad 5/16" (8mm) thick	SHTUPAD8
39x78 Underpad 3/16" (5mm) thick	SHTUPAD5



## SIDE LIFTER WEDGE

For a quick and semi-permanent advantage. Great when used for racers & beginner freestylers. Provides the "wedge" you need. Color: Black Only

Description	Part No.
2" x 13" Black x 2 pieces	TS43
2.5" x 24" Black x 2 pieces	TS44

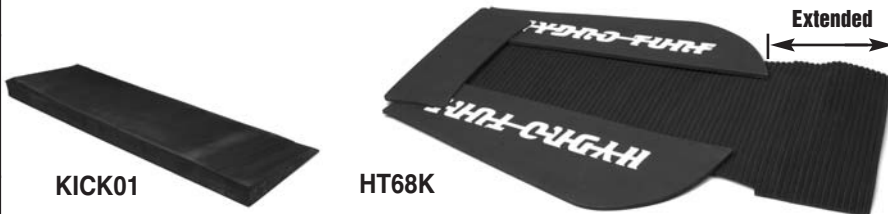

## HYDRO-TURF KICK TAIL

Add a kick tail to your watercraft 1" or 2" wedge. If installed under the traction mats, some models of watercraft may require an extended mat.

Description	Part No.
Kick Tail 5.5" x 17" x 1" Tall	KICK01
Kawasaki 800 SX-R Mat with 1" Kick Tail	HT68K-BLK
Kick Tail 5.5" x 17" x 2" Tall	KICK02

## MAT ADHESIVE

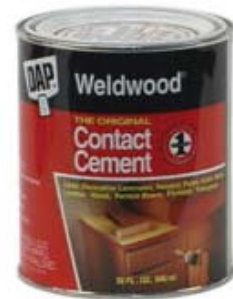

Description	Part No.
Weldwood Contact Cement (16 oz.)	CC20

## HANDLE POLE SHOCK PADS

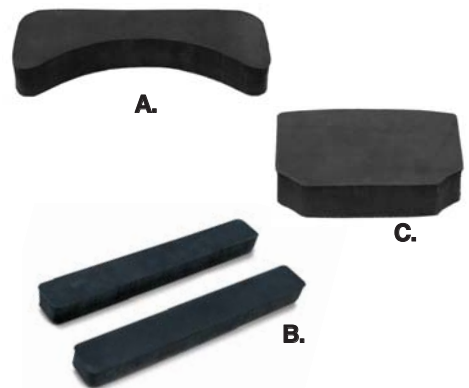

Protects engine hood from damage when Handlepole is dropped. Color: Black only

Description	Part No.
A. Kawasaki 750SX/SXI/800SXR (1)	TS401
B. Kawasaki JS440/550 (2)	TS411
C. Yamaha Super Jet (1)	TS421



JOHN KASZER  
2008 WORLD FINALS • LAKE HAVASU, AZ  
PHOTO COURTESY OF JIN OMURA



**57-7032**  
Flame Design

### JET TRIM SPLASH GUARDS

Description	Part No.
Small • 52" Length • For two seat PWC	57-7029
Large • 60" Length • For three seat PWC	57-7030
Large • 58" Length <i>FLAME DESIGN</i> For three seat PWC	57-7032

### HYDRO-TURF SPLASH GUARDS



Description	Part No.
Hydro-Turf Splash Guard (5.5" x 40") Rivets Included	57-7035



### MACC RACING CARBON RACING REAR SEAT

Macc Racing has developed a Carbon Racing seat for the Ultra 250. The rear seat is about 15lbs lighter than stock and features a cool air induction intake while keeping water out of the engine compartment. \*This Carbon Racing Rear seat is intended for a performance advantage and is not intended to be used as a seat for a passenger.



Description	Part No.
Macc Racing Ultra 250 Carbon Racing Rear Seat	MR-ULTRASEAT



### TBM SPLASH GUARD

FOR STAND-UP MODEL PWC

Description	Part No.
Splash Guard (3" x 34")	TBM128



Inside View



Inside View



Top View

### HYDRO-TURF TRACTION STRIPS



### AP DESIGNS SPLASH GUARD

For Super Jet and K750SXI/Pro

Description	Part No.
Splash Guard (3.25" x 33")	57-7037

2" x 15"



4" x 15"



Description	Part No.
2"x15" Traction Strips 8 pieces per package	TS02
4"x15" Traction Strips 4 pieces per package	TS04



FOUR STROKE	INTAKE SYSTEMS	ENGINE/GASKETS	EXHAUST	DRIVE LINE HANDLING	ELECTRICAL	WATERLINE /BILGE	STEERING & CONTROLS	BODY	ACCESSORIES	SERVICE TOOLS /HARDWARE	CHEMICAL
-------------	----------------	----------------	---------	---------------------	------------	------------------	---------------------	------	-------------	-------------------------	----------

FOUR STROKE  
 INTAKE SYSTEMS  
 ENGINE/GASKETS  
 EXHAUST  
 DRIVE LINE HANDLING  
 ELECTRICAL  
 WATERLINE /BILGE  
 STEERING & CONTROLS  
 BODY  
 SERVICE TOOLS ACCESSORIES /HARDWARE  
 CHEMICAL



### HYDRO-TURF HOOD SEALS

Quality replacement foam hood seal gaskets.

Description	Part. No.
Kawasaki JS440/550	TS55
Yamaha Super Jet	TS56



### HOOD Baffle INSERT FOR FACTORY PIPE 800 SX-R

Use this composite drop in baffle insert to cover the area removed during installation of the factory pipe dry pipe for Kawasaki 800SXR.

Description	Part. No.
Hood Insert 800 SX-R	05-02-108



### R&D SPACE MAKER HOOD INSERT FOR YAMAHA SUPERJET

This insert allows you to remove a portion of the stock hood inner liner and foam, replacing it with the Space Maker Hood Insert creating the extra clearance needed to run the Super Jet Dry Pipe.

Description	Part. No.
Yamaha Super Jet	652-70110



### STORAGE COMPARTMENT & SEAT LATCH ASSEMBLY FOR SEA DOO

Economy replacement of plastic latch assembly used in most Sea Doo watercraft.

Description	Part. No.
Seat Latch Assembly (OEM # 269-00-016)	011-800
Front Compartment Latch RX, RXDI, GTI LE, GTI XP 03-04 (OEM # 269-501-125)	011-805



### RIVA MIRROR BLOCK-OFF KIT FOR KAWASAKI

Lightweight aluminum block-off plates fill openings left when mirrors are removed for competition. Includes reverse lever block-off.

Description	Part. No.
Kawasaki Ultra 250X/LX	RK5-U250X-MB



### RIVA HIGH FLOW HOOD KIT FOR SEA DOO

Integrated ducting delivers increased cool air to engine compartment improving performance.

Description	Part. No.
High Flow Hood Kit RXP and RXP-X	RS5-0050



### KAWASAKI SXR BOW EYE COMPOSITE FRONT COVER

What was Kawasaki thinking? Tired of putting your SXR on the trailer backward so you can actually haul it on your stand-up trailer with your normal bow coupler? Blowsion has the answer.

Description	Part. No.
Kawasaki 800 SX-R Bow Eye Composite Front Cover	05-02-304



### 800 SX-R BILLET HOOD HOOKS

Introducing our Billet Front Hood Hooks for the SX-R 800. A direct replacement for the weak O.E.M. hood latches that bend and commonly fail, our hood latches are manufactured from 6061 billet aluminum. We eliminated all stress risers to ensure our latches will stand up to the most extreme riding conditions eliminating the chance of a failure that can lead to the hood coming loose.

Description	Part. No.
800 SX-R Billet Hood Hooks	TBM109



### KAWASAKI OEM 800 SX-R HOOD AIR INTAKE BLOCK-OFF KIT

The easy solution to water slamming its way into your OEM SXR hood. This trick block-off kit will allow you to stop ingestion of water into the engine compartment, thus limiting the damage caused by racing in rough conditions, wave jumping, submarines, etc. Trick and simple!

Description	Part. No.
800 SX-R Intake Block-Off	04-04-401



**FRONT HOOD HOOKS (96+SJ)**

Don't lose your hood again due to poor spring tension with the stock hooks. Our billet aluminum hooks won't tweak or budge in even the most extreme of conditions. Carbon grey anodized. Sold as a pair complete with stainless fasteners.

Description	Part No.
Superjet Hood Hooks	04-04-105



**FRONT HOOD HOOKS (SX-R)**

Utilizing the many years of Super Jet Freestyle and surf quality hood hook design experience, these bulletproof SX-R billet hood hooks allow for the ultimate abuse of your 2003 and newer SX-R on the race course, river or in big surf.

Description	Part No.
SX-R Hood Hooks	04-04-101



**BILLET HOOD LATCH**

Recently updated and re-machined to also fit the Kawasaki SXR800, SXI Pro all Yamaha Superjet and FX1.

Description	Part No.
Hood Latch Clear	04-04-008
Hood Latch Green	04-04-004
Hood Latch Red	04-04-007



**SXR HAND HOLD KIT MID MOUNT**

SXR Mid Mount drop-in hand holds for stock hoods.

\*Left side mount will not fit with Factory Dry Pipe

Part No.	05-04-213
----------	-----------



**SXR HAND HOLD KIT STANDARD MOUNT**

SXR forward Mount drop-in hand holds for stock hoods.

Part No.	05-04-214
----------	-----------



**SJ96+ HAND HOLD KIT MID MOUNT**

Super Jet 96+ Mid mount drop-in hand holds for stock hoods.

Part No.	05-04-271
----------	-----------



**HAND HOLD KIT "Q" HOLD MOUNT**

Universal mount drop-in hand holds are easily located on any flat surface.

Part No.	05-04-203
----------	-----------



**WAVEBLASTER SPRAY NOZZLE BLOCK-OFF**

This little fitting neatly replaces the water spray nozzle found on the rear

of Yamaha WaveBlasters.

Description	Part No.
Spray Nozzle Block-Off	81-736



**BLOWSION STAINLESS HOOD LATCH ASSEMBLY**

Fits all 650/750/800/X2 Kawasaki. May also be used to retro-fit all years Yamaha Superjet and Fx1. Comes complete with latch assembly and hood clip. 100% polished stainless. Trick and functional. Why incur the factory OEM replacement expense?

Description	Part No.
Stainless Hood Latch	04-04-030



**SX-R RAIL CAPS**

Newly re-tooled and now an even better fit! The composite crew at Blowsion has made new mold sets off of Blowsion's SXR Carbon Hull making these new generation SX-R Rail Caps a PERFECT fit! A complex fitting piece now made with the best fit and features available. Get rid of those extremely slippery factory rubber black rails and go composite.

Description	Part No.
Blowsion SX-R Rail Cap	KASRUP402
800 SXR Mats for use with "Kicker" Footholds and Blowsion Rail Caps	HT68BF
800 SXR Mats with 1" kick tail for use with Blowsion Rail Caps	HT68RC





### LUSTIC KICKER FOOTWELLS

Designed especially for all years Super Jet and the 800 SXR, these beauties have been used exclusively by Josh Lustic on his Blowsion prepared Factory Pro Kawi SXR 800. These custom molded fiberglass insets provide the room in the tray of your ski for lock down aerials.

Description	Part No.
Lustic Footwell	05-03-005
800 SXR Mats for use with	HT68BF
"Kicker" Footholds & Blowsion Rail Caps	
Superjet (96-08) Mats for use	HT751BF
with Blowsion "Kicker" Footholds	



### DIGGER FOOTWELLS

Custom extruded and molded to fit your feet, the Dawson Digger footwell has been designed and updated for 2007. Considered a must have modification for any surf or freerider. The Digger features a recessed "notch" at the back of each footwell to allow rider to wedge foot during tail stands & surf recoveries.

Description	Part No.
Dawson Diggers	05-03-004
Superjet (96-08) Mats for use	HT751FD
with Blowsion "Digger" Footholds	
750SXI Mats for use	HT67F
with Blowsion "Digger" Footholds	



DERRICK KEMNITZ SR.  
2008 WORLD FINALS • LAKE HAVASU, AZ  
PHOTO COURTESY OF JIN OMURA

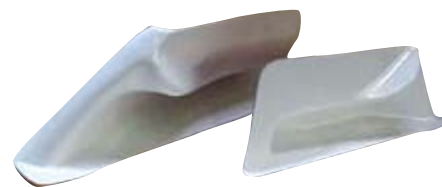

### FOOTWELLS KLOWNERS

Designed especially for the rider who needs MAX room in the tray. These hand-laid, molded fiberglass insets provide extended room in the tray of your ski to position your feet. Comfortably sized for large to very large feet, the Klowner footwells contour to your ankle and also feature a gentle protrusion over the top of your foot for better locking power. Built with safety and performance in mind, the Klowner footwells will keep you in your ski while inverted, and also easily let you go when you feel like you're going to need a hurried dismount to avoid facial impact on fiberglass.

Description	Part No.
Klowners Footwell	05-03-007



### WAMILTON "RICKTER" FOOTWELLS

A must have for surf riding. These Wamilton fiberglass footwells work with Hydro Turf SuperJet freestyle mats.

Description	Part No.
Superjet Rickter Footwells	FHWAM
Superjet (96-08) Mats for use	HT751F
with Wamilton "Rickter" Footwells	



Extended Bow Eye

Yamaha  
57-6280



Kawasaki  
57-6270

### ALUMINUM NOSE BUSHINGS

Description	Part No.
Yamaha All Silver	57-6280
Kawasaki 89+ Silver	57-6270
UMI Kawasaki 89+	JS-03200-CLR
Blowsion Extended Bow Eye	04-03-058

### FOOTWELLS MAC MASHERS

No cutting of the wide SXR tray required. Design in conjunction with pro Kawasaki rider Chris MacClugage and Darren Hedlund. Experience the feel of a standard footwell cut out without having to notch out your SXR tray. 100% race legal.

Description	Part No.
Mac Footwell	05-03-006

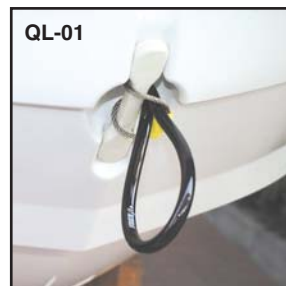

### AWD PRODUCTS QUICK LOOP

A flexible tow loop is required for all watercraft of IJSBA Race. Specially designed to meet IJSBA regulation.

Description	Part No.
Watercraft with "Tow Hook"	QL-01
Watercraft with "Bow Eye"	QL-02





### UMI BILLET GAS CAPS

Yamaha	Part No.
Gas Cap Black	YA20110-BKA



### BLOWSION BILLET GAS CAPS

Kawasaki	Part No.
Clear	04-03-108
Green	04-03-104
Red	04-03-107
Black	04-03-101



### BLOWSION LOW PROFILE BILLET GAS CAPS

Yamaha	Part No.
Low Profile Clear	04-03-158
Low Profile Red	04-03-157
Low Profile Black	04-03-151
Low Profile Blue	04-03-152



### TBM BILLET EXHAUST FLANGE

Kawasaki 800 SXR	Part No.
Clear	TBM110-P
Black	TBM110



### HOT PRODUCTS BILLET GAS CAPS

Sea Doo	Part No.
Platinum	50-9530
Black	50-9531



### TBM RACING KAWASAKI BILLET GAS CAPS

Kawasaki	Part No.
Gas Cap Clear	TBM105-C
Gas Cap Black	TBM105-B



### TBM RACING BILLET FUEL FILLER NECKS

Kawasaki	Part No.
Fuel Filler Neck Kawasaki	TBM105-KFN
Fuel Filler Neck Yamaha	TBM105-YFN



### RIVA BILLET GAS CAPS

Yamaha	Part No.
Gas Cap Silver	RY840-1P
Gas Cap Black	RY840-1B



### ADA RACING BILLET YAMAHA FUEL CAP SOCKET

Billet aluminum fuel cap socket for the Yamaha Super Jet, WaveBlaster, & Wave Raider. Works with the stock plastic or aftermarket billet gas caps. Includes attached chain. Replaces the plastic Yamaha OE part# FN8-67833-00-00.

Description	Part No.
Yam Fuel Socket Black	34-450190



### BLOWSION BILLET EXHAUST NOZZLE

Kawasaki 800 SXR	Part No.
Clear	04-03-208
Green	04-03-204
Red	04-03-207
Black	04-03-201

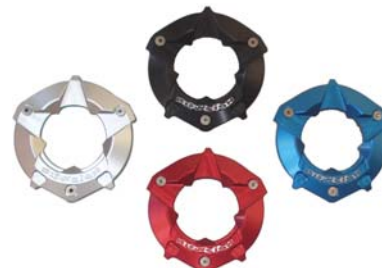

### BILLET EXHAUST NOZZLE FOR YAMAHA SJ96+

Yamaha SJ96+	Part No.
Clear	04-03-258
Blue	04-03-252
Red	04-03-257
Black	04-03-251

FOUR STROKE  
INTAKE SYSTEMS  
ENGINE/GASKETS  
EXHAUST  
DRIVE LINE HANDLING  
ELECTRICAL  
WATERLINE /BILGE  
STEERING & CONTROLS  
BODY  
ACCESSORIES  
SERVICE TOOLS /HARDWARE  
CHEMICAL



Factory Matched Number Kits that resist fuel, fading and scratches. UV coated for shine and protection from the sun. Includes 4 sets of A-Z, 0-9. Total of 146 decals. Size 3" letters.

FOUR STROKE  
INTAKE SYSTEMS  
ENGINE/GASKETS  
EXHAUST  
DRIVE LINE HANDLING  
ELECTRICAL  
WATERLINE /BILGE  
STEERING & CONTROLS  
BODY  
ACCESSORIES  
SERVICE TOOLS /HARDWARE  
CHEMICAL

### Series 200

The original and still the most popular. Outline color shades into body color for that custom airbrushed look.



### Series 300

The first and still the best Factory Matched Carbon Fiber look made. We make the ONLY carbon fiber pattern that looks great in any color that you choose.

\* Made with real chrome material.



### Series 320

Solid body with no shading and a contrasting outline with drop shadow in our popular block font.

\* Made with real glitter.



## Series 305 EC

Same font as our series 320 except no outline. Solid body color.

# ABC123

BLK350EC

# ABC123

BLU350EC

# ABC123

GRN350EC

# ABC123

WHI350EC

# ABC123

RED350EC

## Series 200 EC

Economical one color kits with great style and solid color.

# 123ABC

BLK200EC

# 123ABC

TEA200EC

# 123ABC

WHI200EC



### Sticker-On! Decal Application Fluid

No more bubbled on or wrinkled decals.

### Sticker-Off! Decal Adhesive Remover

Removes messy sticker residue.

Description	Part No.
Sticker-On 2 oz.	964
Sticker-Off 2 oz.	965



### Custom Lettering Kit

1" Custom Letter Kit	Part No.
White	2400W
Black/Red	2410B
Chrome	2420C



### CARBON FIBER NUMBER PLATE BACKGROUNDS

Add style to your number plate background and still be race legal. 3 backgrounds per package.

Style	Yellow	White	
Precut	7248	7249	—
Slanted	8248	8246	8251
Universal	9248	—	9251



### "THE ORIGINAL" DUCKY



DUC-1000

DUC-1001

DUC-1002

Description	Part No.
Water Spot Remover	DUC-1000
32oz. Spray Bottle (946ml.)	
All Purpose Cleaner	DUC-1001
32oz. Spray Bottle (946ml.)	
PWC Detailer	DUC-1002
24oz. Spray Bottle (709ml.)	

### DUCKY WATER SPOT REMOVER — DUC-1000

DUCKY, the first product ever developed specifically for the removal of hard water stains. Ducky Water Spot Remover is non-abrasive, environmentally friendly and easy to use. Simply spray on and wipe off. Use on fiberglass, glass, painted surfaces, chrome, etc.

### DUCKY ALL PURPOSE CLEANER — DUC-1001

Use Ducky All Purpose for cleaning: boat hulls, exhaust deposits, upholstery, carpet, other synthetics, chrome, mirrors and windows. Trigger spray activates rich, deep-cleaning foam that penetrates, lifts and suspends grease and grime.

### DUCKY PWC DETAILER — DUC-1002

Ducky Detailer creates a molecular bond with the surface of your finish, providing ultimate protection from harmful U.V. rays and soil accumulation. Ultra violet brightener will enhance colors while leaving a smooth-to-the-touch, wet-look finish.



### RACING NUMBERS

3 per package. 8" Tall. Black color only.

Number	Part	Number	Part
#0	H1310	#5	H1315
#1	H1311	#6	H1316
#2	H1312	#7	H1317
#3	H1313	#8	H1318
#4	H1314	#9	H1319

FOUR STROKE  
INTAKE SYSTEMS  
ENGINE/GASKETS  
EXHAUST  
DRIVE LINE HANDLING  
ELECTRICAL  
WATERLINE /BILGE  
STEERING & CONTROLS  
BODY  
ACCESSORIES  
SERVICE TOOLS /HARDWARE  
CHEMICAL

# AQUA Performance

## AQUA PERFORMANCE "AQUA STEPS"

The spring-loaded stainless steel step stays in the upward position until needed for added safety benefits. The step features a soft marine foam covering for your non-slip protection and grip. It comes completely assembled with all stainless steel hardware.



Yamaha	Part No.
FX140, HO	Not Available
Wave Blaster II (all years), Wave Blaster (96-98)	1096WBD-BLK
Wave Blaster (93-95) Wave Raider 701 (94)	1077Y-BLK
Wave Raider 701, 1100 (95)	1100YD-BLK
Wave Raider 701, 760, 1100 & STS (96-98)	1100WWD-BLK
Wave Runner III 650 (90-95)	1077Y3D-BLK
Wave Runner LX, VXR, Pro VXR (all years)	1070XL-BLK
Wave Venture 701 (94-95),	1095YWD-BLK
Wave Venture 760 (95, 97-99)	1095YWD-BLK
Wave Venture 701/760/1100 (96-00)	1070XL-BLK
XL701/760 (98-03)	1070XL-BLK
XL800, XLT800 (00-03)	1072XL-BLK
XL1200 (98)	1070XL-BLK
XL1200, XLT1200 (99-04)	1072XL-BLK
XL1200 LTD (99-01)	1072XL-BLK

Honda	Part No.
Aquatrax F-12, F-12X, R12X (02-04)	2002ATX-BLK

Polaris	Part No.
SLH (98-01)	1096SLTX-BLK
SLTH (98-00)	1096SLTX-BLK
SLTX (96-00)	1096SLTX-BLK
SLXH (98-00)	1096SLTX-BLK
Virage, TX, TXI, Freedom (00-04)	1096SLTX-BLK
SLT 700 (96-99)	1075PDT-BLK
SLT 750 (95)	1075PDT-BLK
Hurricane All	1075PDT-BLK

Sea Doo	Part No.
GS (97-02) GSI (97)	1098GS-BLK
GSX (96-00)	1096GXD-BLK
GTI, GTI LE (96)	1095XPD-BLK
GTI/GTI LE (97-04)	1097GTX-BLK
GTI, RFI (05)	2005RFI-BLK
GTI, GTI SE, GTI 130 (96-08)	2006GTI-BLK
GTS (94-96)	1077GD-BLK
GTS (97-00)	1098GTS-BLK
GTS (01-02)	1097GTX-BLK
GTX (94-95)	1077GD-BLK
GTX (96-03)	1097GTX-BLK
HX (95-98)	1085HXD-BLK
RX, RXDI (00-03)	1098GTS-BLK
RXP (04-08, RXP-X (08), RXT (04-07)	2004RXP-BLK
RXT-X 255HP (08)	2008RXT-BLK
SP (88-93) SPI (88-93) SPX (92-93)	1077S3D-BLK
SP (94-95) SPI (94-95) SPX (94-95)	1077SD-BLK
SP (96) SPI (96-98)	1096SXD-BLK
SP (97-98)	1098SP-BLK
SPX (96-00), XP/XP DI (96-04)	1096SPD-BLK
XP, XPDI (93-94)	1077SD-BLK
XP, XPDI (95)	1095XPD-BLK

Kawasaki	Part No.
ZXi 750/900/1100 All	1090KZD-BLK
900STS (01)	1097KTX-BLK
STX 750/900/1100 (96-00)	1097KTX-BLK



## JSU SIDE RAIL MOLDINGS

Gain the secret Pro racers edge. Get rid of those ill-fitting OEM side moldings that scrub speed and cause poor under the rail water flow during racing conditions. These are the same 1 1/2" inch wide molding used by the Kawasaki Racing Team.

Description	Part No.
8' Long Standup Kit	JSU-800-BUMPER
12' Long Sitdown Kit	JSU-STXR-BUMPER



## TBM RACE BUMPERS

Introducing the easiest way to enhance the handling of your SX-R simply by replacing your stock bumper with our adhesive backed bumpers. These eliminate the need for rivets and narrows the bond flange increasing the lean angle of your ski. They also enhance the general appearance significantly.

Description	Part No.
Bumpers 800SXR (7/8" wide)	TBM117
Hydrospace (7/8" wide)	TBM117-HS
STXR/12F/15F/	TBM117-STXR
ULTRA 250X/260X (1 1/4" wide)	



## RIVA RAIL MOLDING KITS FOR KAWASAKI

Directly replaces the bulky, sharp-edged stock rails saving weight as well as your hands! Reduces corner drag on SX-R models. Includes rivets.

Description	Part No.
SX-R	RK5-RMK-080
STX/Ultra 250X	RK5-RMK-085



**Fabric: Glen-Tuf**

Woven polypropylene is very abrasion resistant. Fibers resist moisture, rot, mildew and are treated for UV resistance.

Reinforced openings for trailer pins and attachments. Adjustable heavy duty, multi-strand shock cord sewn in hem.

Reflexite® safety reflectors on back of cover give additional warning notice when watercraft is moored on trailer. (Reflexite® meets both Federal and USCG specifications.)



Non-scratch, corrosion free access zipper for vest and wet-suit storage. Plus a quick-dry mesh bag with Velcro® closure for gloves and other small items.

Durable, double-stitched, overlapped seams.

Strong, bartacked tie-down loops secure cover on watercraft for trailering.



**SEA DOO**

	<b>Part No.</b>
3D (04-06), 3D DI (06)	<b>XW873BL</b>
GSX (96-97), GSX LTD (97-99), GSX RFI (99-00), GS (97-01), GSI (97)	<b>XW836BL</b>
GT (90-91), GTS (92-00), GTX (92-95), GTi (96)	<b>XW812BL</b>
GTI (01-05), GTS (01), GTI LE (02-05), GTI LE RFI (03-05)	<b>XW859BL</b>
GTI SE (06) with mirror	<b>XW877BL</b>
GTI SE (06) without mirror	<b>XW878BL</b>
GTX (96-97 & 00-02), GTX RFI & LTD (98-02), GTI (97-00), DI (00-01)	<b>XW835BL</b>
GTX4TEC (02-05), GTX4TEC SC & LTD (03-05), GTX4TEC VTCE(03-05), GTX DI (02-03)	<b>XW860BL</b>
GTX, GTX Ltd, Wake (07-08), RXT, RXT-X	<b>XW879BL</b>
GTX, Ltd, SC, Wake (05-06), RXT (05-06), Wakeboard (04)	<b>XW874BL</b>
<i>*Note: This Cover has No Tie Down Opening At The Rear</i>	
HX (95-97)	<b>XW834BL</b>
LRV (00-01), LRV DI (02-03)	<b>XW854BL</b>
RX (00-02), RX DI (00-03), RXX (01)	<b>XW855BL</b>
RXP (04-06)	<b>XW868BL</b>
RXP, RXP-X (07-08)	<b>XW880BL</b>
RXT(05-06)	<b>XW860BL</b>
RXT (07-08), RXT-X, GTX, GTX LTD, Wake	<b>XW879BL</b>
SP 580 hull w/o grab rails (88-93)	<b>XW813BL</b>
SPI/SPX 580 hull w/grab rail (93)	<b>XW820BL</b>
SP/SPI 650 (94-97), SPX (94-99), XP650 w/grab rail (93-96)	<b>XW823BL</b>
XP 580 hull w/grab rail (92)	<b>XW811BL</b>
XP (97), XP LTD (98-99), XP (00-02), XPDI (03-04)	<b>XW846BL</b>

**SEA DOO JET BOATS**

	<b>Part No.</b>
Speedster (95-97), Sportster (00-02), Challenger (00-01)	<b>XW840BL</b>
<i>*All 14.5 Feet</i>	

**HONDA**

	<b>Part No.</b>
Aquatrax F12, F12X (02-07), GPScape (05-06)	<b>XW863BL</b>
Aquatrax R-12X (03-07), R12 (04-06)	<b>XW864BL</b>

**POLARIS**

	<b>Part No.</b>
Hurricane 700 (96-97)	<b>XW839BL</b>
Octane (02-04)	<b>XW861BL</b>
Pro 758 (00)	<b>XW810BL</b>
SLT 750 (93-95), SLTX (96-99), SLTX 1050 (97), SLTH (98-99)	<b>XW824BL</b>
SLX (96-00), SLX Pro 785 (97-99), SLXH (98)	<b>XW810BL</b>
Virage (00-04), Virage I (02-04), Virage TX (00-02)	<b>XW858BL</b>
Virage TXi (01-02), Freedom (02-04)	

**KAWASAKI**

	<b>Part No.</b>
550SX (90-95)	<b>XW803BL</b>
650SX (87-93)	<b>XW804BL</b>
650X-2 (86-95)	<b>XW806BL</b>
750SX (92-95), 750SXI (95-96&02), 750SXI-Pro (98-01)	<b>XW805BL</b>
800SXR (03-06)	<b>XW865BL</b>
800SXR (07-08)	<b>XW882BL</b>
1200STXR (02-05), STX-12F (03-04), 1100STX DI (00-03), 900STX (01-05)	<b>XW856BL</b>
SC 650 (91-95) - Sport Cruiser	<b>XW808BL</b>
SS 750 (92-97), SS-Xi (93-99) - Super Sport	<b>XW809BL</b>
ST 750 (93-95), STS 750 (95*97), 750 STX (98), 900 STX (97-98)	<b>XW819BL</b>
STX900 (99-00), STX1100 (97-99), 900STS (01-02)	<b>XW842BL</b>
STX-12F (05-06), STX-15F (04-06)	<b>XW869BL</b>
TS 650 (89-96) - Tandem Sport	<b>XW807BL</b>
Ultra 150 (99-05), Ultra 130 D2 (01-04), 130 DI (02)	<b>XW850BL</b>
Ultra 250X (07), LX (07)	<b>XW881BL</b>
ZXI 750/900 (95-97), ZXI 1100 (96-03)	<b>XW818BL</b>

**YAMAHA**

	<b>Part No.</b>
FX-1 700 (94-95)	<b>XW822</b>
FX140 (02-05), FX160 (04)	<b>XW862BL</b>
FX Cruiser (02-05), FX Cruiser HO (04-05)	<b>XW867BL</b>
FX Cruiser (06), Waverunner (06-08) Cruiser HO (06-08)	<b>XW875BL</b>
FX, FX HO (06)	<b>XW876BL</b>
GP760 & 800 (97-00), GP1200 (97-99)	<b>XW843BL</b>
GP1200R (00-02), GP800R (01-05), GP1300R (03-06)	<b>XW849BL</b>
Super Jet 650 (90-93), Super Jet 700 (94-95)	<b>XW814</b>
Super Jet 700 (96-06)	<b>XW837BL</b>
SUV1200 (99-04)	<b>XW852BL</b>
VX Cruiser (07)	<b>XW883BL</b>
VX110 Deluxe (05-08)	<b>XW871BL</b>
VX110 Sport (05-06)	<b>XW872BL</b>
Wave Blaster 701 (93-96)	<b>XW821BL</b>
Wave Blaster II 750 (96-97)	<b>XW838</b>
Wave Raider 701 & Deluxe (94-97), 760 (96), 1100 (95-96)	<b>XW827</b>
Wave Runner III 650/700 (90-97), GP700 (95)	<b>XW816</b>
Wave Runner XLT 1200 (01-05), XLT 800 (02-04)	<b>XW870</b>
Wave Venture 700 (95-96 & 98), 760 (97), 1100 (96-97)	<b>XW831BL</b>
XL700 (99-04), XL760 (98-99), XL1200 (98)	<b>XW847BL</b>
XLT1200 (01-05), XLT800 (02-04), XL1200LTD (99-00), XL800 (00-01)	<b>XW853BL</b>

Some models listed above might not be inventoried. If they are not inventoried then the item is a "Special Order Item" and may take up to 2 weeks to be available.

FOUR STROKE  
INTAKE SYSTEMS  
ENGINE/GASKETS  
EXHAUST  
DRIVE LINE HANDLING  
ELECTRICAL  
WATERLINE /BILGE  
STEERING & CONTROLS  
BODY  
ACCESSORIES  
SERVICE TOOLS /HARDWARE  
CHEMICAL

FOUR STROKE  
 INTAKE SYSTEMS  
 ENGINE/GASKETS  
 EXHAUST  
 DRIVE LINE HANDLING  
 ELECTRICAL  
 WATERLINE /BILGE  
 STEERING & CONTROLS  
 BODY  
 SERVICE TOOLS ACCESSORIES /HARDWARE  
 CHEMICAL

**Internal Identification Tag**

**Waterproof Dobby Nylon with 3 Layers of PVC Coating Underneath**

**Zippered Gas Flap Opening on Most Models**

**Fat Adjustable Shock Cords are Sewn in Full Length on of the Cover**

**Reinforced Nose Pin Openings**

**2" Tie Downs with Buckles**  
 Sitdown PWC have 4 Tie Down Points  
 Stand Up PWC have 3 Tie Down Points

**Upper/Lower Bow Area is Reinforced with PVC Abrasion Resistant Material**

**Tie Down end has a "Loop N Draw" System for a Tight Secure Fit**

SEA DOO	Part No.
RXP (05-07), RXP-X (08-09)	SDO03010
GTX-LTD (04-08), GTX DI (02-03), GTX-4-TEC Supercharged (03-06), RXT (05-09), RXT-X (08-09), GTX 4-TEC (02-06), GTX WAKE (04-09), GTX (07-08), GTX LTD. (07-08), GTX WAKE (07-08), GTX WAKE 155 & 215 (08)	SDO03018

YAMAHA	Part No.
Superjet 700	YMH04003
FX-HO (06-09), FX-HO Cruiser (06-09)	YMH04019
FX SHO (08-09), FX SHO Cruiser (08-09)	
VX 110 Deluxe & Standard (05-09)	YMH04020
VX Sport (09), VX (09) Non Cruiser	
GP1200R (00-02), GP1300R (03-08), GP800R (01-05)	YMH04001

KAWASAKI	Part No.
800 SX-R (03-09)	KWS05006
STX-15F (04-09), STX 12-F (05-09), STX Base (09)	KWS05011
Ultra 250X/LX (07-09), Ultra 260X (09)	KWS05018
Ultra 260LX "Cruiser Seat" (09)	

# Jettribe

## Personal Watercraft Goggles - Eye Protection



- 100% UV Protection
- Dual Layer Foam For Comfort
- Anti Fogging Air Vents
- They Float

Description	Part No.
Goggles Red Frame with Smoke Lens	JA071301
Goggles Yellow Frame with Smoke Lens	JA071302
Goggles Blue Frame with Smoke Lens	JA071303
Goggles Black Frame with Amber Lens	JA071304
Goggles Black Frame with Smoke Lens	JA071305
Goggles Kids Black Frame with Smoke Lens	JA091302



### GOGGLE GRIP

- Aligns riders preferred goggle strap positioning on helmet
- Prevents strap from shifting or slipping off helmet
- Lift and Hold feature secures goggles under visor between rides
- Simply pinch and lift strap for easy removal
- Low-profile, concave design matches curvature of helmet
- Transparent VHB™ Peel & Stick application with alcohol prep pad



Description	Color	Part No.
Goggle Grip	Clear	70-4040
Goggle Grip	Black	70-4041
Goggle Grip	Silver	70-4042
Goggle Grip	Chrome	70-4043

FOUR STROKE	INTAKE SYSTEMS	ENGINE/GASKETS	EXHAUST	DRIVE LINE HANDLING	ELECTRICAL	WATERLINE /BLIGE	STEERING & CONTROLS	BODY	ACCESSORIES	SERVICE TOOLS /HARDWARE	CHEMICAL
-------------	----------------	----------------	---------	---------------------	------------	------------------	---------------------	------	-------------	-------------------------	----------



### Atlantis NEW SPEC FLOATS

The quick and easy way to float your expensive glasses. These Atlantis Spec Floats have universal ends to fit all types of frames, from skinny to fat ones, just slide them on.

Description	Part No.	Description	Part No.
Purple	A2286	Black	A2287
Yellow	A2291	Red	A2292
Blue	A2282	Grey	A2280

### BLUEYE eyewear



### BLUEYE SQUID WATERSPORTS SUNGLASSES

- Frame is made from TR90 Grilamide
- Rubber touch finish to the frame
- Polycarbonate UVA & UVB lenses offer maximum protection
- Lenses finished with a hydrophobic watershield coating
- Each pair of Squid comes with a floating leash

Description	Part No.
Blueye Black Frame with Red Revo Smoke Lens	SQUID-RED

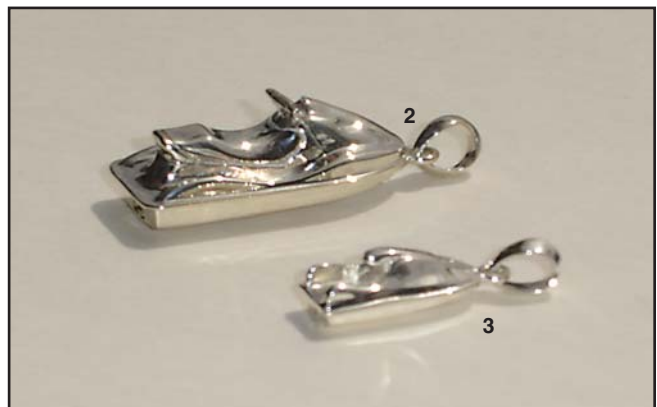

### KAWASAKI PWC SILVER ACCESSORIES

Description	Part No.
1) SXR (Not shown above)	B-SA-SXR-BIG
2) STX-R	B-SA-STX-R
3) SX-R (small)	B-SA-SXR-SML

"929" Silver, Regular size 30mm, small size 18mm, chain is not included.

FOUR  
STROKEINTAKE  
SYSTEMSENGINE/  
GASKETS

EXHAUST

DRIVE LINE  
HANDLING

ELECTRICAL

WATERLINE  
/BILGESTEERING  
& CONTROLS

BODY

SERVICE TOOLS  
ACCESSORIESSERVICE TOOLS  
/HARDWARE

CHEMICAL



## LEG DEFLECTOR

Made with polycarbonate.  
Made in Italy

Description	Part No.
Leg Deflector	1002RACE-02

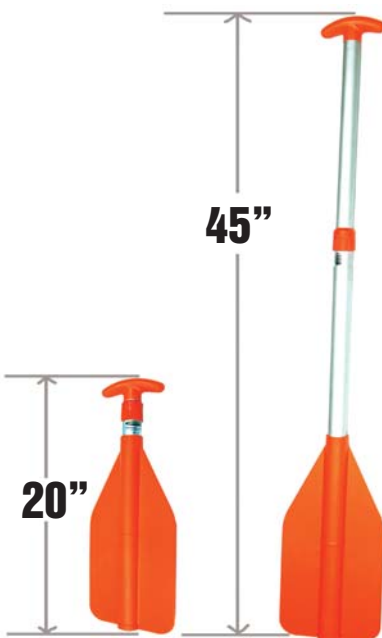

## TELESCOPING PADDLES

Lightweight paddles adjust easily to variable lengths with a simple twist. A section of the aluminum shaft disappears inside the blade for the ultimate in compact storage under boat seats or in PWC storage compartments. 20-45 inch long.

Description	Part No.
Telescoping Paddle	P-1



## LEG DEFLECTOR

Made in England

Description	Part No.
Leg Deflector	70-4012



## DETACHABLE PADS

Constructed of soft foam with adhesive backed Velcro. Can be removed and re-applied by Velcro system. Pads for riding comfort.

Description	Part No.
Detachable Pad	1002PAD



## HYDRO-TURF BACK SUPPORT

Great for racing, recreational riding or just working around the house! Light weight. Will not absorb water. Available in Black only.

Description	Part No.
Black S: 24-30	B20-BLK-S
Black M: 29-36	B20-BLK-M
Black L: 35-42	B20-BLK-L
Black XL: 41-48	B20-BLK-XL



## RESCUE STREAMER DISTRESS SIGNAL

Patented Design Approved for U.S. Military & Coast Guard

This bright orange Streamer, visible from 1.3 miles away at 1,500 ft. altitude, leads Search and Rescue teams right to you. The patented high-strength polyethylene Streamer design, tested and used by the U.S. Military and Coast Guard, is marked with the international distress symbol. It features sealed air-filled struts that keep *RescueStreamer™* afloat on water and open on land to pinpoint your exact location to rescuers. *RescueStreamers™* start at the size of a cellular phone when stored and unroll in seconds! Always ready for use anywhere—land, water and snow. Does not require chemicals, batteries or electronics to signal continuously.

Description	Part No.
Rescue Streamer Distress Signal	RSDS-01







# LIFESLED FOR PWC RESCUE

Lifeguards and public safety agencies around the world are embracing an innovative rescue system that already has saved hundreds of lives, and promises to save thousands more in extreme rough water situations such as ocean storms, heavy surf, rip currents, flooding rivers and other life-threatening situations.

**Non-invasive hookup conveniently attaches LIFESLED to most any PWC without cumbersome rigging or drilling holes.**



- ◆ LIFESLED is highly maneuverable. It barely affects low-speed motoring and increases the overall stability of the craft. There is no chance of windmilling or dumping of victim.
- ◆ Bullet-nose allows 45° fish-tail pivot off the PWC transom.
- ◆ 70/30 rails allow sufficient tracking for stability, and still allow the driver to 'break loose' for quick turns.
- ◆ Inexpensive, replaceable nose-guard protects the nose of the sled and the PWC transom.
- ◆ Overall size is sufficient for two adults yet still highly maneuverable. Weighs only 35 lbs.
- ◆ The Swallow-tail design enables easy victim centering when mounting in the water.
- ◆ Hook-up design allows the sled to be folded over the PWC when not in use.

Description	Part No.
Lifesled	W20018
<i>We do not carry inventory of these items—special order only.</i>	



HONDA



YAHAMA



SEA DOO



FOUR STROKE	INTAKE SYSTEMS	ENGINE/GASKETS	EXHAUST	DRIVE LINE HANDLING	ELECTRICAL	WATERLINE /BILGE	STEERING & CONTROLS	BODY	ACCESSORIES	SERVICE TOOLS /HARDWARE	CHEMICAL
-------------	----------------	----------------	---------	---------------------	------------	------------------	---------------------	------	-------------	-------------------------	----------

# HOT PRODUCTS APPAREL & ACCESSORIES

FOUR STROKE  
INTAKE SYSTEMS  
ENGINE/GASKETS  
EXHAUST  
DRIVE LINE HANDLING  
ELECTRICAL  
WATERLINE /BILGE  
STEERING & CONTROLS  
BODY  
SERVICE TOOLS ACCESSORIES /HARDWARE  
CHEMICAL



Description	Part No.
Hot Products 25th Anniversary T-Shirt - X-Large	70-9025-XL
Hot Products 25th Anniversary T-Shirt - Large	70-9025-L
Hot Products 25th Anniversary T-Shirt - Medium	70-9025-M
Hot Products 25th Anniversary T-Shirt - Small	70-9025-S

## HOT PRODUCTS 25TH ANNIVERSARY T-SHIRT



## KNIGHT TEE ORANGE

Description	Part No.
Knight Tee - Medium	70-7090-M
Knight Tee - Large	70-7090-L
Knight Tee - XLarge	70-7090-XL
Knight Tee - Women	70-7090-WOMEN
Knight Tee - Kids Sm 6-8	70-7090-KIDS-S
Knight Tee - Kids Med 10-12	70-7090-KIDS-M

## CHECKERED FLAG TEE

White



Description	Part No.
Checker Flag Tee - Medium	70-9008-M
Checker Flag Tee - Large	70-9008-L
Checker Flag Tee - XLarge	70-9008-XL
Checker Flag Sweatshirt	70-9011-XL

## DEW DESIGN TEE

Green



Description	Part No.
Dew Design Tee - Medium	70-9087-M
Dew Design Tee - Large	70-9087-L
Dew Design Tee - XLarge	70-9087-XL
Dew Design Tee - 2XL	70-9087-2XL

## SKULL TEE

Black



Description	Part No.
Skull Tee	70-9100-XL

## HOT ESTABLISHED 1985 TEE

Grey



Description	Part No.
Est. 1985 Tee - Large	70-9088-L
Est. 1985 Tee - XLarge	70-9088-XL
Est. 1985 Tee - 2XL	70-9088-2XL
Est. 185 Sweatshirt - Large	70-9089-L
Est. 185 Sweatshirt - XLarge	70-9089-XL

## APBA JUNIOR STAR TOUR SHIRT



Description	Part No.
APBA Jr Star Shirt - Small	70-7095-S
APBA Jr Star Shirt - Medium	70-7095-M
APBA Jr Star Shirt - Large	70-7095-L
APBA Jr Star Shirt - XLarge	70-7095-XL

## MONKEY GRIP TEE

Tan



Description	Part No.
Monkey Grip Tee	70-9050-XL

## HOT PRODUCTS DIE CUT DECALS



Die Cut Decal Size	White	Black	Die Cut Decal Size	White	Black
4" x 16"	70-9151	70-9152	3.5" x 12"	70-9132	70-9133
5" x 24"	70-9153	70-9154	6.5" x 23"	70-9136	70-9137

## HOT PRODUCTS RACING IRON ON TRANSFER



Create your own custom apparel with this easy to use Hot Products Racing Iron on logo. 7 1/2" wide by 2" tall, in white only.

Description	Part No.
Iron On Transfer	LOGO-TRANSFER

# HOT PRODUCTS RACING OUTDOOR/EVENT BANNER



Hot Products Racing Banner. 10' wide by 3' tall. Outdoor vinyl with grommets to hang the Banner up. The Banner is bright red with white lettering.

Description	Part No.
Hot Product Racing Banner	<b>BANNER-ORANGE</b>

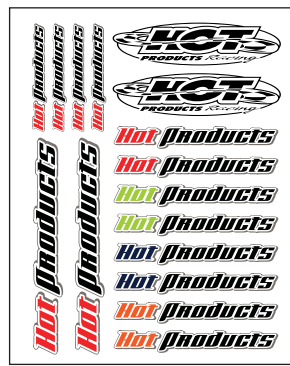

# HOT PRODUCTS DECAL SHEET

Description	Part No.
Hot Products Decal Sheet 8" x 12 1/2"	<b>70-9148</b>



# HOT PRODUCTS BEANIES

Description	Part No.
Hot Products Racing Beanies - Orange	<b>70-9004-ORG</b>
Hot Products Racing Beanies - Black	<b>70-9004-BLK</b>



Description	Part No.
AP Designs Box Tee Red	<b>BT-004-L</b>
AP Designs Box Tee Red	<b>BT-004-XL</b>
AP Designs Box Tee Yellow	<b>BT-005-L</b>
AP Designs Box Tee Yellow	<b>BT-005-XL</b>
AP Designs Box Tee Green	<b>BT-006-L</b>
AP Designs Box Tee Green	<b>BT-006-XL</b>
AP Designs Box Tee Blue	<b>BT-007-L</b>

Description	Part No.
Flame Dutch T White	<b>FD-022-L</b>
Flame Dutch T White	<b>FD-022-XL</b>
Flame Dutch T Black	<b>FD-023-L</b>
Flame Dutch T Black	<b>FD-023-XL</b>



Description	Part No.
Strip Ringer Steel	<b>SRT-008-L</b>
Strip Ringer Steel	<b>SRT-008-XL</b>
Strip Ringer Brown	<b>SRT-009-L</b>
Strip Ringer Brown	<b>SRT-009-XL</b>

Description	Part No.
Spike Hoodie Gray	<b>SH-011-L</b>
Spike Hoodie Gray	<b>SH-011-XL</b>
Spike Hoodie White	<b>SH-012-L</b>
Spike Hoodie White	<b>SH-012-XL</b>

FOUR STROKE	INTAKE SYSTEMS	ENGINE/ GASKETS	EXHAUST	DRIVE LINE HANDLING	ELECTRICAL	WATERLINE /BILGE	STEERING & CONTROLS	BODY	ACCESSORIES	SERVICE TOOLS /HARDWARE	CHEMICAL
----------------	-------------------	--------------------	---------	------------------------	------------	---------------------	------------------------	------	-------------	----------------------------	----------

# Atlantis®

FOUR STROKE  
INTAKE SYSTEMS  
ENGINE/GASKETS  
EXHAUST  
DRIVE LINE HANDLING  
ELECTRICAL  
WATERLINE /BILGE  
STEERING & CONTROLS  
BODY  
SERVICE TOOLS ACCESSORIES /HARDWARE  
CHEMICAL



## FLOATING WRIST LANYARDS

These old favorite lanyards have been redesigned so that they clip apart to be used as a wrist or a vest lanyard. They are the perfect lanyards to replace your factory one; they're made from polyurethane cord and they float. They come with our one hand easy slider.

Description	Black/Black	Black/Red	Purple/Yellow	Yellow/Purple	Black/Silver	Black/Blue	Green/Purple
KPTW*	A2137	A2136	A2141	A2133	A2126	-	A2131
Yamaha	A8147	A8146	A8151	A8143	A8136	A8139	-
Sea Doo	A7467	A7466	A7471	A7463	A7480	-	-

\*KPTW stands for: KAWASAKI, POLARIS, TIGERSHARK, WET JET

## ULTRA VEST FLOATING LANYARDS

Our new improved standard lanyard now floats! Now an easy way to keep an extra lanyard close at hand.

Description	Black	Red	Yellow	Purple	Silver	Blue	Green
KPTW	A2109	A2103	A2097	A2106	A2096	A2107	A2101
Yamaha	A8130	A8123	A8133	A8128	A8134	A8129	-
Sea Doo	A7459	A7453	A7447	A7456	A7445	A7457	-

\*KPTW stands for: KAWASAKI, POLARIS, TIGERSHARK, WET JET

## SEA DOO DESS COMPATIBLE WRIST LANYARDS

Atlantis is proud to offer the only after market lanyards that are compatible with the Sea-Doo's DESS system. These lanyards fit all Sea-Doo watercrafts, Jet Boats, and Snowmobiles from 1996 to current (except '96 XP & GTI). Program with factory programmer.

Description	Black/Yellow	Purple/Yellow
Sea Doo DESS	A7473-DSC	A7471-UDC

## SEA DOO DESS COMPATIBLE FLOATING LANYARDS

Description	Black	Red	Yellow
Sea Doo DESS	A7459-DES	A7453-DES	A7447-DES
Description	Purple	Silver	Blue
Sea Doo DESS	A7456-DES	A7445-DES	A7457-DES



## PRO FLOATING WRIST LANYARDS

Our Pro floating lanyards have been used by the pros for years. They have been made of marine grade webbing, neoprene and Velcro material for strength, safety, and dependability. These lanyards will stay secure during the most strenuous riding, including racing. The whistle attaches and detached quickly.

Description	Black	Red	Yellow	Purple	Silver	Blue
KPTW	A2109-PFW	A2103-PFW	A2104-PFW	A2106-PFW	A2096-PFW	-
Yamaha	A8130-PFW	A8123-PFW	A8126-PFW	A8128-PFW	A8134-PFW	A8129-PFW
Sea Doo	A7459-PFW	A7453-PFW	A7447-PFW	A7456-PFW	A7445-PFW	-

\*KPTW stands for: KAWASAKI, POLARIS, TIGERSHARK, WET JET





## PRO FLOATING LANYARD WRIST BAND

Now available by itself, is our deluxe floating wristband made from marine grade webbing, neoprene, and Velcro. It attaches easily to any clip lanyard and gives the rider a sense of security he has been looking for.

Description	Black	Red	Yellow	Purple	Silver
Wristband	A2070	A2072	A2074	A2071	A2077



## JET LOGIC SAFETY WHISTLE ON FLOATING LANYARD

An audible signal device is required on boats and personal watercraft in most states. A high pitch pealess whistle is a good choice. Clip it onto your life jacket or safety lanyard. Doubles as a floating key chain!

Description	Color	Part No.
Jet Logic Safety Whistle	Purple/Yellow	W-1
Jet Logic Safety Whistle	Red/Black	W-2



## CLIP ON SAFETY WHISTLE

Description	Black	Red	Yellow	Purple
Clip On Whistle	A2700C	A2701C	A2706C	A2705C



## PROWATERCRAFT LANYARD

This race inspired ProWATERcraft Lanyard, is a must have for all watercraft racers. The stock Yamaha lanyard has been the standard till now. ProWATERcraft Lanyard has a

thicker stronger red cord, a metal fastener for the life vest, and added functional finger grip when snapping it back in on the rush. You don't want to get caught off guard wearing anything else. Quality, durability and function is what the pro's use. Fits: All Kawasaki, Yamaha, Honda, Polaris, Tigershark, Hydrospace..... Not Sea Doo.

Description	Part No.
Pro Watercraft Lanyard (Available in Red only)	PWCL-06



## JET LOGIC ULTIMATE PWC SAFETY LANYARDS

The Ultimate PWC safety lanyard has it all! 3 keys to fit ALL brands: Sea Doo, Yamaha, Kawasaki, Polaris, Tiger Shark and Wet Jet. \*Excluding the Sea Doo DESS System.

Description	Part No.
Yellow/Purple	UL-1
Black/Red	UL-2
Blue/Silver	UL-3



## SHOP LANYARDS

Not legal for riding. For shop testing only. These can easily be attached to your belt while working on all PWC and jet boats.

Description	Part No.
KPTW, Yamaha, Sea Doo	A3240
KPTW, Yamaha, Sea Doo DESS	A3250



## ECONOMY WRIST LANYARDS

Economy price lanyards.  
For Sea Doo (Non-DESS) only.

Description	Part No.
Sea Doo Wrist Lanyard Purple/Green	WJ7094PU
Sea Doo Wrist Lanyard Green/Purple	WJ7094GR
Sea Doo Wrist Lanyard Blue/Green	WJ7094B

FOUR STROKE	ENGINE/GASKETS	EXHAUST	DRIVE LINE HANDLING	ELECTRICAL	WATERLINE /BILGE	STEERING & CONTROLS	BODY	ACCESSORIES	SERVICE TOOLS /HARDWARE	CHEMICAL
-------------	----------------	---------	---------------------	------------	------------------	---------------------	------	-------------	-------------------------	----------

# Atlantis®



## ATLANTIS ANCHOR BAG

Our newly redesigned bag anchor is strong as ever but with bright new colors, rope, float, and hook. Just fill with rocks and sand for your anchoring needs. Fits easily into any storage compartment.

Description	Part No.
Anchor Bag (regular)	A2381



## ATLANTIS STAKE ANCHOR

Needing an easy way to keep your personal watercraft tied to a shore? Here it is, just screw the stake into the ground and you have 15' to tether your boat to shore. Easy to store and take with you.

Description	Part No.
Stake Anchor	A2384



## ATLANTIS NAVY ANCHOR W/BAG

This is the new hot set up for those needing an anchor without the hassles of carrying big heavy ones. Easily attaches to and anchors in any personal watercraft, comes with its own handy storage bag. This 2 1/2 lb. anchor is designed to be hand set.

Description	Part No.
Navy Anchor w/Bag	A2382



## ATLANTIS LARGE ANCHOR BAG

This new bag is twice as large as our standard bag. It has sewn-in handles for ease in moving and emptying. Designed for 3 & 4 passenger PWC or mini-jet boats.

Description	Part No.
Large Anchor Bag	A2394



## ATLANTIS DELUXE PWC SAND STAKE KIT

Need to anchor your PWC on a sandy beach. This is the way. Just screw it in and it is set. It will not pull out. Comes with cushioned travel bug.

Description	Part No.
Deluxe PWC Sand Stake Kit	A2391



## ATLANTIS GALVANIZED 6 LB. ANCHOR KIT

The anchor will hold boats from 20' - 24'. It comes with the 4' of chain, 100' rope, shackle and a large storage bag all at a value price.

Description	Part No.
Galvanized 6 lbs Anchor	A2397



## KWIK TEK COMPLETE FOLDING ANCHOR SYSTEM

3-1/3 Lb 4-fluke folding anchor and 25ft. long marine grade rope.

Description	Part No.
Complete Anchor System	A-2



## KWIK TEK 20" DIAMETER BUOY

The affordable alternative! These durable 20" diameter inflatable buoys are perfect for marking anchors, moorings, hazards, swimming areas, or for setting up a personal watercraft or sailboat race course. They deflate quickly and easily for space efficient storage.

Description	Part No.
Yellow Buoy 20"	B-20Y
Red Buoy 20"	B-20R

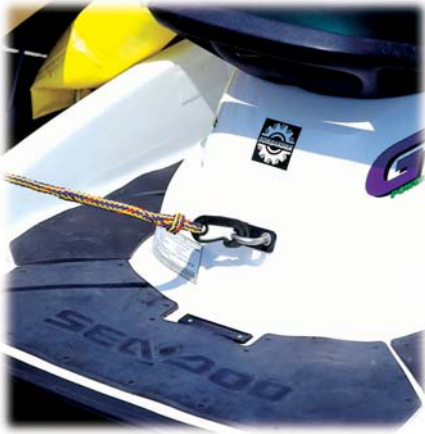

### PWC DOCK LINE

There is a 10" loop on the other end for attaching to dock cleats. Finished length is 7 feet. 2 per clam shell package.

Description	Part No.
PWC Dock Line	PWCP-2



### BUNGEE DOCK LINES

Airhead Bungee Dock Lines absorb shock to boats, cleats, pylons and other hardware. The bungee cord is hidden inside the rope and acts as a built-in snubber. Two foam floats protect the boat from chafing. 4 feet, stretches to 5-1/2 feet.

Description	Part No.
Bungee Dock Line	AHDL-4



### GIANT SNAP HOOK

Perfect for attaching ski lines, dock lines, tow lines, or any rope up to 1/2 inch diameter.

Description	Part No.
Giant Snap Hook	SH-5



### 25' POLYPRO ROPE

The ideal extra rope to carry for any purpose: Docking, anchoring & towing. 1325 lbs. strength. Great to have in any situation.

Description	Part No.
White	A1960
Yellow	A1961
Red	A1962
Blue	A1963



### 3" X 5" ROPE FLOAT

Need a way to mark an area? Need to float a rope for docking? Here is your answer, our easy to use rope floats. Fits up to a 1/2" diameter rope.

Description	Part No.
Red/White	A-1974
Blue/White	A-1975
Yellow/White	A-1976



### DRAWSTRING MESH BAG

Size 20" x 30"

Description	Part No.
Drawstring Mesh Bag	69-1003



### SPARK PLUG HOLDERS

Spark Plug Holder protects the electrode, maintaining the proper gap.

Description	Part No.
2 per blister pack	SPH-2
40 per countertop display	SPH-40



### DOC ALLEN'S VERSATOOL

*The Swiss Army Knife of Hand Tools!*

- Lightweight
- Compact
- Multi-Function
- Stainless Steel
- Use in Tight Places

Description	Part No.
Compact Tool Set	VERSATOOL

FOUR STROKE	INTAKE SYSTEMS	ENGINE/GASKETS	EXHAUST	DRIVE LINE HANDLING	ELECTRICAL	WATERLINE /BILGE	STEERING & CONTROLS	BODY	ACCESSORIES	SERVICE TOOLS /HARDWARE	CHEMICAL
-------------	----------------	----------------	---------	---------------------	------------	------------------	---------------------	------	-------------	-------------------------	----------

# VIEWTAINER

Made in the U.S.A



Description	Part No.
2" x 6" Red	CC26-RED
2" x 6" Blue	CC26-BLU
2" x 6" Green	CC26-GRN
2" x 6" Orange	CC26-ONG
2" x 6" Yellow	CC26-YLW
2" x 6" Black	CC26-BLK

## VIEWTAINER

Ideal to keep your registration papers safe & dry. They are great to carry small tools/supplies, etc.



Description	Part No.
2.75" x 8" Red	CC27508-RED
2.75" x 8" Blue	CC27508-BLU
2.75" x 8" Green	CC27508-GRN
2.75" x 8" Orange	CC27508-ONG
2.75" x 8" Yellow	CC27508-YLW
2.75" x 8" Black	CC27508-BLK



## HYDRO-TURF DRY BOX

Keep your registration papers and small tools/supplies dry and safe. Actual product is black color only.

Description	Part No.
Dry Box 6" x 8.5"	BOX
Color is Black	



### DRY PAK GPS/PDA GAMEBOY CASE

Convenient Stylus Holder  
 • 5" wide x 8" long  
 • maximum circumference = 9in.



### DRY PAK MULTI-PURPOSE CASE

- 9" wide x 12" long
- 2 D-Rings sewn to corners
- Holds owner's manual, registration, snacks, maps, electronics



2008 WORLD FINALS • LAKE HAVASU, AZ  
 PHOTO COURTESY OF JIN OMURA

Description	Part No.	Description	Part No.
GPS/PDA/Gameboy Dry Pak Case	DP-58	Dry Pak Case	DPC-912



### WATERPROOF LINER

This durable and waterproof 19oz. vinyl dry bag with RF-welded seams, fits most PWD storage compartments. Fill it, roll down to fit the height of the storage compartment, then snap it shut. Locating packed items is easy with see-through material. Load it with beverages and ice and use it as a cooler! Size: 12" x 6" x 18".

Description	Part No.
Waterproof Liner Clear	SBL-1



### "DRY PAK" DRY BAGS

Description	Part No.
9.5" Diam. x 16" Yellow	WB-1
11.5" Diam. x 19" Yellow	WB-4
12.5" Diam. x 28" Yellow	WB-7



### HANDLEBAR PACK

Description	Part No.
Handlebar Pack	69-1002





### HEAVY DUTY TUBE ROPE

This heavy tournament quality 3/8" 16-strand braided tow rope is rated at 2375 lbs. tensile strength for 1 and 2 riders. 60 feet.

Description	Part No.
Deluxe Tube Rope	AHTR-60



### 4000LB TUBE ROPE

This heavy duty 9/16" x 60ft. tube rope is rated at over 4375 lbs. tensile strength for 3 and 4 riders.

Description	Part No.
4000lb Tube Rope	AHTR-4000



### 6000LB TUBE ROPE

This super strength 16 strand, 7/8 inch x 60 foot tube tow rope is rated at 6,000 pounds tensile strength! It's the strongest tube rope your money can buy, and is engineered to pull 5 or more riders.

Description	Part No.
6000 lb Tube Rope	AHTR-6000



### WAKEBOARD ROPE

This wakeboard rope has a head turning 15 in. "Squid" patterned EVA grip wrapped around a floating aluminum core. The 5/16 inch, 16 strand, UV treated low stretch rope has 3 sections for wakeboarding at 45, 55 or 65 feet. Full length finger guards help create a comfortable split finger grip. A Rope Keeper is included for tangle-free storage.

Description	Part No.
Wakeboard Rope	AHWR-3



### 20' TOW ROPE

This 20 ft. tow rope has a heavy-duty carabiner at each end. The 12" long "soft hook" doubles as a rope wrap for neat storage. The 3/8" diameter rope is purple/yellow/red.

Description	Part No.
20' Tow-Rope	TR-20



### WATER TOY TOW ROPE

This top quality 16 strand, 3/8" tow rope is 50 feet long.

Description	Part No.
Water Toy Tow Rope	WTR-50



### AIRHEAD LINE WINDER

No more tangled lines with this classic styled floating line winder! It's easy to wind and neatly stow away anchor lines, mooring lines, ski ropes and tube ropes. Get a few for the garage too. Organize your extension cords, wires, clotheslines and Christmas lights once and for all. It's constructed of high impact polypropylene for extra long service. Color: Red. Ropes not included.

Description	Part No.
Airhead Rope Winder	AHLW-1

### AIRHEAD® KWIK-CONNECT™

Conveniently attach and detach tube tow ropes to towables with AIRHEAD's KWIK-CONNECT. There's no need to thread 60 feet of rope through the tow strap each time you connect or disconnect a tow rope. The high impact KWIK-CONNECT has a 1 inch diameter hole to accept up to 6,000 lb. break strength tube ropes. Recommended for 1 to 4 rider towables that are not equipped with Kwik-Connects.



Description	Part No.
Kwik-Connect	AHKC-1



### AIRHEAD HEAVY DUTY TOW HARNESS

This heavy duty tow harness is perfect for pulling skiers, wake boarders and up to 4 rider towables. Simply clip it onto your boat with the 5,000-pound tensile strength hooks, and attach your ski or tube rope to the heavy duty Kwik-Connect. A 6" float keeps the Kwik-Connect floating on top, away from your propeller. 12 feet long to fit larger boats and pontoons. Yellow / Red.

Description	Part No.
Airhead Tow Harness	AHTH-2

FOUR STROKE	INTAKE SYSTEMS	ENGINE/GASKETS	EXHAUST	DRIVE LINE HANDLING	ELECTRICAL	WATERLINE /BILGE	STEERING & CONTROLS	BODY	ACCESSORIES /HARDWARE	SERVICE TOOLS	CHEMICAL
-------------	----------------	----------------	---------	---------------------	------------	------------------	---------------------	------	-----------------------	---------------	----------

FOUR  
STROKEINTAKE  
SYSTEMSENGINE/  
GASKETS

EXHAUST

DRIVE LINE  
HANDLING

ELECTRICAL

WATERLINE  
/BILGESTEERING  
& CONTROLS

BODY

SERVICE TOOLS  
ACCESSORIES

/HARDWARE

CHEMICAL



### STIK-A-FLAG™ SKIER DOWN FLAG

The bright orange 420 denier nylon skier down flag is mounted to a 24" flag. PWC's with Kwik Tek's giant 3-1/4" suction cup. Required in AZ, CA, CO, ID, MO, NE, NM, OR, TX, UT & WA. Recommended everywhere for safety.

Description	Part No.
Skier Down Flag	SAF-1



### IMPELLER PROTECTOR & KICK-BACK PROTECTOR

Specially designed for use on a personal watercraft, this Jet Logic protector reduces the possibility of the tow/ski rope of being sucked up inside the PWC's pump and impeller. This protector also protects PWC passengers from tow/ski rope kicking back when the rider falls.

Description	Part No.
24" long for PWC	IP-24



### TRANSOM MOUNT SKI TOW HOOK

Our transom-mount ski tow is made from highly polished 304 stainless steel. A full stainless steel back plate distributes pressure evenly to prevent gel coat crazing. Tows are supplied with stainless steel nuts and star lock washers.

Description	Part No.
3/8" stock, 2-1/2" diam 4" legs, 2-1/2" transom	59-3437

## AIRHEAD® 120 VOLT HI-PRESSURE AIR PUMP

You'll enjoy the performance of this 120 volt air pump. It inflates and deflates quickly and effectively. Peak pressure is 2.5 psi, plenty of pressure to get high end inflatable boats, rafts and reinforced backyard items nice and firm. You'll immediately notice how they perform better when properly inflated. A Pressure Release Valve is included to limit pressure to 1.4 psi for preventing over-inflating towables, pool toys and other vinyl and nylon covered inflatable items. The accordion-style hose locks onto the pump, eliminating annoying disconnections. Four universal valve fittings fit all popular valves and lock onto the hose. You'll love the screw-on Boston Valve adapter, an AIRHEAD exclusive. For added convenience, there's a carry handle and a 10 ft. long power cord. Draws 6.1 amps / 730 watts. Volume is 460 liters/minute.



Description	Part No.
Airhead Air Pump, 12 V	AHP-120HP

## AIRHEAD® AIR PUMP, 12V

This high-volume (290 liters / minute) 12-volt portable air pump deflates towables, boats, pools, mattresses and beach toys quickly and effectively. Most pumps on the market, even those costing twice as much, don't put out this kind of air pressure and volume (9.6 cu.ft/min., .8 psi). The universal valve fittings fit all popular valves. For added convenience, the cigarette lighter plug is equipped with a 10 ft. long power cord.



Description	Part No.
Airhead Air Pump, 12 V	AHP-12H

## AIRHEAD® DOUBLE ACTION PUMP

### Perfect For Topping off Towables

This pump delivers a continuous stream of air on both the up and down strokes. It quickly inflates and deflates tubes, airbeds, boats, toys and other inflatables. Four universal valve fittings are included. The accordion-style hose stretches to 5 ft. long and interlocks to the pump, so that it doesn't fall off while you're pumping. Capacity is approximately 68 gallons / 60 strokes. Especially great for topping off towables, since peak pressure is 14 psi.



Description	Part No.
Airhead Double Action Pump	AHP-1

## AIR DADDY™

AIR DADDY lets you get to the fun times more quickly! It allows you to inflate towables, swim toys, beach toys, inflatable boats, rafts, airbeds and sport balls with an air compressor at home or at a gas station. AIR DADDY is a universal adapter tapered to fit all valves found on inflatables, including all sizes of stem valves and Boston valves, Halkey-Roberts and Leaffield valves. The screw-on tip creates a high-pressure stream of air, perfect for workshops and garages. Soccer ball or football low on air? Stop by a gas station and use AIR DADDY's needle valve! Both the needle valve and high-pressure tip stow securely in the handle.



Description	Part No.
Air Daddy	AHAD-1

## MULTI-VALVE

### Inflate with Speed & Flexibility

The Airhead Multi-Valve consists of 2 Boston Valves with different thread patterns on the bottom of the Shrader Valve. One of the Boston Valves will fit your inflatable. Use the Shrader Valve to inflate quickly at a gas station or marina. Or, screw off the Shrader Valve and inflate the Boston Valve with a low pressure/high volume pump.



Description	Part No.
Multi-Valve	AHMV-1

# AIRHEAD®



## AIRHEAD® RIP II®

Carve turns with a tube? You can with RIP III. Simply lean in the direction you want to turn and pull on the opposite handle. The plastic fins sewn onto the side of the cover do the carving. RIP II is so much fun that you'll want to ride it all day long! You just might be able to, it's so easy to re-board with the open back design, and a feature that little ones and tired adults really appreciate. RIP II is fully covered with rugged 840-denier double-stitched nylon cover, making it torsionally rigid to respond to the rider's commands.

Description	Valve	Part No.
Airhead Rip II 1 rider	Multi-Valve	AHRI-2



## AIRHEAD® BLAST®

You'll have a real blast on Airhead Blast! The 4 neoprene knuckle guards and deluxe nylon-covered handles provide a sure and comfortable grip. The heavy-duty virgin PVC bladder has a double stitched nylon cover, reinforced internal tow harness and a self-draining floor vent. You'll love the eye-catching graphics on this 1 rider 54" round towable!

Description	Valve	Part No.
Airhead Blast 1 rider	Boston Valve	AHBL-1



## AIRHEAD® SURF™

Face it, stowing a tube on small boats, ski boats, and PWC's can be a hassle! We designed Surf with this watercraft in mind. Despite its small size, 50" x 40" x 6", Surf is big on performance. Sit on top or lie down, either way; you'll love the remarkably stable ride. Four deluxe handles with neoprene knuckle guards provide a great grip. SURF is equipped with a Boston Valve for fast inflating and deflating, 2 board straps and a drain vent.

Description	Valve	Part No.
Airhead Surf 1 rider	Boston Valve	AHSU-1



**IMPROVED**

Tapered Profile



## AIRHEAD® BIG SLICE®

You'll really slice up the water with this 60" diameter low profile towable! Peak performance is guaranteed with Slice's topside neoprene knuckle guards, an Airhead exclusive. The durable 30-gauge virgin PVC bladder is fully encased by a double-stitched nylon cover with a reinforced internal tow harness. Slice is equipped with a super-convenient Kwik-Connect for easy hook-ups and a Boston Valve for fast inflating and deflating. It's easy to climb onto Slice from the water; it's tapered to only 6 in. high at the back. Designed for 1 or 2 riders.

Description	Valve	Part No.
Airhead Slice 1 or 2 riders	Boston Valve	AHSL-4

FOUR  
STROKE

INTAKE  
SYSTEMS

ENGINE/  
GASKETS

EXHAUST

DRIVE LINE  
HANDLING

ELECTRICAL

WATERLINE  
/BLIGE

STEERING  
& CONTROLS

BODY

ACCESSORIES

SERVICE TOOLS  
/HARDWARE

CHEMICAL

# AIRHEAD®

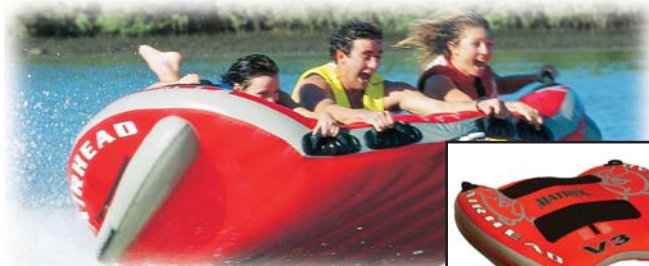

AHMX-V2



AHMX-V3

## AIRHEAD® MATRIX™ V-2 & V-3

Wow! The thrill rides of the century have arrived! If you want real heart stopping tubing action unlike anything you've experienced before, think Matrix. No expense was spared in Matrix's state-of-the-art construction. The durable RF welded virgin vinyl PVC bladder is completely wrapped in double-stitched 840-denier nylon. A heavy-duty Kwik-Connect provides easy hook-ups and the Airhead Multi-Valve provides the ultimate in inflation and deflation convenience. Join the matrix tubing revolution now! Patent pending.

Description			Valve	Part No.
Airhead Matrix	2 riders	80" x 64"	Multi-Valve	AHMX-V2
Airhead Matrix	3 riders	97" x 74"	Multi-Valve	AHMX-V3



## AIRHEAD® G-FORCE™



G-Force is a wild ride for up to 3 thrill-seekers! Defy centrifugal force with G-Force's topside stabilizers fins. The 6 deluxe nylon-wrapped handles with neoprene knuckle guards provide a sure and comfortable grip. G-Force has a tough 30-gauge virgin PVC bladder, fully covered with as 840-denier double-stitched nylon cover. G-Force is 72" x 62" and is equipped with a heavy-duty Kwik-Connect for easy and secure hook-ups. An Airhead Boston valve provides the ultimate in inflation and deflation convenience.

Description			Valve	Part No.
Airhead G-Force	3 riders	72" x 62"	Boston-Valve	AHGF-1



## SPACE SHUTTLE MTC™

*Doubles as a trailer!*

MTC stands for Multi Towing Craft. This humongous and incredibly inflatable has a dual personality! Shuttle your coolers, beach chairs, skis, wake boards, gas cans, and other gear to your favorite beach inside Space Shuttle MTC, while you enjoy a comfortable boat or personal watercraft ride with your friends. Once you unload your gear onto the beach, you'll have the most exhilarating tube ride of your lives with plenty of room to stretch out. Space Shuttle MTC is 80" by 80" (deflated size) with 19" sidewalls. The rugged 30-gauge vinyl tube has an inflatable cushioned floor that drains to keep you and gear dry. The 840-denier double-coated nylon cover has a rear mesh drain vent and a double-reinforced towing harness. A cargo net is included to secure your gear. Eight deluxe handles with neoprene knuckle guards ensure a confident hold for up to four passengers.

Description			Valve	Part No.
Space Shuttle MTC	4 riders	80" x 80" x 19"	Boston-Valve	SS-1



### AIRHEAD® HOT SHOT™

Come on hot shot, show us what you've got! If you like air time, you won't be disappointed! HOT SHOT, AIRHEAD's 57 in. (deflated) round deck tube is one hot ride, built to last and a great value. The rugged PVC bladder is completely covered with a double-stitched nylon cover. The thin profile makes it easy to climb onto from the water. HOT SHOT has 4 deluxe handles with neoprene knuckle guards and is equipped with a Boston valve for quick inflating and deflating.



Description	Valve	Part No.
Airhead Hot Shot	Boston-Valve	AHHS-1



### AIRHEAD® U-TUBE™

U-TUBE is an innovative 1-2 rider towable with 2 different tow points. Pull it from the end and it rocks side to side, adding a new dimension to your tubing excitement. Pull it from the bottom and 2 can rider chariot style! Two oversized neoprene panels provide comfort. Six deluxe handles with neoprene knuckle guards give you lots of gripping options. The durable 30 gauge PVC bladder is fully covered by rugged 840 denier nylon. Dimensions: 61 in. x 60 in. (deflated).

Description	Valve	Part No.
Airhead U-Tube	Boston-Valve	AHUT-1



### AIRHEAD® STING RAY™

Look out, AIRHEAD's STING RAYs are coming to get you! STING RAY graphics are real head turners. There are 3 models of STING RAY for 1, 2 and 3 riders. You'll love the lively performance that the winged design delivers. STING RAYs cross the wake effortlessly, yet they are very stable. The oversized backrests make these recumbent towables popular for all ages. There's a topside neoprene seat pad for each rider. Nylon wrapped handles with neoprene knuckle guards ensure a great grip. The durable RF welded 30 gauge PVC bladder is fully covered by rugged double-stitched 840 denier nylon. The tow harnesses and drain vents have been specially engineered to provide long service life. AHSTR-2: 2 rider, 88 in. x 73 in. (deflated)



Description	Valve	Part No.
Airhead Sting Ray	Boston-Valve	AHSTR-2

FOUR STROKE	INTAKE SYSTEMS	ENGINE/ GASKETS	EXHAUST	DRIVE LINE HARDWARE	ELECTRICAL	WATERLINE /RIGGE	STEERING & CONTROLS	BODY	ACCESSORIES	SERVICE TOOLS /HARDWARE	CHEMICAL
----------------	-------------------	--------------------	---------	------------------------	------------	---------------------	------------------------	------	-------------	----------------------------	----------

# AIRHEAD® PERFORMANCE TRAVEL KAYAKS™

Inflatable kayaks are perfect for camping, vacationing, exploring remote areas, and for cruising yachts. They're also great for paddling enthusiasts that don't want to drive around with a kayak on their rooftop! AIRHEAD Travel Kayaks fit easily into the trunk of your car, duffel bag or suitcase. When you feel the itch to paddle, your boat is with you!



**NMMA**  
CERTIFIED  
using ABYC standards

**NEW**

AIRHEAD® Performance Travel Kayaks Features:

- NMMA Approved
- Lightweight / compact / portable
- Highly visible orange for safety
- All 3 air chambers are completely enclosed by rugged 840-denier nylon with UV and water-resistant coatings
- Neoprene elbow guards for comfort
- Easy to inflate and deflate (3 Boston valves with nylon covers)
- D-rings at bow and stern for securing gear, Stretch net in bow
- Grab handles for easy put-ins and pull-outs
- Designed for lakes and moderate white water
- Inflatable seats with adjustable support backrest and mesh pocket
- Low drag / superior tracking with 4 bottom fins
- Durable tri-laminate bottom for a lifetime of use
- Adjustable foot brace
- Padded Shoulder Carrier Included
- Stainless steel and nylon hardware will not corrode
- Low drag, superior tracking
- Threaded drain plug

Description	Valve	Part No.
Airhead Performance Travel Kayak	Boston-Valve	AHTK-2



## AIRHEAD® COOL ISLAND™

**NEW**

Hang out on AIRHEAD's COOL ISLAND and have a party! Sunbathe on the roomy sundeck, then cool off splashing around in the mesh area. Four drink holders and a sundry holder, perfect for storing suntan lotion, are conveniently located between the wet and dry areas. The boarding platform makes it easy to climb on top from deep water. There are 3 handles welded to the sides for carrying. Two tie down points are strategically welded to the sides for anchoring. Designed for up to 6 adults. Dimensions: 107 in. x 88 in. (deflated).

Description	Valve	Part No.
Airhead Cool Island	Speed-Valve	AHCI-1

## AZ-18 AQUA ZOOKA™

Soak your friends with AQUA ZOOKA! This easy to operate, quick filling bazooka is constructed of high-impact thermoplastics and will last for seasons of fun. Simply dip AQUA ZOOKA into the water and pull back on the handle to siphon water up into the barrel. You're ready to fire, with a range of up to 60 feet! AQUA ZOOKA's are equipped with comfortable EVA handles so that you won't lose your grip, even with wet hands in the heat of battle! The EVA handles also ensure that AQUA ZOOKA will float on top of the water. Doubles as a bilge pump!



Description	Part No.
AQUA ZOOKA 18"	AZ-18

**SPORTSSTUFF**  
**MABLE**  
SERIES



**SUPER MABLE**



**SUPER MABLE**



**BIG MABLE**

**Description**

Big Mable	69" (L) x 70" (W)
2 riders	175 cm (L) x 175 cm (W)
Super Mable	82" (L) x 83" (W)
3 riders	205 cm (L) x 210 cm (W)

**Valve**

Speed Safety Valve
Speed Safety Valve

**Part No.**

S53-2210
S53-2220

**MEGA BOWL**



**Description**

Mega Bowl	68" (L) x 58" (W) x 26 (H)
	170 cm (L) x 145 cm (W) x 65 cm (H)

**Valve**

Speed Safety Valve
--------------------

**Part No.**

S53-1840
----------



FULL NYLON COVER

**HALF-PIPE**



**SUMO**  
**TUBE**

**Description**

Half-pipe Frantic	210" Dia (150cm)	Speed Safety Valve	S53-2160
3 rider			

**Valve**

Speed Safety Valve
--------------------

**Part No.**

S53-2160
----------



TEST PILOT

**CHARIOT**  
TOWABLE SERIES



**Description**

Test Pilot Chariot	48" Dia (120 cm)
--------------------	------------------

**Part No.**

S53-1710
----------

**Description**

Sumo Tube 1 rider	38"L x 33" Dia
-------------------	----------------

**Valve**

Speed Safety Valve
--------------------

**Part No.**

S53-1805
----------

FOUR STROKE	INTAKE SYSTEMS	ENGINE/GASKETS	EXHAUST	DRIVE LINE HANDLING	ELECTRICAL	WATERLINE /BLIGE	STEERING & CONTROLS	BODY	ACCESSORIES	SERVICE TOOLS /HARDWARE	CHEMICAL
-------------	----------------	----------------	---------	---------------------	------------	------------------	---------------------	------	-------------	-------------------------	----------

# FACTORY ZERO

Factory Zero a Japanese based company specializing in the marine manufacturing industry first introduced the Factory Zero Jet Launcher in 1992. The original Jet Launcher was distributed primarily in Japan during the first years of production. The Jet Launcher has been upgraded and modified throughout the years based on all of the input and recommendations by the users and racers. The current Jet Launcher uses the highest quality materials available and easily assembles without any tools required.

In 2006 Factory Zero signed Hot Products as the exclusive USA importer and Worldwide PWC Distributor to supply the PWC Dealers of the world the best PWC Totes and Launchers available in the market.



J-130S

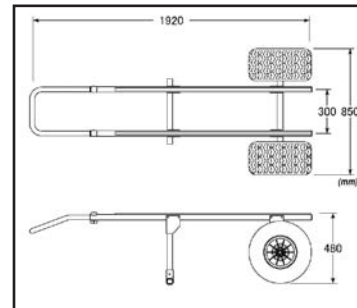

**Description**  
Compact 2-Wheel Tote Stand-Up

**Part No.**  
J-130S

BOX: H1530xW85xD60mm / 4kg, H535xW350xD95mm / 7kg  
TIRE: H475xW475xD510mm / 12kg

## FACTORY ZERO JET LAUNCHER - THE RACERS CHOICE WORLDWIDE



2007 CORONA EUROPEAN  
JET SKI CHAMPIONSHIP  
MURCIA, SPAIN



2007 CORONA EUROPEAN  
JET SKI CHAMPIONSHIP  
ZANDVOORT, NETHERLANDS



2007 IJSBA  
WORLD FINALS  
LAKE HAVASU CITY, AZ • USA

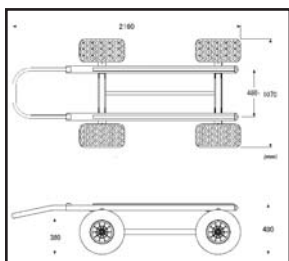

### 4-WHEEL TOTE 3 SEAT PWC

Extra strong and durable design with bolts and nuts assembly. This model is designed for the large 3 seat watercraft. Just load PWC onto tote and push across any and all surfaces.

BOX: H1635xW260xD170mm/ 12.5kg, H640xW530xD90mm / 1.4kg  
TIRE: H475xW475xD510mm / 12kg x 2



J-1480-4

**Description**  
4-Wheel Tote 3 Seat PWC

**Part No.**  
J-1480-4

*\*Due to the size of this product it is not covered by the Hot Products shipping policy*



# FACTORY ZERO



J-1300

## 2-WHEEL TOTE STAND UP/SPORT CLASS

Extra strong and durable design with bolts and nuts assembly. This model is designed for Stand-up and Sport class watercraft. A special designed leverage function frame allows you easy launching and loading of watercraft, all by yourself.

BOX: H1635xW435xD165mm / 11.5kg TIRE: H475xW475xD510mm / 12kg

Description	Part No.
2-Wheel Tote Stand-Up/Sport Class	J-1300

*\*Due to the size of this product it is not covered by the Hot Products shipping policy*



## FACTORY ZERO JET BANK

This Factory Zero model is designed to hold 2 and 3 seat Personal Watercraft. The front two wheels allow for the user to steer the watercraft into the tightest of ares without any issues. Great for showrooms, repair shops, or marine storage facilities.

BOX: H1635xW260xD170mm / 14.5kg H790xW390xD200mm / 5.7kg  
 TIRE: H475xW475xD510mm / 12kg H450xW450xD210mm / 12kg  
 BAR: H2690xW80xD80mm / 6.9kg

Description	Part No.
Factory Zero Jet Bank	J-2260LS

*\*Due to the size of this product it is not covered by the Hot Products shipping policy*

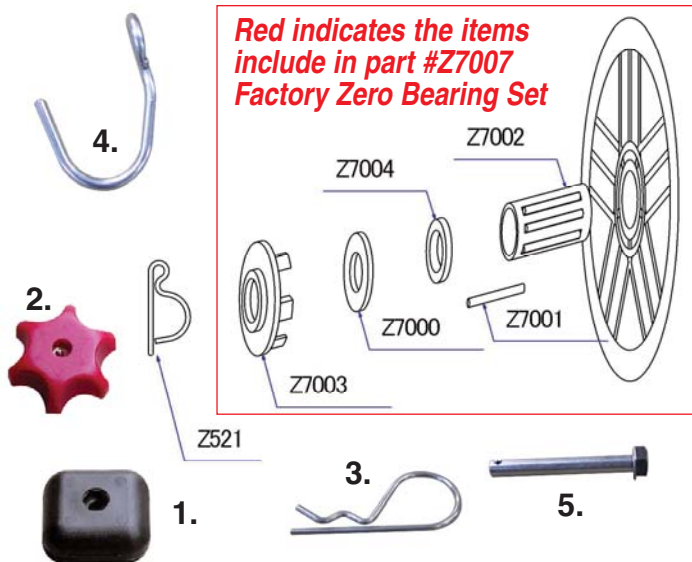

## JET LAUNCHER (J-130S) REPAIR PARTS

Factory Zero offers one of the highest quality Jet Launchers for your Stand-up PWC and has repair/replacement parts available to allow you to utilize your Jet Launcher to a use for many years.

Description	Part No.
Composite Fiber Washer	Z7000
Needle Only (10psi)	Z7001
Bearing Cage Only	Z7002
Nylon Cap	Z7003
Nylon Washer	Z7004
"D" Ring	Z521
Bearing Complete Set	Z7007
1. Plastic Washer for Jet Launcher J-130S	Z6037
2. Plastic Knob for Jet Launcher J-130S	0S0015
3. "R" Pin For Legs of Jet Launcher J-130S	P13-130
4. Stainless Hook for Jet Launcher J-130S	JL100
5. Pin MS-55 for Legs of Jet Launcher J-130S	P-17-16



## AC RACING BEACH STAND

Thick wall tubing and heavy gauge angle aluminum construction. Excellent durability. Not designed for use out of water.

Description	Part No.
2 Seater Personal Watercraft	59-4005*
Stand-Up Personal Watercraft	59-4000*

*\*Due to the size of this product it is not covered by the Hot Products shipping policy*



Sit-down model shown



## AC RACING PWC SHOP/WORK STAND

- 5" swiveling caster wheels
- Aluminum box tubing
- Gray carpeted 2 x 4's

***Not designed for use in water!***

Description	Part No.
High Profile for Stand-up Personal Watercraft	03-0500*
Low Profile for Sit-down Personal Watercraft	03-0600*

*\*Due to the size of this product it is not covered by the Hot Products shipping policy*

FOUR STROKE  
 INTAKE SYSTEMS  
 ENGINE/GASKETS  
 EXHAUST  
 DRIVE LINE HANDLING  
 ELECTRICAL  
 WATERLINE /BILGE  
 STEERING & CONTROLS  
 BODY  
 ACCESSORIES  
 SERVICE TOOLS /HARDWARE  
 CHEMICAL

FOUR  
STROKEINTAKE  
SYSTEMSENGINE/  
GASKETS

EXHAUST

DRIVE LINE  
HANDLING

ELECTRICAL

WATERLINE  
/BILGESTEERING  
& CONTROLS

BODY

SERVICE TOOLS  
ACCESSORIES

/HARDWARE

CHEMICAL



## FILLER HOSE

Upgrade your Scribner (VP Fuel) Jugs with a filler hose to make refueling your PWC easier and make spills a thing of the past.

*\*Designed for use with Scribner Utility Jugs, not compatible with Hunsacker*

Description	Part No.
Filler Hose Kit w/Screw Cap	59-3456



## CARBON TECH FUEL TAGS

Can't remember if you put oil in the gas? Get one of these fuel tags. These plastic tags state "unmixed" on one side and "mixed" on the other side.

Description	Part No.
Carbon Tech Fuel Tag	FT1



## BILLET JUG BREATHER

Fits most 5-gallon utility jugs. Simple one touch operation. Pull to open, push down to shut off.

*\*Designed for use with Scribner Utility Jugs, not compatible with Hunsacker Utility Jugs.*

Description	Part No.
Blue	02-001
Red	02-002
Silver	02-003



## DAS PUMP FINGER TIP PUMP

Simple finger tip pump that removes water from your engine compartment and siphons gas. Includes length of hose to reach the depths of your engine compartment or gas tank.

Gets into the tightest places and is easy to use. Prevents corrosion and rusting to your engine due to condensation. "Das Pump"

Description	Part No.
DAS Pump	57-4045



## DELUXE SIPHON PUMP

Deluxe Siphon Pump made with a heavy duty marine grades siphon bulb and gas resistant hose. This is the easy way to get a siphon started to drain your bilge or to transfer fuel from one place to another.

Description	Part No.
Deluxe Siphon Pump	59-0440



## RATIO RITE CUP & LID

The Ratio Rite measuring cup is specifically designed to help you pre-mix gasoline for your two stroke engine.

16:1 to 70:1 mix ratios are molded into this cup, measure your two cycle oil in cc/milliliters, fluid ounces, and pints. Made from durable, long lasting plastic that is completely safe to use with fuel and oil. \*Ratio Rite lid sold separately

Description	Part No.
Ratio Rite Cup	59-0548
Ratio Rite Lid	59-0582



## LISLE CREEPER SEAT/STEP

Ergonomic design with a 300lb. capacity that can be rotated forward onto rubber feet to make a stable 14" tall ladder. Spacious storage tray below the seat keeps tools, test equipment and parts within easy reach. Perfect for PWC service, PWC pump repairs, etc. Wheels pop into tubular steel legs with an outrigger design for added stability.

Description	Part No.
Lisle Creeper Seat/Step	LS93402



## SCEPTER FLEXIBLE FUNNEL

Scepter's flexible funnel is perfect for all your PWC uses and really helps perform those difficult maintenance and repair applications. Manufactured from quality, high density polymers: the funnel won't rust, dent, or crack. This means no drips and leaks for you to clean up after your done. The funnel length is 18".

Description	Part No.
Scepter 18" Flexible Funnel	MR03603



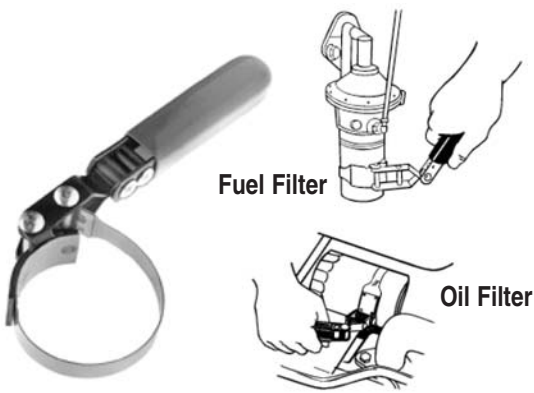

Fuel Filter

Oil Filter

## "SWIVEL GRIP" OIL / FUEL FILTER WRENCH

For Smaller 2 3/8" to 2 5/8" Oil Filters. Also fits Fuel Filters. For small oil and fuel filters. Tough stainless steel band with special "teeth" for extra gripping power...won't slip. Special narrow 1/2" band fits in tight spots. Handle swivels to clear obstructions and makes it easy to turn in hard to reach locations. Vinyl covered handle. Covers a range of 2 3/8" to 2 5/8" (60.3 - 66.7mm)

Description	Part No.
"Swivel Grip" Oil / Fuel Filter Wrench	LS54400



## 4.5 GALLON DRAIN PANS

Now with built-in-ribs for draining filters in the pan. For easy transfer of liquids. High-density polyethylene material is resistant to chemicals and solvents, and is easy to clean. 1" wide diameter spout for quick and easy pouring. The anti-splash lip and baffles help prevent spilling when carrying or pouring. Comes with large, easy-grip handles. Two colors: 17942 is black for oil and 17952 is green for anti-freeze.

Description	Part No.
4.5 Gallon Oil Drain Pan, Black	LS17942
4.5 Gallon Oil Drain Pan, Green	LS17952

## MOELLER MARINE PRODUCTS FLUID EXTRACTOR

- Empties oil in 15 pumps or less
- Extracts warm or cold oil
- Pressure relief valve allows easy transportation and storage
- Single-hand-ease effortless operation
- Tethered cap
- Delivers gulp-free, mess-free performance
- Complete adapter kit is included featuring three extraction tubes

Description	Part No.
Moeller Fluid Extractor (6.5 Liter Fluid Extractor)	MR07398
Moeller Fluid Extractor Tube Replacement Kit	MR08032

\*Note: Not for use with gasoline.

### Complete Adapter Kit Included with MR07398



MR08032 Replacement Tubes

USA Patent #5450924 - Germany Patent #29500683.8 - U.K. Patent #2272948  
Australia Patent #674469 - Taiwan Patent #113238 - China Patent #ZL92241981.7



## RULE FLAT TANK ELECTRIC OIL EXTRACTOR

Eliminate those costly yard service fees with the new quick, clean, compact electric oil extractor. Includes a 3-1/2 gallon compact self-priming diaphragm pump for extraction and an easy pour spout for oil transfer.

- 3.5 gallon (13 liter) leak proof container
- Designed for ease of carrying
- Complete with dipstick, suction tube & battery clamps
- Empties and stows easily

- Self-priming, dry running, 12 or 24 volt diaphragm pump

Description	Part No.
Electric Oil Extractor	17860-0012



## HYDRO-TURF OIL EXTRACTOR

The unit uses a small vacuum system, which pumps fluid through a hose to the 6-liter reservoir. It also includes a pour spout to aid in emptying the reservoir. Pump is removable for easy storage.

Description	Part No.
Hydro-Turf Oil Extractor	OIL01



Tethered Cap & Easy Pour Spout

Pressure Release Valve

No Overflows With Built-in Automatic Shut-off Float!

Durable Plastic Body

Patented Vacuum Pump Pulls Fluid 3x Faster!

Built-In Metal Foot-Ring

FOUR  
STROKE

INTAKE  
SYSTEMS

ENGINE/  
GASKETS

EXHAUST

DRIVE LINE  
HANDLING

ELECTRICAL

WATERLINE  
/BILGE

STEERING  
& CONTROLS

BODY

ACCESSORIES

SERVICE TOOLS  
/HARDWARE

CHEMICAL



## SKEEKEEPER TIE DOWNS

Fits all PWC with 5/8" or 3/4" Bow Eyes.  
Available in Single or Double Hook.

Description	Part No.
Single Hook	TS-60-BLK
Double Hook	TS-62-BLK



## ANCR A WATERCRAFT TRAILER TIE DOWNS

Fits all PWC with 3/4" Bow Eyes.

Color	A. Double Hook Without Bow Eye Pin	B. Single Hook With Bow Eye Pin	C. Double Hook With Bow Eye Pin
	Purple	59-3404-PPL	59-3404-PPL-S
Pink	59-3404-PNK	59-3404-PNK-S	59-3404-PNK-D
Lime Green	59-3404-GRN	59-3404-GRN-S	



## HOO-K-IT TIE DOWN MOUNT

Patented hook retainer eliminates unhooking.  
Provides a location to tie down your watercraft  
where you want it.

Description	Part No.
Hook-It Tie Down Mount	TS-65



## YAMAHA TIE DOWN PIN

The tie down pin can be used to which your  
boat on your trailer, attach a docking line, attach  
anchor, or tie down your Yamaha. Just drop the  
pin in your front or rear bow eye.

Description	Part No.
Yamaha Tie Down Pin	59-3438



## POWERTYE TIE DOWNS

Made from high quality 4500lb. test nylon strap  
with rubber coated hooks. Made in USA

Description	Part No.
Black	59-3425
Navy Blue	59-3428
Silver	59-3429



## SKEEKEEPER BOW PIN

Fits any PWC trailer with a 5/8" bow coupler.  
*Bow stop pictured is not included.*

Description	Part No.
Bow Pin	TS67



## SKEEKEEPER HITCH PIN

Fits any receiver-style hitch with a 2" insert.  
*Trailer hitch receiver and ball pictured is  
not included.*

Description	Part No.
Hitch Pin	TS68



## R&D EZ-SLIDE BUNK GLIDES

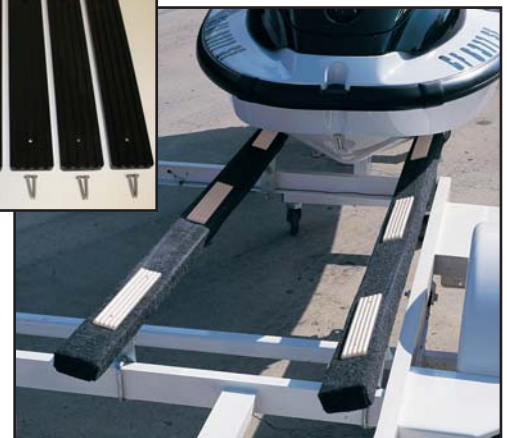

R&D EZ-Slide Bunk Glides are designed to mount directly on the top side of the trailer bunks creating a new low friction slippery surface that allows the watercraft to glide on or off the trailer, making loading and unloading a personal watercraft easy. Designed and molded from high density urethane to significantly support the hull surface for proper trailering. The EZ-Slides are black and come in a six piece set complete with stainless steel button head mounting hardware. One set needed per watercraft.

Description	Part No.
EZ-Slide Bunk Glides (Set of 6)	001-00122

## STOLTZ BOW STOPS AND SUPER ROLLERS

Stoltz polyurethane rollers and bow stops have non-marking assurance built-in and will not put any marks on your boat. No more hard work cleaning your boat. Made in USA.



**PWC-5A**

### Bow Stop

For PWCs with a vertical hole. Fastens with "U" bolts. 3-1/2" Opening



**PWC-9**  
**2" Bow Stop**

Fits 2" wide bracket for 1/2" shaft



Made in U.S.A.



**RP-325**  
**3" End Cap**  
For 1/2" shaft

Descriptions	Part No.
PWC Bow Stop	<b>PWC-5A</b>
PWC 2" Bow Stop	<b>PWC-9</b>
1/2" Shaft 3" End Cap	<b>RP-325</b>



## RV TRAILER WIRING SOCKET ADAPTER

This adapter converts the large 7 prong RV style wiring plug to the standard universal flat 4 way trailer wiring. No cutting or splicing required.

Description	Part No.
RV Trailer Wiring Adapter	<b>73012</b>



Plastic



Metal

## LICENSE PLATE BRACKETS

- Choice of either plastic or metal license plate brackets.
- 1/4" mounting holes on 2" centers.

Description	Part No.
Plastic License Plate Bracket	<b>WB-3211</b>
Metal License Plate Bracket, Plated	<b>WB-3213</b>



## WATERPROOF IDENTIFICATION LIGHT BAR

- For vehicles 80" wide or wider.
- Waterproof lamp. Pre-wired w/60" leads.
- Dimensions: 14-1/4" x 1-1/8" x 1"

Description	Part No.
Waterproof Identification Light Bar	<b>WB-003315</b>



## 4-WAY CONNECTORS WITH ELECTRIC WIRE HARNESS

- Wesbar harnesses conform to all applicable SAE, NMMA & TMA standards.
- Standard 4-way harnesses have an 18" ground wire except where noted.

4-Way Harness	Part No.
18" Trailer Connector—Wunside	<b>WB-007285</b>
18" Trailer Connector—Wishbone	<b>WB-007286</b>
25' Trailer Harness—Wishbone	<b>WB-007261</b>
25' Trailer Harness Kit—Wishbone /Connector	<b>WB-007103</b>
30' Trailer Harness Kit—Wishbone /Connector	<b>WB-007104</b>



## TRUNK CONNECTOR

4-Way female connector mates with most standard flat 4-way plugs

Description	Part No.
4' Trunk Connector	<b>WB-7275</b>
6' Trunk Connector	<b>WB-7272</b>



## TRUNK/TRAILER CONNECTOR SET

Includes 48" trunk and 18" trailer 4-Way connector

Description	Part No.
Trunk/Trailer Connector	<b>WB-7270</b>



## SUBMERSIBLE TAIL LIGHT

Widely used by jet ski and boat trailer manufacturers, these multi-function submersible tail lights are designed to protect the bulbs and contacts when the trailer is under water during launching and loading. They employ a "trapped air" technique to keep water from the bulbs. The bulbs and lenses are easily replaceable. Closed bottom design prevents splashing water and road grit from entering the lamp and meets all applicable DOT regulations. The lights come with pre-installed wire leads and two 1/4" mounting studs on 2" centers.

Description	Part No.
Lens, Tail Lamp	<b>WB-403335</b>
Lens, Side Marker, Red	<b>WB-003337</b>
Lens, Side Marker, Amber	<b>WB-003338</b>
7-Function Tail Lamp , Submersible (LH)	<b>WB-3023</b>
6-Function Tail Lamp , Submersible (RH)	<b>WB-3073</b>



## SEALED 2.5" ROUND CLEARANCE/MARKER LAMP WITH REFLECTOR

Sonically sealed lamp with Reflex reflector. Amber.

Description	Part No.
Amber SM/Clearance	<b>WB-3385</b>

FOUR STROKE  
INTAKE SYSTEMS  
ENGINE/GASKETS  
EXHAUST  
DRIVE LINE HANDLING  
ELECTRICAL  
WATERLINE /BILGE  
STEERING & CONTROLS  
BODY  
ACCESSORIES  
SERVICE TOOLS /HARDWARE  
CHEMICAL

FOUR  
STROKEINTAKE  
SYSTEMSENGINE/  
GASKETS

EXHAUST

DRIVE LINE  
HANDLING

ELECTRICAL

WATERLINE  
/BILGESTEERING  
& CONTROLS

BODY

ACCESSORIES

SERVICE TOOLS  
/HARDWARE

CHEMICAL

## VHF



**ALESSANDER LENZI**  
**VOL. 1 VIDEO**  
71-0009



**ALESSANDER LENZI**  
**VOL. 3 VIDEO**  
71-0008



**ERIC "CYCLONE"**  
**MALONE VIDEO**  
71-0005



**COASTAL RAGE JET**  
**ADDICTION VIDEO**  
71-0012



**V JET WAVE CUP**  
**2003 WORLD**  
**CHAMPIONSHIP**  
71-0016



**CAMPEONATO**  
**BRASILEIRO**  
**DE JET SKI 2004**  
71-0018

## DVD



**2004 LENZI DVD**  
71-0020

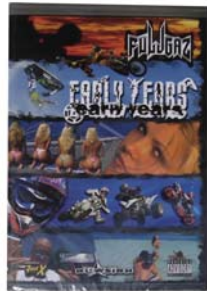

**THE EARLY YEARS DVD**  
FLGZ1



**THE ADDICTION**  
70-0030



**TWANGULATION**  
**DVD**  
70-0022

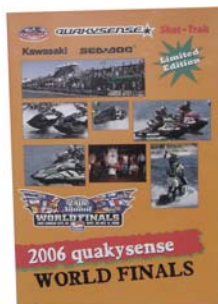

**WORLD FINALS**  
**2006**  
WFDVD2006

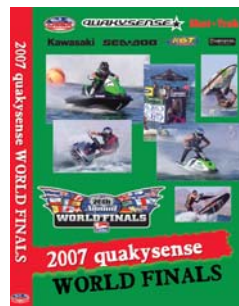

**WORLD FINALS**  
**2007**  
WFDVD2007

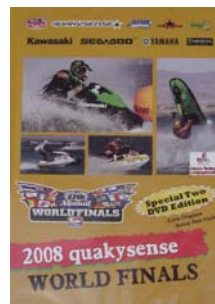

**WORLD FINALS**  
**2008**  
WFDVD2008

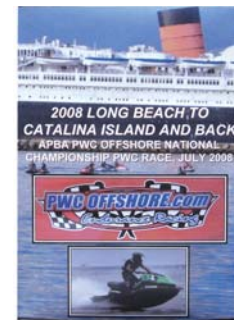

**08 LONG BEACH TO**  
**CATALINA DVD**  
OFFSH002



## NATIONAL CHAMPION MIKE FOLLMER WATERCRAFT RACER MODEL KIT

This kit is a great fun model kit to assemble and then display for all your friends and family to see. Don't miss your chance to purchase this limited production model kit.

**Description**  
Watercraft Racer Model Kit

**Part No.**  
85-5030

## SEA DOO

## KAWASAKI



### SUPER BN MANUAL

For the watercraft tuner working with Super BN series carburetors.

Description	Part No.
Mikuni Manual	53-9999

Sea Doo Water Vehicles  
1988-1996

Standard GT, GTS, GTX,  
SP, SPI, XP

**Part No. W809-3**

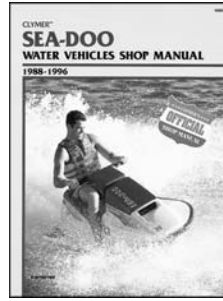

Sea Doo Water Vehicles  
1997-2001

GS/GSI/GSX/GSX RFI/  
GSX Ltd./GTI/GTS/GTX  
GTX DI/GTX RFI/GTX Ltd.  
HX/LRV/RX/RX DI  
SP/SPX/XP Ltd.

**Part No. W810**

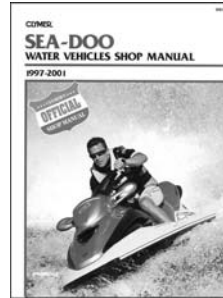

Kawasaki Jet Ski  
1976-1991

JS300, JS550, JS300SX,  
JS550SX, JS400, JF650X-2,  
JS440, JS650SX, JF650TS,  
JL650SC, JB650TS Jet Mate

**Part No. W801**



Kawasaki Jet Ski  
1992-1994

JS440, JS550, JS550SX,  
JB650 Jet Mate, JF650X-2,  
JF650TS, JL650SC,  
JS650SX, JH750SS,  
JS750SX, JH750Xi,  
JT750ST, JH750XIR

**Part No. W802**



## YAMAHA



Yamaha Water Vehicles  
1987-1992

WJ500, WRA650, WR500,  
SJ650, WR650

**Part No. W805**

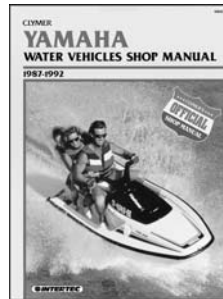

Yamaha Water Vehicles  
1993-1996

WR500, SJ650, WR650,  
WRA650, WRA650A,  
WRB650, WRB650A, FX700,  
SJ700, RA700, RA700A,  
RA700B, WB700A, WRA700,  
WRB700, WVT700, RA760,  
WB760, RA1100, WVT100

**Part No. W806**

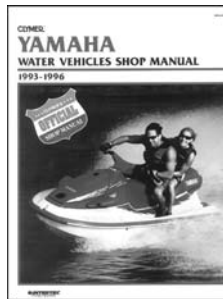

Yamaha Water Vehicles  
Four Stroke 2002-2009\*

05-08 FX, 05-08 FX Cruiser  
04-08 FX Cruiser High Output  
04-08 FX High Output, 02-04 FX140  
02-04 FX140 Cruiser, 05-09 VX  
05-09 VX Cruiser, 05-09 VX Deluxe  
05-09 VX Sport

**Part No. W807**

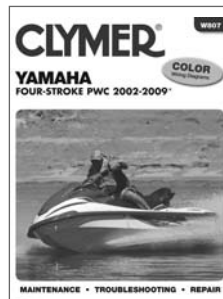

Kawasaki Jet Ski  
Performance Manual,  
all models 1976-1994

**Part No. W804**



## POLARIS

Polaris Water Vehicles  
1993-1995

SL650, SL750, SLT750

**Part No. W819**

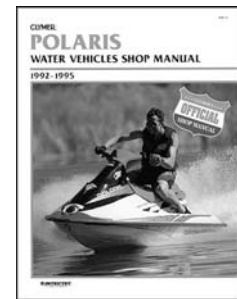

Polaris Water Vehicles  
1996-1999

SL650, SL750, SLT750

**Part No. W820**

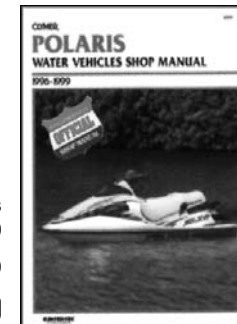

\*Does not cover 1800 cc models. Does not cover 2-stroke models.

FOUR  
STROKE

INTAKE  
SYSTEMS

ENGINE/  
GASKETS

EXHAUST

DRIVE LINE  
HANDLING

ELECTRICAL

WATERLINE  
/BILGE

STEERING  
& CONTROLS

BODY

ACCESSORIES

SERVICE TOOLS  
/HARDWARE

CHEMICAL

FOUR STROKE  
 INTAKE SYSTEMS  
 ENGINE/GASKETS  
 EXHAUST  
 DRIVE LINE HANDLING  
 ELECTRICAL  
 WATERLINE /BILGE  
 STEERING & CONTROLS  
 BODY  
 ACCESSORIES  
 SERVICE TOOLS /HARDWARE  
 CHEMICAL

## METRIC STAINLESS STEEL HEX BOLT PACKS

10 Pcs Per Pack



Size/mm	Part No.
6 x 10	60-3010
6 x 12	60-3012
6 x 14	60-3014
6 x 16	60-3016
6 x 18	60-3018
6 x 20	60-3020
6 x 25	60-3025
6 x 30	60-3030
6 x 35	60-3035

Size/mm	Part No.
6 x 40	60-3040
6 x 45	60-3045
6 x 50	60-3050
6 x 60	60-3060
6 x 70	60-3070
6 x 80	60-3080
8 x 18	60-4018
8 x 20	60-4020

Size/mm	Part No.
8 x 25	60-4025
8 x 30	60-4030
8 x 35	60-4035
8 x 40	60-4040
8 x 50	60-4050
8 x 60	60-4060
8 x 80	60-4080
10 x 25	60-5025

## METRIC STAINLESS STEEL SOCKET HEAD CUP BOLT PACKS

10 Pcs Per Pack



Size/mm	Part No.
4 x 30	61-1030
4 x 16	61-1016
5 x 10	61-2010
5 x 25	61-2025
6 x 10	61-3010
6 x 12	61-3012
6 x 14	61-3014

Size/mm	Part No.
6 x 16	61-3016
6 x 20	61-3020
6 x 25	61-3025
6 x 30	61-3030
6 x 35	61-3035
6 x 40	61-3040
6 x 50	61-3050

Size/mm	Part No.
6 x 60	61-3060
8 x 20	61-4020
8 x 25	61-4025
8 x 30	61-4030
8 x 50	61-4050
8 x 60	61-4060
10 x 25	61-5025

## METRIC STAINLESS STEEL NUTS

10 Pcs Per Pack



Size	Part No.
6mm	63-0006
8mm	63-0008

## METRIC STAINLESS STUD PACKS

10 Pcs Per Pack



Size/mm	Part No.
8 X 30	62-4030

## METRIC STAINLESS STEEL FLAT WASHERS

10 Pcs Per Pack



Size	Part No.
6mm	63-2006
8mm	63-2008
10mm	63-2010

## METRIC STAINLESS STEEL SPRING WASHERS

10 Pcs Per Pack



Size	Part No.
6mm	63-4006
8mm	63-4008
10mm	63-4010

## ZIP TIES



Description	Color	Part No.
3 3/4" x .090	Black	64-0050
7 1/4" x 1.190	Black	64-0051

(Sold in Packages of 100)

## PLASTIC FITTINGS



Plastic T Fitting	Part No.
3/8" x 3/8" x 3/8"	64-0025
1/2" x 1/2" x 1/2"	64-0027

Plastic Y Fitting	Part No.
3/8" x 3/8" x 3/8" (white)	64-0045
1/4" x 1/4" x 1/4" (white)	64-0046
1/4" x 1/4" x 1/4" (black)	64-0047



# BRASS FITTINGS



Straight Hose Barbed	Part No.
1/8" Thread 1/4" Hose	64-0001
1/8" Thread 3/8" Hose	64-0003
1/4" Thread 1/2" Hose	64-0005



Barb Connector	Part No.
1/4" I.D. Hose-1/4" I.D. Hose	64-0057
3/8" I.D. Hose-3/8" I.D. Hose	64-0058
1/2" I.D. Hose-1/2" I.D. Hose	64-0059



Brass Push in Nipple	Part No.
1/8" Straight	53-9936
1/4" Straight	53-9937



90 Degree	Part No.
1/8" Pipe thread 3/8" Hose	64-0007
1/4" Pipe thread 1/2" Hose	64-0009
1/8" Pipe thread 1/4" Hose	64-0010



Garden Hose Adapter	Part No.
3/8"	64-0012
1/2"	64-0014



Press-in 90 Degree Fuel Inlet	Part No.
1/4" 90 Degree	44



45 Degree	Part No.
1/8" Pipe thread 1/4" Hose	64-0065
1/8" Pipe thread 3/8" Hose	64-0066
1/4" Pipe thread 1/2" Hose	64-0067



Brass Fitting	Part No.
1/8" Pipe threaded junction	64-0011
1/8" to 1/4" Adapter	64-0013
9mm Yamaha Flush Adapter	64-0004



T-Fitting	Part No.
Primer Fitting 1/8" x 1/8" x 1/8"	64-0015
Primer 1/4" x 1/4" x 1/8"	64-0017
Fuel Line 1/4" x 1/4" x 1/4"	64-0019

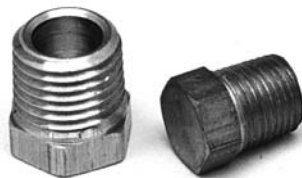

Brass Threaded Plug	Part No.
1/8" Threaded Plug	64-0016
1/4" Threaded Plug	64-0018



2007 WORLD FINALS • LAKE HAVASU, AZ  
PHOTO COURTESY OF JIN OMURA

FOUR STROKE	INTAKE SYSTEMS	ENGINE/GASKETS	EXHAUST	DRIVE LINE HANDLING	ELECTRICAL	WATERLINE /BILGE	STEERING & CONTROLS	BODY	ACCESSORIES SERVICE TOOLS /HARDWARE	CHEMICAL
-------------	----------------	----------------	---------	---------------------	------------	------------------	---------------------	------	-------------------------------------	----------

FOUR  
STROKEINTAKE  
SYSTEMSENGINE/  
GASKETS

EXHAUST

DRIVE LINE  
HANDLING

ELECTRICAL

WATERLINE  
/BILGESTEERING  
& CONTROLS

BODY

SERVICE TOOLS  
ACCESSORIES

/HARDWARE

CHEMICAL



## STAINLESS STEEL HOSE CLAMPS

Clamps	Max. Size	Part No.
#5	(for waterline)	64-0030
#36	2 3/4" - 1 13/16	64-0032
#48	3 1/2" - 2 9/16	64-0031
#60	4 1/4" - 3 5/16	64-0033
#72	5 - 4 1/16	64-0034
#80	5 1/2" - 4 9/16	64-0035



## T-BOLT CLAMPS

Size	Width	Part No.
3"	3/4"	64-0080
3-1/4"	3/4"	64-0081
4-1/2"	3/4"	64-0082
5"	3/4"	64-0084
5-1/4"	3/4"	64-0085
5-1/2"	3/4"	64-0086



## HOSE SHEARS

Scissor-action cutter for hose.

Description	Part No.
Hose Shears	59-4020



## FUEL LINE

Fuel line is made from a thick walled polyurethane tubing. Sold per foot. or 25 feet/pk

Description	Part No.
Blue (1/4") per foot	53-9970
Blue (1/4") 25 feet package	53-9970-25
Primer Line (1/8") per foot	53-9980
Primer Line (1/8") 25 feet package	53-9980-25

## Fast, Easy, Strong and Secure Installation



## SQUEEZE ON STAINLESS STEEL LOW PROFILE CLAMPS

Oetiker Stepless Ear Clamps, due to the reinforcing 'dimple' in the ear, hold against pressure and vibration or hose shrinkage due to temperature changes. A built-in spring action permits the clamp to "breathe" without loosening, the need to retighten is eliminated. Once installed, any tampering is easily visible, making this an excellent clamp for service or security applications.

## Fast & Easy Removal

Description	Clamp Size	Part No.
Pincer Tool	-	59-4015
Clamp for 1/4" Hose (10 pcs/pk)	9/16	59-4016
Clamp for 3/8" Water Line (10 pcs/pk)	11/16	59-4017
Clamp for 1/2" Water Line (10 pcs/pk)	13/16	59-4018

100 Clamp Packs	Clamp Size	Part No.
Clamp for 1/4" Hose (100 pcs/pk)	9/16	59-4016-100
Clamp for 3/8" Water Line (100 pcs/pk)	11/16	59-4017-100
Clamp for 1/2" Water Line (100 pcs/pk)	13/16	59-4018-100



## FLEX-TECH WATER LINE HOSE

Flex-Tech multi purpose hose is more flexible and bendable for those complicated water routing requirements. This waterline is highly recommended for Factory and TBM Dry Pipe installations. Waterline is sold per foot.

Description	Part No.
3/8" Flex-Tech Light Blue Waterline Hose	56-8010



## WATER LINE HOSE

Goodyear hose has been replacing rubber hose or metal tubing designs. Goodyear hose and tubing offers customers a number of benefits, including flexibility, durability, abrasion resistance, lighter weight materials, superior chemical resistance, high pressure capability, and extended product performance. Waterline is sold per foot.

Description	Part No.
3/8" Blue	56-8000
1/2" Blue	56-8004
3/8" Clear Vinyl*	56-8007

\*Clear vinyl hose is not manufactured by Goodyear.

500 foot reel 3/8" blue hose available and  
400 foot reel 1/2" blue hose available  
**Call for special pricing on reel purchases.**

# FUEL SYSTEM SERVICE TOOLS



## CARB SCREW ADJUSTING TOOL

Angled head for the hard-to-reach carb adjustment screws

Description	Part No.
Carb Screw Adjusting Tool	53-9994

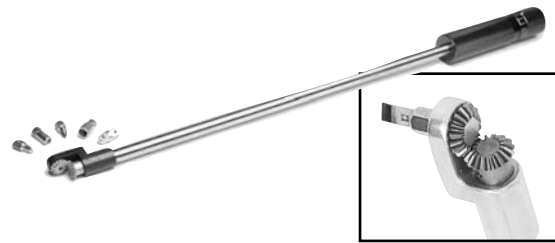

## 90 DEGREE 1/4" HEX DRIVER

Precision made of high-grade aluminum & stainless steel. Designed for hard-to-reach pilot screw. Gear driven 1/4" hex. Includes 1/4" hex bits, straight slot, Phillips, D-shaped pilot screw bit, 6mm hex jet bit and 1/4"-hex-to-1/4" drive bit.

Description	Part No.
90 Degree 1/4" Hex Driver	08-0229

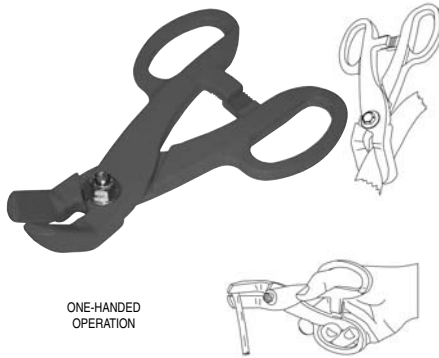

ONE-HANDED OPERATION

## HOSE PINCHER

Clamps and holds hoses up to 3/4" inside diameter. Angled jaws close to create a complete seal every time. Jaws are offset for hard-to-reach areas. The handles lock firmly to hold the jaws in closed position.

Description	Part No.
Hose Pinchers	LS23000

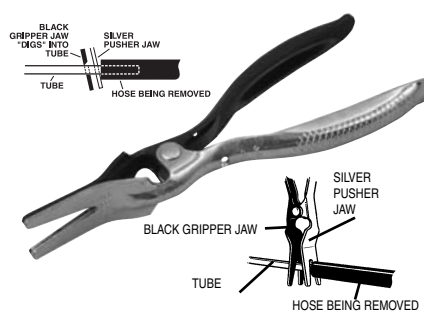

## HOSE REMOVAL PLIERS

For easy removal of 5/32" to 1/2" (4mm to 14mm) hoses. Engage the tube (line) with the black jaw. This sharpened jaw actually "digs" into the tube to grip it! Squeeze, and the hose is easily pushed off by the silver jaw.

Description	Part No.
Hose Removal Pliers	LS47900

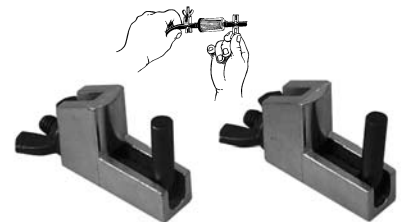

## HOSE PINCHERS

Quick, easy way to pinch off fuel lines, etc. without damaging the line. Sold two per set.

Description	Part No.
Hose Pinchers	LS22850



## MIKUNI TOOL KIT

This handy little kit contains all the tools necessary to make jetting change, perform normal maintenance as well as disassemble and rebuild any Mikuni carburetor

Description	Part No.
Mikuni Tool Kit	53-9989



## ROTARY VALVE TIMING WHEEL

Description	Part No.
Rotary Valve Timing Wheel	012-170

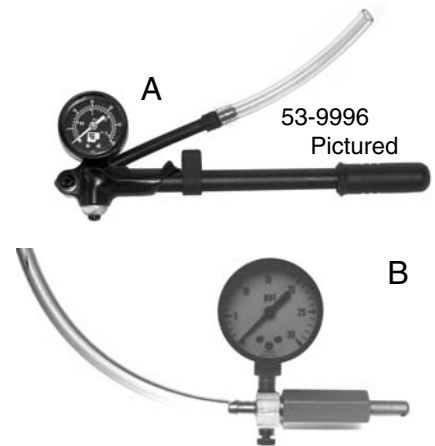

## POP-OFF GAUGE

For Accurate adjustment of pop off pressure levels.

Description	Part No.
A Mikuni Gauge	
30 Lbs.	53-9996
60 Lbs.	53-9996-60
100 Lbs.	53-9996-100
B Aftermarket Thumb Operated Gauge	53-9995



FOUR STROKE  
INTAKE SYSTEMS  
ENGINE/GASKETS  
EXHAUST  
DRIVE LINE HANDLING  
ELECTRICAL  
WATERLINE /BILGE  
STEERING & CONTROLS  
BODY  
ACCESSORIES SERVICE TOOLS /HARDWARE  
CHEMICAL

FOUR  
STROKE

INTAKE  
SYSTEMS

ENGINE/  
GASKETS

EXHAUST

DRIVE LINE  
HANDLING

ELECTRICAL

WATERLINE  
/BILGE

STEERING  
& CONTROLS

BODY

ACCESSORIES

SERVICE TOOLS  
/HARDWARE

CHEMICAL

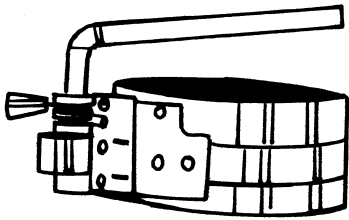

## QUICK RELEASE RING COMPRESSOR

Ring Compressor makes it easy to remove ring from piston. Range is from 2-1/8" – 5" (54mm–127mm).

Description	Part No.
Quick Release Ring Compressor	LS19000

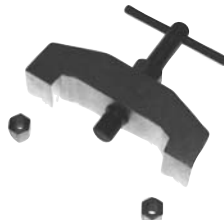

## HEAD PULLER FOR KAWASAKI HEADS

Pull straight up from the spark plug hole while using the studs for leverage.

Description	Part No.
Head Puller for Kawasaki	59-0209

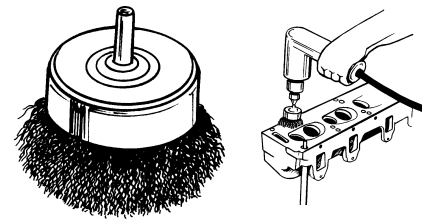

## 2-1/2" WIRE CUP BRUSH

Removes weld scale, rust, paint and corrosion from metal surfaces. Made with .014 carbon steel wire and designed for light duty use with an electric drill. Maximum safe free speed is 4500rpm.

Description	Part No.
2-1/2" Wire Cup Brush	LS14020

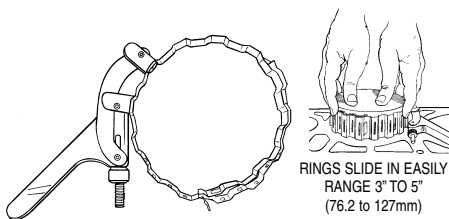

RINGS SLIDE IN EASILY  
RANGE 3" TO 5"  
(76.2 to 127mm)

## WRINKLE BAND RING COMPRESSOR

Wrinkle band cuts friction in half. Rings slide in easily 3" – 5" (76.2mm – 127mm).

Description	Part No.
Wrinkle Band Ring Compressor	LS21700



## SEAL PULLER

Simply insert the tip of the tool behind the oil or grease seal, press and pull. Leverage works for you. Two size tips reach in and fit nearly all seal applications.

Description	Part No.
Seal Puller	LS56750

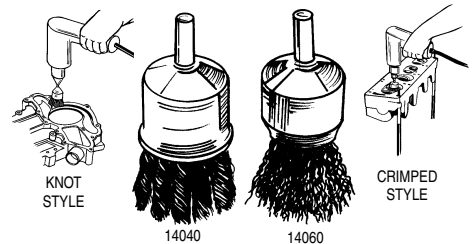

## 1" WIRE END BRUSHES

Made with .020" industrial heat-tempered wire. Use with portable electric and air tools. 20,000rpm maximum safe speed.

Description	Part No.
1" Knot Wire End Brush	LS14040
1" Crimped Wire End Brush	LS14060

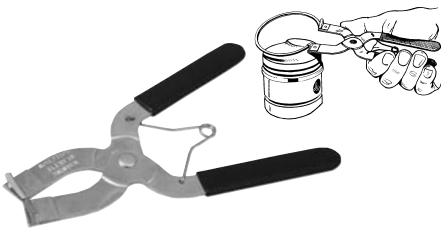

## PISTON RING INSTALLER

Description	Part No.
Piston Ring Installer	LS33500

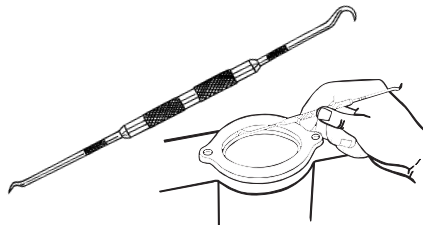

## "O" RING AND SEAL PICK

Quickly removes and installs "O" rings and seals. Tips are hardened to stay sharp.

Description	Part No.
"O" Ring and Seal Pick	LS31840



## PISTON PIN PULLER

Universal piston pin puller easily removes all sizes of piston pins without any damage to the piston.

Description	Part No.
Piston Pin Puller	59-0252



2007 WORLD FINALS • LAKE HAVASU, AZ  
PHOTO COURTESY OF JIN OMURA

## CONVERSION TABLE

Unit	Conversion
<b>Linear Measure</b>	
centimeter (cm.)	0.3937 inch
meter (m.)	3.2808 feet / 1.0936 yards
kilometer (km.)	0.6214 mile
inch (in.)	2.54 centimeters
foot (ft.) = 12 inches	30.48 centimeters
yard (yd.) = 3 feet	0.914 centimeters
rod (rd.) = 5.5. yards	5.0292 meters
chain (ch.) = 4 rods	20.117 meters
furlong (fur.) = 10 chains	201.17 meters
mile (m., mi.) = 8 furlongs	1.6093 kilometers
league (l.) = 3 miles	4.8279 kilometers
<b>Aviordupois Weight</b>	
Gram (g.)	0.0353 oz. avdp.
kilogram (kg.) = 1,00 grams	2.2046 lb. avdp
metric ton (M.T.)	1.1023 short tons
	0.9842 long ton
grain (gr.)	0.0648 gram
dram (dr. avdp.) = 27.34 grains	1.7718 grams
ounce (oz. avdp.) = 16 drams	28.3495 grams
pound (lb. avpd) = 16 ounces	0.4536 kilogram
<b>hundredweight (cwt.)</b>	
(US) = 100 pounds	45.3592 kilograms
(UK) = 112 pounds	50.8024 kilograms
<b>ton (t., tn.)</b>	
(US) = short ton	
=2,000 pounds	0.907 metric ton
(UK) = short ton	
=2,240 pounds	1.106 metric ton

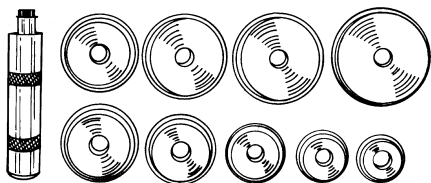

SET INCLUDES ONE OF EACH OF THE FOLLOWING DRIVERS:

DRIVER PART NO.	SIZE
12610	1.565"
12620	1.750"
12630	1.965"
12640	2.325"
12710	2.470"
12650	2.555"
12690	2.830"
12700	2.995"
12970	3.180"

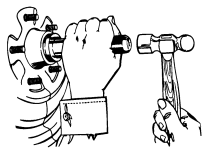

## BEARING RACE AND SEAL DRIVER—MASTER SET

Make it easier to insert bearing race and seals without damage to race. This master set includes nine drivers to fit most standard bearings.

Description	Part No.
Bearing Race and Seal Drive	LS12980
Handle Mini pouched	LS12660



## COMPRESSION TESTER

Contains hoses for 10, 12 & 14mm spark plug applications. Features a quick disconnect with a pressure release valve and a 300lbs. Gauge. Packed in a convenient carry box. Made in USA.

Description	Part No.
Compression Tester	08-0188

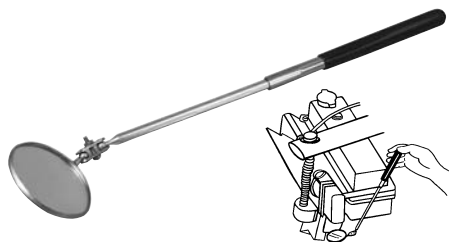

## TELESCOPING MIRROR

Enables you to see around corner. 2-1/4" diameter mirror swivels to any position. Length extends from 10" to 14".

Description	Part No.
Telescoping Mirror	LS32050



## JUMPER CABLES

8 feet long heavy duty 8 gauge copper jumper cables are big on charging power, yet stow conveniently in the 9 x 9 inch nylon bag.

Description	Part No.
Jumper Cables	59-0530



## SPARK PLUG TOOLS

Description	Part No.
Ratchet Plug Wrench	59-0539

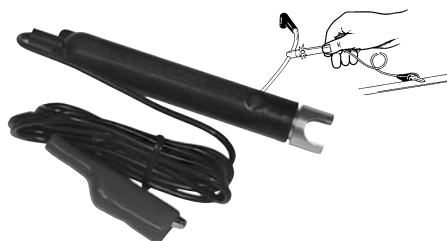

## SPARK PLUG WIRE TESTER

Now you can check spark plug wires without piercing the wires. Light flashes indicating sound wire.

Description	Part No.
Spark Plug Wire Tester	LS26900
Replacement Bulb Assembly	LS26970



## IGNITION SYSTEM SPARK TESTER

This ignition system tester checks the integrity and strength of your system by gauging your systems spark.

Description	Part No.
Ignition System Spark Tester	59-0253

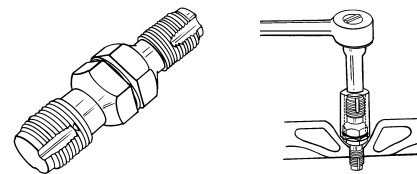

## SPARK PLUG HOLE THREAD CHASER

Cleans threads in spark plug hole. Use with 13/16" spark plug socket. Double-ended for both 14mm and 18mm threads.

Description	Part No.
Spark Plug Hole Thread Chaser	LS20200

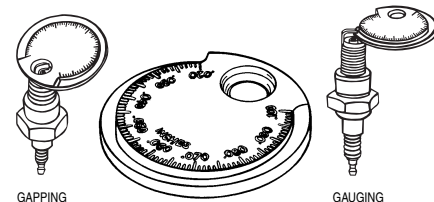

## STANDARD/HIGH ENERGY SPARK PLUG GAUGE AND GAPPER

Gauge and gap all types of spark plugs from .020" to .110 (.50mm to 2.53mm).

Description	Part No.
Spark Plug Gauge and Gapper	LS67870

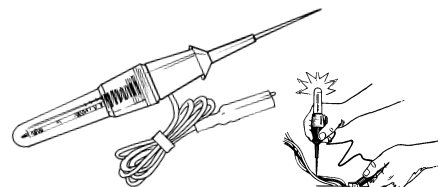

## LOW CIRCUIT TESTER

Quick check both AC and DC current up to 28 volts with power on. Helps locate shorts or breaks in wiring. Complete with insulated grounding grip.

Description	Part No.
Low Circuit Tester	LS26250
Replacement Bulb	LS26270



## SPARK PLUG HOLDERS

Spark Plug Holder protects the electrode, maintaining the proper gap.

Description	Part No.
2 per blister pack	SPH-2
40 per countertop display	SPH-40

FOUR STROKE

INTAKE SYSTEMS

ENGINE/GASKETS

EXHAUST

DRIVE LINE HANDLING

ELECTRICAL

WATERLINE /BILGE

STEERING & CONTROLS

BODY

ACCESSORIES

SERVICE TOOLS /HARDWARE

CHEMICAL



## PRO-CRIMP TOOL

To do a job right, it is important to have the right tools. If you custom build a lot of plug wires, the Pro-Crimp is the right tool for you! The Pro-Crimp features a hardened steel frame, molded hand grips and built-in ratchet action that is also adjustable. The tool is supplied with jaws to fit MSD's Super Conductor Spark Plug wires and can be removed to use additional jaws (sold separately) for crimping common wiring terminals.

Description	Part No.
MSD Pro Crimp Tool	3505
Spark Plug Dies	3508
Amp Pins	3506
Amp Lug Dies	3507
Weathertight Dies	3509
Deutsch Terminal Dies	3510



## TERMINAL DETENT TOOL

The hollow barrel allows you to depress the tab on the terminal end and to remove the wire from the connector without damaging its ends.

Description	Part No.
Terminal Detent Tool	59-0254

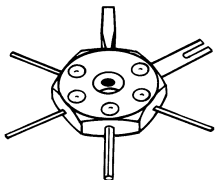

## TERMINAL REMOVAL TOOL

Includes six different shaped blades.

Description	Part No.
Terminal Removal Tool	LS14900



## PERMA-SEAL CONNECTOR KIT

Description	Part No.
MSD Perma-Seal Connector Kit	4377



## TIMING LIGHTS

MSD offers a heavy duty top quality timing light. This timing light is supplied in a heavy duty metal housing and features a high output Linear Xenon strobe with a focused fresnel lens that produces a light that's bright enough to use outdoors. It is equipped with a 6 foot lead and uses a metal inductive pickup that clamps to the spark plug wire.

Description	Part No.
Timing Light	8990



## TDC DIAL INDICATOR KIT

Perfect for indicating TDC (Top Dead Center) when setting ignition and rotary valve timing. CNC-machined spark plug hole (14mm) adapter. 1" travel dial indicator. Rotating Bezel. Measures in .001" increments.

Description	Part No.
TDC Indicator	MT-DIAL



## TIMING DEGREE WHEEL

Set total loss timing with no guess work. Check crank shaft timing to exact degree. A must for porting and port timing.

Description	Part No.
Timing Degree Wheel	08-0092



## FLYWHEEL PULLER

Description	Part No.
Sea Doo 800/951 38mm x 1.5	MP#42
Kawasaki 900/1100 35mm x 1.5	DS#29

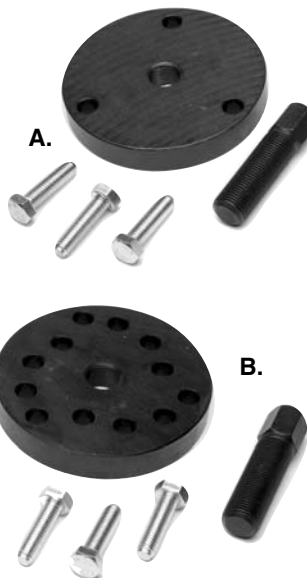

## MAGNETO FLYWHEEL PULLER

Sea Doo	Part No.
A. 580/650/720	DS#34
3 Hole Disc 8mm Bolts	

Polaris	Part No.
B. Polaris ALL & Universal	DS#37
Universal 12 Hole Disc 8mm Bolts	

YAMAHA	Part No.
B. 500/650/Pre 94 701	DS#37
Universal 12 Hole Disc 8mm Bolts	
B. 701/760/800/1100/1200	DS#37
Universal 12 Hole Disc 8mm Bolts	

KAWASAKI	Part No.
B. 300/440/550/650	DS#37
Universal 12 Hole Disc 8mm Bolts	



C. 750/800 Special	MP#18
18mm x 1.5 Right Hand Bolt	



# PUMP SYSTEM SERVICE TOOLS AND BATTERY CHARGERS



## IMPELLER HOLDER TOOL

Sea Doo	Part No.
A. 580/650/720/800/951 All 18mm spline	DS#23
POLARIS	Part No.
B. Polaris ALL & long reach univ.	DS#38



## IMPELLER HOLDER TOOL

Sea Doo	Part No.
K. GTX 4Tec Super Charged	DS#70
L. RXP/RXT 27MM	DS#71



## DRIVE COUPLER TOOLS

Use to remove drive coupler from crankshaft and sub-shaft.

Description	Part No.
650/701	DS#60-3
760/800/110/1200	DS#61-5



## SOLAS IMPELLER HOLDER TOOL

Sea Doo	Part No.
RXP/RXT 27MM	WR012-SRX

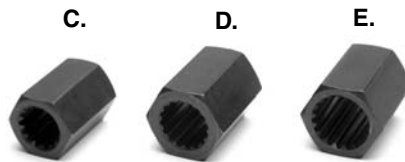

## IMPELLER SHAFT HOLDER TOOL FOR YAMAHA

Yamaha	Part No.
C. WR500, WJ650LX 16mm spline	DS#27
D. 650/701/760/1100/1200 18mm spline	DS#32
E. GP1200R 20mm spline	DS#56



## IMPELLER HOLDER TOOL FOR KAWASAKI

Kawasaki	Part No.
F. 440/550-89 16mm spline	DS#24
G. 650/750/900/1100 18mm spline	DS#23



## MAINTAINER MODEL #CU2602

Total Amps: 0.5  
Battery System: 12Volt



## CHARGER MODEL #CU2606A

Total Amps: 6  
Battery System: 12Volt

## MAINTAINER MODEL #CU2603

Total Amps: 3  
Battery System: 12Volt



## CHARGER MODEL #CU2612A

Total Amps: 10  
Battery System: 12Volt



## GUEST 12 VOLT MAINTAINERS AND PORTABLE BATTERY CHARGERS

AMPS	TYPE	PART/MODEL #	TERMINATION	DIMENSIONS	CHARGING CABLE LENGTH	AC/WALL CABLE LENGTH	WEIGHT
.5	Maintainer	CU2602	Alligator Clips	1.5" x 3.0" x 2.0"	4'	6' w/Standard Plug	.5LBs
3	Charger	CU2603	Alligator Clips	3.1" x 3.5" x 2.34"	4'	6' w/Standard Plug	1LBs
6	Portable	CU2606A	Alligator Clips	5.5" x 5.0" x 2.4"	4'	6' w/Standard Plug	3.5LBs
10	Portable	CU2612A	Alligator Clips	7.5" x 5.0" x 2.4"	4'	6' w/Standard Plug	4.5LBs

FOUR STROKE  
INTAKE SYSTEMS  
ENGINE/GASKETS  
EXHAUST  
DRIVE LINE HANDLING  
ELECTRICAL  
WATERLINE /BILGE  
STEERING & CONTROLS  
BODY  
ACCESSORIES SERVICE TOOLS /HARDWARE  
CHEMICAL

FOUR  
STROKE

INTAKE  
SYSTEMS

ENGINE/  
GASKETS

EXHAUST

DRIVE LINE  
HANDLING

ELECTRICAL

WATERLINE  
/BILGE

STEERING  
& CONTROLS

BODY

ACCESSORIES

SERVICE TOOLS  
/HARDWARE

CHEMICAL



## VALVE COMPRESSION TOOL SD 4-TEC

Our overhead Valve Compression Tool allows easy removal of valve springs and keepers without removing cylinder head. Includes compression adapter to pressurize cylinder keeping valves in place during removal of stock springs and keepers.

**Description** Part No.  
Tool, Valve Compression, SD 4-TEC RS19050-VCT

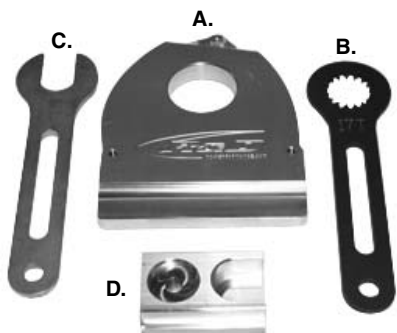

## R&D RXP SC REBUILD TOOL KIT

R&D has designed a custom tool kit that is essential in the rebuilding process of the SeaDoo Supercharger. All tools are specific in application and are cnc machined to ensure a precision job.

Description	Part No.
185 Horsepower Tool Kit*	613-96001
215 Horsepower Tool Kit*	613-96002
A. Supercharger Holder Tool	613-96005
D. Bearing Puller/Installer Tool	613-96006
4-Pin Socket	613-96007
Seal/Bearing Retainer Torx Wrench	613-96008
B. 215HP 16 Tooth Drive Gear Tool	613-96016
B. 185HP 17 Tooth Drive Gear Tool	613-96017
C. 185HP Clutch drive / Lock Washer Tool	613-96018
C. 215HP Clutch drive / Lock Washer Tool	613-96019

\*NOTE: Kit comes with a S/C holder, bearing puller/installer tool, drive gear tool and clutch drive/lock washer tool.



## RIVA SEADOO SUPERCHARGER SHAFT HOLDER TOOL

Our SeaDoo Supercharger Shaft Holder Tool makes servicing your supercharger a snap. Ergonomically designed billet handle allows a sure, firm grip without fatiguing your hand. Working ends are made from heat treated tool-grade steel to resist wear and are oversized to prevent flexing. A must for every mechanic's tool box!

**Description** Part No.  
RIVA SeaDoo SC Shaft Holder Tool RS1750-ISH-949



## TORX® SOCKET SET FOR SEA DOO

Special Star Sockets for Sea Doo 4-Tec & DI engine bolts are made from heat-treated vanadium steel and black oxide coated for durability. Sockets are kept in a convenient vinyl holder.

- Four 3/8" Drive Sockets (T10, T12, T14, T16)
- Three 1/4" Drive Sockets (T6, T7, T8)

**Description** Part No.  
Torx Socket Set LS26750



## SCRATCH BRUSH

Removes rust, scale, paint, and solder from metal surfaces.

**Description** Part No.  
I. Shoe Handle Scratch Brush LS14180  
J. Scratch Brush LS14160



## PARTS CLEANING BRUSH

**Description** Part No.  
Parts Cleaning Brush LS14000



## SUPER OUT SET

A super strong extractor set made of a special hardened, shock-resistant tool steel. Works on both left and right hand threads. Super Outs cut their way straight into bolts, eliminating wedging or further tightening of frozen bolts and screws. Five extractor sizes extract 1/4" to 1/2" and larger bolts and screws.

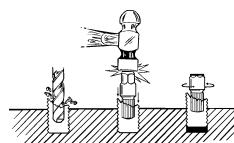

**Description** Part No.  
Super Out Extractor Set LS62900



## 3/8" HAND IMPACT TOOL SET

Loosens Rusted, Frozen Nuts, Bolts and Screws. Unique design delivers over 200 ft. lbs. of "Shock Torque." Can be reversed to tighten. Can also be used with impact sockets!



29200	Impact Set Includes:
29000	3/8" Impact Tool
29520	3/8" Bit Holder
29630	#1 Phillips Bit
30180	#2 Phillips Bit
29550	#3 Phillips Bit
30190	#4 Phillips Bit
30170	3/8" Straight Slot Bit

**Description** Part No.  
3/8" Hand Impact Tool Set LS29200

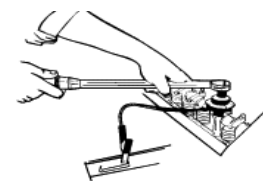

## TORQUE ANGLE METER

For All Torque-to-Yield Fastener Applications. Commonly used for tightening head bolts & other bolts where a torque angle is required. Use with 1/2" drive.

**Description** Part No.  
Torque Angle Meter LS28100





## LISLE CREEPER SEAT/STEP

Ergonomic design with a 300lb. capacity that can be rotated forward onto rubber feet to make a stable 14" tall ladder. Spacious storage tray below the seat keeps tools, test equipment and parts within easy reach. Perfect for PWC service, PWC pump repairs, etc. Wheels pop into tubular steel

legs with an outrigger design for added stability.

<b>Description</b>	<b>Part No.</b>
Lisle Creeper Seat/Step	LS93402



## RULE FLAT TANK ELECTRIC OIL EXTRACTOR

Eliminate those costly yard service fees with the new quick, clean, compact electric oil extractor. Includes a 3-1/2 gallon compact self-priming diaphragm pump for extraction and an easy pour spout for oil transfer.

- 3.5 gallon (13 liter) leak proof container
- Designed for ease of carrying

- Complete with dipstick, suction tube & battery clamps
- Empties and stows easily
- Self-priming, dry running, 12 or 24 volt diaphragm pump

<b>Description</b>	<b>Part No.</b>
Electric Oil Extractor	17860-0012



## HYDRO-TURF OIL EXTRACTOR

The unit uses a small vacuum system, which pumps fluid through a hose to the 6-liter reservoir. It also includes a pour spout to aid in emptying the reservoir. Pump is removable for easy storage.

<b>Description</b>	<b>Part No.</b>
Hydro-Turf Oil Extractor	OIL01

## MOELLER MARINE PRODUCTS FLUID EXTRACTOR

- Empties oil in 15 pumps or less
- Extracts warm or cold oil
- Pressure relief valve allows easy transportation and storage
- Single-hand-ease effortless operation
- Delivers gulp-free, mess-free performance
- Complete adapter kit is included featuring three extraction tubes
- Tethered cap

<b>Description</b>	<b>Part No.</b>
Moeller Oil Extractor (6.5 Liter Fluid Extractor)	MR07398
Moeller Fluid Extractor Tube Replacement Kit	MR08032

\*Note: Not for use with gasoline.

USA Patent #5450924 - Germany Patent #29500683.8 - U.K. Patent #2272948 Australia Patent #674469 - Taiwan Patent #113238 - China Patent #ZL92241981.7



## SHOP LANYARD

Not legal for riding.  
For shop testing only.

A3250 A3240

<b>Description</b>	<b>Part No.</b>
KPTW, Yamaha, Sea Doo	A3240
KPTW, Yamaha, Sea Doo DESS	A3250



## RATIO RITE CUP & LID

<b>Description</b>	<b>Part No.</b>
Ratio Cup	59-0548
Ratio Rite Cup Lid	59-0582

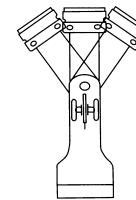

Locks in 3 Different Positions.

## FOLD-UP SCRAPER

The fold-up scraper features three arm positions and a slanted blade for proper scraping. Great for removing decals, etc.

<b>Description</b>	<b>Part No.</b>
Fold-up Scraper	LS52400

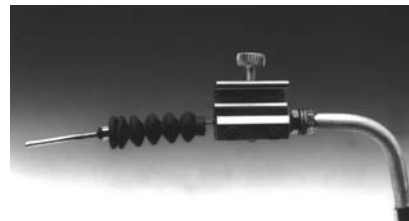

## CABLE LUBBER

Installs quickly and helps free up corroded or tight cables. Note; Damaged cable should be replaced.

<b>Description</b>	<b>Part No.</b>
Cable Lubber	59-0250

FOUR STROKE  
INTAKE SYSTEMS  
ENGINE/GASKETS  
EXHAUST  
DRIVE LINE HANDLING  
ELECTRICAL  
WATERLINE /BILGE  
STEERING & CONTROLS  
BODY  
ACCESSORIES SERVICE TOOLS /HARDWARE  
CHEMICAL

FOUR  
STROKE

INTAKE  
SYSTEMS

ENGINE/  
GASKETS

EXHAUST

DRIVE LINE  
HANDLING

ELECTRICAL

WATERLINE  
/BILGE

STEERING  
& CONTROLS

BODY

SERVICE TOOLS  
ACCESSORIES

/HARDWARE

CHEMICAL



## STUD TOOL

Economy stud installation and removal tool. The kit includes three sizes: 6mm, 8mm and 10mm.

Description	Part No.
Economy Stud Tool Kit	WJ7710



## T-HANDLE RATCHET

Features a compact design that allows it to be used even in tight spaces.

Description	Part No.
1/4" T-Handle Ratchet	08-0231
3/8" T-Handle Ratchet	08-0226



## MAGNETIC SOCKET HOLDERS

Standard and deep sockets fit on one convenient holder with powerful magnets, securely holding on to any steel surface. Red color only.

Description	Part No.
1/4" Holder with 26 compartments	LS40120
3/8" Holder with 28 compartments	LS40200



## STUD INSTALLATION TOOLS

Will install cylinder and intake manifold studs. Hex head is 3/4" or 19mm.

Description	Part No.
6mm x 1.00 Stud Tool	59-0212
8mm x 1.25 Stud Tool	59-0213
10mm x 1.25 Stud Tool	59-0214

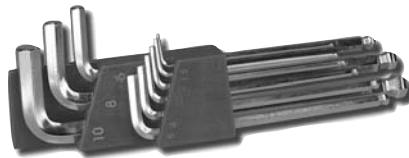

## BALL END ALLEN SET

Made of chrome-vanadium tool steel. Size available 1.5, 2, 2.5, 3, 4, 5, 6, 8, & 10mm. Ball end allows for better access to allen-head bolts (up to 25 degree working angle.)

Description	Part No.
Ball End Allen Set	08-0185

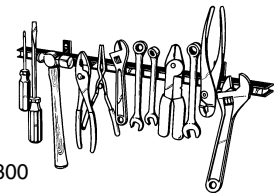

## MAGNETIC TOOL HOLDERS

Powerful magnet holds even heavy hand tools. Ideal for both home and shop.

Description	Part No.
13" long Magnetic Tool Holder	LS21300
24" long Magnetic Tool Holder	LS21400



## HEX-PRO AND STAR-PRO PIVOT HEAD WRENCHES

- Pivot design allows for easy rotation around obstructions
- Heat treated alloy tool steel
- Includes heavy duty folding canvas storage pouch

Description	Part No.
Hex-Pro Metric	08-0420
Hex-Pro SAE	08-0419
Star-Pro	08-0421



## T-HANDLE ALLEN WRENCH

Description	Part No.
5mm - 6" long T-Handle	59-0307
5mm - 9" long T-Handle	59-0309
8mm - 9" long T-Handle	59-0311



## DOC ALLEN'S VERSATOOL

- Lightweight
- Compact
- Multi-Function
- Stainless Steel
- Use in Tight Places

Description	Part No.
Compact Tool Set	VERSATOOL

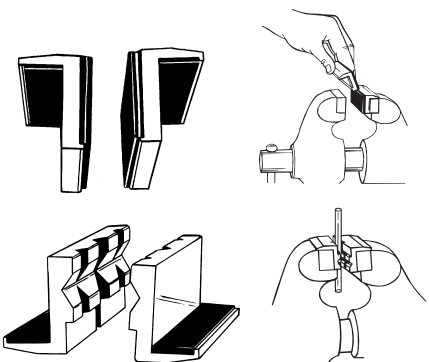

## RUBBER-FACED & ALUMINUM VISE JAW PADS

These vise jaw pads are designed to protect delicate parts from damage. Sold in pairs.

Description	Part No.
A. Rubber-faced Vise Jaw Pads	LS48100
B. Aluminum Vise Jaw Pads	LS48000



DUC-1000

DUC-1001

DUC-1002

### “THE ORIGINAL” DUCKY

#### DUCKY WATER SPOT REMOVER — DUC-1000

DUCKY, the first product ever developed specifically for the removal of hard water stains. Ducky Water Spot Remover is non-abrasive, environmentally friendly and easy to use. Simply spray on and wipe off. Use on fiberglass, glass, painted surfaces, chrome, etc.

#### DUCKY ALL PURPOSE CLEANER — DUC-1001

Use Ducky All Purpose for cleaning: boat hulls, exhaust deposits, upholstery, carpet, other synthetics, chrome, mirrors and windows. Trigger spray activates rich, deep- cleaning foam that penetrates, lifts and suspends grease and grime.

#### DUCKY PWC DETAILER — DUC-1002

Ducky Detailer creates a molecular bond with the surface of your finish, providing ultimate protection from harmful U.V. rays and soil accumulation. Ultra violet brightener will enhance colors while leaving a smooth-to-the-touch, wet-look finish.

Description	Part No.
Water Spot Remover 32oz. (946ml.)	DUC-1000
All Purpose Cleaner 32oz. (946ml.)	DUC-1001
PWC Detailer 24oz. (709ml.)	DUC-1002



### SALT TERMINATOR™

#### Marine Engine Flush & Corrosion Protectant

SALT TERMINATOR™ dissolves salt and leaves a protective sheen, guarding against future salt corrosion. The SALT TERMINATOR™ Mixer automatically dilutes the concentrate and siphons it through a standard garden hose. Connect the hose to your engine's flushing unit and add extra years of service. Spray SALT TERMINATOR™ on all surfaces exposed to salt water or salt air. No scrubbing required!

Description	Part No.
10 oz. Ready-to-Use Spray	SX-10
Quart Concentrate	SX-32
Gallon Concentrate	SX-128
Mixer Only	SX-M



### QUICK CRAFT

QuickCraft forms an insoluble coating that binds a layer of water around the hull. As a result, the drag between the hull and the surrounding water is reduced, and the boat slides through the water with less resistance. Results in increased speed and better fuel efficiency.

Description	Part No.
QuickCraft 16 oz.	QC16
QuickCraft 32 oz.	QC32

2008 WORLD FINALS LAKE HAVASU, AZ  
FRANKY ZAPATA 2008 RUNABOUT GP WORLD CHAMPION  
PHOTO COURTESY OF JIN OMURA

FOUR STROKE	INTAKE SYSTEMS	ENGINE/GASKETS	EXHAUST	DRIVE LINE HANDLING	ELECTRICAL	WATERLINE /BILGE	STEERING & CONTROLS	BODY	ACCESSORIES	SERVICE TOOLS /HARDWARE	CHEMICAL
-------------	----------------	----------------	---------	---------------------	------------	------------------	---------------------	------	-------------	-------------------------	----------

# ThreeBond



#1211AT100

#1207B100G

## THREEBOND SILICON GASKET

### #1211 (White) Silicon Liquid Gasket

High grade silicon liquid gasket used by many OEM's in aluminum case assembly. 1211 is tack free in 90 minutes and fully cured in 24 hours.

### #1207B (Black) Quick Dry Silicon Gasket

Crankcase sealer for large gaps, sheet metal, tough to seal areas, and vertical applications. 1207B is tack free in 5 minutes and fully cured in 24 hours.

Description	Part No.
Silicon Liquid Gasket (White)	1211AT100
Quick Dry Silicon Liquid Gasket (Black)	1207B100G



## THREEBOND PLASTIC REPAIR KIT

- Repairs cracked and broken plastic parts.
- Simple to use, no mixing required.
- Kit will repair at least four to five 6 inch breaks.
- High strength bonding

Description	Part No.
Plastic Repair Kit	TB1743PX



1oz. Bottle



## CORROSION BLOCK MULTI-PURPOSE GREASE

This grease won't soften, breakdown or wash out in wet application. Liquid grease is ideal for use in electrical applications requiring grease.

Description	Part No.
Corrosion Block Liquid 1oz. Bottle	CB-20001



## THREEBOND THREAD LOCK

### (Green Label) High Strength Thread Lock #1303

For various threads, screws, bolts and piping joints which must remain secure.

### (Red Label) Medium Strength Bearing & Stud Thread Lock #1333B

Retain high-strength properties for bearings and studs. Apply heat to soften for easier removal.

### (Red Label) Medium Strength Hi-Temperature Thread Lock #1360

Incorporates anaerobic locking agents and a heat-resistant element for sealing engine and exhaust parts.

### (Blue Label) Low Strength Frequent Repair Thread Lock #1342

Perfect for small screws and bolts.

Description	10mm	50mm
High Strength Thread Lock	1303AT000	1303A50C
Medium Strength Bearing & Stud	1333BT001	1333B50C
Medium Strength Hi-Temperature	1360AT003	1360A50C
Low Strength Frequent Repair	1342AT002	1342A50C



1742BT020



1521A150GM

## THREEBOND SUPERGLUE & ADHESIVE

#1742 Super Glue — Glue attains practical use strength in a matter of seconds.

#1521 Synthetic Rubber Adhesive — A multi-purpose rubber-based adhesive. Bonds rubber, plastic, vinyl, leather. Recommended for stand-up PWC mats.

Description	Part No.
Super Glue	1742BT020
Synthetic Rubber Adhesive	1521A150GM



2008 WORLD FINALS • LAKE HAVASU, AZ  
PHOTO COURTESY OF JIN OMURA

ADA Head & Dome.....	82, 83	Exhaust Valve & Parts.....	111
Adjust-A-Thrust.....	121	Exit Nozzle, Sea Doo.....	122
Air Pump.....	216	Factory Pipe Parts.....	104, 105
Air/Fuel Ratio Kit.....	35	Factory Zero Launcher.....	222, 223
Airhead Tube.....	217-220	Fat Bar.....	15, 39, 176
Anchor, Anchor Bag.....	212	Fat Bar Adapter.....	176
Anti-Cavitation Cone.....	17, 29, 121	Filter Adapters.....	74, 75
AP Design Cover, Mat.....	18, 187, 188, 189	Filter Kit.....	2, 21, 32, 73
Aqua Steps.....	18, 202	Finger Throttle.....	14, 180, 181
ATI Grips.....	182	Fitting.....	63, 157
Auto Trim Kit.....	14, 29, 178	Flame Arrestors.....	72
Back Support.....	206	Flex Hose for Handle Pole.....	166
Banners.....	209	Flip Nozzle Kit.....	179
Battery.....	151	Flow Control Valve.....	110, 159
Battery Charger, Maintainer.....	150	Flush Kit.....	156
Battery Connect.....	151	Flush Kit Adapter.....	45, 157
Beach Stand.....	223	Flywheel Puller.....	146
Beanies.....	209	Foot Hold.....	198
Belt Holder Kit.....	37	Free Flow Exhaust.....	5, 24, 38, 107
Bilge Fitting.....	160	Freestyle Cone.....	121
Bilge Hose.....	160	Front Sponsons.....	129, 132
Bilge Pump.....	160	Fuel Filler, Filler Neck.....	61, 199
Bilge Pump Bracket.....	161	Fuel Injector.....	3, 25
Bilge Sponge.....	163	Fuel Line Hose.....	34, 62, 232
Bilge Switch and Brackets.....	161	Fuel Pick Up.....	60
Blow Off Sound Circulation.....	45	Fuel Pressure Gauge.....	35
Blow Off Valve Block Off.....	6	Fuel Pressure Regulator Kit.....	25, 34
Blow Off Valve Kit.....	6, 36	Fuel Pump Block Off.....	65
Bolts & Nuts.....	230	Fuel Pump Bracket.....	64
Boost Gauge, Adapter.....	35, 37	Fuel Pump Kit.....	26, 35, 64
Boyesen Reeds.....	69	Fuel Pump Upgrade Kit.....	64
Brass Fittings.....	231	Fuel Return Line Kit.....	25
Bulkhead Fitting.....	158	Fuel Tank Filter.....	60
Bumper.....	43, 202	Funnel.....	224
Bunk Glides.....	226	Fuel Pressure Regulator Block Off.....	25
Buoy.....	212	Gas Cap.....	199
Bypass Fitting.....	158	Gasket Set.....	93
Bypass Upgrade Kit.....	32	Goggle Grip.....	205
C1, C2, C3, C4, C5 Charger Wheel.....	9	Grip Lock.....	183
Carb Screw Adjusting Tool.....	52, 233	Grips.....	15, 39, 182-184
Carbon Tech Reeds.....	68	Handle Bar.....	176, 177
Carburetor Kit.....	55	Handle Bar End Caps.....	185
Carburetor Linkage.....	58	Handle Cover Cap, Sea Doo.....	14, 181
Carburetor Rebuild Kit.....	47, 53	Handle Pole Extension.....	170
Carburetor Shaft Collars.....	58	Handle Pole Pivot Bolt Bushing.....	168, 170
Case Block Off, K750.....	65	Handle Pole Shock Pad.....	170
Cat Temperature Sensor.....	107	Handlebar Steering Mount Cover.....	189
Catalytic Converter Removal Plate.....	107	Head.....	80, 81, 82, 83
Catch Can/Oil Breather.....	3	High Flow Exhaust Kit.....	24
Charging Flywheel.....	145	Handle Pole.....	166
Chin Pad.....	169	Handle Pole Bracket.....	166
Chin Pad Cover.....	187	Handle Pole Spring.....	171
Clamps.....	231	Handlebar Adapter.....	41
Coil.....	139, 149	Holeshot Rod.....	14
Compression Tester.....	235	Hood Hand Hold Kit.....	197
Connecting Rod.....	90, 91	Hood Hooks.....	196, 197
Cover.....	203, 204	Hood Insert.....	196
Covercraft Cover.....	203	Hood Seals.....	196
Crank Case Breather.....	3	Hooker Impeller.....	118
Crank Pin Bearings.....	89	Hood Latch.....	197
Crank Shaft Assembly.....	92	Hose Clamps.....	158
Crank Shaft Parts, Sea Doo.....	91	Hose Pinches.....	62, 233
Crank Shaft Bearings.....	91	Hose Removal Plier.....	62, 233
Crankshaft Oil Seal Kit.....	92	Hose Shears.....	62, 232
Crankshaft Web.....	92	Hydro Turf Seat Cover.....	18, 31, 44
Crimp Tool.....	141	Hull Insert.....	128, 129
Decals.....	208	Hydro Turf Mat.....	44, 192, 193
Deep Fuel Pick Up.....	34, 60	Hydro Turf Sheet.....	194
Dock Line.....	213	Idle Gear.....	147
D-Plate.....	107	Igni-Pro Ignition, K800SXR.....	144
Drive Coupler.....	36, 136, 137	Ignition Controller.....	143
Drive Coupler Wrench.....	136	Ignition System.....	138
Drive Gear.....	147	Ignition System Spark tester.....	142, 235
Drive Shaft.....	135, 136, 137	Impeller.....	16
Drive Shaft Bearing Housing.....	137	Impeller Holder Tool.....	16, 29, 237
Driver Wheel Holder Tool.....	37	Impeller Pitch Gauge.....	117
Driveshaft Shim Kit.....	42	Impeller Seal.....	16
Drop Nozzle Kit.....	178	Impro Impellers.....	118
Dry Pak, Box.....	214	Intake Manifold/Intercooler CFM Kit.....	21
Dual Exhaust Kit.....	109	Individual Gasket.....	93-102
Duck Bill Drain System.....	163	Inline Water Filter.....	158
Ducky Spot Remover, Cleaner.....	201	Intake Block Off.....	6
DVD, VHS.....	228	Intake Grate.....	12, 28, 40, 123-125
ECU, Sea Do Pro series.....	11	Intake Hose Kit.....	7, 22
ECU, Yamaha Pro-Series.....	26	Intake Manifold.....	55, 56, 57, 70
EFI Control, GP1300R.....	144	Intake Manifold Upgrade Kit.....	2, 21
Engine Keepers, Blowson.....	79	Intercooler.....	6
Engine Performer Kit, U250.....	33	Intercooler Cooling Kit.....	24
Engine Shim.....	79	Intercooler Core Kit.....	23
Engine Stage 1 Performance Kit, U250.....	33	Intercooler Kit.....	23
Engine Thermometer.....	90	Intercooler Temp Control Pressure Relief Valve.....	24
Enhancer.....	140	Intercooler Temp Control Upgrade Kit.....	37
Exhaust Spring Kit.....	107	Intercooler Upgrade Kit.....	6
Exhaust Bushing, Sea Doo.....	106	Jet Pump Housing.....	136
Exhaust Diffuser.....	106	Jettrim Seat Cover.....	18, 31, 44, 190, 191
Exhaust Manifold Extender.....	5	Jumper Cable.....	151, 235
Exhaust Nozzle.....	111, 199	K&N Flame Arrestors.....	72, 74
Exhaust Outlet.....	24, 38	Keihin Carb & Parts.....	52
Exhaust Power Sleeve.....	109	Keihin Carb Rebuild Kit.....	53
Exhaust Tip.....	38	Keihin Fuel Pump Rebuild Kit.....	52

FOUR STROKE	INTAKE SYSTEMS	ENGINE/ GASKETS	EXHAUST	DRIVE LINE HANDLING	ELECTRICAL	WATERLINE /BILGE	STEERING & CONTROLS	BODY	ACCESSORIES	SERVICE TOOLS /HARDWARE	CHEMICAL

**FOUR STROKE**  
**INTAKE SYSTEMS**  
**ENGINE/ GASKETS**  
**EXHAUST**  
**DRIVE LINE HANDLING**  
**ELECTRICAL**  
**WATERLINE /BILGE**  
**STEERING & CONTROLS**  
**BODY**  
**ACCESSORIES**  
**SERVICE TOOLS /HARDWARE**  
**CHEMICAL**

Kick Tail.....	194	Spark Plug Retainer .....	139, 155
Lanyards .....	210, 211	Spark Plug Wire .....	139, 155
Leg Deflector.....	206	Spark Plug Wrench .....	155, 235
Life Sled for PWC Rescue.....	207	Spec Floats for Sunglasses.....	205
Linkage Rod .....	58	Spigot Mount Flange.....	64
Lizardskins Grips.....	186	Splash Guard .....	195
Lock Rings for ODI Grips .....	184	Sponsons .....	13, 28, 41, 129-133
Magnum Pump .....	42	Spring Tension Stand.....	166, 171
Mat Adhesive.....	194	SportsStuff Tube .....	221
Mat, Side, Bottom.....	187	Stage I, II, III Kit .....	20, 35
Mikuni Carburetor Rebuild Kit.....	47	Starter .....	147, 148
Mikuni Carburetors .....	46	Starter Relay .....	141
Mikuni Jets, Needle & Seat.....	50	Starter Solenoid .....	148
Mikuni Parts .....	48, 49, 50, 51	Steering Cable.....	165
Mikuni Pocket Tuner .....	47	Steering Head, X-Mount, Sea Doo .....	15
Mikuni Tool Kit .....	47, 233	Steering mount Cover. Sea Doo.....	15, 175
Mirror Block Off .....	43, 196	Steering Nozzle .....	14, 29, 179
Motogrip Trainer.....	183	Steering Stop .....	169
Motor Mount .....	78, 79	Steering System.....	39
Multi-Pressure Port Adaptor Kit.....	26	Sunglasses .....	204, 205
Nose Bushing .....	198	Super Pump Cone.....	120
Novi Tec Carburetors .....	54	Supercharger Bearings.....	10, 36
Nujet Impeller .....	119	Supercharger Belt Tensioner Wheel .....	36
Numbers Decals.....	200, 201	Supercharger Clutch Washer .....	10
O2 Sensor Mount Kit.....	24, 107	Supercharger Gear .....	10
ODI Grips .....	184, 185	Supercharger Gear Oil.....	37
Oeitiker Clamp .....	62, 158	Supercharger Impeller & Housing .....	7, 8, 22
Oil Cap .....	45	Supercharger Pulleys .....	36
Oil Extractor.....	19, 103, 225, 229	Supercharger Sleeve .....	10
Oil Filter .....	19, 45, 103	Supercharger Surge Protector.....	7
Oil Injection Block Off .....	65	Supercharger Tool.....	8, 23, 37
One Way Fuel Check Valve .....	60	Supercharger Velocity Stack .....	8
One Way Drain Valve.....	164	Supercharger Wheel Billet Hub Kit .....	37
OPAS Block Off Kit.....	12, 130, 131	Surge Protector Valve .....	7
OPAS Off Shore Kit .....	131	Surge Protector Kit .....	23
Outerwears Pre-filter.....	73	Switch .....	152, 162
Perma-Seal Connection Kit .....	141	Switch Holder .....	152, 175
Piston .....	84, 85, 86, 87, 88	Tachometers .....	150
Pivot Mount.....	171	Tau Ceti Filters .....	73
Pop-Off Gauge.....	47, 233	T-Bolt Clamp .....	106
Power Bomb Carburetor .....	54	Telescoping Paddles .....	206
Power Cooler .....	23	Temp. Sensor Interfacer .....	37
Power Filter Kit, Riva .....	2, 21, 32, 76, 77	Terminal Detent Tool .....	142
Power Plenum Filter Kit, R&D .....	2, 21, 76, 77	Thermostat Kit .....	11
Powershot Fuel Tuner .....	3, 26, 33, 144	T-Fittings .....	230
Pre-Filters.....	73	Throttle Cable Adapter .....	181
Primer Kit .....	63	Throttle Cable Bracket .....	59
Pro-X Pistons .....	88	Throttle Cable Drum.....	59
PTO, Sea Doo .....	135	Throttle Cables.....	75
Pulleys .....	36	Throttle Conversion Kit .....	14
Pump Shoe Seal Kit.....	29, 42, 129	Thru Hull Fitting .....	17, 159
Pump Cone Kit.....	16	Tie Downs .....	226
Pump Extension Kit. RXP, RXP, -X .....	17	Timing Advance Cover .....	145
Pump Housing Bearings, Sea Doo .....	134	Timing Advance Plate .....	140, 146
Pump Shaft.....	134, 136, 137	Timing Light .....	141
Pump Shoe .....	123	Top End Bearings .....	89
Pump Wedge Kit.....	13, 42, 122	Top Stop Billet Steering.....	15
Quick Connect .....	157	Total Loss Flywheel.....	145
Quick Drain .....	45, 163	Total Loss Ignition System .....	138
Quick Loop.....	198	Tow Hook.....	216
Quick Steering Adapter, SJ.....	166, 178	Tow Rope.....	215
Rail Cap, SXR .....	197	Trailer Accessories .....	227
Ratio Rite .....	224	Trim Lever .....	179
Rear Seat, Carbon .....	43	Trim/Switch Housing, SD RXP, .....	15
Rear Seat .....	195	Torx Socket Set for Sea Doo .....	19
Reduction Nozzle .....	14, 122	T-shirts.....	208, 209
Reed Spacers .....	71	Tube .....	217, 218, 219, 220, 221
Reed Stuffers .....	70	Tube Rope .....	215
Registration Numbers .....	200, 201	Turn Plate.....	169, 172, 173
Repair Manual.....	229	UMI Top Stop Billet Steering System .....	173
Rescue Streamer Distress Signal .....	206	Valve .....	89
Restrictor .....	61	Valve Compression Tool .....	11
Rev-Limiter, Sea Doo .....	143	Valve Cover Block Off .....	38
Ride Plate .....	28, 40, 126, 127, 128	Valve Train Upgrade Kit .....	11
Rotary Shaft Puller.....	66	Velocity Stack Kit .....	77
Rotary Valve Timing Wheel.....	66, 233	Ventilation/Oil & Vapor Separator .....	36
Rotary Valve Parts .....	66	Vesiplug Drain System .....	164
RRP Handle Pole .....	166, 167	V-Force Reed Kit .....	67
R-Series Impeller .....	16	View Tainer.....	214
Salt Terminator.....	241	VTS Extension Rod .....	13, 222
Sand & Debris Filter .....	17	VTS Quick Shift Cam Kit .....	29
Sealed Bearing System .....	169, 172	Waste Gate Block Off Kit.....	37
Seat Cover.....	18, 31, 44, 188, 189, 190, 191	Water Box.....	4, 38, 108
Service Tools .....	234, 235, 236, 237, 238, 239	Water Box Hose Clamp .....	4
Shop/Work Stand .....	223	Water Controller.....	109, 143
Shrink Butt Connectors.....	142	Water Filter/Restrictor .....	159
Silicon Couplers.....	4, 24, 104, 105, 106	Water Injection.....	108, 141
Silicon Intake Hose Kit .....	22	Water Restrictor.....	110, 159
Silver Accessories .....	205	Water Strainer .....	159
Skat Trak Impeller .....	16, 29, 43, 112-115	Waterline Filter .....	159
Sleeve.....	84, 85, 86, 87	Waterline Hose.....	158, 232
Snap Connect & Flow Control .....	19, 45, 157	Wear Ring, Sea Doo .....	17, 135
Solas Impeller .....	16, 43, 116, 117	Weathertight Connectors.....	141, 142
Solenoid.....	108	Wet Wolf Adjust-A-Thrust .....	121
Solenoid Post, Kawasaki.....	148	Whistle.....	211
Sound Suppression Removal Tube.....	107	Wiseco Pistons.....	84, 85, 86, 87
Spacer .....	15	Wrist Band .....	211
Spark Plug.....	19, 45, 154, 155	Wrist Pin Bearings .....	89
Spark Plug Boots.....	139, 155	Zip Tie .....	230
Spark Plug Gauge & Gapper.....	155, 235		

[WWW.HOTPRODUCTSUSA.COM](http://WWW.HOTPRODUCTSUSA.COM)

THE HIGH PERFORMANCE WATERCRAFT SPECIALIST SINCE 1985



SALES 858-453-4454 FAX 858-453-2046  
8830 REHCO ROAD #F SAN DIEGO, CA 92121