

AMK inc

PRODUCTS



 THE FERRY CAP & SET SCREW COMPANY BOSTON, MASS. U.S.A.	 MACLEAN-FOGG COMPANY MUNDLEIN, ILLINOIS 60060	 6023548 1000 SEP 24 1968	 SEMS
 STANSREW FASTENERS STANBROOK, CONNECTICUT	 TINNERMAN PRODUCTS, INC. CLEVELAND OHIO	 You Can't Beat Garrett GEORGE K. GARRETT CO. Piquette, OHIO, U.S.A.	 EATON RUBENSON DIVISION RATISBOLA, OHIO, U.S.A. Products of Creative Research
 Specialty Screw Corp. 5350 HOFFMAN ROAD ROCKFORD, ILLINOIS 61103	 CLEVELAND-KENT CHICAGO - BIRMINGHAM	 B	 Larry Fasteners TWIN FALLS, IDAHO

 THE McLAUGHLIN CO. McLaughlin NEW BEDFORD, MASS., U.S.A.	 ACCURATE FASTENERS INC. 1008 W. PERRY ST. CHICAGO, ILL.	 ELCO INDUSTRIES, INC. ROCKFORD DIVISION ROCKFORD, ILLINOIS
 CORBIN CORBIN HOSE CLAMP DIVISION OF BRADCO CORPORATION SERIK, CONNECTICUT 06827	 BOLT & NUT MFG. 439 N. OGDEN AVE CHICAGO, ILL. 60622	 CARR FASTENER 1000 W. 10TH ST., CHICAGO, ILL. 60608
 Garrett OF FINE ALLOY STEEL	 CENTRAL SCREW CO. REGISTERED U.S. PATENT OFFICE 145 HARVEY ST., CHICAGO, ILL.	 National SCREW & MFG. CO. CLEVELAND, OHIO

 REPUBLIC FASTENERS	 Rockford INDUSTRIAL SCREW PRODUCTS CO., ROCKFORD, ILLINOIS RFD, U.S.A.	 Ring Screw Division 2200 SHEWWOOD AVE. WARREN, MICHIGAN	 GREAT LAKES SCREW LAKESIDE, OHIO
 Nylok-Detroit 1893 BARRETT RD. TROY, MICH. 48064 WE'RE ALL FOR BETTER PRODUCTS	 R.B.W. BRUSSEL, BELGIUM & WARD BOLT AND NUT CO. WARD, OHIO	 American 34603-52 511-9701 00-00 0231-0531 2510 42 NT 934930002 SHAKEPROOF	 PALNUT LOCK NUTS AND FASTENERS THE PALNUT COMPANY MILWAUKEE, WISCONSIN
 FORD PART 57139-S39 QUANTITY 800 MFI 271 5656 REPUBLIC STEEL CORP. - CLEVELAND, OHIO	 PALNUT FOR FUNCTIONAL PERFORMANCE PALNUT A LOCKWASH DIVISION OF THE PALNUT COMPANY MILWAUKEE, WISCONSIN	 Tek's SELF-DRAWING FASTENERS SPEED FASTENERS, INCORPORATED 1000 W. 10TH ST., CHICAGO, ILL.	 Everlock Detroit, Inc. Div. of Vare Corp.

 ELCO SCREWS BOLTS NUTS SPECIALS By the Cold Heading Method ELCO TOOL SCREW CORPORATION ROCKFORD, ILLINOIS	 CLEVELAND CAP SCREW 1000 W. PERRY ST., CHICAGO, ILL. 60608 A DIVISION OF STANDARD PROCESS STEEL CO. - ST. LOUIS	 TAPRITE ANOTHER CATEGORY HOLITE FASTENERS 1000 W. PERRY ST., CHICAGO, ILL. 60608	 Everlock Detroit, Inc. Div. of Vare Corp.
 International Screw Co. INDIANAPOLIS, INDIANA A MICRODOT COMPANY	 Townsend Company TOWNSEND OF FASTENERS DIVISION 1000 W. PERRY ST., CHICAGO, ILL. 60608	 Sprockles STEEL COMPANY 1000 W. PERRY ST., CHICAGO, ILL. 60608	 PALNUT FOR FUNCTIONAL PERFORMANCE PALNUT A LOCKWASH DIVISION OF THE PALNUT COMPANY MILWAUKEE, WISCONSIN
 REPUBLIC STEEL BOLT AND NUT DIVISION CHICAGO, OHIO - CLEVELAND, OHIO MADE IN U.S.A.	 Tek's SELF-DRAWING FASTENERS SPEED FASTENERS, INCORPORATED 1000 W. 10TH ST., CHICAGO, ILL.	 Everlock Detroit, Inc. Div. of Vare Corp.	 PALNUT FOR FUNCTIONAL PERFORMANCE PALNUT A LOCKWASH DIVISION OF THE PALNUT COMPANY MILWAUKEE, WISCONSIN

 ANCHOR FASTENERS 1000 W. PERRY ST., CHICAGO, ILL.	 FASTEX THE BRONXVILLE, N.Y. PLANT, ILLINOIS	 BRAINARD RIVETS CHICAGO, ILL.	 QUARTER PAK SPRING LOCK WASHERS PHILADELPHIA STEEL & WIRE CORP. PHILADELPHIA, PENN. - U.S.A.
 THE LAMSON & SESSIONS CO. CLEVELAND, OHIO MADE IN U.S.A.	 PHEOLL INDUSTRIAL SCREW PRODUCTS, INC. CHICAGO, ILLINOIS	 REPUBLIC STEEL BOLT AND NUT DIVISION CHICAGO, OHIO - CLEVELAND, OHIO MADE IN U.S.A.	 NATIONAL LOCK ROCKFORD, ILLINOIS
 Look for the T	 Rockford INDUSTRIAL SCREW PRODUCTS CO. ROCKFORD, ILLINOIS	 NATIONAL LOCK ROCKFORD, ILLINOIS	 34927-54 QUANTITY 3500 MFI 1000 SEP 17 1968 INDUSTRIAL SCREW PRODUCTS CO. ROCK

 CARLTON SCREWS NUTS WASHERS	 GREAT LAKES SCREWS BOLTS NUTS SPECIALS By the Cold Heading Method ELCO TOOL SCREW CORPORATION ROCKFORD, ILLINOIS	 PSN PIONEER SCREW & NUT CO. 1000 W. PERRY ST., CHICAGO, ILL.	 PARKER-KALON QUALITY CARBIDE FASTENERS CHICAGO, ILL.
 WOLVERINE NUT COMPANY DIVISION OF KELCO PRODUCE CORPORATION 1000 W. PERRY ST., CHICAGO, ILL.	 National THE NATIONAL SCREW & BUSHING CO. INDIANAPOLIS, INDIANA	 REPUBLIC STEEL BOLT AND NUT DIVISION CHICAGO, OHIO - CLEVELAND, OHIO MADE IN U.S.A.	 WOODCUT WALKER MFG. CO. MILWAUKEE, WIS.
 CAMCAR TAPRITE MICRODOT SCREW & NUT CO.	 Rockford INDUSTRIAL SCREW PRODUCTS CO. ROCKFORD, ILLINOIS	 SEMS TEKSTAR DIV. 1000 W. PERRY ST., CHICAGO, ILL.	 REPUBLIC STEEL BOLT AND NUT DIVISION CHICAGO, OHIO - CLEVELAND, OHIO MADE IN U.S.A.

"American Automotive Fasteners"

Welcome to AMK Products

AMK Products was founded in 1990. We started in business selling genuine NOS FoMoCo parts purchased from hundreds of dealerships and rebuilding difficult to find chassis and electrical components.

In 1992 AMK purchased 1200 lbs of obsolete FoMoCo fasteners, our immediate success convinced us to move forward.

Today we stock 3500+ different Chrysler, Ford and GM fasteners weighing in at over 1 million lbs !

AMK believes in American Made quality. We design and finish tooling in our Virginia facility and produce 95% of all fasteners here in USA where your American classic was born !

AMK also believes in preserving our environment. We replaced our old metal halide lighting with brighter T8 fluorescent fixtures which use 55% less electricity, replaced our inefficient AC/heating system with geothermal heat pumps and we added a 30KW solar power plant which provides all of our electricity and 10% extra for our neighbors.

Front Cover. We have collected original fastener cartons since our beginning. During the innovative 1960's with fastener manufacturing profits high as screw machined parts continued to be converted to cold forming methods of manufacture many companies purchased colorful advertising for their shipping cartons.



AMK Products, Inc. 800 Airport Road, Winchester, VA 22602

phone 540-662-7820 **fax** 800-518-2871 **on-line catalog** www.amkproducts.com

AMK Products Trademarks



Bolts, Nuts, Screws, Studs	- Other Fasteners -	- Chrysler -
Bolts _____	Bushings _____ 138	Master Kits _____ 196
Bumper _____ 6	Clamps _____ 139	Individual Kits _____ 198
Carriage _____ 8	Clips _____	Radiator Caps _____ 201
Hex 1/4 - 3/8 _____ 9	J _____ 143	
Hex 7/16 + _____ 16	O, S _____ 143	
Hex Flange _____ 24	1X _____ 145	
Hub _____ 31	2X, 4X _____ 149	
J _____ 31	Fittings _____ 151	
Place _____ 32	Pins _____ 152	
Shoulder _____ 34	Plugs _____ 154	
T, U _____ 36	Retainers _____	
Nuts _____	C & E _____ 155	
Hex _____ 39	Dashpad _____ 156	
Hex - Slot _____ 46	Moulding _____ 156	
Hex Flange _____ 48	Panel _____ 158	
Keps _____ 51	Push _____ 158	
Lug _____ 55	Reveal _____ 160	
Nut & Retainers - Cage, J, U _____ 56	Rod End _____ 161	
Nylon _____ 61	Rivets _____	
Pierce _____ 62	Blind _____ 162	
Rivet, Sleeve _____ 62	Drive, Nylon _____ 163	
Spring _____ 64	Semi-Tubular _____ 163	
Stamped _____ 68	Solid, Upset _____ 164	
Stop, Well _____ 72	Rubber _____ 165	
Wing _____ 73	Sealer _____ 166	
Screws - Tapping _____	Spacers _____ 168	
Fillister _____ 74	Springs _____ 172	
Flat _____ 74	Straps _____ 173	
Hex _____ 75	Tape _____ 176	
Hex Washer _____ 77	Washers _____	
Oval _____ 81	Conical, Cup, Finish _____ 177	
Pan _____ 85	Flat _____ 180	
Round Washer _____ 89	Lock Tab, Shims _____ 185	
Truss _____ 91	Split _____ 186	
Wafer _____ 91	Tooth _____ 188	
Screws - UNC & UNF _____	Valve Cover _____ 189	
Fillister _____ 92	Wave _____ 189	
Flat _____ 93		
Hex #8 - 1/4 _____ 94		
Hex 5/16 _____ 100		
Hex 3/8 + _____ 109		
Hex Washer _____ 115		
Oval _____ 120		
Pan _____ 122		
Round _____ 125		
Socket _____ 126		
Wafer, Wing, 12 PT _____ 126		
Studs _____		
Ball _____ 128		
Double End _____ 128		
Full Thread _____ 132		
Hex Collar _____ 133		
Hex Flange _____ 136		
Round Collar _____ 136		
Stud & Retainer _____ 137		
	- Special Category -	
	Brake Hardware _____	
	Ford _____ 190	
	GM _____ 192	
	Headlamp Hardware _____ 193	
	Seat Belt Attachments _____ 194	
		- Ford -
		Master Kits _____
		Body _____ 202
		Engine _____ 204
		Interior _____ 212
		Chassis _____ 214
		Junior Kits _____
		Air Conditioning _____ 217
		Brake & Fuel Lines _____ 216
		Bumper Mounting _____ 203
		Engine Mounting _____ 211
		Folding Seat _____ 213
		Seat Belts _____ 213
		Stainless _____ 219
		Underhood Detailing _____ 218
		Wiring Clips _____ 217
		Individual Kits _____
		Engine _____ 206
		General _____ 220
		Parts _____
		Misc _____ 290
		Exhaust Clamps _____ 294
		Radiator Caps _____ 295
		- GM -
		Master Kits _____
		Body _____ 296
		Engine _____ 298
		Interior _____ 302
		Chassis _____ 303
		Junior Kits _____
		Air Conditioning _____ 305
		Underhood Detailing _____ 306
		Individual Kits _____
		Engine _____ 299
		General _____ 308
		- Information -
		Dealers _____ 416
		Environment _____ IBC
		FAQ _____ 415
		Finish Codes _____ 4,BC
		Glossary _____ 403
		Measuring _____ 3
		OEM Index _____ 405
		Order Form _____ 411
		Policies _____ 412

Nomenclature

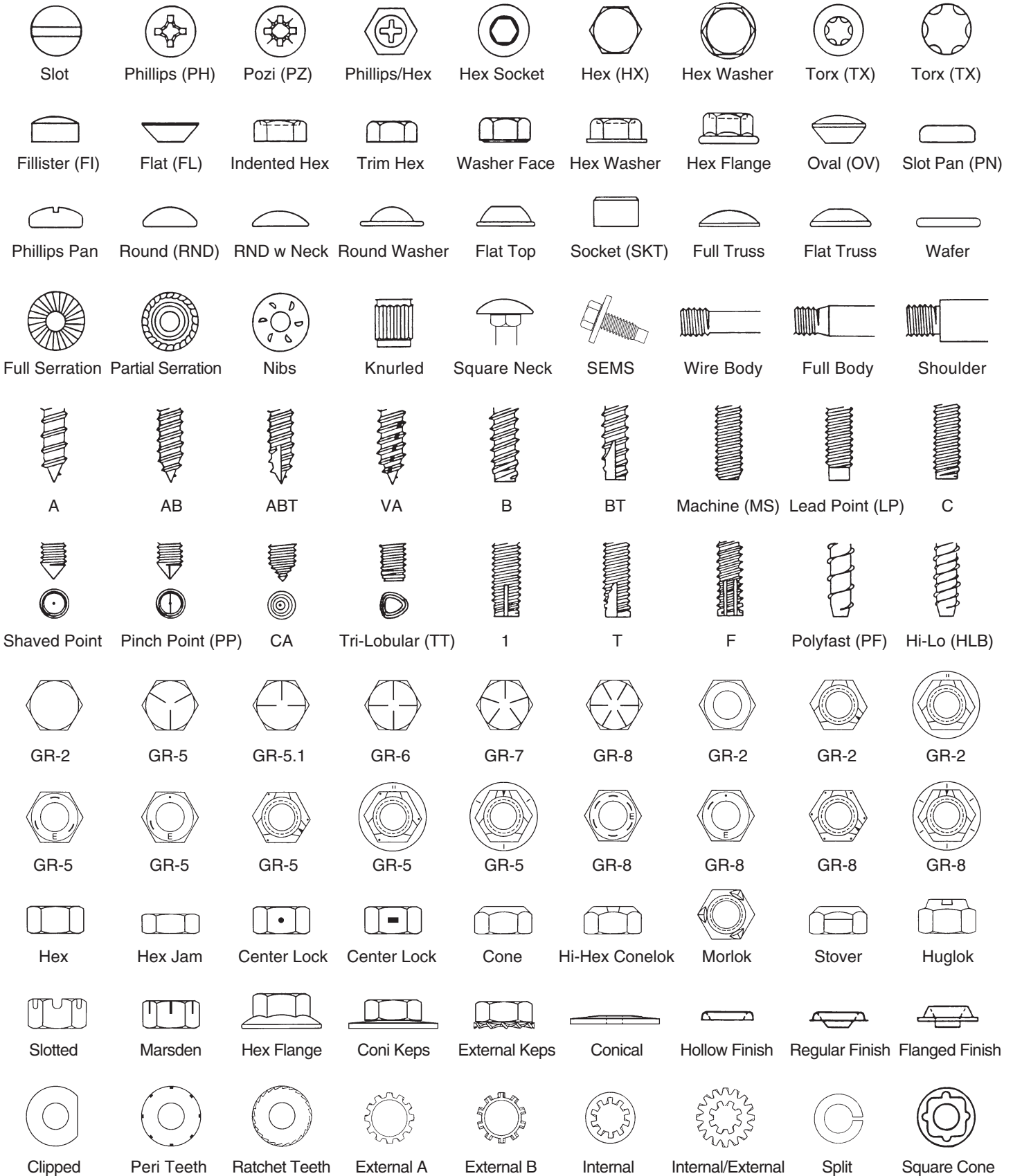

How to Measure

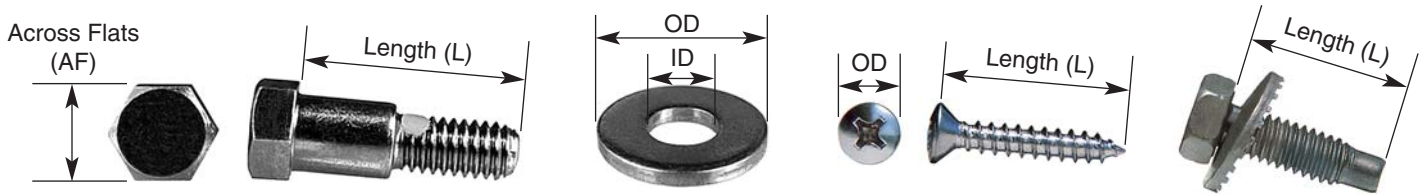

Threads

	INCH				METRIC				INCH				METRIC			
	Size	OD	TPI	Type	Size	OD	TPI	Type	Size	OD	TPI	Type	Size	OD	TPI	Type
	4	.111	40	UNC	12	.215	14	AB, ABT, B, BT	3/8	.374	24	UNF	M3	.5		Coarse
	6	.139	20	AB, ABT, B, BT	12	.215	24	UNC	7/16	.436	14	UNC	M3.5	.6		Coarse
	6	.137	32	UNC	1/4	.246	10	A	7/16	.436	20	UNF	M3.5 (#6)	1.34		AB, ABT, B, BT
	8	.166	15	A	1/4	.246	14	AB, ABT, B, BT	1/2	.498	13	UNC	M4	.7		Coarse
	8	.166	18	AB, ABT, B, BT	1/4	.249	20	UNC	1/2	.498	20	UNF	M4.2 (#8)	1.41		AB, ABT, B, BT
	8	.163	32	UNC	1/4	.249	28	UNF	9/16	.561	12	UNC	M4.8 (#10)	1.59		AB, ABT, B, BT
	10	.189	12	A	5/16	.315	12	AB, ABT, B, BT	9/16	.561	18	UNF	M5	.8		Coarse
	10	.189	16	AB, ABT, B, BT	5/16	.311	18	UNC	5/8	.623	11	UNC	M5	1.59		AB, ABT, B, BT
	10	.189	24	UNC	5/16	.311	24	UNF	5/8	.624	18	UNF				
	10	.189	32	UNF	3/8	.374	16	UNC	3/4	.749	16	UNF				

Scales

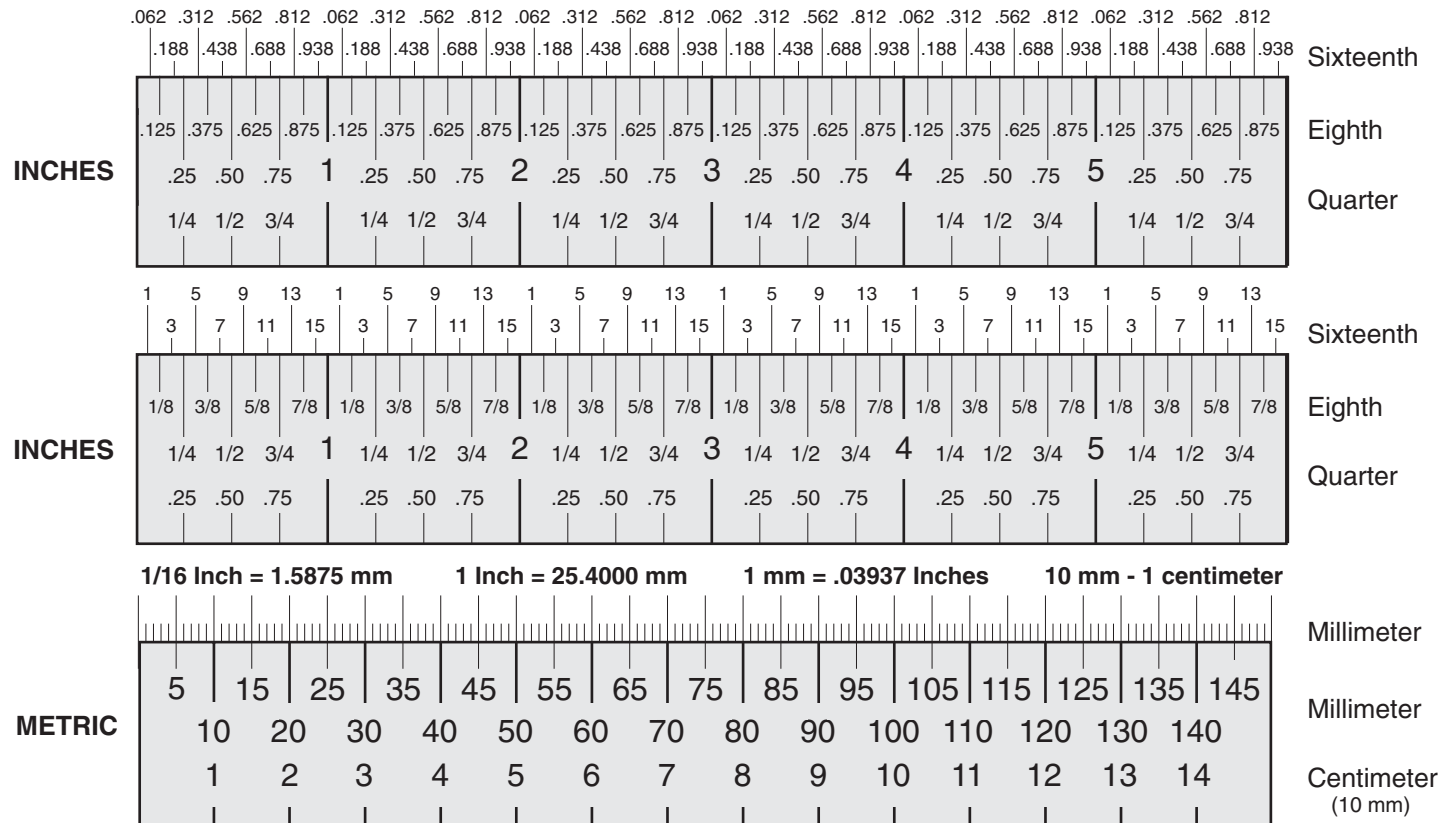

how to use the **BULK** fastener section

About 60% of AMK fasteners are available as bulk. These are popular or common items. The other 40% which includes mostly low volume specialty items are only available in kits.

Due to limited catalog space some bulk items are only displayed online at www.amkproducts.com/bulk1.asp

The diagram shows a product listing for a fastener. The listing includes a photograph of the fastener, a physical description, an internal bin code, a finish code, a table with columns for 'S36', 'Pcs', and 'Price', and a table with columns for 'Chrysler, FORD, GM #', 'Ford numbers end with "-S"', 'Chrysler & GM use a different number for each finish', and 'Chrysler numbers are identified with "▲"'. The fastener is labeled 'Ford Body 72-73' and '5/16-18 x 1 1/16 1/2 AF 7/8 CONICAL'. The internal bin code is 'KWI, 384931-S'. The finish code is 'S36'. The table shows 'Pcs' as 4 and 'Price' as \$5. The AMK Part # is 'B-13229'. The table also shows 'S36', 'Pcs', and 'Price' columns.

common application → Ford Body 72-73

actual size picture →

physical description → thread size, length, across flats washer diameter & type, other relevant info.

internal bin code → for AMK in house use

finish code → this is the finish/color you will get ! read the finish chart carefully.

washer type →

Chrysler, FORD, GM #

FORD numbers end with "-S"

Chrysler & GM use a different number for each finish, these are displayed in order of AMK finish code.

Chrysler numbers are identified with "▲"

Different finishes within one brand are separated with a period "." or identified with the finish code.

pieces per pack →

price →

AMK Part

use only this number when placing an order

Most bulk items also be available in larger quantities of -10, -25, -50, -100, -250, -500, -1M, -2500 and so on.

A 15% discount applies to retail orders. Start with the smallest quantity part # and add the quantity desired as a suffix.

example B-13229-50.

Finish Codes

(also see back cover)

S	= Plain	S60	= Phosphate & Red Pigment
SS	= Stainless Steel	S100	= Special - see note. Also S101, S102 etc.
S2	= Phosphate & Oil (gray - black)	S301	= Silver/Gray epoxy, 480 hrs salt spray
S3	= Black Paint (usually over Phos)	S307	= Black, 480 hrs salt spray
S7	= Cadmium (light silver)	S309	= Zinc & Yellow/Sealer, 120 hrs salt spray
S8	= Zinc (dark silver)	S424	= Black E-Coat & Sealer, 120 hrs salt spray
S13	= Chrome	S426	= Silver/Gray epoxy, 1000 hrs salt spray
S15	= Black Oxide	S427	= Silver/Gray epoxy, 1000 hrs salt spray
S32	= Olive Drab Enamel (soup green)	S428	= Black E-Coat, 100 hrs salt spray
S36	= Zinc Dichromate (yellow - rainbow)	S436	= Black E-Coat, 100 hrs salt spray
S44	= Black Zinc (shiny)	M	= Non-Electrolytic Finish (dull)
S45	= Chrome on Stainless	P	= Nylon Patch or Pellet Lock
S48	= Cad & Red Dye (shiny)	W	= Bi-Wax sealer (gold color on threads)
S55	= Cad & Black Organic, 1000 hrs salt spray	X	= Sealer

the KIT sections

Coverage includes:

Chrysler B & E body, Ford Mustang, Cougar, Fairlane, Falcon, Bronco, Truck, GM Camaro, Firebird, Chevelle, Monte Carlo, Nova.

Choose: **MASTER** or **INDIVIDUAL**

MASTER kits will provide about 85% of the fasteners found on your vehicle (if all kits available).

INDIVIDUAL kits are master kit components and misc applications not covered by a master kit.

We highly recommend that you reference the Factory Assembly Manuals.

They work great in conjunction with AMK faster kits !

GM & Ford assembly manuals may be purchased from your restoration parts supplier. For Chrysler we recommend the *Guide to E Body Fasteners* and *Guide to B Body Fasteners 1968-70* available at www.mmcdetroit.com.

ASSEMBLY INSTRUCTIONS
3940195 1969 CAMARO 12000 SERIES

1	9420821	NUT
2	103321	L. WASHER
3	9419713	BOLT
4	1193463	P. WASHER
5	7806395	GEAR ASM.
6	103320	L. WASHER
7	451399	NUT

NOTE Align flange so that holes match correct size bolt.

NOTE Remove spacers after the column is completely installed in the vehicle refer item 9 sheet 9-A6

CAUTION With the .20", .30" spacing dimension (measured at lower pin) held when column is tightened to I.P. permissible joint distortion is that which results from the steering column to steering gear included shaft angle maintained at 3° (ref.). **NOTE** The minimum upper pin to flange engagement is .01in flush to rear flange surface.

△	60 - 75	LBS FT
△	15 - 25	LBS FT

CHEVROLET MOTOR DIVISION, GMAC		UPC	DATE	SYN	REVISION RECORD	AUTH.	DR	CK
STEERING GEAR		9	8-22-68	1	DOCUMENTATION REQ'D. UDEET			
12000		A3	8-22-68	2	AAS 3-23-68 P.I			
			8-22-68	3	SPACER NOTE ADDED			
			10-2-68	4	SPACER NOTE REVISED			
			12-9-68	5	DOCUMENTATION REMOVED			
			1-22-69	6	WAS 7806395 GEAR ASM			
			1-22-69	7	TORQUE 277(A) WAS 01			

Use our OEM Index on page 405 to cross reference the factory part number to the AMK bulk number and a picture !

Assembly page number is indicated on most GM kit labels and some Ford kit labels



AMK model codes used in kit sections and kit labels

Ford

B = Bronco, D = Falcon, F = Full Size, O = Fairlane
S = Thunderbird, T = Truck, W = Cougar, Z = Mustang

GM

A = Chevelle, F = Camaro, H = Firebird, N = Nova, M = Monte Carlo

AMK Part Number System

Catagory	Prefix	Number
FORD	F	1 - 3999
GM	G	4000 - 7999
Chrysler	C	8000 - 9999
BULK	B	10000 >

BUMPER BOLTS

Mustang Fr Bumper 65-70



5/16-18 x 3/4 .75 OD
QR, 378709-S
S8 & SS CAP

S100	Pcs	Price
B-12749	2	\$3

Camaro Fr & Rr Bumpers 73



3/8-16 x 3/4 .85 OD
KLT, 9433480
S8 & SS CAP

S100	Pcs	Price
B-12750	2	\$3

Camaro Bumpers 67-72



3/8-16 x 7/8 .75 OD
KTU, 6255899
S8 & SS CAP

S100	Pcs	Price
B-12751	2	\$3
B-10887	4	\$5

All bumper bolts are
100% Made in USA !

Chrysler B & E Body



3/8-16 x 1.0 .87 OD
KOE, 6026723
S8 & SS CAP

S100	Pcs	Price
B-13367	4	\$5



3/8-16 x 1 1/4 .86 OD
KVQ
S36 & SS CAP

S100	Pcs	Price
B-12753	50	\$30

Camaro Fr Bumper 69



3/8-16 x 1 3/8 .75 OD
KLV, 3945758
S8 & SS CAP

S100	Pcs	Price
B-12754	2	\$4

Camaro Fr Bumper 68



3/8-16 x 2.0 .75 OD
KSW, 3929905
S8 & SS CAP

S100	Pcs	Price
B-12755	2	\$4



3/8-16 x 2 3/4 .87 OD
KUW
S8 & SS CAP

S100	Pcs	Price
B-12756	25	\$30

Save BIG with BULK pricing.

Order quantities are:

25, 50, 100, 250, 500
1000, 2500, 5000, 10000

Retail customers save 15%

BUMPER BOLTS

Mustang Fr Bumper 65-68, Rr Bumper 65-69



7/16-14 x 7/8 .85 OD
QU, C4ZB-17758
S8 & SS CAP

S100	Pcs	Price
B-12757	2	\$3
B-11439	4	\$5

Mustang Fr & Rr Bumpers 70-73



7/16-14 x 1.0 .88 OD
LVO, 383464-S100 (sim)
S8 & SS CAP

S100	Pcs	Price
B-10423	4	\$5

Chevelle, Nova Bumpers 64-66



7/16-14 x 1.0 .92 OD
OFO, 3760387
S8 & SS CAP

S100	Pcs	Price
B-10069	4	\$5

Chevelle, Nova Bumper Bottom



7/16-14 x 1.0 .94 OD
OLE, 3916531

S8	Pcs	Price
B-10070	4	\$4

Chevelle, Nova Bumpers 67-72



7/16-14 x 1.0 .99 OD
KRM, 9425343
S8 & SS CAP

S100	Pcs	Price
B-12758	2	\$3
B-11440	4	\$5

Fairlane/Falcon 66-69, Mustang Fr Bumper 69



7/16-14 x 1 1/4 .99 OD
KUN, C3AB-17758-B
S8 & SS CAP

S100	Pcs	Price
B-12761	2	\$3
B-11441	4	\$5

Special sizes or lengths are possible

5,000 pc minimum



1/2-13 x 1 1/4 1.11 OD
KUY
S8 & SS CAP

S100	Pcs	Price
B-12762	2	\$3

CARRIAGE BOLTS



1/4-20 x 3/4 .58 OD
LZ, 302317-S, 126218, 126216

S2	S8	Pcs	Price
B-12739	B-12740	4	\$3

Stainless



5/16-18 x 3/4 .69 OD
LGN

SS	Pcs	Price
B-10076	3	\$4

Firebird Endura Bumper 69



5/16-18 x 7/8 .69 OD
OXQ, 9798198

S2	Pcs	Price
B-11350	5	\$4

Mustang Battery Tray 65-66



5/16-18 x 1.0 .73 OD
OJ, 376307-S2

S2	Pcs	Price
B-11612	2	\$3



5/16-18 x 1 3/4 .69 OD
OK, 23498-S, 126377

S2	Pcs	Price
B-12742	4	\$3

Mustang Fr Shock Brackets 65-66

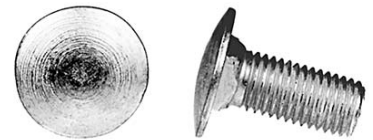

5/16-24 x 3/4 .69 OD
AI, 355471-S

S7	Pcs	Price
B-12741	6	\$5

Mustang Fr Shock Brackets 67-73



3/8-16 x 7/8 .80 OD
KW, 378535-S

S2	Pcs	Price
B-12743	6	\$5

Stainless



3/8-16 x 7/8 .80 OD
LGP

SS	Pcs	Price
B-10072	3	\$4

Stainless



3/8-16 x 1.0 .80 OD
LGO

SS	Pcs	Price
B-10073	4	\$4

Gas Tank GM 64-67A, 67-73F, 64-72N, 71-73 Mustang



3/8-16 x 3 1/2 .80 OD
LPO, 396712, 3792533 (sim)

S2	S8	Pcs	Price
B-10074	B-10075	2	\$5

3/8-16 x 4.0 .80 OD
KBX, 384673-S100 (sim)

S2	Pcs	Price
B-12744	2	\$3

289HP Mustang Engine Mount 65



7/16-14 x 3 5/8 .87 OD
KCU, 379891-S

S2	Pcs	Price
B-12745	1	\$10

HEX BOLTS

SB, BB Chevy Valve Covers



1/4-20 x 9/16 7/16 AF
MXZ, MND, MXO
STAINLESS

RBW	TR	TR	Pcs	Price
B-10133	B-10134	B-10135	8	\$5

SB Ford Cast Aluminum Valve Covers



1/4-20 x 3/4 7/16 AF
BDS, 304646-S, 179795 (s), 9419004.
180020

S2	S8	Pcs	Price
B-11800	B-11841	6	\$5
-----	B-11842	12	\$8

Stainless



1/4-20 x 3/4 7/16 AF
LGS

SS	Pcs	Price
B-11351	8	\$5

Stainless



1/4-20 x 7/8 7/16 AF
LHM

SS	Pcs	Price
B-10132	50	\$30

Ford Clutch Pressure Plate



5/16-18 x 13/16 1/2 AF
KZJ, 350329-S

S2	Pcs	Price
B-13355	6	\$6

Shelby 428 Valve Covers 67-68



5/16-18 x 7/8 1/2 AF
TT, 304664-S, 179817 (s), 9418991. 180078

S2	S8	Pcs	Price
B-13479	-----	4	\$5
-----	B-12626	2	\$5



5/16-18 x 1.0 1/2 AF
KTR, 374709-S

S8	Pcs	Price
B-12627	2	\$3

Stainless



5/16-18 x 1.0 1/2 AF
LGR

SSP	Pcs	Price
B-10172	4	\$6

Chrysler Carburetor



5/16-18 x 1 1/8 1/2 AF
KDH, 181089

S2	Pcs	Price
B-10061	4	\$12

Chrysler Carburetor



5/16-18 x 1 1/8 1/2 AF
OMV, 180080

S8	Pcs	Price
B-13243	4	\$16

Stainless



5/16-18 x 1 1/4 1/2 AF
LVL, 391757-S

SS	Pcs	Price
B-10171	4	\$3

HEX BOLTS

Mustang Seat Adjustment 65-67

383/440/Hemi Distributor



5/16-18 x 1 5/16 1/2 AF
KLK, 179821 (sim)



5/16-18 x 1 5/8 1/2 AF
UK, 379390-S



5/16-18 x 1 7/8 1/2 AF
OMJ, 181095

S2	Pcs	Price
B-12629	4	\$4

S13	Pcs	Price
B-12632	2	\$3

S2	Pcs	Price
B-11442	1	\$6



5/16-18 x 2.0 1/2 AF
UU, 304828-S



5/16-18 x 3.0 1/2 AF
KLS, 300890-S, 9418993, 180113

5/16-18 x 3 1/2 1/2 AF
ZQ, 300902-S, 9419046

S2	Pcs	Price
B-12025	2	\$3

S2	Pcs	Price
B-12634	4	\$5

S2	Pcs	Price
B-12636	2	\$3

Ford SB Water Pump



5/16-18 x 5.0 1/2 AF
EY, 300958-S

S2	Pcs	Price
B-10173	1	\$4

Camaro Stabilizer End Links 70-81

Chevelle Stabilizer End Links 64-72



5/16-18 x 6 1/2 9/16 AF .34 Body
MOD, 3983096, 3790332 (sim)

5/16-18 x 6.91 9/16 AF .34 Body
MVI, 381954

S2	Pcs	Price
B-10174	2	\$6

S2	Pcs	Price
B-10176	2	\$6

HEX BOLTS

Chrysler E Body Stabilizer End Links

Stabilizer End Links, 62-71 Fairlane, 68-73 Cougar/Mustang



5/16-18 x 5 13/16 9/16 AF
OSJ, 2535992



5/16-18 x 6 5/8 9/16 AF
HIM, C8OA-5495-A (s2), 384611-S2
C2OA-5495-D (s8), C9OA-5495-A (s7)

S2	Pcs	Price	S2	S8	Pcs	Price
B-11694	2	\$12	B-10175	B-11623	2	\$8

Stainless

GM Fan Clutch

Ford AC Compressor Clutch



5/16-24 x 7/8 1/2 AF
LGJ



5/16-24 x 1.0 1/2 AF
LSP, 186634



5/16-24 x 1 3/4 1/2 AF
JG, 378741-S

SS	Pcs	Price	S8	Pcs	Price	S2P	S8P	Pcs	Price
B-10507	4	\$5	B-10178	4	\$5	B-12637	B-12638	2	\$3

Corvette Fr Stabilizer End Links 63-82

Camaro Fr Stabilizer End Links 67-69, Nova 64-72



5/16-24 x 5 3/4 9/16 AF .34 Body
MWC, 3817575

5/16-24 x 6 1/2 9/16 AF .34 Body
OTZ, 3790332

S8	Pcs	Price	S8	Pcs	Price
B-10179	10	\$30	B-11706	2	\$6

Mustang Stabilizer End Links 65-67



5/16-24 x 5.82 9/16 AF .37 Body
OSE, CODD-5495-A

S	Pcs	Price
B-11613	2	\$8

HEX BOLTS

Ford Battery Cables, SB Engine Tag



3/8-16 x 1/2, 9/16 AF
DS, 20312-S, 121852



3/8-16 x 3/4 9/16 AF
RU, 304650-S, 9418967. 180120



3/8-16 x 3/4 9/16 AF
OOY, 304650-S, 9418967. 180120

S8	S36	Pcs	Price
B-12639	B-12640	4	\$3

S2	S8	Pcs	Price
B-10163	B-10164	2	\$3

S2	S8	Pcs	Price
B-11595	B-11596	2	\$3

3B3/440/426 Hemi Water Pump



3/8-16 x 7/8 9/16 AF
LRA



3/8-16 x 7/8 9/16 AF
LWC, 454899 (s), 9420942. 454905



3/8-16 x 1.0 9/16 AF
GAI, 179839 (s), 181112

SP	Pcs	Price
B-11696	4	\$6

S2	S8	Pcs	Price
B-10167	B-10168	4	\$5

S2P	Pcs	Price
B-11444	2	\$4

Chrysler & GM Pressure Plate



3/8-16 x 1.0 9/16 AF
KSV, 304684-S, 9418822. 180122



3/8-16 x 1.0 9/16 AF
LJC, 838653



3/8-16 x 1.0 9/16 AF
OJM, 381792-S2

S2	S8	Pcs	Price
B-10148	B-10149	4	\$5

S2	Pcs	Price
B-10150	6	\$6

S2	Pcs	Price
B-10151	2	\$4

Mustang Stabilizer Brackets 67-68



3/8-16 x 1 1/8 9/16 AF
BGI, 20408-S, 9421288, 122138

Chevy SB Intake



3/8-16 x 1 1/8 9/16 AF
MQA, 181113, 304703-S, 179840 (s)
9418823. 180123 (s8)

SB Chevy Intake



3/8-16 x 1 1/8 9/16 AF
LST, 181113, 304703-S, 179840 (s)
9418823

S2	S8	Pcs	Price
B-11614	B-11615	4	\$6

S2	S7	Pcs	Price
B-10141	B-10142	4	\$5

S2	Pcs	Price
B-10143	4	\$4

HEX BOLTS

SB Chevy Intake



3/8-16 x 1 1/8 9/16 AF

MUK, 181113 , 304703-S, 179840 (s)
9418823, 180123

S2	S8	Pcs	Price
B-10138	B-10139	4	\$5

Shelby Export Brace 65-68



3/8-16 x 1 1/4 9/16 AF

GAO, 20428-S, 122145

S8	Pcs	Price
B-12642	4	\$4

Ford Exhaust Manifolds 50's - Mid '66



3/8-16 x 1 1/4 9/16 AF

XP, 304722-S, 179841

S2	Pcs	Price
B-12643	4	\$4



3/8-16 x 1 1/4 9/16 AF

LPQ, 304722-S, 179841 (s), 9418994,
180124

S2	S8	Pcs	Price
B-10136	B-10137	4	\$5

Idler Arm - Chevelle, Camaro, Nova



3/8-16 x 1 1/4 9/16 AF

KUH, 186622

S2	Pcs	Price
B-11616	4	\$6

Stainless



3/8-16 x 1 1/4 9/16 AF

LGG

SS	Pcs	Price
B-10144	4	\$5

BB Chevy Exhaust Manifolds 65-67



3/8-16 x 1 5/16 9/16 AF
MRV

S2	Pcs	Price
B-10147	8	\$6

426 Hemi Exhaust Manifolds 68-71



3/8-16 x 1 3/8 9/16 AF
BET, 186612, 432551 

S2	Pcs	Price
B-11446	3	\$14
B-11447	11	\$40



3/8-16 x 1 1/2 9/16 AF
MJ, 181116 , 304760-S, 374706-S
179843 (s), 9418968

S2	Pcs	Price
B-10631	4	\$4

383/440 Intake Manifold



3/8-16 x 1 1/2 9/16 AF
KFX, 186628, 9421218 

S2	Pcs	Price
B-11448	4	\$18
B-11449	12	\$35

SB Chevy Water Pump 64-67



3/8-16 x 1 3/4 9/16 AF
LUJ, 179845 (s), 9419054

S2	Pcs	Price
B-10145	2	\$3

SB Chevy Water Pump 64-67



3/8-16 x 1 3/4 9/16 AF
MXV, 179845 (s), 9419054

S2	Pcs	Price
B-10146	2	\$3

HEX BOLTS

Mustang/Fairlane Brake Calipers 68-73



3/8-16 x 1.82 9/16 AF
LIU, C8AZ-2B296-A

S2P	Pcs	Price
B-10153	2	\$8

Ford Body Mounts

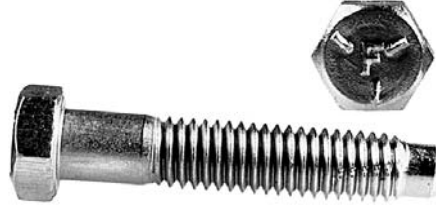

3/8-16 x 2.00 9/16 AF
KTS, 353686-S

S8	Pcs	Price
B-12646	25	\$30

SB Ford Exhaust Manifolds 62 - Mid '66



3/8-16 x 2.0 9/16 AF
XQ, 304830-S

S	Pcs	Price
B-12645	4	\$5

SB Chevy Water Neck



3/8-16 x 2.0 9/16 AF
LSU, 304830-S, 179847 (s), 9419056

S2	Pcs	Price
B-10158	2	\$3

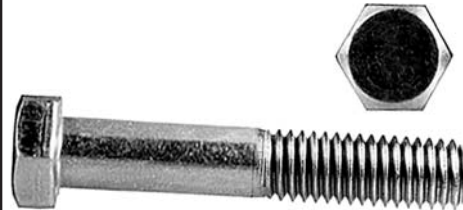

3/8-16 x 2 1/4 9/16 AF
BDI, 20534-S8, 122188

S8	Pcs	Price
B-12647	2	\$3

289HP Exhaust Manifolds 63 - Mid '66



3/8-16 x 2 1/4 9/16 AF
XR, 304860-S, 179848 (s), 9418995

S2	Pcs	Price
B-12649	2	\$3

SB Chevy Water Pump 69 >



3/8-16 x 2 1/4 9/16 AF
MUZ, 304860-S, 179848 (s), 9418995

S2	Pcs	Price
B-10154	2	\$4

Approximately 95%
of the items in this catalog
are Made in USA !

SB Chevy Exhaust Manifolds

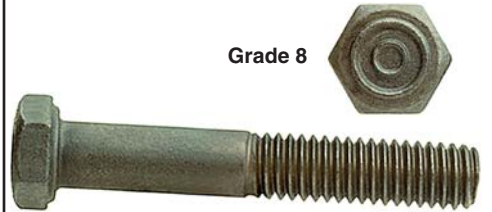

3/8-16 x 2.27 9/16 AF
MRM, 3733130

S2	Pcs	Price
B-10159	6	\$6

340 Water Pump Lower Holes



3/8-16 x 2 3/4 9/16 AF
LOQ

S2P	Pcs	Price
B-10155	2	\$6



3/8-16 x 2 3/4 9/16 AF
LPY, 2129379

S2P	Pcs	Price
B-11457	2	\$8

383/440/426 Hemi Water Pump Housing, Oil Pump



3/8-16 x 2 3/4 9/16 AF
OMI, 179850 (s), 181129

S2	Pcs	Price
B-11450	4	\$14

HEX BOLTS

SB Chevy Exhaust Manifolds 64-67 Nova & Corvette



Grade 8

3/8-16 x 2.80 9/16 AF
MRW, 3733134

S2P	Pcs	Price
B-10155	2	\$4

GM Starter Mounting



3/8-16 x 3 5/8 9/16 AF
LPN, 3733289, 3830134 (sim)

S8	Pcs	Price
B-10161	1	\$4

SB & BB Chrysler P/S pump



3/8-16 x 3.0 9/16 AF
KAI, 181130 (s2) ◆, 300892-S, 9418847, 180138

S2	S8	Pcs	Price
B-11225	B-11451	2	\$3



3/8-16 x 3 5/8 9/16 AF
OMP, 6027152 ◆

S2	Pcs	Price
B-11452	1	\$6

SB Chevy AC Compressor Support 64 >

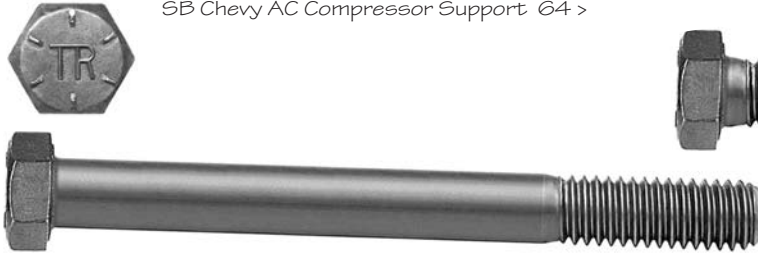

3/8-16 x 3 11/16 9/16 AF
ODO, 3841724

S2	Pcs	Price
B-10162	1	\$3

Chevelle Gas Tank 68-72

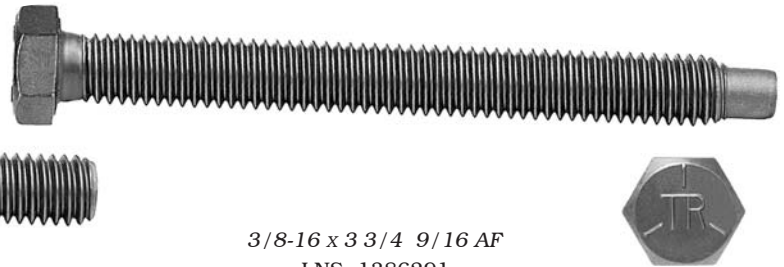

3/8-16 x 3 3/4 9/16 AF
LNS, 1386291

S2	Pcs	Price
B-11628	2	\$4

SB Chevy Alternator Mounting 64-68



3/8-16 x 4.0 9/16 AF
LNF, 191163

S8	Pcs	Price
B-10165	1	\$3

383/440/426 Hemi Alternator



3/8-16 x 4 1/4 9/16 AF
KHN, 151607 (s), 433116 ◆
300926-S, 433114 (s), 9419185

S2	Pcs	Price
B-11454	1	\$6

340 Water Pump



3/8-16 x 5 3/8 9/16 AF
KKV, 9414183 (sim) ◆

S2	Pcs	Price
B-11455	2	\$12

HEX BOLTS

426 Hemi Alternator, Specific 383/440

Specific 383/440 Alternator

SB Chevy Alternator 69 >



3/8-16 x 5 1/2 9/16 AF
MVC, 9423789



3/8-16 x 6.0 9/16 AF
OSO, 9417928



3/8-16 x 6 1/4 9/16 AF
LLU, 9428445, 9422791
3932414 (sim)

S2	Pcs	Price
B-11456	1	\$15

S2	Pcs	Price
B-11609	1	\$6

S2	Pcs	Price
B-10000	1	\$3

GM Control Arm Bushing Retainers

Ford Caliper Inlet Hoses 68-73

GM Axle Retainer Plates



3/8-24 x 7/8 9/16 AF
LFN, 454912 (S), 9419859



3/8-24 x 1.0 9/16 AF
KBI, 382365-S



3/8-24 x 1.0 9/16 AF
LMS, 186627 (S), 9427161 (S2)

S2	Pcs	Price
B-10170	2	\$3
B-13787	4	\$5

S100	Pcs	Price
B-12653	1	\$8

S3	Pcs	Price
B-10169	4	\$4

Mustang Idler Arm & P/S Bracket

Ford Engine Mounts 64-67 SB, 64-68 BB



3/8-24 x 3 5/8 9/16 AF
JAO, 374420-S, 378405-S (sim)



7/16-14 x 7/8 5/8 AF
DG, 304668-S, 9419072. 180144

S2	S60	Pcs	Price
B-12654	B-11617	2	\$6

S2	S8	Pcs	Price
B-12655	B-12656	2	\$3

Nova Bumper Brackets 64-67



7/16-14 x 1.0 5/8 AF
KUZ, 304686-S, 179858 (S), 9419073



7/16-14 x 1 1/8 5/8 AF
KBJ, 20410-S, 122260



7/16-14 x 1 1/4 5/8 AF
OAK, 20430-S, 122267

S2	Pcs	Price
B-13682	4	\$5

S8	Pcs	Price
B-12657	4	\$3

S8	Pcs	Price
B-10183	4	\$5

HEX BOLTS

GM Brake Caliper Brackets 67-68



7/16-14 x 1 1/4 5/8 AF
MWJ, 58654-S, 193221 (s), 9424069

S2	Pcs	Price
B-10184	2	\$3

Corvette Fr Bumper 63-67

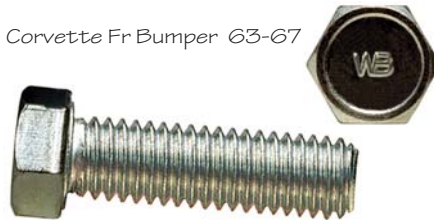

7/16-14 x 1 1/2 5/8 AF
OPU, 122279

S8	Pcs	Price
B-11622	2	\$3

GM Bell Housing
Chrysler H-Pipe

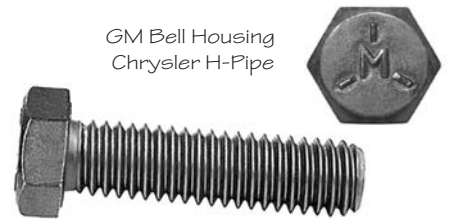

7/16-14 x 1 1/2 5/8 AF
MTI, 181141, 304762-S, 9419077

S2	Pcs	Price
B-11787	4	\$6

Bumper Mountings 74-77 Camaro



7/16-14 x 1 1/2 11/16 AF
MXE, 332319

S2	Pcs	Price
B-10182	4	\$8

Ford Brake Calipers 68-73



7/16-14 x 1 1/2 3/4 AF
BHL, 384114-S100

S2P	Pcs	Price
B-13681	1	\$10



7/16-14 x 1 5/8 5/8 AF
KAG, 181142, 304781-S

S2	S8	Pcs	Price
B-11691	B-11618	4	\$6

Mustang Bumper Brackets 65-68



7/16-14 x 1 3/4 5/8 AF
AC, 372434-S, 376498-S (sim)

S2	Pcs	Price
B-12661	2	\$4

SB Chevy Cylinder Heads



7/16-14 x 1 3/4 5/8 AF
OZK, 3704796

S	Pcs	Price
B-11364	16	\$20

7/16-14 x 1 3/4 5/8 AF
OZX, 3704796

S	Pcs	Price
B-11365	16	\$20

SB Chevy Cylinder Heads



7/16-14 x 3.0 5/8 AF
OZL, 3767468

S	Pcs	Price
B-11366	4	\$6



7/16-14 x 3.0 5/8 AF
OZY, 3767468

S	Pcs	Price
B-11367	4	\$6



7/16-14 x 3 3/4 5/8 AF
OZM, 3734594

S	Pcs	Price
B-11368	14	\$20



7/16-14 x 3 3/4 5/8 AF
OZZ, 3734594

S	Pcs	Price
B-11369	14	\$20

HEX BOLTS

Mustang/Fairlane Brake Calipers 67



7/16-14 x 1 3/4 3/4 AF
OWM, 382101-S2

Chevelle Body Mounts 64-67, Rr Bumper Brackets 70-72



7/16-14 x 2 1/4 5/8 AF
KRJ, 3957278, 1366143 (GR-2), 3993773 (2.0)

S2P	Pcs	Price
B-11352	1	\$8

S2	Pcs	Price
B-12663	2	\$4

Chrysler Fr Shock Mounting



7/16-14 x 2 1/4 5/8 AF
KKK, 179867 (s), 181146, 304862-S, 179867 (s), 9419083

Control Arms, 64-72 Chevelle & Nova, 67-69 Camaro, Corvette



7/16-14 x 2 1/4 5/8 AF
LOE, 381909

S2	Pcs	Price
B-12666	2	\$8

S2	Pcs	Price
B-10016	2	\$6
B-10185	4	\$10

Ford 260/289/302 Cylinder Heads 62 >



7/16-14 x 2.29 11/16 AF
BBI, C2OZ-6065-A

Short

7/16-14 x 3.91 11/16 AF
OKG, C2OZ-6065-B

Long

S	Pcs	Price	S	Pcs	Price
B-12667	2	\$6	B-10189	2	\$6
B-11459	10	\$30	B-11460	10	\$30

Ford 170/200/250 Cylinder Heads



7/16-14 x 3.16 11/16 AF
LRH, C1DE-6065-F

S	Pcs	Price
B-11370	7	\$15

289/302/351 Windage Tray

Some applications may require adding a spacer



7/16-14 x 3 3/16 3/4 AF
LID, C9ZE-6345-A

Mustang Steering Gear 65-68



7/16-14 x 3 3/8 5/8 AF
OMR, 378331-S

S	Pcs	Price
B-10188	2	\$6

S2	S60	Pcs	Price
B-12670	B-11458	3	\$8

HEX BOLTS

426 Hemi LH Engine Mount



7/16-14 x 3 3/4 5/8 AF
OMG, 6026968

S8	Pcs	Price
B-11461	1	\$20

383/440 Engine Mounts



7/16-14 x 4 1/4 5/8 AF
OMS, 6026169

S8	Pcs	Price
B-11462	2	\$25

Brake Inlet Hose

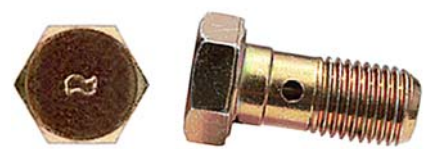

7/16-20 x 15/16 5/8 AF
OIM, K6035098

S36	Pcs	Price
B-10190	25	\$30

Steering Gear 67-69 Camaro, 68-72 Nova, Engine Mount 69-71 Cam/Nova, 70-72 Chevelle



7/16-14 x 3 7/8 5/8 AF
LYP, 3980716, 9419713 (sim)

S2	Pcs	Price
B-10186	1	\$4
B-10187	2	\$6

GM M/T Flywheel



7/16-20 x 1.00 11/16 AF
OJP, 839756

S	Pcs	Price
B-10191	3	\$6

Steering Gear 64-72 Chevelle, 70-81 Camaro



7/16-14 x 4 7/16 5/8 AF
LTF, 3972245 (sim), 399803, 9419714

S2	Pcs	Price
B-11362	3	\$10

GM Brake Inlet Hose 69 >



7/16-20 x 1.09 5/8 AF
MTR, 1385356 (sim)

S36	Pcs	Price
B-10192	1	\$5

Ford Alternator 65 >



7/16-14 x 5 1/2 5/8 AF
AU, 302569-S, 187462 (s8)

S8	S36	Pcs	Price
B-12673	B-13427	1	\$4

HEX BOLTS

Mustang/Fairlane Engine Insulator > Body Brackets 66-69



7/16-14 x 4 3/4 5/8 AF
AE, 379699-S

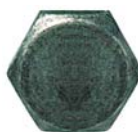

Mustang Strut Rods 67



7/16-20 x 1 1/4 5/8 AF
KCY, 380571-S

S2	Pcs	Price
B-12672	1	\$6
B-11463	2	\$12

S2	Pcs	Price
B-12674	2	\$5

Seat Belts



7/16-20 x 1 3/8 13/16 AF
OIZ, 380527-S (sim)

Seat Belts

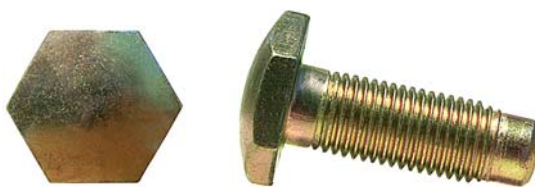

7/16-20 x 1 3/8 13/16 AF
ORU, 380527-S (sim)

Manufacturer made the point a little short, you save 50%

S36	Pcs	Price
B-10193	2	\$10

S36	Pcs	Price
B-11688	4	\$10

Engine Mounts 64-69 Nova, 67-68 Camaro, 68 Chevelle SB



7/16-20 x 3 7/8 5/8 AF
LPJ, 3817224

Mustang Strut Rods 65-66



7/16-20 x 1 3/8 5/8 AF
BHD, 379779-S

S8	Pcs	Price
B-10196	1	\$4
B-11464	2	\$7

S8	Pcs	Price
B-12675	2	\$5

Chrysler Engine Mounts



7/16-20 x 4 3/8 5/8 AF
LRX, 9427473 ◆

Ford 390/428 Ground Cable



1/2-13 x 3/4 3/4 AF
DT, 20352-S

S2	Pcs	Price
B-12110	1	\$6

S36	Pcs	Price
B-13256	2	\$3

HEX BOLTS

Ford Transmission Insulator

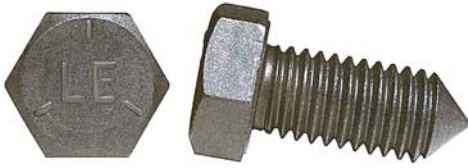

1/2-13 x 1 1/8 3/4 AF
RT, 372821-S

GM Bumper Brackets



1/2-13 x 1 1/4 3/4 AF
KDB, 304726-S, 9419099

1/2-13 x 1 1/2 3/4 AF
KSS, 304764-S, 9419101

S2	S8	Pcs	Price
B-13677	B-13678	2	\$4

S2	Pcs	Price
B-13676	4	\$4

S2	Pcs	Price
B-12590	4	\$4

GM Seat Belts



1/2-13 x 1.20 13/16 AF
OHY, 7668784

Mustang Fr Crossmember



1/2-13 x 1 3/8 7/8 AF
GAA, 379068-S

Mustang Strut Rods 68-73



1/2-13 x 1 11/16 3/4 AF
BHM, C90A-3B284

S36P	Pcs	Price
B-11656	2	\$10

S	Pcs	Price
B-12676	2	\$10

S2	Pcs	Price
B-12677	1	\$8

Chrysler Steering Gear



1/2-13 x 1 3/4 3/4 AF
PAL, 6027185

Mustang & Fairlane Upper Control Arms 67-73



1/2-13 x 1 7/8 3/4 AF
OJK, 380459-S

S2	Pcs	Price
B-10050	3	\$10

S2	Pcs	Price
B-10125	2	\$8

Camaro Upper Control Arms 70-81



1/2-13 x 2 1/4 13/16 AF
MDW, 3964832

Chrysler B Body Rr Shock Upper Mount 64-74



1/2-13 x 2 3/4 3/4 AF
ONH, 181172

S2	Pcs	Price
B-10022	2	\$8

S2	Pcs	Price
B-13375	2	\$8

HEX BOLTS

Ford 352/390/427/428 Cylinder Heads



1/2-13 x 2.77 3/4 AF
OKE, C1AE-6065-C

1/2-13 x 4.47 3/4 AF
OKF, C1AE-6065-A

S	Pcs	Price
B-10126	2	\$8
B-11465	10	\$35

S	Pcs	Price
B-10127	2	\$10
B-11466	10	\$40

GM Fr Lower and Rr Control Arms



1/2-13 x 3 3/4 3/4 AF
LDI, 9421430

S2	Pcs	Price
B-13749	2	\$10

Mustang 67-73, Fairlane LWR Control Arms



1/2-13 x 3 7/8 3/4 AF
KDX, C60A-3B236-A

S2	Pcs	Price
B-13684	1	\$8

Chrysler Upper Control Arms

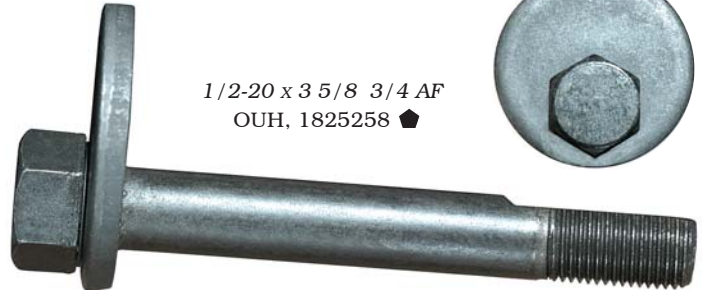

1/2-20 x 3 5/8 3/4 AF
OUH, 1825258

S2	Pcs	Price
B-12111	1	\$10

Chrysler Transmission Crossmember 69



1/2-13 x 3 3/4 3/4 AF
PAI

S2	Pcs	Price
B-13258	2	\$8

Mustang Lower Control Arms 65-66



1/2-20 x 3 1/4 3/4 AF
BFU, 373142-S

S8	Pcs	Price
B-12680	2	\$10

GM Brakes

GM Brakes

Camaro, Nova Caliper Brackets 69-72



1/2-20 x 2 5/32 3/4 AF #95 ID
LZS, 3909795

1/2-20 x 2 21/32 3/4 AF #96 ID
LZO, 3871512

1/2-20 x 2 29/32 3/4 AF #86 ID
MWH

S2	Pcs	Price
B-13250	2	\$8

S2	Pcs	Price
B-13251	2	\$8

S2	Pcs	Price
B-13252	2	\$8

HEX BOLTS

Mustang & Fairlane Leaf Spring Fr Eye 66-67

Mustang Leaf Spring Fr Eye 65



S8	Pcs	Price		S2	Pcs	Price	
B-10128	2	\$8	1/2-13 x 6 1/2 3/4 AF MDX, 58691-S, 380328-S (sim)	B-12679	2	\$14	1/2-20 x 6 1/2 3/4 AF BFB, 378654-S

Mustang Upper Control Arms 65-66

Chrysler Idler Arm



1/2-20 x 2 3/8 3/4 AF
OOE, 379329-S

9/16-18 x 3 1/2 13/16 AF
OYP, 6027776

S2	Pcs	Price		S2	Pcs	Price	
B-10129	2	\$8		B-13253	1	\$10	

Ford Brake Calipers 68-73

Camaro & Nova Body Mounts

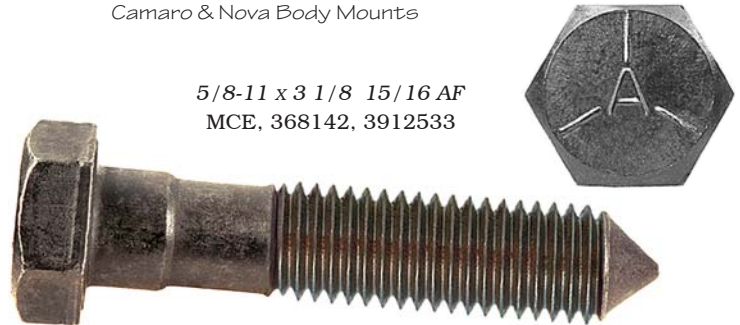

9/16-12 x 2 5/8 13/16 AF BHK, 382713-S

5/8-11 x 3 1/8 15/16 AF
MCE, 368142, 3912533

S2P	Pcs	Price		S2	Pcs	Price	
B-13683	1	\$10		B-10180	2	\$12	

GM Brake Calipers 67 >

Chrysler Leaf Spring Eye



5/8-18 x 7/8 15/16 AF
MWF, 1381744

5/8-18 x 4 1/16 15/16 AF
OWY, 1948876

S	Pcs	Price		S2	Pcs	Price	
B-10181	2	\$14		B-12141	1	\$12	

HEX FLANGE BOLTS



1/4-20 x 5/8 5/16 AF .56 OD
MHV, 56502-S

S2	Pcs	Price
B-10081	8	\$3

GM Steering Column to Dash 69 >



1/4-20 x 5/8 3/8 AF .56 OD
BDN, 56301-S

S2	Pcs	Price
B-12705	6	\$3

Ford A/T Oil Pan



1/4-20 x 3/4 3/8 AF .53 OD
OYN, 56102-S (sim)

S2	S36	Pcs	Price
B-12706	B-12707	4	\$3

GM Differential Cover



5/16-18 x 7/16 1/2 AF .64 OD
MTN, 9431600
COPPER PLATE

S100	Pcs	Price
B-10105	4	\$4

GM A/T Oil Pan



5/16-18 x 9/16 1/2 AF .60 OD
PK, 378782-S

S2	Pcs	Price
B-12496	6	\$3
B-11551	17	\$6

Ford 4 spd Top-Loader Cover



5/16-18 x 5/8 1/2 AF .68 OD
QB

S2	Pcs	Price
B-10104	6	\$6
B-10018	12	\$12

Ford 260/289/302/351 Timing Cover



5/16-18 x 5/8 1/2 AF .76 OD
OBM

S2	Pcs	Price
B-10095	7	\$4
B-10096	14	\$7

Ford 4 spd Top-Loader Cover



5/16-18 x 5/8 1/2 AF .81 OD
OMH

S2	Pcs	Price
B-10728	8	\$8

Ford 260/289 Water Pump 62-65



5/16-18 x 7/8 1/2 AF .67 OD
VP, 376255-S, 9437398

S2	Pcs	Price
B-12502	4	\$5

Ford 260/289 WP & Timing Cover



5/16-18 x 1.0 1/2 AF .81 OD
LJF

S2	Pcs	Price
B-10099	2	\$3



5/16-18 x 1 1/16 1/2 AF .67 OD
VQ, 376256-S, 9423545

S2	Pcs	Price
B-12507	4	\$6



5/16-18 x 2.0 1/2 AF .67 OD
VR, 376257-S

S2	Pcs	Price
B-12509	2	\$3

HEX FLANGE BOLTS

Ford 302 Intake, 302/351 Timing Cover



5/16-18 x 2.0 1/2 AF .67 OD
BGH, 56126-S

S2	Pcs	Price
B-12708	2	\$3

Ford 351W Intake



5/16-18 x 2 1/4 1/2 AF .67 OD
BKG, 56127-S

S2	Pcs	Price
B-12709	2	\$3

BOSS 302 Intake Manifold



5/16-18 x 2 1/2 1/2 AF .67 OD
JAE, 56128-S

S8	Pcs	Price
B-13260	2	\$8

Ford 302/351W/351C Water Pumps



5/16-18 x 3.0 1/2 AF .67 OD
IU, 56130-S

S36	Pcs	Price
B-13261	2	\$8

Ford 351C-4V Intake



5/16-18 x 3 1/4 1/2 AF .67 OD
BHJ, 56131-S

S2	Pcs	Price
B-12710	2	\$4

Ford 260/289/302 Water Pumps 62-69



5/16-18 x 3 7/16 1/2 AF .67 OD
AY, 376258-S

S2	Pcs	Price
B-12711	2	\$4

Ford Body 50's - 64



5/16-24 x 3/4 1/2 AF .67 OD
KKN

S2	Pcs	Price
B-12510	4	\$4

Ford Body 50's - 64



5/16-24 x 1.0 1/2 AF .81 OD
GD, 353714-S

S2	Pcs	Price
B-11949	8	\$10
B-11784	20	\$20

GM Driveshaft Straps 69 >



5/16-24 x 1 5/16 7/16 AF .50 OD
LIZ, 3887348 (sim), 14018700

S2	Pcs	Price
B-10106	4	\$4

HEX FLANGE BOLTS

GM Torque Converter > Flywheel 70 >



3/8-16 x 5/8 9/16 AF .76 OD
MVD, 3987930

S2	Pcs	Price
B-10094	3	\$4

Chrysler 9 3/4" Differential Cover



3/8-16 x 5/8 9/16 AF .79 OD
KYU

S2	Pcs	Price
B-13213	5	\$12
B-13214	10	\$20

Shelby Exhaust Headers



3/8-16 x 3/4 7/16 AF .56 OD
KEL

S2	Pcs	Price
B-12713	4	\$5



3/8-16 x 3/4 9/16 AF .79 OD
FT

S8	Pcs	Price
B-12714	2	\$3

Ford AC & P/S



3/8-16 x 3/4 9/16 AF .88 OD
DB, 370608-S, 274902

S2	S7	Pcs	Price
B-12715	B-13421	2	\$3

Mustang Engine > Body Brackets 67-68



3/8-16 x 7/8 9/16 AF .75 OD
KI, 375116-S

S2	Pcs	Price
B-12716	2	\$4

Ford P/S Pump



3/8-16 x 7/8 9/16 AF .75 OD
HIL, 371041-S

S2	Pcs	Price
B-12719	2	\$4



3/8-16 x 1.0 9/16 AF .79 OD
MOA, 9424320

S2	Pcs	Price
B-10088	2	\$3



3/8-16 x 1.0 9/16 AF .88 OD
QA, 381649-S

S2	S7	Pcs	Price
B-12720	B-13422	2	\$3

Ford Engine & Clutch Brkt's 69-73



3/8-16 x 1 1/8 9/16 AF .78 OD
TP, 56340-S

S2	Pcs	Price
B-12721	2	\$3

BB Chevy Exhaust Manifolds 68 >



3/8-16 x 1 3/16 9/16 AF .68 OD
MRX, 3909821
SPECIAL LOCKING THREAD

S2	Pcs	Price
B-10429	8	\$10

Chrysler Fuel Pump



3/8-16 x 1 1/4 9/16 AF .67 OD
KPH

S2P	Pcs	Price
B-12723	2	\$4

HEX FLANGE BOLTS

Chevy Bell Housing & BB Intake



3/8-16 x 1 1/4 9/16 AF .74 OD
MTF, 3828782

S2	Pcs	Price
B-10082	8	\$10

Chevy Bell Housing & BB Intake



3/8-16 x 1 1/4 9/16 AF .74 OD
MRU, 3828782

S2	Pcs	Price
B-10083	8	\$10

Chevy Bell Housing & BB Intake



3/8-16 x 1 1/4 9/16 AF .73 OD
MRT, 3828782

S8	Pcs	Price
B-10084	6	\$8

Chrysler Fuel Pump



3/8-16 x 1 3/8 9/16 AF .67 OD
KPJ, 6023548

S2P	Pcs	Price
B-12725	2	\$4

Mustang Sway Bar Brkt's 69



3/8-16 x 1 3/8 9/16 AF .79 OD
HID, 56341-S2

S2	Pcs	Price
B-12726	2	\$5

GM Starter Mounting



3/8-16 x 1 9/16 9/16 AF .73 OD
KGL

S8	Pcs	Price
B-12727	1	\$3

GM Starter Mounting



3/8-16 x 1.84 9/16 AF .75 OD
LPC, 3849418 (sim), 3880880, 1366042

S8	Pcs	Price
B-10085	1	\$3

Ford 351C Intake



3/8-16 x 2 1/4 9/16 AF .80 OD
JAJ, 56145-S

S2	Pcs	Price
B-12729	2	\$3

BOSS 302 Intake



3/8-16 x 2 1/2 9/16 AF .75 OD
JAC, 56146-S

S8	Pcs	Price
B-12730	1	\$5

Mustang Engine Mount Body Brackets 66-68

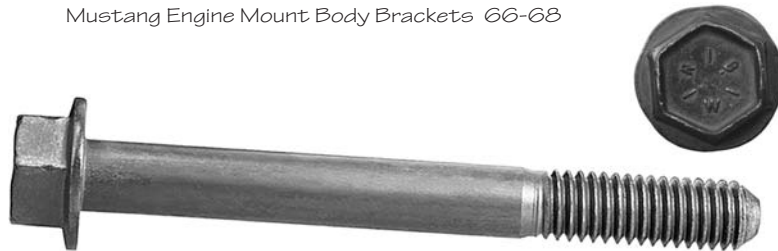

3/8-16 x 3 1/2 9/16 AF .79 OD
MU, 375117-S

S2	Pcs	Price
B-12731	2	\$6

HEX FLANGE BOLTS

Mustang Engine Brackets 69-70



3/8-16 x 3 11/16 9/16 AF .80 OD
GAD, 56350-S, 56349-S (sim)

S2	Pcs	Price
B-12112	2	\$6

Ford & GM Steering Joint



3/8-24 x 1 3/16 7/16 AF .61 OD
II, 358794-S, 385970-S, 5686553
7807271 (sim)

S2	Pcs	Price
B-12734	1	\$3
B-13288	10	\$10

Mustang Transmission Crossmember Brkt's 67-69



3/8-16 x 4 1/4 9/16 AF .76 OD
AR, 374181-S

S2	Pcs	Price
B-11966	2	\$8

Ford Steering Joint 68-79



3/8-24 x 1 3/16 7/16 AF .61 OD
II, 358794-S, 385970-S, 5686553
7807271 (sim)

S60	Pcs	Price
B-11504	1	\$3

Mustang/Fairlane Engine Insulator > Body Brackets 70-73



3/8-16 x 4 11/16 9/16 AF .80 OD
BBN, 56354-S

S2	Pcs	Price
B-10093	1	\$4



3/8-24 x 1 1/4 9/16 AF .92 OD
KQB

S8	Pcs	Price
B-11965	4	\$5

GM Starter



3/8-16 x 4 11/16 9/16 AF .74 OD
LYF, 1366043

S8	Pcs	Price
B-10092	1	\$4

HEX FLANGE BOLTS

Mustang Bumper Brackets 69-70



7/16-14 x 1 3/4 11/16 AF .92 OD
LLK, 56362-S, 383351-S (sim)

S2	Pcs	Price
B-10107	2	\$6

BB Chevy "short" Head Bolt



7/16-14 x 2 1/16 5/8 AF .72 OD
OTM, 3877669

S	Pcs	Price
B-12026	8	\$24

Body Mounts 64-72 Chevelle, 70 > Camaro



7/16-14 x 2 5/8 5/8 AF .88 OD
ONF, 1366144, 3866413 (sim), 3902231 (sim), 3902232 (sim)

S2	Pcs	Price
B-11629	2	\$5
B-11630	6	\$12

Body Mounts @ Radiator Support 68-72 Chevelle

7/16-14 x 3 1/4 5/8 AF .88 OD
OPM, 3920619, 3926929 (sim)

S2	Pcs	Price
B-11631	2	\$8

BOSS 302 Cylinder Heads 351W Alternator



7/16-14 x 4 1/8 11/16 AF .92 OD
LOF, C9ZZ-6065-A, 56172-S (sim)

S2	Pcs	Price
B-13262	2	\$10

Camaro Engine Mounting 73-79



7/16-14 x 4 1/8 5/8 AF .87 OD
MNS, 6262211

S2	Pcs	Price
B-13263	2	\$8

HEX FLANGE BOLTS

Ford P/S Pump 70 >



7/16-14 x 6 1/8 5/8 AF .87 OD
JAG, 383721-S, 383722-S (sim)

S2	Pcs	Price
B-12736	1	\$10

Camaro Bumper Brackets 74-81



1/2-13 x 1 5/8 3/4 AF 1.13 OD
OEH, 492974

S2	Pcs	Price
B-10078	2	\$6

Camaro & Nova Body Mounts



1/2-13 x 3.0 3/4 AF 1.05 OD
OLB, 3914816 (sim), 6264033 (sim)

S2	Pcs	Price
B-10079	2	\$12

351W Cylinder Heads



1/2-13 x 2 1/2 11/16 AF .91 OD
LAE, C9OZ-6065-A

S	Pcs	Price
B-13366	2	\$6
B-13526	10	\$24

1/2-13 x 4.0 11/16 AF .91 OD
LAF, C9OZ-6065-B

S	Pcs	Price
B-13365	2	\$8
B-13527	10	\$32

Mustang Leaf Springs 68-73



1/2-13 x 4 1/2 3/4 AF 1.05 OD
DH, 382486-S (sim), 382393-S (sim)

S2	Pcs	Price
B-12738	2	\$10

Ford Alternator



10-24 x 7/8, .38 OD FITS .19 HOLE
MNR

S8	Pcs	Price
B-11376	100	\$30

Chrysler Leaf Spring Hangers



3/8-16 x 1 1/4 .64 OD FITS .39 HOLE
MAC, 2403247

S2	Pcs	Price
B-10204	4	\$12
B-10035	8	\$20



3/8-24 x 1 3/8 .63 OD FITS .38 HOLE
LHJ

S8	Pcs	Price
B-11378	50	\$30

GM Rr Wheels



3/8-24 x 1 3/8 .70 OD FITS .38 HOLE
LHI

S8	Pcs	Price
B-10205	4	\$5



7/16-20 x 1 1/4 .62 OD FITS .47 HOLE
OKR, 3980406 (sim)

S	Pcs	Price
B-10206	5	\$8



7/16-20 x 1 3/8 .70 OD FITS .50 HOLE
OQU

S	Pcs	Price
B-11377	50	\$30

Ford Fr Drums



1/2-20 x 1 1/2 .81 OD FITS .61 HOLE
LIF, C1AZ-1107-A

S	Pcs	Price
B-10202	5	\$5

Ford Fr Drums



1/2-20 x 1 11/16 .81 OD FITS .61 HOLE
LIO, C3AZ-1107-A

S	Pcs	Price
B-10203	5	\$5

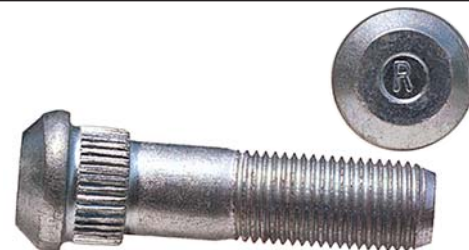

1/2-20 x 1 15/16 .75 OD FITS .61 HOLE
LOW

S8	Pcs	Price
B-10201	5	\$6

Ford Battery Holdown



5/16-18 x 8 1/2
BGW, D0AZ-10756-A

S2	Pcs	Price
B-12763	2	\$6

J & PLACE BOLTS



GM Spare Tire

5/16-18 x 5 7/8
OSM, 3916608, 3986540 (sim)

5/16-18 x 7 7/8
LQO, 3841841, 3823275 (sim)

5/16-18 x 9 3/4
OST, 482942, 364993 (sim)

S8	Pcs	Price	S8	Pcs	Price	S8	Pcs	Price
B-11379	1	\$8	B-11673	1	\$8	B-11380	1	\$8

Chrysler Gas Tank



3/8-16 x 4.0
ONW, 1944171 (sim), 2643824 (sim), 2660872 (sim), 4002006 
GREEN CHROMATE

Ford Smog Pulley SB Camshaft



1/4-20 x 5/8 GR-5 7/16 AF
IY, 45921-S, 192988

S100	Pcs	Price	S	Pcs	Price
B-11470	2	\$12	B-12682	3	\$4

Ford Steering Gear, Chrysler Fan Clutch



5/16-18 x 3/4 GR-5 1/2 AF
PJ, 9408961 , 45964-S, 9408961 (s8)



5/16-18 x 1 1/4 GR-5 1/2 AF
LKC, 45968-S, 220497

SB Ford Intake 68-69



5/16-18 x 2.0 GR-8 1/2 AF
KX, 42964-S, 9409224

S	S8	Pcs	Price	S7	Pcs	Price	S	Pcs	Price
B-12683	-----	3	\$4	B-10210	2	\$4	B-12684	2	\$4
-----	B-11499	4	\$6						

Ford SB Water Pump 65

Ford SB Water Pump 65 >

Ford SB Water Pump w AC 68-69

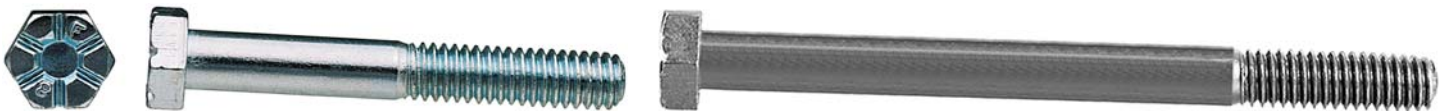

5/16-18 x 2 1/4 GR-8 1/2 AF
UT, 42966-S, 9409621 (s)

5/16-18 x 3 3/4 GR-5 1/2 AF
TN, 379861-S

5/16-18 x 4 1/8 GR-5 1/2 AF
VB, 370807-S

S8	Pcs	Price	S2	Pcs	Price	S2	Pcs	Price
B-12685	2	\$4	B-12686	1	\$3	B-13362	1	\$3

PLACE BOLTS



5/16-24 x 1/2 GR-8 1/2 AF
KCO, 42973-S

S8	Pcs	Price
B-12687	2	\$4

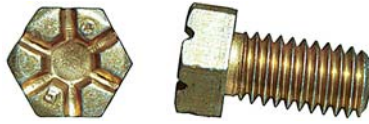

3/8-16 x 3/4 GR-5 9/16 AF
EX, 46006-S, 9420950, 220706

S2	S8	Pcs	Price
B-11500	B-12688	2	\$3



3/8-16 x 7/8 GR-8 9/16 AF
JQ, 220914, 46007-S, 9420951, 9408974

S2	S8	Pcs	Price
B-12689	B-12690	3	\$4



3/8-16 x 1.0 GR-8 9/16 AF
LMA, 42998-S, 9409028, 9409507

S2	S8	S36	Pcs	Price
B-10207	B-10208	B-10209	3	\$4



3/8-16 x 1 3/8 GR-5 9/16 AF
KAX, 46011-S, 9420955

S2	Pcs	Price
B-12692	2	\$3

3/8-16 x 1 3/4 GR-5 9/16 AF
KIT, 43004-S, 9409239

S2	Pcs	Price
B-12695	2	\$4

390/428 Intake

BOSS 302 Smog Pump 70



3/8-16 x 2 5/8 GR-8 9/16 AF
TB, 43011-S

S2	Pcs	Price
B-12697	2	\$5

3/8-16 x 4.0 GR-8 9/16 AF
BGX, 370584-S

S36	Pcs	Price
B-12698	1	\$10



3/8-16 x 4 5/8 GR-5 9/16 AF
LAT, 378946-S

S8	Pcs	Price
B-13363	1	\$3

Powerglide, TH350 Torque Converter



3/8-24 x 3/4 GR-5 9/16 AF
MNK, 3799830 (sim)

S2	Pcs	Price
B-11381	3	\$6



7/16-14 x 1.0 GR-5 5/8 AF
XY, 46050-S, 9423918

S2	Pcs	Price
B-12699	2	\$3



Mustang Calipers 65-67

7/16-14 x 1 5/8 GR-5 3/4 AF
YB, 378225-S

S2	Pcs	Price
B-12700	2	\$8

PLACE & SHOULDER BOLTS

Ford 289/302 Alternator w Smog 66-69



7/16-14 x 3 3/4 GR-5 5/8 AF
VM, 46069-S, 220735

S8	Pcs	Price
B-12703	1	\$5

Ford A/T Flywheel

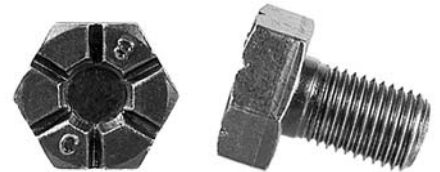

7/16-20 x .66 GR-8 3/4 AF
LUC, 385644-S, 378170-S (sim)
D2AZ-6379-B (sim)

S	Pcs	Price
B-12701	2	\$5

Ford M/T Flywheel or A/T w Reinforcement



7/16-20 x 15/16 GR-8 3/4 AF
KUR, 378172-S, B8AZ-6379-A

S	Pcs	Price
B-12702	2	\$5



9/16-18 x 1 1/2 GR-5 13/16 AF
XX, 46173-S, 221823

S	Pcs	Price
B-12704	1	\$3

Ford Shifter Handle



5/16-18 x 1 3/16 1/2 AF .40 DIA x .52 L
BHO, 379818-S

S8P	Pcs	Price
B-12630	2	\$6



5/16-18 x 1 7/8 9/16 AF .37 DIA x 1.41 L
LKH

S8	Pcs	Price
B-11501	25	\$30



5/16-24 x 1 5/16 9/16 AF .49 DIA x .53 L
LKE

S8	Pcs	Price
B-10219	25	\$30

El Camino Tailgate



3/8-16 x 1.27 3/4 AF .52 DIA x .28 L
OXW, 7740373

S8	Pcs	Price
B-11384	2	\$4

El Camino Tailgate



3/8-16 x 1.53 3/4 AF .52 DIA x .66 L
OXZ, 7740374

S8	Pcs	Price
B-11385	2	\$4

SHOULDER BOLTS



3/8-16 x 1 1/2 5/8 AF .44 DIA x .65 L
LWN, 359337-S

3/8-16 x 2 3/4 5/8 AF .44 DIA x .77 L
KZR, 378832-S

3/8-16 x 2 3/4 5/8 AF .44 DIA x 1.56 L
MBD, 359496-S

S2	Pcs	Price	S8	Pcs	Price	S2	Pcs	Price
B-10214	25	\$30	B-13356	25	\$30	B-10217	25	\$30

Nova Leaf Spring Eye 64-67



7/16-20 x 5 1/8 13/16 AF
OJB, 3792615

S2	Pcs	Price
B-11371	1	\$6

GM Seat Belts



1/2-13 x 1.20 13/16 AF .56 DIA x .31 L SHOULDER
OHW, 7700983

GM Seat Belts



1/2-13 x 1 1/2 13/16 AF .56 DIA x .56 L SHOULDER
OHX, 7765672

S13P	Pcs	Price	S13P	S36	Pcs	Price
B-10124	2	\$12	B-10122	B-10123	2	\$12

Seat Belts



7/16-20 x 1 1/2 13/16 AF .50 D x .50 L SHLDR
OHP, 380528-S (sim). 381872-S (sim)
382516-S (sim)



5/16-18 x 13/16 1/2 AF .75 OD
.43 DIA x .17 L
LIX

GM Brake Hose Distribution Block



5/16-18 x 1 11/16 1/2 AF .62 OD
.37 DIA x .35 L SHOULDER
OAE, 6264039

S13P	S36	Pcs	Price	S2	Pcs	Price	S2	Pcs	Price
B-10194	B-10195	2	\$12	B-10218	25	\$30	B-10101	1	\$4

SPRING CENTER, SQUARE, T & U BOLTS

Ford Leaf Springs



5/16-24 x 1.39 .50 OD
LMH, 378683-S (sim)

S	Pcs	Price
B-10222	2	\$6

Mustang Seat Tracks



5/16-18 x 1 7/16 .50 AF HEAD
OQG

S2	Pcs	Price
B-11662	2	\$4



5/16-18 x 1 3/8 1/2 AF
LY

S2	Pcs	Price
B-13361	4	\$3

Mustang 6 cyl Rr Brake Plates



3/8-24 x 1 3/16 .41 x .82 HEAD
KEM, 374671-S

S2	Pcs	Price
B-13264	4	\$8

Ford Rr Brake Plates

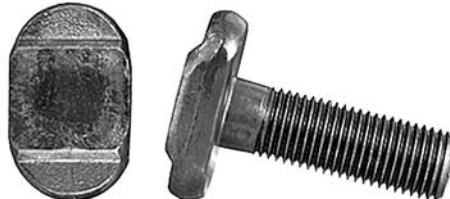

3/8-24 x 1 3/16 .62 x 1.0 HEAD
KOF, 375748-S

S2	Pcs	Price
B-12764	4	\$4

Ford Fr Brake Plates



3/8-24 x 2 3/16 .62 x 1.0 HEAD
KDN, 375381-S

S2	Pcs	Price
B-12766	2	\$4

GM Axle Mounts

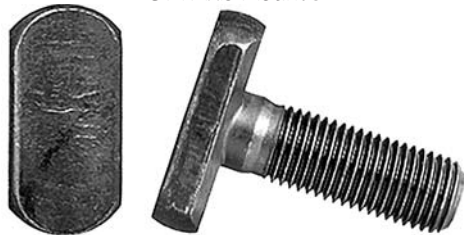

7/16-20 x 1.30 .62 x 1.25 HEAD
KWP, 3791510 (sim), 9792949

S2	Pcs	Price
B-13221	2	\$5
B-10223	8	\$18

GM Axle Mounts w Stabilizer



7/16-20 x 1 15/16 .62 x 1.25 HEAD
KOJ, 481949

S2	Pcs	Price
B-12767	1	\$4
B-10224	4	\$12

Ford U-Joint w 7 Axle

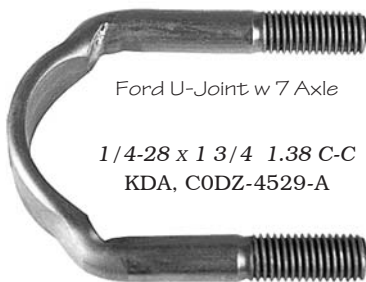

1/4-28 x 1 3/4 1.38 C-C
KDA, C0DZ-4529-A

S	Pcs	Price
B-12768	2	\$8

Ford U-Joint

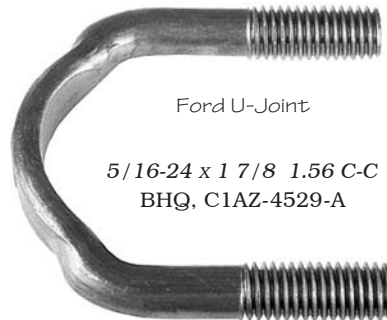

5/16-24 x 1 7/8 1.56 C-C
BHQ, C1AZ-4529-A

S	Pcs	Price
B-12769	2	\$6

GM U-Joint



5/16-18 x 1 7/8 1.41 C-C
KWU, 1358938

S	Pcs	Price
B-13225	2	\$6

U BOLTS



Mustang 64-66, Falcon 64-65

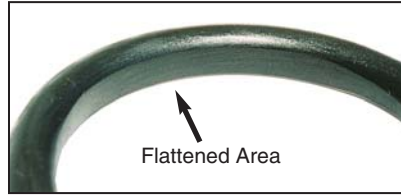

Flattened Area

Corvette U-Joints



3/8-24 x 2.0 1.66 C-C
OCP

7/16-20 x 5.0 2.67 C-C
KBC, C4DA-5705-A

7/16-20 x 6 1/2 2.67 C-C
OWL
EXTRA LONG - NO FLAT AREA

S	Pcs	Price
B-10225	10	\$30

S	Pcs	Price
B-12770	2	\$12

S	Pcs	Price
B-11707	2	\$8

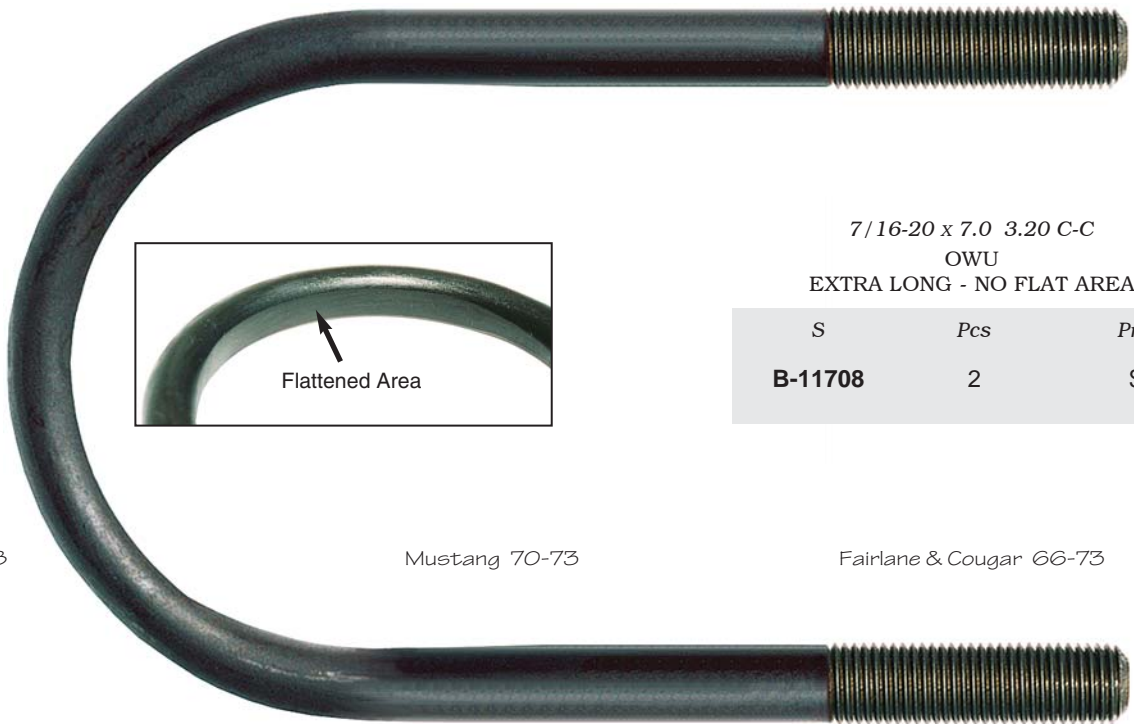

7/16-20 x 7.0 3.20 C-C
OWU
EXTRA LONG - NO FLAT AREA

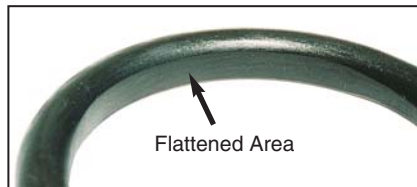

Flattened Area

S	Pcs	Price
B-11708	2	\$8

Mustang 67-68

Mustang 70-73

Fairlane & Cougar 66-73

7/16-20 x 5 1/2 3.20 C-C
KBE, C7ZA-5705-A, C9ZA-A, B

7/16-20 x 5 3/4 3.20 C-C
KBF, D0ZA-5705-B

7/16-20 x 7.0 3.20 C-C
KWS, D3WA-5705-AA, C60A-C, F, C80A-A

S	Pcs	Price
B-12771	2	\$12

S	Pcs	Price
B-12772	2	\$12

S	Pcs	Price
B-13223	2	\$16

U BOLTS

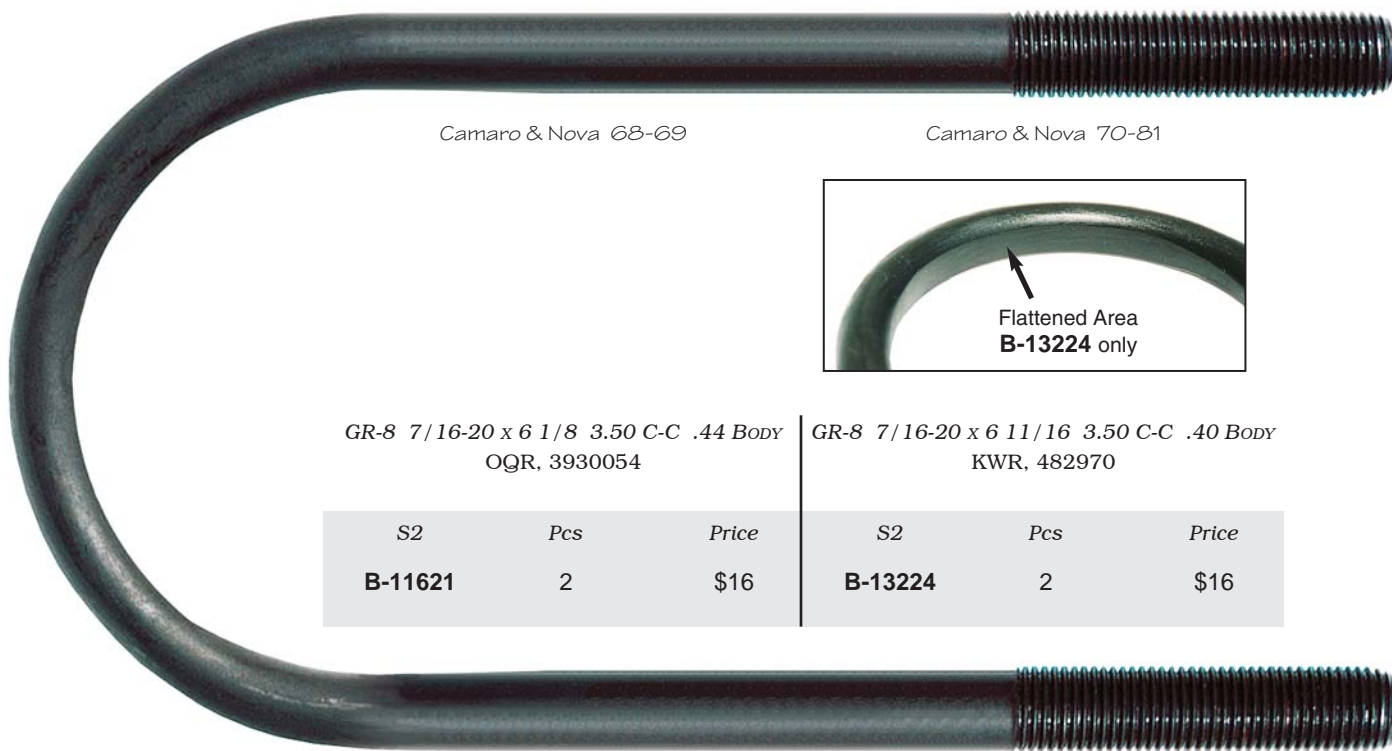

Camaro & Nova 68-69

Camaro & Nova 70-81



GR-8 7/16-20 x 6 1/8 3.50 C-C .44 Body
OQR, 3930054

GR-8 7/16-20 x 6 11/16 3.50 C-C .40 Body
KWR, 482970

S2	Pcs	Price
B-11621	2	\$16

S2	Pcs	Price
B-13224	2	\$16

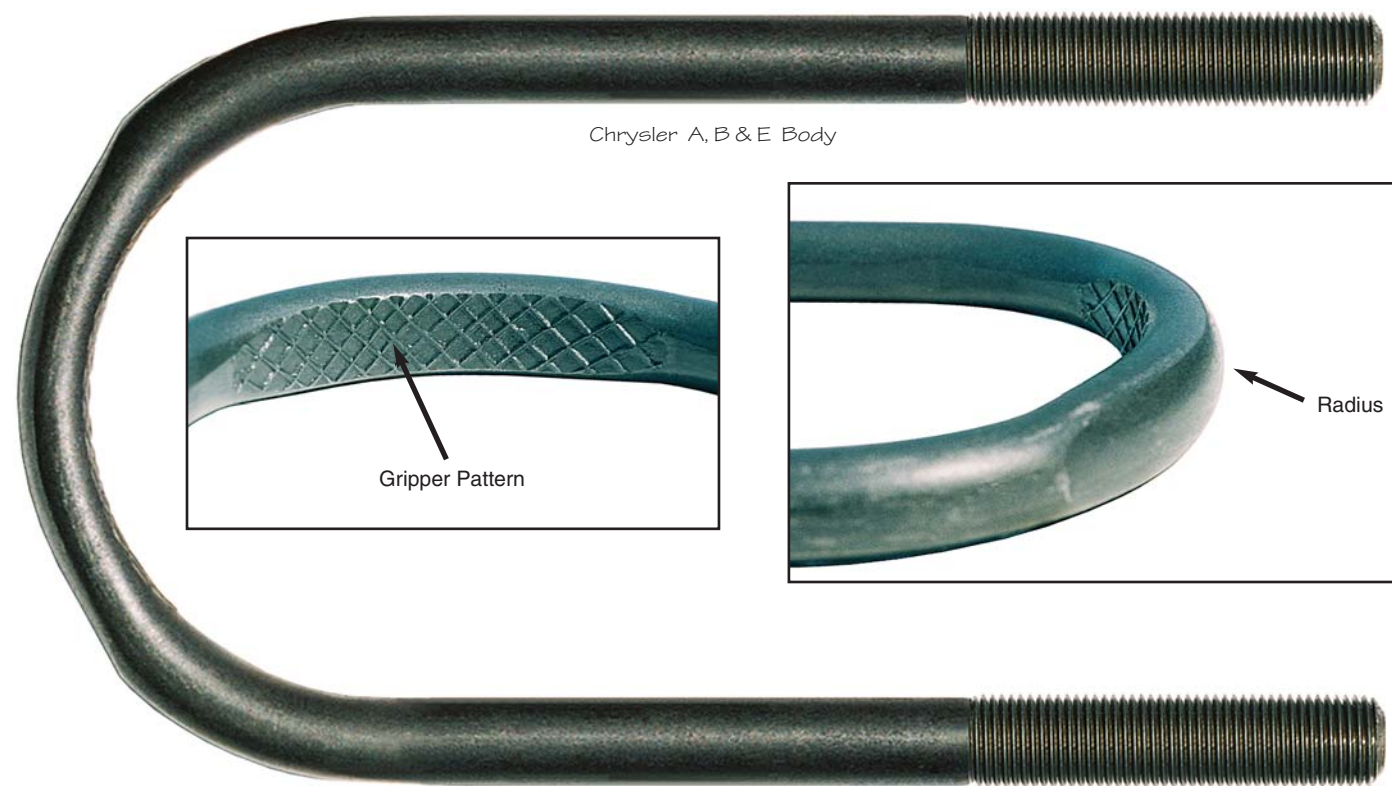

Chrysler A, B & E Body

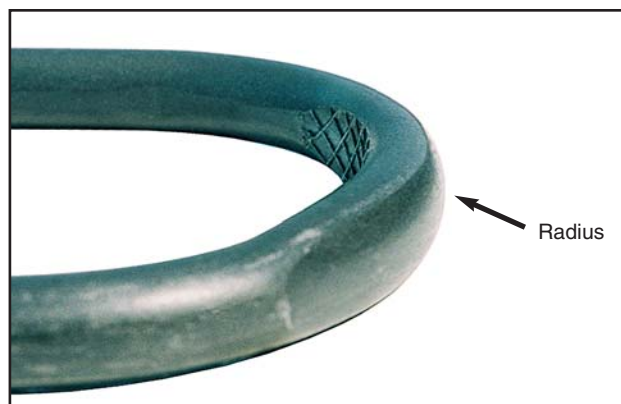
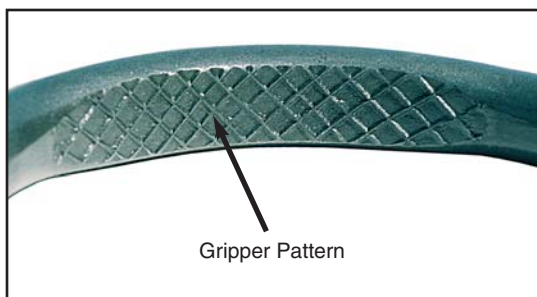

GR-5 1/2-20 x 6 5/8 3.56 C-C
ONE, 1489746

GR-5 1/2-20 x 7 1/8 3.56 C-C
ONP, 1489747

S	Pcs	Price
B-11502	2	\$24

S	Pcs	Price
B-11503	2	\$24

HEX NUTS



8-32 1 1/32 AF .12 TK
YQ, 34052-S, 114653, 120622 (s7-8)

S8	Pcs	Price
B-12773	12	\$3



10-24 3/8 AF .12 TK
LYJ, 34053-S, 120361

S8	Pcs	Price
B-10501	12	\$3

Ford Alternator Terminals 65-69



10-32 3/8 AF .12 TK
BCX, 34079-S, 432230

S36	Pcs	Price
B-12774	12	\$3

GM Alternator & Relay Junction



12-24 7/16 AF .16 TK
LSM, 121743

S8	Pcs	Price
B-10502	12	\$3



1/4-20 7/16 AF .16 TK
WG, 33920-S, 124818

S8	Pcs	Price
B-12775	10	\$3



1/4-20 7/16 AF .19 TK
WI, 33795-S, 9419912

S2	Pcs	Price
B-12776	10	\$3

Brass



1/4-28 7/16 AF .19 TK
BCZ, 33796-S, 110192, 453326

S8	S36	Pcs	Price
B-12777	B-12778	10	\$3



5/16-18 1/2 AF .19 TK
IV, 33922-S, 9419930, 124825, 9412302

S2	S13	S36	Pcs	Price
B-12779	B-12780	B-12781	8	\$3



5/16-18 1/2 AF .27 TK
NC, 33825-S, 134560

S	Pcs	Price
B-12784	6	\$3

GM Stabilizer End Links 64-72A, 70-81F



5/16-18 GR-5 1/2 AF .27 TK
RW, 33797-S, 102634 (s), 9417954, 120376

S2	S8	Pcs	Price
B-12782	B-12783	10	\$3



5/16-18 9/16 AF .33 TK
MNH, 1365065

S2	Pcs	Price
B-10506	2	\$2

Ford Carburetors



5/16-24 7/16 AF .27 TK
BW, 351089-S

S8	Pcs	Price
B-12786	4	\$2

HEX NUTS

340 Exhaust Manifolds 68-70



5/16-24 GR-5 1/2 AF .27 TK
GA, 115729. 120368 , 33798-S
9418892. 120368

S2	S8	Pcs	Price
B-11505	B-12785	10	\$3



5/16-24 1/2 AF 2.50 L
OML, 2863391 

S	Pcs	Price
B-11475	2	\$14

GM Stabilizer End Links 64-72N, 67-69F



5/16-24 9/16 AF .33 TK
OTA, 3654642

S8	Pcs	Price
B-12028	2	\$2

Brass



3/8-16 9/16 AF .22 TK
BL, 33924-S, 9419867. 124829

S2	S8	Pcs	Price
B-12787	B-10504	8	\$3



3/8-16 9/16 AF .33 TK
ZY, 33827-S, 134570

S	Pcs	Price
B-12790	6	\$3



3/8-16 GR-5 9/16 AF .33 TK
QX, 118615. 120377 , 33799-S
9418931. 120377

S2	S8	Pcs	Price
B-12788	B-12789	8	\$3

Ford Rr Shocks 71 >



3/8-16 GR-8 9/16 AF .33 TK
LOI, 9414034

S36	Pcs	Price
B-10503	8	\$3



3/8-16 9/16 AF .33 TK
KCI, 384485-S

S2	Pcs	Price
B-12791	6	\$3

Stainless



3/8-16 9/16 AF .62 TK
OHQ, 391120-S

SS	Pcs	Price
B-10439	6	\$3



3/8-16 5/8 AF .25 TK
KGD, 34057-S

S8	Pcs	Price
B-12792	6	\$3



3/8-24 9/16 AF .22 TK
ZG, 33925-S, 124925

S8	Pcs	Price
B-12793	6	\$3



3/8-24 GR-5 9/16 AF .33 TK
GAW, 114942. 120369 , 33800-S
179319. 120369

S2	S8	Pcs	Price
B-12794	B-12795	8	\$3

HEX NUTS

383/440 Exhaust Manifolds



3/8-24 GR-8 9/16 AF .33 TK
MJJ, 214441



3/8-24 9/16 AF 1.94 L
OMW, 2806982

3/8-24 9/16 AF 2.84 L 3/8-24 ON TOP
OMK, 2268282

S2	Pcs	Price
B-10505	8	\$3

S	Pcs	Price
B-11472	1	\$8
B-11473	3	\$20

S	Pcs	Price
B-11474	2	\$14

GM Shifter Linkage, BOSS 302 Rockers



7/16-14 GR-2 11/16 AF .38 TK
KVZ, 34670-S, 9418897 (sim)



7/16-20 9/16 AF .22 TK
MUV, 383792-S, C9ZZ-6A529-B, 3841497



7/16-20 GR-5 11/16 AF .38 TK
MBF, 271506, 34671-S, 271506

S2	Pcs	Price
B-12796	6	\$3

S2	Pcs	Price
B-10511	4	\$6

S8	Pcs	Price
B-10510	8	\$3

GM Radio Shafts



7/16-28 5/8 AF .12 TK
MON, 7279805



1/2-13 GR-5 3/4 AF .44 TK
KWH, 33845-S, 9418828



1/2-13 GR-8 3/4 AF .44 TK
KAU, 380952-S, 9414511 (s36)

S8	Pcs	Price
B-10556	2	\$4

S2	Pcs	Price
B-12797	6	\$3

S2	S36	S60	Pcs	Price
B-12798	B-11507	B-12799	4	\$3

GM Rr Shocks

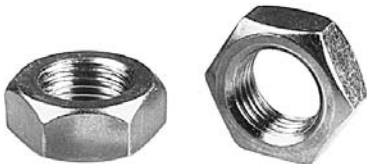

1/2-20 GR-2 3/4 AF .31 TK
ZR, 33943-S



1/2-20 GR-8 3/4 AF .44 TK
BFQ, 352596-S, 9418932. 225857. 9417614
1825449 (s2)



1/2-20 GR-8 3/4 AF .56 TK
LXR, 9421085

S7	Pcs	Price
B-12800	4	\$3

S2	S8	S36	Pcs	Price
B-10499	B-12801	B-10500	4	\$3

S2	Pcs	Price
B-10498	4	\$3

HEX & HEX LOCK NUTS



9/16-18 GR-5 7/8 AF .49 TK
MFC, 103029 (s), 9420041

S2	Pcs	Price
B-10512	6	\$3

Ford Steering Wheel 65-67



5/8-18 15/16 AF .31 TK
LAH, 350983-S

S	Pcs	Price
B-10013	1	\$3



5/8-18 GR-5 15/16 AF .55 TK
MUU, 9420460

S2	Pcs	Price
B-10508	4	\$3

Mustang & Fairlane Strut Rods

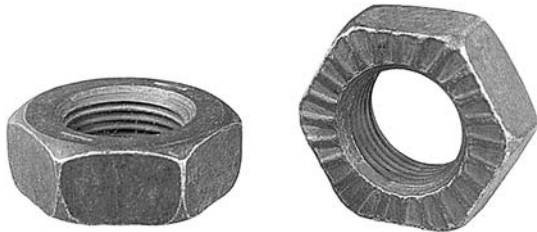

11/16-18 GR-5 1 1/8 AF .43 TK
TK, 380517-S

S2	S60	Pcs	Price
B-12882	B-12883	2	\$6

Ford Alternator Pulley



11/16-20 15/16 AF .31 TK
BCB, 351124-S

S8	S36	Pcs	Price
B-12802	B-12803	2	\$3

Ford Pitman Arm w 1.0 Sector Shaft



3/4-16 1 1/8 AF .42 TK
PZ, 34692-S, 219758

S8	Pcs	Price
B-12804	1	\$2

Pitman Arm: Ford 11/8 Sector Shaft & GM



7/8-14 1 5/16 AF .47 TK
DC, 380771-S, 258779, 9429184

S2	S60	Pcs	Price
B-12805	B-12806	1	\$2



1/4-20 7/16 AF .23 TK
MMU, 34975-S, 9422273

S7	Pcs	Price
B-10522	8	\$3



1/4-28 7/16 AF .22 TK
IAP, 55801-S, 9416430

S8	Pcs	Price
B-12856	8	\$3



5/16-18 1/2 AF .28 TK
TE, 34976-S, 382634-S

S2	Pcs	Price
B-12859	6	\$3

HEX LOCK NUTS



5/16-18 1/2 AF .28 TK
KCJ, 55691-S, 3841103, 9422275

S7	Pcs	Price
B-12858	6	\$3



5/16-24 1/2 AF .30 TK
IAO, 55692-S, 9422276

S7	Pcs	Price
B-12860	6	\$3



5/16-24 1/2 AF .32 TK
OQB

SP	Pcs	Price
B-11658	4	\$3



5/16-24 1/2 AF .33 TK
S, 34443-S, 378866-S

S7	Pcs	Price
B-12861	4	\$3

GM Exhaust Inlet



3/8-16 9/16 AF .33 TK
RV, 9417668, 9416107, 34419-S,
3829086 (s7)

S2	S7	Pcs	Price
B-12863	B-10524	4	\$4



3/8-16 GR-5 9/16 AF .37 TK
GK, 152364, 153187, 34977-S,
9422277 (s7)

S2	S7	Pcs	Price
B-12862	B-10523	6	\$3



3/8-16 GR-8 9/16 AF .33 TK
LUB, 55713-S, 383406-S, 9422297 (s7)

S7	S60	Pcs	Price
B-10526	B-10525	6	\$3



3/8-16 GR-5 9/16 AF .41 TK
ND, 34444-S

S7	Pcs	Price
B-12864	4	\$4



3/8-24 9/16 AF .33 TK
GJ, 55749-S

S7	Pcs	Price
B-12866	4	\$3



3/8-24 9/16 AF .33 TK
JAP, 55674-S, 9422278

S7	Pcs	Price
B-12865	6	\$3

8 3/4 Differential 68 >



3/8-24 9/16 AF .41 TK
LRT, 6027412, 6028915

SP	Pcs	Price
B-10527	5	\$6
B-10528	10	\$10

Tie Rods, 8 3/4 Differential > 67



3/8-24 9/16 AF .41 TK
LIW, 1485066

S36P	Pcs	Price
B-10529	5	\$4
B-13870	10	\$8

Ford Differential & Chassis



3/8-24 9/16 AF .41 TK
V, 34445-S

S7	S48	Pcs	Price
B-12867	B-12868	4	\$4
B-12869	B-12870	10	\$8

Ford SB Rocker Arms



3/8-24 5/8 AF .50 TK
BBC, C2DZ-6A529-A

S7	Pcs	Price
B-12871	4	\$3

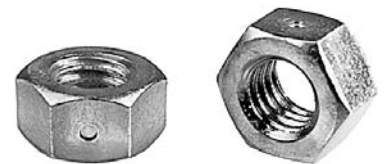

7/16-14 11/16 AF .38 TK
GAN, 55806-S, 9414073

S8	Pcs	Price
B-12872	4	\$3

HEX LOCK NUTS

Ford Trans & BB Engine Mounts

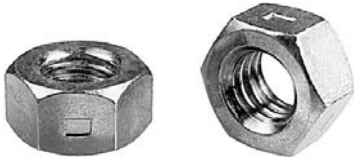

7/16-14 11/16 AF .38 TK
DR, 55806-S, 9414073

S8	Pcs	Price
B-12873	4	\$3



7/16-14 11/16 AF .38 TK
CX, 6028465 ◆, 34421-S

S7	Pcs	Price
B-10531	2	\$3

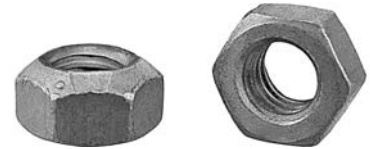

7/16-14 GR-5 11/16 AF .38 TK
TF, 34978-S

S2	Pcs	Price
B-12874	4	\$3



7/16-14 GR-8 11/16 AF .38 TK
LWT, 34988-S, 9422299 (s7)

S2	S7	Pcs	Price
B-10532	B-10533	4	\$3



7/16-14 GR-5 11/16 AF .43 TK
RM, 6023930 (s7) ◆, 55695-S, 9422279 (s7)

S2	S7	Pcs	Price
B-12875	B-12876	4	\$3

Chrysler Engine Mounts & Starter



7/16-20 5/8 AF .38 TK
MPD, 6026750 ◆

S7	Pcs	Price
B-11506	3	\$6

Economical U-Bolt Nut



7/16-20 11/16 AF .38 TK
OYJ

S7	Pcs	Price
B-13212	100	\$30



7/16-20 GR-8 11/16 AF .38 TK
KBU, 55716-S, 9422300

S7	Pcs	Price
B-12878	4	\$3



7/16-20 11/16 AF .39 TK
KBV, 34422-S

S7	Pcs	Price
B-12877	2	\$3

GM Rr Springs > Axle Housing



7/16-20 11/16 AF .45 TK
MAO, 6023018 ◆

S2	Pcs	Price
B-10534	4	\$4



7/16-20 GR-8 11/16 AF .62 TK
LPE, 3901399

S7	Pcs	Price
B-10017	4	\$6
B-11508	8	\$12

B-Body Trans Crossmember 69



1/2-13 3/4 AF .44 TK
PAJ

S2	Pcs	Price
B-13265	4	\$4

HEX LOCK NUTS

Chrysler Shocks



1/2-13 3/4 AF .44 TK
LJY, 9417670 (s2) ◆



1/2-13 3/4 AF .44 TK
LME, 34979-S

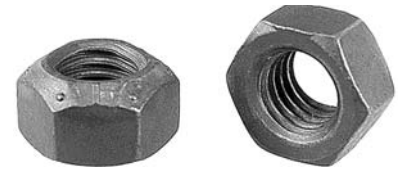

1/2-13 GR-8 3/4 AF .44 TK
GAM, 383407-S, 9422301 (s7)

S2	S7	Pcs	Price
B-11509	B-10516	2	\$3

S2	Pcs	Price
B-10519	4	\$3

S7	S60	Pcs	Price
B-10518	B-12880	4	\$4

GM Brake Plates & Caliper Brackets



1/2-13 GR-5 3/4 AF .57 TK
LUT



1/2-20 GR-8 3/4 AF .44 TK
LZR, 9422302

Chrysler Axle Housing



1/2-20 3/4 AF .56 TK
LRS, 6023019 ◆

S7	Pcs	Price
B-10517	50	\$30

S7	Pcs	Price
B-10521	4	\$4

S2	Pcs	Price
B-13928	4	\$5
B-11510	8	\$10

Ford Full-Size Strut Rods

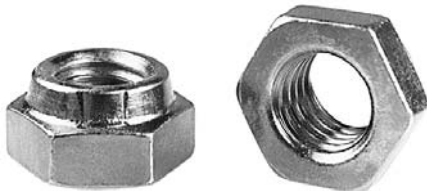

9/16-12 7/8 AF .48 TK
KAW, 34425-S

Camaro Lower Control Arms 73-81



9/16-12 GR-8 7/8 AF .48 TK
MMT, 9422303

Chrysler P/S Pulley



9/16-18 GR-8 7/8 AF .33 TK
LWA, 6026656 ◆

S7	Pcs	Price
B-12881	2	\$4

S7	Pcs	Price
B-10536	4	\$4

S2	Pcs	Price
B-10537	1	\$6

Chrysler Strut Rod > Body



5/8-11 15/16 AF .56 TK
LKW, 6025523 & 6028777 ◆

Ford Steering Wheel 68 >



5/8-18 GR-5 15/16 AF .48 TK
LAR, 382412-S, 9422286

Mustang & Fairlane Strut Rods



11/16-18 GR-5 1.0 AF .57 TK
TJ, 380460-S

S7	Pcs	Price
B-10051	2	\$10

S7	Pcs	Price
B-10014	2	\$3

S7	S48	Pcs	Price
B-12884	B-12885	2	\$6

HEX SLOTTED NUTS

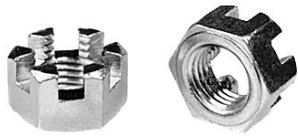

3/8-24 9/16 AF .33 TK
CZ, 33979-S, 125233



3/8-24 9/16 AF .41 TK
JAD, 34030-S, 125348



7/16-20 5/8 AF .38 TK
MPE, 102646

S8	Pcs	Price
B-12842	4	\$3

S8	Pcs	Price
B-12843	4	\$5

S8	Pcs	Price
B-10585	2	\$4



7/16-20 11/16 AF .37 TK
AA, 45300-S, 272073, 9414262

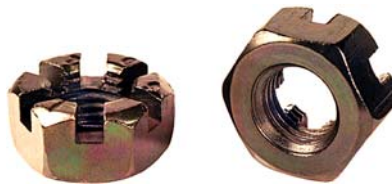

7/16-20 GR-8 3/4 AF .37 TK
OFR, 3983076



1/2-13 3/4 AF .56 TK
LNO, 378514-S

S8	S36	Pcs	Price
B-12844	B-12845	4	\$3

S44	Pcs	Price
B-10586	2	\$4

S2	S8	Pcs	Price
B-10582	B-10583	2	\$3

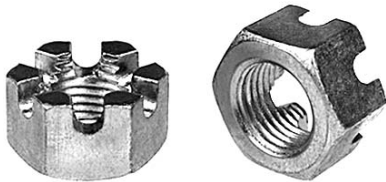

1/2-20 3/4 AF .44 TK
AD, 351059-S, 125250, 9414577



1/2-20 GR-8 7/8 AF .44 TK
OFS, 3983036



1/2-20 3/4 AF .56 TK
OOH, 9425132

S8	S36	Pcs	Price
B-12846	B-12847	2	\$2

S44	Pcs	Price
B-10584	2	\$4

S2	Pcs	Price
B-11486	2	\$4

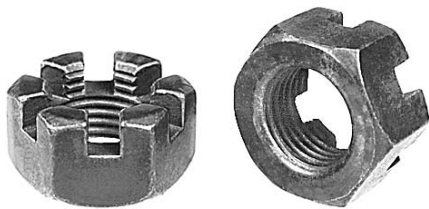

9/16-18 7/8 AF .49 TK
DA, 33985-S, 9429080, 125258

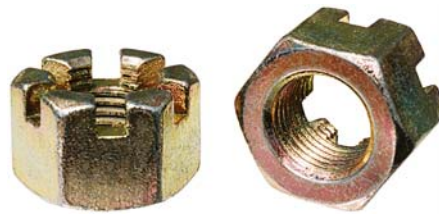

9/16-18 GR-5 7/8 AF .61 TK
BZ, 34033-S, 125375 (s8)

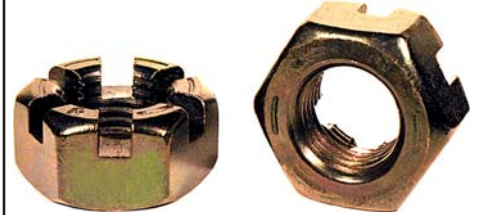

9/16-18 GR-8 15/16 AF .49 TK
OFU, 3983037

S2	S8	Pcs	Price
B-12848	B-12849	2	\$3

S8	S36	Pcs	Price
B-12850	B-12851	2	\$3

S44	Pcs	Price
B-10587	2	\$4

HEX SLOTTED NUTS - LOCKING



5/16-18 1/2 AF .32 TK
KYY

S7	Pcs	Price
B-13369	4	\$3



3/8-16 9/16 AF .41 TK
PM

S7	Pcs	Price
B-12852	4	\$4



7/16-20 5/8 AF .44 TK
KIY

S7	Pcs	Price
B-12854	50	\$30



7/16-20 11/16 AF .44 TK
LAC

S7	Pcs	Price
B-13368	50	\$30



1/2-13 3/4 AF .44 TK
KZB

S7	Pcs	Price
B-13691	25	\$30

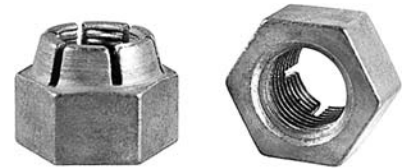

1/2-20 3/4 AF .58 TK
KWW

S7	Pcs	Price
B-13234	25	\$30

426 Hemi Exhaust Pipes



3/8-16 9/16 AF .33 TK
ONS, 9423837

S7	Pcs	Price
B-11496	2	\$4

Ford Spring Cradles & Shackles 64-66



3/8-24 9/16 AF .33 TK
NJ, 34370-S

S7	Pcs	Price
B-10547	2	\$3



7/16-14 5/8 AF .38 TK
MDY

S7	Pcs	Price
B-10548	4	\$4

Chrysler Exhaust Pipes



7/16-14 11/16 AF .38 TK
LGW, 9420434

S2	Pcs	Price
B-10549	4	\$6



7/16-20 5/8 AF .37 TK
LPT

S8	Pcs	Price
B-10060	50	\$30

GM Engine Mounts, Shackles



7/16-20 11/16 AF .37 TK
LUK, 272876

S7	Pcs	Price
B-10045	4	\$6

HEX SLOTTED - LOCK, FLANGE NUTS - SPIN

426 Hemi Engine Insulator



1/2-13 3/4 AF .31 TK
OTC, 145031

S7	Pcs	Price
B-13931	2	\$6



1/2-20 3/4 AF .44 TK
MDN

S8	Pcs	Price
B-10546	2	\$3

Chrysler Leaf Spring @ Fr Eye



5/8-18 15/16 AF .44 TK
ORN, 1948877

S2	Pcs	Price
B-11676	2	\$8



10-24 3/8 AF .52 OD .21 TK
SB, 55731-S, 274303

S2	Pcs	Price
B-12886	10	\$3



1/4-20 7/16 AF .57 OD .24 TK
SI, 55734-S, 9418810, 274551, 9421868

S2	S8	S36	Pcs	Price
B-12887	B-12888	B-12889	8	\$3

GM Windows



1/4-20 7/16 AF .88 OD .27 TK
LOZ, 371068-S, 4405524

S2	Pcs	Price
B-10041	4	\$3

GM Hood Levelers



5/16-18 1/2 AF .67 OD .28 TK
KRB, 1359887

S2	Pcs	Price
B-12891	6	\$3



5/16-18 1/2 AF .67 OD .29 TK
U, 55736-S, 9420466, 273802, 9421869

S2	S8	S36	Pcs	Price
B-12892	B-12893	B-12894	6	\$3
B-11382	B-10476	B-11383	25	\$10

289/302 Intake 68 >



5/16-18 1/2 AF .72 OD .33 TK
WQ, 374031-S

S8	Pcs	Price
B-11055	4	\$3



5/16-24 1/2 AF .67 OD .29 TK
FV, 55737-S, 273796

S2	Pcs	Price
B-12897	6	\$3
B-11785	20	\$9



3/8-16 9/16 AF .68 OD .34 TK
OYM, 488919

S2	Pcs	Price
B-11386	8	\$4



3/8-16 9/16 AF .75 OD .35 TK
KUG, 1361640

S2	Pcs	Price
B-12899	6	\$3

FLANGE NUTS - SPIN - LOCKING



3/8-16 9/16 AF .74 OD .34 TK
IG, 55738-S, 9413192

S2	Pcs	Price
B-12900	6	\$3



3/8-16 9/16 AF .89 OD .40 TK
MZF, 1378333

S2	Pcs	Price
B-10475	6	\$3

Mustang Cowl Braces 67-68



7/16-14 5/8 AF .92 OD .39 TK
ZI, 55740-S, 9415182

S2	Pcs	Price
B-12906	4	\$3

GM Hood Lock Post



1/2-20 3/4 AF 1.01 OD .45 TK
KQY, 9423864

S2	Pcs	Price
B-10469	2	\$3

PREVAILING TORQUE STARTS HERE



1/4-20 GR-5 7/16 AF .58 OD .29 TK
NG, 33777-S

S2	Pcs	Price
B-12890	6	\$3

B Body Fan Shroud

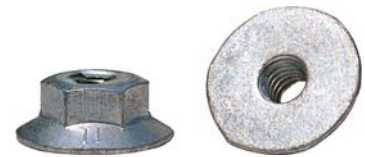

1/4-20 1/2 AF .82 OD .31 TK
LIY, 6028053

S7	Pcs	Price
B-13875	5	\$10

Chrysler Brake Valve, PB Adjuster



5/16-18 1/2 AF .68 OD .32 TK
KKS, 6027518, 6025804
S100 = RED DYE

S2	S100	Pcs	Price
B-11521	B-12895	3	\$3



5/16-18 1/2 AF .66 OD .34 TK
EC, 379930-S

S2	S7	Pcs	Price
B-10477	B-10478	8	\$3
B-10479	B-10480	25	\$8

Chrysler Carburetor Lever Stud



5/16-18 1/2 AF .63 OD .49 TK
JAW, 6028699 (sim)

S2P	Pcs	Price
B-13240	2	\$10



5/16-24 1/2 AF .68 OD .27 TK
JAY, 377703-S (sim)

S7	Pcs	Price
B-12898	6	\$3



3/8-16 GR-5 9/16 AF .75 OD .39 TK
HN, 377706-S, 382801-S

S2	S7	Pcs	Price
B-10472	B-12901	6	\$3
B-10473	B-10474	20	\$9



3/8-16 GR-5 9/16 AF .80 OD .45 TK
YH, 33771-S

S2	Pcs	Price
B-12903	6	\$4
B-11399	20	\$10

FLANGE NUTS - LOCKING

Ford Torque Convertor



3/8-24 GR-8 9/16 AF .79 OD .39 TK
AV, 377704-S

S7	Pcs	Price
B-12905	4	\$3

Ford Exhaust Pipe > Manifolds



7/16-14 GR-5 5/8 AF .76 OD .43 TK
AX, 376420-S

S7	Pcs	Price
B-10482	4	\$3
B-10483	20	\$10



7/16-14 GR-8 11/16 AF .93 OD .39 TK
OG

S7	Pcs	Price
B-12907	4	\$3

Ford Axle Housing



7/16-14 GR-8 11/16 AF .92 OD .47 TK
MYK

S2	Pcs	Price
B-10481	4	\$3



7/16-14 GR-8 11/16 AF .93 OD .49 TK
LA, 6262212

S7	Pcs	Price
B-12908	4	\$3

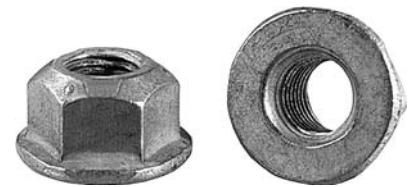

7/16-20 GR-5 11/16 AF .92 OD .48 TK
BB, 379244-S

S7	S48	Pcs	Price
B-12910	B-13438	4	\$6
B-10491	B-11438	8	\$12

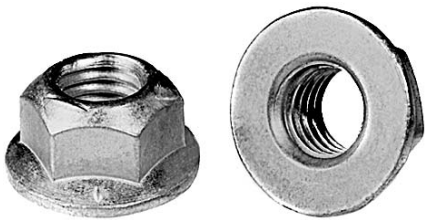

1/2-13 GR-5 3/4 AF 1.01 OD .51 TK
BH, 379696-S

S7	Pcs	Price
B-12911	2	\$3

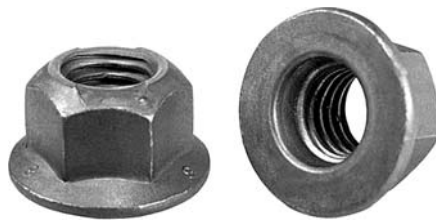

1/2-13 GR-5 3/4 AF 1.05 OD .60 TK
KFA, 33773-S

S2	Pcs	Price
B-12912	2	\$3



1/2-20 GR-8 3/4 AF 1.01 OD .54 TK
KAZ, 378290-S

S7	Pcs	Price
B-13305	2	\$3

Chrysler Strut Rod Back End



9/16-18 GR-8 3/4 AF .89 OD .59 TK
ONC, 6024803

S2	Pcs	Price
B-11469	2	\$10

Ford Differential Pinion



3/4-20 GR-8
1 1/16 AF
1.49 OD x .81 TK

MMF

371518-S (sim), 389546-S
PHOS & SEALER

S100	Pcs	Price
B-10471	1	\$5

KEPS NUTS - CONICAL

Camaro Instrument Cluster & Dashpad 69



8-32 11/32 AF .50 OD .18 OAH
MUM, 9428616

S2	Pcs	Price
B-10453	6	\$4

Ford Alternator Connections 70 >



10-24 5/16 AF .38 OD .17 OAH
GAJ, 383255-S

S36	Pcs	Price
B-12824	4	\$2

GM Electrical



10-24 3/8 AF .45 OD .19 OAH
KNX, 3759924

S7	Pcs	Price
B-13507	8	\$3

Chrysler Tailamps



10-24 3/8 AF .56 OD .31 OAH
LIG

S7	S44	Pcs	Price
B-10057	B-13266	4	\$5

Chrysler Tailamps



10-24 3/8 AF .56 OD .29 OAH
LTR

S36	Pcs	Price
B-10444	4	\$5

Chrysler Tailamps



10-24 3/8 AF .62 OD .34 OAH
KLX

S7X	Pcs	Price
B-12825	4	\$3



10-24 3/8 AF .75 OD .26 OAH
LHE

S36	Pcs	Price
B-13877	4	\$6

Ford Alternator Connections 65-69



10-32 3/8 AF .38 OD .17 OAH
BDE, 379618-S

S36	Pcs	Price
B-12826	100	\$30

GM Tailamps



#14 7/16 AF .69 OD .29 OAH
KMX

S8M	Pcs	Price
B-12835	5	\$5
B-11511	10	\$10

Chevelle Quarter Extensions 66-69



#14 7/16 AF .88 OD .30 OAH
LIV

S8M	Pcs	Price
B-12029	5	\$5
B-12030	10	\$10

GM Spoilers, Tailamps



1/4-20 7/16 AF .56 OD .30 OAH
KOA, 4821091, 4821092 (sealer)

S36	Pcs	Price
B-11679	4	\$3
B-11680	8	\$5

KEPS NUTS - CONICAL



1/4-20 7/16 AF .62 OD .29 OAH
KGN, 45332-S, 3866846 (s2)

Mustang Hood Scoop, Inside Door Handles



1/4-20 7/16 AF .62 OD .25 OAH
JW, 376762-S



1/4-20 7/16 AF .62 OD .34 OAH
OMU, 6025004 ♣

S2	S36	Pcs	Price
B-12828	B-12829	6	\$3
B-11512	B-11513	25	\$10

S2	Pcs	Price
B-11681	4	\$4
B-11682	9	\$8

S2	S7	Pcs	Price
B-11479	B-11610	2	\$4
B-11480	B-11611	8	\$10

Camaro Rear Spoiler 71-81



1/4-20 7/16 AF .75 OD .30 OAH
KQF, 4786092 (s36X), 4801719 (s36)



1/4-20 7/16 AF .75 OD .37 OAH
MLM, 6025005 ♣

Ford Quarter Panel Extensions



1/4-20 7/16 AF .87 OD .39 OAH
BP, 373556-S

S36	Pcs	Price
B-13436	4	\$3

S2	Pcs	Price
B-11481	2	\$4
B-11483	8	\$10

S36X	Pcs	Price
B-12833	4	\$3
B-11514	12	\$8

Chrysler Battery Holdown 70 >



1/4-20 7/16 AF 1.00 OD .37 OAH
ONV, 6025006 ♣, 377476-S (sim)

Chevelle Vent Window Frame 64-67



1/4-20 7/16 AF 1.25 OD .32 OAH
OTR

426 Hemi Intake Manifold



1/4-28 7/16 AF .55 OD .34 OAH
ODY, 6023118 ♣

S2	Pcs	Price
B-11484	2	\$6
B-11485	5	\$10

S13	Pcs	Price
B-12735	2	\$4

S2	Pcs	Price
B-10443	2	\$10
B-12031	6	\$25

383/440/426 Hemi Valve Covers



1/4-28 7/16 AF .62 OD .26 OAH
LIK, 6022582 ♣

Ford Starter & Relay



5/16-18 9/16 AF .56 OD .27 OAH
BF, 381561-S



5/16-18 1/2 AF .75 OD .35 OAH
LIJ, 6025007 ♣, 45338-S

S2	Pcs	Price
B-13868	4	\$8

S36	Pcs	Price
B-12836	3	\$3

S2	S36	Pcs	Price
B-12837	B-10446	4	\$3

KEPS NUTS - CONICAL

GM Seat Tracks



5/16-18 1/2 AF .87 OD .37 OAH
MWT

S36	Pcs	Price
B-11390	6	\$4

Chrysler Seats, Heater Blower

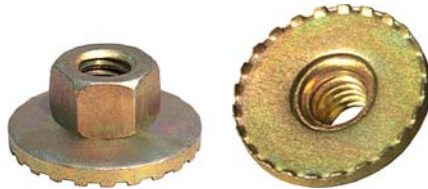

5/16-18 1/2 AF 1.00 OD .45 OAH
MHS, 6024431

S36	Pcs	Price
B-10448	4	\$8

Ford Seats, Body



5/16-18 1/2 AF 1.00 OD .50 OAH
BC, 378643-S

S2	Pcs	Price
B-10447	2	\$3
B-11578	8	\$8

Chrysler Fenders



5/16-18 1/2 AF 1.12 OD .43 OAH
OVF, 6025010

S2	Pcs	Price
B-13242	2	\$3

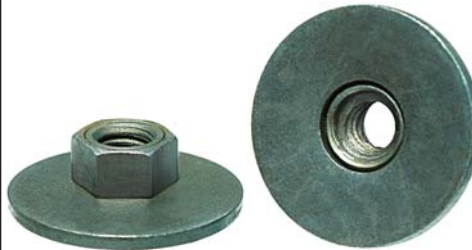

5/16-18 1/2 AF 1.25 OD .41 OAH
HA, 375023-S

S2	Pcs	Price
B-12840	2	\$3

Mustang Fan Shroud 65-66



5/16-24 1/2 AF .75 OD .33 OAH
FQ, 376763-S

S2	Pcs	Price
B-12839	2	\$3

Chrysler Seats



5/16-18 1/2 AF 1.25 OD .47 OAH
LHC

S36	Pcs	Price
B-10449	4	\$8

5/16-18 1/2 AF 1.75 OD .56 OAH
OPH



S8X	Pcs	Price
B-11403	2	\$4



3/8-16 9/16 AF 1.00 OD .46 OAH
KLR, 6025011, 45344-S, 9425691

S2	Pcs	Price
B-12841	4	\$4
B-11515	12	\$10



3/8-24 9/16 AF 1.00 OD .40 OAH
OOM, 6023973

S2	Pcs	Price
B-13238	2	\$6



7/16-14 11/16 AF 1.00 OD .52 OAH
KYO, 384695-S

S2	Pcs	Price
B-10452	2	\$3

KEPS NUTS - CONICAL, EXTERNAL



7/16-14 11/16 AF 1.25 OD .58 OAH
LAX, 6025014 ◆, 45352-S

B-Body Trans Crossmember 67-68



1/2-13 3/4 AF 1.25 OD .60 OAH
LHK, 6025017 ◆

S2	Pcs	Price
B-13408	4	\$4

S2	Pcs	Price
B-10441	2	\$3



8-32 5/16 AF .37 OD .14 OAH
KOH, 3909539



8-32 11/32 AF .38 OD .16 OAH
WJ, 34653-S, 9419336. 271163 (s8)



10-24 3/8 AF .42 OD .16 OAH
FM, 34655-S, 9419337. 271166

S2	Pcs	Price
B-10466	10	\$3

S2	S36	Pcs	Price
B-12807	B-12808	10	\$3

S2	S8	Pcs	Price
B-12809	B-12810	10	\$3



10-32 3/8 AF .41 OD .17 OAH
FN, 34656-S, 271169 (s8)



12-24 7/16 AF .50 OD .21 OAH
KOY, 376528-S, 272474



1/4-20 7/16 AF .50 OD .24 OAH
KG, 34659-S, 9419631. 271172. 9422870

S8	S36	Pcs	Price
B-12811	B-12812	10	\$3

S7	Pcs	Price
B-12813	4	\$3

S2	S8	S36	Pcs	Price
B-12814	B-13779	B-12815	8	\$3

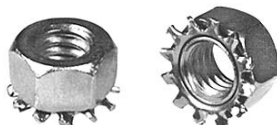

5/16-18 1/2 AF .59 OD .33 OAH
DJ, 271185 (s2), 271184 (s8) ◆, 34661-S
9419338, 271184, 9427645

Ford Starter & Relay July 66 > Nov 66



5/16-18 9/16 AF .59 OD .29 OAH
MME

Ford Starter & Relay 60-66



5/16-24 1/2 AF .59 OD .24 OAH
BY, 359620-S

S2	S36	Pcs	Price
B-12817	B-12818	6	\$3

S36	Pcs	Price
B-10465	3	\$3

S7	Pcs	Price
B-12819	3	\$3

KEPS NUTS - EXTERNAL, LUG NUTS, SQUARE

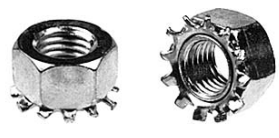

5/16-24 1/2 AF .59 OD .31 OAH
GF, 34662-S, 271187

S8	Pcs	Price
B-12820	6	\$3

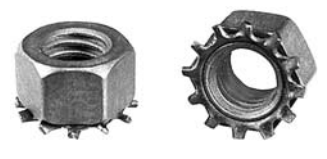

3/8-16 9/16 AF .66 OD .39 OAH
PY, 34663-S, 271191

S2	Pcs	Price
B-12821	6	\$3

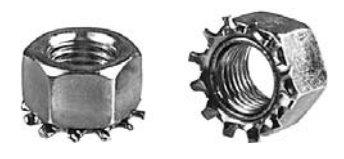

3/8-24 9/16 AF .66 OD .39 OAH
JI, 34664-S, 271193 (s8)

S7	Pcs	Price
B-12822	6	\$3



1 1/16 Hex 1.29 OD x .48 TK
MLL

S	Pcs	Price
B-10732	2	\$3

GM Cars, Chrysler A Body



7/16-20 RH 3/4 AF .56 OAH
MCN, 2409824 ♣, 358501

S8	Pcs	Price
B-10010	5	\$7
B-10545	20	\$25

Chrysler A Body



7/16-20 LH 3/4 AF .56 OAH
KPR, 2409825 ♣
GREEN CHROMATE

S100	Pcs	Price
B-10655	50	\$30

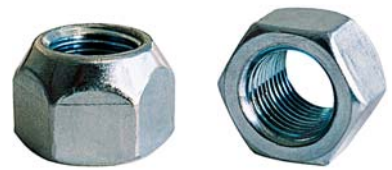

1/2-20 RH 3/4 AF .56 OAH
KNB, 2409826 ♣

S8	Pcs	Price
B-10657	5	\$6
B-10658	10	\$10

Stainless Capped



1/2-20 RH 3/4 AF 1.15 OAH
MXP, 6031535 ♣

S100	Pcs	Price
B-10812	5	\$3
B-10813	20	\$8

Chrysler B, E, Body



1/2-20 LH 3/4 AF .57 OAH
MDQ, 2409827 ♣

S8	Pcs	Price
B-10541	5	\$5
B-10542	10	\$8

Chrysler B, E, Body



1/2-20 LH 3/4 AF .57 OAH
LOV, 2409827 ♣

S8	Pcs	Price
B-10543	25	\$30

Ford Vehicles



1/2-20 RH 13/16 AF .57 OAH
LGX, COAZ-1012-A

S8	Pcs	Price
B-10659	5	\$5
B-10660	20	\$16

Chevelle Body Mounts 64-72



7/16-14 1.0 AF x .43 TK
KRR, 4776763, 8779124

S8	Pcs	Price
B-11698	2	\$3

NUT & RETAINERS - CAGE



#8 .06 - .12 P
LXB, N803685-S

S32	Pcs	Price
B-10597	10	\$3



10-24 .02 - .06 P .53 x .53
KRN

S8	Pcs	Price
B-13371	50	\$30



10-24 .09 - .13 P .53 x .53
MJD

S2	Pcs	Price
B-10440	4	\$3



10-32 .09 - .13 P .53 x .53
LAV

S2	Pcs	Price
B-13372	50	\$30



1/4-20 .06 - .11 P .53 x .54
PV, 357227-S, 357314-S

S2	Pcs	Price
B-12023	4	\$3



1/4-20 .60 x 1.0
NK, 359359-S, 374251-S

S2	Pcs	Price
B-12033	2	\$4



5/16-18 .06 - .09 P .66 x .69
D, 356833-S, 357312-S

S2	Pcs	Price
B-12024	4	\$3



5/16-18 .77 x 1.07
EA, 359613-S

S2	Pcs	Price
B-12034	2	\$8



Hood Leveler

5/16-18
KGK, 384469-S

S2	Pcs	Price
B-12036	2	\$6



5/16-24 .03 - .06 P .65 x .71
KWV, 353418-S, 357252-S

S2	Pcs	Price
B-13236	4	\$3



5/16-24 .77 x 1.07
DZ, 377998-S

S2	Pcs	Price
B-12035	2	\$8



3/8-16 .06 - .09 P .65 x .70
LH

S2	Pcs	Price
B-12032	4	\$4



8-32 .02 - .15 P .51 W x .69 L
BFX, 45262-S

S2	Pcs	Price
B-11968	8	\$5



10-24 .04 - .10 P .67 W x .84 L
KNT

S2	Pcs	Price
B-11969	10	\$5



10-24 .05 - .08 P .57 W x .76 L
KNU

S2	Pcs	Price
B-11970	100	\$30



10-24 .03 - .08 P .57 W x .82 L
KNP

S7	Pcs	Price
B-11971	10	\$5



10-24 .07 - .10 P .57 W x .83 L
TL, 6028394 ◆

S2	Pcs	Price
B-11972	10	\$5



10-24 .02 - .08 P .68 W x .92 L
KNO

S2	Pcs	Price
B-11976	8	\$5



10-24 .04 - .10 P .68 W x .91 L
KPN

S2	Pcs	Price
B-11977	12	\$5



10-24 .14 - .16 P .68 W x .87 L
KNE

S2	Pcs	Price
B-11973	100	\$30



10-24 .14 - .16 P .68 W x .89 L
KNQ

S2	S8	Pcs	Price
B-11974	B-11975	100	\$30



1/4-20 .02 - .07 P .59 W x .84 L
CS, 372881-S

S2	Pcs	Price
B-11979	8	\$6



1/4-20 .09 - .13 P .72 W x .89 L
KNF, 6025699 ◆

S2	Pcs	Price
B-11984	100	\$30

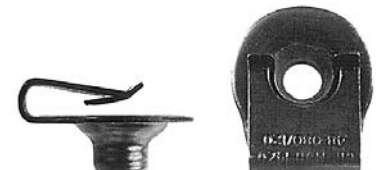

1/4-20 .04 - .08 P .74 W x .90 L
KOU, 6023169 ◆

S2	Pcs	Price
B-11980	6	\$4

NUT & RETAINERS - J & U



1/4-20 .02 - .15 P .58 W x .96 L
EN, 153293 ♠, 45263-S

S2	Pcs	Price
B-11981	10	\$5
B-10787	25	\$10

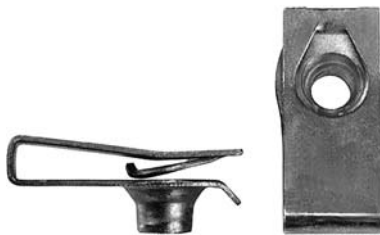

1/4-20 .02 - .15 P .58 W x 1.20 L
KVG, 45267-S

S2	Pcs	Price
B-11982	8	\$5
B-11983	20	\$10



1/4-20 .02 - .10 P .58 W x 1.43 L
LPF

S2	Pcs	Price
B-10614	2	\$3



1/4-20 .02 - .13 P .74 W x .96 L
KOL

S2	Pcs	Price
B-11986	8	\$5



1/4-20 .02 - .08 P .75 W x .96 L
KPG

S2	Pcs	Price
B-11985	8	\$5

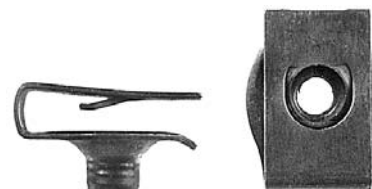

1/4-20 .14 - .20 P .74 W x .95 L
KND

S2	Pcs	Price
B-11987	100	\$30



1/4-20 .05 - .07 P 1.10 W x 1.26 L
TM, 6029402 ♠

S2	Pcs	Price
B-11988	50	\$30

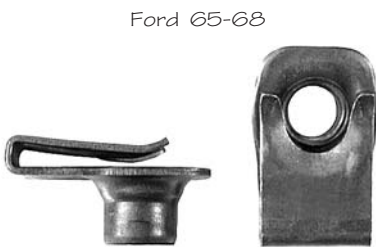

Ford 65-68
5/16-18 .03 - .08 P .69 W x .96 L
SF, 380020-S, 379114-S, 379483-S

S2	Pcs	Price
B-13529	4	\$5
B-11645	10	\$10



Ford 65-68
5/16-18 .03 - .08 P .70 W x 1.25 L
BN, 379831-S

S2	Pcs	Price
B-11516	4	\$5
B-10784	10	\$10

GM Shocks



5/16-18 .12 - .15 P .81 W x .79 L
KWY, 339715

S2	Pcs	Price
B-13235	2	\$4

Ford 65-69



5/16-18 .03 - .08 P .69 W x 1.02 L
TS, 378680-S

S2	Pcs	Price
B-11995	4	\$5
B-13267	10	\$10

Ford 65-68



5/16-18 .03 - .08 P .67 W x 1.30 L
OSA, 378681-S

S2	Pcs	Price
B-13269	4	\$5
B-13270	10	\$10

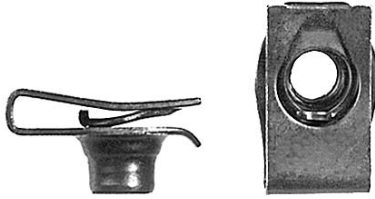

5/16-18 .02 - .15 P .66 W x 1.0 L
KO, 153294 ◆, 45264-S, 1494253

S2	Pcs	Price
B-13530	8	\$4
B-10786	20	\$10

Mustang Bumper > Fender 65-68

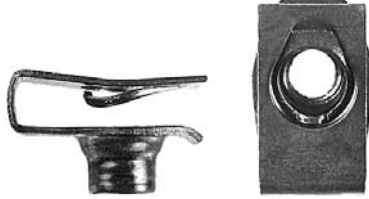

5/16-18 .16 - .22 P .67 W x 1.03 L
KNR

S2	Pcs	Price
B-12000	6	\$4

Mustang Bumper Guards 65-66



5/16-18 .02 - .15 P .64 W x 1.28 L
MF, 45268-S, 1494258

S2	Pcs	Price
B-13531	8	\$4
B-10788	20	\$10

Mustang Bumper Guards 67-68



5/16-18 .12 - .15 P .68 W x 1.04 L
AO, 378711-S

S2	S8	Pcs	Price
B-11996	B-11998	2	\$6

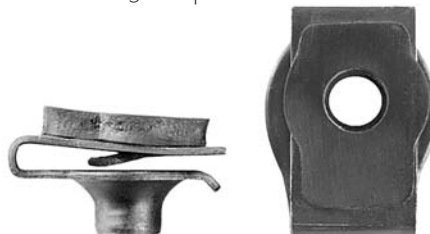

5/16-18 .02 - .13 P .88 W x 1.14 L
TO, 378960-S (sim)

S2	Pcs	Price
B-12004	2	\$6

Mustang Bumper Guards 65-66



5/16-18 .02 - .15 P .64 W x 1.28 L
RF, 379670-S (sim)

S2	Pcs	Price
B-12001	2	\$4

Mustang Bumper Guards 67-68

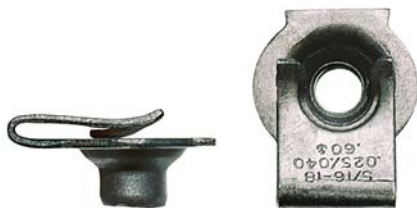

5/16-18 .02 - .06 P .88 W x 1.08 L
NW

S2	Pcs	Price
B-11993	10	\$5
B-11994	25	\$10

GM Body



5/16-18 .02 - .13 P .86 W x 1.13 L
(KZ) 152450 ◆, 379837-S

S2	S8	Pcs	Price
B-12002	B-12003	4	\$3

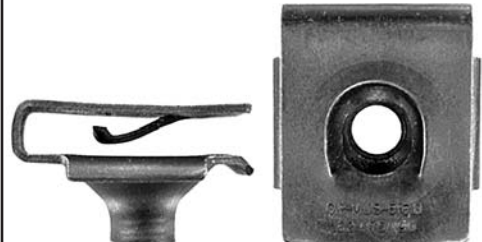

5/16-18 .07 - .19 P 1.10 W x 1.27 L
KPS

S2	Pcs	Price
B-12006	4	\$6

GM Body



5/16-18 .02 - .06 P .69 W x 1.04 L
LQS, 3784845

S2	Pcs	Price
B-10616	4	\$5
B-10617	10	\$12

<<< HEX staked nut <<<
is more common 1964 -68

>>> SQUARE staked nut >>>
is more common 1969-72



5/16-18 .02 - .06 P .69 W x 1.0 L
OET, 3784845

S2	Pcs	Price
B-11517	4	\$5
B-11518	10	\$12

NUT & RETAINERS - J & U



5/16-24 .03 - .06 P .63 W x .95 L
MT

S2	Pcs	Price
B-12007	4	\$5

Ford 60-64



5/16-24 .03 - .08 P .64 W x 1.27 L
KVH

S2	Pcs	Price
B-12008	4	\$5
B-12009	10	\$10



3/8-16 .09 - .14 P .75 W x 1.06 L
LQL

S8	Pcs	Price
B-10615	4	\$3



3/8-16 .05 - .20 P .93 W x 1.35 L
KVI, 152451 ◆, 45265-S, 1494254

S2	Pcs	Price
B-12010	4	\$5



3/8-16 .20 - .38 P .93 W x 1.35 L
MCS, 389115-S

S2	Pcs	Price
B-11632	2	\$3



3/8-16 .05 - .20 P .93 W x 1.72 L
ST, 45269-S

S2	Pcs	Price
B-12011	4	\$5



Camaro Leaf Spring Fr Hangers 67-81, Fenders 70-81



3/8-16 .09 - .20 P .94 W x 1.39 L
KJM, 378276

S2	Pcs	Price
B-12012	2	\$5



Mustang Rr Bumper Brackets 71-73

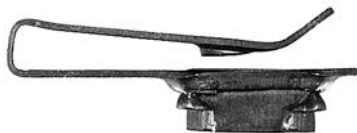

7/16-14 .08 - .18 P .88 W x 1.81 L
SH, 383085-S

S2	Pcs	Price
B-12013	2	\$6



1/2-13 .10 - .22 P .88 W x 2.0 L
MLQ

S2	Pcs	Price
B-11404	1	\$5



NUTS - NYLON



#6 FOR .25 SQR HOLE
.37 X .37 X .032 TK FLANGE
LKK, N802376-S

S	Pcs	Price
B-10552	250	\$30

Headlamp Bezels 64-65 Chevelle, Nova



#8 FOR .25 SQR HOLE
.37 X .37 X .032 TK FLANGE
SK, 383356-S

S	Pcs	Price
B-12913	8	\$3

Headlamp Bezels 66 Chevelle, Nova



#8 FOR .28 SQR HOLE
.37 X .37 X .032 TK FLANGE
SD 376309-S

S	Pcs	Price
B-12915	8	\$3

Headlamp Bezels 67-68 Camaro



#8 FOR .28 SQR HOLE
.50 OD X .075 TK SPACER
KBD, 3788345

S	Pcs	Price
B-13694	8	\$3



#8 FOR .28 SQR HOLE
.50 OD X .12 TK SPACER
LDF, 3783004, 3967142 (sim)

S	Pcs	Price
B-13693	6	\$3

Headlamp Bezels 67 Chevelle

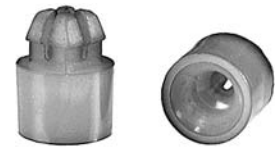

#8 FOR .28 SQR HOLE
.50 OD X .38 TK SPACER
KSI, 152862, 3899847

S	Pcs	Price
B-12914	6	\$3

Grille, Headlamp Extensions 70-73 Camaro



#8 FOR .25 X .35 MIN L SLOT
.34 X .50 X .062 TK FLANGE
MLE, N800503-S

S	Pcs	Price
B-10553	100	\$30



#8 FOR .28 X .39 MIN L SLOT
.43 OD X .19 TK SPACER
KKE, 3880632

S	Pcs	Price
B-12916	6	\$3

Headlamp Bezels 67 Chevelle



#8 FOR .28 X .40 MIN L SLOT
.44 OD X .11 TK SPACER
KKA, 3903951, 3892186 (sim)

S	Pcs	Price
B-12917	6	\$3

Grille, Headlamp Extensions 70-73 Camaro



#8 FOR .31 SQR HOLE
.43 X .43 X .08 TK FLANGE
KQV, 3899596 (sim), 3919773

S	Pcs	Price
B-12919	8	\$3



#8 FOR .28 X .51 MIN L SLOT
.38 X .65 X .060 TK FLANGE
MDD

S	Pcs	Price
B-10551	10	\$3

Headlamp Bezels 67 Chevelle



#8 FOR .31 X .73 MIN L SLOT
.59 X .95 X .060 TK FLANGE
MYS, N800841-S, 1377030 (sim)

S	Pcs	Price
B-10554	5	\$3

Grille, Headlamp Extensions 70-73 Camaro

Camaro Grille 78-81

NUTS - NYLON, PIERCE, RIVET

Door Speaker Grilles 67-68 Mustang



#8 FOR .31 SQR HOLE .25 TK SPACER
KYJ, 381886-S (sim)

S	Pcs	Price
B-10555	6	\$3

Chevelle Dashpad 66-67



#10 FOR .31 SQR HOLE
.50 OD X .18 TK SPACER
ODK, 3884940 (sim)

S	Pcs	Price
B-11406	9	\$3

GM License Plates

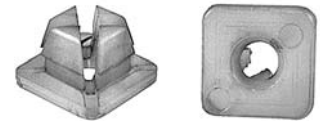

#14 FOR .38 SQR HOLE
.60 X .60 X .08 TK FLANGE
KKJ, 3907444

S	Pcs	Price
B-12920	8	\$3

Chevelle Grille 68



#14 FOR .38 SQR HOLE
.57 X .69 X .53 TK SPACER
KYA, 419961, 3920826 (sim)

S	Pcs	Price
B-13692	4	\$3

Ford License Plates



#14 FOR .40 SQR HOLE
.60 X .60 X .08 TK FLANGE
KTB, 380707-S

S	Pcs	Price
B-12921	8	\$3

GM Headlamp Adjustment



1/4-28 FOR .41 SQR HOLE
.63 X .63 X .14 TK FLANGE
KSM, 3921446

S	Pcs	Price
B-12923	4	\$3

GM Headlamp Adjustment



1/4-28 FOR .41 SQR HOLE
.52 X .52 X .12 TK FLANGE
KSP, 5953006

S	Pcs	Price
B-12922	4	\$3



1/4-20 X .49 X .69 X .21 TK
DQ, 9418784 ♠, 9418784

S2	Pcs	Price
B-10557	6	\$3



5/16-18 X .49 X .69 X .21 TK
MOL, 9418785 ♠, 34348-S, 9418785

S2	Pcs	Price
B-10558	6	\$4

Steel



8-32 .22 X .44 L BODY .36 FLANGE
KGV, 382167-S

S36	Pcs	Price
B-12927	4	\$3

Steel



10-24 .25 X .53 L BODY .40 FLANGE
RJ, 6026292 ♠, 379556-S

S36	Pcs	Price
B-12928	4	\$3

Steel



1/4-20 .33 X .69 L BODY .48 OD FLANGE
KXC, 3818073 (sim)

S8	Pcs	Price
B-13373	4	\$4

NUTS - RIVET, SLEEVE

Steel

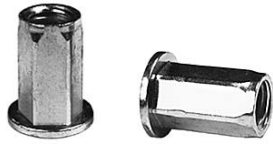

1/4-20 .31 HEX X .57 L BODY .46 OD FLANGE
BEC, 376903-S

S8	Pcs	Price
B-12929	4	\$4

Steel



5/16-18 .41 X .75 L BODY .67 FLANGE
KJV, 374301-S, 3792287

S8	Pcs	Price
B-12930	4	\$3

Steel



3/8-16 .49 X .84 L BODY .78 FLANGE
MSW, 3769099

S8	Pcs	Price
B-10570	2	\$3

Steel Mustang P/S Cylinder Bracket



3/8-16 .465 HEX X .81 L BODY .70 FLANGE
KGI, 375474-S
STEE

S8	Pcs	Price
B-12931	2	\$4

Steel



3/8-24 .46 HEX X .81 L BODY .70 FLANGE
KZY

S8	Pcs	Price
B-13374	2	\$6

Rivet Nut Installation Kit

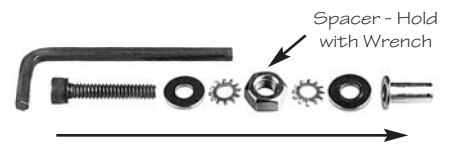

Size	Order #	Price \$
8-32	T-3375	2
10-24	T-2110	2
1/4-20	T-3376	2
5/16-18	T-3377	2
3/8-16	T-3378	2
3/8-24	T-3379	2



3/32 Stud .18 OD
KGQ, 378362-S

S32X	Pcs	Price
B-12924	8	\$3



1/8 Stud .25 OD
AW, 375890-S

S32X	Pcs	Price
B-12925	8	\$3

Plastic



1/8 Stud .26 OD
OJJ, 385417-S

S	Pcs	Price
B-10581	12	\$3



1/8 Stud x .16 L OPENING
MWA, 4673626

S100	Pcs	Price
B-10686	6	\$3



3/16 Stud
KSB, 375480-S

S32X	Pcs	Price
B-12926	8	\$4













GM Stoplamp SW 64 >



.50 SIZE
MFR, 1361699

S	Pcs	Price
B-10729	1	\$2

NUTS - SPRING Push Type

 <p>3/32 Stud .23 x .45 L BFK, 45030-S</p>			<p>Shelby Grille Moulding 69-70</p>  <p>1/8 Stud .37 OD VK, 374177-S</p>			 <p>1/8 Stud .31 x .58 L LRO, 45038-S</p>		
S2	Pcs	Price	S2	Pcs	Price	S2	Pcs	Price
B-12264	10	\$3	B-12972	15	\$3	B-10600	10	\$3
<p>GM Heater & AC Controls</p>  <p>5/32 Stud .44 OD MOG, 381700, 3126659</p>			 <p>3/16 Stud .44 OD OIG, 372927-S 6 SLITS</p>			<p>Chrysler Air Cleaner, Heater</p>  <p>3/16 Stud .44 OD LLV 8 SLITS</p>		
S2	Pcs	Price	S2	Pcs	Price	S2	Pcs	Price
B-10566	15	\$3	B-10563	30	\$3	B-10562	10	\$3
 <p>1/4 Stud .50 OD MZS, 1495028</p>			 <p>5/16 Stud .62 OD MIZ, 6100841, 11502504</p>			 <p>3/8 Stud .78 OD MYT, 1488371</p>		
S2	Pcs	Price	S8	Pcs	Price	S2	Pcs	Price
B-10561	20	\$3	B-10565	20	\$3	B-10564	20	\$3
 <p>7/16 Stud .84 OD OAV</p>			 <p>1/2 Stud .94 OD LTC</p>			<p>Brake Drum Retainer</p>  <p>1/2 Stud .75 x .98 L AJ, 2201842, 6026430, 372188-S</p>		
S2	Pcs	Price	S8	Pcs	Price	S32	Pcs	Price
B-10567	20	\$3	B-10560	250	\$30	B-13226	6	\$3

NUTS - SPRING



#6 .06 - .10 P .50 x .53 L
OH

S32	Pcs	Price
B-12242	10	\$3



#8-18 .41 x .62 L
LAI, 352522-S, 445109

S2	Pcs	Price
B-13370	8	\$3



#8 .02 - .04 P .41 x .72 L
BEY, 45132-S

S2	Pcs	Price
B-12243	8	\$3

GM AC Vacuum Motor Cover & Bezel



#8 .08 - .09 P .44 x .67 L
OCY, 3858749

S8	Pcs	Price
B-10596	8	\$3



#8 .02 - .04 P .50 x .53 L
BFL, 351639-S, 445344

S2	Pcs	Price
B-12244	8	\$3

Mustang Instrument Cluster 65-66



#8 .51 x .89 L
BEX, 379130-S

S32	Pcs	Price
B-10599	4	\$3



#8 .03 - .08 P .38 x .68 L
LYK

S2	Pcs	Price
B-10598	8	\$3



#8 .03 - .08 P .38 x .67 L
OTI, 9427761

S2	Pcs	Price
B-11407	8	\$3



#8 .02 - .06 P .44 x .62 L
BFC, 382656-S, 9422654

S2	Pcs	Price
B-12245	8	\$3

Firebird Headlamp "Hourglass" 67-68



#8 .09 - .12 P .50 x .53 L
OXF

S2	Pcs	Price
B-11408	8	\$3



#8 .02 - .06 P .50 x .57 L
BEZ, 45174-S

S2	Pcs	Price
B-12246	8	\$3



#8 .12 - .18 P .53 x .80 L
MZH, 9433156

S2	Pcs	Price
B-10595	8	\$3

NUTS - SPRING

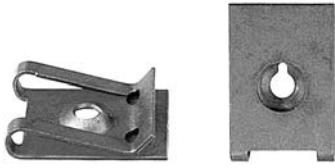

#8 .02 - .13 P .54 x .82 L
EO, 45257-S, 9431530 (sim)

S2	Pcs	Price
B-12247	8	\$3
B-11420	25	\$8



#8 .10 - .14 P .63 x .73 L
MCO

S8	Pcs	Price
B-10594	6	\$3



#8 .02 - .15 P .64 x 1.0 L
HL, 381863-S

S32	Pcs	Price
B-12248	6	\$3



#10 .06 - .09 P .50 x .65 L
PU, 372017-S, 9427498

S2	S36	Pcs	Price
B-12250	B-11412	8	\$3

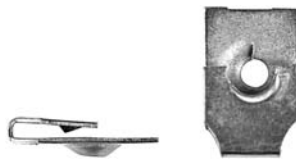

#10 .03 - .06 P .50 x .78 L
QZ, 377195-S, 45144-S, 445359

S2	Pcs	Price
B-12251	8	\$3



#10 .02 - .06 P .44 x .67 L
GAV, 378293-S

S2	S36	Pcs	Price
B-12253	B-12254	8	\$3

GM Speakers @ Kick Panels



#10 .09 - .12 P .44 x .67 L
OGU, 9421814 (sim)

S2	Pcs	Price
B-11409	8	\$3



#10 .03 - .10 P .50 x .69 L
KTC, 9422836 (s2)

S424	Pcs	Price
B-10588	8	\$3



#10 .04 - .08 P .50 x .81 L
KDG, 45188-S, 45189-S

S2	Pcs	Price
B-12256	4	\$3



#10 .04 - .08 P .50 x .98 L
LMO, 45191-S

S2	Pcs	Price
B-10591	4	\$3



#10 .02 - .08 P .56 x .80 L
LQM, 6028153 (sim)

S2	Pcs	Price
B-10589	4	\$3



#10 .02 - .04 P .62 x .56 L
KHX, 45186-S

S2	Pcs	Price
B-12257	6	\$3

Ford Fan Shrouds



#12 .04 - .08 P .62 x .67 L
EK, 383375-S

S2	Pcs	Price
B-12258	4	\$3

Camaro Headlamp Housings 67-68



#14 .02 - .06 P .63 x .64 L
KTT, 3849974

S2	Pcs	Price
B-12259	6	\$3



#14 .02 - .08 P .56 x .98 L
KHT, 45193-S, 445449, 9420153

S2	S8	Pcs	Price
B-12260	B-10590	4	\$3

Firebird Wheelhouses 69



#14 .60 x .88 L
OWS, 9422619 (sim)

S2	Pcs	Price
B-11410	5	\$6

Ford Armrests 67-68

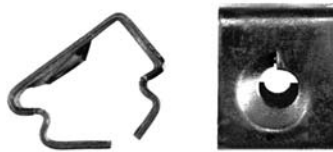

#14 .62 x .74 L
UE, C7AB-6224146-C

S3	Pcs	Price
B-12262	4	\$3

Ford & Chrysler Armrests



#14 .62 x 1.45 L
BFD, 1280134 ♠, BA-7024146-A

S2	Pcs	Price
B-12263	4	\$3

Chrysler Fan Shrouds

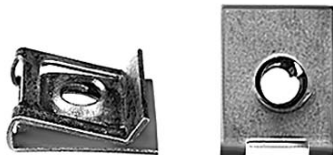

#14 .02 - .15 P .63 x .81 L
EM, 45258-S, 9431532

S2	Pcs	Price
B-12261	6	\$3
B-11421	20	\$8



8-32 .03 - .05 P .48 x .50 L
LTV, 6026634 ♠

S2	Pcs	Price
B-10602	4	\$5



1/4-20 .75 OD
KJB, 383270-S

S32	Pcs	Price
B-12268	4	\$3



1/4-20 .02 - .12 P .50 x 1.0 L
OXX

S32	Pcs	Price
B-11411	4	\$3



1/4-20 .03 - .15 P .56 x 1.10 L
VY, 374803-S

S32	Pcs	Price
B-10042	4	\$4



5/16-18 .03 - .11 P .63 x 1.0 L
MDT

S2	Pcs	Price
B-10601	4	\$3

NUTS - STAMPED Thread Cutting



1/8 1/4 AF
JP, 371136-S, 9420183, 9420178

S8	Pcs	Price
B-12968	250	\$30



1/8 5/16 AF
JX, 377099-S, 9420862

S36	Pcs	Price
B-12969	12	\$3



1/8 5/16 AF .27 TK
LCN, 9416046

S8	Pcs	Price
B-13695	10	\$3



1/8 5/16 AF .44 OD
KSK, 373888-S (sim), 9411466

S8M	Pcs	Price
B-12971	10	\$3



1/8 5/16 AF .53 OD
KTN, 9419753, 9420276 (s36x)

S2	S36X	Pcs	Price
B-10629	B-10630	10	\$3



1/8 11/32 AF .53 OD .80 OAH
KR, 6027352

S8MX	Pcs	Price
B-12967	4	\$3



1/8 3/8 AF .53 OD .54 OAH
LR

S8MX	Pcs	Price
B-12966	4	\$3

Chrysler Grille Emblems



1/8 3/8 AF .75 OD
LGK
DARK GREEN

S100	Pcs	Price
B-10627	4	\$3



5/32 11/32 AF
KYB, 9418239

S2	Pcs	Price
B-10639	12	\$3

Mustang Hood Moulding 71-73



5/32 7/16 AF .38 OAH
LIS, 384441-S

S8	Pcs	Price
B-10640	4	\$5



5/32 11/32 AF .56 OD
WL, 374566-S

S36	Pcs	Price
B-12974	10	\$3

Mastic Sealer
is often used together
with stamped nuts



See page 167



#10 7/16 AF .38 TK
KJC, 9418105

S8	S36	Pcs	Price
B-12975	B-11705	6	\$3



#10 3/8 AF .50 OD
KYD, 375461-S, 9419755 (s2)

S2	Pcs	Price
B-13383	10	\$3



#10 3/8 AF .50 OD
WK, 373503-S (sim), 373504-S, 9415252.
9414966

S2	S36	Pcs	Price
B-13271	B-12980	10	\$3



#10 7/16 AF .63 OD .56 OAH
KCP, 376423-S

S8M	Pcs	Price
B-12976	4	\$3



#10 3/8 AF .63 OD
KSX, 9415253, 9419756 (sim)

S2	Pcs	Price
B-13381	10	\$3

**We have too many items
to fit in this catalog !**

Please visit our BULK section at
www.amkproducts.com



#14 7/16 AF .59 OD
WD, 376482-S, 9420264

S36	Pcs	Price
B-12982	6	\$3



#14 7/16 AF .69 OD
CB, 371024-S, 371882-S (sim), 9414971

S8	Pcs	Price
B-12983	6	\$3



#14 7/16 AF .69 OD
KJD, 9420253 (s), 9420262

S8MX	Pcs	Price
B-12984	6	\$3

Mustang 67 Chevelle 71-72



#14 7/16 AF 1.0 OD
KQT, 372444-S (sim), 9420305

S36M	Pcs	Price
B-10641	5	\$3



5/16 1/2 AF .75 OD
KLN, 8797130 (s2)

S8	Pcs	Price
B-12985	8	\$4



5/16 1/2 AF 1.0 OD
LYS
SILVER PAINT

S100	Pcs	Price
B-10638	6	\$3

NUTS - STAMPED Machine Thread



8-32 11/32 AF .30 OAH
IP, 377522-S

S36	Pcs	Price
B-12938	8	\$3



8-32 11/32 AF .47 OD
KYS, 45245-S, 9426925 (s8)

S8X	Pcs	Price
B-13384	10	\$3



8-32 11/32 AF .53 OD .78 OAH
LBA

S8X	Pcs	Price
B-12954	6	\$3



8-32 11/32 AF .56 OD
EL, 45270-S (no seal), 45271-S

S36	Pcs	Price
B-12941	4	\$3
B-11492	12	\$8



8-32 3/8 AF .56 OD .54 OAH
CF, 45276-S, 45277-S

S36	Pcs	Price
B-12939	4	\$5
B-13274	10	\$10



8-32 11/32 AF .69 OD
MPO

S36X	Pcs	Price
B-10642	4	\$3



8-32 11/32 AF .69 OD
ZX, 45272-S, 45273-S

S36	Pcs	Price
B-12942	2	\$3
B-13273	5	\$6

Mastic Sealer
is often used together
with stamped nuts



See page 167

Coronet Air Grabber, Side Scoops 69-70



8-32 11/32 AF .75 OD .44 OAH
OVQ, 6026218

S8M	Pcs	Price
B-11413	4	\$3



10-24 3/8 AF .33 OAH
JR

S36	Pcs	Price
B-12943	6	\$3



10-24 3/8 AF .50 OD
JS, 45242-S, 9419841, 9419784

S2	S8	S36	Pcs	Price
B-10352	B-12951	B-12952	10	\$3



10-24 3/8 AF .62 OD
CC, 376750-S, 9419842, 9420231

S2	S36M	Pcs	Price
B-10635	B-10636	10	\$3



10-24 3/8 AF .62 OD
AM, 6008043 ◆, 353911-S, 359606-S

S8	Pcs	Price
B-12955	4	\$4
B-11418	12	\$10

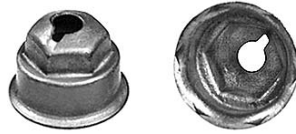

10-24 3/8 AF .63 OD .45 OAH
NI, 6026681 ◆, 375575-S

S36M	Pcs	Price
B-12947	4	\$3

Cuda Tailamps 72-74

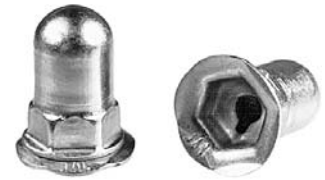

10-24 7/16 AF .63 OD .79 OAH
KQG

S8	Pcs	Price
B-12945	4	\$3



10-24 7/16 AF .63 OD .86 OAH
KFN

S8MX	Pcs	Price
B-12946	4	\$4



10-24 3/8 AF .75 OD
LEQ, 9420868

S8MX	Pcs	Price
B-13697	6	\$3

Challenger Tailamps 72-74



10-24 3/8 AF .75 OD .45 OAH
LTT

S2X	Pcs	Price
B-10634	2	\$4



1/4-20 7/16 AF .59 OD
IA, 45235-S, 440491

S8	Pcs	Price
B-12956	6	\$3

GM Heater > Firewall



1/4-20 7/16 AF .69 OD
KUA, 9419845, 9420647 (sealer)

S2	Pcs	Price
B-12959	5	\$3

Ford Heater > Firewall



1/4-20 7/16 AF .69 OD
CK, 370546-S

S36M	Pcs	Price
B-12958	4	\$3



1/4-20 1/2 AF .75 OD .51 OAH
MQT, 6026686 ◆

S2	Pcs	Price
B-13930	2	\$4



1/4-20 7/16 AF .81 OD
PW, 45234-S, 446069, 9420318

S2	S8M	Pcs	Price
B-13272	B-12961	4	\$3



1/4-20 7/16 AF .87 OD
LFF

S36MX	Pcs	Price
B-13696	4	\$3

NUTS - STAMPED Machine Thread, STOP, WELL



1/4-20 7/16 AF .88 OD .32 OAH
BQ, 45274-S, 45275-S (sealer)



1/4-20 1/2 AF 1.0 OD .69 OAH
LPP



1/4-20 1/2 AF 1.0 OD .51 OAH
KYV

S36	Pcs	Price
B-12963	4	\$5
B-13276	10	\$10

S2X	Pcs	Price
B-13929	25	\$30

S2	Pcs	Price
B-12970	4	\$5

Door Glass



1/4-20 1.50 OD .31 OAH
OYB



3/8-24 9/16 AF
YJ, 45218-S, 9420167



3/8-24 5/8 AF .81 OD
JZ, 376642-S

S100	Pcs	Price
B-11414	2	\$3

S8	Pcs	Price
B-12964	6	\$3

S36M	Pcs	Price
B-12965	4	\$3

Stainless



1/4-20 7/16 AF .31 TK
LGT

Stainless



5/16-18 1/2 AF .34 TK
LGD

Stainless



3/8-16 9/16 AF .44 TK
LGH

SS	Pcs	Price
B-10605	8	\$3

SS	Pcs	Price
B-10606	8	\$3

SS	Pcs	Price
B-10607	6	\$3

GM Voltage Regulator 64-68



8-32 .31 x .42 L BODY .44 OD FLANGE
KHG



10-24 .37 x .56 L BODY .56 OD FLANGE
KQN, 3876130

GM Radiator & AC Condensor



1/4-20 .50 x .63 L BODY .73 OD FLANGE
LQR, 3903539

S	Pcs	Price
B-12935	4	\$3

S	Pcs	Price
B-12936	3	\$3

S	Pcs	Price
B-10608	2	\$3



1/4-20 1.06 WIDE .040 MAT
KID, 6033725 ◆, 33904-S
148312 (s8)

Chrysler Air Cleaner



1/4-20 1.32 WIDE .060 MAT
MVZ, 6028729 ◆

GM Air Cleaner



1/4-20 1.32 WIDE .072 MAT
LPH, 9418699. 219281



5/16-18 1.25 WIDE .048 MAT
KEP, 33905-S, 148327

S8	S36	Pcs	Price	S8	Pcs	Price	S2	S13	Pcs	Price	S2	Pcs	Price
B-11520	B-12932	4	\$3	B-10036	1	\$3	B-10007	-----	1	\$2	B-12934	4	\$3
							-----	B-10008	1	\$3			

Ford Air Cleaner



1/4-20 1.44 WIDE
CL, 358871-S



5/16-18 1.46 WIDE
OSG, 6026841 ◆

S8	Pcs	Price	S8	Pcs	Price
B-12933	2	\$3	B-11415	2	\$3
B-11491	10	\$10			

AMK has

invested thousands of hours
researching fastener kits.
Check out the kit sections.

GM Spare Wheel



5/16-18 3.88 WIDE
LQP, 9785616

S8	Pcs	Price
B-10612	1	\$6

Ford Spare Wheel 59 >



3/8-16 3.53 WIDE .072 MATERIAL
MTL, B9AZ-1462-A

Ford Spare Wheel 68 >



1/2-13 3.53 WIDE .072 MATERIAL
LSE, C8AZ-1462-A

S8	Pcs	Price	S8	Pcs	Price
B-10610	1	\$4	B-10611	1	\$6

TAPPING SCREWS - FILLISTER, FLAT, HEX

Mustang Headlamp Rings 65-70



8-18 x 7/16 .26 OD
AT, 375452-S
STAINLESS

SS	Pcs	Price
B-13446	12	\$4

Mustang Headlamp Doors 65-66



10-12 x 1.0 .30 OD
QY, 378852-S
STAINLESS

SS	Pcs	Price
B-12062	8	\$5

Stainless



8-18 x 3/8 .26 OD
KXG

SS	Pcs	Price
B-13340	20	\$3

Chevelle Quarter Glass 64-67



8-15 x 1/2 .26 OD
TZ, 53425-S, 273552 (s7-8), 178704 (s13)

S8	S13	S36	Pcs	Price
B-12064	B-12066	B-12065	12	\$3



8-18 x 1/2 .26 OD
UF, 9419992

S8	Pcs	Price
B-11419	12	\$3



8-15 x 5/8 .31 OD
ZC, 52017-S, 161416

S2	S13	Pcs	Price
B-12068	B-12069	10	\$3

GM Armrest Pad



8-18 x 5/8 .31 OD
MPS, 52071-S, 162659

S8	Pcs	Price
B-11068	10	\$3



10-16 x 1/2 .36 OD
KD, 52064-S, 162684

S8	Pcs	Price
B-12070	10	\$3



8-18 x 7/16 1/4 AF .38 FLAT
OCL, 9422622 (sim)

S2	Pcs	Price
B-11183	6	\$3

Chevelle Cowl Panel 64-67



8-18 x 1/2 1/4 AF .50 FLAT
LES, 9420508 (sim), 9433193 (sim)
9433347

S2	Pcs	Price
B-13736	5	\$4



8-18 x 1/2 1/4 AF .38 FLAT
OAF, 3937182, 3942681 (sim)

S2	Pcs	Price
B-11185	6	\$3

Camaro & Nova Cowl Panel



8-18 x 9/16 1/4 AF .62 FLAT
KTG, 9421479, 3855894 (wax)

S8	Pcs	Price
B-12172	4	\$3



8-18 x 5/8 1/4 AF .37 FLAT
MUP, 9427877, 9433192 (sim)

S2	Pcs	Price
B-11186	6	\$3



8-18 x 5/8 1/4 AF .50 FLAT
MXI, 9428646

S2	Pcs	Price
B-11187	6	\$3



8-18 x 5/8 1/4 AF .38 FLAT
OAL, 3963759

S2	Pcs	Price
B-11188	6	\$3

TAPPING SCREWS - HEX



8-18 x 7/8 1/4 AF .38 FLAT
OCK, 9433191

S2	Pcs	Price
B-11189	6	\$3



10-16 x 1/2 5/16 AF .44 FLAT
KKI, 9427325, 9429619 (tek)

S2	Pcs	Price
B-12173	8	\$3



#10-16 x 1/2 5/16 AF .50 FLAT
OBK

S2	Pcs	Price
B-11195	6	\$3



#10-16 x 5/8 5/16 AF .44 FLAT
MUO, 9427398

S2	Pcs	Price
B-11190	6	\$3



#10-16 x 3/4 5/16 AF .44 FLAT
OCT, 9428882

S2	Pcs	Price
B-11193	6	\$3



#10-16 x 3/4 5/16 AF .75 FLAT
LMN, 6035041 (s8m) ◆, 9420372 (s2)

S2	S8M	Pcs	Price
B-11191	B-11192	6	\$3



#10-16 x 7/8 5/16 AF .44 FLAT
OCD, 9433190

S2	Pcs	Price
B-11194	6	\$3

50's early 60's GM



1/4-10 x 5/8 3/8 AF
PCE, 189891, 9421298

S2	Pcs	Price
B-13461	8	\$3
B-13462	20	\$10

Chevelle Fender Extensions 70-72



1/4-14 x 3/4 3/8 AF .75 FLAT
KQU, 9421985

S2	Pcs	Price
B-12175	6	\$4

Camaro Steering Column Seal 70 >



1/4-14 x 3/4 3/8 AF 1.25 FLAT
OBU, 3974569

S2	Pcs	Price
B-11430	2	\$3

GM Rr Seat



1/4-14 x 7/8 7/16 AF 1.0 TOOTHED
OAB

S2	Pcs	Price
B-11197	2	\$3

GM Heater Box



1/4-14 x 7/8 7/16 AF .62 FLAT
OAC, 1366017 (sim), 1384828, 1386251 (sim)

S2	Pcs	Price
B-11198	6	\$5

TAPPING SCREWS - HEX

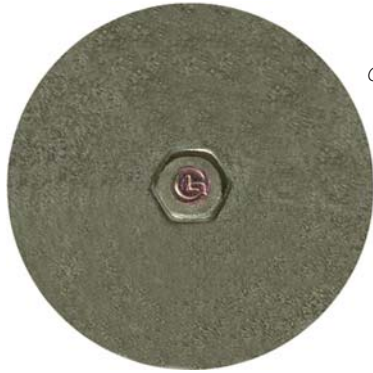

Column Seal 69 Camaro, Nova 69-72



1/4-14 x 7/8 3/8 AF 1.92 FLAT
MOQ, 3949733



Camaro Grille 69

1/4-14 x 1.0 3/8 AF .75 FLAT
LZG, 9422641 (wax), 9425451 (sim)

S2	Pcs	Price	S2	Pcs	Price
B-11199	4	\$5	B-11431	5	\$5

Camaro Grille 69



1/4-14 x 1.0 3/8 AF .75 FLAT
KSL, 9420432

Ford Steering Column Seal, Rr Seat



1/4-14 x 1.0 3/8 AF .88 TOOTHED
OBS, 376276-S

GM Heater Box > Firewall



1/4-14 x 1.0 7/16 AF .69 EXTERNAL
LON, 3863393, 9780719, 14005067 (sim)

S2	Pcs	Price	S36	Pcs	Price	S8	Pcs	Price
B-13735	6	\$4	B-11202	4	\$4	B-11200	2	\$3
						B-11201	6	\$6

Ford Rr Seat Back 68 >



1/4-14 x 1.25 3/8 AF .88 TOOTHED
BFR, 378835-S, 382523-S

Steering Column Cover 69-71 Camaro, 69-72 Nova



1/4-14 x 1 1/2 3/8 AF 1.0 FLAT
MDF, 9429629

S2	Pcs	Price	S2W	Pcs	Price
B-12176	4	\$3	B-11203	2	\$3

AMC Body



5/16-10 x 3/4 1/2 AF .62 FLAT
LJM



5/16-10 x 1.0 1/2 AF .88 FLAT
LFG

S2	Pcs	Price	S8	Pcs	Price
B-11204	50	\$30	B-13778	4	\$5

for Bulk Quantities of

50, 100, 250, 500
1000 (1M), 2500 (2.5M)
5000 (5M), 10000 (10M)

Add a dash (-) plus quantity
to the part number.

Retail discount is 15%

TAPPING SCREWS - HEX WASHER



6-20 x 3/8 1/4 AF .31 OD
MTA, 9423354

S8	Pcs	Price
B-11069	20	\$3



6-18 x 1/2 1/4 AF .31 OD
TU, 42124-S

S2	Pcs	Price
B-12040	15	\$3



6-20 x 1/2 1/4 AF .31 OD
BEJ, 42364-S, 9426693

S2	Pcs	Price
B-12041	15	\$3



8-18 x 1/4 1/4 AF .34 OD
ZA, 55872-S

S2	Pcs	Price
B-12046	20	\$3



8-18 x 1/4 1/4 AF .34 OD
KTY, 42352-S, 447143

S8	Pcs	Price
B-11070	20	\$3



8-18 x 3/8 1/4 AF .34 OD
IK, 42119-S, 55906-S, 3858195 (s2w)
9419699, 9431573 (s2w), 9415191

S2	S8	Pcs	Price
B-12048	B-12049	20	\$3



8-18 x 3/8 1/4 AF .34 OD
KTX

S8	Pcs	Price
B-12050	12	\$3



8-18 x 3/8 1/4 AF .35 OD
MQQ, 3925753 (sim), 3930160

S2	Pcs	Price
B-11071	10	\$3



8-18 x 3/8 1/4 AF .34 OD
ODW, 9420567

S2	Pcs	Price
B-11072	10	\$3



8-18 x 1/2 1/4 AF .34 OD
FG, 55907-S, 9419663, 9415464, 9426269

S2	S8	S36	Pcs	Price
B-13418	B-13419	B-13420	12	\$3
B-11151	B-13750	B-11152	40	\$10

Stainless



8-18 x 1/2 1/4 AF .34 OD
LGQ

SS	Pcs	Price
B-11073	10	\$3

Camaro Rr Window Filler Panel '70-'81



8-18 x 1/2 1/4 AF .40 OD
KVD, 9879001

S8W	Pcs	Price
B-11074	5	\$3



8-18 x 1/2 5/16 AF .40 OD
IJ

S8	S36	Pcs	Price
B-12074	B-12075	8	\$3



8-18 x 1/2 1/4 AF .34 OD
BFS, 42366-S, 9420083 (s2)

S2	S36	Pcs	Price
B-12072	B-12073	10	\$3

Camaro Tailamp Housings '67-'68



8-18 x 1/2 1/4 AF .34 OD
KUC, 5959164

S8	Pcs	Price
B-11075	12	\$3

TAPPING SCREWS - HEX WASHER

Mustang Glove Box Catch 65-66



8-18 x 1/2 1/4 AF .40 OD
KOC

S8	Pcs	Price
B-12076	100	\$30



8-15 x 5/8 1/4 AF .40 EXTERNAL
FH, 374565-S

S2	S8	Pcs	Price
B-11634	B-11635	6	\$3



8-18 x 5/8 1/4 AF .34 OD
BFJ, 55875-S, 9420914

S2	Pcs	Price
B-12077	10	\$3



8-18 x 5/8 1/4 AF .34 OD
LXW, 9420686

S2	Pcs	Price
B-11076	10	\$3



8-18 x 3/4 1/4 AF .34 OD
BFF, 55908-S, 9420425

S2	Pcs	Price
B-12078	10	\$3



8-18 x 3/4 1/4 AF .34 OD
LMX, 42380-S, 9426698

S2	Pcs	Price
B-11077	10	\$3

Cuda Grille 71



8-18 x 1.0 1/4 AF .51 OD
LFS, 6028940

S2	Pcs	Price
B-13864	4	\$3



10-16 x 3/8 5/16 AF .40 OD
QT, 9415162 (s8), 42120-S, 9419320,
9427838 (s2w), 9415162 (s7-8)

S2	S8	S36	Pcs	Price
B-12083	B-12084	B-13445	12	\$3

Mustang Filler Neck 65-70



10-16 x 3/8 5/16 AF .40 OD
Y, 42360-S, 9420453, 451790

S2	S8	Pcs	Price
B-11079	B-11080	5	\$3



10-12 x 1/2 5/16 AF .40 OD
PP, 42127-S, 9420755, 274773

S2	S8	Pcs	Price
B-12079	B-12080	10	\$3
B-11422	B-11423	40	\$10

Stainless



10-12 x 1/2 5/16 AF .40 OD
LGF

SS	Pcs	Price
B-11081	10	\$3



10-16 x 1/2 5/16 AF .40 OD
KTA, 3841230 (s2w), 9419303, 9428469 (s2w),
9419305, 9432341 (tek), 9432572 (tek)

S2	S8	S8W	Pcs	Price
B-12081	B-11082	B-11083	10	\$3



10-16 x 1/2 5/16 AF .40 OD
KAR, 42367-S, 9428123

S36	Pcs	Price
B-12082	10	\$3



10-16 x 1/2 5/16 AF .40 OD
ODS, 9422601

S2	Pcs	Price
B-11085	10	\$3

Stainless



10-12 x 5/8 5/16 AF .40 OD
NE, 42134-S, 456766

S8	Pcs	Price
B-12085	10	\$3
B-11343	20	\$5

TAPPING SCREWS - HEX WASHER



10-16 x 5/8 1/4 AF .42 OD
MOS, 3873951

S2	Pcs	Price
B-11088	8	\$3



10-16 x 5/8 5/16 AF .40 OD
LYR, 9419321, 9424079 (sim). 9417855,
9420731

S2	S8	Pcs	Price
B-11086	B-11087	10	\$3



10-16 x 5/8 1/4 AF .42 OD
ODQ, 3873950

S2	Pcs	Price
B-11089	8	\$3



10-12 x 3/4 5/16 AF .40 OD
WN, 42141-S, 273697 (s8)

S2	S8	Pcs	Price
B-12086	B-12087	8	\$3

Mustang Grille Area Mouldings 67-68



10-12 x 3/4 5/16 AF .49 OD
KU, 372345-S

S2	Pcs	Price
B-12088	6	\$3



10-16 x 3/4 5/16 AF .40 OD
GZ, 377834-S, 3863392 (s2w), 9419322,
9428472. 9416639 (s7-8)

S2	S8	Pcs	Price
B-11090	B-12089	8	\$3



10-16 x 1 1/8 5/16 AF .40 OD
MSX

S2	Pcs	Price
B-11091	8	\$3



10-12 x 1 3/4 5/16 AF .40 OD
YA, 42165-S

S2	Pcs	Price
B-12090	6	\$3

Mustang Fuse Block 65-67

Save time !

See the Kit sections

for the fasteners you need for a specific application combined in one package.

Mustang Fuse Block 68



10-12 x 2.0 5/16 AF .40 OD
ID, 377192-S

S2	Pcs	Price
B-12091	6	\$3

GM Fuse Block 68 >



10-16 x 2 1/4 5/16 AF .40 OD
MOJ, 3919058, 9427721 (s2), 9428475

S2W	Pcs	Price
B-11093	2	\$3



12-11 x 1/2 5/16 AF .42 OD
OE, 42128-S

S8	Pcs	Price
B-12092	6	\$3



1/4-14 x 1/2 3/8 AF .50 OD
Q, 31497-S, 55981-S, 9419400. 9426241.
9421964

S2	S8	S36	Pcs	Price
B-12093	B-12094	B-12095	8	\$4
B-11400	B-10818	B-10819	25	\$10



1/4-14 x 1/2 3/8 AF .50 OD
BBL, 31527-S, 9419909. 177999

S2	S8	Pcs	Price
B-12096	B-11094	6	\$3



1/4-10 x 5/8 3/8 AF .50 OD
P, 31498-S, 9419931. 9411563

S2	S8	Pcs	Price
B-12097	B-12098	8	\$3
B-10816	B-10817	20	\$10

TAPPING SCREWS - HEX WASHER



1/4-14 x 5/8 3/8 AF .50 OD
 ZW, 55876-S, 9419727. 9420415, 9428476
 (wax). 9424939

S2	S8	S36	Pcs	Price
B-12099	B-11097	B-12100	8	\$3
B-11098	B-11099	B-11100	25	\$10

Ford Washer Bottles 69 >



1/4-14 x 5/8 3/8 AF .62 FLAT
 BEN, 382944-S

S2	Pcs	Price
B-12177	3	\$3

Ford License Plates 68 >



1/4-14 x 5/8 3/8 AF .63 OD
 LCG, 384370-S

S8	Pcs	Price
B-11101	4	\$2

Ford Fan Shrouds 68 >



1/4-14 x 5/8 7/16 AF .75 OD
 FY, 382160-S (sim), 383152-S

S2	Pcs	Price
B-12101	4	\$4

License Plates - Rustproof Screws



1/4-14 x .65 5/16 AF .61 OD
 LUO, F4ZB-17A386-AD

S3	Pcs	Price
B-11095	8	\$3
B-11096	100	\$10



1/4-10 x 3/4 3/8 AF .50 OD
 ZE, 42143-S

S8	Pcs	Price
B-11102	6	\$3



1/4-14 x 3/4 3/8 AF .50 OD
 R, 55914-S, 9419380. 9420151,
 9423829 (s7-8).

S2	S8	S36	Pcs	Price
B-12102	B-12103	B-12104	8	\$4
B-10820	B-12105	B-10821	25	\$10



1/4-14 x 3/4 3/8 AF .50 OD
 LVT, 55914-S, 9419380

S2	Pcs	Price
B-11104	25	\$6

Stainless



1/4-14 x 3/4 3/8 AF .50 OD
 LGM, 9431850 (s45)

SS	Pcs	Price
B-11103	6	\$3



1/4-14 x 3/4 3/8 AF .50 OD
 BEL, 42383-S, 9426708

S2	Pcs	Price
B-12106	6	\$3



1/4-14 x 1.0 3/8 AF .50 OD
 KEJ, 55915-S, 9420065

S2	Pcs	Price
B-12108	6	\$3



1/4-14 x 1 1/4 5/16 AF .46 OD
 MBJ, N610962-S

S36M	Pcs	Price
B-11349	250	\$30



1/4-14 x 1 1/4 3/8 AF .50 OD
 GW, 55916-S, 9420878. 9423830

S2	S8	Pcs	Price
B-12114	B-13411	8	\$4



5/16-10 x 11/16 1/2 AF .67 OD
 MEX, 9422232 (sim)

S2	Pcs	Price
B-11107	4	\$3



5/16-12 x 7/8 1/2 AF .67 OD
 MZB, 9423284

S2	Pcs	Price
B-10054	4	\$3

TAPPING SCREWS - OVAL



6-20 x 5/8 .27 OD
A, 55860-S, 9416135

S13	Pcs	Price
B-11109	12	\$3



8-18 x 3/8 .27 OD
YD, 53008-S, 55932-S, 9423743, 9423212, 9414751

S2	S8	S13	Pcs	Price
B-12051	B-12052	B-12053	20	\$4

Stainless



8-18 x 3/8 .31 OD
SM, 55972-S, 454635

SS	Pcs	Price
B-12054	12	\$3

Mustang Door Courtesy Lamps 65-66



8-18 x 3/8 .31 OD
VX, 52407-S
SS/CHROME

S45	Pcs	Price
B-12055	12	\$3



8-18 x 3/8 .27 OD
LUA, 9425317, 9420587

S2	S13	Pcs	Price
B-11110	B-11111	12	\$3

Mustang T/L Bezels 65-66



8-18 x 7/16 .27 OD
XW
SS/CHROME

S45	Pcs	Price
B-13728	8	\$3



8-15 x 1/2 .31 OD
BBE, 52344-S, 148545

S13	Pcs	Price
B-12115	12	\$3

Stainless



8-18 x 1/2 .27 OD
MYC, 55933-S (s13), 55945-S, 376360-S (s45w), 9420610 (s2), 9414752 (s13), 9418464

SS	S15	S45	Pcs	Price
B-11112	B-11113	B-12116	12	\$3
B-11131	B-11132	B-11133	50	\$10



8-18 x 1/2 .31 OD
LM, 55961-S, 9417325 (s7-8), 9417541, 9416166, 9425788

S8	S13	S36	Pcs	Price
B-12117	B-12118	B-12119	12	\$3



8-18 x 1/2 .36 FLUSH
MDL, 3909057 (sim)

S2	Pcs	Price
B-11206	8	\$3

Stainless



8-15 x 5/8 .27 OD
OLW, 53027-S, 145417 (s13)
SS/CHROME

S45	Pcs	Price
B-11114	12	\$3
B-11527	50	\$12

Stainless



8-18 x 5/8 .27 OD
MOU, 376361-S, 3849634
SS/BLACK OXIDE

S15	Pcs	Price
B-11117	12	\$3



8-18 x 5/8 .31 OD
OOK, 52352-S, 9420510

S2	S8	Pcs	Price
B-11116	B-13279	12	\$3



8-18 x 5/8 .31 OD
CU, 52352-S, 162402

S13	Pcs	Price
B-12120	12	\$3
B-11529	50	\$10



8-18 x 5/8 .36 FLUSH
LZQ, 3937139

S2	Pcs	Price
B-11207	8	\$3

TAPPING SCREWS - OVAL



8-15 x 3/4 .27 OD
BGA, 53038-S, 168496

S13	Pcs	Price
B-12122	12	\$3
B-11128	50	\$10



8-18 x 3/4 .27 OD
PQ, 55934-S, 9417974

S2	S8	Pcs	Price
B-11432	B-12146	12	\$3
B-11433	B-11125	50	\$10

Stainless



8-18 x 3/4 .27 OD
KJZ, 55934-S (s11), 55946-S, 376362-S, 343870 (s3), 9421923 (s2), 9414754 (s13), 9417943 (s45)

SS	S15	S45	Pcs	Price
B-11129	B-12145	B-12123	12	\$3
B-11130	B-11126	B-11127	50	\$10

Stainless



8-18 x 3/4 .31 OD
WU, 55962-S (STL), 55974-S, 9416208 (STL), 9417986 (s45) SS/CHROME

S45	Pcs	Price
B-12124	10	\$3
B-11524	50	\$10

Mustang Scuff Plates 65-68



8-18 x 3/4 .31 OD
WU, 55974-S SS/CHROME/WAX

S45W	Pcs	Price
B-12125	6	\$3
B-11526	25	\$10



8-18 x 3/4 .25 FLUSH
MPT, 7716099

S13	Pcs	Price
B-11205	8	\$3



8-18 x 3/4 .29 FLUSH
LYM, 3923905, 3967956

S2	S13	Pcs	Price
B-11208	B-11209	8	\$3



8-18 x 3/4 .36 FLANGED
GT, 374663-S, 3922441 (s13)

S8	S13	Pcs	Price
B-12178	B-12179	8	\$3



8-18 x 3/4 .50 FLANGED
MPV, 4664885

S13	Pcs	Price
B-11216	8	\$3

Headlamp Bezels 78-80 Camaro



M4.2 x 20MM 8MM OD
MYQ, 11504477, 11504478
STAINLESS

S15	S45	Pcs	Price
B-11067	B-13443	8	\$3

Ford Coat Hooks



8-15 x 7/8 .31 OD
JV, 353458-S

S13	Pcs	Price
B-12128	4	\$3



8-18 x 1.0 .31 OD
UG, 52376-S, 162413

S13	Pcs	Price
B-12134	10	\$3



8-18 x 1.0 .27 OD
SY, 55935-S, 9425610

S2	S8	Pcs	Price
B-13277	B-12130	10	\$3
B-13278	B-11428	50	\$10

Stainless



8-18 x 1.0 .27 OD
TI, 55947-S, 376364-S, 9420554 (s2), 9414756 (s13), 9422102 (s45) STAINLESS

SS	S45	Pcs	Price
B-11120	B-12132	10	\$3
B-11122	B-11124	50	\$10

Stainless



8-18 x 1.0 .31 OD
LKI, N610051-S, 55975-S
SS/BLACK PAINTED HEAD

S3	Pcs	Price
B-11119	20	\$3
B-11525	100	\$10

TAPPING SCREWS - OVAL



8-18 x 1.0 .28 FLUSH
MAG, 3949991, 3949982

S2	S13	Pcs	Price
B-11212	B-11213	8	\$3



8-18 x 1.0 .50 FLANGE
MXK, 4720885

S13	Pcs	Price
B-11214	8	\$3



8-18 x 1.0 .27 OD
EB

S13	Pcs	Price
B-12135	10	\$3



8-18 x 1.0 .31 OD
MIY, N610130-S

S424	Pcs	Price
B-11121	250	\$30



8-15 x 1 1/4 .27 OD
BGC, 53066-S, 145419

S13	Pcs	Price
B-12136	8	\$3



Stainless
8-15 x 1 1/4 .31 OD
XC, 52382-S, 162415
SS/CHROME

S45	Pcs	Price
B-12138	8	\$3



8-18 x 1 1/4 .27 OD
DP, 55936-S, 376365-S (ss), 9423719,
9425611 (s7-8), 9414757

S2	S8	S13	Pcs	Price
B-12139	B-12143	B-12144	8	\$3



8-15 x 1 1/2 .31 OD
IAB, 52388-S

S2	Pcs	Price
B-12147	8	\$3



8-18 x 1 1/2 .27 OD
PR, 55937-S, 9414758

S13	Pcs	Price
B-12149	8	\$3



8-18 x 1 1/2 .31 OD
BFN, 55965-S, 350070-S, 9425787,
9420371

S8	S13	Pcs	Price
B-12150	B-11134	8	\$3



8-18 x 1 1/2 .36 FLANGED
KII

S13	Pcs	Price
B-13343	6	\$3



8-18 x 1 1/2 .50 OD
OTY, 4545044 (sim)

S13	Pcs	Price
B-11435	6	\$3

Mustang Headlamp Doors 70



8-18 x 1 3/4 .27 OD
PS, 376406-S (sim)

S3	Pcs	Price
B-13727	4	\$3

Stainless



8-18 x 2 1/2 .27 OD
KIF, 382733-S, 9419268
SS/CHROME

S45	Pcs	Price
B-13342	4	\$3

TAPPING SCREWS - OVAL



10-12 x 1/2 .31 OD
BDU, 53017-S, 168584

S13	Pcs	Price
B-12219	10	\$3



10-16 x 5/8 .31 OD
MMA, 53028-S (sim), 376352-S (sim),
9414763

S13	Pcs	Price
B-11135	10	\$3



10-16 x 5/8 .36 OD
VN, 52422-S, 9414252

S13	Pcs	Price
B-12220	10	\$3

Mustang Rr Spoiler Supports 70-73



10-16 x 5/8 .37 OD
LSX, 384354-S

S44	Pcs	Price
B-13280	12	\$4



10-16 x 3/4 .31 OD
IW, 53039-S (sim), 9419747, 9423258,
9425622

S2	S7	Pcs	Price
B-11137	B-12223	10	\$3

Stainless



10-16 x 3/4 .31 OD
ODI, 53039-S (sim), 3843233, 9414764 (STL)
SS/CHROME

S45	Pcs	Price
B-11136	8	\$3



10-16 x 3/4 .36 OD
YL, 52430-S, 163474

S13	Pcs	Price
B-12224	6	\$3



10-16 x 7/8 .31 OD
LWM, 9423351

S3	Pcs	Price
B-11138	8	\$3



10-16 x 1.0 .31 OD
UL, 53061-S (sim), 9414766

S13	Pcs	Price
B-12225	6	\$3

Stainless



10-16 x 1.0 .36 OD
RC, 378471-S, 9425812

SS	Pcs	Price
B-12226	4	\$3



10-16 x 1 1/4 .31 OD
TY, 53067-S (sim), 9414767

S13	Pcs	Price
B-12227	6	\$3



10-16 x 1 1/4 .36 OD
UM, 33279-S, 52513-S (sim), 380049-S
9416822

S13	Pcs	Price
B-12228	6	\$3

Chevelle Vent Window 64-67



10-16 x 2 1/2 .31 OD
PBW
SS/CHROME

S45	Pcs	Price
B-13281	2	\$3

Camaro Vent Window 67



10-16 x 3.0 .31 OD
MZE, 9426539 (STL)
SS/CHROME

S45	Pcs	Price
B-11139	2	\$3

TAPPING SCREWS - PAN



6-20 x 1/4 .26 OD
LWF, 52773-S, 189993, 9418016

S2	Pcs	Price
B-11140	20	\$3



6-20 x 3/8 .26 OD
JAA, 55922-S, 383850-S, 9425903 (s2)

S2	S44	Pcs	Price
B-12151	B-12038	20	\$3

Stainless



6-20 x 3/8 .26 OD
IAW, 55992-S, 382566-S

S3	Pcs	Price
B-12039	20	\$3



6-20 x 3/8 .26 OD
MEP, 9427849

S2	Pcs	Price
B-11141	20	\$3



6-20 x 1/2 .26 OD
BEU, 55923-S, 9420688

S2	Pcs	Price
B-12042	20	\$3



6-20 x 3/4 .26 OD
OMY, 55924-S

S2	Pcs	Price
B-13282	15	\$3



6-18 x 1.0 .26 OD
BFH, 52746-S

S13	Pcs	Price
B-12043	10	\$3



6-20 x 1.0 .26 OD
BFG, 55925-S

S8	Pcs	Price
B-12044	12	\$3



8-18 x 3/8 .31 OD
MW, 52720-S, 55926-S, 9420408.
9414711 (s7-8), 9417586

S2	S8	S36	Pcs	Price
B-12056	B-12057	B-12058	20	\$3



8-18 x 3/8 .32 EXTERNAL
MTQ, 9424878

S2	Pcs	Price
B-11217	10	\$3



8-18 x 3/8 .38 FLAT
OCI, 9431562

S2	Pcs	Price
B-11218	8	\$3



8-18 x 3/8 .31 OD
BDV, 52780-S, 9428232 (s2)

S2	S36	Pcs	Price
B-12059	B-12060	12	\$3



8-18 x 3/8 .31 OD
MTX, 9422245

S2	Pcs	Price
B-11143	12	\$3

Chrysler Wheel Opening Mouldings 70 >



8-18 x 13/32 .29 OD
KIH, 6028545

S8MW	Pcs	Price
B-12237	36	\$10



8-18 x 1/2 .31 OD
IQ, 55927-S, 384049-S, 9419327, 9419672

S2	S44	Pcs	Price
B-12152	B-12155	15	\$3

TAPPING SCREWS - PAN



8-18 x 1/2 .31 OD
IQ, 55927-S, 9418359 (s8). 9415940

S8	S13	S36	Pcs	Price
B-12153	B-13283	B-12154	15	\$3



8-18 x 1/2 .32 EXTERNAL
FJ, 381817-S, 373147-S (SIM)

S2	Pcs	Price
B-11624	6	\$3



8-18 x 1/2 .38 FLAT
MXH, 9428628

S2	Pcs	Price
B-11220	8	\$3



8-18 x 1/2 .31 OD
WV, 52786-S, 9419858

S2	Pcs	Price
B-12160	10	\$3

Mustang Glove Box Cable 65-66, 69-70



8-18 x 1/2 .31 OD
ZB, 379203-S

S2	Pcs	Price
B-12162	4	\$2



8-18 x 1/2 .31 OD
MDS, 9421137

S2	Pcs	Price
B-11144	10	\$3

Stainless



8-15 x 5/8 .26 OD
OAP, 375954-S (sim)

S15	Pcs	Price
B-11146	10	\$3



8-15 x 5/8 .31 OD
ZD, 52734-S, 455335 (s2)

S2	S8	Pcs	Price
B-12163	B-12164	10	\$3



8-18 x 5/8 .31 OD
VZ, 56009-S, 9419791. 9414713 (s7-8),
9423744. 9421967

S2	S8	S13	Pcs	Price
B-11147	B-12165	B-12166	10	\$3

Stainless



8-18 x 5/8 .31 OD
BBG

SS	Pcs	Price
B-12167	8	\$3



8-18 x 5/8 .50 CONICAL
OCJ, 9427834

S2	Pcs	Price
B-11221	8	\$3



8-15 x 3/4 .31 OD
BFI, 52742-S, 179338 (s2)

S2	S36	Pcs	Price
B-12168	B-12169	10	\$3



8-18 x 3/4 .31 OD
HI, 55928-S, 9420721. 9423863

S2	S8	Pcs	Price
B-12170	B-12171	10	\$3

Grille: Chevelle 70-72, Camaro 70-77



8-18 x 3/4 .38 FLAT
KKF, 9427312

S2	Pcs	Price
B-12180	6	\$3

Camaro Seat Back Panels 67-69



8-18 x 3/4 .50 FLAT
MPC

S8	Pcs	Price
B-11222	4	\$3

TAPPING SCREWS - PAN



8-18 x 3/4 .31 OD
VD, 52802-S

S2	Pcs	Price
B-12181	10	\$3

Mustang B/U Lenses 65-68



8-18 x 3/4 .31 OD
LUR, 376328-S, 380438-S (sim)
STAINLESS

SS	Pcs	Price
B-11149	4	\$2



8-18 x 7/8 .31 OD
MAI, 9422957

S13	Pcs	Price
B-11150	8	\$3

Mustang Parking Lenses 67-73



8-18 x 7/8 .31 OD
LUS, 378179-S, 382046-S (sim)
SS/CHROME

S45	Pcs	Price
B-11153	4	\$2

Mustang Instrument Cluster 65-66



8-15 x 1.0 .31 OD
BEW, 52754-S, 379326-S, 161879 (s13)

S3	S13	Pcs	Price
B-11154	B-12182	6	\$3



8-18 x 1.0 .31 OD
SW, 55929-S, 9425689. 9418805

S2	S8	Pcs	Price
B-12186	B-12187	10	\$3



8-18 x 1.0 .31 OD
BDP, 52814-S

S2	Pcs	Price
B-12183	10	\$3

Mustang Parking Lamp Lenses 65-66



8-18 x 1.0 .31 OD
BBH
STAINLESS

SS	Pcs	Price
B-12185	8	\$3

Mustang Back-up Lenses 69-70



8-18 x 1 1/4 .31 OD
OMQ
STAINLESS

SS	Pcs	Price
B-11453	4	\$2

Mustang Console 69-70



8-18 x 1 1/2 .31 OD
OL, 55931-S, 9414718

S8W	Pcs	Price
B-12184	10	\$3

Chevelle Tailamp Lenses 71-72



8-18 x 1 1/2 .31 OD
OOL
STAINLESS W BLACK ENAMEL

S3	Pcs	Price
B-13241	6	\$3

At AMK
We Live
Fasteners



10-16 x 3/8 .37 OD
YN, 52721-S, 9414721, 9420890

S8	Pcs	Price
B-12188	10	\$3



10-12 x 1/2 .37 OD
UA, 52727-S, 9420362. 161895. 274490

S2	S8	S36	Pcs	Price
B-12189	B-12190	B-12191	10	\$3



10-16 x 1/2 .37 OD
GAB, 376383-S, 9419328

S2	Pcs	Price
B-12192	10	\$3

TAPPING SCREWS - PAN



10-16 x 1/2 .37 OD
BFV, 52787-S, 163217

S13	Pcs	Price
B-11156	6	\$3

GM Outside Mirror



10-16 x 1/2 .37 OD
LZY, 9421495 (sim), 9421496 (sim),
9422724 (sim)

S2	Pcs	Price
B-11223	6	\$3



10-12 x 5/8 .37 OD
UO, 52735-S, 161902 (s13)

S13	S36	Pcs	Price
B-12193	B-12194	10	\$3



10-16 x 5/8 .37 OD
KTO, 9419329, 9414723

S2	S8	Pcs	Price
B-11530	B-12195	10	\$3



10-16 x 5/8 .44 FLAT
KVL, 9421851 (s2), 9437859

S3	Pcs	Price
B-12231	6	\$3

Chrysler Washer Reservoir



10-16 x 11/16 .50 FLAT
LCZ, 6026092

S8	Pcs	Price
B-13734	4	\$4



10-12 x 3/4 .37 OD
UN, 52743-S, 9417225

S2	Pcs	Price
B-12196	10	\$3



10-16 x 3/4 .37 OD
KJY, 376382-S, 9421151, 9424858 (sim),
9414724

S2	S8	Pcs	Price
B-11157	B-12197	10	\$3



10-16 x 3/4 .37 OD
MXD, 273447

S8	Pcs	Price
B-11158	10	\$3



1/4-14 x 1/2 .49 OD
HF, 52729-S, 9420695

S2	Pcs	Price
B-12198	8	\$3



1/4-14 x 5/8 .49 OD
KST, 9419866

S2	Pcs	Price
B-11159	8	\$3

Chrysler Air Cleaner



1/4-10 x 3/4 .48 OD
OAT

S8	Pcs	Price
B-11160	100	\$30



1/4-14 x 3/4 .49 OD
KIW, 381949-S, 9422037

S2	Pcs	Price
B-12199	8	\$3



1/4-14 x 1.0 .49 OD
KKG, 9423636

S2	Pcs	Price
B-12230	8	\$3

DLX Door Pull Straps 68-69 Camaro



1/4-14 x 1 7/16 .37 OD
MTP

S8	Pcs	Price
B-11161	4	\$3

TAPPING SCREWS - ROUND, ROUND WASHER

Ford Voltage Regulator Cover 50's - 66



8-15 x 1/2 .29 OD
FR, 32858-S, 125978

S8	Pcs	Price
B-11162	6	\$2

Camaro STD Armrest Base 68-69



1/4-14 x 1 1/2 .45 OD
MPQ, 9824833

S13	Pcs	Price
B-11163	6	\$4

Chevelle Armrest Base 64-67, Camaro 67



1/4-10 x 1 3/4 .46 OD
MSG

S8	Pcs	Price
B-11625	4	\$3

Chrysler Wheel Opening Mouldings 64-72



8-18 x 3/8 .29 OD
KFV, 6024271 ♣, 4879432

S8W	Pcs	Price
B-12200	12	\$3
B-11164	36	\$10



8-18 x 3/8 .38 OD
DN, 358735-S

S2	Pcs	Price
B-12061	12	\$3



8-18 x 3/8 .38 OD
LDW

S8	Pcs	Price
B-13732	12	\$3
B-13733	30	\$6

Ford Wheel Opening Mouldings



8-18 x 3/8 .38 OD
BGM, 381671-S
SS/CHROME/WAX

S45W	Pcs	Price
B-13434	10	\$4
B-13435	30	\$10



8-18 x 3/8 .38 OD
MHK, 56901-S

S424	Pcs	Price
B-11165	250	\$30



8-18 x 3/8 .50 OD
KVK

S2	Pcs	Price
B-13345	250	\$30

Stainless



8-18 x 7/16 .32 OD
MOV, 3893979, 588546

S15	S45	Pcs	Price
B-11166	B-11531	12	\$3
B-10065	B-10063	32	\$6

GM Wheel Openings



8-18 x 7/16 .32 OD
MOV
SS/CHROME/WAX

S45W	Pcs	Price
B-11532	10	\$3
B-10064	32	\$8



8-18 x 1/2 .28 OD
OTT, 3957097

S2	Pcs	Price
B-11626	10	\$3



8-15 x 1/2 .37 OD
QQ, 357903-S

S2	S8	S13	Pcs	Price
B-12201	B-12202	B-12203	10	\$3



8-18 x 1/2 .28 OD
OPF

S13	Pcs	Price
B-11636	10	\$3



8-18 x 1/2 .37 OD
IAH, 376379-S

S2	S8	Pcs	Price
B-12204	B-12205	10	\$3

TAPPING SCREWS - ROUND WASHER



8-18 x 1/2 .38 OD
MKU, 56902-S

S55	Pcs	Price
B-11167	250	\$3



8-18 x 1/2 .41 OD
MZC, 9420486

S2	S8	S13	Pcs	Price
B-11711	B-11712	B-11168	10	\$3



8-18 x 1/2 .50 OD
RH, 378729-S (sim), 381797-S

S2	S8	Pcs	Price
B-12206	B-12207	8	\$3



8-18 x 1/2 .50 OD
KOW, 56910-S

S2W	Pcs	Price
B-12208	8	\$3



8-18 x 1/2 .48 OD
MKL, W505020-S

S3	Pcs	Price
B-11170	10	\$3



8-18 x 1/2 .40 OD
MJY, 6035217

S3W	Pcs	Price
B-11172	250	\$30



8-18 x 1/2 .42 OD
MB, 380660-S, 381801-S, 4529319 (s13)

S2	S8	S13	Pcs	Price
B-12238	B-12239	B-13284	10	\$3



8-18 x 1/2 .42 OD
MB, 381801-S

S44W	Pcs	Price
B-11178	30	\$3
B-11533	100	\$8



8-18 x 1/2 .41 OD
OIB, 153610

S3	Pcs	Price
B-11169	250	\$3



8-18 x 9/16 .50 OD
KJ, 379767-S

S2	S36	Pcs	Price
B-12210	B-12211	8	\$3



8-15 x 3/4 .38 OD
EW, 350075-S

S2	S8	S13	Pcs	Price
B-13285	B-13286	B-13287	8	\$3



8-18 x 3/4 .49 OD
YK, 382064-S, 375876-S (sim)

S2	Pcs	Price
B-13731	6	\$3



8-18 x 3/4 .49 OD
BBF, 56904-S

S36W	Pcs	Price
B-11227	10	\$3



8-18 x 3/4 .42 OD
IAV, 382413-S

S2	Pcs	Price
B-12240	10	\$3



8-18 x 7/8 .49 OD
BM, 56905-S

S2	Pcs	Price
B-12215	8	\$3

TAPPING SCREWS - ROUND WA, TRUSS, WAFER

Chevelle Seat Side Panels 68-72



8-18 x 1.0 .38 OD
OSZ



8-18 x 1.0 .41 OD
LGA



8-18 x 1 1/4 .37 OD
MCU, W505007-S

S2	Pcs	Price
B-11627	250	\$30

S8	Pcs	Price
B-13289	12	\$3

S424	Pcs	Price
B-11174	10	\$3

Mustang Rr Valance 65



10-16 x 3/4 .50 OD
BFO, 380650-S
SS/CHROME



10-16 x 1.0 .47 OD
LNZ, 154802

E-Body Door Panels



8-18 x 1/2 .34 OD
LDB, 6028157

S45	Pcs	Price
B-11175	6	\$3

S3W	Pcs	Price
B-11176	250	\$30

S13	Pcs	Price
B-13729	4	\$3

Chrysler Scuff Plates



8-18 x 1/2 .37 OD
KAD, 9421977



8-15 x 1/2 .37 OD
MTV
SS/CHROME

Chrysler Scuff Plates 66-67



8-18 x 7/8 .38 OD
LDC
SS/CHROME

S8	Pcs	Price
B-12232	10	\$3

S45	Pcs	Price
B-10530	12	\$6

S45	Pcs	Price
B-13730	4	\$3

GM License Plates



1/4-14 x 1/2 .55 OD
MPR



1/4-14 x 3/4 .88 FLAT
OKD, 379120-S

Ford Armrests



1/4-10 x 1 1/4 .56 OD
BDG, 377905-S

S8	Pcs	Price
B-11179	8	\$3

S8	Pcs	Price
B-11224	2	\$4

S8	Pcs	Price
B-12233	4	\$3

Mustang Coupe Package Tray 65-66



8-18 x 1/2 .49 OD
FC, 377948-S



8-18 x 1.0 .49 OD
PCF



10-16 x 1/2 .50 OD
BEQ, 380858-S, 381997-S (tek)

S2	Pcs	Price
B-12234	8	\$3

S13	Pcs	Price
B-13290	6	\$3

S2	Pcs	Price
B-12235	10	\$3

MACHINE SCREWS - FILLISTER

Stainless



8-32 x 3/8 .26 OD
KAT, 31045-S (sim), 131965 (sim)
SS/NYLON PATCH

SSP	Pcs	Price
B-11677	8	\$3



8-32 x 1/2 .26 OD
KBN, 31061-S, 131973

S8	Pcs	Price
B-12271	250	\$30

Ford Economizer Valve



8-32 x 1/2 .26 SPLIT
HV, 43251-S, 454430. 273081

S8	S36	Pcs	Price
B-12272	B-12273	8	\$3

Holley Accel Cover & Vacuum Sec



8-32 x 5/8 .26 SPLIT
IX, 50937-S

S36	Pcs	Price
B-12275	8	\$3



8-32 x 5/8 .26 SPLIT
HK, 43255-S, 455381. 273082

S8	S36	Pcs	Price
B-11196	B-12274	8	\$3



8-32 x 3/4 .26 SPLIT
HW, 43395-S

S8	S36	Pcs	Price
B-12276	B-12277	250	\$30

Holley Vacuum Secondary



8-32 x 1.0 .26 SPLIT
JY, 43407-S

S36	Pcs	Price
B-12278	6	\$3



8-32 x 1 1/4 .26 SPLIT
KHC

S36	Pcs	Price
B-12279	100	\$30

Holley Fast Idle Plate



8-32 x 1 1/2 .26 SPLIT
HX, 370676-S

S36	Pcs	Price
B-12280	100	\$30

Ford Carb Choke Housing



8-32 x 1 3/4 .26 SPLIT
HU, 378547-S

S8	Pcs	Price
B-12281	3	\$3

GM Sun Visor Clamps



10-24 x 1/2 .30 OD
MOY

S13	Pcs	Price
B-10019	2	\$2
B-10388	4	\$3

Ford 2V Top Cover



10-32 x 5/8 .30 SPLIT
KDQ, 43256-S

S8	S36	Pcs	Price
B-12282	B-12283	6	\$3

Ford 4V



10-32 x 7/8 .30 SPLIT
HY

S36	Pcs	Price
B-12284	100	\$30



10-32 x 1.0 .30 SPLIT
OGD

S8	S44	Pcs	Price
B-10902	B-10058	100	\$30



10-32 x 1.0 .30 SPLIT
KFT, 43408-S, 454416

S8	Pcs	Price
B-12285	6	\$3

MACHINE SCREWS - FILLISTER, FLAT



10-32 x 1 1/4 .30 SPLIT
KEW

S36	Pcs	Price
B-12287	6	\$3

Holley Throttle Body



12-24 x 3/4 .35 SPLIT
KKD, 43365-S

S36	Pcs	Price
B-12288	100	\$30

Bendix Control Valve Cap



1/4-20 x 1 1/2 .40 SPLIT
NH, 358533-S
DARK GREEN CHROMATE

S100	Pcs	Price
B-12289	2	\$3

Headlamp Adjusting



1/4-28 x 1.0 .30 OD
KUP, 924561 (sim)

S8	Pcs	Price
B-12290	4	\$3

Headlamp Adjusting



1/4-28 x 1 1/2 .30 OD
KSN, 3937697 (sim), 9432523 (sim)

S8	Pcs	Price
B-11663	4	\$3

Headlamp Adjusting



1/4-28 x 1 1/2 .30 OD
KSO, C2MB-13032-A, 3937697 (sim),
9432523 (sim)

S8	Pcs	Price
B-12495	4	\$3

Mustang Window Regulator 67-68



8-32 x 1/2 .31 OD
Z, 50012-S

S2	Pcs	Price
B-12291	6	\$3

GM Deluxe Steering Wheel 64-70



10-24 x 1/2 .36 OD
LWZ, 9418712
STAINLESS

SS	Pcs	Price
B-10387	6	\$3

Ford Door Latches



12-24 x 1/2 .43 EXTERNAL
FD, 356782-S, 445638

S8	Pcs	Price
B-12292	6	\$3



5/16-18 x 3/4 .62 EXTERNAL
KET, 379630-S, 9419306, 451269

S2	S8	Pcs	Price
B-12295	B-12296	4	\$3

Ford Door Latch Strikers 65-70



5/16-18 x 3/4 .62 OD
KIA, 378428-S (sim), 4439627 (sim)

S8	Pcs	Price
B-13685	4	\$3

GM Tailgate Latches



5/16-18 x 1.50 .50 OD
LPR, 4848760

S8P	Pcs	Price
B-10397	6	\$6

GM Door Hinges 64-67



5/16-18 x 1 3/8 .68 OD
LRF, 7667647 (sim)

S2	Pcs	Price
B-10040	3	\$4

Certain Ford Door Strikers 60-64



5/16-24 x 3/4 .62 OD
KZN, 377971-S

S8P	Pcs	Price
B-13346	2	\$3



5/16-24 x 7/8 .64 OD
KMN, 273521

S8	Pcs	Price
B-12297	4	\$4

MACHINE SCREWS - HEX



8-32 x 1/2 5/16 AF .50 CONICAL
WM, 57075-S

S2	S8	S36	Pcs	Price
B-11843	B-11844	B-11845	8	\$5



8-32 x 1/2 5/16 AF .31 EXTERNAL
YY, 42722-S, 423586

S8	Pcs	Price
B-13347	6	\$3



8-32 x 3/4 5/16 AF .50 CONICAL
SX, 57077-S

S2	S36	Pcs	Price
B-11847	B-11848	8	\$5

Chrysler Fan Shroud



8-32 x 3/4 5/16 AF .62 FLAT
LQC, 6026635

S8	Pcs	Price
B-10846	4	\$5



10-24 x 3/8 5/16 AF
BGF, 379201-S

S2	Pcs	Price
B-12585	8	\$3



10-24 x 7/16 5/16 AF .50 CONICAL
GR, 375921-S

S2	S8	Pcs	Price
B-11852	B-11853	8	\$5



10-24 x 1/2 5/16 AF .44 CONICAL
OGE

S2	Pcs	Price
B-10809	100	\$30



10-24 x 1/2 3/8 AF .44 CONICAL
MXR, 6024060

S2	Pcs	Price
B-10808	6	\$3



10-24 x 1/2 3/8 AF .44 CONICAL
KPZ

S2	Pcs	Price
B-11849	100	\$30



10-24 x 1/2 3/8 AF .44 CONICAL
KME, 6025301

S2	Pcs	Price
B-11850	100	\$30



10-24 x 1/2 3/8 AF .56 CONICAL
LRY, 6024061

S2	Pcs	Price
B-10807	100	\$30



10-24 x 1/2 3/8 AF .56 CONICAL
KMP, 6025302

S2	Pcs	Price
B-11851	8	\$5



10-24 x 1/2 3/8 AF .38 EXTERNAL
KTF, 54596-S, 423595

S8	Pcs	Price
B-13291	6	\$3

GM Wiper Arm Pivots



10-24 x 1/2 5/16 AF .33 EXTERNAL
MQF, 3933052

S8	Pcs	Price
B-10884	4	\$3



10-24 x 5/8 5/16 AF .44 CONICAL
OBC, 9421033

S2	Pcs	Price
B-10811	4	\$3

MACHINE SCREWS - HEX



10-24 x 5/8 3/8 AF .44 CONICAL
KLM, 6025304

S2	Pcs	Price
B-11857	100	\$30



10-24 x 5/8 3/8 AF .56 CONICAL
KQA, 6024064

S2	Pcs	Price
B-11858	6	\$5



10-24 x 5/8 3/8 AF .56 CONICAL
KPI

S7W	Pcs	Price
B-11859	100	\$30



10-24 x 5/8 5/16 AF .72 CONICAL
BDO, 375922-S

S2	Pcs	Price
B-11860	8	\$5



10-24 x 5/8 3/8 AF .75 CONICAL
MWV

S2	Pcs	Price
B-10778	4	\$3



10-24 x 3/4 3/8 AF .44 CONICAL
KPY

S7	Pcs	Price
B-13228	8	\$5

Hundreds
of additional fasteners
are available online
www.amkproducts.com



10-24 x 3/4 3/8 AF .56 CONICAL
LRW

S44	Pcs	Price
B-10920	6	\$4



10-24 x 3/4 3/8 AF .75 CONICAL
KPK

S44	Pcs	Price
B-11863	4	\$3



10-24 x 7/8 3/8 AF
KPL, 480530

S13	Pcs	Price
B-12511	100	\$30



10-24 x 7/8 3/8 AF .44 CONICAL
KPW, 6025310

S2	Pcs	Price
B-11864	100	\$30



10-24 x 7/8 3/8 AF .56 CONICAL
KKZ

S7	Pcs	Price
B-11866	8	\$5



10-24 x 7/8 5/16 AF .56 CONICAL
LHX

S2	Pcs	Price
B-10779	4	\$3



10-24 x 7/8 3/8 AF .56 CONICAL
KLG, 6025311

S2	Pcs	Price
B-11865	10	\$5



E-Body Shaker Bubble
10-24 x 7/8 3/8 AF .75 CONICAL
MFT, 6025312

S2	Pcs	Price
B-11468	7	\$24

MACHINE SCREWS - HEX, TORX



10-24 x 1.0 3/8 AF .44 CONICAL
KPX, 6025313 ▲

S2	Pcs	Price
B-11867	8	\$5

GM & Ford Wiper Motor



10-24 x 1.0 5/16 AF .33 EXTERNAL
KTZ, 380541-S, 3824124

S8	Pcs	Price
B-12298	6	\$4



12-24 x 5/8 3/8 AF .40 EXTERNAL
TC, 440406

S7	Pcs	Price
B-12299	4	\$3

GM Wheel Cylinders



1/4-20 x 3/8 3/8 AF .47 INTERNAL
OQY

S8	Pcs	Price
B-11659	4	\$3

Chevy Timing Covers & SB Oil Pan



1/4-20 x 7/16 7/16 AF .44 EXTERNAL
STAINLESS LZM, 423554 (s7-8), 3817006 (s8)

SS	Pcs	Price
B-10880	4	\$3
B-10881	10	\$5

GM Outside Door Handles



1/4-20 x 1/2 5/16 AF .50 CONICAL
MOW, 4430409

S2	Pcs	Price
B-10796	4	\$4



1/4-20 x 1/2 7/16 AF .50 CONICAL
KZE, 6023092, 6024560 ▲

S2	S36	Pcs	Price
-	B-12140	2	\$4
B-13423	-	10	\$6



1/4-20 x 1/2 7/16 AF .56 TOOTHED
KMM

S2	Pcs	Price
B-11868	10	\$5



1/4-20 x 1/2 7/16 AF .62 CONICAL
KEV, 6027812 ▲

S2	Pcs	Price
B-12665	10	\$5

Locking Thread



1/4-20 x 1/2 7/16 AF .75 CONICAL
KOZ

S8	Pcs	Price
B-11873	100	\$30



1/4-20 x 1/2 7/16 AF .75 CONICAL
QK, 57487-S, 383049-S, 9421116 (s8)

S2	S8	S36	Pcs	Price
B-11870	B-11871	B-11872	8	\$5

GM Glass Guides 64-67



1/4-20 x 1/2 7/16 AF .88 CONICAL
MQV, 4822427

S13	Pcs	Price
B-10797	4	\$4

Ford AC Compressor Brushes 63-65



1/4-20 x 1/2 7/16 AF .44 EXTERNAL
KEI, 376857-S, 178785

S7	Pcs	Price
B-12301	2	\$3



1/4-20 x 1/2 7/16 AF .46 SPLIT
GAC, 43260-S, 445933

S2	Pcs	Price
B-12302	4	\$3

LARGE bulk quantities are available for most items !
Prices are industry competitive.

MACHINE SCREWS - HEX

GM Front Door @ Rear 64-65



1/4-20 x 5/8 3/8 AF
KUF, 9411890 (sim)



1/4-20 x 5/8 7/16 AF
MWK, 4849928



1/4-20 x 5/8 7/16 AF .50 CONICAL
KYN, 6022201 ◆

S8	Pcs	Price	S13	Pcs	Price	S2	Pcs	Price
B-10053	6	\$3	B-12027	2	\$3	B-12760	4	\$5

Chrysler Valve Covers



1/4-20 x 5/8 7/16 AF .50 TOOTHED
LDY, 6029513 ◆



1/4-20 x 5/8 7/16 AF .62 CONICAL
KMR, 6022202 ◆, 3856691



1/4-20 x 5/8 7/16 AF .62 CONICAL
LQF, 6022202 ◆, 3856691

S7	Pcs	Price	S2	Pcs	Price	S2	Pcs	Price
B-13721	3	\$4	B-11874	12	\$6	B-10803	6	\$8
						B-10804	12	\$15

Chrysler Valve Covers



1/4-20 x 5/8 7/16 AF .62 CONICAL
KLZ, 6022202 ◆, 3856691



1/4-20 x 5/8 7/16 AF .62 CONICAL
KNN



1/4-20 x 5/8 7/16 AF .75 CONICAL
IAM, 6022203 ◆, 57488-S

S2	Pcs	Price	S7	Pcs	Price	S2	Pcs	Price
B-10800	6	\$4	B-10801	6	\$6	B-11880	8	\$5
B-11877	12	\$8	B-11876	12	\$12			

GM Trunk Latch & Striker



1/4-20 x 5/8 7/16 AF .75 TOOTHED
LPU, 9432395

El Camino Tailgate



1/4-20 x 5/8 7/16 AF 1.12 CONICAL
OUQ



1/4-20 x 5/8 7/16 AF .75 CONICAL
KYP, 6025318 ◆

S2	Pcs	Price	S8	Pcs	Price	S2	Pcs	Price
B-10891	5	\$4	B-11704	4	\$6	B-12047	100	\$30

MACHINE SCREWS - HEX

Ford SB & 6 Cyl Valve Covers



1/4-20 x 5/8 7/16 AF .44 SPLIT
KUE, 43263-S, 9409107



1/4-20 x 5/8 7/16 AF .62 SPLIT
NO, 373071-S

Mustang Door Glass Run 69



1/4-20 x 3/4 7/16 AF
JK, 379513-S

S8	Pcs	Price	S7	Pcs	Price	S36	Pcs	Price
B-12303	4	\$3	B-12304	7	\$6	B-12305	4	\$3
			B-10901	18	\$12			



1/4-20 x 3/4 7/16 AF .44 CONICAL
KOR



1/4-20 x 3/4 7/16 AF .50 CONICAL
KYR, 6022205 ◆



1/4-20 x 3/4 7/16 AF .62 CONICAL
KYZ, 6022206 ◆, 3945512

S2	Pcs	Price	S2	Pcs	Price	S2	Pcs	Price
B-11882	100	\$30	B-11916	6	\$5	B-12320	6	\$5

GM Vent Window Frames 64-67



1/4-20 x 3/4 7/16 AF .62 CONICAL
KLY



1/4-20 x 3/4 7/16 AF .75 CONICAL
OTK



1/4-20 x 3/4 7/16 AF .75 CONICAL
KMI

S2	Pcs	Price	S13	Pcs	Price	S2	Pcs	Price
B-11883	100	\$30	B-12109	2	\$3	B-11890	5	\$5

Shelby 68-69



1/4-20 x 3/4 7/16 AF .75 CONICAL
KC

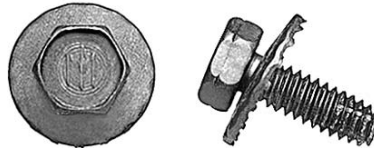

1/4-20 x 3/4 7/16 AF .75 TOOTHED
VW, AO Smith # 14453



1/4-20 x 3/4 7/16 AF .62 CONICAL
KMQ, 6025321 ◆

S2	Pcs	Price	S2	Pcs	Price	S2	Pcs	Price
B-11888	5	\$5	B-11891	4	\$6	B-11886	8	\$5

MACHINE SCREWS - HEX

E-Body Valance Brackets 70



1/4-20 x 3/4 7/16 AF .62 TOOTHED
CR, 372289-S



1/4-20 x 3/4 7/16 AF .62 CONICAL
KOP



1/4-20 x 3/4 7/16 AF .62 CONICAL
KLH, 6025321

S2	Pcs	Price
B-11887	6	\$5
B-11536	12	\$8

S2	Pcs	Price
B-11885	6	\$5

S2	Pcs	Price
B-11884	12	\$5

Chrysler Radiators



1/4-20 x 3/4 7/16 AF .75 CONICAL
KXX, 6025322

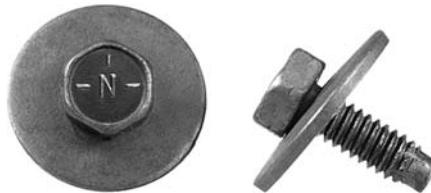

1/4-20 x 3/4 7/16 AF 1.0 CONICAL
KMT, 6025323



1/4-20 x 7/8 7/16 AF .50 CONICAL
KZH, 6022209

S2	Pcs	Price
B-11894	10	\$5

S2	Pcs	Price
B-11895	4	\$6

S2	Pcs	Price
B-12628	4	\$5

Stainless



1/4-20 x 7/8 7/16 AF .75 CONICAL
OQQ, 6025326 (sim)



1/4-20 x 7/8 7/16 AF .75 CONICAL
KM, 57030-S



1/4-20 x 7/8 7/16 AF .75 CONICAL
KRE, 57030-S (STL)

S2	Pcs	Price
B-11598	12	\$10
B-11599	50	\$35

S36	Pcs	Price
B-10783	12	\$10
B-11437	50	\$35

SS	Pcs	Price
B-13871	6	\$8
B-13873	25	\$25

Boss 302/351 & 429 CJ Valve Covers



1/4-20 x 7/8 7/16 AF .44 SPLIT
WR, 57623-S

Chevy 302 Aluminum Valve Covers



1/4-20 x 1.0 3/8 AF
MEI 9415798, 9417888



1/4-20 x 1.0 7/16 AF .50 CONICAL
KMK, 6025328

S7	Pcs	Price
B-12306	8	\$12

S8	Pcs	Price
B-10383	4	\$4

S2	Pcs	Price
B-11900	5	\$5

MACHINE SCREWS - HEX

Ford Neutral Switch



1/4-20 x 1.0 7/16 AF .63 CONICAL
KPD, 6025329



1/4-20 x 1.0 7/16 AF .44 EXTERNAL
JAR, 42746-S, 424204

480 Hour Salt Spray Rating!



1/4-20 x 1 1/8 7/16 AF .75 CONICAL
KFC, 57032-S

S2	Pcs	Price
B-11901	6	\$5

S8	Pcs	Price
B-13719	2	\$3

S3	Pcs	Price
B-11903	6	\$5

Chevelle Bucket Seat Straps 69-72

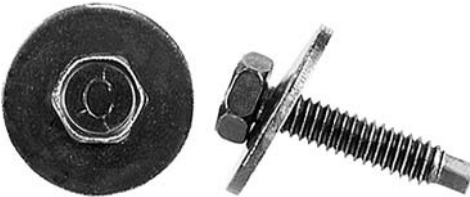

1/4-20 x 1 1/8 7/16 AF 1.0 CONICAL
TA, 57132-S



1/4-20 x 1 3/8 7/16 AF .75 CONICAL
OTV

Mustang Convertible Tack Strip 65-73



1/4-20 x 1 1/2 7/16 AF .75 CONICAL
AL, 377344-S (sim), 380462-S (sim)

S44	Pcs	Price
B-11905	8	\$5

S2	Pcs	Price
B-11713	2	\$3

S36	Pcs	Price
B-13292	12	\$12

426 Hemi Intake Manifold 68-71



1/4-20 x 2 7/16 7/16 AF .62 CONICAL
OEC, 6025700

1/4-20 x 3.0 7/16 AF .62 CONICAL
OEN, 6025701

Chrysler Driveshaft 70 >



1/4-28 x 11/16 3/8 AF .48 CONICAL
KNI, 6029562

S8	Pcs	Price
B-10798	4	\$24

S2	Pcs	Price
B-10799	3	\$20

S2	Pcs	Price
B-11906	4	\$6

Most Chrysler & Ford Wheel Cylinders



5/16-18 x 1/2 1/2 AF .57 EXTERNAL
O, 6028921, 42757-S, 9414427

Stainless



5/16-18 x 1/2 1/2 AF .57 EXTERNAL
KJF



5/16-18 x 1/2 1/2 AF .75 CONICAL
LAY

S2	Pcs	Price
B-12307	4	\$3

SS	Pcs	Price
B-12308	4	\$3

S2	Pcs	Price
B-13409	5	\$5

MACHINE SCREWS - HEX



5/16-18 x 1/2 1/2 AF .54 SPLIT
VG, 42718-S, 193240. 274403

S2	S8	Pcs	Price
B-12309	B-12310	4	\$3



5/16-18 x 9/16 1/2 AF .62 CONICAL
LKA, 2121573 & 6024015

S2	Pcs	Price
B-10844	4	\$4



5/16-18 x 5/8 1/2 AF
H, 40156-S

S2	S8	Pcs	Price
B-12586	B-12587	6	\$3

Chrysler Auto Trans Pan



5/16-18 x 5/8 1/2 AF .75 CONICAL
KXV, 6023355 (sim), 385099 (sim)
3846201

S2	Pcs	Price
B-12548	5	\$5



5/16-18 x 5/8 1/2 AF .88 CONICAL
KKR, 6024016, 57490-S

S2	Pcs	Price
B-11907	50	\$30

GM Battery Trays



5/16-18 x 5/8 1/2 AF 1.12 CONICAL
KJW, 6024018, 57520-S, 9420941

S2	Pcs	Price
B-13716	2	\$3

Chevy Ignition Coil & BB Oil Pan



5/16-18 x 5/8 1/2 AF .58 EXTERNAL
GS, 42758-S, 189989. 9431963

S2	S8	Pcs	Price
B-12311	B-13232	4	\$3



5/16-18 x 5/8 1/2 AF .55 SPLIT
RO, 42719-S, 358716-S, 358723-S,
9419370, 839896 (sim). 9409097

S2	S8	Pcs	Price
B-12312	B-12313	4	\$3

390/428 Oil Pan



5/16-18 x 5/8 1/2 AF .62 SPLIT
VF, 373053-S

S7	Pcs	Price
B-12314	4	\$4
B-10912	17	\$15

Chrysler SB & BB Oil Pan



5/16-18 x 11/16 1/2 AF .62 CONICAL
GAG, 6028581

S2	S2P	Pcs	Price
B-11467	B-11603	7	\$8
B-11602	B-11604	20	\$20

Chrysler Crankshaft Pulley



5/16-18 x 3/4 1/2 AF .56 CONICAL
OPV, 6027028

S2	Pcs	Price
B-11605	6	\$8



5/16-18 x 3/4 1/2 AF .75 CONICAL
KY, 6022226

S2	Pcs	Price
B-11908	6	\$5

MACHINE SCREWS - HEX



5/16-18 x 3/4 1/2 AF .81 CONICAL
ML, 378735-S

S2	S7	Pcs	Price
B-11909	B-11910	6	\$5



5/16-18 x 3/4 1/2 AF 1.0 CONICAL
KQI

S2	Pcs	Price
B-10792	50	\$30



5/16-18 x 3/4 1/2 AF .58 EXTERNAL
MWW

S7	Pcs	Price
B-10879	4	\$3

390/428 Valve Cover & Oil Pan



5/16-18 x 3/4 1/2 AF .55 SPLIT
EP, 42789-S, 57633-S, 358717-S, 358718-S,
3724180 & 3784302 (s), 3945492 & 3953212 (s2)

S2	S8	Pcs	Price
B-12316	B-12317	2	\$3



5/16-18 x 3/4 1/2 AF .62 SPLIT
BR, 372995-S

S7	Pcs	Price
B-12318	3	\$4
B-10910	10	\$12



5/16-18 x 13/16 1/2 AF .62 CONICAL
LEV

S8	Pcs	Price
B-13715	6	\$5

Chrysler Crankshaft Pulley



5/16-18 x 7/8 1/2 AF
IAF, 40182-S, 171106

S7	Pcs	Price
B-12588	4	\$3



5/16-18 x 7/8 1/2 AF .56 CONICAL
LQD, 6027030

S2	Pcs	Price
B-10842	3	\$4



5/16-18 x 7/8 1/2 AF .62 CONICAL
KYW, 6022230 (s2)

S2	S8	Pcs	Price
B-12558	B-10843	4	\$4



5/16-18 x 7/8 1/2 AF .75 CONICAL
KJS, 6022231

S2	Pcs	Price
B-11913	6	\$5



5/16-18 x 7/8 1/2 AF 1.12 SPECIAL
LLE

S2	Pcs	Price
B-11919	2	\$3

Save time !
See the Kit sections
for the fasteners you need
assembled into kits

MACHINE SCREWS - HEX

GM Body > 72



5/16-18 x 7/8 1/2 AF .75 CONICAL
OTJ, 3846202 before 6-28-72

S2	Pcs	Price
B-11709	6	\$5
B-11710	12	\$10

GM Body > 72



5/16-18 x 7/8 1/2 AF .75 CONICAL
KXZ, 3846202 before 6-28-72

S2	Pcs	Price
B-13317	6	\$5
B-10876	12	\$10

GM Horns



5/16-18 x 7/8 1/2 AF .75 TOOTHED
OLF, 3853846

S8	Pcs	Price
B-10900	2	\$4

GM Body 72 >



5/16-18 x 7/8 1/2 AF .75 CONICAL
KJP, 3846202 after 6-28-72

S2	Pcs	Price
B-11914	6	\$4
B-11544	12	\$6

GM Fender Skirts > 72



5/16-18 x 7/8 1/2 AF 1.50 CONI
OQA, 3899538 before 6-28-72

S2	Pcs	Price
B-11600	2	\$3
B-11601	6	\$8



Chrysler Battery Tray



5/16-18 x 7/8 1/2 AF 1.0 CONICAL
OUB

S7	Pcs	Price
B-12113	2	\$4



5/16-18 x 7/8 1/2 AF .75 CONICAL
KLI, 6025346

S2	Pcs	Price
B-11915	6	\$5



5/16-18 x 7/8 1/2 AF .81 TOOTHED
KUU, 378156-S

S2	Pcs	Price
B-11920	12	\$10
B-11921	50	\$35

Mustang Fr Shocks 67-70



5/16-18 x 7/8 1/2 AF .58 EXTERNAL
NT, 42760-S, 425390

S8	Pcs	Price
B-12319	4	\$6

Corvette Front Stabilizer 63-82



5/16-18 x 7/8 1/2 AF .55 SPLIT
KUD, 42846-S, 358719-S, 3719206 (s),
3784303 (s), 3922549, 9409098

S8	Pcs	Price
B-13724	2	\$3



5/16-18 x 7/8 1/2 AF .55 SPLIT
JAS, 42789-S, 57634-S (sim), 9409098

S2	S8	Pcs	Price
B-10913	B-12321	2	\$3

MACHINE SCREWS - HEX

Ford 69 >



5/16-18 x 15/16 1/2 AF .88 CONICAL
GQ, 57039-S

S2	S7	S36	Pcs	Price
B-11354	B-10782	B-11355	12	\$10
B-11357	B-11356	B-11358	50	\$35

Ford 69 >



5/16-18 x 15/16 1/2 AF .88 CONICAL
OPA, 57039-S

S7	Pcs	Price
B-11540	12	\$10
B-11541	50	\$35



5/16-18 x 1.0 1/2 AF .62 SPLIT
KPC, 6022235, 153279

S2	S8	Pcs	Price
B-13204	B-13205	4	\$5

Ford 68

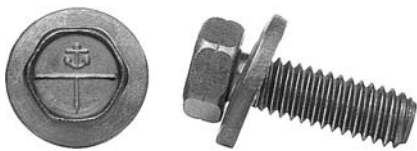

5/16-18 x 1.0 1/2 AF .75 CONICAL
KLJ, 6025351

S2	Pcs	Price
B-10790	4	\$4



5/16-18 x 1.0 1/2 AF .81 CONICAL
GP, 378178-S

S2	S7	Pcs	Price
B-11482	B-11416	12	\$10
B-11923	B-11417	50	\$35



5/16-18 x 1.0 1/2 AF .81 CONICAL
OPJ, 378178-S

S7	Pcs	Price
B-11538	12	\$10
B-11539	50	\$35

About 95% of the
inventory at AMK is

Made in USA !

Ford 68



5/16-18 x 1.0 1/2 AF .81 CONICAL
GO, 378178-S

S7	Pcs	Price
B-10781	12	\$10
B-11396	50	\$35

Ford 68



5/16-18 x 1.0 1/2 AF .81 CONICAL
ORS, 378178-S

S7	Pcs	Price
B-11683	12	\$10
B-11684	50	\$35

Ford 65-67



5/16-18 x 1.0 1/2 AF .81 TOOTHED
GN, 378178-S

S2	S44	Pcs	Price
B-10864	B-13321	12	\$10
B-11353	B-13322	50	\$35

Ford 65-67



5/16-18 x 1.0 1/2 AF .81 TOOTHED
KEN, 378178-S

S2	S44	Pcs	Price
B-11773	B-13323	12	\$10
B-11774	B-13324	50	\$35

Washer has a Copper Tone

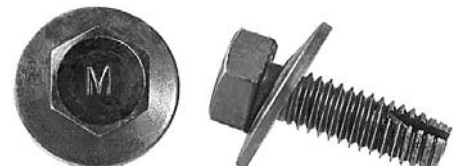

5/16-18 x 1.0 1/2 AF .88 CONICAL
KMC

S2	Pcs	Price
B-11925	8	\$5
B-13293	100	\$35

MACHINE SCREWS - HEX

Ford 69 >

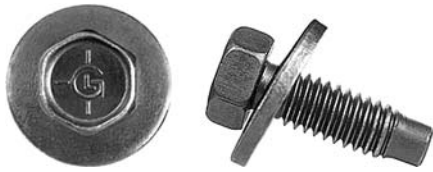

5/16-18 x 1.0 1/2 AF .88 CONICAL
OPK, 6025352 (sim) ◆, 57040-S

S2	S7	Pcs	Price
B-11542	B-11547	12	\$10
B-11543	B-11548	50	\$35

Stainless



5/16-18 x 1.0 1/2 AF .88 CONICAL
QH

SS	Pcs	Price
B-13832	6	\$8
B-13833	25	\$25

GM Trunk Lid, Seats



5/16-18 x 1.0 1/2 AF .88 TOOTHED
LHU

S2	Pcs	Price
B-10895	4	\$4
B-10896	12	\$10

Chrysler Horns



5/16-18 x 1.0 1/2 AF 1.12 TOOTHED
KMD, 6023253 ◆ DARK GREEN CHROMATE

S100	Pcs	Price
B-13325	2	\$5



5/16-18 x 1.0 1/2 AF 1.25 SPECIAL
KH, 378694-S

S2	Pcs	Price
B-11926	50	\$30



5/16-18 x 1.0 1/2 AF 1.25 CONICAL
LKR

S7	Pcs	Price
B-10789	4	\$6



5/16-18 x 1 1/16 1/2 AF .75 CONICAL
KSC, 3847758

S2	Pcs	Price
B-11549	6	\$5

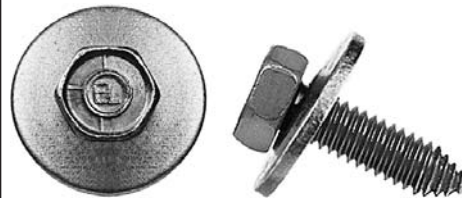

5/16-18 x 1 1/16 1/2 AF 1.0 CONICAL
KNV, 333758

S2	Pcs	Price
B-10923	4	\$4



5/16-18 x 1 1/16 1/2 AF 1.12 CONICAL
SP, 6027063 (sim) ◆, 57140-S

S2	S7	S36	Pcs	Price
B-11931	B-13294	B-11932	4	\$5

Ford 72 >

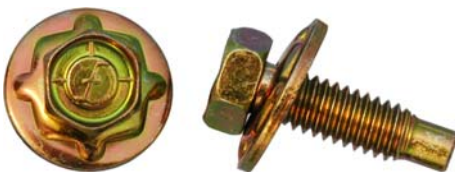

5/16-18 x 1 1/16 1/2 AF .88 SPECIAL
KWI, 384931-S

S36	Pcs	Price
B-13229	4	\$5



5/16-18 x 1 1/8 1/2 AF .62 CONICAL
KZA, 6027837 ◆

S2	Pcs	Price
B-13326	50	\$30



5/16-18 x 1 1/8 1/2 AF .75 CONICAL
OIY, 6035053 ◆

S3	Pcs	Price
B-10837	4	\$3

MACHINE SCREWS - HEX



5/16-18 x 1 1/8 1/2 AF .55 SPLIT
WA, 42848-S (sim), 358720-S, 3782989 (s8)

S8	S36	Pcs	Price
B-10909	B-13348	3	\$4

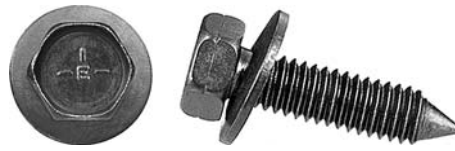

5/16-18 x 1 3/16 1/2 AF .75 CONICAL
KRO, 3847962, 3992648 (sim)

S2	Pcs	Price
B-13230	4	\$5

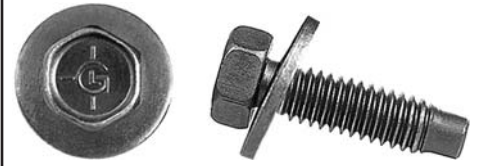

5/16-18 x 1 3/16 1/2 AF .81 CONICAL
OSB, 378242-S, 378337-S (sim)

S2	S7	Pcs	Price
B-11714	B-11715	4	\$4



5/16-18 x 1 3/16 1/2 AF .88 CONICAL
KFB, 6027061 (sim), 6025357 (sim) 
57041-S

S2	S7	S36	Pcs	Price
B-11933	B-11935	B-11937	12	\$10
B-11934	B-11936	B-11938	50	\$35

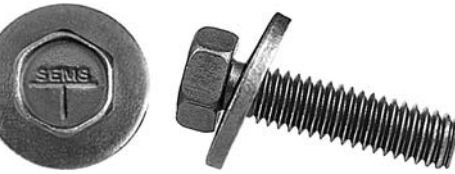

5/16-18 x 1 1/4 1/2 AF .88 CONICAL
SZ, 6022242 , 57096-S

S2	Pcs	Price
B-11940	50	\$30

GM Door Hinges



5/16-18 x 1 1/4 1/2 AF .62 TOOTHED
MPK

S2	Pcs	Price
B-10028	7	\$5
B-11550	30	\$20

GM Door Hinges



5/16-18 x 1 1/4 1/2 AF .62 TOOTHED
MDM

S2	Pcs	Price
B-10039	6	\$6



5/16-18 x 1 1/4 1/2 AF .81 TOOTHED
OYL, 6025358 

S2	Pcs	Price
B-11716	4	\$4

Mustang Bumper Guards 65-68



5/16-18 x 1 1/4 1/2 AF 1.0 CONICAL
OYL 377357-S (sim)

S36	Pcs	Price
B-10836	2	\$3

390/428 Oil Filter Adapter, Water Neck

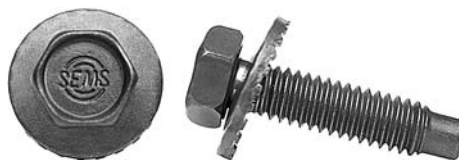

5/16-18 x 1 1/4 1/2 AF .81 TOOTHED
KHW, 378242-S

S2	Pcs	Price
B-11939	6	\$5



5/16-18 x 1 1/4 1/2 AF .55 SPLIT
GY, 358805-S, 9409103

S7	Pcs	Price
B-12322	2	\$3

GM Seat Back Strikers



5/16-18 x 1 3/8 1/2 AF .62 CONICAL
MQG, 351790

S7	Pcs	Price
B-10878	2	\$3

MACHINE SCREWS - HEX



5/16-18 x 1 1/2 1/2 AF .62 CONICAL
KZD, 6022245

S2	Pcs	Price
B-13327	50	\$30



5/16-18 x 1 1/2 1/2 AF .62 TOOTHED
MNP

S2	Pcs	Price
B-10038	6	\$5



5/16-18 x 1 1/2 1/2 AF .75 CONICAL
KZC, 6022246

S2	Pcs	Price
B-13328	4	\$5



5/16-18 x 1 1/2 1/2 AF .81 TOOTHED
BGD, 380297-S

S2	Pcs	Price
B-11941	6	\$5
B-11553	24	\$18

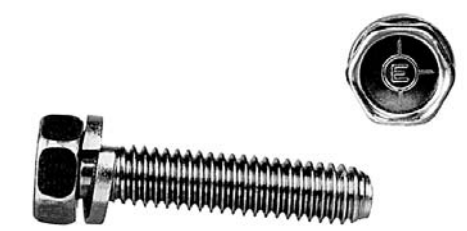

5/16-18 x 1 1/2 1/2 AF .55 SPLIT
NP, 57637-S, 378335-S, 9409099

S8	Pcs	Price
B-12323	2	\$3



5/16-18 x 1 3/4 1/2 AF .88 CONICAL
LLA, 57043-S

S2	Pcs	Price
B-10839	5	\$5

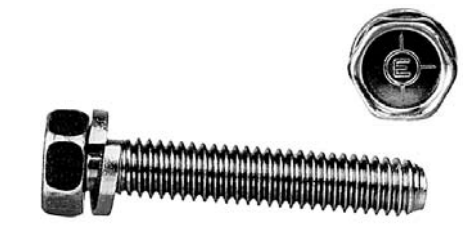

5/16-18 x 1 3/4 1/2 AF .55 SPLIT
NQ, 57638-S, 378338-S, 9413364

S8	Pcs	Price
B-12441	2	\$3

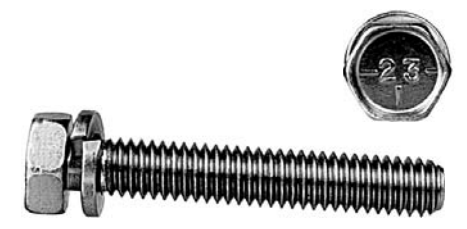

5/16-18 x 2.0 1/2 AF .55 SPLIT
KFH, 376396-S

S8	Pcs	Price
B-12442	2	\$3

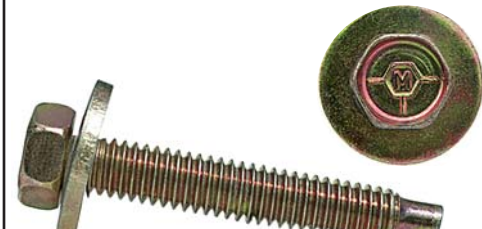

5/16-18 x 2.0 1/2 AF .88 CONICAL
LWR, 57044-S

S2	S36	Pcs	Price
B-10840	B-10841	8	\$5

Ford SB Water Pump 65-69

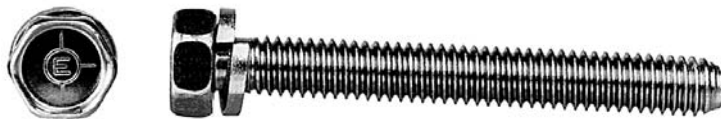

5/16-18 x 2 5/8 1/2 AF .55 SPLIT
NR, 378365-S

S8	Pcs	Price
B-12444	2	\$4

BOSS 302 Windage Tray



5/16-24 x 7/16 1/2 AF .81 TOOTHED
LHZ, 359330-S

S2	Pcs	Price
B-10897	2	\$4

MACHINE SCREWS - HEX

Mustang Fr Shocks 65-66



5/16-24 x 7/8 1/2 AF .58 EXTERNAL
KN, 42767-S, 191678

S8	Pcs	Price
B-12445	4	\$6

Ford Fan Clutch



5/16-24 x 7/8 7/16 AF .55 SPLIT
KRQ, 380288-S

S2	S8	Pcs	Price
B-10918	B-12446	2	\$3

Ford Body 60-64



5/16-24 x 15/16 1/2 AF .81 TOOTHED
KVE, 373687-S

S2	Pcs	Price
B-11945	12	\$10
B-11946	50	\$35

Ford Body 60-64



5/16-24 x 1 1/16 1/2 AF .81 TOOTHED
KVF, 374773-S

S2	Pcs	Price
B-11947	12	\$10
B-11948	50	\$35

BOSS 429 Engine Fan



5/16-24 x 1 1/4 1/2 AF .55 SPLIT
BHX

S2	Pcs	Price
B-12447	2	\$6



5/16-24 x 1 1/2 1/2 AF .55 SPLIT
LGY, 9420518

S2	Pcs	Price
B-10914	2	\$3

Engine Fans



5/16-24 x 2 1/4 1/2 AF .55 SPLIT
LSA, 9425138
HEAD MARK SAME AS LTZ

S2	Pcs	Price
B-10916	2	\$4



5/16-24 x 2 7/16 1/2 AF .55 SPLIT
LTZ, 379205-S (sim), 9420964 (sim)

S2	S8	Pcs	Price
B-10917	B-12449	2	\$4

Engine Fans



5/16-24 x 2 1/2 1/2 AF .55 SPLIT
LTI, 9433518

S2	Pcs	Price
B-10915	2	\$4



5/16-24 x 2 3/4 1/2 AF .55 SPLIT
KHS, 379206-S, 9420515 (s2)

S2	S8	Pcs	Price
B-12450	B-12451	2	\$4

5/16-24 x 3 3/4 1/2 AF .55 SPLIT
KHP, 379192-S
HEAD MARK SAME AS KHS

S8	Pcs	Price
B-12452	2	\$4

MACHINE SCREWS - HEX



3/8-16 x 5/8 9/16 AF .65 EXTERNAL
KGG, 42772-S, 424213

S8	Pcs	Price
B-12453	2	\$3

383/440/426 Timing Cover



3/8-16 x 3/4 9/16 AF .75 CONICAL
KJQ, 6022250 ◆, 9428609 (sim)
9438039 (sim)

S2	Pcs	Price
B-11950	4	\$5



3/8-16 x 3/4 9/16 AF .65 SPLIT
CV, 43265-S (sim), 57644-S, 3744421 (s),
3841492 (s2)

S2	S8	Pcs	Price
B-13722	B-13723	2	\$3

GM Hood Hinges



3/8-16 x 13/16 9/16 AF 1.0 CONICAL
LOO, 9419301

S2	Pcs	Price
B-10835	4	\$5



3/8-16 x 7/8 9/16 AF
IAJ, 54719-S, 9411409 (s8)

S2	S8	Pcs	Price
B-12454	B-12455	100	\$30



3/8-16 x 7/8 9/16 AF .75 CONICAL
KNY, 6022254, 153363 ◆

S2	S7	Pcs	Price
B-13329	B-13330	4	\$5

Chrysler Hood Hinges



3/8-16 x 7/8 9/16 AF .75 CONICAL
KLF, 6025369 ◆

S2	Pcs	Price
B-13237	6	\$5



3/8-16 x 7/8 9/16 AF .65 SPLIT
RS, 359080-S, 3748038, 9411915 (s7-8)

S2	S8	Pcs	Price
B-12456	B-12457	2	\$3



3/8-16 x 15/16 9/16 AF .88 CONICAL
KOD, 3872455, 3872454 (sim)

S2	Pcs	Price
B-11717	2	\$3



3/8-16 x 1.0 9/16 AF .75 CONICAL
LQE, 6022258 ◆

S2	Pcs	Price
B-10834	4	\$5



3/8-16 x 1.0 9/16 AF 1.0 CONICAL
KJR, 3986997, 14011722 (s3)

S2	Pcs	Price
B-13718	4	\$4



3/8-16 x 1.0 9/16 AF .55 SPLIT
KAS, 43514-S, 373293-S, 376025-S,
3786494, 3781994

S2	S8	Pcs	Price
B-10907	B-10908	2	\$3

MACHINE SCREWS - HEX

GM Fr Stabilizer 69 >



3/8-16 x 1 1/8 9/16 AF
MER, 9431970

Ramp-Lok @ Ford Exhaust Manifolds 66 >



3/8-16 x 1 1/8 9/16 AF .75 SPECIAL
RL1, 381730-S

3/8-16 x 1 5/16 9/16 AF .75 SPECIAL
RL2, 374047-S, 377506-S (sim)

S2	Pcs	Price	S2	Pcs	Price	S2	Pcs	Price
B-10413	2	\$3	B-12464	4	\$6	B-12465	4	\$6

Ramp-Lok @ Ford Exhaust Manifolds 66 >

ALSO SEE STUD SECTION



3/8-16 9/16 AF .75 SPECIAL
RL3, 380750-S. RL4 381731-S, 387100-S

LENGTH	S2	S2	Pcs	Price
1 5/8	B-12466	B-12467	4	\$6

3/8-16 9/16 AF .75 SPECIAL
RL5, 381732-S. RL6, 380751-S, 381674-S (sim)

LENGTH	S2	S2	Pcs	Price
2 1/4	B-12468	B-12469	4	\$6



3/8-16 x 1 1/8 9/16 AF .80 CONICAL
KLO, 3918503



3/8-16 x 1 1/8 9/16 AF 1.0" CONICAL
OUP, 3831892



3/8-16 x 1 1/8 9/16 AF 1.12" CONICAL
KLU, 3909140

S2	Pcs	Price	S2	Pcs	Price	S2	Pcs	Price
B-10877	4	\$5	B-11718	2	\$3	B-11719	2	\$3

Ford Brake Booster 65-70



3/8-16 x 1 1/8 9/16 AF .65 SPLIT
LQZ



3/8-16 x 1 1/8 9/16 AF .65 SPLIT
KEB, 43519-S, 3768390. 9409111



3/8-16 x 1 1/8 9/16 AF .65 SPLIT
HIJ, 376977-S, 375864-S (sim)

S2	Pcs	Price	S2	S8	Pcs	Price	S2	Pcs	Price
B-10906	50	\$30	B-12458	B-13437	2	\$3	B-12459	2	\$4

MACHINE SCREWS - HEX



3/8-16 x 1 1/4 9/16 AF .75 CONICAL
KYL, 6022262, 6023187 (sim) ◆

S2	Pcs	Price
B-13333	4	\$5



3/8-16 x 1 1/4 9/16 AF .75 CONICAL
KLE, 6022262, 6023187 (sim) ◆

S2	Pcs	Price
B-11955	4	\$5



3/8-16 x 1 1/4 9/16 AF .75 CONICAL
OVE

S2	Pcs	Price
B-13144	6	\$8



3/8-16 x 1 1/4 9/16 AF 1.0 TOOTHED
OXA, 4409370, 4444052

S2	Pcs	Price
B-13244	6	\$10



3/8-16 x 1 1/4 9/16 AF 1.0 CONICAL
TH, 6025379 (sim) ◆, 57048-S

S2	S36	Pcs	Price
B-11959	B-11960	4	\$5



3/8-16 x 1 1/4 9/16 AF 1.12 CONICAL
OVJ

S2	Pcs	Price
B-13183	4	\$6



3/8-16 x 1 1/4 9/16 AF .75 FLAT
OEX, 339437

S2	Pcs	Price
B-10889	5	\$6



3/8-16 x 1 1/4 9/16 AF .65 SPLIT
NM, 43526-S, 378723-S (sim), 9409112

S2	Pcs	Price
B-12460	2	\$3



3/8-16 x 1 3/8 9/16 AF .75 CONICAL
KYM, 6027865 ◆

S2	Pcs	Price
B-13334	50	\$30



3/8-16 x 1 3/8 9/16 AF 1.0 CONICAL
OXV, 3857663

S2	Pcs	Price
B-11387	4	\$6

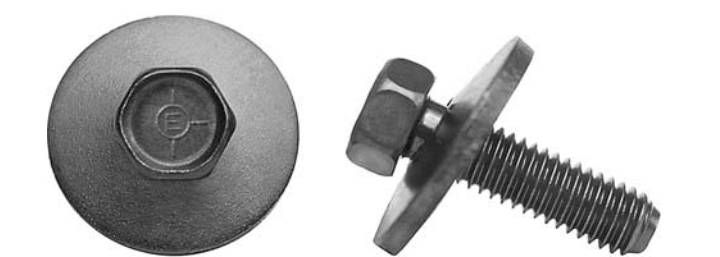

3/8-16 x 1 3/8 9/16 AF 1.31 CONICAL
KQR, 3839741, 3986563 (sim)

S2	Pcs	Price
B-11964	4	\$5

MACHINE SCREWS - HEX



3/8-16 x 1 1/2 9/16 AF .75 CONICAL
LQX, 6028372

S2P	Pcs	Price
B-10814	4	\$5

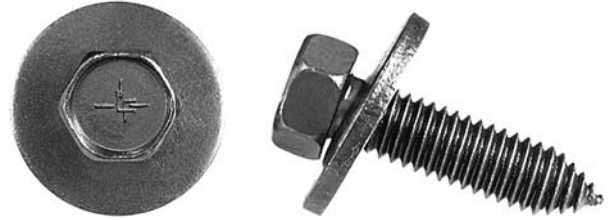

3/8-16 x 1 1/2 9/16 AF 1.12 CONICAL
KJK, 407217, 10008000 (s3)

S2	Pcs	Price
B-11963	4	\$5



3/8-16 x 1 1/2 9/16 AF 1.12 CONICAL
OUC, 3963329

S2	Pcs	Price
B-11720	2	\$3

Chevy SB (s2) and Ford Fuel Pump (s3)



3/8-16 x 1 1/2 9/16 AF .65 SPLIT
FB, 43530-S, 3778526. 274074

S2	S8	Pcs	Price
B-10904	B-12462	2	\$4

Chrysler SB Intake Manifold

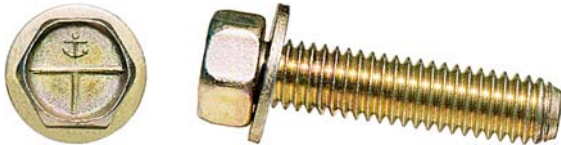

3/8-16 x 1 5/8 9/16 AF .75 FLAT
OPC, 6025982

S36	Pcs	Price
B-11606	4	\$8
B-11607	12	\$20



3/8-16 x 1 3/4 9/16 AF .75 CONICAL
LQW, 6024487

S2P	Pcs	Price
B-10831	50	\$30

El Camino Tailgate Hinge > Body 68-72



3/8-16 x 1 1/2 9/16 AF .75 TOOTHED
OXB, 7668482

S2	Pcs	Price
B-13245	6	\$10



3/8-16 x 1 3/4 9/16 AF 1.0 CONICAL
LJU, 6027873, 57105-S

S2	Pcs	Price
B-10832	50	\$30

MACHINE SCREWS - HEX

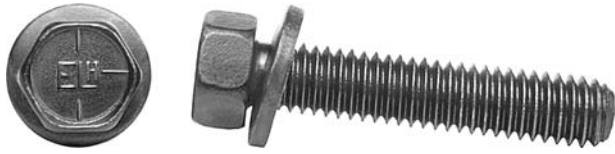

3/8-16 x 1 7/8 9/16 AF .75 CONICAL
LCO, 6027876



3/8-16 x 2 1/8 9/16 AF .65 SPLIT
KDS, 373542-S

S2	Pcs	Price	S2	Pcs	Price
B-10833	2	\$4	B-12463	2	\$3

Chevy SB Crankshaft Pulley up to 68



3/8-24 x 5/8 9/16 AF .68 INTERNAL
MRN, 3784349

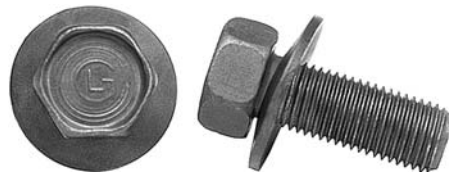

3/8-24 x 1.0 9/16 AF .88 CONICAL
KYT



7/16-14 x 7/8 5/8 AF .74 SPLIT
KGH, 57658-S

S36	Pcs	Price	S2	Pcs	Price	S2	Pcs	Price
B-10890	3	\$6	B-13335	4	\$5	B-12475	2	\$3

426 HEMI Engine Insulator



7/16-14 x 1.0 5/8 AF .75 CONICAL
ONA, 6024023



7/16-14 x 1 1/4 5/8 AF .88 CONICAL
ONN, 6024027



7/16-14 x 1 1/2 5/8 AF .75 CONICAL
OTD, 6025571

S2	Pcs	Price	S2	Pcs	Price	S2	Pcs	Price
B-11372	2	\$10	B-13192	2	\$6	B-13216	2	\$5

Mustang Cowl Braces 70, Tie Downs 68-73, Rr Bumper 69-73



7/16-14 x 1 1/4 5/8 AF 1.12 CONICAL
QC, 57481-S

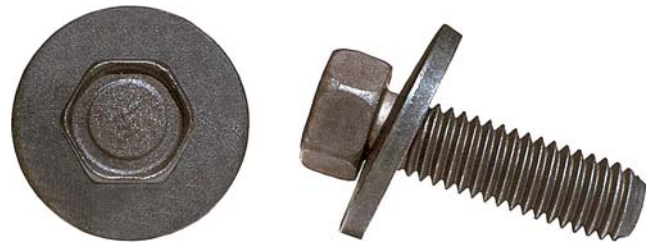

7/16-14 x 1 1/2 5/8 AF 1.25 CONICAL
LDZ, 6024033

S2	Pcs	Price	S2	Pcs	Price
B-13336	4	\$6	B-13717	4	\$6

MACHINE SCREWS - HEX

Chrysler SB A/T Trans > Engine



7/16-14 x 1 3/4 5/8 AF .75 CONICAL
OTL, 6024862 ◆



7/16-14 x 2.0 5/8 AF .75 CONICAL
OXU, 6024863 ◆

S2	Pcs	Price
B-13222	2	\$8

S2	Pcs	Price
B-13239	2	\$8

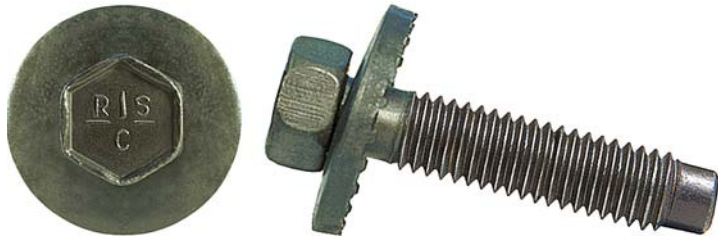

7/16-14 5/8 AF 1.25 TOOTHED LOR, LTA
2.0 2 1/2

S2	S2	Pcs	Price
B-10898	-----	2	\$5
-----	B-10899	25	\$30

Mustang Tie Down Brackets 68-73

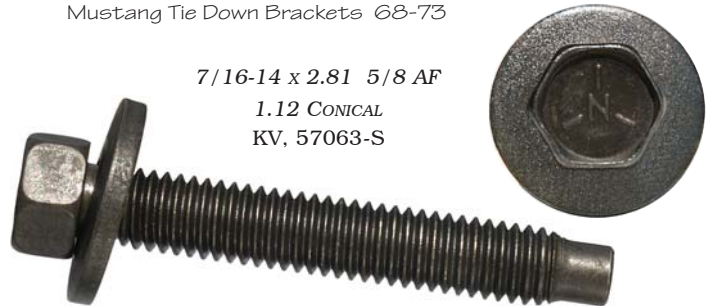

7/16-14 x 2.81 5/8 AF
1.12 CONICAL
KV, 57063-S

S2	Pcs	Price
B-11721	2	\$8

B-Body Fr Bumper Arms

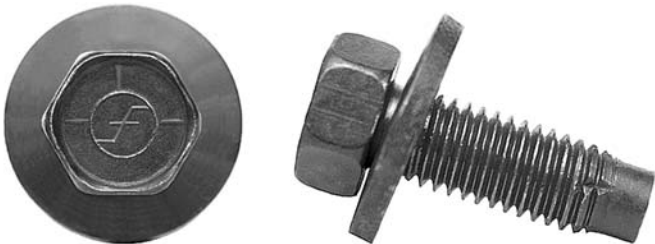

1/2-13 x 1 1/2 3/4 AF 1.25 CONICAL LTD, 6025558 ◆

S2	Pcs	Price
B-10924	4	\$20

E-Body Fr Bumper Arms



1/2-13x 1 3/4 3/4 AF 1.38 TOOTHED PCG, 6029139 ◆

S2	Pcs	Price
B-13463	4	\$20

Chrysler Brake Caliper



1/2-20 x 1 5/8 3/4 AF 1.0 CONICAL
KZI, 6028323 (sim) ◆

S2P	Pcs	Price
B-10794	2	\$20

Chrysler K-Frame



5/8-11 x 2.0 1 1/16 AF 1.27 CONICAL OYU, 2467693 ◆

S2	Pcs	Price
B-11373	2	\$12

MACHINE SCREWS - HEX



8-32 x 3/8 1/4 AF .34 OD
KBO, 40904-S

S2	Pcs	Price
B-12560	8	\$3



8-32 x 1/2 1/4 AF .34 OD
LS, 55377-S, 9422835 (s36)

S2	S36	Pcs	Price
B-12476	B-12477	10	\$3



8-32 x 1/2 1/4 AF .34 EXTERNAL
BEA, 55589-S

S2	Pcs	Price
B-12478	6	\$3

Ford Ignition Coil



8-32 x 1 3/4 1/4 AF .33 OD
WW, 57021-S

S2	Pcs	Price
B-12479	6	\$3



10-24 x 3/8 5/16 AF .39 OD
KDC, 40905-S, 9432459

S2	Pcs	Price
B-12561	8	\$3



10-24 x 7/16 5/16 AF .44 TOOTHED
KKT

S8	Pcs	Price
B-11854	12	\$4



10-24 x 1/2 5/16 AF .40 OD
MEM, 9420431 (sim)

S8	Pcs	Price
B-10411	8	\$3



10-24 x 1/2 5/16 AF .40 EXTERNAL
YX, 55590-S

S2	Pcs	Price
B-12481	6	\$3



10-24 x 3/4 5/16 AF .40 OD
KJA, 40944-S, 9420818

S2	Pcs	Price
B-12562	8	\$3



10-24 x 7/8 5/16 AF .40 OD
XU, 40957-S

S2	Pcs	Price
B-12563	100	\$30

GM Voltage Regulator 64-68



10-24 x 1.0 5/16 AF .50 OD
LPK, 3858888 (s8), 3876129

S2	Pcs	Price
B-10011	3	\$4

Ford Alternator Housings



10-24 x 2 1/8 5/16 AF .40 OD
BCH, 378466-S

S2	S8	Pcs	Price
B-12482	B-12483	3	\$3

Ford Air Cleaner Snorkel 68 >



10-32 x 3/8 5/16 AF .40 OD
FX, 55359-S, 9414416

S8	Pcs	Price
B-12484	4	\$3

GM Door Windows



1/4-20 x 7/16 7/16 AF .55 OD
MDR

S2	Pcs	Price
B-10427	6	\$3



1/4-20 x 7/16 7/16 AF .75 OD
MQM

S2	Pcs	Price
B-10428	4	\$3

MACHINE SCREWS - HEX WASHER



1/4-20 x 7/16 3/8 AF .50 OD
MQ, 378859-S

S8	S36	Pcs	Price
B-12485	B-12486	4	\$3



1/4-20 x 1/2 3/8 AF .50 OD
KOX, 40927-S

S2	S8	Pcs	Price
B-13295	B-12564	6	\$3



1/4-20 x 1/2 3/8 AF .57 EXTERNAL
BED, 55593-S

S2	S36	Pcs	Price
B-12487	B-12488	4	\$3



1/4-20 x 3/4 3/8 AF .60 OD
LCT

S7	Pcs	Price
B-10408	4	\$3



1/4-20 x 3/4 3/8 AF .74 OD
MQN

S2	Pcs	Price
B-10409	100	\$30



1/4-20 x 3/4 3/8 AF .57 EXTERNAL
YU, 55613-S

S2	S36	Pcs	Price
B-12490	B-12491	4	\$3

GM Radiator & AC Mounting



1/4-20 x 13/16 3/8 AF .51 OD
LQB, 3903536

S8	Pcs	Price
B-10384	2	\$4



1/4-20 x 1 3/8 3/8 AF .50 OD
XA, 55247-S

S2	Pcs	Price
B-12492	4	\$3



1/4-20 x 1 13/16 3/8 AF .50 OD
XB, 377387-S

S2	Pcs	Price
B-12493	4	\$3

Ford Road-Draft Tube



1/4-28 x 1/2 3/8 AF .50 OD
FP, 40922-S (sim), 273554

S8	Pcs	Price
B-12494	4	\$3



5/16-18 x 1/2 1/2 AF .65 OD
VV, 40923-S, 451736 (s8)

S2	S8	Pcs	Price
B-12565	B-12566	4	\$3



5/16-18 x 9/16 1/2 AF .66 OD
MUH, 3958062, 3980136

S2	S8	Pcs	Price
B-10415	B-10416	4	\$4

Ford A/T Trans Pan



5/16-18 x 9/16 1/2 AF .59 OD
PK, 378782-S

S2	Pcs	Price
B-12496	6	\$3
B-11551	17	\$6

Camaro R/S Parking Lamps 68



5/16-18 x 5/8 3/8 AF .64 EXTERNAL
MYD, 3773698

S7	Pcs	Price
B-10888	4	\$4

Ford Brake Caliper Stabilizer 68-73



5/16-18 x 5/8 3/8 AF .55 SPLIT
KHF, 381985-S

S36P	Pcs	Price
B-10911	4	\$5

MACHINE SCREWS - HEX WASHER

GM & Chrysler 9 3/4 Differential Cover



5/16-18 x 5/8 1/2 AF .68 OD
QB

S2	Pcs	Price
B-10104	6	\$6
B-10018	12	\$12

GM A/T Oil pan

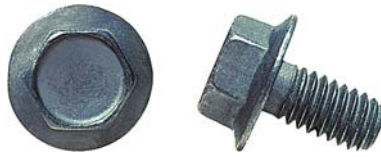

5/16-18 x 5/8 1/2 AF .76 OD
OBM

S2	Pcs	Price
B-10095	7	\$4
B-10096	14	\$7

Ford 4 Spd Top-Loader Cover



5/16-18 x 5/8 1/2 AF .81 OD
OMH

S2	Pcs	Price
B-10728	8	\$8

Ford 352/390/428 Timing Cover

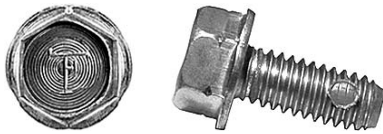

5/16-18 x 3/4 1/2 AF .66 OD
XG, 374408-S

SP	Pcs	Price
B-12497	4	\$6



5/16-18 x 3/4 1/2 AF .66 OD
IH, 381877-S (sim), 9419402

S2	Pcs	Price
B-12589	6	\$4
B-11633	20	\$10

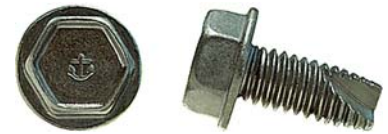

5/16-18 x 3/4 1/2 AF .66 OD
BO, 40949-S (sim), 3975550

S2	Pcs	Price
B-10046	4	\$4

GM Body 64-70



5/16-18 x 3/4 1/2 AF .67 OD
KKW, 9780422

S2	Pcs	Price
B-12498	12	\$8
B-12499	50	\$25

GM Body 64-70



5/16-18 x 3/4 1/2 AF .67 OD
OXP, 9780422

S2	Pcs	Price
B-13306	12	\$8
B-13307	50	\$25

GM Body 70 >



5/16-18 x 13/16 1/2 AF .65 OD
KJN, 3960314, 3968520 (sim)

S2	Pcs	Price
B-12500	12	\$6
B-12501	50	\$20

Stainless



5/16-18 x 7/8 1/2 AF .64 OD
OZH

SS	Pcs	Price
B-11722	100	\$30



5/16-18 x 7/8 1/2 AF .69 OD
JAV, 374032-S

S2	Pcs	Price
B-12504	4	\$3

Ford 289/302/351 Timing Cover



5/16-18 x 7/8 1/2 AF .67 OD
VP, 376255-S, 9437398

S2	Pcs	Price
B-12502	4	\$4

MACHINE SCREWS - HEX WASHER

Ford Body 65-67

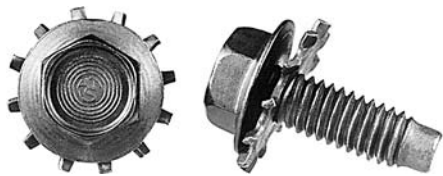

5/16-18 x 15/16 1/2 AF .88 EXTERNAL
KHD, 378156-S (7/8), 378196-S

Ford Body 65-67

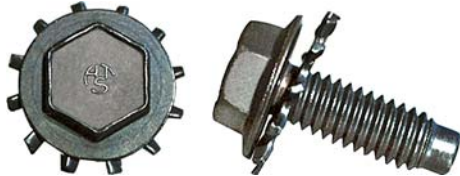

5/16-18 x 15/16 1/2 AF .88 EXTERNAL
GM, 378156-S (7/8), 378196-S

Ford Body 65-67

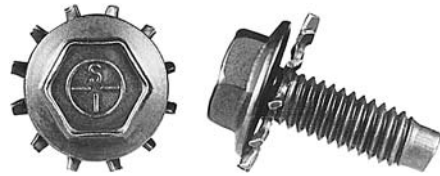

5/16-18 x 15/16 1/2 AF .88 EXTERNAL
WC, 378156-S (7/8), 378196-S

S2	S44	Pcs	Price
B-11641	B-13319	12	\$10
B-11642	B-13320	50	\$35

S2	S7	Pcs	Price
B-10379	B-13501	12	\$10
B-11344	B-13500	50	\$35

S2	Pcs	Price
B-11639	12	\$10
B-11640	50	\$35

GM Body 70 >



5/16-18 x 1.0 1/2 AF .66 OD
KJO, 3968521

Ford 4 Spd Top-Loader Cover



5/16-18 x 1.0 1/2 AF .81 OD
LJF

Ford Body 65-67



5/16-18 x 1 1/16 1/2 AF .88 EXTERNAL
KHE, 378178-S (1.0), 378787-S

S2	Pcs	Price
B-12505	12	\$8
B-12506	50	\$25

S2	Pcs	Price
B-10099	2	\$3

S2	Pcs	Price
B-11643	12	\$10
B-11644	50	\$35

GM Oil Filter Valve 69 >



5/16-18 x 1 1/8 7/16 AF .50 OD
MCC, 3951644

Ford Door Hinges 68 >



5/16-18 x 1 1/8 1/2 AF .68 OD
KPE, 382623-S

Ford Door Hinges 66-67



5/16-18 x 1 1/2 1/2 AF .88 EXTERNAL
QF, 380297-S

S	Pcs	Price
B-10395	2	\$3

S2	Pcs	Price
B-10433	6	\$4
B-11552	24	\$14

S2	Pcs	Price
B-10043	6	\$5
B-11554	22	\$18

260/289 Intake 62-67



5/16-18 x 1 15/16 1/2 AF .56 FLAT
NN, 378484-S
RUBBER COATED ALUMINUM WASHER

Ford Body 50's - 64



5/16-24 x 1.0 1/2 AF .81 OD
GD, 353714-S

S	Pcs	Price
B-12508	4	\$6

S2	Pcs	Price
B-12510	4	\$4

S2	Pcs	Price
B-11949	8	\$10
B-11784	20	\$20

MACHINE SCREWS - HEX WASHER

Ford 352/390/428 Timing Cover



3/8-16 x 7/8 9/16 AF .75 OD
XH, 374409-S

SP	Pcs	Price
B-12512	4	\$6

Mustang Cowl Braces 65-66



3/8-16 x 1.0 9/16 AF .88 EXTERNAL
QP, 377917-S

S2	Pcs	Price
B-11962	4	\$6
B-10886	8	\$12

Ford SB Starter



3/8-16 x 1 1/8 1/2 AF .64 SPLIT
KBR, 382748-S

S8	S36	Pcs	Price
B-12513	B-12514	2	\$3

Ford Door Hinges 65



3/8-16 x 1 5/16 9/16 AF .88 EXTERNAL
SO, 377919-S

S2	Pcs	Price
B-11961	4	\$5
B-11555	22	\$22

BB Chevy Fuel Pump

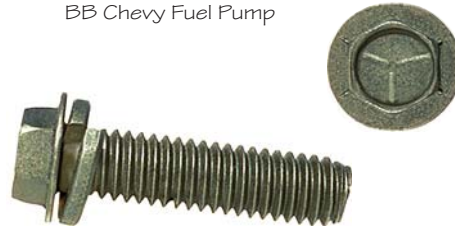

3/8-16 x 1 7/16 7/16 AF .64 SPLIT
KQC, 3874876 (sim)

S2	Pcs	Price
B-12518	2	\$3

Ford Starter



3/8-16 x 1 1/2 1/2 AF .64 SPLIT
LVC, 388466-S

S36	Pcs	Price
B-10905	4	\$3
B-13296	100	\$30

Ford Engine Mount Body Brackets & Trans Mounts 60-65



3/8-24 x 3 3/8 9/16 AF .75 OD
KEX, 372993-S

S2	Pcs	Price
B-12519	2	\$6

Ford Engine Mounts 68 >



7/16-14 x 7/8 5/8 AF .86 OD
HIV, 383232-S

S2	Pcs	Price
B-12593	4	\$6

Mustang Cowl Braces 67-69

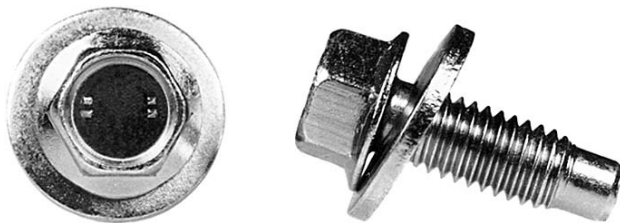

7/16-14 x 1 1/4 5/8 AF 1.12 CONICAL
NU, 380999-S

S36	Pcs	Price
B-11967	2	\$6
B-11556	4	\$10

GM A/T Flexplate



7/16-20 x .70 9/16 AF .74 OD
OKQ, 3727207 (sim), 14088764

S	Pcs	Price
B-10400	6	\$12
B-13297	25	\$25

MACHINE SCREWS - OVAL

Shelby Tailamp Frames 67



6-32 x 1 1/2 .22 OD
LHW
STAINLESS

SS	Pcs	Price
B-10399	6	\$10



8-32 x 3/8 .26 OD
MNC, 168971

S13	Pcs	Price
B-10002	10	\$3



8-32 x 3/8 .31 OD
BBD, 52906-S, 449311

S8	Pcs	Price
B-12567	8	\$3



8-32 x 1/2 .26 OD
OCG, 9422357 (sim)

S2	Pcs	Price
B-11558	10	\$3



8-32 x 1/2 .26 OD
LJA, 9425395

S13	Pcs	Price
B-13897	10	\$3



8-32 x 1/2 .31 OD
KTD, 9425501 (sim)

S2	Pcs	Price
B-12568	8	\$3



8-32 x 5/8 .26 OD
XV, 53272-S, 455703, 168852, 9418962

S2	S8	S36	Pcs	Price
B-12569	B-12570	B-11557	6	\$3



8-32 x 5/8 .31 OD
LCU, 6027140

S3	Pcs	Price
B-13686	6	\$3

Ford Door & Window Handles 67 >



8-32 x 5/8 .31 OD
GX, 381571-S

S8	S13	Pcs	Price
B-12594	B-12595	6	\$3



8-32 x 3/4 .31 OD
KWO, 52937-S, 167545

S13	Pcs	Price
B-10421	8	\$3



8-32 x 3/4 .26 OD
LJJ, 9425397

S13	Pcs	Price
B-10422	8	\$3



8-32 x 7/8 .26 OD
KRU, 53288-S

S13	Pcs	Price
B-12521	100	\$30



8-32 x 7/8 .31 OD
LJD, 167551

S13	Pcs	Price
B-10425	100	\$30

Stainless



8-32 x 1.0 .31 OD
LCV
SS/CHROME

S45	Pcs	Price
B-13687	6	\$3

Chevelle Parking 71-72 Nova T/L 66-69



8-32 x 1 1/8 .26 OD
KHY, 376369-S, 9433151 (sim), 5958143
STAINLESS

S3	S45	Pcs	Price
B-12523	B-11685	8	\$4

MACHINE SCREWS - OVAL

Stainless



8-32 x 1 1/4 .31 OD
LCW
SS/CHROME

S45	Pcs	Price
B-13688	4	\$3



8-32 x 1 3/4 .31 OD
LCY

S13	Pcs	Price
B-13689	4	\$3

GM & Chrysler E-Body Outside Mirror



10-24 x 3/4 .31 OD
ODZ, 187709, 454738 (sim)
SS/CHROME

S45	Pcs	Price
B-10062	4	\$3



10-24 x 3/4 .36 OD
OO

S13P	Pcs	Price
B-10389	6	\$3

Ford Outside Mirror 67 >



10-24 x 1.0 .31 OD
RK, 382968-S
SS/CHROME

S45	Pcs	Price
B-12524	4	\$3

Stainless



10-24 x 1 1/8 .36 OD
KXR
SS/CHROME

S45	Pcs	Price
B-11724	4	\$3



10-24 x 1 1/2 .36 OD
HD, 52979-S (sim), 156994, 156996

S8	S13	Pcs	Price
B-12525	B-12526	4	\$3

GM Inside Rr View Mirror



10-32 x .58 .36 OD
LXI, 565842

S13	Pcs	Price
B-10015	1	\$2
B-10390	2	\$3

T-Bird Convertible Top Clamp 55-57



10-32 x 3/4 .36 OD
OUM
SS/CHROME

S45	Pcs	Price
B-10903	4	\$4

Corvette Door



1/4-20 x 1/2 .44 EXTERNAL
OQS

S8	Pcs	Price
B-11657	6	\$5

Camaro DLX Inside Door Handles 68-69



1/4-20 x 5/8 .41 OD
LUU, 7740945

S7	Pcs	Price
B-10426	4	\$4

GM Door Latches



1/4-20 x 5/8 .48 OD
KUB

S7	Pcs	Price
B-12527	6	\$3

Stainless



1/4-20 x 7/8 .48 OD
LOM, 57368-S SS/CHROME

S45	Pcs	Price
B-10385	6	\$3



1/4-20 x 1.0 .42 OD
OUS

S13	Pcs	Price
B-11723	6	\$4



5/16-18 x 1.0 .63 EXTERNAL
LFC

S36	Pcs	Price
B-13720	4	\$4

MACHINE SCREWS - PAN

Ford Aluminum Valve Cover L Brackets



4-40 x 1/4 .21 OD
JE

S8	Pcs	Price
B-12596	12	\$3



6-32 x 1/4 .26 OD
MY, 51750-S, 449601 (s8)

S2	S8	Pcs	Price
B-12572	B-12573	12	\$3



6-32 x 3/4 .26 OD
HC, 159348

S8	Pcs	Price
B-12529	250	\$30

Ford Distributor Points & Condensor



6-32 x 3/4 .26 OD
LTS

S13	Pcs	Price
B-10417	100	\$30



8-32 x 9/32 .33 OD
AH, 378360-S, 169701 (sim)

S8	Pcs	Price
B-12597	12	\$3

GM Headlamp Retaining Rings



8-32 x 5/16 .27 OD
OJQ, 5959530

S8	Pcs	Price
B-11522	6	\$3

Stainless



8-32 x 3/8 .31 OD
FZ, 383141-S

SS	Pcs	Price
B-12598	12	\$3



8-32 x 3/8 .31 OD
IN, 51755-S

S36	Pcs	Price
B-12574	10	\$3



8-32 x 3/8 .31 EXTERNAL
HE, 50803-S, 9422884

S2	Pcs	Price
B-12530	6	\$3

Camaro Steering Column Cover 67-68



8-32 x 7/16 .38 CONICAL
LZN, 9427208 (sim)

S2	Pcs	Price
B-10848	4	\$3



8-32 x 1/2 .31 OD
IR, 50514-S, 9420146 (s2)

S2	S13	S36	Pcs	Price
B-12531	B-13298	B-12532	10	\$3



8-32 x 1/2 .31 EXTERNAL
LU, 50809-S2

S2	Pcs	Price
B-12533	100	\$30



8-32 x 5/8 .50 CONICAL
LFD, 57258-S

S36	Pcs	Price
B-10847	6	\$4

El Camino Tailamp 67-72 Chevelle B/U 68



8-32 x .65 .31 OD .194 x .340 SHOULDER
OOJ
SS/CHROME

S45	Pcs	Price
B-11489	4	\$4

Camaro R/S 67-68, Nova 64-65 Parking



8-32 x .69 .31 OD .194 x .380 SHOULDER
MCA, 5953438
SS/CHROME

S45	Pcs	Price
B-11108	4	\$4

MACHINE SCREWS - PAN

Chevelle B/U 65, 67 Nova 65-67



8-32 x .71 .31 OD .194 x .302 SHOULDER
OON, 5956445
SS/CHROME

S45	Pcs	Price
B-11493	4	\$4

Shelby Tailamp Bezels 68-70



8-32 x 3/4 .27 OD
LDA

S3	S13	Pcs	Price
B-13299	B-13300	8	\$6



8-32 x 3/4 .31 OD
IO, 51786-S, 449617

S8	Pcs	Price
B-12575	10	\$3

Chevelle Tailamp 66, B/U Lenses 68-72



8-32 x 3/4 .31 OD .194 x .435 SHOULDER
OOR
SS/CHROME

S45	Pcs	Price
B-11495	4	\$4
B-11487	10	\$10

Chevelle Tailamps 64-65, Nova 65-72



8-32 x 13/16 .31 OD
OFE, 5946953, 5955833
SS/CHROME

S45	Pcs	Price
B-10404	4	\$3

Mustang Tailamp Lenses 67-68



8-32 x 13/16 .31 OD
MAJ
SS/CHROME

S45	Pcs	Price
B-10405	4	\$3

Parking 65-66A, 66-69N, 70-73F, T/L 70A



8-32 x 7/8 .31 OD .194 x .488 SHOULDER
OOF, 5961749, 5957808 (sim), 5959383
(sim), 5962696 STAINLESS

S3	S45	Pcs	Price
B-11488	B-11494	4	\$4

Back-Up Lenses 67-68 R/S Camaro



8-32 x 7/8 .31 OD .194 x .550 SHOULDER
OFK, 5957653 (sim)
SS/CHROME

S45	Pcs	Price
B-10402	4	\$4

Ford Distributor Vacuum Unit > 67



8-32 x 7/8 .31 OD
YV, 354988-S, 436698

S8	Pcs	Price
B-12534	4	\$3

Parking Lenses 64 Chevelle



8-32 x 1.0 .31 OD
OQI, 5955349
SS/CHROME

S45	Pcs	Price
B-11620	4	\$3

Parking 67-68A, 67-69F, 70-72N



8-32 x 1 1/8 .31 OD .194 x .640 SHOULDER
OFI, 5958894 (sim), 5960165 (sim)
SS/CHROME

S45	Pcs	Price
B-10403	4	\$4

Parking Lenses 69 Chevelle



8-32 x 1 1/8 .31 OD .194 x .806 SHOULDER
OOX, 5956386 (sim)
SS/CHROME

S45	Pcs	Price
B-11490	4	\$5

Parking Lenses 70 Chevelle



8-32 x 1.29 .31 OD .194 x .915 SHOULDER
BGL, 5959107 (sim)
SS/CHROME

S45	Pcs	Price
B-10550	4	\$5



8-32 x 1 7/16 .31 OD
LJB

S13	Pcs	Price
B-10418	4	\$4



8-32 x 1.83 .31 OD
LKB

S13	Pcs	Price
B-10420	4	\$4

MACHINE SCREWS - PAN

Glove Box Hinge 66-67 Nova, 67-68 Cam



10-24 x 3/8 .37 OD
IM, 51756-S, 449621

S8	Pcs	Price
B-12576	10	\$3



10-24 x 3/8 .44 CONICAL
MQK, 9418551

S2	Pcs	Price
B-10925	3	\$3



10-24 x 1/2 .37 OD
DF, 54505-S, 9424148. 9417019

S2	S13	S36	Pcs	Price
B-13301	B-12536	B-12537	8	\$3

Ford Seat Pivot Covers



10-24 x 1/2 .37 OD
VU, 51765-S, 455134. 449623

S2	S8	Pcs	Price
B-12577	B-12578	8	\$3

Chevelle, Nova Parking Lamps



10-24 x 1/2 .37 EXTERNAL
LT, 54541-S, 9413442. 273513

S2	S8	Pcs	Price
B-12538	B-10885	4	\$3



10-24 x 5/8 .37 OD
IT, 51787-S, 167107

S13	Pcs	Price
B-12579	8	\$3



10-24 x 5/8 .44 CONICAL
KMS, 6028955

S7	Pcs	Price
B-11856	8	\$6



10-24 x 3/4 .37 OD
MID, 167106

S8	Pcs	Price
B-10412	8	\$3



10-24 x 3/4 .37 EXTERNAL
KAQ, 54543-S, 9416929

S8	Pcs	Price
B-12539	6	\$3

Mustang Door Handles 65-68



10-24 x 1 1/8 .37 EXTERNAL
FL, 54546-S

S8	Pcs	Price
B-10883	4	\$3

Stainless



10-24 x 1 1/2 .37 OD
VT, 54511-S, 161085
SS/CHROME

S45	Pcs	Price
B-12541	6	\$3

Carter Fuel Pump Body



10-32 x 5/8 .37 SPLIT
KFW

S8	Pcs	Price
B-12542	6	\$4

Ford Wagons

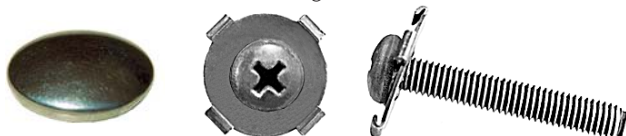

.77 OD
LFE, 358404-S

10-32 x 1 1/4 .72 WASHER
KZP, 373702-S

SS CAP	S32	Pcs	Price
B-13748	-----	3	\$6
-----	B-13350	4	\$5

Holley Carburetor Fuel Bowls



12-24 x 1 7/8 .46 OD
ORB, 3420348

12-24 x 2 1/2 .46 OD
LCQ, 3420341, 359747-S,
3881412

S36	Pcs	Price	S36	Pcs	Price
B-11686	4	\$6	B-10392	4	\$6
B-11687	8	\$10	B-11559	8	\$10

MACHINE SCREWS - PAN, ROUND

Mustang Inside Door Handles 71-73



1/4-20 x 1/2 .49 CONICAL
PAS, 57546-S

S2	Pcs	Price
B-11725	4	\$3

Mustang Floor Hole Plates 65-66



1/4-20 x 1/2 .48 EXTERNAL
RB, 372204-S

S8	Pcs	Price
B-12580	4	\$3



1/4-20 x 5/8 .48 OD
BDQ, 50527-S, 9418566

S2	Pcs	Price
B-12543	6	\$3

License Plates



1/4-20 x 5/8 .48 OD
IAR, 171756

S8	Pcs	Price
B-12581	6	\$3



1/4-20 x 3/4 .48 EXTERNAL
BEO, 50828-S, 455183

S8P	Pcs	Price
B-12545	4	\$3



1/4-20 x 3/4 .48 OD
BDL, 57450-S

S2	Pcs	Price
B-12544	4	\$3



1/4-20 x 1 1/2 .48 OD
BDM, 383119-S (sim), 148510

S2	Pcs	Price
B-12546	4	\$3

Mustang Gas Pedal 65-67



1/4-28 x 1.0 .49 OD
EG, 379538-S (sim), 380503-S

S2	Pcs	Price
B-12547	2	\$3

GM Shoulder Straps 67-68



5/16-18 x 7/8 .49 OD
LCR

S36P	Pcs	Price
B-10398	2	\$5



5/16-18 x 1.0 .62 CONICAL
KLD

S2	Pcs	Price
B-11922	4	\$3

Mustang Bumper Guards, Park Brake 67-68



5/16-18 x 1.0 .60 EXTERNAL
SL, 379949-S

S2	S36	Pcs	Price
B-12549	B-12550	4	\$3

Mustang Parking Brake Control 65-66



5/16-24 x 3/4 .60 EXTERNAL
ZH, 50831-S, 446587

S8	Pcs	Price
B-12551	2	\$3

Mustang Fr Bumper 71-72



3/8-16 x 7/8 .79 OD
Stainless, 384457-S

SS	Pcs	Price
B-12552	2	\$3

Chevy Ignition Coil Strap



10-24 x 1 1/2 .34 OD
OGO

S7	Pcs	Price
B-10882	2	\$3

Chrysler Ignition Coil Strap



10-24 x 1 1/2 .34 OD
OGO

S7	Pcs	Price
B-11675	2	\$3

MACHINE SCREWS - ROUND WA, SOCKET, WAFER

Chrysler Convertible Top Mouldings



8-32 x 5/16 .40 OD
MTY, 9429605 (s8) ◆

S36	Pcs	Price
B-10424	6	\$3

Chrysler AAR Rear Spoiler



10-24 x 5/8 .48 OD
MSV

S8	Pcs	Price
B-11726	4	\$3

Mustang Rr Spoiler



5/16-18 x 3/4 .46 OD
KBG, 383974-S

S44P	Pcs	Price
B-12555	4	\$3

Mustang & T-Bird Window Cranks



10-24 x 1/2 .30 OD
BEH, 379259-S

S13P	Pcs	Price
B-12553	4	\$3

Chrysler Inside Rr View Mirror



10-24 x 9/16 .31 OD
OPP, 6025275 (sim), 6026911 ◆

S8	Pcs	Price
B-11560	1	\$3

Chrysler Window Cranks



10-32 x 9/16 .30 OD
KWG, 6027221 ◆

S13	Pcs	Price
B-10391	4	\$4

426 Hemi Intake Manifold 66-67



1/4-20 x 2 1/2 .50 FLAT
ONU, 6025689 ◆

S	Pcs	Price
B-11562	4	\$16

1/4-20 x 3.0 .50 FLAT
ONY, 6025691 ◆

S	Pcs	Price
B-11563	3	\$12

Mustang Wiper Arm Pivots 71-73



1/4-20 x 1/2 .75 CONCIAL
OYH, 383737-S

S2	Pcs	Price
B-13465	6	\$8

GM Brake Caliper Housing Bolts 69 >



7/16-20 x 3.72 .62 OD
OJF, 5463495

S8	Pcs	Price
B-10401	2	\$6

GM Seat Back Cables



1/4-20 x 11/16 .62 OD .38 x .20 L SHOULDER
MOX

S8P	Pcs	Price
B-10213	2	\$3



5/16-18 x 1 1/8 .75 OD
LKS, Weld Stud

S2	Pcs	Price
B-11693	4	\$3

GM Hood Adjuster



5/16-18 x 1 3/8 .59 OD
MRV, 3839682

S2	Pcs	Price
B-10396	2	\$3

Chrysler Hood Adjuster



5/16-18 x 1 1/2 .69 OD
LQH

S2	Pcs	Price
B-10414	2	\$3

MACHINE SCREWS - SOCKET, MISC

Ford Shoulder Harness



3/8-16 x 1 1/2 .85 OD .50 x .23 L SHOULDER
OIE, 382626-S

S36	Pcs	Price
B-10152	1	\$6

GM Door Striker 64-69



7/16-14 X 2 1/8 OAL BFT, 4472299, 7660559

S8	Pcs	Price
B-12067	1	\$12

GM Door Striker 70 >

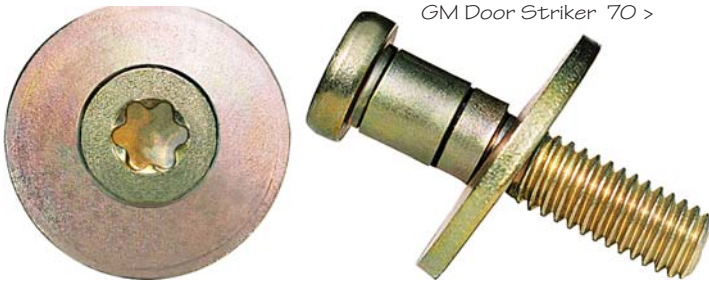

7/16-14 X 2.10 OAL OMF, 8770193

S8	Pcs	Price
B-11672	1	\$12

Ford Rr Seat Belts 3/68 >



7/16-20 x 1 3/8 .85 OD
OHA, 382624-S (sim), 386273-S

7/16-20 x 1 3/4 .85 OD
OHZ, 384966-S

S36	Pcs	Price	S36	Pcs	Price
B-10435	2	\$6	B-11727	4	\$6
B-13302	6	\$12	B-13303	12	\$12

Ford Fr Seat Belts 3/68 >



7/16-20 x 1 3/4 .85 OD .50 x .50 SHOULDER
OTF, 382627-S

S36	Pcs	Price
B-10434	2	\$8



7/16-20 x 1 13/16 .84 OD .50 x 1.0 L SHOULDER
OHS, 6036511AA

S36P	Pcs	Price
B-10436	2	\$5
B-13304	6	\$12



1/4-20 x 7/8 1.46 ACROSS
YI, 359197-S, 379124-S, 383132-S (sim)

S8	Pcs	Price
B-10437	1	\$3

Weld Stud



5/16-18 x 1 1/8 .75 OD
LKS

S2	Pcs	Price
B-11693	4	\$3



5/16-18 x 7/8 1/2 DRIVE .75 CONICAL
KRI, 3979949 (s2)

S2	Pcs	Price
B-11917	6	\$8
B-13452	12	\$12

STUDS - BALL, DOUBLE END

Powerglide Kickdown 69-72



1/4-20 x 1.04 OAL 5/16 AF .22 BALL
OKW, 3949065

S8	Pcs	Price
B-10991	1	\$3

GM Accelerator Cable 68 >



1/4-20 x .98 OAL 5/16 AF .25 BALL
MNL, 3924414

S8	Pcs	Price
B-10992	1	\$5

GM Accelerator Cable 71 >



5/16-18 x 1.0 OAL 3/8 AF .25 BALL
OCF, 3991261

S8	Pcs	Price
B-10993	1	\$5

GM Clutch Bellcrank



3/8-16 x 1.82 OAL .88 BALL
MUB, 3935289

S	Pcs	Price
B-10994	1	\$8

GM Clutch Bellcrank



1/2-13 x 2.42 OAL .88 BALL MUG, 3793522 (sim), 3866568

S	Pcs	Price
B-10995	1	\$10

383/440/426 Valve Covers



1/4 x 1.0 OAL .38 UNC & .50 UNF
OEB, 6024845

S2	Pcs	Price
B-10633	4	\$6



GR-5 1/4 x 1 1/2 OAL .50 UNC & .75 UNF
LMQ

S	Pcs	Price
B-10996	100	\$30



1/4-20 x 2 3/8 .75 TL
MIS, 381529-S

S2	Pcs	Price
B-10997	1	\$4



1/4-20 x 2 5/8 .94 TL
HIE 370970-S

S8	Pcs	Price
B-12604	1	\$4

4.35 .80 TL
OJW, 383729-S

S2P	Pcs	Price
B-11001	1	\$6



1/4-20 x 3.0 .88 TL
F, 376509-S

S8	Pcs	Price
B-12605	2	\$4

426 Hemi Intake Manifold



1/4 x 2 3/4 .38 UNC & .75 UNF
OEF, 6027207

S2	Pcs	Price
B-10998	2	\$9



1/4 x 3.40 .38 UNC & .81 UNF
OEM, 6026994

S2	Pcs	Price
B-10999	3	\$12

1/4 x 3 3/4 .38 UNC & 1.14 UNF
OEZ, 6026429

S2	Pcs	Price
B-11000	1	\$5

STUDS - DOUBLE END

GM Air Cleaner



1/4-20 x 3.0 OAL .50 & .75 TL
MRJ, 3735357

GM Air Cleaner



3 1/2 OAL .60 & 1.25 TL
MRA, 3750992 (sim), 3921975

GM Air Cleaner



4.66 OAL .50 & 1.66 TL
MRG, 3737482

GM Air Cleaner

5 3/8 OAL .50 & 1.50 TL
MRK, 3756988

S2	Pcs	Price	S2	Pcs	Price	S2	Pcs	Price	S8	Pcs	Price
B-10030	1	\$6	B-10031	1	\$6	B-10032	1	\$6	B-10033	1	\$6

GM Fan Clutch



GR-8 5/16 x 1 1/4 .44 UNC & .62 UNF
LJV, 103173



GR-5 5/16 x 1 1/4 .62 UNC & .44 UNF
MAK

Chrysler & Ford Carburetor



GR-5 5/16 x 1 3/8 .50 UNC & .50 UNF
KS, 6025991 (sim), 88381-S

S2	Pcs	Price	S2	Pcs	Price	S2	S8	Pcs	Price
B-11002	4	\$4	B-11003	4	\$3	B-11674	B-12610	4	\$4



5/16 x 1 7/16 .56 UNC & .56 UNF
LAA



GR-8 5/16-18 x 1 1/2 .44 & .88 TL
LMW



GR-5 5/16 x 1.53 .50 UNC & .80 UNF
MXA

S2	Pcs	Price	S2	Pcs	Price	S8	Pcs	Price
B-13352	4	\$3	B-11004	2	\$3	B-11005	2	\$3
						B-11006	4	\$6

Chrysler Fenders



GR-5 5/16-18 x 1 5/8 .35 & 1.12 TL
MSH

**Special Bulk pricing is available
for most items in this catalog.
Discounts can be HUGE.**



GR-5 5/16 x 1 11/16 .50 UNC & .83 UNF
MXF

S2	Pcs	Price	S2	Pcs	Price
B-11007	2	\$3	B-11728	4	\$4

Ford Carburetor with 3/8 Spacer



GR-5 5/16 x 1 11/16 .50 UNC & .83 UNF
MXF



GR-8 5/16-18 x 1 3/4 .75 TL
LMR



GR-5 5/16-18 x 2.0 .44 & .88 TL
MFL

S8	Pcs	Price	S8	Pcs	Price	S8	Pcs	Price
B-12611	4	\$4	B-11009	100	\$30	B-11010	2	\$3

STUDS - DOUBLE END



GR-5 5/16 x 2.0 .56 UNC & 1.0 UNF
LMI

S8	Pcs	Price
B-11011	4	\$4



GR-5 5/16 x 2 1/4 .44 UNC & 1.25 UNF
LVK, 6034643

S2	Pcs	Price
B-11012	4	\$5



Auto Trans 428CJ Carb
5/16 x 2 1/4 .50 UNC & .83 UNF
OKB

S8	Pcs	Price
B-11013	1	\$10

289/302 Intake Manifold



GR-5 5/16-18 x 2 3/8 .62 TL
WP, 382198-S

S2	Pcs	Price
B-12609	2	\$3

Carburetor w 1" Spacer



GR-8 5/16 x 2 1/2 .50 UNC & 1.50 UNF
BGE

S8	Pcs	Price
B-12612	4	\$5

5/16 x 3.0 .38 UNC & 1.50 UNF
KZM

S8	Pcs	Price
B-13353	50	\$30

383/440 Exhaust Manifolds



GR-5 3/8 x 1 9/16 .50 UNC & .80 UNF
LKF, 1613782, 6028023, 103196

S2	Pcs	Price
B-11014	6	\$8
B-11015	12	\$14

Stainless



3/8-16 x 1 5/8 .50 & .75 TL
MEC

SS	Pcs	Price
B-11016	2	\$4



GR-5 3/8-16 x 2.0 .69 & 1.0 TL
LNX, 6033883

S2P	Pcs	Price
B-11017	4	\$4



GR-8 3/8-16 x 2 1/8 .62 & 1.0 TL
MGE

S2	Pcs	Price
B-11018	50	\$30

GM Exhaust Pipe



3/8-16 x 2 1/4 .44 & 1.64 TL
MIB, 3760425

S2	Pcs	Price
B-10625	3	\$8

3/8-16 x 3 3/8 .44 & 1.64 TL
MHO, 3760426

S2	Pcs	Price
B-10624	3	\$8

429 Intake Manifold



GR-5 3/8-16 x 2.45 .62 TL
KVS, 383744-S

S2	Pcs	Price
B-11020	4	\$6



GR-8 3/8 x 2 11/16 .45 UNC & 1.25 UNF
MGA

S	Pcs	Price
B-11021	50	\$30

GR-8 3/8 x 2 3/4 .75 UNC & 1.0 UNF
LWO

S	Pcs	Price
B-11022	100	\$30

STUDS - DOUBLE END

P/S Pump 289/302 67-69, 390/428 67-70



GR-5 3/8-16 x 7 3/8 .62 & 2.25 TL
LD, 377060-S

S2	Pcs	Price
B-12614	1	\$5

426 Hemi Engine Mounts

Chrysler Starter



7/16 x 1 11/16 .62 UNC & .81 UNF
ONJ, 103216 (sim), 103217

7/16 x 2.0 .62 UNC & .88 UNF
LOK, 2095875, 6035606

GR-8 7/16-14 x 2.0 .75 & .94 TL
LNL

S2	Pcs	Price	S36M	Pcs	Price	S	Pcs	Price
B-11660	3	\$8	B-11025	1	\$3	B-11026	50	\$30
			B-13310	6	\$10			

Ford Exhaust Pipe

Ford Exhaust Pipe



7/16-14 x 2 3/8 .62 & 1.12 TL
GG, 380345-S

7/16-14 x 3.81 .50 & 1.25 TL
LF, 380701-S

S2	Pcs	Price	S2	Pcs	Price
B-12616	2	\$3	B-12618	2	\$6



GR-8 7/16-14 x 3 1/8 .62 & 1.81 TL
MBA

GR-8 1/2-13 x 2 1/8
.50 & 1.19, MGF

GR-8 1/2 x 2 1/4
.75 UNC & 1.0 UNF, MFZ

S2	Pcs	Price	S	Pcs	Price	S	Pcs	Price
B-11028	2	\$3	B-11029	50	\$30	B-11030	50	\$30

STUDS - FULL THREAD

Mustang Ram-Air Scoop 71-73



8-32 x 1.0
LAU

S36	Pcs	Price
B-13351	5	\$3

Mustang Hood Turn Lamps 67-68



10-24 x 1.0
ZK

S8	Pcs	Price
B-12600	7	\$4



10-24 x 1 7/8
KIX

S8	Pcs	Price
B-12601	6	\$3

Ford Fender Extensions



1/4-20 x 1.14
MSE

S8	Pcs	Price
B-11031	6	\$3



GR-5 1/4-20 x 1 1/4
MS, 93321-S

S36	Pcs	Price
B-12602	6	\$3

Ford Quarter Extensions



GR-5 1/4-20 x 1 1/2
UW, 93322-S

S36	Pcs	Price
B-12603	6	\$3

BOSS 302 Heat Shroud



5/16-18 x 1.0
XN, 374230-S

S2	Pcs	Price
B-12606	2	\$2



5/16-18 x 1 1/2
KKM

S2	Pcs	Price
B-12607	2	\$2



GR-5 5/16-18 x 1.85
MGB

S	Pcs	Price
B-11032	4	\$3

Ford Engine Accessories 62-69



GR-5 3/8-16 x 1 3/4
MGC

S	Pcs	Price
B-11033	4	\$4



GR-8 3/8-16 x 2.0
YS, 377278-S

S2	Pcs	Price
B-12613	2	\$3

Ford Engine Accessories 70 >



7/16-14 x 2 1/4
YT, 377279-S (sim)

S2	Pcs	Price
B-12615	2	\$3

STUDS - HEX COLLAR

GM AC Evaporator 67 >



1/4-14 x 3/4 x 1/4-20 x 1 1/8 7/16 AF
MAD, 3895910

S2	Pcs	Price
B-11034	1	\$3

289 Heat Shroud 65-67



5/16-18 x 5/8 TL 1/2 AF
G, 379008-S

S8	Pcs	Price
B-12619	1	\$3

289/302 Heat Shroud 68 >



5/16-18 x 9/16 & 13/16 TL 1/2 AF
XM, 382245-S

S8	Pcs	Price
B-12620	1	\$3

70 Chrysler SB Heat Shroud



5/16-18 x 1 1/8 & 1/4-20 x 1/2 1/2 AF
OND, 6028355

S2	Pcs	Price
B-11471	1	\$6

BOSS 429 Valve Covers



GR-5 5/16-18 x 2.0 & 5/8 9/16 AF
MDZ

S2	Pcs	Price
B-11037	1	\$12

GR-5 5/16-18 x 2.0 & 5/8 5/8 AF
MZD

S2	Pcs	Price
B-11036	1	\$4

Ford Carburetor Air Cleaners



5/16-18 x 2 5/16 & 1/4-20 x 1 1/16
OJV, 382717-S, 383596-S (sim)

S2	Pcs	Price
B-11038	1	\$6

5/16-18 x 2 5/16 & 1/4-20 x 1 5/16
MRI, 370971-S

S8	Pcs	Price
B-11039	1	\$6



5/16-18 x 1 3/4 & 3/8-16 x 5/8 9/16 AF
LOX

S7	Pcs	Price
B-11035	50	\$30

SB Chevy Water Neck 69 >



GR-5 3/8-16 x 1.0 & 5/8 9/16 AF
MRQ

S8	Pcs	Price
B-11040	1	\$3

Chevy Intake Manifold



GR-8 3/8-16 x 1 1/8 & 5/16-18 x 5/8 9/16 AF
MNG, 473361. 3792235

S2	S8	Pcs	Price
B-11041	B-11042	1	\$4

Chevy Intake Manifold



GR-5 3/8-16 x 1 1/4 & 5/8 9/16 AF
LBS, 336793, 3975998 (sim)

S8	Pcs	Price
B-11043	1	\$4

STUDS - HEX COLLAR

SB Chevy Water Pump 66-68



GR-5 3/8-16 x 1 7/16 & 15/16 9/16 AF
MNW, 3928906 (sim)

S2	S8	Pcs	Price
B-11044	B-11045	1	\$4

289/302/351C 68 >

428CJ Exhaust Manifold



3/8-16 x 1 5/8 & 5/16-18 x 1/2
RL7, 382338-S

S2	Pcs	Price
B-12470	1	\$4

351W 69 >

200/250 69 >, 429CJ & B429

3/8-16 x 2 5/8 & 5/16-18 x 5/8
RL10, 382330-S

S2	Pcs	Price
B-12473	2	\$8

390GT/428CJ 68 >

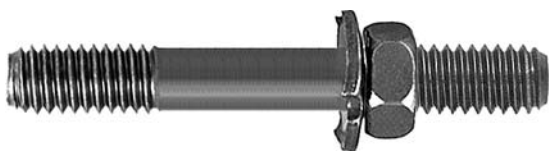

3/8-16 x 1 7/8 & 11/16 9/16 AF
RL8, 382573-S

S2	Pcs	Price
B-12471	2	\$6

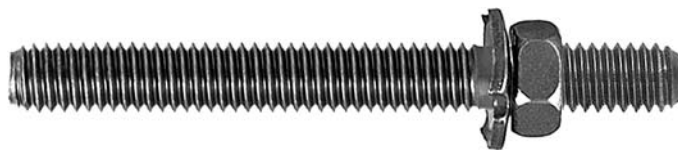

3/8-16 x 2 1/4 & 3/4 9/16 AF
RL9, 382592-S

S2	Pcs	Price
B-12472	2	\$6

3/8-16 x 2 5/8 & 5/8 9/16 AF
RL11, 382803-S

S2	Pcs	Price
B-12474	1	\$4

Chevy SB Water Pump 64-68, BB 65-69



GR-5 3/8-16 x 1 11/16 & 5/16-24 x 9/16 9/16 AF
MFQ, 3740778 (sim), 3759755

S8	Pcs	Price
B-11046	1	\$4

Chevy BB Water Pump 64-68, SB Smog 66-68



GR-5 3/8-16 x 1 13/16 & .90 9/16 AF
MNV, 3877646. 3883996 (sim)

S8	Pcs	Price
B-11047	1	\$4

Chevy SB Exhaust Manifold w AC 64-68



GR-8 3/8-16 x 2 1/16 & 1 11/16 9/16 AF
MFF, 3923299 (sim), 3932448

S2	Pcs	Price
B-11048	1	\$4

390/428CJ Intake Manifold



GR-8 3/8-16 x 2 5/8 & 5/16-18 x 5/8 9/16 AF
WO, 383215-S, 390452-S, 3937247 (sim)

S36	Pcs	Price
B-12624	1	\$6



3/8-16 x 3 1/4 & 3/4 9/16 AF
LAM

S8	Pcs	Price
B-13354	1	\$6

Like your Classic
95% of our fasteners
are proudly
Made in USA !

BB Chevy Alternator 69 >



GR-8 3/8-16 x 5 5/8 & 7/16-14 x .72 5/8 AF
MAR, 3940944

S2	Pcs	Price
B-11049	1	\$6

Ford 170/200/250 Cylinder Head



GR-8 7/16-14 x 1 1/2 & 3/8-16 x .65 5/8 AF
LJW, 391458-S
PHOS & SEALER

S100	Pcs	Price
B-11050	1	\$4



GR-8 7/16-14 x 3 1/8 & 3/8-16 x 3/4 3/4 AF
LIE

S	Pcs	Price
B-11051	1	\$8

Cylinder Head Stud



GR-8 1/2-13 x 3 1/2 & 3/8-16 x 11/16 13/16 AF
LIM

S	Pcs	Price
B-11052	1	\$8

If you don't see it here then visit

www.amkproducts.com

hundreds of additional fasteners are
available in the BULK section

STUDS - HEX FLANGE, ROUND COLLAR



1/4-20 x 1.0 & 3/4 7/16 AF .52 OD
OHG, 6035968AA



5/16-18 x 7/8 & 5/8 1/2 AF .68 OD
LMY, 391079-S



1/4-14 x 5/8 & 1/4-20 x 1 1/4 .63 OD
OHJ, 6036251AA

S8M	Pcs	Price	S2	Pcs	Price	S36	Pcs	Price
B-11053	50	\$30	B-11054	50	\$30	B-11060	2	\$3

BOSS 302 Timing Cover

351W Ram-Air Intake

BOSS 302 Intake

Ford Hood Scoop



5/16-18 x 2.0 & 13/16
BGS, 388552-S, 384039-S
(sim)

5/16-18 x 2 1/4 & 11/16
KVU, 388551-S (sim)

5/16-18 x 2 1/2 & 11/16
BGT, 390681-S

1/4-14 x 5/8 & 1/4-20 x 9/16 .63 OD
LCE

S2	Pcs	Price	S2	Pcs	Price	S36	Pcs	Price	S8	Pcs	Price
B-12621	1	\$6	B-12622	1	\$6	B-12623	1	\$6	B-13780	3	\$5
									B-13781	9	\$12



GR-5 3/8-16 x 5 1/8 & 1 1/16 9/16 AF
LVE, 391459-S

S2	Pcs	Price
B-11056	1	\$6

GM Air Cleaner w Holley

GM Air Cleaner

GM Air Cleaner



1/4-20 x 1 1/2 OAL 5/8 TL .32 OD
MNX, 3873852

1/4-20 x 1 5/8 OAL 7/16 & 1 1/4 L .40 OD
MRZ, 3747933 (sim), 3928914

1/4-20 x 2 5/16 OAL 1/2 & 1 3/4 L .40 OD
LJH, 3869954 (sim), 3901834

S7	Pcs	Price	S2	Pcs	Price	S2	Pcs	Price
B-10029	1	\$6	B-11057	1	\$6	B-11058	1	\$6

Mustang Grille Moulding 70



8-32 x 3/4 .50 x .85 PLATE
EH, 381955-S
S32 & FOAM PAD

S100	Pcs	Price
B-12014	6	\$5

Ford Speaker, Defroster Ducts

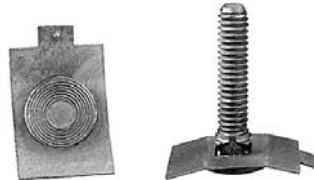

8-32 x 13/16 .50 x .85 PLATE
KGT, 376589-S

S2	Pcs	Price
B-12015	8	\$4

Mustang Rr Valance 69-73



8-32 x 1 1/4 .50 x .85 PLATE
PCC, 382155-S S36 & FOAM PAD

S100	Pcs	Price
B-12016	2	\$5

Mustang Rr Valance 65-68

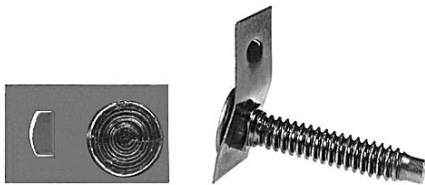

10-24 x 1.0 .50 x .85 PLATE
ED, 372719-S

S8	Pcs	Price
B-12017	4	\$6

Camaro Tailamps 69

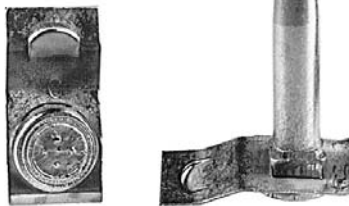

1/4 x 1 1/8 .50 x 1.0 PLATE
KWE, 7793789

S8M	Pcs	Price
B-12269	6	\$6

Torino Rr Valance 70-71



1/4-20 x 1.0 .73 x .83 PLATE
OOU, 383076-S

S36	Pcs	Price
B-11535	2	\$6

Mustang Tailamps 69, 71-73

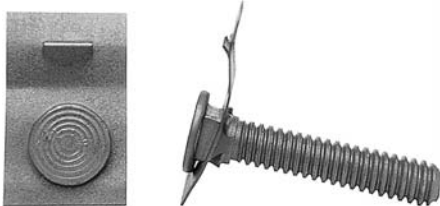

1/4-20 x 1 1/4 .62 x 1.01 PLATE
OD, 382764-S

S2	Pcs	Price
B-10407	4	\$6
B-12020	8	\$10

Mustang Stone Shield

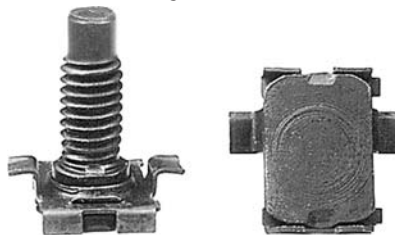

5/16-18 x 5/8 .59 x 80 BASE
PT, 379749-S (sim)

S2	Pcs	Price
B-11564	1	\$4
B-12018	3	\$10



5/16-18 x 1.0 .88 x 1.62 PLATE
KZT, 379149-S

S2	Pcs	Price
B-13338	25	\$30

Battery Holddown



5/16-18 x 1 1/4 .88 x 1.62 PLATE
KDL, 379924-S. OW, COAB-16246-A

S2	S100	Pcs	Price
B-12021	B-12022	2	\$6

Mustang Fender
S100 = FOAM PAD



5/16-24 x 7/8 .88 x 1.62 PLATE
KZZ, S8 SCREW & S2 PLATE

S100	Pcs	Price
B-13339	25	\$30

Ford 58-64

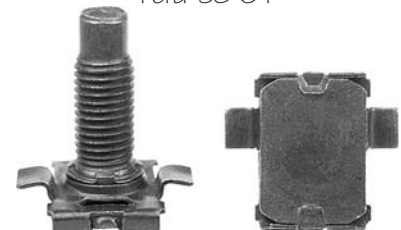

5/16-24 x 7/8 .59 x .80 BASE
KSY, 378130-S

S2	Pcs	Price
B-12019	2	\$7

BUSHINGS

Ford Door Glass Roller



.38 ID x .73 OD
LAS, C0AB-6423240-A

S	Pcs	Price
B-13406	4	\$3

Door Glass Mounting



.38 ID x 1.50 OD x .25 OAH
OYA, C9ZZ-6523258-A, D0ZZ-A

S	Pcs	Price
B-11729	2	\$3

GM Brake & Clutch Pedal Bushing



.62 ID x .94 OD FLANGE
MQS, 3798256, 3965692, 15594358 (sim)

S	Pcs	Price
B-10025	2	\$3

Ford Wiring



.63 ID x 1.06 OD x .31 TK
OLG, C3AB-14603-C

S	Pcs	Price
B-10234	2	\$3

Ford Wiring



1.37 ID x 1.66 OD x .31 TK
OLP, C4AB-14603-A

S	Pcs	Price
B-10235	2	\$5

GM Shock & Stabilizer End Link



.34 ID x 1.0 OD x .88 TK
MMV, 381957, 6264018

S	Pcs	Price
B-10243	4	\$4

GM Shocks, Shifter



.34 ID x 1.21 OD x .89 TK
OFD, 3910700, 5544296, 6270704, 6270752

S	Pcs	Price
B-10237	4	\$3

Nova Fr Shocks 64-67



.37 ID x 1.30 OD x .60 TK
MYM, 3790341

S	Pcs	Price
B-11730	2	\$3

Ford Shifter Linkage



.38 ID x .90 OD x .39 TK
LQG, CODF-7341-A

S	Pcs	Price
B-10238	1	\$3

Ford Shifter Handle



.40 ID x .61 OD x .51 TK
LLP, 379998-S

S	Pcs	Price
B-10241	2	\$4

Ford Stabilizer End Link



.42 ID x 1.06 OD x .85 TK
OAI, KC-55490-A

S	Pcs	Price
B-10239	4	\$4

Ford P/S Cylinder Rod



.54 ID x 1.25 OD x .77 TK
OBP, C70A-3A334-A

S	Pcs	Price
B-10240	2	\$4

CLAMPS - BAND



1 1/16 SIZE 1.14 MAX ID OPEN .98 CLOSED
KZV, 97208-S

S8M	Pcs	Price
B-13386	2	\$5

Ford & GM 5/8 Heater Hoses

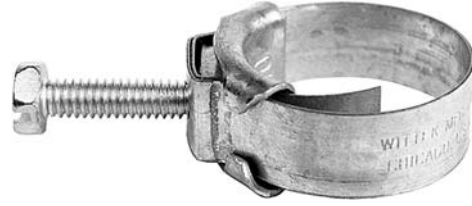

1 1/16 SIZE 1.12 MAX ID OPEN .81 CLOSED
OZ, 97356-S, 9411984, 9423574 (sim), 9423575 (sim)

S8M	Pcs	Price
B-13092	2	\$5
B-11732	6	\$12

Ford & GM 3/4 Heater Hoses



1 3/16 SIZE 1.25 MAX ID OPEN .94 CLOSED
PC, 97358-S, 9414923, 9423576 (sim), 9423577 (sim)

S8M	Pcs	Price
B-13093	2	\$5



1 7/16 SIZE 1.50 MAX ID OPEN 1.19 CLOSED
OSX, 97362-S8M, 9414928, 9423581 (sim)

S8M	Pcs	Price
B-11731	2	\$5



1 3/4 SIZE
1.81 MAX ID OPEN 1.50 CLOSED
PD, 97367-S, 9414931

S8M	Pcs	Price
B-13094	2	\$6

1 15/16 SIZE
2.00 MAX ID OPEN 1.69 CLOSED
PE, 97370-S, 9414933

S8M	Pcs	Price
B-13095	2	\$6



2 1/16 SIZE
2.12 MAX ID OPEN 1.75 CLOSED
LLJ, 97372-S, 9411656

S8M	Pcs	Price
B-13883	2	\$6



2 3/16 SIZE
2.25 MAX ID OPEN 1.88 CLOSED
PF, 97374-S, 9411676

S8M	Pcs	Price
B-13096	2	\$6

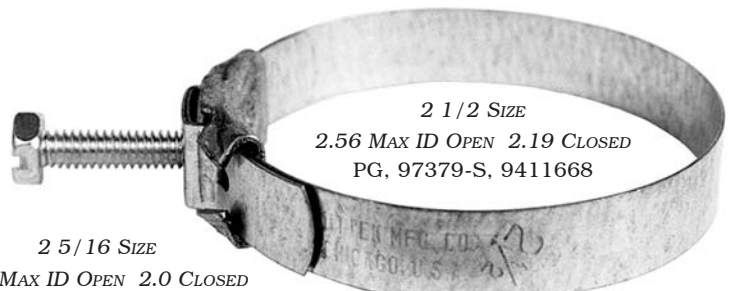

2 5/16 SIZE
2.37 MAX ID OPEN 2.0 CLOSED
LLL, 97376-S, 274765

S8M	Pcs	Price
B-13884	2	\$6

S8M	Pcs	Price
B-13097	2	\$6

CLAMPS - PINCH, SPRING

Ford Fuel Lines 60-67



.52 - .62 RANGE
AB, 376545-S (sim)

SS	Pcs	Price
B-13085	4	\$4

Ford Brake Booster 60-68



.62 - .72 RANGE
KWL, 376428-S, 379012-S (sim)

SS	Pcs	Price
B-13086	4	\$4

Ford P/S Cylinder Boot



.67 - .77 RANGE
GV, C3AZ-3C755-A

S8	Pcs	Price
B-11661	2	\$3



S8M	Pcs	Price
B-10245	3	\$3

GM Vacuum Hoses



.23 - .25 RANGE
MUE, 3891759 (sim), 3949938
BLACK ENAMEL

S3	Pcs	Price
B-10247	4	\$3

GM Fuel Vapor Return Hoses



.48 - .54 RANGE
MVQ, 9770783
RED ENAMEL

S100	Pcs	Price
B-10248	4	\$3

GM Fuel Vapor Return Hoses



.54 - .58 RANGE
MUF, 3786275
YELLOW ENAMEL

S100	Pcs	Price
B-10249	4	\$3

Ford Fuel Hoses 67 >



.57 - .63 RANGE
NB, 380882-S (sim), 382119-S, 398709,
14007703 S100 = SILVER ENAMEL

S32	S100	Pcs	Price
B-10055	B-13087	4	\$3
B-10056	B-11425	25	\$10

GM Fuel Hoses



.62 - .67 RANGE
KVN, 3786276 (sim)
OLIVE DRAB ENAMEL

S32	Pcs	Price
B-13088	4	\$3

Ford & GM Brake Booster, GM Fuel, PCV



.66 - .75 RANGE
LII, 6033369 ◆, 382984-S, 3829058
BLACK ENAMEL

S3	Pcs	Price
B-10250	4	\$3



.70 - .80 RANGE
LWW, 6505054AA ◆

S3	Pcs	Price
B-10251	4	\$3



11/16 SIZE .70 MAX HOSE OD .67 CLOSED
JC, 97329-S, 272846

S36M	S48	Pcs	Price
B-11733	B-13099	6	\$3

Ford PCV Hoses



13/16 SIZE .83 MAX HOSE OD .79 CLOSED
JB, 97331-S, 272848 (sim)

S36M	Pcs	Price
B-13100	6	\$3

CLAMPS - SPRING, WIRE

GM Heater Hoses > 68, Ford PCV

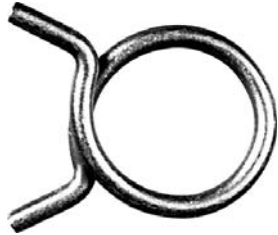

15/16 SIZE .97 MAX HOSE OD .90 CLOSED
BGR, 97333-S, 272850

S36M	Pcs	Price
B-13101	6	\$3

GM Heater Hoses > 68

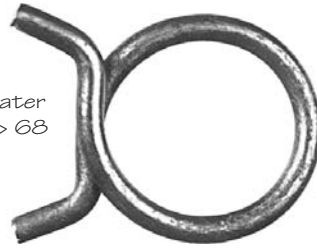

1 1/16 SIZE 1.09 MAX HOSE OD 1.03 CLOSED
ME, 97335-S, 272852

S48M	Pcs	Price
B-13102	4	\$3



2 1/8 SIZE
2.19 MAX HOSE OD 2.06 CLOSED
MC, 97347-S
S100 = GREEN CHROMATE

S36M	S100	Pcs	Price
B-13104	B-13103	2	\$3

Ford 6 Cyl & All V8 (exc 351C) Radiator Hoses 66 >

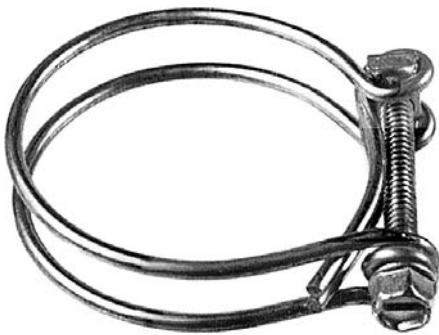

1 15/16 MAX HOSE OD
OX

S8	Pcs	Price
B-13106	2	\$8

All Ford V8

Ford 390/428/429

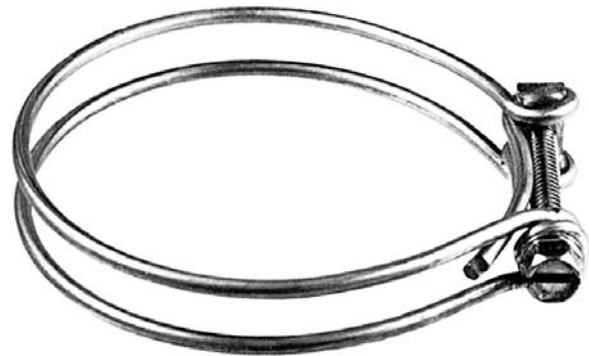

2 3/16 MAX HOSE OD
OY, 378815-S

2 1/2 MAX HOSE OD
YF, 378817-S, 381934-S

S8	Pcs	Price	S8	Pcs	Price
B-13107	2	\$8	B-13108	1	\$5

Mustang Gas Tank Filler Hose 65-70



2 11/16 MAX HOSE OD
KGS, 380153-S

S8	Pcs	Price
B-13109	2	\$6

Radiator Hoses



2.00 - 2.88 RANGE
MFN ALL STAINLESS/BLACK

SS	Pcs	Price
B-10255	2	\$3
B-11568	50	\$30

CLAMPS - PIPE



Correct 1966-73 Ford
(1963-65 clamps are similar except sides have larger cut-out)

2.0" size (2.19 opening)

OVA, C60A-5252-H



All clamps are
MADE IN USA

Cad Nuts 65-68 Phos Nuts 69-73

S100	S101	Pcs	Price
B-11700	B-11701	2	\$24



2 1/8" size (2.30 opening)

OVB, C8ZE-5252-E



S100	Pcs	Price
B-11702	2	\$24



2 1/4" size (2.44 opening)

OVC, C60A-5252-F



S100	Pcs	Price
B-11703	2	\$24

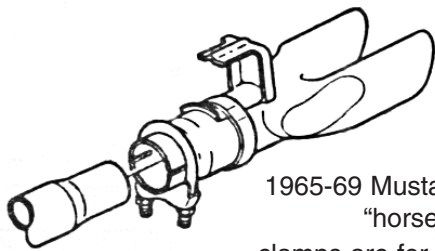

1965-69 Mustang, 1966-67 Shelby
"horse shoe" style
clamps are for 2" dual exhaust only.
(1968 Shelby's use regular exhaust clamps **B-11700**)

S100	Pcs	Price
B-11699	2	\$20



"Horse Shoe" shape

CLIPS - J, O



5/16 CAPACITY .53 W x 1.38 L x .33 HOLE
X, 353118-S (sim), 356640-S, 356764-S
(sim), 372077-S (sim)

S8	Pcs	Price
B-13121	4	\$3
B-13777	12	\$8

Ford Wiring

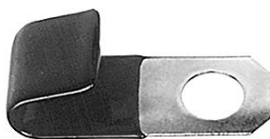

5/16 CAPACITY .53 W x 1.38 L x .33 HOLE
X, 356640-S
S8/RUBBER COATED

S100	Pcs	Price
B-13122	3	\$4
B-10829	10	\$10

Ford AC Compressor Wire

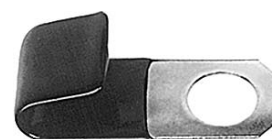

5/16 CAPACITY .53 W x 1.38 L x .41 HOLE
KGA, 353547-S, 372076-S
S8/RUBBER COATED

S100	Pcs	Price
B-13123	2	\$4

GM Wiring



3/8 CAPACITY .50 W x 1.50 L x .28 HOLE
MPB, 3799990, 3894533 & 3909586 (sim)
S3/RUBBER COATED

S100	Pcs	Price
B-10256	2	\$5
B-10312	5	\$10

Mustang Parking Lamp Wires 67



3/8 CAPACITY .75 W x 1.74 L FOR .25 HOLE
KQZ, 352542-S

S	Pcs	Price
B-13120	2	\$3

Mustang @ Front Crossmember 67



.40 CAPACITY .50 W x 2.10 L .25 HOLE
OUI, 377359-S

S	Pcs	Price
B-11734	2	\$4

Mustang @ Front Crossmember 68



.40 & .53 CAPACITIES
.50 W x 2.57 L
FOR .25 HOLE
OYI, 382350-S

S	Pcs	Price
B-11735	2	\$5

Mustang @ Front Crossmember 69-70



.53 CAPACITIES
.50 W x 2.74 L
FOR .25 HOLE
LDX, 382350-S (sim)
383104-S

S	Pcs	Price
B-13744	2	\$5



.16 & .22 CAPACITIES FOR .25 HOLE
MIG

S	Pcs	Price
B-10745	250	\$30



.25 CAPACITY FOR .25 HOLE
EQ, 382929-S

S	Pcs	Price
B-13112	4	\$3
B-10823	12	\$10



.50 CAPACITY FOR .25 HOLE
ER, 382930-S

S	Pcs	Price
B-13113	4	\$3
B-10822	12	\$8



.50 CAPACITY FOR .25 HOLE
LKZ, N806881-S

S	Pcs	Price
B-10746	6	\$3

CLIPS - O, S



.62 CAPACITY FOR .25 HOLE
VE, 383477-S

S	Pcs	Price
B-13114	4	\$3

Handy for Home & Shop



.70 x .88 CAPACITY PEEL & STICK BASE
MDC, 6016269 ◆

S100	Pcs	Price
B-10747	250	\$30



.75 CAPACITY FOR .25 HOLE
ES, 382931-S

S	Pcs	Price
B-13115	4	\$3

.88 CAPACITY
FOR .25 HOLE
KRA, 352541-S (sim)
382184-S



S	Pcs	Price
B-13118	2	\$3



1.0 CAPACITY FOR .25 HOLE
ET, 382932-S

S	Pcs	Price
B-13116	3	\$3



1.0 CAPACITY FOR .25 HOLE
EU, 383207-S

S	Pcs	Price
B-13117	3	\$3

GM Wiring



.10 CAPACITY x .44 W x .34 H .03 - .13 P
OGZ, 3773407. 3833476
S100 = S3/RUBBER

S3	S100	Pcs	Price
B-10740	-----	2	\$3
-----	B-10722	2	\$5

GM Fan Shrouds



.12 CAPACITY x .50 W x .69 H .02 - .04 P
MWI, 3899880 (sim), 3920179

S2	Pcs	Price
B-10720	2	\$2

Ford Fan Shrouds 80-90's



.12 CAPACITY x .75 W x .66 H .04 - .07 P
EV, N804150-S

S3	Pcs	Price
B-10719	2	\$2

Ford Wiring



.14 CAPACITY x .44 W x .85 H .02 - .05 P
LFM, 372302-S (sim), 372303-S
S100 = S8/RUBBER

S2	S100	Pcs	Price
B-11736	-----	2	\$3
-----	B-10723	2	\$4

GM Fan Shrouds



.17 CAPACITY x .50 W x 1.06 H .05 - .10 P
OSS, 3899880

S2	Pcs	Price
B-11737	2	\$3



.22 CAPACITY x .37 W x .76 H .12 - .22 P
MCF

S32	Pcs	Price
B-10727	2	\$3

CLIPS - S, P



.25 CAPACITY x .37 W x 1.06 L .03 - .12 P
LFY, 376118-S

S	Pcs	Price
B-10975	4	\$4



.25 CAPACITY x .37 W x 1.06 L .03 - .12 P
LFR, 379061-S

S	Pcs	Price
B-10974	4	\$4



.31 CAPACITY x .88 W x 1.12 L .02 - .16 P
HS, 352357-S

S32	Pcs	Price
B-13428	2	\$3
B-13429	12	\$10



.31 CAPACITY x .88 W x 1.12 L .02 - .16 P
HS, 372047-S
S32/RUBBER

S100	Pcs	Price
B-10726	2	\$4
B-13430	8	\$10



.37 CAPACITY x .37 W x .77 L .02 - .06 P
MYL, 3827371 (s100)

S3	Pcs	Price
B-10166	4	\$4



396HP A/T Carb Solenoid 69
.37 CAPACITY x .57 W x .87 L .02 - .08 P
OMO, 3927330
S3/RUBBER

S100	Pcs	Price
B-10724	1	\$4

GM Tailamp Wiring 70 >



.47 x .70 CAPACITY x 1.0 W x 1.25 L .62 P
MQI, 9870770

S3	Pcs	Price
B-10725	2	\$3

Ford Brake Lines



.18 SIZE .63 W x 1.21 L .28 HOLE
MMD, 374674-S

S2	Pcs	Price
B-10316	4	\$3

GM Throttle Cable Retainer



.25 SIZE .37 W x 1.04 L .19 HOLE
OMZ, 353074

S8	Pcs	Price
B-10432	50	\$30



.31 SIZE .62 W x 1.12 L .19 HOLE
OA
S8/RUBBER

S100	Pcs	Price
B-13119	50	\$30



.32 SIZE .75 W x 1.47 L .34 HOLE
OCR, 370834-S

S8	Pcs	Price
B-10275	4	\$3



.40 SIZE .75 W x 1.34 L .34 HOLE
LMG, 354663-S

S2	S8	Pcs	Price
B-10279	B-10280	4	\$5

CLIPS - R



.19 CAPACITY .50 W x .69 L .19 HOLE
NY

S	Pcs	Price
B-13110	12	\$3

GM



.19 CAPACITY .56 W x .99 L .34 HOLE
MYA, 140566 (s), 140775

S2	Pcs	Price
B-10303	4	\$3



.19 CAPACITY .62 W x 1.02 L .28 HOLE
LAK, 370431-S, 383695-S (sim)

S2	Pcs	Price
B-13388	4	\$3

Mustang 67-68



.19 CAPACITY .62 W x 1.20 L .25 - .31 HOLE
OBN, 382009-S S8 & FOAM

S100	Pcs	Price
B-10308	1	\$3
B-11569	4	\$10

Mustang 69



.19 CAPACITY .62 W x 1.20 L .25 - .31 HOLE
OBR, 382908-S S8 & FOAM

S100	Pcs	Price
B-10307	1	\$3
B-11570	4	\$10



.19 CAPACITY .62 W x 1.25 L .34 HOLE
MHN, 6031573, 4683653
S100 = SILVER ENAMEL

S2	S100	Pcs	Price
B-10304	B-10305	100	\$30



.19 CAPACITY .62 W x 1.50 L .34 HOLE
LMM, 378526-S, 384532-S (sim)

S2	S8	Pcs	Price
B-10309	B-10310	3	\$3



.25 CAPACITY .50 W x .81 L .20 HOLE
OHN, 4661592

S	Pcs	Price
B-10749	250	\$30



.25 CAPACITY .38 W x .81 L .19 HOLE
NZ

S	Pcs	Price
B-13111	12	\$3

GM



.25 CAPACITY .56 W x 1.03 L .34 HOLE
MYI, 125912

S7	Pcs	Price
B-10301	4	\$3



.25 CAPACITY .75 W x 1.35 L .34 HOLE
HII HEAVY DUTY

S8	Pcs	Price
B-13124	3	\$3



.25 CAPACITY .75 W x 1.70 L .40 HOLE
LMC, 390085-S

S2	Pcs	Price
B-10273	3	\$3

CLIPS - R



.31 CAPACITY .58 W x 1.09 L .25 - .31 HOLE
OMC, 377119-S (sim)

S3	Pcs	Price
B-10274	2	\$3



.31 CAPACITY .56 W x 1.12 L .34 HOLE
MYJ, 140568 (s), 140772

S2	Pcs	Price
B-10314	4	\$3



.31 CAPACITY .75 W x 1.50 L .34 HOLE
MRF, 3952718 Green Enamel

S32	Pcs	Price
B-10023	2	\$4
B-11571	5	\$8

Mustang 65-67



.32 CAPACITY .62 W x 1.81 L .25 - .31 HOLE
OCO, 380374-S S8 & FOAM

S100	Pcs	Price
B-10276	1	\$4

Mustang 67-73



.32 CAPACITY .62 W x 1.81 L .25 - .31 HOLE
OCS, 381832-S S44 & FOAM

S100	Pcs	Price
B-10277	1	\$4



.33 CAPACITY .62 W x 1.25 L .33 HOLE
MWX, 358360-S, 384029-S (sim)

S3	Pcs	Price
B-10284	4	\$3



.35 CAPACITY .69 W x 1.78 L .31 - .37 HOLE
KZL, 373829-S (sim)
S3/RUBBER

S100	Pcs	Price
B-13387	1	\$4



.38 CAPACITY .75 W x 1.50 L .34 HOLE
MUW, 3952717 Blue Enamel

S100	Pcs	Price
B-10024	2	\$4
B-11572	5	\$8



.40 CAPACITY .63 W x .97 L .25 - .31 HOLE
OBX, 358381-S (sim)

S32	Pcs	Price
B-10278	2	\$3



.44 CAPACITY .62 W x 1.33 L .33 HOLE
LLD, 377874-S
S8/RUBBER

S100	Pcs	Price
B-10281	50	\$30



.44 CAPACITY .62 W x 1.44 L .40 HOLE
MAV, 353473-S
S36/RUBBER

S100	Pcs	Price
B-10257	2	\$3



.50 CAPACITY .69 W x 1.94 L .34 HOLE
MHW, 377807-S S8/RUBBER

S100	Pcs	Price
B-10258	1	\$3

CLIPS - R



.69 CAPACITY .75 W x 1.94 L .40 HOLE
MHG, 388592-S S8/RUBBER

S100	Pcs	Price
B-10268	1	\$3

Mustang, Fairlane 289/302/390/428
Starter Cable

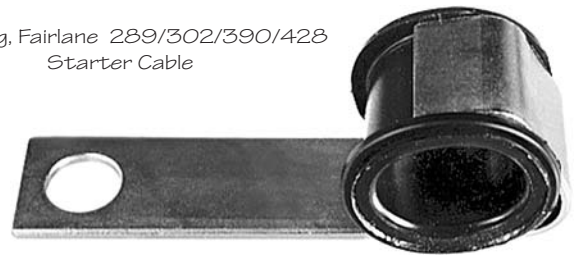

.70 CAPACITY .75 W x 3.20 L .40 HOLE
OMA PLASTIC GROMMET

S8	Pcs	Price
B-10269	1	\$6

Mustang, Torino 351C, 429 Starter Cable



.70 CAPACITY .75 W x 3.65 L .40 HOLE
OMB PLASTIC GROMMET

S8	Pcs	Price
B-10270	1	\$6

1.06 CAPACITY .75 W x 2.65 L .41 HOLE
LZP, 391783-S RUBBER SLEEVE



S427
B-10263

Pcs	Price
2	\$3



.75 CAPACITY .61 W x 1.61 L .27 HOLE
MIE, 378672-S

S	Pcs	Price
B-10750	4	\$3



1.25 CAPACITY .65 W x 2.44 L .34 HOLE

LMD, 387261-S S36/RUBBER

S100	Pcs	Price
B-10285	2	\$3



1.25 CAPACITY .62 W x 2.62 L .40 HOLE

MCM, 372807-S S3/RUBBER

S100	Pcs	Price
B-10260	1	\$3



1.38 CAPACITY .75 W x 2.94 L .40 HOLE
MHF, 391785-S RUBBER SLEEVE

S427	Pcs	Price
B-10264	25	\$30

Frame Clip



.25 - .31 TUBE SIZE .50W x 1.50 L
MHU, 372741-S S8/RUBBER

S100	Pcs	Price
B-10282	50	\$30

CLIPS - R MULTI



.19 x .19 TUBES .20 W x .85 L
MPL, 381799-S

S2	Pcs	Price
B-10328	2	\$3



.19 x .19 TUBES .50 W x 1.35 L .28 HOLE
OAJ, 380091-S, 384028-S (sim)

S2	Pcs	Price
B-10306	2	\$3



.19 x .25 TUBES .75 W x 1.81 L .41 HOLE
MKA, 385197-S

S2	Pcs	Price
B-10292	25	\$30

Mustang 65-66



.19 x .31 TUBES .62 W x 1.50 L
FITS .25 - .31 HOLE
MUQ, 373842-S
S2 CLIP, S8 RETAINER, FOAM

S100	Pcs	Price
B-10283	1	\$3



.19 x .31 TUBES .75 W x 1.41 L .34 HOLE
OEA, 383368-S

S3	Pcs	Price
B-10288	2	\$4



.19 x .38 TUBES .75 W x 1.59 L .34 HOLE
OEK, 384243-S

S3	Pcs	Price
B-10293	2	\$4



.22 x .22 TUBES .75 W x 1.69 L .40 HOLE
MQZ, 382233-S

S2	Pcs	Price
B-10287	2	\$4



.22 TUBES .81 W x 1.53 L FITS .31 HOLE
MUY, 1380949
SILVER PAINT

S100	Pcs	Price
B-13466	2	\$6

Mustang 65-66



.25 x .31 TUBES .75 W x 1.32 L .34 HOLE
MQO, 379605-S

S8	Pcs	Price
B-10733	1	\$3



.25 x .38 TUBES .25 W x .64 L
OEG, 359882-S (sim), 531433 (s2)

S2	S8	Pcs	Price
B-10329	B-11846	2	\$3

Transmission Lines



.31 x .31 TUBES .25 W x .64 L
LYB, 372223-S (sim), 3710497, 15596455

S2	Pcs	Price
B-10272	2	\$3



.31 x .50 TUBES .76 W x 1.68 L .34 HOLE
OEP, 384244-S

S3	Pcs	Price
B-10294	2	\$3

CLIPS - R MULTI



.34 x .41 TUBES .50 W x 1.65 L .19 HOLE
MYF, 3886522

S2	Pcs	Price
B-10318	1	\$3



.69 x .69 TUBES .75 W x 2.56 L .40 HOLE
OGS, 383701-S
S8/RUBBER

S100	Pcs	Price
B-10286	25	\$30

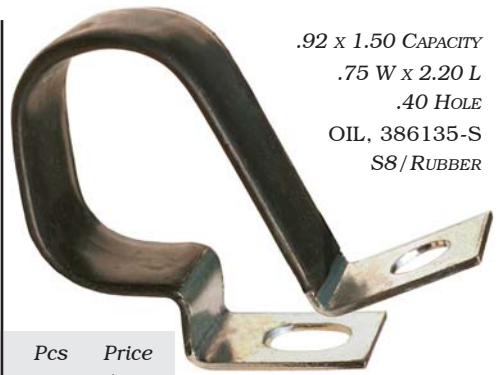

.92 x 1.50 CAPACITY
.75 W x 2.20 L
.40 HOLE
OIL, 386135-S
S8/RUBBER

Pcs	Price
25	\$30

B-10295



.94 x 1.88 CAPACITY
.88 W x 3.25 L .47 HOLE
OHT, 377494-S
S3/RUBBER

S100	Pcs	Price
B-10297	1	\$3



GM Heater Hoses

1.0 x 2.0 CAPACITY
.92 W x 2.21 L
FOR .40 - .50 HOLE
MPF, 3770259

S3	Pcs	Price
B-10004	1	\$4



1.0 x 2.0 CAPACITY
1.0 W x 2.20 L .53 HOLE
OGJ, 385147-S
S8/RUBBER

B-10300

Pcs	Price
25	\$30



GM Heater Hoses

1.02 x 2.12 CAPACITY
.94 W x 3.25 L
.32 HOLE
MRH, 3825416

S3	Pcs	Price
B-10005	1	\$4



.25 x 4 CAPACITYS .75 W x 2.82 L .35 HOLE
MHX, 391914-S
S427/RUBBER

S100	Pcs	Price
B-10302	25	\$30



.255 CAPACITYS 2.23 W x .51 H
LFB, B6A-12297-S

S	Pcs	Price
B-13746	2	\$3



.255 CAPACITYS 2.17 W x 1.02 H
LFA, B8Q-12297-S

S	Pcs	Price
B-13745	2	\$4

FITTINGS - GREASE, ROD END, STEEL



1/4-28 5/16 AF .53 OAL
MWD, 9417901

S8	Pcs	Price
B-10361	6	\$3



1/8 NPT 7/16 AF .62 OAL
OIX, 9411022

S36	Pcs	Price
B-10362	6	\$3

GM A/T Linkage 67 >



5/16-18 .75 DIA X .89 L .40 HOLE
MZI, 1385607

S2	Pcs	Price
B-10367	1	\$6

Ford M/T Shifter Linkage



5/16-18 .37 SHAFT 1.25 OAL
OBT, C9AA-7353-C

S	Pcs	Price
B-10339	1	\$8
B-10340	3	\$20

Ford M/T Shifter Linkage



5/16-24 .37 SHAFT 1.25 OAL
MVE, C1AA-7353-D

S	Pcs	Price
B-10337	1	\$8
B-10338	3	\$20

GM Column Shift and Backdrive



3/8-16 .39 HOLE 1.50 OAL
MTS, 382104

S2	Pcs	Price
B-11573	1	\$6

390/428 Mustang & Fairlane PCV Valve

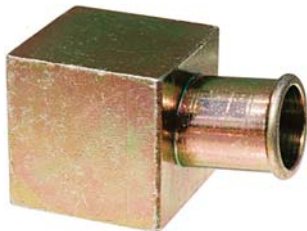

1/4 NPT INT x 1/2 HOSE
IAQ, C7ZE-6A664-A, 381567-S (sim)

S36	Pcs	Price
B-13219	1	\$20



3/8 NPT x 13/32 HOSE 11/16 AF 1.62 OAL
LYV, 1944154
S8/SEALER

S100	Pcs	Price
B-10364	1	\$4
B-13341	10	\$20

Ford Distributors 57-66



5/8-18 x 3/8-24 3/4 AF .48 OAH
KGX, 359546-S

S8	Pcs	Price
B-13211	1	\$10

Mustang Axle Vent



7/16-20 x 5/16 HOSE 9/16 AF 1.60 OAL
OKA, C8ZW-4338-A

S	Pcs	Price
B-10334	1	\$8

Mustang Axle Vent



7/16-20 x 5/16 HOSE 9/16 AF 2.13 OAL
OKI, C4ZW-4338-B

S	Pcs	Price
B-10335	1	\$8

Chrysler & Ford Distributors 66 - 70's

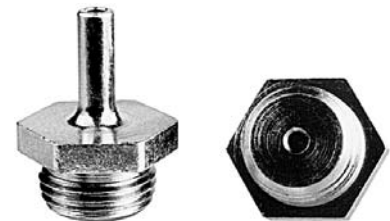

5/8-18 x 3/16 HOSE 3/4 AF 1.07 OAL
KKC, C7AF-12A022-A

S8	Pcs	Price
B-13217	1	\$10

FITTINGS - STEEL, PINS - COTTER

Ford Distributors 68-71



5/8-18 BT, C8AF-12A022-A

S36	Pcs	Price
B-13218	1	\$7

Ford Wheel Cylinders



1/4-28 1/4 AF .92 OAL
OKN, C0DZ-2208-A

S36	Pcs	Price
B-10341	2	\$3

GM Master & Wheel Cylinders



5/16-24 5/16 AF 1.0 OAL
OHD, 5469230

S36	Pcs	Price
B-10344	2	\$3

Brake Calipers: Ford 65-67, GM



3/8-24 3/8 AF .32 NOSE DIA 1.17 OAL
OJH, 8M-2208

S36	Pcs	Price
B-10342	2	\$3

Ford Brake Calipers 68 >



3/8-24 3/8 AF 1.52 OAL
MZQ, C8AZ-2208-A

S36	Pcs	Price
B-10343	2	\$4



.25 x 2 1/4 L
QL

S13	Pcs	Price
B-13391	2	\$12

Stainless



3/32 x 1/2 .87 OAL
MNB, 72004-S, 103372 (STL), 432254

SS	Pcs	Price
B-10647	12	\$3

Stainless



3/32 x 3/4 1.13 OAL
LQA, 72016-S, 103373 (STL)

SS	Pcs	Price
B-10648	12	\$3



3/32 x 7/8 1.30 OAL
HIB, 72025-S, 108629

S	Pcs	Price
B-13132	12	\$3



3/32 x 1.0 1.40 OAL
LB, 72034-S, 103374 (STL)

S	Pcs	Price
B-13133	12	\$3

Stainless



3/32 x 1 1/4 1.71 OAL
LXT, 72052-S, 103375 (STL)

SS	Pcs	Price
B-10646	12	\$3

Stainless



1/8 x 7/8 1.34 OAL
GAE, 72026-S, 108630

SS	Pcs	Price
B-13134	10	\$3



1/8 x 1.0 1.51 OAL
PO, 72035-S, 103385 (STL)

S	Pcs	Price
B-13135	10	\$3

Stainless



1/8 x 1 1/8 1.55 OAL
JAQ, 72044-S, 108635

SS	Pcs	Price
B-13136	10	\$3

Stainless



1/8 x 1 1/4 1.75 OAL
MFA, 72053-S, 103386 (STL)

SS	Pcs	Price
B-10645	10	\$3

PINS - HAIRPIN, ROLLED, SOLID

Ford Seat Pivots



.072 WIRE X .96 OAL
BHE, 353467-S

S2	Pcs	Price
B-13137	4	\$3

Ford Transmission Linkage



.072 WIRE X 1.09 OAL
GAS, 352358-S

S2	S7	Pcs	Price
B-13138	B-13139	4	\$3

GM Transmission Linkage



.072 WIRE X 1.12 OAL
MUI, 1351769 (sim)

S2	Pcs	Price
B-10741	4	\$3



.072 WIRE X 1.35 OAL
LMV, 374845-S

S2	Pcs	Price
B-10742	4	\$3



.072 WIRE X 1.76 OAL
MBR

S2	Pcs	Price
B-10743	100	\$30

GM Trans Linkage



.072 WIRE
KRG, 1137669 ◆, 3749084, 15553615

S2	Pcs	Price
B-13390	3	\$3
B-11574	10	\$6



.090 WIRE X 1.18 OAL
LC, 379897-S

S2	Pcs	Price
B-13140	4	\$3

Ford Brake Light Switch, Clutch Pedal



.090 WIRE X 1.38 OAL
NS, 380699-S

S60	Pcs	Price
B-13141	2	\$3

GM Brake Cables



.090 WIRE
LPS, 3875092

S2	Pcs	Price
B-10009	3	\$3

GM Back-Up Lamp & Neutral SW



3/32 SIZE .026 WIRE X .27 OAL
MOK, 148145

S2	Pcs	Price
B-10744	4	\$2

Ford Brake Cables

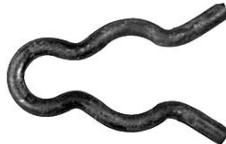

7/16 SIZE .105 WIRE X 1.16 OAL
PH, 74277-S, 383475-S

S2	S60	Pcs	Price
B-11575	B-13142	3	\$3



.13 DIA X .61 OAL
LX

S	Pcs	Price
B-13143	250	\$30



.13 DIA X .94 OAL
MIX, 9417507

S	Pcs	Price
B-10652	10	\$3



.25 DIA X .75 OAL
MKI

S	Pcs	Price
B-10653	250	\$30



.50 DIA X .75 OAL
MHZ

S	Pcs	Price
B-10649	6	\$3

PLUGS - PLASTIC, RUBBER, STEEL

Plastic



Most items
in the BULK section
of this catalog
are available in
LARGE quantities.

.75 SIZE 1.16 OD
OGO, 4725594

1.0 SIZE 1.38 OD
OGP, 4699197

1.25 SIZE 1.62 OD
OGQ, 4729219

S	Pcs	Price	S	Pcs	Price	S	Pcs	Price
B-10666	12	\$3	B-10667	10	\$3	B-10668	8	\$3

Rubber



.50 SIZE .83 OD x .60 TK
LMZ, 353884-S

GM Body



.75 SIZE 1.06 OD x .50 TK
OGM, 4805844

Brake Plates

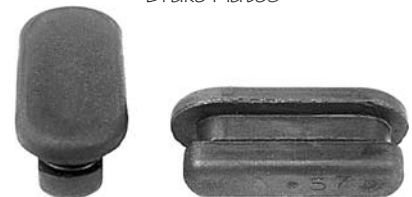

FITS .31 x 1.0 HOLE .55 W x 1.23 L
HQ, 8A-2092

S	Pcs	Price	S	Pcs	Price	S	Pcs	Price
B-10671	6	\$3	B-10669	4	\$4	B-13188	2	\$3

Ford



.14 ID x .30 OD x .63 OAH
EI, 382444-S

.16 ID x .50 OD x .61 OAH
FK, 353538-S

.22 ID x .37 OD x .66 OAH
EJ, 382443-S

.21 ID x .28 OD x .56 OAH
LZZ, N811594-S

S	Pcs	Price	S	Pcs	Price	S	Pcs	Price	S	Pcs	Price
B-13184	6	\$3	B-13186	6	\$3	B-13185	6	\$3	B-10244	12	\$3
B-10827	12	\$5	B-10826	12	\$5	B-10828	12	\$5			

Grease Fitting Plug



1/4-28 9/32 AF .31 OAH
AS, 374714-S

GM Smog Hole Plugs



1/4 NPT 9/16 AF .75 OAH
LXU, 444619, 444618 (s)

Ford Distributor 66-71



5/8-18 3/4 AF .47 OAH
BT, C8AF-12A022-A

S8	Pcs	Price	S8	Pcs	Price	S36	Pcs	Price
B-13127	6	\$3	B-13417	8	\$10	B-13218	1	\$7
B-11342	25	\$10						

PLUGS - STEEL, RETAINERS - C & E

Ford Engine Block Drains



1/4 NPT 3/8 AF .75 OAH
PN, 374259-S

S8	Pcs	Price
B-13128	4	\$3

Ford Intake Manifolds



3/8 NPT 7/16 AF .75 OAH
GI, 372175-S

S8	Pcs	Price
B-13129	2	\$3

GM Intake, BB Chevy Fuel Pump Area



3/8 NPT 7/16 AF .84 OAH
LPD, 445686 (s), 444583

S8	Pcs	Price
B-10665	3	\$3



1/4 NPT 1/4 AF .41 OAH
MBZ, 87837-S
SEALER

S102	Pcs	Price
B-10663	4	\$3



3/8 NPT 5/16 AF .41 OAH
MJM, 87838-S
SEALER

S101	Pcs	Price
B-10664	4	\$3

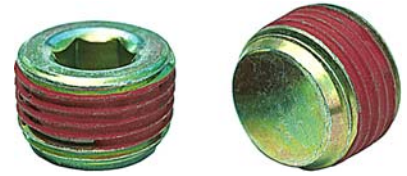

1/2 NPT 3/8 AF .54 OAH
MCP, 87839-S
SEALER

S100	Pcs	Price
B-10662	2	\$3



1/2 NPT 9/16 AF 1.01 OAH
MFB, 87746-S, 444746 (s)
SEALER

S102	Pcs	Price
B-10661	2	\$3

GM AC Control Cable Retainer



.33 ID x .75 W x .75 L
MWB, 7783546

S2	Pcs	Price
B-10691	2	\$3

Brake Hoses



.50 GROOVE SIZE 1.09 W x 1.07 L
PL, 2208893 (sim) ◆ A7AZ-2814-A, C8ZA-A
C9AA-A, C9ZA-A, 386493-S, 476737 (sim)

S3	S60	Pcs	Price
B-13168	B-13169	4	3



3/16 SHAFT SIZE .53 OD .025 TK
MGP, 97409-S

S301	Pcs	Price
B-10680	20	\$3



3/8 SHAFT SIZE .75 OD .036 TK
MXN

S	Pcs	Price
B-10681	20	\$3

GM Door & Window Crank Handles



1/2 SHAFT SIZE .047 WIRE
MQU, 4168122

S8	Pcs	Price
B-10735	10	\$3

RETAINERS - DASHPAD, MOULDING

Mustang 71-73



.61 W x 1.19 L
MWS, D1AB-6504278

S2	Pcs	Price
B-10685	3	\$3

Chevelle 70-72

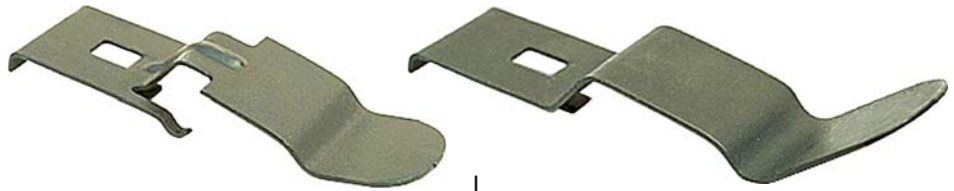

.70 W x 2.44 L
MVV, 3965463

S2	Pcs	Price
B-10684	2	\$5

.70 W x 2.87 L
MVO, 3965462

S2	Pcs	Price
B-10683	2	\$5

Camaro 69



1.0 W x 2.81 L
LYZ, 3950099 (s)
12338152
GRAY E-COAT

S100	Pcs	Price
B-10006	3	\$4

Shelby Grille Mouldings 68

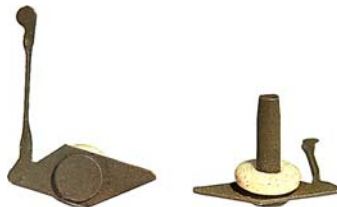

.77 W PLATE 1/8 x 1/2 STUD
LBJ S32 & FOAM SEAL

S100	Pcs	Price
B-13699	3	\$3
B-11690	12	\$12

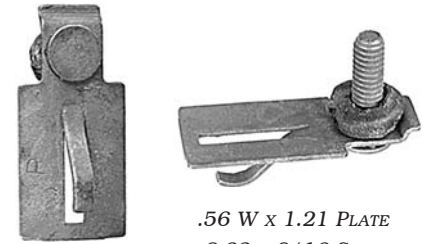

.56 W x 1.21 PLATE
8-32 x 9/16 STUD
KWM S32 & MASTIC SEALER

S100	Pcs	Price
B-13151	3	\$3

Mach 1 Rocker Moldings 70



.62 W x 1.0 PLATE 8-32 x 9/16 STUD
KGU, D0ZB-6321094-D
S32 & FOAM SEAL

S100	Pcs	Price
B-14428	6	\$8

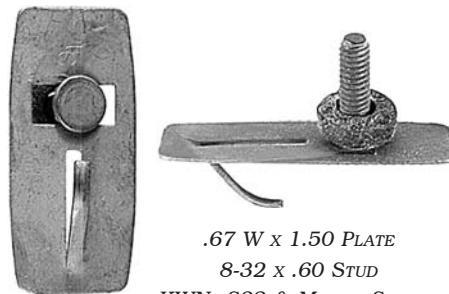

.67 W x 1.50 PLATE
8-32 x .60 STUD
KWN S32 & MASTIC SEALER

S100	Pcs	Price
B-13152	3	\$3



.73 W PLATE 8-32 x 3/4 STUD
BBA

S32	Pcs	Price
B-13145	2	\$3



1.78 W PLATE 8-32 x .46 STUD
MPN S32 & MASTIC SEALER

S100	Pcs	Price
B-10693	2	\$2



2.0 W PLATE 8-32 x 1.0 STUD
KQE S32 & MASTIC SEALER

S100	Pcs	Price
B-13149	2	\$3



.50 x 1.0 PLATE 10-24 x 5/8 STUD
KKY
S32 & FOAM SEAL

S100	Pcs	Price
B-13150	3	\$3



.73 W PLATE 10-24 x 3/4 STUD
KXW

S36	Pcs	Price
B-13394	2	\$3



1.06 W PLATE 10-24 x 3/4 STUD
BBB, C4AB-6242527-A (sim)

S100	Pcs	Price
B-13146	2	\$3



1.44 W PLATE 10-24 x .72 STUD
KSQ

S32	Pcs	Price
B-13148	2	\$3



3.85 W PLATE 10-24 x 3/4 STUD
KXE S3 & FOAM SEAL

S100	Pcs	Price
B-13395	2	\$4

Mustang Dash Trim 65 Package Tray 65-68



.40 x .51 HEAD .055 WIRE .75 OAH
OJD, C3XB-6404561-A

S3	Pcs	Price
B-10736	10	\$3



.94 x 1.15 HEAD .090 WIRE 1.0 OAH
LOA S3 & PLASTISOL

S100	Pcs	Price
B-10737	2	\$3



.43 W x 1.19 L
KKP

S	Pcs	Price
B-13170	6	\$3



.72 W @ Hooks .92 L
LEY

S	Pcs	Price
B-13700	4	\$3



.37 W x .72 L 1/4 RIVET
KRP

S	Pcs	Price
B-13173	6	\$3

Mustang Grille Mouldings 71-72



.31 W x .70 L
LDU, D1ZB-8B251-A

S	Pcs	Price
B-13701	5	\$5

Mustang Grille Mouldings 73



.38 W x .70 L
LDV, D3ZB-8B251-A

S	Pcs	Price
B-13702	5	\$5

RETAINERS - PANEL, PUSH

Ford Trim Panels



.08 x .64 THROAT
KWQ, C3AB-63519A16, 4500027 (sim)

S3	Pcs	Price
B-13161	3	\$3

GM Trim Panels



.07 x .48 THROAT
LYT, 3832616 , 4500027
SILVER PAINT

S100	Pcs	Price
B-10021	6	\$4
B-11576	18	\$10

GM Door Trim Panels



.28 ID
MFM, 4853962
CORRECT FLEXIBLE MATERIAL

S	Pcs	Price
B-10020	6	\$4
B-11577	25	\$10

Ford Seatback Panels



.11 x .62 THROAT .19 TO BULGE
OJU, 358575-S (sim)

S3	Pcs	Price
B-10739	8	\$3
B-10236	22	\$8

Ford Door Trim Panels



.09 x .61 THROAT
.36 TO BULGE
UH, 371904-S, 371911-S
374394-S, 375529-S

S60	Pcs	Price
B-13156	8	\$3
B-11391	40	\$10

Ford Door Trim Panels

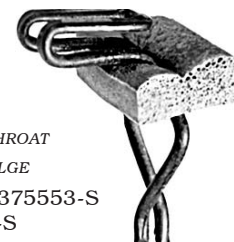

.09 x .61 THROAT
.36 TO BULGE
UH, 371904-S, 375553-S
383033-S

RED PAINT & FOAM PAD

S100	Pcs	Price
B-13157	6	\$3
B-11392	30	\$10

AMK strives for perfection !

In order to deliver the highest quality fasteners to you.

AMK provides exacting specifications to it's manufacturers.

Not all accept the challenge.

Ford Deluxe Door Trim Panels 65-67



.09 x .60 THROAT
.31 TO BULGE
BEV, 380552-S

S60	Pcs	Price
B-13159	8	\$3
B-11393	40	\$10

Ford Deluxe Door Trim Panels 65-67



.09 x .60 THROAT
.31 TO BULGE
BEV, 380552-S
RED PAINT & FOAM PAD

S100	Pcs	Price
B-13160	6	\$3
B-11394	30	\$10

Ford & GM Door Trim Panels



FITS *.25 HOLE .50 PANEL .93 OD*
OKL, 385661-S, 9685057

S	Pcs	Price
B-10699	8	\$3
B-10700	25	\$6

GM Weatherstrip



FITS *1/8 HOLE .19 PANEL .40 OD*
MQH, 8731909

S	Pcs	Price
B-10650	12	\$3

Ford Weatherstrip



FITS *5/32 HOLE .25 PANEL .50 W*
OEV, C5AB-6220586-A

S	Pcs	Price
B-10766	10	\$3

RETAINERS - PUSH

Ford Weatherstrip



FITS 3/16 HOLE .19 PANEL .37 OD
IAU, C1AB-6220807

S	Pcs	Price
B-13165	10	\$3



FITS 7/32 HOLE .56 PANEL 1.0 OD
OHL, N808370-S

S	Pcs	Price
B-10696	250	\$30

Ford Weatherstrip



FITS 1/4 HOLE .25 PANEL .50 OD
SG, 375372-S

S	Pcs	Price
B-13166	6	\$3

Nova Filler Panels & Radiator Seal



FITS 1/4 HOLE .25 PANEL .50 OD
OEE, 382570-S, 3952914 (sim), 9792217

S	Pcs	Price
B-10764	10	\$3

Camaro Seat Pivot Cover 67-69



FITS .25 - .31 HOLE .50 PANEL .60 OD
KSJ, 7719698
SILVER PAINT

S100	Pcs	Price
B-13167	2	\$4
B-13431	6	\$10



FITS .25 HOLE .31 PANEL .61 OD
KZU, 382040-S

S2	Pcs	Price
B-13392	100	\$30

GM Weatherstrip



FITS 1/4 HOLE .50 PANEL .70 OD
LJX, 388577-S, 1605396

S	Pcs	Price
B-10697	20	\$3
B-10698	100	\$10



FITS 1/4 HOLE .38 PANEL 1.0 W
MLG, 3767720 (sim), 480534

S	Pcs	Price
B-10702	6	\$3

Ford AC Tag



FITS 5/16 HOLE .25 PANEL .75 W
OWT, 374372 (sim)

S2	Pcs	Price
B-13215	1	\$3

FITS 1/2 HOLE
1.0 OD .67 PANEL
LLZ, 386540-S, 3868790



S	Pcs	Price
B-10672	2	\$3



FITS 1/4 HOLE .22 PANEL 1.49 W
OHF, 53030582

S	Pcs	Price
B-10976	3	\$3



FITS 5/16 HOLE .15 PANEL 1.90 W
LEZ

S	Pcs	Price
B-13747	2	\$3

RETAINERS - REVEAL

A Body Fr 68-76 B Body Fr & Rr 66-70
E Body Fr 68-69



.10 HOLE EDGE > SHARP CATCH
LCB, 6002263

S100	Pcs	Price
B-13705	5	\$5

E Body 70



.14 HOLE EDGE > SHARP CATCH
LDJ, 6002861 (sim), 6002688
LIGHT BLUE ENAMEL

S100	Pcs	Price
B-13712	6	\$6

Chevelle Fr 64-72 Nova Rr 64-67



.17 HOLE EDGE > SHARP CATCH
LVN, 4506041

S32	Pcs	Price
B-10704	8	\$4
B-10838	25	\$10

Camaro Rr 67-69



.17 HOLE EDGE > SHARP CATCH
LSF, 7698976, 8736591
GRAY ENAMEL

S100	Pcs	Price
B-10386	10	\$6
B-10706	20	\$12

B Body 66-67

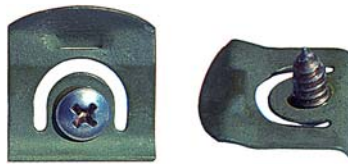

.18 HOLE EDGE > SHARP CATCH
LCF, 6001648

S32	Pcs	Price
B-13710	5	\$5

Mustang Coupe 67-68

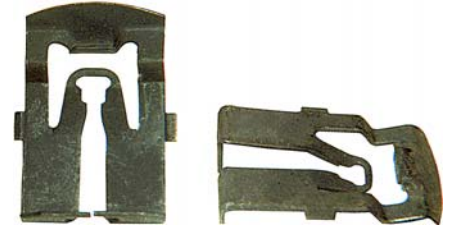

.19 SLOT > CREST OF ROUNDED CATCH
LEW, C7ZB-6542413

S3	Pcs	Price
B-13703	6	\$4

Mustang, Fairlane, Ford Fr & Rr 65-73



.19 SLOT > CREST OF ROUNDED CATCH
QE, C5ZB-6542480, C6AB-6242413
C7AB-6242413, D1AB-6542413

S32	Pcs	Price
B-13154	8	\$4
B-11059	25	\$10

Camaro Fr 67-69



.21 - .31 SLOT > CREST OF ROUNDED CATCH
LUX, 9895598

S60	Pcs	Price
B-10059	8	\$4
B-10894	22	\$10

Camaro Fr & Rr 70-75 Chevelle Rr 68-72



.23 SLOT > CREST OF ROUNDED CATCH
LVU, 8717859, 9854717 & 9606232 (sim)

S2	Pcs	Price
B-10707	10	\$6
B-10892	22	\$12

Nova & Chevelle Fr 64-72



.28 HOLE EDGE > SHARP CATCH
LUV, 8736590

S8	Pcs	Price
B-10708	6	\$3

B Body Fr 66-67

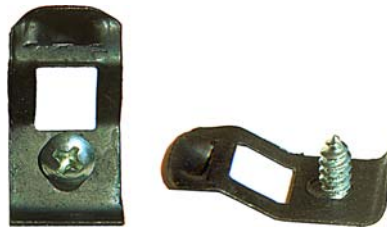

.52 HOLE EDGE > SHARP CATCH
LDO, 6001855

S3	Pcs	Price
B-13713	5	\$6

Camaro Fr Lower 67-69 Nova 68-72



.89 W x 2.0 L
LSI, 1651460,
7663148

S3	Pcs	Price
B-10711	4	\$6

RETAINERS - ROD END

Mustang 65-66 Others w 9/64



9/64 Rod LH .92 OAL
MTM, C5OB-62219A36-A

S100	Pcs	Price
B-13439	1	\$4
B-13440	6	\$20

63-64 Ford, Fairlane, Falcon, T-Bird
Before 3/1/64 Mustang 65-66



9/64 Rod BUSHING ONLY
MLC, C3AB-62219A38-A

S	Pcs	Price
B-13441	6	\$4
B-13442	12	\$7

Ford Heater Control Cables



3/16 Rod .50 OD
KCM, 351699-S

S2	Pcs	Price
B-12981	4	\$2

Mustang 67-73 Others w 5/32



5/32 Rod LH .97 OAL
KNL, C5AB-62219A36-A

S100	Pcs	Price
B-13163	1	\$4
B-13456	7	\$20

Mustang 67-73 Others w 5/32



5/32 Rod BUSHING ONLY
PCR, C5AB-62219A38-A

S	Pcs	Price
B-13457	7	\$4
B-13458	14	\$7

Ford Service Part. Works Perfect!



5/32 Rod BUSHING
LKM, 386656-S, C5AB-62219A38-A (sim)

S	Pcs	Price
B-10717	14	\$4
B-10718	50	\$12



5/32 Rod RH .94 OAL
OCZ, 7003137

S2	Pcs	Price
B-10716	3	\$3



3/16 Rod LH 1.0 OAL
OVU

S2	Pcs	Price
B-11738	3	\$3

Chevelle Parking Brake Release 70-72



7/32 Rod 1.22 OAL MVH, 3980698

S8	Pcs	Price
B-11739	1	\$3

Ford Carb Linkage



3/16 Rod RH 1.0 OAL
MTH, B7A-9825-A

S2	Pcs	Price
B-10715	3	\$4

Powerglide Kickdown



1/4 Rod LH 1.12 OAL
MNI, 3711177

S2	Pcs	Price
B-10714	2	\$3

GM A/T Shifter Cable 68 >



3/16 Rod .53 OD x .25 OAH
LYL, 564708

S2	Pcs	Price
B-10731	2	\$3

Ford A/T Kickdown 69 >



1/4 Rod .62 W x .73 L
OFN, 383212

S2	Pcs	Price
B-10712	2	\$3

Ford Wiper Linkage



5/16 SHAFT .50 W x .77 L
BFY, C4ZB-17450-C

S44	Pcs	Price
B-13164	2	\$3

GM Brake & Clutch Pedal



5/8 SHAFT
.88 W x 1.15 L
LPB, 3828428

S2	Pcs	Price
B-10687	1	\$3

RIVETS - BLIND



1/8 SIZE .06 - .13 PANEL .25 OD
BES, 379229-S
ALL ALUMINUM

S	Pcs	Price
B-13175	20	\$3



1/8 SIZE .06 - .13 PANEL .25 OD
IAT, 375203-S
STAINLESS BODY, STEEL MANDREL

SS	Pcs	Price
B-13178	10	\$3



1/8 SIZE .12 - .19 PANEL .20 OD
KQP, 383229-S
STAINLESS BODY, STEEL MANDREL

SS	Pcs	Price
B-13176	12	\$3



1/8 SIZE .12 - .19 PANEL .25 OD
BFE, 378527-S
ALL ALUMINUM

S	Pcs	Price
B-13177	20	\$3



1/8 SIZE .19 - .25 PANEL .25 OD
IAS, 376807-S
ALUMINUM BODY, STEEL MANDREL

S	Pcs	Price
B-13179	20	\$3

Shelby Body & ID Tag 66-67



1/8 SIZE .19 - .25 PANEL .25 OD
KYG, 375936-S
ALL ALUMINUM BLACK ANODIZED

S100	Pcs	Price
B-13396	8	\$3

Mustang Deluxe Door Panel Cups 69-70



5/32 SIZE .19 - .25 PANEL .31 OD
OOG
ALL ALUMINUM

S	Pcs	Price
B-11534	12	\$3



5/32 SIZE .19 - .25 PANEL .46 OD
MQX, 30306398A
BLACK COATED STEEL

S100	Pcs	Price
B-10758	250	\$30



3/16 SIZE .06 - .50 PANEL .38 OD
MKZ, W705097-S
ALL ALUMINUM

S	Pcs	Price
B-10759	250	\$30



3/16 SIZE .12 - .25 PANEL .62 OD
OIU, 6033249
ALL ALUMINUM BLACK ANODIZED

S100	Pcs	Price
B-10755	500	\$30



3/16 SIZE .18 - .25 PANEL .37 OD
UB, 380334-S
ALL ALUMINUM

S	Pcs	Price
B-13180	10	\$3



3/16 SIZE .19 - .44 PANEL .38 OD
MJB, 840768AB
BLACK ANODIZED ALUMINUM, STEEL MANDREL

S100	Pcs	Price
B-10756	250	\$30

Shelby Grille Nose Panel 67



3/16 SIZE .25 - .38 PANEL .62 OD
KYF ALL ALUMINUM BLACK ANODIZED

S100	Pcs	Price
B-13397	4	\$3

Shelby GT-500KR Ram-Air Plenum 68



1/4 SIZE HUCK DAISY (OBSOLETE)
MWG, AO Smith # 14656
RIVET GUN RENTAL AVAILABLE

S100	Pcs	Price
B-10753	4	\$20

<<< A special rivet gun is required for these Huck Daisy Rivets

Rental cost is \$150 for 3 weeks.
+ \$750 deposit refunded upon return of the gun.

F-3941 contains 9 rivets

RIVETS - DRIVE, NYLON, TUBULAR

Ford M/T ID Plate



#6 x 1/4 L .25 OD
MAP

S	Pcs	Price
B-10761	10	\$3



#6 x 5/16 L .25 OD
MSN

S	Pcs	Price
B-10762	10	\$3

GM Heat Stoves 69 >



5/32 x 3/8 L .34 OD
OBJ, 3959544

S	Pcs	Price
B-10763	8	\$3

SB Ford Intake Baffle



1/4 x 3/8 L .44 OD
OAM

S8	Pcs	Price
B-10760	6	\$3

Mustang Heater Ducts 69-70



3/16 SIZE .37 OD FLANGE .25 PANEL
JAH, 375064-S

S	Pcs	Price
B-13181	6	\$3



3/16 SIZE .35 OD FLANGE .12 - .31 PANEL
MKS, 6502689
NYLON

S	Pcs	Price
B-10757	250	\$30

Mustang Grille 69-70



1/4 SIZE
.62 OD .25 PANEL
FA, 383142-S

S	Pcs	Price
B-13400	5	\$3

Cool Part !



1/4 HOLE SIZE .43 OD FLANGE .31 PANEL
MKF

S	Pcs	Price
B-10765	50	\$30



1/8 x .16 L .22 OD
MIT

S8	Pcs	Price
B-10768	25	\$3



1/8 x .17 L .22 OD
KRD
ALUMINUM

S	Pcs	Price
B-13398	25	\$3



1/8 x .26 L .25 OD
MBW

S7	Pcs	Price
B-10767	25	\$3



5/32 x .28 L .29 OD
MIF

S2	Pcs	Price
B-10770	25	\$3

GM Front End



3/16 x .27 L .38 OD
KSZ, 3779647 (sim), 3855120
ALUMINUM

S	Pcs	Price
B-13399	12	\$3

Camaro Grille & RS Mouldings 67-68



3/16 x .27 L .44 OD
KSH, 3899834
BLACK ANODIZED ALUMINUM

S100	Pcs	Price
B-13426	8	\$3



1/4 x .31 L .50 OD
MIV

S36	Pcs	Price
B-10769	12	\$3

RIVETS - SOLID, UPSET RUBBER - BUMPERS

Camaro Console Ash Tray Door 68-72



.15 x .30 L .22 OD x .48 OAL
MZL, 3919075

S	Pcs	Price
B-10771	2	\$3

Camaro Console Ash Tray Door 67



.15 x .37 L .22 x .18 SHOULDER .44 OD
OEG, 3893867

S	Pcs	Price
B-10772	2	\$3

GM Upper Ball Joints



1/4 x 7/8 L .50 OD
MXL, 104252, 118066 (sim)

S	Pcs	Price
B-10775	10	\$6

Ford Upper Ball Joints



5/16 x .80 L .62 OD
LBL

S	Pcs	Price
B-10773	10	\$6

Ford Lower Ball Joints



5/16 x 7/8 L .62 OD
MXM

S	Pcs	Price
B-10774	8	\$6

Ford Upper Ball Joints



5/16 x .88 L .63 OD
OZN

S2	Pcs	Price
B-11359	10	\$6

El Camino Tailgate



5/16 DIA .62 OD .36 SHOULDER S8
OQM, 9712980 OQZ, 5712852

1.50 L	1.84	Pcs	Price
B-11648	B-11649	50	\$30

Ford & GM Data Plate



1/4 SIZE .34 OD
KVR, 354921-S
ALUMINUM

S	Pcs	Price
B-13182	2	\$2

Ford Tube Clips, GM Mouldings



FITS .25 - .32 HOLE .44 x .50 x .42 H
SC, 352191-S, 3744414, 3747332

S8	Pcs	Price
B-13153	4	\$4

Mustang Console Ash Tray 65-67



.16 D x .10 H x .50 OAL FOR 5/32 HOLE
OPT, 352000-S

S	Pcs	Price
B-11579	4	\$3

Mustang & GM Ash Tray, GM Console



.31 D x .15 H x .54 OAL FOR 5/32 HOLE
OKT, 374212-S, 1304225 (sim), 3861640 (sim), 3919070 (sim)

S	Pcs	Price
B-10227	4	\$3

GM Console Door & Glove Box



.34 D x .29 H x .86 OAL FOR 5/32 HOLE
OKS, 545054, 3693292 & 3765243 (sim)

S	Pcs	Price
B-10228	4	\$3

Ford License Plates



.38 D x .32 H x .65 OAL FOR 1/4 HOLE
OJL, 375838-S

S	Pcs	Price
B-10229	4	\$3

Mustang Glove Box 65-66, 71-73



.47 D x .31 H x .50 OAL FOR 1/4 HOLE
OQP, 353951-S, 376887-S (sim)

S	Pcs	Price
B-11637	4	\$3

Mustang Glove Box 67-70



.47 D x .40 H x .60 OAL FOR 1/4 HOLE
OQX, 354489-S (sim), 357810-S (sim)
380239-S (sim), 384334-S

S	Pcs	Price
B-11638	4	\$3

GM License Plates



.56 D x .50 H x .84 OAL FOR 1/4 HOLE
ORV, 3874534

S	Pcs	Price
B-11689	3	\$3

Mustang Trap Door 67-70



.61 D x .67 H x 1.10 OAH FOR 1/4 HOLE
WE, 370374-S

S	Pcs	Price
B-13187	2	\$3

GM Hood Adjusters



.87 D x .44 H
MSC, 3792828

S	Pcs	Price
B-10231	2	\$3

GM Trunklid



.90 D x .48 H x .77 OAH FOR 1/4 HOLE
MPJ, 7724826

S	Pcs	Price
B-10232	2	\$3

GM Hood Adjuster 74-81

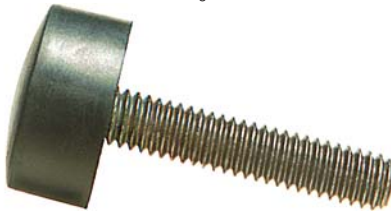

5/16-18 x 1 1/2 1.0 D x .50 TK HEAD
OJR, 340999, 3973952 (bumper)
3973972 (screw)

S100	Pcs	Price
B-10226	1	\$4

Mustang Brake Lines



.25 ID x .82 OD x .30 TK
LXO, 373624-S

S	Pcs	Price
B-10372	2	\$3

Mustang 71-73



.25 & .38 ID x 1.30 OD x .40 TK
OKJ, D1ZA-9K288-AA

S	Pcs	Price
B-10378	1	\$4

Mustang Fuel Line 65-68



.31 ID x .98 OD x .31 TK
N, 351650-S

S	Pcs	Price
B-10373	1	\$3

GM Brake Lines 69 >



.32 ID x .70 OD x .76 L
OFJ, 3958444, 3983038 (sim)

S	Pcs	Price
B-10374	2	\$3

Firebird Grille 67-68



.37 ID x .69 OD x .25 TK
OXY, 9777959

S	Pcs	Price
B-11742	4	\$3

Mustang 71-73



.38 ID x 1.30 OD x .40 TK
OKK, D0DA-9K288-AA

S	Pcs	Price
B-10377	1	\$4

Mustang Fuel Line 69-70



.39 ID x 1.25 OD x .30 TK
EE, 370387-S

S	Pcs	Price
B-10376	1	\$3

RUBBER - GROMMETS, SEALER

Nova Fr Shocks 64-67



.44 ID x .94 OD x .25 TK
OYO, 3852230

S	Pcs	Price
B-11743	4	\$3

Mustang Axle Vent 65-70



.50 ID x 1.06 OD x .31 TK
OLO, 358277-S

S	Pcs	Price
B-10431	1	\$3

Brake Cable Seal



.50 ID x 1.0 OD x .58 TK
KNC

S	Pcs	Price
B-13189	2	\$3



.81 ID x 1.35 OD x 1.10 H
LKV, 374311-S

S	Pcs	Price
B-10375	1	\$3

GM Wiper Motor



.23 ID x .88 OD x .67 TK
MAW, 4910180. MQR 4914625 >

INSULATOR	STRAP	S	Pcs	Price
S100				
B-10233	-----		3	\$8
-----	B-10973		1	\$3

Ford Wiper Motor



.26 ID x .90 OD x .63 TK
MEE, E6AE-17C431

S100	Pcs	Price
B-10371	3	\$4

13 oz Box



Butyl Rubber Sealer



FIVE .31 DIAMETER CORD ON 15' ROLL
PAX, FORD # ESB-M3G143-A

S	Pcs	Price
B-11744	1	\$12

This is great stuff ! Firm yet pliable. Perfect for sealing out water. Typical uses would be glass installation and filling of larger holes or gaps.

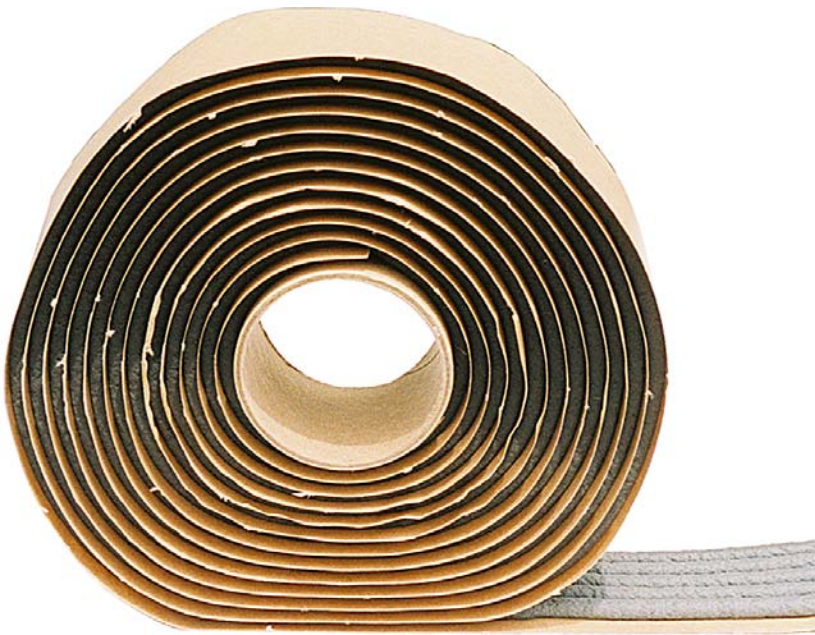

2 Lb Box



Dark Gray Body Sealer - this product is widely used during assembly

FIVE .19 DIAMETER BEADS ON 13' ROLL
OPQ, FORD # ESB-M4G32-A

Air ducts, body openings, door panel water shields, emblems, fenders, floor plugs, kick panels, gas tank & filler neck, firewall openings, heater box, quarter trim panel watershields, seat mounts, valance, window mouldings.

S	Pcs	Price
B-11608	1	\$20

.16 x .44 x .06 TK
LIT
MASTIC SEALER

S	Pcs	Price
B-11245	25	\$3

.16 x .50 x .07 TK
DY
MASTIC SEALER

S	Pcs	Price
B-11445	25	\$3

.22 x .62 x .12 TK
LJR, N805203-S, 3758292 (sim)
MASTIC SEALER

S	Pcs	Price
B-11248	20	\$3

.25 x .80 x .12 TK
LDS, 358768-S, 3868762
MASTIC SEALER

S	Pcs	Price
B-13742	12	\$3

.40 x 1.82 x .15 TK
MYP, 341092
MASTIC SEALER

S	Pcs	Price
B-11280	4	\$3

Sealer is an important assembly component. The factory used sealer to keep water out and prevent squeaks !

SPACERS - REGULAR

Mustang Grille Moulding 70



.19 ID x .25 TK x .50 OD
LLO, C3AB-7124374 NYLON

S	Pcs	Price
B-11588	12	\$3

Nova AC Heater Hose Clamp



.32 ID x .39 TK x .57 OD
HIP, 3785008

S2	Pcs	Price
B-11211	1	\$3

289 Water Pump w AC

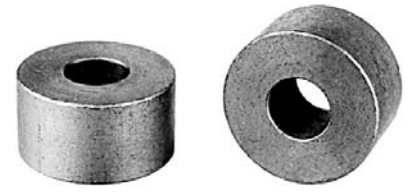

.32 ID x .44 TK x .82 OD
KAM, C5AA-8A652-A

S2	Pcs	Price
B-13190	1	\$4

GM Transmission Linkage



.38 ID x .34 TK x .50 OD
MTT, 382102

S	Pcs	Price
B-10929	2	\$3

289 Smog Pump 66-67



.39 ID x .73 TK x .75 OD
KHM, C6AE-9B461-A

S8	Pcs	Price
B-13191	1	\$4

Chevy AC Compressor 69



.39 ID x 1.63 L x 1.0 OD
OBB, 3932437
ALUMINUM

S	Pcs	Price
B-10931	1	\$6

Chevy P/S Pump 69 >



.40 ID x .25 TK x .73 OD
MUJ, 3792381

S8	Pcs	Price
B-10932	1	\$3

Ford Shoulder Straps



.40 ID x .30 TK x .78 OD
OIC, C7TB-8160228-A, C8AB-6260228-B

S13	Pcs	Price
B-10930	2	\$4

SB Chrysler Alternator Brkt > WP 67-69



.40 ID x .44 TK x .78 OD
ONL

S2	Pcs	Price
B-11584	1	\$3

Ford P/S Pump w/o AC 67-70



.40 ID x .50 TK x 1.25 OD
BGY, C7SZ-3D600-A

S2	Pcs	Price
B-13193	1	\$6

390/428 Intake



.40 ID x 1.0 L x .62 OD
VI

S2	Pcs	Price
B-13725	2	\$4

Camaro Tank 70 >



.40 ID x .1.11 L x .62 OD
OEW, 2206450 3992539

S2	Pcs	Price
B-11586	1	\$3
B-10933	2	\$4

SPACERS - REGULAR

Nova Gas Tank 68-72

Chrysler Alternators



1.42 L
OWP, 3949718

.40 ID x 1.25 L x .62 OD
ONI

1.55 L
ONQ, 6023394

2.12 L
ONM, 6025215

2.35 L
ONO, 2206449

S2	Pcs	Price	S2	Pcs	Price	S2	Pcs	Price	S2	Pcs	Price	S2	Pcs	Price
B-11745	2	\$4	B-11581	1	\$3	B-11585	1	\$3	B-11580	1	\$3	B-11583	1	\$3

Chevelle 283/327 P/S 66-68

Chevy Smog 66-68, 396/454 P/S 70-72

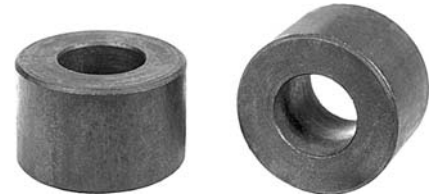

.41 ID x .32 TK x .64 OD
ODE, 3718608

.41 ID x .38 TK x .75 OD
MAU, 3877608 (sim), 3967424
GRAY E-COAT

.44 ID x .56 TK x .87 OD
KGP, C8SZ-3D600-A
3989487 (sim)

S2	Pcs	Price	S100	Pcs	Price	S2	Pcs	Price
B-10935	1	\$3	B-10934	1	\$3	B-13194	1	\$6

390/428 Smog Pump 68-70

BOSS 429 Alternator 69-70

429/460 Alternator 70 >



.41 ID x 1.88 L x .88 OD
KDW, C8AE-10A370-A
ALUMINUM

.42 ID x 2.85 L x .88 OD
KIN, C8VE-10A370-A
ALUMINUM

.42 ID x 2.91 L x .88 OD
KIQ, DOVE-10A370-A
ALUMINUM

S	Pcs	Price	S	Pcs	Price	S	Pcs	Price
B-10950	1	\$10	B-10956	1	\$10	B-10957	1	\$10

Mustang Rr Stabilizer End Links 70-73



.43 ID x 5.08 L x .63 OD
MYY, DOZA-5490-A

.45 ID x 1.26 L x .75 OD
MIW, 389534-S

S	Pcs	Price	S2	Pcs	Price
B-10937	2	\$12	B-10938	2	\$3

SPACERS - REGULAR

396/454 Alternator 69-72



.44 ID x 2.84 L x .80 OD
OBH, 3940943

BOSS 429 Alternator 69-70

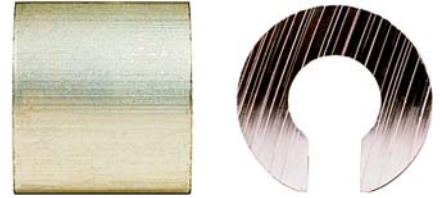

.45 ID x .94 L x 1.0 OD
KIO, C8VE-10A370-B
ALUMINUM

S	Pcs	Price	S	Pcs	Price
B-10936	1	\$6	B-11587	1	\$10

429/460 Alternator

302/351 70 >

390/428 66 >

289/320 66-69

351C



.45 ID x 1.05 L x 1.0 OD
KIR, D0SE-10A370-A
ALUMINUM

1.44 L
KXA, D0OE-10A370-B
ALUMINUM

1.59 L
KIL, C5AE-10A370-B
PINK ANODIZED ALUMINUM

1.64 L
KIM, C5AE-10A370-C
GOLD ANODIZED ALUMINUM

2.25 L
KIP, D0OE-10A370-A
ALUMINUM

S	Pcs	Price	S	Pcs	Price	S100	Pcs	Price	S100	Pcs	Price	S	Pcs	Price
B-10951	1	\$10	B-10952	1	\$10	B-10953	1	\$10	B-10954	1	\$10	B-10955	1	\$10

289 Alternator 65



.46 ID x 1.65 L x 1.0 OD
KIK, C5AE-10A370-A

351C P/S Pump 70 >



.47 ID x .50 TK x 1.25 OD
OGF, 384543-S

.47 ID x .73 TK x 1.25 OD
KGB, D0AA-3D600-A, 384542-S

S44	Pcs	Price	S8	Pcs	Price	S2	Pcs	Price
B-10958	1	\$10	B-11670	1	\$6	B-13195	1	\$6

Camaro Radius Rod 67

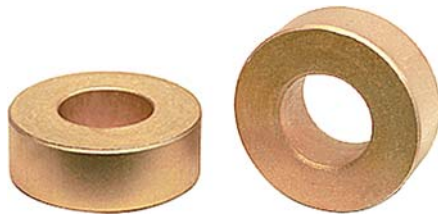

.49 ID x .35 TK x 1.0 OD
OGV, 4708494
GOLD ANODIZED ALUMINUM



.53 ID x .19 TK x .64 OD
OIJ, 55352693AA



.62 ID x 1.87 L x .80 OD
MYX, 3920241

S100	Pcs	Price	S2	Pcs	Price	S	Pcs	Price
B-10939	2	\$3	B-10940	100	\$30	B-10959	1	\$6
B-13459	20	\$20						

SPACERS - ROLLED

GM Transmission Linkage



.32 ID x .36 L x .44 OD
MGQ, 3852838

S	Pcs	Price
B-10928	1	\$3

GM Smog Pumps 69-73



.39 ID x .51 L x .49 OD
MET

S2	Pcs	Price
B-10949	4	\$3

396 Alternator 65-68



.39 ID x .75 L x .52 OD
MUL, 3831946

S44	Pcs	Price
B-10947	2	\$3

283/327/350 Alternator 64-68



.39 ID x 1.0 L x .52 OD
MUT, 3825451

S44	Pcs	Price
B-10946	2	\$3

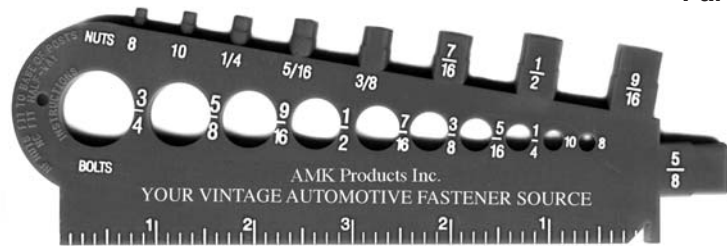

Part # T-101
\$3

E-Body Stabilizer Link



.41 ID x 1.75 L x .54 OD
OSP, 2535991

S2	Pcs	Price
B-11019	2	\$4

Mustang Stabilizer Link 65-67



.45 ID x 1.50 L x .56 OD
OBE, KD-5490-A

S8	Pcs	Price
B-10943	2	\$3

Mustang Stabilizer Link 68-73



.45 ID x 2.23 L x .56 OD
OBD, C20A-5490-A
STAINLESS

SS	Pcs	Price
B-10944	2	\$4

Stabilizer Link: Nova 64-73, Camaro 67-81

Chevelle Stabilizer Link 64-72



.43 ID x 2.46 L x .55 OD
MOF, 3790333

S8	Pcs	Price
B-10945	2	\$3



.43 ID x 3.0 L x .55 OD
MVT, 381955 (STL)
STAINLESS

SS	Pcs	Price
B-10948	2	\$4

SPRINGS

Ford Shifter 62-69



.40 OD x .31 L .62 OD x .34 TK
OJO, C2AA-7C381-A OJY, C2AA-7B125-A

SPRING TRUNNION

S	S7	Pcs	Price
B-10961	-----	2	\$3
-----	B-10926	2	\$6

Mustang H/L 69-73



.45 OD x 2.10 OAL x .072 WIRE
OGA, C7AB-13031-A (sim), D0ZZ-13031-A

S36	Pcs	Price
B-10960	2	\$3

Chevelle H/L 68-70



.48 OD x 1.92 OAL x .067 WIRE
MVP, 3923948

S2	Pcs	Price
B-10963	2	\$3

Chevelle H/L 64-67 Firebird 67-68



.49 OD x 1.16 OAL x .063 WIRE
OGB, 5949989

S8	Pcs	Price
B-10964	2	\$3

Mustang H/L 65-68



.50 OD x 1.81 OAL x .080 WIRE
OFW, C2OB-13031-A

S8	Pcs	Price
B-10965	2	\$3

Chevelle 71-72, Camaro H/L 74-81



.56 OD x 2.17 OAL x .072 WIRE
OGF, 345559, 3987016

S2	Pcs	Price
B-10966	2	\$3

Buick H/L 70-72



.58 OD x 1.91 OAL x .072 WIRE
OZI, 1231641

S2	Pcs	Price
B-11746	2	\$3

GM Parking Brake



.66 OD x 2.67 OAL x .064 WIRE
MVY, 3850084

S	Pcs	Price
B-10967	1	\$5

Firebird H/L 69



.73 OD x 1.08 OAL x .075 WIRE
OWX, 9790354

S36	Pcs	Price
B-11747	2	\$3

Camaro 71-73, Monte Carlo H/L 71-72



.74 OD x 1.04 OAL x .072 WIRE
MVG, 3945882

S36	Pcs	Price
B-10968	2	\$3

Camaro 68-69, Nova LH 68-72, MC 70



.74 OD x 1.06 OAL x .072 WIRE
OGL, 5953168

S2	Pcs	Price
B-10969	2	\$3

Nova RH 68-72



.74 OD x 1.12 OAL x .072 WIRE
MZV, 3929918

S2	Pcs	Price
B-10970	1	\$2

STRAPS - METAL, PLASTIC

Ford Distributor Vacuum Hoses

Ford Heater Hoses

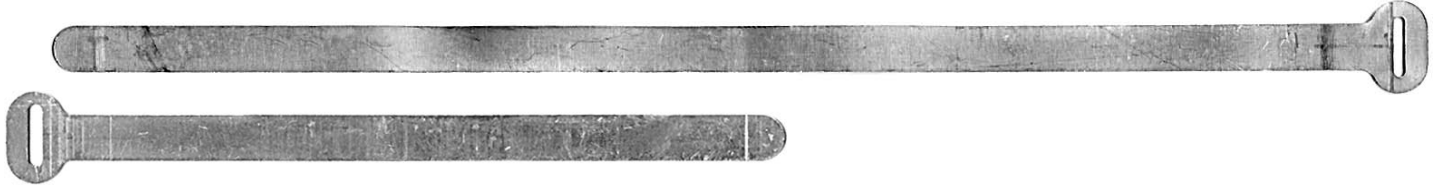

.25 W x 4.05 L
BJ, 8M-18954, 3113732 (sim)
ALUMINUM

.25 W x 7.15 L
BK, FAA-18954-A
ALUMINUM

S	Pcs	Price	S	Pcs	Price
B-13196	1	\$4	B-13197	1	\$5

Chrysler Driveshaft

GM Driveshaft

GM Wiring > Wheelhouse



.28 HOLES 1.50 C-C .60 W x 2.0 OAL
OCQ, 1828824

.33 HOLES 1.56 C-C .65 W x 2.34 OAL
KXH, 3882979

.42 x 2.62 OAL FITS .25 HOLES
KUG, 2977025

S	Pcs	Price	S	Pcs	Price	S	Pcs	Price
B-10990	2	\$5	B-13405	2	\$5	B-13206	2	\$3



.75 W x 2.75 OAL
FITS .25 - .31 HOLES
KVC, 403106



.19 W x 3.12 OAL FITS .25 HOLE
LI, 376914-S

S	Pcs	Price	S	Pcs	Price
B-13207	2	\$3	B-13198	6	\$3

Ford Wiring 70 >



.32 W x 3.17 OAL FITS .25 HOLE
LDH, 3830786 (sim)



.25 W x 3.25 OAL FITS .25 HOLE
LFW, 95831-S

S	Pcs	Price	S	Pcs	Price
B-13726	4	\$3	B-10977	2	\$3

STRAPS - PLASTIC

Ford & Corvette Wiring



.38 W x 3.92 OAL FITS .25 HOLE
KVO, 376756-S, 3825551

S	Pcs	Price
B-13199	4	\$3

Mustang Wiring > Firewall 67-70



.44 W x 4.0 OAL
AP, 374320-S

S	Pcs	Price
B-13209	2	\$3

Ford Wiring 70 >

Picture is Reduced to 80%

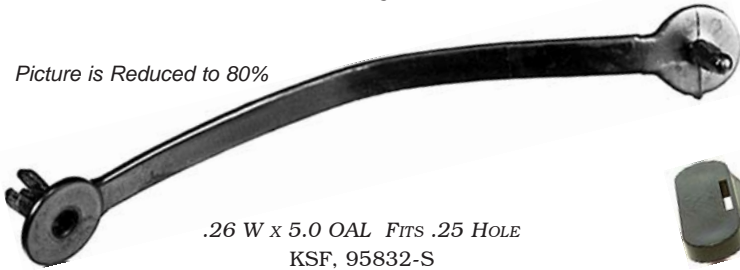

.26 W x 5.0 OAL FITS .25 HOLE
KSF, 95832-S

S	Pcs	Price
B-13200	2	\$3

GM Cables, Hoses, Wiring

Picture is Reduced to 80%



.38 W x 5.15 OAL
MQP, 9422033
CORRECT RUBBER-LIKE MATERIAL

S	Pcs	Price
B-10979	2	\$5

Ford Wiring 71-73

.12 W x 7.0 OAL
PA, 95873-S

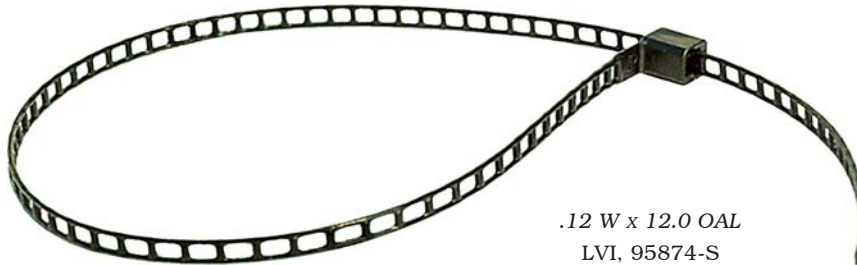

.12 W x 12.0 OAL
LVI, 95874-S

S	Pcs	Price
B-10982	10	\$3

S	Pcs	Price
B-10987	1000	\$30

GM AC Heater Hose Strap

Picture is Reduced to 80%

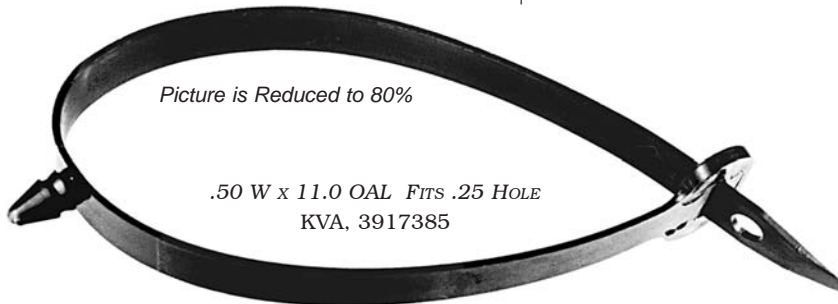

.50 W x 11.0 OAL FITS .25 HOLE
KVA, 3917385

S	Pcs	Price
B-13210	1	\$4



.10 W x 4.0 OAL
MKB, W705621-S
JOINED ON ROLL

S	Pcs	Price
B-10978	2500	\$30

STRAPS - PLASTIC, RUBBER



.19 W x 6.62 OAL
LLH, W701004-S

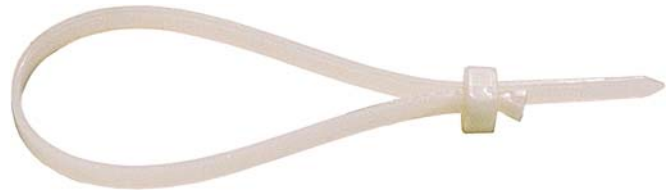

Ford Wiring 69-70

.19 W x 6.70 OAL
LFX, 351053-S
RELEASEABLE

S	Pcs	Price	S	Pcs	Price
B-10980	500	\$30	B-10981	8	\$3

GM Cables, Hoses, Wiring



.38 W x 7.12 OAL Fits .25 HOLE
ODF, 3816659, 4778650 (sim)
CORRECT RUBBER-LIKE MATERIAL

S	Pcs	Price
B-10983	2	\$5

Ford P/S Hoses



.50 W x 7.0 OAL
KBT, C3AA-3A672-A



S	Pcs	Price
B-13203	1	\$6

Ford AC Hoses 61-70



.39 W x 8.25 OAL
WF, C1VF-19B915-A



S	Pcs	Price
B-13202	1	\$6

TAPES

Black Masking Tape



Commonly used to attach GM wiring harnesses to body structure or tie loose wires. Also Mustang heater blower motor center joint. General use.



7 MIL X 180' LONG
 ORR, 3724851. ORO, 3839835

5/8 W	2.0 W	Pcs	Price
B-11664	-----	1	\$5
-----	B-11665	1	\$12

Wire Harness Wrap



This is the original hard to find .007 thick flame retardant non-adhesive tape used to wrap wiring harnesses.



7 MIL X 1.0 W X 140' LONG
 OGW

S	Pcs	Price
B-11666	1	\$6

Electrical Tape



This is the original .007 thick adhesive tape used to terminate wire wrapping and for general use. This tape is super high quality.



7 MIL X .75 W X 108' LONG
 OGV

S	Pcs	Price
B-11667	1	\$6

Cloth Tape



This is used to terminate wire wrapping and for general use.



7 MIL X .75 W X 100' LONG
 ORJ

S	Pcs	Price
B-11669	1	\$6

WASHERS - CONICAL



.26 x 1.13 x .21 OAH
MBE, 6027404

S2	Pcs	Price
B-11313	6	\$3

Chrysler Distributor, Engine Fan



.33 x .62 x .06 TK MAT
LKP, 6022185

S2	Pcs	Price
B-10048	4	\$3

273/318/340 Exhaust Manifolds

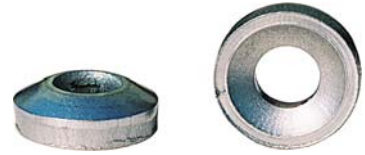

.33 x .75 x .23 OAH
ONZ, 2121223

S	Pcs	Price
B-11476	6	\$12
B-11477	12	\$20



.33 x .87 x .15 OAH
LAL

S2	Pcs	Price
B-13037	100	\$30

Ford Stabilizer End Links



.39 x 1.18 x .12 TK MAT
HIQ, 371169-S, 371216-S

S2	Pcs	Price
B-13068	4	\$3

Chrysler Engine & Transmission



.40 x .75 x .09 TK MAT
LQG, 6022190

S2	Pcs	Price
B-11226	6	\$3

426 Hemi Exhaust Manifolds



.40 x .75 x .27 OAH
KXB, 2780643

S	Pcs	Price
B-11324	4	\$12
B-11478	11	\$30



.40 x 1.0 x .12 TK MAT
LOY

S2	Pcs	Price
B-11316	4	\$5

Chrysler Engine Mounts



.47 x .88 x .12 TK MAT
LQJ, 6023050

S2	Pcs	Price
B-11230	5	\$3

Ford Shocks

.39 x 1.50 x .12 TK MAT
BHR, MG-18041-A

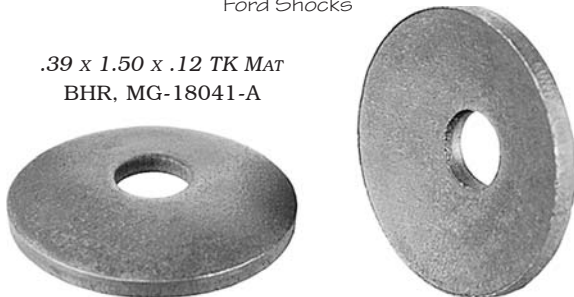

S2	Pcs	Price
B-13067	4	\$4

Ford Shocks

.50 x 1.50 x .12 TK MAT
BHS, MG-18171-A



S2	Pcs	Price
B-13069	4	\$4

WASHERS - CONICAL

Bumper Brackets



.46 x 1.24 x .12 TK MAT
KRK, 1347774

.53 x 1.24 x .12 TK MAT
KRT, 382866-S, 1362249

.52 x 1.0 x .14 TK MAT
ONB, 6023054

S2	Pcs	Price	S2	Pcs	Price	S2	Pcs	Price
B-13072	6	\$4	B-13073	4	\$3	B-11363	2	\$4



.44 x 1.25 x .11 TK MAT
LAN



Camaro Fr Bumper 74-81

.51 x 1.25 x .32 OAH
OES, 492370



Corvette Lower A-arms 63-82

.56 x 1.0 x .12 TK MAT
LBQ, 3779096

S2	Pcs	Price	S2	Pcs	Price	S2	Pcs	Price
B-13385	2	\$3	B-11238	4	\$8	B-13737	4	\$6

GM Control Arm Bushing

.39 x 1.81 x .23 OAH
MRR, 3710586 (s), 9785742 (s)



Camaro Rr Bumper Brackets 74-81

.46 x 1.75 x .12 TK MAT
OEY, 3813432



S2	S7	Pcs	Price	S2	Pcs	Price
B-13460	B-11234	4	\$6	B-11228 B-11229	4 8	\$4 \$6

Mustang Rr Bumper Brackets 65-73

.52 x 1.50 x .08 TK MAT
RD, 380019-S

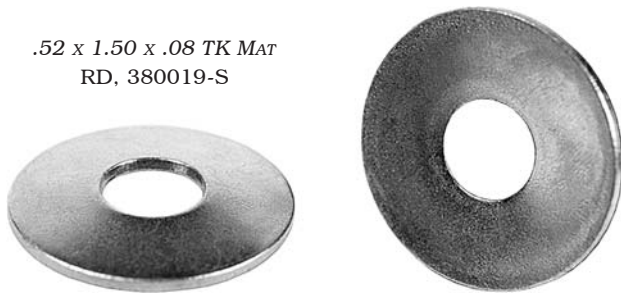

Body Mounts Camaro 67-68, Nova 68

.65 x 1.62 x .08 TK MAT
OKY, 3914049



S36	Pcs	Price	S7	Pcs	Price
B-13070	4	\$4	B-13131	4	\$5

WASHERS - CUPPED, FINISH

Mustang Back-Up Lamps 65-70



.21 x .72 x .38 OAH
AN, 359972-S

S8	Pcs	Price
B-11232	4	\$4

GM Transmission Linkage



.39 x .79 x .27 OAH
MGT, 382103

S2	Pcs	Price
B-11233	1	\$3

GM Chassis



.39 x 1.25 x .22 OAH
MOC, 396797 (sim), 5544049

S8	Pcs	Price
B-11235	4	\$4
B-11236	10	\$8

GM Wheelhouses



.39 x 2.21 x .32 OAH
KJU, 3795490

S2	Pcs	Price
B-13074	4	\$6

Camaro Rr Bumper Brackets 78-81



.52 x 1.75 x .31 OAH
MZR, 463120

S8	Pcs	Price
B-11231	4	\$6

Nova



64-67

.57 x 2.50 x .46 OAH OJA, 3792613

S	Pcs	Price
B-11748	2	\$5

GM Control Arm Bushing

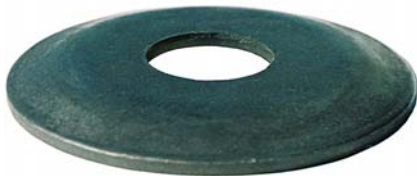

.64 x 2.10 x .19 OAH
MSA, 9787797

S2	Pcs	Price
B-11237	4	\$8



Stainless



#6 HD SIZE .16 x .43 x .09 OAH
UC, 34968-S (STL), 140258

SS	Pcs	Price
B-13075	12	\$3

Stainless



#8 HD SIZE .19 x .53 x .10 OAH
UD, 34969-S (STL), 140259, 453278

SS	Pcs	Price
B-13076	10	\$3

Stainless



#10 HD SIZE .24 x .57 x .11 OAH
VJ, 34970-S (STL), 140260

SS	Pcs	Price
B-13077	10	\$3

Ford Door Latch Reinforcement



#12 HD SIZE .26 x .76 x .12 OAH
LBT
STAINLESS

SS	Pcs	Price
B-11331	6	\$6

WASHERS - FLAT



.19 x .75 x .06 TK
GU, 351218-S, 9417587 (sim)

S2	Pcs	Price
B-11247	12	\$3



.21 x .88 x .08 TK
OUY
.32" x 100° COUNTERSUNK

S8	Pcs	Price
B-11749	8	\$3



.22 x .96 x .011 TK NATURAL NYLON
LGB

S	Pcs	Price
B-11750	10	\$3

GM Door Glass Adjustment 64-65



.26 ID x .78 x 1.62 OD
OUD
INCLUDES NYLON GASKET

S13	Pcs	Price
B-11751	2	\$4



.27 x .62 x .05 TK
IAL, 44718-S

S8	Pcs	Price
B-11251	20	\$3



.28 x .62 x .07 TK
KCQ, 44719-S, 9419892. 120392

S2	S8	Pcs	Price
B-12989	B-12990	20	\$3



.29 x 1.0 x .06 TK
LZT, 9421394 (s2)

S2	S36	Pcs	Price
B-11253	B-11589	15	\$3



.31 x .75 x .07 TK
LV, 44720-S, 9419996. 120386

S2	S8	Pcs	Price
B-12992	B-12993	20	\$3



.33 x 1.0 x .07 TK
TR, 351370-S. 3790662 (s8)

S2	S8	Pcs	Price
B-12994	B-12995	8	\$3

Ford SB Water Pumps



.34 x .69 x .06 TK
UJ, 44722-S, 9418304. 120393. 121814

S2	S8	S13	Pcs	Price
B-12997	B-12998	-----	20	\$3
-----	-----	B-12999	8	\$3



.34 x .75 x .16 TK
EZ, 354033-S

S2	Pcs	Price
B-12996	4	\$3



.35 x .63 x .06 TK
LZU, 9419275

S2	Pcs	Price
B-11266	12	\$3



.38 x .81 x .09 TK
LLT

S2	Pcs	Price
B-11270	12	\$3



.38 x .88 x .08 TK
QS, 44724-S, 9418268. 446363

S2	S8	Pcs	Price
B-13000	B-13001	12	\$3



.38 x .88 x .19 TK
UX, 351415-S

S2	S8	Pcs	Price
B-13002	B-13003	4	\$3

WASHERS - FLAT



.38 x 1.0 x .06 TK
KOV NYLON

S	Pcs	Price
B-13006	250	\$30



.38 x 1.12 x .07 TK
QN, 44725-S, 9421128

S2	S8	Pcs	Price
B-11269	B-13740	12	\$3

Ford Disc Brake Hoses



.39 x .62 x .06 TK
KEH 8M-2149, C9AZ 2149-A
COPPER

S	Pcs	Price
B-10830	8	\$3

GM Exhaust Manifolds



.39 x .69 x .12 TK
MPI

S	Pcs	Price
B-11275	12	\$3
B-11276	16	\$4



.39 x .74 x .06 TK
MAN, 44723-S, 3825452

S2	Pcs	Price
B-11272	10	\$3

GM Transmission Linkage



.39 x .75 x .04 TK
MGR, 382105

S2	Pcs	Price
B-11273	10	\$3

Mustang Idler Arm



.39 x 1.25 x .18 TK
SQ, 377112-S,
378544-S (sim),
3909938

S2	Pcs	Price
B-13009	2	\$3

GM
Wheelhouses
69 >

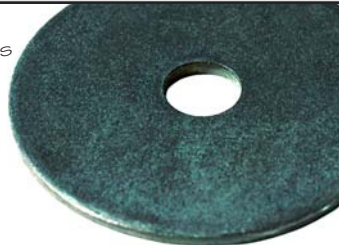

.39 x 2.0
x .09 TK
KRC,
3958325

S2	Pcs	Price
B-11274	4	\$3

Ford Differential Carrier



.40 x .60 x .04 TK
AG, 373820-S
COPPER

S	Pcs	Price
B-13015	10	\$4



.40 x .74 x .13 TK
MDP, 3754153

S8	Pcs	Price
B-11278	8	\$3

Ford Exhaust Manifolds



.38 x .75 x .09 TK
IF, 353992-S

S2	S8	Pcs	Price
B-13004	B-13005	16	\$3



.40 x 1.0 x .13 TK
BX, 352981-S, 382588, 3914674.

S2	S8	Pcs	Price
B-13011	B-13012	6	\$3



.40 x 1.25 x .19 TK
IAN, 372505-S, 384179-S

S2	S8	Pcs	Price
B-13013	B-13014	2	\$3



.41 x .73 x .06 TK
LVY, 9414322 (s), 9419234

S2	Pcs	Price
B-11281	12	\$3

Ford Shifter 64-69



.41 x .75 x .09 TK
AK, 379999-S

S2	Pcs	Price
B-13016	6	\$3

WASHERS - FLAT



.40 x 1.63 x .06 TK
MLZ, 373249-S FIBER

S	Pcs	Price
B-11279	4	\$3



.41 x .81 x .07 TK
ZV, 118775 , 44726-S, 372285-S,
9421042. 120394

S2	S8	Pcs	Price
B-13017	B-13018	12	\$3

Shelby Front Shock Brackets



.41 x 1.0 x .17 TK
ZO

S8	Pcs	Price
B-13019	4	\$3



.48 x .88 x .08 TK
IAZ, 44727-S, 9420081

S2	Pcs	Price
B-13020	12	\$3

GM Brakes Hoses



.45 x .69 x .03 TK
MCB, 231343 COPPER

S	Pcs	Price
B-11283	8	\$3



.45 x .80 x .09 TK
DK, 356382-S, 375277-S (sim)

S2	Pcs	Price
B-11285	12	\$3

SB Chevy Crankshaft Damper



.45 x 1.75
x .31 TK

LUN,
3739422

S2	Pcs	Price
B-11284	2	\$3

GM Steering Gear



.46 x 1.13 x .19 TK
KUK, 479684, 1193463

S2	Pcs	Price
B-11287	3	\$3

Mustang Steering Gear Seat Belts



.46 x 1.25 x .19 TK
MN, 378580-S, 353472-S, 383421-S,
3818180 (s)

S2	S8	Pcs	Price
B-13022	B-13023	2	\$3

Mustang Steering Gear 65-70



.46 x 1.25 x .19 TK
MM, 378581-S

S2	Pcs	Price
B-13024	3	\$4

GM Transmission Mounting



.46 x 1.38 x .18 TK
KUV, 3700338

S2	Pcs	Price
B-13021	2	\$3

Camaro @ Radiator Support 70 >

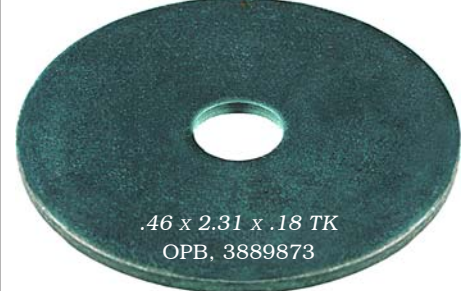

.46 x 2.31 x .18 TK
OPB, 3889873

S2	Pcs	Price
B-11650	2	\$3

WASHERS - FLAT

Chrysler & Ford Engine Mounts



.47 x .93 x .06 TK

KWX, 120395 , 44730-S, 376102-S, 103342 (S), 9420022. 120395

S2	S8	Pcs	Price
B-11292	B-11293	12	\$3

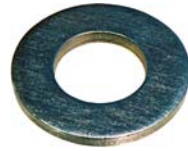

.47 x .93 x .09 TK

LJZ, 380079-S. 3693853 (sim, s8)

S2	S8	Pcs	Price
B-11290	B-11291	12	\$3

Chevelle Body Mounts 64-67



.47 x 1.88 x .12 TK

OPZ, 3760886, 3866421 (sim)

S2	Pcs	Price
B-11651	2	\$3

Chevelle Body Mounts 64-72

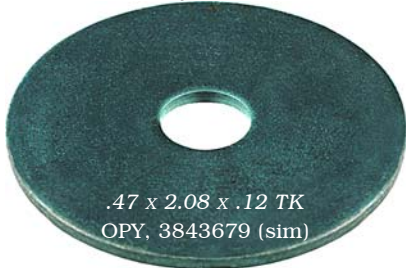

.47 x 2.08 x .12 TK
OPY, 3843679 (sim)

9774425 (s). 3972713 (s8), 3983374 (sim)

S2	S8	Pcs	Price
B-11652	B-11654	2	\$3
B-11653	B-11655	6	\$7

GM Bumper Mounting



.48 x .88 x .06 TK
OVD, 9419276

S2	Pcs	Price
B-11754	12	\$3

Ford Seat Belt Mounting



.50 x .80 x .14 TK
OID, 354959-S
RUBBER

S	Pcs	Price
B-11294	4	\$3



.50 x 1.25 x .08 TK

LNJ, 44732-S, 9421939 (sim), 9429658. 120389 (sim)

S2	S8	Pcs	Price
B-11295	B-11296	12	\$3



.52 x 1.0 x .12 TK
RR, 356474-S

S2	Pcs	Price
B-13025	4	\$3

GM Body Mounts



.52 x 1.55 x .19 TK
MCD, 337559 (s), 1305797

S2	Pcs	Price
B-11297	2	\$3

Control Arm Cam



.52 x 1.71 x .18 TK

OWZ, 1825112 , C6OA-3B238-A 3790331

S2	Pcs	Price
B-13033	2	\$3

Chevelle Bumper Brackets 64-66



.52 x 1.75 x .13 TK
LER, 3838450

S2	Pcs	Price
B-13743	4	\$6

BB Chevy Crankshaft Damper



.52 x 2.04 x .28 TK
MSB, 3864814

S2	Pcs	Price
B-11298	1	\$3

WASHERS - FLAT

Body Mounts: Camaro 67 >, Nova 68 >

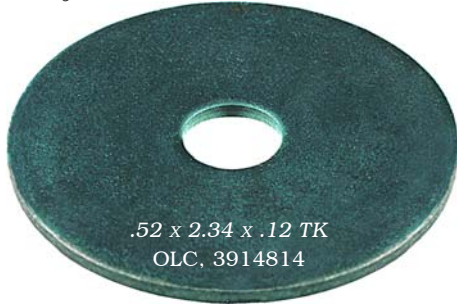

.52 x 2.34 x .12 TK
OLC, 3914814

S2	Pcs	Price
B-11299	2	\$3

Ford Rr Seat Belts



.53 x .88 x .18 TK
OKM, 381559-S (sim), 382582-S (sim),
382583-S (sim)

S36	Pcs	Price
B-11300	4	\$4

GM Leaf Spring Fr Eye



.53 x .92 x .09 TK
LZF, 415919

S2	Pcs	Price
B-11301	10	\$3

Mustang Leaf Spring 65-67



.53 x 1.75 x .16 TK
KDU, 351810-S, 3701312

S8	Pcs	Price
B-13741	2	\$3

GM Clutch Bellcrank



.56 x 1.37 x .28 TK
MUN, 3743360
GRAY FELT

S	Pcs	Price
B-11303	1	\$3

Ford 6 Cyl Crankshaft Damper



.58 x 1.76 x
.23 TK
OLS
CODZ-6378-A

S2	Pcs	Price
B-11305	1	\$3

Mustang Rr Bumper Brackets 65-70



.62 x 1.50 x .25 TK
MXU, C5ZB-6540996-A, FOAM RUBBER

S	Pcs	Price
B-11306	4	\$3

Mustang Rr Bumper Brackets 71-73

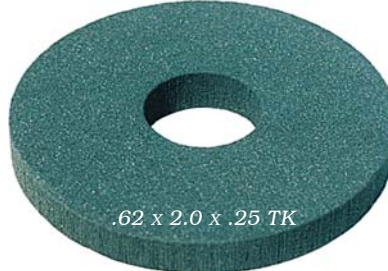

.62 x 2.0 x .25 TK
OME, D1ZB-6540996-A, FOAM RUBBER

S	Pcs	Price
B-11307	4	\$3

Body Mounts: Camaro 67 >, Nova 68 >

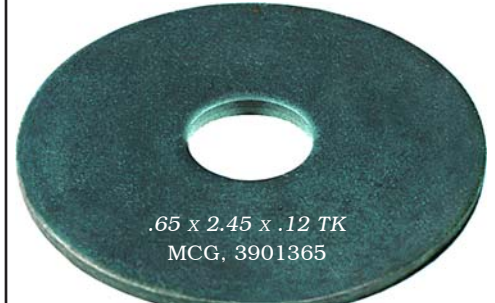

.65 x 2.45 x .12 TK
MCG, 3901365

S2	Pcs	Price
B-11308	4	\$5

Ford Crankshaft Damper



.67 x 1.01 x .09 TK
OYS

S8	S36	Pcs	Price
B-11374	B-11375	4	\$2



.67 x 1.75 x
.25 TK
LKU
B8A-6378-A

S2	Pcs	Price
B-11309	2	\$3

Chrysler Crankshaft Damper



.77 x 1.94 x
.25 TK
MKJ
1855561

S2	Pcs	Price
B-11755	2	\$3

WASHERS - FLAT, LOCK TAB

Ford Oil Filter Adapter



.77 x 1.18 x .06 TK
OJT, EAA-6749-A
FIBER GASKET

S	Pcs	Price
B-10368	1	\$4



1.0 x 3.03 x .025 TK
LNR, D1ZZ-6A636-A
RUBBER COATED STEEL

S100	Pcs	Price
B-10370	1	\$16

Ford Smog Pumps 66-67



.39 x .70 OAL
KHL, 380626-S

S8	Pcs	Price
B-13080	1	\$3

Ford 390HP/406 Exhaust 61-63

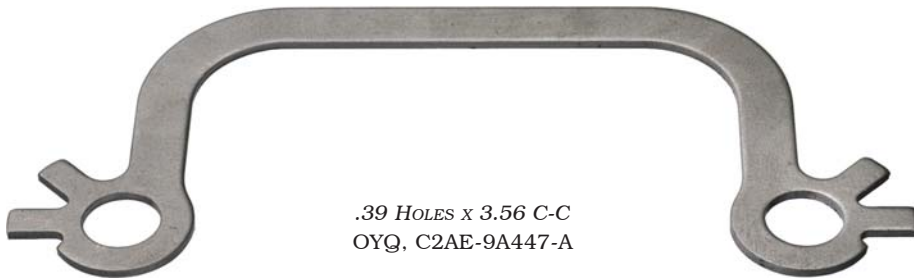

.39 HOLES x 3.56 C-C
OYQ, C2AE-9A447-A

S	Pcs	Price
B-11756	4	\$12

Ford 6 Cyl & 352/390 Exhaust 58-66



.39 x 1.07 OAL
XS, 370383-S

S	Pcs	Price
B-13078	4	\$3

Ford 260/289 Exhaust Manifolds 62-66

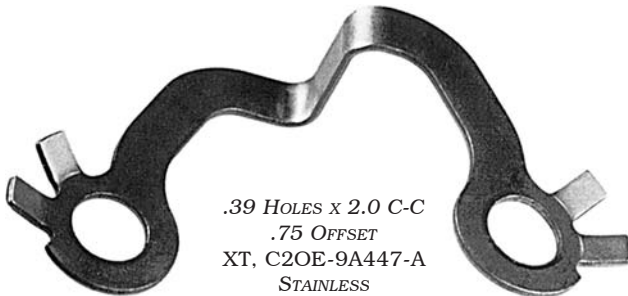

.39 HOLES x 2.0 C-C
.75 OFFSET
XT, C2OE-9A447-A
STAINLESS

SS	Pcs	Price
B-13079	2	\$4
B-11333	8	\$14

Ford 289HP 63-66



.39 HOLES x 2.0 C-C
1.0 OFFSET
YZ, C3OE-9A447-A

S	Pcs	Price
B-13081	2	\$4
B-11334	8	\$14

SB Chevy



.39 HOLES x 2.22 C-C
MPG, 3880844
STAINLESS

SS	Pcs	Price
B-10381	2	\$6
B-10026	4	\$12



BB Chevy 65-67







.39 HOLES x 3.47 C-C
MPH, 3860351
STAINLESS

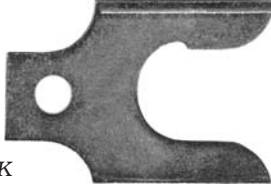
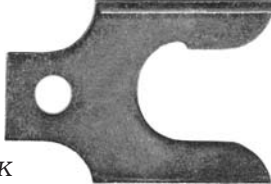

SS	Pcs	Price
B-10382	2	\$6
B-10027	4	\$12

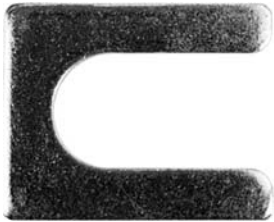

WASHERS - SHIM, SPLIT

 <p><i>.40 W Slot</i> 1.25 x 1.12 x .05 TK LNY</p>			 <p><i>.40 W Slot</i> 1.25 x 1.12 x .11 TK KKO, 3711834</p>			 <p><i>.44 W Slot</i> .94 x 1.39 x .03 TK LOD, 3751282</p>			 <p><i>.44 W Slot</i> .94 x 1.39 x .06 TK LOG, 3751284</p>		
S8	Pcs	Price	S8	Pcs	Price	S8	Pcs	Price	S8	Pcs	Price
B-11325	15	\$3	B-13083	10	\$3	B-11338	8	\$3	B-11339	6	\$3

 <p>Chevelle Body Mount @ Rad Support</p> <p><i>.54 W Slot</i> 1.76 x 1.76 x .12 OQL, 3779892</p>			 <p><i>.58 W Slot</i> 1.0 x 1.67 x .03 TK MEA, 1233894</p>			 <p><i>.58 W Slot</i> 1.0 x 1.67 x .06 TK MEH, 1233895</p>		
S	Pcs	Price	S8	Pcs	Price	S8	Pcs	Price
B-11757	4	\$4	B-11340	10	\$3	B-11341	6	\$3

 <p>Mustang Bumper</p> <p><i>.60 W Slot</i> 1.12 x 1.40 x .12 RE, LA-3043-B</p>			 <p>#8 SIZE <i>.17 x .27 x .045 TK</i> KWC, 34802-S, 453844</p>			 <p>#10 SIZE <i>.20 x .32 x .05 TK</i> BCW, 34803-S, 453435</p>		
S8	Pcs	Price	S36	Pcs	Price	S36	Pcs	Price
B-13084	6	\$3	B-13042	500	\$30	B-13043	25	\$2

 <p><i>1/4 SIZE .26 x .48 x .07 TK</i> BCY, 34805-S, 9420972, 120380, 9421423</p>			<p>QUAD RIB</p>  <p><i>1/4 HEAVY .26 x .48 x .075 TK</i> IZ, 34790-S</p>			 <p><i>5/16 LIGHT .33 x .56 x .07 TK</i> HIW, 34826-S</p>				
S2	S8	S36	Pcs	Price	S8	Pcs	Price	S2	Pcs	Price
B-13044	B-13045	B-13046	25	\$2	B-13047	10	\$2	B-13048	12	\$2

 <p><i>5/16 REGULAR .32 x .58 x .085 TK</i> GB, 34806-S, 187119 (s), 9417953, 120214</p>			<p>QUAD RIB</p>  <p><i>3/8 HEAVY .38 x .65 x .11 TK</i> IE, 123920 (s2) ◆, 34792-S</p>			 <p><i>3/8 LIGHT .38 x .67 x .085 TK</i> BFZ, 34827-S</p>				
S2	S8	Pcs	Price	S2	S8	Pcs	Price	S2	Pcs	Price
B-13049	B-13050	25	\$2	B-13054	B-13055	10	\$2	B-13051	500	\$30

WASHERS - SPLIT



3/8 REGULAR .38 x .68 x .105 TK
MK, 34807-S, 103321 (s), 9419871. 120382

S2	S8	Pcs	Price
B-13052	B-13053	25	\$3



3/8 HEAVY .38 x .68 x .12 TK
IAY, 34847-S, 9429695

S2	Pcs	Price
B-11326	20	\$3



7/16 REGULAR .45 x .77 x .12 TK
CW, 115314. 120383 , 34808-S, 103322 (s), 9418898.120383

S2	S8	Pcs	Price
B-13056	B-13057	20	\$3



7/16 HEAVY .45 x .77 x .14 TK
KRL, 34848-S, 103328 (s), 123153

S2	Pcs	Price
B-13058	20	\$3



7/16 HEAVY .45 x .75 x .14 TK
DM, 123153 (s2) , 34793-S, 373112-S
QUAD RIB

S2	S8	Pcs	Price
B-13059	B-13060	8	\$3



1/2 REGULAR .51 x .86 x .14 TK
DX, 34809-S, 103323 (s), 9419665. 120384

S2	S8	Pcs	Price
B-13061	B-13062	20	\$3



1/2 HEAVY .51 x .88 x .16 TK
LPM, 123174, 6028087 , 103329 (s), 9420963. 131101

S2	S8	Pcs	Price
B-11346	B-11347	15	\$3



9/16 HEAVY .58 x .96 x .15 TK
BHT, 34850-S, 103330 (s), 120292. 131139

S2	S8	Pcs	Price
B-11327	B-11330	8	\$3



5/8 HEAVY .62 x 1.06 x .20 TK
MUS, 131140

S8	Pcs	Price
B-11348	6	\$2



3/4 REGULAR .76 x 1.25 x .20 TK
OP, 34813-S, 103326 (s), 9429692

S2	Pcs	Price
B-13065	4	\$2



















7/8 REGULAR .90 x 1.43 x .23 TK
DD, 34814-S, 103327 (s), 9429693

S2	Pcs	Price
B-13066	3	\$2

Catalog space is limited.
Many more washers
are available at BULK
www.amkproducts.com

WASHERS - TOOTHED

 #6 SIZE .15 x .31 OD LYQ, 34937-S, 138473, 138476			 #8 SIZE .17 x .37 OD KWA, 34938-S, 9423235			 #10 SIZE .20 x .40 OD KWB, 34939-S, 453474			 #12 SIZE .22 x .47 OD LRG, 34927-S, 125751		
S8	Pcs	Price	S36	Pcs	Price	S36	Pcs	Price	S8	Pcs	Price
B-11239	12	\$2	B-13034	12	\$2	B-13035	12	\$2	B-11240	12	\$2
 1/4 SIZE .26 x .50 OD OQ, 34940-S, 121753			 5/16 SIZE .32 x .60 OD OR, 34941-S, 138485			 5/16 SIZE .32 x .60 OD OTO, 34941-S					
S8	Pcs	Price	S2	S8	Pcs	Price	S36	Pcs	Price		
B-13036	12	\$2	B-11671	B-13038	12	\$2	B-11758	8	\$2		
 3/8 SIZE .39 x .68 OD OS, 34942-S, 120930, 138489			 7/16 SIZE .46 x .75 OD OT, 138493 (s2) ♣, 34943-S, 138493, 138494			 7/16 SIZE .46 x .76 OD DL, 34943-S					
S2	S8	Pcs	Price	S2	S8	Pcs	Price	S36	Pcs	Price	
B-13040	B-13041	10	\$2	B-11241	B-11242	10	\$2	B-11243	6	\$2	
 1/2 SIZE .52 x .89 OD OU, 34944-S, 138496			 1/4 SIZE .26 x .47 OD LYC, 34905-S, 120423			 5/16 SIZE .33 x .60 OD OHR, 34906-S, 138540					
S2	Pcs	Price	S8	Pcs	Price	S2	Pcs	Price			
B-11244	10	\$2	B-11310	12	\$2	B-11311	12	\$2			
 3/8 SIZE .39 x .68 OD MIP, 34907-S, 138542			GM Electrical Grounds  1/4 SIZE .26 x .69 OD KFS, 351274-S, 174916			GM Battery Cables  5/16 SIZE .32 x .97 OD MFS, 178537					
S8	Pcs	Price	S8	Pcs	Price	S8	Pcs	Price			
B-11312	12	\$3	B-11314	8	\$3	B-11315	4	\$3			

WASHERS - VALVE COVER, WAVE

Early SB Chevy



.28 x 1.0 x .085 TK

MRL, 3836659 (s), 3836660 (ss)
STAINLESS

SS	Pcs	Price
B-10674	4	\$4
B-11335	8	\$7

SB Chevy



.28 x 1.50 L x .125 TK

MPA
STAINLESS

SS	Pcs	Price
B-10675	4	\$4
B-11336	8	\$7

BB Chevy



.28 x 1.50 x .120 TK

MNA, 3877670
STAINLESS

SS	Pcs	Price
B-10676	7	\$7
B-11337	14	\$12

GM Radio Control Shafts



.19 x .37 x .006 TK SINGLE WAVE
MOP, 7278015

S7	Pcs	Price
B-11318	12	\$3

Mustang Glove Box Cable 65-66, 69-70



.20 x .37 x .017 TK TRIPLE WAVE
KBL, 371271-S

S	Pcs	Price
B-11322	10	\$3



.32 x .62 x .015 TK SINGLE WAVE
MJU, 351341-S, 3952894 (sim)

S2	Pcs	Price
B-11319	8	\$3

Ford Shifter Linkage



.38 x .75 x .010 TK SINGLE WAVE
GAU, 356297-S

S2	S7	Pcs	Price
B-11590	B-11591	8	\$3

Mustang Brake Cables 67-68



.38 x 1.0 x .010 TK SINGLE WAVE
JAZ, 381629-S

S2	Pcs	Price
B-11592	4	\$3



.44 x .70 x .012 TK SINGLE WAVE
OII, 22063139

S8M	Pcs	Price
B-11321	10	\$3

Mustang Bumpers



.64 x 1.0 x .014 TK TRIPLE WAVE
MIJ, 358981-S

S2	Pcs	Price
B-11323	8	\$3



.46 x 1.25 x .050 TK TRIPLE WAVE
QW, C4ZB-17A924-A

S8M	Pcs	Price
B-13082	4	\$3

Fairlane & Ford Bumpers



.46 x 1.75
x .060 TK
TRIPLE WAVE

PCD
C4AB-17A924-A

S8M	Pcs	Price
B-13432	4	\$4

BRAKE HARDWARE - FORD

Pad Retainer 68-73



.16 x 1.31 L
OLH, C8AZ-2069-A

S	Pcs	Price
B-10643	4	\$3



.63 x 1.43 L
OLN, C8AZ-2066-A

S	Pcs	Price
B-10323	2	\$3

Anti-Rattle 68-73



1/4-20 x 1/2 7/16 AF .46 SPLIT
GAC, 43260-S, 445933

S2	Pcs	Price
B-12302	4	\$3



2.15 OAL
OLD, C8AZ-2B164-A

S2	Pcs	Price
B-10321	2	\$3

Caliper Locating 68-73



3/8-16 x 1.82 9/16 AF
LIU, C8AZ-2B296-A

S2P	Pcs	Price
B-10153	2	\$8



1.38 OAL
OLL, C8AZ-2B299-A
RUBBER

S	Pcs	Price
B-10242	2	\$4

Stabilizer 68-73



5/16-18 x 5/8 3/8 AF .55 SPLIT
KHF, 381985-S

S36P	Pcs	Price
B-10911	4	\$5

Inlet Hose 68-73



3/8-24 x 1.0 9/16 AF
KBI, 382365-S

S48	Pcs	Price
B-12653	1	\$8



.39 x .62 x .06 TK
KEH 8M-2149, C9AZ-2149-A
COPPER

S	Pcs	Price
B-10830	8	\$3

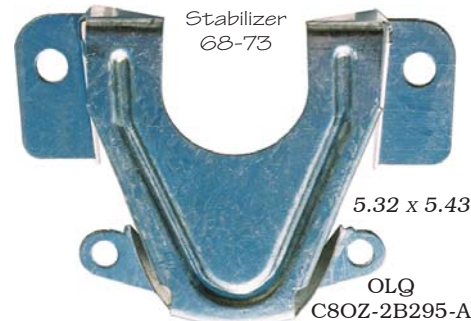

Stabilizer 68-73

5.32 x 5.43
OLQ
C8OZ-2B295-A

S8M	Pcs	Price
B-10296	1	\$10

Wheel Cylinders



1/4-28 1/4 AF .92 OAL
OKN, CODZ-2208-A

S36	Pcs	Price
B-10341	2	\$3

Brake Caliper 65-67



3/8-24 3/8 AF .32 NOSE DIA 1.17 OAL
OJH, 8M-2208

S36	Pcs	Price
B-10342	2	\$3

Brake Caliper 68 >



3/8-24 3/8 AF 1.52 OAL
MZQ, C8AZ-2208-A

S36	Pcs	Price
B-10343	2	\$4

Mustang Calipers 65-early 67



7/16-14 x 1 5/8 GR-5 3/4 AF
YB, 378225-S

Mustang/Fairlane Brake Calipers 67



7/16-14 x 1 3/4 3/4 AF
OWM, 382101-S2

S2	Pcs	Price
B-12700	2	\$8

S2P	Pcs	Price
B-11352	1	\$8

Mustang & Fairlane Calipers 68-73



7/16-14 x 1 1/2 3/4 AF
BHL, 384114-S100



9/16-12 x 2 5/8 13/16 AF
BHK, 382713-S

S2	Pcs	Price
B-13681	1	\$10

S100	Pcs	Price
B-13683	1	\$10

Caliper Brackets 65-67



3/8-24 x 1 1/2 9/16 AF .75 OD
KDD, 379787-S (sim)

3/8-24 x 2 1/2 9/16 AF .75 OD
KDF, 381776-S

S2	Pcs	Price
B-11593	3	\$8

S2	Pcs	Price
B-11594	2	\$5

Caliper Brackets 65-66



3/8-24 GR-8 9/16 AF .79 OD .39 TK
AV, 377704-S

S7	Pcs	Price
B-12905	4	\$3

Caliper Brackets 67



3/8-24 9/16 AF .41 TK
V, 34445-S

S7	Pcs	Price
B-12867	4	\$4

Hose Clip



1.05 W x 1.09 L x .50" GROOVE
PL, A7AZ-2814-A, C8ZA-A, C9AA-A
C9ZA-A, 386493-S

S60	S436	Pcs	Price
B-13169	B-13168	4	3

Anti-Rattle Shields 65-66



1/4-20 x 7/16 7/16 AF .44 EXTERNAL
LZM, 378659-S (sim)
STAINLESS

SS	Pcs	Price
B-10880	4	\$3
B-10881	10	\$5

BRAKE HARDWARE - GM

Piston Return Spring 69 >



.51 x 2.75 L
OLM, 5469180

S3	Pcs	Price
B-10322	2	\$4

We have
1 million pounds of vintage
automotive fasteners
in inventory to serve your needs !

Caliper Bracket 67 >



5/8-18 x 7/8 15/16 AF
MWF

S	Pcs	Price
B-10181	2	\$14

Caliper Locating 69 >



7/16-20 x 3.72 L
OJF, 5463495

S8	Pcs	Price
B-10401	2	\$6



1.05 W x 1.09 L x .50" GROOVE
PL, 476737 (sim)

S436	Pcs	Price
B-13168	4	\$3

Inlet Hose



7/16-20 x 1.09 5/8 AF
MTR, 1385356 (sim)

S36	Pcs	Price
B-10192	1	\$5

GM Brakes Hoses



.45 x .69 x .03 TK
MCB, 231343 COPPER

S	Pcs	Price
B-11283	8	\$3

Wheel Cylinders



1/4-20 x 3/8 3/8 AF .47 INTERNAL
OQY

S8	Pcs	Price
B-11659	4	\$3

Master & Wheel Cylinders



5/16-24 5/16 AF 1.0 OAL .28 D NOSE
OHD, 5469230

S36	Pcs	Price
B-10344	2	\$3









Brake Calipers

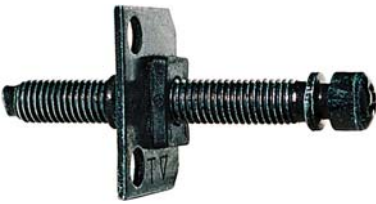

FITS .28 NOSE DIA
OKP, 5469581

S	Pcs	Price
B-11402	4	\$3

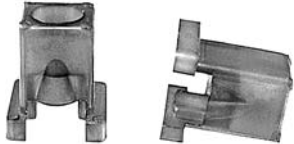
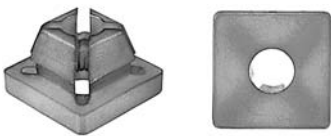
HEADLAMP ADJUSTERS

 <p>Mustang 65-66</p> <p>1/4-28 x 1.0 .30 OD KUP, 924561</p>			 <p>Mustang 65-66</p> <p>1/4-28 x 1 1/2 .30 OD KSO, C2MB-13032-A, 9432523 (sim)</p>			 <p>Mustang 65-66</p> <p>1/4-28 x 1 1/2 .30 OD KSN, 3937697 (sim), 9432523 (sim)</p>		
S8	Pcs	Price	S8	Pcs	Price	S8	Pcs	Price
B-12290	4	\$3	B-12495	4	\$3	B-11663	4	\$3
<p>GM Headlamp Rings</p>  <p>8-32 x 5/16 .27 OD OJQ, 5959530</p>			<p>Firebird 69</p>  <p>1/4-28 x 1.50 FTS .44 SLOT OWW, 1493541 S44 & NYLON</p>			 <p>1/4-28 x 1.75 .80 x 1.32 PLATE OFY, DOZB-13A093-AA (sim) S44 & NYLON</p>		
S8	Pcs	Price	S100	Pcs	Price	S100	Pcs	Price
B-11522	6	\$3	B-11759	2	\$6	B-10001	2	\$6
 <p>1/4-28 x 1.75 .92 x 1.0 PLATE OFT, C9AZ-13032-A S44 & NYLON</p>			<p>Camaro 78-81</p>  <p>1/4-28 x 2.0 FTS .44 SLOT OAH, 365266 S8 & NYLON</p>			<p>GM</p>  <p>1/4-28 FOR .41 SQR HOLE .52 x .52 SQR FLANGE KSP, 5953006</p>		
S100	Pcs	Price	S100	Pcs	Price	S	Pcs	Price
B-10066	2	\$6	B-10067	2	\$3	B-12922	4	\$3
<p>GM</p>  <p>1/4-28 FOR .41 SQR HOLE .63 x .63 x .14 TK FLANGE KSM, 3921446</p>			<p>Mustang 65-66</p>  <p>1/4-28 .81 x 1.25 L OFX, C3MB-13181-A (sim) S8 & NYLON</p>			<p>Ford</p>  <p>1/4-28 .83 x .88 L IAG, C2OB-13021-A S44 & NYLON</p>		
S	Pcs	Price	S100	Pcs	Price	S100	Pcs	Price
B-12923	4	\$3	B-11760	2	\$4	B-10068	2	\$4

HEADLAMP ADJUSTERS, SEAT BELTS

Mustang 69-73



.45 OD x 2.10 OAL x .072 WIRE
OGA, C7AB-13031-A (sim), D0ZZ-13031-A

S36	Pcs	Price
B-10960	2	\$3

Nova & Chevelle 64-67



.49 OD x 1.16 OAL x .063 WIRE
OGB, 5949989

S8	Pcs	Price
B-10964	2	\$3

Mustang 65-68



.50 OD x 1.81 OAL x .080 WIRE
OFW, C2OB-13031-A

S8	Pcs	Price
B-10965	2	\$3

Chevelle 68-70



.48 OD x 1.92 OAL x .067 WIRE
MVP, 3923948

S2	Pcs	Price
B-10963	2	\$3

Buick 70-72



.58 OD x 1.91 OAL x .072 WIRE
OZI, 1231641

S2	Pcs	Price
B-11746	2	\$3

Firebird 69



.73 OD x 1.08 OAL x .075 WIRE
OWX, 9790354

S36	Pcs	Price
B-11747	2	\$3

Chevelle 71-72, Camaro 74-81



.56 OD x 2.17 OAL x .072 WIRE
OGF, 345559, 3987016

S2	Pcs	Price
B-10966	2	\$3

Camaro 71-73, Monte Carlo 71-72



.74 OD x 1.04 OAL x .072 WIRE
MVG, 3945882

S36	Pcs	Price
B-10968	2	\$3

Camaro 68-69, Nova LH 68-72, MC 70



.74 OD x 1.06 OAL x .072 WIRE
OGL, 5953168

S2	Pcs	Price
B-10969	2	\$3

Nova RH 68-72



.74 OD x 1.12 OAL x .072 WIRE
MZV, 3929918

S2	Pcs	Price
B-10970	1	\$2

Ford Rr Seats > 68



7/16-20 x 1 3/8 13/16 AF
OIZ, 380527-S (sim)
Correct .25 Pilot

S36	Pcs	Price
B-10193	2	\$10

7/16-20 x 1 3/8 13/16 AF
ORU
.20 Pilot (SPECIAL BUY)

S36	Pcs	Price
B-11688	4	\$10

SEAT BELTS

Ford 65-68



7/16-20 x 1 1/2 13/16 AF .50 DIA x .50 L SHOULDER
OHP, 380528-S (sim), 381872-S (sim), 382516-S (sim)

S13	S36	Pcs	Price
B-10194	B-10195	2	\$12

Ford 3/68 >



7/16-20 x 1 3/4 13/16 AF .50 DIA x .50 L SHOULDER
OTF, 382627-S, 386274-S (sim)

S36	Pcs	Price
B-10434	2	\$8

Ford Shoulder Harness



3/8-16 x 1 1/2 .85 OD .50 x .23 L SHOULDER
OIE, 382626-S

S36	Pcs	Price
B-10152	1	\$6

Ford Rr Seats 3/68 >



7/16-20 x 1 3/8 .85 OD
OHA, 382624-S (sim), 386273-S

S36	Pcs	Price
B-10435	2	\$6
B-13302	6	\$12



7/16-20 x 1 3/4 .85 OD
OHZ, 384966-S

S36	Pcs	Price
B-11727	4	\$6
B-13303	12	\$12



7/16-20 x 1 13/16 .84 OD .50 x 1.0 L SHOULDER
OHS, 6036511AA

S36P	Pcs	Price
B-10436	2	\$5
B-13304	6	\$12

GM



1/2-13 x 1.20 13/16 AF
OHY, 7668784

S36P	Pcs	Price
B-11656	2	\$10

GM



1/2-13 x 1.20 13/16 AF .56 DIA x .31 L
SHOULDER
OHW, 7700983

S13P	Pcs	Price
B-10124	2	\$12

GM



1/2-13 x 1 1/2 13/16 AF .56 DIA x .56 L
SHOULDER
OHX, 7765672

S13P	S36P	Pcs	Price
B-10122	B-10123	2	\$12

Chrysler Master Kits

ENGINE



The authentic hardware you need to correctly reassemble the engine components which attach to the long-block.

Most fasteners are either meticulous reproductions or New Old Stock.

Automotive companies used multiple suppliers for high volume part numbers. We carefully select popular markings.

The most significant items may be seen in the BULK section, others are not shown.

Most items are made in USA to the same standards required by Chrysler.

Save up to 25% over the individual kit price.

Typical kit includes fasteners to attach:

air cleaner, carburetor, carb solenoid, choke, crank pulley & damper, distributor, exhaust manifolds, exhaust pipe, fan, fan clutch, fuel pump, heat shroud, heat tubes, ignition coil, intake manifold, oil pump (BB only), oil pan, throttle cable brackets, timing cover, valve covers, water neck, water pump & housing.

Details at www.amkproducts.com/Chrysler_Master_Kits.asp

Part #	Year	Body	Engine	Pcs	Price
64-LA	1964-65	AB	273/318	117	\$ 140
66-LA	1966-67	AB	273/318	117	\$ 140
68-LA	1968-70	ABE	273/318	112	\$ 150
68-E55	1968-69	ABE	340	124	\$ 150
70-E55	1970-73	BE	340	136	\$ 160
70-E56	1970	E	340 six pack	139	\$ 180
71-LA	1971-74	ABE	318/360	119	\$ 150
64-BRB	1964-67	B	383/440	139	\$ 200
68-BRB	1968-69	AB	383/440	146	\$ 200
69-E87	1969-71	BE	440 six pack	165	\$ 230
70-BRB	1970-74	BE	383/440	152	\$ 200
66-E74	1966-67	B	426 HEMI	194	\$ 300
68-E74	1968-69	AB	426 HEMI	198	\$ 330
70-E74	1970	BE	426 HEMI	192	\$ 350
71-E74	1971	BE	426 HEMI	192	\$ 375

A = Dart, Demon, Valiant B = Belvedere, Charger, Coronet, Road Runner E = Baracuda, Challenger

CHASSIS



The fasteners you need to properly reassemble your car's chassis in one package !

Most items are made in USA to the same standards required by Chrysler.

Save up to 25% from individual kit prices.

Typical kit includes O.E. fasteners to attach: accelerator pedal, axle housing, ball joints, brake booster, brake calipers, differential carrier, driveshaft, engine brackets, gas tank, idler arm, K-frame, leaf spring hangers & front eye, master cylinder, parking brake control, rotor shields, steering gear & linkage, suspension bumpers, sway bar support, trans crossmember, trans insulator, wheel cylinders. Details at www.amkproducts.com/Chrysler_Master_Kits.asp

Part #	Year	Body	Engine	Fr Brakes	Pcs	Price
66B-SBDR	1966-67	B	273/318	Drum	258	\$ 380
66B-SBDC	1966-67	B	273/318	Disc	252	\$ 380
68B-SBDR	1968-69	B	273/318/340	Drum	262	\$ 390
68B-SBDC	1968-69	B	273/318/340	Disc	256	\$ 390
70B-SBDR	1970	B	318/340	Drum	264	\$ 400
70E-SBDR	1970	E	318/340	Drum	266	\$ 400
70B-SBDC	1970	B	318/340	Disc	262	\$ 430
70E-SBDC	1970	E	318/340	Disc	264	\$ 430
71B-SBDR	1971-72	BE	318/340/360	Drum	258	\$ 400
71B-SBDC	1971-72	BE	318/340/360	Disc	256	\$ 430
73B-SBDC	1973-74	BE	318/340/360	Disc	252	\$ 430
66B-BBDR	1966-67	B	383/440	Drum	272	\$ 400
66B-BBDC	1966-67	B	383/440	Disc	266	\$ 400
68B-BBDR	1968-69	B	383/440	Drum	276	\$ 400
68B-BBDC	1968-69	B	383/440	Disc	270	\$ 400
70B-BBDR	1970	B	383/440	Drum	278	\$ 430
70E-BBDR	1970	E	383/440	Drum	280	\$ 430
70B-BBDC	1970	B	383/440	Disc	276	\$ 450
70E-BBDC	1970	E	383/440	Disc	278	\$ 450
71B-BBDR	1971-72	BE	383/440	Drum	272	\$ 430
71B-BBDC	1971-72	BE	383/440	Disc	270	\$ 450
73B-BBDC	1973-74	BE	383/440	Disc	266	\$ 450
66B-HEDR	1966-67	B	426	Drum	269	\$ 410
66B-HEDC	1966-67	B	426	Disc	263	\$ 410
68B-HEDR	1968-69	B	426	Drum	273	\$ 410
68B-HEDC	1968-69	B	426	Disc	267	\$ 410
70B-HEDR	1970	B	426	Drum	274	\$ 425
70E-HEDR	1970	E	426	Drum	276	\$ 425
70B-HEDC	1970	B	426	Disc	272	\$ 450
70E-HEDC	1970	E	426	Disc	274	\$ 450
71B-HEDR	1971	B	426	Drum	268	\$ 425
71E-HEDR	1971	E	426	Drum	268	\$ 425
71B-HEDC	1971	B	426	Disc	266	\$ 450
71E-HEDC	1971	E	426	Disc	266	\$ 450

Chrysler Fastener Kits**1964 - 74****Engine**

PART #	APPLICATION	NOTES	1960's YEAR					1970's YEAR					PCS	PRICE	
			4	5	6	7	8	9	0	1	2	3			4
C-8078	AIR CLEANER - WING NUT ONLY (1)	CORRECT NUT	4	5	6	7	8	9	0	1	2	3	4	1	3.00
C-8079	AIR CLEANER - WING NUT ONLY (2)	CORRECT NUTS	-	-	6	7	8	9	0	1	2	3	4	2	5.00
C-8174	CARB INTERCONNECTING ROD - 426 HEMI	.75 OD CONI KEPS ONLY	-	-	6	7	-	-	-	-	-	-	-	2	6.00
C-8179	CARB INTERCONNECTING ROD - 426 HEMI	.62 OD CONI KEPS ONLY	-	-	-	-	8	9	0	1	-	-	-	2	4.00
C-8080	CARB LEVER STUD - AII V8	SPECIAL CONI KEPS	-	5	6	7	8	9	-	-	-	-	-	1	10.00
C-8081	CARB LEVER STUD - AII V8	SPECIAL TALL FLNG NUT	-	-	-	-	-	-	0	1	2	3	4	1	6.00
C-8052	CARBURETOR - 4V	STUDS, NUTS	4	5	6	7	-	-	-	-	-	-	-	8	6.00
C-8055	CARBURETOR - 4V	1 1/8" HX BOLTS "H"	-	-	-	-	8	9	0	1	2	3	4	4	12.00
C-8057	CARBURETOR - 4V w 1/8" GASKET	1 1/4" HX BOLTS "RSC"	-	-	-	-	-	-	0	1	2	3	4	4	12.00
C-8154	CARBURETOR AIR HEATER - 318/340/360 (A)	BOLTS, HX CONI SEMS, SCREWS, KEPS	-	-	-	-	-	-	0	1	2	3	4	7	8.00
C-8069	CARBURETOR AIR HEATER - 318/340/360 (BE)	HX BOLTS, CONI KEPS	-	-	-	-	-	-	1	2	3	4	5	8.00	
C-8070	CARBURETOR AIR HEATER - 383/440	HXWA SCREW, STUDS, CONI KEPS	-	-	-	-	-	0	1	-	-	-	5	10.00	
C-8067	CARBURETOR CHOKE - 318/340/383/440-4V	IND HX SCREWS	-	-	-	-	-	-	0	1	-	-	2	3.00	
C-8093	CARBURETOR CHOKE - 318/340/383/440-4V	HX CONI SEMS	-	-	-	-	8	9	0	-	-	-	1	2.00	
C-8068	CARBURETOR CHOKE - 63-67 & SIX PACK	HX CONI SEMS	4	5	6	7	-	9	0	1	-	-	2	4.00	
C-8198	CARBURETOR SOLENOID - 340-6V, 426 HEMI	CONI KEPS NUTS	-	-	-	-	-	-	0	1	-	-	2	2.00	
C-8075	CARBURETOR SOLENOID - 440 SIX PACK	HX CONI SEMS	-	-	-	-	-	9	0	1	-	-	2	4.00	
C-8056	CARBURETORS - 340/440 SIX PACK	1 1/8" HX BOLTS "H"	-	-	-	-	-	9	0	1	-	-	12	34.00	
C-8054	CARBURETORS - 426 HEMI	STUDS, NUTS	-	-	6	7	8	9	-	-	-	-	16	12.00	
C-8058	CARBURETORS - 426 HEMI	1.12" HEX BOLTS "Dogbone"	-	-	-	-	-	-	0	1	-	-	8	32.00	
C-8206	CARBURETORS - 440 SIX PACK	1.12" HEX BOLTS "Dogbone"	-	-	-	-	-	-	1	-	-	-	12	48.00	
C-8204	CRANKSHAFT DAMPER - 383/440	HX BOLT, FLAT WA	4	5	6	7	8	9	0	1	2	3	4	2	8.00
C-8059	CRANKSHAFT DAMPER - SB & 426 HEMI	HX BOLT, FLAT WA	4	5	6	7	8	9	0	1	2	3	4	2	8.00
C-8040	CRANKSHAFT PULLEY - 8 CYL	HX BOLTS, SPLIT WA'S	4	5	6	7	-	-	-	-	-	-	12	8.00	
C-8041	CRANKSHAFT PULLEY - 8 CYL	HX CONI SEMS	-	-	-	-	8	9	0	1	2	3	4	6	8.00
C-8045	DISTRIBUTOR - 273/318/340/360	HX CONI SEMS "Lightning"	4	5	6	7	8	9	0	1	2	3	4	1	3.00
C-8046	DISTRIBUTOR - 383/440/426 HEMI	HX BOLT "H", CONICAL WA	4	5	6	7	8	9	0	1	2	3	4	2	8.00
C-8186	ENGINE FAN - .70 SPACER	1.62 HX BOLTS "H", CONI WA'S	-	-	-	-	8	9	-	-	-	-	8	8.00	
C-8184	ENGINE FAN - 1.24 SPACER	2.25 HX BOLTS, CONI WA'S	-	-	6	7	8	9	0	-	-	-	8	8.00	
C-8182	ENGINE FAN - 1.40 SPACER	2.38 HX BOLTS, CONI WA'S	4	5	6	-	-	-	0	1	2	-	8	8.00	
C-8183	ENGINE FAN - 1.60 SPACER	2.62 HX BOLTS, CONI WA'S	-	-	-	-	-	-	0	1	-	-	8	8.00	
C-8188	ENGINE FAN - 1.72 SPACER	2.75 HX BOLTS, CONI WA'S	-	-	6	-	-	-	0	1	-	-	8	8.00	
C-8185	ENGINE FAN - 1.87 - 2.00 SPACER	3.00 HX BOLTS, CONI WA'S	4	5	6	7	8	9	-	1	2	-	8	8.00	
C-8181	ENGINE FAN - 2.20 SPACER	3.25 HX BOLTS, CONI WA'S	4	5	-	-	8	-	0	1	2	-	8	8.00	
C-8187	ENGINE FAN - 2.38 SPACER	3.38 HX BOLTS, CONI WA'S	-	-	6	7	8	9	-	0	-	-	8	8.00	
C-8136	ENGINE FAN > CLUTCH	HX NUTS, CONI WA'S	4	5	6	7	8	9	0	1	2	3	4	8	4.00
C-8137	ENGINE FAN CLUTCH > WATER PUMP	PLACE BOLTS	4	5	6	7	8	9	0	1	2	3	4	4	6.00
C-8062	EXHAUST MANIFOLDS - 273/318	STUDS, BOLTS, HX NUTS, CONI WA'S	4	5	6	7	8	9	-	-	-	-	28	34.00	
C-8023	EXHAUST MANIFOLDS - 318/360 & 340 1971>	DE & CLR STUDS, BOLTS, NUTS, WA'S	-	-	-	-	-	-	0	1	2	3	4	28	40.00
C-8135	EXHAUST MANIFOLDS - 340	STUDS, BOLTS, SLEEVE NUTS, WA'S	-	-	-	-	8	9	0	-	-	-	28	40.00	
C-8063	EXHAUST MANIFOLDS - 383/440	STUDS, 3 SHORT & 2 L SLEEVE NUTS	4	5	6	7	-	-	-	-	-	-	24	44.00	
C-8065	EXHAUST MANIFOLDS - 383/440	STUDS, 1 SHORT & 2 L SLEEVE NUTS	-	-	-	-	8	9	0	1	2	3	4	24	34.00
C-8066	EXHAUST MANIFOLDS - 440 SIX PACK	CORRECT BOLTS & CONICAL WA'S	-	-	6	7	8	9	0	1	-	-	22	60.00	
C-8217	FLYWHEEL - 383/440 w M/T	15/16 L PLACE BOLTS	4	5	6	7	8	9	0	1	2	3	4	6	14.00
C-8042	FUEL PUMP - 8 CYL	HX FLANGE BOLTS w PELLET	4	5	6	7	8	9	0	1	2	3	4	2	4.00
C-8127	HEAT TUBE CLAMP - 426 HEMI	HX BOLT, NUT, SPLIT WA	-	-	6	7	8	9	0	1	-	-	3	5.00	
C-8126	HEAT TUBES > HEAD - 426 HEMI	HX CONI SEMS	-	-	6	7	8	9	0	1	-	-	4	8.00	
C-8209	INTAKE MANIFOLD - 273	HX BOLTS	4	5	-	-	-	-	-	-	-	-	12	15.00	
C-8047	INTAKE MANIFOLD - 273/318/340/360	HX FLAT SEMS	-	-	6	7	8	9	0	1	2	3	4	12	20.00
C-8048	INTAKE MANIFOLD - 383/440	GR-8 HX BOLTS "TR"	4	5	6	7	8	9	0	1	2	3	4	8	35.00
C-8031	INTAKE MANIFOLD - 426 HEMI	HX CONI SEMS, DE STUDS, CONI KEPS	-	-	-	-	8	9	0	1	-	-	22	140.00	
C-8171	INTAKE MANIFOLD - 426 HEMI	HX SKT SEMS, DE STUDS, CONI KEPS	-	-	6	7	-	-	-	-	-	-	22	100.00	
C-8072	INTAKE MANIFOLD - 440 SIX PACK	HX BOLTS "TR", HX CONI SEMS	-	-	-	-	-	9	0	1	-	-	13	32.00	
C-8077	INTAKE MANIFOLD END RAILS - BB	HX CONI SEMS	4	5	6	7	8	9	0	1	2	3	4	6	10.00
C-8036	OIL PAN - 273/318/340/360	HX CONI SEMS "LG" & "Anchor"	4	5	6	7	8	9	0	1	2	3	4	18	20.00
C-8037	OIL PAN - 383/440/426 HEMI	HX CONI SEMS "23"	4	5	6	7	8	9	0	1	2	3	4	20	20.00
C-8039	OIL PUMP (factory) - 383/440/426 HEMI	HX BOLTS, SPLIT WA'S	4	5	6	7	8	9	0	1	2	3	4	10	15.00
C-8169	OIL PUMP (replacement) - 383/440/426 HEMI	HX BOLTS, SPLIT WA'S	4	5	6	7	8	9	0	1	2	3	4	10	15.00
C-8073	THROTTLE CABLE BRACKET - 426 HEMI	HX CONI SEMS "Anchor"	-	-	6	7	8	9	0	1	-	-	1	3.00	
C-8071	THROTTLE CABLE BRACKET - ALL SIX PACK	HX CONI SEMS "ANCHOR"	-	-	-	-	-	9	0	1	-	-	2	4.00	
C-8173	THROTTLE CABLE RETAINER @ CARB	.75 OD CONI KEPS	4	5	6	7	8	9	0	1	2	3	4	1	3.00
C-8074	THROTTLE SPRING BRACKETS - 426 HEMI	HX CONI SEMS "Anchor"	-	-	6	7	8	9	0	1	-	-	2	5.00	
C-8210	TIMING COVER - 273/318/340	HX BOLTS "A", "M", "TR"	4	5	6	7	8	9	-	-	-	-	5	10.00	
C-8060	TIMING COVER - 318/3340/60	HX BOLTS "A" & "TR"	-	-	-	-	-	-	0	1	2	3	4	4	8.00
C-8061	TIMING COVER - 383/440/426 HEMI	HX CONI SEMS	4	5	6	7	8	9	0	1	2	3	4	8	8.00
C-8032	VALVE COVERS - 273/318/340/360	HX CONI SEMS	4	5	6	7	8	9	0	1	2	3	4	12	12.00
C-8033	VALVE COVERS - 383/440	HX CONI SEMS, STUDS, CONI KEPS	4	5	6	7	8	9	0	1	2	3	4	16	24.00
C-8015	VALVE COVERS - 426 HEMI	STUDS, .62" OD CONI KEPS	-	-	6	7	8	9	0	-	-	-	40	65.00	
C-8035	VALVE COVERS - 426 HEMI	STUDS, .56" OD CONI KEPS	-	-	-	-	-	-	-	1	-	-	40	100.00	
C-8044	WATER NECK - 8 CYL	HX BOLTS "H"	4	5	6	7	8	9	0	1	2	3	4	2	4.00
C-8116	WATER PUMP - 273/318/340/360	HX BOLTS "A", "TR"	4	5	6	7	8	9	-	-	-	-	7	16.00	
C-8049	WATER PUMP - 318/340/360	HX BOLTS "F", "A", HX CONI SEMS, WA'S	-	-	-	-	-	-	0	1	2	3	4	9	30.00
C-8050	WATER PUMP - 383/440/426 HEMI	HX BOLTS "A", "F", "H", "O", "RSC", "UF"	4	5	6	7	8	9	0	1	2	3	4	4	6.00
C-8051	WATER PUMP HOUSING - 383/440/426 HEMI	HEX BOLTS "L5", "H", "A", CONI WA	4	5	6	7	8	9	0	1	2	3	4	7	20.00

Kits Contain Attaching Fasteners for Both Sides

Chrysler Fastener Kits

199

1964 - 74

General

PART #	APPLICATION	NOTES	1960's YEAR					1970's YEAR					PCS	PRICE	
C-8338	ACCELERATOR PEDAL (B & E body)	CONI KEPS, CONI SEMS	-	-	6	7	8	9	0	1	2	3	4	6	6.00
C-8115	AXLE HOUSING > SPRINGS	1/2-20 x 7.12 U-BOLTS, LOCK NUTS	-	-	-	-	-	0	1	2	3	4	12	40.00	
C-8194	AXLE HOUSING > SPRINGS	1/2-20 CENTER LOCK NUTS ONLY	4	5	6	7	8	9	0	1	2	3	4	8	10.00
C-8195	AXLE HOUSING > SPRINGS - 7 1/4	7/16-20 CENTER LOCK NUTS ONLY	4	5	6	7	8	9	0	1	2	3	4	8	8.00
C-8114	AXLE HOUSING > SPRINGS - 8 3/4	1/2-20 x 6 5/8 U-BOLTS, LOCK NUTS	4	5	6	7	8	9	0	1	2	3	4	12	54.00
C-8222	AXLE RETAINING NUTS	HX LOCK NUTS, FLNG NUTS	4	5	6	7	8	9	0	1	2	3	4	10	8.00
C-8224	BALL JOINTS w DISC BRAKES	HX BOLTS, SLOTTED NUTS, PINS	4	5	6	7	8	9	0	1	2	3	4	12	18.00
C-8223	BALL JOINTS w DRUM BRAKES	HX BOLTS, SLOTTED NUTS, PINS	4	5	6	7	8	9	0	1	2	3	4	12	18.00
C-8193	BATTERY CABLE (NEG) > HEAD - 426 HEMI	HX CONI SEMS "Anchor"	-	-	6	7	8	9	0	1	-	-	-	1	3.00
C-8029	BATTERY HOLDOWN	CORRECT WING NUTS	4	5	6	7	8	9	-	-	-	-	-	2	5.00
C-8180	BATTERY HOLDOWN	1.0" OD CONI KEPS ONLY	-	-	-	-	-	0	1	2	3	4	2	6.00	
C-8189	BELL HOUSING (M/T) - 273/318/340/360	HX BOLTS, QUAD RIB WA'S	4	5	6	7	8	9	0	1	2	3	4	11	12.00
C-8098	BELL HOUSING (M/T) - 383/440/426 HEMI	HX BOLTS, CONI & SPLIT WA'S	-	-	6	7	8	9	0	1	2	3	4	12	20.00
C-8227	BRAKE ASSEMBLY (front drum) > SPINDLE	HX BOLTS, SPLIT WA'S, NUTS	4	5	6	7	8	9	0	1	2	3	4	12	10.00
C-8335	BRAKE BOOSTER	EXT KEPS	-	-	6	7	-	-	-	-	-	-	-	4	3.00
C-8336	BRAKE BOOSTER	HX LOCK NUTS	-	-	-	-	8	9	0	1	2	3	4	4	3.00
C-8202	BRAKE CABLE TENSION ADJUSTER	FLANGE LOCK NUT ONLY	4	5	6	7	8	9	0	1	2	3	4	1	2.00
C-8125	BRAKE CALIPER TUBE BRACKETS	HX CONI SEMS	-	5	6	7	8	9	-	-	-	-	-	4	5.00
C-8121	BRAKE CALIPERS > SPINDLE	HX CONI SEMS	-	-	-	-	-	0	1	2	3	4	4	38.00	
C-8225	BRAKE CALIPERS > SPINDLE	HX BOLTS	-	-	6	7	8	9	-	-	-	-	-	4	6.00
C-8177	BRAKE DRUM RETAINERS	1/2" STUD, GREEN PUSH ON RETAINERS	4	5	6	7	8	9	0	1	2	3	4	6	4.00
C-8228	BRAKE HOSES > BRACKETS	U-CLIPS	4	5	6	7	8	9	0	1	2	3	4	3	4.00
C-8122	BRAKE ROTOR SHIELDS	HX CONI SEMS	-	5	6	7	8	9	0	1	2	3	4	6	8.00
C-8212	CONTROL ARMS - UPPER	CAM BOLTS, WASHERS, NUTS	4	5	6	7	8	9	0	1	2	3	4	16	60.00
C-8132	DIFFERENTIAL CARRIER - 8 3/4	NUTS w NYLON PELLET	4	5	6	7	-	-	-	-	-	-	-	10	8.00
C-8133	DIFFERENTIAL CARRIER - 8 3/4	NUTS w NYLON PATCH	-	-	-	-	8	9	0	1	2	3	4	10	10.00
C-8221	DIFFERENTIAL CARRIER COVER - 7 1/4, 8 1/4	5/16-18 HX CONI SEMS	4	5	6	7	8	9	0	1	2	3	4	10	8.00
C-8027	DIFFERENTIAL CARRIER COVER - 9 3/4	3/8" HX FLNG BOLTS "E"	-	-	-	8	9	0	1	2	3	4	10	20.00	
C-8106	DRIVESHAFT > FLANGE	STRAPS, HX BOLTS, SPLIT WA'S	4	5	6	7	8	9	0	1	2	3	4	10	8.00
C-8107	DRIVESHAFT > FLANGE	STRAPS, HX CONI SEMS	-	-	-	-	-	-	-	2	3	4	6	10.00	
C-8089	ENGINE INSULATOR > BODY - HEMI (B body)	HX BOLT "38", CONI SEMS, KEPS & WA'S	-	-	6	7	8	9	-	-	-	-	-	6	34.00
C-8090	ENGINE INSULATOR > BODY - HEMI (B body)	HX BOLT "38", CONI SEMS, KEPS & WA'S	-	-	-	-	-	0	1	-	-	-	-	5	38.00
C-8091	ENGINE INSULATOR > BODY - HEMI (E body)	HX BOLT "38", CONI SEMS, KEPS & WA'S	-	-	-	-	-	-	0	1	-	-	-	5	36.00
C-8088	ENGINE INSULATOR > BODY - V8 exc HEMI	HX BOLTS "38", CONI WA'S	-	-	6	7	8	9	0	1	2	3	4	4	20.00
C-8013	ENGINE INSULATOR > ENG BRKT - 426 HEMI	1/2-13 MARSDEN NUTS	-	-	6	7	8	9	0	1	-	-	-	2	6.00
C-8084	ENGINE INSULATOR > ENG BRKT - exc HEMI	HX NUTS, CONI WA'S	4	5	6	7	8	9	0	1	2	3	4	4	5.00
C-8083	ENGINE MOUNT BRACKETS - 273/318/340	HX BOLTS, HX NUTS, CONI WA'S	-	-	6	-	-	-	-	-	-	-	-	18	24.00
C-8087	ENGINE MOUNT BRACKETS - 273/318/340	HX BOLTS, 5/8 AF NUTS, FLAT WA'S	-	-	-	7	8	9	0	1	2	3	4	18	24.00
C-8085	ENGINE MOUNT BRACKETS - 383/440	HX BOLTS, 5/8 AF NUTS, CONI WA'S	-	-	6	-	-	-	-	-	-	-	-	18	34.00
C-8086	ENGINE MOUNT BRACKETS - 383/440	HX BOLTS, 5/8 AF NUTS, FLAT WA'S	-	-	-	7	8	9	0	1	2	3	4	19	34.00
C-8092	ENGINE MOUNT BRACKETS - 426 HEMI	STUDS, NUTS, QUAD RIB SPLIT WA'S	-	-	6	7	8	9	0	1	-	-	-	18	20.00
C-8129	EXHAUST PIPE > MANIFOLD - 426 HEMI	HX BOLTS, MARSDEN NUTS	-	-	6	7	-	-	-	-	-	-	-	8	14.00
C-8130	EXHAUST PIPE > MANIFOLD - 426 HEMI	HX BOLTS (longer LWR LH), MARS NUTS	-	-	-	-	8	9	0	1	-	-	-	8	14.00
C-8128	EXHAUST PIPE > MANIFOLD - 8 CYL	HX BOLTS, MARSDEN NUTS	4	5	6	7	8	9	0	1	2	3	4	8	12.00
C-8213	FUSE PANEL	PH RND TY-B SCREW	-	-	-	-	-	0	1	2	3	4	2	3.00	
C-8131	GAS TANK	J-BOLTS, LOCK NUTS	-	-	-	-	8	9	0	1	2	3	4	4	24.00
C-8161	HEATER BLOWER MOTOR	1/4-20 X .62 OD HX CONI KEPS	4	5	6	7	8	9	0	1	2	3	4	3	5.00
C-8162	HEATER BLOWER MOTOR	5/16-18 X 1.0 OD CONI KEPS NUT	4	5	6	7	8	9	0	-	-	-	-	3	6.00
C-8215	IDLER ARM	"TR" HEX BOLT, TRI-SLOT NUT, PIN	4	5	6	7	8	9	0	1	2	3	4	3	15.00
C-8076	IGNITION COIL - 340-6V, 440-6V	HX CONI KEPS, SLOT RND SCREW	-	-	-	-	9	0	1	-	-	-	-	3	6.00
C-8053	IGNITION COIL - 426 HEMI	HX CONI SEMS, SLOT RND SCREW	-	-	6	7	8	9	0	1	-	-	-	3	4.00
C-8043	IGNITION COIL - SB & 383/440	HX CONI SEMS, SLOT RND SCREW	4	5	6	7	8	9	0	1	2	3	4	3	4.00
C-8099	INSPECTION COVER (A/T flywheel) - BB	HX CONI SEMS	4	5	6	7	8	9	0	1	2	3	4	4	6.00
C-8155	INSPECTION COVER (A/T flywheel) - SB	HX CONI SEMS	4	5	6	7	8	9	0	1	2	3	4	3	5.00
C-8190	INSPECTION COVER (M/T flywheel) - SB	HX WA TY-1 SCREWS	4	5	6	7	8	9	0	1	2	3	4	2	2.00
C-8034	INSPECTION COVER PAN (M/T flywheel)	HX CONI SEMS	4	5	6	7	8	9	0	1	2	3	4	5	6.00
C-8216	K-FRAME > BODY	SPECIAL HEX CONI SEMS	4	5	6	7	8	9	0	1	2	3	4	4	28.00
C-8112	LEAF SPRING Fr HANGERS	HUB BOLTS, CONI KEPS	4	5	6	7	8	9	0	1	2	3	4	16	32.00
C-8214	LEAF SPRINGS (front eye)	"H" MARKED BOLTS, MARSDEN NUTS	4	5	6	7	8	9	0	1	2	3	4	4	32.00
C-8331	MASTER CYLINDER	EXT KEPS	4	5	6	7	-	-	-	-	-	-	-	4	3.00
C-8332	MASTER CYLINDER	HX LOCK NUTS	-	-	-	-	8	9	0	1	2	3	4	4	3.00
C-8333	MASTER CYLINDER SUPPORT PLATE	CONI KEPS, EXT KEPS, SEALER	4	5	6	7	8	9	-	-	-	-	-	4	3.00
C-8334	MASTER CYLINDER SUPPORT PLATE	CONI KEPS, EXT KEPS, SEALER	-	-	-	-	-	0	1	2	3	4	4	3.00	
C-8205	MIRROR - INSIDE Rr VIEW	SPL HX SOCKET SCREW	4	5	6	7	8	9	0	1	2	3	4	1	3.00
C-8159	MIRRORS (outside) > DOOR (E body)	SS/CHROME PH OV SCREWS, RIV NUTS	-	-	-	-	-	0	1	2	3	4	8	6.00	
C-8082	P/S PUMP PULLEY	CORRECT NUT	4	5	6	7	8	9	0	1	2	3	4	1	6.00
C-8229	PARKING BRAKE CONTROL > BODY	EXT KEPS	-	-	6	7	-	-	-	-	-	-	-	3	4.00
C-8330	PARKING BRAKE CONTROL > BODY	HX CONI SEMS, CONI KEPS	-	-	-	-	8	9	0	1	2	3	4	3	4.00
C-8226	PITMAN ARM	NUT, SPLIT WA	4	5	6	7	8	9	0	1	2	3	4	2	4.00
C-8207	PRESSURE PLATE	SPECIAL HX BOLTS, SPLIT WA'S	4	5	6	7	8	9	0	1	2	3	4	12	6.00
C-8203	PROPORTIONING VALVE > APRON	RED FLANGE LOCK NUT	4	5	6	7	8	9	0	1	2	3	4	1	2.00
C-8030	RADIATOR - 26"	HX CONI SEMS	4	5	6	7	8	9	0	1	2	3	4	4	6.00
C-8196	RADIATOR SHROUD - 26" (64-69 B body)	LARGE FLNG NUTS	4	5	6	7	8	9	-	-	-	-	-	5	10.00
C-8197	RADIATOR SHROUD - 26" (67-69A, 70 > BE)	HX FLAT SEMS, SPRING NUTS	-	-	-	7	8	9	0	1	2	3	4	8	10.00
C-8160	SCUFF PLATES @ DOOR OPENING	SS/CHROME PH A TRUSS SCREWS	4	5	6	7	8	9	0	1	2	3	4	12	6.00

Kits Contain Attaching Fasteners for Both Sides

Chrysler Fastener Kits

1964 - 74

General

PART #	APPLICATION	NOTES	1960's YEAR					1970's YEAR					PCS	PRICE	
C-8163	SEATS > FLOOR	1.0 OD CONI KEPS NUTS	4	5	6	7	8	9	0	1	2	3	4	8	14.00
C-8164	SEATS > FLOOR	1.25 OD CONI KEPS NUTS	4	5	6	7	8	9	0	1	2	3	4	8	14.00
C-8113	SHACKLES - NUTS ONLY	HX NUTS	4	5	6	7	8	9	0	1	2	3	4	4	3.00
C-8038	SHAKER "BUBBLE" > HOOD	HX CONI SEMS "Anchor"	-	-	-	-	-	-	0	1	-	-	-	7	24.00
C-8109	SHOCKS (Fr) - LWR MOUNTING	HX BOLTS "TR" or "D", LOCK NUTS	4	5	6	7	8	9	-	-	-	-	-	4	10.00
C-8110	SHOCKS (Fr) - LWR MOUNTING	7/16 HX BOLTS "TR" or "D", LOCK NUTS	-	-	-	-	-	-	0	1	2	3	4	4	10.00
C-8120	SHOCKS (Rr) - LWR MOUNTING	HX NUTS ONLY	4	5	6	7	8	9	0	1	2	3	4	2	2.00
C-8119	SHOCKS (Rr) - UPR MOUNTING	HX BOLTS, LOCK NUTS	4	5	6	7	8	9	-	-	-	-	-	4	10.00
C-8123	SHOCKS (Rr) - UPR MOUNTING	HX BOLTS, LOCK NUTS	-	-	-	-	-	-	0	1	2	3	4	4	10.00
C-8101	SPEDOMETER CABLE CLAMP	HX CONI SEMS "LG"	4	5	6	7	8	9	0	1	2	3	4	1	3.00
C-8097	STARTER - All V-8 & 426 HEMI A/T 66-69	HX CONI SEMS, STUD, NUT, SPLIT WA	4	5	6	7	8	9	0	1	2	3	4	5	8.00
C-8096	STARTER (Direct-Drive) - 426 HEMI w M/T	HX CONI SEMS, HX BOLT, SPLIT WA	-	-	6	7	8	9	-	-	-	-	-	3	6.00
C-8124	STEERING GEAR (B body)	HI-HX HD BOLTS, SPLIT WA'S	4	5	6	7	8	9	0	1	2	3	4	6	12.00
C-8178	STEERING LINKAGE	TRI-SLOT NUTS, COTTER PINS	-	-	-	-	8	9	0	1	2	3	4	12	14.00
C-8108	STRUT ROD > CONTROL ARM	SPECIAL .59 OAH FLNG NUTS	4	5	6	7	8	9	0	1	2	3	4	2	10.00
C-8105	STRUT ROD > K-FRAME (B & E body)	5/8-11 LOCK NUTS	4	5	6	7	8	9	0	1	2	3	4	4	10.00
C-8117	SUSPENSION BUMPER BRKT > 8 3/4 AXLE	HX CONI SEMS "ANCHOR"	4	5	6	7	8	9	0	1	2	3	4	2	4.00
C-8157	SUSPENSION BUMPER BRKT > 9 3/4 AXLE	HX CONI SEMS "ANCHOR"	-	-	6	7	8	9	0	1	2	3	4	3	6.00
C-8175	SUSPENSION BUMPERS (Fr)	HUG-LOK NUTS	4	5	6	7	8	9	0	-	-	-	-	4	3.00
C-8176	SUSPENSION BUMPERS (Fr)	CONE LOCK NUTS	-	-	-	-	-	-	1	2	3	4	-	4	2.00
C-8118	SUSPENSION BUMPERS (Rr)	HX CONI SEMS "ANCHOR"	4	5	6	7	8	9	-	-	-	-	-	4	5.00
C-8440	SUSPENSION BUMPERS (Rr)	HX FLNG SCREWS	-	-	-	-	-	-	0	1	2	3	4	4	4.00
C-8208	SWAY BAR CENTER SUPPORTS	HX CONI SEMS, HX NUTS	4	5	6	7	8	9	-	-	-	-	-	8	12.00
C-8111	SWAY BAR CENTER SUPPORTS (B & E body)	HX BOLTS "H", CONI SEMS, LOCK NUTS	-	-	-	-	-	-	0	1	2	3	4	16	24.00
C-8156	TRANS (A/T) > ENGINE - 273/318/340/360	HX CONI SEMS	4	5	6	7	8	9	0	1	2	3	4	6	20.00
C-8008	TRANS (A/T) > ENGINE - 383/440/426 HEMI	HX CONI SEMS	4	5	6	7	8	9	0	1	2	3	4	6	20.00
C-8103	TRANS > BELL HOUSING (M/T)	HX BOLTS, TOOTH WA'S	4	5	6	7	8	9	0	1	2	3	4	8	8.00
C-8199	TRANS CROSSMEMBER	HX BOLTS, CONI KEPS, FLAT WA'S	-	-	-	-	-	-	0	-	-	-	-	16	20.00
C-8200	TRANS CROSSMEMBER	FLNG BOLTS, FLNG NUTS	-	-	-	-	-	-	-	1	2	3	4	8	20.00
C-8218	TRANS CROSSMEMBER	HX BOLTS, FLAT WA'S, CONI KEPS	-	-	6	7	8	-	-	-	-	-	-	12	18.00
C-8219	TRANS CROSSMEMBER	HX BOLTS, FLAT WA'S, LOCK NUTS	-	-	-	-	-	9	-	-	-	-	-	16	18.00
C-8102	TRANS DIPSTICK TUBE (A/T) - 383/440/426	HX CONI SEMS	4	5	6	7	8	-	-	-	-	-	-	1	3.00
C-8100	TRANS DIPSTICK TUBE (A/T) - 426 HEMI	DE STUD, HX NUT	-	-	-	-	-	9	0	1	-	-	-	2	4.00
C-8095	TRANS INSULATOR > CROSSMEMBER	LOCK NUT	-	-	6	7	8	9	0	-	-	-	-	1	2.00
C-8339	TRANS INSULATOR > CROSSMEMBER	HX BOLT, FLAT WA, LOCK NUT	-	-	-	-	-	-	0	1	2	3	4	3	8.00
C-8094	TRANS INSULATOR > TRANS	HX CONI SEMS, SQR WA'S	-	-	-	-	-	-	0	1	2	3	4	4	8.00
C-8220	TRANS INSULATOR > TRANS	HX CONI SEMS	-	-	6	7	8	9	-	-	-	-	-	2	6.00
C-8201	TRANS OIL PAN (A/T)	HX CONI SEMS	4	5	6	7	8	9	0	1	2	3	4	14	12.00
C-8104	WHEEL CYLINDERS (2) w 1/4-20	HX FLNG SCREWS	-	-	-	-	-	-	0	1	2	3	4	4	2.00
C-8191	WHEEL CYLINDERS (2) w 5/16-18	5/16-18 HX EXT SEMS	4	5	6	7	8	9	-	-	-	-	-	4	3.00
C-8337	WHEEL CYLINDERS (4) w 1/4-20	HX FLNG SCREWS	-	-	-	-	-	-	0	1	2	3	4	8	3.00
C-8192	WHEEL CYLINDERS (4) w 5/16-18	5/16-18 HX EXT SEMS	4	5	6	7	8	9	-	-	-	-	-	8	6.00
C-8017	WHEEL OPENING MOULDINGS	.28 OD PH RNDWA SCREWS, SEALER	4	5	6	7	8	9	0	1	2	-	-	36	8.00
C-8021	WHEEL OPENING MOULDINGS	.29 OD PH FLAT TOP SCREWS, SEALER	-	-	-	-	-	-	0	1	2	3	4	36	8.00
C-8167	WHEELS - 1/2-20 STD	LH & RH THREAD LUG NUTS	4	5	6	7	8	9	0	-	-	-	-	20	20.00
C-8168	WHEELS - 1/2-20 STD	RH THREAD LUG NUTS	-	-	-	-	-	-	-	1	2	3	4	20	20.00
C-8165	WHEELS - 7/16-20 STD	LH & RH THREADED LUG NUTS	4	5	6	7	8	9	0	-	-	-	-	20	24.00
C-8166	WHEELS - 7/16-20 STD	RH THREAD LUG NUTS	-	-	-	-	-	-	-	1	2	3	4	20	25.00
C-8020	WINDOW (BACK) MOULDINGS (A Coupe)	CLIPS & SCREWS	-	-	-	-	8	9	0	1	2	3	4	22	20.00
C-8026	WINDOW (BACK) MOULDINGS (A Fastback)	Includes Dart Sport, CLIPS & SCREWS	-	-	-	-	-	-	0	1	2	3	4	12	12.00
C-8001	WINDOW (BACK) MOULDINGS (B body)	CLIPS & SCREWS	-	-	-	-	8	9	0	-	-	-	-	20	20.00
C-8007	WINDOW (BACK) MOULDINGS (B body)	CLIPS	-	-	-	-	-	-	-	1	2	3	4	20	20.00
C-8011	WINDOW (BACK) MOULDINGS (B body)	CLIPS & SCREWS	-	-	6	7	-	-	-	-	-	-	-	20	20.00
C-8014	WINDOW (BACK) MOULDINGS (B body) 1962	CLIPS & SCREWS	-	-	-	-	-	-	-	-	-	-	-	23	22.00
C-8016	WINDOW (BACK) MOULDINGS (B body) 1963	CLIPS & SCREWS	-	-	-	-	-	-	-	-	-	-	-	17	5.00
C-8018	WINDOW (BACK) MOULDINGS (B body)	2 DR HARDTOP, CLIPS & SCREWS	4	5	-	-	-	-	-	-	-	-	-	24	24.00
C-8028	WINDOW (BACK) MOULDINGS (B body)	SEDAN, CLIPS & SCREWS	4	5	-	-	-	-	-	-	-	-	-	17	10.00
C-8024	WINDOW (BACK) MOULDINGS (Bara. Coupe)	CLIPS & SCREWS	-	-	-	-	8	9	-	-	-	-	-	18	18.00
C-8022	WINDOW (BACK) MOULDINGS (Bara. Fastback)	CLIPS & SCREWS	-	-	-	-	8	9	-	-	-	-	-	26	26.00
C-8009	WINDOW (BACK) MOULDINGS (Charger)	CLIPS & SCREWS	-	-	-	-	8	9	0	-	-	-	-	20	20.00
C-8003	WINDOW (BACK) MOULDINGS (E body)	CLIPS & SCREWS	-	-	-	-	-	-	0	-	-	-	-	20	20.00
C-8005	WINDOW (BACK) MOULDINGS (E body)	CLIPS & SCREWS	-	-	-	-	-	-	-	1	2	3	4	20	20.00
C-8158	WINDOW CRANK HANDLES	CHROME HX SKT SCREWS	-	-	-	-	8	9	0	1	2	3	4	4	4.00
C-8025	WINDSHIELD MOULDINGS (A body Fastback)	CLIPS & SCREWS	-	-	-	-	-	-	0	1	2	3	4	23	24.00
C-8019	WINDSHIELD MOULDINGS (A Coupe 70-76)	CLIPS & SCREWS	-	-	-	-	8	9	0	1	2	3	4	23	22.00
C-8000	WINDSHIELD MOULDINGS (B body)	CLIPS & SCREWS	-	-	-	-	8	9	0	-	-	-	-	24	24.00
C-8006	WINDSHIELD MOULDINGS (B body)	CLIPS	-	-	-	-	-	-	-	1	2	3	4	20	20.00
C-8010	WINDSHIELD MOULDINGS (B body)	CLIPS & SCREWS, SOME '68'S	-	-	6	7	-	-	-	-	-	-	-	24	24.00
C-8012	WINDSHIELD MOULDINGS (B body)	CLIPS & SCREWS	4	5	-	-	-	-	-	-	-	-	-	18	18.00
C-8002	WINDSHIELD MOULDINGS (E body)	CLIPS & SCREWS	-	-	-	-	-	-	0	-	-	-	-	12	12.00
C-8004	WINDSHIELD MOULDINGS (E body)	CLIPS	-	-	-	-	-	-	-	1	2	3	4	12	12.00
C-8170	WINDSHIELD WASHER BOTTLE (64-69, 70 B)	PH PN CONI SEMS	4	5	6	7	8	9	0	-	-	-	-	2	3.00
C-8064	WINDSHIELD WASHER BOTTLE (B & E body)	PH PN CONI SEMS	-	-	-	-	-	-	0	1	2	3	4	3	3.00
C-8172	WIPER MOTOR	.67 OD X .33 TK HX FLNG NUTS	4	5	6	7	8	9	0	1	2	3	4	3	5.00

Kits Contain Attaching Fasteners for Both Sides

Radiator Caps

Made exclusively for AMK Products by Chrysler's original supplier.



1960 - 66 Zinc
Part # ARC-60Z



1960 - 73 Chrome
Part # ARC-62C



1967-70 Zinc
Part # ARC-67SM



1967 - 70 Zinc
Part # ARC-67BL



1970-74 Zinc
Part # ARC-70SM



1966-70 AMC Zinc
Part # ARC-AMC

Part #	Year	Application	Center Mark	Ear Mark	Finish	Price
ARC-60Z	1960-66	Chrysler	S.M.Co & PAT#	14	Zinc	\$ 20
ARC-62C	1960-73	Chrysler	S.M.Co & PAT#	14	Chrome	\$ 20
ARC-67SM	1967-70	Chrysler	S.M.Co	16	Zinc	\$ 20
ARC-67BL	1967-70	Chrysler	Blank	16	Zinc	\$ 20
ARC-70SM	1970-74	Chrysler	Close Lettering, S.M.Co	16	Zinc	\$ 20
ARC-AMC	1966-70	AMC	S.M.Co	14, AM	Zinc	\$ 35

Markal Paint Sticks

Replace the factory markings with the same paint sticks used at the factory.

1 White + 1 Yellow
Part # MARK-T \$ 3

Box of 12
Part # MARK-12 \$ 20



Each box contains 12 sticks of 10 colors.
1 each of Brown, Pink, Orange, Blue, Red,
Purple, Black, Green, 2 each of White & Yellow

Ford Master Kits

BODY



The authentic hardware you need to properly reassemble your car's sheetmetal in one package !

Save up to 30% over the individual kit price.

Typical kit includes fasteners to attach:

battery tray, bumper guards & brackets, cowl braces, cowl panel, door hinges, door strikers, door latches fenders, fender splash shields, fender extensions, floorboard plates, grille, grille supports, headlamp doors, headlamp housings, hood, hood hinges, hood latch, hood latch catch, hood latch support, outside mirrors, quarter extensions, shock tower braces, stone deflector, trunk latch, trunk latch striker, trunk lid, trunk lid hinges, front valance and rear valance. Kits include all related spring nuts & clips. Details at www.amkproducts.com/Ford_Master_Kits.asp

Part #	Year	Model	#1 Finish	Body Style	Pcs	Price
65Z-M	1965	Mustang	Black Phos	All	371	\$ 199
65Z-M-BLACK*	1965	Mustang	Black Zinc	All	371	\$ 229
66Z-M	1966	Mustang	Black Phos	All	366	\$ 199
66Z-M-BLACK*	1966	Mustang	Black Zinc	All	366	\$ 229
67Z-M	1967	Mustang	Black Phos	All	362	\$ 199
67Z-M-BLACK*	1967	Mustang	Black Zinc	All	362	\$ 229
68Z-M	1968	Mustang	Silver Cad	All	352	\$ 199
69Z-M	1969	Mustang	Silver Cad	All	335	\$ 179
70Z-M	1970	Mustang	Silver Cad	All	321	\$ 179
71Z-M	1971	Mustang	Yellow Zinc	All	355	\$ 179
72Z-M	1972	Mustang	Yellow Zinc	All	348	\$ 179
73Z-M	1973	Mustang	Yellow Zinc	All	338	\$ 179
65M-M	1965	Shelby	Black Phos	All	372	\$ 199
66M-M	1966	Shelby	Black Phos	All	364	\$ 199
67M-M	1967	Shelby	Black Phos	All	449	\$ 220
68M-M	1968	Shelby	Silver Cad	All	384	\$ 220
69M-M	1969-70	Shelby	Silver Cad	All	418	\$ 199
67W-M	1967	Cougar	Black Phos	All	387	\$ 199
68W-M	1968	Cougar	Silver Cad	All	383	\$ 199
69W-M	1969	Cougar	Silver Cad	All	367	\$ 179
70W-M	1970	Cougar	Silver Cad	All	368	\$ 179
66D-M62	1966-67	Falcon	Black Phos	Coupe	240	\$ 149
66D-M66	1966	Falcon	Black Phos	Ranchero	306	\$ 179

* black zinc, this satin finish is more durable than phosphate but not factory correct

BODY

Part #	Year	Model	#1 Finish	Body Style	Pcs	Price
66O-M	1966	Fairlane	Black Phos	All	269	\$ 149
66O-M-BLACK*	1966	Fairlane	Black Phos	All	269	\$ 169
67O-M	1967	Fairlane	Black Phos	All	269	\$ 149
67O-M-BLACK*	1967	Fairlane	Black Phos	All	269	\$ 169
68O-M	1968	Fairlane/Torino	Silver Cad	All	294	\$ 149
69O-M	1969	Fairlane/Torino	Silver Cad	All	284	\$ 149
70O-MS	1970	Torino - Standard	Silver Cad	All	300	\$ 179
70O-MC	1970	Torino - Cobra	Silver Cad	All	300	\$ 179
70O-MH	1970	Torino - Hideaway	Silver Cad	All	310	\$ 179
71O-MS	1971	Torino - Standard	Yellow Zinc	All	300	\$ 179
71O-MC	1971	Torino - Cobra	Yellow Zinc	All	300	\$ 179
71O-MH	1971	Torino - Hideaway	Yellow Zinc	All	310	\$ 179
66G-M	1966-67	Comet	Black Phos	All	263	\$ 149
66B-M	1966	Bronco	Black Phos	All	294	\$ 149
67B-M	1967	Bronco	Black Phos	All	308	\$ 149
68B-M	1968	Bronco	Black Phos	All	337	\$ 149
69B-M	1969-70	Bronco	Black Phos	All	319	\$ 149
67T-M	1967	Truck - Styeside	Black Phos	All	294	\$ 199
68T-M	1968	Truck - Styeside	Black Phos	All	296	\$ 199
69T-M	1969	Truck - Styeside	Black Phos	All	294	\$ 199
70T-M	1970-72	Truck - Styeside	Black Phos	All	298	\$ 199



Bumper Mounting Junior Kits

Everything needed to properly assembly the bumper and bumper brackets to the car. Kits contain the correct stainless capped bolts, hex bolts, flange bolts, shims, washers, mastic and neoprene seals.

Part #	Year	Model	Body Style	Pcs	Price
65Z-BM	1965-66	Mustang & Shelby	All	66	\$ 34
67Z-BM	1967	Mustang & Shelby	All	64	\$ 34
68Z-BM	1968	Mustang & Shelby	All	64	\$ 34
69Z-BM	1969	Mustang	All	54	\$ 34
69M-BM	1969-70	Shelby	All	36	\$ 36
70Z-BM	1970	Mustang	All	54	\$ 34
71Z-BM	1971-72	Mustang	All	66	\$ 50
73Z-BM	1973	Mustang	All	66	\$ 46
67W-BM	1967-68	Cougar	All	64	\$ 28
69W-BM	1969	Cougar	All	48	\$ 36
70W-BM	1970	Cougar	All	48	\$ 36
66D-BM62	1966-67	Falcon	Coupe	64	\$ 30
66D-BM66	1966-67	Falcon	Ranchero	70	\$ 30
66O-BM	1966-67	Fairlane	All	72	\$ 30
68O-BM	1968-69	Fairlane	All	90	\$ 30
70O-BM	1970-71	Fairlane	All	66	\$ 32

* black zinc, this satin finish is more durable than phosphate but not factory correct

Ford Master Kits

ENGINE



The authentic hardware you need to correctly reassemble the engine components which attach to the long-block.

Most fasteners are either meticulous reproductions or New Old Stock.

The most significant items may be seen in the BULK section, others are not shown.

Save up to 40% over the individual kit price.



1966-73 kits feature Original Ramp-Lok® exhaust manifold bolts

Typical kit includes fasteners to attach:

air cleaner, carburetor, crank pulley, distributor & points & condensor & vacuum unit, drain plugs, engine tag, exhaust manifolds, fan & fan clutch, fuel pump, shroud, ignition coil & strap, intake manifold, oil filter adapter, oil pan, starter, timing cover, valve covers, water neck & water pump. Small Block kits include a water pump bolt placement illustration. Details at www.amkproducts.com/Ford_Master_Kits.asp

6 Cylinder

Part #	Year	Models	Engine	Pcs	Price
60D-SX	1960-65	DOZ	170/200	106	\$ 79
66D-SX	1966-67	DOZ	170/200	88	\$ 79
68D-SX	1968-70	DOZ	170/200	86	\$ 79
69D-SX	1969-73	DOZ	250	90	\$ 79

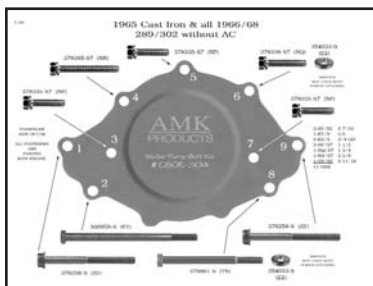

Water Pump Bolt Instructions



Small Block

620-SBS	1962-65	DOZF	221/260/289 w GEN exhaust locks	140	\$ 99
620-SBA	1962-65	DOZF	221/260/289 w GEN, AC & exhaust locks	141	\$ 99
630-SBH	1963-65	OZ	289HP w GEN & exhaust locks	133	\$ 99

D = Falcon F = Big Ford O = Fairlane S = Thunderbird Z = Mustang

ENGINE

Part #	Year	Models	Engine	Pcs	Price
65O-SBAS	1965	DOZF	289 Alum WP w/ ALT & exhaust locks	141	\$ 99
65O-SBIS	1965	DOZF	289 Iron WP w/ ALT & exhaust locks	142	\$ 99
65O-SBAA	1965	DOZF	289 Alum WP w/ ALT, AC & exhaust locks	151	\$ 99
65O-SBAH	1965	OZ	289HP Alum WP w/ ALT & exhaust locks	140	\$ 99
65Z-SBIH	1965	OZ	289HP Iron WP w/ ALT & exhaust locks	139	\$ 99
65M-GT350A	1965	Z	Shelby GT350 w/ Alum WP (289HP)	143	\$ 99
65M-GT350I	1965	Z	Shelby GT350 w/ Iron WP (289HP)	144	\$ 99
66O-SBS	1966-67	DOZF	289 Cast Iron WP & Ramp-Lok's	122	\$ 99
66O-SBA	1966	DOZF	289 Cast Iron WP w/ AC & Ramp-Lok's	126	\$ 99
66M-GT350	1966	Z	Shelby GT350 (289HP)	162	\$ 99
66Z-SBH	1966-67	Z	289HP Cast Iron WP & Ramp-Lok's	115	\$ 99
67O-SBA	1967	DOZF	289 w AC	126	\$ 99
67M-GT350	1967	Z	Shelby GT350 w/o AC (289HP)	144	\$ 99
68O-SBS	1968	DOZF	289/302	131	\$ 99
68O-SBA	1968	DOZ	289/302 w AC	137	\$ 99
68M-GT350S	1968	Z	Shelby GT350 w/o AC (302)	157	\$ 99
68M-GT350A	1968	Z	Shelby GT350 w AC (302)	159	\$ 99
69O-SBS	1969	DOZ	302	131	\$ 99
69O-SBA	1969	DOZ	302 w AC	135	\$ 99
69Z-302B	1969	Z	BOSS 302	134	\$ 160
69O-351WS	1969	DOZ	351W (Windsor)	130	\$ 99
69O-351WA	1969	DOZ	351W w AC	136	\$ 99
69M-GT350S	1969-70	Z	Shelby GT-350 w/o AC (351W)	152	\$ 99
69M-GT350A	1969-70	Z	Shelby GT-350 w AC (351W)	152	\$ 99
70O-SBS	1970	OZ	302	126	\$ 99
71O-SBS	1971-73	OZ	302	123	\$ 99
70Z-302B	1970	Z	BOSS 302	152	\$ 175
70O-351W	1970-73	OZ	351W	128	\$ 99
70O-351C2	1970-71	OZ	351C 2-V	127	\$ 99
70O-351C4	1970-71	OZ	351C 4-V	131	\$ 99
71Z-351B	1971	Z	BOSS 351	131	\$ 120
72O-351C2	1972-73	OZ	351C 2-V	129	\$ 99
72O-351C4	1972-73	OZ	351C 4-V	125	\$ 99

FE Big Block

58F-BBS	1958-65	FS	352/390 Std. exhaust manifolds	149	\$ 109
61F-BBH	1961-62	F	390HP/406	169	\$ 150
63F-427HP	1963-65	F	427 (kit now includes lock tabs)	165	\$ 150
66F-BBS	1966-75	FS	352/390/428 Std. exhaust manifolds	133	\$ 109
66O-390GT	1966	O	390GT	130	\$ 119
66O-427HP	1966-67	O	427	145	\$ 139
67O-390GT	1967	OZ	390GT	133	\$ 119
67M-428PI	1967	Z	Shelby GT-500 (428PI)	180	\$ 139
68O-390GT	1968-69	OZ	390GT	138	\$ 119
68O-428CJ	1968	OZ	428CJ	145	\$ 119
68M-428PI	1968	Z	Shelby GT-500 (428PI)	164	\$ 139
68M-428KR	1968	Z	Shelby GT-500KR (428CJ)	165	\$ 139
69O-428CJ	1969	OZ	428CJ/SCJ (includes Shelby GT-500)	157	\$ 119
70Z-428CJ	1970	Z	428CJ/SCJ	159	\$ 119

429 Big Block

69Z-BOSS9	1969-70	Z	BOSS 429	159	\$ 175
70O-429CJ	1970-71	OZ	429CJ/SCJ	136	\$ 130

Ford Fastener Kits

1963 - 73

Engine

PART #	APPLICATION	NOTES	1960's YEAR						1970's YEAR						PCS	PRICE	
F-1929	AIR CLEANER - 2 X 4V CARBS	3.0" DE STUDS, WING NUTS	3	4	5	6	7	-	-	-	-	-	-	-	4	7.00	
F-355	AIR CLEANER - 289, 390 w FORD CARB	3.83" OAL HX CLR STUD, WING NUT	3	4	5	6	7	-	-	-	-	-	-	-	2	8.00	
F-459	AIR CLEANER - 289/302/351/390 w FORD	3.47" OAL HX CLR STUD, WING NUT	-	-	-	-	-	8	9	0	1	2	3	2	8.00		
F-517	AIR CLEANER - 351-4V/390-4V	3.76" OAL HX CLR STUD, WING NUT	-	-	-	-	-	-	9	0	1	2	3	2	12.00		
F-714	AIR CLEANER - 351C-4V RAM-AIR, 429CJ	4.35" OAL DE STUD, WING NUT	-	-	-	-	-	-	0	1	2	-	-	2	8.00		
F-414	AIR CLEANER - 390 HOLLEY, 428CJ STD	2.38" OAL DE STUD, WING NUT	-	-	-	-	7	-	9	0	-	-	-	2	6.00		
F-513	AIR CLEANER - 390/428 w HOLLEY	2.60" OAL DE STUD, WING NUT	-	-	-	-	-	8	-	-	-	-	-	2	6.00		
F-1277	AIR CLEANER - 4V HOLLEY	2 5/8" DE STUD	-	-	-	-	-	-	9	0	-	-	-	1	3.00		
F-674	AIR CLEANER - 6 CYL	WING BOLT	3	4	5	6	7	8	9	0	1	2	3	1	3.00		
F-375	AIR CLEANER - All V-8	STAMPED WING NUT ONLY	3	4	5	6	7	8	9	0	1	2	3	1	1.50		
F-1348	AIR CLEANER - B302/428/429 w HOLLEY	Ram-Air 428CJ, 2.6 OAL STUD, WING NUT	-	-	-	-	-	-	9	0	1	-	-	2	6.00		
F-1105	AIR CLEANER - RAM-AIR TOP	POZI PN SCREWS, EXT KEPS NUTS	-	-	-	-	-	-	9	0	1	-	-	6	6.00		
F-3474	AIR CLEANER - w HOLLEY CARBURETOR	3.0" DE STUD, WING NUT	3	4	5	6	-	-	-	-	-	-	-	2	4.00		
F-548	AIR CLEANER HEAT SHROUD - 200/250	EXT KEPS NUT	-	-	-	-	-	8	9	0	1	2	3	2	3.00		
F-547	AIR CLEANER HEAT SHROUD - 260/289	HX CLR STUD, NUT, FLAT WA	3	4	5	6	7	-	-	-	-	-	-	3	7.00		
F-532	AIR CLEANER HEAT SHROUD - 289/302	HX CLR STUD, BRASS NUTS, EXT WA'S	-	-	-	-	-	8	9	-	-	-	-	5	7.00		
F-3878	AIR CLEANER HEAT SHROUD - 302	HX CONI MS SEMS, HX FLNG NUT	-	-	-	-	-	-	-	1	2	3	2	3.00			
F-549	AIR CLEANER HEAT SHROUD - 302	HX CLR STUD, CONI & EXT KEPS	-	-	-	-	-	-	9	0	-	-	-	3	7.00		
F-553	AIR CLEANER HEAT SHROUD - 351C	HX MS CONI SEMS	-	-	-	-	-	-	0	1	-	-	-	1	3.00		
F-780	AIR CLEANER HEAT SHROUD - 351C	EXT KEPS NUTS	-	-	-	-	-	-	-	-	2	3	2	2.00			
F-550	AIR CLEANER HEAT SHROUD - 351W	HX NUTS, EXT WA'S	-	-	-	-	-	-	9	-	-	-	-	4	2.00		
F-551	AIR CLEANER HEAT SHROUD - 351W	HX MS CONI SEMS, EXT KEPS NUTS	-	-	-	-	-	-	0	1	2	3	4	4.00			
F-364	AIR CLEANER HEAT SHROUD - 390GT	CONI KEPS NUTS	-	-	-	-	-	8	9	-	-	-	-	2	3.00		
F-888	AIR CLEANER HEAT SHROUD - 429CJ	CONI KEPS NUTS	-	-	-	-	-	-	0	1	-	-	-	2	2.50		
F-552	AIR CLEANER HEAT SHROUD - BOSS 302	STUDS, CONI KEPS NUTS	-	-	-	-	-	-	9	0	-	-	-	4	4.00		
F-1284	AIR CLEANER HEAT SHROUD - BOSS 429	EXT KEPS NUTS	-	-	-	-	-	-	9	0	-	-	-	2	3.00		
F-777	AIR CLEANER SHROUD & TUBE - 428CJ	EXT KEPS NUTS, HXWA AB SCREW	-	-	-	-	-	8	9	0	-	-	-	5	4.00		
F-546	AIR CLEANER SNORKEL	HXWA SCREWS	-	-	-	-	-	-	8	9	0	1	2	3	2	2.00	
F-1798	CAMSHAFT THRUST PLATE - 289/302/351	PLACE HX BOLTS	3	4	5	6	7	8	9	0	1	2	3	2	3.00		
F-1419	CARB RETURN BRKT - 289-4V A/T, 390-4V	HX EXT SEMS	-	-	-	-	7	-	-	-	-	-	-	2	3.00		
F-2928	CARB SOLENOID - HOLLEY w DASHPOT	SLOT PN SPLIT SEMS	-	-	-	-	-	8	9	0	-	-	-	1	2.00		
F-2917	CARB SOLENOID - HOLLEY w ELECTRIC	SLOT PN SPLIT SEMS	-	-	-	-	-	-	9	0	-	-	-	2	3.00		
F-1125	CARBURETOR - 1.00" SPACER	STUDS, 7/16 AF NUTS	3	4	5	6	7	8	9	0	1	2	3	8	8.00		
F-514	CARBURETOR - 1/4 - 3/8" SPACER	STUDS, 7/16 AF NUTS	3	4	5	6	7	8	9	0	1	2	3	8	6.00		
F-3939	CARBURETOR - 1V	STUDS, 7/16 AF NUTS	3	4	5	6	7	8	9	0	1	2	3	4	3.00		
F-3940	CARBURETOR - 1V w 1.00" SPACER	STUDS, 7/16 AF NUTS	3	4	5	6	7	8	9	0	1	2	3	4	3.00		
F-1134	CARBURETOR - 428CJ w A/T	STUDS (1 IS vacuum port), 7/16 NUTS	-	-	-	-	-	8	9	-	-	-	-	8	16.00		
F-817	CARBURETOR - 429CJ	HX BOLTS, STUDS, 7/16 AF NUTS	-	-	-	-	-	-	0	1	-	-	-	6	7.00		
F-511	CARBURETOR - NUTS ONLY	7/16 AF NUTS ONLY	3	4	5	6	7	8	9	0	1	2	3	4	2.00		
F-512	CARBURETOR - w/o SPACER	STUDS, 7/16 AF NUTS	3	4	5	6	7	8	9	0	1	2	3	8	6.00		
F-3296	HEATER (intake) - 429	HX SPLIT SEMS	-	-	-	-	-	-	0	1	-	-	-	2	2.00		
F-618	CARBURETOR CHOKE HOUSING - 2V, 4V	1 3/4" SLOT FILL SPLIT SEMS	3	4	5	6	7	8	9	0	1	2	3	3	3.00		
F-359	CARBURETOR CHOKE SHIELD	PH PN EXT SEMS	3	4	5	6	-	-	-	-	-	-	-	3	2.00		
F-1382	CARBURETOR FLOAT BOWLS - HOLLEY	FLAT TOP SLOT PAN SCREWS	3	4	5	6	7	8	9	0	1	2	3	8	10.00		
F-516	CARBURETOR SPACER > INTAKE MANIFOLD	HX BOLTS	3	4	5	6	7	8	9	0	1	2	3	4	3.00		
F-3475	CARBURETORS - 2 x 4V w/o SPACER	STUDS, SPL NUTS	3	4	5	6	7	-	-	-	-	-	-	16	12.00		
F-1773	CHOKE TUBES CLIP	S" CLIP, ZINC	-	-	5	6	7	-	-	-	-	-	-	1	2.00		
F-2877	CHOKE TUBES CLIP	S" CLIP, PHOS	-	-	-	-	-	8	9	0	1	2	3	1	2.00		
F-510	CRANK PULLEY - 3 Bolt	PLACE BOLTS	-	-	-	-	-	8	9	0	1	2	3	3	4.00		
F-885	CRANK PULLEY - 4 Bolt 429, SB 1970 >	PLACE BOLTS	-	-	-	-	-	-	9	0	1	2	3	4	5.00		
F-509	CRANK PULLEY - All	PLACE BOLTS	3	4	5	6	7	-	-	-	-	-	-	3	4.00		
F-858	CRANKCASE VENT TUBE > ENGINE BLOCK	HX SPLIT SEMS, FLAT WA	3	4	5	-	-	-	-	-	-	-	-	2	2.00		
F-281	CRANKSHAFT DAMPER - 6 CYL	9/16-18 X 1 3/4" GR-8 HX BOLT, FLAT WA	3	4	5	6	7	8	9	0	1	2	3	2	4.00		
F-1191	CRANKSHAFT DAMPER - V8	HX BOLT, FLAT WA	3	4	5	6	7	8	9	0	1	2	3	2	4.00		
F-3932	CYLINDER HEAD - 170/200/250	GR-8 HX BOLTS, HX CLR STUD	3	4	5	6	7	8	9	0	1	2	3	14	35.00		
F-1678	CYLINDER HEADS - 260/289/302	SPL 11/16" HX GR-8 BOLTS	3	4	5	6	7	8	9	0	1	2	3	20	60.00		
F-1771	CYLINDER HEADS - 390/428	SPL GR-8 BOLTS "F"	3	4	5	6	7	8	9	0	1	2	3	20	50.00		
F-458	DISTRIBUTOR - 6 CYL & All V-8	HX SPLIT SEMS	3	4	5	6	7	8	9	0	1	2	3	1	1.50		
F-645	DISTRIBUTOR POINTS & COND - SINGLE	SLOT PN C SCREWS	3	4	5	6	7	8	9	0	1	2	3	3	2.00		
F-646	DISTRIBUTOR POINTS & COND - DUAL	SLOT PN C SCREWS	3	4	5	6	7	8	9	0	1	2	3	5	3.00		
F-1625	DISTRIBUTOR VACUUM FITTING	STEEL LINE FITTING, GASKET	3	4	5	6	-	-	-	-	-	-	-	2	12.00		
F-1626	DISTRIBUTOR VACUUM FITTING	HOSE FITTING, GASKET	-	-	-	-	-	7	8	9	0	1	2	3	2	12.00	
F-1216	DISTRIBUTOR VACUUM HOSES	4.05 L ALUMINUM STRAP	-	-	-	-	-	-	8	9	0	1	2	3	1	4.00	
F-619	DISTRIBUTOR VACUUM UNIT	SLOT PN SCREWS	-	-	-	-	-	-	8	9	0	1	2	3	2	2.00	
F-751	DISTRIBUTOR VACUUM UNIT	SLOT PN SCREWS	3	4	5	6	7	-	-	-	-	-	-	2	1.50		
F-1627	DISTRIBUTOR VACUUM UNIT END PLUG	GOLD HX PLUG, GASKET	-	-	-	-	-	-	8	9	0	1	2	3	2	10.00	
F-1389	ENGINE BLOCK, DRAIN PLUGS	EXT HX PIPE PLUG	3	4	5	6	7	8	9	0	1	2	3	2	3.00		
F-1652	ENGINE FAN - 1.62" SPACER, 427, 200	2 1/8" HX SPLIT SEMS	-	-	-	6	-	-	-	-	-	-	-	4	8.00		
F-1653	ENGINE FAN - 1.91" SPACER	2 3/8" HX SPLIT SEMS, ZINC	-	-	-	6	-	-	-	-	-	-	-	4	6.00		
F-1656	ENGINE FAN - 1.91" SPACER	2 3/8" HX SPLIT SEMS, PHOS	-	-	-	-	7	8	9	0	1	2	3	4	6.00		
F-2109	ENGINE FAN - 2.20" SPACER	2 3/4" HX SPLIT SEMS, PHOS	-	-	-	-	7	8	9	0	1	2	3	4	6.00		
F-1655	ENGINE FAN - 2.20" SPACER, 289HP	2 3/4" HX SPLIT SEMS, ZINC	-	-	5	6	-	-	-	-	-	-	-	4	8.00		
F-1837	ENGINE FAN - 2.70" SPACER, 351C, B302/351	3 1/4" BOLTS, SPLIT WA'S	-	-	-	-	7	-	-	0	1	2	3	8	6.00		
F-3433	ENGINE FAN - 3.00" SPACER	3 1/2" HX BOLTS, SPLIT WA'S	3	4	5	6	7	8	9	0	1	2	3	8	8.00		
F-1651	ENGINE FAN - 3.20" SPACER, 289	3 3/4" HX SPLIT SEMS	-	-	5	-	-	-	-	-	-	-	-	4	8.00		

Kits Contain Attaching Fasteners for Both Sides

Ford Fastener Kits

207

1963 - 73

Engine

PART #	APPLICATION	NOTES	1960's YEAR					1970's YEAR					PCS	PRICE	
F-1654	ENGINE FAN - 3.20" SPACER, 289	3 3/4" HX BOLTS, SPLIT WA'S, ZINC	-	-	-	6	7	-	-	-	-	-	8	8.00	
F-1268	ENGINE FAN - BOSS 429	1 1/4" HX SPLIT SEMS	-	-	-	-	-	-	9	0	-	-	4	12.00	
F-1201	ENGINE FAN > CLUTCH	HX SPLIT SEMS, ZINC	-	-	5	6	7	-	-	-	-	-	4	4.00	
F-1202	ENGINE FAN > CLUTCH	HX SPLIT SEMS, PHOS	-	-	-	-	-	8	9	0	-	-	4	4.00	
F-1800	ENGINE FAN CLUTCH > WATER PUMP	7/16" HX SPLIT SEMS, "SEMS", PHOS	-	-	-	-	-	8	9	0	1	2	3	4	6.00
F-1804	ENGINE FAN CLUTCH > WATER PUMP	7/16" HX SPLIT SEMS, "SEMS", ZC	-	-	5	6	7	-	-	-	-	-	4	6.00	
F-2918	ENGINE LIFT HOOK - 428PI (SHELBY)	SPL THIN HD "RBW" HX BOLTS	-	-	-	-	7	-	-	-	-	-	2	12.00	
F-1375	ENGINE LIFT HOOK - 428CJ	LH SIDE, HX BOLT	-	-	-	-	-	8	9	0	-	-	1	2.00	
F-1617	ENGINE LIFT HOOKS - 302/351W	JAM NUTS	-	-	-	-	-	8	9	0	1	2	3	4	2.00
F-1505	ENGINE LIFT HOOKS - BOSS 429	FLNG & PLACE BOLTS	-	-	-	-	-	-	9	0	-	-	6	12.00	
F-791	ENGINE OIL COOLER - 428 w AC (SHELBY)	HX PERI F SEMS	-	-	-	-	-	8	-	-	-	-	6	15.00	
F-865	ENGINE OIL COOLER > BODY	HX CONI & PERI SEMS, SRTD FLNG NUT	-	-	-	-	-	-	9	0	1	-	4	5.00	
F-1199	ENGINE PLATE (M/T) - 6 CYL & SB	HX SPLIT SEMS	-	-	5	6	7	-	-	-	-	-	2	3.00	
F-1200	ENGINE PLATE (M/T) - 6 CYL & SB	HX SPLIT SEMS	-	-	-	-	-	8	-	-	-	-	2	3.00	
F-1228	ENGINE PLATE (M/T) - 6 CYL & SB	UBS FLNG BOLTS	-	-	-	-	-	-	9	0	1	2	3	2	3.00
F-1806	ENGINE PLATE (M/T) - 429	UBS FLNG BOLTS	-	-	-	-	-	-	9	0	1	2	3	4	5.00
F-2938	ENGINE PLATE (M/T) - BOSS 429	UBS FLNG BOLTS, HX SKT FLT MS	-	-	-	-	-	-	9	0	-	-	4	6.00	
F-1521	EXHAUST HEADERS	CORRECT TRIM HXWA BOLTS	3	4	5	6	7	8	9	0	1	2	3	16	16.00
F-554	EXHAUST MANIFOLD - 144/170/200	LOCK TABS, HX BOLTS "F", FLAT WA'S	3	4	5	6	-	-	-	-	-	-	-	22	18.00
F-525	EXHAUST MANIFOLD - 170/200	SPL "RAMPLOK" HX CONI SEMS	3	4	5	6	7	-	-	-	-	-	11	18.00	
F-526	EXHAUST MANIFOLD - 200/250	SPL "RAMPLOK", 2 w STUD	-	-	-	-	-	8	9	0	1	2	3	11	18.00
F-3457	EXHAUST MANIFOLD - 240 TRUCK	SPL "RAMPLOK" HX CONI SEMS	3	4	5	6	7	8	9	0	1	2	-	13	18.00
F-3476	EXHAUST MANIFOLD - 6 CY w LATE MNFLD	SPL "RAMPLOK", 6 SHORT, 5 LONG	3	4	5	6	-	-	-	-	-	-	-	11	18.00
F-555	EXHAUST MANIFOLDS - 260/289	LOCK TABS, HX BOLTS "F", FLAT WA'S	3	4	5	6	-	-	-	-	-	-	-	40	24.00
F-527	EXHAUST MANIFOLDS - 289	SPL "RAMPLOK" HX CONI SEMS	-	-	-	6	7	-	-	-	-	-	-	16	22.00
F-529	EXHAUST MANIFOLDS - 289/302	SPL "RAMPLOK", 4 w STUD	-	-	-	-	-	8	9	0	-	-	-	16	22.00
F-528	EXHAUST MANIFOLDS - 289HP	SPL "RAMPLOK" HX CONI SEMS	-	-	-	6	7	-	-	-	-	-	-	16	22.00
F-556	EXHAUST MANIFOLDS - 289HP	LOCK TABS, HX BOLTS "F", FLAT WA'S	3	4	5	6	-	-	-	-	-	-	-	40	26.00
F-533	EXHAUST MANIFOLDS - 2V 351C	SPL "RAMPLOK" HX CONI SEMS	-	-	-	-	-	-	0	1	-	-	-	16	22.00
F-535	EXHAUST MANIFOLDS - 2V 351C & 400	SPL "RAMPLOK", 2 w STUD	-	-	-	-	-	-	-	-	2	3	17	22.00	
F-1514	EXHAUST MANIFOLDS - 302 74 < #20001	SPL "RAMPLOK", 1 w STUD	-	-	-	-	-	-	-	-	1	2	3	16	22.00
F-530	EXHAUST MANIFOLDS - 351W	SPL "RAMPLOK" HX CONI SEMS	-	-	-	-	-	-	9	0	1	2	3	16	22.00
F-537	EXHAUST MANIFOLDS - 352/390	SPL "RAMPLOK" HX CONI SEMS	-	-	-	6	7	8	9	0	1	2	3	32	22.00
F-557	EXHAUST MANIFOLDS - 352/390	LOCK TABS, HX BOLTS "F", FLAT WA'S	3	4	5	6	-	-	-	-	-	-	-	48	26.00
F-2922	EXHAUST MANIFOLDS - 390HP/406	LOCK TABS, HX BOLTS "F", FLAT WA'S	3	-	-	-	-	-	-	-	-	-	-	40	40.00
F-538	EXHAUST MANIFOLDS - 390GT	SPL "RAMPLOK" HX CONI SEMS	-	-	-	6	-	-	-	-	-	-	-	32	26.00
F-539	EXHAUST MANIFOLDS - 390GT, GT-500 (428PI)	390GT 67 only, "RAMPLOK" CONI SEMS	-	-	-	-	7	8	-	-	-	-	-	32	26.00
F-540	EXHAUST MANIFOLDS - 390GT	SPL "RAMPLOK", 2 w STUD	-	-	-	-	-	8	9	-	-	-	-	32	26.00
F-541	EXHAUST MANIFOLDS - 427	SPL "RAMPLOK" HX CONI SEMS	-	-	-	6	7	-	-	-	-	-	-	16	26.00
F-542	EXHAUST MANIFOLDS - 428CJ	SPL "RAMPLOK" HX, 2 w STUD	-	-	-	-	-	8	9	0	-	-	-	32	30.00
F-1788	EXHAUST MANIFOLDS - 429/460 LINCOLN only	SPL "RAMPLOK", 2 w STUD	-	-	-	-	-	8	9	0	1	2	3	16	26.00
F-544	EXHAUST MANIFOLDS - 429CJ	SPL "RAMPLOK", 2 w STUD	-	-	-	-	-	-	0	1	-	-	-	16	30.00
F-534	EXHAUST MANIFOLDS - 4V 351C	SPL "RAMPLOK" HX CONI SEMS	-	-	-	-	-	-	-	0	1	-	-	16	22.00
F-536	EXHAUST MANIFOLDS - 4V 351C	SPL "RAMPLOK", 2 w STUD	-	-	-	-	-	-	-	-	2	3	16	22.00	
F-531	EXHAUST MANIFOLDS - BOSS 302	SPL "RAMPLOK", 4 w STUD	-	-	-	-	-	-	-	-	-	-	-	16	26.00
F-543	EXHAUST MANIFOLDS - BOSS 429	SPL "RAMPLOK", 2 w STUD	-	-	-	-	-	-	9	0	1	-	-	15	30.00
F-1840	FLYWHEEL, A/T w/o REINFORCEMENT	3/4" L PLACE BOLTS	3	4	5	6	7	8	9	0	1	2	3	6	14.00
F-1839	FLYWHEEL, M/T & A/T w REINFORCEMENT	15/16" L PLACE BOLTS	3	4	5	6	7	8	9	0	1	2	3	6	14.00
F-3520	FUEL FILTER BRACKET > HEAD - 406/427	HX SPLIT SEMS	3	4	5	6	7	-	-	-	-	-	-	2	3.00
F-518	FUEL PUMP - 144/170/200/250	HX SPLIT SEMS	3	4	5	6	7	8	9	0	1	2	3	2	3.00
F-520	FUEL PUMP - 351C	HX SPLIT SEMS, STUD, SRTD FLNG NUT	-	-	-	-	-	-	0	1	2	3	3	6.00	
F-519	FUEL PUMP - V8 (except 351C)	HX SPLIT SEMS	3	4	5	6	7	8	9	0	1	2	3	2	4.00
F-1629	FUEL PUMP BODY - BOSS 302, 428CJ, 429	PH PN SPLIT SEMS	-	-	-	-	7	8	9	0	1	-	-	6	4.00
F-1613	HEAT RISER TUBES > INTAKE - BOSS 429	HX SPLIT SEMS	-	-	-	-	-	-	9	0	-	-	-	6	8.00
F-478	INTAKE MANIFOLD - 260/289	HX FLAT SEMS w SEALING WA'S	3	4	5	6	7	-	-	-	-	-	-	12	20.00
F-702	INTAKE MANIFOLD - 289 (washers only)	RUBBER COATED ALUM SEALING WA'S	3	4	5	6	7	-	-	-	-	-	-	12	8.00
F-479	INTAKE MANIFOLD - 289/302	PLACE BOLTS, STUDS, FLNG NUTS	-	-	-	-	-	8	9	-	-	-	-	16	22.00
F-1123	INTAKE MANIFOLD - 302	UBS FLNG BOLTS, STUDS, FLNG NUTS	-	-	-	-	-	-	-	0	1	2	3	16	22.00
F-1313	INTAKE MANIFOLD - 351C-2V	HX FLNG BOLTS, HX SPLIT SEMS	-	-	-	-	-	-	-	0	1	2	3	16	22.00
F-1321	INTAKE MANIFOLD - 351C-4V	HX FLNG BOLTS	-	-	-	-	-	-	-	0	1	2	3	12	22.00
F-1131	INTAKE MANIFOLD - 351W	HX FLNG BOLTS	-	-	-	-	-	-	9	0	1	2	3	16	22.00
F-2107	INTAKE MANIFOLD - 351W w RAM-AIR	HX FLNG BOLTS, STUDS	-	-	-	-	-	-	9	0	-	-	-	16	30.00
F-570	INTAKE MANIFOLD - 352/390/428 (regular)	PLACE BOLTS	3	4	5	6	-	-	-	-	-	-	-	10	22.00
F-475	INTAKE MANIFOLD - 390/428CJ	PLACE BOLTS, SPACERS	-	-	-	-	7	8	-	-	-	-	-	12	25.00
F-476	INTAKE MANIFOLD - 390/428CJ	PLACE BOLTS, ONE STUD, SPACERS	-	-	-	-	-	-	9	0	-	-	-	12	28.00
F-493	INTAKE MANIFOLD - 427, 428 (SHELBY)	HX BOLTS "5" MARKING, FLAT WA'S	-	-	5	6	7	-	-	-	-	-	-	20	36.00
F-1412	INTAKE MANIFOLD - 428CJ	PLACE BOLTS, STUDS, SPACERS	-	-	-	-	-	-	-	0	-	-	-	12	28.00
F-2111	INTAKE MANIFOLD - 429/429CJ	HX FLNG BOLTS, STUDS, FLNG NUTS	-	-	-	-	-	-	9	0	1	-	-	20	35.00
F-1306	INTAKE MANIFOLD - BOSS 302	HX FLNG BOLTS, HX FLNG STUD	-	-	-	-	-	-	9	-	-	-	-	16	65.00
F-1320	INTAKE MANIFOLD - BOSS 302	HX FLNG BOLTS, HX FLNG STUDS	-	-	-	-	-	-	-	0	-	-	-	16	65.00
F-1376	INTAKE MANIFOLD - BOSS 429	HX FLNG BOLTS, STUDS, FLAT WA'S	-	-	-	-	-	-	9	0	-	-	-	32	35.00
F-477	INTAKE MANIFOLD - GT-500 (SHELBY)	PLACE BOLTS, FLAT WA'S	-	-	-	-	-	8	-	-	-	-	-	20	32.00
F-1633	INTAKE MANIFOLD GAFFLE - 289/302/351W	1/4" X 3/8 DRIVE RIVETS	3	4	5	6	7	8	9	0	1	2	3	2	2.00
F-380	INTAKE MANIFOLD Rr PLUG w/o PB	EXT HX 3/8 NPT PIPE PLUG	3	4	5	6	7	8	9	0	1	2	3	1	1.50

See factory Assembly Manuals for illustrations

Ford Fastener Kits

1963 - 73

Engine

PART #	APPLICATION	NOTES	1960's YEAR					1970's YEAR					PCS	PRICE	
F-602	INTAKE MANIFOLD Rr PLUGS - FE BB	EXT HX 3/8 NPT PIPE PLUGS	3	4	5	6	7	-	-	-	-	-	3	4.00	
F-381	OIL FILTER ADAPTER - 390/427/428	HX SPLIT SEMS	3	4	5	6	7	8	9	0	1	2	3	4	5.00
F-782	OIL FILTER ADAPTER - BLOCK GASKETS	CORRECT METAL & FIBRE GASKETS	-	-	-	-	-	-	9	0	1	-	-	2	20.00
F-1484	OIL PAN (alum) - 289HP (SHELBY)	HX BOLTS, SPLIT WA'S	3	4	5	6	7	8	9	0	1	2	3	44	16.00
F-808	OIL PAN (alum) - 289HP (SHELBY)	PH PN EXT SEMS, HX BOLTS, EXT WA'S	-	-	5	-	-	-	-	-	-	-	-	26	24.00
F-3313	OIL PAN (alum) - 390/427/428 (SHELBY)	HX CONI SEMS	3	4	5	6	7	8	9	0	1	2	3	20	20.00
F-3486	OIL PAN - 170/200/250	SPL HX SPLIT & HX CONI SEMS	3	4	5	6	7	8	9	0	1	2	3	24	16.00
F-484	OIL PAN - 260/289/302/351W	SPL HX SPLIT & HX CONI SEMS	3	4	5	6	7	8	9	0	1	2	3	22	15.00
F-485	OIL PAN - 351C	SPL HX SPLIT SEMS	-	-	-	-	-	-	0	1	2	3	-	22	15.00
F-340	OIL PAN - 390/427/428	SPL HX SPLIT SEMS	3	4	5	6	7	8	9	0	1	2	3	20	18.00
F-3446	OIL PAN - 428CJ/SCJ w WINDAGE TRAY	SPL HX SPLIT SEMS	-	-	-	-	-	9	0	-	-	-	-	20	18.00
F-486	OIL PAN - 429	SPL HX SPLIT SEMS	-	-	-	-	-	9	0	1	-	-	-	24	17.00
F-1647	OIL PUMP - 260/289/302/351	HX SPLIT SEMS	3	4	5	6	7	8	9	0	1	2	3	2	3.00
F-3482	OIL PUMP - 352/390/427/428	HX SPLIT SEMS	3	4	5	6	7	8	9	0	1	2	3	2	3.00
F-1744	OIL PUMP PICK-UP TUBE - 260/289/302/351	HX SPLIT SEMS	3	4	5	6	7	8	9	0	1	2	3	2	3.00
F-3483	OIL PUMP PICK-UP TUBE - 352/390/427/428	HX SPLIT SEMS	3	4	5	6	7	8	9	0	1	2	3	2	3.00
F-749	RAM-AIR CLEANER BRKT - 351C	HX SPLIT SEMS, CONI KEPS NUTS	-	-	-	-	-	-	0	-	-	-	-	3	3.00
F-748	RAM-AIR CLEANER BRKT - 351W	EXT KEPS NUTS	-	-	-	-	-	9	0	-	-	-	-	3	3.00
F-750	RAM-AIR CLEANER BRKT - B302, 390/428	EXT KEPS NUTS	-	-	-	-	-	9	0	-	-	-	-	2	2.00
F-3782	ROADRAFT TUBE or CRANK VENT ADAPTER	5/16-18 HX SPLIT SEMS	3	4	5	-	-	-	-	-	-	-	-	3	2.00
F-377	ROADRAFT TUBE or VENT ADAPTER - BB	AT REAR OF INTAKE, HXWA SCREWS	3	4	5	-	-	-	-	-	-	-	-	2	2.00
F-811	ROCKER ARM ADJUSTING NUTS	ORIGINAL 5/8" HX LOCKNUTS	3	4	5	6	7	8	9	0	1	2	3	16	8.00
F-2925	ROCKER ARM JAM NUTS - BOSS 302	SPECIAL 9/16 AF MACHINED NUTS	-	-	-	-	-	9	0	-	-	-	-	16	24.00
F-569	TAG, ENGINE ID - 260/289/302	HX BOLT	3	4	5	6	7	8	-	-	-	-	-	1	1.50
F-1928	THROTTLE BRKT > INTAKE - 260/289 w A/T	HX EXT SEMS	3	4	5	-	-	-	-	-	-	-	-	2	3.00
F-898	THROTTLE CABLE BRKT > ENGINE - 428CJ	HX SPLIT SEMS	-	-	-	-	-	-	0	-	-	-	-	2	3.00
F-1364	THROTTLE CABLE BRKT > ENGINE - V8	HX SPLIT SEMS	-	-	-	-	-	-	-	1	2	3	-	2	3.00
F-499	TIMING COVER - 144/170 w GENERATOR	HXWA SCREWS	3	4	5	-	-	-	-	-	-	-	-	7	6.00
F-500	TIMING COVER - 170/200 w ALT	HXWA SCREWS	-	-	5	6	7	8	9	0	-	-	-	7	6.00
F-501	TIMING COVER - 250	HX FLNG BOLTS	-	-	-	-	-	9	0	1	2	3	-	7	6.00
F-489	TIMING COVER - 260/289 w ALT	HX FLNG BOLTS - 5 SHORT 1 LONG	-	-	5	6	7	-	-	-	-	-	-	6	8.00
F-488	TIMING COVER - 260/289 w GENERATOR	HX FLNG BOLTS - 2 SHORT 2 LONG	3	4	5	-	-	-	-	-	-	-	-	6	8.00
F-490	TIMING COVER - 289/302/351	HX FLNG BOLTS - 4 SHORT 2 LONG	-	-	-	-	-	8	9	-	-	-	-	7	10.00
F-1122	TIMING COVER - 302/351W	HX FLNG BOLTS - 2 SHORT 4 LONG	-	-	-	-	-	-	0	1	2	3	-	6	10.00
F-1347	TIMING COVER - 351C	HX FLNG BOLTS	-	-	-	-	-	-	0	1	2	3	-	3	4.00
F-1118	TIMING COVER - 390/427/428	HXWA SCREWS, HX C SCREWS	3	4	5	6	7	-	-	-	-	-	-	10	14.00
F-503	TIMING COVER - 390/427/428	HXWA SCREWS, HX BOLT, HX C SCREWS	-	-	-	-	-	8	9	0	-	-	-	10	14.00
F-1433	TIMING COVER - 429	UBS FLNG BOLTS	-	-	-	-	-	9	0	1	-	-	-	4	8.00
F-1139	TIMING COVER - BOSS 302	UBS FLNG BOLTS & FLNG NUTS	-	-	-	-	-	-	0	-	-	-	-	8	20.00
F-480	VALVE COVER - 144/170/200/250	SPL HX SPLIT SEMS	3	4	5	6	7	8	9	0	1	2	3	7	6.00
F-1341	VALVE COVERS (alum) - "L" BRACKETS	PH PN F SCREWS	-	-	-	-	-	-	0	1	2	-	-	4	2.00
F-1438	VALVE COVERS (alum) - 289/302 (SHELBY)	HX BOLTS "RBW", FLAT & SPLIT WA'S	3	4	5	6	7	8	9	0	1	2	3	36	12.00
F-1619	VALVE COVERS (alum) - 302/351 (SHELBY)	HX BOLTS (no marks), FLAT & SPLIT WA'S	-	-	-	-	-	8	9	0	1	2	3	36	12.00
F-310	VALVE COVERS (alum) - GT-500 (SHELBY)	HX BOLTS "RBW", FLAT & SPLIT WA'S	-	-	-	-	7	8	-	-	-	-	-	30	28.00
F-481	VALVE COVERS (steel) - 289/302/351W	SPL HX SPLIT SEMS	3	4	5	6	7	8	9	0	1	2	3	12	10.00
F-482	VALVE COVERS (steel) - 69 B302 & 70-73 351C	SPL HX SPLIT SEMS	-	-	-	-	-	9	0	1	2	3	-	16	12.00
F-339	VALVE COVERS (steel) - 390/427/428	SPL HX SPLIT SEMS	3	4	5	6	7	8	9	0	1	2	3	10	12.00
F-1628	VALVE COVERS (steel) - 429/460	SPL HX SPLIT SEMS	-	-	-	-	-	9	0	1	-	-	-	14	10.00
F-483	VALVE COVERS - BOSS 302/351, 429CJ	HX SPLIT SEMS "E"	-	-	-	-	-	-	0	1	2	-	-	16	24.00
F-1147	VALVE COVERS - BOSS 429	UBS FLNG BOLTS, HX CLR STUDS	-	-	-	-	-	9	0	-	-	-	-	24	60.00
F-504	WATER NECK - 170/200	HX BOLTS	3	4	5	6	7	8	9	0	1	2	3	2	3.00
F-505	WATER NECK - 250	HX BOLTS	-	-	-	-	-	9	0	1	2	3	-	2	3.00
F-506	WATER NECK - 260/289/351W	HX SPLIT SEMS	3	4	5	6	7	8	9	0	1	2	3	2	3.00
F-1346	WATER NECK - 351C	HX SPLIT SEMS	-	-	-	-	-	-	0	1	2	3	-	2	3.00
F-507	WATER NECK - 390/427/428	HX SPLIT SEMS	3	4	5	6	7	8	9	0	1	2	3	2	3.00
F-1620	WATER NECK - 429	HX SPLIT SEMS	-	-	-	-	-	9	0	1	-	-	-	2	3.00
F-492	WATER PUMP (alum) - 260/289 ALT & AC	HX FLNG, HX & PLACE BOLTS, SPACER	-	-	5	-	-	-	-	-	-	-	-	16	25.00
F-388	WATER PUMP (alum) - 260/289 ALT w/o AC	HX FLNG & PLACE BOLTS, FLAT WA'S	-	-	5	-	-	-	-	-	-	-	-	10	22.00
F-491	WATER PUMP (alum) - 260/289 GEN w AC	HX FLNG & HX BOLTS, SPLIT WA	3	4	5	-	-	-	-	-	-	-	-	10	22.00
F-487	WATER PUMP (alum) - 260/289 GEN w/o AC	HX FLNG BOLTS	3	4	5	-	-	-	-	-	-	-	-	9	22.00
F-242	WATER PUMP (cast iron) - 289/302 w AC	HX FLNG & HX BOLTS, HX SEMS, SPACER	-	-	-	6	-	-	-	-	-	-	-	15	20.00
F-304	WATER PUMP (cast iron) - 289/302 w/o AC	HX FLNG & PLACE BOLTS, HX SPLIT SEMS	-	-	5	6	7	8	-	-	-	-	-	11	20.00
F-498	WATER PUMP - 170/200	HX BOLT, HX SCREWS	3	4	5	6	7	8	9	0	1	2	3	3	3.00
F-558	WATER PUMP - 250	HX BOLTS	-	-	-	-	-	9	0	1	2	3	-	4	4.00
F-249	WATER PUMP - 289 w AC	HX FLNG & HX BOLTS, HX SEMS, SPACER	-	-	-	-	7	-	-	-	-	-	-	16	20.00
F-305	WATER PUMP - 289/302 w AC	HX FLNG, HX & PLACE BOLTS, HX SEMS	-	-	-	-	-	8	-	-	-	-	-	13	20.00
F-308	WATER PUMP - 302/351 w AC	HX FLNG, HX & PLACE BOLTS, HX SEMS	-	-	-	-	-	9	-	-	-	-	-	13	20.00
F-306	WATER PUMP - 302/B302/351W	HX & PLACE BOLTS, HX SPLIT SEMS, WA	-	-	-	-	-	-	0	1	2	3	-	9	22.00
F-307	WATER PUMP - 302/B302/351W w/o AC	HX FLNG, HX & PLACE BOLTS, HX SEMS	-	-	-	-	-	9	-	-	-	-	-	11	20.00
F-309	WATER PUMP - 351C	HX SPLIT SEMS, FLNG BOLTS, SCREWS	-	-	-	-	-	-	0	1	2	3	-	11	22.00
F-497	WATER PUMP - 390/427/428	HX SPLIT SEMS, HX BOLT @ LOWER RH	3	4	5	6	7	8	9	0	1	2	3	4	6.00
F-1499	WATER PUMP - 429	HX BOLTS	-	-	-	-	-	9	0	1	-	-	-	11	14.00
F-3866	WINDAGE TRAY & CAPS - 289/302	HX SEMS, SPL MAIN CAP BOLTS .54" HH	3	4	5	6	7	8	9	0	1	2	3	8	14.00
F-3895	WINDAGE TRAY > MAIN CAPS - 289/302	HX PERI SEMS	3	4	5	6	7	8	9	0	1	2	3	4	8.00

Kits Contain Attaching Fasteners for Both Sides

Ford Fastener Kits

209

1963 - 73

Engine Accessories

PART #	APPLICATION	NOTES	1960's YEAR					1970's YEAR					PCS	PRICE	
F-1611	ALTERNATOR - 170/200 6 CYL w AC	HX SPLIT SEMS, HX BOLTS, WA'S, NUTS	-	-	5	6	7	-	-	-	-	-	-	11	14.00
F-1315	ALTERNATOR - 170/200 6 CYL w/o AC	HX SPLIT SEMS, HX BOLTS, WA'S, NUTS	-	-	5	6	7	-	-	-	-	-	-	8	14.00
F-1316	ALTERNATOR - 200 6 CYL	HX, SRD HX FLNG & PLACE BOLTS, WA	-	-	-	-	-	8	-	-	-	-	-	6	14.00
F-1317	ALTERNATOR - 200 6 CYL	HX, SRD HX FLNG & PLACE BOLTS	-	-	-	-	-	-	9	0	-	-	-	5	18.00
F-1318	ALTERNATOR - 250 6 CYL	HX, SRD HX FLNG & PLACE BOLTS	-	-	-	-	-	-	9	-	-	-	-	5	18.00
F-1319	ALTERNATOR - 250 6 CYL	HX, SRD HX FLNG & PLACE BOLTS	-	-	-	-	-	-	-	0	1	2	3	5	18.00
F-621	ALTERNATOR - 289 less SPACER	HX & PLACE BOLTS, FLAT & SPLIT WA'S	-	-	5	6	7	-	-	-	-	-	-	5	7.00
F-623	ALTERNATOR - 289 w SMOG	PLACE BOLTS, FLAT WA	-	-	-	6	7	-	-	-	-	-	-	3	8.00
F-622	ALTERNATOR - 289 w SPACER	HX, PLACE BOLTS, GOLD SPACER, WA'S	-	-	-	6	7	-	-	-	-	-	-	6	16.00
F-1133	ALTERNATOR - 289 w SPACER	HX, PLACE BOLTS, STEEL SPACER, WA'S	-	-	5	-	-	-	-	-	-	-	-	6	16.00
F-624	ALTERNATOR - 289/302 less SPACER	HX, HX FLNG & PLACE BOLTS, SPLIT WA	-	-	-	-	-	8	9	-	-	-	-	4	7.00
F-626	ALTERNATOR - 289/302 w SMOG	PLACE & FLNG BOLTS	-	-	-	-	-	8	9	-	-	-	-	3	8.00
F-625	ALTERNATOR - 289/302 w SPACER	HX, PLACE BOLTS, GOLD SPACER, WA'S	-	-	-	-	-	8	9	-	-	-	-	5	16.00
F-3533	ALTERNATOR - BOSS 302 w SPACER	HX, FLNG & PLACE BOLTS, SPACER, WA	-	-	-	-	-	-	0	-	-	-	-	7	20.00
F-3315	ALTERNATOR - 302/351W less SPACER	HX, SRD FLNG & PLACE BOLTS, WA	-	-	-	-	-	-	0	1	2	3	5	10.00	
F-3314	ALTERNATOR - 302/351W w SPACER	HX, SRD FLNG & PLACE BOLTS, SPACER	-	-	-	-	-	-	0	1	2	3	6	18.00	
F-3213	ALTERNATOR - 351C less SPACER	HX & SRD FLNG BOLTS, SPLIT WA	-	-	-	-	-	-	0	1	2	3	3	10.00	
F-1494	ALTERNATOR - 351C w SPACER	HX & SRD FLNG BOLTS, SPACER	-	-	-	-	-	-	0	1	2	3	4	16.00	
F-1307	ALTERNATOR - 351W	FLNG, SRD HX FLNG & PLACE BOLTS	-	-	-	-	-	9	-	-	-	-	-	5	16.00
F-627	ALTERNATOR - 390/428 less SPACER	HX SPLIT SEMS, HX, PLACE BOLTS, WA'S	-	-	-	6	7	-	-	-	-	-	-	6	8.00
F-629	ALTERNATOR - 390/428 less SPACER	HX, HX FLNG & PLACE BOLTS, SPLIT WA	-	-	-	-	-	8	9	0	-	-	-	4	7.00
F-628	ALTERNATOR - 390/428 w SPACER	HX SPLIT SEMS, BOLTS, PINK SPACER	-	-	-	6	7	-	-	-	-	-	-	7	17.00
F-630	ALTERNATOR - 390/428 w SPACER	HX, FLNG & PLACE BOLTS, PINK SPACER	-	-	-	-	-	8	9	0	-	-	-	6	18.00
F-1751	ALTERNATOR - BOSS 429	HX, FLNG BOLTS, 2 SPACERS, SPLIT WA	-	-	-	-	-	-	9	0	-	-	-	6	30.00
F-371	EXHAUST PIPE > MANIFOLD - 6 CYL	STUDS 2.25 OAL, HX LOCK NUTS	3	4	5	-	-	-	-	-	-	-	-	4	7.00
F-522	EXHAUST PIPE > MANIFOLD - 6 CYL	STUDS 2.25 OAL, FLNG NUTS	-	-	-	6	7	8	9	0	1	2	3	4	7.00
F-372	EXHAUST PIPE > MANIFOLDS - 289/352/390	STUDS 2.25 OAL, HX LOCK NUTS	3	4	5	-	-	-	-	-	-	-	-	8	10.00
F-524	EXHAUST PIPE > MANIFOLDS - 390/428/B429	STUDS 2.25 & 3.81 OAL, FLNG NUTS	-	-	-	6	7	8	9	0	1	-	-	8	12.00
F-523	EXHAUST PIPE > MANIFOLDS - SB, 69 390GT	STUDS 2.25 OAL, FLNG NUTS	-	-	-	6	7	8	9	0	1	2	3	8	10.00
F-1623	IGNITION COIL STRAP & BRKT - 351C/429	HX SPLIT SEMS, HXWA SCREW, HX NUT	-	-	-	-	-	-	0	1	2	3	3	3.00	
F-421	IGNITION COIL STRAP & BRKT - 6 CYL	HX SPLIT SEMS, HXWA SCREW, HX NUT	3	4	5	6	7	8	-	-	-	-	-	4	3.00
F-422	IGNITION COIL STRAP & BRKT - 6 CYL	HX SPLIT SEMS, HXWA SCREW, HX NUT	-	-	-	-	-	-	9	0	1	2	3	4	3.00
F-420	IGNITION COIL STRAP & BRKT - All V8	HX SPLIT SEMS, HXWA SCREW, HX NUT	3	4	5	6	7	-	-	-	-	-	-	3	3.00
F-376	IGNITION COIL STRAP & BRKT - V8 exc 351C	HX SPLIT SEMS, HXWA SCREW, HX NUT	-	-	-	-	-	8	9	0	1	2	3	3	3.00
F-3889	P/S PUMP - 200	FLNG & HX BOLTS, STUDS, WA'S	-	-	-	-	-	8	9	-	-	-	-	21	20.00
F-3894	P/S PUMP - 200	FLNG & HX BOLTS, FLAT & SPLIT WA'S	-	-	-	-	-	-	0	-	-	-	-	15	18.00
F-3890	P/S PUMP - 250	SRD FLNG BOLTS	-	-	-	-	-	-	9	0	1	2	3	7	8.00
F-3251	P/S PUMP - 260/289 w EATON PUMP	STUD, SPLIT SEMS, BOLT, SPACER, NUTS	3	4	5	-	-	-	-	-	-	-	-	10	16.00
F-703	P/S PUMP - 289 w FORD PUMP & AC	FLNG BOLTS & NUTS, FLAT WA	-	-	5	6	-	-	-	-	-	-	-	7	7.00
F-792	P/S PUMP - 289 w FORD PUMP w/o AC	SRD FLNG BOLTS, FLNG NUT, FLAT WA	-	-	5	6	-	-	-	-	-	-	-	7	10.00
F-647	P/S PUMP - 289/302 w AC	FLNG BOLTS, STUD, LOCK NUT	-	-	-	-	7	8	-	-	-	-	-	6	10.00
F-1074	P/S PUMP - 289/302 w/o AC	FLNG BOLTS, STUD, LOCK NUT, SPACER	-	-	-	-	-	7	8	9	-	-	-	7	18.00
F-3891	P/S PUMP - 302 BOSS w ADAPTER PLATE	FLNG BOLTS, STUD, FLNG NUT	-	-	-	-	-	-	9	-	-	-	-	8	16.00
F-648	P/S PUMP - 302 w AC	FLNG BOLTS, STUD, STRD FLNG NUT	-	-	-	-	-	-	9	-	-	-	-	6	10.00
F-1309	P/S PUMP - 302/351 w AC	FLNG BOLTS	-	-	-	-	-	-	0	1	2	3	6	20.00	
F-1308	P/S PUMP - 302/351W w/o AC	FLNG BOLTS, SPACER	-	-	-	-	-	-	-	0	1	2	3	8	24.00
F-1408	P/S PUMP - 351C w/o AC	FLNG BOLTS, SPACER	-	-	-	-	-	-	-	0	1	2	3	8	24.00
F-3892	P/S PUMP - 351W	FLNG BOLTS, BOLT	-	-	-	-	-	-	9	-	-	-	-	8	16.00
F-3943	P/S PUMP - 390 w AC	PLACE BOLTS, STUDS, LOCK NUTS	-	-	-	6	-	-	-	-	-	-	-	6	8.00
F-3942	P/S PUMP - 390 w/o AC	STUDS, NUTS, BOLTS, SPACERS	-	-	-	6	-	-	-	-	-	-	-	8	14.00
F-649	P/S PUMP - 390/428 w AC	FLNG BOLTS, STUD, LOCK NUT	-	-	-	-	7	8	-	-	-	-	-	8	12.00
F-650	P/S PUMP - 390/428 w AC	FLNG BOLTS, STUD, LOCK NUT	-	-	-	-	-	-	9	0	-	-	-	8	12.00
F-1154	P/S PUMP - 390/428 w/o AC	FLNG BOLTS, STUD, LOCK NUT, SPACER	-	-	-	-	7	8	-	-	-	-	-	9	18.00
F-1155	P/S PUMP - 390/428 w/o AC	FLNG BOLTS, STUD, LOCK NUT, SPACER	-	-	-	-	-	-	9	0	-	-	-	9	18.00
F-1335	P/S PUMP - 429 BOSS	FLNG & HX BOLTS, GOLD SPACER	-	-	-	-	-	-	9	0	-	-	-	8	25.00
F-3295	P/S PUMP - 429 w AC	FLNG BOLTS, STUD, LOCK NUTS, SPACER	-	-	-	-	-	-	-	0	1	-	-	11	12.00
F-3294	P/S PUMP - 429 w/o AC	FLNG BOLTS, STUD, LOCK NUTS, SPACER	-	-	-	-	-	-	-	0	1	-	-	12	22.00
F-794	P/S PUMP - 6 CYL	HX FLNG & PLACE BOLTS, BOLTS, WA'S	-	-	-	6	-	-	-	-	-	-	-	13	14.00
F-3888	P/S PUMP - 6 CYL	FLNG & PLACE BOLTS, HX BOLTS, WA'S	-	-	-	-	7	-	-	-	-	-	-	14	14.00
F-3250	P/S PUMP - 6 CYL w EATON PUMP	HX BOLTS, HX SPLIT SEMS, WA'S	3	4	5	-	-	-	-	-	-	-	-	12	10.00
F-793	P/S PUMP - 6 CYL w FORD PUMP	HX FLNG, HX & PLACE BOLTS, WA'S	-	-	5	-	-	-	-	-	-	-	-	13	14.00
F-1194	PCV HOSES - 390/428	4 WIRE CLAMPS	-	-	-	-	7	8	9	0	-	-	-	4	4.00
F-1197	PCV HOSES - BOSS 302	2 WIRE CLAMPS	-	-	-	-	-	-	9	0	-	-	-	2	2.50
F-1198	PCV HOSES - BOSS 429	1 WIRE CLAMP	-	-	-	-	-	-	9	0	-	-	-	1	2.00
F-1278	PCV VALVE ELBOW - 390/428	1/4" NPT > 1/2" HOSE STEEL ELBOW	-	-	-	-	7	8	9	0	-	-	-	1	20.00
F-1648	SMOG PUMP - 289	BOLTS, SPACERS, LOK TAB, NUTS, WA'S	-	-	-	6	7	-	-	-	-	-	-	16	26.00
F-1649	SMOG PUMP - 289/302	BOLTS, CONI SEMS, SPACER, NUTS, WA'S	-	-	-	-	-	8	9	-	-	-	-	9	22.00
F-1762	SMOG PUMP - 390/428	BOLTS, SPACERS, LOK TAB, NUTS, WA'S	-	-	-	-	7	-	-	-	-	-	-	13	20.00
F-631	SMOG PUMP - 390/428	BOLTS, CONI SEMS, SPACER, NUTS, WA'S	-	-	-	-	-	8	9	0	-	-	-	5	16.00
F-1148	SMOG PUMP - BOSS 302	PLACE BOLT, HX CONI SEMS, FLNG NUTS	-	-	-	-	-	-	-	0	-	-	-	4	22.00
F-1336	SMOG PUMP - BOSS 429	HX BOLT, CONI SEMS, FLAT & SPLIT WA'S	-	-	-	-	-	-	9	0	-	-	-	4	20.00
F-1409	STARTER - 260/289/302/351	HXWA SPLIT SEMS, SILVER ZINC	3	4	5	6	7	-	-	-	-	-	-	2	3.50
F-1410	STARTER - 289/302/351	HXWA SPLIT SEMS, YLW ZINC	-	-	-	-	-	8	9	0	1	2	3	2	3.50
F-1604	STARTER - 6 CYL & 390/428	HX BOLTS, SPLIT WA'S	3	4	5	6	-	-	-	-	-	-	-	6	3.50
F-408	STARTER - 6 CYL & 390/428	HX SPLIT SEMS	-	-	-	-	7	8	9	0	1	2	3	3	4.00

See factory Assembly Manuals for illustrations

Ford Fastener Kits

Engine Mounting

(included in Chassis kits)

1965

PART #	APPLICATION	NOTES						PCS	PRICE
			Z	D	O	W	T		
F-1310	ENG INSULATOR > BLOCK - 260/289/289HP	(BLOCK BRKT'S 289HP) HX BOLTS, WA'S	Z	D	O	-	T	8	6.00
F-1449	ENG INSULATOR > BLOCK BRKT'S - 289HP	SPL CRG BOLTS, LOCK NUTS	Z	-	-	-	-	4	24.00
F-1447	ENG INSULATOR - 6 CYL	HX SPLIT SEMS, LOCK NUTS, FLAT WA'S	Z	D	-	-	-	8	6.00
F-803	ENG INSULATOR > BODY BRKT'S - 289	LOCK NUTS, FLAT WA'S	Z	-	-	-	-	8	6.00
F-1448	ENG INSULATOR > BODY BRKT'S - 289HP	LOCK NUTS, FLAT WA'S	Z	-	-	-	-	4	4.00
F-804	ENG BODY BRACKETS - ALL	POINTED HXWA BOLTS, FLNG NUTS	Z	-	-	-	-	12	18.00

1966

F-184	ENG INSULATOR & BLOCK BRKT'S - 390/428	HX BOLTS, LOCKNUTS, SPLIT WA'S	-	-	O	-	-	16	9.00
F-1310	ENG INSULATOR > BLOCK - 289	HX BOLTS, SPLIT WA'S	Z	D	O	-	T	8	6.00
F-1447	ENG INSULATOR - 6 CYL	HX SPLIT SEMS, LOCK NUTS, FLAT WA'S	Z	D	-	-	-	8	6.00
F-3902	ENG INSULATOR > BODY BRKT'S - 390/428	FLNG NUTS	-	-	O	-	-	2	3.00
F-753	ENG INSULATOR > BODY BRKT'S - M V8, R 289	4 3/4" BOLTS, FLNG NUTS, FLAT WA'S	Z	D	O	-	-	6	14.00
F-3899	ENG BODY BRACKETS - 289	HX BOLTS, FLNG NUTS	-	D	O	-	-	12	6.00
F-3448	ENG BODY BRACKETS - 390/427	HX BOLTS, FLNG NUTS	-	-	O	-	-	16	8.00
F-180	ENG BODY BRACKETS - 6 CYL	FLNG BOLTS & NUTS	Z	-	-	-	-	12	15.00
F-178	ENG BODY BRACKETS - V8	FLNG BOLTS & NUTS	Z	-	-	-	-	12	14.00

1967

F-182	ENG BLOCK BRACKETS - 6 CYL	HX SPLIT SEMS	Z	D	O	-	-	4	5.00
F-183	ENG INSULATOR > BLOCK - 289	HX BOLTS, SPLIT WA'S	Z	D	O	W	T	8	6.00
F-181	ENG INSULATOR & BLOCK BRKT'S - 6 CYL	HX BOLTS, LOCK NUTS, FLAT, SPLIT WA'S	Z	D	O	-	-	14	10.00
F-184	ENG INSULATOR & BLOCK BRKT'S - 390/428	HX BOLTS, LOCKNUTS, SPLIT WA'S	Z	D	O	W	T	16	9.00
F-3902	ENG INSULATOR > BODY BRKT'S - 390/428	FLNG NUTS	-	-	O	-	-	2	3.00
F-753	ENG INSULATOR > BODY BRKT'S - M V8, R 289	4 3/4" BOLTS, FLNG NUTS, FLAT WA'S	Z	D	O	W	-	6	14.00
F-3899	ENG BODY BRACKETS - 289	HX BOLTS, FLNG NUTS	-	D	O	-	-	12	6.00
F-3448	ENG BODY BRACKETS - 390/427	HX BOLTS, FLNG NUTS	-	-	O	-	-	16	8.00
F-180	ENG BODY BRACKETS - 6 CYL	FLNG BOLTS & NUTS	Z	-	-	-	-	12	15.00
F-178	ENG BODY BRACKETS - V8	FLNG BOLTS & NUTS	Z	-	-	W	-	12	14.00

1968

F-182	ENG BLOCK BRACKETS - 6 CYL	HX SPLIT SEMS	Z	-	O	-	-	4	5.00
F-752	ENG INSULATOR > BLOCK - 289/302/351	SPL FLNG BOLTS	Z	-	O	W	T	4	6.00
F-181	ENG INSULATOR & BLOCK BRKT'S - 6 CYL	HX BOLTS, LOCK NUTS, FLAT, SPLIT WA'S	Z	-	O	-	-	14	10.00
F-184	ENG INSULATOR & BLOCK BRKT'S - 390/428	HX BOLTS, LOCKNUTS, SPLIT WA'S	Z	-	O	W	T	16	9.00
F-3902	ENG INSULATOR > BODY BRKT'S - 390/428	FLNG NUTS	-	-	O	-	-	2	3.00
F-753	ENG INSULATOR > BODY BRKT'S - M V8, R SB	4 3/4" BOLTS, FLNG NUTS, FLAT WA'S	Z	-	O	W	-	6	14.00
F-3900	ENG BODY BRACKETS - 302/351	HX BOLTS, FLNG NUTS	-	-	O	-	-	12	6.00
F-3901	ENG BODY BRACKETS - 390/428	HX BOLTS, FLNG NUTS	-	-	O	-	-	16	8.00
F-180	ENG BODY BRACKETS - 6 CYL	FLNG BOLTS & NUTS	Z	-	-	-	-	12	15.00
F-178	ENG BODY BRACKETS - V8	FLNG BOLTS & NUTS	Z	-	-	W	-	12	14.00

1969

F-175	ENG BLOCK BRACKETS - 6 CYL	HX SPLIT SEMS	Z	-	O	-	-	6	6.00
F-752	ENG INSULATOR > BLOCK - 302/351	SPL FLNG BOLTS	Z	-	O	W	T	4	6.00
F-187	ENG INSULATOR & BLK BRKT'S - 390/428/429	SPL FLNG BOLTS, LOCKNUTS	Z	-	O	W	T	10	14.00
F-174	ENG INSULATOR - 6 CYL	LOCK NUTS, FLAT WA'S	Z	-	O	-	-	8	6.00
F-3902	ENG INSULATOR > BODY BRKT'S - 390/428	FLNG NUTS	-	-	O	-	-	2	3.00
F-1269	ENG INSULATOR > BODY BRKT'S - BOSS 429	SPL UBS FLNG BOLTS & NUTS	Z	-	-	-	-	4	26.00
F-753	ENG INSULATOR > BODY BRKT'S - M V8, R SB	4 3/4" BOLTS, FLNG NUTS, FLAT WA'S	Z	-	O	W	-	6	14.00
F-3900	ENG BODY BRACKETS - 302/351	HX BOLTS, FLNG NUTS	-	-	O	-	-	12	6.00
F-3901	ENG BODY BRACKETS - 390/428	HX BOLTS, FLNG NUTS	-	-	O	-	-	16	8.00
F-173	ENG BODY BRACKETS - 6 CYL	UBS FLNG BOLTS & NUTS	Z	-	-	-	-	12	18.00
F-179	ENG BODY BRACKETS - V8	UBS FLNG BOLTS & NUTS	Z	-	-	W	-	12	18.00

Engine Mounting										
(included in Chassis kits)										
1970										
PART #	APPLICATION	NOTES						PCS	PRICE	
			Z	D	O	W	T			
F-175	ENG BLOCK BRACKETS - 6 CYL	HX SPLIT SEMS	Z	-	O	-	-	6	6.00	
F-752	ENG INSULATOR > BLOCK - 302/351	SPL FLNG BOLTS	Z	-	O	W	T	4	6.00	
F-1450	ENG INSULATOR & BLOCK BRKT'S - 428/429	SPL FLNG BOLTS, LOCK NUTS	Z	-	-	W	T	10	12.00	
F-174	ENG INSULATOR - 6 CYL	LOCK NUTS, FLAT WA'S	Z	-	O	-	-	8	6.00	
F-1269	ENG INSULATOR > BODY BRKT'S - BOSS 429	SPL UBS FLNG BOLTS & NUTS	Z	-	-	-	-	4	26.00	
F-467	ENG INSULATOR > BODY BRKT'S - V8	4 3/8" UBS FLNG BOLTS & NUTS	Z	-	O	W	-	4	8.00	
F-173	ENG BODY BRACKETS - 6 CYL	UBS FLNG BOLTS & NUTS	Z	-	-	-	-	12	18.00	
F-1314	ENG BODY BRACKETS - V8	UBS FLNG BOLTS & NUTS	Z	-	-	W	-	12	18.00	
F-853	ENG BODY BRACKETS - V8	UBS FLNG BOLTS & NUTS	-	-	O	-	-	16	15.00	

1971-73										
PART #	APPLICATION	NOTES						PCS	PRICE	
			Z	D	O	W	T			
F-175	ENG INSULATOR > BLOCK - 6 CYL	HX SPLIT SEMS	Z	-	O	-	-	6	6.00	
F-752	ENG INSULATOR > BLOCK - 302/351	SPL FLNG BOLTS	Z	-	O	W	T	4	6.00	
F-1450	ENG INSULATOR & BLOCK BRKT'S - 429	SPL FLNG BOLTS, LOCK NUTS	Z	-	O	W	T	10	12.00	
F-467	ENG INSULATOR > BODY BRKT'S - ALL	4 3/8" UBS FLNG BOLTS & NUTS	Z	-	O	W	-	4	8.00	
F-1498	ENG BODY BRACKETS - 6 CYL	UBS FLNG BOLTS & NUTS	Z	-	-	-	-	12	12.00	
F-853	ENG BODY BRACKETS - V8	UBS FLNG BOLTS & NUTS	Z	-	O	W	-	16	15.00	

Engine Mounting Junior Kits

(included in Chassis kits)

Includes all applicable individual kits from the preceding section.

Part #	Year	Model	Engine	Pcs	Price
65Z-EMSX	1965	Mustang	170/200	20	\$ 24
65Z-EMSB	1965	Mustang	260/289	28	\$ 30
65Z-EMHP	1965	Mustang/Shelby	289HP	28	\$ 50
66Z-EMSX	1966	Mustang	170/200	20	\$ 21
66Z-EMSB	1966	Mustang/Shelby	289/289HP	26	\$ 34
67Z-EMSX	1967-68	Mustang	200	30	\$ 28
67Z-EMSB	1967	Mustang/Cougar/Shelby	289/289HP	26	\$ 34
67Z-EMBB	1967-68	Mustang/Cougar/Shelby	390/428	34	\$ 37
68Z-EMSB	1968	Mustang/Cougar/Shelby	289/302	22	\$ 34
69Z-EMSX	1969-70	Mustang	200/250	26	\$ 30
69Z-EMSB	1969	Mustang/Cougar/Shelby	302/351	22	\$ 38
69Z-EMBB	1969	Mustang/Cougar/Shelby	390/428	28	\$ 46
69Z-EMB9	1969	Mustang	BOSS 429	26	\$ 58
70Z-EMSB	1970	Mustang/Cougar	302/351	20	\$ 32
70Z-EMBB	1970	Mustang/Cougar	428	26	\$ 38
70Z-EMB9	1970	Mustang	BOSS 429	26	\$ 56
71Z-EMSX	1971-73	Mustang	250	22	\$ 26
71Z-EMSB	1971-73	Mustang/Cougar	302/351	24	\$ 29
71Z-EMBB	1971	Mustang/Cougar	429	30	\$ 29
66O-EMSB	1966	Fairlane	289	26	\$ 26
66O-EMBB	1966-67	Fairlane	390/427	34	\$ 20
67O-EMSB	1967	Fairlane	289	26	\$ 26
68O-EMSB	1968-69	Fairlane	289/302/351	22	\$ 26
68O-EMBB	1968	Fairlane	390/428	34	\$ 20
69O-EMBB	1969	Fairlane	390/428	28	\$ 25
70O-EMSB	1970-71	Fairlane	302/351	24	\$ 29
70O-EMBB	1970-71	Fairlane	429	30	\$ 35

Ford Master Kits

INTERIOR



A comprehensive interior assembly fastener kit !

Each application within the Master kit is separately packaged so you know exactly where it goes.

Use this kit in conjunction with the factory assembly manuals.

Most oval head sheet metal screws in our kits are now stainless with chrome, black or zinc finish.

Save up to 25% over the individual kit price.

Typical kit includes fasteners to attach: air vent duct, ash tray & liner, carpet, coat hooks, console, courtesy lamps, dash pad & mouldings, door handles, armrests, dome lamp, door panels & grilles, glove box & liner, glove box latch & catch, headliner retainers, heater control, horn pad, instrument cluster & finish panels, kick panels, mirror bracket, package tray, quarter trim panels, radio bezel, rear seat, scuff plates, seat back adjustment, seat back release, seat mouldings, seat track to body, shifter boot, sun visors & bracket, window crank handles, windshield pillar mouldings and windshield top inside mouldings. Details at www.amkproducts.com/Ford_Master_Kits.asp

Part #	Year	Model	Body	Interior	Pcs	Price
65Z-63A	1965-66	Mustang/Shelby	Fastback	Standard	457	\$ 125
65Z-63B	1965-66	Mustang	Fastback	Deluxe	457	\$ 125
65Z-65A	1965-66	Mustang	Coupe	Standard	236	\$ 85
65Z-65B	1965-66	Mustang	Coupe	Deluxe	248	\$ 85
65Z-76A	1965-66	Mustang	Convertible	Standard	250	\$ 85
65Z-76B	1965-66	Mustang	Convertible	Deluxe	260	\$ 85
67Z-63A*	1967	Mustang	Fastback	Standard	361	\$ 110
67Z-63B*	1967	Mustang/Shelby	Fastback	Deluxe	439	\$ 125
67Z-65A	1967	Mustang	Coupe	Standard	218	\$ 85
67Z-65B	1967	Mustang	Coupe	Deluxe	309	\$ 100
67Z-76A	1967	Mustang	Convertible	Standard	237	\$ 85
67Z-76B	1967	Mustang	Convertible	Deluxe	326	\$ 105
68Z-63*	1968	Mustang/Shelby	Fastback	All	398	\$ 125
68Z-65	1968	Mustang	Coupe	All	269	\$ 90
68Z-76	1968	Mustang/Shelby	Convertible	All	280	\$ 90
69Z-63*	1969	Mustang/Shelby	Fastback	All	377	\$ 110
69Z-65	1969	Mustang	Coupe	All	320	\$ 100
69Z-76	1969	Mustang/Shelby	Convertible	All	329	\$ 100

* Folding Seat was optional on 1967-73 fastbacks - purchase this kit separately. 1965-66 kits include FDS

INTERIOR

Part #	Year	Model	Body	Interior	Pcs	Price
70Z-63D*	1970	Mustang	Fastback	Dark Color	371	\$ 110
70Z-63L*	1970	Mustang	Fastback	Light Color	371	\$ 110
70Z-65D	1970	Mustang	Coupe	Dark Color	314	\$ 100
70Z-65L	1970	Mustang	Coupe	Light Color	314	\$ 100
70Z-76D	1970	Mustang	Convertible	Dark Color	323	\$ 100
70Z-76L	1970	Mustang	Convertible	Light Color	323	\$ 100
71Z-63D*	1971-73	Mustang	Fastback	Dark Color	323	\$ 100
71Z-63L*	1971-73	Mustang	Fastback	Light Color	323	\$ 100
71Z-65D	1971-73	Mustang	Coupe	Dark Color	253	\$ 85
71Z-65L	1971-73	Mustang	Coupe	Light Color	253	\$ 85
71Z-76D	1971-73	Mustang	Convertible	Dark Color	231	\$ 85
71Z-76L	1971-73	Mustang	Convertible	Light Color	231	\$ 85
67W-65A	1967	Cougar	Coupe	Standard	244	\$ 75
67W-65B	1967	Cougar	Coupe	Deluxe	274	\$ 85
68W-65A	1968	Cougar	Coupe	Standard	268	\$ 75
68W-65B	1968	Cougar	Coupe	Deluxe	301	\$ 85

Seat Belt Mounting Kits

These kits include the original style bolts (chrome or yellow color) and rubber/steel washers. Bolts are locking type like originals. Late 68-73 Torx lap belt bolts have slightly different head shape from original.



PART #	APPLICATION	NOTES	1960's YEAR			1970's YEAR			PCS	PRICE			
F-3996	SEAT BELTS (Fr) - BODY 63, 65	CHROME BOLTS, RUBBER & STEEL WA'S	5	6	-	-	-	-	12	24.00			
F-3997	SEAT BELTS (Fr) - BODY 76	CHROME BOLTS, RUBBER & STEEL WA'S	5	6	-	-	-	-	8	22.00			
F-3563	SEAT BELTS (Fr) - SHOULDER STRAPS	TORX SHLDR BOLTS, CHROME SPACERS	-	-	7	8	9	0	1	2	3	4	14.00
F-3560	SEAT BELTS (Fr) < 2-29-68	HX BOLTS, SPACERS, RUBBER WA'S	-	-	7	8	-	-	-	-	-	14	26.00
F-3562	SEAT BELTS (Fr) 2-29-68 >	TORX BOLTS, RUBBER WA'S, SPACERS	-	-	-	8	-	-	-	-	-	14	20.00
F-3561	SEAT BELTS (Fr)	TORX BOLTS, RUBBER WA'S, SPACERS	-	-	-	-	9	0	1	2	3	12	16.00
F-3564	SEAT BELTS (Fr) or (Rr) - 1964 1/2	EYE BOLTS (not exactly like original)	5	-	-	-	-	-	-	-	-	4	12.00
F-3998	SEAT BELTS (Rr)	HX BOLTS	5	6	-	-	-	-	-	-	-	4	16.00
F-3565	SEAT BELTS (Rr) < 2-29-68	HX BOLTS, SPACERS	-	-	7	8	-	-	-	-	-	8	20.00
F-3566	SEAT BELTS (Rr) 2-29-68 >	TORX BOLTS, SPACERS	-	-	-	8	9	0	1	2	3	8	14.00

Fastback

Folding Seat & Trap Door Junior Kits

These kits include fasteners to attach: stop plates Rr floor panel, side latches, rubber bumpers for trap door, trap door door latch & catch, door hinges, prop rod & bracket and all seat trim.



Part #	Year	Pcs	Price
65Z-FDS*	1965	112	\$ 28
66Z-FDS*	1966	114	\$ 28
67Z-FDS	1967	126	\$ 32
68Z-FDS	1968	120	\$ 32
69Z-FDS	1969	136	\$ 32
70Z-FDS	1970	136	\$ 32
71Z-FDS	1971-73	121	\$ 32

* Folding Seat was optional on 1967-73 fastbacks - purchase this kit separately. *1965-66 kits include FDS.

Ford Master Kits

CHASSIS



The fasteners you need to properly reassemble your cars' chassis in one package !

Save up to 25% from individual kit prices.

Typical kit includes O.E. fasteners to attach: accelerator bellcrank, rear axle retainers/rear brake plates, front brake plates, brake booster, brake cables, brake calipers, brake drums, brake hoses, spring perches, control arms, front crossmember, axle housing, differential carrier, driveshaft, engine mounts, gas cap, gas tank, filler neck, idler arm, leaf spring front eye, master cylinder, parking brake control, pitman arm, proportioning valve, rag joint, front shocks, shock brackets, steering gear, steering linkage, strut rods, suspension bumpers, sway bar insulator brackets, transmission crossmember, trans insulator, wheel cylinders. Details at www.amkproducts.com/Ford_Master_Kits.asp

Part #	Year	Model	Engine	Fr Brakes	Pcs	Price
65Z-DRSX	1964-65	Mustang/Falcon	170/200	Drum	310	\$ 245
65Z-DRSB	1964-65	Mustang/Falcon	260/289	Drum	387	\$ 260
65Z-DCSB	1964-65	Mustang/Falcon	260/289	Disc	356	\$ 290
65Z-DCHP	1965	Mustang/Shelby	289HP	Disc	357	\$ 310
66Z-DRSX	1966	Mustang	170/200	Drum	304	\$ 240
66Z-DRSB	1966	Mustang	289	Drum	329	\$ 280
66Z-DCSB	1966	Mustang/Shelby	289/289HP	Disc	348	\$ 310
67Z-DRSX	1967	Mustang	200	Drum	347	\$ 265
67Z-DRSB	1967	Mustang	289	Drum	341	\$ 285
67W-DRSB	1967	Cougar	289	Drum	329	\$ 285
67Z-DCSB	1967	Mustang/Shelby	289/289HP	Disc	366	\$ 310
67W-DCSB	1967	Cougar	289/289HP	Disc	359	\$ 310
67Z-DCBB	1967	Mustang/Shelby	390/428	Disc	374	\$ 300
67W-DCBB	1967	Cougar	390	Disc	349	\$ 300
68Z-DRSX	1968	Mustang	200	Drum	361	\$ 285
68Z-DRSB	1968	Mustang	289/302	Drum	346	\$ 295
68W-DRSB	1968	Cougar	289/302	Drum	340	\$ 295
68Z-DCSB	1968	Mustang/Shelby	289/302	Disc	359	\$ 315
68W-DCSB	1968	Cougar	289/302	Disc	350	\$ 315
68Z-DCBB	1968	Mustang/Shelby	390/428	Disc	371	\$ 330
68W-DCBB	1968	Cougar	390/428	Disc	362	\$ 330

CHASSIS

Part #	Year	Model	Engine	Fr Brakes	Pcs	Price
69Z-DRSS	1969	Mustang	200	Drum	348	\$ 280
69Z-DRSX	1969	Mustang	250	Drum	366	\$ 305
69Z-DRSB	1969	Mustang	302/351	Drum	334	\$ 315
69W-DRSB	1969	Cougar	302/351	Drum	333	\$ 315
69Z-DCSB	1969	Mustang	302/351	Disc	354	\$ 340
69W-DCSB	1969	Cougar	302/351	Disc	352	\$ 350
69Z-DCSB	1969	Shelby < 4/69	351	Disc	354	\$ 340
69Z-HDSB**	1969	Shelby 4/69 >	351	Disc	348	\$ 340
69Z-HDSB**	1969	Mustang	302 Boss	Disc	348	\$ 340
69W-HDSB**	1969	Cougar	302 Boss	Disc	344	\$ 350
69Z-DRBB	1969	Mustang	390/428	Drum	342	\$ 320
69Z-DCBB	1969	Mustang	390/428	Disc	360	\$ 340
69W-DCBB	1969	Cougar	390/428	Disc	356	\$ 350
69Z-DCBB	1969	Shelby < 4/69	428	Disc	360	\$ 340
69M-HDBB**	1969	Shelby 4/69 >	428	Disc	330	\$ 360
69Z-HDBG	1969	Mustang	429 Boss	Disc	367	\$ 390
70Z-DRSS	1970	Mustang	200	Drum	331	\$ 265
70Z-DRSX	1970	Mustang	250	Drum	349	\$ 295
70Z-DRSB	1970	Mustang	302/351	Drum	327	\$ 285
70W-DRSB	1970	Cougar	302/351	Drum	324	\$ 285
70Z-DCSB	1970	Mustang	302/351	Disc	334	\$ 325
70W-DCSB	1970	Cougar	302/351	Disc	330	\$ 325
70Z-HDSB**	1970	Mustang	302 Boss/351	Disc	336	\$ 330
70W-HDSB**	1970	Cougar	302 Boss/351	Disc	312	\$ 330
70Z-DRBB	1970	Mustang	428	Drum	364	\$ 320
70Z-HDBB**	1970	Mustang	428	Disc	360	\$ 340
70W-HDBB**	1970	Cougar	428	Disc	342	\$ 340
70Z-HDBG	1970	Mustang	429 Boss	Disc	359	\$ 360
71Z-DRSX	1971-73	Mustang	250	Drum	310	\$ 275
71Z-DCSX	1971-73	Mustang	250	Disc	305	\$ 295
71Z-DRSB	1971-73	Mustang/Cougar	302/351	Drum	316	\$ 300
71Z-DCSB	1971-73	Mustang/Cougar	302/351	Disc	311	\$ 320
71Z-DCBB	1971	Mustang/Cougar	429	Disc	313	\$ 310
66O-DRSB	1966	Fairlane	289	Drum	309	\$ 265
66O-DRBB	1966	Fairlane	390/427	Drum	324	\$ 275
67O-DRSB	1967	Fairlane	289	Drum	276	\$ 265
67O-DCSB	1967	Fairlane	289	Disc	314	\$ 275
67O-DCBB	1967	Fairlane	390/427	Disc	331	\$ 285
68O-DRSB	1968	Fairlane	289/302	Drum	296	\$ 270
68O-DCSB	1968	Fairlane	289/302	Disc	312	\$ 310
68O-DCBB	1968	Fairlane	390/428	Disc	329	\$ 315
69O-DRSB	1969	Fairlane	302/351	Drum	296	\$ 275
69O-DCSB	1969	Fairlane	302/351	Disc	313	\$ 320
69O-DCBB	1969	Fairlane	390/428	Disc	324	\$ 325
70O-DRSB	1970-71	Torino	302/351	Drum	299	\$ 280
70O-DCSB	1970-71	Torino	302/351	Disc	314	\$ 325
70O-DCBB	1970-71	Torino	429	Disc	328	\$ 340



** HD Suspension identified by 1/2-20 tie rod studs starting April 1969 or by rear stabilizer in 1970

Ford Junior Kits

Brake & Fuel Lines



Includes all the correct clips, screws and rubber grommets needed to assemble the brake & fuel hard lines to the body.

Many items are made by the original suppliers.

Part #	Year	Model	Engine	Fr Brakes	Pcs	Price
65Z-BF6	1965-66	Mustang	6 Cyl	Drum	19	\$ 33
65Z-BF8	1965-66	Mustang	V-8	Drum	21	\$ 34
65Z-BFD	1965-66	Mustang/Shelby	V-8	Disc	21	\$ 34
67Z-BF61	1967	Mustang	6 w 1 pc line (early)	All	26	\$ 36
67Z-BF62H	1967	Mustang - Hardtop	6 w 2 pc line	All	32	\$ 46
67Z-BF62C	1967	Mustang - Convertible	6 w 2 pc line	All	31	\$ 42
67Z-BF81	1967	Mustang/Shelby	V-8 w 1 pc line	All	28	\$ 38
67Z-BF82H	1967	Mustang/Shelby - Hardtop	V-8 w 2 pc line	All	34	\$ 48
67Z-BF82C	1967	Mustang - Convertible	V-8 w 2 pc line	All	33	\$ 44
68Z-BF6H	1968	Mustang - Hardtop	6 Cyl	All	32	\$ 45
68Z-BF6C	1968	Mustang - Convertible	6 Cyl	All	33	\$ 43
68Z-BF8H	1968	Mustang/Shelby - Hardtop	V-8	All	34	\$ 46
68Z-BF8C	1968	Mustang/Shelby - Conv	V-8	All	35	\$ 45
69Z-BF6H	1969	Mustang - Hardtop	6 Cyl	All	31	\$ 46
69Z-BF6C	1969	Mustang - Convertible	6 Cyl	All	32	\$ 45
69Z-BF8H	1969	Mustang/Shelby - Hardtop	V-8	All	33	\$ 48
69Z-BF8C	1969	Mustang/Shelby - Conv	V-8	All	34	\$ 46
70Z-BF6H	1970	Mustang - Hardtop	6 Cyl	All	35	\$ 45
70Z-BF6C	1970	Mustang - Convertible	6 Cyl	All	36	\$ 43
70Z-BF8H	1970	Mustang - Hardtop	V-8	All	37	\$ 46
70Z-BFHV	1970	Mustang - Hardtop	V-8 w Fuel Vapor *	All	37	\$ 52
70Z-BF8C	1970	Mustang - Convertible	V-8	All	38	\$ 45
70Z-BFCV	1970	Mustang - Convertible	V-8 w Fuel Vapor *	All	38	\$ 50
71Z-BF6DR	1971-73	Mustang	6 Cyl	All	41	\$ 54
71Z-BF8DR	1971-73	Mustang	V-8	Drum	46	\$ 59
71Z-BF8DC	1971-73	Mustang	V-8	Disc	46	\$ 59

* California Evaporative Emission System located in trunk area.



Air Conditionng

The fasteners you need to attach AC components to the engine.

Typical kit does:

brush & holder assembly, compressor, compressor bracket & braces, compressor clutch, idler pulleys.



Part #	Year	Model	Engine	Pcs	Price
65Z-AC200	1965	ALL	170/200	35	\$ 26
65Z-AC289	1965	ALL	289	23	\$ 24
66Z-AC200	1966-67	ALL	200	32	\$ 24
66Z-AC289	1966	ALL	289	22	\$ 22
67Z-AC289	1967	ALL	289	23	\$ 26
67Z-AC390	1967	ALL	390/428	25	\$ 30
68Z-AC200	1968	ALL	200	16	\$ 20
68Z-AC289	1968	ALL	289/302	23	\$ 30
68Z-AC390	1968	ALL	390/428	26	\$ 32
69Z-AC200	1969	ALL	200/250	18	\$ 22
69Z-AC302	1969	ALL	302/351	23	\$ 28
69Z-AC390	1969-70	ALL	390/428	27	\$ 32
70Z-AC200	1970-73	ALL	200/250	18	\$ 22
70Z-AC302	1970-73	ALL	302/351	27	\$ 32
70O-AC429	1970-71	ALL	429	27	\$ 30

Wiring Clip Kits

Common wiring clips (not all clips on the car are included)

Typical kit does wiring at:

Battery tray, crossmember, doors, engine feed, fender apron, firewall, gas tank sender, horns, parking lamps, tailamp, under-dash

See website for contents.



Part #	Year	Model	Engine	Pcs	Price
65Z-WC	1965-66	Mustang	All	46	\$ 40
67Z-WC	1967	Mustang	All	27	\$ 28
68Z-WC	1968	Mustang	All	28	\$ 30
69Z-WC	1969	Mustang	All	54	\$ 50
70Z-WC	1970	Mustang	All	47	\$ 55
71Z-WC	1971-73	Mustang	All	48	\$ 32

Ford Detailing Kits

Underhood - Factory



This kit is intended to greatly improve the underhood appearance of an assembled car. Particularity one with incorrect or unsightly fasteners.

Typical kit does: battery holddown, booster hose, cowl braces, cowl panel, fan shroud (67-73), headlamp ground, fender tops, grille, grille bars & ornaments, headlamp doors, heater box, hood & hinges, horns, hood latch & catch & support braces, shocks & brackets, shock tower braces, starter solenoid, voltage regulator, washer bottle & nozzles, washer pump, wiper motor, wiring straps. Details at www.amkproducts.com/Ford_Master_Kits.asp

Part #	Year	Model	Engine	Pcs	Price
65Z-UH	1965	Mustang	All	197	\$ 110
66Z-UH	1966	Mustang	All	176	\$ 100
67Z-UH	1967	Mustang	All	153	\$ 100
68Z-UH	1968	Mustang	All	173	\$ 100
69Z-UH	1969	Mustang	All	176	\$ 120
70Z-UH	1970	Mustang	All	173	\$ 120
71Z-UH	1971	Mustang	All	134	\$ 100
72Z-UH	1972	Mustang	All	129	\$ 100
73Z-UH	1973	Mustang	All	125	\$ 100
65M-UH	1965	Shelby	All	168	\$ 100
66M-UH	1966	Shelby	All	176	\$ 100
67M-UH	1967	Shelby	All	218	\$ 120
68M-UH	1968	Shelby	All	170	\$ 120
69M-UH	1969-70	Shelby	All	235	\$ 135
67W-UH	1967	Cougar	All	193	\$ 120
68W-UH	1968	Cougar	All	200	\$ 120
69W-UH	1969	Cougar	All	195	\$ 120
70W-UH	1970	Cougar	All	178	\$ 115
66O-UH	1966-67	Fairlane	All	131	\$ 70
66G-UH	1966-67	Comet	All	155	\$ 90

Underhood Kit (-) Master Kits

For those who have purchased Master Body, Chassis & Wiring Clip kits - duplicate items are removed.

65Z-XU	1965	Mustang/Shelby	All	29	\$ 20
66Z-XU	1966	Mustang/Shelby	All	23	\$ 20
67Z-XU	1967	Mustang	All	33	\$ 25
68Z-XU	1968	Mustang	All	51	\$ 30
69Z-XU	1969	Mustang	All	42	\$ 35
70Z-XU	1970	Mustang	All	43	\$ 35
71Z-XU	1971	Mustang	All	28	\$ 30
72Z-XU	1972-73	Mustang	All	28	\$ 30
67M-XU	1967	Shelby	All	37	\$ 30
68M-XU	1968	Shelby	All	37	\$ 30
69M-XU	1969-70	Shelby	All	44	\$ 35
67W-XU	1967	Cougar	All	33	\$ 25
68W-XU	1968	Cougar	All	33	\$ 25
69W-XU	1969	Cougar	All	37	\$ 30
70W-XU	1970	Cougar	All	38	\$ 30

Underhood - Stainless

High quality USA made stainless steel for the underhood area.

Body bolts are special AMK engineered screw & washer assemblies.



Typical kit attaches:

cowl or export braces, fender tops, hood & hinges, suspension bumper brackets, hood latch & catch & supports, grille, horns, shocks & brackets, starter solenoid, voltage regulator, washer bottle & pump & nozzles. No U-nuts. Details at www.amkproducts.com/Ford_Master_Kits.asp

Part #	Year	Model	Engine	Pcs	Price
65Z-SD	1965-66	Mustang	All	168	\$ 110
67Z-SD	1967-68	Mustang	All	129	\$ 100
69Z-SD	1969-70	Mustang	All	136	\$ 100
71Z-SD	1971-73	Mustang	All	111	\$ 80

Individual Stainless Kits

PART #	APPLICATION	NOTES	1960's YEAR			1970's YEAR			PCS	PRICE			
F-3839	EXPORT or COWL BRACES	STAINLESS HX BOLTS, NUTS, WA'S	5	6	-	-	-	-	32	14.00			
F-3850	EXPORT or COWL BRACES	STAINLESS HX BOLTS, NUTS, WA'S	-	-	7	8	9	0	1	2	3	16	10.00
F-3845	FENDER TOPS ONLY	STAINLESS HX CONI SEMS	5	6	7	8	9	0	-	-	-	12	16.00
F-3861	FENDER TOPS ONLY	STAINLESS HX CONI SEMS	-	-	-	-	-	-	1	2	3	12	10.00
F-3837	GRILLE	STAINLESS HXWA A SCREWS	5	6	-	-	-	-	-	-	-	8	3.00
F-3848	GRILLE	STAINLESS HX CONI SEMS, SCREWS	-	-	7	8	-	-	-	-	-	5	4.00
F-3857	GRILLE SUPPORT	STAINLESS HX CONI SEMS, NUTS & WA'S	-	-	-	-	9	0	-	-	-	4	3.00
F-3834	HOOD & HINGES	STAINLESS HX CONI SEMS	5	6	7	8	9	0	1	2	3	10	14.00
F-3847	HOOD LATCH & SUPPORT	STAINLESS BODY BOLTS	-	-	7	8	9	0	-	-	-	7	10.00
F-3858	HOOD LATCH & SUPPORT	STAINLESS BODY BOLTS	-	-	-	-	-	-	1	2	3	10	14.00
F-3836	HOOD LATCH & SUPPORT BRACES	STAINLESS BODY BOLTS, NUTS, WA'S	5	6	-	-	-	-	-	-	-	12	12.00
F-3838	HOOD LATCH AUXILLIARY CATCH	STAINLESS BODY BOLTS	5	6	-	-	-	-	-	-	-	2	3.00
F-3844	HORNS	STAINLESS HX CONI SEMS, NUTS, WA'S	5	6	7	8	9	0	-	-	-	6	4.00
F-3862	HORNS	STAINLESS HX CONI SEMS	-	-	-	-	-	-	1	2	3	2	3.00
F-3841	SHOCK BRACKETS (Fr)	STAINLESS CRG BOLTS, NUTS, WA'S	5	6	-	-	-	-	-	-	-	18	10.00
F-3851	SHOCK BRACKETS (Fr)	STAINLESS CRG BOLTS, NUTS, WA'S	-	-	7	8	9	0	-	-	-	18	12.00
F-3860	SHOCK BRACKETS (Fr)	STAINLESS CRG BOLTS, NUTS, WA'S	-	-	-	-	-	-	1	2	3	18	8.00
F-3835	SHOCK TOWER BRACES	STAINLESS HX CONI SEMS, NUTS, WA'S	5	6	-	-	-	-	-	-	-	48	25.00
F-3849	SHOCK TOWER BRACES	STAINLESS HX CONI SEMS, NUTS, WA'S	-	-	7	8	9	0	-	-	-	36	22.00
F-3859	SHOCK TOWER BRACES	STAINLESS HX CONI SEMS, NUTS, WA'S	-	-	-	-	-	-	1	2	3	32	16.00
F-3840	SHOCKS (Fr) - TOP MOUNTING ONLY	STAINLESS HX BOLTS, FLAT WA'S	5	6	-	-	-	-	-	-	-	8	6.00
F-3853	SHOCKS (Fr) - TOP MOUNTING ONLY	STAINLESS HX BOLTS, FLAT WA'S	-	-	7	8	9	0	-	-	-	8	6.00
F-3846	STARTER SOLENOID & VOLT REG	STAINLESS HXWA SCREWS, EXT WA	5	6	7	8	9	0	1	2	3	5	3.00
F-3854	WASHER BOTTLE	STAINLESS HXWA AB SCREWS	-	-	7	8	9	0	1	2	3	3	2.00
F-3852	WASHER NOZZLES & TEE	STAINLESS HXWA AB SCREWS	-	-	7	8	9	0	-	-	-	3	2.00
F-3842	WASHER NOZZLES	STAINLESS PH RNDWA SCREWS	5	6	-	-	-	-	-	-	-	2	1.00
F-3843	WINDSHIELD WA PUMP & BRACKET	STAINLESS HXWA A SCREWS	5	6	-	-	-	-	-	-	-	5	3.00
F-3856	WIPER MOTOR	STAINLESS HX BOLTS	-	-	-	-	9	0	1	2	3	3	3.00

General Fastener Kits



About 80% of these individual kits are found in *Master Kits*. AMK Fastener kits are based on part numbers & finishes specified in the factory Assembly Manuals.

We hold closely to these specifications unless we find otherwise. We have the knowledge, fastener information and sources needed to make accurate and authentic fastener kits.



Ford Fastener Kits

1965

Air Conditioning

PART #	APPLICATION	NOTES								PCS	PRICE	
			MUSTANG	FALCON	FAIRLANE	T-BIRD	FORD	TRUCK				
F-1258	AC BRUSH & HOLDER < 11/65	HX MS EXT SEMS, FLAT WA'S	Z	D	O	S	-	T			4	4.00
F-1607	AC COMP BELT ADJUSTER - 170/200	SQR HD SET SCREW, HX NUT	Z	D	O	-	-	-			2	4.00
F-1606	AC COMPRESSOR - 170/200	HX BOLTS, FLAT & SPLIT WA'S	Z	D	O	-	-	-			14	7.00
F-1253	AC COMPRESSOR - 289	HX & HXWA MS EXT SEMS	Z	D	O	-	-	T			6	6.00
F-1609	AC COMPRESSOR BRACE (Fr) - 170/200	HX BOLT, HX NUT, FLAT & SPLIT WA'S	Z	D	O	-	-	-			5	3.00
F-1608	AC COMPRESSOR BRACE (Rr) - 170/200	HX MS EXT SEMS, HX BOLTS, WA'S	Z	D	O	-	-	-			4	3.00
F-1255	AC COMPRESSOR BRACE (Rr) - 289	HX MS EXT & SPLIT SEMS, WA'S	Z	D	O	-	-	T			3	4.00
F-1605	AC COMPRESSOR BRACKET - 170/200	PLACE & HX BOLTS, INT/EXT WA	Z	D	O	-	-	-			4	4.00
F-1252	AC COMPRESSOR BRACKET - 289	STUDS, LOCK NUTS, FLAT WA'S	Z	D	O	-	-	T			8	8.00
F-2029	AC COMPRESSOR BRACKET - 64 1/2 260	PLACE BOLTS	Z	-	-	-	-	-			2	3.00
F-1257	AC COMPRESSOR CLUTCH	HX BOLT, FLAT WA	Z	D	O	S	-	T			2	3.00
F-2948	AC DEHYDRATOR & RECEIVER TANK	HXWA A SCREWS	Z	-	-	-	-	-			3	2.00
F-1752	AC EVAPORATOR > DASH	HXWA EXT SEMS, EXT KEPS NUT, WA'S	Z	-	-	-	-	-			6	5.00
F-466	AC FIREWALL SEAL RETAINER	HXWA A SCREWS	Z	-	-	-	-	-			2	1.50

Body

F-2934	AIR VENT GRILLES - FASTBACK, OUTSIDE	STUDS, STAMPED NUTS, CONI KEPS	Z	-	-	-	-	-			52	24.00
F-1795	AIR VENTS - FASTBACK QTER, INSIDE	HXWA A SCREWS	Z	-	-	-	-	-			14	3.00
F-105	BATTERY TRAY	HX FLNG EXT SEMS, CRG BOLT, NUTS	Z	-	-	-	-	-			8	5.50
F-993	BRAKE PEDAL SUPPORT	SRTD FLNG BOLTS, HXWA A SCREWS	Z	-	-	-	-	-			4	4.00
F-1814	BUMPER (Fr)	SS CAPPED BOLTS, NUTS, CRUSH WA'S	Z	-	-	-	-	-			22	8.00
F-3605	BUMPER (Fr)	SS CAPPED BOLTS, LOCK NUTS, WA'S	-	D	-	-	-	-			32	20.00
F-1821	BUMPER (Rr)	SS CAPPED BOLTS, NUTS, CRUSH WA'S	Z	-	-	-	-	-			16	7.00
F-3607	BUMPER (Rr)	SS CAPPED BOLTS, LOCK NUTS, WA'S	-	D	-	-	-	-			18	8.00
F-109	BUMPER BRACKETS (Fr)	HX BOLTS, SPLIT WA'S	Z	-	-	-	-	-			8	9.00
F-3604	BUMPER BRACKETS (Fr)	HX BOLTS, SPLIT WA'S	-	D	-	-	-	-			8	6.00
F-110	BUMPER BRACKETS (Fr) > FENDER	HX PERI SEMS, PADDED U-NUTS	Z	-	-	-	-	-			4	8.00
F-106	BUMPER BRACKETS (Rr)	HX BOLTS, SHIMS, CONI WA'S, SEALS	Z	-	-	-	-	-			16	12.00
F-3606	BUMPER BRACKETS (Rr)	HX BOLTS, LOCK NUTS, FLAT WA'S	-	D	-	-	-	-			16	8.00
F-133	BUMPER GUARD MOUNT BRACKETS (Rr)	HX PERI SEMS, U-NUTS	Z	-	-	-	-	-			8	7.00
F-111	BUMPER GUARDS (Fr)	HX PERI & FLNG EXT SEMS, NUTS, WA'S	Z	-	-	-	-	-			14	10.50
F-134	BUMPER GUARDS (Rr)	HX CONI SEMS, PADDED U-NUTS, SEALER	Z	-	-	-	-	-			8	16.50
F-954	CONVERTIBLE PUMP & BRACKETS	HX CONI SEMS, CAGE NUTS, NUTS, WA'S	Z	-	-	-	-	-			8	10.00
F-957	CONVERTIBLE TOP > BODY TACK STRIP	HX CONI SEMS, PH PN A SCREWS	Z	-	-	-	-	-			14	14.00
F-2003	CONVERTIBLE TOP > BOW LISTING	PH OV B SCREWS	Z	-	-	-	-	-			4	2.00
F-2979	CONVERTIBLE TOP CLAMPS TO BODY	HX EXT SEMS	Z	-	-	-	-	-			4	4.00
F-1765	CONVERTIBLE TOP DUST HOOD RETAINER	PH PN F SCREWS	Z	-	-	-	-	-			11	2.00
F-2060	CONVERTIBLE TOP FRAME > BODY	HX CONI SEMS	Z	-	-	-	-	-			6	5.00
F-1763	CONVERTIBLE TOP WELL LINER	PH WAFER SCREWS	Z	-	-	-	-	-			18	4.00
F-260	COWL BRACES > COWL	HX FLNG EXT SEMS, SRTD FLNG NUTS	Z	-	-	-	-	-			16	16.00
F-112	COWL BRACES, TUBULAR - BODY 76	HX FLNG EXT SEMS	Z	-	-	-	-	-			2	2.00
F-107	COWL SEAL BRACKETS	PH RNDWA A SCREWS	Z	-	-	-	-	-			4	2.00
F-3183	DATA PLATE	SPL ALUMINUM RIVETS	Z	D	O	S	F	T			2	2.00
F-973	DOOR HANDLES (outside)	PH PN EXT SEMS, EXT KEPS NUTS	Z	-	-	-	-	-			4	2.50
F-230	DOOR HINGES	3/8-16 HX FLNG EXT SEMS, PHOS	Z	-	-	-	-	-			22	22.00
F-3447	DOOR LATCH REINFORCEMENTS	SS PH OV SCREWS, SS CNTSNK WA'S	Z	D	O	-	-	-			12	5.00
F-1360	DOOR LATCH ROD END BUSHINGS ONLY	5/32 SIZE, EXACTLY ORIGINAL	Z	D	O	-	-	-			14	7.00
F-1357	DOOR LATCH ROD END BUSHINGS ONLY	9/64 SIZE, EXACTLY ORIGINAL	-	-	-	S	F	-			12	7.00
F-1358	DOOR LATCH ROD END CLIPS	5/32 SIZE, EXACTLY ORIGINAL	Z	D	O	-	-	-			14	38.00
F-1356	DOOR LATCH ROD END CLIPS	9/64 SIZE, EXACTLY ORIGINAL	-	-	-	S	F	-			12	38.00
F-1135	DOOR LATCH STRIKERS	POZI FLAT SCREWS	Z	D	O	S	-	-			4	3.00
F-653	DOOR LATCHES > DOOR SHELL	PH FLAT EXT SEMS	Z	D	-	-	-	-			6	3.00
F-276	EXPORT BRACE > COWL (SHELBY)	HX BOLTS, NUTS, FLAT WA'S	Z	-	-	-	-	-			12	10.00
F-101	FENDER SPLASH SHIELDS	HXWA A SCREWS	Z	-	-	-	-	-			16	8.00
F-3428	FENDER TOPS ONLY, "HTS"	HX FLNG EXT SEMS	Z	D	O	-	-	-			12	10.00
F-100	FENDERS	FLNG EXT SEMS, CLIP BOLTS, J & U-NUTS	Z	-	-	-	-	-			54	48.00
F-568	FLOOR REINFORCEMENT - BODY 76	HX CONI SEMS	Z	-	-	-	-	-			6	14.00
F-127	FLOORBOARD HOLE COVERS	PH PN T EXT SEMS	Z	-	-	-	-	-			8	6.00
F-118	GRILLE	HXWA A SCREWS, SPRING NUTS	Z	-	-	-	-	-			12	6.00
F-387	GRILLE & CENTER SUPPORT (SHELBY)	HX BOLTS, NUTS, SLOT PN SCREWS	Z	-	-	-	-	-			6	6.00
F-1516	GRILLE BARS	HC CONI SEMS, HXWA SCREWS, U-NUTS	Z	-	-	-	-	-			10	4.00
F-1759	GRILLE ORNAMENT (Pony & Corral)	HX PERI SEMS, PH OV SCREWS, NUTS	Z	-	-	-	-	-			5	3.00
F-121	GRILLE ORNAMENT RETAINER	HX FLNG EXT SEMS, SCREWS, NUTS	Z	-	-	-	-	-			8	5.50
F-117	GRILLE, LWR SUPPORT (below grille)	HXWA A SCREWS, SPRING NUTS	Z	-	-	-	-	-			10	5.00
F-116	HEADLAMP DOORS	SS PH FILL A SCREWS, SPRING NUTS	Z	-	-	-	-	-			16	7.00
F-1760	HEADLAMP HOUSING ORNAMENTS	ROUND PUSH NUTS	Z	-	-	-	-	-			4	1.50
F-123	HEADLAMP HOUSINGS	HX PERI SEMS	Z	-	-	-	-	-			8	6.00
F-103	HOOD & HINGES	HX FLNG EXT SEMS	Z	-	-	-	-	-			10	10.00
F-122	HOOD BUMPERS, ADJUSTABLE	U-NUTS, JAM NUTS	Z	-	-	-	-	-			4	2.50
F-115	HOOD LATCH	HX FLNG EXT SEMS	Z	-	-	-	-	-			3	3.00
F-125	HOOD LATCH AUXILLIARY CATCH	HX FLNG EXT SEMS	Z	-	-	-	-	-			2	2.00
F-124	HOOD LATCH DOWELL	HX NUT, FLAT WA	Z	-	-	-	-	-			2	1.50

See factory Assembly Manuals for illustrations

Ford Fastener Kits

221

1965

Body

PART #	APPLICATION	NOTES								PCS	PRICE
			MUSTANG	FALCON	FAIRLANE	T-BIRD	FORD	TRUCK			
F-114	HOOD LATCH SUPPORT	HX FLNG EXT SEMS, SRTD FLNG NUT	Z	-	-	-	-	-		4	3.00
F-113	HOOD LATCH SUPPORT BRACE	HX FLNG EXT SEMS, J-NUTS	Z	-	-	-	-	-		5	5.00
F-3588	LICENSE PLATE BUMPERS (Fr & Rr)	ORIGINAL RUBBER BUMPERS	Z	-	-	-	-	-		3	3.00
F-1281	LICENSE PLATES	SLOT PN HD SCREWS, NYLON NUTS	Z	-	-	-	-	-		8	3.00
F-130	MIRROR (outside remote) > DOOR	SS PH OV AB SCREWS	Z	-	-	-	-	-		2	1.50
F-129	MIRROR (outside) > DOOR	CHROME PH OV A SCREWS	Z	-	-	-	-	-		2	1.00
F-128	QTER PANEL EXTENSIONS	STUDS, CONI KEPS NUTS, FLAT & SEALER	Z	-	-	-	-	-		24	9.00
F-1282	ROOFSIDE WEATHERSTRIP - BODY 63	PH RNDWA & WAFER SCREWS, RIVETS	Z	-	-	-	-	-		40	10.00
F-1283	ROOFSIDE WEATHERSTRIP - BODY 65	PH RNDWA & PH WAFER SCREWS	Z	-	-	-	-	-		24	6.00
F-3253	SHOCK TOWER BRACES - 1964 1/2	5/16-24 HX PERI SEMS, NUTS	Z	-	-	-	-	-		32	20.00
F-104	SHOCK TOWER BRACES (cover springs)	HX FLNG EXT SEMS, NUTS	Z	-	-	-	-	-		32	20.00
F-3784	STEERING COLUMN SEAL	HXWA A SCREWS	Z	-	-	-	-	-		3	1.50
F-119	STONE DEFLECTOR	HX FLNG EXT SEMS, STUD BOLT, J-NUTS	Z	-	-	-	-	-		10	10.50
F-256	TIE DOWN BRACKETS (Rr)	BOLTS, LOCK NUTS, FLAT WA'S	Z	-	-	-	-	-		12	12.00
F-164	TRUNK LATCH & STRIKER	HX FLNG EXT SEMS	Z	-	-	-	-	-		4	4.00
F-131	TRUNK LID & HINGES	HX FLNG EXT SEMS, HXWA AB SCREWS	Z	-	-	-	-	-		10	9.00
F-120	VALANCE (Fr)	HX FLNG EXT SEMS, PERI SEMS, J-NUTS	Z	-	-	-	-	-		16	14.00
F-1108	VALANCE (Rr)	CLIP HEAD BOLTS, SCREWS, NUTS	Z	-	-	-	-	-		15	12.00
F-1746	WEATHERSTRIP, DOORS	NYLON PUSH RIVETS	Z	-	-	-	-	-		4	1.50
F-1767	WEATHERSTRIP, WINDSHIELD PILLARS	PH PN, PH RND WA & PH WAFER SCREWS	Z	-	-	-	-	-		12	3.00
F-1789	WINDOW GUIDE @ DOOR OPENINGS	Visible in jamb area, HX PERI SEMS	Z	-	-	-	-	-		4	4.00
F-697	WINDOW SEALS @ DOOR Rr & QTER	PH PN A SCREWS	Z	-	-	-	-	-		22	5.00

Brakes

F-1616	BRAKE ASSEMBLY (front drum) > SPINDLE	T-BOLTS, LOCK NUTS	Z	D	O	-	-	-		16	14.00
F-1477	BRAKE BOOSTER > FIREWALL	HX SPLIT SEMS	Z	-	-	-	-	-		4	8.00
F-3881	BRAKE BOOSTER HOSE	PINCH TYPE CLAMPS	Z	D	O	-	-	T		2	2.00
F-1791	BRAKE CABLE SEAL @ BRAKE PLATES	1.0" DIA X .58 TK RUBBER SEAL	Z	D	O	-	-	-		2	3.00
F-573	BRAKE CABLES > BODY	HXWA AB SCREWS, RETAINERS, NUT	Z	D	-	-	-	-		12	7.00
F-2949	BRAKE CALIPER BLEEDERS	CORRECT SCREWS	Z	-	O	S	-	-		2	4.00
F-1470	BRAKE CALIPER BRACKETS > SPINDLE	GR-8 HXWA BOLTS, FLNG NUTS	Z	D	-	-	-	-		16	24.00
F-3262	BRAKE CALIPER SHIELDS	HX EXT SEMS	Z	D	-	-	-	-		4	3.00
F-603	BRAKE CALIPERS > BRACKET	PLACE SHLDR BOLTS	Z	D	-	-	-	-		4	12.00
F-579	BRAKE DRUM RETAINERS	GREEN PUSH ON RETAINERS	Z	D	O	S	F	T		6	4.00
F-1150	BRAKE HOSE BRKTS (Fr) > BODY	HX HD C SCREWS	Z	D	-	-	-	-		2	2.00
F-576	BRAKE HOSES > BRACKET	U-CLIPS	Z	D	-	-	-	-		3	4.00
F-669	BRAKE PLATE ADJUST HOLE PLUGS (2)	RUBBER PLUGS	Z	D	O	S	F	T		2	3.00
F-1305	DISTRIBUTION BLOCK > APRON	HX C SCREW	Z	D	-	-	-	-		1	1.50
F-1431	MASTER CYLINDER w/o POWER BRAKES	HX SPLIT SEMS	Z	-	-	-	-	-		2	5.00
F-800	PARKING BRAKE CONTROL > BODY	PH PN EXT SEMS, CAGED & LOCK NUTS	Z	D	-	-	-	-		8	5.00
F-1397	PROPORTIONING VALVE > APRON	SRTD HX FLNG SCREW	Z	D	-	-	-	-		1	3.00
F-2950	WHEEL CYLINDER BLEEDERS	1/4-28 x 1/4 HX x 92" OAL SCREWS, ZDC	Z	D	O	S	F	T		2	3.00
F-356	WHEEL CYLINDERS (2) - 250 & All 8 CYL	5/16-18 HX EXT SEMS	Z	D	O	S	F	T		4	3.00
F-1772	WHEEL CYLINDERS (4) - 170/200	1/4-20 HX EXT SEMS	Z	D	-	-	-	-		8	6.00
F-3912	WHEEL CYLINDERS (4) - 250 & All 8 CYL	5/16-18 HX EXT SEMS	Z	D	O	S	F	T		8	6.00

Brake & Fuel Lines - also see page 216

F-3956	BRAKE LINES (not shared) - 6 & 8 CYL	CORRECT CLIPS, SCREWS, GROMMETS	Z	-	-	-	-	-		8	12.00
F-3957	BRAKE LINES (not shared) - 8 CYL w DISC	CORRECT CLIPS, SCREWS, GROMMETS	Z	-	-	-	-	-		8	12.00
F-3958	BRAKE LINES (shared) - 6 & 8 CYL	CORRECT CLIPS, HX C SCREW	Z	-	-	-	-	-		5	15.00
F-667	FUEL LINE GROMMET (fender apron)	RUBBER GROMMET	Z	-	-	-	-	-		1	2.00
F-3959	FUEL LINES (not shared) - 6 CYL	CORRECT CLIPS, SCREWS, GROMMET	Z	-	-	-	-	-		6	10.00
F-3960	FUEL LINES (not shared) - V8	CORRECT CLIPS, SCREWS, GROMMET	Z	-	-	-	-	-		8	11.00

Cooling

F-396	RADIATOR - All	HX FLNG EXT SEMS, J-NUTS	Z	D	-	-	-	-		8	6.00
F-399	RADIATOR FAN SHROUD - 260/289	HXWA AB SCREWS, SPRING NUTS	Z	-	-	-	-	-		8	6.00
F-400	RADIATOR FAN SHROUD - 260/289 w AC	HXWA AB SCREWS, KEPS, SPRING NUTS	Z	D	-	-	-	-		12	8.00
F-398	RADIATOR FAN SHROUD - 6 CYL w AC	HXWA T1 SCREWS, CONI KEPS, WA'S	Z	D	-	-	-	-		12	8.00
F-385	RADIATOR HOSE CLAMPS - 260/289	WITEK TOWER TYPE	Z	D	O	-	-	T		4	12.00
F-657	RADIATOR HOSE CLAMPS - 289/302/351	WIRE TYPE	Z	D	O	S	F	T		4	16.00
F-386	RADIATOR HOSE CLAMPS - 390/428	WITEK TOWER TYPE	-	-	-	-	-	T		4	14.00
F-384	RADIATOR HOSE CLAMPS - 6 CYL	WITEK TOWER TYPE	Z	D	O	-	-	T		4	10.00

Kits Contain Attaching Fasteners for Both Sides

Ford Fastener Kits

1965

Differential

PART #	APPLICATION	NOTES								PCS	PRICE
			Z	D	O	S	F	T			
F-1439	AXLE RETAINER PLATES - 8 CYL	T-BOLTS, LOCK NUTS	Z	D	O	-	-	-		16	20.00
F-663	AXLE RETAINER PLATES - NUTS ONLY	LOCK NUTS (Silver Cad)	Z	D	O	-	-	-		8	6.00
F-1446	AXLE VENT SYSTEM w BRAKE DIST BLOCK	FITTING, HOSE, CLAMPS, SCREW, SLEEVE	Z	-	-	-	-	-		7	25.00
F-1165	DIFFERENTIAL CARRIER > HOUSING	COPPER WA'S ONLY	Z	D	O	S	F	T		10	4.00
F-598	DIFFERENTIAL CARRIER > HOUSING	CAD LOCK NUTS, COPPER WA'S	Z	D	O	S	-	T		20	12.00
F-3987	DIFFERENTIAL FLANGE > PINION	GR-8 3/4-20 TOP-LOK FLNG LOCKNUT	Z	D	O	S	F	T		1	5.00
F-374	DIFFERENTIAL PINION SUPPORT	PLACE BOLTS	Z	D	O	S	F	T		5	8.00

Electrical

F-621	ALTERNATOR - 289 less SPACER	HX & PLACE BOLTS, FLAT & SPLIT WA'S	Z	D	O	-	-	T		5	7.00
F-1133	ALTERNATOR - 289 w SPACER	HX, PLACE BOLTS, STEEL SPACER, WA'S	Z	D	O	-	-	T		6	16.00
F-1611	ALTERNATOR - 6 CYL w AC	HX SPLIT SEMS, HX BOLTS, WA'S, NUTS	Z	D	O	-	-	T		11	14.00
F-1315	ALTERNATOR - 6 CYL w/o AC	HX SPLIT SEMS, HX BOLTS, WA'S, NUTS	Z	D	O	-	-	T		8	14.00
F-651	ALTERNATOR HOUSING THRU BOLTS	HXWA SCREWS	Z	D	O	S	-	T		3	3.00
F-643	ALTERNATOR PULLEY	HX NUT & SPLIT WA (silver ZC)	Z	D	O	S	-	T		2	2.00
F-1119	ALTERNATOR WIRING	EXT KEPS NUT, NUTS, SPLIT & FLAT WA'S	Z	D	O	S	-	T		9	3.00
F-2943	BACK-UP LAMP GROUND WIRE	HX NUT, TOOTH WA	Z	-	-	-	-	-		2	1.50
F-3569	BACK-UP LAMP LENSES	SS PH PN STOP SCREWS	Z	-	-	-	-	-		4	2.00
F-352	BACK-UP LAMPS > Rr VALANCE	STAMPED NUTS, CUPPED WA'S	Z	-	-	-	-	-		8	6.00
F-3805	BACK-UP SWITCH - 4 SPD TRANS	HX MS EXT SEMS	Z	-	-	-	-	-		1	1.50
F-3804	BACK-UP SWITCH & WIRING - 3 SPD TRANS	J-CLIPS, HX MS EXT SEMS	Z	-	-	-	-	-		3	3.00
F-636	BATTERY CABLES - 260/289	HX BOLTS, HXWA SCREWS, KEPS NUTS	Z	D	O	-	-	T		9	6.00
F-632	BATTERY CABLES - 6 CYL	HX BOLT, HXWA SCREW, CONI KEPS	Z	D	O	-	-	T		7	5.00
F-3800	BATTERY GROUND PROTECTOR > APRON	NYLON CANOE CLIPS	Z	-	-	-	-	-		4	2.00
F-741	BATTERY HOLDOWN CLAMP - GROUP 24	CLIP HEAD BOLT, FLNG NUT	Z	D	-	-	-	-		2	3.00
F-1189	BATTERY TERMINALS	SQR HD BOLTS, NUTS	Z	D	O	S	-	T		4	3.00
F-646	DISTRIBUTOR POINTS & COND - DUAL PT	SLOT PN C SCREWS	Z	D	O	S	F	T		5	3.00
F-645	DISTRIBUTOR POINTS & COND - SINGLE	SLOT PN C SCREWS	Z	D	O	S	F	T		3	2.00
F-1329	FOG LAMP BEZELS	SS/CHROME PH OV AB SCREWS	Z	-	-	-	-	-		4	2.00
F-564	FOG LAMPS > GRILLE	HXWA T SCREWS, STRD FLNG NUTS	Z	-	-	-	-	-		4	3.00
F-738	FUSE BLOCK > FIREWALL	HXWA A SCREWS	Z	D	O	-	-	-		2	2.00
F-1386	GENERATOR - 170	SPL HX BOLTS, HX SPLIT SEMS, FLT WA'S	Z	D	O	-	-	T		7	10.00
F-1384	GENERATOR - 260/289	SPL HX BOLTS, HX SPLIT SEMS, FLAT WA	Z	D	O	-	-	T		10	16.00
F-3988	HEADLAMP ADJUSTERS	ADJUSTER NUTS, SCREWS, SPRINGS	Z	-	-	-	-	-		10	10.00
F-740	HEADLAMP DIMMER SWITCH	HXWA AB SCREWS	Z	D	O	-	-	-		2	2.00
F-599	HEADLAMP RETAINING RINGS (2)	SS PH FILL B SCREWS	Z	D	O	-	-	-		6	3.00
F-2959	HEADLAMP WIRING GROMMETS @ APRONS	1.37" ID X 1.66 OD PLASTIC GROMMETS	Z	-	-	-	-	-		2	5.00
F-1304	HEADLAMP WIRING GROUND (near battery)	HXWA A SCREW, EXT WA	Z	-	-	-	-	-		2	1.50
F-3587	HORN RELAY	HXWA AB SCREW	Z	-	-	-	-	-		1	1.50
F-806	HORNS	HX PERI SEMS, SRTD FLNG NUTS	Z	D	O	S	-	T		4	3.00
F-2028	IGNITION COIL > DISTRIBUTOR LEAD	EXT KEPS NUT	Z	D	O	S	-	T		1	0.75
F-421	IGNITION COIL STRAP & BRKT - 6 CYL	HX SPLIT SEMS, HXWA SCREW, HX NUT	Z	D	O	-	-	T		4	3.00
F-420	IGNITION COIL STRAP & BRKT - AII V8	HX SPLIT SEMS, HXWA SCREW, HX NUT	Z	D	O	S	-	T		3	3.00
F-1301	IGNITION COIL STRAP ONLY	HXWA SCREW, HX NUT	Z	D	O	S	F	T		2	1.50
F-446	LICENSE PLATE LAMP	PH PN A SCREWS	Z	-	-	-	-	-		2	1.00
F-3443	NEUTRAL SWITCH	HX EXT SEMS	Z	D	O	S	F	T		2	3.00
F-108	PARKING LAMP LENSES	SS PH PN B STOP SCREWS	Z	-	-	-	-	-		4	2.00
F-2958	PARKING LAMP WIRING GROMMETS	.62" ID X 1.06 OD PLASTIC GROMMETS	Z	-	-	-	-	-		2	4.00
F-679	PARKING LAMPS	STAMPED NUTS	Z	-	-	-	-	-		4	3.00
F-1097	RADIO > INSTRUMENT PANEL	HXWA EXT SEMS, STAMPED NUT	Z	-	-	-	-	-		2	2.00
F-1784	SHOCK BRACKETS (Fr) SHELBY WELD WA'S	.41 x 1.0 x .17 FLAT WASHERS	Z	-	-	-	-	-		4	3.00
F-1409	STARTER - 260/289/302/351	HXWA SPLIT SEMS, SILVER ZINC	Z	D	O	-	-	T		2	3.50
F-1604	STARTER - 6 CYL & 390/428	HX BOLTS, SPLIT WA'S	Z	-	O	S	-	T		6	3.50
F-358	STARTER SOLENOID	HXWA AB SCREWS "D"	Z	D	O	S	-	T		2	1.50
F-366	TAILAMP ASSEMBLY > BODY	STAMPED NUTS ONLY	Z	-	-	-	-	-		8	6.00
F-404	VOLTAGE REGULATOR	HXWA A SCREWS "Diamond", EXT WA	Z	D	O	S	-	T		3	1.50
F-3586	VOLTAGE REGULATOR - GENERATOR	HXWA A SCREWS "D"	Z	-	-	-	-	-		3	2.00
F-1491	VOLTAGE REGULATOR COVER	SLOT RND A SCREWS	Z	D	O	S	-	-		2	1.50
F-3823	WIRING - 6 CYL IGNITION COIL	RUBBER COATED "J" CLIP	Z	D	O	-	-	T		1	1.50
F-3815	WIRING - AC BLOWER > DASH BOTTOM	NYLON "S" CLIP	Z	-	-	-	-	-		1	1.50
F-2921	WIRING - CONSOLE	HXWA SCREWS, NYLON CLIPS, TOOTH WA	Z	-	-	-	-	-		12	4.00
F-3788	WIRING - DOOR COURTESY LAMPS	NYLON "S" CLIPS	Z	-	-	-	-	-		6	4.00
F-584	WIRING - ENGINE BAY	3 1/8" NYLON STRAPS ONLY	Z	D	-	-	-	-		20	10.00
F-460	WIRING - ENGINE FEED - 8 CYL w AC	RUBBER COATED "J" CLIPS	Z	D	O	S	-	T		4	5.00
F-423	WIRING - ENGINE FEED - 8 CYL w/o AC	RUBBER COATED "J" CLIPS	Z	D	O	S	-	T		3	4.00
F-3810	WIRING - FUEL SENDER @ GAS TANK	METAL "S" CLIPS	Z	-	-	-	-	-		2	4.00
F-3302	WIRING - FUEL SENDER @ TRUNK - BODY 63	RUBBER COATED "J" CLIPS, 3 1/8" STRAP	Z	-	-	-	-	-		3	4.00
F-3303	WIRING - FUEL SENDER @ TRUNK - BODY 65	RUBBER COATED "J" CLIPS	Z	-	-	-	-	-		2	3.00
F-442	WIRING - LH TAILAMP	RUBBER COATED "J" CLIP, HX NUT	Z	-	-	-	-	-		2	2.00
F-3799	WIRING - PARKING LAMPS	METAL "S" RETAINERS	Z	-	-	-	-	-		2	4.00
F-3802	WIRING - TAILAMPS @ WHEELHOUSE JOINT	METAL "S" RETAINER	Z	-	-	-	-	-		1	2.00
F-3803	WIRING - TAILAMPS @ WINDSHIELD PILLAR	METAL "S" RETAINERS	Z	-	-	-	-	-		3	6.00
F-3814	WIRING - UNDER DASH	NYLON "S" RETAINERS	Z	-	-	-	-	-		4	5.00

See factory Assembly Manuals for illustrations

Ford Fastener Kits

223

1965

Exhaust

PART #	APPLICATION	NOTES	VEHICLE							PCS	PRICE
			Z	D	O	S	F	T			
F-1451	EXHAUST HANGERS, DUAL	CRG BOLTS, HX & PH PN SCREWS, NUTS	Z	-	-	-	-	-		20	8.00
F-1245	EXHAUST HANGERS, SINGLE	HX C SCREWS	Z	-	-	-	-	-		6	4.00
F-371	EXHAUST PIPE > MANIFOLD - 6 CYL	STUDS 2.25 OAL, HX LOCK NUTS	Z	D	O	-	-	T		4	7.00
F-372	EXHAUST PIPE > MANIFOLDS - 289/352/390	STUDS 2.25 OAL, HX LOCK NUTS	Z	D	O	-	-	T		8	10.00

Fuel - for lines see page 216

F-1457	ACCEL BELLCRANK > FIREWALL - 6 CYL	HXWA A SCREWS	Z	-	-	-	-	-		4	2.00
F-746	ACCEL BELLCRANK > FIREWALL - 8 CYL	HXWA A SCREWS	Z	-	-	-	-	-		3	2.00
F-745	ACCELERATOR PEDAL	SPL PH PN MS, RETAINER	Z	-	-	-	-	-		2	3.00
F-1193	ACCELERATOR ROD > CARB - 8 CYL	3/16" RH ROD END RETAINER	Z	-	-	-	-	-		1	2.00
F-588	FUEL HOSE CLAMPS	SS PINCH TYPE	Z	D	O	-	-	-		8	6.00
F-225	GAS TANK	HXWA A SCREWS	Z	-	-	-	-	-		11	6.00
F-1779	GAS TANK FILLER NECK CLAMPS	CORRECT WIRE CLAMPS	Z	-	-	-	-	-		2	6.00
F-412	GAS TANK FILLER NECK w TWIST CAP	HXWA B SCREWS	Z	-	-	-	-	-		5	3.00

Heater

F-468	DEFROSTER PLENUM > HEATER CASE	HXWA AB SCREWS	Z	-	-	-	-	-		4	2.00
F-383	HEATER & BY-PASS HOSES	WHITEK TOWER CLAMPS	Z	D	O	S	F	T		6	12.00
F-470	HEATER ASSEMBLY > COWL (RH side)	HXWA AB SCREW, SPRING CLIP	Z	-	-	-	-	-		2	2.00
F-432	HEATER ASSEMBLY > FIREWALL	STAMPED NUTS w INTEGRAL SEALER	Z	-	-	-	-	-		4	4.00
F-469	HEATER CABLES > HEATER HOUSING	SLOT HX A SCREWS	Z	-	-	-	-	-		3	2.00
F-3801	HEATER CONTROL CABLES	6 3/4" ALUMINUM STRAP	Z	-	-	-	-	-		1	5.00
F-3214	HEATER DELETE PLATE	HXWA A SCREWS	Z	-	-	-	-	-		4	2.00
F-1213	HEATER HOSE STRAPS	6 3/4" ALUMINUM STRAP	Z	D	O	-	-	-		2	10.00

Interior

F-735	AIR VENT LH UNDER DASH > COWL	STAMPED NUTS	Z	-	-	-	-	-		3	2.50
F-1137	ARMREST BASE & PAD - STD	PH TRUSS & PH PN SCREWS, SPRG NUTS	Z	-	-	-	-	-		12	6.00
F-886	ARMREST BASE & PAD - STD (less nuts)	SCREWS ONLY	Z	-	-	-	-	-		8	3.00
F-3002	ASH TRAY BUMPERS	.31 DIA X .15 H HEAD	Z	-	-	-	-	-		2	2.00
F-692	ASH TRAY LINER	PH PN AB SCREWS	Z	-	-	-	-	-		4	1.50
F-889	CARPET > FLOOR w CONSOLE	RNDWA SCREWS, 2 EXTRA for BODY 63	Z	-	-	-	-	-		8	2.00
F-279	CARPET > FLOOR w/o CONSOLE	RNDWA SCREWS, 2 EXTRA for BODY 63	Z	-	-	-	-	-		10	3.00
F-1016	COAT HOOKS - BODY 63, 65	PH OV AB SCREWS ONLY	Z	-	-	-	-	-		2	2.00
F-1017	COAT HOOKS - BODY 76	PH OV AB SCREWS ONLY	Z	-	-	-	-	-		2	2.00
F-3937	CONSOLE - TRIM PLATES	STAMPED NUTS	Z	-	-	-	-	-		9	3.00
F-783	CONSOLE "Z" BRACKET (Fr)	HXWA & PH PN SCREWS, SPRING NUTS	Z	-	-	-	-	-		6	3.00
F-1635	CONSOLE > FLOOR	PH OV AB SCREWS	Z	-	-	-	-	-		6	3.00
F-2942	CONSOLE ASH TRAY BUMPERS	.16 DIA X .10 H HEAD SIZE	Z	-	-	-	-	-		2	2.00
F-1405	CONSOLE DOOR HINGE	PH PN B SCREWS	Z	-	-	-	-	-		2	2.00
F-496	COURTESY LAMP @ DOORS	PH OV AB & B SCREWS	Z	-	-	-	-	-		8	3.00
F-3584	DASH PAD & MOULDINGS	PH OV SCREWS, STAMP NUTS, RTNRS	Z	-	-	-	-	-		21	6.00
F-947	DOOR HANDLES (inside)	CHROME CNTRS NK HX SKT SCREWS	Z	-	-	-	-	-		2	2.00
F-3863	DOOR LATCH CONTROL (at inside handle)	PH PN EXT SEMS	Z	-	-	-	-	-		6	3.00
F-1041	DOOR PANEL ARMREST BRACKETS - DLX	PH PN A SCREWS, SPRING NUTS	Z	-	-	-	-	-		8	3.00
F-1037	DOOR PANELS - DLX	SCREWS, RETAINERS (pad clips go lower)	Z	-	-	-	-	-		36	10.00
F-1036	DOOR PANELS - STD	RETAINERS (padded clips go lower)	Z	-	-	-	-	-		30	8.00
F-288	FD SEAT LATCH COVERS	PH OV AB SCREWS, FINISH WA'S	Z	-	-	-	-	-		16	4.00
F-771	FD SEAT SIDE LATCHES	HX CONI SEMS	Z	-	-	-	-	-		8	6.00
F-1756	FD SEAT STOP BUMPERS	PH PN SCREWS	Z	-	-	-	-	-		4	3.00
F-928	FD SEAT TRAP DOOR HINGES	HXWA EXT SEMS	Z	-	-	-	-	-		8	3.50
F-924	FD SEAT TRAP DOOR LATCH	HX EXT SEMS	Z	-	-	-	-	-		4	3.00
F-934	FD SEAT TRAP DOOR PROP	HX & HXWA EXT SEMS, RIVET NUTS	Z	-	-	-	-	-		6	6.00
F-772	FD SEAT TRAP DR LATCH CATCH	HX EXT SEMS	Z	-	-	-	-	-		2	2.00
F-1745	FD SEAT TRIM	CHROME PH OV SCREW, PH PN SCREWS	Z	-	-	-	-	-		66	10.00
F-774	FLOOR PANEL (Rr) - Fr ANCHORS	PH PN SCREWS, FINISH WA'S	Z	-	-	-	-	-		4	3.00
F-2939	GLOVE BOX BUMPERS	.31 H RUBBER BUMPER	Z	-	-	-	-	-		2	2.00
F-795	GLOVE BOX CABLE	PN PN B SHLDR SCREWS, WAVE WA'S	Z	-	-	-	-	-		4	3.00
F-778	GLOVE BOX CATCH	HXWA A EXT SEMS	Z	-	-	-	-	-		2	2.00
F-690	GLOVE BOX HINGES	HX CONI SEMS	Z	-	-	-	-	-		6	5.00
F-689	GLOVE BOX LATCH	HX CONI SEMS	Z	-	-	-	-	-		2	2.00
F-877	GLOVE BOX LINER	PH RNDWA SCREWS	Z	-	-	-	-	-		7	2.00
F-997	HEADLINER RETAINER (hardtop @ Fr pillars)	CHROME PH OV AB SCREWS	Z	-	-	-	-	-		2	1.50

Kits Contain Attaching Fasteners for Both Sides

Ford Fastener Kits

1965

Interior

PART #	APPLICATION	NOTES								PCS	PRICE
			Z	D	O	S	F	T			
F-1079	HEATER CONTROL > DASH	EXT KEPS NUTS	Z	-	-	-	-	-		2	1.00
F-1057	INSTR FINISH PANEL (BEZEL) @ CLUSTER	PH PN A SCREWS, SPRING NUTS	Z	-	-	-	-	-		18	8.00
F-879	KICK PANELS	PH RNDWA A SCREWS	Z	-	-	-	-	-		4	2.00
F-1377	LAMPS, COURTESY UNDERDASH	PH PN EXT SEMS, STAMPED NUTS	Z	-	-	-	-	-		4	3.00
F-695	MIRROR (inside) > BRACKET	CHROME PH OV A SCREWS	Z	-	-	-	-	-		3	2.00
F-3909	MIRROR (outside) CONTROL BEZEL	CHROME PH OV AB SCREWS	Z	-	-	-	-	-		2	2.00
F-763	MOULDING (above trap door) - BODY 63	PH OV A SCREWS	Z	-	-	-	-	-		4	5.00
F-1402	PACKAGE TRAY	PH WAFER SCREWS, RETAINER CLIPS	Z	-	-	-	-	-		4	3.00
F-286	QTER TRIM LWR CORNER PANELS - BDY 63	POP RIVETS	Z	-	-	-	-	-		4	2.00
F-762	QTER TRIM MOULDINGS (sides) - BODY 63	PH OV A SCREWS	Z	-	-	-	-	-		8	4.00
F-282	QTER TRIM PANEL BRACKETS - BODY 63	PH PN AB SCREWS	Z	-	-	-	-	-		38	6.00
F-1055	QTER TRIM PANEL BUILD-UP - BODY 76	PH PN A SCREWS, SPRING NUTS	Z	-	-	-	-	-		18	5.00
F-1052	QTER TRIM PANEL CHROME CAPS	PH OV A SCREWS	Z	-	-	-	-	-		2	1.50
F-869	QTER TRIM PANELS - BODY 65A, 65C	HXWA & PH OV A SCREWS, FINISH WA'S	Z	-	-	-	-	-		14	4.00
F-1050	QTER TRIM PANELS - BODY 65B	PH OV SEMS, SCREWS, FINISH WA'S	Z	-	-	-	-	-		14	4.00
F-871	QTER TRIM PANELS - BODY 76	PH OV & PH PN SCREWS, FINISH WA'S	Z	-	-	-	-	-		12	4.00
F-764	QTER TRIM PANELS (lower Fr) - BODY 63	HX PERI SEMS, PH OV SCREWS, J-NUTS	Z	-	-	-	-	-		20	12.00
F-765	QTER TRIM PANELS (upper Fr) - BODY 63	PH PN & PH OV A SCREWS	Z	-	-	-	-	-		10	3.00
F-766	QTER TRIM UPR CORNER PANELS - BODY 63	PH PN A & PH OV A SCREWS	Z	-	-	-	-	-		6	2.00
F-959	RADIO OPENING COVER	LARGE STAMPED NUTS	Z	-	-	-	-	-		2	1.50
F-911	RADIO SPEAKER > DASH	NAIL POINT PH PN SCREWS	Z	-	-	-	-	-		2	1.00
F-900	RADIO SPEAKER GRILLE > DASH	PH OV A SCREWS	Z	-	-	-	-	-		2	1.50
F-494	SCUFF PLATES (door opening)	SS/CHROME PH OV AB SCREWS	Z	-	-	-	-	-		18	8.00
F-298	SEAT BACK ADJUSTMENT (Fr)	CHROME HX BOLTS, NUTS, FLAT WA'S	Z	-	-	-	-	-		6	8.00
F-3763	SEAT BACK COVERS - DLX	WIRE RETAINERS	Z	-	-	-	-	-		22	8.00
F-872	SEAT BACK COVERS - STD	WIRE RETAINERS	Z	-	-	-	-	-		22	8.00
F-3996	SEAT BELTS (Fr) - BODY 63, 65	CHROME BOLTS, RUBBER & STEEL WA'S	Z	-	-	-	-	-		12	24.00
F-3997	SEAT BELTS (Fr) - BODY 76	CHROME BOLTS, STEEL WA'S	Z	-	-	-	-	-		12	22.00
F-3564	SEAT BELTS (Fr) or (Rr) - 1964 1/2	EYE BOLTS (not exactly like original)	Z	-	-	-	-	-		4	12.00
F-3998	SEAT BELTS (Rr)	HX BOLTS	Z	-	-	-	-	-		4	16.00
F-939	SEAT HINGE (Rr) > FLOOR, SEAT - BODY 63	HX CONI SEMS, SLOT FLAT SCREWS	Z	-	-	-	-	-		10	8.00
F-685	SEAT SCUFF PLATES - Fr SEAT BACKS	PH PN A SCREWS	Z	-	-	-	-	-		4	2.00
F-2926	SEAT TRACK STUDS - REPAIR KIT	2 SPECIAL SQR HD BOLTS, RETAINERS	Z	-	-	-	-	-		4	5.00
F-1192	SEAT TRACKS > BODY	ORIGINAL INT/EXT DOME KEPS NUTS	Z	-	-	-	-	-		8	8.00
F-681	SEAT TRIM PANELS	SCREWS, PINS, WA'S (less spacers)	Z	-	-	-	-	-		16	7.00
F-1169	SEAT UPHOLSTERY (Rr) > FLOOR - B 63	PH PN & RND WA SCREWS, SEALER	Z	-	-	-	-	-		8	3.00
F-1109	SEAT UPHOLSTERY (Rr) > FLOOR - B 65, 76	HX PERI SEMS, SEALER	Z	-	-	-	-	-		4	3.00
F-3304	STEERING COLUMN > DASH	STUDS, LOCK NUTS	Z	-	-	-	-	-		4	4.00
F-277	SUN VISOR BRACKETS - BODY 63, 65	PH OV A SCREWS	Z	-	-	-	-	-		6	3.00
F-278	SUN VISORS - BODY 76	PH OV & FLAT SCREWS	Z	-	-	-	-	-		6	3.00
F-767	TRIM PANEL (above trap door) - BODY 63	PH OV A SCREWS, BLIND RIVETS	Z	-	-	-	-	-		6	3.00
F-1124	TRUNK FILLER BOARD < 10-27-66	PH TRUSS AB FLAT SEMS	Z	-	-	-	-	-		2	4.00
F-1002	WINDLACE @ Fr PILLIAR	PH PN F SCREWS	Z	-	-	-	-	-		2	1.00
F-688	WINDOW (Rr) TOP GARNISH MLDNG - BODY 63	PH OV A & AB SCREWS	Z	-	-	-	-	-		5	3.00
F-951	WINDOW CRANK HANDLES	SPL HX SKT SCREWS	Z	-	-	-	-	-		2	2.00
F-698	WINDSHIELD, TOP INSIDE TRIM - BODY 76	PH OV A SCREWS	Z	-	-	-	-	-		4	2.00

Moulding

F-3633	EMBLEM NUTS, Complete - 289 GT	SLEEVE NUTS	Z	-	-	-	-	-		48	18.00
F-3632	EMBLEM NUTS, Complete - 289HP BDY 63	SLEEVE NUTS	Z	-	-	-	-	-		30	12.00
F-3629	EMBLEM NUTS, Complete - 289HP BDY 65, 76	SLEEVE NUTS	Z	-	-	-	-	-		26	10.00
F-3634	EMBLEM NUTS, Complete - 289HP GT	SLEEVE NUTS	Z	-	-	-	-	-		50	18.00
F-3630	EMBLEM NUTS, Complete - 6 CYL BDY 63	SLEEVE NUTS	Z	-	-	-	-	-		24	8.00
F-3627	EMBLEM NUTS, Complete - 6 CYL BDY 65, 76	SLEEVE NUTS	Z	-	-	-	-	-		20	8.00
F-3631	EMBLEM NUTS, Complete - V8 BODY 63	SLEEVE NUTS	Z	-	-	-	-	-		28	10.00
F-3628	EMBLEM NUTS, Complete - V8 BODY 65, 76	SLEEVE NUTS	Z	-	-	-	-	-		24	10.00
F-3609	EMBLEM, FENDER Fr - "289"	3/16" SLEEVE NUTS	Z	-	-	-	-	-		4	2.00
F-3610	EMBLEM, FENDER Fr - "289" & "HIGH PERF"	3/16" SLEEVE NUTS	Z	-	-	-	-	-		6	3.00
F-1262	GRILLE OPENING MOULDINGS (lower)	WIRE TYPE RETAINERS	Z	-	-	-	-	-		8	10.00
F-126	HOOD PEAK MOULDING	SS/CHROME PH RNDWA AB SCREWS	Z	-	-	-	-	-		7	3.50
F-3613	NAMEPLATE, FENDERS "Mustang" & "GT"	3/32" SLEEVE NUTS	Z	-	-	-	-	-		36	12.00
F-3611	NAMEPLATE, FENDERS "Mustang" & PONY	BODY 65 & 76, 3/32" SLEEVE NUTS	Z	-	-	-	-	-		12	5.00
F-3612	NAMEPLATE, FENDERS "Mustang" & PONY	BODY 63, 3/32" SLEEVE NUTS	Z	-	-	-	-	-		16	6.00
F-3608	NAMEPLATE, HOOD "FORD"	3/32" SLEEVE NUTS	Z	-	-	-	-	-		8	3.00
F-566	TAILAMP BEZELS & LENSES	SS/CHROME PH OV B SCREWS	Z	-	-	-	-	-		8	3.00
F-2977	VINYL TOP MOULDINGS	STAMPED NUTS	Z	-	-	-	-	-		6	3.00
F-3558	WINDOW (Fr) MOULDINGS - BODY 63, 65	SCREW-DOWN RETAINERS, PH SCREWS	Z	-	-	-	-	-		44	12.00
F-580	WINDOW (Fr) MOULDINGS - BODY 63, 65	PUSH-ON RETAINERS	Z	-	-	-	-	-		22	10.00
F-3567	WINDOW (Fr) MOULDINGS - BODY 76	SCREW-DOWN TYPE, SCREWS, NUTS	Z	-	-	-	-	-		36	12.00
F-1406	WINDOW (Fr) MOULDINGS - BODY 76	RETAINERS, PH OV SCREWS, NUTS	Z	-	-	-	-	-		22	10.00
F-3519	WINDOW (Rr) MOULDINGS - BODY 63	PUSH-ON RETAINERS	Z	-	-	-	-	-		22	10.00
F-3490	WINDOW (Rr) MOULDINGS - BODY 65	PUSH-ON RETAINERS	Z	-	-	-	-	-		19	8.00
F-3568	WINDOW (Rr) MOULDINGS - BODY 65	SCREW-DOWN RETAINERS, PH SCREWS	Z	-	-	-	-	-		38	12.00

See factory Assembly Manuals for illustrations

Ford Fastener Kits

225

1965

Steering & Suspension

PART #	APPLICATION	NOTES								PCS	PRICE
			MUSTANG	FALCON	FAIRLANE	T-BIRD	FORD	TRUCK			
F-1441	AXLE HOUSING > SPRINGS	5.0" U-BOLTS, FLNG NUTS	Z	D	-	-	-	-		12	26.00
F-367	AXLE HOUSING > SPRINGS - NUTS ONLY	FLNG NUTS (Silver Cad)	Z	D	O	-	-	-		8	12.00
F-1355	BALL JOINTS (RIVETS) - LWR	RIVETS (2 extra), SPL TOOLS, PRESS RQD	Z	D	O	-	-	-		8	6.00
F-1354	BALL JOINTS (RIVETS) - UPPER	RIVETS (2 extra), SPL TOOLS, PRESS RQD	Z	D	O	-	-	-		10	6.00
F-594	COIL SPRING SEATS (perches)	3/8-24 MARSDEN NUTS ONLY	Z	D	O	-	-	-		4	5.00
F-3656	COIL SPRING SEATS (perches)	GR-8 3/8-16 KNURL BOLTS, LOCK NUTS	Z	D	O	-	-	-		8	10.00
F-1111	CONTROL ARMS (lower) > SHOCK TOWER	HX BOLTS, NUTS, SPLIT WA'S	Z	D	-	-	-	-		6	12.00
F-360	CONTROL ARMS (upper) > SHOCK TOWER	GR-8 FLNG NUTS ONLY	Z	D	-	-	-	-		4	6.00
F-3658	CONTROL ARMS (upper) > SHOCK TOWER	GR-8 1/2-20 KNURLED BOLTS, FLNG NUTS	Z	-	-	-	-	-		8	12.00
F-1280	CROSSMEMBER, TUBULAR (Fr)	SPL HX CNTRS NK BOLTS	Z	-	-	-	-	-		2	10.00
F-571	GREASE PLUGS, CHASSIS	HX PLUGS	Z	D	O	S	F	T		9	5.00
F-351	IDLER ARM	HX BOLTS "F", LOCK NUTS, CLIPPED WA'S	Z	D	O	-	-	-		6	12.00
F-3651	LEAF SPRING CENTER BOLTS	GR-8 TALL HD BOLTS, HX NUTS	Z	D	-	-	-	-		4	8.00
F-1064	LEAF SPRINGS (front eye)	POINTED HX BOLTS, FLNG NUTS, WA'S	Z	D	O	-	-	-		6	18.00
F-1650	MONTE CARLO BAR (SHELBY)	HX FLNG EXT SEMS, SRTD FLNG NUTS	Z	-	-	-	-	-		4	3.00
F-3933	P/S CONTROL VALVE DUST COVER CLAMP	SLOT RND B SCREWS	Z	D	O	-	-	-		2	1.50
F-502	P/S CONTROL VALVE SPOOL CAP	SLOT FILL SPLIT SEMS	Z	D	O	-	-	-		2	3.00
F-1615	P/S CYLINDER BRACKET - RIVET NUTS	3/8-16 HX BODY RIVET NUTS ONLY	Z	D	O	-	-	-		2	6.00
F-1324	P/S CYLINDER BRACKET > BODY	HX BOLTS "F", HX NUTS, WA'S	Z	D	O	-	-	-		8	8.00
F-1803	P/S HOSE SUPPORT INSULATOR RETAINER	HXWA F SCREW	Z	D	O	-	-	-		1	1.50
F-3251	P/S PUMP - 260/289 w EATON PUMP	STUD, SPLIT SEMS, BOLT, SPACER, NUTS	Z	D	O	-	-	T		10	16.00
F-703	P/S PUMP - 289 w FORD PUMP & AC	FLNG BOLTS & NUTS, FLAT WA	Z	D	O	S	-	T		7	7.00
F-792	P/S PUMP - 289 w FORD PUMP w/o AC	SRTD FLNG BOLTS, FLNG NUT, FLAT WA	Z	D	O	S	-	T		7	10.00
F-3250	P/S PUMP - 6 CYL w EATON PUMP	HX BOLTS, HX SPLIT SEMS, WA'S	Z	D	O	-	-	T		12	10.00
F-793	P/S PUMP - 6 CYL w FORD PUMP	HX FLNG, HX & PLACE BOLTS, WA'S	Z	D	O	S	-	T		13	14.00
F-3252	P/S PUMP RESERVOIR - EATON PUMP w AC	HX BOLTS, LOCK NUTS, FLAT WA'S	Z	D	O	-	-	-		8	3.00
F-2937	P/S PUMP RESERVOIR NUT	THIN HX NUT ON BACK	Z	D	O	S	F	T		1	3.00
F-1207	P/S RETURN HOSE - 170/200/289/302	NO SLOT STYLE CLAMP	Z	D	-	-	-	-		1	10.00
F-1206	P/S RETURN HOSE - 170/200/289/302	SLOTTED STYLE CLAMP	Z	D	-	-	-	-		1	5.00
F-1811	P/S SLAVE CYLINDER, ROD END	HX NUT, STAMPED NUT	Z	D	O	-	-	-		2	1.50
F-613	PITMAN ARM > GEAR BOX w 1.0" SHAFT	1 1/8 AF HX JAM NUT, SPLIT WA	Z	D	-	-	-	-		2	3.00
F-664	SHACKLE ASSY (Rr) - NUTS ONLY	MARSDEN NUTS	Z	D	O	-	-	-		4	5.00
F-311	SHOCK BRACKETS (Fr)	LOW HD CRG BOLTS, EXT KEPS NUTS	Z	D	-	-	-	-		12	9.00
F-343	SHOCKS (Fr)	EXT HX SEMS "SEMS", LOCK NUTS, WA'S	Z	D	-	-	-	-		12	8.00
F-883	SHOCKS (Fr) - TOP MOUNTING ONLY	EXT HX SEMS "SEMS"	Z	D	-	-	-	-		4	6.00
F-1792	SHOCKS (Rr)	3/8-24 EXT KEPS NUTS	Z	D	O	-	-	-		4	2.00
F-1443	STABILIZER (Fr) > BODY	HX BOLTS, LOCK NUTS	Z	D	O	-	-	-		8	10.00
F-3951	STABILIZER (Fr) END LINKS	BLTS, RTNRS, BSHNGS, SPACERS, NUTS	Z	D	-	-	-	-		22	25.00
F-2945	STABILIZER (Fr) END LINKS	BLTS, RTNRS, BSHNGS, SPACERS, NUTS	-	-	O	-	-	-		22	25.00
F-347	STEERING GEAR BOX	HX BOLTS, CLIPPED FLAT & SPLIT WA'S	Z	D	-	-	-	-		9	12.00
F-672	STEERING GEAR BOX SECTOR COVER	PLACE BOLTS	Z	D	O	S	-	T		3	4.00
F-1302	STEERING LINKAGE - 289 w PS	SLOTTED NUTS, COTTER PINS, FLAT WA	Z	D	-	-	-	-		25	14.00
F-315	STEERING LINKAGE - 289 w/o PS	SLOTTED NUTS, COTTER PINS, FLAT WA	Z	D	-	-	-	-		23	12.00
F-1303	STEERING LINKAGE - 6 CYL w PS	SLOTTED NUTS, COTTER PINS	Z	D	-	-	-	-		24	14.00
F-314	STEERING LINKAGE - 6 CYL w/o PS	SLOTTED NUTS, COTTER PINS	Z	D	-	-	-	-		22	12.00
F-3308	STEERING WHEEL	HX NUT	Z	D	O	S	-	T		1	3.00
F-1464	STRUT ROD THREADED ENDS > BODY	LOCK NUTS ONLY	Z	D	-	-	-	-		2	4.00
F-1156	STRUT RODS > LWR CONTROL ARM	HX BOLTS, LOCK NUTS	Z	D	O	-	-	-		8	14.00
F-365	STRUT RODS > LWR CONTROL ARM - NUTS	LOCK NUTS ONLY	Z	D	O	-	-	-		4	6.00
F-2964	SUSP BUMPER (Rr) - 289HP, 390, 67-68 GT	LOCK NUT	Z	-	-	-	-	-		1	1.50
F-1486	SUSP BUMPER (Rr) 65-66 V8, 67-68 289-2V	HX SCREWS	Z	D	-	-	-	-		2	2.00
F-2946	SUSP BUMPERS (Fr)	EXT KEPS NUTS	Z	-	-	-	-	-		2	1.50
F-379	WHEEL BOLTS, Fr DRUM - 1.48" BOLTS	1/2-20 BOLTS	Z	D	O	S	F	T		10	8.00
F-781	WHEEL BOLTS, Fr DRUM - 1.69" BOLTS	1/2-20 BOLTS	Z	D	O	S	F	T		10	8.00
F-1353	WHEELS	1/2-20 LUG NUTS, 13/16" HX	Z	D	O	S	F	T		20	16.00

Transmission

F-1369	BELL HOUSING (manual) - 170/200	HX BOLTS, SPLIT WA'S	Z	D	O	-	-	-		8	8.00
F-1371	BELL HOUSING (manual) - 260/289 5 BOLT	HX BOLTS, SPLIT WA'S	Z	D	O	-	-	T		10	12.00
F-353	BELL HOUSING (manual) - 260/289 6 BOLT	HX BOLTS, SPLIT WA'S	Z	D	O	-	-	-		12	14.00
F-354	BELL HOUSING (manual) - 390/428 < 2-15-68	HX BOLTS, SPLIT WA'S	-	-	-	-	-	-		12	14.00
F-1777	CLUTCH BELL CRANK BRKT	SRTD FLNG BOLTS	Z	D	-	-	-	-		2	3.00
F-1344	CLUTCH PEDAL SPRING BRACKET	HX SCREWS	Z	-	-	-	-	-		3	3.00
F-1343	CLUTCH PEDAL STOP > PEDAL SUPPORT	CRG BOLT, FLNG NUT	Z	-	-	-	-	-		2	3.00
F-1465	DRIVESHAFT - 6 CYL - All 65-66, M/T 67-68	1/4" U-BOLTS, NUTS, SPLIT WA'S	Z	D	-	-	-	-		6	10.00
F-876	DRIVESHAFT - V8	5/16-24 LOCK NUTS ONLY	Z	D	O	S	F	T		4	3.00
F-1273	DRIVESHAFT - V8, 6 CYL 67-68 A/T, All 69 >	5/16" U-BOLTS, LOCK NUTS	Z	D	O	S	F	T		6	8.00
F-1199	ENGINE PLATE (M/T) - 6 CYL & SB	HX SPLIT SEMS	Z	D	-	-	-	-		2	3.00
F-796	INSPECTION COVER & ENG PLATE - C4 (A/T)	HX SPLIT SEMS	Z	D	O	-	-	T		3	4.00
F-3263	PRESSURE PLATE > FLYWHEEL	SPL HX BOLTS, SPLIT WA'S	Z	D	O	S	F	T		12	6.00
F-907	SHIFTER (manual) LWR BOOT RETAINER	PH PN SCREWS	Z	D	-	-	-	-		4	2.50

Kits Contain Attaching Fasteners for Both Sides

1965

Transmission

PART #	APPLICATION	NOTES								PCS	PRICE
			MUSTANG	FALCON	FAIRLANE	T-BIRD	FORD	TRUCK			
F-1232	SHIFTER ASSY > FLOOR - A/T	PH FLAT A SCREWS	Z	-	-	-	-	-		4	2.00
F-1237	SHIFTER ASSY > FLOOR - A/T (w/wo console)	HX BOLTS, PH PN SCREWS, RETAINERS	Z	D	-	-	-	-		12	4.00
F-1560	SHIFTER CONTROL > TRANS - 3 & 4 SPD	HX SPLIT SEMS	Z	D	O	-	-	T		3	4.00
F-1226	SHIFTER HANDLE - 3 SPD 64-73, 4 SPD 64-69	SHOULDER BOLTS, FLAT WA'S	Z	D	O	-	-	-		4	8.00
F-897	SHIFTER HANDLE (manual) > SHIFTER	FORD SHIFTERS, FLAT WA'S ONLY	Z	D	O	-	-	-		2	1.50
F-1085	SHIFTER HANDLE REBUILD - 3 & 4 SPD	TRUNNIONS (cups), SPRINGS, GROMMETS	Z	D	O	-	-	-		6	12.00
F-1241	SHIFTER LINKAGE - A/T	SRTD FLNG NUTS, PIN, FLAT, WAVE WA'S	Z	D	O	-	-	T		4	4.00
F-1220	SHIFTER RODS - 3 SPD	LOCK NUTS, WA'S, PINS	Z	D	O	-	-	T		14	8.00
F-1221	SHIFTER RODS - 4 SPD	LOCK NUTS, WA'S, PINS	Z	D	O	-	-	T		21	12.00
F-3412	SPEDOMETER CABLE > TRANS	HX BOLT, EXT WA	Z	D	O	S	-	T		2	2.00
F-185	TORQUE CONVERTOR FLEX PLATE	FLNG NUTS	Z	D	O	S	F	T		4	4.00
F-1365	TRANS (auto) > ENGINE - 170/200	HX BOLTS, SPLIT WA'S	Z	D	O	-	-	-		8	8.00
F-1372	TRANS (auto) > ENGINE - 260/289 5 BOLT	HX BOLTS, SPLIT WA'S	Z	D	O	-	-	T		10	12.00
F-215	TRANS (auto) > ENGINE - 289/302 6 BOLT	HX BOLTS, SPLIT WA'S	Z	D	O	-	-	T		12	14.00
F-1244	TRANS (auto) KICKDOWN > ACCEL - ALL	3/16 RH ROD END RETAINER	Z	-	-	-	-	-		1	2.00
F-678	TRANS (manual) > BELL HOUSING	HX BOLTS, SPLIT WA'S	Z	D	O	S	F	T		8	7.00
F-1841	TRANS ACCESS COVER - FORD 4 SPD	CORRECT SRTD FLNG BOLTS, "X" LONG	Z	D	O	S	F	T		10	12.00
F-816	TRANS COOLING LINE CLIPS	C CLIPS	Z	D	O	S	F	T		2	3.00
F-1467	TRANS CROSSMEMBER	POINTED FLNG BOLTS, LOCK NUTS, WA	Z	D	-	-	-	-		5	12.00
F-1342	TRANS ID TAG	DRIVE SCREW	Z	D	O	S	F	T		1	1.00
F-1157	TRANS INSULATOR - 6 CYL	HX BOLTS, HX SPLIT SEMS, NUTS, WA'S	Z	D	-	-	-	-		10	14.00
F-1489	TRANS INSULATOR - A/T	HX BOLTS, LOCK NUTS, WA'S	Z	-	-	-	-	-		8	8.00
F-1159	TRANS INSULATOR - M/T 289/302	HX SPLIT SEMS, LOCK NUTS, FLAT WA'S	Z	D	-	-	-	-		6	8.00
F-1322	TRANS LEVERS > CASE - 3 SPD	HX NUTS, FLAT & SPLIT WA'S	Z	D	O	S	F	T		6	3.00
F-1385	TRANS LEVERS > CASE - 4 SPD	HX NUTS, FLAT & SPLIT WA'S	Z	D	O	S	F	T		9	3.00
F-1621	TRANS OIL PAN - C4	FLNG BOLTS	Z	D	O	S	F	T		11	4.00
F-892	TRANS OIL PAN - C6	FLNG BOLTS	Z	D	O	S	F	T		17	6.00
F-2874	TRANS TAIL HOUSING - M/T	HX BOLTS, SPLIT WA'S	Z	D	O	S	F	T		10	8.00

Wipers

F-425	WASHER NOZZLES	RNDWA AB SCREWS	Z	-	-	-	-	-		2	1.50
F-465	WINDSHIELD WASHER BAG BRACKET	HXWA A SCREWS	Z	-	-	-	-	-		2	1.50
F-464	WINDSHIELD WASHER PUMP - 2 SPD	HXWA A SCREWS	Z	-	-	-	-	-		3	2.00
F-3676	WIPER ARM PIVOTS > COWL PANEL	HX SPLIT SEMS	Z	-	-	-	-	-		6	5.00
F-737	WIPER MOTOR BRACKET > COWL	HX SPLIT SEMS	Z	-	-	-	-	-		4	3.00

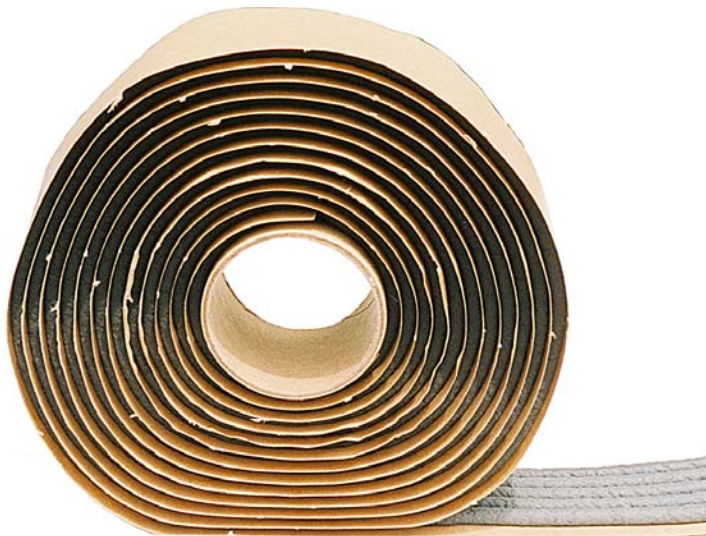

Dark Gray Body Sealer - this product is widely used during assembly



2 Lb Box



*FIVE .19 DIAMETER BEADS ON 13' ROLL
FORD # ESB-M4G32-A*

Air ducts, body openings, door panel water shields, emblems, fenders, floor plugs, kick panels, gas tank & filler neck, firewall openings, heater box, quarter trim panel watershields, seat mounts, valance, window mouldings.

S	Pcs	Price
B-11608	1	\$20

Ford Fastener Kits

227

1966

Air Conditioning

PART #	APPLICATION	NOTES								PCS	PRICE	
			MUSTANG	FALCON	FAIRLANE	T-BIRD	FORD	BRONCO	TRUCK			
F-710	AC BRUSH & HOLDER 10/65 >	HX FLNG SCREWS	Z	D	O	S	-	B	T		2	1.50
F-1607	AC COMP BELT ADJUSTER - 170/200	SQR HD SET SCREW, HX NUT	Z	D	O	-	-	-	-		2	4.00
F-1614	AC COMPRESSOR - 200	HX BOLTS, FLAT & SPLIT WA'S	Z	D	O	-	-	B	-		14	7.00
F-1254	AC COMPRESSOR - 289	HX & HXWA MS EXT SEMS	Z	D	O	-	-	B	T		6	6.00
F-1610	AC COMPRESSOR BRACE (Fr) - 200	HUG-LOK NUT	Z	D	O	-	-	-	-		1	1.00
F-1612	AC COMPRESSOR BRACE (LWR) - 170/200	HX & PLACE BOLTS, SPLIT WA	Z	D	O	-	-	B	-		3	3.00
F-1608	AC COMPRESSOR BRACE (Rr) - 170/200	HX MS EXT SEMS, HX BOLTS, WA'S	Z	D	O	-	-	-	-		4	3.00
F-1256	AC COMPRESSOR BRACE (Rr) - 289	HX MS EXT SEMS, FLAT & EXT WA'S	Z	D	O	-	-	B	T		4	4.00
F-1605	AC COMPRESSOR BRACKET - 170/200	PLACE & HX BOLTS, INT/EXT WA	Z	D	O	-	-	-	-		4	4.00
F-1252	AC COMPRESSOR BRACKET - 289	STUDS, LOCK NUTS, FLAT WA'S	Z	D	O	-	-	B	T		8	8.00
F-711	AC COMPRESSOR CLUTCH	HX BOLT, FLAT WA	Z	D	O	S	-	B	T		2	3.00
F-706	AC COMPRESSOR FIELD	HX FLNG HD SCREWS	Z	D	O	S	-	B	T		4	3.00
F-2948	AC DEHYDRATOR & RECEIVER TANK	HXWA A SCREWS	Z	-	-	-	-	-	-		3	2.00
F-1752	AC EVAPORATOR > DASH	HXWA EXT SEMS, EXT KEPS NUT, WA'S	Z	-	-	-	-	-	-		6	5.00
F-466	AC FIREWALL SEAL RETAINER	HXWA A SCREWS	Z	-	-	-	-	-	-		2	1.50

Body

F-1698	ACCESS HOLE COVERS - Ranchero BED	PH PN & PH OV SCREWS	-	D	-	-	-	-	-		14	4.00
F-2934	AIR VENT GRILLES - FASTBACK, OUTSIDE	STUDS, STAMPED NUTS, CONI KEPS	Z	-	-	-	-	-	-		52	24.00
F-1795	AIR VENTS - FASTBACK QTER, INSIDE	HXWA A SCREWS	Z	-	-	-	-	-	-		14	3.00
F-105	BATTERY TRAY	HX FLNG EXT SEMS, CRG BOLT, NUTS	Z	-	-	-	-	-	-		8	5.50
F-219	BATTERY TRAY	HX PERI SEMS, U-NUTS	-	D	-	-	-	-	-		6	5.50
F-1671	BATTERY TRAY	HX CONI SEMS, J-NUTS, SRTD FLNG NUTS	-	-	O	-	-	-	-		12	7.00
F-1714	BATTERY TRAY	HX FLNG EXT SEMS, J-NUTS	-	-	-	-	-	B	-		4	3.50
F-2328	BED CORNERS - HOLE COVER PLATES	PH PN AB SCREWS	-	-	-	-	-	B	-		2	1.50
F-993	BRAKE PEDAL SUPPORT	SRTD FLNG BOLTS, HXWA A SCREWS	Z	-	-	-	-	-	-		4	4.00
F-1814	BUMPER (Fr)	SS CAPPED BOLTS, NUTS, CRUSH WA'S	Z	-	-	-	-	-	-		22	8.00
F-3598	BUMPER (Fr)	SS CAPPED BOLTS, LOCK NUTS, WA'S	-	D	-	-	-	-	-		24	10.00
F-3577	BUMPER (Fr)	SS CAPPED BOLTS, LOCK NUTS, WA'S	-	-	O	-	-	-	-		28	14.00
F-1821	BUMPER (Rr)	SS CAPPED BOLTS, NUTS, CRUSH WA'S	Z	-	-	-	-	-	-		16	7.00
F-3594	BUMPER (Rr)	SS CAPPED BOLTS, NUTS, CONI WA'S	-	D	O	-	-	-	-		24	10.00
F-109	BUMPER BRACKETS (Fr)	HX BOLTS, SPLIT WA'S	Z	-	-	-	-	-	-		8	9.00
F-3581	BUMPER BRACKETS (Fr)	HX BOLTS, SPLIT WA'S	-	D	O	-	-	-	-		8	5.00
F-110	BUMPER BRACKETS (Fr) > FENDER	HX PERI SEMS, PADDED U-NUTS	Z	-	-	-	-	-	-		4	8.00
F-106	BUMPER BRACKETS (Rr)	HX BOLTS, SHIMS, CONI WA'S, SEALS	Z	-	-	-	-	-	-		16	12.00
F-3591	BUMPER BRACKETS (Rr)	HX CONI SEMS, HX BOLT, WA'S, SEALS	-	D	-	-	-	-	-		8	6.00
F-3590	BUMPER BRACKETS (Rr)	HX CONI SEMS, SEALS	-	-	O	-	-	-	-		12	6.00
F-2449	BUMPER BRACKETS (Rr) - Ranchero	HX BOLTS, LOCK NUTS, WA'S	-	D	-	-	-	-	-		14	8.00
F-3595	BUMPER FILLER PANEL (Rr)	RND WA AB SCREWS	-	D	-	-	-	-	-		4	2.00
F-1681	BUMPER FILLER PANELS (Rr)	PH PN AB SCREWS	-	-	O	-	-	-	-		8	3.00
F-133	BUMPER GUARD MOUNT BRACKETS (Rr)	HX PERI SEMS, U-NUTS	Z	-	-	-	-	-	-		8	7.00
F-111	BUMPER GUARDS (Fr)	HX PERI & FLNG EXT SEMS, NUTS, WA'S	Z	-	-	-	-	-	-		14	10.50
F-134	BUMPER GUARDS (Rr)	HX CONI SEMS, PADDED U-NUTS, SEALER	Z	-	-	-	-	-	-		8	16.50
F-3600	BUMPERS (Fr & Rr) - CHROME	SS CAPPED BOLTS, NUTS, SPLIT WA'S	-	-	-	-	-	B	-		24	10.00
F-3599	BUMPERS (Fr & Rr) - PAINTED	CRG BOLTS, NUTS, SPLIT WA'S	-	-	-	-	-	B	-		24	6.00
F-954	CONVERTIBLE PUMP & BRACKETS	HX CONI SEMS, CAGE NUTS, NUTS, WA'S	Z	-	-	-	-	-	-		8	10.00
F-957	CONVERTIBLE TOP > BODY TACK STRIP	HX CONI SEMS, PH PN A SCREWS	Z	-	-	-	-	-	-		14	14.00
F-2003	CONVERTIBLE TOP > BOW LISTING	PH OV B SCREWS	Z	-	-	-	-	-	-		4	2.00
F-2979	CONVERTIBLE TOP CLAMPS TO BODY	HX EXT SEMS	Z	-	-	-	-	-	-		4	4.00
F-1765	CONVERTIBLE TOP DUST HOOD RETAINER	PH PN F SCREWS	Z	-	-	-	-	-	-		11	2.00
F-2060	CONVERTIBLE TOP FRAME > BODY	HX CONI SEMS	Z	-	-	-	-	-	-		6	5.00
F-1763	CONVERTIBLE TOP WELL LINER	PH WAFER SCREWS	Z	-	-	-	-	-	-		18	4.00
F-260	COWL BRACES > COWL	HX FLNG EXT SEMS, SRTD FLNG NUTS	Z	-	-	-	-	-	-		16	16.00
F-112	COWL BRACES, TUBULAR - BODY 76	HX FLNG EXT SEMS	Z	-	-	-	-	-	-		2	2.00
F-1669	COWL BRACES, TUBULAR - BODY 76	HX FLNG EXT SEMS	-	-	O	-	-	-	-		2	2.00
F-1672	COWL PANEL	HXWA EXT SEMS SCREWS	-	D	O	-	-	-	-		5	3.00
F-107	COWL SEAL BRACKETS	PH RNDWA A SCREWS	Z	-	-	-	-	-	-		4	2.00
F-3183	DATA PLATE	SPL ALUMINUM RIVETS	Z	D	O	S	F	B	T		2	2.00
F-973	DOOR HANDLES (outside)	PH PN EXT SEMS, EXT KEPS NUTS	Z	-	-	-	-	-	-		4	2.50
F-1680	DOOR HANDLES (outside)	EXT KEPS NUTS	-	D	O	-	-	-	-		4	3.00
F-228	DOOR HINGES	5/16-18 HX EXT SEMS	Z	-	-	-	-	-	-		22	18.00
F-3506	DOOR HINGES	HX PERI SEMS	-	D	O	-	-	-	-		24	18.00
F-1116	DOOR HINGES	HX PERI SEMS	-	-	-	-	-	B	-		24	18.00
F-3447	DOOR LATCH REINFORCEMENTS	SS PH OV SCREWS, SS CNTSNK WA'S	Z	D	O	-	-	-	-		12	5.00
F-1357	DOOR LATCH ROD END BUSHINGS ONLY	9/64 SIZE, EXACTLY ORIGINAL	Z	-	-	-	-	B	-		12	7.00
F-1360	DOOR LATCH ROD END BUSHINGS ONLY	5/32 SIZE, EXACTLY ORIGINAL	-	-	O	S	F	-	-		14	7.00
F-1356	DOOR LATCH ROD END CLIPS	9/64 SIZE, EXACTLY ORIGINAL	Z	-	-	-	-	B	-		12	38.00
F-1358	DOOR LATCH ROD END CLIPS	5/32 SIZE, EXACTLY ORIGINAL	-	-	O	S	F	-	-		14	38.00
F-1135	DOOR LATCH STRIKERS	POZI FLAT SCREWS	Z	D	O	S	-	-	-		4	3.00
F-653	DOOR LATCHES > DOOR SHELL	PH FLAT EXT SEMS	Z	D	O	-	-	-	-		6	3.00
F-3281	DOOR STOP STRAPS	PH PN SCREWS	-	-	-	-	-	B	-		8	3.00
F-276	EXPORT BRACE > COWL (SHELBY)	HX BOLTS, NUTS, FLAT WA'S	Z	-	-	-	-	-	-		12	10.00
F-1718	FENDER > APRON BRACKETS	HX PERI SEMS, J-NUTS	-	-	-	-	-	B	-		8	7.00
F-1667	FENDER > RADIATOR SUPPORT BRACKETS	HX PERI SEMS, J-NUTS	-	D	O	-	-	-	-		4	3.50

Kits Contain Attaching Fasteners for Both Sides

Ford Fastener Kits

1966

PART #	APPLICATION	NOTES								PCS	PRICE
			Z	D	O	S	F	B	T		
F-1690	FENDER BRACKETS	HX PERI SEMS, U-NUTS	-	D	-	-	-	-	-	6	5.00
F-1666	FENDER BRACKETS	HX PERI SEMS, J-NUTS	-	-	O	-	-	-	-	4	3.50
F-1665	FENDER SPLASH SHIELD BRACKETS (Rr)	HXWA A SCREWS, SPRING NUTS, WA'S	-	D	O	-	-	-	-	8	3.00
F-101	FENDER SPLASH SHIELDS	HXWA A SCREWS	Z	-	-	-	-	-	-	16	8.00
F-1694	FENDER SPLASH SHIELDS	HXWA A SCREWS	-	D	O	-	-	-	-	14	7.00
F-2883	FENDER TOPS ONLY, "DITTOS"	HX PERI SEMS	Z	D	O	-	-	-	-	12	10.00
F-3429	FENDER TOPS ONLY, "SEMS"	HX PERI SEMS	Z	D	O	-	-	-	-	12	10.00
F-805	FENDERS	HX PERI SEMS, CLIP BOLTS, J & U- NUTS	Z	-	-	-	-	-	-	54	48.00
F-1670	FENDERS	HX PERI SEMS, J, U & CAGE NUTS, WA'S	-	D	O	-	-	-	-	34	30.00
F-1722	FENDERS	HX PERI & POZI EXT SEMS, J, CAGE NUTS	-	-	-	-	B	-	-	42	32.00
F-1692	FENDERS (COMET)	HX PERI SEMS, J, U & CAGE NUTS, WA'S	-	-	O	-	-	-	-	42	36.00
F-1697	FLOOR - TRUCK BED (Ranchero)	POZI PN EXT SEMS, SCREWS, NUTS	-	D	-	-	-	-	-	38	28.00
F-568	FLOOR REINFORCEMENT - BODY 76	HX CONI SEMS	Z	-	-	-	-	-	-	6	14.00
F-1063	FLOORBOARD HOLE COVERS < 12/20/66	PH PN AB SCREWS	Z	D	O	-	-	-	-	8	4.00
F-346	GRILLE	HX PERI SEMS, HXWA A SCREWS, NUTS	Z	-	-	-	-	-	-	16	8.00
F-1682	GRILLE	HX PERI SEMS, HXWA A SCREWS, NUTS	-	D	-	-	-	-	-	10	10.00
F-1658	GRILLE	HX PERI SEMS, HXWA A SCREWS, NUTS	-	-	O	-	-	-	-	26	10.00
F-1706	GRILLE	HX PERI SEMS, HX SPLIT SEMS, J-NUTS	-	-	-	-	B	-	-	22	16.00
F-1683	GRILLE (COMET)	HX PERI SEMS, HXWA SCREWS, NUTS	-	-	O	-	-	-	-	13	10.00
F-1660	GRILLE MOULDINGS	HXWA A SCREWS, SPRING NUTS	-	-	O	-	-	-	-	20	6.00
F-1661	GRILLE ORNAMENT RETAINER	CONI KEPS NUTS	-	-	O	-	-	-	-	3	3.00
F-1684	GRILLE, CENTER BAR (COMET)	HXWA A SCREWS, SPRING NUTS	-	-	O	-	-	-	-	24	8.00
F-117	GRILLE, LWR SUPPORT (below grille)	HXWA A SCREWS, SPRING NUTS	Z	-	-	-	-	-	-	10	5.00
F-1691	GRILLE, OUTER BRACKETS (COMET)	HX PERI SEMS	-	-	O	-	-	-	-	8	7.00
F-1688	GRILLE, UPPER BRACKETS (COMET)	HX PERI SEMS	-	D	O	-	-	-	-	2	2.00
F-116	HEADLAMP DOORS	SS PH FILL A SCREWS, SPRING NUTS	Z	-	-	-	-	-	-	16	7.00
F-1685	HEADLAMP DOORS	PH OV & PN PN SCREWS, SPRING NUTS	-	D	-	-	-	-	-	16	3.00
F-1679	HEADLAMP DOORS	SS/CHROME PH OV AB SCREWS, NUTS	-	-	O	-	-	-	-	16	5.00
F-1686	HEADLAMP DOORS (COMET)	SS/CHROME PH OV AB SCREWS, NUTS	-	-	O	-	-	-	-	8	3.00
F-123	HEADLAMP HOUSINGS	HX PERI SEMS	Z	-	-	-	-	-	-	8	6.00
F-1726	HEADLAMP, SPLASH SHIELDS	PH PN A SCREWS, SPRING NUTS	-	-	-	-	B	-	-	8	3.00
F-1730	HOOD	HX FLNG EXT SEMS	-	-	-	-	B	-	-	4	4.00
F-103	HOOD & HINGES	HX FLNG EXT SEMS	Z	-	-	-	-	-	-	10	10.00
F-1657	HOOD & HINGES	HX FLNG EXT SEMS, J-NUTS	-	D	O	-	-	-	-	14	12.00
F-1673	HOOD BUMPERS > COWL	PH PN AB SCREWS ONLY	-	D	O	-	-	-	-	2	1.50
F-122	HOOD BUMPERS, ADJUSTABLE	U-NUTS, JAM NUTS	Z	D	O	-	-	-	-	4	2.50
F-362	HOOD LATCH	HX FLNG EXT SEMS	Z	-	-	-	-	-	-	2	2.00
F-1710	HOOD LATCH	HX SPLIT SEMS, J-NUTS	-	-	-	-	B	-	-	8	6.00
F-1689	HOOD LATCH & CATCH	HX PERI SEMS, J-NUTS	-	D	-	-	-	-	-	6	5.00
F-1668	HOOD LATCH & CATCH	HX PERI SEMS, J-NUTS	-	-	O	-	-	-	-	6	5.00
F-125	HOOD LATCH AUXILLIARY CATCH	HX FLNG EXT SEMS	Z	-	-	-	-	-	-	2	2.00
F-1734	HOOD LATCH AUXILLIARY CATCH	HX SPLIT SEMS	-	-	-	-	B	-	-	2	2.00
F-124	HOOD LATCH DOWELL	HX NUT, FLAT WA	Z	-	-	-	-	-	-	2	1.50
F-114	HOOD LATCH SUPPORT	HX FLNG EXT SEMS, SRTD FLNG NUT	Z	-	-	-	-	-	-	4	3.00
F-1664	HOOD LATCH SUPPORT	HX PERI SEMS	-	D	O	-	-	-	-	3	3.00
F-113	HOOD LATCH SUPPORT BRACE	HX FLNG EXT SEMS, J-NUTS	Z	-	-	-	-	-	-	5	5.00
F-1727	HOOD PROP ROD	COTTER PIN, FLAT WA'S	-	-	-	-	B	-	-	3	2.00
F-1740	JACK CLAMP > FENDER APRON	HX BOLTS, WING & HX NUTS, FLAT WA'S	-	-	-	-	B	-	-	13	6.00
F-1677	LICENSE PLATE BRACKET (Rr)	HX PERI SEMS, U-NUTS	-	-	O	-	-	-	-	4	4.00
F-3588	LICENSE PLATE BUMPERS (Fr & Rr)	ORIGINAL RUBBER BUMPERS	Z	-	-	-	-	-	-	3	3.00
F-1695	LICENSE PLATE SUPPORT (Rr)	CRG BOLTS, SRTD FLNG NUTS	-	D	-	-	-	-	-	4	3.00
F-2338	LICENSE PLATE SUPPORT (Rr)	PH PN F SCREWS, FLAT WA'S	-	-	-	-	B	-	-	8	3.00
F-1281	LICENSE PLATES	SLOT PN HD SCREWS, NYLON NUTS	Z	-	-	-	-	-	-	8	3.00
F-3273	LIFTGATE BUMPERS	PH FLAT F SCREWS	-	-	-	-	B	-	-	8	2.00
F-3276	LIFTGATE HANDLE	PH OV SCREWS	-	-	-	-	B	-	-	2	2.00
F-3275	LIFTGATE HINGE > TOP	PH OV SCREWS, CONI KEPS NUTS	-	-	-	-	B	-	-	16	5.00
F-3280	LIFTGATE LATCH ACCESS COVERS	PH PN A SCREWS	-	-	-	-	B	-	-	6	2.00
F-3274	LIFTGATE LATCH SHIELDS	PH FLAT F SCREWS	-	-	-	-	B	-	-	4	2.00
F-3271	LIFTGATE LATCH STRIKERS	PH FLAT F SCREWS	-	-	-	-	B	-	-	4	2.00
F-3278	LIFTGATE LATCHES	PH FLAT F SCREWS	-	-	-	-	B	-	-	4	2.00
F-130	MIRROR (outside remote) > DOOR	SS PH OV AB SCREWS	Z	-	-	-	-	-	-	2	1.50
F-129	MIRROR (outside) > DOOR	CHROME PH OV A SCREWS	Z	-	-	-	-	-	-	2	1.00
F-1674	MIRROR (outside) > DOOR	SS PH OV AB SCREWS	-	D	O	-	-	-	-	2	1.50
F-1693	MIRROR (outside) > DOOR (COMET)	SS PH OV AB SCREWS, NYLON NUTS	-	-	O	-	-	-	-	4	3.00
F-128	QTER PANEL EXTENSIONS	STUDS, CONI KEPS NUTS, FLAT & SEALER	Z	-	-	-	-	-	-	24	9.00
F-1282	ROOFSIDE WEATHERSTRIP - BODY 63	PH RNDWA & WAFER SCREWS, RIVETS	Z	-	-	-	-	-	-	40	10.00
F-1283	ROOFSIDE WEATHERSTRIP - BODY 65	PH RNDWA & PH WAFER SCREWS	Z	-	-	-	-	-	-	24	6.00
F-856	SHOCK TOWER BRACES (cover springs)	HX PERI SEMS, SRTD FLNG NUTS	Z	-	-	-	-	-	-	32	20.00
F-1662	SHOCK TOWER BRACES (cover springs)	HX FLNG EXT SEMS, FLNG NUTS	-	D	O	-	-	-	-	24	14.00
F-3784	STEERING COLUMN SEAL	HXWA A SCREWS	Z	-	-	-	-	-	-	3	1.50
F-119	STONE DEFLECTOR	HX FLNG EXT SEMS, STUD BOLT, J-NUTS	Z	-	-	-	-	-	-	10	10.50
F-1687	STONE DEFLECTOR	HX PERI SEMS, J & U-NUTS	-	D	-	-	-	-	-	9	8.00
F-1659	STONE DEFLECTOR	HX PERI SEMS, J-NUTS	-	-	O	-	-	-	-	10	8.00
F-1704	TAILGATE COUNTER-BALANCE BAR CLAMP	PH OV EXT SEMS	-	D	-	-	-	-	-	2	2.00
F-1703	TAILGATE COUNTER-BALANCE BAR CLAMP	HX FLNG EXT SEMS, HX T1 SCREW	-	D	-	-	-	-	-	3	3.00

See factory Assembly Manuals for illustrations

Ford Fastener Kits

229

1966

Body

PART #	APPLICATION	NOTES									PCS	PRICE
			Z	D	O	S	F	B	T			
F-1702	TAILGATE HINGES	CONI KEPS NUTS	-	D	-	-	-	-	-	-	13	10.00
F-2329	TAILGATE HINGES	FLNG BOLTS	-	-	-	-	-	B	-	-	4	5.00
F-1592	TAILGATE LATCH CATCHES	HX CONI SEMS	-	-	-	-	-	B	-	-	4	4.00
F-2332	TAILGATE LATCHES	HX PERI SEMS	-	-	-	-	-	B	-	-	4	4.00
F-1700	TAILGATE LOCK & LATCH	PH FLAT EXT SEMS	-	D	-	-	-	-	-	-	6	3.00
F-1699	TAILGATE PANEL & COVER	PH OV & PH PN SCREWS	-	D	-	-	-	-	-	-	26	8.00
F-1705	TAILGATE RELEASE HANDLE	PH OV EXT SEMS	-	D	-	-	-	-	-	-	2	2.00
F-2335	TAILGATE RELEASE HANDLE BEZEL	HX PERI & PH OV EXT SEMS	-	-	-	-	-	B	-	-	6	4.00
F-1701	TAILGATE STRIKERS	POZI OV EXT SEMS, POZI FLAT SCREWS	-	D	-	-	-	-	-	-	4	3.00
F-2325	TAILGATE SUPPORT ARMS	HX PERI SEMS	-	-	-	-	-	B	-	-	4	4.00
F-1552	TAILGATE SUPPORT BUMPERS	PH PN A SCREWS	-	-	-	-	-	B	-	-	2	4.00
F-256	TIE DOWN BRACKETS (Rr)	BOLTS, LOCK NUTS, FLAT WA'S	Z	-	-	-	-	-	-	-	12	12.00
F-3265	TOP ASSEMBLY, LONG > BODY	HX CONI SEMS, SRTD FLNG NUTS, WA'S	-	-	-	-	-	B	-	-	38	20.00
F-164	TRUNK LATCH & STRIKER	HX FLNG EXT SEMS	Z	-	-	-	-	-	-	-	4	4.00
F-1675	TRUNK LATCH & STRIKER	HX PERI SEMS	-	D	O	-	-	-	-	-	5	4.00
F-1696	TRUNK LATCH & STRIKER (COMET)	HX PERI SEMS	-	-	O	-	-	-	-	-	4	4.00
F-1676	TRUNK LID	HX FLNG EXT SEMS	-	D	O	-	-	-	-	-	4	4.00
F-131	TRUNK LID & HINGES	HX FLNG EXT SEMS, HXWA AB SCREWS	Z	-	-	-	-	-	-	-	10	9.00
F-120	VALANCE (Fr)	HX FLNG EXT SEMS, PERI SEMS, J-NUTS	Z	-	-	-	-	-	-	-	16	14.00
F-132	VALANCE (Rr)	CLIP HEAD BOLTS, PH PN SCREWS, NUTS	Z	-	-	-	-	-	-	-	15	7.50
F-1746	WEATHERSTRIP, DOORS	NYLON PUSH RIVETS	Z	-	-	-	-	-	-	-	4	1.50
F-1767	WEATHERSTRIP, WINDSHIELD PILLARS	PH PN, PH RND WA & PH WAFER SCREWS	Z	-	-	-	-	-	-	-	12	3.00
F-1789	WINDOW GUIDE @ DOOR OPENINGS	Visible in jamb area, HX PERI SEMS	Z	-	-	-	-	-	-	-	4	4.00
F-697	WINDOW SEALS @ DOOR Rr & QTER	PH PN A SCREWS	Z	-	-	-	-	-	-	-	22	5.00
F-2324	WINDSHIELD FRAME	HX SCREWS	-	-	-	-	-	B	-	-	10	5.00
F-1638	WINDSHIELD HOLD-DOWN RETAINER	SRTD FLNG NUTS	-	-	-	-	-	B	-	-	2	1.50

Brakes

F-1616	BRAKE ASSEMBLY (front drum) > SPINDLE	T-BOLTS, LOCK NUTS	Z	D	O	-	-	-	-	-	16	14.00
F-1477	BRAKE BOOSTER > FIREWALL	HX SPLIT SEMS	Z	-	-	-	-	-	-	-	4	8.00
F-1478	BRAKE BOOSTER > FIREWALL	HX SPLIT SEMS, FLNG NUTS	-	D	O	-	-	-	-	-	5	8.00
F-3881	BRAKE BOOSTER HOSE	PINCH TYPE CLAMPS	Z	D	O	-	-	B	T	-	2	2.00
F-1791	BRAKE CABLE SEAL @ BRAKE PLATES	1.0" DIA X .58 TK RUBBER SEAL	Z	D	O	-	-	-	-	-	2	3.00
F-1643	BRAKE CABLES > BODY	HXWA AB SCREWS, RETAINERS, NUT	Z	-	-	-	-	-	-	-	8	5.00
F-3911	BRAKE CABLES > BODY	RETAINING CLIPS	-	D	O	-	-	-	-	-	6	4.00
F-2949	BRAKE CALIPER BLEEDERS	CORRECT SCREWS	Z	-	O	S	-	-	-	-	2	4.00
F-1470	BRAKE CALIPER BRACKETS > SPINDLE	GR-8 HXWA BOLTS, FLNG NUTS	Z	D	O	-	-	-	-	-	16	24.00
F-3262	BRAKE CALIPER SHIELDS	HX EXT SEMS	Z	D	O	-	-	-	-	-	4	3.00
F-603	BRAKE CALIPERS > BRACKET	PLACE SHLDR BOLTS	Z	-	-	-	-	-	-	-	4	12.00
F-579	BRAKE DRUM RETAINERS	GREEN PUSH ON RETAINERS	Z	D	O	S	F	B	T	-	6	4.00
F-1150	BRAKE HOSE BRKTS (Fr) > BODY	HX HD C SCREWS	Z	D	O	-	-	-	-	-	2	2.00
F-576	BRAKE HOSES > BRACKET	U-CLIPS	Z	D	O	-	-	-	-	-	3	4.00
F-669	BRAKE PLATE ADJUST HOLE PLUGS (2)	RUBBER PLUGS	Z	D	O	S	F	B	T	-	2	3.00
F-1305	DISTRIBUTION BLOCK > APRON	HX C SCREW	Z	-	-	-	-	-	-	-	1	1.50
F-1474	MASTER CYLINDER w POWER BRAKES	HX NUTS, SPLIT WA'S	-	D	O	-	-	B	-	-	4	3.00
F-1431	MASTER CYLINDER w/o POWER BRAKES	HX SPLIT SEMS	Z	-	-	-	-	-	-	-	2	5.00
F-800	PARKING BRAKE CONTROL > BODY	PH PN EXT SEMS, CAGED & LOCK NUTS	Z	-	-	-	-	-	-	-	8	5.00
F-1333	PARKING BRAKE CONTROL > BODY	HXWA SRTD SCREWS	-	D	O	-	-	-	-	-	3	4.00
F-1397	PROPORTIONING VALVE > APRON	SRTD HX FLNG SCREW	Z	-	-	-	-	-	-	-	1	3.00
F-1214	PROPORTIONING VALVE > APRON	5/16-18 HXWA F SCREW	-	D	O	-	-	-	-	-	1	1.50
F-2950	WHEEL CYLINDER BLEEDERS	1/4-28 x 1/4 HX x 92" OAL SCREWS, ZDC	Z	D	O	S	F	B	T	-	2	3.00
F-356	WHEEL CYLINDERS (2) - 250 & All 8 CYL	5/16-18 HX EXT SEMS	Z	D	O	S	F	B	T	-	4	3.00
F-1772	WHEEL CYLINDERS (4) - 170/200	1/4-20 HX EXT SEMS	Z	-	-	-	-	-	-	-	8	6.00
F-3912	WHEEL CYLINDERS (4) - 250 & All 8 CYL	5/16-18 HX EXT SEMS	Z	D	O	S	F	B	T	-	8	6.00

Brake & Fuel Lines - also see page 216

F-3956	BRAKE LINES (not shared) - 6 & 8 CYL	CORRECT CLIPS, SCREWS, GROMMETS	Z	-	-	-	-	-	-	-	8	12.00
F-3957	BRAKE LINES (not shared) - 8 CYL w DISC	CORRECT CLIPS, SCREWS, GROMMETS	Z	-	-	-	-	-	-	-	8	12.00
F-3958	BRAKE LINES (shared) - 6 & 8 CYL	CORRECT CLIPS, HX C SCREW	Z	-	-	-	-	-	-	-	5	15.00
F-667	FUEL LINE GROMMET (fender apron)	RUBBER GROMMET	Z	-	-	-	-	-	-	-	1	2.00
F-3959	FUEL LINES (not shared) - 6 CYL	CORRECT CLIPS, SCREWS, GROMMET	Z	-	-	-	-	-	-	-	6	10.00
F-3960	FUEL LINES (not shared) - V8	CORRECT CLIPS, SCREWS, GROMMET	Z	-	-	-	-	-	-	-	8	11.00

Cooling

F-396	RADIATOR - All	HX FLNG EXT SEMS, J-NUTS	Z	-	-	-	-	-	-	-	8	6.00
F-401	RADIATOR FAN SHROUD - 289	HXWA T1 SCREWS, SPRING NUTS	Z	-	-	-	-	-	-	-	8	6.00
F-402	RADIATOR FAN SHROUD - 289 w AC	HXWA T1 SCREWS, CONI KEPS & NUTS	Z	-	-	-	-	-	-	-	12	9.00
F-398	RADIATOR FAN SHROUD - 6 CYL w AC	HXWA T1 SCREWS, CONI KEPS, WA'S	Z	-	-	-	-	-	-	-	12	8.00
F-385	RADIATOR HOSE CLAMPS - 260/289	WITEK TOWER TYPE	Z	D	O	-	-	B	T	-	4	12.00
F-657	RADIATOR HOSE CLAMPS - 289/302/351	WIRE TYPE	Z	D	O	S	F	B	T	-	4	16.00
F-386	RADIATOR HOSE CLAMPS - 390/428	WITEK TOWER TYPE	-	-	O	-	-	-	T	-	4	14.00
F-656	RADIATOR HOSE CLAMPS - 6 CYL	WIRE TYPE	Z	D	O	-	-	B	T	-	4	16.00

Kits Contain Attaching Fasteners for Both Sides

Ford Fastener Kits

1966

Differential

PART #	APPLICATION	NOTES								PCS	PRICE
			MUSTANG	FALCON	FAIRLANE	T-BIRD	FORD	BRONCO	TRUCK		
F-1439	AXLE RETAINER PLATES - 8 CYL	T-BOLTS, LOCK NUTS	Z	D	O	-	-	B	-	16	20.00
F-663	AXLE RETAINER PLATES - NUTS ONLY	LOCK NUTS (Silver Cad)	Z	D	O	-	-	B	-	8	6.00
F-1446	AXLE VENT SYSTEM w BRAKE DIST BLOCK	FITTING, HOSE, CLAMPS, SCREW, SLEEVE	Z	-	-	-	-	-	-	7	25.00
F-1165	DIFFERENTIAL CARRIER > HOUSING	COPPER WA'S ONLY	Z	D	O	S	F	B	T	10	4.00
F-598	DIFFERENTIAL CARRIER > HOUSING	CAD LOCK NUTS, COPPER WA'S	Z	D	O	S	-	B	T	20	12.00
F-3987	DIFFERENTIAL FLANGE > PINION	GR-8 3/4-20 TOP-LOK FLNG LOCKNUT	Z	D	O	S	F	B	T	1	5.00
F-374	DIFFERENTIAL PINION SUPPORT	PLACE BOLTS	Z	D	O	S	F	B	T	5	8.00

Electrical

F-621	ALTERNATOR - 289 less SPACER	HX & PLACE BOLTS, FLAT & SPLIT WA'S	Z	D	O	-	-	B	T	5	7.00
F-623	ALTERNATOR - 289 w SMOG	PLACE BOLTS, FLAT WA	Z	D	O	-	-	B	T	3	8.00
F-622	ALTERNATOR - 289 w SPACER	HX, PLACE BOLTS, GOLD SPACER, WA'S	Z	D	O	-	-	B	T	6	16.00
F-627	ALTERNATOR - 390/428 less SPACER	HX SPLIT SEMS, HX, PLACE BOLTS, WA'S	-	-	-	-	-	-	-	6	8.00
F-628	ALTERNATOR - 390/428 w SPACER	HX SPLIT SEMS, BOLTS, PINK SPACER	-	-	O	-	-	-	-	7	17.00
F-1611	ALTERNATOR - 6 CYL w AC	HX SPLIT SEMS, HX BOLTS, WA'S, NUTS	Z	D	O	-	-	B	T	11	14.00
F-1315	ALTERNATOR - 6 CYL w/o AC	HX SPLIT SEMS, HX BOLTS, WA'S, NUTS	Z	D	O	-	-	B	T	8	14.00
F-651	ALTERNATOR HOUSING THRU BOLTS	HXWA SCREWS	Z	D	O	S	-	B	T	3	3.00
F-643	ALTERNATOR PULLEY	HX NUT & SPLIT WA (silver ZC)	Z	D	O	S	-	B	T	2	2.00
F-1119	ALTERNATOR WIRING	EXT KEPS NUT, NUTS, SPLIT & FLAT WA'S	Z	D	O	S	-	B	T	9	3.00
F-2966	BACK-UP LAMP GROUND WIRE	HX NUT, TOOTH WA	Z	-	-	-	-	-	-	2	1.50
F-3569	BACK-UP LAMP LENSES	SS PH PN STOP SCREWS	Z	-	-	-	-	-	-	4	2.00
F-352	BACK-UP LAMPS > R VALANCE	STAMPED NUTS, CUPPED WA'S	Z	-	-	-	-	-	-	8	6.00
F-3805	BACK-UP SWITCH - 4 SPD TRANS	HX MS EXT SEMS	Z	-	-	-	-	-	-	1	1.50
F-3804	BACK-UP SWITCH & WIRING - 3 SPD TRANS	J-CLIPS, HX MS EXT SEMS	Z	-	-	-	-	-	-	3	3.00
F-636	BATTERY CABLES - 260/289	HX BOLTS, HXWA SCREWS, KEPS NUTS	Z	D	O	-	-	B	T	9	6.00
F-633	BATTERY CABLES - 6 CYL	HX BOLT, HXWA SCREW, CONI KEPS	Z	D	O	-	-	B	T	7	5.00
F-3800	BATTERY GROUND PROTECTOR > APRON	NYLON CANOE CLIPS	Z	-	-	-	-	-	-	4	2.00
F-1195	BATTERY HOLDOWN CLAMP	J- HOOKS, HXWA AB SCREW, CONI KEPS	-	-	O	-	-	-	-	5	6.00
F-741	BATTERY HOLDOWN CLAMP - GROUP 24	CLIP HEAD BOLT, FLNG NUT	Z	D	-	-	-	-	-	2	3.00
F-1189	BATTERY TERMINALS	SQR HD BOLTS, NUTS	Z	D	O	S	-	B	T	4	3.00
F-646	DISTRIBUTOR POINTS & COND - DUAL PT	SLOT PN C SCREWS	Z	D	O	S	F	B	T	5	3.00
F-645	DISTRIBUTOR POINTS & COND - SINGLE	SLOT PN C SCREWS	Z	D	O	S	F	B	T	3	2.00
F-3264	EMERGENCY WARNING SWITCH & FLASHER	HXWA & PH PN SCREWS, EXT KEPS NUTS	Z	D	O	S	-	B	T	5	2.00
F-1329	FOG LAMP BEZELS	SS/CHROME PH OV AB SCREWS	Z	-	-	-	-	-	-	4	2.00
F-563	FOG LAMPS > GRILLE	HXWA SCREWS, STRD FLNG & U-NUTS	Z	-	-	-	-	-	-	16	6.00
F-738	FUSE BLOCK > FIREWALL	HXWA A SCREWS	Z	D	O	-	-	-	-	2	2.00
F-3988	HEADLAMP ADJUSTERS	ADJUSTER NUTS, SCREWS, SPRINGS	Z	-	-	-	-	-	-	10	10.00
F-740	HEADLAMP DIMMER SWITCH	HXWA AB SCREWS	Z	D	O	-	-	-	-	2	2.00
F-599	HEADLAMP RETAINING RINGS (2)	SS PH FILL B SCREWS	Z	D	-	-	-	-	-	6	3.00
F-2959	HEADLAMP WIRING GROMMETS @ APRONS	1.37" ID X 1.66 OD PLASTIC GROMMETS	Z	-	-	-	-	-	-	2	5.00
F-1304	HEADLAMP WIRING GROUND (near battery)	HXWA A SCREW, EXT WA	Z	-	-	-	-	-	-	2	1.50
F-2882	HEADLAMP WIRING GROUND (near battery)	HXWA AB SCREW, EXT WA	-	D	O	-	-	-	-	2	1.50
F-806	HORNS	HX PERI SEMS, SRTD FLNG NUTS	Z	D	O	S	-	B	T	4	3.00
F-2028	IGNITION COIL > DISTRIBUTOR LEAD	EXT KEPS NUT	Z	D	O	S	-	B	T	1	0.75
F-421	IGNITION COIL STRAP & BRKT - 6 CYL	HX SPLIT SEMS, HXWA SCREW, HX NUT	Z	D	O	S	-	B	T	4	3.00
F-420	IGNITION COIL STRAP & BRKT - All V8	HX SPLIT SEMS, HXWA SCREW, HX NUT	Z	D	O	S	-	B	T	3	3.00
F-1301	IGNITION COIL STRAP ONLY	HXWA SCREW, HX NUT	Z	D	O	S	F	B	T	2	1.50
F-446	LICENSE PLATE LAMP	PH PN A SCREWS	Z	-	-	-	-	-	-	2	1.00
F-3443	NEUTRAL SWITCH	HX EXT SEMS	Z	D	O	S	F	B	T	2	3.00
F-108	PARKING LAMP LENSES	SS PH PN B STOP SCREWS	Z	-	-	-	-	-	-	4	2.00
F-2958	PARKING LAMP WIRING GROMMETS	.62" ID X 1.06 OD PLASTIC GROMMETS	Z	-	-	-	-	-	-	2	4.00
F-679	PARKING LAMPS	STAMPED NUTS	Z	-	-	-	-	-	-	4	3.00
F-1097	RADIO > INSTRUMENT PANEL	HXWA EXT SEMS, STAMPED NUT	Z	-	-	-	-	-	-	2	2.00
F-1784	SHOCK BRACKETS (Fr) SHELBY WELD WA'S	.41 x 1.0 x .17 FLAT WASHERS	Z	-	-	-	-	-	-	4	3.00
F-1409	STARTER - 260/289/302/351	HXWA SPLIT SEMS, SILVER ZINC	Z	D	O	-	-	B	T	2	3.50
F-1604	STARTER - 6 CYL & 390/428	HX BOLTS, SPLIT WA'S	Z	D	O	S	-	-	T	6	3.50
F-358	STARTER SOLENOID	HXWA AB SCREWS "D"	Z	D	O	S	-	B	T	2	1.50
F-366	TAILAMP ASSEMBLY > BODY	STAMPED NUTS ONLY	Z	-	-	-	-	-	-	8	6.00
F-404	VOLTAGE REGULATOR	HXWA A SCREWS "Diamond", EXT WA	Z	D	O	S	-	B	T	3	1.50
F-1491	VOLTAGE REGULATOR COVER	SLOT RND A SCREWS	Z	D	O	S	-	B	-	2	1.50
F-3823	WIRING - 6 CYL IGNITION COIL	RUBBER COATED "J" CLIP	Z	D	O	-	-	B	T	1	1.50
F-3815	WIRING - AC BLOWER > DASH BOTTOM	NYLON "S" CLIP	Z	-	-	-	-	-	-	1	1.50
F-2921	WIRING - CONSOLE	HXWA SCREWS, NYLON CLIPS, TOOTH WA	Z	-	-	-	-	-	-	12	4.00
F-3788	WIRING - DOOR COURTESY LAMPS	NYLON "S" CLIPS	Z	-	-	-	-	-	-	6	4.00
F-584	WIRING - ENGINE BAY	3 1/8" NYLON STRAPS ONLY	Z	-	-	-	-	-	-	20	10.00
F-460	WIRING - ENGINE FEED - 8 CYL w AC	RUBBER COATED "J" CLIPS	Z	D	O	S	-	B	T	4	5.00
F-423	WIRING - ENGINE FEED - 8 CYL w/o AC	RUBBER COATED "J" CLIPS	Z	D	O	S	-	B	T	3	4.00
F-3810	WIRING - FUEL SENDER @ GAS TANK	METAL "S" CLIPS	Z	-	-	-	-	-	-	2	4.00
F-3302	WIRING - FUEL SENDER @ TRUNK - BODY 63	RUBBER COATED "J" CLIPS, 3 1/8" STRAP	Z	-	-	-	-	-	-	3	4.00
F-3303	WIRING - FUEL SENDER @ TRUNK - BODY 65	RUBBER COATED "J" CLIPS	Z	-	-	-	-	-	-	2	3.00
F-442	WIRING - LH TAILAMP	RUBBER COATED "J" CLIP, HX NUT	Z	-	-	-	-	-	-	2	2.00

See factory Assembly Manuals for illustrations

Ford Fastener Kits

231

1966

Electrical

PART #	APPLICATION	NOTES									PCS	PRICE	
			Z	D	O	S	F	B	T				
F-3799	WIRING - PARKING LAMPS	METAL "S" RETAINERS	Z	-	-	-	-	-	-	-	-	2	4.00
F-3802	WIRING - TAILAMPS @ WHEELHOUSE JOINT	METAL "S" RETAINER	Z	-	-	-	-	-	-	-	-	1	2.00
F-3803	WIRING - TAILAMPS @ WINDSHIELD PILLAR	METAL "S" RETAINERS	Z	-	-	-	-	-	-	-	-	3	6.00
F-3814	WIRING - UNDER DASH	NYLON "S" RETAINERS	Z	-	-	-	-	-	-	-	-	4	5.00
F-2970	WIRING STRAPS - ENGINE BAY	3 1/8" NYLON STRAPS	-	-	O	-	-	-	-	-	-	16	8.00

Emissions

F-1648	SMOG PUMP - 289	BOLTS, SPACERS, LOK TAB, NUTS, WA'S	Z	D	O	-	-	B	T			16	26.00
F-701	SMOG PUMP PULLEY	PLACE BOLTS	Z	D	O	S	-	B	T			4	8.00

Exhaust

F-1451	EXHAUST HANGERS, DUAL	CRG BOLTS, HX & PH PN SCREWS, NUTS	Z	-	-	-	-	-	-	-	-	20	8.00
F-1245	EXHAUST HANGERS, SINGLE	HX C SCREWS	Z	-	-	-	-	-	-	-	-	6	4.00
F-522	EXHAUST PIPE > MANIFOLD - 6 CYL	STUDS 2.25 OAL, FLNG NUTS	Z	D	O	-	-	B	T			4	7.00
F-524	EXHAUST PIPE > MANIFOLDS - 390/428/B429	STUDS 2.25 & 3.81 OAL, FLNG NUTS	-	-	O	-	-	-	-	-	-	8	12.00
F-523	EXHAUST PIPE > MANIFOLDS - SB, 69 390GT	STUDS 2.25 OAL, FLNG NUTS	Z	D	O	-	-	B	T			8	10.00

Fuel - for lines see page 216

F-1457	ACCEL BELLCRANK > FIREWALL - 6 CYL	HXWA A SCREWS	Z	-	-	-	-	-	-	-	-	4	2.00
F-746	ACCEL BELLCRANK > FIREWALL - 8 CYL	HXWA A SCREWS	Z	-	O	-	-	-	-	-	-	3	2.00
F-745	ACCELERATOR PEDAL	SPL PH PN MS, RETAINER	Z	-	-	-	-	-	-	-	-	2	3.00
F-1193	ACCELERATOR ROD > CARB - 8 CYL	3/16" RH ROD END RETAINER	Z	-	-	-	-	-	-	-	-	1	2.00
F-588	FUEL HOSE CLAMPS	SS PINCH TYPE	Z	D	O	-	-	-	-	-	-	8	6.00
F-225	GAS TANK	HXWA A SCREWS	Z	D	O	-	-	-	-	-	-	11	6.00
F-3910	GAS TANK FILLER NECK	HXWA A SCREWS	-	D	O	-	-	-	-	-	-	5	3.00
F-1779	GAS TANK FILLER NECK CLAMPS	CORRECT WIRE CLAMPS	Z	-	-	-	-	-	-	-	-	2	6.00
F-412	GAS TANK FILLER NECK w TWIST CAP	HXWA B SCREWS	Z	-	-	-	-	-	-	-	-	5	3.00

Heater

F-468	DEFROSTER PLENUM > HEATER CASE	HXWA AB SCREWS	Z	-	-	-	-	-	-	-	-	4	2.00
F-383	HEATER & BY-PASS HOSES	WHITEK TOWER CLAMPS	Z	D	O	S	F	B	T			6	12.00
F-470	HEATER ASSEMBLY > COWL (RH side)	HXWA AB SCREW, SPRING CLIP	Z	-	-	-	-	-	-	-	-	2	2.00
F-432	HEATER ASSEMBLY > FIREWALL	STAMPED NUTS w INTEGRAL SEALER	Z	-	-	-	-	-	-	-	-	4	4.00
F-2855	HEATER ASSEMBLY > FIREWALL	STAMPED NUTS	-	-	O	-	-	-	-	-	-	4	4.00
F-469	HEATER CABLES > HEATER HOUSING	SLOT HX A SCREWS	Z	-	-	-	-	-	-	-	-	3	2.00
F-1483	HEATER CONTROL CABLE RETAINERS	PUSH-ON "TOP-HAT" RETAINERS	Z	-	-	-	-	-	-	-	-	2	1.50
F-3801	HEATER CONTROL CABLES	6 3/4" ALUMINUM STRAP	Z	-	-	-	-	-	-	-	-	1	5.00
F-3215	HEATER DELETE PLATE	HXWA A SCREWS	Z	-	-	-	-	-	-	-	-	4	2.00
F-1213	HEATER HOSE STRAPS	6 3/4" ALUMINUM STRAP	Z	D	O	-	-	-	-	-	-	2	10.00

Interior

F-735	AIR VENT LH UNDER DASH > COWL	STAMPED NUTS	Z	-	-	-	-	-	-	-	-	3	2.50
F-1137	ARMREST BASE & PAD - STD	PH TRUSS & PH PN SCREWS, SPRG NUTS	Z	-	-	-	-	-	-	-	-	12	6.00
F-886	ARMREST BASE & PAD - STD (less nuts)	SCREWS ONLY	Z	-	-	-	-	-	-	-	-	8	3.00
F-3002	ASH TRAY BUMPERS	.31 DIA X .15 H HEAD	Z	-	-	-	-	-	-	-	-	2	2.00
F-692	ASH TRAY LINER	PH PN AB SCREWS	Z	-	-	-	-	-	-	-	-	4	1.50
F-889	CARPET > FLOOR w CONSOLE	RNDWA SCREWS, 2 EXTRA for BODY 63	Z	-	-	-	-	-	-	-	-	8	2.00
F-279	CARPET > FLOOR w/o CONSOLE	RNDWA SCREWS, 2 EXTRA for BODY 63	Z	-	-	-	-	-	-	-	-	10	3.00
F-1016	COAT HOOKS - BODY 63, 65	PH OV AB SCREWS ONLY	Z	-	-	-	-	-	-	-	-	2	2.00
F-1017	COAT HOOKS - BODY 76	PH OV AB SCREWS ONLY	Z	-	-	-	-	-	-	-	-	2	2.00
F-3937	CONSOLE - TRIM PLATES	STAMPED NUTS	Z	-	-	-	-	-	-	-	-	9	3.00
F-783	CONSOLE "Z" BRACKET (Fr)	HXWA & PH PN SCREWS, SPRING NUTS	Z	-	-	-	-	-	-	-	-	6	3.00
F-1635	CONSOLE > FLOOR	PH OV AB SCREWS	Z	-	-	-	-	-	-	-	-	6	3.00
F-2942	CONSOLE ASH TRAY BUMPERS	.16 DIA X .10 H HEAD SIZE	Z	-	-	-	-	-	-	-	-	2	2.00
F-1405	CONSOLE DOOR HINGE	PH PN B SCREWS	Z	-	-	-	-	-	-	-	-	2	2.00
F-496	COURTESY LAMP @ DOORS	PH OV AB & B SCREWS	Z	-	-	-	-	-	-	-	-	8	3.00
F-3585	DASH PAD & MOULDINGS	PH OV & PH PN SCREWS, STAMPED NUTS	Z	-	-	-	-	-	-	-	-	19	5.00
F-947	DOOR HANDLES (inside)	CHROME CNTRS NK HX SKT SCREWS	Z	-	-	-	-	-	-	-	-	2	2.00
F-3863	DOOR LATCH CONTROL (at inside handle)	PH PN EXT SEMS	Z	-	-	-	-	-	-	-	-	6	3.00
F-1041	DOOR PANEL ARMREST BRACKETS - DLX	PH PN A SCREWS, SPRING NUTS	Z	-	-	-	-	-	-	-	-	8	3.00
F-1037	DOOR PANELS - DLX	SCREWS, RETAINERS (pad clips go lower)	Z	-	-	-	-	-	-	-	-	36	10.00
F-1036	DOOR PANELS - STD	RETAINERS (padded clips go lower)	Z	-	-	-	-	-	-	-	-	30	8.00

Kits Contain Attaching Fasteners for Both Sides

Ford Fastener Kits

1966

Interior

PART #	APPLICATION	NOTES								PCS	PRICE
			Z	D	O	S	F	B	T		
F-288	FD SEAT LATCH COVERS	PH OV AB SCREWS, FINISH WA'S	Z	-	-	-	-	-	-	16	4.00
F-773	FD SEAT SIDE LATCHES	HXWA EXT SEMS	Z	-	-	-	-	-	-	8	4.00
F-769	FD SEAT STOP PLATES	PH PN MS & AB SCREWS	Z	-	-	-	-	-	-	6	3.00
F-928	FD SEAT TRAP DOOR HINGES	HXWA EXT SEMS	Z	-	-	-	-	-	-	8	3.50
F-924	FD SEAT TRAP DOOR LATCH	HX EXT SEMS	Z	-	-	-	-	-	-	4	3.00
F-934	FD SEAT TRAP DOOR PROP	HX & HXWA EXT SEMS, RIVET NUTS	Z	-	-	-	-	-	-	6	6.00
F-772	FD SEAT TRAP DR LATCH CATCH	HX EXT SEMS	Z	-	-	-	-	-	-	2	2.00
F-1753	FD SEAT TRIM	CHROME PH OV AB SCREW, JAM NUTS	Z	-	-	-	-	-	-	66	10.00
F-774	FLOOR PANEL (Rr) - Fr ANCHORS	PH PN SCREWS, FINISH WA'S	Z	-	-	-	-	-	-	4	3.00
F-2939	GLOVE BOX BUMPERS	.31 H RUBBER BUMPER	Z	-	-	-	-	-	-	2	2.00
F-795	GLOVE BOX CABLE	PN PN B SHLDR SCREWS, WAVE WA'S	Z	-	-	-	-	-	-	4	3.00
F-778	GLOVE BOX CATCH	HXWA A EXT SEMS	Z	-	-	-	-	-	-	2	2.00
F-690	GLOVE BOX HINGES	HX CONI SEMS	Z	-	-	-	-	-	-	6	5.00
F-689	GLOVE BOX LATCH	HX CONI SEMS	Z	-	-	-	-	-	-	2	2.00
F-1145	GLOVE BOX LINER	PH RNDWA SCREWS	Z	-	-	-	-	-	-	7	2.00
F-997	HEADLINER RETAINER (hardtop @ Fr pillars)	CHROME PH OV AB SCREWS	Z	-	-	-	-	-	-	2	1.50
F-1079	HEATER CONTROL > DASH	EXT KEPS NUTS	Z	-	-	-	-	-	-	2	1.00
F-1057	INSTR FINISH PANEL (BEZEL) @ CLUSTER	PH PN A SCREWS, SPRING NUTS	Z	-	-	-	-	-	-	18	8.00
F-879	KICK PANELS	PH RNDWA A SCREWS	Z	-	-	-	-	-	-	4	2.00
F-1377	LAMPS, COURTESY UNDERDASH	PH PN EXT SEMS, STAMPED NUTS	Z	-	-	-	-	-	-	4	3.00
F-695	MIRROR (inside) > BRACKET	CHROME PH OV A SCREWS	Z	-	-	-	-	-	-	3	2.00
F-3909	MIRROR (outside) CONTROL BEZEL	CHROME PH OV AB SCREWS	Z	-	-	-	-	-	-	2	2.00
F-763	MOULDING (above trap door) - BODY 63	PH OV A SCREWS	Z	-	-	-	-	-	-	4	5.00
F-1402	PACKAGE TRAY	PH WAFER SCREWS, RETAINER CLIPS	Z	-	-	-	-	-	-	4	3.00
F-286	QTER TRIM LWR CORNER PANELS - BDY 63	POP RIVETS	Z	-	-	-	-	-	-	4	2.00
F-762	QTER TRIM MOULDINGS (sides) - BODY 63	PH OV A SCREWS	Z	-	-	-	-	-	-	8	4.00
F-282	QTER TRIM PANEL BRACKETS - BODY 63	PH PN AB SCREWS	Z	-	-	-	-	-	-	38	6.00
F-1055	QTER TRIM PANEL BUILD-UP - BODY 76	PH PN A SCREWS, SPRING NUTS	Z	-	-	-	-	-	-	18	5.00
F-1052	QTER TRIM PANEL CHROME CAPS	PH OV A SCREWS	Z	-	-	-	-	-	-	2	1.50
F-869	QTER TRIM PANELS - BODY 65A, 65C	HXWA & PH OV A SCREWS, FINISH WA'S	Z	-	-	-	-	-	-	14	4.00
F-1050	QTER TRIM PANELS - BODY 65B	PH OV SEMS, SCREWS, FINISH WA'S	Z	-	-	-	-	-	-	14	4.00
F-871	QTER TRIM PANELS - BODY 76	PH OV & PH PN SCREWS, FINISH WA'S	Z	-	-	-	-	-	-	12	4.00
F-764	QTER TRIM PANELS (lower Fr) - BODY 63	HX PERI SEMS, PH OV SCREWS, J-NUTS	Z	-	-	-	-	-	-	20	12.00
F-765	QTER TRIM PANELS (upper Fr) - BODY 63	PH PN & PH OV A SCREWS	Z	-	-	-	-	-	-	10	3.00
F-766	QTER TRIM UP CORNER PANELS - BODY 63	PH PN A & PH OV A SCREWS	Z	-	-	-	-	-	-	6	2.00
F-3920	QUARTER WINDOW TRIM PANELS (SHELBY)	BLACK BLIND RIVETS	Z	-	-	-	-	-	-	50	15.00
F-959	RADIO OPENING COVER	LARGE STAMPED NUTS	Z	-	-	-	-	-	-	2	1.50
F-911	RADIO SPEAKER > DASH	NAIL POINT PH PN SCREWS	Z	-	-	-	-	-	-	2	1.00
F-900	RADIO SPEAKER GRILLE > DASH	PH OV A SCREWS	Z	-	-	-	-	-	-	2	1.50
F-494	SCUFF PLATES (door opening)	SS/CHROME PH OV AB SCREWS	Z	-	-	-	-	-	-	18	8.00
F-298	SEAT BACK ADJUSTMENT (Fr)	CHROME HX BOLTS, NUTS, FLAT WA'S	Z	-	-	-	-	-	-	6	8.00
F-3763	SEAT BACK COVERS - DLX	WIRE RETAINERS	Z	-	-	-	-	-	-	22	8.00
F-872	SEAT BACK COVERS - STD	WIRE RETAINERS	Z	-	-	-	-	-	-	22	8.00
F-3996	SEAT BELTS (Fr) - BODY 63, 65	CHROME BOLTS, RUBBER & STEEL WA'S	Z	-	-	-	-	-	-	12	24.00
F-3997	SEAT BELTS (Fr) - BODY 76	CHROME BOLTS, STEEL WA'S	Z	-	-	-	-	-	-	12	22.00
F-3998	SEAT BELTS (Rr)	HX BOLTS	Z	-	-	-	-	-	-	4	16.00
F-939	SEAT HINGE (Rr) > FLOOR, SEAT - BODY 63	HX CONI SEMS, SLOT FLAT SCREWS	Z	-	-	-	-	-	-	10	8.00
F-685	SEAT SCUFF PLATES - Fr SEAT BACKS	PH PN A SCREWS	Z	-	-	-	-	-	-	4	2.00
F-2926	SEAT TRACK STUDS - REPAIR KIT	2 SPECIAL SQR HD BOLTS, RETAINERS	Z	-	-	-	-	-	-	4	5.00
F-1192	SEAT TRACKS > BODY	ORIGINAL INT/EXT DOME KEPS NUTS	Z	-	-	-	-	-	-	8	8.00
F-681	SEAT TRIM PANELS	SCREWS, PINS, WA'S (less spacers)	Z	-	-	-	-	-	-	16	7.00
F-1169	SEAT UPHOLSTERY (Rr) > FLOOR - B 63	PH PN & RND WA SCREWS, SEALER	Z	-	-	-	-	-	-	8	3.00
F-1109	SEAT UPHOLSTERY (Rr) > FLOOR - B 65, 76	HX PERI SEMS, SEALER	Z	-	-	-	-	-	-	4	3.00
F-3304	STEERING COLUMN > DASH	STUDS, LOCK NUTS	Z	-	-	-	-	-	-	4	4.00
F-277	SUN VISOR BRACKETS - BODY 63, 65	PH OV A SCREWS	Z	-	-	-	-	-	-	6	3.00
F-278	SUN VISORS - BODY 76	PH OV & FLAT SCREWS	Z	-	-	-	-	-	-	6	3.00
F-767	TRIM PANEL (above trap door) - BODY 63	PH OV A SCREWS, BLIND RIVETS	Z	-	-	-	-	-	-	6	3.00
F-1124	TRUNK FILLER BOARD < 10-27-66	PH TRUSS AB FLAT SEMS	Z	-	-	-	-	-	-	2	4.00
F-1002	WINDLACE @ Fr PILLIAR	PH PN F SCREWS	Z	-	-	-	-	-	-	2	1.00
F-688	WINDOW (Rr) TOP GARNISH MLDNG - BODY 63	PH OV A & AB SCREWS	Z	-	-	-	-	-	-	5	3.00
F-951	WINDOW CRANK HANDLES	SPL HX SKT SCREWS	Z	-	-	-	-	-	-	2	2.00
F-698	WINDSHIELD, TOP INSIDE TRIM - BODY 76	PH OV A SCREWS	Z	-	-	-	-	-	-	4	2.00

Moulding

F-3633	EMBLEM NUTS, Complete - 289 GT	SLEEVE NUTS	Z	-	-	-	-	-	-	48	18.00
F-3632	EMBLEM NUTS, Complete - 289HP BDY 63	SLEEVE NUTS	Z	-	-	-	-	-	-	30	12.00
F-3629	EMBLEM NUTS, Complete - 289HP BDY 65, 76	SLEEVE NUTS	Z	-	-	-	-	-	-	26	10.00
F-3634	EMBLEM NUTS, Complete - 289HP GT	SLEEVE NUTS	Z	-	-	-	-	-	-	50	18.00
F-3630	EMBLEM NUTS, Complete - 6 CYL BDY 63	SLEEVE NUTS	Z	-	-	-	-	-	-	24	8.00
F-3627	EMBLEM NUTS, Complete - 6 CYL BDY 65, 76	SLEEVE NUTS	Z	-	-	-	-	-	-	20	8.00
F-3631	EMBLEM NUTS, Complete - V8 BODY 63	SLEEVE NUTS	Z	-	-	-	-	-	-	28	10.00
F-3628	EMBLEM NUTS, Complete - V8 BODY 65, 76	SLEEVE NUTS	Z	-	-	-	-	-	-	24	10.00

See factory Assembly Manuals for illustrations

Ford Fastener Kits

233

1966

Moulding

PART #	APPLICATION	NOTES								PCS	PRICE
			MUSTANG	FALCON	FAIRLANE	T-BIRD	FORD	BRONCO	TRUCK		
F-3609	EMBLEM, FENDER Fr - "289"	3/16" SLEEVE NUTS	Z	-	-	-	-	-	-	4	2.00
F-3610	EMBLEM, FENDER Fr - "289" & "HIGH PERF"	3/16" SLEEVE NUTS	Z	-	-	-	-	-	-	6	3.00
F-3245	EMBLEM, FENDERS - "289", "351", "390"	1/8" SLEEVE NUTS	-	-	O	-	-	-	-	4	2.00
F-1262	GRILLE OPENING MOULDINGS (lower)	WIRE TYPE RETAINERS	Z	-	-	-	-	-	-	8	10.00
F-126	HOOD PEAK MOULDING	SS/CHROME PH RNDWA AB SCREWS	Z	-	-	-	-	-	-	7	3.50
F-3613	NAMEPLATE, FENDERS "Mustang" & "GT"	3/32" SLEEVE NUTS	Z	-	-	-	-	-	-	36	12.00
F-3611	NAMEPLATE, FENDERS "Mustang" & PONY	BODY 65 & 76, 3/32" SLEEVE NUTS	Z	-	-	-	-	-	-	12	5.00
F-3612	NAMEPLATE, FENDERS "Mustang" & PONY	BODY 63, 3/32" SLEEVE NUTS	Z	-	-	-	-	-	-	16	6.00
F-3608	NAMEPLATE, HOOD "FORD"	3/32" SLEEVE NUTS	Z	-	O	-	-	-	-	8	3.00
F-2501	NAMEPLATE, QTER PANELS "Fairlane 500"	1/8" SLEEVE NUTS	-	-	O	-	-	-	-	12	6.00
F-3657	NAMEPLATE, QTER PANELS "Fairlane"	3/32" SLEEVE NUTS	-	-	O	-	-	-	-	16	6.00
F-3659	NAMEPLATE, TRUNK LID "Fairlane 500"	#10 STAMPED NUTS	-	-	O	-	-	-	-	4	2.00
F-2566	NAMEPLATE, TRUNK LID "FORD"	3/32" SLEEVE NUTS	-	-	O	-	-	-	-	8	3.00
F-3615	NAMEPLATES, FENDERS "GT"	1/8" SLEEVE NUTS	-	-	O	-	-	-	-	4	2.00
F-3614	ORNAMENTS, QTER PANEL	STAMPED NUTS	Z	-	-	-	-	-	-	10	3.00
F-566	TAILAMP BEZELS & LENSES	SS/CHROME PH OV B SCREWS	Z	-	-	-	-	-	-	8	3.00
F-2977	VINYL TOP MOULDINGS	STAMPED NUTS	Z	-	-	-	-	-	-	6	3.00
F-580	WINDOW (Fr) MOULDINGS - BODY 63, 65	PUSH-ON RETAINERS	Z	-	-	-	-	-	-	22	10.00
F-1406	WINDOW (Fr) MOULDINGS - BODY 76	RETAINERS, PH OV SCREWS, NUTS	Z	-	-	-	-	-	-	22	10.00
F-3519	WINDOW (Rr) MOULDINGS - BODY 63	PUSH-ON RETAINERS	Z	-	-	-	-	-	-	22	10.00
F-3490	WINDOW (Rr) MOULDINGS - BODY 65	PUSH-ON RETAINERS	Z	-	-	-	-	-	-	19	8.00

Steering/Suspension

F-1441	AXLE HOUSING > SPRINGS	5.0" U-BOLTS, FLNG NUTS	Z	-	-	-	-	-	-	12	26.00
F-3441	AXLE HOUSING > SPRINGS	6 3/4" U-BOLTS, FLNG NUTS	-	D	O	-	-	-	-	12	26.00
F-367	AXLE HOUSING > SPRINGS - NUTS ONLY	FLNG NUTS (Silver Cad)	Z	D	O	-	-	-	-	8	12.00
F-1355	BALL JOINTS (RIVETS) - LWR	RIVETS (2 extra), SPL TOOLS, PRESS RQD	Z	D	O	-	-	-	-	8	6.00
F-1354	BALL JOINTS (RIVETS) - UPPER	RIVETS (2 extra), SPL TOOLS, PRESS RQD	Z	D	O	-	-	-	-	10	6.00
F-3656	COIL SPRING SEATS (perches)	GR-8 3/8-16 KNURL BOLTS, LOCK NUTS	Z	D	O	-	-	-	-	8	10.00
F-594	COIL SPRING SEATS (perches)	3/8-24 MARSDEN NUTS ONLY	Z	D	O	-	-	-	-	4	5.00
F-1111	CONTROL ARMS (lower) > SHOCK TOWER	HX BOLTS, NUTS, SPLIT WA'S	Z	-	-	-	-	-	-	6	12.00
F-3913	CONTROL ARMS (lower) > SHOCK TOWER	GR-8 CAM BOLTS, NUTS, WA'S	-	D	O	-	-	-	-	8	20.00
F-360	CONTROL ARMS (upper) > SHOCK TOWER	GR-8 FLNG NUTS ONLY	Z	-	-	-	-	-	-	4	6.00
F-3658	CONTROL ARMS (upper) > SHOCK TOWER	GR-8 1/2-20 KNURLED BOLTS, FLNG NUTS	Z	-	-	-	-	-	-	8	12.00
F-2846	CONTROL VALVE ACTUATOR	HX SPLIT SEMS	Z	D	O	-	-	-	-	2	3.00
F-1280	CROSSMEMBER, TUBULAR (Fr)	SPL HX CNTRS NK BOLTS	Z	-	-	-	-	-	-	2	10.00
F-571	GREASE PLUGS, CHASSIS	HX PLUGS	Z	D	O	S	F	B	T	9	5.00
F-351	IDLER ARM	HX BOLTS "F", LOCK NUTS, CLIPPED WA'S	Z	D	O	-	-	-	-	6	12.00
F-3651	LEAF SPRING CENTER BOLTS	GR-8 TALL HD BOLTS, HX NUTS	Z	D	O	-	-	-	-	4	8.00
F-1065	LEAF SPRINGS (front eye)	POINTED HX BOLTS, FLNG NUTS, WA'S	Z	D	O	-	-	-	-	6	18.00
F-1650	MONTE CARLO BAR (SHELBY)	HX FLNG EXT SEMS, SRTD FLNG NUTS	Z	-	-	-	-	-	-	4	3.00
F-3933	P/S CONTROL VALVE DUST COVER CLAMP	SLOT RND B SCREWS	Z	D	O	-	-	-	-	2	1.50
F-502	P/S CONTROL VALVE SPOOL CAP	SLOT FILL SPLIT SEMS	Z	D	O	-	-	-	-	2	3.00
F-1615	P/S CYLINDER BRACKET - RIVET NUTS	3/8-16 HX BODY RIVET NUTS ONLY	Z	D	O	-	-	-	-	2	6.00
F-1324	P/S CYLINDER BRACKET > BODY	HX BOLTS "F", HX NUTS, WA'S	Z	D	O	-	-	-	-	8	8.00
F-508	P/S CYLINDER BRACKET > BODY	HX BOLTS "F", LOCK NUTS, WA'S	-	-	O	-	-	-	-	7	10.00
F-1803	P/S HOSE SUPPORT INSULATOR RETAINER	HXWA F SCREW	Z	-	O	-	-	-	-	1	1.50
F-703	P/S PUMP - 289 w FORD PUMP & AC	FLNG BOLTS & NUTS, FLAT WA	Z	D	O	S	-	B	T	7	7.00
F-792	P/S PUMP - 289 w FORD PUMP w/o AC	SRTD FLNG BOLTS, FLNG NUT, FLAT WA	Z	D	O	S	-	B	T	7	10.00
F-3943	P/S PUMP - 390 w AC	PLACE BOLTS, STUDS, LOCK NUTS	-	-	O	-	-	-	-	6	8.00
F-3942	P/S PUMP - 390 w/o AC	STUDS, NUTS, BOLTS, SPACERS	-	-	O	-	-	-	-	8	14.00
F-794	P/S PUMP - 6 CYL	HX FLNG & PLACE BOLTS, BOLTS, WA'S	Z	D	O	S	-	B	T	13	14.00
F-2937	P/S PUMP RESERVOIR NUT	THIN HX NUT ON BACK	Z	D	O	S	F	B	T	1	3.00
F-1206	P/S RETURN HOSE - 170/200/289/302	SLOTTED STYLE CLAMP	Z	-	-	-	-	-	-	1	5.00
F-1207	P/S RETURN HOSE - 170/200/289/302	NO SLOT STYLE CLAMP	Z	-	-	-	-	-	-	1	10.00
F-1811	P/S SLAVE CYLINDER, ROD END	HX NUT, STAMPED NUT	Z	D	O	-	-	-	-	2	1.50
F-1390	PITMAN ARM > GEAR BOX w 1 1/8" SHAFT	1 5/16 AF HX JAM NUT, SPLIT WA	-	D	O	-	-	-	-	2	3.00
F-613	PITMAN ARM > GEAR BOX w 1.0" SHAFT	1 1/8 AF HX JAM NUT, SPLIT WA	Z	-	-	-	-	-	-	2	3.00
F-664	SHACKLE ASSY (Rr) - NUTS ONLY	MARSDEN NUTS	Z	D	O	-	-	-	-	4	5.00
F-311	SHOCK BRACKETS (Fr)	LOW HD CRG BOLTS, EXT KEPS NUTS	Z	-	-	-	-	-	-	12	9.00
F-3907	SHOCK BRACKETS (Fr)	LOW HD CRG BOLTS, EXT KEPS NUTS	-	D	O	-	-	-	-	12	10.00
F-343	SHOCKS (Fr)	EXT HX SEMS "SEMS", LOCK NUTS, WA'S	Z	-	-	-	-	-	-	12	8.00
F-883	SHOCKS (Fr) - TOP MOUNTING ONLY	EXT HX SEMS "SEMS"	Z	-	-	-	-	-	-	4	6.00
F-1792	SHOCKS (Rr)	3/8-24 EXT KEPS NUTS	Z	D	O	-	-	-	-	4	2.00
F-1443	STABILIZER (Fr) > BODY	HX BOLTS, LOCK NUTS	Z	D	O	-	-	-	-	8	10.00
F-1204	STABILIZER (Fr) > BODY (STABILIZER BAR)	HX BOLTS, LOCK NUTS	-	D	O	-	-	-	-	8	10.00
F-3951	STABILIZER (Fr) END LINKS	BLTS, RTNRS, BSHNGS, SPACERS, NUTS	Z	-	-	-	-	-	-	22	25.00
F-2945	STABILIZER (Fr) END LINKS	BLTS, RTNRS, BSHNGS, SPACERS, NUTS	-	D	O	-	-	-	-	22	25.00
F-349	STEERING GEAR BOX	HX BOLTS, CLIPPED FLAT & SPLIT WA'S	Z	D	O	-	-	-	-	9	12.00
F-672	STEERING GEAR BOX SECTOR COVER	PLACE BOLTS	Z	D	O	S	-	B	T	3	4.00
F-1302	STEERING LINKAGE - 289 w PS	SLOTTED NUTS, COTTER PINS, FLAT WA	Z	-	-	-	-	-	-	25	14.00
F-315	STEERING LINKAGE - 289 w/o PS	SLOTTED NUTS, COTTER PINS, FLAT WA	Z	-	-	-	-	-	-	23	12.00
F-1303	STEERING LINKAGE - 6 CYL w PS	SLOTTED NUTS, COTTER PINS	Z	-	-	-	-	-	-	24	14.00

Kits Contain Attaching Fasteners for Both Sides

Ford Fastener Kits

1966

Steering/Suspension

PART #	APPLICATION	NOTES									PCS	PRICE	
			Z	D	O	S	F	B	T				
F-314	STEERING LINKAGE - 6 CYL w/o PS	SLOTTED NUTS, COTTER PINS	Z	-	-	-	-	-	-	-	-	22	12.00
F-317	STEERING LINKAGE w PS	SLOTTED NUTS, COTTER PINS, FLAT WA	-	D	O	-	-	-	-	-	-	23	14.00
F-3308	STEERING WHEEL	HX NUT	Z	D	O	S	-	B	T			1	3.00
F-1464	STRUT ROD THREADED ENDS > BODY	LOCK NUTS ONLY	Z	-	-	-	-	-	-	-	-	2	4.00
F-659	STRUT ROD THREADED ENDS > BODY	LOCK NUTS ONLY	-	D	O	-	-	-	-	-	-	4	10.00
F-1156	STRUT RODS > LWR CONTROL ARM	HX BOLTS, LOCK NUTS	Z	-	-	-	-	-	-	-	-	8	14.00
F-1463	STRUT RODS > LWR CONTROL ARM	HX BOLTS, LOCK NUTS	-	D	O	-	-	-	-	-	-	8	14.00
F-365	STRUT RODS > LWR CONTROL ARM - NUTS	LOCK NUTS ONLY	Z	D	O	-	-	-	-	-	-	4	6.00
F-2964	SUSP BUMPER (Rr) - 289HP, 390, 67-68 GT	LOCK NUT	Z	D	O	-	-	-	-	-	-	1	1.50
F-1486	SUSP BUMPER (Rr) 65-66 V8, 67-68 289-2V	HX SCREWS	Z	D	O	-	-	-	-	-	-	2	2.00
F-2946	SUSP BUMPERS (Fr)	EXT KEPS NUTS	Z	D	O	-	-	-	-	-	-	2	1.50
F-2858	TIE ROD ADJUSTMENT SLEEVE	HX BOLTS, LOCK NUTS	Z	D	O	-	-	B	T			8	6.00
F-379	WHEEL BOLTS, Fr DRUM - 1.48" BOLTS	1/2-20 BOLTS	Z	D	O	S	F	B	T			10	8.00
F-781	WHEEL BOLTS, Fr DRUM - 1.69" BOLTS	1/2-20 BOLTS	Z	D	O	S	F	B	T			10	8.00
F-1353	WHEELS	1/2-20 LUG NUTS, 13/16" HX	Z	D	O	S	F	B	T			20	16.00

Transmission

F-1369	BELL HOUSING (manual) - 170/200	HX BOLTS, SPLIT WA'S	Z	D	O	-	-	B	-			8	8.00
F-353	BELL HOUSING (manual) - 260/289 6 BOLT	HX BOLTS, SPLIT WA'S	Z	D	O	-	-	B	T			12	14.00
F-354	BELL HOUSING (manual) - 390/428 < 2-15-68	HX BOLTS, SPLIT WA'S	-	-	-	-	-	-	-			12	14.00
F-1777	CLUTCH BELLCRANK BRKT	SRTD FLNG BOLTS	Z	-	-	-	-	-	-			2	3.00
F-1344	CLUTCH PEDAL SPRING BRACKET	HX SCREWS	Z	-	-	-	-	-	-			3	3.00
F-1343	CLUTCH PEDAL STOP > PEDAL SUPPORT	CRG BOLT, FLNG NUT	Z	-	-	-	-	-	-			2	3.00
F-1465	DRIVESHAFT - 6 CYL - All 65-66, M/T 67-68	1/4" U-BOLTS, NUTS, SPLIT WA'S	Z	-	-	-	-	-	-			6	10.00
F-876	DRIVESHAFT - V8	5/16-24 LOCK NUTS ONLY	Z	D	O	S	F	B	T			4	3.00
F-1273	DRIVESHAFT - V8, 6 CYL 67-68 A/T, All 69 >	5/16" U-BOLTS, LOCK NUTS	Z	D	O	S	F	B	T			6	8.00
F-1199	ENGINE PLATE (M/T) - 6 CYL & SB	HX SPLIT SEMS	Z	-	-	-	-	-	-			2	3.00
F-796	INSPECTION COVER & ENG PLATE - C4 (A/T)	HX SPLIT SEMS	Z	D	O	-	-	B	T			3	4.00
F-1163	INSPECTION COVER (A/T flywheel) - C6	HX SPLIT SEMS	-	-	O	-	-	-	-			4	4.00
F-3994	INSPECTION COVER (M/T flywheel) - 390/428	HX SPLIT SEMS	-	-	O	-	-	-	-			4	4.00
F-3263	PRESSURE PLATE > FLYWHEEL	SPL HX BOLTS, SPLIT WA'S	Z	D	O	S	F	B	T			12	6.00
F-907	SHIFTER (manual) LWR BOOT RETAINER	PH PN SCREWS	Z	-	-	-	-	-	-			4	2.50
F-1232	SHIFTER ASSY > FLOOR - A/T	PH FLAT A SCREWS	Z	-	-	-	-	-	-			4	2.00
F-1237	SHIFTER ASSY > FLOOR - A/T (w/wo console)	HX BOLTS, PH PN SCREWS, RETAINERS	Z	-	-	-	-	-	-			12	4.00
F-1560	SHIFTER CONTROL > TRANS - 3 & 4 SPD	HX SPLIT SEMS	Z	D	O	-	-	B	T			3	4.00
F-1226	SHIFTER HANDLE - 3 SPD 64-73, 4 SPD 64-69	SHOULDER BOLTS, FLAT WA'S	Z	D	O	-	-	-	-			4	8.00
F-897	SHIFTER HANDLE (manual) > SHIFTER	FORD SHIFTERS, FLAT WA'S ONLY	Z	D	O	-	-	-	-			2	1.50
F-1085	SHIFTER HANDLE REBUILD - 3 & 4 SPD	TRUNNIONS (cups), SPRINGS, GROMMETS	Z	-	-	-	-	-	-			6	12.00
F-1241	SHIFTER LINKAGE - A/T	SRTD FLNG NUTS, PIN, FLAT, WAVE WA'S	Z	D	O	-	-	B	T			4	4.00
F-1220	SHIFTER RODS - 3 SPD	LOCK NUTS, WA'S, PINS	Z	D	O	-	-	B	T			14	8.00
F-1221	SHIFTER RODS - 4 SPD	LOCK NUTS, WA'S, PINS	Z	D	O	-	-	B	T			21	12.00
F-3412	SPEDOMETER CABLE > TRANS	HX BOLT, EXT WA	Z	D	O	S	-	B	T			2	2.00
F-185	TORQUE CONVERTOR FLEX PLATE	FLNG NUTS	Z	D	O	S	F	B	T			4	4.00
F-1365	TRANS (auto) > ENGINE - 170/200	HX BOLTS, SPLIT WA'S	Z	D	O	-	-	B	-			8	8.00
F-215	TRANS (auto) > ENGINE - 289/302 6 BOLT	HX BOLTS, SPLIT WA'S	Z	D	O	-	-	B	T			12	14.00
F-186	TRANS (auto) > ENGINE - 390/428	HX BOLTS, SPLIT WA'S	-	-	O	-	-	-	-			12	14.00
F-1244	TRANS (auto) KICKDOWN > ACCEL - ALL	3/16 RH ROD END RETAINER	Z	-	-	-	-	-	-			1	2.00
F-678	TRANS (manual) > BELL HOUSING	HX BOLTS, SPLIT WA'S	Z	D	O	S	F	B	T			8	7.00
F-1841	TRANS ACCESS COVER - FORD 4 SPD	CORRECT SRTD FLNG BOLTS, "X" LONG	Z	D	O	S	F	B	T			10	12.00
F-816	TRANS COOLING LINE CLIPS	C CLIPS	Z	D	O	S	F	B	T			2	3.00
F-3212	TRANS CROSSMEMBER	PILOTED FLNG BOLTS, LOCK NUTS, WA	Z	-	-	-	-	-	-			5	12.00
F-3903	TRANS CROSSMEMBER	POINTED BOLTS, SLOT NUTS, WA'S, PINS	-	D	O	-	-	-	-			8	10.00
F-1342	TRANS ID TAG	DRIVE SCREW	Z	D	O	S	F	B	T			1	1.00
F-1157	TRANS INSULATOR - 6 CYL	HX BOLTS, HX SPLIT SEMS, NUTS, WA'S	Z	-	-	-	-	-	-			10	14.00
F-1489	TRANS INSULATOR - A/T	HX BOLTS, LOCK NUTS, WA'S	Z	-	-	-	-	-	-			8	8.00
F-3905	TRANS INSULATOR - All	POINTED HX BOLTS, NUTS, WA'S	-	D	O	-	-	-	-			10	8.00
F-1159	TRANS INSULATOR - M/T 289/302	HX SPLIT SEMS, LOCK NUTS, FLAT WA'S	Z	-	-	-	-	-	-			6	8.00
F-1322	TRANS LEVERS > CASE - 3 SPD	HX NUTS, FLAT & SPLIT WA'S	Z	D	O	S	F	B	T			6	3.00
F-1385	TRANS LEVERS > CASE - 4 SPD	HX NUTS, FLAT & SPLIT WA'S	Z	D	O	S	F	B	T			9	3.00
F-1621	TRANS OIL PAN - C4	FLNG BOLTS	Z	D	O	S	F	B	T			11	4.00
F-892	TRANS OIL PAN - C6	FLNG BOLTS	Z	D	O	S	F	B	T			17	6.00
F-2874	TRANS TAIL HOUSING - M/T	HX BOLTS, SPLIT WA'S	Z	D	O	S	F	B	T			10	8.00

Wipers

F-425	WASHER NOZZLES	RNDWA AB SCREWS	Z	-	-	-	-	-	-			2	1.50
F-2851	WASHER NOZZLES	HXWA A EXT SEMS	-	-	O	-	-	-	-			2	2.00
F-465	WINDSHIELD WASHER BAG BRACKET	HXWA A SCREWS	Z	-	O	-	-	-	-			2	1.50
F-1493	WINDSHIELD WASHER PUMP - 2 SPD	HXWA AB SCREWS	Z	-	O	-	-	-	-			2	1.00
F-1770	WIPER ARM PIVOTS > COWL PANEL	HX BOLT, SPLIT WA'S	Z	-	-	-	-	-	-			12	3.00
F-737	WIPER MOTOR BRACKET > COWL	HX SPLIT SEMS	Z	-	-	-	-	-	-			4	3.00
F-3867	WIPER MOTOR BRACKET > COWL	CNTRS NK HX EXT SEMS	-	-	O	-	-	-	-			3	3.00

See factory Assembly Manuals for illustrations

Ford Fastener Kits

235

1967

Air Conditioning

PART #	APPLICATION	NOTES												PCS	PRICE	
			MUSTANG	COUGAR	FALCON	FAIRLANE	FORD	BRONCO	TRUCK							
F-710	AC BRUSH & HOLDER 10/65 >	HX FLNG SCREWS	Z	W	D	O	-	B	T						2	1.50
F-1607	AC COMP BELT ADJUSTER - 170/200	SQR HD SET SCREW, HX NUT	Z	-	D	O	-	-	-						2	4.00
F-1614	AC COMPRESSOR - 200	HX BOLTS, FLAT & SPLIT WA'S	Z	-	D	O	-	B	-					14	7.00	
F-707	AC COMPRESSOR - 289	SRTD HX FLNG & HX BOLTS	Z	W	D	O	-	B	T					6	8.00	
F-713	AC COMPRESSOR - 390/428	SRTD FLNG BOLTS	Z	W	D	O	-	-	T					5	7.00	
F-1610	AC COMPRESSOR BRACE (Fr) - 200	HUG-LOK NUT	Z	-	D	O	-	-	-					1	1.00	
F-1612	AC COMPRESSOR BRACE (LWR) - 170/200	HX & PLACE BOLTS, SPLIT WA	Z	-	D	O	-	B	-					3	3.00	
F-1608	AC COMPRESSOR BRACE (Rr) - 170/200	HX MS EXT SEMS, HX BOLTS, WA'S	Z	-	D	O	-	-	-					4	3.00	
F-709	AC COMPRESSOR BRACE (Rr) - 289/302	HX MS EXT SEMS, SRTD FLNG BOLT	Z	W	D	O	-	B	T					2	3.00	
F-712	AC COMPRESSOR BRACE (side) - 390/428	SRTD FLNG BOLTS	Z	W	D	O	-	-	T					4	6.00	
F-1605	AC COMPRESSOR BRACKET - 170/200	PLACE & HX BOLTS, INT/EXT WA	Z	-	D	O	-	-	-					4	4.00	
F-708	AC COMPRESSOR BRACKET - V8	STUDS, LOCK NUTS	Z	W	D	O	-	B	T					6	6.00	
F-711	AC COMPRESSOR CLUTCH	HX BOLT, FLAT WA	Z	W	D	O	-	B	T					2	3.00	
F-706	AC COMPRESSOR FIELD	HX FLNG HD SCREWS	Z	W	D	O	-	B	T					4	3.00	
F-440	AC CONDENSOR	HXWA T1 SCREWS	Z	W	-	-	-	-	-					3	3.00	
F-2962	AC DEHYDRATOR & RECEIVER TANK	HXWA A SCREWS	Z	W	-	-	-	-	-					3	2.00	
F-434	AC FIREWALL SEAL RETAINER	HXWA A SCREWS	Z	-	-	-	-	-	-					6	3.00	
F-3559	AC HEATER WATER CONTROL VALVE	HXWA AB SCREWS	Z	W	-	-	-	-	-					2	1.50	
F-430	AC HOSES > COWL BRACES	RUBBER STRAPS w STEEL RIVET	Z	W	-	-	-	-	-					4	20.00	
F-704	AC IDLER PULLEYS - 289	SRTD HX & FLNG BOLTS, CRG BOLT	Z	W	D	O	-	B	T					5	7.00	
F-705	AC IDLER PULLEYS - 390/428	SRTD FLNG BOLTS, FLAT WA'S	Z	W	D	O	-	-	T					6	8.00	
F-433	AC UNIT > FIREWALL	STAMPED NUTS w SEALER	Z	-	-	-	-	-	-					3	4.00	
F-729	AC VACUUM RESERVOIR > FENDER APRON	STAMPED NUTS	Z	-	-	-	-	-	-					2	2.00	

Body

F-3654	AIR EXTRACTOR BAFFLES (plastic)	PH PN F SCREWS	Z	-	-	-	-	-	-					16	4.00
F-3655	AIR EXTRACTOR DRAIN ASSY > BODY	HXWA A SCREWS	Z	-	-	-	-	-	-					18	4.00
F-3653	AIR VENT GRILLES - FASTBACK, OUTSIDE	STUDS, STAMPED NUTS, CUP WA'S	Z	-	-	-	-	-	-					30	25.00
F-1796	AIR VENTS - FASTBACK QTER, INSIDE	HXWA A SCREWS	Z	-	-	-	-	-	-					18	4.00
F-219	BATTERY TRAY	HX PERI SEMS, U-NUTS	Z	W	D	-	-	-	-					6	5.50
F-1671	BATTERY TRAY	HX CONI SEMS, J-NUTS, SRTD FLNG NUTS	-	-	-	O	-	-	-					12	7.00
F-1715	BATTERY TRAY	HX PERI SEMS, J-NUTS	-	-	-	-	-	B	-					4	3.50
F-1542	BATTERY TRAY	HX PERI SEMS, CAGE NUT	-	-	-	-	-	-	T					5	6.00
F-1547	BED ASSEMBLY > FRAME (Styleside)	SPL CRG & HX BOLTS, LOCK NUTS, WA'S	-	-	-	-	-	-	T					26	22.00
F-2328	BED CORNERS - HOLE COVER PLATES	PH PN AB SCREWS	-	-	-	-	-	B	-					2	1.50
F-1556	BED CORNERS - HOLE COVER PLATES	PH PN A SCREWS	-	-	-	-	-	-	T					2	1.00
F-993	BRAKE PEDAL SUPPORT	SRTD FLNG BOLTS, HXWA A SCREWS	Z	-	-	-	-	-	-					4	4.00
F-1815	BUMPER (Fr)	SS CAPPED BOLTS, NUTS, CRUSH WA'S	Z	-	-	-	-	-	-					22	8.00
F-3598	BUMPER (Fr)	SS CAPPED BOLTS, LOCK NUTS, WA'S	-	-	D	-	-	-	-					24	10.00
F-3577	BUMPER (Fr)	SS CAPPED BOLTS, LOCK NUTS, WA'S	-	-	-	O	-	-	-					28	14.00
F-3601	BUMPER (Fr)	SS CAPPED BOLTS, NUTS, CRUSH WA'S	-	W	-	-	-	-	-					24	8.00
F-1822	BUMPER (Rr)	SS CAPPED BOLTS, NUTS, CRUSH WA'S	Z	W	-	-	-	-	-					12	7.00
F-3594	BUMPER (Rr)	SS CAPPED BOLTS, NUTS, CONI WA'S	-	-	D	O	-	-	-					24	10.00
F-188	BUMPER BRACKETS (Fr)	HX BOLTS, FLAT & SPLIT WA'S	Z	-	-	-	-	-	-					10	10.00
F-3581	BUMPER BRACKETS (Fr)	HX BOLTS, SPLIT WA'S	-	-	D	O	-	-	-					8	5.00
F-835	BUMPER BRACKETS (Fr)	HX BOLTS, FLAT & SPLIT WA'S	-	W	-	-	-	-	-					12	10.00
F-1997	BUMPER BRACKETS (Fr) > FENDER	HX PERI SEMS, PADDED U-NUTS	Z	-	-	-	-	-	-					4	8.00
F-106	BUMPER BRACKETS (Rr)	HX BOLTS, SHIMS, CONI WA'S, SEALS	Z	W	-	-	-	-	-					16	12.00
F-3591	BUMPER BRACKETS (Rr)	HX CONI SEMS, HX BOLT, WA'S, SEALS	-	-	D	-	-	-	-					8	6.00
F-3590	BUMPER BRACKETS (Rr)	HX CONI SEMS, SEALS	-	-	-	O	-	-	-					12	6.00
F-2449	BUMPER BRACKETS (Rr) - Rancho	HX BOLTS, LOCK NUTS, WA'S	-	-	D	-	-	-	-					14	8.00
F-3595	BUMPER FILLER PANEL (Rr)	RND WA AB SCREWS	-	-	D	-	-	-	-					4	2.00
F-1681	BUMPER FILLER PANELS (Rr)	PH PN AB SCREWS	-	-	-	O	-	-	-					8	3.00
F-222	BUMPER GUARD MOUNT BRACKETS (Rr)	HX CONI SEMS, SHIMS, U-NUTS, SEALER	Z	-	-	-	-	-	-					8	7.00
F-2915	BUMPER GUARD PADS (Fr)	STAMPED NUTS, PH PN AB SCREWS	Z	-	-	-	-	-	-					6	2.00
F-224	BUMPER GUARD PADS (Rr)	STAMPED NUTS	Z	-	-	-	-	-	-					6	2.00
F-189	BUMPER GUARDS (Fr)	HX PERI SEMS, PADDED U-NUTS, J-NUTS	Z	-	-	-	-	-	-					8	9.00
F-832	BUMPER GUARDS (Fr)	HX PERI SEMS, J-NUTS	-	W	-	-	-	-	-					8	7.00
F-223	BUMPER GUARDS (Rr)	HX CONI & PH PN EXT SEMS, PAD U-NUTS	Z	-	-	-	-	-	-					8	9.50
F-1603	BUMPER GUARDS (Rr)	HX CONI SEMS, PADDED U-NUTS, SEALER	-	W	-	-	-	-	-					16	14.00
F-3600	BUMPERS (Fr & Rr) - CHROME	SS CAPPED BOLTS, NUTS, SPLIT WA'S	-	-	-	-	-	B	-					24	10.00
F-3599	BUMPERS (Fr & Rr) - PAINTED	CRG BOLTS, NUTS, SPLIT WA'S	-	-	-	-	-	B	-					24	6.00
F-957	CONVERTIBLE TOP > BODY TACK STRIP	HX CONI SEMS, PH PN A SCREWS	Z	-	-	-	-	-	-					14	14.00
F-2003	CONVERTIBLE TOP > BOW LISTING	PH OV B SCREWS	Z	-	-	-	-	-	-					4	2.00
F-2979	CONVERTIBLE TOP CLAMPS TO BODY	HX EXT SEMS	Z	-	-	-	-	-	-					4	4.00
F-1766	CONVERTIBLE TOP DUST HOOD RETAINER	PH PN F SCREWS	Z	-	-	-	-	-	-					11	2.00
F-2060	CONVERTIBLE TOP FRAME > BODY	HX CONI SEMS	Z	-	-	-	-	-	-					6	5.00
F-1764	CONVERTIBLE TOP WELL LINER	PH WAFER SCREWS	Z	-	-	-	-	-	-					17	4.00
F-205	COWL BRACES > COWL	HX FLNG CONI SEMS BOLTS, FLNG NUTS	Z	W	-	-	-	-	-					8	14.00
F-1669	COWL BRACES, TUBULAR - BODY 76	HX FLNG EXT SEMS	-	-	-	O	-	-	-					2	2.00
F-1672	COWL PANEL	HXWA EXT SEMS SCREWS	-	-	D	O	-	-	-					5	3.00
F-3183	DATA PLATE	SPL ALUMINUM RIVETS	Z	W	D	O	F	B	T					2	2.00
F-973	DOOR HANDLES (outside)	PH PN EXT SEMS, EXT KEPS NUTS	Z	-	-	-	-	-	-					4	2.50
F-1680	DOOR HANDLES (outside)	EXT KEPS NUTS	-	-	D	O	-	-	-					4	3.00

Kits Contain Attaching Fasteners for Both Sides

Ford Fastener Kits

1967

Body

PART #	APPLICATION	NOTES									PCS	PRICE
			MUSTANG	COUGAR	FALCON	FAIRLANE	FORD	BRONCO	TRUCK			
F-1546	DOOR HANDLES (outside)	HXWA EXT SEMS, SRTD FLNG NUTS	-	-	-	-	-	-	T		4	2.00
F-1116	DOOR HINGES	HX PERI SEMS	Z	W	-	-	-	B	-		24	18.00
F-1558	DOOR HINGES	HX PERI SEMS	-	-	-	-	-	-	T		20	14.00
F-3447	DOOR LATCH REINFORCEMENTS	SS PH OV SCREWS, SS CNTSNK WA'S	Z	W	D	O	-	-	-		12	5.00
F-1360	DOOR LATCH ROD END BUSHINGS ONLY	5/32 SIZE, EXACTLY ORIGINAL	Z	W	D	O	F	-	-		14	7.00
F-1357	DOOR LATCH ROD END BUSHINGS ONLY	9/64 SIZE, EXACTLY ORIGINAL	-	-	-	-	-	B	-		12	7.00
F-1358	DOOR LATCH ROD END CLIPS	5/32 SIZE, EXACTLY ORIGINAL	Z	W	D	O	F	-	-		14	38.00
F-1356	DOOR LATCH ROD END CLIPS	9/64 SIZE, EXACTLY ORIGINAL	-	-	-	-	-	B	-		12	38.00
F-1135	DOOR LATCH STRIKERS	POZI FLAT SCREWS	Z	W	D	O	-	-	-		4	3.00
F-653	DOOR LATCHES > DOOR SHELL	PH FLAT EXT SEMS	Z	W	D	O	-	-	-		6	3.00
F-3281	DOOR STOP STRAPS	PH PN SCREWS	-	-	-	-	-	B	-		8	3.00
F-1545	DOOR VENT WINDOWS	PH OV & PH PN AB SCREWS	-	-	-	-	-	-	T		8	3.00
F-801	EXPORT BRACE > COWL (SHELBY)	HX BOLTS, FLNG NUTS, FLAT WA'S	Z	-	-	-	-	-	-		12	10.00
F-1719	FENDER > APRON BRACKETS	HX PERI SEMS, J-NUTS	-	-	-	-	-	B	-		10	7.00
F-833	FENDER > BUMPER ARM BRACKETS	HX PERI SEMS, J & U-NUTS	-	W	-	-	-	-	-		8	6.00
F-206	FENDER > PILLAR BRACKETS	HX PERI SEMS	Z	W	-	-	-	-	-		2	2.00
F-1667	FENDER > RADIATOR SUPPORT BRACKETS	HX PERI SEMS, J-NUTS	-	-	D	O	-	-	-		4	3.50
F-1531	FENDER APRON LWR BRACKETS	HX T SCREWS, FLAT WA'S	-	-	-	-	-	-	T		8	4.00
F-1530	FENDER APRON TOP BRACKETS	HX FLNG EXT SEMS	-	-	-	-	-	-	T		6	8.00
F-1529	FENDER APRONS	HX BOLTS, HX PERI SEMS, LOCK NUTS	-	-	-	-	-	-	T		32	18.00
F-1690	FENDER BRACKETS	HX PERI SEMS, U-NUTS	-	-	D	-	-	-	-		6	5.00
F-1666	FENDER BRACKETS	HX PERI SEMS, J-NUTS	-	-	-	O	-	-	-		4	3.50
F-210	FENDER EXTENSIONS	STUDS & SRTD FLNG NUTS	Z	W	-	-	-	-	-		12	6.00
F-1532	FENDER EXTENSIONS	HX PERI SEMS, CONI KEPS NUT	-	-	-	-	-	-	T		8	6.00
F-199	FENDER SPLASH SHIELD BRACKETS (Rr)	HX PERI SEMS, J-NUTS	Z	W	-	-	-	-	-		4	4.00
F-1665	FENDER SPLASH SHIELD BRACKETS (Rr)	HXWA A SCREWS, SPRING NUTS, WA'S	-	-	D	O	-	-	-		8	3.00
F-198	FENDER SPLASH SHIELD SEALS (Fr)	NYLON RETAINERS	Z	-	-	-	-	-	-		10	2.50
F-197	FENDER SPLASH SHIELDS	HXWA A SCREWS	Z	W	-	-	-	-	-		14	7.00
F-1694	FENDER SPLASH SHIELDS	HXWA A SCREWS	-	-	D	O	-	-	-		14	7.00
F-2883	FENDER TOPS ONLY, "DITTOS"	HX PERI SEMS	Z	W	D	O	-	-	-		12	10.00
F-3429	FENDER TOPS ONLY, "SEMS"	HX PERI SEMS	Z	W	D	O	-	-	-		12	10.00
F-1113	FENDER, SHIELDS TO BUMPER	HXWA A SCREWS	-	W	-	-	-	-	-		6	2.00
F-201	FENDERS	HX PERI SEMS, J & CAGE NUTS, WA'S	Z	W	-	-	-	-	-		48	43.00
F-1670	FENDERS	HX PERI SEMS, J, U & CAGE NUTS, WA'S	-	-	D	O	-	-	-		34	30.00
F-1723	FENDERS	HX PERI & POZI EXT SEMS, J, CAGE NUTS	-	-	-	-	-	B	-		46	36.00
F-1528	FENDERS	HX PERI & EXT SEMS, J & U-NUTS, WA'S	-	-	-	-	-	-	T		34	24.00
F-1692	FENDERS (COMET)	HX PERI SEMS, J, U & CAGE NUTS, WA'S	-	-	-	O	-	-	-		42	36.00
F-1533	FLOOR BRACE ACCESS COVERS	HXWA A SCREWS	-	-	-	-	-	-	T		8	3.00
F-568	FLOOR REINFORCEMENT - BODY 76	HX CONI SEMS	Z	-	-	-	-	-	-		6	14.00
F-171	FLOORBOARD HOLE COVERS 12/20/66 >	HXWA AB SCREWS	Z	-	-	-	-	-	-		8	3.00
F-1063	FLOORBOARD HOLE COVERS < 12/20/66	PH PN AB SCREWS	Z	W	D	O	-	-	-		8	4.00
F-192	GRILLE	HX PERI SEMS, HXWA A SCREWS, NUTS	Z	-	-	-	-	-	-		10	6.00
F-1682	GRILLE	HX PERI SEMS, HXWA A SCREWS, NUTS	-	-	D	-	-	-	-		10	10.00
F-1658	GRILLE	HX PERI SEMS, HXWA A SCREWS, NUTS	-	-	-	O	-	-	-		26	10.00
F-1707	GRILLE	HX FLNG EXT & HX PERI SEMS, J-NUTS	-	-	-	-	-	B	-		22	16.00
F-1539	GRILLE	HX PERI SEMS, SRTD FLNG NUTS, J-NUTS	-	-	-	-	-	-	T		28	18.00
F-1683	GRILLE (COMET)	HX PERI SEMS, HXWA SCREWS, NUTS	-	-	-	O	-	-	-		13	10.00
F-848	GRILLE CENTER SECTION	HX PERI SEMS, U-NUTS	-	W	-	-	-	-	-		8	5.00
F-3282	GRILLE EMBLEM (SHELBY)	CORRECT SLEEVE NUTS	Z	-	-	-	-	-	-		4	3.00
F-1660	GRILLE MOULDINGS	HXWA A SCREWS, SPRING NUTS	-	-	-	O	-	-	-		20	6.00
F-1661	GRILLE ORNAMENT RETAINER	CONI KEPS NUTS	-	-	-	O	-	-	-		3	3.00
F-846	GRILLE RH & LH	HX PERI SEMS, SCREWS, KEPS & U-NUTS	-	W	-	-	-	-	-		20	12.00
F-194	GRILLE SUPPORTS	HX PERI SEMS, J-NUTS	Z	-	-	-	-	-	-		12	9.00
F-1684	GRILLE, CENTER BAR (COMET)	HXWA A SCREWS, SPRING NUTS	-	-	-	O	-	-	-		24	8.00
F-1691	GRILLE, OUTER BRACKETS (COMET)	HX PERI SEMS	-	-	-	O	-	-	-		8	7.00
F-1688	GRILLE, UPPER BRACKETS (COMET)	HX PERI SEMS	-	-	D	O	-	-	-		2	2.00
F-1537	GRILLE, UPPER SUPPORT	HX PERI SEMS, J-NUTS	-	-	-	-	-	-	T		8	6.00
F-3285	GRILLES (CAR Approx. 200 & UP) (SHELBY)	HX PERI SEMS, J-NUTS, BLACK RIVETS	Z	-	-	-	-	-	-		10	10.00
F-3291	HEADLAMP BRKT'S, OUTBOARD (SHELBY)	HX PERI SEMS, J-NUTS, STRD FLNG NUTS	Z	-	-	-	-	-	-		16	10.00
F-850	HEADLAMP COVER HINGE	HXWA MS SCREWS	-	W	-	-	-	-	-		12	3.00
F-842	HEADLAMP COVER HINGE SUPPORT	HX PERI SEMS, SPL BOLTS, KEPS, U-NUTS	-	W	-	-	-	-	-		16	16.00
F-851	HEADLAMP DOOR VACUUM RESERVOIR	HXWA A SCREWS, SPRING CLIPS	-	W	-	-	-	-	-		10	4.00
F-212	HEADLAMP DOORS	SS PH FLAT SCREWS, NYLON NUTS	Z	-	-	-	-	-	-		12	4.50
F-1685	HEADLAMP DOORS	PH OV & PN PN SCREWS, SPRING NUTS	-	-	D	-	-	-	-		16	3.00
F-1679	HEADLAMP DOORS	SS/CHROME PH OV AB SCREWS, NUTS	-	-	-	O	-	-	-		16	5.00
F-1686	HEADLAMP DOORS (COMET)	SS/CHROME PH OV AB SCREWS, NUTS	-	-	-	O	-	-	-		8	3.00
F-268	HEADLAMP DOORS (SHELBY)	CHROME #6 PH OV AB SCREWS	Z	-	-	-	-	-	-		12	4.00
F-1726	HEADLAMP, SPLASH SHIELDS	PH PN A SCREWS, SPRING NUTS	-	-	-	-	-	B	-		8	3.00
F-3283	HEADLAMPS BUCKETS (car 1000 & up) (SHELBY)	SLOT TRUSS MS & HXWA SCREWS, NUTS	Z	-	-	-	-	-	-		24	8.00
F-3284	HEADLAMPS BUCKETS (car 200 > 1000) (SHELBY)	PH TRUSS AB SCREWS	Z	-	-	-	-	-	-		12	4.00
F-1731	HOOD	HX FLNG EXT SEMS	-	-	-	-	-	B	-		4	4.00
F-102	HOOD & HINGES	HX CONI & PERI SEMS, J-NUTS	Z	W	-	-	-	-	-		14	12.00
F-1657	HOOD & HINGES	HX FLNG EXT SEMS, J-NUTS	-	-	D	O	-	-	-		14	12.00
F-1536	HOOD & HINGES	HX CONI & PERI SEMS, U-NUTS	-	-	-	-	-	-	T		14	12.00
F-1673	HOOD BUMPERS > COWL	PH PN AB SCREWS ONLY	-	-	D	O	-	-	-		2	1.50

See factory Assembly Manuals for illustrations

Ford Fastener Kits

237

1967

Body

PART #	APPLICATION	NOTES									PCS	PRICE	
			Z	W	D	O	F	B	T				
F-1534	HOOD BUMPERS > COWL	HX PERI SEMS	-	-	-	-	-	-	-	T		4	4.00
F-1543	HOOD BUMPERS > HOOD	PH PN B SCREWS	-	-	-	-	-	-	-	T		4	1.00
F-122	HOOD BUMPERS, ADJUSTABLE	U-NUTS, JAM NUTS	Z	W	D	O	-	-	-	-		4	2.50
F-1711	HOOD LATCH	HX PERI SEMS, J-NUTS	-	-	-	-	-	B	-	-		8	6.00
F-836	HOOD LATCH	HX PERI SEMS	-	W	-	-	-	-	-	-		2	2.00
F-217	HOOD LATCH & CATCH	HX PERI SEMS, J-NUTS	Z	-	-	-	-	-	-	-		5	5.00
F-1689	HOOD LATCH & CATCH	HX PERI SEMS, J-NUTS	-	-	D	-	-	-	-	-		6	5.00
F-1668	HOOD LATCH & CATCH	HX PERI SEMS, J-NUTS	-	-	-	O	-	-	-	-		6	5.00
F-1538	HOOD LATCH & CATCH	HX PERI SEMS, J-NUTS	-	-	-	-	-	-	T	-		11	12.00
F-1735	HOOD LATCH AUXILLIARY CATCH	HX PERI SEMS	-	-	-	-	-	B	-	-		2	2.00
F-3306	HOOD LATCH AUXILLIARY CATCH	HX PERI SEMS	-	W	-	-	-	-	-	-		2	3.00
F-124	HOOD LATCH DOWELL	HX NUT, FLAT WA	-	W	-	-	-	-	-	-		2	1.50
F-190	HOOD LATCH SUPPORT	HX PERI SEMS	Z	-	-	-	-	-	-	-		3	3.00
F-1664	HOOD LATCH SUPPORT	HX PERI SEMS	-	-	D	O	-	-	-	-		3	3.00
F-838	HOOD LATCH SUPPORT	HX PERI SEMS	-	W	-	-	-	-	-	-		2	2.00
F-840	HOOD LATCH SUPPORT BRACE	HX PERI SEMS, U-NUTS	-	W	-	-	-	-	-	-		9	7.00
F-221	HOOD ORNAMENTS (TURN SIGNALS)	STUDS, STAMPED NUTS ONLY	Z	-	-	-	-	-	-	-		28	20.00
F-1727	HOOD PROP ROD	COTTER PIN, FLAT WA'S	-	-	-	-	-	B	-	-		3	2.00
F-3955	HOOD WEATHERSTRIP (Rr)	NYLON RETAINERS	Z	-	-	-	-	-	-	-		7	3.00
F-1740	JACK CLAMP > FENDER APRON	HX BOLTS, WING & HX NUTS, FLAT WA'S	-	-	-	-	-	B	-	-		13	6.00
F-1544	JACK CLAMP > FENDER APRON	HX PERI SEMS, BOLT, WING & KEPS NUT	-	-	-	-	-	-	T	-		9	6.00
F-831	LICENSE PLATE BRACKET (Fr)	HX BOLTS	-	W	-	-	-	-	-	-		2	2.00
F-3287	LICENSE PLATE BRACKET (Fr) (SHELBY)	HX PERI SEMS, J-NUTS	Z	-	-	-	-	-	-	-		8	7.00
F-1677	LICENSE PLATE BRACKET (Rr)	HX PERI SEMS, U-NUTS	-	-	-	O	-	-	-	-		4	4.00
F-1557	LICENSE PLATE BRACKET (Rr)	HX BOLTS, STAMPED NUT	-	-	-	-	-	-	T	-		4	2.00
F-3589	LICENSE PLATE BUMPERS (Fr & Rr)	ORIGINAL RUBBER BUMPERS	Z	-	-	-	-	-	-	-		4	3.00
F-151	LICENSE PLATE LAMP SHIELD	PH RNDWA AB SCREWS	Z	-	-	-	-	-	-	-		3	1.50
F-1695	LICENSE PLATE SUPPORT (Rr)	CRG BOLTS, SRTD FLNG NUTS	-	-	D	-	-	-	-	-		4	3.00
F-2239	LICENSE PLATE SUPPORT (Rr)	HXWA T1 SCREWS, FLAT WA'S	-	-	-	-	-	B	-	-		8	3.00
F-1281	LICENSE PLATES	SLOT PN HD SCREWS, NYLON NUTS	Z	-	-	-	-	-	-	-		8	3.00
F-3273	LIFTGATE BUMPERS	PH FLAT F SCREWS	-	-	-	-	-	B	-	-		8	2.00
F-3277	LIFTGATE HANDLE	POZI OV SCREWS, CONI KEPS NUTS	-	-	-	-	-	B	-	-		4	3.00
F-3275	LIFTGATE HINGE > TOP	PH OV SCREWS, CONI KEPS NUTS	-	-	-	-	-	B	-	-		16	5.00
F-3280	LIFTGATE LATCH ACCESS COVERS	PH PN A SCREWS	-	-	-	-	-	B	-	-		6	2.00
F-3271	LIFTGATE LATCH STRIKERS	PH FLAT F SCREWS	-	-	-	-	-	B	-	-		4	2.00
F-3278	LIFTGATE LATCHES	PH FLAT F SCREWS	-	-	-	-	-	B	-	-		4	2.00
F-3269	LIFTGATE PROPS	HXWA EXT SEMS, PH PN SCREWS	-	-	-	-	-	B	-	-		8	4.00
F-1674	MIRROR (outside) > DOOR	SS PH OV AB SCREWS	-	-	D	O	-	-	-	-		2	1.50
F-802	MIRROR (outside) > DOOR - 1 MIRROR	SS/CHROME POZI OV SCREW, RIV NUTS	Z	W	D	O	F	B	T	-		4	3.00
F-1512	MIRROR (outside) > DOOR - 2 MIRRORS	SS/CHROME POZI OV SCREW, RIV NUTS	Z	W	D	O	F	B	T	-		8	5.00
F-1693	MIRROR (outside) > DOOR (COMET)	SS PH OV AB SCREWS, NYLON NUTS	-	-	-	O	-	-	-	-		4	3.00
F-3286	NOSE PANEL (SHELBY)	SPL BLACK BLIND RIVETS, SRTD NUTS	Z	-	-	-	-	-	-	-		15	10.00
F-1114	QTER PANEL END SEALS	HXWA A SCREWS	-	W	-	-	-	-	-	-		6	2.00
F-229	QTER PANEL EXTENSIONS	STUDS, CONI KEPS NUTS, FLAT & SEALER	Z	-	-	-	-	-	-	-		26	10.00
F-1146	QTER PANEL EXTENSIONS	STUDS, CONI KEPS NUTS, FLAT & SEALER	-	W	-	-	-	-	-	-		18	9.00
F-3292	QTER PANEL EXTENSIONS (SHELBY)	HX PERI SEMS, PH PN A SCREWS, J-NUTS	Z	-	-	-	-	-	-	-		18	8.00
F-1535	RADIATOR SUPPORT	HX PERI SEMS	-	-	-	-	-	-	T	-		14	12.00
F-1285	ROOFSIDE WEATHERSTRIP - BODY 63	PH WAFER SCREWS, RETAINERS, RIVETS	Z	-	-	-	-	-	-	-		46	10.00
F-1286	ROOFSIDE WEATHERSTRIP - BODY 65	PH RNDWA & PH WAFER AB SCREWS	Z	-	-	-	-	-	-	-		24	6.00
F-203	SHOCK TOWER BRACES (cover springs)	HX PERI SEMS, SRTD FLNG NUTS	Z	W	-	-	-	-	-	-		24	14.00
F-1662	SHOCK TOWER BRACES (cover springs)	HX FLNG EXT SEMS, FLNG NUTS	-	-	D	O	-	-	-	-		24	14.00
F-3952	STEERING COLUMN SEAL	HX AB PERI SEMS	Z	W	-	-	-	-	-	-		4	4.00
F-3953	STEERING COLUMN SEAL - 390 or TILT	HX BOLTS, HX AB PERI SEMS, KEPS NUTS	Z	W	-	-	-	-	-	-		8	6.00
F-208	STONE DEFLECTOR	HX PERI SEMS, STUD BOLTS, J-NUTS	Z	-	-	-	-	-	-	-		10	13.00
F-1687	STONE DEFLECTOR	HX PERI SEMS, J & U-NUTS	-	-	D	-	-	-	-	-		9	8.00
F-1659	STONE DEFLECTOR	HX PERI SEMS, J-NUTS	-	-	-	O	-	-	-	-		10	8.00
F-844	STONE DEFLECTOR	HX PERI SEMS, CAGED & U-NUTS	-	W	-	-	-	-	-	-		12	8.00
F-1541	STONE DEFLECTOR	HX PERI SEMS, CONI SEMS, FLNG, J-NUTS	-	-	-	-	-	-	T	-		20	12.00
F-3290	TAILAMP PANEL (SHELBY)	BLACK BLIND RIVETS	Z	-	-	-	-	-	-	-		8	3.00
F-2330	TAILGATE HINGES	HX FLNG EXT SEMS	-	-	-	-	-	B	-	-		4	5.00
F-1553	TAILGATE HINGES	FLNG BOLTS	-	-	-	-	-	-	T	-		4	5.00
F-1592	TAILGATE LATCH CATCHES	HX CONI SEMS	-	-	-	-	-	B	T	-		4	4.00
F-2332	TAILGATE LATCHES	HX PERI SEMS	-	-	-	-	-	B	-	-		4	4.00
F-1550	TAILGATE LATCHES	HX PERI SEMS	-	-	-	-	-	-	T	-		4	4.00
F-1555	TAILGATE RELEASE HANDLE	CONI KEPS NUT	-	-	-	-	-	-	T	-		1	2.00
F-2335	TAILGATE RELEASE HANDLE BEZEL	HX PERI & PH OV EXT SEMS	-	-	-	-	-	B	-	-		6	4.00
F-1554	TAILGATE RELEASE HANDLE BEZEL	HX PERI & PH OV EXT SEMS, RIVET NUTS	-	-	-	-	-	-	T	-		10	5.00
F-2325	TAILGATE SUPPORT ARMS	HX PERI SEMS	-	-	-	-	-	B	-	-		4	4.00
F-1551	TAILGATE SUPPORT ARMS	HX PERI SEMS	-	-	-	-	-	-	T	-		4	4.00
F-1552	TAILGATE SUPPORT BUMPERS	PH PN A SCREWS	-	-	-	-	-	B	T	-		2	4.00
F-1432	TIE DOWN BRACKETS (Rr)	BOLTS, LOCK NUTS, FLAT & SPLIT WA'S	Z	-	-	-	-	-	-	-		16	14.00
F-3265	TOP ASSEMBLY, LONG > BODY	HX CONI SEMS, SRTD FLNG NUTS, WA'S	-	-	-	-	-	B	-	-		38	20.00
F-227	TRUNK LATCH & STRIKER	HX PERI SEMS	Z	W	-	-	-	-	-	-		5	5.00
F-1675	TRUNK LATCH & STRIKER	HX PERI SEMS	-	-	D	O	-	-	-	-		5	4.00
F-1696	TRUNK LATCH & STRIKER (COMET)	HX PERI SEMS	-	-	-	O	-	-	-	-		4	4.00

Kits Contain Attaching Fasteners for Both Sides

Ford Fastener Kits

1967

PART #	APPLICATION	NOTES									PCS	PRICE
			MUSTANG	COUGAR	FALCON	FAIRLANE	FORD	BRONCO	TRUCK			
F-1676	TRUNK LID	HX FLNG EXT SEMS	-	-	D	O	-	-	-		4	4.00
F-262	TRUNK LID & HINGES	HX FLNG EXT SEMS, SCREWS, J-NUTS	Z	W	-	-	-	-	-		14	10.00
F-572	TRUNK LID BUMPERS (Body 65, 76 69-70)	.50 H BUMPERS	Z	-	-	-	-	-	-		2	5.00
F-211	VALANCE (Fr)	HX PERI SEMS, J-NUTS	Z	-	-	-	-	-	-		16	10.00
F-830	VALANCE (Fr)	HX PERI SEMS, J & U-NUTS	-	W	-	-	-	-	-		12	10.00
F-834	VALANCE (Fr) BRACKETS	HX PERI SEMS, U-NUTS	-	W	-	-	-	-	-		8	6.00
F-132	VALANCE (Rr)	CLIP HEAD BOLTS, PH PN SCREWS, NUTS	Z	W	-	-	-	-	-		15	7.50
F-3310	VEHICLE ID PLATE (SHELBY)	BLACK BLIND RIVETS	Z	-	-	-	-	-	-		2	2.00
F-784	VENT WINDOW RUN @ TOP CORNERS	PH FLAT B SCREWS	Z	-	-	-	-	-	-		2	1.50
F-1747	WEATHERSTRIP, DOORS	NYLON PUSH RIVETS	Z	-	-	-	-	-	-		2	1.50
F-1768	WEATHERSTRIP, WINDSHIELD PILLARS	PH RNDWA & PH WAFER SCREWS	Z	-	-	-	-	-	-		12	3.00
F-700	WINDOW (door) CHANNELS > SUPPORT	PH FLAT SCREWS, U-NUTS	Z	-	-	-	-	-	-		10	6.00
F-1790	WINDOW GUIDE @ DOOR OPENINGS	Visible in jamb area, HX PERI SEMS	Z	-	-	-	-	-	-		4	3.00
F-699	WINDOW SEALS @ DOOR Rr & QTER	PH PN A SCREWS	Z	-	-	-	-	-	-		22	5.00
F-2324	WINDSHIELD FRAME	HX SCREWS	-	-	-	-	-	B	-		10	5.00
F-1638	WINDSHIELD HOLD-DOWN RETAINER	SRTD FLNG NUTS	-	-	-	-	-	B	-		2	1.50

Brakes

F-1616	BRAKE ASSEMBLY (front drum) > SPINDLE	T-BOLTS, LOCK NUTS	Z	W	D	O	-	-	-		16	14.00
F-1478	BRAKE BOOSTER > FIREWALL	HX SPLIT SEMS, FLNG NUTS	Z	W	D	O	-	-	-		5	8.00
F-3881	BRAKE BOOSTER HOSE	PINCH TYPE CLAMPS	Z	W	D	O	-	B	T		2	2.00
F-1791	BRAKE CABLE SEAL @ BRAKE PLATES	1.0" DIA X .58 TK RUBBER SEAL	Z	W	D	O	-	-	-		2	3.00
F-574	BRAKE CABLES > BODY	RETAINERS, HXWA SCREWS, NUT, WA'S	Z	W	-	-	-	-	-		10	7.00
F-3911	BRAKE CABLES > BODY	RETAINING CLIPS	-	-	D	O	-	-	-		6	4.00
F-2949	BRAKE CALIPER BLEEDERS	CORRECT SCREWS	Z	W	-	O	-	-	-		2	4.00
F-1471	BRAKE CALIPER BRACKETS > SPINDLE	GR-8 HXWA BOLTS, LOCK NUTS	Z	W	D	O	-	-	-		16	24.00
F-3262	BRAKE CALIPER SHIELDS	HX EXT SEMS	Z	-	O	-	-	-	-		4	3.00
F-2916	BRAKE CALIPERS > BRACKET	DRILLED GR-8 BOLTS	Z	W	D	O	-	-	-		4	24.00
F-579	BRAKE DRUM RETAINERS	GREEN PUSH ON RETAINERS	Z	W	D	O	F	B	T		6	4.00
F-1248	BRAKE HOSE BRKTS (Fr) > BODY	HX HD C SCREWS	Z	W	D	O	-	-	-		2	2.50
F-576	BRAKE HOSES > BRACKET	U-CLIPS	Z	W	D	O	-	-	-		3	4.00
F-670	BRAKE LIGHT SWITCH	RETAINING PIN	Z	W	D	O	-	B	T		1	2.00
F-669	BRAKE PLATE ADJUST HOLE PLUGS (2)	RUBBER PLUGS	Z	W	D	O	F	B	T		2	3.00
F-1474	MASTER CYLINDER w POWER BRAKES	HX NUTS, SPLIT WA'S	Z	W	D	O	-	B	T		4	3.00
F-1472	MASTER CYLINDER w/o POWER BRAKES	HX SPLIT SEMS	Z	W	D	O	-	B	T		2	4.00
F-1326	PARKING BRAKE CONTROL > BODY	POZI PN EXT SEMS, CAGED & FLNG NUTS	Z	W	-	-	-	-	-		6	4.00
F-1333	PARKING BRAKE CONTROL > BODY	HXWA SRTD SCREWS	-	-	D	O	-	-	-		3	4.00
F-1214	PROPORTIONING VALVE > APRON	5/16-18 HXWA F SCREW	Z	W	D	O	-	-	-		1	1.50
F-2950	WHEEL CYLINDER BLEEDERS	1/4-28 x 1/4 HX x 92" OAL SCREWS, ZDC	Z	W	D	O	F	B	T		2	3.00
F-356	WHEEL CYLINDERS (2) - 250 & All 8 CYL	5/16-18 HX EXT SEMS	Z	W	D	O	F	B	T		4	3.00
F-1772	WHEEL CYLINDERS (4) - 170/200	1/4-20 HX EXT SEMS	Z	-	-	-	-	-	-		8	6.00
F-3912	WHEEL CYLINDERS (4) - 250 & All 8 CYL	5/16-18 HX EXT SEMS	Z	W	D	O	F	B	T		8	6.00

Brake & Fuel Lines - also see page 216

F-3961	BRAKE LINES (not shared) - 6 & 8 CYL, 1 pc	CORRECT CLIPS, SCREWS, GROMMETS	Z	W	-	-	-	-	-		16	20.00
F-3962	BRAKE LINES (not shared) - 6 & 8 CYL, 2 PC	CORRECT CLIPS, SCREWS, GROMMETS	Z	W	-	-	-	-	-		20	32.00
F-3963	BRAKE LINES (shared) - 1 PC FUEL	CORRECT CLIPS	Z	W	-	-	-	-	-		2	8.00
F-3964	FUEL LINE @ ROCKER, Mid 67-70 HT, 71-73	CLIP w SQUEEZE RETAINER	Z	W	-	-	-	-	-		1	4.00
F-667	FUEL LINE GROMMET (fender apron)	RUBBER GROMMET	Z	-	-	-	-	-	-		1	2.00
F-2931	FUEL LINE PROTECTOR @ Rr TORQUE BOX	HXWA SCREWS	Z	W	-	-	-	-	-		3	3.00
F-3967	FUEL LINES - 6 CYL w 2 PC FUEL	CORRECT CLIPS, SCREWS, GROMMET	Z	W	-	-	-	-	-		8	12.00
F-3968	FUEL LINES - V8 w 2 PC FUEL	CORRECT CLIPS, SCREWS, GROMMET	Z	W	-	-	-	-	-		10	17.00
F-3965	FUEL LINES (not shared) - 6 CYL w 1 PC	CORRECT CLIPS, SCREWS, GROMMET	Z	W	-	-	-	-	-		8	12.00
F-3966	FUEL LINES (not shared) - V8 w 1 PC FUEL	CORRECT CLIPS, SCREWS, GROMMET	Z	W	-	-	-	-	-		10	14.00

Cooling

F-394	RADIATOR - 390/428	HX PERI SEMS, CAGED & J-NUTS	Z	W	D	O	-	-	-		8	6.00
F-391	RADIATOR - STD COOLING	HX PERI SEMS, J-NUTS	Z	W	D	O	-	-	-		8	6.00
F-1524	RADIATOR FAN SHROUD - All	HXWA A SCREWS, SPRING NUTS	Z	W	D	O	-	-	-		8	6.00
F-657	RADIATOR HOSE CLAMPS - 289/302/351	WIRE TYPE	Z	W	D	O	F	B	T		4	16.00
F-386	RADIATOR HOSE CLAMPS - 390/428	WITEK TOWER TYPE	Z	W	D	O	-	-	T		4	14.00
F-656	RADIATOR HOSE CLAMPS - 6 CYL	WIRE TYPE	Z	-	D	O	-	B	T		4	16.00

Differential

F-1439	AXLE RETAINER PLATES - 8 CYL	T-BOLTS, LOCK NUTS	Z	W	D	O	-	-	-		16	20.00
F-663	AXLE RETAINER PLATES - NUTS ONLY	LOCK NUTS (Silver Cad)	Z	W	D	O	-	B	-		8	6.00
F-2491	AXLE VENT SYSTEM	FITTING, HOSE, CLAMPS, SCREW, SLEEVE	Z	-	-	-	-	-	-		7	25.00
F-1165	DIFFERENTIAL CARRIER > HOUSING	COPPER WA'S ONLY	Z	W	D	O	F	B	T		10	4.00
F-598	DIFFERENTIAL CARRIER > HOUSING	CAD LOCK NUTS, COPPER WA'S	Z	W	D	O	-	B	T		20	12.00
F-3987	DIFFERENTIAL FLANGE > PINION	GR-8 3/4-20 TOP-LOK FLNG LOCKNUT	Z	W	D	O	F	B	T		1	5.00
F-374	DIFFERENTIAL PINION SUPPORT	PLACE BOLTS	Z	W	D	O	F	B	T		5	8.00

See factory Assembly Manuals for illustrations

Ford Fastener Kits

239

1967

Electrical

PART #	APPLICATION	NOTES											PCS	PRICE
			MUSTANG	COUGAR	FALCON	FAIRLANE	FORD	BRONCO	TRUCK					
F-621	ALTERNATOR - 289 less SPACER	HX & PLACE BOLTS, FLAT & SPLIT WA'S	Z	W	D	O	-	B	T				5	7.00
F-623	ALTERNATOR - 289 w SMOG	PLACE BOLTS, FLAT WA	Z	W	D	O	-	B	T				3	8.00
F-622	ALTERNATOR - 289 w SPACER	HX, PLACE BOLTS, GOLD SPACER, WA'S	Z	W	D	O	-	B	T				6	16.00
F-627	ALTERNATOR - 390/428 less SPACER	HX SPLIT SEMS, HX, PLACE BOLTS, WA'S	Z	W	D	O	-	B	T				6	8.00
F-628	ALTERNATOR - 390/428 w SPACER	HX SPLIT SEMS, BOLTS, PINK SPACER	Z	W	D	O	-	-	T				7	17.00
F-1611	ALTERNATOR - 6 CYL w AC	HX SPLIT SEMS, HX BOLTS, WA'S, NUTS	Z	-	D	O	-	B	T				11	14.00
F-1315	ALTERNATOR - 6 CYL w/o AC	HX SPLIT SEMS, HX BOLTS, WA'S, NUTS	Z	-	D	O	-	B	T				8	14.00
F-652	ALTERNATOR HOUSING THRU BOLTS	HXWA SCREWS	Z	W	D	O	-	B	T				3	3.00
F-644	ALTERNATOR PULLEY	HX NUT & SPLIT WA (ZDC)	Z	W	D	O	-	B	T				2	2.00
F-1120	ALTERNATOR WIRING	HX NUTS, SPLIT WA'S	Z	W	D	O	-	B	T				10	3.00
F-3569	BACK-UP LAMP LENSES	SS PH PN STOP SCREWS	Z	-	-	-	-	-	-				4	2.00
F-352	BACK-UP LAMPS > Rr VALANCE	STAMPED NUTS, CUPPED WA'S	Z	-	-	-	-	-	-				8	6.00
F-3809	BACK-UP SWITCH - 4 SPD TRANS	HX MS EXT SEMS	Z	-	-	-	-	-	-				1	2.00
F-891	BATTERY CABLES - 260/289	HX BOLTS, HXWA SCREWS, CONI KEPS	Z	W	D	O	-	B	T				9	6.00
F-640	BATTERY CABLES - 390/428	HX BOLTS, HXWA SCREW, CONI KEPS	Z	W	D	O	-	-	T				9	6.00
F-634	BATTERY CABLES - 6 CYL	HX BOLT, HXWA SCREW, CONI KEPS	Z	-	D	O	-	B	T				7	5.00
F-1195	BATTERY HOLDOWN CLAMP	J- HOOKS, HXWA AB SCREW, CONI KEPS	Z	W	D	O	-	B	T				5	6.00
F-742	BATTERY HOLDOWN CLAMP - NUT ONLY	CONI KEPS NUTS	Z	W	D	O	-	B	T				2	2.00
F-1190	BATTERY TERMINALS	SQR HD BOLTS, NUTS	Z	W	D	O	-	B	T				4	3.00
F-646	DISTRIBUTOR POINTS & COND - DUAL PT	SLOT PN C SCREWS	Z	W	D	O	F	B	T				5	3.00
F-645	DISTRIBUTOR POINTS & COND - SINGLE	SLOT PN C SCREWS	Z	W	D	O	F	B	T				3	2.00
F-3808	DOME SOCKET LAMP & WIRING - BODY 65	"S" CLIPS, PH PN AB SCREW	Z	-	-	-	-	-	-				6	6.00
F-1329	FOG LAMP BEZELS	SS/CHROME PH OV AB SCREWS	Z	-	-	-	-	-	-				4	2.00
F-731	FOG LAMP SWITCH > DASHBOARD	HXWA AB SCREW	Z	-	-	-	-	-	-				1	1.00
F-565	FOG LAMPS > GRILLE	PH OV SCREWS, SRTD NUTS	Z	-	-	-	-	-	-				6	4.00
F-738	FUSE BLOCK > FIREWALL	HXWA A SCREWS	Z	-	D	O	-	-	-				2	2.00
F-3989	HEADLAMP ADJUSTERS	ADJUSTERS, SCREWS, SPRINGS	Z	-	-	-	-	-	-				14	10.00
F-740	HEADLAMP DIMMER SWITCH	HXWA AB SCREWS	Z	W	D	O	-	-	-				2	2.00
F-599	HEADLAMP RETAINING RINGS (2)	SS PH FILL B SCREWS	Z	-	D	-	-	-	-				6	3.00
F-415	HORNS	HX PERI SEMS, SRTD FLNG NUTS	Z	W	D	O	-	B	T				4	3.00
F-421	IGNITION COIL STRAP & BRKT - 6 CYL	HX SPLIT SEMS, HXWA SCREW, HX NUT	Z	-	D	O	-	B	T				4	3.00
F-420	IGNITION COIL STRAP & BRKT - AII V8	HX SPLIT SEMS, HXWA SCREW, HX NUT	Z	W	D	O	-	B	T				3	3.00
F-1301	IGNITION COIL STRAP ONLY	HXWA SCREW, HX NUT	Z	W	D	O	F	B	T				2	1.50
F-1430	JUNCTION BLOCK @ RH APRON (SHELBY)	HXWA A SCREWS	Z	-	-	-	-	-	-				2	1.50
F-447	LICENSE PLATE LAMP	PH PN A SCREWS, SPRING NUTS	Z	-	-	-	-	-	-				4	2.00
F-3443	NEUTRAL SWITCH	HX EXT SEMS	Z	W	D	O	F	B	T				2	3.00
F-1151	PARKING LAMP LENSES	SS PH PN STOP SCREWS	Z	-	-	-	-	-	-				4	2.00
F-452	PARKING LAMPS	STAMPED NUTS	Z	-	-	-	-	-	-				4	2.00
F-427	RADIO - HOOD GROUND	HXWA AB SCREW ONLY	Z	W	-	-	-	-	-				1	1.50
F-1096	RADIO > INSTRUMENT PANEL	HXWA EXT SEMS, STAMPED NUT	Z	-	-	-	-	-	-				5	3.00
F-2025	RADIO SPEAKER > DASH	CLIP HEAD BOLTS, EXT KEPS NUTS	Z	-	-	-	-	-	-				4	2.00
F-3811	SPEED CONTROL CABLES	RUBBER STRAPS, NYLON "S" RETAINERS	Z	-	-	-	-	-	-				5	15.00
F-1409	STARTER - 260/289/302/351	HXWA SPLIT SEMS, SILVER ZINC	Z	W	D	O	-	B	T				2	3.50
F-408	STARTER - 6 CYL & 390/428	HX SPLIT SEMS	Z	W	D	O	-	-	T				3	4.00
F-358	STARTER SOLENOID	HXWA AB SCREWS "D"	Z	W	D	O	-	B	T				2	1.50
F-443	TAILAMP ASSEMBLY > BODY	EXT KEPS NUTS, RUBBER CAPS	Z	-	-	-	-	-	-				17	6.00
F-3293	TAILAMP BEZELS (SHELBY)	SS PH OV SCREWS (small heads), NUTS	Z	-	-	-	-	-	-				24	20.00
F-3571	TAILAMP LENSES	SS/CHROME PH PN STOP SCREWS	Z	-	-	-	-	-	-				8	5.00
F-3288	TAILAMP RETAINERS > BODY (SHELBY)	BLACK BLIND RIVETS	Z	-	-	-	-	-	-				24	8.00
F-2965	TAILAMP WIRING GROUND @ LATCH	HXWA A SCREW, TOOTH WA (1967 only)	Z	W	-	-	-	-	-				2	1.50
F-3289	TAILAMPS (SHELBY)	SRTD HX FLNG NUTS	Z	-	-	-	-	-	-				12	4.00
F-1775	TRUNK LAMP	HXWA AB SCREW, EXT WA	Z	-	-	-	-	-	-				2	1.50
F-404	VOLTAGE REGULATOR	HXWA A SCREWS "Diamond", EXT WA	Z	W	D	O	-	B	T				3	1.50
F-1492	VOLTAGE REGULATOR COVER	PH PN AB SCREWS	Z	W	D	O	-	-	-				2	1.50
F-3823	WIRING - 6 CYL IGNITION COIL	RUBBER COATED "J" CLIP	Z	-	D	O	-	B	T				1	1.50
F-3807	WIRING - COURTESY LAMP @ QTER - B 63	"S" CLIPS, HXWA A SCREWS, EXT WA'S	Z	-	-	-	-	-	-				8	5.00
F-3817	WIRING - DOOR SPEAKERS	NYLON "S" CLIPS	Z	-	-	-	-	-	-				2	3.00
F-585	WIRING - ENGINE BAY	3 1/8" NYLON STRAPS ONLY	Z	-	-	-	-	-	-				11	6.00
F-460	WIRING - ENGINE FEED - 8 CYL w AC	RUBBER COATED "J" CLIPS	Z	W	D	O	-	B	T				4	5.00
F-423	WIRING - ENGINE FEED - 8 CYL w/o AC	RUBBER COATED "J" CLIPS	Z	W	D	O	-	B	T				3	4.00
F-587	WIRING - FIREWALL	4" NYLON STRAPS (1 for washer hose)	Z	W	-	-	-	-	-				3	4.00
F-3812	WIRING - FOG LAMPS	NYLON "S" CLIPS	Z	-	-	-	-	-	-				4	4.00
F-2148	WIRING - GAUGE FEED > RH TWR (SHELBY)	NYLON "J" CLIP	Z	-	-	-	-	-	-				1	6.00
F-3806	WIRING - PARKING LAMPS	NYLON "J" CLIPS	Z	-	-	-	-	-	-				2	3.00
F-3816	WIRING - RADIO CABLE > DASH	NYLON "S" CLIPS	Z	-	-	-	-	-	-				2	3.00
F-2113	WIRING - RH APRON BELOW RELAY	D-SHAPED NYLON RETAINERS	Z	-	-	-	-	-	-				2	3.00
F-2970	WIRING STRAPS - ENGINE BAY	3 1/8" NYLON STRAPS	-	-	-	O	-	-	-				16	8.00

Emissions

F-1194	PCV HOSES - 390/428	4 WIRE CLAMPS	Z	W	D	O	-	-	T				4	4.00
F-1278	PCV VALVE ELBOW - 390/428	1/4" NPT > 1/2" HOSE STEEL ELBOW	Z	W	D	O	-	B	T				1	20.00
F-1648	SMOG PUMP - 289	BOLTS, SPACERS, LOK TAB, NUTS, WA'S	Z	W	D	O	-	B	T				16	26.00
F-1762	SMOG PUMP - 390/428	BOLTS, SPACERS, LOCK TAB, NUTS, WA'S	Z	W	D	O	-	-	T				13	20.00
F-857	SMOG PUMP PULLEY	HX BOLTS, SPLIT WA'S	Z	W	D	O	-	B	T				8	4.00

Kits Contain Attaching Fasteners for Both Sides

Ford Fastener Kits

1967

Exhaust

PART #	APPLICATION	NOTES								PCS	PRICE	
			Z	W	D	O	F	B	T			
F-1452	EXHAUST HANGERS, DUAL	CRG BOLTS, HX & HXWA SCREWS, NUTS	Z	-	-	-	-	-	-	-	20	8.00
F-1246	EXHAUST HANGERS, SINGLE	HX C SCREWS	Z	-	-	-	-	-	-	-	8	6.00
F-522	EXHAUST PIPE > MANIFOLD - 6 CYL	STUDS 2.25 OAL, FLNG NUTS	Z	-	D	O	-	B	T	-	4	7.00
F-524	EXHAUST PIPE > MANIFOLDS - 390/428/B429	STUDS 2.25 & 3.81 OAL, FLNG NUTS	Z	W	-	O	-	-	-	-	8	12.00
F-523	EXHAUST PIPE > MANIFOLDS - SB, 69 390GT	STUDS 2.25 OAL, FLNG NUTS	Z	W	D	O	-	B	T	-	8	10.00

Fuel - for lines see page 216

F-1266	ACCEL BELLCRANK > FIREWALL - 6 CYL	HXWA A SCREWS	Z	-	-	-	-	-	-	-	4	3.00
F-1458	ACCEL BELLCRANK > FIREWALL - 8 CYL	HXWA A SCREWS	Z	-	-	O	-	-	-	-	3	2.00
F-1401	ACCEL LINKAGE @ CARB - 6 CYL	3/16" RH ROD END RETAINERS	Z	-	-	-	-	-	-	-	4	5.00
F-745	ACCELERATOR PEDAL	SPL PH PN MS, RETAINER	Z	-	-	-	-	-	-	-	2	3.00
F-1193	ACCELERATOR ROD > CARB - 8 CYL	3/16" RH ROD END RETAINER	Z	-	-	-	-	-	-	-	1	2.00
F-3954	FUEL HOSE CLAMPS	FLAT WOUND SPRING TYPE (Green)	Z	W	-	O	-	-	-	-	8	4.00
F-411	GAS CAP (pop open)	PH FLAT A SCREWS ONLY	Z	-	-	-	-	-	-	-	4	2.00
F-225	GAS TANK	HXWA A SCREWS	Z	-	D	O	-	-	-	-	11	6.00
F-3910	GAS TANK FILLER NECK	HXWA A SCREWS	-	-	D	O	-	-	-	-	5	3.00
F-1779	GAS TANK FILLER NECK CLAMPS	CORRECT WIRE CLAMPS	Z	-	-	-	-	-	-	-	2	6.00
F-412	GAS TANK FILLER NECK w TWIST CAP	HXWA B SCREWS	Z	-	-	-	-	-	-	-	5	3.00

Heater

F-3915	DEFROSTER DUCTS > DASH	CLIP HEAD BOLTS, EXT KEPS NUTS	Z	-	-	-	-	-	-	-	8	8.00
F-468	DEFROSTER PLENUM > HEATER CASE	HXWA AB SCREWS	Z	-	-	-	-	-	-	-	4	2.00
F-383	HEATER & BY-PASS HOSES	WHITEK TOWER CLAMPS	Z	W	D	O	F	B	T	-	6	12.00
F-470	HEATER ASSEMBLY > COWL (RH side)	HXWA AB SCREW, SPRING CLIP	Z	-	-	-	-	-	-	-	2	2.00
F-432	HEATER ASSEMBLY > FIREWALL	STAMPED NUTS w INTEGRAL SEALER	Z	W	-	-	-	-	-	-	4	4.00
F-2855	HEATER ASSEMBLY > FIREWALL	STAMPED NUTS	-	-	-	O	-	-	-	-	4	4.00
F-469	HEATER CABLES > HEATER HOUSING	SLOT HX A SCREWS	Z	-	-	-	-	-	-	-	3	2.00
F-3216	HEATER DELETE PLATE	HXWA A SCREWS	Z	-	-	-	-	-	-	-	4	2.00
F-1213	HEATER HOSE STRAPS	6 3/4" ALUMINUM STRAP	Z	W	D	O	-	-	-	-	2	10.00
F-438	HEATER MOTOR GUARD - 390/428	HXWA A SCREWS, JAM NUT	Z	-	-	-	-	-	-	-	3	2.00

Interior

F-736	AIR VENT LH UNDER DASH > COWL	STAMPED NUTS w SEALER	Z	-	-	-	-	-	-	-	4	3.00
F-294	ARMRESTS - STD C7ZB, All C8ZB	HXWA AB SCREWS, SPRING NUTS	Z	W	-	-	-	-	-	-	8	4.00
F-3759	ARMRESTS (Rr)	HXWA AB SCREWS, FLAT WA'S	-	W	-	-	-	-	-	-	8	2.00
F-693	ASH TRAY LINER	PH PN AB SCREWS	Z	W	-	-	-	-	-	-	3	1.00
F-889	CARPET > FLOOR w CONSOLE	RNDWA SCREWS, 2 EXTRA for BODY 63	Z	W	-	-	-	-	-	-	8	2.00
F-279	CARPET > FLOOR w/o CONSOLE	RNDWA SCREWS, 2 EXTRA for BODY 63	Z	-	-	-	-	-	-	-	10	3.00
F-291	COAT HOOKS - BODY 63, 65	PH OV AB SCREWS ONLY	Z	-	-	-	-	-	-	-	2	2.00
F-1017	COAT HOOKS - BODY 76	PH OV AB SCREWS ONLY	Z	-	-	-	-	-	-	-	2	2.00
F-3754	CONSOLE - DLX	PH PN & PH OV SCREWS, RTNRS, NUTS	-	W	-	-	-	-	-	-	24	7.00
F-3518	CONSOLE - STD	PH PN & PH OV SCREWS, RTNRS, NUTS	-	W	-	-	-	-	-	-	29	8.00
F-1600	CONSOLE > FLOOR	PH OV & PN SCREWS, STAMPED NUTS	Z	-	-	-	-	-	-	-	22	8.00
F-1098	CONSOLE > ROOF	PH PN A & AB SCREWS, SPRING NUTS	Z	-	-	-	-	-	-	-	11	3.50
F-2942	CONSOLE ASH TRAY BUMPERS	.16 DIA X .10 H HEAD SIZE	Z	-	-	-	-	-	-	-	2	2.00
F-1084	COURTESY LAMP @ DOORS	PH PN A SCREWS, NYLON NUTS	Z	-	-	-	-	-	-	-	12	2.50
F-902	DASH PAD & MOULDINGS	PH OV A SCREWS, STAMPED NUTS	Z	-	-	-	-	-	-	-	9	4.00
F-3510	DASH PAD & MOULDINGS	PH OV A SCREWS, STAMPED NUTS	-	W	-	-	-	-	-	-	15	4.00
F-3512	DASH PAD LWR	STAMPED NUTS	Z	-	-	-	-	-	-	-	5	2.00
F-1075	DOVE LAMP - BODY 65	PH PN A & AB SCREWS	Z	-	-	-	-	-	-	-	3	2.00
F-948	DOOR HANDLES (inside)	CHROME POZI OV SCREWS	Z	W	-	-	-	-	-	-	2	1.50
F-3863	DOOR LATCH CONTROL (at inside handle)	PH PN EXT SEMS	Z	-	-	-	-	-	-	-	6	3.00
F-1041	DOOR PANEL ARMREST BRACKETS - DLX	PH PN A SCREWS, SPRING NUTS	Z	-	-	-	-	-	-	-	8	3.00
F-3761	DOOR PANELS	SCREWS, RETAINERS (pad clips go lower)	-	W	-	-	-	-	-	-	32	8.00
F-297	DOOR PANELS - DLX	SCREWS, RETAINERS (pad clips go lower)	Z	-	-	-	-	-	-	-	38	12.00
F-296	DOOR PANELS - STD C7ZB & All C8ZB	RETAINERS (padded clips go lower)	Z	-	-	-	-	-	-	-	32	8.00
F-3760	DOOR PULLS	PH WAFER & PH OV AB SCREWS, NUTS	-	W	-	-	-	-	-	-	14	3.00
F-288	FD SEAT LATCH COVERS	PH OV AB SCREWS, FINISH WA'S	Z	-	-	-	-	-	-	-	16	4.00
F-773	FD SEAT SIDE LATCHES	HXWA EXT SEMS	Z	-	-	-	-	-	-	-	8	4.00
F-769	FD SEAT STOP PLATES	PH PN MS & AB SCREWS	Z	-	-	-	-	-	-	-	6	3.00
F-929	FD SEAT TRAP DOOR HINGES	HX PERI SEMS, J-NUTS	Z	-	-	-	-	-	-	-	16	10.00
F-925	FD SEAT TRAP DOOR LATCH	HXWA EXT SEMS	Z	-	-	-	-	-	-	-	4	3.00
F-935	FD SEAT TRAP DOOR PROP	HXWA EXT SEMS, J-NUTS	Z	-	-	-	-	-	-	-	4	4.00
F-428	FD SEAT TRAP DOOR RUBBER BUMPERS	TALL RUBBER BUMPERS	Z	-	-	-	-	-	-	-	2	3.00
F-922	FD SEAT TRAP DR LATCH CATCH 2/67 >	HX CONI SEMS	Z	-	-	-	-	-	-	-	2	2.00
F-1787	FD SEAT TRAP DR LATCH CATCH < 2/67	HXWA EXT SEMS	Z	-	-	-	-	-	-	-	2	2.00
F-1754	FD SEAT TRIM	CHROME PH OV AB SCREW, JAM NUTS	Z	-	-	-	-	-	-	-	68	10.00
F-774	FLOOR PANEL (Rr) - Fr ANCHORS	PH PN SCREWS, FINISH WA'S	Z	-	-	-	-	-	-	-	4	3.00
F-2944	GLOVE BOX BUMPERS	.40 H RUBBER BUMPER	Z	-	-	-	-	-	-	-	2	2.00

Ford Fastener Kits

241

1967

Interior

PART #	APPLICATION	NOTES								PCS	PRICE
			Z	W	D	O	F	B	T		
F-616	GLOVE BOX CATCH	PH PN EXT SEMS	Z	W	-	-	-	-	-	2	2.00
F-914	GLOVE BOX HINGES	HX CONI SEMS	Z	-	-	-	-	-	-	6	5.00
F-691	GLOVE BOX LATCH	PH PN A EXT SEMS	Z	W	-	-	-	-	-	2	2.00
F-878	GLOVE BOX LINER	PH RNDWA AB SCREWS	Z	W	-	-	-	-	-	4	2.00
F-998	HEADLINER TACK STRIP (Rr) - BODY 63	PH WAFER AB SCREWS	Z	-	-	-	-	-	-	12	1.50
F-1081	HEATER CONTROL > DASH - DLX	PH OV & HXWA SCREWS, KEPS, NUTS	Z	-	-	-	-	-	-	8	4.00
F-1080	HEATER CONTROL > DASH - STD	PH OV & HXWA SCREWS, KEPS, NUTS	Z	W	-	-	-	-	-	8	4.00
F-3753	INSTR FINISH PANEL (BEZEL) @ CLUSTER	PH PN SCREWS, SPRG NUTS, CONI KEPS	-	W	-	-	-	-	-	15	6.00
F-1060	INSTR FINISH PANEL (BEZEL) @ CLUSTER - DLX	PH PN SCREWS, SPRING & STAMP NUTS	Z	-	-	-	-	-	-	13	4.00
F-1059	INSTR FINISH PANEL (BEZEL) @ CLUSTER - STD	PH PN SCREWS, SPRING & STAMP NUTS	Z	-	-	-	-	-	-	13	4.00
F-617	INSTRUMENT FINISH PANELS RH > DASH	HXWA SCREWS, STAMPED & KEPS NUTS	Z	-	-	-	-	-	-	12	10.00
F-3516	INSTRUMENT FINISH PANELS RH > DASH	HXWA & SPL PH PN SCREWS, KEPS NUTS	-	W	-	-	-	-	-	15	6.00
F-280	KICK PANELS	PH RNDWA A SCREWS	Z	W	-	-	-	-	-	4	1.50
F-1378	LAMPS, COURTESY UNDERDASH - LH	PH PN EXT SEMS	Z	-	-	-	-	-	-	1	2.00
F-696	MIRROR (inside) > BRACKET	CHROME PH OV A SCREWS	Z	W	-	-	-	-	-	3	2.00
F-755	MOULDING (above trap door) - BODY 63	RETAINERS, STAMPED NUTS	Z	-	-	-	-	-	-	8	5.00
F-3770	PACKAGE TRAY	PH OVAL SCREWS, SS WA'S, CLIPS	Z	W	-	-	-	-	-	6	3.00
F-887	PANELS - FLOOR, TRUNK OPENING w/o FDS	RNDWA DRILL & HXWA AB SCREWS	Z	-	-	-	-	-	-	11	3.00
F-286	QTER TRIM LWR CORNER PANELS - BDY 63	POP RIVETS	Z	-	-	-	-	-	-	4	2.00
F-289	QTER TRIM MOULDINGS (sides) - BODY 63	PH OV AB SCREWS	Z	-	-	-	-	-	-	12	6.00
F-282	QTER TRIM PANEL BRACKETS - BODY 63	PH PN AB SCREWS	Z	-	-	-	-	-	-	38	6.00
F-1055	QTER TRIM PANEL BUILD-UP - BODY 76	PH PN A SCREWS, SPRING NUTS	Z	-	-	-	-	-	-	18	5.00
F-1052	QTER TRIM PANEL CHROME CAPS	PH OV A SCREWS	Z	-	-	-	-	-	-	2	1.50
F-3757	QTER TRIM PANELS	PH OV & PH PN SCREWS	-	W	-	-	-	-	-	8	3.00
F-292	QTER TRIM PANELS - BODY 65A	PH OV A & RNDWA AB SCREWS	Z	-	-	-	-	-	-	6	3.00
F-293	QTER TRIM PANELS - BODY 65B	PH OV FLUSH SEMS & RNDWA SCREWS	Z	-	-	-	-	-	-	6	3.00
F-1054	QTER TRIM PANELS - BODY 76	PH OV & PH PN SCREWS, FINISH WA'S	Z	-	-	-	-	-	-	12	4.00
F-283	QTER TRIM PANELS (lower Fr) - BODY 63	HX PERI SEMS, PH OV A SCREWS, J-NUTS	Z	-	-	-	-	-	-	20	14.00
F-284	QTER TRIM PANELS (upper Fr) - BODY 63	PH OV & PH PN A SCREWS	Z	-	-	-	-	-	-	10	3.50
F-285	QTER TRIM UPR CORNER PANELS - BODY 63	PH OV & PH PN A SCREWS	Z	-	-	-	-	-	-	6	2.00
F-3514	RADIO OPENING BEZEL	PH OV A SCREWS, SPRING NUTS	-	W	-	-	-	-	-	8	3.00
F-912	RADIO OPENING BEZEL or COVER	PH OV A SCREWS, SRPING NUTS	Z	-	-	-	-	-	-	8	3.00
F-3772	ROOF CONSOLE	PH OV A SCREWS, RETAINERS, NUTS	-	W	-	-	-	-	-	6	3.00
F-3774	ROOF CONSOLE BRACKET	PH PN & PH WAFER AB SCREWS, NUTS	-	W	-	-	-	-	-	15	3.00
F-494	SCUFF PLATES (door opening)	SS/CHROME PH OV AB SCREWS	Z	W	-	-	-	-	-	18	8.00
F-1758	SEAT (Rr fixed) - TRIM - BODY 63	PH OV AB SCREWS	Z	-	-	-	-	-	-	22	5.00
F-302	SEAT (Rr fixed) - UPR ANCHORS - BODY 63	SCREWS, ACORN NUTS, WA'S	Z	-	-	-	-	-	-	16	12.00
F-1339	SEAT BACK (Rr) LWR ANCHOR - BODY 63	HX CONI SEMS	Z	-	-	-	-	-	-	4	8.00
F-298	SEAT BACK ADJUSTMENT (Fr)	CHROME HX BOLTS, NUTS, FLAT WA'S	Z	W	-	-	-	-	-	6	8.00
F-872	SEAT BACK COVERS - STD	WIRE RETAINERS	Z	-	-	-	-	-	-	22	8.00
F-3752	SEAT BELT SHOULDER STRAP RETAINERS	PH PN F SCREWS	Z	W	-	-	-	-	-	4	1.50
F-3563	SEAT BELTS (Fr) - SHOULDER STRAPS	TORX SHLDR BOLTS, CHROME SPACERS	Z	-	-	-	-	-	-	4	14.00
F-3560	SEAT BELTS (Fr) < 2-29-68	HX BOLTS, SPACERS, RUBBER WA'S	Z	-	-	-	-	-	-	14	26.00
F-3565	SEAT BELTS (Rr) < 2-29-68	HX BOLTS, SPACERS	Z	W	-	-	-	-	-	8	20.00
F-939	SEAT HINGE (Rr) > FLOOR, SEAT - BODY 63	HX CONI SEMS, SLOT FLAT SCREWS	Z	-	-	-	-	-	-	10	8.00
F-300	SEAT MOULDINGS - DLX	PH OV & PN SCREWS, PINS, NUTS, WA'S	Z	-	-	-	-	-	-	52	16.00
F-299	SEAT MOULDINGS - STD	PH OV & PH SCREWS, PINS, FIBRE WA'S	Z	-	-	-	-	-	-	16	7.00
F-3765	SEAT PIVOT COVERS	PH PN SCREWS, PINS, FIBRE WA'S	-	W	-	-	-	-	-	14	5.00
F-685	SEAT SCUFF PLATES - Fr SEAT BACKS	PH PN A SCREWS	Z	W	-	-	-	-	-	4	2.00
F-2926	SEAT TRACK STUDS - REPAIR KIT	2 SPECIAL SQR HD BOLTS, RETAINERS	Z	-	-	-	-	-	-	4	5.00
F-1192	SEAT TRACKS > BODY	ORIGINAL INT/EXT DOME KEPS NUTS	Z	-	-	-	-	-	-	8	8.00
F-1169	SEAT UPHOLSTERY (Rr) > FLOOR - B 63	PH PN & RND WA SCREWS, SEALER	Z	-	-	-	-	-	-	8	3.00
F-1109	SEAT UPHOLSTERY (Rr) > FLOOR - B 65, 76	HX PERI SEMS, SEALER	Z	W	-	-	-	-	-	4	3.00
F-295	SPEAKER GRILLES > DOOR (deluxe only)	PH OV A SCREWS	Z	-	-	-	-	-	-	12	4.00
F-3301	SPEAKER GRILLES > DOOR (deluxe only)	PH PN A SCREWS, NYLON SPACER NUTS	Z	-	-	-	-	-	-	24	12.00
F-2935	STEERING COLUMN > DASH	STUDS, LOCK NUTS	Z	W	-	-	-	-	-	6	6.00
F-277	SUN VISOR BRACKETS - BODY 63, 65	PH OV A SCREWS	Z	W	-	-	-	-	-	6	3.00
F-278	SUN VISORS - BODY 76	PH OV & FLAT SCREWS	Z	-	-	-	-	-	-	6	3.00
F-287	TRIM PANEL (above trap door) - BODY 63	PH OV A SCREWS, BLIND RIVETS	Z	-	-	-	-	-	-	7	3.50
F-1124	TRUNK FILLER BOARD < 10-27-66	PH TRUSS AB FLAT SEMS	Z	-	-	-	-	-	-	2	4.00
F-3517	TRUNK LINER @ TAILAMPS	PH RNDWA DRILL SCREWS	-	W	-	-	-	-	-	4	1.00
F-290	WINDOW (Rr) TOP GARNISH MLDNG - BODY 63	PH OV SCREWS	Z	-	-	-	-	-	-	6	3.00
F-952	WINDOW CRANK HANDLES	CHROME POZI OV SCREWS	Z	W	-	-	-	-	-	2	1.50
F-1006	WINDSHIELD PILLIAR TRIM	RETAINERS	Z	W	-	-	-	-	-	6	3.00
F-698	WINDSHIELD, TOP INSIDE TRIM - BODY 76	PH OV A SCREWS	Z	-	-	-	-	-	-	4	2.00

Moulding

F-3636	EMBLEM NUTS, Complete - GT	SLEEVE NUTS	Z	-	-	-	-	-	-	26	10.00
F-3650	EMBLEM NUTS, Complete - GT or 6.5 LITRE	SLEEVE NUTS, STAMPED NUTS	-	W	-	-	-	-	-	28	12.00
F-3635	EMBLEM NUTS, Complete - PRODUCTION	SLEEVE NUTS	Z	-	-	-	-	-	-	58	20.00
F-3649	EMBLEM NUTS, Complete - PRODUCTION	SLEEVE NUTS, STAMPED NUTS	-	W	-	-	-	-	-	20	9.00
F-3245	EMBLEM, FENDERS - "289", "351", "390"	1/8" SLEEVE NUTS	-	-	-	O	-	-	-	4	2.00
F-3925	GRILLE BARS & ORNAMENT	STUDS, CONI & PERI KEPS NUTS	Z	-	-	-	-	-	-	10	10.00

Kits Contain Attaching Fasteners for Both Sides

1967

Moulding

PART #	APPLICATION	NOTES								PCS	PRICE
			MUSTANG	COUGAR	FALCON	FAIRLANE	FORD	BRONCO	TRUCK		
F-3887	GRILLE OPENING MOULDINGS (narrow)	RETAINERS, STAMPED NUTS	Z	-	-	-	-	-	-	16	12.00
F-3238	GRILLE OPENING MOULDINGS (wide)	RETAINERS, SCREWS, SPRING NUTS	Z	-	-	-	-	-	-	22	6.00
F-216	HOOD PEAK MOULDING	SS/CHROME PH RNDWA AB SCREWS	Z	-	-	-	-	-	-	6	3.00
F-3645	NAMEPLATE, FENDERS "Mercury"	FLAT PUSH NUTS	-	W	-	-	-	-	-	4	1.50
F-3616	NAMEPLATE, FENDERS "Mustang" & PONY	3/32" SLEEVE NUTS	Z	-	-	-	-	-	-	36	12.00
F-3608	NAMEPLATE, HOOD "FORD"	3/32" SLEEVE NUTS	Z	-	-	-	-	-	-	8	3.00
F-3922	NAMEPLATE, TRUNK "Mustang"	3/32" SLEEVE NUTS	Z	-	-	-	-	-	-	14	5.00
F-3615	NAMEPLATES, FENDERS "GT"	1/8" SLEEVE NUTS	Z	-	-	O	-	-	-	4	2.00
F-3644	NAMEPLATES, FENDERS "GT" or "6.5 LITRE"	1/8" SLEEVE NUTS	-	W	-	-	-	-	-	8	3.00
F-3947	ORNAMENTS, QTER PANEL	LARGE STAMPED NUTS w SEALER	Z	-	-	-	-	-	-	8	4.00
F-655	TAILAMP PANEL MOULDINGS	STAMPED ACORN NUTS, EXT KEPS NUTS	Z	-	-	-	-	-	-	20	12.00
F-1352	TRUNK LID MOULDING	ACORN PALNUTS	-	W	-	-	-	-	-	7	5.00
F-807	TRUNK LID MOULDING - BODY 65	STAMPED ACORN NUTS	Z	-	-	-	-	-	-	9	3.50
F-2978	VINYL TOP MOULDINGS	STAMPED NUTS	Z	-	-	-	-	-	-	6	3.00
F-1636	WHEEL OPENINGS (4)	SS/CHROME PH RNDWA AB SCREWS	Z	-	-	-	-	-	-	28	10.00
F-580	WINDOW (Fr) MOULDINGS - BODY 63, 65	PUSH-ON RETAINERS	Z	-	-	-	-	-	-	22	10.00
F-1406	WINDOW (Fr) MOULDINGS - BODY 76	RETAINERS, PH OV SCREWS, NUTS	Z	-	-	-	-	-	-	22	10.00
F-582	WINDOW (Rr) MOULDINGS - BODY 63	RETAINERS	Z	-	-	-	-	-	-	27	12.00
F-3661	WINDOW (Rr) MOULDINGS - BODY 65	RETAINERS, PH OV SCREWS	Z	-	-	-	-	-	-	19	8.00

Steering & Suspension

F-1403	AXLE HOUSING > SPRINGS	5 1/2" U-BOLTS, FLNG NUTS	Z	-	-	-	-	-	-	12	26.00
F-3441	AXLE HOUSING > SPRINGS	6 3/4" U-BOLTS, FLNG NUTS	-	W	D	O	-	-	-	12	26.00
F-2886	AXLE HOUSING > SPRINGS	7.0" U-BOLTS, FLNG NUTS	-	W	-	-	-	-	-	12	26.00
F-367	AXLE HOUSING > SPRINGS - NUTS ONLY	FLNG NUTS (Silver Cad)	Z	W	D	O	-	-	-	8	12.00
F-1355	BALL JOINTS (RIVETS) - LWR	RIVETS (2 extra), SPL TOOLS, PRESS RQD	Z	W	D	O	-	-	-	8	6.00
F-1354	BALL JOINTS (RIVETS) - UPPER	RIVETS (2 extra), SPL TOOLS, PRESS RQD	Z	W	D	O	-	-	-	10	6.00
F-3656	COIL SPRING SEATS (perches)	GR-8 3/8-16 KNURL BOLTS, LOCK NUTS	Z	W	D	O	-	-	-	8	10.00
F-595	COIL SPRING SEATS (perches)	HUG-LOK NUTS ONLY	Z	W	D	O	-	-	-	4	3.00
F-3913	CONTROL ARMS (lower) > SHOCK TOWER	GR-8 CAM BOLTS, NUTS, WA'S	Z	W	D	O	-	-	-	8	20.00
F-597	CONTROL ARMS (upper) > SHOCK TOWER	GR-8 NUTS ONLY, SPLIT WA'S	Z	W	D	O	-	-	-	8	5.00
F-2490	CONTROL ARMS (upper) > SHOCK TOWER	GR-8 KNURLED BOLTS, NUTS, SPLIT WA'S	Z	W	D	O	-	-	-	12	16.00
F-2846	CONTROL VALVE ACTUATOR	HX SPLIT SEMS	Z	W	D	O	-	-	-	2	3.00
F-1280	CROSSMEMBER, TUBULAR (Fr)	SPL HX CNTRS NK BOLTS	Z	W	-	-	-	-	-	2	10.00
F-571	GREASE PLUGS, CHASSIS	HX PLUGS	Z	W	D	O	F	B	T	9	5.00
F-351	IDLER ARM	HX BOLTS "F", LOCK NUTS, CLIPPED WA'S	Z	W	D	O	-	-	-	6	12.00
F-3651	LEAF SPRING CENTER BOLTS	GR-8 TALL HD BOLTS, HX NUTS	Z	W	D	O	-	-	-	4	8.00
F-1065	LEAF SPRINGS (front eye)	POINTED HX BOLTS, FLNG NUTS, WA'S	Z	W	D	O	-	-	-	6	18.00
F-3933	P/S CONTROL VALVE DUST COVER CLAMP	SLOT RND B SCREWS	Z	W	D	O	-	-	-	2	1.50
F-502	P/S CONTROL VALVE SPOOL CAP	SLOT FILL SPLIT SEMS	Z	W	D	O	-	-	-	2	3.00
F-3532	P/S COOLER HOSE CLAMPS (SHELBY)	SS PINCH CLAMPS	Z	-	-	-	-	-	-	2	2.00
F-1615	P/S CYLINDER BRACKET - RIVET NUTS	3/8-16 HX BODY RIVET NUTS ONLY	Z	W	D	O	-	-	-	2	6.00
F-508	P/S CYLINDER BRACKET > BODY	HX BOLTS "F", LOCK NUTS, WA'S	Z	W	D	O	-	-	-	7	10.00
F-521	P/S HOSE RUBBER STRAP - 390/428	EXTRUDED STRAP w STEEL RIVET	Z	W	D	O	-	B	T	1	6.00
F-675	P/S HOSE SUPPORT INSULATOR RETAINER	HXWA F SCREWS	Z	W	-	-	-	-	-	2	3.00
F-1803	P/S HOSE SUPPORT INSULATOR RETAINER	HXWA F SCREW	-	-	-	O	-	-	-	1	1.50
F-3917	P/S OIL COOLER (SHELBY)	HXWA A SCREWS	Z	-	-	-	-	-	-	2	2.00
F-647	P/S PUMP - 289/302 w AC	FLNG BOLTS, STUD, LOCK NUT	Z	W	D	O	-	B	T	6	10.00
F-1074	P/S PUMP - 289/302 w/o AC	FLNG BOLTS, STUD, LOCK NUT, SPACER	Z	W	D	O	-	B	T	7	18.00
F-649	P/S PUMP - 390/428 w AC	FLNG BOLTS, STUD, LOCK NUT	Z	W	D	O	-	-	T	8	12.00
F-1154	P/S PUMP - 390/428 w/o AC	FLNG BOLTS, STUD, LOCK NUT, SPACER	Z	W	D	O	-	-	T	9	18.00
F-3888	P/S PUMP - 6 CYL	FLNG & PLACE BOLTS, HX BOLTS, WA'S	Z	W	D	O	-	-	-	14	14.00
F-2937	P/S PUMP RESERVOIR NUT	THIN HX NUT ON BACK	Z	W	D	O	F	B	T	1	3.00
F-1207	P/S RETURN HOSE - 170/200/289/302	NO SLOT STYLE CLAMP	Z	W	D	O	-	-	-	1	10.00
F-1206	P/S RETURN HOSE - 170/200/289/302	SLOTTED STYLE CLAMP	Z	W	D	O	-	-	-	1	5.00
F-1208	P/S RETURN HOSE - 390/428	SLOTTED STYLE CLAMP	Z	W	D	O	-	-	-	2	10.00
F-1209	P/S RETURN HOSE - 390/428	NO SLOT STYLE CLAMP	Z	W	D	O	-	-	-	2	20.00
F-1811	P/S SLAVE CYLINDER, ROD END	HX NUT, STAMPED NUT	Z	W	D	O	-	-	-	2	1.50
F-1390	PITMAN ARM > GEAR BOX w 1 1/8" SHAFT	1 5/16 AF HX JAM NUT, SPLIT WA	Z	W	D	O	-	-	-	2	3.00
F-613	PITMAN ARM > GEAR BOX w 1.0" SHAFT	1 1/8 AF HX JAM NUT, SPLIT WA	Z	-	-	-	-	-	-	2	3.00
F-665	SHACKLE ASSY (Rr) - NUTS ONLY	LOCK NUTS	Z	W	D	O	-	-	-	4	3.00
F-312	SHOCK BRACKETS (Fr)	LOW HD CRG BOLTS, FLNG NUTS	Z	W	-	-	-	-	-	12	9.00
F-3907	SHOCK BRACKETS (Fr)	LOW HD CRG BOLTS, EXT KEPS NUTS	-	-	D	O	-	-	-	12	10.00
F-344	SHOCKS (Fr)	HX EXT SEMS "ANCHOR", NUTS, WA'S	Z	W	-	-	-	-	-	12	9.00
F-809	SHOCKS (Fr) - TOP MOUNTING ONLY	HX EXT SEMS "Anchor"	Z	W	-	-	-	-	-	4	6.00
F-1792	SHOCKS (Rr)	3/8-24 EXT KEPS NUTS	Z	W	D	O	-	-	-	4	2.00
F-1204	STABILIZER (Fr) > BODY (STABILIZER BAR)	HX BOLTS, LOCK NUTS	Z	W	D	O	-	-	-	8	10.00
F-3951	STABILIZER (Fr) END LINKS	BLTS, RTNRS, BSHNGS, SPACERS, NUTS	Z	-	-	-	-	-	-	22	25.00
F-2945	STABILIZER (Fr) END LINKS	BLTS, RTNRS, BSHNGS, SPACERS, NUTS	-	W	D	O	-	-	-	22	25.00
F-349	STEERING GEAR BOX	HX BOLTS, CLIPPED FLAT & SPLIT WA'S	Z	W	D	O	-	-	-	9	12.00
F-672	STEERING GEAR BOX SECTOR COVER	PLACE BOLTS	Z	W	D	O	-	B	T	3	4.00
F-317	STEERING LINKAGE w PS	SLOTTED NUTS, COTTER PINS, FLAT WA	Z	W	D	O	-	-	-	23	14.00
F-316	STEERING LINKAGE w/o PS	SLOTTED NUTS, COTTER PINS, FLAT WA	Z	W	D	O	-	-	-	21	12.00
F-3935	STEERING RAG JOINT w TILT	12 PT BOLTS	Z	W	D	O	-	-	-	2	6.00

See factory Assembly Manuals for illustrations

Ford Fastener Kits

243

1967

Steering & Suspension

PART #	APPLICATION	NOTES								PCS	PRICE
			MUSTANG	COUGAR	FALCON	FAIRLANE	FORD	BRONCO	TRUCK		
F-3934	STEERING RAG JOINT w/o TILT	12 PT BOLT, LOCK NUTS	Z	W	D	O	-	-	-	3	4.00
F-3308	STEERING WHEEL	HX NUT	Z	W	D	O	-	B	T	1	3.00
F-659	STRUT ROD THREADED ENDS > BODY	LOCK NUTS ONLY	Z	W	D	O	-	-	-	4	10.00
F-1463	STRUT RODS > LWR CONTROL ARM	HX BOLTS, LOCK NUTS	Z	W	D	O	-	-	-	8	14.00
F-365	STRUT RODS > LWR CONTROL ARM - NUTS	LOCK NUTS ONLY	Z	W	D	O	-	-	-	4	6.00
F-2964	SUSP BUMPER (Rr) - 289HP, 390, 67-68 GT	LOCK NUT	Z	W	D	-	-	-	-	1	1.50
F-1486	SUSP BUMPER (Rr) 65-66 V8, 67-68 289-2V	HX SCREWS	Z	W	D	O	-	-	-	2	2.00
F-2961	SUSP BUMPERS (Fr)	HUG-LOK NUTS	Z	W	D	O	-	-	-	2	2.00
F-2858	TIE ROD ADJUSTMENT SLEEVE	HX BOLTS, LOCK NUTS	Z	-	D	O	-	B	T	8	6.00
F-379	WHEEL BOLTS, Fr DRUM - 1.48" BOLTS	1/2-20 BOLTS	Z	W	D	O	F	B	T	10	8.00
F-781	WHEEL BOLTS, Fr DRUM - 1.69" BOLTS	1/2-20 BOLTS	Z	W	D	O	F	B	T	10	8.00
F-1353	WHEELS	1/2-20 LUG NUTS, 13/16" HX	Z	W	D	O	F	B	T	20	16.00

Transmission

F-1369	BELL HOUSING (manual) - 170/200	HX BOLTS, SPLIT WA'S	Z	-	D	O	-	B	-	8	8.00
F-353	BELL HOUSING (manual) - 260/289 6 BOLT	HX BOLTS, SPLIT WA'S	Z	W	D	O	-	B	T	12	14.00
F-354	BELL HOUSING (manual) - 390/428 < 2-15-68	HX BOLTS, SPLIT WA'S	Z	W	D	O	-	-	T	12	14.00
F-866	CLUTCH BELLCRANK BRKT'S - 390/428	SRTD FLNG BOLTS, HX BOLTS, WA'S	Z	-	-	-	-	-	-	6	6.00
F-867	CLUTCH BELLCRANK BRKT'S (exc 390/428)	SRTD FLNG BOLTS	Z	-	-	-	-	-	-	2	6.00
F-671	CLUTCH PEDAL	RETAINING PIN	Z	-	-	-	-	-	-	1	2.00
F-1465	DRIVESHAFT - 6 CYL - All 65-66, M/T 67-68	1/4" U-BOLTS, NUTS, SPLIT WA'S	Z	-	-	-	-	-	-	6	10.00
F-876	DRIVESHAFT - V8	5/16-24 LOCK NUTS ONLY	Z	W	D	O	F	B	T	4	3.00
F-1273	DRIVESHAFT - V8, 6 CYL 67-68 A/T, All 69 >	5/16" U-BOLTS, LOCK NUTS	Z	W	D	O	F	B	T	6	8.00
F-1199	ENGINE PLATE (M/T) - 6 CYL & SB	HX SPLIT SEMS	Z	-	-	-	-	-	-	2	3.00
F-796	INSPECTION COVER & ENG PLATE - C4 (A/T)	HX SPLIT SEMS	Z	W	D	O	-	B	T	3	4.00
F-1163	INSPECTION COVER (A/T flywheel) - C6	HX SPLIT SEMS	Z	W	D	O	-	-	T	4	4.00
F-3994	INSPECTION COVER (M/T flywheel) - 390/428	HX SPLIT SEMS	Z	-	-	O	-	-	-	4	4.00
F-3263	PRESSURE PLATE > FLYWHEEL	SPL HX BOLTS, SPLIT WA'S	Z	W	D	O	F	B	T	12	6.00
F-907	SHIFTER (manual) LWR BOOT RETAINER	PH PN SCREWS	Z	-	-	-	-	-	-	4	2.50
F-1238	SHIFTER ASSY > FLOOR - A/T	FLNG BOLTS, PH PN AB SCREWS	Z	-	-	-	-	-	-	8	4.00
F-1233	SHIFTER ASSY > FLOOR - A/T	PH FLAT A SCREWS	Z	-	-	-	-	-	-	4	2.00
F-1234	SHIFTER ASSY > FLOOR - A/T w CONSOLE	PH OV A SCREWS	Z	-	-	-	-	-	-	4	2.00
F-1560	SHIFTER CONTROL > TRANS - 3 & 4 SPD	HX SPLIT SEMS	Z	W	D	O	-	B	T	3	4.00
F-1561	SHIFTER CONTROL > TRANS - 390 3 SPD	HX SPLIT SEMS, POZI FLAT SCREWS	Z	W	D	O	-	B	T	6	6.00
F-1559	SHIFTER CONTROL > TRANS - 4 SPD 390/428	HX SPLIT SEMS, POZI FLAT SCREWS	Z	W	D	O	-	B	T	6	5.00
F-1226	SHIFTER HANDLE - 3 SPD 64-73, 4 SPD 64-69	SHOULDER BOLTS, FLAT WA'S	Z	W	D	O	-	-	-	4	8.00
F-897	SHIFTER HANDLE (manual) > SHIFTER	FORD SHIFTERS, FLAT WA'S ONLY	Z	W	D	O	-	-	-	2	1.50
F-1085	SHIFTER HANDLE REBUILD - 3 & 4 SPD	TRUNNIONS (cups), SPRINGS, GROMMETS	Z	W	-	-	-	-	-	6	12.00
F-1241	SHIFTER LINKAGE - A/T	SRTD FLNG NUTS, PIN, FLAT, WAVE WA'S	Z	W	D	O	-	B	T	4	4.00
F-1220	SHIFTER RODS - 3 SPD	LOCK NUTS, WA'S, PINS	Z	W	D	O	-	B	T	14	8.00
F-1221	SHIFTER RODS - 4 SPD	LOCK NUTS, WA'S, PINS	Z	W	D	O	-	B	T	21	12.00
F-3413	SPEDOMETER CABLE > TRANS	HXWA EXT SEMS	Z	W	D	O	-	B	T	1	2.00
F-185	TORQUE CONVERTOR FLEX PLATE	FLNG NUTS	Z	W	D	O	F	B	T	4	4.00
F-1365	TRANS (auto) > ENGINE - 170/200	HX BOLTS, SPLIT WA'S	Z	-	D	O	-	B	-	8	8.00
F-215	TRANS (auto) > ENGINE - 289/302 6 BOLT	HX BOLTS, SPLIT WA'S	Z	W	D	O	-	B	T	12	14.00
F-186	TRANS (auto) > ENGINE - 390/428	HX BOLTS, SPLIT WA'S	-	W	-	O	-	-	T	12	14.00
F-1244	TRANS (auto) KICKDOWN > ACCEL - ALL	3/16 RH ROD END RETAINER	Z	-	-	-	-	-	-	1	2.00
F-678	TRANS (manual) > BELL HOUSING	HX BOLTS, SPLIT WA'S	Z	W	D	O	F	B	T	8	7.00
F-1841	TRANS ACCESS COVER - FORD 4 SPD	CORRECT SRTD FLNG BOLTS, "X" LONG	Z	W	D	O	F	B	T	10	12.00
F-816	TRANS COOLING LINE CLIPS	C CLIPS	Z	W	D	O	F	B	T	2	3.00
F-177	TRANS CROSSMEMBER	HXWA BOLTS, LOCK NUTS, FLAT WA	Z	-	-	-	-	-	-	5	8.00
F-3903	TRANS CROSSMEMBER	POINTED BOLTS, SLOT NUTS, WA'S, PINS	-	-	D	O	-	-	-	8	10.00
F-1342	TRANS ID TAG	DRIVE SCREW	Z	W	D	O	F	B	T	1	1.00
F-176	TRANS INSULATOR - A/T	HX BOLTS, LOCK NUTS, WA'S	Z	-	-	-	-	-	-	8	8.00
F-3905	TRANS INSULATOR - All	POINTED HX BOLTS, NUTS, WA'S	-	-	D	O	-	-	-	10	8.00
F-1414	TRANS INSULATOR - M/T (exc 390/428)	HX SPLIT SEMS, LOCK NUTS, FLAT WA'S	Z	-	-	-	-	-	-	6	8.00
F-1741	TRANS INSULATOR - M/T 390/428/429	POINTED HX BOLTS, NUTS, WA'S	Z	-	-	-	-	-	-	8	8.00
F-1322	TRANS LEVERS > CASE - 3 SPD	HX NUTS, FLAT & SPLIT WA'S	Z	W	D	O	F	B	T	6	3.00
F-1385	TRANS LEVERS > CASE - 4 SPD	HX NUTS, FLAT & SPLIT WA'S	Z	W	D	O	F	B	T	9	3.00
F-1621	TRANS OIL PAN - C4	FLNG BOLTS	Z	W	D	O	F	B	T	11	4.00
F-892	TRANS OIL PAN - C6	FLNG BOLTS	Z	W	D	O	F	B	T	17	6.00
F-2874	TRANS TAIL HOUSING - M/T	HX BOLTS, SPLIT WA'S	Z	W	D	O	F	B	T	10	8.00

Wipers

F-2851	WASHER NOZZLES	HXWA A EXT SEMS	-	-	-	O	-	-	-	2	2.00
F-426	WASHER NOZZLES & TEE	HXWA AB SCREWS	Z	W	-	-	-	-	-	3	2.00
F-895	WINDSHIELD WASHER BOTTLE	HXWA B SCREWS	Z	W	-	O	-	-	-	3	2.00
F-463	WINDSHIELD WASHER PUMP	HXWA A SCREWS	Z	-	-	-	-	-	-	4	2.00
F-1770	WIPER ARM PIVOTS > COWL PANEL	HX BOLT, SPLIT WA'S	Z	-	-	-	-	-	-	12	3.00
F-737	WIPER MOTOR BRACKET > COWL	HX SPLIT SEMS	Z	-	-	-	-	-	-	4	3.00
F-3867	WIPER MOTOR BRACKET > COWL	CNTRSNG HX EXT SEMS	-	-	-	O	-	-	-	3	3.00

Kits Contain Attaching Fasteners for Both Sides

Ford Fastener Kits

1968

Air Conditioning

PART #	APPLICATION	NOTES						PCS	PRICE
			Z	W	O	B	T		
F-716	AC BRUSH & HOLDER	HX FLNG SCREWS	Z	W	O	B	T	2	1.50
F-718	AC COMPRESSOR - 289/302/351/429	SRTD FLNG BOLTS	Z	W	O	B	T	4	6.00
F-713	AC COMPRESSOR - 390/428	SRTD FLNG BOLTS	Z	W	O	-	T	5	7.00
F-726	AC COMPRESSOR - 6 CYL	FLNG BOLTS	Z	-	O	B	T	4	6.00
F-709	AC COMPRESSOR BRACE (Rr) - 289/302	HX MS EXT SEMS, SRTD FLNG BOLT	Z	W	O	B	T	2	3.00
F-727	AC COMPRESSOR BRACE (Rr) - 6 CYL	SRTD FLNG BOLTS, FLAT WA	Z	-	O	B	T	3	3.00
F-728	AC COMPRESSOR BRACE (side) - 6 CYL	SRTD FLNG BOLT, LOCK NUT	Z	-	O	B	T	2	2.00
F-719	AC COMPRESSOR BRACE (side) - V8, 70 FE	SRTD FLNG BOLTS	Z	W	O	-	T	3	6.00
F-725	AC COMPRESSOR BRACKET - 6 CYL	SRTD FLNG BOLTS	Z	-	O	B	T	3	5.00
F-708	AC COMPRESSOR BRACKET - V8	STUDS, LOCK NUTS	Z	W	O	B	T	6	6.00
F-721	AC COMPRESSOR CLUTCH	HX BOLT, FLAT WA	Z	W	O	B	T	2	3.00
F-717	AC COMPRESSOR FIELD	HX FLNG HD SCREWS	Z	W	O	B	T	4	3.00
F-440	AC CONDENSOR	HXWA T1 SCREWS	Z	W	-	-	-	3	3.00
F-2962	AC DEHYDRATOR & RECEIVER TANK	HXWA A SCREWS	Z	W	-	-	-	3	2.00
F-434	AC FIREWALL SEAL RETAINER	HXWA A SCREWS	Z	-	-	-	-	6	3.00
F-3559	AC HEATER WATER CONTROL VALVE	HXWA AB SCREWS	Z	W	-	-	-	2	1.50
F-430	AC HOSES > COWL BRACES	RUBBER STRAPS w STEEL RIVET	Z	W	-	-	-	4	20.00
F-715	AC IDLER PULLEYS - 289/302/351	SRTD FLNG BOLTS	Z	W	O	B	T	4	6.00
F-705	AC IDLER PULLEYS - 390/428	SRTD FLNG BOLTS, FLAT WA'S	Z	W	O	-	T	6	8.00
F-433	AC UNIT > FIREWALL	STAMPED NUTS w SEALER	Z	-	-	-	-	3	4.00
F-729	AC VACUUM RESERVOIR > FENDER APRON	STAMPED NUTS	Z	-	-	-	-	2	2.00

Body

F-3654	AIR EXTRACTOR BAFFLES (plastic)	PH PN F SCREWS	Z	-	-	-	-	16	4.00
F-3655	AIR EXTRACTOR DRAIN ASSY > BODY	HXWA A SCREWS	Z	-	-	-	-	18	4.00
F-275	AIR SCOOPS (SHELBY)	PH OV AB SCREWS, SRTD HX FLNG NUTS	Z	-	-	-	-	16	6.00
F-3663	AIR VENT GRILLES - FASTBACK, OUTSIDE	STUDS, STAMPED NUTS, CUP WA'S	Z	-	-	-	-	30	25.00
F-1797	AIR VENTS - FASTBACK QTER, INSIDE	HXWA AB SCREWS	Z	-	-	-	-	16	3.00
F-220	BATTERY TRAY	HX CONI SEMS, U-NUTS	Z	W	-	-	-	6	5.50
F-219	BATTERY TRAY	HX PERI SEMS, U-NUTS	-	W	-	-	-	6	5.50
F-3540	BATTERY TRAY	HX CONI SEMS, J-NUTS, SRTD FLNG NUTS	-	-	O	-	-	12	7.00
F-1716	BATTERY TRAY	HX CONI SEMS, J-NUTS	-	-	-	B	-	4	3.50
F-1717	BATTERY TRAY	FLNG BOLTS, U-NUTS	-	-	-	B	-	4	3.50
F-1562	BATTERY TRAY	HX CONI SEMS, CAGE NUT	-	-	-	-	T	5	6.00
F-1547	BED ASSEMBLY > FRAME (StyleSide)	SPL CRG & HX BOLTS, LOCK NUTS, WA'S	-	-	-	-	T	26	22.00
F-2328	BED CORNERS - HOLE COVER PLATES	PH PN AB SCREWS	-	-	-	B	-	2	1.50
F-1556	BED CORNERS - HOLE COVER PLATES	PH PN A SCREWS	-	-	-	-	T	2	1.00
F-994	BRAKE PEDAL SUPPORT	SRTD FLNG BOLTS, HXWA AB SCREWS	Z	-	-	-	-	4	6.00
F-1816	BUMPER (Fr)	SS CAPPED BOLTS, NUTS, CRUSH WA'S	Z	-	-	-	-	22	8.00
F-3601	BUMPER (Fr)	SS CAPPED BOLTS, NUTS, CRUSH WA'S	-	W	-	-	-	24	8.00
F-3578	BUMPER (Fr)	SS CAPPED BOLTS, NUTS, WA'S	-	-	O	-	-	38	14.00
F-1822	BUMPER (Rr)	SS CAPPED BOLTS, NUTS, CRUSH WA'S	Z	W	-	-	-	12	7.00
F-3596	BUMPER (Rr)	SS CAPPED BOLTS, LOCK NUTS, WA'S	-	-	O	-	-	30	10.00
F-188	BUMPER BRACKETS (Fr)	HX BOLTS, FLAT & SPLIT WA'S	Z	-	-	-	-	10	10.00
F-835	BUMPER BRACKETS (Fr)	HX BOLTS, FLAT & SPLIT WA'S	-	W	-	-	-	12	10.00
F-3582	BUMPER BRACKETS (Fr)	HX & FLNG BOLTS, SPLIT WA'S	-	-	O	-	-	10	8.00
F-1490	BUMPER BRACKETS (Fr) > FENDER	HX CONI SEMS, PADDED U-NUTS	Z	-	-	-	-	4	8.00
F-106	BUMPER BRACKETS (Rr)	HX BOLTS, SHIMS, CONI WA'S, SEALS	Z	W	-	-	-	16	12.00
F-3592	BUMPER BRACKETS (Rr)	HX CONI SEMS, SEALS	-	-	O	-	-	12	6.00
F-786	BUMPER GUARD MOUNT BRACKETS (Rr)	HX CONI SEMS, SHIMS, U-NUTS, SEALER	Z	-	-	-	-	8	7.00
F-2915	BUMPER GUARD PADS (Fr)	STAMPED NUTS, PH PN AB SCREWS	Z	-	-	-	-	6	2.00
F-224	BUMPER GUARD PADS (Rr)	STAMPED NUTS	Z	-	-	-	-	6	2.00
F-1445	BUMPER GUARDS (Fr)	HX CONI SEMS, PADDED U-NUTS, J-NUTS	Z	-	-	-	-	8	9.00
F-1112	BUMPER GUARDS (Fr)	HX CONI SEMS, J-NUTS	-	W	-	-	-	8	7.00
F-223	BUMPER GUARDS (Rr)	HX CONI & PH PN EXT SEMS, PAD U-NUTS	Z	-	-	-	-	8	9.50
F-787	BUMPER GUARDS (Rr)	HX CONI SEMS, PADDED U-NUTS, SEALER	-	W	-	-	-	16	14.00
F-3600	BUMPERS (Fr & Rr) - CHROME	SS CAPPED BOLTS, NUTS, SPLIT WA'S	-	-	-	B	-	24	10.00
F-3599	BUMPERS (Fr & Rr) - PAINTED	CRG BOLTS, NUTS, SPLIT WA'S	-	-	-	B	-	24	6.00
F-957	CONVERTIBLE TOP > BODY TACK STRIP	HX CONI SEMS, PH PN A SCREWS	Z	-	-	-	-	14	14.00
F-2003	CONVERTIBLE TOP > BOW LISTING	PH OV B SCREWS	Z	-	-	-	-	4	2.00
F-2980	CONVERTIBLE TOP CLAMPS TO BODY	HXWA EXT SEMS	Z	-	-	-	-	4	3.00
F-1766	CONVERTIBLE TOP DUST HOOD RETAINER	PH PN F SCREWS	Z	-	-	-	-	11	2.00
F-2060	CONVERTIBLE TOP FRAME > BODY	HX CONI SEMS	Z	-	-	-	-	6	5.00
F-1764	CONVERTIBLE TOP WELL LINER	PH WAFER SCREWS	Z	-	-	-	-	17	4.00
F-205	COWL BRACES > COWL	HX FLNG CONI SEMS BOLTS, FLNG NUTS	Z	W	-	-	-	8	14.00
F-3666	COWL PANEL	PH PN AB SCREWS	-	-	O	-	-	6	2.00
F-3183	DATA PLATE	SPL ALUMINUM RIVETS	Z	W	O	B	T	2	2.00
F-973	DOOR HANDLES (outside)	PH PN EXT SEMS, EXT KEPS NUTS	Z	-	-	-	-	4	2.50
F-1546	DOOR HANDLES (outside)	HXWA EXT SEMS, SRTD FLNG NUTS	-	-	-	-	T	4	2.00
F-170	DOOR HINGES	ORIGINAL HXWA SCREWS	Z	W	O	-	-	24	14.00
F-1116	DOOR HINGES	HX PERI SEMS	-	-	-	B	-	24	18.00
F-1566	DOOR HINGES	HX CONI SEMS	-	-	-	-	T	20	14.00
F-3447	DOOR LATCH REINFORCEMENTS	SS PH OV SCREWS, SS CNTSNK WA'S	Z	W	O	-	-	12	5.00
F-1360	DOOR LATCH ROD END BUSHINGS ONLY	5/32 SIZE, EXACTLY ORIGINAL	Z	W	O	-	-	14	7.00

See factory Assembly Manuals for illustrations

Ford Fastener Kits

245

1968

Body

PART #	APPLICATION	NOTES						PCS	PRICE
			Z	W	O	B	T		
F-1357	DOOR LATCH ROD END BUSHINGS ONLY	9/64 SIZE, EXACTLY ORIGINAL	-	-	-	B	-	12	7.00
F-1358	DOOR LATCH ROD END CLIPS	5/32 SIZE, EXACTLY ORIGINAL	Z	W	O	-	-	14	38.00
F-1356	DOOR LATCH ROD END CLIPS	9/64 SIZE, EXACTLY ORIGINAL	-	-	-	B	-	12	38.00
F-1135	DOOR LATCH STRIKERS	POZI FLAT SCREWS	Z	W	O	B	-	4	3.00
F-653	DOOR LATCHES > DOOR SHELL	PH FLAT EXT SEMS	Z	W	O	-	-	6	3.00
F-3281	DOOR STOP STRAPS	PH PN SCREWS	-	-	-	B	-	8	3.00
F-1545	DOOR VENT WINDOWS	PH OV & PH PN AB SCREWS	-	-	-	-	T	8	3.00
F-801	EXPORT BRACE > COWL (SHELBY)	HX BOLTS, FLNG NUTS, FLAT WA'S	Z	-	-	-	-	12	10.00
F-1720	FENDER > APRON BRACKETS	HX CONI SEMS, J-NUTS	-	-	-	B	-	10	7.00
F-3665	FENDER > BUMPER ARM BRACKETS	HXWA AB SCREWS, SPRING CLIPS	-	-	O	-	-	6	3.00
F-207	FENDER > PILLAR BRACKETS	HX CONI SEMS	Z	W	-	-	-	2	2.00
F-3663	FENDER > RADIATOR SUPPORT BRACKETS	HX CONI SEMS, J-NUTS	-	-	O	-	-	8	6.00
F-1531	FENDER APRON LWR BRACKETS	HX T SCREWS, FLAT WA'S	-	-	-	-	T	8	4.00
F-1530	FENDER APRON TOP BRACKETS	HX FLNG EXT SEMS	-	-	-	-	T	6	8.00
F-1529	FENDER APRONS	HX BOLTS, HX PERI SEMS, LOCK NUTS	-	-	-	-	T	32	18.00
F-210	FENDER EXTENSIONS	STUDS & SRTD FLNG NUTS	Z	W	-	-	-	12	6.00
F-1584	FENDER EXTENSIONS	HX CONI SEMS, CONI KEPS NUTS	-	-	-	-	T	8	6.00
F-200	FENDER SPLASH SHIELD BRACKETS (Rr)	HX CONI SEMS, J-NUTS	Z	W	-	-	-	4	4.00
F-198	FENDER SPLASH SHIELD SEALS (Fr)	NYLON RETAINERS	Z	-	-	-	-	10	2.50
F-237	FENDER SPLASH SHIELDS	HXWA AB SCREWS	Z	W	-	-	-	14	7.00
F-1783	FENDER TOPS ONLY, "4 DOTS"	HX CONI SEMS, .81 WA OD	Z	W	O	-	-	12	10.00
F-2887	FENDER TOPS ONLY, "ANCHOR"	HX CONI SEMS, .81 WA OD	Z	W	O	-	-	12	10.00
F-2898	FENDER TOPS ONLY, "RBW"	HX CONI SEMS, .81 WA OD	Z	W	O	-	-	12	10.00
F-3430	FENDER TOPS ONLY, "S"	HX CONI SEMS, .81 WA OD	Z	W	O	-	-	12	10.00
F-1113	FENDER, SHIELDS TO BUMPER	HXWA A SCREWS	-	W	-	-	-	6	2.00
F-196	FENDERS	HX CONI SEMS, J & CAGE NUTS, WA'S	Z	W	-	-	-	48	43.00
F-3536	FENDERS	HX CONI SEMS, HXWA SCREWS, NUTS	-	-	O	-	-	50	38.00
F-1724	FENDERS	HX CONI & POZI EXT SEMS, J, CAGE NUTS	-	-	-	B	-	46	36.00
F-1570	FENDERS	HX CONI & EXT SEMS, J & U-NUTS, WA'S	-	-	-	-	T	34	24.00
F-3538	FENDERS BRACES	HX CONI SEMS, HXWA SCREWS, J-NUTS	-	-	O	-	-	6	4.00
F-3488	FILLER PLATES @ T/L PANEL (SHELBY)	HXWA AB SCREWS	Z	-	-	-	-	18	4.00
F-1533	FLOOR BRACE ACCESS COVERS	HXWA A SCREWS	-	-	-	-	T	8	3.00
F-568	FLOOR REINFORCEMENT - BODY 76	HX CONI SEMS	Z	-	-	-	-	6	14.00
F-171	FLOORBOARD HOLE COVERS 12/20/66 >	HXWA AB SCREWS	Z	W	-	-	-	8	3.00
F-193	GRILLE	HX CONI SEMS, HXWA SCREWS, NUTS	Z	-	-	-	-	10	6.00
F-3543	GRILLE	HXWA & PH OV SCREWS, SPRING NUTS	-	-	O	-	-	20	5.00
F-1708	GRILLE	HX FLNG EXT SEMS, PERI SEMS, J-NUTS	-	-	-	B	-	26	18.00
F-1573	GRILLE	HX PERI SEMS, SRTD FLNG NUTS, NUTS	-	-	-	-	T	28	18.00
F-264	GRILLE (SHELBY)	HX PERI & CONI SEMS "Anchor", J-NUTS	Z	-	-	-	-	13	16.00
F-849	GRILLE CENTER SECTION	HX CONI SEMS, U-NUTS	-	W	-	-	-	8	5.00
F-1540	GRILLE ORNAMENT - RANGER & EXPLORER	STAMPED NUTS	-	-	-	-	T	2	2.00
F-847	GRILLE RH & LH	HX CONI SEMS, SCREWS, KEPS & U-NUTS	-	W	-	-	-	20	12.00
F-195	GRILLE SUPPORTS	HX CONI SEMS, J-NUTS	Z	-	-	-	-	12	12.00
F-3546	GRILLE SUPPORTS	HX PERI SEMS	-	-	O	-	-	10	5.00
F-1576	GRILLE, UPPER SUPPORT	HX CONI SEMS, J-NUTS	-	-	-	-	T	8	6.00
F-267	HEADLAMP BUCKET & BRACKET (SHELBY)	J-NUT SPACERS (not early), SCREWS	Z	-	-	-	-	20	8.00
F-850	HEADLAMP COVER HINGE	HXWA MS SCREWS	-	W	-	-	-	12	3.00
F-843	HEADLAMP COVER HINGE SUPPORT	HX CONI SEMS, SPL BOLTS, KEPS, NUTS	-	W	-	-	-	16	16.00
F-852	HEADLAMP DOOR VACUUM RESERVOIR	HXWA AB SCREWS, SPRING CLIPS	-	W	-	-	-	10	4.00
F-213	HEADLAMP DOORS	SS/CHROME PH OV SCREWS, NYL NUTS	Z	-	-	-	-	12	4.50
F-3668	HEADLAMP DOORS	SS/CHROME PH OV SCREWS, NYL NUTS	-	-	O	-	-	16	6.00
F-1363	HEADLAMP DOORS (SHELBY)	CHROME #6 PH OV AB SCREWS, NUTS	Z	-	-	-	-	12	10.00
F-265	HEADLAMP HOUSINGS (SHELBY)	SRTD FLNG NUTS	Z	-	-	-	-	6	3.00
F-1726	HEADLAMP, SPLASH SHIELDS	PH PN A SCREWS, SPRING NUTS	-	-	-	B	-	8	3.00
F-1732	HOOD	HX CONI SEMS	-	-	-	B	-	4	4.00
F-202	HOOD & HINGES	HX CONI SEMS, J-NUTS	Z	W	O	-	-	14	13.00
F-1578	HOOD & HINGES	HX CONI SEMS, U-NUTS	-	-	-	-	T	14	12.00
F-271	HOOD & HINGES (SHELBY)	HX CONI SEMS "Anchor", U-NUTS	Z	-	-	-	-	14	14.00
F-1580	HOOD BUMPERS > COWL	HX CONI SEMS	-	-	-	-	T	4	4.00
F-1543	HOOD BUMPERS > HOOD	PH PN B SCREWS	-	-	-	-	T	4	1.00
F-122	HOOD BUMPERS, ADJUSTABLE	U-NUTS, JAM NUTS	Z	W	O	-	-	4	2.50
F-1482	HOOD HINGE NUTS (in fender aprons)	5/16-18 PIERCE NUTS	Z	W	O	-	-	6	4.00
F-837	HOOD LATCH	HX CONI SEMS	-	W	-	-	-	2	2.00
F-1712	HOOD LATCH	HX CONI SEMS, J-NUTS	-	-	-	B	-	8	6.00
F-218	HOOD LATCH & CATCH	HX CONI SEMS, J-NUTS	Z	-	-	-	-	5	5.00
F-3549	HOOD LATCH & CATCH	HX CONI SEMS, J-NUTS	-	-	O	-	-	6	5.00
F-1583	HOOD LATCH & CATCH	HX CONI SEMS, J-NUTS, CAGE NUTS	-	-	-	-	T	11	12.00
F-274	HOOD LATCH & CATCH (SHELBY)	SHELBY, HX CONI SEMS, J-NUTS, PHOS	Z	-	-	-	-	5	5.00
F-3307	HOOD LATCH AUXILLIARY CATCH	HX CONI SEMS	-	W	-	-	-	2	2.00
F-1736	HOOD LATCH AUXILLIARY CATCH	HX CONI SEMS	-	-	-	B	-	2	2.00
F-124	HOOD LATCH DOWELL	HX NUT, FLAT WA	-	W	-	-	-	2	1.50
F-191	HOOD LATCH SUPPORT	HX CONI SEMS	Z	-	O	-	-	3	3.00
F-839	HOOD LATCH SUPPORT	HX CONI SEMS	-	W	-	-	-	2	2.00
F-841	HOOD LATCH SUPPORT BRACE	HX CONI SEMS, U-NUTS	-	W	-	-	-	9	7.00
F-269	HOOD LOCK BRKT'S > BODY (SHELBY)	ORIGINAL HX F PERI SEMS	Z	-	-	-	-	4	10.00

Kits Contain Attaching Fasteners for Both Sides

Ford Fastener Kits

1968

PART #	APPLICATION	NOTES						PCS	PRICE
			MUSTANG	COUGAR	FAIRLANE	BRONCO	TRUCK		
F-221	HOOD ORNAMENTS (TURN SIGNALS)	STUDS, STAMPED NUTS ONLY	Z	-	-	-	-	28	20.00
F-1728	HOOD PROP ROD	COTTER PIN, FLAT WA'S	-	-	-	B	-	3	2.00
F-3955	HOOD WEATHERSTRIP (Rr)	NYLON RETAINERS	Z	-	-	-	-	7	3.00
F-3941	HOOD, RAM-AIR PLENUM (SHELBY)	NOS Rivets I RENT SPL AMK TOOL	Z	-	-	-	-	9	45.00
F-1740	JACK CLAMP > FENDER APRON	HX BOLTS, WING & HX NUTS, FLAT WA'S	-	-	-	B	-	13	6.00
F-1586	JACK CLAMP > FENDER APRON	HX CONI SEMS, BOLT, WING & KEPS NUT	-	-	-	-	T	9	6.00
F-263	LETTER PANEL (SHELBY)	CORRECT HX F PERI SEMS, SRTD NUTS	Z	-	-	-	-	6	7.00
F-831	LICENSE PLATE BRACKET (Fr)	HX BOLTS	-	W	-	-	-	2	2.00
F-3667	LICENSE PLATE BRACKET (Rr)	CONI KEPS NUTS	-	-	O	-	-	2	2.00
F-1557	LICENSE PLATE BRACKET (Rr)	HX BOLTS, STAMPED NUT	-	-	-	-	T	4	2.00
F-3589	LICENSE PLATE BUMPERS (Fr & Rr)	ORIGINAL RUBBER BUMPERS	Z	-	-	-	-	4	3.00
F-151	LICENSE PLATE LAMP SHIELD	PH RNDWA AB SCREWS	Z	-	-	-	-	3	1.50
F-2440	LICENSE PLATE SUPPORT (Rr)	HXWA T1 SCREWS	-	-	-	B	-	6	3.00
F-3481	LICENSE PLATES	HXWA B SCREWS, NYLON NUTS	Z	W	O	B	T	8	4.00
F-1281	LICENSE PLATES	SLOT PN HD SCREWS, NYLON NUTS	Z	-	-	-	-	8	3.00
F-3273	LIFTGATE BUMPERS	PH FLAT F SCREWS	-	-	-	B	-	8	2.00
F-3277	LIFTGATE HANDLE	POZI OV SCREWS, CONI KEPS NUTS	-	-	-	B	-	4	3.00
F-3275	LIFTGATE HINGE > TOP	PH OV SCREWS, CONI KEPS NUTS	-	-	-	B	-	16	5.00
F-3279	LIFTGATE LATCH (center)	POZI OV EXT SEMS, POZI PN CONI SEMS	-	-	-	B	-	7	4.00
F-3280	LIFTGATE LATCH ACCESS COVERS	PH PN A SCREWS	-	-	-	B	-	6	2.00
F-3274	LIFTGATE LATCH SHIELDS	PH FLAT F SCREWS	-	-	-	B	-	4	2.00
F-3272	LIFTGATE LATCH STRIKERS	POZI OV EXT SEMS	-	-	-	B	-	4	3.00
F-3270	LIFTGATE PROPS	HX CONI SEMS, PH PN SCREWS	-	-	-	B	-	8	4.00
F-802	MIRROR (outside) > DOOR - 1 MIRROR	SS/CHROME POZI OV SCREW, RIV NUTS	Z	W	O	B	T	4	3.00
F-1512	MIRROR (outside) > DOOR - 2 MIRRORS	SS/CHROME POZI OV SCREW, RIV NUTS	Z	W	O	B	T	8	5.00
F-266	NOSE PANEL (SHELBY)	HX CONI SEMS, CRG & HX BOLTS, NUTS	Z	-	-	-	-	30	16.00
F-1114	QTER PANEL END SEALS	HXWA A SCREWS	-	W	-	-	-	6	2.00
F-229	QTER PANEL EXTENSIONS	STUDS, CONI KEPS NUTS, FLAT & SEALER	Z	-	-	-	-	26	10.00
F-1146	QTER PANEL EXTENSIONS	STUDS, CONI KEPS NUTS, FLAT & SEALER	-	W	-	-	-	18	9.00
F-128	QTER PANEL EXTENSIONS	STUDS, CONI KEPS NUTS, FLAT & SEALER	-	-	O	-	-	24	9.00
F-272	QTER PANEL EXTENSIONS (SHELBY)	KEPS NUTS, SCREWS, FLAT & SEAL WA'S	Z	-	-	-	-	14	7.00
F-1548	RADIATOR SUPPORT	HX CONI SEMS	-	-	-	-	T	14	12.00
F-1287	ROOFSIDE WEATHERSTRIP - BODY 63	PH SCREWS, RETAINERS, BLIND RIVETS	Z	-	-	-	-	34	10.00
F-1288	ROOFSIDE WEATHERSTRIP - BODY 65	PH RNDWA DRILL & AB SCREWS	Z	-	-	-	-	24	6.00
F-204	SHOCK TOWER BRACES (cover springs)	HX CONI SEMS, FLNG NUTS	Z	W	O	-	-	24	14.00
F-1602	SHOCK TOWER BRACES (SHELBY)	HX CONI SEMS, FLNG NUTS	Z	-	-	-	-	24	14.00
F-3952	STEERING COLUMN SEAL	HX AB PERI SEMS	Z	W	-	-	-	4	4.00
F-3953	STEERING COLUMN SEAL - 390 or TILT	HX BOLTS, HX AB PERI SEMS, KEPS NUTS	Z	W	-	-	-	8	6.00
F-209	STONE DEFLECTOR	HX CONI SEMS, STUD BOLTS, SPL NUTS	Z	-	-	-	-	10	13.00
F-845	STONE DEFLECTOR	HX CONI SEMS, CAGED & U-NUTS	-	W	-	-	-	10	7.00
F-3556	STONE DEFLECTOR	HX PERI SEMS, J-NUTS	-	-	O	-	-	10	6.00
F-1590	STONE DEFLECTOR	HX CONI SEMS, FLNG & J-NUTS	-	-	-	-	T	20	12.00
F-3554	STONE DEFLECTOR FILLER PANELS	HX PERI SEMS, J-NUTS	-	-	O	-	-	14	6.00
F-273	TAILAMP PANEL (SHELBY)	PH RNDWA DRILL SCREWS	Z	-	-	-	-	14	7.00
F-2330	TAILGATE HINGES	HX FLNG EXT SEMS	-	-	-	B	-	4	5.00
F-1553	TAILGATE HINGES	FLNG BOLTS	-	-	-	-	T	4	5.00
F-1592	TAILGATE LATCH CATCHES	HX CONI SEMS	-	-	-	B	T	4	4.00
F-2333	TAILGATE LATCHES	HX CONI SEMS	-	-	-	B	-	4	5.00
F-1594	TAILGATE LATCHES	HX CONI SEMS	-	-	-	-	T	4	4.00
F-1555	TAILGATE RELEASE HANDLE	CONI KEPS NUT	-	-	-	-	T	1	2.00
F-2336	TAILGATE RELEASE HANDLE BEZEL	POZI OV EXT & HX CONI SEMS	-	-	-	B	-	6	4.00
F-1554	TAILGATE RELEASE HANDLE BEZEL	HX PERI & PH OV EXT SEMS, RIVET NUTS	-	-	-	-	T	10	5.00
F-2326	TAILGATE SUPPORT ARMS	HX CONI SEMS	-	-	-	B	-	4	4.00
F-1598	TAILGATE SUPPORT ARMS	HX CONI SEMS	-	-	-	-	T	4	4.00
F-1552	TAILGATE SUPPORT BUMPERS	PH PN A SCREWS	-	-	-	B	T	2	4.00
F-255	TIE DOWN BRACKETS (Rr)	HX CONI SEMS, LOCK NUTS	Z	-	-	-	-	10	20.00
F-3266	TOP ASSEMBLY, LONG > BODY	HX CONI SEMS, SRTD FLNG NUTS, WA'S	-	-	-	B	-	62	24.00
F-227	TRUNK LATCH & STRIKER	HX PERI SEMS	Z	W	O	-	-	5	5.00
F-3534	TRUNK LID	HX CONI SEMS	-	-	O	-	-	4	4.00
F-226	TRUNK LID & HINGES	HX CONI SEMS, J-NUTS	Z	W	-	-	-	12	11.00
F-270	TRUNK LID & HINGES (SHELBY)	HX CONI SEMS (not painted), J-NUTS	Z	-	-	-	-	12	12.00
F-572	TRUNK LID BUMPERS (Body 65, 76 69-70)	.50 H BUMPERS	Z	-	-	-	-	2	5.00
F-214	VALANCE (Fr)	HX CONI SEMS, HX PERI SEMS, J-NUTS	Z	-	-	-	-	16	14.00
F-1110	VALANCE (Fr)	HX CONI SEMS, J & U-NUTS	-	W	-	-	-	12	10.00
F-1136	VALANCE (Fr) BRACKETS	HX CONI SEMS, U-NUTS	-	W	-	-	-	8	6.00
F-132	VALANCE (Rr)	CLIP HEAD BOLTS, PH PN SCREWS, NUTS	Z	W	-	-	-	15	7.50
F-3310	VEHICLE ID PLATE (SHELBY)	BLACK BLIND RIVETS	Z	-	-	-	-	2	2.00
F-784	VENT WINDOW RUN @ TOP CORNERS	PH FLAT B SCREWS	Z	-	-	-	-	2	1.50
F-1747	WEATHERSTRIP, DOORS	NYLON PUSH RIVETS	Z	-	-	-	-	2	1.50
F-1769	WEATHERSTRIP, WINDSHIELD PILLARS	PH RNDWA & PH WAFER SCREWS	Z	-	-	-	-	12	3.00
F-700	WINDOW (door) CHANNELS > SUPPORT	PH FLAT SCREWS, U-NUTS	Z	-	-	-	-	10	6.00
F-1790	WINDOW GUIDE @ DOOR OPENINGS	Visible in jamb area, HX PERI SEMS	Z	-	-	-	-	4	3.00
F-699	WINDOW SEALS @ DOOR Rr & QTER	PH PN A SCREWS	Z	-	-	-	-	22	5.00
F-2324	WINDSHIELD FRAME	HX SCREWS	-	-	-	B	-	10	5.00
F-1462	WINDSHIELD HOLD-DOWN RETAINER	SRTD FLNG NUTS	-	-	-	B	-	2	1.50

See factory Assembly Manuals for illustrations

Ford Fastener Kits

247

1968

Brakes

PART #	APPLICATION	NOTES						PCS	PRICE
			MUSTANG	COUGAR	FAIRLANE	BRONCO	TRUCK		
F-1616	BRAKE ASSEMBLY (front drum) > SPINDLE	T-BOLTS, LOCK NUTS	Z	W	O	-	-	16	14.00
F-1479	BRAKE BOOSTER > FIREWALL	HX SPLIT SEMS, FLNG NUTS	Z	W	O	-	-	5	8.00
F-3881	BRAKE BOOSTER HOSE	PINCH TYPE CLAMPS	Z	W	O	B	T	2	2.00
F-1791	BRAKE CABLE SEAL @ BRAKE PLATES	1.0" DIA X .58 TK RUBBER SEAL	Z	W	O	-	-	2	3.00
F-1334	BRAKE CABLES > BODY	RETAINERS, HXWA SCREWS, WA'S, NUT	Z	W	-	-	-	10	7.00
F-575	BRAKE CABLES > BODY	RETAINING CLIPS, HX NUTS	-	-	O	-	-	6	4.00
F-2985	BRAKE CALIPER BLEEDERS	CORRECT SCREWS	Z	W	O	-	T	2	4.00
F-3698	BRAKE CALIPER HARDWARE - COMPLETE	STAB'S, CLIPS, INSULATORS, SCREWS	Z	W	O	-	-	30	50.00
F-1263	BRAKE CALIPERS > SPINDLE	DRILLED GR-8 BOLTS, SPLIT WA'S	Z	W	O	-	-	8	38.00
F-579	BRAKE DRUM RETAINERS	GREEN PUSH ON RETAINERS	Z	W	O	B	T	6	4.00
F-1757	BRAKE HOSE > AXLE HSNB - 428CJ & BOSS	HX BOLT, SPLIT WA	Z	W	-	-	-	2	2.00
F-1249	BRAKE HOSE BRKTS (drum) (Fr) > BODY	HXWA C SCREWS	Z	W	O	-	-	4	3.00
F-1250	BRAKE HOSES (disc) > BODY	HXWA C SCREWS, U-CLIP	Z	W	O	-	-	5	5.00
F-577	BRAKE HOSES (drum) > BRACKET	U-CLIPS	Z	W	O	-	-	3	4.00
F-1517	BRAKE HOSES > CALIPER	RED GR-8 DRILLED HX BOLTS, COP WA'S	Z	W	O	-	-	6	20.00
F-670	BRAKE LIGHT SWITCH	RETAINING PIN	Z	W	O	B	T	1	2.00
F-669	BRAKE PLATE ADJUST HOLE PLUGS (2)	RUBBER PLUGS	Z	W	O	B	T	2	3.00
F-1601	BRAKE ROTOR SHIELDS	HX EXT SEMS	Z	W	O	-	-	6	4.00
F-1475	MASTER CYLINDER w/ POWER BRAKES	FLNG NUTS	Z	W	O	B	T	2	3.00
F-1472	MASTER CYLINDER w/o POWER BRAKES	HX SPLIT SEMS	Z	W	O	B	T	2	4.00
F-1327	PARKING BRAKE CONTROL > BODY	POZI PN EXT SEMS, CAGED & FLNG NUTS	Z	W	-	-	-	6	4.00
F-1333	PARKING BRAKE CONTROL > BODY	HXWA SRTD SCREWS	-	-	O	-	-	3	4.00
F-798	PROPORTIONING VALVE > APRON	FLNG NUTS	Z	W	-	-	-	2	2.00
F-1214	PROPORTIONING VALVE > APRON	5/16-18 HXWA F SCREW	-	-	O	-	-	1	1.50
F-2950	WHEEL CYLINDER BLEEDERS	1/4-28 x 1/4 HX x 92" OAL SCREWS, ZDC	Z	W	O	B	T	2	3.00
F-356	WHEEL CYLINDERS (2) - 250 & All 8 CYL	5/16-18 HX EXT SEMS	Z	W	O	B	T	4	3.00
F-1772	WHEEL CYLINDERS (4) - 170/200	1/4-20 HX EXT SEMS	Z	-	-	-	-	8	6.00
F-3912	WHEEL CYLINDERS (4) - 250 & All 8 CYL	5/16-18 HX EXT SEMS	Z	W	O	B	T	8	6.00

Brake & Fuel Lines - also see page 216

F-3962	BRAKE LINES (not shared) - 6 & 8 CYL, 2 PC	CORRECT CLIPS, SCREWS, GROMMETS	Z	W	-	-	-	20	32.00
F-3964	FUEL LINE @ ROCKER, Mid 67-70 HT, 71-73	CLIP w SQUEEZE RETAINER	Z	W	-	-	-	1	4.00
F-2931	FUEL LINE PROTECTOR @ Rr TORQUE BOX	HXWA SCREWS	Z	W	-	-	-	3	3.00
F-3970	FUEL LINES - 6 CYL CNV or V8 HT	CORRECT CLIPS, SCREWS, GROMMET	Z	W	-	-	-	10	16.00
F-3969	FUEL LINES - 6 CYL, HARDTOP	CORRECT CLIPS, SCREWS, GROMMET	Z	W	-	-	-	8	14.00
F-3972	FUEL LINES - V8, BODY 76	CORRECT CLIPS, SCREWS, GROMMET	Z	W	-	-	-	12	18.00

Cooling

F-395	RADIATOR - 289/302 XC, 390/428	HX CONI SEMS, SCREWS, CAGED NUTS	Z	W	O	-	-	6	6.00
F-392	RADIATOR - STD COOLING	HX CONI SEMS, J-NUTS	Z	W	O	-	-	8	6.00
F-403	RADIATOR FAN SHROUD - All	SPL HXWA SCREWS, SPRING NUTS	Z	W	O	-	-	8	6.00
F-657	RADIATOR HOSE CLAMPS - 289/302/351	WIRE TYPE	Z	W	O	B	T	4	16.00
F-386	RADIATOR HOSE CLAMPS - 390/428	WITEK TOWER TYPE	Z	W	O	-	T	4	14.00
F-658	RADIATOR HOSE CLAMPS - 390/428	WIRE TYPE	Z	W	O	-	T	4	20.00
F-656	RADIATOR HOSE CLAMPS - 6 CYL	WIRE TYPE	Z	W	O	-	T	4	16.00

Differential

F-1439	AXLE RETAINER PLATES - 8 CYL	T-BOLTS, LOCK NUTS	Z	W	O	-	-	16	20.00
F-663	AXLE RETAINER PLATES - NUTS ONLY	LOCK NUTS (Silver Cad)	Z	W	O	B	-	8	6.00
F-2491	AXLE VENT SYSTEM	FITTING, HOSE, CLAMPS, SCREW, SLEEVE	Z	-	-	-	-	7	25.00
F-1165	DIFFERENTIAL CARRIER > HOUSING	COPPER WA'S ONLY	Z	W	O	B	T	10	4.00
F-598	DIFFERENTIAL CARRIER > HOUSING	CAD LOCK NUTS, COPPER WA'S	Z	W	O	B	T	20	12.00
F-3987	DIFFERENTIAL FLANGE > PINION	GR-8 3/4-20 TOP-LOK FLNG LOCKNUT	Z	W	O	B	T	1	5.00
F-374	DIFFERENTIAL PINION SUPPORT	PLACE BOLTS	Z	W	O	B	T	5	8.00

Electrical

F-624	ALTERNATOR - 289/302 less SPACER	HX, HX FLNG & PLACE BOLTS, SPLIT WA	Z	W	O	B	T	4	7.00
F-626	ALTERNATOR - 289/302 w SMOG	PLACE & FLNG BOLTS	Z	W	O	B	T	3	8.00
F-625	ALTERNATOR - 289/302 w SPACER	HX, PLACE BOLTS, GOLD SPACER, WA'S	Z	W	O	B	T	5	16.00
F-629	ALTERNATOR - 390/428 less SPACER	HX, HX FLNG & PLACE BOLTS, SPLIT WA	Z	W	O	-	T	4	7.00
F-630	ALTERNATOR - 390/428 w SPACER	HX, FLNG & PLACE BOLTS, PINK SPACER	Z	W	O	-	T	6	18.00
F-1316	ALTERNATOR - 6 CYL	HX, SRTD HX FLNG & PLACE BOLTS, WA	Z	-	O	B	T	6	14.00
F-652	ALTERNATOR HOUSING THRU BOLTS	HXWA SCREWS	Z	W	O	B	T	3	3.00
F-644	ALTERNATOR PULLEY	HX NUT & SPLIT WA (ZDC)	Z	W	O	B	T	2	2.00
F-1120	ALTERNATOR WIRING	HX NUTS, SPLIT WA'S	Z	W	O	B	T	10	3.00
F-3569	BACK-UP LAMP LENSES	SS PH PN STOP SCREWS	Z	-	-	-	-	4	2.00
F-352	BACK-UP LAMPS > Rr VALANCE	STAMPED NUTS, CUPPED WA'S	Z	-	-	-	-	8	6.00

Kits Contain Attaching Fasteners for Both Sides

Ford Fastener Kits

1968

Electrical

PART #	APPLICATION	NOTES						PCS	PRICE
			Z	W	O	B	T		
F-3809	BACK-UP SWITCH - 4 SPD TRANS	HX MS EXT SEMS	Z	-	-	-	-	1	2.00
F-637	BATTERY CABLES - 289/302/351	HX BOLTS, HXWA SCREWS, CONI KEPS	Z	W	O	B	T	7	5.00
F-641	BATTERY CABLES - 390/428	HX BOLTS, HXWA SCREW, CONI KEPS	Z	W	O	-	T	7	5.00
F-634	BATTERY CABLES - 6 CYL	HX BOLT, HXWA SCREW, CONI KEPS	Z	-	O	B	T	7	5.00
F-1195	BATTERY HOLDOWN CLAMP	J- HOOKS, HXWA AB SCREW, CONI KEPS	Z	W	O	B	T	5	6.00
F-742	BATTERY HOLDOWN CLAMP - NUT ONLY	CONI KEPS NUTS	Z	W	O	B	T	2	2.00
F-1190	BATTERY TERMINALS	SQR HD BOLTS, NUTS	Z	W	O	B	T	4	3.00
F-646	DISTRIBUTOR POINTS & COND - DUAL PT	SLOT PN C SCREWS	Z	W	O	B	T	5	3.00
F-645	DISTRIBUTOR POINTS & COND - SINGLE	SLOT PN C SCREWS	Z	W	O	B	T	3	2.00
F-3808	DOME SOCKET LAMP & WIRING - BODY 65	"S" CLIPS, PH PN AB SCREW	Z	-	-	-	-	6	6.00
F-1329	FOG LAMP BEZELS	SS/CHROME PH OV AB SCREWS	Z	-	-	-	-	4	2.00
F-732	FOG LAMP SWITCH > DASHBOARD	PH PN SCREWS, EXT KEPS NUTS	Z	-	-	-	-	4	2.00
F-739	FUSE BLOCK > FIREWALL	HXWA A SCREWS	Z	-	O	-	-	2	2.00
F-3989	HEADLAMP ADJUSTERS	ADJUSTERS, SCREWS, SPRINGS	Z	-	-	-	-	14	10.00
F-740	HEADLAMP DIMMER SWITCH	HXWA AB SCREWS	Z	W	O	-	-	2	2.00
F-599	HEADLAMP RETAINING RINGS (2)	SS PH FILL B SCREWS	Z	-	-	-	-	6	3.00
F-1337	HORNS	HX CONI SEMS, SRTD FLNG NUTS	Z	W	O	B	T	4	3.00
F-421	IGNITION COIL STRAP & BRKT - 6 CYL	HX SPLIT SEMS, HXWA SCREW, HX NUT	Z	-	O	B	T	4	3.00
F-376	IGNITION COIL STRAP & BRKT - V8 exc 351C	HX SPLIT SEMS, HXWA SCREW, HX NUT	Z	W	O	B	T	3	3.00
F-1301	IGNITION COIL STRAP ONLY	HXWA SCREW, HX NUT	Z	W	O	B	T	2	1.50
F-1430	JUNCTION BLOCK @ RH APRON (SHELBY)	HXWA A SCREWS	Z	-	-	-	-	2	1.50
F-447	LICENSE PLATE LAMP	PH PN A SCREWS, SPRING NUTS	Z	-	-	-	-	4	2.00
F-3443	NEUTRAL SWITCH	HX EXT SEMS	Z	W	O	B	T	2	3.00
F-1151	PARKING LAMP LENSES	SS PH PN STOP SCREWS	Z	-	-	-	-	4	2.00
F-452	PARKING LAMPS	STAMPED NUTS	Z	-	-	-	-	4	2.00
F-427	RADIO - HOOD GROUND	HXWA AB SCREW ONLY	Z	W	-	-	-	1	1.50
F-1096	RADIO > INSTRUMENT PANEL	HXWA EXT SEMS, STAMPED NUT	Z	-	-	-	-	5	3.00
F-2025	RADIO SPEAKER > DASH	CLIP HEAD BOLTS, EXT KEPS NUTS	Z	-	-	-	-	4	2.00
F-449	REFLECTORS @ QTER PANELS	STAMPED NUTS, GRAY PROTECTORS	Z	-	-	-	-	6	4.00
F-453	SIDE MARKERS LAMPS (Fr)	JAM NUTS	Z	-	-	-	-	4	2.00
F-3811	SPEED CONTROL CABLES	RUBBER STRAPS, NYLON "S" RETAINERS	Z	-	-	-	-	5	15.00
F-1410	STARTER - 289/302/351	HXWA SPLIT SEMS, YLW ZINC	Z	W	O	B	T	2	3.50
F-408	STARTER - 6 CYL & 390/428	HX SPLIT SEMS	Z	W	O	-	T	3	4.00
F-358	STARTER SOLENOID	HXWA AB SCREWS "D"	Z	W	O	B	T	2	1.50
F-443	TAILAMP ASSEMBLY > BODY	EXT KEPS NUTS, RUBBER CAPS	Z	-	-	-	-	17	6.00
F-3552	TAILAMP ASSEMBLY > BODY	SRTD HX FLNG NUTS	-	-	O	-	-	8	3.00
F-2930	TAILAMP ASSEMBLY > BODY - RANCHERO	PH OV AB SCREWS	-	-	O	-	-	12	6.00
F-3571	TAILAMP LENSES	SS/CHROME PH PN STOP SCREWS	Z	-	-	-	-	8	5.00
F-2965	TAILAMP WIRING GROUND @ LATCH	HXWA A SCREW, TOOTH WA (1967 only)	Z	W	-	-	-	2	1.50
F-1775	TRUNK LAMP	HXWA AB SCREW, EXT WA	Z	-	-	-	-	2	1.50
F-406	VOLTAGE REGULATOR	HXWA A SCREWS "D", EXT WA	Z	W	O	B	T	3	1.50
F-3823	WIRING - 6 CYL IGNITION COIL	RUBBER COATED "J" CLIP	Z	W	O	-	T	1	1.50
F-3807	WIRING - COURTESY LAMP @ QTER - B 63	"S" CLIPS, HXWA A SCREWS, EXT WA'S	Z	-	-	-	-	8	5.00
F-3817	WIRING - DOOR SPEAKERS	NYLON "S" CLIPS	Z	-	-	-	-	2	3.00
F-460	WIRING - ENGINE FEED - 8 CYL w AC	RUBBER COATED "J" CLIPS	Z	W	O	B	T	4	5.00
F-423	WIRING - ENGINE FEED - 8 CYL w/o AC	RUBBER COATED "J" CLIPS	Z	W	O	B	T	3	4.00
F-587	WIRING - FIREWALL	4" NYLON STRAPS (1 for washer hose)	Z	W	-	-	-	3	4.00
F-3813	WIRING - FOG LAMPS	NYLON "S" CLIPS	Z	-	-	-	-	2	3.00
F-462	WIRING - GAS TANK SENDER w DUAL EXH	NYLON "O" CLIPS	Z	-	-	-	-	3	3.00
F-586	WIRING - HORNS & REGULATOR	3 1/8" NYLON STRAPS	Z	W	-	-	-	5	3.00
F-2112	WIRING - LH APRONS	4.0" NYLON STRAPS	Z	-	-	-	-	6	4.00
F-3816	WIRING - RADIO CABLE > DASH	NYLON "S" CLIPS	Z	-	-	-	-	2	3.00
F-2113	WIRING - RH APRON BELOW RELAY	D-SHAPED NYLON RETAINERS	Z	-	-	-	-	2	3.00

Emissions

F-1194	PCV HOSES - 390/428	4 WIRE CLAMPS	Z	W	O	-	T	4	4.00
F-1278	PCV VALVE ELBOW - 390/428	1/4" NPT > 1/2" HOSE STEEL ELBOW	Z	W	O	B	T	1	20.00
F-1649	SMOG PUMP - 289/302	BOLTS, CONI SEMS, SPACER, NUTS, WA'S	Z	W	O	B	T	9	22.00
F-631	SMOG PUMP - 390/428	BOLTS, CONI SEMS, SPACER, NUTS, WA'S	Z	W	O	-	T	5	16.00
F-615	SMOG PUMP PULLEY	PLACE BOLTS	Z	W	O	B	T	3	4.00

Exhaust

F-1453	EXHAUST HANGERS, DUAL	CRG BOLTS, HXWA SCREWS, FLNG NUTS	Z	-	-	-	-	20	8.00
F-1247	EXHAUST HANGERS, SINGLE	HXWA C SCREWS	Z	-	-	-	-	8	4.00
F-522	EXHAUST PIPE > MANIFOLD - 6 CYL	STUDS 2.25 OAL, FLNG NUTS	Z	-	O	B	-	4	7.00
F-524	EXHAUST PIPE > MANIFOLDS - 390/428/B429	STUDS 2.25 & 3.81 OAL, FLNG NUTS	Z	W	O	-	-	8	12.00
F-523	EXHAUST PIPE > MANIFOLDS - SB, 69 390GT	STUDS 2.25 OAL, FLNG NUTS	Z	W	O	B	-	8	10.00

Ford Fastener Kits

249

1968

Fuel - for lines see page 216

PART #	APPLICATION	NOTES						PCS	PRICE
			Z	W	O	B	T		
F-1460	ACCEL BELLCRANK > FIREWALL - 6 CYL	HXWA AB SCREWS	Z	-	-	-	-	4	2.00
F-1459	ACCEL BELLCRANK > FIREWALL - 8 CYL	HXWA AB SCREWS	Z	-	O	-	-	3	2.00
F-1401	ACCEL LINKAGE @ CARB - 6 CYL	3/16" RH ROD END RETAINERS	Z	-	-	-	-	4	5.00
F-1193	ACCELERATOR ROD > CARB - 8 CYL	3/16" RH ROD END RETAINER	Z	-	-	-	-	1	2.00
F-3954	FUEL HOSE CLAMPS	FLAT WOUND SPRING TYPE (Green)	Z	W	O	-	-	8	4.00
F-411	GAS CAP (pop open)	PH FLAT A SCREWS ONLY	Z	-	-	-	-	4	2.00
F-357	GAS TANK	HXWA AB SCREWS	Z	-	O	-	-	11	6.00
F-3910	GAS TANK FILLER NECK	HXWA A SCREWS	-	-	O	-	-	5	3.00
F-1779	GAS TANK FILLER NECK CLAMPS	CORRECT WIRE CLAMPS	Z	-	-	-	-	2	6.00
F-412	GAS TANK FILLER NECK w TWIST CAP	HXWA B SCREWS	Z	-	-	-	-	5	3.00

Heater

F-3915	DEFROSTER DUCTS > DASH	CLIP HEAD BOLTS, EXT KEPS NUTS	Z	-	-	-	-	8	8.00
F-468	DEFROSTER PLENUM > HEATER CASE	HXWA AB SCREWS	Z	-	-	-	-	4	2.00
F-383	HEATER & BY-PASS HOSES	WHITEK TOWER CLAMPS	Z	W	O	B	T	6	12.00
F-470	HEATER ASSEMBLY > COWL (RH side)	HXWA AB SCREW, SPRING CLIP	Z	-	-	-	-	2	2.00
F-432	HEATER ASSEMBLY > FIREWALL	STAMPED NUTS w INTEGRAL SEALER	Z	W	-	-	-	4	4.00
F-2855	HEATER ASSEMBLY > FIREWALL	STAMPED NUTS	-	-	O	-	-	4	4.00
F-469	HEATER CABLES > HEATER HOUSING	SLOT HX A SCREWS	Z	-	-	-	-	3	2.00
F-1213	HEATER HOSE STRAPS	6 3/4" ALUMINUM STRAP	Z	W	O	-	-	2	10.00
F-438	HEATER MOTOR GUARD - 390/428	HXWA A SCREWS, JAM NUT	Z	-	-	-	-	3	2.00

Interior

F-736	AIR VENT LH UNDER DASH > COWL	STAMPED NUTS w SEALER	Z	-	-	-	-	4	3.00
F-294	ARMRESTS - STD C7ZB, All C8ZB	HXWA AB SCREWS, SPRING NUTS	Z	W	-	-	-	8	4.00
F-3759	ARMRESTS (Rr)	HXWA AB SCREWS, FLAT WA'S	-	W	-	-	-	8	2.00
F-693	ASH TRAY LINER	PH PN AB SCREWS	Z	W	-	-	-	3	1.00
F-890	CARPET > FLOOR w CONSOLE	RNDWA SCREWS, 2 EXTRA for BODY 63	Z	W	-	-	-	8	2.00
F-680	CARPET > FLOOR w/o CONSOLE	RNDWA SCREWS, 2 EXTRA for BODY 63	Z	-	-	-	-	10	2.00
F-1012	COAT HOOKS - BODY 63	PH PN AB SCREWS ONLY	Z	-	-	-	-	2	1.00
F-1013	COAT HOOKS - BODY 65	PH PN AB SCREWS ONLY	Z	W	-	-	-	2	1.00
F-3756	CONSOLE - DLX	PH PN & PH OV SCREWS, RTNRS, NUTS	-	W	-	-	-	26	6.00
F-3755	CONSOLE - STD	PH PN & PH OV SCREWS, RTNRS, NUTS	-	W	-	-	-	28	7.00
F-1099	CONSOLE > FLOOR	PH PN & PH OV SCREWS, RTNRS, NUTS	Z	-	-	-	-	28	14.00
F-1100	CONSOLE > ROOF	PH OV & PH TRUSS WA SCREWS, NUTS	Z	-	-	-	-	13	3.50
F-1084	COURTESY LAMP @ DOORS	PH PN A SCREWS, NYLON NUTS	Z	-	-	-	-	12	2.50
F-903	DASH PAD & MOULDINGS	PH OV AB SCREWS, STAMPED NUTS	Z	-	-	-	-	9	4.00
F-3511	DASH PAD & MOULDINGS	PH OV RNDWA SCREWS, STAMP NUTS	-	W	-	-	-	19	4.00
F-3513	DASH PAD LWR	STAMPED NUTS	-	W	-	-	-	4	2.00
F-1075	DOOR LAMP - BODY 65	PH PN A & AB SCREWS	Z	-	-	-	-	3	2.00
F-949	DOOR HANDLES (inside)	POZI OV SCREWS	Z	W	-	-	-	2	1.00
F-3863	DOOR LATCH CONTROL (at inside handle)	PH PN EXT SEMS	Z	-	-	-	-	6	3.00
F-3769	DOOR OPENING PAD	PH OV FLUSH SEMS	-	W	-	-	-	4	2.00
F-3762	DOOR PANELS	SCREWS, RETAINERS (pad clips go lower)	-	W	-	-	-	28	8.00
F-296	DOOR PANELS - STD C7ZB & All C8ZB	RETAINERS (padded clips go lower)	Z	-	-	-	-	32	8.00
F-3760	DOOR PULLS	PH WAFER & PH OV AB SCREWS, NUTS	-	W	-	-	-	14	3.00
F-288	FD SEAT LATCH COVERS	PH OV AB SCREWS, FINISH WA'S	Z	-	-	-	-	16	4.00
F-920	FD SEAT SIDE LATCHES	HXWA EXT SEMS	Z	-	-	-	-	8	2.50
F-770	FD SEAT STOP PLATES	PH PN MS & AB SCREWS	Z	-	-	-	-	6	3.00
F-930	FD SEAT TRAP DOOR HINGES	HX INT/EXT SEMS, J-NUTS	Z	-	-	-	-	16	10.00
F-926	FD SEAT TRAP DOOR LATCH	HXWA SCREWS	Z	-	-	-	-	4	2.00
F-935	FD SEAT TRAP DOOR PROP	HXWA EXT SEMS, J-NUTS	Z	-	-	-	-	4	4.00
F-429	FD SEAT TRAP DOOR RUBBER BUMPERS	TALL RUBBER BUMPERS	Z	-	-	-	-	4	6.00
F-922	FD SEAT TRAP DR LATCH CATCH 2/67 >	HX CONI SEMS	Z	-	-	-	-	2	2.00
F-1755	FD SEAT TRIM	CHROME PH OV AB SCREW, JAM NUTS	Z	-	-	-	-	62	10.00
F-995	FIREWALL SOUND ABSORBER	PH PN DRILL SCREW, FLAT WA	Z	W	-	-	-	2	1.00
F-775	FLOOR PANEL (Rr) - Fr ANCHORS	PH PN SCREWS, FINISH WA'S	Z	-	-	-	-	4	3.00
F-2944	GLOVE BOX BUMPERS	.40 H RUBBER BUMPER	Z	-	-	-	-	2	2.00
F-616	GLOVE BOX CATCH	PH PN EXT SEMS	Z	W	-	-	-	2	2.00
F-914	GLOVE BOX HINGES	HX CONI SEMS	Z	-	-	-	-	6	5.00
F-691	GLOVE BOX LATCH	PH PN A EXT SEMS	Z	W	-	-	-	2	2.00
F-878	GLOVE BOX LINER	PH RNDWA AB SCREWS	Z	W	-	-	-	4	2.00
F-999	HEADLINER RETAINER (hardtop @ Fr pillars)	PH OV AB SCREWS	Z	W	-	-	-	2	1.50
F-1083	HEATER CONTROL > DASH - DLX	HXWA & PH OV SCREWS, SPRING NUTS	Z	-	-	-	-	8	3.00
F-1082	HEATER CONTROL > DASH - STD	PH OV & HXWA SCREWS, KEPS, NUTS	Z	-	-	-	-	8	4.00
F-1051	HORN PAD (2 Spoke Wheel)	PH PN B SCREWS	Z	-	-	-	-	2	2.00
F-1061	INSTR FINISH PANEL (BEZEL) @ CLUSTER	PH PN SCREWS, SPRING & STAMP NUTS	Z	-	-	-	-	11	4.00
F-3753	INSTR FINISH PANEL (BEZEL) @ CLUSTER	PH PN SCREWS, SPRG NUTS, CONI KEPS	-	W	-	-	-	15	6.00
F-617	INSTRUMENT FINISH PANELS RH > DASH	HXWA SCREWS, STAMPED & KEPS NUTS	Z	-	-	-	-	12	10.00
F-3516	INSTRUMENT FINISH PANELS RH > DASH	HXWA & SPL PH PN SCREWS, KEPS NUTS	-	W	-	-	-	15	6.00
F-694	INSTRUMENT PANEL CENTER BRACE	HX CONI SEMS, SRTD FLNG NUTS	Z	-	-	-	-	3	2.50
F-880	KICK PANELS	PH PN AB SCREWS	Z	W	-	-	-	4	2.00
F-1379	LAMPS, COURTESY UNDERDASH	PH PN AB SCREWS	Z	-	-	-	-	2	1.00

Kits Contain Attaching Fasteners for Both Sides

Ford Fastener Kits

1968

Interior

PART #	APPLICATION	NOTES						PCS	PRICE
			Z	W	O	B	T		
F-861	MIRROR (inside) > BRACKET	PH OV F SCREWS	Z	W	-	-	-	2	1.50
F-757	MOULDING (above trap door) - BODY 63	RETAINERS, SRTD FLNG NUTS	Z	-	-	-	-	8	5.00
F-3770	PACKAGE TRAY	PH OVAL SCREWS, SS WA'S, CLIPS	Z	W	-	-	-	6	3.00
F-941	PANELS - FLOOR, TRUNK OPENING w/o FDS	RNDWA DRILL SCREWS	Z	-	-	-	-	11	3.00
F-286	QTER TRIM LWR CORNER PANELS - BDY 63	POP RIVETS	Z	-	-	-	-	4	2.00
F-756	QTER TRIM MOULDINGS (sides) - BODY 63	PH OV AB SCREWS	Z	-	-	-	-	12	6.00
F-761	QTER TRIM PANEL BRACKETS - BODY 63	PH PN AB SCREWS	Z	-	-	-	-	38	6.00
F-1055	QTER TRIM PANEL BUILD-UP - BODY 76	PH PN A SCREWS, SPRING NUTS	Z	-	-	-	-	18	5.00
F-1053	QTER TRIM PANEL CHROME CAPS	PH OV AB SCREWS	Z	-	-	-	-	2	1.50
F-3758	QTER TRIM PANELS	PH OV & PH PN SCREWS	-	W	-	-	-	8	2.00
F-758	QTER TRIM PANELS - BODY 63	HX PERI SEMS, PH OV SCREWS, J-NUTS	Z	-	-	-	-	20	14.00
F-874	QTER TRIM PANELS - BODY 65A, 65C	PH OV, PH PN, PH PNWA AB SCREWS	Z	-	-	-	-	6	2.00
F-875	QTER TRIM PANELS - BODY 76	PH OV & PH PN SCREWS, FINISH WA'S	Z	-	-	-	-	12	3.00
F-759	QTER TRIM PANELS (upper Fr) - BODY 63	PH OV & PH PN SCREWS	Z	-	-	-	-	8	3.50
F-760	QTER TRIM UPR CORNER PANELS - BODY 63	PH OV AB & PH PN A SCREWS	Z	-	-	-	-	6	2.00
F-3515	RADIO OPENING BEZEL	PH OV AB SCREWS, SPRING NUTS	-	W	-	-	-	8	3.00
F-913	RADIO OPENING BEZEL or COVER	PH OV A SCREWS, SPRING NUTS	Z	-	-	-	-	8	2.50
F-3773	ROOF CONSOLE	PH OV A SCREWS, RETAINERS, NUTS	-	W	-	-	-	6	3.00
F-3775	ROOF CONSOLE BRACKET	PH PN & PH SCREWS, SPRING NUTS	-	W	-	-	-	15	3.00
F-494	SCUFF PLATES (door opening)	SS/CHROME PH OV AB SCREWS	Z	W	-	-	-	18	8.00
F-1758	SEAT (Rr fixed) - TRIM - BODY 63	PH OV AB SCREWS	Z	-	-	-	-	22	5.00
F-303	SEAT (Rr fixed) - UPR ANCHORS - BODY 63	SCREWS, ACORN NUTS, WA'S	Z	-	-	-	-	16	12.00
F-3776	SEAT ADJUST KNOBS	PH OV F SCREWS	-	W	-	-	-	2	1.00
F-862	SEAT BACK (Fr) RELEASE KNOB	PH OV F SCREWS	Z	-	-	-	-	2	1.50
F-1340	SEAT BACK (Rr) LWR ANCHOR - BODY 63	HX CONI SEMS	Z	-	-	-	-	4	8.00
F-3764	SEAT BACK COVERS	WIRE RETAINERS	Z	W	-	-	-	20	6.00
F-3752	SEAT BELT SHOULDER STRAP RETAINERS	PH PN F SCREWS	-	W	-	-	-	4	1.50
F-3562	SEAT BELTS (Fr) 2-29-68 >	TORX BOLTS, RUBBER WA'S, SPACERS	Z	-	-	-	-	14	20.00
F-3563	SEAT BELTS (Fr) - SHOULDER STRAPS	TORX SHLDR BOLTS, CHROME SPACERS	Z	-	-	-	-	4	14.00
F-3560	SEAT BELTS (Fr) < 2-29-68	HX BOLTS, SPACERS, RUBBER WA'S	Z	-	-	-	-	14	26.00
F-3566	SEAT BELTS (Rr) 2-29-68 >	TORX BOLTS, SPACERS	Z	-	-	-	-	8	14.00
F-3565	SEAT BELTS (Rr) < 2-29-68	HX BOLTS, SPACERS	Z	W	-	-	-	8	20.00
F-939	SEAT HINGE (Rr) > FLOOR, SEAT - BODY 63	HX CONI SEMS, SLOT FLAT SCREWS	Z	-	-	-	-	10	8.00
F-682	SEAT PIVOTS & COVER	PH PN T1 SCREWS, PINS, FIBRE WA'S	Z	-	-	-	-	14	5.00
F-3766	SEAT PIVOTS & COVER	PH PN SCREWS, PINS, FIBRE WA'S	-	W	-	-	-	14	5.00
F-686	SEAT STOPS - Fr SEAT BACKS	PH PN F SCREWS	Z	W	-	-	-	8	3.00
F-2926	SEAT TRACK STUDS - REPAIR KIT	2 SPECIAL SQR HD BOLTS, RETAINERS	Z	-	-	-	-	4	5.00
F-1192	SEAT TRACKS > BODY	ORIGINAL INT/EXT DOME KEPS NUTS	Z	-	-	-	-	8	8.00
F-1048	SEAT UPHOLSTERY (Rr) > FLOOR - B 63	PH PN & PH WAFER SCREWS, SEALER	Z	-	-	-	-	8	3.00
F-1109	SEAT UPHOLSTERY (Rr) > FLOOR - B 65, 76	HX PERI SEMS, SEALER	Z	W	-	-	-	4	3.00
F-3301	SPEAKER GRILLES > DOOR (deluxe only)	PH PN A SCREWS, NYLON SPACER NUTS	Z	-	-	-	-	24	12.00
F-295	SPEAKER GRILLES > DOOR (deluxe only)	PH OV A SCREWS	Z	-	-	-	-	12	4.00
F-2929	STEERING COLUMN > DASH	EXT HX SEMS, STUDS, LOCK NUTS	Z	W	-	-	-	10	8.00
F-609	SUN VISOR BRACKETS - BODY 63, 65	PH OV & PN AB SCREWS	Z	W	-	-	-	8	4.00
F-604	SUN VISOR BRACKETS - BODY 76	PH OV, PH FLAT & PH PN SCREWS	Z	-	-	-	-	8	5.00
F-287	TRIM PANEL (above trap door) - BODY 63	PH OV A SCREWS, BLIND RIVETS	Z	-	-	-	-	7	3.50
F-3517	TRUNK LINER @ TAILAMPS	PH RNDWA DRILL SCREWS	-	W	-	-	-	4	1.00

Moulding

F-3771	WINDOW (Rr) INSIDE MOULDINGS	PH PN AB SCREWS	-	W	-	-	-	4	1.00
F-893	WINDOW (Rr) TOP GARNISH MLDNG - BODY 63	PH OV SCREWS	Z	-	-	-	-	6	3.00
F-953	WINDOW CRANK HANDLES	OVAL HEAD POZI OV SCREWS	Z	W	-	-	-	2	1.00
F-1006	WINDSHIELD PILLIAR TRIM	RETAINERS	-	W	-	-	-	6	3.00
F-3478	BODYSIDE MOULDINGS - GTE	RETAINING CLIPS, STAMPED NUTS	-	W	-	-	-	108	70.00
F-3638	EMBLEM NUTS, Complete - GT	SLEEVE NUTS	Z	-	-	-	-	18	7.00
F-3650	EMBLEM NUTS, Complete - GT or 6.5 LITRE	SLEEVE NUTS, STAMPED NUTS	-	W	-	-	-	28	12.00
F-3637	EMBLEM NUTS, Complete - PRODUCTION	SLEEVE NUTS, STAMPED NUTS	Z	-	-	-	-	24	9.00
F-3649	EMBLEM NUTS, Complete - PRODUCTION	SLEEVE NUTS, STAMPED NUTS	-	W	-	-	-	20	9.00
F-3244	EMBLEM, FENDER Fr - "289", "302", "390"	1/8" ACORN NUTS	-	-	O	-	-	4	3.00
F-860	GRILLE MOULDINGS (Pony & Corral)	STAMPED NUTS	Z	-	-	-	-	18	6.00
F-870	GRILLE MOULDINGS (SHELBY)	RETAINERS, SLEEVE NUTS	Z	-	-	-	-	52	36.00
F-3887	GRILLE OPENING MOULDINGS (narrow)	RETAINERS, STAMPED NUTS	Z	-	-	-	-	16	12.00
F-3238	GRILLE OPENING MOULDINGS (wide)	RETAINERS, SCREWS, SPRING NUTS	Z	-	-	-	-	22	6.00
F-216	HOOD PEAK MOULDING	SS/CHROME PH RNDWA AB SCREWS	Z	-	-	-	-	6	3.00
F-472	HOOD SCOOP, RAM-AIR - 428CJ	HX EXT SEMS (middle), STUDS, CONI KEPS	Z	-	-	-	-	12	20.00
F-3645	NAMEPLATE, FENDERS "Mercury"	FLAT PUSH NUTS	-	W	-	-	-	4	1.50
F-3617	NAMEPLATE, FENDERS "Mustang"	3/32" SLEEVE NUTS, STAMPED NUTS	Z	-	-	-	-	10	4.00
F-2857	NAMEPLATE, LETTER PANEL "SHELBY"	FLAT PUSH NUTS	Z	-	-	-	-	17	4.00
F-3648	NAMEPLATE, QTER PANELS "Cougar"	3/32" SLEEVE NUTS	-	W	-	-	-	8	3.00
F-3242	NAMEPLATE, QTER PANELS "Fairlane 500"	1/8" STAMPED NUTS	-	-	O	-	-	16	3.00
F-3246	NAMEPLATE, QTER PANELS "Torino"	BODY 63, 1/8" STAMPED NUTS	-	-	O	-	-	8	2.00
F-3646	NAMEPLATE, ROOFSIDES "XR7"	STAMPED NUTS	-	W	-	-	-	4	3.00
F-3240	NAMEPLATE, TAILAMP PANEL "Fairlane"	BODY 63, 1/8" ACORN NUTS	-	-	O	-	-	6	3.00

See factory Assembly Manuals for illustrations

Ford Fastener Kits

251

1968

Moulding

PART #	APPLICATION	NOTES	VEHICLE					PCS	PRICE
			MUSTANG	COUGAR	FAIRLANE	BRONCO	TRUCK		
F-3922	NAMEPLATE, TRUNK "Mustang"	3/32" SLEEVE NUTS	Z	-	-	-	-	14	5.00
F-3247	NAMEPLATE, TRUNK LID "Fairlane"	BODY 54, 65, 76, 1/8" SLEEVE NUTS	-	-	O	-	-	6	3.00
F-3647	NAMEPLATE, TRUNK LID "Mercury"	3/32" SLEEVE NUTS	-	W	-	-	-	4	1.50
F-3248	NAMEPLATE, TRUNK LID "Torino"	BODY 54, 65, 76, 1/8" STAMPED NUTS	-	-	O	-	-	4	2.00
F-3618	NAMEPLATES, FENDERS "GT"	3/16" SLEEVE NUTS	Z	-	-	-	-	4	2.00
F-3644	NAMEPLATES, FENDERS "GT" or "6.5 LITRE"	1/8" SLEEVE NUTS	-	W	-	-	-	8	3.00
F-3928	ORNAMENTS, QTER PANEL	STAMPED NUTS w SEALER	Z	-	-	-	-	6	3.00
F-3484	TAILAMP BEZELS & LENSES (SHELBY)	SS/CHROME PH PN SCREWS (small heads)	Z	-	-	-	-	16	12.00
F-1352	TRUNK LID MOULDING	ACORN PALNUTS	-	W	-	-	-	7	5.00
F-807	TRUNK LID MOULDING - BODY 65	STAMPED ACORN NUTS	Z	-	-	-	-	9	3.50
F-2978	VINYL TOP MOULDINGS	STAMPED NUTS	Z	-	-	-	-	6	3.00
F-2940	VINYL TOP MOULDINGS	STAMPED NUTS, SEALER	-	W	-	-	-	17	6.00
F-1636	WHEEL OPENINGS (4)	SS/CHROME PH RNDWA AB SCREWS	Z	-	-	-	-	28	10.00
F-3542	WINDOW (Fr) MOULDINGS	PUSH-ON RETAINERS	-	-	O	-	-	8	3.00
F-580	WINDOW (Fr) MOULDINGS - BODY 63, 65	PUSH-ON RETAINERS	Z	-	-	-	-	22	10.00
F-1406	WINDOW (Fr) MOULDINGS - BODY 76	RETAINERS, PH OV SCREWS, NUTS	Z	-	-	-	-	22	10.00
F-582	WINDOW (Rr) MOULDINGS - BODY 63	RETAINERS	Z	-	O	-	-	27	12.00
F-3661	WINDOW (Rr) MOULDINGS - BODY 65	RETAINERS, PH OV SCREWS	Z	-	-	-	-	19	8.00

Steering & Suspension

F-1404	AXLE HOUSING > SPRINGS	5 1/2" U-BOLTS, FLNG NUTS	Z	-	-	-	-	12	26.00
F-2886	AXLE HOUSING > SPRINGS	7.0" U-BOLTS, FLNG NUTS	-	W	-	-	-	12	26.00
F-1162	AXLE HOUSING > SPRINGS - NUTS ONLY	FLNG NUTS (Red)	Z	W	O	-	-	8	12.00
F-3442	AXLE HOUSING > SPRINGS (exc Eliminator)	6 3/4" U-BOLTS, FLNG NUTS	-	W	O	-	-	12	26.00
F-1355	BALL JOINTS (RIVETS) - LWR	RIVETS (2 extra), SPL TOOLS, PRESS RQD	Z	W	O	-	-	8	6.00
F-1354	BALL JOINTS (RIVETS) - UPPER	RIVETS (2 extra), SPL TOOLS, PRESS RQD	Z	W	O	-	-	10	6.00
F-3656	COIL SPRING SEATS (perches)	GR-8 3/8-16 KNURL BOLTS, LOCK NUTS	Z	W	O	-	-	8	10.00
F-595	COIL SPRING SEATS (perches)	HUG-LOK NUTS ONLY	Z	W	O	-	-	4	3.00
F-1515	CONTROL ARMS (lower) > SHOCK TOWER	GR-8 CAM BOLTS, RED NUTS, WA'S	Z	W	O	-	-	8	20.00
F-3311	CONTROL ARMS (upper) > SHOCK TOWER	GR-8 1/2-13 KNURLED BOLTS, RED NUTS	Z	W	O	-	-	12	16.00
F-1338	CONTROL ARMS (upper) > SHOCK TOWER	GR-8 RED HX NUTS, SPLIT WA'S	Z	W	O	-	-	8	5.00
F-2846	CONTROL VALVE ACTUATOR	HX SPLIT SEMS	Z	W	O	-	-	2	3.00
F-1280	CROSSMEMBER, TUBULAR (Fr)	SPL HX CNTRS NK BOLTS	Z	W	-	-	-	2	10.00
F-571	GREASE PLUGS, CHASSIS	HX PLUGS	Z	W	O	B	T	9	5.00
F-1323	IDLER ARM	HX BOLTS "F", LOCK NUTS, CLIPPED WA'S	Z	W	O	-	-	6	14.00
F-3651	LEAF SPRING CENTER BOLTS	GR-8 TALL HD BOLTS, HX NUTS	Z	W	O	-	-	4	8.00
F-368	LEAF SPRINGS (front eye)	FLNG BOLTS & NUTS	Z	W	-	-	-	4	18.00
F-3783	LEAF SPRINGS (front eye)	FLNG BOLTS & NUTS	-	-	O	-	-	4	20.00
F-3933	P/S CONTROL VALVE DUST COVER CLAMP	SLOT RND B SCREWS	Z	W	O	-	-	2	1.50
F-502	P/S CONTROL VALVE SPOOL CAP	SLOT FILL SPLIT SEMS	Z	W	O	-	-	2	3.00
F-1615	P/S CYLINDER BRACKET - RIVET NUTS	3/8-16 HX BODY RIVET NUTS ONLY	Z	W	O	-	-	2	6.00
F-1325	P/S CYLINDER BRACKET > BODY	HX BOLTS "F", LOCK NUTS, WA'S	Z	W	O	-	-	7	10.00
F-521	P/S HOSE RUBBER STRAP - 390/428	EXTRUDED STRAP w STEEL RIVET	Z	W	O	B	T	1	6.00
F-675	P/S HOSE SUPPORT INSULATOR RETAINER	HXWA F SCREWS	Z	W	-	-	-	2	3.00
F-864	P/S HOSE SUPPORT INSULATOR RETAINER	HXWA F SCREW	-	-	O	-	-	1	1.50
F-1311	P/S OIL COOLER - BOSS 302/429 & 428CJ	HXWA TT SCREW	Z	W	O	-	-	1	2.00
F-3918	P/S OIL COOLER (SHELBY)	HXWA AB SCREWS	Z	-	-	-	-	2	2.00
F-3889	P/S PUMP - 200	FLNG & HX BOLTS, STUDS, WA'S	Z	-	O	-	-	21	20.00
F-647	P/S PUMP - 289/302 w AC	FLNG BOLTS, STUD, LOCK NUT	Z	W	O	B	T	6	10.00
F-1074	P/S PUMP - 289/302 w/o AC	FLNG BOLTS, STUD, LOCK NUT, SPACER	Z	W	O	B	T	7	18.00
F-649	P/S PUMP - 390/428 w AC	FLNG BOLTS, STUD, LOCK NUT	Z	W	O	-	T	8	12.00
F-1154	P/S PUMP - 390/428 w/o AC	FLNG BOLTS, STUD, LOCK NUT, SPACER	Z	W	O	-	T	9	18.00
F-2937	P/S PUMP RESERVOIR NUT	THIN HX NUT ON BACK	Z	W	O	B	T	1	3.00
F-1206	P/S RETURN HOSE - 170/200/289/302	SLOTTED STYLE CLAMP	Z	W	O	-	-	1	5.00
F-1207	P/S RETURN HOSE - 170/200/289/302	NO SLOT STYLE CLAMP	Z	W	O	-	-	1	10.00
F-1208	P/S RETURN HOSE - 390/428	SLOTTED STYLE CLAMP	Z	W	O	-	-	2	10.00
F-1209	P/S RETURN HOSE - 390/428	NO SLOT STYLE CLAMP	Z	W	O	-	-	2	20.00
F-1811	P/S SLAVE CYLINDER, ROD END	HX NUT, STAMPED NUT	Z	W	O	-	-	2	1.50
F-614	PITMAN ARM > GEAR BOX	HX JAM NUT, SPLIT WA	Z	W	O	-	-	2	3.00
F-665	SHACKLE ASSY (Rr) - NUTS ONLY	LOCK NUTS	Z	W	O	-	-	4	3.00
F-312	SHOCK BRACKETS (Fr)	LOW HD CRG BOLTS, FLNG NUTS	Z	W	-	-	-	12	9.00
F-3908	SHOCK BRACKETS (Fr)	LOW HD CRG BOLTS, EXT KEPS NUTS	-	-	O	-	-	12	10.00
F-345	SHOCKS (Fr)	HX EXT SEMS "Anchor", 5/16-18 NUTS, WA'S	Z	W	-	-	-	12	8.00
F-1845	SHOCKS (Fr)	HX EXT SEMS "Anchor", 5/16-24 NUTS, WA'S	Z	W	-	-	-	12	8.00
F-809	SHOCKS (Fr) - TOP MOUNTING ONLY	HX EXT SEMS "Anchor"	Z	W	-	-	-	4	6.00
F-1793	SHOCKS (Rr)	3/8-16 EXT KEPS NUTS	Z	W	-	-	-	4	2.00
F-3456	STABILIZER (Fr) > BODY - 428CJ	HX BOLTS, LOCK NUTS	Z	W	-	-	-	8	7.00
F-1205	STABILIZER (Fr) > BODY (STABILIZER BAR)	HX BOLTS, LOCK NUTS	Z	W	O	-	-	8	10.00
F-3950	STABILIZER (Fr) END LINKS	BLTS, RTNRS, BSHNGS, SPACERS, NUTS	Z	W	O	-	-	22	25.00
F-1107	STEERING GEAR BOX	HX BOLTS, CLIPPED FLAT & SPLIT WA'S	Z	W	O	-	-	9	12.00
F-672	STEERING GEAR BOX SECTOR COVER	PLACE BOLTS	Z	W	O	B	T	3	4.00
F-317	STEERING LINKAGE w PS	SLOTTED NUTS, COTTER PINS, FLAT WA	Z	W	O	-	-	23	14.00
F-316	STEERING LINKAGE w/o PS	SLOTTED NUTS, COTTER PINS, FLAT WA	Z	W	O	-	-	21	12.00

Kits Contain Attaching Fasteners for Both Sides

Ford Fastener Kits

1968

Steering & Suspension

PART #	APPLICATION	NOTES						PCS	PRICE
			Z	W	O	B	T		
F-610	STEERING RAG JOINT < 11/4/68	12 PT BOLT, 5/16-24 LOCK NUTS	Z	W	O	-	-	3	4.00
F-611	STEERING RAG JOINT w TILT < 11/4/68	12 PT BOLTS	Z	W	O	-	-	2	6.00
F-3309	STEERING WHEEL	LOCK NUT	Z	W	O	B	T	1	3.00
F-660	STRUT ROD THREADED ENDS > BODY	LOCK NUTS, SLOTTED NUTS, PINS	Z	W	O	-	-	8	12.00
F-1264	STRUT RODS > LWR CONTROL ARM	1/2-13 SPL KNRLD BOLTS, NUTS, PINS	Z	W	O	-	-	12	38.00
F-369	STRUT RODS > LWR CONTROL ARM - NUTS	Before 11/11/68, 1/2-20 LOCK NUTS ONLY	Z	W	O	-	-	4	6.00
F-2964	SUSP BUMPER (Rr) - 289HP, 390, 67-68 GT	LOCK NUT	Z	W	-	-	-	1	1.50
F-1486	SUSP BUMPER (Rr) 65-66 V8, 67-68 289-2V	HX SCREWS	Z	W	-	-	-	2	2.00
F-2961	SUSP BUMPERS (Fr)	HUG-LOK NUTS	Z	W	-	-	-	2	2.00
F-2858	TIE ROD ADJUSTMENT SLEEVE	HX BOLTS, LOCK NUTS	Z	-	O	B	T	8	6.00
F-379	WHEEL BOLTS, Fr DRUM - 1.48" BOLTS	1/2-20 BOLTS	Z	W	O	B	T	10	8.00
F-781	WHEEL BOLTS, Fr DRUM - 1.69" BOLTS	1/2-20 BOLTS	Z	W	O	B	T	10	8.00
F-1353	WHEELS	1/2-20 LUG NUTS, 13/16" HX	Z	W	O	B	T	20	16.00

Transmission

F-1369	BELL HOUSING (manual) - 170/200	HX BOLTS, SPLIT WA'S	Z	-	O	B	-	8	8.00
F-353	BELL HOUSING (manual) - 260/289 6 BOLT	HX BOLTS, SPLIT WA'S	Z	W	O	B	T	12	14.00
F-1366	BELL HOUSING (manual) - 390/428 2-15-68 >	HX BOLTS, SPLIT WA'S	Z	W	O	-	T	12	14.00
F-354	BELL HOUSING (manual) - 390/428 < 2-15-68	HX BOLTS, SPLIT WA'S	Z	W	O	-	T	12	14.00
F-866	CLUTCH BELLCRANK BRKT'S - 390/428	SRTD FLNG BOLTS, HX BOLTS, WA'S	Z	-	-	-	-	6	6.00
F-867	CLUTCH BELLCRANK BRKT'S (exc 390/428)	SRTD FLNG BOLTS	Z	-	-	-	-	2	6.00
F-671	CLUTCH PEDAL	RETAINING PIN	Z	-	-	-	-	1	2.00
F-1465	DRIVESHAFT - 6 CYL - All 65-66, M/T 67-68	1/4" U-BOLTS, NUTS, SPLIT WA'S	Z	-	-	-	-	6	10.00
F-876	DRIVESHAFT - V8	5/16-24 LOCK NUTS ONLY	Z	W	O	B	T	4	3.00
F-1273	DRIVESHAFT - V8, 6 CYL 67-68 A/T, All 69 >	5/16" U-BOLTS, LOCK NUTS	Z	W	O	B	T	6	8.00
F-1200	ENGINE PLATE (M/T) - 6 CYL & SB	HX SPLIT SEMS	Z	W	O	B	T	2	3.00
F-797	INSPECTION COVER & ENG PLATE - C4 (A/T)	HX SPLIT SEMS	Z	W	O	B	T	3	4.00
F-3995	INSPECTION COVER (A/T flywheel) - C6	C6 (390/428), HX SPLIT SEMS	Z	W	O	-	T	4	4.00
F-1164	INSPECTION COVER (M/T flywheel) - 390/428	HX SPLIT SEMS	Z	W	O	-	T	4	4.00
F-3263	PRESSURE PLATE > FLYWHEEL	SPL HX BOLTS, SPLIT WA'S	Z	W	O	B	T	12	6.00
F-908	SHIFTER (manual) LWR BOOT RETAINER	PH PN SCREWS	Z	-	-	-	-	4	2.50
F-1238	SHIFTER ASSY > FLOOR - A/T	FLNG BOLTS, PH PN AB SCREWS	Z	-	-	-	-	8	4.00
F-1233	SHIFTER ASSY > FLOOR - A/T	PH FLAT A SCREWS	Z	-	-	-	-	4	2.00
F-1234	SHIFTER ASSY > FLOOR - A/T w CONSOLE	PH OV A SCREWS	Z	-	-	-	-	4	2.00
F-1560	SHIFTER CONTROL > TRANS - 3 & 4 SPD	HX SPLIT SEMS	Z	W	O	B	T	3	4.00
F-1561	SHIFTER CONTROL > TRANS - 390 3 SPD	HX SPLIT SEMS, POZI FLAT SCREWS	Z	W	O	-	T	6	6.00
F-1559	SHIFTER CONTROL > TRANS - 4 SPD 390/428	HX SPLIT SEMS, POZI FLAT SCREWS	Z	W	O	B	T	6	5.00
F-1226	SHIFTER HANDLE - 3 SPD 64-73, 4 SPD 64-69	SHOULDER BOLTS, FLAT WA'S	Z	W	O	-	-	4	8.00
F-897	SHIFTER HANDLE (manual) > SHIFTER	FORD SHIFTERS, FLAT WA'S ONLY	Z	W	O	-	-	2	1.50
F-1085	SHIFTER HANDLE REBUILD - 3 & 4 SPD	TRUNNIONS (cups), SPRINGS, GROMMETS	Z	W	-	-	-	6	12.00
F-1241	SHIFTER LINKAGE - A/T	SRTD FLNG NUTS, PIN, FLAT, WAVE WA'S	Z	W	O	B	T	4	4.00
F-1220	SHIFTER RODS - 3 SPD	LOCK NUTS, WA'S, PINS	Z	W	O	B	T	14	8.00
F-1221	SHIFTER RODS - 4 SPD	LOCK NUTS, WA'S, PINS	Z	W	O	B	T	21	12.00
F-3413	SPEDOMETER CABLE > TRANS	HXWA EXT SEMS	Z	W	O	B	T	1	2.00
F-185	TORQUE CONVERTOR FLEX PLATE	FLNG NUTS	Z	W	O	B	T	4	4.00
F-1365	TRANS (auto) > ENGINE - 170/200	HX BOLTS, SPLIT WA'S	Z	-	O	B	-	8	8.00
F-215	TRANS (auto) > ENGINE - 289/302 6 BOLT	HX BOLTS, SPLIT WA'S	Z	W	O	B	T	12	14.00
F-186	TRANS (auto) > ENGINE - 390/428	HX BOLTS, SPLIT WA'S	Z	W	O	-	T	12	14.00
F-1244	TRANS (auto) KICKDOWN > ACCEL - ALL	3/16 RH ROD END RETAINER	Z	-	-	-	-	1	2.00
F-678	TRANS (manual) > BELL HOUSING	HX BOLTS, SPLIT WA'S	Z	W	O	B	T	8	7.00
F-1841	TRANS ACCESS COVER - FORD 4 SPD	CORRECT SRTD FLNG BOLTS, "X" LONG	Z	W	O	B	T	10	12.00
F-816	TRANS COOLING LINE CLIPS	C CLIPS	Z	W	O	B	T	2	3.00
F-177	TRANS CROSSMEMBER	HXWA BOLTS, LOCK NUTS, FLAT WA	Z	-	-	-	-	5	8.00
F-3904	TRANS CROSSMEMBER	POINTED BOLTS, SLOT NUTS, WA'S, PINS	-	-	O	-	-	8	10.00
F-1342	TRANS ID TAG	DRIVE SCREW	Z	W	O	B	T	1	1.00
F-176	TRANS INSULATOR - A/T	HX BOLTS, LOCK NUTS, WA'S	Z	-	-	-	-	8	8.00
F-3906	TRANS INSULATOR - All	POINTED HX BOLTS, NUTS, WA'S	-	-	O	-	-	10	8.00
F-1414	TRANS INSULATOR - M/T (exc 390/428)	HX SPLIT SEMS, LOCK NUTS, FLAT WA'S	Z	-	-	-	-	6	8.00
F-1741	TRANS INSULATOR - M/T 390/428/429	POINTED HX BOLTS, NUTS, WA'S	Z	-	-	-	-	8	8.00
F-1322	TRANS LEVERS > CASE - 3 SPD	HX NUTS, FLAT & SPLIT WA'S	Z	W	O	B	T	6	3.00
F-1385	TRANS LEVERS > CASE - 4 SPD	HX NUTS, FLAT & SPLIT WA'S	Z	W	O	B	T	9	3.00
F-1621	TRANS OIL PAN - C4	FLNG BOLTS	Z	W	O	B	T	11	4.00
F-892	TRANS OIL PAN - C6	FLNG BOLTS	Z	W	O	B	T	17	6.00
F-2874	TRANS TAIL HOUSING - M/T	HX BOLTS, SPLIT WA'S	Z	W	O	B	T	10	8.00

Wipers

F-426	WASHER NOZZLES & TEE	HXWA AB SCREWS	Z	W	-	-	-	3	2.00
F-896	WINDSHIELD WASHER BOTTLE	HXWA AB SCREWS	Z	W	-	-	-	3	2.00
F-463	WINDSHIELD WASHER PUMP	HXWA A SCREWS	Z	-	-	-	-	4	2.00
F-1770	WIPER ARM PIVOTS > COWL PANEL	HX BOLT, SPLIT WA'S	Z	-	-	-	-	12	3.00
F-737	WIPER MOTOR BRACKET > COWL	HX SPLIT SEMS	Z	-	-	-	-	4	3.00
F-3867	WIPER MOTOR BRACKET > COWL	CNTRSNG HX EXT SEMS	-	-	O	-	-	3	3.00

See factory Assembly Manuals for illustrations

Ford Fastener Kits

253

1969

Air Conditioning

PART #	APPLICATION	NOTES	VEHICLE TYPE					PCS	PRICE
			Z	W	O	B	T		
F-2037	AC BLOWER > DASH	HXWA AB SCREWS, SPRING NUTS	Z	-	-	-	-	6	3.00
F-716	AC BRUSH & HOLDER	HX FLNG SCREWS	Z	W	O	B	T	2	1.50
F-718	AC COMPRESSOR - 289/302/351/429	SRTD FLNG BOLTS	Z	W	O	B	T	4	6.00
F-713	AC COMPRESSOR - 390/428	SRTD FLNG BOLTS	Z	W	O	-	T	5	7.00
F-726	AC COMPRESSOR - 6 CYL	FLNG BOLTS	Z	-	O	B	T	4	6.00
F-727	AC COMPRESSOR BRACE (Rr) - 6 CYL	SRTD FLNG BOLTS, FLAT WA	Z	-	O	B	T	3	3.00
F-728	AC COMPRESSOR BRACE (side) - 6 CYL	SRTD FLNG BOLT, LOCK NUT	Z	-	O	B	T	2	2.00
F-719	AC COMPRESSOR BRACE (side) - V8, 70 FE	SRTD FLNG BOLTS	Z	W	O	-	T	3	6.00
F-725	AC COMPRESSOR BRACKET - 6 CYL	SRTD FLNG BOLTS	Z	-	O	B	T	3	5.00
F-724	AC COMPRESSOR BRACKET - 69 V8, 70 FE	STUDS, LOCK NUTS	Z	W	O	B	T	6	6.00
F-721	AC COMPRESSOR CLUTCH	HX BOLT, FLAT WA	Z	W	O	B	T	2	3.00
F-717	AC COMPRESSOR FIELD	HX FLNG HD SCREWS	Z	W	O	B	T	4	3.00
F-441	AC CONDENSOR	HXWA AB SCREWS	Z	-	-	-	-	4	3.00
F-2962	AC DEHYDRATOR & RECEIVER TANK	HXWA A SCREWS	Z	W	-	-	-	3	2.00
F-436	AC FIREWALL SEAL RETAINER - 428	#14 HXWA AB SCREWS	Z	-	-	-	-	6	3.00
F-435	AC FIREWALL SEAL RETAINER (exc 428)	#8 HXWA AB SCREWS	Z	-	-	-	-	6	3.00
F-430	AC HOSES > COWL BRACES	RUBBER STRAPS w STEEL RIVET	Z	W	-	-	-	4	20.00
F-715	AC IDLER PULLEYS - 289/302/351	SRTD FLNG BOLTS	Z	W	O	B	T	4	6.00
F-722	AC IDLER PULLEYS - 390/428	SRTD FLNG BOLTS, LOCK NUT, WA'S	Z	W	O	-	T	7	8.00
F-2909	AC TAG and COMPRESSOR LEAD WIRE	SPECIAL METAL T RETAINER	Z	W	O	-	-	1	3.00
F-433	AC UNIT > FIREWALL	STAMPED NUTS w SEALER	Z	-	-	-	-	3	4.00
F-729	AC VACUUM RESERVOIR > FENDER APRON	STAMPED NUTS	Z	-	-	-	-	2	2.00

Body

F-3948	AIR VENT OUTLETS @ KICK PANELS	HXWA AB SCREWS	Z	W	-	-	-	12	3.00
F-140	BATTERY TRAY	HX CONI SEMS, U-NUTS	Z	W	-	-	-	6	5.00
F-3541	BATTERY TRAY	HX CONI SEMS, U-NUTS, SRTD FLNG NUTS	-	-	O	-	-	12	7.00
F-1563	BATTERY TRAY	HX CONI SEMS, CAGE NUT	-	-	-	-	T	5	6.00
F-2328	BED CORNERS - HOLE COVER PLATES	PH PN AB SCREWS	-	-	-	B	-	2	1.50
F-1556	BED CORNERS - HOLE COVER PLATES	PH PN A SCREWS	-	-	-	-	T	2	1.00
F-971	BRAKE PEDAL SUPPORT & BRACES	HX CONI SEMS, HXWA AB SCREWS, KEPS	Z	-	-	-	-	10	8.00
F-1817	BUMPER (Fr)	SS CAPPED BOLTS, NUTS, CRUSH WA'S	Z	-	-	-	-	22	8.00
F-3602	BUMPER (Fr)	SS CAPPED BOLTS, NUTS, WA'S	-	W	-	-	-	20	14.00
F-3578	BUMPER (Fr)	SS CAPPED BOLTS, NUTS, WA'S	-	-	O	-	-	38	14.00
F-3579	BUMPER (Fr) (SHELBY)	FLNG BOLTS, FLNG NUTS	Z	-	-	-	-	8	14.00
F-1833	BUMPER (Rr)	SS CAPPED BOLTS, NUTS, CRUSH WA'S	Z	W	-	-	-	12	7.00
F-3596	BUMPER (Rr)	SS CAPPED BOLTS, LOCK NUTS, WA'S	-	-	O	-	-	30	10.00
F-3582	BUMPER BRACKETS (Fr)	HX & FLNG BOLTS, SPLIT WA'S	-	-	O	-	-	10	8.00
F-3893	BUMPER BRACKETS (Fr) > FRAME	SPL UBS BOLTS, 11/16" HX	Z	W	-	-	-	4	12.00
F-776	BUMPER BRACKETS (Fr) > VALANCE	HX CONI SEMS, CAGE NUTS	Z	-	-	-	-	4	3.00
F-167	BUMPER BRACKETS (Rr)	HX CONI SEMS, SHIMS, CONI WA'S	Z	W	-	-	-	12	14.00
F-3592	BUMPER BRACKETS (Rr)	HX CONI SEMS, SEALS	-	-	O	-	-	12	6.00
F-168	BUMPER GUARDS (Fr)	HX CONI SEMS, U-NUTS	Z	-	-	-	-	8	6.00
F-3600	BUMPERS (Fr & Rr) - CHROME	SS CAPPED BOLTS, NUTS, SPLIT WA'S	-	-	-	B	-	24	10.00
F-3599	BUMPERS (Fr & Rr) - PAINTED	CRG BOLTS, NUTS, SPLIT WA'S	-	-	-	B	-	24	6.00
F-955	CONVERTIBLE PUMP & BRACKETS	HX CONI SEMS, CAGE NUTS, NUTS, WA'S	Z	-	-	-	-	8	14.00
F-957	CONVERTIBLE TOP > BODY TACK STRIP	HX CONI SEMS, PH PN A SCREWS	Z	-	-	-	-	14	14.00
F-2003	CONVERTIBLE TOP > BOW LISTING	PH OV B SCREWS	Z	-	-	-	-	4	2.00
F-2060	CONVERTIBLE TOP FRAME > BODY	HX CONI SEMS	Z	-	-	-	-	6	5.00
F-261	COWL BRACES > COWL (70Z B429 only)	HX FLNG CONI SEMS BOLTS, FLNG NUTS	Z	W	-	-	-	8	14.00
F-150	COWL PANEL	HXWA & PH PN AB SCREWS	Z	W	-	-	-	7	3.00
F-3855	COWL PANEL	SS HXWA AB SCREWS	Z	-	-	-	-	5	3.00
F-3666	COWL PANEL	PH PN AB SCREWS	-	-	O	-	-	6	2.00
F-3183	DATA PLATE	SPL ALUMINUM RIVETS	Z	W	O	B	T	2	2.00
F-2914	DOOR GLASS > CHANNEL (BOLT-IN GLASS)	PLASTIC BUSHINGS, ROUND NUTS, SEMS	Z	W	-	-	-	12	10.00
F-974	DOOR HANDLES (outside)	PH PN EXT SEMS, EXT KEPS NUTS	Z	-	-	-	-	4	2.50
F-819	DOOR HANDLES (outside)	EXT KEPS NUTS	-	W	-	-	-	4	2.00
F-1565	DOOR HANDLES (outside)	HXWA EXT SEMS, CONI KEP NUTS	-	-	-	-	T	4	3.00
F-170	DOOR HINGES	ORIGINAL HXWA SCREWS	Z	W	O	-	-	24	14.00
F-3444	DOOR HINGES	HX CONI SEMS	-	-	-	B	-	24	20.00
F-1566	DOOR HINGES	HX CONI SEMS	-	-	-	-	T	20	14.00
F-3447	DOOR LATCH REINFORCEMENTS	SS PH OV SCREWS, SS CNTSNK WA'S	Z	W	O	-	-	12	5.00
F-1360	DOOR LATCH ROD END BUSHINGS ONLY	5/32 SIZE, EXACTLY ORIGINAL	Z	W	O	-	-	14	7.00
F-1357	DOOR LATCH ROD END BUSHINGS ONLY	9/64 SIZE, EXACTLY ORIGINAL	-	-	-	B	-	12	7.00
F-1358	DOOR LATCH ROD END CLIPS	5/32 SIZE, EXACTLY ORIGINAL	Z	W	O	-	-	14	38.00
F-1356	DOOR LATCH ROD END CLIPS	9/64 SIZE, EXACTLY ORIGINAL	-	-	-	B	-	12	38.00
F-1135	DOOR LATCH STRIKERS	POZI FLAT SCREWS	Z	W	O	-	-	4	3.00
F-653	DOOR LATCHES > DOOR SHELL	PH FLAT EXT SEMS	Z	W	O	-	-	6	3.00
F-3281	DOOR STOP STRAPS	PH PN SCREWS	-	-	-	B	-	8	3.00
F-1545	DOOR VENT WINDOWS	PH OV & PH PN AB SCREWS	-	-	-	-	T	8	3.00
F-1721	FENDER > APRON BRACKETS	HX CONI SEMS, U-NUTS	-	-	-	B	-	6	5.00

Kits Contain Attaching Fasteners for Both Sides

Ford Fastener Kits

1969

PART #	APPLICATION	NOTES						PCS	PRICE
			Z	W	O	B	T		
F-3665	FENDER > BUMPER ARM BRACKETS	HXWA AB SCREWS, SPRING CLIPS	-	-	O	-	-	6	3.00
F-3664	FENDER > RADIATOR SUPPORT BRACKETS	HX CONI SEMS, U-NUTS	-	-	O	-	-	8	5.00
F-1531	FENDER APRON LWR BRACKETS	HX T SCREWS, FLAT WA'S	-	-	-	-	T	8	4.00
F-1568	FENDER APRON TOP BRACKETS	HX CONI SEMS	-	-	-	-	T	6	8.00
F-1567	FENDER APRONS	FLNG BOLTS, HX CONI SEMS, NUTS, WA'S	-	-	-	-	T	30	20.00
F-3472	FENDER BRACES (Fr)	HX CONI SEMS, U-NUTS	-	W	-	-	-	8	4.00
F-363	FENDER EXTENSION BRACKETS > SUPPORT	HX CONI SEMS, U-NUTS	Z	-	-	-	-	16	10.00
F-159	FENDER EXTENSIONS	STUDS, SRDT FLNG NUTS	Z	W	-	-	-	12	6.00
F-1569	FENDER EXTENSIONS	UBS FLNG BOLTS & NUTS	-	-	-	-	T	8	6.00
F-135	FENDER SPLASH SHIELDS (Fr) OF FENDER	HXWA AB SCREWS	Z	W	-	-	-	8	4.00
F-136	FENDER SPLASH SHIELDS (Rr) OF FENDER	HX CONI SEMS, HXWA SCREWS, U-NUTS	Z	W	-	-	-	12	8.00
F-3431	FENDER TOPS ONLY, "FLAG"	HX CONI SEMS, .88 WA OD	Z	W	O	-	-	12	10.00
F-2897	FENDER TOPS ONLY, "GL"	HX CONI SEMS, .88 WA OD	Z	W	O	-	-	12	10.00
F-2899	FENDER TOPS ONLY, "RBW"	HX CONI SEMS, .88 WA OD	Z	W	O	-	-	12	10.00
F-768	FENDERS	HX CONI SEMS, U & CAGE NUTS, WA'S	Z	W	-	-	-	44	37.00
F-3537	FENDERS	HX CONI SEMS, SCREWS, U-NUTS, WA'S	-	-	O	-	-	50	38.00
F-1725	FENDERS	HX CONI & POZI EXT SEMS, U, CAGE NUTS	-	-	-	B	-	42	32.00
F-1571	FENDERS	HX CONI SEMS, U-NUTS, FLAT WA'S	-	-	-	-	T	34	24.00
F-1519	FENDERS > HEADLAMP HOUSING (SHELBY)	HXWA AB SCREWS, SPRING NUTS	Z	-	-	-	-	8	4.00
F-1520	FENDERS > RADIATOR SUPPORT (SHELBY)	HXWA AB SCREWS, FLAT WA'S, SHIMS	Z	-	-	-	-	16	5.00
F-3539	FENDERS BRACES	HX CONI SEMS, HXWA SCREWS, U-NUTS	-	-	O	-	-	6	4.00
F-1572	FLOOR BRACE ACCESS COVERS	HXWA AB SCREWS	-	-	-	-	T	8	3.00
F-567	FLOOR REINFORCEMENT - BODY 76	HX CONI SEMS	Z	-	-	-	-	6	12.00
F-171	FLOORBOARD HOLE COVERS 12/20/66 >	HXWA AB SCREWS	Z	W	-	-	-	8	3.00
F-3462	FUEL FILLER DOOR & TRIM	STAMPED NUTS	-	W	-	-	-	8	4.00
F-139	GRILLE	HXWA SCREW, PLASTIC RIVETS, NUT	Z	-	-	-	-	7	3.50
F-3466	GRILLE	HX CONI SEMS, U-NUTS	-	W	-	-	-	16	6.00
F-3544	GRILLE	PH RNDWA AB SCREWS, SPRING NUTS	-	-	O	-	-	6	3.00
F-1709	GRILLE	HX CONI SEMS, J & U-NUTS	-	-	-	B	-	26	18.00
F-1574	GRILLE	HX CONI SEMS, SRDT FLNG NUTS, NUTS	-	-	-	-	T	28	18.00
F-1215	GRILLE (SHELBY)	HX PERI & SEMS, SRDT FLNG & J-NUTS	Z	-	-	-	-	10	10.00
F-138	GRILLE CENTER SUPPORT	HX CONI SEMS, U-NUTS	Z	-	-	-	-	4	3.00
F-2952	GRILLE EMBLEM	STAMPED NUTS	Z	-	-	-	-	2	2.00
F-1507	GRILLE MOULDING & EMBLEM (SHELBY)	PUSHNUTS, FLAT WA'S	Z	-	-	-	-	30	6.00
F-1540	GRILLE ORNAMENT - RANGER & EXPLORER	STAMPED NUTS	-	-	-	-	T	2	2.00
F-3547	GRILLE SUPPORTS	HX CONI SEMS, U-NUTS	-	-	O	-	-	8	6.00
F-3467	GRILLE, OUTER PLATES	STAMPED NUTS	-	W	-	-	-	8	3.00
F-3670	GRILLE, TUBULAR BRACES	HX CONI SEMS, U-NUTS	-	-	O	-	-	4	3.00
F-1577	GRILLE, UPPER SUPPORT	HX CONI SEMS, J-NUTS	-	-	-	-	T	8	6.00
F-3548	HEADLAMP DOOR SUPPORTS	HX CONI SEMS, U-NUTS	-	-	O	-	-	8	6.00
F-169	HEADLAMP DOORS	PH OV, PN, RNDWA SCREWS, NUTS	Z	-	-	-	-	12	5.00
F-3545	HEADLAMP DOORS	SS/CHROME PH OV AB SCREWS, NUTS	-	-	O	-	-	16	6.00
F-1518	HEADLAMP DOORS (SHELBY)	BLACK PH OV AB SCREWS, NYLON NUTS	Z	-	-	-	-	12	4.50
F-1504	HEADLAMP HOUSINGS (SHELBY)	HXWA AB SCREWS, CLIPS, FLAT WA'S	Z	-	-	-	-	18	7.00
F-3465	HEADLAMP HOUSINGS/GRILLE	HX CONI SEMS, U-NUTS	-	W	-	-	-	6	3.00
F-1726	HEADLAMP, SPLASH SHIELDS	PH PN A SCREWS, SPRING NUTS	-	-	-	B	-	8	3.00
F-1733	HOOD	HX CONI SEMS	-	-	-	B	-	4	4.00
F-144	HOOD & HINGES	HX CONI SEMS, U-NUTS	Z	W	-	-	-	14	12.00
F-3550	HOOD & HINGES	HX CONI SEMS, U-NUTS	-	-	O	-	-	14	12.00
F-1579	HOOD & HINGES	HX CONI SEMS, U-NUTS	-	-	-	-	T	14	12.00
F-1581	HOOD BUMPERS > COWL	HX CONI SEMS	-	-	-	-	T	4	4.00
F-1543	HOOD BUMPERS > HOOD	PH PN B SCREWS	-	-	-	-	T	4	1.00
F-3553	HOOD BUMPERS, ADJUSTABLE	U-NUTS, JAM NUTS	-	-	O	-	-	4	2.50
F-1482	HOOD HINGE NUTS (in fender aprons)	5/16-18 PIERCE NUTS	Z	W	O	-	-	6	4.00
F-1713	HOOD LATCH	HX CONI SEMS, U-NUTS	-	-	-	B	-	8	6.00
F-158	HOOD LATCH & CATCH	HX CONI SEMS, U-NUTS	Z	W	O	-	-	6	5.00
F-1585	HOOD LATCH & CATCH	HX CONI SEMS, U-NUTS	-	-	-	-	T	11	10.00
F-1737	HOOD LATCH AUXILLIARY CATCH	HX CONI SEMS, U-NUTS	-	-	-	B	-	4	4.00
F-157	HOOD LATCH SUPPORT	HX CONI SEMS	Z	-	O	-	-	3	3.00
F-3461	HOOD LATCH SUPPORT	HX CONI SEMS	-	W	-	-	-	4	4.00
F-3460	HOOD LATCH VERTICAL SUPPORTS	HX CONI SEMS, U-NUTS	-	W	-	-	-	8	6.00
F-156	HOOD LEVELERS	U-NUTS, JAM NUTS	Z	W	-	-	-	4	2.50
F-1502	HOOD LOCK BRKT'S > BODY (SHELBY)	HX CONI SEMS, U-NUTS	Z	-	-	-	-	12	7.00
F-1729	HOOD PROP ROD	COTTER PIN, FLAT WA'S	-	-	-	B	-	3	2.00
F-3879	HOOD SCOOP	CONI KEPS NUTS, SPL STUDS	Z	-	O	-	-	18	20.00
F-146	HOOD SCOOP	CONI KEPS NUTS	Z	-	O	-	-	9	8.00
F-147	HOOD SCOOP GRILLE & SEAL	PH PN & PH TRUSS WA SCREWS	Z	-	-	-	-	6	2.00
F-1506	HOOD SCOOP GRILLES (SHELBY)	PH RNDWA AB SCREWS	Z	-	-	-	-	8	3.00
F-1259	HOOD SCOOP, RAM-AIR - BOSS 429	EXT KEPS NUTS, STUDS	Z	-	-	-	-	20	14.00
F-967	INSTRUMENT PANEL (welded assembly)	HX CONI SEMS	Z	-	-	-	-	2	2.00
F-970	INSTRUMENT PANEL CENTER BRACES	HX CONI SEMS, HXWA B SCREW	Z	-	-	-	-	3	2.50
F-969	INSTRUMENT PANEL SIDE BRACKETS	HX CONI SEMS, CAGE NUTS	Z	-	-	-	-	6	6.00
F-1740	JACK CLAMP > FENDER APRON	HX BOLTS, WING & HX NUTS, FLAT WA'S	-	-	-	B	-	13	6.00
F-1587	JACK CLAMP > FENDER APRON	HX CONI SEMS, BOLT, WING & KEPS NUT	-	-	-	-	T	9	6.00
F-790	LICENSE PLATE BRACKET (Fr)	HX CONI SEMS, CONI KEPS NUT	Z	-	-	-	-	4	3.50

See factory Assembly Manuals for illustrations

Ford Fastener Kits

255

1969

Body

PART #	APPLICATION	NOTES						PCS	PRICE
			Z	W	O	B	T		
F-3471	LICENSE PLATE BRACKET (Fr)	HX CONI SEMS, CONI KEPS NUTS, U-NUT	-	W	-	-	-	6	3.00
F-1588	LICENSE PLATE BRACKET (Rr)	HX CONI SEMS, FLNG NUTS	-	-	-	-	T	4	3.00
F-1509	LICENSE PLATE BRACKET (Rr) (SHELBY)	CONI KEPS NUTS, FLAT WA'S	Z	-	-	-	-	4	3.00
F-1842	LICENSE PLATE BUMPERS (Rr)	ORIGINAL RUBBER BUMPERS	Z	-	-	-	-	2	2.00
F-151	LICENSE PLATE LAMP SHIELD	PH RNDWA AB SCREWS	Z	-	-	-	-	3	1.50
F-2440	LICENSE PLATE SUPPORT (Rr)	HXWA T1 SCREWS	-	-	-	B	-	6	3.00
F-3481	LICENSE PLATES	HXWA B SCREWS, NYLON NUTS	Z	W	O	B	T	8	4.00
F-3277	LIFTGATE HANDLE	POZI OV SCREWS, CONI KEPS NUTS	-	-	-	B	-	4	3.00
F-3275	LIFTGATE HINGE > TOP	PH OV SCREWS, CONI KEPS NUTS	-	-	-	B	-	16	5.00
F-3279	LIFTGATE LATCH (center)	POZI OV EXT SEMS, POZI PN CONI SEMS	-	-	-	B	-	7	4.00
F-3280	LIFTGATE LATCH ACCESS COVERS	PH PN A SCREWS	-	-	-	B	-	6	2.00
F-3274	LIFTGATE LATCH SHIELDS	PH FLAT F SCREWS	-	-	-	B	-	4	2.00
F-3272	LIFTGATE LATCH STRIKERS	POZI OV EXT SEMS	-	-	-	B	-	4	3.00
F-3270	LIFTGATE PROPS	HX CONI SEMS, PH PN SCREWS	-	-	-	B	-	8	4.00
F-802	MIRROR (outside) > DOOR - 1 MIRROR	SS/CHROME POZI OV SCREW, RIV NUTS	Z	W	O	B	T	4	3.00
F-1512	MIRROR (outside) > DOOR - 2 MIRRORS	SS/CHROME POZI OV SCREW, RIV NUTS	Z	W	O	B	T	8	5.00
F-163	QTER PANEL EXTENSIONS	STUDS, CONI KEPS NUTS, FLAT & SEALER	Z	W	O	-	-	24	12.00
F-1511	QTER PANEL EXTENSIONS (SHELBY)	CONI KEPS NUTS, FLAT & SEAL WA'S	Z	-	-	-	-	12	9.00
F-3525	QTER PANEL SCOOPS - BODY 63	STUDS, STAMPED NUTS, SEALER	Z	-	-	-	-	24	14.00
F-1589	RADIATOR SUPPORT	HX CONI SEMS, U-NUTS	-	-	-	-	T	16	14.00
F-3675	ROCKER PANEL MOULDINGS	RETAINERS, BLIND RIVETS, NUTS	Z	-	-	-	-	36	14.00
F-1289	ROOFSIDE WEATHERSTRIP - BODY 63	PH PH AB & PH DRILL SCREWS, NUTS	Z	-	-	-	-	42	10.00
F-1290	ROOFSIDE WEATHERSTRIP - BODY 65	PH PH AB & DRILL SCREWS, RIVETS	Z	-	-	-	-	34	8.00
F-1068	SHOCK TOWER BRACES - BOSS 429	HX CONI & EXT SEMS	Z	-	-	-	-	12	14.00
F-153	SHOCK TOWER BRACES (cover springs)	HX CONI SEMS, FLNG NUTS	Z	W	O	-	-	24	14.00
F-2920	SPOILER (Fr) - BOSS 302	PH RNDWA AB SCREWS, SEMS, U-NUTS	Z	-	-	-	-	16	7.00
F-2936	SPOILER (Fr) - BOSS 429	HXWA AB SCREWS, INSTRUCTIONS	Z	-	-	-	-	20	6.00
F-3896	SPOILER (Fr) (SHELBY)	HX CONI SEMS, FLNG NUTS, SHELBY	Z	-	-	-	-	30	15.00
F-1774	SPOILER (Rr) SUPPORTS > DECKLID	BOLTS, SPACERS WA'S	Z	W	O	-	-	12	10.00
F-1104	STEERING COLUMN SEAL	LARGE HX PERI SEMS	Z	-	-	-	-	4	6.00
F-137	STONE DEFLECTOR	HX CONI SEMS, U-NUTS	Z	-	-	-	-	8	5.00
F-3470	STONE DEFLECTOR	HX CONI SEMS, U-NUTS	-	W	-	-	-	12	5.00
F-3557	STONE DEFLECTOR	HX CONI SEMS, U-NUTS	-	-	O	-	-	10	5.00
F-1591	STONE DEFLECTOR	HX CONI SEMS, BOLTS, KEPS, U-NUTS	-	-	-	-	T	20	12.00
F-1508	STONE DEFLECTOR (SHELBY)	HX CONI SEMS, CONI KEPS NUTS	Z	-	-	-	-	4	4.00
F-3555	STONE DEFLECTOR FILLER PANELS	HX CONI SEMS, U-NUTS	-	-	O	-	-	14	6.00
F-1501	STONE DEFLECTOR SUPPORT (SHELBY)	HX CONI SEMS, HXWA AB SCREW, U-NUT	Z	-	-	-	-	3	3.00
F-1510	TAILAMP PANEL (SHELBY)	PH RNDWA AB SCREWS	Z	-	-	-	-	16	5.00
F-2331	TAILGATE HINGES	HX CONI SEMS	-	-	-	B	-	4	5.00
F-1593	TAILGATE HINGES	HX CONI SEMS	-	-	-	-	T	4	5.00
F-1592	TAILGATE LATCH CATCHES	HX CONI SEMS	-	-	-	B	T	4	4.00
F-2334	TAILGATE LATCHES	HX CONI SEMS	-	-	-	B	-	4	5.00
F-1595	TAILGATE LATCHES	HX CONI SEMS	-	-	-	-	T	4	4.00
F-1597	TAILGATE RELEASE HANDLE	FLNG NUT ONLY	-	-	-	-	T	1	1.00
F-2337	TAILGATE RELEASE HANDLE BEZEL	POZI OV EXT & HX CONI SEMS	-	-	-	B	-	6	4.00
F-1596	TAILGATE RELEASE HANDLE BEZEL	POZI OV EXT & HX CONI SEMS, RIV NUTS	-	-	-	-	T	10	5.00
F-2327	TAILGATE SUPPORT ARMS	HX CONI SEMS	-	-	-	B	-	4	4.00
F-1599	TAILGATE SUPPORT ARMS	HX CONI SEMS	-	-	-	-	T	4	4.00
F-1552	TAILGATE SUPPORT BUMPERS	PH PN A SCREWS	-	-	-	B	-	2	4.00
F-255	TIE DOWN BRACKETS (Rr)	HX CONI SEMS, LOCK NUTS	Z	-	-	-	-	10	20.00
F-3267	TOP ASSEMBLY, LONG > BODY	HX CONI SEMS, FLNG BOLTS, NUTS, WA'S	-	-	-	B	-	68	34.00
F-165	TRUNK LATCH & STRIKER	HX CONI SEMS	Z	W	O	-	-	5	5.00
F-3535	TRUNK LID	HX CONI SEMS	-	-	O	-	-	4	4.00
F-152	TRUNK LID & HINGES	HX CONI SEMS	Z	-	-	-	-	8	8.00
F-818	TRUNK LID & HINGES	HX CONI SEMS	-	W	-	-	-	8	7.00
F-572	TRUNK LID BUMPERS (Body 65, 76 69-70)	.50 H BUMPERS	Z	-	-	-	-	2	5.00
F-161	VALANCE (Fr)	HX CONI SEMS, U-NUTS	Z	-	-	-	-	18	12.00
F-3468	VALANCE (Fr)	HX CONI SEMS, U-NUTS	-	W	-	-	-	12	5.00
F-1500	VALANCE (Fr) (SHELBY)	CRG & HX BOLTS, SRD FLNG NUTS, WA	Z	-	-	-	-	11	8.00
F-162	VALANCE (Fr) OUTER SUPPORTS	HX CONI SEMS, U-NUTS	Z	-	-	-	-	4	3.00
F-166	VALANCE (Rr)	CLIP HEAD BOLTS, PH PN SCREWS, NUTS	Z	W	-	-	-	15	7.00
F-2954	WEATHERSTRIP - DOOR BOTTOM	PH PN AB SCREWS	Z	W	-	-	-	14	3.00
F-3930	WEATHERSTRIP > CONVERTIBLE TOP	PH PN AB SCREWS, EXT KEPS NUTS	Z	-	-	-	-	31	6.00
F-1748	WEATHERSTRIP, DOORS	SS/BLACK PH PN AB SCREWS	Z	-	-	-	-	10	2.00
F-1261	WINDOW (glue-in) RUN ASSY > DOOR SHELL	HX CONI SEMS, HX SCREWS	Z	-	-	-	-	8	6.00
F-1260	WINDOW (quarter) GUIDE EXTENSIONS	Visable in jamb area, HX CONI SEMS	Z	-	-	-	-	4	4.00
F-1296	WINDOW SEALS @ DOOR Rr & QTER - B 63	PH PN AB SCREWS	Z	-	-	-	-	10	2.00
F-1297	WINDOW SEALS @ DOOR Rr, QTER - 65, 76	PH PN AB SCREWS	Z	-	-	-	-	18	3.00
F-3255	WINDOW SLATS (louvers) - DEALER ADDED	PH OV SCREWS, RUBBER NUT INSERTS	Z	-	-	-	-	16	8.00
F-3254	WINDOW SLATS (louvers) - FACTORY	PH OV SCREWS, STEEL RIVET NUTS	Z	-	-	-	-	16	8.00
F-1153	WINDOW, DOORS - STOP COVERS @ Rr	HX CONI SEMS	Z	-	O	-	-	4	4.00
F-1462	WINDSHIELD HOLD-DOWN RETAINER	SRD FLNG NUTS	-	-	-	B	-	2	1.50

Kits Contain Attaching Fasteners for Both Sides

Ford Fastener Kits

1969

Brakes

PART #	APPLICATION	NOTES						PCS	PRICE
			MUSTANG	COUGAR	FAIRLANE	BRONCO	TRUCK		
F-1616	BRAKE ASSEMBLY (front drum) > SPINDLE	T-BOLTS, LOCK NUTS	Z	W	O	-	-	16	14.00
F-1480	BRAKE BOOSTER > FIREWALL	HX SPLIT SEMS, FLNG NUTS	Z	W	O	-	-	5	8.00
F-3882	BRAKE BOOSTER HOSE	FLAT WOUND SPRING CLAMPS, BLACK	Z	W	O	B	T	2	2.00
F-1276	BRAKE BOOSTER HOSE > BOSS 429	BRASS FITTING FROM KAR-KRAFT	Z	-	-	-	-	1	20.00
F-1791	BRAKE CABLE SEAL @ BRAKE PLATES	1.0" DIA X .58 TK RUBBER SEAL	Z	W	O	-	-	2	3.00
F-575	BRAKE CABLES > BODY	RETAINING CLIPS, HX NUTS	Z	W	O	-	-	6	4.00
F-2985	BRAKE CALIPER BLEEDERS	CORRECT SCREWS	Z	W	O	-	T	2	4.00
F-3698	BRAKE CALIPER HARDWARE - COMPLETE	STAB'S, CLIPS, INSULATORS, SCREWS	Z	W	O	-	-	30	50.00
F-1263	BRAKE CALIPERS > SPINDLE	DRILLED GR-8 BOLTS, SPLIT WA'S	Z	W	O	-	-	8	38.00
F-579	BRAKE DRUM RETAINERS	GREEN PUSH ON RETAINERS	Z	W	O	B	T	6	4.00
F-1757	BRAKE HOSE > AXLE HSNB - 428CJ & BOSS	HX BOLT, SPLIT WA	Z	W	-	-	-	2	2.00
F-1249	BRAKE HOSE BRKTS (drum) (Fr) > BODY	HXWA C SCREWS	Z	W	O	-	-	4	3.00
F-1250	BRAKE HOSES (disc) > BODY	HXWA C SCREWS, U-CLIP	Z	W	O	-	-	5	5.00
F-577	BRAKE HOSES (drum) > BRACKET	U-CLIPS	Z	W	O	-	-	3	4.00
F-1517	BRAKE HOSES > CALIPER	RED GR-8 DRILLED HX BOLTS, COP WA'S	Z	W	O	-	-	6	20.00
F-670	BRAKE LIGHT SWITCH	RETAINING PIN	Z	W	O	B	T	1	2.00
F-669	BRAKE PLATE ADJUST HOLE PLUGS (2)	RUBBER PLUGS	Z	W	O	B	T	2	3.00
F-1601	BRAKE ROTOR SHIELDS	HX EXT SEMS	Z	W	O	-	-	6	4.00
F-1475	MASTER CYLINDER w POWER BRAKES	FLNG NUTS	Z	W	O	B	T	2	3.00
F-1473	MASTER CYLINDER w/o POWER BRAKES	HX SPLIT SEMS	Z	W	O	-	-	2	5.00
F-1333	PARKING BRAKE CONTROL > BODY	HXWA SRD SCREWS	Z	W	O	-	-	3	4.00
F-798	PROPORTIONING VALVE > APRON	FLNG NUTS	Z	W	-	-	-	2	2.00
F-1214	PROPORTIONING VALVE > APRON	5/16-18 HXWA F SCREW	-	-	O	-	-	1	1.50
F-2950	WHEEL CYLINDER BLEEDERS	1/4-28 x 1/4 HX x 92" OAL SCREWS, ZDC	Z	W	O	B	T	2	3.00
F-356	WHEEL CYLINDERS (2) - 250 & All 8 CYL	5/16-18 HX EXT SEMS	Z	W	O	B	T	4	3.00
F-1772	WHEEL CYLINDERS (4) - 170/200	1/4-20 HX EXT SEMS	Z	-	-	-	-	8	6.00
F-3912	WHEEL CYLINDERS (4) - 250 & All 8 CYL	5/16-18 HX EXT SEMS	Z	W	O	B	T	8	6.00

Brake & Fuel Lines - also see page 216

F-3973	BRAKE LINES - 6 & 8 CYL	CORRECT CLIPS, SCREWS, GROMMETS	Z	W	-	-	-	20	32.00
F-3964	FUEL LINE @ ROCKER, Mid 67-70 HT, 71-73	CLIP w SQUEEZE RETAINER	Z	W	-	-	-	1	4.00
F-668	FUEL LINE GROMMET (fender apron)	RUBBER GROMMET	Z	W	-	-	-	1	3.00
F-3975	FUEL LINES - 6 CYL CNV or V8 HT	CORRECT CLIPS, SCREWS, GROMMET	Z	W	-	-	-	12	18.00
F-3974	FUEL LINES - 6 CYL HARDTOP	CORRECT CLIPS, SCREWS, GROMMET	Z	W	-	-	-	10	16.00
F-3976	FUEL LINES - V8 CONVERTIBLE	CORRECT CLIPS, SCREWS, GROMMET	Z	W	-	-	-	14	20.00

Cooling

F-390	RADIATOR - 250 w AC	HX CONI SEMS, J-NUTS	Z	-	O	-	-	8	6.00
F-389	RADIATOR - 302/351 XC, 390/428	HX CONI SEMS, SCREWS, CAGED NUTS	Z	W	O	-	-	6	5.00
F-392	RADIATOR - STD COOLING	HX CONI SEMS, J-NUTS	Z	W	O	-	-	8	6.00
F-1312	RADIATOR - TOP SCREWS (if equipped)	5/16" DIA HX A SCREWS	Z	-	-	-	-	2	3.00
F-403	RADIATOR FAN SHROUD - All	SPL HXWA SCREWS, SPRING NUTS	Z	W	O	-	-	8	6.00
F-657	RADIATOR HOSE CLAMPS - 289/302/351	WIRE TYPE	Z	W	O	B	T	4	16.00
F-658	RADIATOR HOSE CLAMPS - 390/428	WIRE TYPE	Z	W	O	-	T	4	20.00
F-656	RADIATOR HOSE CLAMPS - 6 CYL	WIRE TYPE	Z	W	O	-	T	4	16.00
F-2919	RADIATOR HOSE CLAMPS - All 429	WIRE TYPE	Z	-	-	-	-	4	20.00

Differential

F-1440	AXLE RETAINER PLATES - 250 & 8 CYL	T-BOLTS, LOCK NUTS	Z	W	O	-	-	16	20.00
F-1161	AXLE RETAINER PLATES - NUTS ONLY	LOCK NUTS (Red)	Z	W	O	-	-	8	6.00
F-2491	AXLE VENT SYSTEM	FITTING, HOSE, CLAMPS, SCREW, SLEEVE	Z	-	-	-	-	7	25.00
F-785	DIFFERENTIAL CARRIER > HOUSING	RED LOCK NUTS, COPPER WA'S	Z	W	O	B	T	20	12.00
F-1165	DIFFERENTIAL CARRIER > HOUSING	COPPER WA'S ONLY	Z	W	O	B	T	10	4.00
F-3987	DIFFERENTIAL FLANGE > PINION	GR-8 3/4-20 TOP-LOK FLNG LOCKNUT	Z	W	O	B	T	1	5.00
F-374	DIFFERENTIAL PINION SUPPORT	PLACE BOLTS	Z	W	O	B	T	5	8.00

Ford Fastener Kits

257

1969

Electrical

PART #	APPLICATION	NOTES						PCS	PRICE
			MUSTANG	COUGAR	FAIRLANE	BRONCO	TRUCK		
F-1317	ALTERNATOR - 200 6 CYL	HX, SRTD HX FLNG & PLACE BOLTS	Z	-	O	B	-	5	18.00
F-1318	ALTERNATOR - 250 6 CYL	HX, SRTD HX FLNG & PLACE BOLTS	Z	-	O	B	T	5	18.00
F-624	ALTERNATOR - 289/302 less SPACER	HX, HX FLNG & PLACE BOLTS, SPLIT WA	Z	W	O	B	T	4	7.00
F-626	ALTERNATOR - 289/302 w SMOG	PLACE & FLNG BOLTS	Z	W	O	B	T	3	8.00
F-625	ALTERNATOR - 289/302 w SPACER	HX, PLACE BOLTS, GOLD SPACER, WA'S	Z	W	O	B	T	5	16.00
F-1307	ALTERNATOR - 351W	FLNG, SRTD FLNG & PLACE BOLTS	Z	W	O	B	-	5	16.00
F-629	ALTERNATOR - 390/428 less SPACER	HX, HX FLNG & PLACE BOLTS, SPLIT WA	Z	W	O	-	T	4	7.00
F-630	ALTERNATOR - 390/428 w SPACER	HX, FLNG & PLACE BOLTS, PINK SPACER	Z	W	O	-	T	6	18.00
F-1751	ALTERNATOR - BOSS 429	HX & FLNG BOLTS, 2 SPACERS, SPLIT WA	Z	-	-	-	-	6	30.00
F-652	ALTERNATOR HOUSING THRU BOLTS	HXWA SCREWS	Z	W	O	B	T	3	3.00
F-644	ALTERNATOR PULLEY	HX NUT & SPLIT WA (ZDC)	Z	W	O	B	T	2	2.00
F-1121	ALTERNATOR WIRING	EXT KEPS NUT, NUTS, SPLIT & FLAT WA'S	Z	W	O	B	T	6	3.00
F-779	ANTENNA > FENDER	PH OV AB SCREWS	Z	W	O	B	T	4	2.00
F-1152	BACK-UP LAMP LENSES	1.25" L SS PH PN B STOP SCREWS	Z	-	-	-	-	4	2.00
F-471	BACK-UP LAMPS > Rr VALANCE	STAMPED NUTS, CUPPED WA'S	Z	W	O	B	T	8	6.00
F-637	BATTERY CABLES - 289/302/351	HX BOLTS, HXWA SCREWS, CONI KEPS	Z	W	O	B	T	7	5.00
F-641	BATTERY CABLES - 390/428	HX BOLTS, HXWA SCREW, CONI KEPS	Z	W	O	-	T	7	5.00
F-634	BATTERY CABLES - 6 CYL	HX BOLT, HXWA SCREW, CONI KEPS	Z	-	O	B	T	7	5.00
F-1106	BATTERY CABLES ROUTING - 428CJ w TRUNK	NYLON CLIPS, HXWA SCREWS	Z	-	-	-	-	6	6.00
F-1195	BATTERY HOLDOWN CLAMP	J- HOOKS, HXWA AB SCREW, CONI KEPS	Z	W	O	B	T	5	6.00
F-742	BATTERY HOLDOWN CLAMP - NUT ONLY	CONI KEPS NUTS	Z	W	O	B	T	2	2.00
F-1190	BATTERY TERMINALS	SQR HD BOLTS, NUTS	Z	W	O	B	T	4	3.00
F-646	DISTRIBUTOR POINTS & COND - DUAL PT	SLOT PN C SCREWS	Z	W	O	B	T	5	3.00
F-645	DISTRIBUTOR POINTS & COND - SINGLE	SLOT PN C SCREWS	Z	W	O	B	T	3	2.00
F-3990	HEADLAMP ADJUSTERS	ADJUSTERS, SCREWS, SPRINGS	Z	-	-	-	-	28	20.00
F-2933	HEADLAMP ADJUSTERS	ADJUSTERS, SCREWS, SPRINGS	-	W	-	-	-	28	20.00
F-3991	HEADLAMP ADJUSTERS (SHELBY)	ADJUSTERS, SCREWS, SPRINGS	Z	-	-	-	-	14	10.00
F-740	HEADLAMP DIMMER SWITCH	HXWA AB SCREWS	Z	W	O	-	-	2	2.00
F-600	HEADLAMP RETAINING RINGS (4)	SS PH PN SCREWS	Z	-	-	-	-	12	3.00
F-2941	HEATER MOTOR GROUND	HXWA AB SCREW	Z	W	-	-	-	1	1.50
F-3222	HOOD SCOOP TURN LAMPS & WIRING	HXWA AB & PH PN B SCREWS, CLIPS	Z	-	-	-	-	8	5.00
F-1166	HORNS	HX CONI SEMS, SRTD FLNG NUTS	Z	W	O	B	T	4	3.00
F-422	IGNITION COIL STRAP & BRKT - 6 CYL	HX SPLIT SEMS, HXWA SCREW, HX NUT	Z	W	O	B	T	4	3.00
F-376	IGNITION COIL STRAP & BRKT - V8 exc 351C	HX SPLIT SEMS, HXWA SCREW, HX NUT	Z	W	O	B	T	3	3.00
F-1301	IGNITION COIL STRAP ONLY	HXWA SCREW, HX NUT	Z	W	O	B	T	2	1.50
F-1430	JUNCTION BLOCK @ RH APRON (SHELBY)	HXWA A SCREWS	Z	-	-	-	-	2	1.50
F-448	LICENSE PLATE LAMP	HXWA AB SCREWS	Z	-	-	-	-	2	1.00
F-2968	MAP LIGHT @ GLOVE BOX - DLX	PH PN AB SCREWS	Z	-	-	-	-	3	2.00
F-2967	MAP LIGHT @ GLOVE BOX - STD	HXWA SCREWS	Z	-	-	-	-	2	1.50
F-3443	NEUTRAL SWITCH	HX EXT SEMS	Z	W	O	B	T	2	3.00
F-2947	PARKING LAMP LENSES	SS PH PN STOP SCREWS	Z	-	-	-	-	4	2.00
F-455	PARKING LAMPS (below bumper)	HX CONI SEMS	Z	-	-	-	-	4	4.00
F-427	RADIO - HOOD GROUND	HXWA AB SCREW ONLY	Z	W	-	-	-	1	1.50
F-1092	RADIO > INSTRUMENT PANEL	HXWA AB SCREWS, EXT KEPS & NUTS	Z	-	-	-	-	5	2.00
F-2026	RADIO SPEAKER > DASH	CLIP HEAD BOLTS, EXT KEPS NUTS	Z	-	-	-	-	8	3.00
F-1070	REV LIMETER & SHIELD - BOSS 302/429	HXWA AB SCREWS, EXT KEPS NUT	Z	W	-	-	-	6	3.00
F-454	SIDE MARKERS LAMPS (Fr)	STAMPED NUTS	Z	-	-	-	-	4	6.00
F-450	SIDE MARKERS LAMPS (Rr)	STAMPED NUTS	Z	-	-	-	-	4	3.00
F-1410	STARTER - 289/302/351	HXWA SPLIT SEMS, YLW ZINC	Z	W	O	B	T	2	3.50
F-408	STARTER - 6 CYL & 390/428	HX SPLIT SEMS	Z	W	O	-	T	3	4.00
F-407	STARTER SOLENOID	HXWA AB SCREWS "D"	Z	W	O	B	T	2	1.50
F-444	TAILAMP ASSEMBLY > BODY	CLIP HEAD BOLTS, NUTS, SEALER	Z	-	-	-	-	16	20.00
F-820	TAILAMP ASSEMBLY > BODY	NUTS w SEALER, STUDS	-	W	-	-	-	24	10.00
F-3552	TAILAMP ASSEMBLY > BODY	SRTD HX FLNG NUTS	-	-	O	-	-	8	3.00
F-2930	TAILAMP ASSEMBLY > BODY - RANCHERO	PH OV AB SCREWS	-	-	O	-	-	12	6.00
F-3489	TAILAMP LENSES	SS PH PN B SCREWS	Z	-	-	-	-	12	3.00
F-2497	TAILAMP SHIELD IN TRUNK (SHELBY)	KEY BOLTS, STAMPED NUTS, SCREWS	Z	-	-	-	-	6	8.00
F-2956	TAILAMP WIRING GROUND @ LATCH	HXWA AB SCREW	Z	W	-	-	-	1	1.50
F-1775	TRUNK LAMP	HXWA AB SCREW, EXT WA	Z	-	-	-	-	2	1.50
F-405	VOLTAGE REGULATOR & SPLASH SHIELD	HXWA A SCREWS "D", EXT WA	Z	W	O	-	-	5	2.00
F-3820	WIRING - CONVERTIBLE TOP CONTROL	NYLON "O" CLIPS, 4" FLAT NYLON STRAP	Z	-	-	-	-	7	6.00
F-3819	WIRING - DOOR COURTESY & SPEAKER	NYLON "O" CLIPS	Z	-	-	-	-	2	3.00
F-460	WIRING - ENGINE FEED - 8 CYL w AC	RUBBER COATED "J" CLIPS	Z	W	O	B	T	4	5.00
F-423	WIRING - ENGINE FEED - 8 CYL w/o AC	RUBBER COATED "J" CLIPS	Z	W	O	B	T	3	4.00
F-587	WIRING - FIREWALL	4" NYLON STRAPS (1 for washer hose)	Z	W	-	-	-	3	4.00
F-3523	WIRING - FRONT CROSSMEMBER	DOUBLE LOOP NYLON RETAINERS	Z	-	-	-	-	4	10.00
F-462	WIRING - GAS TANK SENDER w DUAL EXH	NYLON "O" CLIPS	Z	-	-	-	-	3	3.00
F-416	WIRING - HORN FEED	NYLON "O" CLIPS	Z	W	-	-	-	4	4.00
F-2112	WIRING - LH APRONS	4.0" NYLON STRAPS	Z	W	-	-	-	6	4.00
F-3816	WIRING - RADIO CABLE > DASH	NYLON "S" CLIPS	Z	-	-	-	-	2	3.00
F-2113	WIRING - RH APRON BELOW RELAY	D-SHAPED NYLON RETAINERS	Z	W	-	-	-	2	3.00
F-418	WIRING - SIDE MARKER & HEADLAMPS	NYLON "O" CLIPS	Z	W	-	-	-	4	5.00
F-461	WIRING - TURN SIGNAL LAMPS ON SCOOP	NYLON "O" CLIPS	Z	-	-	-	-	2	3.00
F-3818	WIRING - UNDER DASH	NYLON "O" CLIPS	Z	-	-	-	-	7	7.00
F-3830	WIRING - VARIOUS LOCATIONS	ZIP TIES	Z	-	-	-	-	12	4.00

Kits Contain Attaching Fasteners for Both Sides

Ford Fastener Kits

1969

Emissions

PART #	APPLICATION	NOTES						PCS	PRICE
			Z	W	O	B	T		
F-1194	PCV HOSES - 390/428	4 WIRE CLAMPS	Z	W	O	-	T	4	4.00
F-1197	PCV HOSES - BOSS 302	2 WIRE CLAMPS	Z	W	-	-	-	2	2.50
F-1198	PCV HOSES - BOSS 429	1 WIRE CLAMP	Z	-	-	-	-	1	2.00
F-1278	PCV VALVE ELBOW - 390/428	1/4" NPT > 1/2" HOSE STEEL ELBOW	Z	W	O	B	T	1	20.00
F-1649	SMOG PUMP - 289/302	BOLTS, CONI SEMS, SPACER, NUTS, WA'S	Z	W	O	B	T	9	22.00
F-631	SMOG PUMP - 390/428	BOLTS, CONI SEMS, SPACER, NUTS, WA'S	Z	W	O	-	T	5	16.00
F-1336	SMOG PUMP - BOSS 429	HX BOLT, CONI SEMS, FLAT & SPLIT WA'S	Z	-	-	-	-	4	20.00
F-615	SMOG PUMP PULLEY	PLACE BOLTS	Z	W	O	B	T	3	4.00
F-2951	SMOG PUMP PULLEY - BOSS 429	HX SPLIT SEMS	Z	-	-	-	-	3	6.00

Exhaust

F-2498	EXHAUST COLLECTOR (SHELBY)	HX SKT SCREWS	Z	-	-	-	-	3	5.00
F-1454	EXHAUST HANGERS, DUAL (transverse mflr)	CRG BOLTS, HXWA SCREWS, FLNG NUTS	Z	-	-	-	-	20	8.00
F-1247	EXHAUST HANGERS, SINGLE	HXWA C SCREWS	Z	-	-	-	-	8	4.00
F-522	EXHAUST PIPE > MANIFOLD - 6 CYL	STUDS 2.25 OAL, FLNG NUTS	Z	-	O	B	-	4	7.00
F-524	EXHAUST PIPE > MANIFOLDS - 390/428/B429	STUDS 2.25 & 3.81 OAL, FLNG NUTS	Z	W	O	-	-	8	12.00
F-523	EXHAUST PIPE > MANIFOLDS - SB, 69 390GT	STUDS 2.25 OAL, FLNG NUTS	Z	W	O	B	-	8	10.00

Fuel - for lines see page 216

F-747	ACCEL BELLCRANK > FIREWALL	HXWA AB SCREWS	Z	-	O	-	-	3	2.00
F-589	FUEL HOSE CLAMPS	FLAT WOUND SPRING TYPE (Silver)	Z	W	O	-	-	8	4.00
F-411	GAS CAP (pop open)	PH FLAT A SCREWS ONLY	Z	-	-	-	-	4	2.00
F-357	GAS TANK	HXWA AB SCREWS	Z	-	O	-	-	11	6.00
F-3910	GAS TANK FILLER NECK	HXWA A SCREWS	-	-	O	-	-	5	3.00
F-1779	GAS TANK FILLER NECK CLAMPS	CORRECT WIRE CLAMPS	Z	-	-	-	-	2	6.00
F-413	GAS TANK FILLER NECK w TWIST CAP	HXWA B SCREWS	Z	-	-	-	-	5	3.00

Heater

F-3916	DEFROSTER DUCTS > DASH	CLIP HEAD BOLTS, EXT KEPS NUTS	Z	-	-	-	-	6	4.00
F-383	HEATER & BY-PASS HOSES	WHITEK TOWER CLAMPS	Z	W	O	B	T	6	12.00
F-2855	HEATER ASSEMBLY > FIREWALL	STAMPED NUTS	-	-	O	-	-	4	4.00
F-431	HEATER ASSEMBLY > FIREWALL w/o AC	STAMPED NUTS, SEALER WA'S	Z	W	-	-	-	5	6.00
F-1213	HEATER HOSE STRAPS	6 3/4" ALUMINUM STRAP	Z	W	O	-	-	2	10.00
F-439	HEATER MOTOR GUARD - 390/428	HXWA AB SCREWS, LOCK NUT	Z	-	-	-	-	3	2.00

Interior

F-1043	ARMRESTS - STD	HXWA AB SCREWS, SPRING NUTS	Z	-	-	-	-	12	4.00
F-964	ASH TRAY	HXWA A SCREWS	Z	-	-	-	-	3	1.50
F-961	CLOCK OPENING COVER - BODY 63C, 65E	FLAT SPRING NUTS	Z	-	-	-	-	2	1.00
F-960	CLOCK OPENING COVER (exc 63C, 65E)	HXWA B SCREWS	Z	-	-	-	-	2	1.00
F-1010	COAT HOOKS	PH PN AB SCREWS ONLY	Z	-	-	-	-	4	1.50
F-1046	CONSOLE > FLOOR	PH PN & PH OV SCREWS, STAMP NUTS	Z	-	-	-	-	16	7.00
F-1049	COURTESY LAMP @ DOORS	STAMPED NUTS	Z	-	-	-	-	4	1.50
F-904	DASH PAD	PH PN & PH RNDWA SCREWS, SPRING NUTS	Z	-	-	-	-	11	3.50
F-1076	DOME LAMP	PH PN A & AB SCREWS	Z	-	-	-	-	4	2.00
F-950	DOOR HANDLES (inside)	CONI KEPS NUTS	Z	-	-	-	-	4	4.00
F-1042	DOOR PANEL ARMREST BRACKETS - DLX	PH PN SCREWS, SPRG, RND PUSH NUTS	Z	-	-	-	-	8	1.50
F-1039	DOOR PANELS - DLX	SCREWS, RETAINERS (pad clips go lower)	Z	-	-	-	-	30	12.00
F-1038	DOOR PANELS - STD	PADDED RETAINERS	Z	-	-	-	-	20	10.00
F-1044	DOOR PANELS - TOP MOULDING	PH OV & PN AB SCREWS	Z	-	-	-	-	8	2.00
F-920	FD SEAT SIDE LATCHES	HXWA EXT SEMS	Z	-	-	-	-	8	2.50
F-770	FD SEAT STOP PLATES	PH PN MS & AB SCREWS	Z	-	-	-	-	6	3.00
F-930	FD SEAT TRAP DOOR HINGES	HX INT/EXT SEMS, J-NUTS	Z	-	-	-	-	16	10.00
F-926	FD SEAT TRAP DOOR LATCH	HXWA SCREWS	Z	-	-	-	-	4	2.00
F-936	FD SEAT TRAP DOOR PROP & BRACKET	HXWA EXT SEMS, J & U-NUTS	Z	-	-	-	-	8	5.50
F-429	FD SEAT TRAP DOOR RUBBER BUMPERS	TALL RUBBER BUMPERS	Z	-	-	-	-	4	6.00
F-2911	FD SEAT TRAP DOOR TRIM PANEL BRACKETS	PH PN AB SCREWS FOR BRACKETS ONLY !!	Z	-	-	-	-	12	2.00
F-923	FD SEAT TRAP DR LATCH CATCH	HX CONI SEMS	Z	-	-	-	-	2	2.00
F-1755	FD SEAT TRIM	CHROME PH OV AB SCREW, JAM NUTS	Z	-	-	-	-	62	10.00
F-996	FIREWALL SOUND ABSORBER	PH PN DRILL SCREW, FLAT WA	Z	-	-	-	-	4	2.00
F-775	FLOOR PANEL (Rr) - Fr ANCHORS	PH PN SCREWS, FINISH WA'S	Z	-	-	-	-	4	3.00
F-2944	GLOVE BOX BUMPERS	.40 H RUBBER BUMPER	Z	-	-	-	-	2	2.00
F-795	GLOVE BOX CABLE	PN PN B SHLDR SCREWS, WAVE WA'S	Z	-	-	-	-	4	3.00

See factory Assembly Manuals for illustrations

Ford Fastener Kits

259

1969

Interior

PART #	APPLICATION	NOTES						PCS	PRICE
			MUSTANG	COUGAR	FAIRLANE	BRONCO	TRUCK		
F-917	GLOVE BOX CATCH	POZI PH PN CONI SEMS, PH PN SCREWS	Z	-	-	-	-	3	2.00
F-3239	GLOVE BOX HINGES	HX CONI SEMS	Z	-	-	-	-	4	3.00
F-1170	GLOVE BOX LATCH	PH PN EXT SEMS	Z	-	-	-	-	2	2.00
F-915	GLOVE BOX LINER	PH PN AB SCREWS	Z	-	-	-	-	5	2.00
F-1000	HEADLINER TACK STRIP (Rr) - BODY 63, 65	PH PN AB SCREWS	Z	-	-	-	-	6	1.50
F-1086	HEATER CONTROL > DASH	HXWA AB SCREWS, SPRING NUTS	Z	-	-	-	-	6	3.00
F-1051	HORN PAD (2 Spoke Wheel)	PH PN B SCREWS	Z	-	-	-	-	2	2.00
F-1058	HORN PAD (3 Spoke Wheel)	PH PN AB & B SCREWS	Z	-	-	-	-	6	3.00
F-963	INSTR FINISH PANEL (BEZEL) @ CLUSTER	HXWA & PH PN SCREWS, SPRING NUTS	Z	-	-	-	-	18	5.00
F-966	INSTR FINISH PANEL > DASHBOARD CENTER	PH PN B SCREWS, SPRING NUTS	Z	-	-	-	-	4	3.00
F-958	INSTRUMENT FINISH PANEL RH > DASH	PH OV & PN PN B SCREWS, SPRING NUTS	Z	-	-	-	-	14	5.00
F-2030	INSTRUMENT PANEL CENTER MOULDINGS	PH PNWA AB SCREWS, SPRING NUTS	Z	-	-	-	-	4	2.50
F-962	INSTRUMENT PANEL END MOULDINGS	PH OV & PH RNDWA AB SCREWS, NUTS	Z	-	-	-	-	8	2.50
F-882	KICK PANELS (LT COLOR INT ONLY 1970)	PH OV AB SCREWS	Z	-	-	-	-	4	2.00
F-1379	LAMPS, COURTESY UNDERDASH	PH PN AB SCREWS	Z	-	-	-	-	2	1.00
F-861	MIRROR (inside) > BRACKET	PH OV F SCREWS	Z	-	-	-	-	2	1.50
F-1033	PACKAGE TRAY	PH PN AB SCREWS	Z	-	-	-	-	13	3.00
F-1045	PACKAGE TRAY TRIM - BODY 63 w/o FDS	PH OV AB SCREWS	Z	-	-	-	-	5	2.00
F-1019	QTER TRIM PANEL BRACKETS - BODY 63	PH PN AB SCREWS	Z	-	-	-	-	24	4.00
F-1056	QTER TRIM PANEL BUILD-UP - BODY 76	PH PN AB SCREWS, SPRING NUTS	Z	-	-	-	-	12	3.00
F-2140	QTER TRIM PANELS - BODY 63	HX CONI SEMS, SCREWS, U-NUTS, RIVETS	Z	-	-	-	-	40	14.00
F-1026	QTER TRIM PANELS - BODY 65 w DARK INT	PH PN AB SCREWS, RETAINERS	Z	-	-	-	-	14	4.00
F-1025	QTER TRIM PANELS - BODY 65 w LT INT	PH PN AB SCREWS, RETAINERS	Z	-	-	-	-	14	4.00
F-1027	QTER TRIM PANELS - BODY 76	PH PN AB SCREWS, PH OV SEMS	Z	-	-	-	-	20	5.00
F-1035	ROOFSIDE INT TRIM PANELS - BODY 65	WIRE RETAINERS	Z	-	-	-	-	2	1.50
F-859	SCUFF PLATES (door opening)	SS/CHROME PH OV AB SCREWS	Z	-	-	-	-	8	3.00
F-1758	SEAT (Rr fixed) - TRIM - BODY 63	PH OV AB SCREWS	Z	-	-	-	-	22	5.00
F-303	SEAT (Rr fixed) - UPR ANCHORS - BODY 63	SCREWS, ACORN NUTS, WA'S	Z	-	-	-	-	16	12.00
F-862	SEAT BACK (Fr) RELEASE KNOB	PH OV F SCREWS	Z	-	-	-	-	2	1.50
F-3767	SEAT BACK COVERS	WIRE RETAINERS	Z	-	-	-	-	12	4.00
F-3561	SEAT BELTS (Fr)	TORX BOLTS, RUBBER WA'S, SPACERS	Z	-	-	-	-	12	16.00
F-3563	SEAT BELTS (Fr) - SHOULDER STRAPS	TORX SHLDR BOLTS, CHROME SPACERS	Z	-	-	-	-	4	14.00
F-3566	SEAT BELTS (Rr) 2-29-68 >	TORX BOLTS, SPACERS	Z	-	-	-	-	8	14.00
F-939	SEAT HINGE (Rr) > FLOOR, SEAT - BODY 63	HX CONI SEMS, SLOT FLAT SCREWS	Z	-	-	-	-	10	8.00
F-884	SEAT PIVOTS & COVER (LT INT ONLY 1970)	PH PN T1 SCREWS, PINS, FIBRE WA'S	Z	-	-	-	-	14	5.00
F-687	SEAT STOPS - Fr SEAT BACKS	PH PN AB SCREWS	Z	-	-	-	-	8	3.00
F-2926	SEAT TRACK STUDS - REPAIR KIT	2 SPECIAL SQR HD BOLTS, RETAINERS	Z	-	-	-	-	4	5.00
F-1192	SEAT TRACKS > BODY	ORIGINAL INT/EXT DOME KEPS NUTS	Z	-	-	-	-	8	8.00
F-1048	SEAT UPHOLSTERY (Rr) > FLOOR - B 63	PH PN & PH WAFER SCREWS, SEALER	Z	-	-	-	-	8	3.00
F-1047	SEAT UPHOLSTERY (Rr) > FLOOR - B 65, 76	HX PERI SEMS, SEALER	Z	-	-	-	-	4	3.00
F-899	SPEAKER GRILLES > DOOR	PH OV AB SCREWS	Z	-	-	-	-	8	3.50
F-1091	STEERING COLUMN SHROUD	PH RNDWA B SCREWS	Z	-	-	-	-	2	1.50
F-605	SUN VISOR BRACKETS - BODY 63, 65	PH OV & PH PN AB SCREWS	Z	-	-	-	-	7	3.00
F-606	SUN VISOR BRACKETS - BODY 76	PH OV & PH PN AB SCREWS	Z	-	-	-	-	10	5.00
F-953	WINDOW CRANK HANDLES	OVAL HEAD POZI OV SCREWS	Z	-	-	-	-	2	1.00
F-2031	WINDSHIELD PILLIAR TRIM	PH OV AB FLUSH SEMS	Z	-	-	-	-	4	2.00
F-1003	WINDSHIELD, TOP INSIDE TRIM - All	PH OV AB SCREWS	Z	-	-	-	-	4	2.00

Moulding

F-3640	EMBLEM NUTS, Complete - "Grande"	1/8" SLEEVE NUTS	Z	-	-	-	-	24	9.00
F-3639	EMBLEM NUTS, Complete - PRODUCTION	SLEEVE NUTS	Z	-	-	-	-	20	7.00
F-3641	EMBLEM NUTS, Complete - PRODUCTION	SLEEVE NUTS	Z	-	-	-	-	6	3.00
F-2493	EMBLEM, FENDER Fr - "390"	1/8" STAMPED NUTS	-	W	-	-	-	4	2.00
F-3245	EMBLEM, FENDERS - "289", "351", "390"	1/8" SLEEVE NUTS	-	-	O	-	-	4	2.00
F-3785	FENDER EXTENSION MOULDINGS (narrow)	RETAINERS, STAMPED NUTS	Z	-	-	-	-	12	10.00
F-3505	FENDER EXTENSION MOULDINGS (wide)	NYLON RETAINERS	Z	-	-	-	-	4	2.00
F-1503	FENDER MOULDINGS (SHELBY)	CONI KEPS NUTS	Z	-	-	-	-	6	3.00
F-3786	GRILLE MOULDING, LWR CENTER (narrow)	RETAINERS, STAMPED NUTS	Z	-	-	-	-	12	10.00
F-3926	GRILLE MOULDING, LWR CENTER (wide)	RNDWA SCREWS, STUDS, STAMP NUTS	Z	-	-	-	-	8	4.00
F-149	HOOD LATCH PLATES (Mach 1)	CHROME PLATED SS PH PN AB SCREWS	Z	-	-	-	-	8	3.00
F-141	HOOD PEAK MOULDING	STAMPED ACORN NUTS ONLY !	Z	-	-	-	-	6	8.00
F-3931	HOOD PEAK MOULDING	STAMPED ACORN NUTS, RETAINERS	Z	-	-	-	-	12	16.00
F-1742	MOULDINGS, TRUNK LID & EXTENSIONS	RETAINERS, PH RNDWA SCREWS, NUTS	Z	-	-	-	-	22	12.00
F-3619	NAMEPLATE, FENDERS "Mustang"	1/8" SLEEVE NUTS	Z	-	-	-	-	6	3.00
F-2492	NAMEPLATE, QTER PANELS "Cougar"	1/8" ACORN NUTS	-	W	-	-	-	8	4.00
F-3243	NAMEPLATE, QTER PANELS "Fairlane 500"	1/8" ACORN NUTS	-	-	O	-	-	15	8.00
F-3246	NAMEPLATE, QTER PANELS "Torino"	BODY 63, 1/8" STAMPED NUTS	-	-	O	-	-	8	2.00
F-3621	NAMEPLATE, ROOFSIDES "Grande"	1/8" SLEEVE NUTS	Z	-	-	-	-	4	2.00
F-3922	NAMEPLATE, TRUNK "Mustang"	3/32" SLEEVE NUTS	Z	-	-	-	-	14	5.00
F-3247	NAMEPLATE, TRUNK LID "Fairlane"	BODY 54, 65, 76, 1/8" SLEEVE NUTS	-	-	O	-	-	6	3.00
F-3241	NAMEPLATE, TRUNK LID "FORD"	BODY 63, 1/8" ACORN NUTS	-	-	O	-	-	8	4.00
F-3248	NAMEPLATE, TRUNK LID "Torino"	BODY 54, 65, 76, 1/8" STAMPED NUTS	-	-	O	-	-	4	2.00

Kits Contain Attaching Fasteners for Both Sides

Ford Fastener Kits

1969

Moulding

PART #	APPLICATION	NOTES						PCS	PRICE
			MUSTANG	COUGAR	FAIRLANE	BRONCO	TRUCK		
F-3620	ORNAMENTS, QTER PANEL	STAMPED NUTS w SEALER	Z	-	-	-	-	12	4.00
F-620	QTER WINDOW, "BOOMERANG" MOULDINGS	STAMPED NUTS, PH PN SCREWS	Z	-	-	-	-	12	4.00
F-2156	SHAKER TRIM RING	REPLACEMENT 9/16" OD STAMPED NUTS	Z	-	-	-	-	10	3.00
F-3485	TAILAMP BEZELS & LENSES (SHELBY)	SS/BLACK PH PN SCREWS (small heads)	Z	-	-	-	-	16	12.00
F-3551	TAILAMP PANEL MOULDINGS	MT STAMPED NUTS w SEALER	-	-	O	-	-	15	12.00
F-1352	TRUNK LID MOULDING	ACORN PALNUTS	-	W	-	-	-	7	5.00
F-1636	WHEEL OPENINGS (4)	SS/CHROME PH RNDWA AB SCREWS	Z	-	-	-	-	28	10.00
F-3542	WINDOW (Fr) MOULDINGS	PUSH-ON RETAINERS	-	-	O	-	-	8	3.00
F-581	WINDOW (Fr) MOULDINGS - BODY 63, 65	Sides & Top only, RETAINERS	Z	-	-	-	-	13	6.00
F-3929	WINDOW (Fr) MOULDINGS - BODY 76	Sides & Top only, NUTS, SCREWS	Z	-	-	-	-	11	8.00
F-582	WINDOW (Rr) MOULDINGS - BODY 63	RETAINERS	Z	-	O	-	-	27	12.00

Steering & Suspension

F-1404	AXLE HOUSING > SPRINGS	5 1/2" U-BOLTS, FLNG NUTS	Z	-	-	-	-	12	26.00
F-2886	AXLE HOUSING > SPRINGS	7.0" U-BOLTS, FLNG NUTS	-	W	-	-	-	12	26.00
F-1162	AXLE HOUSING > SPRINGS - NUTS ONLY	FLNG NUTS (Red)	Z	W	O	-	-	8	12.00
F-3442	AXLE HOUSING > SPRINGS (exc Eliminator)	6 3/4" U-BOLTS, FLNG NUTS	-	W	O	-	-	12	26.00
F-1355	BALL JOINTS (RIVETS) - LWR	RIVETS (2 extra), SPL TOOLS, PRESS RQD	Z	W	O	-	-	8	6.00
F-1354	BALL JOINTS (RIVETS) - UPPER	RIVETS (2 extra), SPL TOOLS, PRESS RQD	Z	W	O	-	-	10	6.00
F-596	COIL SPRING SEATS (perches)	LOCK NUTS ONLY	Z	W	O	-	-	4	3.00
F-2924	COIL SPRING SEATS (perches)	GR-8 KNURLED BOLTS, LOCK NUTS	Z	W	O	-	-	8	10.00
F-1515	CONTROL ARMS (lower) > SHOCK TOWER	GR-8 CAM BOLTS, RED NUTS, WA'S	Z	W	O	-	-	8	20.00
F-3311	CONTROL ARMS (upper) > SHOCK TOWER	GR-8 1/2-13 KNURLED BOLTS, RED NUTS	Z	W	O	-	-	12	16.00
F-361	CONTROL ARMS (upper) > SHOCK TOWER	GR-8 RED NUTS ONLY, SPLIT WA'S	Z	W	O	-	-	8	5.00
F-2846	CONTROL VALVE ACTUATOR	HX SPLIT SEMS	Z	W	O	-	-	2	3.00
F-1280	CROSSMEMBER, TUBULAR (Fr)	SPL HX CNTRS NK BOLTS	Z	W	-	-	-	2	10.00
F-571	GREASE PLUGS, CHASSIS	HX PLUGS	Z	W	O	B	T	9	5.00
F-1265	IDLER ARM	HX BOLTS, LOCK NUTS, CLIPPED WA'S	Z	W	O	-	-	6	20.00
F-3651	LEAF SPRING CENTER BOLTS	GR-8 TALL HD BOLTS, HX NUTS	Z	W	O	-	-	4	8.00
F-251	LEAF SPRINGS (front eye)	FLNG BOLTS & NUTS	Z	W	-	-	-	4	18.00
F-3783	LEAF SPRINGS (front eye)	FLNG BOLTS & NUTS	-	-	O	-	-	4	20.00
F-3933	P/S CONTROL VALVE DUST COVER CLAMP	SLOT RND B SCREWS	Z	W	O	-	-	2	1.50
F-502	P/S CONTROL VALVE SPOOL CAP	SLOT FILL SPLIT SEMS	Z	W	O	-	-	2	3.00
F-1615	P/S CYLINDER BRACKET - RIVET NUTS	3/8-16 HX BODY RIVET NUTS ONLY	Z	W	O	-	-	2	6.00
F-1362	P/S CYLINDER BRACKET > BODY	HX BOLTS, LOCK NUTS, WA'S	Z	W	O	-	-	7	14.00
F-521	P/S HOSE RUBBER STRAP - 390/428	EXTRUDED STRAP w STEEL RIVET	Z	W	O	B	T	1	6.00
F-676	P/S HOSE SUPPORT INSULATOR RETAINER	HXWA SCREWS	Z	W	O	-	-	2	3.00
F-1311	P/S OIL COOLER - BOSS 302/429 & 428CJ	HXWA TT SCREW	Z	W	O	-	-	1	2.00
F-3889	P/S PUMP - 200	FLNG & HX BOLTS, STUDS, WA'S	Z	-	O	-	-	21	20.00
F-3890	P/S PUMP - 250	SRTD FLNG BOLTS	Z	-	O	-	-	7	8.00
F-1074	P/S PUMP - 289/302 w/o AC	FLNG BOLTS, STUD, LOCK NUT, SPACER	Z	W	O	-	-	7	18.00
F-3891	P/S PUMP - 302 BOSS w ADAPTER PLATE	FLNG BOLTS, STUD, FLNG NUT	Z	-	-	-	-	8	16.00
F-648	P/S PUMP - 302 w AC	FLNG BOLTS, STUD, STRD FLNG NUT	Z	W	O	B	T	6	10.00
F-3892	P/S PUMP - 351W	FLNG BOLTS, BOLT	Z	W	O	-	-	8	16.00
F-650	P/S PUMP - 390/428 w AC	FLNG BOLTS, STUD, LOCK NUT	Z	W	O	-	T	8	12.00
F-1155	P/S PUMP - 390/428 w/o AC	FLNG BOLTS, STUD, LOCK NUT, SPACER	Z	W	O	-	T	9	18.00
F-1335	P/S PUMP - 429 BOSS	FLNG & HX BOLTS, GOLD SPACER	Z	-	-	-	-	8	25.00
F-2937	P/S PUMP RESERVOIR NUT	THIN HX NUT ON BACK	Z	W	O	B	T	1	3.00
F-1212	P/S RETURN HOSE - 250	SLOTTED STYLE CLAMP	Z	-	O	-	-	1	5.00
F-1211	P/S RETURN HOSE - 302/351	NO SLOT STYLE CLAMP	Z	W	O	-	-	2	20.00
F-1210	P/S RETURN HOSE - 302/351	SLOTTED STYLE CLAMP	Z	W	O	-	-	2	10.00
F-1208	P/S RETURN HOSE - 390/428	SLOTTED STYLE CLAMP	Z	W	O	-	-	2	10.00
F-1209	P/S RETURN HOSE - 390/428	NO SLOT STYLE CLAMP	Z	W	O	-	-	2	20.00
F-1811	P/S SLAVE CYLINDER, ROD END	HX NUT, STAMPED NUT	Z	W	O	-	-	2	1.50
F-614	PITMAN ARM > GEAR BOX	HX JAM NUT, SPLIT WA	Z	W	O	-	-	2	3.00
F-665	SHACKLE ASSY (Rr) - NUTS ONLY	LOCK NUTS	Z	W	O	-	-	4	3.00
F-313	SHOCK BRACKETS (Fr)	LOW HD CRG BOLTS, FLNG NUTS	Z	W	-	-	-	12	9.00
F-3908	SHOCK BRACKETS (Fr)	LOW HD CRG BOLTS, EXT KEPS NUTS	-	-	O	-	-	12	10.00
F-1845	SHOCKS (Fr)	HX EXT SEMS "Anchor", 5/16-24 NUTS, WA'S	Z	W	-	-	-	12	8.00
F-345	SHOCKS (Fr)	HX EXT SEMS "Anchor", 5/16-18 NUTS, WA'S	Z	W	-	-	-	12	8.00
F-809	SHOCKS (Fr) - TOP MOUNTING ONLY	HX EXT SEMS "Anchor"	Z	W	-	-	-	4	6.00
F-1793	SHOCKS (Rr)	3/8-16 EXT KEPS NUTS	Z	W	-	-	-	4	2.00
F-662	STABILIZER (Fr) > BODY	UBS FLNG BOLTS "M" & FLNG NUTS	Z	W	O	-	-	8	10.00
F-1279	STABILIZER (Fr) > BODY (STABILIZER BAR)	UBS FLNG BOLTS "F" & FLNG NUTS	Z	W	O	-	-	8	14.00
F-3950	STABILIZER (Fr) END LINKS	BLTS, RTNRS, BSHNGS, SPACERS, NUTS	Z	W	O	-	-	22	25.00
F-868	STABILIZER (Rr) > BODY	HXWA SCREWS	Z	W	-	-	-	4	5.00
F-350	STEERING GEAR BOX	GR-8 HX BOLTS, CLIP FLAT & SPLIT WA'S	Z	W	O	-	-	9	12.00
F-672	STEERING GEAR BOX SECTOR COVER	PLACE BOLTS	Z	W	O	B	T	3	4.00
F-814	STEERING LINKAGE w PS	SLOTTED NUTS, COTTER PINS, FLAT WA	Z	W	O	-	-	23	14.00
F-335	STEERING LINKAGE w PS - 69 HD, All 70	SLOTTED NUTS, COTTER PINS, FLAT WA	Z	W	-	-	-	23	14.00
F-813	STEERING LINKAGE w/o PS	SLOTTED NUTS, COTTER PINS, FLAT WA	Z	W	O	-	-	21	12.00
F-318	STEERING LINKAGE w/o PS - 69 HD, All 70	SLOTTED NUTS, COTTER PINS, FLAT WA	Z	W	O	-	-	21	12.00
F-612	STEERING RAG JOINT 11/4/68 >	12 PT BOLT, 5/16-18 LOCK NUTS	Z	W	O	-	-	3	4.00

See factory Assembly Manuals for illustrations

Ford Fastener Kits

261

1969

Steering & Suspension

PART #	APPLICATION	NOTES						PCS	PRICE
			MUSTANG	COUGAR	FAIRLANE	BRONCO	TRUCK		
F-610	STEERING RAG JOINT < 11/4/68	12 PT BOLT, 5/16-24 LOCK NUTS	Z	W	O	-	-	3	4.00
F-611	STEERING RAG JOINT w TILT < 11/4/68	12 PT BOLTS	Z	W	O	-	-	2	6.00
F-3309	STEERING WHEEL	LOCK NUT	Z	W	O	B	T	1	3.00
F-661	STRUT ROD THREADED ENDS > BODY	LOCK NUTS ONLY	Z	W	O	-	-	4	10.00
F-660	STRUT ROD THREADED ENDS > BODY	LOCK NUTS, SLOTTED NUTS, PINS	Z	W	O	-	-	8	12.00
F-1264	STRUT RODS > LWR CONTROL ARM	1/2-13 SPL KNRLD BOLTS, NUTS, PINS	Z	W	O	-	-	12	38.00
F-370	STRUT RODS > LWR CONTROL ARM - NUTS	After 11/11/68, 1/2-13 LOCK NUTS ONLY	Z	W	O	-	-	4	4.00
F-369	STRUT RODS > LWR CONTROL ARM - NUTS	Before 11/11/68, 1/2-20 LOCK NUTS ONLY	Z	W	O	-	-	4	6.00
F-2957	SUSP BUMPER (Rr)	LOCK NUT	Z	W	O	-	-	1	2.00
F-1487	SUSP BUMPER BRKT (Rr) - 250 & 302	HXWA SCREWS	Z	W	-	-	-	2	2.00
F-2960	SUSP BUMPERS (Fr)	5/16-18 LOCK NUTS	Z	W	-	-	-	2	2.00
F-2858	TIE ROD ADJUSTMENT SLEEVE	HX BOLTS, LOCK NUTS	Z	W	O	B	T	8	6.00
F-379	WHEEL BOLTS, Fr DRUM - 1.48" BOLTS	1/2-20 BOLTS	Z	W	O	B	T	10	8.00
F-781	WHEEL BOLTS, Fr DRUM - 1.69" BOLTS	1/2-20 BOLTS	Z	W	O	B	T	10	8.00
F-1353	WHEELS	1/2-20 LUG NUTS, 13/16" HX	Z	W	O	B	T	20	16.00

Transmission

F-1370	BELL HOUSING (manual) - 200	HX BOLTS, SPLIT WA'S	Z	-	O	-	-	8	8.00
F-1368	BELL HOUSING (manual) - 302/351	HX BOLTS, SPLIT WA'S	Z	W	O	B	T	12	14.00
F-1366	BELL HOUSING (manual) - 390/428 2-15-68 >	HX BOLTS, SPLIT WA'S	Z	W	O	-	T	12	14.00
F-1374	BELL HOUSING (manual) - 429	HX BOLTS, SPLIT WA'S	Z	-	-	-	-	12	14.00
F-474	CLUTCH BELLCRANK BRKT (exc 390/428)	FLNG BOLTS	Z	-	-	-	-	2	3.00
F-473	CLUTCH BELLCRANK BRKT'S - 390/428	FLNG BOLTS	Z	-	-	-	-	4	6.00
F-876	DRIVESHAFT - V8	5/16-24 LOCK NUTS ONLY	Z	W	O	B	T	4	3.00
F-1273	DRIVESHAFT - V8, 6 CYL 67-68 A/T, All 69 >	5/16" U-BOLTS, LOCK NUTS	Z	W	O	B	T	6	8.00
F-1806	ENGINE PLATE (M/T) - 429	UBS FLNG BOLTS	Z	-	-	-	-	4	5.00
F-1228	ENGINE PLATE (M/T) - 6 CYL & SB	UBS FLNG BOLTS	Z	W	O	B	T	2	3.00
F-2938	ENGINE PLATE (M/T) - BOSS 429	UBS FLNG BOLTS, HX SKT FLAT MS	Z	-	-	-	-	4	6.00
F-1230	INSPECTION COVER & ENG PLATE - C4, FMX	UBS FLNG BOLTS	Z	W	O	B	T	3	4.00
F-1229	INSPECTION COVER (A/T flywheel) - C6	UBS FLNG BOLTS	Z	W	O	B	T	4	4.00
F-2953	INSPECTION COVER (A/T or M/T flywheel)	HXWA AB SCREW	Z	-	-	-	-	2	3.00
F-1227	INSPECTION COVER (M/T flywheel) - 390/428	UBS FLNG BOLTS	Z	W	O	-	T	4	6.00
F-3263	PRESSURE PLATE > FLYWHEEL	SPL HX BOLTS, SPLIT WA'S	Z	W	O	B	T	12	6.00
F-909	SHIFTER (manual) LWR BOOT RETAINER	POZI PN SCREWS	Z	-	-	-	-	4	3.00
F-1239	SHIFTER ASSY > FLOOR - A/T	FLNG BOLTS	Z	-	-	-	-	4	3.00
F-1235	SHIFTER ASSY > FLOOR - A/T	PH OV T1 SCREWS	Z	-	-	-	-	4	2.00
F-1217	SHIFTER CONTROL > TRANS - 3 SPD	UBS FLNG BOLTS	Z	W	O	B	T	2	3.00
F-1218	SHIFTER CONTROL > TRANS - 4 SPD	FLNG BOLTS, POZI FLAT, SKT SCREWS	Z	W	O	B	T	5	12.00
F-1226	SHIFTER HANDLE - 3 SPD 64-73, 4 SPD 64-69	SHOULDER BOLTS, FLAT WA'S	Z	W	O	-	-	4	8.00
F-897	SHIFTER HANDLE (manual) > SHIFTER	FORD SHIFTERS, FLAT WA'S ONLY	Z	W	O	-	-	2	1.50
F-1242	SHIFTER LINKAGE - A/T	PERI KEPS NUT, PIN, FLAT & WAVE WA'S	Z	W	O	B	T	4	4.00
F-1222	SHIFTER RODS - 3 SPD	LOCK NUTS, WA'S, PINS	Z	W	O	B	T	14	8.00
F-1223	SHIFTER RODS - 4 SPD	LOCK NUTS, WA'S, PINS	Z	W	O	B	T	21	12.00
F-3413	SPEDOMETER CABLE > TRANS	HXWA EXT SEMS	Z	W	O	B	T	1	2.00
F-185	TORQUE CONVERTOR FLEX PLATE	FLNG NUTS	Z	W	O	B	T	4	4.00
F-1365	TRANS (auto) > ENGINE - 170/200	HX BOLTS, SPLIT WA'S	Z	-	O	B	-	8	8.00
F-1367	TRANS (auto) > ENGINE - 250/302/351 C4/FMX	HX BOLTS, SPLIT WA'S	Z	W	O	B	T	12	14.00
F-186	TRANS (auto) > ENGINE - 390/428	HX BOLTS, SPLIT WA'S	Z	W	O	-	T	12	14.00
F-3986	TRANS (auto) KICKDOWN RETAINERS - V8	Does both ends, CORRECT CLIPS	Z	W	-	-	-	2	4.00
F-678	TRANS (manual) > BELL HOUSING	HX BOLTS, SPLIT WA'S	Z	W	O	B	T	8	7.00
F-1841	TRANS ACCESS COVER - FORD 4 SPD	CORRECT SRTD FLNG BOLTS, "X" LONG	Z	W	O	B	T	10	12.00
F-816	TRANS COOLING LINE CLIPS	C CLIPS	Z	W	O	B	T	2	3.00
F-1203	TRANS CROSSMEMBER	FLNG BOLTS, LOCK NUTS, FLAT WA	Z	-	-	-	-	5	8.00
F-3904	TRANS CROSSMEMBER	POINTED BOLTS, SLOT NUTS, WA'S, PINS	-	-	O	-	-	8	10.00
F-1342	TRANS ID TAG	DRIVE SCREW	Z	W	O	B	T	1	1.00
F-176	TRANS INSULATOR - A/T	HX BOLTS, LOCK NUTS, WA'S	Z	-	-	-	-	8	8.00
F-3906	TRANS INSULATOR - All	POINTED HX BOLTS, NUTS, WA'S	-	-	O	-	-	10	8.00
F-1414	TRANS INSULATOR - M/T (exc 390/428)	HX SPLIT SEMS, LOCK NUTS, FLAT WA'S	Z	-	-	-	-	6	8.00
F-1741	TRANS INSULATOR - M/T 390/428/429	POINTED HX BOLTS, NUTS, WA'S	Z	-	-	-	-	8	8.00
F-1322	TRANS LEVERS > CASE - 3 SPD	HX NUTS, FLAT & SPLIT WA'S	Z	W	O	B	T	6	3.00
F-1385	TRANS LEVERS > CASE - 4 SPD	HX NUTS, FLAT & SPLIT WA'S	Z	W	O	B	T	9	3.00
F-1621	TRANS OIL PAN - C4	FLNG BOLTS	Z	W	O	B	T	11	4.00
F-892	TRANS OIL PAN - C6	FLNG BOLTS	Z	W	O	B	T	17	6.00
F-1622	TRANS OIL PAN - FMX	FLNG BOLTS	Z	W	O	B	T	14	5.00
F-2874	TRANS TAIL HOUSING - M/T	HX BOLTS, SPLIT WA'S	Z	W	O	B	T	10	8.00

Wipers

F-424	WASHER NOZZLES & TEE	HXWA AB TAPPING SCREWS	Z	W	-	-	-	3	2.50
F-978	WINDSHIELD WASHER BOTTLE	HXWA AB FLAT SEMS	Z	-	O	-	-	3	3.00
F-944	WIPER ARM PIVOTS > COWL PANEL	HX CONI SEMS	Z	-	-	-	-	6	4.00
F-733	WIPER MOTOR	HXWA EXT SEMS, HXWA AB SCREW	Z	W	-	-	-	4	4.00
F-3867	WIPER MOTOR BRACKET > COWL	CNTRS NK HX EXT SEMS	-	-	O	-	-	3	3.00
F-1415	WIPERS, INTERMITTENT GOVENOR	HXWA AB SCREWS	Z	-	-	-	-	2	2.00

See factory Assembly Manuals for illustrations

Ford Fastener Kits

1970

Air Conditioning

PART #	APPLICATION	NOTES						PCS	PRICE
			Z	W	O	B	T		
F-2037	AC BLOWER > DASH	HXWA AB SCREWS, SPRING NUTS	Z	-	-	-	-	6	3.00
F-716	AC BRUSH & HOLDER	HX FLNG SCREWS	Z	W	O	B	T	2	1.50
F-718	AC COMPRESSOR - 289/302/351/429	SRTD FLNG BOLTS	Z	W	O	B	T	4	6.00
F-713	AC COMPRESSOR - 390/428	SRTD FLNG BOLTS	Z	W	-	-	T	5	7.00
F-3299	AC COMPRESSOR - 429	SRTD HX FLNG & PLACE BOLTS	-	-	O	-	-	6	8.00
F-726	AC COMPRESSOR - 6 CYL	FLNG BOLTS	Z	-	O	B	T	4	6.00
F-727	AC COMPRESSOR BRACE (Rr) - 6 CYL	SRTD FLNG BOLTS, FLAT WA	Z	-	O	B	T	3	3.00
F-1291	AC COMPRESSOR BRACE (side) - 302/351	SRTD FLNG BOLTS	Z	W	O	B	T	4	6.00
F-3298	AC COMPRESSOR BRACE (side) - 429	SRTD FLNG BOLTS	Z	-	O	-	-	5	5.00
F-728	AC COMPRESSOR BRACE (side) - 6 CYL	SRTD FLNG BOLT, LOCK NUT	Z	-	O	B	T	2	2.00
F-719	AC COMPRESSOR BRACE (side) - V8, 70 FE	SRTD FLNG BOLTS	Z	-	-	-	T	3	6.00
F-720	AC COMPRESSOR BRACKET - 302/351	STUDS, LOCK NUTS	Z	W	O	B	T	6	8.00
F-3946	AC COMPRESSOR BRACKET - 429	STUDS, FLNG BOLTS, NUTS	Z	-	O	-	-	6	8.00
F-725	AC COMPRESSOR BRACKET - 6 CYL	SRTD FLNG BOLTS	Z	-	O	B	T	3	5.00
F-724	AC COMPRESSOR BRACKET - 69 V8, 70 FE	STUDS, LOCK NUTS	Z	W	-	-	T	6	6.00
F-721	AC COMPRESSOR CLUTCH	HX BOLT, FLAT WA	Z	W	O	B	T	2	3.00
F-717	AC COMPRESSOR FIELD	HX FLNG HD SCREWS	Z	W	O	B	T	4	3.00
F-441	AC CONDENSOR	HXWA AB SCREWS	Z	-	-	-	-	4	3.00
F-2962	AC DEHYDRATOR & RECEIVER TANK	HXWA A SCREWS	Z	W	-	-	-	3	2.00
F-436	AC FIREWALL SEAL RETAINER - 428	#14 HXWA AB SCREWS	Z	-	-	-	-	6	3.00
F-435	AC FIREWALL SEAL RETAINER (exc 428)	#8 HXWA AB SCREWS	Z	-	-	-	-	6	3.00
F-430	AC HOSES > COWL BRACES	RUBBER STRAPS w STEEL RIVET	Z	W	-	-	-	4	20.00
F-723	AC IDLER PULLEYS - 302/351	SRTD FLNG BOLTS, STUD, NUT, WA'S	Z	W	O	B	T	7	9.00
F-722	AC IDLER PULLEYS - 390/428	SRTD FLNG BOLTS, LOCK NUT, WA'S	Z	W	-	-	T	7	8.00
F-3297	AC IDLER PULLEYS & SUPPORT - 429	SRTD FLNG BOLTS, STUD, LOCK NUT	-	-	O	-	-	6	8.00
F-2909	AC TAG and COMPRESSOR LEAD WIRE	SPECIAL METAL T RETAINER	Z	W	O	-	-	1	3.00
F-433	AC UNIT > FIREWALL	STAMPED NUTS w SEALER	Z	-	-	-	-	3	4.00
F-729	AC VACUUM RESERVOIR > FENDER APRON	STAMPED NUTS	Z	-	-	-	-	2	2.00

Body

F-3622	AIR VENT GRILLES @ QTER PANELS	SS/BLACK PH PN AB SCREWS	Z	-	-	-	-	2	1.50
F-3948	AIR VENT OUTLETS @ KICK PANELS	HXWA AB SCREWS	Z	W	-	-	-	12	3.00
F-140	BATTERY TRAY	HX CONI SEMS, U-NUTS	Z	W	-	-	-	6	5.00
F-1717	BATTERY TRAY	FLNG BOLTS, U-NUTS	-	-	-	B	-	4	3.50
F-1563	BATTERY TRAY	HX CONI SEMS, CAGE NUT	-	-	-	-	T	5	6.00
F-2328	BED CORNERS - HOLE COVER PLATES	PH PN AB SCREWS	-	-	-	B	-	2	1.50
F-1556	BED CORNERS - HOLE COVER PLATES	PH PN A SCREWS	-	-	-	-	T	2	1.00
F-972	BRAKE PEDAL SUPPORT & BRACES	HX CONI SEMS, HXWA B SCREWS, KEPS	Z	-	-	-	-	11	8.00
F-1818	BUMPER (Fr)	SS CAPPED BOLTS, NUTS, CRUSH WA'S	Z	-	-	-	-	22	8.00
F-3603	BUMPER (Fr)	SS CAPPED BOLTS, NUTS, WA'S	-	W	-	-	-	20	14.00
F-3580	BUMPER (Fr)	SS CAPPED BOLTS, U & HX NUTS, WA'S	-	-	O	-	-	28	14.00
F-1834	BUMPER (Rr)	SS CAPPED BOLTS, LOCK NUTS	Z	W	-	-	-	12	9.00
F-3597	BUMPER (Rr)	SS CAPPED BOLTS, NUTS, CRUSH WA'S	-	-	O	-	-	24	10.00
F-3583	BUMPER BRACKETS (Fr)	FLNG BOLTS, CONI WA'S	-	-	O	-	-	8	10.00
F-3893	BUMPER BRACKETS (Fr) > FRAME	SPL UBS BOLTS, 11/16" HX	Z	W	-	-	-	4	12.00
F-776	BUMPER BRACKETS (Fr) > VALANCE	HX CONI SEMS, CAGE NUTS	Z	-	-	-	-	4	3.00
F-167	BUMPER BRACKETS (Rr)	HX CONI SEMS, SHIMS, CONI WA'S	Z	W	-	-	-	12	14.00
F-3593	BUMPER BRACKETS (Rr)	HX CONI SEMS	-	-	O	-	-	6	6.00
F-168	BUMPER GUARDS (Fr)	HX CONI SEMS, U-NUTS	Z	-	-	-	-	8	6.00
F-3600	BUMPERS (Fr & Rr) - CHROME	SS CAPPED BOLTS, NUTS, SPLIT WA'S	-	-	-	B	-	24	10.00
F-3599	BUMPERS (Fr & Rr) - PAINTED	CRG BOLTS, NUTS, SPLIT WA'S	-	-	-	B	-	24	6.00
F-955	CONVERTIBLE PUMP & BRACKETS	HX CONI SEMS, CAGE NUTS, NUTS, WA'S	Z	-	-	-	-	8	14.00
F-957	CONVERTIBLE TOP > BODY TACK STRIP	HX CONI SEMS, PH PN A SCREWS	Z	-	-	-	-	14	14.00
F-2003	CONVERTIBLE TOP > BOW LISTING	PH OV B SCREWS	Z	-	-	-	-	4	2.00
F-2060	CONVERTIBLE TOP FRAME > BODY	HX CONI SEMS	Z	-	-	-	-	6	5.00
F-155	COWL BRACES > COWL	HX CONI SEMS, FLNG NUTS	Z	W	-	-	-	8	10.00
F-261	COWL BRACES > COWL (70Z B429 only)	HX FLNG CONI SEMS BOLTS, FLNG NUTS	Z	-	-	-	-	8	14.00
F-150	COWL PANEL	HXWA & PH PN AB SCREWS	Z	W	-	-	-	7	3.00
F-3855	COWL PANEL	SS HXWA AB SCREWS	Z	-	-	-	-	5	3.00
F-2914	DOOR GLASS > CHANNEL (BOLT-IN GLASS)	PLASTIC BUSHINGS, ROUND NUTS, SEMS	Z	W	-	-	-	12	10.00
F-974	DOOR HANDLES (outside)	PH PN EXT SEMS, EXT KEPS NUTS	Z	-	-	-	-	4	2.50
F-819	DOOR HANDLES (outside)	EXT KEPS NUTS	-	W	-	-	-	4	2.00
F-1565	DOOR HANDLES (outside)	HXWA EXT SEMS, CONI KEP NUTS	-	-	-	-	T	4	3.00
F-170	DOOR HINGES	ORIGINAL HXWA SCREWS	Z	W	-	-	-	24	14.00
F-3444	DOOR HINGES	HX CONI SEMS	-	-	-	B	-	24	20.00
F-2932	DOOR HINGES	HX CONI SEMS	-	-	-	-	T	24	14.00
F-3447	DOOR LATCH REINFORCEMENTS	SS PH OV SCREWS, SS CNTSNK WA'S	Z	W	O	-	-	12	5.00
F-1360	DOOR LATCH ROD END BUSHINGS ONLY	5/32 SIZE, EXACTLY ORIGINAL	Z	W	O	-	-	14	7.00
F-1357	DOOR LATCH ROD END BUSHINGS ONLY	9/64 SIZE, EXACTLY ORIGINAL	-	-	-	B	-	12	7.00
F-1358	DOOR LATCH ROD END CLIPS	5/32 SIZE, EXACTLY ORIGINAL	Z	W	O	-	-	14	38.00
F-1356	DOOR LATCH ROD END CLIPS	9/64 SIZE, EXACTLY ORIGINAL	-	-	-	B	-	12	38.00

See factory Assembly Manuals for illustrations

Ford Fastener Kits

263

1970

Body

PART #	APPLICATION	NOTES						PCS	PRICE
			Z	W	O	B	T		
F-1135	DOOR LATCH STRIKERS	POZI FLAT SCREWS	Z	W	O	-	-	4	3.00
F-653	DOOR LATCHES > DOOR SHELL	PH FLAT EXT SEMS	Z	W	O	-	-	6	3.00
F-3281	DOOR STOP STRAPS	PH PN SCREWS	-	-	-	B	-	8	3.00
F-1545	DOOR VENT WINDOWS	PH OV & PH PN AB SCREWS	-	-	-	-	T	8	3.00
F-1721	FENDER > APRON BRACKETS	HX CONI SEMS, U-NUTS	-	-	-	B	-	6	5.00
F-1531	FENDER APRON LWR BRACKETS	HX T SCREWS, FLAT WA'S	-	-	-	-	T	8	4.00
F-1568	FENDER APRON TOP BRACKETS	HX CONI SEMS	-	-	-	-	T	6	8.00
F-1567	FENDER APRONS	FLNG BOLTS, HX CONI SEMS, NUTS, WA'S	-	-	-	-	T	30	20.00
F-3472	FENDER BRACES (Fr)	HX CONI SEMS, U-NUTS	-	W	-	-	-	8	4.00
F-160	FENDER EXTENSION PLATES (plastic)	PH PN B SCREWS	Z	-	-	-	-	4	1.00
F-172	FENDER EXTENSIONS	STUDS, CONI KEPS NUTS	Z	W	-	-	-	12	6.00
F-1569	FENDER EXTENSIONS	UBS FLNG BOLTS & NUTS	-	-	-	-	T	8	6.00
F-135	FENDER SPLASH SHIELDS (Fr) OF FENDER	HXWA AB SCREWS	Z	W	-	-	-	8	4.00
F-136	FENDER SPLASH SHIELDS (Rr) OF FENDER	HX CONI SEMS, HXWA SCREWS, U-NUTS	Z	W	-	-	-	12	8.00
F-3431	FENDER TOPS ONLY, "FLAG"	HX CONI SEMS, .88 WA OD	Z	W	O	-	-	12	10.00
F-2897	FENDER TOPS ONLY, "GL"	HX CONI SEMS, .88 WA OD	Z	W	O	-	-	12	10.00
F-2899	FENDER TOPS ONLY, "RBW"	HX CONI SEMS, .88 WA OD	Z	W	O	-	-	12	10.00
F-768	FENDERS	HX CONI SEMS, U & CAGE NUTS, WA'S	Z	W	-	-	-	44	37.00
F-3671	FENDERS	HX CONI SEMS, U-NUTS, SHIMS	-	-	O	-	-	50	34.00
F-1725	FENDERS	HX CONI & POZI EXT SEMS, U, CAGE NUTS	-	-	-	B	-	42	32.00
F-1571	FENDERS	HX CONI SEMS, U-NUTS, FLAT WA'S	-	-	-	-	T	34	24.00
F-1572	FLOOR BRACE ACCESS COVERS	HXWA AB SCREWS	-	-	-	-	T	8	3.00
F-567	FLOOR REINFORCEMENT - BODY 76	HX CONI SEMS	Z	-	-	-	-	6	12.00
F-171	FLOORBOARD HOLE COVERS 12/20/66 >	HXWA AB SCREWS	Z	W	-	-	-	8	3.00
F-3462	FUEL FILLER DOOR & TRIM	STAMPED NUTS	-	W	-	-	-	8	4.00
F-139	GRILLE	HXWA SCREW, PLASTIC RIVETS, NUT	Z	-	-	-	-	7	3.50
F-3672	GRILLE	HX CONI & POZI PN SEMS, U-NUTS	-	-	O	-	-	52	18.00
F-1709	GRILLE	HX CONI SEMS, J & U-NUTS	-	-	-	B	-	26	18.00
F-1575	GRILLE	HX CONI SEMS, J & U-NUTS	-	-	-	-	T	30	18.00
F-3463	GRILLE @ HOOD PEAK	HX CONI SEMS, STAMPED & U-NUTS	-	W	-	-	-	12	4.00
F-3464	GRILLE @ HOOD PEAK, SUPPORT ROD	HX CONI SEMS, HXWA AB SCREW, U-NUT	-	W	-	-	-	3	2.00
F-3673	GRILLE BRACKETS	U-NUTS	-	-	O	-	-	4	2.00
F-138	GRILLE CENTER SUPPORT	HX CONI SEMS, U-NUTS	Z	-	-	-	-	4	3.00
F-2952	GRILLE EMBLEM	STAMPED NUTS	Z	-	-	-	-	2	2.00
F-3459	GRILLE, RH & LH	HX CONI SEMS, U-NUTS	-	W	-	-	-	8	4.00
F-1577	GRILLE, UPPER SUPPORT	HX CONI SEMS, J-NUTS	-	-	-	-	T	8	6.00
F-258	HEADLAMP DOORS	PH OV & PN AB SCREWS, NYLON NUTS	Z	-	-	-	-	10	4.00
F-3674	HEADLAMP DOORS - FLAT TYPE	PH PN SCREWS, NYLON NUTS	-	-	O	-	-	12	3.00
F-3458	HEADLAMP HOUSINGS	HX CONI SEMS, U-NUTS	-	W	-	-	-	6	3.00
F-1726	HEADLAMP, SPLASH SHIELDS	PH PN A SCREWS, SPRING NUTS	-	-	-	B	-	8	3.00
F-1733	HOOD	HX CONI SEMS	-	-	-	B	-	4	4.00
F-144	HOOD & HINGES	HX CONI SEMS, U-NUTS	Z	W	-	-	-	14	12.00
F-1579	HOOD & HINGES	HX CONI SEMS, U-NUTS	-	-	-	-	T	14	12.00
F-1582	HOOD BUMPERS > HOOD	PH PN AB SCREWS	-	-	-	-	T	8	2.00
F-1482	HOOD HINGE NUTS (in fender aprons)	5/16-18 PIERCE NUTS	Z	W	-	-	-	6	4.00
F-1713	HOOD LATCH	HX CONI SEMS, U-NUTS	-	-	-	B	-	8	6.00
F-158	HOOD LATCH & CATCH	HX CONI SEMS, U-NUTS	Z	W	-	-	-	6	5.00
F-1585	HOOD LATCH & CATCH	HX CONI SEMS, U-NUTS	-	-	-	-	T	11	10.00
F-1737	HOOD LATCH AUXILIARY CATCH	HX CONI SEMS, U-NUTS	-	-	-	B	-	4	4.00
F-157	HOOD LATCH SUPPORT	HX CONI SEMS	Z	-	-	-	-	3	3.00
F-3461	HOOD LATCH SUPPORT	HX CONI SEMS	-	W	-	-	-	4	4.00
F-3460	HOOD LATCH VERTICAL SUPPORTS	HX CONI SEMS, U-NUTS	-	W	-	-	-	8	6.00
F-156	HOOD LEVELERS	U-NUTS, JAM NUTS	Z	-	-	-	-	4	2.50
F-1729	HOOD PROP ROD	COTTER PIN, FLAT WA'S	-	-	-	B	-	3	2.00
F-3880	HOOD SCOOP	STAMPED NUTS w SEALER, SPL STUDS	Z	-	-	-	-	18	24.00
F-1160	HOOD SCOOP	STAMPED NUTS w SEALER	Z	-	-	-	-	9	12.00
F-1801	HOOD SCOOP	STAMPED NUTS w SEALER	-	W	-	-	-	20	16.00
F-147	HOOD SCOOP GRILLE & SEAL	PH PN & PH TRUSS WA SCREWS	Z	-	-	-	-	6	2.00
F-1259	HOOD SCOOP, RAM-AIR - BOSS 429	EXT KEPS NUTS, STUDS	Z	-	-	-	-	20	14.00
F-1350	HOOD TWIST LOCK CATCHES (on extension)	HX CONI SEMS, U-NUTS	Z	-	-	-	-	8	6.00
F-1351	HOOD TWIST LOCK EXTENSIONS	HX CONI SEMS, U-NUTS	Z	-	-	-	-	12	7.00
F-1349	HOOD TWIST LOCK RETAINERS (on hood)	HX CONI SEMS	Z	-	-	-	-	4	4.00
F-968	INSTRUMENT PANEL (welded assembly)	PH PN B SCREWS	Z	-	-	-	-	2	1.00
F-970	INSTRUMENT PANEL CENTER BRACES	HX CONI SEMS, HXWA B SCREW	Z	-	-	-	-	3	2.50
F-969	INSTRUMENT PANEL SIDE BRACKETS	HX CONI SEMS, CAGE NUTS	Z	-	-	-	-	6	6.00
F-1740	JACK CLAMP > FENDER APRON	HX BOLTS, WING & HX NUTS, FLAT WA'S	-	-	-	B	-	13	6.00
F-1587	JACK CLAMP > FENDER APRON	HX CONI SEMS, BOLT, WING & KEPS NUT	-	-	-	-	T	9	6.00
F-790	LICENSE PLATE BRACKET (Fr)	HX CONI SEMS, CONI KEPS NUT	Z	-	-	-	-	4	3.50
F-3471	LICENSE PLATE BRACKET (Fr)	HX CONI SEMS, CONI KEPS NUTS, U-NUT	-	W	-	-	-	6	3.00
F-1588	LICENSE PLATE BRACKET (Rr)	HX CONI SEMS, FLNG NUTS	-	-	-	-	T	4	3.00
F-1842	LICENSE PLATE BUMPERS (Rr)	ORIGINAL RUBBER BUMPERS	Z	-	-	-	-	2	2.00
F-151	LICENSE PLATE LAMP SHIELD	PH RNDWA AB SCREWS	Z	-	-	-	-	3	1.50
F-2440	LICENSE PLATE SUPPORT (Rr)	HXWA T1 SCREWS	-	-	-	B	-	6	3.00
F-3481	LICENSE PLATES	HXWA B SCREWS, NYLON NUTS	Z	W	O	B	T	8	4.00
F-3277	LIFTGATE HANDLE	POZI OV SCREWS, CONI KEPS NUTS	-	-	-	B	-	4	3.00

Kits Contain Attaching Fasteners for Both Sides

Ford Fastener Kits

1970

Body

PART #	APPLICATION	NOTES						PCS	PRICE
			MUSTANG	COUGAR	FAIRLANE	BRONCO	TRUCK		
F-3275	LIFTGATE HINGE > TOP	PH OV SCREWS, CONI KEPS NUTS	-	-	-	B	-	16	5.00
F-3279	LIFTGATE LATCH (center)	POZI OV EXT SEMS, POZI PN CONI SEMS	-	-	-	B	-	7	4.00
F-3280	LIFTGATE LATCH ACCESS COVERS	PH PN A SCREWS	-	-	-	B	-	6	2.00
F-3274	LIFTGATE LATCH SHIELDS	PH FLAT F SCREWS	-	-	-	B	-	4	2.00
F-3272	LIFTGATE LATCH STRIKERS	POZI OV EXT SEMS	-	-	-	B	-	4	3.00
F-3270	LIFTGATE PROPS	HX CONI SEMS, PH PN SCREWS	-	-	-	B	-	8	4.00
F-802	MIRROR (outside) > DOOR - 1 MIRROR	SS/CHROME POZI OV SCREW, RIV NUTS	Z	W	O	B	T	4	3.00
F-1512	MIRROR (outside) > DOOR - 2 MIRRORS	SS/CHROME POZI OV SCREW, RIV NUTS	Z	W	O	B	T	8	5.00
F-163	QTER PANEL EXTENSIONS	STUDS, CONI KEPS NUTS, FLAT & SEALER	Z	W	-	-	-	24	12.00
F-1589	RADIATOR SUPPORT	HX CONI SEMS, U-NUTS	-	-	-	-	T	16	14.00
F-1292	ROOFSIDE WEATHERSTRIP - BODY 63	PH PN & PH RNDWA SCREWS, NUTS	Z	-	-	-	-	36	10.00
F-1293	ROOFSIDE WEATHERSTRIP - BODY 65	PH PH AB & PH DRILL SCREWS, RIVETS	Z	-	-	-	-	34	8.00
F-1068	SHOCK TOWER BRACES - BOSS 429	HX CONI & EXT SEMS	Z	-	-	-	-	12	14.00
F-154	SHOCK TOWER BRACES (cover springs)	HX CONI SEMS, FLNG NUTS	Z	W	-	-	-	24	14.00
F-976	SPOILER (Fr)	PH RNDWA AB SCREWS	Z	-	-	-	-	12	6.00
F-3921	SPOILER (Rr) > SUPPORTS	SKT HD SCREWS, PH OV SCREWS, WA'S	Z	-	-	-	-	18	6.00
F-1434	SPOILER (Rr) SUPPORTS > DECKLID	CONI KEPS NUTS, RUBBER CAPS, SEALER	Z	-	-	-	-	12	6.00
F-1104	STEERING COLUMN SEAL	LARGE HX PERI SEMS	Z	-	-	-	-	4	6.00
F-137	STONE DEFLECTOR	HX CONI SEMS, U-NUTS	Z	-	-	-	-	8	5.00
F-3470	STONE DEFLECTOR	HX CONI SEMS, U-NUTS	-	W	-	-	-	12	5.00
F-1591	STONE DEFLECTOR	HX CONI SEMS, BOLTS, KEPS, U-NUTS	-	-	-	-	T	20	12.00
F-2331	TAILGATE HINGES	HX CONI SEMS	-	-	-	B	-	4	5.00
F-1593	TAILGATE HINGES	HX CONI SEMS	-	-	-	-	T	4	5.00
F-1592	TAILGATE LATCH CATCHES	HX CONI SEMS	-	-	-	B	T	4	4.00
F-2334	TAILGATE LATCHES	HX CONI SEMS	-	-	-	B	-	4	5.00
F-1595	TAILGATE LATCHES	HX CONI SEMS	-	-	-	-	T	4	4.00
F-1597	TAILGATE RELEASE HANDLE	FLNG NUT ONLY	-	-	-	-	T	1	1.00
F-2337	TAILGATE RELEASE HANDLE BEZEL	POZI OV EXT & HX CONI SEMS	-	-	-	B	-	6	4.00
F-1596	TAILGATE RELEASE HANDLE BEZEL	POZI OV EXT & HX CONI SEMS, RIV NUTS	-	-	-	-	T	10	5.00
F-2327	TAILGATE SUPPORT ARMS	HX CONI SEMS	-	-	-	B	-	4	4.00
F-1599	TAILGATE SUPPORT ARMS	HX CONI SEMS	-	-	-	-	T	4	4.00
F-1552	TAILGATE SUPPORT BUMPERS	PH PN A SCREWS	-	-	-	B	-	2	4.00
F-255	TIE DOWN BRACKETS (Rr)	HX CONI SEMS, LOCK NUTS	Z	-	-	-	-	10	20.00
F-3267	TOP ASSEMBLY, LONG > BODY	HX CONI SEMS, FLNG BOLTS, NUTS, WA'S	-	-	-	B	-	68	34.00
F-165	TRUNK LATCH & STRIKER	HX CONI SEMS	Z	W	-	-	-	5	5.00
F-152	TRUNK LID & HINGES	HX CONI SEMS	Z	-	-	-	-	8	8.00
F-818	TRUNK LID & HINGES	HX CONI SEMS	-	W	-	-	-	8	7.00
F-572	TRUNK LID BUMPERS (Body 65, 76 69-70)	.50 H BUMPERS	Z	-	-	-	-	2	5.00
F-2955	TRUNK LID PROP ROD	PH PN AB SCREW	Z	-	-	-	-	1	1.50
F-161	VALANCE (Fr)	HX CONI SEMS, U-NUTS	Z	-	-	-	-	18	12.00
F-3469	VALANCE (Fr)	HX CONI SEMS, U-NUTS	-	W	-	-	-	18	9.00
F-162	VALANCE (Fr) OUTER SUPPORTS	HX CONI SEMS, U-NUTS	Z	-	-	-	-	4	3.00
F-166	VALANCE (Rr)	CLIP HEAD BOLTS, PH PN SCREWS, NUTS	Z	W	-	-	-	15	7.00
F-2853	VALANCE (Rr)	CLIP-HEAD BOLTS, HXWA SCREWS, NUTS	-	-	O	-	-	12	20.00
F-2954	WEATHERSTRIP - DOOR BOTTOM	PH PN AB SCREWS	Z	W	-	-	-	14	3.00
F-3930	WEATHERSTRIP > CONVERTIBLE TOP	PH PN AB SCREWS, EXT KEPS NUTS	Z	-	-	-	-	31	6.00
F-1749	WEATHERSTRIP, DOORS	PH PN AB SCREWS	Z	-	-	-	-	10	2.00
F-1260	WINDOW (quarter) GUIDE EXTENSIONS	Visible in jamb area, HX CONI SEMS	Z	-	-	-	-	4	4.00
F-1298	WINDOW SEALS @ DOOR Rr & QTER - B 63	PH PN AB SCREWS	Z	-	-	-	-	10	2.00
F-1299	WINDOW SEALS @ DOOR Rr, QTER - 65, 76	PH PN AB SCREWS	Z	-	-	-	-	18	3.00
F-3255	WINDOW SLATS (louvers) - DEALER ADDED	PH OV SCREWS, RUBBER NUT INSERTS	Z	-	-	-	-	16	8.00
F-3254	WINDOW SLATS (louvers) - FACTORY	PH OV SCREWS, STEEL RIVET NUTS	Z	-	-	-	-	16	8.00
F-1153	WINDOW, DOORS - STOP COVERS @ Rr	HX CONI SEMS	Z	-	-	-	-	4	4.00
F-1462	WINDSHIELD HOLD-DOWN RETAINER	SRTD FLNG NUTS	-	-	-	B	-	2	1.50

Brakes

F-1616	BRAKE ASSEMBLY (front drum) > SPINDLE	T-BOLTS, LOCK NUTS	Z	W	O	-	-	16	14.00
F-1480	BRAKE BOOSTER > FIREWALL	HX SPLIT SEMS, FLNG NUTS	Z	W	O	-	-	5	8.00
F-3882	BRAKE BOOSTER HOSE	FLAT WOUND SPRING CLAMPS, BLACK	Z	W	O	B	T	2	2.00
F-1276	BRAKE BOOSTER HOSE > BOSS 429	BRASS FITTING FROM KAR-KRAFT	Z	-	-	-	-	1	20.00
F-1791	BRAKE CABLE SEAL @ BRAKE PLATES	1.0" DIA X .58 TK RUBBER SEAL	Z	W	O	-	-	2	3.00
F-575	BRAKE CABLES > BODY	RETAINING CLIPS, HX NUTS	Z	W	O	-	-	6	4.00
F-2985	BRAKE CALIPER BLEEDERS	CORRECT SCREWS	Z	W	O	-	T	2	4.00
F-3698	BRAKE CALIPER HARDWARE - COMPLETE	STAB'S, CLIPS, INSULATORS, SCREWS	Z	W	O	-	-	30	50.00
F-1263	BRAKE CALIPERS > SPINDLE	DRILLED GR-8 BOLTS, SPLIT WA'S	Z	W	O	-	-	8	38.00
F-579	BRAKE DRUM RETAINERS	GREEN PUSH ON RETAINERS	Z	W	O	B	T	6	4.00
F-1757	BRAKE HOSE > AXLE HSNG - 428CJ & BOSS	HX BOLT, SPLIT WA	Z	W	-	-	-	2	2.00
F-1249	BRAKE HOSE BRKTS (drum) (Fr) > BODY	HXWA C SCREWS	Z	W	O	-	-	4	3.00
F-1250	BRAKE HOSES (disc) > BODY	HXWA C SCREWS, U-CLIP	Z	W	O	-	-	5	5.00
F-577	BRAKE HOSES (drum) > BRACKET	U-CLIPS	Z	W	O	-	-	3	4.00
F-1517	BRAKE HOSES > CALIPER	RED GR-8 DRILLED HX BOLTS, COP WA'S	Z	W	O	-	-	6	20.00
F-670	BRAKE LIGHT SWITCH	RETAINING PIN	Z	W	O	B	T	1	2.00

See factory Assembly Manuals for illustrations

1970

Brakes

PART #	APPLICATION	NOTES						PCS	PRICE
			Z	W	O	B	T		
F-669	BRAKE PLATE ADJUST HOLE PLUGS (2)	RUBBER PLUGS	Z	W	O	B	T	2	3.00
F-1601	BRAKE ROTOR SHIELDS	HX EXT SEMS	Z	W	O	-	-	6	4.00
F-1475	MASTER CYLINDER w POWER BRAKES	FLNG NUTS	Z	W	O	B	T	2	3.00
F-1473	MASTER CYLINDER w/o POWER BRAKES	HX SPLIT SEMS	Z	W	O	B	-	2	5.00
F-1333	PARKING BRAKE CONTROL > BODY	HXWA SRTD SCREWS	Z	W	O	-	-	3	4.00
F-799	PROPORTIONING VALVE > APRON	UBS FLNG NUTS	Z	W	O	-	-	2	2.00
F-2950	WHEEL CYLINDER BLEEDERS	1/4-28 x 1/4 HX x 92" OAL SCREWS, ZDC	Z	W	O	B	T	2	3.00
F-356	WHEEL CYLINDERS (2) - 250 & All 8 CYL	5/16-18 HX EXT SEMS	Z	W	O	B	T	4	3.00
F-1772	WHEEL CYLINDERS (4) - 170/200	1/4-20 HX EXT SEMS	Z	-	-	-	-	8	6.00
F-3912	WHEEL CYLINDERS (4) - 250 & All 8 CYL	5/16-18 HX EXT SEMS	Z	W	O	B	T	8	6.00

Brake & Fuel Lines - also see page 216

F-3978	BRAKE LINES (shared fuel vapor line)	CORRECT CLIPS, SCREWS, GROMMETS	Z	W	-	-	-	18	28.00
F-3977	BRAKE LINES (w/o fuel emission system)	CORRECT CLIPS, SCREWS, GROMMETS	Z	W	-	-	-	24	30.00
F-3964	FUEL LINE @ ROCKER, Mid 67-70 HT, 71-73	CLIP w SQUEEZE RETAINER	Z	W	-	-	-	1	4.00
F-668	FUEL LINE GROMMET (fender apron)	RUBBER GROMMET	Z	W	-	-	-	1	3.00
F-3975	FUEL LINES - 6 CYL CNV or V8 HT	CORRECT CLIPS, SCREWS, GROMMET	Z	W	-	-	-	12	18.00
F-3974	FUEL LINES - 6 CYL HARDTOP	CORRECT CLIPS, SCREWS, GROMMET	Z	W	-	-	-	10	16.00
F-3976	FUEL LINES - V8 CONVERTIBLE	CORRECT CLIPS, SCREWS, GROMMET	Z	W	-	-	-	14	20.00
F-3979	FUEL VAPOR LINES (not shared with brake)	CLIPS, HXWA AB SCREWS	Z	W	-	-	-	6	8.00

Cooling

F-389	RADIATOR - 302/351 XC, 390/428	HX CONI SEMS, SCREWS, CAGED NUTS	Z	W	O	-	-	6	5.00
F-393	RADIATOR - STD COOLING	HX CONI SEMS, U-NUTS	Z	W	O	-	-	8	6.00
F-1312	RADIATOR - TOP SCREWS (if equipped)	5/16" DIA HX A SCREWS	Z	-	-	-	-	2	3.00
F-403	RADIATOR FAN SHROUD - All	SPL HXWA SCREWS, SPRING NUTS	Z	W	O	-	-	8	6.00
F-657	RADIATOR HOSE CLAMPS - 289/302/351	WIRE TYPE	Z	W	O	B	T	4	16.00
F-3936	RADIATOR HOSE CLAMPS - 351C	WIRE TYPE	Z	W	O	-	-	4	16.00
F-658	RADIATOR HOSE CLAMPS - 390/428	WIRE TYPE	Z	W	O	-	T	4	20.00
F-656	RADIATOR HOSE CLAMPS - 6 CYL	WIRE TYPE	Z	W	O	-	T	4	16.00
F-2919	RADIATOR HOSE CLAMPS - All 429	WIRE TYPE	Z	-	-	-	-	4	20.00

Differential

F-1440	AXLE RETAINER PLATES - 250 & 8 CYL	T-BOLTS, LOCK NUTS	Z	W	O	-	-	16	20.00
F-1161	AXLE RETAINER PLATES - NUTS ONLY	LOCK NUTS (Red)	Z	W	O	-	-	8	6.00
F-2491	AXLE VENT SYSTEM	FITTING, HOSE, CLAMPS, SCREW, SLEEVE	Z	-	-	-	-	7	25.00
F-1165	DIFFERENTIAL CARRIER > HOUSING	COPPER WA'S ONLY	Z	W	O	B	T	10	4.00
F-785	DIFFERENTIAL CARRIER > HOUSING	RED LOCK NUTS, COPPER WA'S	Z	W	O	B	T	20	12.00
F-3987	DIFFERENTIAL FLANGE > PINION	GR-8 3/4-20 TOP-LOK FLNG LOCKNUT	Z	W	O	B	T	1	5.00
F-374	DIFFERENTIAL PINION SUPPORT	PLACE BOLTS	Z	W	O	B	T	5	8.00

Electrical

F-1317	ALTERNATOR - 200 6 CYL	HX, SRTD HX FLNG & PLACE BOLTS	Z	-	O	B	-	5	18.00
F-1319	ALTERNATOR - 250 6 CYL	HX, SRTD HX FLNG & PLACE BOLTS	Z	-	O	B	T	5	18.00
F-3315	ALTERNATOR - 302/351W less SPACER	HX, SRTD FLNG & PLACE BOLTS, WA	Z	W	O	B	T	5	10.00
F-3314	ALTERNATOR - 302/351W w SPACER	HX, SRTD FLNG & PLACE BOLTS, SPACER	Z	W	O	B	T	6	18.00
F-3213	ALTERNATOR - 351C less SPACER	HX & SRTD FLNG BOLTS, SPLIT WA	Z	W	O	B	T	3	10.00
F-1494	ALTERNATOR - 351C w SPACER	HX & SRTD FLNG BOLTS, SPACER	Z	W	O	B	T	4	16.00
F-629	ALTERNATOR - 390/428 less SPACER	HX, HX FLNG & PLACE BOLTS, SPLIT WA	Z	W	O	-	T	4	7.00
F-630	ALTERNATOR - 390/428 w SPACER	HX, FLNG & PLACE BOLTS, PINK SPACER	Z	W	O	-	T	6	18.00
F-3300	ALTERNATOR - 429	HX FLNG & PLACE BOLTS, SPACERS	-	-	O	-	-	6	34.00
F-3533	ALTERNATOR - BOSS 302 w SPACER	HX, FLNG & PLACE BOLTS, SPACER, WA	Z	W	-	-	-	7	20.00
F-1751	ALTERNATOR - BOSS 429	HX & FLNG BOLTS, 2 SPACERS, SPLIT WA	Z	-	-	-	-	6	30.00
F-652	ALTERNATOR HOUSING THRU BOLTS	HXWA SCREWS	Z	W	O	B	T	3	3.00
F-644	ALTERNATOR PULLEY	HX NUT & SPLIT WA (ZDC)	Z	W	O	B	T	2	2.00
F-1172	ALTERNATOR WIRING	10-24 CONI KEPS NUTS	Z	W	O	B	T	2	1.50
F-779	ANTENNA > FENDER	PH OV AB SCREWS	Z	W	O	B	T	4	2.00
F-1152	BACK-UP LAMP LENSES	1.25" L SS PH PN B STOP SCREWS	Z	-	-	-	-	4	2.00
F-471	BACK-UP LAMPS > Rr VALANCE	STAMPED NUTS, CUPPED WA'S	Z	W	O	B	T	8	6.00
F-638	BATTERY CABLES - 302/351W	HX BOLT, CONI KEPS, EXT WA	Z	W	O	B	T	5	4.00

Kits Contain Attaching Fasteners for Both Sides

Ford Fastener Kits

1970

Electrical

PART #	APPLICATION	NOTES						PCS	PRICE
			MUSTANG	COUGAR	FAIRLANE	BRONCO	TRUCK		
F-639	BATTERY CABLES - 351C	HX BOLTS, CONI KEPS, EXT WA'S	Z	W	O	B	T	7	4.00
F-642	BATTERY CABLES - 390/428	HX BOLT, CONI KEPS, EXT WA	Z	W	O	-	T	5	4.00
F-635	BATTERY CABLES - 6 CYL	HX BOLT, CONI KEPS, EXT WA	Z	-	O	B	T	5	4.00
F-1195	BATTERY HOLDOWN CLAMP	J- HOOKS, HXWA AB SCREW, CONI KEPS	Z	W	O	B	T	5	6.00
F-742	BATTERY HOLDOWN CLAMP - NUT ONLY	CONI KEPS NUTS	Z	W	O	B	T	2	2.00
F-1190	BATTERY TERMINALS	SQR HD BOLTS, NUTS	Z	W	O	B	T	4	3.00
F-646	DISTRIBUTOR POINTS & COND - DUAL PT	SLOT PN C SCREWS	Z	W	O	B	T	5	3.00
F-645	DISTRIBUTOR POINTS & COND - SINGLE	SLOT PN C SCREWS	Z	W	O	B	T	3	2.00
F-1149	HEADLAMP ADJUSTER NUT > EXTENSION	PH PN B SCREWS	Z	-	-	-	-	8	2.50
F-3992	HEADLAMP ADJUSTERS	ADJUSTERS, SCREWS, SPRINGS	Z	-	-	-	-	14	10.00
F-2933	HEADLAMP ADJUSTERS	ADJUSTERS, SCREWS, SPRINGS	-	W	-	-	-	28	20.00
F-740	HEADLAMP DIMMER SWITCH	HXWA AB SCREWS	Z	W	O	-	-	2	2.00
F-599	HEADLAMP RETAINING RINGS (2)	SS PH FILL B SCREWS	Z	-	-	-	-	6	3.00
F-2941	HEATER MOTOR GROUND	HXWA AB SCREW	Z	W	-	-	-	1	1.50
F-3222	HOOD SCOOP TURN LAMPS & WIRING	HXWA AB & PH PN B SCREWS, CLIPS	Z	-	-	-	-	8	5.00
F-1166	HORNS	HX CONI SEMS, SRTD FLNG NUTS	Z	W	O	B	T	4	3.00
F-1805	IGNITION COIL BRACKET - BOSS 302	HX SPLIT SEMS	Z	W	-	-	-	3	5.00
F-1623	IGNITION COIL STRAP & BRKT - 351C/429	HX SPLIT SEMS, HXWA SCREW, HX NUT	Z	W	O	B	T	3	3.00
F-422	IGNITION COIL STRAP & BRKT - 6 CYL	HX SPLIT SEMS, HXWA SCREW, HX NUT	Z	W	O	B	T	4	3.00
F-376	IGNITION COIL STRAP & BRKT - V8 exc 351C	HX SPLIT SEMS, HXWA SCREW, HX NUT	Z	W	O	B	T	3	3.00
F-1301	IGNITION COIL STRAP ONLY	HXWA SCREW, HX NUT	Z	W	O	B	T	2	1.50
F-448	LICENSE PLATE LAMP	HXWA AB SCREWS	Z	-	-	-	-	2	1.00
F-2968	MAP LIGHT @ GLOVE BOX - DLX	PH PN AB SCREWS	Z	-	-	-	-	3	2.00
F-2967	MAP LIGHT @ GLOVE BOX - STD	HXWA SCREWS	Z	-	-	-	-	2	1.50
F-3443	NEUTRAL SWITCH	HX EXT SEMS	Z	W	O	B	T	2	3.00
F-2947	PARKING LAMP LENSES	SS PH PN STOP SCREWS	Z	-	-	-	-	4	2.00
F-456	PARKING LAMPS (below bumper)	HX CONI SEMS	Z	-	-	-	-	4	4.00
F-427	RADIO - HOOD GROUND	HXWA AB SCREW ONLY	Z	W	-	-	-	1	1.50
F-1092	RADIO > INSTRUMENT PANEL	HXWA AB SCREWS, EXT KEPS & NUTS	Z	-	-	-	-	5	2.00
F-2026	RADIO SPEAKER > DASH	CLIP HEAD BOLTS, EXT KEPS NUTS	Z	-	-	-	-	8	3.00
F-894	REV LIMETER & SHIELD - 428CJ	HXWA AB SCREWS, HX CLR STUD, NUT	Z	W	-	-	-	7	8.00
F-1070	REV LIMETER & SHIELD - BOSS 302/429	HXWA AB SCREWS, EXT KEPS NUT	Z	W	-	-	-	6	3.00
F-457	SIDE MARKERS LAMPS (Fr)	MT STAMPED NUTS	Z	-	-	-	-	4	4.00
F-451	SIDE MARKERS LAMPS (Rr)	STAMPED NUTS, FLAT WA'S, CAPS	Z	-	-	-	-	12	6.00
F-3487	SPORT LAMP BRACKETS (Mach 1 grille)	HX CONI SEMS, U-NUTS	Z	-	-	-	-	8	4.00
F-1071	SPORT LAMPS (Mach 1 grille)	PH RNDWA SCREWS, SPRG & STMP NUTS	Z	-	-	-	-	24	8.00
F-1410	STARTER - 289/302/351	HXWA SPLIT SEMS, YLW ZINC	Z	W	O	B	T	2	3.50
F-408	STARTER - 6 CYL & 390/428	HX SPLIT SEMS	Z	W	O	-	T	3	4.00
F-407	STARTER SOLENOID	HXWA AB SCREWS "D"	Z	W	O	B	T	2	1.50
F-445	TAILAMP ASSEMBLY > BODY	NUTS, GRAY CAPS, SEALER	Z	-	-	-	-	10	12.00
F-820	TAILAMP ASSEMBLY > BODY	NUTS w SEALER, STUDS	-	W	-	-	-	24	10.00
F-1761	TAILAMP WIRING > T/L BODY STUDS	ROUND FLAT NUTS	Z	-	-	-	-	4	3.00
F-2956	TAILAMP WIRING GROUND @ LATCH	HXWA AB SCREW	Z	W	-	-	-	1	1.50
F-1775	TRUNK LAMP	HXWA AB SCREW, EXT WA	Z	-	-	-	-	2	1.50
F-405	VOLTAGE REGULATOR & SPLASH SHIELD	HXWA A SCREWS "D", EXT WA	Z	W	-	-	-	5	2.00
F-3823	WIRING - 6 CYL IGNITION COIL	RUBBER COATED "J" CLIP	Z	W	O	-	T	1	1.50
F-3821	WIRING - CONVERTIBLE TOP CONTROL	NYLON "O" CLIPS, 4" FLAT NYLON STRAP	Z	-	-	-	-	7	6.00
F-3819	WIRING - DOOR COURTESY & SPEAKER	NYLON "O" CLIPS	Z	-	-	-	-	2	3.00
F-460	WIRING - ENGINE FEED - 8 CYL w AC	RUBBER COATED "J" CLIPS	Z	W	O	B	T	4	5.00
F-423	WIRING - ENGINE FEED - 8 CYL w/o AC	RUBBER COATED "J" CLIPS	Z	W	O	B	T	3	4.00
F-587	WIRING - FIREWALL	4" NYLON STRAPS (1 for washer hose)	Z	W	-	-	-	3	4.00
F-3523	WIRING - FRONT CROSSMEMBER	DOUBLE LOOP NYLON RETAINERS	Z	-	-	-	-	4	10.00
F-416	WIRING - HORN FEED	NYLON "O" CLIPS	Z	W	-	-	-	4	4.00
F-1809	WIRING - P/L LEADS (exc Mach 1)	6 3/4" NYLON STRAPS	Z	-	-	-	-	2	4.00
F-3816	WIRING - RADIO CABLE > DASH	NYLON "S" CLIPS	Z	-	-	-	-	2	3.00
F-417	WIRING - RH COWL BRACE & ALTERNATOR	NYLON "O" CLIPS	Z	W	-	-	-	4	5.00
F-1807	WIRING - RH SHOCK TOWER	5" NYLON STRAPS	Z	W	-	-	-	2	3.00
F-418	WIRING - SIDE MARKER & HEADLAMPS	NYLON "O" CLIPS	Z	W	-	-	-	4	5.00
F-419	WIRING - SPORT LAMPS	6 3/4" NYLON STRAPS, NYLON "O" CLIPS	Z	-	-	-	-	4	6.00
F-461	WIRING - TURN SIGNAL LAMPS ON SCOOP	NYLON "O" CLIPS	Z	-	-	-	-	2	3.00
F-3818	WIRING - UNDER DASH	NYLON "O" CLIPS	Z	-	-	-	-	7	7.00
F-3830	WIRING - VARIOUS LOCATIONS	ZIP TIES	Z	-	-	-	-	12	4.00

Emissions

F-1194	PCV HOSES - 390/428	4 WIRE CLAMPS	Z	W	-	-	T	4	4.00
F-1197	PCV HOSES - BOSS 302	2 WIRE CLAMPS	Z	W	-	-	-	2	2.50
F-1198	PCV HOSES - BOSS 429	1 WIRE CLAMP	Z	-	-	-	-	1	2.00
F-1278	PCV VALVE ELBOW - 390/428	1/4" NPT > 1/2" HOSE STEEL ELBOW	Z	W	O	B	T	1	20.00
F-631	SMOG PUMP - 390/428	BOLTS, CONI SEMS, SPACER, NUTS, WA'S	Z	W	-	-	T	5	16.00
F-1148	SMOG PUMP - BOSS 302	PLACE BOLT, HX CONI SEMS, FLNG NUTS	Z	W	-	-	-	4	22.00
F-1336	SMOG PUMP - BOSS 429	HX BOLT, CONI SEMS, FLAT & SPLIT WA'S	Z	-	-	-	-	4	20.00
F-2951	SMOG PUMP PULLEY - BOSS 429	HX SPLIT SEMS	Z	-	-	-	-	3	6.00
F-1066	VACUUM TREE > FIREWALL	HXWA AB SCREWS	Z	W	O	-	-	2	1.50

See factory Assembly Manuals for illustrations

Ford Fastener Kits

267

1970

Exhaust

PART #	APPLICATION	NOTES						PCS	PRICE
			MUSTANG	COUGAR	FAIRLANE	BRONCO	TRUCK		
F-1455	EXHAUST HANGERS, DUAL	HXWA C SCREWS	Z	-	-	-	-	12	6.00
F-1454	EXHAUST HANGERS, DUAL (transverse mflr)	CRG BOLTS, HXWA SCREWS, FLNG NUTS	Z	-	-	-	-	20	8.00
F-1247	EXHAUST HANGERS, SINGLE	HXWA C SCREWS	Z	-	-	-	-	8	4.00
F-522	EXHAUST PIPE > MANIFOLD - 6 CYL	STUDS 2.25 OAL, FLNG NUTS	Z	-	O	B	-	4	7.00
F-524	EXHAUST PIPE > MANIFOLDS - 390/428/B429	STUDS 2.25 & 3.81 OAL, FLNG NUTS	Z	W	O	-	-	8	12.00
F-523	EXHAUST PIPE > MANIFOLDS - SB, 69 390GT	STUDS 2.25 OAL, FLNG NUTS	Z	W	O	B	-	8	10.00

Fuel - for lines see page 216

F-1461	ACCEL BELLCRANK > FIREWALL	HXWA AB SCREWS	Z	-	O	-	-	2	1.50
F-589	FUEL HOSE CLAMPS	FLAT WOUND SPRING TYPE (Silver)	Z	W	O	-	-	8	4.00
F-3981	FUEL VAPOR HOSE (Rr) w HANDLING PKG	CLIPS, HXWA AB SCREWS	Z	W	-	-	-	5	8.00
F-3980	FUEL VAPOR HOSE (Rr) w/o HANDLING PKG	CLIPS, HXWA AB SCREWS	Z	W	-	-	-	6	8.00
F-3971	FUEL VAPOR STORAGE CANISTER	HXWA TT SCREW, LOCK NUT	Z	-	-	-	-	2	3.00
F-411	GAS CAP (pop open)	PH FLAT A SCREWS ONLY	Z	-	-	-	-	4	2.00
F-410	GAS TANK	HXWA AB SCREWS	Z	W	O	-	-	11	6.00
F-1779	GAS TANK FILLER NECK CLAMPS	CORRECT WIRE CLAMPS	Z	-	-	-	-	2	6.00
F-413	GAS TANK FILLER NECK w TWIST CAP	HXWA B SCREWS	Z	-	-	-	-	5	3.00
F-301	GAS TANK FILLER NECK w TWIST CAP	HXWA AB SCREW	-	-	O	-	-	5	3.00

Heater

F-3916	DEFROSTER DUCTS > DASH	CLIP HEAD BOLTS, EXT KEPS NUTS	Z	-	-	-	-	6	4.00
F-383	HEATER & BY-PASS HOSES	WHITEK TOWER CLAMPS	Z	W	O	B	T	6	12.00
F-431	HEATER ASSEMBLY > FIREWALL w/o AC	STAMPED NUTS, SEALER WA'S	Z	W	-	-	-	5	6.00
F-1213	HEATER HOSE STRAPS	6 3/4" ALUMINUM STRAP	Z	W	O	-	-	2	10.00
F-439	HEATER MOTOR GUARD - 390/428	HXWA AB SCREWS, LOCK NUT	Z	-	-	-	-	3	2.00

Interior

F-1043	ARMRESTS - STD	HXWA AB SCREWS, SPRING NUTS	Z	-	-	-	-	12	4.00
F-1089	ASH TRAY	RNDWA B SCREWS	Z	-	-	-	-	2	1.00
F-961	CLOCK OPENING COVER - BODY 63C, 65E	FLAT SPRING NUTS	Z	-	-	-	-	2	1.00
F-960	CLOCK OPENING COVER (exc 63C, 65E)	HXWA B SCREWS	Z	-	-	-	-	2	1.00
F-1010	COAT HOOKS	PH PN AB SCREWS ONLY	Z	-	-	-	-	4	1.50
F-1046	CONSOLE > FLOOR	PH PN & PH OV SCREWS, STAMP NUTS	Z	-	-	-	-	16	7.00
F-1049	COURTESY LAMP @ DOORS	STAMPED NUTS	Z	-	-	-	-	4	1.50
F-905	DASH PAD	PH PN & RNDWA SCREWS, SPRING NUTS	Z	-	-	-	-	11	3.50
F-1077	DOME LAMP	PH PN AB SCREWS	Z	-	-	-	-	4	1.50
F-950	DOOR HANDLES (inside)	CONI KEPS NUTS	Z	-	-	-	-	4	4.00
F-1042	DOOR PANEL ARMREST BRACKETS - DLX	PH PN SCREWS, SPRG, RND PUSH NUTS	Z	-	-	-	-	8	1.50
F-1039	DOOR PANELS - DLX	SCREWS, RETAINERS (pad clips go lower)	Z	-	-	-	-	30	12.00
F-1038	DOOR PANELS - STD	PADDED RETAINERS	Z	-	-	-	-	20	10.00
F-1044	DOOR PANELS - TOP MOULDING	PH OV & PN AB SCREWS	Z	-	-	-	-	8	2.00
F-920	FD SEAT SIDE LATCHES	HXWA EXT SEMS	Z	-	-	-	-	8	2.50
F-770	FD SEAT STOP PLATES	PH PN MS & AB SCREWS	Z	-	-	-	-	6	3.00
F-931	FD SEAT TRAP DOOR HINGES	HX CONI SEMS, U-NUTS	Z	-	-	-	-	16	10.00
F-926	FD SEAT TRAP DOOR LATCH	HXWA SCREWS	Z	-	-	-	-	4	2.00
F-936	FD SEAT TRAP DOOR PROP & BRACKET	HXWA EXT SEMS, J & U-NUTS	Z	-	-	-	-	8	5.50
F-429	FD SEAT TRAP DOOR RUBBER BUMPERS	TALL RUBBER BUMPERS	Z	-	-	-	-	4	6.00
F-2911	FD SEAT TRAP DOOR TRIM PANEL BRACKETS	PH PN AB SCREWS FOR BRACKETS ONLY !!	Z	-	-	-	-	12	2.00
F-923	FD SEAT TRAP DR LATCH CATCH	HX CONI SEMS	Z	-	-	-	-	2	2.00
F-1755	FD SEAT TRIM	CHROME PH OV AB SCREW, JAM NUTS	Z	-	-	-	-	62	10.00
F-996	FIREWALL SOUND ABSORBER	PH PN DRILL SCREW, FLAT WA	Z	-	-	-	-	4	2.00
F-775	FLOOR PANEL (Rr) - Fr ANCHORS	PH PN SCREWS, FINISH WA'S	Z	-	-	-	-	4	3.00
F-1062	GAUGE CLUSTER FINISH PANEL	HXWA & PN PN AB SCREWS, NUTS	Z	-	-	-	-	14	5.00
F-2944	GLOVE BOX FINISH	.40 H RUBBER BUMPER	Z	-	-	-	-	2	2.00
F-795	GLOVE BOX CABLE	PN PN B SHLDR SCREWS, WAVE WA'S	Z	-	-	-	-	4	3.00
F-918	GLOVE BOX CATCH	POZI PH PN CONI SEMS	Z	-	-	-	-	2	2.00
F-3239	GLOVE BOX HINGES	HX CONI SEMS	Z	-	-	-	-	4	3.00
F-1170	GLOVE BOX LATCH	PH PN EXT SEMS	Z	-	-	-	-	2	2.00
F-916	GLOVE BOX LINER	PH PN B SCREWS	Z	-	-	-	-	5	2.00
F-1000	HEADLINER TACK STRIP (Rr) - BODY 63, 65	PH PN AB SCREWS	Z	-	-	-	-	6	1.50
F-1086	HEATER CONTROL > DASH	HXWA AB SCREWS, SPRING NUTS	Z	-	-	-	-	6	3.00
F-1115	HORN PAD & COVER, (2 or 3 Spoke Wheel)	PH PN & HXWA SCREWS	Z	-	-	-	-	6	2.00
F-966	INSTR FINISH PANEL > DASHBOARD CENTER	PH PN B SCREWS, SPRING NUTS	Z	-	-	-	-	4	3.00

Kits Contain Attaching Fasteners for Both Sides

Ford Fastener Kits

1970

Interior

PART #	APPLICATION	NOTES						PCS	PRICE
			Z	W	O	B	T		
F-958	INSTRUMENT FINISH PANEL RH > DASH	PH OV & PN PN B SCREWS, SPRING NUTS	Z	-	-	-	-	14	5.00
F-965	INSTRUMENT PANEL CENTER MOULDINGS	PH PN B SCREWS, SPRING NUTS	Z	-	-	-	-	4	2.50
F-962	INSTRUMENT PANEL END MOULDINGS	PH OV & PH RNDWA AB SCREWS, NUTS	Z	-	-	-	-	8	2.50
F-882	KICK PANELS (LT COLOR INT ONLY 1970)	PH OV AB SCREWS	Z	-	-	-	-	4	2.00
F-881	KICK PANELS - DARK COLOR INTERIOR	PH OV AB SCREWS	Z	-	-	-	-	4	2.00
F-1380	LAMPS, COURTESY UNDERDASH	HXWA B SCREWS	Z	-	-	-	-	2	1.00
F-1033	PACKAGE TRAY	PH PN AB SCREWS	Z	-	-	-	-	13	3.00
F-1045	PACKAGE TRAY TRIM - BODY 63 w/o FDS	PH OV AB SCREWS	Z	-	-	-	-	5	2.00
F-1019	QTER TRIM PANEL BRACKETS - BODY 63	PH PN AB SCREWS	Z	-	-	-	-	24	4.00
F-1056	QTER TRIM PANEL BUILD-UP - BODY 76	PH PN AB SCREWS, SPRING NUTS	Z	-	-	-	-	12	3.00
F-1022	QTER TRIM PANELS - BODY 63 w DARK INT	HX CONI SEMS, SCREWS, U-NUTS, RIVETS	Z	-	-	-	-	40	14.00
F-1021	QTER TRIM PANELS - BODY 63 w LT INT	HX CONI SEMS, SCREWS, U-NUTS, RIVETS	Z	-	-	-	-	40	14.00
F-1026	QTER TRIM PANELS - BODY 65 w DARK INT	PH PN AB SCREWS, RETAINERS	Z	-	-	-	-	14	4.00
F-1025	QTER TRIM PANELS - BODY 65 w LT INT	PH PN AB SCREWS, RETAINERS	Z	-	-	-	-	14	4.00
F-1027	QTER TRIM PANELS - BODY 76	PH PN AB SCREWS, PH OV SEMS	Z	-	-	-	-	20	5.00
F-1094	RADIO OPENING BEZEL	HXWA AB SCREWS, SPRING NUTS	Z	-	-	-	-	4	2.50
F-1035	ROOFSIDE INT TRIM PANELS - BODY 65	WIRE RETAINERS	Z	-	-	-	-	2	1.50
F-859	SCUFF PLATES (door opening)	SS/CHROME PH OV AB SCREWS	Z	-	-	-	-	8	3.00
F-1758	SEAT (Rr fixed) - TRIM - BODY 63	PH OV AB SCREWS	Z	-	-	-	-	22	5.00
F-303	SEAT (Rr fixed) - UPR ANCHORS - BODY 63	SCREWS, ACORN NUTS, WA'S	Z	-	-	-	-	16	12.00
F-862	SEAT BACK (Fr) RELEASE KNOB	PH OV F SCREWS	Z	-	-	-	-	2	1.50
F-3767	SEAT BACK COVERS	WIRE RETAINERS	Z	-	-	-	-	12	4.00
F-3561	SEAT BELTS (Fr)	TORX BOLTS, RUBBER WA'S, SPACERS	Z	-	-	-	-	12	16.00
F-3563	SEAT BELTS (Fr) - SHOULDER STRAPS	TORX SHLDR BOLTS, CHROME SPACERS	Z	-	-	-	-	4	14.00
F-3566	SEAT BELTS (Rr) 2-29-68 >	TORX BOLTS, SPACERS	Z	-	-	-	-	8	14.00
F-939	SEAT HINGE (Rr) > FLOOR, SEAT - BODY 63	HX CONI SEMS, SLOT FLAT SCREWS	Z	-	-	-	-	10	8.00
F-683	SEAT PIVOTS & COVER - DARK INTERIOR	PH PN T1 SCREWS, PINS, FIBRE WA'S	Z	-	-	-	-	14	5.00
F-884	SEAT PIVOTS & COVER (LT INT ONLY 1970)	PH PN T1 SCREWS, PINS, FIBRE WA'S	Z	-	-	-	-	14	5.00
F-687	SEAT STOPS - Fr SEAT BACKS	PH PN AB SCREWS	Z	-	-	-	-	8	3.00
F-2926	SEAT TRACK STUDS - REPAIR KIT	2 SPECIAL SQR HD BOLTS, RETAINERS	Z	-	-	-	-	4	5.00
F-1192	SEAT TRACKS > BODY	ORIGINAL INT/EXT DOME KEPS NUTS	Z	-	-	-	-	8	8.00
F-1048	SEAT UPHOLSTERY (Rr) > FLOOR - B 63	PH PN & PH WAFER SCREWS, SEALER	Z	-	-	-	-	8	3.00
F-1047	SEAT UPHOLSTERY (Rr) > FLOOR - B 65, 76	HX PERI SEMS, SEALER	Z	-	-	-	-	4	3.00
F-899	SPEAKER GRILLES > DOOR	PH OV AB SCREWS	Z	-	-	-	-	8	3.50
F-1091	STEERING COLUMN SHROUD	PH RNDWA B SCREWS	Z	-	-	-	-	2	1.50
F-605	SUN VISOR BRACKETS - BODY 63, 65	PH OV & PH PN AB SCREWS	Z	-	-	-	-	7	3.00
F-606	SUN VISOR BRACKETS - BODY 76	PH OV & PH PN AB SCREWS	Z	-	-	-	-	10	5.00
F-953	WINDOW CRANK HANDLES	OVAL HEAD POZI OV SCREWS	Z	-	-	-	-	2	1.00
F-1007	WINDSHIELD PILLIAR TRIM	PH OV AB SCREWS	Z	-	-	-	-	4	2.00
F-1003	WINDSHIELD, TOP INSIDE TRIM - All	PH OV AB SCREWS	Z	-	-	-	-	4	2.00

Moulding

F-3640	EMBLEM NUTS, Complete - "Grande"	1/8" SLEEVE NUTS	Z	-	-	-	-	24	9.00
F-3639	EMBLEM NUTS, Complete - PRODUCTION	SLEEVE NUTS	Z	-	-	-	-	20	7.00
F-3403	EMBLEM, FENDER Fr - "351", "429"	STAMPED NUTS	-	-	O	-	-	4	4.00
F-2493	EMBLEM, FENDER Fr - "390"	1/8" STAMPED NUTS	-	W	-	-	-	4	2.00
F-1140	FENDER EXTENSION MOULDINGS (Fr)	SS/CHROME PH RNDWA SCREWS	Z	-	-	-	-	8	3.00
F-1141	GRILLE MOULDING, LWR	CLIP BOLTS, SCREWS, NUTS, SPACERS	Z	-	-	-	-	22	12.00
F-142	HOOD PEAK MOULDING	ACORN NUTS w SEALER, BLIND RIVETS	Z	-	-	-	-	12	4.00
F-3619	NAMEPLATE, FENDERS "Mustang"	1/8" SLEEVE NUTS	Z	-	-	-	-	6	3.00
F-2492	NAMEPLATE, QTER PANELS "Cougar"	1/8" ACORN NUTS	-	W	-	-	-	8	4.00
F-3242	NAMEPLATE, QTER PANELS "Fairlane 500"	1/8" STAMPED NUTS	-	-	O	-	-	16	3.00
F-3246	NAMEPLATE, QTER PANELS "Torino"	BODY 63, 1/8" STAMPED NUTS	-	-	O	-	-	8	2.00
F-3621	NAMEPLATE, ROOFSIDES "Grande"	1/8" SLEEVE NUTS	Z	-	-	-	-	4	2.00
F-3922	NAMEPLATE, TRUNK "Mustang"	3/32" SLEEVE NUTS	Z	-	-	-	-	14	5.00
F-3644	NAMEPLATES, FENDERS "GT" or "6.5 LITRE"	1/8" SLEEVE NUTS	-	-	O	-	-	8	3.00
F-620	QTER WINDOW, "BOOMERANG" MOULDINGS	STAMPED NUTS, PH PN SCREWS	Z	-	-	-	-	12	4.00
F-2156	SHAKER TRIM RING	REPLACEMENT 9/16" OD STAMPED NUTS	Z	-	-	-	-	10	3.00
F-1196	TAILAMP PANEL MOULDINGS	STAMPED ACORN NUTS, RETAINERS	Z	-	-	-	-	24	22.00
F-373	TAILAMP PANEL MOULDINGS	STAMPED ACORN NUTS ONLY	Z	-	-	-	-	12	15.00
F-1636	WHEEL OPENINGS (4)	SS/CHROME PH RNDWA AB SCREWS	Z	-	-	-	-	28	10.00
F-581	WINDOW (Fr) MOULDINGS - BODY 63, 65	Sides & Top only, RETAINERS	Z	-	-	-	-	13	6.00
F-3929	WINDOW (Fr) MOULDINGS - BODY 76	Sides & Top only, NUTS, SCREWS	Z	-	-	-	-	11	8.00
F-582	WINDOW (Rr) MOULDINGS - BODY 63	RETAINERS	Z	-	-	-	-	27	12.00

See factory Assembly Manuals for illustrations

Ford Fastener Kits

269

1970

Steering & Suspension

PART #	APPLICATION	NOTES						PCS	PRICE
			MUSTANG	COUGAR	FAIRLANE	BRONCO	TRUCK		
F-1444	AXLE HOUSING > SPRINGS	5 3/4" U-BOLTS, FLNG NUTS	Z	-	-	-	-	12	26.00
F-2886	AXLE HOUSING > SPRINGS	7.0" U-BOLTS, FLNG NUTS	-	W	-	-	-	12	26.00
F-1162	AXLE HOUSING > SPRINGS - NUTS ONLY	FLNG NUTS (Red)	Z	W	O	-	-	8	12.00
F-3442	AXLE HOUSING > SPRINGS (exc Eliminator)	6 3/4" U-BOLTS, FLNG NUTS	-	W	O	-	-	12	26.00
F-1355	BALL JOINTS (RIVETS) - LWR	RIVETS (2 extra), SPL TOOLS, PRESS RQD	Z	W	O	-	-	8	6.00
F-1354	BALL JOINTS (RIVETS) - UPPER	RIVETS (2 extra), SPL TOOLS, PRESS RQD	Z	W	O	-	-	10	6.00
F-2924	COIL SPRING SEATS (perches)	GR-8 KNURLED BOLTS, LOCK NUTS	Z	W	O	-	-	8	10.00
F-596	COIL SPRING SEATS (perches)	LOCK NUTS ONLY	Z	W	O	-	-	4	3.00
F-1515	CONTROL ARMS (lower) > SHOCK TOWER	GR-8 CAM BOLTS, RED NUTS, WA'S	-	W	O	-	-	8	20.00
F-3311	CONTROL ARMS (upper) > SHOCK TOWER	GR-8 1/2-13 KNURLED BOLTS, RED NUTS	Z	W	O	-	-	12	16.00
F-361	CONTROL ARMS (upper) > SHOCK TOWER	GR-8 RED NUTS ONLY, SPLIT WA'S	Z	W	O	-	-	8	5.00
F-2846	CONTROL VALVE ACTUATOR	HX SPLIT SEMS	Z	W	O	-	-	2	3.00
F-1280	CROSSMEMBER, TUBULAR (Fr)	SPL HX CNTRSNK BOLTS	Z	W	-	-	-	2	10.00
F-1844	FUEL VAPOR HOSE > RH SHOCK TOWER	NYLON P CLAMP w DRIVE RIVET	Z	W	-	-	-	1	6.00
F-571	GREASE PLUGS, CHASSIS	HX PLUGS	Z	W	O	B	T	9	5.00
F-1265	IDLER ARM	HX BOLTS, LOCK NUTS, CLIPPED WA'S	Z	W	O	-	-	6	20.00
F-3651	LEAF SPRING CENTER BOLTS	GR-8 TALL HD BOLTS, HX NUTS	Z	W	O	-	-	4	8.00
F-251	LEAF SPRINGS (front eye)	FLNG BOLTS & NUTS	Z	W	-	-	-	4	18.00
F-3783	LEAF SPRINGS (front eye)	FLNG BOLTS & NUTS	-	-	O	-	-	4	20.00
F-3933	P/S CONTROL VALVE DUST COVER CLAMP	SLOT RND B SCREWS	Z	W	O	-	-	2	1.50
F-502	P/S CONTROL VALVE SPOOL CAP	SLOT FILL SPLIT SEMS	Z	-	O	-	-	2	3.00
F-1615	P/S CYLINDER BRACKET - RIVET NUTS	3/8-16 HX BODY RIVET NUTS ONLY	Z	W	O	-	-	2	6.00
F-1362	P/S CYLINDER BRACKET > BODY	HX BOLTS, LOCK NUTS, WA'S	Z	W	O	-	-	7	14.00
F-521	P/S HOSE RUBBER STRAP - 390/428	EXTRUDED STRAP w STEEL RIVET	Z	W	O	B	T	1	6.00
F-676	P/S HOSE SUPPORT INSULATOR RETAINER	HXWA SCREWS	Z	-	-	-	-	2	3.00
F-864	P/S HOSE SUPPORT INSULATOR RETAINER	HXWA F SCREW	-	-	O	-	-	1	1.50
F-1311	P/S OIL COOLER - BOSS 302/429 & 428CJ	HXWA TT SCREW	Z	W	O	-	-	1	2.00
F-3894	P/S PUMP - 200	FLNG & HX BOLTS, FLAT & SPLIT WA'S	Z	-	-	-	-	15	18.00
F-3890	P/S PUMP - 250	SRTD FLNG BOLTS	Z	-	O	-	-	7	8.00
F-1309	P/S PUMP - 302/351 w AC	FLNG BOLTS	Z	W	O	B	T	6	20.00
F-1308	P/S PUMP - 302/351W w/o AC	FLNG BOLTS, SPACER	Z	W	O	B	T	8	24.00
F-1408	P/S PUMP - 351C w/o AC	FLNG BOLTS, SPACER	Z	W	O	B	T	8	24.00
F-650	P/S PUMP - 390/428 w AC	FLNG BOLTS, STUD, LOCK NUT	Z	W	-	-	T	8	12.00
F-1155	P/S PUMP - 390/428 w/o AC	FLNG BOLTS, STUD, LOCK NUT, SPACER	Z	W	-	-	T	9	18.00
F-1335	P/S PUMP - 429 BOSS	FLNG & HX BOLTS, GOLD SPACER	Z	-	-	-	-	8	25.00
F-3295	P/S PUMP - 429 w AC	FLNG BOLTS, STUD, LOCK NUTS	Z	-	O	-	T	11	12.00
F-3294	P/S PUMP - 429 w/o AC	FLNG BOLTS, STUD, LOCK NUTS, SPACER	-	-	O	-	-	12	22.00
F-673	P/S PUMP - ADJUSTMENT BOLT ONLY	SRTD FLNG BOLT	Z	W	O	B	T	1	4.00
F-2937	P/S PUMP RESERVOIR NUT	THIN HX NUT ON BACK	Z	W	O	B	T	1	3.00
F-1212	P/S RETURN HOSE - 250	SLOTTED STYLE CLAMP	Z	-	O	-	-	1	5.00
F-1210	P/S RETURN HOSE - 302/351	SLOTTED STYLE CLAMP	Z	W	O	-	-	2	10.00
F-1211	P/S RETURN HOSE - 302/351	NO SLOT STYLE CLAMP	Z	W	O	-	-	2	20.00
F-1208	P/S RETURN HOSE - 390/428	SLOTTED STYLE CLAMP	Z	W	-	-	-	2	10.00
F-1209	P/S RETURN HOSE - 390/428	NO SLOT STYLE CLAMP	Z	W	-	-	-	2	20.00
F-1811	P/S SLAVE CYLINDER, ROD END	HX NUT, STAMPED NUT	Z	W	O	-	-	2	1.50
F-614	PITMAN ARM > GEAR BOX	HX JAM NUT, SPLIT WA	Z	W	O	-	-	2	3.00
F-666	SHACKLE ASSY (Rr) - NUTS ONLY	UBS FLNG NUTS	Z	W	O	-	-	4	5.00
F-313	SHOCK BRACKETS (Fr)	LOW HD CRG BOLTS, FLNG NUTS	Z	W	-	-	-	12	9.00
F-3908	SHOCK BRACKETS (Fr)	LOW HD CRG BOLTS, EXT KEPS NUTS	-	-	O	-	-	12	10.00
F-345	SHOCKS (Fr)	HX EXT SEMS "Anchor", 5/16-18 NUTS, WA'S	Z	W	-	-	-	12	8.00
F-1845	SHOCKS (Fr)	HX EXT SEMS "Anchor", 5/16-24 NUTS, WA'S	Z	W	-	-	-	12	8.00
F-809	SHOCKS (Fr) - TOP MOUNTING ONLY	HX EXT SEMS "Anchor"	Z	W	-	-	-	4	6.00
F-1793	SHOCKS (Rr)	3/8-16 EXT KEPS NUTS	Z	W	-	-	-	4	2.00
F-810	STABILIZER (Fr) > BODY (STABILIZER BAR)	HX CONI SEMS, LOCK NUTS	Z	W	O	-	-	8	6.00
F-3950	STABILIZER (Fr) END LINKS	BLTS, RTNRS, BSHNGS, SPACERS, NUTS	Z	W	O	-	-	22	25.00
F-868	STABILIZER (Rr) > BODY	HXWA SCREWS	Z	W	-	-	-	4	5.00
F-3949	STABILIZER (Rr) END LINKS (SWAY BAR))	BLTS, RTNRS, BSHNGS, SPACERS, NUTS	Z	-	-	-	-	22	60.00
F-1843	STEERING COLUMN CLAMP > TUBE	UBS FLNG BOLTS	Z	W	-	-	-	4	6.00
F-350	STEERING GEAR BOX	GR-8 HX BOLTS, CLIP FLAT & SPLIT WA'S	Z	W	O	-	-	9	12.00
F-672	STEERING GEAR BOX SECTOR COVER	PLACE BOLTS	Z	W	O	B	T	3	4.00
F-335	STEERING LINKAGE w PS - 69 HD, All 70	SLOTTED NUTS, COTTER PINS, FLAT WA	Z	W	O	-	-	23	14.00
F-318	STEERING LINKAGE w/o PS - 69 HD, All 70	SLOTTED NUTS, COTTER PINS, FLAT WA	Z	W	O	-	-	21	12.00
F-612	STEERING RAG JOINT 11/4/68 >	12 PT BOLT, 5/16-18 LOCK NUTS	Z	W	O	-	-	3	4.00
F-3309	STEERING WHEEL	LOCK NUT	Z	W	O	B	T	1	3.00
F-661	STRUT ROD THREADED ENDS > BODY	LOCK NUTS ONLY	Z	W	O	-	-	4	10.00
F-1264	STRUT RODS > LWR CONTROL ARM	1/2-13 SPL KNRLD BOLTS, NUTS, PINS	Z	W	O	-	-	12	38.00
F-370	STRUT RODS > LWR CONTROL ARM - NUTS	After 11/11/68, 1/2-13 LOCK NUTS ONLY	Z	W	O	-	-	4	4.00
F-2957	SUSP BUMPER (Rr)	LOCK NUT	Z	W	O	-	-	1	2.00
F-1487	SUSP BUMPER BRKT (Rr) - 250 & 302	HXWA SCREWS	Z	W	O	-	-	2	2.00
F-2960	SUSP BUMPERS (Fr)	5/16-18 LOCK NUTS	Z	W	O	-	-	2	2.00
F-2858	TIE ROD ADJUSTMENT SLEEVE	HX BOLTS, LOCK NUTS	Z	W	O	B	T	8	6.00
F-379	WHEEL BOLTS, Fr DRUM - 1.48" BOLTS	1/2-20 BOLTS	Z	W	O	B	T	10	8.00
F-781	WHEEL BOLTS, Fr DRUM - 1.69" BOLTS	1/2-20 BOLTS	Z	W	O	B	T	10	8.00
F-1353	WHEELS	1/2-20 LUG NUTS, 13/16" HX	Z	W	O	B	T	20	16.00

Kits Contain Attaching Fasteners for Both Sides

Ford Fastener Kits

1970

Transmission

PART #	APPLICATION	NOTES						PCS	PRICE
			MUSTANG	COUGAR	FAIRLANE	BRONCO	TRUCK		
F-1370	BELL HOUSING (manual) - 200	HX BOLTS, SPLIT WA'S	Z	-	O	-	-	8	8.00
F-1368	BELL HOUSING (manual) - 302/351	HX BOLTS, SPLIT WA'S	Z	W	O	B	T	12	14.00
F-1366	BELL HOUSING (manual) - 390/428 2-15-68 >	HX BOLTS, SPLIT WA'S	Z	W	-	-	T	12	14.00
F-1374	BELL HOUSING (manual) - 429	HX BOLTS, SPLIT WA'S	Z	-	O	-	-	12	14.00
F-474	CLUTCH BELLCRANK BRKT (exc 390/428)	FLNG BOLTS	Z	-	-	-	-	2	3.00
F-473	CLUTCH BELLCRANK BRKT'S - 390/428	FLNG BOLTS	Z	-	-	-	-	4	6.00
F-876	DRIVESHAFT - V8	5/16-24 LOCK NUTS ONLY	Z	W	O	B	T	4	3.00
F-1273	DRIVESHAFT - V8, 6 CYL 67-68 A/T, All 69 >	5/16" U-BOLTS, LOCK NUTS	Z	W	O	B	T	6	8.00
F-1806	ENGINE PLATE (M/T) - 429	UBS FLNG BOLTS	Z	-	O	-	-	4	5.00
F-1228	ENGINE PLATE (M/T) - 6 CYL & SB	UBS FLNG BOLTS	Z	W	O	B	T	2	3.00
F-2938	ENGINE PLATE (M/T) - BOSS 429	UBS FLNG BOLTS, HX SKT FLAT MS	Z	-	-	-	-	4	6.00
F-1230	INSPECTION COVER & ENG PLATE - C4, FMX	UBS FLNG BOLTS	Z	W	O	B	T	3	4.00
F-1229	INSPECTION COVER (A/T flywheel) - C6	UBS FLNG BOLTS	Z	W	O	B	T	4	4.00
F-2953	INSPECTION COVER (A/T or M/T flywheel)	HXWA AB SCREW	Z	-	-	-	-	2	3.00
F-1227	INSPECTION COVER (M/T flywheel) - 390/428	UBS FLNG BOLTS	Z	W	-	-	T	4	6.00
F-3263	PRESSURE PLATE > FLYWHEEL	SPL HX BOLTS, SPLIT WA'S	Z	W	O	B	T	12	6.00
F-909	SHIFTER (manual) LWR BOOT RETAINER	POZI PN SCREWS	Z	-	-	-	-	4	3.00
F-1240	SHIFTER ASSY > FLOOR - A/T	UBS FLNG BOLTS	Z	-	-	-	-	4	3.00
F-1235	SHIFTER ASSY > FLOOR - A/T	PH OV T1 SCREWS	Z	-	-	-	-	4	2.00
F-1217	SHIFTER CONTROL > TRANS - 3 SPD	UBS FLNG BOLTS	Z	W	O	B	T	2	3.00
F-1219	SHIFTER CONTROL > TRANS - 4 SPD	FLNG & HX BOLTS, SCREWS, FLAT, WA'S	Z	W	O	B	T	7	16.00
F-1226	SHIFTER HANDLE - 3 SPD 64-73, 4 SPD 64-69	SHOULDER BOLTS, FLAT WA'S	Z	W	O	-	-	4	8.00
F-897	SHIFTER HANDLE (manual) > SHIFTER	FORD SHIFTERS, FLAT WA'S ONLY	Z	W	O	-	-	2	1.50
F-1243	SHIFTER LINKAGE - A/T	PERI KEPS NUT, FLAT & WAVE WA'S, PINS	Z	W	O	B	T	9	9.00
F-1224	SHIFTER RODS - 3 SPD	LOCK NUTS, WA'S, PINS	Z	W	O	B	T	8	10.00
F-1225	SHIFTER RODS - 4 SPD	LOCK NUTS, WA'S, PIN	Z	W	O	B	T	5	10.00
F-3413	SPEDOMETER CABLE > TRANS	HXWA EXT SEMS	Z	W	O	B	T	1	2.00
F-185	TORQUE CONVERTOR FLEX PLATE	FLNG NUTS	Z	W	O	B	T	4	4.00
F-1367	TRANS (auto) > ENGINE - 250/302/351 C4/FMX	HX BOLTS, SPLIT WA'S	Z	W	O	B	T	12	14.00
F-3341	TRANS (auto) > ENGINE - 351C w C6	HX BOLTS, SPLIT WA'S	Z	W	O	B	T	12	14.00
F-186	TRANS (auto) > ENGINE - 390/428	HX BOLTS, SPLIT WA'S	Z	W	O	-	T	12	14.00
F-1373	TRANS (auto) > ENGINE - 429	HX BOLTS, SPLIT WA'S	-	-	O	-	-	18	14.00
F-3986	TRANS (auto) KICKDOWN RETAINERS - V8	Does both ends, CORRECT CLIPS	Z	W	-	-	-	2	4.00
F-678	TRANS (manual) > BELL HOUSING	HX BOLTS, SPLIT WA'S	Z	W	O	B	T	8	7.00
F-1841	TRANS ACCESS COVER - FORD 4 SPD	CORRECT SRTD FLNG BOLTS, "X" LONG	Z	W	O	B	T	10	12.00
F-816	TRANS COOLING LINE CLIPS	C CLIPS	Z	W	O	B	T	2	3.00
F-1143	TRANS CROSSMEMBER	UBS FLNG BOLTS & NUTS	Z	-	-	-	-	4	8.00
F-3904	TRANS CROSSMEMBER	POINTED BOLTS, SLOT NUTS, WA'S, PINS	-	-	O	-	-	8	10.00
F-1342	TRANS ID TAG	DRIVE SCREW	Z	W	O	B	T	1	1.00
F-1496	TRANS INSULATOR - A/T & All 428CJ	POINTED HX BOLTS, FLNG NUTS, WA'S	Z	W	-	-	-	6	14.00
F-3906	TRANS INSULATOR - All	POINTED HX BOLTS, NUTS, WA'S	-	-	O	-	-	10	8.00
F-1497	TRANS INSULATOR - M/T exc 428CJ	HX SPLIT SEMS, UBS FLNG NUTS	Z	-	-	-	-	4	8.00
F-1322	TRANS LEVERS > CASE - 3 SPD	HX NUTS, FLAT & SPLIT WA'S	Z	W	O	B	T	6	3.00
F-1385	TRANS LEVERS > CASE - 4 SPD	HX NUTS, FLAT & SPLIT WA'S	Z	W	O	B	T	9	3.00
F-1621	TRANS OIL PAN - C4	FLNG BOLTS	Z	W	O	B	T	11	4.00
F-892	TRANS OIL PAN - C6	FLNG BOLTS	Z	W	O	B	T	17	6.00
F-1622	TRANS OIL PAN - FMX	FLNG BOLTS	Z	W	O	B	T	14	5.00
F-2874	TRANS TAIL HOUSING - M/T	HX BOLTS, SPLIT WA'S	Z	W	O	B	T	10	8.00

Wipers

F-424	WASHER NOZZLES & TEE	HXWA AB TAPPING SCREWS	Z	W	-	-	-	3	2.50
F-978	WINDSHIELD WASHER BOTTLE	HXWA AB FLAT SEMS	Z	-	-	-	-	3	3.00
F-945	WIPER ARM PIVOTS > COWL PANEL	HX CONI SEMS	Z	-	-	-	-	6	4.00
F-734	WIPER MOTOR	HXWA EXT SEMS, HXWA AB SCREW	Z	W	-	-	-	5	5.00
F-3867	WIPER MOTOR BRACKET > COWL	CNTRS NK HX EXT SEMS	-	-	O	-	-	3	3.00
F-437	WIPERS, INTERMITTENT GOVENOR	HXWA AB SCREW (share 1 motor screw)	Z	-	-	-	-	1	1.00

2 Lb Box



S	Pcs	Price
B-11608	1	\$20

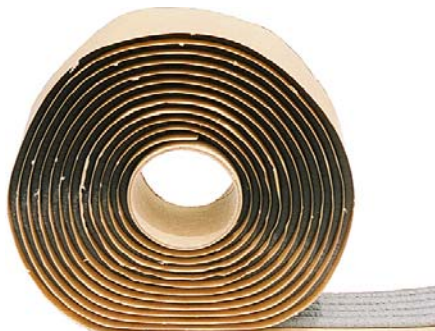

Dark Gray Body Sealer



FIVE .19 DIAMETER BEADS ON 13' ROLL
FORD # ESB-M4G32-A

Ford Fastener Kits

271

1971

Air Conditioning

PART #	APPLICATION	NOTES						PCS	PRICE
			MUSTANG	COUGAR	FAIRLANE	BRONCO	TRUCK		
F-716	AC BRUSH & HOLDER	HX FLNG SCREWS	Z	W	O	B	T	2	1.50
F-718	AC COMPRESSOR - 289/302/351/429	SRTD FLNG BOLTS	Z	W	O	B	T	4	6.00
F-713	AC COMPRESSOR - 390/428	SRTD FLNG BOLTS	-	-	-	-	T	5	7.00
F-3299	AC COMPRESSOR - 429	SRTD HX FLNG & PLACE BOLTS	Z	-	O	-	T	6	8.00
F-726	AC COMPRESSOR - 6 CYL	FLNG BOLTS	Z	-	O	B	T	4	6.00
F-727	AC COMPRESSOR BRACE (Rr) - 6 CYL	SRTD FLNG BOLTS, FLAT WA	Z	-	O	B	T	3	3.00
F-1291	AC COMPRESSOR BRACE (side) - 302/351	SRTD FLNG BOLTS	Z	W	O	B	T	4	6.00
F-3298	AC COMPRESSOR BRACE (side) - 429	SRTD FLNG BOLTS	Z	-	O	-	T	5	5.00
F-728	AC COMPRESSOR BRACE (side) - 6 CYL	SRTD FLNG BOLT, LOCK NUT	Z	-	O	B	T	2	2.00
F-719	AC COMPRESSOR BRACE (side) - V8, 70 FE	SRTD FLNG BOLTS	-	-	-	-	T	3	6.00
F-720	AC COMPRESSOR BRACKET - 302/351	STUDS, LOCK NUTS	Z	W	O	B	T	6	8.00
F-3946	AC COMPRESSOR BRACKET - 429	STUDS, FLNG BOLTS, NUTS	Z	-	O	-	-	6	8.00
F-725	AC COMPRESSOR BRACKET - 6 CYL	SRTD FLNG BOLTS	Z	-	O	B	T	3	5.00
F-724	AC COMPRESSOR BRACKET - 69 V8, 70 FE	STUDS, LOCK NUTS	-	-	-	-	T	6	6.00
F-721	AC COMPRESSOR CLUTCH	HX BOLT, FLAT WA	Z	W	O	B	T	2	3.00
F-717	AC COMPRESSOR FIELD	HX FLNG HD SCREWS	Z	W	O	B	T	4	3.00
F-3439	AC CONDENSOR & TUBE	FLNG BOLTS, HXWA SCREWS, U-NUTS	Z	W	-	-	-	10	5.00
F-2963	AC DEHYDRATOR & RECEIVER TANK	FLAT & HXWA A SCREWS	Z	W	-	-	-	3	2.00
F-1781	AC EVAPORATOR & BLOWER > FIREWALL	STAMPED NUTS, SEALER	Z	-	-	-	-	3	4.00
F-723	AC IDLER PULLEYS - 302/351	SRTD FLNG BOLTS, STUD, NUT, WA'S	Z	W	O	B	T	7	9.00
F-722	AC IDLER PULLEYS - 390/428	SRTD FLNG BOLTS, LOCK NUT, WA'S	-	-	-	-	T	7	8.00
F-3297	AC IDLER PULLEYS & SUPPORT - 429	SRTD FLNG BOLTS, STUD, LOCK NUT	Z	-	O	-	T	6	8.00
F-2909	AC TAG and COMPRESSOR LEAD WIRE	SPECIAL METAL T RETAINER	Z	W	O	-	-	1	3.00

Body

F-3622	AIR VENT GRILLES @ QTER PANELS	SS/BLACK PH PN AB SCREWS	Z	-	-	-	-	2	1.50
F-239	BATTERY TRAY	HX CONI SEMS, U-NUTS	Z	-	-	-	-	4	4.00
F-1563	BATTERY TRAY	HX CONI SEMS, CAGE NUT	-	-	-	-	T	5	6.00
F-1556	BED CORNERS - HOLE COVER PLATES	PH PN A SCREWS	-	-	-	-	T	2	1.00
F-1819	BUMPER (Fr)	SS PH PN SCREWS, U-NUTS, NYLON WA'S	Z	-	-	-	-	18	14.00
F-3580	BUMPER (Fr)	SS CAPPED BOLTS, U & HX NUTS, WA'S	-	-	O	-	-	28	14.00
F-1835	BUMPER (Rr)	SS CAPPED BOLTS, CONI KEPS NUTS	Z	-	-	-	-	8	10.00
F-3597	BUMPER (Rr)	SS CAPPED BOLTS, NUTS, CRUSH WA'S	-	-	O	-	-	24	10.00
F-1813	BUMPER BRACKETS (Fr)	FLNG BOLTS, LOCK NUTS, EXT WA'S	Z	-	-	-	-	12	16.00
F-3583	BUMPER BRACKETS (Fr)	FLNG BOLTS, CONI WA'S	-	-	O	-	-	8	10.00
F-1527	BUMPER BRACKETS (Rr)	HX CONI SEMS, U-NUTS, WA'S, SEALS	Z	-	-	-	-	16	16.00
F-3593	BUMPER BRACKETS (Rr)	HX CONI SEMS	-	-	O	-	-	6	6.00
F-2496	BUMPER GUARD PADS (Rr)	MULTI-THREAD STAMPED NUTS	Z	-	-	-	-	12	8.00
F-341	BUMPER GUARDS (Fr & Rr)	HX CONI SEMS	Z	-	-	-	-	8	6.00
F-243	BUMPER REINFORCEMENT (Fr)	CRG BOLTS, LOCK NUTS, WA'S	Z	-	-	-	-	12	7.00
F-3600	BUMPERS (Fr & Rr) - CHROME	SS CAPPED BOLTS, NUTS, SPLIT WA'S	-	-	-	B	-	24	10.00
F-3599	BUMPERS (Fr & Rr) - PAINTED	CRG BOLTS, NUTS, SPLIT WA'S	-	-	-	B	-	24	6.00
F-956	CONVERTIBLE PUMP & BRACKETS	CONI KEPS NUTS, FLAT WA'S	Z	-	-	-	-	4	3.00
F-957	CONVERTIBLE TOP > BODY TACK STRIP	HX CONI SEMS, PH PN A SCREWS	Z	-	-	-	-	14	14.00
F-2003	CONVERTIBLE TOP > BOW LISTING	PH OV B SCREWS	Z	-	-	-	-	4	2.00
F-2060	CONVERTIBLE TOP FRAME > BODY	HX CONI SEMS	Z	-	-	-	-	6	5.00
F-145	COWL BRACES > COWL	HX CONI SEMS, FLNG NUTS	Z	-	-	-	-	8	9.00
F-253	COWL BUMPERS	PH PN AB SCREWS	Z	-	-	-	-	3	1.00
F-975	DOOR HANDLES (outside)	CONI KEPS NUTS	Z	-	-	-	-	4	2.00
F-1565	DOOR HANDLES (outside)	HXWA EXT SEMS, CONI KEP NUTS	-	-	-	-	T	4	3.00
F-170	DOOR HINGES	ORIGINAL HXWA SCREWS	Z	-	-	-	-	24	14.00
F-3444	DOOR HINGES	HX CONI SEMS	-	-	-	B	-	24	20.00
F-2932	DOOR HINGES	HX CONI SEMS	-	-	-	-	T	24	14.00
F-3447	DOOR LATCH REINFORCEMENTS	SS PH OV SCREWS, SS CNTSNK WA'S	Z	W	O	-	-	12	5.00
F-1383	DOOR LATCH ROD END BUSHINGS ONLY	5/32 SIZE, EXACTLY ORIGINAL	Z	W	O	-	-	12	6.00
F-1357	DOOR LATCH ROD END BUSHINGS ONLY	9/64 SIZE, EXACTLY ORIGINAL	-	-	-	B	-	12	7.00
F-1361	DOOR LATCH ROD END CLIPS	5/32 SIZE, EXACTLY ORIGINAL	Z	W	O	-	-	12	36.00
F-1356	DOOR LATCH ROD END CLIPS	9/64 SIZE, EXACTLY ORIGINAL	-	-	-	B	-	12	38.00
F-653	DOOR LATCHES > DOOR SHELL	PH FLAT EXT SEMS	Z	W	O	-	-	6	3.00
F-1545	DOOR VENT WINDOWS	PH OV & PH PN AB SCREWS	-	-	-	-	T	8	3.00
F-1531	FENDER APRON LWR BRACKETS	HX T SCREWS, FLAT WA'S	-	-	-	-	T	8	4.00
F-1568	FENDER APRON TOP BRACKETS	HX CONI SEMS	-	-	-	-	T	6	8.00
F-1567	FENDER APRONS	FLNG BOLTS, HX CONI SEMS, NUTS, WA'S	-	-	-	-	T	30	20.00
F-1569	FENDER EXTENSIONS	UBS FLNG BOLTS & NUTS	-	-	-	-	T	8	6.00
F-248	FENDER SHIELDS > BUMPER	PH RNDWA AB SCREWS, SPRING NUTS	Z	-	-	-	-	10	5.00
F-231	FENDER SPLASH SHIELDS	HXWA AB SCREWS	Z	-	-	-	-	12	6.00
F-3432	FENDER TOPS ONLY, "FLAG"	HX CONI SEMS, .75 WA OD	Z	-	-	-	-	12	10.00
F-3431	FENDER TOPS ONLY, "FLAG"	HX CONI SEMS, .88 WA OD	-	-	O	-	-	12	10.00
F-2897	FENDER TOPS ONLY, "GL"	HX CONI SEMS, .88 WA OD	-	-	O	-	-	12	10.00
F-2899	FENDER TOPS ONLY, "RBW"	HX CONI SEMS, .88 WA OD	-	-	O	-	-	12	10.00
F-238	FENDERS	HX CONI SEMS, SCREWS, U-NUTS, SHIMS	Z	-	-	-	-	44	38.00

Kits Contain Attaching Fasteners for Both Sides

Ford Fastener Kits

1971

Body

PART #	APPLICATION	NOTES	Z	W	O	B	T							PCS	PRICE
F-3671	FENDERS	HX CONI SEMS, U-NUTS, SHIMS	-	-	O	-	-							50	34.00
F-1571	FENDERS	HX CONI SEMS, U-NUTS, FLAT WA'S	-	-	-	-	T							34	24.00
F-246	FENDERS BRACES (Fr)	HX CONI SEMS, U-NUTS	Z	-	-	-	-							4	3.00
F-233	FENDERS FILLER PANELS @ PILLARS	PH RNDWA AB SCREWS	Z	-	-	-	-							4	2.00
F-1572	FLOOR BRACE ACCESS COVERS	HXWA AB SCREWS	-	-	-	-	T							8	3.00
F-567	FLOOR REINFORCEMENT - BODY 76	HX CONI SEMS	Z	-	-	-	-							6	12.00
F-171	FLOORBOARD HOLE COVERS 12/20/66 >	HXWA AB SCREWS	Z	-	-	-	-							8	3.00
F-3672	GRILLE	HX CONI & POZI PN SEMS, U-NUTS	-	-	O	-	-							52	18.00
F-1575	GRILLE	HX CONI SEMS, J & U-NUTS	-	-	-	-	T							30	18.00
F-592	GRILLE & CENTER SUPPORT	HX CONI SEMS, PH PN SCREWS, NUTS	Z	-	-	-	-							18	14.00
F-3673	GRILLE BRACKETS	U-NUTS	-	-	O	-	-							4	2.00
F-1577	GRILLE, UPPER SUPPORT	HX CONI SEMS, J-NUTS	-	-	-	-	T							8	6.00
F-259	HEADLAMP DOORS	PH PN AB SCREWS, NYLON NUTS	Z	-	-	-	-							4	2.00
F-3674	HEADLAMP DOORS - FLAT TYPE	PH PN SCREWS, NYLON NUTS	-	-	O	-	-							12	3.00
F-235	HEADLAMP HOUSINGS	HX CONI SEMS, U-NUTS	Z	-	-	-	-							16	12.00
F-234	HEADLAMP SUPPORT BRACKETS	HX CONI SEMS, U-NUTS	Z	-	-	-	-							24	20.00
F-232	HOOD & HINGES	HX CONI SEMS, U-NUTS	Z	-	-	-	-							16	16.00
F-1579	HOOD & HINGES	HX CONI SEMS, U-NUTS	-	-	-	-	T							14	12.00
F-1582	HOOD BUMPERS > HOOD	PH PN AB SCREWS	-	-	-	-	T							8	2.00
F-236	HOOD LATCH & CATCH	HX CONI SEMS, U-NUTS	Z	-	-	-	-							6	5.00
F-1585	HOOD LATCH & CATCH	HX CONI SEMS, U-NUTS	-	-	-	-	T							11	10.00
F-593	HOOD LATCH SUPPORT	HX CONI SEMS, U-NUTS	Z	-	-	-	-							6	5.00
F-143	HOOD SCOOPS, RAM-AIR	SPL STAMPED NUTS w SEALER, STUDS	Z	-	-	-	-							20	20.00
F-1631	HOOD TWIST LOCK CATCHES (on extension)	HX CONI SEMS, U-NUTS	Z	-	-	-	-							8	6.00
F-1351	HOOD TWIST LOCK EXTENSIONS	HX CONI SEMS, U-NUTS	Z	-	-	-	-							12	7.00
F-1630	HOOD TWIST LOCK RETAINERS (on hood)	HX CONI SEMS	Z	-	-	-	-							4	4.00
F-863	HOOD, RAM-AIR PLENUM	PH RNDWA AB SCREWS	Z	-	-	-	-							24	10.00
F-981	INSTRUMENT PANEL (welded assembly)	HX CONI SEMS	Z	-	-	-	-							2	2.00
F-982	INSTRUMENT PANEL CENTER BRACE	HX CONI SEMS	Z	-	-	-	-							2	2.50
F-979	INSTRUMENT PANEL LH CENTER BRACE	HX CONI SEMS, HXWA AB FLAT SEMS	Z	-	-	-	-							5	5.00
F-980	INSTRUMENT PANEL LH UPPER BRACE	HX CONI SEMS	Z	-	-	-	-							4	4.00
F-983	INSTRUMENT PANEL LWR BRACES	HX CONI SEMS	Z	-	-	-	-							4	4.00
F-1587	JACK CLAMP > FENDER APRON	HX CONI SEMS, BOLT, WING & KEPS NUT	-	-	-	-	T							9	6.00
F-244	LICENSE PLATE BRACKET (Fr)	HX CONI SEMS, U-NUTS	Z	-	-	-	-							6	4.50
F-1588	LICENSE PLATE BRACKET (Rr)	HX CONI SEMS, FLNG NUTS	-	-	-	-	T							4	3.00
F-3481	LICENSE PLATES	HXWA B SCREWS, NYLON NUTS	Z	W	O	B	T							8	4.00
F-802	MIRROR (outside) > DOOR - 1 MIRROR	SS/CHROME POZI OV SCREW, RIV NUTS	Z	W	O	B	T							4	3.00
F-1512	MIRROR (outside) > DOOR - 2 MIRRORS	SS/CHROME POZI OV SCREW, RIV NUTS	Z	W	O	B	T							8	5.00
F-254	QTER PANEL EXTENSIONS	STUDS, CONI KEPS NUTS, FLAT & SEALER	Z	-	-	-	-							40	14.00
F-1589	RADIATOR SUPPORT	HX CONI SEMS, U-NUTS	-	-	-	-	T							16	14.00
F-1294	ROOFSIDE WEATHERSTRIP - BODY 63	PH PN & PH RNDWA SCREWS, RIVETS	Z	-	-	-	-							32	10.00
F-1295	ROOFSIDE WEATHERSTRIP - BODY 65	PH OV, PH PN & PH SCREWS, RIVETS	Z	-	-	-	-							56	12.00
F-590	SHOCK TOWER BRACES (cover springs)	HX CONI SEMS, FLNG NUTS	Z	-	-	-	-							20	14.00
F-977	SPOILER (Fr)	HXWA AB FLAT SEMS	Z	-	-	-	-							14	12.00
F-3921	SPOILER (Rr) > SUPPORTS	SKT HD SCREWS, PH OV SCREWS, WA'S	Z	-	-	-	-							18	6.00
F-1435	SPOILER (Rr) SUPPORTS > DECKLID	CONI KEPS NUTS, RUBBER CAPS	Z	-	-	-	-							8	6.00
F-3522	STEERING COLUMN SEAL	LARGE HX PERI SEMS	Z	-	-	-	-							3	4.50
F-1591	STONE DEFLECTOR	HX CONI SEMS, BOLTS, KEPS, U-NUTS	-	-	-	-	T							20	12.00
F-1593	TAILGATE HINGES	HX CONI SEMS	-	-	-	-	T							4	5.00
F-1592	TAILGATE LATCH CATCHES	HX CONI SEMS	-	-	-	-	T							4	4.00
F-1595	TAILGATE LATCHES	HX CONI SEMS	-	-	-	-	T							4	4.00
F-1597	TAILGATE RELEASE HANDLE	FLNG NUT ONLY	-	-	-	-	T							1	1.00
F-1596	TAILGATE RELEASE HANDLE BEZEL	POZI OV EXT & HX CONI SEMS, RIV NUTS	-	-	-	-	T							10	5.00
F-1599	TAILGATE SUPPORT ARMS	HX CONI SEMS	-	-	-	-	T							4	4.00
F-255	TIE DOWN BRACKETS (Rr)	HX CONI SEMS, LOCK NUTS	Z	-	-	-	-							10	20.00
F-165	TRUNK LATCH & STRIKER	HX CONI SEMS	Z	-	-	-	-							5	5.00
F-1802	TRUNK LID - BODY 65, 76	1/4-20 HX CONI SEMS	Z	-	-	-	-							4	4.00
F-257	TRUNK LID & HINGES - BODY 63	5/16-18 HX CONI SEMS	Z	-	-	-	-							6	6.00
F-591	VALANCE (Fr)	HX CONI SEMS, U-NUTS	Z	-	-	-	-							16	10.00
F-166	VALANCE (Rr)	CLIP HEAD BOLTS, PH PN SCREWS, NUTS	Z	-	-	-	-							15	7.00
F-2853	VALANCE (Rr)	CLIP-HEAD BOLTS, HXWA SCREWS, NUTS	-	-	O	-	-							12	20.00
F-1750	WEATHERSTRIP, DOORS	PH PN AB SCREWS	Z	-	-	-	-							12	2.00
F-1300	WINDOW SEALS @ DOOR Rr, QTER - 65, 76	PH PN AB SCREWS	Z	-	-	-	-							22	4.00

Brakes

F-1616	BRAKE ASSEMBLY (front drum) > SPINDLE	T-BOLTS, LOCK NUTS	Z	W	O	-	-							16	14.00
F-1481	BRAKE BOOSTER > FIREWALL	FLNG NUTS	Z	W	O	B	-							4	8.00
F-3882	BRAKE BOOSTER HOSE	FLAT WOUND SPRING CLAMPS, BLACK	Z	W	O	B	T							2	2.00
F-1791	BRAKE CABLE SEAL @ BRAKE PLATES	1.0" DIA X .58 TK RUBBER SEAL	Z	W	O	-	-							2	3.00
F-575	BRAKE CABLES > BODY	RETAINING CLIPS, HX NUTS	-	W	O	-	-							6	4.00
F-2985	BRAKE CALIPER BLEEDERS	CORRECT SCREWS	Z	W	O	-	T							2	4.00
F-3698	BRAKE CALIPER HARDWARE - COMPLETE	STAB'S, CLIPS, INSULATORS, SCREWS	Z	W	O	-	-							30	50.00
F-1263	BRAKE CALIPERS > SPINDLE	DRILLED GR-8 BOLTS, SPLIT WA'S	Z	W	O	-	-							8	38.00
F-579	BRAKE DRUM RETAINERS	GREEN PUSH ON RETAINERS	Z	W	O	B	T							6	4.00

1971

Brakes

PART #	APPLICATION	NOTES						PCS	PRICE
			Z	W	O	B	T		
F-1332	BRAKE HOSE BRKTS (drum) (Fr) > BODY	HXWA C SCREWS	Z	W	O	-	-	6	4.00
F-1249	BRAKE HOSE BRKTS (drum) (Fr) > BODY	HXWA C SCREWS	-	-	O	-	-	4	3.00
F-1250	BRAKE HOSES (disc) > BODY	HXWA C SCREWS, U-CLIP	Z	W	O	-	-	5	5.00
F-577	BRAKE HOSES (drum) > BRACKET	U-CLIPS	Z	W	O	-	-	3	4.00
F-1517	BRAKE HOSES > CALIPER	RED GR-8 DRILLED HX BOLTS, COP WA'S	Z	W	O	-	-	6	20.00
F-670	BRAKE LIGHT SWITCH	RETAINING PIN	Z	W	O	B	T	1	2.00
F-854	BRAKE PEDAL > FIREWALL	FLNG NUTS	Z	-	-	-	-	4	3.00
F-669	BRAKE PLATE ADJUST HOLE PLUGS (2)	RUBBER PLUGS	Z	W	O	B	T	2	3.00
F-1601	BRAKE ROTOR SHIELDS	HX EXT SEMS	Z	W	O	-	-	6	4.00
F-1475	MASTER CYLINDER w POWER BRAKES	FLNG NUTS	Z	W	O	B	T	2	3.00
F-1473	MASTER CYLINDER w/o POWER BRAKES	HX SPLIT SEMS	Z	W	O	B	-	2	5.00
F-1333	PARKING BRAKE CONTROL > BODY	HXWA SRTD SCREWS	Z	W	O	-	-	3	4.00
F-799	PROPORTIONING VALVE > APRON	UBS FLNG NUTS	Z	W	O	-	-	2	2.00
F-2950	WHEEL CYLINDER BLEEDERS	1/4-28 x 1/4 HX x 92" OAL SCREWS, ZDC	Z	W	O	B	T	2	3.00
F-356	WHEEL CYLINDERS (2) - 250 & All 8 CYL	5/16-18 HX EXT SEMS	Z	W	O	B	T	4	3.00
F-3912	WHEEL CYLINDERS (4) - 250 & All 8 CYL	5/16-18 HX EXT SEMS	Z	W	O	B	T	8	6.00

Brake & Fuel Lines - also see page 216

F-3983	BRAKE LINES (shared vapor) - Fr DISC	CORRECT CLIPS, SCREWS, GROMMETS	Z	W	-	-	-	32	44.00
F-3982	BRAKE LINES (shared) - Fr DRUM & 250 DISC	CORRECT CLIPS, SCREWS, GROMMETS	Z	W	-	-	-	32	44.00
F-3964	FUEL LINE @ ROCKER, Mid 67-70 HT, 71-73	CLIP w SQUEEZE RETAINER	Z	W	-	-	-	1	4.00
F-3984	FUEL LINES - 6 CYL	CORRECT CLIPS, SCREWS, GROMMET	Z	W	-	-	-	9	16.00
F-3985	FUEL LINES - V8	CORRECT CLIPS, SCREWS, GROMMET	Z	W	-	-	-	14	22.00

Cooling

F-389	RADIATOR - 302/351 XC, 390/428	HX CONI SEMS, SCREWS, CAGED NUTS	-	-	O	-	-	6	5.00
F-397	RADIATOR - All	HX CONI SEMS	Z	-	-	-	-	6	6.00
F-252	RADIATOR FAN GUARD	HXWA AB SCREW	Z	-	-	-	-	2	1.50
F-1525	RADIATOR FAN SHROUD - 250/302/351	SPL HXWA SCREWS, S CLIPS, NUTS	Z	-	-	-	-	6	6.00
F-1526	RADIATOR FAN SHROUD - 429	SPL HXWA SCREWS, SPRING NUTS	Z	-	-	-	-	8	6.00
F-657	RADIATOR HOSE CLAMPS - 289/302/351	WIRE TYPE	Z	W	O	B	T	4	16.00
F-3936	RADIATOR HOSE CLAMPS - 351C	WIRE TYPE	Z	W	O	-	-	4	16.00
F-658	RADIATOR HOSE CLAMPS - 390/428	WIRE TYPE	Z	W	O	-	T	4	20.00
F-656	RADIATOR HOSE CLAMPS - 6 CYL	WIRE TYPE	Z	W	O	-	T	4	16.00
F-2919	RADIATOR HOSE CLAMPS - All 429	WIRE TYPE	Z	-	-	-	-	4	20.00

Differential

F-1440	AXLE RETAINER PLATES - 250 & 8 CYL	T-BOLTS, LOCK NUTS	Z	W	O	-	-	16	20.00
F-1161	AXLE RETAINER PLATES - NUTS ONLY	LOCK NUTS (Red)	Z	W	O	-	-	8	6.00
F-1663	AXLE VENT SYSTEM	FITTING, HOSE, CLAMPS, HXWA SCREW	Z	-	-	-	-	5	20.00
F-785	DIFFERENTIAL CARRIER > HOUSING	RED LOCK NUTS, COPPER WA'S	Z	W	O	B	T	20	12.00
F-1165	DIFFERENTIAL CARRIER > HOUSING	COPPER WA'S ONLY	Z	W	O	B	T	10	4.00
F-3987	DIFFERENTIAL FLANGE > PINION	GR-8 3/4-20 TOP-LOK FLNG LOCKNUT	Z	W	O	B	T	1	5.00
F-374	DIFFERENTIAL PINION SUPPORT	PLACE BOLTS	Z	W	O	B	T	5	8.00

Electrical

F-1319	ALTERNATOR - 250 6 CYL	HX, SRTD HX FLNG & PLACE BOLTS	Z	-	-	B	T	5	18.00
F-3315	ALTERNATOR - 302/351W less SPACER	HX, SRTD FLNG & PLACE BOLTS, WA	Z	W	O	B	T	5	10.00
F-3314	ALTERNATOR - 302/351W w SPACER	HX, SRTD FLNG & PLACE BOLTS, SPACER	Z	W	O	B	T	6	18.00
F-3213	ALTERNATOR - 351C less SPACER	HX & SRTD FLNG BOLTS, SPLIT WA	Z	W	O	B	T	3	10.00
F-1494	ALTERNATOR - 351C w SPACER	HX & SRTD FLNG BOLTS, SPACER	Z	W	O	B	T	4	16.00
F-3300	ALTERNATOR - 429	HX FLNG & PLACE BOLTS, SPACERS	Z	-	O	-	-	6	34.00
F-652	ALTERNATOR HOUSING THRU BOLTS	HXWA SCREWS	Z	W	O	B	T	3	3.00
F-644	ALTERNATOR PULLEY	HX NUT & SPLIT WA (ZDC)	Z	W	O	B	T	2	2.00
F-1172	ALTERNATOR WIRING	10-24 CONI KEPS NUTS	Z	W	O	B	T	2	1.50
F-779	ANTENNA > FENDER	PH OV AB SCREWS	Z	W	O	B	T	4	2.00
F-638	BATTERY CABLES - 302/351W	HX BOLT, CONI KEPS, EXT WA	Z	W	O	B	T	5	4.00
F-639	BATTERY CABLES - 351C	HX BOLTS, CONI KEPS, EXT WA'S	Z	W	O	B	T	7	4.00
F-642	BATTERY CABLES - 390/428	HX BOLT, CONI KEPS, EXT WA	-	-	-	-	T	5	4.00
F-635	BATTERY CABLES - 6 CYL	HX BOLT, CONI KEPS, EXT WA	Z	-	O	B	T	5	4.00

Kits Contain Attaching Fasteners for Both Sides

1971

Electrical

PART #	APPLICATION	NOTES						PCS	PRICE
			Z	W	O	B	T		
F-743	BATTERY HOLDOWN CLAMP	J- HOOKS, HXWA AB SCREW, CONI KEPS	Z	W	-	-	-	5	7.00
F-1195	BATTERY HOLDOWN CLAMP	J- HOOKS, HXWA AB SCREW, CONI KEPS	-	-	O	B	T	5	6.00
F-646	DISTRIBUTOR POINTS & COND - DUAL PT	SLOT PN C SCREWS	Z	W	O	B	T	5	3.00
F-645	DISTRIBUTOR POINTS & COND - SINGLE	SLOT PN C SCREWS	Z	W	O	B	T	3	2.00
F-1073	DRIVING LAMPS @ GRILLE	HXWA AB SCREWS	Z	-	-	-	-	4	2.00
F-3993	HEADLAMP ADJUSTERS	ADJUSTER NUTS, SCREWS, SPRINGS	Z	-	-	-	-	10	8.00
F-2933	HEADLAMP ADJUSTERS	ADJUSTERS, SCREWS, SPRINGS	-	W	-	-	-	28	20.00
F-740	HEADLAMP DIMMER SWITCH	HXWA AB SCREWS	Z	W	O	-	-	2	2.00
F-601	HEADLAMP RETAINING RINGS (2)	SS PH PN SCREWS	Z	-	-	-	-	6	2.00
F-1167	HORNS	HX PERI SEMS	Z	W	O	B	T	2	2.50
F-1623	IGNITION COIL STRAP & BRKT - 351C/429	HX SPLIT SEMS, HXWA SCREW, HX NUT	Z	W	O	B	T	3	3.00
F-422	IGNITION COIL STRAP & BRKT - 6 CYL	HX SPLIT SEMS, HXWA SCREW, HX NUT	Z	W	O	B	T	4	3.00
F-376	IGNITION COIL STRAP & BRKT - V8 exc 351C	HX SPLIT SEMS, HXWA SCREW, HX NUT	Z	W	O	B	T	3	3.00
F-1301	IGNITION COIL STRAP ONLY	HXWA SCREW, HX NUT	Z	W	O	B	T	2	1.50
F-3449	JUNCTION BLOCK @ STARTER SOLENOID	HXWA AB SCREWS, CONI KEPS NUT	Z	W	-	-	-	3	2.00
F-1174	LICENSE PLATE LAMP	PH PN AB SCREWS	Z	-	-	-	-	2	1.00
F-3443	NEUTRAL SWITCH	HX EXT SEMS	Z	W	O	B	T	2	3.00
F-3570	PARKING LAMP LENSES	SS/CHROME PH PN STOP SCREWS	Z	-	-	-	-	4	2.00
F-1072	PARKING LAMPS (below bumper)	MT STAMPED NUTS	Z	-	-	-	-	4	4.00
F-427	RADIO - HOOD GROUND	HXWA AB SCREW ONLY	Z	-	-	-	-	1	1.50
F-1095	RADIO > INSTRUMENT PANEL	EXT KEPS NUT	Z	-	-	-	-	1	2.50
F-2027	RADIO SPEAKER > DASH	HXWA B SCREWS, SPRING NUTS	Z	-	-	-	-	8	2.00
F-1171	REV LIMETER	HXWA AB SCREWS	Z	-	-	-	-	3	2.00
F-450	SIDE MARKERS LAMPS (Rr)	STAMPED NUTS	Z	-	-	-	-	4	3.00
F-1410	STARTER - 289/302/351	HXWA SPLIT SEMS, YLW ZINC	Z	W	O	B	T	2	3.50
F-408	STARTER - 6 CYL & 390/428	HX SPLIT SEMS	Z	-	-	-	T	3	4.00
F-407	STARTER SOLENOID	HXWA AB SCREWS "D"	Z	W	O	B	T	2	1.50
F-1173	TAILAMP ASSEMBLY > BODY	CLIP HEAD BOLTS, CONI KEPS, RBR CAPS	Z	-	-	-	-	18	16.00
F-3826	TAILAMP WIRING & GROUND	NYLON "O" CLIPS, HXWA B SCREW	Z	-	-	-	-	9	6.00
F-1776	TRUNK LAMP - BODY 65	HXWA B SCREW	Z	-	-	-	-	1	1.00
F-3827	TRUNK LAMP & WIRING - BODY 63	HXWA B SCREW, NYLON "O" CLIPS	Z	-	-	-	-	3	3.00
F-2142	VOLTAGE REGULATOR	HXWA A SCREWS "D", EXT WA	Z	W	O	B	T	3	1.50
F-3823	WIRING - 6 CYL IGNITION COIL	RUBBER COATED "J" CLIP	Z	-	-	-	T	1	1.50
F-3822	WIRING - BACK-UP LAMP > FIREWALL	4" FLAT NYLON STRAP	Z	-	-	-	-	1	1.50
F-3825	WIRING - CONVERTIBLE TOP CONTROL	NYLON "O" CLIPS	Z	-	-	-	-	4	3.00
F-3829	WIRING - DOOR SPEAKERS	NYLON "O" CLIPS	Z	-	-	-	-	2	3.00
F-3828	WIRING - RADIO CABLE > DASH	NYLON "S" CLIPS	Z	-	-	-	-	3	4.00
F-1808	WIRING - RH FENDER APRON	5" NYLON STRAPS	Z	-	-	-	-	2	3.00
F-1810	WIRING - SIDE MARKER & HEADLAMPS	3.25" NYLON STRAPS	Z	-	-	-	-	3	5.00
F-3824	WIRING - UNDER DASH	NYLON "O" CLIPS	Z	-	-	-	-	5	5.00
F-3831	WIRING - VARIOUS LOCATIONS	ZIP TIES	Z	-	-	-	-	20	5.00

Emissions

F-1066	VACUUM TREE > FIREWALL	HXWA AB SCREWS	Z	-	-	-	-	2	1.50
--------	------------------------	----------------	---	---	---	---	---	---	------

Exhaust

F-1455	EXHAUST HANGERS, DUAL	HXWA C SCREWS	Z	-	-	-	-	12	6.00
F-1247	EXHAUST HANGERS, SINGLE	HXWA C SCREWS	Z	-	-	-	-	8	4.00
F-522	EXHAUST PIPE > MANIFOLD - 6 CYL	STUDS 2.25 OAL, FLNG NUTS	Z	-	O	B	-	4	7.00
F-524	EXHAUST PIPE > MANIFOLDS - 390/428/B429	STUDS 2.25 & 3.81 OAL, FLNG NUTS	Z	W	O	-	-	8	12.00
F-523	EXHAUST PIPE > MANIFOLDS - SB, 69 390GT	STUDS 2.25 OAL, FLNG NUTS	Z	W	O	B	-	8	10.00

Fuel - for lines see page 216

F-1456	ACCEL BELLCRANK > FIREWALL	HXWA AB SCREWS, SRTD FLNG NUTS	Z	-	-	-	-	6	3.00
F-1461	ACCEL BELLCRANK > FIREWALL	HXWA AB SCREWS	-	-	O	-	-	2	1.50
F-589	FUEL HOSE CLAMPS	FLAT WOUND SPRING TYPE (Silver)	Z	W	O	-	-	8	4.00
F-754	FUEL VAPOR STORAGE CANISTER	EXT KEPS NUTS	Z	-	-	-	-	3	3.00
F-3417	GAS CAP (pop open)	PH FLAT A SCREWS	Z	-	-	-	-	5	3.00
F-1411	GAS TANK	CRG BOLTS, FLNG NUTS	Z	-	-	-	-	4	6.00
F-410	GAS TANK	HXWA AB SCREWS	-	-	O	-	-	11	6.00
F-992	GAS TANK FILLER NECK SEAL	PH PN B SCREWS	Z	-	-	-	-	4	3.00
F-301	GAS TANK FILLER NECK w TWIST CAP	HXWA AB SCREW	Z	-	O	-	-	5	3.00

See factory Assembly Manuals for illustrations

Ford Fastener Kits

275

1971

Heater

PART #	APPLICATION	NOTES						PCS	PRICE
			Z	W	O	B	T		
F-3916	DEFROSTER DUCTS > DASH	CLIP HEAD BOLTS, EXT KEPS NUTS	Z	-	-	-	-	6	4.00
F-383	HEATER & BY-PASS HOSES	WHITEK TOWER CLAMPS	Z	W	O	B	T	6	12.00
F-1780	HEATER ASSEMBLY > FIREWALL	STAMPED NUTS, SEALER WA'S	Z	-	-	-	-	4	6.00
F-1213	HEATER HOSE STRAPS	6 3/4" ALUMINUM STRAP	-	-	O	-	-	2	10.00

Interior

PART #	APPLICATION	NOTES						PCS	PRICE
			Z	W	O	B	T		
F-3440	ARMRESTS - STD	HXWA AB SCREWS, SPRING NUTS	Z	-	-	-	-	8	4.00
F-1011	COAT HOOKS	PH OV AB SCREWS ONLY	Z	-	-	-	-	4	1.50
F-1101	CONSOLE (full) > FLOOR	PH OB & PH PN AB SCREWS	Z	-	-	-	-	10	5.00
F-1102	CONSOLE (short) > FLOOR	PH OV AB SCREWS	Z	-	-	-	-	3	7.00
F-906	DASH PAD & SUPPORT	PH PN SCREWS, RETAINERS, NUTS	Z	-	-	-	-	18	6.00
F-1078	DOME LAMP	PH PN B SCREWS	Z	-	-	-	-	2	1.00
F-1391	DOOR HANDLES (inside)	POZI PAN CONI SEMS	Z	-	-	-	-	2	2.00
F-1040	DOOR PANELS	PADDED RETAINERS	Z	-	-	-	-	28	12.00
F-940	FD SEAT > FLOOR	HX CONI SEMS	Z	-	-	-	-	4	6.00
F-938	FD SEAT CARPETED Rr PANEL	PH OV FLUSH & CUPPED SEMS, NUTS	Z	-	-	-	-	6	3.00
F-921	FD SEAT SIDE LATCH	HX CONI SEMS, U-NUT	Z	-	-	-	-	6	2.50
F-943	FD SEAT SIDE LATCH STRIKER	HX CONI SEMS	Z	-	-	-	-	2	4.00
F-937	FD SEAT STOP PLATES	PH TRUSS AB SCREWS	Z	-	-	-	-	4	3.00
F-932	FD SEAT TRAP DOOR HINGES & TRIM	HXWA & PH OV AB SCREWS	Z	-	-	-	-	27	5.00
F-927	FD SEAT TRAP DOOR LATCH	HX CONI SEMS	Z	-	-	-	-	4	3.00
F-942	FD SEAT TRAP DOOR WIRE LATCHES	HX CONI SEMS	Z	-	-	-	-	4	3.00
F-933	FD SEAT TRAP DR OPENING STRAINERS	HXWA AB SCREWS	Z	-	-	-	-	8	3.00
F-3477	FD SEAT TRIM	CHROME PH OV AB SCREW, JAM NUTS	Z	-	-	-	-	56	10.00
F-2939	GLOVE BOX BUMPERS	.31 H RUBBER BUMPER	Z	-	-	-	-	2	2.00
F-918	GLOVE BOX CATCH	POZI PH PN CONI SEMS	Z	-	-	-	-	2	2.00
F-989	GLOVE BOX FINISH PANEL	SPL PH PN SCREWS	Z	-	-	-	-	7	2.00
F-1170	GLOVE BOX LATCH	PH PN EXT SEMS	Z	-	-	-	-	2	2.00
F-919	GLOVE BOX LINER	PH PNWA B SCREWS	Z	-	-	-	-	5	2.00
F-1015	HEADLINER ROOFSIDE TRIM - BODY 63, 65	DARK INTERIOR, PH OV AB SCREWS	Z	-	-	-	-	6	2.50
F-1014	HEADLINER ROOFSIDE TRIM - BODY 63, 65	LIGHT INTERIOR, PH OV AB SCREWS	Z	-	-	-	-	6	2.50
F-1001	HEADLINER TACK STRIP - BODY 63, 65	HXWA AB SCREWS	Z	-	-	-	-	18	3.50
F-1087	HEATER CONTROL > DASH	HXWA B SCREWS, SPRING NUTS	Z	-	-	-	-	8	3.00
F-1115	HORN PAD & COVER, (2 or 3 Spoke Wheel)	PH PN & HXWA SCREWS	Z	-	-	-	-	6	2.00
F-986	INSTR FINISH PANEL (BEZEL) @ CLUSTER	PH PN B SCREWS, SPRING NUTS	Z	-	-	-	-	9	3.00
F-991	INSTR FINISH PANEL > COLUMN SHROUD	PH PN & PH RNDWA B SCREWS	Z	-	-	-	-	4	2.00
F-985	INSTR FINISH PANEL > DASHBOARD CENTER	PH PN AB SCREWS	Z	-	-	-	-	5	2.00
F-988	INSTR FINISH PANEL > LH END	PH PN B SCREWS, SPRING CLIPS	Z	-	-	-	-	4	2.00
F-990	INSTR FINISH PANEL > RH AC BEZELS	HXWA AB SCREWS	Z	-	-	-	-	10	2.00
F-987	INSTR FINISH PANEL > RH END	PH OV B SCREWS	Z	-	-	-	-	2	1.50
F-1088	INSTR GAUGE CLUSTER > STRUCTURE	HXWA B SCREWS, SPRING NUTS	Z	-	-	-	-	8	3.00
F-984	INSTRUMENT FINISH PANEL RH > DASH	PH PN SCREWS, SPRING & STAMP NUTS	Z	-	-	-	-	8	5.00
F-1018	KICK PANELS	SPL RETAINING CLIPS	Z	-	-	-	-	4	0.00
F-1381	LAMPS, COURTESY UNDERDASH	HXWA B SCREWS	Z	-	-	-	-	2	1.00
F-1034	PACKAGE TRAY	HXWA AB SCREWS	Z	-	-	-	-	3	1.00
F-3898	PACKAGE TRAY & TRIM - BODY 63	PH PN & PH OV AB SCREWS, RIVETS	Z	-	-	-	-	15	3.00
F-1020	QTER TRIM PANEL BRACKETS - BODY 63	PH PN AB SCREWS	Z	-	-	-	-	24	4.00
F-1024	QTER TRIM PANELS - BODY 63 w DARK INT	HX CONI SEMS, SCREWS, U-NUTS, WA'S	Z	-	-	-	-	36	14.00
F-1023	QTER TRIM PANELS - BODY 63 w LT INT	HX CONI SEMS, SCREWS, U-NUTS, WA'S	Z	-	-	-	-	36	14.00
F-1030	QTER TRIM PANELS - BODY 65 w DARK INT	PH RNDWA SCREWS	Z	-	-	-	-	6	4.00
F-1029	QTER TRIM PANELS - BODY 65 w LT INT	PH RNDWA SCREWS	Z	-	-	-	-	6	4.00
F-1032	QTER TRIM PANELS - BODY 76 DARK INT	PH OV & PH PN AB SCREWS	Z	-	-	-	-	16	4.00
F-1031	QTER TRIM PANELS - BODY 76 LT INT	PH OV & PH PN AB SCREWS	Z	-	-	-	-	16	4.00
F-1093	RADIO OPENING BEZEL	PH OV AB SCREWS	Z	-	-	-	-	4	2.50
F-1090	RADIO OPENING COVER	HXWA AB SCREWS, FLAT WA'S	Z	-	-	-	-	4	1.00
F-495	SCUFF PLATES (door opening)	SS/CHROME PH OV AB SCREWS	Z	-	-	-	-	12	4.00
F-3768	SEAT BACK COVERS	PH RNDWA SCREWS, WIRE RETAINERS	Z	-	-	-	-	12	3.00
F-3561	SEAT BELTS (Fr)	TORX BOLTS, RUBBER WA'S, SPACERS	Z	-	-	-	-	12	16.00
F-3563	SEAT BELTS (Fr) - SHOULDER STRAPS	TORX SHLDR BOLTS, CHROME SPACERS	Z	-	-	-	-	4	14.00
F-3566	SEAT BELTS (Rr) 2-29-68 >	TORX BOLTS, SPACERS	Z	-	-	-	-	8	14.00
F-684	SEAT PIVOT COVERS	PH OV T1 SCREWS	Z	-	-	-	-	4	2.00
F-687	SEAT STOPS - Fr SEAT BACKS	PH PN AB SCREWS	Z	-	-	-	-	8	3.00
F-3473	SEAT TRACKS > BODY	FLNG BOLTS, CONI KEPS NUTS	Z	-	-	-	-	10	6.00
F-1048	SEAT UPHOLSTERY (Rr) > FLOOR - B 63	PH PN & PH WAFER SCREWS, SEALER	Z	-	-	-	-	8	3.00
F-1047	SEAT UPHOLSTERY (Rr) > FLOOR - B 65, 76	HX PERI SEMS, SEALER	Z	-	-	-	-	4	3.00
F-607	SUN VISOR BRACKETS - BODY 63, 65	PH OV AB SCREWS	Z	-	-	-	-	8	4.00
F-1388	SUN VISOR BRACKETS - BODY 76, DK INT	PH OV & PH PN AB SCREWS	Z	-	-	-	-	8	4.00
F-608	SUN VISOR BRACKETS - BODY 76, LT INT	PH OV & PH PN AB SCREWS	Z	-	-	-	-	8	4.00
F-953	WINDOW CRANK HANDLES	OVAL HEAD POZI OV SCREWS	Z	-	-	-	-	2	1.00
F-1009	WINDSHIELD PILLIAR TRIM - BODY 76 DARK	PH OV AB SCREWS	Z	-	-	-	-	4	2.00
F-1008	WINDSHIELD PILLIAR TRIM - BODY 76 LIGHT	PH OV AB SCREWS	Z	-	-	-	-	4	2.00
F-1005	WINDSHIELD, TOP INSIDE TRIM - 63, 65 DARK	PH OV AB SCREWS	Z	-	-	-	-	6	2.50
F-1004	WINDSHIELD, TOP INSIDE TRIM - 63, 65 LIGHT	PH OV AB SCREWS	Z	-	-	-	-	6	2.50

Kits Contain Attaching Fasteners for Both Sides

1971

Moulding

PART #	APPLICATION	NOTES						PCS	PRICE
			Z	W	O	B	T		
F-3509	BODY SIDE MOULDINGS - LWR (Metro Parts only)	RETAINERS, STAMPED NUTS	Z	-	-	-	-	44	30.00
F-3642	EMBLEM NUTS, Complete - "Grande"	1/8" SLEEVE NUTS	Z	-	-	-	-	10	5.00
F-2495	EMBLEM, FENDER Fr - "Cougar"	1/8" STAMPED NUTS	-	W	-	-	-	4	2.00
F-3652	EMBLEM, TRUNK LID - "Cobra"	1/8" SLEEVE NUTS	-	-	O	-	-	3	2.00
F-654	FENDER MOULDINGS	STAMPED NUTS	Z	-	-	-	-	6	3.00
F-3450	GRILLE MOULDINGS	PLASTIC RETAINERS	Z	-	-	-	-	18	20.00
F-3869	HOOD PEAK MOULDING	ACORN NUTS w SEALER	Z	-	-	-	-	7	6.00
F-3619	NAMEPLATE, FENDERS "Mustang"	1/8" SLEEVE NUTS	Z	-	-	-	-	6	3.00
F-2494	NAMEPLATE, QTER PANELS "500"	1/8" ACORN NUTS	-	-	O	-	-	4	3.00
F-3246	NAMEPLATE, QTER PANELS "Torino"	BODY 63, 1/8" STAMPED NUTS	-	-	O	-	-	8	2.00
F-3404	NAMEPLATE, QTER PANELS "Torino"	BODY 63C, 65A,C, 1/8" STAMP, SLV NUTS	-	-	O	-	-	8	3.00
F-3621	NAMEPLATE, ROOFSIDES "Grande"	1/8" SLEEVE NUTS	Z	-	-	-	-	4	2.00
F-3927	NAMEPLATE, TRUNK LID "Mustang"	ORIGINAL SLEEVE NUTS	Z	-	-	-	-	3	2.00
F-3644	NAMEPLATES, FENDERS "GT" or "6.5 LITRE"	1/8" SLEEVE NUTS	-	W	-	-	-	8	3.00
F-1196	TAILAMP PANEL MOULDINGS	STAMPED ACORN NUTS, RETAINERS	Z	-	-	-	-	24	22.00
F-373	TAILAMP PANEL MOULDINGS	STAMPED ACORN NUTS ONLY	Z	-	-	-	-	12	15.00
F-1636	WHEEL OPENINGS (4)	SS/CHROME PH RNDWA AB SCREWS	Z	-	-	-	-	28	10.00
F-3503	WINDOW (Fr) MOULDINGS - BODY 63, 65	RETAINERS	Z	-	-	-	-	16	8.00
F-3504	WINDOW (Fr) MOULDINGS - BODY 76	HX CONI KEPS, BLIND RIVETS	Z	-	-	-	-	9	4.00
F-583	WINDOW (Rr) MOULDINGS - BODY 63	RETAINERS, PH RNDWA SCREWS	Z	-	-	-	-	21	8.00
F-3623	WINDOW (Rr) MOULDINGS - BODY 65	RETAINERS	Z	-	-	-	-	18	8.00

Steering & Suspension

F-1444	AXLE HOUSING > SPRINGS	5 3/4" U-BOLTS, FLNG NUTS	Z	-	-	-	-	12	26.00
F-1162	AXLE HOUSING > SPRINGS - NUTS ONLY	FLNG NUTS (Red)	Z	-	O	-	-	8	12.00
F-3442	AXLE HOUSING > SPRINGS (exc Eliminator)	6 3/4" U-BOLTS, FLNG NUTS	-	W	O	-	-	12	26.00
F-1355	BALL JOINTS (RIVETS) - LWR	RIVETS (2 extra), SPL TOOLS, PRESS RQD	Z	W	O	-	-	8	6.00
F-1354	BALL JOINTS (RIVETS) - UPPER	RIVETS (2 extra), SPL TOOLS, PRESS RQD	Z	W	O	-	-	10	6.00
F-2924	COIL SPRING SEATS (perches)	GR-8 KNURLED BOLTS, LOCK NUTS	Z	W	O	B	-	8	10.00
F-596	COIL SPRING SEATS (perches)	LOCK NUTS ONLY	Z	-	O	-	-	4	3.00
F-1515	CONTROL ARMS (lower) > SHOCK TOWER	GR-8 CAM BOLTS, RED NUTS, WA'S	Z	-	O	-	-	8	20.00
F-3311	CONTROL ARMS (upper) > SHOCK TOWER	GR-8 1/2-13 KNURLED BOLTS, RED NUTS	Z	W	O	B	-	12	16.00
F-361	CONTROL ARMS (upper) > SHOCK TOWER	GR-8 RED NUTS ONLY, SPLIT WA'S	Z	-	O	-	-	8	5.00
F-2846	CONTROL VALVE ACTUATOR	HX SPLIT SEMS	Z	W	O	-	-	2	3.00
F-571	GREASE PLUGS, CHASSIS	HX PLUGS	Z	W	O	B	T	9	5.00
F-1267	IDLER ARM	HX BOLTS, LOCK NUTS, CLIPPED WA'S	Z	-	-	-	-	6	20.00
F-3651	LEAF SPRING CENTER BOLTS	GR-8 TALL HD BOLTS, HX NUTS	Z	W	O	-	-	4	8.00
F-1103	LEAF SPRINGS (front eye)	FLNG BOLTS & NUTS	Z	-	-	-	-	4	18.00
F-3783	LEAF SPRINGS (front eye)	FLNG BOLTS & NUTS	-	-	O	-	-	4	20.00
F-3933	P/S CONTROL VALVE DUST COVER CLAMP	SLOT RND B SCREWS	Z	W	O	B	T	2	1.50
F-502	P/S CONTROL VALVE SPOOL CAP	SLOT FILL SPLIT SEMS	-	-	O	-	-	2	3.00
F-1615	P/S CYLINDER BRACKET - RIVET NUTS	3/8-16 HX BODY RIVET NUTS ONLY	-	-	O	-	-	2	6.00
F-1362	P/S CYLINDER BRACKET > BODY	GR-8 RED NUTS, LOCK NUTS, WA'S	-	-	O	-	-	7	14.00
F-864	P/S HOSE SUPPORT INSULATOR RETAINER	HXWA F SCREW	-	-	O	-	-	1	1.50
F-3890	P/S PUMP - 250	SRTD FLNG BOLTS	Z	-	O	-	-	7	8.00
F-1309	P/S PUMP - 302/351 w AC	FLNG BOLTS	Z	W	O	B	T	6	20.00
F-1308	P/S PUMP - 302/351W w/o AC	FLNG BOLTS, SPACER	Z	W	O	B	T	8	24.00
F-1408	P/S PUMP - 351C w/o AC	FLNG BOLTS, SPACER	Z	W	O	B	T	8	24.00
F-3295	P/S PUMP - 429 w AC	FLNG BOLTS, STUD, LOCK NUTS	Z	W	O	-	T	11	12.00
F-3294	P/S PUMP - 429 w/o AC	FLNG BOLTS, STUD, LOCK NUTS, SPACER	Z	W	O	-	-	12	22.00
F-673	P/S PUMP - ADJUSTMENT BOLT ONLY	SRTD FLNG BOLT	Z	W	O	B	T	1	4.00
F-2937	P/S PUMP RESERVOIR NUT	THIN HX NUT ON BACK	Z	W	O	B	T	1	3.00
F-1212	P/S RETURN HOSE - 250	SLOTTED STYLE CLAMP	-	-	O	-	-	1	5.00
F-1211	P/S RETURN HOSE - 302/351	NO SLOT STYLE CLAMP	-	-	O	-	-	2	20.00
F-1210	P/S RETURN HOSE - 302/351	SLOTTED STYLE CLAMP	-	-	O	-	-	2	10.00
F-1811	P/S SLAVE CYLINDER, ROD END	HX NUT, STAMPED NUT	-	-	O	-	-	2	1.50
F-614	PITMAN ARM > GEAR BOX	HX JAM NUT, SPLIT WA	Z	W	O	-	-	2	3.00
F-666	SHACKLE ASSY (Rr) - NUTS ONLY	UBS FLNG NUTS	-	-	O	-	-	4	5.00
F-1251	SHOCK BRACKETS (Fr)	LOW HD CRG BOLTS, LOCK NUTS	Z	-	-	-	-	12	9.00
F-3908	SHOCK BRACKETS (Fr)	LOW HD CRG BOLTS, EXT KEPS NUTS	-	-	O	-	-	12	10.00
F-1794	SHOCKS (Rr)	SRTD HX NUTS	Z	-	O	-	-	4	2.00
F-810	STABILIZER (Fr) > BODY (STABILIZER BAR)	HX CONI SEMS, LOCK NUTS	Z	-	O	-	-	8	6.00
F-3950	STABILIZER (Fr) END LINKS	BLTS, RTNRS, BSHNGS, SPACERS, NUTS	Z	W	O	-	-	22	25.00
F-868	STABILIZER (Rr) > BODY	HXWA SCREWS	Z	-	-	-	-	4	5.00
F-3949	STABILIZER (Rr) END LINKS (SWAY BAR))	BLTS, RTNRS, BSHNGS, SPACERS, NUTS	Z	-	-	-	-	22	60.00
F-1442	STEERING GEAR BOX	HX BOLTS, FLAT WA'S	Z	-	-	-	-	6	10.00
F-815	STEERING LINKAGE	SLOTTED NUTS, COTTER PINS	Z	-	O	-	-	21	12.00
F-335	STEERING LINKAGE w PS - 69 HD, All 70	SLOTTED NUTS, COTTER PINS, FLAT WA	-	-	O	-	-	23	14.00
F-612	STEERING RAG JOINT 11/4/68 >	12 PT BOLT, 5/16-18 LOCK NUTS	Z	-	O	-	-	3	4.00
F-3309	STEERING WHEEL	LOCK NUT	Z	W	O	B	T	1	3.00
F-661	STRUT ROD THREADED ENDS > BODY	LOCK NUTS ONLY	Z	W	O	-	-	4	10.00
F-1264	STRUT RODS > LWR CONTROL ARM	1/2-13 SPL KNRLD BOLTS, NUTS, PINS	Z	-	O	-	-	12	38.00

Ford Fastener Kits

1971

Steering & Suspension

PART #	APPLICATION	NOTES						PCS	PRICE
			Z	W	O	B	T		
F-370	STRUT RODS > LWR CONTROL ARM - NUTS	After 11/11/68, 1/2-13 LOCK NUTS ONLY	Z	-	O	-	-	4	4.00
F-2957	SUSP BUMPER (Rr)	LOCK NUT	Z	W	O	-	-	1	2.00
F-1488	SUSP BUMPER BRKT (Rr) - 250 & 302	HXWA C SCREWS	Z	-	O	-	-	2	2.00
F-2960	SUSP BUMPERS (Fr)	5/16-18 LOCK NUTS	-	-	O	-	-	2	2.00
F-2858	TIE ROD ADJUSTMENT SLEEVE	HX BOLTS, LOCK NUTS	Z	W	O	B	T	8	6.00
F-379	WHEEL BOLTS, Fr DRUM - 1.48" BOLTS	1/2-20 BOLTS	Z	W	O	B	T	10	8.00
F-781	WHEEL BOLTS, Fr DRUM - 1.69" BOLTS	1/2-20 BOLTS	Z	W	O	B	T	10	8.00
F-1353	WHEELS	1/2-20 LUG NUTS, 13/16" HX	Z	W	O	B	T	20	16.00

Transmission

PART #	APPLICATION	NOTES						PCS	PRICE
			Z	W	O	B	T		
F-1370	BELL HOUSING (manual) - 200	HX BOLTS, SPLIT WA'S	-	-	O	-	-	8	8.00
F-1368	BELL HOUSING (manual) - 302/351	HX BOLTS, SPLIT WA'S	Z	W	O	B	T	12	14.00
F-1374	BELL HOUSING (manual) - 429	HX BOLTS, SPLIT WA'S	Z	W	O	-	-	12	14.00
F-876	DRIVESHAFT - V8	5/16-24 LOCK NUTS ONLY	Z	W	O	B	T	4	3.00
F-1273	DRIVESHAFT - V8, 6 CYL 67-68 A/T, All 69 >	5/16" U-BOLTS, LOCK NUTS	Z	W	O	B	T	6	8.00
F-1806	ENGINE PLATE (M/T) - 429	UBS FLNG BOLTS	Z	W	O	-	-	4	5.00
F-1228	ENGINE PLATE (M/T) - 6 CYL & SB	UBS FLNG BOLTS	Z	W	O	B	T	2	3.00
F-1230	INSPECTION COVER & ENG PLATE - C4, FMX	UBS FLNG BOLTS	Z	W	O	B	T	3	4.00
F-1229	INSPECTION COVER (A/T flywheel) - C6	UBS FLNG BOLTS	Z	W	O	B	T	4	4.00
F-2953	INSPECTION COVER (A/T or M/T flywheel)	HXWA AB SCREW	Z	-	-	-	-	2	3.00
F-3263	PRESSURE PLATE > FLYWHEEL	SPL HX BOLTS, SPLIT WA'S	Z	W	O	B	T	12	6.00
F-910	SHIFTER (manual) LWR BOOT RETAINER	HX BOLTS	Z	-	-	-	-	4	2.50
F-1240	SHIFTER ASSY > FLOOR - A/T	UBS FLNG BOLTS	Z	-	-	-	-	4	3.00
F-1236	SHIFTER ASSY > FLOOR - A/T w CONSOLE	PH PN AB SCREWS	Z	-	-	-	-	4	2.00
F-1217	SHIFTER CONTROL > TRANS - 3 SPD	UBS FLNG BOLTS	Z	W	O	B	T	2	3.00
F-1219	SHIFTER CONTROL > TRANS - 4 SPD	FLNG & HX BOLTS, SCREWS, FLAT, WA'S	Z	W	O	B	T	7	16.00
F-1226	SHIFTER HANDLE - 3 SPD 64-73, 4 SPD 64-69	SHOULDER BOLTS, FLAT WA'S	Z	W	O	-	-	4	8.00
F-897	SHIFTER HANDLE (manual) > SHIFTER	FORD SHIFTERS, FLAT WA'S ONLY	Z	W	O	-	-	2	1.50
F-1243	SHIFTER LINKAGE - A/T	PERI KEPS NUT, FLAT & WAVE WA'S, PINS	Z	W	O	B	T	9	9.00
F-1224	SHIFTER RODS - 3 SPD	LOCK NUTS, WA'S, PINS	Z	W	O	B	T	8	10.00
F-1225	SHIFTER RODS - 4 SPD	LOCK NUTS, WA'S, PIN	Z	W	O	B	T	5	10.00
F-3413	SPEEDOMETER CABLE > TRANS	HXWA EXT SEMS	Z	W	O	B	T	1	2.00
F-185	TORQUE CONVERTOR FLEX PLATE	FLNG NUTS	Z	W	O	B	T	4	4.00
F-1367	TRANS (auto) > ENGINE - 250/302/351 C4/FMX	HX BOLTS, SPLIT WA'S	Z	W	O	B	T	12	14.00
F-3341	TRANS (auto) > ENGINE - 351C w C6	HX BOLTS, SPLIT WA'S	Z	W	O	B	T	12	14.00
F-186	TRANS (auto) > ENGINE - 390/428	HX BOLTS, SPLIT WA'S	-	-	-	-	T	12	14.00
F-1373	TRANS (auto) > ENGINE - 429	HX BOLTS, SPLIT WA'S	Z	W	O	-	-	18	14.00
F-3986	TRANS (auto) KICKDOWN RETAINERS - V8	Does both ends, CORRECT CLIPS	Z	W	-	-	-	2	4.00
F-678	TRANS (manual) > BELL HOUSING	HX BOLTS, SPLIT WA'S	Z	W	O	B	T	8	7.00
F-1841	TRANS ACCESS COVER - FORD 4 SPD	CORRECT SRTD FLNG BOLTS, "X" LONG	Z	W	O	B	T	10	12.00
F-816	TRANS COOLING LINE CLIPS	C CLIPS	Z	W	O	B	T	2	3.00
F-1143	TRANS CROSSMEMBER	UBS FLNG BOLTS & NUTS	Z	-	-	-	-	4	8.00
F-3904	TRANS CROSSMEMBER	POINTED BOLTS, SLOT NUTS, WA'S, PINS	-	-	O	-	-	8	10.00
F-1342	TRANS ID TAG	DRIVE SCREW	Z	W	O	B	T	1	1.00
F-3906	TRANS INSULATOR - All	POINTED HX BOLTS, NUTS, WA'S	-	-	O	-	-	10	8.00
F-1322	TRANS LEVERS > CASE - 3 SPD	HX NUTS, FLAT & SPLIT WA'S	Z	W	O	B	T	6	3.00
F-1385	TRANS LEVERS > CASE - 4 SPD	HX NUTS, FLAT & SPLIT WA'S	Z	W	O	B	T	9	3.00
F-1621	TRANS OIL PAN - C4	FLNG BOLTS	Z	W	O	B	T	11	4.00
F-892	TRANS OIL PAN - C6	FLNG BOLTS	Z	W	O	B	T	17	6.00
F-1622	TRANS OIL PAN - FMX	FLNG BOLTS	Z	W	O	B	T	14	5.00
F-2874	TRANS TAIL HOUSING - M/T	HX BOLTS, SPLIT WA'S	Z	W	O	B	T	10	8.00

Wipers

PART #	APPLICATION	NOTES						PCS	PRICE
			Z	W	O	B	T		
F-855	WASHER NOZZLES	PH PN AB SCREWS	Z	-	-	-	-	2	1.00
F-1743	WINDSHIELD WASHER BOTTLE	HXWA AB FLAT SEMS	Z	-	-	-	-	2	2.50
F-946	WIPER ARM PIVOTS > COWL PANEL	TORX WAFER CONI SEMS	Z	-	-	-	-	6	8.00
F-1782	WIPER MOTOR	UBS FLNG BOLTS	Z	-	-	-	-	3	3.00
F-3867	WIPER MOTOR BRACKET > COWL	CNTRS NK HX EXT SEMS	-	-	O	-	-	3	3.00

Air Conditioning

PART #	APPLICATION	NOTES	Z	W	O	B	T							PCS	PRICE
F-716	AC BRUSH & HOLDER	HX FLNG SCREWS	Z	W	O	B	T							2	1.50
F-718	AC COMPRESSOR - 289/302/351/429	SRTD FLNG BOLTS	Z	W	O	B	T							4	6.00
F-713	AC COMPRESSOR - 390/428	SRTD FLNG BOLTS	-	-	-	-	T							5	7.00
F-3299	AC COMPRESSOR - 429	SRTD HX FLNG & PLACE BOLTS	-	-	-	-	T							6	8.00
F-727	AC COMPRESSOR BRACE (Rr) - 6 CYL	SRTD FLNG BOLTS, FLAT WA	Z	-	O	B	T							3	3.00
F-3298	AC COMPRESSOR BRACE (side) - 429	SRTD FLNG BOLTS	-	-	-	-	T							5	5.00
F-719	AC COMPRESSOR BRACE (side) - V8, 70 FE	SRTD FLNG BOLTS	-	-	-	-	T							3	6.00
F-724	AC COMPRESSOR BRACKET - 69 V8, 70 FE	STUDS, LOCK NUTS	-	-	-	-	T							6	6.00
F-721	AC COMPRESSOR CLUTCH	HX BOLT, FLAT WA	Z	W	O	B	T							2	3.00
F-717	AC COMPRESSOR FIELD	HX FLNG HD SCREWS	Z	W	O	B	T							4	3.00
F-3439	AC CONDENSOR & TUBE	FLNG BOLTS, HXWA SCREWS, U-NUTS	Z	W	-	-	-							10	5.00
F-2963	AC DEHYDRATOR & RECEIVER TANK	FLAT & HXWA A SCREWS	Z	W	-	-	-							3	2.00
F-1781	AC EVAPORATOR & BLOWER > FIREWALL	STAMPED NUTS, SEALER	Z	-	-	-	-							3	4.00
F-722	AC IDLER PULLEYS - 390/428	SRTD FLNG BOLTS, LOCK NUT, WA'S	-	-	-	-	T							7	8.00
F-3297	AC IDLER PULLEYS & SUPPORT - 429	SRTD FLNG BOLTS, STUD, LOCK NUT	-	-	-	-	T							6	8.00
F-2909	AC TAG and COMPRESSOR LEAD WIRE	SPECIAL METAL T RETAINER	Z	W	O	-	-							1	3.00

Body

F-3622	AIR VENT GRILLES @ QTER PANELS	SS/BLACK PH PN AB SCREWS	Z	-	-	-	-							2	1.50
F-2158	BATTERY TRAY	SPL CONI SEMS, U-NUT	Z	-	-	-	-							4	4.00
F-1563	BATTERY TRAY	HX CONI SEMS, CAGE NUT	-	-	-	-	T							5	6.00
F-1556	BED CORNERS - HOLE COVER PLATES	PH PN A SCREWS	-	-	-	-	T							2	1.00
F-1819	BUMPER (Fr)	SS PH PN SCREWS, U-NUTS, NYLON WA'S	Z	-	-	-	-							18	14.00
F-1835	BUMPER (Rr)	SS CAPPED BOLTS, CONI KEPS NUTS	Z	-	-	-	-							8	10.00
F-1813	BUMPER BRACKETS (Fr)	FLNG BOLTS, LOCK NUTS, EXT WA'S	Z	-	-	-	-							12	16.00
F-1527	BUMPER BRACKETS (Rr)	HX CONI SEMS, U-NUTS, WA'S, SEALS	Z	-	-	-	-							16	16.00
F-2496	BUMPER GUARD PADS (Rr)	MULTI-THREAD STAMPED NUTS	Z	-	-	-	-							12	8.00
F-341	BUMPER GUARDS (Fr & Rr)	HX CONI SEMS	Z	-	-	-	-							8	6.00
F-243	BUMPER REINFORCEMENT (Fr)	CRG BOLTS, LOCK NUTS, WA'S	Z	-	-	-	-							12	7.00
F-3600	BUMPERS (Fr & Rr) - CHROME	SS CAPPED BOLTS, NUTS, SPLIT WA'S	-	-	-	B	-							24	10.00
F-3599	BUMPERS (Fr & Rr) - PAINTED	CRG BOLTS, NUTS, SPLIT WA'S	-	-	-	B	-							24	6.00
F-956	CONVERTIBLE PUMP & BRACKETS	CONI KEPS NUTS, FLAT WA'S	Z	-	-	-	-							4	3.00
F-957	CONVERTIBLE TOP > BODY TACK STRIP	HX CONI SEMS, PH PN A SCREWS	Z	-	-	-	-							14	14.00
F-2003	CONVERTIBLE TOP > BOW LISTING	PH OV B SCREWS	Z	-	-	-	-							4	2.00
F-2060	CONVERTIBLE TOP FRAME > BODY	HX CONI SEMS	Z	-	-	-	-							6	5.00
F-145	COWL BRACES > COWL	HX CONI SEMS, FLNG NUTS	Z	-	-	-	-							8	9.00
F-253	COWL BUMPERS	PH PN AB SCREWS	Z	-	-	-	-							3	1.00
F-975	DOOR HANDLES (outside)	CONI KEPS NUTS	Z	-	-	-	-							4	2.00
F-1565	DOOR HANDLES (outside)	HXWA EXT SEMS, CONI KEP NUTS	-	-	-	-	T							4	3.00
F-170	DOOR HINGES	ORIGINAL HXWA SCREWS	Z	-	-	-	-							24	14.00
F-2932	DOOR HINGES	HX CONI SEMS	-	-	-	-	T							24	14.00
F-3447	DOOR LATCH REINFORCEMENTS	SS PH OV SCREWS, SS CNTSNK WA'S	Z	W	-	-	-							12	5.00
F-1383	DOOR LATCH ROD END BUSHINGS ONLY	5/32 SIZE, EXACTLY ORIGINAL	Z	W	-	-	-							12	6.00
F-1357	DOOR LATCH ROD END BUSHINGS ONLY	9/64 SIZE, EXACTLY ORIGINAL	-	-	-	B	-							12	7.00
F-1361	DOOR LATCH ROD END CLIPS	5/32 SIZE, EXACTLY ORIGINAL	Z	W	-	-	-							12	36.00
F-1356	DOOR LATCH ROD END CLIPS	9/64 SIZE, EXACTLY ORIGINAL	-	-	-	B	-							12	38.00
F-653	DOOR LATCHES > DOOR SHELL	PH FLAT EXT SEMS	Z	W	-	-	-							6	3.00
F-1545	DOOR VENT WINDOWS	PH OV & PH PN AB SCREWS	-	-	-	-	T							8	3.00
F-1531	FENDER APRON LWR BRACKETS	HX T SCREWS, FLAT WA'S	-	-	-	-	T							8	4.00
F-1568	FENDER APRON TOP BRACKETS	HX CONI SEMS	-	-	-	-	T							6	8.00
F-1567	FENDER APRONS	FLNG BOLTS, HX CONI SEMS, NUTS, WA'S	-	-	-	-	T							30	20.00
F-1569	FENDER EXTENSIONS	UBS FLNG BOLTS & NUTS	-	-	-	-	T							8	6.00
F-248	FENDER SHIELDS > BUMPER	PH RNDWA AB SCREWS, SPRING NUTS	Z	-	-	-	-							10	5.00
F-231	FENDER SPLASH SHIELDS	HXWA AB SCREWS	Z	-	-	-	-							12	6.00
F-3432	FENDER TOPS ONLY, "FLAG"	HX CONI SEMS, .75 WA OD	Z	-	-	-	-							12	10.00
F-238	FENDERS	HX CONI SEMS, SCREWS, U-NUTS, SHIMS	Z	-	-	-	-							44	38.00
F-1571	FENDERS	HX CONI SEMS, U-NUTS, FLAT WA'S	-	-	-	-	T							34	24.00
F-246	FENDERS BRACES (Fr)	HX CONI SEMS, U-NUTS	Z	-	-	-	-							4	3.00
F-233	FENDERS FILLER PANELS @ PILLARS	PH RNDWA AB SCREWS	Z	-	-	-	-							4	2.00
F-1572	FLOOR BRACE ACCESS COVERS	HXWA AB SCREWS	-	-	-	-	T							8	3.00
F-567	FLOOR REINFORCEMENT - BODY 76	HX CONI SEMS	Z	-	-	-	-							6	12.00
F-171	FLOORBOARD HOLE COVERS 12/20/66 >	HXWA AB SCREWS	Z	-	-	-	-							8	3.00
F-1575	GRILLE	HX CONI SEMS, J & U-NUTS	-	-	-	-	T							30	18.00
F-247	GRILLE & CENTER SUPPORT	HX CONI SEMS, PH PN SCREWS, NUTS	Z	-	-	-	-							14	12.00
F-1577	GRILLE, UPPER SUPPORT	HX CONI SEMS, J-NUTS	-	-	-	-	T							8	6.00
F-259	HEADLAMP DOORS	PH PN AB SCREWS, NYLON NUTS	Z	-	-	-	-							4	2.00
F-235	HEADLAMP HOUSINGS	HX CONI SEMS, U-NUTS	Z	-	-	-	-							16	12.00
F-234	HEADLAMP SUPPORT BRACKETS	HX CONI SEMS, U-NUTS	Z	-	-	-	-							24	20.00
F-232	HOOD & HINGES	HX CONI SEMS, U-NUTS	Z	-	-	-	-							16	16.00
F-1579	HOOD & HINGES	HX CONI SEMS, U-NUTS	-	-	-	-	T							14	12.00
F-1582	HOOD BUMPERS > HOOD	PH PN AB SCREWS	-	-	-	-	T							8	2.00

Ford Fastener Kits

1972

Body

PART #	APPLICATION	NOTES						PCS	PRICE
			Z	W	O	B	T		
F-2157	HOOD LATCH & CATCH	HX CONI & SQR SEMS, U-NUTS	Z	-	-	-	-	6	6.00
F-1585	HOOD LATCH & CATCH	HX CONI SEMS, U-NUTS	-	-	-	-	T	11	10.00
F-241	HOOD LATCH SUPPORT	SPL HX SQR CONED SEMS, U-NUTS	Z	-	-	-	-	5	4.00
F-143	HOOD SCOOPS, RAM-AIR	SPL STAMPED NUTS w SEALER, STUDS	Z	-	-	-	-	20	20.00
F-1631	HOOD TWIST LOCK CATCHES (on extension)	HX CONI SEMS, U-NUTS	Z	-	-	-	-	8	6.00
F-1351	HOOD TWIST LOCK EXTENSIONS	HX CONI SEMS, U-NUTS	Z	-	-	-	-	12	7.00
F-1630	HOOD TWIST LOCK RETAINERS (on hood)	HX CONI SEMS	Z	-	-	-	-	4	4.00
F-863	HOOD, RAM-AIR PLENUM	PH RNDWA AB SCREWS	Z	-	-	-	-	24	10.00
F-981	INSTRUMENT PANEL (welded assembly)	HX CONI SEMS	Z	-	-	-	-	2	2.00
F-982	INSTRUMENT PANEL CENTER BRACE	HX CONI SEMS	Z	-	-	-	-	2	2.50
F-979	INSTRUMENT PANEL LH CENTER BRACE	HX CONI SEMS, HXWA AB FLAT SEMS	Z	-	-	-	-	5	5.00
F-980	INSTRUMENT PANEL LH UPPER BRACE	HX CONI SEMS	Z	-	-	-	-	4	4.00
F-983	INSTRUMENT PANEL LWR BRACES	HX CONI SEMS	Z	-	-	-	-	4	4.00
F-1587	JACK CLAMP > FENDER APRON	HX CONI SEMS, BOLT, WING & KEPS NUT	-	-	-	-	T	9	6.00
F-244	LICENSE PLATE BRACKET (Fr)	HX CONI SEMS, U-NUTS	Z	-	-	-	-	6	4.50
F-1588	LICENSE PLATE BRACKET (Rr)	HX CONI SEMS, FLNG NUTS	-	-	-	-	T	4	3.00
F-3481	LICENSE PLATES	HXWA B SCREWS, NYLON NUTS	Z	W	O	B	T	8	4.00
F-802	MIRROR (outside) > DOOR - 1 MIRROR	SS/CHROME POZI OV SCREW, RIV NUTS	Z	W	O	B	T	4	3.00
F-1512	MIRROR (outside) > DOOR - 2 MIRRORS	SS/CHROME POZI OV SCREW, RIV NUTS	Z	W	O	B	T	8	5.00
F-254	QTER PANEL EXTENSIONS	STUDS, CONI KEPS NUTS, FLAT & SEALER	Z	-	-	-	-	40	14.00
F-1589	RADIATOR SUPPORT	HX CONI SEMS, U-NUTS	-	-	-	-	T	16	14.00
F-1294	ROOFSIDE WEATHERSTRIP - BODY 63	PH PN & PH RNDWA SCREWS, RIVETS	Z	-	-	-	-	32	10.00
F-1295	ROOFSIDE WEATHERSTRIP - BODY 65	PH OV, PH PN & PH SCREWS, RIVETS	Z	-	-	-	-	56	12.00
F-240	SHOCK TOWER BRACES (cover springs)	HX SQR CONE SEMS, NUTS	Z	-	-	-	-	20	14.00
F-977	SPOILER (Fr)	HXWA AB FLAT SEMS	Z	-	-	-	-	14	12.00
F-3921	SPOILER (Rr) > SUPPORTS	SKT HD SCREWS, PH OV SCREWS, WA'S	Z	-	-	-	-	18	6.00
F-1435	SPOILER (Rr) SUPPORTS > DECKLID	CONI KEPS NUTS, RUBBER CAPS	Z	-	-	-	-	8	6.00
F-3522	STEERING COLUMN SEAL	LARGE HX PERI SEMS	Z	-	-	-	-	3	4.50
F-1591	STONE DEFLECTOR	HX CONI SEMS, BOLTS, KEPS, U-NUTS	-	-	-	-	T	20	12.00
F-1593	TAILGATE HINGES	HX CONI SEMS	-	-	-	-	T	4	5.00
F-1592	TAILGATE LATCH CATCHES	HX CONI SEMS	-	-	-	-	T	4	4.00
F-1595	TAILGATE LATCHES	HX CONI SEMS	-	-	-	-	T	4	4.00
F-1597	TAILGATE RELEASE HANDLE	FLNG NUT ONLY	-	-	-	-	T	1	1.00
F-1596	TAILGATE RELEASE HANDLE BEZEL	POZI OV EXT & HX CONI SEMS, RIV NUTS	-	-	-	-	T	10	5.00
F-1599	TAILGATE SUPPORT ARMS	HX CONI SEMS	-	-	-	-	T	4	4.00
F-255	TIE DOWN BRACKETS (Rr)	HX CONI SEMS, LOCK NUTS	Z	-	-	-	-	10	20.00
F-165	TRUNK LATCH & STRIKER	HX CONI SEMS	Z	-	-	-	-	5	5.00
F-1802	TRUNK LID - BODY 65, 76	1/4-20 HX CONI SEMS	Z	-	-	-	-	4	4.00
F-257	TRUNK LID & HINGES - BODY 63	5/16-18 HX CONI SEMS	Z	-	-	-	-	6	6.00
F-245	VALANCE (Fr)	HX CONI SEMS, U-NUTS	Z	-	-	-	-	14	11.00
F-166	VALANCE (Rr)	CLIP HEAD BOLTS, PH PN SCREWS, NUTS	Z	-	-	-	-	15	7.00
F-1750	WEATHERSTRIP, DOORS	PH PN AB SCREWS	Z	-	-	-	-	12	2.00
F-1300	WINDOW SEALS @ DOOR Rr, QTER - 65, 76	PH PN AB SCREWS	Z	-	-	-	-	22	4.00

Brakes

F-1616	BRAKE ASSEMBLY (front drum) > SPINDLE	T-BOLTS, LOCK NUTS	Z	W	-	-	-	16	14.00
F-1481	BRAKE BOOSTER > FIREWALL	FLNG NUTS	Z	W	O	B	-	4	8.00
F-3882	BRAKE BOOSTER HOSE	FLAT WOUND SPRING CLAMPS, BLACK	Z	W	O	B	T	2	2.00
F-1791	BRAKE CABLE SEAL @ BRAKE PLATES	1.0" DIA X .58 TK RUBBER SEAL	Z	W	-	-	-	2	3.00
F-575	BRAKE CABLES > BODY	RETAINING CLIPS, HX NUTS	Z	W	-	-	-	6	4.00
F-2985	BRAKE CALIPER BLEEDERS	CORRECT SCREWS	Z	W	-	-	T	2	4.00
F-3698	BRAKE CALIPER HARDWARE - COMPLETE	STAB'S, CLIPS, INSULATORS, SCREWS	Z	W	-	-	-	30	50.00
F-1263	BRAKE CALIPERS > SPINDLE	DRILLED GR-8 BOLTS, SPLIT WA'S	Z	W	O	-	-	8	38.00
F-579	BRAKE DRUM RETAINERS	GREEN PUSH ON RETAINERS	Z	W	O	B	T	6	4.00
F-1332	BRAKE HOSE BRKTS (drum) (Fr) > BODY	HXWA C SCREWS	Z	W	-	-	-	6	4.00
F-1250	BRAKE HOSES (disc) > BODY	HXWA C SCREWS, U-CLIP	Z	W	-	-	-	5	5.00
F-577	BRAKE HOSES (drum) > BRACKET	U-CLIPS	Z	W	-	-	-	3	4.00
F-1517	BRAKE HOSES > CALIPER	RED GR-8 DRILLED HX BOLTS, COP WA'S	Z	W	O	-	-	6	20.00
F-670	BRAKE LIGHT SWITCH	RETAINING PIN	Z	W	O	B	T	1	2.00
F-854	BRAKE PEDAL > FIREWALL	FLNG NUTS	Z	-	-	-	-	4	3.00
F-669	BRAKE PLATE ADJUST HOLE PLUGS (2)	RUBBER PLUGS	Z	W	O	B	T	2	3.00
F-1601	BRAKE ROTOR SHIELDS	HX EXT SEMS	Z	W	-	-	-	6	4.00
F-1475	MASTER CYLINDER w POWER BRAKES	FLNG NUTS	Z	W	O	B	T	2	3.00
F-1473	MASTER CYLINDER w/o POWER BRAKES	HX SPLIT SEMS	Z	W	O	B	-	2	5.00
F-1333	PARKING BRAKE CONTROL > BODY	HXWA SRTD SCREWS	Z	W	-	-	-	3	4.00
F-799	PROPORTIONING VALVE > APRON	UBS FLNG NUTS	Z	W	-	-	-	2	2.00
F-2950	WHEEL CYLINDER BLEEDERS	1/4-28 x 1/4 HX x 92" OAL SCREWS, ZDC	Z	W	O	B	T	2	3.00
F-356	WHEEL CYLINDERS (2) - 250 & All 8 CYL	5/16-18 HX EXT SEMS	Z	W	O	B	T	4	3.00
F-3912	WHEEL CYLINDERS (4) - 250 & All 8 CYL	5/16-18 HX EXT SEMS	Z	W	O	B	T	8	6.00

Kits Contain Attaching Fasteners for Both Sides

Ford Fastener Kits

1972

Brake & Fuel Lines - also see page 216

PART #	APPLICATION	NOTES											PCS	PRICE	
			Z	W	O	B	T								
F-3983	BRAKE LINES (shared vapor) - Fr DISC	CORRECT CLIPS, SCREWS, GROMMETS	Z	W	-	-	-							32	44.00
F-3982	BRAKE LINES (shared) - Fr DRUM & 250 DISC	CORRECT CLIPS, SCREWS, GROMMETS	Z	W	-	-	-							32	44.00
F-3964	FUEL LINE @ ROCKER, Mid 67-70 HT, 71-73	CLIP w SQUEEZE RETAINER	Z	W	-	-	-							1	4.00
F-3984	FUEL LINES - 6 CYL	CORRECT CLIPS, SCREWS, GROMMET	Z	W	-	-	-							9	16.00
F-3985	FUEL LINES - V8	CORRECT CLIPS, SCREWS, GROMMET	Z	W	-	-	-							14	22.00

Cooling

PART #	APPLICATION	NOTES											PCS	PRICE	
			Z	W	O	B	T								
F-250	RADIATOR - All	HX SQR CONE SEMS	Z	-	-	-	-							6	6.00
F-252	RADIATOR FAN GUARD	HXWA AB SCREW	Z	-	-	-	-							2	1.50
F-1525	RADIATOR FAN SHROUD - 250/302/351	SPL HXWA SCREWS, S CLIPS, NUTS	Z	-	-	-	-							6	6.00
F-657	RADIATOR HOSE CLAMPS - 289/302/351	WIRE TYPE	Z	W	O	B	T							4	16.00
F-3936	RADIATOR HOSE CLAMPS - 351C	WIRE TYPE	Z	W	-	-	-							4	16.00
F-658	RADIATOR HOSE CLAMPS - 390/428	WIRE TYPE	-	-	-	-	T							4	20.00
F-656	RADIATOR HOSE CLAMPS - 6 CYL	WIRE TYPE	-	-	-	-	T							4	16.00

Differential

PART #	APPLICATION	NOTES											PCS	PRICE	
			Z	W	O	B	T								
F-1440	AXLE RETAINER PLATES - 250 & 8 CYL	T-BOLTS, LOCK NUTS	Z	W	-	-	-							16	20.00
F-1161	AXLE RETAINER PLATES - NUTS ONLY	LOCK NUTS (Red)	Z	W	O	-	-							8	6.00
F-1663	AXLE VENT SYSTEM	FITTING, HOSE, CLAMPS, HXWA SCREW	Z	-	-	-	-							5	20.00
F-785	DIFFERENTIAL CARRIER > HOUSING	RED LOCK NUTS, COPPER WA'S	Z	W	O	B	T							20	12.00
F-1165	DIFFERENTIAL CARRIER > HOUSING	COPPER WA'S ONLY	Z	W	O	B	T							10	4.00
F-3987	DIFFERENTIAL FLANGE > PINION	GR-8 3/4-20 TOP-LOK FLNG LOCKNUT	Z	W	O	B	T							1	5.00
F-374	DIFFERENTIAL PINION SUPPORT	PLACE BOLTS	Z	W	O	B	T							5	8.00

Electrical

PART #	APPLICATION	NOTES											PCS	PRICE	
			Z	W	O	B	T								
F-1319	ALTERNATOR - 250 6 CYL	HX, SRTD HX FLNG & PLACE BOLTS	Z	-	-	B	T							5	18.00
F-3315	ALTERNATOR - 302/351W less SPACER	HX, SRTD FLNG & PLACE BOLTS, WA	Z	W	O	B	T							5	10.00
F-3314	ALTERNATOR - 302/351W w SPACER	HX, SRTD FLNG & PLACE BOLTS, SPACER	Z	W	O	B	T							6	18.00
F-3213	ALTERNATOR - 351C less SPACER	HX & SRTD FLNG BOLTS, SPLIT WA	Z	W	O	B	T							3	10.00
F-1494	ALTERNATOR - 351C w SPACER	HX & SRTD FLNG BOLTS, SPACER	Z	W	O	B	T							4	16.00
F-652	ALTERNATOR HOUSING THRU BOLTS	HXWA SCREWS	Z	W	O	B	T							3	3.00
F-644	ALTERNATOR PULLEY	HX NUT & SPLIT WA (ZDC)	Z	W	O	B	T							2	2.00
F-1172	ALTERNATOR WIRING	10-24 CONI KEPS NUTS	Z	W	O	B	T							2	1.50
F-779	ANTENNA > FENDER	PH OV AB SCREWS	Z	W	O	B	T							4	2.00
F-638	BATTERY CABLES - 302/351W	HX BOLT, CONI KEPS, EXT WA	Z	W	O	B	T							5	4.00
F-639	BATTERY CABLES - 351C	HX BOLTS, CONI KEPS, EXT WA'S	Z	W	O	B	T							7	4.00
F-642	BATTERY CABLES - 390/428	HX BOLT, CONI KEPS, EXT WA	-	-	-	-	T							5	4.00
F-635	BATTERY CABLES - 6 CYL	HX BOLT, CONI KEPS, EXT WA	Z	-	O	B	T							5	4.00
F-744	BATTERY HOLDOWN CLAMP	J- HOOKS, HX CONI SEMS, FLNG NUTS	Z	W	-	-	-							5	7.00
F-1195	BATTERY HOLDOWN CLAMP	J- HOOKS, HXWA AB SCREW, CONI KEPS	-	-	O	B	T							5	6.00
F-646	DISTRIBUTOR POINTS & COND - DUAL PT	SLOT PN C SCREWS	Z	W	O	B	T							5	3.00
F-645	DISTRIBUTOR POINTS & COND - SINGLE	SLOT PN C SCREWS	Z	W	O	B	T							3	2.00
F-1073	DRIVING LAMPS @ GRILLE	HXWA AB SCREWS	Z	-	-	-	-							4	2.00
F-3993	HEADLAMP ADJUSTERS	ADJUSTER NUTS, SCREWS, SPRINGS	Z	-	-	-	-							10	8.00
F-2933	HEADLAMP ADJUSTERS	ADJUSTERS, SCREWS, SPRINGS	-	W	-	-	-							28	20.00
F-740	HEADLAMP DIMMER SWITCH	HXWA AB SCREWS	Z	W	-	-	-							2	2.00
F-601	HEADLAMP RETAINING RINGS (2)	SS PH PN SCREWS	Z	-	-	-	-							6	2.00
F-1167	HORNS	HX PERI SEMS	Z	W	O	B	T							2	2.50
F-1623	IGNITION COIL STRAP & BRKT - 351C/429	HX SPLIT SEMS, HXWA SCREW, HX NUT	Z	W	O	B	T							3	3.00
F-422	IGNITION COIL STRAP & BRKT - 6 CYL	HX SPLIT SEMS, HXWA SCREW, HX NUT	Z	W	O	B	T							4	3.00
F-376	IGNITION COIL STRAP & BRKT - V8 exc 351C	HX SPLIT SEMS, HXWA SCREW, HX NUT	Z	W	O	B	T							3	3.00
F-1301	IGNITION COIL STRAP ONLY	HXWA SCREW, HX NUT	Z	W	O	B	T							2	1.50
F-3449	JUNCTION BLOCK @ STARTER SOLENOID	HXWA AB SCREWS, CONI KEPS NUT	Z	W	-	-	-							3	2.00
F-1174	LICENSE PLATE LAMP	PH PN AB SCREWS	Z	-	-	-	-							2	1.00
F-3443	NEUTRAL SWITCH	HX EXT SEMS	Z	W	O	B	T							2	3.00
F-3570	PARKING LAMP LENSES	SS/CHROME PH PN STOP SCREWS	Z	-	-	-	-							4	2.00
F-1072	PARKING LAMPS (below bumper)	MT STAMPED NUTS	Z	-	-	-	-							4	4.00
F-427	RADIO - HOOD GROUND	HXWA AB SCREW ONLY	Z	-	-	-	-							1	1.50
F-1095	RADIO > INSTRUMENT PANEL	EXT KEPS NUT	Z	-	-	-	-							1	2.50
F-2027	RADIO SPEAKER > DASH	HXWA B SCREWS, SPRING NUTS	Z	-	-	-	-							8	2.00
F-1171	REV LIMETER	HXWA AB SCREWS	Z	-	-	-	-							3	2.00
F-450	SIDE MARKERS LAMPS (Rr)	STAMPED NUTS	Z	-	-	-	-							4	3.00
F-1410	STARTER - 289/302/351	HXWA SPLIT SEMS, YLW ZINC	Z	W	O	B	T							2	3.50
F-408	STARTER - 6 CYL & 390/428	HX SPLIT SEMS	Z	-	-	-	T							3	4.00

See factory Assembly Manuals for illustrations

Ford Fastener Kits

281

1972

Electrical

PART #	APPLICATION	NOTES						PCS	PRICE
			Z	W	O	B	T		
F-407	STARTER SOLENOID	HXWA AB SCREWS "D"	Z	W	O	B	T	2	1.50
F-1173	TAILAMP ASSEMBLY > BODY	CLIP HEAD BOLTS, CONI KEPS, RBR CAPS	Z	-	-	-	-	18	16.00
F-3826	TAILAMP WIRING & GROUND	NYLON "O" CLIPS, HXWA B SCREW	Z	-	-	-	-	9	6.00
F-1776	TRUNK LAMP - BODY 65	HXWA B SCREW	Z	-	-	-	-	1	1.00
F-3827	TRUNK LAMP & WIRING - BODY 63	HXWA B SCREW, NYLON "O" CLIPS	Z	-	-	-	-	3	3.00
F-2142	VOLTAGE REGULATOR	HXWA A SCREWS "D", EXT WA	Z	W	O	B	T	3	1.50
F-3823	WIRING - 6 CYL IGNITION COIL	RUBBER COATED "J" CLIP	Z	-	-	-	T	1	1.50
F-3822	WIRING - BACK-UP LAMP > FIREWALL	4" FLAT NYLON STRAP	Z	-	-	-	-	1	1.50
F-3825	WIRING - CONVERTIBLE TOP CONTROL	NYLON "O" CLIPS	Z	-	-	-	-	4	3.00
F-3829	WIRING - DOOR SPEAKERS	NYLON "O" CLIPS	Z	-	-	-	-	2	3.00
F-3828	WIRING - RADIO CABLE > DASH	NYLON "S" CLIPS	Z	-	-	-	-	3	4.00
F-1808	WIRING - RH FENDER APRON	5" NYLON STRAPS	Z	-	-	-	-	2	3.00
F-1810	WIRING - SIDE MARKER & HEADLAMPS	3.25" NYLON STRAPS	Z	-	-	-	-	3	5.00
F-3824	WIRING - UNDER DASH	NYLON "O" CLIPS	Z	-	-	-	-	5	5.00
F-3831	WIRING - VARIOUS LOCATIONS	ZIP TIES	Z	-	-	-	-	20	5.00

Emissions

F-1066	VACUUM TREE > FIREWALL	HXWA AB SCREWS	Z	-	-	-	-	2	1.50
--------	------------------------	----------------	---	---	---	---	---	---	------

Exhaust

F-1455	EXHAUST HANGERS, DUAL	HXWA C SCREWS	Z	-	-	-	-	12	6.00
F-1247	EXHAUST HANGERS, SINGLE	HXWA C SCREWS	Z	-	-	-	-	8	4.00
F-522	EXHAUST PIPE > MANIFOLD - 6 CYL	STUDS 2.25 OAL, FLNG NUTS	Z	-	O	B	-	4	7.00
F-523	EXHAUST PIPE > MANIFOLDS - SB, 69 390GT	STUDS 2.25 OAL, FLNG NUTS	Z	W	O	B	-	8	10.00

Fuel - for lines see page 216

F-1456	ACCEL BELLCRANK > FIREWALL	HXWA AB SCREWS, SRTD FLNG NUTS	Z	-	-	-	-	6	3.00
F-589	FUEL HOSE CLAMPS	FLAT WOUND SPRING TYPE (Silver)	Z	W	-	-	-	8	4.00
F-754	FUEL VAPOR STORAGE CANISTER	EXT KEPS NUTS	Z	-	-	-	-	3	3.00
F-3417	GAS CAP (pop open)	PH FLAT A SCREWS	Z	-	-	-	-	5	3.00
F-1411	GAS TANK	CRG BOLTS, FLNG NUTS	Z	-	-	-	-	4	6.00
F-992	GAS TANK FILLER NECK SEAL	PH PN B SCREWS	Z	-	-	-	-	4	3.00
F-301	GAS TANK FILLER NECK w TWIST CAP	HXWA AB SCREW	Z	-	-	-	-	5	3.00

Heater

F-3916	DEFROSTER DUCTS > DASH	CLIP HEAD BOLTS, EXT KEPS NUTS	Z	-	-	-	-	6	4.00
F-383	HEATER & BY-PASS HOSES	WHITEK TOWER CLAMPS	Z	W	O	B	T	6	12.00
F-1780	HEATER ASSEMBLY > FIREWALL	STAMPED NUTS, SEALER WA'S	Z	-	-	-	-	4	6.00

Interior

F-3440	ARMRESTS - STD	HXWA AB SCREWS, SPRING NUTS	Z	-	-	-	-	8	4.00
F-1011	COAT HOOKS	PH OV AB SCREWS ONLY	Z	-	-	-	-	4	1.50
F-1101	CONSOLE (full) > FLOOR	PH OB & PH PN AB SCREWS	Z	-	-	-	-	10	5.00
F-1102	CONSOLE (short) > FLOOR	PH OV AB SCREWS	Z	-	-	-	-	3	7.00
F-906	DASH PAD & SUPPORT	PH PN SCREWS, RETAINERS, NUTS	Z	-	-	-	-	18	6.00
F-1078	DOME LAMP	PH PN B SCREWS	Z	-	-	-	-	2	1.00
F-1391	DOOR HANDLES (inside)	POZI PAN CONI SEMS	Z	-	-	-	-	2	2.00
F-1040	DOOR PANELS	PADDED RETAINERS	Z	-	-	-	-	28	12.00
F-940	FD SEAT > FLOOR	HX CONI SEMS	Z	-	-	-	-	4	6.00
F-938	FD SEAT CARPETED Rr PANEL	PH OV FLUSH & CUPPED SEMS, NUTS	Z	-	-	-	-	6	3.00
F-921	FD SEAT SIDE LATCH	HX CONI SEMS, U-NUT	Z	-	-	-	-	6	2.50
F-943	FD SEAT SIDE LATCH STRIKER	HX CONI SEMS	Z	-	-	-	-	2	4.00
F-937	FD SEAT STOP PLATES	PH TRUSS AB SCREWS	Z	-	-	-	-	4	3.00
F-932	FD SEAT TRAP DOOR HINGES & TRIM	HXWA & PH OV AB SCREWS	Z	-	-	-	-	27	5.00
F-927	FD SEAT TRAP DOOR LATCH	HX CONI SEMS	Z	-	-	-	-	4	3.00
F-942	FD SEAT TRAP DOOR WIRE LATCHES	HX CONI SEMS	Z	-	-	-	-	4	3.00
F-933	FD SEAT TRAP DR OPENING STRAINERS	HXWA AB SCREWS	Z	-	-	-	-	8	3.00
F-3477	FD SEAT TRIM	CHROME PH OV AB SCREW, JAM NUTS	Z	-	-	-	-	56	10.00
F-2939	GLOVE BOX BUMPERS	.31 H RUBBER BUMPER	Z	-	-	-	-	2	2.00
F-918	GLOVE BOX CATCH	POZI PH PN CONI SEMS	Z	-	-	-	-	2	2.00
F-989	GLOVE BOX FINISH PANEL	SPL PH PN SCREWS	Z	-	-	-	-	7	2.00
F-1170	GLOVE BOX LATCH	PH PN EXT SEMS	Z	-	-	-	-	2	2.00
F-919	GLOVE BOX LINER	PH PNWA B SCREWS	Z	-	-	-	-	5	2.00
F-1014	HEADLINER ROOFSIDE TRIM - BODY 63, 65	LIGHT INTERIOR, PH OV AB SCREWS	Z	-	-	-	-	6	2.50
F-1015	HEADLINER ROOFSIDE TRIM - BODY 63, 65	DARK INTERIOR, PH OV AB SCREWS	Z	-	-	-	-	6	2.50

Kits Contain Attaching Fasteners for Both Sides

Ford Fastener Kits

1972

Interior

PART #	APPLICATION	NOTES											PCS	PRICE	
			Z	W	O	B	T	MUSTANG	COUGAR	FAIRLANE	BRONCO	TRUCK			
F-1001	HEADLINER TACK STRIP - BODY 63, 65	HXWA AB SCREWS	Z	-	-	-	-							18	3.50
F-1087	HEATER CONTROL > DASH	HXWA B SCREWS, SPRING NUTS	Z	-	-	-	-							8	3.00
F-1115	HORN PAD & COVER, (2 or 3 Spoke Wheel)	PH PN & HXWA SCREWS	Z	-	-	-	-							6	2.00
F-986	INSTR FINISH PANEL (BEZEL) @ CLUSTER	PH PN B SCREWS, SPRING NUTS	Z	-	-	-	-							9	3.00
F-991	INSTR FINISH PANEL > COLUMN SHROUD	PH PN & PH RNDWA B SCREWS	Z	-	-	-	-							4	2.00
F-985	INSTR FINISH PANEL > DASHBOARD CENTER	PH PN AB SCREWS	Z	-	-	-	-							5	2.00
F-988	INSTR FINISH PANEL > LH END	PH PN B SCREWS, SPRING CLIPS	Z	-	-	-	-							4	2.00
F-990	INSTR FINISH PANEL > RH AC BEZELS	HXWA AB SCREWS	Z	-	-	-	-							10	2.00
F-987	INSTR FINISH PANEL > RH END	PH OV B SCREWS	Z	-	-	-	-							2	1.50
F-1088	INSTR GAUGE CLUSTER > STRUCTURE	HXWA B SCREWS, SPRING NUTS	Z	-	-	-	-							8	3.00
F-984	INSTRUMENT FINISH PANEL RH > DASH	PH PN SCREWS, SPRING & STAMP NUTS	Z	-	-	-	-							8	5.00
F-1018	KICK PANELS	SPL RETAINING CLIPS	Z	-	-	-	-							4	0.00
F-1381	LAMPS, COURTESY UNDERDASH	HXWA B SCREWS	Z	-	-	-	-							2	1.00
F-1034	PACKAGE TRAY	HXWA AB SCREWS	Z	-	-	-	-							3	1.00
F-3898	PACKAGE TRAY & TRIM - BODY 63	PH PN & PH OV AB SCREWS, RIVETS	Z	-	-	-	-							15	3.00
F-1020	QTER TRIM PANEL BRACKETS - BODY 63	PH PN AB SCREWS	Z	-	-	-	-							24	4.00
F-1024	QTER TRIM PANELS - BODY 63 w DARK INT	HX CONI SEMS, SCREWS, U-NUTS, WA'S	Z	-	-	-	-							36	14.00
F-1023	QTER TRIM PANELS - BODY 63 w LT INT	HX CONI SEMS, SCREWS, U-NUTS, WA'S	Z	-	-	-	-							36	14.00
F-1030	QTER TRIM PANELS - BODY 65 w DARK INT	PH RNDWA SCREWS	Z	-	-	-	-							6	4.00
F-1029	QTER TRIM PANELS - BODY 65 w LT INT	PH RNDWA SCREWS	Z	-	-	-	-							6	4.00
F-1032	QTER TRIM PANELS - BODY 76 DARK INT	PH OV & PH PN AB SCREWS	Z	-	-	-	-							16	4.00
F-1031	QTER TRIM PANELS - BODY 76 LT INT	PH OV & PH PN AB SCREWS	Z	-	-	-	-							16	4.00
F-1093	RADIO OPENING BEZEL	PH OV AB SCREWS	Z	-	-	-	-							4	2.50
F-1090	RADIO OPENING COVER	HXWA AB SCREWS, FLAT WA'S	Z	-	-	-	-							4	1.00
F-495	SCUFF PLATES (door opening)	SS/CHROME PH OV AB SCREWS	Z	-	-	-	-							12	4.00
F-3768	SEAT BACK COVERS	PH RNDWA SCREWS, WIRE RETAINERS	Z	-	-	-	-							12	3.00
F-3561	SEAT BELTS (Fr)	TORX BOLTS, RUBBER WA'S, SPACERS	Z	-	-	-	-							12	16.00
F-3563	SEAT BELTS (Fr) - SHOULDER STRAPS	TORX SHLDR BOLTS, CHROME SPACERS	Z	-	-	-	-							4	14.00
F-3566	SEAT BELTS (Rr) 2-29-68 >	TORX BOLTS, SPACERS	Z	-	-	-	-							8	14.00
F-684	SEAT PIVOT COVERS	PH OV T1 SCREWS	Z	-	-	-	-							4	2.00
F-687	SEAT STOPS - Fr SEAT BACKS	PH PN AB SCREWS	Z	-	-	-	-							8	3.00
F-3473	SEAT TRACKS > BODY	FLNG BOLTS, CONI KEPS NUTS	Z	-	-	-	-							10	6.00
F-1048	SEAT UPHOLSTERY (Rr) > FLOOR - B 63	PH PN & PH WAFER SCREWS, SEALER	Z	-	-	-	-							8	3.00
F-1047	SEAT UPHOLSTERY (Rr) > FLOOR - B 65, 76	HX PERI SEMS, SEALER	Z	-	-	-	-							4	3.00
F-607	SUN VISOR BRACKETS - BODY 63, 65	PH OV AB SCREWS	Z	-	-	-	-							8	4.00
F-1388	SUN VISOR BRACKETS - BODY 76, DK INT	PH OV & PH PN AB SCREWS	Z	-	-	-	-							8	4.00
F-608	SUN VISOR BRACKETS - BODY 76, LT INT	PH OV & PH PN AB SCREWS	Z	-	-	-	-							8	4.00
F-953	WINDOW CRANK HANDLES	OVAL HEAD POZI OV SCREWS	Z	-	-	-	-							2	1.00
F-1009	WINDSHIELD PILLIAR TRIM - BODY 76 DARK	PH OV AB SCREWS	Z	-	-	-	-							4	2.00
F-1008	WINDSHIELD PILLIAR TRIM - BODY 76 LIGHT	PH OV AB SCREWS	Z	-	-	-	-							4	2.00
F-1005	WINDSHIELD, TOP INSIDE TRIM - 63, 65 DARK	PH OV AB SCREWS	Z	-	-	-	-							6	2.50
F-1004	WINDSHIELD, TOP INSIDE TRIM - 63, 65 LIGHT	PH OV AB SCREWS	Z	-	-	-	-							6	2.50

Moulding

F-3642	EMBLEM NUTS, Complete - "Grande"	1/8" SLEEVE NUTS	Z	-	-	-	-							10	5.00
F-654	FENDER MOULDINGS	STAMPED NUTS	Z	-	-	-	-							6	3.00
F-3450	GRILLE MOULDINGS	PLASTIC RETAINERS	Z	-	-	-	-							18	20.00
F-3869	HOOD PEAK MOULDING	ACORN NUTS w SEALER	Z	-	-	-	-							7	6.00
F-3619	NAMEPLATE, FENDERS "Mustang"	1/8" SLEEVE NUTS	Z	-	-	-	-							6	3.00
F-3621	NAMEPLATE, ROOFSIDES "Grande"	1/8" SLEEVE NUTS	Z	-	-	-	-							4	2.00
F-3927	NAMEPLATE, TRUNK LID "Mustang"	ORIGINAL SLEEVE NUTS	Z	-	-	-	-							3	2.00
F-373	TAILAMP PANEL MOULDINGS	STAMPED ACORN NUTS ONLY	Z	-	-	-	-							12	15.00
F-1196	TAILAMP PANEL MOULDINGS	STAMPED ACORN NUTS, RETAINERS	Z	-	-	-	-							24	22.00
F-1636	WHEEL OPENINGS (4)	SS/CHROME PH RNDWA AB SCREWS	Z	-	-	-	-							28	10.00
F-3503	WINDOW (Fr) MOULDINGS - BODY 63, 65	RETAINERS	Z	-	-	-	-							16	8.00
F-3504	WINDOW (Fr) MOULDINGS - BODY 76	HX CONI KEPS, BLIND RIVETS	Z	-	-	-	-							9	4.00
F-583	WINDOW (Rr) MOULDINGS - BODY 63	RETAINERS, PH RNDWA SCREWS	Z	-	-	-	-							21	8.00
F-3623	WINDOW (Rr) MOULDINGS - BODY 65	RETAINERS	Z	-	-	-	-							18	8.00

Steering & Suspension

F-1444	AXLE HOUSING > SPRINGS	5 3/4" U-BOLTS, FLNG NUTS	Z	-	-	-	-							12	26.00
F-1162	AXLE HOUSING > SPRINGS - NUTS ONLY	FLNG NUTS (Red)	Z	-	-	-	-							8	12.00
F-3442	AXLE HOUSING > SPRINGS (exc Eliminator)	6 3/4" U-BOLTS, FLNG NUTS	-	W	-	-	-							12	26.00
F-1355	BALL JOINTS (RIVETS) - LWR	RIVETS (2 extra), SPL TOOLS, PRESS RQD	Z	W	-	-	-							8	6.00
F-1354	BALL JOINTS (RIVETS) - UPPER	RIVETS (2 extra), SPL TOOLS, PRESS RQD	Z	W	-	-	-							10	6.00
F-2924	COIL SPRING SEATS (perches)	GR-8 KNURLED BOLTS, LOCK NUTS	Z	W	O	B	-							8	10.00
F-596	COIL SPRING SEATS (perches)	LOCK NUTS ONLY	Z	-	-	-	-							4	3.00
F-1515	CONTROL ARMS (lower) > SHOCK TOWER	GR-8 CAM BOLTS, RED NUTS, WA'S	Z	-	-	-	-							8	20.00
F-3311	CONTROL ARMS (upper) > SHOCK TOWER	GR-8 1/2-13 KNURLED BOLTS, RED NUTS	Z	W	O	B	-							12	16.00
F-361	CONTROL ARMS (upper) > SHOCK TOWER	GR-8 RED NUTS ONLY, SPLIT WA'S	Z	-	-	-	-							8	5.00
F-2846	CONTROL VALVE ACTUATOR	HX SPLIT SEMS	Z	W	O	-	-							2	3.00

See factory Assembly Manuals for illustrations

1972

Steering & Suspension

PART #	APPLICATION	NOTES						PCS	PRICE
			MUSTANG	COUGAR	FAIRLANE	BRONCO	TRUCK		
F-571	GREASE PLUGS, CHASSIS	HX PLUGS	Z	W	O	B	T	9	5.00
F-1267	IDLER ARM	HX BOLTS, LOCK NUTS, CLIPPED WA'S	Z	-	-	-	-	6	20.00
F-3651	LEAF SPRING CENTER BOLTS	GR-8 TALL HD BOLTS, HX NUTS	Z	W	-	-	-	4	8.00
F-1103	LEAF SPRINGS (front eye)	FLNG BOLTS & NUTS	Z	-	-	-	-	4	18.00
F-3933	P/S CONTROL VALVE DUST COVER CLAMP	SLOT RND B SCREWS	Z	W	O	B	T	2	1.50
F-3890	P/S PUMP - 250	SRTD FLNG BOLTS	Z	-	-	-	-	7	8.00
F-1309	P/S PUMP - 302/351 w AC	FLNG BOLTS	Z	W	O	B	T	6	20.00
F-1308	P/S PUMP - 302/351W w/o AC	FLNG BOLTS, SPACER	Z	W	O	B	T	8	24.00
F-1408	P/S PUMP - 351C w/o AC	FLNG BOLTS, SPACER	Z	W	O	B	T	8	24.00
F-673	P/S PUMP - ADJUSTMENT BOLT ONLY	SRTD FLNG BOLT	Z	W	O	B	T	1	4.00
F-2937	P/S PUMP RESERVOIR NUT	THIN HX NUT ON BACK	Z	W	O	B	T	1	3.00
F-614	PITMAN ARM > GEAR BOX	HX JAM NUT, SPLIT WA	Z	W	-	-	-	2	3.00
F-1251	SHOCK BRACKETS (Fr)	LOW HD CRG BOLTS, LOCK NUTS	Z	-	-	-	-	12	9.00
F-1794	SHOCKS (Rr)	SRTD HX NUTS	Z	-	-	-	-	4	2.00
F-810	STABILIZER (Fr) > BODY (STABILIZER BAR)	HX CONI SEMS, LOCK NUTS	Z	-	-	-	-	8	6.00
F-3950	STABILIZER (Fr) END LINKS	BLTS, RTNRS, BSHNGS, SPACERS, NUTS	Z	W	-	-	-	22	25.00
F-868	STABILIZER (Rr) > BODY	HXWA SCREWS	Z	-	-	-	-	4	5.00
F-3949	STABILIZER (Rr) END LINKS (SWAY BAR))	BLTS, RTNRS, BSHNGS, SPACERS, NUTS	Z	-	-	-	-	22	60.00
F-1442	STEERING GEAR BOX	HX BOLTS, FLAT WA'S	Z	-	-	-	-	6	10.00
F-815	STEERING LINKAGE	SLOTTED NUTS, COTTER PINS	Z	-	-	-	-	21	12.00
F-612	STEERING RAG JOINT 11/4/68 >	12 PT BOLT, 5/16-18 LOCK NUTS	Z	-	-	-	-	3	4.00
F-3309	STEERING WHEEL	LOCK NUT	Z	W	O	B	T	1	3.00
F-661	STRUT ROD THREADED ENDS > BODY	LOCK NUTS ONLY	Z	W	O	-	-	4	10.00
F-1264	STRUT RODS > LWR CONTROL ARM	1/2-13 SPL KNRLD BOLTS, NUTS, PINS	Z	-	-	-	-	12	38.00
F-370	STRUT RODS > LWR CONTROL ARM - NUTS	After 11/11/68, 1/2-13 LOCK NUTS ONLY	Z	-	-	-	-	4	4.00
F-2957	SUSP BUMPER (Rr)	LOCK NUT	Z	W	-	-	-	1	2.00
F-1488	SUSP BUMPER BRKT (Rr) - 250 & 302	HXWA C SCREWS	Z	-	-	-	-	2	2.00
F-2858	TIE ROD ADJUSTMENT SLEEVE	HX BOLTS, LOCK NUTS	Z	W	O	B	T	8	6.00
F-379	WHEEL BOLTS, Fr DRUM - 1.48" BOLTS	1/2-20 BOLTS	Z	W	O	B	T	10	8.00
F-781	WHEEL BOLTS, Fr DRUM - 1.69" BOLTS	1/2-20 BOLTS	Z	W	O	B	T	10	8.00
F-1353	WHEELS	1/2-20 LUG NUTS, 13/16" HX	Z	W	O	B	T	20	16.00

Transmission

F-1368	BELL HOUSING (manual) - 302/351	HX BOLTS, SPLIT WA'S	Z	W	O	B	T	12	14.00
F-876	DRIVESHAFT - V8	5/16-24 LOCK NUTS ONLY	Z	W	O	B	T	4	3.00
F-1273	DRIVESHAFT - V8, 6 CYL 67-68 A/T, All 69 >	5/16" U-BOLTS, LOCK NUTS	Z	W	O	B	T	6	8.00
F-1228	ENGINE PLATE (M/T) - 6 CYL & SB	UBS FLNG BOLTS	Z	W	O	B	T	2	3.00
F-1230	INSPECTION COVER & ENG PLATE - C4, FMX	UBS FLNG BOLTS	Z	W	-	-	-	3	4.00
F-2159	INSPECTION COVER (A/T flywheel) - C6	HX SPLIT SEMS, UBS FLNG BOLT	Z	W	O	B	T	3	3.00
F-3263	PRESSURE PLATE > FLYWHEEL	SPL HX BOLTS, SPLIT WA'S	Z	W	O	B	T	12	6.00
F-910	SHIFTER (manual) LWR BOOT RETAINER	HX BOLTS	Z	-	-	-	-	4	2.50
F-1240	SHIFTER ASSY > FLOOR - A/T	UBS FLNG BOLTS	Z	-	-	-	-	4	3.00
F-1236	SHIFTER ASSY > FLOOR - A/T w CONSOLE	PH PN AB SCREWS	Z	-	-	-	-	4	2.00
F-1217	SHIFTER CONTROL > TRANS - 3 SPD	UBS FLNG BOLTS	Z	W	O	B	T	2	3.00
F-1219	SHIFTER CONTROL > TRANS - 4 SPD	FLNG & HX BOLTS, SCREWS, FLAT, WA'S	Z	W	O	B	T	7	16.00
F-897	SHIFTER HANDLE (manual) > SHIFTER	FORD SHIFTERS, FLAT WA'S ONLY	Z	W	-	-	-	2	1.50
F-1243	SHIFTER LINKAGE - A/T	PERI KEPS NUT, FLAT & WAVE WA'S, PINS	Z	W	O	B	T	9	9.00
F-1224	SHIFTER RODS - 3 SPD	LOCK NUTS, WA'S, PINS	Z	W	O	B	T	8	10.00
F-1225	SHIFTER RODS - 4 SPD	LOCK NUTS, WA'S, PIN	Z	W	O	B	T	5	10.00
F-3413	SPEDOMETER CABLE > TRANS	HXWA EXT SEMS	Z	W	O	B	T	1	2.00
F-185	TORQUE CONVERTOR FLEX PLATE	FLNG NUTS	Z	W	O	B	T	4	4.00
F-1367	TRANS (auto) > ENGINE - 250/302/351 C4/FMX	HX BOLTS, SPLIT WA'S	Z	W	O	B	T	12	14.00
F-3341	TRANS (auto) > ENGINE - 351C w C6	HX BOLTS, SPLIT WA'S	Z	W	O	B	T	12	14.00
F-186	TRANS (auto) > ENGINE - 390/428	HX BOLTS, SPLIT WA'S	-	-	-	-	T	12	14.00
F-3986	TRANS (auto) KICKDOWN RETAINERS - V8	Does both ends, CORRECT CLIPS	Z	W	-	-	-	2	4.00
F-678	TRANS (manual) > BELL HOUSING	HX BOLTS, SPLIT WA'S	Z	W	O	B	T	8	7.00
F-1841	TRANS ACCESS COVER - FORD 4 SPD	CORRECT SRTD FLNG BOLTS, "X" LONG	Z	W	O	B	T	10	12.00
F-816	TRANS COOLING LINE CLIPS	C CLIPS	Z	W	O	B	T	2	3.00
F-1143	TRANS CROSSMEMBER	UBS FLNG BOLTS & NUTS	Z	-	-	-	-	4	8.00
F-1342	TRANS ID TAG	DRIVE SCREW	Z	W	O	B	T	1	1.00
F-1322	TRANS LEVERS > CASE - 3 SPD	HX NUTS, FLAT & SPLIT WA'S	Z	W	O	B	T	6	3.00
F-1385	TRANS LEVERS > CASE - 4 SPD	HX NUTS, FLAT & SPLIT WA'S	Z	W	O	B	T	9	3.00
F-1621	TRANS OIL PAN - C4	FLNG BOLTS	Z	W	O	B	T	11	4.00
F-892	TRANS OIL PAN - C6	FLNG BOLTS	Z	W	O	B	T	17	6.00
F-1622	TRANS OIL PAN - FMX	FLNG BOLTS	Z	W	O	B	T	14	5.00
F-2874	TRANS TAIL HOUSING - M/T	HX BOLTS, SPLIT WA'S	Z	W	O	B	T	10	8.00

Wipers

F-855	WASHER NOZZLES	PH PN AB SCREWS	Z	-	-	-	-	2	1.00
F-1743	WINDSHIELD WASHER BOTTLE	HXWA AB FLAT SEMS	Z	-	-	-	-	2	2.50
F-946	WIPER ARM PIVOTS > COWL PANEL	TORX WAFER CONI SEMS	Z	-	-	-	-	6	8.00
F-1782	WIPER MOTOR	UBS FLNG BOLTS	Z	-	-	-	-	3	3.00

Kits Contain Attaching Fasteners for Both Sides

Ford Fastener Kits

1973

Air Conditioning

PART #	APPLICATION	NOTES						PCS	PRICE
			MUSTANG	COUGAR	FAIRLANE	BRONCO	TRUCK		
F-716	AC BRUSH & HOLDER	HX FLNG SCREWS	Z	W	O	B	T	2	1.50
F-718	AC COMPRESSOR - 289/302/351/429	SRTD FLNG BOLTS	Z	W	O	B	T	4	6.00
F-713	AC COMPRESSOR - 390/428	SRTD FLNG BOLTS	-	-	-	-	T	5	7.00
F-3299	AC COMPRESSOR - 429	SRTD HX FLNG & PLACE BOLTS	-	-	-	-	T	6	8.00
F-726	AC COMPRESSOR - 6 CYL	FLNG BOLTS	Z	-	-	B	T	4	6.00
F-727	AC COMPRESSOR BRACE (Rr) - 6 CYL	SRTD FLNG BOLTS, FLAT WA	Z	-	O	B	T	3	3.00
F-1291	AC COMPRESSOR BRACE (side) - 302/351	SRTD FLNG BOLTS	Z	W	O	B	T	4	6.00
F-3298	AC COMPRESSOR BRACE (side) - 429	SRTD FLNG BOLTS	-	-	-	-	T	5	5.00
F-728	AC COMPRESSOR BRACE (side) - 6 CYL	SRTD FLNG BOLT, LOCK NUT	Z	-	-	B	T	2	2.00
F-719	AC COMPRESSOR BRACE (side) - V8, 70 FE	SRTD FLNG BOLTS	-	-	-	-	T	3	6.00
F-720	AC COMPRESSOR BRACKET - 302/351	STUDS, LOCK NUTS	Z	W	O	B	T	6	8.00
F-725	AC COMPRESSOR BRACKET - 6 CYL	SRTD FLNG BOLTS	Z	-	-	B	T	3	5.00
F-724	AC COMPRESSOR BRACKET - 69 V8, 70 FE	STUDS, LOCK NUTS	-	-	-	-	T	6	6.00
F-721	AC COMPRESSOR CLUTCH	HX BOLT, FLAT WA	Z	W	O	B	T	2	3.00
F-717	AC COMPRESSOR FIELD	HX FLNG HD SCREWS	Z	W	O	B	T	4	3.00
F-3439	AC CONDENSOR & TUBE	FLNG BOLTS, HXWA SCREWS, U-NUTS	Z	W	-	-	-	10	5.00
F-2963	AC DEHYDRATOR & RECEIVER TANK	FLAT & HXWA A SCREWS	Z	W	-	-	-	3	2.00
F-1781	AC EVAPORATOR & BLOWER > FIREWALL	STAMPED NUTS, SEALER	Z	-	-	-	-	3	4.00
F-723	AC IDLER PULLEYS - 302/351	SRTD FLNG BOLTS, STUD, NUT, WA'S	Z	W	O	B	T	7	9.00
F-722	AC IDLER PULLEYS - 390/428	SRTD FLNG BOLTS, LOCK NUT, WA'S	-	-	-	-	T	7	8.00
F-3297	AC IDLER PULLEYS & SUPPORT - 429	SRTD FLNG BOLTS, STUD, LOCK NUT	-	-	-	-	T	6	8.00
F-2909	AC TAG and COMPRESSOR LEAD WIRE	SPECIAL METAL T RETAINER	Z	W	O	-	-	1	3.00

Body

F-3622	AIR VENT GRILLES @ QTER PANELS	SS/BLACK PH PN AB SCREWS	Z	-	-	-	-	2	1.50
F-2158	BATTERY TRAY	SPL CONI SEMS, U-NUT	Z	-	-	-	-	4	4.00
F-1632	BUMPER (Fr)	HX CONI SEMS, CONI KEPS NUTS	Z	-	-	-	-	10	10.00
F-1820	BUMPER (Fr) COVER SUPPORTS	HXWA SCREWS	Z	-	-	-	-	4	2.00
F-3259	BUMPER (Rr)	SS CAPPED BOLTS, KEPS, SHIMS, WA'S	Z	-	-	-	-	16	8.00
F-3576	BUMPER ARMS > REINFORCEMENT	HX CONI SEMS ONLY	Z	-	-	-	-	8	10.00
F-3575	BUMPER BRACKETS (Fr)	HX BOLTS, SPLIT & FLAT WA'S	Z	-	-	-	-	12	8.00
F-1527	BUMPER BRACKETS (Rr)	HX CONI SEMS, U-NUTS, WA'S, SEALS	Z	-	-	-	-	16	16.00
F-3258	BUMPER GUARD PADS - FULL LENGTH (Rr)	CONI KEPS NUTS	Z	-	-	-	-	16	5.00
F-3257	BUMPER GUARD PADS (Rr)	CONI KEPS NUTS	Z	-	-	-	-	4	2.00
F-3260	BUMPER GUARDS (Rr)	HX CONI SEMS	Z	-	-	-	-	4	4.00
F-3600	BUMPERS (Fr & Rr) - CHROME	SS CAPPED BOLTS, NUTS, SPLIT WA'S	-	-	-	B	-	24	10.00
F-3599	BUMPERS (Fr & Rr) - PAINTED	CRG BOLTS, NUTS, SPLIT WA'S	-	-	-	B	-	24	6.00
F-956	CONVERTIBLE PUMP & BRACKETS	CONI KEPS NUTS, FLAT WA'S	Z	-	-	-	-	4	3.00
F-957	CONVERTIBLE TOP > BODY TACK STRIP	HX CONI SEMS, PH PN A SCREWS	Z	-	-	-	-	14	14.00
F-2003	CONVERTIBLE TOP > BOW LISTING	PH OV B SCREWS	Z	-	-	-	-	4	2.00
F-2060	CONVERTIBLE TOP FRAME > BODY	HX CONI SEMS	Z	-	-	-	-	6	5.00
F-145	COWL BRACES > COWL	HX CONI SEMS, FLNG NUTS	Z	-	-	-	-	8	9.00
F-253	COWL BUMPERS	PH PN AB SCREWS	Z	-	-	-	-	3	1.00
F-975	DOOR HANDLES (outside)	CONI KEPS NUTS	Z	-	-	-	-	4	2.00
F-170	DOOR HINGES	ORIGINAL HXWA SCREWS	Z	-	-	-	-	24	14.00
F-3447	DOOR LATCH REINFORCEMENTS	SS PH OV SCREWS, SS CNTSNK WA'S	Z	W	-	-	-	12	5.00
F-1383	DOOR LATCH ROD END BUSHINGS ONLY	5/32 SIZE, EXACTLY ORIGINAL	Z	W	-	-	-	12	6.00
F-1357	DOOR LATCH ROD END BUSHINGS ONLY	9/64 SIZE, EXACTLY ORIGINAL	-	-	-	B	-	12	7.00
F-1361	DOOR LATCH ROD END CLIPS	5/32 SIZE, EXACTLY ORIGINAL	Z	W	-	-	-	12	36.00
F-1356	DOOR LATCH ROD END CLIPS	9/64 SIZE, EXACTLY ORIGINAL	-	-	-	B	-	12	38.00
F-653	DOOR LATCHES > DOOR SHELL	PH FLAT EXT SEMS	Z	W	-	-	-	6	3.00
F-248	FENDER SHIELDS > BUMPER	PH RNDWA AB SCREWS, SPRING NUTS	Z	-	-	-	-	10	5.00
F-231	FENDER SPLASH SHIELDS	HXWA AB SCREWS	Z	-	-	-	-	12	6.00
F-3432	FENDER TOPS ONLY, "FLAG"	HX CONI SEMS, .75 WA OD	Z	-	-	-	-	12	10.00
F-238	FENDERS	HX CONI SEMS, SCREWS, U-NUTS, SHIMS	Z	-	-	-	-	44	38.00
F-246	FENDERS BRACES (Fr)	HX CONI SEMS, U-NUTS	Z	-	-	-	-	4	3.00
F-233	FENDERS FILLER PANELS @ PILLARS	PH RNDWA AB SCREWS	Z	-	-	-	-	4	2.00
F-567	FLOOR REINFORCEMENT - BODY 76	HX CONI SEMS	Z	-	-	-	-	6	12.00
F-171	FLOORBOARD HOLE COVERS 12/20/66 >	HXWA AB SCREWS	Z	-	-	-	-	8	3.00
F-247	GRILLE & CENTER SUPPORT	HX CONI SEMS, PH PN SCREWS, NUTS	Z	-	-	-	-	14	12.00
F-3502	HEADLAMP DOORS	PH OV AB SCREWS, NYLON NUTS	Z	-	-	-	-	4	2.00
F-235	HEADLAMP HOUSINGS	HX CONI SEMS, U-NUTS	Z	-	-	-	-	16	12.00
F-234	HEADLAMP SUPPORT BRACKETS	HX CONI SEMS, U-NUTS	Z	-	-	-	-	24	20.00
F-232	HOOD & HINGES	HX CONI SEMS, U-NUTS	Z	-	-	-	-	16	16.00
F-2157	HOOD LATCH & CATCH	HX CONI & SQR SEMS, U-NUTS	Z	-	-	-	-	6	6.00
F-241	HOOD LATCH SUPPORT	SPL HX SQR CONED SEMS, U-NUTS	Z	-	-	-	-	5	4.00
F-143	HOOD SCOOPS, RAM-AIR	SPL STAMPED NUTS w SEALER, STUDS	Z	-	-	-	-	20	20.00
F-1631	HOOD TWIST LOCK CATCHES (on extension)	HX CONI SEMS, U-NUTS	Z	-	-	-	-	8	6.00
F-1351	HOOD TWIST LOCK EXTENSIONS	HX CONI SEMS, U-NUTS	Z	-	-	-	-	12	7.00
F-1630	HOOD TWIST LOCK RETAINERS (on hood)	HX CONI SEMS	Z	-	-	-	-	4	4.00
F-863	HOOD, RAM-AIR PLENUM	PH RNDWA AB SCREWS	Z	-	-	-	-	24	10.00

See factory Assembly Manuals for illustrations

Ford Fastener Kits

285

1973

Body

PART #	APPLICATION	NOTES						PCS	PRICE
			MUSTANG	COUGAR	FAIRLANE	BRONCO	TRUCK		
F-981	INSTRUMENT PANEL (welded assembly)	HX CONI SEMS	Z	-	-	-	-	2	2.00
F-982	INSTRUMENT PANEL CENTER BRACE	HX CONI SEMS	Z	-	-	-	-	2	2.50
F-979	INSTRUMENT PANEL LH CENTER BRACE	HX CONI SEMS, HXWA AB FLAT SEMS	Z	-	-	-	-	5	5.00
F-980	INSTRUMENT PANEL LH UPPER BRACE	HX CONI SEMS	Z	-	-	-	-	4	4.00
F-983	INSTRUMENT PANEL LWR BRACES	HX CONI SEMS	Z	-	-	-	-	4	4.00
F-3481	LICENSE PLATES	HXWA B SCREWS, NYLON NUTS	Z	W	O	B	T	8	4.00
F-802	MIRROR (outside) > DOOR - 1 MIRROR	SS/CHROME POZI OV SCREW, RIV NUTS	Z	W	O	B	T	4	3.00
F-1512	MIRROR (outside) > DOOR - 2 MIRRORS	SS/CHROME POZI OV SCREW, RIV NUTS	Z	W	O	B	T	8	5.00
F-254	QTER PANEL EXTENSIONS	STUDS, CONI KEPS NUTS, FLAT & SEALER	Z	-	-	-	-	40	14.00
F-1294	ROOFSIDE WEATHERSTRIP - BODY 63	PH PN & PH RNDWA SCREWS, RIVETS	Z	-	-	-	-	32	10.00
F-1295	ROOFSIDE WEATHERSTRIP - BODY 65	PH OV, PH PN & PH SCREWS, RIVETS	Z	-	-	-	-	56	12.00
F-240	SHOCK TOWER BRACES (cover springs)	HX SQR CONE SEMS, NUTS	Z	-	-	-	-	20	14.00
F-977	SPOILER (Fr)	HXWA AB FLAT SEMS	Z	-	-	-	-	14	12.00
F-3921	SPOILER (Rr) > SUPPORTS	SKT HD SCREWS, PH OV SCREWS, WA'S	Z	-	-	-	-	18	6.00
F-1435	SPOILER (Rr) SUPPORTS > DECKLID	CONI KEPS NUTS, RUBBER CAPS	Z	-	-	-	-	8	6.00
F-3522	STEERING COLUMN SEAL	LARGE HX PERI SEMS	Z	-	-	-	-	3	4.50
F-1799	STONE DEFLECTOR (Rr)	HXWA AB SCREW, STAMPED NUTS	Z	-	-	-	-	8	6.00
F-255	TIE DOWN BRACKETS (Rr)	HX CONI SEMS, LOCK NUTS	Z	-	-	-	-	10	20.00
F-165	TRUNK LATCH & STRIKER	HX CONI SEMS	Z	-	-	-	-	5	5.00
F-1802	TRUNK LID - BODY 65, 76	1/4-20 HX CONI SEMS	Z	-	-	-	-	4	4.00
F-257	TRUNK LID & HINGES - BODY 63	5/16-18 HX CONI SEMS	Z	-	-	-	-	6	6.00
F-245	VALANCE (Fr)	HX CONI SEMS, U-NUTS	Z	-	-	-	-	14	11.00
F-166	VALANCE (Rr)	CLIP HEAD BOLTS, PH PN SCREWS, NUTS	Z	-	-	-	-	15	7.00
F-1750	WEATHERSTRIP, DOORS	PH PN AB SCREWS	Z	-	-	-	-	12	2.00
F-1300	WINDOW SEALS @ DOOR Rr, QTER - 65, 76	PH PN AB SCREWS	Z	-	-	-	-	22	4.00

Brakes

F-1616	BRAKE ASSEMBLY (front drum) > SPINDLE	T-BOLTS, LOCK NUTS	Z	W	-	-	-	-	16	14.00
F-1481	BRAKE BOOSTER > FIREWALL	FLNG NUTS	Z	W	O	B	-	-	4	8.00
F-3882	BRAKE BOOSTER HOSE	FLAT WOUND SPRING CLAMPS, BLACK	Z	W	O	B	T	-	2	2.00
F-1791	BRAKE CABLE SEAL @ BRAKE PLATES	1.0" DIA X .58 TK RUBBER SEAL	Z	W	-	-	-	-	2	3.00
F-575	BRAKE CABLES > BODY	RETAINING CLIPS, HX NUTS	Z	W	-	-	-	-	6	4.00
F-2985	BRAKE CALIPER BLEEDERS	CORRECT SCREWS	Z	W	-	-	T	-	2	4.00
F-3698	BRAKE CALIPER HARDWARE - COMPLETE	STAB'S, CLIPS, INSULATORS, SCREWS	Z	W	O	-	-	-	30	50.00
F-1263	BRAKE CALIPERS > SPINDLE	DRILLED GR-8 BOLTS, SPLIT WA'S	Z	W	O	-	-	-	8	38.00
F-579	BRAKE DRUM RETAINERS	GREEN PUSH ON RETAINERS	Z	W	O	B	T	-	6	4.00
F-1332	BRAKE HOSE BRKTS (drum) (Fr) > BODY	HXWA C SCREWS	Z	W	-	-	-	-	6	4.00
F-1250	BRAKE HOSES (disc) > BODY	HXWA C SCREWS, U-CLIP	Z	W	-	-	-	-	5	5.00
F-577	BRAKE HOSES (drum) > BRACKET	U-CLIPS	Z	W	-	-	-	-	3	4.00
F-1517	BRAKE HOSES > CALIPER	RED GR-8 DRILLED HX BOLTS, COP WA'S	Z	W	O	-	-	-	6	20.00
F-670	BRAKE LIGHT SWITCH	RETAINING PIN	Z	W	O	B	T	-	1	2.00
F-854	BRAKE PEDAL > FIREWALL	FLNG NUTS	Z	-	-	-	-	-	4	3.00
F-669	BRAKE PLATE ADJUST HOLE PLUGS (2)	RUBBER PLUGS	Z	W	O	B	T	-	2	3.00
F-1601	BRAKE ROTOR SHIELDS	HX EXT SEMS	Z	W	-	-	-	-	6	4.00
F-1475	MASTER CYLINDER w POWER BRAKES	FLNG NUTS	Z	W	O	B	T	-	2	3.00
F-1473	MASTER CYLINDER w/o POWER BRAKES	HX SPLIT SEMS	Z	W	O	B	-	-	2	5.00
F-1333	PARKING BRAKE CONTROL > BODY	HXWA SRTD SCREWS	Z	W	-	-	-	-	3	4.00
F-799	PROPORTIONING VALVE > APRON	UBS FLNG NUTS	Z	W	-	-	-	-	2	2.00
F-2950	WHEEL CYLINDER BLEEDERS	1/4-28 x 1/4 HX x 92" OAL SCREWS, ZDC	Z	W	O	B	T	-	2	3.00
F-356	WHEEL CYLINDERS (2) - 250 & All 8 CYL	5/16-18 HX EXT SEMS	Z	W	O	B	T	-	4	3.00
F-3912	WHEEL CYLINDERS (4) - 250 & All 8 CYL	5/16-18 HX EXT SEMS	Z	W	O	B	T	-	8	6.00

Brake & Fuel Lines - also see page 216

F-3983	BRAKE LINES (shared vapor) - Fr DISC	CORRECT CLIPS, SCREWS, GROMMETS	Z	W	-	-	-	-	32	44.00
F-3982	BRAKE LINES (shared) - Fr DRUM & 250 DISC	CORRECT CLIPS, SCREWS, GROMMETS	Z	W	-	-	-	-	32	44.00
F-3964	FUEL LINE @ ROCKER, Mid 67-70 HT, 71-73	CLIP w SQUEEZE RETAINER	Z	W	-	-	-	-	1	4.00
F-3984	FUEL LINES - 6 CYL	CORRECT CLIPS, SCREWS, GROMMET	Z	W	-	-	-	-	9	16.00
F-3985	FUEL LINES - V8	CORRECT CLIPS, SCREWS, GROMMET	Z	W	-	-	-	-	14	22.00
F-250	RADIATOR - All	HX SQR CONE SEMS	Z	-	-	-	-	-	6	6.00

Cooling

F-252	RADIATOR FAN GUARD	HXWA AB SCREW	Z	-	-	-	-	-	2	1.50
F-1525	RADIATOR FAN SHROUD - 250/302/351	SPL HXWA SCREWS, S CLIPS, NUTS	Z	-	-	-	-	-	6	6.00
F-657	RADIATOR HOSE CLAMPS - 289/302/351	WIRE TYPE	Z	W	O	B	T	-	4	16.00
F-3936	RADIATOR HOSE CLAMPS - 351C	WIRE TYPE	Z	W	-	-	-	-	4	16.00
F-658	RADIATOR HOSE CLAMPS - 390/428	WIRE TYPE	-	-	-	-	T	-	4	20.00
F-656	RADIATOR HOSE CLAMPS - 6 CYL	WIRE TYPE	-	-	-	-	T	-	4	16.00

Kits Contain Attaching Fasteners for Both Sides

Ford Fastener Kits

1973

Differential

PART #	APPLICATION	NOTES						PCS	PRICE
			MUSTANG	COUGAR	FAIRLANE	BRONCO	TRUCK		
F-1440	AXLE RETAINER PLATES - 250 & 8 CYL	T-BOLTS, LOCK NUTS	Z	W	-	-	-	16	20.00
F-1161	AXLE RETAINER PLATES - NUTS ONLY	LOCK NUTS (Red)	Z	W	O	-	-	8	6.00
F-1663	AXLE VENT SYSTEM	FITTING, HOSE, CLAMPS, HXWA SCREW	Z	-	-	-	-	5	20.00
F-1165	DIFFERENTIAL CARRIER > HOUSING	COPPER WA'S ONLY	Z	W	O	B	T	10	4.00
F-785	DIFFERENTIAL CARRIER > HOUSING	RED LOCK NUTS, COPPER WA'S	Z	W	O	B	T	20	12.00
F-3987	DIFFERENTIAL FLANGE > PINION	GR-8 3/4-20 TOP-LOK FLNG LOCKNUT	Z	W	O	B	T	1	5.00
F-374	DIFFERENTIAL PINION SUPPORT	PLACE BOLTS	Z	W	O	B	T	5	8.00

Electrical

F-1319	ALTERNATOR - 250 6 CYL	HX, SRTD HX FLNG & PLACE BOLTS	Z	-	-	B	T	5	18.00
F-3315	ALTERNATOR - 302/351W less SPACER	HX, SRTD FLNG & PLACE BOLTS, WA	Z	W	O	B	T	5	10.00
F-3314	ALTERNATOR - 302/351W w SPACER	HX, SRTD FLNG & PLACE BOLTS, SPACER	Z	W	O	B	T	6	18.00
F-3213	ALTERNATOR - 351C less SPACER	HX & SRTD FLNG BOLTS, SPLIT WA	Z	W	O	B	T	3	10.00
F-1494	ALTERNATOR - 351C w SPACER	HX & SRTD FLNG BOLTS, SPACER	Z	W	O	B	T	4	16.00
F-652	ALTERNATOR HOUSING THRU BOLTS	HXWA SCREWS	Z	W	O	B	T	3	3.00
F-644	ALTERNATOR PULLEY	HX NUT & SPLIT WA (ZDC)	Z	W	O	B	T	2	2.00
F-1172	ALTERNATOR WIRING	10-24 CONI KEPS NUTS	Z	W	O	B	T	2	1.50
F-779	ANTENNA > FENDER	PH OV AB SCREWS	Z	W	O	B	T	4	2.00
F-638	BATTERY CABLES - 302/351W	HX BOLT, CONI KEPS, EXT WA	Z	W	O	B	T	5	4.00
F-639	BATTERY CABLES - 351C	HX BOLTS, CONI KEPS, EXT WA'S	Z	W	O	B	T	7	4.00
F-642	BATTERY CABLES - 390/428	HX BOLT, CONI KEPS, EXT WA	-	-	-	-	T	5	4.00
F-635	BATTERY CABLES - 6 CYL	HX BOLT, CONI KEPS, EXT WA	Z	-	O	B	T	5	4.00
F-744	BATTERY HOLDOWN CLAMP	J- HOOKS, HX CONI SEMS, FLNG NUTS	Z	W	-	-	-	5	7.00
F-1195	BATTERY HOLDOWN CLAMP	J- HOOKS, HXWA AB SCREW, CONI KEPS	-	-	O	B	T	5	6.00
F-646	DISTRIBUTOR POINTS & COND - DUAL PT	SLOT PN C SCREWS	Z	W	O	B	T	5	3.00
F-645	DISTRIBUTOR POINTS & COND - SINGLE	SLOT PN C SCREWS	Z	W	O	B	T	3	2.00
F-1073	DRIVING LAMPS @ GRILLE	HXWA AB SCREWS	Z	-	-	-	-	4	2.00
F-3993	HEADLAMP ADJUSTERS	ADJUSTER NUTS, SCREWS, SPRINGS	Z	-	-	-	-	10	8.00
F-2933	HEADLAMP ADJUSTERS	ADJUSTERS, SCREWS, SPRINGS	-	W	-	-	-	28	20.00
F-740	HEADLAMP DIMMER SWITCH	HXWA AB SCREWS	Z	W	-	-	-	2	2.00
F-601	HEADLAMP RETAINING RINGS (2)	SS PH PN SCREWS	Z	-	-	-	-	6	2.00
F-1167	HORNS	HX PERI SEMS	Z	W	O	B	T	2	2.50
F-1623	IGNITION COIL STRAP & BRKT - 351C/429	HX SPLIT SEMS, HXWA SCREW, HX NUT	Z	W	O	B	T	3	3.00
F-422	IGNITION COIL STRAP & BRKT - 6 CYL	HX SPLIT SEMS, HXWA SCREW, HX NUT	Z	W	O	B	T	4	3.00
F-376	IGNITION COIL STRAP & BRKT - V8 exc 351C	HX SPLIT SEMS, HXWA SCREW, HX NUT	Z	W	O	B	T	3	3.00
F-1301	IGNITION COIL STRAP ONLY	HXWA SCREW, HX NUT	Z	W	O	B	T	2	1.50
F-3449	JUNCTION BLOCK @ STARTER SOLENOID	HXWA AB SCREWS, CONI KEPS NUT	Z	W	-	-	-	3	2.00
F-1174	LICENSE PLATE LAMP	PH PN AB SCREWS	Z	-	-	-	-	2	1.00
F-3443	NEUTRAL SWITCH	HX EXT SEMS	Z	W	O	B	T	2	3.00
F-2969	PARKING LAMPS > GRILLE	PH RNDWA B SCREWS	Z	-	-	-	-	4	3.00
F-427	RADIO - HOOD GROUND	HXWA AB SCREW ONLY	Z	-	-	-	-	1	1.50
F-1095	RADIO > INSTRUMENT PANEL	EXT KEPS NUT	Z	-	-	-	-	1	2.50
F-2027	RADIO SPEAKER > DASH	HXWA B SCREWS, SPRING NUTS	Z	-	-	-	-	8	2.00
F-450	SIDE MARKERS LAMPS (Rr)	STAMPED NUTS	Z	-	-	-	-	4	3.00
F-1410	STARTER - 289/302/351	HXWA SPLIT SEMS, YLW ZINC	Z	W	O	B	T	2	3.50
F-408	STARTER - 6 CYL & 390/428	HX SPLIT SEMS	Z	-	-	-	T	3	4.00
F-407	STARTER SOLENOID	HXWA AB SCREWS "D"	Z	W	O	B	T	2	1.50
F-1173	TAILAMP ASSEMBLY > BODY	CLIP HEAD BOLTS, CONI KEPS, RBR CAPS	Z	-	-	-	-	18	16.00
F-3826	TAILAMP WIRING & GROUND	NYLON "O" CLIPS, HXWA B SCREW	Z	-	-	-	-	9	6.00
F-1776	TRUNK LAMP - BODY 65	HXWA B SCREW	Z	-	-	-	-	1	1.00
F-3827	TRUNK LAMP & WIRING - BODY 63	HXWA B SCREW, NYLON "O" CLIPS	Z	-	-	-	-	3	3.00
F-2142	VOLTAGE REGULATOR	HXWA A SCREWS "D", EXT WA	Z	W	O	B	T	3	1.50
F-3823	WIRING - 6 CYL IGNITION COIL	RUBBER COATED "J" CLIP	Z	-	-	-	T	1	1.50
F-3822	WIRING - BACK-UP LAMP > FIREWALL	4" FLAT NYLON STRAP	Z	-	-	-	-	1	1.50
F-3825	WIRING - CONVERTIBLE TOP CONTROL	NYLON "O" CLIPS	Z	-	-	-	-	4	3.00
F-3829	WIRING - DOOR SPEAKERS	NYLON "O" CLIPS	Z	-	-	-	-	2	3.00
F-3828	WIRING - RADIO CABLE > DASH	NYLON "S" CLIPS	Z	-	-	-	-	3	4.00
F-1808	WIRING - RH FENDER APRON	5" NYLON STRAPS	Z	-	-	-	-	2	3.00
F-1810	WIRING - SIDE MARKER & HEADLAMPS	3.25" NYLON STRAPS	Z	-	-	-	-	3	5.00
F-3824	WIRING - UNDER DASH	NYLON "O" CLIPS	Z	-	-	-	-	5	5.00
F-3831	WIRING - VARIOUS LOCATIONS	ZIP TIES	Z	-	-	-	-	20	5.00

Emissions

F-1066	VACUUM TREE > FIREWALL	HXWA AB SCREWS	Z	-	-	-	-	2	1.50
--------	------------------------	----------------	---	---	---	---	---	---	------

See factory Assembly Manuals for illustrations

Ford Fastener Kits

287

1973

Exhaust

PART #	APPLICATION	NOTES	VEHICLE					PCS	PRICE
			Z	W	O	B	T		
F-1455	EXHAUST HANGERS, DUAL	HXWA C SCREWS	Z	-	-	-	-	12	6.00
F-1247	EXHAUST HANGERS, SINGLE	HXWA C SCREWS	Z	-	-	-	-	8	4.00
F-522	EXHAUST PIPE > MANIFOLD - 6 CYL	STUDS 2.25 OAL, FLNG NUTS	Z	-	O	B	-	4	7.00
F-523	EXHAUST PIPE > MANIFOLDS - SB, 69 390GT	STUDS 2.25 OAL, FLNG NUTS	Z	W	O	B	-	8	10.00

Fuel - for lines see page 216

F-1456	ACCEL BELLCRANK > FIREWALL	HXWA AB SCREWS, SRTD FLNG NUTS	Z	-	-	-	-	6	3.00
F-589	FUEL HOSE CLAMPS	FLAT WOUND SPRING TYPE (Silver)	Z	W	-	-	-	8	4.00
F-754	FUEL VAPOR STORAGE CANISTER	EXT KEPS NUTS	Z	-	-	-	-	3	3.00
F-3417	GAS CAP (pop open)	PH FLAT A SCREWS	Z	-	-	-	-	5	3.00
F-1411	GAS TANK	CRG BOLTS, FLNG NUTS	Z	-	-	-	-	4	6.00
F-992	GAS TANK FILLER NECK SEAL	PH PN B SCREWS	Z	-	-	-	-	4	3.00
F-3204	GAS TANK FILLER NECK w TWIST CAP	PH PN AB SCREWS	Z	-	-	-	-	5	3.00
F-301	GAS TANK FILLER NECK w TWIST CAP	HXWA AB SCREW	Z	-	-	-	-	5	3.00

Heater

F-3916	DEFROSTER DUCTS > DASH	CLIP HEAD BOLTS, EXT KEPS NUTS	Z	-	-	-	-	6	4.00
F-383	HEATER & BY-PASS HOSES	WHITEK TOWER CLAMPS	Z	W	O	B	T	6	12.00
F-1780	HEATER ASSEMBLY > FIREWALL	STAMPED NUTS, SEALER WA'S	Z	-	-	-	-	4	6.00

Interior

F-3440	ARMRESTS - STD	HXWA AB SCREWS, SPRING NUTS	Z	-	-	-	-	8	4.00
F-1011	COAT HOOKS	PH OV AB SCREWS ONLY	Z	-	-	-	-	4	1.50
F-1101	CONSOLE (full) > FLOOR	PH OB & PH PN AB SCREWS	Z	-	-	-	-	10	5.00
F-1102	CONSOLE (short) > FLOOR	PH OV AB SCREWS	Z	-	-	-	-	3	7.00
F-906	DASH PAD & SUPPORT	PH PN SCREWS, RETAINERS, NUTS	Z	-	-	-	-	18	6.00
F-1078	DOME LAMP	PH PN B SCREWS	Z	-	-	-	-	2	1.00
F-1391	DOOR HANDLES (inside)	POZI PAN CONI SEMS	Z	-	-	-	-	2	2.00
F-1040	DOOR PANELS	PADDED RETAINERS	Z	-	-	-	-	28	12.00
F-940	FD SEAT > FLOOR	HX CONI SEMS	Z	-	-	-	-	4	6.00
F-938	FD SEAT CARPETED Rr PANEL	PH OV FLUSH & CUPPED SEMS, NUTS	Z	-	-	-	-	6	3.00
F-921	FD SEAT SIDE LATCH	HX CONI SEMS, U-NUT	Z	-	-	-	-	6	2.50
F-943	FD SEAT SIDE LATCH STRIKER	HX CONI SEMS	Z	-	-	-	-	2	4.00
F-937	FD SEAT STOP PLATES	PH TRUSS AB SCREWS	Z	-	-	-	-	4	3.00
F-932	FD SEAT TRAP DOOR HINGES & TRIM	HXWA & PH OV AB SCREWS	Z	-	-	-	-	27	5.00
F-927	FD SEAT TRAP DOOR LATCH	HX CONI SEMS	Z	-	-	-	-	4	3.00
F-942	FD SEAT TRAP DOOR WIRE LATCHES	HX CONI SEMS	Z	-	-	-	-	4	3.00
F-933	FD SEAT TRAP DR OPENING STRAINERS	HXWA AB SCREWS	Z	-	-	-	-	8	3.00
F-3477	FD SEAT TRIM	CHROME PH OV AB SCREW, JAM NUTS	Z	-	-	-	-	56	10.00
F-2939	GLOVE BOX BUMPERS	.31 H RUBBER BUMPER	Z	-	-	-	-	2	2.00
F-918	GLOVE BOX CATCH	POZI PH PN CONI SEMS	Z	-	-	-	-	2	2.00
F-989	GLOVE BOX FINISH PANEL	SPL PH PN SCREWS	Z	-	-	-	-	7	2.00
F-1170	GLOVE BOX LATCH	PH PN EXT SEMS	Z	-	-	-	-	2	2.00
F-919	GLOVE BOX LINER	PH PNWA B SCREWS	Z	-	-	-	-	5	2.00
F-1015	HEADLINER ROOFSIDE TRIM - BODY 63, 65	DARK INTERIOR, PH OV AB SCREWS	Z	-	-	-	-	6	2.50
F-1014	HEADLINER ROOFSIDE TRIM - BODY 63, 65	LIGHT INTERIOR, PH OV AB SCREWS	Z	-	-	-	-	6	2.50
F-1001	HEADLINER TACK STRIP - BODY 63, 65	HXWA AB SCREWS	Z	-	-	-	-	18	3.50
F-1087	HEATER CONTROL > DASH	HXWA B SCREWS, SPRING NUTS	Z	-	-	-	-	8	3.00
F-1115	HORN PAD & COVER, (2 or 3 Spoke Wheel)	PH PN & HXWA SCREWS	Z	-	-	-	-	6	2.00
F-986	INSTR FINISH PANEL (BEZEL) @ CLUSTER	PH PN B SCREWS, SPRING NUTS	Z	-	-	-	-	9	3.00
F-991	INSTR FINISH PANEL > COLUMN SHROUD	PH PN & PH RNDWA B SCREWS	Z	-	-	-	-	4	2.00
F-985	INSTR FINISH PANEL > DASHBOARD CENTER	PH PN AB SCREWS	Z	-	-	-	-	5	2.00
F-988	INSTR FINISH PANEL > LH END	PH PN B SCREWS, SPRING CLIPS	Z	-	-	-	-	4	2.00
F-990	INSTR FINISH PANEL > RH AC BEZELS	HXWA AB SCREWS	Z	-	-	-	-	10	2.00
F-987	INSTR FINISH PANEL > RH END	PH OV B SCREWS	Z	-	-	-	-	2	1.50
F-1088	INSTR GAUGE CLUSTER > STRUCTURE	HXWA B SCREWS, SPRING NUTS	Z	-	-	-	-	8	3.00
F-984	INSTRUMENT FINISH PANEL RH > DASH	PH PN SCREWS, SPRING & STAMP NUTS	Z	-	-	-	-	8	5.00
F-1018	KICK PANELS	SPL RETAINING CLIPS	Z	-	-	-	-	4	0.00
F-1381	LAMPS, COURTESY UNDERDASH	HXWA B SCREWS	Z	-	-	-	-	2	1.00
F-1034	PACKAGE TRAY	HXWA AB SCREWS	Z	-	-	-	-	3	1.00
F-3898	PACKAGE TRAY & TRIM - BODY 63	PH PN & PH OV AB SCREWS, RIVETS	Z	-	-	-	-	15	3.00
F-1020	QTER TRIM PANEL BRACKETS - BODY 63	PH PN AB SCREWS	Z	-	-	-	-	24	4.00
F-1024	QTER TRIM PANELS - BODY 63 w DARK INT	HX CONI SEMS, SCREWS, U-NUTS, WA'S	Z	-	-	-	-	36	14.00

Kits Contain Attaching Fasteners for Both Sides

1973

Interior

PART #	APPLICATION	NOTES						PCS	PRICE	
			MUSTANG	COUGAR	FAIRLANE	BRONCO	TRUCK			
F-1023	QTER TRIM PANELS - BODY 63 w LT INT	HX CONI SEMS, SCREWS, U-NUTS, WA'S	Z	-	-	-	-	-	36	14.00
F-1030	QTER TRIM PANELS - BODY 65 w DARK INT	PH RNDWA SCREWS	Z	-	-	-	-	-	6	4.00
F-1029	QTER TRIM PANELS - BODY 65 w LT INT	PH RNDWA SCREWS	Z	-	-	-	-	-	6	4.00
F-1032	QTER TRIM PANELS - BODY 76 DARK INT	PH OV & PH PN AB SCREWS	Z	-	-	-	-	-	16	4.00
F-1031	QTER TRIM PANELS - BODY 76 LT INT	PH OV & PH PN AB SCREWS	Z	-	-	-	-	-	16	4.00
F-1093	RADIO OPENING BEZEL	PH OV AB SCREWS	Z	-	-	-	-	-	4	2.50
F-1090	RADIO OPENING COVER	HXWA AB SCREWS, FLAT WA'S	Z	-	-	-	-	-	4	1.00
F-495	SCUFF PLATES (door opening)	SS/CHROME PH OV AB SCREWS	Z	-	-	-	-	-	12	4.00
F-3768	SEAT BACK COVERS	PH RNDWA SCREWS, WIRE RETAINERS	Z	-	-	-	-	-	12	3.00
F-3561	SEAT BELTS (Fr)	TORX BOLTS, RUBBER WA'S, SPACERS	Z	-	-	-	-	-	12	16.00
F-3563	SEAT BELTS (Fr) - SHOULDER STRAPS	TORX SHLDR BOLTS, CHROME SPACERS	Z	-	-	-	-	-	4	14.00
F-3566	SEAT BELTS (Rr) 2-29-68 >	TORX BOLTS, SPACERS	Z	-	-	-	-	-	8	14.00
F-684	SEAT PIVOT COVERS	PH OV T1 SCREWS	Z	-	-	-	-	-	4	2.00
F-687	SEAT STOPS - Fr SEAT BACKS	PH PN AB SCREWS	Z	-	-	-	-	-	8	3.00
F-3473	SEAT TRACKS > BODY	FLNG BOLTS, CONI KEPS NUTS	Z	-	-	-	-	-	10	6.00
F-1048	SEAT UPHOLSTERY (Rr) > FLOOR - B 63	PH PN & PH WAFER SCREWS, SEALER	Z	-	-	-	-	-	8	3.00
F-1047	SEAT UPHOLSTERY (Rr) > FLOOR - B 65, 76	HX PERI SEMS, SEALER	Z	-	-	-	-	-	4	3.00
F-607	SUN VISOR BRACKETS - BODY 63, 65	PH OV AB SCREWS	Z	-	-	-	-	-	8	4.00
F-1388	SUN VISOR BRACKETS - BODY 76, DK INT	PH OV & PH PN AB SCREWS	Z	-	-	-	-	-	8	4.00
F-608	SUN VISOR BRACKETS - BODY 76, LT INT	PH OV & PH PN AB SCREWS	Z	-	-	-	-	-	8	4.00
F-953	WINDOW CRANK HANDLES	OVAL HEAD POZI OV SCREWS	Z	-	-	-	-	-	2	1.00
F-1009	WINDSHIELD PILLIAR TRIM - BODY 76 DARK	PH OV AB SCREWS	Z	-	-	-	-	-	4	2.00
F-1008	WINDSHIELD PILLIAR TRIM - BODY 76 LIGHT	PH OV AB SCREWS	Z	-	-	-	-	-	4	2.00
F-1005	WINDSHIELD, TOP INSIDE TRIM - 63, 65 DARK	PH OV AB SCREWS	Z	-	-	-	-	-	6	2.50
F-1004	WINDSHIELD, TOP INSIDE TRIM - 63, 65 LIGHT	PH OV AB SCREWS	Z	-	-	-	-	-	6	2.50

Moulding

F-3509	BODY SIDE MOULDINGS - LWR (Metro Parts only)	RETAINERS, STAMPED NUTS	Z	-	-	-	-	-	44	30.00
F-3643	EMBLEM NUTS, Complete - PRODUCTION	PLASTIC SLEEVE NUTS	Z	-	-	-	-	-	6	3.00
F-654	FENDER MOULDINGS	STAMPED NUTS	Z	-	-	-	-	-	6	3.00
F-3451	GRILLE MOULDINGS	PLASTIC RETAINERS	Z	-	-	-	-	-	18	20.00
F-3869	HOOD PEAK MOULDING	ACORN NUTS w SEALER	Z	-	-	-	-	-	7	6.00
F-3624	NAMEPLATE, FENDERS "Mustang"	PLASTIC SLEEVE NUTS	Z	-	-	-	-	-	6	2.00
F-3626	NAMEPLATE, ROOFSIDES "Mustang"	PLASTIC SLEEVE NUTS	Z	-	-	-	-	-	6	2.00
F-3625	NAMEPLATE, TRUNK LID "Mustang"	PLASTIC SLEEVE NUTS	Z	-	-	-	-	-	3	1.50
F-373	TAILAMP PANEL MOULDINGS	STAMPED ACORN NUTS ONLY	Z	-	-	-	-	-	12	15.00
F-1196	TAILAMP PANEL MOULDINGS	STAMPED ACORN NUTS, RETAINERS	Z	-	-	-	-	-	24	22.00
F-1636	WHEEL OPENINGS (4)	SS/CHROME PH RNDWA AB SCREWS	Z	-	-	-	-	-	28	10.00
F-3503	WINDOW (Fr) MOULDINGS - BODY 63, 65	RETAINERS	Z	-	-	-	-	-	16	8.00
F-3504	WINDOW (Fr) MOULDINGS - BODY 76	HX CONI KEPS, BLIND RIVETS	Z	-	-	-	-	-	9	4.00
F-583	WINDOW (Rr) MOULDINGS - BODY 63	RETAINERS, PH RNDWA SCREWS	Z	-	-	-	-	-	21	8.00
F-3623	WINDOW (Rr) MOULDINGS - BODY 65	RETAINERS	Z	-	-	-	-	-	18	8.00

Steering & Suspension

F-1444	AXLE HOUSING > SPRINGS	5 3/4" U-BOLTS, FLNG NUTS	Z	-	-	-	-	-	12	26.00
F-1162	AXLE HOUSING > SPRINGS - NUTS ONLY	FLNG NUTS (Red)	Z	-	-	-	-	-	8	12.00
F-3442	AXLE HOUSING > SPRINGS (exc Eliminator)	6 3/4" U-BOLTS, FLNG NUTS	-	W	-	-	-	-	12	26.00
F-1355	BALL JOINTS (RIVETS) - LWR	RIVETS (2 extra), SPL TOOLS, PRESS RQD	Z	W	-	-	-	-	8	6.00
F-1354	BALL JOINTS (RIVETS) - UPPER	RIVETS (2 extra), SPL TOOLS, PRESS RQD	Z	W	-	-	-	-	10	6.00
F-2924	COIL SPRING SEATS (perches)	GR-8 KNURLED BOLTS, LOCK NUTS	Z	W	O	B	-	-	8	10.00
F-596	COIL SPRING SEATS (perches)	LOCK NUTS ONLY	Z	-	-	-	-	-	4	3.00
F-1515	CONTROL ARMS (lower) > SHOCK TOWER	GR-8 CAM BOLTS, RED NUTS, WA'S	Z	-	-	-	-	-	8	20.00
F-3311	CONTROL ARMS (upper) > SHOCK TOWER	GR-8 1/2-13 KNURLED BOLTS, RED NUTS	Z	W	O	B	-	-	12	16.00
F-361	CONTROL ARMS (upper) > SHOCK TOWER	GR-8 RED NUTS ONLY, SPLIT WA'S	Z	-	-	-	-	-	8	5.00
F-2846	CONTROL VALVE ACTUATOR	HX SPLIT SEMS	Z	W	O	-	-	-	2	3.00
F-571	GREASE PLUGS, CHASSIS	HX PLUGS	Z	W	O	B	T	-	9	5.00
F-3205	HUBCAPS (Mag Wheels)	CHROME PH OV T1 SCREWS	Z	-	-	-	-	-	20	5.00
F-1267	IDLER ARM	HX BOLTS, LOCK NUTS, CLIPPED WA'S	Z	-	-	-	-	-	6	20.00
F-3651	LEAF SPRING CENTER BOLTS	GR-8 TALL HD BOLTS, HX NUTS	Z	W	-	-	-	-	4	8.00
F-1103	LEAF SPRINGS (front eye)	FLNG BOLTS & NUTS	Z	-	-	-	-	-	4	18.00
F-3933	P/S CONTROL VALVE DUST COVER CLAMP	SLOT RND B SCREWS	Z	W	O	B	T	-	2	1.50
F-3890	P/S PUMP - 250	SRTD FLNG BOLTS	Z	-	-	-	-	-	7	8.00
F-1309	P/S PUMP - 302/351 w AC	FLNG BOLTS	Z	W	O	B	T	-	6	20.00
F-1308	P/S PUMP - 302/351W w/o AC	FLNG BOLTS, SPACER	Z	W	O	B	T	-	8	24.00
F-1408	P/S PUMP - 351C w/o AC	FLNG BOLTS, SPACER	Z	W	O	B	T	-	8	24.00
F-673	P/S PUMP - ADJUSTMENT BOLT ONLY	SRTD FLNG BOLT	Z	W	O	B	T	-	1	4.00
F-2937	P/S PUMP RESERVOIR NUT	THIN HX NUT ON BACK	Z	W	O	B	T	-	1	3.00
F-614	PITMAN ARM > GEAR BOX	HX JAM NUT, SPLIT WA	Z	W	-	-	-	-	2	3.00

See factory Assembly Manuals for illustrations

1973

Steering & Suspension

PART #	APPLICATION	NOTES	VEHICLE					PCS	PRICE
			MUSTANG	COUGAR	FAIRLANE	BRONCO	TRUCK		
F-1251	SHOCK BRACKETS (Fr)	LOW HD CRG BOLTS, LOCK NUTS	Z	-	-	-	-	12	9.00
F-1794	SHOCKS (Rr)	SRTD HX NUTS	Z	-	-	-	-	4	2.00
F-810	STABILIZER (Fr) > BODY (STABILIZER BAR)	HX CONI SEMS, LOCK NUTS	Z	-	-	-	-	8	6.00
F-3950	STABILIZER (Fr) END LINKS	BLTS, RTNRS, BSHNGS, SPACERS, NUTS	Z	W	-	-	-	22	25.00
F-868	STABILIZER (Rr) > BODY	HXWA SCREWS	Z	-	-	-	-	4	5.00
F-3949	STABILIZER (Rr) END LINKS (SWAY BAR))	BLTS, RTNRS, BSHNGS, SPACERS, NUTS	Z	-	-	-	-	22	60.00
F-1442	STEERING GEAR BOX	HX BOLTS, FLAT WA'S	Z	-	-	-	-	6	10.00
F-815	STEERING LINKAGE	SLOTTED NUTS, COTTER PINS	Z	-	-	-	-	21	12.00
F-612	STEERING RAG JOINT 11/4/68 >	12 PT BOLT, 5/16-18 LOCK NUTS	Z	-	-	-	-	3	4.00
F-3309	STEERING WHEEL	LOCK NUT	Z	W	O	B	T	1	3.00
F-661	STRUT ROD THREADED ENDS > BODY	LOCK NUTS ONLY	Z	W	O	-	-	4	10.00
F-1264	STRUT RODS > LWR CONTROL ARM	1/2-13 SPL KNRLD BOLTS, NUTS, PINS	Z	-	-	-	-	12	38.00
F-370	STRUT RODS > LWR CONTROL ARM - NUTS	After 11/11/68, 1/2-13 LOCK NUTS ONLY	Z	-	-	-	-	4	4.00
F-2957	SUSP BUMPER (Rr)	LOCK NUT	Z	W	-	-	-	1	2.00
F-1488	SUSP BUMPER BRKT (Rr) - 250 & 302	HXWA C SCREWS	Z	-	-	-	-	2	2.00
F-2858	TIE ROD ADJUSTMENT SLEEVE	HX BOLTS, LOCK NUTS	Z	W	O	B	T	8	6.00
F-379	WHEEL BOLTS, Fr DRUM - 1.48" BOLTS	1/2-20 BOLTS	Z	W	O	B	T	10	8.00
F-781	WHEEL BOLTS, Fr DRUM - 1.69" BOLTS	1/2-20 BOLTS	Z	W	O	B	T	10	8.00
F-1353	WHEELS	1/2-20 LUG NUTS, 13/16" HX	Z	W	O	B	T	20	16.00

Transmission

F-1368	BELL HOUSING (manual) - 302/351	HX BOLTS, SPLIT WA'S	Z	W	O	B	T	12	14.00
F-876	DRIVESHAFT - V8	5/16-24 LOCK NUTS ONLY	Z	W	O	B	T	4	3.00
F-1273	DRIVESHAFT - V8, 6 CYL 67-68 A/T, All 69 >	5/16" U-BOLTS, LOCK NUTS	Z	W	O	B	T	6	8.00
F-1228	ENGINE PLATE (M/T) - 6 CYL & SB	UBS FLNG BOLTS	Z	W	O	B	T	2	3.00
F-1230	INSPECTION COVER & ENG PLATE - C4, FMX	UBS FLNG BOLTS	Z	W	-	-	-	3	4.00
F-2159	INSPECTION COVER (A/T flywheel) - C6	HX SPLIT SEMS, UBS FLNG BOLT	Z	W	O	B	T	3	3.00
F-3263	PRESSURE PLATE > FLYWHEEL	SPL HX BOLTS, SPLIT WA'S	Z	W	O	B	T	12	6.00
F-910	SHIFTER (manual) LWR BOOT RETAINER	HX BOLTS	Z	-	-	-	-	4	2.50
F-1240	SHIFTER ASSY > FLOOR - A/T	UBS FLNG BOLTS	Z	-	-	-	-	4	3.00
F-1236	SHIFTER ASSY > FLOOR - A/T w CONSOLE	PH PN AB SCREWS	Z	-	-	-	-	4	2.00
F-1217	SHIFTER CONTROL > TRANS - 3 SPD	UBS FLNG BOLTS	Z	W	O	B	T	2	3.00
F-1219	SHIFTER CONTROL > TRANS - 4 SPD	FLNG & HX BOLTS, SCREWS, FLAT, WA'S	Z	W	O	B	T	7	16.00
F-897	SHIFTER HANDLE (manual) > SHIFTER	FORD SHIFTERS, FLAT WA'S ONLY	Z	W	-	-	-	2	1.50
F-1243	SHIFTER LINKAGE - A/T	PERI KEPS NUT, FLAT & WAVE WA'S, PINS	Z	W	O	B	T	9	9.00
F-1224	SHIFTER RODS - 3 SPD	LOCK NUTS, WA'S, PINS	Z	W	O	B	T	8	10.00
F-1225	SHIFTER RODS - 4 SPD	LOCK NUTS, WA'S, PIN	Z	W	O	B	T	5	10.00
F-3413	SPEDOMETER CABLE > TRANS	HXWA EXT SEMS	Z	W	O	B	T	1	2.00
F-185	TORQUE CONVERTOR FLEX PLATE	FLNG NUTS	Z	W	O	B	T	4	4.00
F-1367	TRANS (auto) > ENGINE - 250/302/351 C4/FMX	HX BOLTS, SPLIT WA'S	Z	W	O	B	T	12	14.00
F-3341	TRANS (auto) > ENGINE - 351C w C6	HX BOLTS, SPLIT WA'S	Z	W	O	B	T	12	14.00
F-186	TRANS (auto) > ENGINE - 390/428	HX BOLTS, SPLIT WA'S	-	-	-	-	T	12	14.00
F-3986	TRANS (auto) KICKDOWN RETAINERS - V8	Does both ends, CORRECT CLIPS	Z	W	-	-	-	2	4.00
F-678	TRANS (manual) > BELL HOUSING	HX BOLTS, SPLIT WA'S	Z	W	O	B	T	8	7.00
F-1841	TRANS ACCESS COVER - FORD 4 SPD	CORRECT SRTD FLNG BOLTS, "X" LONG	Z	W	O	B	T	10	12.00
F-816	TRANS COOLING LINE CLIPS	C CLIPS	Z	W	O	B	T	2	3.00
F-1143	TRANS CROSSMEMBER	UBS FLNG BOLTS & NUTS	Z	-	-	-	-	4	8.00
F-1342	TRANS ID TAG	DRIVE SCREW	Z	W	O	B	T	1	1.00
F-1322	TRANS LEVERS > CASE - 3 SPD	HX NUTS, FLAT & SPLIT WA'S	Z	W	O	B	T	6	3.00
F-1385	TRANS LEVERS > CASE - 4 SPD	HX NUTS, FLAT & SPLIT WA'S	Z	W	O	B	T	9	3.00
F-1621	TRANS OIL PAN - C4	FLNG BOLTS	Z	W	O	B	T	11	4.00
F-892	TRANS OIL PAN - C6	FLNG BOLTS	Z	W	O	B	T	17	6.00
F-1622	TRANS OIL PAN - FMX	FLNG BOLTS	Z	W	O	B	T	14	5.00
F-2874	TRANS TAIL HOUSING - M/T	HX BOLTS, SPLIT WA'S	Z	W	O	B	T	10	8.00

Wipers

F-855	WASHER NOZZLES	PH PN AB SCREWS	Z	-	-	-	-	2	1.00
F-1743	WINDSHIELD WASHER BOTTLE	HXWA AB FLAT SEMS	Z	-	-	-	-	2	2.50
F-946	WIPER ARM PIVOTS > COWL PANEL	TORX WAFER CONI SEMS	Z	-	-	-	-	6	8.00
F-1782	WIPER MOTOR	UBS FLNG BOLTS	Z	-	-	-	-	3	3.00

- 274 pages
- 750 photos & Illustrations
- identifies 12,300 fasteners
- spiral bound
- plus**
- history
- finishes
- measuring
- refinishing

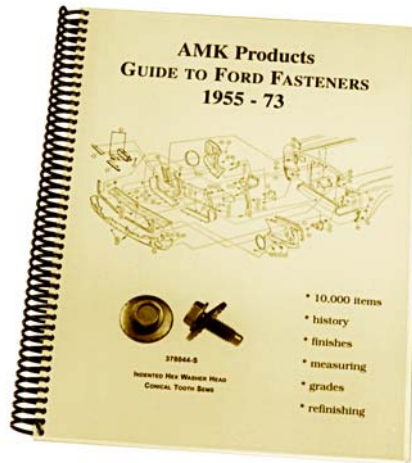

Go by the Book !

Part # ABK-FASTBOOK \$ 30

Every Assembly Manual or Parts Book user needs this book !

Air Cleaner Decals



small radius

numbers printed in a secondary operation

Mustang 68-71

"AF", "GF" and "OF" listings also fit Fairlane/Torino/Comet/Cyclone

Part # = 9600 base plus prefix & suffix

example **D0ZF-9600-N**

\$ 6 each



	1968 STD	1968 RAM-AIR	1969 BEF 2-17-69 STD	1969 AFT 2-17-69 STD	1969 BEF 2-17-69 RAM-AIR	1969 AFT 2-17-69 RAM-AIR	1969/70 SHELBY	1970 STD	1970 RAM-AIR	1971 STD	1971 RAM-AIR
200	C8ZF-A FA-51		C8ZF-A FA-51	C8ZF-A FA-51				D0DF-E FA-52			
250			C9ZF-C FA-68	C9ZF-C FA-68				D0OF-D FA-68		D1OF-CB FA-68	
289/302	C8AF-C FA-50		C8AF-C FA-50	C8AF-C FA-50				D0AF-A FA-50		D1AF-GB FA-50	
BOSS 302			C8OF-C FA-41	C8OF-C FA-41				D0GF-C FA-41	D0ZF-N FA-41		
351W			C9AF-C FA-50	C9AF-C FA-50	C9ZF-H FA-41	C9ZF-K FA-41	C8AF-C FA-50	D0OF-B FA-50	D0ZF-G FA-41	D1AF-FC FA-50	
351C								D0ZF-Z FA-50	D0ZF-AA FA-74	D1AF-FC FA-50	D1ZF-CC FA-50
390-4V	C8OF-B FA-50		C9OF-E FA-41	C9OF-E FA-41							
390GT	C8OF-A FA-41		C8OF-C FA-41	C8OF-C FA-41	C9ZF-J FA-41	C9ZF-J FA-41					
428CJ		** See Below	C8OF-C FA-41	C9OF-H FA-41	C9ZF-E FA-41	C9ZF-F FA-41	Same as Mustang	D0GF-C FA-41	D0ZF-T FA-41		
429CJ										D1AF-HB FA-50	D1ZF-FC FA-41
429SCJ									D0OF-F FA-74	D1ZF-HB FA-41	D1ZF-AC FA-50

** C9ZA-A before approx. 5/14/68, C9ZA-C after 5/14/68. 1969 part number is correct for 1968 428CJ !

Decals & Tags

NOS Originals

6000-Mile or 6 Month Maintenance Performed

Mileage _____
Date _____

Oil and Oil Filter Changed

SW-10W-20 10W-20W-30 20W-40

Next 6000-Mile or 6 Month Maintenance Due:
Mileage _____
Date _____

Additional Quality Car Care Maintenance Performed	Mileage
Air Cleaner Element: <input type="checkbox"/> Cleaned <input type="checkbox"/> Replaced	
Crankcase Vent. System	
Front Wheel Bearings	
Front Suspension Ball Joints and Steering Linkage	
Fuel Filter	
Engine Coolant	

P&S
AF-5593 Mar 66

March '66 dated
Part #
ROTUNDA-OIL
\$ 35

6000-Mile or 6 Month Maintenance Performed

Mileage _____
Date _____

Oil and Oil Filter Changed

SW-10W-20 10W-20W-30 20W-40 10W-40

Next 6000-Mile or 6 Month Maintenance Due:
Mileage _____
Date _____

Additional Maintenance Performed	Mileage
Air Cleaner Element: <input type="checkbox"/> Cleaned <input type="checkbox"/> Replaced	
Crankcase Vent. System	
Front Wheel Bearings	
Front Suspension Ball Joints and Steering Linkage	
Fuel Filter	
Engine Coolant	

MA1
AF-5593 Jul 68

July '68 Dated
Part #
FORD-OIL
\$ 3



1966-67 Fairlane
& 1967 Shelby
embossed foil paper
Part # ADC-PLAZA
\$ 20

1965-73
Tie Down Instructions
from Original Artwork
Part # ADC-TIE
\$ 6

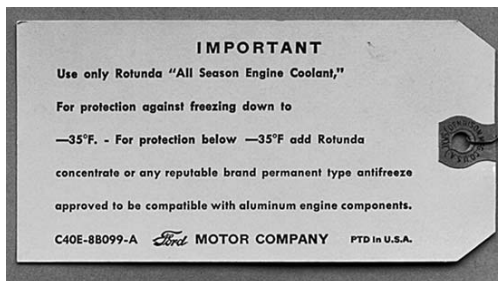
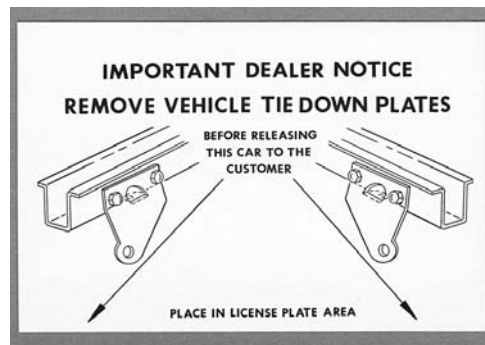

NOS Factory Anti-Freeze, All 1964-67 cars
Part # C40E-8B099-A
\$ 15



NOS Move Vehicle Tag
1961-67 cars
Part # C1TT-19C501-A
\$ 10

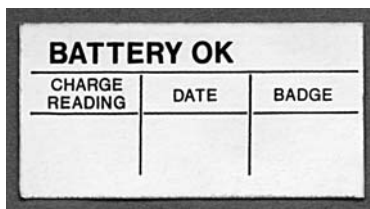

Part #
ADC-BAT-OK
\$ 3

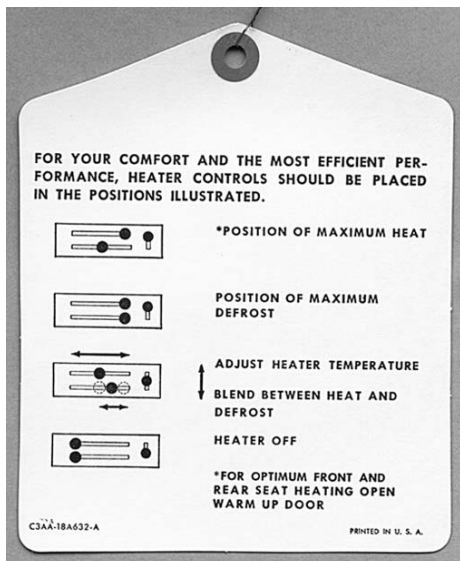

NOS 1963-64 Ford Heater Instructions
Part # C3AA-18A632-A
\$ 5

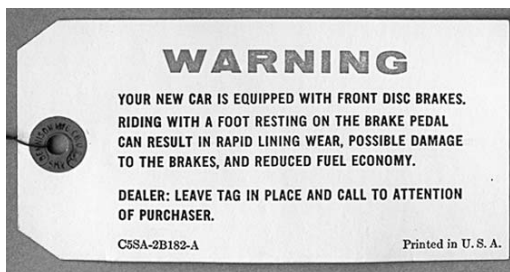

NOS Disc Brake Warning, 1965-67 cars
Part # C5SA-2B182-A
\$ 15

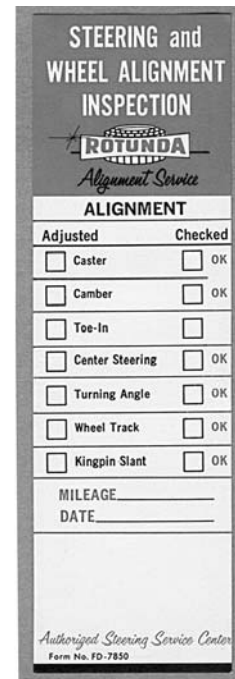

NOS Rotunda Alignment
Part #
FD-7850
\$ 5

Ford Parts

Carter Fuel Pump Rebuild Kit



Part # AFP-67
\$ 35

Fits 1967 & up with screwed-together body.

428CJ/SCJ (ID #4441), BOSS 302 (#4910), 429CJ (#4907), BOSS 429/429SCJ (#4842)

Also fits Carter aftermarket pumps with same application. Diaphragm is 4 1/16" D with 3 5/8" D screw circle.

Markal Paint Sticks

Replace the factory markings with the same paint sticks used at the factory.



1 White + 1 Yellow
Part # MARK-T \$ 3

Box of 12
Part # MARK-12 \$ 20

Each box contains 12 sticks of 10 colors.
 1 each of Brown, Pink, Orange, Blue, Red,
 Purple, Black, Green, 2 each of White & Yellow

Hood Pin Set

Original Equipment on '65-66 Mustang GT-350 & '67 GT-350/500

Correct
 "Bullet" end

O.E.M.
 stainless cable
 assemblies

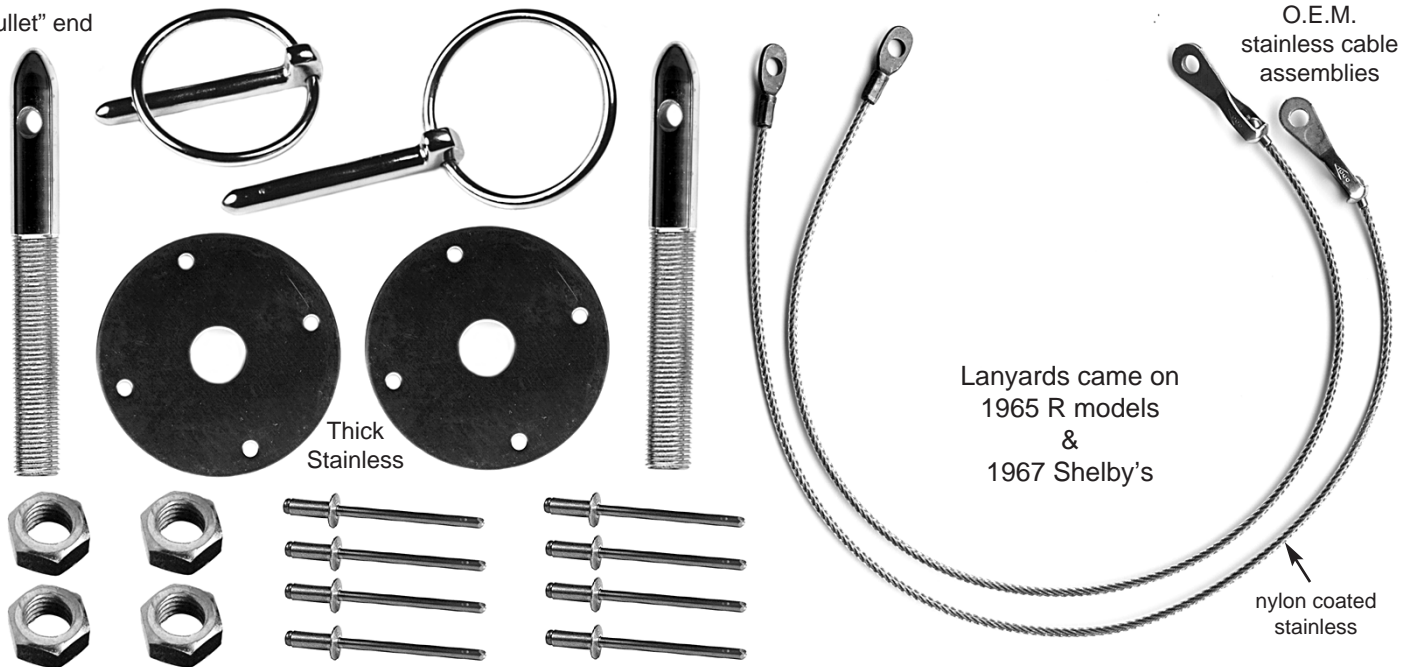

Thick
 Stainless

Lanyards came on
 1965 R models
 &
 1967 Shelby's

nylon coated
 stainless

1965-66 (no cables) Part # AHP-65 \$ 70

1967 (includes cables) Part # AHP-67 \$ 140

Brake Caliper Hardware Kit

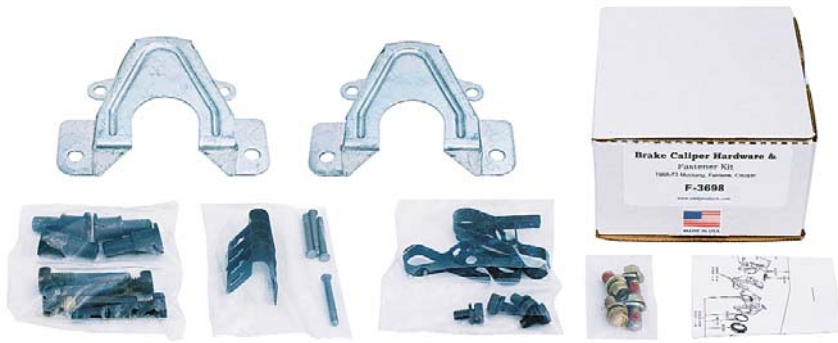

Part # F-3698

\$ 50

This kit includes all the hardware required to outfit the brake calipers on your 1968-73 Mustang, Cougar, Fairlane, Torino, Comet or Cyclone.

Leaf Spring Clamps

Fits 2 1/2" wide 4-leaf springs.

Applications include 1965-73 Mustang.

Set of 6 clamps & insulators.

Made in USA

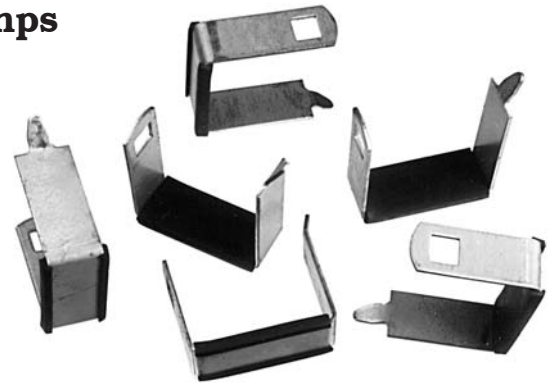

Part # ALS-65CLAMP

\$ 25 Set

NOS Parts

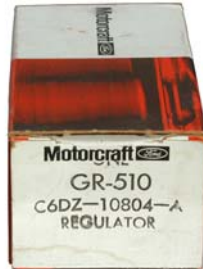

Instrument Voltage Regulator
1967-68 Mustang
1966-68 Fairlane
1969 Fairlane w Tach

Part # C6DZ-10804-A
\$ 25

Instrument Voltage Regulator
1969-73 Mustang
1969-71 Fairlane
w/o Tach

Part # C9AZ-10804-A
\$ 25



OEM in Aftermarket Box



Water Temperature Sender
1966-68 Mustang
1969-73 Mustang
except 302/351

Part # C6DZ-10884-B
\$ 25

Glove & Trunk Locks
1967-68 Mustang
& others

Part #
C7AZ-6243507-B
\$ 25 Set



Washer Bottle



1967-68 Comet, Cougar, Fairlane, Falcon, Mustang

Part # C7OZ-17618-A \$ 50 bottle w cap
Part # C7OZ-17632-A \$ 3 cap only



Made in USA on original tooling !



Ford Parts

Exhaust Clamps



Correct 1966-73 Ford
(1963-65 clamps are similar except sides have larger cut-out)

2.0" size (2.19 opening)

Ford part # C6OA-5252-H

1966-68 w cad nuts **Part # B-11700 \$ 24 pair**

1969-73 w phos nuts **Part # B-11701 \$ 24 pair**



All clamps are
MADE IN USA



2 1/8" size (2.30 opening)

Ford part # C8ZE-5252-E

Part # B-11702 \$ 24 pair



2 1/4" size (2.44 opening)

Ford part # C6OA-5252-F

Part # B-11703 \$ 24 pair



Tip Clamps

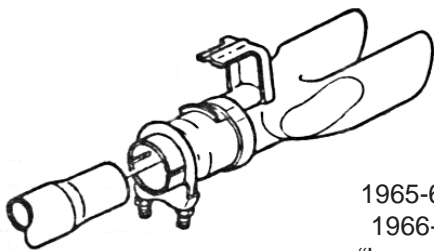

1965-69 Mustang
1966-67 Shelby
"horse shoe" style

clamps are for 2" dual exhaust only.

(1968 Shelby's use regular exhaust clamps **B-11700**)

Part # AET-65CLAMP \$ 20 pair



1.92"
opening

"Horse Shoe" shape

Radiator Caps

This very high quality cap is made by Ford's original supplier exclusively for AMK. Chrome caps have chrome rivet.



Part # ARC-58Z



Part # ARC-60Z



Part # ARC-62C



Part # ARC-67Z



Part # ARC-67C



Part # ARC-70Z



Part # ARC-72Z

Part #	Years	Application	Center Mark	Ear Mark	Finish	Price
ARC-58Z	1958-64	All Ford	S.M.Co & PAT#	14, B8A	Zinc	\$ 20
ARC-60Z	1960-66	All Ford	S.M.Co & PAT#	14	Zinc	\$ 20
ARC-62C	1962-66	Shelby, Dress-up	S.M.Co & PAT#	14	Chrome	\$ 20
ARC-67Z	1967-69	All Ford	Autolite	#13, RS-12	Zinc	\$ 20
ARC-67C	1967-69	Shelby, Dress-up	Autolite	#13, RS-12	Chrome	\$ 20
ARC-70Z	1970-71	All Ford	Autolite	#13, RS-12	Zinc	\$ 20
ARC-72Z	1972-74	All Ford	Motorcraft	#13, RS-12A	Zinc	\$ 20
ARC-72C	1972-74	Dress-up	Motorcraft	#13, RS-12A	Chrome	\$ 20

Radiator Tags



About 1/2 of 65-68 and 1/10 of 69-70 Ford's used these soldered on ID tags. If yours has this info marked into the top tank or radiator bracket, it doesn't use a tag.

Part # = 8005 base plus prefix & suffix \$ 20 each

example C6ZE-8005-H2



FRONT OF CAR



	1965 6 cyl	1965 8 cyl	1966 6 cyl	1966 289	1967 6 cyl	1967 289	1967 390/428	1968 6 cyl	1968 289/302	1968 390/428
Manual w/o AC	C4ZE A2	C4ZE Y2 [†]	C6ZE G2	C6ZE H2	C7ZE A2	C7ZE H2 [√]	C7ZE Y2 [*]	C7ZE AC2	C8ZE D2	C8ZE L2
Manual w AC	C4ZE A2	C4ZE Y2	C6ZE G2	C6ZE H2	C7ZE AC2	C7ZE H2	C7ZE F2	C8ZE P2	C8ZE E2	C8ZE L2
Auto w/o AC	C4ZE F2	C4ZE H2	C6ZE D2 ^o	C4ZE H2	C7ZE B2 ^Δ	C7ZE S2 ^f	C7ZE Z2 ^Ω	C7ZE L2	C8ZE G2	C8ZE M2
Auto w AC	C4ZE F2	C4ZE M2	C6ZE D2	C4ZE M2	C7ZE AB2	C7ZE U2	C7ZE G2	C8ZE N2	C8ZE F2	C8ZE M2

†C4ZE-G2 early oC4ZE-Z2 w TE ΔC7ZE-L2 T/E or IMPCO √C7ZE-R2 after 12/66 fC7ZE-J2 early *C7ZE-D2 early ΩC7ZE-E2 early

GM Master Kits

BODY

Save up to 30% over the individual kit price.



The hardware you need to properly reassemble your car's body bumper to bumper in one package.

Each label includes assembly manual page number !

Typical kit includes fasteners to attach: back-up lamps, battery tray, bumpers & brackets & guards, bumper filler panel, cowl panel, door latches, fenders & braces & extensions & splash shields, grille & brackets & mouldings, headlamp bezels, housings & adjusters, header panel, hood & hinges, hood levelers, hood catch & lock plate, hood catch support hood mouldings, license plate brackets, marker lamps, nameplates, parking lamps, tailamps, trunk latch & striker, trunk lid, valance, wheelhouses & brackets. Details at www.amkproducts.com/GM_Master_Kits.asp.

Part #	Year	Model	Body Style	Pcs	Price
67FB-S	1967	Camaro	All	421	\$ 189
67FB-RS	1967	Camaro RS	All	460	\$ 199
68FB-S	1968	Camaro	All	409	\$ 189
68FB-RS	1968	Camaro RS	All	442	\$ 199
69FB-S	1969	Camaro	All	417	\$ 189
69FB-RS	1969	Camaro RS	All	445	\$ 199
70FB-S	1970-72	Camaro	All	368	\$ 189
70FB-RS	1970-72	Camaro RS	All	403	\$ 199
73FB-S	1973	Camaro	All	360	\$ 189
73FB-RS	1973	Camaro RS	All	414	\$ 199
74FB	1974-76	Camaro	All	556	\$ 235
77FB	1977	Camaro	All	515	\$ 235
78FB	1978	Camaro	All	486	\$ 220
79FB	1979	Camaro	All	489	\$ 220
80FB	1980-81	Camaro	All	491	\$ 220
<hr/>					
67HB	1967-68	Firebird	All	393	\$ 199
69HB	1969	Firebird	All	513	\$ 235

BODY

Part #	Year	Model	Body Style	Pcs	Price
64AB	1964	Chevelle	All	435	\$ 179
65AB	1965	Chevelle	All	397	\$ 179
66AB	1966	Chevelle	All	444	\$ 179
67AB	1967	Chevelle	All	406	\$ 179
68AB	1968	Chevelle	All	449	\$ 179
69AB	1969	Chevelle	All	473	\$ 179
70AB	1970	Chevelle	All	408	\$ 189
71AB	1971-72	Chevelle	All	374	\$ 189
<hr/>					
64EB	1964	El Camino	All	456	\$ 189
65EB	1965	El Camino	All	426	\$ 189
66EB	1966	El Camino	All	469	\$ 189
67EB	1967	El Camino	All	409	\$ 189
68EB	1968	El Camino	All	444	\$ 199
69EB	1969	El Camino	All	477	\$ 199
70EB	1970	El Camino	All	444	\$ 199
71EB	1971-72	El Camino	All	388	\$ 199
<hr/>					
70MB	1970	Monte Carlo	All	441	\$ 189
71MB	1971-72	Monte Carlo	All	439	\$ 189
<hr/>					
64NB	1964	Nova	All	376	\$ 159
65NB	1965	Nova	All	383	\$ 159
66NB	1966	Nova	All	383	\$ 149
67NB	1967	Nova	All	384	\$ 149
68NB	1968	Nova	All	322	\$ 149
69NB	1969	Nova	All	327	\$ 149
70NB	1970	Nova	All	317	\$ 149
71NB	1971-72	Nova	All	314	\$ 149

Markal Paint Sticks

Replace the factory markings with the same paint sticks used at the factory.

1 White + 1 Yellow
Part # MARK-T \$ 3

Box of 12
Part # MARK-12 \$ 20

Each box contains 12 sticks of 10 colors.
 1 each of Brown, Pink, Orange, Blue, Red,
 Purple, Black, Green, 2 each of White & Yellow



GM Fastener Kits

MASTER ENGINE

The authentic hardware you need to correctly reassemble the engine components which attach to the long-block.

Most fasteners have correct markings for the time period. Valve cover bolts & retainers, exhaust lock bridges & washers, timing cover & oil pan bolts are made of stainless steel material !

The most significant items may be seen in the BULK section, others are not shown.

Practically all items are made in USA to the same standards required by GM.

Save up to 35% over the individual kit price.



Typical kit attaches:

air cleaner, carburetor & choke cover, crank pulley & damper, distributor, engine vent adapter, exhaust manifolds, exhaust pipe, engine fan, fan clutch, fuel pump & plate & plug, heat shroud, ignition coil & strap, intake manifold & plug, oil filter valve, oil pan, PCV adapter, PCV hose clamps, timing cover, valve covers, water neck, water pump.

Details at www.amkproducts.com/GM_Master_Kits.asp.

Part #	Year	Model	Engine	Pcs	Price
Small Block					
64-SBS	1964-65	A	283/327 w/o AC	151	\$ 99
64-SBA	1964-65	A	283/327 w AC	169	\$ 99
64N-SBS	1964-65	N	283/327 w/o AC	150	\$ 99
64N-SBA	1964-65	N	283/327 w AC	170	\$ 99
65-SBH	1965	A	327HP (L79)	178	\$ 99
66-SBH	1966-67	A	327HP (L79)	172	\$ 99
66N-SBS	1966-67	N	283/327 w/o AC	153	\$ 99
66N-SBA	1966-67	N	283/327 w AC	165	\$ 99
66N-SBH	1966-67	N	327HP (L79)	175	\$ 99
66-SBS	1966-68	A F N-68 only	283/327/350 w/o AC	152	\$ 99
66-SBA	1966-68	A F N-68 only	283/327/350 w AC	164	\$ 99
67-Z28	1967-68	F	302	174	\$ 99
69-SB	1969-71	A F N	307/327/350	170	\$ 99
69-Z28	1969-71	F	302/350 (Z28)	162	\$ 99
72-SB	1972-73	A F N	307/350	139	\$ 99
72-Z28	1972-73	F	350 (Z28)	145	\$ 99
Big Block					
65-BBH	1965	A	396 Alum Intake	183	\$ 99
66-BBS	1966-67	AF	396 Iron Intake	193	\$ 99
66-BBH	1966-67	AF	396HP/427 Alum Intake	169	\$ 99
68-BBS	1968	A F N	396 Iron Intake	159	\$ 99
68-BBH	1968	A F N	396HP/427 Alum Intake	149	\$ 99
69-BBS	1969-72	A F N	396/454 Iron Intake (LS5)	143	\$ 99
69-BBH	1969	A F N	396HP/427 Alum Intake	155	\$ 99
70-BBH	1970-72	A F N	396HP/454 Alum Intake (LS6)	152	\$ 99

A = Chevelle F = Camaro N = Nova

GM Fastener Kits

299

1964 - 73

Engine

PART #	APPLICATION	NOTES	1960's YEAR								1970's YEAR				PCS	PRICE
G-5018	AIR CLEANER - 283	3.5" STUD, PHOS WING NUT	4	5	6	-	-	-	-	-	-	-	-	2	8.00	
G-5445	AIR CLEANER - 283-4V, 327-4V	5.38" STUD, PHOS WING NUT	4	5	6	-	-	-	-	-	-	-	-	2	8.00	
G-5667	AIR CLEANER - 302, 396HP ZL2, 70AFN 396HP	1.62" RND CLR STUD, CHROME WING	-	-	-	-	-	9	0	-	-	-	-	2	8.00	
G-5878	AIR CLEANER - 307 (71 Malibu & MC) & 350-2V	3.5" STUD, ZC PLATE WING NUT	-	-	-	-	-	-	1	2	-	-	-	2	6.00	
G-5333	AIR CLEANER - 307-2V (71A)	2.3" RND CLR STUD, WING NUT	-	-	-	-	-	-	1	2	3	-	-	2	8.00	
G-4756	AIR CLEANER - 307-2V, 327-2V, 350-2V	68-71 "Chevelle", 2.3" CLR STUD, WG NUT	-	-	-	7	8	9	0	1	-	-	-	2	8.00	
G-4757	AIR CLEANER - 327-4V, 350 > 67F, 69AF 70-1N	+307 Mal/MC, 3.5" STUD, PHOS WING	-	-	-	7	8	9	0	1	-	-	-	2	8.00	
G-5424	AIR CLEANER - 327-4V, 350-4V	4.66" STUD, PHOS WING NUT	-	-	-	-	8	9	-	-	-	-	-	2	8.00	
G-5446	AIR CLEANER - 327HP	3.0" STUD, CHROME WING NUT	-	5	6	-	-	-	-	-	-	-	-	2	8.00	
G-5729	AIR CLEANER - 350 - 69F ZL2, 70-71F 4V, 72A	3.5" STUD, CHROME WING NUT	-	-	-	-	8	9	0	1	2	3	-	2	8.00	
G-5334	AIR CLEANER - 350-2V, 73 307 (F only)	1.62" RND CLR STUD, WING NUT	-	-	-	-	-	-	-	2	3	-	-	2	8.00	
G-5332	AIR CLEANER - 350-4V (Z28), 454 (LS6) 71A	1.62" RND CLR STUD, CHROME WING	-	-	-	-	-	-	1	2	3	-	-	2	8.00	
G-5983	AIR CLEANER - 350-4V or A/T SB 72A (A only)	4.66" STUD, ZC WING NUT	-	-	-	-	-	-	1	2	-	-	-	2	8.00	
G-4894	AIR CLEANER - 396	3.5" STUD, CHROME WING NUT	-	-	-	-	8	9	0	1	2	-	-	2	8.00	
G-5443	AIR CLEANER - 396 (A only)	2.30" RND CLR STUD, PHOS WING NUT	-	5	6	7	-	-	-	-	-	-	-	2	8.00	
G-5982	AIR CLEANER - 396 (L34) w ZL-2	5.38" STUD, PHOS WING NUT	-	-	-	-	-	-	0	-	-	-	-	2	8.00	
G-5981	AIR CLEANER - 396 (L78) or 454 (LS6) w ZL2	STUD, PHOS WING NUT	-	-	-	-	-	0	-	-	-	-	-	2	8.00	
G-5879	AIR CLEANER - 396 (LS3) 454 (LS5) CLOSED	4.66" STUD, CHROME WING NUT	-	-	-	-	-	0	1	2	-	-	-	2	8.00	
G-5728	AIR CLEANER - 396 SS 325HP (A only)	3.5" STUD, PHOS WING NUT	-	-	-	7	-	-	-	-	-	-	-	2	8.00	
G-5666	AIR CLEANER - 396 TRI-POWER	2.30" CLR STUD, CHROME WING NUT	-	-	-	7	-	-	-	-	-	-	-	4	10.00	
G-5444	AIR CLEANER - 396HP (A only)	2.30" CLR STUD, CHROME WING NUT	-	5	6	7	-	-	-	-	-	-	-	2	8.00	
G-5880	AIR CLEANER - 454 (LS5,LS6) w ZL2	5.38" STUD, ZC WING NUT	-	-	-	-	-	-	1	2	-	-	-	2	8.00	
G-4773	AIR CLEANER - HOLLEY - 302, 327HP, 396HP	1.50" RND CLR STUD, CHROME WING	-	-	-	7	8	9	0	-	-	-	-	2	8.00	
G-6317	AIR CLEANER - HOLLEY - 396HP (exc F)	CLR STUD, CHROME WING NUT	-	-	-	-	8	9	-	-	-	-	-	2	8.00	
G-4653	AIR CLEANER - WING NUT ONLY	PHOS FINISH, see catalog for stud	4	5	6	7	8	9	0	1	-	-	-	1	2.00	
G-5309	AIR CLEANER - WING NUT ONLY	CHROME, see catalog for stud	4	5	6	7	8	9	0	1	2	3	-	1	3.00	
G-4797	AIR CLEANER DUCT - 396 (69 AC, A/T) (A only)	SIDE SCREW STYLE CLAMP	-	-	-	-	-	9	0	1	2	-	-	1	6.00	
G-4983	AIR CLEANER DUCT - 396 w AC or A/T (A only)	CLOSED AIR CLNR, TOWER CLAMPS	-	-	-	-	8	-	-	-	-	-	-	2	6.00	
G-5272	AIR CLEANER HEAT STOVE TUBE - 396	HX BOLT, SPLIT WA	-	-	-	-	-	9	-	1	2	-	-	2	2.00	
G-4910	AIR CLEANER HEAT TUBE - SB w AC or A/T	HXWA B SCREW	-	-	-	-	8	-	-	-	-	-	-	1	1.00	
G-4760	CARBURETOR - HOLLEY 4V	STUDS, NUTS	4	5	6	7	8	9	0	1	2	3	-	8	6.00	
G-4654	CARBURETOR - ROCHESTER 2V	STUDS, NUTS, COPPER WA'S (Fr studs)	4	5	6	7	8	9	0	-	-	-	-	10	6.00	
G-5154	CARBURETOR - ROCHESTER 2V	STUDS, NUTS	-	-	-	-	-	-	1	-	-	-	-	8	6.00	
G-5330	CARBURETOR - ROCHESTER 2V	HX BOLTS	-	-	-	-	-	-	-	2	3	-	-	2	3.00	
G-5979	CARBURETOR - ROCHESTER 2V w HT SHIELD	STUDS, SPACERS, NUTS	-	-	-	-	-	0	-	-	-	-	-	12	12.00	
G-4755	CARBURETOR - ROCHESTER 4V	STUDS, HX BOLTS, NUTS	4	5	6	7	8	9	-	-	-	-	-	6	6.00	
G-5263	CARBURETOR - ROCHESTER 4V	STUDS, HX BOLTS, NUTS, COPP WA'S	-	-	-	-	-	0	-	-	-	-	-	8	6.00	
G-5268	CARBURETOR - ROCHESTER 4V	STUDS, HX BOLTS, NUTS	-	-	-	-	-	-	1	-	-	-	-	6	6.00	
G-5331	CARBURETOR - ROCHESTER 4V	HX BOLTS	-	-	-	-	-	-	-	2	3	-	-	4	4.00	
G-5895	CARBURETOR - ROCHESTER 4V w HT SHIELD	HX BOLTS, NUTS, SPACERS	-	-	-	-	-	0	-	-	-	-	-	8	12.00	
G-4652	CARBURETOR CHOKE COVER - All	PN HD SCREW	4	5	6	7	8	9	0	-	-	-	-	1	1.00	
G-5155	CARBURETOR CHOKE COVER - All	PH PN EXT SEMS, ROD END CLIP	-	-	-	-	-	-	1	2	3	-	-	2	3.00	
G-5264	CARBURETOR CHOKE COVER - 396/454	PH PN MS	-	-	-	-	-	0	-	-	-	-	-	1	1.00	
G-6621	CARBURETOR FLOAT BOWLS - HOLLEY	FLAT TOP SLOT PAN SCREWS	4	5	6	7	8	9	0	1	2	3	-	8	10.00	
G-5104	CARBURETOR FUEL LINE > BRACKET - 302	HXWA SCREW	-	-	-	-	-	9	0	1	2	-	-	1	1.50	
G-5271	CARBURETOR SOL CLAMP - 69N, 350 70FN	HX BOLT, FLAT WA	-	-	-	-	-	9	0	-	-	-	-	2	2.00	
G-6525	CARBURETOR SOL WIRE @ VALVE COVER	RUBBER COATED J CLIP	-	-	-	-	-	9	0	-	-	-	-	1	3.00	
G-5156	CARBURETOR SOLENOID (70F only)	NUT, SPLIT WA	-	-	-	-	-	0	-	-	-	-	-	2	1.50	
G-5074	CARBURETOR SOLENOID CLAMP	HX BOLT, FLAT WA	-	-	-	-	-	9	-	-	-	-	-	2	1.50	
G-5157	CARBURETOR THROTTLE RETURN VALVE	HX JAM NUT	-	-	-	-	-	0	-	-	-	-	-	1	1.50	
G-5462	CRANK DAMPER - 396/454	GR-8 BOLT, SPLIT & FLAT WA'S	-	5	6	7	8	9	0	1	2	-	-	3	6.00	
G-4772	CRANK DAMPER - SB	GR-8 BOLT, TOOTHED & FLAT WA'S	4	5	6	7	8	9	0	1	2	3	-	3	4.00	
G-5540	CRANK PULLEY - 327HP	HX BOLT, INT TOOTH & FLAT WA'S	-	5	-	-	-	-	-	-	-	-	-	9	4.00	
G-4806	CRANK PULLEY - 396/454 w PS (exc 68-72FN)	HX BOLTS, SPLIT & FLAT WA'S	-	-	-	7	8	9	0	1	2	-	-	9	5.00	
G-4768	CRANK PULLEY - 396/454	HX BOLTS, WA'S	-	5	6	7	8	9	0	1	2	-	-	6	4.00	
G-4644	CRANK PULLEY - SB	HX INT TOOTH SEMS	4	5	6	7	8	-	-	-	-	-	-	3	6.00	
G-4965	CRANK PULLEY - SB	HX BOLTS, SPLIT WA'S	-	-	-	-	-	9	0	1	2	3	-	6	4.00	
G-5265	CRANKCASE > AIR CLEANER HOSE (70F only)	TOWER TYPE CLAMPS	-	-	-	-	-	0	-	-	-	-	-	2	5.00	
G-6936	CYLINDER HEADS - SB	OEM, DOUBLE CIRCLE HEAD MARKINGS	4	5	6	7	8	9	0	1	2	3	-	34	40	
G-6937	CYLINDER HEADS - SB	OEM, "TR" HEAD MARKINGS	4	5	6	7	8	9	0	1	2	4	-	34	40	
G-4886	DIPSTICK TUBE > ENGINE (N only)	HX NUT, TOOTH WA	4	5	6	7	-	-	-	-	-	-	-	2	1.00	
G-5438	DISTRIBUTOR	HX BOLT	4	5	6	7	8	9	0	1	2	3	-	1	1.50	
G-5019	ENGINE FAN & CLUTCH - AC or 396HP/454HP	7/8" L HX BOLTS, STUDS, NUTS, WA'S	-	-	-	-	-	9	0	1	2	-	-	20	8.00	
G-4742	ENGINE FAN & CLUTCH - AC or HP	1.0" L HX BOLTS, STUDS, NUTS, WA'S	4	5	6	7	8	9	0	-	-	-	-	20	8.00	
G-5875	ENGINE FAN - 350 & All 72N V-8 (exc F)	1 7/8" SPLIT SEMS	-	-	-	-	-	-	-	2	-	-	-	4	6.00	
G-6406	ENGINE FAN - 396HP (N only)	3/4" L HX BOLTS, SPLIT WA'S	-	-	-	-	-	0	-	-	-	-	-	8	4.00	
G-4964	ENGINE FAN - 69F & 69-71N SB, 72AF 396/454	2.0" GR-8 BOLTS, SPLIT WA'S	-	-	-	-	-	9	0	1	2	-	-	8	6.00	
G-5621	ENGINE FAN - 396 (w/o fan clutch) (A only)	3.0" GR-8 BOLTS, WA'S	-	-	6	-	-	-	-	-	-	-	-	8	6.00	
G-5622	ENGINE FAN - 396 (w/o fan clutch) (A only)	3 1/4" GR-8 BOLTS, WA'S	-	-	-	7	-	-	-	-	-	-	-	8	6.00	
G-4767	ENGINE FAN - 396 (w/o fan clutch) (F only)	2 1/4" GR-8 BOLTS, WA'S	-	-	-	7	-	-	-	-	-	-	-	8	6.00	
G-5448	ENGINE FAN - SB	2 3/4" GR-8 BOLTS, SPLIT WA'S	4	5	6	7	-	-	-	-	-	-	-	8	6.00	
G-5213	ENGINE FAN - SB (AF only)	2 3/8" HX SPLIT SEMS	-	-	-	-	-	-	-	2	3	-	-	4	6.00	
G-4716	ENGINE FAN - SB (exc 69F & 68, 70-71N)	2 1/2" GR-8 HX BOLTS, SPLIT WA'S	-	-	-	-	8	9	0	1	-	-	-	8	6.00	
G-5451	EXHAUST MANIFOLDS - 396	HX BOLTS, FLAT WA'S, SS LOCKS	-	5	6	7	-	-	-	-	-	-	-	36	20.00	

A = Chevelle F = Camaro N = Nova

1964 - 73

Engine

PART #	APPLICATION	NOTES	1960's YEAR				1970's YEAR				PCS	PRICE			
G-5452	EXHAUST MANIFOLDS - 396/454	SPECIAL FORM THREAD FLNG BOLTS	-	-	-	-	8	9	0	1	2	-	16	20.00	
G-5429	EXHAUST MANIFOLDS - SB (64-68 w/o AC)	HX BOLTS, FLAT WA'S, SS LOCKS	4	5	6	7	8	9	0	1	2	3	28	22.00	
G-5430	EXHAUST MANIFOLDS - SB (N only)	HX BOLTS, FLAT WA'S	4	5	6	7	-	-	-	-	-	-	24	22.00	
G-5447	EXHAUST MANIFOLDS - SB w AC (exc 64-67N)	HX BOLTS, STUD, FLAT WA'S, SS LOCKS	4	5	6	7	8	-	-	-	-	-	28	24.00	
G-4589	FUEL PUMP & PLATE - SB	HX EXT & SPLIT SEMS	4	5	6	7	8	9	0	1	2	3	4	5.00	
G-4758	FUEL PUMP - 396/454	HXWA SPLIT SEMS, 7/16" AF	-	5	6	7	8	9	0	1	2	-	2	3.00	
G-5073	HEAT STOVES > EXH MANIFOLD - SB	A/T only 1969, DRIVE RIVETS	-	-	-	-	-	9	0	1	2	3	4	2.00	
G-4648	IGNITION WIRE BRACKETS	HX SPLIT SEMS, HXWA B SCREWS	4	5	6	7	8	9	0	-	-	-	3	2.00	
G-5342	IGNITION WIRE BRACKETS	HX CONI SEMS, HXWA B SCREWS	-	-	-	-	-	-	-	1	2	3	3	3.00	
G-6020	IGNITION WIRE BRACKETS & SHIELDS (N only)	HX SPLIT SEMS	4	5	6	7	-	-	-	-	-	-	6	2.00	
G-4656	INTAKE HOLE PLUG, 3/8" PIPE	HX TYPE w SEALER	-	5	6	7	8	9	0	1	2	3	1	2.00	
G-5454	INTAKE MANIFOLD (aluminum) - 396	"A" FLNG BOLTS	-	5	6	7	8	-	-	-	-	-	16	20.00	
G-5464	INTAKE MANIFOLD (aluminum) - 396	"A" FLNG BOLTS, 4 HX CLR STUDS	-	-	-	-	-	9	-	-	-	-	17	24.00	
G-5557	INTAKE MANIFOLD (aluminum) - 396/454	"A" FLNG BOLTS, 2 HX CLR STUDS	-	-	-	-	-	-	0	1	2	-	16	20.00	
G-5542	INTAKE MANIFOLD (aluminum) - SB	"M" HX BOLTS, 1 HX CLR STUD, WA'S	-	5	6	7	8	-	-	-	-	-	25	18.00	
G-5450	INTAKE MANIFOLD (aluminum) - SB	"M" HX BOLTS, SS WA'S	-	-	-	-	-	8	9	0	1	2	3	24	16.00
G-6610	INTAKE MANIFOLD (iron) - 396	"FP" FLNG BOLTS	-	5	6	7	8	-	-	-	-	-	16	20.00	
G-5453	INTAKE MANIFOLD (iron) - 396	"M" FLNG BOLTS	-	5	6	7	8	-	-	-	-	-	16	20.00	
G-5463	INTAKE MANIFOLD (iron) - 396/454	"M" FLNG BOLTS, 2 HX CLR STUDS	-	-	-	-	-	9	0	1	2	-	16	20.00	
G-5469	INTAKE MANIFOLD (iron) - SB	"AP" HX BOLTS ONLY	4	5	-	-	-	-	-	-	-	-	12	12.00	
G-5449	INTAKE MANIFOLD (iron) - SB	"M" HX BOLTS (without Stud)	4	5	6	7	8	9	0	1	2	3	12	12.00	
G-6217	INTAKE MANIFOLD (iron) - SB	"M" HX BOLTS, 1 HX CLR STUD	-	-	6	7	8	-	-	-	-	-	13	14.00	
G-4168	INTAKE MANIFOLD (iron) - SB	"M" HX BOLTS, 1 HX CLR STUD (TCS)	-	-	-	-	-	9	0	1	2	3	13	14.00	
G-5460	OIL FILTER VALVE	HX BOLTS	4	5	6	7	-	-	-	-	-	-	2	3.00	
G-4845	OIL FILTER VALVE	HX BOLTS	-	-	-	-	8	-	-	-	-	-	2	3.00	
G-5115	OIL FILTER VALVE	HXWA MS SCREWS	-	-	-	-	-	9	0	1	2	3	2	3.00	
G-5457	OIL PAN - 396/454	HX EXT SEMS	-	5	6	7	8	9	0	1	2	-	22	10.00	
G-4167	OIL PAN - SB	SS EXT SEMS "L"	4	5	6	7	8	9	0	1	2	3	18	7.00	
G-5090	OIL PRES LINE BRKT w CONSOLE - 396 (F)	SS EXT SEMS "L"	-	-	-	-	-	9	-	-	-	-	1	1.50	
G-6491	OIL PRESSURE GAUGE LINE > DASH (N only)	S CLIP	4	5	-	-	-	-	-	-	-	-	1	3.00	
G-4759	PLUG BENEATH FUEL PUMP - 396/454	3/8-16 PIPE, EXT HX TYPE	-	5	6	7	8	9	0	1	2	-	1	2.00	
G-4361	TIMING COVER - SB & 396/454	SS HX EXT SEMS "L"	4	5	6	7	8	9	0	1	2	3	10	5.00	
G-5346	VACUUM ADVANCE DELAY RELAY (exc A)	HXWA AB SCREW	-	-	-	-	-	-	-	-	2	-	1	1.00	
G-5427	VALVE COVERS - 396/454	SQR "TR" SS BOLTS & SS RETAINERS	-	5	6	7	8	9	0	1	2	-	28	22.00	
G-5626	VALVE COVERS - 396/454	"RBW" SS HX BOLTS & SS RETAINERS	-	5	6	7	8	9	0	1	2	-	28	22.00	
G-5253	VALVE COVERS - 396/454	WIDE "TR" SS BOLTS & SS RETAINERS	-	5	6	7	8	9	0	1	2	-	28	22.00	
G-5426	VALVE COVERS - SB (aluminum)	HX MS SCREWS "CIRCLE" MARK	-	-	-	-	-	9	0	1	2	3	8	6.00	
G-6322	VALVE COVERS - SB (steel)	SQR "TR" SS BOLTS & SS RETAINERS	4	5	-	-	-	-	-	-	-	-	16	15.00	
G-5428	VALVE COVERS - SB (steel)	WIDE "TR" SS BOLTS & SS RETAINERS	4	5	-	-	-	-	-	-	-	-	16	15.00	
G-6321	VALVE COVERS - SB (steel)	"RBW" SS HX BOLTS & SS RETAINERS	4	5	-	-	-	-	-	-	-	-	16	15.00	
G-5425	VALVE COVERS - SB (steel)	WIDE "TR" SS BOLTS & SS RETAINERS	-	-	6	7	8	9	0	1	2	3	16	15.00	
G-6319	VALVE COVERS - SB (steel)	SQR "TR" SS BOLTS & SS RETAINERS	-	-	6	7	8	9	0	1	2	3	16	15.00	
G-6320	VALVE COVERS - SB (steel)	"RBW" SS HX BOLTS & SS RETAINERS	-	-	6	7	8	9	0	1	2	3	16	15.00	
G-5441	WATER NECK - 396/454	HX BOLTS	-	-	6	7	8	9	0	1	2	-	2	3.00	
G-5455	WATER NECK - 396 w SPACER	HX BOLTS	-	5	-	7	8	9	-	-	-	-	2	4.00	
G-5439	WATER NECK - SB	HX BOLTS	4	5	6	7	8	-	-	-	-	-	2	3.00	
G-5440	WATER NECK - SB	HX BOLT, HX CLR STUD	-	-	-	-	-	9	0	1	2	3	2	5.00	
G-6939	WATER NECK - 302, 327HP	HX BOLTS "TR"	-	-	6	7	-	-	-	-	-	-	2	4.00	
G-5437	WATER PUMP - 396	HX BOLTS, HX CLR STUDS	-	5	6	7	8	-	-	-	-	-	4	8.00	
G-5456	WATER PUMP - 396/454	HX BOLTS	-	-	-	-	-	9	0	1	2	-	4	6.00	
G-5433	WATER PUMP - SB	HX BOLTS "TR"	-	-	-	-	-	9	0	1	2	3	4	6.00	
G-5431	WATER PUMP - SB (exc 66-67A, 67F)	HX BOLTS, HX CLR STUD, SPLIT WA'S	4	5	6	7	-	-	-	-	-	-	8	8.00	
G-5520	WATER PUMP - SB w AC (A only)	HX BOLTS, SPLIT WA'S	4	5	-	-	-	-	-	-	-	-	8	6.00	
G-5432	WATER PUMP - SB w/o AC (exc 66-67N)	HX BOLTS, HX CLR STUDS	-	-	6	7	8	-	-	-	-	-	4	10.00	
G-5434	WATER PUMP - SB w AC (exc 66-67N)	HX BOLTS, HX CLR STUD	-	-	6	7	8	-	-	-	-	-	4	8.00	

Engine Accessories

G-4828	ALTERNATOR - 302	HX BOLTS, WA'S, NUTS, SPACER	-	-	-	7	8	-	-	-	-	-	15	12.00
G-4962	ALTERNATOR - 302, 307, 327, 350	HX BOLTS, WA'S, NUT	-	-	-	-	-	9	0	1	2	3	13	10.00
G-4645	ALTERNATOR - 327, 350	HX BOLTS, WA'S, NUTS, SPACER	-	-	6	7	8	-	-	-	-	-	16	10.00
G-5541	ALTERNATOR - 327HP (L79)	HX BOLTS, WA'S, NUT, SPACER	-	5	-	-	-	-	-	-	-	-	16	12.00
G-4766	ALTERNATOR - 396	HX BOLTS, WA'S, NUTS, SPACER	-	5	6	7	8	-	-	-	-	-	18	12.00
G-5049	ALTERNATOR - 396/454	HX CLR STUD, SPACER, BOLTS, NUTS	-	-	-	-	-	9	0	1	2	-	16	25.00
G-5530	ALTERNATOR - 62 AMP	HX BOLTS, NUTS, WA'S	4	5	-	-	-	-	-	-	-	-	14	10.00
G-5664	ALTERNATOR - BB 62 AMP	HX BOLTS, NUTS, WA'S	-	-	6	-	-	-	-	-	-	-	16	10.00
G-5491	ALTERNATOR - SB (A only)	HX BOLTS, WA'S, NUT, SPACER	4	5	-	-	-	-	-	-	-	-	14	10.00
G-6019	ALTERNATOR - SB (N only)	HX BOLTS, WA'S, NUT, SPACER	4	5	6	7	-	-	-	-	-	-	14	10.00
G-5663	ALTERNATOR - SB 62 AMP	HX BOLTS, NUTS, WA'S	-	-	6	-	-	-	-	-	-	-	16	10.00
G-5266	EXHAUST PIPE > MANIFOLDS	STUDS, LOCK NUTS	4	5	6	7	8	9	0	1	2	3	12	14.00

A = Chevelle F = Camaro N = Nova

1964 - 73

Engine Accessories

PART #	APPLICATION	NOTES	1960's YEAR					1970's YEAR					PCS	PRICE
G-4647	IGNITION COIL & STRAP	HX EXT SEMS, SLOT RND T SCREW	4	5	6	7	8	9	0	1	2	3	3	4.00
G-5545	IGNITION COIL STRAP - 327HP (L79)	SLOT RND EXT SEMS	-	5	-	-	-	-	-	-	-	1	3.00	
G-5576	P/S PUMP - 283, 327 (A only)	HX BOLTS, FLAT & SPLIT WA'S, NUTS	4	5	-	-	-	-	-	-	-	12	8.00	
G-5679	P/S PUMP - 283, 327 (A only)	HX BOLTS, SPACER, WA'S, NUTS	-	-	6	7	8	-	-	-	-	14	12.00	
G-4917	P/S PUMP - 302, 327HP (68N), 350 (FN only)	HX BOLTS, HX SPLIT SEMS, WA'S, NUTS	-	-	-	-	8	-	-	-	-	13	10.00	
G-4804	P/S PUMP - 302, 350 (F only)	HX BOLTS, HX SPLIT SEMS, WA'S, NUTS	-	-	-	7	-	-	-	-	-	13	10.00	
G-5291	P/S PUMP - 307, 350 (F only)	HX BOLTS, NUTS, WA'S, SPACER	-	-	-	-	-	-	-	2	3	19	12.00	
G-4803	P/S PUMP - 327 (F only)	HX BOLTS, HX SPLIT SEMS, WA'S, NUTS	-	-	-	7	-	-	-	-	-	12	10.00	
G-4916	P/S PUMP - 327 (FN only)	HX BOLTS, HX SPLIT SEMS, WA'S, NUTS	-	-	-	-	8	-	-	-	-	14	8.00	
G-5578	P/S PUMP - 396	HX BOLTS, FLAT & SPLIT WA'S, NUTS	-	5	6	-	-	-	-	-	-	10	8.00	
G-5084	P/S PUMP - 396	HX BOLTS, NUTS, WA'S, SPACER	-	-	-	-	-	9	-	-	-	20	12.00	
G-5681	P/S PUMP - 396 (66 SMOG) (A only)	HX BOLTS, NUTS, WA'S	-	-	6	7	8	-	-	-	-	13	12.00	
G-4805	P/S PUMP - 396 (F only)	HX BOLTS, HX SPLIT SEMS, WA'S, NUTS	-	-	-	7	-	-	-	-	-	12	8.00	
G-4918	P/S PUMP - 396 (FN only)	HX BOLTS, HX SPLIT SEMS, WA'S, NUTS	-	-	-	-	8	-	-	-	-	13	10.00	
G-5292	P/S PUMP - 396/454	HX BOLTS, NUTS, WA'S, SPACER	-	-	-	-	-	-	0	1	2	19	12.00	
G-5082	P/S PUMP - SB	HX BOLTS, NUTS, WA'S, SPACER	-	-	-	-	-	9	0	1	2	19	12.00	
G-6117	P/S PUMP - SB (N only)	HX BOLTS, WA'S, NUTS	4	5	6	7	-	-	-	-	-	12	6.00	
G-4891	PCV (HD) CONNECTOR > SB AIR CLEANER	NUT, COTTER PIN	-	-	-	-	8	9	-	-	-	2	3.00	
G-5544	PCV ADAPTER & TUBE > INTAKE - 327-4V	HX BOLTS, SPLIT, FLAT & FIBRE WA'S	-	5	-	-	-	-	-	-	-	5	6.00	
G-5528	PCV ADAPTER & TUBE > INTAKE - SB	HX BOLT, FLAT & FIBRE WA'S	4	5	-	-	-	-	-	-	-	3	4.00	
G-4751	PCV ADAPTER INTAKE - 283, 302, 327-4V	HX BOLT, FLAT & FIBRE WA'S, NUT	-	-	6	7	-	-	-	-	-	5	8.00	
G-4770	PCV HOSE CLAMPS	FLAT WOUND SPRING CLAMPS (Black)	-	5	6	7	8	9	0	-	-	2	1.50	
G-5158	PCV HOSE CLAMPS	FLAT WOUND SPRING CLAMPS (Green)	-	-	-	-	-	-	1	2	-	2	2.00	
G-5660	PCV HOSE CLAMPS - SB w SMOG & 4V Carb	FLAT WOUND SPRING CLAMPS (Black)	-	-	-	7	-	-	-	-	-	4	2.00	
G-5059	PCV LINE CLIP > CARB STUD - 396HP	FLAT WA ONLY !	-	-	-	-	-	9	-	-	-	1	1.00	
G-4963	SMOG PUMP	HX BOLTS, SPLIT WA'S, SPACER	-	-	-	-	-	9	0	-	-	7	12.00	
G-6285	SMOG PUMP - 302, 327, 350 w AC	HX BOLTS, SPLIT WA'S, SPACER	-	-	-	-	8	-	-	-	-	7	14.00	
G-4247	SMOG PUMP - 302, 327, 350 w/o AC	HX BOLTS, WA'S, NUT, 2 SPACERS, STUD	-	-	-	-	8	-	-	-	-	8	20.00	
G-5261	SMOG PUMP - 350 NB2 TYPE 72	HX BOLTS, SPLIT WA'S, SPACER	-	-	-	-	-	-	0	1	2	3	7	10.00
G-4746	SMOG PUMP - 396 (F only)	HX BOLTS, HX CLR STUD, NUTS, WA'S	-	-	-	7	-	-	-	-	-	8	12.00	
G-4896	SMOG PUMP - 396 (F only)	HX BOLTS, WA'S, NUT, SPACER	-	-	-	-	8	-	-	-	-	5	12.00	
G-5887	SMOG PUMP - K19 TYPE	HX BOLTS, SPLIT WA'S, SPACER	-	-	-	-	-	-	0	1	2	7	10.00	
G-4744	SMOG PUMP - SB w AC (66N & All 67)	HX BOLTS, HX CLR STUD, SPACER, NUTS	-	-	6	7	-	-	-	-	-	8	18.00	
G-5659	SMOG PUMP - SB w AC (A only)	HX CLR STUD, BOLTS, NUTS	-	-	6	-	-	-	-	-	-	7	10.00	
G-4743	SMOG PUMP - SB w/o AC	HX BOLTS, HX CLR STUD, SPACER, NUTS	-	-	-	7	-	-	-	-	-	9	18.00	
G-5658	SMOG PUMP - SB w/o AC (A only)	HX BOLTS, HX CLR STUD, SPACER, NUTS	-	-	6	-	-	-	-	-	-	8	18.00	
G-6216	SMOG PUMP - SB w/o AC (N only)	HX BOLTS, HX CLR STUD, SPACER, NUTS	-	-	6	-	-	-	-	-	-	7	16.00	
G-4769	STARTER & BRACE - 396	3.62 L HX BOLTS, EXT SEMS, FLNG NUT	-	5	6	7	-	-	-	-	-	4	8.00	
G-5873	STARTER & BRACE - 396/454 & 350 w A/T	4.69 L FLNG BOLTS, SEMS, NUT, WA	-	-	-	-	-	-	-	2	3	5	8.00	
G-5340	STARTER & BRACE - 396/454 (exc 72 A/T)	3.62 L HX BOLTS, SEMS, NUT, WA	-	-	-	-	-	-	0	1	2	3	5	8.00
G-5727	STARTER & BRACE - 396	3.62 L HX BOLTS, HX SPLIT SEMS, NUT	-	-	-	-	8	9	-	-	-	4	8.00	
G-4646	STARTER & BRACE - SB	1.84 & 4.69 FLNG BOLTS, SPLIT SEMS, NUT	4	5	6	7	-	-	-	-	-	4	8.00	
G-5006	STARTER & BRACE - SB	1.84 & 4.69 FLNG BOLTS, CONI SEMS, NUT	-	-	-	-	8	9	-	-	-	4	8.00	
G-5152	STARTER - 307, 70F & 71AF 350, 72F 396 A/T	1.84 & 4.69 FLNG BOLTS, SEMS, NUT, WA	-	-	-	-	-	-	0	1	2	3	5	8.00
G-5874	STARTER - 350 70A, 71MC, 72F, 72A/73F M/T	3.62 L HX BOLTS, SEMS, NUT, WA	-	-	-	-	-	-	0	1	2	3	5	8.00
G-5341	TCS SOLENOID > SB INTAKE	HX CLR STUD, NUT, SPLIT WA	-	-	-	-	-	-	0	2	-	3	6.00	
G-5260	THROTTLE BRACKET > CARBURETOR - 396HP	FLAT WA	-	-	-	-	-	-	0	-	-	1	1.00	

Engine Mounts

G-5724	ENGINE MOUNT THRU - 396 (A only)	POINTED BOLTS, SPLIT WA'S	-	-	-	-	8	9	-	-	-	4	8.00
G-5723	ENGINE MOUNT THRU - SB (A only)	HX BOLTS, WA'S, NUT	-	-	-	-	8	-	-	-	-	5	10.00
G-5725	ENGINE MOUNT THRU - SB (A only)	POINTED BOLTS, FLAT WA'S	-	-	-	-	-	9	-	-	-	4	8.00
G-4650	ENGINE MOUNT THRU - V8 (67-68F & all N)	POINTED BOLTS, WA'S, MARSDEN NUTS	4	5	6	7	8	9	-	-	-	8	10.00
G-4967	ENGINE MOUNT THRU - V8 (69F & all 70-72)	POINTED BOLTS, WA'S, LOCK NUTS	-	-	-	-	-	9	0	1	2	8	12.00
G-5492	ENGINE MOUNT THRU - V8 (A only)	POINTED HX BOLTS, WA'S	4	5	6	7	-	-	-	-	-	4	8.00
G-5337	ENGINE MOUNT THRU - V8 (F only)	FLNG BOLTS, FLNG NUTS	-	-	-	-	-	-	-	2	3	4	10.00
G-4651	ENGINE MOUNTS > BLOCK - V8	HX SPLIT SEMS	4	5	6	7	8	9	0	1	2	6	8.00
G-5336	ENGINE MOUNTS > BLOCK - V8 (F only)	GR-8 BOLTS, SPLIT WA'S	-	-	-	-	-	-	-	-	3	12	6.00
G-4346	ENGINE MOUNTS > FRAME - V8 (67F, 68FN)	HX SPLIT SEMS, FLNG NUTS	-	-	-	-	7	8	-	-	-	12	10.00
G-4966	ENGINE MOUNTS > FRAME - V8 (69FN, 70N)	HX SPLIT SEMS, WA'S, FLNG NUTS	-	-	-	-	-	9	0	-	-	14	10.00
G-5151	ENGINE MOUNTS > FRAME - V8 (70-1F, 71-2N)	GR-8 BOLTS, WA'S, LOCK NUTS	-	-	-	-	-	-	0	1	2	14	10.00
G-4597	ENGINE MOUNTS > FRAME - V8 (A only)	GR-5 HX BOLTS, WA'S, NUTS	4	5	6	7	-	-	-	-	-	21	5.00
G-4587	ENGINE MOUNTS > FRAME - V8 (A only)	HX BOLTS, WA'S, NUTS	-	-	-	-	8	9	-	-	-	28	6.00
G-5876	ENGINE MOUNTS > FRAME - V8 (A only)	HX BOLTS, WA'S, NUTS	-	-	-	-	-	-	0	-	-	24	6.00
G-5877	ENGINE MOUNTS > FRAME - V8 (A only)	GR-8 BOLTS, WA'S, NUTS	-	-	-	-	-	-	-	1	2	16	6.00
G-5338	ENGINE MOUNTS > FRAME - V8 (F only)	GR-8 FLNG BOLTS, FLNG NUTS	-	-	-	-	-	-	-	2	3	12	10.00
G-6021	ENGINE MOUNTS > FRAME - V8 (N only)	GR-8 BOLTS, ZDC NUTS, WA'S	4	5	6	7	-	-	-	-	-	12	8.00

A = Chevelle F = Camaro N = Nova

GM Master Kits

INTERIOR

A comprehensive interior assembly fastener package.

Many of our high quality components have never before been available.

Save up to 35% over the individual kit price.



Kits include fasteners to attach:

air outlet bezels, air vents in door jam, armrest base & pad, ash tray retainer, coat hook, console & door & hinge & lamp, courtesy lamps, dash pad, dimmer switch, dome lamp, door panels, door handles, door pull straps, firewall insulation, glove box door & latch & liner, grab bar, heater control, instrument cluster, kick panels, mirror, nameplates, pillar moldings, quarter glass weatherstrip, quarter trim panels, radio trim panel, radio control shafts, rocker panel cover plates, scuff plates, seat back stop bumpers & strikers, seat back cables, seat back panels, rear seat > body, seat pivot clips & covers, seat tracks > floor, shifter plate, shoulder harness retainers, steering column > dash, steering column cover at dash & firewall, steering wheel shroud, sun visor brackets & clamps, turn signal lever, window cranks, vent window channels (67F). Details at www.amkproducts.com/GM_Master_Kits.asp

Part #	Year	Model	Body	Interior	Pcs	Price
67FN-CPS	1967	Camaro	Coupe	Standard	271	\$ 105
67FN-CPD	1967	Camaro	Coupe	Deluxe	278	\$ 105
67FN-CVS	1967	Camaro	Convertible	Standard	255	\$ 100
67FN-CVD	1967	Camaro	Convertible	Deluxe	266	\$ 105
68FN-CPS	1968	Camaro	Coupe	Standard	297	\$ 110
68FN-CPD	1968	Camaro	Coupe	Deluxe	308	\$ 115
68FN-CVS	1968	Camaro	Convertible	Standard	273	\$ 105
68FN-CVD	1968	Camaro	Convertible	Deluxe	288	\$ 110
69FN-CPS	1969	Camaro	Coupe	Standard	315	\$ 120
69FN-CPD	1969	Camaro	Coupe	Deluxe	359	\$ 135
69FN-CVS	1969	Camaro	Convertible	Standard	291	\$ 115
69FN-CVD	1969	Camaro	Convertible	Deluxe	339	\$ 135
64AN-CP	1964-65	Chevelle	Coupe	All	224	\$ 85
64AN-CV	1964-65	Chevelle	Convertible	All	201	\$ 85
66AN-CP	1966	Chevelle	Coupe	All	280	\$ 90
66AN-CV	1966	Chevelle	Convertible	All	257	\$ 85
67AN-CP	1967	Chevelle	Coupe	All	293	\$ 90
67AN-CV	1967	Chevelle	Convertible	All	270	\$ 95
68AN-CP	1968	Chevelle	Coupe	All	322	\$ 90
68AN-CV	1968	Chevelle	Convertible	All	273	\$ 85
69AN-CP	1969	Chevelle	Coupe	All	347	\$ 95
69AN-CV	1969	Chevelle	Convertible	All	306	\$ 90
70AN-CP	1970-72	Chevelle	Coupe	All	418	\$ 140
70AN-CV	1970-72	Chevelle	Convertible	All	375	\$ 130

Seat Belt Mounting Kits

G-6535	1967	Camaro	All	Front	4	\$ 18
G-6536	1968-69	Camaro	All	Front	4	\$ 18
G-6537	1967-69	Camaro	All	Rear	4	\$ 16
G-6566	1967-68	Camaro	All	Shoulder Straps	4	\$ 8
G-6538	1969	Camaro	All	Shoulder Straps	4	\$ 8

CHASSIS



The fasteners you need to properly assemble your car's chassis in one package.

Each label includes assembly manual page number !

Save up to 20% over the individual kit prices.

Typical kit includes fasteners to attach:

accelerator lever & support, axle housing > springs, axle retainer plates, brake booster & hose, brake cables, brake plates, brake hose retainers & brackets, brake valve & pressure switch, calipers & brackets & shields, upper & lower control arms, control arm bushings, differential cover, driveshaft, engine mounts, fuel filler neck cover, fuel hoses, gas tank, grease fittings, idler arm, leaf spring hangers & front eye, master cylinder & push rod, parking brake control, pitman arm, radius rod & bracket & bumper, shackles (nuts), shocks & brackets, stabilizer bar brackets and end links (includes rubber), steering gear & rag joint, steering linkage & ball joints, spedo cable > trans, suspension bumpers, trans crossmember & insulator, wheel cylinders. Details at www.amkproducts.com/GM_Master_Kits.asp

Part #	Year	Model	Engine	Fr Brakes	Rr Springs	Pcs	Price
67FS-Z28	1967	Camaro	302	Disc	Mono	374	\$ 300
67FS-DRSB	1967	Camaro	327/350	Drum	Mono	343	\$ 260
67FS-DCSB	1967	Camaro	327/350	Disc	Mono	351	\$ 275
67FS-BB	1967	Camaro	396	Disc	Mono	352	\$ 280
67FS-L78	1967	Camaro	396HP	Disc	Mono	375	\$ 300
68FS-DRSB1	1968	Camaro	327/350	Drum	Mono	341	\$ 260
68FS-DRSB4	1968	Camaro	327/350	Drum	Multi	339	\$ 265
68FS-DCSB1	1968	Camaro	327/350	Disc	Mono	349	\$ 275
68FS-DCSB4	1968	Camaro	302/327/350	Disc	Multi	347	\$ 280
68FS-BB	1968	Camaro	396 all	Disc	Multi	348	\$ 280
69FS-DRSB1	1969	Camaro	307/327/350	Drum	Mono	356	\$ 270
69FS-DRSB4	1969	Camaro	307/327/350	Drum	Multi	354	\$ 275
69FS-DCSB1	1969	Camaro	307/327/350	Disc	Mono	346	\$ 270
69FS-DCSB4	1969	Camaro	302/327/307/350	Disc	Multi	354	\$ 300
69FS-BB	1969	Camaro	396 all	Disc	Multi	361	\$ 300
70FS-SB	1970-71	Camaro	307/350	Disc	Multi	347	\$ 290
70FS-F41SB	1970-71	Camaro	307/350	Disc	Multi w Sway	347	\$ 300
70FS-BB	1970-71	Camaro	396 all	Disc	Multi w Sway	350	\$ 300
72FS-SB	1972	Camaro	307/350	Disc	Multi	339	\$ 285
72FS-F41SB	1972	Camaro	307/350	Disc	Multi w Sway	357	\$ 295
72FS-BB	1972	Camaro	396 all	Disc	Multi w Sway	360	\$ 300
73FS-SB	1973	Camaro	307/350	Disc	Multi	345	\$ 285
73FS-F41SB	1973	Camaro	307/350	Disc	Multi w Sway	363	\$ 295

Air Conditioning

The fasteners needed to assemble Air Conditioning related components in

Three Kits

- 1 On engine
- 2 Front of firewall
- 3 Rear of firewall



Details at www.amkproducts.com/GM_Master_Kits.asp

Year	Model	Engine	1 On Engine		2 Front of Firewall		3 Rear of Firewall	
			Part #	Price \$	Part #	Price	Part #	Price
1967	Camaro	SB	66AA-SB	24	67FA-F	42	67FA-R	33
1967	Camaro	SB w Smog	67AA-SSB	24	67FA-F	42	67FA-R	33
1968	Camaro	SB	68FA-SB	28	68FA-F	44	68FA-R	33
1968	Camaro	SB w Smog	68FA-SSB	28	68FA-F	44	68FA-R	33
1968	Camaro	BB	68FA-BB	38	68FA-F	44	68FA-R	33
1969	Camaro	SB	69AA-SB	36	69FA-F	60	69FA-R	35
1969	Camaro	BB	69AA-BB	28	69FA-F	60	69FA-R	35
1970	Camaro	SB	70AA-SB	32	70FA-F	52	70FA-R	24
1970	Camaro	BB	70AA-BB	28	70FA-F	52	70FA-R	24
1971	Camaro	SB	71AA-SB	26	71FA-F	54	71FA-R	28
1971	Camaro	BB	70AA-BB	28	71FA-F	54	71FA-R	28
1972	Camaro	SB	72AA-SB	26	72FA-F	44	72FA-R	28
1972	Camaro	BB	70AA-BB	28	72FA-F	44	72FA-R	28
1973	Camaro	SB	72AA-SB	26	73FA-F	48	72FA-R	28
1964-65	Chevelle	SB	64AA-SB	26	64AA-F	22	64AA-R	12
1966	Chevelle	SB	66AA-SB	24	66AA-F	22	66AA-R	14
1966	Chevelle	BB	66AA-BB	35	66AA-F	22	66AA-R	14
1967	Chevelle	SB	66AA-SB	24	67AA-F	22	67AA-R	18
1967	Chevelle	SB w Smog	67AA-SSB	24	67AA-F	22	67AA-R	18
1967	Chevelle	BB	67AA-BB	35	67AA-F	22	67AA-R	18
1968	Chevelle	SB	68AA-SB	24	68AA-F	38	68AA-R	18
1968	Chevelle	SB w Smog	68AA-SSB	26	68AA-F	38	68AA-R	18
1968	Chevelle	BB	68AA-BB	35	68AA-F	38	68AA-R	18
1969	Chevelle	SB	69AA-SB	36	69AA-F	44	69AA-R	18
1969	Chevelle	BB	69AA-BB	28	69AA-F	44	69AA-R	18
1970	Chevelle	SB	70AA-SB	32	70AA-F	36	70AA-R	16
1970	Chevelle	BB	70AA-BB	28	70AA-F	36	70AA-R	16
1971	Chevelle	SB	71AA-SB	26	70AA-F	36	71AA-R	16
1971	Chevelle	BB	70AA-BB	28	70AA-F	36	71AA-R	16
1972	Chevelle	SB	72AA-SB	26	70AA-F	36	72AA-R	14
1972	Chevelle	BB	70AA-BB	28	70AA-F	36	72AA-R	14
1968	Nova	SB	68AA-SB	24	68NA-F	40	68NA-R	22
1968	Nova	SB w Smog	68AA-SSB	26	68NA-F	40	68NA-R	22
1969	Nova	SB	69AA-SB	36	69NA-F	48	69NA-R	28
1970	Nova	SB	70AA-SB	32	70NA-F	48	70NA-R	26
1971	Nova	SB	71AA-SB	26	71NA-F	44	71NA-R	25
1972	Nova	SB	72AA-SB	26	72NA-F	42	72NA-R	25

GM Detailing Kits

Underhood



This kit is intended to improve the underhood appearance of an assembled car, particularly one with incorrect or unsightly fasteners.

Kit includes fasteners (including clips & straps) to attach items common to every engine bay.

Save up to 25% over the individual kit price.

Typical kit does: accelerator lever & support, battery holddown clamp, brake booster, clutch push rod seal, control arm bushings, fender tie bar, fenders > firewall & radiator support, fuel vapor canister, grille & brackets & mouldings, headlamp grounds, heater box, heater hose clips (included) at wheelhouse & alternator bracket, hood catch & lock plate, hood & hinges, hood levelers, horn & relay, master cylinder, radiator & fan shroud, radio ground straps, vacuum hoses, voltage regulator & ground wire, wiper motor (includes insulators), washer bottle & bracket, washer nozzles, wheelhouses to fenders, wiring at blower motor, wiring gutter at firewall, wiring harness > rad support & wheelhouse. Details at www.amkproducts.com/GM_Master_Kits.asp

Part #	Year	Model	Engine	Pcs	Price
67F-UH	1967	Camaro	All	144	\$ 100
67F-RUH	1967	Camaro R/S	All	139	\$ 110
68F-UH	1968	Camaro	All	154	\$ 100
68F-RUH	1968	Camaro R/S	All	157	\$ 120
69F-UH	1969	Camaro	All	160	\$ 110
69F-RUH	1969	Camaro R/S	All	180	\$ 130
70F-UH	1970	Camaro	All	114	\$ 100
71F-UH	1971	Camaro	All	104	\$ 100
72F-UH	1972	Camaro	All	105	\$ 100
73F-UH	1973	Camaro	All	117	\$ 100
73F-RUH	1973	Camaro R/S	All	140	\$ 115
64A-UH	1964	Chevelle	All	155	\$ 110
65A-UH	1965	Chevelle	All	157	\$ 110
66A-UH	1966	Chevelle	All	146	\$ 110
67A-UH	1967	Chevelle	All	162	\$ 110
68A-UH	1968	Chevelle	All	134	\$ 110
69A-UH	1969	Chevelle	All	136	\$ 110
70A-UH	1970	Chevelle & Monte Carlo	All	123	\$ 110
71A-UH	1971	Chevelle & Monte Carlo	All	124	\$ 110
72A-UH	1972	Chevelle & Monte Carlo	All	122	\$ 110
64N-UH	1964	Nova	All	170	\$ 100
65N-UH	1965	Nova	All	178	\$ 100
66N-UH	1966	Nova	All	169	\$ 100
67N-UH	1967	Nova	All	174	\$ 100
68N-UH	1968	Nova	All	157	\$ 100
69N-UH	1969	Nova	All	164	\$ 110
70N-UH	1970	Nova	All	153	\$ 110
71N-UH	1971	Nova	All	143	\$ 110
72N-UH	1972	Nova	All	148	\$ 110

Underhood (-) Master Kits



For those who have purchased Master Body & Chassis kits - duplicate items are removed.

The fasteners (including clips & straps) to attach items common to every engine bay:

battery holddown clamp, headlamp grounds, heater box, heater hose clips (included) at wheelhouse & alternator bracket, horn & relay, radiator & fan shroud, radio ground straps, vacuum hoses, voltage regulator & ground wire, wiper motor (includes insulators), washer bottle & bracket, washer nozzles, wiring at blower motor, wiring gutter at firewall, wiring harness > radiator support & wheelhouse.

Details at www.amkproducts.com/GM_Master_Kits.asp

Part #	Year	Model	Engine	Pcs	Price
67F-XU	1967	Camaro	All	65	\$ 65
67F-RXU	1967	Camaro R/S	All	69	\$ 65
68F-XU	1968	Camaro	All	67	\$ 65
68F-RXU	1968	Camaro R/S	All	82	\$ 75
69F-XU	1969	Camaro	All	65	\$ 65
69F-RXU	1969	Camaro R/S	All	88	\$ 85
70F-XU	1970	Camaro - All	All	55	\$ 55
71F-XU	1971	Camaro - All	All	52	\$ 55
72F-XU	1972	Camaro - All	All	53	\$ 55
73F-XU	1973	Camaro - All	All	65	\$ 65
64A-XU	1964	Chevelle	All	62	\$ 60
65A-XU	1965	Chevelle	All	62	\$ 60
66A-XU	1966	Chevelle	All	67	\$ 60
67A-XU	1967	Chevelle	All	69	\$ 60
68A-XU	1968	Chevelle	All	62	\$ 60
69A-XU	1969	Chevelle	All	64	\$ 60
70A-XU	1970-71	Chevelle & Monte Carlo	All	60	\$ 60
72A-XU	1972	Chevelle & Monte Carlo	All	56	\$ 55
64N-XU	1964-66	Nova	All	61	\$ 55
67N-XU	1967	Nova	All	64	\$ 55
68N-XU	1968	Nova	All	64	\$ 55
69N-XU	1969-70	Nova	All	63	\$ 55
71N-XU	1971	Nova	All	51	\$ 55
72N-XU	1972	Nova	All	53	\$ 55

General Fastener Kits



About 80% of these individual kits are found in *Master Kits*. AMK Fastener kits are based on part numbers & finishes specified in the factory Assembly Manuals.

We hold closely to these specifications unless we find otherwise. We have the knowledge, fastener information and sources needed to make accurate and authentic fastener kits.



1964

Air Conditioning

PART #	APPLICATION	NOTES	CHEVELLE		NOVA		PCS	PRICE
			A	N	A	N		
G-5512	AC AIR DISTRIBUTION DUCT - CENTRAL	HXWA T SCREWS	A	-			4	3.00
G-6489	AC BATTERY CABLE EXT WIRE	4.05" L ALUMINUM STRAPS	-	N			2	5.00
G-6087	AC COMP BRACES > COMPRESSOR	HX BOLTS, FLAT & SPLIT WA'S	-	N			7	4.00
G-4709	AC COMP LWR ADJUSTMENT - SB	HX BOLTS, FLAT & SPLIT WA'S	A	-			3	2.00
G-4712	AC COMP Rr BRACE > INTAKE - SB	HX BOLTS, FLAT & SPLIT WA'S	A	-			7	5.00
G-6089	AC COMP SUPPORT > BRACKETS	HX BOLT, NUTS, FLAT WA'S	-	N			8	5.00
G-6088	AC COMP SUPPORT > ENGINE	FLNG SCREWS	-	N			3	4.00
G-4708	AC COMP SUPPORT > EXH MANIFOLD - SB	GR-8 "TR" HX BOLT, SPACER, LOCK NUT	A	-			3	6.00
G-4710	AC COMP SUPPORT, LWR Rr - SB & 396	HX BOLTS, WA'S, LOCK NUT	A	-			6	4.00
G-4864	AC COMP UPPER Fr BRACE - SB w/o SMOG	HX BOLTS, NUTS, FLAT & SPLIT WA'S	A	-			6	4.00
G-6095	AC COMPRESSOR GROUND WIRE - V8	HXWA T SCREW	-	N			1	1.00
G-6437	AC COMPRESSOR WIRING	7.1" FLEXIBLE STRAPS	-	N			3	6.00
G-6091	AC DISTRIBUTOR & AIR OUTLET	HXWA & HI-HXWA AB SCREWS	-	N			6	3.00
G-6098	AC DIVERTER DOOR SWITCH	PH PN AB SCREWS	-	N			2	1.00
G-5516	AC DUCT > BLOWER HOUSING	HXWA T SCREWS	A	-			6	3.00
G-5513	AC DUCT HOUSING > KICK PANEL	HXWA SCREWS, FLAT WA'S, SPRING NUT	A	-			10	4.00
G-6090	AC EVAPORATOR > DASH	HXWA AB SCREWS, WA'S, NUTS	-	N			11	4.00
G-5515	AC EVAPORATOR > FIREWALL	HX AB FLAT SEMS	A	-			6	6.00
G-6092	AC EVAPORATOR DRAIN HOSE	FLAT WOUND SPRING CLAMPS (Green)	-	N			2	1.50
G-5523	AC FITTING & MUFFLER ASSEMBLY	HX BOLT, FLAT & SPLIT WA'S	A	N			3	3.00
G-4720	AC HEATER HOSE CLAMP > COMP - SB	HX BOLTS, NUTS, SPLIT WA'S	A	-			6	3.00
G-6094	AC HEATER HOSE CLAMP > COMP BRACKET	HOSE CLIP, BOLT, SPACER, TOOTH WA	-	N			4	10.00
G-6445	AC HOSE	7.1" FLEXIBLE STRAPS	A	-			2	5.00
G-6436	AC HOSE	7.1" FLEXIBLE STRAP	-	N			1	3.00
G-6093	AC HOSE CLAMP > FENDER SKIRT	HXWA AB SCREWS	-	N			2	1.50
G-5519	AC RECEIVER TANK > FENDER SKIRT	HX BOLTS, RIVET NUTS	A	-			4	5.00
G-6085	AC RECIEVER TANK > FENDER SKIRT	HXWA AB SCREWS	-	N			4	2.00
G-6097	AC RELAY > EVAPORATOR	HXWA AB SCREWS, TOOTH WA'S	-	N			4	2.00
G-5524	AC RESISTOR & RELAY > EVAPORATOR	HXWA AB SCREWS	A	-			3	1.50
G-5514	AC RH OUTLET HOSE > DUCT	HXWA ABT SCREWS	A	-			2	1.50
G-6142	AC SELECTOR DUCT > FIREWALL	STAMPED NUTS	A	-			6	3.00
G-5521	AC SWITCHES	PH PN & HXWA SCREWS, HX FLAT SEMS	A	-			6	2.00
G-6086	AC TUBING CLAMPS @ CONDENSER & DASH	HX MS & HXWA T1 SCREWS, CONI KEPS	-	N			6	3.00
G-6444	AC VACUUM HOSE S CLIP @ BLOWER HSNG	STEEL S CLIP	A	-			1	3.00
G-5522	AC VALVE, TUBE BRKT'S > EVAPORATOR	HX BOLTS, HXWA SCREWS, KEPS NUTS	A	-			9	4.00

Body

G-4554	BATTERY TRAY	HX MS & PP CONI SEMS	A	-			3	3.00
G-6069	BATTERY TRAY	HX PP CONI SEMS	-	N			4	3.00
G-5480	BODY MOUNTS - CONVERTIBLE	ORIGINAL BOLTS, NUTS, WA'S	A	-			30	24.00
G-6305	BODY MOUNTS - HARDTOP	ORIGINAL BOLTS, NUTS, WA'S	A	-			22	24.00
G-5498	BODY MOUNTS @ RADIATOR SUPPORT	ORIGINAL BOLTS, NUTS, WA'S, SHIMS	A	-			14	10.00
G-6099	BRAKE PEDAL SUPPORT w PB	HX BOLTS, NUTS, FLAT WA'S	-	N			5	3.00
G-4637	BRAKE PEDAL SUPPORT w/o PB	NUTS, SPLIT WA'S	A	-			4	2.00
G-4481	BUMPER (Fr)	SS CAP BOLTS, NUTS, FLAT, SPLIT WA'S	-	N			28	10.00
G-6081	BUMPER (Fr)	SS CAP BOLTS, FLAT, SPLIT WA'S, NUTS	-	N			32	10.00
G-4570	BUMPER (Fr) FILLER PANEL	HX PP CONI SEMS, U-NUTS, NUTS	A	-			15	9.00
G-6047	BUMPER (Fr) FILLER PANEL	HX MS & PP CONI SEMS, U-NUTS	-	N			8	6.00
G-6058	BUMPER (Fr) FILLER PANEL & BRACKETS	HX CONI SEMS, U-NUTS	-	N			8	6.00
G-4563	BUMPER (Rr)	SS CAPPED BOLTS, NUTS, WA'S	A	-			32	14.00
G-6084	BUMPER (Rr)	SS CAPPED BOLTS, WA'S, NUTS	-	N			30	10.00
G-4541	BUMPER BRACKETS (Fr)	HX BOLTS, WA'S, NUTS	A	-			16	10.00
G-6082	BUMPER BRACKETS (Fr)	HX BOLTS, SPLIT & FLAT WA'S	-	N			10	6.00
G-4564	BUMPER BRACKETS (Rr)	HX BOLTS, TOOTHED WA'S, NUTS	A	-			16	14.00
G-6083	BUMPER BRACKETS (Rr)	HX BOLTS, SPLIT & FLAT WA'S	-	N			18	6.00
G-4522	BUMPER BRACKETS (Rr) - El Camino	HX BOLTS, SPECIAL WA'S, NUTS	A	-			26	20.00
G-5593	BUMPER GUARDS (Fr)	HX BOLTS, SPLIT WA'S, NUTS	A	-			10	5.00
G-5595	BUMPER GUARDS (Rr)	HX BOLTS, SPLIT WA'S, NUTS	A	-			10	4.00
G-6130	BUMPER GUARDS (Rr)	HX BOLTS, NUTS, SPLIT & FLAT WA'S	-	N			10	3.00
G-4594	COWL VENT PANEL	HX AB FLAT SEMS	A	-			5	4.00
G-5374	DOOR HANDLES (outside)	SPECIAL 5/16 AF HX CONI SEMS	A	-			4	4.00
G-6942	DOOR HINGES	FLAT EXT SEMS, HX & PZI HX CONI SEMS	A	-			24	24.00
G-4332	DOOR LATCHES	OV HD TT SCREWS	A	-			6	3.00
G-6572	DOOR LOCK STRIKERS	HEX SOCKET DRIVE	A	-			2	24.00
G-5399	DOOR WEATHERSTRIPS	PLASTIC PINS	A	-			4	1.50
G-4572	EMBLEM, FENDER (Rr)	STAMPED NUTS	A	-			4	2.00
G-4565	FENDER > WHEELHOUSE Fr BRACES	CONI PP SEMS, NUTS	A	-			4	3.00
G-6042	FENDER BRACES (Fr bottom lip)	HX PP CONI SEMS, NUTS	-	N			8	5.00
G-6594	FENDER TOPS ONLY (also found in fender kit)	HX MS & PP CONI SEMS	-	N			12	10.00
G-4569	FENDERS	HX MS & PP CONI SEMS, U-NUTS, SHIMS	A	-			26	16.00
G-6043	FENDERS	HX CONI SEMS, U-NUTS, SCREWS, SHIMS	-	N			44	18.00

See factory Assembly Manuals for illustrations

GM Fastener Kits

309

1964

Body

PART #	APPLICATION	NOTES					PCS	PRICE
			A	N				
G-6218	FENDERS > FIREWALL (also in fender kits)	LARGE HX CONI SEMS	A	-			4	5.00
G-6601	FENDERS > RAD SUPPORT (also in fender kit)	HX PP CONI SEMS	A	-			6	5.00
G-4550	FENDERS, Fr TIE BAR	HX PP CONI SEMS, NUTS	A	-			5	3.00
G-4576	GRILLE	TUBULAR RIVETS	A	-			11	3.00
G-6063	GRILLE & TIE BAR	ALUMINUM RIVETS	-	N			14	4.00
G-5497	GRILLE BRACKETS	HX PP CONI SEMS	A	-			4	3.00
G-6056	GRILLE BRACKETS	HX PP CONI SEMS	-	N			4	3.00
G-6129	GRILLE GUARD	NUTS, SPLIT & FLAT WA'S	-	N			7	2.00
G-6065	HEADLAMP ASSEMBLIES	RNDWA SCREWS, SPR NUTS, NYL NUTS	-	N			12	5.00
G-4580	HEADLAMP BEZELS	CHROME SCREWS, NYLON NUTS	A	-			16	6.00
G-6067	HEADLAMP BEZELS	SS/CHROME SCREWS, NYLON NUTS	-	N			12	4.00
G-4581	HEADLAMP BODIES	HX PP CONI SEMS, PH PN SCREWS	A	-			10	6.00
G-6041	HEADLAMP FILLER PANELS	HX PP CONI SEMS, U-NUTS	-	N			14	12.00
G-4244	HOOD & HINGES	HX CONI SEMS	A	N			8	8.00
G-4477	HOOD CATCH & LOCK PLATE	HX PP CONI SEMS	A	-			9	6.00
G-6054	HOOD CATCH & LOCK PLATE	HX PP CONI SEMS, WA'S, NUTS	-	N			15	6.00
G-4476	HOOD CATCH SUPPORT	HX PP CONI SEMS, U-NUT	A	-			2	3.00
G-6055	HOOD CATCH SUPPORT & LWR BRACKET	HX PP & MS CONI SEMS	-	N			2	2.00
G-4574	HOOD LETTERING "CHEVROLET"	STAMPED NUTS	A	-			18	3.00
G-4249	HOOD LEVELERS (Fr)	SCREWS, FLNG NUTS, RUBBER BUMPERS	A	N			6	8.00
G-4250	HOOD LOCK POST	MOUNTING NUT ONLY	A	N			1	2.00
G-4561	LICENSE PLATE BRACKET (Fr)	PH TRUSS MS SCREWS, WA'S, NUTS	A	-			6	2.00
G-4562	LICENSE PLATE BRACKET (Rr)	HX BOLTS, WA'S, NUTS	A	-			6	2.00
G-4717	MIRROR (outside fixed) & BRACKET	PH OV MS SCREW, PH PN B EXT SEMS	A	N			3	2.00
G-5596	MIRROR (outside remote) BRACKET	PH PN B EXT SEMS	A	N			2	1.50
G-4571	NAMEPLATE, FENDERS "Chevelle"	STAMPED NUTS	A	-			8	3.00
G-6061	NAMEPLATE, GRILLE	STAMPED NUTS ONLY	-	N			3	1.00
G-6424	NAMEPLATE, QUARTER PANELS	#10 ACORN NUTS	A	-			10	4.00
G-4671	STEERING COLUMN SEAL RETAINER	HXWA AB SCREWS, FLAT WA'S	A	-			8	3.00
G-6037	STEERING COLUMN SEAL RETAINER	HX A SCREWS	-	N			4	2.00
G-6929	TAILGATE HINGES - El Camino	HX CONI SEMS	A	-			12	20.00
G-6934	TAILGATE LATCHES	OV HD TT SCREWS	A	-			6	3.00
G-6931	TAILGATE STRIKERS > BODY	POZI FLAT SCREWS	A	-			6	6.00
G-6932	TAILGATE SUPPORTS	POZI FLAT SCREWS	A	-			12	6.00
G-4154	TRUNK LATCH & STRIKER	HX CONI TOOTH SEMS	A	N			5	4.00
G-4155	TRUNK LID > HINGES	HX CONI TOOTH SEMS	A	N			4	4.00
G-4568	WHEELHOUSE EXTENSIONS	HX PP CONI SEMS, U-NUTS	A	-			8	7.00
G-4567	WHEELHOUSES	MS & PP CONI SEMS, CUP WA'S, U-NUTS	A	-			40	26.00
G-6046	WHEELHOUSES	MS & PP CONI SEMS, BOLTS, WA'S, NUTS	-	N			34	14.00
G-6040	WHEELHOUSES > BODY	HX CONI SEMS, BOLTS, NUTS, WA'S	-	N			38	16.00
G-6595	WHEELHOUSES > BODY (also in fender kit)	HX CONI SEMS	-	N			6	5.00
G-6608	WHEELHOUSES > FENDERS (also in WH kit)	HX CONI SEMS, CUP WA'S	A	-			8	8.00
G-6607	WHEELHOUSES > RAD SUPPORT (also WH kit)	HX PP CONI SEMS	-	N			2	2.00
G-5937	WHEELHOUSES > RADIATOR SUPPORT	HX PP CONI SEMS, U-NUTS	A	-			4	4.00

Brakes

G-5007	AXLE RETAINER PLATES	GR-8 HX BOLTS, NUTS, SPLIT WA'S	A	N			24	10.00
G-4738	BRAKE BOOSTER	HX NUTS, SPLIT WA'S	A	N			8	3.00
G-4740	BRAKE BOOSTER HOSE - SB	FLAT WOUND SPRING CLAMPS (Black)	A	N			2	2.00
G-5527	BRAKE BOOSTER HOSE SUPPORT	PH PN SCREW	A	-			1	1.00
G-4642	BRAKE CABLES	WIRE TYPE RETAINERS, HX NUTS	A	-			5	5.00
G-6017	BRAKE CABLES & BRACKETS	RETAINERS, HX C SCREWS, NUTS	-	N			9	5.00
G-6015	BRAKE HOSE BRACKET (Rr)	HX C SCREWS	-	N			2	2.00
G-6014	BRAKE HOSE BRACKETS (Fr)	HX BOLTS, SPLIT WA'S, NUTS	-	N			12	3.00
G-6240	BRAKE HOSE GASKETS	COPPER MATERIAL	A	N			2	1.50
G-4641	BRAKE HOSE RETAINERS	U-RETAINERS	A	-			4	3.00
G-6013	BRAKE HOSE RETAINERS	U-RETAINERS	-	N			6	4.00
G-5602	BRAKE PEDAL BUSHINGS	NYLON BUSHINGS ONLY	A	N			2	3.00
G-4794	BRAKE PEDAL RETAINER w A/T	FOLDED SPRING METAL	A	-			1	3.00
G-6044	BRAKE PEDAL RETURN SPRING	NOS SPRING	A	-			1	4.00
G-5008	BRAKE PLATE ASSEMBLY (Fr) > SPINDLE	GR-8 HX BOLTS, LOCK NUTS	A	N			8	12.00
G-5487	MASTER CYLINDER	HX BOLTS, SPLIT WA'S	A	-			4	3.00
G-4635	MASTER CYLINDER	HX NUTS, SPLIT WA'S	-	N			4	2.00
G-4829	MASTER CYLINDER PUSH ROD > PEDAL	RETAINING CLIP	A	N			1	3.00
G-5489	PARKING BRAKE CONTROL > DASH	HX SPLIT SEMS, FLNG NUTS, SEALER	A	-			5	3.00
G-6016	PARKING BRAKE CONTROL > DASH	PH TRUSS CONI SEMS	-	N			1	2.00
G-6018	PARKING BRAKE LEVER PIN RETAINERS	WIRE RETAINERS	-	N			2	2.00
G-4739	STOPLAMP SWITCH STRIKER (on pedal)	w POWER BRAKES, BOLT, STAMPED NUT	A	-			2	2.00
G-6576	WHEEL CYLINDER (2) BLEEDERS	Does 2 cylinders, 5/16-24 SCREWS	A	N			2	3.00
G-6577	WHEEL CYLINDER (4) BLEEDERS	Does 4 cylinders, 5/16-24 SCREWS	A	N			4	5.00
G-6581	WHEEL CYLINDERS (2)	HX INT SEMS	A	N			4	3.00
G-6582	WHEEL CYLINDERS (4)	HX INT SEMS	A	N			8	5.00

Kits Contain Attaching Fasteners for Both Sides

GM Fastener Kits

1964

Cooling

PART #	APPLICATION	NOTES	CHEVELLE		NOVA		PCS	PRICE
			A	N	A	N		
G-6025	RADIATOR & CENTER SHROUD	HX PP CONI SEMS, U-NUTS	-	N			16	12.00
G-4599	RADIATOR & CENTER SHROUD (SB only 65, 67)	HX PP CONI SEMS, U-NUTS	A	-			12	10.00
G-5592	RADIATOR FAN SHROUD (HD 64-65A)	HX CONI SEMS	A	N			4	3.00
G-4844	RADIATOR HOSES - V8	TOWER TYPE CLAMPS	A	N			4	12.00

Differential

G-5466	DIFFERENTIAL COVER - 10 BOLT	SRTD FLNG SCREWS "E"	A	N			10	10.00
--------	------------------------------	----------------------	---	---	--	--	----	-------

Electrical

G-5530	ALTERNATOR - 62 AMP	HX BOLTS, NUTS, WA'S	A	N			14	10.00
G-5491	ALTERNATOR - SB (A only)	HX BOLTS, WA'S, NUT, SPACER	A	-			14	10.00
G-6019	ALTERNATOR - SB (N only)	HX BOLTS, WA'S, NUT, SPACER	-	N			14	10.00
G-4981	ALTERNATOR HARNESS > ALTERNATOR	12-24 NUT, #14 TOOTH WA	A	-			2	1.50
G-6071	ALTERNATOR HARNESS > ALTERNATOR	NUTS, TOOTH & SPLIT WA	-	N			4	2.00
G-6103	ALTERNATOR HARNESS > ALTERNATOR - K81	HX NUT, SPLIT WA	A	-			2	1.50
G-6102	ALTERNATOR HARNESS > ALTERNATOR - K81	NUT, SPLIT & TOOTH WA'S, SCREW	-	N			4	2.00
G-6293	ALTERNATOR PULLEY	NUT, FLAT WA	A	N			2	3.00
G-6127	ANTENNA (Fr) BRACKET	HXWA & PH PN AB SCREWS, SPR NUTS	-	N			5	3.00
G-5556	BACK-UP LAMP SW & SHIELD - 4 SPD	HXWA SCREWS, TOOTH WA'S, RETAINER	A	N			6	3.00
G-6115	BACK-UP/NEUTRAL SWITCH & ROD - FLOOR	HX BOLT, RETAINERS, WA'S	-	N			5	3.00
G-5569	BACK-UP/NEUTRAL SWITCH (on Column)	HXWA B SCREWS	A	N			2	1.50
G-6298	BATTERY CABLE > RH WHEELHOUSE	3.17" NYLON STRAP	A	-			1	2.00
G-5526	BATTERY CABLES - V8 w AC	HX BOLT, HXWA AB SCREW, NUT, WA'S	A	-			6	4.00
G-6096	BATTERY CABLES - V8 w AC	HX BOLT, JAM NUT, TOOTH WA'S	-	N			5	3.00
G-6194	BATTERY CABLES - V8 w/o AC	HXWA AB SCREWS, NUTS, WA'S	A	-			6	3.00
G-5502	BATTERY CABLES - V8 w/o AC	NUTS, TOOTH WA'S	-	N			4	2.00
G-6124	BATTERY HOLDOWN CLAMP - HD & 67N 327	HX CONI SEMS, WA'S, WING NUT, HX NUT	-	N			5	4.00
G-5959	CLOCK - IN DASH	HXWA SCREWS	-	N			3	1.50
G-5583	CLOCK (dash top) & GROUND CONNECTION	SCREWS, TOOTH WA , NUT	A	N			7	3.00
G-5506	COURTESY LAMPS, UNDERDASH	HXWA SCREWS, SPRING NUTS	A	-			4	3.00
G-4989	DIMMER SWITCH	HXWA AB SCREWS	-	-			2	2.00
G-6073	DIMMER SWITCH	PH PN EXT SEMS	-	N			2	3.00
G-4986	FUSE PANEL > FIREWALL	#10 x 2 1/4 HXWA AB SCREWS w SEALER	A	-			2	3.00
G-6074	FUSE PANEL > FIREWALL	HXWA B SCREWS	-	N			2	2.00
G-5751	H/L GROUND	HXWA AB SCREW, TOOTH WA	A	-			2	1.50
G-5750	H/L GROUND	HXWA B SCREW, TOOTH WA	-	N			2	1.50
G-4535	HEADLAMP ADJUSTERS	SCREWS, NYLON NUTS, SPRINGS	A	-			20	12.00
G-6531	HEADLAMP ADJUSTERS	SCREWS, NYLON NUTS, SPRING NUTS	-	N			10	6.00
G-6567	HEADLAMP RETAINING RINGS	SLOT PN SCREWS	A	-			6	3.00
G-5475	HEATER SWITCH or AC BLOWER (66N < 12/65)	PH PN B SCREWS	A	-			2	1.00
G-5503	HORN (1)	HX PP CONI TOOTH SEMS	A	-			1	3.00
G-4801	HORN CONTACT ASSY - WOOD GRAIN WHEEL	PH PN MS SCREWS	A	-			3	2.00
G-4682	HORN RELAY	HXWA AB SCREW	A	N			1	1.00
G-4679	HORNS (2) (3 '66)	HX PP CONI TOOTH SEMS	-	N			2	4.00
G-5529	IGNITION AMPLIFIER & GROUND	HXWA SCREWS, TOOTHED WA'S	A	-			8	4.00
G-6678	IGNITION COIL & STRAP	HXWA MS, SLOT RND T SCREW	A	N			3	4.00
G-4559	LICENSE PLATE LAMPS	PH PN AB SCREWS, FLAT SPRING NUTS	A	-			8	3.00
G-6080	LICENSE PLATE LAMPS	PH PN AB SCREWS	-	N			2	1.50
G-6624	PARKING LAMP LENSES (67F STD)	1.0 L SS/CHROME PH PN SCREWS	A	-			4	3.00
G-6421	PARKING LAMP LENSES (Camaro R/S)	SS/CHROME PH PN .380 SHLDR SCREWS	-	N			4	4.00
G-4579	PARKING LAMPS	HXWA AB SCREWS	A	-			4	2.00
G-6072	PARKING LAMPS & BEZELS	SS/CHROME PH OV SCREWS, SPR NUTS	-	N			8	4.00
G-5511	POWER TOP ELECTRICAL CONNECTIONS	CONI KEPS NUTS, HXWA & OV SCREWS	A	-			6	4.00
G-5584	RADIO BRACKET	HXWA B SCREWS, SPRING NUTS	A	-			4	3.00
G-6126	RADIO BRACKET - 3 SPD M/T	EXT KEPS NUTS, FLAT WA'S	-	N			3	2.00
G-6125	RADIO BRACKET (exc 3 SPD M/T)	EXT KEPS NUT	-	N			1	1.00
G-5587	RADIO GROUND STRAPS > FIREWALL	HXWA AB SCREWS, TOOTH WA'S	A	N			4	2.00
G-5589	RADIO HOOD GROUND CLIP > COWL	PH PN AB SCREW	PH PN AB SCREW	-			1	1.00
G-4822	RADIO NOISE CAPACITOR > COIL BRACKET	HXWA T SCREW, TOOTH WA	A	N			2	1.50
G-5504	RESISTOR (electrical output) > RAD SUPPORT	HXWA AB SCREW	A	N			1	1.00
G-5586	SPEAKER > DASH	HXWA AB SCREW, SPRING NUT	A	N			2	2.00
G-4646	STARTER & BRACE - SB	1.84 & 4.69 FLNG BOLTS, SPLIT SEMS, NUT	A	N			4	8.00
G-5201	STOPLAMP SWITCH	SPECIAL ROUND RETAINER	A	-			1	2.00
G-4689	STOPLAMP SWITCH	STAMPED HX NUTS	-	N			2	2.00
G-5297	TACHOMETER	HXWA B SCREWS	A	N			3	1.50
G-5581	TACHOMETER CONNECTIONS	HX NUTS, SPLIT WA'S	A	N			4	2.00
G-6418	TAILAMP LENSES	SS/CHROME PH PN MS SCREWS	A	-			8	4.00

See factory Assembly Manuals for illustrations

1964

Electrical

PART #	APPLICATION	NOTES	CHEVELLE		NOVA		PCS	PRICE
			A	N	A	N		
G-6425	TAILAMP LENSES	SS/CHROME PH PN & PH RND SCREWS	-	N			8	4.00
G-4582	TAILAMPS > BODY	CONI TOOTH KEPS NUTS	A	-			8	6.00
G-6078	TAILAMPS > BODY	STAMPED NUTS	-	N			8	4.00
G-5508	TURN SIGNAL LEVER	PH PN BT SCREW	A	-			1	1.00
G-6077	TURN SIGNAL SWITCH	PH PN AB SCREW	-	N			1	1.50
G-5574	TURN SIGNAL SWITCH w TILT	HXWA B SCREWS	A	-			2	2.00
G-5509	TURN SIGNAL SWITCH w/o TILT	PH PN MS SCREWS	A	-			3	2.00
G-4649	VOLTAGE REGULATOR	SRTD HXWA MS SCREWS, WELL-NUTS	A	N			6	6.00
G-5531	VOLTAGE REGULATOR w 62 AMP ALT	HXWA AB SCREWS	A	N			3	2.00
G-6677	WEATHERSTRIP, QUARTER GLASS @ JAMB	PH FLT AB SCREWS	A	-			4	2.00
G-6528	WIRING - 4 SPD B/U LAMP WIRE > SPED CABLE	3.17" NYLON STRAP	A	-			1	2.00
G-6515	WIRING - BLOWER MOTOR/STARTER WIRING	RUBBER COATED J-CLIPS	A	-			2	5.00
G-5505	WIRING - CLOCK & INSTRUMENT GROUND	HXWA SCREWS	A	-			3	1.50
G-6509	WIRING - ENGINE/STARTER @ BLOWER MTR	RUBBER COATED J-CLIP	-	N			1	3.00
G-4666	WIRING - FUEL SENDER UNIT GROUND	HXWA SCREW, TOOTH WA	A	N			2	1.00
G-6510	WIRING - INSTR HARNESS CLIP @ CLUSTER	3.17" NYLON STRAP	-	N			1	2.00
G-5193	WIRING - STARTER TERMINALS	NUTS, SPLIT & TOOTH WA'S	A	N			4	1.50
G-5672	WIRING - TRANS OD WIRE EXTENSION	HX EXT SEMS	A	-			1	1.50
G-4982	WIRING - VOLTAGE REGULATOR GROUND	HXWA AB SCREWS, TOOTH WA	A	N			3	2.00
G-5499	WIRING "GUTTER" > FIREWALL	HXWA AB SCREWS	A	-			2	1.50
G-6070	WIRING HARNESS > LH WHEELHOUSE	PUSH-ENDS BLACK PLASTIC STRAPS	-	N			3	4.00
G-6484	WIRING HARNESS > RADIATOR SUPPORT	3" NYLON STRAPS, S CLIPS	A	-			7	8.00
G-6193	WIRING HARNESS > RADIATOR SUPPORT	3" NYLON STRAPS	-	N			3	3.00

Emissions

G-4655	ENGINE VENT ADAPTER > INTAKE	HX BOLT, FLAT & SEALING WA'S	A	N			3	3.00
G-5528	PCV ADAPTER & TUBE > INTAKE - SB	HX BOLT, FLAT & FIBRE WA'S	A	N			3	4.00

Exhaust

G-5573	EXHAUST HANGERS, DUAL	HXWA C SCREWS, RETAINERS	A	-			6	8.00
G-6105	EXHAUST HANGERS, DUAL	HX BOLTS, HX SPLIT SEMS, NUTS, WA'S	-	N			20	10.00
G-4846	EXHAUST HANGERS, SINGLE	HXWA C SCREWS, RETAINERS	A	-			5	5.00
G-6033	EXHAUST HANGERS, SINGLE	HX BOLTS, HX SPLIT SEMS, NUTS, WA'S	-	N			13	5.00
G-5266	EXHAUST PIPE > MANIFOLDS	STUDS, LOCK NUTS	A	N			12	14.00

Fuel

G-5623	ACCELERATOR LEVER & SUPPORT	HX BOLT, HXWA AB SCREWS, WA'S, NUT	A	N			6	3.00
G-4643	FUEL FILLER NECK > BODY	HXWA B SCREWS	-	N			3	2.00
G-5056	FUEL HOSES	FLAT WOUND SPRING CLAMPS (Yellow)	A	N			4	3.00
G-5533	FUEL HOSES, 283-4V, 307, 327 (All 68-69A)	FLAT WOUND SPRING CLAMPS (Green)	A	-			4	3.00
G-4334	FUEL TANK FILLER NECK HOSE	WHITEK TOWER TYPE CLAMPS	A	N			2	6.00
G-4657	GAS TANK	CRG BOLTS, NUTS	A	-			4	5.00
G-6035	GAS TANK	HX BOLTS, NUTS, SPACERS	-	N			8	10.00
G-4847	GAS TANK - El Camino	HX CONI SEMS, BOLTS, NUTS, WA'S	A	-			18	10.00

Heater

G-5996	HEATER AIR DISTRIBUTOR	HX & HXWA AB SCREWS	-	N			2	2.00
G-4327	HEATER BLOWER MOTOR	SRTD HXWA AB SCREWS	A	N			5	1.50
G-5477	HEATER BOX > FIREWALL	HX AB FLAT SEMS, STAMPED NUTS	A	-			7	5.00
G-5989	HEATER BOX > FIREWALL & COWL	HXWA SCREW, STAMPED NUTS, SEALER	-	N			4	3.00
G-5476	HEATER CONTROL CABLES	HXWA AB & T SCREWS, RETAINERS	A	-			10	4.00
G-5995	HEATER CONTROL CABLES	PUSH RETAINERS	-	N			4	2.00
G-5525	HEATER CONTROL CABLES w AC	HXWA & HI-HXWA SCREWS, PUSH NUTS	A	-			14	4.00
G-5397	HEATER HOSE CLIP @ WHEELHOUSE	FOLDOVER METAL CLIP	A	N			1	4.00
G-4613	HEATER HOSES	WIRE TYPE SPRING CLAMPS, COL CODED	A	N			4	3.00
G-5993	HEATER INLET ADAPTER > COWL	HXWA AB SCREWS	-	N			4	2.00
G-5478	HEATER or AC OUTLET (LH under dash)	HXWA AB SCREWS	A	-			2	1.00
G-5994	HEATER OUTLET (LH under dash)	PH PN BT SCREWS	-	N			2	1.00
G-4616	HEATER RESISTOR > BOX	HXWA AB SCREWS	A	N			2	1.00

Kits Contain Attaching Fasteners for Both Sides

1964

Interior

PART #	APPLICATION	NOTES	CHEVELLE		NOVA		PCS	PRICE
			A	N	A	N		
G-5517	AIR OUTLET BEZELS (w AC) > DASH	HXWA AB & B SCREWS, SPRING NUTS	A	-			15	4.00
G-6673	ARMREST PAD & BASE @ Fr DOORS	PH FLAT B & PH RND A SCREWS	A	-			8	4.00
G-6674	ARMREST PAD & BASE @ Rr SEATS - COUPE	PH FLAT B & PH RND A SCREWS	A	-			10	4.00
G-5473	ASH TRAY RETAINER	PH PN B SCREWS	A	-			3	1.50
G-5986	ASH TRAY RETAINER	PH PN B SCREWS	-	N			3	1.50
G-6679	COAT HOOKS	SS/CHROME PH OV SCREWS	A	-			2	1.50
G-5650	DOME LAMP	PH PN SCREWS	A	-			2	1.50
G-5384	DOOR PANELS	CLIPS, PLUGS (flexible !), PH OV AB SEMS	A	-			32	12.00
G-5470	GLOVE BOX DOOR & LINER	RNDWA AB SCREWS	A	-			6	2.00
G-6585	GLOVE BOX DOOR BUMPERS	RUBBER BUMPERS	-	N			2	2.00
G-5896	GLOVE BOX LATCH & STRIKER	PH PN T SCREWS	-	N			3	2.00
G-5816	GLOVE BOX LINER	SCREWS	-	N			4	2.00
G-5474	HEATER CONTROL > DASH	PH FLAT & HXWA SCREWS	A	-			4	2.00
G-5471	INSTRUMENT CLUSTER > DASH	PH PN AB SCREWS, SPRING NUTS	A	-			18	6.00
G-6075	INSTRUMENT CLUSTER > DASH	PH FILL AB SCREWS, SPRING NUTS	-	N			8	4.00
G-6686	KICK PANELS	CHROME PH OV FINISH WA SEMS, .50" DIA	A	-			4	2.00
G-4621	MIRROR (inside Rr view) > BRACKET	CHROME SLOT OV SHLDR SCREW	A	N			1	2.00
G-6690	MIRROR (inside Rr view) BRACKET	CHROME PH OV AB SCREWS	A	-			3	2.00
G-5597	MIRROR, REMOTE CONTROL BEZEL > DOOR	SS/CHROME PH OV AB SCREWS	A	N			2	1.50
G-6672	MOLDINGS @ DOOR/QTR TRIM PANEL TOPS	PH FLAT AB SCREWS	A	-			18	3.00
G-6648	QUARTER TRIM SAIL PANELS	RETAINING CLIPS	A	-			4	3.00
G-4821	RADIO CONTROL SHAFTS & KNOBS	SPECIAL THIN HX NUTS, SPRING WA'S	A	N			4	4.00
G-6685	ROOF RAIL INSIDE MOLDINGS	SS/CHROME PH OV SCREWS	A	-			4	2.00
G-4321	SCUFF PLATES, DOOR OPENING	SS/CHROME PH OV AB SCREWS	A	-			8	2.50
G-6148	SCUFF PLATES, DOOR OPENING	SS/CHROME PH OV AB SCREWS	-	N			12	3.00
G-6657	SEAT BACK (Fr) STOP BUMPERS	PH PN AB SCREWS	A	-			4	1.50
G-6687	SEAT BACK (Fr) STRIKERS	COUNTERSUNK FLAT WA SCREWS	A	-			4	3.00
G-6662	SEAT BACK SIDE MOLDINGS	PH OV AB SCREWS	A	-			8	2.00
G-5560	SEAT SEPERATOR LAMP LENS	CHROME PH PN T SCREWS	A	-			2	2.00
G-5559	SEAT SEPERATOR PLATES > FLOOR	CHROME PH OV AB SCREWS, SPR NUTS	A	-			12	5.00
G-6107	SEAT SEPERATOR PLATES > FLOOR	CHROME PH OV AB SCREWS, SPR NUTS	-	N			12	5.00
G-6653	SEAT TRACKS > FLOOR	HX CONI TOOTH SEMS, PERI KEPS	A	-			8	5.00
G-5472	STEERING COLUMN COVER > DASH	PH PN AB SCREWS	A	-			2	1.50
G-5924	STEERING COLUMN COVER > FIREWALL	RUBBER RETAINERS	A	-			2	3.00
G-6681	SUN VISOR & MIRROR BRACKETS - COUPE	SS/CHROME PH OV SCREWS	A	-			9	3.00
G-6669	SUN VISOR BRACKETS - CONVERTIBLE	PH OV SCREWS	A	-			4	4.00
G-5378	SUN VISOR CLAMPS	CHROME SLOT FILL SCREWS	A	-			2	2.00
G-6665	VENT WINDOW FRAME > DOORS	CHROME HX CONI SEMS, CONI KEPS, WA'S	A	-			8	10.00
G-6666	VENT WINDOW CHANNEL > DOOR	#10 X 3.0" SS/CHROME PH OV SCREWS	A	-			2	3.00
G-6682	WEATHERSTRIP (Felt), QUARTER GLASS	PH FLAT AB #6 HD	A	-			4	2.00
G-5400	WINDOW CRANK HANDLES	RETAINING CLIPS	A	-			4	1.50
G-6663	WINDOW RUN (Rr) - FRONT DOORS	CHROME HX CONI & SPL PLATE SEMS, WA'S	A	-			10	10.00

Mouldings

G-4578	BUMPER (Fr) FILLER PANEL MOULDINGS	STAMPED NUTS	A	-			8	3.00
G-4577	FENDER "EYEBROW" MOULDINGS	STAMPED NUTS	A	-			6	2.00
G-4575	GRILLE MOULDING, UPPER	TUBULAR RIVETS	A	-			6	2.00
G-4573	HOOD CROWN MOULDING	STAMPED NUTS	A	-			6	2.00
G-6053	HOOD CROWN MOULDING	STAMPED NUTS	-	N			6	2.00
G-4514	HOOD MOULDING (Fr)	CONI KEPS NUTS	A	-			9	4.00
G-5479	ROCKER MOULDINGS	HXWA & PH RNDWA SCREWS, SPR NUTS	A	-			22	6.00
G-5997	ROCKER MOULDINGS - DLX	PH RNDWA & HXWA SCREWS, SPR NUTS	-	N			18	4.00
G-5373	WHEEL OPENING MOULDINGS	CHROME/SS PH OV & RNDWA SCREWS	A	-			32	6.00
G-6543	WINDOW (Fr) MOULDINGS	RETAINING CLIPS, PH PN AB SCREWS	A	-			34	12.00
G-6554	WINDOW (Fr) MOULDINGS	RETAINING CLIPS, PH PN AB SCREWS	-	N			34	12.00
G-6545	WINDOW (Rr) MOULDINGS	RETAINING CLIPS	A	-			24	12.00
G-6557	WINDOW (Rr) MOULDINGS	RETAINING CLIPS	-	N			24	12.00
G-6546	WINDOW (Rr) MOULDINGS - El Camino	RETAINING CLIPS, PH PN AB SCREWS	A	-			24	12.00

Steering & Suspension

G-4631	AXLE HSNG > SPRINGS	SPECIAL GR-8 LOCK NUTS ONLY !	-	N			8	12.00
G-5904	AXLE HSNG > SPRINGS (mono spring)	SPECIAL GR-8 LOCK NUTS & T BOLTS	-	N			16	26.00
G-6151	BALL JOINTS - UPPER	SOLID RIVETS (2 are extra)	A	-			10	6.00
G-6152	BALL JOINTS - UPPER or LWR	SOLID RIVETS (2 are extra)	-	N			8	4.00
G-6002	COIL SPRING SEATS	3/8-24 NUTS, SPLIT WA	-	N			8	3.00
G-4612	CONTROL ARM BUSHINGS - UPPER	HX BOLTS "SSC", WA'S, RETAINERS	A	-			12	12.00
G-4608	CONTROL ARMS - LWR	POINTED BOLTS, LOCK NUTS	A	-			8	20.00
G-5999	CONTROL ARMS - LWR	CAM BOLTS, WA'S, NUTS	-	N			8	24.00
G-4627	CONTROL ARMS - UPPER	GR-8 KNURL BOLTS, LOCK NUTS, SHIMS	A	-			18	14.00

See factory Assembly Manuals for illustrations

1964

Steering & Suspension

PART #	APPLICATION	NOTES	CHEVELLE		NOVA		PCS	PRICE
			A	N	A	N		
G-5998	CONTROL ARMS - UPPER	GR-8 KNURL BOLTS, LOCK NUTS	-	N			8	10.00
G-4609	CONTROL ARMS (Rr)	GR-8 POINTED BOLTS, LOCK NUTS	A	-			16	32.00
G-4669	GREASE FITTINGS	STRAIGHT	A	N			10	3.00
G-4265	IDLER ARM > FRAME	GR-8 HX BOLTS, WA'S, NUTS	A	-			6	6.00
G-6038	IDLER ARM > FRAME	HX BOLTS, NUTS, WA'S	-	N			16	5.00
G-6010	LEAF SPRINGS, Fr EYE	HX BOLTS, NUTS, WA'S	-	N			8	14.00
G-6123	P/S CONTROL VALVE CLAMP	HX BOLT, SPLIT WA	-	N			2	2.00
G-6122	P/S HOSE BRACKET & CLAMP	HX BOLTS, WA'S, NUTS	-	N			7	3.00
G-5576	P/S PUMP - 283, 327 (A only)	HX BOLTS, FLAT & SPLIT WA'S, NUTS	A	-			12	8.00
G-6117	P/S PUMP - SB (N only)	HX BOLTS, WA'S, NUTS	-	N			12	6.00
G-4807	P/S PUMP PULLEY	THIN LOCK NUT	A	N			1	6.00
G-4919	P/S RETURN HOSE	ORIGINAL CLAMPS	A	-			2	20.00
G-4668	PITMAN ARM > GEAR BOX	HX NUT, SPLIT WA	A	N			2	3.00
G-4838	SHACKLES	11/16" AF MARDEN NUTS ONLY	-	N			4	6.00
G-6004	SHOCK BRACKETS (Fr)	CRG BOLTS, NUTS, WA'S	-	N			24	8.00
G-6012	SHOCK BRACKETS (Rr) > BODY	HX SPLIT SEMS	-	N			4	5.00
G-4585	SHOCKS (Fr) - LWR MOUNTING	HX PP CONI SEMS	A	-			4	3.00
G-6005	SHOCKS (Fr) - LWR MOUNTING	GROMMETS, NUTS, WA'S	-	N			20	10.00
G-4836	SHOCKS (Fr) - UPR MOUNTING	RETAINERS, BUSHINGS, 3/8-24 NUTS	A	-			10	6.00
G-6006	SHOCKS (Fr) - UPR MOUNTING	GROMMETS, RETAINERS, 3/8-24 NUTS	-	N			10	10.00
G-5483	SHOCKS (Rr)	BOLTS, LOCK NUTS, FLAT & SPLIT WA'S	A	-			16	8.00
G-6011	SHOCKS (Rr) LWR MOUNTING	HX BOLTS, NUTS, SPLIT WA'S	-	N			6	4.00
G-6101	SHOCKS (Rr) UPR MOUNTING	RETAINERS, BUSHINGS, 3/8-24 NUTS	-	N			10	8.00
G-4675	SPARE WHEEL (F convertible only)	7 7/8" J-BOLT, WING NUT	A	N			2	14.00
G-5485	SPRINGS (Rr) - CLAMPS	HX BOLTS, NUTS, FLAT & SPLIT WA'S	A	-			8	6.00
G-4628	STABILIZER BAR (Fr) BRACKETS	HXWA C SCREWS	A	-			4	6.00
G-6009	STABILIZER BAR (Fr) BRACKETS	HX BOLTS, SPLIT & FLAT WA'S	-	N			12	5.00
G-5481	STABILIZER BAR (Fr) END LINKS	HX BOLTS, RETAINERS, BUSHINGS, NUTS	A	-			22	25.00
G-4837	STABILIZER BAR (Fr) END LINKS	HX BOLTS, RETAINERS, BUSHINGS, NUTS	-	N			22	20.00
G-5494	STEERING COLUMN > DASH	HX PP CONI SEMS, FLNG NUTS	A	-			4	3.00
G-6036	STEERING COLUMN > DASH	NUTS, SPLIT WA'S	-	N			4	1.50
G-5495	STEERING COLUMN CLAMPS	HX PP CONI SEMS, HXWA AB SCREW	A	-			2	2.00
G-4354	STEERING GEAR "RAG" JOINT	12 PT BOLT ONLY	A	-			1	3.00
G-6039	STEERING GEAR > FRAME	HI-HX BOLTS, WA'S, NUTS	-	N			15	10.00
G-5180	STEERING GEAR BOX > FRAME	GR-8 HX BOLTS, FLAT WA'S	A	-			6	12.00
G-4615	STEERING LINKAGE & BALL JOINTS	SLOTTED NUTS, COTTER PINS	A	-			20	10.00
G-6121	STEERING LINKAGE & BALL JOINTS w PS	SLOTTED NUTS, COTTER PINS	-	N			24	10.00
G-6003	STEERING LINKAGE & BALL JOINTS w/o PS	SLOTTED NUTS, COTTER PINS	-	N			22	10.00
G-4841	STEERING SHAFT > COUPLING	HX NUTS, SPLIT WA'S	A	-			4	2.00
G-4674	STEERING WHEEL	HX JAM NUT, FLAT WA	A	-			2	3.00
G-4802	STEERING WHEEL - DLX	SS PH FLAT MS SCREWS	A	-			6	3.00
G-6000	STRUT ROD THREADED ENDS > BODY	11/16-18 THREAD NUTS ONLY	-	N			4	10.00
G-6001	STRUT RODS > LWR CONTROL ARM	HX BOLTS, NUTS, WA'S	-	N			12	10.00
G-6007	SUSPENSION BUMPER BRACKETS (Fr)	HX CONI SEMS, NUTS	-	N			24	10.00
G-4596	SUSPENSION BUMPERS (Fr)	HX NUTS	A	-			2	1.00
G-6008	SUSPENSION BUMPERS (Fr)	NUTS, SPLIT WA'S	-	N			4	1.50
G-5484	SUSPENSION BUMPERS (Rr) - El Camino	HX BOLTS, NUTS, SPLIT WA'S	A	-			3	2.00
G-6583	WHEEL STUDS - 1 AXLE (Fr or Rr)	Does 2 wheels, 7/16-20 x 1.38" L	A	N			10	14.00
G-5060	WHEELS - STD	ORIGINAL LUG NUTS w "DIAMONDS"	A	N			20	25.00

Transmission

G-6149	BELL HOUSING > ENGINE	FLNG BOLTS (Flat Top) "A" MARKING	A	N			6	8.00
G-6611	BELL HOUSING > ENGINE	FLNG BOLTS, "M" MARKING	A	N			6	8.00
G-5416	BELL HOUSING Fr COVER PLATE	SS EXT SEMS "L"	A	N			4	3.00
G-5907	CLUTCH BELLCRANK	BALL STUDS, SEATS, RETAINER, WA'S	A	N			9	32.00
G-6032	CLUTCH BELLCRANK BRACKET > FRAME	HX BOLTS, SPLIT WA'S	-	N			4	2.00
G-5603	CLUTCH PEDAL BUSHINGS	NYLON BUSHINGS ONLY	A	N			2	3.00
G-6031	CLUTCH PEDAL PUSH ROD SEAL	SLOT HX SCREWS	-	N			2	1.50
G-4850	CLUTCH PEDAL PUSH RODS	RETAINING CLIPS ONLY	A	-			3	3.00
G-6030	CLUTCH PEDAL PUSH RODS	RETAINING CLIPS, FLAT WA'S	-	N			5	4.00
G-4659	CLUTCH PEDAL RETAINER	FOLDED SPRING METAL	A	N			1	3.00
G-4629	DRIVESHAFT > REAR KNUCKLE	U-BOLTS, NUTS, WA'S	A	N			10	8.00
G-6573	FLYWHEEL - A/T	GR-8 HXWA SCREWS	A	N			12	16.00
G-4429	FLYWHEEL - M/T	11/16" AF X 1.0" L HX BOLTS	A	N			12	12.00
G-6150	PRESSURE PLATE > FLYWHEEL	SPECIAL HX BOLTS, SPLIT WA'S	A	N			12	6.00
G-5572	SEAT SEPERATOR SHIFT GUIDES (A/T)	PH PN F SCREWS	A	-			8	2.00
G-5551	SHIFTER BEZEL & SEAL RETAINER - M/T	w/o CONSOLE, PH OV AB SCREWS	A	-			8	2.00
G-6118	SHIFTER BEZEL & SEAL, SEAT SEPRTR - A/T	HXWA T SCREWS, STAMPED NUT	-	N			8	3.00
G-5627	SHIFTER CONTROL & SUPPORT - 3 SPD (floor)	HX BOLT, HX SPLIT SEMS, TOOTH WA	A	-			3	4.00
G-5553	SHIFTER CONTROL > TRANS - 4 SPD	HX BOLT, HX SPLIT SEMS, SPLIT WA	A	N			3	4.00
G-5566	SHIFTER DIAL & LAMP - FIXED COLUMN	PH OV BT & PH PN AB SCREWS	A	-			3	2.00
G-4786	SHIFTER DIAL RETAINER - FIXED COLUMN	CHROME OV HD BT SCREWS	-	N			2	1.50

Kits Contain Attaching Fasteners for Both Sides

1964

Transmission

PART #	APPLICATION	NOTES	CHEVELLE		NOVA		PCS	PRICE
			A	N	A	N		
G-5575	SHIFTER DIAL RETAINER - TILT COLUMN	CHROME PH RND MS SCREWS	A	-			2	2.00
G-5554	SHIFTER HANDLE > CONTROL - 3 or 4 SPD	LOCK NUTS, FLAT WA'S	A	N			4	3.00
G-6114	SHIFTER LEVER > FLOOR - A/T FLOOR SHIFT	HX SPLIT SEMS	-	N			4	6.00
G-5564	SHIFTER LEVER > FLOOR - PG	HXWA AB SCREWS, SPRING NUTS	A	-			12	5.00
G-5900	SHIFTER LEVERS > CASE - 3 SPD	NUTS, SPLIT & FLAT WA'S	A	-			6	2.00
G-5565	SHIFTER LINKAGE, A/T FLOOR SHIFT	RETAINING CLIPS, FLAT WA'S ONLY	A	-			13	5.00
G-5571	SHIFTER PLATE & DIAL - A/T w SEAT SPRTR	PH OV, PH PN SCREWS, WA'S	A	-			12	3.00
G-5625	SHIFTER RODS - 3 SPD	RETAINERS, COTTER, CLEVIS PINS, NUTS	A	-			9	8.00
G-5552	SHIFTER RODS - 4 SPD	RETAINERS, PIN, NUTS, WA	A	N			14	10.00
G-6119	SHIFTER SEAL RETAINER - A/T CONSOLE	PH OV AB SCREWS	-	N			6	2.00
G-5558	SHIFTER SEAL RETAINER - M/T CONSOLE	PH PN BT SCREWS	A	-			4	2.00
G-4694	SPEDOMETER CABLE > TRANS	HX SPLIT SEMS	A	N			1	2.00
G-5567	STEERING COLUMN CLAMPING RING - A/T	HX SPLIT SEMS	A	N			3	3.00
G-5555	STEERING COLUMN JACKET - 4 SPD	PH PN AB SCREWS	A	-			2	1.00
G-4788	TORQUE CONVERTOR > FLYWHL - PG, TH350	PLACE BOLTS, NUTS, WASHERS	A	N			9	8.00
G-5568	TRANS (Powerglide) KICKDOWN LINKAGE	ROD END CLIP, NUTS, WA'S	A	N			7	6.00
G-4169	TRANS CROSSMEMBER	HX BOLTS, WA'S (RH SIDE), NUTS	A	-			14	6.00
G-6022	TRANS CROSSMEMBER	HX BOLTS, SRTD FLNG NUTS	-	N			4	6.00
G-4603	TRANS INSULATOR	HX BOLTS, FLAT & SPLIT WA'S	A	-			10	6.00
G-6023	TRANS INSULATOR	HX BOLTS, FLAT & SPLIT WA'S	-	N			10	6.00
G-5561	TRANS LINKAGE or BACKDRIVE SUPPORT	> FRAME: HXWA C SCREWS	A	-			3	3.00
G-5548	TRANS OD CONTROL HANDLE & CABLE	PH PN AB SCREWS, BOLT, NUTS, WA'S	A	-			7	3.00
G-6308	TRANS OIL PAN - PG (exc 68-72 console)	LRG FLNG HEAD SCREWS	A	N			14	7.00
G-5549	TRANS OVERDRIVE (OD) RELAY	HXWA AB SCREWS	A	-			2	1.00
G-5562	TRANSMISSION (Powerglide) > ENGINE	HX BOLTS, LOCK WA'S (for brackets)	A	N			9	6.00
G-6028	TRANSMISSION (STD) > BELL HOUSING	HX BOLTS, SPLIT WA'S	A	N			8	5.00
G-5563	TRANSMISSION LINKAGE - A/T CLM SHIFT	RETAINERS, FITTINGS, NUTS, WA'S	A	-			10	16.00
G-5804	TRANSMISSION LINKAGE - M/T CLM SHIFT	RETAINERS, FITTINGS, NUTS, WA'S	A	-			20	24.00
G-4909	TRANSMISSION OIL COOLER LINES	C SHAPED SPRING CLIPS	A	N			2	3.00
G-4789	UNDERPAN - Powerglide A/T	HX EXT TOOTH SEMS	A	N			4	3.00

Wipers

G-5598	ANTI-FREEZE JAR BRACKET	HXWA AB SCREWS	A	-			2	1.00
G-6131	ANTI-FREEZE JAR BRACKET	HX AB SCREWS	-	N			2	1.00
G-4302	WINDSHIELD WASHER BOTTLE BRACKET	HXWA AB SCREWS	A	-			3	2.00
G-6132	WINDSHIELD WASHER BOTTLE BRACKET	HX AB SCREWS	-	N			3	1.50
G-6490	WINDSHIELD WASHER HOSE	ALUMINUM STRAP	-	N			1	3.00
G-4598	WINDSHIELD WASHER NOZZLES	HX AB FLAT SEMS	A	-			2	1.50
G-6133	WINDSHIELD WASHER NOZZLES	HX AB SCREWS	-	N			2	1.00
G-4464	WIPER ARM PIVOTS > COWL	HX EXT SEMS	A	-			4	3.00
G-5992	WIPER ARM PIVOTS > COWL	HX EXT SEMS	-	N			4	2.00
G-4329	WIPER MOTOR	HX CNTRS NK EXT SEMS	A	N			3	3.00
G-5465	WIPER MOTOR	GROMMETS, GRD STRAP, RIVET, SCREWS	A	N			8	12.00
G-5599	WIPER MOTOR BRACKET - 1, 2S w/o WASHER	HX EXT SEMS	A	-			3	2.00
G-6141	WIPER MOTOR LINKAGE RETAINER	ATTACHES TO WIPER MOTOR ARM	A	-			1	2.00
G-5991	WIPER MOTOR LINKAGE RETAINER	ATTACHES TO WIPER MOTOR ARM	-	N			1	2.00
G-4623	WIPER SWITCH GROUND WASHER	EXT TOOTH WA	-	N			1	1.00

Part # T-101

\$3

Free with
Faxed Fastener
orders over \$50
Just ask for it !

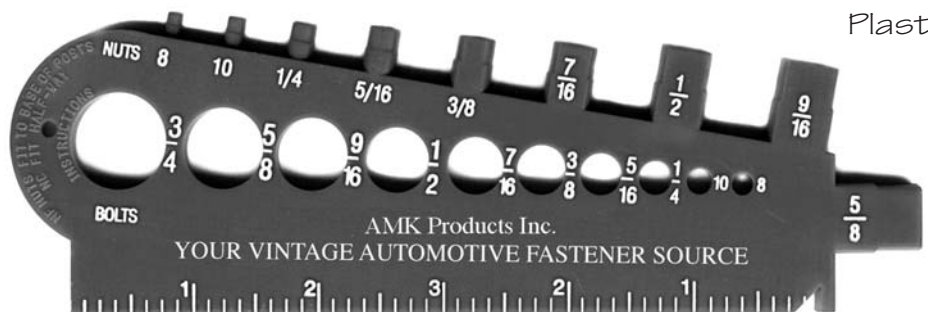

Plastic

GM Fastener Kits

315

1965

Air Conditioning

PART #	APPLICATION	NOTES	CHEVELLE		NOVA		PCS	PRICE
			A	N				
G-5512	AC AIR DISTRIBUTION DUCT - CENTRAL	HXWA T SCREWS	A	-			4	3.00
G-6087	AC COMP BRACES > COMPRESSOR	HX BOLTS, FLAT & SPLIT WA'S	-	N			7	4.00
G-4709	AC COMP LWR ADJUSTMENT - SB	HX BOLTS, FLAT & SPLIT WA'S	A	-			3	2.00
G-4712	AC COMP Rr BRACE > INTAKE - SB	HX BOLTS, FLAT & SPLIT WA'S	A	-			7	5.00
G-6089	AC COMP SUPPORT > BRACKETS	HX BOLT, NUTS, FLAT WA'S	-	N			8	5.00
G-6088	AC COMP SUPPORT > ENGINE	FLNG SCREWS	-	N			3	4.00
G-4708	AC COMP SUPPORT > EXH MANIFOLD - SB	GR-8 "TR" HX BOLT, SPACER, LOCK NUT	A	-			3	6.00
G-4710	AC COMP SUPPORT, LWR Rr - SB & 396	HX BOLTS, WA'S, LOCK NUT	A	-			6	4.00
G-4864	AC COMP UPPER Fr BRACE - SB w/o SMOG	HX BOLTS, NUTS, FLAT & SPLIT WA'S	A	-			6	4.00
G-6095	AC COMPRESSOR GROUND WIRE - V8	HXWA T SCREW	-	N			1	1.00
G-6437	AC COMPRESSOR WIRING	7.1" FLEXIBLE STRAPS	-	N			3	6.00
G-6091	AC DISTRIBUTOR & AIR OUTLET	HXWA & HI-HXWA AB SCREWS	-	N			6	3.00
G-6098	AC DIVERTER DOOR SWITCH	PH PN AB SCREWS	-	N			2	1.00
G-5516	AC DUCT > BLOWER HOUSING	HXWA T SCREWS	A	-			6	3.00
G-5513	AC DUCT HOUSING > KICK PANEL	HXWA SCREWS, FLAT WA'S, SPRING NUT	A	-			10	4.00
G-6090	AC EVAPORATOR > DASH	HXWA AB SCREWS, WA'S, NUTS	-	N			11	4.00
G-5515	AC EVAPORATOR > FIREWALL	HX AB FLAT SEMS	A	-			6	6.00
G-6092	AC EVAPORATOR DRAIN HOSE	FLAT WOUND SPRING CLAMPS (Green)	-	N			2	1.50
G-5523	AC FITTING & MUFFLER ASSEMBLY	HX BOLT, FLAT & SPLIT WA'S	A	N			3	3.00
G-4720	AC HEATER HOSE CLAMP > COMP - SB	HX BOLTS, NUTS, SPLIT WA'S	A	-			6	3.00
G-6094	AC HEATER HOSE CLAMP > COMP BRACKET	HOSE CLIP, BOLT, SPACER, TOOTH WA	-	N			4	10.00
G-6445	AC HOSE	7.1" FLEXIBLE STRAPS	A	-			2	5.00
G-6436	AC HOSE	7.1" FLEXIBLE STRAP	-	N			1	3.00
G-6093	AC HOSE CLAMP > FENDER SKIRT	HXWA AB SCREWS	-	N			2	1.50
G-5519	AC RECEIVER TANK > FENDER SKIRT	HX BOLTS, RIVET NUTS	A	-			4	5.00
G-6085	AC RECIEVER TANK > FENDER SKIRT	HXWA AB SCREWS	-	N			4	2.00
G-6097	AC RELAY > EVAPORATOR	HXWA AB SCREWS, TOOTH WA'S	-	N			4	2.00
G-5524	AC RESISTOR & RELAY > EVAPORATOR	HXWA AB SCREWS	A	-			3	1.50
G-5514	AC RH OUTLET HOSE > DUCT	HXWA ABT SCREWS	A	-			2	1.50
G-6142	AC SELECTOR DUCT > FIREWALL	STAMPED NUTS	A	-			6	3.00
G-5521	AC SWITCHES	PH PN & HXWA SCREWS, HX FLAT SEMS	A	-			6	2.00
G-6086	AC TUBING CLAMPS @ CONDENSER & DASH	HX MS & HXWA T1 SCREWS, CONI KEPS	-	N			6	3.00
G-6444	AC VACUUM HOSE S CLIP @ BLOWER HSNB	STEEL S CLIP	A	-			1	3.00
G-5522	AC VALVE, TUBE BRKT'S > EVAPORATOR	HX BOLTS, HXWA SCREWS, KEPS NUTS	A	-			9	4.00

Body

G-4554	BATTERY TRAY	HX MS & PP CONI SEMS	A	-			3	3.00
G-6069	BATTERY TRAY	HX PP CONI SEMS	-	N			4	3.00
G-5480	BODY MOUNTS - CONVERTIBLE	ORIGINAL BOLTS, NUTS, WA'S	A	-			30	24.00
G-6305	BODY MOUNTS - HARDTOP	ORIGINAL BOLTS, NUTS, WA'S	A	-			22	24.00
G-5500	BODY MOUNTS @ RADIATOR SUPPORT	ORIGINAL BOLTS, NUTS, WA'S	A	-			12	10.00
G-6099	BRAKE PEDAL SUPPORT w PB	HX BOLTS, NUTS, FLAT WA'S	-	N			5	3.00
G-4637	BRAKE PEDAL SUPPORT w/o PB	NUTS, SPLIT WA'S	A	-			4	2.00
G-4481	BUMPER (Fr)	SS CAP BOLTS, NUTS, FLAT, SPLIT WA'S	A	-			28	10.00
G-6081	BUMPER (Fr)	SS CAP BOLTS, FLAT, SPLIT WA'S, NUTS	-	N			32	10.00
G-4546	BUMPER (Fr) FILLER PANEL	HX CONI PP CONI SEMS, FLNG & U-NUTS	A	-			15	10.00
G-6048	BUMPER (Fr) FILLER PANEL	HX CONI SEMS	-	N			4	3.00
G-4563	BUMPER (Rr)	SS CAPPED BOLTS, NUTS, WA'S	A	-			32	14.00
G-6084	BUMPER (Rr)	SS CAPPED BOLTS, WA'S, NUTS	-	N			30	10.00
G-4541	BUMPER BRACKETS (Fr)	HX BOLTS, WA'S, NUTS	A	-			16	10.00
G-6082	BUMPER BRACKETS (Fr)	HX BOLTS, SPLIT & FLAT WA'S	-	N			10	6.00
G-4564	BUMPER BRACKETS (Rr)	HX BOLTS, TOOTHED WA'S, NUTS	A	-			16	14.00
G-6083	BUMPER BRACKETS (Rr)	HX BOLTS, SPLIT & FLAT WA'S	-	N			18	6.00
G-4522	BUMPER BRACKETS (Rr) - El Camino	HX BOLTS, SPECIAL WA'S, NUTS	A	-			26	20.00
G-5594	BUMPER GUARDS (Fr)	HX BOLTS, SPLIT WA'S	A	-			4	3.00
G-5595	BUMPER GUARDS (Rr)	HX BOLTS, SPLIT WA'S, NUTS	A	-			10	4.00
G-6130	BUMPER GUARDS (Rr)	HX BOLTS, NUTS, SPLIT & FLAT WA'S	-	N			10	3.00
G-4594	COWL VENT PANEL	HX AB FLAT SEMS	A	-			5	4.00
G-5374	DOOR HANDLES (outside)	SPECIAL 5/16 AF HX CONI SEMS	A	-			4	4.00
G-6942	DOOR HINGES	FLAT EXT SEMS, HX & PZI HX CONI SEMS	A	-			24	24.00
G-4332	DOOR LATCHES	OV HD TT SCREWS	A	-			6	3.00
G-6572	DOOR LOCK STRIKERS	HEX SOCKET DRIVE	A	-			2	24.00
G-5399	DOOR WEATHERSTRIPS	PLASTIC PINS	A	-			4	1.50
G-5538	EMBLEM, FENDERS "396 FLAG"	STAMPED NUTS	A	-			8	3.00
G-4547	EMBLEM, FENDERS "FLAG"	STAMPED NUTS	A	N			4	2.00
G-4565	FENDER > WHEELHOUSE Fr BRACES	CONI PP SEMS, NUTS	A	-			4	3.00
G-6042	FENDER BRACES (Fr bottom lip)	HX PP CONI SEMS, NUTS	-	N			8	5.00
G-6594	FENDER TOPS ONLY (also found in fender kit)	HX MS & PP CONI SEMS	-	N			12	10.00
G-4569	FENDERS	HX MS & PP CONI SEMS, U-NUTS, SHIMS	A	-			26	16.00
G-6043	FENDERS	HX CONI SEMS, U-NUTS, SCREWS, SHIMS	-	N			44	18.00
G-6218	FENDERS > FIREWALL (also in fender kits)	LARGE HX CONI SEMS	A	-			4	5.00

Kits Contain Attaching Fasteners for Both Sides

GM Fastener Kits

1965

Body

PART #	APPLICATION	NOTES			CHEVELLE		NOVA		PCS	PRICE
			A	N						
G-6601	FENDERS > RAD SUPPORT (also in fender kit)	HX PP CONI SEMS	A	-					6	5.00
G-4550	FENDERS, Fr TIE BAR	HX PP CONI SEMS, NUTS	A	-					5	3.00
G-4551	GRILLE	TUBULAR RIVETS, RETAINERS	A	-					15	4.00
G-6064	GRILLE & TIE BAR	ALUMINUM RIVETS	-	N					28	6.00
G-5497	GRILLE BRACKETS	HX PP CONI SEMS	A	-					4	3.00
G-6057	GRILLE BRACKETS	HX CONI SEMS	-	N					6	4.00
G-4552	GRILLE EXTENSIONS	RETAINERS	A	-					4	3.00
G-6129	GRILLE GUARD	NUTS, SPLIT & FLAT WA'S	-	N					7	2.00
G-6066	HEADLAMP ASSEMBLIES	RNDWA SCREWS, SPR NUTS, NYL NUTS	-	N					14	6.00
G-4555	HEADLAMP BEZELS	SS/BLACK SCREWS	A	-					8	3.00
G-6067	HEADLAMP BEZELS	SS/CHROME SCREWS, NYLON NUTS	-	N					12	4.00
G-4556	HEADLAMP BODIES	HX PP CONI SEMS	A	-					4	3.00
G-6041	HEADLAMP FILLER PANELS	HX PP CONI SEMS, U-NUTS	-	N					14	12.00
G-4244	HOOD & HINGES	HX CONI SEMS	A	N					8	8.00
G-4477	HOOD CATCH & LOCK PLATE	HX PP CONI SEMS	A	-					9	6.00
G-6054	HOOD CATCH & LOCK PLATE	HX PP CONI SEMS, WA'S, NUTS	-	N					15	6.00
G-4476	HOOD CATCH SUPPORT	HX PP CONI SEMS, U-NUT	A	-					2	3.00
G-6055	HOOD CATCH SUPPORT & LWR BRACKET	HX PP & MS CONI SEMS	-	N					2	2.00
G-4249	HOOD LEVELERS (Fr)	SCREWS, FLNG NUTS, RUBBER BUMPERS	A	N					6	8.00
G-4250	HOOD LOCK POST	MOUNTING NUT ONLY	A	N					1	2.00
G-4561	LICENSE PLATE BRACKET (Fr)	PH TRUSS MS SCREWS, WA'S, NUTS	A	-					6	2.00
G-4562	LICENSE PLATE BRACKET (Rr)	HX BOLTS, WA'S, NUTS	A	-					6	2.00
G-4717	MIRROR (outside fixed) & BRACKET	PH OV MS SCREW, PH PN B EXT SEMS	A	N					3	2.00
G-5596	MIRROR (outside remote) BRACKET	PH PN B EXT SEMS	A	N					2	1.50
G-4548	NAMEPLATE, FENDERS "283", "307"	STAMPED NUTS	A	N					4	1.50
G-5601	NAMEPLATE, FENDERS "Malibu SS"	STAMPED HX NUTS	A	-					10	3.00
G-6062	NAMEPLATE, GRILLE	STAMPED NUTS ONLY	-	N					2	1.00
G-6424	NAMEPLATE, QUARTER PANELS	#10 ACORN NUTS	A	-					10	4.00
G-6615	PLUG, DOOR HINGES @ LH	1.25" RECESSED PLASTIC PLUG	A	-					1	1.50
G-5496	STEERING COLUMN SEAL RETAINER	HI-HXWA AB SCREWS, FLAT WA'S	A	-					8	3.00
G-6037	STEERING COLUMN SEAL RETAINER	HX A SCREWS	-	N					4	2.00
G-6929	TAILGATE HINGES - El Camino	HX CONI SEMS	A	-					12	20.00
G-6934	TAILGATE LATCHES	OV HD TT SCREWS	A	-					6	3.00
G-6931	TAILGATE STRIKERS > BODY	POZI FLAT SCREWS	A	-					6	6.00
G-6932	TAILGATE SUPPORTS	POZI FLAT SCREWS	A	-					12	6.00
G-4154	TRUNK LATCH & STRIKER	HX CONI TOOTH SEMS	A	N					5	4.00
G-4155	TRUNK LID > HINGES	HX CONI TOOTH SEMS	A	N					4	4.00
G-4567	WHEELHOUSES	MS & PP CONI SEMS, CUP WA'S, U-NUTS	A	-					40	26.00
G-6046	WHEELHOUSES	MS & PP CONI SEMS, BOLTS, WA'S, NUTS	-	N					34	14.00
G-6040	WHEELHOUSES > BODY	HX CONI SEMS, BOLTS, NUTS, WA'S	-	N					38	16.00
G-6595	WHEELHOUSES > BODY (also in fender kit)	HX CONI SEMS	-	N					6	5.00
G-6608	WHEELHOUSES > FENDERS (also in WH kit)	HX CONI SEMS, CUP WA'S	A	-					8	8.00
G-6607	WHEELHOUSES > RAD SUPPORT (also WH kit)	HX PP CONI SEMS	-	N					2	2.00
G-5937	WHEELHOUSES > RADIATOR SUPPORT	HX PP CONI SEMS, U-NUTS	A	-					4	4.00

Brakes

G-5007	AXLE RETAINER PLATES	GR-8 HX BOLTS, NUTS, SPLIT WA'S	A	N					24	10.00
G-4738	BRAKE BOOSTER	HX NUTS, SPLIT WA'S	A	N					8	3.00
G-4740	BRAKE BOOSTER HOSE - SB	FLAT WOUND SPRING CLAMPS (Black)	A	N					2	2.00
G-5527	BRAKE BOOSTER HOSE SUPPORT	PH PN SCREW	A	-					1	1.00
G-4642	BRAKE CABLES	WIRE TYPE RETAINERS, HX NUTS	A	-					5	5.00
G-6017	BRAKE CABLES & BRACKETS	RETAINERS, HX C SCREWS, NUTS	-	N					9	5.00
G-6015	BRAKE HOSE BRACKET (Rr)	HX C SCREWS	-	N					2	2.00
G-6014	BRAKE HOSE BRACKETS (Fr)	HX BOLTS, SPLIT WA'S, NUTS	-	N					12	3.00
G-6240	BRAKE HOSE GASKETS	COPPER MATERIAL	A	N					2	1.50
G-4641	BRAKE HOSE RETAINERS	U-RETAINERS	A	-					4	3.00
G-6013	BRAKE HOSE RETAINERS	U-RETAINERS	-	N					6	4.00
G-5602	BRAKE PEDAL BUSHINGS	NYLON BUSHINGS ONLY	A	N					2	3.00
G-4794	BRAKE PEDAL RETAINER w A/T	FOLDED SPRING METAL	A	-					1	3.00
G-6044	BRAKE PEDAL RETURN SPRING	NOS SPRING	A	-					1	4.00
G-5008	BRAKE PLATE ASSEMBLY (Fr) > SPINDLE	GR-8 HX BOLTS, LOCK NUTS	A	N					8	12.00
G-4635	MASTER CYLINDER	HX NUTS, SPLIT WA'S	A	N					4	2.00
G-4829	MASTER CYLINDER PUSH ROD > PEDAL	RETAINING CLIP	A	N					1	3.00
G-5489	PARKING BRAKE CONTROL > DASH	HX SPLIT SEMS, FLNG NUTS, SEALER	A	-					5	3.00
G-6016	PARKING BRAKE CONTROL > DASH	PH TRUSS CONI SEMS	-	N					1	2.00
G-6018	PARKING BRAKE LEVER PIN RETAINERS	WIRE RETAINERS	-	N					2	2.00
G-4739	STOPLAMP SWITCH STRIKER (on pedal)	w POWER BRAKES, BOLT, STAMPED NUT	A	-					2	2.00
G-6576	WHEEL CYLINDER (2) BLEEDERS	Does 2 cylinders, 5/16-24 SCREWS	A	N					2	3.00
G-6577	WHEEL CYLINDER (4) BLEEDERS	Does 4 cylinders, 5/16-24 SCREWS	A	N					4	5.00
G-6581	WHEEL CYLINDERS (2)	HX INT SEMS	A	N					4	3.00
G-6582	WHEEL CYLINDERS (4)	HX INT SEMS	A	N					8	5.00

See factory Assembly Manuals for illustrations

GM Fastener Kits

317

1965

Cooling

PART #	APPLICATION	NOTES	CHEVELLE		NOVA		PCS	PRICE
			A	N	A	N		
G-5536	RADIATOR - 396	HX PP CONI SEMS	A	-			4	3.00
G-6025	RADIATOR & CENTER SHROUD	HX PP CONI SEMS, U-NUTS	-	N			16	12.00
G-4599	RADIATOR & CENTER SHROUD (SB only 65, 67)	HX PP CONI SEMS, U-NUTS	A	-			12	10.00
G-4601	RADIATOR FAN SHROUD - 65 STD, 66-67 HD	HX PP CONI SEMS	A	-			4	3.00
G-5592	RADIATOR FAN SHROUD (HD 64-65A)	HX CONI SEMS	A	N			4	3.00
G-5535	RADIATOR HOSES - 396	TOWER TYPE CLAMPS	A	-			4	12.00
G-4844	RADIATOR HOSES - V8	TOWER TYPE CLAMPS	A	N			4	12.00

Differential

G-5466	DIFFERENTIAL COVER - 10 BOLT	SRTD FLNG SCREWS "E"	A	N			10	10.00
G-5467	DIFFERENTIAL COVER - 12 BOLT	SRTD FLNG SCREWS "E"	A	N			12	12.00

Electrical

G-5541	ALTERNATOR - 327HP (L79)	HX BOLTS, WA'S, NUT, SPACER	A	-			16	12.00
G-4766	ALTERNATOR - 396	HX BOLTS, WA'S, NUTS, SPACER	A	-			18	12.00
G-5530	ALTERNATOR - 62 AMP	HX BOLTS, NUTS, WA'S	A	N			14	10.00
G-5491	ALTERNATOR - SB (A only)	HX BOLTS, WA'S, NUT, SPACER	A	-			14	10.00
G-6019	ALTERNATOR - SB (N only)	HX BOLTS, WA'S, NUT, SPACER	-	N			14	10.00
G-4981	ALTERNATOR HARNESS > ALTERNATOR	12-24 NUT, #14 TOOTH WA	A	-			2	1.50
G-6071	ALTERNATOR HARNESS > ALTERNATOR	NUTS, TOOTH & SPLIT WA	-	N			4	2.00
G-6103	ALTERNATOR HARNESS > ALTERNATOR - K81	HX NUT, SPLIT WA	A	-			2	1.50
G-6102	ALTERNATOR HARNESS > ALTERNATOR - K81	NUT, SPLIT & TOOTH WA'S, SCREW	-	N			4	2.00
G-6293	ALTERNATOR PULLEY	NUT, FLAT WA	A	N			2	3.00
G-6127	ANTENNA (Fr) BRACKET	HXWA & PH PN AB SCREWS, SPR NUTS	-	N			5	3.00
G-6633	BACK-UP LAMP LENSES	SS/CHROME PH PN .302 SHLDR SCREWS	A	N			4	4.00
G-4785	BACK-UP LAMP SW & ROD - 4 SPD (floor 68N)	HX EXT SEMS, RETAINING PINS	A	N			4	3.00
G-4558	BACK-UP LAMPS or COVERS	PH PN AB SCREWS, SPRING NUTS	A	-			8	3.00
G-5569	BACK-UP/NEUTRAL SWITCH (on Column)	HXWA B SCREWS	A	N			2	1.50
G-6612	BATTERY CABLE (-) CLIP @ BATTERY TRAY	J-CLIP, RETAINER	-	N			2	5.00
G-6298	BATTERY CABLE > RH WHEELHOUSE	3.17" NYLON STRAP	A	-			1	2.00
G-4725	BATTERY CABLES - V8 w AC	HX BOLT, SCREW, NUTS, WA'S	A	-			7	4.00
G-6096	BATTERY CABLES - V8 w AC	HX BOLT, JAM NUT, TOOTH WA'S	-	N			5	3.00
G-4678	BATTERY CABLES - V8 w/o AC	HXWA AB SCREW, NUTS, WA'S	A	-			7	4.00
G-5502	BATTERY CABLES - V8 w/o AC	NUTS, TOOTH WA'S	-	N			4	2.00
G-6124	BATTERY HOLDOWN CLAMP - HD & 67N 327	HX CONI SEMS, WA'S, WING NUT, HX NUT	-	N			5	4.00
G-5634	CLOCK - IN DASH	HXWA SCREWS	A	-			2	1.00
G-5959	CLOCK - IN DASH	HXWA SCREWS	-	N			3	1.50
G-5683	CLOCK (dash top) & GROUND CONNECTION	SCREWS, TOOTH WA , SPRING NUT	A	-			6	3.00
G-5583	CLOCK (dash top) & GROUND CONNECTION	SCREWS, TOOTH WA , NUT	-	N			7	3.00
G-5506	COURTESY LAMPS, UNDERDASH	HXWA SCREWS, SPRING NUTS	A	-			4	3.00
G-4696	DEFOGGER SWITCH - Rr WINDOW	OV HD SCREWS	A	N			2	1.00
G-4690	DIMMER SWITCH	HI-HXWA AB SCREWS	A	-			2	2.00
G-6073	DIMMER SWITCH	PH PN EXT SEMS	-	N			2	3.00
G-4688	FLASHER BRACKET > DASH	PH PN AB SCREW	A	N			1	1.00
G-4986	FUSE PANEL > FIREWALL	#10 x 2 1/4 HXWA AB SCREWS w SEALER	A	-			2	3.00
G-6074	FUSE PANEL > FIREWALL	HXWA B SCREWS	-	N			2	2.00
G-5751	H/L GROUND	HXWA AB SCREW, TOOTH WA	-	N			2	1.50
G-5501	H/L GROUND, JUNCTION BLOCK	HXWA AB & B SCREWS, TOOTH WA	A	-			3	2.00
G-4535	HEADLAMP ADJUSTERS	SCREWS, NYLON NUTS, SPRINGS	A	-			20	12.00
G-6531	HEADLAMP ADJUSTERS	SCREWS, NYLON NUTS, SPRING NUTS	-	N			10	6.00
G-6567	HEADLAMP RETAINING RINGS	SLOT PN SCREWS	A	-			6	3.00
G-5475	HEATER SWITCH or AC BLOWER (66N < 12/65)	PH PN B SCREWS	A	-			2	1.00
G-5503	HORN (1)	HX PP CONI TOOTH SEMS	A	-			1	3.00
G-5580	HORN (low note)	HXWA SCREWS, INT/EXT TOOTH WA	A	N			4	3.00
G-4801	HORN CONTACT ASSY - WOOD GRAIN WHEEL	PH PN MS SCREWS	A	-			3	2.00
G-4682	HORN RELAY	HXWA AB SCREW	A	N			1	1.00
G-4679	HORNS (2) (3 '66)	HX PP CONI TOOTH SEMS	-	N			2	4.00
G-5529	IGNITION AMPLIFIER & GROUND	HXWA SCREWS, TOOTHED WA'S	A	-			8	4.00
G-6678	IGNITION COIL & STRAP	HXWA MS, SLOT RND T SCREW	A	N			3	4.00
G-5545	IGNITION COIL STRAP - 327HP (L79)	SLOT RND EXT SEMS	A	-			1	3.00
G-4559	LICENSE PLATE LAMPS	PH PN AB SCREWS, FLAT SPRING NUTS	A	-			8	3.00
G-6080	LICENSE PLATE LAMPS	PH PN AB SCREWS	-	N			2	1.50
G-6625	PARKING LAMP LENSES	SS/CHROME PH PN .488 SHLDR SCREWS	A	-			4	4.00
G-6421	PARKING LAMP LENSES (Camaro R/S)	SS/CHROME PH PN .380 SHLDR SCREWS	-	N			4	4.00
G-4537	PARKING LAMPS	PH PN SCREWS	A	N			4	3.00
G-5511	POWER TOP ELECTRICAL CONNECTIONS	CONI KEPS NUTS, HXWA & OV SCREWS	A	-			6	4.00
G-5585	RADIO BRACKET	HXWA AB SCREWS, SPRING NUTS	A	-			4	3.00

Kits Contain Attaching Fasteners for Both Sides

GM Fastener Kits

1965

Electrical

PART #	APPLICATION	NOTES	CHEVELLE		NOVA		PCS	PRICE
			A	N	A	N		
G-6126	RADIO BRACKET - 3 SPD M/T	EXT KEPS NUTS, FLAT WA'S	-	N			3	2.00
G-6125	RADIO BRACKET (exc 3 SPD M/T)	EXT KEPS NUT	-	N			1	1.00
G-5588	RADIO GROUND STRAP > FRAME	HXWA AB & T1 SCREWS, TOOTH WA'S	A	-			4	2.00
G-5587	RADIO GROUND STRAPS > FIREWALL	HXWA AB SCREWS, TOOTH WA'S	A	N			4	2.00
G-5589	RADIO HOOD GROUND CLIP > COWL	PH PN AB SCREW	A	-			1	1.00
G-4822	RADIO NOISE CAPACITOR > COIL BRACKET	HXWA T SCREW, TOOTH WA	A	N			2	1.50
G-5504	RESISTOR (electrical output) > RAD SUPPORT	HXWA AB SCREW	A	N			1	1.00
G-5537	SPARK PLUG SHIELD - 396	SS EXT SEMS, FLAT WA'S	A	-			16	6.00
G-5586	SPEAKER > DASH	HXWA AB SCREW, SPRING NUT	A	N			2	2.00
G-5591	SPEAKERS & GRILLES @ KICK PANELS	PH OV AB SCREWS, SPRING NUTS	A	-			16	5.00
G-4769	STARTER & BRACE - 396	3.62" L HX BOLTS, HX EXT SEMS, FLNG NUT	A	-			4	8.00
G-4646	STARTER & BRACE - SB	1.84 & 4.69 FLNG BOLTS, SPLIT SEMS, NUT	A	N			4	8.00
G-5590	STEREO ADAPTER > DASH	HX BOLTS, PH PN SCREWS, EXT KEPS	A	-			8	3.00
G-5201	STOPLAMP SWITCH	SPECIAL ROUND RETAINER	A	-			1	2.00
G-4689	STOPLAMP SWITCH	STAMPED HX NUTS	-	N			2	2.00
G-5297	TACHOMETER	HXWA B SCREWS	A	N			3	1.50
G-5581	TACHOMETER CONNECTIONS	HX NUTS, SPLIT WA'S	A	N			4	2.00
G-6419	TAILAMP LENSES	SS/CHROME PH PN MS SCREWS	A	-			6	3.00
G-6418	TAILAMP LENSES	SS/CHROME PH PN MS SCREWS	-	N			8	4.00
G-4583	TAILAMPS > BODY	CONI TOOTH KEPS NUTS	A	-			8	6.00
G-6079	TAILAMPS > BODY	CONI KEPS NUTS	-	N			4	3.00
G-5508	TURN SIGNAL LEVER	PH PN BT SCREW	A	-			1	1.00
G-6077	TURN SIGNAL SWITCH	PH PN AB SCREW	-	N			1	1.50
G-5574	TURN SIGNAL SWITCH w TILT	HXWA B SCREWS	A	-			2	2.00
G-5509	TURN SIGNAL SWITCH w/o TILT	PH PN MS SCREWS	A	-			3	2.00
G-4649	VOLTAGE REGULATOR	SRTD HXWA MS SCREWS, WELL-NUTS	A	N			6	6.00
G-5532	VOLTAGE REGULATOR w 62 AMP ALT	HX BOLTS, TOOTH WA'S, NUTS	A	N			9	3.00
G-6677	WEATHERSTRIP, QUARTER GLASS @ JAMB	PH FLT AB SCREWS	A	-			4	2.00
G-6515	WIRING - BLOWER MOTOR/STARTER WIRING	RUBBER COATED J-CLIPS	A	-			2	5.00
G-6509	WIRING - ENGINE/STARTER @ BLOWER MTR	RUBBER COATED J-CLIP	-	N			1	3.00
G-4666	WIRING - FUEL SENDER UNIT GROUND	HXWA SCREW, TOOTH WA	A	N			2	1.00
G-6464	WIRING - HORN (low note) LEAD	5.1" FLEXIBLE STRAPS	A	-			2	5.00
G-6462	WIRING - HORN (low note) LEAD	3.17" NYLON STRAP	-	N			1	2.00
G-6510	WIRING - INSTR HARNESS CLIP @ CLUSTER	3.17" NYLON STRAP	-	N			1	2.00
G-6239	WIRING - NEUTRAL SAFETY SW w CONSOLE	"S" CLIPS	-	N			3	4.00
G-5193	WIRING - STARTER TERMINALS	NUTS, SPLIT & TOOTH WA'S	A	N			4	1.50
G-5672	WIRING - TRANS OD WIRE EXTENSION	HX EXT SEMS	A	-			1	1.50
G-4982	WIRING - VOLTAGE REGULATOR GROUND	HXWA AB SCREWS, TOOTH WA	A	N			3	2.00
G-5499	WIRING "GUTTER" > FIREWALL	HXWA AB SCREWS	A	-			2	1.50
G-6070	WIRING HARNESS > LH WHEELHOUSE	PUSH-ENDS BLACK PLASTIC STRAPS	-	N			3	4.00
G-6299	WIRING HARNESS > RADIATOR SUPPORT	3" NYLON STRAP	A	-			1	2.00
G-6193	WIRING HARNESS > RADIATOR SUPPORT	3" NYLON STRAPS	-	N			3	3.00

Emissions

G-4655	ENGINE VENT ADAPTER > INTAKE	HX BOLT, FLAT & SEALING WA'S	A	N			3	3.00
G-5544	PCV ADAPTER & TUBE > INTAKE - 327-4V	HX BOLTS, SPLIT, FLAT & FIBRE WA'S	A	-			5	6.00
G-5528	PCV ADAPTER & TUBE > INTAKE - SB	HX BOLT, FLAT & FIBRE WA'S	A	N			3	4.00
G-4770	PCV HOSE CLAMPS	FLAT WOUND SPRING CLAMPS (Black)	A	-			2	1.50

Exhaust

G-5573	EXHAUST HANGERS, DUAL	HXWA C SCREWS, RETAINERS	A	-			6	8.00
G-6306	EXHAUST HANGERS, DUAL	HXWA SCREWS, SPLIT SEMS, RIV-NUTS	-	N			13	8.00
G-4846	EXHAUST HANGERS, SINGLE	HXWA C SCREWS, RETAINERS	A	-			5	5.00
G-6034	EXHAUST HANGERS, SINGLE - 327-4V	HXWA C SCREWS, HX SPLIT SEMS, WA'S	-	N			6	4.00
G-6159	EXHAUST HANGERS, SINGLE - STD & All 67N	HX SPLIT SEMS, BOLT, NUT, SPLIT WA	-	N			7	4.00
G-5266	EXHAUST PIPE > MANIFOLDS	STUDS, LOCK NUTS	A	N			12	14.00

Fuel

G-5623	ACCELERATOR LEVER & SUPPORT	HX BOLT, HXWA AB SCREWS, WA'S, NUT	A	N			6	3.00
G-4643	FUEL FILLER NECK > BODY	HXWA B SCREWS	-	N			3	2.00
G-5056	FUEL HOSES	FLAT WOUND SPRING CLAMPS (Yellow)	A	N			4	3.00
G-5533	FUEL HOSES, 283-4V, 307, 327 (All 68-69A)	FLAT WOUND SPRING CLAMPS (Green)	A	-			4	3.00
G-4334	FUEL TANK FILLER NECK HOSE	WHITEK TOWER TYPE CLAMPS	A	N			2	6.00
G-4657	GAS TANK	CRG BOLTS, NUTS	A	-			4	5.00
G-6035	GAS TANK	HX BOLTS, NUTS, SPACERS	-	N			8	10.00
G-4847	GAS TANK - El Camino	HX CONI SEMS, BOLTS, NUTS, WA'S	A	-			18	10.00

See factory Assembly Manuals for illustrations

GM Fastener Kits

319

1965

Heater

PART #	APPLICATION	NOTES	CHEVELLE		NOVA		PCS	PRICE
			A	N	A	N		
G-5996	HEATER AIR DISTRIBUTOR	HX & HXWA AB SCREWS	-	N			2	2.00
G-4327	HEATER BLOWER MOTOR	SRTD HXWA AB SCREWS	A	N			5	1.50
G-6234	HEATER BOX > FIREWALL	HX AB FLAT SEMS, STMPD NUTS, SEALER	A	-			12	6.00
G-5989	HEATER BOX > FIREWALL & COWL	HXWA SCREW, STAMPED NUTS, SEALER	-	N			4	3.00
G-5476	HEATER CONTROL CABLES	HXWA AB & T SCREWS, RETAINERS	A	-			10	4.00
G-5995	HEATER CONTROL CABLES	PUSH RETAINERS	-	N			4	2.00
G-5525	HEATER CONTROL CABLES w AC	HXWA & HI-HXWA SCREWS, PUSH NUTS	A	-			14	4.00
G-5397	HEATER HOSE CLIP @ WHEELHOUSE	FOLDOVER METAL CLIP	A	N			1	4.00
G-4613	HEATER HOSES	WIRE TYPE SPRING CLAMPS, COL CODED	A	N			4	3.00
G-5993	HEATER INLET ADAPTER > COWL	HXWA AB SCREWS	-	N			4	2.00
G-5478	HEATER or AC OUTLET (LH under dash)	HXWA AB SCREWS	A	-			2	1.00
G-5994	HEATER OUTLET (LH under dash)	PH PN BT SCREWS	-	N			2	1.00
G-4616	HEATER RESISTOR > BOX	HXWA AB SCREWS	A	N			2	1.00

Interior

G-5518	AIR OUTLET BEZELS (w AC) > DASH	HXWA & PH OV SCREWS, SPR NUTS, WA	A	-			16	4.00
G-6673	ARMREST PAD & BASE @ Fr DOORS	PH FLAT B & PH RND A SCREWS	A	-			8	4.00
G-6674	ARMREST PAD & BASE @ Rr SEATS - COUPE	PH FLAT B & PH RND A SCREWS	A	-			10	4.00
G-5987	ASH TRAY FACE PLATE	PH PN B SCREWS	-	N			2	1.00
G-5473	ASH TRAY RETAINER	PH PN B SCREWS	A	-			3	1.50
G-5986	ASH TRAY RETAINER	PH PN B SCREWS	-	N			3	1.50
G-6679	COAT HOOKS	SS/CHROME PH OV SCREWS	A	-			2	1.50
G-5650	DOME LAMP	PH PN SCREWS	A	-			2	1.50
G-5384	DOOR PANELS	CLIPS, PLUGS (flexible !), PH OV AB SEMS	A	-			32	12.00
G-5985	GLOVE BOX & RH MOULDINGS	PH PN B SCREWS	-	N			4	1.50
G-5470	GLOVE BOX DOOR & LINER	RNDWA AB SCREWS	A	-			6	2.00
G-6585	GLOVE BOX DOOR BUMPERS	RUBBER BUMPERS	-	N			2	2.00
G-5896	GLOVE BOX LATCH & STRIKER	PH PN T SCREWS	-	N			3	2.00
G-5816	GLOVE BOX LINER	SCREWS	-	N			4	2.00
G-5474	HEATER CONTROL > DASH	PH FLAT & HXWA SCREWS	A	-			4	2.00
G-5988	INSTR PANEL TRIM PLATES	PH PN B SCREWS	-	N			2	1.00
G-5471	INSTRUMENT CLUSTER > DASH	PH PN AB SCREWS, SPRING NUTS	A	-			18	6.00
G-6075	INSTRUMENT CLUSTER > DASH	PH FILL AB SCREWS, SPRING NUTS	-	N			8	4.00
G-6686	KICK PANELS	CHROME PH OV FINISH WA SEMS, .50" DIA	A	-			4	2.00
G-4621	MIRROR (inside Rr view) > BRACKET	CHROME SLOT OV SHLDR SCREW	A	N			1	2.00
G-6690	MIRROR (inside Rr view) BRACKET	CHROME PH OV AB SCREWS	A	-			3	2.00
G-5597	MIRROR, REMOTE CONTROL BEZEL > DOOR	SS/CHROME PH OV AB SCREWS	A	N			2	1.50
G-6672	MOLDINGS @ DOOR/QTR TRIM PANEL TOPS	PH FLAT AB SCREWS	A	-			18	3.00
G-6648	QUARTER TRIM SAIL PANELS	RETAINING CLIPS	A	-			4	3.00
G-4821	RADIO CONTROL SHAFTS & KNOBS	SPECIAL THIN HX NUTS, SPRING WA'S	A	N			4	4.00
G-6685	ROOF RAIL INSIDE MOLDINGS	SS/CHROME PH OV SCREWS	A	-			4	2.00
G-4321	SCUFF PLATES, DOOR OPENING	SS/CHROME PH OV AB SCREWS	A	-			8	2.50
G-6148	SCUFF PLATES, DOOR OPENING	SS/CHROME PH OV AB SCREWS	-	N			12	3.00
G-6687	SEAT BACK (Fr) STRIKERS	COUNTERSUNK FLAT WA SCREWS	A	-			4	3.00
G-6662	SEAT BACK SIDE MOLDINGS	PH OV AB SCREWS	A	-			8	2.00
G-6108	SEAT SEPERATOR > FLOOR (A/T 66-67N)	PH RNDWA AB SCREWS, SPRING NUTS	-	N			8	4.00
G-5560	SEAT SEPERATOR LAMP LENS	CHROME PH PN T SCREWS	A	-			2	2.00
G-5559	SEAT SEPERATOR PLATES > FLOOR	CHROME PH OV AB SCREWS, SPR NUTS	A	-			12	5.00
G-6109	SEAT SEPERATOR TRIM PLATE	STAMPED NUTS, FLAT WA'S	-	N			10	3.00
G-6653	SEAT TRACKS > FLOOR	HX CONI TOOTH SEMS, PERI KEPS	A	-			8	5.00
G-5472	STEERING COLUMN COVER > DASH	PH PN AB SCREWS	A	-			2	1.50
G-5924	STEERING COLUMN COVER > FIREWALL	RUBBER RETAINERS	A	-			2	3.00
G-6681	SUN VISOR & MIRROR BRACKETS - COUPE	SS/CHROME PH OV SCREWS	A	-			9	3.00
G-6669	SUN VISOR BRACKETS - CONVERTIBLE	PH OV SCREWS	A	-			4	4.00
G-5378	SUN VISOR CLAMPS	CHROME SLOT FILL SCREWS	A	-			2	2.00
G-6665	VENT WINDOW FRAME > DOORS	CHROME HX CONI SEMS, CONI KEPS, WA'S	A	-			8	10.00
G-6666	VENT WINDOW CHANNEL > DOOR	#10 X 3.0" SS/CHROME PH OV SCREWS	A	-			2	3.00
G-6682	WEATHERSTRIP (Felt), QUARTER GLASS	PH FLAT AB #6 HD	A	-			4	2.00
G-5400	WINDOW CRANK HANDLES	RETAINING CLIPS	A	-			4	1.50
G-6663	WINDOW RUN (Rr) - FRONT DOORS	CHROME HX CONI & SPL PLATE SEMS, WA'S	A	-			10	10.00

Mouldings

G-4553	FENDER "EYEBROW" MOULDINGS	STAMPED & NYLON NUTS, SCREWS	A	-			8	3.00
G-6068	FENDER MOULDINGS (surround headlamps)	SS/CHROME SCREWS, NYLON NUTS	-	N			6	3.00
G-4549	HOOD CROWN MOULDING	STAMPED NUTS	A	-			8	2.00
G-6053	HOOD CROWN MOULDING	STAMPED NUTS	-	N			6	2.00
G-4514	HOOD MOULDING (Fr)	CONI KEPS NUTS	A	-			9	4.00
G-5482	ROCKER MOULDINGS (STD only 66-67A)	HXWA AB SCREWS	A	-			24	4.00
G-4496	WHEEL OPENING MOULDINGS	CHROME/SS PH RNDWA AB SCREWS	A	-			32	6.00

Kits Contain Attaching Fasteners for Both Sides

1965

Mouldings

PART #	APPLICATION	NOTES	CHEVELLE		NOVA		PCS	PRICE
			A	N	A	N		
G-4196	WHEEL OPENING MOULDINGS	CHROME/SS PH RNDWA AB SCREWS	-	N			28	6.00
G-6543	WINDOW (Fr) MOULDINGS	RETAINING CLIPS, PH PN AB SCREWS	A	-			34	12.00
G-6554	WINDOW (Fr) MOULDINGS	RETAINING CLIPS, PH PN AB SCREWS	-	N			34	12.00
G-6545	WINDOW (Rr) MOULDINGS	RETAINING CLIPS	A	-			24	12.00
G-6557	WINDOW (Rr) MOULDINGS	RETAINING CLIPS	-	N			24	12.00
G-6546	WINDOW (Rr) MOULDINGS - El Camino	RETAINING CLIPS, PH PN AB SCREWS	A	-			24	12.00

Steering & Suspension

G-4631	AXLE HSNG > SPRINGS	SPECIAL GR-8 LOCK NUTS ONLY !	-	N			8	12.00
G-5904	AXLE HSNG > SPRINGS (mono spring)	SPECIAL GR-8 LOCK NUTS & T BOLTS	-	N			16	26.00
G-6151	BALL JOINTS - UPPER	SOLID RIVETS (2 are extra)	A	-			10	6.00
G-6152	BALL JOINTS - UPPER or LWR	SOLID RIVETS (2 are extra)	-	N			8	4.00
G-6002	COIL SPRING SEATS	3/8-24 NUTS, SPLIT WA	-	N			8	3.00
G-4612	CONTROL ARM BUSHINGS - UPPER	HX BOLTS "SSC", WA'S, RETAINERS	A	-			12	12.00
G-4608	CONTROL ARMS - LWR	POINTED BOLTS, LOCK NUTS	A	-			8	20.00
G-5999	CONTROL ARMS - LWR	CAM BOLTS, WA'S, NUTS	-	N			8	24.00
G-4627	CONTROL ARMS - UPPER	GR-8 KNURL BOLTS, LOCK NUTS, SHIMS	A	-			18	14.00
G-5998	CONTROL ARMS - UPPER	GR-8 KNURL BOLTS, LOCK NUTS	-	N			8	10.00
G-4609	CONTROL ARMS (Rr)	GR-8 POINTED BOLTS, LOCK NUTS	A	-			16	32.00
G-5539	FRAME REINFORCEMENTS - HP APPLICATIONS	HARDENED FLAT WA'S	A	-			2	3.00
G-4669	GREASE FITTINGS	STRAIGHT	A	N			10	3.00
G-4265	IDLER ARM > FRAME	GR-8 HX BOLTS, WA'S, NUTS	GR-8 HX BOLTS, WA'S, NUTS	-	N		6	6.00
G-6038	IDLER ARM > FRAME	HX BOLTS, NUTS, WA'S	-	N			16	5.00
G-6010	LEAF SPRINGS, Fr EYE	HX BOLTS, NUTS, WA'S	-	N			8	14.00
G-6123	P/S CONTROL VALVE CLAMP	HX BOLT, SPLIT WA	-	N			2	2.00
G-6122	P/S HOSE BRACKET & CLAMP	HX BOLTS, WA'S, NUTS	-	N			7	3.00
G-5576	P/S PUMP - 283, 327 (A only)	HX BOLTS, FLAT & SPLIT WA'S, NUTS	A	-			12	8.00
G-5578	P/S PUMP - 396	HX BOLTS, FLAT & SPLIT WA'S, NUTS	A	-			10	8.00
G-6117	P/S PUMP - SB (N only)	HX BOLTS, WA'S, NUTS	-	N			12	6.00
G-4807	P/S PUMP PULLEY	THIN LOCK NUT	A	N			1	6.00
G-5579	P/S PUMP RESERVOIR - 396	HX SPLIT SEMS	A	-			2	3.00
G-5682	P/S RESERVOIR HOSE - 396	WHITEK TOWER TYPE CLAMPS	A	-			2	5.00
G-4919	P/S RETURN HOSE	ORIGINAL CLAMPS	A	-			2	20.00
G-4668	PITMAN ARM > GEAR BOX	HX NUT, SPLIT WA	A	N			2	3.00
G-4838	SHACKLES	11/16" AF MARSDEN NUTS ONLY	-	N			4	6.00
G-6004	SHOCK BRACKETS (Fr)	CRG BOLTS, NUTS, WA'S	-	N			24	8.00
G-6012	SHOCK BRACKETS (Rr) > BODY	HX SPLIT SEMS	-	N			4	5.00
G-4585	SHOCKS (Fr) - LWR MOUNTING	HX PP CONI SEMS	A	-			4	3.00
G-6005	SHOCKS (Fr) - LWR MOUNTING	GROMMETS, NUTS, WA'S	-	N			20	10.00
G-4836	SHOCKS (Fr) - UPR MOUNTING	RETAINERS, BUSHINGS, 3/8-24 NUTS	A	-			10	6.00
G-6006	SHOCKS (Fr) - UPR MOUNTING	GROMMETS, RETAINERS, 3/8-24 NUTS	-	N			10	10.00
G-5483	SHOCKS (Rr)	BOLTS, LOCK NUTS, FLAT & SPLIT WA'S	A	-			16	8.00
G-6011	SHOCKS (Rr) LWR MOUNTING	HX BOLTS, NUTS, SPLIT WA'S	-	N			6	4.00
G-6101	SHOCKS (Rr) UPR MOUNTING	RETAINERS, BUSHINGS, 3/8-24 NUTS	-	N			10	8.00
G-4675	SPARE WHEEL (F convertible only)	7 7/8" J-BOLT, WING NUT	A	N			2	14.00
G-5485	SPRINGS (Rr) - CLAMPS	HX BOLTS, NUTS, FLAT & SPLIT WA'S	A	-			8	6.00
G-4628	STABILIZER BAR (Fr) BRACKETS	HXWA C SCREWS	A	-			4	6.00
G-6009	STABILIZER BAR (Fr) BRACKETS	HX BOLTS, SPLIT & FLAT WA'S	-	N			12	5.00
G-5481	STABILIZER BAR (Fr) END LINKS	HX BOLTS, RETAINERS, BUSHINGS, NUTS	A	-			22	25.00
G-4837	STABILIZER BAR (Fr) END LINKS	HX BOLTS, RETAINERS, BUSHINGS, NUTS	-	N			22	20.00
G-5600	STABILIZER BAR (Rr)	HX BOLTS, NUTS	A	-			8	6.00
G-5494	STEERING COLUMN > DASH	HX PP CONI SEMS, FLNG NUTS	HX PP CONI SEMS, FLNG NUTS	-	N		4	3.00
G-6036	STEERING COLUMN > DASH	NUTS, SPLIT WA'S	-	N			4	1.50
G-5495	STEERING COLUMN CLAMPS	HX PP CONI SEMS, HXWA AB SCREW	A	-			2	2.00
G-4354	STEERING GEAR "RAG" JOINT	12 PT BOLT ONLY	A	-			1	3.00
G-6039	STEERING GEAR > FRAME	HI-HX BOLTS, WA'S, NUTS	-	N			15	10.00
G-5180	STEERING GEAR BOX > FRAME	GR-8 HX BOLTS, FLAT WA'S	A	-			6	12.00
G-4615	STEERING LINKAGE & BALL JOINTS	SLOTTED NUTS, COTTER PINS	A	-			20	10.00
G-6121	STEERING LINKAGE & BALL JOINTS w PS	SLOTTED NUTS, COTTER PINS	-	N			24	10.00
G-6003	STEERING LINKAGE & BALL JOINTS w/o PS	SLOTTED NUTS, COTTER PINS	-	N			22	10.00
G-4841	STEERING SHAFT > COUPLING	HX NUTS, SPLIT WA'S	A	-			4	2.00
G-4674	STEERING WHEEL	HX JAM NUT, FLAT WA	A	-			2	3.00
G-4802	STEERING WHEEL - DLX	SS PH FLAT MS SCREWS	A	-			6	3.00
G-6000	STRUT ROD THREADED ENDS > BODY	11/16-18 THREAD NUTS ONLY	-	N			4	10.00
G-6001	STRUT RODS > LWR CONTROL ARM	HX BOLTS, NUTS, WA'S	-	N			12	10.00
G-6007	SUSPENSION BUMPER BRACKETS (Fr)	HX CONI SEMS, NUTS	-	N			24	10.00
G-4596	SUSPENSION BUMPERS (Fr)	HX NUTS	A	-			2	1.00
G-6008	SUSPENSION BUMPERS (Fr)	NUTS, SPLIT WA'S	-	N			4	1.50
G-5484	SUSPENSION BUMPERS (Rr) - El Camino	HX BOLTS, NUTS, SPLIT WA'S	A	-			3	2.00
G-6583	WHEEL STUDS - 1 AXLE (Fr or Rr)	Does 2 wheels, 7/16-20 x 1.38" L	A	N			10	14.00
G-5060	WHEELS - STD	ORIGINAL LUG NUTS w "DIAMONDS"	A	N			20	25.00

See factory Assembly Manuals for illustrations

GM Fastener Kits

321

1965

Transmission

PART #	APPLICATION	NOTES	CHEVELLE		NOVA		PCS	PRICE
			A	N	A	N		
G-6611	BELL HOUSING > ENGINE	FLNG BOLTS, "M" MARKING	A	N			6	8.00
G-6149	BELL HOUSING > ENGINE	FLNG BOLTS (Flat Top) "A" MARKING	A	N			6	8.00
G-5416	BELL HOUSING Fr COVER PLATE	SS EXT SEMS "L"	A	N			4	3.00
G-5907	CLUTCH BELLCRANK	BALL STUDS, SEATS, RETAINER, WA'S	A	N			9	32.00
G-6032	CLUTCH BELLCRANK BRACKET > FRAME	HX BOLTS, SPLIT WA'S	-	N			4	2.00
G-5603	CLUTCH PEDAL BUSHINGS	NYLON BUSHINGS ONLY	A	N			2	3.00
G-4850	CLUTCH PEDAL PUSH RODS	RETAINING CLIPS ONLY	A	-			3	3.00
G-6030	CLUTCH PEDAL PUSH RODS	RETAINING CLIPS, FLAT WA'S	-	N			5	4.00
G-4659	CLUTCH PEDAL RETAINER	FOLDED SPRING METAL	A	N			1	3.00
G-4629	DRIVESHAFT > REAR KNUCKLE	U-BOLTS, NUTS, WA'S	A	N			10	8.00
G-6573	FLYWHEEL - A/T	GR-8 HXWA SCREWS	A	N			12	16.00
G-4429	FLYWHEEL - M/T	11/16" AF X 1.0" L HX BOLTS	A	N			12	12.00
G-6150	PRESSURE PLATE > FLYWHEEL	SPECIAL HX BOLTS, SPLIT WA'S	A	N			12	6.00
G-5572	SEAT SEPERATOR SHIFT GUIDES (A/T)	PH PN F SCREWS	A	-			8	2.00
G-5551	SHIFTER BEZEL & SEAL RETAINER - M/T	w/o CONSOLE, PH OV AB SCREWS	A	-			8	2.00
G-6110	SHIFTER BEZEL & SEAL, SEAT SEPRTR - M/T	PH PN SCREWS, STAMPED NUTS, WA'S	-	N			10	3.00
G-5627	SHIFTER CONTROL & SUPPORT - 3 SPD (floor)	HX BOLT, HX SPLIT SEMS, TOOTH WA	A	-			3	4.00
G-5553	SHIFTER CONTROL > TRANS - 4 SPD	HX BOLT, HX SPLIT SEMS, SPLIT WA	A	-			3	4.00
G-5566	SHIFTER DIAL & LAMP - FIXED COLUMN	PH OV BT & PH PN AB SCREWS	PH OV BT & PH PN AB SCREWS	-			3	2.00
G-4786	SHIFTER DIAL RETAINER - FIXED COLUMN	CHROME OV HD BT SCREWS	-	N			2	1.50
G-5575	SHIFTER DIAL RETAINER - TILT COLUMN	CHROME PH RND MS SCREWS	A	-			2	2.00
G-5554	SHIFTER HANDLE > CONTROL - 3 or 4 SPD	LOCK NUTS, FLAT WA'S	A	N			4	3.00
G-6116	SHIFTER LEVER > FLOOR - A/T FLOOR SHIFT	EXT SEMS, HXWA SCREWS, NUTS, WA'S	-	N			14	4.00
G-5564	SHIFTER LEVER > FLOOR - PG	HXWA AB SCREWS, SPRING NUTS	A	-			12	5.00
G-5900	SHIFTER LEVERS > CASE - 3 SPD	NUTS, SPLIT & FLAT WA'S	A	-			6	2.00
G-5565	SHIFTER LINKAGE, A/T FLOOR SHIFT	RETAINING CLIPS, FLAT WA'S ONLY	A	-			13	5.00
G-4791	SHIFTER LINKAGE, A/T FLOOR SHIFT - PG	RETAINERS, FLAT WA'S, NUTS	-	N			9	4.00
G-5571	SHIFTER PLATE & DIAL - A/T w SEAT SPRTR	PH OV, PH PN SCREWS, WA'S	A	-			12	3.00
G-6120	SHIFTER PLATE & DIAL - A/T w SEAT SPRTR	HXWA B & PH OV BT SCREWS	-	N			8	3.00
G-5625	SHIFTER RODS - 3 SPD	RETAINERS, COTTER, CLEVIS PINS, NUTS	A	-			9	8.00
G-5552	SHIFTER RODS - 4 SPD	RETAINERS, PIN, NUTS, WA	A	N			14	10.00
G-6119	SHIFTER SEAL RETAINER - A/T CONSOLE	PH OV AB SCREWS	-	N			6	2.00
G-5558	SHIFTER SEAL RETAINER - M/T CONSOLE	PH PN BT SCREWS	A	-			4	2.00
G-4694	SPEDOMETER CABLE > TRANS	HX SPLIT SEMS	A	N			1	2.00
G-5567	STEERING COLUMN CLAMPING RING - A/T	HX SPLIT SEMS	A	N			3	3.00
G-5555	STEERING COLUMN JACKET - 4 SPD	PH PN AB SCREWS	PH PN AB SCREWS	-			2	1.00
G-4788	TORQUE CONVERTOR > FLYWHL - PG, TH350	PLACE BOLTS, NUTS, WASHERS	A	N			9	8.00
G-5568	TRANS (Powerglide) KICKDOWN LINKAGE	ROD END CLIP, NUTS, WA'S	A	N			7	6.00
G-4169	TRANS CROSSMEMBER	HX BOLTS, WA'S (RH SIDE), NUTS	A	-			14	6.00
G-6022	TRANS CROSSMEMBER	HX BOLTS, SRTD FLNG NUTS	-	N			4	6.00
G-4603	TRANS INSULATOR	HX BOLTS, FLAT & SPLIT WA'S	A	-			10	6.00
G-6023	TRANS INSULATOR	HX BOLTS, FLAT & SPLIT WA'S	-	N			10	6.00
G-5561	TRANS LINKAGE or BACKDRIVE SUPPORT	> FRAME: HXWA C SCREWS	A	-			3	3.00
G-5548	TRANS OD CONTROL HANDLE & CABLE	PH PN AB SCREWS, BOLT, NUTS, WA'S	A	-			7	3.00
G-6308	TRANS OIL PAN - PG (exc 68-72 console)	LRG FLNG HEAD SCREWS	A	N			14	7.00
G-5550	TRANS OVERDRIVE (OD) RELAY	HXWA AB SCREWS	HXWA AB SCREWS	-			2	1.50
G-5562	TRANSMISSION (Powerglide) > ENGINE	HX BOLTS, LOCK WA'S (for brackets)	A	N			9	6.00
G-6028	TRANSMISSION (STD) > BELL HOUSING	HX BOLTS, SPLIT WA'S	A	N			8	5.00
G-5563	TRANSMISSION LINKAGE - A/T CLM SHIFT	RETAINERS, FITTINGS, NUTS, WA'S	A	-			10	16.00
G-5804	TRANSMISSION LINKAGE - M/T CLM SHIFT	RETAINERS, FITTINGS, NUTS, WA'S	A	-			20	24.00
G-4909	TRANSMISSION OIL COOLER LINES	C SHAPED SPRING CLIPS	A	N			2	3.00
G-4789	UNDERPAN - Powerglide A/T	HX EXT TOOTH SEMS	A	N			4	3.00

Wipers

G-5598	ANTI-FREEZE JAR BRACKET	HXWA AB SCREWS	A	-			2	1.00
G-6131	ANTI-FREEZE JAR BRACKET	HX AB SCREWS	-	N			2	1.00
G-4302	WINDSHIELD WASHER BOTTLE BRACKET	HXWA AB SCREWS	A	-			3	2.00
G-6132	WINDSHIELD WASHER BOTTLE BRACKET	HX AB SCREWS	-	N			3	1.50
G-6490	WINDSHIELD WASHER HOSE	ALUMINUM STRAP	-	N			1	3.00
G-4598	WINDSHIELD WASHER NOZZLES	HX AB FLAT SEMS	A	-			2	1.50
G-6133	WINDSHIELD WASHER NOZZLES	HX AB SCREWS	-	N			2	1.00
G-4464	WIPER ARM PIVOTS > COWL	HX EXT SEMS	A	-			4	3.00
G-5992	WIPER ARM PIVOTS > COWL	HX EXT SEMS	-	N			4	2.00
G-5465	WIPER MOTOR	GROMETTS, GRD STRAP, RIVET, SCREWS	A	N			8	12.00
G-4329	WIPER MOTOR	HX CNTRSNK EXT SEMS	HX CNTRSNK EXT SEMS	N			3	3.00
G-5599	WIPER MOTOR BRACKET - 1, 2S w/o WASHER	HX EXT SEMS	A	-			3	2.00
G-6141	WIPER MOTOR LINKAGE RETAINER	ATTACHES TO WIPER MOTOR ARM	A	-			1	2.00
G-5991	WIPER MOTOR LINKAGE RETAINER	ATTACHES TO WIPER MOTOR ARM	-	N			1	2.00
G-4623	WIPER SWITCH GROUND WASHER	EXT TOOTH WA	-	N			1	1.00

Kits Contain Attaching Fasteners for Both Sides

1966

Air Conditioning

PART #	APPLICATION	NOTES	CHEVELLE		NOVA		PCS	PRICE
			A	N				
G-5649	AC / HEAT DIVERTER DOOR SWITCH & BRKT	LOCATED ON AC DUCT, HXWA SCREWS	A	-			4	2.00
G-5639	AC AIR DISTRIBUTION DUCT - CENTRAL	HI-HXWA ABT SCREWS	A	-			4	3.00
G-5644	AC COMP BRACE > INTAKE - 396	HX BOLTS, FLAT & SPLIT WA'S	A	-			9	4.00
G-4869	AC COMP BRACE, UPPER Fr - 396	HX BOLTS, FLAT & SPLIT WA'S	A	-			6	5.00
G-6087	AC COMP BRACES > COMPRESSOR	HX BOLTS, FLAT & SPLIT WA'S	-	N			7	4.00
G-5643	AC COMP LWR ADJUST & Fr SUPPORT - 396	HX BOLTS, FLAT & SPLIT WA'S	A	-			5	6.00
G-4709	AC COMP LWR ADJUSTMENT - SB	HX BOLTS, FLAT & SPLIT WA'S	A	-			3	2.00
G-4712	AC COMP Rr BRACE > INTAKE - SB	HX BOLTS, FLAT & SPLIT WA'S	A	-			7	5.00
G-6089	AC COMP SUPPORT > BRACKETS	HX BOLT, NUTS, FLAT WA'S	-	N			8	5.00
G-6088	AC COMP SUPPORT > ENGINE	FLNG SCREWS	-	N			3	4.00
G-5642	AC COMP SUPPORT > EXH MANIFOLD - 396	HX CLR STUD, HX BOLTS, NUTS, WA'S	A	-			7	14.00
G-4708	AC COMP SUPPORT > EXH MANIFOLD - SB	GR-8 "TR" HX BOLT, SPACER, LOCK NUT	A	-			3	6.00
G-4710	AC COMP SUPPORT, LWR Rr - SB & 396	HX BOLTS, WA'S, LOCK NUT	A	-			6	4.00
G-4711	AC COMP UPPER Fr BRACE - SB w SMOG	HX BOLT, NUTS, FLAT & SPLIT WA'S	A	-			4	3.00
G-4864	AC COMP UPPER Fr BRACE - SB w/o SMOG	HX BOLTS, NUTS, FLAT & SPLIT WA'S	A	-			6	4.00
G-6095	AC COMPRESSOR GROUND WIRE - V8	HXWA T SCREW	-	N			1	1.00
G-6437	AC COMPRESSOR WIRING	7.1" FLEXIBLE STRAPS	-	N			3	6.00
G-6098	AC DIVERTER DOOR SWITCH	PH PN AB SCREWS	-	N			2	1.00
G-5640	AC DUCT > BLOWER HOUSING	HI-HXWA ABT SCREWS	A	-			6	3.00
G-5513	AC DUCT HOUSING > KICK PANEL	HXWA SCREWS, FLAT WA'S, SPRING NUT	A	-			10	4.00
G-6213	AC EVAPORATOR > DASH	HXWA SCREWS, KEPS NUTS, TOOTH WA	-	N			9	4.00
G-5515	AC EVAPORATOR > FIREWALL	HX AB FLAT SEMS	A	-			6	6.00
G-4718	AC FITTING & MUFFLER ASSEMBLY	HX BOLT, HX CONI SEMS, WA'S	A	-			5	3.00
G-5523	AC FITTING & MUFFLER ASSEMBLY	HX BOLT, FLAT & SPLIT WA'S	-	N			3	3.00
G-5779	AC HEATER HOSE CLAMP > COMP - 396	HX BOLTS, NUTS, SPLIT WA'S	A	-			6	3.00
G-4720	AC HEATER HOSE CLAMP > COMP - SB	HX BOLTS, NUTS, SPLIT WA'S	A	-			6	3.00
G-6094	AC HEATER HOSE CLAMP > COMP BRACKET	HOSE CLIP, BOLT, SPACER, TOOTH WA	-	N			4	10.00
G-6446	AC HOSE	7.1" FLEXIBLE STRAPS	A	-			3	6.00
G-6436	AC HOSE	7.1" FLEXIBLE STRAP	-	N			1	3.00
G-6093	AC HOSE CLAMP > FENDER SKIRT	HXWA AB SCREWS	-	N			2	1.50
G-6210	AC HOSE GROMMET @ RADIATOR SUPPORT	HXWA AB SCREWS	-	N			3	1.50
G-5519	AC RECEIVER TANK > FENDER SKIRT	HX BOLTS, RIVET NUTS	A	-			4	5.00
G-6211	AC RECIEVER TANK > FENDER SKIRT	HXWA AB SCREWS	-	N			2	1.50
G-4722	AC RESISTOR & RELAY > EVAPORATOR	HI-HXWA ABT SCREWS	A	-			3	3.00
G-6143	AC SELECTOR DUCT > FIREWALL	STAMPED NUTS, SEALER	A	-			6	3.00
G-6209	AC TUBING CLAMPS @ CONDENSER & DASH	HX MS & HXWA AB SCREWS, CONI KEPS	-	N			6	3.00
G-6444	AC VACUUM HOSE S CLIP @ BLOWER HSNG	STEEL S CLIP	A	-			1	3.00
G-5646	AC VALVE, TUBE BRKT'S > EVAPORATOR	HXWA AB SCREWS	A	-			2	1.50

Body

G-4540	BATTERY TRAY	HX MS & PP CONI SEMS	A	-			4	3.00
G-6069	BATTERY TRAY	HX PP CONI SEMS	-	N			4	3.00
G-5618	BODY MOUNTS - CONVERTIBLE	ORIGINAL BOLTS, FLAT WA'S	A	-			28	24.00
G-5617	BODY MOUNTS - HARDTOP	ORIGINAL BOLTS, FLAT WA'S	A	-			24	24.00
G-5500	BODY MOUNTS @ RADIATOR SUPPORT	ORIGINAL BOLTS, NUTS, WA'S	A	-			12	10.00
G-6099	BRAKE PEDAL SUPPORT w PB	HX BOLTS, NUTS, FLAT WA'S	-	N			5	3.00
G-4637	BRAKE PEDAL SUPPORT w/o PB	NUTS, SPLIT WA'S	A	-			4	2.00
G-4481	BUMPER (Fr)	SS CAP BOLTS, NUTS, FLAT, SPLIT WA'S	A	-			28	10.00
G-6203	BUMPER (Fr)	SS CAPPED BOLTS, WA'S, NUTS	-	N			24	8.00
G-4525	BUMPER (Fr) FILLER PANEL	HX PP CONI SEMS, U-NUTS, RIVETS	A	-			18	9.00
G-6180	BUMPER (Fr) FILLER PANEL	HX PP CONI SEMS, U-NUTS	-	N			14	10.00
G-4542	BUMPER (Rr)	SS CAPPED BOLTS, NUTS, WA'S	A	-			24	12.00
G-6206	BUMPER (Rr)	SS CAPPED BOLTS, WA'S, NUTS	-	N			32	10.00
G-4541	BUMPER BRACKETS (Fr)	HX BOLTS, WA'S, NUTS	A	-			16	10.00
G-6201	BUMPER BRACKETS (Fr)	HX BOLTS, TOOTH & FLAT WA'S	-	N			12	6.00
G-4543	BUMPER BRACKETS (Rr)	HX BOLTS, CLIPPED WA'S, NUTS	A	-			26	18.00
G-6205	BUMPER BRACKETS (Rr)	HX BOLTS, SPLIT & FLAT WA'S	-	N			18	6.00
G-4522	BUMPER BRACKETS (Rr) - El Camino	HX BOLTS, SPECIAL WA'S, NUTS	A	-			26	20.00
G-5693	BUMPER GUARDS (Fr)	HX BOLTS, SPLIT & FLAT WA'S	A	-			10	4.00
G-6227	BUMPER GUARDS (Fr)	HX BOLTS, NUTS, WA'S, SHIMS	-	N			12	4.00
G-5694	BUMPER GUARDS (Rr)	HX BOLTS, WA'S, NUTS	A	-			12	4.00
G-6228	BUMPER GUARDS (Rr)	HX BOLTS, NUTS, WA'S	-	N			12	3.00
G-4594	COWL VENT PANEL	HX AB FLAT SEMS	A	-			5	4.00
G-5374	DOOR HANDLES (outside)	SPECIAL 5/16 AF HX CONI SEMS	A	-			4	4.00
G-6942	DOOR HINGES	FLAT EXT SEMS, HX & PZI HX CONI SEMS	A	-			24	24.00
G-4332	DOOR LATCHES	OV HD TT SCREWS	A	-			6	3.00
G-6572	DOOR LOCK STRIKERS	HEX SOCKET DRIVE	A	-			2	24.00
G-5399	DOOR WEATHERSTRIPS	PLASTIC PINS	A	-			4	1.50
G-5538	EMBLEM, FENDERS "396 FLAG"	STAMPED NUTS	A	-			8	3.00
G-4547	EMBLEM, FENDERS "FLAG"	STAMPED NUTS	-	N			4	2.00
G-4532	EMBLEM, GRILLE	STAMPED NUTS, less SPACERS	A	-			2	3.00

See factory Assembly Manuals for illustrations

1966

Body

PART #	APPLICATION	NOTES	CHEVELLE		NOVA		PCS	PRICE
			A	N	A	N		
G-6179	EMBLEM, HOOD (Fr) - Nova	STAMPED NUTS	-	N			6	2.00
G-4179	FENDER > WHEELHOUSE Fr BRACES	HXWA C SCREWS	A	N			2	2.00
G-6594	FENDER TOPS ONLY (also found in fender kit)	HX MS & PP CONI SEMS	-	N			12	10.00
G-4523	FENDERS	HX CONI SEMS, U-NUTS, SHIMS	A	-			24	20.00
G-6174	FENDERS	HX CONI SEMS, NUT RETAINERS, SHIMS	-	N			30	15.00
G-6218	FENDERS > FIREWALL (also in fender kits)	LARGE HX CONI SEMS	A	-			4	5.00
G-6602	FENDERS > RAD SUPPORT (also in fender kit)	HX PP CONI SEMS	A	-			4	4.00
G-4524	FENDERS, Fr TIE BAR	CONI SEMS	A	-			8	4.00
G-4531	GRILLE	TUBULAR RIVETS	A	-			16	4.00
G-6181	GRILLE	ALUMINUM SEMI-TUBULAR RIVETS	-	N			19	4.00
G-6196	HEADLAMP ASSEMBLIES	HX CONI SEMS, SPRING NUTS	-	N			12	5.00
G-4538	HEADLAMP BEZELS	PH OV AB SCREWS, NYL NUTS, RIVETS	A	-			12	4.00
G-6197	HEADLAMP BEZELS	SS/CHROME PH OV SCREWS, NYL NUTS	-	N			16	4.00
G-4539	HEADLAMP BODIES	HX PP CONI SEMS	A	-			8	6.00
G-6172	HEADLAMP FILLER PANELS	HX PP CONI SEMS	-	N			6	3.00
G-6183	HEADLAMP/GRILLE SUPPORTS	HX MS & PP CONI SEMS	HX MS & PP CONI SEMS	N			6	3.00
G-4244	HOOD & HINGES	HX CONI SEMS	A	N			8	8.00
G-4477	HOOD CATCH & LOCK PLATE	HX PP CONI SEMS	A	-			9	6.00
G-6189	HOOD CATCH & LOCK PLATE	HX PP & MS CONI SEMS, HX NUT	-	N			10	5.00
G-4476	HOOD CATCH SUPPORT	HX PP CONI SEMS, U-NUT	A	-			2	3.00
G-6186	HOOD CATCH SUPPORT	HX PP CONI SEMS	-	N			1	1.00
G-4249	HOOD LEVELERS (Fr)	SCREWS, FLNG NUTS, RUBBER BUMPERS	A	N			6	8.00
G-4250	HOOD LOCK POST	MOUNTING NUT ONLY	A	N			1	2.00
G-4526	HOOD ORNAMENT (Fr)	STAMPED NUTS	A	-			2	1.00
G-4527	HOOD ORNAMENTS (Rr)	STAMPED NUTS, FLAT WA'S	A	-			32	5.00
G-5609	INSTRUMENT PANEL > COWL BRACE	HX PP CONI SEMS	A	-			2	2.00
G-4485	LICENSE PLATE BRACKET (Fr) 70-72, (Rr) All	HX BOLTS, EXT KEPS NUTS	A	-			4	3.00
G-4855	LICENSE PLATES (Fr & Rr)	SLOT TRUSS B SCREWS, NYLON NUTS	A	N			8	4.00
G-4717	MIRROR (outside fixed) & BRACKET	PH OV MS SCREW, PH PN B EXT SEMS	A	N			3	2.00
G-4729	MIRROR (outside remote) & BRACKET	PH OV MS SCREW, PH PN B EXT SEMS	A	N			3	2.00
G-4548	NAMEPLATE, FENDERS "283", "307"	STAMPED NUTS	-	N			4	1.50
G-5665	NAMEPLATE, FENDERS "327"	STAMPED NUTS	A	-			4	2.00
G-5631	NAMEPLATE, FENDERS "FLAGS" or "Nova"	STAMPED NUTS	A	-			4	2.00
G-4512	NAMEPLATE, FENDERS, 396 "FLAGS"	STAMPED NUTS	A	-			8	3.00
G-6062	NAMEPLATE, GRILLE	STAMPED NUTS ONLY	-	N			2	1.00
G-4533	NAMEPLATE, GRILLE "El Camino"	STAMPED NUTS ONLY	A	-			2	1.00
G-6424	NAMEPLATE, QUARTER PANELS	#10 ACORN NUTS	A	-			10	4.00
G-6615	PLUG, DOOR HINGES @ LH	1.25" RECESSED PLASTIC PLUG	A	-			1	1.50
G-6340	QUARTER PANEL EXTENSIONS	CONI KEPS NUTS, FLAT WA'S, SEALER	A	-			30	10.00
G-5496	STEERING COLUMN SEAL RETAINER	HI-HXWA AB SCREWS, FLAT WA'S	A	-			8	3.00
G-6037	STEERING COLUMN SEAL RETAINER	HX A SCREWS	-	N			4	2.00
G-6929	TAILGATE HINGES - El Camino	HX CONI SEMS	A	-			12	20.00
G-6934	TAILGATE LATCHES	OV HD TT SCREWS	A	-			6	3.00
G-6931	TAILGATE STRIKERS > BODY	POZI FLAT SCREWS	A	-			6	6.00
G-6932	TAILGATE SUPPORTS	POZI FLAT SCREWS	A	-			12	6.00
G-4154	TRUNK LATCH & STRIKER	HX CONI TOOTH SEMS	A	N			5	4.00
G-4155	TRUNK LID > HINGES	HX CONI TOOTH SEMS	A	N			4	4.00
G-4508	WHEELHOUSES	HX PP CONI SEMS, CUP WA'S, U-NUTS	A	-			44	26.00
G-6173	WHEELHOUSES	MS & PP CONI SEMS, BOLTS, WA'S, U-NUTS	-	N			36	16.00
G-6040	WHEELHOUSES > BODY	HX CONI SEMS, BOLTS, NUTS, WA'S	-	N			38	16.00
G-6595	WHEELHOUSES > BODY (also in fender kit)	HX CONI SEMS	-	N			6	5.00
G-5869	WHEELHOUSES > FENDERS (also in WH kit)	HX PP CONI SEMS, CUP WA'S, U-NUTS	A	-			12	12.00
G-6607	WHEELHOUSES > RAD SUPPORT (also WH kit)	HX PP CONI SEMS	-	N			2	2.00
G-4234	WHEELHOUSES > RADIATOR SUPPORT	HX PP CONI SEMS, U-NUTS	A	-			8	6.00

Brakes

G-5007	AXLE RETAINER PLATES	GR-8 HX BOLTS, NUTS, SPLIT WA'S	A	N			24	10.00
G-4738	BRAKE BOOSTER	HX NUTS, SPLIT WA'S	A	N			8	3.00
G-4740	BRAKE BOOSTER HOSE - SB	FLAT WOUND SPRING CLAMPS (Black)	A	N			2	2.00
G-5527	BRAKE BOOSTER HOSE SUPPORT	PH PN SCREW	A	-			1	1.00
G-4642	BRAKE CABLES	WIRE TYPE RETAINERS, HX NUTS	A	-			5	5.00
G-6017	BRAKE CABLES & BRACKETS	RETAINERS, HX C SCREWS, NUTS	-	N			9	5.00
G-6015	BRAKE HOSE BRACKET (Rr)	HX C SCREWS	-	N			2	2.00
G-6014	BRAKE HOSE BRACKETS (Fr)	HX BOLTS, SPLIT WA'S, NUTS	-	N			12	3.00
G-6240	BRAKE HOSE GASKETS	COPPER MATERIAL	A	N			2	1.50
G-4641	BRAKE HOSE RETAINERS	U-RETAINERS	A	-			4	3.00
G-6013	BRAKE HOSE RETAINERS	U-RETAINERS	-	N			6	4.00
G-5602	BRAKE PEDAL BUSHINGS	NYLON BUSHINGS ONLY	A	N			2	3.00
G-4794	BRAKE PEDAL RETAINER w A/T	FOLDED SPRING METAL	A	N			1	3.00
G-6044	BRAKE PEDAL RETURN SPRING	NOS SPRING	A	-			1	4.00
G-5008	BRAKE PLATE ASSEMBLY (Fr) > SPINDLE	GR-8 HX BOLTS, LOCK NUTS	A	N			8	12.00

Kits Contain Attaching Fasteners for Both Sides

GM Fastener Kits

1966

Brakes

PART #	APPLICATION	NOTES	CHEVELLE		NOVA		PCS	PRICE
			A	N	A	N		
G-4635	MASTER CYLINDER	HX NUTS, SPLIT WA'S	A	N			4	2.00
G-4829	MASTER CYLINDER PUSH ROD > PEDAL	RETAINING CLIP	A	N			1	3.00
G-5489	PARKING BRAKE CONTROL > DASH	HX SPLIT SEMS, FLNG NUTS, SEALER	A	-			5	3.00
G-6208	PARKING BRAKE CONTROL > DASH w AC	PH TRUSS MS SCREWS, TOOTH WA'S	-	N			4	2.00
G-6158	PARKING BRAKE CONTROL > DASH w/o AC	PH PN MS SCREWS, CONI WA'S	-	N			4	3.00
G-6018	PARKING BRAKE LEVER PIN RETAINERS	WIRE RETAINERS	-	N			2	2.00
G-4739	STOPLAMP SWITCH STRIKER (on pedal)	w POWER BRAKES, BOLT, STAMPED NUT	A	-			2	2.00
G-6576	WHEEL CYLINDER (2) BLEEDERS	Does 2 cylinders, 5/16-24 SCREWS	A	N			2	3.00
G-6577	WHEEL CYLINDER (4) BLEEDERS	Does 4 cylinders, 5/16-24 SCREWS	A	N			4	5.00
G-6581	WHEEL CYLINDERS (2)	HX INT SEMS	A	N			4	3.00
G-6582	WHEEL CYLINDERS (4)	HX INT SEMS	A	N			8	5.00

Cooling

PART #	APPLICATION	NOTES	CHEVELLE		NOVA		PCS	PRICE
			A	N	A	N		
G-5536	RADIATOR - 396	HX PP CONI SEMS	A	-			4	3.00
G-6025	RADIATOR & CENTER SHROUD	HX PP CONI SEMS, U-NUTS	-	N			16	12.00
G-4599	RADIATOR & CENTER SHROUD (SB only 65, 67)	HX PP CONI SEMS, U-NUTS	A	-			12	10.00
G-6226	RADIATOR FAN SHROUD	HX CONI SEMS	-	N			4	3.00
G-4601	RADIATOR FAN SHROUD - 65 STD, 66-67 HD	HX PP CONI SEMS	A	-			4	3.00
G-4844	RADIATOR HOSES - V8	TOWER TYPE CLAMPS	A	N			4	12.00

Differential

PART #	APPLICATION	NOTES	CHEVELLE		NOVA		PCS	PRICE
			A	N	A	N		
G-5466	DIFFERENTIAL COVER - 10 BOLT	SRTD FLNG SCREWS "E"	A	N			10	10.00
G-5467	DIFFERENTIAL COVER - 12 BOLT	SRTD FLNG SCREWS "E"	A	N			12	12.00

Electrical

PART #	APPLICATION	NOTES	CHEVELLE		NOVA		PCS	PRICE
			A	N	A	N		
G-4645	ALTERNATOR - 327, 350	HX BOLTS, WA'S, NUTS, SPACER	A	-			16	10.00
G-4766	ALTERNATOR - 396	HX BOLTS, WA'S, NUTS, SPACER	A	-			18	12.00
G-5664	ALTERNATOR - BB 62 AMP	HX BOLTS, NUTS, WA'S	A	-			16	10.00
G-6019	ALTERNATOR - SB (N only)	HX BOLTS, WA'S, NUT, SPACER	-	N			14	10.00
G-5663	ALTERNATOR - SB 62 AMP	HX BOLTS, NUTS, WA'S	A	N			16	10.00
G-4981	ALTERNATOR HARNESS > ALTERNATOR	12-24 NUT, #14 TOOTH WA	12-24	NUT, #14	TOOTH	WA	2	1.50
G-4681	ALTERNATOR HARNESS > ALTERNATOR	12-24 HX NUT, #12 TOOTH WA	-	N			2	1.50
G-5668	ALTERNATOR IDLER PULLEY - 396HP	HX BOLTS, HX SPLIT SEMS, FLAT WA'S	A	-			9	6.00
G-6293	ALTERNATOR PULLEY	NUT, FLAT WA	A	N			2	3.00
G-6225	ANTENNA (Rr) - ELECTRIC	HXWA SCREWS, SPR & WELL-NUTS	-	N			7	5.00
G-6633	BACK-UP LAMP LENSES	SS/CHROME PH PN .302 SHLDR SCREWS	-	N			4	4.00
G-4785	BACK-UP LAMP SW & ROD - 4 SPD (floor 68N)	HX EXT SEMS, RETAINING PINS	A	N			4	3.00
G-4777	BACK-UP SW ROD - 3 SPD FLOOR SHIFT	RETAINING PINS	A	-			2	1.50
G-5569	BACK-UP/NEUTRAL SWITCH (on Column)	HXWA B SCREWS	A	N			2	1.50
G-6612	BATTERY CABLE (-) CLIP @ BATTERY TRAY	J-CLIP, RETAINER	-	N			2	5.00
G-5633	BATTERY CABLE ROUTING CLIP > FRAME	HXWA T1 SCREW, TOOTH WA	A	-			2	1.50
G-4725	BATTERY CABLES - V8 w AC	HX BOLT, SCREW, NUTS, WA'S	A	-			7	4.00
G-6190	BATTERY CABLES - V8 w AC	HX BOLT, NUT, TOOTH WA'S	-	N			4	3.00
G-4678	BATTERY CABLES - V8 w/o AC	HXWA AB SCREW, NUTS, WA'S	A	-			7	4.00
G-6194	BATTERY CABLES - V8 w/o AC	HXWA AB SCREWS, NUTS, WA'S	-	N			6	3.00
G-4352	BATTERY HOLDOWN CLAMP	HX CONI SEMS	A	-			1	1.50
G-6124	BATTERY HOLDOWN CLAMP - HD & 67N 327	HX CONI SEMS, WA'S, WING NUT, HX NUT	-	N			5	4.00
G-5653	CLOCK - CONSOLE	SCREWS	A	-			4	1.00
G-5634	CLOCK - IN DASH	HXWA SCREWS	A	-			2	1.00
G-5683	CLOCK (dash top) & GROUND CONNECTION	SCREWS, TOOTH WA, SPRING NUT	A	-			6	3.00
G-5506	COURTESY LAMPS, UNDERDASH	HXWA SCREWS, SPRING NUTS	A	-			4	3.00
G-4696	DEFOGGER SWITCH - Rr WINDOW	OV HD SCREWS	A	N			2	1.00
G-4690	DIMMER SWITCH	HI-HXWA AB SCREWS	A	-			2	2.00
G-6073	DIMMER SWITCH	PH PN EXT SEMS	-	N			2	3.00
G-4688	FLASHER BRACKET > DASH	PH PN AB SCREW	A	N			1	1.00
G-5695	FLASHER LAMP SW BRACKET	PH PN AB SCREW	A	-			1	1.00
G-4986	FUSE PANEL > FIREWALL	#10 x 2 1/4 HXWA AB SCREWS w SEALER	-	-			2	3.00
G-6074	FUSE PANEL > FIREWALL	HXWA B SCREWS	-	N			2	2.00
G-6191	H/L, P/L GROUNDS	HXWA AB SCREWS, TOOTH WA'S	-	N			4	2.00
G-4680	H/L, P/L GROUNDS, JUNCTION BLOCK	HXWA AB & B SCREWS, TOOTH WA'S	A	-			5	3.00
G-4535	HEADLAMP ADJUSTERS	SCREWS, NYLON NUTS, SPRINGS	A	-			20	12.00
G-6531	HEADLAMP ADJUSTERS	SCREWS, NYLON NUTS, SPRING NUTS	-	N			10	6.00
G-6567	HEADLAMP RETAINING RINGS	SLOT PN SCREWS	A	-			6	3.00

See factory Assembly Manuals for illustrations

GM Fastener Kits

325

1966

Electrical

PART #	APPLICATION	NOTES	CHEVELLE		NOVA		PCS	PRICE
			A	N	A	N		
G-6138	HEATER SWITCH	PH PN BT SCREWS	-	N			2	1.50
G-5607	HEATER SWITCH or AC BLOWER	HXWA AB SCREWS	A	-			2	1.00
G-5475	HEATER SWITCH or AC BLOWER (66N < 12/65)	PH PN B SCREWS	-	N			2	1.00
G-5503	HORN (1)	HX PP CONI TOOTH SEMS	A	-			1	3.00
G-4801	HORN CONTACT ASSY - WOOD GRAIN WHEEL	PH PN MS SCREWS	A	-			3	2.00
G-4682	HORN RELAY	HXWA AB SCREW	A	N			1	1.00
G-4679	HORNS (2) (3 '66)	HX PP CONI TOOTH SEMS	-	N			2	4.00
G-5529	IGNITION AMPLIFIER & GROUND	HXWA SCREWS, TOOTHED WA'S	A	N			8	4.00
G-6678	IGNITION COIL & STRAP	HXWA MS, SLOT RND T SCREW	A	N			3	4.00
G-4312	LICENSE PLATE LAMP	PH PN AB SCREWS	A	N			2	1.00
G-5202	PARKING BRAKE ALARM SWITCH	HXWA AB SCREW	A	-			1	1.00
G-6625	PARKING LAMP LENSES	SS/CHROME PH PN .488 SHLDR SCREWS	A	N			4	4.00
G-4537	PARKING LAMPS	PH PN SCREWS	A	N			4	3.00
G-5511	POWER TOP ELECTRICAL CONNECTIONS	CONI KEPS NUTS, HXWA & OV SCREWS	A	-			6	4.00
G-5692	RADIO BRACKET	HXWA & PH PN AB SCREWS, SPR NUTS	A	-			4	3.00
G-6224	RADIO BRACKETS	HI-HXWA AB SCREWS, SPRING NUTS	-	N			8	4.00
G-5588	RADIO GROUND STRAP > FRAME	HXWA AB & T1 SCREWS, TOOTH WA'S	A	-			4	2.00
G-5587	RADIO GROUND STRAPS > FIREWALL	HXWA AB SCREWS, TOOTH WA'S	A	N			4	2.00
G-4822	RADIO NOISE CAPACITOR > COIL BRACKET	HXWA T SCREW, TOOTH WA	A	N			2	1.50
G-4819	SPEAKER > DASH	HXWA AB SCREW, SPRING NUT	A	N			2	2.00
G-4769	STARTER & BRACE - 396	3.62" L HX BOLTS, HX EXT SEMS, FLNG NUT	A	-			4	8.00
G-4646	STARTER & BRACE - SB	1.84 & 4.69 FLNG BOLTS, SPLIT SEMS, NUT	A	-			4	8.00
G-5201	STOPLAMP SWITCH	SPECIAL ROUND RETAINER	A	-			1	2.00
G-4689	STOPLAMP SWITCH	STAMPED HX NUTS	-	N			2	2.00
G-5687	TACHOMETER > INSTRUMENT CLUSTER	HI-HXWA ABT SCREW	A	-			1	1.00
G-4961	TAILAMP LENSES	SS/CHROME PH PN & PH OV MS SCREWS	-	N			8	4.00
G-4994	TAILAMP LENSES - El Camino	SS/CHROME PH PN MS SCREWS	A	-			8	8.00
G-6629	TAILAMP LENSES - STD	NOW KIT # 4557	A	-			10	10.00
G-5803	TAILAMPS > BODY	EXT TOOTH KEPS NUTS	-	N			6	3.00
G-4557	TAILAMPS > QUARTER EXTENSIONS	SS/CHROME PH PN .435 SHLDR SCREWS	A	-			10	5.00
G-6230	TRUNK LAMP	HXWA AB SCREW	A	N			1	1.00
G-5508	TURN SIGNAL LEVER	PH PN BT SCREW	A	N			1	1.00
G-5509	TURN SIGNAL SWITCH w/o TILT	PH PN MS SCREWS	A	N			3	2.00
G-5688	UNDERHOOD LAMP	HXWA AB SCREWS, TOOTH WA	A	N			2	1.50
G-4649	VOLTAGE REGULATOR	SRTD HXWA MS SCREWS, WELL-NUTS	A	N			6	6.00
G-5532	VOLTAGE REGULATOR w 62 AMP ALT	HX BOLTS, TOOTH WA'S, NUTS	A	-			9	3.00
G-6677	WEATHERSTRIP, QUARTER GLASS @ JAMB	PH FLT AB SCREWS	A	-			4	2.00
G-6521	WIRING - B/U LAMP WIRE (M/T) > INSTR HRNSS	3.17" NYLON STRAP	A	-			1	2.00
G-6515	WIRING - WIRING MOTOR/STARTER WIRING	RUBBER COATED J-CLIPS	A	-			2	5.00
G-6522	WIRING - BRAKE WARNING SWITCH > LINE	3.17" NYLON STRAP	A	-			1	2.00
G-6485	WIRING - CONSOLE LAMP	RUBBER COATED J & S CLIPS	A	-			3	7.00
G-6509	WIRING - ENGINE/STARTER @ BLOWER MTR	RUBBER COATED J-CLIP	-	N			1	3.00
G-4666	WIRING - FUEL SENDER UNIT GROUND	HXWA SCREW, TOOTH WA	A	-			2	1.00
G-6613	WIRING - HEATER RESISTOR	J-CLIP	A	-			1	3.00
G-6513	WIRING - INSTR HARNESS CLIPS	RUBBER COATED J-CLIPS	-	N			2	5.00
G-6486	WIRING - NEUTRAL SAFETY SW w CONSOLE	RUBBER COATED J & S CLIPS	A	-			3	6.00
G-6239	WIRING - NEUTRAL SAFETY SW w CONSOLE	"S" CLIPS	-	N			3	4.00
G-5193	WIRING - STARTER TERMINALS	NUTS, SPLIT & TOOTH WA'S	A	N			4	1.50
G-5672	WIRING - TRANS OD WIRE EXTENSION	HX EXT SEMS	A	-			1	1.50
G-6499	WIRING - TRUNK LAMP	S CLIPS	A	N			3	7.00
G-6465	WIRING - UNDERHOOD LAMP	5.1" FLEXIBLE STRAPS, S CLIPS	A	-			5	10.00
G-6463	WIRING - UNDERHOOD LAMP	5.1" FLEXIBLE STRAPS, S CLIPS	-	N			3	6.00
G-4982	WIRING - VOLTAGE REGULATOR GROUND	HXWA AB SCREWS, TOOTH WA	A	N			3	2.00
G-6492	WIRING - WIPER MOTOR > DASH	S CLIP	-	N			2	4.00
G-5499	WIRING "GUTTER" > FIREWALL	HXWA AB SCREWS	A	-			2	1.50
G-6070	WIRING HARNESS > LH WHEELHOUSE	PUSH-ENDS BLACK PLASTIC STRAPS	-	N			3	4.00
G-6299	WIRING HARNESS > RADIATOR SUPPORT	3" NYLON STRAP	A	-			1	2.00
G-6193	WIRING HARNESS > RADIATOR SUPPORT	3" NYLON STRAPS	-	N			3	3.00

Emissions

G-4750	AIR CLEANER VENT HOSE (w/o SMOG)	TOWER CLAMPS	A	-			2	5.00
G-4655	ENGINE VENT ADAPTER > INTAKE	HX BOLT, FLAT & SEALING WA'S	A	N			3	3.00
G-4751	PCV ADAPTER INTAKE - 283, 302, 327-4V	HX BOLT, FLAT & FIBRE WA'S, NUT	A	N			5	8.00
G-4770	PCV HOSE CLAMPS	FLAT WOUND SPRING CLAMPS (Black)	A	N			2	1.50
G-4747	SMOG HOSE CLAMPS - ALL V-8	TOWER TYPE CLAMPS	A	N			10	15.00
G-4744	SMOG PUMP - SB w AC (66N & All 67)	HX BOLTS, HX CLR STUD, SPACER, NUTS	-	N			8	18.00
G-4842	SMOG PUMP PULLEY	HX BOLTS, SPLIT WA'S	A	N			8	4.00
G-5662	SMOG VALVE CLAMP - 396 (L34)	WING NUT	A	-			1	2.00
G-5661	SMOG VALVE CLAMP - 396 (L35)	HX SCREW ONLY	A	-			1	1.00

Kits Contain Attaching Fasteners for Both Sides

GM Fastener Kits

1966

Exhaust

PART #	APPLICATION	NOTES	CHEVELLE		NOVA		PCS	PRICE
			A	N	A	N		
G-5573	EXHAUST HANGERS, DUAL	HXWA C SCREWS, RETAINERS	A	-			6	8.00
G-6222	EXHAUST HANGERS, DUAL	HXWA SCREWS, SPLIT SEMS, RIV-NUTS	-	N			16	10.00
G-4846	EXHAUST HANGERS, SINGLE	HXWA C SCREWS, RETAINERS	A	-			5	5.00
G-6034	EXHAUST HANGERS, SINGLE - 327-4V	HXWA C SCREWS, HX SPLIT SEMS, WA'S	-	N			6	4.00
G-6159	EXHAUST HANGERS, SINGLE - STD & All 67N	HX SPLIT SEMS, BOLT, NUT, SPLIT WA	-	N			7	4.00
G-5266	EXHAUST PIPE > MANIFOLDS	STUDS, LOCK NUTS	A	N			12	14.00

Fuel

G-5623	ACCELERATOR LEVER & SUPPORT	HX BOLT, HXWA AB SCREWS, WA'S, NUT	A	N			6	3.00
G-4643	FUEL FILLER NECK > BODY	HXWA B SCREWS	-	N			3	2.00
G-5056	FUEL HOSES	FLAT WOUND SPRING CLAMPS (Yellow)	A	N			4	3.00
G-5533	FUEL HOSES, 283-4V, 307, 327 (All 68-69A)	FLAT WOUND SPRING CLAMPS (Green)	A	-			4	3.00
G-4334	FUEL TANK FILLER NECK HOSE	WHITEK TOWER TYPE CLAMPS	A	N			2	6.00
G-4657	GAS TANK	CRG BOLTS, NUTS	A	-			4	5.00
G-6035	GAS TANK	HX BOLTS, NUTS, SPACERS	-	N			8	10.00
G-4847	GAS TANK - El Camino	HX CONI SEMS, BOLTS, NUTS, WA'S	A	-			18	10.00

Heater

G-5604	DEFROSTER DUCTS	HXWA SCREWS, FLAT WA'S	A	-			4	2.00
G-6137	DEFROSTER DUCTS	HXWA SCREWS	-	N			2	1.50
G-5996	HEATER AIR DISTRIBUTOR	HX & HXWA AB SCREWS	-	N			2	2.00
G-4327	HEATER BLOWER MOTOR	SRTD HXWA AB SCREWS	A	N			5	1.50
G-6234	HEATER BOX > FIREWALL	HX AB FLAT SEMS, STMPD NUTS, SEALER	A	-			12	6.00
G-5989	HEATER BOX > FIREWALL & COWL	HXWA SCREW, STAMPED NUTS, SEALER	-	N			4	3.00
G-5606	HEATER CONTROL CABLES	HI-HXWA ABT SCREWS, RETAINERS	A	-			11	4.00
G-6139	HEATER CONTROL CABLES	HI-HXWA ABT SCREWS, RETAINERS	-	N			9	4.00
G-5648	HEATER CONTROL CABLES w AC	HI-HXWA ABT SCREWS, RETAINERS	A	-			17	4.00
G-5397	HEATER HOSE CLIP @ WHEELHOUSE	FOLDOVER METAL CLIP	A	N			1	4.00
G-4613	HEATER HOSES	WIRE TYPE SPRING CLAMPS, COL CODED	A	N			4	3.00
G-5478	HEATER or AC OUTLET (LH under dash)	HXWA AB SCREWS	A	-			2	1.00
G-5994	HEATER OUTLET (LH under dash)	PH PN BT SCREWS	-	N			2	1.00
G-4616	HEATER RESISTOR > BOX	HXWA AB SCREWS	A	N			2	1.00

Interior

G-5637	AIR OUTLET BEZELS (w AC) > DASH	PH OV AB SCREWS, SPRING NUTS	A	-			10	4.00
G-6673	ARMREST PAD & BASE @ Fr DOORS	PH FLAT B & PH RND A SCREWS	A	-			8	4.00
G-6674	ARMREST PAD & BASE @ Rr SEATS - COUPE	PH FLAT B & PH RND A SCREWS	A	-			10	4.00
G-5473	ASH TRAY RETAINER	PH PN B SCREWS	A	N			3	1.50
G-6679	COAT HOOKS	SS/CHROME PH OV SCREWS	A	-			2	1.50
G-6568	CONSOLE > FLOOR	PH PN & PH TRUSS SCREWS, SPR NUTS	A	-			12	4.00
G-6586	CONSOLE DOOR BUMPERS	RUBBER BUMPERS	A	-			2	2.00
G-5655	CONSOLE LAMP LENS	CHROME PH OV SCREWS	A	-			2	1.50
G-5651	CONSOLE TOP PANELS, DOOR & LATCH	SCREWS, STAMPED NUTS	A	-			17	5.00
G-5608	DASH PAD	PH OV SCREWS, CONI SEMS, NYL NUTS	A	-			22	8.00
G-5650	DOME LAMP	PH PN SCREWS	A	-			2	1.50
G-6667	DOOR PANELS	CLIPS, PLUGS (flexible !), PH OV AB SEMS	A	-			28	10.00
G-6144	GLOVE BOX DOOR	PH PN CONI SEMS	-	N			3	3.00
G-5614	GLOVE BOX DOOR & LINER	PH RNDWA AB SCREWS, CONI KEPS NUTS	A	-			10	4.00
G-6585	GLOVE BOX DOOR BUMPERS	RUBBER BUMPERS	-	N			2	2.00
G-6145	GLOVE BOX FINISH PANEL	PH PN SCREWS w SMALL HEADS	-	N			10	3.00
G-4357	GLOVE BOX LATCH & STRIKER	PH PN AB FLAT SEMS, PH PN T SCREWS	-	N			4	2.00
G-4359	GLOVE BOX LINER	PH PN AB FLAT SEMS, SPRING NUTS	-	N			14	6.00
G-5613	GLOVE BOX STRIKER	PH PN AB EXT SEMS	A	-			2	2.00
G-5605	HEATER CONTROL > DASH	PH PN AB SCREWS	A	-			2	1.50
G-6140	HEATER CONTROL > DASH	PH PN AB SCREWS	-	N			2	1.50
G-5610	INSTR PANEL TRIM PLATES	PH PN BT & HXWA AB SCREWS	A	-			23	3.00
G-5635	INSTRUMENT CLUSTER > DASH	SCREWS, SPRING NUTS	A	-			16	5.00
G-6199	INSTRUMENT CLUSTER > DASH	PH OV AB SCREWS, SPRING NUTS	-	N			11	4.00
G-6136	INSULATION > FIREWALL	RUBBER RETAINERS	-	N			7	10.00
G-6686	KICK PANELS	CHROME PH OV FINISH WA SEMS, .50" DIA	A	-			4	2.00
G-4621	MIRROR (inside Rr view) > BRACKET	CHROME SLOT OV SHLDR SCREW	A	N			1	2.00
G-6690	MIRROR (inside Rr view) BRACKET	CHROME PH OV AB SCREWS	A	-			3	2.00
G-6668	MOULDINGS @ DOOR/QTR TRIM PANEL TOPS	PH FLAT AB SCREWS	A	-			16	2.00

See factory Assembly Manuals for illustrations

GM Fastener Kits

327

1966

Interior

PART #	APPLICATION	NOTES	CHEVELLE		NOVA		PCS	PRICE
			A	N	A	N		
G-6648	QUARTER TRIM SAIL PANELS	RETAINING CLIPS	A	-			4	3.00
G-4821	RADIO CONTROL SHAFTS & KNOBS	SPECIAL THIN HX NUTS, SPRING WA'S	A	N			4	4.00
G-6680	ROOF RAIL INSIDE MOLDINGS	SS/CHROME PH OV SCREWS	A	-			2	1.50
G-4321	SCUFF PLATES, DOOR OPENING	SS/CHROME PH OV AB SCREWS	A	-			8	2.50
G-6148	SCUFF PLATES, DOOR OPENING	SS/CHROME PH OV AB SCREWS	-	N			12	3.00
G-6657	SEAT BACK (Fr) STOP BUMPERS	PH PN AB SCREWS	A	-			4	1.50
G-6660	SEAT BACK PANELS	PH PNWA FLAT TOP SCREWS	A	-			4	2.00
G-6108	SEAT SEPERATOR > FLOOR (A/T 66-67N)	PH RNDWA AB SCREWS, SPRING NUTS	-	N			8	4.00
G-6220	SEAT SEPERATOR > FLOOR (M/T)	HXWA & RNDWA AB SCREWS, SPR NUTS	-	N			11	4.00
G-6109	SEAT SEPERATOR TRIM PLATE	STAMPED NUTS, FLAT WA'S	-	N			10	3.00
G-6661	SEAT SIDE PANELS	CHROME PH OV FLUSH SEMS	A	-			12	4.00
G-6653	SEAT TRACKS > FLOOR	HX CONI TOOTH SEMS, PERI KEPS	A	-			8	5.00
G-5615	STEERING COLUMN COVER > DASH	HXWA AB SCREWS	A	-			2	1.50
G-5924	STEERING COLUMN COVER > FIREWALL	RUBBER RETAINERS	A	-			2	3.00
G-6681	SUN VISOR & MIRROR BRACKETS - COUPE	SS/CHROME PH OV SCREWS	A	-			9	3.00
G-6670	SUN VISOR BRACKETS - CONVERTIBLE	CHROME PH OV SCREWS w #12 HD	A	-			6	4.00
G-5378	SUN VISOR CLAMPS	CHROME SLOT FILL SCREWS	A	-			2	2.00
G-6665	VENT WINDOW FRAME > DOORS	CHROME HX CONI SEMS, CONI KEPS, WA'S	A	-			8	10.00
G-6666	VENT WINDOW CHANNEL > DOOR	#10 X 3.0" SS/CHROME PH OV SCREWS	A	-			2	3.00
G-6614	VENT WINDOW HANDLE SPACER - NUTS	7/16-20 ORIGINAL HX DRIVE, CHROME	A	-			2	10.00
G-6682	WEATHERSTRIP (Felt), QUARTER GLASS	PH FLAT AB #6 HD	A	-			4	2.00
G-5400	WINDOW CRANK HANDLES	RETAINING CLIPS	A	-			4	1.50
G-6664	WINDOW RUN (Rr) - FRONT DOORS	CHROME HX CONI SEMS, PLASTIC WA'S	A	-			4	5.00

Mouldings

G-4529	BUMPER (Fr) FILLER PANEL MOULDINGS	STAMPED NUTS	A	-			13	4.00
G-4534	FENDER "EYEBROW" MOULDINGS	STAMPED NUTS	A	-			8	3.00
G-6175	FENDER MOULDINGS - STD Nova	STAMPED NUTS ONLY !	-	N			14	3.00
G-4514	HOOD MOULDING (Fr)	CONI KEPS NUTS	A	N			9	4.00
G-5616	ROCKER MOULDINGS - DLX	PH FLAT B SCREWS	A	-			4	2.00
G-6146	ROCKER MOULDINGS - Nova SS	SS/BLACK PH OV SCREWS, PN EXT SEMS	-	N			34	6.00
G-6147	ROCKER MOULDINGS - Nova STD	HXWA ABT SCREWS	-	N			24	4.00
G-5482	ROCKER MOULDINGS (STD only 66-67A)	HXWA AB SCREWS	A	-			24	4.00
G-4496	WHEEL OPENING MOULDINGS	CHROME/SS PH RNDWA AB SCREWS	A	N			32	6.00
G-6543	WINDOW (Fr) MOULDINGS	RETAINING CLIPS, PH PN AB SCREWS	A	-			34	12.00
G-6554	WINDOW (Fr) MOULDINGS	RETAINING CLIPS, PH PN AB SCREWS	-	N			34	12.00
G-6557	WINDOW (Rr) MOULDINGS	RETAINING CLIPS	-	N			24	12.00
G-6548	WINDOW (Rr) MOULDINGS - El Camino	RETAINING CLIPS, PH PN AB SCREWS	A	-			22	12.00

Steering & Suspension

G-4631	AXLE HSNB > SPRINGS	SPECIAL GR-8 LOCK NUTS ONLY !	-	N			8	12.00
G-5904	AXLE HSNB > SPRINGS (mono spring)	SPECIAL GR-8 LOCK NUTS & T BOLTS	-	N			16	26.00
G-6151	BALL JOINTS - UPPER	SOLID RIVETS (2 are extra)	A	-			10	6.00
G-6152	BALL JOINTS - UPPER or LWR	SOLID RIVETS (2 are extra)	-	N			8	4.00
G-6002	COIL SPRING SEATS	3/8-24 NUTS, SPLIT WA	-	N			8	3.00
G-4612	CONTROL ARM BUSHINGS - UPPER	HX BOLTS "SSC", WA'S, RETAINERS	A	-			12	12.00
G-4608	CONTROL ARMS - LWR	POINTED BOLTS, LOCK NUTS	A	-			8	20.00
G-5999	CONTROL ARMS - LWR	CAM BOLTS, WA'S, NUTS	-	N			8	24.00
G-4627	CONTROL ARMS - UPPER	GR-8 KNURL BOLTS, LOCK NUTS, SHIMS	A	-			18	14.00
G-5998	CONTROL ARMS - UPPER	GR-8 KNURL BOLTS, LOCK NUTS	-	N			8	10.00
G-4609	CONTROL ARMS (Rr)	GR-8 POINTED BOLTS, LOCK NUTS	A	-			16	32.00
G-5539	FRAME REINFORCEMENTS - HP APPLICATIONS	HARDENED FLAT WA'S	A	-			2	3.00
G-4669	GREASE FITTINGS	STRAIGHT	A	N			10	3.00
G-4265	IDLER ARM > FRAME	GR-8 HX BOLTS, WA'S, NUTS	A	-			6	6.00
G-6168	IDLER ARM > FRAME	HX BOLTS, NUTS, WA'S	-	N			12	5.00
G-6010	LEAF SPRINGS, Fr EYE	HX BOLTS, NUTS, WA'S	-	N			8	14.00
G-6123	P/S CONTROL VALVE CLAMP	HX BOLT, SPLIT WA	-	N			2	2.00
G-6122	P/S HOSE BRACKET & CLAMP	HX BOLTS, WA'S, NUTS	-	N			7	3.00
G-5679	P/S PUMP - 283, 327 (A only)	HX BOLTS, SPACER, WA'S, NUTS	A	-			14	12.00
G-5578	P/S PUMP - 396	HX BOLTS, FLAT & SPLIT WA'S, NUTS	A	-			10	8.00
G-5681	P/S PUMP - 396 (66 SMOG) (A only)	HX BOLTS, NUTS, WA'S	A	-			13	12.00
G-6117	P/S PUMP - SB (N only)	HX BOLTS, WA'S, NUTS	-	N			12	6.00
G-4807	P/S PUMP PULLEY	THIN LOCK NUT	A	N			1	6.00
G-5579	P/S PUMP RESERVOIR - 396	HX SPLIT SEMS	A	-			2	3.00
G-5682	P/S RESERVOIR HOSE - 396	WHITEK TOWER TYPE CLAMPS	A	-			2	5.00
G-4919	P/S RETURN HOSE	ORIGINAL CLAMPS	A	-			2	20.00
G-4668	PITMAN ARM > GEAR BOX	HX NUT, SPLIT WA	A	N			2	3.00

Kits Contain Attaching Fasteners for Both Sides

1966

Steering & Suspension

PART #	APPLICATION	NOTES	CHEVELLE		NOVA		PCS	PRICE
			A	N	A	N		
G-4838	SHACKLES	11/16" AF MARSDEN NUTS ONLY	-	N			4	6.00
G-6004	SHOCK BRACKETS (Fr)	CRG BOLTS, NUTS, WA'S	-	N			24	8.00
G-6012	SHOCK BRACKETS (Rr) > BODY	HX SPLIT SEMS	-	N			4	5.00
G-4585	SHOCKS (Fr) - LWR MOUNTING	HX PP CONI SEMS	A	-			4	3.00
G-6005	SHOCKS (Fr) - LWR MOUNTING	GROMMETS, NUTS, WA'S	-	N			20	10.00
G-4836	SHOCKS (Fr) - UPR MOUNTING	RETAINERS, BUSHINGS, 3/8-24 NUTS	A	-			10	6.00
G-6006	SHOCKS (Fr) - UPR MOUNTING	GROMMETS, RETAINERS, 3/8-24 NUTS	-	N			10	10.00
G-5483	SHOCKS (Rr)	BOLTS, LOCK NUTS, FLAT & SPLIT WA'S	A	-			16	8.00
G-6011	SHOCKS (Rr) LWR MOUNTING	HX BOLTS, NUTS, SPLIT WA'S	-	N			6	4.00
G-6101	SHOCKS (Rr) UPR MOUNTING	RETAINERS, BUSHINGS, 3/8-24 NUTS	-	N			10	8.00
G-4675	SPARE WHEEL (F convertible only)	7 7/8" J-BOLT, WING NUT	A	N			2	14.00
G-5485	SPRINGS (Rr) - CLAMPS	HX BOLTS, NUTS, FLAT & SPLIT WA'S	A	-			8	6.00
G-4628	STABILIZER BAR (Fr) BRACKETS	HXWA C SCREWS	A	-			4	6.00
G-6009	STABILIZER BAR (Fr) BRACKETS	HX BOLTS, SPLIT & FLAT WA'S	-	N			12	5.00
G-5481	STABILIZER BAR (Fr) END LINKS	HX BOLTS, RETAINERS, BUSHINGS, NUTS	A	-			22	25.00
G-4837	STABILIZER BAR (Fr) END LINKS	HX BOLTS, RETAINERS, BUSHINGS, NUTS	-	N			22	20.00
G-5494	STEERING COLUMN > DASH	HX PP CONI SEMS, FLNG NUTS	A	-			4	3.00
G-6163	STEERING COLUMN > DASH	HX PP CONI SEMS	-	N			2	3.00
G-5495	STEERING COLUMN CLAMPS	HX PP CONI SEMS, HXWA AB SCREW	A	-			2	2.00
G-4354	STEERING GEAR "RAG" JOINT	12 PT BOLT ONLY	A	-			1	3.00
G-6039	STEERING GEAR > FRAME	HI-HX BOLTS, WA'S, NUTS	-	N			15	10.00
G-5180	STEERING GEAR BOX > FRAME	GR-8 HX BOLTS, FLAT WA'S	A	-			6	12.00
G-4615	STEERING LINKAGE & BALL JOINTS	SLOTTED NUTS, COTTER PINS	A	-			20	10.00
G-6121	STEERING LINKAGE & BALL JOINTS w PS	SLOTTED NUTS, COTTER PINS	-	N			24	10.00
G-6003	STEERING LINKAGE & BALL JOINTS w/o PS	SLOTTED NUTS, COTTER PINS	-	N			22	10.00
G-4841	STEERING SHAFT > COUPLING	HX NUTS, SPLIT WA'S	A	-			4	2.00
G-4674	STEERING WHEEL	HX JAM NUT, FLAT WA	A	-			2	3.00
G-4802	STEERING WHEEL - DLX	SS PH FLAT MS SCREWS	A	-			6	3.00
G-6000	STRUT ROD THREADED ENDS > BODY	11/16-18 THREAD NUTS ONLY	-	N			4	10.00
G-6001	STRUT RODS > LWR CONTROL ARM	HX BOLTS, NUTS, WA'S	-	N			12	10.00
G-6007	SUSPENSION BUMPER BRACKETS (Fr)	HX CONI SEMS, NUTS	-	N			24	10.00
G-4596	SUSPENSION BUMPERS (Fr)	HX NUTS	A	-			2	1.00
G-6008	SUSPENSION BUMPERS (Fr)	NUTS, SPLIT WA'S	-	N			4	1.50
G-5484	SUSPENSION BUMPERS (Rr) - El Camino	HX BOLTS, NUTS, SPLIT WA'S	A	-			3	2.00
G-6170	WHEEL COVER ORNAMENT "SS"	HXWA B SCREWS	-	N			16	3.00
G-6583	WHEEL STUDS - 1 AXLE (Fr or Rr)	Does 2 wheels, 7/16-20 x 1.38" L	A	N			10	14.00
G-5060	WHEELS - STD	ORIGINAL LUG NUTS w "DIAMONDS"	A	N			20	25.00

Transmission

G-6149	BELL HOUSING > ENGINE	FLNG BOLTS (Flat Top) "A" MARKING	A	N			6	8.00
G-6611	BELL HOUSING > ENGINE	FLNG BOLTS, "M" MARKING	A	N			6	8.00
G-5416	BELL HOUSING Fr COVER PLATE	SS EXT SEMS "L"	A	N			4	3.00
G-5907	CLUTCH BELLCRANK	BALL STUDS, SEATS, RETAINER, WA'S	A	N			9	32.00
G-6032	CLUTCH BELLCRANK BRACKET > FRAME	HX BOLTS, SPLIT WA'S	-	N			4	2.00
G-5603	CLUTCH PEDAL BUSHINGS	NYLON BUSHINGS ONLY	A	N			2	3.00
G-4850	CLUTCH PEDAL PUSH RODS	RETAINING CLIPS ONLY	A	-			3	3.00
G-4659	CLUTCH PEDAL RETAINER	FOLDED SPRING METAL	A	N			1	3.00
G-4629	DRIVESHAFT > REAR KNUCKLE	U-BOLTS, NUTS, WA'S	A	N			10	8.00
G-6573	FLYWHEEL - A/T	GR-8 HXWA SCREWS	A	N			12	16.00
G-4429	FLYWHEEL - M/T	11/16" AF X 1.0" L HX BOLTS	A	N			12	12.00
G-6150	PRESSURE PLATE > FLYWHEEL	SPECIAL HX BOLTS, SPLIT WA'S	A	N			12	6.00
G-5551	SHIFTER BEZEL & SEAL RETAINER - M/T	w/o CONSOLE, PH OV AB SCREWS	A	-			8	2.00
G-6110	SHIFTER BEZEL & SEAL, SEAT SEPRTR - M/T	PH PN SCREWS, STAMPED NUTS, WA'S	-	N			10	3.00
G-5627	SHIFTER CONTROL & SUPPORT - 3 SPD (floor)	HX BOLT, HX SPLIT SEMS, TOOTH WA	A	-			3	4.00
G-5553	SHIFTER CONTROL > TRANS - 4 SPD	HX BOLT, HX SPLIT SEMS, SPLIT WA	A	-			3	4.00
G-4786	SHIFTER DIAL RETAINER - FIXED COLUMN	CHROME OV HD BT SCREWS	-	N			2	1.50
G-6221	SHIFTER DIAL RETAINER (exc Nova SS)	CHROME PH OV AB & PH PN T1 SCREWS	-	N			6	2.00
G-5554	SHIFTER HANDLE > CONTROL - 3 or 4 SPD	LOCK NUTS, FLAT WA'S	A	N			4	3.00
G-6116	SHIFTER LEVER > FLOOR - A/T FLOOR SHIFT	EXT SEMS, HXWA SCREWS, NUTS, WA'S	-	N			14	4.00
G-5564	SHIFTER LEVER > FLOOR - PG	HXWA AB SCREWS, SPRING NUTS	A	-			12	5.00
G-5897	SHIFTER LEVERS > CASE - 3 SPD M/T	HX BOLTS, SPLIT & FLAT WA'S	A	N			6	3.00
G-4781	SHIFTER LEVERS > CASE - 4 SPD STD	HX BOLTS, FLAT & SPLIT WA'S	A	N			9	3.00
G-5565	SHIFTER LINKAGE, A/T FLOOR SHIFT	RETAINING CLIPS, FLAT WA'S ONLY	A	-			13	5.00
G-4791	SHIFTER LINKAGE, A/T FLOOR SHIFT - PG	RETAINERS, FLAT WA'S, NUTS	-	N			9	4.00
G-6120	SHIFTER PLATE & DIAL - A/T w SEAT SPTR	HXWA B & PH OV BT SCREWS	-	N			8	3.00
G-5652	SHIFTER PLATE, LENS, SEAL - A/T CONSOLE	PH PN BT & T & PH OV C SCREWS, WA'S	A	-			18	2.00
G-5625	SHIFTER RODS - 3 SPD	RETAINERS, COTTER, CLEVIS PINS, NUTS	A	-			9	8.00
G-5552	SHIFTER RODS - 4 SPD	RETAINERS, PIN, NUTS, WA	A	N			14	10.00
G-6119	SHIFTER SEAL RETAINER - A/T CONSOLE	PH OV AB SCREWS	-	N			6	2.00
G-4694	SPEDOMETER CABLE > TRANS	HX SPLIT SEMS	A	N			1	2.00
G-5567	STEERING COLUMN CLAMPING RING - A/T	HX SPLIT SEMS	A	N			3	3.00

See factory Assembly Manuals for illustrations

1966

Transmission

PART #	APPLICATION	NOTES	CHEVELLE		NOVA		PCS	PRICE
			A	N	A	N		
G-4788	TORQUE CONVERTOR > FLYWHL - PG, TH350	PLACE BOLTS, NUTS, WASHERS	A	N			9	8.00
G-4795	TRANS (Powerglide) KICKDOWN LINKAGE	ROD END CLIP, NUTS, WA'S	A	N			5	4.00
G-4662	TRANS (Powerglide) KICKDOWN LINKAGE 396	COTTER PIN, NUTS, WA'S	A	-			6	2.00
G-4169	TRANS CROSSMEMBER	HX BOLTS, WA'S (RH SIDE), NUTS	A	-			14	6.00
G-6022	TRANS CROSSMEMBER	HX BOLTS, SRD FLNG NUTS	-	N			4	6.00
G-4603	TRANS INSULATOR	HX BOLTS, FLAT & SPLIT WA'S	A	-			10	6.00
G-6023	TRANS INSULATOR	HX BOLTS, FLAT & SPLIT WA'S	-	N			10	6.00
G-5561	TRANS LINKAGE or BACKDRIVE SUPPORT	> FRAME: HXWA C SCREWS	A	-			3	3.00
G-5669	TRANS OD CONTROL HANDLE & CABLE	SCREWS, BOLT, HX & SPRING NUTS, WA'S	A	-			10	4.00
G-6308	TRANS OIL PAN - PG (exc 68-72 console)	LRG FLNG HEAD SCREWS	A	N			14	7.00
G-5550	TRANS OVERDRIVE (OD) RELAY	HXWA AB SCREWS	A	-			2	1.50
G-4787	TRANSMISSION (Powerglide) > ENGINE	HX BOLTS, FLAT & SPLIT WA'S (for brkts)	A	N			9	6.00
G-4590	TRANSMISSION (STD) > BELL HOUSING	HX BOLTS, SPLIT WA'S	A	N			8	5.00
G-5563	TRANSMISSION LINKAGE - A/T CLM SHIFT	RETAINERS, FITTINGS, NUTS, WA'S	A	-			10	16.00
G-4839	TRANSMISSION LINKAGE - M/T CLM SHIFT	RETAINERS, FITTINGS, NUTS, WA'S	A	-			23	24.00
G-5901	TRANSMISSION LINKAGE - M/T CLM SHIFT	RETAINERS, FITTINGS, NUTS, WA'S	-	N			18	20.00
G-4909	TRANSMISSION OIL COOLER LINES	C SHAPED SPRING CLIPS	A	N			2	3.00
G-4789	UNDERPAN - Powerglide A/T	HX EXT TOOTH SEMS	A	N			4	3.00

Wipers

G-5598	ANTI-FREEZE JAR BRACKET	HXWA AB SCREWS	A	-			2	1.00
G-4302	WINDSHIELD WASHER BOTTLE BRACKET	HXWA AB SCREWS	A	-			3	2.00
G-6132	WINDSHIELD WASHER BOTTLE BRACKET	HX AB SCREWS	-	N			3	1.50
G-6490	WINDSHIELD WASHER HOSE	ALUMINUM STRAP	-	N			1	3.00
G-4598	WINDSHIELD WASHER NOZZLES	HX AB FLAT SEMS	A	-			2	1.50
G-6133	WINDSHIELD WASHER NOZZLES	HX AB SCREWS	-	N			2	1.00
G-6433	WINDSHIELD WIPER HOSES	3" NYLON STRAPS	A	-			2	2.00
G-4464	WIPER ARM PIVOTS > COWL	HX EXT SEMS	A	-			4	3.00
G-5992	WIPER ARM PIVOTS > COWL	HX EXT SEMS	-	N			4	2.00
G-5465	WIPER MOTOR	GROMMETS, GRD STRAP, RIVET, SCREWS	A	N			8	12.00
G-4329	WIPER MOTOR	HX CNTRS NK EXT SEMS	A	N			3	3.00
G-5599	WIPER MOTOR BRACKET - 1, 2S w/o WASHER	HX EXT SEMS	A	-			3	2.00
G-6141	WIPER MOTOR LINKAGE RETAINER	ATTACHES TO WIPER MOTOR ARM	A	-			1	2.00
G-5991	WIPER MOTOR LINKAGE RETAINER	ATTACHES TO WIPER MOTOR ARM	-	N			1	2.00
G-4623	WIPER SWITCH GROUND WASHER	EXT TOOTH WA	A	-			1	1.00

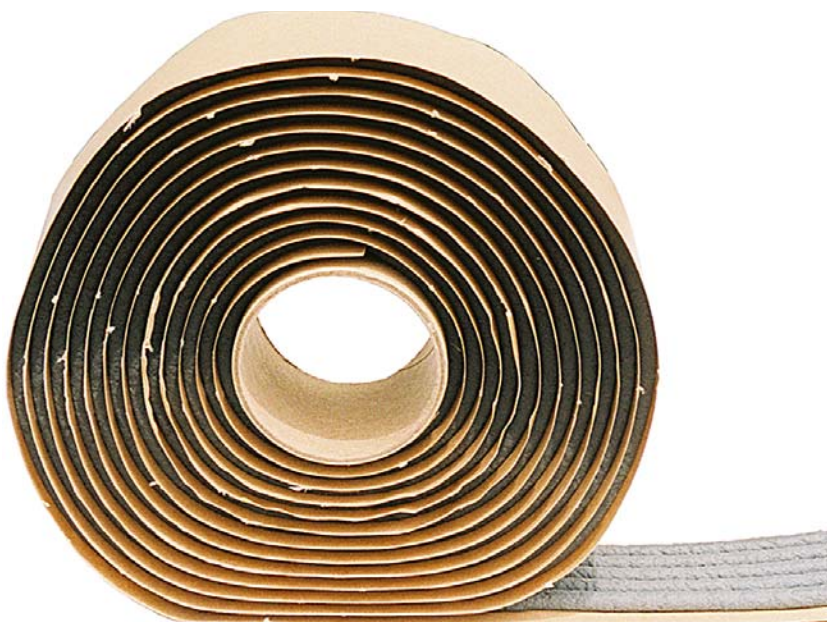

2 Lb Box

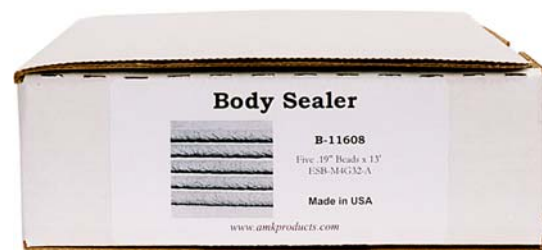

FIVE .19 DIAMETER BEADS ON 13' ROLL

Dark Grey Body Sealer - this product is widely used during assembly

Air ducts, body openings, door panel water shields, emblems, fenders, floor plugs, kick panels, gas tank & filler neck, firewall openings, heater box, quarter trim panel watershields, seat mounts, valance, window mouldings.

S	Pcs	Price
B-11608	1	\$20

1967

Air Conditioning

PART #	APPLICATION	NOTES					PCS	PRICE
			CAMARO	FIREBIRD	CHEVELLE	NOVA		
G-5649	AC / HEAT DIVERTER DOOR SWITCH & BRKT	LOCATED ON AC DUCT, HXWA SCREWS	-	-	A	-	4	2.00
G-5639	AC AIR DISTRIBUTION DUCT - CENTRAL	HI-HXWA ABT SCREWS	-	-	A	-	4	3.00
G-4702	AC AIR DISTRIBUTION DUCTS - CENTRAL	HI-HXWA ABT SCREWS	F	-	-	-	3	2.00
G-4703	AC AIR OUTLET @ FLOOR - CENTER	HI-HXWA AB SCREWS, FLAT WA'S	F	-	-	-	4	2.00
G-5645	AC COMP BRACE > INTAKE - 396	HX BOLTS, FLAT & SPLIT WA'S, NUT	-	-	A	-	10	4.00
G-4869	AC COMP BRACE, UPPER Fr - 396	HX BOLTS, FLAT & SPLIT WA'S	-	-	A	-	6	5.00
G-6087	AC COMP BRACES > COMPRESSOR	HX BOLTS, FLAT & SPLIT WA'S	-	-	-	N	7	4.00
G-5643	AC COMP LWR ADJUST & Fr SUPPORT - 396	HX BOLTS, FLAT & SPLIT WA'S	-	-	A	-	5	6.00
G-4709	AC COMP LWR ADJUSTMENT - SB	HX BOLTS, FLAT & SPLIT WA'S	F	-	A	-	3	2.00
G-4712	AC COMP Rr BRACE > INTAKE - SB	HX BOLTS, FLAT & SPLIT WA'S	F	-	A	-	7	5.00
G-4865	AC COMP Rr BRACE > INTAKE - SB w SMOG	HX BOLTS, FLAT & SPLIT WA'S	F	-	A	-	7	6.00
G-6089	AC COMP SUPPORT > BRACKETS	HX BOLT, NUTS, FLAT WA'S	-	-	-	N	8	5.00
G-6212	AC COMP SUPPORT > ENGINE	HX BOLTS, FLAT & SPLIT WA'S	-	-	-	N	6	4.00
G-5642	AC COMP SUPPORT > EXH MANIFOLD - 396	HX CLR STUD, HX BOLTS, NUTS, WA'S	-	-	A	-	7	14.00
G-4708	AC COMP SUPPORT > EXH MANIFOLD - SB	GR-8 "TR" HX BOLT, SPACER, LOCK NUT	F	-	A	-	3	6.00
G-4710	AC COMP SUPPORT, LWR Rr - SB & 396	HX BOLTS, WA'S, LOCK NUT	F	-	A	-	6	4.00
G-4711	AC COMP UPPER Fr BRACE - SB w SMOG	HX BOLT, NUTS, FLAT & SPLIT WA'S	F	-	A	-	4	3.00
G-4864	AC COMP UPPER Fr BRACE - SB w/o SMOG	HX BOLTS, NUTS, FLAT & SPLIT WA'S	F	-	A	-	6	4.00
G-6095	AC COMPRESSOR GROUND WIRE - V8	HXWA T SCREW	-	-	-	N	1	1.00
G-6437	AC COMPRESSOR WIRING	7.1" FLEXIBLE STRAPS	-	-	-	N	3	6.00
G-4706	AC CONDENSER & BRACKETS	HX CONI SEMS, HXWA SCREWS, U-NUTS	F	-	-	-	16	10.00
G-5641	AC CONDENSER & BRACKETS	HXWA SCREWS, SPRING NUTS, WA'S	-	-	A	-	14	5.00
G-6312	AC CONTROL CABLES END RETAINERS	C SHAPED	F	-	-	-	2	3.00
G-4701	AC DISTRIBUTOR & AIR OUTLET - LH	HXWA & HI-HXWA AB SCREWS	F	-	-	-	5	3.00
G-6098	AC DIVERTER DOOR SWITCH	PH PN AB SCREWS	-	-	-	N	2	1.00
G-5640	AC DUCT > BLOWER HOUSING	HI-HXWA ABT SCREWS	-	-	A	-	6	3.00
G-5513	AC DUCT HOUSING > KICK PANEL	HXWA SCREWS, FLAT WA'S, SPRING NUT	-	-	A	-	10	4.00
G-6438	AC EQUALIZER LINE > EVAPORATOR	3.17" NYLON STRAP	F	-	-	-	1	2.00
G-6213	AC EVAPORATOR > DASH	HXWA SCREWS, KEPS NUTS, TOOTH WA	-	-	-	N	9	4.00
G-4713	AC EVAPORATOR > FIREWALL	HX INT/EXT SEMS, CLR STUD, NUTS, WA'S	F	-	-	-	5	8.00
G-6233	AC EVAPORATOR > FIREWALL	HX AB INT/EXT SEMS	-	-	A	-	6	6.00
G-6304	AC EVAPORATOR CASE	HXWA BT SCREWS	F	-	-	-	6	4.00
G-4715	AC EVAPORATOR DRAIN HOSE CLAMP	WIRE CLAMP	F	-	-	-	1	2.00
G-4718	AC FITTING & MUFFLER ASSEMBLY	HX BOLT, HX CONI SEMS, WA'S	F	-	A	-	5	3.00
G-5523	AC FITTING & MUFFLER ASSEMBLY	HX BOLT, FLAT & SPLIT WA'S	-	-	-	N	3	3.00
G-4723	AC GROUND > FIREWALL	HXWA AB SCREW, TOOTH WA	F	-	-	-	2	1.50
G-4721	AC HEATER HOSE > DASH GROMMETS	HI-HXWA ABT SCREWS	F	-	-	-	4	2.00
G-5779	AC HEATER HOSE CLAMP > COMP - 396	HX BOLTS, NUTS, SPLIT WA'S	-	-	A	-	6	3.00
G-4720	AC HEATER HOSE CLAMP > COMP - SB	HX BOLTS, NUTS, SPLIT WA'S	F	-	A	-	6	3.00
G-6094	AC HEATER HOSE CLAMP > COMP BRACKET	HOSE CLIP, BOLT, SPACER, TOOTH WA	-	-	-	N	4	10.00
G-6618	AC HEATER HOSE PROTECTOR	RED PLASTIC CAP	F	-	-	-	1	1.50
G-6436	AC HOSE	7.1" FLEXIBLE STRAP	F	-	A	N	1	3.00
G-6093	AC HOSE CLAMP > FENDER SKIRT	HXWA AB SCREWS	-	-	-	N	2	1.50
G-5647	AC HOSE CLAMP > RADIATOR SUPPORT	HXWA AB SCREWS ONLY	-	-	A	-	2	1.00
G-4719	AC HOSE GROMMET @ FENDER SKIRT	HXWA AB SCREWS	F	-	A	-	4	1.50
G-6210	AC HOSE GROMMET @ RADIATOR SUPPORT	HXWA AB SCREWS	-	-	-	N	3	1.50
G-6584	AC OUTLET HOSE LH > DASH	11.25" FLEXIBLE STRAP, HXWA SCREW	F	-	-	-	2	5.00
G-4699	AC PLENUM VALVE & BRACKET	HXWA SCREWS, NUTS, WA'S, RETAINER	F	-	-	-	16	5.00
G-5519	AC RECEIVER TANK > FENDER SKIRT	HX BOLTS, RIVET NUTS	-	-	A	-	4	5.00
G-4707	AC RECIEVER TANK > FENDER SKIRT	HXWA AB SCREWS	F	-	-	-	2	1.50
G-6211	AC RECIEVER TANK > FENDER SKIRT	HXWA AB SCREWS	-	-	-	N	2	1.50
G-4722	AC RESISTOR & RELAY > EVAPORATOR	HI-HXWA ABT SCREWS	F	-	A	-	3	3.00
G-4700	AC SELECTOR DUCT > FIREWALL	HX INT/EXT SEMS, STMPD NUTS, SEALER	F	-	-	-	8	5.00
G-6143	AC SELECTOR DUCT > FIREWALL	STAMPED NUTS, SEALER	-	-	A	-	6	3.00
G-6209	AC TUBING CLAMPS @ CONDENSER & DASH	HX MS & HXWA AB SCREWS, CONI KEPS	-	-	-	N	6	3.00
G-6434	AC VACUUM HOSE @ FIREWALL	5.1" FLEXIBLE STRAP	F	-	-	-	1	3.00
G-5040	AC VACUUM HOSE CLAMPS	FLAT WOUND SPRING CLAMPS (Black)	F	-	-	-	6	5.00
G-4727	AC VACUUM HOSE GROMMETS > FIREWALL	HXWA AB SCREWS	F	-	-	-	2	1.50
G-6444	AC VACUUM HOSE S CLIP @ BLOWER HSNG	STEEL S CLIP	-	-	A	-	1	3.00
G-4697	AC VACUUM MOTOR @ RH COWL	HXWA SCREWS, NUTS, TOOTH WA'S	F	-	-	-	7	3.00
G-4698	AC VACUUM MOTOR COVER	PH OV FIN WA SEMS .50 OD, SPRG NUTS	F	-	-	-	6	3.00
G-4724	AC VACUUM TANK	HXWA AB SCREWS	F	-	-	-	2	2.00
G-4714	AC VALVE, TUBE BRKT'S > EVAPORATOR	HXWA AB & ABT SCREWS	F	-	-	-	2	1.50
G-5646	AC VALVE, TUBE BRKT'S > EVAPORATOR	HXWA AB SCREWS	-	-	A	-	2	1.50

Body

G-4255	BATTERY TRAY	HX CONI SEMS, HXWA PP SCREWS	F	H	A	-	4	3.00
G-6069	BATTERY TRAY	HX PP CONI SEMS	-	-	-	N	4	3.00
G-4625	BODY DAMPENERS - CONVERTIBLE	CONI SEMS, CLIPPED, CUP WA'S, NUTS	F	-	-	-	10	12.00
G-4950	BODY MOUNTS	ORIGINAL BOLTS, WA'S, NUTS	F	H	-	-	22	40.00
G-5618	BODY MOUNTS - CONVERTIBLE	ORIGINAL BOLTS, FLAT WA'S	-	-	A	-	28	24.00
G-5617	BODY MOUNTS - HARDTOP	ORIGINAL BOLTS, FLAT WA'S	-	-	A	-	24	24.00
G-5500	BODY MOUNTS @ RADIATOR SUPPORT	ORIGINAL BOLTS, NUTS, WA'S	-	-	A	-	12	10.00

See factory Assembly Manuals for illustrations

GM Fastener Kits

331

1967

Body

PART #	APPLICATION	NOTES					PCS	PRICE
			CAMARO	FIREBIRD	CHEVELLE	NOVA		
G-6099	BRAKE PEDAL SUPPORT w PB	HX BOLTS, NUTS, FLAT WA'S	-	-	-	N	5	3.00
G-4637	BRAKE PEDAL SUPPORT w/o PB	NUTS, SPLIT WA'S	F	-	A	-	4	2.00
G-4267	BUMPER (Fr)	SS CAPPED BOLTS, CONI KEPS NUTS	F	-	-	-	16	14.00
G-6698	BUMPER (Fr)	SS CAP, HX & CRG BOLTS, CONI KEPS NUTS	-	H	-	-	12	14.00
G-6202	BUMPER (Fr)	SS CAP BOLTS, FLAT, SPLIT WA'S, NUTS	-	-	A	-	28	10.00
G-6204	BUMPER (Fr)	SS CAPPED BOLTS, WA'S, NUTS	-	-	-	N	24	8.00
G-6699	BUMPER (Fr) BRACKETS	CRG BOLTS, RATCHET TOOTH WA'S, NUTS	-	H	-	-	12	12.00
G-4511	BUMPER (Fr) FILLER PANEL	HX CONI SEMS, SCREWS, U-NUTS, RVTS	-	-	A	-	16	9.00
G-6180	BUMPER (Fr) FILLER PANEL	HX PP CONI SEMS, U-NUTS	-	-	-	N	14	10.00
G-6702	BUMPER (Fr) REINFORCEMENT STABILIZERS	NUTS & FLAT WA'S ONLY	-	H	-	-	8	5.00
G-6700	BUMPER (Fr) REINFORCEMENTS	CRG BOLTS, FLAT & SPLIT WA'S, NUTS	-	H	-	-	32	10.00
G-4275	BUMPER (Rr)	SS CAPPED BOLTS, CONI KEPS NUTS	F	-	-	-	12	12.00
G-6694	BUMPER (Rr)	SS CAPPED BOLTS, KEPS NUTS, SCREWS	-	H	-	-	18	18.00
G-4520	BUMPER (Rr)	SS CAPPED BOLTS, NUTS, WA'S	-	-	A	-	24	12.00
G-6207	BUMPER (Rr)	SS CAPPED BOLTS, WA'S, NUTS	-	-	-	N	32	10.00
G-4266	BUMPER BRACKETS (Fr)	HX BOLTS, RATCHET TOOTH WA'S, NUTS	F	-	-	-	16	12.00
G-4519	BUMPER BRACKETS (Fr)	HX BOLTS, RATCHET TOOTH WA'S, NUTS	-	-	A	-	14	10.00
G-6201	BUMPER BRACKETS (Fr)	HX BOLTS, TOOTH & FLAT WA'S	-	-	-	N	12	6.00
G-4274	BUMPER BRACKETS (Rr)	HX PP CONI SEMS	F	-	-	-	8	8.00
G-6695	BUMPER BRACKETS (Rr)	HX PP CONI SEMS, CONI KEPS, CRG BOLTS	-	H	-	-	12	14.00
G-4521	BUMPER BRACKETS (Rr)	HX BOLTS, RATCHET TOOTH WA'S, NUTS	-	-	A	-	26	18.00
G-6205	BUMPER BRACKETS (Rr)	HX BOLTS, SPLIT & FLAT WA'S	-	-	-	N	18	6.00
G-5510	BUMPER BRACKETS (Rr) - El Camino	HX BOLTS, RATCHET TOOTH WA'S, NUTS	-	-	A	-	26	20.00
G-4280	BUMPER GUARD PADS (Fr or Rr)	STAMPED NUTS	F	-	A	-	6	3.00
G-4282	BUMPER GUARDS (Fr)	HX BOLTS, WA'S, NUTS	F	-	A	-	10	4.00
G-6227	BUMPER GUARDS (Fr)	HX BOLTS, NUTS, WA'S, SHIMS	-	-	-	N	12	4.00
G-5970	BUMPER GUARDS (Rr)	HX BOLTS, WA'S	-	-	A	-	4	2.00
G-6228	BUMPER GUARDS (Rr)	HX BOLTS, NUTS, WA'S	-	-	-	N	12	3.00
G-4279	BUMPER GUARDS (Rr) w PADS	HX BOLTS, HX PP CONI SEMS, WA'S	F	-	-	-	8	5.00
G-4277	BUMPER GUARDS (Rr) w/o PADS	HX BOLTS, WA'S	F	-	-	-	14	6.00
G-4611	CONVERTIBLE FLOOR REINFORCEMENT	HX PP CONI SEMS	F	-	-	-	6	8.00
G-4301	COWL VENT PANEL	HX AB FLAT SEMS	F	H	-	-	4	3.00
G-4594	COWL VENT PANEL	HX AB FLAT SEMS	-	-	A	-	5	4.00
G-5402	DOOR HANDLE CONTROLS (inside)	HXWA SCREWS	F	-	-	-	6	3.00
G-5374	DOOR HANDLES (outside)	SPECIAL 5/16 AF HX CONI SEMS	F	-	A	-	4	4.00
G-5385	DOOR HINGES	FLAT EXT SEMS, HX & PZI HX CONI SEMS	F	-	A	-	24	24.00
G-5136	DOOR LATCH - CONTROL	HXWA THREAD FORMER SCREWS	F	-	-	-	6	3.00
G-4332	DOOR LATCHES	OV HD TT SCREWS	F	H	A	-	6	3.00
G-6572	DOOR LOCK STRIKERS	HEX SOCKET DRIVE	F	-	A	-	2	24.00
G-5399	DOOR WEATHERSTRIPS	PLASTIC PINS	F	-	A	-	4	1.50
G-5137	DOOR WINDOW REGULATOR	HXWA THREAD FORMER SCREWS	F	-	-	-	14	6.00
G-4547	EMBLEM, FENDERS "FLAG"	STAMPED NUTS	-	-	-	N	4	2.00
G-6909	EMBLEM, GRILLE	STAMPED NUTS	-	H	-	-	2	2.00
G-6187	EMBLEM, GRILLE "Nova SS"	STAMPED NUTS ONLY !	-	-	-	N	2	1.50
G-6185	EMBLEM, GRILLE "SS"	STAMPED NUTS	-	-	-	N	2	1.00
G-4288	EMBLEM, GRILLE "SS", "R/S"	STAMPED NUTS	F	-	-	-	2	1.00
G-4518	EMBLEM, GRILLE & ORNAMENT	STAMPED NUTS	-	-	A	-	4	1.50
G-4235	FENDER > RADIATOR SUPPORT BRACES	HXWA PP SCREWS	F	H	-	-	4	3.00
G-6903	FENDER > RADIATOR SUPPORT GUSSETS	HXWA PP BOLTS, U-NUTS	-	H	-	-	8	8.00
G-4179	FENDER > WHEELHOUSE Fr BRACES	HXWA C SCREWS	-	-	A	N	2	2.00
G-4285	FENDER EMBLEMS - "RS"	STAMPED NUTS	F	-	-	-	12	3.00
G-4239	FENDER LWR EXTENSIONS	HX PP CONI SEMS, U-NUTS	F	-	-	-	16	10.00
G-6594	FENDER TOPS ONLY (also found in fender kit)	HX MS & PP CONI SEMS	-	-	-	N	12	10.00
G-4237	FENDERS	HX CONI SEMS, HXWA SCREWS, SHIMS	F	H	-	-	22	14.00
G-4510	FENDERS	HX PP CONI SEMS, U-NUTS, SHIMS	-	-	A	-	24	20.00
G-6174	FENDERS	HX CONI SEMS, NUT RETAINERS, SHIMS	-	-	-	N	30	15.00
G-6218	FENDERS > FIREWALL (also in fender kits)	LARGE HX CONI SEMS	F	-	A	-	4	5.00
G-6604	FENDERS > RAD SUPPORT (also in fender kit)	HXWA PP SCREWS	F	-	-	-	4	3.00
G-6603	FENDERS > RAD SUPPORT (also in fender kit)	HX PP CONI SEMS, HXWA PP SCREWS	-	-	A	-	4	4.00
G-4509	FENDERS, Fr TIE BAR	HXWA PP SCREWS, RIVETS	-	-	A	-	4	2.00
G-4516	GRILLE	RIVETS, SCREW, NUT	-	-	A	-	16	4.00
G-6182	GRILLE	HX CONI SEMS, NUTS, WA'S, RIVETS	-	-	-	N	24	5.00
G-6906	GRILLE & H/L DIVIDER "hourglass"	HXWA & PH OV SCREWS, U-NUTS	-	H	-	-	20	5.00
G-6907	GRILLE BRACKETS	CRG BOLTS, NUTS, FLAT & SPLIT WA'S	-	H	-	-	16	5.00
G-4517	GRILLE EXTENSIONS	SCREWS, NYLON NUTS, CON KEPS NUTS	-	-	A	-	18	6.00
G-4287	GRILLE, CENTER - R/S	BLACK SEMI-TUBULAR RIVETS	F	-	-	-	13	5.00
G-4251	GRILLE, CENTER - STD	BLACK SEMI-TUBULAR RIVETS	F	-	-	-	14	5.00
G-4295	GRILLE, LWR - R/S	HXWA SCREWS, SPRING NUTS	F	-	-	-	12	3.00
G-4290	GRILLE, LWR - STD	RIVETS, HXWA SCREW, SPRING NUT	F	-	-	-	10	5.00
G-4289	GRILLE, UPPER - STD	SCREWS & SPRING NUTS	F	-	-	-	12	5.00
G-4294	GRILLE, UPPER - STD (68F) & R/S	EXT TOOTH KEPS NUTS	F	-	-	-	6	3.00
G-4243	HEADER PANEL	HXWA PP SCREWS, U-NUTS	F	-	-	-	11	6.00
G-6196	HEADLAMP ASSEMBLIES	HX CONI SEMS, SPRING NUTS	-	-	-	N	12	5.00
G-4263	HEADLAMP BEZELS	SCREWS, NYLON NUTS, SPRING NUTS	F	-	-	-	12	6.00
G-4536	HEADLAMP BEZELS	SS/CHROME PH OV SCREWS, NYL NUTS	-	-	A	-	12	4.00

Kits Contain Attaching Fasteners for Both Sides

GM Fastener Kits

1967

Body										
			CAMARO	FIREBIRD	CHEVELLE	NOVA				
PART #	APPLICATION	NOTES	F	H	A	N			PCS	PRICE
G-6198	HEADLAMP BEZELS	SS/BLACK PH OV AB SCREWS, SPR NUTS	-	-	-	N			16	4.00
G-4283	HEADLAMP BEZELS - R/S	PH OV AB SCREWS, NYLON NUTS	F	-	-	-			16	6.00
G-6922	HEADLAMP BODIES	HX CONI SEMS	-	H	-	-			8	6.00
G-4297	HEADLAMP COVERS > PLATE - R/S	PH OV MS SCREWS	F	-	-	-			8	3.00
G-6172	HEADLAMP FILLER PANELS	HX PP CONI SEMS	-	-	-	N			6	3.00
G-4299	HEADLAMP HOUSINGS - R/S	HXWA PP SCREWS, SHIMS	F	-	-	-			14	5.00
G-4256	HEADLAMP HOUSINGS - STD	HXWA AB & PP SCREWS, SPRING NUTS	F	-	-	-			14	6.00
G-6184	HEADLAMP/GRILLE SUPPORTS	HX PP CONI SEMS	-	-	-	N			4	3.00
G-4244	HOOD & HINGES	HX CONI SEMS	F	H	A	N			8	8.00
G-4246	HOOD CATCH & LOCK PLATE	HXWA SCREWS, HX CONI SEMS, U-NUTS	F	-	-	-			9	6.00
G-4477	HOOD CATCH & LOCK PLATE	HX PP CONI SEMS	-	-	A	-			9	6.00
G-6189	HOOD CATCH & LOCK PLATE	HX PP & MS CONI SEMS, HX NUT	-	-	-	N			10	5.00
G-4245	HOOD CATCH SUPPORT	HXWA PP SCREW	F	H	-	-			1	1.00
G-4476	HOOD CATCH SUPPORT	HX PP CONI SEMS, U-NUT	-	-	A	-			2	3.00
G-6186	HOOD CATCH SUPPORT	HX PP CONI SEMS	-	-	-	N			1	1.00
G-6911	HOOD LATCH, BRACE, PLATE & SPRING	HXWA PP SCREWS, U-NUTS	-	H	-	-			15	14.00
G-4249	HOOD LEVELERS (Fr)	SCREWS, FLNG NUTS, RUBBER BUMPERS	F	H	A	N			6	8.00
G-4250	HOOD LOCK POST	MOUNTING NUT ONLY	F	-	A	N			1	2.00
G-4315	HOOD ORNAMENTS	STAMPED NUTS	F	-	-	-			20	5.00
G-4316	HOOD ORNAMENTS	STAMPED NUTS	-	-	A	-			12	4.00
G-5609	INSTRUMENT PANEL > COWL BRACE	HX PP CONI SEMS	-	-	A	-			2	2.00
G-4271	LICENSE PLATE BRACKET (Fr)	HXWA AB SCREWS, NYLON NUTS	F	-	-	-			6	3.00
G-4485	LICENSE PLATE BRACKET (Fr) 70-72, (Rr) All	HX BOLTS, EXT KEPS NUTS	-	-	A	-			4	3.00
G-4855	LICENSE PLATES (Fr & Rr)	SLOT TRUSS B SCREWS, NYLON NUTS	F	-	A	N			8	4.00
G-4717	MIRROR (outside fixed) & BRACKET	PH OV MS SCREW, PH PN B EXT SEMS	F	H	A	N			3	2.00
G-4729	MIRROR (outside remote) & BRACKET	PH OV MS SCREW, PH PN B EXT SEMS	F	-	A	N			3	2.00
G-4306	NAMEPLATE, FENDERS - ENG DESIGNATION	STAMPED NUTS	F	-	-	-			8	3.00
G-4548	NAMEPLATE, FENDERS "283", "307"	STAMPED NUTS	-	-	-	N			4	1.50
G-4304	NAMEPLATE, FENDERS "Camaro"	STAMPED NUTS	F	-	-	-			6	2.00
G-5631	NAMEPLATE, FENDERS "FLAGS" or "Nova"	STAMPED NUTS	-	-	A	-			4	2.00
G-4370	NAMEPLATE, FENDERS "Nova", "Firebird"	STAMPED NUTS	-	H	-	-			4	1.50
G-4313	NAMEPLATE, FENDERS "SS, R/S"	STAMPED NUTS	F	-	-	-			12	3.00
G-4512	NAMEPLATE, FENDERS, 396 "FLAGS"	STAMPED NUTS	-	-	A	-			8	3.00
G-4253	NAMEPLATE, GRILLE (STD)	STAMPED NUTS	F	-	-	-			2	1.50
G-4311	NAMEPLATE, HEADER PANEL	STAMPED NUTS	F	-	-	-			4	1.50
G-4513	NAMEPLATE, HOOD	STAMPED NUTS	-	-	A	-			3	1.00
G-6424	NAMEPLATE, QUARTER PANELS	#10 ACORN NUTS	-	-	A	-			10	4.00
G-4328	NAMEPLATE, TRUNK LID	STAMPED NUTS	F	-	-	-			4	1.50
G-6615	PLUG, DOOR HINGES @ LH	1.25" RECESSED PLASTIC PLUG	-	-	A	-			1	1.50
G-6506	PLUGS, FLOOR, TRUNK, WHEEL WELLS	RUBBER & PLASTIC PLUGS	F	-	-	-			12	8.00
G-6343	QUARTER PANEL EXTENSIONS	CONI KEPS NUTS, FLAT WA'S, SEALER	-	-	A	-			24	8.00
G-6915	RADIATOR SUPPORT > FENDER GUSSETS	PH WAFER SCREWS	-	H	-	-			4	4.00
G-4278	SPOILER (Fr)	#10 HXWA AB SCREWS	F	-	-	-			5	3.00
G-4673	STEERING COLUMN SEAL RETAINER	FLAT SEMS, HXWA SCREWS, SEAL WA'S	F	-	-	-			5	5.00
G-5630	STEERING COLUMN SEAL RETAINER	HXWA AB SCREWS	-	-	A	-			6	3.00
G-6167	STEERING COLUMN SEAL RETAINER	FLAT SEMS, HXWA SCREWS, SEAL WA'S	-	-	-	N			4	2.00
G-6929	TAILGATE HINGES - El Camino	HX CONI SEMS	-	-	A	-			12	20.00
G-6934	TAILGATE LATCHES	OV HD TT SCREWS	-	-	A	-			6	3.00
G-6931	TAILGATE STRIKERS > BODY	POZI FLAT SCREWS	-	-	A	-			6	6.00
G-6932	TAILGATE SUPPORTS	POZI FLAT SCREWS	-	-	A	-			12	6.00
G-4154	TRUNK LATCH & STRIKER	HX CONI TOOTH SEMS	F	-	A	-			5	4.00
G-4155	TRUNK LID > HINGES	HX CONI TOOTH SEMS	F	H	A	-			4	4.00
G-4241	VALANCE (Fr)	HXWA PP SCREWS, U-NUTS	F	-	-	-			14	8.00
G-6914	VALANCE (Fr)	HXWA AB & PP SCREWS, U-NUTS	-	H	-	-			20	16.00
G-6910	VALANCE (Fr) BRACKETS (3)	HXWA PP SCREWS, U-NUTS	-	H	-	-			8	8.00
G-5389	WEATHERSTRIP, QUARTER GLASS @ JAMB	.28 OD PH RNDWA AB SCREWS	F	-	-	-			4	2.00
G-6689	WHEELHOUSE Rr BRACES > BODY	HX MS & PP CONI SEMS, HX NUTS	F	-	-	-			6	5.00
G-6918	WHEELHOUSE Rr BRACES > BODY	HX CONI SEMS	-	H	-	-			4	4.00
G-4230	WHEELHOUSES	HXWA SCREWS, SEMS, CUP WA'S, U-NUTS	F	-	-	-			46	26.00
G-6916	WHEELHOUSES	HXWA SCREWS, SEMS, CUP WA'S, U-NUTS	-	H	-	-			50	30.00
G-4508	WHEELHOUSES	HX PP CONI SEMS, CUP WA'S, U-NUTS	-	-	A	-			44	26.00
G-6173	WHEELHOUSES	MS & PP CONI SEMS, BOLTS, WA'S, NUTS	-	-	-	N			36	16.00
G-6040	WHEELHOUSES > BODY	HX CONI SEMS, BOLTS, NUTS, WA'S	-	-	-	N			38	16.00
G-6595	WHEELHOUSES > BODY (also in fender kit)	HX CONI SEMS	-	-	-	N			6	5.00
G-6379	WHEELHOUSES > FENDERS (also in WH kit)	HXWA PP SCREWS, CUP WA'S, U-NUTS	F	-	-	-			12	12.00
G-5869	WHEELHOUSES > FENDERS (also in WH kit)	HX PP CONI SEMS, CUP WA'S, U-NUTS	-	-	A	-			12	12.00
G-6607	WHEELHOUSES > RAD SUPPORT (also WH kit)	HX PP CONI SEMS	-	-	-	N			2	2.00
G-4233	WHEELHOUSES > RADIATOR SUPPORT	HXWA PP SCREWS, U-NUTS	F	H	-	-			8	6.00
G-4234	WHEELHOUSES > RADIATOR SUPPORT	HX PP CONI SEMS, U-NUTS	-	-	A	-			8	6.00
G-5401	WINDOW (door) GUIDE PLATES	HX CONI TOOTH SEMS	F	-	-	-			8	4.00
G-5403	WINDOW (door) REAR STOP	HX TT CONI TOOTH SEMS	F	-	-	-			4	3.00
G-5414	WINDOW (Qter) REGULATOR, STOP, GUIDE	HXWA TT SCREWS, LRG FLNG NUTS	F	-	-	-			16	8.00
G-5405	WINDOW GLASS (Door) > CHANNEL	SRTD FLNG NUTS	F	-	-	-			4	1.50
G-5404	WINDOW GUIDE CHANNEL @ DOOR (Fr)	HX TT CONI TOOTH SEMS	F	-	-	-			6	3.00
G-5393	WINDOW GUIDE CHANNEL @ DOOR (Rr)	HX CONI TOOTH SEMS	F	-	-	-			6	3.00

See factory Assembly Manuals for illustrations

1967

Brakes

PART #	APPLICATION	NOTES					PCS	PRICE
			CAMARO	FIREBIRD	CHEVELLE	NOVA		
G-5007	AXLE RETAINER PLATES	GR-8 HX BOLTS, NUTS, SPLIT WA'S	F	H	A	N	24	10.00
G-6579	BRAKE BLEEDER SCREWS w DISC	All - CALIPERS, M/C, WHEEL CYLINDERS	F	-	A	-	6	10.00
G-4738	BRAKE BOOSTER	HX NUTS, SPLIT WA'S	F	H	A	N	8	3.00
G-4888	BRAKE BOOSTER HOSE - 396	CLAMPS & WA FOR TUBE BRACKET	F	H	-	-	3	3.00
G-4740	BRAKE BOOSTER HOSE - SB	FLAT WOUND SPRING CLAMPS (Black)	F	H	A	N	2	2.00
G-4642	BRAKE CABLES	WIRE TYPE RETAINERS, HX NUTS	F	H	A	-	5	5.00
G-6157	BRAKE CABLES & BRACKETS	RETAINERS, HX C SCREWS, HX NUTS	-	-	-	N	9	5.00
G-6575	BRAKE CALIPER BLEEDERS	3/8-24 SCREWS, .28 NOSE TO FIT CAP	F	-	A	-	2	4.00
G-5938	BRAKE CALIPER BRACKETS & SHIELDS	SPECIAL GR-8 HX BOLTS, LOCK NUTS	F	H	A	N	10	24.00
G-6045	BRAKE CALIPERS > BRACKET	GR-8 HX BOLTS	F	H	A	N	4	5.00
G-5657	BRAKE HOSE (Fr disc) BRACKETS > SPINDLE	HXWA T SCREWS	-	-	A	-	2	2.00
G-6215	BRAKE HOSE > CALIPER	U-RETAINERS	F	H	A	N	2	2.00
G-6360	BRAKE HOSE BRACKET (Rr)	HX SPLIT SEMS	F	H	-	-	2	3.00
G-6015	BRAKE HOSE BRACKET (Rr)	HX C SCREWS	-	-	-	N	2	2.00
G-4640	BRAKE HOSE BRACKETS (Fr)	HX C SCREWS	F	H	-	-	2	2.00
G-5620	BRAKE HOSE BRACKETS (Fr)	HX C SCREWS	-	-	A	-	2	2.00
G-6014	BRAKE HOSE BRACKETS (Fr)	HX BOLTS, SPLIT WA'S, NUTS	-	-	-	N	12	3.00
G-6240	BRAKE HOSE GASKETS	COPPER MATERIAL	F	-	A	N	2	1.50
G-4641	BRAKE HOSE RETAINERS	U-RETAINERS	F	H	A	-	4	3.00
G-6013	BRAKE HOSE RETAINERS	U-RETAINERS	-	-	-	N	6	4.00
G-5602	BRAKE PEDAL BUSHINGS	NYLON BUSHINGS ONLY	F	-	A	N	2	3.00
G-4794	BRAKE PEDAL RETAINER w A/T	FOLDED SPRING METAL	F	-	A	N	1	3.00
G-6044	BRAKE PEDAL RETURN SPRING	NOS SPRING	F	-	A	-	1	4.00
G-5008	BRAKE PLATE ASSEMBLY (Fr) > SPINDLE	GR-8 HX BOLTS, LOCK NUTS	F	H	A	N	8	12.00
G-5619	BRAKE PRESSURE SWITCH	HXWA C SCREW	-	-	A	-	1	1.00
G-4705	BRAKE PRESSURE VALVE - 67 AC, 396, 68 4V	TO FRAME, HX C SCREW	F	H	-	-	1	1.50
G-4636	BRAKE PRESSURE VALVE & SW - DRUM	HX SPLIT SEMS	F	H	-	N	1	1.50
G-4741	MASTER CYL BALANCE VALVE w DISC	HX EXT SEMS	F	H	A	N	1	2.00
G-4635	MASTER CYLINDER	HX NUTS, SPLIT WA'S	F	H	A	N	4	2.00
G-6580	MASTER CYLINDER BLEEDERS w DISC	5/16-24 SCREWS	F	-	A	-	2	3.00
G-4829	MASTER CYLINDER PUSH ROD > PEDAL	RETAINING CLIP	F	H	A	N	1	3.00
G-4347	PARKING BRAKE CONTROL > DASH	HX CONI SEMS, FLNG NUTS	F	H	-	-	3	3.00
G-5489	PARKING BRAKE CONTROL > DASH	HX SPLIT SEMS, FLNG NUTS, SEALER	-	-	A	-	5	3.00
G-6208	PARKING BRAKE CONTROL > DASH w AC	PH TRUSS MS SCREWS, TOOTH WA'S	-	-	-	N	4	2.00
G-6158	PARKING BRAKE CONTROL > DASH w/o AC	PH PN MS SCREWS, CONI WA'S	-	-	-	N	4	3.00
G-6018	PARKING BRAKE LEVER PIN RETAINERS	WIRE RETAINERS	-	-	-	N	2	2.00
G-4739	STOPLAMP SWITCH STRIKER (on pedal)	w POWER BRAKES, BOLT, STAMPED NUT	F	-	A	-	2	2.00
G-6576	WHEEL CYLINDER (2) BLEEDERS	Does 2 cylinders, 5/16-24 SCREWS	F	-	A	-	2	3.00
G-6577	WHEEL CYLINDER (4) BLEEDERS	Does 4 cylinders, 5/16-24 SCREWS	F	-	A	-	4	5.00
G-6581	WHEEL CYLINDERS (2)	HX INT SEMS	F	H	A	-	4	3.00
G-6582	WHEEL CYLINDERS (4)	HX INT SEMS	F	H	A	-	8	5.00

Cooling

G-4600	RADIATOR - 396	HXWA PP SCREWS	-	-	A	-	4	3.00
G-6025	RADIATOR & CENTER SHROUD	HX PP CONI SEMS, U-NUTS	-	-	-	N	16	12.00
G-4599	RADIATOR & CENTER SHROUD (SB only 65, 67)	HX PP CONI SEMS, U-NUTS	-	-	A	-	12	10.00
G-4676	RADIATOR (396 only 68N)	HXWA MS & PP SCREWS, WELL-NUTS	F	-	-	-	6	8.00
G-6226	RADIATOR FAN SHROUD	HX CONI SEMS	-	-	-	N	4	3.00
G-4601	RADIATOR FAN SHROUD - 65 STD, 66-67 HD	HX PP CONI SEMS	-	-	A	-	4	3.00
G-4677	RADIATOR FAN SHROUD & BRACKET	TOP MOUNTING ONLY. SCREWS, U-NUTS	F	-	-	-	5	5.00
G-4844	RADIATOR HOSES - V8	TOWER TYPE CLAMPS	F	-	A	N	4	12.00

Differential

G-5466	DIFFERENTIAL COVER - 10 BOLT	SRTD FLNG SCREWS "E"	F	H	A	N	10	10.00
G-5467	DIFFERENTIAL COVER - 12 BOLT	SRTD FLNG SCREWS "E"	F	H	A	N	12	12.00

Electrical

G-4828	ALTERNATOR - 302	HX BOLTS, WA'S, NUTS, SPACER	F	-	-	-	15	12.00
G-4645	ALTERNATOR - 327, 350	HX BOLTS, WA'S, NUTS, SPACER	F	-	A	-	16	10.00
G-4766	ALTERNATOR - 396	HX BOLTS, WA'S, NUTS, SPACER	F	-	A	-	18	12.00
G-6019	ALTERNATOR - SB (N only)	HX BOLTS, WA'S, NUT, SPACER	-	-	-	N	14	10.00
G-4681	ALTERNATOR HARNESS > ALTERNATOR	12-24 HX NUT, #12 TOOTH WA	F	-	-	N	2	1.50
G-4981	ALTERNATOR HARNESS > ALTERNATOR	12-24 NUT, #14 TOOTH WA	-	-	A	-	2	1.50
G-6293	ALTERNATOR PULLEY	NUT, FLAT WA	F	-	A	N	2	3.00
G-4812	ASH TRAY LAMP	SMALL PH PN B SCREW	F	-	-	-	1	1.00
G-6633	BACK-UP LAMP LENSES	SS/CHROME PH PN .302 SHLDR SCREWS	-	-	A	N	4	4.00

Kits Contain Attaching Fasteners for Both Sides

GM Fastener Kits

1967

Electrical

PART #	APPLICATION	NOTES					PCS	PRICE
			CAMARO	FIREBIRD	CHEVELLE	NOVA		
G-6423	BACK-UP LAMP LENSES - R/S	CHROME/SS PH PN .550 SHLDR SCREWS	F	-	-	-	4	4.00
G-4785	BACK-UP LAMP SW & ROD - 4 SPD (floor 68N)	HX EXT SEMS, RETAINING PINS	F	-	A	N	4	3.00
G-4505	BACK-UP LAMPS	PH PN EXT SEMS	-	-	A	-	4	3.00
G-4318	BACK-UP LAMPS - R/S	HX NUTS	F	-	-	-	4	1.00
G-4777	BACK-UP SW ROD - 3 SPD FLOOR SHIFT	RETAINING PINS	F	-	A	-	2	1.50
G-4693	BACK-UP/NEUTRAL SWITCH (Column A/T)	EXT KEPS NUTS	F	-	A	N	2	1.50
G-4793	BACK-UP/NEUTRAL SWITCH (Console A/T)	HX SCREWS, FLAT & TOOTH WA'S	F	-	-	-	6	2.00
G-6612	BATTERY CABLE (-) CLIP @ BATTERY TRAY	J-CLIP, RETAINER	-	-	-	N	2	5.00
G-6298	BATTERY CABLE > RH WHEELHOUSE	3.17" NYLON STRAP	F	-	-	-	1	2.00
G-5633	BATTERY CABLE ROUTING CLIP > FRAME	HXWA T1 SCREW, TOOTH WA	-	-	A	-	2	1.50
G-4725	BATTERY CABLES - V8 w AC	HX BOLT, SCREW, NUTS, WA'S	F	-	A	-	7	4.00
G-6195	BATTERY CABLES - V8 w AC	HX BOLT, NUTS, TOOTH WA'S	-	-	-	N	5	4.00
G-4678	BATTERY CABLES - V8 w/o AC	HXWA AB SCREW, NUTS, WA'S	F	-	A	-	7	4.00
G-4352	BATTERY HOLDOWN CLAMP	HX CONI SEMS	F	-	A	-	1	1.50
G-6124	BATTERY HOLDOWN CLAMP - HD & 67N 327	HX CONI SEMS, WA'S, WING NUT, HX NUT	-	-	-	N	5	4.00
G-5653	CLOCK - CONSOLE	SCREWS	-	-	A	-	4	1.00
G-4813	CLOCK - FLOOR MOUNTED	SCREW, WA , NUT, RIVET NUTS	F	-	-	-	7	5.00
G-5634	CLOCK - IN DASH	HXWA SCREWS	-	-	A	N	2	1.00
G-5685	CLOCK BRACKET > FLOOR	HXWA SCREWS, RIVET NUTS	-	-	A	-	4	3.00
G-4809	CONSOLE CIRCUIT BOARD	SMALL SCREWS, NUTS, WA'S	F	-	-	-	7	2.00
G-5636	COURTESY LAMPS, UNDERDASH	PH PN FLAT WA SEMS	-	-	A	-	2	2.00
G-4691	COURTESY LAMPS, UNDERDASH (69F COUPE)	PH PN SCREW, PH PN AB FLAT SEMS, WA	F	-	-	-	3	2.00
G-6452	CRUISE CONTROL CABLES	7.1" FLEXIBLE STRAPS	F	-	-	-	3	6.00
G-4752	CRUISE CONTROL REGULATOR & BRACKET	HX CONI SEMS, BOLTS, NUTS, WA'S	F	-	A	-	7	3.00
G-4753	CRUISE CONTROL SERVO & BRACKET	SCREWS, NUTS, WA'S	F	-	A	-	7	2.00
G-4754	CRUISE CONTROL SW STRIKER & BRACKET	HX BOLTS, NUTS, WA'S	F	-	A	-	6	3.00
G-4696	DEFOGGER SWITCH - Rr WINDOW	OV HD SCREWS	F	-	A	N	2	1.00
G-4690	DIMMER SWITCH	HI-HXWA AB SCREWS	F	-	-	-	2	2.00
G-4989	DIMMER SWITCH	HXWA AB SCREWS	-	-	A	-	2	2.00
G-6073	DIMMER SWITCH	PH PN EXT SEMS	-	-	-	N	2	3.00
G-4688	FLASHER BRACKET > DASH	PH PN AB SCREW	F	-	A	N	1	1.00
G-4986	FUSE PANEL > FIREWALL	#10 x 2 1/4 HXWA AB SCREWS w SEALER	F	-	A	-	2	3.00
G-6074	FUSE PANEL > FIREWALL	HXWA B SCREWS	-	-	-	N	2	2.00
G-4680	H/L, P/L GROUNDS, JUNCTION BLOCK	HXWA AB & B SCREWS, TOOTH WA'S	F	-	A	N	5	3.00
G-4260	HEADLAMP ADJUSTERS	SCREWS, NYLON NUTS, SPRINGS	F	-	-	-	10	8.00
G-4535	HEADLAMP ADJUSTERS	SCREWS, NYLON NUTS, SPRINGS	-	H	A	-	20	12.00
G-6531	HEADLAMP ADJUSTERS	SCREWS, NYLON NUTS, SPRING NUTS	-	-	-	N	10	6.00
G-4826	HEADLAMP DOOR (R/S) LIMIT SW & BRACKET	SCREWS, NUTS, WA'S	F	-	-	-	36	8.00
G-4935	HEADLAMP MOTOR - R/S	HXWA MS SCREWS, NUTS, TOOTH WA'S	F	-	-	-	24	3.00
G-4827	HEADLAMP MOTOR RELAY, BRACKET - R/S	HXWA SCREWS, CONI SEMS, NUTS	F	-	-	-	12	6.00
G-6567	HEADLAMP RETAINING RINGS	SLOT PN SCREWS	F	-	A	-	6	3.00
G-6138	HEATER SWITCH	PH PN BT SCREWS	-	-	-	N	2	1.50
G-5607	HEATER SWITCH or AC BLOWER	HXWA AB SCREWS	-	-	A	-	2	1.00
G-4726	HEATER SWITCH or AC FAN (AC 68N)	HXWA T1 SCREWS	F	-	-	-	2	1.50
G-4808	HORN (3)	HX CONI TOOTH SEMS, FLAT WA	F	-	A	-	4	5.00
G-4801	HORN CONTACT ASSY - WOOD GRAIN WHEEL	PH PN MS SCREWS	F	-	A	N	3	2.00
G-4682	HORN RELAY	HXWA AB SCREW	F	-	A	N	1	1.00
G-4679	HORNS (2) (3 '66)	HX PP CONI TOOTH SEMS	F	-	A	N	2	4.00
G-4647	IGNITION COIL & STRAP	HX EXT SEMS, SLOT RND T SCREW	F	-	A	N	3	4.00
G-4686	INSTRUMENT CLUSTER CIRCUIT BOARD	HXWA B SCREWS, NUTS, WA'S	F	-	-	-	10	3.00
G-6652	KICK PANELS w/o AC	HXWA SCREWS	-	-	A	-	10	3.00
G-5689	LAMP MONITORS - FENDER MOUNTED	STAMPED NUTS	-	-	A	-	4	2.00
G-4312	LICENSE PLATE LAMP	PH PN AB SCREWS	F	H	A	N	2	1.00
G-4692	PARKING BRAKE ALARM SWITCH	NUT, TOOTH WA	F	-	-	-	2	1.00
G-5202	PARKING BRAKE ALARM SWITCH	HXWA AB SCREW	-	-	A	-	1	1.00
G-6200	PARKING BRAKE ALARM SWITCH	SCREWS, TOOTH WA, CONI KEPS NUT	-	-	-	N	4	3.00
G-6625	PARKING LAMP LENSES	SS/CHROME PH PN .488 SHLDR SCREWS	-	-	-	N	4	4.00
G-6420	PARKING LAMP LENSES (67-68F STD)	SS/CHROME PH PN .640 SHLDR SCREWS	F	-	A	-	4	4.00
G-6624	PARKING LAMP LENSES (67F STD)	1.0 L SS/CHROME PH PN SCREWS	F	-	-	-	4	3.00
G-6421	PARKING LAMP LENSES (Camaro R/S)	SS/CHROME PH PN .380 SHLDR SCREWS	F	-	-	-	4	4.00
G-4261	PARKING LAMPS	STAMPED NUTS	F	-	-	-	4	2.00
G-6924	PARKING LAMPS	PH PN AB SCREWS, U-NUTS	-	H	-	-	8	4.00
G-4480	PARKING LAMPS	PH PN EXT SEMS	-	-	A	N	4	3.00
G-4695	POWER TOP ELECTRICAL CONNECTIONS	CONI KEPS NUTS, HXWA & OV SCREWS	F	-	-	-	6	4.00
G-5511	POWER TOP ELECTRICAL CONNECTIONS	CONI KEPS NUTS, HXWA & OV SCREWS	-	-	A	-	6	4.00
G-5692	RADIO BRACKET	HXWA & PH PN AB SCREWS, SPR NUTS	-	-	A	-	4	3.00
G-4820	RADIO BRACKETS	HXWA & PN TRUSS SCREWS, SPR NUTS	F	-	-	-	4	3.00
G-6224	RADIO BRACKETS	HI-HXWA AB SCREWS, SPRING NUTS	-	-	-	N	8	4.00
G-5813	RADIO GROUND STRAP > FRAME	HXWA AB & T1 SCREWS	-	-	A	-	2	2.00
G-4823	RADIO GROUND STRAPS > FIREWALL	HXWA AB SCREWS	F	-	A	N	2	1.50
G-4822	RADIO NOISE CAPACITOR > COIL BRACKET	HXWA T SCREW, TOOTH WA	F	-	A	N	2	1.50
G-4819	SPEAKER > DASH	HXWA AB SCREW, SPRING NUT	F	-	A	N	2	2.00
G-4818	SPEAKERS & GRILLES @ KICK PANELS	PH OV AB SCREWS, SPRING NUTS	F	-	-	-	16	5.00
G-5691	SPEAKERS & GRILLES @ KICK PANELS	PH OV AB SCREWS, SPRING NUTS	-	-	A	-	16	5.00
G-6453	SPEDO > TRANS CABLE w CRUISE CONTROL	3" NYLON STRAP	F	-	A	-	1	2.00

See factory Assembly Manuals for illustrations

GM Fastener Kits

335

1967

Electrical

PART #	APPLICATION	NOTES					PCS	PRICE
			CAMARO	FIREBIRD	CHEVELLE	NOVA		
G-4769	STARTER & BRACE - 396	3.62" L HX BOLTS, HX EXT SEMS, FLNG NUT	F	-	A	-	4	8.00
G-4646	STARTER & BRACE - SB	1.84 & 4.69 FLNG BOLTS, SPLIT SEMS, NUT	F	-	A	-	4	8.00
G-4689	STOPLAMP SWITCH	STAMPED HX NUTS	F	-	-	N	2	2.00
G-5201	STOPLAMP SWITCH	SPECIAL ROUND RETAINER	-	-	A	-	1	2.00
G-4333	TAILAMP HOUSINGS > BODY	HXWA BF SCREWS	F	-	-	-	12	3.00
G-4961	TAILAMP LENSES	SS/CHROME PH PN & PH OV MS SCREWS	-	-	-	N	8	4.00
G-6631	TAILAMP LENSES - El Camino	SS/CHROME PH PN .340 SHLDR SCREWS	-	-	A	-	8	8.00
G-4323	TAILAMPS > BODY	CONI TOOTH KEPS NUTS	F	-	-	-	10	10.00
G-6927	TAILAMPS > BODY	QUICKY BOLTS, CONI TOOTH KEPS NUTS	-	H	-	-	16	16.00
G-5803	TAILAMPS > BODY	EXT TOOTH KEPS NUTS	-	-	-	N	6	3.00
G-4506	TAILAMPS > QUARTER EXTENSIONS	STAMPED NUTS	-	-	A	-	8	3.00
G-4815	TAPE PLAYER - CONSOLE w/o AC	SCREWS, RIVET NUTS, WA'S	F	-	-	-	16	6.00
G-4817	TAPE PLAYER - CONVECTOR > DASH	PH PN AB SCREW, SPRING NUT	F	-	-	-	2	3.00
G-4814	TAPE PLAYER (under dash)	SCREWS, NUTS, WA'S	F	-	-	-	22	5.00
G-5690	TAPE PLAYER (under dash)	SCREWS, SPRING NUTS, WA'S	-	-	A	-	16	5.00
G-4810	TRUNK LAMP	HX AB FLAT SEMS	F	-	A	N	1	1.00
G-4991	TURN SIGNAL LEVER	PH PN T SCREW	F	-	A	N	1	1.50
G-4811	UNDERHOOD LAMP	HX AB FLAT SEMS, TOOTH WA	F	-	-	N	2	1.50
G-5688	UNDERHOOD LAMP	HXWA AB SCREWS, TOOTH WA	-	-	A	-	2	1.50
G-4649	VOLTAGE REGULATOR	SRTD HXWA MS SCREWS, WELL-NUTS	F	-	A	N	6	6.00
G-5532	VOLTAGE REGULATOR w 62 AMP ALT	HX BOLTS, TOOTH WA'S, NUTS	-	-	A	-	9	3.00
G-6677	WEATHERSTRIP, QUARTER GLASS @ JAMB	PH FLT AB SCREWS	-	-	A	-	4	2.00
G-6521	WIRING - B/U LAMP WIRE (M/T) > INSTR HRNSS	3.17" NYLON STRAP	-	-	A	-	1	2.00
G-6515	WIRING - BLOWER MOTOR/STARTER WIRING	RUBBER COATED J-CLIPS	F	-	A	-	2	5.00
G-6522	WIRING - BRAKE WARNING SWITCH > LINE	3.17" NYLON STRAP	-	-	A	-	1	2.00
G-6504	WIRING - CONSOLE & GROUND - 350	RUBBER COATED J CLIPS, SCREWS, WA'S	F	-	-	-	12	16.00
G-4737	WIRING - CONSOLE & GROUND (exc 350)	J-CLIP, SCREW, TOOTH WA	F	-	-	-	7	12.00
G-6485	WIRING - CONSOLE LAMP	RUBBER COATED J & S CLIPS	-	-	A	-	3	7.00
G-6454	WIRING - CRUISE CONTROL	5.1" FLEXIBLE STRAPS	-	-	A	-	2	5.00
G-6509	WIRING - ENGINE/STARTER @ BLOWER MTR	RUBBER COATED J-CLIP	-	-	-	N	1	3.00
G-4666	WIRING - FUEL SENDER UNIT GROUND	HXWA SCREW, TOOTH WA	F	-	A	N	2	1.00
G-6613	WIRING - HEATER RESISTOR	J-CLIP	-	-	A	-	1	3.00
G-6464	WIRING - HORN (low note) LEAD	5.1" FLEXIBLE STRAPS	F	-	-	-	2	5.00
G-6467	WIRING - HORN LEAD - R/S	5.1" FLEXIBLE STRAPS	F	-	-	-	3	7.00
G-6498	WIRING - HORN LEAD - R/S	S CLIP	F	-	-	-	1	3.00
G-4687	WIRING - INSTR HARNESS > DEFROST DUCT	J-CLIP, HXWA AB SCREW, FLAT SPR NUT	F	-	-	-	3	4.00
G-6513	WIRING - INSTR HARNESS CLIPS	RUBBER COATED J-CLIPS	-	-	-	N	2	5.00
G-6486	WIRING - NEUTRAL SAFETY SW w CONSOLE	RUBBER COATED J & S CLIPS	-	-	A	-	3	6.00
G-6239	WIRING - NEUTRAL SAFETY SW w CONSOLE	"S" CLIPS	-	-	-	N	3	4.00
G-6451	WIRING - POWER TOP @ LH FENDER	5.1" FLEXIBLE STRAPS	F	-	-	-	3	7.00
G-5193	WIRING - STARTER TERMINALS	NUTS, SPLIT & TOOTH WA'S	F	-	A	N	4	1.50
G-6481	WIRING - TAPE PLAYER	5.1" FLEXIBLE STRAP	-	-	A	-	1	3.00
G-6470	WIRING - TRANS (TH400) CONTROL	5.1" FLEXIBLE STRAPS	F	-	-	-	2	5.00
G-5672	WIRING - TRANS OD WIRE EXTENSION	HX EXT SEMS	-	-	A	-	1	1.50
G-6499	WIRING - TRUNK LAMP	S CLIPS	F	-	A	N	3	7.00
G-6468	WIRING - UNDERHOOD LAMP	5.1" FLEXIBLE STRAP, S CLIPS	F	-	-	-	3	6.00
G-6465	WIRING - UNDERHOOD LAMP	5.1" FLEXIBLE STRAPS, S CLIPS	-	-	A	-	5	10.00
G-6463	WIRING - UNDERHOOD LAMP	5.1" FLEXIBLE STRAPS, S CLIPS	-	-	-	N	3	6.00
G-4982	WIRING - VOLTAGE REGULATOR GROUND	HXWA AB SCREWS, TOOTH WA	-	-	-	N	3	2.00
G-5195	WIRING "GUTTER" > FIREWALL	HX AB FLAT SEMS	F	-	A	-	2	2.00
G-6070	WIRING HARNESS > LH WHEELHOUSE	PUSH-ENDS BLACK PLASTIC STRAPS	-	-	-	N	3	4.00
G-6193	WIRING HARNESS > RADIATOR SUPPORT	3" NYLON STRAPS	-	-	-	N	3	3.00

Emissions

G-4750	AIR CLEANER VENT HOSE (w/o SMOG)	TOWER CLAMPS	F	-	A	N	2	5.00
G-4655	ENGINE VENT ADAPTER > INTAKE	HX BOLT, FLAT & SEALING WA'S	F	-	A	N	3	3.00
G-4749	ENGINE VENT ADAPTER CLAMP - 396	TOWER CLAMP	F	-	-	-	1	3.00
G-4751	PCV ADAPTER INTAKE - 283, 302, 327-4V	HX BOLT, FLAT & FIBRE WA'S, NUT	F	-	A	N	5	8.00
G-4770	PCV HOSE CLAMPS	FLAT WOUND SPRING CLAMPS (Black)	F	-	A	N	2	1.50
G-5660	PCV HOSE CLAMPS - SB w SMOG & 4V Carb	FLAT WOUND SPRING CLAMPS (Black)	F	-	A	-	4	2.00
G-4890	SMOG HOLE PLUGS - 396	HX PLUGS	F	-	-	-	8	10.00
G-4747	SMOG HOSE CLAMPS - ALL V-8	TOWER TYPE CLAMPS	F	-	A	N	10	15.00
G-4746	SMOG PUMP - 396 (F only)	HX BOLTS, HX CLR STUD, NUTS, WA'S	F	-	-	-	8	12.00
G-4744	SMOG PUMP - SB w AC (66N & All 67)	HX BOLTS, HX CLR STUD, SPACER, NUTS	F	-	A	N	8	18.00
G-4743	SMOG PUMP - SB w/o AC	HX BOLTS, HX CLR STUD, SPACER, NUTS	F	-	A	N	9	18.00
G-4745	SMOG PUMP LH BRACE > INTAKE - 302, 327HP	HX BOLT, SPLIT WA	F	-	-	N	2	3.00
G-4842	SMOG PUMP PULLEY	HX BOLTS, SPLIT WA'S	F	-	A	N	8	4.00
G-5661	SMOG VALVE CLAMP - 396 (L35)	HX SCREW ONLY	-	-	A	-	1	1.00

Kits Contain Attaching Fasteners for Both Sides

GM Fastener Kits

1967

Exhaust

PART #	APPLICATION	NOTES					PCS	PRICE
			CAMARO	FIREBIRD	CHEVELLE	NOVA		
G-5573	EXHAUST HANGERS, DUAL	HXWA C SCREWS, RETAINERS	-	-	A	-	6	8.00
G-6223	EXHAUST HANGERS, DUAL	HX SPLIT SEMS, BOLTS, NUT, RIV-NUTS	-	-	-	N	19	10.00
G-4343	EXHAUST HANGERS, DUAL - CONVERTIBLE	HX SCREWS, SPLIT SEMS, RIVET NUTS	F	-	-	-	10	10.00
G-4341	EXHAUST HANGERS, DUAL - COUPE	SCREWS, SPLIT SEMS, RIVET NUTS	F	-	-	-	12	12.00
G-4661	EXHAUST HANGERS, SINGLE	HX SCREWS, HX SPLIT SEMS	F	-	-	-	4	4.00
G-4846	EXHAUST HANGERS, SINGLE	HXWA C SCREWS, RETAINERS	-	-	A	-	5	5.00
G-6159	EXHAUST HANGERS, SINGLE - STD & All 67N	HX SPLIT SEMS, BOLT, NUT, SPLIT WA	-	-	-	N	7	4.00
G-5266	EXHAUST PIPE > MANIFOLDS	STUDS, LOCK NUTS	F	-	A	N	12	14.00

Fuel

G-4351	ACCELERATOR LEVER & SUPPORT	HX BOLT, HXWA AB SCREWS, WA'S, NUT	F	H	-	-	6	3.00
G-5623	ACCELERATOR LEVER & SUPPORT	HX BOLT, HXWA AB SCREWS, WA'S, NUT	-	-	A	N	6	3.00
G-4683	FUEL FILLER NECK > BODY	HXWA AB SCREWS	F	-	-	-	8	3.00
G-4643	FUEL FILLER NECK > BODY	HXWA B SCREWS	-	-	-	N	3	2.00
G-4667	FUEL FILLER NECK COVER	HXWA AB SCREW	F	H	-	-	1	1.00
G-4664	FUEL HOSES	FLAT WOUND SPRING CLAMPS (Green)	F	H	-	-	4	3.00
G-5056	FUEL HOSES	FLAT WOUND SPRING CLAMPS (Yellow)	-	-	A	N	4	3.00
G-5533	FUEL HOSES, 283-4V, 307, 327 (All 68-69A)	FLAT WOUND SPRING CLAMPS (Green)	-	-	A	-	4	3.00
G-4334	FUEL TANK FILLER NECK HOSE	WHITEK TOWER TYPE CLAMPS	F	-	A	N	2	6.00
G-4663	GAS TANK	CRG BOLTS, WA'S, NUTS, SCREWS	F	H	-	N	10	8.00
G-4657	GAS TANK	CRG BOLTS, NUTS	-	-	A	-	4	5.00
G-5628	GAS TANK - El Camino	HX CONI SEMS, BOLTS, NUTS, WA'S	-	-	A	-	24	12.00

Heater

G-4764	DEFROSTER DUCTS	HXWA SCREWS, FLAT WA	F	-	-	-	4	2.00
G-5604	DEFROSTER DUCTS	HXWA SCREWS, FLAT WA'S	-	-	A	-	4	2.00
G-6137	DEFROSTER DUCTS	HXWA SCREWS	-	-	-	N	2	1.50
G-5996	HEATER AIR DISTRIBUTOR	HX & HXWA AB SCREWS	-	-	-	N	2	2.00
G-4327	HEATER BLOWER MOTOR	SRTD HXWA AB SCREWS	F	-	A	-	5	1.50
G-4326	HEATER BOX > FIREWALL	HX INT/EXT SEMS, STMPD NUTS, SEALER	F	-	A	-	12	5.00
G-5989	HEATER BOX > FIREWALL & COWL	HXWA SCREW, STAMPED NUTS, SEALER	-	-	-	N	4	3.00
G-4765	HEATER CONTROL CABLES	HXWA SCREWS, RETAINERS, SPRING NUT	F	-	-	-	13	4.00
G-5606	HEATER CONTROL CABLES	HI-HXWA ABT SCREWS, RETAINERS	-	-	A	-	11	4.00
G-6139	HEATER CONTROL CABLES	HI-HXWA ABT SCREWS, RETAINERS	-	-	-	N	9	4.00
G-5648	HEATER CONTROL CABLES w AC	HI-HXWA ABT SCREWS, RETAINERS	-	-	A	-	17	4.00
G-4763	HEATER DUCT OUTLET (under dash)	HXWA AB SCREWS, HX AB FLAT SEMS	F	-	-	-	6	3.00
G-5397	HEATER HOSE CLIP @ WHEELHOUSE	FOLDOVER METAL CLIP	F	-	A	N	1	4.00
G-4771	HEATER HOSE SEAL RETAINER - 396, All 68N	HI-HXWA AB SCREWS	F	-	-	-	2	2.00
G-4613	HEATER HOSES	WIRE TYPE SPRING CLAMPS, COL CODED	F	-	A	N	4	3.00
G-5478	HEATER or AC OUTLET (LH under dash)	HXWA AB SCREWS	-	-	A	-	2	1.00
G-4616	HEATER RESISTOR > BOX	HXWA AB SCREWS	F	-	A	N	2	1.00

Interior

G-4704	AIR OUTLET BEZELS (w AC) > DASH	PH OV SCREWS, CONI SEMS, SPR NUTS	F	-	-	-	8	4.00
G-5638	AIR OUTLET BEZELS (w AC) > DASH	CHROME PH OV AB SCREWS, SPRG NUTS	-	-	A	-	12	4.00
G-5382	ARMREST PAD & BASE @ Fr DOORS	PH FLAT B & PH RND A SCREWS	F	-	-	-	8	4.00
G-6673	ARMREST PAD & BASE @ Fr DOORS	PH FLAT B & PH RND A SCREWS	-	-	A	-	8	4.00
G-6674	ARMREST PAD & BASE @ Rr SEATS - COUPE	PH FLAT B & PH RND A SCREWS	-	-	A	-	10	4.00
G-5421	ARMRESTS (Rr) - DLX CONVERTIBLE	CHROME PH OV AB FINWA SEMS .50" OD	F	-	-	-	8	3.00
G-5420	ARMRESTS (Rr) - DLX COUPE	CHROME PH OV AB FINWA SEMS .50" OD	F	-	-	-	4	2.00
G-4622	ASH TRAY RETAINER	PH PN B SCREWS	F	-	-	-	3	1.50
G-5473	ASH TRAY RETAINER	PH PN B SCREWS	-	-	A	N	3	1.50
G-5406	COAT HOOK	CHROME PH PN SCREW	F	-	-	-	2	1.00
G-6679	COAT HOOKS	SS/CHROME PH OV SCREWS	-	-	A	-	2	1.50
G-5243	CONSOLE - ASH TRAY DOOR	RIVETS, RETAINERS	F	-	-	-	4	4.00
G-4730	CONSOLE > FLOOR	PH TRUSS SCREWS, RIVET NUTS, NUTS	F	-	-	-	6	5.00
G-6568	CONSOLE > FLOOR	PH PN & PH TRUSS SCREWS, SPR NUTS	-	-	A	-	12	4.00
G-6588	CONSOLE ASH TRAY DOOR BUMPERS	RUBBER BUMPERS	F	-	-	-	2	2.00
G-4731	CONSOLE BRACKET & TOP FRAME	HXWA MS & PH OV SCREWS, SPR NUTS	F	-	-	-	9	4.00
G-4732	CONSOLE DOOR & HINGE	PH PN MS SCREWS	F	-	-	-	8	2.00
G-6587	CONSOLE DOOR BUMPERS	RUBBER BUMPERS	F	-	-	-	2	2.00
G-6586	CONSOLE DOOR BUMPERS	RUBBER BUMPERS	-	-	A	-	2	2.00
G-4736	CONSOLE LAMP LENS	PH OV F SCREWS, PHOS	F	-	-	-	2	1.50

See factory Assembly Manuals for illustrations

GM Fastener Kits

337

1967

Interior

PART #	APPLICATION	NOTES					PCS	PRICE
			CAMARO	FIREBIRD	CHEVELLE	NOVA		
			F	H	A	N		
G-5655	CONSOLE LAMP LENS	CHROME PH OV SCREWS	-	-	A	-	2	1.50
G-5651	CONSOLE TOP PANELS, DOOR & LATCH	SCREWS, STAMPED NUTS	-	-	A	-	17	5.00
G-5391	DASH PAD	PH PN AB SCREWS	F	-	-	-	5	2.00
G-5608	DASH PAD	PH OV SCREWS, CONI SEMS, NYL NUTS	-	-	A	-	22	8.00
G-5650	DOVE LAMP	PH PN SCREWS	F	-	A	-	2	1.50
G-5395	DOOR HANDLES (inside) - DLX	HI-HXWA SCREWS	F	-	-	-	2	3.00
G-5409	DOOR HANDLES (inside) - STD	WIRE RETAINERS	F	-	-	-	2	1.00
G-5418	DOOR PANEL CUPS (DLX)	CHROME PH OV SEMS	F	-	-	-	4	2.00
G-5384	DOOR PANELS	CLIPS, PLUGS (flexible !), PH OV AB SEMS	F	-	-	-	32	12.00
G-6667	DOOR PANELS	CLIPS, PLUGS (flexible !), PH OV AB SEMS	-	-	A	-	28	10.00
G-6941	DOOR PANELS - DLX	CLIPS, PLUGS (flexible !), PH OV AB SEMS	F	-	-	-	36	12.00
G-4358	GLOVE BOX DOOR	PH PN CONI SEMS	F	-	-	-	2	2.00
G-6144	GLOVE BOX DOOR	PH PN CONI SEMS	-	-	-	N	3	3.00
G-5614	GLOVE BOX DOOR & LINER	PH RNDWA AB SCREWS, CONI KEPS NUTS	-	-	A	-	10	4.00
G-6585	GLOVE BOX DOOR BUMPERS	RUBBER BUMPERS	F	-	-	N	2	2.00
G-6145	GLOVE BOX FINISH PANEL	PH PN SCREWS w SMALL HEADS	-	-	-	N	10	3.00
G-4357	GLOVE BOX LATCH & STRIKER	PH PN AB FLAT SEMS, PH PN T SCREWS	F	-	-	N	4	2.00
G-4359	GLOVE BOX LINER	PH PN AB FLAT SEMS, SPRING NUTS	F	-	-	N	14	6.00
G-5613	GLOVE BOX STRIKER	PH PN AB EXT SEMS	-	-	A	-	2	2.00
G-4618	HEATER CONTROL > DASH	PH PN AB SCREWS	F	-	-	-	4	3.00
G-5605	HEATER CONTROL > DASH	PH PN AB SCREWS	-	-	A	-	2	1.50
G-6140	HEATER CONTROL > DASH	PH PN AB SCREWS	-	-	-	N	2	1.50
G-5612	INSTR PANEL TRIM PLATES - Malibu	PH PN BT SCREWS, STAMPED NUTS	-	-	A	-	12	4.00
G-5611	INSTR PANEL TRIM PLATES (exc Malibu)	PH PN BT SCREWS	-	-	A	-	12	2.00
G-4685	INSTRUMENT CLUSTER > DASH	PH OV AB SCREWS, SPRING NUTS	F	-	-	-	14	5.00
G-5635	INSTRUMENT CLUSTER > DASH	SCREWS, SPRING NUTS	-	-	A	-	16	5.00
G-6199	INSTRUMENT CLUSTER > DASH	PH OV AB SCREWS, SPRING NUTS	-	-	-	N	11	4.00
G-4617	INSULATION > FIREWALL	RUBBER RETAINERS	F	-	-	-	4	6.00
G-6136	INSULATION > FIREWALL	RUBBER RETAINERS	-	-	-	N	7	10.00
G-5390	KICK PANELS	CHROME PH OV FINISH WA SEMS, .50" DIA	F	-	-	-	10	3.00
G-4621	MIRROR (inside Rr view) > BRACKET	CHROME SLOT OV SHLDR SCREW	F	-	A	N	1	2.00
G-6690	MIRROR (inside Rr view) BRACKET	CHROME PH OV AB SCREWS	-	-	A	-	3	2.00
G-5435	MOULDINGS - CONVERTIBLE HEADER	SS/CHROME PH OV AB SCREWS	F	-	-	-	5	3.00
G-6668	MOULDINGS @ DOOR/QTR TRIM PANEL TOPS	PH FLAT AB SCREWS	-	-	A	-	16	2.00
G-6541	PILLAR MOULDINGS - CONVERTIBLE	PH OV AB FLUSH SEMS	F	-	-	-	4	2.00
G-5387	PILLAR MOULDINGS - COUPE	PH OV AB FLUSH SEMS	F	-	-	-	6	3.00
G-5142	QUARTER TRIM PANELS - MAIN	CHROME PH PN AB SCREWS	F	-	-	-	2	1.50
G-5408	QUARTER TRIM PANELS @ Rr WINDOW SIDES	PH OV AB SCREWS	F	-	-	-	4	1.50
G-4913	QUARTER TRIM SAIL PANELS	RETAINING CLIPS	-	-	-	-	6	4.00
G-6648	QUARTER TRIM SAIL PANELS	RETAINING CLIPS	-	-	A	-	4	3.00
G-4821	RADIO CONTROL SHAFTS & KNOBS	SPECIAL THIN HX NUTS, SPRING WA'S	F	-	-	N	4	4.00
G-4620	RADIO OPENING TRIM PLATE & RETAINER	PN HD AB SCREWS	F	-	-	-	5	2.00
G-5415	ROCKER PANEL COVER PLATES	PH PN AB SCREWS	F	-	-	-	8	2.00
G-6680	ROOF RAIL INSIDE MOULDINGS	SS/CHROME PH OV SCREWS	-	-	A	-	2	1.50
G-4321	SCUFF PLATES, DOOR OPENING	SS/CHROME PH OV AB SCREWS	F	-	A	-	8	2.50
G-6148	SCUFF PLATES, DOOR OPENING	SS/CHROME PH OV AB SCREWS	-	-	-	N	12	3.00
G-5375	SEAT BACK (Fr) STOP BUMPERS	CHROME PH PN AB SCREWS	F	-	-	-	2	1.50
G-6657	SEAT BACK (Fr) STOP BUMPERS	PH PN AB SCREWS	-	-	A	-	4	1.50
G-5398	SEAT BACK (Fr) STRIKERS	TRIM HX CA CONI SEMS	F	-	-	-	4	4.00
G-5380	SEAT BACK (Rr) > BODY	HX AB CONI TOOTH SEMS	F	-	A	-	2	3.00
G-5376	SEAT BACK CABLE	PH WAFER MS SHLDR SCREWS	F	-	-	-	2	3.00
G-5381	SEAT BACK PANELS	PH PN AB FLAT SEMS	F	-	-	-	4	3.00
G-6660	SEAT BACK PANELS	PH PNWA FLAT TOP SCREWS	-	-	A	-	4	2.00
G-6658	SEAT BACK RELEASE ESCUTCHEONS	CHROME PH OV AB SCREWS	-	-	A	-	8	2.00
G-5654	SEAT BELT BUCKLE RETAINERS	CHROME PH OV SCREWS, FL SPR NUTS	-	-	A	N	4	6.00
G-6535	SEAT BELTS (Fr)	CHROME BOLTS w NYLON PELLETT	F	-	-	-	4	18.00
G-6537	SEAT BELTS (Rr)	ZDC PLATED BOLTS w NYLON LOCK	F	-	-	-	4	16.00
G-6161	SEAT PIVOT	"E" CLIPS	F	-	-	-	4	3.00
G-5379	SEAT PIVOT COVERS	ORIGINAL METAL RETAINERS	F	-	-	-	4	8.00
G-6108	SEAT SEPERATOR > FLOOR (A/T 66-67N)	PH RNDWA AB SCREWS, SPRING NUTS	-	-	-	N	8	4.00
G-6220	SEAT SEPERATOR > FLOOR (M/T)	HXWA & RNDWA AB SCREWS, SPR NUTS	-	-	-	N	11	4.00
G-6109	SEAT SEPERATOR TRIM PLATE	STAMPED NUTS, FLAT WA'S	-	-	-	N	10	3.00
G-6661	SEAT SIDE PANELS	CHROME PH OV FLUSH SEMS	-	-	A	-	12	4.00
G-5148	SEAT TRACKS > FLOOR	HX CONI TOOTH SEMS	F	-	-	-	8	6.00
G-6653	SEAT TRACKS > FLOOR	HX CONI TOOTH SEMS, PERI KEPS	-	-	A	-	8	5.00
G-6566	SHOULDER STRAPS > ROOF	PH PN MS SCREWS w NYLON PELLETT	F	-	-	-	4	8.00
G-4619	STEERING COLUMN COVER > DASH	PH PN CONI SEMS	F	-	-	-	4	3.00
G-4762	STEERING COLUMN COVER > FIREWALL	HX AB FLAT SEMS w SEALER	F	-	-	-	2	3.00
G-5924	STEERING COLUMN COVER > FIREWALL	RUBBER RETAINERS	-	-	A	-	2	3.00
G-5377	SUN VISOR & MIRROR BRACKETS - COUPE	SS/CHROME PH OV & PH PN AB SCREWS	F	-	-	-	9	3.00
G-6681	SUN VISOR & MIRROR BRACKETS - COUPE	SS/CHROME PH OV SCREWS	-	-	A	-	9	3.00
G-5422	SUN VISOR BRACKETS - CONVERTIBLE	SS/CHROME PH OV MS SCREWS	F	-	-	-	4	3.00
G-6670	SUN VISOR BRACKETS - CONVERTIBLE	CHROME PH OV SCREWS w #12 HD	-	-	A	-	6	4.00
G-5378	SUN VISOR CLAMPS	CHROME SLOT FILL SCREWS	F	-	A	-	2	2.00
G-5678	TRANS SHIFT INDICATOR - COLUMN A/T w TILT	PH PN AB SCREW, FLAT WA	-	-	A	-	2	1.50

Kits Contain Attaching Fasteners for Both Sides

GM Fastener Kits

1967

Interior

PART #	APPLICATION	NOTES	CAMARO				FIREBIRD				CHEVELLE				NOVA				PCS	PRICE
			F	H	A	N	F	H	A	N	F	H	A	N	F	H	A	N		
G-6665	VENT WINDOW FRAME > DOORS	CHROME HX CONI SEMS, CONI KEPS, WA'S	-	-	A	-	-	-	-	-	-	-	-	-	-	-	-	8	10.00	
G-6362	VENT WINDOW CHANNEL > DOOR	#10 X 3.0" SS/CHROME PH OV SCREWS	F	-	-	-	-	-	-	-	-	-	-	-	-	-	-	2	3.00	
G-6666	VENT WINDOW CHANNEL > DOOR	#10 X 3.0" SS/CHROME PH OV SCREWS	-	-	A	-	-	-	-	-	-	-	-	-	-	-	-	2	3.00	
G-6614	VENT WINDOW HANDLE SPACER - NUTS	7/16-20 ORIGINAL HX DRIVE, CHROME	F	-	A	-	-	-	-	-	-	-	-	-	-	-	-	2	10.00	
G-6682	WEATHERSTRIP (Felt), QUARTER GLASS	PH FLAT AB #6 HD	-	-	A	-	-	-	-	-	-	-	-	-	-	-	-	4	2.00	
G-5400	WINDOW CRANK HANDLES	RETAINING CLIPS	F	-	A	-	-	-	-	-	-	-	-	-	-	-	-	4	1.50	
G-6664	WINDOW RUN (Rr) - FRONT DOORS	CHROME HX CONI SEMS, PLASTIC WA'S	-	-	A	-	-	-	-	-	-	-	-	-	-	-	-	4	5.00	

Mouldings

G-4825	BODY SIDE MOULDINGS - R/S	SS/CHROME PH OV & RNDWA SCREWS	F	-	-	-	-	-	-	-	-	-	-	-	-	-	-	10	4.00
G-5632	FENDER MOULDINGS	STAMPED NUTS	-	-	A	-	-	-	-	-	-	-	-	-	-	-	-	4	2.00
G-6176	FENDER MOULDINGS - STD Nova	STAMPED NUTS ONLY !	-	-	-	-	N	-	-	-	-	-	-	-	-	-	-	14	3.00
G-4296	HEADLAMP COVER MOULDINGS - R/S	BLACK SEMI-TUBULAR RIVETS	F	-	-	-	-	-	-	-	-	-	-	-	-	-	-	10	3.00
G-4514	HOOD MOULDING (Fr)	CONI KEPS NUTS	-	-	A	-	N	-	-	-	-	-	-	-	-	-	-	9	4.00
G-4624	ROCKER MOULDINGS	PH PN BT & PH OV SS/CHROME SCREWS	F	-	-	-	-	-	-	-	-	-	-	-	-	-	-	14	4.00
G-5706	ROCKER MOULDINGS	PH PN AB SCREWS ONLY	-	-	-	-	N	-	-	-	-	-	-	-	-	-	-	24	4.00
G-5616	ROCKER MOULDINGS - DLX	PH FLAT B SCREWS	-	-	A	-	-	-	-	-	-	-	-	-	-	-	-	4	2.00
G-5482	ROCKER MOULDINGS (STD only 66-67A)	HXWA AB SCREWS	-	-	A	-	-	-	-	-	-	-	-	-	-	-	-	24	4.00
G-4196	WHEEL OPENING MOULDINGS	CHROME/SS PH RNDWA AB SCREWS	F	H	-	-	-	-	-	-	-	-	-	-	-	-	-	28	6.00
G-4496	WHEEL OPENING MOULDINGS	CHROME/SS PH RNDWA AB SCREWS	-	-	A	-	N	-	-	-	-	-	-	-	-	-	-	32	6.00
G-6543	WINDOW (Fr) MOULDINGS	RETAINING CLIPS, PH PN AB SCREWS	-	-	A	-	-	-	-	-	-	-	-	-	-	-	-	34	12.00
G-6554	WINDOW (Fr) MOULDINGS	RETAINING CLIPS, PH PN AB SCREWS	-	-	-	-	N	-	-	-	-	-	-	-	-	-	-	34	12.00
G-4665	WINDOW (Fr) MOULDINGS, LWR	RETAINING CLIPS (less the 2 end clips)	F	-	-	-	-	-	-	-	-	-	-	-	-	-	-	8	12.00
G-4639	WINDOW (Fr) MOULDINGS, SIDES, UPR	RETAINING CLIPS	F	-	-	-	-	-	-	-	-	-	-	-	-	-	-	13	8.00
G-6553	WINDOW (Fr) MOULDINGS, SIDES, UPR - CONV	RETAINING CLIPS	F	-	-	-	-	-	-	-	-	-	-	-	-	-	-	13	8.00
G-6552	WINDOW (Fr) MOULDINGS, SIDES, UPR - VINYL	RETAINING CLIPS	F	-	-	-	-	-	-	-	-	-	-	-	-	-	-	13	8.00
G-6539	WINDOW (Rr) MOULDINGS	RETAINING CLIPS	F	-	-	-	-	-	-	-	-	-	-	-	-	-	-	20	12.00
G-6557	WINDOW (Rr) MOULDINGS	RETAINING CLIPS	-	-	-	-	N	-	-	-	-	-	-	-	-	-	-	24	12.00
G-6548	WINDOW (Rr) MOULDINGS - El Camino	RETAINING CLIPS, PH PN AB SCREWS	-	-	A	-	-	-	-	-	-	-	-	-	-	-	-	22	12.00

Steering & Suspension

G-4631	AXLE HSNB > SPRINGS	SPECIAL GR-8 LOCK NUTS ONLY !	F	-	-	-	N	-	-	-	-	-	-	-	-	-	-	8	12.00
G-5904	AXLE HSNB > SPRINGS (mono spring)	SPECIAL GR-8 LOCK NUTS & T BOLTS	F	H	-	-	N	-	-	-	-	-	-	-	-	-	-	16	26.00
G-6151	BALL JOINTS - UPPER	SOLID RIVETS (2 are extra)	F	-	A	-	-	-	-	-	-	-	-	-	-	-	-	10	6.00
G-6152	BALL JOINTS - UPPER or LWR	SOLID RIVETS (2 are extra)	-	-	-	-	N	-	-	-	-	-	-	-	-	-	-	8	4.00
G-6002	COIL SPRING SEATS	3/8-24 NUTS, SPLIT WA	-	-	-	-	N	-	-	-	-	-	-	-	-	-	-	8	3.00
G-4612	CONTROL ARM BUSHINGS - UPPER	HX BOLTS "SSC", WA'S, RETAINERS	F	H	A	-	-	-	-	-	-	-	-	-	-	-	-	12	12.00
G-4608	CONTROL ARMS - LWR	POINTED BOLTS, LOCK NUTS	F	H	A	-	-	-	-	-	-	-	-	-	-	-	-	8	20.00
G-5999	CONTROL ARMS - LWR	CAM BOLTS, WA'S, NUTS	-	-	-	-	N	-	-	-	-	-	-	-	-	-	-	8	24.00
G-4627	CONTROL ARMS - UPPER	GR-8 KNURL BOLTS, LOCK NUTS, SHIMS	F	H	A	-	-	-	-	-	-	-	-	-	-	-	-	18	14.00
G-5998	CONTROL ARMS - UPPER	GR-8 KNURL BOLTS, LOCK NUTS	-	-	-	-	N	-	-	-	-	-	-	-	-	-	-	8	10.00
G-4609	CONTROL ARMS (Rr)	GR-8 POINTED BOLTS, LOCK NUTS	-	-	A	-	-	-	-	-	-	-	-	-	-	-	-	16	32.00
G-5539	FRAME REINFORCEMENTS - HP APPLICATIONS	HARDENED FLAT WA'S	-	-	A	-	-	-	-	-	-	-	-	-	-	-	-	2	3.00
G-4669	GREASE FITTINGS	STRAIGHT	F	H	A	-	N	-	-	-	-	-	-	-	-	-	-	10	3.00
G-4265	IDLER ARM > FRAME	GR-8 HX BOLTS, WA'S, NUTS	F	H	A	-	-	-	-	-	-	-	-	-	-	-	-	6	6.00
G-6168	IDLER ARM > FRAME	HX BOLTS, NUTS, WA'S	-	-	-	-	N	-	-	-	-	-	-	-	-	-	-	12	5.00
G-4606	LEAF SPRING, Fr HANGERS	HX CA CONI SEMS, SPECIAL U-NUTS	F	H	-	-	-	-	-	-	-	-	-	-	-	-	-	12	18.00
G-4630	LEAF SPRINGS, Fr EYE	GR-8 BOLTS, NUTS, WA'S	F	H	-	-	-	-	-	-	-	-	-	-	-	-	-	8	12.00
G-6010	LEAF SPRINGS, Fr EYE	HX BOLTS, NUTS, WA'S	-	-	-	-	N	-	-	-	-	-	-	-	-	-	-	8	14.00
G-6123	P/S CONTROL VALVE CLAMP	HX BOLT, SPLIT WA	-	-	-	-	N	-	-	-	-	-	-	-	-	-	-	2	2.00
G-6122	P/S HOSE BRACKET & CLAMP	HX BOLTS, WA'S, NUTS	-	-	-	-	N	-	-	-	-	-	-	-	-	-	-	7	3.00
G-5679	P/S PUMP - 283, 327 (A only)	HX BOLTS, SPACER, WA'S, NUTS	-	-	A	-	-	-	-	-	-	-	-	-	-	-	-	14	12.00
G-4804	P/S PUMP - 302, 350 (F only)	HX BOLTS, HX SPLIT SEMS, WA'S, NUTS	F	-	-	-	-	-	-	-	-	-	-	-	-	-	-	13	10.00
G-4803	P/S PUMP - 327 (F only)	HX BOLTS, HX SPLIT SEMS, WA'S, NUTS	F	-	-	-	-	-	-	-	-	-	-	-	-	-	-	12	10.00
G-5681	P/S PUMP - 396 (66 SMOG) (A only)	HX BOLTS, NUTS, WA'S	-	-	A	-	-	-	-	-	-	-	-	-	-	-	-	13	12.00
G-4805	P/S PUMP - 396 (F only)	HX BOLTS, HX SPLIT SEMS, WA'S, NUTS	F	-	-	-	-	-	-	-	-	-	-	-	-	-	-	12	8.00
G-6117	P/S PUMP - SB (N only)	HX BOLTS, WA'S, NUTS	-	-	-	-	N	-	-	-	-	-	-	-	-	-	-	12	6.00
G-4807	P/S PUMP PULLEY	THIN LOCK NUT	F	-	A	-	N	-	-	-	-	-	-	-	-	-	-	1	6.00
G-5579	P/S PUMP RESERVOIR - 396	HX SPLIT SEMS	-	-	A	-	-	-	-	-	-	-	-	-	-	-	-	2	3.00
G-5682	P/S RESERVOIR HOSE - 396	WHITEK TOWER TYPE CLAMPS	-	-	A	-	-	-	-	-	-	-	-	-	-	-	-	2	5.00
G-4919	P/S RETURN HOSE	ORIGINAL CLAMPS	F	-	A	-	-	-	-	-	-	-	-	-	-	-	-	2	20.00
G-4668	PITMAN ARM > GEAR BOX	HX NUT, SPLIT WA	F	H	A	-	N	-	-	-	-	-	-	-	-	-	-	2	3.00
G-4774	RADIUS ROD (Rr axle) - 302, 396HP	HX BOLTS, WA'S, NUTS	F	H	-	-	-	-	-	-	-	-	-	-	-	-	-	6	10.00
G-4775	RADIUS ROD (Rr axle) BRACKET > FLOOR	CONI SEMS, STUDS, WA , SEALER, NUTS	F	H	-	-	-	-	-	-	-	-	-	-	-	-	-	12	6.00
G-4776	RADIUS ROD STOP & BUMPER > AXLE HSNB	BOLT, HXWA SCREW, NUT, WA , SPACER	F	H	-	-	-	-	-	-	-	-	-	-	-	-	-	5	14.00
G-4838	SHACKLES	11/16" AF MARSDEN NUTS ONLY	F	H	-	-	N	-	-	-	-	-	-	-	-	-	-	4	6.00
G-6004	SHOCK BRACKETS (Fr)	CRG BOLTS, NUTS, WA'S	-	-	-	-	N	-	-	-	-	-	-	-	-	-	-	24	8.00

See factory Assembly Manuals for illustrations

1967

Steering & Suspension

PART #	APPLICATION	NOTES					PCS	PRICE
			CAMARO	FIREBIRD	CHEVELLE	NOVA		
G-4634	SHOCK BRACKETS (Rr) > BODY	HX SPLIT SEMS, SEALING WA'S	F	H	-	-	8	6.00
G-6012	SHOCK BRACKETS (Rr) > BODY	HX SPLIT SEMS	-	-	-	N	4	5.00
G-4585	SHOCKS (Fr) - LWR MOUNTING	HX PP CONI SEMS	F	H	A	-	4	3.00
G-6005	SHOCKS (Fr) - LWR MOUNTING	GROMMETS, NUTS, WA'S	-	-	-	N	20	10.00
G-4836	SHOCKS (Fr) - UPR MOUNTING	RETAINERS, BUSHINGS, 3/8-24 NUTS	F	-	A	-	10	6.00
G-6006	SHOCKS (Fr) - UPR MOUNTING	GROMMETS, RETAINERS, 3/8-24 NUTS	-	-	-	N	10	10.00
G-5483	SHOCKS (Rr)	BOLTS, LOCK NUTS, FLAT & SPLIT WA'S	-	-	A	-	16	8.00
G-6011	SHOCKS (Rr) LWR MOUNTING	HX BOLTS, NUTS, SPLIT WA'S	-	-	-	N	6	4.00
G-4632	SHOCKS (Rr) LWR MOUNTING - MONO SPRING	HX BOLTS, NUTS, SPLIT WA'S	F	H	-	-	6	4.00
G-6101	SHOCKS (Rr) UPR MOUNTING	RETAINERS, BUSHINGS, 3/8-24 NUTS	F	-	-	N	10	8.00
G-4675	SPARE WHEEL (F convertible only)	7 7/8" J-BOLT, WING NUT	F	-	A	N	2	14.00
G-6938	SPARE WHEEL (F coupe only)	5 7/8" J-BOLT, WING NUT	F	-	-	-	2	14.00
G-5085	SPARE WHEEL w TIRE INFLATOR	J-BOLT, FORGED WING NUT	F	-	-	N	2	15.00
G-5485	SPRINGS (Rr) - CLAMPS	HX BOLTS, NUTS, FLAT & SPLIT WA'S	-	-	A	-	8	6.00
G-4628	STABILIZER BAR (Fr) BRACKETS	HXWA C SCREWS	F	H	A	-	4	6.00
G-6009	STABILIZER BAR (Fr) BRACKETS	HX BOLTS, SPLIT & FLAT WA'S	-	-	-	N	12	5.00
G-4837	STABILIZER BAR (Fr) END LINKS	HX BOLTS, RETAINERS, BUSHINGS, NUTS	F	H	-	N	22	20.00
G-5481	STABILIZER BAR (Fr) END LINKS	HX BOLTS, RETAINERS, BUSHINGS, NUTS	-	-	A	-	22	25.00
G-4672	STEERING COLUMN > DASH	HX CONI SEMS, HX BOLTS, FLNG NUTS	F	-	-	-	9	5.00
G-5629	STEERING COLUMN > DASH	HX PP SEMS, HX BOLTS, NUTS, WA	-	-	A	-	11	5.00
G-6164	STEERING COLUMN > DASH	HX BOLTS, FLAT WA'S	-	-	-	N	12	4.00
G-4354	STEERING GEAR "RAG" JOINT	12 PT BOLT ONLY	F	H	A	-	1	3.00
G-6039	STEERING GEAR > FRAME	HI-HX BOLTS, WA'S, NUTS	-	-	-	N	15	10.00
G-4293	STEERING GEAR BOX > FRAME	GR-8 HX BOLTS, FLAT WA'S	F	H	-	-	6	12.00
G-5180	STEERING GEAR BOX > FRAME	GR-8 HX BOLTS, FLAT WA'S	-	-	A	-	6	12.00
G-4615	STEERING LINKAGE & BALL JOINTS	SLOTTED NUTS, COTTER PINS	F	H	A	-	20	10.00
G-6121	STEERING LINKAGE & BALL JOINTS w PS	SLOTTED NUTS, COTTER PINS	-	-	-	N	24	10.00
G-6003	STEERING LINKAGE & BALL JOINTS w/o PS	SLOTTED NUTS, COTTER PINS	-	-	-	N	22	10.00
G-4670	STEERING SHAFT > COUPLING	REG & HVY NUTS, SPLIT WA'S	F	H	A	-	4	3.00
G-6165	STEERING SHAFT CLAMP	GR-8 BOLT, LOCK NUT	-	-	-	N	2	3.00
G-4674	STEERING WHEEL	HX JAM NUT, FLAT WA	F	-	A	-	2	3.00
G-4802	STEERING WHEEL - DLX	SS PH FLAT MS SCREWS	F	-	A	N	6	3.00
G-6000	STRUT ROD THREADED ENDS > BODY	11/16-18 THREAD NUTS ONLY	-	-	-	N	4	10.00
G-6001	STRUT RODS > LWR CONTROL ARM	HX BOLTS, NUTS, WA'S	-	-	-	N	12	10.00
G-6007	SUSPENSION BUMPER BRACKETS (Fr)	HX CONI SEMS, NUTS	-	-	-	N	24	10.00
G-4626	SUSPENSION BUMPERS (Fr)	FLNG NUTS	F	H	-	N	2	2.00
G-4596	SUSPENSION BUMPERS (Fr)	HX NUTS	-	-	A	-	2	1.00
G-4335	SUSPENSION BUMPERS (Rr)	HXWA C SCREWS	F	H	-	-	4	3.00
G-5484	SUSPENSION BUMPERS (Rr) - El Camino	HX BOLTS, NUTS, SPLIT WA'S	-	-	A	-	3	2.00
G-6171	WHEEL COVER ORNAMENT "SS"	PH PN BT SCREWS	-	-	-	N	12	3.00
G-6583	WHEEL STUDS - 1 AXLE (Fr or Rr)	Does 2 wheels, 7/16-20 x 1.38" L	F	-	A	-	10	14.00
G-5060	WHEELS - STD	ORIGINAL LUG NUTS w "DIAMONDS"	F	-	A	N	20	25.00

Transmission

G-6611	BELL HOUSING > ENGINE	FLNG BOLTS, "M" MARKING	F	-	A	N	6	8.00
G-6149	BELL HOUSING > ENGINE	FLNG BOLTS (Flat Top) "A" MARKING	F	-	A	N	6	8.00
G-5416	BELL HOUSING Fr COVER PLATE	SS EXT SEMS "L"	F	-	A	-	4	3.00
G-5907	CLUTCH BELLCRANK	BALL STUDS, SEATS, RETAINER, WA'S	F	-	A	N	9	32.00
G-4660	CLUTCH BELLCRANK BRACKET > FRAME	HXWA SCREWS	F	-	-	-	3	4.00
G-6032	CLUTCH BELLCRANK BRACKET > FRAME	HX BOLTS, SPLIT WA'S	-	-	-	N	4	2.00
G-5603	CLUTCH PEDAL BUSHINGS	NYLON BUSHINGS ONLY	F	-	A	N	2	3.00
G-4658	CLUTCH PEDAL PUSH ROD SEAL	HXWA AB SCREWS	F	-	-	N	2	1.00
G-4850	CLUTCH PEDAL PUSH RODS	RETAINING CLIPS ONLY	F	-	A	-	3	3.00
G-4659	CLUTCH PEDAL RETAINER	FOLDED SPRING METAL	F	-	A	N	1	3.00
G-4792	COVER - CLUTCH PEDAL HOLE	HXWA SCREWS	F	-	-	-	2	1.50
G-4629	DRIVESHAFT > REAR KNUCKLE	U-BOLTS, NUTS, WA'S	F	H	A	N	10	8.00
G-4796	DRIVESHAFT, TH400 '69 > 302, 350, BB. All 71 >	STRAPS, FLNG BOLTS	F	-	A	-	6	8.00
G-6573	FLYWHEEL - A/T	GR-8 HXWA SCREWS	F	-	A	-	12	16.00
G-4429	FLYWHEEL - M/T	11/16" AF X 1.0" L HX BOLTS	F	-	A	-	12	12.00
G-4798	FLYWHEEL (TH400) > CONVERTOR	3/8-16 GR-5 HX BOLTS, 11/16" AF	F	-	A	-	3	5.00
G-6150	PRESSURE PLATE > FLYWHEEL	SPECIAL HX BOLTS, SPLIT WA'S	F	-	A	N	12	6.00
G-5551	SHIFTER BEZEL & SEAL RETAINER - M/T	w/o CONSOLE, PH OV AB SCREWS	-	-	A	-	8	2.00
G-5624	SHIFTER BEZEL & SEAL RETAINER - M/T SS	w/o CONSOLE, PH OV AB SCREWS	-	-	A	-	8	3.00
G-6110	SHIFTER BEZEL & SEAL, SEAT SEPRTR - M/T	PH PN SCREWS, STAMPED NUTS, WA'S	-	-	-	N	10	3.00
G-5676	SHIFTER CABLE & SEAL RETAINER	U-RTNRS, HXWA SCREWS, SPLIT SEMS	-	-	A	-	6	5.00
G-5627	SHIFTER CONTROL & SUPPORT - 3 SPD (floor)	HX BOLT, HX SPLIT SEMS, TOOTH WA	-	-	A	-	3	4.00
G-4783	SHIFTER CONTROL & SUPPORT (exc 69F M20)	HX BOLTS, NUTS, SPLIT WA'S	F	-	-	-	13	4.00
G-5553	SHIFTER CONTROL > TRANS - 4 SPD	HX BOLT, HX SPLIT SEMS, SPLIT WA	-	-	A	-	3	4.00
G-4786	SHIFTER DIAL RETAINER - FIXED COLUMN	CHROME OV HD BT SCREWS	F	-	A	N	2	1.50
G-5554	SHIFTER HANDLE > CONTROL - 3 or 4 SPD	LOCK NUTS, FLAT WA'S	-	-	A	N	4	3.00
G-6116	SHIFTER LEVER > FLOOR - A/T FLOOR SHIFT	EXT SEMS, HXWA SCREWS, NUTS, WA'S	-	-	-	N	14	4.00

Kits Contain Attaching Fasteners for Both Sides

Transmission

PART #	APPLICATION	NOTES					PCS	PRICE
			CAMARO	FIREBIRD	CHEVELLE	NOVA		
G-5564	SHIFTER LEVER > FLOOR - PG	HXWA AB SCREWS, SPRING NUTS	-	-	A	-	12	5.00
G-4790	SHIFTER LEVER > FLOOR - PG, TH400 w CNSL	HXWA T1 SCREWS	F	-	-	-	4	2.00
G-5675	SHIFTER LEVER > FLOOR - TH400 A/T	HXWA & HI-HXWA AB SCREWS	-	-	A	-	6	4.00
G-5897	SHIFTER LEVERS > CASE - 3 SPD M/T	HX BOLTS, SPLIT & FLAT WA'S	F	-	A	N	6	3.00
G-4782	SHIFTER LEVERS > CASE - 4 SPD HD	NUTS, SPLIT WA'S	F	-	-	-	6	3.00
G-4781	SHIFTER LEVERS > CASE - 4 SPD STD	HX BOLTS, FLAT & SPLIT WA'S	F	-	A	-	9	3.00
G-4791	SHIFTER LINKAGE, A/T FLOOR SHIFT - PG	RETAINERS, FLAT WA'S, NUTS	F	-	-	N	9	4.00
G-6120	SHIFTER PLATE & DIAL - A/T w SEAT SPRTR	HXWA B & PH OV BT SCREWS	-	-	-	N	8	3.00
G-4779	SHIFTER PLATE & SEAL RETAINERS - 4 SPD	PH OV AB & BT SCREWS	F	-	-	-	8	3.00
G-4733	SHIFTER PLATE & SEALS - M/T CONSOLE	HXWA & PH OV T SCREWS	F	-	-	-	12	3.00
G-5652	SHIFTER PLATE, LENS, SEAL - A/T CONSOLE	PH PN BT & T & PH OV C SCREWS, WA'S	-	-	A	-	18	2.00
G-4734	SHIFTER PLATE, RETAINERS - A/T CONSOLE	PH OV & HXWA CUTTER SCREWS	F	-	-	-	10	3.00
G-5625	SHIFTER RODS - 3 SPD	RETAINERS, COTTER, CLEVIS PINS, NUTS	-	-	A	-	9	8.00
G-4780	SHIFTER RODS - 4 SPD	RETAINING CLIPS, JAM NUTS	F	-	-	-	12	10.00
G-5552	SHIFTER RODS - 4 SPD	RETAINERS, PIN, NUTS, WA	-	-	A	N	14	10.00
G-4778	SHIFTER RODS - HD 3 SPD	RETAINERS, NUTS	F	-	-	-	8	6.00
G-6119	SHIFTER SEAL RETAINER - A/T CONSOLE	PH OV AB SCREWS	-	-	-	N	6	2.00
G-4784	SHIFTER STAB SHAFT - M/T (327)	HX BOLTS, NUTS, RETAINERS, BUSHINGS	F	-	-	-	10	12.00
G-4902	SHIFTER STAB SHAFT - M/T (350/396)	HX BOLTS, NUTS, RETAINERS, BUSHINGS	F	-	-	-	10	12.00
G-4694	SPEDOMETER CABLE > TRANS	HX SPLIT SEMS	F	H	A	N	1	2.00
G-4788	TORQUE CONVERTOR > FLYWHL - PG, TH350	PLACE BOLTS, NUTS, WASHERS	F	-	A	N	9	8.00
G-4795	TRANS (Powerglide) KICKDOWN LINKAGE	ROD END CLIP, NUTS, WA'S	F	-	A	-	5	4.00
G-4662	TRANS (Powerglide) KICKDOWN LINKAGE 396	COTTER PIN, NUTS, WA'S	-	-	A	-	6	2.00
G-4799	TRANS CONTROL SW & LEVER - TH400	HX EXT SEMS, HXWA AB SCREW	F	-	A	-	3	3.00
G-4169	TRANS CROSSMEMBER	HX BOLTS, WA'S (RH SIDE), NUTS	F	H	A	-	14	6.00
G-6022	TRANS CROSSMEMBER	HX BOLTS, SRTD FLNG NUTS	-	-	-	N	4	6.00
G-4603	TRANS INSULATOR	HX BOLTS, FLAT & SPLIT WA'S	F	H	A	-	10	6.00
G-6023	TRANS INSULATOR	HX BOLTS, FLAT & SPLIT WA'S	-	-	-	N	10	6.00
G-5677	TRANS LINKAGE - A/T TH400, All 69, 72 M38	RETAINERS, SWIVEL, NUT, WA'S	-	-	A	-	7	12.00
G-5561	TRANS LINKAGE or BACKDRIVE SUPPORT	> FRAME: HXWA C SCREWS	-	-	A	-	3	3.00
G-5069	TRANS LINKAGE SUPPORT > FRAME	HXWA C SCREWS	-	-	A	-	2	2.00
G-5802	TRANS LINKAGE SUPPORT > FRAME (CLM sft)	HX BOLTS, RIVET NUTS, SPLIT WA'S	F	-	-	-	4	4.00
G-5670	TRANS OD CONTROL HANDLE & CABLE	SCREWS, BOLT, HX & SPRING NUTS, WA'S	-	-	A	-	9	4.00
G-6308	TRANS OIL PAN - PG (exc 68-72 console)	LRG FLNG HEAD SCREWS	F	-	A	N	14	7.00
G-6311	TRANS OIL PAN w CNSL TH350 73-81, TH400	LRG FLNG HEAD SCREWS	F	-	A	-	13	7.00
G-6310	TRANS OIL PAN w/o CNSL - TH350 All, TH400	LRG FLNG HEAD SCREWS	F	-	A	N	13	6.00
G-5671	TRANS OVERDRIVE (OD) RELAY	HXWA AB SCREW, PLASTIC CAP	-	-	A	-	2	1.50
G-5070	TRANSMISSION (A/T) > ENGINE (exc 67-68 PG)	HX BOLTS, SPLIT & FLAT WA'S	F	-	A	-	9	6.00
G-4787	TRANSMISSION (Powerglide) > ENGINE	HX BOLTS, FLAT & SPLIT WA'S (for brkts)	F	-	A	N	9	6.00
G-4590	TRANSMISSION (STD) > BELL HOUSING	HX BOLTS, SPLIT WA'S	F	-	A	N	8	5.00
G-4866	TRANSMISSION LINKAGE - A/T CLM SHIFT	RETAINERS, FITTINGS, NUTS, WA'S	F	-	-	N	11	16.00
G-5673	TRANSMISSION LINKAGE - A/T CLM SHIFT	RETAINERS, FITTINGS, NUTS, WA'S	-	-	A	-	9	16.00
G-5901	TRANSMISSION LINKAGE - M/T CLM SHIFT	RETAINERS, FITTINGS, NUTS, WA'S	F	-	-	N	18	20.00
G-4839	TRANSMISSION LINKAGE - M/T CLM SHIFT	RETAINERS, FITTINGS, NUTS, WA'S	-	-	A	-	23	24.00
G-4909	TRANSMISSION OIL COOLER LINES	C SHAPED SPRING CLIPS	F	-	A	N	2	3.00
G-4789	UNDERPAN - Powerglide A/T	HX EXT TOOTH SEMS	F	-	A	N	4	3.00
G-4735	UNDERPAN - TH400, 70F PG	HX T1 SCREWS	F	-	A	-	4	2.00

Wipers

G-4302	WINDSHIELD WASHER BOTTLE BRACKET	HXWA AB SCREWS	F	-	-	-	3	2.00
G-4595	WINDSHIELD WASHER BOTTLE BRACKET	HXWA AB SCREWS, RUBBER CAPS	-	-	A	-	6	3.00
G-6134	WINDSHIELD WASHER BOTTLE BRACKET	HXWA AB SCREWS	-	-	-	N	3	1.50
G-6490	WINDSHIELD WASHER HOSE	ALUMINUM STRAP	-	-	-	N	1	3.00
G-4303	WINDSHIELD WASHER NOZZLES	#8 HXWA B SCREWS	F	-	A	-	2	1.25
G-6135	WINDSHIELD WASHER NOZZLES	HXWA AB SCREWS	-	-	-	N	2	1.50
G-6432	WINDSHIELD WIPER HOSES	3" NYLON STRAPS	F	-	A	-	3	3.00
G-4464	WIPER ARM PIVOTS > COWL	HX EXT SEMS	F	H	A	-	4	3.00
G-5992	WIPER ARM PIVOTS > COWL	HX EXT SEMS	-	-	-	N	4	2.00
G-4329	WIPER MOTOR	HX CNTRS NK EXT SEMS	F	H	A	N	3	3.00
G-5465	WIPER MOTOR	GROMMETS, GRD STRAP, RIVET, SCREWS	F	-	A	N	8	12.00
G-5599	WIPER MOTOR BRACKET - 1, 2S w/o WASHER	HX EXT SEMS	-	-	A	-	3	2.00
G-6141	WIPER MOTOR LINKAGE RETAINER	ATTACHES TO WIPER MOTOR ARM	-	-	A	-	1	2.00
G-5991	WIPER MOTOR LINKAGE RETAINER	ATTACHES TO WIPER MOTOR ARM	-	-	-	N	1	2.00
G-4623	WIPER SWITCH GROUND WASHER	EXT TOOTH WA	F	-	A	-	1	1.00

GM Fastener Kits

341

1968

Air Conditioning

PART #	APPLICATION	NOTES					PCS	PRICE
			CAMARO	FIREBIRD	CHEVELLE	NOVA		
G-4877	AC / HEAT DIVERTER DOOR SWITCH	HXWA AB SCREWS	F	-	A	N	2	1.50
G-5767	AC AIR DISTRIBUTION DUCT - CENTRAL	HX ABT FLAT SEMS	-	-	A	N	2	2.00
G-4858	AC AIR DISTRIBUTION DUCTS - CENTRAL	HXWA AB & HI-HXWA ABT SCREW	F	-	-	-	3	2.00
G-4859	AC AIR OUTLET @ FLOOR - CENTER	HXWA AB SCREWS, FLAT WA'S	F	-	-	-	4	2.00
G-6307	AC AIR OUTLET @ FLOOR - CENTER	HX ABT FLAT SEMS	-	-	-	N	2	1.50
G-4876	AC AMBIENT SWITCH > EVAPORATOR	HI-HXWA ABT SCREWS, SPRING NUTS	F	-	A	N	4	3.00
G-5785	AC BLOWER CONTROL SWITCH (in control)	HXWA T1 SCREWS	F	-	A	N	2	1.50
G-4871	AC COMP BRACE > INTAKE - 396 w A/T	HX BOLTS, NUT, FLAT & SPLIT WA'S	F	-	A	-	11	4.00
G-4870	AC COMP BRACE > INTAKE - 396 w M/T	HX BOLTS, NUT, FLAT & SPLIT WA'S	F	-	A	-	8	3.00
G-4869	AC COMP BRACE, UPPER Fr - 396	HX BOLTS, FLAT & SPLIT WA'S	F	-	A	-	6	5.00
G-4868	AC COMP LWR ADJUST & Fr SUPPORT - 396	HX BOLTS, FLAT & SPLIT WA'S	F	-	-	-	5	6.00
G-5775	AC COMP LWR ADJUST & Fr SUPPORT - 396	HX BOLTS, FLAT & SPLIT WA'S	-	-	A	-	5	6.00
G-4862	AC COMP LWR ADJUSTMENT - SB	HX BOLTS, FLAT & SPLIT WA'S	F	-	A	N	3	2.00
G-4712	AC COMP Rr BRACE > INTAKE - SB	HX BOLTS, FLAT & SPLIT WA'S	F	-	A	N	7	5.00
G-4865	AC COMP Rr BRACE > INTAKE - SB w SMOG	HX BOLTS, FLAT & SPLIT WA'S	F	-	A	N	7	6.00
G-4867	AC COMP SUPPORT > EXH MANIFOLD - 396	HX CLR STUD, HX BOLTS, NUTS, WA'S	F	-	A	-	11	14.00
G-4708	AC COMP SUPPORT > EXH MANIFOLD - SB	GR-8 "TR" HX BOLT, SPACER, LOCK NUT	F	-	A	N	3	6.00
G-4710	AC COMP SUPPORT, LWR Rr - SB & 396	HX BOLTS, WA'S, LOCK NUT	F	-	A	N	6	4.00
G-4863	AC COMP UPPER Fr BRACE - SB w SMOG	HX BOLTS, NUTS, WA'S	F	-	A	N	6	4.00
G-4864	AC COMP UPPER Fr BRACE - SB w/o SMOG	HX BOLTS, NUTS, FLAT & SPLIT WA'S	F	-	A	N	6	4.00
G-4706	AC CONDENSER & BRACKETS	HX CONI SEMS, HXWA SCREWS, U-NUTS	F	-	-	-	16	10.00
G-5772	AC CONDENSER & BRACKETS	HXWA SCREWS, SPRING NUTS, WA'S	-	-	A	-	14	4.00
G-6281	AC CONDENSER & BRACKETS	HXWA SCREWS, SPRING NUTS, WA'S	-	-	-	N	16	5.00
G-6312	AC CONTROL CABLES END RETAINERS	C SHAPED	F	-	-	-	2	3.00
G-4857	AC DEFROSTER DISTRIBUTOR	HI-HXWA ABT SCREWS	F	-	-	N	3	2.00
G-6438	AC EQUALIZER LINE > EVAPORATOR	3.17" NYLON STRAP	F	-	-	N	1	2.00
G-4872	AC EVAPORATOR > FIREWALL	HX INT/EXT SEMS, CLR STUD, NUTS, WA'S	F	-	-	N	6	8.00
G-5776	AC EVAPORATOR > FIREWALL	HX AB FLAT SEMS	-	-	A	-	6	6.00
G-6304	AC EVAPORATOR CASE	HXWA BT SCREWS	F	-	A	-	6	4.00
G-4715	AC EVAPORATOR DRAIN HOSE CLAMP	WIRE CLAMP	F	-	-	N	1	2.00
G-4873	AC FITTING & MUFFLER ASSEMBLY	HX BOLTS, FLAT & SPLIT WA'S	F	-	-	-	5	3.00
G-4718	AC FITTING & MUFFLER ASSEMBLY	HX BOLT, HX CONI SEMS, WA'S	-	-	A	N	5	3.00
G-4723	AC GROUND > FIREWALL	HXWA AB SCREW, TOOTH WA	F	-	A	N	2	1.50
G-4721	AC HEATER HOSE > DASH GROMMETS	HI-HXWA ABT SCREWS	F	-	-	-	4	2.00
G-5781	AC HEATER HOSE CLAMP > COMP - 396	HX BOLTS, NUTS, SPLIT WA'S	-	-	A	-	4	3.00
G-4720	AC HEATER HOSE CLAMP > COMP - SB	HX BOLTS, NUTS, SPLIT WA'S	-	-	A	N	6	3.00
G-4875	AC HEATER HOSE CLAMP > COMP BRACKET	HX BOLTS, SPACER, NUTS, WA'S	F	-	-	-	7	6.00
G-6618	AC HEATER HOSE PROTECTOR	RED PLASTIC CAP	F	-	-	-	1	1.50
G-6436	AC HOSE	7.1" FLEXIBLE STRAP	F	-	-	N	1	3.00
G-6445	AC HOSE	7.1" FLEXIBLE STRAPS	-	-	A	-	2	5.00
G-4874	AC HOSE > RH WHEELHOUSE	HXWA AB SCREWS ONLY	F	-	A	-	2	1.50
G-4719	AC HOSE GROMMET @ FENDER SKIRT	HXWA AB SCREWS	-	-	A	N	4	1.50
G-5780	AC HOSES > RADIATOR SUPPORT	FOLDOVER METAL CLIP	-	-	A	-	1	4.00
G-5768	AC LH OUTLET DUCT SUPPORT	HXWA & RNDWA SCREWS, SPRING NUT	-	-	A	-	3	2.00
G-6584	AC OUTLET HOSE LH > DASH	11.25" FLEXIBLE STRAP, HXWA SCREW	F	-	-	-	2	5.00
G-4699	AC PLENUM VALVE & BRACKET	HXWA SCREWS, NUTS, WA'S, RETAINER	F	-	-	N	16	5.00
G-5763	AC PLENUM VALVE & BRACKET	HXWA & PH PN SCREWS, NUTS, WA'S	-	-	A	-	11	3.00
G-4861	AC RADIATOR SEALS - COUPE	HX BOLTS, CLIPPED WA'S, JAM NUTS	F	-	-	-	16	10.00
G-6375	AC RADIATOR SHIELD	HX & HXWA SCREWS, NYL NUTS, WA'S	-	-	-	N	12	4.00
G-5519	AC RECEIVER TANK > FENDER SKIRT	HX BOLTS, RIVET NUTS	-	-	A	-	4	5.00
G-6282	AC RECIEVER TANK > FENDER SKIRT	HX BOLTS, FLNG NUTS	-	-	-	N	4	3.00
G-4860	AC RECIEVER TANK > RADIATOR SUPPORT	HXWA AB SCREWS	F	-	-	-	2	2.00
G-4722	AC RESISTOR & RELAY > EVAPORATOR	HI-HXWA ABT SCREWS	F	-	A	N	3	3.00
G-4856	AC SELECTOR DUCT > FIREWALL	HX INT/EXT SEMS, NUTS, SEALER, WA'S	F	-	-	-	11	5.00
G-5215	AC SELECTOR DUCT > FIREWALL	HX AB INT/EXT SEMS, NUTS, WA'S	-	-	A	-	8	4.00
G-5212	AC SELECTOR DUCT > FIREWALL	HI-HXWA SCREWS, NUTS, SEALER, WA'S	-	-	-	N	9	3.00
G-6434	AC VACUUM HOSE @ FIREWALL	5.1" FLEXIBLE STRAP	F	-	-	N	1	3.00
G-4728	AC VACUUM HOSE CLAMPS	FLAT WOUND SPRING CLAMPS (Black)	F	-	A	N	5	4.00
G-5766	AC VACUUM HOSE GROMMET > FIREWALL	HXWA AB SCREW	-	-	A	-	1	1.00
G-4727	AC VACUUM HOSE GROMMETS > FIREWALL	HXWA AB SCREWS	F	-	-	N	2	1.50
G-4697	AC VACUUM MOTOR @ RH COWL	HXWA SCREWS, NUTS, TOOTH WA'S	F	-	-	N	7	3.00
G-4698	AC VACUUM MOTOR COVER	PH OV FIN WA SEMS .50 OD, SPRG NUTS	F	-	-	N	6	3.00
G-4724	AC VACUUM TANK	HXWA AB SCREWS	F	-	A	N	2	2.00
G-4714	AC VALVE, TUBE BRKT'S > EVAPORATOR	HXWA AB & ABT SCREWS	F	-	-	N	2	1.50
G-5777	AC VALVE, TUBE BRKT'S > EVAPORATOR	HXWA AB SCREW	-	-	A	-	1	1.00
G-5029	AC VALVE, TUBE BRKT'S > EVAPORATOR 396	HXWA AB & ABT SCREWS	F	-	-	-	3	2.00
G-6447	AC WIRING CLIP, RH UNDERDASH	STEEL S CLIP	-	-	A	-	1	3.00

Kits Contain Attaching Fasteners for Both Sides

GM Fastener Kits

1968

Body			1968							
			CAMARO	FIREBIRD	CHEVELLE	NOVA				
PART #	APPLICATION	NOTES	F	H	A	N			PCS	PRICE
G-5135	AIR VENTS @ DOOR JAMB	.28 OD PH TRUSS WA AB SCREWS	F	-	-	-			2	1.50
G-4255	BATTERY TRAY	HX CONI SEMS, HXWA PP SCREWS	F	H	-	N			4	3.00
G-4503	BATTERY TRAY	HX CONI SEMS, HXWA PP SCREWS	-	-	A	-			4	4.00
G-4625	BODY DAMPENERS - CONVERTIBLE	CONI SEMS, CLIPPED, CUP WA'S, NUTS	F	-	-	-			10	12.00
G-4950	BODY MOUNTS	ORIGINAL BOLTS, WA'S, NUTS	F	H	-	-			22	40.00
G-6365	BODY MOUNTS	ORIGINAL BOLTS, WA'S, NUTS	-	-	-	N			22	40.00
G-5710	BODY MOUNTS - CONVERTIBLE	ORIGINAL BOLTS, NUTS, WA'S	-	-	A	-			22	24.00
G-5709	BODY MOUNTS - HARDTOP	ORIGINAL BOLTS, NUTS, WA'S	-	-	A	-			18	20.00
G-5746	BODY MOUNTS @ RADIATOR SUPPORT	ORIGINAL BOLTS, NUTS, WA'S, SHIMS	-	-	A	-			14	10.00
G-5717	BRAKE PEDAL SUPPORT	HX NUTS, FLAT WA'S	-	-	A	-			4	1.50
G-4637	BRAKE PEDAL SUPPORT w/o PB	NUTS, SPLIT WA'S	F	-	-	N			4	2.00
G-4268	BUMPER (Fr)	SS CAPPED BOLTS, CONI KEPS NUTS	F	-	-	-			12	12.00
G-6698	BUMPER (Fr)	SS CAP, HX & CRG BOLTS, CONI KEPS NUTS	-	H	-	-			12	14.00
G-6202	BUMPER (Fr)	SS CAP BOLTS, FLAT, SPLIT WA'S, NUTS	-	-	A	-			28	10.00
G-6273	BUMPER (Fr)	SS CAPPED BOLTS, WA'S, NUTS	-	-	-	N			32	10.00
G-6699	BUMPER (Fr) BRACKETS	CRG BOLTS, RATCHET TOOTH WA'S, NUTS	-	H	-	-			12	12.00
G-6024	BUMPER (Fr) BRACKETS	HX BOLTS, RATCHET TOOTH WA'S, NUTS	-	-	-	N			16	12.00
G-4499	BUMPER (Fr) FILLER PANEL	HX CONI SEMS, SCREWS, NUTS, RVTS	-	-	A	-			17	9.00
G-6261	BUMPER (Fr) FILLER PANEL & SUPPORT	HXWA & CONI SEMS PP, U-NUTS, RTNRS	-	-	-	N			18	12.00
G-6702	BUMPER (Fr) REINFORCEMENT STABILIZERS	NUTS & FLAT WA'S ONLY	-	H	-	-			8	5.00
G-6700	BUMPER (Fr) REINFORCEMENTS	CRG BOLTS, FLAT & SPLIT WA'S, NUTS	-	H	-	-			32	10.00
G-4854	BUMPER (Fr) VALANCE PAD BRACKET	BOLTS, NUTS, WA'S	F	-	-	-			6	2.00
G-4275	BUMPER (Rr)	SS CAPPED BOLTS, CONI KEPS NUTS	F	-	-	-			12	12.00
G-6694	BUMPER (Rr)	SS CAPPED BOLTS, KEPS NUTS, SCREWS	-	H	-	-			18	18.00
G-4486	BUMPER (Rr)	SS CAPPED BOLTS, NUTS, WA'S	-	-	A	-			31	20.00
G-6275	BUMPER (Rr)	SS CAPPED BOLTS, WA'S, NUTS	-	-	-	N			32	10.00
G-4483	BUMPER (Rr) - El Camino	SS CAPPED BOLTS, NUTS, WA'S	-	-	A	-			39	24.00
G-4266	BUMPER BRACKETS (Fr)	HX BOLTS, RATCHET TOOTH WA'S, NUTS	F	-	-	-			16	12.00
G-4482	BUMPER BRACKETS (Fr)	HX BOLTS, RATCHET TOOTH WA'S, NUTS	-	-	A	-			16	14.00
G-4274	BUMPER BRACKETS (Rr)	HX PP CONI SEMS	F	-	-	N			8	8.00
G-6695	BUMPER BRACKETS (Rr)	HX PP CONI SEMS, CONI KEPS, CRG BOLTS	-	H	-	-			12	14.00
G-4507	BUMPER BRACKETS (Rr)	HX BOLTS, RATCHET TOOTH WA'S, NUTS	-	-	A	-			26	22.00
G-4487	BUMPER BRACKETS (Rr) - El Camino	HX BOLTS, RATCHET TOOTH WA'S, NUTS	-	-	A	-			22	20.00
G-4222	BUMPER GUARD PADS (Fr & Rr)	STAMPED NUTS	-	-	A	N			12	3.00
G-4280	BUMPER GUARD PADS (Fr or Rr)	STAMPED NUTS	F	-	-	-			6	3.00
G-6334	BUMPER GUARDS (Fr & Rr)	HX BOLTS, SPLIT WA'S, NUTS	-	-	-	N			20	5.00
G-4282	BUMPER GUARDS (Fr)	HX BOLTS, WA'S, NUTS	F	-	A	-			10	4.00
G-5817	BUMPER GUARDS (Rr)	HX BOLTS, TOOTH & FLAT WA'S	-	-	A	-			12	3.00
G-4279	BUMPER GUARDS (Rr) w PADS	HX BOLTS, HX PP CONI SEMS, WA'S	F	-	-	-			8	5.00
G-4611	CONVERTIBLE FLOOR REINFORCEMENT	HX PP CONI SEMS	F	-	-	-			6	8.00
G-4301	COWL VENT PANEL	HX AB FLAT SEMS	F	H	-	N			4	3.00
G-5402	DOOR HANDLE CONTROLS (inside)	HXWA SCREWS	F	-	-	-			6	3.00
G-5374	DOOR HANDLES (outside)	SPECIAL 5/16 AF HX CONI SEMS	F	-	A	-			4	4.00
G-5386	DOOR HINGES	HX CONI TOOTH SEMS	F	-	A	-			30	20.00
G-5136	DOOR LATCH - CONTROL	HXWA THREAD FORMER SCREWS	F	-	-	-			6	3.00
G-4332	DOOR LATCHES	OV HD TT SCREWS	F	H	A	-			6	3.00
G-6572	DOOR LOCK STRIKERS	HEX SOCKET DRIVE	F	-	A	-			2	24.00
G-5399	DOOR WEATHERSTRIPS	PLASTIC PINS	F	-	A	-			4	1.50
G-5137	DOOR WINDOW REGULATOR	HXWA THREAD FORMER SCREWS	F	-	-	-			14	6.00
G-6909	EMBLEM, GRILLE	STAMPED NUTS	-	H	-	-			2	2.00
G-4495	EMBLEM, GRILLE "SS 396"	STAMPED NUTS	-	-	A	-			2	1.00
G-6315	EMBLEM, GRILLE "SS"	STAMPED NUTS	-	-	-	N			2	1.00
G-4288	EMBLEM, GRILLE "SS", "R/S"	STAMPED NUTS	F	-	-	-			2	1.00
G-4235	FENDER > RADIATOR SUPPORT BRACES	HXWA PP SCREWS	F	H	-	-			4	3.00
G-6903	FENDER > RADIATOR SUPPORT GUSSETS	HXWA PP BOLTS, U-NUTS	-	H	-	-			8	8.00
G-4179	FENDER > WHEELHOUSE Fr BRACES	HXWA C SCREWS	-	-	A	N			2	2.00
G-4239	FENDER LWR EXTENSIONS	HX PP CONI SEMS, U-NUTS	F	-	-	-			16	10.00
G-4237	FENDERS	HX CONI SEMS, HXWA SCREWS, SHIMS	F	H	-	-			22	14.00
G-4488	FENDERS	HX CONI SEMS, U-NUTS, SHIMS	-	-	A	-			28	20.00
G-6253	FENDERS	HX CONI SEMS, U-NUTS, SHIMS	-	-	-	N			26	20.00
G-6218	FENDERS > FIREWALL (also in fender kits)	LARGE HX CONI SEMS	F	-	A	N			4	5.00
G-6604	FENDERS > RAD SUPPORT (also in fender kit)	HXWA PP SCREWS	F	-	A	N			4	3.00
G-4490	GRILLE	HXWA SCREWS, NYLON NUTS, RIVETS	-	-	A	-			12	5.00
G-4252	GRILLE - STD	SCREWS, NUTS, TUBULAR RIVETS	F	-	-	-			22	6.00
G-6906	GRILLE & H/L DIVIDER "hourglass"	HXWA & PH OV SCREWS, U-NUTS	-	H	-	-			20	5.00
G-6259	GRILLE & REINFORCEMENT	HXWA SCREWS, SPR NUTS, BLK RIVETS	-	-	-	N			22	6.00
G-6907	GRILLE BRACKETS	CRG BOLTS, NUTS, FLAT & SPLIT WA'S	-	H	-	-			16	5.00
G-4500	GRILLE BRACKETS	HXWA PP SCREWS	-	-	A	-			3	2.00
G-6257	GRILLE BRACKETS	HXWA PP SCREWS	-	-	-	N			4	3.00
G-4491	GRILLE EXTENSIONS	SCREWS, NYLON NUTS, RIVETS	-	-	A	-			16	5.00
G-4287	GRILLE, CENTER - R/S	BLACK SEMI-TUBULAR RIVETS	F	-	-	-			13	5.00
G-4295	GRILLE, LWR - R/S	HXWA SCREWS, SPRING NUTS	F	-	-	-			12	3.00
G-4292	GRILLE, LWR - STD	STAMPED NUTS	F	-	-	-			6	2.00
G-4294	GRILLE, UPPER - STD (68F) & R/S	EXT TOOTH KEPS NUTS	F	-	-	-			6	3.00
G-4243	HEADER PANEL	HXWA PP SCREWS, U-NUTS	F	-	-	-			11	6.00

See factory Assembly Manuals for illustrations

GM Fastener Kits

343

1968

Body

PART #	APPLICATION	NOTES					PCS	PRICE
			CAMARO	FIREBIRD	CHEVELLE	NOVA		
G-4489	HEADER PANEL	HXWA SCREWS, HX CONI SEMS, RIVETS	-	-	A	-	9	6.00
G-4936	HEADLAMP ACTUATOR SHIELDS - R/S	HX PP CONI SEMS	F	-	-	-	10	8.00
G-4937	HEADLAMP ACTUATOR SUPPORT - R/S	HX CONI SEMS, CONI KEPS NUTS	F	-	-	-	8	4.00
G-4263	HEADLAMP BEZELS	SCREWS, NYLON NUTS, SPRING NUTS	F	-	-	-	12	6.00
G-4501	HEADLAMP BEZELS	SS/CHROME PH OV SCREWS, SPR NUTS	-	-	A	-	16	5.00
G-6269	HEADLAMP BEZELS	SS/CHROME PH OV SCREWS, SPR NUTS	-	-	-	N	20	6.00
G-4283	HEADLAMP BEZELS - R/S	PH OV AB SCREWS, NYLON NUTS	F	-	-	-	16	6.00
G-6922	HEADLAMP BODIES	HX CONI SEMS	-	H	-	-	8	6.00
G-4300	HEADLAMP COVER BUMPER BRACKETS	HX EXT SEMS	F	-	-	-	4	2.00
G-4297	HEADLAMP COVERS > PLATE - R/S	PH OV MS SCREWS	F	-	-	-	8	3.00
G-4299	HEADLAMP HOUSINGS - R/S	HXWA PP SCREWS, SHIMS	F	-	-	-	14	5.00
G-4256	HEADLAMP HOUSINGS - STD	HXWA AB & PP SCREWS, SPRING NUTS	F	-	-	-	14	6.00
G-4939	HEADLAMP LEVER SUPPORT - R/S	HX PP CONI SEMS, FLNG NUTS	F	-	-	-	8	5.00
G-4941	HEADLAMP VACUUM TANK & RELAY - R/S	HX PP CONI SEMS, HX EXT SEMS	F	-	-	-	5	5.00
G-4244	HOOD & HINGES	HX CONI SEMS	F	H	A	N	8	8.00
G-4246	HOOD CATCH & LOCK PLATE	HXWA SCREWS, HX CONI SEMS, U-NUTS	F	-	-	-	9	6.00
G-4498	HOOD CATCH & LOCK PLATE	HXWA PP SCREWS, HX PP CONI SEMS	-	-	A	-	9	6.00
G-6268	HOOD CATCH & LOCK PLATE	HX PP CONI SEMS, U-NUTS	-	-	-	N	11	8.00
G-4245	HOOD CATCH SUPPORT	HXWA PP SCREW	F	H	-	-	1	1.00
G-4476	HOOD CATCH SUPPORT	HX PP CONI SEMS, U-NUT	-	-	A	-	2	3.00
G-6911	HOOD LATCH, BRACE, PLATE & SPRING	HXWA PP SCREWS, U-NUTS	-	H	-	-	15	14.00
G-4249	HOOD LEVELERS (Fr)	SCREWS, FLNG NUTS, RUBBER BUMPERS	F	H	A	N	6	8.00
G-4250	HOOD LOCK POST	MOUNTING NUT ONLY	F	-	A	N	1	2.00
G-4494	HOOD LOUVERS - SS models	STAMPED NUTS	-	-	A	-	10	3.00
G-4316	HOOD ORNAMENTS	STAMPED NUTS	F	-	-	-	12	4.00
G-4271	LICENSE PLATE BRACKET (Fr)	HXWA AB SCREWS, NYLON NUTS	F	-	-	-	6	3.00
G-5759	LICENSE PLATE BRACKET (Fr)	HX BOLTS, EXT KEPS NUTS	-	-	A	-	4	3.00
G-4485	LICENSE PLATE BRACKET (Fr) 70-72, (Rr) All	HX BOLTS, EXT KEPS NUTS	-	-	A	N	4	3.00
G-4855	LICENSE PLATES (Fr & Rr)	SLOT TRUSS B SCREWS, NYLON NUTS	F	-	-	-	8	4.00
G-5046	LICENSE PLATES (Fr & Rr)	SLOT TRUSS B SCREWS, NYLON NUTS	-	-	-	N	8	6.00
G-4717	MIRROR (outside fixed) & BRACKET	PH OV MS SCREW, PH PN B EXT SEMS	F	H	A	N	3	2.00
G-5787	MIRROR (outside remote) & BRACKET	PH OV MS SCREW, PH PN B EXT SEMS	-	-	A	N	2	2.00
G-4307	NAMEPLATE, FENDERS - ENG DESIGNATION	STAMPED NUTS	F	-	-	-	6	2.00
G-4472	NAMEPLATE, FENDERS - MODEL or ENGINE	STAMPED NUTS	-	-	A	-	8	3.00
G-4305	NAMEPLATE, FENDERS "Camaro"	STAMPED NUTS	F	-	-	-	8	2.00
G-4370	NAMEPLATE, FENDERS "Nova", "Firebird"	STAMPED NUTS	-	H	-	-	4	1.50
G-4317	NAMEPLATE, FENDERS "Rally Sport"	STAMPED NUTS	F	-	-	-	8	2.00
G-4314	NAMEPLATE, FENDERS "SS", "Z28", "350"	STAMPED NUTS	F	-	-	N	6	2.00
G-4253	NAMEPLATE, GRILLE (STD)	STAMPED NUTS	F	-	-	-	2	1.50
G-4311	NAMEPLATE, HEADER PANEL	STAMPED NUTS	F	-	-	-	4	1.50
G-4492	NAMEPLATE, HEADER PANEL	STAMPED NUTS	-	-	A	-	4	1.50
G-4328	NAMEPLATE, TRUNK LID	STAMPED NUTS	F	-	-	-	4	1.50
G-6506	PLUGS, FLOOR, TRUNK, WHEEL WELLS	RUBBER & PLASTIC PLUGS	F	-	-	-	12	8.00
G-6343	QUARTER PANEL EXTENSIONS	CONI KEPS NUTS, FLAT WA'S, SEALER	-	-	A	-	24	8.00
G-6915	RADIATOR SUPPORT > FENDER GUSSETS	PH WAFER SCREWS	-	H	-	-	4	4.00
G-6263	SEAL RETAINER - LH WHEELHOUSE @ DASH	HX CONI SEMS, NUTS	-	-	-	N	4	2.00
G-4278	SPOILER (Fr)	#10 HXWA AB SCREWS	F	-	-	-	5	3.00
G-4673	STEERING COLUMN SEAL RETAINER	FLAT SEMS, HXWA SCREWS, SEAL WA'S	F	-	-	N	5	5.00
G-5739	STEERING COLUMN SEAL RETAINER	HXWA AB SCREWS	-	-	A	-	7	3.00
G-6930	TAILGATE HINGES - El Camino	HX CONI SEMS, FLAT EXT SEMS	-	-	A	-	12	20.00
G-6934	TAILGATE LATCHES	OV HD TT SCREWS	-	-	A	-	6	3.00
G-6931	TAILGATE STRIKERS > BODY	POZI FLAT SCREWS	-	-	A	-	6	6.00
G-6933	TAILGATE SUPPORT CABLES	HX SHOULDER BOLTS, FLAT WA'S	-	-	A	-	8	8.00
G-4154	TRUNK LATCH & STRIKER	HX CONI TOOTH SEMS	F	-	A	N	5	4.00
G-4155	TRUNK LID > HINGES	HX CONI TOOTH SEMS	F	H	A	N	4	4.00
G-5068	TRUNK LID BUMPERS	.90" DIA X .48 TK RUBBER BUMPERS	-	-	A	-	2	3.00
G-4241	VALANCE (Fr)	HXWA PP SCREWS, U-NUTS	F	-	-	-	14	8.00
G-6914	VALANCE (Fr)	HXWA AB & PP SCREWS, U-NUTS	-	H	-	-	20	16.00
G-6910	VALANCE (Fr) BRACKETS (3)	HXWA PP SCREWS, U-NUTS	-	H	-	-	8	8.00
G-5389	WEATHERSTRIP, QUARTER GLASS @ JAMB	.28 OD PH RNDWA AB SCREWS	F	-	-	-	4	2.00
G-6642	WEATHERSTRIP, QUARTER GLASS @ JAMB	.28 OD PH RNDWA AB SCREWS	-	-	A	-	6	2.00
G-4232	WHEELHOUSE Rr BRACES > BODY	HX MS & PP CONI SEMS, HX NUTS	F	-	-	-	6	5.00
G-6918	WHEELHOUSE Rr BRACES > BODY	HX CONI SEMS	-	H	-	-	4	4.00
G-4230	WHEELHOUSES	HXWA SCREWS, SEMS, CUP WA'S, U-NUTS	F	-	-	-	46	26.00
G-6916	WHEELHOUSES	HXWA SCREWS, SEMS, CUP WA'S, U-NUTS	-	H	-	-	50	30.00
G-4497	WHEELHOUSES	SCREWS, HX CONI SEMS, WA'S, U-NUTS	-	-	A	-	44	26.00
G-6264	WHEELHOUSES	HXWA PP SCREWS, CUP WA'S, U-NUTS	-	-	-	N	24	20.00
G-6379	WHEELHOUSES > FENDERS (also in WH kit)	HXWA PP SCREWS, CUP WA'S, U-NUTS	F	-	A	N	12	12.00
G-4233	WHEELHOUSES > RADIATOR SUPPORT	HXWA PP SCREWS, U-NUTS	F	H	A	N	8	6.00
G-5401	WINDOW (door) GUIDE PLATES	HX CONI TOOTH SEMS	F	-	-	-	8	4.00
G-5403	WINDOW (door) REAR STOP	HX TT CONI TOOTH SEMS	F	-	-	-	4	3.00
G-5414	WINDOW (Qter) REGULATOR, STOP, GUIDE	HXWA TT SCREWS, LRG FLNG NUTS	F	-	-	-	16	8.00
G-5405	WINDOW GLASS (Door) > CHANNEL	SRTD FLNG NUTS	F	-	-	-	4	1.50
G-5404	WINDOW GUIDE CHANNEL @ DOOR (Fr)	HX TT CONI TOOTH SEMS	F	-	-	-	6	3.00
G-5393	WINDOW GUIDE CHANNEL @ DOOR (Rr)	HX CONI TOOTH SEMS	F	-	-	-	6	3.00

Kits Contain Attaching Fasteners for Both Sides

GM Fastener Kits

1968

Brakes

PART #	APPLICATION	NOTES					PCS	PRICE
			CAMARO	FIREBIRD	CHEVELLE	NOVA		
G-5007	AXLE RETAINER PLATES	GR-8 HX BOLTS, NUTS, SPLIT WA'S	F	H	A	N	24	10.00
G-6579	BRAKE BLEEDER SCREWS w DISC	All - CALIPERS, M/C, WHEEL CYLINDERS	F	-	A	N	6	10.00
G-4738	BRAKE BOOSTER	HX NUTS, SPLIT WA'S	F	H	A	N	8	3.00
G-4888	BRAKE BOOSTER HOSE - 396	CLAMPS & WA FOR TUBE BRACKET	F	H	-	N	3	3.00
G-4740	BRAKE BOOSTER HOSE - SB	FLAT WOUND SPRING CLAMPS (Black)	F	H	A	N	2	2.00
G-4642	BRAKE CABLES	WIRE TYPE RETAINERS, HX NUTS	F	H	A	N	5	5.00
G-6575	BRAKE CALIPER BLEEDERS	3/8-24 SCREWS, .28 NOSE TO FIT CAP	F	-	A	N	2	4.00
G-5938	BRAKE CALIPER BRACKETS & SHIELDS	SPECIAL GR-8 HX BOLTS, LOCK NUTS	F	H	A	N	10	24.00
G-6045	BRAKE CALIPERS > BRACKET	GR-8 HX BOLTS	F	H	A	N	4	5.00
G-6215	BRAKE HOSE > CALIPER	U-RETAINERS	F	H	A	N	2	2.00
G-4348	BRAKE HOSE BRACKET (Rr)	HX PP CONI SEMS	F	H	-	N	2	3.00
G-4640	BRAKE HOSE BRACKETS (Fr)	HX C SCREWS	F	H	-	N	2	2.00
G-5718	BRAKE HOSE BRACKETS (Fr)	HXWA C SCREWS	-	-	A	-	2	2.00
G-6240	BRAKE HOSE GASKETS	COPPER MATERIAL	F	-	A	N	2	1.50
G-4641	BRAKE HOSE RETAINERS	U-RETAINERS	F	H	A	N	4	3.00
G-5486	BRAKE LINE SHIELDS (Rr) - El Camino	HXWA C SCREWS	-	-	A	-	4	3.00
G-5602	BRAKE PEDAL BUSHINGS	NYLON BUSHINGS ONLY	F	-	A	N	2	3.00
G-4794	BRAKE PEDAL RETAINER w A/T	FOLDED SPRING METAL	F	-	A	N	1	3.00
G-6044	BRAKE PEDAL RETURN SPRING	NOS SPRING	F	-	A	N	1	4.00
G-5008	BRAKE PLATE ASSEMBLY (Fr) > SPINDLE	GR-8 HX BOLTS, LOCK NUTS	F	H	A	N	8	12.00
G-5619	BRAKE PRESSURE SWITCH	HXWA C SCREW	-	-	A	-	1	1.00
G-4705	BRAKE PRESSURE VALVE - 67 AC, 396, 68 4V	TO FRAME, HX C SCREW	F	H	-	-	1	1.50
G-4636	BRAKE PRESSURE VALVE & SW - DRUM	HX SPLIT SEMS	F	H	-	N	1	1.50
G-4741	MASTER CYL BALANCE VALVE w DISC	HX EXT SEMS	F	H	A	N	1	2.00
G-4635	MASTER CYLINDER	HX NUTS, SPLIT WA'S	F	H	A	N	4	2.00
G-6580	MASTER CYLINDER BLEEDERS w DISC	5/16-24 SCREWS	F	-	A	N	2	3.00
G-4829	MASTER CYLINDER PUSH ROD > PEDAL	RETAINING CLIP	F	H	A	N	1	3.00
G-4347	PARKING BRAKE CONTROL > DASH	HX CONI SEMS, FLNG NUTS	F	H	-	N	3	3.00
G-5489	PARKING BRAKE CONTROL > DASH	HX SPLIT SEMS, FLNG NUTS, SEALER	-	-	A	-	5	3.00
G-4887	STOPLAMP SWITCH STRIKER - PWR BRAKES	w POWER BRAKES, BOLT, STAMPED NUT	F	-	A	N	2	2.00
G-6576	WHEEL CYLINDER (2) BLEEDERS	Does 2 cylinders, 5/16-24 SCREWS	F	-	A	N	2	3.00
G-6577	WHEEL CYLINDER (4) BLEEDERS	Does 4 cylinders, 5/16-24 SCREWS	F	-	A	N	4	5.00
G-6581	WHEEL CYLINDERS (2)	HX INT SEMS	F	H	A	N	4	3.00
G-6582	WHEEL CYLINDERS (4)	HX INT SEMS	F	H	A	N	8	5.00

Cooling

G-4592	RADIATOR - 307/327/350	HXWA PP SCREWS	-	-	A	N	3	3.00
G-4600	RADIATOR - 396	HXWA PP SCREWS	-	-	A	-	4	3.00
G-4676	RADIATOR (396 only 68N)	HXWA MS & PP SCREWS, WELL-NUTS	F	-	-	N	6	8.00
G-5749	RADIATOR FAN SHROUD - 396	HX PP CONI SEMS, U-NUTS, S CLIPS	-	-	A	-	8	6.00
G-5747	RADIATOR FAN SHROUD - SB	HX PP CONI SEMS, U-NUTS, S CLIPS	-	-	A	N	6	5.00
G-4677	RADIATOR FAN SHROUD & BRACKET	TOP MOUNTING ONLY. SCREWS, U-NUTS	F	-	-	-	5	5.00
G-6297	RADIATOR FAN SHROUD & BRACKET - 396	TOP MOUNTING ONLY. SCREWS, SPR NUT	-	-	-	N	3	3.00
G-4844	RADIATOR HOSES - V8	TOWER TYPE CLAMPS	F	-	-	N	4	12.00
G-5162	RADIATOR HOSES - V8	TOWER TYPE CLAMPS	-	-	A	-	4	12.00
G-6296	RADIATOR SEAL - 396	NYLON RETAINERS	-	-	-	N	6	3.00

Differential

G-5466	DIFFERENTIAL COVER - 10 BOLT	SRTD FLNG SCREWS "E"	F	H	A	N	10	10.00
G-5467	DIFFERENTIAL COVER - 12 BOLT	SRTD FLNG SCREWS "E"	F	H	A	N	12	12.00

Electrical

G-4828	ALTERNATOR - 302	HX BOLTS, WA'S, NUTS, SPACER	F	-	-	-	15	12.00
G-4645	ALTERNATOR - 327, 350	HX BOLTS, WA'S, NUTS, SPACER	F	-	A	N	16	10.00
G-4766	ALTERNATOR - 396	HX BOLTS, WA'S, NUTS, SPACER	F	-	A	N	18	12.00
G-4681	ALTERNATOR HARNESS > ALTERNATOR	12-24 HX NUT, #12 TOOTH WA	F	-	-	-	2	1.50
G-4981	ALTERNATOR HARNESS > ALTERNATOR	12-24 NUT, #14 TOOTH WA	-	-	A	-	2	1.50
G-6293	ALTERNATOR PULLEY	NUT, FLAT WA	F	-	A	N	2	3.00
G-6634	BACK-UP LAMP LENSES	SS/CHROME PH PN .340 SHLDR SCREWS	-	-	A	-	4	4.00
G-6635	BACK-UP LAMP LENSES - El Camino	SS/CHROME PH PN .435 SHLDR SCREWS	-	-	A	-	4	4.00
G-6423	BACK-UP LAMP LENSES - R/S	CHROME/SS PH PN .550 SHLDR SCREWS	F	-	-	-	4	4.00
G-4785	BACK-UP LAMP SW & ROD - 4 SPD (floor 68N)	HX EXT SEMS, RETAINING PINS	F	-	A	N	4	3.00
G-6497	BACK-UP LAMP WIRING - R/S	S CLIPS	F	-	-	-	2	5.00

See factory Assembly Manuals for illustrations

GM Fastener Kits

345

1968

Electrical

PART #	APPLICATION	NOTES					PCS	PRICE
			CAMARO	FIREBIRD	CHEVELLE	NOVA		
G-4505	BACK-UP LAMPS	PH PN EXT SEMS	-	-	A	-	4	3.00
G-4318	BACK-UP LAMPS - R/S	HX NUTS	F	-	-	-	4	1.00
G-4777	BACK-UP SW ROD - 3 SPD FLOOR SHIFT	RETAINING PINS	F	-	A	N	2	1.50
G-4793	BACK-UP/NEUTRAL SWITCH (Console A/T)	HX SCREWS, FLAT & TOOTH WA'S	F	-	A	N	6	2.00
G-6298	BATTERY CABLE > RH WHEELHOUSE	3.17" NYLON STRAP	F	-	-	-	1	2.00
G-5753	BATTERY CABLE ROUTING CLIP > FRAME	HXWA T1 SCREW	-	-	A	-	1	1.00
G-4725	BATTERY CABLES - V8 w AC	HX BOLT, SCREW, NUTS, WA'S	F	-	A	N	7	4.00
G-4678	BATTERY CABLES - V8 w/o AC	HXWA AB SCREW, NUTS, WA'S	F	-	A	N	7	4.00
G-4352	BATTERY HOLDOWN CLAMP	HX CONI SEMS	F	-	A	N	1	1.50
G-5814	CAPACITOR - RADIO NOISE, AM/FM, AC 68	HXWA SCREW	-	-	A	-	1	1.00
G-4813	CLOCK - FLOOR MOUNTED	SCREW, WA , NUT, RIVET NUTS	F	-	-	-	7	5.00
G-5634	CLOCK - IN DASH	HXWA SCREWS	-	-	A	-	2	1.00
G-6328	CLOCK - IN DASH	HXWA SCREWS, FLAT WA'S	-	-	-	N	4	2.00
G-4920	CONSOLE CIRCUIT BOARD	SMALL SCREWS, NUTS, WA'S	F	-	-	-	7	2.00
G-5636	COURTESY LAMPS, UNDERDASH	PH PN FLAT WA SEMS	-	-	A	N	2	2.00
G-4691	COURTESY LAMPS, UNDERDASH (69F COUPE)	PH PN SCREW, PH PN AB FLAT SEMS, WA	F	-	-	-	3	2.00
G-6452	CRUISE CONTROL CABLES	7.1" FLEXIBLE STRAPS	F	-	-	-	3	6.00
G-4752	CRUISE CONTROL REGULATOR & BRACKET	HX CONI SEMS, BOLTS, NUTS, WA'S	F	-	-	-	7	3.00
G-4753	CRUISE CONTROL SERVO & BRACKET	SCREWS, NUTS, WA'S	F	-	-	-	7	2.00
G-4892	CRUISE CONTROL SW STRIKER & BRACKET	HX BOLTS, NUTS, WA'S	F	-	-	-	6	3.00
G-4696	DEFOGGER SWITCH - Rr WINDOW	OV HD SCREWS	F	-	A	N	2	1.00
G-4690	DIMMER SWITCH	HI-HXWA AB SCREWS	F	-	A	N	2	2.00
G-4688	FLASHER BRACKET > DASH	PH PN AB SCREW	F	-	A	N	1	1.00
G-4986	FUSE PANEL > FIREWALL	#10 x 2 1/4 HXWA AB SCREWS w SEALER	F	-	A	N	2	3.00
G-4851	H/L, P/L GROUNDS, JUNCTION BLOCK	HXWA AB & B SCREWS, TOOTH WA'S	F	-	-	-	7	4.00
G-4680	H/L, P/L GROUNDS, JUNCTION BLOCK	HXWA AB & B SCREWS, TOOTH WA'S	-	-	A	N	5	3.00
G-4259	HEADLAMP ADJUSTERS	SCREWS, NYLON NUTS, SPRINGS	F	-	-	-	10	8.00
G-4535	HEADLAMP ADJUSTERS	SCREWS, NYLON NUTS, SPRINGS	-	H	-	-	20	12.00
G-4830	HEADLAMP ADJUSTERS	SCREWS, NYLON NUTS, SPRINGS	-	-	A	-	20	12.00
G-6562	HEADLAMP ADJUSTERS	SCREWS, NYLON NUTS, SPRINGS	-	-	-	N	10	8.00
G-6567	HEADLAMP RETAINING RINGS	SLOT PN SCREWS	F	-	A	-	6	3.00
G-6237	HEATER SWITCH	PH PN AB SCREWS	-	-	-	N	2	1.50
G-4726	HEATER SWITCH or AC FAN (AC 68N)	HXWA T1 SCREWS	F	-	A	N	2	1.50
G-5503	HORN (1)	HX PP CONI TOOTH SEMS	-	-	A	-	1	3.00
G-6323	HORN (1)	HX PP CONI TOOTH SEMS, PLASTIC CAP	-	-	-	N	2	4.00
G-4808	HORN (3)	HX CONI TOOTH SEMS, FLAT WA	F	-	-	-	4	5.00
G-4801	HORN CONTACT ASSY - WOOD GRAIN WHEEL	PH PN MS SCREWS	F	-	A	N	3	2.00
G-4682	HORN RELAY	HXWA AB SCREW	F	-	A	N	1	1.00
G-4679	HORNS (2) (3 '66)	HX PP CONI TOOTH SEMS	F	-	-	-	2	4.00
G-4647	IGNITION COIL & STRAP	HX EXT SEMS, SLOT RND T SCREW	F	-	A	N	3	4.00
G-5726	IGNITION SWITCH GROUND BRACKET	HI-HXWA AB SCREWS	-	-	A	-	4	2.00
G-4686	INSTRUMENT CLUSTER CIRCUIT BOARD	HXWA B SCREWS, NUTS, WA'S	F	-	-	-	10	3.00
G-6272	INSTRUMENT CLUSTER CIRCUIT BOARD	HXWA B SCREWS, WA'S, NUTS	-	-	-	N	10	3.00
G-4853	INSTRUMENT CLUSTER GROUND	HXWA AB SCREW, TOOTH WA	F	-	-	-	2	1.50
G-6652	KICK PANELS w/o AC	HXWA SCREWS	-	-	A	-	10	3.00
G-4924	LAMP MONITORS - FENDER MOUNTED	STAMPED NUTS	F	-	A	-	4	2.00
G-4312	LICENSE PLATE LAMP	PH PN AB SCREWS	F	H	A	N	2	1.00
G-4322	MARKER LAMPS (Fr & Rr)	STAMPED NUTS	F	-	-	N	8	3.00
G-4502	MARKER LAMPS (Fr & Rr)	STAMPED NUTS	-	-	A	-	8	3.00
G-4692	PARKING BRAKE ALARM SWITCH	NUT, TOOTH WA	F	-	-	N	2	1.00
G-5202	PARKING BRAKE ALARM SWITCH	HXWA AB SCREW	-	-	A	-	1	1.00
G-6627	PARKING LAMP LENSES	SS/CHROME PH PN .806 SHLDR SCREWS	-	H	-	-	4	5.00
G-6625	PARKING LAMP LENSES	SS/CHROME PH PN .488 SHLDR SCREWS	-	-	-	N	4	4.00
G-6420	PARKING LAMP LENSES (67-68F STD)	SS/CHROME PH PN .640 SHLDR SCREWS	F	-	A	-	4	4.00
G-6421	PARKING LAMP LENSES (Camaro R/S)	SS/CHROME PH PN .380 SHLDR SCREWS	F	-	-	-	4	4.00
G-6924	PARKING LAMPS	PH PN AB SCREWS, U-NUTS	-	H	-	-	8	4.00
G-4480	PARKING LAMPS	PH PN EXT SEMS	-	-	A	N	4	3.00
G-4934	PARKING LAMPS - R/S	HXWA EXT SEMS "RBW"	F	-	-	-	4	4.00
G-4262	PARKING LAMPS - STD	STAMPED NUTS	F	-	-	-	4	2.00
G-4695	POWER TOP ELECTRICAL CONNECTIONS	CONI KEPS NUTS, HXWA & OV SCREWS	F	-	-	-	6	4.00
G-5511	POWER TOP ELECTRICAL CONNECTIONS	CONI KEPS NUTS, HXWA & OV SCREWS	-	-	A	-	6	4.00
G-5810	RADIO - STEREO ADAPTER & BRACKET	SCREWS, SPRING NUTS	-	-	A	-	8	3.00
G-5811	RADIO BRACKET	HXWA AB SCREW, SPRING NUT	-	-	A	-	2	1.50
G-6331	RADIO BRACKET	SCREWS, SPRING NUTS	-	-	-	N	4	3.00
G-4820	RADIO BRACKETS	HXWA & PN TRUSS SCREWS, SPR NUTS	F	-	-	-	4	3.00
G-5813	RADIO GROUND STRAP > FRAME	HXWA AB & T1 SCREWS	-	-	A	-	2	2.00
G-4823	RADIO GROUND STRAPS > FIREWALL	HXWA AB SCREWS	F	-	A	-	2	1.50
G-6332	RADIO GROUND STRAPS > FIREWALL	HXWA AB & T1 SCREWS	-	-	-	N	3	2.00
G-5812	RADIO HOOD GROUND CLIP > COWL	HX AB FLAT SEMS	-	-	A	-	1	1.50
G-4931	RADIO MULTIPLEX ADAPTER w CONSOLE	HXWA AB SCREW	F	-	-	-	1	1.50
G-4929	RADIO MULTIPLEX ADAPTER w/o CONSOLE	HXWA AB & PH PN MS SCREWS	F	-	-	-	6	3.00
G-4822	RADIO NOISE CAPACITOR > COIL BRACKET	HXWA T SCREW, TOOTH WA	F	-	-	N	2	1.50
G-5815	RADIO, STEREO ADAPTER (under dash)	PH PN SCREWS, EXT KEPS NUTS	-	-	A	-	8	3.00
G-4819	SPEAKER > DASH	HXWA AB SCREW, SPRING NUT	F	-	A	-	2	2.00
G-4818	SPEAKERS & GRILLES @ KICK PANELS	PH OV AB SCREWS, SPRING NUTS	F	-	-	N	16	5.00

Kits Contain Attaching Fasteners for Both Sides

GM Fastener Kits

1968

Electrical

PART #	APPLICATION	NOTES					PCS	PRICE
			CAMARO	FIREBIRD	CHEVELLE	NOVA		
G-5591	SPEAKERS & GRILLES @ KICK PANELS	PH OV AB SCREWS, SPRING NUTS	-	-	A	-	16	5.00
G-6453	SPEDO > TRANS CABLE w CRUISE CONTROL	3" NYLON STRAP	F	-	-	-	1	2.00
G-5727	STARTER & BRACE - 396	3.62" L HX BOLTS, HX SPLIT SEMS, FLNG	F	-	A	-	4	8.00
G-5006	STARTER & BRACE - SB	NUT	F	-	A	N	4	8.00
G-4689	STOPLAMP SWITCH	1.84 & 4.69 L FLNG BOLTS, CONI SEMS, NUT	F	-	-	N	2	2.00
G-5201	STOPLAMP SWITCH	STAMPED HX NUTS	-	-	A	-	1	2.00
G-6325	TACHOMETER	SPECIAL ROUND RETAINER	-	-	-	N	2	1.50
G-4333	TAILAMP HOUSINGS > BODY	HXWA B SCREWS	F	-	-	-	12	3.00
G-4961	TAILAMP LENSES	HXWA BF SCREWS	-	-	-	N	8	4.00
G-6631	TAILAMP LENSES - El Camino	SS/CHROME PH PN & PH OV MS SCREWS	-	-	A	-	8	8.00
G-4323	TAILAMPS > BODY	SS/CHROME PH PN .340 SHLDR SCREWS	F	-	-	-	10	10.00
G-6927	TAILAMPS > BODY	CONI TOOTH KEPS NUTS	-	H	-	-	16	16.00
G-5803	TAILAMPS > BODY	QUICKY BOLTS, CONI TOOTH KEPS NUTS	-	-	-	N	6	3.00
G-6416	TAILAMPS > QUARTER EXTENSIONS	EXT TOOTH KEPS NUTS	-	-	A	-	8	3.00
G-4927	TAPE PLAYER - CONVECTOR ASSY	PH FLAT TT SCREWS	F	-	-	-	2	1.50
G-4814	TAPE PLAYER (under dash)	HXWA AB SCREWS	F	-	-	-	22	5.00
G-5809	TAPE PLAYER (under dash)	SCREWS, NUTS, WA'S	-	-	A	-	10	3.00
G-6329	TAPE PLAYER (under dash)	SCREWS, EXT KEPS NUTS	-	-	-	N	9	4.00
G-4926	TAPE PLAYER w CONSOLE	PH FLAT & HXWA SCREWS, SPRING NUTS	F	-	-	-	19	10.00
G-4810	TRUNK LAMP	MANY SCREWS, ACORN NUTS	F	-	A	N	1	1.00
G-4991	TURN SIGNAL LEVER	HX AB FLAT SEMS	F	-	A	N	1	1.50
G-4922	UNDERHOOD LAMP	PH PN T SCREW	F	-	A	N	2	1.50
G-6457	VACUUM HOSES - R/S HEADLAMPS	HXWA AB SCREWS	F	-	-	-	9	18.00
G-4649	VOLTAGE REGULATOR	5.1" FLEXIBLE STRAPS	F	-	-	N	6	6.00
G-4593	VOLTAGE REGULATOR	SRTD HXWA MS SCREWS, WELL-NUTS	-	-	A	-	3	2.00
G-6521	WIRING - B/U LAMP WIRE (M/T) > INSTR HRNSS	HXWA AB SCREWS	-	-	A	-	1	2.00
G-6515	WIRING - BLOWER MOTOR/STARTER WIRING	3.17" NYLON STRAP	F	-	A	N	2	5.00
G-5758	WIRING - CLOCK & INSTRUMENT GROUND	RUBBER COATED J-CLIPS	-	-	A	-	4	1.50
G-6292	WIRING - CONSOLE & GROUND	HXWA SCREWS, TOOTH WA	-	-	-	N	4	4.00
G-6505	WIRING - CONSOLE & GROUND - 350	J-CLIP, SCREWS, TOOTH WA	F	-	-	-	8	8.00
G-4885	WIRING - CONSOLE & GROUND (exc 350)	RUBBER COATED J CLIPS, SCREWS, WA'S	F	-	-	-	3	4.00
G-6327	WIRING - CONSOLE INSTRUMENT GROUND	J-CLIP, SCREW, TOOTH WA	-	-	-	N	2	1.50
G-6487	WIRING - CONSOLE LAMP	HXWA SCREW, TOOTH WA	-	-	A	-	4	6.00
G-6455	WIRING - CRUISE CONTROL	RUBBER COATED S CLIPS	-	-	A	-	1	3.00
G-6393	WIRING - DOOR JAMB SW > DEFROST DUCT	5.1" FLEXIBLE STRAP	-	-	A	-	1	3.00
G-5752	WIRING - ENGINE NEAR WIPER MOTOR	RUBBER COATED J-CLIP	-	-	A	-	2	3.00
G-4666	WIRING - FUEL SENDER UNIT GROUND	RUBBER COATED J-CLIP, HXWA SCREW	F	-	A	N	2	1.00
G-6523	WIRING - HORN	HXWA SCREW, TOOTH WA	-	-	A	-	3	7.00
G-6498	WIRING - HORN LEAD - R/S	S CLIPS	F	-	-	-	1	3.00
G-4687	WIRING - INSTR HARNESS > DEFROST DUCT	S CLIP	F	-	-	N	3	4.00
G-6501	WIRING - LAMP MONITOR (Rr) - CONVERTIBLE	J-CLIP, HXWA AB SCREW, FLAT SPR NUT	F	-	-	-	9	18.00
G-6500	WIRING - LAMP MONITOR (Rr) - COUPE	S CLIPS	F	-	A	-	4	8.00
G-6496	WIRING - LICENSE PLATE LAMP - El Camino	S CLIPS	-	-	A	-	1	3.00
G-6451	WIRING - POWER TOP @ LH FENDER	S CLIP	F	-	-	-	3	7.00
G-6503	WIRING - SHIFT (floor) BEZEL > HEATER DUCT	5.1" FLEXIBLE STRAPS	F	-	-	-	1	3.00
G-5193	WIRING - STARTER TERMINALS	RUBBER COATED J CLIP	F	-	A	N	4	1.50
G-6470	WIRING - TRANS (TH400) CONTROL	NUTS, SPLIT & TOOTH WA'S	F	-	-	N	2	5.00
G-5672	WIRING - TRANS OD WIRE EXTENSION	5.1" FLEXIBLE STRAPS	-	-	A	-	1	1.50
G-6499	WIRING - TRUNK LAMP	HX EXT SEMS	F	-	A	N	3	7.00
G-6468	WIRING - UNDERHOOD LAMP	S CLIPS	F	-	-	-	3	6.00
G-6494	WIRING - UNDERHOOD LAMP	5.1" FLEXIBLE STRAP, S CLIPS	-	-	A	-	3	7.00
G-6493	WIRING - UNDERHOOD LAMP	5.1" FLEXIBLE STRAPS	-	-	-	N	2	5.00
G-5195	WIRING "GUTTER" > FIREWALL	5.1" FLEXIBLE STRAPS	F	-	A	-	2	2.00
G-5499	WIRING "GUTTER" > FIREWALL	HX AB FLAT SEMS	-	-	-	N	2	1.50
G-4356	WIRING HARNESS > LH WHEELHOUSE	HXWA AB SCREWS	-	-	A	N	2	3.00
G-6616	WIRING HARNESS > LH WHEELHOUSE @ Rr	PUSH-ENDS BLACK PLASTIC STRAPS	-	-	-	N	1	3.00

Emissions

G-4770	PCV HOSE CLAMPS	< 12-26-68, RUBBER COATED S CLIP	F	-	-	N	2	1.50
G-4890	SMOG HOLE PLUGS - 396	FLAT WOUND SPRING CLAMPS (Black)	F	-	-	N	8	10.00
G-4971	SMOG HOSE CLAMPS	HX PLUGS	F	-	A	N	4	8.00
G-4849	SMOG HOSE CLAMPS w PUMP SIDE VALVE	TOWER TYPE CLAMPS	F	-	A	N	6	12.00
G-6285	SMOG PUMP - 302, 327, 350 w AC	TOWER TYPE CLAMPS	F	-	A	N	7	14.00
G-4247	SMOG PUMP - 302, 327, 350 w/o AC	HX BOLTS, SPLIT WA'S, SPACER	F	-	A	N	8	20.00
G-4896	SMOG PUMP - 396 (F only)	HX BOLTS, WA'S, NUT, 2 SPACERS, STUD	F	-	-	-	5	12.00
G-4848	SMOG PUMP DIVERTER VALVE - 327	HX BOLTS, WA'S, NUT, SPACER	F	-	-	N	4	3.00
G-4895	SMOG PUMP ELBOW, DIVERTER VALVE - 396	HX BOLTS, SPLIT WA'S	F	-	A	N	6	4.00
G-4843	SMOG PUMP PULLEY	HX BOLTS, SPLIT WA'S	F	-	A	N	6	3.00
G-4893	SMOG VALVE & BRACKET - 302, 327, 350	HX BOLTS, SPLIT WA'S	F	-	A	N	8	3.00

See factory Assembly Manuals for illustrations

GM Fastener Kits

347

1968

Exhaust

PART #	APPLICATION	NOTES					PCS	PRICE
			CAMARO	FIREBIRD	CHEVELLE	NOVA		
G-5573	EXHAUST HANGERS, DUAL	HX BOLTS, SPLIT WA'S	-	-	A	-	6	8.00
G-5081	EXHAUST HANGERS, DUAL	HXWA C SCREWS, RETAINERS	-	-	-	N	16	10.00
G-4344	EXHAUST HANGERS, DUAL - 68 Conv, All 69	HX SPLIT SEMS, RIVET NUTS, SCREWS	F	-	-	-	8	8.00
G-4912	EXHAUST HANGERS, DUAL - COUPE	HX T1 SCREWS, HX SPLIT SEMS MS	F	-	-	-	10	10.00
G-4661	EXHAUST HANGERS, SINGLE	SCREWS, SPLIT SEMS, RIVET NUTS	F	-	-	N	4	4.00
G-4846	EXHAUST HANGERS, SINGLE	HX SCREWS, HX SPLIT SEMS	-	-	A	-	5	5.00
G-5266	EXHAUST PIPE > MANIFOLDS	HXWA C SCREWS, RETAINERS	F	-	A	N	12	14.00

Fuel

G-5159	ACCELERATOR CABLE	STUDS, LOCK NUTS	-	-	A	-	2	6.00
G-6359	ACCELERATOR CABLE > FIREWALL	1/4-20 BALL STUD, KEPS NUT	-	-	-	N	1	1.00
G-4351	ACCELERATOR LEVER & SUPPORT	HXWA AB SCREW	F	H	-	N	6	3.00
G-5730	ACCELERATOR LEVER SUPPORT	HX BOLT, HXWA AB SCREWS, WA'S, NUT	-	-	A	-	2	1.50
G-5735	FUEL FILLER NECK - El Camino	HXWA AB SCREWS	-	-	A	-	1	1.00
G-4683	FUEL FILLER NECK > BODY	HXWA AB SCREW	F	-	-	-	8	3.00
G-4667	FUEL FILLER NECK COVER	HXWA AB SCREWS	F	H	-	-	1	1.00
G-4664	FUEL HOSES	HXWA AB SCREW	F	H	-	-	4	3.00
G-6247	FUEL HOSES	FLAT WOUND SPRING CLAMPS (Green)	-	-	-	N	6	3.00
G-5533	FUEL HOSES, 283-4V, 307, 327 (All 68-69A)	FLAT WOUND SPRING CLAMPS (Yellow)	-	-	A	-	4	3.00
G-4334	FUEL TANK FILLER NECK HOSE	FLAT WOUND SPRING CLAMPS (Green)	F	-	-	-	2	6.00
G-5736	FUEL VAPOR HOSES & CLIP	WHITEK TOWER TYPE CLAMPS	-	-	A	-	3	3.00
G-4663	GAS TANK	HXWA SCREW, SPR CLAMPS (Blk & Red)	F	H	-	-	10	8.00
G-5734	GAS TANK	CRG BOLTS, WA'S, NUTS, SCREWS	-	-	A	-	6	6.00
G-6244	GAS TANK	SPECIAL BOLTS, HXWA SCREWS, U-NUTS	-	-	-	N	12	8.00

Heater

G-4764	DEFROSTER DUCTS	BOLTS, WA'S, NUTS, SCREWS, SPACERS	F	-	-	N	4	2.00
G-5711	DEFROSTER DUCTS	HXWA SCREWS, FLAT WA	-	-	A	-	3	2.00
G-4327	HEATER BLOWER MOTOR	HXWA SCREWS	F	-	A	N	5	1.50
G-4326	HEATER BOX > FIREWALL	SRTD HXWA AB SCREWS	F	-	A	N	12	5.00
G-4835	HEATER CONTROL CABLES	HX INT/EXT SEMS, STMPD NUTS, SEALER	F	-	-	-	12	4.00
G-5713	HEATER CONTROL CABLES	HI-HXWA SCREWS, RETAINERS	-	-	A	-	16	5.00
G-6235	HEATER CONTROL CABLES	HXWA SCREWS, HX FLAT SEMS, RTNRS	-	-	-	N	14	6.00
G-6482	HEATER CONTROL CABLES (AC 68A)	HXWA SCREWS, RTNRS, PLASTIC CAP	-	-	A	-	1	3.00
G-5769	HEATER CONTROL CABLES w AC	5.1" FLEXIBLE STRAP	-	-	A	-	12	4.00
G-4834	HEATER DUCT OUTLET (under dash)	HX ABT FLAT SEMS, RETAINERS	F	-	-	-	4	2.00
G-6364	HEATER DUCT OUTLET (under dash)	HX AB FLAT SEMS	-	-	-	N	2	2.00
G-5397	HEATER HOSE CLIP @ WHEELHOUSE	HX ABT FLAT SEMS	F	-	A	N	1	4.00
G-4771	HEATER HOSE SEAL RETAINER - 396, All 68N	FOLDOVER METAL CLIP	F	-	-	N	2	2.00
G-4613	HEATER HOSES	HI-HXWA AB SCREWS	F	-	A	N	4	3.00
G-5478	HEATER or AC OUTLET (LH under dash)	WIRE TYPE SPRING CLAMPS, COL CODED	-	-	A	-	2	1.00
G-4616	HEATER RESISTOR > BOX	HXWA AB SCREWS	F	-	A	N	2	1.00

Interior

G-4704	AIR OUTLET BEZELS (w AC) > DASH	HXWA AB SCREWS	F	-	-	-	8	4.00
G-5764	AIR OUTLET BEZELS (w AC) > DASH	PH OV SCREWS, CONI SEMS, SPR NUTS	-	-	A	-	13	4.00
G-6277	AIR OUTLET BEZELS (w AC) > DASH	PH OV SEMS, HXWA SCREWS, SPR NUTS	-	-	-	N	8	4.00
G-5383	ARMREST PAD & BASE @ Fr DOORS	PH OV AB FINWA SEMS, SPRING NUTS	F	-	A	-	10	5.00
G-6683	ARMREST PAD & BASE @ Rr SEATS - COUPE	CHROME PH RND & PH FLAT SCREWS	-	-	A	-	8	4.00
G-5421	ARMRESTS (Rr) - DLX CONVERTIBLE	PH FLAT B & PH RND AB SCREWS	F	-	-	-	8	3.00
G-5420	ARMRESTS (Rr) - DLX COUPE	CHROME PH OV AB FINWA SEMS .50" OD	F	-	-	-	4	2.00
G-4832	ASH TRAY RETAINER	CHROME PH OV AB FINWA SEMS .50" OD	F	-	-	-	3	1.50
G-5699	ASH TRAY RETAINER	PH PN AB SCREWS	-	-	A	-	3	1.50
G-6231	ASH TRAY RETAINER	PH PN SCREWS, PH OV AB FLUSH SEMS	-	-	-	N	3	1.50
G-5406	COAT HOOK	PH PN AB SCREWS	F	-	-	-	2	1.00
G-6643	COAT HOOKS	CHROME PH PN SCREW	-	-	A	-	2	1.50
G-6276	CONSOLE - ASH TRAY DOOR	SS/CHROME PH OV SCREWS	F	-	-	-	4	4.00
G-4878	CONSOLE > FLOOR	RIVETS, RETAINERS	F	-	-	-	6	6.00
G-5788	CONSOLE > FLOOR	HX PP CONI SEMS, RIV-NUTS, FLNG NUTS	-	-	A	-	7	3.00
G-6288	CONSOLE > FLOOR	HXWA, PH OV, PAN HD SCREWS	-	-	-	N	8	3.00
G-6588	CONSOLE ASH TRAY DOOR BUMPERS	HXWA & PH OV SCREWS, SPRING NUTS	F	-	-	-	2	2.00
G-4880	CONSOLE DOOR & HINGE	RUBBER BUMPERS	F	-	-	-	8	3.00
G-5793	CONSOLE DOOR & HINGE	PH PN SCREWS	-	-	A	-	6	2.00

Kits Contain Attaching Fasteners for Both Sides

GM Fastener Kits

1968

Interior

PART #	APPLICATION	NOTES					PCS	PRICE
			CAMARO	FIREBIRD	CHEVELLE	NOVA		
G-6587	CONSOLE DOOR BUMPERS	CHROME PH PN SCREWS	F	-	-	-	2	2.00
G-6586	CONSOLE DOOR BUMPERS	RUBBER BUMPERS	-	-	A	-	2	2.00
G-5790	CONSOLE END COVER	RUBBER BUMPERS	-	-	A	-	4	2.00
G-4881	CONSOLE INSERT & EMBLEM	CHROME PH OV SCREWS	F	-	-	-	10	3.00
G-5698	CONSOLE INSERT & EMBLEM	STAMPED NUTS, FLAT WA'S	-	-	-	N	7	1.50
G-4921	CONSOLE INSTRUMENT CLUSTER	STAMPED NUTS	F	-	-	-	8	3.00
G-4884	CONSOLE LAMP LENS	HI-HXWA SCREWS, FLAT WA'S	F	-	-	-	2	1.50
G-5791	CONSOLE MOULDINGS	HXWA BT SCREWS	-	-	A	-	14	2.00
G-4879	CONSOLE TOP FRAME & BRACKETS	STAMPED NUTS ONLY	F	-	-	-	9	3.00
G-5392	DASH PAD	HXWA & PH PN BT SCREWS	F	-	-	-	9	9.00
G-6232	DASH PAD	PH PN AB SCREWS, STAMPED NUTS	-	-	-	N	10	4.00
G-5650	DOME LAMP	HXWA AB SCREWS & NUTS ONLY !	F	-	A	-	2	1.50
G-5419	DOOR HANDLE PLATES - DLX	PH PN SCREWS	F	-	-	-	6	3.00
G-5396	DOOR HANDLES (inside) - DLX	CHROME PH OV SEMS	F	-	-	-	4	4.00
G-5409	DOOR HANDLES (inside) - STD	PH OV SCREWS	F	-	-	-	2	1.00
G-5384	DOOR PANELS	WIRE RETAINERS	F	-	A	-	32	12.00
G-5394	DOOR PULL STRAPS	CLIPS, PLUGS (flexible !), PH OV AB SEMS	F	-	-	-	4	3.00
G-5704	EMBLEM, ABOVE GLOVE BOX - DLX	#14 PH PN (#10 HD) AB SCREWS	-	-	A	-	2	1.00
G-4358	GLOVE BOX DOOR	STAMPED NUTS	F	-	-	-	2	2.00
G-4947	GLOVE BOX DOOR	PH PN CONI SEMS	-	-	-	N	3	2.00
G-5701	GLOVE BOX DOOR & LINER w/o AC	HX AB FLAT SEMS	-	-	A	-	7	4.00
G-6585	GLOVE BOX DOOR BUMPERS	PH RNDWA AB SCREWS, CONI KEPS NUTS	F	-	A	N	2	2.00
G-5771	GLOVE BOX DOOR, LINER & SHIELD w AC	RUBBER BUMPERS	-	-	A	-	9	4.00
G-4357	GLOVE BOX LATCH & STRIKER	CONI KEPS NUTS, PH RNDWA AB SCREWS	F	-	-	-	4	2.00
G-4359	GLOVE BOX LINER	PH PN AB FLAT SEMS, PH PN T SCREWS	F	-	-	-	14	6.00
G-4360	GLOVE BOX LINER	PH PN AB FLAT SEMS, SPRING NUTS	-	-	-	N	6	3.00
G-5702	GLOVE BOX STRIKER	PH PN AB FLAT SEMS	-	-	A	-	4	2.00
G-4943	GLOVE BOX STRIKER	SCREWS, SPRING NUTS	-	-	-	N	2	1.50
G-4942	GRAB BAR (above glove box)	PN PN AB FLAT SEMS	F	-	-	-	2	1.50
G-6651	HEADLINER RETAINERS - Fr & SIDES	STAMPED NUTS	-	-	A	-	22	3.00
G-5714	HEATER CONTROL & BRACKET > DASH	5/16 AF HXWA AB SCREWS	-	-	A	-	12	4.00
G-4618	HEATER CONTROL > DASH	PH OV SEMS, HXWA SCREWS, SPR NUTS	F	-	-	-	4	3.00
G-5703	INSTR PANEL MOULDING ABOVE GLOVE BOX	PH PN AB SCREWS	-	-	A	-	5	2.00
G-6271	INSTRUMENT CLUSTER & CARRIER > DASH	STAMPED NUTS	-	-	-	N	14	4.00
G-5756	INSTRUMENT CLUSTER > CARRIER	PH OV & HX AB FLAT SEMS, SPR NUTS	-	-	A	-	7	3.00
G-4685	INSTRUMENT CLUSTER > DASH	HI-HXWA & PH OV AB SCREWS	F	-	-	-	14	5.00
G-6270	INSTRUMENT CLUSTER > DASH	PH OV AB SCREWS, SPRING NUTS	-	-	-	N	18	5.00
G-5755	INSTRUMENT CLUSTER CARRIER > DASH	HX & OV AB FLUSH SEMS, SPRING NUTS	-	-	A	-	22	6.00
G-4617	INSULATION > FIREWALL	CHROME PH OV AB SEMS, SPRING NUTS	F	-	-	-	4	6.00
G-5825	INSULATION > FIREWALL	RUBBER RETAINERS	-	-	-	N	3	5.00
G-5390	KICK PANELS	RUBBER RETAINERS	F	-	-	-	10	3.00
G-5762	KICK PANELS w AC	CHROME PH OV FINISH WA SEMS, .50" DIA	-	-	A	-	4	3.00
G-4621	MIRROR (inside Rr view) > BRACKET	PH OV AB FLUSH SEMS	F	-	A	N	1	2.00
G-6691	MIRROR (inside Rr view) BRACKET	CHROME SLOT OV SHLDR SCREW	-	-	A	-	3	1.00
G-5597	MIRROR, REMOTE CONTROL BEZEL > DOOR	PH PN AB SCREWS	-	-	A	N	2	1.50
G-5435	MOULDINGS - CONVERTIBLE HEADER	SS/CHROME PH OV AB SCREWS	F	-	-	-	5	3.00
G-5388	PILLAR MOULDINGS - CONVERTIBLE	SS/CHROME PH OV AB SCREWS	F	-	-	-	4	2.00
G-6684	PILLAR MOULDINGS - CONVERTIBLE	PH OV AB SCREWS	-	-	A	-	4	3.00
G-6571	PILLAR MOULDINGS - COUPE	PH OV AB SEMS, PH RNDWA TEK SCREWS	F	-	-	-	6	3.00
G-5142	QUARTER TRIM PANELS - MAIN	PH OV AB FLUSH SEMS	F	-	-	-	2	1.50
G-6943	QUARTER TRIM PANELS - MAIN	CHROME PH PN AB SCREWS	-	-	A	-	4	2.00
G-5408	QUARTER TRIM PANELS @ Rr WINDOW SIDES	PH OV FINWA SEMS	F	-	-	-	4	1.50
G-4913	QUARTER TRIM SAIL PANELS	PH OV AB SCREWS	F	-	-	-	6	4.00
G-6648	QUARTER TRIM SAIL PANELS	RETAINING CLIPS	-	-	A	-	4	3.00
G-4928	RADIO CONTROL SHAFTS & KNOBS	RETAINING CLIPS	F	-	A	N	3	4.00
G-4620	RADIO OPENING TRIM PLATE & RETAINER	SPECIAL THIN HX NUT, SPRING WA'S	F	-	-	-	5	2.00
G-5415	ROCKER PANEL COVER PLATES	PN HD AB SCREWS	F	-	-	-	8	2.00
G-4321	SCUFF PLATES, DOOR OPENING	PH PN AB SCREWS	F	-	A	-	8	2.50
G-6148	SCUFF PLATES, DOOR OPENING	SS/CHROME PH OV AB SCREWS	-	-	-	N	12	3.00
G-5375	SEAT BACK (Fr) STOP BUMPERS	SS/CHROME PH OV AB SCREWS	F	-	-	-	2	1.50
G-6657	SEAT BACK (Fr) STOP BUMPERS	CHROME PH PN AB SCREWS	-	-	A	-	4	1.50
G-5398	SEAT BACK (Fr) STRIKERS	PH PN AB SCREWS	F	-	-	-	4	4.00
G-5380	SEAT BACK (Rr) > BODY	TRIM HX CA CONI SEMS	F	-	A	-	2	3.00
G-5376	SEAT BACK CABLE	HX AB CONI TOOTH SEMS	F	-	-	-	2	3.00
G-5381	SEAT BACK PANELS	PH WAFER MS SHLDR SCREWS	F	-	-	-	4	3.00
G-6659	SEAT BACK PANELS	PH PN AB FLAT SEMS	-	-	A	-	6	2.00
G-6658	SEAT BACK RELEASE ESCUTCHEONS	PH PNWA FLAT TOP SCREWS	-	-	A	-	8	2.00
G-5654	SEAT BELT BUCKLE RETAINERS	CHROME PH OV AB SCREWS	-	-	A	N	4	6.00
G-6536	SEAT BELTS (Fr)	CHROME PH OV SCREWS, FL SPR NUTS	F	-	-	-	4	18.00
G-6537	SEAT BELTS (Rr)	CHROME & ZDC BOLTS w NYLON PELLET	F	-	-	-	4	16.00
G-6161	SEAT PIVOT	ZDC PLATED BOLTS w NYLON LOCK	F	-	-	-	4	3.00
G-5379	SEAT PIVOT COVERS	"E" CLIPS	F	-	-	-	4	8.00
G-6656	SEAT SIDE PANELS	ORIGINAL METAL RETAINERS	-	-	A	-	12	3.00
G-5148	SEAT TRACKS > FLOOR	.41 DIA PH RNDWA SCREWS	F	-	-	-	8	6.00
G-6653	SEAT TRACKS > FLOOR	HX CONI TOOTH SEMS	-	-	A	-	8	5.00

See factory Assembly Manuals for illustrations

GM Fastener Kits

349

1968

Interior

PART #	APPLICATION	NOTES					PCS	PRICE
			CAMARO	FIREBIRD	CHEVELLE	NOVA		
G-5407	SHOULDER HARNESS RETAINERS	HX CONI TOOTH SEMS, PERI KEPS	F	-	A	-	8	2.00
G-6566	SHOULDER STRAPS > ROOF	CHROME PH OV AB SCREWS	F	-	-	-	4	8.00
G-4619	STEERING COLUMN COVER > DASH	PH PN MS SCREWS w NYLON PELLETT	F	-	-	-	4	3.00
G-5700	STEERING COLUMN COVER > DASH	PH PN CONI SEMS	-	-	A	-	8	4.00
G-4762	STEERING COLUMN COVER > FIREWALL	PH OV AB FLUSH SEMS, SPRING NUTS	F	-	-	N	2	3.00
G-5925	STEERING COLUMN COVER > FIREWALL	HX AB FLAT SEMS w SEALER	-	-	A	-	2	2.00
G-4914	STEERING WHEEL SHROUD	HXWA AB SCREWS	F	-	A	-	3	2.00
G-4915	STEERING WHEEL SHROUD EMBLEM	PH PN F SCREWS	F	-	A	N	2	1.50
G-5377	SUN VISOR & MIRROR BRACKETS - COUPE	STAMPED NUTS	F	-	A	-	9	3.00
G-5422	SUN VISOR BRACKETS - CONVERTIBLE	SS/CHROME PH OV & PH PN AB SCREWS	F	-	-	-	4	3.00
G-6670	SUN VISOR BRACKETS - CONVERTIBLE	SS/CHROME PH OV MS SCREWS	-	-	A	-	6	4.00
G-5378	SUN VISOR CLAMPS	CHROME PH OV SCREWS w #12 HD	F	-	A	-	2	2.00
G-5187	VENTILATION DUCT ADAPTERS > COWL	CHROME SLOT FILL SCREWS	F	-	-	-	6	3.00
G-4833	VENTILATION OUTLET BEZELS	PH PN AB EXT SEMS	F	-	-	-	6	3.00
G-5400	WINDOW CRANK HANDLES	CHROME PH OV AB SCREWS, SPR NUTS	F	-	A	-	4	1.50

Mouldings

G-5632	FENDER MOULDINGS	RETAINING CLIPS	-	-	A	-	4	2.00
G-6335	FENDER MOULDINGS - LWR	STAMPED NUTS	-	-	-	N	6	3.00
G-4493	HEADER & FENDER "EYE BROW" MOULDINGS	STAMPED NUTS ONLY !	-	-	A	-	12	4.00
G-4296	HEADLAMP COVER MOULDINGS - R/S	STAMPED NUTS	F	-	-	-	10	3.00
G-6255	HOOD & FENDER Fr MOULDINGS	BLACK SEMI-TUBULAR RIVETS	-	-	-	N	20	4.00
G-4624	ROCKER MOULDINGS	Does hood emblem, STMPD NUTS, CAPS	F	-	-	-	14	4.00
G-5706	ROCKER MOULDINGS	PH PN BT & PH OV SS/CHROME SCREWS	-	-	A	N	24	4.00
G-6336	ROCKER MOULDINGS @ WELD SEAM	PH PN AB SCREWS ONLY	-	-	-	N	14	4.00
G-4196	WHEEL OPENING MOULDINGS	HX AB FLAT SEMS	F	H	-	-	28	6.00
G-4496	WHEEL OPENING MOULDINGS	CHROME/SS PH RNDWA AB SCREWS	-	-	A	-	32	6.00
G-6544	WINDOW (Fr) MOULDINGS	CHROME/SS PH RNDWA AB SCREWS	-	-	A	-	32	12.00
G-6555	WINDOW (Fr) MOULDINGS	RETAINING CLIPS, PH PN AB SCREWS	-	-	-	N	32	12.00
G-6561	WINDOW (Fr) MOULDINGS - CONVERTIBLE	RETAINING CLIPS, PH PN AB SCREWS	-	-	A	-	26	12.00
G-4665	WINDOW (Fr) MOULDINGS, LWR	RETAINING CLIPS, PH PN AB SCREWS	F	-	-	N	8	12.00
G-4639	WINDOW (Fr) MOULDINGS, SIDES, UPR	RETAINING CLIPS (less the 2 end clips)	F	-	-	-	13	8.00
G-6553	WINDOW (Fr) MOULDINGS, SIDES, UPR - CONV	RETAINING CLIPS	F	-	-	-	13	8.00
G-6552	WINDOW (Fr) MOULDINGS, SIDES, UPR - VINYL	RETAINING CLIPS	F	-	-	-	13	8.00
G-6556	WINDOW (Fr) MOULDINGS, SIDES, UPR - VINYL	RETAINING CLIPS	-	-	-	N	20	12.00
G-6539	WINDOW (Rr) MOULDINGS	RETAINING CLIPS, SCREWS	F	-	-	-	20	12.00
G-6549	WINDOW (Rr) MOULDINGS	RETAINING CLIPS	-	-	A	-	20	12.00
G-6558	WINDOW (Rr) MOULDINGS	RETAINING CLIPS	-	-	-	N	20	12.00
G-6550	WINDOW (Rr) MOULDINGS - El Camino	RETAINING CLIPS	-	-	A	-	20	12.00
G-6551	WINDOW (Rr) MOULDINGS - El Camino - VINYL	RETAINING CLIPS	-	-	A	-	20	12.00
G-6560	WINDOW (Rr) MOULDINGS - Vinyl Top	RETAINING CLIPS	-	-	A	-	20	12.00
G-6559	WINDOW (Rr) MOULDINGS - Vinyl Top	RETAINING CLIPS	-	-	-	N	20	12.00

Steering & Suspension

G-4631	AXLE HSNQ > SPRINGS	RETAINING CLIPS	F	-	-	N	8	12.00
G-6639	AXLE HSNQ > SPRINGS - 302/350/396	SPECIAL GR-8 LOCK NUTS ONLY !	F	H	-	N	14	38.00
G-5904	AXLE HSNQ > SPRINGS (mono spring)	MULTI SPRINGS, T, U BOLTS, LOCK NUTS	F	H	-	N	16	26.00
G-6151	BALL JOINTS - UPPER	SPECIAL GR-8 LOCK NUTS & T BOLTS	F	-	A	N	10	6.00
G-4612	CONTROL ARM BUSHINGS - UPPER	SOLID RIVETS (2 are extra)	F	H	A	N	12	12.00
G-4608	CONTROL ARMS - LWR	HX BOLTS "SSC", WA'S, RETAINERS	F	H	A	N	8	20.00
G-4627	CONTROL ARMS - UPPER	POINTED BOLTS, LOCK NUTS	F	H	A	N	18	14.00
G-4610	CONTROL ARMS (Rr)	GR-8 KNURL BOLTS, LOCK NUTS, SHIMS	-	-	A	-	16	32.00
G-5539	FRAME REINFORCEMENTS - HP APPLICATIONS	GR-8 POINTED BOLTS, LOCK NUTS	-	-	A	-	2	3.00
G-4669	GREASE FITTINGS	HARDENED FLAT WA'S	F	H	A	N	10	3.00
G-4265	IDLER ARM > FRAME	STRAIGHT	F	H	A	N	6	6.00
G-4606	LEAF SPRING, Fr HANGERS	GR-8 HX BOLTS, WA'S, NUTS	F	H	-	N	12	18.00
G-4630	LEAF SPRINGS, Fr EYE	HX CA CONI SEMS, SPECIAL U-NUTS	F	H	-	N	8	12.00
G-5679	P/S PUMP - 283, 327 (A only)	GR-8 BOLTS, NUTS, WA'S	-	-	A	-	14	12.00
G-4917	P/S PUMP - 302, 327HP (68N), 350 (FN only)	HX BOLTS, SPACER, WA'S, NUTS	F	-	-	N	13	10.00
G-4916	P/S PUMP - 327 (FN only)	HX BOLTS, HX SPLIT SEMS, WA'S, NUTS	F	-	-	N	14	8.00
G-5681	P/S PUMP - 396 (66 SMOG) (A only)	HX BOLTS, HX SPLIT SEMS, WA'S, NUTS	-	-	A	-	13	12.00
G-4918	P/S PUMP - 396 (FN only)	HX BOLTS, NUTS, WA'S	F	-	-	N	13	10.00
G-4807	P/S PUMP PULLEY	HX BOLTS, HX SPLIT SEMS, WA'S, NUTS	F	-	A	N	1	6.00
G-5083	P/S PUMP RESERVOIR - 396	THIN LOCK NUT	-	-	A	-	1	1.00
G-5682	P/S RESERVOIR HOSE - 396	HXWA SCREW	-	-	A	-	2	5.00
G-4919	P/S RETURN HOSE	WHITEK TOWER TYPE CLAMPS	F	-	A	N	2	20.00
G-4668	PITMAN ARM > GEAR BOX	ORIGINAL CLAMPS	F	H	A	N	2	3.00

Kits Contain Attaching Fasteners for Both Sides

GM Fastener Kits

1968

Steering & Suspension

PART #	APPLICATION	NOTES					PCS	PRICE
			CAMARO	FIREBIRD	CHEVELLE	NOVA		
G-4838	SHACKLES	HX NUT, SPLIT WA	F	H	-	N	4	6.00
G-4634	SHOCK BRACKETS (Rr) > BODY	11/16" AF MARSDEN NUTS ONLY	F	H	-	-	8	6.00
G-4585	SHOCKS (Fr) - LWR MOUNTING	HX SPLIT SEMS, SEALING WA'S	F	H	-	N	4	3.00
G-4586	SHOCKS (Fr) - LWR MOUNTING	HX PP CONI SEMS	-	-	A	-	8	8.00
G-4836	SHOCKS (Fr) - UPR MOUNTING	HXWA CA SCREWS, U-NUTS	F	-	A	N	10	6.00
G-5483	SHOCKS (Rr)	RETAINERS, BUSHINGS, 3/8-24 NUTS	-	-	A	-	16	8.00
G-4632	SHOCKS (Rr) LWR MOUNTING - MONO SPRING	BOLTS, LOCK NUTS, FLAT & SPLIT WA'S	F	H	-	N	6	4.00
G-4898	SHOCKS (Rr) LWR MOUNTING - MULTI SPRING	HX BOLTS, NUTS, SPLIT WA'S	F	H	-	N	4	3.00
G-6101	SHOCKS (Rr) UPR MOUNTING	THICK HX NUTS, SPLIT WA'S	F	-	-	-	10	8.00
G-6100	SHOCKS (Rr) UPR MOUNTING	RETAINERS, BUSHINGS, 3/8-24 NUTS	-	-	-	N	4	6.00
G-4675	SPARE WHEEL (F convertible only)	HX SPLIT SEMS	F	-	-	-	2	14.00
G-6938	SPARE WHEEL (F coupe only)	7 7/8" J-BOLT, WING NUT	F	-	A	N	2	14.00
G-4628	STABILIZER BAR (Fr) BRACKETS	5 7/8" J-BOLT, WING NUT	F	H	A	N	4	6.00
G-4837	STABILIZER BAR (Fr) END LINKS	HXWA C SCREWS	F	H	-	N	22	20.00
G-5481	STABILIZER BAR (Fr) END LINKS	HX BOLTS, RETAINERS, BUSHINGS, NUTS	-	-	A	-	22	25.00
G-4672	STEERING COLUMN > DASH	HX BOLTS, RETAINERS, BUSHINGS, NUTS	F	-	-	-	9	5.00
G-5741	STEERING COLUMN > DASH	HX CONI SEMS, HX BOLTS, FLNG NUTS	-	-	A	-	10	6.00
G-6250	STEERING COLUMN > DASH	HXWA PP SCREWS, BOLT, NUTS, WA	-	-	-	N	6	4.00
G-4354	STEERING GEAR "RAG" JOINT	HX CONI SEMS, FLNG NUTS	F	H	A	N	1	3.00
G-4293	STEERING GEAR BOX > FRAME	12 PT BOLT ONLY	F	H	-	N	6	12.00
G-5180	STEERING GEAR BOX > FRAME	GR-8 HX BOLTS, FLAT WA'S	-	-	A	-	6	12.00
G-4615	STEERING LINKAGE & BALL JOINTS	GR-8 HX BOLTS, FLAT WA'S	F	H	A	N	20	10.00
G-4670	STEERING SHAFT > COUPLING	SLOTTED NUTS, COTTER PINS	F	H	A	N	4	3.00
G-4674	STEERING WHEEL	REG & HVY NUTS, SPLIT WA'S	F	-	A	-	2	3.00
G-4802	STEERING WHEEL - DLX	HX JAM NUT, FLAT WA	F	-	A	N	6	3.00
G-5716	SUSPENSION BUMPER & BRACKET (Rr)	SS PH FLAT MS SCREWS	-	-	A	-	7	3.00
G-4336	SUSPENSION BUMPER BRACKETS (Rr)	HX BOLTS, NUTS, SPLIT WA'S	F	H	-	-	6	6.00
G-4596	SUSPENSION BUMPERS (Fr)	HX PP CONI SEMS	F	H	A	N	2	1.00
G-6316	SUSPENSION BUMPERS (Fr) - 350, 396	HX NUTS	-	-	-	N	6	3.00
G-4335	SUSPENSION BUMPERS (Rr)	HX NUTS, FLNG NUTS, WA'S	-	-	-	N	4	3.00
G-5484	SUSPENSION BUMPERS (Rr) - El Camino	HXWA C SCREWS	-	-	A	-	3	2.00
G-6583	WHEEL STUDS - 1 AXLE (Fr or Rr)	HX BOLTS, NUTS, SPLIT WA'S	F	-	A	N	10	14.00
G-5060	WHEELS - STD	Does 2 wheels, 7/16-20 x 1.38" L	F	-	A	N	20	25.00

Transmission

G-6611	BELL HOUSING > ENGINE	ORIGINAL LUG NUTS w "DIAMONDS"	F	-	A	N	6	8.00
G-6149	BELL HOUSING > ENGINE	FLNG BOLTS, "M" MARKING	F	-	A	N	6	8.00
G-5416	BELL HOUSING Fr COVER PLATE	FLNG BOLTS (Flat Top) "A" MARKING	F	-	A	N	4	3.00
G-5907	CLUTCH BELLCRANK	SS EXT SEMS "L"	F	-	A	N	9	32.00
G-4660	CLUTCH BELLCRANK BRACKET > FRAME	BALL STUDS, SEATS, RETAINER, WA'S	F	-	-	N	3	4.00
G-5603	CLUTCH PEDAL BUSHINGS	HXWA SCREWS	F	-	A	N	2	3.00
G-4658	CLUTCH PEDAL PUSH ROD SEAL	NYLON BUSHINGS ONLY	F	-	-	N	2	1.00
G-4850	CLUTCH PEDAL PUSH RODS	HXWA AB SCREWS	F	-	A	N	3	3.00
G-4659	CLUTCH PEDAL RETAINER	RETAINING CLIPS ONLY	F	-	A	N	1	3.00
G-4792	COVER - CLUTCH PEDAL HOLE	FOLDED SPRING METAL	F	-	-	N	2	1.50
G-4629	DRIVESHAFT > REAR KNUCKLE	HXWA SCREWS	F	H	A	N	10	8.00
G-4796	DRIVESHAFT, TH400 '69 > 302, 350, BB. All 71 >	U-BOLTS, NUTS, WA'S	F	-	A	-	6	8.00
G-6573	FLYWHEEL - A/T	STRAPS, FLNG BOLTS	F	-	A	N	12	16.00
G-4429	FLYWHEEL - M/T	GR-8 HXWA SCREWS	F	-	A	N	12	12.00
G-4798	FLYWHEEL (TH400) > CONVERTOR	11/16" AF X 1.0" L HX BOLTS	F	-	A	N	3	5.00
G-6150	PRESSURE PLATE > FLYWHEEL	3/8-16 GR-5 HX BOLTS, 11/16" AF	F	-	A	N	12	6.00
G-4899	SHIFTER (TH400) LENS & HOUSING > FLOOR	SPECIAL HX BOLTS, SPLIT WA'S	F	-	-	-	14	4.00
G-4528	SHIFTER BEZEL & SEAL RETAINER - M/T	HXWA & PH OV AB SCREWS, SPR NUTS	-	-	A	N	10	3.00
G-4908	SHIFTER CABLE - PG, TH400 w CONSOLE	w/o CONSOLE, HXWA AB SCREWS	F	-	A	-	6	6.00
G-5733	SHIFTER CONTROL - HD 3 SPD or 4 SPD	U & PUSH RETAINERS, NUT, WA	-	-	A	-	16	8.00
G-4783	SHIFTER CONTROL & SUPPORT (exc 69F M20)	HX BOLTS, WA'S, NUTS	F	-	-	N	13	4.00
G-4786	SHIFTER DIAL RETAINER - FIXED COLUMN	HX BOLTS, NUTS, SPLIT WA'S	F	-	-	-	2	1.50
G-5732	SHIFTER HANDLE - HD 3 SPD M/T, 70-72 4 SPD	CHROME OV HD BT SCREWS	-	-	A	-	2	3.00
G-4907	SHIFTER LEVER > FLOOR - A/T w CONSOLE	HX SPLIT SEMS	F	-	-	-	9	5.00
G-4852	SHIFTER LEVER > FLOOR - A/T w CONSOLE	HX BOLTS, RIVET NUTS, SPLIT WA'S	-	-	A	-	3	2.00
G-4790	SHIFTER LEVER > FLOOR - PG, TH400 w CNSL	HXWA AB SCREWS	-	-	-	N	4	2.00
G-5897	SHIFTER LEVERS > CASE - 3 SPD M/T	HXWA T1 SCREWS	F	-	A	N	6	3.00
G-4781	SHIFTER LEVERS > CASE - 4 SPD STD	HX BOLTS, SPLIT & FLAT WA'S	F	-	-	N	9	3.00
G-5799	SHIFTER LEVERS > CASE - 4 SPD STD	HX BOLTS, FLAT & SPLIT WA'S	-	-	A	-	6	4.00
G-5798	SHIFTER LINKAGE, A/T FLOOR - TH350, TH400	HX SPLIT SEMS, FLAT WA'S	F	-	-	N	9	4.00
G-4900	SHIFTER LINKAGE, A/T FLOOR SHIFT	RETAINERS, NUTS, FLAT WA'S	F	-	-	-	6	3.00
G-4791	SHIFTER LINKAGE, A/T FLOOR SHIFT - PG	RETAINING CLIPS, FLAT WA'S ONLY	-	-	-	N	9	4.00
G-4883	SHIFTER PLATE - A/T CONSOLE	RETAINERS, FLAT WA'S, NUTS	F	-	-	-	12	4.00
G-4901	SHIFTER PLATE & SEAL RETAINERS - 4 SPD	PH OV B SCREWS, STAMPED NUTS	F	-	-	-	7	3.00
G-6291	SHIFTER PLATE & SEALS - A/T CONSOLE	PH OV T & BT SCREWS	-	-	-	N	14	4.00
G-4882	SHIFTER PLATE & SEALS - M/T CONSOLE	HXWA T, PH OV AB SCREWS, SPR NUTS	F	-	-	-	12	4.00

See factory Assembly Manuals for illustrations

1968

Transmission

PART #	APPLICATION	NOTES					PCS	PRICE
			CAMARO	FIREBIRD	CHEVELLE	NOVA		
G-6290	SHIFTER PLATE & SEALS - M/T CONSOLE	PH OV B & T SCREWS, STAMPED NUTS	-	-	-	N	16	4.00
G-5796	SHIFTER PLATE, LENS, SEAL - A/T CONSOLE	PH OV & HXWA SCREWS, SPRING NUTS	-	-	A	-	12	3.00
G-4780	SHIFTER RODS - 4 SPD	HXWA, OV SCREWS, STMPD NUTS, WA'S	F	-	A	N	12	10.00
G-4778	SHIFTER RODS - HD 3 SPD	RETAINING CLIPS, JAM NUTS	F	-	-	-	8	6.00
G-5786	SHIFTER SEAL RETAINER - M/T CONSOLE	RETAINERS, NUTS	-	-	A	-	6	2.00
G-4904	SHIFTER STAB 68FN 327, 69FN, 68-72AN 3, 4	HXWA AB SCREWS	F	-	A	N	8	12.00
G-4903	SHIFTER STAB SHAFT - M/T (302/350/396)	Floor Shift. BOLTS, NUTS, RET'S, BSHNGS	F	-	-	N	9	12.00
G-5792	SHIFTER TRIM PLATE (console only)	HX BOLTS, NUTS, RETAINERS, BUSHINGS	-	-	A	-	6	2.00
G-5795	SHIFTER TRIM PLATE EMBLEM	PH OV C SCREWS	-	-	A	-	2	1.00
G-4694	SPEDOMETER CABLE > TRANS	STAMPED NUTS	F	H	A	N	1	2.00
G-4788	TORQUE CONVERTOR > FLYWHL - PG, TH350	HX SPLIT SEMS	F	-	A	N	9	8.00
G-4795	TRANS (Powerglide) KICKDOWN LINKAGE	PLACE BOLTS, NUTS, WASHERS	F	-	A	N	5	4.00
G-4662	TRANS (Powerglide) KICKDOWN LINKAGE 396	ROD END CLIP, NUTS, WA'S	-	-	A	-	6	2.00
G-5286	TRANS (TH400) CONTROL SW (at gas pedal)	COTTER PIN, NUTS, WA'S	-	-	A	-	1	1.00
G-4911	TRANS CONTROL SW & LEVER - TH400	HXWA AB SCREW	F	-	-	N	5	3.00
G-4169	TRANS CROSSMEMBER	HX BOLT, SCREW, NUT, INT TOOTH WA	F	H	A	N	14	6.00
G-4603	TRANS INSULATOR	HX BOLTS, WA'S (RH SIDE), NUTS	F	H	-	N	10	6.00
G-4604	TRANS INSULATOR (exc 69 TH400)	HX BOLTS, FLAT & SPLIT WA'S	-	-	A	-	12	6.00
G-5677	TRANS LINKAGE - A/T TH400, All 69, 72 M38	HX BOLTS, FLAT & SPLIT WA'S	-	-	A	-	7	12.00
G-5561	TRANS LINKAGE or BACKDRIVE SUPPORT	RETAINERS, SWIVEL, NUT, WA'S	F	-	A	N	3	3.00
G-5069	TRANS LINKAGE SUPPORT > FRAME	> FRAME: HXWA C SCREWS	F	-	A	N	2	2.00
G-5670	TRANS OD CONTROL HANDLE & CABLE	HXWA C SCREWS	-	-	A	-	9	4.00
G-6308	TRANS OIL PAN - PG (exc 68-72 console)	SCREWS, BOLT, HX & SPRING NUTS, WA'S	F	-	A	N	14	7.00
G-6309	TRANS OIL PAN - PG w CONSOLE	LRG FLNG HEAD SCREWS	F	-	A	N	14	7.00
G-6311	TRANS OIL PAN w CNSL TH350 73-81, TH400	LRG FLNG HEAD SCREWS, SPLIT SEMS	F	-	A	N	13	7.00
G-6310	TRANS OIL PAN w/o CNSL - TH350 All, TH400	LRG FLNG HEAD SCREWS	F	-	A	N	13	6.00
G-5671	TRANS OVERDRIVE (OD) RELAY	LRG FLNG HEAD SCREWS	-	-	A	-	2	1.50
G-5070	TRANSMISSION (A/T) > ENGINE (exc 67-68 PG)	HXWA AB SCREW, PLASTIC CAP	F	-	A	N	9	6.00
G-4787	TRANSMISSION (Powerglide) > ENGINE	HX BOLTS, SPLIT & FLAT WA'S	F	-	A	N	9	6.00
G-4590	TRANSMISSION (STD) > BELL HOUSING	HX BOLTS, FLAT & SPLIT WA'S (for brkts)	F	-	A	N	8	5.00
G-4866	TRANSMISSION LINKAGE - A/T CLM SHIFT	HX BOLTS, SPLIT WA'S	F	-	-	N	11	16.00
G-5673	TRANSMISSION LINKAGE - A/T CLM SHIFT	RETAINERS, FITTINGS, NUTS, WA'S	-	-	A	-	9	16.00
G-5901	TRANSMISSION LINKAGE - M/T CLM SHIFT	RETAINERS, FITTINGS, NUTS, WA'S	F	-	-	N	18	20.00
G-5731	TRANSMISSION LINKAGE - M/T CLM SHIFT	RETAINERS, FITTINGS, NUTS, WA'S	-	-	A	-	15	24.00
G-4909	TRANSMISSION OIL COOLER LINES	RETAINERS, FITTINGS, NUTS, WA'S	F	-	A	N	2	3.00
G-4906	UNDERPAN - Powerglide A/T	C SHAPED SPRING CLIPS	F	-	A	N	4	3.00
G-4735	UNDERPAN - TH400, 70F PG	HX PP CONI SEMS	F	-	A	N	4	2.00

Wipers

G-4302	WINDSHIELD WASHER BOTTLE BRACKET	HX T1 SCREWS	F	-	A	N	3	2.00
G-4940	WINDSHIELD WASHER BOTTLE BRACKET - R/S	HXWA AB SCREWS	F	-	-	-	5	2.00
G-4303	WINDSHIELD WASHER NOZZLES	HXWA & PH PN AB SCREWS	F	-	A	N	2	1.25
G-6432	WINDSHIELD WIPER HOSES	#8 HXWA B SCREWS	F	-	-	-	3	3.00
G-4464	WIPER ARM PIVOTS > COWL	3" NYLON STRAPS	F	H	-	N	4	3.00
G-5423	WIPER ARM PIVOTS > COWL	HX EXT SEMS	-	-	A	-	5	5.00
G-5696	WIPER ARM PIVOTS > COWL	HX CNTRSNK & REG HX EXT SEMS	-	-	A	-	5	5.00
G-4329	WIPER MOTOR	NOW # G-5423	F	H	A	N	3	3.00
G-5465	WIPER MOTOR	HX CNTRSNK EXT SEMS	F	-	A	N	8	12.00
G-5599	WIPER MOTOR BRACKET - 1, 2S w/o WASHER	GROMMETS, GRD STRAP, RIVET, SCREWS	-	-	A	-	3	2.00
G-4946	WIPER SWITCH	HX EXT SEMS	-	-	A	-	3	2.00

Part # T-101

\$3

Free with
Faxed Fastener
orders over \$50
Just ask for it!



GM Fastener Kits

1969

Air Conditioning

PART #	APPLICATION	NOTES					PCS	PRICE
			CAMAHO	FIREBIRD	CHEVELLE	NOVA		
G-5039	AC / HEAT DIVERTER DOOR SWITCH	HI-HXWA AB SCREWS	F	-	-	N	2	1.50
G-4877	AC / HEAT DIVERTER DOOR SWITCH	HXWA AB SCREWS	-	-	A	-	2	1.50
G-5767	AC AIR DISTRIBUTION DUCT - CENTRAL	HX ABT FLAT SEMS	F	-	A	N	2	2.00
G-5003	AC AIR OUTLET @ FLOOR - CENTER	STAPLES, FLAT WA'S	F	-	-	-	4	2.00
G-6307	AC AIR OUTLET @ FLOOR - CENTER	HX ABT FLAT SEMS	-	-	-	N	2	1.50
G-5011	AC AIR OUTLET DUCT - CENTER	HX AB FLAT SEMS	F	-	-	-	2	1.50
G-5035	AC AMBIENT SWITCH > EVAPORATOR	HXWA ABT SCREWS	F	-	A	N	2	2.00
G-5785	AC BLOWER CONTROL SWITCH (in control)	HXWA T1 SCREWS	F	-	A	N	2	1.50
G-5027	AC COMP BRACE > INTAKE - SB	HX BOLTS, FLAT & SPLIT WA'S, SPACER	F	-	A	N	6	10.00
G-5026	AC COMP BRACE, UPPER Fr - 396	HX BOLTS, FLAT & SPLIT WA'S	F	-	A	-	11	4.00
G-5023	AC COMP BRACE, UPPER Fr - SB	HX BOLTS, FLAT, SPLIT & TOOTH WA'S	F	-	A	N	11	6.00
G-5028	AC COMP BRACE, UPPER Rr - 396	HX BOLTS, FLAT & SPLIT WA'S, SPACER	F	-	A	-	6	10.00
G-5024	AC COMP SUPPORT > EXH MANIFOLD - 396	HX BOLTS, SPLIT WA'S	F	-	A	-	6	3.00
G-5020	AC COMP SUPPORT > EXH MANIFOLD - SB	GR-8 "TR" HX BOLTS, SPACER	F	-	A	N	3	8.00
G-5025	AC COMP SUPPORT, LWR Fr - 396	HX BOLTS, SPLIT WA'S	F	-	A	-	6	3.00
G-5021	AC COMP SUPPORT, LWR Fr - SB	HX BOLTS, SPLIT & TOOTH WA'S	F	-	A	N	6	4.00
G-5022	AC COMP SUPPORT, LWR Rr - ALL	HX BOLTS, SPLIT WA'S	F	-	A	N	6	3.00
G-6442	AC COMPRESSOR WIRING	5.1" FLEXIBLE STRAPS	F	-	-	-	2	5.00
G-5012	AC CONDENSER	SCREWS, SPRING NUTS, WELL-NUTS	F	-	-	-	8	10.00
G-5773	AC CONDENSER & BRACKETS	SCREWS, SPRING & WELL-NUTS, WA'S	-	-	A	-	18	8.00
G-6351	AC CONDENSER & BRACKETS	SCREWS, SPRING NUTS, WELL-NUTS	-	-	-	N	24	10.00
G-5770	AC CONTROL CABLES @ KICK PANELS	HXWA ABT SCREWS, RETAINERS	-	-	A	-	6	2.00
G-6312	AC CONTROL CABLES END RETAINERS	C SHAPED	F	-	-	-	2	3.00
G-5004	AC DEFROSTER DISTRIBUTOR	HX ABT FLAT SEMS	F	-	-	N	3	2.00
G-6438	AC EQUALIZER LINE > EVAPORATOR	3.17" NYLON STRAP	F	-	-	N	1	2.00
G-4872	AC EVAPORATOR > FIREWALL	HX INT/EXT SEMS, CLR STUD, NUTS, WA'S	F	-	-	-	6	8.00
G-5776	AC EVAPORATOR > FIREWALL	HX AB FLAT SEMS	-	-	A	-	6	6.00
G-6304	AC EVAPORATOR CASE	HXWA BT SCREWS	F	-	A	-	6	4.00
G-4715	AC EVAPORATOR DRAIN HOSE CLAMP	WIRE CLAMP	F	-	-	N	1	2.00
G-5030	AC FITTING & MUFFLER ASSEMBLY	HX BOLTS, FLAT & SPLIT WA'S	F	-	A	N	5	4.00
G-4723	AC GROUND > FIREWALL	HXWA AB SCREW, TOOTH WA	F	-	A	N	2	1.50
G-4721	AC HEATER HOSE > DASH GROMMETS	HI-HXWA ABT SCREWS	F	-	-	-	4	2.00
G-5033	AC HEATER HOSE CLAMP > ALT BRACKET	METAL HOSE CLIP, HXWA SCREW	F	-	A	N	2	5.00
G-6352	AC HEATER HOSE SEAL RETAINER	HXWA ABT SCREWS	-	-	-	N	2	1.50
G-6439	AC HOSE > HEATER HOSE	11.25" FLEXIBLE STRAP	F	-	A	N	1	6.00
G-4874	AC HOSE > RH WHEELHOUSE	HXWA AB SCREWS ONLY	-	-	A	-	2	1.50
G-6287	AC HOSE > RH WHEELHOUSE	3/16" POP RIVETS	-	-	-	N	2	2.00
G-6286	AC HOSE GROMMET @ FENDER SKIRT	HXWA AB SCREWS	-	-	-	N	3	1.50
G-6280	AC LH & RH OUTLET CONTROL CABLES	HX AB FLAT SEMS, SCREWS, RETAINERS	-	-	A	-	6	3.00
G-6279	AC LH & RH OUTLET CONTROL CABLES	HX AB FLAT SEMS, HXWA AB SCREW	-	-	-	N	3	2.00
G-5010	AC OUTLET CONTROL BEZELS @ KICK PNLS	PH OV AB FLUSH SEMS, SPRING NUTS	F	-	A	N	8	4.00
G-4699	AC PLENUM VALVE & BRACKET	HXWA SCREWS, NUTS, WA'S, RETAINER	F	-	-	N	16	5.00
G-5763	AC PLENUM VALVE & BRACKET	HXWA & PH PN SCREWS, NUTS, WA'S	-	-	A	-	11	3.00
G-6283	AC RADIATOR SEAL	NYLON RETAINERS	-	-	-	N	4	2.00
G-5015	AC RADIATOR SEALS - CONVERTIBLE	HXWA T1 SCREWS ONLY	F	-	-	-	2	2.00
G-5014	AC RADIATOR SEALS - COUPE	HX CONI SEMS, U-NUTS	F	-	-	-	4	4.00
G-5016	AC RADIATOR SHIELD - 327, 350	HX C SCREWS, FLAT WA'S	F	-	-	-	12	6.00
G-5017	AC RADIATOR SHIELD - 396, 427 or Does All	HX C SCREWS, FLAT WA'S	F	-	-	-	18	8.00
G-5774	AC RECIEVER TANK & TUBING > CONDENSER	HXWA AB SCREWS, SPRING NUTS	-	-	A	-	9	3.00
G-6282	AC RECIEVER TANK > FENDER SKIRT	HX BOLTS, FLNG NUTS	-	-	-	N	4	3.00
G-4860	AC RECIEVER TANK > RADIATOR SUPPORT	HXWA AB SCREWS	F	-	-	-	2	2.00
G-5034	AC RESISTOR & RELAY > EVAPORATOR	HXWA ABT SCREWS	F	-	-	N	3	2.00
G-4722	AC RESISTOR & RELAY > EVAPORATOR	HI-HXWA ABT SCREWS	-	-	A	-	3	3.00
G-4856	AC SELECTOR DUCT > FIREWALL	HX INT/EXT SEMS, NUTS, SEALER, WA'S	F	-	-	N	11	5.00
G-5215	AC SELECTOR DUCT > FIREWALL	HX AB INT/EXT SEMS, NUTS, WA'S	-	-	A	-	8	4.00
G-6434	AC VACUUM HOSE @ FIREWALL	5.1" FLEXIBLE STRAP	-	-	-	N	1	3.00
G-6435	AC VACUUM HOSE @ FIREWALL - V8	5.1" FLEXIBLE STRAPS	F	-	-	-	2	5.00
G-5041	AC VACUUM HOSE @ FIREWALL & CONTROL	HXWA AB SCREW, HX FLAT ABT SEMS	F	-	-	N	2	1.50
G-5784	AC VACUUM HOSE > WATER VALVE	PUSH RETAINER	-	-	A	-	1	1.00
G-5040	AC VACUUM HOSE CLAMPS	FLAT WOUND SPRING CLAMPS (Black)	F	-	-	-	6	5.00
G-4728	AC VACUUM HOSE CLAMPS	FLAT WOUND SPRING CLAMPS (Black)	-	-	A	N	5	4.00
G-4697	AC VACUUM MOTOR @ RH COWL	HXWA SCREWS, NUTS, TOOTH WA'S	F	-	-	N	7	3.00
G-5001	AC VACUUM MOTOR COVER	PH OV FIN WA SEMS .50 OD, SPRG NUTS	F	-	-	N	6	3.00
G-5038	AC VACUUM TANK	HXWA AB SCREWS	F	-	-	N	2	1.00
G-5783	AC VACUUM TANK	HXWA ABT SCREWS	-	-	A	-	2	1.50
G-4714	AC VALVE, TUBE BRKT'S > EVAPORATOR	HXWA AB & ABT SCREWS	F	-	-	N	2	1.50
G-5778	AC VALVE, TUBE BRKT'S > EVAPORATOR	HXWA AB SCREWS	-	-	A	-	2	1.50
G-5029	AC VALVE, TUBE BRKT'S > EVAPORATOR 396	HXWA AB & ABT SCREWS	F	-	-	-	3	2.00
G-5031	AC WATER SHUT-OFF VALVE	3/16" POP RIVETS	-	-	A	N	2	2.00
G-6447	AC WIRING CLIP, RH UNDERDASH	STEEL S CLIP	-	-	A	-	1	3.00

See factory Assembly Manuals for illustrations

GM Fastener Kits

353

1969

Body

PART #	APPLICATION	NOTES					PCS	PRICE
			CAMARO	FIREBIRD	CHEVELLE	NOVA		
G-5135	AIR VENTS @ DOOR JAMB	.28 OD PH TRUSS WA AB SCREWS	F	-	-	-	2	1.50
G-4255	BATTERY TRAY	HX CONI SEMS, HXWA PP SCREWS	F	H	-	N	4	3.00
G-4478	BATTERY TRAY	HX CONI SEMS, HXWA CA SCREW	-	-	A	-	4	3.00
G-4625	BODY DAMPENERS - CONVERTIBLE	CONI SEMS, CLIPPED, CUP WA'S, NUTS	F	-	-	-	10	12.00
G-4951	BODY MOUNTS	ORIGINAL BOLTS, WA'S, NUTS	F	H	-	-	18	34.00
G-6363	BODY MOUNTS	ORIGINAL BOLTS, WA'S, NUTS	-	-	-	N	18	34.00
G-5710	BODY MOUNTS - CONVERTIBLE	ORIGINAL BOLTS, NUTS, WA'S	-	-	A	-	22	24.00
G-5709	BODY MOUNTS - HARDTOP	ORIGINAL BOLTS, NUTS, WA'S	-	-	A	-	18	20.00
G-5746	BODY MOUNTS @ RADIATOR SUPPORT	ORIGINAL BOLTS, NUTS, WA'S, SHIMS	-	-	A	-	14	10.00
G-5717	BRAKE PEDAL SUPPORT	HX NUTS, FLAT WA'S	-	-	A	-	4	1.50
G-4637	BRAKE PEDAL SUPPORT w/o PB	NUTS, SPLIT WA'S	F	-	-	N	4	2.00
G-6202	BUMPER (Fr)	SS CAP BOLTS, FLAT, SPLIT WA'S, NUTS	-	-	A	-	28	10.00
G-6273	BUMPER (Fr)	SS CAPPED BOLTS, WA'S, NUTS	-	-	-	N	32	10.00
G-4270	BUMPER (Fr) - CHROME	SS CAP BOLTS, CONI SEMS, NUTS, WA'S	F	-	-	-	16	12.00
G-5099	BUMPER (Fr) - PAINTED	HX PP CONI SEMS, HX SKT SCREWS	F	-	-	-	10	12.00
G-6699	BUMPER (Fr) BRACKETS	CRG BOLTS, RATCHET TOOTH WA'S, NUTS	-	H	-	-	12	12.00
G-6024	BUMPER (Fr) BRACKETS	HX BOLTS, RATCHET TOOTH WA'S, NUTS	-	-	-	N	16	12.00
G-4273	BUMPER (Fr) BRACKETS, OUTER	HX PP CONI SEMS	F	-	-	-	4	5.00
G-6703	BUMPER (Fr) CENTER	CRG BOLTS, CONI KEPS NUTS	-	H	-	-	28	20.00
G-6905	BUMPER (Fr) FILLER & SEAL	HI-HXWA SCREWS, STAMPED NUTS	-	H	-	-	14	6.00
G-4475	BUMPER (Fr) FILLER PANEL	SCREWS, NUTS, RIVETS	-	-	A	-	17	10.00
G-6261	BUMPER (Fr) FILLER PANEL & SUPPORT	HXWA & CONI SEMS PP, U-NUTS, RTNRS	-	-	-	N	18	12.00
G-6702	BUMPER (Fr) REINFORCEMENT STABILIZERS	NUTS & FLAT WA'S ONLY	-	H	-	-	8	5.00
G-6701	BUMPER (Fr) REINFORCEMENTS	CRG BOLTS, FLAT & SPLIT WA'S, NUTS	-	H	-	-	40	16.00
G-6704	BUMPER (Fr) SUB-ASSEMBLIES @ HEADLAMPS	CRG BOLTS, NUTS, WASHERS	-	H	-	-	50	12.00
G-4275	BUMPER (Rr)	SS CAPPED BOLTS, CONI KEPS NUTS	F	-	-	-	12	12.00
G-6694	BUMPER (Rr)	SS CAPPED BOLTS, KEPS NUTS, SCREWS	-	H	-	-	18	18.00
G-5760	BUMPER (Rr)	SS CAPPED BOLTS, NUTS, WA'S	-	-	A	-	32	20.00
G-6275	BUMPER (Rr)	SS CAPPED BOLTS, WA'S, NUTS	-	-	-	N	32	10.00
G-4483	BUMPER (Rr) - El Camino	SS CAPPED BOLTS, NUTS, WA'S	-	-	A	-	39	24.00
G-4269	BUMPER BRACKET EXTENSIONS (Fr)	HX BOLTS, NUTS, WA'S	F	-	-	-	12	4.00
G-4225	BUMPER BRACKETS (Fr)	HX BOLTS, RATCHET TOOTH WA'S, NUTS	F	-	-	-	16	12.00
G-4482	BUMPER BRACKETS (Fr)	HX BOLTS, RATCHET TOOTH WA'S, NUTS	-	-	A	-	16	14.00
G-4274	BUMPER BRACKETS (Rr)	HX PP CONI SEMS	F	-	-	N	8	8.00
G-6696	BUMPER BRACKETS (Rr)	HX PP CONI SEMS	-	H	-	-	10	10.00
G-4484	BUMPER BRACKETS (Rr)	HX BOLTS, RATCHET WA'S, NUTS, SHIMS	-	-	A	-	24	16.00
G-4487	BUMPER BRACKETS (Rr) - El Camino	HX BOLTS, RATCHET TOOTH WA'S, NUTS	-	-	A	-	22	20.00
G-4222	BUMPER GUARD PADS (Fr & Rr)	STAMPED NUTS	-	-	A	N	12	3.00
G-4280	BUMPER GUARD PADS (Fr or Rr)	STAMPED NUTS	F	-	-	-	6	3.00
G-6334	BUMPER GUARDS (Fr & Rr)	HX BOLTS, SPLIT WA'S, NUTS	-	-	-	N	20	5.00
G-4282	BUMPER GUARDS (Fr)	HX BOLTS, WA'S, NUTS	F	-	-	-	10	4.00
G-5821	BUMPER GUARDS (Rr)	HX BOLTS, TOOTH & FLAT WA'S	-	-	A	-	14	4.00
G-4281	BUMPER GUARDS (Rr) w PADS	HX BOLTS, WA'S	F	-	-	-	6	3.00
G-4276	BUMPER GUARDS (Rr) w/o PADS	HX SPLIT & CONI SEMS	F	-	-	-	4	4.00
G-4611	CONVERTIBLE FLOOR REINFORCEMENT	HX PP CONI SEMS	F	-	-	-	6	8.00
G-5112	COWL INDUCTION HOOD EMBLEM - "302"	STAMPED NUTS	F	-	-	-	4	2.00
G-5109	COWL INDUCTION VALVE FRAME	HX EXT SEMS ONLY !	F	-	-	-	6	3.00
G-4301	COWL VENT PANEL	HX AB FLAT SEMS	F	H	-	N	4	3.00
G-5402	DOOR HANDLE CONTROLS (inside)	HXWA SCREWS	F	-	-	-	6	3.00
G-5374	DOOR HANDLES (outside)	SPECIAL 5/16 AF HX CONI SEMS	F	-	A	-	4	4.00
G-5386	DOOR HINGES	HX CONI TOOTH SEMS	F	-	A	-	30	20.00
G-5136	DOOR LATCH - CONTROL	HXWA THREAD FORMER SCREWS	F	-	-	-	6	3.00
G-4332	DOOR LATCHES	OV HD TT SCREWS	F	H	A	-	6	3.00
G-6483	DOOR LOCK (power) VACUUM HOSES	5.1" FLEXIBLE STRAPS	-	-	A	-	3	7.00
G-6572	DOOR LOCK STRIKERS	HEX SOCKET DRIVE	F	-	A	-	2	24.00
G-5399	DOOR WEATHERSTRIPS	PLASTIC PINS	F	-	A	-	4	1.50
G-5137	DOOR WINDOW REGULATOR	HXWA THREAD FORMER SCREWS	F	-	-	-	14	6.00
G-4532	EMBLEM, GRILLE	STAMPED NUTS, less SPACERS	-	H	-	-	2	3.00
G-4127	EMBLEM, GRILLE "BOWTIE", "Z28, "SS"	STAMPED NUTS	F	-	-	-	2	1.00
G-6315	EMBLEM, GRILLE "SS"	STAMPED NUTS	-	-	-	N	2	1.00
G-4288	EMBLEM, GRILLE "SS", "R/S"	STAMPED NUTS	-	-	A	-	2	1.00
G-4236	FENDER > RADIATOR SUPPORT BRACES	HX CONI SEMS, HXWA CA SCREWS	F	-	-	-	4	4.00
G-4235	FENDER > RADIATOR SUPPORT BRACES	HXWA PP SCREWS	-	H	-	-	4	3.00
G-4179	FENDER > WHEELHOUSE Fr BRACES	HXWA C SCREWS	-	-	A	N	2	2.00
G-4286	FENDER EMBLEMS - "Rally Sport"	STAMPED NUTS	F	-	-	-	8	3.00
G-4240	FENDER LWR EXTENSIONS	HXWA PP SCREWS, U-NUTS	F	-	-	-	16	10.00
G-6919	FENDER ORNAMENTS	STAMPED NUTS	-	H	-	-	8	2.00
G-6912	FENDER SUPPORTS	HX BOLTS, FLAT & CLIPPED WA'S, NUTS	-	H	-	-	16	10.00
G-4238	FENDERS	HX CONI SEMS, SHIMS	F	-	-	-	22	14.00
G-6913	FENDERS	HX CONI SEMS, HXWA SCREWS, SHIMS	-	H	-	-	22	14.00
G-4466	FENDERS	HX CONI SEMS, U-NUTS, SHIMS	-	-	A	-	28	20.00
G-6254	FENDERS	HX CONI SEMS, U-NUTS, SHIMS	-	-	-	N	26	20.00
G-6606	FENDERS > RAD SUPPORT (also in fender kit)	HX MS CONI SEMS	F	-	-	N	4	4.00
G-6604	FENDERS > RAD SUPPORT (also in fender kit)	HXWA PP SCREWS	-	-	A	-	4	3.00

Kits Contain Attaching Fasteners for Both Sides

GM Fastener Kits

1969

Body			1969									
			CAMARO	FIREBIRD	CHEVELLE	NOVA						
PART #	APPLICATION	NOTES	F	H	A	N			PCS	PRICE		
G-4254	GRILLE	HX AB FLAT SEMS, NYLON & SPR NUTS	F	-	-	-			30	8.00		
G-6908	GRILLE	HXWA SREWS, U-NUTS	-	H	-	-			24	8.00		
G-4468	GRILLE	PH PN SCREWS, NYLON NUTS	-	-	A	-			20	6.00		
G-6259	GRILLE & REINFORCEMENT	HXWA SCREWS, SPR NUTS, BLK RIVETS	-	-	-	N			22	6.00		
G-4500	GRILLE BRACKETS	HXWA PP SCREWS	-	-	A	-			3	2.00		
G-6257	GRILLE BRACKETS	HXWA PP SCREWS	-	-	-	N			4	3.00		
G-4469	GRILLE EXTENSIONS	SCREWS, NYLON NUTS	-	-	A	-			6	3.00		
G-4243	HEADER PANEL	HXWA PP SCREWS, U-NUTS	F	-	-	-			11	6.00		
G-4467	HEADER PANEL	HI-HXWA SCREWS, HX CONI SEMS, RVTS	-	-	A	-			6	5.00		
G-5103	HEADLAMP ACTUATOR BRACKET - R/S	HX PP CONI SEMS	F	-	-	-			4	3.00		
G-5102	HEADLAMP ACTUATOR SHIELDS - R/S	HX PP CONI SEMS, U-NUTS	F	-	-	-			8	8.00		
G-4937	HEADLAMP ACTUATOR SUPPORT - R/S	HX CONI SEMS, CONI KEPS NUTS	F	-	-	-			8	4.00		
G-5754	HEADLAMP BEZEL BRACKETS	ALUMINUM RIVETS	-	-	A	-			8	2.00		
G-4264	HEADLAMP BEZELS	PH OV AB SCREWS, SPRING NUTS	F	-	-	-			12	4.00		
G-6921	HEADLAMP BEZELS	SS/CHROME PH OV SCREWS, J-NUTS	-	H	-	-			16	6.00		
G-4176	HEADLAMP BEZELS	Does Early & Late, SCREWS, NYLON NUTS	-	-	A	-			24	5.00		
G-6269	HEADLAMP BEZELS	SS/CHROME PH OV SCREWS, SPR NUTS	-	-	-	N			20	6.00		
G-6923	HEADLAMP BODIES & BRACKETS	HX & HXWA AB FLAT SEMS, U-NUTS	-	H	-	-			20	14.00		
G-4300	HEADLAMP COVER BUMPER BRACKETS	HX EXT SEMS	F	-	-	-			4	2.00		
G-4298	HEADLAMP COVERS > PLATE - R/S	PH OV MS SCREWS, STAMPED NUTS	F	-	-	-			8	3.00		
G-4257	HEADLAMP HOUSINGS	HXWA PP SCREWS	F	-	-	-			8	5.00		
G-5100	HEADLAMP LEVER SUPPORT - R/S	HX PP CONI SEMS, FLNG NUTS	F	-	-	-			12	8.00		
G-4941	HEADLAMP VACUUM TANK & RELAY - R/S	HX PP CONI SEMS, HX EXT SEMS	F	-	-	-			5	5.00		
G-4244	HOOD & HINGES	HX CONI SEMS	F	H	-	-			8	8.00		
G-4106	HOOD & HINGES	HX CONI SEMS	-	-	A	N			8	10.00		
G-4246	HOOD CATCH & LOCK PLATE	HXWA SCREWS, HX CONI SEMS, U-NUTS	F	-	-	-			9	6.00		
G-4477	HOOD CATCH & LOCK PLATE	HX PP CONI SEMS	-	-	A	-			9	6.00		
G-6268	HOOD CATCH & LOCK PLATE	HX PP CONI SEMS, U-NUTS	-	-	-	N			11	8.00		
G-4245	HOOD CATCH SUPPORT	HXWA PP SCREW	F	H	-	-			1	1.00		
G-4476	HOOD CATCH SUPPORT	HX PP CONI SEMS, U-NUT	-	-	A	-			2	3.00		
G-6911	HOOD LATCH, BRACE, PLATE & SPRING	HXWA PP SCREWS, U-NUTS	-	H	-	-			15	14.00		
G-4249	HOOD LEVELERS (Fr)	SCREWS, FLNG NUTS, RUBBER BUMPERS	F	H	A	N			6	8.00		
G-4250	HOOD LOCK POST	MOUNTING NUT ONLY	F	-	A	N			1	2.00		
G-4494	HOOD LOUVERS - SS models	STAMPED NUTS	-	-	A	-			10	3.00		
G-4316	HOOD ORNAMENTS	STAMPED NUTS	F	-	-	N			12	4.00		
G-4272	LICENSE PLATE BRACKET (Fr)	HXWA AB & PP SCREWS, NYL & U-NUTS	F	-	-	-			6	4.00		
G-4485	LICENSE PLATE BRACKET (Fr) 70-72, (Rr) All	HX BOLTS, EXT KEPS NUTS	-	-	A	N			4	3.00		
G-4100	LICENSE PLATE BRACKET (Rr)	HX BOLTS	F	-	-	-			2	2.00		
G-6697	LICENSE PLATE BRACKET (Rr)	FLNG NUTS	-	H	-	-			2	2.00		
G-5046	LICENSE PLATES (Fr & Rr)	SLOT TRUSS B SCREWS, NYLON NUTS	F	-	-	N			8	6.00		
G-5827	MIRROR & BRACKET (STD or remote)	PH PN AB SCREWS, PH OV MS, WA	-	-	-	N			4	2.00		
G-4717	MIRROR (outside fixed) & BRACKET	PH OV MS SCREW, PH PN B EXT SEMS	F	H	A	N			3	2.00		
G-5787	MIRROR (outside remote) & BRACKET	PH OV MS SCREW, PH PN B EXT SEMS	-	-	A	-			2	2.00		
G-4310	NAMEPLATE, FENDERS - ENG DESIGNATION	STAMPED NUTS	F	-	-	-			6	2.00		
G-4472	NAMEPLATE, FENDERS - MODEL or ENGINE	STAMPED NUTS	-	-	A	-			8	3.00		
G-4305	NAMEPLATE, FENDERS "Camaro"	STAMPED NUTS	F	-	-	-			8	2.00		
G-5631	NAMEPLATE, FENDERS "FLAGS" or "Nova"	STAMPED NUTS	-	-	-	N			4	2.00		
G-4370	NAMEPLATE, FENDERS "Nova", "Firebird"	STAMPED NUTS	-	H	-	-			4	1.50		
G-5269	NAMEPLATE, FENDERS "SS"	STAMPED NUTS	F	-	-	-			8	3.00		
G-4314	NAMEPLATE, FENDERS "SS", "Z28", "350"	STAMPED NUTS	F	-	-	N			6	2.00		
G-4471	NAMEPLATE, GRILLE "BOWTIE"	STAMPED NUTS	-	-	A	-			2	1.00		
G-4311	NAMEPLATE, HEADER PANEL	STAMPED NUTS	F	-	-	-			4	1.50		
G-4473	NAMEPLATE, HEADER PANEL	STAMPED NUTS	-	-	A	-			6	2.00		
G-4328	NAMEPLATE, TRUNK LID	STAMPED NUTS	F	-	-	-			4	1.50		
G-6507	PLUGS, FLOOR, TRUNK, WHEEL WELLS	RUBBER & PLASTIC PLUGS	F	-	-	-			12	12.00		
G-6343	QUARTER PANEL EXTENSIONS	CONI KEPS NUTS, FLAT WA'S, SEALER	-	-	A	-			24	8.00		
G-6915	RADIATOR SUPPORT > FENDER GUSSETS	PH WAFER SCREWS	-	H	-	-			4	4.00		
G-5974	REFLECTORS, Rr BUMPER - El Caminno	PH PN EXT SEMS	-	-	A	-			4	3.00		
G-6926	SPOILER	CONI KEPS NUTS, MASTIC SEALER	-	H	-	-			8	5.00		
G-4320	SPOILER (Fr) - Z28	CONI SEMS, HXWA SCREWS, NUTS, WA'S	F	-	-	-			28	8.00		
G-4151	SPOILER (Rr) - 1 PIECE	CONI KEPS NUTS, SEALING WA'S	F	-	-	-			24	6.00		
G-4975	STEERING COLUMN SEAL RETAINER	HX AB FLAT SEMS, HXWA AB SCREWS	F	-	-	N			6	6.00		
G-5740	STEERING COLUMN SEAL RETAINER	HXWA AB SCREWS, HX AB CONI SEMS	-	-	A	-			7	5.00		
G-6930	TAILGATE HINGES - El Camino	HX CONI SEMS, FLAT EXT SEMS	-	-	A	-			12	20.00		
G-6934	TAILGATE LATCHES	OV HD TT SCREWS	-	-	A	-			6	3.00		
G-6931	TAILGATE STRIKERS > BODY	POZI FLAT SCREWS	-	-	A	-			6	6.00		
G-6933	TAILGATE SUPPORT CABLES	HX SHOULDER BOLTS, FLAT WA'S	-	-	A	-			8	8.00		
G-4154	TRUNK LATCH & STRIKER	HX CONI TOOTH SEMS	F	-	A	N			5	4.00		
G-4155	TRUNK LID > HINGES	HX CONI TOOTH SEMS	F	H	A	N			4	4.00		
G-5068	TRUNK LID BUMPERS	.90" DIA X .48 TK RUBBER BUMPERS	-	-	A	-			2	3.00		
G-4241	VALANCE (Fr)	HXWA PP SCREWS, U-NUTS	F	-	-	-			14	8.00		
G-6914	VALANCE (Fr)	HXWA AB & PP SCREWS, U-NUTS	-	H	-	-			20	16.00		
G-6910	VALANCE (Fr) BRACKETS (3)	HXWA PP SCREWS, U-NUTS	-	H	-	-			8	8.00		
G-5389	WEATHERSTRIP, QUARTER GLASS @ JAMB	.28 OD PH RNDWA AB SCREWS	F	-	-	-			4	2.00		
G-6642	WEATHERSTRIP, QUARTER GLASS @ JAMB	.28 OD PH RNDWA AB SCREWS	-	-	A	-			6	2.00		

See factory Assembly Manuals for illustrations

GM Fastener Kits

355

1969

Body

PART #	APPLICATION	NOTES					PCS	PRICE
			CAMARO	FIREBIRD	CHEVELLE	NOVA		
G-4232	WHEELHOUSE Rr BRACES > BODY	HX MS & PP CONI SEMS, HX NUTS	F	-	-	-	6	5.00
G-6918	WHEELHOUSE Rr BRACES > BODY	HX CONI SEMS	-	H	-	-	4	4.00
G-4231	WHEELHOUSES	SCREWS, HX CONI SEMS, WA'S, U-NUTS	F	-	-	-	46	26.00
G-6917	WHEELHOUSES	HXWA SCREWS, SEMS, CUP WA'S, U-NUTS	-	H	-	-	50	34.00
G-4474	WHEELHOUSES	HX MS & PP CONI SEMS, WA'S, U-NUTS	-	-	A	-	48	24.00
G-6264	WHEELHOUSES	HXWA PP SCREWS, CUP WA'S, U-NUTS	-	-	-	N	24	20.00
G-6379	WHEELHOUSES > FENDERS (also in WH kit)	HXWA PP SCREWS, CUP WA'S, U-NUTS	F	-	-	N	12	12.00
G-6596	WHEELHOUSES > FENDERS (also in WH kit)	HX PP CONI SEMS, FLAT WA'S, U-NUTS	-	-	A	-	12	8.00
G-4234	WHEELHOUSES > RADIATOR SUPPORT	HX PP CONI SEMS, U-NUTS	F	H	-	-	8	6.00
G-5745	WHEELHOUSES > RADIATOR SUPPORT	HXWA PP SCREWS, U-NUTS	-	-	A	-	8	5.00
G-4233	WHEELHOUSES > RADIATOR SUPPORT	HXWA PP SCREWS, U-NUTS	-	-	-	N	8	6.00
G-5401	WINDOW (door) GUIDE PLATES	HX CONI TOOTH SEMS	F	-	-	-	8	4.00
G-5403	WINDOW (door) REAR STOP	HX TT CONI TOOTH SEMS	F	-	-	-	4	3.00
G-5414	WINDOW (Qter) REGULATOR, STOP, GUIDE	HXWA TT SCREWS, LRG FLNG NUTS	F	-	-	-	16	8.00
G-5405	WINDOW GLASS (Door) > CHANNEL	SRTD FLNG NUTS	F	-	-	-	4	1.50
G-5404	WINDOW GUIDE CHANNEL @ DOOR (Fr)	HX TT CONI TOOTH SEMS	F	-	-	-	6	3.00
G-5393	WINDOW GUIDE CHANNEL @ DOOR (Rr)	HX CONI TOOTH SEMS	F	-	-	-	6	3.00

Brakes

G-5007	AXLE RETAINER PLATES	GR-8 HX BOLTS, NUTS, SPLIT WA'S	F	H	A	N	24	10.00
G-6579	BRAKE BLEEDER SCREWS w DISC	All - CALIPERS, M/C, WHEEL CYLINDERS	F	-	A	N	6	10.00
G-4738	BRAKE BOOSTER	HX NUTS, SPLIT WA'S	F	H	A	N	8	3.00
G-4888	BRAKE BOOSTER HOSE - 396	CLAMPS & WA FOR TUBE BRACKET	F	H	-	N	3	3.00
G-4740	BRAKE BOOSTER HOSE - SB	FLAT WOUND SPRING CLAMPS (Black)	F	H	A	N	2	2.00
G-4642	BRAKE CABLES	WIRE TYPE RETAINERS, HX NUTS	F	H	A	N	5	5.00
G-6575	BRAKE CALIPER BLEEDERS	3/8-24 SCREWS, .28 NOSE TO FIT CAP	F	-	A	N	2	4.00
G-5468	BRAKE CALIPER BRACKETS & SHIELDS	HX BOLTS, LOCK NUTS	F	H	-	N	10	24.00
G-6636	BRAKE CALIPER BRACKETS & SHIELDS	HX BOLTS, LOCK NUTS	-	-	A	-	10	24.00
G-6426	BRAKE CALIPER LOCATING BOLTS	3.70" L HX SOCKET BOLTS	F	-	A	N	4	12.00
G-6609	BRAKE CALIPER PISTON RETURN CLIPS	ATTACH TO CALIPER PISTONS, COATED	F	-	A	N	2	4.00
G-4956	BRAKE HOSE (Fr disc) > CONTROL ARM	HXWA T SCREWS	F	H	-	N	2	2.00
G-4960	BRAKE HOSE (Rr) DIST BLOCK > BRACKET	HX BOLT	F	H	A	N	1	2.00
G-5866	BRAKE HOSE > CALIPER	DRILLED BOLTS, COPPER WA'S	F	-	A	N	6	10.00
G-4348	BRAKE HOSE BRACKET (Rr)	HX PP CONI SEMS	F	H	-	N	2	3.00
G-5047	BRAKE HOSE BRACKETS (Fr)	HX T CONI SEMS	F	H	A	N	2	2.00
G-6240	BRAKE HOSE GASKETS	COPPER MATERIAL	F	-	A	N	2	1.50
G-4958	BRAKE HOSE RETAINERS	U-RETAINERS	F	H	A	N	3	3.00
G-5486	BRAKE LINE SHIELDS (Rr) - El Camino	HXWA C SCREWS	-	-	A	-	4	3.00
G-5602	BRAKE PEDAL BUSHINGS	NYLON BUSHINGS ONLY	F	-	A	N	2	3.00
G-4794	BRAKE PEDAL RETAINER w A/T	FOLDED SPRING METAL	F	-	-	N	1	3.00
G-6044	BRAKE PEDAL RETURN SPRING	NOS SPRING	F	-	A	N	1	4.00
G-5008	BRAKE PLATE ASSEMBLY (Fr) > SPINDLE	GR-8 HX BOLTS, LOCK NUTS	F	H	A	N	8	12.00
G-4636	BRAKE PRESSURE VALVE & SW - DRUM	HX SPLIT SEMS	F	H	-	N	1	1.50
G-5057	BRAKE PRESSURE VALVE (Rr) - 302/350 & BB	HXWA T SCREW	F	H	A	-	1	1.50
G-4741	MASTER CYL BALANCE VALVE w DISC	HX EXT SEMS	F	H	A	N	1	2.00
G-4635	MASTER CYLINDER	HX NUTS, SPLIT WA'S	F	H	A	N	4	2.00
G-6580	MASTER CYLINDER BLEEDERS w DISC	5/16-24 SCREWS	F	-	A	N	2	3.00
G-4829	MASTER CYLINDER PUSH ROD > PEDAL	RETAINING CLIP	F	H	A	N	1	3.00
G-4347	PARKING BRAKE CONTROL > DASH	HX CONI SEMS, FLNG NUTS	F	H	-	N	3	3.00
G-5489	PARKING BRAKE CONTROL > DASH	HX SPLIT SEMS, FLNG NUTS, SEALER	-	-	A	-	5	3.00
G-4887	STOPLAMP SWITCH STRIKER - PWR BRAKES	w POWER BRAKES, BOLT, STAMPED NUT	F	-	A	N	2	2.00
G-6576	WHEEL CYLINDER (2) BLEEDERS	Does 2 cylinders, 5/16-24 SCREWS	F	-	A	N	2	3.00
G-6577	WHEEL CYLINDER (4) BLEEDERS	Does 4 cylinders, 5/16-24 SCREWS	F	-	A	N	4	5.00
G-6578	WHEEL CYLINDER BLEEDER PROTECTORS	PLASTIC CAPS w STRAP	F	-	A	N	2	2.00
G-6581	WHEEL CYLINDERS (2)	HX INT SEMS	F	H	A	N	4	3.00
G-6582	WHEEL CYLINDERS (4)	HX INT SEMS	F	H	A	N	8	5.00

Cooling

G-4592	RADIATOR - 307/327/350	HXWA PP SCREWS	-	-	A	N	3	3.00
G-4600	RADIATOR - 396	HXWA PP SCREWS	-	-	A	-	4	3.00
G-4676	RADIATOR (396 only 68N)	HXWA MS & PP SCREWS, WELL-NUTS	F	-	-	N	6	8.00
G-5189	RADIATOR FAN SHROUD	S CLIPS, HX FLAT SEMS, SPRING NUTS	F	-	-	N	6	6.00
G-5748	RADIATOR FAN SHROUD - SB	SCREWS, WA'S, SPRING NUTS, S CLIPS	-	-	A	-	8	6.00
G-4980	RADIATOR FAN SHROUD & BRACKET	HXWA AB & CA SCREWS, SPR & U-NUTS	F	-	-	-	7	6.00
G-6301	RADIATOR FAN SHROUD & BRACKET - 396	TOP MOUNTING ONLY. SCREWS, SPR NUT	-	-	-	N	3	3.00
G-4844	RADIATOR HOSES - V8	TOWER TYPE CLAMPS	F	-	-	-	4	12.00
G-5162	RADIATOR HOSES - V8	TOWER TYPE CLAMPS	-	-	A	N	4	12.00
G-6296	RADIATOR SEAL - 396	NYLON RETAINERS	-	-	-	N	6	3.00

Kits Contain Attaching Fasteners for Both Sides

GM Fastener Kits

1969

Differential

PART #	APPLICATION	NOTES					PCS	PRICE
			F	H	A	N		
G-5466	DIFFERENTIAL COVER - 10 BOLT	SRTD FLNG SCREWS "E"	F	H	A	N	10	10.00
G-5467	DIFFERENTIAL COVER - 12 BOLT	SRTD FLNG SCREWS "E"	F	H	A	N	12	12.00

Electrical

PART #	APPLICATION	NOTES					PCS	PRICE
			F	H	A	N		
G-4962	ALTERNATOR - 302, 307, 327, 350	HX BOLTS, WA'S, NUT	F	-	A	N	13	10.00
G-5049	ALTERNATOR - 396/454	BOLTS, HX CLR STUD, SPACER, NUTS	F	-	A	N	16	25.00
G-4981	ALTERNATOR HARNESS > ALTERNATOR	12-24 NUT, #14 TOOTH WA	F	-	A	N	2	1.50
G-6293	ALTERNATOR PULLEY	NUT, FLAT WA	F	-	A	N	2	3.00
G-5808	AMMETER > INSTRUMENT CLUSTER	HXWA AB SCREWS	-	-	A	-	4	1.50
G-6635	BACK-UP LAMP LENSES - El Camino	SS/CHROME PH PN .435 SHLDR SCREWS	-	-	A	-	4	4.00
G-6423	BACK-UP LAMP LENSES - R/S	CHROME/SS PH PN .550 SHLDR SCREWS	F	-	-	-	4	4.00
G-4319	BACK-UP LAMPS - R/S	PH PN AB SCREWS, SPRING NUTS	F	-	-	-	8	4.00
G-4793	BACK-UP/NEUTRAL SWITCH (Console A/T)	HX SCREWS, FLAT & TOOTH WA'S	F	-	A	N	6	2.00
G-6298	BATTERY CABLE > RH WHEELHOUSE	3.17" NYLON STRAP	F	-	-	N	1	2.00
G-5753	BATTERY CABLE ROUTING CLIP > FRAME	HXWA T1 SCREW	-	-	A	-	1	1.00
G-4984	BATTERY CABLES - 302, 327, 350	HXWA AB SCREW, TOOTH WA, NUTS	F	-	A	N	4	3.00
G-5055	BATTERY CABLES - 396	HX BOLT, NUTS, WA'S, SCREW	F	-	A	N	6	4.00
G-4352	BATTERY HOLDOWN CLAMP	HX CONI SEMS	F	-	A	N	1	1.50
G-5814	CAPACITOR - RADIO NOISE, AM/FM, AC 68	HXWA SCREW	-	-	A	-	1	1.00
G-5096	CAPACITORS - RADIO NOISE	SCREWS, TOOTH WA	F	-	-	-	3	2.00
G-5680	CLOCK - IN DASH	HXWA SCREWS	-	-	A	-	4	1.50
G-6328	CLOCK - IN DASH	HXWA SCREWS, FLAT WA'S	-	-	-	N	4	2.00
G-5636	COURTESY LAMPS, UNDERDASH	PH PN FLAT WA SEMS	-	-	A	-	2	2.00
G-4990	COURTESY LAMPS, UNDERDASH (69F CONV)	HXWA SCREWS	F	-	-	N	2	1.50
G-4691	COURTESY LAMPS, UNDERDASH (69F COUPE)	PH PN SCREW, PH PN AB FLAT SEMS, WA	F	-	-	-	3	2.00
G-5111	COWL INDUCTION RELAY	HXWA SCREW, TOOTH WA	F	-	-	-	2	1.50
G-5110	COWL INDUCTION SOLENOID	HX CONI SEMS	F	-	-	-	1	1.50
G-5000	DEFOGGER SWITCH BEZEL - Rr WINDOW	EXT KEPS NUTS	F	-	A	N	2	1.50
G-4989	DIMMER SWITCH	HXWA AB SCREWS	F	-	A	N	2	2.00
G-4988	FLASHER BRACKET & GROUND > DASH	HXWA SCREWS, TOOTH WA	F	-	-	N	3	2.00
G-4688	FLASHER BRACKET > DASH	PH PN AB SCREW	-	-	A	-	1	1.00
G-4986	FUSE PANEL > FIREWALL	#10 x 2 1/4 HXWA AB SCREWS w SEALER	F	-	A	N	2	3.00
G-4680	H/L, P/L GROUNDS, JUNCTION BLOCK	HXWA AB & B SCREWS, TOOTH WA'S	F	-	A	N	5	3.00
G-4259	HEADLAMP ADJUSTERS	SCREWS, NYLON NUTS, SPRINGS	F	-	-	-	10	8.00
G-6920	HEADLAMP ADJUSTERS	ADJUSTER ASSEMBLIES, SPRINGS	-	H	-	-	12	30.00
G-4830	HEADLAMP ADJUSTERS	SCREWS, NYLON NUTS, SPRINGS	-	-	A	-	20	12.00
G-6562	HEADLAMP ADJUSTERS	SCREWS, NYLON NUTS, SPRINGS	-	-	-	N	10	8.00
G-6622	HEADLAMP RETAINING RINGS	PH RND SCREWS	F	-	A	N	6	2.00
G-6567	HEADLAMP RETAINING RINGS	SLOT PN SCREWS	F	-	A	N	6	3.00
G-6473	HEADLAMP WASHER HOSES	5.1" FLEXIBLE STRAPS, S CLIPS	F	-	-	-	5	10.00
G-6472	HEADLAMP WASHER HOSES	5.1" FLEXIBLE STRAPS	-	-	A	-	7	14.00
G-4726	HEATER SWITCH or AC FAN (AC 68N)	HXWA T1 SCREWS	F	-	A	N	2	1.50
G-6323	HORN (1)	HX PP CONI TOOTH SEMS, PLASTIC CAP	-	-	-	N	2	4.00
G-4997	HORN CONTACT ASSEMBLY	PH PN EXT SEMS	F	-	A	N	2	1.50
G-4801	HORN CONTACT ASSY - WOOD GRAIN WHEEL	PH PN MS SCREWS	F	-	A	N	3	2.00
G-4682	HORN RELAY	HXWA AB SCREW	F	-	A	N	1	1.00
G-4679	HORNS (2) (3 '66)	HX PP CONI TOOTH SEMS	F	-	-	-	2	4.00
G-4647	IGNITION COIL & STRAP	HX EXT SEMS, SLOT RND T SCREW	F	-	A	N	3	4.00
G-6272	INSTRUMENT CLUSTER CIRCUIT BOARD	HXWA B SCREWS, WA'S, NUTS	-	-	-	N	10	3.00
G-4853	INSTRUMENT CLUSTER GROUND	HXWA AB SCREW, TOOTH WA	F	-	-	N	2	1.50
G-5757	INSTRUMENT CLUSTER GROUNDS	HXWA AB & B SCREWS, TOOTH WA'S	-	-	A	-	3	1.50
G-6652	KICK PANELS w/o AC	HXWA SCREWS	-	-	A	-	10	3.00
G-4924	LAMP MONITORS - FENDER MOUNTED	STAMPED NUTS	F	-	A	-	4	2.00
G-4312	LICENSE PLATE LAMP	PH PN AB SCREWS	F	H	A	N	2	1.00
G-4322	MARKER LAMPS (Fr & Rr)	STAMPED NUTS	F	-	-	N	8	3.00
G-4479	MARKER LAMPS (Fr & Rr)	STAMPED NUTS	-	-	A	-	8	3.00
G-5722	NEUTRAL STARTING SWITCH - CLUTCH	HXWA AB SCREW	-	-	A	-	1	1.00
G-4969	NEUTRAL STARTING SWITCH - M/T	HXWA AB SCREWS, RETAINING PINS	F	-	-	N	4	2.00
G-4692	PARKING BRAKE ALARM SWITCH	NUT, TOOTH WA	F	-	-	N	2	1.00
G-5202	PARKING BRAKE ALARM SWITCH	HXWA AB SCREW	-	-	A	-	1	1.00
G-6422	PARKING LAMP LENSES	SS/CHROME PH PN .640 SHLDR SCREWS	F	-	-	-	6	6.00
G-6627	PARKING LAMP LENSES	SS/CHROME PH PN .806 SHLDR SCREWS	-	-	A	-	4	5.00
G-6625	PARKING LAMP LENSES	SS/CHROME PH PN .488 SHLDR SCREWS	-	-	-	N	4	4.00
G-6925	PARKING LAMPS	HX NUTS, TOOTH WA'S	-	H	-	-	8	3.00
G-4480	PARKING LAMPS	PH PN EXT SEMS	-	-	A	N	4	3.00
G-4115	PARKING LAMPS (All 69F, 70-73F R/S)	EXT KEPS NUTS	F	-	-	-	4	3.00
G-4999	POWER TOP ELECTRICAL CONNECTIONS	HXWA AB SCREWS, CONI & EXT KEPS	F	-	-	-	6	4.00
G-5097	RADIO - MULTIPLEX AMPLIFIER	SCREW & RETAINER, BOLTS, NUTS	F	-	-	N	4	4.00
G-5819	RADIO BRACKET	HXWA SCREW, SPRING NUT	-	-	A	-	2	2.00
G-5095	RADIO BRACKETS	HXWA AB SCREWS, SPRING NUTS	F	-	-	N	4	3.00
G-5813	RADIO GROUND STRAP > FRAME	HXWA AB & T1 SCREWS	-	-	A	-	2	2.00
G-4823	RADIO GROUND STRAPS > FIREWALL	HXWA AB SCREWS	F	-	A	-	2	1.50
G-6333	RADIO GROUND STRAPS > FIREWALL, FRAME	HXWA AB & T1 SCREWS	-	-	-	N	5	3.00

See factory Assembly Manuals for illustrations

GM Fastener Kits

357

1969

Electrical

PART #	APPLICATION	NOTES					PCS	PRICE
			CAMARO	FIREBIRD	CHEVELLE	NOVA		
G-4822	RADIO NOISE CAPACITOR > COIL BRACKET	HXWA T SCREW, TOOTH WA	-	-	-	N	2	1.50
G-5820	RADIO, STEREO AMPLIFIER (under dash)	PH PN B EXT SEMS, SPRING NUTS	-	-	A	-	4	2.00
G-6654	SEAT BACK PANELS	PH PN FLAT SEMS	-	-	A	-	6	3.00
G-5094	SPEAKER > DASH	HXWA AB SCREW, SPRING NUT	F	-	A	N	2	1.50
G-5098	SPEAKERS & GRILLES @ KICK PANELS	PH OV AB SCREWS, SPRING NUTS	F	-	-	-	16	6.00
G-5591	SPEAKERS & GRILLES @ KICK PANELS	PH OV AB SCREWS, SPRING NUTS	-	-	A	-	16	5.00
G-5086	SPEED WARNING BUZZER & BRACKET	HXWA AB SCREWS, SPRING NUT	F	-	-	N	4	3.00
G-5807	SPEED WARNING BUZZER BRACKET	PH OV AB FLUSH SEMS, SPRING NUT	-	-	A	-	2	1.50
G-5727	STARTER & BRACE - 396	3.62" L HX BOLTS, SPLIT SEMS, FLNG NUT	F	-	A	N	4	8.00
G-5006	STARTER & BRACE - SB	1.84 & 4.69 L FLNG BOLTS, CONI SEMS, NUT	F	-	A	N	4	8.00
G-4689	STOPLAMP SWITCH	STAMPED HX NUTS	F	-	-	N	2	2.00
G-5201	STOPLAMP SWITCH	SPECIAL ROUND RETAINER	-	-	A	-	1	2.00
G-6325	TACHOMETER	HXWA B SCREWS	-	-	-	N	2	1.50
G-5806	TACHOMETER > INSTRUMENT CLUSTER	HXWA B SCREWS	-	-	A	-	3	1.50
G-4961	TAILAMP LENSES	SS/CHROME PH PN & PH OV MS SCREWS	-	-	-	N	8	4.00
G-6631	TAILAMP LENSES - El Camino	SS/CHROME PH PN .340 SHLDR SCREWS	-	-	A	-	8	8.00
G-4324	TAILAMPS > BODY	QUICKY BOLTS, CONI TOOTH KEPS NUTS	F	H	-	-	20	20.00
G-5803	TAILAMPS > BODY	EXT TOOTH KEPS NUTS	-	-	-	N	6	3.00
G-6417	TAILAMPS > QUARTER EXTENSIONS	HXWA TT SCREWS	-	-	A	-	8	3.00
G-5093	TAPE PLAYER - CONVECTOR ASSY	HXWA AB SCREWS	F	-	-	-	3	2.00
G-5091	TAPE PLAYER (under dash)	HX FLT SEMS, PH FLT SCREWS, SPR NUT	F	-	-	-	8	4.00
G-6330	TAPE PLAYER (under dash)	HX AB FLAT SEMS, SCREWS, SPR NUTS	-	-	-	N	10	4.00
G-5092	TAPE PLAYER w CONSOLE	SCREWS, ACORN NUTS, TOOTH WA	F	-	-	-	23	10.00
G-4810	TRUNK LAMP	HX AB FLAT SEMS	F	-	A	N	1	1.00
G-4992	TURN SIGNAL LEVER	PH PN AB SCREW	F	-	A	N	1	1.00
G-4922	UNDERHOOD LAMP	HXWA AB SCREWS	F	-	A	N	2	1.50
G-6458	VACUUM HOSES - R/S HEADLAMPS	7.1" FLEXIBLE STRAPS, 3" NYL STRAPS	F	-	-	-	9	14.00
G-4968	VOLTAGE REGULATOR	HXWA B SCREWS	F	-	-	N	3	2.00
G-4588	VOLTAGE REGULATOR	HXWA AB SCREWS	-	-	A	-	3	2.00
G-6532	WIRING - ALTERNATOR > HEATER HOSE	5.1" FLEXIBLE STRAP	-	-	A	-	1	3.00
G-6518	WIRING - ALTERNATOR > HEATER HOSE	7.1" FLEXIBLE STRAP	-	-	-	N	1	3.00
G-6515	WIRING - BLOWER MOTOR/STARTER WIRING	RUBBER COATED J-CLIPS	F	-	A	N	2	5.00
G-6617	WIRING - CARBURETOR SOL - 396HP A/T	SPL RUBBER COATED CLIP	F	-	A	N	1	4.00
G-6292	WIRING - CONSOLE & GROUND	J-CLIP, SCREWS, TOOTH WA	-	-	-	N	4	4.00
G-6505	WIRING - CONSOLE & GROUND - 350	RUBBER COATED J CLIPS, SCREWS, WA'S	F	-	-	-	8	8.00
G-4885	WIRING - CONSOLE & GROUND (exc 350)	J-CLIP, SCREW, TOOTH WA	F	-	-	-	3	4.00
G-6327	WIRING - CONSOLE INSTRUMENT GROUND	HXWA SCREW, TOOTH WA	-	-	-	N	2	1.50
G-6487	WIRING - CONSOLE LAMP	RUBBER COATED S CLIPS	-	-	A	-	4	6.00
G-6475	WIRING - COWL INDUCTION	5.1" FLEXIBLE STRAP	F	-	-	-	1	3.00
G-6393	WIRING - DOOR JAMB SW > DEFROST DUCT	RUBBER COATED J-CLIP	-	-	A	-	1	3.00
G-5752	WIRING - ENGINE NEAR WIPER MOTOR	RUBBER COATED J-CLIP, HXWA SCREW	-	-	A	-	2	3.00
G-4666	WIRING - FUEL SENDER UNIT GROUND	HXWA SCREW, TOOTH WA	-	-	A	N	2	1.00
G-6523	WIRING - HORN	S CLIPS	-	-	A	-	3	7.00
G-4687	WIRING - INSTR HARNESS > DEFROST DUCT	J-CLIP, HXWA AB SCREW, FLAT SPR NUT	F	-	-	-	3	4.00
G-6519	WIRING - INSTR HARNESS > DEFROST DUCTS	J-CLIP, HXWA SCREW, FLAT SPRING NUT	-	-	-	N	6	6.00
G-6589	WIRING - INSTR HARNESS LAMP WIRES	S CLIPS	F	-	-	-	2	5.00
G-6501	WIRING - LAMP MONITOR (Rr) - CONVERTIBLE	S CLIPS	F	-	-	-	9	18.00
G-6500	WIRING - LAMP MONITOR (Rr) - COUPE	S CLIPS	F	-	A	-	4	8.00
G-6496	WIRING - LICENSE PLATE LAMP - El Camino	S CLIP	-	-	A	-	1	3.00
G-6440	WIRING - PARKING LAMP - AC ONLY	RUBBER COATED J & S-CLIPS	-	-	A	-	2	6.00
G-6451	WIRING - POWER TOP @ LH FENDER	5.1" FLEXIBLE STRAPS	F	-	-	-	3	7.00
G-5194	WIRING - STARTER TERMINALS	NUTS, TOOTH WA'S	F	-	A	N	4	1.50
G-5089	WIRING - TEMPERATURE SENDER	NUT, TOOTH WA	F	-	A	N	2	1.50
G-6470	WIRING - TRANS (TH400) CONTROL	5.1" FLEXIBLE STRAPS	F	-	-	N	2	5.00
G-6499	WIRING - TRUNK LAMP	S CLIPS	F	-	A	N	3	7.00
G-6468	WIRING - UNDERHOOD LAMP	5.1" FLEXIBLE STRAP, S CLIPS	F	-	-	-	3	6.00
G-6494	WIRING - UNDERHOOD LAMP	5.1" FLEXIBLE STRAPS	-	-	A	-	3	7.00
G-6493	WIRING - UNDERHOOD LAMP	5.1" FLEXIBLE STRAPS	-	-	-	N	2	5.00
G-5195	WIRING "GUTTER" > FIREWALL	HX AB FLAT SEMS	F	-	A	-	2	2.00
G-5499	WIRING "GUTTER" > FIREWALL	HXWA AB SCREWS	-	-	-	N	2	1.50
G-6529	WIRING @ WIPER MOTOR	5.1" FLEXIBLE STRAP	F	-	-	-	1	3.00
G-4356	WIRING HARNESS > LH WHEELHOUSE	PUSH-ENDS BLACK PLASTIC STRAPS	F	-	A	N	2	3.00
G-6616	WIRING HARNESS > LH WHEELHOUSE @ Rr	< 12-26-68, RUBBER COATED S CLIP	-	-	-	N	1	3.00

Emissions

G-4770	PCV HOSE CLAMPS	FLAT WOUND SPRING CLAMPS (Black)	F	-	-	-	2	1.50
G-5059	PCV LINE CLIP > CARB STUD - 396HP	FLAT WA ONLY !	F	-	-	N	1	1.00
G-4890	SMOG HOLE PLUGS - 396	HX PLUGS	F	-	-	-	8	10.00
G-4971	SMOG HOSE CLAMPS	TOWER TYPE CLAMPS	F	-	A	N	4	8.00
G-4963	SMOG PUMP - 302, 307, 327, 350, 396	HX BOLTS, SPLIT WA'S, SPACER	F	-	A	N	7	12.00
G-5048	SMOG PUMP DELETE - BLOCK HOLES	HX BOLTS	F	-	-	-	2	2.00
G-4843	SMOG PUMP PULLEY	HX BOLTS, SPLIT WA'S	F	-	A	N	6	3.00
G-6471	SMOG PUMP VACUUM HOSE > SMOG HOSE	5.1" FLEXIBLE STRAP	F	-	A	-	1	3.00
G-4970	SMOG VALVE & BRACKET	HX BOLTS, SPLIT & FLAT WA'S	F	-	A	N	12	4.00

Kits Contain Attaching Fasteners for Both Sides

GM Fastener Kits

1969

Exhaust

PART #	APPLICATION	NOTES					PCS	PRICE
			CAMARO	FIREBIRD	CHEVELLE	NOVA		
G-5573	EXHAUST HANGERS, DUAL	HXWA C SCREWS, RETAINERS	-	-	A	-	6	8.00
G-5081	EXHAUST HANGERS, DUAL	HX SPLIT SEMS, RIVET NUTS, SCREWS	-	-	-	N	16	10.00
G-4344	EXHAUST HANGERS, DUAL - 68 Conv, All 69	HX T1 SCREWS, HX SPLIT SEMS MS	F	-	-	-	8	8.00
G-6380	EXHAUST HANGERS, DUAL - CHAMBERED	HX MS SCREWS, HX SPLIT SEMS	F	-	-	-	6	6.00
G-4972	EXHAUST HANGERS, SINGLE	HX SPLIT SEMS, HX SCREWS	F	-	-	-	4	4.00
G-4846	EXHAUST HANGERS, SINGLE	HXWA C SCREWS, RETAINERS	-	-	A	-	5	5.00
G-6361	EXHAUST HANGERS, SINGLE	HXWA C SCREWS, HX T1 SCREWS	-	-	-	N	4	4.00
G-5266	EXHAUST PIPE > MANIFOLDS	STUDS, LOCK NUTS	F	-	A	N	12	14.00

Fuel

G-5159	ACCELERATOR CABLE	1/4-20 BALL STUD, KEPS NUT	-	-	A	-	2	6.00
G-6359	ACCELERATOR CABLE > FIREWALL	HXWA AB SCREW	-	-	-	N	1	1.00
G-4351	ACCELERATOR LEVER & SUPPORT	HX BOLT, HXWA AB SCREWS, WA'S, NUT	F	H	-	N	6	3.00
G-5730	ACCELERATOR LEVER SUPPORT	HXWA AB SCREWS	-	-	A	-	2	1.50
G-5058	FUEL DISTRIBUTION TEE BRACKET - 396HP	HX NUT, FLAT & SPLIT WA'S	F	-	A	N	3	2.00
G-5735	FUEL FILLER NECK - El Camino	HXWA AB SCREW	-	-	A	-	1	1.00
G-5051	FUEL FILTER - 396, 350 71N	HX BOLT, SPLIT WA	F	-	A	N	2	2.00
G-4664	FUEL HOSES	FLAT WOUND SPRING CLAMPS (Green)	F	H	-	-	4	3.00
G-6247	FUEL HOSES	FLAT WOUND SPRING CLAMPS (Yellow)	-	-	-	N	6	3.00
G-5533	FUEL HOSES, 283-4V, 307, 327 (All 68-69A)	FLAT WOUND SPRING CLAMPS (Green)	-	-	A	-	4	3.00
G-5052	FUEL RETURN HOSES	FLAT WOUND SPRING CLAMPS (Red)	F	H	A	-	6	4.00
G-5267	FUEL RETURN HOSES	FLAT WOUND SPRING CLAMPS (Red)	-	-	-	N	8	5.00
G-5050	FUEL RETURN LINE ON ENGINE - 396	"C" CLIPS	F	-	A	-	2	3.00
G-5736	FUEL VAPOR HOSES & CLIP	HXWA SCREW, SPR CLAMPS (Blk & Red)	-	-	A	-	3	3.00
G-4663	GAS TANK	CRG BOLTS, WA'S, NUTS, SCREWS	F	H	-	-	10	8.00
G-5734	GAS TANK	SPECIAL BOLTS, HXWA SCREWS, U-NUTS	-	-	A	-	6	6.00
G-6244	GAS TANK	BOLTS, WA'S, NUTS, SCREWS, SPACERS	-	-	-	N	12	8.00

Heater

G-4764	DEFROSTER DUCTS	HXWA SCREWS, FLAT WA	F	-	-	N	4	2.00
G-5711	DEFROSTER DUCTS	HXWA SCREWS	-	-	A	-	3	2.00
G-4327	HEATER BLOWER MOTOR	SRTD HXWA AB SCREWS	F	-	A	N	5	1.50
G-4326	HEATER BOX > FIREWALL	HX INT/EXT SEMS, STMPD NUTS, SEALER	F	-	A	N	12	5.00
G-4953	HEATER CONTROL CABLES	HX ABT FLAT SEMS, SCREW, RTNRS, NUT	F	-	-	N	14	5.00
G-5713	HEATER CONTROL CABLES	HXWA SCREWS, HX FLAT SEMS, RTNRS	-	-	A	-	16	5.00
G-6482	HEATER CONTROL CABLES (AC 68A)	5.1" FLEXIBLE STRAP	-	-	A	-	1	3.00
G-5769	HEATER CONTROL CABLES w AC	HX ABT FLAT SEMS, RETAINERS	-	-	A	-	12	4.00
G-4834	HEATER DUCT OUTLET (under dash)	HX AB FLAT SEMS	F	-	-	-	4	2.00
G-6364	HEATER DUCT OUTLET (under dash)	HX ABT FLAT SEMS	-	-	-	N	2	2.00
G-5397	HEATER HOSE CLIP @ WHEELHOUSE	FOLDOVER METAL CLIP	F	-	A	N	1	4.00
G-5715	HEATER HOSE CLIP > ALT BRACKET w/o AC	FOLDOVER METAL CLIP	-	-	A	-	1	4.00
G-6300	HEATER HOSE SEAL RETAINER - 396	HXWA AB SCREWS	-	-	-	N	2	1.50
G-4771	HEATER HOSE SEAL RETAINER - 396, All 68N	HI-HXWA AB SCREWS	F	-	-	-	2	2.00
G-4952	HEATER HOSES	BAND CLAMPS w STRAIGHT UP SCREW	F	-	A	N	4	8.00
G-5032	HEATER HOSES w AC	BAND CLAMPS w STRAIGHT UP SCREW	F	-	-	N	6	12.00
G-5782	HEATER HOSES w AC	BAND, WORM, WIRE CLAMPS	-	-	A	-	6	10.00
G-5478	HEATER or AC OUTLET (LH under dash)	HXWA AB SCREWS	-	-	A	-	2	1.00
G-4616	HEATER RESISTOR > BOX	HXWA AB SCREWS	F	-	A	N	2	1.00

Interior

G-5009	AIR OUTLET BEZELS (w AC) > DASH	PH OV & HX SEMS, SPRING NUTS, WA	F	-	-	-	11	5.00
G-5765	AIR OUTLET BEZELS (w AC) > DASH	PH OV SEMS, HXWA SCREWS, SPR NUTS	-	-	A	-	16	4.00
G-6278	AIR OUTLET BEZELS (w AC) > DASH	SCREWS, NUTS, SPRING NUTS, WA	-	-	-	N	13	4.00
G-5383	ARMREST PAD & BASE @ Fr DOORS	CHROME PH RND & PH FLAT SCREWS	F	-	A	-	10	5.00
G-6683	ARMREST PAD & BASE @ Rr SEATS - COUPE	PH FLAT B & PH RND AB SCREWS	-	-	A	-	8	4.00
G-5421	ARMRESTS (Rr) - DLX CONVERTIBLE	CHROME PH OV AB FINWA SEMS .50" OD	F	-	-	-	8	3.00
G-5420	ARMRESTS (Rr) - DLX COUPE	CHROME PH OV AB FINWA SEMS .50" OD	F	-	-	-	4	2.00
G-4622	ASH TRAY RETAINER	PH PN B SCREWS	F	-	-	N	3	1.50
G-5699	ASH TRAY RETAINER	PH PN SCREWS, PH OV AB FLUSH SEMS	-	-	A	-	3	1.50
G-5406	COAT HOOK	CHROME PH PN SCREW	F	-	-	-	2	1.00
G-6643	COAT HOOKS	SS/CHROME PH OV SCREWS	-	-	A	-	2	1.50
G-6276	CONSOLE - ASH TRAY DOOR	RIVETS, RETAINERS	F	-	-	-	4	4.00
G-4878	CONSOLE > FLOOR	HX PP CONI SEMS, RIV-NUTS, FLNG NUTS	F	-	-	-	6	6.00
G-5789	CONSOLE > FLOOR	HXWA & PN HD SCREWS	-	-	A	-	7	3.00

See factory Assembly Manuals for illustrations

GM Fastener Kits

359

1969

Interior

PART #	APPLICATION	NOTES					PCS	PRICE
			CAMARO	FIREBIRD	CHEVELLE	NOVA		
			F	H	A	N		
G-6288	CONSOLE > FLOOR	HXWA & PH OV SCREWS, SPRING NUTS	-	-	-	N	8	3.00
G-6588	CONSOLE ASH TRAY DOOR BUMPERS	RUBBER BUMPERS	F	-	-	-	2	2.00
G-5043	CONSOLE DOOR & HINGE	HI-HXWA & PH PN SCREWS	F	-	-	-	8	3.00
G-6587	CONSOLE DOOR BUMPERS	RUBBER BUMPERS	F	-	-	-	2	2.00
G-5794	CONSOLE DOOR, HINGE & STRIKER	PH OV & PH PN SCREWS	-	-	A	-	11	3.00
G-5790	CONSOLE END COVER	CHROME PH OV SCREWS	-	-	A	-	4	2.00
G-4881	CONSOLE INSERT & EMBLEM	STAMPED NUTS, FLAT WA'S	F	-	-	-	10	3.00
G-5698	CONSOLE INSERT & EMBLEM	STAMPED NUTS	-	-	-	N	7	1.50
G-4921	CONSOLE INSTRUMENT CLUSTER	HI-HXWA SCREWS, FLAT WA'S	F	-	-	-	8	3.00
G-4884	CONSOLE LAMP LENS	HXWA BT SCREWS	F	-	-	-	2	1.50
G-5791	CONSOLE MOULDINGS	STAMPED NUTS ONLY	-	-	A	-	14	2.00
G-4879	CONSOLE TOP FRAME & BRACKETS	HXWA & PH PN BT SCREWS	F	-	-	-	9	3.00
G-4944	DASH PAD	SPECIAL SCREWS, NUTS, RETAINERS	F	-	-	-	22	12.00
G-6232	DASH PAD	HXWA AB SCREWS & NUTS ONLY !	-	-	-	N	10	4.00
G-5650	DOVE LAMP	PH PN SCREWS	F	-	A	-	2	1.50
G-5419	DOOR HANDLE PLATES - DLX	CHROME PH OV SEMS	F	-	-	-	6	3.00
G-5396	DOOR HANDLES (inside) - DLX	PH OV SCREWS	F	-	-	-	4	4.00
G-5409	DOOR HANDLES (inside) - STD	WIRE RETAINERS	F	-	-	-	2	1.00
G-5384	DOOR PANELS	CLIPS, PLUGS (flexible !), PH OV AB SEMS	F	-	A	-	32	12.00
G-5394	DOOR PULL STRAPS	#14 PH PN (#10 HD) AB SCREWS	F	-	-	-	4	3.00
G-5705	EMBLEM, GLOVE BOX - RH	STAMPED NUTS	-	-	A	-	2	1.00
G-6688	FENDERS > FIREWALL (also in fender kits)	HX PP CONI SEMS	F	-	A	N	4	6.00
G-4947	GLOVE BOX DOOR	HX AB FLAT SEMS	F	-	-	N	3	2.00
G-5701	GLOVE BOX DOOR & LINER w/o AC	PH RNDWA AB SCREWS, CONI KEPS NUTS	-	-	A	-	7	4.00
G-6585	GLOVE BOX DOOR BUMPERS	RUBBER BUMPERS	F	-	A	N	2	2.00
G-5771	GLOVE BOX DOOR, LINER & SHIELD w AC	CONI KEPS NUTS, PH RNDWA AB SCREWS	-	-	A	-	9	4.00
G-4360	GLOVE BOX LINER	PH PN AB FLAT SEMS	F	-	-	N	6	3.00
G-4943	GLOVE BOX STRIKER	PN PN AB FLAT SEMS	F	-	-	N	2	1.50
G-5702	GLOVE BOX STRIKER	SCREWS, SPRING NUTS	-	-	A	-	4	2.00
G-4942	GRAB BAR (above glove box)	STAMPED NUTS	F	-	-	-	2	1.50
G-6651	HEADLINER RETAINERS - Fr & SIDES	5/16 AF HXWA AB SCREWS	-	-	A	-	22	3.00
G-5417	HEADREST ESCUTCHEONS	CHROME PH OV AB SCREWS	F	-	-	-	8	3.00
G-6655	HEADREST ESCUTCHEONS & FABRIC RETAINER	CHROME PH OV AB & PH FLAT SCREWS	-	-	A	-	16	4.00
G-5714	HEATER CONTROL & BRACKET > DASH	PH OV SEMS, HXWA SCREWS, SPR NUTS	-	-	A	-	12	4.00
G-4954	HEATER CONTROL > DASH	PH OV AB FLUSH SEMS, SPRING NUTS	F	-	-	-	8	5.00
G-6238	HEATER CONTROL > DASH	PH OV AB SEMS, SPRING NUTS	-	-	-	N	6	3.00
G-5703	INSTR PANEL MOULDING ABOVE GLOVE BOX	STAMPED NUTS	-	-	A	-	5	2.00
G-6271	INSTRUMENT CLUSTER & CARRIER > DASH	PH OV & HX AB FLAT SEMS, SPR NUTS	-	-	-	N	14	4.00
G-5756	INSTRUMENT CLUSTER > CARRIER	HI-HXWA & PH OV AB SCREWS	-	-	A	-	7	3.00
G-6395	INSTRUMENT CLUSTER > CARRIER	HXWA AB SCREWS	-	-	-	N	8	2.00
G-4985	INSTRUMENT CLUSTER > DASH	SCREWS, SPRING NUTS, CONI KEPS NUTS	F	-	-	-	16	8.00
G-5755	INSTRUMENT CLUSTER CARRIER > DASH	CHROME PH OV AB SEMS, SPRING NUTS	-	-	A	-	22	6.00
G-5072	INSTRUMENT CLUSTER REINFORCEMENT - A/T	PH PN BT SCREWS	F	-	-	-	2	1.50
G-5106	INSTRUMENT PANEL TRIM PLATE - RH	PH PN AB FLAT SEMS, HX NUTS, WA'S	F	-	-	-	11	2.00
G-4617	INSULATION > FIREWALL	RUBBER RETAINERS	F	-	-	-	4	6.00
G-5825	INSULATION > FIREWALL	RUBBER RETAINERS	-	-	-	N	3	5.00
G-5390	KICK PANELS	CHROME PH OV FINISH WA SEMS, .50" DIA	F	-	-	-	10	3.00
G-5762	KICK PANELS w AC	PH OV AB FLUSH SEMS	-	-	A	-	4	3.00
G-4621	MIRROR (inside Rr view) > BRACKET	CHROME SLOT OV SHLDR SCREW	F	-	A	N	1	2.00
G-6691	MIRROR (inside Rr view) BRACKET	PH PN AB SCREWS	-	-	A	-	3	1.00
G-5597	MIRROR, REMOTE CONTROL BEZEL > DOOR	SS/CHROME PH OV AB SCREWS	-	-	A	N	2	1.50
G-5435	MOULDINGS - CONVERTIBLE HEADER	SS/CHROME PH OV AB SCREWS	F	-	-	-	5	3.00
G-4945	NAMEPLATE "ASTRO VENTILATION"	STAMPED NUTS	F	-	-	-	2	1.50
G-4948	NAMEPLATE, RH DASH "Camaro"	STAMPED NUTS	F	-	-	-	3	1.50
G-5107	NAMEPLATE, RH DASH "Camaro"	STAMPED HX NUTS	F	-	-	-	3	1.50
G-5388	PILLAR MOULDINGS - CONVERTIBLE	PH OV AB SCREWS	F	-	-	-	4	2.00
G-6684	PILLAR MOULDINGS - CONVERTIBLE	PH OV AB SEMS, PH RNDWA TEK SCREWS	-	-	A	-	4	3.00
G-6571	PILLAR MOULDINGS - COUPE	PH OV AB FLUSH SEMS	F	-	-	-	6	3.00
G-5142	QUARTER TRIM PANELS - MAIN	CHROME PH PN AB SCREWS	F	-	-	-	2	1.50
G-6943	QUARTER TRIM PANELS - MAIN	PH OV FINWA SEMS	-	-	A	-	4	2.00
G-5408	QUARTER TRIM PANELS @ Rr WINDOW SIDES	PH OV AB SCREWS	F	-	-	-	4	1.50
G-4913	QUARTER TRIM SAIL PANELS	RETAINING CLIPS	F	-	-	-	6	4.00
G-6648	QUARTER TRIM SAIL PANELS	RETAINING CLIPS	-	-	A	-	4	3.00
G-5299	RADIO CONTROL SHAFTS & KNOBS	Early 70F, SLOTTED NUTS, TEFLON WA'S	F	-	A	N	4	4.00
G-5415	ROCKER PANEL COVER PLATES	PH PN AB SCREWS	F	-	-	-	8	2.00
G-4321	SCUFF PLATES, DOOR OPENING	SS/CHROME PH OV AB SCREWS	-	-	A	-	8	2.50
G-6148	SCUFF PLATES, DOOR OPENING	SS/CHROME PH OV AB SCREWS	-	-	-	N	12	3.00
G-5375	SEAT BACK (Fr) STOP BUMPERS	CHROME PH PN AB SCREWS	F	-	-	-	2	1.50
G-6657	SEAT BACK (Fr) STOP BUMPERS	PH PN AB SCREWS	-	-	A	-	4	1.50
G-5398	SEAT BACK (Fr) STRIKERS	TRIM HX CA CONI SEMS	F	-	-	-	4	4.00
G-5380	SEAT BACK (Rr) > BODY	HX AB CONI TOOTH SEMS	F	-	A	-	2	3.00
G-5376	SEAT BACK CABLE	PH WAFER MS SHLDR SCREWS	F	-	-	-	2	3.00
G-5381	SEAT BACK PANELS	PH PN AB FLAT SEMS	F	-	-	-	4	3.00
G-6659	SEAT BACK PANELS	PH PNWA FLAT TOP SCREWS	-	-	A	-	6	2.00
G-6658	SEAT BACK RELEASE ESCUTCHEONS	CHROME PH OV AB SCREWS	-	-	A	-	8	2.00

Kits Contain Attaching Fasteners for Both Sides

GM Fastener Kits

1969

Interior

PART #	APPLICATION	NOTES					PCS	PRICE
			CAMARO	FIREBIRD	CHEVELLE	NOVA		
G-6675	SEAT BACK STRAP > SEAT BASE	ROUNDED TRIM HX CONI SEMS	-	-	A	-	4	6.00
G-5654	SEAT BELT BUCKLE RETAINERS	CHROME PH OV SCREWS, FL SPR NUTS	-	-	A	-	4	6.00
G-6536	SEAT BELTS (Fr)	CHROME & ZDC BOLTS w NYLON PELLET	F	-	-	-	4	18.00
G-6537	SEAT BELTS (Rr)	ZDC PLATED BOLTS w NYLON LOCK	F	-	-	-	4	16.00
G-6161	SEAT PIVOT	"E" CLIPS	F	-	-	-	4	3.00
G-5379	SEAT PIVOT COVERS	ORIGINAL METAL RETAINERS	F	-	-	-	4	8.00
G-6656	SEAT SIDE PANELS	.41 DIA PH RNDWA SCREWS	-	-	A	-	12	3.00
G-5148	SEAT TRACKS > FLOOR	HX CONI TOOTH SEMS	F	-	-	-	8	6.00
G-6653	SEAT TRACKS > FLOOR	HX CONI TOOTH SEMS, PERI KEPS	-	-	A	-	8	5.00
G-5407	SHOULDER HARNESS RETAINERS	CHROME PH OV AB SCREWS	F	-	A	-	8	2.00
G-6538	SHOULDER STRAPS > ROOF	HX BOLTS w PILOT	F	-	-	-	4	8.00
G-4978	STEERING COLUMN COVER > DASH	PH OV AB FLUSH SEMS, SPRING NUTS	F	-	-	-	4	3.00
G-5700	STEERING COLUMN COVER > DASH	PH OV AB FLUSH SEMS, SPRING NUTS	-	-	A	-	8	4.00
G-6252	STEERING COLUMN COVER > DASH	PH OV SEMS, HX FLAT SEMS, SPR NUTS	-	-	-	N	6	3.00
G-4977	STEERING COLUMN COVER > FIREWALL	HX AB FLAT SEMS w SEALER	F	-	-	N	2	3.00
G-5926	STEERING COLUMN COVER > FIREWALL	HXWA AB SCREWS	-	-	A	-	2	2.00
G-4998	STEERING WHEEL SHROUD	PH PN EXT SEMS	F	-	A	N	4	2.00
G-4915	STEERING WHEEL SHROUD EMBLEM	STAMPED NUTS	F	-	A	N	2	1.50
G-5377	SUN VISOR & MIRROR BRACKETS - COUPE	SS/CHROME PH OV & PH PN AB SCREWS	F	-	A	-	9	3.00
G-5422	SUN VISOR BRACKETS - CONVERTIBLE	SS/CHROME PH OV MS SCREWS	F	-	-	-	4	3.00
G-6670	SUN VISOR BRACKETS - CONVERTIBLE	CHROME PH OV SCREWS w #12 HD	-	-	A	-	6	4.00
G-5378	SUN VISOR CLAMPS	CHROME SLOT FILL SCREWS	F	-	A	-	2	2.00
G-5108	TRIM PLATES - DLX RADIO & LIGHTS	STAMPED NUTS	F	-	-	-	4	3.00
G-5187	VENTILATION DUCT ADAPTERS > COWL	PH PN AB EXT SEMS	F	-	-	-	6	3.00
G-5708	VENTILATION OUTLET BEZELS	PH OV AB FLUSH SEMS, SPRING NUTS	-	-	A	-	7	3.00
G-4949	VENTILATION OUTLETS	HX AB & HI-HX BT FLAT SEMS, SPR NUT	F	-	-	-	6	4.00
G-5400	WINDOW CRANK HANDLES	RETAINING CLIPS	F	-	A	-	4	1.50

Mouldings

G-5632	FENDER MOULDINGS	STAMPED NUTS	-	-	A	-	4	2.00
G-6335	FENDER MOULDINGS - LWR	STAMPED NUTS ONLY !	-	-	-	N	6	3.00
G-6337	FENDER ORNAMENTS	STAMPED NUTS	-	-	-	N	10	3.00
G-4284	GRILLE MOULDING - R/S	STAMPED NUTS	F	-	-	-	12	3.00
G-4470	GRILLE MOULDINGS	STAMPED NUTS ONLY	-	-	A	-	22	6.00
G-4493	HEADER & FENDER "EYE BROW" MOULDINGS	STAMPED NUTS	-	-	A	-	12	4.00
G-6255	HOOD & FENDER Fr MOULDINGS	Does hood emblem, STMPD NUTS, CAPS	-	-	-	N	20	4.00
G-4624	ROCKER MOULDINGS	PH PN BT & PH OV SS/CHROME SCREWS	F	-	-	-	14	4.00
G-5706	ROCKER MOULDINGS	PH PN AB SCREWS ONLY	-	-	-	N	24	4.00
G-4496	WHEEL OPENING MOULDINGS	CHROME/SS PH RNDWA AB SCREWS	F	-	A	-	32	6.00
G-4196	WHEEL OPENING MOULDINGS	CHROME/SS PH RNDWA AB SCREWS	-	H	-	-	28	6.00
G-6544	WINDOW (Fr) MOULDINGS	RETAINING CLIPS, PH PN AB SCREWS	-	-	A	-	32	12.00
G-6555	WINDOW (Fr) MOULDINGS	RETAINING CLIPS, PH PN AB SCREWS	-	-	-	N	32	12.00
G-6561	WINDOW (Fr) MOULDINGS - CONVERTIBLE	RETAINING CLIPS, PH PN AB SCREWS	-	-	A	-	26	12.00
G-4665	WINDOW (Fr) MOULDINGS, LWR	RETAINING CLIPS (less the 2 end clips)	F	-	-	N	8	12.00
G-4639	WINDOW (Fr) MOULDINGS, SIDES, UPR	RETAINING CLIPS	F	-	-	-	13	8.00
G-6553	WINDOW (Fr) MOULDINGS, SIDES, UPR - CONV	RETAINING CLIPS	F	-	-	-	13	8.00
G-6552	WINDOW (Fr) MOULDINGS, SIDES, UPR - VINYL	RETAINING CLIPS	F	-	-	-	13	8.00
G-6556	WINDOW (Fr) MOULDINGS, SIDES, UPR - VINYL	RETAINING CLIPS, SCREWS	-	-	-	N	20	12.00
G-6539	WINDOW (Rr) MOULDINGS	RETAINING CLIPS	F	-	-	-	20	12.00
G-6549	WINDOW (Rr) MOULDINGS	RETAINING CLIPS	-	-	A	-	20	12.00
G-6558	WINDOW (Rr) MOULDINGS	RETAINING CLIPS	-	-	-	N	20	12.00
G-6550	WINDOW (Rr) MOULDINGS - El Camino	RETAINING CLIPS	-	-	A	-	20	12.00
G-6551	WINDOW (Rr) MOULDINGS - El Camino - VINYL	RETAINING CLIPS	-	-	A	-	20	12.00
G-6560	WINDOW (Rr) MOULDINGS - Vinyl Top	RETAINING CLIPS	-	-	A	-	20	12.00
G-6559	WINDOW (Rr) MOULDINGS - Vinyl Top	RETAINING CLIPS	-	-	-	N	20	12.00

Steering & Suspension

G-4631	AXLE HSNG > SPRINGS	SPECIAL GR-8 LOCK NUTS ONLY !	F	-	-	N	8	12.00
G-6639	AXLE HSNG > SPRINGS - 302/350/396	MULTI SPRINGS, T, U BOLTS, LOCK NUTS	F	H	-	N	14	38.00
G-5904	AXLE HSNG > SPRINGS (mono spring)	SPECIAL GR-8 LOCK NUTS & T BOLTS	F	H	-	N	16	26.00
G-6151	BALL JOINTS - UPPER	SOLID RIVETS (2 are extra)	F	-	A	N	10	6.00
G-4612	CONTROL ARM BUSHINGS - UPPER	HX BOLTS "SSC", WA'S, RETAINERS	F	H	A	N	12	12.00
G-4608	CONTROL ARMS - LWR	POINTED BOLTS, LOCK NUTS	F	H	A	N	8	20.00
G-4627	CONTROL ARMS - UPPER	GR-8 KNURL BOLTS, LOCK NUTS, SHIMS	F	H	A	N	18	14.00
G-4610	CONTROL ARMS (Rr)	GR-8 POINTED BOLTS, LOCK NUTS	-	-	A	-	16	32.00
G-5539	FRAME REINFORCEMENTS - HP APPLICATIONS	HARDENED FLAT WA'S	-	-	A	-	2	3.00
G-4669	GREASE FITTINGS	STRAIGHT	F	H	A	N	10	3.00

See factory Assembly Manuals for illustrations

1969

Steering & Suspension

PART #	APPLICATION	NOTES					PCS	PRICE
			CAMARO	FIREBIRD	CHEVELLE	NOVA		
G-4265	IDLER ARM > FRAME	GR-8 HX BOLTS, WA'S, NUTS	F	H	A	N	6	6.00
G-4606	LEAF SPRING, Fr HANGERS	HX CA CONI SEMS, SPECIAL U-NUTS	F	H	-	N	12	18.00
G-4630	LEAF SPRINGS, Fr EYE	GR-8 BOLTS, NUTS, WA'S	F	H	-	N	8	12.00
G-5084	P/S PUMP - 396	HX BOLTS, NUTS, WA'S, SPACER	F	-	A	N	20	12.00
G-5082	P/S PUMP - SB	HX BOLTS, NUTS, WA'S, SPACER	F	-	A	N	19	12.00
G-4807	P/S PUMP PULLEY	THIN LOCK NUT	F	-	A	N	1	6.00
G-4919	P/S RETURN HOSE	ORIGINAL CLAMPS	F	-	A	N	2	20.00
G-4668	PITMAN ARM > GEAR BOX	HX NUT, SPLIT WA	F	H	A	N	2	3.00
G-4838	SHACKLES	11/16" AF MARSDEN NUTS ONLY	F	H	-	N	4	6.00
G-4634	SHOCK BRACKETS (Rr) > BODY	HX SPLIT SEMS, SEALING WA'S	F	H	-	-	8	6.00
G-4586	SHOCKS (Fr) - LWR MOUNTING	HXWA CA SCREWS, U-NUTS	F	H	A	N	8	8.00
G-4836	SHOCKS (Fr) - UPR MOUNTING	RETAINERS, BUSHINGS, 3/8-24 NUTS	F	-	A	N	10	6.00
G-5483	SHOCKS (Rr)	BOLTS, LOCK NUTS, FLAT & SPLIT WA'S	-	-	A	-	16	8.00
G-4632	SHOCKS (Rr) LWR MOUNTING - MONO SPRING	HX BOLTS, NUTS, SPLIT WA'S	F	H	-	N	6	4.00
G-4898	SHOCKS (Rr) LWR MOUNTING - MULTI SPRING	THICK HX NUTS, SPLIT WA'S	F	H	-	N	4	3.00
G-6101	SHOCKS (Rr) UPR MOUNTING	RETAINERS, BUSHINGS, 3/8-24 NUTS	F	-	-	-	10	8.00
G-6100	SHOCKS (Rr) UPR MOUNTING	HX SPLIT SEMS	-	-	-	N	4	6.00
G-4675	SPARE WHEEL (F convertible only)	7 7/8" J-BOLT, WING NUT	F	-	-	-	2	14.00
G-6938	SPARE WHEEL (F coupe only)	5 7/8" J-BOLT, WING NUT	F	-	A	N	2	14.00
G-5085	SPARE WHEEL w TIRE INFLATOR	J-BOLT, FORGED WING NUT	F	-	-	-	2	15.00
G-6461	SPARE WHEEL WRENCH > JACK	7.1" FLEXIBLE STRAPS	F	-	-	-	2	5.00
G-5141	STABILIZER BAR (Fr) BRACKETS	HX TY-T SCREWS	F	H	-	-	4	6.00
G-4628	STABILIZER BAR (Fr) BRACKETS	HXWA C SCREWS	-	-	A	N	4	6.00
G-4955	STABILIZER BAR (Fr) CLAMPS	HX BOLTS, NUTS, SPLIT & FLAT WA'S	F	H	-	-	8	4.00
G-4837	STABILIZER BAR (Fr) END LINKS	HX BOLTS, RETAINERS, BUSHINGS, NUTS	F	H	-	N	22	20.00
G-5481	STABILIZER BAR (Fr) END LINKS	HX BOLTS, RETAINERS, BUSHINGS, NUTS	-	-	A	-	22	25.00
G-5600	STABILIZER BAR (Rr)	HX BOLTS, NUTS	-	-	A	-	8	6.00
G-4976	STEERING COLUMN > DASH	FLNG NUTS, FLNG SCREWS (copper plate)	F	-	-	N	6	5.00
G-5742	STEERING COLUMN > DASH	HXWA PP SCREWS, BOLT, NUTS, WA	-	-	A	-	10	6.00
G-4354	STEERING GEAR "RAG" JOINT	12 PT BOLT ONLY	F	H	A	N	1	3.00
G-4293	STEERING GEAR BOX > FRAME	GR-8 HX BOLTS, FLAT WA'S	F	H	-	N	6	12.00
G-5180	STEERING GEAR BOX > FRAME	GR-8 HX BOLTS, FLAT WA'S	-	-	A	-	6	12.00
G-4615	STEERING LINKAGE & BALL JOINTS	SLOTTED NUTS, COTTER PINS	F	H	A	N	20	10.00
G-4670	STEERING SHAFT > COUPLING	REG & HVY NUTS, SPLIT WA'S	F	H	A	N	4	3.00
G-4674	STEERING WHEEL	HX JAM NUT, FLAT WA	F	-	A	-	2	3.00
G-4802	STEERING WHEEL - DLX	SS PH FLAT MS SCREWS	-	-	A	N	6	3.00
G-5716	SUSPENSION BUMPER & BRACKET (Rr)	HX BOLTS, NUTS, SPLIT WA'S	-	-	A	-	7	3.00
G-4339	SUSPENSION BUMPER BRACKETS (Rr)	HX PP CONI SEMS, HXWA T SCREWS	F	H	-	-	8	8.00
G-4596	SUSPENSION BUMPERS (Fr)	HX NUTS	F	H	A	N	2	1.00
G-6316	SUSPENSION BUMPERS (Fr) - 350, 396	HX NUTS, FLNG NUTS, WA'S	-	-	-	N	6	3.00
G-6355	SUSPENSION BUMPERS (Rr)	HXWA T SCREWS	-	-	-	N	6	4.00
G-5484	SUSPENSION BUMPERS (Rr) - El Camino	HX BOLTS, NUTS, SPLIT WA'S	-	-	A	-	3	2.00
G-6583	WHEEL STUDS - 1 AXLE (Fr or Rr)	Does 2 wheels, 7/16-20 x 1.38" L	F	-	A	N	10	14.00
G-5060	WHEELS - STD	ORIGINAL LUG NUTS w "DIAMONDS"	F	-	A	N	20	25.00

Transmission

G-6611	BELL HOUSING > ENGINE	FLNG BOLTS, "M" MARKING	F	-	A	N	6	8.00
G-6149	BELL HOUSING > ENGINE	FLNG BOLTS (Flat Top) "A" MARKING	F	-	A	N	6	8.00
G-5416	BELL HOUSING Fr COVER PLATE	SS EXT SEMS "L"	F	-	A	N	4	3.00
G-5907	CLUTCH BELLCRANK	BALL STUDS, SEATS, RETAINER, WA'S	F	-	A	N	9	32.00
G-4660	CLUTCH BELLCRANK BRACKET > FRAME	HXWA SCREWS	F	-	-	N	3	4.00
G-5603	CLUTCH PEDAL BUSHINGS	NYLON BUSHINGS ONLY	F	-	A	N	2	3.00
G-4658	CLUTCH PEDAL PUSH ROD SEAL	HXWA AB SCREWS	F	-	-	N	2	1.00
G-4850	CLUTCH PEDAL PUSH RODS	RETAINING CLIPS ONLY	F	-	A	N	3	3.00
G-4659	CLUTCH PEDAL RETAINER	FOLDED SPRING METAL	F	-	A	N	1	3.00
G-4792	COVER - CLUTCH PEDAL HOLE	HXWA SCREWS	F	-	-	N	2	1.50
G-4629	DRIVESHAFT > REAR KNUCKLE	U-BOLTS, NUTS, WA'S	F	H	A	N	10	8.00
G-4796	DRIVESHAFT, TH400 '69 > 302, 350, BB. All 71 >	STRAPS, FLNG BOLTS	F	H	A	N	6	8.00
G-6573	FLYWHEEL - A/T	GR-8 HXWA SCREWS	F	-	A	N	12	16.00
G-4429	FLYWHEEL - M/T	11/16" AF X 1.0" L HX BOLTS	F	-	A	N	12	12.00
G-4798	FLYWHEEL (TH400) > CONVERTOR	3/8-16 GR-5 HX BOLTS, 11/16" AF	F	-	A	N	3	5.00
G-6150	PRESSURE PLATE > FLYWHEEL	SPECIAL HX BOLTS, SPLIT WA'S	F	-	A	N	12	6.00
G-4528	SHIFTER BEZEL & SEAL RETAINER - M/T	w/o CONSOLE, HXWA AB SCREWS	-	-	A	N	10	3.00
G-4908	SHIFTER CABLE - PG, TH400 w CONSOLE	U & PUSH RETAINERS, NUT, WA	F	-	A	-	6	6.00
G-5076	SHIFTER CABLE - TH350 w CONSOLE	SCREW, U & PUSH RETAINERS, NUT, WA	F	-	A	-	8	6.00
G-5733	SHIFTER CONTROL - HD 3 SPD or 4 SPD	HX BOLTS, WA'S, NUTS	-	-	A	-	16	8.00
G-4783	SHIFTER CONTROL & SUPPORT (exc 69F M20)	HX BOLTS, NUTS, SPLIT WA'S	F	-	-	N	13	4.00
G-5801	SHIFTER DIAL CABLE - IN DASH	PH FLAT B SCREW	-	-	A	N	1	1.00
G-5732	SHIFTER HANDLE - HD 3 SPD M/T, 70-72 4 SPD	HX SPLIT SEMS	-	-	A	-	2	3.00
G-5071	SHIFTER LEVER > FLOOR - A/T w CONSOLE	HX BOLTS, RIVET NUTS, SPLIT WA'S	F	-	-	-	12	6.00
G-4852	SHIFTER LEVER > FLOOR - A/T w CONSOLE	HXWA AB SCREWS	-	-	A	-	3	2.00

Kits Contain Attaching Fasteners for Both Sides

GM Fastener Kits

1969

Transmission

PART #	APPLICATION	NOTES					PCS	PRICE
			CAMARO	FIREBIRD	CHEVELLE	NOVA		
G-4790	SHIFTER LEVER > FLOOR - PG, TH400 w CNSL	HXWA T1 SCREWS	-	-	-	N	4	2.00
G-5898	SHIFTER LEVERS - 4S, 70-71A HD, 70F L65	HX BOLTS, FLAT & SPLIT WA'S	-	-	-	N	9	4.00
G-5897	SHIFTER LEVERS > CASE - 3 SPD M/T	HX BOLTS, SPLIT & FLAT WA'S	F	-	A	N	6	3.00
G-6295	SHIFTER LEVERS > CASE - 4 SPD	HX BOLTS, SPLIT & FLAT WA'S	F	-	-	-	9	3.00
G-5799	SHIFTER LEVERS > CASE - 4 SPD STD	HX SPLIT SEMS, FLAT WA'S	-	-	A	-	6	4.00
G-5798	SHIFTER LINKAGE, A/T FLOOR - TH350, TH400	RETAINERS, NUTS, FLAT WA'S	-	-	-	N	9	4.00
G-4791	SHIFTER LINKAGE, A/T FLOOR SHIFT - PG	RETAINERS, FLAT WA'S, NUTS	-	-	-	N	9	4.00
G-5063	SHIFTER PLATE - 4 SPD w/o CONSOLE	CHROME PH PN AB SCREWS	F	-	-	-	4	2.00
G-4883	SHIFTER PLATE - A/T CONSOLE	PH OV B SCREWS, STAMPED NUTS	F	-	-	-	12	4.00
G-5044	SHIFTER PLATE & SEALS - 3 SPD CONSOLE	PH FLAT & PH OV SCREWS, STMPD NUTS	F	-	-	-	12	3.00
G-5045	SHIFTER PLATE & SEALS - 4 SPD CONSOLE	PH OV & PH PN SCREWS, STAMPED NUTS	F	-	-	-	12	3.00
G-6291	SHIFTER PLATE & SEALS - A/T CONSOLE	HXWA T, PH OV AB SCREWS, SPR NUTS	-	-	-	N	14	4.00
G-6290	SHIFTER PLATE & SEALS - M/T CONSOLE	PH OV & HXWA SCREWS, SPRING NUTS	-	-	-	N	16	4.00
G-5796	SHIFTER PLATE, LENS, SEAL - A/T CONSOLE	HXWA, OV SCREWS, STMPD NUTS, WA'S	-	-	A	-	12	3.00
G-5066	SHIFTER RODS - 4 SPD	COTTER PINS, SPRING, FLAT WA'S, NUTS	F	-	-	-	19	5.00
G-4780	SHIFTER RODS - 4 SPD	RETAINING CLIPS, JAM NUTS	-	-	A	N	12	10.00
G-4778	SHIFTER RODS - HD 3 SPD	RETAINERS, NUTS	F	-	A	-	8	6.00
G-5786	SHIFTER SEAL RETAINER - M/T CONSOLE	HXWA AB SCREWS	-	-	A	-	6	2.00
G-4904	SHIFTER STAB 68FN 327, 69FN, 68-72AN 3, 4	Floor Shift. BOLTS, NUTS, RET'S, BSHNGS	F	-	A	N	8	12.00
G-6563	SHIFTER STAB SHAFT - HD 3 SPD	Floor Shift. BOLT, RET'S, NUTS, BUSHINGS	F	-	A	-	9	8.00
G-4903	SHIFTER STAB SHAFT - M/T (302/350/396)	HX BOLTS, NUTS, RETAINERS, BUSHINGS	-	-	-	N	9	12.00
G-5792	SHIFTER TRIM PLATE (console only)	PH OV C SCREWS	-	-	A	-	6	2.00
G-5795	SHIFTER TRIM PLATE EMBLEM	STAMPED NUTS	-	-	A	-	2	1.00
G-4694	SPEEDOMETER CABLE > TRANS	HX SPLIT SEMS	F	H	A	N	1	2.00
G-4788	TORQUE CONVERTOR > FLYWHL - PG, TH350	PLACE BOLTS, NUTS, WASHERS	F	-	A	N	9	8.00
G-5283	TRANS (Powerglide) KICKDOWN LINKAGE	BALL STUD, NUTS, WA'S, ROD END CLIP	F	-	A	-	7	8.00
G-4795	TRANS (Powerglide) KICKDOWN LINKAGE	ROD END CLIP, NUTS, WA'S	-	-	-	N	5	4.00
G-6508	TRANS (TH350) DETENT CABLE > TUBE	4.05" ALUMINUM STRAP	F	-	A	N	1	3.00
G-5079	TRANS (TH400) CONTROL SW - 396HP	HX EXT SEMS	F	-	-	-	2	2.00
G-5286	TRANS (TH400) CONTROL SW (at gas pedal)	HXWA AB SCREW	-	-	A	-	1	1.00
G-5078	TRANS (TH400) CONTROL SW, LEVER - 396	HX EXT SEMS, BOLT, NUT, SPLIT WA	F	-	-	N	5	3.00
G-5061	TRANS BACKDRIVE - 4 SPD (exc 69-70 L65)	RETAINERS, FITTINGS, NUTS, WA'S	-	-	A	-	10	14.00
G-5800	TRANS BACKDRIVE - 4 SPD 302, 350, 396	RETAINERS, FITTINGS, NUTS, WA'S	F	-	-	N	11	16.00
G-5067	TRANS BACKDRIVE - HD 3S, 69-70 L65 4S	RETAINERS, FITTINGS, NUTS, WA'S	-	-	A	-	14	16.00
G-5062	TRANS BACKDRIVE - M11 & 4 SPD 307/327	RETAINERS, FITTINGS, NUTS, WA'S	F	-	-	N	15	6.00
G-4169	TRANS CROSSMEMBER	HX BOLTS, WA'S (RH SIDE), NUTS	F	H	A	N	14	6.00
G-4603	TRANS INSULATOR	HX BOLTS, FLAT & SPLIT WA'S	F	H	-	N	10	6.00
G-4905	TRANS INSULATOR - TH400 (also does All)	HX BOLTS, FLAT & SPLIT WA'S	-	-	A	-	12	6.00
G-4604	TRANS INSULATOR (exc 69 TH400)	HX BOLTS, FLAT & SPLIT WA'S	-	-	A	-	12	6.00
G-5677	TRANS LINKAGE - A/T TH400, All 69, 72 M38	RETAINERS, SWIVEL, NUT, WA'S	-	-	A	-	7	12.00
G-5561	TRANS LINKAGE or BACKDRIVE SUPPORT	> FRAME: HXWA C SCREWS	F	-	A	N	3	3.00
G-5069	TRANS LINKAGE SUPPORT > FRAME	HXWA C SCREWS	F	-	A	N	2	2.00
G-6308	TRANS OIL PAN - PG (exc 68-72 console)	LRG FLNG HEAD SCREWS	F	-	A	N	14	7.00
G-6309	TRANS OIL PAN - PG w CONSOLE	LRG FLNG HEAD SCREWS, SPLIT SEMS	F	-	A	N	14	7.00
G-6311	TRANS OIL PAN w CNSL TH350 73-81, TH400	LRG FLNG HEAD SCREWS	F	-	A	N	13	7.00
G-6310	TRANS OIL PAN w/o CNSL - TH350 All, TH400	LRG FLNG HEAD SCREWS	F	-	A	N	13	6.00
G-5070	TRANSMISSION (A/T) > ENGINE (exc 67-68 PG)	HX BOLTS, SPLIT & FLAT WA'S	F	-	A	N	9	6.00
G-4590	TRANSMISSION (STD) > BELL HOUSING	HX BOLTS, SPLIT WA'S	F	-	A	N	8	5.00
G-4866	TRANSMISSION LINKAGE - A/T CLM SHIFT	RETAINERS, FITTINGS, NUTS, WA'S	F	-	-	N	11	16.00
G-5901	TRANSMISSION LINKAGE - M/T CLM SHIFT	RETAINERS, FITTINGS, NUTS, WA'S	F	-	-	N	18	20.00
G-5731	TRANSMISSION LINKAGE - M/T CLM SHIFT	RETAINERS, FITTINGS, NUTS, WA'S	-	-	A	-	15	24.00
G-4909	TRANSMISSION OIL COOLER LINES	C SHAPED SPRING CLIPS	F	-	A	N	2	3.00
G-5013	TRANSMISSION OIL COOLER LINES	HXWA AB SCREW, SPR NUTS, "C" CLIPS	F	-	-	-	4	4.00
G-4906	UNDERPAN - Powerglide A/T	HX PP CONI SEMS	F	-	A	N	4	3.00
G-4735	UNDERPAN - TH400, 70F PG	HX T1 SCREWS	F	-	A	N	4	2.00

Wipers

G-4302	WINDSHIELD WASHER BOTTLE BRACKET	HXWA AB SCREWS	F	-	A	N	3	2.00
G-5101	WINDSHIELD WASHER BOTTLE BRACKET - R/S	HXWA & PH PN SCREWS, RUBBER CAPS	F	-	-	-	10	4.00
G-6460	WINDSHIELD WASHER HOSE - R/S w AC	5.1" & 7.1" FLEXIBLE STRAPS	F	-	-	-	3	6.00
G-6459	WINDSHIELD WASHER HOSE - R/S w/o AC	5.1" & 7.1" FLEXIBLE STRAPS	F	-	-	-	4	8.00
G-4303	WINDSHIELD WASHER NOZZLES	#8 HXWA B SCREWS	F	-	A	N	2	1.25
G-4464	WIPER ARM PIVOTS > COWL	HX EXT SEMS	F	H	-	N	4	3.00
G-5423	WIPER ARM PIVOTS > COWL	HX CNTRSNG & REG HX EXT SEMS	-	-	A	-	5	5.00
G-4329	WIPER MOTOR	HX CNTRSNG EXT SEMS	F	H	A	N	3	3.00
G-5465	WIPER MOTOR	GROMMETS, GRD STRAP, RIVET, SCREWS	F	-	A	N	8	12.00
G-5599	WIPER MOTOR BRACKET - 1, 2S w/o WASHER	HX EXT SEMS	-	-	A	-	3	2.00
G-4946	WIPER SWITCH	HI-HXWA SCREWS	F	-	A	N	3	2.00

See factory Assembly Manuals for illustrations

GM Fastener Kits

363

1970

Air Conditioning

PART #	APPLICATION	NOTES	CAMARO				CHEVELLE		MONTE CARLO		NOVA		PCS	PRICE
			F	A	M	N								
G-5039	AC / HEAT DIVERTER DOOR SWITCH	HI-HXWA AB SCREWS	-	-	-	N						2	1.50	
G-5767	AC AIR DISTRIBUTION DUCT - CENTRAL	HX ABT FLAT SEMS	-	A	M	N						2	2.00	
G-5237	AC AIR DISTRIBUTION DUCTS - CENTRAL	HX FLAT SEMS, RETAINER, WA	F	-	-	-						7	6.00	
G-5251	AC AIR DUCT - CONSOLE	HX ABT FLAT SEMS, PH RND WA SCREW	F	-	-	-						4	3.00	
G-5216	AC AIR OUTLET @ FLOOR - CENTER	HX ABT FLAT SEMS	F	-	-	-						3	2.00	
G-6307	AC AIR OUTLET @ FLOOR - CENTER	HX ABT FLAT SEMS	-	-	-	N						2	1.50	
G-5218	AC AIR OUTLET DUCT - LH	HXWA AB SCREWS	F	-	-	-						3	1.50	
G-5035	AC AMBIENT SWITCH > EVAPORATOR	HXWA ABT SCREWS	F	A	M	N						2	2.00	
G-5785	AC BLOWER CONTROL SWITCH (in control)	HXWA T1 SCREWS	-	-	-	N						2	1.50	
G-5227	AC COMP BRACE > INTAKE - 396/454	HX BOLTS, HX CLR STUD, NUT, WA'S	F	A	M	-						7	6.00	
G-5223	AC COMP BRACE > INTAKE - SB	HX BOLTS, FLAT & SPLIT WA'S	F	A	M	N						5	4.00	
G-5849	AC COMP BRACE, UPPER Fr - 396/454	HX BOLTS, FLAT, SPLIT & TOOTH WA'S	F	A	M	-						9	5.00	
G-5023	AC COMP BRACE, UPPER Fr - SB	HX BOLTS, FLAT, SPLIT & TOOTH WA'S	F	A	M	N						11	6.00	
G-5225	AC COMP SUPPORT > EXH MANIFOLD - 396/454	HX BOLTS, SPLIT WA'S	F	A	M	-						6	3.00	
G-5020	AC COMP SUPPORT > EXH MANIFOLD - SB	GR-8 "TR" HX BOLTS, SPACER	F	A	M	N						3	8.00	
G-5226	AC COMP SUPPORT, LWR Fr - 396/454	HX BOLTS, SPLIT WA'S	F	A	M	-						6	3.00	
G-5021	AC COMP SUPPORT, LWR Fr - SB	HX BOLTS, SPLIT & TOOTH WA'S	F	A	M	N						6	4.00	
G-5224	AC COMP SUPPORT, LWR Rr - 396/454	HX BOLTS, FLAT & SPLIT WA'S	F	A	M	-						11	4.00	
G-5222	AC COMP SUPPORT, LWR Rr - SB	HX BOLTS, SPLIT WA'S	F	A	M	N						10	4.00	
G-6442	AC COMPRESSOR WIRING	5.1" FLEXIBLE STRAPS	F	-	-	-						2	5.00	
G-5220	AC CONDENSER	HX SPLIT SEMS, FLNG NUTS	F	-	-	-						16	6.00	
G-5845	AC CONDENSER	HX CONI SEMS, FLNG NUTS, U-NUTS	-	A	M	-						18	7.00	
G-6351	AC CONDENSER & BRACKETS	SCREWS, SPRING NUTS, WELL-NUTS	-	-	-	N						24	10.00	
G-5004	AC DEFROSTER DISTRIBUTOR	HX ABT FLAT SEMS	-	-	-	N						3	2.00	
G-6438	AC EQUALIZER LINE > EVAPORATOR	3.17" NYLON STRAP	-	-	-	N						1	2.00	
G-5228	AC EVAPORATOR > FIREWALL	HX FLAT SEMS, CLR STUD, NUTS, WA'S	F	-	-	-						10	8.00	
G-5776	AC EVAPORATOR > FIREWALL	HX AB FLAT SEMS	-	A	M	-						6	6.00	
G-4872	AC EVAPORATOR > FIREWALL	HX INT/EXT SEMS, CLR STUD, NUTS, WA'S	-	-	-	N						6	8.00	
G-6304	AC EVAPORATOR CASE	HXWA BT SCREWS	F	A	M	-						6	4.00	
G-4715	AC EVAPORATOR DRAIN HOSE CLAMP	WIRE CLAMP	-	-	-	N						1	2.00	
G-5235	AC FITTING & MUFFLER ASSEMBLY	HX BOLT, FLAT & SPLIT WA'S	F	A	M	N						3	3.00	
G-4723	AC GROUND > FIREWALL	HXWA AB SCREW, TOOTH WA	F	A	M	N						2	1.50	
G-5229	AC HEATER HOSE > DASH GROMMET	HX ABT FLAT SEMS	F	-	-	-						2	1.50	
G-5033	AC HEATER HOSE CLAMP > ALT BRACKET	METAL HOSE CLIP, HXWA SCREW	F	A	M	N						2	5.00	
G-6352	AC HEATER HOSE SEAL RETAINER	HXWA ABT SCREWS	-	-	-	N						2	1.50	
G-6439	AC HOSE > HEATER HOSE	11.25" FLEXIBLE STRAP	F	A	M	N						1	6.00	
G-5853	AC HOSE > RH WHEELHOUSE	HXWA AB SCREWS	F	A	M	-						2	1.50	
G-6287	AC HOSE > RH WHEELHOUSE	3/16" POP RIVETS	-	-	-	N						2	2.00	
G-6279	AC LH & RH OUTLET CONTROL CABLES	HX AB FLAT SEMS, HXWA AB SCREW	-	-	-	N						3	2.00	
G-5010	AC OUTLET CONTROL BEZELS @ KICK PNLS	PH OV AB FLUSH SEMS, SPRING NUTS	-	-	-	N						8	4.00	
G-5214	AC PLENUM VALVE & BRACKET	HXWA AB SCREWS, CONI KEPS NUTS	F	-	-	-						9	4.00	
G-5763	AC PLENUM VALVE & BRACKET	HXWA & PH PN SCREWS, NUTS, WA'S	-	A	M	-						11	3.00	
G-4699	AC PLENUM VALVE & BRACKET	HXWA SCREWS, NUTS, WA'S, RETAINER	-	-	-	N						16	5.00	
G-6283	AC RADIATOR SEAL	NYLON RETAINERS	-	-	-	N						4	2.00	
G-5846	AC RECIEVER TANK > CONDENSER	HXWA AB SCREWS	-	A	M	-						2	1.50	
G-6282	AC RECIEVER TANK > FENDER SKIRT	HX BOLTS, FLNG NUTS	-	-	-	N						4	3.00	
G-5221	AC RECIEVER TANK > RADIATOR SUPPORT	HXWA AB SCREWS, SPRING NUTS	F	-	-	-						6	3.00	
G-5034	AC RESISTOR & RELAY > EVAPORATOR	HXWA ABT SCREWS	F	A	M	N						3	2.00	
G-4856	AC SELECTOR DUCT > FIREWALL	HX INT/EXT SEMS, NUTS, SEALER, WA'S	F	-	-	N						11	5.00	
G-5215	AC SELECTOR DUCT > FIREWALL	HX AB INT/EXT SEMS, NUTS, WA'S	-	A	M	-						8	4.00	
G-6448	AC VACUUM HOSE @ EVAPORATOR	5.1" FLEXIBLE STRAP	-	A	M	-						1	3.00	
G-6434	AC VACUUM HOSE @ FIREWALL	5.1" FLEXIBLE STRAP	-	-	-	N						1	3.00	
G-5041	AC VACUUM HOSE @ FIREWALL & CONTROL	HXWA AB SCREW, HX FLAT ABT SEMS	-	-	-	N						2	1.50	
G-6449	AC VACUUM HOSE @ SELECT DUCT	5.1" FLEXIBLE STRAP	-	A	M	-						1	3.00	
G-5231	AC VACUUM HOSE ATTACHMENTS	HX AB SCREWS & RETAINERS ONLY	F	-	-	-						6	3.00	
G-5851	AC VACUUM HOSE ATTACHMENTS	HXWA AB SCREWS, RETAINER	-	A	M	-						4	2.00	
G-5233	AC VACUUM HOSE CLAMPS	FLAT WOUND SPRING CLAMPS (Black)	F	-	-	-						2	1.50	
G-5002	AC VACUUM HOSE CLAMPS	FLAT WOUND SPRING CLAMPS (Black)	-	-	-	N						3	3.00	
G-6450	AC VACUUM HOSE CLIPS @ SELECTOR DUCT	RUBBER COATED S CLIPS	-	A	M	-						2	4.00	
G-4697	AC VACUUM MOTOR @ RH COWL	HXWA SCREWS, NUTS, TOOTH WA'S	F	-	-	N						7	3.00	
G-4698	AC VACUUM MOTOR COVER	PH OV FIN WA SEMS .50 OD, SPRG NUTS	F	-	-	-						6	3.00	
G-5001	AC VACUUM MOTOR COVER	PH OV FIN WA SEMS .50 OD, SPRG NUTS	-	-	-	N						6	3.00	
G-4724	AC VACUUM TANK	HXWA AB SCREWS	F	-	-	-						2	2.00	
G-5038	AC VACUUM TANK	HXWA AB SCREWS	-	-	-	N						2	1.00	
G-4714	AC VALVE, TUBE BRKT'S > EVAPORATOR	HXWA AB & ABT SCREWS	F	-	-	N						2	1.50	
G-5850	AC VALVE, TUBE BRKT'S > EVAPORATOR	HXWA AB SCREWS	-	A	M	-						2	2.00	
G-5230	AC WATER SHUT-OFF VALVE	HXWA DRILL SCREWS	F	-	-	-						2	1.50	
G-5031	AC WATER SHUT-OFF VALVE	3/16" POP RIVETS	-	A	M	N						2	2.00	
G-6443	AC WIRING @ EVAPORATOR	5.1" FLEXIBLE STRAP	F	-	-	-						1	3.00	

Kits Contain Attaching Fasteners for Both Sides

GM Fastener Kits

1970

Body			CAMARO		CHEVELLE MONTE CARLO		NOVA					
			F	A	M	N			PCS	PRICE		
PART #	APPLICATION	NOTES	F	A	M	N					PCS	PRICE
G-4101	BATTERY TRAY	HX CONI SEMS, HXWA CA SCREWS	F	-	-	N					4	3.00
G-4198	BATTERY TRAY	HX MS & PP CONI SEMS, U-NUT	-	A	-	-					5	6.00
G-4197	BATTERY TRAY	HX CONI SEMS, HXWA SCREW, U-NUTS	-	-	M	-					7	6.00
G-5936	BODY MOUNT BRACKETS @ RAD SUPPORT	BOLTS, RATCHET TOOTH WA'S, NUTS	F	-	-	-					16	12.00
G-5935	BODY MOUNT BRACKETS @ RAD SUPPORT	HX PP CONI SEMS	-	A	M	-					6	3.00
G-5127	BODY MOUNTS	ORIGINAL BOLTS, CONI KEPS NUTS, WA'S	F	-	-	-					14	40.00
G-5831	BODY MOUNTS	ORIGINAL BOLTS, NUTS, WA'S	-	-	M	-					28	32.00
G-6363	BODY MOUNTS	ORIGINAL BOLTS, WA'S, NUTS	-	-	-	N					18	34.00
G-5830	BODY MOUNTS - CONVERTIBLE & El Camino	ORIGINAL BOLTS, NUTS, WA'S	-	A	-	-					22	30.00
G-5829	BODY MOUNTS - HARDTOP	ORIGINAL BOLTS, NUTS, WA'S	-	A	-	-					18	24.00
G-5188	BODY MOUNTS @ RADIATOR SUPPORT	ORIGINAL BOLTS, FLAT WA'S	F	-	-	-					4	6.00
G-5746	BODY MOUNTS @ RADIATOR SUPPORT	ORIGINAL BOLTS, NUTS, WA'S, SHIMS	-	A	-	-					14	10.00
G-4340	BRAKE PEDAL SUPPORT w/o PB	FLNG NUTS	F	A	M	N					2	2.00
G-4227	BUMPER (Fr)	SS CAP & UNCAP BOLTS, WA'S, NUTS	-	A	M	-					32	10.00
G-6273	BUMPER (Fr)	SS CAPPED BOLTS, WA'S, NUTS	-	-	-	N					32	10.00
G-5371	BUMPER (Fr) - R/S	SS CAPPED BOLTS, CONI KEPS NUTS	F	-	-	-					8	6.00
G-4135	BUMPER (Fr) - STD	SS CAPPED BOLTS, CONI KEPS NUTS	F	-	-	-					10	8.00
G-5969	BUMPER (Fr) BRACKETS	HX BOLTS, RATCHET TOOTH WA'S, NUTS	-	A	-	-					16	12.00
G-6024	BUMPER (Fr) BRACKETS	HX BOLTS, RATCHET TOOTH WA'S, NUTS	-	-	-	N					16	12.00
G-4180	BUMPER (Fr) FILLER PANEL	HX CONI SEMS, SCREWS, U-NUTS, NUTS	-	A	M	-					16	9.00
G-6262	BUMPER (Fr) FILLER PANEL & SUPPORT	HX CONI SEMS, SCREWS, U-NUTS, RTNRS	-	-	-	N					18	12.00
G-4226	BUMPER (Fr) OUTER PAD BRACKETS	BOLTS, RATCHET TOOTH WA'S	-	A	M	-					4	4.00
G-4136	BUMPER (Rr)	SS CAPPED BOLTS, CONI KEPS NUTS	F	-	-	-					14	14.00
G-4218	BUMPER (Rr)	SS CAP BOLTS, RATCHET WA'S, NUTS	-	A	-	-					28	12.00
G-4224	BUMPER (Rr)	SS CAP BOLTS, RATCHET WA'S, NUTS	-	-	M	-					40	20.00
G-6275	BUMPER (Rr)	SS CAPPED BOLTS, WA'S, NUTS	-	-	-	N					32	10.00
G-5973	BUMPER (Rr) - El Camino	SS CAP BOLTS, RATCHET WA'S, NUTS	-	A	-	-					39	20.00
G-4614	BUMPER BRACES & BRACKETS (Fr) - R/S	HX PP CONI SEMS, SCREWS, CONI KEPS	F	-	-	-					10	8.00
G-4131	BUMPER BRACES & BRACKETS (Fr) - STD	HX PP CONI SEMS, HXWA SCREWS, NUTS	F	-	-	-					10	8.00
G-4225	BUMPER BRACKETS (Fr)	HX BOLTS, RATCHET TOOTH WA'S, NUTS	-	-	M	-					16	12.00
G-4137	BUMPER BRACKETS (Rr)	HX PP CONI SEMS	F	-	-	-					8	8.00
G-4215	BUMPER BRACKETS (Rr)	POINTED BOLTS, RATCHET TOOTH WA'S	-	A	-	-					12	12.00
G-4223	BUMPER BRACKETS (Rr)	HX BOLTS, RATCHET TOOTH WA'S, NUTS	-	-	M	-					20	14.00
G-4274	BUMPER BRACKETS (Rr)	HX PP CONI SEMS	-	-	-	N					8	8.00
G-5972	BUMPER BRACKETS (Rr) - El Camino	HX BOLTS, RATCHET TOOTH WA'S, NUTS	-	A	-	-					20	20.00
G-4222	BUMPER GUARD PADS (Fr & Rr)	STAMPED NUTS	-	A	M	N					12	3.00
G-6334	BUMPER GUARDS (Fr & Rr)	HX BOLTS, SPLIT WA'S, NUTS	-	-	-	N					20	5.00
G-4134	BUMPER GUARDS (Fr)	HX MS & PP CONI SEMS	F	-	-	-					4	6.00
G-4282	BUMPER GUARDS (Fr)	HX BOLTS, WA'S, NUTS	-	A	M	-					10	4.00
G-4157	BUMPER GUARDS (Rr)	HX BOLTS, HX CONI SEMS, WELL-NUTS	F	-	-	-					8	6.00
G-5971	BUMPER GUARDS (Rr)	HX BOLTS, SPLIT WA'S	-	A	M	-					8	3.00
G-4160	BUMPER PADS - FULL BUMPER (Fr)	EXT KEPS NUTS	F	-	-	-					21	5.00
G-4161	BUMPER PADS (Fr) R/S	EXT KEPS NUTS	F	-	-	-					14	4.00
G-4158	BUMPER PADS (Rr)	EXT KEPS NUTS	F	-	-	-					14	4.00
G-5109	COWL INDUCTION VALVE FRAME	HX EXT SEMS ONLY !	-	A	-	-					6	3.00
G-5945	COWL INDUCTION VALVE SCREEN	BLACK SS SCREWS ONLY	-	A	-	-					8	3.00
G-4301	COWL VENT PANEL	HX AB FLAT SEMS	-	-	-	N					4	3.00
G-5374	DOOR HANDLES (outside)	SPECIAL 5/16 AF HX CONI SEMS	F	A	M	-					4	4.00
G-5386	DOOR HINGES	HX CONI TOOTH SEMS	F	A	M	-					30	20.00
G-4332	DOOR LATCHES	OV HD TT SCREWS	F	A	M	N					6	3.00
G-6619	DOOR LOCK STRIKERS	TORX DRIVE	F	A	-	-					2	24.00
G-5399	DOOR WEATHERSTRIPS	PLASTIC PINS	-	A	M	-					4	1.50
G-6060	EMBLEM, GRILLE	STAMPED NUTS	-	-	M	-					2	1.00
G-4127	EMBLEM, GRILLE "BOWTIE", "Z28", "SS"	STAMPED NUTS	F	-	-	-					2	1.00
G-6315	EMBLEM, GRILLE "SS"	STAMPED NUTS	-	-	-	N					2	1.00
G-5310	EMBLEM, Rr SPOILER "Z28"	STAMPED NUTS	F	-	-	-					2	1.00
G-4105	FENDER > RADIATOR SUPPORT BRACES	HXWA CA SCREWS	F	-	-	-					4	3.00
G-4179	FENDER > WHEELHOUSE Fr BRACES	HXWA C SCREWS	-	A	M	N					2	2.00
G-4177	FENDER 90 DEG BRACKETS > RAD SUPPORT	HXWA CA SCREWS	-	-	M	-					4	3.00
G-4286	FENDER EMBLEMS - "Rally Sport"	STAMPED NUTS	F	-	-	-					8	3.00
G-5270	FENDER EMBLEMS - "Z28", "350" w SS, R/S	STAMPED NUTS	F	-	-	-					4	1.50
G-4175	FENDER EXTENSIONS	SCREWS, SPRING NUTS	-	A	-	-					34	10.00
G-4171	FENDER EXTENSIONS	HXWA & PH OV SCREWS, SPRING NUTS	-	-	M	-					14	6.00
G-4152	FENDER SPLASH SEALS	SEMS TAPPING SCREWS	F	-	-	-					12	5.00
G-4104	FENDERS	HX CONI SEMS, U-NUTS, SHIMS	F	-	-	-					26	20.00
G-4170	FENDERS	HX CONI SEMS, U-NUTS, SHIMS	-	A	M	-					32	22.00
G-6381	FENDERS	HX CONI SEMS, U-NUTS, SHIMS	-	-	-	N					26	20.00
G-6593	FENDERS > FIREWALL (also in fender kits)	HX CA CONI SEMS	F	A	M	N					4	5.00
G-6605	FENDERS > RAD SUPPORT (also in fender kit)	HXWA CA SCREWS	F	A	M	-					4	3.00
G-6606	FENDERS > RAD SUPPORT (also in fender kit)	HX MS CONI SEMS	-	-	-	N					4	4.00
G-4156	FILLER PANEL, Rr WINDOW	PH HXWA AB SCREWS	F	-	-	-					5	3.00
G-4120	FILLER PANELS - BELOW HEADLAMPS	HX AB FLAT SEMS	F	-	-	-					2	2.00
G-4211	GRILLE	PH PN FLAT SEMS, NYLON NUTS	-	A	-	-					12	5.00
G-4210	GRILLE	HX CONI SEMS, SPRING NUTS	-	-	M	-					11	5.00
G-5306	GRILLE - R/S	PH PN AB FLAT SEMS, PLASTIC NUTS	F	-	-	-					16	7.00

See factory Assembly Manuals for illustrations

GM Fastener Kits

365

1970

Body

PART #	APPLICATION	NOTES	CAMARO				CHEVELLE MONTE CARLO		NOVA		PCS	PRICE
			F	A	M	N						
G-4118	GRILLE - STD	PH PN AB FLAT SEMS, PLASTIC NUTS	F	-	-	-				12	6.00	
G-6260	GRILLE & REINFORCEMENT	HXWA SCREWS, SPR NUTS, BLK RIVETS	-	-	-	N				22	6.00	
G-4208	GRILLE BRACKETS	HXWA CA SCREWS	-	A	M	-				3	2.00	
G-6258	GRILLE BRACKETS	HXWA CA SCREWS	-	-	-	N				4	3.00	
G-4119	GRILLE FILLER - R/S	PH PN SCREWS, PLASTIC NUTS	F	-	-	-				12	5.00	
G-5186	HEADER PANEL	HXWA CA SCREWS, HX NUTS	F	-	-	-				13	5.00	
G-4117	HEADLAMP BEZELS	SS/CHROME PH OV SCREWS, NYL NUTS	F	-	-	-				12	5.00	
G-5493	HEADLAMP BEZELS	SS/CHROME PH OV SCREWS, NYL NUTS	-	A	-	-				16	5.00	
G-6391	HEADLAMP BEZELS	PH OV AB SCREWS, SPRING NUTS	-	-	-	N				16	5.00	
G-4174	HEADLAMP BEZELS - STD Malibu 72A	SS/CHROME PH OV SCREWS, NYL NUTS	-	-	M	-				8	3.00	
G-4129	HEADLAMP HOUSINGS	HXWA CA SCREWS	F	-	-	-				6	4.00	
G-4106	HOOD & HINGES	HX CONI SEMS	F	A	M	N				8	10.00	
G-4404	HOOD CATCH & LOCK PLATE	HX PP CONI SEMS	F	-	-	-				7	5.00	
G-4213	HOOD CATCH & LOCK PLATE	HX PP CONI SEMS	-	A	M	-				8	6.00	
G-6268	HOOD CATCH & LOCK PLATE	HX PP CONI SEMS, U-NUTS	-	-	-	N				11	8.00	
G-4109	HOOD CATCH SUPPORT	HXWA CA SCREW	F	-	-	N				1	1.00	
G-5743	HOOD CATCH SUPPORT	HXWA CA SCREW, U-NUT	-	A	M	-				2	2.00	
G-5210	HOOD LEVELER (Rr) - CENTER	BUMPER, ADJUSTER, FLNG NUT, U-NUT	F	-	-	-				4	5.00	
G-4249	HOOD LEVELERS (Fr)	SCREWS, FLNG NUTS, RUBBER BUMPERS	F	A	M	N				6	8.00	
G-4183	HOOD LEVELERS (Rr)	JAM NUTS only	-	A	M	-				2	2.00	
G-4365	HOOD LEVELERS (Rr) - OUTER	JAM NUTS only	F	-	-	-				2	3.00	
G-4182	HOOD LOCK POST	FLNG NUT ONLY	F	A	M	N				1	2.00	
G-4308	HOOD ORNAMENT	STAMPED NUTS	-	-	M	-				3	1.50	
G-4316	HOOD ORNAMENTS	STAMPED NUTS	-	-	-	N				12	4.00	
G-5941	HOOD PIN CABLES	SS/BLACK RNDWA AB SCREWS ONLY	-	A	-	-				2	1.50	
G-5319	HOOD SEAL	T SHAPED NYLON RETAINERS	F	A	M	-				13	5.00	
G-5940	HOOD STUD PLATES	CHROME PH OV AB SCREWS ONLY	-	A	-	-				8	3.00	
G-5942	HOOD STUDS	FLNG NUTS ONLY	-	A	-	-				4	3.00	
G-5826	INSTRUMENT PANEL ASSEMBLY	HXWA ABT SCREWS	-	A	M	-				6	4.00	
G-5123	INSTRUMENT PANEL REINFORCEMENTS	HX PP CONI SEMS, HXWA AB SCREWS	F	-	-	-				13	6.00	
G-5697	INSTRUMENT PANEL REINFORCEMENTS	HX MS & BT SEMS, HXWA AB SCREWS	-	A	M	-				9	4.00	
G-4121	LICENSE PLATE BRACKET (Fr)	SS HXWA SCREWS, NYLON NUTS	F	-	-	-				4	3.00	
G-4485	LICENSE PLATE BRACKET (Fr) 70-72, (Rr) All	HX BOLTS, EXT KEPS NUTS	-	A	M	N				4	3.00	
G-4100	LICENSE PLATE BRACKET (Rr)	HX BOLTS	F	-	-	-				2	2.00	
G-5046	LICENSE PLATES (Fr & Rr)	SLOT TRUSS B SCREWS, NYLON NUTS	-	-	-	N				8	6.00	
G-5827	MIRROR & BRACKET (STD or remote)	PH PN AB SCREWS, PH OV MS, WA	-	A	M	N				4	2.00	
G-4717	MIRROR (outside fixed) & BRACKET	PH OV MS SCREW, PH PN B EXT SEMS	-	-	-	N				3	2.00	
G-4307	NAMEPLATE, FENDERS - ENG DESIGNATION	STAMPED NUTS	-	A	-	-				6	2.00	
G-6256	NAMEPLATE, FENDERS - ENG DESIGNATION	STAMPED NUTS	-	-	-	N				4	2.00	
G-4548	NAMEPLATE, FENDERS "283", "307"	STAMPED NUTS	-	A	-	-				4	1.50	
G-5631	NAMEPLATE, FENDERS "FLAGS" or "Nova"	STAMPED NUTS	-	-	-	N				4	2.00	
G-4309	NAMEPLATE, FENDERS "Malibu", "El Camino"	STAMPED NUTS	-	A	-	-				6	2.00	
G-5978	NAMEPLATE, FENDERS "SS 454"	HXWA T SCREWS	-	-	M	-				4	2.00	
G-5269	NAMEPLATE, FENDERS "SS"	STAMPED NUTS	F	-	-	-				8	3.00	
G-5262	NAMEPLATE, FENDERS "SS"	STAMPED NUTS	-	A	-	-				12	3.00	
G-4314	NAMEPLATE, FENDERS "SS", "Z28", "350"	STAMPED NUTS	F	-	-	-				6	2.00	
G-4192	NAMEPLATE, GRILLE	STAMPED NUTS	-	A	-	-				2	1.00	
G-4122	NAMEPLATE, HEADER PANEL	STAMPED NUTS	F	-	-	-				3	2.00	
G-4124	NAMPELATE, FENDERS "Camaro"	7/16" OD STAMPED NUTS	F	-	-	-				6	1.50	
G-4146	NOSE PANEL - R/S	HX CA CONI SEMS	F	-	-	-				4	6.00	
G-4149	NOSE PANEL VERTICAL BAR - R/S	HX CONI SEMS, CONI KEPS NUTS	F	-	-	-				8	8.00	
G-4150	PAD, NOSE PANEL VERTICAL BAR - R/S	CONI KEPS NUTS	F	-	-	-				3	2.00	
G-6339	QUARTER PANEL EXTENSIONS	STAMPED NUTS, SEALER	-	-	M	-				16	5.00	
G-5930	SEAL, COWL FRONT	T SHAPED NYLON RETAINERS	-	A	M	-				5	3.00	
G-5179	SEALS - BEHIND Rr BUMPER	NYLON RETAINERS	-	-	M	-				12	3.00	
G-5311	SEALS (L shaped) @ COWL SIDES	T SHAPED NYLON RETAINERS	F	-	-	-				4	2.00	
G-5352	SEALS (tubular), COWL Fr SIDES	T SHAPED NYLON RETAINERS	F	-	-	-				4	2.00	
G-4151	SPOILER (Rr) - 1 PIECE	CONI KEPS NUTS, SEALING WA'S	F	-	-	-				24	6.00	
G-5181	STEERING COLUMN SEAL RETAINER	HX AB FLAT SEMS	F	-	-	-				2	3.00	
G-5740	STEERING COLUMN SEAL RETAINER	HXWA AB SCREWS, HX AB CONI SEMS	-	A	M	-				7	5.00	
G-4975	STEERING COLUMN SEAL RETAINER	HX AB FLAT SEMS, HXWA AB SCREWS	-	-	-	N				6	6.00	
G-6930	TAILGATE HINGES - El Camino	HX CONI SEMS, FLAT EXT SEMS	-	A	-	-				12	20.00	
G-6934	TAILGATE LATCHES	OV HD TT SCREWS	-	A	-	-				6	3.00	
G-6931	TAILGATE STRIKERS > BODY	POZI FLAT SCREWS	-	A	-	-				6	6.00	
G-6933	TAILGATE SUPPORT CABLES	HX SHOULDER BOLTS, FLAT WA'S	-	A	-	-				8	8.00	
G-4154	TRUNK LATCH & STRIKER	HX CONI TOOTH SEMS	F	A	M	N				5	4.00	
G-4155	TRUNK LID > HINGES	HX CONI TOOTH SEMS	F	A	M	N				4	4.00	
G-5068	TRUNK LID BUMPERS	.90" DIA X .48 TK RUBBER BUMPERS	-	A	M	-				2	3.00	
G-4103	VALANCE (Fr)	HXWA CA SCREWS, U-NUTS	F	-	-	-				26	15.00	
G-4221	VALANCE (Rr)	HX PP CONI SEMS, U-NUTS	-	A	-	-				4	4.00	
G-6642	WEATHERSTRIP, QUARTER GLASS @ JAMB	.28 OD PH RNDWA AB SCREWS	-	A	M	-				6	2.00	
G-4189	WHEELHOUSE "U-CHANNEL" BRACES (Rr)	HX CONI SEMS, U-NUTS	-	-	M	-				8	7.00	
G-4187	WHEELHOUSE BRACKETS (Rr)	HX PP CONI SEMS	-	-	M	-				4	5.00	
G-5934	WHEELHOUSE DUST SHIELDS	T SHAPED NYLON RETAINERS	-	A	M	-				4	2.00	
G-4188	WHEELHOUSE EXTENSIONS	HXWA PP CREWS, U-NUTS	-	-	M	-				16	10.00	

Kits Contain Attaching Fasteners for Both Sides

GM Fastener Kits

1970

Body

PART #	APPLICATION	NOTES					PCS	PRICE
			CAMARO	CHEVELLE MONTE CARLO	NOVA			
G-4113	WHEELHOUSE Rr BRACES > BODY	HX CONI SEMS, U-NUTS	F	-	-	-	12	7.00
G-4191	WHEELHOUSE SPLASH SHIELDS	HXWA AB & T1 SCREWS, U-NUTS, WA'S	-	-	M	-	16	4.00
G-4112	WHEELHOUSES	SCREWS, HX CONI SEMS, WA'S, U-NUTS	F	-	-	-	38	22.00
G-6692	WHEELHOUSES	SCREWS, HX SEMS, CUP WA'S, U-NUTS	-	A	-	-	42	24.00
G-4186	WHEELHOUSES	SCREWS, HX CONI SEMS, WA'S, U-NUTS	-	-	M	-	42	26.00
G-6265	WHEELHOUSES	HXWA PP SCREWS, CUP WA'S, U-NUTS	-	-	-	N	24	20.00
G-4185	WHEELHOUSES - PLASTIC	SCREWS, HX CONI SEMS, WA'S, U-NUTS	-	A	-	-	42	24.00
G-6599	WHEELHOUSES > FENDERS (also in WH kit)	HXWA CA SCREWS, CUP WA'S	F	-	-	-	8	8.00
G-6597	WHEELHOUSES > FENDERS (also in WH kit)	HX PP CONI SEMS, FLAT WA'S	-	A	M	-	8	6.00
G-6598	WHEELHOUSES > FENDERS (also in WH kit)	HXWA CA SCREWS, CUP WA'S, U-NUTS	-	-	-	N	12	12.00
G-4111	WHEELHOUSES > RADIATOR SUPPORT	HXWA CA SCREWS	F	-	-	-	4	3.00
G-4190	WHEELHOUSES > RADIATOR SUPPORT	HX PP CONI SEMS, U-NUTS	-	A	M	-	8	8.00
G-6267	WHEELHOUSES > RADIATOR SUPPORT	HXWA CA SCREWS, U-NUTS	-	-	-	N	8	6.00

Brakes

G-5007	AXLE RETAINER PLATES	GR-8 HX BOLTS, NUTS, SPLIT WA'S	F	A	M	N		24	10.00
G-6579	BRAKE BLEEDER SCREWS w DISC	All - CALIPERS, M/C, WHEEL CYLINDERS	F	A	M	N		6	10.00
G-5863	BRAKE BOOSTER	FLNG NUTS	F	A	M	N		4	3.00
G-5259	BRAKE BOOSTER HOSE - 396/454	CLAMPS & NUT FOR TUBE BRACKET	F	A	M	N		3	3.00
G-4740	BRAKE BOOSTER HOSE - SB	FLAT WOUND SPRING CLAMPS (Black)	F	A	M	N		2	2.00
G-4642	BRAKE CABLES	WIRE TYPE RETAINERS, HX NUTS	-	A	M	N		5	5.00
G-4349	BRAKE CABLES & BRACKETS	WIRE RETAINING CLIPS, SCREWS, NUTS	F	-	-	-		13	10.00
G-6575	BRAKE CALIPER BLEEDERS	3/8-24 SCREWS, .28 NOSE TO FIT CAP	F	A	M	N		2	4.00
G-6636	BRAKE CALIPER BRACKETS & SHIELDS	HX BOLTS, LOCK NUTS	-	A	M	-		10	24.00
G-5468	BRAKE CALIPER BRACKETS & SHIELDS	HX BOLTS, LOCK NUTS	-	-	-	N		10	24.00
G-6426	BRAKE CALIPER LOCATING BOLTS	3.70" L HX SOCKET BOLTS	F	A	M	N		4	12.00
G-6609	BRAKE CALIPER PISTON RETURN CLIPS	ATTACH TO CALIPER PISTONS, COATED	-	A	M	N		2	4.00
G-6162	BRAKE CALIPER SHIELDS	HX CONI SEMS	F	-	-	-		6	4.00
G-4956	BRAKE HOSE (Fr disc) > CONTROL ARM	HXWA T SCREWS	-	-	-	N		2	2.00
G-5252	BRAKE HOSE (Rr) DIST BLOCK > AXLE HSNG	HX SPLIT SEMS	F	-	-	-		1	3.00
G-4960	BRAKE HOSE (Rr) DIST BLOCK > BRACKET	HX BOLT	-	A	M	N		1	2.00
G-5866	BRAKE HOSE > CALIPER	DRILLED BOLTS, COPPER WA'S	F	A	M	N		6	10.00
G-4348	BRAKE HOSE BRACKET (Rr)	HX PP CONI SEMS	-	-	-	N		2	3.00
G-5047	BRAKE HOSE BRACKETS (Fr)	HX T CONI SEMS	F	A	M	N		2	2.00
G-6240	BRAKE HOSE GASKETS	COPPER MATERIAL	F	A	M	N		2	1.50
G-4958	BRAKE HOSE RETAINERS	U-RETAINERS	F	A	M	N		3	3.00
G-5486	BRAKE LINE SHIELDS (Rr) - El Camino	HXWA C SCREWS	-	A	-	-		4	3.00
G-5867	BRAKE LINES (Fr) BRACKET	HXWA C SCREWS	-	A	-	-		2	2.00
G-5602	BRAKE PEDAL BUSHINGS	NYLON BUSHINGS ONLY	F	A	M	N		2	3.00
G-4794	BRAKE PEDAL RETAINER w A/T	FOLDED SPRING METAL	-	A	M	N		1	3.00
G-6044	BRAKE PEDAL RETURN SPRING	NOS SPRING	F	A	M	N		1	4.00
G-5284	BRAKE PEDAL w A/T	HX BOLT, LOCK NUT	F	-	-	-		2	4.00
G-5008	BRAKE PLATE ASSEMBLY (Fr) > SPINDLE	GR-8 HX BOLTS, LOCK NUTS	-	A	M	N		8	12.00
G-4636	BRAKE PRESSURE VALVE & SW - DRUM	HX SPLIT SEMS	-	-	-	N		1	1.50
G-5057	BRAKE PRESSURE VALVE (Rr) - 302/350 & BB	HXWA T SCREW	F	A	M	N		1	1.50
G-4741	MASTER CYL BALANCE VALVE w DISC	HX EXT SEMS	F	-	M	N		1	2.00
G-5144	MASTER CYLINDER	FLNG NUTS	F	A	M	N		2	2.00
G-6580	MASTER CYLINDER BLEEDERS w DISC	5/16-24 SCREWS	F	A	M	N		2	3.00
G-4829	MASTER CYLINDER PUSH ROD > PEDAL	RETAINING CLIP	F	A	M	N		1	3.00
G-5150	PARKING BRAKE CONTROL > DASH	HX CONI SEMS, FLNG NUTS	F	-	-	-		4	2.00
G-5864	PARKING BRAKE CONTROL > DASH	HX CONI SEMS, FLNG NUTS, SEALER	-	A	M	-		6	4.00
G-4347	PARKING BRAKE CONTROL > DASH	HX CONI SEMS, FLNG NUTS	-	-	-	N		3	3.00
G-5990	PARKING BRAKE RELEASE ROD CLIP	ROD END CLIP	-	A	M	-		1	3.00
G-4887	STOPLAMP SWITCH STRIKER - PWR BRAKES	w POWER BRAKES, BOLT, STAMPED NUT	-	A	M	N		2	2.00
G-5258	STOPLAMP SWITCH STRIKER (on pedal)	w POWER BRAKES, BOLT, STAMPED NUT	F	-	-	-		2	3.00
G-6576	WHEEL CYLINDER (2) BLEEDERS	Does 2 cylinders, 5/16-24 SCREWS	F	A	M	N		2	3.00
G-6577	WHEEL CYLINDER (4) BLEEDERS	Does 4 cylinders, 5/16-24 SCREWS	-	A	-	N		4	5.00
G-6578	WHEEL CYLINDER BLEEDER PROTECTORS	PLASTIC CAPS w STRAP	F	A	M	N		2	2.00
G-6581	WHEEL CYLINDERS (2)	HX INT SEMS	F	A	M	N		4	3.00
G-6582	WHEEL CYLINDERS (4)	HX INT SEMS	-	A	-	N		8	5.00

Cooling

G-4591	RADIATOR - 307/327 350	HXWA CA SCREWS	F	A	M	N		3	3.00
G-4979	RADIATOR - 307/327/350	HXWA CA & MS SCREWS, WELL-NUTS	-	-	-	N		6	8.00
G-6944	RADIATOR - 396	HX PP CONI SEMS	-	A	-	N		4	3.00
G-5189	RADIATOR FAN SHROUD	S CLIPS, HX FLAT SEMS, SPRING NUTS	F	A	M	N		6	6.00
G-6301	RADIATOR FAN SHROUD & BRACKET - 396	TOP MOUNTING ONLY. SCREWS, SPR NUT	-	-	-	N		3	3.00
G-5162	RADIATOR HOSES - V8	TOWER TYPE CLAMPS	F	A	M	N		4	12.00
G-6296	RADIATOR SEAL - 396	NYLON RETAINERS	-	-	-	N		6	3.00

See factory Assembly Manuals for illustrations

GM Fastener Kits

367

1970

Differential

PART #	APPLICATION	NOTES	CAMAHO				CHEVELLE		MONTE CARLO		NOVA		PCS	PRICE
			F	A	M	N								
G-5466	DIFFERENTIAL COVER - 10 BOLT	SRTD FLNG SCREWS "E"	F	A	M	N						10	10.00	
G-5467	DIFFERENTIAL COVER - 12 BOLT	SRTD FLNG SCREWS "E"	F	A	M	N						12	12.00	

Electrical

G-4962	ALTERNATOR - 302, 307, 327, 350	HX BOLTS, WA'S, NUT	F	A	M	N						13	10.00
G-5049	ALTERNATOR - 396/454	BOLTS, HX CLR STUD, SPACER, NUTS	F	A	M	N						16	25.00
G-5191	ALTERNATOR HARNESS > ALTERNATOR	12-24 EXT KEPS NUT	F	A	M	N						1	2.00
G-6293	ALTERNATOR PULLEY	NUT, FLAT WA	F	A	M	N						2	3.00
G-6635	BACK-UP LAMP LENSES - El Camino	SS/CHROME PH PN .435 SHLDR SCREWS	-	A	-	-						4	4.00
G-4505	BACK-UP LAMPS	PH PN EXT SEMS	-	-	M	-						4	3.00
G-4793	BACK-UP/NEUTRAL SWITCH (Console A/T)	HX SCREWS, FLAT & TOOTH WA'S	F	A	M	N						6	2.00
G-5203	BACK-UP/NEUTRAL SWITCH (exc 70-71F A/T)	SCREWS	F	A	M	N						2	1.50
G-6389	BATTERY CABLES	HXWA SCREWS, NUTS, WA	-	-	-	N						6	4.00
G-5055	BATTERY CABLES - 396	HX BOLT, NUTS, WA'S, SCREW	-	-	-	N						6	4.00
G-5197	BATTERY CABLES & CLAMP	HXWA SCREWS, NUT, WA	F	-	-	-						6	4.00
G-5744	BATTERY CABLES & CLAMP	HXWA SCREWS, NUT, WA	-	A	M	-						6	4.00
G-4352	BATTERY HOLDOWN CLAMP	HX CONI SEMS	F	A	M	N						1	1.50
G-6399	CAPACITOR - RADIO NOISE w AC	HXWA SCREW, TOOTH WA	-	-	-	N						2	1.50
G-5814	CAPACITOR - RADIO NOISE, AM/FM, AC 68	HXWA SCREW	-	A	M	-						1	1.00
G-5298	CLOCK - IN DASH	HXWA SCREWS	F	-	-	-						2	1.00
G-5959	CLOCK - IN DASH	HXWA SCREWS	-	-	M	-						3	1.50
G-6328	CLOCK - IN DASH	HXWA SCREWS, FLAT WA'S	-	-	-	N						4	2.00
G-5958	CLOCK or COVER - IN DASH	SLOT HX SCREWS	-	A	-	-						3	1.50
G-5954	COURTESY LAMP, GLOVE BOX	HX ABT FLAT SEMS	-	A	M	-						1	1.50
G-5305	COURTESY LAMP, GLOVE BOX w AC	HX ABT FLAT SEMS	F	-	-	-						1	1.50
G-5636	COURTESY LAMPS, UNDERDASH	PH PN FLAT WA SEMS	-	A	M	-						2	2.00
G-4990	COURTESY LAMPS, UNDERDASH (69F CONV)	HXWA SCREWS	F	-	-	N						2	1.50
G-5881	COWL INDUCTION RELAY	HXWA SCREW	-	A	-	-						1	1.00
G-5110	COWL INDUCTION SOLENOID	HX CONI SEMS	-	A	-	-						1	1.50
G-5939	COWL INDUCTION SWITCH (at gas pedal)	HXWA SCREW	-	A	-	-						1	1.50
G-5882	CRUISE CONTROL REGULATOR & BRACKET	HX CONI SEMS, BOLTS, NUTS, WA'S	-	A	M	-						11	5.00
G-5507	CRUISE CONTROL SERVO & BRACKET	HX CONI SEMS, NUTS, WA'S	-	A	M	-						11	4.00
G-5885	CRUISE CONTROL SW STRIKER	HX BOLT, STAMPED NUT	-	A	M	-						2	2.00
G-5000	DEFOGGER SWITCH BEZEL - Rr WINDOW	EXT KEPS NUTS	-	A	M	N						2	1.50
G-5211	DEFOGGER SWITCH HOUSING - Rr WINDOW	HXWA SCREWS	F	-	-	-						2	1.50
G-4989	DIMMER SWITCH	HXWA AB SCREWS	F	A	M	N						2	2.00
G-4988	FLASHER BRACKET & GROUND > DASH	HXWA SCREWS, TOOTH WA	-	-	-	N						3	2.00
G-5200	FLASHER BRACKET > DASH	HXWA SCREW, TOOTH WA	F	-	-	-						2	2.00
G-5953	FLASHER BRACKET > DASH	PH PN AB FLAT SEMS	-	A	M	-						1	1.50
G-4986	FUSE PANEL > FIREWALL	#10 x 2 1/4 HXWA AB SCREWS w SEALER	F	A	M	N						2	3.00
G-5192	H/L, P/L GROUNDS, JUNCTION BLOCK	HXWA AB SCREWS, NUTS, TOOTH WA	F	A	M	-						4	3.00
G-4680	H/L, P/L GROUNDS, JUNCTION BLOCK	HXWA AB & B SCREWS, TOOTH WA'S	-	-	-	N						5	3.00
G-6530	HEADLAMP ADJUSTERS	SCREWS, NYLON NUTS, SPRING NUTS	F	-	-	-						10	8.00
G-4830	HEADLAMP ADJUSTERS	SCREWS, NYLON NUTS, SPRINGS	-	A	-	-						20	12.00
G-4259	HEADLAMP ADJUSTERS	SCREWS, NYLON NUTS, SPRINGS	-	-	M	-						10	8.00
G-6562	HEADLAMP ADJUSTERS	SCREWS, NYLON NUTS, SPRINGS	-	-	-	N						10	8.00
G-6567	HEADLAMP RETAINING RINGS	SLOT PN SCREWS	F	A	M	N						6	3.00
G-6622	HEADLAMP RETAINING RINGS	PH RND SCREWS	F	A	M	N						6	2.00
G-5854	HEATER SWITCH	HI-HXWA ABT SCREWS	-	A	M	-						2	1.50
G-5128	HEATER SWITCH (exc 70-72A) or AC FAN	HXWA B SCREWS	F	A	M	-						2	1.50
G-4726	HEATER SWITCH or AC FAN (AC 68N)	HXWA T1 SCREWS	-	-	-	N						2	1.50
G-4207	HORN (1)	HX PP CONI SEMS	F	A	M	-						1	1.50
G-6323	HORN (1)	HX PP CONI TOOTH SEMS, PLASTIC CAP	-	-	-	N						2	4.00
G-4997	HORN CONTACT ASSEMBLY	PH PN EXT SEMS	-	A	M	N						2	1.50
G-4801	HORN CONTACT ASSY - WOOD GRAIN WHEEL	PH PN MS SCREWS	-	A	M	-						3	2.00
G-5196	HORN RELAY	HXWA AB SCREW	F	A	M	N						1	1.00
G-4647	IGNITION COIL & STRAP	HX EXT SEMS, SLOT RND T SCREW	F	A	M	N						3	4.00
G-5960	INSTRUMENT CLUSTER CIRCUIT BOARD	HXWA B SCREWS, NUTS, WA'S	-	A	M	-						14	3.00
G-6272	INSTRUMENT CLUSTER CIRCUIT BOARD	HXWA B SCREWS, WA'S, NUTS	-	-	-	N						10	3.00
G-4853	INSTRUMENT CLUSTER GROUND	HXWA AB SCREW, TOOTH WA	-	-	-	N						2	1.50
G-5757	INSTRUMENT CLUSTER GROUNDS	HXWA AB & B SCREWS, TOOTH WA'S	-	A	M	-						3	1.50
G-5199	INSTRUMENTS CIRCUIT BOARD	NUTS, FLAT WA'S	F	-	-	-						6	2.00
G-5296	INSTRUMENTS CIRCUIT BOARD w GAUGES	HXWA B SCREWS, NUTS, FLAT WA'S	F	-	-	-						20	4.00
G-6652	KICK PANELS w/o AC	HXWA SCREWS	-	A	M	-						10	3.00
G-4312	LICENSE PLATE LAMP	PH PN AB SCREWS	-	A	M	N						2	1.00
G-4128	MARKER LAMPS (Fr & Rr)	STAMPED NUTS	F	-	-	-						8	4.00
G-4479	MARKER LAMPS (Fr & Rr)	STAMPED NUTS	-	-	-	N						8	3.00
G-4201	MARKER LAMPS (Fr)	PH PN AB SCREWS, SPRING NUTS	-	A	M	-						8	2.00
G-4228	MARKER LAMPS (Rr)	STAMPED NUTS	-	A	M	-						4	2.00
G-5153	NEUTRAL STARTING SWITCH - M/T	HXWA AB SCREW, FLAT WA	F	A	M	N						2	1.50
G-5202	PARKING BRAKE ALARM SWITCH	HXWA AB SCREW	F	A	M	-						1	1.00

Kits Contain Attaching Fasteners for Both Sides

GM Fastener Kits

1970

Electrical

PART #	APPLICATION	NOTES					PCS	PRICE
			CAMARO	CHEVELLE MONTE CARLO	NOVA			
			F	A	M	N		
G-6396	PARKING BRAKE ALARM SWITCH	NUTS, SPLIT WA'S	-	-	-	N	4	1.50
G-6625	PARKING LAMP LENSES	SS/CHROME PH PN .488 SHLDR SCREWS	F	A	M	-	4	4.00
G-6620	PARKING LAMP LENSES	SS/CHROME PH PN .915 SHLDR SCREWS	-	A	-	-	4	5.00
G-6420	PARKING LAMP LENSES (67-68F STD)	SS/CHROME PH PN .640 SHLDR SCREWS	-	-	-	N	4	4.00
G-4480	PARKING LAMPS	PH PN EXT SEMS	-	A	-	N	4	3.00
G-5948	PARKING LAMPS - El Camino & Monte Carlo	PH PN AB SCREWS, TOOTH WA'S	-	A	M	-	6	2.00
G-4116	PARKING LAMPS - STD	PH PN AB SCREWS, SPRING NUTS	F	-	-	-	8	3.00
G-4115	PARKING LAMPS (All 69F, 70-73F R/S)	EXT KEPS NUTS	F	-	-	-	4	3.00
G-5967	RADIO BRACKET	HXWA & PN PN AB SCREWS, SPR NUTS	-	A	M	-	5	3.00
G-5294	RADIO BRACKETS	HXWA AB & B SCREWS, SPRING NUTS	F	-	-	-	8	3.00
G-5095	RADIO BRACKETS	HXWA AB SCREWS, SPRING NUTS	-	-	-	N	4	3.00
G-5980	RADIO GROUND CLIPS > HOOD	HXWA AB SCREW, HX AB FLAT SEMS	-	A	M	-	2	2.00
G-5813	RADIO GROUND STRAP > FRAME	HXWA AB & T1 SCREWS	-	A	M	-	2	2.00
G-4823	RADIO GROUND STRAPS > FIREWALL	HXWA AB SCREWS	-	A	M	-	2	1.50
G-6333	RADIO GROUND STRAPS > FIREWALL, FRAME	HXWA AB & T1 SCREWS	-	-	-	N	5	3.00
G-5301	RADIO NOISE CAPACITOR > COIL BRACKET	HXWA T SCREW, TOOTH WA	F	-	-	-	2	1.50
G-4822	RADIO NOISE CAPACITOR > COIL BRACKET	HXWA T SCREW, TOOTH WA	-	A	M	N	2	1.50
G-6654	SEAT BACK PANELS	PH PN FLAT SEMS	-	A	M	-	6	3.00
G-5300	SPEAKER > DASH	HXWA AB SCREW	F	-	-	-	1	1.00
G-5094	SPEAKER > DASH	HXWA AB SCREW, SPRING NUT	-	-	-	N	2	1.50
G-5965	SPEAKER > DASH w AC	HXWA AB & B SCREWS, SPRING NUTS	-	A	-	-	14	4.00
G-5966	SPEAKER > DASH w AC	HXWA SCREWS, FLAT SEMS, SPR NUTS	-	-	M	-	14	4.00
G-5963	SPEAKER > DASH w/o AC	HXWA AB SCREWS, SPRING NUTS	-	A	-	-	10	3.00
G-5964	SPEAKER > DASH w/o AC	HXWA AB SCREWS, SPRING NUTS	-	-	M	-	11	3.00
G-5098	SPEAKERS & GRILLES @ KICK PANELS	PH OV AB SCREWS, SPRING NUTS	-	-	-	N	16	6.00
G-5302	SPEAKERS > DASH (stereo)	CONI KEPS NUTS	F	-	-	-	10	4.00
G-5152	STARTER - 307, 70F & 71AF 350, 72F 396 A/T	1.84 & 4.69 FLNG BOLTS, SEMS, NUT, WA	F	A	M	N	5	8.00
G-5874	STARTER - 350 70A, 71MC, 72F, 72A/73F M/T	3.62 L HX BOLTS, HX CONI SEMS, NUT, WA	-	A	M	-	5	8.00
G-5340	STARTER & BRACE - 396/454 (exc 72 A/T)	3.62 L HX BOLTS, HX CONI SEMS, NUT, WA	F	A	M	N	5	8.00
G-5201	STOPLAMP SWITCH	SPECIAL ROUND RETAINER	F	A	M	-	1	2.00
G-4689	STOPLAMP SWITCH	STAMPED HX NUTS	-	-	-	N	2	2.00
G-5297	TACHOMETER	HXWA B SCREWS	F	A	M	-	3	1.50
G-6325	TACHOMETER	HXWA B SCREWS	-	-	-	N	2	1.50
G-6626	TAILAMP LENSES	SS/BLACK PH PN .488 SHLDR SCREWS	-	A	-	-	8	8.00
G-6356	TAILAMP LENSES	SS/CHROME PH PN MS SCREWS	-	-	-	N	8	4.00
G-6631	TAILAMP LENSES - El Camino	SS/CHROME PH PN .340 SHLDR SCREWS	-	A	-	-	8	8.00
G-4165	TAILAMPS > BODY	CONI TOOTH KEPS NUTS	F	-	-	-	8	8.00
G-4840	TAILAMPS > BODY	EXT TOOTH KEPS NUTS	-	-	-	N	8	3.00
G-4203	TAILAMPS > BUMPER	HXWA T1 & PH PN BT SCREWS	-	A	-	-	8	3.00
G-4204	TAILAMPS > QUARTER EXTENSIONS	PH OV SCREWS, NYLON NUTS	-	-	M	-	12	3.00
G-4810	TRUNK LAMP	HX AB FLAT SEMS	F	-	-	N	1	1.00
G-4992	TURN SIGNAL LEVER	PH PN AB SCREW	F	A	M	N	1	1.00
G-5304	UNDERHOOD LAMP	HXWA B SCREWS	F	A	M	-	2	1.50
G-4922	UNDERHOOD LAMP	HXWA AB SCREWS	-	-	-	N	2	1.50
G-4588	VOLTAGE REGULATOR	HXWA AB SCREWS	F	A	M	-	3	2.00
G-4968	VOLTAGE REGULATOR	HXWA B SCREWS	-	-	-	N	3	2.00
G-6532	WIRING - ALTERNATOR > HEATER HOSE	5.1" FLEXIBLE STRAP	F	-	-	-	1	3.00
G-6518	WIRING - ALTERNATOR > HEATER HOSE	7.1" FLEXIBLE STRAP	-	A	M	N	1	3.00
G-6515	WIRING - BLOWER MOTOR/STARTER WIRING	RUBBER COATED J-CLIPS	F	A	M	N	2	5.00
G-6476	WIRING - CIRCUIT BREAKER	5.1" FLEXIBLE STRAPS	F	-	-	-	4	9.00
G-5209	WIRING - CIRCUIT BREAKER > HORN RELAY	CONI KEPS NUT	F	-	-	-	2	1.50
G-6292	WIRING - CONSOLE & GROUND	J-CLIP, SCREWS, TOOTH WA	-	-	-	N	4	4.00
G-6488	WIRING - CONSOLE > HEATER DUCT	RUBBER COATED J CLIP	F	-	-	-	1	3.00
G-6327	WIRING - CONSOLE INSTRUMENT GROUND	HXWA SCREW, TOOTH WA	-	-	-	N	2	1.50
G-6487	WIRING - CONSOLE LAMP	RUBBER COATED S CLIPS	-	A	M	-	4	6.00
G-6475	WIRING - COWL INDUCTION	5.1" FLEXIBLE STRAP	-	A	-	-	1	3.00
G-6456	WIRING - CRUISE CONTROL	7.1" FLEXIBLE STRAP	-	A	M	-	1	3.00
G-5752	WIRING - ENGINE NEAR WIPER MOTOR	RUBBER COATED J-CLIP, HXWA SCREW	-	A	M	-	2	3.00
G-6376	WIRING - FUEL SENDER UNIT GROUND	HXWA B SCREW	-	A	M	N	1	1.00
G-6524	WIRING - HORN	S CLIPS	-	A	M	-	2	5.00
G-6519	WIRING - INSTR HARNESS > DEFROST DUCTS	J-CLIP, HXWA SCREW, FLAT SPRING NUT	-	-	-	N	6	6.00
G-6495	WIRING - LICENSE PLATE LAMP	S CLIPS	-	A	-	-	2	4.00
G-6496	WIRING - LICENSE PLATE LAMP - El Camino	S CLIP	-	A	-	-	1	3.00
G-5194	WIRING - STARTER TERMINALS	NUTS, TOOTH WA'S	F	A	M	N	4	1.50
G-5955	WIRING - TAILAMP HARNESS GROUND	HXWA AB SCREW, TOOTH WA	-	A	M	-	2	1.50
G-5089	WIRING - TEMPERATURE SENDER	NUT, TOOTH WA	F	A	M	N	2	1.50
G-6499	WIRING - TRUNK LAMP	S CLIPS	-	A	M	N	3	7.00
G-6466	WIRING - UNDERHOOD LAMP	5.1" FLEXIBLE STRAPS	F	A	M	-	4	9.00
G-6493	WIRING - UNDERHOOD LAMP	5.1" FLEXIBLE STRAPS	-	-	-	N	2	5.00
G-5195	WIRING "GUTTER" > FIREWALL	HX AB FLAT SEMS	F	A	M	-	2	2.00
G-5499	WIRING "GUTTER" > FIREWALL	HXWA AB SCREWS	-	-	-	N	2	1.50
G-4356	WIRING HARNESS > LH WHEELHOUSE	PUSH-ENDS BLACK PLASTIC STRAPS	F	A	M	N	2	3.00
G-4987	WIRING HARNESS CONNECTOR > FIREWALL	HXWA SCREWS	F	-	-	-	2	2.00

See factory Assembly Manuals for illustrations

GM Fastener Kits

369

1970

Emissions

PART #	APPLICATION	NOTES					PCS	PRICE
			CAMARO	CHEVELLE MONTE CARLO	NOVA			
G-4770	PCV HOSE CLAMPS	FLAT WOUND SPRING CLAMPS (Black)	F	A	M	N	2	1.50
G-4971	SMOG HOSE CLAMPS	TOWER TYPE CLAMPS	F	A	M	N	4	8.00
G-4963	SMOG PUMP - 302, 307, 327, 350, 396	HX BOLTS, SPLIT WA'S, SPACER	-	-	-	N	7	12.00
G-5261	SMOG PUMP - 350 NB2 TYPE 72	HX BOLTS, SPLIT WA'S, SPACER	F	-	-	-	7	10.00
G-5887	SMOG PUMP - K19 TYPE	HX BOLTS, SPLIT WA'S, SPACER	F	A	M	-	7	10.00
G-4843	SMOG PUMP PULLEY	HX BOLTS, SPLIT WA'S	F	A	M	N	6	3.00
G-6471	SMOG PUMP VACUUM HOSE > SMOG HOSE	5.1" FLEXIBLE STRAP	F	-	-	-	1	3.00
G-4970	SMOG VALVE & BRACKET	HX BOLTS, SPLIT & FLAT WA'S	F	A	M	N	12	4.00

Exhaust

G-5246	EXHAUST HANGERS, DUAL	HXWA SCREWS, HX SPLIT SEMS	F	-	-	-	6	8.00
G-5573	EXHAUST HANGERS, DUAL	HXWA C SCREWS, RETAINERS	-	A	M	-	6	8.00
G-5081	EXHAUST HANGERS, DUAL	HX SPLIT SEMS, RIVET NUTS, SCREWS	-	-	-	N	16	10.00
G-5173	EXHAUST HANGERS, SINGLE	HXWA SCREWS, HX SPLIT SEMS	F	-	-	-	4	6.00
G-5914	EXHAUST HANGERS, SINGLE	HXWA C SCREWS, RETAINERS	-	A	M	-	6	6.00
G-6361	EXHAUST HANGERS, SINGLE	HXWA C SCREWS, HX T1 SCREWS	-	-	-	N	4	4.00
G-5266	EXHAUST PIPE > MANIFOLDS	STUDS, LOCK NUTS	F	A	M	N	12	14.00

Fuel

G-5159	ACCELERATOR CABLE	1/4-20 BALL STUD, KEPS NUT	F	A	M	N	2	6.00
G-6359	ACCELERATOR CABLE > FIREWALL	HXWA AB SCREW	-	-	-	N	1	1.00
G-5161	ACCELERATOR LEVER SUPPORT	HX AB FLAT SEMS	F	-	-	-	3	3.00
G-5730	ACCELERATOR LEVER SUPPORT	HXWA AB SCREWS	-	A	M	-	2	1.50
G-5163	ACCELERATOR LEVER SUPPORT	HXWA AB SCREWS	-	-	-	N	2	1.50
G-5307	ACCELERATOR PEDAL - Z28	HXWA DRILL SCREW, NUTS, SPLIT WA'S	F	-	-	-	5	2.00
G-5735	FUEL FILLER NECK - El Camino	HXWA AB SCREW	-	A	-	-	1	1.00
G-5908	FUEL HOSES	FLAT WOUND SPR CLAMPS (Black, Silver)	-	A	M	-	4	3.00
G-6247	FUEL HOSES	FLAT WOUND SPRING CLAMPS (Yellow)	-	-	-	N	6	3.00
G-5174	FUEL HOSES - 307, 350, '70 396	FLAT WOUND SPR CLAMPS (Blk, Green)	F	-	-	-	6	4.00
G-5267	FUEL RETURN HOSES	FLAT WOUND SPRING CLAMPS (Red)	F	-	-	N	8	5.00
G-5052	FUEL RETURN HOSES	FLAT WOUND SPRING CLAMPS (Red)	F	-	-	-	6	4.00
G-5913	FUEL RETURN HOSES - 396/454	FLAT WOUND SPRING CLAMPS (Red)	-	A	M	-	4	3.00
G-6405	FUEL RETURN LINE @ ENGINE	CLIPS ONLY	F	-	-	N	2	4.00
G-5287	FUEL VAPOR CANISTER	HXWA AB & B SCREWS	F	-	M	-	4	3.00
G-5308	FUEL VAPOR CANISTER	HXWA AB & T SCREWS	-	A	-	-	4	4.00
G-6377	FUEL VAPOR CANISTER	HXWA CA SCREWS, HX CONI SEMS	-	-	-	N	4	3.00
G-6378	FUEL VAPOR DRAIN HOSE	FLAT WOUND SPRING CLAMP (Black)	F	-	-	N	1	1.00
G-6477	FUEL VAPOR HOSE	5.1" FLEXIBLE STRAP	F	A	M	N	1	3.00
G-5288	FUEL VAPOR LINE HOSES	FLAT WOUND SPR CLAMPS (Green, Yell)	F	-	-	N	22	8.00
G-5916	FUEL VAPOR LINE HOSES	FLAT WOUND SPR CLAMPS (4 Colors)	-	A	M	-	18	8.00
G-5290	FUEL VAPOR LINE HOSES - Z28	SPRING CLAMPS (Green, Red, Yellow)	F	-	-	-	22	8.00
G-5922	FUEL VAPOR SEPARATOR > BODY - El Camino	HXWA SCREWS, NUTS, WA'S	-	A	-	-	6	3.00
G-5176	GAS TANK	BOLTS, WA'S, NUTS, SCREWS, SPACERS	F	-	-	-	12	12.00
G-5734	GAS TANK	SPECIAL BOLTS, HXWA SCREWS, U-NUTS	-	A	M	-	6	6.00
G-6244	GAS TANK	BOLTS, WA'S, NUTS, SCREWS, SPACERS	-	-	-	N	12	8.00
G-5260	THROTTLE BRACKET > CARBURETOR - 396HP	FLAT WA	F	-	-	-	1	1.00

Heater

G-5133	DEFROSTER DUCTS	HX SEMS, RIVETS, SPR NUTS, RETAINERS	F	-	-	-	6	3.00
G-5832	DEFROSTER DUCTS	PH PN & HX AB FLAT SEMS	-	A	M	-	4	2.00
G-4764	DEFROSTER DUCTS	HXWA SCREWS, FLAT WA	-	-	-	N	4	2.00
G-4327	HEATER BLOWER MOTOR	SRTD HXWA AB SCREWS	F	A	M	N	5	1.50
G-4326	HEATER BOX > FIREWALL	HX INT/EXT SEMS, STMPD NUTS, SEALER	F	A	M	N	12	5.00
G-5129	HEATER CONTROL CABLES	HH & HXWA SCREWS, WA'S, RTNRS	F	-	-	-	11	3.00
G-5834	HEATER CONTROL CABLES	HXWA SCREWS, SPRING NUTS, RTNRS	-	A	M	-	19	5.00
G-4953	HEATER CONTROL CABLES	HX ABT FLAT SEMS, SCREW, RTNRS, NUT	-	-	-	N	14	5.00
G-6469	HEATER CONTROL CABLES > RADIO BRACE	5.1" FLEXIBLE STRAP	F	-	-	-	1	3.00
G-5236	HEATER CONTROL CABLES w AC	SCREWS, WA , RETAINERS, RIVETS	F	-	-	-	9	4.00
G-5855	HEATER CONTROL CABLES w AC	HXWA AB & ABT SCREWS, RETAINERS	-	A	M	-	5	3.00
G-5131	HEATER DUCT OUTLET (under dash)	HX AB FLAT SEMS	F	-	-	-	3	2.00
G-6364	HEATER DUCT OUTLET (under dash)	HX ABT FLAT SEMS	-	-	-	N	2	2.00
G-5397	HEATER HOSE CLIP @ WHEELHOUSE	FOLDOVER METAL CLIP	F	A	M	N	1	4.00
G-5715	HEATER HOSE CLIP > ALT BRACKET w/o AC	FOLDOVER METAL CLIP	-	A	M	-	1	4.00
G-6300	HEATER HOSE SEAL RETAINER - 396	HXWA AB SCREWS	-	-	-	N	2	1.50
G-4952	HEATER HOSES	BAND CLAMPS w STRAIGHT UP SCREW	F	A	M	N	4	8.00
G-5032	HEATER HOSES w AC	BAND CLAMPS w STRAIGHT UP SCREW	F	-	-	N	6	12.00
G-5478	HEATER or AC OUTLET (LH under dash)	HXWA AB SCREWS	-	A	M	-	2	1.00
G-4616	HEATER RESISTOR > BOX	HXWA AB SCREWS	F	A	M	N	2	1.00

Kits Contain Attaching Fasteners for Both Sides

GM Fastener Kits

1970

Interior

PART #	APPLICATION	NOTES	CAMARO				CHEVELLE MONTE CARLO		NOVA		PCS	PRICE
			F	A	M	N						
G-5219	AIR OUTLET BEZELS (w AC) - Under Dash	HX AB FLAT SEMS, SPRING NUTS	F	-	-	-				14	5.00	
G-5844	AIR OUTLET BEZELS (w AC) - Under Dash	CHROME PH OV SEMS, NUTS	-	A	M	-				6	3.00	
G-5217	AIR OUTLET BEZELS (w AC) > DASH	HI-HX BT FLAT SEMS	F	-	-	-				8	4.00	
G-5828	AIR OUTLET BEZELS (w AC) > DASH	HX BT & ABT FLAT SEMS	-	A	M	-				9	4.00	
G-6278	AIR OUTLET BEZELS (w AC) > DASH	SCREWS, NUTS, SPRING NUTS, WA	-	-	-	N				13	4.00	
G-6644	AIR VENTS @ DOOR JAMB	CHROME PH TRUSS WA TEK SCREWS	-	A	M	-				2	1.50	
G-5383	ARMREST PAD & BASE @ Fr DOORS	CHROME PH RND & PH FLAT SCREWS	-	A	-	-				10	5.00	
G-6645	ARMREST PANELS @ Rr SEATS	PH OV SEMS, PH PN SCREWS, SPRG NUTS	-	A	M	-				12	4.00	
G-5114	ASH TRAY FACE PLATE	HI-HX BT FLAT SEMS	F	-	-	-				2	2.00	
G-5113	ASH TRAY RETAINER	HXWA AB SCREWS	F	-	-	-				3	2.00	
G-5840	ASH TRAY RETAINER	PH FLT TOP RNDWA SCREWS	-	A	-	-				4	1.50	
G-5841	ASH TRAY RETAINER	PH RNDWA AB SCREWS	-	-	M	-				4	1.50	
G-4622	ASH TRAY RETAINER	PH PN B SCREWS	-	-	-	N				3	1.50	
G-6643	COAT HOOKS	SS/CHROME PH OV SCREWS	-	A	M	-				2	1.50	
G-6276	CONSOLE - ASH TRAY DOOR	RIVETS, RETAINERS	F	-	-	-				4	4.00	
G-5244	CONSOLE - Fr COVER	SCREWS, SPRING NUTS	F	-	-	-				8	3.00	
G-5789	CONSOLE > FLOOR	HXWA & PN HD SCREWS	-	A	M	-				7	3.00	
G-6288	CONSOLE > FLOOR	HXWA & PH OV SCREWS, SPRING NUTS	-	-	-	N				8	3.00	
G-5239	CONSOLE > FLOOR BRACKETS	PH PN AB FLAT SEMS, SPRING NUTS	F	-	-	-				12	5.00	
G-6588	CONSOLE ASH TRAY DOOR BUMPERS	RUBBER BUMPERS	F	-	-	-				2	2.00	
G-5248	CONSOLE DOOR LATCH	PH PN MS	F	A	M	-				1	1.00	
G-6415	CONSOLE DOOR, HINGE & LATCH	PH PN BT FLAT SEMS & SCREWS	F	-	-	-				8	5.00	
G-5794	CONSOLE DOOR, HINGE & STRIKER	PH OV & PH PN SCREWS	-	A	M	-				11	3.00	
G-5790	CONSOLE END COVER	CHROME PH OV SCREWS	-	A	M	-				4	2.00	
G-5242	CONSOLE END PANELS, UPPER & LWR	SCREWS, SPRING NUTS	F	-	-	-				12	3.00	
G-5250	CONSOLE FLOOR BRACKETS	HX SPLIT SEMS, RIVET NUTS	F	-	-	-				12	6.00	
G-6289	CONSOLE INSERT & EMBLEM	STAMPED NUTS	-	-	-	N				7	2.00	
G-5249	CONSOLE LAMP LENS	HX AB FLAT SEMS	F	-	-	-				2	1.50	
G-5791	CONSOLE MOULDINGS	STAMPED NUTS ONLY	-	A	M	-				14	2.00	
G-5976	CONSOLE SIDE CONTAINERS	PH RNDWA SCREWS	-	A	M	-				4	1.50	
G-5240	CONSOLE TOP FRAME	HX FLAT & PN PN AB SEMS	F	-	-	-				12	5.00	
G-5837	COVER - A/C HOLE OUTLET ON DASH	HI-HX BT SCREWS	-	A	M	-				2	2.00	
G-5125	DASH PAD	HXWA SCREWS, FLAT SEMS, SPR NUTS	F	-	-	-				20	6.00	
G-5822	DASH PAD	RETAINING CLIPS, SCREWS	-	A	M	-				12	14.00	
G-5650	DOME LAMP	PH PN SCREWS	-	A	M	-				2	1.50	
G-5409	DOOR HANDLES (inside) - STD	WIRE RETAINERS	-	A	M	-				2	1.00	
G-5384	DOOR PANELS	CLIPS, PLUGS (flexible !), PH OV AB SEMS	-	A	M	-				32	12.00	
G-6641	ESCUTCHEON @ Rr WINDOW LWR CORNERS	CHROME PH OV AB SEMS	-	A	-	-				2	1.50	
G-6647	FILLER PANELS - Rr SEAT BACK	PH OV SCREWS	-	A	M	-				4	2.00	
G-4947	GLOVE BOX DOOR	HX AB FLAT SEMS	-	-	-	N				3	2.00	
G-5117	GLOVE BOX DOOR & STOP	SCREWS, SPRING NUTS	F	-	-	-				18	5.00	
G-5836	GLOVE BOX DOOR & STOP	PH PN & RNDWA SCREWS, PH OV SEMS	-	A	M	-				14	3.00	
G-6585	GLOVE BOX DOOR BUMPERS	RUBBER BUMPERS	F	A	M	N				2	2.00	
G-5119	GLOVE BOX LINER	HXWA AB SCREW	F	-	-	-				1	1.50	
G-4360	GLOVE BOX LINER	PH PN AB FLAT SEMS	-	-	-	N				6	3.00	
G-5116	GLOVE BOX STRIKER	HXWA SCREWS, SPRING NUTS	F	-	-	-				4	2.00	
G-5835	GLOVE BOX STRIKER	RND WA SCREWS, SPRING NUTS	-	A	M	-				4	2.00	
G-4943	GLOVE BOX STRIKER	PN PN AB FLAT SEMS	-	-	-	N				2	1.50	
G-6651	HEADLINER RETAINERS - Fr & SIDES	5/16 AF HXWA AB SCREWS	-	A	M	-				22	3.00	
G-6650	HEADLINER RETAINERS - Rr	PH RNDWA SCREWS	-	A	M	-				15	4.00	
G-6655	HEADREST ESCUTCHEONS & FABRIC RETAINER	CHROME PH OV AB & PH FLAT SCREWS	-	A	M	-				16	4.00	
G-5833	HEATER CONTROL & SUPPORT > DASH	HXWA SCREWS, FLAT SEMS, SPR NUTS	-	A	M	-				7	3.00	
G-6346	HEATER CONTROL > DASH	HX FLAT BT SEMS	F	-	-	-				3	2.00	
G-6238	HEATER CONTROL > DASH	PH OV AB SEMS, SPRING NUTS	-	-	-	N				6	3.00	
G-5198	INSTRUMENT CLUSTER & CARRIER > DASH	PH OV AB & HX BT FLAT SEMS, SPR NUTS	F	-	-	-				18	6.00	
G-6271	INSTRUMENT CLUSTER & CARRIER > DASH	PH OV & HX AB FLAT SEMS, SPR NUTS	-	PH OV	-	N				14	4.00	
G-6395	INSTRUMENT CLUSTER > CARRIER	HXWA AB SCREWS	-	-	-	N				8	2.00	
G-5957	INSTRUMENT CLUSTER > DASH	HI-HX BT FLAT SEMS	-	A	M	-				8	4.00	
G-4617	INSULATION > FIREWALL	RUBBER RETAINERS	F	-	-	N				4	6.00	
G-5825	INSULATION > FIREWALL	RUBBER RETAINERS	-	A	M	-				3	5.00	
G-6646	KICK PANELS w AC	PH OV AB FINWA SEMS	-	A	M	-				3	3.00	
G-4621	MIRROR (inside Rr view) > BRACKET	CHROME SLOT OV SHLDR SCREW	-	A	M	N				1	2.00	
G-6691	MIRROR (inside Rr view) BRACKET	PH PN AB SCREWS	-	A	-	-				3	1.00	
G-5597	MIRROR, REMOTE CONTROL BEZEL > DOOR	SS/CHROME PH OV AB SCREWS	-	A	M	N				2	1.50	
G-5124	PILLAR MOULDINGS	CHROME PH OV AB SCREWS	F	-	-	-				2	1.50	
G-6684	PILLAR MOULDINGS - CONVERTIBLE	PH OV AB SEMS, PH RNDWA TEK SCREWS	-	A	M	-				4	3.00	
G-5824	PILLAR MOULDINGS - METAL	PH OV & PH TRUSSWA SCREWS	-	A	-	-				4	2.00	
G-6649	QUARTER TRIM PANELS - MAIN	PH OV FINWA SEMS, PH PN AB SCREWS	-	A	M	-				4	3.00	
G-6648	QUARTER TRIM SAIL PANELS	RETAINING CLIPS	-	A	M	-				4	3.00	
G-5299	RADIO CONTROL SHAFTS & KNOBS	Early 70F, SLOTTED NUTS, TEFLON WA'S	F	A	M	N				4	4.00	
G-6398	RADIO CONTROL SHAFTS & KNOBS	SPECIAL THIN HX NUTS, TEFLON WA'S	F	-	-	-				4	4.00	
G-4321	SCUFF PLATES, DOOR OPENING	SS/CHROME PH OV AB SCREWS	F	A	M	-				8	2.50	
G-6148	SCUFF PLATES, DOOR OPENING	SS/CHROME PH OV AB SCREWS	-	-	-	N				12	3.00	
G-6657	SEAT BACK (Fr) STOP BUMPERS	PH PN AB SCREWS	-	A	M	-				4	1.50	
G-5380	SEAT BACK (Rr) > BODY	HX AB CONI TOOTH SEMS	-	A	M	-				2	3.00	

See factory Assembly Manuals for illustrations

1970

Interior

PART #	APPLICATION	NOTES	CAMARO				CHEVELLE MONTE CARLO		NOVA		PCS	PRICE
			F	A	M	N						
G-6675	SEAT BACK STRAP > SEAT BASE	ROUNDED TRIM HX CONI SEMS	-	A	M	-				4	6.00	
G-5241	SEAT BELT BUCKLE RETAINERS	PH OV AB FLUSH SEMS, SPRING NUTS	F	-	-	-				8	3.00	
G-6656	SEAT SIDE PANELS	.41 DIA PH RNDWA SCREWS	-	A	M	-				12	3.00	
G-6653	SEAT TRACKS > FLOOR	HX CONI TOOTH SEMS, PERI KEPS	F	A	M	-				8	5.00	
G-5134	SEAT TRACKS > SEAT	SCREWS	F	-	-	-				8	6.00	
G-5407	SHOULDER HARNESS RETAINERS	CHROME PH OV AB SCREWS	-	A	M	-				8	2.00	
G-5182	STEERING COLUMN COVER > DASH	HXWA SCREWS, PH OV SEMS, SPR NUTS	F	-	-	-				8	3.00	
G-5823	STEERING COLUMN COVER > DASH	CHROME PH OV FLUSH SEMS, SPR NUTS	-	A	M	-				8	3.00	
G-6252	STEERING COLUMN COVER > DASH	PH OV SEMS, HX FLAT SEMS, SPR NUTS	-	-	-	N				6	3.00	
G-4977	STEERING COLUMN COVER > FIREWALL	HX AB FLAT SEMS w SEALER	F	-	-	N				2	3.00	
G-5926	STEERING COLUMN COVER > FIREWALL	HXWA AB SCREWS	-	A	M	-				2	2.00	
G-5183	STEERING WHEEL SHROUD	PH PN EXT SEMS	F	-	-	-				2	1.50	
G-4998	STEERING WHEEL SHROUD	PH PN EXT SEMS	-	A	M	N				4	2.00	
G-5204	STEERING WHEEL SHROUD EMBLEM	STAMPED HX NUTS	F	-	-	-				2	1.50	
G-4915	STEERING WHEEL SHROUD EMBLEM	STAMPED NUTS	-	A	M	-				2	1.50	
G-5377	SUN VISOR & MIRROR BRACKETS - COUPE	SS/CHROME PH OV & PH PN AB SCREWS	-	A	M	-				9	3.00	
G-6670	SUN VISOR BRACKETS - CONVERTIBLE	CHROME PH OV SCREWS w #12 HD	-	A	-	-				6	4.00	
G-5378	SUN VISOR CLAMPS	CHROME SLOT FILL SCREWS	-	A	M	-				2	2.00	
G-6348	VENTILATION OUTLETS & DUCT	HI-HX BT FLAT SEMS, HXWA AB SCREWS	F	-	-	-				8	3.00	
G-5400	WINDOW CRANK HANDLES	RETAINING CLIPS	-	A	M	-				4	1.50	

Mouldings

G-5931	FENDER MOULDINGS	STAMPED NUTS ONLY	-	-	M	N				14	3.00
G-5933	FENDER MOULDINGS - El Camino Custom	STAMPED NUTS ONLY	-	A	-	-				10	3.00
G-6335	FENDER MOULDINGS - LWR	STAMPED NUTS ONLY !	-	-	-	N				6	3.00
G-5932	FENDER MOULDINGS - Malibu	STAMPED NUTS ONLY	-	A	-	-				12	3.00
G-4159	HOOD & FENDER EDGE MOULDINGS	PH TRUSS WA AB SCREWS	F	-	-	-				10	3.00
G-6255	HOOD & FENDER Fr MOULDINGS	Does hood emblem, STMPD NUTS, CAPS	-	-	-	N				20	4.00
G-6640	QUARTER PANEL EXTENSION MOULDINGS	SS/CHROME PH OV SCREWS	-	-	M	-				6	3.00
G-5126	ROCKER MOULDINGS	SCREWS ONLY	F	-	-	-				20	4.00
G-5706	ROCKER MOULDINGS	PH PN AB SCREWS ONLY	-	A	-	N				24	4.00
G-4196	WHEEL OPENING MOULDINGS	CHROME/SS PH RNDWA AB SCREWS	-	A	M	-				28	6.00
G-6542	WINDOW (Fr) MOULDINGS	RETAINING CLIPS	F	-	-	-				22	12.00
G-6544	WINDOW (Fr) MOULDINGS	RETAINING CLIPS, PH PN AB SCREWS	-	A	-	-				32	12.00
G-6555	WINDOW (Fr) MOULDINGS	RETAINING CLIPS, PH PN AB SCREWS	-	-	-	N				32	12.00
G-6561	WINDOW (Fr) MOULDINGS - CONVERTIBLE	RETAINING CLIPS, PH PN AB SCREWS	-	A	-	-				26	12.00
G-4665	WINDOW (Fr) MOULDINGS, LWR	RETAINING CLIPS (less the 2 end clips)	-	-	-	N				8	12.00
G-6556	WINDOW (Fr) MOULDINGS, SIDES, UPR - VINYL	RETAINING CLIPS, SCREWS	-	-	-	N				20	12.00
G-6540	WINDOW (Rr) MOULDINGS	RETAINING CLIPS	F	-	-	-				22	12.00
G-6549	WINDOW (Rr) MOULDINGS	RETAINING CLIPS	-	A	-	-				20	12.00
G-6558	WINDOW (Rr) MOULDINGS	RETAINING CLIPS	-	-	-	N				20	12.00
G-6550	WINDOW (Rr) MOULDINGS - El Camino	RETAINING CLIPS	-	A	-	-				20	12.00
G-6551	WINDOW (Rr) MOULDINGS - El Camino - VINYL	RETAINING CLIPS	-	A	-	-				20	12.00
G-6560	WINDOW (Rr) MOULDINGS - Vinyl Top	RETAINING CLIPS	-	A	-	-				20	12.00
G-6559	WINDOW (Rr) MOULDINGS - Vinyl Top	RETAINING CLIPS	-	-	-	N				20	12.00

Steering & Suspension

G-4631	AXLE HSNB > SPRINGS	SPECIAL GR-8 LOCK NUTS ONLY !	F	-	-	N				8	12.00
G-6639	AXLE HSNB > SPRINGS - 302/350/396	MULTI SPRINGS, T, U BOLTS, LOCK NUTS	-	-	-	N				14	38.00
G-4897	AXLE HSNB > SPRINGS - 70F > w/o STAB BAR	MULTI SPRINGS, T, U BOLTS, LOCK NUTS	F	-	-	-				14	32.00
G-5904	AXLE HSNB > SPRINGS (mono spring)	SPECIAL GR-8 LOCK NUTS & T BOLTS	-	-	-	N				16	26.00
G-5257	AXLE HSNB > SPRINGS w STABILIZER BAR	LONG T- BOLTS, U-BOLTS, LOCK NUTS	F	-	-	-				14	34.00
G-6151	BALL JOINTS - UPPER	SOLID RIVETS (2 are extra)	-	A	M	N				10	6.00
G-5458	CONTROL ARM BUSHINGS - UPPER	RETAINERS, LOCK NUTS	F	-	-	-				8	12.00
G-4612	CONTROL ARM BUSHINGS - UPPER	HX BOLTS "SSC", WA'S, RETAINERS	-	A	M	N				12	12.00
G-4608	CONTROL ARMS - LWR	POINTED BOLTS, LOCK NUTS	F	A	M	N				8	20.00
G-5138	CONTROL ARMS - UPPER	GR-8 KNURL BOLTS, LOCK NUTS, SHIMS	F	-	-	-				18	20.00
G-4627	CONTROL ARMS - UPPER	GR-8 KNURL BOLTS, LOCK NUTS, SHIMS	-	A	M	N				18	14.00
G-4610	CONTROL ARMS (Rr)	GR-8 POINTED BOLTS, LOCK NUTS	-	A	M	-				16	32.00
G-5539	FRAME REINFORCEMENTS - HP APPLICATIONS	HARDENED FLAT WA'S	-	A	M	-				2	3.00
G-4669	GREASE FITTINGS	STRAIGHT	F	A	M	N				10	3.00
G-4265	IDLER ARM > FRAME	GR-8 HX BOLTS, WA'S, NUTS	F	A	-	N				6	6.00
G-5036	IDLER ARM > FRAME	GR-8 HX BOLTS, WA'S, NUTS	-	-	M	-				6	6.00
G-4607	LEAF SPRING, Fr HANGERS	HX PP CONI SEMS, SPECIAL U-NUTS	F	-	-	-				12	18.00
G-6354	LEAF SPRING, Fr HANGERS	GR-8 BOLTS, SPECIAL U-NUTS	-	-	-	N				12	18.00
G-4630	LEAF SPRINGS, Fr EYE	GR-8 BOLTS, NUTS, WA'S	F	-	-	N				8	12.00
G-5293	P/S HOSE CLAMP	HXWA AB SCREW	F	-	-	-				1	1.00

Kits Contain Attaching Fasteners for Both Sides

GM Fastener Kits

1970

Steering & Suspension

PART #	APPLICATION	NOTES					PCS	PRICE
			F	A	M	N		
G-5292	P/S PUMP - 396/454	HX BOLTS, NUTS, WA'S, SPACER	F	A	M	N	19	12.00
G-5082	P/S PUMP - SB	HX BOLTS, NUTS, WA'S, SPACER	F	A	M	N	19	12.00
G-4807	P/S PUMP PULLEY	THIN LOCK NUT	F	A	M	N	1	6.00
G-4668	PITMAN ARM > GEAR BOX	HX NUT, SPLIT WA	F	A	M	N	2	3.00
G-4838	SHACKLES	11/16" AF MARSDEN NUTS ONLY	F	-	-	N	4	6.00
G-4586	SHOCKS (Fr) - LWR MOUNTING	HXWA CA SCREWS, U-NUTS	F	A	M	N	8	8.00
G-4836	SHOCKS (Fr) - UPR MOUNTING	RETAINERS, BUSHINGS, 3/8-24 NUTS	F	A	M	N	10	6.00
G-5483	SHOCKS (Rr)	BOLTS, LOCK NUTS, FLAT & SPLIT WA'S	-	A	M	-	16	8.00
G-5143	SHOCKS (Rr) LWR MOUNTING	RETAINERS, BUSHINGS, 3/8-24 NUTS	F	-	-	-	10	8.00
G-4632	SHOCKS (Rr) LWR MOUNTING - MONO SPRING	HX BOLTS, NUTS, SPLIT WA'S	-	-	-	N	6	4.00
G-4898	SHOCKS (Rr) LWR MOUNTING - MULTI SPRING	THICK HX NUTS, SPLIT WA'S	-	-	-	N	4	3.00
G-6100	SHOCKS (Rr) UPR MOUNTING	HX SPLIT SEMS	F	-	-	-	4	6.00
G-5185	SPARE WHEEL	9 5/8" J-BOLT, WING NUT, FLAT WA	F	-	-	-	3	16.00
G-6938	SPARE WHEEL (F coupe only)	5 7/8" J-BOLT, WING NUT	-	A	M	N	2	14.00
G-6461	SPARE WHEEL WRENCH > JACK	7.1" FLEXIBLE STRAPS	F	-	-	-	2	5.00
G-5141	STABILIZER BAR (Fr) BRACKETS	HX TY-T SCREWS	F	A	M	N	4	6.00
G-4955	STABILIZER BAR (Fr) CLAMPS	HX BOLTS, NUTS, SPLIT & FLAT WA'S	-	-	-	N	8	4.00
G-5140	STABILIZER BAR (Fr) END LINKS	HX BOLTS, RETAINERS, BUSHINGS, NUTS	F	-	-	-	22	20.00
G-5481	STABILIZER BAR (Fr) END LINKS	HX BOLTS, RETAINERS, BUSHINGS, NUTS	-	A	M	-	22	25.00
G-4837	STABILIZER BAR (Fr) END LINKS	HX BOLTS, RETAINERS, BUSHINGS, NUTS	-	-	-	N	22	20.00
G-5600	STABILIZER BAR (Rr)	HX BOLTS, NUTS	-	A	M	-	8	6.00
G-6403	STABILIZER BAR (Rr) END BRACKETS	HX BOLTS, SPLIT WA'S, NUTS	-	-	-	N	12	4.00
G-5256	STABILIZER BAR (Rr) SUPPORTS	HX BOLTS, WA'S, NUTS	F	-	-	-	18	10.00
G-6402	STABILIZER BAR (Rr) SUPPORTS	HX BOLTS, SPLIT WA'S, NUTS	-	-	-	N	12	6.00
G-4976	STEERING COLUMN > DASH	FLNG NUTS, FLNG SCREWS (copper plate)	F	-	-	N	6	5.00
G-5928	STEERING COLUMN > DASH	FLNG SCREWS, FLNG NUTS, CONI SEMS	-	A	M	-	7	6.00
G-6638	STEERING COLUMN BRACKET REINF	HX PP CONI SEMS	F	-	-	-	4	3.00
G-4354	STEERING GEAR "RAG" JOINT	12 PT BOLT ONLY	F	A	M	N	1	3.00
G-5180	STEERING GEAR BOX > FRAME	GR-8 HX BOLTS, FLAT WA'S	F	A	M	-	6	12.00
G-4293	STEERING GEAR BOX > FRAME	GR-8 HX BOLTS, FLAT WA'S	-	-	-	N	6	12.00
G-5139	STEERING LINKAGE & BALL JOINTS	GR-8 LRG HX SLOT NUTS, COTTER PINS	F	-	-	-	20	15.00
G-5858	STEERING LINKAGE & BALL JOINTS	SLOTTED NUTS, COTTER PINS	-	A	M	-	20	10.00
G-4615	STEERING LINKAGE & BALL JOINTS	SLOTTED NUTS, COTTER PINS	-	-	-	N	20	10.00
G-4670	STEERING SHAFT > COUPLING	REG & HVY NUTS, SPLIT WA'S	F	A	M	N	4	3.00
G-4802	STEERING WHEEL - DLX	SS PH FLAT MS SCREWS	-	A	M	-	6	3.00
G-5716	SUSPENSION BUMPER & BRACKET (Rr)	HX BOLTS, NUTS, SPLIT WA'S	-	A	M	-	7	3.00
G-4337	SUSPENSION BUMPERS & BRACKETS (Rr)	HX PP CONI SEMS, HXWA SCREWS, NUTS	F	-	-	-	12	10.00
G-4596	SUSPENSION BUMPERS (Fr)	HX NUTS	F	A	M	N	2	1.00
G-6355	SUSPENSION BUMPERS (Rr)	HXWA T SCREWS	-	-	-	N	6	4.00
G-5484	SUSPENSION BUMPERS (Rr) - El Camino	HX BOLTS, NUTS, SPLIT WA'S	-	A	-	-	3	2.00
G-6583	WHEEL STUDS - 1 AXLE (Fr or Rr)	Does 2 wheels, 7/16-20 x 1.38" L	F	A	M	N	10	14.00
G-5060	WHEELS - STD	ORIGINAL LUG NUTS w "DIAMONDS"	F	A	M	N	20	25.00

Transmission

G-6149	BELL HOUSING > ENGINE	FLNG BOLTS (Flat Top) "A" MARKING	F	A	M	N	6	8.00
G-6611	BELL HOUSING > ENGINE	FLNG BOLTS, "M" MARKING	F	A	M	N	6	8.00
G-5416	BELL HOUSING Fr COVER PLATE	SS EXT SEMS "L"	F	A	M	N	4	3.00
G-5907	CLUTCH BELLCRANK	BALL STUDS, SEATS, RETAINER, WA'S	F	A	M	N	9	32.00
G-5172	CLUTCH BELLCRANK BRACKET > FRAME	HXWA SCREWS	F	-	-	-	3	3.00
G-5888	CLUTCH BELLCRANK BRACKET > FRAME	HXWA C SCREWS	-	A	M	-	2	2.00
G-4660	CLUTCH BELLCRANK BRACKET > FRAME	HXWA SCREWS	-	-	-	N	3	4.00
G-5146	CLUTCH PEDAL	HX BOLT, WA , NUT ONLY !	F	-	-	-	3	4.00
G-5603	CLUTCH PEDAL BUSHINGS	NYLON BUSHINGS ONLY	F	A	M	N	2	3.00
G-4658	CLUTCH PEDAL PUSH ROD SEAL	HXWA AB SCREWS	F	-	-	N	2	1.00
G-4850	CLUTCH PEDAL PUSH RODS	RETAINING CLIPS ONLY	F	A	M	N	3	3.00
G-4659	CLUTCH PEDAL RETAINER	FOLDED SPRING METAL	-	A	M	N	1	3.00
G-5490	CONTROL LINKAGE > COLUMN - ALL	RETAINERS, FITTINGS, NUTS, WA'S	-	-	-	N	12	18.00
G-6192	CONTROL LINKAGE > COLUMN - M38/M40	RETAINERS, SLEEVE, WA'S, NUT, SCREW	F	-	-	-	8	12.00
G-5254	CONTROL LINKAGE > COLUMN - PG	RETAINERS, SLEEVE, WA'S, NUT, SCREW	F	-	-	-	10	12.00
G-4792	COVER - CLUTCH PEDAL HOLE	HXWA SCREWS	F	-	-	N	2	1.50
G-4629	DRIVESHAFT > REAR KNUCKLE	U-BOLTS, NUTS, WA'S	-	A	M	N	10	8.00
G-4796	DRIVESHAFT, TH400 '69 > 302, 350, BB. All 71 >	STRAPS, FLNG BOLTS	F	A	M	N	6	8.00
G-6573	FLYWHEEL - A/T	GR-8 HXWA SCREWS	F	A	M	N	12	16.00
G-4429	FLYWHEEL - M/T	11/16" AF X 1.0" L HX BOLTS	F	A	M	N	12	12.00
G-6150	PRESSURE PLATE > FLYWHEEL	SPECIAL HX BOLTS, SPLIT WA'S	F	A	M	N	12	6.00
G-4528	SHIFTER BEZEL & SEAL RETAINER - M/T	w/o CONSOLE, HXWA AB SCREWS	-	A	M	N	10	3.00
G-5165	SHIFTER BOOT PLATE w/o CONSOLE	CHROME PH OV AB SCREWS	F	-	-	-	4	2.00
G-4908	SHIFTER CABLE - PG, TH400 w CONSOLE	U & PUSH RETAINERS, NUT, WA	F	A	M	-	6	6.00
G-5076	SHIFTER CABLE - TH350 w CONSOLE	SCREW, U & PUSH RETAINERS, NUT, WA	F	A	M	-	8	6.00
G-5903	SHIFTER CABLE - TH350 w CONSOLE	U & PUSH RETAINERS, HX SPLIT SEMS	-	A	M	-	6	6.00
G-5733	SHIFTER CONTROL - HD 3 SPD or 4 SPD	HX BOLTS, WA'S, NUTS	-	A	M	-	16	8.00

See factory Assembly Manuals for illustrations

GM Fastener Kits

373

1970

Transmission

PART #	APPLICATION	NOTES					PCS	PRICE
			CAMAHO	CHEVELLE MONTE CARLO	NOVA			
G-5164	SHIFTER CONTROL & SUPPORT - 3 SPD	HX BOLTS, SPLIT & FLAT WA'S	F	-	-	-	9	6.00
G-4783	SHIFTER CONTROL & SUPPORT (exc 69F M20)	HX BOLTS, NUTS, SPLIT WA'S	-	-	-	N	13	4.00
G-5278	SHIFTER DIAL (A/T) & SENDER - IN DASH	PH FLAT B SCREW, HI-HX BT FLAT SEMS	F	-	-	-	3	2.00
G-5801	SHIFTER DIAL CABLE - IN DASH	PH FLAT B SCREW	-	A	M	-	1	1.00
G-5732	SHIFTER HANDLE - HD 3 SPD M/T, 70-72 4 SPD	HX SPLIT SEMS	-	A	M	-	2	3.00
G-4852	SHIFTER LEVER > FLOOR - A/T w CONSOLE	HXWA AB SCREWS	-	A	M	-	3	2.00
G-4790	SHIFTER LEVER > FLOOR - PG, TH400 w CNSL	HXWA T1 SCREWS	-	-	-	N	4	2.00
G-5898	SHIFTER LEVERS - 4S, 70-71A HD, 70F L65	HX BOLTS, FLAT & SPLIT WA'S	F	A	M	N	9	4.00
G-5897	SHIFTER LEVERS > CASE - 3 SPD M/T	HX BOLTS, SPLIT & FLAT WA'S	F	A	M	N	6	3.00
G-5799	SHIFTER LEVERS > CASE - 4 SPD STD	HX SPLIT SEMS, FLAT WA'S	-	A	M	-	6	4.00
G-5798	SHIFTER LINKAGE, A/T FLOOR - TH350, TH400	RETAINERS, NUTS, FLAT WA'S	-	-	-	N	9	4.00
G-5245	SHIFTER PLATE - M/T or A/T CONSOLE	CHROME PH OV B SCREWS, STMPD NUTS	F	-	-	-	10	3.00
G-6291	SHIFTER PLATE & SEALS - A/T CONSOLE	HXWA T, PH OV AB SCREWS, SPR NUTS	-	-	-	N	14	4.00
G-6290	SHIFTER PLATE & SEALS - M/T CONSOLE	PH OV & HXWA SCREWS, SPRING NUTS	-	-	-	N	16	4.00
G-5894	SHIFTER PLATE, LENS, SEAL - A/T CONSOLE	HXWA AB CREWS, STAMPED NUTS	-	A	M	-	8	3.00
G-5167	SHIFTER RODS - 3 SPD	RETAINERS, FALT & WAVE WA'S, NUTS	F	-	-	-	14	8.00
G-5276	SHIFTER RODS - 4 SPD	RETAINERS, FLAT & WAVE WA'S	F	-	-	-	21	12.00
G-4780	SHIFTER RODS - 4 SPD	RETAINING CLIPS, JAM NUTS	-	A	M	N	12	10.00
G-4778	SHIFTER RODS - HD 3 SPD	RETAINERS, NUTS	-	A	M	-	8	6.00
G-5893	SHIFTER SEAL RETAINER - M/T CONSOLE	HXWA AB SCREWS	-	A	M	-	6	2.00
G-4904	SHIFTER STAB 68FN 327, 69FN, 68-72AN 3, 4	Floor Shift. BOLTS, NUTS, RET'S, BSHNGS	-	A	M	N	8	12.00
G-6563	SHIFTER STAB SHAFT - HD 3 SPD	Floor Shift. BOLT, RET'S, NUTS, BUSHINGS	-	A	M	-	9	8.00
G-5792	SHIFTER TRIM PLATE (console only)	PH OV C SCREWS	-	A	M	-	6	2.00
G-4694	SPEEDOMETER CABLE > TRANS	HX SPLIT SEMS	F	A	M	N	1	2.00
G-6347	TCS RELAY - EARLY 70 & 71-72	HXWA AB SCREWS w SEALER	F	A	M	N	2	1.50
G-5341	TCS SOLENOID > INTAKE	HX CLR STUD, NUT, SPLIT WA	F	A	M	N	3	6.00
G-5280	TORQUE CONVERTOR > FLYWHEEL - TH400	FLNG BOLTS	F	A	M	N	6	6.00
G-4788	TORQUE CONVERTOR > FLYWHL - PG, TH350	PLACE BOLTS, NUTS, WASHERS	F	A	M	N	9	8.00
G-5283	TRANS (Powerglide) KICKDOWN LINKAGE	BALL STUD, NUTS, WA'S, ROD END CLIP	F	A	M	N	7	8.00
G-6508	TRANS (TH350) DETENT CABLE > TUBE	4.05" ALUMINUM STRAP	F	A	M	N	1	3.00
G-5286	TRANS (TH400) CONTROL SW (at gas pedal)	HXWA AB SCREW	F	A	M	N	1	1.00
G-5078	TRANS (TH400) CONTROL SW, LEVER - 396	HX EXT SEMS, BOLT, NUT, SPLIT WA	-	-	-	N	5	3.00
G-5061	TRANS BACKDRIVE - 4 SPD (exc 69-70 L65)	RETAINERS, FITTINGS, NUTS, WA'S	-	A	M	-	10	14.00
G-5067	TRANS BACKDRIVE - HD 3S, 69-70 L65 4S	RETAINERS, FITTINGS, NUTS, WA'S	-	A	M	-	14	16.00
G-5171	TRANS BACKDRIVE - M/T	RETAINERS, FITTINGS, NUTS, WA'S	F	-	-	-	13	16.00
G-6564	TRANS BACKDRIVE - M11, M20 (72N, 70N STD)	RETAINERS, FITTINGS, NUTS, WA'S	-	-	-	N	15	18.00
G-6565	TRANS BACKDRIVE - M20 (350/396 only 70N)	RETAINERS, FITTINGS, NUTS, WA'S	-	-	-	N	11	16.00
G-4169	TRANS CROSSMEMBER	HX BOLTS, WA'S (RH SIDE), NUTS	F	A	M	N	14	6.00
G-4603	TRANS INSULATOR	HX BOLTS, FLAT & SPLIT WA'S	-	-	-	N	10	6.00
G-4605	TRANS INSULATOR - 70A, 72 350, 71M, 72 BB	HX BOLTS, FLAT & SPLIT WA'S	-	A	M	-	12	7.00
G-5886	TRANS INSULATOR - TH400 (also does All)	HX BOLTS, FLAT & SPLIT WA'S	-	A	M	-	14	7.00
G-5170	TRANS LINK SUPPORT 70-72 M/T, 71-72N A/T	> FRAME, HXWA T SCREWS	F	-	-	-	3	3.00
G-5891	TRANS LINKAGE - A/T PG	RETAINERS, SWIVEL, NUT, WA'S	-	A	M	-	8	12.00
G-5892	TRANS LINKAGE - A/T TH350 & TH400	RETAINERS, SWIVEL, NUT, WA'S	-	A	M	-	7	12.00
G-5561	TRANS LINKAGE or BACKDRIVE SUPPORT	> FRAME: HXWA C SCREWS	-	A	M	N	3	3.00
G-5069	TRANS LINKAGE SUPPORT > FRAME	HXWA C SCREWS	F	A	M	N	2	2.00
G-6308	TRANS OIL PAN - PG (exc 68-72 console)	LRG FLNG HEAD SCREWS	F	A	M	N	14	7.00
G-6309	TRANS OIL PAN - PG w CONSOLE	LRG FLNG HEAD SCREWS, SPLIT SEMS	F	A	M	N	14	7.00
G-6311	TRANS OIL PAN w CNSL TH350 73-81, TH400	LRG FLNG HEAD SCREWS	F	A	M	N	13	7.00
G-6310	TRANS OIL PAN w/o CNSL - TH350 All, TH400	LRG FLNG HEAD SCREWS	F	A	M	N	13	6.00
G-5070	TRANSMISSION (A/T) > ENGINE (exc 67-68 PG)	HX BOLTS, SPLIT & FLAT WA'S	F	A	M	N	9	6.00
G-4590	TRANSMISSION (STD) > BELL HOUSING	HX BOLTS, SPLIT WA'S	F	A	M	N	8	5.00
G-5731	TRANSMISSION LINKAGE - M/T CLM SHIFT	RETAINERS, FITTINGS, NUTS, WA'S	-	A	M	-	15	24.00
G-5232	TRANSMISSION LINKAGE - M/T CLM SHIFT	RETAINERS, FITTINGS, NUTS, WA'S	-	-	-	N	18	20.00
G-4909	TRANSMISSION OIL COOLER LINES	C SHAPED SPRING CLIPS	F	A	M	N	2	3.00
G-4735	UNDERPAN - TH400, 70F PG	HX T1 SCREWS	F	A	M	N	4	2.00

Wipers

G-5303	WASHER FLUID MONITOR > DASH	HX SCREW, NUT	F	-	-	-	2	1.50
G-4330	WINDSHIELD WASHER BOTTLE	HXWA AB SCREWS	F	A	M	-	2	1.50
G-4302	WINDSHIELD WASHER BOTTLE BRACKET	HXWA AB SCREWS	-	-	-	N	3	2.00
G-4163	WINDSHIELD WASHER NOZZLES	#10 HXWA AB SCREWS	F	-	-	-	2	1.00
G-4303	WINDSHIELD WASHER NOZZLES	#8 HXWA B SCREWS	-	A	M	N	2	1.25
G-4153	WIPER ARM PIVOTS > COWL	HX CONI TOOTH SEMS	F	-	-	-	6	3.00
G-5423	WIPER ARM PIVOTS > COWL	HX CNTRSNK & REG HX EXT SEMS	-	A	M	-	5	5.00
G-4464	WIPER ARM PIVOTS > COWL	HX EXT SEMS	-	-	-	N	4	3.00
G-5465	WIPER MOTOR	GROMMETS, GRD STRAP, RIVET, SCREWS	F	A	M	N	8	12.00
G-4329	WIPER MOTOR	HX CNTRSNK EXT SEMS	F	A	M	N	3	3.00
G-5599	WIPER MOTOR BRACKET - 1, 2S w/o WASHER	HX EXT SEMS	-	A	M	-	3	2.00
G-4946	WIPER SWITCH	HI-HXWA SCREWS	-	-	-	N	3	2.00
G-5120	WIPER SWITCH & GROUND	HXWA AB & B SCREWS, TOOTH WA	F	-	-	-	5	2.00
G-5839	WIPER SWITCH & STRAP	HI-HX FLAT SEMS, HXWA SCREWS, WA	-	A	M	-	6	2.00

Kits Contain Attaching Fasteners for Both Sides

1971

Air Conditioning

PART #	APPLICATION	NOTES					PCS	PRICE
			F	A	M	N		
G-5039	AC / HEAT DIVERTER DOOR SWITCH	HI-HXWA AB SCREWS	-	-	-	N	2	1.50
G-5767	AC AIR DISTRIBUTION DUCT - CENTRAL	HX ABT FLAT SEMS	-	A	M	N	2	2.00
G-5237	AC AIR DISTRIBUTION DUCTS - CENTRAL	HX FLAT SEMS, RETAINER, WA	F	-	-	-	7	6.00
G-5251	AC AIR DUCT - CONSOLE	HX ABT FLAT SEMS, PH RND WA SCREW	F	-	-	-	4	3.00
G-5216	AC AIR OUTLET @ FLOOR - CENTER	HX ABT FLAT SEMS	F	-	-	-	3	2.00
G-6307	AC AIR OUTLET @ FLOOR - CENTER	HX ABT FLAT SEMS	-	-	-	N	2	1.50
G-5035	AC AMBIENT SWITCH > EVAPORATOR	HXWA ABT SCREWS	F	A	M	N	2	2.00
G-5238	AC ANTI-DIESELING RELAY	HXWA AB SCREW	F	A	M	N	1	1.00
G-5785	AC BLOWER CONTROL SWITCH (in control)	HXWA T1 SCREWS	-	-	-	N	2	1.50
G-5227	AC COMP BRACE > INTAKE - 396/454	HX BOLTS, HX CLR STUD, NUT, WA'S	F	A	M	-	7	6.00
G-5223	AC COMP BRACE > INTAKE - SB	HX BOLTS, FLAT & SPLIT WA'S	F	A	M	N	5	4.00
G-5849	AC COMP BRACE, UPPER Fr - 396/454	HX BOLTS, FLAT, SPLIT & TOOTH WA'S	F	A	M	-	9	5.00
G-5023	AC COMP BRACE, UPPER Fr - SB	HX BOLTS, FLAT, SPLIT & TOOTH WA'S	F	A	M	N	11	6.00
G-5225	AC COMP SUPPORT > EXH MANIFOLD - 396/454	HX BOLTS, SPLIT WA'S	F	A	M	-	6	3.00
G-5847	AC COMP SUPPORT > EXH MANIFOLD - SB	GR-8 "TR" HX BOLTS	F	A	M	N	2	3.00
G-5226	AC COMP SUPPORT, LWR Fr - 396/454	HX BOLTS, SPLIT WA'S	F	A	M	-	6	3.00
G-5021	AC COMP SUPPORT, LWR Fr - SB	HX BOLTS, SPLIT & TOOTH WA'S	F	A	M	N	6	4.00
G-5224	AC COMP SUPPORT, LWR Rr - 396/454	HX BOLTS, FLAT & SPLIT WA'S	F	A	M	-	11	4.00
G-5222	AC COMP SUPPORT, LWR Rr - SB	HX BOLTS, SPLIT WA'S	F	A	M	N	10	4.00
G-6442	AC COMPRESSOR WIRING	5.1" FLEXIBLE STRAPS	F	-	-	-	2	5.00
G-5220	AC CONDENSER	HX SPLIT SEMS, FLNG NUTS	F	-	-	-	16	6.00
G-5845	AC CONDENSER	HX CONI SEMS, FLNG NUTS, U-NUTS	-	A	M	-	18	7.00
G-6351	AC CONDENSER & BRACKETS	SCREWS, SPRING NUTS, WELL-NUTS	-	-	-	N	24	10.00
G-5004	AC DEFROSTER DISTRIBUTOR	HX ABT FLAT SEMS	-	-	-	N	3	2.00
G-5228	AC EVAPORATOR > FIREWALL	HX FLAT SEMS, CLR STUD, NUTS, WA'S	F	-	-	-	10	8.00
G-5776	AC EVAPORATOR > FIREWALL	HX AB FLAT SEMS	-	A	M	-	6	6.00
G-4872	AC EVAPORATOR > FIREWALL	HX INT/EXT SEMS, CLR STUD, NUTS, WA'S	-	-	-	N	6	8.00
G-6304	AC EVAPORATOR CASE	HXWA BT SCREWS	F	A	M	-	6	4.00
G-5235	AC FITTING & MUFFLER ASSEMBLY	HX BOLT, FLAT & SPLIT WA'S	F	A	M	N	3	3.00
G-4723	AC GROUND > FIREWALL	HXWA AB SCREW, TOOTH WA	F	A	M	N	2	1.50
G-5229	AC HEATER HOSE > DASH GROMMET	HX ABT FLAT SEMS	F	-	-	-	2	1.50
G-5033	AC HEATER HOSE CLAMP > ALT BRACKET	METAL HOSE CLIP, HXWA SCREW	F	A	M	N	2	5.00
G-6352	AC HEATER HOSE SEAL RETAINER	HXWA ABT SCREWS	-	-	-	N	2	1.50
G-6439	AC HOSE > HEATER HOSE	11.25" FLEXIBLE STRAP	F	A	M	N	1	6.00
G-5853	AC HOSE > RH WHEELHOUSE	HXWA AB SCREWS	F	A	M	-	2	1.50
G-6287	AC HOSE > RH WHEELHOUSE	3/16" POP RIVETS	-	-	-	N	2	2.00
G-5214	AC PLENUM VALVE & BRACKET	HXWA AB SCREWS, CONI KEPS NUTS	F	-	-	-	9	4.00
G-5763	AC PLENUM VALVE & BRACKET	HXWA & PH PN SCREWS, NUTS, WA'S	-	A	M	-	11	3.00
G-4699	AC PLENUM VALVE & BRACKET	HXWA SCREWS, NUTS, WA'S, RETAINER	-	-	-	N	16	5.00
G-6283	AC RADIATOR SEAL	NYLON RETAINERS	-	-	-	N	4	2.00
G-5846	AC RECIEVER TANK > CONDENSER	HXWA AB SCREWS	-	A	M	-	2	1.50
G-6282	AC RECIEVER TANK > FENDER SKIRT	HX BOLTS, FLNG NUTS	-	-	-	N	4	3.00
G-5221	AC RECIEVER TANK > RADIATOR SUPPORT	HXWA AB SCREWS, SPRING NUTS	F	-	-	-	6	3.00
G-5034	AC RESISTOR & RELAY > EVAPORATOR	HXWA ABT SCREWS	F	A	M	N	3	2.00
G-5215	AC SELECTOR DUCT > FIREWALL	HX AB INT/EXT SEMS, NUTS, WA'S	F	A	M	N	8	4.00
G-6434	AC VACUUM HOSE @ FIREWALL	5.1" FLEXIBLE STRAP	-	-	-	N	1	3.00
G-5041	AC VACUUM HOSE @ FIREWALL & CONTROL	HXWA AB SCREW, HX FLAT ABT SEMS	-	-	-	N	2	1.50
G-6449	AC VACUUM HOSE @ SELECT DUCT	5.1" FLEXIBLE STRAP	-	A	M	-	1	3.00
G-6441	AC VACUUM HOSE @ VALVE COVER	5.1" FLEXIBLE STRAP	-	-	-	N	1	3.00
G-5234	AC VACUUM HOSE ATTACHMENTS	FLAT SEMS, HXWA SCREWS, RETAINERS	F	-	-	-	7	3.00
G-5852	AC VACUUM HOSE ATTACHMENTS	HXWA AB SCREW, NUT, RETAINER	-	A	M	-	3	2.00
G-5002	AC VACUUM HOSE CLAMPS	FLAT WOUND SPRING CLAMPS (Black)	-	-	-	N	3	3.00
G-6450	AC VACUUM HOSE CLIPS @ SELECTOR DUCT	RUBBER COATED S CLIPS	-	A	M	-	2	4.00
G-4697	AC VACUUM MOTOR @ RH COWL	HXWA SCREWS, NUTS, TOOTH WA'S	F	-	-	N	7	3.00
G-5001	AC VACUUM MOTOR COVER	PH OV FIN WA SEMS .50 OD, SPRG NUTS	F	-	-	N	6	3.00
G-5038	AC VACUUM TANK	HXWA AB SCREWS	-	-	-	N	2	1.00
G-4714	AC VALVE, TUBE BRKT'S > EVAPORATOR	HXWA AB & ABT SCREWS	F	-	-	N	2	1.50
G-5850	AC VALVE, TUBE BRKT'S > EVAPORATOR	HXWA AB SCREWS	-	A	M	-	2	2.00
G-6502	AC WIRING CLIP @ EVAPORATOR RELAY	RUBBER COATED J CLIP	F	-	-	-	1	3.00

Body

G-4101	BATTERY TRAY	HX CONI SEMS, HXWA CA SCREWS	F	-	-	N	4	3.00
G-4198	BATTERY TRAY	HX MS & PP CONI SEMS, U-NUT	-	A	-	-	5	6.00
G-4197	BATTERY TRAY	HX CONI SEMS, HXWA SCREW, U-NUTS	-	-	M	-	7	6.00
G-5936	BODY MOUNT BRACKETS @ RAD SUPPORT	BOLTS, RATCHET TOOTH WA'S, NUTS	F	-	-	-	16	12.00
G-5935	BODY MOUNT BRACKETS @ RAD SUPPORT	HX PP CONI SEMS	-	A	M	-	6	3.00
G-5127	BODY MOUNTS	ORIGINAL BOLTS, CONI KEPS NUTS, WA'S	F	-	-	-	14	40.00
G-5831	BODY MOUNTS	ORIGINAL BOLTS, NUTS, WA'S	-	-	M	-	28	32.00
G-6363	BODY MOUNTS	ORIGINAL BOLTS, WA'S, NUTS	-	-	-	N	18	34.00
G-5830	BODY MOUNTS - CONVERTIBLE & El Camino	ORIGINAL BOLTS, NUTS, WA'S	-	A	-	-	22	30.00
G-5829	BODY MOUNTS - HARDTOP	ORIGINAL BOLTS, NUTS, WA'S	-	A	-	-	18	24.00
G-5188	BODY MOUNTS @ RADIATOR SUPPORT	ORIGINAL BOLTS, FLAT WA'S	F	-	-	-	4	6.00
G-5746	BODY MOUNTS @ RADIATOR SUPPORT	ORIGINAL BOLTS, NUTS, WA'S, SHIMS	-	A	-	-	14	10.00

See factory Assembly Manuals for illustrations

GM Fastener Kits

375

1971

Body

PART #	APPLICATION	NOTES					PCS	PRICE
			CAMARO	CHEVELLE MONTE CARLO	NOVA			
G-4340	BRAKE PEDAL SUPPORT w/o PB	FLNG NUTS	F	A	M	N	2	2.00
G-4227	BUMPER (Fr)	SS CAP & UNCAP BOLTS, WA'S, NUTS	-	A	M	-	32	10.00
G-6273	BUMPER (Fr)	SS CAPPED BOLTS, WA'S, NUTS	-	-	-	N	32	10.00
G-5371	BUMPER (Fr) - R/S	SS CAPPED BOLTS, CONI KEPS NUTS	F	-	-	-	8	6.00
G-4135	BUMPER (Fr) - STD	SS CAPPED BOLTS, CONI KEPS NUTS	F	-	-	-	10	8.00
G-5969	BUMPER (Fr) BRACKETS	HX BOLTS, RATCHET TOOTH WA'S, NUTS	-	A	-	-	16	12.00
G-6024	BUMPER (Fr) BRACKETS	HX BOLTS, RATCHET TOOTH WA'S, NUTS	-	-	-	N	16	12.00
G-4180	BUMPER (Fr) FILLER PANEL	HX CONI SEMS, SCREWS, U-NUTS, NUTS	-	-	M	-	16	9.00
G-6262	BUMPER (Fr) FILLER PANEL & SUPPORT	HX CONI SEMS, SCREWS, U-NUTS, RTNRS	-	-	-	N	18	12.00
G-4178	BUMPER (Fr) FILLER PANELS	HX CONI SEMS, HXWA SCREWS, U-NUTS	-	A	-	-	18	12.00
G-4226	BUMPER (Fr) OUTER PAD BRACKETS	BOLTS, RATCHET TOOTH WA'S	-	A	M	-	4	4.00
G-4136	BUMPER (Rr)	SS CAPPED BOLTS, CONI KEPS NUTS	F	-	-	-	14	14.00
G-4218	BUMPER (Rr)	SS CAP BOLTS, RATCHET WA'S, NUTS	-	A	-	-	28	12.00
G-4224	BUMPER (Rr)	SS CAP BOLTS, RATCHET WA'S, NUTS	-	-	M	-	40	20.00
G-6275	BUMPER (Rr)	SS CAPPED BOLTS, WA'S, NUTS	-	-	-	N	32	10.00
G-5973	BUMPER (Rr) - El Camino	SS CAP BOLTS, RATCHET WA'S, NUTS	-	A	-	-	39	20.00
G-4614	BUMPER BRACES & BRACKETS (Fr) - R/S	HX PP CONI SEMS, SCREWS, CONI KEPS	F	-	-	-	10	8.00
G-4131	BUMPER BRACES & BRACKETS (Fr) - STD	HX PP CONI SEMS, HXWA SCREWS, NUTS	F	-	-	-	10	8.00
G-4225	BUMPER BRACKETS (Fr)	HX BOLTS, RATCHET TOOTH WA'S, NUTS	-	-	M	-	16	12.00
G-5207	BUMPER BRACKETS (Rr)	HX PP CONI SEMS, CONI KEPS NUTS	F	-	-	-	8	8.00
G-4215	BUMPER BRACKETS (Rr)	POINTED BOLTS, RATCHET TOOTH WA'S	-	A	-	-	12	12.00
G-4223	BUMPER BRACKETS (Rr)	HX BOLTS, RATCHET TOOTH WA'S, NUTS	-	-	M	-	20	14.00
G-4274	BUMPER BRACKETS (Rr)	HX PP CONI SEMS	-	-	-	N	8	8.00
G-5972	BUMPER BRACKETS (Rr) - El Camino	HX BOLTS, RATCHET TOOTH WA'S, NUTS	-	A	-	-	20	20.00
G-4222	BUMPER GUARD PADS (Fr & Rr)	STAMPED NUTS	-	A	M	N	12	3.00
G-6334	BUMPER GUARDS (Fr & Rr)	HX BOLTS, SPLIT WA'S, NUTS	-	-	-	N	20	5.00
G-4134	BUMPER GUARDS (Fr)	HX MS & PP CONI SEMS	F	-	-	-	4	6.00
G-4219	BUMPER GUARDS (Fr)	HX SPLIT SEMS	-	A	-	-	4	4.00
G-4282	BUMPER GUARDS (Fr)	HX BOLTS, WA'S, NUTS	-	-	M	-	10	4.00
G-4157	BUMPER GUARDS (Rr)	HX BOLTS, HX CONI SEMS, WELL-NUTS	F	-	-	-	8	6.00
G-4220	BUMPER GUARDS (Rr)	HX SPLIT SEMS	-	A	-	-	4	5.00
G-5971	BUMPER GUARDS (Rr)	HX BOLTS, SPLIT WA'S	-	-	M	-	8	3.00
G-4160	BUMPER PADS - FULL BUMPER (Fr)	EXT KEPS NUTS	F	-	-	-	21	5.00
G-4161	BUMPER PADS (Fr) R/S	EXT KEPS NUTS	F	-	-	-	14	4.00
G-4158	BUMPER PADS (Rr)	EXT KEPS NUTS	F	-	-	-	14	4.00
G-5109	COWL INDUCTION VALVE FRAME	HX EXT SEMS ONLY !	-	A	-	-	6	3.00
G-5945	COWL INDUCTION VALVE SCREEN	BLACK SS SCREWS ONLY	-	A	-	-	8	3.00
G-4301	COWL VENT PANEL	HX AB FLAT SEMS	-	-	-	N	4	3.00
G-5374	DOOR HANDLES (outside)	SPECIAL 5/16 AF HX CONI SEMS	F	A	M	-	4	4.00
G-5386	DOOR HINGES	HX CONI TOOTH SEMS	F	A	M	-	30	20.00
G-4332	DOOR LATCHES	OV HD TT SCREWS	F	A	M	N	6	3.00
G-6619	DOOR LOCK STRIKERS	TORX DRIVE	F	A	-	-	2	24.00
G-5399	DOOR WEATHERSTRIPS	PLASTIC PINS	-	A	M	-	4	1.50
G-6060	EMBLEM, GRILLE	STAMPED NUTS	-	-	M	-	2	1.00
G-4127	EMBLEM, GRILLE "BOWTIE", "Z28", "SS"	STAMPED NUTS	F	-	-	-	2	1.00
G-6315	EMBLEM, GRILLE "SS"	STAMPED NUTS	-	-	-	N	2	1.00
G-5975	EMBLEM, Rr BUMPER "SS"	CONI KEPS NUTS	-	A	-	-	2	2.00
G-4105	FENDER > RADIATOR SUPPORT BRACES	HXWA CA SCREWS	F	-	-	-	4	3.00
G-5929	FENDER > WHEELHOUSE Fr BRACES	HXWA T SCREWS	-	A	M	N	2	3.00
G-4177	FENDER 90 DEG BRACKETS > RAD SUPPORT	HXWA CA SCREWS	-	-	M	-	4	3.00
G-4286	FENDER EMBLEMS - "Rally Sport"	STAMPED NUTS	F	-	-	-	8	3.00
G-5270	FENDER EMBLEMS - "Z28", "350" w SS, R/S	STAMPED NUTS	F	-	-	-	4	1.50
G-4173	FENDER EXTENSION, TOP BRACKETS	HX CONI AB SEMS, SPRING NUTS	-	A	-	-	4	3.00
G-4172	FENDER EXTENSIONS	HX CONI SCREWS, STMPD NUTS, U-NUTS	-	A	-	-	12	4.00
G-4171	FENDER EXTENSIONS	HXWA & PH OV SCREWS, SPRING NUTS	-	-	M	-	14	6.00
G-4152	FENDER SPLASH SEALS	SEMS TAPPING SCREWS	F	-	-	-	12	5.00
G-4104	FENDERS	HX CONI SEMS, U-NUTS, SHIMS	F	-	-	-	26	20.00
G-4170	FENDERS	HX CONI SEMS, U-NUTS, SHIMS	-	A	M	-	32	22.00
G-6381	FENDERS	HX CONI SEMS, U-NUTS, SHIMS	-	-	-	N	26	20.00
G-6593	FENDERS > FIREWALL (also in fender kits)	HX CA CONI SEMS	F	A	M	N	4	5.00
G-6606	FENDERS > RAD SUPPORT (also in fender kit)	HX MS CONI SEMS	F	-	-	N	4	4.00
G-6605	FENDERS > RAD SUPPORT (also in fender kit)	HXWA CA SCREWS	-	A	M	-	4	3.00
G-4156	FILLER PANEL, Rr WINDOW	PH HXWA AB SCREWS	F	-	-	-	5	3.00
G-4120	FILLER PANELS - BELOW HEADLAMPS	HX AB FLAT SEMS	F	-	-	-	2	2.00
G-4209	GRILLE	PH PN SEMS, NYLON NUTS	-	A	-	-	12	6.00
G-4210	GRILLE	HX CONI SEMS, SPRING NUTS	-	-	M	-	11	5.00
G-5306	GRILLE - R/S	PH PN AB FLAT SEMS, PLASTIC NUTS	F	-	-	-	16	7.00
G-4118	GRILLE - STD	PH PN AB FLAT SEMS, PLASTIC NUTS	F	-	-	-	12	6.00
G-6260	GRILLE & REINFORCEMENT	HXWA SCREWS, SPR NUTS, BLK RIVETS	-	-	-	N	22	6.00
G-4208	GRILLE BRACKETS	HXWA CA SCREWS	-	A	M	-	3	2.00
G-6258	GRILLE BRACKETS	HXWA CA SCREWS	-	-	-	N	4	3.00
G-4119	GRILLE FILLER - R/S	PH PN SCREWS, PLASTIC NUTS	F	-	-	-	12	5.00
G-5186	HEADER PANEL	HXWA CA SCREWS, HX NUTS	F	-	-	-	13	5.00
G-4117	HEADLAMP BEZELS	SS/CHROME PH OV SCREWS, NYL NUTS	F	-	-	-	12	5.00
G-6391	HEADLAMP BEZELS	PH OV AB SCREWS, SPRING NUTS	-	-	-	N	16	5.00

Kits Contain Attaching Fasteners for Both Sides

GM Fastener Kits

1971

Body			CAMARO				CHEVELLE		MONTE CARLO		NOVA		PCS	PRICE
			F	A	M	N								
PART #	APPLICATION	NOTES												
G-4174	HEADLAMP BEZELS - STD Malibu 72A	SS/CHROME PH OV SCREWS, NYL NUTS	-	A	M	-						8	3.00	
G-4129	HEADLAMP HOUSINGS	HXWA CA SCREWS	F	-	-	-						6	4.00	
G-4106	HOOD & HINGES	HX CONI SEMS	F	A	M	N						8	10.00	
G-4107	HOOD CATCH & LOCK PLATE	12 PT CONI SEMS, HX SEMS FOR HORN	F	-	-	-						7	6.00	
G-4184	HOOD CATCH & LOCK PLATE	12 PT CONI SEMS	-	A	M	-						8	8.00	
G-6384	HOOD CATCH & LOCK PLATE	12 PT CONI SEMS, U-NUTS	-	-	-	N						11	10.00	
G-4109	HOOD CATCH SUPPORT	HXWA CA SCREW	F	-	-	N						1	1.00	
G-5743	HOOD CATCH SUPPORT	HXWA CA SCREW, U-NUT	-	A	M	-						2	2.00	
G-5210	HOOD LEVELER (Rr) - CENTER	BUMPER, ADJUSTER, FLNG NUT, U-NUT	F	-	-	-						4	5.00	
G-4249	HOOD LEVELERS (Fr)	SCREWS, FLNG NUTS, RUBBER BUMPERS	F	A	M	-						6	8.00	
G-4183	HOOD LEVELERS (Rr)	JAM NUTS only	-	A	M	-						2	2.00	
G-4365	HOOD LEVELERS (Rr) - OUTER	JAM NUTS only	F	-	-	-						2	3.00	
G-4182	HOOD LOCK POST	FLNG NUT ONLY	F	A	M	N						1	2.00	
G-4308	HOOD ORNAMENT	STAMPED NUTS	-	-	M	-						3	1.50	
G-4316	HOOD ORNAMENTS	STAMPED NUTS	-	-	-	N						12	4.00	
G-5941	HOOD PIN CABLES	SS/BLACK RNDWA AB SCREWS ONLY	-	A	-	-						2	1.50	
G-5319	HOOD SEAL	T SHAPED NYLON RETAINERS	F	A	M	-						13	5.00	
G-5940	HOOD STUD PLATES	CHROME PH OV AB SCREWS ONLY	-	A	-	-						8	3.00	
G-5942	HOOD STUDS	FLNG NUTS ONLY	-	A	-	-						4	3.00	
G-5826	INSTRUMENT PANEL ASSEMBLY	HXWA ABT SCREWS	-	A	M	-						6	4.00	
G-5123	INSTRUMENT PANEL REINFORCEMENTS	HX PP CONI SEMS, HXWA AB SCREWS	F	-	-	-						13	6.00	
G-5697	INSTRUMENT PANEL REINFORCEMENTS	HX MS & BT SEMS, HXWA AB SCREWS	-	A	M	-						9	4.00	
G-4121	LICENSE PLATE BRACKET (Fr)	SS HXWA SCREWS, NYLON NUTS	F	-	-	-						4	3.00	
G-4485	LICENSE PLATE BRACKET (Fr) 70-72, (Rr) All	HX BOLTS, EXT KEPS NUTS	-	A	M	N						4	3.00	
G-4100	LICENSE PLATE BRACKET (Rr)	HX BOLTS	F	-	-	-						2	2.00	
G-5046	LICENSE PLATES (Fr & Rr)	SLOT TRUSS B SCREWS, NYLON NUTS	-	-	-	N						8	6.00	
G-4307	NAMEPLATE, FENDERS - ENG DESIGNATION	STAMPED NUTS	-	A	-	-						6	2.00	
G-6256	NAMEPLATE, FENDERS - ENG DESIGNATION	STAMPED NUTS	-	-	-	N						4	2.00	
G-5631	NAMEPLATE, FENDERS "FLAGS" or "Nova"	STAMPED NUTS	-	-	-	N						4	2.00	
G-4194	NAMEPLATE, FENDERS "GMC SPRINT"	STAMPED NUTS	-	A	-	N						4	2.00	
G-4309	NAMEPLATE, FENDERS "Malibu", "El Camino"	STAMPED NUTS	-	A	-	-						6	2.00	
G-5978	NAMEPLATE, FENDERS "SS 454"	HXWA T SCREWS	-	-	M	-						4	2.00	
G-5269	NAMEPLATE, FENDERS "SS"	STAMPED NUTS	F	-	-	-						8	3.00	
G-5262	NAMEPLATE, FENDERS "SS"	STAMPED NUTS	-	A	-	-						12	3.00	
G-4192	NAMEPLATE, GRILLE	STAMPED NUTS	-	A	M	-						2	1.00	
G-4122	NAMEPLATE, HEADER PANEL	STAMPED NUTS	F	-	-	-						3	2.00	
G-4124	NAMPELATE, FENDERS "Camaro"	7/16" OD STAMPED NUTS	F	-	-	-						6	1.50	
G-4146	NOSE PANEL - R/S	HX CA CONI SEMS	F	-	-	-						4	6.00	
G-4149	NOSE PANEL VERTICAL BAR - R/S	HX CONI SEMS, CONI KEPS NUTS	F	-	-	-						8	8.00	
G-4150	PAD, NOSE PANEL VERTICAL BAR - R/S	CONI KEPS NUTS	F	-	-	-						3	2.00	
G-6339	QUARTER PANEL EXTENSIONS	STAMPED NUTS, SEALER	-	-	M	-						16	5.00	
G-5179	SEALS - BEHIND Rr BUMPER	NYLON RETAINERS	-	-	M	-						12	3.00	
G-5311	SEALS (L shaped) @ COWL SIDES	T SHAPED NYLON RETAINERS	F	-	-	-						4	2.00	
G-5352	SEALS (tubular), COWL Fr SIDES	T SHAPED NYLON RETAINERS	F	-	-	-						4	2.00	
G-4151	SPOILER (Rr) - 1 PIECE	CONI KEPS NUTS, SEALING WA'S	F	-	-	-						24	6.00	
G-4166	SPOILER (Rr) - 3 PIECE	CONI KEPS NUTS, SEALER WA'S	F	-	-	-						24	12.00	
G-5181	STEERING COLUMN SEAL RETAINER	HX AB FLAT SEMS	F	-	-	-						2	3.00	
G-5927	STEERING COLUMN SEAL RETAINER	HX AB CONI SEMS, HXWA AB SCREWS	-	A	M	-						7	6.00	
G-4975	STEERING COLUMN SEAL RETAINER	HX AB FLAT SEMS, HXWA AB SCREWS	-	-	-	N						6	6.00	
G-6930	TAILGATE HINGES - El Camino	HX CONI SEMS, FLAT EXT SEMS	-	A	-	-						12	20.00	
G-6934	TAILGATE LATCHES	OV HD TT SCREWS	-	A	-	-						6	3.00	
G-6931	TAILGATE STRIKERS > BODY	POZI FLAT SCREWS	-	A	-	-						6	6.00	
G-6933	TAILGATE SUPPORT CABLES	HX SHOULDER BOLTS, FLAT WA'S	-	A	-	-						8	8.00	
G-4154	TRUNK LATCH & STRIKER	HX CONI TOOTH SEMS	F	A	M	N						5	4.00	
G-4155	TRUNK LID > HINGES	HX CONI TOOTH SEMS	F	A	M	N						4	4.00	
G-5068	TRUNK LID BUMPERS	.90" DIA X .48 TK RUBBER BUMPERS	-	A	M	-						2	3.00	
G-4103	VALANCE (Fr)	HXWA CA SCREWS, U-NUTS	F	-	-	-						26	15.00	
G-4221	VALANCE (Rr)	HX PP CONI SEMS, U-NUTS	-	A	-	-						4	4.00	
G-6642	WEATHERSTRIP, QUARTER GLASS @ JAMB	.28 OD PH RNDWA AB SCREWS	-	A	M	-						6	2.00	
G-4189	WHEELHOUSE "U-CHANNEL" BRACES (Rr)	HX CONI SEMS, U-NUTS	-	-	M	-						8	7.00	
G-4187	WHEELHOUSE BRACKETS (Rr)	HX PP CONI SEMS	-	-	M	-						4	5.00	
G-4188	WHEELHOUSE EXTENSIONS	HXWA PP CREWS, U-NUTS	-	-	M	-						16	10.00	
G-4113	WHEELHOUSE Rr BRACES > BODY	HX CONI SEMS, U-NUTS	F	-	-	-						12	7.00	
G-4191	WHEELHOUSE SPLASH SHIELDS	HXWA AB & T1 SCREWS, U-NUTS, WA'S	-	-	M	-						16	4.00	
G-4112	WHEELHOUSES	SCREWS, HX CONI SEMS, WA'S, U-NUTS	F	-	-	-						38	22.00	
G-6692	WHEELHOUSES	SCREWS, HX SEMS, CUP WA'S, U-NUTS	-	A	-	-						42	24.00	
G-4186	WHEELHOUSES	SCREWS, HX CONI SEMS, WA'S, U-NUTS	-	-	M	-						42	26.00	
G-6265	WHEELHOUSES	HXWA PP SCREWS, CUP WA'S, U-NUTS	-	-	-	N						24	20.00	
G-4185	WHEELHOUSES - PLASTIC	SCREWS, HX CONI SEMS, WA'S, U-NUTS	-	A	-	-						42	24.00	
G-6599	WHEELHOUSES > FENDERS (also in WH kit)	HXWA CA SCREWS, CUP WA'S	F	-	-	-						8	8.00	
G-6597	WHEELHOUSES > FENDERS (also in WH kit)	HX PP CONI SEMS, FLAT WA'S	-	A	M	-						8	6.00	
G-6598	WHEELHOUSES > FENDERS (also in WH kit)	HXWA CA SCREWS, CUP WA'S, U-NUTS	-	-	-	N						12	12.00	
G-4111	WHEELHOUSES > RADIATOR SUPPORT	HXWA CA SCREWS	F	-	-	-						4	3.00	
G-4190	WHEELHOUSES > RADIATOR SUPPORT	HX PP CONI SEMS, U-NUTS	-	A	M	-						8	8.00	
G-6267	WHEELHOUSES > RADIATOR SUPPORT	HXWA CA SCREWS, U-NUTS	-	-	-	N						8	6.00	

See factory Assembly Manuals for illustrations

GM Fastener Kits

377

1971

Brakes

PART #	APPLICATION	NOTES	CAMARO				CHEVELLE		MONTE CARLO		NOVA		PCS	PRICE
			F	A	M	N								
G-5007	AXLE RETAINER PLATES	GR-8 HX BOLTS, NUTS, SPLIT WA'S	F	A	M	N						24	10.00	
G-6579	BRAKE BLEEDER SCREWS w DISC	All - CALIPERS, M/C, WHEEL CYLINDERS	F	A	M	N						6	10.00	
G-5863	BRAKE BOOSTER	FLNG NUTS	F	A	M	N						4	3.00	
G-5259	BRAKE BOOSTER HOSE - 396/454	CLAMPS & NUT FOR TUBE BRACKET	F	A	M	-						3	3.00	
G-4740	BRAKE BOOSTER HOSE - SB	FLAT WOUND SPRING CLAMPS (Black)	F	A	M	N						2	2.00	
G-4642	BRAKE CABLES	WIRE TYPE RETAINERS, HX NUTS	-	A	M	N						5	5.00	
G-4349	BRAKE CABLES & BRACKETS	WIRE RETAINING CLIPS, SCREWS, NUTS	F	-	-	-						13	10.00	
G-6575	BRAKE CALIPER BLEEDERS	3/8-24 SCREWS, .28 NOSE TO FIT CAP	F	A	M	N						2	4.00	
G-6636	BRAKE CALIPER BRACKETS & SHIELDS	HX BOLTS, LOCK NUTS	-	A	M	-						10	24.00	
G-5468	BRAKE CALIPER BRACKETS & SHIELDS	HX BOLTS, LOCK NUTS	-	-	-	N						10	24.00	
G-6426	BRAKE CALIPER LOCATING BOLTS	3.70" L HX SOCKET BOLTS	F	A	M	N						4	12.00	
G-6609	BRAKE CALIPER PISTON RETURN CLIPS	ATTACH TO CALIPER PISTONS, COATED	F	A	M	N						2	4.00	
G-6162	BRAKE CALIPER SHIELDS	HX CONI SEMS	F	-	-	-						6	4.00	
G-4956	BRAKE HOSE (Fr disc) > CONTROL ARM	HXWA T SCREWS	-	-	-	N						2	2.00	
G-5252	BRAKE HOSE (Rr) DIST BLOCK > AXLE HSNB	HX SPLIT SEMS	F	-	-	-						1	3.00	
G-4960	BRAKE HOSE (Rr) DIST BLOCK > BRACKET	HX BOLT	-	A	M	N						1	2.00	
G-5866	BRAKE HOSE > CALIPER	DRILLED BOLTS, COPPER WA'S	F	A	M	N						6	10.00	
G-4348	BRAKE HOSE BRACKET (Rr)	HX PP CONI SEMS	-	-	-	N						2	3.00	
G-5047	BRAKE HOSE BRACKETS (Fr)	HX T CONI SEMS	F	-	-	N						2	2.00	
G-5719	BRAKE HOSE BRACKETS (Fr)	HXWA AB SCREWS	-	A	M	-						2	2.00	
G-6240	BRAKE HOSE GASKETS	COPPER MATERIAL	F	A	M	N						2	1.50	
G-4958	BRAKE HOSE RETAINERS	U-RETAINERS	F	A	M	N						3	3.00	
G-5871	BRAKE LINE SHIELDS (Rr) - El Camino	HXWA AB SCREWS	-	A	-	-						4	3.00	
G-5868	BRAKE LINES (Fr) BRACKET	HXWA AB SCREWS	-	A	-	-						2	2.00	
G-5602	BRAKE PEDAL BUSHINGS	NYLON BUSHINGS ONLY	F	A	M	N						2	3.00	
G-4794	BRAKE PEDAL RETAINER w A/T	FOLDED SPRING METAL	-	A	M	N						1	3.00	
G-6044	BRAKE PEDAL RETURN SPRING	NOS SPRING	F	A	M	N						1	4.00	
G-5284	BRAKE PEDAL w A/T	HX BOLT, LOCK NUT	F	-	-	-						2	4.00	
G-5008	BRAKE PLATE ASSEMBLY (Fr) > SPINDLE	GR-8 HX BOLTS, LOCK NUTS	-	A	M	N						8	12.00	
G-4636	BRAKE PRESSURE VALVE & SW - DRUM	HX SPLIT SEMS	-	-	-	N						1	1.50	
G-5861	BRAKE PRESSURE VALVE & SW > FRAME	HXWA AB SCREW	-	A	-	-						1	1.00	
G-4633	BRAKE PRESSURE VALVE & SW w/o PB	HXWA SCREWS, SPACER	F	-	-	-						3	5.00	
G-5865	BRAKE PRESSURE VALVE & SW, DISC (F w PB)	HXWA T SCREWS	F	-	M	N						2	2.00	
G-5057	BRAKE PRESSURE VALVE (Rr) - 302/350 & BB	HXWA T SCREW	-	-	-	N						1	1.50	
G-5144	MASTER CYLINDER	FLNG NUTS	F	A	M	N						2	2.00	
G-6580	MASTER CYLINDER BLEEDERS w DISC	5/16-24 SCREWS	F	A	M	N						2	3.00	
G-4829	MASTER CYLINDER PUSH ROD > PEDAL	RETAINING CLIP	F	A	M	N						1	3.00	
G-5150	PARKING BRAKE CONTROL > DASH	HX CONI SEMS, FLNG NUTS	F	-	-	-						4	2.00	
G-5864	PARKING BRAKE CONTROL > DASH	HX CONI SEMS, FLNG NUTS, SEALER	-	A	M	-						6	4.00	
G-4347	PARKING BRAKE CONTROL > DASH	HX CONI SEMS, FLNG NUTS	-	-	-	N						3	3.00	
G-5990	PARKING BRAKE RELEASE ROD CLIP	ROD END CLIP	-	A	M	-						1	3.00	
G-4887	STOPLAMP SWITCH STRIKER - PWR BRAKES	w POWER BRAKES, BOLT, STAMPED NUT	-	A	M	N						2	2.00	
G-5258	STOPLAMP SWITCH STRIKER (on pedal)	w POWER BRAKES, BOLT, STAMPED NUT	F	-	-	-						2	3.00	

Cooling

G-6576	WHEEL CYLINDER (2) BLEEDERS	Does 2 cylinders, 5/16-24 SCREWS	F	A	M	N						2	3.00
G-6577	WHEEL CYLINDER (4) BLEEDERS	Does 4 cylinders, 5/16-24 SCREWS	-	A	-	N						4	5.00
G-6578	WHEEL CYLINDER BLEEDER PROTECTORS	PLASTIC CAPS w STRAP	F	A	M	N						2	2.00
G-6581	WHEEL CYLINDERS (2)	HX INT SEMS	F	A	M	N						4	3.00
G-6582	WHEEL CYLINDERS (4)	HX INT SEMS	-	A	-	N						8	5.00

Differential

G-4591	RADIATOR - 307/327 350	HXWA CA SCREWS	F	A	M	-						3	3.00
G-6387	RADIATOR - 307/327/350	HX CONI SEMS	-	-	-	N						3	3.00
G-6944	RADIATOR - 396	HX PP CONI SEMS	-	A	-	N						4	3.00
G-5189	RADIATOR FAN SHROUD	S CLIPS, HX FLAT SEMS, SPRING NUTS	F	A	M	-						6	6.00
G-6386	RADIATOR FAN SHROUD	S CLIPS, HX FLAT SEMS, SPRING NUTS	-	-	-	N						6	6.00
G-5162	RADIATOR HOSES - V8	TOWER TYPE CLAMPS	F	A	M	N						4	12.00

GM Fastener Kits

1971

Electrical

PART #	APPLICATION	NOTES					PCS	PRICE
			F	A	M	N		
G-5466	DIFFERENTIAL COVER - 10 BOLT	SRTD FLNG SCREWS "E"	F	A	M	N	10	10.00
G-5467	DIFFERENTIAL COVER - 12 BOLT	SRTD FLNG SCREWS "E"	F	A	M	N	12	12.00
G-4962	ALTERNATOR - 302, 307, 327, 350	HX BOLTS, WA'S, NUT	F	A	M	N	13	10.00
G-5049	ALTERNATOR - 396/454	BOLTS, HX CLR STUD, SPACER, NUTS	F	A	M	-	16	25.00
G-5191	ALTERNATOR HARNESS > ALTERNATOR	12-24 EXT KEPS NUT	F	A	M	N	1	2.00
G-6293	ALTERNATOR PULLEY	NUT, FLAT WA	F	A	M	N	2	3.00
G-6635	BACK-UP LAMP LENSES - El Camino	SS/CHROME PH PN .435 SHLDR SCREWS	-	A	-	-	4	4.00
G-4505	BACK-UP LAMPS	PH PN EXT SEMS	-	-	M	-	4	3.00
G-5203	BACK-UP/NEUTRAL SWITCH (exc 70-71F A/T)	SCREWS	F	A	M	N	2	1.50
G-6390	BATTERY CABLES	HXWA SCREWS, BRASS NUT, WA	-	-	-	N	5	4.00
G-5197	BATTERY CABLES & CLAMP	HXWA SCREWS, NUT, WA	F	-	-	-	6	4.00
G-5744	BATTERY CABLES & CLAMP	HXWA SCREWS, NUT, WA	-	A	M	-	6	4.00
G-4352	BATTERY HOLDOWN CLAMP	HX CONI SEMS	F	A	M	N	1	1.50
G-6399	CAPACITOR - RADIO NOISE w AC	HXWA SCREW, TOOTH WA	-	-	-	N	2	1.50
G-5814	CAPACITOR - RADIO NOISE, AM/FM, AC 68	HXWA SCREW	-	A	M	-	1	1.00
G-5298	CLOCK - IN DASH	HXWA SCREWS	F	-	-	-	2	1.00
G-5959	CLOCK - IN DASH	HXWA SCREWS	-	-	M	-	3	1.50
G-6328	CLOCK - IN DASH	HXWA SCREWS, FLAT WA'S	-	-	-	N	4	2.00
G-5958	CLOCK or COVER - IN DASH	SLOT HX SCREWS	-	A	-	-	3	1.50
G-5954	COURTESY LAMP, GLOVE BOX	HX ABT FLAT SEMS	-	A	M	-	1	1.50
G-5305	COURTESY LAMP, GLOVE BOX w AC	HX ABT FLAT SEMS	F	-	-	-	1	1.50
G-5961	COURTESY LAMPS, UNDERDASH	HXWA BT SCREWS	-	A	M	-	2	1.50
G-4990	COURTESY LAMPS, UNDERDASH (69F CONV)	HXWA SCREWS	F	-	-	N	2	1.50
G-5881	COWL INDUCTION RELAY	HXWA SCREW	-	A	-	-	1	1.00
G-5110	COWL INDUCTION SOLENOID	HX CONI SEMS	-	A	-	-	1	1.50
G-5939	COWL INDUCTION SWITCH (at gas pedal)	HXWA SCREW	-	A	-	-	1	1.50
G-5977	CRUISE CONTROL CABLE BRACE	HX BOLTS, EXT KEPS NUTS	-	A	M	-	2	2.00
G-6452	CRUISE CONTROL CABLES	7.1" FLEXIBLE STRAPS	-	A	M	-	3	6.00
G-5882	CRUISE CONTROL REGULATOR & BRACKET	HX CONI SEMS, BOLTS, NUTS, WA'S	-	A	M	-	11	5.00
G-5883	CRUISE CONTROL SERVO & BRACKET	HX CONI SEMS, NUTS, WA'S	-	A	M	-	9	4.00
G-5885	CRUISE CONTROL SW STRIKER	HX BOLT, STAMPED NUT	-	A	M	-	2	2.00
G-5000	DEFOGGER SWITCH BEZEL - Rr WINDOW	EXT KEPS NUTS	-	A	M	N	2	1.50
G-5211	DEFOGGER SWITCH HOUSING - Rr WINDOW	HXWA SCREWS	F	-	-	-	2	1.50
G-4989	DIMMER SWITCH	HXWA AB SCREWS	F	A	M	N	2	2.00
G-4988	FLASHER BRACKET & GROUND > DASH	HXWA SCREWS, TOOTH WA	-	-	-	N	3	2.00
G-5200	FLASHER BRACKET > DASH	HXWA SCREW, TOOTH WA	F	-	-	-	2	2.00
G-5953	FLASHER BRACKET > DASH	PH PN AB FLAT SEMS	-	A	M	-	1	1.50
G-4986	FUSE PANEL > FIREWALL	#10 x 2 1/4 HXWA AB SCREWS w SEALER	F	A	M	N	2	3.00
G-5192	H/L, P/L GROUNDS, JUNCTION BLOCK	HXWA AB SCREWS, NUTS, TOOTH WA	F	A	M	-	4	3.00
G-4680	H/L, P/L GROUNDS, JUNCTION BLOCK	HXWA AB & B SCREWS, TOOTH WA'S	-	-	-	N	5	3.00
G-6530	HEADLAMP ADJUSTERS	SCREWS, NYLON NUTS, SPRING NUTS	F	-	M	-	10	8.00
G-4258	HEADLAMP ADJUSTERS	SCREWS, NYLON NUTS, SPRING NUTS	-	A	-	-	10	8.00
G-6562	HEADLAMP ADJUSTERS	SCREWS, NYLON NUTS, SPRINGS	-	-	-	N	10	8.00
G-6567	HEADLAMP RETAINING RINGS	SLOT PN SCREWS	F	A	M	N	6	3.00
G-6622	HEADLAMP RETAINING RINGS	PH RND SCREWS	F	A	M	N	6	2.00
G-5854	HEATER SWITCH	HI-HXWA ABT SCREWS	-	A	M	-	2	1.50
G-5128	HEATER SWITCH (exc 70-72A) or AC FAN	HXWA B SCREWS	F	A	M	-	2	1.50
G-4726	HEATER SWITCH or AC FAN (AC 68N)	HXWA T1 SCREWS	-	-	-	N	2	1.50
G-4207	HORN (1)	HX PP CONI SEMS	F	A	M	-	1	1.50
G-6323	HORN (1)	HX PP CONI TOOTH SEMS, PLASTIC CAP	-	-	-	N	2	4.00
G-5196	HORN RELAY	HXWA AB SCREW	F	A	M	N	1	1.00
G-4647	IGNITION COIL & STRAP	HX EXT SEMS, SLOT RND T SCREW	F	A	M	N	3	4.00
G-5960	INSTRUMENT CLUSTER CIRCUIT BOARD	HXWA B SCREWS, NUTS, WA'S	-	A	M	-	14	3.00
G-6272	INSTRUMENT CLUSTER CIRCUIT BOARD	HXWA B SCREWS, WA'S, NUTS	-	-	-	N	10	3.00
G-4853	INSTRUMENT CLUSTER GROUND	HXWA AB SCREW, TOOTH WA	-	-	-	N	2	1.50
G-5757	INSTRUMENT CLUSTER GROUNDS	HXWA AB & B SCREWS, TOOTH WA'S	-	A	M	-	3	1.50
G-5199	INSTRUMENTS CIRCUIT BOARD	NUTS, FLAT WA'S	F	-	-	-	6	2.00
G-5296	INSTRUMENTS CIRCUIT BOARD w GAUGES	HXWA B SCREWS, NUTS, FLAT WA'S	F	-	-	-	20	4.00
G-6652	KICK PANELS w/o AC	HXWA SCREWS	-	A	M	-	10	3.00
G-4205	LICENSE PLATE LAMP	HXWA AB SCREWS	-	A	M	-	2	1.00
G-4312	LICENSE PLATE LAMP	PH PN AB SCREWS	-	-	-	N	2	1.00
G-4128	MARKER LAMPS (Fr & Rr)	STAMPED NUTS	F	-	-	-	8	4.00
G-4479	MARKER LAMPS (Fr & Rr)	STAMPED NUTS	-	-	-	N	8	3.00
G-4201	MARKER LAMPS (Fr)	PH PN AB SCREWS, SPRING NUTS	-	-	M	-	8	2.00
G-4228	MARKER LAMPS (Rr)	STAMPED NUTS	-	A	M	-	4	2.00
G-5153	NEUTRAL STARTING SWITCH - M/T	HXWA AB SCREW, FLAT WA	F	A	M	N	2	1.50
G-5202	PARKING BRAKE ALARM SWITCH	HXWA AB SCREW	F	A	M	-	1	1.00
G-6396	PARKING BRAKE ALARM SWITCH	NUTS, SPLIT WA'S	-	-	-	N	4	1.50
G-4229	PARKING LAMP BEZELS	CHROME PH OV MS SCREWS	-	A	-	-	8	4.00
G-6625	PARKING LAMP LENSES	SS/CHROME PH PN .488 SHLDR SCREWS	F	-	-	-	4	4.00
G-6676	PARKING LAMP LENSES	SS/CHROME PH PN B SCREWS	-	-	M	-	4	3.00
G-6420	PARKING LAMP LENSES (67-68F STD)	SS/CHROME PH PN .640 SHLDR SCREWS	-	-	-	N	4	4.00
G-5949	PARKING LAMPS	PN PN & HXWA AB SCREWS, SPR NUTS	-	-	M	-	6	3.00
G-4480	PARKING LAMPS	PH PN EXT SEMS	-	-	-	N	4	3.00
G-4116	PARKING LAMPS - STD	PH PN AB SCREWS, SPRING NUTS	F	-	-	-	8	3.00

See factory Assembly Manuals for illustrations

GM Fastener Kits

379

1971

Electrical

PART #	APPLICATION	NOTES					PCS	PRICE
			CAMARO	CHEVELLE MONTE CARLO	NOVA			
			F	A	M	N		
G-4115	PARKING LAMPS (All 69F, 70-73F R/S)	EXT KEPS NUTS	F	-	-	-	4	3.00
G-5369	POWER ACCY CIRCUIT BREAKER	NYLON INSERT HX NUTS	-	A	M	-	2	1.50
G-5967	RADIO BRACKET	HXWA & PN PN AB SCREWS, SPR NUTS	-	A	M	-	5	3.00
G-5295	RADIO BRACKETS	HXWA AB & B SCREWS, SPRING NUTS	F	-	-	-	8	3.00
G-5095	RADIO BRACKETS	HXWA AB SCREWS, SPRING NUTS	-	-	-	N	4	3.00
G-5301	RADIO NOISE CAPACITOR > COIL BRACKET	HXWA T SCREW, TOOTH WA	F	A	M	N	2	1.50
G-6654	SEAT BACK PANELS	PH PN FLAT SEMS	-	A	M	-	6	3.00
G-5368	SPEAKER > DASH	HXWA AB SCREW, SPRING NUT	F	-	-	-	2	1.50
G-5094	SPEAKER > DASH	HXWA AB SCREW, SPRING NUT	-	-	-	N	2	1.50
G-5965	SPEAKER > DASH w AC	HXWA AB & B SCREWS, SPRING NUTS	-	A	-	-	14	4.00
G-5966	SPEAKER > DASH w AC	HXWA SCREWS, FLAT SEMS, SPR NUTS	-	-	M	-	14	4.00
G-5963	SPEAKER > DASH w/o AC	HXWA AB SCREWS, SPRING NUTS	-	A	-	-	10	3.00
G-5964	SPEAKER > DASH w/o AC	HXWA AB SCREWS, SPRING NUTS	-	-	M	-	11	3.00
G-5302	SPEAKERS > DASH (stereo)	CONI KEPS NUTS	F	-	-	-	10	4.00
G-5152	STARTER - 307, 70F & 71AF 350, 72F 396 A/T	1.84 & 4.69 FLNG BOLTS, SEMS, NUT, WA	F	A	M	N	5	8.00
G-5874	STARTER - 350 70A, 71MC, 72F, 72A/73F M/T	3.62 L HX BOLTS, HX CONI SEMS, NUT, WA	-	-	M	-	5	8.00
G-5340	STARTER & BRACE - 396/454 (exc 72 A/T)	3.62 L HX BOLTS, HX CONI SEMS, NUT, WA	F	A	M	-	5	8.00
G-5201	STOPLAMP SWITCH	SPECIAL ROUND RETAINER	F	A	M	-	1	2.00
G-4689	STOPLAMP SWITCH	STAMPED HX NUTS	-	-	-	N	2	2.00
G-5297	TACHOMETER	HXWA B SCREWS	F	A	M	-	3	1.50
G-6325	TACHOMETER	HXWA B SCREWS	-	-	-	N	2	1.50
G-6632	TAILAMP LENSES	SS/BLK PH PN B SCREWS	-	A	-	-	6	3.00
G-6356	TAILAMP LENSES	SS/CHROME PH PN MS SCREWS	-	-	-	N	8	4.00
G-6631	TAILAMP LENSES - El Camino	SS/CHROME PH PN .340 SHLDR SCREWS	-	A	-	-	8	8.00
G-4165	TAILAMPS > BODY	CONI TOOTH KEPS NUTS	F	-	-	-	8	8.00
G-4840	TAILAMPS > BODY	EXT TOOTH KEPS NUTS	-	-	-	N	8	3.00
G-4202	TAILAMPS > BUMPER	HXWA AB & PH PN BT SCREWS	-	A	-	-	8	3.00
G-4204	TAILAMPS > QUARTER EXTENSIONS	PH OV SCREWS, NYLON NUTS	-	-	M	-	12	3.00
G-4810	TRUNK LAMP	HX AB FLAT SEMS	-	-	-	N	1	1.00
G-4992	TURN SIGNAL LEVER	PH PN AB SCREW	F	A	M	N	1	1.00
G-5304	UNDERHOOD LAMP	HXWA B SCREWS	F	A	M	-	2	1.50
G-4922	UNDERHOOD LAMP	HXWA AB SCREWS	-	-	-	N	2	1.50
G-4588	VOLTAGE REGULATOR	HXWA AB SCREWS	F	A	M	-	3	2.00
G-4968	VOLTAGE REGULATOR	HXWA B SCREWS	-	-	-	N	3	2.00
G-6532	WIRING - ALTERNATOR > HEATER HOSE	5.1" FLEXIBLE STRAP	F	-	-	-	1	3.00
G-6518	WIRING - ALTERNATOR > HEATER HOSE	7.1" FLEXIBLE STRAP	-	A	M	N	1	3.00
G-6515	WIRING - BLOWER MOTOR/STARTER WIRING	RUBBER COATED J-CLIPS	F	A	M	N	2	5.00
G-6292	WIRING - CONSOLE & GROUND	J-CLIP, SCREWS, TOOTH WA	-	-	-	N	4	4.00
G-6488	WIRING - CONSOLE > HEATER DUCT	RUBBER COATED J CLIP	F	-	-	-	1	3.00
G-6327	WIRING - CONSOLE INSTRUMENT GROUND	HXWA SCREW, TOOTH WA	-	-	-	N	2	1.50
G-6487	WIRING - CONSOLE LAMP	RUBBER COATED S CLIPS	-	A	M	-	4	6.00
G-6475	WIRING - COWL INDUCTION	5.1" FLEXIBLE STRAP	-	A	-	-	1	3.00
G-5752	WIRING - ENGINE NEAR WIPER MOTOR	RUBBER COATED J-CLIP, HXWA SCREW	-	A	M	-	2	3.00
G-5177	WIRING - FUEL SENDER UNIT GROUND	HXWA AB SCREW	F	A	M	N	1	1.00
G-6376	WIRING - FUEL SENDER UNIT GROUND	HXWA B SCREW	F	-	-	-	1	1.00
G-6519	WIRING - INSTR HARNESS > DEFROST DUCTS	J-CLIP, HXWA SCREW, FLAT SPRING NUT	-	-	-	N	6	6.00
G-6495	WIRING - LICENSE PLATE LAMP	S CLIPS	-	A	-	-	2	4.00
G-6496	WIRING - LICENSE PLATE LAMP - El Camino	S CLIP	-	A	-	-	1	3.00
G-5194	WIRING - STARTER TERMINALS	NUTS, TOOTH WA'S	F	A	M	N	4	1.50
G-5956	WIRING - TAILAMP	RETAINING CLIPS @ LH TRUNK OPENING	F	A	M	-	3	4.00
G-5955	WIRING - TAILAMP HARNESS GROUND	HXWA AB SCREW, TOOTH WA	-	A	M	-	2	1.50
G-5089	WIRING - TEMPERATURE SENDER	NUT, TOOTH WA	F	A	M	N	2	1.50
G-6466	WIRING - UNDERHOOD LAMP	5.1" FLEXIBLE STRAPS	F	-	-	-	4	9.00
G-5195	WIRING "GUTTER" > FIREWALL	HX AB FLAT SEMS	F	A	M	-	2	2.00
G-5499	WIRING "GUTTER" > FIREWALL	HXWA AB SCREWS	-	-	-	N	2	1.50
G-5190	WIRING HARNESS > LH WHEELHOUSE	PUSH-ENDS BLACK PLASTIC STRAPS	F	-	-	-	3	4.00
G-4356	WIRING HARNESS > LH WHEELHOUSE	PUSH-ENDS BLACK PLASTIC STRAPS	-	A	M	N	2	3.00
G-4987	WIRING HARNESS CONNECTOR > FIREWALL	HXWA SCREWS	F	-	-	-	2	2.00

Emissions

G-5158	PCV HOSE CLAMPS	FLAT WOUND SPRING CLAMPS (Green)	F	A	M	N	2	2.00
G-4971	SMOG HOSE CLAMPS	TOWER TYPE CLAMPS	F	A	M	-	4	8.00
G-5261	SMOG PUMP - 350 NB2 TYPE 72	HX BOLTS, SPLIT WA'S, SPACER	F	-	-	-	7	10.00
G-5887	SMOG PUMP - K19 TYPE	HX BOLTS, SPLIT WA'S, SPACER	-	A	M	-	7	10.00
G-4843	SMOG PUMP PULLEY	HX BOLTS, SPLIT WA'S	F	A	M	-	6	3.00
G-6471	SMOG PUMP VACUUM HOSE > SMOG HOSE	5.1" FLEXIBLE STRAP	F	-	-	-	1	3.00
G-4970	SMOG VALVE & BRACKET	HX BOLTS, SPLIT & FLAT WA'S	F	A	M	-	12	4.00

Kits Contain Attaching Fasteners for Both Sides

GM Fastener Kits

1971

Exhaust

PART #	APPLICATION	NOTES	CAMARO				CHEVELLE MONTE CARLO		NOVA		PCS	PRICE
			F	A	M	N						
G-5246	EXHAUST HANGERS, DUAL	HXWA SCREWS, HX SPLIT SEMS	F	-	-	-				6	8.00	
G-5917	EXHAUST HANGERS, DUAL	HXWA AB SCREWS	-	A	M	-				6	4.00	
G-5918	EXHAUST HANGERS, DUAL - El Camino	HXWA SCREWS, RETAINERS	-	A	-	-				12	8.00	
G-5173	EXHAUST HANGERS, SINGLE	HXWA SCREWS, HX SPLIT SEMS	F	-	-	-				4	6.00	
G-5915	EXHAUST HANGERS, SINGLE	HXWA SCREWS, RETAINERS	-	A	M	-				6	6.00	
G-6367	EXHAUST HANGERS, SINGLE	HXWA SCREWS	-	-	-	N				6	4.00	
G-5266	EXHAUST PIPE > MANIFOLDS	STUDS, LOCK NUTS	F	A	M	N				12	14.00	

Fuel

G-5160	ACCELERATOR CABLE	5/16-18 BALL STUD, KEPS NUT	F	A	M	-				2	6.00
G-5159	ACCELERATOR CABLE	1/4-20 BALL STUD, KEPS NUT	-	-	-	N				2	6.00
G-6359	ACCELERATOR CABLE > FIREWALL	HXWA AB SCREW	-	-	-	N				1	1.00
G-5161	ACCELERATOR LEVER SUPPORT	HX AB FLAT SEMS	F	-	-	-				3	3.00
G-5730	ACCELERATOR LEVER SUPPORT	HXWA AB SCREWS	-	A	M	-				2	1.50
G-5163	ACCELERATOR LEVER SUPPORT	HXWA AB SCREWS	-	-	-	N				2	1.50
G-5307	ACCELERATOR PEDAL - Z28	HXWA DRILL SCREW, NUTS, SPLIT WA'S	F	-	-	-				5	2.00
G-5051	FUEL FILTER - 396, 350 71N	HX BOLT, SPLIT WA	-	-	-	N				2	2.00
G-5275	FUEL FILTER BRACKET - 396HP	HX BOLT, SPLIT WA , MACHINE SCREW	F	-	-	-				3	3.00
G-5909	FUEL HOSES	FLAT WOUND SPR CLAMPS (Black, Yell)	-	-	M	-				4	3.00
G-6247	FUEL HOSES	FLAT WOUND SPRING CLAMPS (Yellow)	-	-	-	N				6	3.00
G-5174	FUEL HOSES - 307, 350, '70 396	FLAT WOUND SPR CLAMPS (Blk, Green)	F	-	-	-				6	4.00
G-5274	FUEL HOSES - 396	FLAT WOUND SPR CLAMPS (Green, Blk)	F	-	-	-				10	6.00
G-5910	FUEL HOSES - All 71, 72 (exc 350 & 396/454)	FLAT WOUND SPRING CLAMPS (Yellow)	-	A	-	-				4	3.00
G-5052	FUEL RETURN HOSES	FLAT WOUND SPRING CLAMPS (Red)	F	-	-	N				6	4.00
G-5267	FUEL RETURN HOSES	FLAT WOUND SPRING CLAMPS (Red)	F	-	-	N				8	5.00
G-5913	FUEL RETURN HOSES - 396/454	FLAT WOUND SPRING CLAMPS (Red)	-	A	M	-				4	3.00
G-6405	FUEL RETURN LINE @ ENGINE	CLIPS ONLY	F	-	-	N				2	4.00
G-4164	FUEL VAPOR CANISTER	HXWA AB & B SCREWS	F	-	-	-				4	2.00
G-5534	FUEL VAPOR CANISTER	HXWA AB & CA SCREWS	-	A	M	-				3	3.00
G-6377	FUEL VAPOR CANISTER	HXWA CA SCREWS, HX CONI SEMS	-	-	-	N				4	3.00
G-6378	FUEL VAPOR DRAIN HOSE	FLAT WOUND SPRING CLAMP (Black)	-	-	-	N				1	1.00
G-5273	FUEL VAPOR LINE HOSES	FLAT WOUND SPR CLAMPS (Blk, Grn, Red)	F	-	-	-				3	3.00
G-5805	FUEL VAPOR LINE HOSES	FLAT WOUND SPR CLAMPS (Green, Yell)	-	A	M	-				10	5.00
G-5923	FUEL VAPOR SEPARATOR > BODY - El Camino	HXWA SCREWS, NUTS, WA'S	-	A	-	-				6	3.00
G-5176	GAS TANK	BOLTS, WA'S, NUTS, SCREWS, SPACERS	F	-	-	-				12	12.00
G-5734	GAS TANK	SPECIAL BOLTS, HXWA SCREWS, U-NUTS	-	A	M	-				6	6.00
G-6244	GAS TANK	BOLTS, WA'S, NUTS, SCREWS, SPACERS	-	-	-	N				12	8.00

Heater

G-5133	DEFROSTER DUCTS	HX SEMS, RIVETS, SPR NUTS, RETAINERS	F	-	-	-				6	3.00
G-5832	DEFROSTER DUCTS	PH PN & HX AB FLAT SEMS	-	A	M	-				4	2.00
G-4764	DEFROSTER DUCTS	HXWA SCREWS, FLAT WA	-	-	-	N				4	2.00
G-5005	HEATER AIR, LH OUTLET DUCT (console only)	HX AB FLAT SEMS	-	-	-	N				2	2.00
G-4327	HEATER BLOWER MOTOR	SRTD HXWA AB SCREWS	F	A	M	N				5	1.50
G-5132	HEATER BOX > FIREWALL	HX INT/EXT AB SEMS, STAMPED NUTS	F	-	-	N				7	4.00
G-4326	HEATER BOX > FIREWALL	HX INT/EXT SEMS, STMPD NUTS, SEALER	-	A	M	-				12	5.00
G-5129	HEATER CONTROL CABLES	HH & HXWA SCREWS, WA'S, RTNRS	F	-	-	-				11	3.00
G-5834	HEATER CONTROL CABLES	HXWA SCREWS, SPRING NUTS, RTNRS	-	A	M	-				19	5.00
G-4953	HEATER CONTROL CABLES	HX ABT FLAT SEMS, SCREW, RTNRS, NUT	-	-	-	N				14	5.00
G-5236	HEATER CONTROL CABLES w AC	SCREWS, WA , RETAINERS, RIVETS	F	-	-	-				9	4.00
G-5856	HEATER CONTROL CABLES w AC	HXWA SCREWS, HX FLAT SEMS, RTNRS	-	A	M	-				5	3.00
G-5131	HEATER DUCT OUTLET (under dash)	HX AB FLAT SEMS	F	-	-	-				3	2.00
G-6364	HEATER DUCT OUTLET (under dash)	HX ABT FLAT SEMS	-	-	-	N				2	2.00
G-5397	HEATER HOSE CLIP @ WHEELHOUSE	FOLDOVER METAL CLIP	F	A	M	N				1	4.00
G-5715	HEATER HOSE CLIP > ALT BRACKET w/o AC	FOLDOVER METAL CLIP	-	A	M	-				1	4.00
G-4952	HEATER HOSES	BAND CLAMPS w STRAIGHT UP SCREW	F	A	M	N				4	8.00
G-5478	HEATER or AC OUTLET (LH under dash)	HXWA AB SCREWS	-	A	M	-				2	1.00
G-4616	HEATER RESISTOR > BOX	HXWA AB SCREWS	F	A	M	N				2	1.00

GM Fastener Kits

381

1971

Interior

PART #	APPLICATION	NOTES					PCS	PRICE
			F	A	M	N		
G-5219	AIR OUTLET BEZELS (w AC) - Under Dash	HX AB FLAT SEMS, SPRING NUTS	F	-	-	-	14	5.00
G-5844	AIR OUTLET BEZELS (w AC) - Under Dash	CHROME PH OV SEMS, NUTS	-	A	M	-	6	3.00
G-5217	AIR OUTLET BEZELS (w AC) > DASH	HI-HX BT FLAT SEMS	F	-	-	-	8	4.00
G-5828	AIR OUTLET BEZELS (w AC) > DASH	HX BT & ABT FLAT SEMS	-	A	M	-	9	4.00
G-6278	AIR OUTLET BEZELS (w AC) > DASH	SCREWS, NUTS, SPRING NUTS, WA	-	-	-	N	13	4.00
G-6644	AIR VENTS @ DOOR JAMB	CHROME PH TRUSS WA TEK SCREWS	-	A	M	-	2	1.50
G-5383	ARMREST PAD & BASE @ Fr DOORS	CHROME PH RND & PH FLAT SCREWS	-	A	-	-	10	5.00
G-6645	ARMREST PANELS @ Rr SEATS	PH OV SEMS, PH PN SCREWS, SPRG NUTS	-	A	M	-	12	4.00
G-5114	ASH TRAY FACE PLATE	HI-HX BT FLAT SEMS	F	-	-	-	2	2.00
G-5113	ASH TRAY RETAINER	HXWA AB SCREWS	F	-	-	-	3	2.00
G-5840	ASH TRAY RETAINER	PH FLT TOP RNDWA SCREWS	-	A	-	-	4	1.50
G-5841	ASH TRAY RETAINER	PH RNDWA AB SCREWS	-	-	M	-	4	1.50
G-4832	ASH TRAY RETAINER	PH PN AB SCREWS	-	-	-	N	3	1.50
G-6643	COAT HOOKS	SS/CHROME PH OV SCREWS	-	A	M	-	2	1.50
G-6276	CONSOLE - ASH TRAY DOOR	RIVETS, RETAINERS	F	-	-	-	4	4.00
G-5244	CONSOLE - Fr COVER	SCREWS, SPRING NUTS	F	-	-	-	8	3.00
G-5789	CONSOLE > FLOOR	HXWA & PN HD SCREWS	-	A	M	-	7	3.00
G-6288	CONSOLE > FLOOR	HXWA & PH OV SCREWS, SPRING NUTS	-	-	-	N	8	3.00
G-5239	CONSOLE > FLOOR BRACKETS	PH PN AB FLAT SEMS, SPRING NUTS	F	-	-	-	12	5.00
G-6588	CONSOLE ASH TRAY DOOR BUMPERS	RUBBER BUMPERS	F	-	-	-	2	2.00
G-5248	CONSOLE DOOR LATCH	PH PN MS	F	A	M	-	1	1.00
G-6415	CONSOLE DOOR, HINGE & LATCH	PH PN BT FLAT SEMS & SCREWS	F	-	-	-	8	5.00
G-5794	CONSOLE DOOR, HINGE & STRIKER	PH OV & PH PN SCREWS	-	A	M	-	11	3.00
G-5790	CONSOLE END COVER	CHROME PH OV SCREWS	-	A	M	-	4	2.00
G-5242	CONSOLE END PANELS, UPPER & LWR	SCREWS, SPRING NUTS	F	-	-	-	12	3.00
G-5250	CONSOLE FLOOR BRACKETS	HX SPLIT SEMS, RIVET NUTS	F	-	-	-	12	6.00
G-6345	CONSOLE INSERT	STAMPED NUTS	-	-	-	N	4	1.50
G-5249	CONSOLE LAMP LENS	HX AB FLAT SEMS	F	-	-	-	2	1.50
G-5791	CONSOLE MOULDINGS	STAMPED NUTS ONLY	-	A	M	-	14	2.00
G-5976	CONSOLE SIDE CONTAINERS	PH RNDWA SCREWS	-	A	M	-	4	1.50
G-5240	CONSOLE TOP FRAME	HX FLAT & PN PN AB SEMS	F	-	-	-	12	5.00
G-5837	COVER - A/C HOLE OUTLET ON DASH	HI-HX BT SCREWS	-	A	M	-	2	2.00
G-5125	DASH PAD	HXWA SCREWS, FLAT SEMS, SPR NUTS	F	-	-	-	20	6.00
G-5822	DASH PAD	RETAINING CLIPS, SCREWS	-	A	M	-	12	14.00
G-5650	DOME LAMP	PH PN SCREWS	-	A	M	-	2	1.50
G-5409	DOOR HANDLES (inside) - STD	WIRE RETAINERS	-	A	M	-	2	1.00
G-5384	DOOR PANELS	CLIPS, PLUGS (flexible !), PH OV AB SEMS	-	A	M	-	32	12.00
G-6641	ESCUTCHEON @ Rr WINDOW LWR CORNERS	CHROME PH OV AB SEMS	-	A	-	-	2	1.50
G-6647	FILLER PANELS - Rr SEAT BACK	PH OV SCREWS	-	A	M	-	4	2.00
G-4947	GLOVE BOX DOOR	HX AB FLAT SEMS	-	-	-	N	3	2.00
G-5117	GLOVE BOX DOOR & STOP	SCREWS, SPRING NUTS	F	-	-	-	18	5.00
G-5836	GLOVE BOX DOOR & STOP	PH PN & RNDWA SCREWS, PH OV SEMS	-	A	M	-	14	3.00
G-6585	GLOVE BOX DOOR BUMPERS	RUBBER BUMPERS	F	A	M	N	2	2.00
G-5119	GLOVE BOX LINER	HXWA AB SCREW	F	-	-	-	1	1.50
G-4360	GLOVE BOX LINER	PH PN AB FLAT SEMS	-	-	-	N	6	3.00
G-5116	GLOVE BOX STRIKER	HXWA SCREWS, SPRING NUTS	F	-	-	-	4	2.00
G-5835	GLOVE BOX STRIKER	RND WA SCREWS, SPRING NUTS	-	A	M	-	4	2.00
G-4943	GLOVE BOX STRIKER	PN PN AB FLAT SEMS	-	-	-	N	2	1.50
G-6651	HEADLINER RETAINERS - Fr & SIDES	5/16 AF HXWA AB SCREWS	-	A	M	-	22	3.00
G-6650	HEADLINER RETAINERS - Rr	PH RNDWA SCREWS	-	A	M	-	15	4.00
G-6655	HEADREST ESCUTCHEONS & FABRIC RETAINER	CHROME PH OV AB & PH FLAT SCREWS	-	A	M	-	16	4.00
G-5833	HEATER CONTROL & SUPPORT > DASH	HXWA SCREWS, FLAT SEMS, SPR NUTS	-	A	M	-	7	3.00
G-6346	HEATER CONTROL > DASH	HX FLAT BT SEMS	F	-	-	-	3	2.00
G-6238	HEATER CONTROL > DASH	PH OV AB SEMS, SPRING NUTS	-	-	-	N	6	3.00
G-5198	INSTRUMENT CLUSTER & CARRIER > DASH	PH OV AB & HX BT FLAT SEMS, SPR NUTS	F	-	-	-	18	6.00
G-6271	INSTRUMENT CLUSTER & CARRIER > DASH	PH OV & HX AB FLAT SEMS, SPR NUTS	-	-	-	N	14	4.00
G-5957	INSTRUMENT CLUSTER > DASH	HI-HX BT FLAT SEMS	-	A	M	-	8	4.00
G-4617	INSULATION > FIREWALL	RUBBER RETAINERS	F	-	-	N	4	6.00
G-5825	INSULATION > FIREWALL	RUBBER RETAINERS	-	A	M	-	3	5.00
G-6646	KICK PANELS w AC	PH OV AB FINWA SEMS	-	A	M	-	3	3.00
G-4621	MIRROR (inside Rr view) > BRACKET	CHROME SLOT OV SHLDR SCREW	-	A	M	-	1	2.00
G-6691	MIRROR (inside Rr view) BRACKET	PH PN AB SCREWS	-	A	-	-	3	1.00
G-5124	PILLAR MOULDINGS	CHROME PH OV AB SCREWS	F	-	-	-	2	1.50
G-6684	PILLAR MOULDINGS - CONVERTIBLE	PH OV AB SEMS, PH RNDWA TEK SCREWS	-	A	M	-	4	3.00
G-5824	PILLAR MOULDINGS - METAL	PH OV & PH TRUSSWA SCREWS	-	A	-	-	4	2.00
G-6649	QUARTER TRIM PANELS - MAIN	PH OV FINWA SEMS, PH PN AB SCREWS	-	A	M	-	4	3.00
G-6648	QUARTER TRIM SAIL PANELS	RETAINING CLIPS	-	A	M	-	4	3.00
G-5318	RADIO CONTROL SHAFTS	SPECIAL THIN HX NUTS	F	-	-	-	2	4.00
G-6397	RADIO CONTROL SHAFTS & KNOBS	SPECIAL SLOTTED NUTS	-	A	M	N	4	4.00
G-4321	SCUFF PLATES, DOOR OPENING	SS/CHROME PH OV AB SCREWS	F	A	M	-	8	2.50
G-6148	SCUFF PLATES, DOOR OPENING	SS/CHROME PH OV AB SCREWS	-	-	-	N	12	3.00
G-6657	SEAT BACK (Fr) STOP BUMPERS	PH PN AB SCREWS	-	A	M	-	4	1.50
G-5380	SEAT BACK (Rr) > BODY	HX AB CONI TOOTH SEMS	-	A	M	-	2	3.00
G-6675	SEAT BACK STRAP > SEAT BASE	ROUNDED TRIM HX CONI SEMS	-	A	M	-	4	6.00
G-5241	SEAT BELT BUCKLE RETAINERS	PH OV AB FLUSH SEMS, SPRING NUTS	F	-	-	-	8	3.00

Kits Contain Attaching Fasteners for Both Sides

GM Fastener Kits

1971

Interior

PART #	APPLICATION	NOTES					PCS	PRICE
			CAMARO	CHEVELLE	MONTÉ CARLO	NOVA		
G-6656	SEAT SIDE PANELS	.41 DIA PH RNDWA SCREWS	-	A	M	-	12	3.00
G-6653	SEAT TRACKS > FLOOR	HX CONI TOOTH SEMS, PERI KEPS	-	A	M	-	8	5.00
G-5134	SEAT TRACKS > SEAT	SCREWS	F	-	-	-	8	6.00
G-5407	SHOULDER HARNESS RETAINERS	CHROME PH OV AB SCREWS	-	A	M	-	8	2.00
G-5182	STEERING COLUMN COVER > DASH	HXWA SCREWS, PH OV SEMS, SPR NUTS	F	-	-	-	8	3.00
G-5823	STEERING COLUMN COVER > DASH	CHROME PH OV FLUSH SEMS, SPR NUTS	-	A	M	-	8	3.00
G-6252	STEERING COLUMN COVER > DASH	PH OV SEMS, HX FLAT SEMS, SPR NUTS	-	-	-	N	6	3.00
G-4977	STEERING COLUMN COVER > FIREWALL	HX AB FLAT SEMS w SEALER	F	-	-	N	2	3.00
G-5926	STEERING COLUMN COVER > FIREWALL	HXWA AB SCREWS	-	A	M	-	2	2.00
G-5184	STEERING WHEEL SHROUD	PH PN AB SCREWS, SPRING NUTS	F	A	M	N	4	2.00
G-5377	SUN VISOR & MIRROR BRACKETS - COUPE	SS/CHROME PH OV & PH PN AB SCREWS	-	A	M	-	9	3.00
G-6670	SUN VISOR BRACKETS - CONVERTIBLE	CHROME PH OV SCREWS w #12 HD	-	A	-	-	6	4.00
G-5378	SUN VISOR CLAMPS	CHROME SLOT FILL SCREWS	-	A	M	-	2	2.00
G-5838	VENTILATION OUTLET BEZELS	HX ABT FLAT SEMS	-	A	M	-	6	3.00
G-6348	VENTILATION OUTLETS & DUCT	HI-HX BT FLAT SEMS, HXWA AB SCREWS	F	-	-	-	8	3.00
G-5400	WINDOW CRANK HANDLES	RETAINING CLIPS	-	A	M	-	4	1.50

Mouldings

G-5931	FENDER MOULDINGS	STAMPED NUTS ONLY	-	-	M	-	14	3.00
G-6401	FENDER MOULDINGS	STAMPED NUTS ONLY	-	-	-	N	14	3.00
G-5933	FENDER MOULDINGS - El Camino Custom	STAMPED NUTS ONLY	-	A	-	-	10	3.00
G-6382	HOOD & FENDER "EYE BROW" MOULDINGS	DOES HOOD EMBLEM, STMPD NUTS, CAPS	-	-	-	N	20	4.00
G-6640	QUARTER PANEL EXTENSION MOULDINGS	SS/CHROME PH OV SCREWS	-	-	M	-	6	3.00
G-5126	ROCKER MOULDINGS	SCREWS ONLY	F	-	-	-	20	4.00
G-5706	ROCKER MOULDINGS	PH PN AB SCREWS ONLY	-	A	-	N	24	4.00
G-4196	WHEEL OPENING MOULDINGS	CHROME/SS PH RNDWA AB SCREWS	-	A	M	-	28	6.00
G-6542	WINDOW (Fr) MOULDINGS	RETAINING CLIPS	F	-	-	-	22	12.00
G-6544	WINDOW (Fr) MOULDINGS	RETAINING CLIPS, PH PN AB SCREWS	-	A	-	-	32	12.00
G-6555	WINDOW (Fr) MOULDINGS	RETAINING CLIPS, PH PN AB SCREWS	-	-	-	N	32	12.00
G-6561	WINDOW (Fr) MOULDINGS - CONVERTIBLE	RETAINING CLIPS, PH PN AB SCREWS	-	A	-	-	26	12.00
G-4665	WINDOW (Fr) MOULDINGS, LWR	RETAINING CLIPS (less the 2 end clips)	-	-	-	N	8	12.00
G-6556	WINDOW (Fr) MOULDINGS, SIDES, UPR - VINYL	RETAINING CLIPS, SCREWS	-	-	-	N	20	12.00
G-6540	WINDOW (Rr) MOULDINGS	RETAINING CLIPS	F	-	-	-	22	12.00
G-6549	WINDOW (Rr) MOULDINGS	RETAINING CLIPS	-	A	-	-	20	12.00
G-6558	WINDOW (Rr) MOULDINGS	RETAINING CLIPS	-	-	-	N	20	12.00
G-6550	WINDOW (Rr) MOULDINGS - El Camino	RETAINING CLIPS	-	A	-	-	20	12.00
G-6551	WINDOW (Rr) MOULDINGS - El Camino - VINYL	RETAINING CLIPS	-	A	-	-	20	12.00
G-6560	WINDOW (Rr) MOULDINGS - Vinyl Top	RETAINING CLIPS	-	A	-	-	20	12.00
G-6559	WINDOW (Rr) MOULDINGS - Vinyl Top	RETAINING CLIPS	-	-	-	N	20	12.00

Steering & Suspension

G-4631	AXLE HSNB > SPRINGS	SPECIAL GR-8 LOCK NUTS ONLY !	F	-	-	N	8	12.00
G-6639	AXLE HSNB > SPRINGS - 302/350/396	MULTI SPRINGS, T, U BOLTS, LOCK NUTS	-	-	-	N	14	38.00
G-4897	AXLE HSNB > SPRINGS - 70F > w/o STAB BAR	MULTI SPRINGS, T, U BOLTS, LOCK NUTS	F	-	-	-	14	32.00
G-5904	AXLE HSNB > SPRINGS (mono spring)	SPECIAL GR-8 LOCK NUTS & T BOLTS	-	-	-	N	16	26.00
G-5257	AXLE HSNB > SPRINGS w STABILIZER BAR	LONG T- BOLTS, U-BOLTS, LOCK NUTS	F	-	-	-	14	34.00
G-6151	BALL JOINTS - UPPER	SOLID RIVETS (2 are extra)	-	A	M	N	10	6.00
G-5458	CONTROL ARM BUSHINGS - UPPER	RETAINERS, LOCK NUTS	F	-	-	-	8	12.00
G-4612	CONTROL ARM BUSHINGS - UPPER	HX BOLTS "SSC", WA'S, RETAINERS	-	A	M	N	12	12.00
G-4608	CONTROL ARMS - LWR	POINTED BOLTS, LOCK NUTS	F	A	M	N	8	20.00
G-5138	CONTROL ARMS - UPPER	GR-8 KNURL BOLTS, LOCK NUTS, SHIMS	F	-	-	-	18	20.00
G-4627	CONTROL ARMS - UPPER	GR-8 KNURL BOLTS, LOCK NUTS, SHIMS	-	A	M	N	18	14.00
G-4610	CONTROL ARMS (Rr)	GR-8 POINTED BOLTS, LOCK NUTS	-	A	M	-	16	32.00
G-5539	FRAME REINFORCEMENTS - HP APPLICATIONS	HARDENED FLAT WA'S	-	A	M	-	2	3.00
G-4669	GREASE FITTINGS	STRAIGHT	F	A	M	N	10	3.00
G-4265	IDLER ARM > FRAME	GR-8 HX BOLTS, WA'S, NUTS	F	A	-	N	6	6.00
G-5036	IDLER ARM > FRAME	GR-8 HX BOLTS, WA'S, NUTS	-	-	M	-	6	6.00
G-4607	LEAF SPRING, Fr HANGERS	HX PP CONI SEMS, SPECIAL U-NUTS	F	-	-	-	12	18.00
G-6354	LEAF SPRING, Fr HANGERS	GR-8 BOLTS, SPECIAL U-NUTS	-	-	-	N	12	18.00
G-4630	LEAF SPRINGS, Fr EYE	GR-8 BOLTS, NUTS, WA'S	F	-	-	N	8	12.00
G-5293	P/S HOSE CLAMP	HXWA AB SCREW	F	-	-	-	1	1.00
G-5292	P/S PUMP - 396/454	HX BOLTS, NUTS, WA'S, SPACER	F	A	M	-	19	12.00
G-5082	P/S PUMP - SB	HX BOLTS, NUTS, WA'S, SPACER	F	A	M	N	19	12.00
G-4807	P/S PUMP PULLEY	THIN LOCK NUT	F	A	M	N	1	6.00
G-4668	PITMAN ARM > GEAR BOX	HX NUT, SPLIT WA	F	A	M	N	2	3.00
G-4838	SHACKLES	11/16" AF MARSDEN NUTS ONLY	F	-	-	N	4	6.00
G-4586	SHOCKS (Fr) - LWR MOUNTING	HXWA CA SCREWS, U-NUTS	F	A	M	N	8	8.00

See factory Assembly Manuals for illustrations

1971

Steering & Suspension

PART #	APPLICATION	NOTES					PCS	PRICE
			F	A	M	N		
G-4836	SHOCKS (Fr) - UPR MOUNTING	RETAINERS, BUSHINGS, 3/8-24 NUTS	F	A	M	N	10	6.00
G-5859	SHOCKS (Rr)	HXWA SCREWS, TK NUTS, SPLIT WA'S	-	A	M	-	12	6.00
G-5143	SHOCKS (Rr) LWR MOUNTING	RETAINERS, BUSHINGS, 3/8-24 NUTS	F	-	-	-	10	8.00
G-4632	SHOCKS (Rr) LWR MOUNTING - MONO SPRING	HX BOLTS, NUTS, SPLIT WA'S	-	-	-	N	6	4.00
G-4898	SHOCKS (Rr) LWR MOUNTING - MULTI SPRING	THICK HX NUTS, SPLIT WA'S	-	-	-	N	4	3.00
G-6100	SHOCKS (Rr) UPR MOUNTING	HX SPLIT SEMS	F	-	-	N	4	6.00
G-5185	SPARE WHEEL	9 5/8" J-BOLT, WING NUT, FLAT WA	F	-	-	-	3	16.00
G-6938	SPARE WHEEL (F coupe only)	5 7/8" J-BOLT, WING NUT	-	A	M	N	2	14.00
G-6461	SPARE WHEEL WRENCH > JACK	7.1" FLEXIBLE STRAPS	F	-	-	-	2	5.00
G-5141	STABILIZER BAR (Fr) BRACKETS	HX TY-T SCREWS	F	A	M	N	4	6.00
G-4955	STABILIZER BAR (Fr) CLAMPS	HX BOLTS, NUTS, SPLIT & FLAT WA'S	-	-	-	N	8	4.00
G-5140	STABILIZER BAR (Fr) END LINKS	HX BOLTS, RETAINERS, BUSHINGS, NUTS	F	-	-	-	22	20.00
G-5481	STABILIZER BAR (Fr) END LINKS	HX BOLTS, RETAINERS, BUSHINGS, NUTS	-	A	M	-	22	25.00
G-4837	STABILIZER BAR (Fr) END LINKS	HX BOLTS, RETAINERS, BUSHINGS, NUTS	-	-	-	N	22	20.00
G-5862	STABILIZER BAR (Rr)	HX BOLTS, LOCK NUTS	-	A	M	-	8	6.00
G-6403	STABILIZER BAR (Rr) END BRACKETS	HX BOLTS, SPLIT WA'S, NUTS	-	-	-	N	12	4.00
G-5256	STABILIZER BAR (Rr) SUPPORTS	HX BOLTS, WA'S, NUTS	F	-	-	-	18	10.00
G-6402	STABILIZER BAR (Rr) SUPPORTS	HX BOLTS, SPLIT WA'S, NUTS	-	-	-	N	12	6.00
G-4976	STEERING COLUMN > DASH	FLNG NUTS, FLNG SCREWS (copper plate)	F	-	-	N	6	5.00
G-5928	STEERING COLUMN > DASH	FLNG SCREWS, FLNG NUTS, CONI SEMS	-	A	M	-	7	6.00
G-6638	STEERING COLUMN BRACKET REINF	HX PP CONI SEMS	F	-	-	-	4	3.00
G-4354	STEERING GEAR "RAG" JOINT	12 PT BOLT ONLY	F	A	M	N	1	3.00
G-5180	STEERING GEAR BOX > FRAME	GR-8 HX BOLTS, FLAT WA'S	F	A	M	-	6	12.00
G-4293	STEERING GEAR BOX > FRAME	GR-8 HX BOLTS, FLAT WA'S	-	-	-	N	6	12.00
G-5139	STEERING LINKAGE & BALL JOINTS	GR-8 LRG HX SLOT NUTS, COTTER PINS	F	-	-	-	20	15.00
G-5858	STEERING LINKAGE & BALL JOINTS	SLOTTED NUTS, COTTER PINS	-	A	M	-	20	10.00
G-4615	STEERING LINKAGE & BALL JOINTS	SLOTTED NUTS, COTTER PINS	-	-	-	N	20	10.00
G-4670	STEERING SHAFT > COUPLING	REG & HVY NUTS, SPLIT WA'S	F	A	M	N	4	3.00
G-5716	SUSPENSION BUMPER & BRACKET (Rr)	HX BOLTS, NUTS, SPLIT WA'S	-	A	M	-	7	3.00
G-4337	SUSPENSION BUMPERS & BRACKETS (Rr)	HX PP CONI SEMS, HXWA SCREWS, NUTS	F	-	-	-	12	10.00
G-4596	SUSPENSION BUMPERS (Fr)	HX NUTS	F	A	M	N	2	1.00
G-6355	SUSPENSION BUMPERS (Rr)	HXWA T SCREWS	-	-	-	N	6	4.00
G-5484	SUSPENSION BUMPERS (Rr) - El Camino	HX BOLTS, NUTS, SPLIT WA'S	-	A	-	-	3	2.00
G-6583	WHEEL STUDS - 1 AXLE (Fr or Rr)	Does 2 wheels, 7/16-20 x 1.38" L	F	A	M	N	10	14.00
G-5060	WHEELS - STD	ORIGINAL LUG NUTS w "DIAMONDS"	F	A	M	N	20	25.00

Transmission

G-6149	BELL HOUSING > ENGINE	FLNG BOLTS (Flat Top) "A" MARKING	F	A	M	N	6	8.00
G-6611	BELL HOUSING > ENGINE	FLNG BOLTS, "M" MARKING	F	A	M	N	6	8.00
G-5416	BELL HOUSING Fr COVER PLATE	SS EXT SEMS "L"	F	A	M	N	4	3.00
G-5907	CLUTCH BELLCRANK	BALL STUDS, SEATS, RETAINER, WA'S	F	A	M	N	9	32.00
G-5172	CLUTCH BELLCRANK BRACKET > FRAME	HXWA SCREWS	F	-	-	N	3	3.00
G-5890	CLUTCH BELLCRANK BRACKET > FRAME	HXWA SCREWS	-	A	M	-	3	3.00
G-5146	CLUTCH PEDAL	HX BOLT, WA, NUT ONLY !	F	-	-	-	3	4.00
G-5603	CLUTCH PEDAL BUSHINGS	NYLON BUSHINGS ONLY	F	A	M	N	2	3.00
G-4658	CLUTCH PEDAL PUSH ROD SEAL	HXWA AB SCREWS	F	-	-	N	2	1.00
G-4850	CLUTCH PEDAL PUSH RODS	RETAINING CLIPS ONLY	F	A	M	N	3	3.00
G-4659	CLUTCH PEDAL RETAINER	FOLDED SPRING METAL	-	A	M	N	1	3.00
G-5490	CONTROL LINKAGE > COLUMN - ALL	RETAINERS, FITTINGS, NUTS, WA'S	-	-	-	N	12	18.00
G-6192	CONTROL LINKAGE > COLUMN - M38/M40	RETAINERS, SLEEVE, WA'S, NUT, SCREW	F	-	-	-	8	12.00
G-5254	CONTROL LINKAGE > COLUMN - PG	RETAINERS, SLEEVE, WA'S, NUT, SCREW	F	-	-	-	10	12.00
G-4792	COVER - CLUTCH PEDAL HOLE	HXWA SCREWS	F	-	-	N	2	1.50
G-4796	DRIVESHAFT, TH400 '69 > 302, 350, BB. All 71 >	STRAPS, FLNG BOLTS	F	A	M	N	6	8.00
G-6573	FLYWHEEL - A/T	GR-8 HXWA SCREWS	F	A	M	N	12	16.00
G-4429	FLYWHEEL - M/T	11/16" AF X 1.0" L HX BOLTS	F	A	M	N	12	12.00
G-6150	PRESSURE PLATE > FLYWHEEL	SPECIAL HX BOLTS, SPLIT WA'S	F	A	M	N	12	6.00
G-4528	SHIFTER BEZEL & SEAL RETAINER - M/T	w/o CONSOLE, HXWA AB SCREWS	-	A	M	N	10	3.00
G-5165	SHIFTER BOOT PLATE w/o CONSOLE	CHROME PH OV AB SCREWS	F	-	-	-	4	2.00
G-4908	SHIFTER CABLE - PG, TH400 w CONSOLE	U & PUSH RETAINERS, NUT, WA	F	A	M	-	6	6.00
G-5076	SHIFTER CABLE - TH350 w CONSOLE	SCREW, U & PUSH RETAINERS, NUT, WA	F	A	M	-	8	6.00
G-5733	SHIFTER CONTROL - HD 3 SPD or 4 SPD	HX BOLTS, WA'S, NUTS	-	A	M	-	16	8.00
G-5164	SHIFTER CONTROL & SUPPORT - 3 SPD	HX BOLTS, SPLIT & FLAT WA'S	F	-	-	-	9	6.00
G-4783	SHIFTER CONTROL & SUPPORT (exc 69F M20)	HX BOLTS, NUTS, SPLIT WA'S	-	-	-	N	13	4.00
G-5278	SHIFTER DIAL (A/T) & SENDER - IN DASH	PH FLAT B SCREW, HI-HX BT FLAT SEMS	F	-	-	-	3	2.00
G-5801	SHIFTER DIAL CABLE - IN DASH	PH FLAT B SCREW	-	A	M	N	1	1.00
G-5732	SHIFTER HANDLE - HD 3 SPD M/T, 70-72 4 SPD	HX SPLIT SEMS	-	A	M	-	2	3.00
G-5166	SHIFTER KNOB	CHROME HX JAM NUT	F	A	M	N	1	2.00
G-4852	SHIFTER LEVER > FLOOR - A/T w CONSOLE	HXWA AB SCREWS	-	A	M	-	3	2.00
G-4790	SHIFTER LEVER > FLOOR - PG, TH400 w CNSL	HXWA T1 SCREWS	-	-	-	N	4	2.00
G-5898	SHIFTER LEVERS - 4S, 70-71A HD, 70F L65	HX BOLTS, FLAT & SPLIT WA'S	F	A	M	N	9	4.00
G-5899	SHIFTER LEVERS > CASE - 3 SPD HD (floor)	HX SPLIT SEMS, FLAT WA'S	-	A	M	-	4	4.00

Kits Contain Attaching Fasteners for Both Sides

1972

Air Conditioning

PART #	APPLICATION	NOTES					PCS	PRICE
			CAMARO	CHEVELLE MONTE CARLO	NOVA			
G-5039	AC / HEAT DIVERTER DOOR SWITCH	HI-HXWA AB SCREWS	-	-	-	N	2	1.50
G-5767	AC AIR DISTRIBUTION DUCT - CENTRAL	HX ABT FLAT SEMS	-	A	M	N	2	2.00
G-5237	AC AIR DISTRIBUTION DUCTS - CENTRAL	HX FLAT SEMS, RETAINER, WA	F	-	-	-	7	6.00
G-5251	AC AIR DUCT - CONSOLE	HX ABT FLAT SEMS, PH RND WA SCREW	F	-	-	-	4	3.00
G-5216	AC AIR OUTLET @ FLOOR - CENTER	HX ABT FLAT SEMS	F	-	-	-	3	2.00
G-6307	AC AIR OUTLET @ FLOOR - CENTER	HX ABT FLAT SEMS	-	-	-	N	2	1.50
G-5035	AC AMBIENT SWITCH > EVAPORATOR	HXWA ABT SCREWS	F	A	M	N	2	2.00
G-5785	AC BLOWER CONTROL SWITCH (in control)	HXWA T1 SCREWS	-	-	-	N	2	1.50
G-5227	AC COMP BRACE > INTAKE - 396/454	HX BOLTS, HX CLR STUD, NUT, WA'S	F	A	M	-	7	6.00
G-5327	AC COMP BRACE > INTAKE - SB	HX BOLTS, FLAT & SPLIT WA'S	F	A	M	N	5	4.00
G-5849	AC COMP BRACE, UPPER Fr - 396/454	HX BOLTS, FLAT, SPLIT & TOOTH WA'S	F	A	M	-	9	5.00
G-5848	AC COMP BRACE, UPPER Fr - SB	HX BOLTS, FLAT, SPLIT & WA'S, NUTS	F	A	M	N	13	6.00
G-5225	AC COMP SUPPORT > EXH MANIFOLD - 396/454	HX BOLTS, SPLIT WA'S	F	A	M	-	6	3.00
G-5847	AC COMP SUPPORT > EXH MANIFOLD - SB	GR-8 "TR" HX BOLTS	F	A	M	N	2	3.00
G-5226	AC COMP SUPPORT, LWR Fr - 396/454	HX BOLTS, SPLIT WA'S	F	A	M	-	6	3.00
G-5326	AC COMP SUPPORT, LWR Fr - SB	HX BOLTS, SPLIT & TOOTH WA'S	F	A	M	N	6	3.00
G-5224	AC COMP SUPPORT, LWR Rr - 396/454	HX BOLTS, FLAT & SPLIT WA'S	F	A	M	-	11	4.00
G-5222	AC COMP SUPPORT, LWR Rr - SB	HX BOLTS, SPLIT WA'S	F	A	M	N	10	4.00
G-6520	AC COMPRESSOR WIRING	5.1" FLEXIBLE STRAP	F	-	-	N	1	3.00
G-5220	AC CONDENSER	HX SPLIT SEMS, FLNG NUTS	F	-	-	-	16	6.00
G-5845	AC CONDENSER	HX CONI SEMS, FLNG NUTS, U-NUTS	-	A	M	-	18	7.00
G-6351	AC CONDENSER & BRACKETS	SCREWS, SPRING NUTS, WELL-NUTS	-	-	-	N	24	10.00
G-5004	AC DEFROSTER DISTRIBUTOR	HX ABT FLAT SEMS	-	-	-	N	3	2.00
G-5228	AC EVAPORATOR > FIREWALL	HX FLAT SEMS, CLR STUD, NUTS, WA'S	F	-	-	-	10	8.00
G-5776	AC EVAPORATOR > FIREWALL	HX AB FLAT SEMS	-	A	M	-	6	6.00
G-4872	AC EVAPORATOR > FIREWALL	HX INT/EXT SEMS, CLR STUD, NUTS, WA'S	-	-	-	N	6	8.00
G-6304	AC EVAPORATOR CASE	HXWA BT SCREWS	F	A	M	-	6	4.00
G-5235	AC FITTING & MUFFLER ASSEMBLY	HX BOLT, FLAT & SPLIT WA'S	F	A	M	N	3	3.00
G-4723	AC GROUND > FIREWALL	HXWA AB SCREW, TOOTH WA	F	A	M	N	2	1.50
G-5229	AC HEATER HOSE > DASH GROMMET	HX ABT FLAT SEMS	F	-	-	-	2	1.50
G-6352	AC HEATER HOSE SEAL RETAINER	HXWA ABT SCREWS	-	-	-	N	2	1.50
G-6439	AC HOSE > HEATER HOSE	11.25" FLEXIBLE STRAP	F	A	M	N	1	6.00
G-5853	AC HOSE > RH WHEELHOUSE	HXWA AB SCREWS	F	A	M	-	2	1.50
G-6353	AC HOSE CLIP > CONDENSOR	HX AB FLAT SEMS & SPRING NUT ONLY !	-	-	-	N	2	2.00
G-5214	AC PLENUM VALVE & BRACKET	HXWA AB SCREWS, CONI KEPS NUTS	F	-	-	-	9	4.00
G-5763	AC PLENUM VALVE & BRACKET	HXWA & PH PN SCREWS, NUTS, WA'S	-	A	M	-	11	3.00
G-4699	AC PLENUM VALVE & BRACKET	HXWA SCREWS, NUTS, WA'S, RETAINER	-	-	-	N	16	5.00
G-6283	AC RADIATOR SEAL	NYLON RETAINERS	-	-	-	N	4	2.00
G-5846	AC RECIEVER TANK > CONDENSER	HXWA AB SCREWS	-	A	M	-	2	1.50
G-6282	AC RECIEVER TANK > FENDER SKIRT	HX BOLTS, FLNG NUTS	-	-	-	N	4	3.00
G-5221	AC RECIEVER TANK > RADIATOR SUPPORT	HXWA AB SCREWS, SPRING NUTS	F	-	-	-	6	3.00
G-5034	AC RESISTOR & RELAY > EVAPORATOR	HXWA ABT SCREWS	F	A	M	N	3	2.00
G-5215	AC SELECTOR DUCT > FIREWALL	HX AB INT/EXT SEMS, NUTS, WA'S	F	A	M	N	8	4.00
G-5041	AC VACUUM HOSE @ FIREWALL & CONTROL	HXWA AB SCREW, HX FLAT ABT SEMS	-	-	-	N	2	1.50
G-5234	AC VACUUM HOSE ATTACHMENTS	FLAT SEMS, HXWA SCREWS, RETAINERS	F	-	-	-	7	3.00
G-5852	AC VACUUM HOSE ATTACHMENTS	HXWA AB SCREW, NUT, RETAINER	-	A	M	-	3	2.00
G-5002	AC VACUUM HOSE CLAMPS	FLAT WOUND SPRING CLAMPS (Black)	-	-	-	N	3	3.00
G-6450	AC VACUUM HOSE CLIPS @ SELECTOR DUCT	RUBBER COATED S CLIPS	-	A	M	-	2	4.00
G-5329	AC VACUUM MOTOR @ RH COWL	HXWA AB & T1 SCREWS, NUTS	F	-	-	N	5	3.00
G-5001	AC VACUUM MOTOR COVER	PH OV FIN WA SEMS .50 OD, SPRG NUTS	F	-	-	N	6	3.00
G-4714	AC VALVE, TUBE BRKT'S > EVAPORATOR	HXWA AB & ABT SCREWS	F	-	-	N	2	1.50
G-5850	AC VALVE, TUBE BRKT'S > EVAPORATOR	HXWA AB SCREWS	-	A	M	-	2	2.00
G-6502	AC WIRING CLIP @ EVAPORATOR RELAY	RUBBER COATED J CLIP	F	-	-	-	1	3.00

Body

G-4101	BATTERY TRAY	HX CONI SEMS, HXWA CA SCREWS	F	-	-	N	4	3.00
G-4198	BATTERY TRAY	HX MS & PP CONI SEMS, U-NUT	-	A	-	-	5	6.00
G-4197	BATTERY TRAY	HX CONI SEMS, HXWA SCREW, U-NUTS	-	-	M	-	7	6.00
G-5936	BODY MOUNT BRACKETS @ RAD SUPPORT	BOLTS, RATCHET TOOTH WA'S, NUTS	F	-	-	-	16	12.00
G-5935	BODY MOUNT BRACKETS @ RAD SUPPORT	HX PP CONI SEMS	-	A	M	-	6	3.00
G-5127	BODY MOUNTS	ORIGINAL BOLTS, CONI KEPS NUTS, WA'S	F	-	-	-	14	40.00
G-6363	BODY MOUNTS	ORIGINAL BOLTS, WA'S, NUTS	-	-	-	N	18	34.00
G-5830	BODY MOUNTS - CONVERTIBLE & El Camino	ORIGINAL BOLTS, NUTS, WA'S	-	A	-	-	22	30.00
G-5829	BODY MOUNTS - HARDTOP	ORIGINAL BOLTS, NUTS, WA'S	-	A	-	-	18	24.00
G-5188	BODY MOUNTS @ RADIATOR SUPPORT	ORIGINAL BOLTS, FLAT WA'S	F	-	-	-	4	6.00
G-5746	BODY MOUNTS @ RADIATOR SUPPORT	ORIGINAL BOLTS, NUTS, WA'S, SHIMS	-	A	-	-	14	10.00
G-4340	BRAKE PEDAL SUPPORT w/o PB	FLNG NUTS	F	A	M	N	2	2.00
G-4227	BUMPER (Fr)	SS CAP & UNCAP BOLTS, WA'S, NUTS	-	A	M	-	32	10.00
G-6273	BUMPER (Fr)	SS CAPPED BOLTS, WA'S, NUTS	-	-	-	N	32	10.00
G-5371	BUMPER (Fr) - R/S	SS CAPPED BOLTS, CONI KEPS NUTS	F	-	-	-	8	6.00
G-4135	BUMPER (Fr) - STD	SS CAPPED BOLTS, CONI KEPS NUTS	F	-	-	-	10	8.00

Kits Contain Attaching Fasteners for Both Sides

GM Fastener Kits

1972

Body			CAMARO		CHEVELLE MONTE CARLO		NOVA			
			F	A	M	N			PCS	PRICE
PART #	APPLICATION	NOTES								
G-5969	BUMPER (Fr) BRACKETS	HX BOLTS, RATCHET TOOTH WA'S, NUTS	-	A	-	-			16	12.00
G-6024	BUMPER (Fr) BRACKETS	HX BOLTS, RATCHET TOOTH WA'S, NUTS	-	-	-	N			16	12.00
G-4180	BUMPER (Fr) FILLER PANEL	HX CONI SEMS, SCREWS, U-NUTS, NUTS	-	-	M	-			16	9.00
G-6262	BUMPER (Fr) FILLER PANEL & SUPPORT	HX CONI SEMS, SCREWS, U-NUTS, RTNRS	-	-	-	N			18	12.00
G-4178	BUMPER (Fr) FILLER PANELS	HX CONI SEMS, HXWA SCREWS, U-NUTS	-	A	-	-			18	12.00
G-4226	BUMPER (Fr) OUTER PAD BRACKETS	BOLTS, RATCHET TOOTH WA'S	-	A	M	-			4	4.00
G-4136	BUMPER (Rr)	SS CAPPED BOLTS, CONI KEPS NUTS	F	-	-	-			14	14.00
G-4218	BUMPER (Rr)	SS CAP BOLTS, RATCHET WA'S, NUTS	-	A	-	-			28	12.00
G-4224	BUMPER (Rr)	SS CAP BOLTS, RATCHET WA'S, NUTS	-	-	M	-			40	20.00
G-6275	BUMPER (Rr)	SS CAPPED BOLTS, WA'S, NUTS	-	-	-	N			32	10.00
G-5973	BUMPER (Rr) - El Camino	SS CAP BOLTS, RATCHET WA'S, NUTS	-	A	-	-			39	20.00
G-4614	BUMPER BRACES & BRACKETS (Fr) - R/S	HX PP CONI SEMS, SCREWS, CONI KEPS	F	-	-	-			10	8.00
G-4131	BUMPER BRACES & BRACKETS (Fr) - STD	HX PP CONI SEMS, HXWA SCREWS, NUTS	F	-	-	-			10	8.00
G-4225	BUMPER BRACKETS (Fr)	HX BOLTS, RATCHET TOOTH WA'S, NUTS	-	-	M	-			16	12.00
G-5372	BUMPER BRACKETS (Rr)	HX PP CONI SEMS, CONI KEPS NUTS	F	-	-	-			8	8.00
G-4215	BUMPER BRACKETS (Rr)	POINTED BOLTS, RATCHET TOOTH WA'S	-	A	-	-			12	12.00
G-4223	BUMPER BRACKETS (Rr)	HX BOLTS, RATCHET TOOTH WA'S, NUTS	-	-	M	-			20	14.00
G-4274	BUMPER BRACKETS (Rr)	HX PP CONI SEMS	-	-	-	N			8	8.00
G-5972	BUMPER BRACKETS (Rr) - El Camino	HX BOLTS, RATCHET TOOTH WA'S, NUTS	-	A	-	-			20	20.00
G-4222	BUMPER GUARD PADS (Fr & Rr)	STAMPED NUTS	-	A	M	N			12	3.00
G-6334	BUMPER GUARDS (Fr & Rr)	HX BOLTS, SPLIT WA'S, NUTS	-	-	-	N			20	5.00
G-4134	BUMPER GUARDS (Fr)	HX MS & PP CONI SEMS	F	-	-	-			4	6.00
G-4219	BUMPER GUARDS (Fr)	HX SPLIT SEMS	-	A	-	-			4	4.00
G-4282	BUMPER GUARDS (Fr)	HX BOLTS, WA'S, NUTS	-	-	M	-			10	4.00
G-4157	BUMPER GUARDS (Rr)	HX BOLTS, HX CONI SEMS, WELL-NUTS	F	-	-	-			8	6.00
G-4220	BUMPER GUARDS (Rr)	HX SPLIT SEMS	-	A	-	-			4	5.00
G-5971	BUMPER GUARDS (Rr)	HX BOLTS, SPLIT WA'S	-	-	M	-			8	3.00
G-4160	BUMPER PADS - FULL BUMPER (Fr)	EXT KEPS NUTS	F	-	-	-			21	5.00
G-4161	BUMPER PADS (Fr) R/S	EXT KEPS NUTS	F	-	-	-			14	4.00
G-4158	BUMPER PADS (Rr)	EXT KEPS NUTS	F	-	-	-			14	4.00
G-5109	COWL INDUCTION VALVE FRAME	HX EXT SEMS ONLY !	-	A	-	-			6	3.00
G-5945	COWL INDUCTION VALVE SCREEN	BLACK SS SCREWS ONLY	-	A	-	-			8	3.00
G-4301	COWL VENT PANEL	HX AB FLAT SEMS	-	-	-	N			4	3.00
G-5374	DOOR HANDLES (outside)	SPECIAL 5/16 AF HX CONI SEMS	F	A	M	-			4	4.00
G-5386	DOOR HINGES	HX CONI TOOTH SEMS	F	A	M	-			30	20.00
G-4332	DOOR LATCHES	OV HD TT SCREWS	F	A	M	N			6	3.00
G-6619	DOOR LOCK STRIKERS	TORX DRIVE	F	A	-	-			2	24.00
G-5399	DOOR WEATHERSTRIPS	PLASTIC PINS	-	A	M	-			4	1.50
G-4130	EMBLEM / NAMEPLATE, GRILLE	9/16" OD STAMPED NUTS	F	-	-	-			2	1.00
G-6185	EMBLEM, GRILLE "SS"	STAMPED NUTS	-	-	-	N			2	1.00
G-5975	EMBLEM, Rr BUMPER "SS"	CONI KEPS NUTS	-	A	-	-			2	2.00
G-4105	FENDER > RADIATOR SUPPORT BRACES	HXWA CA SCREWS	F	-	-	-			4	3.00
G-5929	FENDER > WHEELHOUSE Fr BRACES	HXWA T SCREWS	-	A	M	N			2	3.00
G-4177	FENDER 90 DEG BRACKETS > RAD SUPPORT	HXWA CA SCREWS	-	-	M	-			4	3.00
G-4173	FENDER EXTENSION, TOP BRACKETS	HX CONI AB SEMS, SPRING NUTS	-	A	-	-			4	3.00
G-4172	FENDER EXTENSIONS	HX CONI SCREWS, STMPD NUTS, U-NUTS	-	A	-	-			12	4.00
G-4171	FENDER EXTENSIONS	HXWA & PH OV SCREWS, SPRING NUTS	-	-	M	-			14	6.00
G-4152	FENDER SPLASH SEALS	SEMS TAPPING SCREWS	F	-	-	-			12	5.00
G-4104	FENDERS	HX CONI SEMS, U-NUTS, SHIMS	F	-	-	-			26	20.00
G-4170	FENDERS	HX CONI SEMS, U-NUTS, SHIMS	-	A	M	-			32	22.00
G-6381	FENDERS	HX CONI SEMS, U-NUTS, SHIMS	-	-	-	N			26	20.00
G-6593	FENDERS > FIREWALL (also in fender kits)	HX CA CONI SEMS	F	A	M	N			4	5.00
G-6606	FENDERS > RAD SUPPORT (also in fender kit)	HX MS CONI SEMS	F	-	-	N			4	4.00
G-6605	FENDERS > RAD SUPPORT (also in fender kit)	HXWA CA SCREWS	-	A	M	-			4	3.00
G-4156	FILLER PANEL, Rr WINDOW	PH HXWA AB SCREWS	F	-	-	-			5	3.00
G-4120	FILLER PANELS - BELOW HEADLAMPS	HX AB FLAT SEMS	-	-	-	-			2	2.00
G-4209	GRILLE	PH PN SEMS, NYLON NUTS	-	A	-	-			12	6.00
G-4210	GRILLE	HX CONI SEMS, SPRING NUTS	-	-	M	-			11	5.00
G-5306	GRILLE - R/S	PH PN AB FLAT SEMS, PLASTIC NUTS	F	-	-	-			16	7.00
G-4118	GRILLE - STD	PH PN AB FLAT SEMS, PLASTIC NUTS	F	-	-	-			12	6.00
G-6260	GRILLE & REINFORCEMENT	HXWA SCREWS, SPR NUTS, BLK RIVETS	-	-	-	N			22	6.00
G-4208	GRILLE BRACKETS	HXWA CA SCREWS	-	A	M	-			3	2.00
G-6258	GRILLE BRACKETS	HXWA CA SCREWS	-	-	-	N			4	3.00
G-4119	GRILLE FILLER - R/S	PH PN SCREWS, PLASTIC NUTS	F	-	-	-			12	5.00
G-5186	HEADER PANEL	HXWA CA SCREWS, HX NUTS	F	-	-	-			13	5.00
G-4117	HEADLAMP BEZELS	SS/CHROME PH OV SCREWS, NYL NUTS	F	-	-	-			12	5.00
G-6391	HEADLAMP BEZELS	PH OV AB SCREWS, SPRING NUTS	-	-	-	N			16	5.00
G-5950	HEADLAMP BEZELS - exc STD Malibu	BLACK PH OV SCREWS, NYLON NUTS	-	A	-	-			8	4.00
G-4174	HEADLAMP BEZELS - STD Malibu 72A	SS/CHROME PH OV SCREWS, NYL NUTS	-	A	M	-			8	3.00
G-4129	HEADLAMP HOUSINGS	HXWA CA SCREWS	F	-	-	-			6	4.00
G-4106	HOOD & HINGES	HX CONI SEMS	F	A	M	N			8	10.00
G-4107	HOOD CATCH & LOCK PLATE	12 PT CONI SEMS, HX SEMS FOR HORN	F	-	-	-			7	6.00
G-4184	HOOD CATCH & LOCK PLATE	12 PT CONI SEMS	-	A	M	-			8	8.00
G-6384	HOOD CATCH & LOCK PLATE	12 PT CONI SEMS, U-NUTS	-	-	-	N			11	10.00
G-4109	HOOD CATCH SUPPORT	HXWA CA SCREW	F	-	-	N			1	1.00

See factory Assembly Manuals for illustrations

GM Fastener Kits

387

1972

Body

PART #	APPLICATION	NOTES	CAMARO				CHEVELLE MONTE CARLO		NOVA		PCS	PRICE
			F	A	M	N						
G-5743	HOOD CATCH SUPPORT	HXWA CA SCREW, U-NUT	-	A	M	-				2	2.00	
G-5210	HOOD LEVELER (Rr) - CENTER	BUMPER, ADJUSTER, FLNG NUT, U-NUT	F	-	-	-				4	5.00	
G-4249	HOOD LEVELERS (Fr)	SCREWS, FLNG NUTS, RUBBER BUMPERS	F	A	M	-				6	8.00	
G-4183	HOOD LEVELERS (Rr)	JAM NUTS only	-	A	M	-				2	2.00	
G-4365	HOOD LEVELERS (Rr) - OUTER	JAM NUTS only	F	-	-	-				2	3.00	
G-4182	HOOD LOCK POST	FLNG NUT ONLY	F	A	M	N				1	2.00	
G-4193	HOOD ORNAMENT	STAMPED NUTS	-	-	M	-				3	1.50	
G-6388	HOOD ORNAMENTS	STAMPED NUTS	-	-	-	N				12	3.00	
G-5941	HOOD PIN CABLES	SS/BLACK RNDWA AB SCREWS ONLY	-	A	-	-				2	1.50	
G-5319	HOOD SEAL	T SHAPED NYLON RETAINERS	F	A	M	-				13	5.00	
G-5940	HOOD STUD PLATES	CHROME PH OV AB SCREWS ONLY	-	A	-	-				8	3.00	
G-5942	HOOD STUDS	FLNG NUTS ONLY	-	A	-	-				4	3.00	
G-5826	INSTRUMENT PANEL ASSEMBLY	HXWA ABT SCREWS	-	A	M	-				6	4.00	
G-5313	INSTRUMENT PANEL REINFORCEMENTS	HX PP CONI SEMS, HX AB FLAT SEMS	F	-	-	-				13	6.00	
G-5697	INSTRUMENT PANEL REINFORCEMENTS	HX MS & BT SEMS, HXWA AB SCREWS	-	A	M	-				9	4.00	
G-4121	LICENSE PLATE BRACKET (Fr)	SS HXWA SCREWS, NYLON NUTS	F	-	-	-				4	3.00	
G-4485	LICENSE PLATE BRACKET (Fr) 70-72, (Rr) All	HX BOLTS, EXT KEPS NUTS	-	A	M	N				4	3.00	
G-4100	LICENSE PLATE BRACKET (Rr)	HX BOLTS	F	-	-	-				2	2.00	
G-5046	LICENSE PLATES (Fr & Rr)	SLOT TRUSS B SCREWS, NYLON NUTS	-	-	-	N				8	6.00	
G-6256	NAMEPLATE, FENDERS - ENG DESIGNATION	STAMPED NUTS	-	-	-	N				4	2.00	
G-4125	NAMEPLATE, FENDERS "350" "396" "Z28"	9/16" OD STAMPED NUTS	F	-	-	-				4	2.00	
G-5947	NAMEPLATE, FENDERS "350", "400"	STAMPED NUTS	-	A	-	-				6	2.00	
G-4194	NAMEPLATE, FENDERS "GMC SPRINT"	STAMPED NUTS	-	A	-	-				4	2.00	
G-4195	NAMEPLATE, FENDERS "Malibu, El Cam, SS"	STAMPED NUTS	-	A	-	-				6	2.00	
G-4370	NAMEPLATE, FENDERS "Nova", "Firebird"	STAMPED NUTS	-	-	-	N				4	1.50	
G-4313	NAMEPLATE, FENDERS "SS, R/S"	STAMPED NUTS	-	A	-	-				12	3.00	
G-4192	NAMEPLATE, GRILLE	STAMPED NUTS	-	A	M	-				2	1.00	
G-4123	NAMEPLATE, HEADER PANEL	9/16" OD STAMPED NUTS	F	-	-	-				3	2.00	
G-4124	NAMPELATE, FENDERS "Camaro"	7/16" OD STAMPED NUTS	F	-	-	-				6	1.50	
G-4126	NAMPELATE, FENDERS "Rally Sport"	9/16" OD STAMPED NUTS	F	-	-	-				8	3.00	
G-4146	NOSE PANEL - R/S	HX CA CONI SEMS	F	-	-	-				4	6.00	
G-4149	NOSE PANEL VERTICAL BAR - R/S	HX CONI SEMS, CONI KEPS NUTS	F	-	-	-				8	8.00	
G-4150	PAD, NOSE PANEL VERTICAL BAR - R/S	CONI KEPS NUTS	F	-	-	-				3	2.00	
G-6339	QUARTER PANEL EXTENSIONS	STAMPED NUT, SEALER	-	-	M	-				16	5.00	
G-5930	SEAL, COWL FRONT	T SHAPED NYLON RETAINERS	-	A	M	-				5	3.00	
G-5179	SEALS - BEHIND Rr BUMPER	NYLON RETAINERS	-	-	M	-				12	3.00	
G-5311	SEALS (L shaped) @ COWL SIDES	T SHAPED NYLON RETAINERS	F	-	-	-				4	2.00	
G-5352	SEALS (tubular), COWL Fr SIDES	T SHAPED NYLON RETAINERS	F	-	-	-				4	2.00	
G-4166	SPOILER (Rr) - 3 PIECE	CONI KEPS NUTS, SEALER WA'S	F	-	-	-				24	12.00	
G-5181	STEERING COLUMN SEAL RETAINER	HX AB FLAT SEMS	F	-	-	-				2	3.00	
G-5927	STEERING COLUMN SEAL RETAINER	HX AB CONI SEMS, HXWA AB SCREWS	-	A	M	-				7	6.00	
G-4975	STEERING COLUMN SEAL RETAINER	HX AB FLAT SEMS, HXWA AB SCREWS	-	-	-	N				6	6.00	
G-6930	TAILGATE HINGES - El Camino	HX CONI SEMS, FLAT EXT SEMS	-	A	-	-				12	20.00	
G-6934	TAILGATE LATCHES	OV HD TT SCREWS	-	A	-	-				6	3.00	
G-6931	TAILGATE STRIKERS > BODY	POZI FLAT SCREWS	-	A	-	-				6	6.00	
G-6933	TAILGATE SUPPORT CABLES	HX SHOULDER BOLTS, FLAT WA'S	-	A	-	-				8	8.00	
G-4154	TRUNK LATCH & STRIKER	HX CONI TOOTH SEMS	F	A	M	N				5	4.00	
G-4155	TRUNK LID > HINGES	HX CONI TOOTH SEMS	F	A	M	N				4	4.00	
G-5068	TRUNK LID BUMPERS	.90" DIA X .48 TK RUBBER BUMPERS	-	A	M	-				2	3.00	
G-4103	VALANCE (Fr)	HXWA CA SCREWS, U-NUTS	F	-	-	-				26	15.00	
G-4221	VALANCE (Rr)	HX PP CONI SEMS, U-NUTS	-	A	-	-				4	4.00	
G-6642	WEATHERSTRIP, QUARTER GLASS @ JAMB	.28 OD PH RNDWA AB SCREWS	-	A	M	-				6	2.00	
G-4189	WHEELHOUSE "U-CHANNEL" BRACES (Rr)	HX CONI SEMS, U-NUTS	-	-	M	-				8	7.00	
G-4187	WHEELHOUSE BRACKETS (Rr)	HX PP CONI SEMS	-	-	M	-				4	5.00	
G-4188	WHEELHOUSE EXTENSIONS	HXWA PP CREWS, U-NUTS	-	-	M	-				16	10.00	
G-4113	WHEELHOUSE Rr BRACES > BODY	HX CONI SEMS, U-NUTS	F	-	-	-				12	7.00	
G-4191	WHEELHOUSE SPLASH SHIELDS	HXWA AB & T1 SCREWS, U-NUTS, WA'S	-	-	M	-				16	4.00	
G-4112	WHEELHOUSES	SCREWS, HX CONI SEMS, WA'S, U-NUTS	F	-	-	-				38	22.00	
G-6692	WHEELHOUSES	SCREWS, HX SEMS, CUP WA'S, U-NUTS	-	A	-	-				42	24.00	
G-4186	WHEELHOUSES	SCREWS, HX CONI SEMS, WA'S, U-NUTS	-	-	M	-				42	26.00	
G-6265	WHEELHOUSES	HXWA PP SCREWS, CUP WA'S, U-NUTS	-	-	-	N				24	20.00	
G-4185	WHEELHOUSES - PLASTIC	SCREWS, HX CONI SEMS, WA'S, U-NUTS	-	A	-	-				42	24.00	
G-6599	WHEELHOUSES > FENDERS (also in WH kit)	HXWA CA SCREWS, CUP WA'S	F	-	-	-				8	8.00	
G-6597	WHEELHOUSES > FENDERS (also in WH kit)	HX PP CONI SEMS, FLAT WA'S	-	A	M	-				8	6.00	
G-6598	WHEELHOUSES > FENDERS (also in WH kit)	HXWA CA SCREWS, CUP WA'S, U-NUTS	-	-	-	N				12	12.00	
G-4111	WHEELHOUSES > RADIATOR SUPPORT	HXWA CA SCREWS	F	-	-	-				4	3.00	
G-4190	WHEELHOUSES > RADIATOR SUPPORT	HX PP CONI SEMS, U-NUTS	-	A	M	-				8	8.00	
G-6267	WHEELHOUSES > RADIATOR SUPPORT	HXWA CA SCREWS, U-NUTS	-	-	-	N				8	6.00	

Kits Contain Attaching Fasteners for Both Sides

GM Fastener Kits

1972

Brakes

PART #	APPLICATION	NOTES					PCS	PRICE
			CAMARO	CHEVELLE MONTE CARLO	NOVA			
G-5007	AXLE RETAINER PLATES	GR-8 HX BOLTS, NUTS, SPLIT WA'S	F	A	M	N	24	10.00
G-6579	BRAKE BLEEDER SCREWS w DISC	All - CALIPERS, M/C, WHEEL CYLINDERS	F	A	M	N	6	10.00
G-5863	BRAKE BOOSTER	FLNG NUTS	F	A	M	N	4	3.00
G-5259	BRAKE BOOSTER HOSE - 396/454	CLAMPS & NUT FOR TUBE BRACKET	F	A	M	-	3	3.00
G-4740	BRAKE BOOSTER HOSE - SB	FLAT WOUND SPRING CLAMPS (Black)	F	A	M	N	2	2.00
G-4642	BRAKE CABLES	WIRE TYPE RETAINERS, HX NUTS	-	A	M	N	5	5.00
G-4349	BRAKE CABLES & BRACKETS	WIRE RETAINING CLIPS, SCREWS, NUTS	F	-	-	-	13	10.00
G-6575	BRAKE CALIPER BLEEDERS	3/8-24 SCREWS, .28 NOSE TO FIT CAP	F	A	M	N	2	4.00
G-6636	BRAKE CALIPER BRACKETS & SHIELDS	HX BOLTS, LOCK NUTS	-	A	M	-	10	24.00
G-5468	BRAKE CALIPER BRACKETS & SHIELDS	HX BOLTS, LOCK NUTS	-	-	-	N	10	24.00
G-6426	BRAKE CALIPER LOCATING BOLTS	3.70" L HX SOCKET BOLTS	F	A	M	N	4	12.00
G-6609	BRAKE CALIPER PISTON RETURN CLIPS	ATTACH TO CALIPER PISTONS, COATED	F	A	M	N	2	4.00
G-6162	BRAKE CALIPER SHIELDS	HX CONI SEMS	F	-	-	-	6	4.00
G-4956	BRAKE HOSE (Fr disc) > CONTROL ARM	HXWA T SCREWS	-	-	-	N	2	2.00
G-5149	BRAKE HOSE (Rr) DIST BLOCK > AXLE HSNQ	FLNG HD SHLDR BOLT	F	-	-	-	1	4.00
G-4960	BRAKE HOSE (Rr) DIST BLOCK > BRACKET	HX BOLT	-	A	M	N	1	2.00
G-4348	BRAKE HOSE BRACKET (Rr)	HX PP CONI SEMS	-	-	-	N	2	3.00
G-5047	BRAKE HOSE BRACKETS (Fr)	HX T CONI SEMS	F	-	-	N	2	2.00
G-5719	BRAKE HOSE BRACKETS (Fr)	HXWA AB SCREWS	-	A	M	-	2	2.00
G-6240	BRAKE HOSE GASKETS	COPPER MATERIAL	F	A	M	N	2	1.50
G-4958	BRAKE HOSE RETAINERS	U-RETAINERS	F	A	M	N	3	3.00
G-5871	BRAKE LINE SHIELDS (Rr) - El Camino	HXWA AB SCREWS	-	A	-	-	4	3.00
G-5868	BRAKE LINES (Fr) BRACKET	HXWA AB SCREWS	-	A	-	-	2	2.00
G-5602	BRAKE PEDAL BUSHINGS	NYLON BUSHINGS ONLY	F	A	M	N	2	3.00
G-4794	BRAKE PEDAL RETAINER w A/T	FOLDED SPRING METAL	-	A	M	N	1	3.00
G-6044	BRAKE PEDAL RETURN SPRING	NOS SPRING	F	A	M	N	1	4.00
G-5284	BRAKE PEDAL w A/T	HX BOLT, LOCK NUT	F	-	-	-	2	4.00
G-5008	BRAKE PLATE ASSEMBLY (Fr) > SPINDLE	GR-8 HX BOLTS, LOCK NUTS	-	A	M	N	8	12.00
G-4636	BRAKE PRESSURE VALVE & SW - DRUM	HX SPLIT SEMS	-	-	-	N	1	1.50
G-5861	BRAKE PRESSURE VALVE & SW > FRAME	HXWA AB SCREW	-	A	-	-	1	1.00
G-4633	BRAKE PRESSURE VALVE & SW w/o PB	HXWA SCREWS, SPACER	F	-	-	-	3	5.00
G-5865	BRAKE PRESSURE VALVE & SW, DISC (F w PB)	HXWA T SCREWS	F	-	M	N	2	2.00
G-5144	MASTER CYLINDER	FLNG NUTS	F	A	M	N	2	2.00
G-6580	MASTER CYLINDER BLEEDERS w DISC	5/16-24 SCREWS	F	A	M	N	2	3.00
G-4829	MASTER CYLINDER PUSH ROD > PEDAL	RETAINING CLIP	F	A	M	N	1	3.00
G-5150	PARKING BRAKE CONTROL > DASH	HX CONI SEMS, FLNG NUTS	F	-	-	-	4	2.00
G-5864	PARKING BRAKE CONTROL > DASH	HX CONI SEMS, FLNG NUTS, SEALER	-	A	M	-	6	4.00
G-4347	PARKING BRAKE CONTROL > DASH	HX CONI SEMS, FLNG NUTS	-	-	-	N	3	3.00
G-5990	PARKING BRAKE RELEASE ROD CLIP	ROD END CLIP	-	A	M	-	1	3.00
G-4887	STOPLAMP SWITCH STRIKER - PWR BRAKES	w POWER BRAKES, BOLT, STAMPED NUT	-	A	M	N	2	2.00
G-5258	STOPLAMP SWITCH STRIKER (on pedal)	w POWER BRAKES, BOLT, STAMPED NUT	F	-	-	-	2	3.00
G-6576	WHEEL CYLINDER (2) BLEEDERS	Does 2 cylinders, 5/16-24 SCREWS	F	A	M	N	2	3.00
G-6577	WHEEL CYLINDER (4) BLEEDERS	Does 4 cylinders, 5/16-24 SCREWS	-	A	-	N	4	5.00
G-6578	WHEEL CYLINDER BLEEDER PROTECTORS	PLASTIC CAPS w STRAP	F	A	M	N	2	2.00
G-6581	WHEEL CYLINDERS (2)	HX INT SEMS	F	A	M	N	4	3.00
G-6582	WHEEL CYLINDERS (4)	HX INT SEMS	-	A	-	N	8	5.00

Cooling

G-4591	RADIATOR - 307/327 350	HXWA CA SCREWS	F	A	M	-	3	3.00
G-6387	RADIATOR - 307/327/350	HX CONI SEMS	-	-	-	N	3	3.00
G-6944	RADIATOR - 396	HX PP CONI SEMS	-	A	-	N	4	3.00
G-5189	RADIATOR FAN SHROUD	S CLIPS, HX FLAT SEMS, SPRING NUTS	F	A	M	-	6	6.00
G-6386	RADIATOR FAN SHROUD	S CLIPS, HX FLAT SEMS, SPRING NUTS	-	-	-	N	6	6.00
G-5162	RADIATOR HOSES - V8	TOWER TYPE CLAMPS	F	A	M	N	4	12.00

Differential

G-5466	DIFFERENTIAL COVER - 10 BOLT	SRTD FLNG SCREWS "E"	F	A	M	N	10	10.00
G-5467	DIFFERENTIAL COVER - 12 BOLT	SRTD FLNG SCREWS "E"	F	A	M	N	12	12.00

Electrical

G-4962	ALTERNATOR - 302, 307, 327, 350	HX BOLTS, WA'S, NUT	F	A	M	N	13	10.00
G-5049	ALTERNATOR - 396/454	BOLTS, HX CLR STUD, SPACER, NUTS	F	A	M	-	16	25.00
G-5191	ALTERNATOR HARNESS > ALTERNATOR	12-24 EXT KEPS NUT	F	A	M	N	1	2.00
G-6293	ALTERNATOR PULLEY	NUT, FLAT WA	F	A	M	N	2	3.00
G-6635	BACK-UP LAMP LENSES - El Camino	SS/CHROME PH PN .435 SHLDR SCREWS	-	A	-	-	4	4.00
G-4505	BACK-UP LAMPS	PH PN EXT SEMS	-	-	M	-	4	3.00

See factory Assembly Manuals for illustrations

GM Fastener Kits

389

1972

Electrical

PART #	APPLICATION	NOTES	CAMARO				CHEVELLE MONTE CARLO		NOVA		PCS	PRICE
			F	A	M	N						
G-5203	BACK-UP/NEUTRAL SWITCH (exc 70-71F A/T)	SCREWS	F	A	M	N				2	1.50	
G-6390	BATTERY CABLES	HXWA SCREWS, BRASS NUT, WA	-	A	M	N				5	4.00	
G-5354	BATTERY CABLES & CLAMP	HXWA SCREWS, BRASS NUT, WA	F	-	-	-				6	4.00	
G-4352	BATTERY HOLDOWN CLAMP	HX CONI SEMS	F	A	M	N				1	1.50	
G-5968	CAPACITOR - RADIO NOISE @ VR	HXWA SCREW	-	-	M	-				1	1.50	
G-6399	CAPACITOR - RADIO NOISE w AC	HXWA SCREW, TOOTH WA	-	-	-	N				2	1.50	
G-5362	CAPACITOR - RADIO NOISE w GAUGES	EXT KEPS NUT	F	A	M	N				2	2.00	
G-5814	CAPACITOR - RADIO NOISE, AM/FM, AC 68	HXWA SCREW	-	A	M	-				1	1.00	
G-5298	CLOCK - IN DASH	HXWA SCREWS	F	-	-	-				2	1.00	
G-5959	CLOCK - IN DASH	HXWA SCREWS	-	-	M	-				3	1.50	
G-6328	CLOCK - IN DASH	HXWA SCREWS, FLAT WA'S	-	-	-	N				4	2.00	
G-5958	CLOCK or COVER - IN DASH	SLOT HX SCREWS	-	A	-	-				3	1.50	
G-5954	COURTESY LAMP, GLOVE BOX	HX ABT FLAT SEMS	-	A	M	-				1	1.50	
G-5305	COURTESY LAMP, GLOVE BOX w AC	HX ABT FLAT SEMS	F	-	-	-				1	1.50	
G-5961	COURTESY LAMPS, UNDERDASH	HXWA BT SCREWS	-	A	M	-				2	1.50	
G-4990	COURTESY LAMPS, UNDERDASH (69F CONV)	HXWA SCREWS	F	-	-	N				2	1.50	
G-5881	COWL INDUCTION RELAY	HXWA SCREW	-	A	-	-				1	1.00	
G-5110	COWL INDUCTION SOLENOID	HX CONI SEMS	-	A	-	-				1	1.50	
G-5977	CRUISE CONTROL CABLE BRACE	HX BOLTS, EXT KEPS NUTS	-	A	M	-				2	2.00	
G-6452	CRUISE CONTROL CABLES	7.1" FLEXIBLE STRAPS	-	A	M	-				3	6.00	
G-5882	CRUISE CONTROL REGULATOR & BRACKET	HX CONI SEMS, BOLTS, NUTS, WA'S	-	A	M	-				11	5.00	
G-5883	CRUISE CONTROL SERVO & BRACKET	HX CONI SEMS, NUTS, WA'S	-	A	M	-				9	4.00	
G-5885	CRUISE CONTROL SW STRIKER	HX BOLT, STAMPED NUT	-	A	M	-				2	2.00	
G-5884	CRUISE CONTROL VAC HOSE SEAL RETAINER	TO FIREWALL, SCREWS	-	A	M	-				2	2.00	
G-5000	DEFOGGER SWITCH BEZEL - Rr WINDOW	EXT KEPS NUTS	-	A	M	N				2	1.50	
G-5211	DEFOGGER SWITCH HOUSING - Rr WINDOW	HXWA SCREWS	F	-	-	-				2	1.50	
G-4989	DIMMER SWITCH	HXWA AB SCREWS	F	A	M	N				2	2.00	
G-5200	FLASHER BRACKET > DASH	HXWA SCREW, TOOTH WA	F	-	-	-				2	2.00	
G-5953	FLASHER BRACKET > DASH	PH PN AB FLAT SEMS	-	A	M	-				1	1.50	
G-5355	FLASHER BRACKET > DASH	HXWA AB SCREW	-	-	-	N				1	1.00	
G-4986	FUSE PANEL > FIREWALL	#10 x 2 1/4 HXWA AB SCREWS w SEALER	F	A	M	N				2	3.00	
G-5360	H/L, P/L GROUND, HORN RELAY JUNCTION	HXWA AB SCREW, TOOTH WA , NUT	F	-	-	-				3	2.00	
G-6410	H/L, P/L GROUND, HORN RELAY JUNCTION	HXWA AB SCREWS, TOOTH WA'S, NUTS	-	A	M	N				6	3.00	
G-6530	HEADLAMP ADJUSTERS	SCREWS, NYLON NUTS, SPRING NUTS	F	-	M	-				10	8.00	
G-4258	HEADLAMP ADJUSTERS	SCREWS, NYLON NUTS, SPRING NUTS	-	A	-	-				10	8.00	
G-6562	HEADLAMP ADJUSTERS	SCREWS, NYLON NUTS, SPRINGS	-	-	-	N				10	8.00	
G-6567	HEADLAMP RETAINING RINGS	SLOT PN SCREWS	F	A	M	N				6	3.00	
G-6622	HEADLAMP RETAINING RINGS	PH RND SCREWS	F	A	M	N				6	2.00	
G-5854	HEATER SWITCH	HI-HXWA ABT SCREWS	-	A	M	-				2	1.50	
G-5128	HEATER SWITCH (exc 70-72A) or AC FAN	HXWA B SCREWS	F	A	M	-				2	1.50	
G-4726	HEATER SWITCH or AC FAN (AC 68N)	HXWA T1 SCREWS	-	-	-	N				2	1.50	
G-4207	HORN (1)	HX PP CONI SEMS	F	A	M	-				1	1.50	
G-6323	HORN (1)	HX PP CONI TOOTH SEMS, PLASTIC CAP	-	-	-	N				2	4.00	
G-6349	HORN RELAY	HXWA AB SCREW w SEALER	F	A	M	N				1	1.00	
G-5962	HORN RELAY TERMINAL POST	12-24 EXT KEPS NUT	F	A	-	N				1	2.00	
G-4647	IGNITION COIL & STRAP	HX EXT SEMS, SLOT RND T SCREW	F	A	M	N				3	4.00	
G-5367	IGNITION KEY WARNING BUZZER	HXWA AB SCREW	F	-	-	-				1	1.50	
G-5960	INSTRUMENT CLUSTER CIRCUIT BOARD	HXWA B SCREWS, NUTS, WA'S	-	A	M	-				14	3.00	
G-6272	INSTRUMENT CLUSTER CIRCUIT BOARD	HXWA B SCREWS, WA'S, NUTS	-	-	-	N				10	3.00	
G-4853	INSTRUMENT CLUSTER GROUND	HXWA AB SCREW, TOOTH WA	-	-	-	N				2	1.50	
G-5757	INSTRUMENT CLUSTER GROUNDS	HXWA AB & B SCREWS, TOOTH WA'S	-	A	M	-				3	1.50	
G-5199	INSTRUMENTS CIRCUIT BOARD	NUTS, FLAT WA'S	F	-	-	-				6	2.00	
G-5296	INSTRUMENTS CIRCUIT BOARD w GAUGES	HXWA B SCREWS, NUTS, FLAT WA'S	F	-	-	-				20	4.00	
G-6652	KICK PANELS w/o AC	HXWA SCREWS	-	A	M	-				10	3.00	
G-4205	LICENSE PLATE LAMP	HXWA AB SCREWS	-	A	M	-				2	1.00	
G-4312	LICENSE PLATE LAMP	PH PN AB SCREWS	-	-	-	N				2	1.00	
G-4128	MARKER LAMPS (Fr & Rr)	STAMPED NUTS	F	-	-	-				8	4.00	
G-4479	MARKER LAMPS (Fr & Rr)	STAMPED NUTS	-	-	-	N				8	3.00	
G-4201	MARKER LAMPS (Fr)	PH PN AB SCREWS, SPRING NUTS	-	-	M	-				8	2.00	
G-4228	MARKER LAMPS (Rr)	STAMPED NUTS	-	A	M	-				4	2.00	
G-5153	NEUTRAL STARTING SWITCH - M/T	HXWA AB SCREW, FLAT WA	F	A	M	N				2	1.50	
G-5202	PARKING BRAKE ALARM SWITCH	HXWA AB SCREW	F	A	M	-				1	1.00	
G-6396	PARKING BRAKE ALARM SWITCH	NUTS, SPLIT WA'S	-	-	-	N				4	1.50	
G-4199	PARKING LAMP BEZELS	BLACK PH OV MS SCREWS	-	A	-	-				8	4.00	
G-6625	PARKING LAMP LENSES	SS/CHROME PH PN .488 SHLDR SCREWS	F	-	-	-				4	4.00	
G-6420	PARKING LAMP LENSES (67-68F STD)	SS/CHROME PH PN .640 SHLDR SCREWS	-	-	M	N				4	4.00	
G-5949	PARKING LAMPS	PN PN & HXWA AB SCREWS, SPR NUTS	-	-	M	-				6	3.00	
G-4480	PARKING LAMPS	PH PN EXT SEMS	-	-	-	N				4	3.00	
G-4116	PARKING LAMPS - STD	PH PN AB SCREWS, SPRING NUTS	F	-	-	-				8	3.00	
G-4115	PARKING LAMPS (All 69F, 70-73F R/S)	EXT KEPS NUTS	F	-	-	-				4	3.00	
G-5967	RADIO BRACKET	HXWA & PN PN AB SCREWS, SPR NUTS	-	A	M	-				5	3.00	
G-5295	RADIO BRACKETS	HXWA AB & B SCREWS, SPRING NUTS	F	-	-	-				8	3.00	
G-5095	RADIO BRACKETS	HXWA AB SCREWS, SPRING NUTS	-	-	-	N				4	3.00	
G-5301	RADIO NOISE CAPACITOR > COIL BRACKET	HXWA T SCREW, TOOTH WA	F	A	M	N				2	1.50	
G-6654	SEAT BACK PANELS	PH PN FLAT SEMS	-	A	M	-				6	3.00	

Kits Contain Attaching Fasteners for Both Sides

GM Fastener Kits

1972

Electrical

PART #	APPLICATION	NOTES	CAMARO				CHEVELLE		MONTE CARLO		NOVA		PCS	PRICE
			F	A	M	N								
G-5359	SEAT BELT WARNING RELAY	HXWA AB SCREWS	F	A	M	N						2	1.50	
G-5368	SPEAKER > DASH	HXWA AB SCREW, SPRING NUT	F	-	-	-						2	1.50	
G-5094	SPEAKER > DASH	HXWA AB SCREW, SPRING NUT	-	-	-	N						2	1.50	
G-5965	SPEAKER > DASH w AC	HXWA AB & B SCREWS, SPRING NUTS	-	A	-	-						14	4.00	
G-5966	SPEAKER > DASH w AC	HXWA SCREWS, FLAT SEMS, SPR NUTS	-	-	M	-						14	4.00	
G-5963	SPEAKER > DASH w/o AC	HXWA AB SCREWS, SPRING NUTS	-	A	-	-						10	3.00	
G-5964	SPEAKER > DASH w/o AC	HXWA AB SCREWS, SPRING NUTS	-	-	M	-						11	3.00	
G-5152	STARTER - 307, 70F & 71AF 350, 72F 396 A/T	1.84 & 4.69 FLNG BOLTS, SEMS, NUT, WA	F	A	M	N						5	8.00	
G-5873	STARTER & BRACE - 396/454 & 350 w A/T	4.69 L FLNG BOLTS, CONI SEMS, NUT, WA	-	A	M	-						5	8.00	
G-5340	STARTER & BRACE - 396/454 (exc 72 A/T)	3.62 L HX BOLTS, HX CONI SEMS, NUT, WA	F	A	M	-						5	8.00	
G-5201	STOPLAMP SWITCH	SPECIAL ROUND RETAINER	F	A	M	-						1	2.00	
G-4689	STOPLAMP SWITCH	STAMPED HX NUTS	-	-	-	N						2	2.00	
G-5365	TACHOMETER	HXWA AB SCREWS	F	-	-	-						3	1.30	
G-5297	TACHOMETER	HXWA B SCREWS	-	A	M	-						3	1.50	
G-6325	TACHOMETER	HXWA B SCREWS	-	-	-	N						2	1.50	
G-6632	TAILAMP LENSES	SS/BLK PH PN B SCREWS	-	A	-	-						6	3.00	
G-6356	TAILAMP LENSES	SS/CHROME PH PN MS SCREWS	-	-	-	N						8	4.00	
G-6631	TAILAMP LENSES - El Camino	SS/CHROME PH PN .340 SHLDR SCREWS	-	A	-	-						8	8.00	
G-6928	TAILAMPS > BODY	STAMPED NUTS	F	-	-	-						8	5.00	
G-4840	TAILAMPS > BODY	EXT TOOTH KEPS NUTS	-	-	-	N						8	3.00	
G-4202	TAILAMPS > BUMPER	HXWA AB & PH PN BT SCREWS	-	A	-	-						8	3.00	
G-4204	TAILAMPS > QUARTER EXTENSIONS	PH OV SCREWS, NYLON NUTS	-	-	M	-						12	3.00	
G-4992	TURN SIGNAL LEVER	PH PN AB SCREW	F	A	M	-						1	1.00	
G-5304	UNDERHOOD LAMP	HXWA B SCREWS	F	A	M	N						2	1.50	
G-4588	VOLTAGE REGULATOR	HXWA AB SCREWS	F	A	M	-						3	2.00	
G-4968	VOLTAGE REGULATOR	HXWA B SCREWS	-	-	-	N						3	2.00	
G-6518	WIRING - ALTERNATOR > HEATER HOSE	7.1" FLEXIBLE STRAP	-	-	M	N						1	3.00	
G-6515	WIRING - BLOWER MOTOR/STARTER WIRING	RUBBER COATED J-CLIPS	F	A	M	N						2	5.00	
G-6488	WIRING - CONSOLE > HEATER DUCT	RUBBER COATED J CLIP	-	-	-	-						1	3.00	
G-6266	WIRING - CONSOLE HARNESS	RUBBER COATED J-CLIP, HX FLAT SEMS	-	-	-	N						2	3.00	
G-6327	WIRING - CONSOLE INSTRUMENT GROUND	HXWA SCREW, TOOTH WA	-	-	-	N						2	1.50	
G-6487	WIRING - CONSOLE LAMP	RUBBER COATED S CLIPS	-	A	M	-						4	6.00	
G-6475	WIRING - COWL INDUCTION	5.1" FLEXIBLE STRAP	-	A	-	-						1	3.00	
G-5752	WIRING - ENGINE NEAR WIPER MOTOR	RUBBER COATED J-CLIP, HXWA SCREW	-	A	M	-						2	3.00	
G-5177	WIRING - FUEL SENDER UNIT GROUND	HXWA AB SCREW	F	A	M	N						1	1.00	
G-6519	WIRING - INSTR HARNESS > DEFROST DUCTS	J-CLIP, HXWA SCREW, FLAT SPRING NUT	-	-	-	N						6	6.00	
G-6495	WIRING - LICENSE PLATE LAMP	S CLIPS	-	A	-	-						2	4.00	
G-6496	WIRING - LICENSE PLATE LAMP - El Camino	S CLIP	-	A	-	-						1	3.00	
G-5194	WIRING - STARTER TERMINALS	NUTS, TOOTH WA'S	F	A	M	N						4	1.50	
G-5956	WIRING - TAILAMP	RETAINING CLIPS @ LH TRUNK OPENING	F	A	M	-						3	4.00	
G-6474	WIRING - TCS SWITCH > DIPSTICK TUBE	5.1" FLEXIBLE STRAP	F	-	-	N						1	3.00	
G-5089	WIRING - TEMPERATURE SENDER	NUT, TOOTH WA	F	A	M	N						2	1.50	
G-6466	WIRING - UNDERHOOD LAMP	5.1" FLEXIBLE STRAPS	F	-	-	-						4	9.00	
G-5195	WIRING "GUTTER" > FIREWALL	HX AB FLAT SEMS	F	A	M	-						2	2.00	
G-5499	WIRING "GUTTER" > FIREWALL	HXWA AB SCREWS	-	-	-	N						2	1.50	
G-5190	WIRING HARNESS > LH WHEELHOUSE	PUSH-ENDS BLACK PLASTIC STRAPS	F	-	-	-						3	4.00	
G-4356	WIRING HARNESS > LH WHEELHOUSE	PUSH-ENDS BLACK PLASTIC STRAPS	-	A	M	N						2	3.00	
G-4987	WIRING HARNESS CONNECTOR > FIREWALL	HXWA SCREWS	F	-	-	-						2	2.00	

Emissions

G-5158	PCV HOSE CLAMPS	FLAT WOUND SPRING CLAMPS (Green)	F	A	M	N						2	2.00
G-4971	SMOG HOSE CLAMPS	TOWER TYPE CLAMPS	F	A	M	N						4	8.00
G-5261	SMOG PUMP - 350 NB2 TYPE 72	HX BOLTS, SPLIT WA'S, SPACER	F	A	M	N						7	10.00
G-5887	SMOG PUMP - K19 TYPE	HX BOLTS, SPLIT WA'S, SPACER	F	A	M	-						7	10.00
G-4843	SMOG PUMP PULLEY	HX BOLTS, SPLIT WA'S	F	A	M	N						6	3.00
G-6471	SMOG PUMP VACUUM HOSE > SMOG HOSE	5.1" FLEXIBLE STRAP	F	-	-	-						1	3.00
G-4970	SMOG VALVE & BRACKET	HX BOLTS, SPLIT & FLAT WA'S	F	A	M	-						12	4.00

Exhaust

G-5246	EXHAUST HANGERS, DUAL	HXWA SCREWS, HX SPLIT SEMS	F	-	-	-						6	8.00
G-5917	EXHAUST HANGERS, DUAL	HXWA AB SCREWS	-	A	M	-						6	4.00
G-5918	EXHAUST HANGERS, DUAL - El Camino	HXWA SCREWS, RETAINERS	-	A	-	-						12	8.00
G-5173	EXHAUST HANGERS, SINGLE	HXWA SCREWS, HX SPLIT SEMS	F	-	-	-						4	6.00
G-5915	EXHAUST HANGERS, SINGLE	HXWA SCREWS, RETAINERS	-	A	M	-						6	6.00
G-6367	EXHAUST HANGERS, SINGLE	HXWA SCREWS	-	-	-	N						6	4.00
G-5266	EXHAUST PIPE > MANIFOLDS	STUDS, LOCK NUTS	F	A	M	N						12	14.00
G-5325	EXHAUST PIPE, SHIELDS	HX AB FLAT SEMS	F	-	-	-						8	4.00
G-6350	EXHAUST PIPE, SHIELDS	HX AB FLAT SEMS	-	-	-	N						2	2.00

See factory Assembly Manuals for illustrations

GM Fastener Kits

391

1972

Fuel

PART #	APPLICATION	NOTES					PCS	PRICE
			CAMARO	CHEVELLE MONTE CARLO	NOVA			
G-5160	ACCELERATOR CABLE	5/16-18 BALL STUD, KEPS NUT	F	A	M	-	2	6.00
G-5159	ACCELERATOR CABLE	1/4-20 BALL STUD, KEPS NUT	-	-	-	N	2	6.00
G-5161	ACCELERATOR LEVER SUPPORT	HX AB FLAT SEMS	F	-	-	-	3	3.00
G-5730	ACCELERATOR LEVER SUPPORT	HXWA AB SCREWS	-	A	M	-	2	1.50
G-5163	ACCELERATOR LEVER SUPPORT	HXWA AB SCREWS	-	-	-	N	2	1.50
G-5275	FUEL FILTER BRACKET - 396HP	HX BOLT, SPLIT WA, MACHINE SCREW	F	-	-	-	3	3.00
G-5909	FUEL HOSES	FLAT WOUND SPR CLAMPS (Black, Yell)	-	-	M	-	4	3.00
G-6247	FUEL HOSES	FLAT WOUND SPRING CLAMPS (Yellow)	-	-	-	N	6	3.00
G-5174	FUEL HOSES - 307, 350, '70 396	FLAT WOUND SPR CLAMPS (Blk, Green)	F	-	-	-	6	4.00
G-5911	FUEL HOSES - 350 & 396/454	FLAT WOUND SPR CLAMPS (Green, Yel)	-	A	-	-	4	3.00
G-5910	FUEL HOSES - All 71, 72 (exc 350 & 396/454)	FLAT WOUND SPRING CLAMPS (Yellow)	-	A	-	-	4	3.00
G-5052	FUEL RETURN HOSES	FLAT WOUND SPRING CLAMPS (Red)	F	-	-	N	6	4.00
G-5267	FUEL RETURN HOSES	FLAT WOUND SPRING CLAMPS (Red)	F	-	-	-	8	5.00
G-5913	FUEL RETURN HOSES - 396/454	FLAT WOUND SPRING CLAMPS (Red)	-	A	M	-	4	3.00
G-6405	FUEL RETURN LINE @ ENGINE	CLIPS ONLY	F	-	-	-	2	4.00
G-4164	FUEL VAPOR CANISTER	HXWA AB & B SCREWS	F	-	-	-	4	2.00
G-5534	FUEL VAPOR CANISTER	HXWA AB & CA SCREWS	-	A	M	-	3	3.00
G-6377	FUEL VAPOR CANISTER	HXWA CA SCREWS, HX CONI SEMS	-	-	-	N	4	3.00
G-6378	FUEL VAPOR DRAIN HOSE	FLAT WOUND SPRING CLAMP (Black)	-	-	-	N	1	1.00
G-5273	FUEL VAPOR LINE HOSES	FLAT WOUND SPR CLAMPS (Blk, Grn, Red)	F	-	-	-	3	3.00
G-5805	FUEL VAPOR LINE HOSES	FLAT WOUND SPR CLAMPS (Green, Yell)	-	A	M	-	10	5.00
G-5923	FUEL VAPOR SEPARATOR > BODY - El Camino	HXWA SCREWS, NUTS, WA'S	-	A	-	-	6	3.00
G-5176	GAS TANK	BOLTS, WA'S, NUTS, SCREWS, SPACERS	F	-	-	-	12	12.00
G-5734	GAS TANK	SPECIAL BOLTS, HXWA SCREWS, U-NUTS	-	A	M	-	6	6.00
G-6244	GAS TANK	BOLTS, WA'S, NUTS, SCREWS, SPACERS	-	-	-	N	12	8.00

Heater

G-5133	DEFROSTER DUCTS	HX SEMS, RIVETS, SPR NUTS, RETAINERS	F	-	-	-	6	3.00
G-5832	DEFROSTER DUCTS	PH PN & HX AB FLAT SEMS	-	A	M	-	4	2.00
G-4764	DEFROSTER DUCTS	HXWA SCREWS, FLAT WA	-	-	-	N	4	2.00
G-5005	HEATER AIR, LH OUTLET DUCT (console only)	HX AB FLAT SEMS	-	-	-	N	2	2.00
G-4327	HEATER BLOWER MOTOR	SRTD HXWA AB SCREWS	F	A	M	N	5	1.50
G-5132	HEATER BOX > FIREWALL	HX INT/EXT AB SEMS, STAMPED NUTS	F	-	-	N	7	4.00
G-4326	HEATER BOX > FIREWALL	HX INT/EXT SEMS, STMPD NUTS, SEALER	-	A	M	-	12	5.00
G-5129	HEATER CONTROL CABLES	HH & HXWA SCREWS, WA'S, RTNRS	F	-	-	-	11	3.00
G-5834	HEATER CONTROL CABLES	HXWA SCREWS, SPRING NUTS, RTNRS	-	A	M	-	19	5.00
G-4953	HEATER CONTROL CABLES	HX ABT FLAT SEMS, SCREW, RTNRS, NUT	-	-	-	N	14	5.00
G-5236	HEATER CONTROL CABLES w AC	SCREWS, WA, RETAINERS, RIVETS	F	-	-	-	9	4.00
G-5856	HEATER CONTROL CABLES w AC	HXWA SCREWS, HX FLAT SEMS, RTNRS	-	A	M	-	5	3.00
G-5131	HEATER DUCT OUTLET (under dash)	HX AB FLAT SEMS	F	-	-	-	3	2.00
G-6364	HEATER DUCT OUTLET (under dash)	HX ABT FLAT SEMS	-	-	-	N	2	2.00
G-5397	HEATER HOSE CLIP @ WHEELHOUSE	FOLDOVER METAL CLIP	F	A	M	N	1	4.00
G-5857	HEATER HOSE CLIP > ALT BRACKET	HOSE CLIP, HXWA T SCREW	F	A	M	N	2	5.00
G-4952	HEATER HOSES	BAND CLAMPS w STRAIGHT UP SCREW	F	A	M	N	4	8.00
G-5478	HEATER or AC OUTLET (LH under dash)	HXWA AB SCREWS	-	A	M	-	2	1.00
G-4616	HEATER RESISTOR > BOX	HXWA AB SCREWS	F	A	M	N	2	1.00

Interior

G-6160	AIR OUTLET BEZELS (w AC) - Under Dash	HX AB FLAT SEMS, SPRING NUTS	F	-	-	-	14	5.00
G-5844	AIR OUTLET BEZELS (w AC) - Under Dash	CHROME PH OV SEMS, NUTS	-	A	M	-	6	3.00
G-5328	AIR OUTLET BEZELS (w AC) > DASH	HX ABT FLAT SEMS, STAMPED NUTS	F	-	-	-	8	4.00
G-5828	AIR OUTLET BEZELS (w AC) > DASH	HX BT & ABT FLAT SEMS	-	A	M	-	9	4.00
G-6278	AIR OUTLET BEZELS (w AC) > DASH	SCREWS, NUTS, SPRING NUTS, WA	-	-	-	N	13	4.00
G-6644	AIR VENTS @ DOOR JAMB	CHROME PH TRUSS WA TEK SCREWS	-	A	M	-	2	1.50
G-5383	ARMREST PAD & BASE @ Fr DOORS	CHROME PH RND & PH FLAT SCREWS	-	A	-	-	10	5.00
G-6645	ARMREST PANELS @ Rr SEATS	PH OV SEMS, PH PN SCREWS, SPRG NUTS	-	A	M	-	12	4.00
G-6302	ASH TRAY FACE PLATE	HX AB FLAT SEMS	F	-	-	-	2	2.00
G-5113	ASH TRAY RETAINER	HXWA AB SCREWS	F	-	-	-	3	2.00
G-5840	ASH TRAY RETAINER	PH FLT TOP RNDWA SCREWS	-	A	-	-	4	1.50
G-5841	ASH TRAY RETAINER	PH RNDWA AB SCREWS	-	-	M	-	4	1.50
G-4832	ASH TRAY RETAINER	PH PN AB SCREWS	-	-	-	N	3	1.50
G-6643	COAT HOOKS	SS/CHROME PH OV SCREWS	-	A	M	-	2	1.50
G-6276	CONSOLE - ASH TRAY DOOR	RIVETS, RETAINERS	F	-	-	-	4	4.00
G-5244	CONSOLE - Fr COVER	SCREWS, SPRING NUTS	F	-	-	-	8	3.00
G-5789	CONSOLE > FLOOR	HXWA & PN HD SCREWS	-	A	M	-	7	3.00
G-6288	CONSOLE > FLOOR	HXWA & PH OV SCREWS, SPRING NUTS	-	-	-	N	8	3.00
G-5239	CONSOLE > FLOOR BRACKETS	PH PN AB FLAT SEMS, SPRING NUTS	F	-	-	-	12	5.00
G-6588	CONSOLE ASH TRAY DOOR BUMPERS	RUBBER BUMPERS	F	-	-	-	2	2.00
G-5248	CONSOLE DOOR LATCH	PH PN MS	F	A	M	-	1	1.00

Kits Contain Attaching Fasteners for Both Sides

GM Fastener Kits

1972

Interior

PART #	APPLICATION	NOTES					PCS	PRICE
			CAMARO	CHEVELLE MONTE CARLO	NOVA			
G-6415	CONSOLE DOOR, HINGE & LATCH	PH PN BT FLAT SEMS & SCREWS	F	-	-	-	8	5.00
G-5794	CONSOLE DOOR, HINGE & STRIKER	PH OV & PH PN SCREWS	-	A	M	-	11	3.00
G-5790	CONSOLE END COVER	CHROME PH OV SCREWS	-	A	M	-	4	2.00
G-5242	CONSOLE END PANELS, UPPER & LWR	SCREWS, SPRING NUTS	F	-	-	-	12	3.00
G-6345	CONSOLE INSERT	STAMPED NUTS	-	-	-	N	4	1.50
G-5791	CONSOLE MOULDINGS	STAMPED NUTS ONLY	-	A	M	-	14	2.00
G-5240	CONSOLE TOP FRAME	HX FLAT & PN PN AB SEMS	F	-	-	-	12	5.00
G-5837	COVER - A/C HOLE OUTLET ON DASH	HI-HX BT SCREWS	-	A	M	-	2	2.00
G-5314	DASH PAD	HXWA SCREWS, FLAT SEMS, SPR NUTS	F	-	-	-	17	6.00
G-5822	DASH PAD	RETAINING CLIPS, SCREWS	-	A	M	-	12	14.00
G-5650	DOME LAMP	PH PN SCREWS	-	A	M	-	2	1.50
G-5409	DOOR HANDLES (inside) - STD	WIRE RETAINERS	-	A	M	-	2	1.00
G-5384	DOOR PANELS	CLIPS, PLUGS (flexible !), PH OV AB SEMS	-	A	M	-	32	12.00
G-6641	ESCUTCHEON @ Rr WINDOW LWR CORNERS	CHROME PH OV AB SEMS	-	A	-	-	2	1.50
G-6647	FILLER PANELS - Rr SEAT BACK	PH OV SCREWS	-	A	M	-	4	2.00
G-5366	FLASHER KNOB	PH OV MS	F	A	M	N	1	1.50
G-4947	GLOVE BOX DOOR	HX AB FLAT SEMS	-	-	-	N	3	2.00
G-5317	GLOVE BOX DOOR & STOP	SCREWS, SPRING NUTS	F	-	-	-	18	5.00
G-5836	GLOVE BOX DOOR & STOP	PH PN & RNDWA SCREWS, PH OV SEMS	-	A	M	-	14	3.00
G-6585	GLOVE BOX DOOR BUMPERS	RUBBER BUMPERS	F	A	M	N	2	2.00
G-5119	GLOVE BOX LINER	HXWA AB SCREW	F	-	-	-	1	1.50
G-4360	GLOVE BOX LINER	PH PN AB FLAT SEMS	-	-	-	N	6	3.00
G-5316	GLOVE BOX STRIKER	HXWA SCREWS, SPRING NUTS	F	A	M	-	4	2.00
G-6344	GLOVE BOX STRIKER	HX FLAT SEMS	-	-	-	N	2	2.00
G-6651	HEADLINER RETAINERS - Fr & SIDES	5/16 AF HXWA AB SCREWS	-	A	M	-	22	3.00
G-6650	HEADLINER RETAINERS - Rr	PH RNDWA SCREWS	-	A	M	-	15	4.00
G-6655	HEADREST ESCUTCHEONS & FABRIC RETAINER	CHROME PH OV AB & PH FLAT SCREWS	-	A	M	-	16	4.00
G-5833	HEATER CONTROL & SUPPORT > DASH	HXWA SCREWS, FLAT SEMS, SPR NUTS	-	A	M	-	7	3.00
G-5130	HEATER CONTROL > DASH	HX ABT FLAT SEMS	F	-	-	-	3	2.00
G-6238	HEATER CONTROL > DASH	PH OV AB SEMS, SPRING NUTS	-	-	-	N	6	3.00
G-5118	INSTRUMENT CLUSTER & CARRIER > DASH	PH OV AB & HX FLAT SEMS, SPR NUTS	F	-	-	-	18	6.00
G-6271	INSTRUMENT CLUSTER & CARRIER > DASH	PH OV & HX AB FLAT SEMS, SPR NUTS	-	-	-	N	14	4.00
G-5957	INSTRUMENT CLUSTER > DASH	HI-HX BT FLAT SEMS	-	A	M	-	8	4.00
G-4617	INSULATION > FIREWALL	RUBBER RETAINERS	F	-	-	N	4	6.00
G-6646	KICK PANELS w AC	PH OV AB FINWA SEMS	-	A	M	-	3	3.00
G-4621	MIRROR (inside Rr view) > BRACKET	CHROME SLOT OV SHLDR SCREW	-	A	M	-	1	2.00
G-6691	MIRROR (inside Rr view) BRACKET	PH PN AB SCREWS	-	A	-	-	3	1.00
G-5124	PILLAR MOULDINGS	CHROME PH OV AB SCREWS	F	-	-	-	2	1.50
G-6684	PILLAR MOULDINGS - CONVERTIBLE	PH OV AB SEMS, PH RNDWA TEK SCREWS	-	A	M	-	4	3.00
G-5824	PILLAR MOULDINGS - METAL	PH OV & PH TRUSSWA SCREWS	-	A	-	-	4	2.00
G-6649	QUARTER TRIM PANELS - MAIN	PH OV FINWA SEMS, PH PN AB SCREWS	-	A	M	-	4	3.00
G-6648	QUARTER TRIM SAIL PANELS	RETAINING CLIPS	-	A	M	-	4	3.00
G-5318	RADIO CONTROL SHAFTS	SPECIAL THIN HX NUTS	F	-	-	-	2	4.00
G-6397	RADIO CONTROL SHAFTS & KNOBS	SPECIAL SLOTTED NUTS	-	A	M	N	4	4.00
G-4321	SCUFF PLATES, DOOR OPENING	SS/CHROME PH OV AB SCREWS	F	A	M	-	8	2.50
G-6148	SCUFF PLATES, DOOR OPENING	SS/CHROME PH OV AB SCREWS	-	-	-	N	12	3.00
G-6657	SEAT BACK (Fr) STOP BUMPERS	PH PN AB SCREWS	-	A	M	-	4	1.50
G-5380	SEAT BACK (Rr) > BODY	HX AB CONI TOOTH SEMS	-	A	M	-	2	3.00
G-6675	SEAT BACK STRAP > SEAT BASE	ROUNDED TRIM HX CONI SEMS	-	A	M	-	4	6.00
G-6656	SEAT SIDE PANELS	.41 DIA PH RNDWA SCREWS	-	A	M	-	12	3.00
G-6653	SEAT TRACKS > FLOOR	HX CONI TOOTH SEMS, PERI KEPS	-	A	M	-	8	5.00
G-5134	SEAT TRACKS > SEAT	SCREWS	F	-	-	-	8	6.00
G-5407	SHOULDER HARNESS RETAINERS	CHROME PH OV AB SCREWS	-	A	M	-	8	2.00
G-5182	STEERING COLUMN COVER > DASH	HXWA SCREWS, PH OV SEMS, SPR NUTS	F	-	-	-	8	3.00
G-5823	STEERING COLUMN COVER > DASH	CHROME PH OV FLUSH SEMS, SPR NUTS	-	A	M	-	8	3.00
G-6252	STEERING COLUMN COVER > DASH	PH OV SEMS, HX FLAT SEMS, SPR NUTS	-	-	-	N	6	3.00
G-5315	STEERING COLUMN COVER > FIREWALL	HX AB FLAT SEMS w SEALER	F	-	-	-	2	3.00
G-5926	STEERING COLUMN COVER > FIREWALL	HXWA AB SCREWS	-	A	M	-	2	2.00
G-4977	STEERING COLUMN COVER > FIREWALL	HX AB FLAT SEMS w SEALER	-	-	-	N	2	3.00
G-5184	STEERING WHEEL SHROUD	PH PN AB SCREWS, SPRING NUTS	F	A	M	N	4	2.00
G-5377	SUN VISOR & MIRROR BRACKETS - COUPE	SS/CHROME PH OV & PH PN AB SCREWS	-	A	M	-	9	3.00
G-6670	SUN VISOR BRACKETS - CONVERTIBLE	CHROME PH OV SCREWS w #12 HD	-	A	-	-	6	4.00
G-5378	SUN VISOR CLAMPS	CHROME SLOT FILL SCREWS	-	A	M	-	2	2.00
G-5838	VENTILATION OUTLET BEZELS	HX ABT FLAT SEMS	-	A	M	-	6	3.00
G-5121	VENTILATION OUTLETS & DUCT	HX ABT FLAT SEMS, HXWA AB SCREWS	F	-	-	-	8	3.00
G-5400	WINDOW CRANK HANDLES	RETAINING CLIPS	-	A	M	-	4	1.50

Mouldings

G-5946	FENDER MOULDINGS	STAMPED NUTS ONLY	-	A	-	-	4	2.00
G-6385	FENDER MOULDINGS	STAMPED NUTS ONLY	-	-	-	N	14	3.00
G-5933	FENDER MOULDINGS - El Camino Custom	STAMPED NUTS ONLY	-	A	-	-	10	3.00
G-4371	FENDER MOULDINGS @ Rr TOP	CHROME SCREWS	F	-	-	-	4	2.00

See factory Assembly Manuals for illustrations

1972

Mouldings

PART #	APPLICATION	NOTES					PCS	PRICE
			CAMARO	CHEVELLE MONTE CARLO	NOVA			
G-6383	HOOD & FENDER "EYE BROW" MOULDINGS	DOES HOOD EMBLEM, STMPD NUTS, CAPS	-	-	-	N	18	3.00
G-6640	QUARTER PANEL EXTENSION MOULDINGS	SS/CHROME PH OV SCREWS	-	-	M	-	6	3.00
G-5126	ROCKER MOULDINGS	SCREWS ONLY	F	-	-	-	20	4.00
G-5706	ROCKER MOULDINGS	PH PN AB SCREWS ONLY	-	A	-	N	24	4.00
G-4196	WHEEL OPENING MOULDINGS	CHROME/SS PH RNDWA AB SCREWS	-	A	M	-	28	6.00
G-6542	WINDOW (Fr) MOULDINGS	RETAINING CLIPS	F	-	-	-	22	12.00
G-6544	WINDOW (Fr) MOULDINGS	RETAINING CLIPS, PH PN AB SCREWS	-	A	-	-	32	12.00
G-6555	WINDOW (Fr) MOULDINGS	RETAINING CLIPS, PH PN AB SCREWS	-	-	-	N	32	12.00
G-6561	WINDOW (Fr) MOULDINGS - CONVERTIBLE	RETAINING CLIPS, PH PN AB SCREWS	-	A	-	-	26	12.00
G-4665	WINDOW (Fr) MOULDINGS, LWR	RETAINING CLIPS (less the 2 end clips)	-	-	-	N	8	12.00
G-6556	WINDOW (Fr) MOULDINGS, SIDES, UPR - VINYL	RETAINING CLIPS, SCREWS	-	-	-	N	20	12.00
G-6540	WINDOW (Rr) MOULDINGS	RETAINING CLIPS	F	-	-	-	22	12.00
G-6549	WINDOW (Rr) MOULDINGS	RETAINING CLIPS	-	A	-	-	20	12.00
G-6558	WINDOW (Rr) MOULDINGS	RETAINING CLIPS	-	-	-	N	20	12.00
G-6550	WINDOW (Rr) MOULDINGS - El Camino	RETAINING CLIPS	-	A	-	-	20	12.00
G-6551	WINDOW (Rr) MOULDINGS - El Camino - VINYL	RETAINING CLIPS	-	A	-	-	20	12.00
G-6560	WINDOW (Rr) MOULDINGS - Vinyl Top	RETAINING CLIPS	-	A	-	-	20	12.00
G-6559	WINDOW (Rr) MOULDINGS - Vinyl Top	RETAINING CLIPS	-	-	-	N	20	12.00

Steering & Suspension

G-4631	AXLE HSNB > SPRINGS	SPECIAL GR-8 LOCK NUTS ONLY !	F	-	-	N	8	12.00
G-6639	AXLE HSNB > SPRINGS - 302/350/396	MULTI SPRINGS, T, U BOLTS, LOCK NUTS	-	-	-	N	14	38.00
G-4897	AXLE HSNB > SPRINGS - 70F > w/o STAB BAR	MULTI SPRINGS, T, U BOLTS, LOCK NUTS	F	-	-	-	14	32.00
G-5904	AXLE HSNB > SPRINGS (mono spring)	SPECIAL GR-8 LOCK NUTS & T BOLTS	-	-	-	N	16	26.00
G-5257	AXLE HSNB > SPRINGS w STABILIZER BAR	LONG T- BOLTS, U-BOLTS, LOCK NUTS	F	-	-	-	14	34.00
G-6151	BALL JOINTS - UPPER	SOLID RIVETS (2 are extra)	-	A	M	N	10	6.00
G-5458	CONTROL ARM BUSHINGS - UPPER	RETAINERS, LOCK NUTS	F	-	-	-	8	12.00
G-4612	CONTROL ARM BUSHINGS - UPPER	HX BOLTS "SSC", WA'S, RETAINERS	-	A	M	N	12	12.00
G-4608	CONTROL ARMS - LWR	POINTED BOLTS, LOCK NUTS	F	A	M	N	8	20.00
G-5138	CONTROL ARMS - UPPER	GR-8 KNURL BOLTS, LOCK NUTS, SHIMS	F	-	-	-	18	20.00
G-4627	CONTROL ARMS - UPPER	GR-8 KNURL BOLTS, LOCK NUTS, SHIMS	-	A	M	N	18	14.00
G-4610	CONTROL ARMS (Rr)	GR-8 POINTED BOLTS, LOCK NUTS	-	A	M	-	16	32.00
G-5539	FRAME REINFORCEMENTS - HP APPLICATIONS	HARDENED FLAT WA'S	-	A	M	-	2	3.00
G-4669	GREASE FITTINGS	STRAIGHT	F	A	M	N	10	3.00
G-4265	IDLER ARM > FRAME	GR-8 HX BOLTS, WA'S, NUTS	F	A	-	N	6	6.00
G-5036	IDLER ARM > FRAME	GR-8 HX BOLTS, WA'S, NUTS	-	-	M	-	6	6.00
G-4607	LEAF SPRING, Fr HANGERS	HX PP CONI SEMS, SPECIAL U-NUTS	F	-	-	-	12	18.00
G-6354	LEAF SPRING, Fr HANGERS	GR-8 BOLTS, SPECIAL U-NUTS	-	-	-	N	12	18.00
G-4630	LEAF SPRINGS, Fr EYE	GR-8 BOLTS, NUTS, WA'S	F	-	-	N	8	12.00
G-5293	P/S HOSE CLAMP	HXWA AB SCREW	F	-	-	-	1	1.00
G-5291	P/S PUMP - 307, 350 (F only)	HX BOLTS, NUTS, WA'S, SPACER	F	-	-	-	19	12.00
G-5292	P/S PUMP - 396/454	HX BOLTS, NUTS, WA'S, SPACER	F	A	M	-	19	12.00
G-5082	P/S PUMP - SB	HX BOLTS, NUTS, WA'S, SPACER	-	A	M	N	19	12.00
G-4807	P/S PUMP PULLEY	THIN LOCK NUT	F	A	M	N	1	6.00
G-4668	PITMAN ARM > GEAR BOX	HX NUT, SPLIT WA	F	A	M	N	2	3.00
G-4838	SHACKLES	11/16" AF MARSDEN NUTS ONLY	F	-	-	N	4	6.00
G-4586	SHOCKS (Fr) - LWR MOUNTING	HXWA CA SCREWS, U-NUTS	F	A	M	N	8	8.00
G-4836	SHOCKS (Fr) - UPR MOUNTING	RETAINERS, BUSHINGS, 3/8-24 NUTS	F	A	M	N	10	6.00
G-5859	SHOCKS (Rr)	HXWA SCREWS, TK NUTS, SPLIT WA'S	-	A	M	-	12	6.00
G-5143	SHOCKS (Rr) LWR MOUNTING	RETAINERS, BUSHINGS, 3/8-24 NUTS	F	-	-	-	10	8.00
G-4632	SHOCKS (Rr) LWR MOUNTING - MONO SPRING	HX BOLTS, NUTS, SPLIT WA'S	-	-	-	N	6	4.00
G-4898	SHOCKS (Rr) LWR MOUNTING - MULTI SPRING	THICK HX NUTS, SPLIT WA'S	-	-	-	N	4	3.00
G-6100	SHOCKS (Rr) UPR MOUNTING	HX SPLIT SEMS	F	-	-	N	4	6.00
G-5185	SPARE WHEEL	9 5/8" J-BOLT, WING NUT, FLAT WA	F	-	-	-	3	16.00
G-6938	SPARE WHEEL (F coupe only)	5 7/8" J-BOLT, WING NUT	-	A	M	N	2	14.00
G-6461	SPARE WHEEL WRENCH > JACK	7.1" FLEXIBLE STRAPS	F	-	-	-	2	5.00
G-5141	STABILIZER BAR (Fr) BRACKETS	HX TY-T SCREWS	F	A	M	N	4	6.00
G-4955	STABILIZER BAR (Fr) CLAMPS	HX BOLTS, NUTS, SPLIT & FLAT WA'S	-	-	-	N	8	4.00
G-5140	STABILIZER BAR (Fr) END LINKS	HX BOLTS, RETAINERS, BUSHINGS, NUTS	F	-	-	-	22	20.00
G-5481	STABILIZER BAR (Fr) END LINKS	HX BOLTS, RETAINERS, BUSHINGS, NUTS	-	A	M	-	22	25.00
G-4837	STABILIZER BAR (Fr) END LINKS	HX BOLTS, RETAINERS, BUSHINGS, NUTS	-	-	-	N	22	20.00
G-5862	STABILIZER BAR (Rr)	HX BOLTS, LOCK NUTS	-	A	M	-	8	6.00
G-6403	STABILIZER BAR (Rr) END BRACKETS	HX BOLTS, SPLIT WA'S, NUTS	-	-	-	N	12	4.00
G-5256	STABILIZER BAR (Rr) SUPPORTS	HX BOLTS, WA'S, NUTS	F	-	-	-	18	10.00
G-6404	STABILIZER BAR (Rr) SUPPORTS	HX BOLTS, FLAT WA'S, NUTS	-	-	-	N	12	6.00
G-4976	STEERING COLUMN > DASH	FLNG NUTS, FLNG SCREWS (copper plate)	F	-	-	N	6	5.00
G-5928	STEERING COLUMN > DASH	FLNG SCREWS, FLNG NUTS, CONI SEMS	-	A	M	-	7	6.00
G-6638	STEERING COLUMN BRACKET REINF	HX PP CONI SEMS	F	-	-	-	4	3.00
G-4354	STEERING GEAR "RAG" JOINT	12 PT BOLT ONLY	F	A	M	N	1	3.00
G-5180	STEERING GEAR BOX > FRAME	GR-8 HX BOLTS, FLAT WA'S	F	A	M	-	6	12.00
G-4293	STEERING GEAR BOX > FRAME	GR-8 HX BOLTS, FLAT WA'S	-	-	-	N	6	12.00
G-5139	STEERING LINKAGE & BALL JOINTS	GR-8 LRG HX SLOT NUTS, COTTER PINS	F	-	-	-	20	15.00
G-5858	STEERING LINKAGE & BALL JOINTS	SLOTTED NUTS, COTTER PINS	-	A	M	-	20	10.00

Kits Contain Attaching Fasteners for Both Sides

1972

Steering & Suspension

PART #	APPLICATION	NOTES					PCS	PRICE
			F	A	M	N		
G-4615	STEERING LINKAGE & BALL JOINTS	SLOTTED NUTS, COTTER PINS	-	-	-	N	20	10.00
G-4670	STEERING SHAFT > COUPLING	REG & HVY NUTS, SPLIT WA'S	F	A	M	N	4	3.00
G-5716	SUSPENSION BUMPER & BRACKET (Rr)	HX BOLTS, NUTS, SPLIT WA'S	-	A	M	-	7	3.00
G-4337	SUSPENSION BUMPERS & BRACKETS (Rr)	HX PP CONI SEMS, HXWA SCREWS, NUTS	F	-	-	-	12	10.00
G-4596	SUSPENSION BUMPERS (Fr)	HX NUTS	F	A	M	N	2	1.00
G-6316	SUSPENSION BUMPERS (Fr) - 350, 396	HX NUTS, FLNG NUTS, WA'S	-	-	-	N	6	3.00
G-6355	SUSPENSION BUMPERS (Rr)	HXWA T SCREWS	-	-	-	N	6	4.00
G-5484	SUSPENSION BUMPERS (Rr) - El Camino	HX BOLTS, NUTS, SPLIT WA'S	-	A	-	-	3	2.00
G-6583	WHEEL STUDS - 1 AXLE (Fr or Rr)	Does 2 wheels, 7/16-20 x 1.38" L	F	A	M	N	10	14.00
G-5060	WHEELS - STD	ORIGINAL LUG NUTS w "DIAMONDS"	F	A	M	N	20	25.00

Transmission

G-6149	BELL HOUSING > ENGINE	FLNG BOLTS (Flat Top) "A" MARKING	F	A	M	N	6	8.00
G-6611	BELL HOUSING > ENGINE	FLNG BOLTS, "M" MARKING	F	A	M	N	6	8.00
G-5416	BELL HOUSING Fr COVER PLATE	SS EXT SEMS "L"	F	A	M	N	4	3.00
G-5907	CLUTCH BELLCRANK	BALL STUDS, SEATS, RETAINER, WA'S	-	A	M	N	9	32.00
G-5172	CLUTCH BELLCRANK BRACKET > FRAME	HXWA SCREWS	F	-	-	N	3	3.00
G-5890	CLUTCH BELLCRANK BRACKET > FRAME	HXWA SCREWS	-	A	M	-	3	3.00
G-5146	CLUTCH PEDAL	HX BOLT, WA, NUT ONLY !	F	-	-	-	3	4.00
G-5603	CLUTCH PEDAL BUSHINGS	NYLON BUSHINGS ONLY	F	A	M	N	2	3.00
G-4658	CLUTCH PEDAL PUSH ROD SEAL	HXWA AB SCREWS	F	-	-	N	2	1.00
G-6628	CLUTCH PEDAL PUSH RODS	WIRE RETAINERS, FLAT WA	F	-	-	-	4	4.00
G-4850	CLUTCH PEDAL PUSH RODS	RETAINING CLIPS ONLY	-	A	M	N	3	3.00
G-4659	CLUTCH PEDAL RETAINER	FOLDED SPRING METAL	-	A	M	N	1	3.00
G-6192	CONTROL LINKAGE > COLUMN - M38/M40	RETAINERS, SLEEVE, WA'S, NUT, SCREW	F	-	-	N	8	12.00
G-5254	CONTROL LINKAGE > COLUMN - PG	RETAINERS, SLEEVE, WA'S, NUT, SCREW	F	-	-	N	10	12.00
G-4792	COVER - CLUTCH PEDAL HOLE	HXWA SCREWS	F	-	-	N	2	1.50
G-4796	DRIVESHAFT, TH400 '69 > 302, 350, BB. All 71 >	STRAPS, FLNG BOLTS	F	A	M	N	6	8.00
G-6573	FLYWHEEL - A/T	GR-8 HXWA SCREWS	F	A	M	N	12	16.00
G-4429	FLYWHEEL - M/T	11/16" AF X 1.0" L HX BOLTS	F	A	M	N	12	12.00
G-6150	PRESSURE PLATE > FLYWHEEL	SPECIAL HX BOLTS, SPLIT WA'S	F	A	M	N	12	6.00
G-4528	SHIFTER BEZEL & SEAL RETAINER - M/T	w/o CONSOLE, HXWA AB SCREWS	-	A	M	N	10	3.00
G-5165	SHIFTER BOOT PLATE w/o CONSOLE	CHROME PH OV AB SCREWS	F	-	-	-	4	2.00
G-4908	SHIFTER CABLE - PG, TH400 w CONSOLE	U & PUSH RETAINERS, NUT, WA	F	A	M	-	6	6.00
G-5076	SHIFTER CABLE - TH350 w CONSOLE	SCREW, U & PUSH RETAINERS, NUT, WA	F	A	M	-	8	6.00
G-5902	SHIFTER CABLE GROMMET	HXWA SCREWS	F	A	M	-	2	2.00
G-5733	SHIFTER CONTROL - HD 3 SPD or 4 SPD	HX BOLTS, WA'S, NUTS	-	A	M	-	16	8.00
G-5164	SHIFTER CONTROL & SUPPORT - 3 SPD	HX BOLTS, SPLIT & FLAT WA'S	F	-	-	-	9	6.00
G-4783	SHIFTER CONTROL & SUPPORT (exc 69F M20)	HX BOLTS, NUTS, SPLIT WA'S	-	-	-	N	13	4.00
G-6303	SHIFTER DIAL (A/T) & SENDER - IN DASH	PH FLAT B SCREW, HX AB FLAT SEMS	F	-	-	-	3	2.00
G-5801	SHIFTER DIAL CABLE - IN DASH	PH FLAT B SCREW	-	A	M	N	1	1.00
G-5732	SHIFTER HANDLE - HD 3 SPD M/T, 70-72 4 SPD	HX SPLIT SEMS	-	A	M	-	2	3.00
G-5166	SHIFTER KNOB	CHROME HX JAM NUT	F	A	M	N	1	2.00
G-5348	SHIFTER LEVER > FLOOR - A/T w CONSOLE	HXWA CA SCREWS, RIVET NUTS	F	-	-	-	8	6.00
G-4852	SHIFTER LEVER > FLOOR - A/T w CONSOLE	HXWA AB SCREWS	-	A	M	-	3	2.00
G-4790	SHIFTER LEVER > FLOOR - PG, TH400 w CNSL	HXWA T1 SCREWS	-	-	-	N	4	2.00
G-5898	SHIFTER LEVERS - 4S, 70-71A HD, 70F L65	HX BOLTS, FLAT & SPLIT WA'S	F	-	-	N	9	4.00
G-5899	SHIFTER LEVERS > CASE - 3 SPD HD (floor)	HX SPLIT SEMS, FLAT WA'S	-	A	M	-	4	4.00
G-5897	SHIFTER LEVERS > CASE - 3 SPD M/T	HX BOLTS, SPLIT & FLAT WA'S	F	A	M	N	6	3.00
G-5799	SHIFTER LEVERS > CASE - 4 SPD STD	HX SPLIT SEMS, FLAT WA'S	-	A	M	-	6	4.00
G-5798	SHIFTER LINKAGE, A/T FLOOR - TH350, TH400	RETAINERS, NUTS, FLAT WA'S	-	-	-	N	9	4.00
G-5245	SHIFTER PLATE - M/T or A/T CONSOLE	CHROME PH OV B SCREWS, STMPD NUTS	F	-	-	-	10	3.00
G-6291	SHIFTER PLATE & SEALS - A/T CONSOLE	HXWA T, PH OV AB SCREWS, SPR NUTS	-	-	-	N	14	4.00
G-6290	SHIFTER PLATE & SEALS - M/T CONSOLE	PH OV & HXWA SCREWS, SPRING NUTS	-	-	-	N	16	4.00
G-5894	SHIFTER PLATE, LENS, SEAL - A/T CONSOLE	HXWA AB CREWS, STAMPED NUTS	-	A	M	-	8	3.00
G-5167	SHIFTER RODS - 3 SPD	RETAINERS, FALT & WAVE WA'S, NUTS	F	-	-	-	14	8.00
G-5276	SHIFTER RODS - 4 SPD	RETAINERS, FLAT & WAVE WA'S	F	-	-	-	21	12.00
G-4780	SHIFTER RODS - 4 SPD	RETAINING CLIPS, JAM NUTS	-	A	M	N	12	10.00
G-4778	SHIFTER RODS - HD 3 SPD	RETAINERS, NUTS	-	A	M	-	8	6.00
G-5893	SHIFTER SEAL RETAINER - M/T CONSOLE	HXWA AB SCREWS	-	A	-	-	6	2.00
G-4904	SHIFTER STAB 68FN 327, 69FN, 68-72AN 3, 4	Floor Shift, BOLTS, NUTS, RET'S, BSHNGS	-	A	M	N	8	12.00
G-5792	SHIFTER TRIM PLATE (console only)	PH OV C SCREWS	-	A	M	-	6	2.00
G-4694	SPEDOMETER CABLE > TRANS	HX SPLIT SEMS	F	A	M	N	1	2.00
G-5363	SPEDOMETER CABLE > TRANS (M38, M40)	USED WITH ADAPTER, HX BOLT	F	A	M	-	1	1.50
G-5905	TCS RELAY	HXWA AB SCREW, SPRING NUT	-	A	M	-	2	2.00
G-6347	TCS RELAY - EARLY 70 & 71-72	HXWA AB SCREWS w SEALER	F	-	-	N	2	1.50
G-5341	TCS SOLENOID > INTAKE	HX CLR STUD, NUT, SPLIT WA	F	A	M	N	3	6.00
G-5279	TORQUE CONVERTOR > FLYWHEEL - PG, TH350	FLNG BOLTS, NUTS	F	A	M	N	6	5.00
G-5280	TORQUE CONVERTOR > FLYWHEEL - TH400	FLNG BOLTS	F	A	M	-	6	6.00
G-5283	TRANS (Powerglide) KICKDOWN LINKAGE	BALL STUD, NUTS, WA'S, ROD END CLIP	F	A	M	N	7	8.00
G-6508	TRANS (TH350) DETENT CABLE > TUBE	4.05" ALUMINUM STRAP	F	A	M	N	1	3.00
G-5286	TRANS (TH400) CONTROL SW (at gas pedal)	HXWA AB SCREW	F	A	M	-	1	1.00
G-5061	TRANS BACKDRIVE - 4 SPD (exc 69-70 L65)	RETAINERS, FITTINGS, NUTS, WA'S	-	A	M	-	10	14.00

See factory Assembly Manuals for illustrations

1972

Transmission

PART #	APPLICATION	NOTES	CAMARO				CHEVELLE MONTE CARLO		NOVA		PCS	PRICE
			F	A	M	N						
G-5067	TRANS BACKDRIVE - HD 3S, 69-70 L65 4S	RETAINERS, FITTINGS, NUTS, WA'S	-	A	M	-				14	16.00	
G-5171	TRANS BACKDRIVE - M/T	RETAINERS, FITTINGS, NUTS, WA'S	F	-	-	-				13	16.00	
G-6564	TRANS BACKDRIVE - M11, M20 (72N, 70N STD)	RETAINERS, FITTINGS, NUTS, WA'S	-	-	-	N				15	18.00	
G-5345	TRANS BACKDRIVE SUPPORT > FRAME (M/T)	HXWA AB SCREWS	-	A	M	-				3	3.00	
G-4169	TRANS CROSSMEMBER	HX BOLTS, WA'S (RH SIDE), NUTS	F	A	M	N				14	6.00	
G-4603	TRANS INSULATOR	HX BOLTS, FLAT & SPLIT WA'S	F	-	-	N				10	6.00	
G-4605	TRANS INSULATOR - 70A, 72 350, 71M, 72 BB	HX BOLTS, FLAT & SPLIT WA'S	-	A	M	-				12	7.00	
G-5886	TRANS INSULATOR - TH400 (also does All)	HX BOLTS, FLAT & SPLIT WA'S	-	A	M	-				14	7.00	
G-5170	TRANS LINK SUPPORT 70-72 M/T, 71-72N A/T	> FRAME, HXWA T SCREWS	F	-	-	N				3	3.00	
G-5891	TRANS LINKAGE - A/T PG	RETAINERS, SWIVEL, NUT, WA'S	-	A	M	-				8	12.00	
G-5677	TRANS LINKAGE - A/T TH400, All 69, 72 M38	RETAINERS, SWIVEL, NUT, WA'S	-	A	M	-				7	12.00	
G-5343	TRANS LINKAGE SUPPORT A/T > FRAME	HXWA T SCREW	F	-	-	N				1	1.50	
G-6308	TRANS OIL PAN - PG (exc 68-72 console)	LRG FLNG HEAD SCREWS	F	A	M	N				14	7.00	
G-6309	TRANS OIL PAN - PG w CONSOLE	LRG FLNG HEAD SCREWS, SPLIT SEMS	F	A	M	N				14	7.00	
G-6311	TRANS OIL PAN w CNSL TH350 73-81, TH400	LRG FLNG HEAD SCREWS	F	A	M	N				13	7.00	
G-6310	TRANS OIL PAN w/o CNSL - TH350 All, TH400	LRG FLNG HEAD SCREWS	F	A	M	N				13	6.00	
G-5070	TRANSMISSION (A/T) > ENGINE (exc 67-68 PG)	HX BOLTS, SPLIT & FLAT WA'S	F	A	M	-				9	6.00	
G-4590	TRANSMISSION (STD) > BELL HOUSING	HX BOLTS, SPLIT WA'S	F	A	M	N				8	5.00	
G-5731	TRANSMISSION LINKAGE - M/T CLM SHIFT	RETAINERS, FITTINGS, NUTS, WA'S	-	A	M	-				15	24.00	
G-5232	TRANSMISSION LINKAGE - M/T CLM SHIFT	RETAINERS, FITTINGS, NUTS, WA'S	-	-	-	N				18	20.00	
G-4909	TRANSMISSION OIL COOLER LINES	C SHAPED SPRING CLIPS	F	A	M	N				2	3.00	

Wipers

G-4162	WINDSHIELD WASHER BOTTLE	HXWA AB SCREWS, SPRING NUTS	F	-	-	-				4	2.00
G-4330	WINDSHIELD WASHER BOTTLE	HXWA AB SCREWS	-	A	M	N				2	1.50
G-4163	WINDSHIELD WASHER NOZZLES	#10 HXWA AB SCREWS	F	A	M	-				2	1.00
G-4303	WINDSHIELD WASHER NOZZLES	#8 HXWA B SCREWS	-	-	-	N				2	1.25
G-5842	WINDSHIELD WASHER NOZZLES SS, YF3, YE7	#8 HXWA AB SCREWS, TOOTH WA'S	-	A	-	-				4	1.50
G-4153	WIPER ARM PIVOTS > COWL	HX CONI TOOTH SEMS	F	-	-	-				6	3.00
G-5423	WIPER ARM PIVOTS > COWL	HX CNTRS NK & REG HX EXT SEMS	-	A	M	-				5	5.00
G-4464	WIPER ARM PIVOTS > COWL	HX EXT SEMS	-	-	-	N				4	3.00
G-5465	WIPER MOTOR	GROMMETS, GRD STRAP, RIVET, SCREWS	F	A	M	N				8	12.00
G-4329	WIPER MOTOR	HX CNTRS NK EXT SEMS	F	A	M	N				3	3.00
G-5599	WIPER MOTOR BRACKET - 1, 2S w/o WASHER	HX EXT SEMS	-	A	M	-				3	2.00
G-5335	WIPER SWITCH	HXWA AB SCREWS, TOOTH WA	F	-	-	-				4	1.50
G-5843	WIPER SWITCH	HI-HX BT FLAT SEMS	-	A	M	-				4	2.00

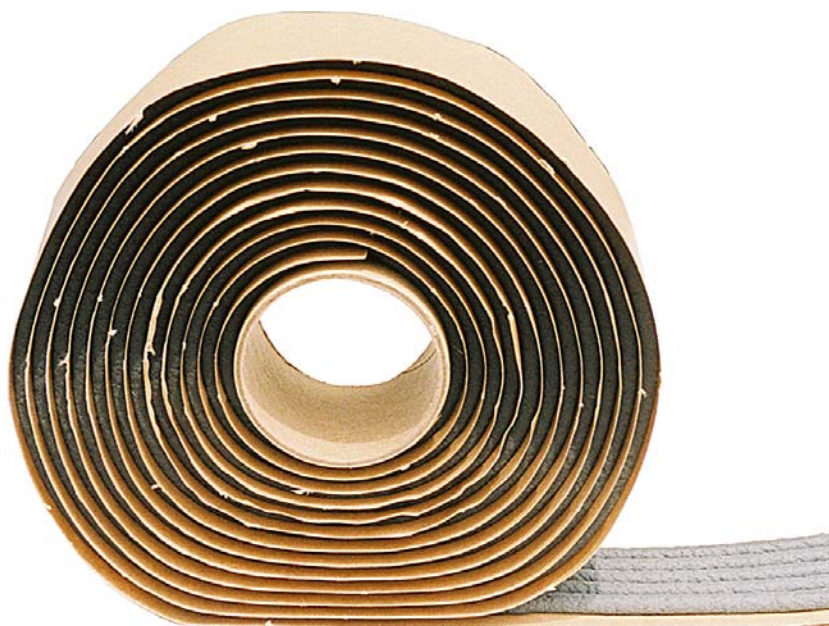

2 Lb Box



FIVE .19 DIAMETER BEADS ON 13' ROLL

Dark Grey Body Sealer - this product is widely used during assembly

Air ducts, body openings, door panel water shields, emblems, fenders, floor plugs, kick panels, gas tank & filler neck, firewall openings, heater box, quarter trim panel watershields, seat mounts, valance, window mouldings.

S	Pcs	Price
B-11608	1	\$20

1973

Air Conditioning

PART #	APPLICATION	NOTES	F	CAMARO								PCS	PRICE
G-5237	AC AIR DISTRIBUTION DUCTS - CENTRAL	HX FLAT SEMS, RETAINER, WA	F									7	6.00
G-5251	AC AIR DUCT - CONSOLE	HX ABT FLAT SEMS, PH RND WA SCREW	F									4	3.00
G-5216	AC AIR OUTLET @ FLOOR - CENTER	HX ABT FLAT SEMS	F									3	2.00
G-5035	AC AMBIENT SWITCH > EVAPORATOR	HXWA ABT SCREWS	F									2	2.00
G-5327	AC COMP BRACE > INTAKE - SB	HX BOLTS, FLAT & SPLIT WA'S	F									5	4.00
G-5848	AC COMP BRACE, UPPER Fr - SB	HX BOLTS, FLAT, SPLIT & WA'S, NUTS	F									13	6.00
G-5847	AC COMP SUPPORT > EXH MANIFOLD - SB	GR-8 "TR" HX BOLTS	F									2	3.00
G-5326	AC COMP SUPPORT, LWR Fr - SB	HX BOLTS, SPLIT & TOOTH WA'S	F									6	3.00
G-5222	AC COMP SUPPORT, LWR Rr - SB	HX BOLTS, SPLIT WA'S	F									10	4.00
G-6520	AC COMPRESSOR WIRING	5.1" FLEXIBLE STRAP	F									1	3.00
G-5220	AC CONDENSER	HX SPLIT SEMS, FLNG NUTS	F									16	6.00
G-5228	AC EVAPORATOR > FIREWALL	HX FLAT SEMS, CLR STUD, NUTS, WA'S	F									10	8.00
G-6304	AC EVAPORATOR CASE	HXWA BT SCREWS	F									6	4.00
G-5235	AC FITTING & MUFFLER ASSEMBLY	HX BOLT, FLAT & SPLIT WA'S	F									3	3.00
G-4723	AC GROUND > FIREWALL	HXWA AB SCREW, TOOTH WA	F									2	1.50
G-4407	AC HARNES > FIREWALL	BLACK NYLON CLIP, HX AB FLAT SEMS	F									2	3.00
G-5229	AC HEATER HOSE > DASH GROMMET	HX ABT FLAT SEMS	F									2	1.50
G-6439	AC HOSE > HEATER HOSE	11.25" FLEXIBLE STRAP	F									1	6.00
G-5853	AC HOSE > RH WHEELHOUSE	HXWA AB SCREWS	F									2	1.50
G-5214	AC PLENUM VALVE & BRACKET	HXWA AB SCREWS, CONI KEPS NUTS	F									9	4.00
G-5221	AC RECIEVER TANK > RADIATOR SUPPORT	HXWA AB SCREWS, SPRING NUTS	F									6	3.00
G-5034	AC RESISTOR & RELAY > EVAPORATOR	HXWA ABT SCREWS	F									3	2.00
G-5215	AC SELECTOR DUCT > FIREWALL	HX AB INT/EXT SEMS, NUTS, WA'S	F									8	4.00
G-5234	AC VACUUM HOSE ATTACHMENTS	FLAT SEMS, HXWA SCREWS, RETAINERS	F									7	3.00
G-5329	AC VACUUM MOTOR @ RH COWL	HXWA AB & T1 SCREWS, NUTS	F									5	3.00
G-5001	AC VACUUM MOTOR COVER	PH OV FIN WA SEMS .50 OD, SPRG NUTS	F									6	3.00
G-4714	AC VALVE, TUBE BRKT'S > EVAPORATOR	HXWA AB & ABT SCREWS	F									2	1.50
G-6443	AC WIRING @ EVAPORATOR	5.1" FLEXIBLE STRAP	F									1	3.00
G-6502	AC WIRING CLIP @ EVAPORATOR RELAY	RUBBER COATED J CLIP	F									1	3.00

Body

G-4101	BATTERY TRAY	HX CONI SEMS, HXWA CA SCREWS	F									4	3.00
G-5936	BODY MOUNT BRACKETS @ RAD SUPPORT	BOLTS, RATCHET TOOTH WA'S, NUTS	F									16	12.00
G-5127	BODY MOUNTS	ORIGINAL BOLTS, CONI KEPS NUTS, WA'S	F									14	40.00
G-5188	BODY MOUNTS @ RADIATOR SUPPORT	ORIGINAL BOLTS, FLAT WA'S	F									4	6.00
G-4340	BRAKE PEDAL SUPPORT w/o PB	FLNG NUTS	F									2	2.00
G-4144	BUMPER (Fr) - R/S	HX BOLTS	F									10	8.00
G-4140	BUMPER (Fr) - STD	SS CAP BOLTS, CONI SEMS, CONI KEPS	F									18	16.00
G-4325	BUMPER (Rr)	SS CAPPED BOLTS, CONI KEPS NUTS	F									14	16.00
G-4614	BUMPER BRACES & BRACKETS (Fr) - R/S	HX PP CONI SEMS, SCREWS, CONI KEPS	F									10	8.00
G-4141	BUMPER BRACKETS & BRACES (Fr)	HX MS & PP CONI SEMS, NUTS	F									12	10.00
G-5372	BUMPER BRACKETS (Rr)	HX PP CONI SEMS, CONI KEPS NUTS	F									8	8.00
G-4143	BUMPER GUARD PADS (Fr)	STAMPED NUTS	F									6	3.00
G-4142	BUMPER GUARDS (Fr)	HX CONI SEMS	F									6	6.00
G-5374	DOOR HANDLES (outside)	SPECIAL 5/16 AF HX CONI SEMS	F									4	4.00
G-5386	DOOR HINGES	HX CONI TOOTH SEMS	F									30	20.00
G-4332	DOOR LATCHES	OV HD TT SCREWS	F									6	3.00
G-6619	DOOR LOCK STRIKERS	TORX DRIVE	F									2	24.00
G-4130	EMBLEM / NAMEPLATE, GRILLE	9/16" OD STAMPED NUTS	F									2	1.00
G-4372	EMBLEM, HEADER PANEL	STAMPED NUTS	F									3	1.00
G-4105	FENDER > RADIATOR SUPPORT BRACES	HXWA CA SCREWS	F									4	3.00
G-4114	FENDER > RADIATOR SUPPORT BRACES - R/S	HX SEMS, RIVET NUTS	F									12	8.00
G-4152	FENDER SPLASH SEALS	SEMS TAPPING SCREWS	F									12	5.00
G-4104	FENDERS	HX CONI SEMS, U-NUTS, SHIMS	F									26	20.00
G-6593	FENDERS > FIREWALL (also in fender kits)	HX CA CONI SEMS	F									4	5.00
G-6606	FENDERS > RAD SUPPORT (also in fender kit)	HX MS CONI SEMS	F									4	4.00
G-4156	FILLER PANEL, Rr WINDOW	PH HXWA AB SCREWS	F									5	3.00
G-4120	FILLER PANELS - BELOW HEADLAMPS	HX AB FLAT SEMS	F									2	2.00
G-5306	GRILLE - R/S	PH PN AB FLAT SEMS, PLASTIC NUTS	F									16	7.00
G-4118	GRILLE - STD	PH PN AB FLAT SEMS, PLASTIC NUTS	F									12	6.00
G-4119	GRILLE FILLER - R/S	PH PN SCREWS, PLASTIC NUTS	F									12	5.00
G-5186	HEADER PANEL	HXWA CA SCREWS, HX NUTS	F									13	5.00
G-4117	HEADLAMP BEZELS	SS/CHROME PH OV SCREWS, NYL NUTS	F									12	5.00
G-4129	HEADLAMP HOUSINGS	HXWA CA SCREWS	F									6	4.00
G-4106	HOOD & HINGES	HX CONI SEMS	F									8	10.00
G-4107	HOOD CATCH & LOCK PLATE	12 PT CONI SEMS, HX SEMS FOR HORN	F									7	6.00
G-4110	HOOD CATCH BRACES & RNFRMNT - R/S	HXWA CA SCREWS	F									3	2.00
G-4109	HOOD CATCH SUPPORT	HXWA CA SCREW	F									1	1.00
G-5210	HOOD LEVELER (Rr) - CENTER	BUMPER, ADJUSTER, FLNG NUT, U-NUT	F									4	5.00
G-4249	HOOD LEVELERS (Fr)	SCREWS, FLNG NUTS, RUBBER BUMPERS	F									6	8.00
G-4365	HOOD LEVELERS (Rr) - OUTER	JAM NUTS only	F									2	3.00

See factory Assembly Manuals for illustrations

GM Fastener Kits

397

1973

Body

PART #	APPLICATION	NOTES	F	CAMARO										PCS	PRICE	
G-4182	HOOD LOCK POST	FLNG NUT ONLY	F												1	2.00
G-5319	HOOD SEAL	T SHAPED NYLON RETAINERS	F												13	5.00
G-5313	INSTRUMENT PANEL REINFORCEMENTS	HX PP CONI SEMS, HX AB FLAT SEMS	F												13	6.00
G-4121	LICENSE PLATE BRACKET (Fr)	SS HXWA SCREWS, NYLON NUTS	F												4	3.00
G-4100	LICENSE PLATE BRACKET (Rr)	HX BOLTS	F												2	2.00
G-4125	NAMEPLATE, FENDERS "350" "396" "Z28"	9/16" OD STAMPED NUTS	F												4	2.00
G-4123	NAMEPLATE, HEADER PANEL	9/16" OD STAMPED NUTS	F												3	2.00
G-4124	NAMPELATE, FENDERS "Camaro"	7/16" OD STAMPED NUTS	F												6	1.50
G-4126	NAMPELATE, FENDERS "Rally Sport"	9/16" OD STAMPED NUTS	F												8	3.00
G-4147	NOSE PANEL - R/S	HX CONI & SPLIT SEMS, CONI KEPS NUTS	F												12	10.00
G-4149	NOSE PANEL VERTICAL BAR - R/S	HX CONI SEMS, CONI KEPS NUTS	F												8	8.00
G-4148	NOSE PANEL, UPPER & LWR BRKTS - R/S	HXWA CA SCREWS, RIVET NUTS	F												8	6.00
G-4150	PAD, NOSE PANEL VERTICAL BAR - R/S	CONI KEPS NUTS	F												3	2.00
G-5311	SEALS (L shaped) @ COWL SIDES	T SHAPED NYLON RETAINERS	F												4	2.00
G-5352	SEALS (tubular), COWL Fr SIDES	T SHAPED NYLON RETAINERS	F												4	2.00
G-4166	SPOILER (Rr) - 3 PIECE	CONI KEPS NUTS, SEALER WA'S	F												24	12.00
G-5181	STEERING COLUMN SEAL RETAINER	HX AB FLAT SEMS	F												2	3.00
G-4154	TRUNK LATCH & STRIKER	HX CONI TOOTH SEMS	F												5	4.00
G-4155	TRUNK LID > HINGES	HX CONI TOOTH SEMS	F												4	4.00
G-4103	VALANCE (Fr)	HXWA CA SCREWS, U-NUTS	F												26	15.00
G-4113	WHEELHOUSE Rr BRACES > BODY	HX CONI SEMS, U-NUTS	F												12	7.00
G-4214	WHEELHOUSES	SCREWS, HX CONI SEMS, WA'S, U-NUTS	F												36	16.00
G-6600	WHEELHOUSES > FENDERS (also in WH kit)	HXWA CA SCREWS, FLAT WA'S	F												8	5.00
G-4111	WHEELHOUSES > RADIATOR SUPPORT	HXWA CA SCREWS	F												4	3.00

Brakes

G-5007	AXLE RETAINER PLATES	GR-8 HX BOLTS, NUTS, SPLIT WA'S	F													24	10.00
G-6579	BRAKE BLEEDER SCREWS w DISC	All - CALIPERS, M/C, WHEEL CYLINDERS	F													6	10.00
G-5863	BRAKE BOOSTER	FLNG NUTS	F													4	3.00
G-4740	BRAKE BOOSTER HOSE - SB	FLAT WOUND SPRING CLAMPS (Black)	F													2	2.00
G-4349	BRAKE CABLES & BRACKETS	WIRE RETAINING CLIPS, SCREWS, NUTS	F													13	10.00
G-6575	BRAKE CALIPER BLEEDERS	3/8-24 SCREWS, .28 NOSE TO FIT CAP	F													2	4.00
G-6609	BRAKE CALIPER PISTON RETURN CLIPS	ATTACH TO CALIPER PISTONS, COATED	F													2	4.00
G-6162	BRAKE CALIPER SHIELDS	HX CONI SEMS	F													6	4.00
G-5149	BRAKE HOSE (Rr) DIST BLOCK > AXLE HSNG	FLNG HD SHLDR BOLT	F													1	4.00
G-5047	BRAKE HOSE BRACKETS (Fr)	HX T CONI SEMS	F													2	2.00
G-6240	BRAKE HOSE GASKETS	COPPER MATERIAL	F													2	1.50
G-4958	BRAKE HOSE RETAINERS	U-RETAINERS	F													3	3.00
G-5602	BRAKE PEDAL BUSHINGS	NYLON BUSHINGS ONLY	F													2	3.00
G-6044	BRAKE PEDAL RETURN SPRING	NOS SPRING	F													1	4.00
G-5284	BRAKE PEDAL w A/T	HX BOLT, LOCK NUT	F													2	4.00
G-4633	BRAKE PRESSURE VALVE & SW w/o PB	HXWA SCREWS, SPACER	F													3	5.00
G-5865	BRAKE PRESSURE VALVE & SW, DISC (F w PB)	HXWA T SCREWS	F													2	2.00
G-5144	MASTER CYLINDER	FLNG NUTS	F													2	2.00
G-6580	MASTER CYLINDER BLEEDERS w DISC	5/16-24 SCREWS	F													2	3.00
G-4829	MASTER CYLINDER PUSH ROD > PEDAL	RETAINING CLIP	F													1	3.00
G-5150	PARKING BRAKE CONTROL > DASH	HX CONI SEMS, FLNG NUTS	F													4	2.00
G-5258	STOPLAMP SWITCH STRIKER (on pedal)	w POWER BRAKES, BOLT, STAMPED NUT	F													2	3.00
G-6576	WHEEL CYLINDER (2) BLEEDERS	Does 2 cylinders, 5/16-24 SCREWS	F													2	3.00
G-6578	WHEEL CYLINDER BLEEDER PROTECTORS	PLASTIC CAPS w STRAP	F													2	2.00
G-6581	WHEEL CYLINDERS (2)	HX INT SEMS	F													4	3.00

Cooling

G-5370	COOLANT RECOVERY TANK	HXWA AB SCREWS, SPRING NUTS	F													6	3.00
G-4591	RADIATOR - 307/327 350	HXWA CA SCREWS	F													3	3.00
G-5189	RADIATOR FAN SHROUD	S CLIPS, HX FLAT SEMS, SPRING NUTS	F													6	6.00
G-5162	RADIATOR HOSES - V8	TOWER TYPE CLAMPS	F													4	12.00

Differential

G-5466	DIFFERENTIAL COVER - 10 BOLT	SRTD FLNG SCREWS "E"	F													10	10.00
G-5467	DIFFERENTIAL COVER - 12 BOLT	SRTD FLNG SCREWS "E"	F													12	12.00

Kits Contain Attaching Fasteners for Both Sides

1973

Electrical

PART #	APPLICATION	NOTES	F	CAMARO								PCS	PRICE
G-4962	ALTERNATOR - 302, 307, 327, 350	HX BOLTS, WA'S, NUT	F									13	10.00
G-5358	ALTERNATOR HARNESS > ALTERNATOR	12-24 LOCK NUT	F									1	2.00
G-6293	ALTERNATOR PULLEY	NUT, FLAT WA	F									2	3.00
G-5203	BACK-UP/NEUTRAL SWITCH (exc 70-71F A/T)	SCREWS	F									2	1.50
G-5354	BATTERY CABLES & CLAMP	HXWA SCREWS, BRASS NUT, WA	F									6	4.00
G-4352	BATTERY HOLDOWN CLAMP	HX CONI SEMS	F									1	1.50
G-5362	CAPACITOR - RADIO NOISE w GAUGES	EXT KEPS NUT	F									2	2.00
G-5298	CLOCK - IN DASH	HXWA SCREWS	F									2	1.00
G-5305	COURTESY LAMP, GLOVE BOX w AC	HX ABT FLAT SEMS	F									1	1.50
G-4990	COURTESY LAMPS, UNDERDASH (69F CONV)	HXWA SCREWS	F									2	1.50
G-5211	DEFOGGER SWITCH HOUSING - Rr WINDOW	HXWA SCREWS	F									2	1.50
G-4989	DIMMER SWITCH	HXWA AB SCREWS	F									2	2.00
G-5355	FLASHER BRACKET > DASH	HXWA AB SCREW	F									1	1.00
G-4986	FUSE PANEL > FIREWALL	#10 x 2 1/4 HXWA AB SCREWS w SEALER	F									2	3.00
G-6410	H/L, P/L GROUND, HORN RELAY JUNCTION	HXWA AB SCREWS, TOOTH WA'S, NUTS	F									6	3.00
G-5361	H/L, P/L GROUNDS	HXWA AB SCREWS, TOOTH WA'S	F									4	2.00
G-6530	HEADLAMP ADJUSTERS	SCREWS, NYLON NUTS, SPRING NUTS	F									10	8.00
G-6622	HEADLAMP RETAINING RINGS	PH RND SCREWS	F									6	2.00
G-6567	HEADLAMP RETAINING RINGS	SLOT PN SCREWS	F									6	3.00
G-5128	HEATER SWITCH (exc 70-72A) or AC FAN	HXWA B SCREWS	F									2	1.50
G-4207	HORN (1)	HX PP CONI SEMS	F									1	1.50
G-6349	HORN RELAY	HXWA AB SCREW w SEALER	F									1	1.00
G-5356	HORN, HIGH NOTE - BASE MODEL	HXWA AB SCREW w SEALER, FLAT WA	F									2	3.00
G-4647	IGNITION COIL & STRAP	HX EXT SEMS, SLOT RND T SCREW	F									3	4.00
G-5367	IGNITION KEY WARNING BUZZER	HXWA AB SCREW	F									1	1.50
G-5199	INSTRUMENTS CIRCUIT BOARD	NUTS, FLAT WA'S	F									6	2.00
G-5296	INSTRUMENTS CIRCUIT BOARD w GAUGES	HXWA B SCREWS, NUTS, FLAT WA'S	F									20	4.00
G-4128	MARKER LAMPS (Fr & Rr)	STAMPED NUTS	F									8	4.00
G-5153	NEUTRAL STARTING SWITCH - M/T	HXWA AB SCREW, FLAT WA	F									2	1.50
G-5202	PARKING BRAKE ALARM SWITCH	HXWA AB SCREW	F									1	1.00
G-6625	PARKING LAMP LENSES	SS/CHROME PH PN .488 SHLDR SCREWS	F									4	4.00
G-4116	PARKING LAMPS - STD	PH PN AB SCREWS, SPRING NUTS	F									8	3.00
G-4115	PARKING LAMPS (All 69F, 70-73F R/S)	EXT KEPS NUTS	F									4	3.00
G-5369	POWER ACCY CIRCUIT BREAKER	NYLON INSERT HX NUTS	F									2	1.50
G-5295	RADIO BRACKETS	HXWA AB & B SCREWS, SPRING NUTS	F									8	3.00
G-5301	RADIO NOISE CAPACITOR > COIL BRACKET	HXWA T SCREW, TOOTH WA	F									2	1.50
G-5368	SPEAKER > DASH	HXWA AB SCREW, SPRING NUT	F									2	1.50
G-5152	STARTER - 307, 70F & 71AF 350, 72F 396 A/T	1.84 & 4.69 FLNG BOLTS, SEMS, NUT, WA	F									5	8.00
G-5874	STARTER - 350 70A, 71MC, 72F, 72A/73F M/T	3.62 L HX BOLTS, HX CONI SEMS, NUT, WA	F									5	8.00
G-5873	STARTER & BRACE - 396/454 & 350 w A/T	4.69 L FLNG BOLTS, CONI SEMS, NUT, WA	F									5	8.00
G-5340	STARTER & BRACE - 396/454 (exc 72 A/T)	3.62 L HX BOLTS, HX CONI SEMS, NUT, WA	F									5	8.00
G-5201	STOPLAMP SWITCH	SPECIAL ROUND RETAINER	F									1	2.00
G-5365	TACHOMETER	HXWA AB SCREWS	F									3	1.30
G-6928	TAILAMPS > BODY	STAMPED NUTS	F									8	5.00
G-4992	TURN SIGNAL LEVER	PH PN AB SCREW	F									1	1.00
G-5304	UNDERHOOD LAMP	HXWA B SCREWS	F									2	1.50
G-6534	WIRING - BLOWER MOTOR	RUBBER COATED J-CLIP	F									1	3.00
G-5364	WIRING - ENGINE > HORN RELAY JUNCTION	12-24 LOCK NUT	F									1	2.00
G-5177	WIRING - FUEL SENDER UNIT GROUND	HXWA AB SCREW	F									1	1.00
G-6533	WIRING - HEATER > CASE	RUBBER COATED J-CLIP	F									1	3.00
G-6464	WIRING - HORN (low note) LEAD	5.1" FLEXIBLE STRAPS	F									2	5.00
G-5357	WIRING - INSTR HARNESS GROUND @ flasher	HXWA AB SCREW, TOOTH WA	F									2	1.50
G-5194	WIRING - STARTER TERMINALS	NUTS, TOOTH WA'S	F									4	1.50
G-5956	WIRING - TAILAMP	RETAINING CLIPS @ LH TRUNK OPENING	F									3	4.00
G-6474	WIRING - TCS SWITCH > DIPSTICK TUBE	5.1" FLEXIBLE STRAP	F									1	3.00
G-5089	WIRING - TEMPERATURE SENDER	NUT, TOOTH WA	F									2	1.50
G-5190	WIRING HARNESS > LH WHEELHOUSE	PUSH-ENDS BLACK PLASTIC STRAPS	F									3	4.00
G-4987	WIRING HARNESS CONNECTOR > FIREWALL	HXWA SCREWS	F									2	2.00

Emissions

G-4971	SMOG HOSE CLAMPS	TOWER TYPE CLAMPS	F									4	8.00
G-5261	SMOG PUMP - 350 NB2 TYPE 72	HX BOLTS, SPLIT WA'S, SPACER	F									7	10.00
G-4843	SMOG PUMP PULLEY	HX BOLTS, SPLIT WA'S	F									6	3.00
G-5339	SMOG VALVE & BRACKET	HX FLNG SCREWS	F									4	4.00

Exhaust

G-5247	EXHAUST HANGERS, DUAL	HXWA SCREWS, HX SPLIT SEMS	F									6	8.00
G-5173	EXHAUST HANGERS, SINGLE	HXWA SCREWS, HX SPLIT SEMS	F									4	6.00
G-5266	EXHAUST PIPE > MANIFOLDS	STUDS, LOCK NUTS	F									12	14.00
G-5325	EXHAUST PIPE, SHIELDS	HX AB FLAT SEMS	F									8	4.00

See factory Assembly Manuals for illustrations

1973

Fuel

PART #	APPLICATION	NOTES	F	CAMARO										PCS	PRICE	
G-5160	ACCELERATOR CABLE	5/16-18 BALL STUD, KEPS NUT	F												2	6.00
G-5161	ACCELERATOR LEVER SUPPORT	HX AB FLAT SEMS	F												3	3.00
G-5174	FUEL HOSES - 307, 350, '70 396	FLAT WOUND SPR CLAMPS (Blk, Green)	F												6	4.00
G-5052	FUEL RETURN HOSES	FLAT WOUND SPRING CLAMPS (Red)	F												6	4.00
G-4164	FUEL VAPOR CANISTER	HXWA AB & B SCREWS	F												4	2.00
G-5273	FUEL VAPOR LINE HOSES	FLAT WOUND SPR CLAMPS (Blk, Grn, Red)	F												3	3.00
G-5176	GAS TANK	BOLTS, WA'S, NUTS, SCREWS, SPACERS	F												12	12.00

Heater

G-5133	DEFROSTER DUCTS	HX SEMS, RIVETS, SPR NUTS, RETAINERS	F												6	3.00
G-4327	HEATER BLOWER MOTOR	SRTD HXWA AB SCREWS	F												5	1.50
G-5132	HEATER BOX > FIREWALL	HX INT/EXT AB SEMS, STAMPED NUTS	F												7	4.00
G-5129	HEATER CONTROL CABLES	HH & HXWA SCREWS, WA'S, RTNRS	F												11	3.00
G-5236	HEATER CONTROL CABLES w AC	SCREWS, WA , RETAINERS, RIVETS	F												9	4.00
G-5131	HEATER DUCT OUTLET (under dash)	HX AB FLAT SEMS	F												3	2.00
G-5397	HEATER HOSE CLIP @ WHEELHOUSE	FOLDOVER METAL CLIP	F												1	4.00
G-5857	HEATER HOSE CLIP > ALT BRACKET	HOSE CLIP, HXWA T SCREW	F												2	5.00
G-4952	HEATER HOSES	BAND CLAMPS w STRAIGHT UP SCREW	F												4	8.00
G-4616	HEATER RESISTOR > BOX	HXWA AB SCREWS	F												2	1.00

Interior

G-6160	AIR OUTLET BEZELS (w AC) - Under Dash	HX AB FLAT SEMS, SPRING NUTS	F												14	5.00
G-5328	AIR OUTLET BEZELS (w AC) > DASH	HX ABT FLAT SEMS, STAMPED NUTS	F												8	4.00
G-6302	ASH TRAY FACE PLATE	HX AB FLAT SEMS	F												2	2.00
G-5113	ASH TRAY RETAINER	HXWA AB SCREWS	F												3	2.00
G-5320	CONSOLE > FLOOR BRACKETS	HXWA AB & TEK SCREWS	F												6	3.00
G-5281	CONSOLE BRACKET > A/T SHIFTER	HX BOLTS	F												3	2.00
G-5323	CONSOLE COMPARTMENT	HXWA SCREWS	F												2	1.50
G-5324	CONSOLE END	HXWA SCREWS	F												2	1.50
G-5314	DASH PAD	HXWA SCREWS, FLAT SEMS, SPR NUTS	F												17	6.00
G-5366	FLASHER KNOB	PH OV MS	F												1	1.50
G-5317	GLOVE BOX DOOR & STOP	SCREWS, SPRING NUTS	F												18	5.00
G-6585	GLOVE BOX DOOR BUMPERS	RUBBER BUMPERS	F												2	2.00
G-5119	GLOVE BOX LINER	HXWA AB SCREW	F												1	1.50
G-5316	GLOVE BOX STRIKER	HXWA SCREWS, SPRING NUTS	F												4	2.00
G-5130	HEATER CONTROL > DASH	HX ABT FLAT SEMS	F												3	2.00
G-5118	INSTRUMENT CLUSTER & CARRIER > DASH	PH OV AB & HX FLAT SEMS, SPR NUTS	F												18	6.00
G-4617	INSULATION > FIREWALL	RUBBER RETAINERS	F												4	6.00
G-5124	PILLAR MOULDINGS	CHROME PH OV AB SCREWS	F												2	1.50
G-5318	RADIO CONTROL SHAFTS	SPECIAL THIN HX NUTS	F												2	4.00
G-4321	SCUFF PLATES, DOOR OPENING	SS/CHROME PH OV AB SCREWS	F												8	2.50
G-5134	SEAT TRACKS > SEAT	SCREWS	F												8	6.00
G-5182	STEERING COLUMN COVER > DASH	HXWA SCREWS, PH OV SEMS, SPR NUTS	F												8	3.00
G-5315	STEERING COLUMN COVER > FIREWALL	HX AB FLAT SEMS w SEALER	F												2	3.00
G-5121	VENTILATION OUTLETS & DUCT	HX ABT FLAT SEMS, HXWA AB SCREWS	F												8	3.00

Mouldings

G-4371	FENDER MOULDINGS @ Rr TOP	CHROME SCREWS	F												4	2.00
G-5126	ROCKER MOULDINGS	SCREWS ONLY	F												20	4.00
G-6542	WINDOW (Fr) MOULDINGS	RETAINING CLIPS	F												22	12.00
G-6540	WINDOW (Rr) MOULDINGS	RETAINING CLIPS	F												22	12.00

Steering & Suspension

G-4631	AXLE HSNB > SPRINGS	SPECIAL GR-8 LOCK NUTS ONLY !	F												8	12.00
G-4897	AXLE HSNB > SPRINGS - 70F > w/o STAB BAR	MULTI SPRINGS, T, U BOLTS, LOCK NUTS	F												14	32.00
G-5257	AXLE HSNB > SPRINGS w STABILIZER BAR	LONG T- BOLTS, U-BOLTS, LOCK NUTS	F												14	34.00
G-5458	CONTROL ARM BUSHINGS - UPPER	RETAINERS, LOCK NUTS	F												8	12.00
G-5037	CONTROL ARMS - LWR	GR-8 HX BOLTS, LOCK NUTS	F												8	20.00
G-5138	CONTROL ARMS - UPPER	GR-8 KNURL BOLTS, LOCK NUTS, SHIMS	F												18	20.00
G-4669	GREASE FITTINGS	STRAIGHT	F												10	3.00
G-4465	IDLER ARM > FRAME	GR-8 HX BOLTS, WA'S, NUTS	F												6	8.00
G-4607	LEAF SPRING, Fr HANGERS	HX PP CONI SEMS, SPECIAL U-NUTS	F												12	18.00
G-4630	LEAF SPRINGS, Fr EYE	GR-8 BOLTS, NUTS, WA'S	F												8	12.00
G-5291	P/S PUMP - 307, 350 (F only)	HX BOLTS, NUTS, WA'S, SPACER	F												19	12.00
G-4807	P/S PUMP PULLEY	THIN LOCK NUT	F												1	6.00
G-4668	PITMAN ARM > GEAR BOX	HX NUT, SPLIT WA	F												2	3.00
G-4838	SHACKLES	11/16" AF MARSDEN NUTS ONLY	F												4	6.00

1973

Steering & Suspension

PART #	APPLICATION	NOTES	F	CAMARO							PCS	PRICE
G-4586	SHOCKS (Fr) - LWR MOUNTING	HXWA CA SCREWS, U-NUTS	F								8	8.00
G-4836	SHOCKS (Fr) - UPR MOUNTING	RETAINERS, BUSHINGS, 3/8-24 NUTS	F								10	6.00
G-5143	SHOCKS (Rr) LWR MOUNTING	RETAINERS, BUSHINGS, 3/8-24 NUTS	F								10	8.00
G-6100	SHOCKS (Rr) UPR MOUNTING	HX SPLIT SEMS	F								4	6.00
G-5185	SPARE WHEEL	9 5/8" J-BOLT, WING NUT, FLAT WA	F								3	16.00
G-6461	SPARE WHEEL WRENCH > JACK	7.1" FLEXIBLE STRAPS	F								2	5.00
G-5141	STABILIZER BAR (Fr) BRACKETS	HX TY-T SCREWS	F								4	6.00
G-5140	STABILIZER BAR (Fr) END LINKS	HX BOLTS, RETAINERS, BUSHINGS, NUTS	F								22	20.00
G-5256	STABILIZER BAR (Rr) SUPPORTS	HX BOLTS, WA'S, NUTS	F								18	10.00
G-4976	STEERING COLUMN > DASH	FLNG NUTS, FLNG SCREWS (copper plate)	F								6	5.00
G-6638	STEERING COLUMN BRACKET REINF	HX PP CONI SEMS	F								4	3.00
G-4354	STEERING GEAR "RAG" JOINT	12 PT BOLT ONLY	F								1	3.00
G-5180	STEERING GEAR BOX > FRAME	GR-8 HX BOLTS, FLAT WA'S	F								6	12.00
G-5139	STEERING LINKAGE & BALL JOINTS	GR-8 LRG HX SLOT NUTS, COTTER PINS	F								20	15.00
G-4670	STEERING SHAFT > COUPLING	REG & HVY NUTS, SPLIT WA'S	F								4	3.00
G-4337	SUSPENSION BUMPERS & BRACKETS (Rr)	HX PP CONI SEMS, HXWA SCREWS, NUTS	F								12	10.00
G-4596	SUSPENSION BUMPERS (Fr)	HX NUTS	F								2	1.00
G-6583	WHEEL STUDS - 1 AXLE (Fr or Rr)	Does 2 wheels, 7/16-20 x 1.38" L	F								10	14.00
G-5060	WHEELS - STD	ORIGINAL LUG NUTS w "DIAMONDS"	F								20	25.00

Transmission

G-6611	BELL HOUSING > ENGINE	FLNG BOLTS, "M" MARKING	F								6	8.00
G-6149	BELL HOUSING > ENGINE	FLNG BOLTS (Flat Top) "A" MARKING	F								6	8.00
G-5416	BELL HOUSING Fr COVER PLATE	SS EXT SEMS "L"	F								4	3.00
G-6630	CLUTCH BELLCRANK BRACKET > FRAME	HXWA SCREWS	F								3	3.00
G-5146	CLUTCH PEDAL	HX BOLT, WA, NUT ONLY !	F								3	4.00
G-5603	CLUTCH PEDAL BUSHINGS	NYLON BUSHINGS ONLY	F								2	3.00
G-4658	CLUTCH PEDAL PUSH ROD SEAL	HXWA AB SCREWS	F								2	1.00
G-6628	CLUTCH PEDAL PUSH RODS	WIRE RETAINERS, FLAT WA	F								4	4.00
G-6192	CONTROL LINKAGE > COLUMN - M38/M40	RETAINERS, SLEEVE, WA'S, NUT, SCREW	F								8	12.00
G-4792	COVER - CLUTCH PEDAL HOLE	HXWA SCREWS	F								2	1.50
G-4796	DRIVESHAFT, TH400 '69 > 302, 350, BB. All 71 >	STRAPS, FLNG BOLTS	F								6	8.00
G-6573	FLYWHEEL - A/T	GR-8 HXWA SCREWS	F								12	16.00
G-4429	FLYWHEEL - M/T	11/16" AF X 1.0" L HX BOLTS	F								12	12.00
G-6150	PRESSURE PLATE > FLYWHEEL	SPECIAL HX BOLTS, SPLIT WA'S	F								12	6.00
G-5165	SHIFTER BOOT PLATE w/o CONSOLE	CHROME PH OV AB SCREWS	F								4	2.00
G-5164	SHIFTER CONTROL & SUPPORT - 3 SPD	HX BOLTS, SPLIT & FLAT WA'S	F								9	6.00
G-6303	SHIFTER DIAL (A/T) & SENDER - IN DASH	PH FLAT B SCREW, HX AB FLAT SEMS	F								3	2.00
G-5166	SHIFTER KNOB	CHROME HX JAM NUT	F								1	2.00
G-5349	SHIFTER LEVER > FLOOR - A/T w CONSOLE	EXT SEMS, HXWA SCREWS, RIV-NUTS	F								6	6.00
G-5898	SHIFTER LEVERS - 4S, 70-71A HD, 70F L65	HX BOLTS, FLAT & SPLIT WA'S	F								9	4.00
G-5897	SHIFTER LEVERS > CASE - 3 SPD M/T	HX BOLTS, SPLIT & FLAT WA'S	F								6	3.00
G-5167	SHIFTER RODS - 3 SPD	RETAINERS, FALT & WAVE WA'S, NUTS	F								14	8.00
G-5276	SHIFTER RODS - 4 SPD	RETAINERS, FLAT & WAVE WA'S	F								21	12.00
G-4694	SPEDOMETER CABLE > TRANS	HX SPLIT SEMS	F								1	2.00
G-5363	SPEDOMETER CABLE > TRANS (M38, M40)	USED WITH ADAPTER, HX BOLT	F								1	1.50
G-5169	TCS RELAY	HXWA AB SCREWS	F								2	1.50
G-5279	TORQUE CONVERTOR > FLYWHEEL - PG, TH350	FLNG BOLTS, NUTS	F								6	5.00
G-5280	TORQUE CONVERTOR > FLYWHEEL - TH400	FLNG BOLTS	F								6	6.00
G-6508	TRANS (TH350) DETENT CABLE > TUBE	4.05" ALUMINUM STRAP	F								1	3.00
G-5286	TRANS (TH400) CONTROL SW (at gas pedal)	HXWA AB SCREW	F								1	1.00
G-5171	TRANS BACKDRIVE - M/T	RETAINERS, FITTINGS, NUTS, WA'S	F								13	16.00
G-5345	TRANS BACKDRIVE SUPPORT > FRAME (M/T)	HXWA AB SCREWS	F								3	3.00
G-4169	TRANS CROSSMEMBER	HX BOLTS, WA'S (RH SIDE), NUTS	F								14	6.00
G-4603	TRANS INSULATOR	HX BOLTS, FLAT & SPLIT WA'S	F								10	6.00
G-5344	TRANS LINKAGE SUPPORT > FRAME	HXWA AB SCREW	F								1	2.00
G-6311	TRANS OIL PAN w CNSL TH350 73-81, TH400	LRG FLNG HEAD SCREWS	F								13	7.00
G-6310	TRANS OIL PAN w/o CNSL - TH350 All, TH400	LRG FLNG HEAD SCREWS	F								13	6.00
G-5070	TRANSMISSION (A/T) > ENGINE (exc 67-68 PG)	HX BOLTS, SPLIT & FLAT WA'S	F								9	6.00
G-4590	TRANSMISSION (STD) > BELL HOUSING	HX BOLTS, SPLIT WA'S	F								8	5.00
G-4909	TRANSMISSION OIL COOLER LINES	C SHAPED SPRING CLIPS	F								2	3.00
G-6637	UNDERPAN - TH400	HXWA AB SCREWS	F								4	2.00

Wipers

G-4162	WINDSHIELD WASHER BOTTLE	HXWA AB SCREWS, SPRING NUTS	F								4	2.00
G-4163	WINDSHIELD WASHER NOZZLES	#10 HXWA AB SCREWS	F								2	1.00
G-4153	WIPER ARM PIVOTS > COWL	HX CONI TOOTH SEMS	F								6	3.00
G-4329	WIPER MOTOR	HX CNTRSNK EXT SEMS	F								3	3.00
G-5465	WIPER MOTOR	GROMMETS, GRD STRAP, RIVET, SCREWS	F								8	12.00
G-5335	WIPER SWITCH	HXWA AB SCREWS, TOOTH WA	F								4	1.50

See factory Assembly Manuals for illustrations

GM Fastener Kits

401

1974 - 81 Camaro

Body

PART #	APPLICATION	NOTES	1970's YEAR					1980's YEAR					PCS	PRICE
G-4463	AIR DEFLECTORS @ Rr QUARTERS	PH RNDWA SCREWS, CONI KEPS, SEALER	-	-	-	-	-	9	0	-	-	-	16	6.00
G-4101	BATTERY TRAY	HX CONI SEMS, HXWA CA SCREWS	4	5	6	7	8	9	0	-	-	-	4	3.00
G-4380	BUMPER (Fr) 11-16-75 >	CRG BOLTS, LG FLNG NUTS	-	-	6	7	-	-	-	-	-	-	22	10.00
G-4379	BUMPER (Fr) < 11-16-75	CRG BOLTS, FLNG NUTS	4	5	6	-	-	-	-	-	-	-	32	14.00
G-4453	BUMPER (Fr) AIR DEFLECTORS	1/4" PUSH-ON NUTS	-	-	-	-	-	9	0	-	-	-	8	2.00
G-4385	BUMPER (Fr) CENTER & OUTER BRACKETS	11/16" AF HX BOLTS, NUTS, WA'S	4	5	6	7	-	-	-	-	-	-	12	10.00
G-4391	BUMPER (Fr) CROSSMEMBER	HX FLAT SEMS	4	5	6	7	8	9	0	-	-	-	4	6.00
G-4384	BUMPER (Fr) FILLER PANELS	HX AB FLAT SEMS, SPRING NUTS	4	5	6	7	-	-	-	-	-	-	24	10.00
G-4390	BUMPER (Fr) FRAME BRACKETS	SPECIAL FLNG BOLTS, NUTS, CONE WA'S	4	5	6	7	8	9	0	-	-	-	12	20.00
G-4387	BUMPER (Fr) GUIDE TUBES	BOLTS, WA'S	4	5	6	7	-	-	-	-	-	-	8	6.00
G-4388	BUMPER (Fr) SPRING ARMS	NUTS, SPLIT WA'S	4	5	6	7	-	-	-	-	-	-	4	2.00
G-4389	BUMPER (Fr) TUBULAR BRACES	HX CONI SEMS, FLNG NUTS	4	5	6	7	-	-	-	-	-	-	4	4.00
G-4436	BUMPER (Rr)	CRG BOLTS, SEALING WA'S, NUTS	-	-	-	-	8	-	-	-	-	-	34	16.00
G-4454	BUMPER (Rr)	CRG BOLTS, SEALING WA'S, NUTS	-	-	-	-	-	9	0	-	-	-	32	15.00
G-4394	BUMPER (Rr) 2-5-76 >	HX CA FLAT SEMS, LRG FLNG NUTS	-	-	6	7	-	-	-	-	-	-	24	14.00
G-4393	BUMPER (Rr) < 2-5-76	CRG BOLTS, HX CA FLAT SEMS, NUTS	4	5	6	-	-	-	-	-	-	-	33	18.00
G-4400	BUMPER (Rr) CENTER & OUTER BRACKETS	11/16" AF HX BOLT, NUTS, FLAT WA'S	4	5	6	7	-	-	-	-	-	-	12	10.00
G-4401	BUMPER (Rr) FILLER PANELS	HX FLAT SEMS, NYLON RETAINERS	4	5	6	-	-	-	-	-	-	-	17	8.00
G-5312	BUMPER (Rr) FILLER PANELS	HX FLAT SEMS, NYLON RETAINERS	-	-	-	7	-	-	-	-	-	-	16	8.00
G-4397	BUMPER (Rr) SPRING ARMS & SUPPORTS	CRG BOLTS, CONI WA'S, NUTS, SEALER	4	5	6	7	-	-	-	-	-	-	28	18.00
G-4430	BUMPER BAR (Fr) > OUTER PLATES	CRG BOLTS, LRG FLNG NUTS	-	-	-	-	8	9	0	-	-	-	24	12.00
G-4431	BUMPER BAR (Fr) CENTER PLATE	CRG BOLTS, LRG FLNG NUTS	-	-	-	-	8	9	0	-	-	-	12	6.00
G-4433	BUMPER BAR (Fr) OUTER PLATES	FLNG NUTS, RETAINERS	-	-	-	-	8	9	0	-	-	-	8	5.00
G-4434	BUMPER BAR (Fr) TUBULAR BRACES	HX BOLTS, RATCHET WA'S, FLNG NUTS	-	-	-	-	8	9	0	-	-	-	6	8.00
G-4392	BUMPER GUARDS (Fr)	LRG FLNG NUTS	4	5	6	7	-	-	-	-	-	-	4	3.00
G-4382	BUMPER PAD (Fr) 11-16-75 >	STAMPED NUTS	-	-	6	7	-	-	-	-	-	-	4	2.00
G-4381	BUMPER PAD (Fr) < 11-16-75	STAMPED NUTS	4	5	6	-	-	-	-	-	-	-	16	5.00
G-4396	BUMPER PAD (Rr) 2-5-76 >	STAMPED NUTS	-	-	6	7	-	-	-	-	-	-	6	3.00
G-4395	BUMPER PAD (Rr) < 2-5-76	STAMPED NUTS	4	5	6	-	-	-	-	-	-	-	14	5.00
G-4332	DOOR LATCHES	OV HD TT SCREWS	4	5	6	7	-	-	-	-	-	-	6	3.00
G-4130	EMBLEM / NAMEPLATE, GRILLE	9/16" OD STAMPED NUTS	4	-	-	-	8	9	0	-	-	-	2	1.00
G-4372	EMBLEM, HEADER PANEL	STAMPED NUTS	-	5	6	7	-	-	-	-	-	-	3	1.00
G-4105	FENDER > RADIATOR SUPPORT BRACES	HXWA CA SCREWS	4	5	6	7	8	9	-	-	-	-	4	3.00
G-4460	FENDER > RADIATOR SUPPORT BRACES	12 PT CONI SEMS	-	-	-	-	-	-	0	-	-	-	4	3.00
G-4415	FENDER GRILLES	STAMPED NUTS	-	-	-	-	8	9	0	-	-	-	12	4.00
G-4410	FENDER LWR EXTENSION BRACES	HX CONI SCREWS, U-NUTS	-	-	-	-	8	9	-	-	-	-	6	3.00
G-4457	FENDER LWR EXTENSION BRACES	CRG BOLTS, HX CONI SEMS, NUTS	-	-	-	-	-	0	-	-	-	-	8	4.00
G-4409	FENDER LWR EXTENSIONS	HX CONI SEMS, U-NUTS	-	-	-	-	8	9	-	-	-	-	12	6.00
G-4455	FENDER LWR EXTENSIONS	HXWA SCREWS, U-NUTS	-	-	-	-	-	-	0	-	-	-	12	5.00
G-4152	FENDER SPLASH SEALS	SEMS TAPPING SCREWS	4	5	6	7	8	9	0	-	-	-	12	5.00
G-4104	FENDERS	HX CONI SEMS, U-NUTS, SHIMS	4	5	6	7	8	-	-	-	-	-	26	20.00
G-4441	FENDERS	12 PT & HX CONI SEMS, SHIMS	-	-	-	-	-	9	0	-	-	-	26	20.00
G-6593	FENDERS > FIREWALL (also in fender kits)	HX CA CONI SEMS	4	5	6	7	8	-	-	-	-	-	4	5.00
G-4156	FILLER PANEL, Rr WINDOW	PH HXWA AB SCREWS	4	5	6	7	8	9	0	-	-	-	5	3.00
G-4378	GRILLE	PH PN AB FLAT SEMS, NYLON NUTS	4	-	-	-	-	-	-	-	-	-	22	6.00
G-6430	GRILLE	PH PN AB FLAT SEMS, NYLON NUTS	-	5	6	7	-	-	-	-	-	-	17	5.00
G-4427	GRILLE	FLAT SEMS, NYLON NUTS	-	-	-	-	8	-	-	-	-	-	18	8.00
G-4448	GRILLE	FLAT SEMS, NYLON NUTS	-	-	-	-	-	9	-	-	-	-	18	8.00
G-4461	GRILLE	HXWA SCREWS, SPRING & NYLON NUTS	-	-	-	-	-	-	0	-	-	-	16	8.00
G-4449	GRILLE BRACKET, CENTER	HX CONI CA SEMS	-	-	-	-	-	9	-	-	-	-	1	1.00
G-4373	HEADLAMP BEZELS - STD	SS/CHROME PH OV SCREWS, SPR NUTS	4	5	6	7	-	-	-	-	-	-	12	4.00
G-4418	HEADLAMP BEZELS - STD	SS/CHROME TORX OV AB SCREWS	-	-	-	-	8	9	0	-	-	-	8	3.00
G-4374	HEADLAMP BEZELS - Z28	SS/BLACK PH OV AB SCREWS, SPR NUTS	4	5	6	-	-	-	-	-	-	-	12	4.00
G-6569	HEADLAMP BEZELS - Z28	BLACKPOZI OV AB SCREWS, SPR NUTS	-	-	-	7	-	-	-	-	-	-	12	4.00
G-4419	HEADLAMP BEZELS - Z28 & R/S	SS/BLACK TORX OV AB SCREWS	-	-	-	-	8	9	0	-	-	-	8	3.00
G-4375	HEADLAMP HOUSINGS	HX CONI CA SEMS, U-NUTS	4	5	6	7	-	-	-	-	-	-	12	6.00
G-4106	HOOD & HINGES	HX CONI SEMS	4	5	6	7	8	-	-	-	-	-	8	10.00
G-4442	HOOD & HINGES	HX CA & MS CONI SEMS	-	-	-	-	-	9	0	-	-	-	8	10.00
G-4445	HOOD CATCH & LOCK PLATE	12 PT CONI SEMS, HX CA CONI SEMS	-	-	-	-	-	9	0	-	-	-	7	6.00
G-4424	HOOD CATCH & LOCK PLATE 6-27-78 >	12 PT CONI SEMS, HX CA CONI SEMS	-	-	-	-	8	-	-	-	-	-	7	6.00
G-4366	HOOD CATCH & LOCK PLATE < 6-27-78	12 PT CONI SEMS, HXWA CA SCREWS	4	5	6	7	8	-	-	-	-	-	7	7.00
G-4364	HOOD CATCH SUPPORT	HX CA CONI SEMS, U-NUT	4	5	6	7	8	-	-	-	-	-	2	2.00
G-4444	HOOD CATCH SUPPORTS	HXWA CA SCREWS, U-NUTS	-	-	-	-	-	9	0	-	-	-	4	3.00
G-5210	HOOD LEVELER (Rr) - CENTER	BUMPER, ADJUSTER, FLNG NUT, U-NUT	4	5	6	7	-	-	-	-	-	-	4	5.00
G-6592	HOOD LEVELER (Rr) - CENTER	BUMPER ASSEMBLIES, FLNG NUT, U-NUT	-	-	-	-	8	9	0	-	-	-	3	5.00
G-6591	HOOD LEVELERS (Fr)	BUMPER ASSEMBLIES, FLNG NUTS	4	5	6	7	8	9	0	-	-	-	4	8.00
G-4365	HOOD LEVELERS (Rr) - OUTER	JAM NUTS only	4	5	6	7	8	9	0	-	-	-	2	3.00
G-4182	HOOD LOCK POST	FLNG NUT ONLY	4	5	6	7	8	9	0	1	-	-	1	2.00
G-4416	HOOD SCOOP	STAMPED NUTS	-	-	-	-	8	9	-	-	-	-	12	4.00
G-6431	HOOD SCOOP	STAMPED NUTS	-	-	-	-	-	-	0	-	-	-	13	4.00
G-5319	HOOD SEAL	T SHAPED NYLON RETAINERS	4	5	6	7	8	9	-	-	-	-	13	5.00
G-4432	JACKING BRACKETS > Fr BUMPER	CRG BOLTS, FLNG NUTS, RETAINERS	-	-	-	-	8	9	0	-	-	-	12	6.00
G-4438	LICENSE PLATE (Fr)	HX CONI SEMS, SCREWS, "JACK" NUTS	-	-	-	-	8	9	-	-	-	-	8	5.00
G-4995	LICENSE PLATE (Fr)	HX CONI SEMS, SCREWS, NYLON NUTS	-	-	-	-	-	-	0	-	-	-	7	4.00
G-6219	LICENSE PLATE BRACKET (Fr) 11-18-75 >	HX CA FLAT SEMS, FLNG NUTS	-	-	6	7	-	-	-	-	-	-	4	3.00

Kits Contain Attaching Fasteners for Both Sides

GM Fastener Kits

1974 - 81 Camaro

Body

PART #	APPLICATION	NOTES	1970's YEAR					1980's YEAR					PCS	PRICE
G-4402	LICENSE PLATE BRACKET (Fr) < 11-18-75	HX CA FLAT SEMS, FLNG NUTS	4	5	6	-	-	-	-	-	-	-	4	3.00
G-4100	LICENSE PLATE BRACKET (Rr)	HX BOLTS	4	5	6	7	8	-	-	-	-	2	2.00	
G-4125	NAMEPLATE, FENDERS "350" "396" "Z28"	9/16" OD STAMPED NUTS	4	-	-	-	-	-	-	-	-	4	2.00	
G-4398	NAMPELATE, FENDERS "Camaro"	STAMPED NUTS	4	5	6	7	-	-	-	-	-	6	2.00	
G-4362	NOSE PANEL	HX CA CONI SEMS, HXWA SCREWS, NUTS	4	5	6	7	-	-	-	-	-	21	8.00	
G-4428	NOSE PANEL (impact bar cover)	HX CONI SEMS, U-NUTS, RETAINERS, KEPS	-	-	-	-	8	-	-	-	-	28	16.00	
G-4450	NOSE PANEL (impact bar cover)	HX CONI SEMS, RETAINERS, U-NUTS, KEPS	-	-	-	-	-	9	-	-	-	28	16.00	
G-4456	NOSE PANEL (impact bar cover)	HX CONI SEMS, U-NUTS, RETAINERS, KEPS	-	-	-	-	-	-	0	-	-	32	16.00	
G-4435	NOSE PANEL SUPPORT	HX CONI SEMS, HX AB FLAT SEMS, SHIMS	-	-	-	-	8	-	-	-	-	33	12.00	
G-4452	NOSE PANEL SUPPORT	12 PT & HX SEMS, HX FLAT SEMS, SHIMS	-	-	-	-	-	9	0	-	-	29	14.00	
G-4458	NOSE PANEL SUPPORT, CENTER BRACE	HX MS CONI & HX AB FLAT SEMS	-	-	-	-	-	-	0	-	-	2	3.00	
G-4363	NOSE PANEL SUPPORTS	HXWA CA SCREWS	4	5	6	7	-	-	-	-	-	4	3.00	
G-4411	RADIATOR SUPPORT	HX CA CONI SEMS	-	-	-	-	8	9	0	-	-	12	6.00	
G-4414	RADIATOR SUPPORT CROSS BRACES	HXWA CA SCREWS	-	-	-	-	8	-	-	-	-	4	3.00	
G-4446	RADIATOR SUPPORT CROSS BRACES	12 PT CONI SEMS	-	-	-	-	-	9	0	-	-	4	4.00	
G-5311	SEALS (L shaped) @ COWL SIDES	T SHAPED NYLON RETAINERS	4	5	6	7	8	9	0	-	-	4	2.00	
G-5352	SEALS (tubular), COWL Fr SIDES	T SHAPED NYLON RETAINERS	4	5	6	7	8	9	0	-	-	4	2.00	
G-4166	SPOILER (Rr) - 3 PIECE	CONI KEPS NUTS, SEALER WA'S	4	5	6	7	8	9	0	-	-	24	12.00	
G-4154	TRUNK LATCH & STRIKER	HX CONI TOOTH SEMS	4	5	6	7	8	9	0	1	-	5	4.00	
G-4155	TRUNK LID > HINGES	HX CONI TOOTH SEMS	4	5	6	7	8	9	0	-	-	4	4.00	
G-4383	VALANCE (Fr)	HX CONI SEMS, HXWA SCREWS, U-NUTS	4	5	6	7	-	-	-	-	-	22	8.00	
G-4113	WHEELHOUSE Rr BRACES > BODY	HX CONI SEMS, U-NUTS	4	5	6	-	-	-	-	-	-	12	7.00	
G-4368	WHEELHOUSE Rr BRACES > BODY	HXWA CA SCREWS, U-NUTS	-	-	-	-	7	8	9	0	-	12	6.00	
G-4214	WHEELHOUSES	SCREWS, HX CONI SEMS, WA'S, U-NUTS	4	5	6	-	-	-	-	-	-	36	16.00	
G-4367	WHEELHOUSES	SCREWS, HX CONI SEMS, WA'S, U-NUTS	-	-	-	-	7	-	-	-	-	36	20.00	
G-4413	WHEELHOUSES	SCREWS, HX CONI SEMS, WA'S, U-NUTS	-	-	-	-	-	8	9	0	-	48	24.00	
G-4111	WHEELHOUSES > RADIATOR SUPPORT	HXWA CA SCREWS	4	5	6	7	-	-	-	-	-	4	3.00	
G-4412	WHEELHOUSES > RADIATOR SUPPORT	HX CA CONI SEMS	-	-	-	-	-	8	9	-	-	4	3.00	
G-4459	WHEELHOUSES > RADIATOR SUPPORT	12 PT CONI SEMS	-	-	-	-	-	-	0	-	-	4	4.00	

Other Kits

G-5161	ACCELERATOR LEVER SUPPORT	HX AB FLAT SEMS	4	-	-	-	-	-	-	-	-	3	3.00
G-4352	BATTERY HOLDOWN CLAMP	HX CONI SEMS	4	5	6	7	8	9	0	-	-	1	1.50
G-5416	BELL HOUSING Fr COVER PLATE	SS EXT SEMS "L"	4	5	6	7	8	9	0	-	-	4	3.00
G-6579	BRAKE BLEEDER SCREWS w DISC	All - CALIPERS, M/C, WHEEL CYLINDERS	4	5	6	7	8	-	-	-	-	6	10.00
G-6575	BRAKE CALIPER BLEEDERS	3/8-24 SCREWS, .28 NOSE TO FIT CAP	4	5	6	7	-	-	-	-	-	2	4.00
G-4437	BUMPER (Rr) JOINT COVER MOULDINGS	STAMPED NUTS, POZI OV SCREWS	-	-	-	-	8	9	0	-	-	6	3.00
G-5370	COOLANT RECOVERY TANK	HXWA AB SCREWS, SPRING NUTS	4	5	6	-	-	-	-	-	-	6	3.00
G-4426	COOLANT RECOVERY TANK	HXWA SCREWS, SPRING NUTS	-	-	-	-	7	-	-	-	-	6	3.00
G-4443	COOLANT RECOVERY TANK	HXWA AB SCREWS, SPRING NUTS	-	-	-	-	-	8	9	0	-	4	2.00
G-4371	FENDER MOULDINGS @ Rr TOP	CHROME SCREWS	4	5	6	-	-	-	-	-	-	4	2.00
G-6573	FLYWHEEL - A/T	GR-8 HXWA SCREWS	4	5	6	7	8	9	0	1	-	12	16.00
G-4429	FLYWHEEL - M/T	11/16" AF X 1.0" L HX BOLTS	4	5	6	7	8	9	0	1	-	12	12.00
G-4369	GRILLE MOULDINGS	HXWA SCREWS	4	5	6	7	-	-	-	-	-	22	3.00
G-4258	HEADLAMP ADJUSTERS	SCREWS, NYLON NUTS, SPRING NUTS	4	5	6	7	-	-	-	-	-	10	8.00
G-4417	HEADLAMP ADJUSTERS	ADJUSTER ASSEMBLIES, SPRINGS	-	-	-	-	8	9	0	-	-	6	8.00
G-6622	HEADLAMP RETAINING RINGS	PH RND SCREWS	4	5	6	7	8	9	0	1	-	6	2.00
G-6567	HEADLAMP RETAINING RINGS	SLOT PN SCREWS	4	5	6	7	8	9	0	1	-	6	3.00
G-5132	HEATER BOX > FIREWALL	HX INT/EXT AB SEMS, STAMPED NUTS	4	5	-	-	-	-	-	-	-	7	4.00
G-4439	HEATER BOX > FIREWALL	HX INT/EXT AB SEMS, STAMPED NUTS	-	-	6	7	8	9	0	-	-	7	4.00
G-4207	HORN (1)	HX PP CONI SEMS	4	5	6	7	8	9	0	-	-	1	1.50
G-4425	HORN (high note) > LH APRON	HXWA SCREW, FLAT WA	4	5	6	7	-	-	-	-	-	2	2.00
G-4451	HORN (low note) > RH APRON	HXWA AB SCREW, FLAT WA	-	-	-	-	8	9	0	-	-	2	2.00
G-4423	LICENSE PLATE LAMP	PH OV AB FLAT SEMS	-	-	-	-	-	8	9	-	-	2	1.00
G-4128	MARKER LAMPS (Fr & Rr)	STAMPED NUTS	4	5	6	7	8	9	0	-	-	8	4.00
G-6580	MASTER CYLINDER BLEEDERS w DISC	5/16-24 SCREWS	4	5	6	7	8	-	-	-	-	2	3.00
G-4420	PARKING LAMP BEZELS - STD	SS/CHROME TORX OV AB SCREWS	-	-	-	-	-	8	9	0	-	6	3.00
G-4421	PARKING LAMP BEZELS - Z28 & R/S	SS/BLACK TORX OV AB SCREWS	-	-	-	-	-	8	9	0	-	6	3.00
G-4422	PARKING LAMPS	HX AB FLAT SEMS, SPRING NUTS	-	-	-	-	-	8	9	0	-	8	4.00
G-4377	PARKING LAMPS - Z28	POZI PN AB FLAT SEMS, SPRING NUTS	-	-	-	-	7	-	-	-	-	8	4.00
G-4376	PARKING LAMPS (exc 77F Z28)	PH PN AB SCREWS, SPRING NUTS	4	5	6	7	-	-	-	-	-	8	4.00
G-4403	TAILAMPS > BODY	CONI TOOTH KEPS NUTS	4	-	-	-	-	-	-	-	-	12	6.00
G-6508	TRANS (TH350) DETENT CABLE > TUBE	4.05" ALUMINUM STRAP	4	5	-	-	-	-	-	-	-	1	3.00
G-6576	WHEEL CYLINDER (2) BLEEDERS	Does 2 cylinders, 5/16-24 SCREWS	4	5	6	7	8	-	-	-	-	2	7.00
G-6578	WHEEL CYLINDER BLEEDER PROTECTORS	PLASTIC CAPS w STRAP	4	5	6	7	8	9	0	1	-	2	2.00
G-6581	WHEEL CYLINDERS (2)	HX INT SEMS	4	5	6	7	8	-	-	-	-	4	3.00
G-6583	WHEEL STUDS - 1 AXLE (Fr or Rr)	Does 2 wheels, 7/16-20 x 1.38" L	4	5	6	7	8	9	0	1	-	10	14.00
G-6542	WINDOW (Fr) MOULDINGS	RETAINING CLIPS	4	5	-	-	-	-	-	-	-	22	12.00
G-6540	WINDOW (Rr) MOULDINGS	RETAINING CLIPS	4	-	-	-	-	-	-	-	-	22	12.00
G-4162	WINDSHIELD WASHER BOTTLE	HXWA AB SCREWS, SPRING NUTS	4	-	-	-	-	-	-	-	-	4	2.00
G-4163	WINDSHIELD WASHER NOZZLES	#10 HXWA AB SCREWS	4	5	6	7	8	9	0	-	-	2	1.00

See factory Assembly Manuals for illustrations

Term	Definition	Term	Definition
17	Type. sheet metal screw. AB with cutting slot (same as ABT)	DR	drum brakes
2V or 4V	two barrel or four barrel carburetor	drill screw	drill point tapping screw - also known as a TEK screw
63	FORD body style 63, "Fastback", has long sloping Rr window	drive screw	screw with twist thread - intended to be hammered or pressed in
63A, 65A, 76A	A" signifies Standard interior - FORD	E body	Chrysler: Baracuda & Challenger 1970-74
63B, 65B, 76B	B" signifies Deluxe interior - FORD	exc	excluding, does not contain
65	Mustang body style 65 - "Coupe", near vertical Rr window	EXH	exhaust
6V or 8V	3 two barrel carburetors or 2 four barrel carburetors	export Brace	one piece chassis stiffening brace for export or HP Mustangs
76	body style 76 - Convertible, all FORD	EXT	external
<	before this date	EXT SEMS	screw & external tooth washer assembly
>	after this date, one part to another (ex. Fuse Block > Firewall)	external tooth	locking washer featuring twisted teeth on OD
A	Type. sheet metal screw with pointed end	F	Type. machine screw with several cutting slots at flat end
A body	GM: mid-size Chevelle, LeMans etc. Chrysler: Dart, Duster etc	F body	GM: Camaro & Firebird
A/T	automatic transmission	F/P	fuel pump
AB	Type. sheet metal screw with pointed end - finer pitch than A	FD	fold down (seat)
ABT	Type. sheet metal screw with pointed end and cutting slot	FDR	fender
AC	air conditioning	FDS	fold down seat
ACCEL	accelerator	FE	352/390/427/428 Big Block - FORD
acorn nut	closed nut with acorn shaped top	fender extension	panel between headlamps and fender, usually zinc die cast
ADJ	adjustment	FILL	fillister head style
AF	across flats (wrench size)	flange bolt	hex head bolt with 22 degree slope from hex to washer OD
ALT	alternator	flange screw	hex head screw with 22 degree slope from hex to washer OD
ALUM	aluminum	flat head	V-shaped head screw, flat on top
AMP	ampere, current flow volume	FLAT SEMS	screw & flat washer assembly
ASSY	assembly	FLNG	flange
B	Type. sheet metal screw with flat end - finer pitch than A	FLUSH SEMS	screw & countersunk washer assembly
B body	Chrysler: mid-size Belvedere, Charger, Coronet, Roadrunner	FMX	automatic transmission - FORD, introduced 1968
BB	big block	former	thread forming screw C, CA, TT etc, no cutting slot
BEF	before, as in prior to a certain date, < 2/15/68	Fr	front
BF	Type. sheet metal screw with flat end and cutting slots	FRT	front
BLK	block	FT	full thread
body bolt	fender bolt, common sheet metal attaching fastener	GEN	generator
bolt	threaded fastener designed to be tightened by a nut	grade	strength/material specification
BRG	bearing	GRD	ground
BRKT	bracket	GT	model name derived from Grand Touring or Grand Torismo
BT	Type. sheet metal screw with flat end and large cutting slot	H-pipe	dual exhaust inlet pipe for 8 cyl exhaust manifolds, H shape
C	Cleveland (351 engine) - Cleveland, OH engine plant	hardtop	cars with a metal roof (not a convertible)
C4 or C6	automatic transmission - FORD	HD	head, heavy duty
CA	Type. thread forming machine screw threaded to point	headers	welded steel tubes used in place iron manifolds to improve flow
canoe clip	push clip with hollowed out body	headlamp doors	trim which fill space between headlamps and surrounding area
CARB	carburetor	HEX	hexagon, also see AF (across flats)
CDC	cadmium with yellow chromate (yellow color)	HI-HXWA	hex washer head with higher hex
CJ	Cobra Jet - FORD 351, 428, 429	hockey stick	trim around quarter window C shaped like a hockey stick
clipped	round part with side cut-off (ex. D shape)	HP	Hi-Po, Hi-Performance
CLR	collar - hex or round	HSG	housing
CONI	conical spring washer	HTR	heater
conical tooth	conical spring washer with teeth	HVY	heavy - larger hex size and greater thickness
countersunk	V-shaped under head	HX	hex
cowl	panel in front of windshield, usually vented to supply outside air	HXWA	hex washer head
CP	coupe	ID	inside diameter
CRG	carriage bolt	IGN	ignition
CTR	center	INST	instrument
cutter	thread cutting screw F, T, BT, 17, 1 etc, always has cutting slot	INT SEMS	screw & internal tooth washer assembly
CV	convertible	internal tooth	locking washer featuring twisted teeth on ID
CYL	cylinder (ex. 6 cyl)	Jam Nut	hex nut that is thinner than a regular nut
C_	Type. thread forming machine screw, 3-4 thread taper to flat end	KEPS	nut & washer assembly
DC	disc brakes	KR	1968 Shelby Mustang model - meaning "King of the Road"
DE	double end	L/W	lock washer
DIA	diameter	L78	GM: 396HP
differential	gears located in axle housing, may be mounted inside a carrier	LH	left hand
DLX	deluxe	Lock Nut	nut with any type of locking feature

Glossary

Term	Definition	Term	Definition
LRG	large	serrated	ramped teeth used as locking feature
LWR	lower	shaker	type of Ram-Air, part of engine air cleaner visible from outside
M/T	manual transmission	shaved	machined point (used when point cannot be formed)
M20	GM: 4 speed transmission	shock tower	vertical body-chassis structure surrounding the Fr coil springs
M35	Powerglide transmission - GM	sill plates	trim panel at bottom of door opening, also called scuff plates
M38	TH350 transmission - GM	sim	similar
M40	TH400 transmission - GM	SKT	socket
Machine Screw	screws with thread (UNC, UNF) for use w threaded holes or nuts	sleeve nut	a self-retaining tubular nut which accepts a push-in stud
Marsden	hex nut with narrow slots which function as lock feature	slotted nut	nut with slots for locking pin
MLDG	moulding	SMS	sheet metal screw - identified by coarse thread pitch
Monte Carlo bar	chassis stiffening bar located between shock towers - FORD	SPL	special
MS	screws with thread (UNC, UNF) for use w threaded holes or nuts	split lock	helical spring washer used to prevent loosening of joint
MT	multi thread, an extruded cone in a stamping with 3+ threads	SPLIT SEMS	screw & split washer assembly
MTR	motor	SPR	spring
NOS	new old stock	SQR	square
nose panel	large one piece panel at front of car	Square Cone	special domed conical washer - see B-13229
notchback	refers to a Mustang Coupe (body 65), near vertical Rr window	SRTD	serrated
NPT	National Pipe Thread", special self sealing tapered thread	SS	stainless steel, or Super Sport
OD	outer diameter	STD	standard
OE	original equipment	STL	steel
outlet pipe	exhaust pipe from muffler to end	SUSP	suspension
OV	oval head, V-shaped head screw with lightly rounded top	sway bar	another name for stabilizer bar, reduces body roll in turns
oval head	V-shaped head screw, lightly rounded on top	T	Type. thread cutting machine screw, flat end w large cutting slot
P/L	parking lamps	T-bolt	bolt with T shape
P/S	power steering	T1	Type 1. thread cutting machine screw utilizing narrow slot
pan head	screw head resembling inverted kitchen pan	tapping screw	screw with a thread cutting or forming feature
PCS	pieces	TE	thermactor emissions, "smog"
perch	used to connect coil spring to upper control arm	TEK	drill point tapping screw
PERI	conical washer with teeth under perimeter edge	TEMP	temperature
PG	Powerglide transmission - GM	TH	Turbo Hydromatic - GM
PH	Phillips drive (looks like +) also phosphate finish	TK	thick
PHOS	phosphate crystal surface finish usually with oil, gray to black	TORX	6-lobe drive
PI	Police Interceptor - FORD 428	TRANS	transmission
pillar	refers to a vertical sheet metal structure	transverse	mounted left - right (ex. transverse muffler)
place bolt	hex bolt with slots on top of head which function as lock feature	trap door	door located between interior and trunk on Mustang Fastback
plenum	air chamber (ex. heater plenum or ram-air plenum)	truss head	screw head with low rounded shape
PN	pan head - screw head resembling inverted kitchen pan	TT	Taptite - thread forming identified by tri-lobular shape
Pony interior	refers to 1965-66 Mustang Deluxe interior	U-Joint	universal joint (for driveshaft)
Pozi	screw drive similar to Phillips, identified by extra "cross hairs"	UBS	Unified Bearing Stress (HD Ford design for flange bolts & nuts)
PP	pinch point, machine screw with pinch formed V-shaped point	UNC	Unified National Coarse
PT	point	UNF	Unified National Fine
QTER	quarter	unibody	design where body & frame are one, most small & mid-size cars
QTR	quarter (ex. QTR Panel)	UPR	upper
QUICKY bolt	screw stud staked to a rectangular retainer plate	VAC	vacuum
R/S	Rally Sport	VENT	ventilation
RAD	radiator	W	Windsor (351 engine) - Windsor, Ontario engine plant
Ramp-Lok	special conical tooth SEMS washer with locking ramp on top	w	with
REV	engine revolution	w/o	without
RH	right hand	WA	washer
rivet nut	threaded tubular nut installed by collapsing nut wall	WA'S	washers
RNDWA	round washer head	wafer head	thin flat head - screw looks like a T
Rr	rear	water neck	thermostat housing
S/T	standard transmission	wave washer	spring washer designed to remove slack from pivot joint
saddle	used to connect coil spring to upper control arm	WELL-NUT	rubber nut with brass thread insert
SB	small block	wheelhouses	GM, large panels shielding engine area from wheels/road dirt
SCJ	Super Cobra Jet - FORD 428, 429	XC	Extra Cooling
screw	threaded fastener designed to be tightened by the head	Y-pipe	single exhaust inlet pipe for 6, 8 cyl exhaust manifolds, Y shape
scuff plates	trim panel at bottom of door opening, also called sill plates	Z-bar	clutch linkage also known as bellcrank or equalizer
self threading	stamped nuts, identified by a single thread with two notches	ZC	Zinc (silver color)
SEMS	screw & washer assembly, also used as headmark by innovator	ZDC	Zinc Di-Chromate (yellow color)

Part #	Pg	Chrysler							FORD						
103173	129	1825112	183	6022254	109	6025346	103	6028355	133	20312-S	12	34662-S	55	42141-S	79
103196	130	1825258	22	6022258	109	6025351	104	6028372	112	20352-S	20	34663-S	55	42143-S	80
103216	131	1825449	41	6022262	111	6025352	105	6028394	57	20408-S	12	34664-S	55	42165-S	79
103217	131	1828824	173	6022582	52	6025357	106	6028465	44	20410-S	16	34670-S	41	42352-S	77
114942	40	1855561	184	6023018	44	6025358	106	6028545	85	20428-S	13	34671-S	41	42360-S	78
115314	187	1944154	151	6023019	45	6025369	109	6028581	101	20430-S	16	34692-S	42	42364-S	77
115729	40	1944171	32	6023050	177	6025379	111	6028699	49	20450-S	17	34790-S	186	42366-S	77
118615	40	1948877	48	6023054	178	6025523	45	6028729	73	20534-S	14	34792-S	186	42367-S	78
118775	182	2095875	131	6023092	94	6025558	115	6028777	45	23498-S	8	34793-S	187	42380-S	78
120368	40	2121223	177	6023118	52	6025571	113	6028915	43	31045-S	92	34802-S	186	42383-S	80
120369	40	2121573	100	6023169	57	6025689	126	6028921	100	31061-S	92	34803-S	186	42718-S	101
120377	40	2129379	14	6023187	111	6025691	126	6028940	78	31497-S	79	34805-S	186	42719-S	101
120383	187	2201842	64	6023355	101	6025699	57	6028955	124	31498-S	79	34806-S	186	42722-S	94
120395	183	2206449	169	6023394	169	6025700	100	6029402	58	31527-S	79	34807-S	187	42746-S	100
123153	187	2206450	168	6023548	27	6025701	100	6029513	97	32858-S	89	34808-S	187	42757-S	100
134174	187	2208893	155	6023930	44	6025804	49	6029562	100	33279-S	84	34809-S	187	42758-S	101
123920	186	2268282	41	6023973	53	6025982	112	6031535	55	33770-S	49	34813-S	187	42760-S	103
138493	188	2403247	31	6024015	101	6025991	129	6031573	146	33771-S	49	34814-S	187	42767-S	108
151607	15	2409824	55	6024016	101	6026092	88	6033249	162	33773-S	50	34826-S	186	42772-S	109
152364	43	2409825	55	6024018	101	6026169	19	6033369	140	33777-S	49	34827-S	186	42789-S	103
152450	59	2409826	55	6024023	113	6026218	70	6033725	73	33795-S	39	34847-S	187	42789-S	102
152451	60	2409827	55	6024027	113	6026292	62	6033883	130	33796-S	39	34848-S	187	42846-S	103
152862	61	2467693	114	6024033	113	6026429	128	6034643	130	33797-S	39	34850-S	187	42848-S	106
153187	43	2535991	171	6024060	94	6026430	64	6035041	75	33798-S	40	34905-S	188	42964-S	32
153279	104	2535992	11	6024061	94	6026634	67	6035053	105	33799-S	40	34906-S	188	42966-S	32
153293	58	2643824	32	6024064	95	6026635	94	K6035098	19	33800-S	40	34907-S	188	42973-S	33
153294	59	2660872	32	6024271	89	6026656	45	6035217	90	33825-S	39	34927-S	188	42998-S	33
153363	109	2780643	177	6024431	53	6026681	70	6035606	131	33827-S	40	34937-S	188	43011-S	33
153610	90	2806982	41	6024487	112	6026686	71	6035968AA	136	33845-S	41	34938-S	188	43251-S	92
154802	91	2863391	40	6024560	96	6026723	6	6036251AA	136	33904-S	73	34939-S	188	43255-S	92
179839	12	3420341	124	6024648	96	6026750	44	6036511AA	127	33905-S	73	34940-S	188	43256-S	92
179850	14	3420348	124	6024803	50	6026841	73	6036511AA	195	33920-S	39	34941-S	188	43260-S	96
179867	18	3832616	158	6024845	128	6026911	126	6100841	64	33922-S	39	34942-S	188	43260-S	190
180080	9	4002006	32	6024862	114	6026968	19	6502689	163	33924-S	40	34943-S	188	43263-S	98
181089	9	4661592	146	6024863	114	6026994	128	6505054AA	140	33925-S	40	34944-S	188	43265-S	109
181095	10	4683653	146	6025004	52	6027028	101	9408961	32	33943-S	41	34968-S	179	43365-S	93
181112	12	4708494	170	6025005	52	6027030	102	9411022	151	33979-S	46	34969-S	179	43395-S	92
181113	12	6001648	160	6025006	52	6027061	106	9414183	15	33985-S	46	34970-S	179	43407-S	92
181113	13	6001855	160	6025007	52	6027063	105	9415162	78	34030-S	46	34975-S	42	43408-S	92
181116	13	6002688	160	6025010	53	6027152	13	9416107	43	34033-S	46	34976-S	42	43514-S	109
181129	14	6002861	160	6025011	53	6027152	15	9417668	43	34052-S	39	34977-S	43	43519-S	110
181130	15	6008043	70	6025014	54	6027185	21	9417670	45	34053-S	39	34978-S	44	43526-S	111
181141	17	6016269	144	6025017	54	6027207	128	9417928	16	34057-S	40	34979-S	45	43530-S	112
181142	17	6029139	115	6025215	169	6027221	126	9418784	62	34079-S	39	34988-S	44	44718-S	180
181146	18	6022185	177	6025275	126	6027352	68	9418785	62	34348-S	62	40156-S	101	44719-S	180
181172	21	6022190	177	6025301	94	6027404	177	9420434	47	34370-S	47	40182-S	102	44720-S	180
186612	13	6022201	97	6025302	94	6027412	43	9421218	13	34371-S	47	40904-S	115	44722-S	180
186628	13	6022202	97	6025304	95	6027518	49	9423789	16	34419-S	43	40905-S	115	44723-S	181
187709	121	6022203	97	6025310	95	6027776	23	9423837	47	34421-S	44	40922-S	116	44724-S	180
220914	33	6022205	98	6025311	95	6027812	96	9425132	46	34422-S	44	40923-S	116	44725-S	181
271185	54	6022206	98	6025312	95	6027837	105	9427473	20	34425-S	45	40927-S	116	44726-S	182
271506	41	6022209	99	6025313	96	6027865	111	9428445	16	34443-S	43	40944-S	115	44727-S	182
432551	13	6022226	101	6025318	97	6027873	112	9429605	126	34444-S	43	40949-S	117	44730-S	183
433116	15	6022230	102	6025321	98	6027876	113	22063139	189	34445-S	43	40957-S	115	44732-S	183
480530	95	6022231	102	6025321	99	6028023	130	30306398A	162	34445-S	191	42119-S	77	45030-S	64
840768AB	162	6022235	104	6025322	99	6028053	49	53030582	159	34653-S	54	42120-S	78	45038-S	64
1137669	153	6022242	106	6025323	99	6028087	187	55352693AA	170	34655-S	54	42124-S	77	45132-S	65
1280134	67	6022245	107	6025326	99	6028153	66			34656-S	54	42127-S	78	45144-S	66
1485066	43	6022246	107	6025328	99	6028157	91			34659-S	54	42128-S	79	45174-S	65
1613782	130	6022250	109	6025329	100	6028323	114			34661-S	54	42134-S	78	45186-S	66

FORD

Part #	Pg														
45188-S	66	52382-S	83	55737-S	48	56354-S	28	93322-S	132	351415-S	180	358723-S	101	372741-S	148
45189-S	66	52388-S	83	55738-S	49	56362-S	29	95831-S	173	351639-S	65	358735-S	89	372807-S	148
45191-S	66	52389-S	84	55740-S	49	56502-S	24	95832-S	174	351650-S	165	358768-S	167	372821-S	21
45193-S	67	52407-S	81	55749-S	43	56901-S	89	95873-S	174	351699-S	161	358794-S	28	372881-S	57
45218-S	72	52422-S	84	55801-S	42	56902-S	90	95874-S	174	351810-S	184	358805-S	106	372927-S	64
45234-S	71	52430-S	84	55806-S	43	56904-S	90	97208-S	139	352000-S	164	358871-S	73	372993-S	119
45235-S	71	52513-S	84	55806-S	44	56905-S	90	97329-S	140	352191-S	164	358981-S	189	372995-S	102
45242-S	70	52720-S	85	55860-S	81	56910-S	90	97331-S	140	352357-S	145	359080-S	109	373053-S	101
45245-S	70	52721-S	87	55872-S	77	57021-S	115	97333-S	141	352358-S	153	359197-S	127	373071-S	98
45257-S	66	52727-S	87	55875-S	78	57030-S	99	97335-S	141	352522-S	65	359330-S	107	373112-S	187
45258-S	67	52729-S	88	55876-S	80	57032-S	100	97347-S	141	352541-S	144	359337-S	35	373142-S	22
45262-S	57	52734-S	86	55906-S	77	57039-S	104	97356-S	139	352542-S	143	359359-S	56	373147-S	86
45263-S	58	52735-S	88	55907-S	77	57039-S	104	97358-S	139	352596-S	41	359496-S	35	373249-S	182
45264-S	59	52742-S	86	55908-S	78	57040-S	105	97362-S	139	352981-S	181	359546-S	151	373293-S	109
45265-S	60	52743-S	88	55914-S	80	57041-S	106	97367-S	139	353118-S	143	359606-S	70	373503-S	69
45267-S	58	52746-S	85	55915-S	80	57043-S	107	97370-S	139	353418-S	56	359613-S	56	373504-S	6
45268-S	59	52754-S	87	55916-S	80	57044-S	107	97372-S	139	353458-S	82	359620-S	54	373542-S	113
45269-S	60	52773-S	85	55922-S	85	57048-S	111	97374-S	139	353467-S	153	359747-S	124	373556-S	52
45270-S	70	52780-S	85	55923-S	85	57063-S	114	97376-S	139	353472-S	182	359882-S	149	373624-S	165
45271-S	70	52786-S	86	55924-S	85	57075-S	94	97379-S	139	353473-S	147	359972-S	179	373687-S	108
45274-S	72	52787-S	88	55925-S	85	57077-S	94	97409-S	155	353538-S	154	370374-S	165	373702-S	124
45275-S	72	52802-S	87	55926-S	85	57096-S	106	300890-S	10	353547-S	143	370383-S	185	373820-S	181
45276-S	70	52814-S	87	55927-S	85	57105-S	112	300892-S	15	353686-S	14	370387-S	165	373829-S	147
45277-S	70	52906-S	120	55927-S	86	57132-S	100	300902-S	10	353714-S	25	370431-S	146	373842-S	149
45300-S	46	52937-S	120	55928-S	86	57140-S	105	300926-S	15	353714-S	118	370546-S	71	373888-S	68
45332-S	52	52979-S	121	55929-S	87	57258-S	122	300958-S	10	353884-S	154	370584-S	33	374031-S	48
45338-S	52	53008-S	81	55931-S	87	57368-S	121	302317-S	8	353911-S	70	370608-S	26	374032-S	117
45344-S	53	53027-S	81	55932-S	81	57450-S	125	302569-S	19	353951-S	164	370676-S	92	374047-S	110
45352-S	54	53028-S	84	55933-S	81	57481-S	113	304632-S	9	353992-S	181	370807-S	32	374177-S	64
45921-S	32	53038-S	82	55934-S	82	57487-S	96	304646-S	9	354033-S	180	370834-S	145	374212-S	164
45964-S	32	53039-S	84	55935-S	82	57487-S	96	304650-S	12	354489-S	164	370970-S	128	374230-S	132
45968-S	32	53061-S	84	55936-S	83	57488-S	97	304662-S	9	354663-S	145	370971-S	133	374251-S	56
46006-S	33	53066-S	83	55937-S	83	57490-S	101	304664-S	9	354921-S	164	371024-S	69	374259-S	155
46007-S	33	53067-S	84	55945-S	81	57520-S	101	304668-S	16	354959-S	183	371041-S	26	374301-S	63
46011-S	33	53272-S	120	55946-S	82	57546-S	125	304684-S	12	354988-S	123	371068-S	48	374311-S	166
46050-S	33	53288-S	120	55947-S	82	57623-S	99	304686-S	16	355471-S	8	371136-S	68	374320-S	174
46069-S	34	53425-S	74	55961-S	81	57633-S	102	304703-S	12	356297-S	189	371169-S	177	374394-S	158
46173-S	34	54505-S	124	55962-S	82	57634-S	103	304703-S	13	356382-S	182	371216-S	177	374408-S	117
50012-S	93	54511-S	124	55965-S	83	57637-S	107	304722-S	13	356474-S	183	371271-S	189	374409-S	119
50514-S	122	54541-S	124	55972-S	81	57638-S	107	304726-S	21	356640-S	143	371518-S	50	374420-S	16
50527-S	125	54543-S	124	55974-S	82	57644-S	109	304760-S	13	356764-S	143	371882-S	69	374565-S	78
50803-S	122	54546-S	124	55974-S	82	57658-S	113	304762-S	17	356782-S	93	371904-S	158	374566-S	68
50809-S	122	54596-S	94	55975-S	82	58654-S	17	304764-S	21	356833-S	56	371911-S	158	374663-S	82
50828-S	125	54719-S	109	55981-S	79	58691-S	23	304781-S	17	357227-S	56	372017-S	66	374671-S	36
50831-S	125	55247-S	116	55992-S	85	72004-S	152	304828-S	10	357252-S	56	372047-S	145	374674-S	145
50937-S	92	55359-S	115	56009-S	86	72016-S	152	304830-S	14	357312-S	56	372076-S	143	374706-S	13
51750-S	122	55377-S	115	56102-S	24	72025-S	152	304860-S	14	357314-S	56	372077-S	143	374709-S	9
51755-S	122	55589-S	115	56126-S	25	72026-S	152	304862-S	18	357810-S	164	372175-S	155	374714-S	154
51756-S	124	55590-S	115	56127-S	25	72034-S	152	350070-S	83	357903-S	89	372188-S	64	374773-S	108
51765-S	124	55593-S	116	56128-S	25	72035-S	152	350075-S	90	358277-S	166	372204-S	125	374803-S	67
51786-S	123	55613-S	116	56130-S	25	72044-S	152	350329-S	9	358360-S	147	372223-S	149	374845-S	153
51787-S	124	55674-S	43	56131-S	25	72052-S	152	350983-S	42	358381-S	147	372285-S	182	375023-S	53
52017-S	74	55691-S	43	56145-S	27	72053-S	152	351053-S	175	358404-S	124	372289-S	99	375064-S	163
52064-S	74	55692-S	43	56146-S	27	74277-S	153	351059-S	46	358533-S	93	372302-S	144	375117-S	27
52071-S	74	55695-S	44	56172-S	27	87746-S	155	351089-S	39	358575-S	158	372303-S	144	375203-S	162
52344-S	81	55713-S	43	56301-S	24	87837-S	155	351124-S	42	358716-S	101	372345-S	79	375277-S	182
52352-S	81	55716-S	44	56340-S	26	87838-S	155	351218-S	180	358717-S	102	372434-S	17	375372-S	159
52352-S	81	55731-S	48	56341-S	27	87839-S	155	351274-S	188	358718-S	102	372444-S	69	375381-S	36
52361-S	84	55734-S	48	56349-S	28	88381-S	129	351341-S	189	358719-S	103	372505-S	181	375452-S	74
52376-S	82	55736-S	48	56350-S	28	93321-S	132	351370-S	180	358720-S	106	372719-S	137	375461-S	69

FORD

Part #	Pg														
375474-S	63	377112-S	181	378581-S	182	379787-S	191	381674-S	110	382626-S	127	383974-S	126	N610051-S	82
375480-S	63	377119-S	147	378643-S	53	379818-S	34	381730-S	110	382626-S	195	384028-S	149	N610130-S	83
375529-S	158	377192-S	79	378654-S	23	379831-S	58	381731-S	110	382627-S	127	384029-S	147	N800503-S	61
375553-S	158	377195-S	66	378659-S	191	379837-S	59	381732-S	110	382627-S	195	384039-S	136	N800841-S	61
375575-S	70	377278-S	132	378672-S	148	379861-S	32	381776-S	191	382634-S	42	384049-S	85	N802376-S	61
375748-S	36	377279-S	132	378680-S	58	379891-S	8	381792-S	12	382656-S	65	384114-S	17	N803685-S	56
375838-S	164	377344-S	100	378681-S	58	379897-S	153	381797-S	90	382713-S	191	384114-S	191	N804150-S	144
375864-S	110	377357-S	106	378683-S	36	379924-S	137	381799-S	149	382713-S	23	384179-S	181	N804435-S	154
375890-S	63	377359-S	143	378694-S	105	379930-S	49	381801-S	90	382717-S	133	384243-S	149	N806881-S	143
375921-S	94	377387-S	116	378709-S	6	379949-S	125	381817-S	86	382733-S	83	384244-S	149	N808370-S	159
375922-S	95	377476-S	52	378711-S	59	379998-S	138	381832-S	147	382748-S	119	384334-S	164	N808877-S	140
375936-S	162	377494-S	150	378723-S	111	379999-S	181	381863-S	66	382764-S	137	384354-S	84	N811594-S	154
375954-S	86	377506-S	110	378729-S	90	380019-S	178	381872-S	35	382801-S	49	384370-S	80	W505007-S	91
375876-S	90	377522-S	70	378735-S	102	380020-S	58	381872-S	195	382803-S	134	384441-S	68	W505020-S	90
376025-S	109	377703-S	49	378741-S	11	380049-S	84	381877-S	117	382866-S	178	384457-S	125	W701004-S	175
376102-S	183	377704-S	50	378782-S	24	380079-S	183	381886-S	62	382908-S	146	384469-S	56	W705097-S	162
376118-S	145	377704-S	191	378782-S	116	380091-S	149	381934-S	141	382929-S	143	384485-S	40	W705621-S	174
376255-S	117	377706-S	49	378787-S	118	380153-S	141	381949-S	88	382930-S	143	384532-S	146	C0AZ-1012-A	55
376255-S	24	377807-S	147	378815-S	141	380239-S	164	381955-S	137	382931-S	144	384542-S	170	C1AZ-1107-A	31
376256-S	24	377834-S	79	378817-S	141	380288-S	108	381985-S	116	382932-S	144	384543-S	170	C3AZ-1107-A	31
376257-S	24	377874-S	147	378832-S	35	380297-S	107	381985-S	190	382944-S	80	384611-S	11	B9AZ-1462-A	73
376258-S	25	377905-S	91	378835-S	76	380297-S	118	381997-S	91	382951-S	110	384673-S	8	C8AZ-1462-A	73
376276-S	76	377917-S	119	378852-S	74	380328-S	23	382009-S	146	382968-S	121	384695-S	53	C8AZ-2066-A	190
376307-S	8	377919-S	119	378859-S	116	380334-S	162	382040-S	159	382984-S	140	384931-S	105	C8AZ-2069-A	190
376309-S	61	377948-S	91	378866-S	43	380345-S	131	382046-S	87	383033-S	158	384966-S	127	8M-2149	181
376328-S	87	377971-S	93	378946-S	33	380374-S	147	382064-S	90	383049-S	96	384966-S	195	C9AZ-2149-A	181
376352-S	84	377998-S	56	378960-S	59	380438-S	87	382101-S	18	383076-S	137	385147-S	150	C8AZ-2B164	190
376360-S	81	378130-S	137	379008-S	133	380459-S	21	382101-S	191	383085-S	60	385197-S	149	8M-2208	152
376361-S	81	378156-S	118	379012-S	140	380460-S	45	382119-S	140	383104-S	143	385417-S	63	C0DZ-2208-A	152
376362-S	82	378156-S	103	379061-S	145	380462-S	100	382155-S	137	383119-S	125	385644-S	34	C8AZ-2208-A	152
376364-S	82	378170-S	34	379068-S	21	380503-S	125	382160-S	80	383132-S	127	385661-S	158	C8OZ-2B295	190
376365-S	83	378172-S	34	379114-S	58	380517-S	42	382167-S	62	383141-S	122	385970-S	28	C8AZ-2B296	190
376369-S	120	378178-S	104	379120-S	91	380527-S	20	382184-S	144	383142-S	163	386135-S	150	C8AZ-2B299	190
376379-S	89	378178-S	118	379124-S	127	380527-S	194	382198-S	130	383152-S	80	386273-S	195	A7AZ-2814-A	155
376382-S	88	378179-S	87	379130-S	65	380528-S	35	382233-S	149	383207-S	144	386273-S	127	C8ZA-2814-A	155
376383-S	87	378196-S	118	379149-S	137	380528-S	195	382245-S	133	383215-S	134	386274-S	195	C9AA-2814-A	155
376396-S	107	378225-S	191	379192-S	108	380541-S	96	382309-S	68	383229-S	162	386493-S	155	C9ZA-2814-A	155
376406-S	83	378225-S	33	379201-S	94	380552-S	158	382330-S	134	383232-S	119	386540-S	159	LA-3043-B	186
376420-S	50	378242-S	106	379203-S	86	380571-S	20	382338-S	134	383255-S	51	386656-S	161	C6OA-3B236	22
376423-S	69	378290-S	50	379205-S	108	380626-S	185	382350-S	143	383270-S	67	387100-S	110	C6OA-3B238	183
376428-S	140	378293-S	66	379206-S	108	380650-S	91	382365-S	16	383351-S	29	387261-S	148	C9OA-3B284	21
376482-S	69	378331-S	18	379229-S	162	380660-S	90	382365-S	190	383356-S	61	388466-S	119	C7OA-3A334	138
376498-S	17	378335-S	107	379244-S	50	380699-S	153	382393-S	30	383368-S	149	388551-S	136	C7SZ-3D600	168
376509-S	128	378337-S	106	379259-S	126	380701-S	131	382412-S	45	383375-S	67	388552-S	136	C8SZ-3D600	169
376528-S	54	378338-S	107	379326-S	87	380707-S	62	382413-S	90	383406-S	43	388577-S	159	D0AA-3D600	170
376545-S	140	378360-S	122	379329-S	23	380750-S	110	382443-S	154	383407-S	45	388592-S	148	D0OA-3D600	170
376589-S	137	378362-S	63	379390-S	10	380751-S	110	382444-S	154	383421-S	182	389115-S	60	C3AA-3A672	175
376642-S	72	378365-S	107	379483-S	58	380771-S	42	382486-S	30	383464-S	7	389534-S	169	C3AZ-3C755	140
376750-S	70	378405-S	16	379513-S	98	380858-S	91	382516-S	195	383475-S	153	389546-S	50	C4ZW-4338-A	151
376756-S	174	378428-S	93	379538-S	125	380882-S	140	382516-S	35	383477-S	144	390085-S	146	C8ZW-4338-A	151
376762-S	52	378466-S	115	379556-S	62	380952-S	41	382523-S	76	383596-S	133	390452-S	134	C0DZ-4529-A	36
376763-S	53	378471-S	84	379605-S	149	380999-S	119	382566-S	85	383695-S	146	390681-S	136	C1AZ-4529-A	36
376807-S	162	378484-S	118	379618-S	51	381529-S	128	382570-S	159	383701-S	150	391079-S	136	KD-5490-A	171
376857-S	96	378514-S	46	379630-S	93	381559-S	184	382573-S	134	383721-S	30	391120-S	40	C2OA-5490-A	171
376887-S	164	378526-S	146	379670-S	59	381561-S	52	382582-S	184	383722-S	30	391458-S	135	D0ZA-5490-A	169
376903-S	63	378527-S	162	379696-S	50	381567-S	51	382583-S	184	383729-S	128	391459-S	136	C0ZA-5495-D	11
376914-S	173	378535-S	8	379699-S	20	381571-S	120	382592-S	134	383737-S	126	391757-S	9	C8OA-5495-A	11
376977-S	110	378544-S	181	379749-S	137	381629-S	189	382623-S	118	383744-S	130	391783-S	148	C9OA-5495-A	11
377060-S	131	378547-S	92	379767-S	90	381649-S	26	382624-S	127	383792-S	41	391785-S	148	C4DA-5705-A	37
377099-S	68	378580-S	182	379779-S	20	381671-S	89	382624-S	195	383850-S	85	391914-S	150	C6OA-5705-C	37

OEM Index

FORD			GM											
Part #	Pg													
C60A-5705-F	37	E6AE-17C431 166	102634	39	124825	39	163474	84	193240	101	365266	193	451736	116
C7ZA-5705-A	37	C4ZB-17450-C 161	102646	46	124829	40	167106	124	214441	41	368142	23	451790	78
C80A-5705-A	37	C3AB-17758-B 7	103029	42	124925	40	167107	124	219281	73	374372	159	453278	179
C9ZA-5705-A	37	C4ZB-17758 7	103321	187	125233	46	167545	120	219758	42	378276	60	453326	39
C9ZA-5705-B	37	C4ZB-17A924 189	103322	187	125250	46	167551	120	220497	32	380527	20	453435	186
D0ZA-5705-B	37	MG-18041-A 177	103323	187	125258	46	168496	82	220706	33	381700	64	453474	188
D3WA-5705-A	37	MG-18171-A 177	103326	187	125348	46	168584	84	220735	34	381909	18	453844	186
C1AE-6065-A	22	8M-18954 173	103327	187	125375	46	168852	120	221823	34	381954	10	454416	92
C1AE-6065-C	22	FAA-18954-A 173	103328	187	125751	188	168971	120	225857	41	381955	171	454430	92
C2OZ-6065-A	18	C1VF-19B915 175	103329	187	125912	146	169701	122	231343	182	381957	138	454635	81
C2OZ-6065-B	18	KC-55490-A 138	103330	187	125978	89	171106	102	231343	192	382102	168	454738	121
C9OZ-6065-A	30	C5AB-6220586 158	103342	183	126216	8	171756	125	258779	42	382103	179	454899	12
C9OZ-6065-B	30	C1AB-6220807 159	103372	152	126218	8	174916	188	271163	54	382104	151	454905	12
C9ZZ-6065-A	29	C5AB-62219A36-A 161	103373	152	126377	8	177999	79	271166	54	382105	181	454912	16
C9ZE-6345-A	18	C5OB-62219A36-A 161	103374	152	131101	187	178537	188	271169	54	382588	181	455134	124
B8A-6378-A	184	C3AB-62219A38-A 161	103375	152	131139	187	178704	74	271172	54	383212	161	455183	125
C0DZ-6378-A	184	C5AB-62219A38-A 161	103385	152	131140	187	178785	96	271187	55	385099	101	455335	86
B8AZ-6379-A	34	C5AB-6221952 161	103386	152	131965	92	179319	40	271191	55	396712	8	455381	92
D2AZ-6379-B	34	C7AB-6224146 67	104252	164	131973	92	179338	86	271193	55	396797	179	455703	120
C2DZ-6A529	43	C6AB-6242413 160	106337	17	134560	39	179795	9	271506	41	398709	140	456766	78
C9ZZ-6A529-B	41	C7AB-6242413 160	108629	152	134570	40	179817	9	272073	46	399803	19	456944	111
D1ZZ-6A636-A	185	C4AB-6242527 157	108630	152	138473	188	179821	10	272474	54	403106	173	463120	179
C7ZE-6A664-A	151	C8AB-6260228 168	108635	152	138476	188	179840	13	272846	140	407217	112	473361	133
EAA-6749-A	185	C3XB-6404561-D 157	110192	39	138485	188	179840	12	272848	140	415919	184	476737	155
C2AA-7B125	172	D0ZB-6321094-D 157	114653	39	138489	188	179841	13	272850	141	419961	62	476737	192
C0DF-7341-A	138	C3AB-63519A16 158	118066	164	138493	188	179843	13	272852	141	423554	96	476737	155
C1AA-7353-D	151	C0AB-6423240 138	120214	186	138494	188	179845	13	272876	47	423586	94	479684	182
C9AA-7353-C	151	D1AB-6504278 156	120292	187	138496	188	179847	14	273081	92	423595	94	480534	159
C2AA-7C381	172	C9ZZ-6523258 138	120361	39	138540	188	179848	14	273082	92	424204	100	481949	36
D1ZB-8B251	157	D0ZZ-6523258 138	120368	40	138542	188	179850	15	273447	88	424213	109	482942	32
D3ZB-8B251	157	C5ZB-6540996 184	120369	40	140258	179	179851	15	273513	124	425390	103	482970	38
C5AA-8A652	168	D1ZB-6540996 184	120376	39	140259	179	179858	16	273521	93	432230	39	488919	48
D0DA-9K288	165	C7ZB-6542413 160	120377	40	140260	179	179867	18	273552	74	432254	152	492370	178
D1ZA-9K288	165	D1AB-6542413 160	120380	186	140566	146	180018	9	273554	116	433114	15	492974	30
C2OE-9A447	185	C5ZB-6542480 160	120382	187	140568	147	180020	9	273697	79	436698	123	531433	149
C3OE-9A447	185	BA-7024146-A 67	120383	187	140772	147	180021	9	273796	48	440406	96	545054	164
C6AE-9B461	168	C3AB-7124374 168	120384	187	140775	146	180078	9	273802	48	440491	71	564708	161
B7A-9825-A	161	C7TB-8160228 168	120386	180	145031	48	180113	10	274074	112	444583	155	565842	121
C5AE-10A370	170	ESB-M4G32-A 167	120389	183	145417	81	180120	12	274303	48	444618	154	588546	89
C8AE-10A370	169		120392	180	145419	83	180122	12	274403	101	444619	154	838653	12
C8VE-10A370	169		120393	180	148145	153	180123	12	274490	87	444746	155	839756	19
C8VE-10A370	170		120394	182	148312	73	180123	13	274551	48	445109	65	839896	101
D0OE-10A370	170		120395	183	148327	73	180123	12	274765	139	445344	65	924561	93
D0SE-10A370	170		120423	188	148510	125	180124	13	274773	78	445359	66	924561	193
D0VE-10A370	169		120622	39	148545	81	180137	15	274902	26	445449	67	942551	76
D0AZ-10756-A	31		120930	188	156994	121	180138	15	332319	17	445638	93	1193463	182
C7AF-12A022	151		121743	39	156996	121	180144	16	333758	105	445686	155	1231641	194
C8AF-12A022	154		121753	188	159348	122	186622	13	336793	133	445933	96	1231641	172
B6A-12297-A	150		121814	180	161085	124	186627	16	337559	183	445933	190	1233894	186
B8Q-12297-A	150		121852	12	161416	74	186634	11	339437	111	446069	71	1233895	186
C2OB-13021-A	193		122138	12	161879	87	187119	186	339715	58	446363	180	1304225	164
C2OB-13031-A	172		122145	13	161895	87	187462	19	340999	165	446587	125	1305797	183
C7AB-13031-A	172		122188	14	161902	88	187482	84	341092	167	447143	77	1347774	178
D0ZZ-13031-A	172		122260	16	162402	81	189891	75	343870	82	449311	120	1351769	153
C9AZ-13032-A	193		122267	16	162413	82	189989	101	345559	194	449601	122	1358938	36
D0ZB-13A093	193		122273	17	162415	83	189993	85	345559	172	449617	123	1359887	48
C3AB-14603-C	138		122276	17	162488	84	191163	15	351790	106	449621	124	1361640	48
C4AB-14603-A	138		122279	17	162659	74	191678	108	353074	145	449623	124	1361699	63
C0AB-16246-A	137		123153	187	162684	74	192988	32	358501	55	451269	93	1362249	178
F4ZB-17A386	80		124818	39	163217	88	193221	17	364993	32	451736	116	1365065	39

GM

Part #	Pg														
1366017	75	3756988	129	3825451	171	3873852	136	3919773	61	3958444	165	4736092	52	7663148	160
1366042	27	3758292	167	3825452	181	3873950	79	3920179	144	3959544	163	4776763	55	7667647	93
1366043	28	3759755	134	3825551	174	3873951	79	3920241	170	3960314	117	4778650	175	7668482	112
1366143	18	3759924	51	3827371	145	3874534	165	3920619	29	3963329	112	4801719	52	7668784	21
1366144	29	3760387	7	3828428	161	3874876	119	3920826	62	3963759	74	4805844	154	7668784	195
1377030	61	3760425	130	3828782	27	3875092	153	3921446	62	3964832	21	4821091	51	7698976	160
1378333	49	3760426	130	3828782	27	3876129	115	3921446	193	3965462	156	4821092	51	7700983	35
1381744	23	3760886	183	3829058	140	3876130	72	3921975	129	3965463	156	4822427	96	7700983	195
1384828	75	3765243	164	3830134	15	3877608	169	3922441	82	3965692	138	4848760	93	7716099	82
1385356	192	3767468	17	3830786	173	3877646	134	3922549	103	3967142	61	4849928	97	7719698	159
1385356	19	3767720	159	3831892	110	3877669	29	3923299	134	3967424	169	4853962	158	7724826	165
1385607	151	3768390	110	3831946	171	3877670	189	3923905	82	3967956	82	4879432	89	7740373	34
1386251	75	3769099	63	3833476	144	3880632	61	3923948	194	3968520	117	4910180	166	7740374	34
1386291	15	3770259	150	3836659	189	3880844	185	3923948	172	3968521	118	4914625	166	7740945	121
1488371	64	3773407	144	3836660	189	3880880	27	3924414	128	3972245	19	5463495	126	7765672	35
1493541	193	3773698	116	3838450	183	3881412	124	3925753	77	3972713	183	5463495	192	7765672	195
1494253	59	3778526	112	3839682	126	3882979	173	3926929	29	3973952	165	5469180	192	7783546	155
1494254	60	3779096	178	3839741	111	3883996	134	3927330	145	3973972	165	5469230	192	7793789	137
1494258	59	3779647	163	3839835	176	3884940	62	3928906	134	3974569	75	5469230	152	7807271	28
1495028	64	3779892	186	3841103	43	3886522	150	3928914	136	3975550	117	5469581	192	8717859	160
1605396	159	3781994	109	3841230	78	3887348	25	3929905	6	3975998	133	5544049	179	8731909	158
1651460	160	3782989	106	3841492	109	3889873	182	3929918	194	3979949	127	5544296	138	8736590	160
2977025	173	3783004	61	3841497	41	3891759	140	3929918	172	3980136	116	5686553	28	8736591	160
3113732	173	3784302	102	3841724	15	3893867	164	3930054	38	3980406	31	5712852	164	8770193	127
3126659	64	3784303	103	3841841	32	3893979	89	3930160	77	3980698	161	5946953	123	8779124	55
3654642	40	3784349	113	3843233	84	3894533	143	3932414	16	3980716	19	5949989	194	8797130	69
3693292	164	3784845	59	3843679	183	3895910	133	3932437	168	3983036	46	5949989	172	9408961	32
3693853	183	3785008	168	3846201	101	3899538	103	3932448	134	3983037	46	5953006	193	9408961	32
3700338	182	3786275	140	3846202	103	3899596	61	3933052	94	3983038	165	5953006	62	9408974	33
3701312	184	3786276	140	3847758	105	3899834	163	3935289	128	3983076	46	5953168	172	9409028	33
3704796	17	3786494	109	3847962	106	3899847	61	3937139	81	3983096	10	5953168	194	9409097	101
3704796	17	3788345	61	3849418	27	3899880	144	3937182	74	3983374	183	5953438	122	9409098	103
3710497	149	3790331	183	3849634	81	3901365	184	3937247	134	3986540	32	5955349	123	9409099	107
3710586	178	3790332	10	3849974	67	3901399	44	3937697	93	3986563	111	5955833	123	9409103	106
3711177	161	3790333	171	3850084	172	3901834	136	3937697	193	3986997	109	5956386	123	9409107	98
3711834	186	3790341	138	3852230	166	3902231	29	3940943	170	3987016	194	5956445	123	9409111	110
3718608	169	3790662	180	3852838	171	3902232	29	3940944	135	3987016	172	5957653	123	9409112	111
3719206	103	3791510	36	3853846	103	3903536	116	3942681	74	3987930	26	5957808	123	9409224	32
3724180	102	3792235	133	3855120	163	3903539	72	3945492	102	3989487	169	5958143	120	9409507	33
3724851	176	3792287	63	3855894	74	3903951	61	3945512	98	3991261	128	5958894	123	9409621	32
3727207	119	3792381	168	3856691	97	3907444	62	3945758	6	3992539	168	5959107	123	9411409	109
3733130	14	3792533	8	3857663	111	3909057	81	3945882	194	3992648	106	5959164	77	9411466	68
3733134	15	3792613	179	3858195	77	3909140	110	3945882	172	3993773	18	5959383	123	9411563	79
3733289	15	3792615	35	3858749	65	3909539	54	3949065	128	4168122	155	5959530	193	9411656	139
3734594	17	3792828	165	3858888	115	3909586	143	3949718	169	4405524	48	5959530	122	9411668	139
3735357	129	3793522	128	3860351	185	3909795	22	3949733	76	4409370	111	5960165	123	9411676	139
3737482	129	3795490	179	3861640	164	3909821	26	3949938	140	4430409	96	5961749	123	9411890	97
3739422	182	3798256	138	3863392	79	3909938	181	3949982	83	4439627	93	5962696	123	9411915	109
3740778	134	3799830	33	3863393	76	3910700	138	3949991	83	4444052	111	6255899	6	9411984	139
3743360	184	3799990	143	3864814	183	3912533	23	3950099	156	4472299	127	6262211	29	9412302	39
3744414	164	3813432	178	3866413	29	3914674	181	3951644	118	4500027	158	6262212	50	9413192	49
3744421	109	3816659	175	3866421	183	3914814	184	3952717	147	4506041	160	6264018	138	9413364	107
3747332	164	3817006	96	3866568	128	3914816	30	3952718	147	4529319	90	6264033	30	9413442	124
3747933	136	3817224	20	3866846	52	3916531	7	3952894	189	4545044	83	6264039	35	9414034	40
3748038	109	3817575	11	3868762	167	3916608	32	3952914	159	4664885	82	6270704	138	9414073	43
3749084	153	3818073	62	3868790	159	3917385	174	3953212	102	4673626	63	6270752	138	9414073	44
3750992	129	3818180	182	3869954	136	3918503	110	3957097	89	4699197	154	7003137	161	9414252	84
3751282	186	3823275	32	3871512	22	3919058	79	3957278	18	4720885	83	7278015	189	9414262	46
3751284	186	3824124	96	3872454	109	3919070	164	3958062	116	4725594	154	7279805	41	9414322	181
3754153	181	3825416	150	3872455	109	3919075	164	3958325	181	4729219	154	7660559	127	9414416	115

GM

Part #	Pg												
9414427	100	9418239	68	9419338	54	9420453	78	9422037	88	9425343	7	9431970	110
9414511	41	9418268	180	9419370	101	9420460	42	9422102	82	9425395	120	9432341	78
9414577	46	9418304	180	9419380	80	9420466	48	9422232	80	9425397	120	9432395	97
9414711	85	9418359	86	9419400	79	9420486	90	9422245	85	9425501	120	9432459	115
9414713	86	9418464	81	9419402	117	9420508	74	9422273	42	9425610	82	9432523	93
9414718	87	9418551	124	9419485	71	9420510	81	9422275	43	9425611	83	9432523	193
9414721	87	9418566	125	9419631	54	9420515	108	9422276	43	9425622	84	9432572	78
9414723	88	9418699	73	9419663	77	9420518	108	9422277	43	9425689	87	9433151	120
9414724	88	9418712	93	9419665	187	9420554	82	9422278	43	9425691	53	9433156	65
9414751	81	9418784	62	9419672	85	9420567	77	9422279	44	9425787	83	9433190	75
9414752	81	9418785	62	9419699	77	9420587	81	9422286	45	9425788	81	9433191	75
9414754	82	9418805	87	9419713	19	9420610	81	9422297	43	9425812	84	9433192	74
9414756	82	9418810	48	9419714	19	9420647	71	9422299	44	9425903	85	9433193	74
9414757	83	9418822	12	9419727	80	9420686	78	9422300	44	9426241	79	9433347	74
9414758	83	9418823	12	9419747	84	9420688	85	9422301	45	9426269	77	9433480	6
9414763	84	9418823	13	9419753	68	9420695	88	9422302	45	9426539	84	9433489	6
9414764	84	9418828	41	9419755	69	9420721	86	9422303	45	9426693	77	9433518	108
9414766	84	9418847	15	9419756	69	9420731	79	9422357	120	9426698	78	9437398	24
9414767	84	9418892	40	9419784	70	9420755	78	9422601	78	9426708	80	9437398	117
9414923	139	9418897	41	9419791	86	9420818	115	9422619	67	9426925	70	9437859	88
9414928	139	9418898	187	9419841	70	9420862	68	9422622	74	9427161	16	9438039	109
9414931	139	9418931	40	9419842	70	9420868	71	9422641	76	9427208	122	9606232	160
9414933	139	9418932	41	9419858	86	9420878	80	9422654	65	9427312	86	9685057	158
9414966	69	9418962	120	9419859	16	9420890	87	9422724	88	9427325	75	9708469	41
9414971	69	9418967	12	9419866	88	9420914	78	9422791	16	9427398	75	9712980	164
9415162	78	9418968	13	9419867	40	9420941	101	9422835	115	9427498	66	9770783	140
9415182	49	9418991	9	9419871	187	9420942	12	9422836	66	9427645	54	9774425	183
9415191	77	9418993	10	9419892	180	9420950	33	9422870	54	9427721	79	9777959	165
9415252	77	9418994	13	9419909	79	9420951	33	9422884	122	9427761	65	9780422	117
9415253	69	9418995	14	9419912	39	9420955	33	9422957	87	9427832	85	9780719	76
9415464	77	9418995	14	9419930	39	9420963	187	9423212	81	9427834	86	9785616	73
9415798	99	9419002	9	9419931	79	9420964	108	9423235	188	9427838	78	9785742	178
9415940	86	9419004	9	9419992	74	9420972	186	9423258	84	9427849	85	9787797	178
9416046	68	9419046	10	9419996	180	9421033	94	9423284	80	9427877	74	9790354	172
9416135	81	9419054	13	9420022	183	9421042	182	9423351	84	9428123	78	9790354	194
9416166	81	9419056	14	9420041	42	9421085	41	9423354	77	9428232	85	9792217	159
9416208	82	9419061	15	9420065	80	9421112	90	9423545	24	9428469	78	9792949	36
9416430	42	9419072	16	9420081	182	9421116	96	9423574	139	9428472	79	9798198	8
9416639	79	9419073	16	9420083	77	9421128	181	9423575	139	9428475	79	9824833	89
9416822	84	9419077	17	9420146	122	9421137	86	9423576	139	9428476	80	9854717	160
9416929	124	9419083	18	9420151	80	9421151	88	9423577	139	9428609	109	9870770	145
9417019	124	9419099	21	9420153	67	9421288	12	9423581	139	9428616	51	9879001	77
9417225	88	9419101	21	9420167	72	9421298	75	9423636	88	9428628	86	9895598	160
9417318	84	9419185	15	9420178	68	9421394	180	9423719	83	9428646	74	10008000	112
9417325	81	9419234	181	9420183	68	9421423	186	9423743	81	9428882	75	11502504	69
9417507	153	9419268	83	9420231	70	9421430	22	9423744	86	9429080	46	11504477	82
9417541	81	9419275	180	9420253	69	9421479	74	9423829	80	9429184	42	11504478	82
9417586	85	9419276	183	9420262	69	9421495	88	9423830	80	9429619	75	12338152	156
9417587	180	9419301	109	9420264	69	9421496	88	9423863	86	9429629	76	14005067	76
9417614	41	9419303	78	9420276	68	9421814	66	9423864	49	9429658	183	14007703	140
9417855	79	9419305	78	9420305	69	9421851	88	9423918	33	9429692	187	14011722	109
9417888	99	9419306	93	9420318	71	9421868	48	9424069	17	9429693	187	14018700	25
9417901	151	9419320	78	9420362	87	9421869	48	9424079	79	9429695	187	14088764	119
9417943	82	9419321	79	9420371	83	9421923	82	9424148	124	9431530	66	15553615	153
9417953	186	9419322	79	9420372	75	9421939	183	9424320	26	9431532	67	15594358	138
9417954	39	9419327	85	9420408	85	9421964	79	9424858	88	9431562	85	15596455	149
9417974	82	9419328	87	9420415	80	9421967	86	9424878	85	9431573	77		
9417986	82	9419329	88	9420425	78	9421977	91	9424939	80	9431600	24		
9418016	85	9419336	54	9420431	115	9421985	75	9425138	108	9431850	80		
9418105	69	9419337	54	9420432	76	9422033	174	9425317	81	9431963	101		

ORDER FORM

Ship To

Name _____
 Address _____
 City _____ State _____
 ZIP _____ Country _____
 Phone #1 _____ #2 _____
 Cell # _____ FAX _____
 Email _____

Credit Card Billing Address

Name _____
 Address _____
 City _____ State _____
 ZIP _____ Country _____
 Phone #1 _____ #2 _____

Year	194 _____ 195 _____ 196 _____ 197 _____ 198 _____
Build Date	_____ Plant _____
Make	AMC Chrysler FORD GM _____
Model	Mustang Camaro Chevelle _____
Body	Coupe Sedan Fastback Convertible
Engine	170/200 250 221 260 283 289 289HP 302 GM 302 FORD 302 Boss 307 318 327 340 350 351C-2V 351C-4V 351W 352 383 390 390GT 396 406 426 Hemi 427 428 428CJ/SCJ 428PI 429 440 429CJ/SCJ 429 Boss 454 _____
Other	AC Alt Gen A/T _____ M/T _____ PS Smog R/S SS
Chassis	Fr Disc Fr Drum HD Susp Mono Multi springs Rr Sway
Interior	Console STD DLX Light Dark FDS _____

USA 48 states orders are shipped UPS Ground or Priority Mail
 The following are Air Mail only, insurance is required
Alaska, Hawaii, PO Boxes, Canada & Overseas

#	Pkg's	Part #	Page	Description	Price	TOTAL
1						
2						
3						
4						
5						
6						
7						
8						
9						
10						
11						
12						
13						
14						
15						
16						
17						
18						

PRINT CLEARLY
MAKE COPIES

CHECK ENCLOSED C.O.D. VISA/MC

Minimum Order 3 0 0 0

VA resident sales tax 5%

Exp _____ 3 Digits _____

*Shipping 5% **\$8 Min** 8 0 0

_____ signature

C O D \$10

AMK Products, Inc.

800 Airport Road, Winchester, VA 22602

phone 540-662-7820 fax 800-518-2871

*Heavy items, Export or Rush cost extra

TOTAL

3	0	0	0
8	0	0	0

AMK POLICIES

ORDERING - \$30 minimum

1. Online catalog: www.amkproducts.com
2. FAX. 800-518-2871 **Please use part numbers.**
3. Mail. AMK Products, Inc. 800 Airport Road, Winchester, VA 22602 Contact AMK to verify parts availability.
4. Out of stock items will be Back Ordered if we can ship within 2 weeks otherwise they will be Cancelled, reorder later.
5. Order processing time. Expect 1-20 days January - August, 1-7 days September - December.
6. Address Corrections. UPS charges AMK for incorrect or incomplete addresses. Customer fee is \$8 per incident.
UPS Requires a full street address including "Ave, Blvd, CT, DR, ST" etc, UPS does not deliver to PO boxes.
If unsure of your address go to the official USPS website address lookup page: <http://zip4.usps.com/zip4/>
7. Holidays. AMK is closed Earth Day, Memorial Day, July 4, Labor Day, Thanksgiving and Friday after, last week of year.

PAYMENT

1. VISA/MC. Declined cards will cause delays, your order will be held for 3-4 days then retried.
2. Money Order (US Postal or Western Union only)
3. COD \$10 extra. (US Postal or Western Union only) Ground orders only (No Air), you must provide a fax number.
4. Personal checks drawn on US banks only (No foreign checks). Checks are held until cleared.

SHIPPING - \$8 minimum

1. UPS Ground to the lower 48 states.
2. Priority Mail. "Mail Receptacle" required. Insurance required.
3. Canada & overseas orders ship Priority Mail International insured. Shipping documents are marked "Antique Auto Parts".
4. Expedited Services: UPS 3 Day Select, 2 Day Air, Next Day Air (expedited ship service does not reduce processing time).
5. Drop Ship. USA only. Shipments to restoration shops, shipping centers etc are subject to a \$5 drop ship fee.

RECEIVING, SHORTAGES & DAMAGED GOODS

1. If possible report damaged boxes to the driver when receiving. Check your purchase promptly for damage.
2. Inspect and compare your purchase with the invoice. Report discrepancies to AMK within 7 days, have invoice # ready.
3. Take notice of back ordered or cancelled items.
4. Examine packaging carefully before discarding to avoid throwing away purchased items.
5. If damage is suspected, keep all original packaging and contents together for carrier's inspection.
6. Contact AMK promptly to report shortages or damaged goods.

CATALOG

1. Online catalog: www.amkproducts.com
2. Hardcopy catalog is free with \$30 order of items available to ship. Additional copies with an order cost \$6.
3. Hardcopy catalog only is \$10 US delivered in USA. \$15 Canada, \$20 Overseas. No foreign checks please.

PRICING

1. All prices are figured in US dollars.
2. We reserve the right to change prices.

RETURNED GOODS

1. No return refunds under \$10.
2. No mail-in order refunds (because parts not available) under \$4.
3. Returned goods are subject to a restocking fee ranging 15% to 25 %, shipping costs are not refundable.
4. All returns must have a return authorization number (RMA), contact AMK for a number.
5. No returns after 45 days from invoice date.
6. All returns must be sent pre-paid (COD not accepted).
7. Copy of invoice required.
8. No return of used fasteners or starter solenoids.

GUARANTEE

1. 60 days from purchase.
2. Starter solenoids. NO RETURN. 20 years of experience have shown us that most problems are due to improper installation, poor wiring, weak electrical grounds, missing ground straps or other faults within the vehicle.
3. Testing. Our service department will test parts for operation, faulty parts will be repaired or replaced.
4. Liability is limited to the replacement of the defective part.

ORDER FORM

Ship To

Name _____
 Address _____
 City _____ State _____
 ZIP _____ Country _____
 Phone #1 _____ #2 _____
 Cell # _____ FAX _____
 Email _____

Credit Card Billing Address

Name _____
 Address _____
 City _____ State _____
 ZIP _____ Country _____
 Phone #1 _____ #2 _____

Year	194 _____ 195 _____ 196 _____ 197 _____ 198 _____
Build Date	_____ Plant _____
Make	AMC Chrysler FORD GM _____
Model	Mustang Camaro Chevelle _____
Body	Coupe Sedan Fastback Convertible
Engine	170/200 250 221 260 283 289 289HP 302 GM 302 FORD 302 Boss 307 318 327 340 350 351C-2V 351C-4V 351W 352 383 390 390GT 396 406 426 Hemi 427 428 428CJ/SCJ 428PI 429 440 429CJ/SCJ 429 Boss 454 _____
Other	AC Alt Gen A/T _____ M/T _____ PS Smog R/S SS
Chassis	Fr Disc Fr Drum HD Susp Mono Multi springs Rr Sway
Interior	Console STD DLX Light Dark FDS _____

USA 48 states orders are shipped UPS Ground or Priority Mail
 The following are Air Mail only, insurance is required
Alaska, Hawaii, PO Boxes, Canada & Overseas

#	Pkg's	Part #	Page	Description	Price	TOTAL
1						
2						
3						
4						
5						
6						
7						
8						
9						
10						
11						
12						
13						
14						
15						
16						
17						
18						

PRINT CLEARLY
MAKE COPIES

CHECK ENCLOSED C.O.D. VISA/MC

Minimum Order 3 0 0 0

VA resident sales tax 5%

Exp _____ 3 Digits _____

*Shipping 5% **\$8 Min** 8 0 0

_____ signature

C O D \$10

AMK Products, Inc.

800 Airport Road, Winchester, VA 22602

phone 540-662-7820 fax 800-518-2871

*Heavy items, Export or Rush cost extra

TOTAL

3	0	0	0
8	0	0	0

AMK POLICIES

ORDERING - \$30 minimum

1. Online catalog: www.amkproducts.com
2. FAX. 800-518-2871 **Please use part numbers.**
3. Mail. AMK Products, Inc. 800 Airport Road, Winchester, VA 22602 Contact AMK to verify parts availability.
4. Out of stock items will be Back Ordered if we can ship within 2 weeks otherwise they will be Cancelled, reorder later.
5. Order processing time. Expect 1-20 days January - August, 1-7 days September - December.
6. Address Corrections. UPS charges AMK for incorrect or incomplete addresses. Customer fee is \$8 per incident.
UPS Requires a full street address including "Ave, Blvd, CT, DR, ST" etc, UPS does not deliver to PO boxes.
If unsure of your address go to the official USPS website address lookup page: <http://zip4.usps.com/zip4/>
7. Holidays. AMK is closed Earth Day, Memorial Day, July 4, Labor Day, Thanksgiving and Friday after, last week of year.

PAYMENT

1. VISA/MC. Declined cards will cause delays, your order will be held for 3-4 days then retried.
2. Money Order (US Postal or Western Union only)
3. COD \$10 extra. (US Postal or Western Union only) Ground orders only (No Air), you must provide a fax number.
4. Personal checks drawn on US banks only (No foreign checks). Checks are held until cleared.

SHIPPING - \$8 minimum

1. UPS Ground to the lower 48 states.
2. Priority Mail. "Mail Receptacle" required. Insurance required.
3. Canada & overseas orders ship Priority Mail International insured. Shipping documents are marked "Antique Auto Parts".
4. Expedited Services: UPS 3 Day Select, 2 Day Air, Next Day Air (expedited ship service does not reduce processing time).
5. Drop Ship. USA only. Shipments to restoration shops, shipping centers etc are subject to a \$5 drop ship fee.

RECEIVING, SHORTAGES & DAMAGED GOODS

1. If possible report damaged boxes to the driver when receiving. Check your purchase promptly for damage.
2. Inspect and compare your purchase with the invoice. Report discrepancies to AMK within 7 days, have invoice # ready.
3. Take notice of back ordered or cancelled items.
4. Examine packaging carefully before discarding to avoid throwing away purchased items.
5. If damage is suspected, keep all original packaging and contents together for carrier's inspection.
6. Contact AMK promptly to report shortages or damaged goods.

CATALOG

1. Online catalog: www.amkproducts.com
2. Hardcopy catalog is free with \$30 order of items available to ship. Additional copies with an order cost \$6.
3. Hardcopy catalog only is \$10 US delivered in USA. \$15 Canada, \$20 Overseas. No foreign checks please.

PRICING

1. All prices are figured in US dollars.
2. We reserve the right to change prices.

RETURNED GOODS

1. No return refunds under \$10.
2. No mail-in order refunds (because parts not available) under \$4.
3. Returned goods are subject to a restocking fee ranging 15% to 25 %, shipping costs are not refundable.
4. All returns must have a return authorization number (RMA), contact AMK for a number.
5. No returns after 45 days from invoice date.
6. All returns must be sent pre-paid (COD not accepted).
7. Copy of invoice required.
8. No return of used fasteners or starter solenoids.

GUARANTEE

1. 60 days from purchase.
2. Starter solenoids. NO RETURN. 20 years of experience have shown us that most problems are due to improper installation, poor wiring, weak electrical grounds, missing ground straps or other faults within the vehicle.
3. Testing. Our service department will test parts for operation, faulty parts will be repaired or replaced.
4. Liability is limited to the replacement of the defective part.

Do you offer a kit for the whole car ? Not exactly. If we have all the Master and Junior kits for your model you can get about 85% in one easy purchase. Misc items not covered by a Master kit heading can be purchased in addition.

How accurate are the kits ? Most kits are right on. Sometimes we do have to make substitutions in order to be practical, fasteners are costly to manufacture and it makes sense to substitute if a closely similar part is already in the warehouse.

Do you offer front end kits ? No. Instead AMK offers a more accurate and comprehensive solution: the "Master Body" kit.

Should I buy assembly manuals ? Absolutely ! They are like the instructions for your AMK kit. Plus they provide torque specs.

I do not see my headmark ? The headmarking identifies the manufacturer and grade. Car companies source fasteners from multiple suppliers, especially heavily used items. AMK has reproduced the most popular old markings and has registered them as our trademarks. If the kit does not include the marking you want then check our bulk section because we may offer the same part with other markings. As a last resort you could replate the originals you wish to preserve.

Do chrome valve covers use chrome bolts ? The factory did not use chrome bolts for valve covers.

Why do exhaust manifold bolts rust ? From the factory, the bolts, like the exhaust manifolds are plain finish.

What is the best way to place my order ? #1 AMK shopping cart www.amkproducts.com #2 fax 800-518-2871 (order form is online or back of catalog), #3 phone 540-662-7820 M-T 9-3 PM, F 9-11 AM (note lunch break is 11:45 - 12:45 daily).

What payment is accepted ? Visa, MC, money orders (US Postal or Western Union), personal checks drawn on US banks only - orders are held until check clears, COD paid with a US Postal or Western Union money order - provide a fax number.

What information is needed when placing my order ? #1 AMK part numbers, #2 shipping address, #3 billing address - please make sure you have the correct billing address otherwise costs increase, #4 phone number, #5 clear hand writing.

When will my order ship ? Depends on size of order and time of year. Expect 7-30 days Jan-Aug, 1-7 days Sept-Dec.

How will my order ship ? Our standard method of shipping is UPS Ground or Priority Mail. We also offer UPS 3 Day Select, 2 Day Air, Next Day Air. Transit time to Eastern US is 1-2 days, Midwest 3-4 days and 5-6 days to the West.

Why is no one answering the phone ? Our staff works hard 40 hrs per week producing fastener kits and filling orders. Restricting the phone to 22 hrs allows us time to completely focus on production. Lunch break is 11:45 - 12:45 daily. Also AMK Products primarily ships to distributors. We maintain retail phone sales in order to stay connected with our customers.

Can I pay to rush my order ? Orders are processed first come first served. Expedited shipping methods are available.

Can I have my order sent Priority Mail ? Yes in most cases. You must have a Mail Receptical Box.

I do not see my model ? We have meticulously researched many popular models and offer thousands of fastener kits and are working on additional kits, meanwhile we recommend that you use our bulk section or pick a similar model.

What does SEMS mean ? It stands for "screw and washer assembly". The original manufacturer also used it as a marking.

Where are AMK fasteners made ? About 95% of our fasteners are made in USA by quality certified manufacturers. AMK supplies the manufacturers with the tooling needed to form the head and markings. Beyond the basic dimensional and strength requirements AMK imposes very stringent aesthetic standards. This makes for a huge difference in overall quality.

How are fasteners made ? Most fasteners are cold formed from wire by cold heading machines. During the winter months cold heading shops require little heating because so much heat is generated by the metal as it changes shape ! Threads on most fasteners are "rolled". The threaded area is made undersize during forming and the rolling process displaces material.

What is phosphate ? It is the application of a crystal structure on the surface of steel. In the automotive industry phosphate is used to retain oil which provides light corrosion protection or it is used as a primer base for other coatings.

What is plating ? Plating is the application of another metal onto the surface in or to prevent corrosion or provide an appearance. There are two main types of plating. Most fasteners are electroplated where another material such as zinc or cadmium is deposited on the surface in a tank containing electrolyte liquid, a cathode (parts), anode (material to deposit), electricity and controls. Parts that are subject to possible hydrogen embrittlement damage from the electroplating process are often instead "mechanically" plated. This process basically blasts the fasteners with the plating material until sufficient coating thickness is achieved. Zinc is usually used. A mechanical finish can be identified by the texture and somewhat dull finish. Mechanical plating is often used on thin spring steel fasteners such as wave washers and stamped nuts.

How do I install a rivet nut ? If it is a hex body nut, just place it in the hole and install the fastener, the hex body prevents rotation as the rivet nut body collapses. For round rivet nuts see the installation picture shown on page 63. Stack the parts onto the screw in the order shown and spin the rivet nut onto the screw. Insert the assembly into the hole and hold the nut firmly with a wrench as you tighten down the screw with an allen wrench until the rivet nut body is totally collapsed.

Shop these AMK distributors.

Ask for AMK Products by name and reference the AMK Part number

Early Birds
Toronto, ONT
800-463-0546

Ground Up
Meriden, CT
203-235-1200

Bowtie Restorations
Langley, BC
604-539-0785

Nostalgia Speed
Surrey, BC
604-940-1977

Rocket Restorations
Olympia, WA
360-705-0943

Bel-Kirk Mustang
Bellevue, WA
425-455-1199

The Mustang Shop
Calgary, ALB
403-243-1582

D & R Automotive
Warrenville, IL
888-226-2761

The Parts Place
Elburn, IL
630-365-1800

Mega Parts
Coon Valley, WI
608-452-2045

Signature Auto Classics
Columbus, OH
614-238-4000

KAR Auto Group
Columbus, OH
614-294-4433

National MoParts
Beaverton, ONT
888-652-7464

Tony Branda
Altoona, PA
800-458-3477

Antique Chevrolet Parts
Oakville, ONT
905-827-3162

Cobra Automotive
Wallingford, CT
203-284-3863

Mustangs Unlimited
Manchester, CT
888-398-9898

CJ Pony Parts
Harrisburg, PA
800-888-6473

Biscay's Classic Chevy
Centralia, WA
360-273-6520

Camaro Central
Richmond, KY
800-990-1969

Kentucky Mustang
Jeffersonville, KY
888-861-0176

National Parts Depot
Canton, MI
800-521-6104

Hearbeat City
Shelby Township, MI
586-226-8811

Jeff's Bronco
Brighton, MI
248-437-5060

North Coast Mustang
Willoughby, OH
800-233-6573

Ohio Mustang
Sheffield Village, OH
440-949-2556

Laurel Mustang
Ruffsdale, PA
888-925-7669

MAC'S Antique Auto Parts
Lockport, NY
800-777-0948

East Coast Chevelle
Deer Park, NY
877-371-3400

Fairfield's Pontiac GMC
Keen, NH
603-499-4300

Glazier's Mustang Barn
Souderton, PA
215-723-9674

Totally Auto
Feasterville, PA
215-322-2277

Roger Gibson Auto Restoration
Richmond, VA
804-275-2155

East Coast Bolts
Winchester, VA
540-905-4812

Virginia Mustang
Broadway, VA
540-896-2695

Auto Krafters
Broadway, VA
800-228-7346

Big Tony's Chevelle Parts
336-228-9022

Forever Classic
Clemmons, NC
336-283-9469

West Coast Classic Cougar
Salem, OR
503-463-1130

American Mustang
Rancho Cordova
800-824-6026

Mustangs Plus
Stockton
800-999-4289

Steve's Camaro
San Bruno, CA
800-544-4451

Restoration Parts Source
Hayward, CA
510-786-2067

E-Body Parts
Madera, CA
559-645-7243

Colorado Mustang
Aurora, CO
877-687-8864

R & A Motorsports
Lee's Summit, MO
816-246-9094

Mustang Plus
Kansas City, MO
816-483-5678

SEMO
Gordonville
573-243-7664

Classic & Perf Mustang
Denver, CO
888-222-8560

RPC
Tempe, AZ
888-509-8249

California Mustang
City of Industry, CA
800-775-0101

Classic Industries
Huntington Beach
800-854-1280

Larry's Thunderbird & Mustang
Corona, CA
800-854-0393

TruckandCarShop
Orange, CA
800-243-8947

True Connections
Riverside, CA
800-600-4144

Mustangs & More
Ventura, CA
800-356-6573

Mustangs Etc.
Van Nuys, CA
818-787-7634

National Parts Depot
Ventura, CA
800-235-3445

Australia

Mustang Auto Parts
Bulimba, QLD
07-3399-6477

RSP Automotive
Campbellfield, VIC
03-9305-4000

Sweden

VP Autoparts
Fristad, Sweden
033-20-6464
vp-autoparts.com

Melvin Little Mustang Parts
Sapulpa, OK
918-227-0678

Muscle Car Restoration
Claremore, OK
918-630-7635

Dallas Mustang
Dallas, TX
800-687-8264

Firewheel Classics
Murphy, TX
800-711-0125

Texas Mustang
Waco, TX
254-662-2790

John's Mustang
Houston, TX
713-668-5646

Mustang Mania
Katy, TX
888-302-3703

South Texas Muscle
Katy, TX
281-770-6627

Stilwell's Ford Parts
Evansville, IN
812-425-4794

Gordon's Classic Restoration
Dallas, GA
770-445-9409

Melvin's Classic Ford Parts
Lithonia, GA
770-761-6800

JJ Classic Mustang
Chattanooga, TN
423-894-2068

Jimmy's BowtieSupply
Shelbyville, TN
800-414-5467

Year One
Braselton, GA
800-932-7663

Mustangs Unlimited
Lawrenceville, GA
888-229-2929

AMD Direct
Buford, GA
866-591-8309

CHQ
Athens, GA
800-441-3866

Rick's First Generation
Athens, GA
800-359-7717

John's Classic Cars and Parts
Douglasville, GA
770-920-8675

National Parts Depot
Charlotte, NC
800-368-6451

National Parts Depot
Ocala, FL
800-874-7595

Factory Muscle Parts
Ridge Manor, FL
352-583-2212

Hinshaw's
Elon, NC
336-586-0802

Harris Mustang
Charlotte, NC
704-598-1412

T.J.'s Mustang
Salem, VA
540-387-3863

Harrisburg, PA
800-888-6473

AMK

*** Additional distributors are listed at www.amkproducts.com/dealers.htm ***

Important

When ordering remind the dealer that you must have the AMK part, otherwise you may receive something else !

Our packaging is always marked "AMK Products, Inc" or "www.amkproducts.com". If the dealer doesn't have what you're looking for then please contact us for the name of a stocking dealer or to place the order directly.

Thanks for supporting quality AMK Products.

Environment

We are happy to be alive on this tiny planet and wish to help take care of it.

Clean energy is needed in the Eastern US for two reasons: mountain top removal and air pollution. The process well described in the documentary film "Mountain Top Removal" levels mountains and releases toxins into the groundwater and creates a permanent eyesore. Left over rock has buried hundreds of miles of streams in a process known as "valley fill".

Toxic emissions from coal burning include: small particles (soot) that cause health problems such as asthma, sulphur dioxide causing haze, acid rain that is killing our oceans, mercury that poisons our fish and 40% of U.S. CO2 emissions !

Today there are many clean energy technologies ready to lead us into the future !

Nuclear, solar, wind and geothermal solutions produce clean electricity while keeping our skies clear and water clean. Solar and geothermal sources can also provide big energy savings by heating or cooling water. Energy demand itself can be dramatically reduced by installing programmable thermostats, photo/motion sensor light switches, updating lighting, HVAC equipment, minimizing HVAC outside air intake and adding inversion fans to move heated air down from the ceiling.

The AMK facility is a small example.

We generate 100% of electricity and collect 100% of water onsite.

New T8 lighting uses 55% less electricity and geothermal heat pumps replaced our old energy hog units.

The company gofor truck is a Ford built 100% electric Ranger EV !



**30KW
Solar Power Plant**

Solar output is highest when electricity demand is highest during the summer !

Excess electricity is automatically distributed to nearby users.

Because the energy is produced locally where it is consumed the need for long distance transmission lines is eliminated.

Green Thoughts

1. Restoring and driving a vintage car is better for the environment than manufacturing a new one because a huge amount of energy is saved and CO2 emissions prevented.
2. Reusing is the best form of recycling, AMK Master kit boxes are great for reuse.
3. Worldwide most steel products including fasteners are made from recycled material !
4. AMK fastener kit bags are #4 and can be recycled at your grocery store together with grocery bags.
5. AMK practices "carbon conscious shipping". Our choice both saves the customer money and reduces CO2 emissions.

AMK FINISHES



S
NO FINISH
Natural Material

SS
STAINLESS STEEL
Silver



S2
PHOSPATE & OIL
Gray - Black



S3
BLACK PAINT
Satin Black



S7
CADMIUM
Soft Silver

S8
ZINC
Dark Silver - Blue



S13
CHROME
Bright Silver



S32
OLIVE DRAB PAINT
Pea Green

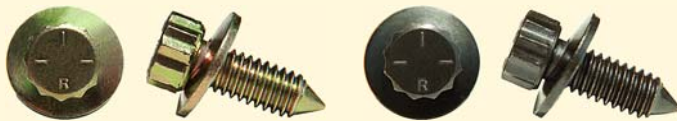

S36
ZINC DICHROMATE
Yellow - Rainbow

S44
BLACK CAD/ZINC
Shiny Black



S45
STAINLESS & CHROME
Bright Silver



S48
RED DYE
Shiny Red



S60
PHOSPATE & RED
Dull Red

M
NON-ELECTROLYTIC
Dull & Heavy



P
NYLON LOCK
Pellet or Patch



W & X
WAX, SEALER
Golden, Flexible Black

.062 .312 .562 .812 .062 .312 .562 .812 .062 .312 .562 .812 .062 .312 .562 .812 .062 .312 .562 .812 .062 .312 .562 .812

.188 .438 .688 .938 .188 .438 .688 .938 .188 .438 .688 .938 .188 .438 .688 .938 .188 .438 .688 .938 .188 .438 .688 .938

Sixteenth

.125 .375 .625 .875 .125 .375 .625 .875 .125 .375 .625 .875 .125 .375 .625 .875 .125 .375 .625 .875

Eighth

INCHES

.25 .50 .75 1 .25 .50 .75 2 .25 .50 .75 3 .25 .50 .75 4 .25 .50 .75 5 .25 .50 .75
1/4 1/2 3/4 1/4 1/2 3/4 1/4 1/2 3/4 1/4 1/2 3/4 1/4 1/2 3/4 1/4 1/2 3/4

Quarter

5 15 25 35 45 55 65 75 85 95 105 115 125 135 145

Millimeter

METRIC

10 20 30 40 50 60 70 80 90 100 110 120 130 140
1 2 3 4 5 6 7 8 9 10 11 12 13 14

Centimeter



800 Airport Road, Winchester, VA 22602

phone 540-662-7820 fax 800-518-2871

www.amkproducts.com