

# 2015 Price List

Material Handling,  
Healthcare, Cleanroom, Lab



**EAGLE**  
MHC Division

Material Handling, Healthcare & Cleanroom Equipment

# - Table of Contents -

Detailed contents listing at the start of each individual section.



**Shelving / Retail Display .....5-90**



**Wall Shelves.....91-100**



**Cleanroom / Lab Equipment ....101-114**



**Healthcare .....115-130**



**Electronics.....131-144**



**Tables .....145-180**



**Sinks / Floor Troughs .....181-226**

**Warranty Information .....2**

**Terms & Conditions .....3**

**SpecFAB® Custom Fabrications .....227-232**

## How to order:

### EAGLE'S Customer Service Center

Committed to customer service and customer satisfaction along with quality products.

**Toll Free: 1-800-637-5100**

**Phone: (302) 653-3000**

**Fax: (302) 653-2065**

**Email: customerservice@eaglegrp.com**

### VISIT US ON THE WEB

To find an EAGLE representative, dealer or service center in your area go to

**www.eaglegrp.com**

### STOCK STATUS IS INDICATED BY:

MTS (•) - make-to-stock items with shipment same day or next day.

MTO ( ) - make-to-order items.

### LOOK!

#### FOR THESE EMBLEMS

Located to the right of or below each appropriate product title and/or product subtitle:

see spec sheet **EG01.00** - catalog spec sheet reference (available online [www.eaglegrp.com](http://www.eaglegrp.com))



- approved by the National Sanitation Foundation



- approved by Underwriters Laboratories for U.S.A. ONLY

**NFPA-96** - Meets the standards of the National Fire Protection Association, Bulletin #96

#### REGISTERED TRADEMARKS OF EAGLE MHC® - a division of EAGLE GROUP

Add-A-Shelf®, adjusTable®, EAGLEbrite®, EAGLEgard®, FLEX-MASTER®, Floor Trak®, LIFESTOR®, MasterSeal®, Master Trak®, MICROGARD®, Quad-Adjust®, QuadPLUS®, QuadTruss®, Quik-Set®, Redi-Pak®, SPEC AIR®, SpecFAB®, SPEC-MASTER®, Snap-n-Slide®, Sterile-Eze®, uni-lok®, Valu-Gard®, VALU-MASTER®, and WALSTOR®.

#### TRADEMARKS OF EAGLE MHC® - a division of EAGLE GROUP

Lok-n-Fold™, Shelf Select™, and STAND-OUTS™.

# WARRANTY INFORMATION

## EAGLE Shelving Warranty

EAGLE MHC® warrants that goods supplied hereunder manufactured by EAGLE MHC® will be free from defects in material and workmanship at the time they leave our factory. Upon factory inspection, we guarantee to replace any shelf that is defective for a period of up to one year from the date of original installation, not to exceed 18 months from date of shipment from EAGLE, provided that it has been properly installed and maintained. If a shelf proves to be defective, or not in conformity with the specification, customers are entitled only to replacement of such unit. Under no circumstances will we be liable for any claims for labor or subsequent damage.

To the original owner, EAGLE GROUP warrants against rust formation over more than 5% of the shelving surface as stated below following original date of installation:

	<b>WARRANTY</b>	<b>DRY STORAGE</b>	<b>COOLER STORAGE</b>
Chrome	1-year warranty	✓	-
EAGLEbrite®	3-year warranty	✓	-
VALU-MASTER® and Valu-Gard®	5-year warranty	✓	✓
EAGLEgard® (with MICROGARD®)	15-year warranty	✓	✓
Stainless Steel	15-year warranty	✓	✓
QuadPLUS®	*	✓	✓
* Polymer Shelf Mats have a lifetime warranty against rust and corrosion. * Wire Truss Frames, based on finish, have same warranty duration as outlined above.			
LIFESTOR® (with MICROGARD®)	**	✓	✓
** 1-year manufacturer's warranty on all component parts. ** Lifetime limited warranty against rust or corrosion on stainless steel posts and stainless steel rails (3-year warranty on zinc with clear epoxy).			
Solid Shelving	1-year warranty	✓	✓

EAGLE wire shelving must be cleaned with soft cloths and mild detergents. Using harsh detergents, abrasive materials, scrapers or stiff brushes will void this warranty, as will physical damage, rupturing the coating or sustained exposure to corrosive substances and vapors. Warranty applies only when shelves have been continuously used within a temperature range from -20°F to +120°F, with intermittent exposure up to +200°F for VALU-MASTER® or EAGLEgard® epoxy finishes, and up to +175°F for chrome or EAGLEbrite® zinc finishes.

In the event of a warranty claim, an EAGLE GROUP representative will examine the installation and determine return or repair disposition. Repairs will be handled by the initial owner. Returns, including disassembly and subsequent reassembly, become the responsibility of the initial owner. Replacements will be shipped prepaid FOB the nearest distribution point.

There are no warranties which extend beyond these warranties. All other expressed or implied warranties, including those of merchantability or fitness for a particular purpose, which exceed the warranties stated above, are disclaimed by EAGLE MHC® and excluded from this agreement. No employee or agent of ours has any authority to make any representation or warranty which exceeds the warranties stated above.

**NO EAGLE EQUIPMENT MAY BE RETURNED EXCEPT UPON WRITTEN AUTHORIZATION FROM EAGLE MHC®. SEE PAGE 3 FOR TERMS & CONDITIONS.**

\* \* \*

## EAGLE Worktable and Sink Warranty

EAGLE MHC® warrants that goods supplied hereunder manufactured by EAGLE MHC® will be free from defects in material and workmanship at the time they leave our factory.

Within a period of one year from the date of original installation of the equipment, not to exceed 18 months from date of shipment from EAGLE, EAGLE MHC®, will replace, without charge, any defective parts or component material upon demonstration to its satisfaction that a breach of warranty did not exist. Under no circumstances will we be liable for any claims for labor or subsequent damage. Using harsh chemicals, abrasive materials, scrapers or stiff brushes may void the warranty.

There are no warranties which extend beyond these warranties. All other expressed or implied warranties, including those of merchantability or fitness for a particular purpose, which exceed the warranties stated above, are disclaimed by EAGLE MHC® and excluded from this agreement. No employee or agent of ours has any authority to make any representation or warranty which exceeds the warranties stated above.

**NO EAGLE EQUIPMENT MAY BE RETURNED EXCEPT UPON WRITTEN AUTHORIZATION FROM EAGLE MHC®. SEE PAGE 3 FOR TERMS & CONDITIONS.**

\* \* \*

## EAGLE Surgical Case Carts

EAGLE MHC® warrants that goods supplied hereunder manufactured by EAGLE MHC® will be free from defects in material and workmanship at the time they leave our factory.

Within a period of three years from the date of shipment from EAGLE, EAGLE MHC® will replace, without charge, any defective parts or component material upon demonstration to its satisfaction that a breach of warranty did not exist. Under no circumstances will we be liable for any claims for labor or subsequent damage.

There are no warranties which extend beyond these warranties. All other expressed or implied warranties, including those of merchantability or fitness for a particular purpose, which exceed the warranties stated above, are disclaimed by EAGLE MHC® and excluded from this agreement. No employee or agent of ours has any authority to make any representation or warranty which exceeds the warranties stated above.

**NO EAGLE EQUIPMENT MAY BE RETURNED EXCEPT UPON WRITTEN AUTHORIZATION FROM EAGLE MHC®. SEE PAGE 3 FOR TERMS & CONDITIONS.**

**EAGLE Material Handling, Healthcare & Cleanroom Equipment (MHC®) is a division of EAGLE GROUP.  
(formerly known as Metal Masters)**

# - Terms and Conditions -

## PRICES

All merchandise will be billed at our current published list prices in effect at the time of shipment.

## PERFORMANCE

All shipping dates are approximate. Fulfillment is always subject to availability of material and to conditions affecting shipment that are beyond our control. EAGLE shall not be held liable for any delay in performance due to reasons beyond our control.

## SHORTAGE

All claims for shortage must be brought to our attention within five (5) business days from date merchandise is received. Please be certain that you receive the number of packages signed for.

## CANCELLATIONS

Cancellations are not accepted on orders in transit or on custom items. Standard orders that are cancelled while already in production will be subject to up to a 30% restocking charge based upon product ordered.

## RETURNS

**Custom and modified standard equipment is non-returnable.**

Authorization Policy for Standard Returns:

- ✓ Previously written approval from EAGLE's Customer Service is mandatory on all returns.
- ✓ Return authorization must be requested within 60 days from date of shipment.
- ✓ Authorized return shipments, in which merchandise is not defective and orders have been properly filled, must be shipped prepaid and properly packaged to prevent merchandise damage.
- ✓ Each return authorization number (*located on the upper right hand corner of the form*), must be written on the outside of each carton returned to EAGLE.
- ✓ No credits will be processed for a return until we have confirmation that the item has been received, has been inspected and it is confirmed that item is in unused and new, sellable condition

Restocking:

- ✓ Restocking and equipment repair fees for merchandise damaged during return shipment to EAGLE will be withheld from issued credit.
- ✓ Returns of made-to-stock merchandise are subject to a 30% restocking fee.
- ✓ Returns of standard made-to-order merchandise are subject to a 50% restocking fee.

Restocking (continued):

- ✓ \$75 net minimum on merchandise returns.
- ✓ No returns on electropolished items.
- ✓ No returns on custom items.

## PRINTS & DRAWINGS

All prints and drawings submitted with orders are accepted as a final approval in the custom order process. Errors that arise due to incorrect submittals are the responsibility of the customer. There are no cancellations on custom orders.

## DAMAGES

EAGLE's responsibility ceases immediately upon our retaining receipt of pickup from our dock by the transportation company, unless the merchandise is refused by the consignee. If a container shows rough handling, do not give the carrier a clear delivery receipt and inspect the merchandise immediately. Note the damage on the delivery receipt/bill of lading while the driver is there. If you sign your name on the freight bill without noting any damages, then you are stating you have received your order/shipment in acceptable condition. Upon finding damage while unpacking the product, call the carrier without further unpacking, ask for an inspection, and follow through by filing a claim with the carrier immediately.

## ORDER APPROVAL

All orders are subject to final approval by EAGLE's home office. Acceptance and/or performance shall be at all times subject to the approval of EAGLE's Credit Department. Minimum order \$50.00 net.

## TERMS

Discount and discount date are clearly marked at the bottom of each invoice should you be entitled to any discount, subject to current status of your account.

## FOB

All shipments are shipped from FOB point "collect" unless otherwise specified. All orders shipped prepaid and add will receive a 20% administrative surcharge added to the freight charge.

## UPS

All UPS shipments will be charged a minimum of \$25.00.

**- MONETARY VALUES ARE BASED ON U.S. CURRENCY. -**

### ***IMPORTANT NOTICE:***

Due to the continuing cost fluctuations of stainless steel and other materials, we at EAGLE MHC® reserve the right to modify our price lists by charging dealer discounts and/or imposing a surcharge.



100 Industrial Boulevard, Clayton, DE 19938-8903 U.S.A.  
Phone: 800-637-5100 or 302-653-3000. Fax: 302-653-2065  
<http://www.eaglegrp.com>

# OTHERS' WIRE SHELVES COMPARED TO EAGLE GROUP'S...

(18" x 60" shelves shown)

## EAGLE GROUP's shelves...

...incorporate more perimeter and interior serpentine trusses and mat continuity support wires than any competitive shelves.

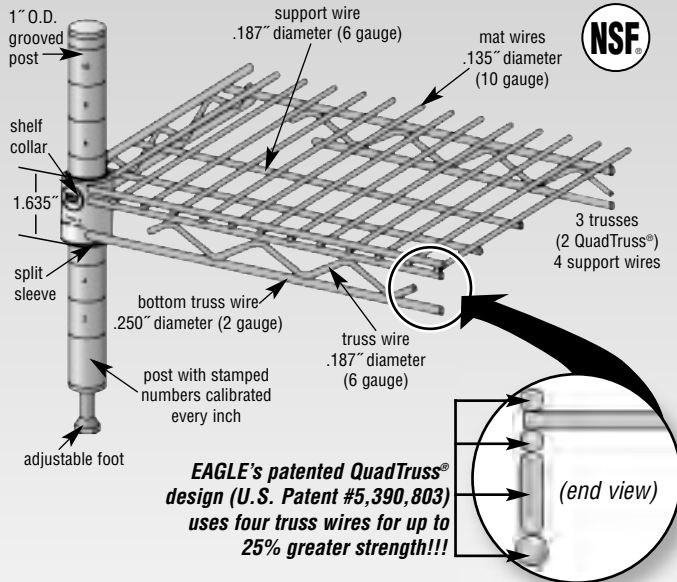

## Metro and most imported shelves...

...incorporate both perimeter and interior serpentine trusses and mat continuity support wires, but fewer than EAGLE GROUP's.

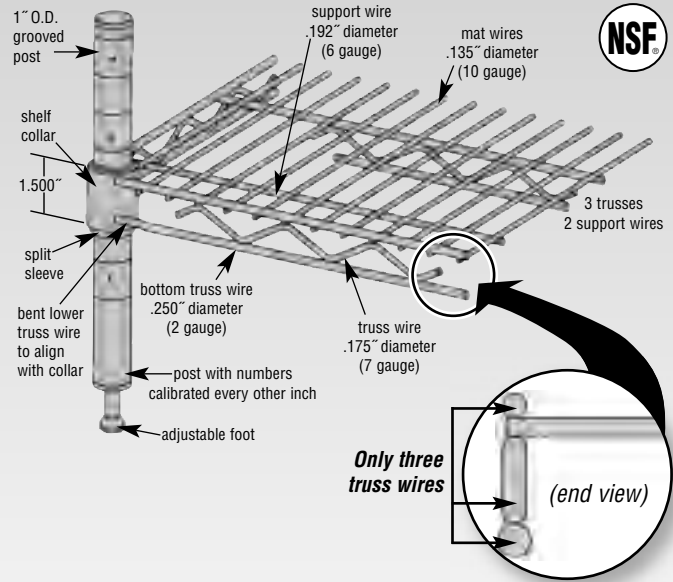

**Eagle Group has the strongest wire shelf in the industry—no matter how you stack it!**

## SHELF AND POST FINISHES AVAILABLE

### Stainless Steel Finish—OUR BEST!

Stainless Steel

- NSF-listed for all environments.
- Type 304 stainless steel.

NOTE: Stainless steel shelving is electropolished.

15-YEAR LIMITED WARRANTY

### EAGLEgard® Hybrid Epoxy

Zinc Chloride  
Clear Chromate  
MasterSeal® Sealer  
Blue Green (translucent)  
- hybrid epoxy with MICROGARD®\*

- NSF-listed for all environments.
- Zinc chloride plating followed by clear chromate plating with MasterSeal® Sealer and a hybrid epoxy final coat.

15-YEAR LIMITED WARRANTY

### Valu-Gard® Green Epoxy

Phosphate Conversion Coating  
MasterSeal® Sealer  
Green (opaque)  
- hybrid metallic epoxy

- NSF-listed for wet or dry storage environments.
- Phosphate conversion coating followed by green hybrid epoxy coating.

5-YEAR LIMITED WARRANTY

### VALU-MASTER® Gray Epoxy

Phosphate Conversion Coating  
MasterSeal® Sealer  
Pewter Gray Epoxy

- NSF-listed for wet or dry storage environments.
- Phosphate conversion coating followed by metallic gray epoxy coating.

5-YEAR LIMITED WARRANTY

### Chrome Finish

Bright Nickel  
Chrome  
Air-dry Lacquer

- NSF-listed for dry storage environments.
- Bright nickel plating followed by chrome plating.

NOTE: Optional clear hybrid epoxy, NSF-listed for all environments, is available.

1-YEAR LIMITED WARRANTY

### EAGLEbrite® Zinc

Zinc chloride  
Clear Chromate  
MasterSeal® Sealer

- NSF-listed for dry storage environments.
- Bright zinc chloride plating followed by clear chromate plating with MasterSeal® sealer for improved rust protection.

NOTE: Wire shelves feature MasterSeal® Sealer. NSF-listed for all environments.

3-YEAR LIMITED WARRANTY

### \* MICROGARD®...

...is an antimicrobial agent which contains built-in protection to retard the growth of a broad range of bacteria, mold and mildew on shelf surface that causes stains, odors and degradation.

...combines inorganic antimicrobial silver ions with a patented delivery system. The silver ions react with bacteria in three ways:

1) suffocates the cell, 2) stops the cell reproduction system, and 3) stops the cell from growing.

...is standard on all EAGLEgard® shelving.

# Shelving / Retail Display

## Accessories/Components

Casters .....	9, 39, 60, 73, 77
Casting for Leveling Feet .....	46
Collar Plug .....	46
Dividers .....	14, 48, 61
Enclosure Panels .....	47
Foot Plates .....	46
Glides .....	46
Inlays .....	60
Label Holders .....	23, 38
Ledges .....	49, 61, 78
Leveling Feet.....	46
Post Cap .....	46
Post Clamp .....	46
Retaining Clamp .....	46
Rods & Tabs .....	47
“S” Hooks .....	46
Split Sleeves .....	46
More Accessories and Components.....	8-9, 46-54

## Add-A-Shelf® and Accessories .....20-21

## Cantilever Shelving System Wall Mount .....84-88

## Carts

Angled Shelf/ Visual Merchandising Carts .....	31-32
Black Polymer Utility Cart.....	32
Cart Covers .....	30
Hardwood Top Demo & Wine Carts ..	64
Mobile Platform Carts.....	32
Polymer Utility Carts.....	32, 80
Utility Carts .....	23, 25, 27-28
Stem Caster Carts.....	29
Wire Basket Utility Carts .....	25

## Dolly Frames / Dolly Trucks

Aluminum Truck Dollies .....	37
Dolly Frames.....	38
Dolly Trucks .....	33

## LIFESTOR® Polymer Shelving

Accessories/Components .....	77-79
Add-On Units .....	75
Dunnage Racks.....	80
Floor-Trak® Storage Systems .....	81
Shelving / Posts .....	76-77
Starter Units .....	74
Utility Carts .....	80
Overhead Track Storage Systems .....	82-83

## Posts .....8, 15, 21, 61

## QuadPLUS® Polymer Shelf Mats, Starter Units, Accessories ..12-14

## Quik-Set® Solid Shelving ....70-73

## Racks and Platforms

Dunnage Racks .....	35-37
Platforms .....	34
Polymer Dunnage Racks.....	36
Tank Racks/Accessories .....	44

## Redi-Pak®

Utility Carts .....	23
Wire Shelving Units .....	22

## Retail Display Shelving and Accessories

Accessories/Components .....	60-62
Decorative Shelves .....	59
Front Case Merchandise Shelving.....	63
Garment Racks/Accessories .....	34
Gondola Shelving/Accessories ....	66-68
Pot/Pan Rack / Accessories .....	65
Retail Display Workstation .....	64
Secure Display Merchandiser .....	65
Soft Goods Display .....	63
Wire Display Shelving/ Accessories .....	68-69

## Security Units and Accessories .....40-43

## Shelves / Shelving Units

Adjustable Wire Shelving • Add-A-Shelf® .....	20-21
• Quad-Adjust® .....	10-11
Cantilever Shelves.....	8, 62
Dunnage Shelf; Starter Units .....	36
Four/Five-Shelf Add-On Units .....	17, 19
Four/Five-Shelf Starter Units .....	11, 13, 16, 18
Hybrid Shelves .....	24-25
Reverse Mat Shelves/ Label Holders .....	23
Seismic Shelves/Posts .....	15
Slanted Shelves .....	48
Sliding Shelf .....	52
Solid Shelves/Accessories .....	7
Triangle Shelf .....	51
Wire Basket Shelf .....	38
Wire Shelves.....	6

## Tables .....45

## Track Systems

Floor Track Storage Systems .....	57-58, 81
Overhead Track Storage Systems.....	55-56, 82-83

## Wine Shelves and Components .....26

## Workstations

Modular Desks/Workstations .....	44
Retail Display Workstation .....	64

For the  
“Wall Shelves” section,  
go to pages 91–100.



### Wire Shelves

see spec sheet **EG01.00**



patented  
**QuadTruss**<sup>®</sup>  
design

(Patent #5,390,803)

#### Patented QuadTruss<sup>®</sup> Design

makes shelves up to 25% stronger and provides a retaining ledge for increased strength and product retention.

#### WEIGHT CAPACITIES:

- Shelves up to 48" (1219mm): 800 lb. (363 kg).
- 54"-72" (1372-1829mm) shelves: 600 lb. (272 kg) - evenly distributed static load.

**Note:** Shelving units should not exceed 2400 lbs. (1089 kg) per set of four posts.

#### PACKAGING:

- 24"-48" (610-1219mm) lengths: Four per box.
- 54"-72" (1372-1829mm) lengths: Two per box.
- Four pairs of split sleeves per shelf.

**Freight class is 70.0.**

(•) MTS (made to stock) / ( ) MTO (made to order)

	length		weight		cu ft	EAGLEbrite <sup>®</sup>		chrome		Valu-Master <sup>®</sup>		Valu-Gard <sup>®</sup>		EAGLEgard <sup>®</sup>		stainless	
	in.	mm	lb.	kg		model #	list	model #	list	model #	list	model #	list	model #	list	model #	list
14" width (356mm)	24"	610	6	2.7	0.5	1424Z •	48	1424C •	56	1424V •	57	1424VG •	57	1424E •	65	1424S •	196
	30"	762	7	3.2	0.5	1430Z •	51	1430C •	58	1430V •	60	1430VG •	60	1430E •	68	1430S •	198
	36"	914	8	3.6	0.5	1436Z •	55	1436C •	62	1436V •	64	1436VG •	64	1436E •	71	1436S •	200
	42"	1067	9	4.1	0.7	1442Z •	64	1442C •	71	1442V •	74	1442VG •	74	1442E •	82	1442S •	246
	48"	1219	10	4.5	0.7	1448Z •	64	1448C •	71	1448V •	74	1448VG •	74	1448E •	82	1448S •	246
	54"	1372	12	5.5	0.9	1454Z •	66	1454C •	74	1454V •	84	1454VG •	84	1454E •	94	1454S •	312
	60"	1524	14	6.4	0.9	1460Z •	76	1460C •	81	1460V •	84	1460VG •	84	1460E •	94	1460S •	312
	72"	1829	17	7.7	1.1	1472Z •	86	1472C •	94	1472V •	99	1472VG •	99	1472E •	108	1472S •	353
18" width (457mm)	24"	610	7	3.2	0.7	1824Z •	60	1824C •	62	1824V •	64	1824VG •	64	1824E •	74	1824S •	240
	30"	762	8	3.6	0.7	1830Z •	62	1830C •	63	1830V •	69	1830VG •	69	1830E •	77	1830S •	244
	36"	914	9	4.1	0.7	1836Z •	64	1836C •	65	1836V •	72	1836VG •	72	1836E •	80	1836S •	246
	42"	1067	11	5.0	0.9	1842Z •	74	1842C •	78	1842V •	85	1842VG •	85	1842E •	96	1842S •	294
	48"	1219	12	5.5	0.9	1848Z •	74	1848C •	78	1848V •	85	1848VG •	85	1848E •	96	1848S •	294
	54"	1372	15	6.8	1.2	1854Z •	86	1854C •	92	1854V •	104	1854VG •	104	1854E •	114	1854S •	374
	60"	1524	17	7.7	1.2	1860Z •	86	1860C •	92	1860V •	104	1860VG •	104	1860E •	114	1860S •	374
	72"	1829	20	9.1	1.3	1872Z •	103	1872C •	109	1872V •	119	1872VG •	119	1872E •	132	1872S •	444
21" width (533mm)	24"	610	8	3.6	0.7	2124Z •	66	2124C •	72	2124V •	73	2124VG •	73	2124E •	84	2124S •	278
	30"	762	9	4.1	0.7	2130Z •	68	2130C •	74	2130V •	78	2130VG •	78	2130E •	86	2130S •	281
	36"	914	11	5.0	0.8	2136Z •	71	2136C •	77	2136V •	80	2136VG •	80	2136E •	91	2136S •	283
	42"	1067	12	5.5	1.1	2142Z •	81	2142C •	89	2142V •	94	2142VG •	94	2142E •	106	2142S •	327
	48"	1219	14	6.4	1.1	2148Z •	81	2148C •	89	2148V •	94	2148VG •	94	2148E •	106	2148S •	327
	54"	1372	16	7.3	1.3	2154Z •	99	2154C •	105	2154V •	113	2154VG •	113	2154E •	124	2154S •	436
	60"	1524	18	8.2	1.3	2160Z •	99	2160C •	105	2160V •	113	2160VG •	113	2160E •	124	2160S •	436
	72"	1829	24	10.9	1.4	2172Z •	119	2172C •	125	2172V •	137	2172VG •	137	2172E •	152	2172S •	516
24" width (610mm)	24"	610	9	4.1	0.8	2424Z •	71	2424C •	76	2424V •	79	2424VG •	79	2424E •	93	2424S •	300
	30"	762	11	5.0	0.8	2430Z •	73	2430C •	79	2430V •	84	2430VG •	84	2430E •	95	2430S •	302
	36"	914	13	5.9	0.8	2436Z •	76	2436C •	81	2436V •	86	2436VG •	86	2436E •	97	2436S •	306
	42"	1067	15	6.8	1.2	2442Z •	91	2442C •	97	2442V •	108	2442VG •	108	2442E •	119	2442S •	371
	48"	1219	16	7.3	1.2	2448Z •	91	2448C •	97	2448V •	108	2448VG •	108	2448E •	119	2448S •	371
	54"	1372	19	8.6	1.5	2454Z •	111	2454C •	116	2454V •	127	2454VG •	127	2454E •	141	2454S •	453
	60"	1524	21	9.5	1.5	2460Z •	111	2460C •	116	2460V •	127	2460VG •	127	2460E •	141	2460S •	453
	72"	1829	26	11.8	1.6	2472Z •	126	2472C •	137	2472V •	148	2472VG •	148	2472E •	165	2472S •	565
30" width (762mm)	30"	762	16	7.3	1.0	3030Z •	92	3030C •	105	3030V •	107	3030VG •	107	3030E •	125	3030S •	357
	36"	914	17	7.7	1.0	3036Z •	104	3036C •	119	3036V •	122	3036VG •	122	3036E •	144	3036S •	405
	48"	1219	20	9.1	1.5	3048Z •	119	3048C •	137	3048V •	141	3048VG •	141	3048E •	164	3048S •	472
	60"	1524	25	11.4	1.8	3060Z •	134	3060C •	151	3060V •	157	3060VG •	157	3060E •	187	3060S •	524
	72"	1829	30	13.6	2.3	3072Z •	161	3072C •	181	3072V •	188	3072VG •	188	3072E •	225	3072S •	636
36" width (914mm)	36"	914	21	9.5	1.3	3636Z •	113	3636C •	133	3636V •	134	3636VG •	134	3636E •	161	3636S •	453
	48"	1219	26	11.8	1.9	3648Z •	135	3648C •	153	3648V •	159	3648VG •	159	3648E •	187	3648S •	533
	60"	1524	34	15.4	2.3	3660Z •	155	3660C •	178	3660V •	182	3660VG •	182	3660E •	220	3660S •	621
	72"	1829	43	19.5	2.8	3672Z •	187	3672C •	207	3672V •	221	3672VG •	221	3672E •	259	3672S •	740



## Catalog Section 1

### Solid Shelves

see spec sheet **EG01.01**

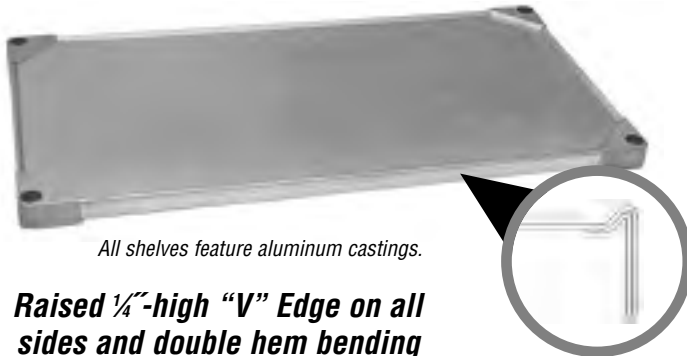

All shelves feature aluminum castings.

**Raised 1/4"-high "V" Edge on all sides and double hem bending provides quality and strength!**

side view of solid shelf, showing raised "V" edge

#### WEIGHT CAPACITY:

- Shelves up to 48" (1219mm): 600 lb. (272 kg).
- 54"-72" (1372-1829mm) shelves: 400 lb. (181 kg) - evenly distributed static load.

#### PACKAGING:

- 24"-48" (610-1219mm) lengths: Four per box.
- 54"-72" (1372-1829mm) lengths: Two per box.
- Four pairs of split sleeves per shelf.

**All items can be shipped UPS.**

**Note:** For cleanroom applications add prefix "CR" to stainless steel model number. **Example: CRSS1424S.** Electropolished finish available. Consult factory. Please note: Shelf with electropolished finish will have a flat surface without "V" edge.

**Freight class is 70.0.**

(•) MTS (made to stock) / ( ) MTO (made to order)

	length		weight		cu ft	galvanized		VALU-MASTER®		Valu-Gard®		stainless	
	in.	mm	lb.	kg		model #	list	model #	list	model #	list	model #	list
<b>14" width</b> (356mm)	24"	610	10	4.5	0.5	<b>SS1424G</b>	143	<b>SS1424V</b>	157	<b>SS1424VG</b>	157	<b>SS1424S</b>	239
	30"	762	12	5.5	0.5	<b>SS1430G</b>	146	<b>SS1430V</b>	160	<b>SS1430VG</b>	160	<b>SS1430S</b>	248
	36"	914	14	6.4	0.5	<b>SS1436G</b>	153	<b>SS1436V</b>	166	<b>SS1436VG</b>	166	<b>SS1436S</b> •	248
	42"	1067	15	6.8	0.7	<b>SS1442G</b>	157	<b>SS1442V</b>	173	<b>SS1442VG</b>	173	<b>SS1442S</b>	298
	48"	1219	17	7.7	0.7	<b>SS1448G</b>	159	<b>SS1448V</b>	176	<b>SS1448VG</b>	176	<b>SS1448S</b> •	298
	54"	1372	20	9.1	0.9	<b>SS1454G</b>	172	<b>SS1454V</b>	190	<b>SS1454VG</b>	190	<b>SS1454S</b>	324
	60"	1524	22	10.0	0.9	<b>SS1460G</b>	173	<b>SS1460V</b>	197	<b>SS1460VG</b>	197	<b>SS1460S</b> •	356
<b>18" width</b> (457mm)	72"	1829	26	11.8	1.1	<b>SS1472G</b>	181	<b>SS1472V</b>	207	<b>SS1472VG</b>	207	<b>SS1472S</b>	413
	24"	610	11	5.0	0.7	<b>SS1824G</b>	142	<b>SS1824V</b>	160	<b>SS1824VG</b>	160	<b>SS1824S</b> •	271
	30"	762	14	6.4	0.7	<b>SS1830G</b>	149	<b>SS1830V</b>	163	<b>SS1830VG</b>	163	<b>SS1830S</b> •	277
	36"	914	16	7.3	0.7	<b>SS1836G</b> •	152	<b>SS1836V</b>	171	<b>SS1836VG</b>	171	<b>SS1836S</b> •	277
	42"	1067	18	8.2	0.9	<b>SS1842G</b>	161	<b>SS1842V</b>	178	<b>SS1842VG</b>	178	<b>SS1842S</b>	340
	48"	1219	20	9.1	0.9	<b>SS1848G</b> •	163	<b>SS1848V</b> •	181	<b>SS1848VG</b>	181	<b>SS1848S</b> •	340
	54"	1372	22	10.0	1.2	<b>SS1854G</b>	177	<b>SS1854V</b>	197	<b>SS1854VG</b>	197	<b>SS1854S</b>	384
<b>21" width</b> (533mm)	60"	1524	24	10.9	1.2	<b>SS1860G</b> •	180	<b>SS1860V</b>	200	<b>SS1860VG</b>	200	<b>SS1860S</b> •	407
	72"	1829	28	12.7	1.3	<b>SS1872G</b>	188	<b>SS1872V</b>	213	<b>SS1872VG</b>	213	<b>SS1872S</b> •	489
	24"	610	13	5.9	0.7	<b>SS2124G</b>	153	<b>SS2124V</b>	170	<b>SS2124VG</b>	170	<b>SS2124S</b>	302
	30"	762	15	6.8	0.7	<b>SS2130G</b>	157	<b>SS2130V</b>	174	<b>SS2130VG</b>	174	<b>SS2130S</b>	309
	36"	914	18	8.2	0.8	<b>SS2136G</b>	168	<b>SS2136V</b>	184	<b>SS2136VG</b>	184	<b>SS2136S</b> •	309
	42"	1067	21	9.5	1.1	<b>SS2142G</b>	171	<b>SS2142V</b>	190	<b>SS2142VG</b>	190	<b>SS2142S</b>	388
	48"	1219	23	10.5	1.1	<b>SS2148G</b>	176	<b>SS2148V</b>	194	<b>SS2148VG</b>	194	<b>SS2148S</b>	388
<b>24" width</b> (610mm)	54"	1372	25	11.4	1.3	<b>SS2154G</b>	189	<b>SS2154V</b>	212	<b>SS2154VG</b>	212	<b>SS2154S</b>	403
	60"	1524	28	12.7	1.3	<b>SS2160G</b>	189	<b>SS2160V</b>	214	<b>SS2160VG</b>	214	<b>SS2160S</b>	476
	72"	1829	30	13.6	1.4	<b>SS2172G</b>	206	<b>SS2172V</b>	283	<b>SS2172VG</b>	283	<b>SS2172S</b>	518
	24"	610	15	6.8	0.8	<b>SS2424G</b> •	154	<b>SS2424V</b>	171	<b>SS2424VG</b>	171	<b>SS2424S</b> •	327
	30"	762	17	7.7	0.8	<b>SS2430G</b>	159	<b>SS2430V</b>	174	<b>SS2430VG</b>	174	<b>SS2430S</b>	333
	36"	914	19	8.6	0.8	<b>SS2436G</b> •	169	<b>SS2436V</b> •	186	<b>SS2436VG</b>	186	<b>SS2436S</b> •	333
	42"	1067	23	10.5	1.0	<b>SS2442G</b>	174	<b>SS2442V</b>	196	<b>SS2442VG</b>	196	<b>SS2442S</b> •	406
	48"	1219	24	10.9	1.2	<b>SS2448G</b> •	180	<b>SS2448V</b>	199	<b>SS2448VG</b>	199	<b>SS2448S</b> •	406
	54"	1372	27	12.3	1.5	<b>SS2454G</b>	194	<b>SS2454V</b>	216	<b>SS2454VG</b>	216	<b>SS2454S</b>	456
	60"	1524	31	14.1	1.5	<b>SS2460G</b> •	199	<b>SS2460V</b>	223	<b>SS2460VG</b>	223	<b>SS2460S</b> •	478
	72"	1829	33	15.0	1.6	<b>SS2472G</b> •	211	<b>SS2472V</b>	242	<b>SS2472VG</b>	242	<b>SS2472S</b> •	560

### Solid Shelf Joining Clamp

see spec sheet **EG01.03D**



model #	list per pair
<b>A203078</b>	27

**Note:** Two required per shelf.

#### FEATURES:

- Clamp and two additional posts create various shelving add-on configurations.
- Joins shelves end-to-end, back-to-back, or at right angles.

(•) MTS (made to stock) / ( ) MTO (made to order)



100 Industrial Boulevard, Clayton, DE 19938-8903 U.S.A.  
Phone: 800-637-5100 or 302-653-3000. Fax: 302-653-2065  
<http://www.eaglegrp.com>



### Posts

see spec sheets **EG01.00** **EG01.01** **EG01.11A** **EG01.14**

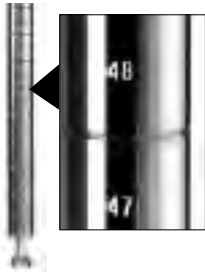

**Posts are numbered on vertical 1" (25mm) increments to help ensure fast and level assembly.**

- Height includes leveling bolt and cap.
- EAGLEbrite® posts feature air-dry lacquer and can be used for walk-in coolers.

**FEATURES:**

**Notes:** For special length post, apply price at next higher length plus a cutting charge of **\$11.00 list per post.**

See page 9 for appropriate stem casters.

**Freight class is 50.0.**

(•) MTS (made to stock) / ( ) MTO (made to order)

### For Stationary Applications

height		cu	weight		EAGLEbrite®		chrome		Valu-Gard®		VALU-MASTER®		EAGLEgard®		stainless steel	
in.	mm	ft	lb.	kg	model #	list	model #	list	model #	list	model #	list	model #	list	model #	list
7"	178	0.1	1.0	0.5	P7-Z •	11	P7-C	12	P7-VG	13	P7-V	13	P7-E •	15	P7-S	31
14"	356	0.1	1.0	0.5	P14-Z •	13	P14-C •	14	P14-VG	15	P14-V	15	P14-E •	16	P14-S	33
18"	457	0.1	1.5	0.7	P18-Z •	15	P18-C •	16	P18-VG	17	P18-V	17	P18-E	23	P18-S •	46
33"	838	0.1	2.0	0.9	P33-Z •	16	P33-C •	17	P33-VG •	19	P33-V •	19	P33-E •	24	P33-S •	54
54"	1372	0.1	3.0	1.4	P54-Z •	22	P54-C •	23	P54-VG •	24	P54-V •	24	P54-E •	25	P54-S •	60
63"	1600	0.3	3.5	1.8	P63-Z •	23	P63-C •	24	P63-VG •	25	P63-V •	25	P63-E •	28	P63-S •	67
74"	1880	0.5	4.0	1.8	P74-Z •	24	P74-C •	26	P74-VG •	27	P74-V •	27	P74-E •	31	P74-S •	76
86"	2184	0.8	5.0	2.3	P86-Z •	29	P86-C •	32	P86-VG •	33	P86-V •	33	P86-E •	36	P86-S •	86
96"	2438	0.9	6.0	2.7	n/a		P96-C •*	37	n/a		n/a		n/a		P96-S •*	97

\* 96" (2438mm) posts are NOT to be used on units less than 24" (610mm) front-to-back. Recommend using in conjunction with foot plates to affix to floor, and with post clamps where applicable.

### For Mobile Applications

height		cu	weight		EAGLEbrite®		chrome		Valu-Gard®		VALU-MASTER®		EAGLEgard®		stainless steel	
in.	mm	ft	lb.	kg	model #	list	model #	list	model #	list	model #	list	model #	list	model #	list
7"	178	0.1	1.0	0.5	CP7-Z	11	CP7-C	12	CP7-VG	13	CP7-V	13	CP7-E	15	CP7-S	31
14"	356	0.1	1.0	0.5	CP14-Z	13	CP14-C	14	CP14-VG	15	CP14-V	15	CP14-E	16	CP14-S	33
18"	457	0.1	1.5	0.7	CP18-Z	15	CP18-C	16	CP18-VG	17	CP18-V	17	CP18-E	23	CP18-S	46
33"	838	0.1	2.0	0.9	CP33-Z •	16	CP33-C •	17	CP33-VG •	19	CP33-V	19	CP33-E	24	CP33-S •	54
54"	1372	0.1	3.0	1.4	CP54-Z •	22	CP54-C •	23	CP54-VG	24	CP54-V	24	CP54-E	25	CP54-S	60
63"	1600	0.3	3.5	1.8	CP63-Z •	23	CP63-C •	24	CP63-VG •	25	CP63-V •	25	CP63-E •	28	CP63-S •	67
74"	1880	0.5	4.0	1.8	CP74-Z •	24	CP74-C •	26	CP74-VG •	27	CP74-V •	27	CP74-E •	31	CP74-S •	76
86"	2184	0.8	5.0	2.3	CP86-Z •	29	CP86-C •	32	CP86-VG •	33	CP86-V	33	CP86-E •	36	CP86-S	86

### Cantilever Shelves

see spec sheet **EG01.03E**



- 1" (25mm) wraparound ledge.
- 12" (305mm) wide shelves.

**FEATURES:**

**NOTE:** When ordering back posts, confirm with customer service, the correct post height to accommodate these shelves.

**Freight class is 70.0.**

(•) MTS (made to stock) / ( ) MTO (made to order)

length		weight		cubic	chrome		stainless steel	
in.	mm	lb.	kg	feet	model #	list	model #	list
24"	610	5	2.3	0.5	CS1224-C	60	CS1224-S	192
30"	762	5	2.3	0.8	CS1230-C	64	CS1230-S	208
36"	914	6	2.7	0.8	CS1236-C	66	CS1236-S	218
42"	1067	7	3.2	0.9	CS1242-C	74	CS1242-S	231
48"	1219	8	3.6	1.0	CS1248-C •	77	CS1248-S	242
54"	1372	9	4.1	1.1	CS1254-C	83	CS1254-S	257
60"	1524	10	4.5	1.3	CS1260-C •	89	CS1260-S	283

**Ideal for adding extra storage above an existing shelving unit.**

**Packaged two per box.**



## Catalog Section 1

### Stem Casters

see spec sheet **EG01.05A**

**Note:** Decorative stem casters also available (see page 60).  
Conductive stem casters available (see page 140).  
These casters cannot be used with Master Trak®.

**Add  
mobility to your  
stationary unit.**

FEATURES:

- Use with posts.
- Donut bumpers.
- Swivel casters have a temperature rating of -15°F.

**Freight class is 65.0.**

(•) MTS (made to stock) / ( ) MTO (made to order)

### Cart-Washable Casters

- Features stainless steel boot, swivel stem, sealed precision bearings, and polyurethane wheels.

type	capacity		wheel diameter		wheel face		weight		cubic feet	model #	list
	lbs.	kg	in.	mm	in.	mm	lbs.	kg			
swivel	300	136.1	5"	127	1 1/4"	32	2.0	0.9	0.1	<b>CSS5WPS-300</b>	133
w/brake	300	136.1	5"	127	1 1/4"	32	2.0	0.9	0.1	<b>CSB5WPS-300</b>	145



resilient

resilient step-pedal brake caster

### Resilient

type	wheel diameter		wheel face		weight		cu ft	zinc				stainless steel			
	in.	mm	in.	mm	lbs.	kg		capacity lbs.	capacity kg	model #	list	capacity lbs.	capacity kg	model #	list
swivel	4"	102	1"	25	1.1	0.5	0.1	125	56.7	<b>CSS4-125 •</b>	23	-	-	-	-
swivel	5"	127	1"	25	2.0	0.9	0.1	125	56.7	<b>CSS5-125 •</b>	25	-	-	-	-
swivel	5"	127	1 1/4"	32	2.5	1.2	0.1	300	136.1	<b>CSS5-300 •</b>	28	200	90.7	<b>CSS5S-200</b>	138
w/brake	5"	127	1 1/4"	32	2.8	1.3	0.1	300	136.1	<b>CSB5-300 •</b>	34	200	90.7	<b>CSB5S-200</b>	152
w/step-pedal brake	5"	127	1 1/4"	32	2.8	1.3	0.1	300	136.1	<b>CSPB5-300</b>	49	-	-	-	-
rigid ▼	5"	127	1 1/4"	32	3.5	1.6	0.1	300	136.1	<b>CSR5-300 •</b>	32	200	90.7	<b>CSR5S-200</b>	133

### Polyurethane

type	capacity		wheel diameter		wheel face		weight		cu ft	nickel plated		stainless steel	
	lbs.	kg	in.	mm	in.	mm	lbs.	kg		model #	list	model #	list
swivel	300	136.1	5"	127	1 1/4"	32	2.5	1.2	0.1	<b>CSS5P-300 •</b>	46	<b>CSS5PS-300 •</b>	144
w/brake	300	136.1	5"	127	1 1/4"	32	2.8	1.3	0.1	<b>CSB5P-300 •</b>	51	<b>CSB5PS-300 •</b>	159
w/step-pedal brake	300	136.1	5"	127	1 1/4"	32	2.8	1.3	0.1	<b>CSPB5P-300</b>	56	-	-
rigid ▼	300	136.1	5"	127	1 1/4"	32	3.5	1.6	0.1	<b>CSR5P-300 •</b>	52	<b>CSR5PS-300</b>	133



(nickel plated) swivel stem caster with polyurethane tread

### Cart Washable Polymer Casters

- Corrosion-resistant stainless steel axle, stainless steel stem, polymer horn, and 5" (127mm)-diameter polyurethane wheel.

type	type of bearing	capacity		wheel diameter		wheel face		weight		cu ft	model #	list
		lbs.	kg	in.	mm	in.	mm	lbs.	kg			
swivel	delrin	250	113.4	5"	127	1 1/4"	32	2.0	0.9	0.1	<b>CPSS5-250 •</b>	75
w/brake	delrin	250	113.4	5"	127	1 1/4"	32	2.0	0.9	0.1	<b>CPSB5-250 •</b>	92



### ▼ Channel Frames for Rigid Stem Casters

**Please note:** Shelf width must be known when ordering rigid stem casters in order to ship appropriate channel frame to lock rigid casters.

shelf width		weight		cubic feet	model #	list
in.	mm	lbs.	kg			
14"	356	1.5	0.7	0.1	<b>A201706</b>	15
18"	457	2.0	0.9	0.1	<b>A201007</b>	20
21"	533	2.5	1.1	0.1	<b>A201008</b>	25
24"	610	2.8	1.3	0.1	<b>A201009</b>	25
30"	762	3.5	1.6	0.1	<b>A204795</b>	27
36"	914	4.0	1.8	0.1	<b>A207562</b>	28



channel frame for rigid stem casters

### Replacement Donut Bumpers for Stem Casters

description	model #	list
3 1/2" (89mm) diameter	<b>A200019 •</b>	7
5" (127mm) diameter, with swivel center	<b>A213261 •</b>	12



donut bumper

### Quad-Adjust® Wire Shelving

see spec sheet **EG01.14**



**PATENTED!**  
(patent #7,992,731)

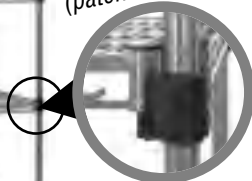

Each shelf corner fits in collar mounted to split sleeve

patented  
**QuadTruss**  
design

(Patent #5,390,803)

**Patented QuadTruss® Design**

makes shelves up to 25% stronger and provides a retaining ledge for increased strength and product retention.

**FEATURES:**

- Shelves feature special interlocking corners that fit in collars mounted to split sleeves, allowing addition or removal of a shelf without the need to disassemble the entire shelf unit.
- Tapered split sleeves create a positive lock that becomes stronger as the load increases.
- Posts (page 8) are numbered in increments of 1" (25mm) to ensure fast and level assembly.
- Leveling feet are provided to help compensate for uneven floor surfaces.
- Shelves utilize patented QuadTruss® design: the mat wires are sandwiched between two top truss wires, adding significant strength and distributing the entire load without stress and strain on the welds.

**Note:** To create a mobile shelf unit, top and bottom shelves must be standard shelves (page 6).

Quad-Adjust® shelves assembled with posts (see page 8 for posts)

Weight capacities and packaging are the same as that of Wire Shelves (page 6).

HOW TO ASSEMBLE:



**1.**

Snap split sleeves onto post over number of your choice.

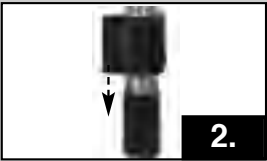

**2.**

Attach Quad-Adjust® collar onto split sleeves.

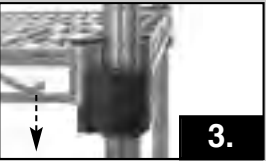

**3.**

Slide shelf into slots in collar to complete.

**Freight class is 70.0.**

(•) MTS (made to stock) / ( ) MTO (made to order)

### Quad-Adjust® Shelves

	length		weight		cu ft	EAGLEbrite®		chrome		VALU-MASTER®		Valu-Gard®		EAGLEgard®		stainless steel	
	in.	mm	lb.	kg		model #	list	model #	list	model #	list	model #	list	model #	list	model #	list
<b>14" width (356mm)</b>	24"	610	6	2.7	0.5	QA1424Z	85	QA1424C	94	QA1424V	91	QA1424VG	91	QA1424E	104	QA1424S	268
	30"	762	7	3.2	0.5	QA1430Z	91	QA1430C	97	QA1430V	95	QA1430VG	95	QA1430E	107	QA1430S	272
	36"	914	8	3.6	0.5	QA1436Z	93	QA1436C	99	QA1436V	101	QA1436VG	101	QA1436E	111	QA1436S	273
	42"	1067	9	4.1	0.7	QA1442Z	99	QA1442C	109	QA1442V	113	QA1442VG	113	QA1442E	121	QA1442S	325
	48"	1219	10	4.6	0.7	QA1448Z	104	QA1448C	112	QA1448V	116	QA1448VG	116	QA1448E	127	QA1448S	326
	54"	1372	12	5.5	0.9	QA1454Z	111	QA1454C	116	QA1454V	118	QA1454VG	118	QA1454E	132	QA1454S	399
	60"	1524	14	6.4	0.9	QA1460Z	116	QA1460C	121	QA1460V	132	QA1460VG	132	QA1460E	137	QA1460S	409
72"	1829	17	7.7	1.1	QA1472Z	131	QA1472C	137	QA1472V	140	QA1472VG	140	QA1472E	152	QA1472S	458	
<b>18" width (457mm)</b>	24"	610	7	3.2	0.7	QA1824Z	98	QA1824C	99	QA1824V	98	QA1824VG	98	QA1824E	116	QA1824S	323
	30"	762	8	3.6	0.7	QA1830Z	100	QA1830C	103	QA1830V	108	QA1830VG	108	QA1830E	117	QA1830S	325
	36"	914	9	4.1	0.7	QA1836Z	104	QA1836C	• 105	QA1836V	• 114	QA1836VG	• 114	QA1836E	• 120	QA1836S	328
	42"	1067	11	5.0	0.9	QA1842Z	112	QA1842C	116	QA1842V	122	QA1842VG	122	QA1842E	137	QA1842S	383
	48"	1219	12	5.5	0.9	QA1848Z	116	QA1848C	118	QA1848V	• 132	QA1848VG	• 132	QA1848E	• 140	QA1848S	387
	54"	1372	15	6.8	1.2	QA1854Z	127	QA1854C	132	QA1854V	140	QA1854VG	140	QA1854E	155	QA1854S	479
	60"	1524	17	7.7	1.2	QA1860Z	131	QA1860C	135	QA1860V	• 146	QA1860VG	• 146	QA1860E	• 160	QA1860S	485
72"	1829	20	9.1	1.3	QA1872Z	146	QA1872C	153	QA1872V	171	QA1872VG	171	QA1872E	178	QA1872S	569	
<b>21" width (533mm)</b>	24"	610	8	3.6	0.8	QA2124Z	105	QA2124C	112	QA2124V	107	QA2124VG	107	QA2124E	127	QA2124S	367
	30"	762	9	4.1	0.8	QA2130Z	107	QA2130C	116	QA2130V	116	QA2130VG	116	QA2130E	131	QA2130S	372
	36"	914	11	5.0	0.8	QA2136Z	111	QA2136C	117	QA2136V	127	QA2136VG	127	QA2136E	133	QA2136S	375
	42"	1067	12	5.5	1.1	QA2142Z	118	QA2142C	128	QA2142V	135	QA2142VG	135	QA2142E	146	QA2142S	425
	48"	1219	14	6.4	1.1	QA2148Z	121	QA2148C	132	QA2148V	140	QA2148VG	140	QA2148E	148	QA2148S	428
	54"	1372	16	7.3	1.3	QA2154Z	140	QA2154C	145	QA2154V	151	QA2154VG	151	QA2154E	167	QA2154S	555
	60"	1524	18	8.2	1.3	QA2160Z	141	QA2160C	147	QA2160V	153	QA2160VG	153	QA2160E	172	QA2160S	558
72"	1829	24	10.9	1.4	QA2172Z	166	QA2172C	173	QA2172V	185	QA2172VG	185	QA2172E	203	QA2172S	656	
<b>24" width (610mm)</b>	24"	610	9	4.1	0.8	QA2424Z	111	QA2424C	116	QA2424V	117	QA2424VG	117	QA2424E	136	QA2424S	396
	30"	762	11	5.0	0.8	QA2430Z	113	QA2430C	118	QA2430V	127	QA2430VG	127	QA2430E	138	QA2430S	398
	36"	914	13	5.9	0.8	QA2436Z	116	QA2436C	121	QA2436V	• 133	QA2436VG	• 133	QA2436E	• 141	QA2436S	402
	42"	1067	15	6.8	1.2	QA2442Z	131	QA2442C	138	QA2442V	143	QA2442VG	143	QA2442E	162	QA2442S	476
	48"	1219	16	7.3	1.2	QA2448Z	133	QA2448C	• 141	QA2448V	• 154	QA2448VG	• 154	QA2448E	• 166	QA2448S	478
	54"	1372	19	8.6	1.5	QA2454Z	152	QA2454C	159	QA2454V	168	QA2454VG	168	QA2454E	186	QA2454S	578
	60"	1524	21	9.5	1.5	QA2460Z	154	QA2460C	161	QA2460V	• 178	QA2460VG	• 178	QA2460E	• 189	QA2460S	581
72"	1829	26	11.8	1.6	QA2472Z	174	QA2472C	185	QA2472V	205	QA2472VG	205	QA2472E	217	QA2472S	717	

**Note:** MICROGARD® antimicrobial protection standard on all EAGLEgard® shelving.



### Quad-Adjust® Wire Shelving (continued)

see spec sheet **EG01.14**

Freight class is 70.0.

(•) MTS (made to stock) / ( ) MTO (made to order)

#### Quad-Adjust® Reverse Mat Shelves

Built-in ledges prevent shelf contents from falling off.

	length		weight		cu ft	EAGLEbrite®		chrome		VALU-MASTER®		Valu-Gard®		EAGLEgard®		stainless steel	
	in.	mm	lb.	kg		model #	list	model #	list	model #	list	model #	list	model #	list	model #	list
<b>14"</b> (356mm)	24"	610	6	2.7	0.5	QAR1424Z	93	QAR1424C	99	QAR1424V	96	QAR1424VG	96	QAR1424E	111	QAR1424S	284
	36"	914	8	3.6	0.5	QAR1436Z	98	QAR1436C	106	QAR1436V	108	QAR1436VG	108	QAR1436E	117	QAR1436S	289
	48"	1219	10	4.6	0.7	QAR1448Z	106	QAR1448C	118	QAR1448V	122	QAR1448VG	122	QAR1448E	136	QAR1448S	348
<b>18"</b> (457mm)	24"	610	7	3.2	0.7	QAR1824Z	104	QAR1824C	105	QAR1824V	107	QAR1824VG	107	QAR1824E	122	QAR1824S	343
	36"	914	9	4.1	0.7	QAR1836Z	111	QAR1836C	112	QAR1836V	120	QAR1836VG	120	QAR1836E	128	QAR1836S	351
	48"	1219	12	5.5	0.9	QAR1848Z	122	QAR1848C	126	QAR1848V	139	QAR1848VG	139	QAR1848E	148	QAR1848S	412
<b>21"</b> (533mm)	24"	610	8	3.6	0.7	QAR2124Z	108	QAR2124C	109	QAR2124V	114	QAR2124VG	114	QAR2124E	129	QAR2124S	353
	36"	914	11	5.0	0.8	QAR2136Z	117	QAR2136C	125	QAR2136V	136	QAR2136VG	136	QAR2136E	140	QAR2136S	397
	48"	1219	14	6.4	1.1	QAR2148Z	131	QAR2148C	139	QAR2148V	148	QAR2148VG	148	QAR2148E	159	QAR2148S	456
<b>24"</b> (610mm)	24"	610	9	4.1	0.8	QAR2424Z	118	QAR2424C	122	QAR2424V	124	QAR2424VG	124	QAR2424E	144	QAR2424S	421
	36"	914	13	5.9	0.8	QAR2436Z	124	QAR2436C	131	QAR2436V	140	QAR2436VG	140	QAR2436E	149	QAR2436S	428
	48"	1219	16	7.3	1.2	QAR2448Z	140	QAR2448C	149	QAR2448V	165	QAR2448VG	165	QAR2448E	176	QAR2448S	507

Note: MICROGARD® antimicrobial protection standard on all EAGLEgard® shelving.

### Quad-Adjust® 4-Tier Starter Units — Convenient easy-to-order starter unit kits.

see product announcement **EG8115M**

patented  
**QuadTruss®**  
design

(Patent #5,390,803)

Consists of (2) standard wire shelves, (2) Quad-Adjust® shelves (patent #7,992,731), and (4) 74" (1880mm) posts.

	length		weight		cu ft	EAGLEbrite®		chrome		VALU-MASTER®		Valu-Gard®		EAGLEgard®		stainless steel	
	in.	mm	lb.	kg		model #	list	model #	list	model #	list	model #	list	model #	list	model #	list
<b>18"</b> width (457mm)	36"	914	65	40	2.7	F2QA2-74-1836Z	432	F2QA2-74-1836C	444	F2QA2-74-1836V	480	F2QA2-74-1836VG	480	F2QA2-74-1836E	524	F2QA2-74-1836S	1452
	48"	1219	78	36	3.6	F2QA2-74-1848Z	476	F2QA2-74-1848C	430	F2QA2-74-1848V	542	F2QA2-74-1848VG	542	F2QA2-74-1848E	596	F2QA2-74-1848S	1666
	60"	1524	102	46	4.3	F2QA2-74-1860Z	530	F2QA2-74-1860C	498	F2QA2-74-1860V	608	F2QA2-74-1860VG	608	F2QA2-74-1860E	672	F2QA2-74-1860S	2022
<b>24"</b> width (610mm)	72"	1819	117	53	5.1	F2QA2-74-1872Z	594	F2QA2-74-1872C	628	F2QA2-74-1872V	688	F2QA2-74-1872VG	688	F2QA2-74-1872E	744	F2QA2-74-1872S	2330
	36"	914	81	37	3.6	F2QA2-74-2436Z	480	F2QA2-74-2436C	508	F2QA2-74-2436V	546	F2QA2-74-2436VG	546	F2QA2-74-2436E	600	F2QA2-74-2436S	1720
	48"	1219	98	45	4.6	F2QA2-74-2448Z	544	F2QA2-74-2448C	580	F2QA2-74-2448V	632	F2QA2-74-2448VG	632	F2QA2-74-2448E	694	F2QA2-74-2448S	2002
<b>24"</b> width (610mm)	60"	1524	122	55	5.7	F2QA2-74-2460Z	626	F2QA2-74-2460C	658	F2QA2-74-2460V	718	F2QA2-74-2460VG	718	F2QA2-74-2460E	784	F2QA2-74-2460S	2372
	72"	1819	149	68	6.9	F2QA2-74-2472Z	696	F2QA2-74-2472C	748	F2QA2-74-2472V	814	F2QA2-74-2472VG	814	F2QA2-74-2472E	888	F2QA2-74-2472S	2868

Note: MICROGARD® antimicrobial protection standard on all EAGLEgard® shelving.

Contact us:  
[revit@eaglegrp.com](mailto:revit@eaglegrp.com)

Access Eagle's Revit Libraries on  
AutoQuotes, KCL, and AutoDesk Seek.

**EAGLE**  
GROUP

Profit from the Eagle Advantage®



### QuadPLUS® Polymer Shelf Mats...

see spec sheets **EG01.47A** **EG01.47B**

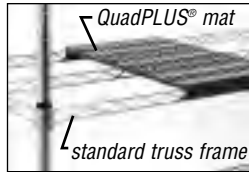

#### FEATURES

- Blue\* polymer louvered or solid shelf mats.
- MICROGARD® antimicrobial protection standard on mats.
- Easy assembly—no tools required!

**Note:** Packaging is the same as that of Wire Shelves (page 6).

#### ...with Standard Wire Truss Frame...

	length		weight		cu ft	...with Louvered Mats		...with Solid Mats					
	in.	mm	lb.	kg		w/chrome finish* model #	list	w/Valu-Master® finish* model #	list	w/chrome finish* model #	list	w/Valu-Master® finish* model #	list
<b>18" width</b> (457mm)	24"	610	7	3.2	0.7	<b>QPF-1824C-BL</b>	87	<b>QPF-1824V-BL</b>	92	<b>QPF-1824C-BS</b>	92	<b>QPF-1824V-BS</b>	97
	30"	762	8	3.6	0.7	<b>QPF-1830C-BL</b>	92	<b>QPF-1830V-BL</b>	97	<b>QPF-1830C-BS</b>	97	<b>QPF-1830V-BS</b>	102
	36"	914	10	4.5	0.7	<b>QPF-1836C-BL</b>	92	<b>QPF-1836V-BL</b>	97	<b>QPF-1836C-BS</b>	97	<b>QPF-1836V-BS</b>	102
	42"	1067	11	5.0	0.9	<b>QPF-1842C-BL</b>	111	<b>QPF-1842V-BL</b>	116	<b>QPF-1842C-BS</b>	117	<b>QPF-1842V-BS</b>	123
	48"	1219	12	5.4	0.9	<b>QPF-1848C-BL</b>	111	<b>QPF-1848V-BL</b>	116	<b>QPF-1848C-BS</b>	117	<b>QPF-1848V-BS</b>	123
	54"	1372	15	6.8	1.2	<b>QPF-1854C-BL</b>	131	<b>QPF-1854V-BL</b>	138	<b>QPF-1854C-BS</b>	138	<b>QPF-1854V-BS</b>	145
<b>21" width</b> (533mm)	60"	1524	17	7.7	1.2	<b>QPF-1860C-BL</b>	131	<b>QPF-1860V-BL</b>	138	<b>QPF-1860C-BS</b>	138	<b>QPF-1860V-BS</b>	145
	72"	1829	20	9.0	1.3	<b>QPF-1872C-BL</b>	149	<b>QPF-1872V-BL</b>	157	<b>QPF-1872C-BS</b>	157	<b>QPF-1872V-BS</b>	165
	24"	610	8	3.6	0.7	<b>QPF-2124C-BL</b>	99	<b>QPF-2124V-BL</b>	104	<b>QPF-2124C-BS</b>	104	<b>QPF-2124V-BS</b>	109
	30"	762	9	4.1	0.7	<b>QPF-2130C-BL</b>	102	<b>QPF-2130V-BL</b>	107	<b>QPF-2130C-BS</b>	107	<b>QPF-2130V-BS</b>	113
	36"	914	11	5.0	0.8	<b>QPF-2136C-BL</b>	102	<b>QPF-2136V-BL</b>	107	<b>QPF-2136C-BS</b>	107	<b>QPF-2136V-BS</b>	113
	42"	1067	13	5.9	1.1	<b>QPF-2142C-BL</b>	120	<b>QPF-2142V-BL</b>	126	<b>QPF-2142C-BS</b>	126	<b>QPF-2142V-BS</b>	133
<b>24" width</b> (610mm)	48"	1219	14	6.4	1.1	<b>QPF-2148C-BL</b>	120	<b>QPF-2148V-BL</b>	126	<b>QPF-2148C-BS</b>	126	<b>QPF-2148V-BS</b>	133
	54"	1372	16	7.3	1.3	<b>QPF-2154C-BL</b>	141	<b>QPF-2154V-BL</b>	148	<b>QPF-2154C-BS</b>	149	<b>QPF-2154V-BS</b>	157
	60"	1524	18	8.2	1.3	<b>QPF-2160C-BL</b>	141	<b>QPF-2160V-BL</b>	148	<b>QPF-2160C-BS</b>	149	<b>QPF-2160V-BS</b>	157
	72"	1829	23	10.4	1.4	<b>QPF-2172C-BL</b>	172	<b>QPF-2172V-BL</b>	181	<b>QPF-2172C-BS</b>	182	<b>QPF-2172V-BS</b>	192
	24"	610	10	4.5	0.8	<b>QPF-2424C-BL</b>	109	<b>QPF-2424V-BL</b>	115	<b>QPF-2424C-BS</b>	116	<b>QPF-2424V-BS</b>	122
	30"	762	11	5.0	0.8	<b>QPF-2430C-BL</b>	111	<b>QPF-2430V-BL</b>	117	<b>QPF-2430C-BS</b>	118	<b>QPF-2430V-BS</b>	124
<b>24" width</b> (610mm)	36"	914	13	5.9	0.8	<b>QPF-2436C-BL</b>	111	<b>QPF-2436V-BL</b>	117	<b>QPF-2436C-BS</b>	118	<b>QPF-2436V-BS</b>	124
	42"	1067	15	6.8	1.2	<b>QPF-2442C-BL</b>	136	<b>QPF-2442V-BL</b>	143	<b>QPF-2442C-BS</b>	142	<b>QPF-2442V-BS</b>	149
	48"	1219	16	7.3	1.2	<b>QPF-2448C-BL</b>	136	<b>QPF-2448V-BL</b>	143	<b>QPF-2448C-BS</b>	142	<b>QPF-2448V-BS</b>	149
	54"	1372	19	8.6	1.5	<b>QPF-2454C-BL</b>	161	<b>QPF-2454V-BL</b>	169	<b>QPF-2454C-BS</b>	169	<b>QPF-2454V-BS</b>	178
	60"	1524	21	9.5	1.5	<b>QPF-2460C-BL</b>	161	<b>QPF-2460V-BL</b>	169	<b>QPF-2460C-BS</b>	169	<b>QPF-2460V-BS</b>	178
	72"	1829	25	11.3	1.6	<b>QPF-2472C-BL</b>	188	<b>QPF-2472V-BL</b>	198	<b>QPF-2472C-BS</b>	198	<b>QPF-2472V-BS</b>	208

#### ...with Quad-Adjust® Truss Frame...

	length		weight		cu ft	...with Louvered Mats		...with Solid Mats					
	in.	mm	lb.	kg		w/chrome finish* model #	list	w/Valu-Master® finish* model #	list	w/chrome finish* model #	list	w/Valu-Master® finish* model #	list
<b>18" width</b> (457mm)	24"	610	7	3.2	0.7	<b>QPF-QA1824C-BL</b>	103	<b>QPF-QA1824V-BL</b>	107	<b>QPF-QA1824C-BS</b>	107	<b>QPF-QA1824V-BS</b>	114
	30"	762	8	3.6	0.7	<b>QPF-QA1830C-BL</b>	107	<b>QPF-QA1830V-BL</b>	114	<b>QPF-QA1830C-BS</b>	114	<b>QPF-QA1830V-BS</b>	120
	36"	914	10	4.5	0.7	<b>QPF-QA1836C-BL</b>	107	<b>QPF-QA1836V-BL</b>	114	<b>QPF-QA1836C-BS</b>	114	<b>QPF-QA1836V-BS</b>	120
	42"	1067	11	5.0	0.9	<b>QPF-QA1842C-BL</b>	131	<b>QPF-QA1842V-BL</b>	136	<b>QPF-QA1842C-BS</b>	138	<b>QPF-QA1842V-BS</b>	145
	48"	1219	12	5.4	0.9	<b>QPF-QA1848C-BL</b>	131	<b>QPF-QA1848V-BL</b>	136	<b>QPF-QA1848C-BS</b>	138	<b>QPF-QA1848V-BS</b>	145
	54"	1372	15	6.8	1.2	<b>QPF-QA1854C-BL</b>	154	<b>QPF-QA1854V-BL</b>	162	<b>QPF-QA1854C-BS</b>	162	<b>QPF-QA1854V-BS</b>	171
<b>21" width</b> (533mm)	60"	1524	17	7.7	1.2	<b>QPF-QA1860C-BL</b>	154	<b>QPF-QA1860V-BL</b>	162	<b>QPF-QA1860C-BS</b>	162	<b>QPF-QA1860V-BS</b>	171
	72"	1829	20	9.0	1.3	<b>QPF-QA1872C-BL</b>	176	<b>QPF-QA1872V-BL</b>	184	<b>QPF-QA1872C-BS</b>	184	<b>QPF-QA1872V-BS</b>	195
	24"	610	8	3.6	0.7	<b>QPF-QA2124C-BL</b>	117	<b>QPF-QA2124V-BL</b>	122	<b>QPF-QA2124C-BS</b>	122	<b>QPF-QA2124V-BS</b>	128
	30"	762	9	4.1	0.7	<b>QPF-QA2130C-BL</b>	120	<b>QPF-QA2130V-BL</b>	126	<b>QPF-QA2130C-BS</b>	126	<b>QPF-QA2130V-BS</b>	133
	36"	914	11	5.0	0.8	<b>QPF-QA2136C-BL</b>	120	<b>QPF-QA2136V-BL</b>	126	<b>QPF-QA2136C-BS</b>	126	<b>QPF-QA2136V-BS</b>	133
	42"	1067	13	5.9	1.1	<b>QPF-QA2142C-BL</b>	141	<b>QPF-QA2142V-BL</b>	148	<b>QPF-QA2142C-BS</b>	148	<b>QPF-QA2142V-BS</b>	156
<b>24" width</b> (610mm)	48"	1219	14	6.4	1.1	<b>QPF-QA2148C-BL</b>	141	<b>QPF-QA2148V-BL</b>	148	<b>QPF-QA2148C-BS</b>	148	<b>QPF-QA2148V-BS</b>	156
	54"	1372	16	7.3	1.3	<b>QPF-QA2154C-BL</b>	166	<b>QPF-QA2154V-BL</b>	175	<b>QPF-QA2154C-BS</b>	176	<b>QPF-QA2154V-BS</b>	184
	60"	1524	18	8.2	1.3	<b>QPF-QA2160C-BL</b>	166	<b>QPF-QA2160V-BL</b>	175	<b>QPF-QA2160C-BS</b>	176	<b>QPF-QA2160V-BS</b>	184
	72"	1829	23	10.4	1.4	<b>QPF-QA2172C-BL</b>	202	<b>QPF-QA2172V-BL</b>	213	<b>QPF-QA2172C-BS</b>	215	<b>QPF-QA2172V-BS</b>	225
	24"	610	10	4.5	0.8	<b>QPF-QA2424C-BL</b>	128	<b>QPF-QA2424V-BL</b>	135	<b>QPF-QA2424C-BS</b>	136	<b>QPF-QA2424V-BS</b>	143
	30"	762	11	5.0	0.8	<b>QPF-QA2430C-BL</b>	131	<b>QPF-QA2430V-BL</b>	138	<b>QPF-QA2430C-BS</b>	139	<b>QPF-QA2430V-BS</b>	146
<b>24" width</b> (610mm)	36"	914	13	5.9	0.8	<b>QPF-QA2436C-BL</b>	131	<b>QPF-QA2436V-BL</b>	138	<b>QPF-QA2436C-BS</b>	139	<b>QPF-QA2436V-BS</b>	146
	42"	1067	15	6.8	1.2	<b>QPF-QA2442C-BL</b>	160	<b>QPF-QA2442V-BL</b>	168	<b>QPF-QA2442C-BS</b>	167	<b>QPF-QA2442V-BS</b>	176
	48"	1219	16	7.3	1.2	<b>QPF-QA2448C-BL</b>	160	<b>QPF-QA2448V-BL</b>	168	<b>QPF-QA2448C-BS</b>	167	<b>QPF-QA2448V-BS</b>	176
	54"	1372	19	8.6	1.5	<b>QPF-QA2454C-BL</b>	189	<b>QPF-QA2454V-BL</b>	199	<b>QPF-QA2454C-BS</b>	199	<b>QPF-QA2454V-BS</b>	209
	60"	1524	21	9.5	1.5	<b>QPF-QA2460C-BL</b>	189	<b>QPF-QA2460V-BL</b>	199	<b>QPF-QA2460C-BS</b>	199	<b>QPF-QA2460V-BS</b>	209
	72"	1829	25	11.3	1.6	<b>QPF-QA2472C-BL</b>	222	<b>QPF-QA2472V-BL</b>	233	<b>QPF-QA2472C-BS</b>	233	<b>QPF-QA2472V-BS</b>	245

\*Available with green polymer mats and truss frames coated with EAGLEgard® green epoxy (w/MICROGARD®) or Valu-Gard® green epoxy finish.  
See spec sheets **EG01.47A** and **EG01.47B**.

## Catalog Section 1



### QuadPLUS® 5-Tier Starter Units — Convenient easy-to-order starter unit kits.

see spec sheet **EG01.36M**

Consists of:

- (1) Standard collar truss frame with louvered QuadPLUS® blue shelf mats
- (3) Quad-Adjust® collar truss frames with louvered QuadPLUS® blue shelf mats
- (1) Standard collar truss frame with solid QuadPLUS® blue shelf mats
- (4) 74" (1880mm) posts. Mobile units feature 5" (127mm) resilient swivel stem casters—two with brake.

	Stationary				Mobile					
	length		with chrome		with Valu-Master®		with chrome		with Valu-Master®	
	in.	mm	model #	list	model #	list	model #	list	model #	list
18" width (457mm)	36"	914	QPSU1836C-B5-74	738	QPSU1836V-B5-74	614	QPMU1836C-B5-74	773	QPMU1836V-B5-74	649
	48"	1219	QPSU1848C-B5-74	849	QPSU1848V-B5-74	725	QPMU1848C-B5-74	879	QPMU1848V-B5-74	755
	60"	1524	QPSU1860C-B5-74	959	QPSU1860V-B5-74	835	QPMU1860C-B5-74	1001	QPMU1860V-B5-74	877
21" width (533mm)	36"	914	QPSU2136C-B5-74	797	QPSU2136V-B5-74	673	QPMU2136C-B5-74	830	QPMU2136V-B5-74	706
	48"	1219	QPSU2148C-B5-74	897	QPSU2148V-B5-74	773	QPMU2148C-B5-74	935	QPMU2148V-B5-74	811
	60"	1524	QPSU2160C-B5-74	1016	QPSU2160V-B5-74	892	QPMU2160C-B5-74	1062	QPMU2160V-B5-74	938
24" width (610mm)	36"	914	QPSU2436C-B5-74	850	QPSU2436V-B5-74	726	QPMU2436C-B5-74	887	QPMU2436V-B5-74	763
	48"	1219	QPSU2448C-B5-74	986	QPSU2448V-B5-74	862	QPMU2448C-B5-74	1028	QPMU2448V-B5-74	904
	60"	1524	QPSU2460C-B5-74	1125	QPSU2460V-B5-74	1001	QPMU2460C-B5-74	1176	QPMU2460V-B5-74	1052

### QuadPLUS® Wire Baskets and Truss Frames

see product announcement **EG8155M**

These baskets are used in conjunction with specially-made truss frames. Once truss frame is assembled to posts, set basket inside frame. It's that easy!

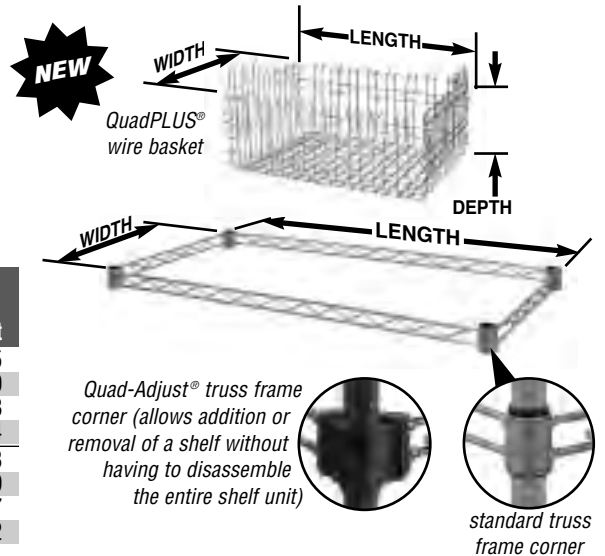

#### Wire Baskets

	length		depth		chrome finish		Valu-Master® gray epoxy	
	in.	mm	in.	mm	model #	list	model #	list
18" width (457mm)	16"	406	6"	152	QPB1816C-6	201	QPB1816V-6	205
	16"	406	9"	229	QPB1816C-9	216	QPB1816V-9	220
	22"	559	6"	152	QPB1822C-6	223	QPB1822V-6	228
	22"	559	9"	229	QPB1822C-9	239	QPB1822V-9	244
24" width (610mm)	16"	406	6"	152	QPB2416C-6	209	QPB2416V-6	213
	16"	406	9"	229	QPB2416C-9	224	QPB2416V-9	229
	22"	559	6"	152	QPB2422C-6	232	QPB2422V-6	237
	22"	559	9"	229	QPB2422C-9	247	QPB2422V-9	252

	Truss Frames with Standard Corners				Truss Frames with Quad-Adjust® Corners				Basket Capacity per Truss Frame			
	length		chrome finish		Valu-Master® gray epoxy		chrome finish		Valu-Master® gray epoxy		quantity of 16"-long basket	quantity of 22"-long basket
	in.	mm	model #	list	model #	list	model #	list	model #	list		
18" width (457mm)	24"	610	QPAF-1824C	61	QPAF-1824V	62	QPAF-QA1824C	129	QPAF-QA1824V	132		1
	30"	760	QPAF-1830C	63	QPAF-1830V	64	QPAF-QA1830C	131	QPAF-QA1830V	134		1
	36"	914	QPAF-1836C	65	QPAF-1836V	66	QPAF-QA1836C	131	QPAF-QA1836V	134	2	
	42"	1060	QPAF-1842C	67	QPAF-1842V	68	QPAF-QA1842C	133	QPAF-QA1842V	136	1	1
	48"	1220	QPAF-1848C	69	QPAF-1848V	70	QPAF-QA1848C	135	QPAF-QA1848V	138		2
	54"	1372	QPAF-1854C	70	QPAF-1854V	71	QPAF-QA1854C	139	QPAF-QA1854V	142		2
	60"	1524	QPAF-1860C	72	QPAF-1860V	73	QPAF-QA1860C	141	QPAF-QA1860V	144	2	1
	72"	1829	QPAF-1872C	74	QPAF-1872V	76	QPAF-QA1872C	142	QPAF-QA1872V	145		3
24" width (610mm)	24"	610	QPAF-2424C	70	QPAF-2424V	71	QPAF-QA2424C	136	QPAF-QA2424V	139		1
	30"	760	QPAF-2430C	73	QPAF-2430V	74	QPAF-QA2430C	139	QPAF-QA2430V	142		1
	36"	914	QPAF-2436C	75	QPAF-2436V	77	QPAF-QA2436C	142	QPAF-QA2436V	145	2	
	42"	1060	QPAF-2442C	77	QPAF-2442V	79	QPAF-QA2442C	145	QPAF-QA2442V	148	1	1
	48"	1220	QPAF-2448C	82	QPAF-2448V	84	QPAF-QA2448C	148	QPAF-QA2448V	151		2
	54"	1372	QPAF-2454C	83	QPAF-2454V	85	QPAF-QA2454C	151	QPAF-QA2454V	154		2
	60"	1524	QPAF-2460C	83	QPAF-2460V	85	QPAF-QA2460C	152	QPAF-QA2460V	155	2	1
	72"	1829	QPAF-2472C	93	QPAF-2472V	95	QPAF-QA2472C	158	QPAF-QA2472V	161		3



100 Industrial Boulevard, Clayton, DE 19938-8903 U.S.A.  
 Phone: 800-637-5100 or 302-653-3000. Fax: 302-653-2065  
<http://www.eaglegrp.com>

### QuadPLUS® Accessories



see product announcement **EG8165M**



tray drying rack

### Tray Drying Racks

Fits over existing QuadPLUS® polymer shelving. Constructed of 6-gauge wire with chrome or Valu-Master® gray epoxy coating. Comes in widths of 18", 21" and 24". Lengths range from 24" long to 60".

	...with 1-1/2" (38mm) Spacing				...with 3" (76mm) Spacing					
	length		with Valu-Master®		with stainless finish		with Valu-Master®		with stainless finish	
	in.	mm	model #	list	model #	list	model #	list	model #	list
24" width (610mm)	36"	914	QTR24361-V	205	QTR24361-S	223	QTR24363-V	202	QTR24363-S	219
	48"	1219	QTR24481-V	215	QTR24481-S	239	QTR24483-V	212	QTR24483-S	235
	60"	1524	QTR24601-V	229	QTR24601-S	258	QTR24603-V	225	QTR24603-S	254

### Drop-In Drying Racks

Wire rack hangs onto front, center and rear trusses of frame included. All drying racks are stainless steel, with your choice of Valu-Master® gray epoxy or stainless steel truss frame.



drop-in drying rack

	length		w/Valu-Master® finish on truss frame		with stainless finish on truss frame	
	in.	mm	model #	list	model #	list
24" width (610mm)	36"	914	QDR2436-V	272	QDR2436-S	291
	48"	1219	QDR2448-V	283	QDR2448-S	308
	60"	1524	QDR2460-V	300	QDR2460-S	328

### Ledges



#### Front-to-Back Ledges...

	width		cu ft	weight		1"-high (25mm)		4"-high (102mm)		
	in.	mm		lb.	kg	w/chrome model # list	w/Valu-Master® model # list	w/chrome model # list	w/Valu-Master® model # list	
18"	457	0.3	0.3	0.1	QL18W-1C 31	QL18W-1V 32	0.9	0.4	QL18W-4C 32	QL18W-4V 33
21"	533	0.3	0.4	0.2	QL21W-1C 33	QL21W-1V 34	1.0	0.5	QL21W-4C 35	QL21W-4V 36
24"	610	0.3	0.5	0.2	QL24W-1C 34	QL24W-1V 35	1.2	0.6	QL24W-4C 35	QL24W-4V 36

#### Left-to-Right Ledges...

	length		cu ft	weight		1"-high (25mm)		4"-high (102mm)		
	in.	mm		lb.	kg	w/chrome model # list	w/Valu-Master® model # list	w/chrome model # list	w/Valu-Master® model # list	
24"	610	0.3	0.5	0.2	QL24L-1C 34	QL24L-1V 35	1.2	0.6	QL24L-4C 35	QL24L-4V 36
30"	762	0.5	0.7	0.3	QL30L-1C 40	QL30L-1V 41	1.4	0.6	QL30L-4C 44	QL30L-4V 45
36"	914	0.6	0.9	0.4	QL36L-1C 47	QL36L-1V 48	1.6	0.7	QL36L-4C 53	QL36L-4V 54
42"	1067	0.6	1.1	0.5	QL42L-1C 49	QL42L-1V 50	1.8	0.8	QL42L-4C 54	QL42L-4V 55
48"	1092	0.7	1.3	0.6	QL48L-1C 50	QL48L-1V 51	2.0	0.9	QL48L-4C 55	QL48L-4V 56
54"	1372	0.8	1.5	0.7	QL54L-1C 55	QL54L-1V 56	2.2	1.0	QL54L-4C 57	QL54L-4V 58
60"	1524	0.8	1.7	0.8	QL60L-1C 61	QL60L-1V 62	2.4	1.1	QL60L-4C 65	QL60L-4V 66
72"	1829	1.0	2.1	1.0	QL72L-1C 67	QL72L-1V 68	2.6	1.2	QL72L-4C 71	QL72L-4V 72

### QuadPLUS® Dividers

8" (203mm) height.

length	w/chrome		w/Valu-Master®		
	in.	mm	model #	list	
18"	457	QPSD18-C	68	QPSD18-V	69
21"	533	QPSD21-C	69	QPSD21-V	71
24"	610	QPSD24-C	74	QPSD24-V	75





## Catalog Section 1

### Seismic Shelving

see spec sheet **EG01.27**

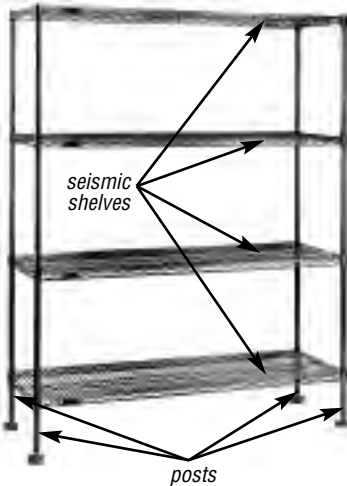

**Designed to withstand earthquakes without labor-intensive sway braces.**



PACKAGING:

- 24"-48" (610-1219mm) lengths: Four per box.
- 54"-60" (1372-1524mm) lengths: Two per box.
- Four pairs of aluminum split sleeves per shelf.

Note: Shelves and posts sold separately.

Freight class is 70.0.

patented  
**QuadTruss**  
design

(Patent #5,390,803)

**Patented QuadTruss® Design** makes shelves up to 25% stronger and provides a retaining ledge for increased strength and product retention.

**Approved by the California Office of Statewide Health Planning and Development.**

Note: OSHPD ongoing evaluation may affect EAGLE GROUP's approve/pre-approve status. Consult factory.

### Shelves

	length		weight		cu	EAGLEbrite®		chrome		Valu-Master®		Valu-Gard®		EAGLgard®		stainless	
	in.	mm	lb.	kg		ft	model #	list	model #	list	model #	list	model #	list	model #	list	model #
<b>18" width</b> (457mm)	24"	610	7	3.2	0.7	SA1824Z	84	SA1824C	94	SA1824V	95	SA1824VG	95	SA1824E	119	SA1824S	316
	30"	762	9	4.1	0.7	SA1830Z	94	SA1830C	103	SA1830V	104	SA1830VG	104	SA1830E	130	SA1830S	318
	36"	914	10	4.5	0.7	SA1836Z	99	SA1836C	108	SA1836V	109	SA1836VG	109	SA1836E	137	SA1836S	323
	42"	1067	12	5.4	0.9	SA1842Z	108	SA1842C	120	SA1842V	121	SA1842VG	121	SA1842E	152	SA1842S	381
	48"	1219	13	5.8	0.9	SA1848Z	120	SA1848C	129	SA1848V	131	SA1848VG	131	SA1848E	164	SA1848S	383
	54"	1372	14	6.4	1.2	SA1854Z	136	SA1854C	146	SA1854V	148	SA1854VG	148	SA1854E	186	SA1854S	483
<b>21" width</b> (533mm)	24"	610	8	3.6	0.7	SA2124Z	95	SA2124C	102	SA2124V	103	SA2124VG	103	SA2124E	129	SA2124S	362
	30"	762	10	4.5	0.7	SA2130Z	102	SA2130C	115	SA2130V	116	SA2130VG	116	SA2130E	144	SA2130S	366
	36"	914	12	5.4	0.8	SA2136Z	109	SA2136C	124	SA2136V	126	SA2136VG	126	SA2136E	158	SA2136S	368
	42"	1067	13	5.8	1.1	SA2142Z	121	SA2142C	137	SA2142V	138	SA2142VG	138	SA2142E	172	SA2142S	426
	48"	1219	15	6.8	1.1	SA2148Z	129	SA2148C	142	SA2148V	144	SA2148VG	144	SA2148E	181	SA2148S	428
	54"	1372	17	7.7	1.3	SA2154Z	146	SA2154C	164	SA2154V	166	SA2154VG	166	SA2154E	208	SA2154S	565
<b>24" width</b> (610mm)	60"	1524	19	8.6	1.3	SA2160Z	158	SA2160C	169	SA2160V	171	SA2160VG	171	SA2160E	214	SA2160S	568
	24"	610	9	4.1	0.8	SA2424Z	102	SA2424C	112	SA2424V	113	SA2424VG	113	SA2424E	142	SA2424S	392
	30"	762	12	5.4	0.8	SA2430Z	112	SA2430C	120	SA2430V	121	SA2430VG	121	SA2430E	152	SA2430S	396
	36"	914	14	6.4	0.8	SA2436Z	115	SA2436C	128	SA2436V	130	SA2436VG	130	SA2436E	163	SA2436S	401
	42"	1067	16	7.3	1.0	SA2442Z	128	SA2442C	142	SA2442V	144	SA2442VG	144	SA2442E	181	SA2442S	479
	48"	1219	17	7.7	1.2	SA2448Z	137	SA2448C	157	SA2448V	158	SA2448VG	158	SA2448E	197	SA2448S	482
	54"	1372	18	8.2	1.5	SA2454Z	158	SA2454C	173	SA2454V	175	SA2454VG	175	SA2454E	219	SA2454S	589
	60"	1524	22	10.0	1.5	SA2460Z	167	SA2460C	185	SA2460V	186	SA2460VG	186	SA2460E	233	SA2460S	592

### Posts for Seismic Shelving

see spec sheet **EG01.27**

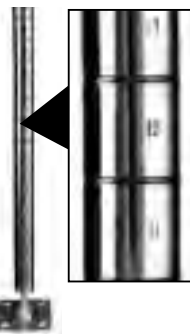

**Posts are numbered on vertical 1" (25mm) increments to help ensure fast and level assembly.**

FEATURES:

- Four staked posts required; per unit.
- Foot plates standard with each post.

Freight class is 50.0.

post height		weight		cu	EAGLEbrite®		chrome	
in.	mm	lb.	kg		model #	list	model #	list
54"	1372	3.0	1.4	0.003	SAP54-Z	29	SAP54-C	32
63"	1600	3.5	1.6	0.008	SAP63-Z	31	SAP63-C	36
72"	1829	4.0	1.8	0.014	SAP72-Z	32	SAP72-C	37



### Four-Shelf Starter Units

see spec sheet **EG01.25**

- Four shelves.
- Four posts (*same finish as shelves*).
- Shipped knocked-down.

INCLUDES:

Note: 54" (1372mm) shelves available (*see page 6*).

**Freight class is 70.0.**

(•) MTS (*made to stock*) / ( ) MTO (*made to order*)



**EAGLEgard® finish standard with MICROGARD® protection.**

See bottom of page 4 for details.



(Patent #5,390,803)

**Patented QuadTruss® Design** makes shelves up to 25% stronger and provides a retaining ledge for increased strength and product retention.

### Models with 63" (1600mm) Height

	length		cu	EAGLEbrite®		chrome		VALU-MASTER®		Valu-Gard®		EAGLEgard®		stainless	
	in.	mm		lb.	kg	ft	model #	list	model #	list	model #	list	model #	list	model #
<b>18" width (457mm)</b>	24"	610	42	19	1.8	S4-63-1824Z • 332	S4-63-1824C • 344	S4-63-1824V • 356	S4-63-1824VG • 356	S4-63-1824E • 408	S4-63-1824S • 1228				
	30"	762	47	21	2.2	S4-63-1830Z • 340	S4-63-1830C • 348	S4-63-1830V • 376	S4-63-1830VG • 376	S4-63-1830E • 420	S4-63-1830S • 1244				
	36"	914	53	24	2.6	S4-63-1836Z • 348	S4-63-1836C • 356	S4-63-1836V • 388	S4-63-1836VG • 388	S4-63-1836E • 432	S4-63-1836S • 1252				
	42"	1067	57	26	3.0	S4-63-1842Z • 388	S4-63-1842C • 408	S4-63-1842V • 440	S4-63-1842VG • 440	S4-63-1842E • 496	S4-63-1842S • 1444				
	48"	1219	63	29	3.5	S4-63-1848Z • 388	S4-63-1848C • 408	S4-63-1848V • 440	S4-63-1848VG • 440	S4-63-1848E • 496	S4-63-1848S • 1444				
	60"	1524	82	37	4.2	S4-63-1860Z • 436	S4-63-1860C • 464	S4-63-1860V • 516	S4-63-1860VG • 516	S4-63-1860E • 568	S4-63-1860S • 1764				
<b>21" width (533mm)</b>	24"	610	46	21	2.1	S4-63-2124Z • 356	S4-63-2124C • 384	S4-63-2124V • 392	S4-63-2124VG • 392	S4-63-2124E • 448	S4-63-2124S • 1380				
	30"	762	52	24	2.6	S4-63-2130Z • 364	S4-63-2130C • 392	S4-63-2130V • 412	S4-63-2130VG • 412	S4-63-2130E • 456	S4-63-2130S • 1392				
	36"	914	59	27	3.0	S4-63-2136Z • 376	S4-63-2136C • 404	S4-63-2136V • 420	S4-63-2136VG • 420	S4-63-2136E • 476	S4-63-2136S • 1400				
	42"	1067	65	30	3.5	S4-63-2142Z • 416	S4-63-2142C • 452	S4-63-2142V • 476	S4-63-2142VG • 476	S4-63-2142E • 536	S4-63-2142S • 1576				
	48"	1219	71	32	4.0	S4-63-2148Z • 416	S4-63-2148C • 452	S4-63-2148V • 476	S4-63-2148VG • 476	S4-63-2148E • 536	S4-63-2148S • 1576				
	60"	1524	88	40	5.0	S4-63-2160Z • 488	S4-63-2160C • 516	S4-63-2160V • 552	S4-63-2160VG • 552	S4-63-2160E • 608	S4-63-2160S • 2012				
<b>24" width (610mm)</b>	24"	610	50	23	2.8	S4-63-2424Z • 376	S4-63-2424C • 400	S4-63-2424V • 416	S4-63-2424VG • 416	S4-63-2424E • 484	S4-63-2424S • 1468				
	30"	762	57	26	2.9	S4-63-2430Z • 384	S4-63-2430C • 412	S4-63-2430V • 436	S4-63-2430VG • 436	S4-63-2430E • 492	S4-63-2430S • 1476				
	36"	914	65	30	3.5	S4-63-2436Z • 396	S4-63-2436C • 420	S4-63-2436V • 444	S4-63-2436VG • 444	S4-63-2436E • 500	S4-63-2436S • 1492				
	42"	1067	72	33	3.6	S4-63-2442Z • 456	S4-63-2442C • 484	S4-63-2442V • 516	S4-63-2442VG • 516	S4-63-2442E • 588	S4-63-2442S • 1752				
	48"	1219	79	36	4.5	S4-63-2448Z • 456	S4-63-2448C • 484	S4-63-2448V • 516	S4-63-2448VG • 516	S4-63-2448E • 588	S4-63-2448S • 1752				
	60"	1524	98	45	5.6	S4-63-2460Z • 536	S4-63-2460C • 560	S4-63-2460V • 608	S4-63-2460VG • 608	S4-63-2460E • 676	S4-63-2460S • 2080				
	72"	1829	120	55	6.8	S4-63-2472Z • 596	S4-63-2472C • 644	S4-63-2472V • 692	S4-63-2472VG • 692	S4-63-2472E • 772	S4-63-2472S • 2528				

### Models with 74" (1880mm) Height

	length		cu	EAGLEbrite®		chrome		VALU-MASTER®		Valu-Gard®		EAGLEgard®		stainless	
	in.	mm		lb.	kg	ft	model #	list	model #	list	model #	list	model #	list	model #
<b>18" width (457mm)</b>	24"	610	51	23	1.9	S4-74-1824Z • 336	S4-74-1824C • 352	S4-74-1824V • 364	S4-74-1824VG • 364	S4-74-1824E • 420	S4-74-1824S • 1264				
	30"	762	58	26	2.3	S4-74-1830Z • 344	S4-74-1830C • 356	S4-74-1830V • 384	S4-74-1830VG • 384	S4-74-1830E • 432	S4-74-1830S • 1280				
	36"	914	65	30	2.7	S4-74-1836Z • 352	S4-74-1836C • 364	S4-74-1836V • 396	S4-74-1836VG • 396	S4-74-1836E • 444	S4-74-1836S • 1288				
	42"	1067	70	32	3.1	S4-74-1842Z • 392	S4-74-1842C • 416	S4-74-1842V • 448	S4-74-1842VG • 448	S4-74-1842E • 508	S4-74-1842S • 1480				
	48"	1219	78	36	3.6	S4-74-1848Z • 392	S4-74-1848C • 416	S4-74-1848V • 448	S4-74-1848VG • 448	S4-74-1848E • 508	S4-74-1848S • 1480				
	60"	1524	102	46	4.3	S4-74-1860Z • 440	S4-74-1860C • 472	S4-74-1860V • 524	S4-74-1860VG • 524	S4-74-1860E • 580	S4-74-1860S • 1800				
<b>21" width (533mm)</b>	24"	610	57	26	2.2	S4-74-2124Z • 360	S4-74-2124C • 392	S4-74-2124V • 400	S4-74-2124VG • 400	S4-74-2124E • 460	S4-74-2124S • 1416				
	30"	762	64	29	2.7	S4-74-2130Z • 368	S4-74-2130C • 400	S4-74-2130V • 420	S4-74-2130VG • 420	S4-74-2130E • 468	S4-74-2130S • 1428				
	36"	914	73	33	3.1	S4-74-2136Z • 380	S4-74-2136C • 412	S4-74-2136V • 428	S4-74-2136VG • 428	S4-74-2136E • 488	S4-74-2136S • 1436				
	42"	1067	81	37	3.6	S4-74-2142Z • 420	S4-74-2142C • 460	S4-74-2142V • 484	S4-74-2142VG • 484	S4-74-2142E • 548	S4-74-2142S • 1612				
	48"	1219	88	40	4.1	S4-74-2148Z • 420	S4-74-2148C • 460	S4-74-2148V • 484	S4-74-2148VG • 484	S4-74-2148E • 548	S4-74-2148S • 1612				
	60"	1524	109	50	5.1	S4-74-2160Z • 492	S4-74-2160C • 524	S4-74-2160V • 560	S4-74-2160VG • 560	S4-74-2160E • 620	S4-74-2160S • 2048				
<b>24" width (610mm)</b>	24"	610	62	28	2.5	S4-74-2424Z • 380	S4-74-2424C • 408	S4-74-2424V • 424	S4-74-2424VG • 424	S4-74-2424E • 496	S4-74-2424S • 1504				
	30"	762	71	32	3.0	S4-74-2430Z • 388	S4-74-2430C • 420	S4-74-2430V • 444	S4-74-2430VG • 444	S4-74-2430E • 504	S4-74-2430S • 1512				
	36"	914	81	37	3.6	S4-74-2436Z • 400	S4-74-2436C • 428	S4-74-2436V • 452	S4-74-2436VG • 452	S4-74-2436E • 512	S4-74-2436S • 1528				
	42"	1067	89	40	3.7	S4-74-2442Z • 460	S4-74-2442C • 492	S4-74-2442V • 524	S4-74-2442VG • 524	S4-74-2442E • 600	S4-74-2442S • 1788				
	48"	1219	98	45	4.6	S4-74-2448Z • 460	S4-74-2448C • 492	S4-74-2448V • 524	S4-74-2448VG • 524	S4-74-2448E • 600	S4-74-2448S • 1788				
	60"	1524	122	55	5.7	S4-74-2460Z • 540	S4-74-2460C • 568	S4-74-2460V • 616	S4-74-2460VG • 616	S4-74-2460E • 688	S4-74-2460S • 2116				
	72"	1829	149	68	6.9	S4-74-2472Z • 600	S4-74-2472C • 652	S4-74-2472V • 700	S4-74-2472VG • 700	S4-74-2472E • 784	S4-74-2472S • 2564				



## Catalog Section 1

### Four-Shelf Add-On Units

see spec sheet **EG01.25**



**EAGLEgard® finish standard with MICROGARD® protection.**  
See bottom of page 4 for details.

- Four shelves.
- Two posts (*same finish as shelves*).
- Two “S” hooks per shelf.
- Shipped knocked-down.

**INCLUDES:**

**Note:** 54” (1372mm) shelves available see page 6.

**Freight class is 70.0.**

(•) MTS (*made to stock*) / ( ) MTO (*made to order*)

patented  
**QuadTruss®**  
design  
(Patent #5,390,803)

**Patented QuadTruss® Design**  
makes shelves up to 25% stronger and provides a retaining ledge for increased strength and product retention.

### Models with 63” (1600mm) Height

	length		weight		cu ft	EAGLEbrite®		chrome		VALU-MASTER®		Valu-Gard®		EAGLEgard®		stainless	
	in.	mm	lb.	kg		model #	list	model #	list	model #	list	model #	list	model #	list	model #	list
<b>18” width (457mm)</b>	24”	610	35	16	1.8	A4-63-1824Z •	310	A4-63-1824C •	320	A4-63-1824V •	330	A4-63-1824VG •	330	A4-63-1824E •	376	A4-63-1824S •	1118
	30”	762	40	18	2.2	A4-63-1830Z •	318	A4-63-1830C •	324	A4-63-1830V •	350	A4-63-1830VG •	350	A4-63-1830E •	388	A4-63-1830S •	1134
	36”	914	46	21	2.6	A4-63-1836Z •	326	A4-63-1836C •	332	A4-63-1836V •	362	A4-63-1836VG •	362	A4-63-1836E •	400	A4-63-1836S •	1142
	42”	1067	50	23	3.0	A4-63-1842Z •	366	A4-63-1842C •	384	A4-63-1842V •	414	A4-63-1842VG •	414	A4-63-1842E •	464	A4-63-1842S •	1334
	48”	1219	56	25	3.5	A4-63-1848Z •	366	A4-63-1848C •	384	A4-63-1848V •	414	A4-63-1848VG •	414	A4-63-1848E •	464	A4-63-1848S •	1334
	60”	1524	75	34	4.2	A4-63-1860Z •	414	A4-63-1860C •	440	A4-63-1860V •	490	A4-63-1860VG •	490	A4-63-1860E •	536	A4-63-1860S •	1654
72”	1829	87	40	5.0	A4-63-1872Z •	506	A4-63-1872C •	508	A4-63-1872V •	550	A4-63-1872VG •	550	A4-63-1872E •	608	A4-63-1872S •	1934	
<b>21” width (533mm)</b>	24”	610	39	18	2.1	A4-63-2124Z •	334	A4-63-2124C •	360	A4-63-2124V •	366	A4-63-2124VG •	366	A4-63-2124E •	416	A4-63-2124S •	1270
	30”	762	45	21	2.6	A4-63-2130Z •	342	A4-63-2130C •	368	A4-63-2130V •	386	A4-63-2130VG •	386	A4-63-2130E •	424	A4-63-2130S •	1282
	36”	914	52	24	3.0	A4-63-2136Z •	354	A4-63-2136C •	380	A4-63-2136V •	394	A4-63-2136VG •	394	A4-63-2136E •	444	A4-63-2136S •	1290
	42”	1067	58	26	3.5	A4-63-2142Z •	394	A4-63-2142C •	428	A4-63-2142V •	450	A4-63-2142VG •	450	A4-63-2142E •	504	A4-63-2142S •	1466
	48”	1219	64	29	4.0	A4-63-2148Z •	394	A4-63-2148C •	428	A4-63-2148V •	450	A4-63-2148VG •	450	A4-63-2148E •	504	A4-63-2148S •	1466
	60”	1524	81	37	5.0	A4-63-2160Z •	466	A4-63-2160C •	492	A4-63-2160V •	526	A4-63-2160VG •	526	A4-63-2160E •	576	A4-63-2160S •	1902
72”	1829	92	42	7.8	A4-63-2172Z •	546	A4-63-2172C •	572	A4-63-2172V •	622	A4-63-2172VG •	622	A4-63-2172E •	688	A4-63-2172S •	2222	
<b>24” width (610mm)</b>	24”	610	43	20	2.4	A4-63-2424Z •	354	A4-63-2424C •	376	A4-63-2424V •	390	A4-63-2424VG •	390	A4-63-2424E •	450	A4-63-2424S •	1358
	30”	762	50	23	2.9	A4-63-2430Z •	362	A4-63-2430C •	388	A4-63-2430V •	410	A4-63-2430VG •	410	A4-63-2430E •	458	A4-63-2430S •	1366
	36”	914	58	26	3.5	A4-63-2436Z •	374	A4-63-2436C •	396	A4-63-2436V •	418	A4-63-2436VG •	418	A4-63-2436E •	466	A4-63-2436S •	1382
	42”	1067	65	30	3.6	A4-63-2442Z •	434	A4-63-2442C •	460	A4-63-2442V •	490	A4-63-2442VG •	490	A4-63-2442E •	554	A4-63-2442S •	1642
	48”	1219	72	33	4.5	A4-63-2448Z •	434	A4-63-2448C •	460	A4-63-2448V •	490	A4-63-2448VG •	490	A4-63-2448E •	554	A4-63-2448S •	1642
	60”	1524	91	41	5.6	A4-63-2460Z •	514	A4-63-2460C •	536	A4-63-2460V •	582	A4-63-2460VG •	582	A4-63-2460E •	642	A4-63-2460S •	1970
72”	1829	113	51	6.8	A4-63-2472Z •	574	A4-63-2472C •	620	A4-63-2472V •	666	A4-63-2472VG •	666	A4-63-2472E •	738	A4-63-2472S •	2418	

### Models with 74” (1880mm) Height

	length		weight		cu ft	EAGLEbrite®		chrome		VALU-MASTER®		Valu-Gard®		EAGLEgard®		stainless	
	in.	mm	lb.	kg		model #	list	model #	list	model #	list	model #	list	model #	list	model #	list
<b>18” width (457mm)</b>	24”	610	43	20	1.9	A4-74-1824Z •	336	A4-74-1824C •	324	A4-74-1824V •	334	A4-74-1824VG •	334	A4-74-1824E •	382	A4-74-1824S •	1136
	30”	762	50	23	2.3	A4-74-1830Z •	344	A4-74-1830C •	328	A4-74-1830V •	354	A4-74-1830VG •	354	A4-74-1830E •	394	A4-74-1830S •	1152
	36”	914	57	26	2.7	A4-74-1836Z •	356	A4-74-1836C •	336	A4-74-1836V •	366	A4-74-1836VG •	366	A4-74-1836E •	406	A4-74-1836S •	1160
	42”	1067	62	28	3.1	A4-74-1842Z •	396	A4-74-1842C •	388	A4-74-1842V •	418	A4-74-1842VG •	418	A4-74-1842E •	470	A4-74-1842S •	1352
	48”	1219	70	32	3.6	A4-74-1848Z •	396	A4-74-1848C •	388	A4-74-1848V •	418	A4-74-1848VG •	418	A4-74-1848E •	470	A4-74-1848S •	1352
	60”	1524	93	42	4.3	A4-74-1860Z •	468	A4-74-1860C •	444	A4-74-1860V •	494	A4-74-1860VG •	494	A4-74-1860E •	542	A4-74-1860S •	1672
72”	1829	108	49	5.1	A4-74-1872Z •	548	A4-74-1872C •	512	A4-74-1872V •	554	A4-74-1872VG •	554	A4-74-1872E •	614	A4-74-1872S •	1952	
<b>21” width (533mm)</b>	24”	610	48	22	2.2	A4-74-2124Z •	336	A4-74-2124C •	364	A4-74-2124V •	370	A4-74-2124VG •	370	A4-74-2124E •	422	A4-74-2124S •	1288
	30”	762	56	26	2.7	A4-74-2130Z •	344	A4-74-2130C •	372	A4-74-2130V •	390	A4-74-2130VG •	390	A4-74-2130E •	430	A4-74-2130S •	1300
	36”	914	65	30	3.1	A4-74-2136Z •	356	A4-74-2136C •	384	A4-74-2136V •	398	A4-74-2136VG •	398	A4-74-2136E •	450	A4-74-2136S •	1308
	42”	1067	73	33	3.6	A4-74-2142Z •	396	A4-74-2142C •	432	A4-74-2142V •	454	A4-74-2142VG •	454	A4-74-2142E •	510	A4-74-2142S •	1484
	48”	1219	80	36	4.1	A4-74-2148Z •	396	A4-74-2148C •	432	A4-74-2148V •	454	A4-74-2148VG •	454	A4-74-2148E •	510	A4-74-2148S •	1484
	60”	1524	101	46	5.1	A4-74-2160Z •	468	A4-74-2160C •	496	A4-74-2160V •	530	A4-74-2160VG •	530	A4-74-2160E •	582	A4-74-2160S •	1920
72”	1829	113	51	7.7	A4-74-2172Z •	548	A4-74-2172C •	576	A4-74-2172V •	626	A4-74-2172VG •	626	A4-74-2172E •	694	A4-74-2172S •	2240	
<b>24” width (610mm)</b>	24”	610	53	24	2.5	A4-74-2424Z •	356	A4-74-2424C •	380	A4-74-2424V •	394	A4-74-2424VG •	394	A4-74-2424E •	454	A4-74-2424S •	1376
	30”	762	62	28	3.0	A4-74-2430Z •	364	A4-74-2430C •	392	A4-74-2430V •	414	A4-74-2430VG •	414	A4-74-2430E •	462	A4-74-2430S •	1384
	36”	914	73	33	3.6	A4-74-2436Z •	376	A4-74-2436C •	400	A4-74-2436V •	422	A4-74-2436VG •	422	A4-74-2436E •	470	A4-74-2436S •	1400
	42”	1067	81	37	3.7	A4-74-2442Z •	436	A4-74-2442C •	464	A4-74-2442V •	494	A4-74-2442VG •	494	A4-74-2442E •	558	A4-74-2442S •	1660
	48”	1219	90	41	4.6	A4-74-2448Z •	436	A4-74-2448C •	464	A4-74-2448V •	494	A4-74-2448VG •	494	A4-74-2448E •	558	A4-74-2448S •	1660
	60”	1524	113	51	5.7	A4-74-2460Z •	516	A4-74-2460C •	540	A4-74-2460V •	586	A4-74-2460VG •	586	A4-74-2460E •	646	A4-74-2460S •	1988
72”	1829	141	64	6.9	A4-74-2472Z •	576	A4-74-2472C •	624	A4-74-2472V •	670	A4-74-2472VG •	670	A4-74-2472E •	742	A4-74-2472S •	2436	



100 Industrial Boulevard, Clayton, DE 19938-8903 U.S.A.  
Phone: 800-637-5100 or 302-653-3000. Fax: 302-653-2065  
<http://www.eaglegrp.com>

### Five-Shelf Starter Units

see spec sheet **EG01.25**



**EAGLEgard® finish standard with MICROGARD® protection.**  
See bottom of page 4 for details.

- Five wire shelves.
- Four posts (*same finish as shelves*).
- Shipped knocked-down.

INCLUDES:

**Note:** 54" (1372mm) shelves available see page 6.

**Freight class is 70.0.**

(\*) MTS (*made to stock*) / ( ) MTO (*made to order*)



(Patent #5,390,803)

**Patented QuadTruss® Design** makes shelves up to 25% stronger and provides a retaining ledge for increased strength and product retention.

### Models with 74" (1880mm) Height

	length		weight		cu ft	EAGLEbrite®		chrome		VALU-MASTER®		Valu-Gard®		EAGLEgard®		stainless	
	in.	mm	lb.	kg		model #	list	model #	list	model #	list	model #	list	model #	list	model #	list
<b>18" width (457mm)</b>	24"	610	51	23	1.9	S5-74-1824Z •	396	S5-74-1824C •	414	S5-74-1824V •	428	S5-74-1824VG •	428	S5-74-1824E •	494	S5-74-1824S •	1504
	30"	762	58	26	2.3	S5-74-1830Z •	406	S5-74-1830C •	419	S5-74-1830V •	453	S5-74-1830VG •	453	S5-74-1830E •	509	S5-74-1830S •	1524
	36"	914	65	30	2.7	S5-74-1836Z •	416	S5-74-1836C •	429	S5-74-1836V •	468	S5-74-1836VG •	468	S5-74-1836E •	524	S5-74-1836S •	1534
	42"	1067	70	32	3.1	S5-74-1842Z •	466	S5-74-1842C •	494	S5-74-1842V •	533	S5-74-1842VG •	533	S5-74-1842E •	604	S5-74-1842S •	1774
	48"	1219	78	36	3.6	S5-74-1848Z •	466	S5-74-1848C •	494	S5-74-1848V •	533	S5-74-1848VG •	533	S5-74-1848E •	604	S5-74-1848S •	1774
	60"	1524	102	46	4.3	S5-74-1860Z •	526	S5-74-1860C •	564	S5-74-1860V •	628	S5-74-1860VG •	628	S5-74-1860E •	694	S5-74-1860S •	2174
72"	1829	117	53	5.1	S5-74-1872Z •	641	S5-74-1872C •	649	S5-74-1872V •	703	S5-74-1872VG •	703	S5-74-1872E •	784	S5-74-1872S •	2524	
<b>21" width (533mm)</b>	24"	610	57	26	2.2	S5-74-2124Z •	426	S5-74-2124C •	464	S5-74-2124V •	473	S5-74-2124VG •	473	S5-74-2124E •	544	S5-74-2124S •	1694
	30"	762	64	29	2.7	S5-74-2130Z •	436	S5-74-2130C •	474	S5-74-2130V •	498	S5-74-2130VG •	498	S5-74-2130E •	554	S5-74-2130S •	1709
	36"	914	73	33	3.1	S5-74-2136Z •	451	S5-74-2136C •	489	S5-74-2136V •	508	S5-74-2136VG •	508	S5-74-2136E •	579	S5-74-2136S •	1719
	42"	1067	81	37	3.6	S5-74-2142Z •	501	S5-74-2142C •	549	S5-74-2142V •	578	S5-74-2142VG •	578	S5-74-2142E •	654	S5-74-2142S •	1939
	48"	1219	88	40	4.1	S5-74-2148Z •	501	S5-74-2148C •	549	S5-74-2148V •	578	S5-74-2148VG •	578	S5-74-2148E •	654	S5-74-2148S •	1939
	60"	1524	109	50	5.1	S5-74-2160Z •	591	S5-74-2160C •	629	S5-74-2160V •	673	S5-74-2160VG •	673	S5-74-2160E •	744	S5-74-2160S •	2484
72"	1829	122	55	7.7	S5-74-2172Z •	691	S5-74-2172C •	729	S5-74-2172V •	793	S5-74-2172VG •	793	S5-74-2172E •	884	S5-74-2172S •	2884	
<b>24" width (610mm)</b>	24"	610	62	28	2.5	S5-74-2424Z •	451	S5-74-2424C •	484	S5-74-2424V •	503	S5-74-2424VG •	503	S5-74-2424E •	589	S5-74-2424S •	1804
	30"	762	71	32	3.0	S5-74-2430Z •	461	S5-74-2430C •	499	S5-74-2430V •	528	S5-74-2430VG •	528	S5-74-2430E •	599	S5-74-2430S •	1814
	36"	914	81	37	3.6	S5-74-2436Z •	476	S5-74-2436C •	509	S5-74-2436V •	538	S5-74-2436VG •	538	S5-74-2436E •	609	S5-74-2436S •	1834
	42"	1067	89	40	3.7	S5-74-2442Z •	551	S5-74-2442C •	589	S5-74-2442V •	628	S5-74-2442VG •	628	S5-74-2442E •	719	S5-74-2442S •	2159
	48"	1219	98	45	4.6	S5-74-2448Z •	551	S5-74-2448C •	589	S5-74-2448V •	628	S5-74-2448VG •	628	S5-74-2448E •	719	S5-74-2448S •	2159
	60"	1524	122	55	5.7	S5-74-2460Z •	651	S5-74-2460C •	684	S5-74-2460V •	743	S5-74-2460VG •	743	S5-74-2460E •	829	S5-74-2460S •	2569
72"	1829	149	68	6.9	S5-74-2472Z •	726	S5-74-2472C •	789	S5-74-2472V •	848	S5-74-2472VG •	848	S5-74-2472E •	949	S5-74-2472S •	3129	

### Models with 86" (2184mm) Height

	length		weight		cu ft	EAGLEbrite®		chrome		VALU-MASTER®		Valu-Gard®		EAGLEgard®		stainless	
	in.	mm	lb.	kg		model #	list	model #	list	model #	list	model #	list	model #	list	model #	list
<b>18" width (457mm)</b>	24"	610	55	25	3.9	S5-86-1824Z •	416	S5-86-1824C •	438	S5-86-1824V •	452	S5-86-1824VG •	452	S5-86-1824E •	514	S5-86-1824S •	1544
	30"	762	60	27	3.9	S5-86-1830Z •	426	S5-86-1830C •	443	S5-86-1830V •	477	S5-86-1830VG •	477	S5-86-1830E •	529	S5-86-1830S •	1564
	36"	914	65	30	3.9	S5-86-1836Z •	436	S5-86-1836C •	453	S5-86-1836V •	492	S5-86-1836VG •	492	S5-86-1836E •	544	S5-86-1836S •	1574
	42"	1067	75	34	4.9	S5-86-1842Z •	486	S5-86-1842C •	518	S5-86-1842V •	557	S5-86-1842VG •	557	S5-86-1842E •	624	S5-86-1842S •	1814
	48"	1219	80	36	4.9	S5-86-1848Z •	486	S5-86-1848C •	518	S5-86-1848V •	557	S5-86-1848VG •	557	S5-86-1848E •	624	S5-86-1848S •	1814
	60"	1524	105	48	6.4	S5-86-1860Z •	546	S5-86-1860C •	588	S5-86-1860V •	652	S5-86-1860VG •	652	S5-86-1860E •	714	S5-86-1860S •	2214
72"	1829	120	54	7.4	S5-86-1872Z •	661	S5-86-1872C •	673	S5-86-1872V •	727	S5-86-1872VG •	727	S5-86-1872E •	804	S5-86-1872S •	2564	
<b>21" width (533mm)</b>	24"	610	60	27	3.9	S5-86-2124Z •	446	S5-86-2124C •	488	S5-86-2124V •	497	S5-86-2124VG •	497	S5-86-2124E •	564	S5-86-2124S •	1734
	30"	762	65	30	3.9	S5-86-2130Z •	456	S5-86-2130C •	498	S5-86-2130V •	522	S5-86-2130VG •	522	S5-86-2130E •	574	S5-86-2130S •	1749
	36"	914	75	34	4.4	S5-86-2136Z •	471	S5-86-2136C •	513	S5-86-2136V •	532	S5-86-2136VG •	532	S5-86-2136E •	599	S5-86-2136S •	1759
	42"	1067	80	36	5.9	S5-86-2142Z •	521	S5-86-2142C •	573	S5-86-2142V •	602	S5-86-2142VG •	602	S5-86-2142E •	674	S5-86-2142S •	1979
	48"	1219	90	41	5.9	S5-86-2148Z •	521	S5-86-2148C •	573	S5-86-2148V •	602	S5-86-2148VG •	602	S5-86-2148E •	674	S5-86-2148S •	1979
	60"	1524	110	50	6.9	S5-86-2160Z •	611	S5-86-2160C •	653	S5-86-2160V •	697	S5-86-2160VG •	697	S5-86-2160E •	764	S5-86-2160S •	2524
72"	1829	140	64	8.4	S5-86-2172Z •	711	S5-86-2172C •	753	S5-86-2172V •	817	S5-86-2172VG •	817	S5-86-2172E •	904	S5-86-2172S •	2924	
<b>24" width (610mm)</b>	24"	610	65	30	4.4	S5-86-2424Z •	471	S5-86-2424C •	508	S5-86-2424V •	527	S5-86-2424VG •	527	S5-86-2424E •	609	S5-86-2424S •	1844
	30"	762	75	34	4.4	S5-86-2430Z •	481	S5-86-2430C •	523	S5-86-2430V •	552	S5-86-2430VG •	552	S5-86-2430E •	619	S5-86-2430S •	1854
	36"	914	85	39	4.4	S5-86-2436Z •	496	S5-86-2436C •	533	S5-86-2436V •	562	S5-86-2436VG •	562	S5-86-2436E •	629	S5-86-2436S •	1874
	42"	1067	95	43	6.4	S5-86-2442Z •	571	S5-86-2442C •	613	S5-86-2442V •	652	S5-86-2442VG •	652	S5-86-2442E •	739	S5-86-2442S •	2199
	48"	1219	100	45	6.4	S5-86-2448Z •	571	S5-86-2448C •	613	S5-86-2448V •	652	S5-86-2448VG •	652	S5-86-2448E •	739	S5-86-2448S •	2199
	60"	1524	125	57	7.9	S5-86-2460Z •	671	S5-86-2460C •	708	S5-86-2460V •	767	S5-86-2460VG •	767	S5-86-2460E •	849	S5-86-2460S •	2609
72"	1829	150	68	9.4	S5-86-2472Z •	746	S5-86-2472C •	813	S5-86-2472V •	872	S5-86-2472VG •	872	S5-86-2472E •	969	S5-86-2472S •	3169	

## Catalog Section 1

### Five-Shelf Add-On Units

see spec sheet **EG01.25**



**EAGLEgard® finish standard with MICROGARD® protection.**  
See bottom of page 4 for details.

- Five wire shelves.
- Two posts (*same finish as shelves*).
- Two "S" hooks per shelf.
- Shipped knocked-down.

INCLUDES:

Note: 54" (1372mm) shelves available see page 6.

**Freight class is 70.0.**

(•) MTS (*made to stock*) / ( ) MTO (*made to order*)

patented  
**QuadTruss®**  
design  
(Patent #5,390,803)

**Patented QuadTruss® Design**  
makes shelves up to 25% stronger and provides a retaining ledge for increased strength and product retention.

### Models with 74" (1880mm) Height

	length		weight		cu ft	EAGLEbrite®		chrome		VALU-MASTER®		Valu-Gard®		EAGLEgard®		stainless	
	in.	mm	lb.	kg		model #	list	model #	list	model #	list	model #	list	model #	list	model #	list
<b>18" width (457mm)</b>	24"	610	43	20	1.9	A5-74-1824Z •	378	A5-74-1824C •	392	A5-74-1824V •	404	A5-74-1824VG •	404	A5-74-1824E •	464	A5-74-1824S •	1384
	30"	762	50	23	2.3	A5-74-1830Z •	388	A5-74-1830C •	397	A5-74-1830V •	429	A5-74-1830VG •	429	A5-74-1830E •	479	A5-74-1830S •	1404
	36"	914	57	26	2.7	A5-74-1836Z •	398	A5-74-1836C •	407	A5-74-1836V •	444	A5-74-1836VG •	444	A5-74-1836E •	494	A5-74-1836S •	1414
	42"	1067	62	28	3.1	A5-74-1842Z •	448	A5-74-1842C •	472	A5-74-1842V •	509	A5-74-1842VG •	509	A5-74-1842E •	574	A5-74-1842S •	1654
	48"	1219	80	36	3.6	A5-74-1848Z •	448	A5-74-1848C •	472	A5-74-1848V •	509	A5-74-1848VG •	509	A5-74-1848E •	574	A5-74-1848S •	1654
	60"	1524	93	42	4.3	A5-74-1860Z •	508	A5-74-1860C •	542	A5-74-1860V •	604	A5-74-1860VG •	604	A5-74-1860E •	664	A5-74-1860S •	2054
	72"	1829	108	49	5.1	A5-74-1872Z •	623	A5-74-1872C •	627	A5-74-1872V •	679	A5-74-1872VG •	679	A5-74-1872E •	754	A5-74-1872S •	2404
<b>21" width (533mm)</b>	24"	610	48	22	2.2	A5-74-2124Z •	408	A5-74-2124C •	442	A5-74-2124V •	451	A5-74-2124VG •	451	A5-74-2124E •	514	A5-74-2124S •	1574
	30"	762	56	26	2.7	A5-74-2130Z •	418	A5-74-2130C •	452	A5-74-2130V •	476	A5-74-2130VG •	476	A5-74-2130E •	524	A5-74-2130S •	1589
	36"	914	65	30	3.1	A5-74-2136Z •	433	A5-74-2136C •	467	A5-74-2136V •	486	A5-74-2136VG •	486	A5-74-2136E •	549	A5-74-2136S •	1599
	42"	1067	73	33	3.6	A5-74-2142Z •	483	A5-74-2142C •	527	A5-74-2142V •	556	A5-74-2142VG •	556	A5-74-2142E •	624	A5-74-2142S •	1819
	48"	1219	80	36	4.1	A5-74-2148Z •	483	A5-74-2148C •	527	A5-74-2148V •	556	A5-74-2148VG •	556	A5-74-2148E •	624	A5-74-2148S •	1819
	60"	1524	101	46	5.1	A5-74-2160Z •	573	A5-74-2160C •	607	A5-74-2160V •	651	A5-74-2160VG •	651	A5-74-2160E •	714	A5-74-2160S •	2364
	72"	1829	113	51	7.7	A5-74-2172Z •	673	A5-74-2172C •	707	A5-74-2172V •	771	A5-74-2172VG •	771	A5-74-2172E •	854	A5-74-2172S •	2764
<b>24" width (610mm)</b>	24"	610	53	24	2.5	A5-74-2424Z •	433	A5-74-2424C •	462	A5-74-2424V •	481	A5-74-2424VG •	481	A5-74-2424E •	555	A5-74-2424S •	1684
	30"	762	62	28	3.0	A5-74-2430Z •	443	A5-74-2430C •	477	A5-74-2430V •	506	A5-74-2430VG •	506	A5-74-2430E •	565	A5-74-2430S •	1694
	36"	914	73	33	3.6	A5-74-2436Z •	458	A5-74-2436C •	487	A5-74-2436V •	516	A5-74-2436VG •	516	A5-74-2436E •	575	A5-74-2436S •	1714
	42"	1067	81	37	3.7	A5-74-2442Z •	533	A5-74-2442C •	567	A5-74-2442V •	606	A5-74-2442VG •	606	A5-74-2442E •	685	A5-74-2442S •	2039
	48"	1219	90	41	4.6	A5-74-2448Z •	533	A5-74-2448C •	567	A5-74-2448V •	606	A5-74-2448VG •	606	A5-74-2448E •	685	A5-74-2448S •	2039
	60"	1524	113	51	5.7	A5-74-2460Z •	633	A5-74-2460C •	662	A5-74-2460V •	721	A5-74-2460VG •	721	A5-74-2460E •	795	A5-74-2460S •	2449
	72"	1829	141	64	6.9	A5-74-2472Z •	708	A5-74-2472C •	767	A5-74-2472V •	826	A5-74-2472VG •	826	A5-74-2472E •	915	A5-74-2472S •	3009

### Models with 86" (2184mm) Height

	length		weight		cu ft	EAGLEbrite®		chrome		VALU-MASTER®		Valu-Gard®		EAGLEgard®		stainless	
	in.	mm	lb.	kg		model #	list	model #	list	model #	list	model #	list	model #	list	model #	list
<b>18" width (457mm)</b>	24"	610	45	20	3.7	A5-86-1824Z •	388	A5-86-1824C •	404	A5-86-1824V •	416	A5-86-1824VG •	416	A5-86-1824E •	474	A5-86-1824S •	1404
	30"	762	51	23	3.7	A5-86-1830Z •	398	A5-86-1830C •	409	A5-86-1830V •	441	A5-86-1830VG •	441	A5-86-1830E •	489	A5-86-1830S •	1424
	36"	914	56	25	3.7	A5-86-1836Z •	408	A5-86-1836C •	419	A5-86-1836V •	456	A5-86-1836VG •	456	A5-86-1836E •	504	A5-86-1836S •	1434
	42"	1067	66	30	4.7	A5-86-1842Z •	458	A5-86-1842C •	484	A5-86-1842V •	521	A5-86-1842VG •	521	A5-86-1842E •	584	A5-86-1842S •	1674
	48"	1219	71	32	4.7	A5-86-1848Z •	458	A5-86-1848C •	484	A5-86-1848V •	521	A5-86-1848VG •	521	A5-86-1848E •	584	A5-86-1848S •	1674
	60"	1524	96	44	6.2	A5-86-1860Z •	518	A5-86-1860C •	554	A5-86-1860V •	616	A5-86-1860VG •	616	A5-86-1860E •	674	A5-86-1860S •	2074
	72"	1829	111	50	7.2	A5-86-1872Z •	633	A5-86-1872C •	639	A5-86-1872V •	691	A5-86-1872VG •	691	A5-86-1872E •	764	A5-86-1872S •	2424
<b>21" width (533mm)</b>	24"	610	51	23	3.7	A5-86-2124Z •	418	A5-86-2124C •	454	A5-86-2124V •	463	A5-86-2124VG •	463	A5-86-2124E •	524	A5-86-2124S •	1594
	30"	762	56	25	3.7	A5-86-2130Z •	428	A5-86-2130C •	464	A5-86-2130V •	488	A5-86-2130VG •	488	A5-86-2130E •	534	A5-86-2130S •	1609
	36"	914	66	30	4.2	A5-86-2136Z •	443	A5-86-2136C •	479	A5-86-2136V •	498	A5-86-2136VG •	498	A5-86-2136E •	559	A5-86-2136S •	1619
	42"	1067	71	32	5.7	A5-86-2142Z •	493	A5-86-2142C •	539	A5-86-2142V •	568	A5-86-2142VG •	568	A5-86-2142E •	634	A5-86-2142S •	1839
	48"	1219	81	37	5.7	A5-86-2148Z •	493	A5-86-2148C •	539	A5-86-2148V •	568	A5-86-2148VG •	568	A5-86-2148E •	634	A5-86-2148S •	1839
	60"	1524	101	46	6.7	A5-86-2160Z •	583	A5-86-2160C •	619	A5-86-2160V •	663	A5-86-2160VG •	663	A5-86-2160E •	724	A5-86-2160S •	2384
	72"	1829	131	59	8.2	A5-86-2172Z •	683	A5-86-2172C •	719	A5-86-2172V •	783	A5-86-2172VG •	783	A5-86-2172E •	864	A5-86-2172S •	2784
<b>24" width (610mm)</b>	24"	610	56	25	4.2	A5-86-2424Z •	443	A5-86-2424C •	474	A5-86-2424V •	493	A5-86-2424VG •	493	A5-86-2424E •	565	A5-86-2424S •	1704
	30"	762	66	30	4.2	A5-86-2430Z •	453	A5-86-2430C •	489	A5-86-2430V •	518	A5-86-2430VG •	518	A5-86-2430E •	575	A5-86-2430S •	1714
	36"	914	76	35	4.2	A5-86-2436Z •	468	A5-86-2436C •	499	A5-86-2436V •	528	A5-86-2436VG •	528	A5-86-2436E •	585	A5-86-2436S •	1734
	42"	1067	86	39	6.2	A5-86-2442Z •	543	A5-86-2442C •	579	A5-86-2442V •	618	A5-86-2442VG •	618	A5-86-2442E •	695	A5-86-2442S •	2059
	48"	1219	91	41	6.2	A5-86-2448Z •	543	A5-86-2448C •	579	A5-86-2448V •	618	A5-86-2448VG •	618	A5-86-2448E •	695	A5-86-2448S •	2059
	60"	1524	116	53	7.7	A5-86-2460Z •	643	A5-86-2460C •	674	A5-86-2460V •	733	A5-86-2460VG •	733	A5-86-2460E •	805	A5-86-2460S •	2469
	72"	1829	141	64	9.2	A5-86-2472Z •	718	A5-86-2472C •	779	A5-86-2472V •	838	A5-86-2472VG •	838	A5-86-2472E •	925	A5-86-2472S •	3029



100 Industrial Boulevard, Clayton, DE 19938-8903 U.S.A.  
Phone: 800-637-5100 or 302-653-3000. Fax: 302-653-2065  
<http://www.eaglegrp.com>

### Add-A-Shelf®

see spec sheet **EG01.11A** **WEIGHT CAPACITY:**

- 300 lb. (136.1 kg); per shelf.
- using an evenly distributed load.



#### Add-A-Shelf® Collars

allows addition or removal of shelf without breaking down the entire unit.

description	model #	list
set of four	<b>A208891</b>	9

- One set of four included with each shelf.
  - Must be used with split sleeves.
- To order: Model # **PLASTIC SPLIT SLEEVES**, list (per set of four): \$5.

**Note:** Top and bottom shelves of unit must be standard shelves. Post are sold separately.

(For Chrome finish, see page 6;  
for black, red, or white epoxy, see page 59).

- Use Add-A-Shelf® shelves for intermediate shelves. Add-A-Shelf® is not recommended for mobile applications.

**WARNING:**

**Freight class is 70.0.**

(•) MTS (made to stock) / ( ) MTO (made to order)



(Patent #5,390,803)

#### Patented QuadTruss® Design

makes shelves up to 25% stronger and provides a retaining ledge for increased strength and product retention.

### Add-A-Shelf® Adjustable Shelves - Patent # 5,884,567

	length		weight		cu ft	EAGLEbrite®		chrome		black		red		white	
	in.	mm	lb.	kg		model #	list	model #	list	model #	list	model #	list	model #	list
<b>14" width</b> (356mm)	36"	914	8	3.6	0.5	<b>A1436Z</b>	63	<b>A1436C</b> •	68	<b>A1436BL</b> •	69	<b>A1436R</b>	69	<b>A1436W</b>	69
	48"	1219	10	4.5	0.7	<b>A1448Z</b>	71	<b>A1448C</b> •	78	<b>A1448BL</b>	79	<b>A1448R</b>	79	<b>A1448W</b>	79
<b>18" width</b> (457mm)	36"	914	9	4.1	0.7	<b>A1836Z</b>	69	<b>A1836C</b> •	71	<b>A1836BL</b>	72	<b>A1836R</b>	72	<b>A1836W</b>	72
	48"	1219	12	5.5	0.9	<b>A1848Z</b>	81	<b>A1848C</b> •	84	<b>A1848BL</b>	85	<b>A1848R</b>	85	<b>A1848W</b>	85
	60"	1524	15	6.8	1.0	<b>A1860Z</b>	95	<b>A1860C</b>	99	<b>A1860BL</b>	100	<b>A1860R</b>	100	<b>A1860W</b>	100
<b>21" width</b> (533mm)	36"	914	11	5.0	0.8	<b>A2136Z</b>	78	<b>A2136C</b>	83	<b>A2136BL</b>	84	<b>A2136R</b>	84	<b>A2136W</b>	84
	48"	1219	14	6.4	1.1	<b>A2148Z</b>	89	<b>A2148C</b>	96	<b>A2148BL</b>	97	<b>A2148R</b>	97	<b>A2148W</b>	97
	60"	1524	17	7.7	1.3	<b>A2160Z</b>	106	<b>A2160C</b>	118	<b>A2160BL</b>	119	<b>A2160R</b>	119	<b>A2160W</b>	119
<b>24" width</b> (610mm)	36"	914	13	5.9	0.8	<b>A2436Z</b>	82	<b>A2436C</b> •	89	<b>A2436BL</b>	91	<b>A2436R</b>	91	<b>A2436W</b>	91
	48"	1219	16	7.3	1.2	<b>A2448Z</b>	97	<b>A2448C</b> •	105	<b>A2448BL</b>	106	<b>A2448R</b>	106	<b>A2448W</b>	106
	60"	1524	21	9.5	1.5	<b>A2460Z</b>	118	<b>A2460C</b> •	134	<b>A2460BL</b>	135	<b>A2460R</b>	135	<b>A2460W</b>	135

#### PACKAGING:

- 36" and 48" lengths: Four per box.
- 60" lengths: Two per box.
- Four pairs split sleeves per shelf.
- Four-pack collars per shelf.

### Add-A-Shelf® Reverse Mat Shelves - Patent # 5,884,567

	length		weight		cu ft	EAGLEbrite®		chrome		black		red		white	
	in.	mm	lb.	kg		model #	list	model #	list	model #	list	model #	list	model #	list
<b>14" width</b> (356mm)	36"	914	8	3.6	0.5	<b>D1436Z</b>	65	<b>D1436C</b>	71	<b>D1436BL</b>	72	<b>D1436R</b>	72	<b>D1436W</b>	72
	48"	1219	10	4.5	0.7	<b>D1448Z</b>	73	<b>D1448C</b>	80	<b>D1448BL</b>	81	<b>D1448R</b>	81	<b>D1448W</b>	81
<b>18" width</b> (457mm)	36"	914	9	4.1	0.7	<b>D1836Z</b>	72	<b>D1836C</b>	73	<b>D1836BL</b>	74	<b>D1836R</b>	74	<b>D1836W</b>	74
	48"	1219	12	5.5	0.9	<b>D1848Z</b>	83	<b>D1848C</b>	86	<b>D1848BL</b>	87	<b>D1848R</b>	87	<b>D1848W</b>	87
<b>21" width</b> (533mm)	36"	914	11	5.0	0.8	<b>D2136Z</b>	80	<b>D2136C</b>	85	<b>D2136BL</b>	86	<b>D2136R</b>	86	<b>D2136W</b>	86
	48"	1219	14	6.4	1.1	<b>D2148Z</b>	92	<b>D2148C</b>	99	<b>D2148BL</b>	100	<b>D2148R</b>	100	<b>D2148W</b>	100
<b>24" width</b> (610mm)	36"	914	13	5.9	0.8	<b>D2436Z</b>	84	<b>D2436C</b>	92	<b>D2436BL</b>	93	<b>D2436R</b>	93	<b>D2436W</b>	93
	48"	1219	16	7.3	1.2	<b>D2448Z</b>	100	<b>D2448C</b>	107	<b>D2448BL</b>	108	<b>D2448R</b>	108	<b>D2448W</b>	108

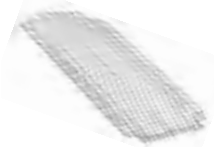

#### HOW TO ASSEMBLE: Add-A-Shelf® Collar

Numerically calibrated grooved posts, tapered plastic split sleeves and shelf collars combine to make shelving assembly a **SIMPLE 3 STEP EXERCISE:**



1. Snap split sleeves onto post over the number of your choice.



2. Slide collar over split sleeves. When together, a positive lock is created without the use of tools.

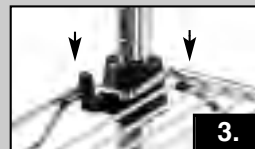

3. Place shelf over collar to complete.



Add-A-Shelf® as a merchandise display unit

## Catalog Section 1

### Posts for Add-A-Shelf®

see spec sheet **EG01.11A**

Freight class is 50.0.

(•) MTS (made to stock) / ( ) MTO (made to order)



post height	weight		cu ft	EAGLEbrite®		chrome		black		red		white		
	in.	mm		lb.	kg	model #	list	model #	list	model #	list	model #	list	
7"	178	0.8	0.4	0.1	<b>P7-Z •</b>	11	<b>P7-C</b>	12	<b>P7-BL</b>	13	<b>P7-R</b>	13	<b>P7-W</b>	13
14"	356	1.0	0.5	0.1	<b>P14-Z •</b>	13	<b>P14-C •</b>	14	<b>P14-BL •</b>	15	<b>P14-R</b>	15	<b>P14-W</b>	15
33"	838	2.0	0.9	0.1	<b>P33-Z •</b>	16	<b>P33-C •</b>	17	<b>P33-BL •</b>	19	<b>P33-R</b>	19	<b>P33-W</b>	19
54"	1372	3.0	1.4	0.1	<b>P54-Z •</b>	22	<b>P54-C •</b>	23	<b>P54-BL •</b>	24	<b>P54-R</b>	24	<b>P54-W</b>	24
63"	1600	3.5	1.8	0.3	<b>P63-Z •</b>	23	<b>P63-C •</b>	24	<b>P63-BL •</b>	25	<b>P63-R</b>	25	<b>P63-W</b>	25
74"	1880	4.0	1.8	0.5	<b>P74-Z •</b>	24	<b>P74-C •</b>	26	<b>P74-BL •</b>	27	<b>P74-R</b>	27	<b>P74-W</b>	27
86"	2184	5.0	2.3	0.8	<b>P86-Z •</b>	29	<b>P86-C •</b>	32	<b>P86-BL •</b>	33	<b>P86-R</b>	33	<b>P86-W</b>	33

### Add-A-Shelf® Post Clamps

see spec sheet **EG01.11A**

Freight class is 70.0.



model #	zinc		model #	black epoxy	
	list	list		list	list
<b>ADD-A-CLAMP</b>	8		<b>ADD-A-CLAMP-BL</b>	11	

### Add-A-Shelf® Starter Units

see spec sheet **EG01.11B**

FEATURES:

- Front edge of shelf can be lowered 4" (102mm) to create slanted shelf.

Note: Top and bottom shelves of unit must be standard shelves.

WARNING:

- Use Add-A-Shelf® shelves for intermediate shelves. Add-A-Shelf® is not recommended for mobile applications.

Freight class is 70.0.



#### Kit Includes:

- Two standard shelves.
- Two Add-A-Shelf® shelves.
- Four Redi-Pak® posts.
- Four bags of split sleeves.
- Two bags of Add-A-Shelf® collars.

**ALL IN ONE BOX  
LOWERING SHIPPING COST!**



(Patent #5,390,803)

**Patented QuadTruss® Design** makes shelves up to 25% stronger and provides a retaining ledge for increased strength and product retention.

#### Units with 63" (1600mm) Posts

#### Units with 74" (1880mm) Posts

	length		chrome		black epoxy		chrome		black epoxy	
	in.	mm	model #	list	model #	list	model #	list	model #	list
<b>14" width</b> (356mm)	36"	914	<b>RS4-63-A1436C</b>	461	<b>RS4-63-A1436BL</b>	466	<b>RS4-74-A1436C</b>	490	<b>RS4-74-A1436BL</b>	495
	48"	1219	<b>RS4-63-A1448C</b>	491	<b>RS4-63-A1448BL</b>	496	<b>RS4-74-A1448C</b>	520	<b>RS4-74-A1448BL</b>	525
<b>18" width</b> (457mm)	36"	914	<b>RS4-63-A1836C</b>	492	<b>RS4-63-A1836BL</b>	497	<b>RS4-74-A1836C</b>	523	<b>RS4-74-A1836BL</b>	528
	48"	1219	<b>RS4-63-A1848C</b>	532	<b>RS4-63-A1848BL</b>	537	<b>RS4-74-A1848C</b>	562	<b>RS4-74-A1848BL</b>	568
<b>21" width</b> (533mm)	36"	914	<b>RS4-63-A2136C</b>	506	<b>RS4-63-A2136BL</b>	511	<b>RS4-74-A2136C</b>	537	<b>RS4-74-A2136BL</b>	542
	48"	1219	<b>RS4-63-A2148C</b>	558	<b>RS4-63-A2148BL</b>	564	<b>RS4-74-A2148C</b>	588	<b>RS4-74-A2148BL</b>	594
<b>24" width</b> (610mm)	36"	914	<b>RS4-63-A2436C</b>	537	<b>RS4-63-A2436BL</b>	542	<b>RS4-74-A2436C</b>	566	<b>RS4-74-A2436BL</b>	572
	48"	1219	<b>RS4-63-A2448C</b>	613	<b>RS4-63-A2448BL</b>	619	<b>RS4-74-A2448C</b>	642	<b>RS4-74-A2448BL</b>	648





### Redi-Pak® Wire Shelving Units

see spec sheet **EG01.26**



# Redi-Pak®



Packed and shipped in one box.

**SAVES UP TO 50%  
ON SHIPPING COSTS!**

4-SHELF UNITS:

- Four wire shelves.
- Four two-piece posts.

5-SHELF UNITS:

- Five wire shelves.
- Four two-piece posts.

Can be shipped UPS.

Freight class is 70.0.

(•) MTS (made to stock) / ( ) MTO (made to order)

patented  
**QuadTruss®**  
design

(Patent #5,390,803)

**Patented QuadTruss® Design**

makes shelves up to 25% stronger and provides a retaining ledge for increased strength and product retention.

### 4-Shelf Units, 63" (1600mm) Height

	length		weight		cu ft	EAGLEbrite®		chrome		VALU-MASTER®		Valu-Gard®		EAGLEgard®	
	in.	mm	lb.	kg		model #	list	model #	list	model #	list	model #	list	model #	list
18" width (457mm)	36"	914	52	23.6	2.8	<b>1836Z63</b>	419	<b>1836C63</b>	445	<b>1836V63</b>	479	<b>1836VG63</b>	479	<b>1836E63</b>	541
	48"	1219	64	29.0	3.6	<b>1848Z63</b>	472	<b>1848C63</b>	506	<b>1848V63</b>	545	<b>1848VG63</b>	545	<b>1848E63</b>	621
	60"	1524	84	38.1	4.8	<b>1860Z63</b>	556	<b>1860C63</b>	574	<b>1860V63</b>	619	<b>1860VG63</b>	619	<b>1860E63</b>	708
24" width (610mm)	36"	914	68	30.8	3.2	<b>2436Z63</b>	478	<b>2436C63</b>	519	<b>2436V63</b>	559	<b>2436VG63</b>	559	<b>2436E63</b>	626
	48"	1219	80	36.3	4.8	<b>2448Z63</b>	548	<b>2448C63</b>	599	<b>2448V63</b>	643	<b>2448VG63</b>	643	<b>2448E63</b>	740
	60"	1524	100	45.4	6.0	<b>2460Z63</b>	642	<b>2460C63</b>	696	<b>2460V63</b>	747	<b>2460VG63</b>	747	<b>2460E63</b>	840

### 4-Shelf Units, 74" (1880mm) Height

	length		weight		cu ft	EAGLEbrite®		chrome		VALU-MASTER®		Valu-Gard®		EAGLEgard®	
	in.	mm	lb.	kg		model #	list	model #	list	model #	list	model #	list	model #	list
18" width (457mm)	36"	914	52	23.6	2.8	<b>1836Z74</b>	426	<b>1836C74</b>	454	<b>1836V74</b>	488	<b>1836VG74</b>	488	<b>1836E74</b>	543
	48"	1219	74	33.6	3.6	<b>1848Z74</b>	493	<b>1848C74</b>	525	<b>1848V74</b>	565	<b>1848VG74</b>	565	<b>1848E74</b>	640
	60"	1524	84	38.1	4.8	<b>1860Z74</b>	556	<b>1860C74</b>	587	<b>1860V74</b>	633	<b>1860VG74</b>	633	<b>1860E74</b>	752
24" width (610mm)	36"	914	68	30.8	3.2	<b>2436Z74</b>	494	<b>2436C74</b>	528	<b>2436V74</b>	568	<b>2436VG74</b>	568	<b>2436E74</b>	639
	48"	1219	80	36.3	4.8	<b>2448Z74</b>	574	<b>2448C74</b>	616	<b>2448V74</b>	662	<b>2448VG74</b>	662	<b>2448E74</b>	765
	60"	1524	100	45.4	6.0	<b>2460Z74</b>	667	<b>2460C74</b>	714	<b>2460V74</b>	768	<b>2460VG74</b>	768	<b>2460E74</b>	864

### 5-Shelf Units, 63" (1600mm) Height

	length		weight		cu ft	EAGLEbrite®		chrome		VALU-MASTER®		Valu-Gard®		EAGLEgard®	
	in.	mm	lb.	kg		model #	list	model #	list	model #	list	model #	list	model #	list
18" width (457mm)	36"	914	61	27.7	3.5	<b>1836Z63-5</b>	504	<b>1836C63-5</b>	537	<b>1836V63-5</b>	577	<b>1836VG63-5</b>	577	<b>1836E63-5</b>	643
	48"	1219	76	34.5	4.5	<b>1848Z63-5</b>	577	<b>1848C63-5</b>	613	<b>1848V63-5</b>	660	<b>1848VG63-5</b>	660	<b>1848E63-5</b>	756
	60"	1524	101	45.8	6.0	<b>1860Z63-5</b>	629	<b>1860C63-5</b>	704	<b>1860V63-5</b>	758	<b>1860VG63-5</b>	758	<b>1860E63-5</b>	869
24" width (610mm)	36"	914	81	36.7	4.0	<b>2436Z63-5</b>	587	<b>2436C63-5</b>	634	<b>2436V63-5</b>	679	<b>2436VG63-5</b>	679	<b>2436E63-5</b>	764
	48"	1219	96	43.6	6.0	<b>2448Z63-5</b>	678	<b>2448C63-5</b>	743	<b>2448V63-5</b>	798	<b>2448VG63-5</b>	798	<b>2448E63-5</b>	831
	60"	1524	121	54.9	7.5	<b>2460Z63-5</b>	793	<b>2460C63-5</b>	841	<b>2460V63-5</b>	906	<b>2460VG63-5</b>	906	<b>2460E63-5</b>	1026

### 5-Shelf Units, 74" (1880mm) Height

	length		weight		cu ft	EAGLEbrite®		chrome		VALU-MASTER®		Valu-Gard®		EAGLEgard®	
	in.	mm	lb.	kg		model #	list	model #	list	model #	list	model #	list	model #	list
18" width (457mm)	36"	914	61	27.7	3.5	<b>1836Z74-5</b>	505	<b>1836C74-5</b>	557	<b>1836V74-5</b>	599	<b>1836VG74-5</b>	599	<b>1836E74-5</b>	676
	48"	1219	76	34.5	4.5	<b>1848Z74-5</b>	595	<b>1848C74-5</b>	640	<b>1848V74-5</b>	692	<b>1848VG74-5</b>	692	<b>1848E74-5</b>	785
	60"	1524	101	45.8	6.0	<b>1860Z74-5</b>	640	<b>1860C74-5</b>	729	<b>1860V74-5</b>	784	<b>1860VG74-5</b>	784	<b>1860E74-5</b>	903
24" width (610mm)	36"	914	81	36.7	4.0	<b>2436Z74-5</b>	605	<b>2436C74-5</b>	659	<b>2436V74-5</b>	707	<b>2436VG74-5</b>	707	<b>2436E74-5</b>	795
	48"	1219	96	43.6	6.0	<b>2448Z74-5</b>	701	<b>2448C74-5</b>	763	<b>2448V74-5</b>	822	<b>2448VG74-5</b>	822	<b>2448E74-5</b>	940
	60"	1524	121	54.9	7.5	<b>2460Z74-5</b>	815	<b>2460C74-5</b>	864	<b>2460V74-5</b>	927	<b>2460VG74-5</b>	927	<b>2460E74-5</b>	1057

## Catalog Section 1

### Redi-Pak® Utility Carts

see spec sheet **EG01.10**

# Redi-Pak®



Packed and shipped in one box.

**SAVES UP TO 50%  
ON SHIPPING COSTS!**



*Easy handling  
and inventory  
tracking!*

WEIGHT CAPACITY:

- Medium-duty 500 lb. (227 kg).

INCLUDES:

- 36½" (927mm) height.
- One handle.
- Two posts.
- Four resilient 4" (102mm) casters with donut bumpers.
- Either two or three chrome shelves with built-in 1" (25mm) ledge on three sides.

**Can be shipped UPS.**

**Freight class is 70.0.**

(•) MTS (made to stock) / ( ) MTO (made to order)

#### 2-Shelf Unit

#### 3-Shelf Unit

width	length		cubic feet	weight		model #	list	weight		model #	list
	in.	mm		lb.	kg			lbs.	kg		
18" (457mm)	36"	914	3.0	38	17.2	U2-1836C-RP	339	45	20.4	U3-1836C-RP	409

patented  
**QuadTruss®**  
design  
(Patent #5,390,803)

### Reverse Mat Shelves

see spec sheet **EG01.03E**

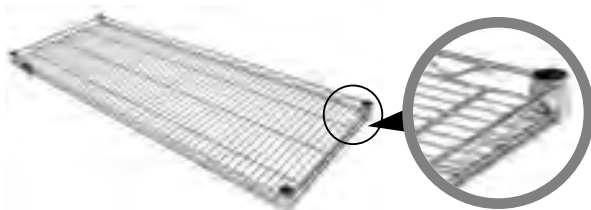

*Shelves have  
built-in ledges  
which prevent  
contents from  
falling off!*

WEIGHT CAPACITY:

- 250 lb. (113 kg); per shelf.

**Freight class is 70.0.**

(•) MTS (made to stock) / ( ) MTO (made to order)

patented  
**QuadTruss®**  
design  
(Patent #5,390,803)

**Patented QuadTruss® Design**  
makes shelves up to 25% stronger and  
provides a retaining ledge for increased  
strength and product retention.

	length		weight		cu ft	EAGLEbrite®		chrome		black		red		white	
	in.	mm	lb.	kg		model #	list	model #	list	model #	list	model #	list	model #	list
<b>14" width</b> (356mm)	36"	914	7	3.2	0.5	RM1436Z	57	RM1436C	64	RM1436BL	65	RM1436R	65	RM1436W	65
	48"	1219	10	4.5	0.7	RM1448Z	66	RM1448C	73	RM1448BL	74	RM1448R	74	RM1448W	74
<b>18" width</b> (457mm)	36"	914	9	4.1	0.7	RM1836Z	66	RM1836C	66	RM1836BL	67	RM1836R	67	RM1836W	67
	48"	1219	11	4.9	0.9	RM1848Z	77	RM1848C	80	RM1848BL	81	RM1848R	81	RM1848W	81
<b>21" width</b> (533mm)	36"	914	11	4.9	0.8	RM2136Z	73	RM2136C	79	RM2136BL	80	RM2136R	80	RM2136W	80
	48"	1219	13	5.9	1.1	RM2148Z	83	RM2148C	92	RM2148BL	93	RM2148R	93	RM2148W	93
<b>24" width</b> (610mm)	24"	610	9	4.1	0.8	RM2424Z	73	RM2424C	78	RM2424BL	79	RM2424R	79	RM2424W	79
	36"	914	12	5.4	0.8	RM2436Z	78	RM2436C	83	RM2436BL	84	RM2436R	84	RM2436W	84
	48"	1219	15	6.8	1.2	RM2448Z	93	RM2448C	100	RM2448BL	101	RM2448R	101	RM2448W	101

### Label Holders for Reverse Mat Shelves

see spec sheet **EG01.03E**



length	fits shelf size		model #	list
	in.	mm		
3¼"	83	all	A225494	6
13"	330	18" 457	A225512	9
19"	483	24" 610	A225513	12
25"	635	30" 762	A225514	14
31"	787	36" 914	A225515	24
43"	1092	48" 1219	A225516	26
45"	1143	48" 1219	A225517	45
55"	1397	60" 1524	A225518	47
67"	1702	72" 1829	A225519	49

FEATURES:

- Clear plastic.
- Snaps onto shelf edge.
- Provides easy identification of shelf contents or section.
- Holds 1¼" (32mm) high labels.

**Note:** These also work on standard shelves.

**Freight class is 70.0.**



100 Industrial Boulevard, Clayton, DE 19938-8903 U.S.A.  
Phone: 800-637-5100 or 302-653-3000. Fax: 302-653-2065  
http://www.eaglegrp.com

### Hybrid Shelves

see spec sheet **EG01.46**



four-post system  
with hybrid shelves

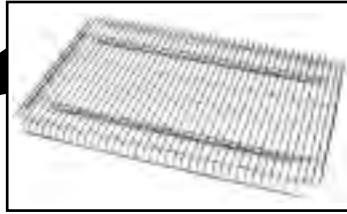

hybrid shelf

- Shelves mount over two crossbraces of a four-post high-density system.
- Available for new systems or can be retrofitted to existing systems.
- Can be mixed or matched with solid metal shelves as required.
- Load tested to 250 lbs. (113.4 kg).
- Open-wire construction.

**FEATURES:**

**PACKAGING:**

- 24"-48" (610-1219mm) lengths: Four per box.

**Freight class is 70.0.**

### Additional Side-to-Side Partitions for Optional Center Stop Assemblies

length		EAGLEbrite®	
in.	mm	model #	list
30"	762	A219390	42
36"	914	A219391	65
42"	1067	A219392	71
48"	1219	A219393	76



front-to-back ledge

side-to-side partition

### Optional Center Stop Assemblies

- For Standard Four-Post Series only.
- Comes with one side-to-side partition that interlocks with two front-to-back ledges to form an "H".

### Standard Four-Post Series

	length		EAGLEbrite®		VALU-MASTER®		stainless steel		EAGLEbrite®		VALU-MASTER®		stainless steel	
	in.	mm	model #	list	model #	list	model #	list	model #	list	model #	list	model #	list
<b>12" width</b> (305mm)	24"	610	SP1224Z	51	SP1224V	55	SP1224S	85	SPD1224-Z	67	SPD1224-V	72	SPD1224-S	116
	36"	914	SP1236Z	56	SP1236V	60	SP1236S	120	SPD1236-Z	73	SPD1236-V	81	SPD1236-S	161
	42"	1067	SP1242Z	59	SP1242V	71	SP1242S	132	SPD1242-Z	79	SPD1242-V	95	SPD1242-S	175
	48"	1219	SP1248Z	72	SP1248V	74	SP1248S	135	SPD1248-Z	96	SPD1248-V	99	SPD1248-S	179
<b>15" width</b> (381mm)	30"	762	SP1530Z	55	SP1530V	57	SP1530S	93	SPD1530-Z	95	SPD1530-V	99	SPD1530-S	122
	36"	914	SP1536Z	60	SP1536V	64	SP1536S	126	SPD1536-Z	119	SPD1536-V	125	SPD1536-S	168
	42"	1067	SP1542Z	71	SP1542V	74	SP1542S	137	SPD1542-Z	125	SPD1542-V	133	SPD1542-S	182
	48"	1219	SP1548Z	74	SP1548V	78	SP1548S	141	SPD1548-Z	132	SPD1548-V	138	SPD1548-S	188
<b>16" width</b> (406mm)	30"	762	SP1630Z	58	SP1630V	60	SP1630S	94	SPD1630-Z	98	SPD1630-V	103	SPD1630-S	124
	36"	914	SP1636Z	64	SP1636V	67	SP1636S	109	SPD1636-Z	122	SPD1636-V	128	SPD1636-S	146
	42"	1067	SP1642Z	73	SP1642V	77	SP1642S	128	SPD1642-Z	127	SPD1642-V	135	SPD1642-S	172
	48"	1219	SP1648Z	78	SP1648V	81	SP1648S	143	SPD1648-Z	135	SPD1648-V	141	SPD1648-S	191
<b>18" width</b> (457mm)	30"	762	SP1830Z	59	SP1830V	62	SP1830S	103	SPD1830-Z	99	SPD1830-V	104	SPD1830-S	137
	36"	914	SP1836Z	65	SP1836V	69	SP1836S	121	SPD1836-Z	124	SPD1836-V	132	SPD1836-S	163
	42"	1067	SP1842Z	73	SP1842V	77	SP1842S	141	SPD1842-Z	127	SPD1842-V	138	SPD1842-S	188
	48"	1219	SP1848Z	78	SP1848V	81	SP1848S	159	SPD1848-Z	136	SPD1848-V	143	SPD1848-S	212
<b>21" width</b> (533mm)	30"	762	SP2130Z	64	SP2130V	67	SP2130S	114	SPD2130-Z	103	SPD2130-V	108	SPD2130-S	152
	36"	914	SP2136Z	71	SP2136V	74	SP2136S	135	SPD2136-Z	127	SPD2136-V	135	SPD2136-S	179
	42"	1067	SP2142Z	77	SP2142V	80	SP2142S	154	SPD2142-Z	135	SPD2142-V	141	SPD2142-S	206
	48"	1219	SP2148Z	82	SP2148V	85	SP2148S	174	SPD2148-Z	139	SPD2148-V	146	SPD2148-S	232
<b>24" width</b> (610mm)	30"	762	SP2430Z	73	SP2430V	77	SP2430S	148	SPD2430-Z	108	SPD2430-V	114	SPD2430-S	199
	36"	914	SP2436Z	74	SP2436V	78	SP2436S	174	SPD2436-Z	134	SPD2436-V	140	SPD2436-S	232
	42"	1067	SP2442Z	91	SP2442V	95	SP2442S	202	SPD2442-Z	138	SPD2442-V	145	SPD2442-S	271
	48"	1219	SP2448Z	94	SP2448V	98	SP2448S	224	SPD2448-Z	144	SPD2448-V	151	SPD2448-S	300
<b>30" width</b> (762mm)	30"	762	SP3030Z	85	SP3030V	93	SP3030S	175	SPD3030-Z	118	SPD3030-V	124	SPD3030-S	233
	36"	914	SP3036Z	91	SP3036V	95	SP3036S	203	SPD3036-Z	143	SPD3036-V	149	SPD3036-S	272
	42"	1067	SP3042Z	103	SP3042V	107	SP3042S	237	SPD3042-Z	148	SPD3042-V	157	SPD3042-S	316
	48"	1219	SP3048Z	111	SP3048V	117	SP3048S	262	SPD3048-Z	154	SPD3048-V	163	SPD3048-S	352
<b>32" width</b> (813mm)	36"	914	SP3236Z	97	SP3236V	101	SP3236S	205	SPD3236-Z	168	SPD3236-V	178	SPD3236-S	275
	42"	1067	SP3242Z	112	SP3242V	118	SP3242S	205	SPD3242-Z	175	SPD3242-V	184	SPD3242-S	275
	48"	1219	SP3248Z	119	SP3248V	125	SP3248S	268	SPD3248-Z	180	SPD3248-V	189	SPD3248-S	356
<b>36" width</b> (914mm)	36"	914	SP3636Z	107	SP3636V	114	SP3636S	267	SPD3636-Z	174	SPD3636-V	182	SPD3636-S	355
	42"	1067	SP3642Z	117	SP3642V	122	SP3642S	307	SPD3642-Z	180	SPD3642-V	189	SPD3642-S	408
	48"	1219	SP3648Z	122	SP3648V	131	SP3648S	348	SPD3648-Z	186	SPD3648-V	196	SPD3648-S	463

## Catalog Section 1

### Hybrid Shelves (Cont.)

Freight class is 70.0.

see spec sheet **EG01.46**

#### Case Work Series

	length		EAGLEbrite®		VALU-MASTER®		stainless steel			length		EAGLEbrite®		VALU-MASTER®		stainless steel	
	in.	mm	model #	list	model #	list	model #	list		in.	mm	model #	list	model #	list	model #	list
<b>12" width</b> (305mm)	28"	711	SPL1224Z	51	SPL1224V	55	SPL1224S	85	<b>21" width</b> (533mm)	28"	711	SPL2130Z	64	SPL2130V	67	SPL2130S	114
	34"	864	SPL1236Z	56	SPL1236V	60	SPL1236S	120		34"	864	SPL2136Z	71	SPL2136V	74	SPL2136S	135
	40"	1016	SPL1242Z	59	SPL1242V	71	SPL1242S	132		40"	1016	SPL2142Z	77	SPL2142V	80	SPL2142S	154
	46"	1168	SPL1248Z	72	SPL1248V	74	SPL1248S	135		46"	1168	SPL2148Z	82	SPL2148V	85	SPL2148S	174
<b>15" width</b> (381mm)	28"	711	SPL1530Z	55	SPL1530V	57	SPL1530S	93	<b>24" width</b> (610mm)	28"	711	SPL2430Z	73	SPL2430V	77	SPL2430S	148
	34"	864	SPL1536Z	60	SPL1536V	64	SPL1536S	126		34"	864	SPL2436Z	74	SPL2436V	78	SPL2436S	174
	40"	1016	SPL1542Z	71	SPL1542V	74	SPL1542S	137		40"	1016	SPL2442Z	91	SPL2442V	95	SPL2442S	202
	46"	1168	SPL1548Z	74	SPL1548V	78	SPL1548S	141		46"	1168	SPL2448Z	94	SPL2448V	98	SPL2448S	224
<b>16" width</b> (406mm)	28"	711	SPL1630Z	58	SPL1630V	60	SPL1630S	94	<b>30" width</b> (762mm)	28"	711	SPL3030Z	85	SPL3030V	93	SPL3030S	175
	34"	864	SPL1636Z	64	SPL1636V	67	SPL1636S	109		34"	864	SPL3036Z	91	SPL3036V	95	SPL3036S	203
	40"	1016	SPL1642Z	73	SPL1642V	77	SPL1642S	128		40"	1016	SPL3042Z	103	SPL3042V	107	SPL3042S	237
	46"	1168	SPL1648Z	78	SPL1648V	81	SPL1648S	143		46"	1168	SPL3048Z	111	SPL3048V	117	SPL3048S	262
<b>18" width</b> (457mm)	28"	711	SPL1830Z	59	SPL1830V	62	SPL1830S	103	<b>32" width</b> (813mm)	34"	864	SPL3236Z	97	SPL3236V	101	SPL3236S	205
	34"	864	SPL1836Z	65	SPL1836V	69	SPL1836S	121		40"	1016	SPL3242Z	112	SPL3242V	118	SPL3242S	205
	40"	1016	SPL1842Z	73	SPL1842V	77	SPL1842S	141		46"	1168	SPL3248Z	119	SPL3248V	125	SPL3248S	268
	46"	1168	SPL1848Z	78	SPL1848V	81	SPL1848S	159		36"	34"	864	SPL3636Z	107	SPL3636V	114	SPL3636S
									40"	1016	SPL3642Z	117	SPL3642V	122	SPL3642S	307	
									46"	1168	SPL3648Z	122	SPL3648V	131	SPL3648S	348	

### Wire Basket Utility Carts

see spec sheet **EG01.35**



Note: For Wire Basket Shelves, see page 38.

- Includes four 4" (102mm) swivel stem casters with bumpers and two push handles.
- 40" (1016mm) overall cart height.

FEATURES:

Freight class is 70.0.

description	weight		model #	list
	lbs.	kg		
1 chrome basket shelf, 1 chrome standard shelf	31	14.1	<b>WBC1836C-1B1W</b>	342
2 chrome basket shelves	32	14.5	<b>WBC1836C-2B</b>	301

### Stainless Utility Carts

see product announcement **EG8179M**

*Shelves are hemmed for further strength and stability!*



#UUC-322

FEATURES:

- Three stainless steel hemmed shelves welded to angle legs.
- Galvanized bottom channel frame featuring four 4" (102mm) swivel plate casters.
- 1"-diameter handle on one end.

Freight class is 70.0.

#### Standard Duty Carts — 300-lb. weight capacity.

overall width x length x height in.	overall width x length x height mm	shelf width x length (inner dimensions) in.		shelf clearance in.		weight lbs.	weight kg	with * standard upturns		with upturn on all sides of all shelves	
		in.	mm	in.	mm			model #	list	model #	list
16 1/2" x 27 1/8" x 32"	426 x 702 x 813	16 1/2"	25 5/8"	12 1/2"	318	29	13.2	<b>UC-311</b>	615	<b>UUC-311</b>	645
19" x 31" x 32"	483 x 787 x 813	18 3/8"	28 1/16"	12 1/2"	318	32	14.5	<b>UC-322</b>	637	<b>UUC-322</b>	668

\* Upturn on sides and rear of top and center shelves.

#### Medium Duty Carts — 500-lb. weight capacity.

overall width x length x height in.	overall width x length x height mm	shelf width x length (inner dimensions) in.		shelf clearance in.		weight lbs.	weight kg	with * standard upturns		with upturn on all sides of all shelves	
		in.	mm	in.	mm			model #	list	model #	list
16 1/2" x 27 1/8" x 32"	426 x 702 x 813	16 1/2"	25 5/8"	12 1/2"	318	39	17.6	<b>UC-411</b>	628	<b>UUC-411</b>	660
19" x 31" x 32"	483 x 787 x 813	18 3/8"	28 1/16"	12 1/2"	318	42	19.1	<b>UC-422</b>	651	<b>UUC-422</b>	683

\* Upturn on sides and rear of top and center shelves.



100 Industrial Boulevard, Clayton, DE 19938-8903 U.S.A.  
Phone: 800-637-5100 or 302-653-3000. Fax: 302-653-2065  
http://www.eaglegrp.com

# WINE SHELVES

Convert your existing shelving unit by adding cradle wine shelves onto standard posts.

## Cradle Wine Shelves

see spec sheet **EG01.20**

Freight class is 70.0.

(•) MTS (made to stock) / ( ) MTO (made to order)



*Each bottle is "cradled" by heavy gauge wire to avoid movement.*

	length		weight		cu ft	capacity (750ml bottles)	chrome		black epoxy	
	in.	mm	lb.	kg			model #	list	model #	list
<b>14" width (356mm)</b>	36"	914	7	3.2	1.0	9	<b>W1436C</b> •	119	<b>W1436BL</b>	119
	48"	1219	9	4.1	1.3	12	<b>W1448C</b> •	135	<b>W1448BL</b>	135

## Bulk Wine Shelf Units

see spec sheet **EG01.24**



*Largest capacity offered in the industry; bottles are stored in bulk.*

- Each compartment is adjustable for bottle diameter.
- Holds one dozen bottles per compartment.
- Bottles are retained with removable dividers, back panels and end panels.
- Panels are chrome plated.
- 74" (1880mm) height.

FEATURES:

Note: Not for mobile applications.

Freight class is 70.0.

	length		weight		cu ft	capacity (750ml bottles)	chrome		black epoxy	
	in.	mm	lb.	kg			model #	list	model #	list
<b>14" width (356mm)</b>	36"	914	140	63.5	5	180	<b>BW1436C</b>	2061	<b>BW1436BL</b>	2061
	48"	1219	160	72.5	9	240	<b>BW1448C</b>	2637	<b>BW1448BL</b>	2426

### Bulk Wine Shelf Units with Security Doors

	length		weight		cu ft	capacity (750ml bottles)	chrome		black epoxy	
	in.	mm	lb.	kg			model #	list	model #	list
<b>14" width (356mm)</b>	36"	914	183	83.0	5	180	<b>BW1436C-SC</b>	3124	<b>BW1436BL-SC</b>	3124
	48"	1219	205	93.0	9	240	<b>BW1448C-SC</b>	3680	<b>BW1448BL-SC</b>	3385

## Wine Glass Racks

see spec sheet **EG01.03E**



FEATURES:

- Fits onto underside of existing wire shelves or wire overshelves.
- 18" & 24" (457 & 610mm) lengths available.
- No hardware or tools required for installation.

Freight class is 70.0.

	length		zinc		chrome	
	in.	mm	model #	list ea	model #	list ea
18"	457	<b>WGR18-Z</b>	35	<b>WGR18-C</b>	38	
24"	610	<b>WGR24-Z</b>	39	<b>WGR24-C</b>	42	

## Catalog Section 1

*A highly flexible and maneuverable transport product which can be configured in either wire or solid shelves, or a combination of both.*

### Medium Duty Utility Carts

see spec sheet **EG01.10**



patented  
**QuadTruss**  
design

(Patent #5,390,803)

**Patented QuadTruss® Design** makes shelves up to 25% stronger and provides a retaining ledge for increased strength and product retention.

**WEIGHT CAPACITY:** • 500 lb. (227 kg) maximum.

**INCLUDES:**

- Two chrome handles.
- Four resilient rubber casters.
- 18" wide carts have 4" (102mm) casters.
- 21" and 24" carts have 5" (127mm) casters.

**Note:** For conductive use, order aluminum split sleeves or plastic conductive split sleeves (page 46), and optional grounding cable or anti-static drag chain (page 132).

LIFESTOR® Utility Carts available (see page 80).

See page 28 for optional stainless steel handles.

**Freight class is 70.0.**

(•) MTS (made to stock) / ( ) MTO (made to order)

### 2-Shelf Units

	width	length		cu ft	weight		EAGLEbrite®		chrome		stainless steel		
		in.	mm		lbs.	kg	model #	list	model #	list	model #	list	
40" height* (1016mm)	18" (457mm)	24"	610	2.5	32	14.5	EU2-1824Z•	291	EU2-1824C•	294	EU2-1824S	725	
		30"	762	2.5	35	15.8	EU2-1830Z•	299	EU2-1830C•	301	EU2-1830S	786	
		36"	914	2.5	38	17.2	EU2-1836Z•	303	EU2-1836C•	306	EU2-1836S	829	
	including casters	21" (533mm)	36"	914	2.9	42	19.1	EU2-2136Z•	331	EU2-2136C•	344	EU2-2136S	926
		24" (610mm)	36"	914	2.9	45	20.4	EU2-2436Z•	344	EU2-2436C•	355	EU2-2436S	978

\* Stainless steel cart are 40" (1016mm) height. Chrome carts 37 3/4" (959mm) height including casters.

### 3-Shelf Units

	width	length		cu ft	weight		EAGLEbrite®		chrome		stainless steel		
		in.	mm		lbs.	kg	model #	list	model #	list	model #	list	
40" height* (1016mm)	18" (457mm)	24"	610	2.5	37	16.7	EU3-1824Z•	355	EU3-1824C•	360	EU3-1824S	927	
		30"	762	2.5	41	18.5	EU3-1830Z•	366	EU3-1830C•	371	EU3-1830S	1020	
		36"	914	2.5	45	20.4	EU3-1836Z•	375	EU3-1836C•	378	EU3-1836S	1083	
	including casters	21" (533mm)	36"	914	2.9	48	21.8	EU3-2136Z•	408	EU3-2136C•	426	EU3-2136S	1214
		24" (610mm)	36"	914	2.9	58	26.3	EU3-2436Z•	425	EU3-2436C•	444	EU3-2436S	1294

\* Stainless steel cart are 40" (1016mm) height. Chrome carts 37 3/4" (959mm) height including casters.

### Utility Carts with Solid Shelf

see spec sheet **EG01.10**



patented  
**QuadTruss**  
design

(Patent #5,390,803)

**Patented QuadTruss® Design** makes shelves up to 25% stronger and provides a retaining ledge for increased strength and product retention.

**INCLUDES:**

- Two chrome handles.
- Four casters.
- Two chrome finish open-wire shelves.
- One stainless steel solid shelf.

**Note:** For conductive use, order aluminum split sleeves or plastic conductive split sleeves (page 46), and optional grounding cable or anti-static drag chain (page 132).

LIFESTOR® Utility Carts available (see page 80).

See page 28 for optional stainless steel handles.

**Freight class is 70.0.**

	width	length		caster diameter		weight		cu ft	model #	list
		in.	mm	in.	mm	lbs.	kg			
37 3/4" height (959mm)	18" (457mm)	24"	610	4"	102	36	16.3	2.5	EU3-1824CS	516
		30"	762	4"	102	39	17.7	2.5	EU3-1830CS	535
		36"	914	4"	102	42	19.1	2.5	EU3-1836CS	561
including casters	21" (533mm)	36"	914	5"	127	65	29.5	2.9	U3-2136CS	612
		24" (610mm)	36"	914	5"	127	71	32.2	3.3	U3-2436CS



### Heavy Duty Utility Carts

see spec sheet **EG01.10**

WEIGHT CAPACITY:

- 800 lb. (363 kg) maximum.



patented  
**QuadTruss<sup>®</sup>**  
design

(Patent #5,390,803)

**Patented QuadTruss<sup>®</sup> Design**  
makes shelves up to 25% stronger and  
provides a retaining ledge for increased  
strength and product retention.

INCLUDES:

- Two handles (see below)—one on each end.
- Four 5" (127mm) resilient rubber swivel casters.

**Note:** Carts can be made conductive with the use of aluminum split sleeves or plastic conductive split sleeves (page 46), and optional grounding cable or anti-static drag chain (page 132).

LIFESTOR<sup>®</sup> Utility Carts available (see page 80).

**Freight class is 70.0.**

(•) MTS (made to stock) / ( ) MTO (made to order)

### 2-Shelf Units

	length	cu	weight	EAGLEbrite <sup>®</sup>		chrome		stainless steel				
				in.	mm	ft	lbs.	kg	model #	list	model #	list
40" height* (1016mm)  including casters	18" width (457mm)	36"	914	2.5	38	17.2	<b>U2-1836Z</b> •	331	<b>U2-1836C</b> •	335	<b>U2-1836S</b>	901
		42"	1067	2.9	41	18.5	<b>U2-1842Z</b> •	347	<b>U2-1842C</b> •	355	<b>U2-1842S</b>	996
	21" width (533mm)	36"	914	2.9	42	19.1	<b>U2-2136Z</b> •	347	<b>U2-2136C</b> •	361	<b>U2-2136S</b>	978
		42"	1067	3.4	44	20.0	<b>U2-2142Z</b> •	366	<b>U2-2142C</b> •	381	<b>U2-2142S</b>	1072
		48"	1219	3.9	48	21.8	<b>U2-2148Z</b> •	372	<b>U2-2148C</b> •	385	<b>U2-2148S</b>	1072
	24" width (610mm)	36"	914	3.3	46	20.9	<b>U2-2436Z</b> •	361	<b>U2-2436C</b> •	375	<b>U2-2436S</b>	1031
		42"	1067	3.9	50	22.7	<b>U2-2442Z</b> •	385	<b>U2-2442C</b> •	402	<b>U2-2442S</b>	1163
		48"	1219	4.4	52	23.6	<b>U2-2448Z</b> •	392	<b>U2-2448C</b> •	409	<b>U2-2448S</b>	1163
		60"	1524	5.5	62	28.1	<b>U2-2460Z</b> •	437	<b>U2-2460C</b> •	447	<b>U2-2460S</b>	1333

\* Stainless steel cart are 40" (1016mm) height. Chrome carts 37" (959mm) height including casters.

### 3-Shelf Units

	length	cu	weight	EAGLEbrite <sup>®</sup>		chrome		stainless steel				
				in.	mm	ft	lbs.	kg	model #	list	model #	list
40" height* (1016mm)  including casters	18" width (457mm)	36"	914	2.5	48	21.8	<b>U3-1836Z</b> •	399	<b>U3-1836C</b> •	405	<b>U3-1836S</b>	1156
		42"	1067	2.9	52	23.6	<b>U3-1842Z</b> •	424	<b>U3-1842C</b> •	438	<b>U3-1842S</b>	1299
	21" width (533mm)	36"	914	2.9	53	24.0	<b>U3-2136Z</b> •	423	<b>U3-2136C</b> •	445	<b>U3-2136S</b>	1271
		42"	1067	3.4	56	25.4	<b>U3-2142Z</b> •	449	<b>U3-2142C</b> •	473	<b>U3-2142S</b>	1409
		48"	1219	3.9	62	28.1	<b>U3-2148Z</b> •	458	<b>U3-2148C</b> •	481	<b>U3-2148S</b>	1409
	24" width (610mm)	36"	914	3.3	59	26.8	<b>U3-2436Z</b> •	444	<b>U3-2436C</b> •	461	<b>U3-2436S</b>	1346
		42"	1067	3.9	65	29.5	<b>U3-2442Z</b> •	480	<b>U3-2442C</b> •	505	<b>U3-2442S</b>	1544
		48"	1219	4.4	68	30.8	<b>U3-2448Z</b> •	488	<b>U3-2448C</b> •	515	<b>U3-2448S</b>	1544
		60"	1524	5.5	83	37.6	<b>U3-2460Z</b> •	556	<b>U3-2460C</b> •	572	<b>U3-2460S</b>	1800

\* Stainless steel cart are 40" (1016mm) height. Chrome carts 37" (959mm) height including casters.

### Handles for Utility Carts

see spec sheets **EG01.03B** **EG04.07**

**Note:** Electropolished Utility Hands for cleanroom applications.

**Freight class is 70.0.**

(•) MTS (made to stock) / ( ) MTO (made to order)



width	weight	cubic	chrome*		stainless steel**		electropolished**			
			in.	mm	lbs.	kg	feet	model #	list	model #
18"	457	4.0	1.8	0.9	<b>UH18-C</b> •	43	<b>UH18-S</b>	112	<b>EPUH18-S</b>	139
21"	533	4.2	1.9	0.9	<b>UH21-C</b> •	44	<b>UH21-S</b>	113	<b>EPUH21-S</b>	141
24"	610	4.5	2.1	0.9	<b>UH24-C</b> •	44	<b>UH24-S</b>	116	<b>EPUH24-S</b>	144

\*31½" (800mm) height without casters  
\*\*33¾" (848mm) height without casters



### Stem Caster Carts

see spec sheet **EG01.07**

Freight class is 70.0.

(•) MTS (made to stock) / ( ) MTO (made to order)



**INCLUDES:**

- Four 63" (1600mm) posts.
- Four shelves.
- Plastic split sleeves.
- Donut bumpers.
- Indicated 5" x 1 1/4" (127 x 32mm) casters.
- 68" (1727mm) overall height.
- Fast assembly without the use of tools.
- Shipped knocked-down.

**Note:** Carts can be made conductive with the use of aluminum split sleeves or plastic conductive split sleeves (page 46), and optional grounding cable or anti-static drag chain (page 132).

patented  
**QuadTruss**<sup>®</sup>  
design

(Patent #5,390,803)

**Patented QuadTruss<sup>®</sup> Design**

makes shelves up to 25% stronger and provides a retaining ledge for increased strength and product retention.

		weight		cu	caster	wheel	EAGLEbrite <sup>®</sup>		chrome		
		lbs.	kg				ft	model #	list	model #	list
18" width (457mm)	36" length (914mm)				swivel	resilient	CC1836Z-S	• 489	CC1836C-S	• 494	
					swivel	poly	CC1836Z-SP	• 562	CC1836C-SP	• 567	
		58	26.3	2.6	swivel/brake	resilient	CC1836Z-SB	• 501	CC1836C-SB	• 505	
					swivel/brake	poly	CC1836Z-SBP	• 574	CC1836C-SBP	• 581	
					swivel/rigid	resilient	CC1836Z-SR	• 514	CC1836C-SR	• 528	
					swivel/rigid	poly	CC1836Z-SRP	• 575	CC1836C-SRP	• 594	
		48" length (1219mm)				swivel	resilient	CC1848Z-S	• 494	CC1848C-S	• 540
					swivel	poly	CC1848Z-SP	• 567	CC1848C-SP	• 615	
	70		31.7	3.5	swivel/brake	resilient	CC1848Z-SB	• 554	CC1848C-SB	• 569	
					swivel/brake	poly	CC1848Z-SBP	• 627	CC1848C-SBP	• 642	
					swivel/rigid	resilient	CC1848Z-SR	• 558	CC1848C-SR	• 585	
					swivel/rigid	poly	CC1848Z-SRP	• 621	CC1848C-SRP	• 651	
	60" length (1524mm)				swivel	resilient	CC1860Z-S	• 597	CC1860C-S	• 615	
				swivel	poly	CC1860Z-SP	• 669	CC1860C-SP	• 688		
86		39.0	4.4	swivel/brake	resilient	CC1860Z-SB	• 612	CC1860C-SB	• 627		
				swivel/brake	poly	CC1860Z-SBP	• 686	CC1860C-SBP	• 701		
				swivel/rigid	resilient	CC1860Z-SR	• 613	CC1860C-SR	• 640		
				swivel/rigid	poly	CC1860Z-SRP	• 678	CC1860C-SRP	• 704		
21" width (533mm)	36" length (914mm)				swivel	resilient	CC2136Z-S	• 525	CC2136C-S	• 552	
					swivel	poly	CC2136Z-SP	• 597	CC2136C-SP	• 624	
		67	30.4	3.0	swivel/brake	resilient	CC2136Z-SB	• 538	CC2136C-SB	• 565	
					swivel/brake	poly	CC2136Z-SBP	• 612	CC2136C-SBP	• 637	
					swivel/rigid	resilient	CC2136Z-SR	• 542	CC2136C-SR	• 582	
					swivel/rigid	poly	CC2136Z-SRP	• 607	CC2136C-SRP	• 646	
		48" length (1219mm)				swivel	resilient	CC2148Z-S	• 572	CC2148C-S	• 604
					swivel	poly	CC2148Z-SP	• 645	CC2148C-SP	• 677	
	79		35.8	4.0	swivel/brake	resilient	CC2148Z-SB	• 585	CC2148C-SB	• 617	
					swivel/brake	poly	CC2148Z-SBP	• 659	CC2148C-SBP	• 691	
					swivel/rigid	resilient	CC2148Z-SR	• 588	CC2148C-SR	• 634	
					swivel/rigid	poly	CC2148Z-SRP	• 653	CC2148C-SRP	• 697	
	60" length (1524mm)				swivel	resilient	CC2160Z-S	• 645	CC2160C-S	• 669	
				swivel	poly	CC2160Z-SP	• 717	CC2160C-SP	• 745		
96		43.5	5.0	swivel/brake	resilient	CC2160Z-SB	• 659	CC2160C-SB	• 686		
				swivel/brake	poly	CC2160Z-SBP	• 732	CC2160C-SBP	• 758		
				swivel/rigid	resilient	CC2160Z-SR	• 664	CC2160C-SR	• 700		
				swivel/rigid	poly	CC2160Z-SRP	• 731	CC2160C-SRP	• 762		
24" width (610mm)	36" length (914mm)				swivel	resilient	CC2436Z-S	• 546	CC2436C-S	• 572	
					swivel	poly	CC2436Z-SP	• 620	CC2436C-SP	• 645	
		74	33.5	3.5	swivel/brake	resilient	CC2436Z-SB	• 560	CC2436C-SB	• 585	
					swivel/brake	poly	CC2436Z-SBP	• 633	CC2436C-SBP	• 659	
					swivel/rigid	resilient	CC2436Z-SR	• 566	CC2436C-SR	• 598	
					swivel/rigid	poly	CC2436Z-SRP	• 629	CC2436C-SRP	• 662	
		48" length (1219mm)				swivel	resilient	CC2448Z-S	• 609	CC2448C-S	• 639
					swivel	poly	CC2448Z-SP	• 681	CC2448C-SP	• 713	
	90		40.8	4.5	swivel/brake	resilient	CC2448Z-SB	• 622	CC2448C-SB	• 654	
					swivel/brake	poly	CC2448Z-SBP	• 665	CC2448C-SBP	• 727	
					swivel/rigid	resilient	CC2448Z-SR	• 626	CC2448C-SR	• 668	
					swivel/rigid	poly	CC2448Z-SRP	• 692	CC2448C-SRP	• 735	
	60" length (1524mm)				swivel	resilient	CC2460Z-S	• 698	CC2460C-S	• 717	
				swivel	poly	CC2460Z-SP	• 772	CC2460C-SP	• 792		
110		49.9	5.6	swivel/brake	resilient	CC2460Z-SB	• 709	CC2460C-SB	• 732		
				swivel/brake	poly	CC2460Z-SBP	• 783	CC2460C-SBP	• 804		
				swivel/rigid	resilient	CC2460Z-SR	• 714	CC2460C-SR	• 748		
				swivel/rigid	poly	CC2460Z-SRP	• 779	CC2460C-SRP	• 815		



## Cart Covers

see spec sheet **EG01.09**

**Meets J.C.A.H. standards  
for transporting clean linen!**



cart cover  
enveloping entire cart/truck

cart cover with panel folded back for  
easy shelf accessibility

**Light weight,  
easy to handle!**

**FEATURES:**

- Top corners are reinforced.
- Choice of white coated, white uncoated, or transparent vinyl.
- Coated cart covers available in powder blue (suffix "PB") and light green (suffix "LG"). Example: CVC-63-1836PB. Other colors available—consult factory.
- Covers are nonreturnable.

**Note:** Cart covers to fit Security Units (pages 41-42) available.

To order cart cover for Stationary or Mobile Security Unit, add suffix "-S" to end of model number (ex: CV-63-2436-S) and add 20% to list price.

To order cart cover for Dolly Truck Security Unit, add suffix "-D" to end of model number (ex: CV-63-2436-D) and add 20% to list price.

**Double-Flap option available. \$21 upcharge.**

To order, add suffix "-DF" to model number (ex: CV-63-2436-DF).

Black electrostatic discharge (ESD) cart covers also available—see page 140.

**Freight class is 70.0.**

					White Coated Nylon*				White Uncoated Polyester				Transparent**				
	length		post height		weight		cu ft	zipper		velcro		zipper		zipper			
	in.	mm	in.	mm	lbs.	kg		model #	list	model #	list	model #	list	model #	list		
<b>18" width (457mm)</b>	36"	914	54"	1372	3	1.4	1	CZC-54-1836	235	CVC-54-1836	243	CZ-54-1836	136	CV-54-1836	149	CZ-54-1836-T	302
			63"	1600				CZC-63-1836	239	CVC-63-1836	252	CZ-63-1836	144	CV-63-1836	154	CZ-63-1836-T	302
	48"	1219	54"	1372	4	1.8	1	CZC-54-1848	243	CVC-54-1848	256	CZ-54-1848	152	CV-54-1848	161	CZ-54-1848-T	307
			63"	1600				CZC-63-1848	251	CVC-63-1848	259	CZ-63-1848	153	CV-63-1848	164	CZ-63-1848-T	307
60"	1524	54"	1372	5	2.3	1	CZC-54-1860	264	CVC-54-1860	273	CZ-54-1860	157	CV-54-1860	166	CZ-54-1860-T	318	
		63"	1600				CZC-63-1860	268	CVC-63-1860	278	CZ-63-1860	159	CV-63-1860	168	CZ-63-1860-T	339	
<b>21" width (533mm)</b>	48"	1219	54"	1372	4	1.8	1	CZC-54-2148	271	CVC-54-2148	282	CZ-54-2148	176	CV-54-2148	186	CZ-54-2148-T	336
			63"	1600				CZC-63-2148	282	CVC-63-2148	295	CZ-63-2148	194	CV-63-2148	203	CZ-63-2148-T	357
	60"	1524	74"	1880	5	2.3	1	CZC-74-2148	286	CVC-74-2148	297	CZ-74-2148	221	CV-74-2148	233	CZ-74-2148-T	376
			54"	1372				CZC-54-2160	311	CVC-54-2160	319	CZ-54-2160	183	CV-54-2160	197	CZ-54-2160-T	373
<b>24" width (610mm)</b>	48"	1219	63"	1600	5	2.3	1	CZC-63-2160	316	CVC-63-2160	326	CZ-63-2160	203	CV-63-2160	213	CZ-63-2160-T	396
			74"	1880				CZC-74-2160	320	CVC-74-2160	332	CZ-74-2160	237	CV-74-2160	243	CZ-74-2160-T	417
	60"	1524	54"	1372	3	1.4	1	CZC-54-2424	286	CVC-54-2424	287	CZ-54-2424	321	CV-54-2424	213	CZ-54-2424-T	323
			63"	1600				CZC-63-2424	291	CVC-63-2424	299	CZ-63-2424	333	CV-63-2424	255	CZ-63-2424-T	323
<b>24" width (610mm)</b>	36"	914	54"	1372	3	1.4	1	CZC-54-2436	239	CVC-54-2436	252	CZ-54-2436	156	CV-54-2436	165	CZ-54-2436-T	328
			63"	1600				CZC-63-2436	252	CVC-63-2436	264	CZ-63-2436	161	CV-63-2436	173	CZ-63-2436-T	328
	72"	1829	74"	1880	6	2.7	1	CZC-74-2436	258	CVC-74-2436	269	CZ-74-2436	197	CV-74-2436	202	CZ-74-2436-T	400
			86"	2184				CZC-86-2436	280	CVC-86-2436	299	CZ-86-2436	245	CV-86-2436	251	CZ-86-2436-T	422
<b>24" width (610mm)</b>	48"	1219	54"	1372	4	1.8	1	CZC-54-2448	284	CVC-54-2448	296	CZ-54-2448	168	CV-54-2448	181	CZ-54-2448-T	346
			63"	1600				CZC-63-2448	297	CVC-63-2448	311	CZ-63-2448	199	CV-63-2448	211	CZ-63-2448-T	346
	60"	1524	74"	1880	5	2.3	1	CZC-74-2448	303	CVC-74-2448	314	CZ-74-2448	215	CV-74-2448	229	CZ-74-2448-T	357
			86"	2184				CZC-86-2448	349	CVC-86-2448	359	CZ-86-2448	261	CV-86-2448	269	CZ-86-2448-T	444
<b>24" width (610mm)</b>	60"	1524	54"	1372	5	2.3	1	CZC-54-2460	318	CVC-54-2460	328	CZ-54-2460	226	CV-54-2460	237	CZ-54-2460-T	379
			63"	1600				CZC-63-2460	323	CVC-63-2460	336	CZ-63-2460	235	CV-63-2460	243	CZ-63-2460-T	379
	72"	1829	74"	1880	6	2.7	1	CZC-74-2460	328	CVC-74-2460	339	CZ-74-2460	266	CV-74-2460	277	CZ-74-2460-T	462
			86"	2184				CZC-86-2460	379	CVC-86-2460	379	CZ-86-2460	311	CV-86-2460	320	CZ-86-2460-T	486
<b>24" width (610mm)</b>	72"	1829	54"	1372	6	2.7	1	CZC-54-2472	323	CVC-54-2472	336	CZ-54-2472	233	CV-54-2472	241	CZ-54-2472-T	424
			63"	1600				CZC-63-2472	329	CVC-63-2472	343	CZ-63-2472	251	CV-63-2472	259	CZ-63-2472-T	433
	86"	2184	74"	1880	6	2.7	1	CZC-74-2472	338	CVC-74-2472	346	CZ-74-2472	273	CV-74-2472	284	CZ-74-2472-T	476
			86"	2184				CZC-86-2472	397	CVC-86-2472	392	CZ-86-2472	326	CV-86-2472	336	CZ-86-2472-T	500

\* White-coated nylon covers are fire-retardant; \*\* Entire cover is transparent except for the seams. Transparent covers with velcro available at same price.

**Helps keep equipment clean on shelf carts and shelf trucks.**

## Catalog Section 1

### Angled Shelf/ Visual Merchandising Carts

see spec sheet **EG01.44**



visual merchandising cart  
with optional shelf dividers

**Ideal for displaying  
POINT-OF-SALE  
or SPECIAL SALE ITEMS.**

**FEATURES:**

- 68" (1727mm) height.
- 3/4" (83mm) upturn at front
- 1/4" (32mm) downturn at rear.
- Shelves are reversible.
- Units available in 2' to 5' lengths (610 to 1524mm).

**WEIGHT CAPACITY:**

- 300 lbs. (136.1 kg) per shelf.

**INCLUDES:**

- Four shelves adjust on 1" (25mm) vertical increments and the 0°-30° slope of each shelf.
- Four posts.
- Four 5" x 1 1/4" (127 x 32mm) resilient swivel casters, two with brake.
- Additional caster sizes are available.
- Standard wire shelves (page 6) can be used.

**Note:** To order red or white epoxy finish, add suffix "R" (red) or "W" (white). **Example: M1836R.** Priced same as black epoxy.

Additional shelves and wire dividers available as options.

**Freight class is 70.0.**

(•) MTS (made to stock) / ( ) MTO (made to order)

length		weight		cu	EAGLEbrite®		chrome		black		VALU-MASTER®		Valu-Gard®	
in.	mm	lb.	kg	ft	model #	list	model #	list	model #	list	model #	list	model #	list
24"	610	52	23.6	3.6	M1824Z-4	581	M1824C-4	652	M1824BL-4	663	M1824V-4	663	M1824VG-4	663
36"	914	60	27.2	4.4	M1836Z-4 •	608	M1836C-4	669	M1836BL-4	679	M1836V-4	679	M1836VG-4	679
48"	1219	68	30.8	5.8	M1848Z-4 •	675	M1848C-4	698	M1848BL-4	727	M1848V-4	727	M1848VG-4	727
60"	1524	76	34.5	7.3	M1860Z-4 •	722	M1860C-4	745	M1860BL-4	769	M1860V-4	769	M1860VG-4	769

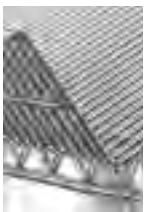

### Additional Angled Shelves for Angled Shelf / Visual Merchandising Carts - Hanger rails included.

length		weight		cu	EAGLEbrite®		chrome		black		VALU-MASTER®		Valu-Gard®	
in.	mm	lb.	kg	ft	model #	list	model #	list	model #	list	model #	list	model #	list
24"	610	4	1.8	2.2	M1824Z	92	M1824C	107	M1824BL	113	M1824V	113	M1824VG	113
36"	914	9	4.1	2.5	M1836Z	98	M1836C	112	M1836BL	117	M1836V	117	M1836VG	117
48"	1219	12	5.5	2.8	M1848Z	114	M1848C	119	M1848BL	126	M1848V	126	M1848VG	126
60"	1524	17	7.7	3.1	M1860Z	126	M1860C	132	M1860BL	137	M1860V	137	M1860VG	137

**Note:** If purchased as component piece for unit assembly, two 3-sided truss frames must be ordered (see page 32).



### Shelf Dividers for Angled Shelf / Visual Merchandising Carts - 4 1/2" (114mm) height.

length		weight		cu	chrome		black		VALU-MASTER®		Valu-Gard®	
in.	mm	lb.	kg	ft	model #	list	model #	list	model #	list	model #	list
18"	457	1.0	0.5	0.6	M18C	38	M18BL	40	M18V	40	M18VG	40

### Front-to-Back Hanger Rail for Angled Shelf / Visual Merchandising Carts

length		weight		cu	EAGLEbrite®		chrome		black		VALU-MASTER®		Valu-Gard®	
in.	mm	lb.	kg	ft	model #	list	model #	list	model #	list	model #	list	model #	list
18"	457	0.7	0.3	2.0	WR18-Z	15	WR18-C	17	WR18-BL	17	WR18-V	22	WR18-VG	22

### Side-to-Side Hanger Rails for Angled Shelf / Visual Merchandising Carts

length		weight		cu	EAGLEbrite®		chrome		black		VALU-MASTER®		Valu-Gard®	
in.	mm	lb.	kg	ft	model #	list	model #	list	model #	list	model #	list	model #	list
24"	610	1.5	0.7	0.3	LR24-Z	22	LR24-C	26	LR24-BL	28	LR24-V	28	LR24-VG	28
36"	914	1.9	0.9	0.6	LR36-Z	23	LR36-C	31	LR36-BL	35	LR36-V	35	LR36-VG	35
48"	1219	2.1	1.0	0.7	LR48-Z	24	LR48-C	38	LR48-BL	40	LR48-V	40	LR48-VG	40
60"	1524	2.5	1.1	0.8	LR60-Z	26	LR60-C	43	LR60-BL	44	LR60-V	44	LR60-VG	44



100 Industrial Boulevard, Clayton, DE 19938-8903 U.S.A.  
Phone: 800-637-5100 or 302-653-3000. Fax: 302-653-2065  
http://www.eaglegrp.com

## ...Merchandising Carts (Cont.)

see spec sheet **EG01.44**

Freight class is 70.0.



three-sided truss snare  
18" (457mm) front-to-back.



four-sided truss snare  
18" (457mm) front-to-back.

### 3-Sided Truss Frame for Angled Shelf/Visual Merchandising Cart

length		weight		cu ft	EAGLEbrite®		chrome		black		VALU-MASTER®		Valu-Gard®	
in.	mm	lb.	kg		model #	list	model #	list	model #	list	model #	list	model #	list
36"	914	3.5	1.6	2	3TF1836-Z	31	3TF1836-C	33	3TF1836-BL	36	3TF1836-V	36	3TF1836-VG	36
48"	1219	4.0	1.8	3	3TF1848-Z	33	3TF1848-C	38	3TF1848-BL	41	3TF1848-V	41	3TF1848-VG	41
60"	1524	4.5	2.0	4	3TF1860-Z	37	3TF1860-C	41	3TF1860-BL	45	3TF1860-V	45	3TF1860-VG	45

### 4-Sided Truss Frame for Angled Shelf/Visual Merchandising Carts

length		weight		cu ft	EAGLEbrite®		chrome		black		VALU-MASTER®		Valu-Gard®	
in.	mm	lb.	kg		model #	list	model #	list	model #	list	model #	list	model #	list
36"	914	3.5	1.6	2	4TF1836-Z	51	4TF1836-C	55	4TF1836-BL	60	4TF1836-V	60	4TF1836-VG	60
48"	1219	4.0	1.8	3	4TF1848-Z	55	4TF1848-C	62	4TF1848-BL	65	4TF1848-V	65	4TF1848-VG	65
60"	1524	4.5	2.0	4	4TF1860-Z	58	4TF1860-C	68	4TF1860-BL	73	4TF1860-V	73	4TF1860-VG	73

## Mobile Platform Carts

see spec sheet **EG60.36**

- Heavy duty all-aluminum construction.
- 1½" x 2¼" (38 x 70mm) square tubing.
- 5" (127mm) casters—two swivel with brake and two rigid.

FEATURES:

Freight class is 70.0.



**Lifetime guarantee against rust and corrosion!**

**5-year guarantee against workmanship and material defects!**

overall dimensions			deck size		weight capacity		model #	list					
width	depth	height	width	depth	lbs.	kg							
in.	mm	mm	in.	mm									
20"	37¼"	42"	508	959	1067	20"	36"	508	914	1200	544.3	<b>1202</b>	659
20"	49¼"	42"	508	1264	1067	20"	48"	508	1219	1200	544.3	<b>1203</b>	726
20"	61¼"	42"	508	1569	1067	20"	60"	508	1524	1200	544.3	<b>1212</b>	845

## Black Polymer Utility Cart

see spec sheet **EG01.06**

WEIGHT CAPACITY: • 200 lb. (90.7 kg).

- Four 4" (102mm) diameter swivel casters, two with brake.
- Stylish brushed aluminum uprights.

FEATURES:

Freight class is 70.0.



**Utilizes three heavy duty black polymer shelves and utility handles!**

height		width	length		weight		model #	list	
in.	mm		in.	mm	lbs.	kg			
37¼"	(959mm)	18¾"	(473mm)	33¾"	854	30	13.6	<b>EU3-2030-P</b>	702

## Catalog Section 1

### Dolly Trucks

see spec sheet **EG01.08**



#### FEATURES:

- Fast assembly without tools.
- Open wire construction.
- Shipped knocked-down.

#### INCLUDES:

- Four shelves.
- Four posts.
- Plastic split sleeves.
- Four designated 5" x 1 1/4" (127 x 32mm) casters.
- Aluminum truck dolly with wraparound bumper.

**Freight class is 70.0.**

**QuadTruss**  
design  
(Patent #5,390,803)

**Patented QuadTruss® Design**  
makes shelves up to 25% stronger and provides a retaining ledge for increased strength and product retention.

		shelf dimensions		weight		cu ft	caster type	wheel tread	with EAGLEbrite® shelf unit		with chrome shelf unit		
		in.	mm	lbs.	kg				model #	list	model #	list	
69" height (1753mm)	23 3/4" width (603mm)	40 1/8" length (1038mm)	18" x 36"	457 x 914	72	32.7	4.2	swivel	resilient	DT1836-ZS	909	DT1836-CS	939
			swivel	poly	DT1836-ZSP	881	DT1836-CSP	909					
		52 1/8" length (1343mm)	18" x 48"	457 x 1219	86	39.0	5.6	swivel/brake	resilient	DT1836-ZSB	918	DT1836-CSB	946
								swivel/brake	poly	DT1836-ZSBP	892	DT1836-CSBP	918
		64 1/8" length (1648mm)	18" x 36"	457 x 914	100	45.4	6.8	swivel	resilient	DT1848-ZS	980	DT1848-CS	1019
								swivel	poly	DT1848-ZSP	952	DT1848-CSP	989
	52 1/8" length (1343mm)	18" x 48"	457 x 1219	86	39.0	5.6	swivel/brake	resilient	DT1848-ZSB	987	DT1848-CSB	1027	
							swivel/brake	poly	DT1848-ZSBP	960	DT1848-CSBP	998	
	64 1/8" length (1648mm)	18" x 36"	457 x 914	100	45.4	6.8	swivel	resilient	DT1860-ZS	1069	DT1860-CS	1109	
							swivel	poly	DT1860-ZSP	1042	DT1860-CSP	1081	
	52 1/8" length (1343mm)	18" x 48"	457 x 1219	86	39.0	5.6	swivel/brake	resilient	DT1860-ZSB	1078	DT1860-CSB	1116	
							swivel/brake	poly	DT1860-ZSBP	1048	DT1860-CSBP	1088	
69" height (1753mm)	26 3/4" width (680mm)	40 1/8" length (1038mm)	21" x 36"	533 x 914	82	37.2	4.8	swivel	resilient	DT2136-ZS	960	DT2136-CS	1009
			swivel	poly	DT2136-ZSP	936	DT2136-CSP	982					
		52 1/8" length (1343mm)	21" x 48"	533 x 1219	98	44.5	6.4	swivel/brake	resilient	DT2136-ZSB	967	DT2136-CSB	1019
								swivel/brake	poly	DT2136-ZSBP	942	DT2136-CSBP	989
		64 1/8" length (1648mm)	21" x 48"	533 x 1219	98	44.5	6.4	swivel	resilient	DT2148-ZS	1031	DT2148-CS	1084
								swivel	poly	DT2148-ZSP	1004	DT2148-CSP	1058
	52 1/8" length (1343mm)	21" x 48"	533 x 1219	98	44.5	6.4	swivel/brake	resilient	DT2148-ZSB	1039	DT2148-CSB	1093	
							swivel/brake	poly	DT2148-ZSBP	1012	DT2148-CSBP	1066	
	64 1/8" length (1648mm)	21" x 60"	533 x 1524	114	51.7	7.9	swivel	resilient	DT2160-ZS	1134	DT2160-CS	1178	
							swivel	poly	DT2160-ZSP	1108	DT2160-CSP	1152	
	52 1/8" length (1343mm)	21" x 60"	533 x 1524	114	51.7	7.9	swivel/brake	resilient	DT2160-ZSB	1142	DT2160-CSB	1186	
							swivel/brake	poly	DT2160-ZSBP	1115	DT2160-CSBP	1197	
69" height (1753mm)	29 3/4" width (756mm)	40 1/8" length (1038mm)	24" x 36"	610 x 914	90	40.8	5.6	swivel	resilient	DT2436-ZS	978	DT2436-CS	1022
			swivel	poly	DT2436-ZSP	951	DT2436-CSP	994					
		52 1/8" length (1343mm)	24" x 48"	610 x 1219	112	50.8	7.2	swivel/brake	resilient	DT2436-ZSB	986	DT2436-CSB	1031
								swivel/brake	poly	DT2436-ZSBP	959	DT2436-CSBP	1004
		64 1/8" length (1648mm)	24" x 48"	610 x 1219	112	50.8	7.2	swivel	resilient	DT2448-ZS	1066	DT2448-CS	1122
								swivel	poly	DT2448-ZSP	1039	DT2448-CSP	1093
	52 1/8" length (1343mm)	24" x 48"	610 x 1219	112	50.8	7.2	swivel/brake	resilient	DT2448-ZSB	1075	DT2448-CSB	1128	
							swivel/brake	poly	DT2448-ZSBP	1045	DT2448-CSBP	1101	
	64 1/8" length (1648mm)	24" x 60"	610 x 1524	134	60.8	8.9	swivel	resilient	DT2460-ZS	1183	DT2460-CS	1226	
							swivel	poly	DT2460-ZSP	1156	DT2460-CSP	1201	
	52 1/8" length (1343mm)	24" x 60"	610 x 1524	134	60.8	8.9	swivel/brake	resilient	DT2460-ZSB	1193	DT2460-CSB	1234	
							swivel/brake	poly	DT2460-ZSBP	1163	DT2460-CSBP	1207	



100 Industrial Boulevard, Clayton, DE 19938-8903 U.S.A.  
Phone: 800-637-5100 or 302-653-3000. Fax: 302-653-2065  
<http://www.eaglegrp.com>

### Garment Racks



model #  
GRS1836C

see spec sheet **EG01.28**

patented  
**QuadTruss**  
design

(Patent #5,390,803)

INCLUDES:

- Four chrome post with adjustable feet.
- Two wire chrome plated shelves.
- 74" (1880mm) height on stationary units.
- 80" (3032mm) height on mobile units.
- Mobile racks four 5" (127mm) polyurethane tread casters, with rubber donut bumper.

**Freight class is 70.0.**

(•) MTS (made to stock) / ( ) MTO (made to order)

#### Patented QuadTruss® Design

makes shelves up to 25% stronger and provides a retaining ledge for increased strength and product retention.

**Convenient storage of coats, uniforms, or garments.**

length	weight		cu	description	STATIONARY		MOBILE			
	in.	mm			lbs.	kg	model #	list	model #	list
18" width (457mm)	36"	914	48	21.8	2.2	unit as shown	GR1836C	312	UR1836C	493
	36"	914	64	29.0	2.2	same, plus 1 solid shelf	GRS1836C	431	URS1836C	647
	48"	1219	52	23.6	2.6	unit as shown	GR1848C	339	UR1848C	528
	48"	1219	72	32.7	2.6	same, plus 1 solid shelf	GRS1848C	473	URS1848C	709
	60"	1524	58	26.3	3.2	unit as shown	GR1860C	381	UR1860C	571
	60"	1524	82	37.2	3.2	same, plus 1 solid shelf	GRS1860C	542	URS1860C	813

### Optional Wire Shelves

length	weight		cu	model #	list	
	in.	mm				lbs.
18" width (457mm)	36"	914	9	4.1	0.7	<b>1836C</b> • 65
	48"	1219	12	5.5	0.9	<b>1848C</b> • 78
	60"	1524	17	7.7	1.2	<b>1860C</b> • 92

### Replacement Coat Hanger Tubes

length	weight		cubic	model #	list
	in.	mm			
24"	610	1.5	0.7	0.1	<b>CH24</b> 37
30"	762	1.7	0.8	0.1	<b>CH30</b> 39
36"	914	2.2	1.0	0.1	<b>CH36</b> 41
42"	1067	2.7	1.2	0.1	<b>CH42</b> 42
48"	1219	3.2	1.5	0.1	<b>CH48</b> • 43
54"	1372	3.5	1.6	0.2	<b>CH54</b> 46
60"	1524	3.8	1.7	0.2	<b>CH60</b> 49



### Optional Hangers

description	weight		cu	chrome	
	lbs.	kg		model #	list
open loop hanger	0.4	0.2	0.3	<b>OLH-C</b> •	13
closed loop hanger	0.4	0.2	0.3	<b>CLH-C</b>	13



### Platforms

see spec sheet **EG01.13**



**600 lbs.**  
**weight capacity**

FEATURES:

- Open-wire construction for improved air circulation, minimizing dust.

**Freight class is 70.0.**

(•) MTS (made to stock) / ( ) MTO (made to order)

patented  
**QuadTruss**  
design  
(Patent #5,390,803)

#### Patented QuadTruss® Design

makes shelves up to 25% stronger and provides a retaining ledge for increased strength and product retention.

	length	weight		cu	EAGLEbrite®		chrome		EAGLEgard®			
		in.	mm		lbs.	kg	ft	model #	list	model #	list	model #
14" height (356mm)	18" width (457mm)	24"	610	10	4.5	0.7	PF1824-Z •	112	PF1824-C •	118	PF1824-E •	140
		30"	762	11	5.0	0.7	PF1830-Z •	113	PF1830-C •	119	PF1830-E •	143
		36"	914	13	5.9	0.7	PF1836-Z •	116	PF1836-C •	121	PF1836-E •	146
	21" width (533mm)	24"	610	12	5.4	0.7	PF2124-Z •	118	PF2124-C •	128	PF2124-E •	151
		30"	762	13	5.9	0.7	PF2130-Z •	120	PF2130-C •	132	PF2130-E •	153
		36"	914	14	6.4	0.8	PF2136-Z •	122	PF2136-C •	134	PF2136-E •	155
	24" width (610mm)	24"	610	13	5.9	0.8	PF2424-Z •	122	PF2424-C •	133	PF2424-E •	159
		30"	762	15	6.8	0.8	PF2430-Z •	125	PF2430-C •	136	PF2430-E •	161
		36"	914	17	7.7	0.8	PF2436-Z •	127	PF2436-C •	138	PF2436-E •	163

## Catalog Section 1

### Dunnage Shelves

see spec sheet **EG01.13**



**Improves your system's weight-bearing capacity.**

- Four-sided frame with center supports.
- Removable heavy duty  $\frac{3}{16}$ " (8mm)-diameter wire mat assembly.

**FEATURES:**

**Note:** All weights and cubic feet are approximate.

**Freight class is 70.0.**

(•) MTS (made to stock) / ( ) MTO (made to order)

	length		weight		cu ft	chrome		EAGLEgard®		stainless steel	
	in.	mm	lbs.	kg		model #	list	model #	list	model #	list
<b>18" width</b> (457mm)	24"	610	14	6.4	0.6	<b>DS1824-C</b>	152	<b>DS1824-E</b>	192	n/a	n/a
	30"	762	18	8.2	0.7	<b>DS1830-C</b>	167	<b>DS1830-E</b>	203	n/a	n/a
	36"	914	21	9.5	0.8	<b>DS1836-C</b>	178	<b>DS1836-E</b>	216	<b>DS1836-S</b>	558
	48"	1219	28	12.7	1.1	<b>DS1848-C</b>	206	<b>DS1848-E •</b>	241	<b>DS1848-S</b>	678
	60"	1524	33	15.0	1.3	<b>DS1860-C</b>	240	<b>DS1860-E •</b>	286	<b>DS1860-S</b>	798
<b>21" width</b> (533mm)	24"	610	15	6.8	0.6	<b>DS2124-C</b>	171	<b>DS2124-E</b>	209	n/a	n/a
	30"	762	19	8.6	0.8	<b>DS2130-C</b>	176	<b>DS2130-E</b>	218	n/a	n/a
	36"	914	22	10.0	0.9	<b>DS2136-C</b>	187	<b>DS2136-E</b>	229	n/a	n/a
	48"	1219	28	12.7	1.2	<b>DS2148-C</b>	214	<b>DS2148-E</b>	261	n/a	n/a
	60"	1524	34	15.4	1.5	<b>DS2160-C</b>	244	<b>DS2160-E</b>	309	n/a	n/a
<b>24" width</b> (610mm)	24"	610	16	7.3	0.8	<b>DS2424-C</b>	165	<b>DS2424-E</b>	202	n/a	n/a
	30"	762	20	9.0	0.9	<b>DS2430-C</b>	181	<b>DS2430-E</b>	218	n/a	n/a
	36"	914	24	10.9	1.1	<b>DS2436-C</b>	196	<b>DS2436-E</b>	235	<b>DS2436-S</b>	609
	48"	1219	30	13.6	1.4	<b>DS2448-C</b>	220	<b>DS2448-E •</b>	268	<b>DS2448-S</b>	735
	60"	1524	37	16.8	1.8	<b>DS2460-C</b>	261	<b>DS2460-E •</b>	316	<b>DS2460-S</b>	882

### Dunnage Racks

see spec sheet **EG01.13**



**Store large items off the floor!**

**Snag-free wire surface.**

**WEIGHT CAPACITY:**

- Up to 36" long: 1600 lbs. (635 kg).
- 48" long: 1300 lbs. (590 kg).
- 60" long: 1000 lbs. (454 kg).
- static load equally distributed.

**Note:** All weights and cubic feet are approximate.

**Freight class is 70.0.**

(•) MTS (made to stock) / ( ) MTO (made to order)

	length		weight		cu ft	chrome		EAGLEgard®		stainless steel		
	in.	mm	lbs.	kg		model #	list	model #	list	model #	list	
<b>14" overall height</b> (356mm)	<b>18" width</b> (457mm)	24"	610	21	9.5	0.5	<b>DR1824-C</b>	245	<b>DR1824-E</b>	286	n/a	n/a
		30"	762	24	10.9	1.0	<b>DR1830-C</b>	260	<b>DR1830-E</b>	306	n/a	n/a
		36"	914	31	14.1	1.6	<b>DR1836-C</b>	277	<b>DR1836-E</b>	324	<b>DR1836-S</b>	707
		48"	1219	37	16.8	2.2	<b>DR1848-C</b>	327	<b>DR1848-E •</b>	388	<b>DR1848-S</b>	942
		60"	1524	43	19.5	3.0	<b>DR1860-C</b>	405	<b>DR1860-E</b>	429	n/a	n/a
	<b>21" width</b> (533mm)	24"	610	24	10.9	0.8	<b>DR2124-C</b>	255	<b>DR2124-E</b>	303	n/a	n/a
		30"	762	27	12.2	2.0	<b>DR2130-C</b>	274	<b>DR2130-E</b>	324	n/a	n/a
		36"	914	33	15.0	2.0	<b>DR2136-C</b>	293	<b>DR2136-E</b>	344	n/a	n/a
		48"	1219	39	17.6	2.9	<b>DR2148-C</b>	347	<b>DR2148-E</b>	406	n/a	n/a
		60"	1524	45	20.4	3.3	<b>DR2160-C</b>	395	<b>DR2160-E</b>	445	n/a	n/a
	<b>24" width</b> (610mm)	24"	610	27	12.2	1.4	<b>DR2424-C</b>	261	<b>DR2424-E</b>	309	n/a	n/a
		30"	762	30	13.6	1.8	<b>DR2430-C</b>	281	<b>DR2430-E</b>	326	n/a	n/a
		36"	914	35	15.9	2.1	<b>DR2436-C •</b>	300	<b>DR2436-E •</b>	353	<b>DR2436-S</b>	811
		48"	1219	41	18.6	2.8	<b>DR2448-C •</b>	354	<b>DR2448-E •</b>	417	<b>DR2448-S</b>	1032
		60"	1524	47	21.3	3.5	<b>DR2460-C</b>	408	<b>DR2460-E</b>	469	n/a	n/a





### Mobile Dunnage Racks

see spec sheet **EG01.13** WEIGHT CAPACITY:



INCLUDES:

- 800 lbs. (363 kg).  
- equally distributed on the top surface.
- Four 5" swivel polyurethane tread casters, two with brakes.
- 3-sided frame with 1" (25mm)-square tubing.
- Snag-free wire surface.

Note: All weights and cubic feet are approximate.

**Freight class is 70.0.**

		length		weight		cu ft	chrome		EAGLEgard®		stainless steel	
		in.	mm	lbs.	kg		model #	list	model #	list	model #	list
14" overall height (356mm)	18" width (457mm)	24"	610	33	15.0	1.0	<b>MDR1824-C</b>	551	<b>MDR1824-E</b>	634	n/a	n/a
		30"	762	36	16.3	2.3	<b>MDR1830-C</b>	562	<b>MDR1830-E</b>	646	n/a	n/a
		36"	914	43	19.5	2.3	<b>MDR1836-C</b>	604	<b>MDR1836-E</b>	676	<b>MDR1836-S</b>	1122
		48"	1219	49	22.2	3.0	<b>MDR1848-C</b>	657	<b>MDR1848-E</b>	769	<b>MDR1848-S</b>	1326
		60"	1524	55	24.9	4.5	<b>MDR1860-C</b>	668	<b>MDR1860-E</b>	779	n/a	n/a
	21" width (533mm)	24"	610	36	16.3	3.1	<b>MDR2124-C</b>	566	<b>MDR2124-E</b>	652	n/a	n/a
		30"	762	39	17.6	3.3	<b>MDR2130-C</b>	571	<b>MDR2130-E</b>	661	n/a	n/a
		36"	914	45	20.4	3.0	<b>MDR2136-C</b>	584	<b>MDR2136-E</b>	676	n/a	n/a
		48"	1219	51	23.1	4.0	<b>MDR2148-C</b>	637	<b>MDR2148-E</b>	741	n/a	n/a
		60"	1524	57	25.9	5.0	<b>MDR2160-C</b>	688	<b>MDR2160-E</b>	782	n/a	n/a
	24" width (610mm)	24"	610	40	18.1	3.0	<b>MDR2424-C</b>	569	<b>MDR2424-E</b>	659	n/a	n/a
		30"	762	42	19.1	3.0	<b>MDR2430-C</b>	575	<b>MDR2430-E</b>	665	n/a	n/a
		36"	914	47	21.3	3.0	<b>MDR2436-C</b>	622	<b>MDR2436-E</b>	698	<b>MDR2436-S</b>	1197
		48"	1219	53	24.0	4.0	<b>MDR2448-C</b>	678	<b>MDR2448-E</b>	768	<b>MDR2448-S</b>	1413
		60"	1524	63	28.6	5.0	<b>MDR2460-C</b>	704	<b>MDR2460-E</b>	821	n/a	n/a

### Polymer Dunnage Racks

see spec sheet **EG01.17**

*Durable polyethylene construction prevents corrosion and rust.*



FEATURES:

- No assembly required.

**Freight class is 70.0.**

	width		length		weight		cubic feet	capacity		color	model #	list
	in.	mm	in.	mm	lbs.	kg		lbs.	kg			
12" height (305mm)	22"	559	36"	914	18	8.2	5.5	2000	907	black	<b>PD3622</b>	304
	22"	559	48"	1219	24	10.9	7.3	3000	1361	black	<b>PD4822</b>	367
	22"	559	60"	1524	28	12.7	9.2	3000	1361	black	<b>PD6022</b>	422
	36"	914	48"	1219	35	15.9	14.5	3500	1588	black	<b>PD4836</b>	404

### Starter Units with Dunnage Shelf

see spec sheet **EG01.19**

*Heavy duty dunnage shelf improves the units overall weight-bearing capacity.*



FEATURES:

- Tapered split sleeves create a positive lock that becomes stronger as the load increases.
- 74" (1880mm) posts numbered in increments of 1" (25mm) to ensure fast and level assembly.

**Freight class is 70.0.**

#### Stationary

width x length		zinc		chrome		EAGLEgard®	
in.	mm	model #	list	model #	list	model #	list
24" x 48"	610 x 1219	<b>DS4-P74-2448Z</b>	700	<b>DS4-P74-2448C</b>	803	<b>DS4-P74-2448E</b>	821

**patented QuadTruss design**  
(Patent #5,390,803)

#### Mobile

width x length		zinc		chrome		EAGLEgard®	
in.	mm	model #	list	model #	list	model #	list
24" x 48"	610 x 1219	<b>DS4-CP74-2448Z</b>	762	<b>DS4-CP74-2448C</b>	861	<b>DS4-CP74-2448E</b>	877

Note: Mobile models feature 5" resilient swivel casters with bumpers.

## Catalog Section 1

### Aluminum Dunnage Racks

see spec sheet **EG01.17**



- 1½" (38mm) square tubing.
- Plastic feet.

FEATURES:

Freight class is 70.0.

(•) MTS (made to stock) / ( ) MTO (made to order)

	length		weight		cubic feet	weight capacity		number of lats	RACKS WITH 8" (203mm) HEIGHT		RACKS WITH 12" (305mm) HEIGHT	
	in.	mm	lbs.	kg		lbs.	kg		model #	list	model #	list
20" width (508mm)	36"	914	10	4.5	6.8	2000	907	4	WDR203608-A •	254	WDR203612-A •	254
	48"	1219	14	6.4	8.9	2000	907	4	WDR204808-A •	295	WDR204812-A •	295
	60"	1524	18	8.2	11.0	1500	680	4	WDR206008-A •	332	WDR206012-A •	332
24" width (610mm)	36"	914	12	5.4	8.0	2000	907	5	WDR243608-A •	286	WDR243612-A •	286
	48"	1219	16	7.3	10.5	2000	907	5	WDR244808-A •	322	WDR244812-A •	322
	60"	1524	20	9.1	13.1	1500	680	5	WDR246008-A •	372	WDR246012-A •	372

### Nesting Dunnage Racks

see spec sheet **EG01.17**



FEATURES:

- All-aluminum construction.

Freight class is 70.0.

Racks are stackable, saving space when not in use.

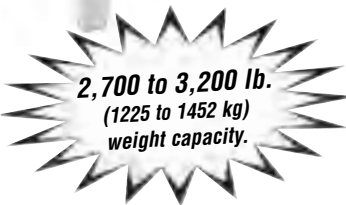

2,700 to 3,200 lb.  
(1225 to 1452 kg)  
weight capacity.

		length		weight		cubic feet	weight capacity		model #	list
		in.	mm	lbs.	kg		lbs.	kg		
12" height (305mm)	18" width (457mm)	24"	610	8	3.6	3.0	3200	1452	NDR182412-A	243
		36"	914	10	4.5	4.5	3200	1452	NDR183612-A	280
		48"	1219	12	5.4	6.0	2700	1225	NDR184812-A	313
	20" width (508mm)	24"	610	8	3.6	3.4	3200	1452	NDR202412-A	243
		36"	914	10	4.5	5.1	3200	1452	NDR203612-A	280
		48"	1219	12	5.4	6.7	2700	1225	NDR204812-A	313
	24" width (610mm)	24"	610	9	4.1	4.0	3200	1452	NDR242412-A	287
		36"	914	11	5.0	6.0	3200	1452	NDR243612-A	320
		48"	1219	14	6.4	8.0	2700	1225	NDR244812-A	372

### Aluminum Truck Dollies

see spec sheet **EG01.03B**



INCLUDES:

- Four designated 5" x 1¼" (127 x 32mm) casters with poly tread.
- Wraparound bumpers.

Freight class is 70.0.

	length		weight		cubic feet	caster type	caster load rate (each)		model #	list
	in.	mm	lbs.	kg			lbs.	kg		
29¾" width (756mm)	52"	1343	41	18.6	6.3	swivel	300	136.1	TD2448-SP	546
	52"	1343	44	20.0	6.3	swivel/brake	300	136.1	TD2448-BSP	1124
	64"	1648	48	21.8	7.6	swivel	300	136.1	TD2460-SP	574
	64"	1648	50	22.7	7.6	swivel/brake	300	136.1	TD2460-BSP	1131



## Dolly Frames with Wraparound Bumper

see spec sheet **EG01.03B**



dolly frames  
with wraparound bumper

- If ordering casters list dolly frame and caster model numbers separately.
- Holes are prepunched for use with plate casters on page 39.

ORDERING:

**Freight class is 70.0.**

(•) MTS (made to stock) / ( ) MTO (made to order)

	Aluminum					Chrome Plated Steel						
	length		weight		cu	weight		cu				
	in.	mm	lbs.	kg	ft	lbs.	kg	ft	model #	list		
<b>23 3/4" width</b> (603mm)	40"	1038	14	6.4	1.6	<b>DF1836-A</b>	323	16	7.3	1.6	<b>DF1836-C</b>	488
	46"	1191	16	7.3	1.9	<b>DF1842-A</b>	339	18	8.2	1.9	<b>DF1842-C</b>	513
	52"	1343	18	8.2	2.1	<b>DF1848-A</b>	351	20	9.1	2.1	<b>DF1848-C</b>	528
	64"	1648	21	9.6	2.6	<b>DF1860-A</b>	385	23	10.4	2.6	<b>DF1860-C</b>	584
	76"	1953	23	10.4	2.9	<b>DF1872-A</b>	448	25	11.3	2.9	<b>DF1872-C</b>	677
<b>26 3/4" width</b> (680mm)	40"	1038	17	7.7	1.8	<b>DF2136-A</b>	348	19	8.6	1.8	<b>DF2136-C</b>	524
	46"	1191	19	8.6	2.1	<b>DF2142-A</b>	360	21	9.6	2.1	<b>DF2142-C</b>	542
	52"	1343	21	9.6	2.4	<b>DF2148-A</b>	376	24	10.9	2.4	<b>DF2148-C</b>	566
	64"	1648	23	10.4	2.9	<b>DF2160-A</b>	404	23	11.8	2.9	<b>DF2160-C</b>	608
	76"	1953	25	11.3	3.5	<b>DF2172-A</b>	424	28	12.7	3.5	<b>DF2172-C</b>	642
<b>29 3/4" width</b> (756mm)	40"	1038	21	9.6	2.1	<b>DF2436-A</b>	341	23	10.4	2.1	<b>DF2436-C</b>	516
	46"	1191	26	11.8	2.4	<b>DF2442-A</b>	358	29	13.2	2.4	<b>DF2442-C</b>	540
	52"	1343	29	13.2	3.9	<b>DF2448-A</b>	372	32	14.5	3.9	<b>DF2448-C</b>	561
	64"	1648	31	14.1	4.2	<b>DF2460-A</b> •	404	34	15.4	4.2	<b>DF2460-C</b>	608
	76"	1953	39	17.7	4.5	<b>DF2472-A</b>	473	42	19.1	4.5	<b>DF2472-C</b>	713

## Plastic Label Holders

see spec sheet **EG01.03D**



gray plastic label holder    black plastic label holder    clear plastic label holder

FEATURES:

- Snaps onto shelf edge.
- Provides easy identification of shelf contents or section.
- Holds 1" to 1 1/4" (25 to 32mm) high labels.

**Freight class is 70.0.**

(•) MTS (made to stock) / ( ) MTO (made to order)

length		fits shelf size		gray		black		clear	
in.	mm	in.	mm	model #	list	model #	list	model #	list
3"	76	all	all	<b>A204331*</b>	4	<b>A206216 *</b>	4	<b>A208746</b>	4
13"	330	18"	457	<b>A206196</b>	7	<b>A206217</b>	7	<b>A208747</b>	7
19"	483	24"	610	<b>A206197</b>	9	<b>A206218</b>	9	<b>A208749</b>	9
25"	635	30"	762	<b>A206198</b>	11	<b>A206219</b>	11	<b>A208750</b>	11
31"	787	36"	914	<b>A206199</b>	12	<b>A206220</b>	12	<b>A208751</b>	12
33"	838	36"	914	<b>A213096</b>	12	<b>A227763</b>	12	<b>A227764</b>	12
37"	940	42"	1067	<b>A223747</b>	13	<b>A223748</b>	13	<b>A223749</b>	13
43"	1092	48"	1219	<b>A206200</b>	14	<b>A206221</b>	14	<b>A208752</b>	14
45"	1143	48"	1219	<b>A212494</b>	17	<b>A225208</b>	17	<b>A217621</b>	17
55"	1397	60"	1524	<b>A206201</b>	20	<b>A206222</b>	20	<b>A208753</b>	20
67"	1702	72"	1829	<b>A227842</b>	26	<b>A227841</b>	26	<b>A222144</b>	26

\* Actual length: 3 1/4" (83mm)



## Wire Basket Shelf

see spec sheet **EG01.03E**

**400-lb. (181.4 kg) weight capacity!**



width	length	weight		chrome	
	in mm	lbs.	kg	model #	list
<b>18" (457mm)</b>	36"	914	10	4.5	<b>WBS1836C</b> 93

FEATURES:

- Chrome-plated.
- For use with standard shelving posts.
- 4 1/4" (107mm) depth.

**Freight class is 70.0.**

## Catalog Section 1

### Plate Casters

see spec sheet **EG01.05B**

Freight class is 65.0.

(•) MTS (made to stock) / ( ) MTO (made to order)

#### Cart Washable Polymer - Polyurethane tread.

type	capacity		wheel diameter		wheel face		weight		model #	list
	lbs.	kg	in.	mm	in.	mm	lbs.	kg		
swivel	250	90.7	5"	127	1 1/4"	32	2.8	1.3	<b>PCPS5-250</b>	58
lock	250	90.7	5"	127	1 1/4"	32	2.8	1.3	<b>PCPL5-250</b>	73



#### Resilient

type	capacity		wheel diameter		wheel face		weight		cu ft	EAGLEbrite® zinc	
	lbs.	kg	in.	mm	in.	mm	lbs.	kg		model #	list
swivel	200	90.7	5"	127	1 1/4"	29	2.8	1.3	0.5	<b>CPS5-200</b>	37
brake	200	90.7	5"	127	1 1/4"	29	2.8	1.3	0.5	<b>CPB5-200</b>	41
rigid	200	90.7	5"	127	1 1/4"	29	2.8	1.3	0.5	<b>CPR5-200</b>	41
swivel	250	90.7	5"	127	1 1/4"	32	3.0	1.4	0.5	<b>CPS5-250 •</b>	47
brake	250	90.7	5"	127	1 1/4"	32	3.0	1.4	0.5	<b>CPB5-250</b>	51
rigid	250	90.7	5"	127	1 1/4"	32	3.0	1.4	0.5	<b>CPR5-250</b>	51
swivel	500	226.8	6"	152	2"	51	9.0	4.1	0.5	<b>CPS6-500</b>	71
brake	500	226.8	6"	152	2"	51	9.0	4.1	0.5	<b>CPB6-500</b>	79
rigid	500	226.8	6"	152	2"	51	9.0	4.1	0.5	<b>CPR6-500</b>	71



#### Polyurethane

type	capacity		wheel diameter		wheel face		weight		cu ft	EAGLEbrite® zinc	
	lbs.	kg	in.	mm	in.	mm	lbs.	kg		model #	list
swivel	300	136.1	5"	127	1 1/4"	32	3.0	1.4	0.5	<b>CPS5P-300 •</b>	41
brake	300	136.1	5"	127	1 1/4"	32	3.0	1.4	0.5	<b>CPB5P-300 •</b>	45
rigid	300	136.1	5"	127	1 1/4"	32	3.0	1.4	0.5	<b>CPR5P-300</b>	42
swivel	500	226.8	5"	127	2"	51	8.0	3.6	0.5	<b>CPS5P-500 •</b>	83
brake	500	226.8	5"	127	2"	51	8.0	3.6	0.5	<b>CPB5P-500 •</b>	95
rigid	500	226.8	5"	127	2"	51	8.0	3.6	0.5	<b>CPR5P-500</b>	95
swivel	600	272.1	6"	152	2"	51	9.0	4.1	0.5	<b>CPS6P-600 •</b>	92
brake	600	272.1	6"	152	2"	51	9.0	4.1	0.5	<b>CPB6P-600 •</b>	104
rigid	600	272.1	6"	152	2"	51	9.0	4.1	0.5	<b>CPR6P-600</b>	104
swivel	700	317.5	8"	203	2"	51	10.5	4.8	1.0	<b>CPS8P-700</b>	104
brake	700	317.5	8"	203	2"	51	10.5	4.8	1.0	<b>CPB8P-700</b>	116
rigid	700	317.5	8"	203	2"	51	10.5	4.8	1.0	<b>CPR8P-700</b>	116



with brake

#### Swivel/Lock Casters - Polyurethane tread.

type	capacity		wheel diameter		wheel face		weight		cu ft	EAGLEbrite® zinc	
	lbs.	kg	in.	mm	in.	mm	lbs.	kg		model #	list
swivel/lock	800	362.9	6"	152	2"	51	9.0	4.1	1.0	<b>CPL6Z-800</b>	173
swivel	800	362.9	6"	152	2"	51	9.0	4.1	1.0	<b>CPS6Z-800</b>	72
rigid	800	362.9	6"	152	2"	51	9.0	4.1	1.0	<b>CPR6Z-800</b>	67
brake	800	362.9	6"	152	2"	51	9.0	4.1	1.0	<b>CPB6Z-800</b>	85
swivel/lock	900	408.2	8"	203	2"	51	10.0	4.8	1.0	<b>CPL8Z-900</b>	179
swivel	900	408.2	8"	203	2"	51	10.0	4.8	1.0	<b>CPS8Z-900</b>	81
rigid	900	408.2	8"	203	2"	51	10.0	4.8	1.0	<b>CPR8Z-900</b>	74
brake	900	408.2	8"	203	2"	51	10.0	4.8	1.0	<b>CPB8Z-900</b>	94



#### Stainless Steel Pressure Washable Casters - Polyurethane tread.

type	capacity		wheel diameter		wheel face		weight		cu ft	stainless steel	
	lbs.	kg	in.	mm	in.	mm	lbs.	kg		model #	list
swivel/lock	300	136.1	5"	127	1 1/4"	32	3.0	1.4	0.5	<b>CPCM5S-300</b>	146
swivel	300	136.1	5"	127	1 1/4"	32	3.0	1.4	0.5	<b>CPS5S-300</b>	130
brake	300	136.1	5"	127	1 1/4"	32	3.0	1.4	0.5	<b>CPB5S-300</b>	142



with brake



100 Industrial Boulevard, Clayton, DE 19938-8903 U.S.A.  
 Phone: 800-637-5100 or 302-653-3000. Fax: 302-653-2065  
<http://www.eaglegrp.com>

## Security Modules

see spec sheet **EG01.16**



shown with hinged door  
(shown mounted to shelf unit  
sold separately)



shown with flip-up door  
(shown mounted to shelf unit  
sold separately)

- End panels.
- Rear panel.
- Door(s).
- Fits in between two wire shelves spaced 20" (508mm) apart.

INCLUDES:

Note: Shelving units sold separately—see pages 16 and 18.

Freight class is 70.0.



**Converts portion of shelf unit into a lockable enclosed security unit, adding versatility to shelf unit. More than one module can be added to unit, depending on unit's overall height.**

### Hinged Doors

	length		weight		EAGLEbrite® zinc		chrome		EAGLE-Gard®		stainless steel	
	in.	mm	lb.	kg	model #	list	model #	list	model #	list	model #	list
<b>18" width</b> (457mm)	30"	762	20	9.0	SECM1830Z	349	SECM1830C	457	SECM1830E	481	SECM1830S	1235
	36"	914	23	10.4	SECM1836Z	356	SECM1836C	462	SECM1836E	487	SECM1836S	1258
	48"	1219	27	12.2	SECM1848Z	379	SECM1848C	491	SECM1848E	517	SECM1848S	1345
	60"	1524	32	14.5	SECM1860Z	382	SECM1860C	552	SECM1860E	580	SECM1860S	1353
<b>21" width</b> (533mm)	30"	762	21	9.5	SECM2130Z	355	SECM2130C	461	SECM2130E	486	SECM2130S	1254
	36"	914	24	10.9	SECM2136Z	363	SECM2136C	469	SECM2136E	494	SECM2136S	1280
	48"	1219	29	13.2	SECM2148Z	388	SECM2148C	500	SECM2148E	527	SECM2148S	1378
	60"	1524	33	15.0	SECM2160Z	394	SECM2160C	559	SECM2160E	588	SECM2160S	1392
<b>24" width</b> (610mm)	30"	762	24	10.9	SECM2430Z	361	SECM2430C	468	SECM2430E	493	SECM2430S	1274
	36"	914	27	12.2	SECM2436Z	373	SECM2436C	500	SECM2436E	527	SECM2436S	1319
	48"	1219	31	14.1	SECM2448Z	397	SECM2448C	567	SECM2448E	598	SECM2448S	1408
	60"	1524	35	15.9	SECM2460Z	421	SECM2460C	636	SECM2460E	668	SECM2460S	1500

### Flip-Up Door

	length		weight		EAGLEbrite® zinc		chrome		EAGLE-Gard®		stainless steel	
	in.	mm	lb.	kg	model #	list	model #	list	model #	list	model #	list
<b>18" width</b> (457mm)	30"	762	24	10.9	SECM1830FZ	411	SECM1830FC	488	SECM1830FE	516	SECM1830FS	1442
	36"	914	29	13.2	SECM1836FZ	416	SECM1836FC	494	SECM1836FE	520	SECM1836FS	1463
	48"	1219	34	15.4	SECM1848FZ	434	SECM1848FC	518	SECM1848FE	545	SECM1848FS	1535
	60"	1524	39	17.6	SECM1860FZ	438	SECM1860FC	518	SECM1860FE	589	SECM1860FS	1544
<b>21" width</b> (533mm)	30"	762	26	11.8	SECM2130FZ	415	SECM2130FC	494	SECM2130FE	520	SECM2130FS	1460
	36"	914	30	13.6	SECM2136FZ	422	SECM2136FC	500	SECM2136FE	527	SECM2136FS	1482
	48"	1219	35	15.9	SECM2148FZ	448	SECM2148FC	528	SECM2148FE	556	SECM2148FS	1562
	60"	1524	40	18.1	SECM2160FZ	454	SECM2160FC	568	SECM2160FE	599	SECM2160FS	1578
<b>24" width</b> (610mm)	30"	762	28	12.7	SECM2430FZ	420	SECM2430FC	498	SECM2430FE	524	SECM2430FS	1476
	36"	914	32	14.5	SECM2436FZ	429	SECM2436FC	524	SECM2436FE	553	SECM2436FS	1514
	48"	1219	38	17.2	SECM2448FZ	449	SECM2448FC	577	SECM2448FE	606	SECM2448FS	1588
	60"	1524	43	19.5	SECM2460FZ	471	SECM2460FC	627	SECM2460FE	661	SECM2460FS	1663

# FULL-SIZE SECURITY UNITS

Safely store and transport costly materials and items subject to pilferage.

## Full-Size Stationary Security Units

see spec sheet **EG01.22**

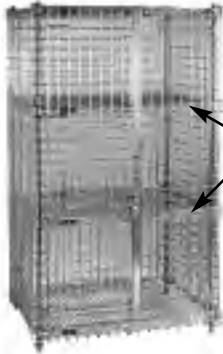

additional center shelves  
(see page 42)

patented  
**QuadTruss<sup>®</sup>**  
design

(Patent #5,390,803)

### Patented QuadTruss<sup>®</sup> Design

makes shelves up to 25% stronger and provides a retaining ledge for increased strength and product retention.

### FEATURES:

- 2" x 2" (51 x 51mm) mesh.
- Shipped knocked-down.

**Note:** See page 30 for optional cart covers available. Doors on front and rear of unit available. To order, add suffix "-2D" (ex: SC2436S-2D). **20% upcharge.**

**Freight class is 70.0.**

(•) MTS (made to stock) / ( ) MTO (made to order)

		length		weight		cu ft	chrome		EAGLEgard <sup>®</sup>		stainless steel	
		in.	mm	lbs.	kg		model #	list	model #	list	model #	list
67" overall height (1702mm)	17 1/4" width (438mm)	33 3/4"	845	114	51.7	5	SC1430	1019	SC1430E	1022	SC1430S	2414
		39 1/4"	997	123	55.8	5	SC1436 •	1132	SC1436E	1136	SC1436S	2681
		51 1/4"	1302	141	64.0	9	SC1448 •	1407	SC1448E	1425	SC1448S	3265
		63 3/4"	1607	159	72.1	10	SC1460	1559	SC1460E	1543	SC1460S	3403
	27 1/4" width (692mm)	33 3/4"	845	123	55.8	9	SC2430	1087	SC2430E	1328	SC2430S	3011
		39 1/4"	997	145	65.8	9	SC2436 •	1207	SC2436E •	1476	SC2436S	3344
		51 1/4"	1302	171	77.6	13	SC2448 •	1504	SC2448E •	1834	SC2448S	4072
		63 3/4"	1607	197	89.4	15	SC2460 •	1631	SC2460E	1991	SC2460S	4217
	33 1/4" width (845mm)	33 3/4"	845	145	65.8	15	SC3030	1366	SC3030E	1623	SC3030S	3761
		39 1/4"	997	163	73.9	13	SC3036	1517	SC3036E	1803	SC3036S	4179
		51 1/4"	1302	181	82.1	15	SC3048	1889	SC3048E	2358	SC3048S	5092
		63 3/4"	1607	207	93.9	18	SC3060	2039	SC3060E	2535	SC3060S	5271

## Full-Size Mobile Security Units

see spec sheet **EG01.22**

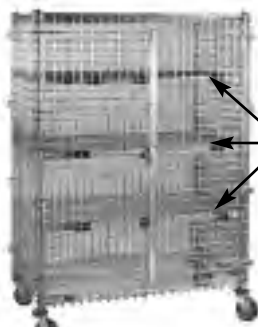

additional center shelves  
(see page 42)

patented  
**QuadTruss<sup>®</sup>**  
design

(Patent #5,390,803)

### Patented QuadTruss<sup>®</sup> Design

makes shelves up to 25% stronger and provides a retaining ledge for increased strength and product retention.

### FEATURES:

- Four swivel 5" x 1 1/4" (127 x 32mm) stem casters with polyurethane tread, two with brake.
- 2" x 2" (51 x 51mm) mesh.
- Shipped knocked-down.

**Note:** All stainless steel mobile security units come with stainless steel casters with polyurethane tread. See page 9 for other stem casters available. See page 30 for optional cart covers available. Doors on front and rear of unit available. To order, add suffix "-2D" (ex: CSC2430-2D). **20% upcharge.**

**Freight class is 70.0.**

(•) MTS (made to stock) / ( ) MTO (made to order)

		length		weight		cu ft	chrome		EAGLEgard <sup>®</sup>		stainless steel	
		in.	mm	lbs.	kg		model #	list	model #	list	model #	list
69" overall height (1753mm)	27 1/4" width (692mm)	33 3/4"	845	135	61.2	9	CSC2430	1277	CSC2430E	1516	CSC2430S	3011
		39 1/4"	997	161	73.0	9	CSC2436 •	1419	CSC2436E •	1684	CSC2436S	3344
		51 1/4"	1302	185	83.9	13	CSC2448 •	1715	CSC2448E •	2047	CSC2448S	4073
		63 3/4"	1607	204	92.5	15	CSC2460 •	1844	CSC2460E	2202	CSC2460S	4217
	33 1/4" width (845mm)	33 3/4"	845	161	73.0	15	CSC3030	1614	CSC3030E	1943	CSC3030S	3761
		39 1/4"	997	179	87.2	13	CSC3036	1793	CSC3036E	2160	CSC3036S	4179
		51 1/4"	1302	203	92.1	15	CSC3048	2162	CSC3048E •	2622	CSC3048S	5092
		63 3/4"	1607	221	100.2	18	CSC3060 •	2324	CSC3060E	2822	CSC3060S	5271



100 Industrial Boulevard, Clayton, DE 19938-8903 U.S.A.  
Phone: 800-637-5100 or 302-653-3000. Fax: 302-653-2065  
<http://www.eaglegrp.com>

### Full-Size Dolly Truck Security Units

see spec sheet **EG01.22**



patented  
**QuadTruss**  
design

(Patent #5,390,803)

#### Patented QuadTruss® Design

makes shelves up to 25% stronger and provides a retaining ledge for increased strength and product retention.

- Dolly with wraparound bumper.
- 2" x 2" (51x 51mm) mesh.
- Four swivel 5" x 1 1/4" (127 x 32mm) poly plate casters, two with brakes.
- Shipped knocked down.

#### INCLUDES:

**Note:** See page 39 for optional plate casters.  
See page 30 for optional cart covers available.  
Doors on front and rear of unit available. To order, add suffix "-2D" (ex: DTSC2448-2D). **20% upcharge.**

**Freight class is 70.0.**

(\*) MTS (made to stock) / ( ) MTO (made to order)

		length		weight		cu ft	chrome shelf unit with aluminum dolly		EAGLEgard® shelf unit with aluminum dolly		stainless steel shelf unit with stainless steel dolly	
		in.	mm	lbs.	kg		model #	list	model #	list	model #	list
<b>69" overall height</b> (1753mm)	<b>29 3/4" width</b> (756mm)	34 1/4"	886	161	73.0	7.3	<b>DTSC2430</b>	1534	<b>DTSC2430E</b>	2658	<b>DTSC2430S</b>	4949
		40 1/4"	1038	177	80.3	10.7	<b>DTSC2436</b>	1704	<b>DTSC2436E</b>	2953	<b>DTSC2436S</b>	5499
		52 1/4"	1343	214	97.1	18.5	<b>DTSC2448</b>	2021	<b>DTSC2448E</b>	3515	<b>DTSC2448S</b>	6526
		64 1/4"	1648	245	111.1	22.9	<b>DTSC2460</b>	2172	<b>DTSC2460E</b>	3876	<b>DTSC2460S</b>	6700

#### Optional Posts for Full-Size Security Units

post height	weight	cu	chrome		EAGLEgard®		stainless steel			
			in.	mm	lbs.	kg	ft	model #	list	model #
74"	1880	4	1.8	0.5	<b>SP74-CS</b>	31	<b>SP74-ES</b>	37	<b>SP74-SS</b>	80
86"	2184	5	2.3	0.8	<b>SP86-CS</b>	38	<b>SP86-ES</b>	41	<b>SP86-SS</b>	92

#### Optional Shelves for Full-Size Security Units

	length	weight	cu	Wire Shelves Must be installed when assembling unit.						Optional Quad-Adjust® Shelves For use as intermediate shelves only.						
				chrome		EAGLEgard®		stainless steel		chrome		EAGLEgard®		stainless steel		
				in.	mm	lbs.	kg	ft	model #	list	model #	list	model #	list	model #	list
<b>14" width*</b> (356mm)	30"	762	7	3.2	0.5	<b>1430C</b> • 58	<b>1430E</b> • 68	<b>1430S</b> • 198	n/a	n/a	n/a	n/a	n/a	n/a	n/a	n/a
	36"	914	8	3.6	0.5	<b>1436C</b> • 62	<b>1436E</b> • 71	<b>1436S</b> • 200	<b>QA1436C</b> 99	<b>QA1436E</b> 111	<b>QA1436S</b> 273					
	48"	1219	10	4.5	0.7	<b>1448C</b> • 71	<b>1448E</b> • 82	<b>1448S</b> • 246	<b>QA1448C</b> 112	<b>QA1448E</b> 127	<b>QA1448S</b> 326					
	60"	1524	14	6.4	0.9	<b>1460C</b> • 81	<b>1460E</b> • 94	<b>1460S</b> • 312	<b>QA1460C</b> 121	<b>QA1460E</b> 137	<b>QA1460S</b> 409					
<b>24" width</b> (610mm)	30"	762	11	5.0	0.8	<b>2430C</b> • 79	<b>2430E</b> • 95	<b>2430S</b> • 302	n/a	n/a	n/a					
	36"	914	13	5.9	0.8	<b>2436C</b> • 81	<b>2436E</b> • 97	<b>2436S</b> • 306	<b>QA2436C</b> 121	<b>QA2436E</b> 141	<b>QA2436S</b> 402					
	48"	1219	16	7.3	1.2	<b>2448C</b> • 97	<b>2448E</b> • 119	<b>2448S</b> • 371	<b>QA2448C</b> 141	<b>QA2448E</b> 166	<b>QA2448S</b> 478					
	60"	1524	21	9.5	1.5	<b>2460C</b> • 116	<b>2460E</b> • 141	<b>2460S</b> • 453	<b>QA2460C</b> 161	<b>QA2460E</b> 189	<b>QA2460S</b> 581					
<b>30" width*</b> (762mm)	30"	762	16	7.3	1.0	<b>3030C</b> 105	<b>3030E</b> 125	<b>3030S</b> 357								
	36"	914	17	7.7	1.0	<b>3036C</b> • 119	<b>3036E</b> • 144	<b>3036S</b> • 405								
	48"	1219	20	9.1	1.5	<b>3048C</b> • 137	<b>3048E</b> • 164	<b>3048S</b> • 472								
	60"	1524	25	11.4	1.8	<b>3060C</b> • 151	<b>3060E</b> • 187	<b>3060S</b> • 524								

\* 14" and 30" widths (356 and 762mm) do not fit Full-Size Dolly Truck Security Units.

#### Ordering Full Size Security Units Assembled:

- Security carts shipped assembled, add \$350 to list price and add suffix "-A".  
**Example: SC1460E-A.**
- For assembled unit with center shelves installed (evenly spaced), indicate number of center shelves wanted by adding a number before the "A" in suffix "-A".
- For example, suffix "-1A" indicates assembled unit with one center shelf, suffix "-2A" indicates assembled unit with two center shelves, and so on.  
**Example: SC1460E-2A.**
- **PRICING:** add \$350 to list price of security unit, and add list price of each applicable center shelf to be added.

## Catalog Section 1

### Mini Security Units

see spec sheet **EG01.22**



patented  
**QuadTruss**  
design

(Patent #5,390,803)

**Patented QuadTruss® Design** makes shelves up to 25% stronger and provides a retaining ledge for increased strength and product retention.

- Stationary chrome plated units.
- 40" (1016mm) height.
- Shipped knocked down.

FEATURES:

**Freight class is 70.0.**

(•) MTS (made to stock) / ( ) MTO (made to order)

	length		weight		cubic	model #	list
	in.	mm	lbs.	kg	feet		
<b>16" width</b> (406mm)	38"	965	88	39.9	8.6	<b>MSC1436</b> •	975
	50"	1270	104	47.2	9.6	<b>MSC1448</b>	1247
<b>26" width</b> (660mm)	38"	965	100	45.4	9.2	<b>MSC2436</b> *	1013
	50"	1270	114	51.7	10.6	<b>MSC2448</b> *	1294

\* Optional stem casters (page 9) available only for these models.

### Optional Shelves for Mini Security Units

- With chrome plated finish.

	length		weight		cubic	model #	list
	in.	mm	lbs.	kg	feet		
<b>14" width</b> (356mm)	36"	914	8	3.6	0.5	<b>1436C</b> •	62
	48"	1219	10	4.5	0.7	<b>1448C</b> •	71
<b>24" width</b> (610mm)	36"	914	13	6.0	0.8	<b>2436C</b> •	81
	48"	1219	16	7.3	1.2	<b>2448C</b> •	97



### Optional Add-A-Shelf® Adjustable Shelves for All Security Units

see spec sheet **EG01.22**



optional Add-A-Shelf® being added to security unit

WEIGHT CAPACITY: • 300 lb. (136.1 kg) per shelf.

**Note:** Top and bottom shelves of unit must be standard shelves—see page 42.

**WARNING:** • Use Add-A-Shelf® shelves for intermediate shelves.

FEATURES: • Chrome finish.

**Freight class is 70.0.**

(•) MTS (made to stock) / ( ) MTO (made to order)

patented  
**QuadTruss**  
design

(Patent #5,390,803)

**Patented QuadTruss® Design** makes shelves up to 25% stronger and provides a retaining ledge for increased strength and product retention.

	length		weight		cubic	model #	list
	in.	mm	lbs.	kg	feet		
<b>14" width</b> (356mm)	36"	914	8	3.6	0.5	<b>A1436C</b> •	68
	48"	1219	10	4.6	0.7	<b>A1448C</b> •	78
<b>24" width</b> (610mm)	36"	914	13	5.9	0.8	<b>A2436C</b> •	89
	48"	1219	16	7.3	1.2	<b>A2448C</b> •	105
	60"	1524	21	9.5	1.5	<b>A2460C</b> •	134

Just a quick note...



**GET FREE DOWNLOADS**

- Spec Sheet • Product Instructions •
- Special Flyers • Brochures •

**www.eaglegrp.com**



100 Industrial Boulevard, Clayton, DE 19938-8903 U.S.A.  
Phone: 800-637-5100 or 302-653-3000. Fax: 302-653-2065  
<http://www.eaglegrp.com>



## Tank Racks

see spec sheet **EG01.31**

**FEATURES:**

- All models chrome-plated.
- Two styles available.

**Freight class is 70.0.**



style "B" tank rack with optional drip pan shown



style "A" tank rack with optional drip pan shown

**Style "A" – 33" (838mm) height Includes:**

- One dunnage mat with frame.
- One 3-sided frame.
- Four 33" (838mm) posts.
- Cable assembly.

**Style "B" – 74" (1880mm) height Includes:**

- One dunnage mat with frame.
- One 3-sided frame.
- Four 74" (1880mm) posts.
- Cable assembly.
- Two standard shelves.

	length		weight		cu	model #	list	weight		cu	model #	list
	in.	mm	lb.	kg	ft			lb.	kg	ft		
<b>24" width (610mm)</b>	30"	762	40	18.1	0.2	<b>STR2430A</b>	449	68	30.8	0.3	<b>STR2430B</b>	686
	48"	1219	50	22.7	0.3	<b>STR2448A</b>	538	88	39.9	0.4	<b>STR2448B</b>	832

### Optional Drip Pans for Tank Racks

- Stainless steel.



	length		weight		cu	model #	list
	in.	mm	lb.	kg	ft		
<b>24" width (610mm)</b>	30"	762	8	3.6	0.2	<b>DP30</b>	239
	48"	1219	12	5.4	0.3	<b>DP48</b>	272

### Optional Cylinder Retainer for Tank Racks

- Chrome-plated.
- Cylinders are secured to retainer to further prevent damage.

	width		weight		cu	model #	list
	in.	mm	lb.	kg	ft		
24"	610	7	3.2	0.3		<b>CRR24-C</b>	113



## Modular Desks / Workstations

see spec sheet **EG01.02**



	length		weight		cubic	model #	list
	in.	mm	lb.	kg	feet		
<b>24" width (610mm)</b>	36"	914	78	35.3	1.0	<b>MD2436</b>	1236
	48"	1219	85	38.6	1.0	<b>MD2448</b>	1339

- Heavy gauge type 304 stainless steel.
- Two chrome cantilever open-wire shelves.
- 16 gauge 1" (25mm) diameter chrome-plated posts with exclusive MasterSeal® coating.
- Rear grid panel constructed of chrome
- Three-sided 1" (25mm) channel frame.
- Leveling feet.

**FEATURES:**

**Note:** Optional keyboard drawer available. To order add suffix "-K" to model number (example: MD2448-K) and \$357 to list price.

**Freight class is 70.0.**

### Optional Keyboard Station

- Mounts under tabletop.
- 20½" wide x 11½" deep (521 x 292mm).

weight		cubic	stainless steel	
lbs.	kg	feet	model #	list
6.0	2.7	0.35	<b>KBD-1/SS</b>	357



## Catalog Section 1

### adjuSTable® Work Surface Systems

see spec sheet **EG10.09**

CUSTOM:

- Unit can be expanded and customized by adding optional shelving accessories (pages 46-52).
- Custom configurations available, including alternate finishes and solid shelving. Contact factory to configure your custom workstation.
- Optional drawers available (see pages 174-177).



### CUSTOMIZABLE WORK SURFACE CONFIGURATIONS TO MEET YOUR NEEDS!

**Note:** To order table with 5" (127mm) resilient-tread casters, add suffix "-CAH" and add to list price \$528 (for tables with four legs) or \$792 (for tables with six legs). Example: T3036EBW-1-CAH.

To order table with 5" (127mm) poly-tread casters, add suffix "-CAHP" and add to list price \$457 (for tables with four legs) or \$686 (for tables with six legs). Example: T3036EBW-1-CAHP.

**Freight class is 70.0.**

(•) MTS (made to stock) / ( ) MTO (made to order)



**Patented QuadTruss® Design** makes shelves up to 25% stronger and provides a retaining ledge for increased strength and product retention.



Additional wire undershelves, solid stainless steel undershelves, chrome wire overshelves, or solid stainless steel overshelves make the possibilities almost unlimited.

		Basic Units 33½" (851mm) overall height.						1-tier Units 54½" (1384mm) overall height.						2-tier Units 62½" (1588mm) overall height.					
		weight		16/304		14/304		weight		16/304		14/304		weight		16/304		14/304	
length	cu	lbs.	kg	model #	list	model #	list	lbs.	kg	model #	list	model #	list	lbs.	kg	model #	list	model #	list
<b>24"</b>	36" 914	4.5	65 29.5	T2436EBW	833	T2436EW	913	73 33.1	T2436EBW-1	1037	T2436EW-1	1116	81 36.7	T2436EBW-2	1137	T2436EW-2	1218		
<b>width</b>	48" 1219	5.7	81 36.7	T2448EBW	905	T2448EW	1048	91 41.3	T2448EBW-1	1162	T2448EW-1	1271	101 45.8	T2448EBW-2	1282	T2448EW-2	1392		
<b>(610mm)</b>	60" 1524	7.1	99 44.9	T2460EBW	1059	T2460EW	1205	113 51.3	T2460EBW-1	1312	T2460EW-1	1436	127 57.6	T2460EBW-2	1442	T2460EW-2	1567		
<b>30"</b>	36" 914	4.5	75 34.0	T3036EBW	923	T3036EW	1034	83 37.6	T3036EBW-1	1126	T3036EW-1	1241	91 41.3	T3036EBW-2	1225	T3036EW-2	1341		
<b>width</b>	48" 1219	5.7	94 42.6	T3048EBW	1041	T3048EW	1187	104 47.2	T3048EBW-1	1264	T3048EW-1	1405	114 51.7	T3048EBW-2	1382	T3048EW-2	1532		
<b>(762mm)</b>	60" 1524	7.1	115 52.2	T3060EBW	1205	T3060EW	1372	129 58.5	T3060EBW-1	1436	T3060EW-1	1605	143 64.9	T3060EBW-2	1566	T3060EW-2	1738		

**CONSISTS OF:**

- Stainless steel table top/work surface with hat channel supports.
- Four 33" (838mm) chrome posts.
- Two chrome wire undershelves.\*

**CONSISTS OF:**

- Stainless steel table top/work surface with hat channel supports.
- Two 54" (1372mm) rear chrome posts.
- Two 33" (838mm) front chrome posts.
- Two 21" (533mm) front chrome posts for overshelf.
- One 14" (356mm) wide chrome wire overshelf.
- Two chrome wire undershelves.\*

**CONSISTS OF:**

- Stainless steel table top/work surface with hat channel supports.
- Two 63" (1600mm) rear chrome posts.
- Two 33" (838mm) front chrome posts.
- Two 29" (737mm) front chrome posts for overshelves.
- Two 14" (356mm) wide chrome wire overshelves.
- Two chrome wire undershelves.\*

\*18" (457mm) wide undershelves used for 24" (610mm) wide tables; 24" (610mm) wide undershelves used for 30" (762mm) wide tables.

### Optional Keyboard Stations

- 20½" wide x 11½" deep (521 x 292mm).

			Table Mount		Wire Mount			
			stainless steel		chrome		stainless steel	
weight	cubic		model #	list	model #	list	model #	list
lbs.	kg	feet						
6.0	2.7	0.35	KBD-1/SS	357	KBD-2•	223	KBD-2/SS	377



table mount keyboard station



wire mount keyboard station

### Post Clamp for 1-tier and 2-tier Units

- Attaches 3" x 3" (76 x 76mm) grid panel (see enclosure panels on page 47 and wall mats on page 92) onto AdjuSTable® systems with overshelves.
- Chrome-plated collar with ¼-20 weld stud, chrome acorn nut and heavy gauge clamp.

model #	list each
A210098	5



100 Industrial Boulevard, Clayton, DE 19938-8903 U.S.A.  
 Phone: 800-637-5100 or 302-653-3000. Fax: 302-653-2065  
<http://www.eaglegrp.com>

### Shelving Components / Accessories

see spec sheets **EG01.03A** **EG01.03D**

Freight class is 70.0.

(•) MTS (made to stock) / ( ) MTO (made to order)

#### Collar Plug

- Fills shelf corner openings where posts have been eliminated by use of "S" hooks.
- Packed four per bag.

model #	list
<b>COLLAR PLUG</b>	5
<i>(set of four)</i>	



#### Post Cap

- Fills post end openings at top of shelving unit.

model #	list ea
<b>POST CAP</b>	1



#### Post Clamps

- Provides maximum strength when shelving units are connected by clamping posts securely together.



chrome		black epoxy	
model #	list ea	model #	list ea
<b>POST CLAMP</b>	7	<b>A214169</b>	8

#### Retaining Clamp

- Chrome-plated.
- For use with enclosure panels (page 47) in conjunction with wire shelf.



model #	list ea
<b>RETAINING CLAMP</b>	4

#### Glides

- Fits under leveling bolt to protect floors from abrasion.



model #	list ea
<b>GLIDES</b>	2

#### Foot Plates

- These allow unit to be bolted to the floor.
- Can be used without bolts when a wider foot is desired for more stability.



triangular



square



"space-saving" square

#### Aluminum Split Sleeves

- For conductive, over-the-road or high-temperature installations.
- Set of four.



aluminum split sleeves and ring



with zinc rings		with stainless rings	
model #	list	model #	list
<b>A208909</b> •	16	<b>A208908</b> •	26

#### Plastic Split Sleeves

- Four included with each shelf.
- High-temperature-resistant ABS plastic create a positive lock that becomes stronger as the load increases.



model #	list
<b>PLASTIC SPLIT SLEEVES</b>	5
<i>(set of four)</i>	

#### Plastic Conductive Split Sleeves

- Packed four per bag.



model #	list
<b>A219236</b>	11

#### Casting

- Stabilizes leveling foot.

model #	list ea
<b>A203568</b>	2



casting

leveling foot

#### Leveling Foot

- Use these to accommodate for uneven floors.

model #	list ea
<b>LEVELING FOOT</b>	1

#### Security "S" Hooks

- Discourages separation of adjoined shelf units.
- Hardware included.

model #	list ea
<b>S-HOOKS-SK</b>	8

#### "S" Hooks

- Join individual shelving units in a number of combinations using "S" hooks.
- Joins end-to-end, back-to-back, or at right angles.
- Two hooks required per connection.

model #	list ea
<b>A200012</b> •	3



type of foot plate	chrome		black epoxy		stainless steel	
	model #	list ea	model #	list ea	model #	list ea
Triangular	<b>FOOT PLATE</b>	13	<b>FOOT PLATE-BL</b>	14	<b>FOOT PLATE-S</b>	26
Square	<b>A207199</b>	20	<b>A226104</b>	20	<b>A208627</b>	28
"Space-Saving" Square	<b>A226093</b>	22	<b>A226105</b>	22	<b>A226096</b>	31

## Catalog Section 1

### Enclosure Panels

see spec sheet **EG01.03A**

- Includes four retaining clamps.

*Helps secure shelf contents,  
enclosing the back and sides of unit.*

shelf	panel width		post height		weight		cubic feet	chrome		stainless	
	in.	mm	in.	mm	lb.	kg		model #	list	model #	list
18" width (457mm)	14"	356	54"	1372	6	2.7	1.5	E1854-C	63	E1854-S	140
	14"	356	63"	1600	7	3.2	1.8	E1863-C •	66	E1863-S	149
	14"	356	74"	1880	8	3.6	2.0	E1874-C •	72	E1874-S	177
	14"	356	86"	2184	9	4.1	2.3	E1886-C	130	E1886-S	181
24" width (610mm)	20"	233	54"	1372	9	4.1	2.1	E2454-C	74	E2454-S	169
	20"	233	63"	1600	10	4.5	2.3	E2463-C •	79	E2463-S	185
	20"	233	74"	1880	11	5.0	2.6	E2474-C •	82	E2474-S	202
	20"	233	86"	2184	12	5.4	2.8	E2486-C	145	E2486-S	213

Freight class is 70.0.

(•) MTS (made to stock) / ( ) MTO (made to order)

Note: These do not work with corner castings of solid shelves.  
Recommended for use with wire shelves only.

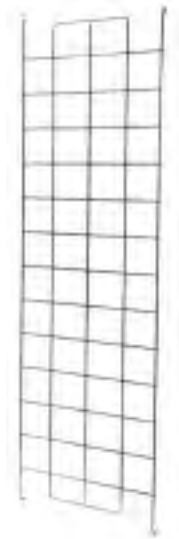

### CONSULT THESE TABLES FOR NUMBER OF PANELS REQUIRED:

Panels sold individually. Consult charts below for number of panels needed.

For the Back of Unit	shelf length		54" (1372mm) post ht.	63" (1600mm) post ht.	74" (1880mm) post ht.	86" (2184mm) post ht.
	in.	mm	—panel(s) required	—panel(s) required	—panel(s) required	—panel(s) required
	30"	762	(1) E2454	(1) E2463	(1) E2474	(1) E2486
	36"	914	(2) E1854	(2) E1863	(2) E1874	(2) E1886
	42"	1067	(1) E1854	(1) E1863	(1) E1874	(1) E1886
			(1) E2454	(1) E2463	(1) E2474	(1) E2486
	48"	1092	(2) E2454	(2) E2463	(2) E2474	(2) E2486
	54"	1372	(2) E1854	(2) E1863	(2) E1874	(2) E1886
			(1) E2454	(1) E2463	(1) E2474	(1) E2486
	60"	1524	(2) E2454	(2) E2463	(2) E2474	(2) E2486
			(1) E1854	(1) E1863	(1) E1874	(1) E1886
	72"	1829	(3) E2454	(3) E2463	(3) E2474	(3) E2486

For Each End	shelf width		54" (1372mm) post ht.	63" (1600mm) post ht.	74" (1880mm) post ht.	86" (2184mm) post ht.
	in.	mm	—panel(s) required	—panel(s) required	—panel(s) required	—panel(s) required
	18"	457	(1) E1854	(1) E1863	(1) E1874	(1) E1886
	21"	533	(1) E1854	(1) E1863	(1) E1874	(1) E1886
	24"	610	(1) E2454	(1) E2463	(1) E2474	(1) E2486
	30"	762	(1) E2454	(1) E2463	(1) E2474	(1) E2486
	36"	914	(2) E1854	(2) E1863	(2) E1874	(1) E1886

### Clips for Solid Shelves (ONLY)

spec sheet **EG01.03A**

...for Bottom Shelves ONLY

Set of four.



**NEW**  
list per set of 4  
model # **SSENCBKT** 56

...for All Other Solid Shelves

Sold individually.

model # **A204318** list each 1

### Rods and Tabs

see spec sheet **EG01.03D**



chrome		stainless steel	
model #	list ea	model #	list ea
R54-C	11	R54-S	35
R63-C •	12	R63-S	38
R74-C •	13	R74-S	43
R86-C •	15	R86-S	46

FEATURES:

- Used to enclose backs or sides of shelving units to prevent contents from falling.
- Also used to partition shelving units by positioning rods interior to shelves.
- Model number indicates height.
- Each rod comes with four tabs.

Freight class is 70.0.

(•) MTS (made to stock) / ( ) MTO (made to order)



100 Industrial Boulevard, Clayton, DE 19938-8903 U.S.A.  
Phone: 800-637-5100 or 302-653-3000. Fax: 302-653-2065  
http://www.eaglegrp.com

### Dividers

see spec sheet **EG01.03A**

FEATURES:

- 8" high (203mm) dividers keep shelf contents organized.

#### Solid Shelving Dividers

length		cubic	weight		chrome		stainless steel	
in.	mm	feet	lb.	kg	model #	list	model #	list
14"	356	0.6	1.0	0.5	SSD14-C	23	SSD14-S	76
18"	457	0.6	1.3	0.6	SSD18-C	26	SSD18-S	79
21"	533	0.8	1.5	0.7	SSD21-C	28	SSD21-S	93
24"	610	1.0	1.8	0.8	SSD24-C •	32	SSD24-S	95
30"	762	1.2	2.3	1.0	SSD30-C	43	SSD30-S	118
36"	914	1.4	3.0	1.4	SSD36-C	54	SSD36-S	139

Freight class is 70.0.

(•) MTS (made to stock) / ( ) MTO (made to order)



#### Wire Shelving Dividers

length		cubic	weight		chrome		VALU-MASTER®		Valu-Gard®		EAGLEgard®		stainless	
in.	mm	feet	lb.	kg	model #	list	model #	list	model #	list	model #	list	model #	list
14"	356	0.6	1.0	0.5	SD14-C •	23	SD14-V	24	SD14-VG	24	SD14-E	25	SD14-S	66
18"	457	0.6	1.0	0.5	SD18-C	26	SD18-V	27	SD18-VG	27	SD18-E	28	SD18-S	75
21"	533	0.8	2.0	0.9	SD21-C •	28	SD21-V	29	SD21-VG	29	SD21-E	32	SD21-S	85
24"	610	1.0	2.0	0.9	SD24-C •	33	SD24-V	36	SD24-VG	36	SD24-E	39	SD24-S •	92
30"	762	1.2	2.0	0.9	SD30-C	39	SD30-V	40	SD30-VG	40	n/a	n/a	SD30-S	112
36"	914	1.4	3.0	1.4	SD36-C	45	SD36-V	48	SD36-VG	48	n/a	n/a	SD36-S	135

### Slanted Shelves

see spec sheet **EG01.03E**

FEATURES:

- Shipped knocked-down.

Freight class is 70.0.



2" slant increases visibility, allows easy access to shelf contents.

optional slanted shelves

patented QuadTruss® design

(Patent #5,390,803)

#### Patented QuadTruss® Design

makes shelves up to 25% stronger and provides a retaining ledge for increased strength and product retention.

	length		weight		cubic	EAGLEbrite®		chrome		EAGLEgard®	
	in.	mm	lb.	kg	feet	model #	list	model #	list	model #	list
21" width (533mm)	36"	914	11	5.0	0.8	SL2136Z	97	SL2136C	107	SL2136E	126
	48"	1219	14	6.4	1.1	SL2148Z	126	SL2148C	139	SL2148E	167
	60"	1524	18	8.2	1.1	SL2160Z	136	SL2160C	149	SL2160E	195
24" width (610mm)	36"	914	13	5.9	0.8	SL2436Z	120	SL2436C	134	SL2436E	160
	48"	1219	16	7.3	1.2	SL2448Z	140	SL2448C	155	SL2448E	188
	60"	1524	21	9.5	1.5	SL2460Z	152	SL2460C	164	SL2460E	200

### Stationary Wire Wall Mounts

see spec sheet **EG02.12**

END UNIT:

- One single shelf support and mounting plate.

MID UNIT:

- One double shelf support and mounting plate.

Freight class is 70.0.

(•) MTS (made to stock) / ( ) MTO (made to order)



end unit

Designed for fixed application

Note: Shelves (page 6) sold separately.

End Units*										Mid Units								
length		cu	weight**		chrome		Valu-Gard®		stainless**		weight**		chrome		Valu-Gard®		stainless**	
in.	mm	ft	lbs.	kg	model #	list	model #	list	model #	list	lbs.	kg	model #	list	model #	list	model #	list
14"	356	0.5	6	2.7	WB14-C •	41	WB14-VG •	41	WB14-S •	91	8	3.6	DWB14-C •	62	DWB14-VG	62	DWB14-S	135
18"	457	0.5	8	3.6	WB18-C •	42	WB18-VG •	42	WB18-S •	94	10	4.5	DWB18-C •	64	DWB18-VG	64	DWB18-S	143
21"	533	0.7	10	4.5	WB21-C •	42	WB21-VG	42	WB21-S	98	12	5.5	DWB21-C	65	DWB21-VG	65	DWB21-S	146
24"	610	0.7	12	5.5	WB24-C •	43	WB24-VG	43	WB24-S •	101	14	6.4	DWB24-C •	66	DWB24-VG	66	DWB24-S	151

\*End Units priced per piece; \*\*For stainless steel units, add 1 lb. (0.5 kg) weight.

## Catalog Section 1

### Ledges

see spec sheet **EG01.03A**

**FEATURES:**

- Prevents contents from falling off unit.
- Easily attaches without the use of tools.

**Freight class is 70.0.**

(•) MTS (made to stock) / ( ) MTO (made to order)

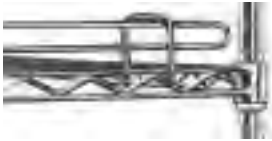

1"-high (25mm) ledge  
for wire shelving



4"-high (102mm) ledge  
for wire shelving

### Solid Shelving Ledges

#### 1"-high (25mm) Ledges \*

#### 4"-high (102mm) Ledges

length in.	length mm	cu ft	weight		chrome		stainless steel		weight lb.	weight kg	chrome		stainless steel	
			lb.	kg	model #	list	model #	list			model #	list	model #	list
14"	356	0.2	0.2	0.1	<b>SL14-1C</b>	16	<b>SL14-1S</b>	34	0.8	0.4	<b>SL14-4C</b>	22	<b>SL14-4S</b>	41
18"	457	0.3	0.3	0.1	<b>SL18-1C</b>	18	<b>SL18-1S</b>	36	0.9	0.4	<b>SL18-4C</b>	23	<b>SL18-4S</b>	43
21"	533	0.3	0.4	0.2	<b>SL21-1C</b>	19	<b>SL21-1S</b>	39	1.0	0.5	<b>SL21-4C</b>	24	<b>SL21-4S</b>	48
24"	610	0.3	0.5	0.2	<b>SL24-1C</b>	22	<b>SL24-1S</b>	44	1.2	0.6	<b>SL24-4C</b>	25	<b>SL24-4S</b>	55
30"	762	0.5	0.7	0.3	<b>SL30-1C</b>	26	<b>SL30-1S</b>	53	1.4	0.6	<b>SL30-4C</b>	29	<b>SL30-4S</b>	64
36"	914	0.6	0.9	0.4	<b>SL36-1C</b>	28	<b>SL36-1S</b>	62	1.6	0.7	<b>SL36-4C</b>	33	<b>SL36-4S</b>	76
42"	1067	0.6	1.1	0.5	<b>SL42-1C</b>	29	<b>SL42-1S</b>	67	1.8	0.8	<b>SL42-4C</b>	35	<b>SL42-4S</b>	82
48"	1092	0.7	1.3	0.6	<b>SL48-1C</b>	33	<b>SL48-1S</b>	78	2.0	0.9	<b>SL48-4C</b>	40	<b>SL48-4S</b>	207
54"	1372	0.8	1.5	0.7	<b>SL54-1C</b>	35	<b>SL54-1S</b>	86	2.2	1.0	<b>SL54-4C</b>	41	<b>SL54-4S</b>	214
60"	1524	0.8	1.7	0.8	<b>SL60-1C</b>	36	<b>SL60-1S</b>	90	2.4	1.1	<b>SL60-4C</b>	42	<b>SL60-4S</b>	222
72"	1829	1.0	2.1	1.0	<b>SL72-1C</b>	40	<b>SL72-1S</b>	101	2.6	1.2	<b>SL72-4C</b>	49	<b>SL72-4S</b>	226

\* When installed, actual height of ledge is 1½" (38mm).

### Wire Shelving 1"-high (25mm) Ledges \*

length in.	length mm	cu ft	weight		chrome		VALU-MASTER®		Valu-Gard®		stainless	
			lb.	kg	model #	list	model #	list	model #	list	model #	list
14"	356	0.2	0.2	0.1	<b>L14-1C</b>	12	<b>L14-1V</b>	13	<b>L14-1VG</b>	13	<b>L14-1S</b>	21
18"	457	0.3	0.3	0.1	<b>L18-1C</b>	13	<b>L18-1V</b>	14	<b>L18-1VG</b>	14	<b>L18-1S</b>	23
21"	533	0.3	0.4	0.2	<b>L21-1C</b>	14	<b>L21-1V</b>	15	<b>L21-1VG</b>	15	<b>L21-1S</b>	25
24"	610	0.3	0.5	0.2	<b>L24-1C</b> •	15	<b>L24-1V</b>	16	<b>L24-1VG</b>	16	<b>L24-1S</b>	27
30"	762	0.5	0.7	0.3	<b>L30-1C</b>	18	<b>L30-1V</b>	19	<b>L30-1VG</b>	19	<b>L30-1S</b>	37
36"	914	0.6	0.9	0.4	<b>L36-1C</b>	22	<b>L36-1V</b>	23	<b>L36-1VG</b>	23	<b>L36-1S</b>	41
42"	1067	0.6	1.1	0.5	<b>L42-1C</b>	23	<b>L42-1V</b>	24	<b>L42-1VG</b>	24	<b>L42-1S</b>	46
48"	1092	0.7	1.3	0.6	<b>L48-1C</b> •	24	<b>L48-1V</b>	25	<b>L48-1VG</b>	25	<b>L48-1S</b>	46
54"	1372	0.8	1.5	0.7	<b>L54-1C</b> •	26	<b>L54-1V</b>	27	<b>L54-1VG</b>	27	<b>L54-1S</b>	57
60"	1524	0.8	1.7	0.8	<b>L60-1C</b> •	26	<b>L60-1V</b>	28	<b>L60-1VG</b>	28	<b>L60-1S</b>	57
72"	1829	1.0	2.1	1.0	<b>L72-1C</b>	27	<b>L72-1V</b>	29	<b>L72-1VG</b>	29	<b>L72-1S</b>	64

\* When installed, actual height of ledge is 1½" (38mm).

### Wire Shelving 4"-high (102mm) Ledges

length in.	length mm	cu ft	weight		chrome		VALU-MASTER®		Valu-Gard®		EAGLEgard®		stainless	
			lb.	kg	model #	list	model #	list	model #	list	model #	list	model #	list
14"	356	0.2	0.8	0.4	<b>L14-4C</b> •	17	<b>L14-4V</b>	19	<b>L14-4VG</b>	19	<b>L14-4E</b>	20	<b>L14-4S</b>	38
18"	457	0.3	0.9	0.4	<b>L18-4C</b> •	19	<b>L18-4V</b>	20	<b>L18-4VG</b>	20	<b>L18-4E</b>	24	<b>L18-4S</b> •	42
21"	533	0.3	1.0	0.5	<b>L21-4C</b> •	20	<b>L21-4V</b>	22	<b>L21-4VG</b>	22	<b>L21-4E</b>	25	<b>L21-4S</b>	48
24"	610	0.3	1.2	0.6	<b>L24-4C</b> •	23	<b>L24-4V</b>	24	<b>L24-4VG</b>	24	<b>L24-4E</b>	26	<b>L24-4S</b> •	51
30"	762	0.5	1.4	0.6	<b>L30-4C</b> •	26	<b>L30-4V</b>	27	<b>L30-4VG</b>	27	<b>L30-4E</b>	31	<b>L30-4S</b>	63
36"	914	0.6	1.6	0.7	<b>L36-4C</b> •	28	<b>L36-4V</b>	29	<b>L36-4VG</b>	29	<b>L36-4E</b>	33	<b>L36-4S</b> •	74
42"	1067	0.6	1.8	0.8	<b>L42-4C</b> •	35	<b>L42-4V</b>	37	<b>L42-4VG</b>	37	<b>L42-4E</b>	41	<b>L42-4S</b>	94
48"	1092	0.7	2.0	0.9	<b>L48-4C</b> •	35	<b>L48-4V</b>	38	<b>L48-4VG</b>	38	<b>L48-4E</b>	41	<b>L48-4S</b>	94
54"	1372	0.8	2.2	1.0	<b>L54-4C</b>	38	<b>L54-4V</b>	40	<b>L54-4VG</b>	40	<b>L54-4E</b>	44	<b>L54-4S</b>	107
60"	1524	0.8	2.4	1.1	<b>L60-4C</b> •	38	<b>L60-4V</b>	41	<b>L60-4VG</b>	41	<b>L60-4E</b>	44	<b>L60-4S</b>	107
72"	1829	1.0	2.6	1.2	<b>L72-4C</b> •	45	<b>L72-4V</b>	48	<b>L72-4VG</b>	48	<b>L72-4E</b>	54	<b>L72-4S</b> •	135



100 Industrial Boulevard, Clayton, DE 19938-8903 U.S.A.  
 Phone: 800-637-5100 or 302-653-3000. Fax: 302-653-2065  
<http://www.eaglegrp.com>

### Slide Systems

see spec sheet **EG01.03C**



slide system with tote boxes

**Clever way to improve space efficiency.**

LOAD CAPACITY: • Up to 35 lbs. (15.9 kg).

FEATURES: • Easily attaches without the use of tools.

**Freight class is 70.0.**

(•) MTS (made to stock) / ( ) MTO (made to order)



fits shelf width	adaptable tote boxes	width x length x depth	weight lbs.	kg	cubic feet	model #	list
24" (610mm)	TB1022-3, TB1022-6	21 1/2" x 14" x 10 1/4" (683 x 356 x 260mm)	5.0	2.3	2.0	<b>TS1421</b>	105
24" (610mm)	TB1722-3, TB1722-6, TB1722-9	21 1/2" x 20" x 10 1/4" (683 x 508 x 260mm)	7.5	3.4	3.8	<b>TS2021</b> •	109
21" (533mm)	TB1016-3, TB1016-6	17 1/2" x 14" x 10 1/4" (543 x 356 x 260mm)	4.0	1.8	1.8	<b>TS1417</b>	104
21" (533mm)	TB1722-3*, TB1722-6*, TB1722-9*	17 1/2" x 25 1/2" x 10 1/4" (543 x 797 x 260mm)	5.0	2.3	4.0	<b>TS2517</b>	108

\* Fits TS2517 sideways

### Tote Boxes for Slide Systems

see spec sheet **EG01.03C**



TB1016 & TB1722 series



TB1022 series

**ESD Tote Boxes and Accessories also available! See pages 137 and 138.**

FEATURES: • Dividable up to 1 1/8" (29mm) square compartments. • Injection molded from high-density polyethylene material.

Note: Also available in molded fiberglass (see page 51).

**Freight class is 70.0.**

(•) MTS (made to stock) / ( ) MTO (made to order)

fits slide system	width x length x depth inches	mm	weight lbs.	kg	cubic feet	color	model #	list
TS1417	10 1/8" x 16 1/2" x 3 1/2"	276 x 419 x 89	1.0	0.5	0.4	gray	<b>TB1016-3</b>	32
TS1417	10 1/8" x 16 1/2" x 6"	276 x 419 x 152	1.5	0.7	0.8	gray	<b>TB1016-6</b>	35
TS2021, TS2517	17 1/2" x 22 1/2" x 3"	444 x 572 x 76	2.3	1.0	0.8	gray	<b>TB1722-3</b> *	52
TS2021, TS2517	17 1/2" x 22 1/2" x 6"	444 x 572 x 152	3.5	1.6	1.5	gray	<b>TB1722-6</b> ••	60
TS2021, TS2517	17 1/2" x 22 1/2" x 8"	444 x 572 x 203	4.0	1.8	3.0	gray	<b>TB1722-9</b> *	72
TS1421, TS2517	11" x 22 1/2" x 3"	279 x 572 x 76	1.5	0.7	0.6	white	<b>TB1022-3</b>	38
TS1421, TS2517	11" x 22 1/2" x 5 3/4"	279 x 572 x 146	2.0	0.9	1.1	white	<b>TB1022-6</b>	44

\* Fits TS2517 sideways

### Tote Box Dividers and Covers

fits tote box	color	Long Dividers			Short Dividers			Covers	
		model #	list	max. # accepted	model #	list	max. # accepted	model #	list
TB1016-3	gray	<b>A217766</b>	4	7	<b>A217760</b>	4	11	<b>A217765</b>	29
TB1016-6	gray	<b>A203841</b>	5	7	<b>A203843</b>	4	11	<b>A217765</b>	29
TB1722-3	gray	<b>A217763</b>	4	11	<b>A217764</b>	4	15	<b>A217638</b>	37
TB1722-6	gray	<b>A203842</b>	5	11	<b>A203844</b>	6	15	<b>A217638</b>	37
TB1722-9	gray	<b>A203845</b>	7	11	<b>A203846</b>	6	15	<b>A217638</b>	37
TB1022-3	white	<b>A203838</b>	4	7	<b>A203839</b>	4	15	<b>A203874</b>	32
TB1022-6	white	<b>A217759</b>	5	7	<b>A217791</b>	4	15	<b>A203874</b>	32



cover (for TB1016 and TB1722 tote boxes)



dividers

## Catalog Section 1

### Card Holders for Tote Boxes

see spec sheet **EG01.03C**



holds labels		model #	list
in.	mm		
2" x 8"	51 x 203	<b>CH28</b>	8
3" x 5"	76 x 127	<b>CH35</b>	9
5" x 8"	127 x 203	<b>CH58</b>	11

FEATURES: • Clear vinyl.

Freight class is 70.0.

### Molded Fiberglass Boxes and Trays

see spec sheet **EG01.03C**



assorted molded fiberglass boxes and trays

**Boxes are stackable for maximum storage efficiency!**

description	bottom inside dimensions length x width x depth		top outside dimensions length x width x height		cu ft	model #	list
	in.	mm	in.	mm			
tray	24 $\frac{3}{4}$ " x 16 $\frac{1}{4}$ " x 1"	619 x 413 x 25	25 $\frac{3}{4}$ " x 17 $\frac{1}{2}$ " x 1 $\frac{1}{2}$ "	654 x 454 x 29	0.1	<b>A208505</b>	76
stacking box	23 $\frac{3}{4}$ " x 15 $\frac{1}{2}$ " x 2 $\frac{1}{2}$ "	606 x 403 x 73	25 $\frac{3}{4}$ " x 17 $\frac{1}{4}$ " x 3"	654 x 451 x 76	0.6	<b>A208506</b>	101
stacking box	23 $\frac{3}{4}$ " x 15 $\frac{1}{2}$ " x 4 $\frac{1}{2}$ "	606 x 403 x 114	25 $\frac{3}{4}$ " x 17 $\frac{1}{4}$ " x 4 $\frac{1}{2}$ "	654 x 451 x 114	1.0	<b>A208507</b>	93
stacking box	23 $\frac{3}{4}$ " x 15 $\frac{1}{2}$ " x 5 $\frac{1}{4}$ "	606 x 403 x 146	25 $\frac{3}{4}$ " x 17 $\frac{1}{4}$ " x 6"	654 x 451 x 152	1.3	<b>A208508</b>	89
lid	—	—	25 $\frac{3}{4}$ " x 17 $\frac{1}{4}$ "	654 x 451	—	<b>A208513*</b>	54

\* Model #A208513 lid fits models A208506, A208507, and A208508 stacking boxes.

FEATURES: • Made of thermoset polyester composite material.  
• Flame and chemical resistant.

Freight class is 70.0.

### Storage Baskets

see spec sheet **EG01.03E**



width x length x height	weight	cubic	model #	list
13 $\frac{3}{4}$ " x 5" x 7"	340 x 127 x 178	9 4.1 0.4	<b>A216650</b>	38
17 $\frac{1}{2}$ " x 7 $\frac{1}{2}$ " x 5"	441 x 191 x 127	7 3.2 0.6	<b>A216651</b>	41
17 $\frac{1}{2}$ " x 7 $\frac{1}{2}$ " x 10"	441 x 191 x 254	11 5.0 1.0	<b>A216652</b>	56

FEATURES: • Chrome-plated.  
• Easily attaches to hanger rail or side of wire shelf.

Freight class is 70.0.

### File Basket

see spec sheet **EG01.03E**



**Ideal for organizing standard-sized file folders.**

width x length x height		weight		cubic	model #	list
in.	mm	lbs.	kg			
2 $\frac{1}{2}$ " x 12 $\frac{3}{4}$ " x 8 $\frac{3}{4}$ "	67 x 324 x 222	2 0.9	0.3	<b>A216649</b>	45	

FEATURES: • Chrome-plated.  
• Fits all widths.

Freight class is 70.0.

### Triangle Shelf

see spec sheet **EG01.03E**



width	weight		chrome		black epoxy	
	lbs.	kg	model #	list	model #	list
18" (457mm)	16	7.3	<b>TR18C</b>	45	<b>TR18BL</b>	51

FEATURES: • Attached to standard posts (sold separately —see pages 12 and 21), can be a freestanding unit.  
• Or added onto standard 18" wide wire shelving (page 6) via "S" hooks.

Freight class is 70.0.





### Sliding Shelf

see spec sheet **EG01.03E**



width x length		weight		chrome	
in	mm	lbs.	kg	model #	list
18" x 36"	457 x 914	9	4.1	<b>SLS1836C</b>	81

FEATURES:

- Chrome-plated.
- For use with standard 1" (25mm)-diameter posts—on wire shelf or solid shelf units.

**Freight class is 70.0.**

### Tray Slides

see spec sheet **EG01.03C**



**Slides help maximize your use of space!**

FEATURES:

- 1¾" (45mm) spacing, 22" (559mm) height.
- Sold as a set of two.
- 18" or 24" (457 or 610mm) wide applications.
- Can be used with tote boxes on page 50.

**Freight class is 70.0.**

#### Standard

Holds 9 trays.

#### Heavy Duty

Holds 11 trays. Features panel assembly welded to the back of slides

width	cu ft	weight		chrome		EAGLEgard®		weight lbs. kg	chrome		EAGLEgard®		
		lbs.	kg	model #	list	model #	list		model #	list	model #	list	
<b>17½" (435mm)</b>	2.3	9	4.1	<b>TS18-C</b>	85	<b>TS18-E</b>	101	12	5.4	<b>HDTS18-C</b>	202	<b>HDTS18-E</b>	224
<b>23½" (587mm)</b>	3.0	11	5.0	<b>TS24-C</b>	91	<b>TS24-E</b>	106	15	6.8	<b>HDTS24-C</b>	222	<b>HDTS24-E</b>	247

### Adjustable Undershelf Slides

see spec sheet **EG01.03C**



adjustable undershelf slides with tote box

FEATURES:

- Stainless steel.
- Accommodates any tote box side-to-side dimension.
- Sold as a set.

**Freight class is 70.0.**

(•) MTS (made to stock) / ( ) MTO (made to order)

description	weight		model #		list
	lbs.	kg			
slides for 18" (457mm) wide shelf	3	1.4	<b>US18-S</b>	59	
slides for 21" (533mm) wide shelf	3	1.4	<b>US21-S</b>	64	
slides for 24" (610mm) wide shelf	3	1.4	<b>US24-S</b>	67	
slides for 30" (762mm) wide shelf	4	1.8	<b>US30-S</b>	71	
slides with side-to-side mount, for 24" (610mm) wide shelf	3	1.4	<b>USS24-S</b>	132	
slides with side-to-side mount, for 30" (762mm) wide shelf	4	1.8	<b>USS30-S</b>	159	

### Tote Boxes for Adjustable Undershelf Slides

width x length x depth			weight		cubic feet	model #		list
in.	mm		lbs.	kg				
17½" x 22½" x 3"	446 x 568 x 76	2	0.9	0.8	<b>TB1722-3</b>	52		
17½" x 22½" x 6"	446 x 568 x 152	3	1.4	1.4	<b>TB1722-6•</b>	60		
17½" x 22½" x 8"	446 x 568 x 203	4	1.8	2.3	<b>TB1722-9</b>	72		

### One-Piece Slides

see spec sheet **EG01.03C**



one-piece slide with tote box

FEATURES:

- Easily attaches to shelf.

**Freight class is 70.0.**

(•) MTS (made to stock) / ( ) MTO (made to order)

**Helps prevent shelf clutter!**

### Tote Box for One-Piece Slides

width x length x depth			weight		cubic feet	model #		list
in.	mm		lbs.	kg				
17½" x 22½" x 6"	446 x 568 x 152	3.5	1.6	1.5	<b>TB1722-6•</b>	60		

## Catalog Section 1

### Post Extension Kit and Components

see spec sheet **EG01.03D**

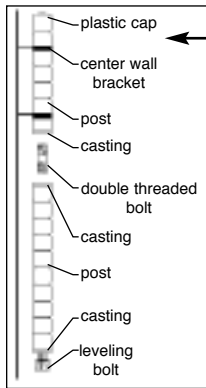

#### Post Extension Kit

description	model #	list
consists of components listed below, set of four	<b>4PEK</b>	64

#### Components

item	model #	list
double-threaded bolt	<b>A200868</b>	2
wall bracket	<b>B201023</b>	9
casting	<b>A207351</b>	5

#### FEATURES:

- Screw posts together with double-threaded bolt and extra foot casting.

**Note:** DO NOT attempt to use any higher combinations than P54 and P86 maximum, 140" (3556mm) total. Any combinations higher than 86" (2184mm) must be attached to walls using wall bracket on post adjacent to wall. Place units only against wall, not in center of room.

(•) MTS (made to stock) / ( ) MTO (made to order)

### 3-Sided Double Truss Frames

see spec sheet **EG01.03B**

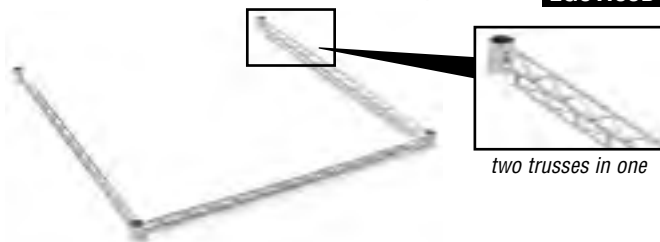

**Note:** See page 54 for 3-Sided Channel Frames.

**Freight class is 70.0.**

**Improves support and stability!**

	length		weight		cu ft	chrome		EAGLEgard®		stainless steel	
	in.	mm	lbs.	kg		model #	list	model #	list	model #	list
<b>18" width</b> (457mm)	24"	610	5	2.2	0.7	<b>DTF1824-C</b>	71	<b>DTF1824-E</b>	79	<b>DTF1824-S</b>	216
	30"	762	6	2.7	0.7	<b>DTF1830-C</b>	72	<b>DTF1830-E</b>	81	<b>DTF1830-S</b>	222
	36"	914	6	2.7	0.7	<b>DTF1836-C</b>	73	<b>DTF1836-E</b>	84	<b>DTF1836-S</b>	227
	42"	1067	7	3.2	0.8	<b>DTF1842-C</b>	74	<b>DTF1842-E</b>	85	<b>DTF1842-S</b>	234
	48"	1219	7	3.2	0.8	<b>DTF1848-C</b>	77	<b>DTF1848-E</b>	86	<b>DTF1848-S</b>	239
	60"	1524	8	3.6	1.0	<b>DTF1860-C</b>	86	<b>DTF1860-E</b>	101	<b>DTF1860-S</b>	275
	72"	1829	9	4.1	1.4	<b>DTF1872-C</b>	97	<b>DTF1872-E</b>	113	<b>DTF1872-S</b>	304
<b>21" width</b> (533mm)	24"	610	5	2.2	0.8	<b>DTF2124-C</b>	73	<b>DTF2124-E</b>	83	<b>DTF2124-S</b>	219
	30"	762	6	2.7	0.8	<b>DTF2130-C</b>	74	<b>DTF2130-E</b>	84	<b>DTF2130-S</b>	222
	36"	914	6	2.7	0.8	<b>DTF2136-C</b>	77	<b>DTF2136-E</b>	86	<b>DTF2136-S</b>	226
	42"	1067	7	3.2	0.9	<b>DTF2142-C</b>	79	<b>DTF2142-E</b>	94	<b>DTF2142-S</b>	241
	48"	1219	8	3.6	0.9	<b>DTF2148-C</b>	80	<b>DTF2148-E</b>	95	<b>DTF2148-S</b>	244
	60"	1524	8	3.6	1.1	<b>DTF2160-C</b>	96	<b>DTF2160-E</b>	112	<b>DTF2160-S</b>	283
	72"	1829	10	4.5	1.4	<b>DTF2172-C</b>	125	<b>DTF2172-E</b>	148	<b>DTF2172-S</b>	311
<b>24" width</b> (610mm)	24"	610	6	2.7	1.5	<b>DTF2424-C</b>	73	<b>DTF2424-E</b>	84	<b>DTF2424-S</b>	220
	30"	762	7	3.2	1.5	<b>DTF2430-C</b>	74	<b>DTF2430-E</b>	85	<b>DTF2430-S</b>	226
	36"	914	7	3.2	1.5	<b>DTF2436-C</b>	78	<b>DTF2436-E</b>	92	<b>DTF2436-S</b>	236
	42"	1067	8	3.6	2.0	<b>DTF2442-C</b>	79	<b>DTF2442-E</b>	94	<b>DTF2442-S</b>	242
	48"	1219	9	4.1	2.5	<b>DTF2448-C</b>	81	<b>DTF2448-E</b>	97	<b>DTF2448-S</b>	245
	60"	1524	10	4.5	2.5	<b>DTF2460-C</b>	97	<b>DTF2460-E</b>	113	<b>DTF2460-S</b>	286
	72"	1829	11	5.0	2.7	<b>DTF2472-C</b>	125	<b>DTF2472-E</b>	148	<b>DTF2472-S</b>	433
<b>30" width</b> (762mm)	36"	914	7	3.2	2.0	<b>DTF3036-C</b>	89	<b>DTF3036-E</b>	105	<b>DTF3036-S</b>	289
	48"	1219	9	4.1	2.5	<b>DTF3048-C</b>	96	<b>DTF3048-E</b>	112	<b>DTF3048-S</b>	304
	60"	1524	10	4.5	2.5	<b>DTF3060-C</b>	105	<b>DTF3060-E</b>	122	<b>DTF3060-S</b>	351
	72"	1829	11	5.0	2.7	<b>DTF3072-C</b>	134	<b>DTF3072-E</b>	160	<b>DTF3072-S</b>	385
<b>36" width</b> (914mm)	36"	914	7	3.2	2.5	<b>DTF3636-C</b>	104	<b>DTF3636-E</b>	119	<b>DTF3636-S</b>	300
	48"	1219	9	4.1	2.7	<b>DTF3648-C</b>	109	<b>DTF3648-E</b>	125	<b>DTF3648-S</b>	309
	60"	1524	10	4.5	2.7	<b>DTF3660-C</b>	120	<b>DTF3660-E</b>	137	<b>DTF3660-S</b>	355
	72"	1829	11	5.0	3.0	<b>DTF3672-C</b>	151	<b>DTF3672-E</b>	175	<b>DTF3672-S</b>	392



100 Industrial Boulevard, Clayton, DE 19938-8903 U.S.A.  
 Phone: 800-637-5100 or 302-653-3000. Fax: 302-653-2065  
<http://www.eaglegrp.com>

## 3-Sided Channel Frames

see spec sheet **EG01.03B**

Freight class is 70.0.

(•) MTS (made to stock) / ( ) MTO (made to order)



	length		weight		cu ft	chrome		EAGLEgard®		stainless steel	
	in.	mm	lbs.	kg		model #	list	model #	list	model #	list
<b>18" width</b> (457mm)	24"	610	5	2.2	0.7	<b>CF1824-C</b>	95	<b>CF1824-E</b>	112	<b>CF1824-S</b>	245
	30"	762	6	2.7	0.7	<b>CF1830-C</b>	99	<b>CF1830-E</b>	118	<b>CF1830-S</b>	257
	36"	914	6	2.7	0.7	<b>CF1836-C</b>	100	<b>CF1836-E</b>	119	<b>CF1836-S</b>	267
	42"	1067	7	3.2	0.8	<b>CF1842-C</b>	104	<b>CF1842-E</b>	122	<b>CF1842-S</b>	269
	48"	1219	7	3.2	0.8	<b>CF1848-C</b>	105	<b>CF1848-E</b>	124	<b>CF1848-S</b>	274
	60"	1524	8	3.6	1.0	<b>CF1860-C</b>	117	<b>CF1860-E</b>	139	<b>CF1860-S</b>	314
	72"	1829	9	4.1	1.4	<b>CF1872-C</b>	132	<b>CF1872-E</b>	159	<b>CF1872-S</b>	345
<b>21" width</b> (533mm)	24"	610	5	2.2	0.8	<b>CF2124-C</b>	97	<b>CF2124-E</b>	114	<b>CF2124-S</b>	249
	30"	762	6	2.7	0.8	<b>CF2130-C</b>	100	<b>CF2130-E</b>	119	<b>CF2130-S</b>	257
	36"	914	6	2.7	0.8	<b>CF2136-C</b>	104	<b>CF2136-E</b>	122	<b>CF2136-S</b>	262
	42"	1067	7	3.2	0.9	<b>CF2142-C</b>	107	<b>CF2142-E</b>	126	<b>CF2142-S</b>	274
	48"	1219	8	3.6	0.9	<b>CF2148-C</b>	108	<b>CF2148-E</b>	127	<b>CF2148-S</b>	276
	60"	1524	8	3.6	1.1	<b>CF2160-C</b>	125	<b>CF2160-E</b>	151	<b>CF2160-S</b>	324
	72"	1829	10	4.5	1.4	<b>CF2172-C</b>	175	<b>CF2172-E</b>	212	<b>CF2172-S</b>	357
<b>24" width</b> (610mm)	24"	610	6	2.7	1.5	<b>CF2424-C</b>	100	<b>CF2424-E</b>	119	<b>CF2424-S</b>	257
	30"	762	7	3.2	1.5	<b>CF2430-C</b>	104	<b>CF2430-E</b>	122	<b>CF2430-S</b>	268
	36"	914	7	3.2	1.5	<b>CF2436-C</b>	107	<b>CF2436-E</b>	126	<b>CF2436-S</b>	274
	42"	1067	8	3.6	2.0	<b>CF2442-C</b>	108	<b>CF2442-E</b>	127	<b>CF2442-S</b>	283
	48"	1219	9	4.1	2.5	<b>CF2448-C•</b>	109	<b>CF2448-E•</b>	132	<b>CF2448-S</b>	286
	60"	1524	10	4.5	2.5	<b>CF2460-C•</b>	132	<b>CF2460-E•</b>	159	<b>CF2460-S</b>	335
	72"	1829	11	5.0	2.7	<b>CF2472-C</b>	182	<b>CF2472-E</b>	218	<b>CF2472-S</b>	367
<b>30" width</b> (762mm)	36"	914	7	3.2	2.0	<b>CF3036-C</b>	112	<b>CF3036-E</b>	136	<b>CF3036-S</b>	335
	48"	1219	9	4.1	2.5	<b>CF3048-C</b>	116	<b>CF3048-E</b>	139	<b>CF3048-S</b>	345
	60"	1524	10	4.5	2.5	<b>CF3060-C</b>	184	<b>CF3060-E</b>	168	<b>CF3060-S</b>	399
	72"	1829	11	5.0	2.7	<b>CF3072-C</b>	195	<b>CF3072-E</b>	236	<b>CF3072-S</b>	440
<b>36" width</b> (914mm)	36"	914	7	3.2	2.5	<b>CF3636-C</b>	121	<b>CF3636-E</b>	147	<b>CF3636-S</b>	342
	48"	1219	9	4.1	2.7	<b>CF3648-C</b>	125	<b>CF3648-E</b>	151	<b>CF3648-S</b>	356
	60"	1524	10	4.5	2.7	n/a	n/a	<b>CF3660-E</b>	181	<b>CF3660-S</b>	407
	72"	1829	11	5.0	3.0	n/a	n/a	<b>CF3672-E</b>	255	<b>CF3672-S</b>	452

## Handles for Caster Carts

see spec sheet **EG01.03B**

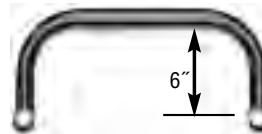

FEATURES: 

- Fits unit widths only.



**Push Handles**  
Easily slips over posts.

**Extended Push Handles**  
Designed to prevent damage to knuckles.

width		weight		cubic feet	chrome		stainless steel		cubic feet	chrome		stainless steel	
in.	mm	lbs.	kg		model #	list	model #	list		model #	list	model #	list
14"	356	1.7	0.8	0.1	<b>PH14-C</b>	27	<b>PH14-S</b>	74	0.2	<b>EH14-C</b>	32	<b>EH14-S</b>	106
18"	457	1.9	0.9	0.1	<b>PH18-C•</b>	31	<b>PH18-S</b>	84	0.3	<b>EH18-C</b>	40	<b>EH18-S</b>	128
21"	533	2.1	1.0	0.1	<b>PH21-C</b>	32	<b>PH21-S</b>	93	0.3	<b>EH21-C</b>	41	<b>EH21-S</b>	134
24"	610	2.3	1.1	0.2	<b>PH24-C•</b>	32	<b>PH24-S</b>	100	0.4	<b>EH24-C</b>	41	<b>EH24-S</b>	143
30"	762	2.6	1.2	0.3	<b>PH30-C</b>	40	<b>PH30-S</b>	109	0.5	<b>EH30-C</b>	49	<b>EH30-S</b>	149
36"	914	3.0	1.4	0.3	<b>PH36-C</b>	45	<b>PH36-S</b>	116	0.5	<b>EH36-C</b>	60	<b>EH36-S</b>	162

Note: Stainless steel models include electropolished finish.

## Catalog Section 1



patented  
**QuadTruss®**  
design  
(Patent #5,390,803)

**Patented QuadTruss® Design** makes shelves up to 25% stronger and provides a retaining ledge for increased strength and product retention.



### UNIQUE ROLLER DESIGN

- Patent #5,680,942.
- Makes moving mobile units easy.
- Eliminates binding due to uneven floors.
- Rollers also support track.

### SHELVES

sold separately (see page 6) are available in EAGLEbrite® zinc, chrome, VALU-MASTER® pewter gray epoxy, EAGLEgard® green epoxy, and stainless steel finish.

Maximum shelf length should not exceed 60" (1524mm).

# Master Trak®

## Overhead Track High-Density Storage System NSF

**Note:** Master Trak® not recommended for use in carpeted areas.

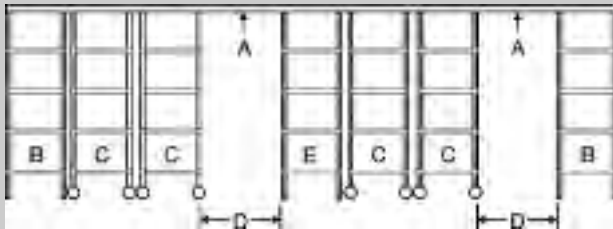

### Components

Shelves sold separately (see page 6).

- A** front & rear overhead tracks
- B** stationary end units
- C** mobile units
- D** open aisle—30" to 36" (762 to 914mm) is recommended
- E** stationary mid unit (optional—use same model # as stationary end unit kit)

## Stationary End / Intermediate Unit Kits

see spec sheet **EG01.18**

- Posts.
- Hardware necessary for connecting stationary end units to track.
- One kit is required for each end unit.
- End units must be anchored to the floor to prevent movement.
- Priced per kit.

**Note:** Shelves sold separately see page 6.

**Freight class is 70.0.**

(•) MTS (made to stock) / ( ) MTO (made to order)

### 74" (1880mm) Posts

### 86" (2184mm) Posts

weight		cu	EAGLEbrite®		chrome		EAGLEgard®		weight		cu	EAGLEbrite®		chrome		EAGLEgard®	
lbs.	kg	ft	model #	list	model #	list	model #	list	lbs.	kg	ft	model #	list	model #	list	model #	list
17	7.7	0.1	EP74-Z•	184	EP74-C•	198	EP74-E•	216	21	9.5	0.1	EP86-Z	192	EP86-C	208	EP86-E	231



100 Industrial Boulevard, Clayton, DE 19938-8903 U.S.A.  
Phone: 800-637-5100 or 302-653-3000. Fax: 302-653-2065  
<http://www.eaglegrp.com>

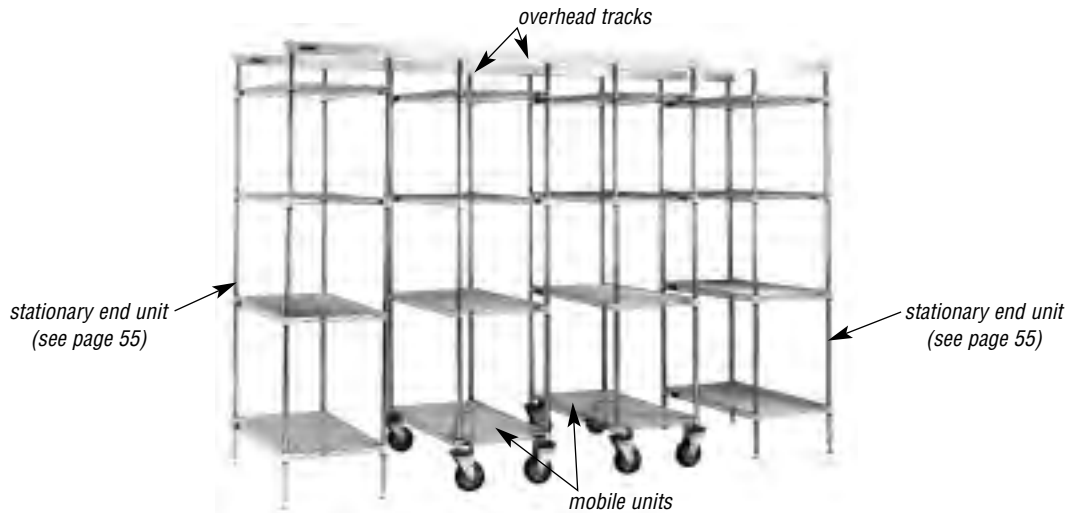

(Shelves shown are sold separately—see page 6)

### Master Trak® Mobile Unit Kits

see spec sheet **EG01.18**

WEIGHT CAPACITY: • 900 lbs. (408 kg).

Note: Shelves sold separately see page 6.

- Posts.
- Casters are 5" x 1½" (127 x 38mm) polymer.
- All parts and necessary hardware.
- One kit is required for each mobile unit.
- Priced per kit.

**Freight class is 70.0.**

(•) MTS (made to stock) / ( ) MTO (made to order)

#### 74" (1880mm) Height\*

width		cu	weight		EAGLEbrite®		chrome		EAGLEgard®		weight		EAGLEbrite®		chrome		EAGLEgard®	
in.	mm		lbs.	kg	model #	list	model #	list	model #	list	lbs.	kg	model #	list	model #	list	model #	list
18"	457	0.1	33	15.0	MUK18-Z	405	MUK18-C•	449	MUK18-E	751	37	16.8	MUK18-Z86	420	MUK18-C86	466	MUK18-E86	762
21"	533	0.1	34	15.4	MUK21-Z	419	MUK21-C	461	MUK21-E	761	38	17.2	MUK21-Z86	437	MUK21-C86	480	MUK21-E86	782
24"	610	0.1	35	15.9	MUK24-Z	423	MUK24-C•	468	MUK24-E•	773	39	17.6	MUK24-Z86	443	MUK24-C86	488	MUK24-E86	801
30"	762	0.1	35	15.9	MUK30-Z	432	MUK30-C	480	MUK30-E	795	39	17.6	MUK30-Z86	449	MUK30-C86	499	MUK30-E86	822
36"	914	0.1	36	16.3	MUK36-Z	442	MUK36-C	501	MUK36-E	817	40	18.1	MUK36-Z86	457	MUK36-C86	523	MUK36-E86	842

\* Casters are included in post height.

#### 86" (2184mm) Height\*

### Master Trak® Overhead Track Kits

see spec sheet **EG01.18**

PACKAGING: • Kits 13' (3962mm) and longer are wood-crated.

- All necessary sections of front and rear tracks for assembling track lengths of 6' to 21' (1829 to 6401mm), plus all hardware.

Note: Any kits 9' (2743mm) or longer include two or more front and rear track sections, with joiner pieces and all hardware. A mid-stationary unit is recommended on lengths of over 30' (9144mm).

**Freight class is 70.0.**

(•) MTS (made to stock) / ( ) MTO (made to order)

length	weight	cu					
ft.	mm		lbs.	kg	ft	model #	list
6'	1829	1.8	18	8.2	1.8	OHT-6	442
7'	2134	2.1	21	9.5	2.1	OHT-7	492
8'	2438	2.4	24	10.9	2.4	OHT-8	740
9'	2743	2.7	27	12.2	2.7	OHT-9	804
10'	3048	3.0	30	13.6	3.0	OHT-10	872

length	weight	cu					
ft.	mm		lbs.	kg	ft	model #	list
11'	3353	3.3	33	15.0	3.3	OHT-11	938
12'	3658	3.6	36	16.3	3.6	OHT-12	1004
13'	3962	3.9	39	17.7	3.9	OHT-13	1066
14'	4267	4.2	42	19.1	4.2	OHT-14	1127
15'	4572	4.5	45	20.4	4.5	OHT-15	1369

length	weight	cu					
ft.	mm		lbs.	kg	ft	model #	list
16'	4877	4.8	48	21.8	4.8	OHT-16	1436
17'	5181	5.1	51	23.1	5.1	OHT-17•	1501
18'	5486	5.4	54	24.5	5.4	OHT-18	1566
19'	5791	5.7	57	25.9	5.7	OHT-19	1629
20'	6096	6.0	60	27.2	6.0	OHT-20	1693
21'	6401	6.3	63	28.6	6.3	OHT-21	1755

## Catalog Section 1

### Single-Deep Floor-Trak® High-Density Storage System

see spec sheet **EG01.39A**

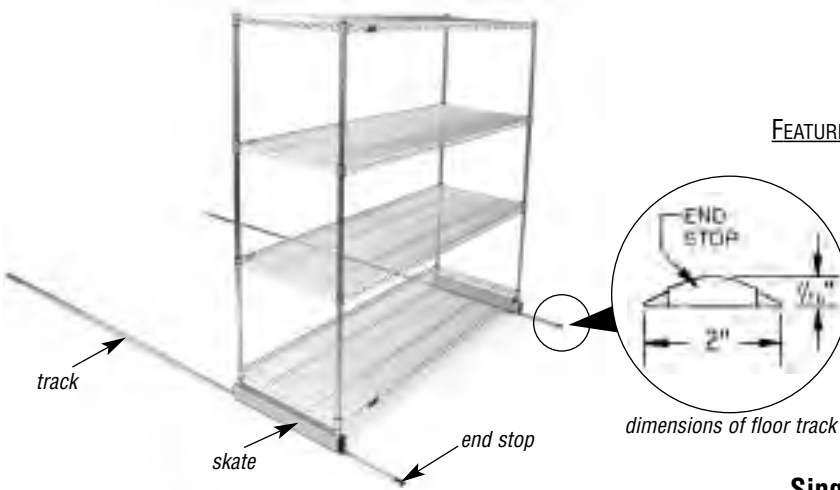

single deep unit shown assembled with wire starter unit

#### FEATURES:

- Non-corrosive track constructed of anodized aluminum.
- The system is ADA-compliant. NSF approved.
- Simple and easy to install.
- Easy to add on additional units.
- Open construction allows for the use of cart covers when required.
- Industrial-type, hardened steel bearings allow loaded units to glide effortlessly over the track.

**Note:** Unit will tilt if not loaded properly.  
**LOAD BOTTOM FIRST!**

**Freight class is 70.0.**

#### Single-Deep Skate Kits

- Two skates.
- All necessary parts and hardware.
- One kit is required for each mobile unit.
- Skates are aircraft-quality aluminum with stainless steel inserts and hardened steel ball bearings.
- Weight capacity of 2000 lbs (907.2 kg) per mobile section.

**Note:** Shelves (page 6) and posts (page 8) sold separately.

width		weight		cu	model #	list
in.	mm	lbs.	kg	ft		
18"	457	6	2.7	0.09	<b>SDSK-18</b>	572
21"	533	7	3.2	0.11	<b>SDSK-21</b>	593
24"	610	7	3.2	0.23	<b>SDSK-24</b>	617
30"	762	8	3.6	0.15	<b>SDSK-30</b>	689
36"	914	10	4.5	0.18	<b>SDSK-36</b>	912

#### Bumper Brackets for use with Floor-Trak® Skate Kits

Stainless steel. Set of four.

model #	list
<b>SDSKATB-S</b>	200

#### ...sold individually

Hardware included.

model #	list
<b>SKATB-S</b>	67



#### Optional Shim Kits

Accommodates uneven floors.

model #	list
<b>912991</b>	153

#### Optional Foot Brake Kit

Mounts onto frontmost skate.

model #	list
<b>MFBK-S</b>	96

#### Single-Deep Floor Track Kits

- Pair of aluminum tracks with plastic end stops.
- All hardware included.

**Note:** Not recommended to piece tracks together. Order length needed. Custom lengths available. Consult factory.

length		weight		cu	model #	list
ft.	mm	lbs.	kg	ft		
6'	1829	5	2.3	0.06	<b>SDFT-6</b>	581
7'	2134	5	2.3	0.07	<b>SDFT-7</b>	659
8'	2438	6	2.7	0.08	<b>SDFT-8</b>	736
9'	2743	7	3.2	0.09	<b>SDFT-9</b>	815
10'	3048	8	3.6	0.10	<b>SDFT-10</b>	892
11'	3353	8	3.6	0.11	<b>SDFT-11</b>	968
12'	3658	9	4.1	0.12	<b>SDFT-12</b>	1046
13'	3962	10	4.5	0.13	<b>SDFT-13</b>	1125
14'	4267	11	5.0	0.14	<b>SDFT-14</b>	1203
15'	4572	11	5.0	0.15	<b>SDFT-15</b>	1280
16'	4877	12	5.4	0.16	<b>SDFT-16</b>	1360
17'	5181	13	5.8	0.17	<b>SDFT-17</b>	1437
18'	5486	14	6.4	0.18	<b>SDFT-18</b>	1515
19'	5791	14	6.4	0.19	<b>SDFT-19</b>	1591
20'	6096	15	6.8	0.20	<b>SDFT-20</b>	1671
21'	6401	16	7.3	0.21	<b>SDFT-21</b>	1748
22'	6706	17	7.7	0.21	<b>SDFT-22</b>	1791
23'	7010	18	8.2	0.21	<b>SDFT-23</b>	1817
24'	7315	19	8.6	0.21	<b>SDFT-24</b>	1891
25'	7620	20	9.0	0.21	<b>SDFT-25</b>	1965
26'	7925	21	9.5	0.21	<b>SDFT-26</b>	2039
27'	8230	22	10.0	0.21	<b>SDFT-27</b>	2113
28'	8534	23	10.4	0.21	<b>SDFT-28</b>	2187
29'	8839	24	10.9	0.21	<b>SDFT-29</b>	2261
30'	9144	25	11.3	0.21	<b>SDFT-30</b>	2337



### Double-Deep Floor-Trak® High-Density Storage System

see spec sheet **EG01.39B**

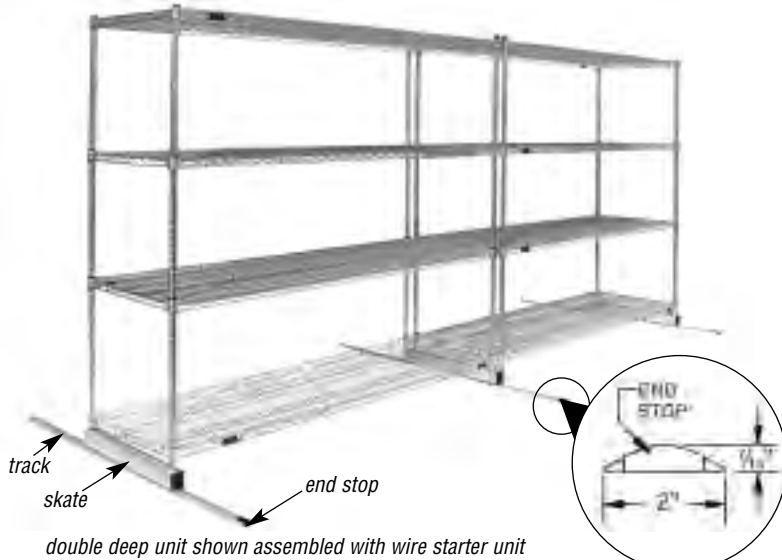

double deep unit shown assembled with wire starter unit

dimensions of floor track

#### Double-Deep Skate Kits

- Three skates.
- All necessary parts and hardware.
- One kit is required for each mobile unit.
- Skates are aircraft-quality aluminum with stainless steel inserts and hardened steel ball bearings.
- Weight capacity of 1500 lbs (680.4 kg) per mobile section —3000 lbs. (1361 kg) at middle skate.

**Note:** Shelves (see page 6) and posts sold separately (see page 8).

width		weight		cu	model #	list
in.	mm	lbs.	kg	ft		
18"	457	10	4.5	0.14	<b>DDSK-18</b>	1039
21"	533	11	5.0	0.16	<b>DDSK-21</b>	1068
24"	610	12	5.4	0.18	<b>DDSK-24</b>	1108
30"	762	14	6.4	0.23	<b>DDSK-30</b>	1214
36"	914	16	7.3	0.27	<b>DDSK-36</b>	1547

#### Optional Shim Kits

Accommodates uneven floors.

model #	list
<b>912991</b>	153

#### Optional Foot Brake Kit

Mounts onto frontmost skate.

model #	list
<b>MFBK-S</b>	96

#### Inside Posts for Double-Deep Units

- Each double-deep unit requires a set of four 'inside' posts (listed below) along with four standard stationary posts.

**Note:** See page 8 for standard stationary posts and page 6 for wire shelves (posts and shelves sold separately).

##### Sets of four 74" (1880mm) posts

weight	cu	EAGLEbrite®		chrome		EAGLEgard®	
		model #	list	model #	list	model #	list
17	7.7	<b>TEP74-Z</b>	147	<b>TEP74-C</b>	166	<b>TEP74-E</b>	179

##### Sets of four 86" (2184mm) posts

weight	cu	EAGLEbrite®		chrome		EAGLEgard®	
		model #	list	model #	list	model #	list
21	9.5	<b>TEP86-Z</b>	173	<b>TEP86-C</b>	185	<b>TEP86-E</b>	199

**IMPORTANT:** Maximum post height per skate size: 18"-, 21"-, and 24"-wide skates on 74" post height or less; 30"- and 36"-wide skates on 86" post height or less.

Freight class is 70.0.

**Note:** Unit will tilt if not loaded properly.  
**LOAD BOTTOM FIRST!**

#### Double-Deep Floor Track Kits

- Three aluminum tracks with plastic end stops.
- All hardware included.

**Note:** Not recommended to piece tracks together. Order length needed. Custom lengths available. Consult factory.

Double-deep units should not exceed depths of 12' (3658mm). 11' and 12' (2794 and 3658mm)-deep units should be used only with 24", 30" or 36" (610, 762, or 914mm)-wide shelves.

length		weight		cu	model #	list
ft.	mm	lbs.	kg	ft		
6'	1829	7	3.2	0.09	<b>DDFT-6</b>	871
7'	2134	8	3.6	0.11	<b>DDFT-7</b>	987
8'	2438	9	4.1	0.12	<b>DDFT-8</b>	1103
9'	2743	10	4.5	0.14	<b>DDFT-9</b>	1220
10'	3048	13	5.8	0.16	<b>DDFT-10</b>	1338
11'	3353	14	6.4	0.17	<b>DDFT-11</b>	1454
12'	3658	15	6.8	0.18	<b>DDFT-12</b>	1572
13'	3962	16	7.3	0.20	<b>DDFT-13</b>	1687
14'	4267	16	7.3	0.21	<b>DDFT-14</b>	1805
15'	4572	17	7.7	0.23	<b>DDFT-15</b>	1921
16'	4877	18	8.2	0.24	<b>DDFT-16</b>	2037
17'	5181	19	8.6	0.26	<b>DDFT-17</b>	2155
18'	5486	21	9.5	0.27	<b>DDFT-18</b>	2272
19'	5791	22	10.0	0.29	<b>DDFT-19</b>	2388
20'	6096	23	10.4	0.30	<b>DDFT-20</b>	2505
21'	6401	24	10.9	0.32	<b>DDFT-21</b>	2622
22'	6706	25	11.3	0.32	<b>DDFT-22</b>	2692
23'	7010	26	11.8	0.32	<b>DDFT-23</b>	2724
24'	7315	27	12.2	0.32	<b>DDFT-24</b>	2836
25'	7620	28	12.7	0.32	<b>DDFT-25</b>	2947
26'	7925	29	13.2	0.32	<b>DDFT-26</b>	3059
27'	8230	30	13.6	0.32	<b>DDFT-27</b>	3169
28'	8534	31	14.1	0.32	<b>DDFT-28</b>	3282
29'	8839	32	14.5	0.32	<b>DDFT-29</b>	3394
30'	9144	33	15.0	0.32	<b>DDFT-30</b>	3504

#### Bumper Brackets for use with Floor-Trak® Skate Kits

Stainless steel. Set of six.

model #	list
<b>DDSKATB-S</b>	273

...sold individually

Hardware included.

model #	list
<b>SKATB-S</b>	67





**Show-off your merchandise when you use our wire display shelving units in various configurations highlighted by our brilliant finishes.**

- Open wire grid shelf allows maximum merchandise visibility.
- Easy to assemble.
- Shelf spacing adjusts in seconds.
- Choose from our custom and standard colors.

## Decorative Shelves

see spec sheet **EG01.34A**



patented  
**QuadTruss®**  
design

(Patent #5,390,803)

### Patented QuadTruss® Design

makes shelves up to 25% stronger and provides a retaining ledge for increased strength and product retention.

#### INCLUDES:

- Four plastic split sleeves per shelf ordered, packaged four per bag.
- Black sleeves except white shelves.
- White shelves come with white sleeves.

**Note:** To order custom decorative colors, add suffix "BM" (black matte), "L" (lilac), "M" (maroon), "SV" (silver vein), "SA" (sapphire), "SG" (smoked glass), "T" (teal), "GV" (gold vein), "CV" (copper vein), or "RU" (ruby) to the desired shelf size model number when ordering. **Call for custom decorative color pricing.**

**Freight class is 70.0.**

(•) MTS (made to stock) / ( ) MTO (made to order)

	length		weight		cubic feet	red		white		black	
	in.	mm	lbs.	kg		model #	list	model #	list	model #	list
<b>14" width</b> (356mm)	24"	610	6	2.9	0.5	<b>1424R</b> •	57	<b>1424W</b> •	57	<b>1424BL</b> •	57
	30"	762	7	3.2	0.5	<b>1430R</b>	60	<b>1430W</b>	60	<b>1430BL</b>	60
	36"	914	8	3.6	0.5	<b>1436R</b>	64	<b>1436W</b>	64	<b>1436BL</b> •	64
	42"	1067	9	3.9	0.7	<b>1442R</b>	72	<b>1442W</b>	72	<b>1442BL</b>	72
	48"	1219	10	4.4	0.7	<b>1448R</b>	74	<b>1448W</b>	74	<b>1448BL</b> •	74
	54"	1372	12	5.4	0.9	<b>1454R</b>	81	<b>1454W</b>	81	<b>1454BL</b> •	81
	60"	1524	14	6.4	0.9	<b>1460R</b>	84	<b>1460W</b>	84	<b>1460BL</b> •	84
72"	1829	17	7.7	1.1	<b>1472R</b>	99	<b>1472W</b>	99	<b>1472BL</b> •	99	
<b>18" width</b> (457mm)	24"	610	7	3.2	0.7	<b>1824R</b>	64	<b>1824W</b>	64	<b>1824BL</b>	64
	30"	762	8	3.6	0.7	<b>1830R</b>	69	<b>1830W</b> •	69	<b>1830BL</b> •	69
	36"	914	9	3.9	0.7	<b>1836R</b>	72	<b>1836W</b>	72	<b>1836BL</b> •	72
	42"	1067	11	5.0	0.9	<b>1842R</b>	80	<b>1842W</b>	80	<b>1842BL</b> •	80
	48"	1219	12	5.4	0.9	<b>1848R</b>	85	<b>1848W</b>	85	<b>1848BL</b>	85
	54"	1372	15	6.8	1.2	<b>1854R</b>	103	<b>1854W</b>	103	<b>1854BL</b> •	103
	60"	1524	17	7.7	1.2	<b>1860R</b>	104	<b>1860W</b>	104	<b>1860BL</b> •	104
72"	1829	20	9.1	1.3	<b>1872R</b>	119	<b>1872W</b>	119	<b>1872BL</b>	119	
<b>21" width</b> (533mm)	24"	610	8	3.7	0.7	<b>2124R</b>	73	<b>2124W</b>	73	<b>2124BL</b>	73
	30"	762	9	4.1	0.7	<b>2130R</b>	78	<b>2130W</b>	78	<b>2130BL</b> •	78
	36"	914	11	5.0	0.8	<b>2136R</b>	80	<b>2136W</b>	80	<b>2136BL</b>	80
	42"	1067	12	5.4	1.1	<b>2142R</b>	93	<b>2142W</b>	93	<b>2142BL</b> •	93
	48"	1219	14	6.4	1.1	<b>2148R</b>	94	<b>2148W</b>	94	<b>2148BL</b>	94
	54"	1372	16	7.3	1.3	<b>2154R</b>	111	<b>2154W</b>	111	<b>2154BL</b>	111
	60"	1524	18	8.2	1.3	<b>2160R</b>	113	<b>2160W</b>	113	<b>2160BL</b>	113
72"	1829	24	10.9	1.4	<b>2172R</b>	137	<b>2172W</b>	137	<b>2172BL</b> •	137	
<b>24" width</b> (610mm)	24"	610	9	4.1	0.8	<b>2424R</b>	79	<b>2424W</b>	79	<b>2424BL</b>	79
	30"	762	11	5.0	0.8	<b>2430R</b> •	84	<b>2430W</b>	84	<b>2430BL</b> •	84
	36"	914	13	5.9	0.8	<b>2436R</b>	86	<b>2436W</b>	86	<b>2436BL</b>	86
	42"	1067	15	6.8	1.2	<b>2442R</b>	104	<b>2442W</b>	104	<b>2442BL</b> •	104
	48"	1219	16	7.3	1.2	<b>2448R</b>	108	<b>2448W</b>	108	<b>2448BL</b>	108
	54"	1372	19	8.6	1.5	<b>2454R</b>	121	<b>2454W</b>	121	<b>2454BL</b> •	121
	60"	1524	21	9.5	1.5	<b>2460R</b>	127	<b>2460W</b>	127	<b>2460BL</b> •	127
72"	1829	26	11.8	1.6	<b>2472R</b>	148	<b>2472W</b>	148	<b>2472BL</b>	148	

**Add a  
Splash of Color!**



100 Industrial Boulevard, Clayton, DE 19938-8903 U.S.A.  
Phone: 800-637-5100 or 302-653-3000. Fax: 302-653-2065  
<http://www.eaglegrp.com>



## STAND-OUTS™ Decorative Shelving Accessories

see spec sheet **EG01.34A** **EG01.34B**

Freight class is 70.0.

(•) MTS (made to stock) / ( ) MTO (made to order)

### Decorative Casters

- For use with Stationary Posts (page 61).

type	wheel diameter		weight		cubic feet	model #	list
	in.	mm	lbs.	kg			
swivel	2"	51	0.4	0.2	0.03	<b>A208903</b> •	9
swivel/brake	2"	51	0.4	0.2	0.03	<b>A208904</b> •	11
swivel	4"	102	0.7	0.3	0.03	<b>A208905</b> •	23
swivel/brake	4"	102	0.8	0.4	0.03	<b>A208906</b> •	29



### Decorative Foot Plate

diameter		model #	list
in.	mm		
2"	51	<b>A204942</b>	5



### Inlays

- Fits between posts and levels with top of shelf edge.



**Black and White**  
Reversible. Priced per inlay. 1/8"-thick.

**Clear \***  
Priced per pack of four. 1/32"-thick.

	length		weight**		cu ft	model #	list	model #	list
	in.	mm	lbs.	kg					
<b>14" width</b> (356mm)	30"	762	1.0	0.5	0.2	<b>DSI-1430</b>	48	<b>CSI-1430</b>	77
	36"	914	1.0	0.5	0.2	<b>DSI-1436</b>	52	<b>CSI-1436</b>	81
	48"	1219	1.0	0.5	0.2	<b>DSI-1448</b>	60	<b>CSI-1448</b> •	98
	60"	1524	1.0	0.5	0.2	<b>DSI-1460</b>	63	<b>CSI-1460</b>	137
<b>18" width</b> (457mm)	36"	914	1.0	0.5	0.2	<b>DSI-1836</b>	59	<b>CSI-1836</b> •	84
	48"	1219	1.0	0.5	0.2	<b>DSI-1848</b>	67	<b>CSI-1848</b>	100
	60"	1524	1.0	0.5	0.2	<b>DSI-1860</b>	69	<b>CSI-1860</b>	118
	72"	1829	1.0	0.5	0.2	<b>DSI-1872</b>	73	<b>CSI-1872</b>	135
<b>21" width</b> (533mm)	36"	914	1.1	0.5	0.2	<b>DSI-2136</b>	65	<b>CSI-2136</b>	91
	48"	1219	1.2	0.5	0.3	<b>DSI-2148</b>	69	<b>CSI-2148</b>	105
	60"	1524	1.3	0.5	0.3	<b>DSI-2160</b>	73	<b>CSI-2160</b>	120
	72"	1829	1.4	0.5	0.3	<b>DSI-2172</b>	76	<b>CSI-2172</b>	137
<b>24" width</b> (610mm)	24"	610	1.0	0.5	0.2	<b>DSI-2424</b>	56	<b>CSI-2424</b>	78
	30"	762	1.0	0.5	0.3	<b>DSI-2430</b>	61	<b>CSI-2430</b>	89
	36"	914	1.0	0.5	0.3	<b>DSI-2436</b>	67	<b>CSI-2436</b>	94
	48"	1219	1.1	0.5	0.3	<b>DSI-2448</b>	78	<b>CSI-2448</b>	109
	54"	1372	1.3	0.6	0.3	<b>DSI-2454</b>	82	<b>CSI-2454</b>	121
	60"	1524	1.4	0.6	0.3	<b>DSI-2460</b>	86	<b>CSI-2460</b>	138
<b>30" width</b> (762mm)	60"	1524	2.0	0.9	0.3	<b>DSI-3060</b>	96	<b>CSI-3060</b>	217
	72"	1829	2.5	1.1	0.3	<b>DSI-3072</b>	101	<b>CSI-3072</b>	220

\* Actual width of CSI Inlays is minus 1/4" (32mm).

\*\* Weight shown per inlay.

### Display Arms

- For everything from pots to purses; perfect for 'quick-pick' items.
- Easily attaches to standard posts.

length	weight	EAGLEbrite®		chrome		red		white		black			
		in.	mm	lbs.	kg	model #	list	model #	list	model #	list		
6"	25	20	9	<b>DA6-Z</b>	16	<b>DA6-C</b>	16	<b>DA6-R</b>	17	<b>DA6-W</b>	17	<b>DA6-BL</b>	17



## Catalog Section 1

### Posts

see spec sheet **EG01.34A**

Freight class is 50.0.

(•) MTS (made to stock) / ( ) MTO (made to order)



					For Stationary Applications				For Mobile Applications			
height		weight		cu	Model #				Model #			
in.	mm	lbs.	kg	ft	red	white	black	list	red	white	black	list
7"	178	0.8	0.4	0.1	P7-R	P7-W	P7-BL	13	CP7-R	CP7-W	CP7-BL	13
14"	356	1.0	0.5	0.1	P14-R	P14-W	P14-BL •	15	CP14-R	CP14-W	CP14-BL	15
33"	838	2.0	0.9	0.1	P33-R	P33-W	P33-BL •	19	CP33-R	CP33-W	CP33-BL	19
54"	1372	3.0	1.4	0.1	P54-R	P54-W	P54-BL •	24	CP54-R	CP54-W	CP54-BL •	24
63"	1600	3.5	1.8	0.3	P63-R	P63-W	P63-BL •	25	CP63-R	CP63-W	CP63-BL	25
74"	1880	4.0	1.8	0.5	P74-R	P74-W	P74-BL •	27	CP74-R	CP74-W	CP74-BL •	27
86"	2184	5.0	2.3	0.8	P86-R	P86-W	P86-BL •	33	CP86-R	CP86-W	CP86-BL	33

### Ledges

see spec sheet **EG01.34A**

Freight class is 70.0.

(•) MTS (made to stock) / ( ) MTO (made to order)

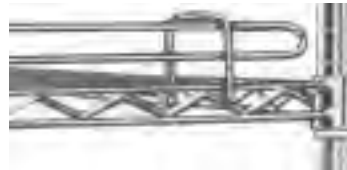

1" (25mm) Ledges\*

4" (102mm) Ledges

length		cu	weight		Model numbers				weight		Model numbers			
in.	mm	ft	lbs.	kg	red	white	black	list	lbs.	kg	red	white	black	list
14"	356	0.2	0.2	0.1	L14-1R	L14-1W	L14-1BL	14	0.8	0.4	L14-4R	L14-4W	L14-4BL	19
18"	457	0.3	0.3	0.1	L18-1R	L18-1W	L18-1BL	15	0.9	0.4	L18-4R	L18-4W	L18-4BL	20
21"	533	0.3	0.4	0.2	L21-1R	L21-1W	L21-1BL	16	1.0	0.5	L21-4R	L21-4W	L21-4BL	22
24"	610	0.3	0.5	0.2	L24-1R	L24-1W	L24-1BL	17	1.2	0.6	L24-4R	L24-4W	L24-4BL	24
30"	762	0.5	0.7	0.3	L30-1R	L30-1W	L30-1BL	20	1.4	0.6	L30-4R	L30-4W	L30-4BL	27
36"	914	0.6	0.9	0.4	L36-1R	L36-1W	L36-1BL	24	1.6	0.7	L36-4R	L36-4W	L36-4BL •	29
42"	1067	0.6	1.1	0.5	L42-1R	L42-1W	L42-1BL	25	1.8	0.8	L42-4R	L42-4W	L42-4BL	37
48"	1219	0.7	1.3	0.6	L48-1R	L48-1W	L48-1BL	26	2.0	0.9	L48-4R	L48-4W	L48-4BL •	38
54"	1372	0.8	1.5	0.7	L54-1R	L54-1W	L54-1BL	28	2.2	1.0	L54-4R	L54-4W	L54-4BL	40
60"	1524	0.8	1.7	0.8	L60-1R	L60-1W	L60-1BL	29	2.4	1.1	L60-4R	L60-4W	L60-4BL	41
72"	1829	1.0	2.1	1.0	L72-1R	L72-1W	L72-1BL	31	2.6	1.2	L72-4R	L72-4W	L72-4BL	48

\* When installed, actual height of ledge is 1½" (38mm).

### Shelf Dividers

see spec sheet **EG01.34A**

Freight class is 70.0.

(•) MTS (made to stock) / ( ) MTO (made to order)



**Organize shelf contents with these snap-on dividers!**

length		weight		cubic	red		white		black	
in.	mm	lbs.	kg	feet	model #	list	model #	list	model #	list
14"	356	1.0	0.5	0.6	SD14-R	24	SD14-W	24	SD14-BL	24
18"	457	1.3	0.6	0.6	SD18-R	27	SD18-W	27	SD18-BL	27
21"	533	1.5	0.7	0.8	SD21-R	29	SD21-W	29	SD21-BL	29
24"	610	1.8	0.8	1.0	SD24-R	36	SD24-W	36	SD24-BL	36
30"	762	2.2	1.0	1.2	SD30-R	40	SD30-W	40	SD30-BL	40
36"	914	2.7	1.2	1.4	SD36-R	48	SD36-W	48	SD36-BL	48

## Cantilever Shelves

see spec sheet **EG01.34B**



*Ideal for adding extra storage above an existing shelving unit.*

*Packaged two per box.*

**FEATURES:**

- 1" (25mm) wraparound ledge.
- 12" (305mm) wide shelves.

**NOTE:** When ordering back posts, confirm with customer service, the correct post height to accommodate these shelves.

**Freight class is 70.0.**

	length		weight		cu ft	red		white		black	
	in.	mm	lbs.	kg		model #	list	model #	list	model #	list
12" width (305mm)	24"	610	4	1.8	0.5	CS1224-R	62	CS1224-W	62	CS1224-BL	62
	30"	762	5	2.3	0.8	CS1230-R	66	CS1230-W	66	CS1230-BL	66
	36"	914	6	2.7	0.8	CS1236-R	68	CS1236-W	68	CS1236-BL	68
	42"	1067	7	3.2	0.9	CS1242-R	76	CS1242-W	76	CS1242-BL	76
	48"	1219	8	3.6	1.0	CS1248-R	79	CS1248-W	79	CS1248-BL	79
	54"	1371	8	3.6	1.0	CS1254-R	85	CS1254-W	85	CS1254-BL	85
	60"	1524	9	4.1	1.0	CS1260-R	92	CS1260-W	92	CS1260-BL	92

## Etagere Top

see spec sheet **EG01.34B**



**FEATURES:**

- Decorative top fits 24" (610mm) long shelving.

**Freight class is 70.0.**

	length		weight		cu ft	chrome		red		white		black	
	in.	mm	lbs.	kg		model #	list	model #	list	model #	list	model #	list
24"	305		1.5	0.7	1.3	ET24-C	27	ET24-R	28	ET24-W	28	ET24-BL	28

## Hanger Rails

see spec sheet **EG01.34B**

**Freight class is 70.0.**

### Front-to-Back

width	weight	cu	red		white		black		chrome			
			in.	mm	lbs.	kg	ft	model #	list	model #	list	model #
14"	356	1.0	0.5	0.2	WR14-R	20	WR14-W	20	WR14-BL	20	WR14-C	19
18"	457	1.1	0.5	0.3	WR18-R	21	WR18-W	21	WR18-BL	17	WR18-C	17
24"	610	1.5	0.7	0.3	WR24-R	24	WR24-W	24	WR24-BL	24	WR24-C	23
30"	762	1.7	0.8	0.5	WR30-R	26	WR30-W	26	WR30-BL	26	WR30-C	25
36"	914	1.9	0.9	0.6	WR36-R	27	WR36-W	27	WR36-BL	27	WR36-C	26



### Left-to-Right

width	weight	cu	red		white		black		chrome			
			in.	mm	lbs.	kg	ft	model #	list	model #	list	model #
24"	610	1.5	0.7	0.3	LR24-R	28	LR24-W	28	LR24-BL	28	LR24-C	26
30"	762	1.7	0.8	0.5	LR30-R	32	LR30-W	32	LR30-BL	32	LR30-C	28
36"	914	1.9	0.9	0.6	LR36-R	35	LR36-W	35	LR36-BL	35	LR36-C	31
42"	1067	2.0	0.9	0.6	LR42-R	37	LR42-W	37	LR42-BL	37	LR42-C	35
48"	1092	2.1	1.0	0.7	LR48-R	40	LR48-W	40	LR48-BL	40	LR48-C	38
54"	1372	2.3	1.0	0.8	LR54-R	42	LR54-W	42	LR54-BL	42	LR54-C	40
60"	1524	2.5	1.1	0.8	LR60-R	44	LR60-W	44	LR60-BL	44	LR60-C	43
66"	1676	2.7	1.2	0.9	LR66-R	48	LR66-W	48	LR66-BL	48	LR66-C	44
72"	1829	2.9	1.3	1.0	LR72-R	57	LR72-W	57	LR72-BL	57	LR72-C	52

## Catalog Section 1

### Hooks

see spec sheet **EG01.34B**

Freight class is 70.0.

These snap-on hooks are heavy-gauge mild steel.

length x width x height in. mm		weight lbs. kg		cu ft	description	black		chrome	
						model #	list	model #	list
1 1/4" x 4 1/4" x 3/8"	32 x 108 x 10	0.3	0.1	0.1	small snap hook	SH-BL	13	SH-C	13
2 1/4" x 4 1/4" x 3/8"	57 x 108 x 10	0.3	0.1	0.1	large snap hook	LH-BL	16	LH-C	16
2 1/4" x 4 1/4" x 3/8"	57 x 108 x 10	0.3	0.1	0.1	large double hook	LDH-BL	27	LDH-C	27

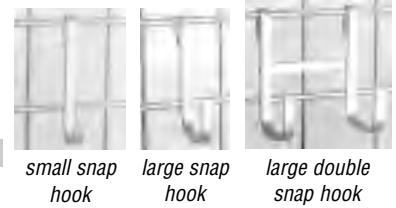

### Front Case Merchandise Shelving

see product announcement **EG8105**

FEATURES:

- 14" (356mm) standard height.
- Set of four split sleeves per shelf.

Freight class is 70.0.



patented  
**QuadTruss**  
design  
(Patent #5,390,803)

**Note:** To order unit with decorative casters, add suffix "-DC" to model number (example: FCM1448V-DC) and \$21. To order unit with 18" (457mm)-high posts, add suffix "-18" to model number (example: HDFCM1424C-18). For units with cantilever overshelf, add \$6. For units with two standard shelves, add \$12.

#### Units with 12" (305mm)-wide Cantilever Overshelf

width (356mm)	length		chrome		black		red		VALU-MASTER®		Valu-Gard®		white	
	in.	mm	model #	list	model #	list	model #	list	model #	list	model #	list	model #	list
14"	24"	610	FCM1424C	221	FCM1424BL	225	FCM1424R	225	FCM1424V	225	FCM1424VG	225	FCM1424W	225
	30"	762	FCM1430C	234	FCM1430BL	238	FCM1430R	238	FCM1430V	238	FCM1430VG	238	FCM1430W	238
	36"	914	FCM1436C	246	FCM1436BL	251	FCM1436R	251	FCM1436V	251	FCM1436VG	251	FCM1436W	251
	42"	1067	FCM1442C	272	FCM1442BL	276	FCM1442R	276	FCM1442V	276	FCM1442VG	276	FCM1442W	276
	48"	1219	FCM1448C	276	FCM1448BL	280	FCM1448R	280	FCM1448V	280	FCM1448VG	280	FCM1448W	280
	54"	1372	FCM1454C	287	FCM1454BL	292	FCM1454R	292	FCM1454V	292	FCM1454VG	292	FCM1454W	292
60"	1524	FCM1460C	304	FCM1460BL	308	FCM1460R	308	FCM1460V	308	FCM1460VG	308	FCM1460W	308	

#### Units with Two Standard Shelves

width (356mm)	length		chrome		black		red		VALU-MASTER®		Valu-Gard®		white	
	in.	mm	model #	list	model #	list	model #	list	model #	list	model #	list	model #	list
14"	24"	610	HDFCM1424C	199	HDFCM1424BL	203	HDFCM1424R	203	HDFCM1424V	203	HDFCM1424VG	203	HDFCM1424W	203
	30"	762	HDFCM1430C	208	HDFCM1430BL	213	HDFCM1430R	213	HDFCM1430V	213	HDFCM1430VG	213	HDFCM1430W	213
	36"	914	HDFCM1436C	219	HDFCM1436BL	223	HDFCM1436R	223	HDFCM1436V	223	HDFCM1436VG	223	HDFCM1436W	223
	42"	1067	HDFCM1442C	242	HDFCM1442BL	246	HDFCM1442R	246	HDFCM1442V	246	HDFCM1442VG	246	HDFCM1442W	246
	48"	1219	HDFCM1448C	246	HDFCM1448BL	251	HDFCM1448R	251	HDFCM1448V	251	HDFCM1448VG	251	HDFCM1448W	251
	54"	1372	HDFCM1454C	257	HDFCM1454BL	261	HDFCM1454R	261	HDFCM1454V	261	HDFCM1454VG	261	HDFCM1454W	261
60"	1524	HDFCM1460C	272	HDFCM1460BL	276	HDFCM1460R	276	HDFCM1460V	276	HDFCM1460VG	276	HDFCM1460W	276	

### Soft Goods Display

see product announcement **EG8084**



shown with optional hooks

INCLUDES:

- Standard adjustable feet.
- Standard color is red.
- Three shelves.
- Display arm.
- Two hanger rails.
- Two etagere tops used for signage.

Freight class is 70.0.

**Note:** Options include the finish of your choice (see page 59 for custom colors and suffix codes), additional shelves and hooks, hanger tube, and decorative casters.

height	width	length		weight		cubic feet	model #	list
		in.	mm	lbs.	kg			
64" (1626mm)	24" (610mm)	24"	610	49	22.2	3	SDG2424R	424



## Retail Display Workstation

see product announcement **EG8082**



retail display workstation shown with optional accessories

### Available accessories:

(see pages 60-63)

- Hanger rails
- Display arms
- Ledges
- Dividers
- Wire grids panels
- Display hooks

### Available options:

- Additional wood tabletop choices.
- Laminate top in lieu of wood.
- Your custom logo displayed on wood caps.
- European-style corners on wood caps.

**CONSULT FACTORY.**

### FEATURES:

- 63" (1600mm) high freestanding rear shelf unit.
- 34" (864mm) high table, both capped with a hardwood finish.

### SHELVES FEATURES:

- Four 14" (356mm) wide chrome shelves and posts.

### TABLE FEATURES:

- Two 18" (457mm) wide chrome wire undershelves and posts.

**Freight class is 70.0.**

width	length		weight		cu ft	model #	list
	in.	mm	lbs.	kg			
36" (914mm)	50"	1270	110	49.9	6	<b>RDW48CB</b>	3238

## Hardwood Top Wine Cart

see spec sheet **EG01.48**



patented  
**QuadTruss**  
design

(Patent #5,390,803)

### INCLUDES:

- 1 1/4" (45mm) thick hardwood butcher block top.
- Two chrome wine racks that can hold up to 18 bottles of wine.
- Chrome wire shelf for storage.

**Freight class is 70.0.**

width	length		weight		cu ft	model #	list
	in.	mm	lbs.	kg			
18" (457mm)	40"	1016	69	31.3	7.7	<b>WR1840C</b>	1168

**Smooth rolling casters for easy mobility.**

## Hardwood Top Demo Carts

see product announcement **EG8181**



### INCLUDES:

- 1 1/4" (45mm) thick hardwood butcher block top.
- Two wire undershelves, Valu-Master® gray finish.
- 5" (127mm)-diameter decorative casters with donut bumpers.

**Note:** Available accessories include laminate top in lieu of wood, wire basket, and utility hooks.

Options include the finish of your choice (see page 59 for custom colors and suffix codes).

**Freight class is 70.0.**

height	width	length		weight		cubic feet	model #	list
		in.	mm	lbs.	kg			
34" (864mm)	24" (610mm)	36"	914	61	27.7	4.0	<b>DC2436V</b>	1284
		48"	1219	73	33.1	5.0	<b>DC2448V</b>	1337
		60"	1524	91	41.3	6.0	<b>DC2460V</b>	1496

## Catalog Section 1

### Pot / Pan Rack

see product announcement **EG8085**



**Designed for displaying items such as cookware, while allowing plenty of tabletop room for other display.**

pot/pan rack shown with additional bracket

- 33" (838mm) high.
- Chrome plated.
- Overall bracket length is 10" (254mm).
- Base is screwed into bottom of post.
- Entire assembly screws onto tabletop.
- Threaded stud welded into middle of 12" (305mm) square heavy gauge mild steel base.
- Three display brackets with 8" (203mm) hexagon pad welded onto each bracket.

**FEATURES:**

**Note:** Options include the finish of your choice (see page 59 for custom colors and suffix codes), specified post height and additional brackets.

**Freight class is 70.0.**

width	length in. mm	weight lbs. kg	cu ft	model #	list
12" (305mm)	12" 305	15 6.8	1.2	A210115	96

### Optional Freestanding Base for Pot / Pan Rack

- Chrome.
- 22" x 30" (559 x 762mm).
- Available as an option to mounting.

model #	list
A210109	41

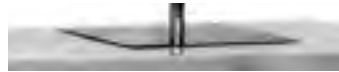

### Additional Bracket for Pot / Pan Rack

- Chrome.

model #	list
A210075	21



### Secure Display Merchandiser

see product announcement **EG8083**



secure display merchandiser shown with optional accessories

- Posts and shelves are chrome plated.
- Mylar inlay for top shelf.
- Four 2 3/8" (60mm) decorative casters.

**FEATURES:**

**Freight class is 70.0.**

(•) MTS (made to stock) / ( ) MTO (made to order)

height	width	length in. mm	weight lbs. kg	cubic feet	model #	list
40" (1016mm)	14" (356mm)	36" 914	90 40.8	9	SDM1436C	1252

### Options for Secure Display Merchandiser

description	model #	list
center wire shelf	A1436C •	68
polymer top	SDM1436C-P	122
natural wood top	SDM1436C-W	98
laminated top	SDM1436C-L	392
wall grid panel / sign holder	SDMB36-C	213

### STAND-OUTS™ Gondola Wire Shelving

see spec sheet **EG01.33**



**STAND SOLD SEPARATELY!**

Manufacturers' ID numbers	
1-Kent	4-Madix/Lozier
2-Universal Nolin	5-Royston
3-Streater	6-PermaSteel

- Use on all major shelving fixtures (see "Manufacturers' ID numbers" box).
- Pair of shelf brackets notched to securely hold the display shelf in place. Brackets can be positioned horizontally or slanted.
- Available in 3' and 4' (914 and 1219mm) lengths.
- Available in 18", 21", and 24" (457, 533, and 508mm) depths.
- Choose from custom and standard colors.

**FEATURES:**

**Steps to follow when ordering:**

- 1) **Determine decorative color of gondola shelf.** For standard colors, refer to chart (below). For custom colors, add suffix below to the desired model number when ordering:

**BM** (black matte), **L** (lilac), **M** (maroon),  
**SV** (silver vein), **SA** (sapphire), **SG** (smoked glass),  
**T** (teal), **GV** (gold vein), **CV** (copper vein), **RU** (ruby)  
*Call factory for pricing.*

- 2) **Determine correct brackets.** Refer to the "Manufacturers' ID numbers" table (left) and add the corresponding ID number to the end of the desired gondola shelf model number when ordering. **Example: Model #HG1836BL-3** indicates an 18" x 36" (457 x 914mm) gondola shelf with black epoxy finish and brackets that fit a gondola made by Streater.

**Freight class is 70.0.**

**Gondola Shelves - Patent # 6,345,795**

- Price includes shelf with standard color and pair of shelf brackets.

	length		weight		cu	chrome		red		white		black	
	in.	mm	lbs.	kg		model #	list	model #	list	model #	list	model #	list
<b>18" width</b> (457mm)	36"	914	12	5.8	0.7	<b>HG1836C</b>	92	<b>HG1836R</b>	94	<b>HG1836W</b>	94	<b>HG1836BL</b>	94
	48"	1219	15	6.8	0.9	<b>HG1848C</b>	106	<b>HG1848R</b>	108	<b>HG1848W</b>	108	<b>HG1848BL</b>	108
<b>21" width</b> (533mm)	36"	914	14	6.4	0.8	<b>HG2136C</b>	97	<b>HG2136R</b>	99	<b>HG2136W</b>	99	<b>HG2136BL</b>	99
	48"	1219	17	7.7	1.1	<b>HG2148C</b>	112	<b>HG2148R</b>	115	<b>HG2148W</b>	115	<b>HG2148BL</b>	115
<b>24" width</b> (610mm)	36"	914	16	7.3	0.8	<b>HG2436C</b>	104	<b>HG2436R</b>	107	<b>HG2436W</b>	107	<b>HG2436BL</b>	107
	48"	1219	19	8.6	1.2	<b>HG2448C</b>	118	<b>HG2448R</b>	122	<b>HG2448W</b>	122	<b>HG2448BL</b>	122

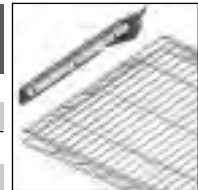

*gondola shelf and bracket*

**Replacement Brackets - Patent # D 435,787**

- Sold in pairs.
- Order replacement brackets to utilize standard shelves in different gondola systems.

length	weight	cu	Kent		U. Nolin		Streater		Madix/Lozier		Royston		PermaSteel			
			in.	mm	lbs.	kg	ft	model #	list	model #	list	model #	list	model #	list	
18"	457	4.8	2.2	1.0	<b>HGK18</b>	32	<b>HGU18</b>	32	<b>HGS18</b>	32	<b>HGML18</b>	32	<b>HGR18</b>	32	<b>HGP18</b>	32
21"	533	5.3	2.4	1.0	<b>HGK21</b>	37	<b>HGU21</b>	37	<b>HGS21</b>	37	<b>HGML21</b>	37	<b>HGR21</b>	37	<b>HGP21</b>	37
24"	610	5.8	2.6	1.0	<b>HGK24</b>	42	<b>HGU24</b>	42	<b>HGS24</b>	42	<b>HGML24</b>	42	<b>HGR24</b>	42	<b>HGP24</b>	42

**Wall Standards**

- Use for mounting directly to walls instead of gondolas, if desired.
- Sold and priced individually.
- 12 gauge zinc plated mild steel.

**Note:** Shelving used only with Universal Nolin (suffix "-2") will fit wall standards.

height	weight	cu	Kent		U. Nolin		Streater		Madix/Lozier		Royston		PermaSteel	
			in.	mm	lbs.	kg	ft	model #	list	model #	list	model #	list	model #
24"	610	3.0	1.4	0.1	<b>NUR24</b>	27								
36"	914	4.5	2.0	0.1	<b>NUR36</b>	29								
48"	1219	6.0	2.7	0.1	<b>NUR48</b>	31								



*wall standard shown with Universal Nolin gondola bracket*

## Catalog Section 1

### Freestanding Gondola Inset Adjustable Wire Shelving

see spec sheet **EG01.32**

**FEATURES:**

- These units can stand side-by-side on gondolas without size interference, giving shelf contents a cleaner, more efficient appearance.
- Easy assembly — no tools required.

**Note:** For posts, see page 61, for collars and split sleeves see page 68.

**Freight class is 70.0.**

#### Two Wire Shelves (top and bottom)

Featuring patented QuadTruss® Design, making shelves up to 25% stronger. Shelves consist of a top mat assembly using 10 gauge mat wires spaced on 7/8" (22mm) centers and welded to full length 6 gauge serpentine trusses.



patented **QuadTruss®** design

(Patent #5,390,803)

#### Two Add-A-Shelf® Center Shelves

300 lb. (136.1 kg) capacity. Shelves can be added or removed without disassembling the entire shelf unit. Add-A-Shelf® Reverse Mat Shelves, featuring a built-in ledge, available as an alternative. See below.

**STAND SOLD SEPARATELY!**

*gondola inset adjustable wire shelving unit used with gondola*



#### Gondola Inset Wire Shelves\*

	length		weight		EAGLEbrite®		chrome		black		red		white	
	in.	mm	lb.	kg	model #	list	model #	list	model #	list	model #	list	model #	list
<b>14" width</b> (356mm)	35 1/2"	902	8	3.6	<b>G1436Z</b>	58	<b>G1436C</b>	66	<b>G1436BL</b>	69	<b>G1436R</b>	69	<b>G1436W</b>	69
	47 1/2"	1207	10	4.6	<b>G1448Z</b>	68	<b>G1448C</b>	77	<b>G1448BL</b>	81	<b>G1448R</b>	81	<b>G1448W</b>	81
<b>18" width</b> (457mm)	35 1/2"	902	9	4.1	<b>G1836Z</b>	69	<b>G1836C</b>	74	<b>G1836BL</b>	78	<b>G1836R</b>	78	<b>G1836W</b>	78
	47 1/2"	1207	12	5.5	<b>G1848Z</b>	82	<b>G1848C</b>	91	<b>G1848BL</b>	95	<b>G1848R</b>	95	<b>G1848W</b>	95
<b>21" width</b> (533mm)	35 1/2"	902	11	5.0	<b>G2136Z</b>	77	<b>G2136C</b>	85	<b>G2136BL</b>	91	<b>G2136R</b>	91	<b>G2136W</b>	91
	47 1/2"	1207	14	6.4	<b>G2148Z</b>	89	<b>G2148C</b>	100	<b>G2148BL</b>	103	<b>G2148R</b>	103	<b>G2148W</b>	103
<b>24" width</b> (610mm)	35 1/2"	902	13	5.9	<b>G2436Z</b>	83	<b>G2436C</b>	92	<b>G2436BL</b>	95	<b>G2436R</b>	95	<b>G2436W</b>	95
	47 1/2"	1207	16	7.3	<b>G2448Z</b>	99	<b>G2448C</b>	109	<b>G2448BL</b>	114	<b>G2448R</b>	114	<b>G2448W</b>	114

\*These shelves are designed specifically for use with gondolas. They are 1/2" (13mm) shorter than our regular wire shelving.

#### Add-A-Shelf® for Gondola Inset Wire Shelving - Patented # 5,884,567

- To specify finish, add suffix **Z** (EAGLEbrite® zinc), **C** (chrome), **BL** (black), **R** (red), or **W** (white) to model number when ordering. For example: **A1448W** indicates a white Add-A-Shelf® shelf.



	length**		weight		model #	Add-A-Shelf® Shelves					Add-A-Shelf® Reverse Mat Shelves					
	in.	mm	lb.	kg		List prices					List prices					
						EAGLEbrite®	chrome	black	red	white	model #	EAGLEbrite®	chrome	black	red	white
<b>14" width</b> (356mm)	36"	914	8	3.6	<b>A1436</b>	60	65	66	66	66	<b>D1436</b>	62	67	68	68	68
	48"	1219	10	4.6	<b>A1448</b>	67	74	75	75	75	<b>D1448</b>	69	76	77	77	77
<b>18" width</b> (457mm)	36"	914	9	4.1	<b>A1836</b>	66	67	68	68	68	<b>D1836</b>	68	69	70	70	70
	48"	1219	12	5.5	<b>A1848</b>	77	80	81	81	81	<b>D1848</b>	79	82	83	83	83
<b>21" width</b> (533mm)	36"	914	11	5.0	<b>A2136</b>	74	79	80	80	80	<b>D2136</b>	76	81	82	82	82
	48"	1219	14	6.4	<b>A2148</b>	85	91	92	92	92	<b>D2148</b>	87	94	95	95	95
<b>24" width</b> (610mm)	36"	914	13	5.9	<b>A2436</b>	78	85	86	86	86	<b>D2436</b>	80	87	88	88	88
	48"	1219	16	7.3	<b>A2448</b>	92	100	101	101	101	<b>D2448</b>	95	102	103	103	103

\*\* Dimensions are nominal



100 Industrial Boulevard, Clayton, DE 19938-8903 U.S.A.  
Phone: 800-637-5100 or 302-653-3000. Fax: 302-653-2065  
<http://www.eaglegrp.com>



## Posts for Gondola Inset Wire Shelving

see spec sheet **EG01.32**

Freight class is 50.0.

(•) MTS (made to stock) / ( ) MTO (made to order)

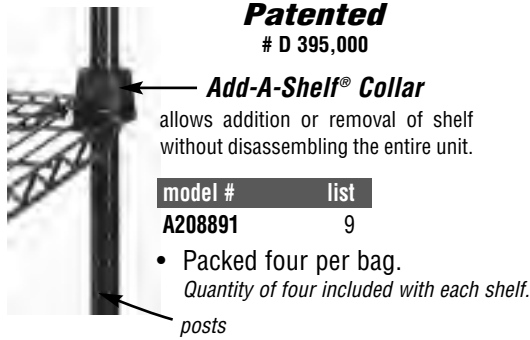

### Split Sleeves

description	model #	list
plastic split sleeves for all shelves, set of four	<b>PLASTIC SPLIT SLEEVES</b>	5



height in.	mm	weight		EAGLEbrite®		chrome		black		red		white	
		lb.	kg	model #	list	model #	list	model #	list	model #	list	model #	list
14"	356	1.0	0.5	<b>P14-Z</b> •	13	<b>P14-C</b> •	14	<b>P14-BL</b> •	15	<b>P14-R</b>	15	<b>P14-W</b>	15
33"	838	2.0	0.9	<b>P33-Z</b> •	16	<b>P33-C</b> •	17	<b>P33-BL</b> •	19	<b>P33-R</b>	19	<b>P33-W</b>	19
54"	1372	3.0	1.4	<b>P54-Z</b> •	22	<b>P54-C</b> •	23	<b>P54-BL</b> •	24	<b>P54-R</b>	24	<b>P54-W</b>	24
63"	1600	3.5	1.6	<b>P63-Z</b> •	23	<b>P63-C</b> •	24	<b>P63-BL</b> •	25	<b>P63-R</b>	25	<b>P63-W</b>	25
74"	1880	4.0	1.8	<b>P74-Z</b> •	24	<b>P74-C</b> •	26	<b>P74-BL</b> •	27	<b>P74-R</b>	27	<b>P74-W</b>	27
86"	2184	5.0	2.3	<b>P86-Z</b> •	29	<b>P86-C</b> •	32	<b>P86-BL</b> •	33	<b>P86-R</b>	33	<b>P86-W</b>	33

## Wire Display Shelving

see spec sheet **EG01.21** WEIGHT CAPACITY:



**STAND SOLD SEPARATELY!**

**MasterSeal® coating**  
for improved rust protection.

### Manufacturers' ID numbers

1-Kent	4-Madix/Lozier
2-Universal Nolin	5-Royston
3-Streater	6-PermaSteel

- Heavy-duty shelves can hold up to 40 lbs. (18 kg) per linear foot.
- EAGLEbrite® zinc finish with MasterSeal® coating.
- Used primarily for gondolas.
- Designed for use on all major shelving fixtures such as Kent, Madix/Lozier, Royston, Streater, Universal Nolin, and PermaSteel.
- One-piece shelf bracket, tier notched to securely hold the display shelf in place.
- Brackets can be positioned horizontally or slanted.
- Shelving can be displayed using the 1" or 3" (25 or 76mm) integral fence by simply rotating the shelf 180°.
- Available in 3' and 4' (914 and 1219mm) lengths.

FEATURES:

Freight class is 70.0.

	width		weight		cu ft	model #	list
	in.	mm	lbs.	kg			
<b>36" length</b> (914mm)	10"	254	10	4.5	0.5	<b>81036</b>	84
	12"	309	11	5.0	0.7	<b>81236</b>	91
	14"	356	11	5.0	0.7	<b>81436</b>	94
	16"	406	12	5.5	0.7	<b>81636</b>	97
	18"	457	12	5.5	0.7	<b>81836</b>	106
	20"	508	13	5.9	0.7	<b>82036</b>	113
<b>48" length</b> (1219mm)	10"	254	12	5.5	0.7	<b>81048</b>	89
	12"	309	13	5.9	0.7	<b>81248</b>	99
	14"	356	14	6.4	0.9	<b>81448</b>	105
	16"	406	15	6.8	0.9	<b>81648</b>	107
	18"	457	16	7.3	1.1	<b>81848</b>	114
	20"	508	17	7.7	1.1	<b>82048</b>	118

Note: Price includes shelf & brackets.

### Steps to follow when ordering:

- 1) Find your shelving system supplier in "Manufacturers' ID Numbers" table at middle of this page.
- 2) **Determine correct brackets.** Add the corresponding ID number to the end of the desired display shelf model number when ordering. **Example: Model #810365** indicates a 10" x 36" (254 x 914mm) display shelf with brackets that fit a shelving fixture made by Royston.

## Catalog Section 1

### Wire Display Shelving Accessories

see spec sheet **EG01.21**

Freight class is 70.0.

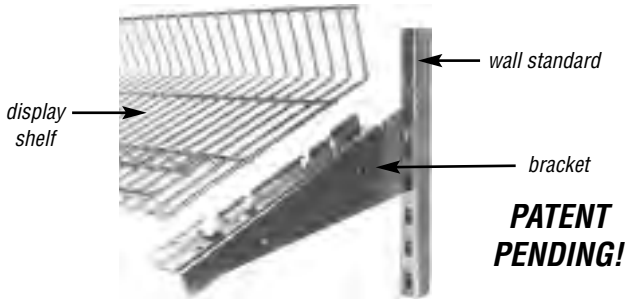

wall standard shown with display shelf and Universal Nolin bracket



### Replacement Brackets

- Sold in pairs.
- Order replacement brackets to utilize standard shelves in different gondola systems.

length		weight		cu	Kent		U. Nolin		Streater		Madix/Lozier		Royston		PermaSteel	
in.	mm	lbs.	kg	ft	model #	list	model #	list	model #	list	model #	list	model #	list	model #	list
10"	254	2.6	1.2	0.6	<b>K10</b>	42	<b>U10</b>	42	<b>S10</b>	42	<b>ML10</b>	42	<b>R10</b>	42	<b>P10</b>	42
12"	309	3.2	1.5	0.6	<b>K12</b>	45	<b>U12</b>	45	<b>S12</b>	45	<b>ML12</b>	45	<b>R12</b>	45	<b>P12</b>	45
14"	356	3.7	1.7	0.6	<b>K14</b>	49	<b>U14</b>	49	<b>S14</b>	49	<b>ML14</b>	49	<b>R14</b>	49	<b>P14</b>	49
16"	406	4.3	2.0	0.6	<b>K16</b>	55	<b>U16</b>	55	<b>S16</b>	55	<b>ML16</b>	55	<b>R16</b>	55	<b>P16</b>	55
18"	457	4.8	2.2	0.6	<b>K18</b>	57	<b>U18</b>	57	<b>S18</b>	57	<b>ML18</b>	57	<b>R18</b>	57	<b>P18</b>	57
20"	508	5.3	2.4	0.6	<b>K20</b>	60	<b>U20</b>	60	<b>S20</b>	60	<b>ML20</b>	60	<b>R20</b>	60	<b>P20</b>	60

### Dividers / Ends

length		weight		cu	model #		list
in.	mm	lbs.	kg	ft	model #	list	list
10"	254	0.5	0.2	0.3	<b>D10</b>	31	
12"	309	0.6	0.3	0.4	<b>D12</b>	33	
14"	356	0.7	0.3	0.4	<b>D14</b>	36	
16"	406	0.8	0.4	0.7	<b>D16</b>	37	
18"	457	0.9	0.4	0.7	<b>D18</b>	39	
20"	508	1.0	0.5	1.0	<b>D20</b>	44	



### Wall Standards

- Use for mounting directly to walls.
- Sold and priced individually.
- Order shelving with ID#2 (*Universal Nolin* – see chart below) for use with wall standards.

height		weight		cu	model #		list
in.	mm	lbs.	kg	ft	model #	list	list
24"	610	3.0	1.4	0.1	<b>NUR24</b>	27	
36"	914	4.5	2.0	0.1	<b>NUR36</b>	29	
48"	1219	6.0	2.7	0.1	<b>NUR48</b>	31	

## Manufacturers' I.D. Numbers

Match your bracket to one of these drawings to determine manufacturer's I.D. number.

(Note: Bracket diagrams are not to scale - for reference purposes only)



① - Kent



② - Universal Nolin



③ - Streater



④ - Madix/Lozier



⑤ - Royston



⑥ - PermaSteel



## Quik-Set® Flat Solid Shelves

see spec sheet **EG01.23**



**FEATURES:**

- Heavy duty.
- All sides of shelves are constructed with a 2" (51mm) downturn and marine edge.
- Each corner is fitted with a heavy-duty aluminum casting to accept a split sleeve.
- No tools are required for assembly.

**Freight class is 70.0.**

### Stainless Steel

	length		cu ft	14 gauge				16 gauge			
	in.	mm		weight		model #	list	weight		model #	list
				lb.	kg			lb.	kg		
<b>18" width</b> (457mm)	36"	914	0.8	24	10.9	<b>SHDS1836SF</b>	436	19	8.6	<b>HDS1836SF</b>	417
	42"	1067	0.9	26	11.8	<b>SHDS1842SF</b>	484	21	9.5	<b>HDS1842SF</b>	453
	48"	1219	1.0	29	13.2	<b>SHDS1848SF</b>	527	24	10.9	<b>HDS1848SF</b>	489
	54"	1372	1.1	33	15.0	<b>SHDS1854SF</b>	574	27	12.2	<b>HDS1854SF</b>	535
	60"	1524	1.3	36	16.3	<b>SHDS1860SF</b>	619	29	13.2	<b>HDS1860SF</b>	584
<b>24" width</b> (610mm)	36"	914	1.0	35	15.9	<b>SHDS2436SF</b>	565	28	12.7	<b>HDS2436SF</b>	518
	42"	1067	1.2	39	17.6	<b>SHDS2442SF</b>	620	32	14.5	<b>HDS2442SF</b>	584
	48"	1219	1.3	43	19.5	<b>SHDS2448SF</b>	696	36	16.3	<b>HDS2448SF</b>	633
	54"	1372	1.5	48	21.8	<b>SHDS2454SF</b>	752	41	18.6	<b>HDS2454SF</b>	689
	60"	1524	1.7	55	24.9	<b>SHDS2460SF</b>	805	47	21.3	<b>HDS2460SF</b>	740

### VALU-MASTER® Gray Epoxy

	length		cu ft	14 gauge				16 gauge			
	in.	mm		weight		model #	list	weight		model #	list
				lb.	kg			lb.	kg		
<b>18" width</b> (457mm)	36"	914	0.8	24	10.9	<b>SHDS1836VF</b>	222	19	8.6	<b>HDS1836VF</b>	215
	42"	1067	0.9	26	11.8	<b>SHDS1842VF</b>	236	21	9.5	<b>HDS1842VF</b>	225
	48"	1219	1.0	29	13.2	<b>SHDS1848VF</b>	243	24	10.9	<b>HDS1848VF</b>	233
	54"	1372	1.1	33	15.0	<b>SHDS1854VF</b>	260	27	12.2	<b>HDS1854VF</b>	234
	60"	1524	1.3	36	16.3	<b>SHDS1860VF</b>	273	29	13.2	<b>HDS1860VF</b>	257
<b>24" width</b> (610mm)	36"	914	1.0	35	15.9	<b>SHDS2436VF</b>	241	28	12.7	<b>HDS2436VF</b>	231
	42"	1067	1.2	39	17.6	<b>SHDS2442VF</b>	253	32	14.5	<b>HDS2442VF</b>	240
	48"	1219	1.3	43	19.5	<b>SHDS2448VF</b>	261	36	16.3	<b>HDS2448VF</b>	248
	54"	1372	1.5	48	21.8	<b>SHDS2454VF</b>	285	41	18.6	<b>HDS2454VF</b>	268
	60"	1524	1.7	55	24.9	<b>SHDS2460VF</b>	294	47	21.3	<b>HDS2460VF</b>	279

### Valu-Gard® Green Epoxy

	length		cu ft	14 gauge				16 gauge			
	in.	mm		weight		model #	list	weight		model #	list
				lb.	kg			lb.	kg		
<b>18" width</b> (457mm)	36"	914	0.8	24	10.9	<b>SHDS1836VGF</b>	222	19	8.6	<b>HDS1836VGF</b>	215
	42"	1067	0.9	26	11.8	<b>SHDS1842VGF</b>	236	21	9.5	<b>HDS1842VGF</b>	225
	48"	1219	1.0	29	13.2	<b>SHDS1848VGF</b>	243	24	10.9	<b>HDS1848VGF</b>	233
	54"	1372	1.1	33	15.0	<b>SHDS1854VGF</b>	260	27	12.2	<b>HDS1854VGF</b>	234
	60"	1524	1.3	36	16.3	<b>SHDS1860VGF</b>	273	29	13.2	<b>HDS1860VGF</b>	257
<b>24" width</b> (610mm)	36"	914	1.0	35	15.9	<b>SHDS2436VGF</b>	241	28	12.7	<b>HDS2436VGF</b>	231
	42"	1067	1.2	39	17.6	<b>SHDS2442VGF</b>	253	32	14.5	<b>HDS2442VGF</b>	240
	48"	1219	1.3	43	19.5	<b>SHDS2448VGF</b>	261	36	16.3	<b>HDS2448VGF</b>	248
	54"	1372	1.5	48	21.8	<b>SHDS2454VGF</b>	285	41	18.6	<b>HDS2454VGF</b>	268
	60"	1524	1.7	55	24.9	<b>SHDS2460VGF</b>	294	47	21.3	<b>HDS2460VGF</b>	279

## Catalog Section 1

### Quik-Set® Embossed Solid Shelves

see spec sheet **EG01.23**

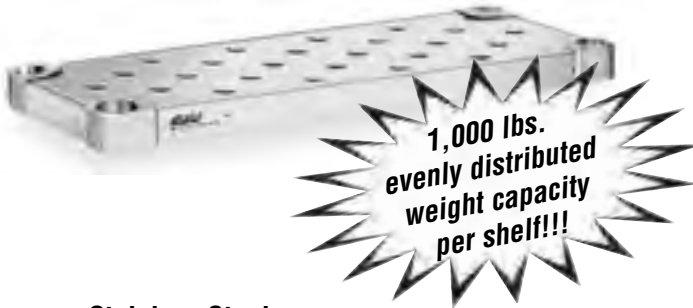

- Heavy duty.
- Constructed with a 2" (51mm) downturn and marine edge.
- Each corner is fitted with a heavy-duty aluminum casting to accept a split sleeve.
- Top of shelf is die stamped with a 1" (25mm) diameter drawn impression to provide a raised area for air circulation.
- Each emboss is on 3" (76mm) centers for the width and 3" (76mm) centers for the length.

FEATURES:

Freight class is 70.0.

#### Stainless Steel

	length		cu ft	14 gauge				16 gauge			
	weight			weight		weight		weight			
	in.	mm		lb.	kg	model #	list	lb.	kg	model #	list
18" width (457mm)	36"	914	0.8	24	10.9	SHDS1836SE	475	19	8.6	HDS1836SE	461
	42"	1067	0.9	26	11.8	SHDS1842SE	527	21	9.5	HDS1842SE	511
	48"	1219	1.0	29	13.2	SHDS1848SE	573	24	10.9	HDS1848SE	559
	54"	1372	1.1	33	15.0	SHDS1854SE	615	27	12.2	HDS1854SE	584
	60"	1524	1.3	36	16.3	SHDS1860SE	657	29	13.2	HDS1860SE	613
24" width (610mm)	36"	914	1.0	35	15.9	SHDS2436SE	593	28	12.7	HDS2436SE	552
	42"	1067	1.2	39	17.6	SHDS2442SE	609	32	14.5	HDS2442SE	600
	48"	1219	1.3	43	19.5	SHDS2448SE	660	36	16.3	HDS2448SE	636
	54"	1372	1.5	48	21.8	SHDS2454SE	741	41	18.6	HDS2454SE	707
	60"	1524	1.7	55	24.9	SHDS2460SE	821	47	21.3	HDS2460SE	758

#### VALU-MASTER® Gray Epoxy

	length		cu ft	14 gauge				16 gauge			
	weight			weight		weight		weight			
	in.	mm		lb.	kg	model #	list	lb.	kg	model #	list
18" width (457mm)	36"	914	0.8	24	10.9	SHDS1836VE	231	19	8.6	HDS1836VE	220
	42"	1067	0.9	26	11.8	SHDS1842VE	241	21	9.5	HDS1842VE	232
	48"	1219	1.0	29	13.2	SHDS1848VE	246	24	10.9	HDS1848VE	236
	54"	1372	1.1	33	15.0	SHDS1854VE	266	27	12.2	HDS1854VE	255
	60"	1524	1.3	36	16.3	SHDS1860VE	276	29	13.2	HDS1860VE	261
24" width (610mm)	36"	914	1.0	35	15.9	SHDS2436VE	245	28	12.7	HDS2436VE	236
	42"	1067	1.2	39	17.6	SHDS2442VE	257	32	14.5	HDS2442VE	244
	48"	1219	1.3	43	19.5	SHDS2448VE	266	36	16.3	HDS2448VE	254
	54"	1372	1.5	48	21.8	SHDS2454VE	288	41	18.6	HDS2454VE	275
	60"	1524	1.7	55	24.9	SHDS2460VE	301	47	21.3	HDS2460VE	283

#### Valu-Gard® Green Epoxy

	length		cu ft	14 gauge				16 gauge			
	weight			weight		weight		weight			
	in.	mm		lb.	kg	model #	list	lb.	kg	model #	list
18" width (457mm)	36"	914	0.8	24	10.9	SHDS1836VGE	231	19	8.6	HDS1836VGE	220
	42"	1067	0.9	26	11.8	SHDS1842VGE	241	21	9.5	HDS1842VGE	232
	48"	1219	1.0	29	13.2	SHDS1848VGE	246	24	10.9	HDS1848VGE	236
	54"	1372	1.1	33	15.0	SHDS1854VGE	266	27	12.2	HDS1854VGE	255
	60"	1524	1.3	36	16.3	SHDS1860VGE	276	29	13.2	HDS1860VGE	261
24" width (610mm)	36"	914	1.0	35	15.9	SHDS2436VGE	245	28	12.7	HDS2436VGE	236
	42"	1067	1.2	39	17.6	SHDS2442VGE	257	32	14.5	HDS2442VGE	244
	48"	1219	1.3	43	19.5	SHDS2448VGE	266	36	16.3	HDS2448VGE	254
	54"	1372	1.5	48	21.8	SHDS2454VGE	288	41	18.6	HDS2454VGE	275
	60"	1524	1.7	55	24.9	SHDS2460VGE	301	47	21.3	HDS2460VGE	283



## Quik-Set® Louvered Solid Shelves

see spec sheet **EG01.23**

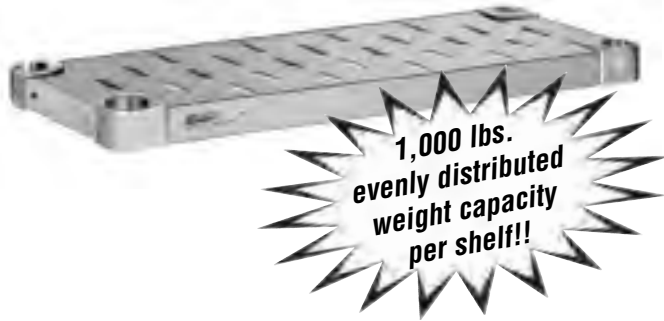

- Heavy duty.
- Shelves are constructed with a 2" (51mm) downturn and marine edge.
- Each corner is fitted with a heavy-duty aluminum casting to accept a split sleeve.
- Top of shelf is die stamped with a 2¾" x ½" (70 x 13mm) opening with a ¼" (2mm) drawn depression around the opening to provide reinforcement.
- Each opening is on 3" (76mm) centers for the width and 3" (76mm) centers for the length.

FEATURES:

**Freight class is 70.0.**

### Stainless Steel

	length		cu ft	14 gauge				16 gauge			
	weight			weight		weight		weight			
	in.	mm		lb.	kg	model #	list	lb.	kg	model #	list
18" width (457mm)	36"	914	0.8	24	10.9	SHDS1836SL	475	17	7.7	HDS1836SL	461
	42"	1067	0.9	26	11.8	SHDS1842SL	527	19	8.6	HDS1842SL	511
	48"	1219	1.0	29	13.2	SHDS1848SL	573	22	10.0	HDS1848SL	559
	54"	1372	1.1	33	15.0	SHDS1854SL	615	25	11.3	HDS1854SL	584
	60"	1524	1.3	36	16.3	SHDS1860SL	657	27	12.2	HDS1860SL	613
24" width (610mm)	36"	914	1.0	35	15.9	SHDS2436SL	593	26	11.8	HDS2436SL	552
	42"	1067	1.2	39	17.6	SHDS2442SL	609	30	13.6	HDS2442SL	600
	48"	1219	1.3	43	19.5	SHDS2448SL	660	34	15.4	HDS2448SL	654
	54"	1372	1.5	48	21.8	SHDS2454SL	741	39	17.6	HDS2454SL	707
	60"	1524	1.7	55	24.9	SHDS2460SL	821	45	20.4	HDS2460SL	758

### VALU-MASTER® Gray Epoxy

	length		cu ft	14 gauge				16 gauge			
	weight			weight		weight		weight			
	in.	mm		lb.	kg	model #	list	lb.	kg	model #	list
18" width (457mm)	36"	914	0.8	22	10.4	SHDS1836VL	233	17	7.7	HDS1836VL	221
	42"	1067	0.9	24	10.9	SHDS1842VL	243	19	8.6	HDS1842VL	234
	48"	1219	1.0	27	12.2	SHDS1848VL	252	22	10.0	HDS1848VL	240
	54"	1372	1.1	31	14.5	SHDS1854VL	256	25	11.3	HDS1854VL	249
	60"	1524	1.3	34	15.4	SHDS1860VL	280	27	12.2	HDS1860VL	258
24" width (610mm)	36"	914	1.0	33	15.0	SHDS2436VL	248	26	11.8	HDS2436VL	237
	42"	1067	1.2	37	16.8	SHDS2442VL	259	30	13.6	HDS2442VL	246
	48"	1219	1.3	41	18.6	SHDS2448VL	271	34	15.4	HDS2448VL	256
	54"	1372	1.5	47	21.3	SHDS2454VL	294	39	17.6	HDS2454VL	280
	60"	1524	1.7	53	24.0	SHDS2460VL	304	45	20.4	HDS2460VL	286

### Valu-Gard® Green Epoxy

	length		cu ft	14 gauge				16 gauge			
	weight			weight		weight		weight			
	in.	mm		lb.	kg	model #	list	lb.	kg	model #	list
18" width (457mm)	36"	914	0.8	22	10.4	SHDS1836VGL	233	17	7.7	HDS1836VGL	221
	42"	1067	0.9	24	10.9	SHDS1842VGL	243	19	8.6	HDS1842VGL	234
	48"	1219	1.0	27	12.2	SHDS1848VGL	252	22	10.0	HDS1848VGL	240
	54"	1372	1.1	31	14.5	SHDS1854VGL	256	25	11.3	HDS1854VGL	249
	60"	1524	1.3	34	15.4	SHDS1860VGL	280	27	12.2	HDS1860VGL	258
24" width (610mm)	36"	914	1.0	33	15.0	SHDS2436VGL	248	26	11.8	HDS2436VGL	237
	42"	1067	1.2	37	16.8	SHDS2442VGL	259	30	13.6	HDS2442VGL	246
	48"	1219	1.3	41	18.6	SHDS2448VGL	271	34	15.4	HDS2448VGL	256
	54"	1372	1.5	47	21.3	SHDS2454VGL	294	39	17.6	HDS2454VGL	280
	60"	1524	1.7	53	24.0	SHDS2460VGL	304	45	20.4	HDS2460VGL	286

## Catalog Section 1

### Quik-Set® Solid Shelving Accessories

see spec sheet **EG01.23A**

Freight class is 50.0.

(•) MTS (made to stock) / ( ) MTO (made to order)

#### Posts

1½" (42mm) diameter. Grooved in 2" (51mm) increments.

				Stationary Posts						Caster Posts						
height in.	weight mm	cu lb.	cu kg	VALU-MASTER®		Valu-Gard®		stainless steel		VALU-MASTER®		Valu-Gard®		stainless steel		
				model #	list	model #	list	model #	list	model #	list	model #	list	model #	list	
14"	356	1.0	0.5	0.2	HDSP14-V	20	HDSP14-VG	20	HDSP14-S	54	HDSCP14-V	20	HDSCP14-VG	20	HDSCP14-S	54
33"	838	2.0	0.9	0.2	HDSP33-V	25	HDSP33-VG	25	HDSP33-S	74	HDSCP33-V	25	HDSCP33-VG	25	HDSCP33-S	74
54"	1372	3.0	1.4	0.2	HDSP54-V	29	HDSP54-VG	29	HDSP54-S	78	HDSCP54-V	29	HDSCP54-VG	29	HDSCP54-S	78
63"	1600	3.5	1.8	0.2	HDSP63-V	32	HDSP63-VG	32	HDSP63-S	91	HDSCP63-V	32	HDSCP63-VG	32	HDSCP63-S	91
74"	1880	4.0	1.8	0.2	HDSP74-V	37	HDSP74-VG	37	HDSP74-S	103	HDSCP74-V	37	HDSCP74-VG	37	HDSCP74-S	103
86"	2184	6.0	2.7	0.2	HDSP86-V	39	HDSP86-VG	39	HDSP86-S	114	HDSCP86-V	39	HDSCP86-VG	39	HDSCP86-S	114

#### Adjustable Foot

Adjust from minimum height of 1½" to maximum height of 2½" (38 to 64mm).

weight lb.	kg	model #	list
0.25	0.1	301036	9



#### Post Cap

Black plastic cap fits inside 1½" (32mm) diameter post.

weight lb.	kg	model #	list
0.25	0.1	330010	4

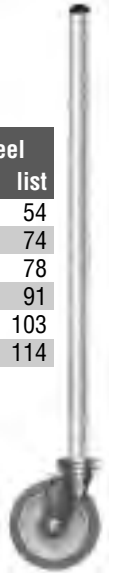

#### Casters

- 5" (127mm) diameter.
- Set of four (two swivel, two with brake).

Freight class is 65.0.

(•) MTS (made to stock) / ( ) MTO (made to order)



#### Polymer Cart Washable with Polymer Tread

weight capacity per caster		model #	list per set
lbs.	kg		
250	113.4	CAHW4-SB •	567

#### Zinc with Rubber Tread

weight capacity per caster		model #	list per set
lbs.	kg		
250	113.4	CAHP4-SB •	457

### **NEW** Stainless Steel Caster Cradle®

see product announcement **EG8108M**



**PATENTED!**  
(patent #US 8,678,335 B2)



FEATURES:

- The only caster stabilizing device with a patented uniform circular design (patent #US 8,678,335 B2) that allows for approach from any angle.
- Units are secured to the floor where the casters are to be centered.

Freight class is 85.0.

description	model #	list/pkg
quantity of 2 per package	CC-S-2	83
quantity of 10 per package	CC-S-10	329
quantity of 60 per package	CC-S-60	1847

# LIFESTOR® Polymer Shelving

## LIFESTOR® Starter Units

see spec sheet **EG01.12A**



INCLUDES:

- Four posts.
- Four shelves.
- Combination of stainless steel or zinc posts, rails, high density green polymer shelving sections and fittings provide a heavy duty unit that is virtually non-corrosive.

**Freight class is 70.0.**

(•) MTS (made to stock) / ( ) MTO (made to order)

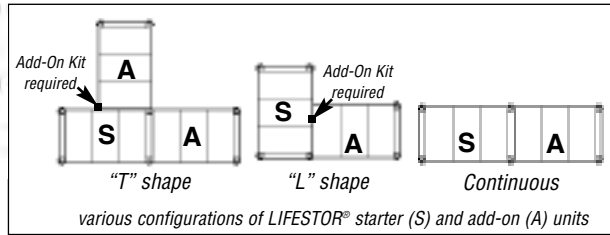

### Featuring MICROGARD®

an antimicrobial agent which contains built-in protection to retard the growth of a broad range of bacteria, mold and mildew on shelf surface that causes stains, odors and degradation.

**Standard on all LIFESTOR® Shelving.**

### 63" (1600mm)-High Starter Units — With 63" (1600mm) high posts.

	length		weight		cu ft	stainless steel				EAGLEbrite®			
						w/ 4 Solid Shelves		w/ 4 Louvered Shelves		w/ 4 Solid Shelves		w/ 4 Louvered Shelves	
	in.	mm	lb.	kg		model #	list	model #	list	model #	list	model #	list
<b>18" width</b> (457mm)	24"	610	42	19.1	3.6	S4-63S-S1824PM	732	S4-63S-L1824PM	672	S4-63Z-S1824PM	653	S4-63Z-L1824PM	609
	30"	762	52	23.6	4.5	S4-63S-S1830PM	744	S4-63S-L1830PM	708	S4-63Z-S1830PM	669	S4-63Z-L1830PM	617
	36"	914	60	27.2	5.6	S4-63S-S1836PM	780	S4-63S-L1836PM •	756	S4-63Z-S1836PM	693	S4-63Z-L1836PM •	633
	42"	1067	65	29.5	5.8	S4-63S-S1842PM	848	S4-63S-L1842PM •	788	S4-63Z-S1842PM	761	S4-63Z-L1842PM •	713
	48"	1219	70	31.8	6.0	S4-63S-S1848PM •	900	S4-63S-L1848PM •	824	S4-63Z-S1848PM •	773	S4-63Z-L1848PM •	721
	54"	1372	78	35.4	6.8	S4-63S-S1854PM	1000	S4-63S-L1854PM •	892	S4-63Z-S1854PM	873	S4-63Z-L1854PM •	801
<b>23" width</b> (584mm)	60"	1524	86	39.0	7.6	S4-63S-S1860PM	1088	S4-63S-L1860PM •	904	S4-63Z-S1860PM •	885	S4-63Z-L1860PM •	817
	24"	610	48	21.8	4.4	S4-63S-S2324PM	776	S4-63S-L2324PM	776	S4-63Z-S2324PM	757	S4-63Z-L2324PM	705
	30"	762	60	27.2	5.6	S4-63S-S2330PM •	884	S4-63S-L2330PM	788	S4-63Z-S2330PM	769	S4-63Z-L2330PM	713
	36"	914	70	31.8	6.0	S4-63S-S2336PM	920	S4-63S-L2336PM •	800	S4-63Z-S2336PM	781	S4-63Z-L2336PM •	725
	42"	1067	76	34.5	6.5	S4-63S-S2342PM •	1012	S4-63S-L2342PM •	928	S4-63Z-S2342PM	909	S4-63Z-L2342PM •	833
	48"	1219	82	37.2	7.2	S4-63S-S2348PM •	1060	S4-63S-L2348PM •	948	S4-63Z-S2348PM •	929	S4-63Z-L2348PM •	849
	54"	1372	94	42.6	8.4	S4-63S-S2354PM	1144	S4-63S-L2354PM •	1052	S4-63Z-S2354PM	1033	S4-63Z-L2354PM •	945
	60"	1524	102	46.3	9.6	S4-63S-S2360PM •	1160	S4-63S-L2360PM •	1064	S4-63Z-S2360PM	1045	S4-63Z-L2360PM •	957

### 74" (1880mm)-High Starter Units — With 74" (1880mm) high posts.

	length		weight		cu ft	stainless steel				EAGLEbrite®			
						w/ 4 Solid Shelves		w/ 4 Louvered Shelves		w/ 4 Solid Shelves		w/ 4 Louvered Shelves	
	in.	mm	lb.	kg		model #	list	model #	list	model #	list	model #	list
<b>18" width</b> (457mm)	24"	610	44	20.0	4.0	S4-74S-S1824PM	764	S4-74S-L1824PM	704	S4-74Z-S1824PM	672	S4-74Z-L1824PM	628
	30"	762	54	24.5	4.9	S4-74S-S1830PM	776	S4-74S-L1830PM	740	S4-74Z-S1830PM	688	S4-74Z-L1830PM	636
	36"	914	62	28.1	6.0	S4-74S-S1836PM	812	S4-74S-L1836PM •	788	S4-74Z-S1836PM	712	S4-74Z-L1836PM •	652
	42"	1067	67	30.4	6.2	S4-74S-S1842PM	880	S4-74S-L1842PM •	820	S4-74Z-S1842PM	780	S4-74Z-L1842PM •	732
	48"	1219	72	32.7	6.4	S4-74S-S1848PM •	932	S4-74S-L1848PM •	856	S4-74Z-S1848PM •	792	S4-74Z-L1848PM •	740
	54"	1372	80	36.3	7.2	S4-74S-S1854PM	1032	S4-74S-L1854PM •	924	S4-74Z-S1854PM	892	S4-74Z-L1854PM •	820
<b>23" width</b> (584mm)	60"	1524	88	39.9	8.0	S4-74S-S1860PM	1120	S4-74S-L1860PM •	936	S4-74Z-S1860PM •	904	S4-74Z-L1860PM •	836
	24"	610	50	22.7	5.0	S4-74S-S2324PM	808	S4-74S-L2324PM	808	S4-74Z-S2324PM	776	S4-74Z-L2324PM	724
	30"	762	62	28.1	6.0	S4-74S-S2330PM •	916	S4-74S-L2330PM	820	S4-74Z-S2330PM	788	S4-74Z-L2330PM	732
	36"	914	72	32.7	6.4	S4-74S-S2336PM	952	S4-74S-L2336PM •	832	S4-74Z-S2336PM	800	S4-74Z-L2336PM •	744
	42"	1067	76	34.5	7.0	S4-74S-S2342PM •	1044	S4-74S-L2342PM •	960	S4-74Z-S2342PM	928	S4-74Z-L2342PM •	852
	48"	1219	84	38.1	7.6	S4-74S-S2348PM •	1092	S4-74S-L2348PM •	980	S4-74Z-S2348PM •	948	S4-74Z-L2348PM •	868
	54"	1372	96	43.6	9.0	S4-74S-S2354PM	1176	S4-74S-L2354PM •	1084	S4-74Z-S2354PM	1052	S4-74Z-L2354PM •	964
	60"	1524	106	48.1	10.5	S4-74S-S2360PM •	1192	S4-74S-L2360PM •	1096	S4-74Z-S2360PM	1064	S4-74Z-L2360PM •	976



## Catalog Section 1

### LIFESTOR® Add-On Units

see spec sheet **EG01.12B**



**400 lbs.  
per shelf  
weight capacity**

- Two posts.
- Four shelves.
- Combination of stainless steel or zinc posts, rails, high density green polymer shelving sections and fittings provide a heavy duty unit that is virtually non-corrosive.

INCLUDES:

**Freight class is 70.0.**

(•) MTS (made to stock) / ( ) MTO (made to order)

#### Featuring MICROGARD®

an antimicrobial agent which contains built-in protection to retard the growth of a broad range of bacteria, mold and mildew on shelf surface that causes stains, odors and degradation.

**Standard on all LIFESTOR® Shelving.**

#### 63" (1600mm)-High Add-On Units — With 63" (1600mm) high posts.

	length		weight		cu ft	stainless steel				EAGLEbrite®			
						w/ 4 Solid Shelves		w/ 4 Louvered Shelves		w/ 4 Solid Shelves		w/ 4 Louvered Shelves	
	in.	mm	lb.	kg		model #	list	model #	list	model #	list	model #	list
<b>18" width</b> (457mm)	24"	610	35	15.9	2.8	A4-63S-S1824PM	640	A4-63S-L1824PM	580	A4-63Z-S1824PM	571	A4-63Z-L1824PM	527
	30"	762	45	20.4	3.7	A4-63S-S1830PM	652	A4-63S-L1830PM	616	A4-63Z-S1830PM	587	A4-63Z-L1830PM	535
	36"	914	53	24.0	4.8	A4-63S-S1836PM	688	A4-63S-L1836PM •	664	A4-63Z-S1836PM	611	A4-63Z-L1836PM •	551
	42"	1067	58	26.3	5.0	A4-63S-S1842PM	756	A4-63S-L1842PM	696	A4-63Z-S1842PM	679	A4-63Z-L1842PM •	631
	48"	1219	63	28.6	5.2	A4-63S-S1848PM •	808	A4-63S-L1848PM •	732	A4-63Z-S1848PM •	691	A4-63Z-L1848PM •	639
	54"	1372	71	32.7	6.0	A4-63S-S1854PM	908	A4-63S-L1854PM •	800	A4-63Z-S1854PM	791	A4-63Z-L1854PM •	719
	60"	1524	77	34.9	6.8	A4-63S-S1860PM	996	A4-63S-L1860PM •	812	A4-63Z-S1860PM •	803	A4-63Z-L1860PM •	735
<b>23" width</b> (584mm)	24"	610	41	18.6	3.6	A4-63S-S2324PM	684	A4-63S-L2324PM	684	A4-63Z-S2324PM	675	A4-63Z-L2324PM	623
	30"	762	53	24.0	4.8	A4-63S-S2330PM •	792	A4-63S-L2330PM	696	A4-63Z-S2330PM	687	A4-63Z-L2330PM	631
	36"	914	63	28.6	5.2	A4-63S-S2336PM	828	A4-63S-L2336PM •	708	A4-63Z-S2336PM	699	A4-63Z-L2336PM •	643
	42"	1067	70	31.8	6.1	A4-63S-S2342PM •	920	A4-63S-L2342PM •	836	A4-63Z-S2342PM	827	A4-63Z-L2342PM •	751
	48"	1219	75	34.0	6.4	A4-63S-S2348PM •	968	A4-63S-L2348PM •	856	A4-63Z-S2348PM •	847	A4-63Z-L2348PM •	767
	54"	1372	87	39.5	7.6	A4-63S-S2354PM	1052	A4-63S-L2354PM	960	A4-63Z-S2354PM	951	A4-63Z-L2354PM •	863
	60"	1524	95	43.1	8.4	A4-63S-S2360PM •	1068	A4-63S-L2360PM •	972	A4-63Z-S2360PM	963	A4-63Z-L2360PM •	875

#### 74" (1880mm)-High Add-On Units — With 74" (1880mm) high posts.

	length		weight		cu ft	stainless steel				EAGLEbrite®			
						w/ 4 Solid Shelves		w/ 4 Louvered Shelves		w/ 4 Solid Shelves		w/ 4 Louvered Shelves	
	in.	mm	lb.	kg		model #	list	model #	list	model #	list	model #	list
<b>18" width</b> (457mm)	24"	610	37	16.7	3.0	A4-74S-S1824PM	656	A4-74S-L1824PM	596	A4-74Z-S1824PM	580	A4-74Z-L1824PM	536
	30"	762	47	21.3	3.9	A4-74S-S1830PM	668	A4-74S-L1830PM	632	A4-74Z-S1830PM	596	A4-74Z-L1830PM	544
	36"	914	55	24.9	5.0	A4-74S-S1836PM	704	A4-74S-L1836PM •	680	A4-74Z-S1836PM	620	A4-74Z-L1836PM •	560
	42"	1067	60	27.2	5.2	A4-74S-S1842PM	772	A4-74S-L1842PM •	712	A4-74Z-S1842PM	688	A4-74Z-L1842PM •	640
	48"	1219	65	29.4	5.4	A4-74S-S1848PM •	824	A4-74S-L1848PM •	748	A4-74Z-S1848PM •	700	A4-74Z-L1848PM •	648
	54"	1372	73	33.1	6.2	A4-74S-S1854PM	924	A4-74S-L1854PM •	816	A4-74Z-S1854PM	800	A4-74Z-L1854PM •	728
	60"	1524	80	36.3	7.0	A4-74S-S1860PM	1012	A4-74S-L1860PM •	828	A4-74Z-S1860PM •	812	A4-74Z-L1860PM •	744
<b>23" width</b> (584mm)	24"	610	43	19.5	4.0	A4-74S-S2324PM	700	A4-74S-L2324PM	700	A4-74Z-S2324PM	684	A4-74Z-L2324PM	632
	30"	762	55	24.9	5.0	A4-74S-S2330PM •	808	A4-74S-L2330PM	712	A4-74Z-S2330PM	696	A4-74Z-L2330PM	640
	36"	914	65	29.4	5.4	A4-74S-S2336PM	844	A4-74S-L2336PM •	724	A4-74Z-S2336PM	708	A4-74Z-L2336PM •	652
	42"	1067	68	30.8	6.5	A4-74S-S2342PM •	936	A4-74S-L2342PM •	852	A4-74Z-S2342PM	836	A4-74Z-L2342PM •	760
	48"	1219	77	34.9	7.6	A4-74S-S2348PM •	984	A4-74S-L2348PM •	872	A4-74Z-S2348PM •	856	A4-74Z-L2348PM •	776
	54"	1372	89	40.3	8.0	A4-74S-S2354PM	1068	A4-74S-L2354PM •	976	A4-74Z-S2354PM	960	A4-74Z-L2354PM •	872
	60"	1524	98	44.5	8.3	A4-74S-S2360PM •	1084	A4-74S-L2360PM •	988	A4-74Z-S2360PM	972	A4-74Z-L2360PM •	884



100 Industrial Boulevard, Clayton, DE 19938-8903 U.S.A.  
Phone: 800-637-5100 or 302-653-3000. Fax: 302-653-2065  
<http://www.eaglegrp.com>



## LIFESTOR® Shelving

see spec sheet **EG01.12C**



assembled LIFESTOR®  
stationary unit  
(see page 77 for posts)

**400 lbs.  
per shelf  
weight  
capacity**



assembled LIFESTOR®  
mobile unit  
(see page 77 for posts)

- Rails.
- Side braces.
- Four connector kits.
- Combination of stainless steel or zinc posts, rails, high density green polymer shelving sections and fittings provide a heavy duty unit that is virtually non-corrosive.

INCLUDES:

**Freight class is 70.0.**

(•) MTS (made to stock) / ( ) MTO (made to order)

### Featuring MICROGARD®

an antimicrobial agent which contains built-in protection to retard the growth of a broad range of bacteria, mold and mildew on shelf surface that causes stains, odors and degradation.

**Standard on all LIFESTOR® Shelving.**

### Shelves for Stationary Applications – Front-to-back side braces are polymer for stationary use.

	length*		weight		cu ft	shelves w/ stainless steel rails				shelves w/ EAGLEbrite® zinc rails			
						Solid Shelves		Louvered Shelves		Solid Shelves		Louvered Shelves	
	in.	mm	lb.	kg		model #	list	model #	list	model #	list	model #	list
<b>18" width</b> (457mm)	24"	610	7.0	3.2	0.5	<b>S1824PSM</b>	137	<b>L1824PSM</b>	122	<b>S1824PZM</b>	122	<b>L1824PZM</b>	111
	30"	762	8.5	3.9	0.7	<b>S1830PSM</b>	140	<b>L1830PSM</b>	131	<b>S1830PZM</b>	126	<b>L1830PZM</b>	113
	36"	914	10.0	4.5	0.9	<b>S1836PSM</b>	149	<b>L1836PSM</b> •	143	<b>S1836PZM</b>	132	<b>L1836PZM</b> •	117
	42"	1067	11.5	5.2	1.1	<b>S1842PSM</b>	166	<b>L1842PSM</b> •	151	<b>S1842PZM</b>	149	<b>L1842PZM</b> •	137
	48"	1219	13.0	5.9	1.3	<b>S1848PSM</b> •	179	<b>L1848PSM</b> •	160	<b>S1848PZM</b> •	152	<b>L1848PZM</b> •	139
	54"	1372	14.5	6.6	1.5	<b>S1854PSM</b>	204	<b>L1854PSM</b> •	177	<b>S1854PZM</b>	177	<b>L1854PZM</b> •	159
	60"	1524	16.0	7.3	1.7	<b>S1860PSM</b>	226	<b>L1860PSM</b> •	180	<b>S1860PZM</b> •	180	<b>L1860PZM</b> •	163
<b>23" width</b> (584mm)	24"	610	8.5	3.9	0.7	<b>S2324PSM</b>	148	<b>L2324PSM</b>	148	<b>S2324PZM</b>	148	<b>L2324PZM</b>	135
	30"	762	10.0	4.5	0.9	<b>S2330PSM</b> •	175	<b>L2330PSM</b>	151	<b>S2330PZM</b>	151	<b>L2330PZM</b>	137
	36"	914	11.5	4.8	1.1	<b>S2336PSM</b>	184	<b>L2336PSM</b> •	154	<b>S2336PZM</b>	154	<b>L2336PZM</b> •	140
	42"	1067	13.0	5.9	1.3	<b>S2342PSM</b> •	207	<b>L2342PSM</b> •	186	<b>S2342PZM</b>	186	<b>L2342PZM</b> •	167
	48"	1219	14.5	6.6	1.5	<b>S2348PSM</b> •	219	<b>L2348PSM</b> •	191	<b>S2348PZM</b> •	191	<b>L2348PZM</b> •	171
	54"	1372	16.0	7.3	1.7	<b>S2354PSM</b>	240	<b>L2354PSM</b> •	217	<b>S2354PZM</b>	217	<b>L2354PZM</b> •	195
	60"	1524	17.5	7.9	1.9	<b>S2360PSM</b> •	244	<b>L2360PSM</b> •	220	<b>S2360PZM</b>	220	<b>L2360PZM</b> •	198

### Shelves for Mobile Applications – Finish of front-to-back side braces match finish of side-to-side rails. Rails enhance stability.

	length*		weight		cu ft	shelves w/ stainless steel rails				shelves w/ EAGLEbrite® zinc rails			
						Solid Shelves		Louvered Shelves		Solid Shelves		Louvered Shelves	
	in.	mm	lb.	kg		model #	list	model #	list	model #	list	model #	list
<b>18" width</b> (457mm)	24"	610	7.0	3.2	0.5	<b>S1824PSM-M</b>	205	<b>L1824PSM-M</b>	191	<b>S1824PZM-M</b>	184	<b>L1824PZM-M</b>	173
	30"	762	8.5	3.9	0.7	<b>S1830PSM-M</b>	227	<b>L1830PSM-M</b>	217	<b>S1830PZM-M</b>	198	<b>L1830PZM-M</b>	184
	36"	914	10.0	4.5	0.9	<b>S1836PSM-M</b>	254	<b>L1836PSM-M</b>	246	<b>S1836PZM-M</b>	218	<b>L1836PZM-M</b>	204
	42"	1067	11.5	5.2	1.1	<b>S1842PSM-M</b>	280	<b>L1842PSM-M</b>	264	<b>S1842PZM-M</b>	246	<b>L1842PZM-M</b>	234
	48"	1219	13.0	5.9	1.3	<b>S1848PSM-M</b>	300	<b>L1848PSM-M</b>	280	<b>S1848PZM-M</b>	254	<b>L1848PZM-M</b>	241
	54"	1372	14.5	6.6	1.5	<b>S1854PSM-M</b>	337	<b>L1854PSM-M</b>	309	<b>S1854PZM-M</b>	289	<b>L1854PZM-M</b>	272
	60"	1524	16.0	7.3	1.7	<b>S1860PSM-M</b>	378	<b>L1860PSM-M</b>	331	<b>S1860PZM-M</b>	301	<b>L1860PZM-M</b>	283
<b>23" width</b> (584mm)	24"	610	8.5	3.9	0.7	<b>S2324PSM-M</b>	233	<b>L2324PSM-M</b>	217	<b>S2324PZM-M</b>	209	<b>L2324PZM-M</b>	196
	30"	762	10.0	4.5	0.9	<b>S2330PSM-M</b>	261	<b>L2330PSM-M</b>	239	<b>S2330PZM-M</b>	221	<b>L2330PZM-M</b>	207
	36"	914	11.5	4.8	1.1	<b>S2336PSM-M</b>	287	<b>L2336PSM-M</b>	258	<b>S2336PZM-M</b>	242	<b>L2336PZM-M</b>	227
	42"	1067	13.0	5.9	1.3	<b>S2342PSM-M</b>	321	<b>L2342PSM-M</b>	300	<b>S2342PZM-M</b>	283	<b>L2342PZM-M</b>	264
	48"	1219	14.5	6.6	1.5	<b>S2348PSM-M</b>	340	<b>L2348PSM-M</b>	312	<b>S2348PZM-M</b>	293	<b>L2348PZM-M</b>	272
	54"	1372	16.0	7.3	1.7	<b>S2354PSM-M</b>	372	<b>L2354PSM-M</b>	349	<b>S2354PZM-M</b>	329	<b>L2354PZM-M</b>	308
	60"	1524	17.5	7.9	1.9	<b>S2360PSM-M</b>	395	<b>L2360PSM-M</b>	372	<b>S2360PZM-M</b>	341	<b>L2360PZM-M</b>	317

\* Shelves up to 48" (1219mm) long hold 400 lbs. (181.4 kg). Shelves over 48" (1219mm) hold 300 lbs. (136.1 kg).

## Catalog Section 1

### LIFESTOR® Shelving (continued)

see spec sheet **EG01.12C**

Freight class is 70.0.

(•) MTS (made to stock) / ( ) MTO (made to order)

#### Posts...

- Constructed of stainless steel or zinc plated mild steel with a clear antimicrobial epoxy coating.
- 1¼" (32mm) outside diameter, grooved at 2" (51mm) increments for easy assembly.
- Post cap included.

			...For Stationary use*				...For Mobile use**				
height in.	weight		cu ft	stainless		EAGLEbrite®		stainless		EAGLEbrite®	
	mm	lbs. kg		model #	list	model #	list	model #	list	model #	list
14"	356	1.0 0.5	0.2	PP14-S	27	PP14-Z	26	CPP14-S•	27	CPP14-Z	26
33"	383	2.0 0.9	0.4	PP33-S•	39	PP33-Z•	31	CPP33-S	39	CPP33-Z	37
54"	1372	3.0 1.4	0.4	PP54-S	41	PP54-Z	38	CPP54-S	41	CPP54-Z	38
63"	1600	3.5 1.6	0.4	PP63-S•	46	PP63-Z•	41	CPP63-S•	46	CPP63-Z•	41
74"	1880	4.0 1.8	0.5	PP74-S•	54	PP74-Z•	46	CPP74-S•	54	CPP74-Z•	46
86"	2184	5.0 2.3	0.5	PP86-S•	62	PP86-Z	54	CPP86-S•	62	CPP86-Z	54



caster post  
shown with caster  
(caster sold separately)

\* Stationary posts include adjustable feet.

\*\* Stainless steel or zinc side braces are required for mobile use – two per shelf.

### LIFESTOR® Shelving Components

see spec sheet **EG01.12C**

Freight class is 50.0.

(•) MTS (made to stock) / ( ) MTO (made to order)

#### Casters

- For use with #CPP caster posts, and not for LIFESTOR® Dunnage Racks, page 80.

**Note:** Stainless steel or zinc side braces are required for use with casters. Two braces per shelf are required.

**IMPORTANT: Not for cart-wash use.**



louvered shelf section



solid shelf section

#### Shelf Sections

- Green polymer.
- Features MICROGARD® protection.

caster description	weight		cubic feet	model #	list
	lbs.	kg			
5" (127mm) dia. swivel heavy-duty 250 lb. (113 kg) cap. - urethane	3.0	1.4	0.1	A205340•	73
same as above with brake	3.5	1.6	0.1	A205341•	76
5" (127mm) rotary bumper, each	1.0	0.5	0.1	A205342	16

shelf width		weight		cu ft	solid		louvered	
in.	mm	lbs.	kg		model #	list	model #	list
18"	457	1.9	0.9	0.4	A216242	17	A216244	16
23"	584	2.4	1.1	0.4	A216243	27	A216245	24

#### Replacement Side Braces (front-to-back)...

- Two per shelf required.

#### ...For Stationary use

shelf width in.	mm	cu ft	weight		polymer	
			lbs.	kg	model #	list
18"	457	0.2	0.8	0.4	A216246	9
23"	584	0.2	1.0	0.5	A216247	12

#### ...For Mobile use

shelf width in. mm		cu ft	zinc				stainless			
			weight		model #	lis	weight		model #	list
lbs.	kg	lbs.	kg							
18"	457	0.2	1.2	0.5	A211331•	20	1.2	0.5	A216240	24
23"	584	0.2	1.5	0.7	A211332•	32	1.5	0.7	A216241•	35



#### Featuring MICROGARD®

an antimicrobial agent which contains built-in protection to retard the growth of a broad range of bacteria, mold and mildew on shelf surface that causes stains, odors and degradation.

**Standard on all LIFESTOR® Shelving.**



100 Industrial Boulevard, Clayton, DE 19938-8903 U.S.A.  
Phone: 800-637-5100 or 302-653-3000. Fax: 302-653-2065  
<http://www.eaglegrp.com>

## LIFESTOR® Shelving Components

see spec sheet **EG01.12C**



### Rails (side-to-side)

- Constructed of stainless steel or zinc plated mild steel with a clear antimicrobial epoxy coating.
- Each end fits securely into a lug.

fits shelf length		actual rail length		weight		stainless steel		EAGLEbrite®	
in.	mm	in.	mm	lbs.	kg	model #	list	model #	list
24"	610	18 <sup>3</sup> / <sub>16</sub> "	478	1.4	0.6	<b>A215051</b>	33	<b>A215152</b>	29
30"	762	24 <sup>3</sup> / <sub>16</sub> "	631	1.8	0.8	<b>A215052</b>	41	<b>A215153</b>	34
36"	914	30 <sup>3</sup> / <sub>16</sub> "	783	2.1	0.9	<b>A215053</b>	49	<b>A215154</b>	41
42"	1067	36 <sup>3</sup> / <sub>16</sub> "	935	2.5	1.1	<b>A215054</b>	54	<b>A215155</b>	46
48"	1219	42 <sup>3</sup> / <sub>16</sub> "	1087	2.8	1.3	<b>A215055</b>	57	<b>A215156</b>	48
54"	1372	48 <sup>3</sup> / <sub>16</sub> "	1240	3.2	1.5	<b>A215056</b>	63	<b>A215157</b>	54
60"	1392	54 <sup>3</sup> / <sub>16</sub> "	1392	3.5	1.6	<b>A215057</b>	72	<b>A215158</b>	57

### "L" or "T" Add-On Kits

- Consist of "U" connector and notched shelf section.
- Features MICROGARD® protection.
- For add-on units, see page 75.

louvered shelf section with notch

shelf width		weight		cu	solid		louvered	
in.	mm	lbs.	kg	ft	model #	list	model #	list
18"	457	2.0	0.9	0.4	<b>18-SM</b>	40	<b>18-LM</b>	34
23"	584	2.5	1.1	0.4	<b>23-SM</b>	40	<b>23-LM</b>	34

"U" connector

Freight class is 70.0.



2-sided lug



4-sided lug



"U" connector

### Connectors

description	weight		cu	model #	list
	lbs.	kg			
2-sided lug	0.4	0.2	.04	<b>A208137</b>	10
4-sided lug	0.4	0.2	.04	<b>A208139</b>	10
"U" Connector	0.2	0.1	.04	<b>A208140</b>	11



split sleeve



adjustable foot



cap

### Miscellaneous

description	model #	list
split sleeve *	<b>A208141</b>	4
adjustable foot	<b>A208143</b>	8
cap	<b>A208144</b>	4

\*Split sleeve must be ordered as a separate component.

## LIFESTOR® Shelving Accessories

see spec sheet **EG01.12D**

### Ledges

- Ledges snap over post without tools.
- Valu-Gard® green epoxy finish.
- Consult factory for other finishes.

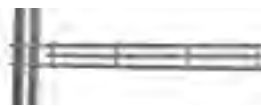

length		weight		1" (25mm)		4" (102mm)	
in.	mm	lbs.	kg	model #	list	model #	list
*18"	457	0.5	0.2	<b>LSL18-1VG</b>	23	<b>LSL18-4VG</b>	25
*23"	584	0.6	0.3	<b>LSL23-1VG</b>	25	<b>LSL23-4VG</b>	27
24"	610	0.6	0.3	<b>LSL24-1VG</b>	25	<b>LSL24-4VG</b>	27
30"	762	0.7	0.3	<b>LSL30-1VG</b>	27	<b>LSL30-4VG</b>	29
36"	914	0.8	0.4	<b>LSL36-1VG</b>	38	<b>LSL36-4VG</b>	42
42"	1067	0.8	0.4	<b>LSL42-1VG</b>	40	<b>LSL42-4VG</b>	43
48"	1219	0.9	0.4	<b>LSL48-1VG</b>	42	<b>LSL48-4VG</b>	44
54"	1372	1.2	0.5	<b>LSL54-1VG</b>	46	<b>LSL54-4VG</b>	52
60"	1524	1.4	0.5	<b>LSL60-1VG</b>	51	<b>LSL60-4VG</b>	57

\* Front-to-back. All other lengths are used side-to-side.

Freight class is 70.0.

### Dividers

- 8" (203mm).
- Dividers snap onto shelf via two 16 gauge stainless steel clips.
- Valu-Gard® green epoxy finish.
- Consult factory for other finishes.



width		weight		model #	list
in.	mm	lbs.	kg		
18"	457	1.3	0.6	<b>LSD18-VG</b>	15
23"	584	1.8	0.8	<b>LSD23-VG</b>	19

## Catalog Section 1

### LIFESTOR® Shelving Accessories

see spec sheet **EG01.12D**

Freight class is 70.0.

(•) MTS (made to stock) / ( ) MTO (made to order)

#### Enclosure Panels

- 3" (76mm) grid.
- Panels attach to shelf via six 14 gauge stainless steel clips.
- A flat blade screwdriver is required for installation.
- Valu-Gard® green epoxy finish.
- Consult factory for other finishes.

width		for 54" (1372mm) post height		for 63" (1600mm) post height		for 74" (1880mm) post height	
in.	mm	model #	list	model #	list	model #	list
12"	305	LSE1254-VG	72	LSE1263-VG	75	LSE1274-VG	86
18"	457	LSE1854-VG	78	LSE1863-VG	89	LSE1874-VG	92

#### Ordering requirements for Enclosure Panels:

- Panels for 63" (1600mm) posts used as example below.

shelf width		enclosure panel	
in.	mm	model #	qty
18"	457	LSE1263-VG	1
23"	584	LSE1863-VG	1

shelf length		enclosure panel	
in.	mm	model #	qty
24"	610	LSE1263-VG	1
30"	762	LSE1863-VG	1
36"	914	LSE1263-VG	2
42"	1067	LSE1863-VG	2
48"	1219	LSE1863-VG	2
54"	1372	LSE1263-VG	4
60"	1524	LSE1863-VG	3

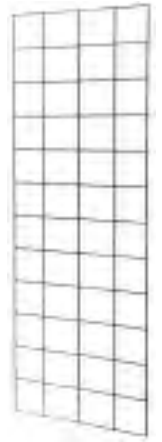

#### Tote Slide Systems

- Only available for 23" (584mm) wide shelves.
- System is suspended from the unit's rails via four shelf slide clips (sold separately).
- Load capacity up to 35 lbs. (15.9 kg).



shelf slide clip

width x length x depth		weight		cubic	list	
in.	mm	lbs.	kg	feet	model #	per pair
14" x 21 1/2" x 10 1/4"	356 x 683 x 260	5.0	2.3	2.0	TS1421	100
20" x 21 1/2" x 10 1/4"	508 x 683 x 260	7.5	3.4	3.8	TS2021 •	104

#### Shelf Slide Clips for Tote Slide Systems

- Set of four.

weight		cubic	list	
lbs.	kg	feet	model #	list
0.5	0.2	0.1	SSC	51

#### Wall Brackets

- **LIFESTOR® can now be mounted to the wall!**
- Each bracket consists of one single shelf support and one mounting plate.
- Valu-Gard® green epoxy finish.

for shelf width		weight		cubic	list	
in.	mm	lbs.	kg	feet	model #	per pair
18"	457	10	4.5	0.5	LWB18-VG	68
23"	584	14	6.4	0.7	LWB23-VG	78



**Go Green.  
Go Eagle.**

Look for the tag  
on the bar code 



## LIFESTOR® Dunnage Racks

see spec sheet **EG01.13**



stationary dunnage rack with louvered shelves



mobile dunnage rack with louvered shelves

### Featuring MICROGARD®

an antimicrobial agent which contains built-in protection to retard the growth of a broad range of bacteria, mold and mildew on shelf surface that causes stains, odors and degradation.

**Standard on all LIFESTOR® Shelving.**

**Stationary Racks:** 1,000 lbs. (454 kg).

**Mobile Racks:** 800 lbs. (363 kg).

**WEIGHT CAPACITY:**

**MOBILE FEATURES:**

- Four 5" (127mm) diameter heavy duty swivel casters with rubber tread, two with brakes.

**STATIONARY FEATURES:**

- Stainless steel bullet feet.

**BOTH FEATURES:**

- 1½" (41mm) diameter stainless steel legs.
- 1¼" (32mm) diameter stainless steel crossbracing on all four sides.
- 14" (356mm) height.

**Freight class is 70.0.**

	size			Stationary				Mobile			
	in.		cu	w/ Solid Shelves		w/ Louvered Shelves		w/ Solid Shelves		w/ Louvered Shelves	
	in.	mm	ft	model #	list	model #	list	model #	list	model #	list
<b>18" width</b> (457mm)	32"	813	2.0	DR-S1832PSM	452	DR-L1832PSM	448	MDR-S1832PSM	617	MDR-L1832PSM	612
	41"	1041	2.6	DR-S1841PSM	492	DR-L1841PSM	486	MDR-S1841PSM	671	MDR-L1841PSM	654
	50"	1270	3.1	DR-S1850PSM	529	DR-L1850PSM	524	MDR-S1850PSM	722	MDR-L1850PSM	716
<b>23" width</b> (584mm)	32"	813	2.0	DR-S2332PSM	473	DR-L2332PSM	463	MDR-S2332PSM	639	MDR-L2332PSM	633
	41"	1041	2.6	DR-S2341PSM	520	DR-L2341PSM	507	MDR-S2341PSM	698	MDR-L2341PSM	687
	50"	1270	3.1	DR-S2350PSM	566	DR-L2350PSM	553	MDR-S2350PSM	758	MDR-L2350PSM	742

## LIFESTOR® Utility Carts

see spec sheet **EG01.41**

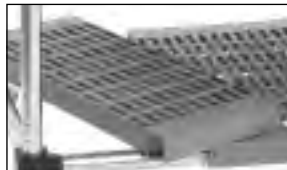

**Allows for removal or adjustment of shelves without disassembling entire cart.**

- Green polymer shelving sections are non-corrosive, dishwasher-safe.
- Easy to assemble in minutes—only one person required.
- All units feature three tiers.
- Heavy duty 5" (127mm) diameter swivel casters with rotary bumper, two with brake.

**FEATURES:**

**Freight class is 70.0.**

### Featuring MICROGARD®

an antimicrobial agent which contains built-in protection to retard the growth of a broad range of bacteria, mold and mildew on shelf surface that causes stains, odors and degradation.

**Standard on all LIFESTOR® Shelving.**

	Stainless Steel Finish						EAGLEbrite® Zinc Finish			
	shelf size		w/ solid shelves		w/ louvered shelves		w/ solid shelves		w/ louvered shelves	
	in.	mm	model #	list	model #	list	model #	list	model #	list
<b>18" width</b> (457mm)	36"	914	U3-S1836PSM	1164	U3-L1836PSM	1143	U3-S1836PZM	920	U3-L1836PZM	898
	48"	1219	U3-S1848PSM	1289	U3-L1848PSM	1259	U3-S1848PZM	1099	U3-L1848PZM	1006
<b>23" width</b> (584mm)	36"	914	U3-S2336PSM	1283	U3-L2336PSM	1229	U3-S2336PZM	1006	U3-L2336PZM	954
	48"	1219	U3-S2348PSM	1453	U3-L2348PSM	1378	U3-S2348PZM	1143	U3-L2348PZM	1066

## Catalog Section 1

### Floor-Trak® Storage System designed for LIFESTOR® Polymer Shelving

see spec sheet **EG01.40**



Floor-Trak® unit shown assembled with LIFESTOR® starter unit

- Non-corrosive tracks constructed of anodized aluminum.
- System is ADA-compliant.
- Simple and easy to install.
- Easy to add on additional tracks and units.
- Open construction allows for the use of cart covers when required.
- Industrial-type, hardened steel bearings allow loaded units to glide effortlessly over the track.
- Single-deep only.

#### FEATURES:

**Note:** LIFESTOR® shelves and posts sold separately (see pages 76 & 77—not for use with LIFESTOR® starter units).

Unit will tilt if not loaded properly.  
**LOAD BOTTOM FIRST!**

**Freight class is 70.0.**

#### Featuring MICROGARD®

an antimicrobial agent which contains built-in protection to retard the growth of a broad range of bacteria, mold and mildew on shelf surface that causes stains, odors and degradation.

**Standard on all LIFESTOR® Shelving.**

#### Floor-Trak® Kits

- A pair of aluminum tracks with end stops.
- All hardware and assembly instructions included.

**Note:** Not recommended to piece tracks together. Order length needed. Custom lengths available. Consult factory.

width		weight		cu	model #	list
ft.	mm	lbs.	kg			
6'	1829	5	2.3	0.06	<b>SDFT-6</b>	581
7'	2134	5	2.3	0.07	<b>SDFT-7</b>	659
8'	2438	6	2.7	0.08	<b>SDFT-8</b>	736
9'	2743	7	3.2	0.09	<b>SDFT-9</b>	815
10'	3048	8	3.6	0.10	<b>SDFT-10</b>	892
11'	3353	8	3.6	0.11	<b>SDFT-11</b>	968
12'	3658	9	4.1	0.12	<b>SDFT-12</b>	1046
13'	3962	10	4.5	0.13	<b>SDFT-13</b>	1125
14'	4267	11	5.0	0.14	<b>SDFT-14</b>	1203
15'	4572	11	5.0	0.15	<b>SDFT-15</b>	1280
16'	4877	12	5.4	0.16	<b>SDFT-16</b>	1360
17'	5181	13	5.8	0.17	<b>SDFT-17</b>	1437
18'	5486	14	6.4	0.18	<b>SDFT-18</b>	1515
19'	5791	14	6.4	0.19	<b>SDFT-19</b>	1591
20'	6096	15	6.8	0.20	<b>SDFT-20</b>	1671
21'	6401	16	7.3	0.21	<b>SDFT-21</b>	1748

#### Skate Kits

- Two skates and all necessary parts and hardware.
- Skates are aircraft-quality aluminum with stainless steel inserts and hardened steel ball bearings.
- One kit is required for each mobile unit.

**Note:** Skate kits require the use of one of the post kits listed in chart below.

width		weight		cu	model #	list
in.	mm	lbs.	kg			
18"	457	6	2.7	0.09	<b>LSDSK-18</b>	592
23"	584	7	3.2	0.23	<b>LSDSK-23</b>	637

#### Post Kits for use with Floor-Trak® Skate Kits

- Required for use with Skate Kits.
- Each kit includes four 16 gauge type 304 posts and hardware.

post height		weight		stainless steel	
in.	mm	lbs.	kg	model #	list
63"	1600	17	7.7	<b>TLEP63-S</b>	512
74"	1880	20	9.0	<b>TLEP74-S</b>	537

#### Bumper Brackets for Floor-Trak® Skate Kits...

Stainless steel. Set of four.

model #	list
<b>SDSKATB-S</b>	200

#### ...sold individually

Hardware included.

model #	list
<b>SKATB-S</b>	67



#### Optional Shim Kits

Accommodates uneven floors.

model #	list
<b>912991</b>	153

#### Optional Foot Brake Kit

Mounts onto frontmost skate.

model #	list
<b>MFBK-S</b>	96



100 Industrial Boulevard, Clayton, DE 19938-8903 U.S.A.  
Phone: 800-637-5100 or 302-653-3000. Fax: 302-653-2065  
<http://www.eaglegrp.com>

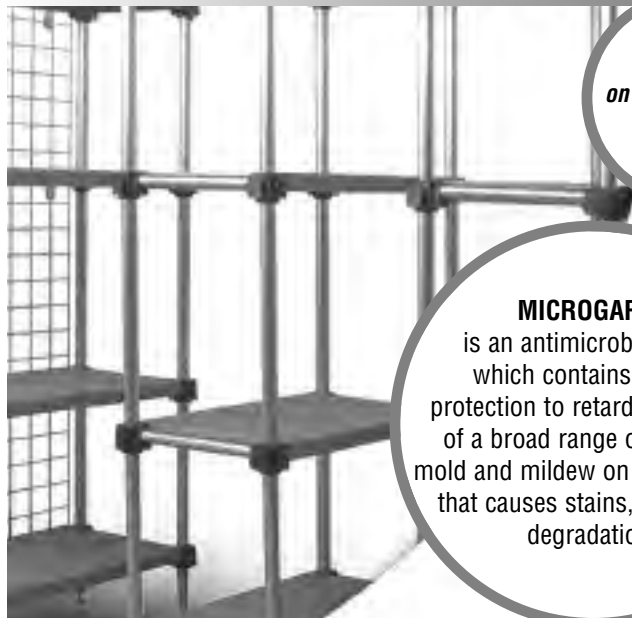

Standard on all LIFESTOR® Shelving.

**MICROGARD®** is an antimicrobial agent which contains built-in protection to retard the growth of a broad range of bacteria, mold and mildew on shelf surface that causes stains, odors and degradation.

**Features:**

- Removable shelf mats are dishwasher-safe for sanitation.
- Quick and easy assembly.
- All units include hardware necessary for connecting units to overhead track.
- Optional ledges, dividers and enclosure panels available. See pages 78 and 79.
- Posts on all units are 74" (1880mm) and grooved in 1" (25mm) increments. Shelves sold separately (see page 76).
- Recommended aisle widths are 30" - 36" (762 - 914mm). However, larger items stored within the system may require an aisle width over 36" (914mm)

Freight class is 70.0.

## LIFESTOR® Master Trak®

### Overhead Track Polymer Storage System NSF

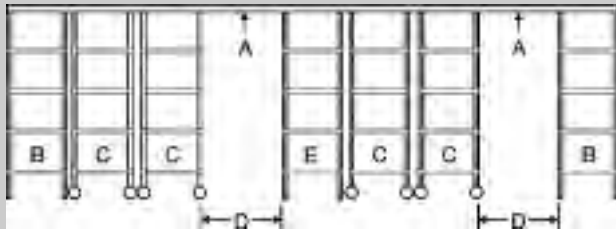

**Components**

Shelves sold separately (see page 76).

- A** front & rear overhead tracks
- B** stationary end units
- C** mobile units
- D** open aisle—30" to 36" (762 to 914mm) is recommended
- E** stationary mid unit (optional—use same model # as stationary end unit kit)

## Stationary Units NSF

see spec sheet **EG01.30**

- Positioned on each end, and also serve as a mid unit.
- The width of the end-stationary units and mid-stationary units should be the same or bigger than the width of the mobile units.
- Stationary units must be bolted to the floor.
- A maximum of three mobile units and 36" (914mm) aisle space is allowed before a mid unit is necessary.
- Four 16 gauge type 304 posts, stainless steel footplates, and hardware.

**Note:** End-stationary units and mid-stationary units must have a minimum of four shelves.

post height		weight		stainless steel	
in.	mm	lbs.	kg	model #	list
74"	1880	17	7.7	LEP74-S	697

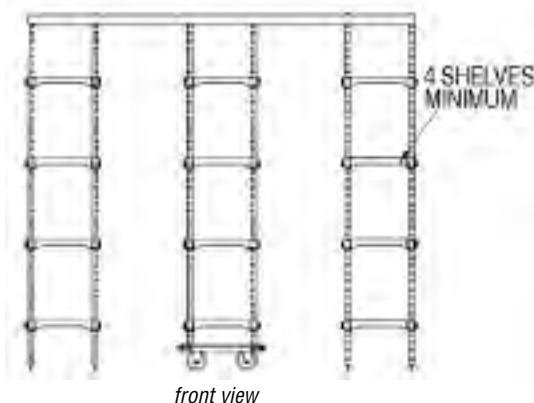

Freight class is 50.0.



## Catalog Section 1

### Mobile Unit Kits

see spec sheet **EG01.30**

- One 14 gauge stainless steel dolly frame.
- Four 5" (127mm) rigid poly casters
- Four 1" (25mm) thick gray PVC corner bumpers.
- Four 16 gauge type 304 stainless steel posts.
- Hardware.

**Note:** Mobile units require stainless steel or zinc side braces, not polymer (see page 77).

	length*		overall dimensions		weight		model #	list	
	in.	mm	in.	mm	lbs.	kg			
<b>18"</b> *	36"	914	22" x 40"	559 x 1016	54	24.5	<b>LMUK1836-S</b>	1399	
	42"	1067	22" x 46"	559 x 1169	57	25.9	<b>LMUK1842-S</b>	1418	
	<b>width</b>	48"	1219	22" x 52"	559 x 1321	60	27.2	<b>LMUK1848-S</b>	1436
	(457mm)	54"	1372	22" x 58"	559 x 1473	62	28.1	<b>LMUK1854-S</b>	1462
	60"	1524	22" x 64"	559 x 1626	64	29.0	<b>LMUK1860-S</b>	1486	
<b>23"</b> *	36"	914	27" x 40"	686 x 1016	62	28.1	<b>LMUK2336-S</b>	1422	
	42"	1067	27" x 46"	686 x 1169	63	28.6	<b>LMUK2342-S</b>	1440	
	<b>width</b>	48"	1219	27" x 52"	686 x 1321	64	29.0	<b>LMUK2348-S</b>	1458
	(584mm)	54"	1372	27" x 58"	686 x 1473	66	29.9	<b>LMUK2354-S</b>	1480
	60"	1524	27" x 64"	686 x 1626	68	30.8	<b>LMUK2360-S</b>	1558	

\* Dimensions of dolly frame, excludes corner bumpers.

Freight class is 70.0.

#### Featuring MICROGARD®

an antimicrobial agent which contains built-in protection to retard the growth of a broad range of bacteria, mold and mildew on shelf surface that causes stains, odors and degradation.

**Standard on all LIFESTOR® Shelving.**

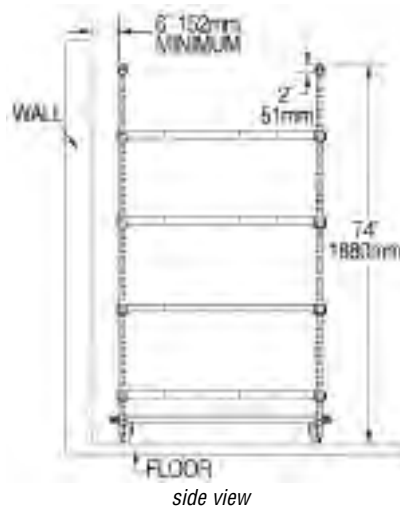

### Overhead Track Units

see spec sheet **EG01.30**

- Front and rear 2" x 2" x 1/4" (51 x 51 x 6mm) aluminum channels for lengths up to 9' (2743mm).
- Any unit 10' (3048mm) or longer will have multiple track sections.
- Each section will be joined with a 2" x 2" (51 x 51mm) 14 gauge stainless steel connector and hardware to join tracks.

length		weight		model #	list	length		weight		model #	list
ft.	mm	lbs.	kg			ft.	mm	lbs.	kg		
6'	1829	18	8.2	<b>LOHT-6</b>	262	14'	4267	42	19.1	<b>LOHT-14</b>	647
7'	2134	21	9.5	<b>LOHT-7</b>	266	15'	4572	45	20.4	<b>LOHT-15</b>	693
8'	2438	24	10.9	<b>LOHT-8</b>	279	16'	4877	48	21.8	<b>LOHT-16</b>	734
9'	2743	27	12.2	<b>LOHT-9</b>	306	17'	5181	51	23.1	<b>LOHT-17</b>	775
10'	3048	30	13.6	<b>LOHT-10</b>	335	18'	5486	54	24.5	<b>LOHT-18</b>	802
11'	3353	33	15.0	<b>LOHT-11</b>	546	19'	5791	57	25.9	<b>LOHT-19</b>	1039
12'	3658	36	16.3	<b>LOHT-12</b>	602	20'	6096	60	27.2	<b>LOHT-20</b>	1082
13'	3962	39	17.6	<b>LOHT-13</b>	625	21'	6401	63	28.6	<b>LOHT-21</b>	1128

Freight class is 70.0.

#### Featuring MICROGARD®

an antimicrobial agent which contains built-in protection to retard the growth of a broad range of bacteria, mold and mildew on shelf surface that causes stains, odors and degradation.

**Standard on all LIFESTOR® Shelving.**

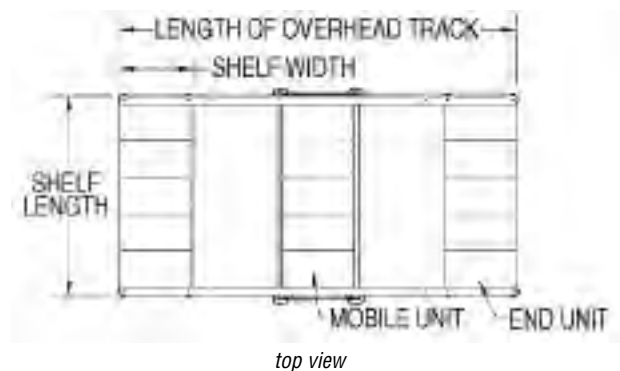



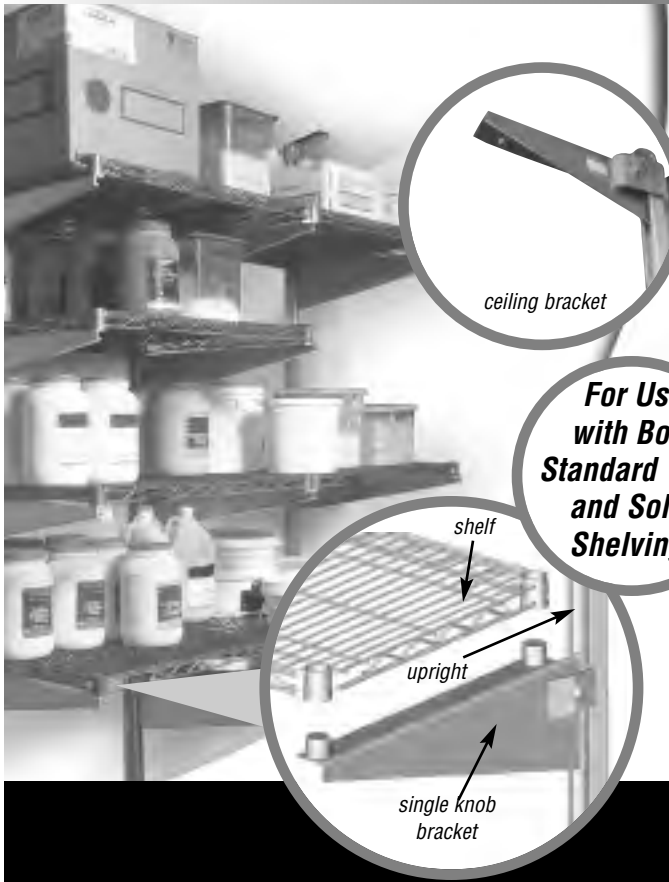

**For Use with Both Standard Wire and Solid Shelving!**

Weight Capacities					
Allowable Bracket Loading (per bracket)				Shelf Load Capacity (per shelf)	
				Shelves not included.	
bracket length		maximum load recommended		shelf description	weight capacity
in.	mm	lb.	kg		lb. kg
14"	356	540	244.9	Shelves 24" to 48" (610 to 1219mm) long	800 362.8
18"	457	465	210.9		
21"	533	395	179.2	Shelves 54" to 72" (1372 to 1829mm) long	600 272.2
24"	610	360	163.3		

**Features:**

- Requires no post supports to get in the way, making shelf loading and unloading easier.
- 100% usable shelving surface, from section to section, wall to wall, and front to back.
- Floor is unobstructed.
- Infinite height adjustability, no slots or keyholes to line up for leveling.
- Heavy-duty, rugged construction.
- Cantilever shelving components are listed on pages 84 through 88.

**Freight class is 70.0.**

## Cantilever Shelving Systems

## Standard Uprights

see spec sheet **EG01.45A**



**For wall-mounted storage.**

- 14 gauge.
- Continuously seam-welded.
- Rust and corrosion resistant.

**FEATURES:**

**Note:** Prices do not include ceiling brackets.

**Freight class is 70.0.**

		Gray Epoxy				Stainless Steel				Aluminum										
height	cu	weight		REGULAR		NSF		weight		REGULAR		NSF								
in.	mm	ft	lb.	kg	model #	list	model #	list	lb.	kg	model #	list	model #	list						
12"	305	0.02	1	0.5	MMU-1	24	MMNSU-1	27	1	0.5	MMUSS-1	82	MMNSUSS-1	86	1	0.5	MMU/A-1	24	MMNSU/A-1	27
24"	610	0.04	3	1.4	MMU-2	43	MMNSU-2	45	3	1.4	MMUSS-2	149	MMNSUSS-2	156	2	0.9	MMU/A-2	43	MMNSU/A-2	45
36"	914	0.06	4	1.8	MMU-3	69	MMNSU-3	73	4	1.8	MMUSS-3	224	MMNSUSS-3	237	2	0.9	MMU/A-3	69	MMNSU/A-3	73
48"	1219	0.08	6	2.7	MMU-4	81	MMNSU-4	86	5	2.3	MMUSS-4	299	MMNSUSS-4	313	3	1.4	MMU/A-4	81	MMNSU/A-4	86
60"	1524	0.10	7	3.2	MMU-5	102	MMNSU-5	108	7	3.2	MMUSS-5	375	MMNSUSS-5	395	4	1.8	MMU/A-5	102	MMNSU/A-5	108
72"	1829	0.13	9	4.1	MMU-6	122	MMNSU-6	132	8	3.6	MMUSS-6	447	MMNSUSS-6	465	4	1.8	MMU/A-6	122	MMNSU/A-6	132
84"	2134	0.15	10	4.5	MMU-7	144	MMNSU-7	154	9	4.1	MMUSS-7	520	MMNSUSS-7	543	5	2.3	MMU/A-7	144	MMNSU/A-7	154
96"	2438	0.17	11	5.0	MMU-8	165	MMNSU-8	179	11	5.0	MMUSS-8	593	MMNSUSS-8	622	6	2.7	MMU/A-8	165	MMNSU/A-8	179
108"	2743	0.19	13	5.8	MMU-9	186	MMNSU-9	203	12	5.4	MMUSS-9	665	MMNSUSS-9	699	7	3.2	MMU/A-9	186	MMNSU/A-9	203
120"	3048	0.21	14	6.4	MMU-10	208	MMNSU-10	224	13	5.8	MMUSS-10	738	MMNSUSS-10	777	7	3.2	MMU/A-10	208	MMNSU/A-10	224
144"	3658	0.23	17	7.7	MMU-12	256	MMNSU-12	276	16	7.3	MMUSS-12	887	MMNSUSS-12	933	9	4.1	MMU/A-12	256	MMNSU/A-12	276
156"	3962	0.25	20	9.0	MMU-14	300	n/a	n/a	-	-	n/a	n/a	n/a	n/a	10	4.5	MMU/A-14	300	MMNSU/A-14	321
168"	4267	0.30	23	10.4	MMU-16	341	n/a	n/a	-	-	n/a	n/a	n/a	n/a	12	5.4	MMU/A-16	341	MMNSU/A-16	367



## Catalog Section 1

### Back-To-Back Uprights — Floor-To-Ceiling

see spec sheet **EG01.45A**

FEATURES:

- Attaches to floor and ceiling.
- Two uprights are bolted or welded back-to-back.

Note: Prices do not include ceiling brackets.



For center room storage.

Freight class is 70.0.

		Gray Epoxy				Stainless Steel				Aluminum								
height in.	cu mm	weight ft	REGULAR		NSF		weight lb.	kg	REGULAR		NSF		weight lb.	kg	REGULAR			
			model #	list	model #	list			model #	list	model #	list			model #	list		
48"	1219	0.29	11	5.0	MMBB/FC-4	178	MMNSBB/FC-4	194	11	5.0	MMBSS/FC-4	595	MMNSBSS/FC-4	682	11	5.0	MMBB/FC/A-4	178
60"	1524	0.37	14	6.4	MMBB/FC-5	222	MMNSBB/FC-5	239	24	10.9	MMBSS/FC-5	747	MMNSBSS/FC-5	858	14	6.4	MMBB/FC/A-5	222
72"	1829	0.44	17	7.7	MMBB/FC-6	267	MMNSBB/FC-6	288	28	12.7	MMBSS/FC-6	887	MMNSBSS/FC-6	1021	17	7.7	MMBB/FC/A-6	267
84"	2134	0.51	20	9.0	MMBB/FC-7	314	MMNSBB/FC-7	340	33	15.0	MMBSS/FC-7	1036	MMNSBSS/FC-7	1192	20	9.0	MMBB/FC/A-7	314
96"	2438	0.59	23	10.4	MMBB/FC-8	361	MMNSBB/FC-8	392	38	17.2	MMBSS/FC-8	1181	MMNSBSS/FC-8	1358	23	10.4	MMBB/FC/A-8	361
108"	2743	0.66	26	11.8	MMBB/FC-9	407	MMNSBB/FC-9	441	42	19.1	MMBSS/FC-9	1329	MMNSBSS/FC-9	1527	26	11.8	MMBB/FC/A-9	407
120"	3048	0.73	29	13.2	MMBB/FC-10	563	MMNSBB/FC-10	492	47	21.3	MMBSS/FC-10	1477	MMNSBSS/FC-10	1698	29	13.2	MMBB/FC/A-10	563
144"	3658	0.88	34	15.4	MMBB/FC-12	580	MMNSBB/FC-12	608	57	25.9	MMBSS/FC-12	1774	MMNSBSS/FC-12	2040	34	15.4	MMBB/FC/A-12	580

### Heavy-Duty Back-To-Back Uprights — Floor-To-Ceiling

see spec sheet **EG01.45C**

FEATURES:

- Double-faced unitized uprights.
- Attaches to floor and ceiling.
- Two uprights are bolted or welded back-to-back.

Note: Prices do not include ceiling brackets.



For center room storage.

Freight class is 70.0.

		Gray Epoxy				Stainless Steel				Aluminum								
height in.	cu mm	weight ft	REGULAR		NSF		weight lb.	kg	REGULAR		NSF		weight lb.	kg	REGULAR			
			model #	list	model #	list			model #	list	model #	list			model #	list		
48"	1219	0.29	20	9.0	MMBB-4	306	MMNSBB-4	347	11	5.0	MMBSS-4	708	MMNSBSS-4	813	14	6.4	MMBB/A-4	311
60"	1524	0.37	25	11.3	MMBB-5	361	MMNSBB-5	417	24	10.9	MMBSS-5	891	MMNSBSS-5	1024	17	7.7	MMBB/A-5	352
72"	1829	0.44	30	13.6	MMBB-6	434	MMNSBB-6	498	28	12.7	MMBSS-6	1074	MMNSBSS-6	1233	21	9.5	MMBB/A-6	420
84"	2134	0.51	35	15.9	MMBB-7	506	MMNSBB-7	581	33	15.0	MMBSS-7	1253	MMNSBSS-7	1435	24	10.9	MMBB/A-7	494
96"	2438	0.59	40	18.1	MMBB-8	581	MMNSBB-8	663	38	17.2	MMBSS-8	1431	MMNSBSS-8	1640	28	12.7	MMBB/A-8	562
108"	2743	0.66	45	20.4	MMBB-9	654	MMNSBB-9	744	42	19.1	MMBSS-9	1608	MMNSBSS-9	1846	31	14.1	MMBB/A-9	635
120"	3048	0.73	50	22.7	MMBB-10	726	MMNSBB-10	832	47	21.3	MMBSS-10	1786	MMNSBSS-10	2052	34	15.4	MMBB/A-10	703
144"	3658	0.88	60	27.2	MMBB-12	868	MMNSBB-12	996	57	25.9	MMBSS-12	2153	MMNSBSS-12	2458	41	18.6	MMBB/A-12	845

### Ceiling Brackets for Standard and Back-To-Back Uprights

see spec sheet **EG01.45B**

Note: Required for all installations.

Freight class is 70.0.



		Gray Epoxy				Stainless Steel				Aluminum			
description	REGULAR		NSF		REGULAR		NSF		REGULAR		NSF		
	model #	list	model #	list	model #	list	model #	list	model #	list	model #	list	
left	MMCB-6-L	22	MMNSCB-6-L	22	MMCBSS-6-L	54	MMNSCBSS-6-L	56	MMCB/A6-L	35	MMNSCB/A6-L	35	
right	MMCB-6-R	22	MMNSCB-6-R	22	MMCBSS-6-R	54	MMNSCBSS-6-R	56	MMCB/A6-R	35	MMNSCB/A6-R	35	



### Heavy Duty Crossbraces

see spec sheet **EG01.45C**

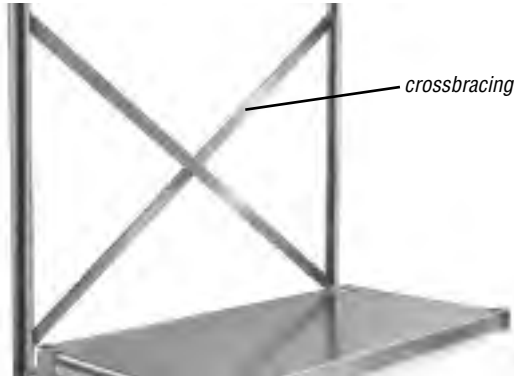

- Adds to stability of unit.
- 1" (25mm) wide 7-gauge steel.

FEATURES:

Freight class is 70.0.

fits shelf length		crossbrace length		Gray Epoxy				Nickel			
in.	mm	in.	mm	weight lb.	weight kg	model #	list	weight lb.	weight kg	model #	list
36"	914	48"	1219	2	0.9	<b>MMXB-48</b>	23	2	0.9	<b>MMXB-N-48</b>	60
48"	1219	60"	1524	3	1.4	<b>MMXB-60</b>	27	3	1.4	<b>MMXB-N-60</b>	73
60"	1524	72"	1829	4	1.8	<b>MMXB-72</b>	32	4	1.8	<b>MMXB-N-72</b>	86
72"	1829	84"	2134	5	2.3	<b>MMXB-84</b>	37	5	2.3	<b>MMXB-N-84</b>	101

### Single Knob Brackets

see spec sheet **EG01.45B**



- With flange on top left or right, these brackets support single shelf or end of shelf run.

FEATURES:

Freight class is 70.0.

#### Left Single Knob Brackets

Gray Epoxy				Stainless Steel				Aluminum					
length in.	cu in.	weight lb.	weight kg	REGULAR model #	NSF model #	weight lb.	weight kg	REGULAR model #	NSF model #	weight lb.	weight kg	REGULAR model #	NSF model #
14"	356	0.09	2 0.9	<b>MMB-K-14-L</b> 60	<b>MMNSB-K-14-L</b> 66	2	0.9	<b>MMBSS-K-14-L</b> 129	<b>MMNSBSS-K-14-L</b> 140	1	0.5	<b>MMB-K/A-14-L</b> 69	<b>MMNSB-K/A-14-L</b> 74
18"	457	0.12	3 1.4	<b>MMB-K-18-L</b> 74	<b>MMNSB-K-18-L</b> 81	2	0.9	<b>MMBSS-K-18-L</b> 180	<b>MMNSBSS-K-18-L</b> 187	1	0.5	<b>MMB-K/A-18-L</b> 78	<b>MMNSB-K/A-18-L</b> 85
21"	533	0.15	3 1.4	<b>MMB-K-21-L</b> 82	<b>MMNSB-K-21-L</b> 93	3	1.4	<b>MMBSS-K-21-L</b> 215	<b>MMNSBSS-K-21-L</b> 226	1	0.5	<b>MMB-K/A-21-L</b> 86	<b>MMNSB-K/A-21-L</b> 97
24"	610	0.17	3 1.4	<b>MMB-K-24-L</b> 93	<b>MMNSB-K-24-L</b> 100	3	1.4	<b>MMBSS-K-24-L</b> 233	<b>MMNSBSS-K-24-L</b> 243	2	0.9	<b>MMB-K/A-24-L</b> 100	<b>MMNSB-K/A-24-L</b> 108

#### Right Single Knob Brackets

Gray Epoxy				Stainless Steel				Aluminum					
length in.	cu in.	weight lb.	weight kg	REGULAR model #	NSF model #	weight lb.	weight kg	REGULAR model #	NSF model #	weight lb.	weight kg	REGULAR model #	NSF model #
14"	356	0.09	2 0.9	<b>MMB-K-14-R</b> 60	<b>MMNSB-K-14-R</b> 66	2	0.9	<b>MMBSS-K-14-R</b> 129	<b>MMNSBSS-K-14-R</b> 140	1	0.5	<b>MMB-K/A-14-R</b> 69	<b>MMNSB-K/A-14-R</b> 74
18"	457	0.12	3 1.4	<b>MMB-K-18-R</b> 74	<b>MMNSB-K-18-R</b> 81	2	0.9	<b>MMBSS-K-18-R</b> 180	<b>MMNSBSS-K-18-R</b> 187	1	0.5	<b>MMB-K/A-18-R</b> 78	<b>MMNSB-K/A-18-R</b> 85
21"	533	0.15	3 1.4	<b>MMB-K-21-R</b> 82	<b>MMNSB-K-21-R</b> 93	3	1.4	<b>MMBSS-K-21-R</b> 215	<b>MMNSBSS-K-21-R</b> 226	1	0.5	<b>MMB-K/A-21-R</b> 86	<b>MMNSB-K/A-21-R</b> 97
24"	610	0.17	3 1.4	<b>MMB-K-24-R</b> 93	<b>MMNSB-K-24-R</b> 100	3	1.4	<b>MMBSS-K-24-R</b> 233	<b>MMNSBSS-K-24-R</b> 243	2	0.9	<b>MMB-K/A-24-R</b> 100	<b>MMNSB-K/A-24-R</b> 108

### Double Knob Brackets

see spec sheet **EG01.45B**



**For use with wire or solid shelving**

- With flanges on top left and right, these brackets support two adjoining wire or solid shelves on a common upright.

FEATURES:

Freight class is 70.0.

Gray Epoxy				Stainless Steel				Aluminum					
length in.	cu in.	weight lb.	weight kg	REGULAR model #	NSF model #	weight lb.	weight kg	REGULAR model #	NSF model #	weight lb.	weight kg	REGULAR model #	NSF model #
14"	356	0.19	3 1.4	<b>MMDB-K-14</b> 104	<b>MMNSDB-K-14</b> 103	3	1.4	<b>MMDBSS-K-14</b> 180	<b>MMNSDBSS-K-14</b> 195	1	0.5	<b>MMDB-K/A-14</b> 103	<b>MMNSDB-K/A-14</b> 114
18"	457	0.25	4 1.8	<b>MMDB-K-18</b> 122	<b>MMNSDB-K-18</b> 135	3	1.4	<b>MMDBSS-K-18</b> 258	<b>MMNSDBSS-K-18</b> 273	2	0.9	<b>MMDB-K/A-18</b> 135	<b>MMNSDB-K/A-18</b> 147
21"	533	0.29	4 1.8	<b>MMDB-K-21</b> 135	<b>MMNSDB-K-21</b> 149	4	1.8	<b>MMDBSS-K-21</b> 308	<b>MMNSDBSS-K-21</b> 325	2	0.9	<b>MMDB-K/A-21</b> 144	<b>MMNSDB-K/A-21</b> 159
24"	610	0.33	5 2.3	<b>MMDB-K-24</b> 139	<b>MMNSDB-K-24</b> 153	4	1.8	<b>MMDBSS-K-24</b> 336	<b>MMNSDBSS-K-24</b> 346	2	0.9	<b>MMDB-K/A-24</b> 152	<b>MMNSDB-K/A-24</b> 168

## Catalog Section 1

### Optional Single Foot Brackets with Knobs

see spec sheet **EG01.45B**



*For use with wire  
and solid shelving*

- Serves as a base for bottom shelf.
- Left brackets and right brackets available.
- 9 7/8" (238mm) height.

FEATURES:

**Freight class is 70.0.**

### Left Single Foot Brackets with Knobs

		Gray Epoxy						Stainless Steel						
length		cu	weight		REGULAR		NSF		weight		REGULAR		NSF	
in.	mm	ft	lb.	kg	model #	list	model #	list	lb.	kg	model #	list	model #	list
14"	356	0.13	4	1.8	MMFB-K-14-L	101	MMNSFB-K-14-L	109	4	1.8	MMFBSSK-149-L	297	MMNSFBSSK-149-L	341
18"	457	0.17	5	2.3	MMFB-K-18-L	121	MMNSFB-K-18-L	133	6	2.7	MMFBSSK-189-L	393	MMNSFBSSK-189-L	449
21"	533	0.19	6	2.7	MMFB-K-21-L	137	MMNSFB-K-21-L	152	-	-	n/a	n/a	n/a	n/a
24"	610	0.21	6	2.7	MMFB-K-24-L	149	MMNSFB-K-24-L	165	7	3.2	MMFBSSK-249-L	506	MMNSFBSSK-249-L	580

### Right Single Foot Brackets with Knobs

		Gray Epoxy						Stainless Steel						
length		cu	weight		REGULAR		NSF		weight		REGULAR		NSF	
in.	mm	ft	lb.	kg	model #	list	model #	list	lb.	kg	model #	list	model #	list
14"	356	0.13	4	1.8	MMFB-K-14-R	101	MMNSFB-K-14-R	109	4	1.8	MMFBSSK-149-R	297	MMNSFBSSK-149-R	341
18"	457	0.17	5	2.3	MMFB-K-18-R	121	MMNSFB-K-18-R	133	6	2.7	MMFBSSK-189-R	393	MMNSFBSSK-189-R	449
21"	533	0.19	6	2.7	MMFB-K-21-R	137	MMNSFB-K-21-R	152	-	-	n/a	n/a	n/a	n/a
24"	610	0.21	6	2.7	MMFB-K-24-R	149	MMNSFB-K-24-R	165	7	3.2	MMFBSSK-249-R	506	MMNSFBSSK-249-R	580

### Optional Double Foot Brackets with Knobs

see spec sheet **EG01.45B**



- For use with wire or solid shelving.
- Serves as a base for adjoining two bottom shelves.
- 9 7/8" (238mm) height.

FEATURES:

**Freight class is 70.0.**

		Gray Epoxy						Stainless Steel						
length		cu	weight		REGULAR		NSF		weight		REGULAR		NSF	
in.	mm	ft	lb.	kg	model #	list	model #	list	lb.	kg	model #	list	model #	list
14"	356	0.26	4	1.8	MMDFB-K-14	164	MMNSDFB-K-14	180	5	2.3	MMDFBSSK-149	340	MMNSDFBSSK-149	392
18"	457	0.33	5	2.3	MMDFB-K-18	212	MMNSDFB-K-18	235	7	3.2	MMDFBSSK-189	433	MMNSDFBSSK-189	500
21"	533	0.39	6	2.7	MMDFB-K-21	234	MMNSDFB-K-21	256	-	-	n/a	n/a	n/a	n/a
24"	610	0.42	7	3.2	MMDFB-K-24	241	MMNSDFB-K-24	266	8	3.6	MMDFBSSK-249	577	MMNSDFBSSK-249	665

### Heavy Duty Single Knob "C" Brackets

see spec sheet **EG01.45C**

- For dynamic loads.
- For use with wire or solid shelving.

FEATURES:

**Freight class is 70.0.**



#### Left Single Knob Brackets

		Gray Epoxy				Stainless Steel				Aluminum				
		weight		REGULAR		NSF		weight		REGULAR		NSF		
length	cu	lb.	kg	model #	list	model #	list	lb.	kg	model #	list	model #	list	
in.	mm	ft												
18"	457	0.12	3	1.4	MMBC-K-18-L 64	MMNSBC-K-18-L 69	2	0.9	MMBCSS-K-18-L 118	MMNSBCSS-K-18-L 124	1	0.5	MMBC-K/A-18-L 60	MMNSBC-K/A-18-L 64
21"	533	0.15	3	1.4	MMBC-K-21-L 73	MMNSBC-K-21-L 78	3	1.4	MMBCSS-K-21-L 146	MMNSBCSS-K-21-L 160	1	0.5	MMBC-K/A-21-L 69	MMNSBC-K/A-21-L 73
24"	610	0.17	3	1.4	MMBC-K-24-L 82	MMNSBC-K-24-L 86	3	1.4	MMBCSS-K-24-L 174	MMNSBCSS-K-24-L 187	2	0.9	MMBC-K/A-24-L 73	MMNSBC-K/A-24-L 78

#### Right Single Knob Brackets

		Gray Epoxy				Stainless Steel				Aluminum				
		weight		REGULAR		NSF		weight		REGULAR		NSF		
length	cu	lb.	kg	model #	list	model #	list	lb.	kg	model #	list	model #	list	
in.	mm	ft												
18"	457	0.12	3	1.4	MMBC-K-18-R 64	MMNSBC-K-18-R 69	2	0.9	MMBCSS-K-18-R 118	MMNSBCSS-K-18-R 124	1	0.5	MMBC-K/A-18-R 60	MMNSBC-K/A-18-R 64
21"	533	0.15	3	1.4	MMBC-K-21-R 73	MMNSBC-K-21-R 78	3	1.4	MMBCSS-K-21-R 146	MMNSBCSS-K-21-R 160	1	0.5	MMBC-K/A-21-R 69	MMNSBC-K/A-21-R 73
24"	610	0.17	3	1.4	MMBC-K-24-R 82	MMNSBC-K-24-R 86	3	1.4	MMBCSS-K-24-R 174	MMNSBCSS-K-24-R 187	2	0.9	MMBC-K/A-24-R 73	MMNSBC-K/A-24-R 78

### Heavy Duty Double Knob "C" Brackets

see spec sheet **EG01.45C**

- For dynamic loads.
- With flanges on top left and right, these brackets support two adjoining wire or solid shelves on a common upright.

FEATURES:

**Freight class is 70.0.**



		Gray Epoxy				Stainless Steel				Aluminum				
		weight		REGULAR		NSF		weight		REGULAR		NSF		
length	cu	lb.	kg	model #	list	model #	list	lb.	kg	model #	list	model #	list	
in.	mm	ft												
18"	457	0.25	4	1.8	MMDBC-K-18 99	MMNSDBC-K-18 108	3	1.4	MMDBCSS-K-18 169	MMNSDBCSS-K-18 178	2	0.9	MMDBC-K/A-18 91	MMNSDBC-K/A-18 99
21"	533	0.29	4	1.8	MMDBC-K-21 112	MMNSDBC-K-21 122	4	1.8	MMDBCSS-K-21 195	MMNSDBCSS-K-21 208	2	0.9	MMDBC-K/A-21 104	MMNSDBC-K/A-21 108
24"	610	0.33	5	2.3	MMDBC-K-24 118	MMNSDBC-K-24 126	4	1.8	MMDBCSS-K-24 218	MMNSDBCSS-K-24 234	2	0.9	MMDBC-K/A-24 112	MMNSDBC-K/A-24 112



Two columns of horizontal lines for taking notes.





# Wall Shelves

## Adjustable Post Wire Wall Mounts

Sold as Components.....	99
Sold as Prepackaged Units.....	98

## Snap-n-Slide®

Wall Shelves.....	94
Wire Wall Shelves.....	95

## Wall Shelves

Piggyback Wall Mounted Shelf Kits.....	96
Shelves with Removable Hooks.....	97
Single Bar Pot Racks.....	97
Stationary Wire Wall Mounts.....	99

Tab Lock Shelves.....	95
Wall Mounted Shelves.....	96
Equipment Shelves with Cord Cutout.....	98
Wire Wall Shelf Kits.....	95

## WALSTOR® Modular Wall System.....92

## WALSTOR® Modular Wall System Accessories.....93

# WALSTOR® Modular Wall System

**Convert wasted wall space into a productive and organized work area.**

### Imagine the possibilities!

- Maximize space.
- Keep every thing within easy reach, without taking up valuable floor space.
- Organize room effectively and efficiently with total flexibility.
- Sway-resistant design locks individual shelves firmly into place uneven loads safely on the system.
- Positioned anywhere on a wall, regardless of stud position.

**To learn more about WalStor®, see pages 92 and 93.**

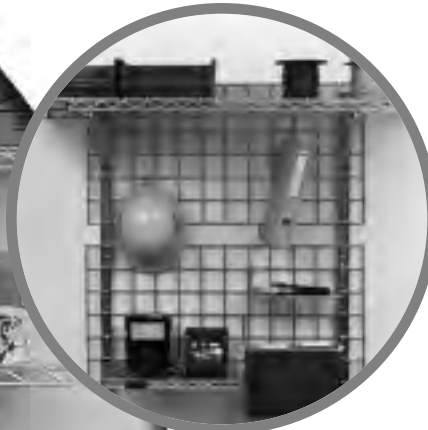

Single Shelf Kit



Double Shelf Kit  
(with extra shelves)



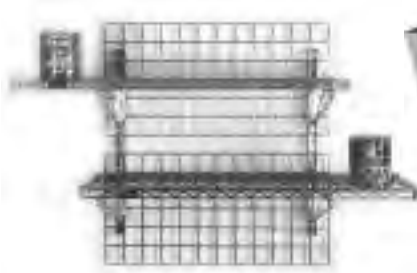

**WalStor® system  
shown demonstrating  
an uneven load capability.**

## Modular Wall System

see spec sheet **EG02.00A**

### Wall Mats

- 3" x 3" (76 x 76mm) zinc-plated grids.
- Required only for hanging accessories.

	length		weight		cubic feet	model #	list
	height in.	mm	lbs.	kg			
<b>18" (457mm)</b>	36"	914	9	4.1	0.2	<b>WM1836</b> •	82
	48"	1219	11	5.0	0.3	<b>WM1848</b> •	107
	60"	1524	14	6.4	0.3	<b>WM1860</b>	124
<b>24" (609mm)</b>	48"	1219	13	5.8	0.3	<b>WM2448</b> •	125
	72"	1828	19	8.6	0.5	<b>WM2472</b>	144
	84"	2133	22	9.9	0.6	<b>WM2484</b>	173
	96"	2438	25	11.3	0.7	<b>WM2496</b>	182
<b>33" (838mm)</b>	54"	1372	22	9.9	0.5	<b>WM3354</b>	211
<b>48" (1219mm)</b>	48"	1219	19	8.6	0.7	<b>WM4848</b>	204

### Vertical Wall Uprights

- Zinc-plated finish.
- Sold in pairs.

height in.	mm	weight		cu ft	model #	list
		lbs.	kg			
12"	305	2	0.9	0.2	<b>PR12VU</b> •	47
30"	762	4	1.8	0.4	<b>PR30VU</b> •	78
45"	1143	5	2.3	0.5	<b>PR45VU</b> •	97



wall mats and vertical wall uprights

### Wire Shelf Brackets

- Zinc-plated finish.
- Sold in pairs.

(Note: Must be ordered with Vertical Wall Uprights)

depth in.	mm	weight		cubic feet	model #	list
		lbs.	kg			
14"	356	3	1.5	0.1	<b>PR14B</b> •	105
18"	457	4	2.0	0.1	<b>PR18B</b> •	113
21"	533	4	2.0	0.1	<b>PR21B</b>	117
24"	610	5	2.0	0.1	<b>PR24B</b>	151



**Note:** WalStor® must be mounted to a solid surface or studs in a wall. User needs to determine installation materials and methods suitable to hold and support the WalStor® system.

**Freight class is 70.0.**

(•) MTS (made to stock) / ( ) MTO (made to order)

### Single Shelf Kits

- One EAGLEbrite® shelf.
- One wall mat.
- One pair of 30" (762mm) vertical wall uprights.
- One pair of 18" (457mm) wire shelf brackets.



	shelf and wall mat size		weight		cu ft	model #	list
	in.	mm	lbs.	kg			
<b>18" width (457mm)</b>	36"	914	35	15.9	3.5	<b>WAL-1-1836</b>	345
	48"	1219	36	16.3	4.5	<b>WAL-1-1848</b>	382

### Double Shelf Kits

- Two EAGLEbrite® shelves.
- Two wall mats.
- One pair of 45" (1143mm) vertical wall uprights.
- Two pairs of 18" (457mm) wire shelf brackets.

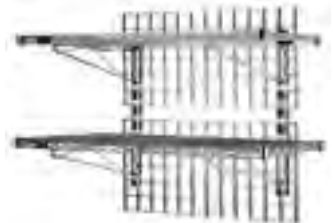

	shelf dimensions		weight		cubic feet	model #	list
	in.	mm	lbs.	kg			
<b>18" width (457mm)</b>	36"	914	41	18.6	2.0	<b>WAL-2-1836</b>	632
	48"	1219	49	22.2	2.4	<b>WAL-2-1848</b>	705

### Wall Grid Shelving - see spec sheet **EG02.00C**

width x length		weight		cubic feet	chrome		Valu-Gard®		EAGLEbrite®	
in.	mm	lbs.	kg		model #	list	model #	list	model #	list
14" x 30"	356 x 762	7	3.2	3.1	<b>1430WGS-C</b>	117	<b>1430WGS-VG</b>	121	<b>1430WGS-Z</b>	108
14" x 36"	356 x 914	9	4.1	3.6	<b>1436WGS-C</b>	122	<b>1436WGS-VG</b>	126	<b>1436WGS-Z</b>	114
18" x 30"	457 x 762	9	4.1	3.7	<b>1830WGS-C</b>	125	<b>1830WGS-VG</b>	129	<b>1830WGS-Z</b>	117
18" x 36"	457 x 914	12	5.4	4.5	<b>1836WGS-C</b>	131	<b>1836WGS-VG</b>	135	<b>1836WGS-Z</b>	120
18" x 48"	457 x 1219	15	6.8	6.0	<b>1848WGS-C</b>	151	<b>1848WGS-VG</b> •	155	<b>1848WGS-Z</b>	139

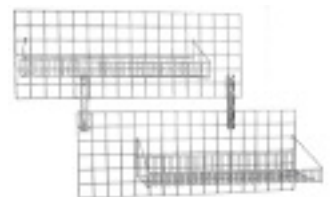

## Catalog Section 2



Custom configurations allow you to personalize your WalStor® system for merchandise displays or over-the-workstation storage. Engineered with the idea that a perfect storage system adapts easily to individual requirements.

### Modular Wall System Accessories

see spec sheet **EG02.00B**

Freight class is 70.0.

(•) MTS (made to stock) / ( ) MTO (made to order)



WalStor® system with optional accessories shown

**shelf collar plugs** ▶  
Model #: **COLLAR PLUG**  
(4 per shelf required)



**utensil rack** ▶

Model #: **SCOOP10-VG**. List: \$57  
5" depth x 10-1/2" length (127 x 267mm),  
2 lbs., 0.5 cu. ft. ValuGuard® epoxy finish.



**small\*\*  
snap  
hook** ▶



**large\*\*  
snap  
hook** ▶



**utensil\*\*  
hook** ▶



**large\*\*  
double  
hook** ▶



**book  
holder** ▶



**light duty  
utility  
shelf** ▶



**grid  
shelf** ▶



**triangle  
shelf** ▶



**towel  
rack** ▶



**spice  
rack** ▶



**merchandising\*\*  
display hook** ▶



### Vertical uprights for display shelf

See page 68 for display shelves.  
Specify Universal Nolin (manufacturer ID #2).  
Requires a pair of DSS (display shelf standards).

**large  
bin** ▶



**small  
bin** ▶



**hanging  
file  
holder** ▶



**plastic  
bin  
holder** ▶



**grid panel  
wall bracket** ▶



**1/2-size  
pan  
holder** ▶



**drop  
basket** ▶



**wire  
basket** ▶



**grid  
panel  
basket** ▶



description	length x width x height		weight		cu ft	model #	list	description	length x width x height		weight		cu ft	model #	list
	in.	mm	lbs.	kg					in.	mm	lbs.	kg			
1/2 size pan holder	12" x 8" x 3"	305 x 203 x 76	1.0	0.5	0.2	PH3RD	52	merch. dsp hook	12" x 3"	304 x 76	0.2	0.1	0.1	MDH-12**	23
book holder	3" x 12" x 10"	76 x 305 x 254	2.0	0.9	0.2	BH-1	148	plastic bin dividers	10 1/2" x 5"	276 x 127	2.0	0.9	0.1	A204237	20
vertical uprights	2" x 8 3/4"	51 x 222	2.0	0.9	0.3	DSS	101	plastic bin holder	4" x 2"	102 x 51	0.3	0.1	0.4	PBH •	38
drop basket (for 18" wire shelf)	22" x 18" x 11"	559 x 457 x 280	3.0	1.4	0.3	DB	112	small plastic bin	10 1/2" x 5 1/2" x 5"	276 x 140 x 127	0.75	0.3	0.2	A203877 *	17
grid shelf	16 1/2" x 16 1/2"	426 x 426	4.0	1.8	0.6	GS17	146	small snap hook	1 1/4" x 4 1/4" x 3 1/2"	32 x 127 x 76	0.3	0.1	0.1	SH ** •	4
hanging file holder	12" x 8" x 3"	305 x 203 x 76	1.0	0.5	0.2	HFH	51	spice rack	14" x 2"	356 x 51	1.0	0.5	0.1	SR14	64
large double hook	2 1/4" x 4 1/4" x 3 1/2"	57 x 108 x 3	0.3	0.1	0.1	LDH** •	9	spice rack	24" x 2"	610 x 51	1.5	0.7	0.2	SR24	68
large plastic bin	10 1/2" x 11" x 5"	276 x 280 x 127	1.0	0.5	0.3	A203879 *	23	towel rack	10 1/2" x 5" x 3.5"	267 x 127 x 76	1.0	0.5	0.3	TR10	51
large snap hook	2 1/4" x 4 1/4" x 3 1/2"	57 x 108 x 3	0.3	0.1	0.1	LH** •	7	utensil hook	2 1/2" x 2"	64 x 51	0.3	0.1	0.1	UH ** •	12
lt. duty utility shelf	11 1/2" x 8" x 3 1/2"	286 x 203 x 89	2.0	0.9	0.2	LDUS12	62	wire basket	13 3/8" x 5" x 7"	340 x 127 x 178	0.5	0.2	0.2	WB •	34
merch. dsp hook	4" x 3"	101 x 76	0.2	0.1	0.1	MDH-4**	14	2-deck can rack	8 1/2" x 13" x 14"	219 x 330 x 356	1.0	0.5	0.1	CR2D	168
merch. dsp hook	6" x 3"	152 x 76	0.2	0.1	0.1	MDH-6**	15	4-deck can rack	8 1/2" x 8 1/2" x 28 1/2"	210 x 216 x 724	3.0	1.3	1.2	CR4D	187
merch. dsp hook	8" x 3"	203 x 76	0.2	0.1	0.1	MDH-8**	20	wall bracket	3" x 4" x 4"	76 x 102 x 102	0.2	0.1	0.1	GPWB	22
merch. dsp hook	10" x 3"	254 x 76	0.2	0.1	0.1	MDH-10**	21	triangle shelf	24" x 24"	610 x 610	3.6	1.6	0.5	GPS24-C	73
								grid panel basket	15" x 24"	381 x 610	2.8	1.2	0.4	GBP15-C	81

\*A203877 requires (1) PBH. A203879 requires (2) PBH. \*\*All hooks are heavy gauge chrome-plated.



100 Industrial Boulevard, Clayton, DE 19938-8903 U.S.A.  
Phone: 800-637-5100 or 302-653-3000. Fax: 302-653-2065  
http://www.eaglegrp.com

## Snap-n-Slide® Wall Shelves

see spec sheet **EG02.01**



- Brackets can be mounted to wall studs – no wall backing required.
- 1½" (38mm) upturn on rear and ends.
- Heavy gauge stainless steel construction.
- No tools required to attach shelf to wall brackets.

FEATURES:

**Freight class is 70.0.**

(•) MTS (made to stock) / ( ) MTO (made to order)

### Optional Dividers for Snap-n-Slide® Wall Shelves

- 4" (102mm) height.

description	model #	list
for 12" (305mm) shelving	<b>358114</b>	39
for 15" (381mm) shelving	<b>358115</b>	41



### 12" (305mm) wide Snap-n-Slide® Shelves with Rolled Front Edge

length in.	mm	weight		wt. capacity*		cu ft	16 gauge type 430		16 gauge type 304		14 gauge type 304	
		lbs.	kg	lbs.	kg		model #	list	model #	list	model #	list
24"	610	12	5.4	90	40.8	0.7	<b>SWS1224-16/4</b> •	239	<b>SWS1224-16/3</b> •	287	<b>SWS1224-14/3</b>	304
36"	915	14	6.4	135	61.2	1.1	<b>SWS1236-16/4</b> •	258	<b>SWS1236-16/3</b> •	363	<b>SWS1236-14/3</b> •	388
48"	1219	17	7.7	180	81.6	1.4	<b>SWS1248-16/4</b> •	318	<b>SWS1248-16/3</b> •	402	<b>SWS1248-14/3</b> •	433
60"	1524	23	10.4	225	102.1	1.8	<b>SWS1260-16/4</b> •	338	<b>SWS1260-16/3</b> •	440	<b>SWS1260-14/3</b>	468
72"	1829	25	11.3	270	122.5	2.1	<b>SWS1272-16/4</b> •	418	<b>SWS1272-16/3</b> •	541	<b>SWS1272-14/3</b>	592

### 15" (381mm) wide Snap-n-Slide® Shelves with Rolled Front Edge

length in.	mm	weight		wt. capacity*		cu ft	16 gauge type 430		16 gauge type 304		14 gauge type 304	
		lbs.	kg	lbs.	kg		model #	list	model #	list	model #	list
24"	610	15	6.8	90	40.8	1.1	<b>SWS1524-16/4</b>	258	<b>SWS1524-16/3</b>	314	<b>SWS1524-14/3</b>	342
36"	915	17	7.7	135	61.2	1.7	<b>SWS1536-16/4</b> •	266	<b>SWS1536-16/3</b> •	374	<b>SWS1536-14/3</b>	422
48"	1219	21	9.5	180	81.6	2.2	<b>SWS1548-16/4</b> •	321	<b>SWS1548-16/3</b> •	456	<b>SWS1548-14/3</b>	514
60"	1524	28	12.7	225	102.1	2.7	<b>SWS1560-16/4</b> •	348	<b>SWS1560-16/3</b> •	500	<b>SWS1560-14/3</b>	529
72"	1829	30	13.6	270	122.5	3.3	<b>SWS1572-16/4</b>	425	<b>SWS1572-16/3</b>	623	<b>SWS1572-14/3</b>	704

### 15" (381mm) wide Snap-n-Slide® Shelves with "V" Marine Front Edge 14 gauge

length in.	mm	weight		wt. capacity*		cu ft	14 gauge type 304		14 gauge type 316	
		lbs.	kg	lbs.	kg		model #	list	model #	list
24"	610	15	6.8	90	40.8	1.1	<b>SWS1524-14/304-VMAR</b>	444	<b>SWS1524-14/316-VMAR</b>	495
36"	915	17	7.7	135	61.2	1.7	<b>SWS1536-14/304-VMAR</b>	465	<b>SWS1536-14/316-VMAR</b>	574
48"	1219	21	9.5	180	81.6	2.2	<b>SWS1548-14/304-VMAR</b>	605	<b>SWS1548-14/316-VMAR</b>	712
60"	1524	28	12.7	225	102.1	2.7	<b>SWS1560-14/304-VMAR</b>	672	<b>SWS1560-14/316-VMAR</b>	801
72"	1829	30	13.6	270	122.5	3.3	<b>SWS1572-14/304-VMAR</b>	795	<b>SWS1572-14/316-VMAR</b>	940

### 15" (381mm) wide Snap-n-Slide® Shelves with "V" Marine Front Edge 16 gauge

length in.	mm	weight		wt. capacity*		cu ft	16 gauge type 430		16 gauge type 304	
		lbs.	kg	lbs.	kg		model #	list	model #	list
24"	610	15	6.8	90	40.8	1.1	<b>SWS1524-16/430-VMAR</b>	388	<b>SWS1524-16/304-VMAR</b>	436
36"	915	17	7.7	135	61.2	1.7	<b>SWS1536-16/430-VMAR</b>	420	<b>SWS1536-16/304-VMAR</b>	485
48"	1219	21	9.5	180	81.6	2.2	<b>SWS1548-16/430-VMAR</b>	496	<b>SWS1548-16/304-VMAR</b>	580
60"	1524	28	12.7	225	102.1	2.7	<b>SWS1560-16/430-VMAR</b>	533	<b>SWS1560-16/304-VMAR</b>	636
72"	1829	30	13.6	270	122.5	3.3	<b>SWS1572-16/430-VMAR</b>	627	<b>SWS1572-16/304-VMAR</b>	746

\* Weight capacities pertain to evenly distributed weight.

## Catalog Section 2

### Snap-n-Slide® Wire Wall Shelves

see spec sheet **EG02.02**



- Wire design allows for air circulation.
- Brackets can be mounted to studs with no backing required.

**FEATURES:**

**Note:** See page 94 for solid Snap-n-Slide® Wall Shelves.

**Freight class is 70.0.**

	length		weight		weight *		cu ft	chrome		VALU-MASTER®		Valu-Gard®		EAGLEgard®	
	in.	mm	lbs.	kg	lbs.	kg		model #	list	model #	list	model #	list	model #	list
<b>12" width</b> (305mm)	24"	610	5	2.3	70	31.8	0.7	<b>SNSW1224C</b>	109	<b>SNSW1224V</b>	115	<b>SNSW1224VG</b>	115	<b>SNSW1224E</b>	128
	36"	915	7	3.2	105	47.6	1.1	<b>SNSW1236C</b>	144	<b>SNSW1236V</b>	153	<b>SNSW1236VG</b>	153	<b>SNSW1236E</b>	166
	48"	1219	9	4.1	140	63.5	1.4	<b>SNSW1248C</b>	180	<b>SNSW1248V</b>	189	<b>SNSW1248VG</b>	189	<b>SNSW1248E</b>	202
	60"	1524	11	5.0	175	79.5	1.8	<b>SNSW1260C</b>	196	<b>SNSW1260V</b>	205	<b>SNSW1260VG</b>	205	<b>SNSW1260E</b>	221
	72"	1829	14	6.4	210	95.3	2.1	<b>SNSW1272C</b>	251	<b>SNSW1272V</b>	264	<b>SNSW1272VG</b>	264	<b>SNSW1272E</b>	276

\* Weight capacity pertains to evenly distributed weight.

### Wire Wall Shelf Kits

see spec sheet **EG02.04**



- One wire shelf.
- Two stationary wire wall mounts.

**INCLUDES:**

**Freight class is 70.0.**

	length		weight		chrome		VALU-MASTER®		Valu-Gard®	
	in.	mm	lb.	kg	model #	list	model #	list	model #	list
<b>14" width</b> (356mm)	36"	914	12	5.4	<b>GWB1436C</b>	113	<b>GWB1436V</b>	115	<b>GWB1436VG</b>	115
	48"	1219	14	6.4	<b>GWB1448C</b>	126	<b>GWB1448V</b>	129	<b>GWB1448VG</b>	129
<b>18" width</b> (457mm)	36"	914	14	6.4	<b>GWB1836C</b>	120	<b>GWB1836V</b>	129	<b>GWB1836VG</b>	129
	48"	1219	17	7.7	<b>GWB1848C</b>	134	<b>GWB1848V</b>	146	<b>GWB1848VG</b>	146

### Tab Lock Shelves

see spec sheet **EG02.09**



- 16 gauge, type 430 stainless steel.
- 1½" (38mm) roll on front.
- 1½" (38mm) upturn on rear and ends.
- Tab lock for easy assembly.
- Die-formed stainless steel mounting brackets.
- Not available in other widths.
- 60" (1524mm) length max.

**FEATURES:**

**Freight class is 70.0.**

(•) MTS (made to stock) / ( ) MTO (made to order)

	length		weight		cubic feet	model #	
	in.	mm	lbs.	kg		list	list
<b>10" width</b> (254mm)	24"	610	10	4.5	0.6	<b>WS1024TL</b>	• 199
	36"	915	12	5.4	0.9	<b>WS1036TL</b>	• 212
	48"	1219	15	6.8	1.3	<b>WS1048TL</b>	• 242
	60"	1524	20	9.0	1.6	<b>WS1060TL</b>	• 274
<b>12" width</b> (305mm)	24"	610	12	5.4	0.6	<b>WS1224TL</b>	• 213
	36"	915	14	6.4	0.9	<b>WS1236TL</b>	• 231
	48"	1219	17	7.7	1.3	<b>WS1248TL</b>	• 261
	60"	1524	23	10.4	1.6	<b>WS1260TL</b>	• 292



### Wall Mounted Shelves

see spec sheet **EG02.05**



**Die-formed stainless steel mounting brackets are stud-welded to shelf.**

- 1½" (38mm) roll on front.
- 1½" (38mm) upturn on rear and ends.

**FEATURES:**

**Note:** 15" and 18" (381 and 457mm) wide shelves available. To order, replace "12" in model number with a "15" or "18" indicating desired shelf width (example: **WS1548-16/3**). For 15" (381mm) wide shelves, add 15% to list price of 12" (305mm) wide models. For 18" wide shelves, add 30% to list price of 12" (305mm) shelves.

**Freight class is 70.0.**

(•) MTS (made to stock) / ( ) MTO (made to order)

	length		weight		cubic feet	16 gauge, type 430		16 gauge, type 304		14 gauge, type 304	
	in.	mm	lbs.	kg		model #	list	model #	list	model #	list
<b>10" width (254mm)</b>	24"	610	10	4.5	0.5	<b>WS1024-16/4</b>	455	<b>WS1024-16/3</b>	533	<b>WS1024-14/3</b>	587
	36"	915	12	5.4	0.7	<b>WS1036-16/4</b> •	489	<b>WS1036-16/3</b>	602	<b>WS1036-14/3</b>	663
	48"	1219	15	6.8	0.9	<b>WS1048-16/4</b> •	494	<b>WS1048-16/3</b>	641	<b>WS1048-14/3</b>	702
	60"	1524	20	9.0	1.2	<b>WS1060-16/4</b> •	528	<b>WS1060-16/3</b>	708	<b>WS1060-14/3</b>	777
	72"	1829	22	10.0	1.4	<b>WS1072-16/4</b> •	563	<b>WS1072-16/3</b>	774	<b>WS1072-14/3</b>	848
	84"	2133	24	10.9	1.7	<b>WS1084-16/4</b>	593	<b>WS1084-16/3</b>	839	<b>WS1084-14/3</b>	919
	96"	2438	29	13.2	1.9	<b>WS1096-16/4</b>	687	<b>WS1096-16/3</b>	968	<b>WS1096-14/3</b>	1064
	108"	2743	32	14.5	2.1	<b>WS10108-16/4</b>	747	<b>WS10108-16/3</b>	1061	<b>WS10108-14/3</b>	1168
<b>12" width (305mm)</b>	120"	3048	34	15.4	2.3	<b>WS10120-16/4</b>	783	<b>WS10120-16/3</b>	1198	<b>WS10120-14/3</b>	1318
	24"	610	12	5.4	0.6	<b>WS1224-16/4</b> •	489	<b>WS1224-16/3</b> •	569	<b>WS1224-14/3</b>	627
	36"	915	14	6.4	0.9	<b>WS1236-16/4</b> •	525	<b>WS1236-16/3</b> •	639	<b>WS1236-14/3</b>	701
	48"	1219	17	7.7	1.1	<b>WS1248-16/4</b> •	538	<b>WS1248-16/3</b> •	685	<b>WS1248-14/3</b>	754
	60"	1524	23	10.4	1.4	<b>WS1260-16/4</b> •	573	<b>WS1260-16/3</b> •	756	<b>WS1260-14/3</b>	829
	72"	1829	25	11.3	1.7	<b>WS1272-16/4</b> •	612	<b>WS1272-16/3</b> •	826	<b>WS1272-14/3</b> •	906
	84"	2133	28	12.7	2.0	<b>WS1284-16/4</b> •	648	<b>WS1284-16/3</b> •	897	<b>WS1284-14/3</b>	986
	96"	2438	31	14.1	2.2	<b>WS1296-16/4</b> •	760	<b>WS1296-16/3</b> •	981	<b>WS1296-14/3</b>	1078
108"	2743	36	16.3	2.5	<b>WS12108-16/4</b>	831	<b>WS12108-16/3</b>	1151	<b>WS12108-14/3</b>	1262	
120"	3048	39	17.6	2.8	<b>WS12120-16/4</b>	866	<b>WS12120-16/3</b>	1216	<b>WS12120-14/3</b>	1338	

### Piggyback Wall Mounted Shelf Kits **PATENTED!**

see spec sheet **EG02.13**



**Additional Brackets (pair)**

18" (457mm) width. Chrome.

**FEATURES:**

- Brackets can be mounted to studs – no wall backing required.
- Freedom to move the shelves left or right.
- Wire design allows for air circulation.
- 18" (457mm) width.
- No tools required to attach shelf to wall brackets.

**Freight class is 70.0.**

description	weight		model #	list
	lbs.	kg		
three-tier	7.3	3.3	<b>SSW18B3-C</b>	89
five-tier	10.8	4.9	<b>SSW18B5-C</b>	106

### Three-Tier Units – Includes one pair of 23¾" (606mm)-high brackets.

shelf width x length in. mm	Units with One Chrome Shelf				Units with Two Chrome Shelves				Units with Three Chrome Shelves				Additional Shelves chrome			
	weight		model #	list	weight		model #	list	weight		model #	list	weight		model #	list
lbs.	kg	lbs.			kg	lbs.			kg	lbs.			kg	lbs.		
18" x 24" 457 x 610	12	5.4	<b>S1-3B-SSW1824C</b>	113	17	7.7	<b>S2-3B-SSW1824C</b>	173	22	10.0	<b>S3-3B-SSW1824C</b>	232	5	2.3	<b>SSW1824C</b>	60
18" x 30" 457 x 762	13	5.9	<b>S1-3B-SSW1830C</b>	127	19	8.6	<b>S2-3B-SSW1830C</b>	199	25	11.3	<b>S3-3B-SSW1830C</b>	269	6	2.7	<b>SSW1830C</b>	74
18" x 36" 457 x 914	14	6.4	<b>S1-3B-SSW1836C</b>	135	21	9.5	<b>S2-3B-SSW1836C</b>	214	28	12.7	<b>S3-3B-SSW1836C</b>	294	7	3.2	<b>SSW1836C</b>	82
18" x 42" 457 x 1067	16	7.3	<b>S1-3B-SSW1842C</b>	147	24	10.9	<b>S2-3B-SSW1842C</b>	243	33	15.0	<b>S3-3B-SSW1842C</b>	339	9	4.1	<b>SSW1842C</b>	99
18" x 48" 457 x 1219	17	7.7	<b>S1-3B-SSW1848C</b>	155	27	12.2	<b>S2-3B-SSW1848C</b>	256	37	16.8	<b>S3-3B-SSW1848C</b>	356	10	4.5	<b>SSW1848C</b>	104
18" x 60" 457 x 1524	22	10.0	<b>S1-3B-SSW1860C</b>	181	37	16.8	<b>S2-3B-SSW1860C</b>	308	51	23.1	<b>S3-3B-SSW1860C</b>	435	15	6.8	<b>SSW1860C</b>	132

### Five-Tier Units – Includes one pair of 33¾" (860mm)-high brackets.

shelf width x length in. mm	Units with Three Chrome Shelf				Units with Four Chrome Shelves				Units with Five Chrome Shelves				Additional Shelves chrome			
	weight		model #	list	weight		model #	list	weight		model #	list	weight		model #	list
lbs.	kg	lbs.			kg	lbs.			kg	lbs.			kg	lbs.		
18" x 24" 457 x 610	19	8.6	<b>S3-5B-SSW1824C</b>	252	22	10.0	<b>S4-5B-SSW1824C</b>	309	29	13.2	<b>S5-5B-SSW1824C</b>	367	5	2.3	<b>SSW1824C</b>	60
18" x 30" 457 x 762	22	10.0	<b>S3-5B-SSW1830C</b>	289	28	12.7	<b>S4-5B-SSW1830C</b>	362	34	15.4	<b>S5-5B-SSW1830C</b>	434	6	2.7	<b>SSW1830C</b>	74
18" x 36" 457 x 914	25	11.3	<b>S3-5B-SSW1836C</b>	314	32	14.5	<b>S4-5B-SSW1836C</b>	393	39	17.6	<b>S5-5B-SSW1836C</b>	473	7	3.2	<b>SSW1836C</b>	82
18" x 42" 457 x 1067	30	13.6	<b>S3-5B-SSW1842C</b>	357	38	17.2	<b>S4-5B-SSW1842C</b>	454	47	21.3	<b>S5-5B-SSW1842C</b>	548	9	4.1	<b>SSW1842C</b>	99
18" x 48" 457 x 1219	34	15.4	<b>S3-5B-SSW1848C</b>	376	44	20.0	<b>S4-5B-SSW1848C</b>	477	54	24.5	<b>S5-5B-SSW1848C</b>	577	10	4.5	<b>SSW1848C</b>	104
18" x 60" 457 x 1524	49	22.2	<b>S3-5B-SSW1860C</b>	455	64	29.0	<b>S4-5B-SSW1860C</b>	582	79	35.8	<b>S5-5B-SSW1860C</b>	708	15	6.8	<b>SSW1860C</b>	132



## Catalog Section 2

### Shelves with Removable Hooks

see spec sheet **EG02.06**



- 16 gauge type 430 shelf with type 304 stainless steel pot rack.
- 1½" (38mm) roll on front.
- 1½" (38mm) upturn on rear and ends.
- Furnished with one double-prong hook per foot.

FEATURES:

**Freight class is 70.0.**

(•) MTS (made to stock) / ( ) MTO (made to order)



#### Additional Hook for Shelves with Removable Hooks

- Stainless steel.

weight	cu	list
lbs. kg	ft	model # ea.
0.2 0.1	0.1	<b>300696</b> 26

10" (254mm) Wide Shelves						12" (305mm) Wide Shelves					
length		weight		cu	model #	list	weight		cu	model #	list
in.	mm	lbs.	kg	ft			lbs.	kg	ft		
36"	914	12	5.4	1.0	<b>WSP1036</b>	827	15	6.8	1.1	<b>WSP1236</b>	858
48"	1219	23	10.4	1.3	<b>WSP1048</b>	845	29	13.2	1.5	<b>WSP1248</b> •	889
60"	1524	37	16.8	1.6	<b>WSP1060</b>	882	43	19.5	1.8	<b>WSP1260</b> •	931
72"	1829	51	23.1	1.9	<b>WSP1072</b>	913	57	25.9	2.2	<b>WSP1272</b> •	967
84"	2134	65	29.5	2.2	<b>WSP1084</b>	957	71	32.2	2.6	<b>WSP1284</b>	1022
96"	2438	79	35.8	2.5	<b>WSP1096</b>	1023	85	38.6	2.9	<b>WSP1296</b>	1044
108"	2743	93	42.2	2.8	<b>WSP10108</b>	1343	99	44.9	3.3	<b>WSP12108</b>	1427
120"	3048	107	48.5	3.1	<b>WSP10120</b>	1374	113	51.3	3.6	<b>WSP12120</b>	1460
132"	3353	121	54.9	3.4	<b>WSP10132</b>	1455	127	57.6	4.0	<b>WSP12132</b>	1536
144"	3658	135	61.2	3.7	<b>WSP10144</b>	1487	141	64.0	4.4	<b>WSP12144</b>	1564

15" (381mm) Wide Shelves						18" (457mm) Wide Shelves					
length		weight		cu	model #	list	weight		cu	model #	list
in.	mm	lbs.	kg	ft			lbs.	kg	ft		
36"	914	21	9.5	1.3	<b>WSP1536</b>	1122	27	12.2	1.6	<b>WSP1836</b>	1343
48"	1219	35	15.9	1.8	<b>WSP1548</b>	1145	41	18.6	2.2	<b>WSP1848</b>	1365
60"	1524	49	22.2	2.3	<b>WSP1560</b>	1304	55	24.9	2.7	<b>WSP1860</b>	1437
72"	1829	63	28.6	2.7	<b>WSP1572</b>	1414	69	31.3	3.2	<b>WSP1872</b>	1538
84"	2134	77	34.9	3.2	<b>WSP1584</b>	1620	83	37.6	3.7	<b>WSP1884</b>	1668
96"	2438	91	41.3	3.6	<b>WSP1596</b>	1697	97	44.0	4.3	<b>WSP1896</b>	1766
108"	2743	105	47.6	4.0	<b>WSP15108</b>	1843	111	50.3	4.8	<b>WSP18108</b>	2147
120"	3048	119	54.0	4.5	<b>WSP15120</b>	1873	125	56.7	5.3	<b>WSP18120</b>	2180
132"	3353	133	60.3	4.9	<b>WSP15132</b>	2012	139	63.1	5.9	<b>WSP18132</b>	2221
144"	3658	147	66.7	5.4	<b>WSP15144</b>	2046	153	69.4	6.4	<b>WSP18144</b>	2256

### Single Bar Utility Racks

see spec sheet **EG10.06**



- Flat 3/16" (5mm)-thick, 2" (51mm)-wide solid bar.
- 24" (610mm) racks are one-piece, all others come with support brackets.
- Includes one two-prong hook per foot.

FEATURES:

**Freight class is 70.0.**



#### Additional Hook for Single Bar Utility Racks

- Stainless steel.

weight	cu	list
lbs. kg	ft	model # ea.
0.2 0.1	0.1	<b>300696</b> 26

length*	ALUMINUM				STAINLESS STEEL					
	in.	mm	weight	model #	list	weight	model #	list		
24"	610	5	2.3	<b>SBPR-24-A</b>	412	9	4.1	<b>SBPR-24-S</b>	548	
36"	915	6	2.7	<b>SBPR-36-A</b>	433	12	5.4	<b>SBPR-36-S</b>	577	
48"	1219	7	3.2	<b>SBPR-48-A</b>	446	15	6.8	<b>SBPR-48-S</b>	593	
8½" width (216mm)	60"	1524	9	4.1	<b>SBPR-60-A</b>	458	18	8.2	<b>SBPR-60-S</b>	611
	72"	1829	11	5.0	<b>SBPR-72-A</b>	473	21	9.5	<b>SBPR-72-S</b>	629
	84"	2134	13	5.9	<b>SBPR-84-A</b>	484	25	11.3	<b>SBPR-84-S</b>	645
	96"	2438	15	6.8	<b>SBPR-96-A</b>	534	29	13.2	<b>SBPR-96-S</b>	711
	108"	2743	17	7.7	<b>SBPR-108-A</b>	587	34	15.4	<b>SBPR-108-S</b>	779
120"	3048	20	9.0	<b>SBPR-120-A</b>	637	39	17.6	<b>SBPR-120-S</b>	849	

\* For overall lengths, add 5-1/8" (130mm).



## Equipment Shelves with Cord Cutout

see spec sheet **EG02.10M**



- 24" (610mm) length.
- Made of highly polished heavy gauge type 430 stainless steel.
- Marine counter edge in front that prevents contents from sliding off.
- Hole with grommet at center rear for wiring.

FEATURES:

**Freight class is 70.0.**

(•) MTS (made to stock) / ( ) MTO (made to order)



width		weight		cubic feet	model #	list
in.	mm	lbs.	kg			
18"	457	17	7.7	4.8	<b>MWS1824 •</b>	485
24"	610	23	10.4	4.8	<b>MWS2424 •</b>	553

## Adjustable Post Wire Wall Mounts Sold as Prepackaged Units

see spec sheet **EG02.11**

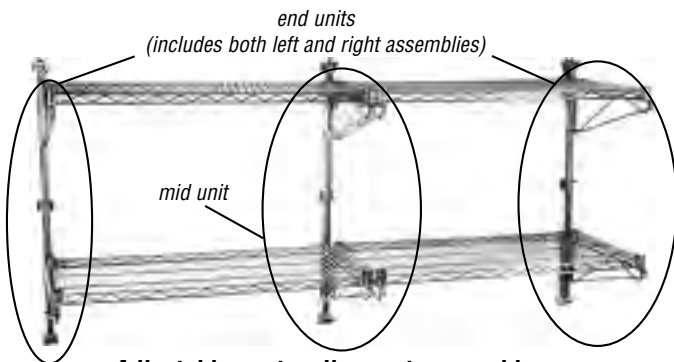

**Adjustable post wall mounts are sold as prepackaged end and mid units, or sold as components (see page 99). The prepackaged units contain all needed components except shelves and wall bolts. Wall bolts must be selected according to wall type.**

FEATURES:

### END UNITS.

- Two posts, single shelf brackets, post supports.
- Number of shelf brackets depends on the height of the posts.
  - 14" (356mm) posts: one row of brackets.
  - 33" (838mm) posts: two rows of brackets
  - ...and so on.

### MID UNITS

- One post, double shelf brackets, post supports.
- Number of shelf brackets corresponds to post height the same as end units.

ORDERING:

- One shelf long, order only one end unit.
- Two shelves long, order one end and one mid unit.
- Three shelves long, order one end and two mid units. And so on.

**Freight class is 70.0.**

**Note:** Shelves (page 6) and accessories (pages 48 & 49) are sold separately.

### Prepackaged End Units

### Prepackaged Mid Units

	post		# of shelves	cu ft	weight*		chrome		Valu-Gard®		stainless steel		chrome		Valu-Gard®		stainless steel			
	height				lbs.	kg	model #	list	model #	list	model #	list	model #	list	model #	list	model #	list	model #	list
	in.	mm																		
<b>14" width (356mm)</b>	14"	356	1	0.6	7	3.2	<b>PWE14-1C</b>	183	<b>PWE14-1VG</b>	183	<b>PWE14-1S</b>	513	<b>PWM14-1C</b>	118	<b>PWM14-1VG</b>	118	<b>PWM14-1S</b>	329		
	33"	838	2	0.7	14	6.4	<b>PWE14-2C</b>	297	<b>PWE14-2VG</b>	297	<b>PWE14-2S</b>	909	<b>PWM14-2C</b>	201	<b>PWM14-2VG</b>	201	<b>PWM14-2S</b>	598		
	54"	1372	3	0.7	22	10.0	<b>PWE14-3C</b>	412	<b>PWE14-3VG</b>	412	<b>PWE14-3S</b>	1168	<b>PWM14-3C</b>	283	<b>PWM14-3VG</b>	283	<b>PWM14-3S</b>	797		
	63"	1600	4	0.7	28	13.0	<b>PWE14-4C</b>	497	<b>PWE14-4VG</b>	497	<b>PWE14-4S</b>	1433	<b>PWM14-4C</b>	351	<b>PWM14-4VG</b>	351	<b>PWM14-4S</b>	999		
<b>18" width (457mm)</b>	14"	356	1	0.6	8	3.6	<b>PWE18-1C</b>	185	<b>PWE18-1VG</b>	185	<b>PWE18-1S</b>	529	<b>PWM18-1C</b>	120	<b>PWM18-1VG</b>	120	<b>PWM18-1S</b>	341		
	33"	838	2	0.6	15	6.8	<b>PWE18-2C</b>	297	<b>PWE18-2VG</b>	297	<b>PWE18-2S</b>	948	<b>PWM18-2C</b>	202	<b>PWM18-2VG</b>	202	<b>PWM18-2S</b>	623		
	54"	1372	3	0.7	23	10.0	<b>PWE18-3C</b>	414	<b>PWE18-3VG</b>	414	<b>PWE18-3S</b>	1223	<b>PWM18-3C</b>	287	<b>PWM18-3VG</b>	287	<b>PWM18-3S</b>	825		
	63"	1600	4	0.7	29	13.0	<b>PWE18-4C</b>	499	<b>PWE18-4VG</b>	499	<b>PWE18-4S</b>	1507	<b>PWM18-4C</b>	354	<b>PWM18-4VG</b>	354	<b>PWM18-4S</b>	961		
<b>21" width (533mm)</b>	14"	356	1	0.7	9	4.1	<b>PWE21-1C</b>	188	<b>PWE21-1VG</b>	188	<b>PWE21-1S</b>	533	<b>PWM21-1C</b>	124	<b>PWM21-1VG</b>	124	<b>PWM21-1S</b>	346		
	33"	838	2	0.8	16	7.3	<b>PWE21-2C</b>	306	<b>PWE21-2VG</b>	306	<b>PWE21-2S</b>	955	<b>PWM21-2C</b>	214	<b>PWM21-2VG</b>	214	<b>PWM21-2S</b>	629		
	54"	1372	3	0.9	25	11.0	<b>PWE21-3C</b>	427	<b>PWE21-3VG</b>	427	<b>PWE21-3S</b>	1232	<b>PWM21-3C</b>	300	<b>PWM21-3VG</b>	300	<b>PWM21-3S</b>	838		
	63"	1600	4	0.9	32	15.0	<b>PWE21-4C</b>	519	<b>PWE21-4VG</b>	519	<b>PWE21-4S</b>	1507	<b>PWM21-4C</b>	375	<b>PWM21-4VG</b>	375	<b>PWM21-4S</b>	1032		
<b>24" width (610mm)</b>	14"	356	1	0.7	10	4.5	<b>PWE24-1C</b>	188	<b>PWE24-1VG</b>	188	<b>PWE24-1S</b>	543	<b>PWM24-1C</b>	125	<b>PWM24-1VG</b>	125	<b>PWM24-1S</b>	349		
	33"	838	2	0.8	17	7.7	<b>PWE24-2C</b>	309	<b>PWE24-2VG</b>	309	<b>PWE24-2S</b>	975	<b>PWM24-2C</b>	214	<b>PWM24-2VG</b>	214	<b>PWM24-2S</b>	632		
	54"	1372	3	0.9	26	12.0	<b>PWE24-3C</b>	433	<b>PWE24-3VG</b>	433	<b>PWE24-3S</b>	1260	<b>PWM24-3C</b>	303	<b>PWM24-3VG</b>	303	<b>PWM24-3S</b>	848		
	63"	1600	4	0.9	34	16.0	<b>PWE24-4C</b>	524	<b>PWE24-4VG</b>	524	<b>PWE24-4S</b>	1557	<b>PWM24-4C</b>	377	<b>PWM24-4VG</b>	377	<b>PWM24-4S</b>	1069		

\* For stainless steel units, add 1 lb. (0.5 kg) weight.



## Catalog Section 2

### Adjustable Post Wire Wall Mounts Sold as Components

see spec sheet **EG02.11**

- Designed to allow inter-mixing of shelf widths or customizing of units to fit specification needs.
- All components priced individually.

FEATURES:

**Freight class is 70.0.**

(•) MTS (made to stock) / ( ) MTO (made to order)

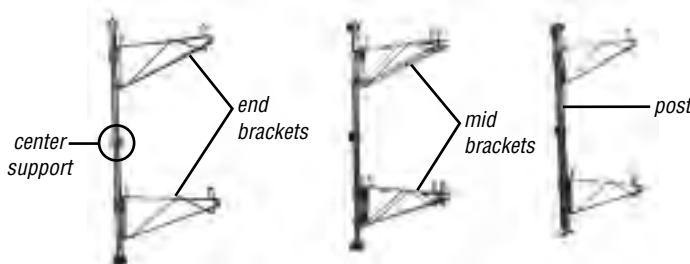

brackets used in conjunction with posts and center supports

#### End Brackets

length in. mm	weight		cu ft	chrome		Valu-Gard®		stainless steel	
	lbs.	kg		model #	list	model #	list	model #	list
14" 356	3	1.4	0.5	PWB14C • 44	PWB14VG • 44	PWB14S • 143			
18" 457	4	1.8	0.6	PWB18C • 45	PWB18VG • 45	PWB18S 146			
21" 533	5	2.3	1.0	PWB21C • 46	PWB21VG 46	PWB21S 155			
24" 610	6	2.7	1.0	PWB24C • 48	PWB24VG 48	PWB24S • 159			

Note: Must be used with posts to mount to the wall.

#### Posts

height in. mm	weight		cu ft	chrome		Valu-Gard®		stainless steel	
	lbs.	kg		model #	list	model #	list	model #	list
14" 356	2	0.9	0.1	PW14C • 51	PW14VG • 51	PW14S 146			
33" 838	3	1.4	0.1	PW33C • 65	PW33VG • 65	PW33S 234			
54" 1372	5	2.3	0.1	PW54C • 81	PW54VG 81	PW54S 238			
63" 1524	6	2.7	0.2	PW63C 83	PW63VG 83	PW63S 243			

#### Mid Brackets

length in. mm	weight		cu ft	chrome		Valu-Gard®		stainless steel	
	lbs.	kg		model #	list	model #	list	model #	list
14" 356	6	2.7	0.5	PDWB14C • 69	PDWB14VG • 69	PDWB14S 218			
18" 457	8	3.6	0.6	PDWB18C • 72	PDWB18VG 72	PDWB18S 225			
21" 533	10	4.5	1.0	PDWB21C • 75	PDWB21VG 75	PDWB21S 234			
24" 610	12	5.4	1.0	PDWB24C 77	PDWB24VG 77	PDWB24S 238			

Note: Must be used with posts to mount to the wall.

#### Center Support for Posts

weight lbs.	cu ft	chrome		Valu-Gard®		stainless steel	
		model #	list	model #	list	model #	list
1	0.5	A203059	12	A218017	12	A207016	43

Note: Must be used in conjunction with post.

### Stationary Wire Wall Mounts

see spec sheet **EG02.12**

**Freight class is 70.0.**

(•) MTS (made to stock) / ( ) MTO (made to order)

**Designed for fixed application where vertical adjustment is not required.**



#### End Units\*

One single shelf support and mounting plate.



#### Mid Units

One double shelf support and mounting plate.

length in. mm	cu ft	weight**		chrome		Valu-Gard®		stainless**		weight** lbs. kg	chrome		Valu-Gard®		stainless**	
		lbs.	kg	model #	list	model #	list	model #	list		model #	list	model #	list		
14" 356	0.5	6	2.7	WB14-C • 44	WB14-VG • 45	WB14-S • 106	8	3.6	DWB14-C • 66	DWB14-VG 67	DWB14-S 159					
18" 457	0.5	8	3.6	WB18-C • 45	WB18-VG • 46	WB18-S • 111	10	4.5	DWB18-C • 68	DWB18-VG 69	DWB18-S 169					
21" 533	0.7	10	4.5	WB21-C • 45	WB21-VG 46	WB21-S 114	12	5.5	DWB21-C 68	DWB21-VG 69	DWB21-S 173					
24" 610	0.7	12	5.5	WB24-C • 46	WB24-VG 47	WB24-S • 118	14	6.4	DWB24-C • 69	DWB24-VG 71	DWB24-S 180					

\*End Units priced per piece; \*\*For stainless steel units, add 1 lb. (0.5 kg) weight.



100 Industrial Boulevard, Clayton, DE 19938-8903 U.S.A.  
Phone: 800-637-5100 or 302-653-3000. Fax: 302-653-2065  
http://www.eaglegrp.com



## Wall Mounted Drop Tables/Shelves

see product announcement **EG8134**

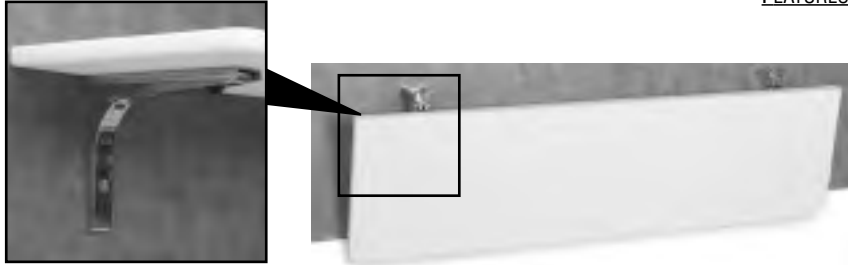

drop bracket shown in raised-up position

poly drop table/shelf mounted onto wall —shown in dropped-down position

- 3/4" (19mm) thick shelf.
- Pair of chrome-plated drop brackets.
- Weight capacity of 80 lbs. (36.3 kg).

FEATURES:

Freight class is 70.0.

width		length		weight		Poly *		weight		Richlite® **		weight		16/3 Stainless Steel	
in.	mm	in.	mm	lb.	kg	model #	list	lb.	kg	model #	list	lb.	kg	model #	list
10"	254	24"	610	7	3.2	<b>DSP-1024</b>	241	7	3.2	<b>DSR-1024</b>	364	11	5.0	<b>DSS-1024</b>	283
10"	254	30"	762	9	4.1	<b>DSP-1030</b>	252	9	4.1	<b>DSR-1030</b>	416	13	5.9	<b>DSS-1030</b>	288
10"	254	36"	914	11	5.0	<b>DSP-1036</b>	266	11	5.0	<b>DSR-1036</b>	471	15	6.8	<b>DSS-1036</b>	301
12"	305	24"	610	8	3.6	<b>DSP-1224</b>	248	8	3.6	<b>DSR-1224</b>	395	12	5.4	<b>DSS-1224</b>	285
12"	305	30"	762	10	4.5	<b>DSP-1230</b>	261	10	4.5	<b>DSR-1230</b>	397	14	6.4	<b>DSS-1230</b>	300
12"	305	36"	914	12	5.4	<b>DSP-1236</b>	278	12	5.4	<b>DSR-1236</b>	535	16	7.3	<b>DSS-1236</b>	309

\* Poly tables/shelves can withstand hot items up to 180°F without discoloration.

\*\* Richlite® tables/shelves can withstand hot items up to 350°F without discoloration.

## Wall Cabinets

see spec sheet **EG02.07**



wall cabinet with hinged doors



wall cabinet with sliding doors

- Heavy gauge stainless steel.
- Back is recessed with full-length concealed mounting plate for easy installation.
- Fixed center shelf.
- Hinged doors provided with lift-off pin hinges.
- 15" (381mm) width. 28" (711mm) overall height.

FEATURES:

Freight class is 100.0.

length		weight		cubic feet	Open Front		Hinged Doors		Sliding Doors	
in.	mm	lbs.	kg		model #	list	model #	list	model #	list
24"	610	95	43.1	13.5	<b>WCO-24</b>	3293	<b>WCH-24</b>	4468	<b>WCS-24</b>	3725
30"	762	115	52.2	17.3	<b>WCO-30</b>	3297	<b>WCH-30</b>	4952	<b>WCS-30</b>	4539
36"	914	125	56.7	18.0	<b>WCO-36</b>	3419	<b>WCH-36</b>	5038	<b>WCS-36</b>	4679
42"	1067	145	65.8	18.2	—	—	<b>WCH-42</b>	5294	<b>WCS-42</b>	4702
48"	1219	165	74.8	18.3	<b>WCO-48</b>	3938	<b>WCH-48</b>	5458	<b>WCS-48</b>	5126
54"	1372	180	81.6	25.4	—	—	<b>WCH-54</b>	5580	<b>WCS-54</b>	5221
60"	1524	195	88.5	22.6	<b>WCO-60</b>	4309	<b>WCH-60</b>	6258	<b>WCS-60</b>	5928
66"	1676	210	95.3	30.6	—	—	<b>WCH-66</b>	6303	—	—
72"	1829	225	102.0	26.8	<b>WCO-72</b>	4573	<b>WCH-72</b>	7011	<b>WCS-72</b>	6639
84"	2134	255	115.7	38.5	<b>WCO-84</b>	4825	<b>WCH-84</b> *	7209	<b>WCS-84</b> *	6811
90"	2286	267	121.1	41.7	—	—	<b>WCH-90</b> *	7618	<b>WCS-90</b> *	7213
96"	2438	260	117.9	35.2	<b>WCO-96</b>	5403	<b>WCH-96</b> *	7854	<b>WCS-96</b> *	7436
120"	3048	360	163.3	55.8	—	—	—	—	<b>WCS-120</b> *	8960

\* Features two pairs of doors.



# Cleanroom / Lab Equipment

## Accessories/Components

Hangers & Hanger Bar Kits .....105  
 Polymer Stem Casters .....106  
 Posts, Electropolished .....106  
 Replacement Garment Hanger Tubes ..105  
 Vibration Dampening Casters .....106

## adjuSTable® Work Surface Systems

adjuSTable® Work Surface Systems ..110

Cantilevered Overhead System.....111  
 Wire Overshelf System.....112

## Freestanding Gowning Racks

with Hanger Rail.....102  
 with Wire Shelving Components ....103

## Workstations

Mobile Computer Workstations .....108  
 Workstations .....108

## More Cleanroom/Lab Equipment

Cleanroom Tables.....113  
 Gowning Benches.....107  
 Roll Bag Dispensers .....110  
 Shoe Racks .....109  
 Stainless Steel Countertops .....114  
 Vertical Storage Cabinets .....109  
 Wall Mounted Gowning Racks .....104

## Wall Mounted Stainless Steel Tables

see spec sheet **EG10.01**



table featuring backsplash with box marine counter edge

*Facilitates small rolling cabinets which can be moved in and out.*

FEATURES:

- 14-gauge brackets with hole for electrical wire run.
- Wall mounted for environments with frequent wash downs.
- Available in same configuration as a standard worktable (pages 148-159).
- 200 lb. (90.7 kg) weight capacity.
- Options available include integral sink bowls, drawers, end splashes, and latex sound deadening.

**Freight class is 70.0.**

Tables with 16 gauge type 304 stainless steel tabletops available! See page 145.

Optional table edges available:

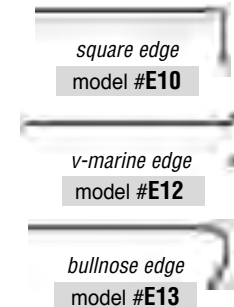

	length in. mm	weights* lbs. kg	no. of brackets	14/304 TABLETOP WITH ROLLED EDGE		14/304 TABLETOP WITH BOX MARINE COUNTER EDGE	
				model #	list	model #	list
<b>Tables with Flat Top</b>							
30" width (762mm)	48" 1219	79 35.8	3	WT3048SE	817	WT3048SEM	1147
	60" 1524	91 41.3	3	WT3060SE	933	WT3060SEM	1223
	72" 1829	105 47.6	4	WT3072SE	1091	WT3072SEM	1381
<b>Tables with 1½" Upturn</b>							
30" width (762mm)	48" 1219	79 35.8	3	UWT3048SE	961	UWT3048SEM	1349
	60" 1524	91 41.3	3	UWT3060SE	1097	UWT3060SEM	1439
	72" 1829	105 47.6	4	UWT3072SE	1283	UWT3072SEM	1625
<b>Tables with 4½" Backsplash</b>							
30" width (762mm)	48" 1219	83 37.6	3	WT3048SE-BS	1021	WT3048SEM-BS	1435
	60" 1524	96 43.6	3	WT3060SE-BS	1166	WT3060SEM-BS	1529
	72" 1829	107 48.5	4	WT3072SE-BS	1363	WT3072SEM-BS	1726

## Sterilizer Trays

### Features include:

- Heavy gauge type 304 stainless steel with electropolish finish.
- Handles seamlessly blended with cover.
- Perforated bottom.
- Safety edges.
- Customized to fit your needs.

EAGLE's SpecFAB® Division provides a way to short-cut the design and fabrication process.

To learn more about SpecFAB®, visit us at [www.eaglegrp.com](http://www.eaglegrp.com).

Just another way you can **Profit From The EAGLE Advantage®**.



100 Industrial Boulevard, Clayton, DE 19938-8903 U.S.A.  
 Phone: 800-637-5100 or 302-653-3000. Fax: 302-653-2065  
<http://www.eaglegrp.com>

## Freestanding Gowning Racks with Hanger Rail

see spec sheet **EG04.01A**



shown with single gowning rack – freestanding for non-removable hangers

shown with double gowning rack – freestanding for removable hangers

shown with cantilevered gowning rack – freestanding for removable hangers

- Stainless steel construction offers a non-contaminating surface that eliminates particle shedding.
- Electropolished models feature electrochemically passivated surfaces for the most demanding requirements.
- 75" (1905mm) height.
- Hanger slots are standard 3" (76mm) centers, but other center configurations are available.

**FEATURES:**

**Note:** Prices do not include hangers. See page 105 for optional hangers. All models use open loop hangers.

**Freight class is 70.0.**

**Designed for efficient storage of garments in the cleanroom.**

### Single Rack Models

							for Non-Removable Hangers				for Removable Hangers			
	length		weight		cu	number of hanger slots	stainless steel		electropolished		stainless steel		electropolished	
	in.	mm	lbs.	kg	ft		model #	list	model #	list	model #	list	model #	list
<b>24" width (610mm)</b>	48"	1219	40	18.1	15.0	15	<b>S2448-SGRN</b>	2555	<b>EP2448-SGRN</b>	2907	<b>S2448-SGRR</b>	2215	<b>EP2448-SGRR</b>	2573
	60"	1524	45	20.4	15.0	19	<b>S2460-SGRN</b>	2612	<b>EP2460-SGRN</b>	3149	<b>S2460-SGRR</b>	2259	<b>EP2460-SGRR</b>	2791
	72"	1829	50	22.7	15.0	23	<b>S2472-SGRN</b>	2654	<b>EP2472-SGRN</b>	3260	<b>S2472-SGRR</b>	2318	<b>EP2472-SGRR</b>	2915
	84"	2134	55	24.9	17.5	27	<b>S2484-SGRN</b>	2845	<b>EP2484-SGRN</b>	3441	<b>S2484-SGRR</b>	2489	<b>EP2484-SGRR</b>	3079

### Double Rack Models

							for Non-Removable Hangers				for Removable Hangers			
	length		weight		cu	number of hanger slots	stainless steel		electropolished		stainless steel		electropolished	
	in.	mm	lbs.	kg	ft		model #	list	model #	list	model #	list	model #	list
<b>24" width (610mm)</b>	48"	1219	59	26.7	15.0	32	<b>S2448-DGRN</b>	3822	<b>EP2448-DGRN</b>	4543	<b>S2448-DGRR</b>	3466	<b>EP2448-DGRR</b>	4058
	60"	1524	68	30.8	15.0	40	<b>S2460-DGRN</b>	3977	<b>EP2460-DGRN</b>	4848	<b>S2460-DGRR</b>	3675	<b>EP2460-DGRR</b>	4328
	72"	1829	77	34.9	15.0	48	<b>S2472-DGRN</b>	4151	<b>EP2472-DGRN</b>	5156	<b>S2472-DGRR</b>	3794	<b>EP2472-DGRR</b>	4603
	84"	2134	86	39.0	17.5	56	<b>S2484-DGRN</b>	4333	<b>EP2484-DGRN</b>	5339	<b>S2484-DGRR</b>	3978	<b>EP2484-DGRR</b>	4766

### Cantilevered Rack Models

							for Non-Removable Hangers				for Removable Hangers			
	length		weight		cu	number of hanger slots	stainless steel		electropolished		stainless steel		electropolished	
	in.	mm	lbs.	kg	ft		model #	list	model #	list	model #	list	model #	list
<b>24" width (610mm)</b>	48"	1219	45	20.4	15.0	16	<b>S2448-CGRN</b>	2555	<b>EP2448-CGRN</b>	2907	<b>S2448-CGRR</b>	2215	<b>EP2448-CGRR</b>	2573
	60"	1524	50	22.7	15.0	20	<b>S2460-CGRN</b>	2612	<b>EP2460-CGRN</b>	3149	<b>S2460-CGRR</b>	2259	<b>EP2460-CGRR</b>	2791
	72"	1829	55	24.9	15.0	24	<b>S2472-CGRN</b>	2654	<b>EP2472-CGRN</b>	3260	<b>S2472-CGRR</b>	2318	<b>EP2472-CGRR</b>	2915
	84"	2134	60	27.2	17.5	28	<b>S2484-CGRN</b>	2844	<b>EP2484-CGRN</b>	3441	<b>S2484-CGRR</b>	2489	<b>EP2484-CGRR</b>	3079

## Catalog Section 4

**EAGLE offers gowning racks that incorporate wire shelving components with specially designed gown storage options. They offer a more economical rack option in less demanding environments in chrome plated steel as well as electropolished stainless steel models.**

### Freestanding Gowning Racks with Wire Shelving Components

see spec sheet **EG04.01B**

**FEATURES:**

- 86" (2184mm) height.
- Wire shelf features QuadTruss® Design. Patent #5,390,803.

**Note:** See each model for spacing centers.

**Freight class is 70.0.**

#### with Hanger Slots

- Hanger slots on standard 2½" (64mm) centers.
- Custom spacing available.
- Prices do not include hangers – see page 105 for optional hangers.

	length		weight		cubic feet	number of hanger slots	electropolished		chrome	
	in.	mm	lbs.	kg			model #	list	model #	list
<b>24"</b>	48"	1219	30	13.6	5.4	17	<b>EP2448-GR</b>	1212	<b>C2448-GR</b>	531
<b>width</b>	60"	1524	37	16.8	6.5	22	<b>EP2460-GR</b>	1447	<b>C2460-GR</b>	599
<b>(610mm)</b>	72"	1829	40	18.1	7.0	27	<b>EP2472-GR</b>	1695	<b>C2472-GR</b>	682



#### Optional Keeper Bars for above Gowning Racks

- Makes hangers non-removable.

length in.	mm	number of hanger slots	electropolished		chrome	
			model #	list	model #	list
48"	1219	17	<b>KB48-EP</b>	75	<b>KB48-C</b>	64
60"	1524	22	<b>KB60-EP</b>	83	<b>KB60-C</b>	72
72"	1829	27	<b>KB72-EP</b>	92	<b>KB72-C</b>	79



#### with Hooks

- Hooks welded on all four shelf sides are spaced on 1½" (38mm) centers and are staggered 1" (25mm) vertically hook-to-hook for ease of access.

	length		weight		cubic feet	number of hooks	electropolished		chrome	
	in.	mm	lbs.	kg			model #	list	model #	list
<b>14"</b>	48"	1219	56	25.4	5.4	72	<b>EP1448-GRH</b>	2400	<b>C1448-GRH</b>	1257
<b>width</b>	60"	1524	68	30.8	6.5	88	<b>EP1460-GRH</b>	2868	<b>C1460-GRH</b>	1309
<b>(356mm)</b>	72"	1829	80	36.3	7.0	104	<b>EP1472-GRH</b>	3495	<b>C1472-GRH</b>	1571

#### with Hanger Tube

- 1" (25mm) diameter tubular bar which easily mounts to underside of wire shelf.
- Facilitates laminar flow.
- See page 105 for replacement garment hanger tubes.

	length		weight		cubic feet	stainless steel		chrome	
	in.	mm	lbs.	kg		model #	list	model #	list
<b>24"</b>	48"	1219	27	12.2	5.4	<b>S2448-GRT</b>	921	<b>C2448-GRT</b>	366
<b>width</b>	60"	1524	34	15.4	6.5	<b>S2460-GRT</b>	1005	<b>C2460-GRT</b>	397
<b>(610mm)</b>	72"	1829	37	16.7	7.0	<b>S2472-GRT</b>	1114	<b>C2472-GRT</b>	448

**Convenient for storage of lab coats, uniforms and garments.**



## Wall Mounted Gowning Racks

see spec sheet **EG04.08**

**When space management is critical, EAGLE offers three wall mounted options for garment storage.**

- Open wire top shelf for laminar flow. Features QuadTruss® Design. Patent #5,390,803.
- Economical models are available in chrome plated steel, in addition to electropolished stainless steel.
- Hangers are not included.

**FEATURES:**

**Note:** See page 105 for optional hangers available.

**Freight class is 70.0.**

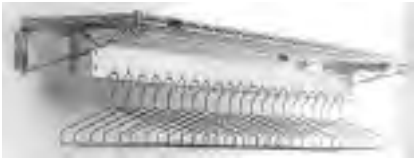

*gowning rack – wall mounted with optional hangers*

### with Hanger Slots

- Hanger slots on 2½" (64mm) centers.
- Prices do not include hangers.

	length		weight		cubic feet	number of hanger slots	electropolished		chrome	
	in.	mm	lbs.	kg			model #	list	model #	list
<b>24"</b>	48"	1219	19	8.6	1.4	17	<b>EP2448-WGR</b>	956	<b>C2448-WGR</b>	407
<b>width (610mm)</b>	60"	1524	24	10.9	1.7	22	<b>EP2460-WGR</b>	1166	<b>C2460-WGR</b>	493
	72"	1829	29	13.2	2.0	27	<b>EP2472-WGR</b>	1401	<b>C2472-WGR</b>	567

### Optional Keeper Bars for above Gowning Racks

- Makes hangers non-removable.

length in.	mm	number of hanger slots	electropolished		chrome	
			model #	list	model #	list
48"	1219	17	<b>KB48-EP</b>	75	<b>KB48-C</b>	64
60"	1524	22	<b>KB60-EP</b>	83	<b>KB60-C</b>	72
72"	1829	27	<b>KB72-EP</b>	92	<b>KB72-C</b>	79



*gowning rack – wall mounted with hooks*

### with Hooks

- Hooks welded on 1½" (38mm) centers.

	length		weight		cubic feet	number of hooks	electropolished		chrome	
	in.	mm	lbs.	kg			model #	list	model #	list
<b>14"</b>	48"	1219	21	9.5	1.4	30	<b>EP1448-WGRH</b>	1241	<b>C1448-WGRH</b>	572
<b>width (356mm)</b>	60"	1524	27	12.2	1.7	38	<b>EP1460-WGRH</b>	1480	<b>C1460-WGRH</b>	659
	72"	1829	31	14.1	2.0	46	<b>EP1472-WGRH</b>	1779	<b>C1472-WGRH</b>	801



*wall mounted tubular gowning rack*

### with Hanger Tube

- See page 105 for replacement garment hanger tubes.

	length		weight		cubic feet	electropolished		chrome	
	in.	mm	lbs.	kg		model #	list	model #	list
<b>18"</b>	48"	1219	17	7.7	1.4	<b>S1848-WGRT</b>	487	<b>C1848-WGRT</b>	203
<b>width (457mm)</b>	60"	1524	22	10.0	1.7	<b>S1860-WGRT</b>	559	<b>C1860-WGRT</b>	218
	72"	1829	27	12.2	2.0	<b>S1872-WGRT</b>	652	<b>C1872-WGRT</b>	234

### Accessories

#### Hangers

see spec sheet **EG04.06**



open loop hanger



closed loop hanger

#### Open Loop Hangers

weight		cubic		chrome		stainless steel		electropolished	
lbs.	kg	feet		model #	list	model #	list	model #	list
0.4	0.2	0.3		<b>OLH-C</b> •	13	<b>OLH-S</b> •	19	<b>OLH-EP</b>	21

**Freight class is 70.0.**

(•) MTS (made to stock) / ( ) MTO (made to order)

#### Closed Loop Hangers

weight		cubic		chrome		stainless steel		electropolished	
lbs.	kg	feet		model #	list	model #	list	model #	list
0.4	0.2	0.3		<b>CLH-C</b>	13	<b>CLH-S</b>	19	<b>CLH-EP</b>	21

#### 2-Piece Hangers

- Use with non-removable hanger rack models.
- Top component is affixed to the gowning rack, while the bottom component is removable for convenient mounting of the garment.
- These hangers discourage removal from the gowning area.



weight		cubic		chrome		stainless steel		electropolished	
lbs.	kg	feet		model #	list	model #	list	model #	list
0.5	0.2	0.3		<b>TPH-C</b>	43	<b>TPH-S</b>	51	<b>TPH-EP</b>	58

#### Hanger Bar Kits

see spec sheet **EG04.06**



Note: For freestanding or wall mounted gowning racks, removable or non-removable models (pages 102-104).

- For use with 2-piece and open loop hangers.
- Retrofits existing shelving into freestanding or wall mounted gowning racks.
- 24" (610mm) wide shelves only.
- Hanger slots on standard 2½" (64mm) centers.
- Custom spacing available.
- Prices do not include hangers.

FEATURES:

**Freight class is 70.0.**

length		weight		cu ft	number of hanger slots	electropolished		stainless steel		chrome	
in.	mm	lbs.	kg			model #	list	model #	list	model #	list
48"	1219	7.0	3.2	0.8	17	<b>HBK-48EP</b>	335	<b>HBK-48S</b>	278	<b>HBK-48C</b>	231
60"	1524	9.5	4.3	1.2	22	<b>HBK-60EP</b>	373	<b>HBK-60S</b>	309	<b>HBK-60C</b>	265
72"	1829	12.0	5.4	1.6	27	<b>HBK-72EP</b>	392	<b>HBK-72S</b>	343	<b>HBK-72C</b>	294

#### Replacement Garment Hanger Tubes

see spec sheet **EG04.07**

length		weight		cubic feet	chrome		stainless steel	
in.	mm	lbs.	kg		model #	list	model #	list
24"	610	1.5	0.7	0.1	<b>CH24</b>	37	<b>CH24-S</b>	80
30"	762	1.7	0.8	0.1	<b>CH30</b>	39	<b>CH30-S</b>	82
36"	914	2.2	1.0	0.1	<b>CH36</b>	41	<b>CH36-S</b>	84
42"	1067	2.7	1.2	0.1	<b>CH42</b>	42	<b>CH42-S</b>	88
48"	1219	3.2	1.5	0.1	<b>CH48</b> •	43	<b>CH48-S</b>	91
54"	1372	3.5	1.6	0.2	<b>CH54</b>	46	<b>CH54-S</b>	102
60"	1524	3.8	1.7	0.2	<b>CH60</b>	49	<b>CH60-S</b>	111
72"	1929	4.7	2.1	0.2	<b>CH72</b>	52	<b>CH72-S</b>	115

Note: Mounts onto 18", 21", and 24" (457, 533, and 610mm) wide shelves only.

For freestanding or wall mounted gowning racks with hanger tubes (pages 103 & 104).

**Freight class is 50.0.**

(•) MTS (made to stock) / ( ) MTO (made to order)

**Weight Capacity: 50 lbs.**



garment hanger tube



### Electropolished Posts

Freight class is 50.0.

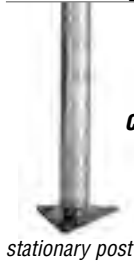

Stationary posts come standard with electropolished foot plates.

see spec sheet **EG04.07**

post height		weight		cu	...Stationary		...Mobile	
in.	mm	lbs.	kg	ft	model #	list	model #	list
33"	383	2.0	0.9	0.4	P33-EPS	63	CP33-EPS	63
54"	1372	3.0	1.4	0.4	P54-EPS	84	CP54-EPS	84
63"	1600	3.5	1.6	0.4	P63-EPS	91	CP63-EPS	91
74"	1880	4.0	1.8	0.5	P74-EPS	102	CP74-EPS	102
86"	2184	5.0	2.3	0.5	P86-EPS	112	CP86-EPS	112

stationary post

### Vibration Dampening Casters

see spec sheet **EG04.07**

Where vibration dampening is important, these unique 50 Shore A hardness "Softie™" casters reduce vibration transfer for work in process.

Note: For use with mobile posts (see above).

Freight class is 65.0.

(•) MTS (made to stock) / ( ) MTO (made to order)

type	capacity		wheel diameter		wheel face		weight		cu	zinc	
	lbs.	kg	in.	mm	in.	mm	lbs.	kg	ft	model #	list
stem/swivel	180	81.6	5"	127	1 1/2"	35	2.0	0.9	0.1	SCSS5-180 •	40
stem/brake	180	81.6	5"	127	1 1/2"	35	2.5	1.1	0.1	SCSB5-180	43
stem/rigid*	180	81.6	5"	127	1 1/2"	35	2.8	1.3	0.1	SCSR5-180	40

\* Channel frames for rigid stem casters available. See page 9.



"Softie™" caster

### Replacement Caster Wheels

- Retrofit your existing casters.

Fits	model #	list
5" (127mm) casters	SCW-180	13



### Polymer Stem Casters

see spec sheets **EG01.05** **EG04.07**

- Stainless steel axle.
- Zinc-plated stem.
- Polymer horn.
- Polyurethane wheel.

These casters offer total corrosion resistance.

Note: For use with mobile posts (see top of this page).

Freight class is 65.0.

(•) MTS (made to stock) / ( ) MTO (made to order)

type	type of bearing	capacity		wheel diameter		wheel face		weight		cu	model #	list
		lbs.	kg	in.	mm	in.	mm	lbs.	kg	ft		
stem/swivel	delrin	250	113.4	5"	127	1 1/4"	32	2.0	0.9	0.1	CPSS5-250 •	75
stem/brake	delrin	250	113.4	5"	127	1 1/4"	32	2.0	0.9	0.1	CPSB5-250 •	92



### NEW Stainless Steel Caster Cradle®

see product announcement **EG8108M**

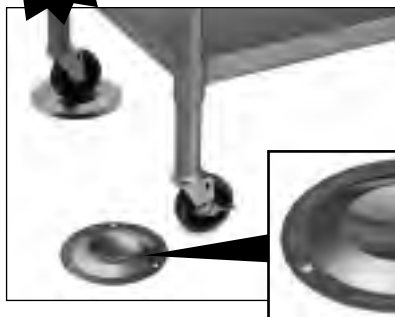

**PATENTED!**  
(patent #US 8,678,335 B2)

FEATURES:

- The only caster stabilizing device with a patented uniform circular design (patent #US 8,678,335 B2) that allows for approach from any angle.
- Units are secured to the floor where the casters are to be centered.

Freight class is 85.0.

description	model #	list/pkg
quantity of 2 per package	CC-S-2	83
quantity of 10 per package	CC-S-10	329
quantity of 60 per package	CC-S-60	1847

## Catalog Section 4

### Gowning Benches

see spec sheet **EG04.03**

#### Solid

- 14 gauge type 304 stainless steel seat.
- Front and rear feature a rolled edge, with ends turned down at 90°.
- Shipped knocked-down.
- 17" (432mm) overall height.

FEATURES:

- Flanged stainless foot plates for convenient attachment to the floor.
- Available in brushed finish 304 stainless steel or electropolished finish.

**Freight class is 70.0.**

(•) MTS (made to stock) / ( ) MTO (made to order)

**Hold up to 500 lbs.!**

	length		weight		cubic feet	electropolished		stainless steel	
	in.	mm	lbs.	kg		model #	list	model #	list
<b>9" width</b> (229mm)	36"	914	26	11.8	5.8	<b>CRB0936EP</b>	1238	<b>CRB0936</b>	1011
	48"	1219	32	14.5	8.2	<b>CRB0948EP</b>	1303	<b>CRB0948</b>	1061
	60"	1524	39	17.6	11.0	<b>CRB0960EP</b>	1459	<b>CRB0960</b>	1134
	72"	1829	46	20.9	14.6	<b>CRB0972EP</b>	1579	<b>CRB0972</b>	1232
<b>12" width</b> (305mm)	36"	914	30	13.6	2.0	<b>CRB1236EP</b>	1307	<b>CRB1236</b>	• 1078
	48"	1219	40	18.1	3.0	<b>CRB1248EP</b>	1375	<b>CRB1248</b>	• 1133
	60"	1524	50	22.7	3.6	<b>CRB1260EP</b>	1509	<b>CRB1260</b>	• 1184
	72"	1829	60	27.2	4.3	<b>CRB1272EP*</b>	1631	<b>CRB1272*</b>	• 1285
	84"	2134	70	31.8	5.2	<b>CRB1284EP*</b>	1686	<b>CRB1284*</b>	1338

\* Comes with six legs.



#### Wire

- Four (4) 18" (457mm) legs with foot plates.
- One (1) three-sided channel frame.
- One (1) wire shelf featuring QuadTruss® Design (patent #5,390,803).

	length		weight		cubic feet	chrome		stainless steel	
	in.	mm	lbs.	kg		model #	list	model #	list
<b>14" width</b> (356mm)	36"	914	15	6.8	0.5	<b>W1436-GBC</b>	268	<b>W1436-GBS</b>	805
	48"	1219	19	8.6	0.7	<b>W1448-GBC</b>	296	<b>W1448-GBS</b>	894
	60"	1524	25	11.3	0.9	<b>W1460-GBC</b>	322	<b>W1460-GBS</b>	934
	72"	1829	30	13.6	1.1	<b>W1472-GBC</b>	338	<b>W1472-GBS</b>	989



**An economical gowning bench using wire shelving components that offers 62% laminar flow.**

**Ideal for less demanding environments, or during construction as the room is brought into clean.**

#### Gowning Benches with Standard Undersheff...

- Designated seat, legs, foot plates, and one wire undersheff (additional wire undersheffs and dividers are optional).
- 72" (1829mm) units have six legs.
- Standard undersheff for all 72" (1829mm) units consists of two #1436S wire shelves with S-hooks.
- All wire undersheffs are 14" (356mm)-wide and feature QuadTruss® Design (patent #5,390,803).
- 19" (483mm) overall height.

#### ...with Perforated Seat

3½" (89mm) perforated on one inch center.

	length		weight		cubic feet	electropolished		stainless steel	
	in.	mm	lbs.	kg		model #	list	model #	list
<b>18" width</b> (457mm)	36"	914	38	17.2	4.4	<b>PCRB1836EP</b>	1976	<b>PCRB1836</b>	1676
	48"	1219	43	19.5	5.7	<b>PCRB1848EP</b>	2081	<b>PCRB1848</b>	1765
	60"	1524	49	22.0	7.1	<b>PCRB1860EP</b>	2291	<b>PCRB1860</b>	1872
	72"	1829	55	24.9	8.5	<b>PCRB1872EP</b>	2472	<b>PCRB1872</b>	2020

**Seats hold up to 500 lbs.!**



*gowning bench with standard undersheff and perforated seat, shown with additional undersheff and dividers*

#### ...with Solid Seat

	length		weight		cubic feet	electropolished		stainless steel	
	in.	mm	lbs.	kg		model #	list	model #	list
<b>18" width</b> (457mm)	36"	914	38	17.2	4.4	<b>CRB1836EP</b>	1754	<b>CRB1836</b>	1454
	48"	1219	43	19.5	5.7	<b>CRB1848EP</b>	1845	<b>CRB1848</b>	1532
	60"	1524	49	22.0	7.1	<b>CRB1860EP</b>	2028	<b>CRB1860</b>	1620
	72"	1829	55	25.0	8.5	<b>CRB1872EP</b>	2189	<b>CRB1872</b>	1753

#### Options for Gowning Benches with Undersheff

**Dividers** — 4" high.

model	list
<b>SD14-4S</b>	53

**Additional Undersheffs\***

model	list
<b>1436S</b> •	200
<b>1448S</b> •	246
<b>1460S</b> •	312

\* For 72" (1829mm) long gowning benches, two #1436S undersheffs are required.





### Workstations

see spec sheet **EG04.10**



basic wire workstation

wire top workstation with two overshelves

**WEIGHT CAPACITY:**

- Up to 800 lb. (363kg) load-bearing capacity.

**FEATURES:**

- Mobile units come with four 5" (127mm) poly stem casters (two with brake).
- Wire units offer 62% laminar flow.
- All units have standard working height of 33" (838mm).

**Freight class is 70.0.**

(•) MTS (made to stock) / ( ) MTO (made to order)

### Basic Wire Units

#### Stationary Units

#### Mobile Units

	length		cu ft	weight		chrome		stainless steel		weight lbs. kg	chrome		stainless steel		
	in.	mm		lbs.	kg	model #	list	model #	list		model #	list	model #	list	
<b>24" width (610mm)</b>	36"	914	3.0	21	9.5	<b>WS2436C</b>	238	<b>WS2436S</b>	882	29	13.2	<b>MWS2436C</b>	548	<b>MWS2436S</b>	1219
	48"	1219	3.8	28	12.7	<b>WS2448C</b>	271	<b>WS2448S</b>	962	36	16.3	<b>MWS2448C</b>	580	<b>MWS2448S</b>	1300

### Wire Top Units with Two Overshelves

#### Stationary Units

#### Mobile Units

	length		cu ft	weight		chrome		stainless steel		weight lbs. kg	chrome		stainless steel		
	in.	mm		lbs.	kg	model #	list	model #	list		model #	list	model #	list	
<b>24" width (610mm)</b>	36"	914	4.4	34	15.4	<b>WS2436WT</b>	367	<b>WS2436WT-S</b>	1380	42	19.1	<b>MWS2436WT</b>	682	<b>MWS2436WT-S</b>	1624
	48"	1219	5.5	41	18.6	<b>WS2448WT</b>	424	<b>WS2448WT-S</b>	1415	56	25.4	<b>MWS2448WT</b>	734	<b>MWS2448WT-S</b>	1753

### Optional Keyboard Stations for Workstations

- 20½" wide x 11½" deep (521 x 292mm).
- Works on 24" (610mm) wide shelves.



chrome keyboard station shown

weight		cubic feet	chrome		stainless steel	
lbs.	kg		model #	list	model #	list
6.0	2.7	0.35	<b>KBD-2•</b>	192	<b>KBD-2/SS</b>	389

### Mobile Computer Workstations

see spec sheet **EG01.04**

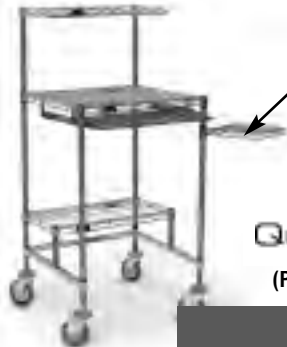

with optional mouse shelf

#### Optional Mouse Shelf

width x length		cu ft	weight		model # list	
in.	mm		lbs.	kg	model #	list
7" x 7"	178 x 178	0.1	2.0	0.9	<b>MS-C</b>	12

patented **QuadTruss** design  
(Patent #5,390,803)

**FEATURES:**

- 5" (127mm) casters—two with brake.
- Cantilevered shelf, undershelf, keyboard drawer.
- 38½" (981mm) working height.
- 53½" (1362mm) overall height.

Note: Call factory for information on other casters available.

**Freight class is 70.0.**

(•) MTS (made to stock) / ( ) MTO (made to order)

#### with Resilient-Tread Casters

#### w/Polyurethane-Tread Casters

width**	length		weight		cu ft	chrome		stainless steel		chrome		stainless steel	
	in.	mm	lbs.	kg		model #	*list	model #	*list	model #	*list	model #	*list
<b>24" (610mm)</b>	24"	610	40	18.1	3.7	<b>MCWS2424C</b>	• 549	<b>MCWS2424S</b>	1144	<b>MCWS2424C-P</b>	621	<b>MCWS2424S-P</b>	1169
<b>30" (762mm)</b>	30"	762	56	25.4	4.5	<b>MCWS3030C</b>	602	<b>MCWS3030S</b>	1196	<b>MCWS3030C-P</b>	674	<b>MCWS3030S-P</b>	1222

\* List prices do not include cost of mouse shelf.

\*\* 24" x 24" (610 x 610mm) units feature 14" x 24" (357 x 610mm) undershelf, 30" x 30" (762 x 762mm) units feature 18" x 30" (457 x 762mm) undershelf.

## Catalog Section 4

### Shoe Racks

see spec sheet **EG04.09**



patented  
**QuadTruss**  
design

(Patent #5,390,803)

**Wire shelves offer the optimum combination of laminar flow and ventilation for the storage of cleanroom shoes.**

**FEATURES:**

- Rods & tabs run through the shelves to create the cubbies for each pair of shoes.
- Shoe racks may be configured in chrome plated as well as electropolished stainless steel.
- Foot plates are included for fastening to the floor.
- 86" (2184mm) post height.

**Note:** Optional snap-on plastic label holders are available for identification of each cubby.

**Freight class is 70.0.**

	length*		weight		cu ft	# of cubbies	cubby size width x height		chrome		stainless steel	
	in.	mm	lbs.	kg			in.	mm	model #	list	model #	list
<b>14" width (356mm)</b>	60"	1524	190	86.2	15	60	10" x 6½"	254 x 165	<b>SR1460C</b>	1533	<b>SR1460S</b>	4287
	72"	1829	220	99.8	18	80	9" x 6½"	229 x 165	<b>SR1472C</b>	1696	<b>SR1472S</b>	5163

\*Available in any shelf length. For information on shelf lengths, see "Wire Shelves," page 6.

### Vertical Storage Cabinets

see spec sheet **EG04.11**



vertical storage cabinet with flat top

**FEATURES:**

- 18 gauge type 430 stainless steel cabinet body.
- Shelves adjustable on 4" (102mm) vertical centers.
- Double pan 20 gauge stainless steel hinged doors.
- Transverse rod handles featuring keyed locks.

**Note:** Factory-installed 5" (127mm) plate casters with brake available. To order, add suffix **"-CPB5"** (example: **VSC2436-3-CPB5**) and **\$307 list** (set of four).

**Freight class is 92.5.**

#### Optional Additional Shelves for Vertical Storage Cabinets

Freight class is 70.0

description	weight		cu ft	model #	list
	lbs.	kg			
fits 36" (914mm) long cabinets	25	11.3	1.5	<b>VSC36</b>	180
fits 48" (1219mm) long cabinets	30	13.6	2.0	<b>VSC48</b>	202

#### with Flat Top

width x length x height in. mm	cu ft	wt. cap. per shelf		UNITS WITH 3 SHELVES				UNITS WITH 4 SHELVES			
		lbs.	kg	weight		model #	list	weight		model #	list
24" x 36" x 72" 610 x 914 x 1829	53	150	68.0	413	187.3	<b>VSC2436-3</b>	4971	416	188.7	<b>VSC2436-4</b>	5205
24" x 48" x 72" 610 x 1219 x 1829	68	200	90.7	485	220.2	<b>VSC2448-3</b>	5680	490	222.3	<b>VSC2448-4</b>	5939

#### with Slanted Top

width x length x height in. mm	cu ft	wt. cap. per shelf		UNITS WITH 3 SHELVES				UNITS WITH 4 SHELVES			
		lbs.	kg	weight		model #	list	weight		model #	list
24" x 36" x 78½" 610 x 914 x 1994	53	150	68.0	416	188.7	<b>VSCS2436-3</b>	4971	419	190.1	<b>VSCS2436-4</b>	5205
24" x 48" x 78½" 610 x 1219 x 1994	68	200	90.7	488	221.4	<b>VSCS2448-3</b>	5680	495	223.6	<b>VSCS2448-4</b>	5939



## Roll Bag Dispensers

see spec sheet **EG04.00**



*An effective means for dispensing rolls of bags, film, or tube stock. An easy way to establish protocol by avoiding inadvertent mixing of non-compatible chemicals.*

- Two 14" x 48" (356 x 1219mm) wire shelves.
- Eight removable dispensing bars.
- One 3-sided channel frame.
- Four 74" (1829mm) posts with 30" (762mm) outrigger feet for stability.
- Dispensing bars are adjustable on 1" (25mm) increments.
- Custom sizes available.

FEATURES:

Freight class is 70.0.

overall width x length		shelf width x length		weight		cu	chrome		stainless steel	
in.	mm	in.	mm	lbs.	kg	ft	model #	list	model #	list
30" x 48"	762 x 1219	14" x 48"	356 x 1219	79	35.8	2.3	<b>BD1448C</b>	1596	<b>BD1448S</b>	2381

Not recommended on casters.

## adjuSTable® Work Surface Systems

see spec sheet **EG04.04A**



with H-frame base and wire shelf



with C-frame base and wire shelf

- Four 33" (838mm) posts and your choice of base combination.
- Tabletops on all models feature hat channels underneath for added strength.

FEATURES:

Freight class is 70.0.

(•) MTS (made to stock) / ( ) MTO (made to order)

**EAGLE's adjuSTable® system allows you to create work surfaces in the configuration of your choice.**

	length		weight*		cu ft	AC Series		AS Series		AP Series*		AEP Series		APEP Series	
	in.	mm	lb.	kg		model #	list	model #	list	model #	list	model #	list	model #	list
<b>24" width (610mm)</b>	36"	914	65	29.5	4.5	<b>AC2436T</b>	787	<b>AS2436T</b>	1185	<b>AP2436T</b>	1488	<b>AEP2436T</b>	1428	<b>APEP2436T</b>	1733
	48"	1219	81	36.7	5.7	<b>AC2448T</b>	921	<b>AS2448T</b>	1368	<b>AP2448T</b>	1675	<b>AEP2448T</b>	1713	<b>APEP2448T</b>	2019
	60"	1524	97	44.0	7.1	<b>AC2460T</b>	1039	<b>AS2460T</b>	1586	<b>AP2460T</b>	1893	<b>AEP2460T</b>	2082	<b>APEP2460T</b>	2387
	72"	1829	113	51.3	8.5	<b>AC2472T</b>	1132	<b>AS2472T</b>	1804	<b>AP2472T</b>	2112	<b>AEP2472T</b>	2342	<b>APEP2472T</b>	2644
<b>30" width (762mm)</b>	36"	914	75	34.0	4.5	<b>AC3036T</b>	859	<b>AS3036T</b>	1349	<b>AP3036T</b>	1654	<b>AEP3036T</b>	1846	<b>APEP3036T</b>	2152
	48"	1219	94	42.6	5.7	<b>AC3048T</b>	1018	<b>AS3048T</b>	1572	<b>AP3048T</b>	1880	<b>AEP3048T</b>	2146	<b>APEP3048T</b>	2454
	60"	1524	113	51.3	7.1	<b>AC3060T</b>	1153	<b>AS3060T</b>	1803	<b>AP3060T</b>	2111	<b>AEP3060T</b>	2379	<b>APEP3060T</b>	2685
	72"	1829	132	59.9	8.5	<b>AC3072T</b>	1257	<b>AS3072T</b>	2104	<b>AP3072T</b>	2408	<b>AEP3072T</b>	2705	<b>APEP3072T</b>	3017
<b>36" width (914mm)</b>	36"	914	85	38.6	5.6	<b>AC3636T</b>	1082	<b>AS3636T</b>	1566	<b>AP3636T</b>	1871	<b>AEP3636T</b>	2058	<b>APEP3636T</b>	2284
	48"	1219	108	49.0	7.1	<b>AC3648T</b>	1236	<b>AS3648T</b>	1891	<b>AP3648T</b>	2196	<b>AEP3648T</b>	2425	<b>APEP3648T</b>	2691
	60"	1524	131	59.4	8.9	<b>AC3660T</b>	1354	<b>AS3660T</b>	2176	<b>AP3660T</b>	2482	<b>AEP3660T</b>	2804	<b>APEP3660T</b>	3116
	72"	1829	154	69.9	10.6	<b>AC3672T</b>	1505	<b>AS3672T</b>	2486	<b>AP3672T</b>	2644	<b>AEP3672T</b>	3144	<b>APEP3672T</b>	3459

\* Note: For perforated tops, laminar air flow is 23-25% depending on size.

### 1) Select work surface (from chart above).

Prefixes in chart:

- "AC" - 16 gauge type 304 brushed stainless top with chrome base
- "AS" - 16 gauge type 304 brushed stainless top with stainless base
- \* "AP" - 14 gauge type 304 brushed stainless top with 3/4" (19mm) perforations on 1" (25mm) centers with stainless base.
- \* "AEP" - Electropolished solid top with stainless base.
- "APEP" - Electropolished perforated top with stainless base.

### 2) Select base combination.

Must be specified with your choice of work surface.

Base combination is included in table price.

Choose from the following combinations:

- Base with two C-frames
- Base with two H-frames
- Base with one C-frame and one wire shelf
- Base with one H-frame and one wire shelf

For wire mount keyboard stations see page 111.

## Catalog Section 4

### adjuSTable® Work Surface Systems with Cantilevered Overhead System

see spec sheet **EG04.04B**

**Allows you to create work surfaces of your choice with cantilevered overhead or wire overshelf systems. Tabletops on all models feature hat channels underneath for added strength.**

Work surface of your choice is combined with two 33" (838mm) front posts, two 63" (1600mm) rear posts, two cantilevered wire overshelves, and your choice of base combination.

FEATURES: • 34½" (876mm) working height.

Freight class is 70.0.



#### 1) Select work surface.

Prefixes in chart below:

“OAC” – 16 gauge type 304 brushed stainless top, with chrome base and chrome overshelves.

“OAS” – 16 gauge type 304 brushed stainless top, with stainless base and stainless overshelves.

\* “OAP” – 14 gauge type 304 brushed stainless top with ¼" (19mm) perforations on 1" (25mm) centers, with stainless base and stainless overshelves.

“OAEP” – 14 gauge type 304 electropolished solid top, with stainless base and stainless overshelves.

\* “OAPEP” – 14 gauge type 304 electropolished perforated top, with stainless base and stainless overshelves.

	length		weight*		cu ft	OAC Series		OAS Series		OAP Series*		OAEP Series		OAPEP Series*	
	in.	mm	lb.	kg		model #	list	model #	list	model #	list	model #	list	model #	list
<b>24"</b>	36"	914	65	29.5	4.4	<b>OAC2436T-2</b>	938	<b>OAS2436T-2</b>	1631	<b>OAP2436T-2</b>	1875	<b>OAEP2436T-2</b>	1937	<b>OAPEP2436T-2</b>	2180
<b>width</b>	48"	1219	81	36.7	5.7	<b>OAC2448T-2</b>	1080	<b>OAS2448T-2</b>	1865	<b>OAP2448T-2</b>	2171	<b>OAEP2448T-2</b>	2207	<b>OAPEP2448T-2</b>	2515
(610mm)	60"	1524	97	44.0	7.0	<b>OAC2460T-2</b>	1224	<b>OAS2460T-2</b>	2164	<b>OAP2460T-2</b>	2471	<b>OAEP2460T-2</b>	2662	<b>OAPEP2460T-2</b>	2967
<b>30"</b>	36"	914	75	34.0	4.4	<b>OAC3036T-2</b>	998	<b>OAS3036T-2</b>	1797	<b>OAP3036T-2</b>	2101	<b>OAEP3036T-2</b>	2295	<b>OAPEP3036T-2</b>	2599
<b>width</b>	48"	1219	94	42.6	5.7	<b>OAC3048T-2</b>	1177	<b>OAS3048T-2</b>	2069	<b>OAP3048T-2</b>	2375	<b>OAEP3048T-2</b>	2640	<b>OAPEP3048T-2</b>	2948
(762mm)	60"	1524	113	51.3	7.0	<b>OAC3060T-2</b>	1336	<b>OAS3060T-2</b>	2384	<b>OAP3060T-2</b>	2691	<b>OAEP3060T-2</b>	2956	<b>OAPEP3060T-2</b>	3262
<b>36"</b>	36"	914	85	38.6	5.0	<b>OAC3636T-2</b>	1218	<b>OAS3636T-2</b>	2011	<b>OAP3636T-2</b>	2318	<b>OAEP3636T-2</b>	2504	<b>OAPEP3636T-2</b>	2732
<b>width</b>	48"	1219	108	49.0	7.0	<b>OAC3648T-2</b>	1393	<b>OAS3648T-2</b>	2386	<b>OAP3648T-2</b>	2692	<b>OAEP3648T-2</b>	2919	<b>OAPEP3648T-2</b>	3185
(914mm)	60"	1524	131	59.4	9.0	<b>OAC3660T-2</b>	1522	<b>OAS3660T-2</b>	2753	<b>OAP3660T-2</b>	3059	<b>OAEP3660T-2</b>	3381	<b>OAPEP3660T-2</b>	3693

\* Note: For perforated tops, laminar air flow is 23-25% depending on size.

#### 2) Select base combination.

Base combination is included in table price.

Must be specified with your choice of work surface.

Choose from the following combinations:

- Base with two C-frames
- Base with two H-frames
- Base with one C-frame and one wire shelf
- Base with one H-frame and one wire shelf

Contact factory for custom workstation.

#### Optional Keyboard Stations for adjuSTable® Work Surface Systems 20½" wide x 11½" deep (521 x 292mm).

			Table Mount		Wire Mount			
weight lbs.	kg	cubic feet	stainless steel		chrome		stainless steel	
			model #	list	model #	list	model #	list
6.0	2.7	0.35	<b>KBD-1/SS</b>	357	<b>KBD-2 •</b>	223	<b>KBD-2/SS</b>	377



table mount keyboard station



wire mount keyboard station for tables on page 108



## adjuSTable® Work Surface Systems with Wire Overshelf System

see spec sheet **EG04.04C**

- FEATURES: • 34½" (876mm) working height.
- Freight class is 70.0.
- (•) MTS (made to stock) / ( ) MTO (made to order)

**Allows you to create work surfaces of your choice with cantilevered overhead or wire overshelf systems. Tabletops on all models feature hat channels underneath for added strength.**

Work surface of your choice is combined with two 33" (838mm) front posts, two 63" (1600mm) rear posts, two wire overshelves, two 29" (737mm) front posts for wire overshelves, and your choice of base combination.



### 1) Select work surface.

Prefixes in the chart below:

- "WOAC" – 16 gauge type 304 brushed stainless top, with chrome base and chrome overshelves.
- "WOAS" – 16 gauge type 304 brushed stainless top, with stainless base and stainless overshelves.
- \* "WOAP" – 14 gauge type 304 brushed stainless top with ¾" (19mm) perforations on 1" (25mm) centers, with stainless base and stainless overshelves.
- "WOAEP" – 14 gauge type 304 electropolished solid top, with stainless base and stainless overshelves.
- \* "WOAPEP" – 14 gauge type 304 electropolished perforated top, with stainless base and stainless overshelves.

	length		weight		cu ft	WOAC Series		WOAS Series		WOAP Series*		WOAEP Series		WOAPEP* Series	
	in.	mm	lb.	kg		model #	list	model #	list	model #	list	model #	list	model #	list
<b>24"</b> width (610mm)	36"	914	65	29.5	4.4	WOAC2436T-2	992	WOAS2436T-2	1718	WOAP2436T-2	1962	WOAEP2436T-2	2023	WOAPEP2436T-2	2265
	48"	1219	81	36.7	5.7	WOAC2448T-2	1129	WOAS2448T-2	1996	WOAP2448T-2	2299	WOAEP2448T-2	2339	WOAPEP2448T-2	2644
	60"	1524	97	44.0	7.0	WOAC2460T-2	1268	WOAS2460T-2	2342	WOAP2460T-2	2649	WOAEP2460T-2	2839	WOAPEP2460T-2	3146
<b>30"</b> width (762mm)	36"	914	75	34.0	4.4	WOAC3036T-2	1049	WOAS3036T-2	1883	WOAP3036T-2	2119	WOAEP3036T-2	2380	WOAPEP3036T-2	2685
	48"	1219	94	42.6	5.7	WOAC3048T-2	1225	WOAS3048T-2	2201	WOAP3048T-2	2505	WOAEP3048T-2	2773	WOAPEP3048T-2	3078
	60"	1524	113	51.3	7.0	WOAC3060T-2	1379	WOAS3060T-2	2562	WOAP3060T-2	2867	WOAEP3060T-2	3136	WOAPEP3060T-2	3439
<b>36"</b> width (914mm)	36"	914	85	38.6	5.0	WOAC3636T-2	1273	WOAS3636T-2	2098	WOAP3636T-2	2402	WOAEP3636T-2	2591	WOAPEP3636T-2	2818
	48"	1219	108	49.0	7.0	WOAC3648T-2	1441	WOAS3648T-2	2516	WOAP3648T-2	2820	WOAEP3648T-2	3051	WOAPEP3648T-2	3318
	60"	1524	131	59.4	9.0	WOAC3660T-2	1565	WOAS3660T-2	2934	WOAP3660T-2	3236	WOAEP3660T-2	3560	WOAPEP3660T-2	3872

\* Note: For perforated tops, laminar air flow is 23-25% depending on size.

### 2) Select base combination.

Base combination is included in table price. Must be specified with your choice of work surface. Choose from the following combinations:

- Base with two C-frames
- Base with two H-frames
- Base with one C-frame and one wire shelf
- Base with one H-frame and one wire shelf

Contact factory for custom configurations.

### Optional Utility Drawers for adjuSTable® Work Surface Systems

Stainless steel construction. Enclosed assembly comes complete with housing, drawer, drawer pan, and drawer front. Guides and rollers included.

length x width x height in. mm	cu ft	with Pull Flange and Full Front				Enclosed Assembly			
		weight lbs.	kg	part #	list	weight lbs.	kg	part #	list
20" x 20" x 5" 508 x 508 x 127	3.0	25	11.3	501571•	394	35	15.9	501572•	717



## Catalog Section 4

### Cleanroom Tables

see spec sheet **EG04.02**

#### There are two steps in ordering a cleanroom table:

- Step 1) Choose a tabletop.
  - Step 2) Choose a base frame.
- Each order must be specified.

FEATURES:

- Available with solid or perforated tops.
- Brushed or electropolished finish.
- Perforated tops allow for 40% laminar flow, depending on size.
- All tops are 14 gauge type 301 stainless.
- Shipped knocked down, reducing freight costs and the potential for freight damage.

**Freight class is 70.0.**

#### STEP 1: Select Cleanroom Tabletops – Alcohol-Wiped and Cleanroom-Bagged

Prefixes in chart below:

- “CRT” – Brushed stainless solid top.
- “CRPT” – Brushed stainless perforated top (3/4" dia. holes on 1" center).
- “SEP” – Electropolished solid top.
- “EPCRT” – Electropolished perforated top (3/4" dia. holes on 1" center).

Please note: Cleanroom Tables are not eligible for returns.

	length		weight*		cu	CRT Series*		CRPT Series		SEP Series*		EPCRT Series	
	in.	mm	lb.	kg		ft	model #	list	model #	list	model #	list	model #
<b>24"</b> width (610mm)	24"	610	30	13.6	2.9	CRT2424T	1257	CRPT2424T	1433	SEP2424T	1803	EPCRT2424T	1721
	36"	914	40	18.1	3.5	CRT2436T	1396	CRPT2436T	1686	SEP2436T	2004	EPCRT2436T	2022
	48"	1219	50	22.7	4.6	CRT2448T	1458	CRPT2448T	1971	SEP2448T	2509	EPCRT2448T	2521
	60"	1524	58	26.3	5.7	CRT2460T	1517	CRPT2460T	2128	SEP2460T	2699	EPCRT2460T	2721
	72"	1829	76	34.5	6.9	CRT2472T	1723	CRPT2472T	2726	SEP2472T	3339	EPCRT2472T	3358
	84"	2134	80	36.3	7.9	CRT2484T	2082	CRPT2484T	3021	SEP2484T	3824	EPCRT2484T	3854
<b>30"</b> width (762mm)	96"	2438	101	45.8	9.1	CRT2496T	2223	CRPT2496T	3929	SEP2496T	4577	EPCRT2496T	4603
	30"	762	32	14.5	2.9	CRT3030T	1276	CRPT3030T	1488	n/a	n/a	n/a	n/a
	36"	914	42	19.1	3.5	CRT3036T	1418	CRPT3036T	1753	SEP3036T	2260	EPCRT3036T	2276
	48"	1219	55	24.9	4.6	CRT3048T	1473	CRPT3048T	2034	SEP3048T	2623	EPCRT3048T	2636
	60"	1524	66	29.9	5.7	CRT3060T	1680	CRPT3060T	2199	SEP3060T	2940	EPCRT3060T	2960
	72"	1829	79	35.8	6.9	CRT3072T	1827	CRPT3072T	2734	SEP3072T	3398	EPCRT3072T	3411
<b>36"</b> width (914mm)	84"	2134	91	41.3	7.9	CRT3084T	2165	CRPT3084T	3260	SEP3084T	3940	EPCRT3084T	3959
	96"	2438	112	50.8	9.1	CRT3096T	2314	CRPT3096T	4027	SEP3096T	4701	EPCRT3096T	4735
	36"	914	50	22.7	4.4	CRT3636T	1469	CRPT3636T	1841	SEP3636T	2342	EPCRT3636T	2489
	48"	1219	63	28.6	5.5	CRT3648T	1545	CRPT3648T	2094	SEP3648T	2760	EPCRT3648T	2938
	60"	1524	75	34.0	6.8	CRT3660T	1956	CRPT3660T	2433	SEP3660T	3182	EPCRT3660T	3395
	72"	1829	90	40.8	8.1	CRT3672T	2122	CRPT3672T	2752	SEP3672T	3512	EPCRT3672T	3745
	84"	2134	106	48.1	9.5	CRT3684T	2264	CRPT3684T	3287	n/a	n/a	n/a	n/a
	96"	2438	125	56.7	10.8	CRT3696T	2483	CRPT3696T	4129	n/a	n/a	n/a	n/a

\* For CRT and SEP Series, add 10 lbs. to weight.



with perforated top and H-frame base



with solid top and C-frame base

#### STEP 2: Select Cleanroom Table Base Frame

The following options are included in the table price (above). Must be specified with your choice of tabletop.

- For CRT and CRPT Series tables only:**
  - Knocked down stainless steel H-frame
  - Knocked down stainless steel C-frame
- For SEP and EPCRT Series tables only:**
  - Knocked down electropolished H-frame
  - Knocked down electropolished C-frame

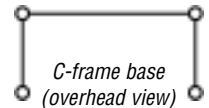
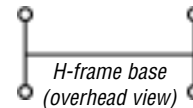

#### Optional Base Frames available for Cleanroom Tables

The following options are not included in the table price.

Contact Customer Service for pricing.

- For CRT and CRPT Series tables only:**
  - Solid stainless steel undershelf.
  - Perforated stainless steel undershelf.
  - Welded construction H-frame.
  - Welded construction C-frame.
- For SEP and EPCRT Series tables only:**
  - Solid undershelf electropolished.
  - Perforated undershelf electropolished.

### Stainless Steel Cleaner & Polish



- Cleans and polishes in one step.
- Does not streak or leave fingerprints.
- Leaves a protective invisible coating.

weight		model #	list
oz.	kg		
15	0.4	<b>004026</b>	18



100 Industrial Boulevard, Clayton, DE 19938-8903 U.S.A.  
 Phone: 800-637-5100 or 302-653-3000. Fax: 302-653-2065  
<http://www.eaglegrp.com>

### Stainless Steel Countertops

see spec sheet **EG04.12**

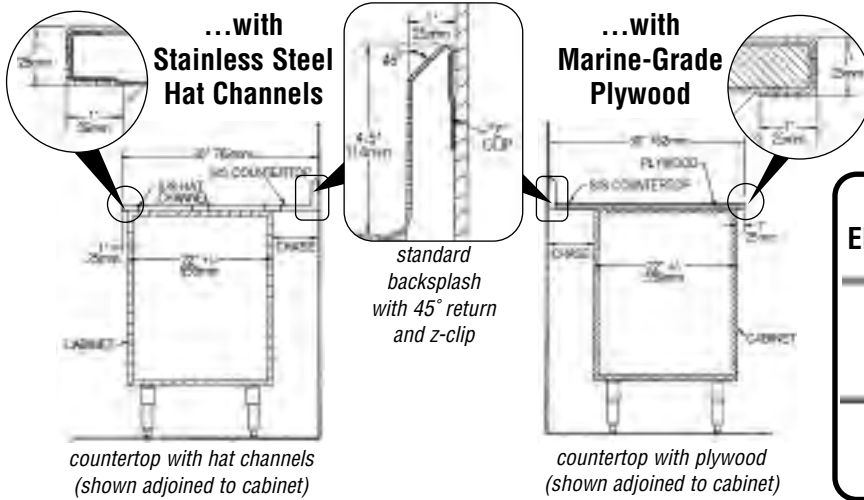

- Countertops for cabinet base (*by others*) are 16 gauge type 304 stainless steel with a #4 finish.
- All countertops are 30" (762mm) front-to-back and include 4½" x 1" (114 x 25mm) backsplash with 45° return and z-clip(s).
- Custom configurations also available. Consult factory.

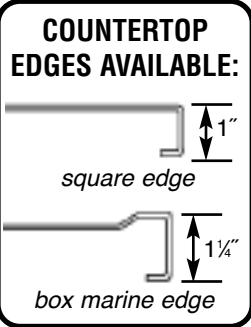

length in.	mm	Countertops with Stainless Steel Hat Channels		Countertops with Marine-Grade Plywood					
		with square edge model #	with box marine edge list	with square edge model #	with box marine edge list				
24"	610	CTC3024-SQ	1185	CTC3024-BM	1185	CTW3024-SQ	1172	CTW3024-BM	1172
30"	762	CTC3030-SQ	1209	CTC3030-BM	1209	CTW3030-SQ	1197	CTW3030-BM	1197
36"	914	CTC3036-SQ	1236	CTC3036-BM	1236	CTW3036-SQ	1222	CTW3036-BM	1222
42"	1067	CTC3042-SQ	1291	CTC3042-BM	1291	CTW3042-SQ	1277	CTW3042-BM	1277
48"	1219	CTC3048-SQ	1346	CTC3048-BM	1346	CTW3048-SQ	1333	CTW3048-BM	1333
54"	1372	CTC3054-SQ	1403	CTC3054-BM	1403	CTW3054-SQ	1388	CTW3054-BM	1388
60"	1524	CTC3060-SQ	1460	CTC3060-BM	1460	CTW3060-SQ	1444	CTW3060-BM	1444
66"	1676	CTC3066-SQ	1516	CTC3066-BM	1516	CTW3066-SQ	1500	CTW3066-BM	1500
72"	1829	CTC3072-SQ	1667	CTC3072-BM	1667	CTW3072-SQ	1556	CTW3072-BM	1556
78"	1981	CTC3078-SQ	1724	CTC3078-BM	1724	CTW3078-SQ	1611	CTW3078-BM	1611
84"	2134	CTC3084-SQ	1783	CTC3084-BM	1783	CTW3084-SQ	1667	CTW3084-BM	1667
90"	2286	CTC3090-SQ	1844	CTC3090-BM	1844	CTW3090-SQ	1722	CTW3090-BM	1722
96"	2438	CTC3096-SQ	1898	CTC3096-BM	1898	CTW3096-SQ	1779	CTW3096-BM	1779
102"	2591	CTC30102-SQ	1957	CTC30102-BM	1957	CTW30102-SQ	1929	CTW30102-BM	1929
108"	2743	CTC30108-SQ	2015	CTC30108-BM	2015	CTW30108-SQ	2081	CTW30108-BM	2081
114"	2896	CTC30114-SQ	2072	CTC30114-BM	2072	CTW30114-SQ	2137	CTW30114-BM	2137
120"	3048	CTC30120-SQ	2129	CTC30120-BM	2129	CTW30120-SQ	2194	CTW30120-BM	2194
126"	3200	CTC30126-SQ	2187	CTC30126-BM	2187	CTW30126-SQ	2248	CTW30126-BM	2248
132"	3353	CTC30132-SQ	2245	CTC30132-BM	2245	CTW30132-SQ	2303	CTW30132-BM	2303
138"	3505	CTC30138-SQ	2303	CTC30138-BM	2303	CTW30138-SQ	2359	CTW30138-BM	2359
144"	3658	CTC30144-SQ	2361	CTC30144-BM	2361	CTW30144-SQ	2415	CTW30144-BM	2415

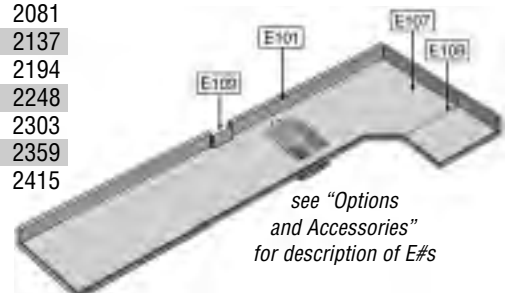

see "Options and Accessories" for description of E#s

### Options and Accessories

model #	description	list
E101	10" (254mm) high backsplash, per linear foot	61
E107	90° corner	1363
E108	Welded field joint	266
E109	Cutout for pipes, columns	666
E37	NSF sprayed-on latex sound deadening - up to 12' (3658mm)	680
E37A	Latex sound deadening, for each additional ft.	54
Type 316 S/S	Add per countertop/item	45%

### Optional Drawn Bowl Sinks with Faucet & Basket Drain

model #	description	list
E20	14" x 10" x 9½" (356 x 254 x 241mm)	1078
E21	16" x 14" x 9½" (406 x 356 x 241mm)	1132
E22	20" x 16" x 8" (508 x 406 x 203mm)	1207
E23	20" x 16" x 14" (508 x 406 x 356mm)	1339
E24	20" x 18" x 14" (508 x 457 x 356mm)	1468
E24A	20" x 20" x 14" (508 x 508 x 356mm)	1478
E25	24" x 24" x 14" (610 x 610 x 356mm)	2001

**Exchange Carts**

EC Series .....116  
 ECD Series .....116  
 ECD7/ECE7 Series .....119  
 ECDS Series .....117  
 ECDT Series .....118  
 ECE Series .....116  
 ECES Series .....117  
 ECET Series .....119  
 ECS Series .....117  
 ECT Series .....118

**Carts**

Basket .....123  
 Catheter Procedure .....124  
 Inhalation Therapy .....122  
 Linen .....122  
 Mail .....122  
 Patient Article Carts/Accessories ....120  
 Stainless Steel Case .....126  
 Sterile Wrap .....125  
 Suture .....121  
 Wire Basket Utility .....123

**Steril-Eze® Surgical Case Carts**

Closed .....125  
 Open .....124  
 Open Wire .....125

**More Healthcare**

Cart Covers .....128  
 Double-Sided Bin-Holder Rails .....130  
 Foot Stools .....121  
 I.V. Stands .....120  
 Instrument Tables .....127  
 Mobile Garment Racks .....127  
 Plate Casters .....120  
 Stainless Steel Overlays .....130  
 Storage Bins .....129  
 Surgical Scrub Sinks .....123

**Shower Benches**

product announcement **EG8189**

*Teak wood slats offer superior water resistance, and can withstand heat, moisture and mold.*

**FEATURES:**

- Seat is made of full-length 1½"-thick x 3½"-wide (29 x 89mm) Burmese teak wood slats, featuring finished top edges, spaced for drainage.
- Wall-mounted model includes 11-gauge stainless steel drop brackets, allowing the bench to be folded down when not in use.
- Options available include lengths from 24" to 36" (610 to 914mm), towel ring, soap/shower basket.

**Freight class is 70.0.**

*Consult factory for pricing.*

description	width		length		model #
	in.	mm	in.	mm	
wall mount, stainless brackets	16"	762	30"	762	<b>SB1630W</b>
floor mount, stainless base	16"	762	30"	762	<b>SB1630-S</b>
floor mount, teak wood base	16"	762	30"	762	<b>SB1630-T</b>

**NEW**

**Storage Supply Cart**

**FEATURES:**

- Nine 24" x 48" (610 x 1219mm) wire shelves.
- Four 63" (1600mm) posts.
- Set of 5" (127mm) swivel casters, two with brake.
- 48 supply bins. Each bin is 23½" front-to-back, 6½" side-to-side, and 4" tall (600 x 168 x 102mm).
- Shelves and posts come with chrome finish.



width		length		height		model #	list
in.	mm	in.	mm	in.	mm		
24"	610	48"	1219	68"	1727	<b>SSC2448C63-48</b>	2215





### Exchange Carts

see spec sheet **EG05.09A**

**Meets all requirements for supply exchange in any healthcare environment.**

patented  
**QuadTruss®**  
design

(Patent #5,390,803)

#### Patented QuadTruss® Design

makes shelves up to 25% stronger and provides a retaining ledge for increased strength and product retention.

- Chrome-plated posts are grooved and are numbered on one-inch increments, enabling shelving to be adjusted up and down.
- Open-wire construction reduces dust and contamination build-up.
- Five chrome-plated wire shelves.
- With various shelving configurations, caster styles, accessory packages, and a number of sizes, these carts are the ultimate in versatility!

FEATURES:

**Freight class is 70.0.**



#EC2160C

#### EC Series

5" (127mm) resilient stem casters (two with brake). Six plastic label holders. 69" (1753mm) overall height.

shelf width x length		weight		cubic	model #	list
in.	mm	lbs.	kg	feet		
21" x 48"	533 x 1219	93	42.2	6.3	<b>EC2148C</b>	641
21" x 60"	533 x 1524	114	51.7	7.3	<b>EC2160C</b>	717
24" x 48"	610 x 1219	106	48.1	6.8	<b>EC2448C</b>	692
24" x 60"	610 x 1524	131	59.4	8.3	<b>EC2460C</b>	780



#ECD2448C

#### ECD Series

6" (152mm) polyurethane casters (two with brake). Chrome dolly frame with wraparound bumper. 6" (152mm) deep tote boxes with dividers. Shelf dividers. Six plastic label holders. One slide assembly. 70" (1778mm) overall height.

shelf width x length		weight		cubic	# of tote	# of shelf	model #	list
in.	mm	lbs.	kg	feet	boxes	dividers		
21" x 48"	533 x 1219	123	55.8	9.9	2	2	<b>ECD2148C</b>	1946
21" x 60"	533 x 1524	146	66.2	12.2	2	3	<b>ECD2160C</b>	2040
24" x 48"	610 x 1219	163	73.9	19.6	2	2	<b>ECD2448C</b>	2012
24" x 60"	610 x 1524	188	85.3	19.6	2	3	<b>ECD2460C</b>	2137



#ECE2448C

#### ECE Series

8" (203mm) polyurethane casters (two with brake). Chrome dolly frame with wraparound bumper. Side and back enclosure panels. Slide assemblies. 6" (152mm) deep tote boxes with box dividers. Shelf dividers. 12 plastic label holders. 72" (1829mm) overall height.

shelf width x length		weight		cubic	# of tote	# of shelf	# of super	model #	list
in.	mm	lbs.	kg	feet	boxes	dividers	slides		
21" x 48"	533 x 1219	160	72.6	20.3	2	4	1	<b>ECE2148C</b>	2359
21" x 60"	533 x 1524	185	83.9	25.2	4	6	2	<b>ECE2160C</b>	2777
24" x 48"	610 x 1219	178	80.7	23.5	2	4	1	<b>ECE2448C</b>	2426
24" x 60"	610 x 1524	203	92.1	34.8	4	6	2	<b>ECE2460C</b>	2883

**Catalog Section 5**

**Exchange Carts**

see spec sheet **EG05.09A** **EG05.09B**

**Meets all requirements for supply exchange in any healthcare environment.**



(Patent #5,390,803)

**Patented QuadTruss® Design**

makes shelves up to 25% stronger and provides a retaining ledge for increased strength and product retention.

**FEATURES:**

- Chrome-plated posts are grooved and are numbered on one-inch increments, enabling shelving to be adjusted up and down.
- Open-wire construction reduces dust and contamination build-up.
- Four chrome-plated wire shelves.
- With various shelving configurations, caster styles, accessory packages, and a number of sizes, these carts are the ultimate in versatility!

**Freight class is 70.0.**

**ECS Series**

5" (127mm) resilient stem casters (two with brake). One stainless steel solid shelf. Six plastic label holders. 69" (1753mm) overall height.

shelf width x length		weight		cubic	model #	list
in.	mm	lbs.	kg	feet		
21" x 48"	533 x 1219	158	71.6	6.3	<b>ECS2148C</b>	820
21" x 60"	533 x 1524	183	83.0	7.3	<b>ECS2160C</b>	923
24" x 48"	610 x 1219	173	78.5	6.8	<b>ECS2448C</b>	873
24" x 60"	610 x 1524	193	87.5	8.3	<b>ECS2460C</b>	995



#ECS2160C

**ECDS Series**

6" (152mm) polyurethane casters (two with brake). One stainless steel solid shelf. Chrome dolly frame with wraparound bumper. One slide assembly. 6" (152mm) deep tote boxes with box dividers. Shelf dividers. Six plastic label holders. 70" (1778mm) overall height.

shelf width x length		weight		cubic	# of tote	# of shelf	model #	list
in.	mm	lbs.	kg	feet	boxes	dividers		
21" x 48"	533 x 1219	185	83.9	15.8	2	2	<b>ECDS2148C</b>	2126
21" x 60"	533 x 1524	200	90.7	19.2	2	3	<b>ECDS2160C</b>	2269
24" x 48"	610 x 1219	192	87.1	15.8	2	2	<b>ECDS2448C</b>	2169
24" x 60"	610 x 1524	218	98.9	19.2	2	3	<b>ECDS2460C</b>	2352



#ECDS2160C

**ECES Series**

8" (203mm) polyurethane casters (two with brake). One stainless steel solid shelf. Chrome dolly frame with wraparound bumper. Side and back enclosure panels. Slide assemblies. 6" (152mm) deep tote boxes with box dividers. Shelf dividers. 12 plastic label holders. 72" (1829mm) overall height.

shelf width x length		weight		cubic	# of tote	# of shelf	# of super	model #	list
in.	mm	lbs.	kg	feet	boxes	dividers	slides		
21" x 48"	533 x 1219	160	72.6	20.3	2	4	1	<b>ECES2148C</b>	2502
21" x 60"	533 x 1524	185	83.9	25.2	4	6	2	<b>ECES2160C</b>	2778
24" x 48"	610 x 1219	178	80.7	23.5	2	4	1	<b>ECES2448C</b>	2560
24" x 60"	610 x 1524	203	92.1	34.8	4	6	2	<b>ECES2460C</b>	2955



#ECES2160C



### Exchange Carts

see spec sheet **EG05.09B** **EG05.09C**



(Patent #5,390,803)

**Patented QuadTruss® Design** makes shelves up to 25% stronger and provides a retaining ledge for increased strength and product retention.

**Meets all requirements for supply exchange in any healthcare environment.**

*With various shelving configurations, caster styles, accessory packages, and a number of sizes, these exchange carts are the ultimate in versatility.*

- Chrome-plated posts are grooved and are numbered on one-inch increments, enabling shelving to be adjusted up and down.
- Open-wire construction reduces dust and contamination build-up.
- Four chrome-plated wire shelves.
- Choice of chrome-plated wire or stainless steel solid fifth shelf.

FEATURES:

**Freight class is 70.0.**



#ECT2160C

#### ECT Series

5" (127mm) resilient stem casters (two with brake). One slide assembly. Two 6" (152mm) deep tote boxes with box dividers. Six plastic label holders. 69" (1753mm) overall height.

shelf width x length		weight		cubic feet	# of tote boxes	shelves	model #	list
in.	mm	lbs.	kg					
21" x 60"	533 x 1524	166	75.3	11.6	2	5-wire	<b>ECT2160C</b>	937
21" x 60"	533 x 1524	191	86.6	11.6	2	4-wire, 1-solid	<b>ECTS2160C</b>	1146
24" x 60"	610 x 1524	181	82.1	11.6	2	5-wire	<b>ECT2460C</b>	1003
24" x 60"	610 x 1524	206	93.4	11.6	2	4-wire, 1-solid	<b>ECTS2460C</b>	1217



#ECDTS2160C

#### ECDT Series

6" (152mm) polyurethane casters (two with brake). Chrome dolly frame with wraparound bumper. Three slide assemblies. Six tote boxes with box dividers. Three shelf dividers. Six plastic label holders. 70" (1778mm) overall height.

shelf width x length		weight		cu ft	tote boxes			shelves	model #	list
in.	mm	lbs.	kg		3" (76mm)	6" (152mm)	9" (229mm)			
21" x 60"	533 x 1524	231	104.7	26.6	1	4	1	5-wire	<b>ECDT2160C</b>	2500
21" x 60"	533 x 1524	241	109.3	26.6	1	4	1	4-wire, 1-solid	<b>ECDS2160C</b>	2709
24" x 60"	610 x 1524	246	111.6	26.6	1	4	1	5-wire	<b>ECDT2460C</b>	2583
24" x 60"	610 x 1524	256	116.1	26.6	1	4	1	4-wire, 1-solid	<b>ECDS2460C</b>	2797

**Catalog Section 5**

**Exchange Carts**

see spec sheet **EG05.09C**



(Patent #5,390,803)

**Patented QuadTruss® Design**

makes shelves up to 25% stronger and provides a retaining ledge for increased strength and product retention.

**Meets all requirements for supply exchange in any healthcare environment.**

*With various shelving configurations, caster styles, accessory packages, and a number of sizes, these exchange carts are the ultimate in versatility.*

- Chrome-plated posts are grooved and are numbered on one-inch increments, enabling shelving to be adjusted up and down.
- Open-wire construction reduces dust and contamination build-up.
- Four chrome-plated wire shelves.
- Choice of chrome-plated wire or stainless steel solid fifth shelf.

FEATURES:

**Freight class is 70.0.**



**ECET Series**

6" (152mm) polyurethane casters (two with brake). Chrome dolly frame with wraparound bumper. Side and back enclosure panels. Three slide assemblies. Six tote boxes with box dividers. 12 plastic label holders. 72" (1829mm) overall height.

shelf width x length in. mm	weight lbs. kg	cu ft	tote boxes 3" (76mm)	tote boxes 6" (152mm)	tote boxes 9" (229mm)	shelves	model #	list
21" x 60" 533 x 1524	250 113.4	29.6	1	4	1	5-wire	<b>ECET2160C</b>	2786
21" x 60" 533 x 1524	260 117.9	29.6	1	4	1	4-wire, 1-solid	<b>ECETS2160C</b>	2993
24" x 60" 610 x 1524	262 118.8	29.6	1	4	1	5-wire	<b>ECET2460C</b>	2849
24" x 60" 610 x 1524	272 123.4	29.6	1	4	1	4-wire, 1-solid	<b>ECETS2460C</b>	3062

**ECD7/ECE7 Series**

8" (203mm) polyurethane casters (two with brake). Choice of three shelf dividers or side and back enclosure panels. Three slide assemblies. Seven tote boxes with snap on card holders and box dividers. 12 plastic label holders. Chrome dolly frame with wraparound bumper. 72" (1829mm) overall height.



shelf width x length in. mm	weight lbs. kg	cu ft	tote boxes 3" (76mm)	tote boxes 6" (152mm)	shelves	other	model #	list
24" x 60" 610 x 1524	226 102.5	19.6	2	5	5-wire	shelf dividers	<b>ECD72460C</b>	2751
24" x 60" 610 x 1524	236 107.0	19.6	2	5	4-wire, 1-solid	shelf dividers	<b>ECD7S2460C</b>	2966
24" x 60" 610 x 1524	250 113.4	28.8	2	5	5-wire	enclosure panels	<b>ECE72460C</b>	3022
24" x 60" 610 x 1524	260 117.9	28.8	2	5	4-wire, 1-solid	enclosure panels	<b>ECE7S2460C</b>	3237



I.V. Stands



see product announcement **EG8128**

description	model #	list
with black epoxy coated top	IV-1	474
with blue epoxy coated top	IV-2	474
with green epoxy coated top	IV-3	474
with red epoxy coated top	IV-4	474

*Easily adjusts from 66" to 99" height by a turn of the knob.*



FEATURES:

- 16 gauge type 304 stainless steel 1" (25mm)-diameter pole.
- Heavy carbon steel five-leg base with epoxy finish.
- 3" (76mm) swivel casters with chrome-plated hood and rubber tread—two with brake.
- Four-hook top. All stainless steel finish.

Freight class is 70.0.

Accessories for I.V. Stands

description	model #	list
patient handle & accessory tray	380401	149
two-cylinder holder	380402	122
electrical strip	380403	447
wire basket	380404	122



Patient Article Carts

see spec sheet **EG05.10**

FEATURES:

- 24" (610mm) long coat hanger tube and 12 rods.

Freight class is 92.5.

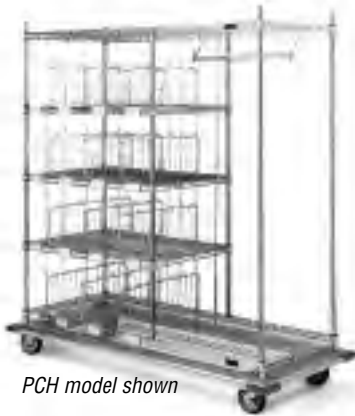

PCH model shown

	length		weight		cu ft	intermediate shelf length		style	# of dividers	# of bin markers	model #	list
	in.	mm	lbs.	kg		in.	mm					
24" width (610mm)	48"	1219	103	46.7	13.6	24"	610	standard	8	12	PC2448-C	1120
	60"	1524	126	57.2	18.2	36"	914	standard	12	16	PC2460-C	1303
	48"	1219	166	75.8	24.8	24"	610	heavy duty	8	12	PCH2448-C	1334
	60"	1524	188	85.3	25.4	36"	914	heavy duty	12	16	PCH2460-C	1464

Patient Article Cart Covers - Freight class 70.0

shelf width x length		post height		weight		cu ft	uncoated w/zipper		coated w/zipper	
in.	mm	in.	mm	lbs.	kg		model #	list	model #	list
24" x 48"	610 x 1219	63"	1600	4	1.8	0.5	CZ-63-2448	199	CZC-63-2448	297
24" x 60"	610 x 1524	63"	1600	5	2.3	0.6	CZ-63-2460	235	CZC-63-2460	323

Accessories for Patient Article Carts - Freight class 70.0

description	weight		cubic feet	model #	list
	lbs.	kg			
8" (203mm) divider	1.8	0.8	0.5	SD24-C	33
rod (includes 4 fastening tabs)	0.5	0.2	0.4	R63-C	12
plastic label holder	—	—	—	A204331	4
24" x 24" (610 x 610mm) chrome shelf	9.5	4.3	0.8	2424C	76
24" x 36" (610 x 914mm) chrome shelf	13.6	6.2	0.8	2436C	81

Polyurethane Plate Casters

see spec sheet **EG01.05B**

Freight class is 65.0.

(•) MTS (made to stock) / ( ) MTO (made to order)

type	capacity		wheel diameter		wheel face		weight		cu ft	EAGLEbrite® zinc	
	lbs.	kg	in.	mm	in.	mm	lbs.	kg		model #	list
swivel	600	272.1	6"	152	2"	51	9.0	4.1	0.5	CPS6P-600 •	92
brake	600	272.1	6"	152	2"	51	9.0	4.1	0.5	CPB6P-600 •	104
rigid	600	272.1	6"	152	2"	51	9.0	4.1	0.5	CPR6P-600	104
swivel	700	317.5	8"	203	2"	51	10.5	4.8	1.0	CPS8P-700	104
brake	700	317.5	8"	203	2"	51	10.5	4.8	1.0	CPB8P-700	116
rigid	700	317.5	8"	203	2"	51	10.5	4.8	1.0	CPR8P-700	116



with brake



**Catalog Section 5**

**Suture Carts**

see spec sheet **EG05.08**



- 18" (457mm) width.
- Four or five specially designed, adjustable slanted shelves for quick and easy access to sutures.
- Shelves adjust up to 30° slant.
- Open-wire construction.
- All models include three dividers per shelf.
- 5" (127mm) casters, two of which have brakes, are chrome-plated with polyurethane tread.
- All components are chrome-plated.

FEATURES:

**Freight class is 70.0.**

(•) MTS (made to stock) / ( ) MTO (made to order)

**4-Shelf Units**

	length		post height		weight		cu		
	in.	mm	in.	mm	lbs.	kg	ft	model #	list
<b>18" width</b> (457mm)	36"	914	54"	1372	62	28.1	2.5	<b>SCH1836C-4</b>	932
	48"	1219	54"	1372	66	29.9	3.5	<b>SCH1848C-4</b>	935

**Options for Suture Carts** - Freight class is 30.0.

Customize your unit to suit any application.

	length		weight		cubic			
	in.	mm	lbs.	kg	feet	description	model #	list
	36"	914	3	1.4	1.0	3 shelf add-on	<b>SCH1836C</b>	95
	48"	1219	5	2.3	1.8	4 shelf add-on	<b>SCH1848C</b>	107
	18"	457	1	0.5	0.3	divider	<b>M18C</b> •	38

**5-Shelf Units**

	length		post height		weight		cu		
	in.	mm	in.	mm	lbs.	kg	ft	model #	list
<b>18" width</b> (457mm)	36"	914	63"	1600	73	33.1	3.5	<b>SCH1836C-5</b>	1115
	48"	1219	63"	1600	81	36.7	5.3	<b>SCH1848C-5</b>	1175

**Suture Cart Covers**

Models below are with a zipper. For cart covers with velcro, see page 30.

shelf width x length	post height	weight	cu	uncoated		coated				
				in.	mm	in.	mm	lbs.	kg	ft
18" x 36"	457 x 914	54"	1372	3	1.4	0.8	<b>CZ-54-1836</b>	136	<b>CZC-54-1836</b>	235
18" x 48"	457 x 1219	54"	1372	4	1.8	0.9	<b>CZ-54-1848</b>	152	<b>CZC-54-1848</b>	243
18" x 36"	457 x 914	63"	1600	3	1.4	0.8	<b>CZ-63-1836</b>	144	<b>CZC-63-1836</b>	239
18" x 48"	457 x 1219	63"	1600	4	1.8	0.9	<b>CZ-63-1848</b>	153	<b>CZC-63-1848</b>	251

**Foot Stools**

see spec sheet **EG05.04**



**300-lb.  
Weight capacity!**

FEATURES:

- Single-step foot stool.
- All-welded construction.
- Flared legs with rubber tips.
- Non-slip rubber mat.
- Chrome or stainless steel finish.

**Freight class is 85.0.**

width x length x height	weight	cubic					
in.	mm	lbs.	kg	feet	finish	model #	list
11 1/2" x 14 1/4" x 9"	289 x 362 x 229	8	3.6	1.0	stainless steel	<b>SFS16S</b>	278
11 1/2" x 14 1/4" x 9"	289 x 362 x 229	10	4.5	1.0	chrome	<b>SFS14C</b>	112



100 Industrial Boulevard, Clayton, DE 19938-8903 U.S.A.  
 Phone: 800-637-5100 or 302-653-3000. Fax: 302-653-2065  
<http://www.eaglegrp.com>

Linen Carts

see spec sheet **EG05.02**



STANDARD FEATURES:

- Four chrome-plated wire shelves.
- One solid stainless steel shelf.
- Chrome-plated 63" (1600mm) posts.
- 5" (127mm) resilient stem casters (two with brake).
- Donut bumpers.

HEAVY DUTY FEATURES:

- Four chrome-plated wire shelves.
- One solid stainless steel shelf.
- Chrome-plated dolly frame with wraparound bumper.
- 6" (152mm) polyurethane casters (two with brake).
- Side and back enclosure panels.
- Chrome plated posts, aluminum split sleeves.
- Locking hardware.

Freight class is 70.0.

Heavy Duty Linen Cart

*width x length in. mm	weight lbs. kg	cubic feet	model #	list
24" x 60" 610 x 1524	240 108.9	29	<b>LCD2460C</b>	2486

\* Shelf width x length. Dolly is 29 1/4" width x 64 1/4" length (756 x 1648mm).

Standard Duty Linen Cart

*width x length in. mm	weight lbs. kg	cubic feet	model #	list
24" x 60" 610 x 1524	190 86.2	8.3	<b>LC2460C</b>	996

\* Shelf width x length. Dolly is 29 1/4" width x 64 1/4" length (756 x 1648mm).

Mail Cart

see spec sheet **EG05.04**



**Designed to handle  
internal/external mail  
distribution.**

FEATURES:

- 5" (127mm) swivel casters on front.
- 10" (254mm) rigid roller-bearing casters on rear.
- Nickel-chrome finished.
- 1" (25mm) tubular frame.
- 11" (279mm) height top basket for files.
- 7" (178mm) height bottom basket for boxes.

Freight class is 70.0.

overall width x length x height in. mm	weight lbs. kg	cubic feet	model #	list
28" x 47" x 38 1/2" 711 x 1194 x 978	60 27.2	6.0	<b>MC-1</b>	1001

Inhalation Therapy Cart

see spec sheet **EG05.12**



patented  
**QuadTruss®**  
design  
(Patent #5,390,803)

**Patented QuadTruss® Design**  
makes shelves up to 25% stronger and provides  
a retaining ledge for increased strength and  
product retention.

FEATURES:

- Bottom shelf, handles and trussed frames are chrome plated.
- Cylinder racks are 5/16" (8mm) in diameter with 4 1/2" x 4 1/2" (114 x 114mm) openings for gas cylinders.
- Racks accommodate twelve D or E cylinders and are plastisol coated.
- Cart design conforms to NFPA-99.
- Aluminum split sleeves and four UL recognized 5" (127mm) conductive casters.

Freight class is 70.0.

(•) MTS (made to stock) / ( ) MTO (made to order)

width x length x height in. mm	weight lbs. kg	cubic feet	model #	list
20" x 27" x 31 1/2" 508 x 686 x 1016	41 19	3.5	<b>GCC1•</b>	644

**Catalog Section 5**

**Surgical Scrub Sinks**

see product announcement **EG8178**



- 16 gauge type 304 stainless steel.
- Removable front access panel.
- Electronic-eye gooseneck faucet.
- 4" (102mm)-high backsplash.
- Square edge on front and sides.
- Sink bowl with deep slope basin.
- Temperature control mixing valve.
- Z-clips for wall mounting.
- Includes stainless steel flat strainer drain, tail piece, and p-trap.
- Includes flexible stainless steel supply hoses.

FEATURES:

**Freight class is 85.0.**

#SHS2424-1D

#SHS2424-1W-ADA

description	overall width x length x height		bowl width x length x depth		weight		model #	list
	in.	mm	in.	mm	lbs.	kg		
wall-mount unit with deck mount faucet	24½" x 24" x 28"	622 x 610 x 711	17½" x 20" x 11"	445 x 508 x 279	87	39.5	<b>SHS2424-1D</b>	4047
ADA wall-mount unit with splash-mount faucet	20" x 24" x 29½"	508 x 610 x 749	16½" x 20" x 6½"	419 x 508 x 165	83	37.6	<b>SHS2424-1W-ADA</b>	3560

**Basket Carts**

see spec sheet **EG05.04**



**Collapsible X-frame is ideal for mail, pharmacy, lab, medical records and other small tasks.**

FEATURES:

- Maneuvers easily and quietly on 3" (76mm) swivel casters with rubber tread.
- Tubular, chrome plated frame.
- Poly-coated wire baskets and basket support.

**Freight class is 70.0.**

width x length x height	weight	cubic	description	model #	list
in. mm	lbs. kg	feet			
18" x 26" x 37"	457 x 661 x 940	26 11.8	12.0	cart with (2) 6" baskets	<b>BC18</b> 611
18" x 26" x 37"	457 x 661 x 940	27 12.2	12.0	cart with (1) 6" and (1) 12" basket	<b>BC18-1</b> 635

**Baskets for Basket Carts** - Poly-coated white wire baskets.

width x length x height	weight	cubic	model #	list
in. mm	lbs. kg	feet		
14¼" x 24½" x 6"	362 x 620 x 152	5.5 2.5	1.8	<b>A203895</b> 69
14¼" x 24½" x 12"	362 x 620 x 305	6.5 3.0	2.8	<b>A203929</b> 94

**Wire Basket Utility Carts** 

spec sheet **EG01.35**



- Includes swivel stem casters with bumpers and two push handles.
- 36½" (927mm) overall cart height.

FEATURES:

**Freight class is 70.0.**

description	weight		model #	list
	lbs.	kg		
1 chrome basket shelf, 1 chrome standard shelf	31	14.1	<b>WBC1836C-1B1W</b>	342
2 chrome basket shelves	32	14.5	<b>WBC1836C-2B</b>	301





**Catheter Procedure Carts**

see spec sheet **EG05.03**



model #CPC6024D



model #CPC48B

**Capable of holding a variety of sizes and styles of catheter packages.**

**FEATURES:**

- All components are adjustable.
- Support bars are readily removable.
- Hooks, boxes, slides, bins, and wire ledges included with appropriate models.
- 5" (127mm) swivel casters with polyurethane tread, two with brakes.
- 73" (1854mm) height.

**Freight class is 70.0.**

(•) MTS (made to stock) / ( ) MTO (made to order)



(Patent #5,390,803)

**Patented QuadTruss® Design**

makes shelves up to 25% stronger and provides a retaining ledge for increased strength and product retention.

**Combination-Style Carts with 36" (914mm) Side Shelves and four 24" (610mm) Bars**

	length		weight		cubic	# of hooks	maximum	max.	tote	super	ledges	model #	list
	in.	mm	lbs.	kg	feet	included	# of hooks per bar	# of boxes	slides	bins			
<b>24" width (610mm)</b>	60"	1524	146	66.2	15.0	16	5	N/A	N/A	N/A	N/A	<b>CPC6036</b>	1740
	60"	1524	174	78.9	17.8	16	5	2	1	6	6	<b>CPC6036D</b>	2276

**Combination-Style Carts with 24" (610mm) Side Shelves and four 36" (914mm) Bars**

	length		weight		cubic	# of hooks	maximum	max.	tote	super	ledges	model #	list
	in.	mm	lbs.	kg	feet	included	# of hooks per bar	# of boxes	slides	bins			
<b>24" width (610mm)</b>	60"	1524	149	67.6	9.8	24	9	N/A	N/A	N/A	N/A	<b>CPC6024</b>	1865
	60"	1524	162	73.5	18.6	24	9	2	1	6	6	<b>CPC6024D</b>	2369

**Bulk Storage Carts with four 48" (1219mm) Bars**

width	length		weight		cubic	# of hooks	maximum	max.	tote	super	ledges	model #	list
	in.	mm	lbs.	kg	feet	included	# of hooks per bar	# of boxes	slides	bins			
<b>24" (610mm)</b>	48"	1219	82	37.2	8.7	32	13	N/A	N/A	6	6	<b>CPC48B</b>	1837

**Bulk Storage Carts with four 60" (1524mm) Bars**

width	length		weight		cubic	# of hooks	maximum	max.	tote	super	ledges	model #	list
	in.	mm	lbs.	kg	feet	included	# of hooks per bar	# of boxes	slides	bins			
<b>24" (610mm)</b>	60"	1524	101	45.8	7.4	40	17	N/A	N/A	6	6	<b>CPC60B</b>	2031

**Steril-Eze® Open Surgical Case Carts**

see spec sheet **EG05.15**



**FEATURES:**

- Adjustable shelves.
- All type 304 stainless steel.
- Hemmed safety edges.
- 5" (127mm) swivel casters with polyurethane tread, two with brakes.

**Freight class is 92.5.**

(•) MTS (made to stock) / ( ) MTO (made to order)

width x length x height in.	width x length x height mm	weight lbs.	weight kg	cu ft	description	model #	list
24" x 36" x 36"	610 x 914 x 914	89	40.4	3.8	open surgical case cart	<b>OSCC2436</b>	1729
24" x 48" x 36"	610 x 1219 x 914	118	53.5	3.8	open surgical case cart	<b>OSCC2448</b>	1840
12" x 20" x 4"	305 x 508 x 102	6	2.7	4.9	optional drawer	<b>A204178</b>	223



**Catalog Section 5**

**Steril-Eze® Open Wire Surgical Case Carts**

see spec sheet **EG05.17**



patented  
**QuadTruss®**  
design  
(Patent #5,390,803)

**Patented QuadTruss® Design**  
makes shelves up to 25% stronger and provides a retaining ledge for increased strength and product retention.

- FEATURES:**
- Wire shelves.
  - Tote boxes & slides.
  - Enclosure panels.
  - Stainless steel finish.
  - 5" (127mm) swivel casters with polyurethane tread, two with brakes.

**Freight class is 70.0.**

(•) MTS (made to stock) / ( ) MTO (made to order)

width x length x height*		weight		description	model #	list
in.	mm	lbs.	kg			
24" x 24" x 60 1/4"	610 x 610 x 1530	88	39.9	4 wire shelves, 1 tote box	<b>OCC2424S</b>	2487
24" x 48" x 60 1/4"	610 x 1219 x 1530	130	59.0	4 wire shelves, 2 tote boxes	<b>OCC2448S</b>	2998

\* Height includes casters.

**Sterile Wrap Carts**

see spec sheet **EG05.05**



- FEATURES:**
- Chrome bottom shelf.
  - Channel frame - chrome.
  - Post material are chrome.
  - 5" (127mm) swivel casters with poly tread.

**Freight class is 70.0.**

(•) MTS (made to stock) / ( ) MTO (made to order)

width x length x height		weight		cubic feet	model #	list
in.	mm	lbs.	kg			
24" x 48" x 68"	610 x 1219 x 1727	83	37.6	7.6	<b>SWC2448C</b>	1144
24" x 60" x 68"	610 x 1524 x 1727	94	42.6	8.3	<b>SWC2460C</b>	1231

**Sterile Wrap Cart Covers**

shelf width x length		post height		weight		cu ft	uncoated		coated	
in.	mm	in.	mm	lbs.	kg		model #	list	model #	list
24" x 48"	610 x 1219	63"	1600	4	1.8	0.4	<b>CZ-63-2448</b>	199	<b>CZC-63-2448</b>	297
24" x 48"	610 x 1219	63"	1600	4	1.8	0.4	<b>CV-63-2448</b>	211	<b>CVC-63-2448</b>	311
24" x 60"	610 x 1524	63"	1600	5	2.3	0.4	<b>CZ-63-2460</b>	235	<b>CZC-63-2460</b>	323
24" x 60"	610 x 1524	63"	1600	5	2.3	0.4	<b>CV-63-2460</b>	243	<b>CVC-63-2460</b>	336

**NOTE:** In model numbers, "Z" stands for zipper and "V" for velcro enclosures

**Additional Support Bars**

Freight class is 50.0.

length		weight		cu ft	model #	list
in.	mm	lbs.	kg			
48"	1219	2.7	1.2	0.1	<b>SB48</b>	62
60"	1524	3.4	1.5	0.2	<b>SB60</b>	72

**Steril-Eze® Closed Surgical Case Carts**

see spec sheets **EG05.13** **EG05.14**



horizontal...



...vertical

**Call factory for pricing.**

- FEATURES:**
- Accessibility of an open cart.
  - Pull-out center shelf for easier access to instruments.

**Freight class is 92.5.**

(•) MTS (made to stock) / ( ) MTO (made to order)

width x length x height		weight		cubic feet	description	model #
in.	mm	lbs.	kg			
24" x 36" x 36"	610 x 914 x 914	181	82.1	18.0	horizontal cart	<b>CSCC2436</b>
24" x 48" x 36"	610 x 1219 x 914	272	123.4	24.0	horizontal cart	<b>CSCC2448</b>
23" x 27" x 54"	686 x 584 x 1372	190	86.2	26.6	vertical cart	<b>CSCC2327</b>





**Stainless Steel Closed Case Carts**

see spec sheet **EG8091**



single-width cart



double-width cart

**FEATURES:**

- Type 300 series stainless steel construction.
- 16-gauge stainless steel top.
- 18-gauge stainless steel cabinet.
- Double-panel reinforced door(s) with integrated weep holes to promote drainage.
- Set of 6" (152mm) plate casters—two with brake—with polyurethane tread.
- Features also include bumpers, letter-size document holder, and push handle.
- Carts offered in single or double width.

Freight class is 92.5.

**Contact Factory For Pricing.**

**STEP 1: Select cart body.**

**Single-Width Carts**

overall dimensions width x length x height* in. mm		cabinet dimensions width x length x height in. mm		model #
30" x 29" x 31½"	762 x 737 x 801	24¾" x 24" x 21¾"	629 x 610 x 553	<b>ELCSC-1</b>
30" x 29" x 40½"	762 x 737 x 1029	24¾" x 24" x 30¾"	629 x 610 x 782	<b>ELCSC-2</b>
30" x 29" x 57½"	762 x 737 x 1461	24¾" x 24" x 47¾"	629 x 610 x 1213	<b>ELCSC-3</b>

**Double-Width Carts**

overall dimensions width x length x height* in. mm		cabinet dimensions width x length x height in. mm		model #
30" x 46" x 57½"	762 x 1168 x 1461	24¾" x 39" x 47¾"	629 x 610 x 1213	<b>ELCSC-4</b>
30" x 46" x 40½"	762 x 1168 x 1029	24¾" x 39" x 30¾"	629 x 610 x 782	<b>ELCSC-5</b>

**Extended Double-Width Cart**

overall dimensions width x length x height* in. mm		cabinet dimensions width x length x height in. mm		model #
30" x 55" x 40½"	762 x 1397 x 1029	24¾" x 49" x 30¾"	629 x 1245 x 782	<b>ELCSC-6</b>

\* Heights include 6" (152mm) -diameter casters. See Step 2 below for casters.

**STEP 2: Select set of four casters.**

Add suffix at end of cart model number. Example: ELCSC-1-6.

description	STAINLESS add suffix
5"-diameter—(4) swivel	<b>-6</b>
6"-diameter—(4) swivel	<b>-7A</b>
5"-diameter—(3) swivel, (1) swivel lock	<b>-7</b>
6"-diameter—(2) swivel, (2) swivel brake	<b>-8</b>
6"-diameter—(1) swivel, (2) swivel brake, (1) swivel lock	<b>-9</b>

**STEP 3: Select internal shelves.**

shelf description	FOR SINGLE-WIDE CARTS model #	FOR DOUBLE-WIDE CARTS model #	FOR EXTENDED DOUBLE-WIDE CARTS model #
perforated shelf	<b>ELCSCS-P</b>	<b>ELCSCD-P</b>	<b>ELCSCE-P</b>
wire shelf	<b>ELCSCS-W</b>	<b>ELCSCD-W</b>	<b>ELCSCE-W</b>
solid shelf	<b>ELCSCS-S</b>	<b>ELCSCD-S</b>	<b>ELCSCE-S</b>

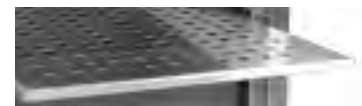

perforated shelf



wire shelf



**Catalog Section 5**

**Mobile Garment Racks**

see spec sheet **EG01.28**



model #  
UR1836C

**Convenient storage or transportation of lab coats, uniforms, or garments.**

- Top shelf for hats or flat items.
- Bottom shelf (*shelves*) for drying shoes or boots.
- 74" (1880mm) height on stationary units,
- 80" (2032mm) height on mobile units.
- 5" (127mm) polyurethane tread casters.

FEATURES:

**Freight class is 70.0.**

(•) MTS (*made to stock*) / ( ) MTO (*made to order*)

width x length x height in. mm	weight lbs. kg	cubic feet	description	model #	list
18" x 36" x 80" 457 x 914 x 2032	48 21.8	2.2	unit as shown	<b>UR1836C</b>	493
18" x 36" x 80" 457 x 914 x 2032	64 29.0	2.2	same, plus 1 solid shelf	<b>URS1836C</b>	647
18" x 48" x 80" 457 x 1219 x 2032	52 23.6	2.6	unit as shown	<b>UR1848C</b>	528
18" x 48" x 80" 457 x 1219 x 2032	72 32.7	2.6	same, plus 1 solid shelf	<b>URS1848C</b>	709
18" x 60" x 80" 457 x 1524 x 2032	58 26.3	3.2	unit as shown	<b>UR1860C</b>	571
18" x 60" x 80" 457 x 1524 x 2032	82 37.2	3.2	same, plus 1 solid shelf	<b>URS1860C</b>	813

**Optional Wire Shelves**

width x length in. mm	weight lbs. kg	cubic feet	model #	list
18" x 36" 457 x 914	9 4.1	0.7	<b>1836C</b>	65
18" x 48" 457 x 1219	12 5.5	0.9	<b>1848C</b>	78
18" x 60" 457 x 1524	17 7.7	1.2	<b>1860C</b>	92

**Optional Open Loop Hangers**

weight lbs. kg	cubic feet	chrome model #	list	stainless steel model #	list	electropolished model #	list
0.4 0.2	0.3	<b>OLH-C</b> •	13	<b>OLH-S</b> •	19	<b>OLH-EP</b>	21

**Optional Closed Loop Hangers**

weight lbs. kg	cubic feet	chrome model #	list	stainless steel model #	list	electropolished model #	list
0.4 0.2	0.3	<b>CLH-C</b>	13	<b>CLH-S</b>	19	<b>CLH-EP</b>	21

**Replacement Coat Hanger Tubes**

Freight class is 50.0.

length in. mm	weight lbs. kg	cubic feet	model #	list
24" 610	1.5 0.7	0.1	<b>CH24</b>	37
30" 762	1.7 0.8	0.1	<b>CH30</b>	39
36" 914	2.2 1.0	0.1	<b>CH36</b>	41
42" 1067	2.7 1.2	0.1	<b>CH42</b>	42
48" 1219	3.2 1.5	0.1	<b>CH48</b>	43
54" 1372	3.5 1.6	0.2	<b>CH54</b>	46
60" 1524	3.8 1.7	0.2	<b>CH60</b>	49

**Instrument Tables**

see spec sheet **EG05.01**



with undershelf

**All Welded Assembly.**

- Top surface, undershelf, and legs are heavy gauge type 304 stainless steel.
- Edges of the top are safety hemmed.
- 1" (25mm) diameter tubular legs with 4" (102mm) diameter swivel casters.
- 34" (864mm) overall height.

FEATURES:

**Freight class is 70.0.**

width x length in. mm	weight lbs. kg	cu ft	with H-frame model #	list	with undershelf model #	list
16" x 20" 406 x 508	25 11.3	6.3	<b>ITT1620</b>	1100	<b>ITU1620</b>	1038
16" x 30" 406 x 762	30 13.6	9.5	<b>ITT1630</b>	1127	<b>ITU1630</b>	1081
18" x 34" 457 x 864	33 15.0	12.1	<b>ITT1834</b>	1136	<b>ITU1834</b>	1099
20" x 36" 508 x 914	36 16.3	14.2	<b>ITT2036</b>	1159	<b>ITU2036</b>	1146
20" x 48" 508 x 1219	47 21.3	18.9	<b>ITT2048</b>	1197	<b>ITU2048</b>	1213
24" x 36" 610 x 914	39 17.7	17.0	<b>ITT2436</b>	1180	<b>ITU2436</b>	1185
24" x 46" 610 x 1168	50 22.7	21.8	<b>ITT2446</b>	1215	<b>ITU2446</b>	1253
24" x 58" 610 x 1473	59 26.8	37.4	<b>ITT2458</b>	1259	<b>ITU2458</b>	1329



### Cart Covers

see spec sheet **EG01.09**



cart cover enveloping entire cart/truck



cart cover with panel folded back for easy shelf accessibility

- Top corners are reinforced.
- Choice of white coated, white uncoated, or transparent vinyl.
- Coated cart covers available in powder blue (suffix "PB") and light green (suffix "LG"). Example: CVC-63-1836PB
- Covers are nonreturnable.

**FEATURES:**

**Note:** Black electrostatic discharge (ESD) cart covers also available—see page 140.

**Double-Flap option available. \$21 upcharge.**  
To order, add suffix "-DF" to model number  
(ex: CV-63-2436-DF).

**Freight class is 70.0.**

**Light weight,  
easy to handle!**

**Meets J.C.A.H. standards  
for transporting clean linen!**

				White Coated Nylon*				White Uncoated Polyester				Transparent**					
	length		post height	weight		cu	zipper		velcro		zipper		zipper				
	in.	mm	in.	mm	lbs.		kg	ft	model #	list	model #	list	model #	list	model #	list	
<b>18" width</b> (457mm)	36"	914	54"	1372	3	1.4	1	CZC-54-1836	235	CVC-54-1836	243	CZ-54-1836	136	CV-54-1836	149	CZ-54-1836-T	302
			63"	1600				CZC-63-1836	239	CVC-63-1836	252	CZ-63-1836	144	CV-63-1836	154	CZ-63-1836-T	302
	48"	1219	54"	1372	4	1.8	1	CZC-54-1848	243	CVC-54-1848	256	CZ-54-1848	152	CV-54-1848	161	CZ-54-1848-T	307
			63"	1600				CZC-63-1848	251	CVC-63-1848	259	CZ-63-1848	153	CV-63-1848	164	CZ-63-1848-T	307
	60"	1524	54"	1372	5	2.3	1	CZC-54-1860	264	CVC-54-1860	273	CZ-54-1860	157	CV-54-1860	166	CZ-54-1860-T	318
			63"	1600				CZC-63-1860	268	CVC-63-1860	278	CZ-63-1860	159	CV-63-1860	168	CZ-63-1860-T	339
<b>21" width</b> (533mm)	48"	1219	54"	1372	4	1.8	1	CZC-54-2148	271	CVC-54-2148	282	CZ-54-2148	176	CV-54-2148	186	CZ-54-2148-T	336
			63"	1600				CZC-63-2148	282	CVC-63-2148	295	CZ-63-2148	194	CV-63-2148	203	CZ-63-2148-T	357
			74"	1880				CZC-74-2148	286	CVC-74-2148	297	CZ-74-2148	221	CV-74-2148	233	CZ-74-2148-T	376
	60"	1524	54"	1372	5	2.3	1	CZC-54-2160	311	CVC-54-2160	319	CZ-54-2160	183	CV-54-2160	197	CZ-54-2160-T	373
			63"	1600				CZC-63-2160	316	CVC-63-2160	326	CZ-63-2160	203	CV-63-2160	213	CZ-63-2160-T	396
			74"	1880				CZC-74-2160	320	CVC-74-2160	332	CZ-74-2160	237	CV-74-2160	243	CZ-74-2160-T	417
<b>24" width</b> (610mm)	24"	610	54"	1372	3	1.4	1	CZC-54-2424	286	CVC-54-2424	287	CZ-54-2424	321	CV-54-2424	213	CZ-54-2424-T	323
			63"	1600				CZC-63-2424	291	CVC-63-2424	299	CZ-63-2424	333	CV-63-2424	255	CZ-63-2424-T	323
	36"	914	54"	1372	3	1.4	1	CZC-54-2436	239	CVC-54-2436	252	CZ-54-2436	156	CV-54-2436	165	CZ-54-2436-T	328
			63"	1600				CZC-63-2436	252	CVC-63-2436	264	CZ-63-2436	161	CV-63-2436	173	CZ-63-2436-T	328
	48"	1219	74"	1880	4	1.8	1	CZC-74-2436	258	CVC-74-2436	269	CZ-74-2436	197	CV-74-2436	202	CZ-74-2436-T	400
			86"	2184				CZC-86-2436	280	CVC-86-2436	299	CZ-86-2436	245	CV-86-2436	251	CZ-86-2436-T	422
	60"	1524	54"	1372	5	2.3	1	CZC-54-2448	284	CVC-54-2448	296	CZ-54-2448	168	CV-54-2448	181	CZ-54-2448-T	346
			63"	1600				CZC-63-2448	297	CVC-63-2448	311	CZ-63-2448	199	CV-63-2448	211	CZ-63-2448-T	346
	72"	1829	74"	1880	6	2.7	1	CZC-74-2448	303	CVC-74-2448	314	CZ-74-2448	215	CV-74-2448	229	CZ-74-2448-T	357
			86"	2184				CZC-86-2448	349	CVC-86-2448	359	CZ-86-2448	261	CV-86-2448	269	CZ-86-2448-T	444
	60"	1524	54"	1372	5	2.3	1	CZC-54-2460	318	CVC-54-2460	328	CZ-54-2460	226	CV-54-2460	237	CZ-54-2460-T	379
			63"	1600				CZC-63-2460	323	CVC-63-2460	336	CZ-63-2460	235	CV-63-2460	243	CZ-63-2460-T	379
72"	1829	74"	1880	6	2.7	1	CZC-74-2460	328	CVC-74-2460	339	CZ-74-2460	266	CV-74-2460	277	CZ-74-2460-T	462	
		86"	2184				CZC-86-2460	379	CVC-86-2460	379	CZ-86-2460	311	CV-86-2460	320	CZ-86-2460-T	486	
72"	1829	54"	1372	6	2.7	1	CZC-54-2472	323	CVC-54-2472	336	CZ-54-2472	233	CV-54-2472	241	CZ-54-2472-T	424	
		63"	1600				CZC-63-2472	329	CVC-63-2472	343	CZ-63-2472	251	CV-63-2472	259	CZ-63-2472-T	433	
86"	2184	74"	1880	6	2.7	1	CZC-74-2472	338	CVC-74-2472	346	CZ-74-2472	273	CV-74-2472	284	CZ-74-2472-T	476	
		86"	2184				CZC-86-2472	397	CVC-86-2472	392	CZ-86-2472	326	CV-86-2472	336	CZ-86-2472-T	500	

\* White-coated nylon covers are fire-retardant; \*\* Entire cover is transparent except for the seams. Transparent covers with velcro available at same price.

**Helps keep equipment clean on shelf carts and shelf trucks.**

**Catalog Section 5**

**Storage Bins**

Freight class is 70.0.

see spec sheet **EG05.07**

*The perfect solution to organizing or storing small, easy-to-lose items. Lightweight but durable.*

**Exchange Bins**

Available in three sizes.

color	length x width x height		weight		cubic feet	minimum order qty	model #	list each
	in.	mm	lbs.	kg				
blue	18" x 4 1/2" x 4"	457 x 105 x 102	8	3.6	0.2	12	<b>A203885</b>	6
blue	18" x 6 5/8" x 4"	457 x 168 x 102	12	5.5	0.3	12	<b>A203887</b>	8
blue	23 5/8" x 6 5/8" x 4"	600 x 168 x 102	8	3.6	0.4	6	<b>A203889</b>	14



**Dividers for Exchange Bins**

Note: Sold only in cartons of 24.

color	length x height		weight		cubic feet	carton quantity	model #	list per ctn.
	in.	mm	lbs.	kg				
black	4 1/2" x 4"	105 x 102	1	0.5	—	24	<b>A204235</b>	20
black	6 5/8" x 4"	168 x 102	2	0.9	—	24	<b>A204236</b>	25

**Supply Bins**

Available in four sizes.

color	length x width x height		weight		cubic feet	minimum order qty	model #	list each
	in.	mm	lbs.	kg				
blue	10 7/8" x 5 1/2" x 5"	276 x 140 x 127	12	5.5	0.2	12	<b>A203877</b>	14
blue	10 7/8" x 11" x 5"	276 x 280 x 127	9	4.1	0.4	6	<b>A203879</b>	20
blue	14 3/4" x 8 3/4" x 7"	374 x 210 x 178	22	10.0	0.6	12	<b>A203881</b>	22
blue	14 3/4" x 16 1/2" x 7"	374 x 419 x 178	18	8.1	1.0	6	<b>A203883</b>	29



**Dividers for Supply Bins**

Note: Sold only in cartons of 6.

color	length x height		weight		cubic feet	carton quantity	model #	list per ctn.
	in.	mm	lbs.	kg				
black	10 7/8" x 5"	276 x 127	2	0.9	—	6	<b>A204237</b>	22
black	14 3/4" x 7"	374 x 178	3	1.4	—	6	<b>A204238</b>	26

**Stock Bin**

These stackable bins are built for heavy-duty use.

color	length x width x height		weight		cubic feet	carton quantity	model #	list each
	in.	mm	lbs.	kg				
beige	17 7/8" x 8 1/2" x 4"	454 x 216 x 102	21	9.5	0.8	6	<b>A203891</b>	31



**Divider for Stock Bin**

Note: Shipped in cartons only.

color	length x height		weight		cubic feet	carton quantity	model #	list each
	in.	mm	lbs.	kg				
black	8 1/2" x 4"	216 x 102	1	0.5	—	6	<b>A204239</b>	16

**Bulk Supply Tub**

Durable. Perfect for transporting or storing larger items.

color	length x width x height		weight		cubic feet	carton quantity	model #	list each
	in.	mm	lbs.	kg				
gray	24 1/2" x 19" x 9 1/2"	622 x 483 x 241	20	9.1	2.8	6	<b>A203893</b>	60



**Stainless Steel Overlays**

see product announcement **EG8177**

width x length *		model#	list
in.	mm		
24" x 24"	610 x 610	<b>353761</b>	405
24" x 30"	610 x 762	<b>353762</b>	426
24" x 36"	610 x 914	<b>353763</b>	454
24" x 48"	610 x 1219	<b>353764</b>	505
24" x 51"	610 x 1295	<b>353765</b>	533
24" x 60"	610 x 1524	<b>353766</b>	624
24" x 72"	610 x 1829	<b>353767</b>	687
24" x 96"	610 x 2438	<b>353768</b>	846
30" x 30"	762 x 762	<b>353770</b>	451
30" x 36"	762 x 914	<b>353771</b>	487
30" x 48"	762 x 1219	<b>353772</b>	549
30" x 51"	762 x 1295	<b>353773</b>	573
30" x 60"	762 x 1524	<b>353774</b>	682
30" x 72"	762 x 1829	<b>353775</b>	742
30" x 96"	762 x 2438	<b>353776</b>	919
36" x 72"	914 x 1829	<b>362659</b>	1082

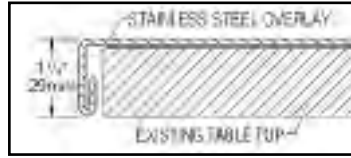

overlay fitted onto tabletop

FEATURES:

- For process tables.
- Economical upgrade to existing work surface, with no fasteners required.
- 20 gauge type 304 stainless steel construction with satin finish.
- Liquid adhesive could be used per application.
- Durable finish allowing easy cleanup.
- Hemmed safety edge on all four sides.
- Corners are welded and polished.
- Custom sizes and material gauges are available.

**Freight class is 88.0.**



\* inside measurements

**Double-Sided Bin-Holder Rails** **PATENTED!**  
 (patent #8,141,724 B2)  
 see product announcement **EG8152M**



shown assembled as a cart  
 (\*bins sold separately)

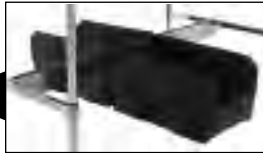

Assembly — numerically calibrated grooved posts, tapered plastic split sleeves and rail collars combine to make shelving assembly a simple two-step exercise:

- 1) snap the split sleeves onto a post over the number of your choice
- 2) slide a rail collar over the split sleeves. A positive lock between rail bin and post is created without the use of any tools.

BIN-HOLDER RAILS:

- Bin-holder rails are sold as an accessory or purchased with posts as a kit.
- EAGLEbrite® zinc or chrome plated.
- Bins attach to both sides of rail - no tools required.

BIN-HOLDER RAIL CARTS:

- Carts consist of four bin-holder rails and four 63" posts with casters.
- Posts are numbered in increments of 1" (25mm) to ensure fast and level assembly.

**Freight class is 70.0.**



Bin holder rails can also be used on EAGLE Floor-Trak® units

\*For additional information on Floor-Trak® Systems, refer to spec sheet EG01.39 or visit us on-line, [www.eaglegrp.com](http://www.eaglegrp.com).

**Bin-Holder Rails**

**Bin-Holder Rail Carts**

	length		weight		Zinc		Chrome		weight	Zinc		Chrome		
	in.	mm	lbs.	kg	model #	list	model#	list		lbs.	kg	model #	list	model#
<b>24" width</b> (610mm)	36"	914	11.0	5.0	<b>DBH2436Z</b>	159	<b>DBH2436C</b>	220	64	29.0	<b>DBHC2436Z-4</b>	988	<b>DBHC2436C-4</b>	1042
	42"	1067	12.5	5.7	<b>DBH2442Z</b>	219	<b>DBH2442C</b>	223	70	31.8	<b>DBHC2442Z-4</b>	1056	<b>DBHC2442C-4</b>	1056
	48"	1219	14.0	6.4	<b>DBH2448Z</b>	232	<b>DBH2448C</b>	256	76	34.5	<b>DBHC2448Z-4</b>	1091	<b>DBHC2448C-4</b>	1185
	54"	1372	15.5	7.0	<b>DBH2454Z</b>	237	<b>DBH2454C</b>	260	82	37.2	<b>DBHC2454Z-4</b>	1113	<b>DBHC2454C-4</b>	1203
	60"	1524	17.0	7.7	<b>DBH2460Z</b>	252	<b>DBH2460C</b>	281	88	39.9	<b>DBHC2460Z-4</b>	1173	<b>DBHC2460C-4</b>	1284
<b>30" width</b> (762mm)	36"	914	12.5	5.7	<b>DBH3036Z</b>	217	<b>DBH3036C</b>	241	70	31.8	<b>DBHC3036Z-4</b>	1037	<b>DBHC3036C-4</b>	1126
	42"	1067	14.0	6.4	<b>DBH3042Z</b>	222	<b>DBH3042C</b>	251	76	34.5	<b>DBHC3042Z-4</b>	1058	<b>DBHC3042C-4</b>	1162
	48"	1219	15.5	7.0	<b>DBH3048Z</b>	252	<b>DBH3048C</b>	283	82	37.2	<b>DBHC3048Z-4</b>	1172	<b>DBHC3048C-4</b>	1297
	54"	1372	17.0	7.7	<b>DBH3054Z</b>	257	<b>DBH3054C</b>	296	88	39.9	<b>DBHC3054Z-4</b>	1194	<b>DBHC3054C-4</b>	1346
	60"	1524	18.5	8.4	<b>DBH3060Z</b>	278	<b>DBH3060C</b>	333	94	42.6	<b>DBHC3060Z-4</b>	1276	<b>DBHC3060C-4</b>	1495



## Accessories

Card Holders .....	138
Conductive Bins and Dividers .....	139
Conductive Casters .....	140
Dividers for ESD Tote Boxes .....	138
ESD Cart Covers .....	140
ESD Tote Boxes & Accessories .....	137
Molded Fiberglass ESD Boxes and Tray .....	139
Split Sleeves .....	141
Vibration Dampening Casters .....	140

## adjuTable®

Extras .....	143
with Cantilever Overhead System ..	141
with Wire Overshelf System .....	142

## Carts

Burn-In Carts.....	134
Electronic Tray.....	132
Electronic Vibration Dampening ....	132
Gravity Flow Line Feed .....	133

## More Electronics

All-Welded Units with Solid Tray Racks .....	134
Benchside Tote Box Carriers .....	137
Double-Sided Bin-Holder Rails .....	144
Mobile Computer Workstation.....	135
Reel Shelves .....	135
Stencil Shelf .....	134
Tote Box Carriers.....	136





**Electronic Tray Carts**

see spec sheet **EG07.05**



Trays sold separately.  
See page 139 for  
Molded Fiberglass Trays.

- Knock-down units.
- EAGLEbrite® zinc-plated wire shelves.
- Chrome posts.
- Aluminum split sleeves.
- End-load and side-load racks offer a practical and economical method of transporting or storing 17½" x 25¼" (454 x 654mm) product on trays.
- Units require no tools for assembly.
- 5" (127mm) diameter resilient swivel casters, two with brake.
- Units can be made conductive by adding drag chain or ESD cable.

FEATURES:

**Freight class is 70.0.**

(•) MTS (made to stock) / ( ) MTO (made to order)

description	overall dimensions width x length x height		weight		cu ft	sliding space		full size pan capacity	model #	list
	in.	mm	lbs.	kg		in.	mm			
end load	30" x 21" x 67½"	762 x 533 x 1711	65	29.5	15.0	1½"	38	38	<b>WTRE38-Z •</b>	525
end load	30" x 21" x 67½"	762 x 533 x 1711	74	33.6	15.0	3"	76	20	<b>WTRE20-Z •</b>	521
side load	21" x 30" x 67½"	533 x 762 x 1711	65	29.5	15.0	1½"	38	38	<b>WTRS38-Z •</b>	525
side load	21" x 30" x 67½"	533 x 762 x 1711	74	33.6	15.0	3"	76	20	<b>WTRS20-Z •</b>	521

**Electronic Vibration Dampening Tray Carts**

see spec sheet **EG07.04**



**Engineered to provide maximum benefit in three key areas: vibration transfer, ESD safe, and cost.**

- Polyurethane 50 shore A casters dramatically reduce vibration transfer.
- Standard caster configuration features two swivel and two with brake.
- Carts are made ESD safe with the use of aluminum split sleeves and optional grounding device.
- EAGLEbrite® zinc-plated wire shelves.
- Product safety is ensured with front and back locks on all models.

FEATURES:

**Freight class is 70.0.**

(•) MTS (made to stock) / ( ) MTO (made to order)

electronic vibration dampening tray cart (half size)

Trays sold separately.  
See page 139  
for Molded  
Fiberglass Trays.

description	overall dimensions width x length x height		weight		cu ft	sliding space		full size pan capacity	model #	list
	in.	mm	lbs.	kg		in.	mm			
end load, half height	31¼" x 21¼" x 49½"	807 x 543 x 1254	80	36.3	15.0	1¾"	45	20	<b>ETCE20-Z</b>	852
end load, full height	31¼" x 21¼" x 62½"	807 x 543 x 1584	97	44.0	15.0	1¾"	45	30	<b>ETCE30-Z *</b>	962
side load, half height	21¼" x 31¼" x 49½"	543 x 807 x 1254	80	36.3	15.0	1¾"	45	20	<b>ETCS20-Z</b>	852
side load, full height	21¼" x 31¼" x 62½"	543 x 807 x 1584	97	44.0	15.0	1¾"	45	30	<b>ETCS30-Z *</b>	962

\* Half-height carts include two ergonomically positioned push handles.

**Options for Electronic Tray Carts and Vibration Dampening Tray Carts**



**Optional ESD Grounding Cable**

- Provides greater dependability on mobile units.
- Replaces conductive casters when used with conductive split sleeves.
- Easily installed.

model #	list
<b>GC-16</b>	23



**Optional Anti-Static Drag Chain**

- 16" (406mm) long.
- Used for conductive applications.
- Clips into shelf.

model #	list
<b>DC16-S •</b>	22



**Catalog Section 7**

**Gravity Flow Line Feed Carts**

see spec sheet **EG07.03**



*Offers the ergonomic advantage of an angled shelf along with added visibility in the storage bins.*

- Standard model includes three EAGLEbrite® zinc-plated angled shelves, four posts, four casters (*two with brake*), one 3-sided truss, and one 4-sided truss.
- Flexibility to adjust shelves on 1" (25mm) vertical increments and the slope of each shelf.
- Open-wire construction for high visibility of merchandise.
- Chrome posts.
- 5" x 1 1/4" (127 x 32mm) standard resilient swivel casters, two with brake — each with a weight capacity of 300 lbs. (136.1 kg).
- Mobile units are 69" (1753mm) height, including casters.
- Stationary units are 63" (1600mm) height.

**FEATURES:**

**Note:** Additional shelves available as options. Additional caster sizes available.

**Freight class is 70.0.**

			Stationary		Mobile		
length		weight		EAGLEbrite®		EAGLEbrite®	
in.	mm	lbs.	kg	model #	list	model #	list
36"	914	93	42.2	SM3636Z-3	623	M3636Z-3	728
48"	1219	114	51.7	SM3648Z-3	699	M3648Z-3	804
60"	1524	144	65.3	SM3660Z-3	862	M3660Z-3	947

**Replacement/Additional Components for Gravity Flow Line Feed Carts:**



**Angled Shelves**

- Hanger rails included.

length		weight		EAGLEbrite®	
in.	mm	lbs.	kg	model #	list
36"	914	26	11.8	M3636Z	175
48"	1219	32	14.5	M3648Z	189
60"	1524	40	18.1	M3660Z	226



**Side-to-Side Hanger Rails...**

length		weight		EAGLEbrite®	
in.	mm	lbs.	kg	model #	list
36"	914	3	1.4	A215543	32
48"	1219	4	1.8	A215544	36
60"	1524	5	2.3	A215546	38

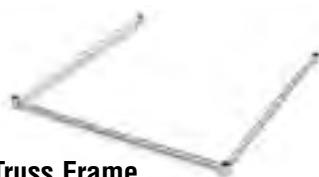

**3-Sided Truss Frame**

- 36" (914mm) wide.

length		weight		EAGLEbrite®	
in.	mm	lbs.	kg	model #	list
36"	914	7	3.2	A215538	38
48"	1219	10	4.5	A215539	49
60"	1524	12	5.4	A215541	54

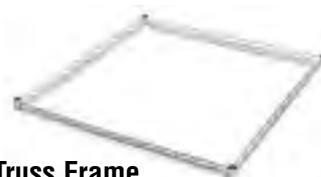

**4-Sided Truss Frame**

- 36" (914mm) wide.

length		weight		EAGLEbrite®	
in.	mm	lbs.	kg	model #	list
36"	914	9	4.1	A215532	57
48"	1219	12	5.4	A215534	68
60"	1524	15	6.8	A215536	78



**Burn-In Carts**

see spec sheet **EG07.07**



**A simple testing and preparation station for electronic products.**

FEATURES:

- For transporting products to and from testing areas.
- Casters are resilient swivel 5" (127mm) diameter and include donut bumpers.
- Standard power harness is designed to be used on four-shelf unit as shown.
- 69" (1753mm) high.
- Aluminum split sleeves.

**Freight class is 70.0.**

width x length in. mm	weight lbs. kg	cubic feet	chrome model # list	zinc model # list
28" x 64" 711 x 1626	114 51.7	6.0	<b>BIC</b> 3824	<b>BIC-Z</b> 3801



(Patent #5,390,803)

**Replacement Power Harness** Nine outlets each. NEMA 5-15P plug.

description	weight		cubic feet	model # list	
	lbs.	kg		model #	list
one strip w/cord & plug	2	0.9	0.7	<b>MHPH</b>	785
four strips wired to one cord & plug	8	3.6	2.8	<b>MHPH-4</b>	1484

**Patented QuadTruss® Design** makes shelves up to 25% stronger and provides a retaining ledge for increased strength and product retention.

**All-Welded Units with Solid Tray Racks**

see spec sheet **EG07.00**



**Holds 10" x 26" pans.**

FEATURES:

- All-welded aluminum frame construction.
- Frame and supports are 1" (25mm) square aluminum tubing.
- Tray slides are 1 1/2" (48mm) wide with two raised beads to minimize friction.
- 5" (127mm) casters.

**Freight class is 70.0.**

(•) MTS (made to stock) / ( ) MTO (made to order)

description	overall dimensions width x length x height in. mm		weight lbs. kg		cu ft	sliding space in. mm		full size pan capacity	model #	list				
	width	length	height	width		height								
front load	20 1/2"	26"	69 1/4"	518	660	1759	47	21.3	21.0	2"	51	30	<b>OUR-1830-2/W</b> •	1057
side load	28 1/2"	20"	69 1/4"	724	457	1759	32	14.5	25.2	2"	51	30	<b>OUR-2630-2/W</b>	1016

**Aluminum Tray**

description	dimensions		model #	list
	in.	mm		
solid, 18 gauge	17 3/4"	25 3/4"	<b>SP1826-18</b> •	25



**Stencil Shelf**

see spec sheet **EG07.08**



**The stencil shelf may be used with any combination of posts and casters that best meets your requirements.**

FEATURES:

- EAGLEbrite® zinc finish.
- One bottom and one top partitioned shelf.
- One ST1836Z-13 is required for each tier desired.
- Each unit has (15) 2" (51mm) partitions.

**Note:** Stationary unit can be made conductive with the use of optional aluminum split sleeves (page 141).

Mobile unit may be made conductive with the use of optional aluminum split sleeves (page 141) and an optional drag chain (page 132).

**Freight class is 70.0.**

posts and casters sold separately —see pages 8 & 9

#ST1836Z-13 includes two shelves.

width x length in. mm	weight lbs. kg	cu ft	capacity	model #	list
18" x 36" 457 x 914	18 8.2	5.0	holds (15) stencils	<b>ST1836Z-13</b>	238

two tiers of stencil shelves shown in mobile unit configuration



**Catalog Section 7**

**Mobile Computer Workstations**

see spec sheet **EG01.04**



with optional mouse shelf



**Patented QuadTruss® Design**  
makes shelves up to 25% stronger and provides a retaining ledge for increased strength and product retention.

**FEATURES:**

- 5" (127mm) casters—two with brake.
- Cantilevered shelf, undershelf, keyboard drawer.
- 38 3/8" (981mm) working height.
- 53 3/8" (1362mm) overall height.

**Note:** See page 140 for other casters available.

**Freight class is 70.0.**

(•) MTS (made to stock) / ( ) MTO (made to order)

width**	length		weight		cu ft	with Resilient-Tread Casters		w/Polyurethane-Tread Casters					
	in.	mm	lbs.	kg		chrome model #	*list	stainless steel model #	*list	chrome model #	*list	stainless steel model #	*list
24" (610mm)	24"	610	40	18.1	3.7	MCWS2424C	• 549	MCWS2424S	1144	MCWS2424C-P	621	MCWS2424S-P	1169
30" (762mm)	30"	762	56	25.4	4.5	MCWS3030C	602	MCWS3030S	1196	MCWS3030C-P	674	MCWS3030S-P	1222

\* List prices do not include cost of mouse shelf.

\*\* 24" x 24" (610 x 610mm) units feature 14" x 24" (357 x 610mm) undershelf, 30" x 30" (762 x 762mm) units feature 18" x 30" (457 x 762mm) undershelf.

**Optional Mouse Shelf for Mobile Computer Workstation**

width x length		cu ft	weight		model #	list
in.	mm		lbs.	kg		
7" x 7"	178 x 178	0.1	2.0	0.9	MS-C	12



**Reel Shelves**

see spec sheet **EG07.06**

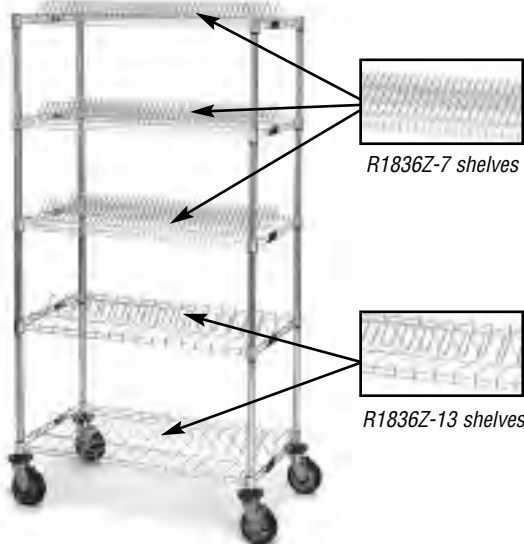

reel shelves shown in mobile unit configuration - posts and casters sold separately (see pages 8 & 9)

**FEATURES:**

- EAGLEbrite® zinc plated finish with MasterSeal®, 9-gauge wire for the mat, and 6-gauge wire for the cradle and trusses.
- R1836-7 has a 3/4" (19mm) open space for each reel.
- R1836-13 has a 2" (51mm) open space for each reel.
- The reel shelves may be used with any combination of posts and casters that best meets your requirements.

**Freight class is 70.0.**

**The perfect solution to store and transport surface mount reels.**

width x length in.	width x length mm	weight lbs. kg		cubic feet	capacity	model #	list
18" x 36"	457 x 914	10	4.5	5.0	holds (78) 7"-diameter reels	R1836Z-7	114
18" x 36"	457 x 914	9	4.1	5.0	holds (15) 13"-diameter reels or 15"-diameter reels	R1836Z-13	105



**Tote Box Carriers**

see spec sheet **EG07.01**

*The ideal way to transport totes, trays, and other containers.*

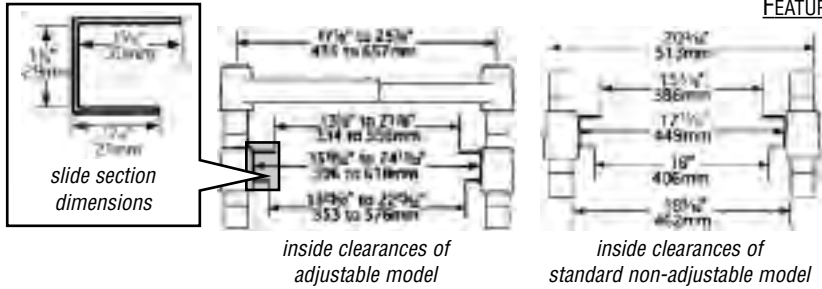

**FEATURES:**

- Three sets of tote box slides.
- Two brake and two swivel casters, resilient or polymer.
- 68" (1727mm) height, includes casters
- 63" (1600mm) 16-gauge chrome-plated posts.
- 26" (660mm) length from front to back.

**Note:** See pages 137 and 138 for tote boxes and tote box accessories.

**Note:** To order units with aluminum split sleeves in place of standard plastic split sleeves, add suffix "-ESD". Example: TBC1-R-ESD

**Freight class is 70.0.**

(•) MTS (made to stock) / ( ) MTO (made to order)

**One-Bay**

- Adjustable or standard.
- Comes with three single slide sets.

width x length in. mm	weight lbs. kg	cubic feet	caster type	description	model #	list
26" x 22 1/2" 660 x 575	55 24.9	3.5	resilient	1 section, non-adjustable	<b>TBC1-R *</b>	552
	55 24.9	3.5	poly	1 section, non-adjustable	<b>TBC1-P *</b>	654
26" x 20 1/2" to 26" x 29 1/2" 660 x 524 to 660 x 746	55 24.9	3.5	resilient	1 section, adjustable	<b>TBC-R</b>	723
	55 24.9	3.5	poly	1 section, adjustable	<b>TBC-P</b>	808

\* For Non-Adjustable units, applicable tote boxes are #TB3030XL, TB3060XL, TB3080XL, and TB3120XL (page 137).

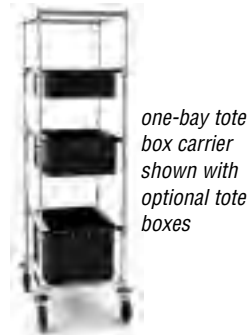

one-bay tote box carrier shown with optional tote boxes

**Two-Bay**

- Comes with three single slide sets and three double slides.

width x length in. mm	weight lbs. kg	cubic feet	caster type	description	model #	list
26" x 41 1/2" 660 x 1060	112 50.8	9	resilient	2 section, non-adjustable	<b>TBC2-R *</b>	782
26" x 41 1/2" 660 x 1060	112 50.8	9	poly	2 section, non-adjustable	<b>TBC2-P *</b>	846

\* For Non-Adjustable units, applicable tote boxes are #TB3030XL, TB3060XL, TB3080XL, and TB3120XL (page 137).



two-bay tote box carrier shown with optional tote boxes

**Three-Bay**

- Comes with three single slide sets and six double slides.

width x length in. mm	weight lbs. kg	cubic feet	caster type	description	model #	list
26" x 60 1/2" 660 x 1546	168 76.2	12	resilient	3 section, non-adjustable	<b>TBC3-R *</b>	1014
26" x 60 1/2" 660 x 1546	168 76.2	12	poly	3 section, non-adjustable	<b>TBC3-P *</b>	1079

\* For Non-Adjustable units, applicable tote boxes are #TB3030XL, TB3060XL, TB3080XL, and TB3120XL (page 137).



three-bay tote box carrier shown with optional tote boxes and additional slides

**Tote Box Slides for Tote Box Carriers**

- Made of 16 gauge chrome plated steel with a channel opening of 1 1/8" (29mm).

type	weight lbs. kg	cubic feet	model #	list
single slides (sold in pairs)	1.5 0.7	0.5	<b>TBC-S •</b>	80 per pair
double slide (sold individually)	3.0 1.4	0.5	<b>TBC-SD</b>	75 each



**Catalog Section 7**

**Benchside Tote Box Carriers**

see spec sheet **EG07.02**

- Angled wire shelf with 3½" (89mm) upturn.
- Wire undershelf.
- Posts joined to 5" (127mm)-diameter swivel casters with resilient tread—two with brake.
- All shelves and posts are zinc-plated.

**FEATURES:**

**Note:** For static dissipation, add aluminum split sleeves (page 141) and drag chain (page 132).

*Variable shelf angle is ergonomically sensitive to repetitive pick-and-place activity.*

**Freight class is 70.0.**



*benchside tote box carrier shown with optional tote boxes*

width x length in. mm	height in. mm	weight lbs. kg	cubic feet	caster type	model #	list
18" x 24" 457 x 610	(rear) 39" 991 (front) 30" 762	50 22.7	3.3	(2) 5" resilient swivel (2) 5" resilient w/brake	<b>1824BTZ</b>	325
18" x 36" 457 x 914	(rear) 39" 991 (front) 30" 762	55 24.9	4.5	(2) 5" resilient swivel (2) 5" resilient w/brake	<b>1836BTZ</b>	352
18" x 48" 457 x 1219	(rear) 39" 991 (front) 30" 762	60 27.2	6.0	(2) 5" resilient swivel (2) 5" resilient w/brake	<b>1848BTZ</b>	372
18" x 60" 457 x 1524	(rear) 39" 991 (front) 30" 762	65 29.5	7.5	(2) 5" resilient swivel (2) 5" resilient w/brake	<b>1860BTZ</b>	392

**Optional ESD Tote Boxes & Tote Box Accessories**

see spec sheet **EG07.09**

**Freight class is 70.0.**

(•) MTS (made to stock) / ( ) MTO (made to order)



*assorted divider tote boxes*

**ESD Tote Boxes**

- Made of conductive material.
- Fits tote box carriers (page 136).
- Containers can be divided into compartments by length and/or width.
- Dividers are on 1¼" (32mm) centers.

dimensions of outside top length x width x height in. mm	weight lbs. kg	cu ft	max. divider slots		model #	list
			long in. mm	short in. mm		
10.8" x 8.5" x 3.5" 274 x 216 x 89	0.7 0.3	0.2	5" 127	7" 178	<b>TB1035XL</b>	25
10.8" x 8.5" x 5.0" 274 x 216 x 127	0.9 0.4	0.3	5" 127	7" 178	<b>TB1050XL</b>	28
16.5" x 10.9" x 3.5" 419 x 277 x 89	1.2 0.5	0.4	7" 178	11" 279	<b>TB2035XL</b>	29
16.5" x 10.9" x 6.0" 419 x 277 x 152	1.6 0.7	0.6	7" 178	11" 279	<b>TB2060XL</b>	41
16.5" x 10.9" x 8.0" 419 x 277 x 203	2.0 0.9	0.8	7" 178	11" 279	<b>TB2080XL</b>	46
22.4" x 17.4" x 3.0" 567 x 442 x 76	1.8 0.8	0.7	11" 279	15" 381	<b>TB3030XL</b> *	72
22.4" x 17.4" x 6.0" 567 x 442 x 152	3.5 1.6	1.3	11" 279	15" 381	<b>TB3060XL</b> *	75
22.4" x 17.4" x 8.0" 567 x 442 x 203	4.1 1.9	1.8	11" 279	15" 381	<b>TB3080XL</b> *	91
22.4" x 17.4" x 12.0" 567 x 442 x 305	6.0 2.7	1.7	11" 279	15" 381	<b>TB3120XL</b> *	125

\* Only the TB3000 series tote boxes fit non-adjustable tote box carriers (page 136).

**ESD Snap-On Tote Box Covers**

Conductive. Black.

*Protect the contents of your divider box with these hi-density injection molded covers.*

for container model	weight lbs. kg	cubic feet	model #	list
TB1000 Series	0.2 0.1	0.1	<b>CTB1000-XL</b>	19
TB2000 Series	0.5 0.2	0.1	<b>CTB2000-XL</b>	35
TB3000 Series	1.2 0.5	0.3	<b>CTB3000-XL</b>	56



**For ESD Tote Box Dividers and Card Holders, see page 138.**



**ESD Tote Box Accessories (continued)**

see spec sheet **EG07.09**

**Dividers**

Freight class is 70.0.



*Conductive. These injection molded dividers compartmentalize width and length of box interior to prevent part movement.*

fits tote box	Long Dividers			Short Dividers		
	model #	list	max. # accepted	model #	list	max. # accepted
TB1035XL	<b>DL1035-XL</b>	4	5	<b>DS1035-XL</b>	3	7
TB1050XL	<b>DL1050-XL</b>	5	5	<b>DS1050-XL</b>	4	7
TB2035XL	<b>DL2035-XL</b>	5	7	<b>DS2035-XL</b>	4	11
TB2060XL	<b>DL2060-XL</b>	7	7	<b>DS2060-XL</b>	6	11
TB2080XL	<b>DL2080-XL</b>	9	7	<b>DS2080-XL</b>	7	11
TB3030XL	<b>DL3030-XL</b>	7	11	<b>DS3030-XL</b>	5	15
TB3060XL	<b>DL3060-XL</b>	8	11	<b>DS3060-XL</b>	6	15
TB3080XL	<b>DL3080-XL</b>	9	11	<b>DS3080-XL</b>	7	15
TB3120XL	<b>DL3120-XL</b>	26	11	<b>DS3120-XL</b>	22	15

**Card Holders for ESD Tote Boxes**



- Static dissipative.
- Transparent blue vinyl material.
- Easily snaps onto TB3000 Series divider boxes (page 137).

FEATURES:

Freight class is 70.0.

holds labels		model #	list
in.	mm		
2" x 8"	51 x 203	<b>CH28S</b>	9
3" x 5"	76 x 127	<b>CH35S</b>	12
5" x 8"	127 x 203	<b>CH58S</b>	13

**Go Green. Go ECO-Built™ by EAGLE.**

*For institutions concerned about meeting their own green standards, buying Eco-Built™ is simply the right thing to do.*

Look for the ECO-Built™ tag on the bar code



**Catalog Section 7**

**Molded Fiberglass ESD Boxes and Tray**

Freight class is 70.0.

see spec sheet **EG07.10**



molded fiberglass ESD boxes and trays

**Molded Fiberglass ESD Boxes**

- Made of thermoset polyester composite material.
- Flame and chemical resistant.

*These black ESD boxes are stackable for maximum storage efficiency.*

description	inside length x width		outside length x width		depth		cu ft	model #	list
	in.	mm	in.	mm	in.	mm			
stacking box	24"	619	25 1/4"	654	3"	76	0.6	<b>A208510</b>	62
stacking box	24"	619	25 1/4"	654	4 1/2"	114	1.0	<b>A208511</b>	68
stacking box	24"	619	25 1/4"	654	6"	152	1.3	<b>A208512</b>	77
lid	24"	619	25 1/4"	654	—	—	—	<b>A208514 *</b>	48

\*Model #A208514 lid fits all stacking boxes listed in chart.

**Molded Fiberglass ESD Tray**

- Made of thermoset polyester composite material.
- Flame and chemical resistant.

description	inside length x width		outside length x width		depth		cu ft	model #	list
	in.	mm	in.	mm	in.	mm			
black	24"	619	25 1/4"	654	1 1/8"	29	0.1	<b>A208509</b>	63

**Note:** Model #A208509 cannot be used safely in a lab oven. Do not heat.

**Conductive Bins and Dividers**

see spec sheet **EG07.11**

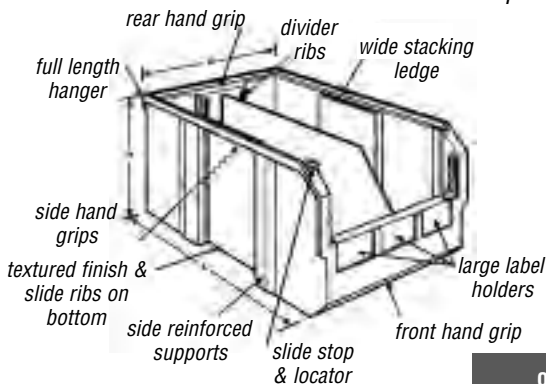

FEATURES:

- Molded with a carbon-filled copolymer polypropylene material which protects sensitive electronic components from typical electromagnetic interference (EMI).

Freight class is 70.0.

*Ultra-strong stackable containers are ideal for storage and transportation of electronic components and parts, assemblies, and loaded circuit boards.*



assorted conductive bins

bins with dividers

overall dimensions			weight*	cu*	carton	Bins		Dividers		
width	length	height				model #	list	model #	list	
in.	mm	mm	lbs.	kg	quantity	each	each	each		
4 1/2"	114	76	0.5	0.2	0.7	48	<b>A208336</b>	6	<b>A208348</b>	8
4 1/2"	138	76	0.5	0.2	0.8	48	<b>A208337</b>	6	<b>A208349</b>	9
4 1/2"	191	76	0.5	0.2	1.0	48	<b>A208338</b>	8	<b>A208350</b>	13
5 1/2"	279	127	0.5	0.2	0.6	12	<b>A208339</b>	21	<b>A208351</b>	19
5 1/2"	343	127	1.0	0.5	0.5	12	<b>A208340</b>	22	<b>A208352</b>	19
11"	279	127	1.5	0.7	0.5	8	<b>A208341</b>	28	<b>A208353</b>	19
8 1/4"	279	178	1.5	0.7	0.5	8	<b>A208342</b>	29	<b>A208354</b>	31
8 1/4"	375	178	1.5	0.7	1.1	8	<b>A208343</b>	32	<b>A208355</b>	37
16 1/2"	419	178	3.0	1.4	1.8	6	<b>A208344</b>	57	<b>A208356</b>	37
11"	406	203	2.5	1.1	1.3	4	<b>A208345</b>	60	<b>A208357</b>	44
11"	457	254	2.8	1.2	1.7	4	<b>A208346</b>	68	<b>A208358</b>	51
16 1/2"	457	279	4.0	1.8	2.6	4	<b>A208347</b>	92	<b>A208359</b>	51

\* Total carton





**ESD Cart Covers**

see spec sheet **EG07.12**

**Controls electrostatic discharge while protecting contents from moisture and contamination.**

- Controls electrostatic discharge while protecting contents from moisture and contamination.
- All cart covers have a flap on one side.
- "ETC" model cart covers have both side and end flaps for side or end load.
- Comes with brass zipper and paperwork pouch.
- ESD cart covers are waterproof, tear-resistant, antibacterial and flame retardant.



**Black outside,  
Green inside.**

**FEATURES:**

**Freight class is 70.0.**

shelf width x length		post height		weight		cubic	model #	list
in.	mm	in.	mm	lbs.	kg	feet		
18" x 36"	457 x 914	63"	1600	3	1.4	2.5	<b>CZ-63-1836-ESD</b>	428
18" x 48"	457 x 1219	63"	1600	4	1.8	2.5	<b>CZ-63-1848-ESD</b>	480
24" x 24"	610 x 610	63"	1600	3	1.4	2.5	<b>CZ-63-2424-ESD</b>	428
24" x 36"	610 x 914	63"	1600	3	1.4	2.5	<b>CZ-63-2436-ESD</b>	447
24" x 48"	610 x 1219	63"	1600	4	1.8	2.5	<b>CZ-63-2448-ESD</b>	519
24" x 60"	610 x 1524	63"	1600	5	2.3	2.5	<b>CZ-63-2460-ESD</b>	561
fits #ETCE20-Z (page 132)		49"	1245	3	1.4	2.5	<b>CZ-49-ETC</b>	438
fits #ETCS20-Z (page 132)								
fits #ETCE30-Z (page 132)		63"	1600	4	1.8	2.5	<b>CZ-63-ETC</b>	495
fits #ETCS30-Z (page 132)								

**Vibration Dampening Casters**

see spec sheets **EG01.05A EG07.12**

**Where vibration dampening is important, these unique 50A shore hardness "Softie™" casters reduce vibration transfer for work in process.**

**Note:** These casters can be substituted for resilient casters in Electronic Tray Carts (page 132), where vibration dampening is important. **Add \$30 to WTR cart model number list prices.**

**Freight class is 65.0.**

(•) MTS (made to stock) / ( ) MTO (made to order)

type	capacity		wheel diameter		wheel face		weight		cu	zinc	
	lbs.	kg	in.	mm	in.	mm	lbs.	kg	ft	model #	list
stem/swivel	180	81.6	5"	127	1 1/4"	35	2.0	0.9	0.1	<b>SCSS5-180</b> •	40
stem/brake	180	81.6	5"	127	1 1/4"	35	2.5	1.1	0.1	<b>SCSB5-180</b>	43
stem/rigid*	180	81.6	5"	127	1 1/4"	35	2.8	1.3	0.1	<b>SCSR5-180</b>	40

\* Channel frames for rigid stem casters available. See page 9.



"Softie™" caster

**Replacement Caster Wheels for Vibration Dampening Casters**

- Retrofit your existing casters.

Fits	model #	list
5" (127mm) casters	<b>SCW-180</b>	13



**Conductive Casters**

see spec sheets **EG01.05A EG07.12**

**FEATURES:**

- Meets federal specification FF-C-88C regarding conductivity.

**Freight class is 65.0.**

(•) MTS (made to stock) / ( ) MTO (made to order)

type	capacity		wheel diameter		wheel face		weight		cu	zinc	
	lbs.	kg	in.	mm	in.	mm	lbs.	kg	ft	model #	list
stem/swivel	200	90.7	5"	127	1 1/4"	32	2.5	1.2	0.1	<b>CSS5-CC</b> •	59
stem/brake	200	90.7	5"	127	1 1/4"	32	2.8	1.3	0.1	<b>CSB5-CC</b> •	65
stem/rigid*	200	90.7	5"	127	1 1/4"	32	3.5	1.6	0.1	<b>CSR5-CC</b>	67

\* Channel frames for rigid stem casters available. See page 9.



**Catalog Section 7**

**Split Sleeves**

see spec sheets **EG01.03D** **EG07.12**

**Freight class is 70.0.**

(•) MTS (made to stock) / ( ) MTO (made to order)

**Aluminum Split Sleeves**

- For conductive, over the road or high-temperature installations.
- Set of four.

with zinc rings		with stainless rings	
model #	list	model #	list
A208909 •	16	A208908 •	26



**Plastic Conductive Split Sleeves**

- Packed four per bag.

model #	list
A219236	12



**adjuSTable® with Cantilevered Overhead System**

see spec sheet **EG07.13A**

FEATURES:

- 34½" (876mm) working height.
- Tabletops on all models feature hat channels underneath for added strength.

**Freight class is 70.0.**

**Allows you to create work surfaces of your choice with cantilevered overhead system.**



adjuSTable® with overhead cantilevered system shown with H-frame & wire undershelf base, and optional bin holder, reel holder, and bench power center

Work surface of your choice is combined with two 33" (838mm) front posts, two 63" (1600mm) rear posts, two cantilevered overshelves, and your choice of base combination.

**1) Select work surface.**

- "OAC" – 16 gauge type 304 brushed stainless top, with chrome base and chrome overshelves.
- "OAS" – 16 gauge type 304 brushed stainless top, with stainless base and stainless overshelves.

	length		weight		cubic feet	OAC Series		OAS Series	
	in.	mm	lb.	kg		model #	list	model #	list
<b>24" width (610mm)</b>	36"	914	65	29.5	4.4	OAC2436T-2	938	OAS2436T-2	1631
	48"	1219	81	36.7	5.7	OAC2448T-2	1080	OAS2448T-2	1865
	60"	1524	97	44.0	7.0	OAC2460T-2	1224	OAS2460T-2	2164
<b>30" width (762mm)</b>	36"	914	75	34.0	4.4	OAC3036T-2	998	OAS3036T-2	1797
	48"	1219	94	42.6	5.7	OAC3048T-2	1177	OAS3048T-2	2069
	60"	1524	113	51.3	7.0	OAC3060T-2	1336	OAS3060T-2	2384
<b>36" width (914mm)</b>	36"	914	85	38.6	5.0	OAC3636T-2	1218	OAS3636T-2	2011
	48"	1219	108	49.0	7.0	OAC3648T-2	1393	OAS3648T-2	2386
	60"	1524	131	59.4	9.0	OAC3660T-2	1522	OAS3660T-2	2753

**2) Select base combination.**

Base combination is included in table price. Must be specified with your choice of work surface.

**Choose from the following combinations:**

- Base with two C-frames
- Base with one C-frame and one wire shelf
- Base with two H-frames
- Base with one H-frame and one wire shelf

**Consult factory for custom configurations.**



**adjuTable®  
with Wire Overshelf System**

see spec sheet **EG07.13A**

**FEATURES:**

- 34½" (876mm) working height.
- Tabletops on all models feature hat channels underneath for added strength.

**Freight class is 70.0.**

**Allows you to create work surfaces of your choice with wire overshelf systems.**

Work surface of your choice is combined with two 33" (838mm) front posts, two 63" (1600mm) rear posts, two wire overshelves, two 29" (737mm) front posts for wire overshelves, and your choice of base combination.



adjuTable® with wire overshelf system shown with C-frame bases

**1) Select work surface.**

"WOAC" – 16 gauge type 304 brushed stainless top with chrome base

"WOAS" – 16 gauge type 304 brushed stainless top with stainless base

	length		weight		cubic feet	OAC Series		OAS Series	
	in.	mm	lb.	kg		model #	list	model #	list
<b>24" width</b> (610mm)	36"	914	65	29.5	4.4	<b>WOAC2436T-2</b>	992	<b>WOAS2436T-2</b>	1718
	48"	1219	81	36.7	5.7	<b>WOAC2448T-2</b>	1129	<b>WOAS2448T-2</b>	1996
	60"	1524	97	44.0	7.0	<b>WOAC2460T-2</b>	1268	<b>WOAS2460T-2</b>	2342
<b>30" width</b> (762mm)	36"	914	75	34.0	4.4	<b>WOAC3036T-2</b>	1049	<b>WOAS3036T-2</b>	1883
	48"	1219	94	42.6	5.7	<b>WOAC3048T-2</b>	1225	<b>WOAS3048T-2</b>	2201
	60"	1524	113	51.3	7.0	<b>WOAC3060T-2</b>	1379	<b>WOAS3060T-2</b>	2562
<b>36" width</b> (914mm)	36"	914	85	38.6	5.0	<b>WOAC3636T-2</b>	1273	<b>WOAS3636T-2</b>	2098
	48"	1219	108	49.0	7.0	<b>WOAC3648T-2</b>	1441	<b>WOAS3648T-2</b>	2516
	60"	1524	131	59.4	9.0	<b>WOAC3660T-2</b>	1565	<b>WOAS3660T-2</b>	2934

**2) Select base combination.**

Base combination is included in table price.

Must be specified with your choice of work surface.

**Choose from the following combinations:**

- Base with two C-frames
- Base with one C-frame and one wire shelf
- Base with two H-frames
- Base with one H-frame and one wire shelf

**Consult factory for custom configurations.**

**Go Green. Go ECO-Built™ by EAGLE.**

For institutions concerned about meeting their own green standards, buying Eco-Built™ is simply the right thing to do.

Look for the ECO-Built™ tag on the bar code



## Catalog Section 7

### Extras for adjusTable® with Overhead Systems

Freight class is 70.0.

(•) MTS (made to stock) / ( ) MTO (made to order)

see spec sheet **EG07.13B**

#### Bin Holders

- Accommodates supply and conductive bins.
- Constructed of 1½" x ½" (41 x 13mm) 12-gauge mild steel, angle-welded to two conical collars for support.
- Shipped with two plastic split sleeves for attachment to posts.

workstation length		weight		cu ft	bin capacity		model #	list
in.	mm	lbs.	kg		in.	mm		
36"	914	3.0	1.4	0.1	33"	838	<b>BH36C</b>	32
48"	1219	4.0	1.8	0.1	45"	1143	<b>BH48C •</b>	34
60"	1524	4.5	2.0	0.3	57"	1448	<b>BH60C •</b>	36



**Chrome-plated bin holders allow you to sort, store and separate supplies.**

#### Reel Holders

- Constructed of 1¼" x 1¼" x 3" (32 x 32 x 76mm) chrome-plated 14-gauge "C" channel, welded to a conical collar.
- Shipped with plastic split sleeves for attachment to posts.
- Rod is constructed of ⅝" (16mm) diameter 16 gauge stainless steel tubing.
- Tubing is held within rod holders with removable 1½" (38mm) long zinc-plated hairpin cotter clips.

workstation length		weight		cu ft	reel capacity		model #	list
in.	mm	lbs.	kg		in.	mm		
36"	914	3.0	1.4	0.1	31"	787	<b>RH36-C</b>	72
48"	1219	4.0	1.8	0.1	42"	1067	<b>RH48-C</b>	75
60"	1524	4.5	2.0	0.3	54"	1372	<b>RH60-C</b>	77



**Chrome-plated reel holders allow you to sort and store wire and labels.**

#### Bench Power Centers

- UL-approved 115-volt, 20-amp power strip comes complete with mounting hardware and 6' (1829mm) cord.
- Cleat included to secure power cord when not in use.

workstation length		weight		cu ft	outlet capacity		model #	list
in.	mm	lbs.	kg		115V - 20A			
36"	914	10	4.5	0.1	5	<b>BPC36C</b>	333	
48"	1219	15	6.8	0.1	7	<b>BPC48C</b>	336	
60"	1524	20	9.0	0.3	9	<b>BPC60C</b>	340	



**See pages 174-177 for optional utility drawers.**

### Stainless Steel Cleaner & Polish

weight		model #	list
oz.	kg		
15	0.4	<b>004026</b>	18



FEATURES:

- Cleans and polishes in one step.
- Does not streak or leave fingerprints.
- Leaves a protective invisible coating.



**Double-Sided Bin-Holder Rails**

see product announcement **EG8152M**

**PATENTED!**  
(patent #8,141,724 B2)

- Bin-holder rails are sold as an accessory or purchased with posts as a kit.
- EAGLEbrite® zinc or chrome plated.
- Bins attach to both sides of rail – no tools required.

**BIN-HOLDER RAILS:**

- Carts consist of four bin-holder rails and four 63" (1600mm) posts with casters.
- Posts are numbered in increments of 1" (25mm) to ensure fast and level assembly.
- Assembly — numerically calibrated grooved posts, tapered plastic split sleeves and rail collars combine to make shelving assembly a simple two-step exercise:
  - 1) snap the split sleeves onto a post over the number of your choice; and
  - 2) slide a rail collar over the split sleeves. A positive lock between rail bin and post is created without the use of any tools.

**BIN-HOLDER  
RAIL CARTS:**



shown assembled as a cart  
(bins sold separately)



bin holder rail  
(bins sold separately)

**Freight class is 70.0.**

**Bin-Holder Rails**

	length		weight		Zinc		Chrome	
	in.	mm	lbs.	kg	model #	list	model#	list
<b>24" width</b> (610mm)	36"	914	11.0	5.0	<b>DBH2436Z</b>	159	<b>DBH2436C</b>	220
	42"	1067	12.5	5.7	<b>DBH2442Z</b>	219	<b>DBH2442C</b>	223
	48"	1219	14.0	6.4	<b>DBH2448Z</b>	232	<b>DBH2448C</b>	256
	54"	1372	15.5	7.0	<b>DBH2454Z</b>	237	<b>DBH2454C</b>	260
	60"	1524	17.0	7.7	<b>DBH2460Z</b>	252	<b>DBH2460C</b>	281
<b>30" width</b> (762mm)	36"	914	12.5	5.7	<b>DBH3036Z</b>	217	<b>DBH3036C</b>	241
	42"	1067	14.0	6.4	<b>DBH3042Z</b>	222	<b>DBH3042C</b>	251
	48"	1219	15.5	7.0	<b>DBH3048Z</b>	252	<b>DBH3048C</b>	283
	54"	1372	17.0	7.7	<b>DBH3054Z</b>	257	<b>DBH3054C</b>	296
	60"	1524	18.5	8.4	<b>DBH3060Z</b>	278	<b>DBH3060C</b>	333



Bin holder rails can also be used on  
Eagle Floor-Trak® units

For additional information on Floor-Trak® Systems, refer to spec sheet EG01.39, or visit us online at [www.eaglegrp.com](http://www.eaglegrp.com)

**Bin-Holder Rail Carts**

	length		weight		Zinc		Chrome	
	in.	mm	lbs.	kg	model #	list	model#	list
<b>24" width</b> (610mm)	36"	914	64	29.0	<b>DBHC2436Z-4</b>	988	<b>DBHC2436C-4</b>	1042
	42"	1067	70	31.8	<b>DBHC2442Z-4</b>	1056	<b>DBHC2442C-4</b>	1056
	48"	1219	76	34.5	<b>DBHC2448Z-4</b>	1091	<b>DBHC2448C-4</b>	1185
	54"	1372	82	37.2	<b>DBHC2454Z-4</b>	1113	<b>DBHC2454C-4</b>	1203
	60"	1524	88	39.9	<b>DBHC2460Z-4</b>	1173	<b>DBHC2460C-4</b>	1284
<b>30" width</b> (762mm)	36"	914	70	31.8	<b>DBHC3036Z-4</b>	1037	<b>DBHC3036C-4</b>	1126
	42"	1067	76	34.5	<b>DBHC3042Z-4</b>	1058	<b>DBHC3042C-4</b>	1162
	48"	1219	82	37.2	<b>DBHC3048Z-4</b>	1172	<b>DBHC3048C-4</b>	1297
	54"	1372	88	39.9	<b>DBHC3054Z-4</b>	1194	<b>DBHC3054C-4</b>	1346
	60"	1524	94	42.6	<b>DBHC3060Z-4</b>	1276	<b>DBHC3060C-4</b>	1495

## Accessories/Components

Casters .....160-161, 167  
 More Accessories  
 and Components .....160, 162,  
 171, 173

## Custom Options .....180

## Drawers .....174-177

## Hardwood Worktables .....161

## Overshelves / Table Mounted

Flex-Master® Adjustable.....169-171  
 Microwave .....173  
 Non-Adjustable / All-Welded.....172

## SPEC-MASTER®

Enclosed Worktables  
 with Backsplash .....165  
 with Flat Top .....163  
 with Upturn .....164

## Specialty Tables

adjuTable® Work Surface Systems ....166  
 Folding Tables .....168

## Stands

Mobile Utility Stands.....168  
 Mobile with Undershef.....168  
 Stationary Utility Stands .....167

## Utility Tool Racks .....178-179

## Wall Cabinets .....171

## Worktables w/Stainless Steel Top

with Backsplash and  
 Tubular Base .....158-159  
 with Backsplash and  
 Undershef Base .....156-157  
 with Flat Top and  
 Tubular Base .....150-151  
 with Flat Top and  
 Undershef Base .....148-149  
 with Upturn and  
 Tubular Base .....154-155  
 with Upturn and  
 Undershef Base .....152-153  
 Filler Tables .....162  
 Knock Down Worktables  
 with Cabinet Kit .....162

For Wall Shelves, see page 91.

## Wall Mounted Stainless Steel Tables

see spec sheet **EG10.01**

Facilitates  
small rolling  
cabinets which  
can be moved  
in and out.

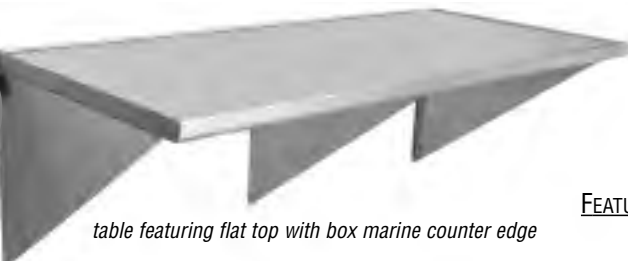

table featuring flat top with box marine counter edge

FEATURES:

- Tabletop available in 16- or 14-gauge stainless steel.
- 14-gauge brackets with hole for electrical wire run.
- Wall mounted for environments with frequent wash downs.
- Available in same configuration as a standard worktable (pages 148-159).
- 200 lb. (90.7 kg) weight capacity.
- Options available include integral sink bowls, drawers, end splashes, and sound deadening.

Freight class is 70.0.

		16/304 TABLETOP WITH ROLLED EDGE		14/304 TABLETOP * WITH ROLLED EDGE		14/304 TABLETOP WITH * BOX MARINE COUNTER EDGE				
	length in. mm	weights* lbs. kg	no. of brackets	model #	list	model #	list	model #	list	
<b>Tables with Flat Top</b>										
30" width (762mm)	48"	1219	71 32.2	3	WT3048SEB	577	WT3048SE	817	WT3048SEM	1147
	60"	1524	82 37.6	3	WT3060SEB	676	WT3060SE	933	WT3060SEM	1223
	72"	1829	95 43.1	4	WT3072SEB	758	WT3072SE	1091	WT3072SEM	1381
<b>Tables with 1½" Upturn</b>										
30" width (762mm)	48"	1219	71 32.2	3	UWT3048SEB	679	UWT3048SE	961	UWT3048SEM	1349
	60"	1524	83 37.6	3	UWT3060SEB	795	UWT3060SE	1097	UWT3060SEM	1439
	72"	1829	95 43.1	4	UWT3072SEB	892	UWT3072SE	1283	UWT3072SEM	1625
<b>Tables with 4½" Backsplash</b>										
30" width (762mm)	48"	1219	73 33.1	3	WT3048SEB-BS	721	WT3048SE-BS	1021	WT3048SEM-BS	1435
	60"	1524	84 38.1	3	WT3060SEB-BS	845	WT3060SE-BS	1166	WT3060SEM-BS	1529
	72"	1829	97 44.0	4	WT3072SEB-BS	947	WT3072SE-BS	1363	WT3072SEM-BS	1726

\* Increase stated weight by 10%.

### Optional table edges available:

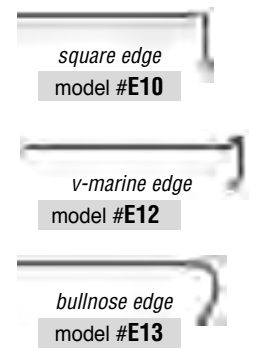

# SPEC-MASTER® Marine Series

14 gauge, type 304 stainless steel tabletop.  
Features a marine counter edge to prevent spillage.

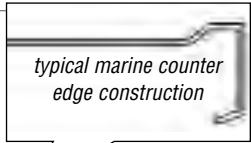

**WITH  
FLAT TOP AND  
UNDERSHELF...**  
*See pages 148-149*



**WITH  
FLAT TOP AND  
TUBULAR BASE...**  
*See pages 150-151*



**WITH  
4½" (267MM)  
BACKSPLASH AND  
UNDERSHELF...**  
*See pages 156-157*



**WITH  
4½" (267MM)  
BACKSPLASH AND  
TUBULAR BASE...**  
*See pages 158-159*

EM, SEM, GTEM, and STEM series

# SPEC-MASTER® Series

14 gauge, type 304 stainless steel tabletop.



**WITH  
FLAT TOP AND  
UNDERSHELF...**  
*See pages 148-149*



**WITH  
UPTURN AND  
UNDERSHELF...**  
*See pages 152-153*



**WITH  
BACKSPLASH AND  
UNDERSHELF...**  
*See pages 156-157*



**WITH  
FLAT TOP AND  
TUBULAR BASE...**  
*See pages 150-151*



**WITH  
UPTURN AND  
TUBULAR BASE...**  
*See pages 154-155*



**WITH  
BACKSPLASH AND  
TUBULAR BASE...**  
*See pages 158-159*

E, SE, GTE, and STE series

# Deluxe Series

16 gauge, type 304 stainless steel table top.

typical rolled edge construction



**WITH  
FLAT TOP AND  
UNDERSHELF...**

*See pages 148-149*



**WITH  
UPTURN AND  
UNDERSHELF...**

*See pages 152-153*



**WITH  
BACKSPLASH AND  
UNDERSHELF...**

*See pages 156-157*



**WITH  
FLAT TOP AND  
TUBULAR BASE...**

*See pages 150-151*



**WITH  
UPTURN AND  
TUBULAR BASE...**

*See pages 154-155*



**WITH  
BACKSPLASH AND  
TUBULAR BASE...**

*See pages 158-159*

**EB, SEB, GTEB, and STEB series**

# Budget Series

16 gauge, type 430 stainless steel table top.

typical rolled edge construction



**WITH  
FLAT TOP AND  
UNDERSHELF...**

*See pages 148-149*



**WITH  
UPTURN AND  
UNDERSHELF...**

*See pages 152-153*



**WITH  
BACKSPLASH AND  
UNDERSHELF...**

*See pages 156-157*



**WITH  
FLAT TOP AND  
TUBULAR BASE...**

*See pages 150-151*



**WITH  
UPTURN AND  
TUBULAR BASE...**

*See pages 154-155*



**WITH  
BACKSPLASH AND  
TUBULAR BASE...**

*See pages 158-159*

**B, SB, GTB, and STB series**



# Worktables with Stainless Steel Flat Top & Galvanized Legs/Undershelf

see spec sheets **EG10.40A** **EG10.40B** **EG10.40C** **EG10.40D**

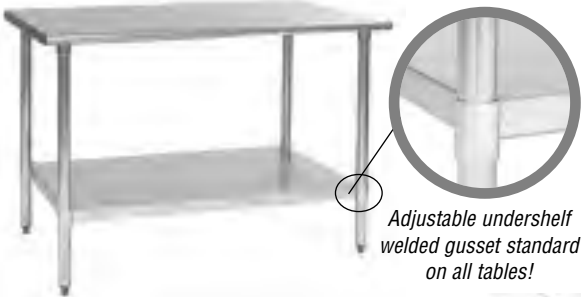

Adjustable undershelf welded gusset standard on all tables!

FEATURES:

- 1½" (41mm) diameter legs and adjustable undershelf are heavy gauge galvanized steel.
- Heavy gauge polished stainless steel top.
- Offers worktables with a rolled edge on front and rear, with ends turned 90°, except SPEC-MASTER® Marine edge.
- 35½" - 36½" (892 - 918mm) adjustable working height.

**Note:** All shipping weights and cubic feet are approximate.

NSF sprayed-on sound deadening available. To order, add **\$680 to list price** and suffix **"-SD"**. Example: **T2424B-SD**.

Optional fixed undershelf available in place of standard adjustable undershelf. To order, add **10% to list price**, and **"-F"** to end of suffix. Example: **T2424B-F**.



(Patent #5,165,349)

**Freight class is 70.0.**

For FLEX-MASTER® overshelf kits, see page 171.

For drawer kits, see page 177.



See page 160 for optional casters available.

(•) MTS (made to stock) / ( ) MTO (made to order)

	length		# of legs	weight		cu ft	BUDGET		DELUXE		*SPEC-MASTER®		* ▼ Marine	
	in.	mm		lbs.	kg		16 ga. type 430 top model #	list	16 ga. 300 series top model #	list	14 ga. 300 series top model #	list	14 ga. 300 series top model #	list
<b>24" width (610mm)</b>	24"	610	4	40	18.1	3.5	<b>T2424B</b> •	689	<b>T2424EB</b>	760	<b>T2424E</b>	798	<b>T2424EM</b>	1333
	30"	762	4	45	20.4	3.8	<b>T2430B</b> •	747	<b>T2430EB</b>	828	<b>T2430E</b>	883	<b>T2430EM</b>	1428
	36"	914	4	50	22.7	4.4	<b>T2436B</b> •	812	<b>T2436EB</b>	891	<b>T2436E</b>	946	<b>T2436EM</b>	1491
	48"	1219	4	60	27.2	5.7	<b>T2448B</b> •	827	<b>T2448EB</b>	906	<b>T2448E</b>	962	<b>T2448EM</b>	1515
	60"	1524	4	70	31.8	7.1	<b>T2460B</b> •	873	<b>T2460EB</b>	982	<b>T2460E</b>	1055	<b>T2460EM</b>	1603
	72"	1829	4	80	36.3	8.5	<b>T2472B</b> •	934	<b>T2472EB</b>	1064	<b>T2472E</b>	1143	<b>T2472EM</b>	1701
	84"	2134	4	90	40.8	11.2	<b>T2484B</b>	1191	<b>T2484EB</b>	1522	<b>T2484E</b>	1557	<b>T2484EM</b>	2077
	96"	2438	6	100	45.4	11.2	<b>T2496B</b> •	1355	<b>T2496EB</b>	1631	<b>T2496E</b>	1672	<b>T2496EM</b>	2196
	108"	2743	6	110	49.9	14.0	<b>T24108B</b>	2204	<b>T24108EB</b>	2356	<b>T24108E</b>	2307	<b>T24108EM</b>	2882
	120"	3048	6	120	54.4	14.0	<b>T24120B</b>	2267	<b>T24120EB</b>	2423	<b>T24120E</b>	2540	<b>T24120EM</b>	2949
<b>30" width (762mm)</b>	132"	3353	8	130	59.0	16.8	<b>T24132B</b>	2279	<b>T24132EB</b>	2467	<b>T24132E</b>	2674	<b>T24132EM</b>	3164
	144"	3658	8	140	63.5	16.8	<b>T24144B</b>	2281	<b>T24144EB</b>	2540	<b>T24144E</b>	2683	<b>T24144EM</b>	3232
	30"	762	4	46	20.9	3.8	<b>T3030B</b> •	768	<b>T3030EB</b>	858	<b>T3030E</b>	913	<b>T3030EM</b>	1460
	36"	914	4	52	23.6	4.4	<b>T3036B</b> •	829	<b>T3036EB</b>	921	<b>T3036E</b>	975	<b>T3036EM</b>	1527
	48"	1219	4	64	29.0	5.7	<b>T3048B</b> •	842	<b>T3048EB</b> •	948	<b>T3048E</b>	1014	<b>T3048EM</b>	1567
	60"	1524	4	76	34.5	7.1	<b>T3060B</b> •	921	<b>T3060EB</b> •	1043	<b>T3060E</b>	1117	<b>T3060EM</b>	1680
	72"	1829	4	84	38.1	8.5	<b>T3072B</b> •	1001	<b>T3072EB</b> •	1143	<b>T3072E</b>	1223	<b>T3072EM</b>	1792
	84"	2134	4	96	43.6	11.2	<b>T3084B</b> •	1249	<b>T3084EB</b>	1545	<b>T3084E</b>	1643	<b>T3084EM</b>	2168
	96"	2438	6	108	49.0	11.2	<b>T3096B</b> •	1446	<b>T3096EB</b>	1685	<b>T3096E</b>	1795	<b>T3096EM</b>	2319
	108"	2743	6	120	54.4	14.0	<b>T30108B</b>	2225	<b>T30108EB</b>	2496	<b>T30108E</b>	2627	<b>T30108EM</b>	3101
<b>36" width (914mm)</b>	120"	3048	6	132	59.9	14.0	<b>T30120B</b>	2300	<b>T30120EB</b>	2569	<b>T30120E</b>	2698	<b>T30120EM</b>	3169
	132"	3353	8	144	65.3	16.8	<b>T30132B</b>	2415	<b>T30132EB</b>	2711	<b>T30132E</b>	2786	<b>T30132EM</b>	3356
	144"	3658	8	156	70.8	16.8	<b>T30144B</b>	2487	<b>T30144EB</b>	2731	<b>T30144E</b>	2940	<b>T30144EM</b>	3427
	48"	1219	4	70	31.8	7.0	<b>T3648B</b>	1049	<b>T3648EB</b>	1155	<b>T3648E</b>	1189	<b>T3648EM</b>	1884
	60"	1524	4	82	37.2	8.8	<b>T3660B</b>	1182	<b>T3660EB</b>	1295	<b>T3660E</b>	1333	<b>T3660EM</b>	2031
	72"	1829	4	96	43.6	10.5	<b>T3672B</b>	1293	<b>T3672EB</b>	1405	<b>T3672E</b>	1453	<b>T3672EM</b>	2163
	84"	2134	4	108	49.0	12.2	<b>T3684B</b>	1778	<b>T3684EB</b>	1908	<b>T3684E</b>	1945	<b>T3684EM</b>	2608
	96"	2438	6	120	54.4	13.9	<b>T3696B</b>	1889	<b>T3696EB</b>	2023	<b>T3696E</b>	2080	<b>T3696EM</b>	2734
	108"	2743	6	132	59.9	17.3	<b>T36108B</b>	2686	<b>T36108EB</b>	2996	<b>T36108E</b>	3067	<b>T36108EM</b>	3583
	120"	3048	6	144	65.3	17.3	<b>T36120B</b>	2747	<b>T36120EB</b>	3067	<b>T36120E</b>	3139	<b>T36120EM</b>	3654
<b>48" width (1219mm)</b>	132"	3353	8	156	70.8	20.7	<b>T36132B</b>	2816	<b>T36132EB</b>	3169	<b>T36132E</b>	3278	<b>T36132EM</b>	3869
	144"	3658	8	168	76.2	20.7	<b>T36144B</b>	2971	<b>T36144EB</b>	3238	<b>T36144E</b>	3447	<b>T36144EM</b>	3944
	48"	1219	4	124	56.2	9.3	n/a	n/a	n/a	n/a	<b>T4848E</b>	2774	<b>T4848EM</b>	3697
	60"	1524	4	146	66.2	14.0	n/a	n/a	n/a	n/a	<b>T4860E</b>	3101	<b>T4860EM</b>	4024
	72"	1829	6	171	77.6	14.0	n/a	n/a	n/a	n/a	<b>T4872E</b>	3367	<b>T4872EM</b>	4293
	84"	2134	6	197	89.4	18.7	n/a	n/a	n/a	n/a	<b>T4884E</b>	4572	<b>T4884EM</b>	5493
	96"	2438	8	241	109.3	18.7	n/a	n/a	n/a	n/a	<b>T4896E</b>	4835	<b>T4896EM</b>	5759
	108"	2743	8	278	126.1	23.3	n/a	n/a	n/a	n/a	<b>T48108E</b>	7234	<b>T48108EM</b>	8163
	120"	3048	8	316	143.3	23.3	n/a	n/a	n/a	n/a	<b>T48120E</b>	7317	<b>T48120EM</b>	8229
	132"	3353	10	353	160.1	27.9	n/a	n/a	n/a	n/a	<b>T48132E</b>	7948	<b>T48132EM</b>	8863
144"	3658	10	391	177.4	27.9	n/a	n/a	n/a	n/a	<b>T48144E</b>	8005	<b>T48144EM</b>	8935	

\* On SPEC-MASTER® and SPEC-MASTER® Marine tables, increase stated weight by 10%. ▼ SPEC-MASTER® Marine tables feature a marine counter edge to prevent spillage.



**Catalog Section 10**

**Worktables with Stainless Steel Flat Top & Stainless Steel Legs/Undershelf** 

see spec sheets **EG10.41A** **EG10.41B** **EG10.41C** **EG10.41D**



(Patent #5,165,349)



See page 160 for optional casters available.

- 1 5/8" (41mm) diameter legs and adjustable undershelf are heavy gauge stainless steel.
- Heavy gauge polished stainless steel top.
- Offers worktables with a rolled edge on front and rear, with ends turned 90°, except SPEC-MASTER® Marine.
- 35 1/8" - 36 1/2" (892 - 918mm) adjustable working height.

**FEATURES:**

**Note:** All shipping weights and cubic feet are approximate.

NSF sprayed-on sound deadening available. To order, add **\$680** to list price and suffix **"-SD"**. Example: **T2424SB-SD**.

For FLEX-MASTER® overshelf kits, see page 171.

For drawer kits, see page 177.

**Freight class is 70.0.**

(•) MTS (made to stock) / ( ) MTO (made to order)

	length		# of legs	weight		cu ft	BUDGET		DELUXE		*SPEC-MASTER®		* ▼ Marine		
	in.	mm		lbs.	kg		16 ga. type 430 top	16 ga. 300 series top	14 ga. 300 series top	14 ga. 300 series top	16 ga. 300 series top	16 ga. 300 series top	14 ga. 300 series top	14 ga. 300 series top	
	model #	list		model #	list		model #	list	model #	list	model #	list	model #	list	
24" width (610mm)	24"	610	4	40	18.1	3.5	<b>T2424SB</b>	968	<b>T2424SEB</b> •	1033	<b>T2424SE</b> •	1114	<b>T2424SEM</b>	1664	
	30"	762	4	45	20.4	3.8	<b>T2430SB</b>	1055	<b>T2430SEB</b>	1137	<b>T2430SE</b>	1236	<b>T2430SEM</b>	1785	
	36"	914	4	50	22.7	4.4	<b>T2436SB</b> •	1115	<b>T2436SEB</b> •	1199	<b>T2436SE</b>	1299	<b>T2436SEM</b>	1847	
	48"	1219	4	60	27.2	5.7	<b>T2448SB</b> •	1146	<b>T2448SEB</b> •	1242	<b>T2448SE</b>	1355	<b>T2448SEM</b>	1905	
	60"	1524	4	70	31.8	7.1	<b>T2460SB</b>	1238	<b>T2460SEB</b>	1352	<b>T2460SE</b>	1476	<b>T2460SEM</b>	2027	
	72"	1829	4	80	36.3	8.5	<b>T2472SB</b>	1328	<b>T2472SEB</b>	1459	<b>T2472SE</b>	1600	<b>T2472SEM</b>	2152	
	84"	2134	4	90	40.8	11.2	<b>T2484SB</b>	1641	<b>T2484SEB</b>	2006	<b>T2484SE</b>	2188	<b>T2484SEM</b>	2654	
	96"	2438	6	100	45.4	11.2	<b>T2496SB</b>	1761	<b>T2496SEB</b>	2147	<b>T2496SE</b>	2345	<b>T2496SEM</b>	2807	
	108"	2743	6	110	49.9	14.0	<b>T24108SB</b>	2859	<b>T24108SEB</b>	2981	<b>T24108SE</b>	3357	<b>T24108SEM</b>	3626	
	120"	3048	6	120	54.4	14.0	<b>T24120SB</b>	2926	<b>T24120SEB</b>	3165	<b>T24120SE</b>	3425	<b>T24120SEM</b>	3696	
	132"	3353	8	130	59.0	16.8	<b>T24132SB</b>	2991	<b>T24132SEB</b>	3256	<b>T24132SE</b>	3539	<b>T24132SEM</b>	3985	
	144"	3658	8	140	63.5	16.8	<b>T24144SB</b>	3148	<b>T24144SEB</b>	3322	<b>T24144SE</b>	3713	<b>T24144SEM</b>	4055	
	30" width (762mm)	30"	762	4	46	20.9	3.8	<b>T3030SB</b>	1098	<b>T3030SEB</b> •	1208	<b>T3030SE</b>	1309	<b>T3030SEM</b>	1860
		36"	914	4	52	23.6	4.4	<b>T3036SB</b> •	1174	<b>T3036SEB</b> •	1268	<b>T3036SE</b>	1376	<b>T3036SEM</b>	1924
48"		1219	4	64	29.0	5.7	<b>T3048SB</b> •	1221	<b>T3048SEB</b> •	1333	<b>T3048SE</b> •	1458	<b>T3048SEM</b>	2002	
60"		1524	4	76	34.5	7.1	<b>T3060SB</b> •	1336	<b>T3060SEB</b> •	1469	<b>T3060SE</b> •	1603	<b>T3060SEM</b>	2153	
72"		1829	4	84	38.1	8.5	<b>T3072SB</b> •	1447	<b>T3072SEB</b> •	1600	<b>T3072SE</b> •	1756	<b>T3072SEM</b>	2379	
84"		2134	4	96	43.6	11.2	<b>T3084SB</b>	1700	<b>T3084SEB</b>	2096	<b>T3084SE</b>	2284	<b>T3084SEM</b>	2747	
96"		2438	6	108	49.0	11.2	<b>T3096SB</b> •	1906	<b>T3096SEB</b> •	2318	<b>T3096SE</b> •	2531	<b>T3096SEM</b>	2858	
108"		2743	6	120	54.4	14.0	<b>T30108SB</b>	3033	<b>T30108SEB</b>	3311	<b>T30108SE</b>	3586	<b>T30108SEM</b>	3923	
120"		3048	6	132	59.9	14.0	<b>T30120SB</b>	3102	<b>T30120SEB</b>	3382	<b>T30120SE</b>	3659	<b>T30120SEM</b>	3993	
132"		3353	8	144	65.3	16.8	<b>T30132SB</b>	3296	<b>T30132SEB</b>	3615	<b>T30132SE</b>	3926	<b>T30132SEM</b>	4256	
144"		3658	8	156	70.8	16.8	<b>T30144SB</b>	3365	<b>T30144SEB</b>	3688	<b>T30144SE</b>	3998	<b>T30144SEM</b>	4327	
36" width (914mm)	48"	1219	4	70	31.8	7.0	<b>T3648SB</b>	1408	<b>T3648SEB</b>	1572	<b>T3648SE</b>	1664	<b>T3648SEM</b>	2338	
	60"	1524	4	82	37.2	8.8	<b>T3660SB</b>	1559	<b>T3660SEB</b>	1724	<b>T3660SE</b>	1832	<b>T3660SEM</b>	2514	
	72"	1829	4	96	43.6	10.5	<b>T3672SB</b>	1705	<b>T3672SEB</b>	1883	<b>T3672SE</b>	2001	<b>T3672SEM</b>	2695	
	84"	2134	4	108	49.0	12.2	<b>T3684SB</b>	2357	<b>T3684SEB</b>	2559	<b>T3684SE</b>	2709	<b>T3684SEM</b>	3287	
	96"	2438	6	120	54.4	13.9	<b>T3696SB</b>	2541	<b>T3696SEB</b>	2743	<b>T3696SE</b>	2913	<b>T3696SEM</b>	3489	
	108"	2743	6	132	59.9	17.3	<b>T36108SB</b>	3609	<b>T36108SEB</b>	3933	<b>T36108SE</b>	4168	<b>T36108SEM</b>	4522	
	120"	3048	6	144	65.3	17.3	<b>T36120SB</b>	3682	<b>T36120SEB</b>	4003	<b>T36120SE</b>	4240	<b>T36120SEM</b>	4588	
	132"	3353	8	156	70.8	20.7	<b>T36132SB</b>	3811	<b>T36132SEB</b>	4173	<b>T36132SE</b>	4558	<b>T36132SEM</b>	4902	
144"	3658	8	168	76.2	20.7	<b>T36144SB</b>	3989	<b>T36144SEB</b>	4364	<b>T36144SE</b>	4627	<b>T36144SEM</b>	4975		
48" width (1219mm)	48"	1219	4	124	56.2	9.3	n/a	n/a	n/a	n/a	<b>T4848SE</b>	3216	<b>T4848SEM</b>	4141	
	60"	1524	4	146	66.2	14.0	n/a	n/a	n/a	n/a	<b>T4860SE</b>	3557	<b>T4860SEM</b>	4486	
	72"	1829	6	171	77.6	14.0	n/a	n/a	n/a	n/a	<b>T4872SE</b>	3885	<b>T4872SEM</b>	4814	
	84"	2134	6	197	89.4	18.7	n/a	n/a	n/a	n/a	<b>T4884SE</b>	5253	<b>T4884SEM</b>	6178	
	96"	2438	8	241	109.3	18.7	n/a	n/a	n/a	n/a	<b>T4896SE</b>	5669	<b>T4896SEM</b>	6597	
	108"	2743	8	278	126.1	23.3	n/a	n/a	n/a	n/a	<b>T48108SE</b>	8267	<b>T48108SEM</b>	9198	
	120"	3048	8	316	143.3	23.3	n/a	n/a	n/a	n/a	<b>T48120SE</b>	8339	<b>T48120SEM</b>	9265	
132"	3353	10	353	160.1	27.9	n/a	n/a	n/a	n/a	<b>T48132SE</b>	8966	<b>T48132SEM</b>	9891		
144"	3658	10	391	177.4	27.9	n/a	n/a	n/a	n/a	<b>T48144SE</b>	9034	<b>T48144SEM</b>	9961		

\* SPEC-MASTER® and SPEC-MASTER® Marine tables feature all stainless steel construction. Increase stated weight by 10%.

▼ SPEC-MASTER® Marine tables feature a marine counter edge to prevent spillage.



100 Industrial Boulevard, Clayton, DE 19938-8903 U.S.A.  
 Phone: 800-637-5100 or 302-653-3000. Fax: 302-653-2065  
<http://www.eaglegrp.com>

# Worktables with Stainless Steel Flat Top & Galvanized Tubular Base

see spec sheets **EG10.42A** **EG10.42B** **EG10.42C** **EG10.42D**



FEATURES:

- Tubular base.
- 1½" (41mm)-diameter legs and 1¼" (32mm)-diameter crossbracing are heavy gauge galvanized steel.
- Heavy gauge polished stainless steel top.
- Offers worktables with a rolled edge on front and rear, with ends turned 90°, except SPEC-MASTER® Marine.
- 35½" - 36½" (892 - 918mm) adjustable working height.

**Note:** All shipping weights and cubic feet are approximate.

NSF sprayed-on sound deadening available. To order, add **\$680 to list price** and suffix **"-SD"**. Example: **T2424GTB-SD**.

For FLEX-MASTER® overshelf kits, see page 171.

For drawer kits, see page 177.

**Freight class is 70.0.**

(•) MTS (made to stock) / ( ) MTO (made to order)

	length		# of legs	weight		cu ft	BUDGET		DELUXE		*SPEC-MASTER®		* ▼ Marine	
	in.	mm		lbs.	kg		16 ga. type 430 top model #	list	16 ga. 300 series top model #	list	14 ga. 300 series top model #	list	14 ga. 300 series top model #	list
24" width (610mm)	24"	610	4	40	18.1	3.5	T2424GTB	805	T2424GTB	880	T2424GTE	915	T2424GTEM	1454
	30"	762	4	45	20.4	3.8	T2430GTB	864	T2430GTB	948	T2430GTE	1002	T2430GTEM	1543
	36"	914	4	50	22.7	4.4	T2436GTB	926	T2436GTB	1012	T2436GTE	1064	T2436GTEM	1609
	48"	1219	4	60	27.2	5.7	T2448GTB	941	T2448GTB	1025	T2448GTE	1085	T2448GTEM	1636
	60"	1524	4	70	31.8	7.1	T2460GTB	988	T2460GTB	1101	T2460GTE	1171	T2460GTEM	1724
	72"	1829	4	80	36.3	8.5	T2472GTB	1051	T2472GTB	1184	T2472GTE	1259	T2472GTEM	1825
	84"	2134	4	90	40.8	11.2	T2484GTB	1306	T2484GTB	1643	T2484GTE	1679	T2484GTEM	2198
	96"	2438	6	100	45.4	11.2	T2496GTB	1469	T2496GTB	1753	T2496GTE	1787	T2496GTEM	2314
	108"	2743	6	110	49.9	14.0	T24108GTB	2243	T24108GTB	2468	T24108GTE	2716	T24108GTEM	3001
	120"	3048	6	120	54.4	14.0	T24120GTB	2323	T24120GTB	2537	T24120GTE	2745	T24120GTEM	3067
30" width (762mm)	132"	3353	8	130	59.0	16.8	T24132GTB	2380	T24132GTB	2588	T24132GTE	2782	T24132GTEM	3282
	144"	3658	8	140	63.5	16.8	T24144GTB	2389	T24144GTB	2657	T24144GTE	2792	T24144GTEM	3352
	30"	762	4	47	21.3	3.8	T3030GTB	885	T3030GTB	977	T3030GTE	1033	T3030GTEM	1582
	36"	914	4	53	24.0	4.4	T3036GTB	945	T3036GTB	1043	T3036GTE	1095	T3036GTEM	1644
	48"	1219	4	65	29.5	5.7	T3048GTB	960	T3048GTB	1065	T3048GTE	1134	T3048GTEM	1686
	60"	1524	4	77	34.9	7.1	T3060GTB	1038	T3060GTB	1162	T3060GTE	1240	T3060GTEM	1800
	72"	1829	4	89	40.4	8.5	T3072GTB	1114	T3072GTB •	1259	T3072GTE	1343	T3072GTEM	1912
	84"	2134	4	101	45.8	11.2	T3084GTB	1363	T3084GTB	1665	T3084GTE	1759	T3084GTEM	2287
36" width (914mm)	96"	2438	6	113	51.3	11.2	T3096GTB	1563	T3096GTB	1802	T3096GTE	1916	T3096GTEM	2440
	108"	2743	6	125	56.7	14.0	T30108GTB	2346	T30108GTB	2612	T30108GTE	2743	T30108GTEM	3218
	120"	3048	6	137	62.1	14.0	T30120GTB	2415	T30120GTB	2685	T30120GTE	2816	T30120GTEM	3291
	132"	3353	8	149	67.6	16.8	T30132GTB	2457	T30132GTB	2754	T30132GTE	2903	T30132GTEM	3475
	144"	3658	8	161	73.0	16.8	T30144GTB	2599	T30144GTB	2909	T30144GTE	3058	T30144GTEM	3546
	48"	1219	4	73	33.1	7.0	T3648GTB	1167	T3648GTB	1273	T3648GTE	1454	T3648GTEM	2002
	60"	1524	4	87	39.5	8.8	T3660GTB	1299	T3660GTB	1412	T3660GTE	1458	T3660GTEM	2147
	72"	1829	4	101	45.8	10.5	T3672GTB	1408	T3672GTB	1522	T3672GTE	1572	T3672GTEM	2284
48" width (1219mm)	84"	2134	4	115	52.2	12.2	T3684GTB	1892	T3684GTB	2027	T3684GTE	2081	T3684GTEM	2731
	96"	2438	6	129	58.5	13.9	T3696GTB	1983	T3696GTB	2141	T3696GTE	2199	T3696GTEM	2857
	108"	2743	6	143	64.9	17.3	T36108GTB	2717	T36108GTB	3026	T36108GTE	3187	T36108GTEM	3704
	120"	3048	6	157	71.2	17.3	T36120GTB	2866	T36120GTB	3187	T36120GTE	3260	T36120GTEM	3775
	132"	3353	8	171	77.6	20.7	T36132GTB	2927	T36132GTB	3285	T36132GTE	3396	T36132GTEM	3993
	144"	3658	8	185	83.9	20.7	T36144GTB	3085	T36144GTB	3454	T36144GTE	3465	T36144GTEM	4065
48" width (1219mm)	48"	1219	4	87	39.5	9.3	n/a	n/a	n/a	n/a	T4848GTE	2889	T4848GTEM	3794
	60"	1524	4	101	45.8	14.0	n/a	n/a	n/a	n/a	T4860GTE	3222	T4860GTEM	4141
	72"	1829	6	115	52.2	14.0	n/a	n/a	n/a	n/a	T4872GTE	3487	T4872GTEM	4492
	84"	2134	6	120	54.4	18.7	n/a	n/a	n/a	n/a	T4884GTE	4692	T4884GTEM	5609
	96"	2438	8	143	64.9	18.7	n/a	n/a	n/a	n/a	T4896GTE	4948	T4896GTEM	5878
	108"	2743	8	157	71.2	23.3	n/a	n/a	n/a	n/a	T48108GTE	7348	T48108GTEM	8277
	120"	3048	8	171	77.6	23.3	n/a	n/a	n/a	n/a	T48120GTE	7431	T48120GTEM	8348
132"	3353	10	185	83.9	27.9	n/a	n/a	n/a	n/a	T48132GTE	8067	T48132GTEM	8978	
144"	3658	10	199	90.3	27.9	n/a	n/a	n/a	n/a	T48144GTE	8134	T48144GTEM	9047	

\* On SPEC-MASTER® and SPEC-MASTER® Marine tables, increase stated weight by 10%. ▼ SPEC-MASTER® Marine tables feature a marine counter edge to prevent spillage.



**Catalog Section 10**

**Worktables with Stainless Steel Flat Top & Stainless Steel Tubular Base** 

see spec sheets **EG10.43A EG10.43B EG10.43C EG10.43D**



**FEATURES:**

- Tubular base.
- 1½" (41mm)-diameter legs and 1¼" (32mm)-diameter crossbracing are heavy gauge stainless steel.
- Heavy gauge polished stainless steel top.
- Offers worktables with a rolled edge on front and rear, with ends turned 90°, except SPEC-MASTER® Marine.
- 35½" - 36½" (892 - 918mm) adjustable working height.

**Note:** All shipping weights and cubic feet are approximate.

NSF sprayed-on sound deadening available. To order, add **\$680 to list price** and suffix **"-SD"**. Example: **T2424STB-SD**.

For FLEX-MASTER® overshelf kits, see page 171.

For drawer kits, see page 177.

**Freight class is 70.0.**

(•) MTS (made to stock) / ( ) MTO (made to order)

	length		# of legs	weight		cu ft	BUDGET		DELUXE		*SPEC-MASTER®		* ▼ Marine	
	in.	mm		lbs.	kg		16 ga. type 430 top		16 ga. 300 series top		14 ga. 300 series top		14 ga. 300 series top	
							model #	list	model #	list	model #	list	model #	list
<b>24" width (610mm)</b>	24"	610	4	40	18.1	3.5	<b>T2424STB</b>	1082	<b>T2424STEB</b>	1151	<b>T2424STE</b>	1233	<b>T2424STEM</b>	1783
	30"	762	4	45	20.4	3.8	<b>T2430STB</b>	1171	<b>T2430STEB</b>	1257	<b>T2430STE</b>	1355	<b>T2430STEM</b>	1905
	36"	914	4	50	22.7	4.4	<b>T2436STB</b>	1232	<b>T2436STEB</b>	1320	<b>T2436STE</b>	1418	<b>T2436STEM</b>	1969
	48"	1219	4	60	27.2	5.7	<b>T2448STB</b>	1260	<b>T2448STEB</b>	1362	<b>T2448STE</b>	1474	<b>T2448STEM</b>	1976
	60"	1524	4	70	31.8	7.1	<b>T2460STB</b>	1352	<b>T2460STEB</b>	1469	<b>T2460STE</b>	1596	<b>T2460STEM</b>	2146
	72"	1829	4	80	36.3	8.5	<b>T2472STB</b>	1445	<b>T2472STEB</b>	1581	<b>T2472STE</b>	1721	<b>T2472STEM</b>	2275
	84"	2134	4	90	40.8	11.2	<b>T2484STB</b>	1754	<b>T2484STEB</b>	2129	<b>T2484STE</b>	2303	<b>T2484STEM</b>	2773
	96"	2438	6	100	45.4	11.2	<b>T2496STB</b>	1879	<b>T2496STEB</b>	2271	<b>T2496STE</b>	2461	<b>T2496STEM</b>	2985
	108"	2743	6	110	49.9	14.0	<b>T24108STB</b>	2886	<b>T24108STEB</b>	3213	<b>T24108STE</b>	3479	<b>T24108STEM</b>	3741
	120"	3048	6	120	54.4	14.0	<b>T24120STB</b>	3040	<b>T24120STEB</b>	3284	<b>T24120STE</b>	3543	<b>T24120STEM</b>	3814
	132"	3353	8	130	59.0	16.8	<b>T24132STB</b>	3104	<b>T24132STEB</b>	3372	<b>T24132STE</b>	3656	<b>T24132STEM</b>	4100
144"	3658	8	140	63.5	16.8	<b>T24144STB</b>	3171	<b>T24144STEB</b>	3441	<b>T24144STE</b>	3725	<b>T24144STEM</b>	4172	
<b>30" width (762mm)</b>	30"	762	4	47	21.3	3.8	<b>T3030STB</b>	1227	<b>T3030STEB</b>	1326	<b>T3030STE</b>	1431	<b>T3030STEM</b>	1980
	36"	914	4	53	24.0	4.4	<b>T3036STB</b>	1289	<b>T3036STEB</b>	1387	<b>T3036STE</b>	1495	<b>T3036STEM</b>	2043
	48"	1219	4	65	29.5	5.7	<b>T3048STB</b>	1338	<b>T3048STEB</b>	• 1454	<b>T3048STE</b>	1579	<b>T3048STEM</b>	2126
	60"	1524	4	77	34.9	7.1	<b>T3060STB</b>	1454	<b>T3060STEB</b>	• 1587	<b>T3060STE</b>	1736	<b>T3060STEM</b>	2276
	72"	1829	4	89	40.4	8.5	<b>T3072STB</b>	1564	<b>T3072STEB</b>	• 1721	<b>T3072STE</b>	1876	<b>T3072STEM</b>	2499
	84"	2134	4	101	45.8	11.2	<b>T3084STB</b>	• 1821	<b>T3084STEB</b>	2217	<b>T3084STE</b>	2404	<b>T3084STEM</b>	2871
	96"	2438	6	113	51.3	11.2	<b>T3096STB</b>	2020	<b>T3096STEB</b>	2438	<b>T3096STE</b>	2654	<b>T3096STEM</b>	2976
	108"	2743	6	125	56.7	14.0	<b>T30108STB</b>	3148	<b>T30108STEB</b>	3429	<b>T30108STE</b>	3705	<b>T30108STEM</b>	4043
	120"	3048	6	137	62.1	14.0	<b>T30120STB</b>	3218	<b>T30120STEB</b>	3502	<b>T30120STE</b>	3776	<b>T30120STEM</b>	4111
	132"	3353	8	149	67.6	16.8	<b>T30132STB</b>	3313	<b>T30132STEB</b>	3626	<b>T30132STE</b>	3932	<b>T30132STEM</b>	4379
	144"	3658	8	161	73.0	16.8	<b>T30144STB</b>	3480	<b>T30144STEB</b>	3803	<b>T30144STE</b>	4117	<b>T30144STEM</b>	4449
<b>36" width (914mm)</b>	48"	1219	4	73	33.1	7.0	<b>T3648STB</b>	1527	<b>T3648STEB</b>	1693	<b>T3648STE</b>	1783	<b>T3648STEM</b>	2456
	60"	1524	4	87	39.5	8.8	<b>T3660STB</b>	1674	<b>T3660STEB</b>	1844	<b>T3660STE</b>	1953	<b>T3660STEM</b>	2635
	72"	1829	4	101	45.8	10.5	<b>T3672STB</b>	1823	<b>T3672STEB</b>	2001	<b>T3672STE</b>	2125	<b>T3672STEM</b>	2815
	84"	2134	4	115	52.2	12.2	<b>T3684STB</b>	2475	<b>T3684STEB</b>	2672	<b>T3684STE</b>	2825	<b>T3684STEM</b>	3408
	96"	2438	6	129	58.5	13.9	<b>T3696STB</b>	2656	<b>T3696STEB</b>	2866	<b>T3696STE</b>	3029	<b>T3696STEM</b>	3613
	108"	2743	6	143	64.9	17.3	<b>T36108STB</b>	3622	<b>T36108STEB</b>	4011	<b>T36108STE</b>	4285	<b>T36108STEM</b>	4639
	120"	3048	6	157	71.2	17.3	<b>T36120STB</b>	3796	<b>T36120STEB</b>	4127	<b>T36120STE</b>	4358	<b>T36120STEM</b>	4707
	132"	3353	8	171	77.6	20.7	<b>T36132STB</b>	3922	<b>T36132STEB</b>	4358	<b>T36132STE</b>	4536	<b>T36132STEM</b>	5017
144"	3658	8	185	83.9	20.7	<b>T36144STB</b>	3989	<b>T36144STEB</b>	4485	<b>T36144STE</b>	4751	<b>T36144STEM</b>	5092	
<b>48" width (1219mm)</b>	48"	1219	4	87	39.5	9.3	n/a	n/a	n/a	n/a	<b>T4848STE</b>	3458	<b>T4848STEM</b>	4258
	60"	1524	4	101	45.8	14.0	n/a	n/a	n/a	n/a	<b>T4860STE</b>	3674	<b>T4860STEM</b>	4606
	72"	1829	6	115	52.2	14.0	n/a	n/a	n/a	n/a	<b>T4872STE</b>	4001	<b>T4872STEM</b>	4926
	84"	2134	6	120	54.4	18.7	n/a	n/a	n/a	n/a	<b>T4884STE</b>	5377	<b>T4884STEM</b>	6296
	96"	2438	8	143	64.9	18.7	n/a	n/a	n/a	n/a	<b>T4896STE</b>	5785	<b>T4896STEM</b>	6709
	108"	2743	8	157	71.2	23.3	n/a	n/a	n/a	n/a	<b>T48108STE</b>	8398	<b>T48108STEM</b>	9311
	120"	3048	8	171	77.6	23.3	n/a	n/a	n/a	n/a	<b>T48120STE</b>	8456	<b>T48120STEM</b>	9378
	132"	3353	10	185	83.9	27.9	n/a	n/a	n/a	n/a	<b>T48132STE</b>	9095	<b>T48132STEM</b>	10008
144"	3658	10	199	90.3	27.9	n/a	n/a	n/a	n/a	<b>T48144STE</b>	9166	<b>T48144STEM</b>	10075	

\* SPEC-MASTER® and SPEC-MASTER® Marine tables feature all stainless steel construction. Increase stated weight by 10%.

▼ SPEC-MASTER® Marine tables feature a marine counter edge to prevent spillage.



100 Industrial Boulevard, Clayton, DE 19938-8903 U.S.A.  
 Phone: 800-637-5100 or 302-653-3000. Fax: 302-653-2065  
<http://www.eaglegrp.com>

**Worktables with Stainless Steel Top, Upturn & Galvanized Legs/Undershelf** 

see spec sheets **EG10.02A EG10.02B EG10.02C**



adjustable undershelf welded gusset

**NOW STANDARD!**

FEATURES:



(Patent #5,165,349)

- 1½" (38mm) upturn at the rear of the table.
- 1½" (41mm)-diameter legs and adjustable undershelf are heavy gauge galvanized steel.
- Heavy gauge polished stainless steel top.
- 35½" - 36½" (892 - 918mm) adjustable working height.

**Note:** All shipping weights and cubic feet are approximate.

NSF sprayed-on sound deadening available. To order, add **\$680 to list price** and suffix **"-SD"**. Example: **UT2424B-SD**.

Optional fixed undershelf available in place of standard adjustable undershelf. To order, add **10% to list price**, and **"-F"** to end of suffix. Example: **UT2424EB-F**.

For FLEX-MASTER® overshelf kits, see page 171.

For drawer kits, see page 177.

**Freight class is 70.0.**

(•) MTS (made to stock) / ( ) MTO (made to order)



See page 160 for optional casters available.

	length		# of legs	weight		cu ft	BUDGET		DELUXE		*SPEC-MASTER®	
	in.	mm		lbs.	kg		16 gauge type 430 top		16 gauge 300 series top		14 gauge 300 series top	
							model #	list	model #	list	model #	list
24" width (610mm)	24"	610	4	40	18.1	3.5	UT2424B	780	UT2424EB	856	UT2424E	891
	30"	762	4	45	20.4	3.8	UT2430B •	841	UT2430EB	921	UT2430E	977
	36"	914	4	50	22.7	4.4	UT2436B •	899	UT2436EB	983	UT2436E	1043
	48"	1219	4	60	27.2	5.7	UT2448B •	914	UT2448EB	1002	UT2448E	1061
	60"	1524	4	70	31.8	7.1	UT2460B •	967	UT2460EB	1077	UT2460E	1148
	72"	1829	4	80	36.3	8.5	UT2472B •	1027	UT2472EB	1158	UT2472E	1236
	84"	2134	4	90	40.8	11.2	UT2484B	1280	UT2484EB	1623	UT2484E	1656
	96"	2438	6	100	45.4	11.2	UT2496B	1447	UT2496EB	1728	UT2496E	1764
	108"	2743	6	110	49.9	14.0	UT24108B	2288	UT24108EB	2375	UT24108E	2495
	120"	3048	6	120	54.4	14.0	UT24120B	2336	UT24120EB	2517	UT24120E	2640
30" width (762mm)	132"	3353	8	130	59.0	16.8	UT24132B	2358	UT24132EB	2565	UT24132E	2780
	144"	3658	8	140	63.5	16.8	UT24144B	2372	UT24144EB	2712	UT24144E	2865
	30"	762	4	50	22.7	3.8	UT3030B •	862	UT3030EB	954	UT3030E	1005
	36"	914	4	55	24.9	4.4	UT3036B •	921	UT3036EB	1018	UT3036E	1068
	48"	1219	4	65	29.5	5.7	UT3048B •	934	UT3048EB	1042	UT3048E	1106
	60"	1524	4	75	34.0	7.1	UT3060B •	1013	UT3060EB	1143	UT3060E	1215
	72"	1829	4	85	38.6	8.5	UT3072B •	1091	UT3072EB	1236	UT3072E	1320
	84"	2134	4	95	43.1	11.2	UT3084B	1341	UT3084EB	1641	UT3084E	1740
36" width (914mm)	96"	2438	6	105	47.6	11.2	UT3096B •	1538	UT3096EB	1782	UT3096E	1889
	108"	2743	6	115	52.2	14.0	UT30108B	2318	UT30108EB	2589	UT30108E	2722
	120"	3048	6	125	56.7	14.0	UT30120B	2386	UT30120EB	2664	UT30120E	2794
	132"	3353	8	135	61.2	16.8	UT30132B	2505	UT30132EB	2737	UT30132E	2879
	144"	3658	8	145	65.8	16.8	UT30144B	2577	UT30144EB	2804	UT30144E	2946
	48"	1219	4	75	34.0	7.0	UT3648B	1143	UT3648EB	1253	UT3648E	1287
	60"	1524	4	85	38.6	8.8	UT3660B	1275	UT3660EB	1387	UT3660E	1431
	72"	1829	4	95	43.1	10.5	UT3672B	1385	UT3672EB	1502	UT3672E	1545
36" width (914mm)	84"	2134	4	105	47.6	12.2	UT3684B	1869	UT3684EB	2001	UT3684E	2059
	96"	2438	6	115	52.2	13.9	UT3696B	1980	UT3696EB	2117	UT3696E	2175
	108"	2743	6	125	56.7	17.3	UT36108B	2775	UT36108EB	2982	UT36108E	3076
	120"	3048	6	135	61.2	17.3	UT36120B	2845	UT36120EB	3165	UT36120E	3235
	132"	3353	8	145	65.8	20.7	UT36132B	2905	UT36132EB	3261	UT36132E	3373
	144"	3658	8	155	70.3	20.7	UT36144B	3063	UT36144EB	3333	UT36144E	3443

\* On SPEC-MASTER® tables, increase stated weight by 10%.



Catalog Section 10

# Worktables with Stainless Steel Top Upturn & Stainless Steel Legs/Undershelf

see spec sheets **EG10.48A** **EG10.48B** **EG10.48C**



(Patent #5,165,349)



See page 160 for optional casters available.

FEATURES:

- 1½" (38mm) upturn at the rear of the table.
- 1½" (41mm)-diameter legs and adjustable undershelf are heavy gauge stainless steel.
- Heavy gauge polished stainless steel top.
- 35½" - 36½" (892 - 918mm) adjustable working height.

**Note:** All shipping weights and cubic feet are approximate.

NSF sprayed-on sound deadening available. To order, add **\$680 to list price** and suffix "**-SD**". Example: **UT2424SB-SD**.

For FLEX-MASTER® overshelf kits, see page 171.

For drawer kits, see page 177.

**Freight class is 70.0.**

	length		# of legs	weight		cu ft	BUDGET		DELUXE		*SPEC-MASTER®	
	in.	mm		lbs.	kg		16 gauge type 430 top		16 gauge 300 series top		14 gauge 300 series top	
							model #	list	model #	list	model #	list
24" width (610mm)	24"	610	4	40	18.1	3.5	UT2424SB	1063	UT2424SEB	1126	UT2424SE	1209
	30"	762	4	45	20.4	3.8	UT2430SB	1147	UT2430SEB	1231	UT2430SE	1332
	36"	914	4	50	22.7	4.4	UT2436SB	1208	UT2436SEB	1298	UT2436SE	1396
	48"	1219	4	60	27.2	5.7	UT2448SB	1240	UT2448SEB	1339	UT2448SE	1453
	60"	1524	4	70	31.8	7.1	UT2460SB	1328	UT2460SEB	1445	UT2460SE	1577
	72"	1829	4	80	36.3	8.5	UT2472SB	1418	UT2472SEB	1551	UT2472SE	1698
	84"	2134	4	90	40.8	11.2	UT2484SB	1731	UT2484SEB	2104	UT2484SE	2283
	96"	2438	6	100	45.4	11.2	UT2496SB	1855	UT2496SEB	2240	UT2496SE	2438
	108"	2743	6	110	49.9	14.0	UT24108SB	2949	UT24108SEB	3187	UT24108SE	3447
	120"	3048	6	120	54.4	14.0	UT24120SB	3017	UT24120SEB	3260	UT24120SE	3518
30" width (762mm)	132"	3353	8	130	59.0	16.8	UT24132SB	3081	UT24132SEB	3446	UT24132SE	3628
	144"	3658	8	140	63.5	16.8	UT24144SB	3241	UT24144SEB	3516	UT24144SE	3811
	30"	762	4	50	22.7	3.8	UT3030SB	1205	UT3030SEB	1301	UT3030SE	1405
	36"	914	4	55	24.9	4.4	UT3036SB	1265	UT3036SEB	1367	UT3036SE	1466
	48"	1219	4	65	29.5	5.7	UT3048SB	1312	UT3048SEB	1431	UT3048SE	1549
	60"	1524	4	75	34.0	7.1	UT3060SB	1427	UT3060SEB	1565	UT3060SE	1701
	72"	1829	4	85	38.6	8.5	UT3072SB	1543	UT3072SEB	1698	UT3072SE	1853
	84"	2134	4	95	43.1	11.2	UT3084SB	1798	UT3084SEB	2191	UT3084SE	2379
	96"	2438	6	105	47.6	11.2	UT3096SB	1997	UT3096SEB	2419	UT3096SE	2627
	108"	2743	6	115	52.2	14.0	UT30108SB	3127	UT30108SEB	3406	UT30108SE	3685
36" width (914mm)	120"	3048	6	125	56.7	14.0	UT30120SB	3197	UT30120SEB	3476	UT30120SE	3756
	132"	3353	8	135	61.2	16.8	UT30132SB	3293	UT30132SEB	3600	UT30132SE	4021
	144"	3658	8	145	65.8	16.8	UT30144SB	3358	UT30144SEB	3778	UT30144SE	4096
	48"	1219	4	75	34.0	7.0	UT3648SB	1500	UT3648SEB	1665	UT3648SE	1757
	60"	1524	4	85	38.6	8.8	UT3660SB	1649	UT3660SEB	1825	UT3660SE	1928
	72"	1829	4	95	43.1	10.5	UT3672SB	1801	UT3672SEB	1980	UT3672SE	2097
	84"	2134	4	105	47.6	12.2	UT3684SB	2448	UT3684SEB	2654	UT3684SE	2806
	96"	2438	6	115	52.2	13.9	UT3696SB	2633	UT3696SEB	2838	UT3696SE	3014
	108"	2743	6	125	56.7	17.3	UT36108SB	3701	UT36108SEB	3912	UT36108SE	4264
	120"	3048	6	135	61.2	17.3	UT36120SB	3774	UT36120SEB	4100	UT36120SE	4337
132"	3353	8	145	65.8	20.7	UT36132SB	4012	UT36132SEB	4267	UT36132SE	4516	
144"	3658	8	155	70.3	20.7	UT36144SB	4088	UT36144SEB	4464	UT36144SE	4724	

\* On SPEC-MASTER® tables, increase stated weight by 10%. All stainless steel construction.



100 Industrial Boulevard, Clayton, DE 19938-8903 U.S.A.  
Phone: 800-637-5100 or 302-653-3000. Fax: 302-653-2065  
<http://www.eaglegrp.com>

**Worktables with Stainless Steel Top, Upturn & Galvanized Tubular Base** NSF

see spec sheets **EG10.03A** **EG10.03B** **EG10.03C**

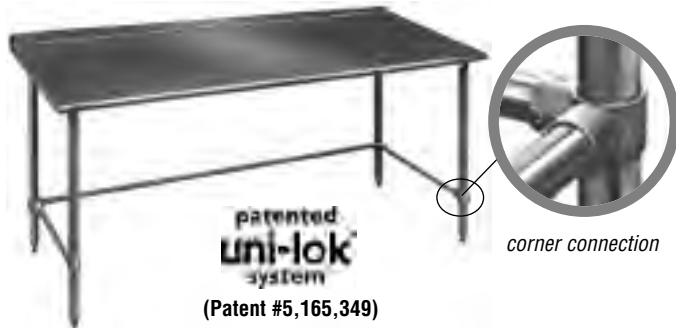

**FEATURES:**

- 1½" (38mm) upturn at the rear of the table.
- Tubular base.
- 1½" (41mm)-diameter legs and 1¼" (32mm)-diameter crossbracing are heavy gauge galvanized steel.
- Heavy gauge polished stainless steel top.
- 35½" - 36½" (892 - 918mm) adjustable working height.

**Note:** All shipping weights and cubic feet are approximate.

NSF sprayed-on sound deadening available. To order, add **\$680 to list price** and suffix "-SD". Example: **UT2424GTB-SD**.

For FLEX-MASTER® overshelf kits, see page 171.

For drawer kits, see page 177.

**Freight class is 70.0.**



See page 160 for optional casters available.

	length		# of legs	weight		cu ft	BUDGET		DELUXE		*SPEC-MASTER®	
	in.	mm		lbs.	kg		16 gauge type 430 top		16 gauge 300 series top		14 gauge 300 series top	
							model #	list	model #	list	model #	list
24" width (610mm)	24"	610	4	40	18.1	3.5	UT2424GTB	896	UT2424GTB	976	UT2424GTE	1099
	30"	762	4	45	20.4	3.8	UT2430GTB	956	UT2430GTB	1042	UT2430GTE	1148
	36"	914	4	50	22.7	4.4	UT2436GTB	1018	UT2436GTB	1103	UT2436GTE	1167
	48"	1219	4	60	27.2	5.7	UT2448GTB	1032	UT2448GTB	1119	UT2448GTE	1224
	60"	1524	4	70	31.8	7.1	UT2460GTB	1080	UT2460GTB	1197	UT2460GTE	1264
	72"	1829	4	80	36.3	8.5	UT2472GTB	1144	UT2472GTB	1282	UT2472GTE	1355
	84"	2134	4	90	40.8	11.2	UT2484GTB	1397	UT2484GTB	1740	UT2484GTE	1776
	96"	2438	6	100	45.4	11.2	UT2496GTB	1564	UT2496GTB	1847	UT2496GTE	1884
	108"	2743	6	110	49.9	14.0	UT24108GTB	2336	UT24108GTB	2494	UT24108GTE	2608
	120"	3048	6	120	54.4	14.0	UT24120GTB	2478	UT24120GTB	2636	UT24120GTE	2754
30" width (762mm)	132"	3353	8	130	59.0	16.8	UT24132GTB	2483	UT24132GTB	2678	UT24132GTE	2816
	144"	3658	8	140	63.5	16.8	UT24144GTB	2492	UT24144GTB	2746	UT24144GTE	2884
	30"	762	4	50	22.7	3.8	UT3030GTB	976	UT3030GTB	1073	UT3030GTE	1126
	36"	914	4	53	24.0	4.4	UT3036GTB	1038	UT3036GTB	1137	UT3036GTE	1189
	48"	1219	4	57	25.9	5.7	UT3048GTB	1051	UT3048GTB	1160	UT3048GTE	1229
	60"	1524	4	67	30.4	7.1	UT3060GTB	1128	UT3060GTB	1259	UT3060GTE	1333
	72"	1829	4	77	34.9	8.5	UT3072GTB	1205	UT3072GTB	1355	UT3072GTE	1438
	84"	2134	4	87	39.5	11.2	UT3084GTB	1458	UT3084GTB	1758	UT3084GTE	1860
	96"	2438	6	97	44.0	11.2	UT3096GTB	1654	UT3096GTB	1900	UT3096GTE	2008
	108"	2743	6	107	48.5	14.0	UT30108GTB	2371	UT30108GTB	2712	UT30108GTE	2838
36" width (914mm)	120"	3048	6	117	53.1	14.0	UT30120GTB	2499	UT30120GTB	2782	UT30120GTE	2913
	132"	3353	8	127	57.6	16.8	UT30132GTB	2552	UT30132GTB	2853	UT30132GTE	3084
	144"	3658	8	137	62.1	16.8	UT30144GTB	2619	UT30144GTB	2922	UT30144GTE	3161
	48"	1219	4	61	27.7	7.0	UT3648GTB	1258	UT3648GTB	1371	UT3648GTE	1405
	60"	1524	4	73	33.1	8.8	UT3660GTB	1392	UT3660GTB	1509	UT3660GTE	1547
	72"	1829	4	85	38.6	10.5	UT3672GTB	1500	UT3672GTB	1623	UT3672GTE	1665
	84"	2134	4	97	44.0	12.2	UT3684GTB	1988	UT3684GTB	2125	UT3684GTE	2176
	96"	2438	6	109	49.4	13.9	UT3696GTB	2096	UT3696GTB	2236	UT3696GTE	2295
	108"	2743	6	121	54.9	17.3	UT36108GTB	2891	UT36108GTB	3121	UT36108GTE	3191
	120"	3048	6	133	60.3	17.3	UT36120GTB	2960	UT36120GTB	3284	UT36120GTE	3356
132"	3353	8	145	65.8	20.7	UT36132GTB	3018	UT36132GTB	3379	UT36132GTE	3488	
144"	3658	8	157	71.2	20.7	UT36144GTB	3086	UT36144GTB	3451	UT36144GTE	3557	

\* On SPEC-MASTER® tables, increase stated weight by 10%.



Catalog Section 10

Worktables with Stainless Steel Top,   
Upturn & Stainless Steel Tubular Base

see spec sheets **EG10.49A** **EG10.49B** **EG10.49C**



FEATURES:

- 1½" (38mm) upturn at the rear of the table.
- Tubular base.
- 1½" (41mm)-diameter legs and 1¼" (32mm)-diameter crossbracing are heavy gauge stainless steel.
- Heavy gauge polished stainless steel top.
- 35½" - 36½" (892 - 918mm) adjustable working height.

Note: All shipping weights and cubic feet are approximate.

NSF sprayed-on sound deadening available. To order, add **\$680 to list price** and suffix "-SD". Example: **UT2424STB-SD**.

For FLEX-MASTER® overshelf kits, see page 171.

For drawer kits, see page 177.

Freight class is 70.0.



See page 160 for optional casters available.

	length		# of legs	weight		cu ft	BUDGET		DELUXE		*SPEC-MASTER®	
	in.	mm		lbs.	kg		16 gauge type 430 top		16 gauge 300 series top		14 gauge 300 series top	
							model #	list	model #	list	model #	list
24" width (610mm)	24"	610	4	40	18.1	3.5	UT2424STB	1196	UT2424STEB	1243	UT2424STE	1326
	30"	762	4	45	20.4	3.8	UT2430STB	1262	UT2430STEB	1352	UT2430STE	1453
	36"	914	4	50	22.7	4.4	UT2436STB	1326	UT2436STEB	1414	UT2436STE	1515
	48"	1219	4	60	27.2	5.7	UT2448STB	1354	UT2448STEB	1459	UT2448STE	1572
	60"	1524	4	70	31.8	7.1	UT2460STB	1445	UT2460STEB	1565	UT2460STE	1694
	72"	1829	4	80	36.3	8.5	UT2472STB	1537	UT2472STEB	1673	UT2472STE	1817
	84"	2134	4	90	40.8	11.2	UT2484STB	1848	UT2484STEB	2222	UT2484STE	2400
	96"	2438	6	100	45.4	11.2	UT2496STB	1968	UT2496STEB	2364	UT2496STE	2562
	108"	2743	6	110	49.9	14.0	UT24108STB	2978	UT24108STEB	3216	UT24108STE	3567
	120"	3048	6	120	54.4	14.0	UT24120STB	3132	UT24120STEB	3379	UT24120STE	3642
30" width (762mm)	132"	3353	8	130	59.0	16.8	UT24132STB	3196	UT24132STEB	3464	UT24132STE	3745
	144"	3658	8	140	63.5	16.8	UT24144STB	3199	UT24144STEB	3536	UT24144STE	3929
	30"	762	4	50	22.7	3.8	UT3030STB	1323	UT3030STEB	1424	UT3030STE	1522
	36"	914	4	53	24.0	4.4	UT3036STB	1384	UT3036STEB	1487	UT3036STE	1586
	48"	1219	4	57	25.9	5.7	UT3048STB	1431	UT3048STEB	1547	UT3048STE	1672
	60"	1524	4	67	30.4	7.1	UT3060STB	1544	UT3060STEB	1685	UT3060STE	1825
	72"	1829	4	77	34.9	8.5	UT3072STB	1655	UT3072STEB	1817	UT3072STE	1973
	84"	2134	4	87	39.5	11.2	UT3084STB	1912	UT3084STEB	2313	UT3084STE	2499
	96"	2438	6	97	44.0	11.2	UT3096STB	2112	UT3096STEB	2534	UT3096STE	2743
	108"	2743	6	107	48.5	14.0	UT30108STB	3152	UT30108STEB	3524	UT30108STE	3802
36" width (914mm)	120"	3048	6	117	53.1	14.0	UT30120STB	3311	UT30120STEB	3596	UT30120STE	3869
	132"	3353	8	127	57.6	16.8	UT30132STB	3402	UT30132STEB	3718	UT30132STE	4141
	144"	3658	8	137	62.1	16.8	UT30144STB	3474	UT30144STEB	3899	UT30144STE	4213
	48"	1219	4	61	27.7	7.0	UT3648STB	1614	UT3648STEB	1785	UT3648STE	1881
	60"	1524	4	73	33.1	8.8	UT3660STB	1767	UT3660STEB	1940	UT3660STE	2047
	72"	1829	4	85	38.6	10.5	UT3672STB	1918	UT3672STEB	2097	UT3672STE	2218
	84"	2134	4	97	44.0	12.2	UT3684STB	2565	UT3684STEB	2773	UT3684STE	2922
	96"	2438	6	109	49.4	13.9	UT3696STB	2746	UT3696STEB	2959	UT3696STE	3128
	108"	2743	6	121	54.9	17.3	UT36108STB	3709	UT36108STEB	4029	UT36108STE	4383
	120"	3048	6	133	60.3	17.3	UT36120STB	3888	UT36120STEB	4218	UT36120STE	4455
132"	3353	8	145	65.8	20.7	UT36132STB	4008	UT36132STEB	4380	UT36132STE	4613	
144"	3658	8	157	71.2	20.7	UT36144STB	4079	UT36144STEB	4582	UT36144STE	4706	

\* On SPEC-MASTER® tables, increase stated weight by 10%.  
SPEC-MASTER® tables feature all stainless steel construction.





# Worktables with Stainless Steel Top, Backsplash & Galvanized Legs/Undershelf

see spec sheets **EG10.44A** **EG10.44B** **EG10.44C** **EG10.44D**



adjustable undershelf welded gusset

**NOW STANDARD!**

patented uni-lok system  
(Patent #5,165,349)

**FEATURES:**

- 4½" (114mm) backsplash at the rear of the table.
- 1½" (41mm)-diameter legs and adjustable undershelf are heavy gauge galvanized steel.
- Heavy gauge polished stainless steel top.
- SPEC-MASTER® Marine series worktables feature a marine counter edge on front and both ends.
- 35½" - 36½" (892 - 918mm) adjustable working height.

**Note:** All shipping weights and cubic feet are approximate.

NSF sprayed-on sound deadening available. To order, add **\$680 to list price** and suffix **"-SD"**. Example: **T2424B-BS-SD**.

Optional fixed undershelf available in place of standard adjustable undershelf. To order, add **10% to list price**, and **"-F"** to end of suffix. Example: **T3048EM-BS-F**.

**Freight class is 70.0.**

For optional power strips (only for tables with backsplash), see page 160.

For FLEX-MASTER® overshelf kits, see page 171.

For drawer kits, see page 177.



See page 160 for optional casters available.

(•) MTS (made to stock) / ( ) MTO (made to order)

	length		# of legs	weight		cu ft	BUDGET		DELUXE		*SPEC-MASTER®		* ▼ Marine	
	in.	mm		lbs.	kg		16 ga. type 430 top model #	list	16 ga. 300 series top model #	list	14 ga. 300 series top model #	list	14 ga. 300 series top model #	list
<b>24" width (610mm)</b>	24"	610	4	43	19.5	3.5	<b>T2424B-BS</b>	947	<b>T2424EB-BS</b>	1034	<b>T2424E-BS</b>	1060	<b>T2424EM-BS</b>	1781
	30"	762	4	48	21.8	3.8	<b>T2430B-BS</b>	1013	<b>T2430EB-BS</b>	1117	<b>T2430E-BS</b>	1151	<b>T2430EM-BS</b>	1931
	36"	914	4	53	24.0	4.4	<b>T2436B-BS</b>	1072	<b>T2436EB-BS</b>	1181	<b>T2436E-BS</b>	1214	<b>T2436EM-BS</b>	1938
	48"	1219	4	63	28.6	5.7	<b>T2448B-BS</b> •	1079	<b>T2448EB-BS</b>	1207	<b>T2448E-BS</b>	1242	<b>T2448EM-BS</b>	2027
	60"	1524	4	73	33.1	7.1	<b>T2460B-BS</b> •	1152	<b>T2460EB-BS</b>	1295	<b>T2460E-BS</b>	1333	<b>T2460EM-BS</b>	2064
	72"	1829	4	85	38.6	8.5	<b>T2472B-BS</b> •	1218	<b>T2472EB-BS</b>	1381	<b>T2472E-BS</b>	1431	<b>T2472EM-BS</b>	2161
	84"	2134	4	97	44.0	11.2	<b>T2484B-BS</b>	1494	<b>T2484EB-BS</b>	1758	<b>T2484E-BS</b>	1819	<b>T2484EM-BS</b>	2545
	96"	2438	6	114	51.7	11.2	<b>T2496B-BS</b>	1667	<b>T2496EB-BS</b>	1898	<b>T2496E-BS</b>	1940	<b>T2496EM-BS</b>	2669
	108"	2743	6	142	64.4	14.0	<b>T24108B-BS</b>	2511	<b>T24108EB-BS</b>	2688	<b>T24108E-BS</b>	2778	<b>T24108EM-BS</b>	3383
	120"	3048	6	154	69.9	14.0	<b>T24120B-BS</b>	2577	<b>T24120EB-BS</b>	2749	<b>T24120E-BS</b>	2838	<b>T24120EM-BS</b>	3555
<b>30" width (762mm)</b>	132"	3353	8	166	75.3	16.8	<b>T24132B-BS</b>	2640	<b>T24132EB-BS</b>	2752	<b>T24132E-BS</b>	2907	<b>T24132EM-BS</b>	3675
	144"	3658	8	178	80.7	16.8	<b>T24144B-BS</b>	2782	<b>T24144EB-BS</b>	2967	<b>T24144E-BS</b>	3064	<b>T24144EM-BS</b>	3745
	30"	762	4	50	22.7	3.8	<b>T3030B-BS</b> •	1032	<b>T3030EB-BS</b>	1151	<b>T3030E-BS</b>	1184	<b>T3030EM-BS</b>	1894
	36"	914	4	53	24.0	4.4	<b>T3036B-BS</b> •	1094	<b>T3036EB-BS</b>	1214	<b>T3036E-BS</b>	1246	<b>T3036EM-BS</b>	1905
	48"	1219	4	70	31.8	5.7	<b>T3048B-BS</b> •	1113	<b>T3048EB-BS</b>	1253	<b>T3048E-BS</b>	1294	<b>T3048EM-BS</b>	2080
	60"	1524	4	81	36.7	7.1	<b>T3060B-BS</b> •	1194	<b>T3060EB-BS</b>	1355	<b>T3060E-BS</b>	1402	<b>T3060EM-BS</b>	2202
	72"	1829	4	94	42.6	8.5	<b>T3072B-BS</b> •	1274	<b>T3072EB-BS</b>	1462	<b>T3072E-BS</b>	1515	<b>T3072EM-BS</b>	2252
	84"	2134	4	108	49.0	11.2	<b>T3084B-BS</b>	1563	<b>T3084EB-BS</b>	1840	<b>T3084E-BS</b>	1905	<b>T3084EM-BS</b>	2718
	96"	2438	6	130	59.0	11.2	<b>T3096B-BS</b> •	1767	<b>T3096EB-BS</b>	1996	<b>T3096E-BS</b>	2066	<b>T3096EM-BS</b>	2887
	108"	2743	6	150	68.0	14.0	<b>T30108B-BS</b>	2646	<b>T30108EB-BS</b>	2825	<b>T30108E-BS</b>	2922	<b>T30108EM-BS</b>	3617
<b>36" width (914mm)</b>	120"	3048	6	170	77.1	14.0	<b>T30120B-BS</b>	2717	<b>T30120EB-BS</b>	2900	<b>T30120E-BS</b>	2994	<b>T30120EM-BS</b>	3685
	132"	3353	8	188	85.3	16.8	<b>T30132B-BS</b>	2877	<b>T30132EB-BS</b>	3067	<b>T30132E-BS</b>	3179	<b>T30132EM-BS</b>	3881
	144"	3658	8	207	93.9	16.8	<b>T30144B-BS</b>	2944	<b>T30144EB-BS</b>	3139	<b>T30144E-BS</b>	3251	<b>T30144EM-BS</b>	3946
	48"	1219	4	77	34.9	7.0	<b>T3648B-BS</b>	1446	<b>T3648EB-BS</b>	1507	<b>T3648E-BS</b>	1551	<b>T3648EM-BS</b>	2353
	60"	1524	4	90	40.8	8.8	<b>T3660B-BS</b>	1566	<b>T3660EB-BS</b>	1724	<b>T3660E-BS</b>	1783	<b>T3660EM-BS</b>	2501
	72"	1829	4	106	48.1	10.5	<b>T3672B-BS</b>	1662	<b>T3672EB-BS</b>	1843	<b>T3672E-BS</b>	1908	<b>T3672EM-BS</b>	2639
	84"	2134	4	123	55.8	12.2	<b>T3684B-BS</b>	1963	<b>T3684EB-BS</b>	2157	<b>T3684E-BS</b>	2236	<b>T3684EM-BS</b>	3102
	96"	2438	6	132	59.9	13.9	<b>T3696B-BS</b>	2207	<b>T3696EB-BS</b>	2427	<b>T3696E-BS</b>	2513	<b>T3696EM-BS</b>	3229
	108"	2743	6	169	76.7	17.3	<b>T36108B-BS</b>	3121	<b>T36108EB-BS</b>	3315	<b>T36108E-BS</b>	3427	<b>T36108EM-BS</b>	4117
	120"	3048	6	192	87.1	17.3	<b>T36120B-BS</b>	3189	<b>T36120EB-BS</b>	3385	<b>T36120E-BS</b>	3499	<b>T36120EM-BS</b>	4185
132"	3353	8	216	98.0	20.7	<b>T36132B-BS</b>	3277	<b>T36132EB-BS</b>	3485	<b>T36132E-BS</b>	3713	<b>T36132EM-BS</b>	4418	
144"	3658	8	239	108.4	20.7	<b>T36144B-BS</b>	3345	<b>T36144EB-BS</b>	3659	<b>T36144E-BS</b>	3789	<b>T36144EM-BS</b>	4486	

\* On SPEC-MASTER® and SPEC-MASTER® Marine tables, increase stated weight by 10%.

▼ SPEC-MASTER® Marine tables feature a marine counter edge to prevent spillage.



Catalog Section 10

# Worktables with Stainless Steel Top, Backsplash & Stainless Steel Legs/Undershelf

see spec sheets **EG10.45A** **EG10.45B** **EG10.45C** **EG10.45D**



FEATURES:

- 4½" (114mm) backsplash at the rear of the table.
- 1½" (41mm)-diameter legs and adjustable undershelf are heavy gauge stainless steel.
- Heavy gauge polished stainless steel top.
- SPEC-MASTER® Marine series worktables feature a marine counter edge on front and both ends.
- 35½" - 36½" (892 - 918mm) adjustable working height.



(Patent #5,165,349)

Note: All shipping weights and cubic feet are approximate.

NSF sprayed-on sound deadening available. To order, add **\$680 to list price** and suffix **"-SD"**. Example: **T2424SB-BS-SD**.

For FLEX-MASTER® overshelf kits, see page 171.

For drawer kits, see page 177.

**Freight class is 70.0.**

(•) MTS (made to stock) / ( ) MTO (made to order)

For optional power strips (only for tables with backsplash), see page 160.



See page 160 for optional casters available.

	length		# of legs	weight		cu ft	BUDGET		DELUXE		*SPEC-MASTER®		* ▼ Marine	
	in.	mm		lbs.	kg		16 ga. type 430 top model #	list	16 ga. 300 series top model #	list	14 ga. 300 series top model #	list	14 ga. 300 series top model #	list
24" width (610mm)	24"	610	4	43	19.5	3.5	T2424SB-BS	1301	T2424SEB-BS	1356	T2424SE-BS	1433	T2424SEM-BS	2096
	30"	762	4	48	21.8	3.8	T2430SB-BS	1402	T2430SEB-BS	1460	T2430SE-BS	1558	T2430SEM-BS	2218
	36"	914	4	53	24.0	4.4	T2436SB-BS	1462	T2436SEB-BS •	1527	T2436SE-BS	1656	T2436SEM-BS	2283
	48"	1219	4	63	28.6	5.7	T2448SB-BS	1494	T2448SEB-BS •	1581	T2448SE-BS •	1693	T2448SEM-BS	2342
	60"	1524	4	73	33.1	7.1	T2460SB-BS	1583	T2460SEB-BS	1698	T2460SE-BS •	1819	T2460SEM-BS	2460
	72"	1829	4	85	38.6	8.5	T2472SB-BS	1677	T2472SEB-BS	1817	T2472SE-BS •	1952	T2472SEM-BS	2583
	84"	2134	4	97	44.0	11.2	T2484SB-BS	1988	T2484SEB-BS	2331	T2484SE-BS	2499	T2484SEM-BS	3084
	96"	2438	6	114	51.7	11.2	T2496SB-BS	2107	T2496SEB-BS	2483	T2496SE-BS	2665	T2496SEM-BS	3237
	108"	2743	6	142	64.4	14.0	T24108SB-BS	2994	T24108SEB-BS	3460	T24108SE-BS	3713	T24108SEM-BS	4067
	120"	3048	6	154	69.9	14.0	T24120SB-BS	3272	T24120SEB-BS	3528	T24120SE-BS	3778	T24120SEM-BS	4133
132"	3353	8	166	75.3	16.8	T24132SB-BS	3331	T24132SEB-BS	3735	T24132SE-BS	3897	T24132SEM-BS	4416	
144"	3658	8	178	80.7	16.8	T24144SB-BS	3499	T24144SEB-BS	3805	T24144SE-BS	4086	T24144SEM-BS	4486	
30" width (762mm)	30"	762	4	50	22.7	3.8	T3030SB-BS	1461	T3030SEB-BS	1533	T3030SE-BS	1637	T3030SEM-BS	2293
	36"	914	4	53	24.0	4.4	T3036SB-BS	1523	T3036SEB-BS •	1596	T3036SE-BS	1700	T3036SEM-BS	2357
	48"	1219	4	70	31.8	5.7	T3048SB-BS •	1572	T3048SEB-BS •	1667	T3048SE-BS •	1787	T3048SEM-BS	2437
	60"	1524	4	81	36.7	7.1	T3060SB-BS •	1684	T3060SEB-BS •	1815	T3060SE-BS •	1945	T3060SEM-BS	2587
	72"	1829	4	94	42.6	8.5	T3072SB-BS •	1788	T3072SEB-BS •	1955	T3072SE-BS •	2105	T3072SEM-BS	2736
	84"	2134	4	108	49.0	11.2	T3084SB-BS	2049	T3084SEB-BS	2419	T3084SE-BS	2595	T3084SEM-BS	3182
	96"	2438	6	130	59.0	11.2	T3096SB-BS	2253	T3096SEB-BS •	2654	T3096SE-BS	2856	T3096SEM-BS	3419
	108"	2743	6	150	68.0	14.0	T30108SB-BS	3380	T30108SEB-BS	3667	T30108SE-BS	3942	T30108SEM-BS	4358
	120"	3048	6	170	77.1	14.0	T30120SB-BS	3451	T30120SEB-BS	3740	T30120SE-BS	4015	T30120SEM-BS	4428
	132"	3353	8	188	85.3	16.8	T30132SB-BS	3643	T30132SEB-BS	3993	T30132SE-BS	4299	T30132SEM-BS	4694
144"	3658	8	207	93.9	16.8	T30144SB-BS	3712	T30144SEB-BS	4065	T30144SE-BS	4367	T30144SEM-BS	4767	
36" width (914mm)	48"	1219	4	77	34.9	7.0	T3648SB-BS	1754	T3648SEB-BS	1958	T3648SE-BS	2104	T3648SEM-BS	2776
	60"	1524	4	90	40.8	8.8	T3660SB-BS	1906	T3660SEB-BS	2211	T3660SE-BS	2372	T3660SEM-BS	2951
	72"	1829	4	106	48.1	10.5	T3672SB-BS	2058	T3672SEB-BS	2371	T3672SE-BS	2542	T3672SEM-BS	3131
	84"	2134	4	123	55.8	12.2	T3684SB-BS	2703	T3684SEB-BS	2819	T3684SE-BS	3029	T3684SEM-BS	3726
	96"	2438	6	132	59.9	13.9	T3696SB-BS	2885	T3696SEB-BS	3017	T3696SE-BS	3246	T3696SEM-BS	3929
	108"	2743	6	169	76.7	17.3	T36108SB-BS	3958	T36108SEB-BS	4280	T36108SE-BS	4600	T36108SEM-BS	4946
	120"	3048	6	192	87.1	17.3	T36120SB-BS	4027	T36120SEB-BS	4348	T36120SE-BS	4673	T36120SEM-BS	5018
	132"	3353	8	216	98.0	20.7	T36132SB-BS	4268	T36132SEB-BS	4514	T36132SE-BS	4857	T36132SEM-BS	5336
144"	3658	8	239	108.4	20.7	T36144SB-BS	4344	T36144SEB-BS	4584	T36144SE-BS	5075	T36144SEM-BS	5409	

\* SPEC-MASTER® and SPEC-MASTER® Marine tables feature all stainless steel construction. Increase stated weight by 10%.

▼ SPEC-MASTER® Marine tables feature a marine counter edge to prevent spillage.



100 Industrial Boulevard, Clayton, DE 19938-8903 U.S.A.  
 Phone: 800-637-5100 or 302-653-3000. Fax: 302-653-2065  
<http://www.eaglegrp.com>

# Worktables with Stainless Steel Top, Backsplash & Galvanized Tubular Base

see spec sheets **EG10.46A** **EG10.46B** **EG10.46C** **EG10.46D**



- 4½" (114mm) backsplash at the rear of the table.
- Tubular base.
- 1½" (41mm)-diameter legs and 1¼" (32mm)-diameter crossbracing are heavy gauge galvanized steel.
- Heavy gauge polished stainless steel top.
- SPEC-MASTER® Marine series worktables feature a marine counter edge on front and both ends.
- 35½" - 36½" (892 - 918mm) adjustable working height.

**FEATURES:**

**Note:** All shipping weights and cubic feet are approximate.

NSF sprayed-on sound deadening available. To order, add \$680 to list price and suffix "-SD". Example: T2424GTB-BS-SD.

**Freight class is 70.0.**

For optional power strips (only for tables with backsplash), see page 160.

For FLEX-MASTER® overshelf kits, see page 171.

For drawer kits, see page 177.



See page 160 for optional casters available.

	length		# of legs	weight		cu ft	BUDGET		DELUXE		*SPEC-MASTER®		* ▼ Marine	
	in.	mm		lbs.	kg		16 ga. type 430 top model #	list	16 ga. 300 series top model #	list	14 ga. 300 series top model #	list	14 ga. 300 series top model #	list
24" width (610mm)	24"	610	4	41	18.6	3.5	T2424GTB-BS	1065	T2424GTB-BS	1152	T2424GTE-BS	1180	T2424GTEM-BS	1953
	30"	762	4	46	20.9	3.8	T2430GTB-BS	1127	T2430GTB-BS	1240	T2430GTE-BS	1266	T2430GTEM-BS	2054
	36"	914	4	51	23.1	4.4	T2436GTB-BS	1192	T2436GTB-BS	1301	T2436GTE-BS	1332	T2436GTEM-BS	2115
	48"	1219	4	61	27.7	5.7	T2448GTB-BS	1194	T2448GTB-BS	1323	T2448GTE-BS	1362	T2448GTEM-BS	2146
	60"	1524	4	71	32.2	7.1	T2460GTB-BS	1268	T2460GTB-BS	1412	T2460GTE-BS	1454	T2460GTEM-BS	2240
	72"	1829	4	81	36.7	8.5	T2472GTB-BS	1334	T2472GTB-BS	1502	T2472GTE-BS	1547	T2472GTEM-BS	2345
	84"	2134	4	91	41.3	11.2	T2484GTB-BS	1608	T2484GTB-BS	1882	T2484GTE-BS	1939	T2484GTEM-BS	2741
	96"	2438	6	101	45.8	11.2	T2496GTB-BS	1782	T2496GTB-BS	1998	T2496GTE-BS	2062	T2496GTEM-BS	2871
	108"	2743	6	111	50.3	14.0	T24108GTB-BS	2552	T24108GTB-BS	2726	T24108GTE-BS	2818	T24108GTEM-BS	3611
	120"	3048	6	121	54.9	14.0	T24120GTB-BS	2693	T24120GTB-BS	2873	T24120GTE-BS	2959	T24120GTEM-BS	3672
30" width (762mm)	132"	3353	8	131	59.4	16.8	T24132GTB-BS	2749	T24132GTB-BS	2932	T24132GTE-BS	3022	T24132GTEM-BS	3906
	144"	3658	8	141	64.0	16.8	T24144GTB-BS	2816	T24144GTB-BS	3017	T24144GTE-BS	3092	T24144GTEM-BS	3974
	30"	762	4	51	23.1	3.8	T3030GTB-BS	1147	T3030GTB-BS	1266	T3030GTE-BS	1301	T3030GTEM-BS	2082
	36"	914	4	56	25.4	4.4	T3036GTB-BS	1208	T3036GTB-BS	1332	T3036GTE-BS	1367	T3036GTEM-BS	2146
	48"	1219	4	66	29.9	5.7	T3048GTB-BS	1224	T3048GTB-BS	1371	T3048GTE-BS	1409	T3048GTEM-BS	2199
	60"	1524	4	76	34.5	7.1	T3060GTB-BS	1308	T3060GTB-BS	1474	T3060GTE-BS	1519	T3060GTEM-BS	2318
	72"	1829	4	86	39.0	8.5	T3072GTB-BS	1389	T3072GTB-BS	1584	T3072GTE-BS	1636	T3072GTEM-BS	2438
	84"	2134	4	96	43.6	11.2	T3084GTB-BS	1681	T3084GTB-BS	1958	T3084GTE-BS	2026	T3084GTEM-BS	2837
	96"	2438	6	106	48.1	11.2	T3096GTB-BS	1882	T3096GTB-BS	2114	T3096GTE-BS	2182	T3096GTEM-BS	3014
	108"	2743	6	116	52.6	14.0	T30108GTB-BS	2765	T30108GTB-BS	2865	T30108GTE-BS	3040	T30108GTEM-BS	3843
36" width (914mm)	120"	3048	6	126	57.2	14.0	T30120GTB-BS	2829	T30120GTB-BS	3021	T30120GTE-BS	3111	T30120GTEM-BS	3911
	132"	3353	8	136	61.7	16.8	T30132GTB-BS	2991	T30132GTB-BS	3099	T30132GTE-BS	3202	T30132GTEM-BS	4111
	144"	3658	8	146	66.2	16.8	T30144GTB-BS	3067	T30144GTB-BS	3168	T30144GTE-BS	3273	T30144GTEM-BS	4185
	48"	1219	4	71	32.1	7.0	T3648GTB-BS	1563	T3648GTB-BS	1625	T3648GTE-BS	1673	T3648GTEM-BS	2536
	60"	1524	4	81	36.7	8.8	T3660GTB-BS	1684	T3660GTB-BS	1844	T3660GTE-BS	1902	T3660GTEM-BS	2691
	72"	1829	4	91	41.3	10.5	T3672GTB-BS	1722	T3672GTB-BS	1959	T3672GTE-BS	2027	T3672GTEM-BS	2836
	84"	2134	4	101	45.8	12.2	T3684GTB-BS	2079	T3684GTB-BS	2282	T3684GTE-BS	2357	T3684GTEM-BS	3312
	96"	2438	6	111	50.3	13.9	T3696GTB-BS	2248	T3696GTB-BS	2542	T3696GTE-BS	2633	T3696GTEM-BS	3445
	108"	2743	6	121	54.9	17.3	T36108GTB-BS	3144	T36108GTB-BS	3337	T36108GTE-BS	3546	T36108GTEM-BS	4356
	120"	3048	6	131	59.4	17.3	T36120GTB-BS	3304	T36120GTB-BS	3507	T36120GTE-BS	3618	T36120GTEM-BS	4426
	132"	3353	8	141	64.0	20.7	T36132GTB-BS	3392	T36132GTB-BS	3599	T36132GTE-BS	3725	T36132GTEM-BS	4665
	144"	3658	8	151	68.5	20.7	T36144GTB-BS	3455	T36144GTB-BS	3669	T36144GTE-BS	3794	T36144GTEM-BS	4735

\* On SPEC-MASTER® and SPEC-MASTER® Marine tables, increase stated weight by 10%.

▼ SPEC-MASTER® Marine tables feature a marine counter edge to prevent spillage.



## Catalog Section 10

### Worktables with Stainless Steel Top, Backsplash & Stainless Steel Tubular Base

see spec sheets **EG10.47A** **EG10.47B** **EG10.47C** **EG10.47D**

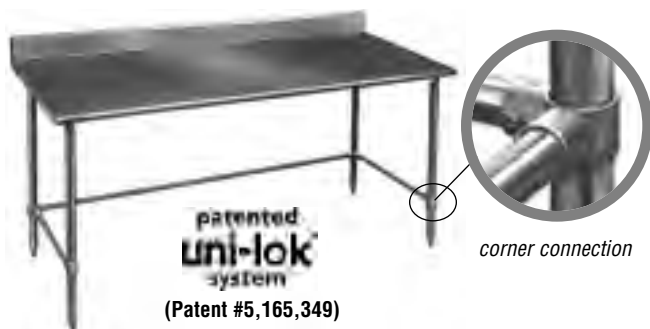

#### FEATURES:

- 4½" (114mm) backsplash at the rear of the table.
- Tubular base.
- 1½" (41mm)-diameter legs and 1¼" (32mm)-diameter crossbracing are heavy gauge stainless steel.
- Heavy gauge polished stainless steel top.
- SPEC-MASTER® Marine series worktables feature a marine counter edge on front and both ends.
- 35½" - 36½" (892 - 918mm) adjustable working height.

**Note:** All shipping weights and cubic feet are approximate.

NSF sprayed-on sound deadening available. To order, add **\$680** to list price and suffix "-SD". Example: T2424STB-BS-SD.

**Freight class is 70.0.**

For optional power strips (only for tables with backsplash), see page 160.

For FLEX-MASTER® overshelf kits, see page 171.

For drawer kits, see page 177.



See page 160 for optional casters available.

	length		# of legs	weight		cu ft	BUDGET		DELUXE		*SPEC-MASTER®		* ▼ Marine	
	in.	mm		lbs.	kg		16 ga. type 430 top model #	list	16 ga. 300 series top model #	list	14 ga. 300 series top model #	list	14 ga. 300 series top model #	list
24" width (610mm)	24"	610	4	41	18.6	3.5	T2424STB-BS	1416	T2424STEB-BS	1476	T2424STE-BS	1549	T2424STEM-BS	2217
	30"	762	4	46	20.9	3.8	T2430STB-BS	1517	T2430STEB-BS	1582	T2430STE-BS	1680	T2430STEM-BS	2341
	36"	914	4	51	23.1	4.4	T2436STB-BS	1579	T2436STEB-BS	1644	T2436STE-BS	1744	T2436STEM-BS	2402
	48"	1219	4	61	27.7	5.7	T2448STB-BS	1608	T2448STEB-BS	1698	T2448STE-BS	1809	T2448STEM-BS	2457
	60"	1524	4	71	32.2	7.1	T2460STB-BS	1697	T2460STEB-BS	1817	T2460STE-BS	1939	T2460STEM-BS	2582
	72"	1829	4	81	36.7	8.5	T2472STB-BS	1793	T2472STEB-BS	1937	T2472STE-BS	2069	T2472STEM-BS	2705
	84"	2134	4	91	41.3	11.2	T2484STB-BS	2100	T2484STEB-BS	2451	T2484STE-BS	2619	T2484STEM-BS	3202
	96"	2438	6	101	45.8	11.2	T2496STB-BS	2222	T2496STEB-BS	2598	T2496STE-BS	2784	T2496STEM-BS	3358
	108"	2743	6	111	50.3	14.0	T24108STB-BS	3226	T24108STEB-BS	3474	T24108STE-BS	3718	T24108STEM-BS	4181
	120"	3048	6	121	54.9	14.0	T24120STB-BS	3388	T24120STEB-BS	3647	T24120STE-BS	3899	T24120STEM-BS	4253
30" width (762mm)	132"	3353	8	131	59.4	16.8	T24132STB-BS	3443	T24132STEB-BS	3743	T24132STE-BS	4019	T24132STEM-BS	4537
	144"	3658	8	141	64.0	16.8	T24144STB-BS	3509	T24144STEB-BS	3926	T24144STE-BS	4086	T24144STEM-BS	4608
	30"	762	4	51	23.1	3.8	T3030STB-BS	1578	T3030STEB-BS	1652	T3030STE-BS	1756	T3030STEM-BS	2413
	36"	914	4	56	25.4	4.4	T3036STB-BS	1640	T3036STEB-BS	1716	T3036STE-BS	1823	T3036STEM-BS	2480
	48"	1219	4	66	29.9	5.7	T3048STB-BS	1685	T3048STEB-BS	1786	T3048STE-BS	1919	T3048STEM-BS	2561
	60"	1524	4	76	34.5	7.1	T3060STB-BS	1800	T3060STEB-BS	1934	T3060STE-BS	2068	T3060STEM-BS	2627
	72"	1829	4	86	39.0	8.5	T3072STB-BS	1912	T3072STEB-BS	2077	T3072STE-BS	2223	T3072STEM-BS	2858
	84"	2134	4	96	43.6	11.2	T3084STB-BS	2165	T3084STEB-BS	2534	T3084STE-BS	2716	T3084STEM-BS	3303
	96"	2438	6	106	48.1	11.2	T3096STB-BS	2371	T3096STEB-BS	2773	T3096STE-BS	2971	T3096STEM-BS	3541
	108"	2743	6	116	52.6	14.0	T30108STB-BS	3499	T30108STEB-BS	3742	T30108STE-BS	4061	T30108STEM-BS	4480
36" width (914mm)	120"	3048	6	126	57.2	14.0	T30120STB-BS	3568	T30120STEB-BS	3785	T30120STE-BS	4136	T30120STEM-BS	4552
	132"	3353	8	136	61.7	16.8	T30132STB-BS	3653	T30132STEB-BS	4111	T30132STE-BS	4418	T30132STEM-BS	4815
	144"	3658	8	146	66.2	16.8	T30144STB-BS	3716	T30144STEB-BS	4185	T30144STE-BS	4487	T30144STEM-BS	4887
	48"	1219	4	71	32.1	7.0	T3648STB-BS	1869	T3648STEB-BS	2080	T3648STE-BS	2222	T3648STEM-BS	2652
	60"	1524	4	81	36.7	8.8	T3660STB-BS	2020	T3660STEB-BS	2326	T3660STE-BS	2493	T3660STEM-BS	2978
	72"	1829	4	91	41.3	10.5	T3672STB-BS	2168	T3672STEB-BS	2489	T3672STE-BS	2666	T3672STEM-BS	3252
	84"	2134	4	101	45.8	12.2	T3684STB-BS	2817	T3684STEB-BS	2940	T3684STE-BS	3153	T3684STEM-BS	3847
	96"	2438	6	111	50.3	13.9	T3696STB-BS	3005	T3696STEB-BS	3137	T3696STE-BS	3366	T3696STEM-BS	4049
	108"	2743	6	121	54.9	17.3	T36108STB-BS	4075	T36108STEB-BS	4273	T36108STE-BS	4720	T36108STEM-BS	5069
	120"	3048	6	131	59.4	17.3	T36120STB-BS	4144	T36120STEB-BS	4471	T36120STE-BS	4788	T36120STEM-BS	5139
132"	3353	8	141	64.0	20.7	T36132STB-BS	4257	T36132STEB-BS	4635	T36132STE-BS	5124	T36132STEM-BS	5453	
144"	3658	8	151	68.5	20.7	T36144STB-BS	4324	T36144STEB-BS	4701	T36144STE-BS	5201	T36144STEM-BS	5525	

\* SPEC-MASTER® and SPEC-MASTER® Marine tables feature all stainless steel construction. Increase stated weight by 10%.

▼ SPEC-MASTER® Marine tables feature a marine counter edge to prevent spillage.



100 Industrial Boulevard, Clayton, DE 19938-8903 U.S.A.  
Phone: 800-637-5100 or 302-653-3000. Fax: 302-653-2065  
<http://www.eaglegrp.com>

### Optional LIFESTOR® Undershelves for Stainless Steel Worktables NSF

see spec sheet **EG10.53**

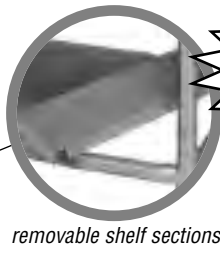

removable shelf sections

**The ONLY machine washable undershelf in the market today!**

patented **uni-lok** system

(Patent #5,165,349)

**FEATURES:**

- Solid polymer shelf sections available for tubular-base tables only.
- Dishwasher-safe and non-corrosive.
- Four-sided adjustable stainless steel bracing

**Note:** Undershelves work with any tubular series worktable at time of order and cannot retrofit in field due to leg spacing. Recommended for use with stationary tables only. To order undershelves, add suffix “-L1” to worktable model number. **Example: T2484STB-L1.** See chart below for pricing.

**Freight class is 70.0.**

**For 24" (610mm) wide worktables**

worktable length	LIFESTOR® undershelf	worktable length	LIFESTOR® undershelf
in. mm	list	in. mm	list
24" 610	105	84" 2134	259
30" 762	122	96" 2438	379
36" 914	145	108" 2743	418
48" 1219	169	120" 3048	427
60" 1524	211	132" 3353	464
72" 1829	237	144" 3658	506

**For 30" (762mm) wide worktables**

worktable length	LIFESTOR® undershelf	worktable length	LIFESTOR® undershelf
in. mm	list	in. mm	list
30" 762	139	96" 2438	454
36" 914	168	108" 2743	509
48" 1219	188	120" 3048	519
60" 1524	256	132" 3353	555
72" 1829	288	144" 3658	615
84" 2134	319		

Featuring **MICROGARD®** an antimicrobial agent which contains built-in protection to retard the growth of a broad range of bacteria, mold and mildew on shelf surface that causes stains, odors and degradation. **Standard on all LIFESTOR® Shelving.**

### Optional Power Strips for Stainless Steel Worktables with Backsplash

length	number of outlets	model #	list
in. mm			
24" 610	8	<b>PS2408</b>	182
36" 914	12	<b>PS3612</b>	199
48" 1219	16	<b>PS4816</b>	205
60" 1524	20	<b>PS6020</b>	255



**FEATURES:**

- Brushed aluminum finish.
- 15' (4572mm) cord and plug.
- Reset button.
- Toggle ON-OFF switch.
- Mounts via pair of stainless steel clips—no tools required.

### Optional Casters NSF

see spec sheet **EG10.59**

description	wt. cap. per caster	model #	list
	lbs. kg		
<b>Zinc with Resilient Tread</b>			
4" (102mm) dia., set of four (two swivel, two w/brake)	115 52.2	<b>CA4-SB•</b>	398
4" (102mm) dia., set of six (three swivel, three w/brake)	115 52.2	<b>CA6-SB</b>	596
4" (102mm) dia., set of eight (four swivel, four w/brake)	115 52.2	<b>CA8-SB</b>	796
5" (127mm) dia., set of four (two swivel, two w/brake)	200 90.7	<b>CAH4-SB•</b>	528
5" (127mm) dia., set of six (three swivel, three w/brake)	200 90.7	<b>CAH6-SB</b>	792
5" (127mm) dia., set of eight (four swivel, four w/brake)	200 90.7	<b>CAH8-SB</b>	1057
<b>Zinc with Poly Tread</b>			
5" (127mm) dia., set of four (two swivel, two w/brake)	250 113.4	<b>CAHP4-SB•</b>	457
5" (127mm) dia., set of six (three swivel, three w/brake)	250 113.4	<b>CAHP6-SB</b>	686
5" (127mm) dia., set of eight (four swivel, four w/brake)	250 113.4	<b>CAHP8-SB</b>	914
<b>Polymer Cart Washable with Polymer Tread</b>			
5" (127mm) dia., set of four (two swivel, two w/brake)	250 113.4	<b>CAHW4-SB</b>	567
5" (127mm) dia., set of six (three swivel, three w/brake)	250 113.4	<b>CAHW6-SB</b>	852
5" (127mm) dia., set of eight (four swivel, four w/brake)	250 113.4	<b>CAHW8-SB</b>	1134

**Note:** To determine set of casters applicable, see “# of legs” column in Worktables charts (pages 148-159). See page 177 for **NEW** optional caster stabilizers.

**Freight class is 65.0.**

(•) MTS (made to stock) / ( ) MTO (made to order)





## Catalog Section 10

### Hardwood Worktables

see spec sheet **EG10.10**

#### FEATURES:

- 1 1/4" (44mm) hardwood tops.
- With flat top or with 4" (102mm) covered backsplash and end splashes.
- Shipped knocked down.

**Note:** All shipping weights and cubic feet are approximate.  
For optional drawer assemblies, see page 176.



hardwood table with flat top and undershelf...

...with flat top and tubular base...

...with backsplash and undershelf...

...with backsplash and tubular base

**Freight class is 55.0.**

(•) MTS (made to stock) / ( ) MTO (made to order)

### Flat Top Hardwood Worktables...

		...with Adjustable Undershelf						...with Tubular Base							
	length		cu	weight		galvanized legs & undershelf		stainless steel legs and undershelf		weight		galvanized tubular base		stainless steel tubular base	
	in.	mm		lbs.	kg	model #	list	model #	list	lbs.	kg	model #	list	model #	list
<b>24" width (610mm)</b>	48"	1219	5.3	94	42.6	<b>MT2448B</b>	884	<b>MT2448S</b>	1064	92	41.7	<b>MT2448GT</b>	785	<b>MT2448ST</b>	1002
	60"	1524	6.6	118	53.5	<b>MT2460B</b>	992	<b>MT2460S</b>	1207	117	53.1	<b>MT2460GT</b>	869	<b>MT2460ST</b>	1122
	72"	1829	8.0	141	64.0	<b>MT2472B</b>	1100	<b>MT2472S</b>	1349	138	62.6	<b>MT2472GT</b>	953	<b>MT2472ST</b>	1247
	96"	2438	10.7	189	85.7	<b>MT2496B</b>	1559	<b>MT2496S</b>	1883	182	82.6	<b>MT2496GT</b>	1367	<b>MT2496ST</b>	1558
<b>30" width (762mm)</b>	48"	1219	6.7	141	64.0	<b>MT3048B</b>	976	<b>MT3048S</b>	1207	139	63.1	<b>MT3048GT</b>	882	<b>MT3048ST</b>	1146
	60"	1524	8.3	147	66.7	<b>MT3060B</b>	1109	<b>MT3060S</b>	1383	145	65.8	<b>MT3060GT</b>	991	<b>MT3060ST</b>	1307
	72"	1829	9.9	177	80.3	<b>MT3072B</b>	1240	<b>MT3072S</b>	1560	174	77.8	<b>MT3072GT</b>	1097	<b>MT3072ST</b>	1463
	96"	2438	13.2	235	106.6	<b>MT3096B</b>	1778	<b>MT3096S</b>	2175	230	104.3	<b>MT3096GT</b>	1580	<b>MT3096ST</b>	2045

### Hardwood Worktables with Backsplash & End Splashes...

		...with Adjustable Undershelf						...with Tubular Base							
	length		cu	weight		galvanized legs & undershelf		stainless steel legs and undershelf		weight		galvanized tubular base		stainless steel tubular base	
	in.	mm		lbs.	kg	model #	list	model #	list	lbs.	kg	model #	list	model #	list
<b>30" width (762mm)</b>	48"	1219	7.0	110	49.9	<b>MT3048B-BS</b>	1865	<b>MT3048S-BS</b>	2399	119	54.0	<b>MT3048GT-BS</b>	1790	<b>MT3048ST-BS</b>	2275
	60"	1524	9.8	149	67.6	<b>MT3060B-BS</b>	1951	<b>MT3060S-BS</b>	2525	147	66.7	<b>MT3060GT-BS</b>	1824	<b>MT3060ST-BS</b>	2395
	72"	1829	11.7	180	81.6	<b>MT3072B-BS</b>	2345	<b>MT3072S-BS</b>	2886	177	80.3	<b>MT3072GT-BS</b>	2192	<b>MT3072ST-BS</b>	2812
	96"	2438	15.5	240	108.9	<b>MT3096B-BS</b>	3207	<b>MT3096S-BS</b>	3819	235	106.6	<b>MT3096GT-BS</b>	3005	<b>MT3096ST-BS</b>	3617

### Optional Casters for Hardwood Worktables



zinc casters

cart washable casters

**Note:** See page 177 for **NEW** optional caster stabilizers.

description	Zinc with Resilient Tread			Zinc with Poly Tread			Polymer Cart Washable with Polymer Tread				
	wt. cap. per caster	list per set	model #	wt. cap. per caster	list per set	model #	wt. cap. per caster	list per set	model #	wt. cap. per caster	list per set
4" (102mm) dia., set of 4 (2 swivel, 2 w/brake)	115	52.2	<b>CA4-SB</b> • 398	n/a	n/a	n/a	n/a	n/a	n/a	n/a	n/a
4" (102mm) dia., set of 6 (3 swivel, 3 w/brake)	115	52.2	<b>CA6-SB</b> 596	n/a	n/a	n/a	n/a	n/a	n/a	n/a	n/a
5" (127mm) dia., set of 4 (2 swivel, 2 w/brake)	200	90.7	<b>CAH4-SB</b> • 528	250	113.4	<b>CAHP4-SB</b> • 457	250	113.4	<b>CAHW4-SB</b> 567		
5" (127mm) dia., set of 6 (3 swivel, 3 w/brake)	200	90.7	<b>CAH6-SB</b> 792	250	113.4	<b>CAHP6-SB</b> 686	250	113.4	<b>CAHW6-SB</b> 852		



**Knock Down Worktables with Cabinet Kit** 

see spec sheet **EG10.36**



- Type 430 stainless steel tabletop and side panels.
- Tabletop is 30" (762mm) with 4½" (114mm) high backsplash.
- Stainless steel side panels and front doors with open rear.
- Easy assembly via machine screws and threaded inserts.

FEATURES:

**Freight class is 70.0.**

(\*) MTS (made to stock) / ( ) MTO (made to order)



(Patent #5,165,349)

	length		cubic feet	weight		...with Hinged Doors		...with Sliding Doors	
	in.	mm		lbs.	kg	model #	list	model #	list
<b>30" width</b> (914mm)	36"	914	4.4	52	23.6	<b>T3036BA-BS-HGD</b>	1591	<b>T3036BA-BS-SLD</b>	1751
	48"	1219	5.4	66	29.9	<b>T3048BA-BS-HGD</b>	1698	<b>T3048BA-BS-SLD</b>	1869
	60"	1524	7.1	79	35.8	<b>T3060BA-BS-HGD</b>	1821	<b>T3060BA-BS-SLD</b>	2001

**Filler Tables** 

see spec sheet **EG10.51**



**Note:** Filler tables are not designed to stand alone or to hold heavy equipment loads. Application and safe installation are the responsibility of the end user.

FEATURES:

- Standard flanged feet adds stability to 12" and 15" (305 and 381mm) long tables.
- 18" (457mm) feature bullet feet.
- 1½" (38mm) upturn.
- Stainless steel legs crossbraced front-to-back and side-to-side.

**Freight class is 70.0.**

(\*) MTS (made to stock) / ( ) MTO (made to order)



(Patent #5,165,349)

	length		cubic feet	weight *		Deluxe 16 gauge type 304 stainless steel top.		SPEC-MASTER® * 14 gauge type 304 stainless steel top.	
	in.	mm		lbs.	kg	model #	list	model #	list
<b>24" width</b> (610mm)	12"	305	2.9	30	13.6	<b>UT2412STEB</b>	784	<b>UT2412STE</b>	853
	15"	381	2.9	34	15.4	<b>UT2415STEB</b>	803	<b>UT2415STE</b>	873
	18"	457	2.9	36	16.3	<b>UT2418STEB</b>	839	<b>UT2418STE</b>	912
<b>30" width</b> (762mm)	12"	305	2.9	34	15.4	<b>UT3012STEB</b> •	847	<b>UT3012STE</b>	921
	15"	381	2.9	36	16.3	<b>UT3015STEB</b> •	866	<b>UT3015STE</b>	941
	18"	457	2.9	40	18.1	<b>UT3018STEB</b> •	914	<b>UT3018STE</b>	994
<b>36" width</b> (914mm)	12"	305	3.5	37	16.8	<b>UT3612STEB</b>	903	<b>UT3612STE</b>	981
	15"	381	3.5	40	18.1	<b>UT3615STEB</b>	931	<b>UT3615STE</b>	1011
	18"	457	3.5	45	20.4	<b>UT3618STEB</b>	967	<b>UT3618STE</b>	1051

\* Add 10% weight for SPEC-MASTER®.

**Worktable Stabilizer Bar (pair)**

see spec sheet **EG10.59**

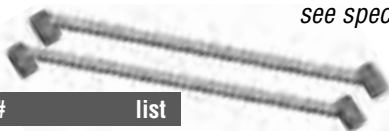

model #	list
<b>WTS30</b>	176

FEATURES:

- Fits standard 30" and 36" (762 and 914mm) width worktables.
- Heavy 12 gauge steel angle and gussets.
- Valu-Master® epoxy coated.

**Freight class is 70.0.**



Catalog Section 10

**SPEC-MASTER® Enclosed Worktables with Flat Top** 

see spec sheet **EG10.30**



patented  
**uni-lok**  
system

(Patent #5,165,349)

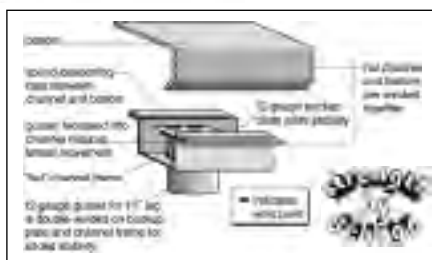

**FEATURES:**

- All-welded cabinet.
- Top mechanically polished to satin finish.
- Sound-deadened between top and frame.
- 1 5/8" (42mm) diameter type 304 stainless legs.
- 1" (25mm) adjustable feet.
- 1 1/2" (38mm) sanitary rolled rim on front and back with square edge on ends for flush fit.

**Note:** Full length fixed center shelf available. To order full width, add 20% to list price and suffix "-FCS". To order two-thirds width, add 20% to list price and suffix "-CS". Example: OB2436SE-CS.

To order table with 4" (102mm) casters, add suffix "-CA" and add to list price \$398 (for tables with four legs) or \$596 (for tables with six legs). Example: OB2436SE-CA.

To order table with 5" (127mm) casters, add suffix "-CAH" and add to list price \$528 (for tables with four legs) or \$792 (for tables with six legs). Example: OB2436SE-CAH.

NSF sprayed-on sound deadening available. To order, add \$680 to list price and suffix "-SD". Example: OB2436SE-SD.

For enhanced utility, add overselves from page 172.

Freight class is 125.0.

	length		# of legs	cu ft	weight		with Open Front		with Sliding Doors*		with Hinged Doors*		with Hinged Doors*			
	in.	mm			lbs.	kg	model #	list	lbs.	kg	model #	list	lbs.	kg	model #	list
<b>24" width</b> (610mm)	36"	914	4	36	132	59.9	OB2436SE	2362	138	62.6	CB2436SE	3015	138	62.6	CBH2436SE	3695
	48"	1219	4	49	160	72.6	OB2448SE	2453	170	77.1	CB2448SE	3372	170	77.1	CBH2448SE	3868
	60"	1524	4	63	200	90.7	OB2460SE	2624	212	96.2	CB2460SE	3623	212	96.2	CBH2460SE	4125
	72"	1829	4	72	240	108.9	OB2472SE	2797	254	115.2	CB2472SE	3885	254	115.2	CBH2472SE	4378
	84"	2134	6	83	281	127.5	OB2484SE	3043	299	135.6	CB2484SE**	4442	299	135.6	CBH2484SE**	4925
	96"	2438	6	95	322	146.1	OB2496SE	3198	339	153.8	CB2496SE**	4798	339	153.8	CBH2496SE**	5283
<b>30" width</b> (762mm)	120"	3048	6	105	366	166.0	OB24120SE	3791	384	174.2	CB24120SE**	5543	384	174.2	CBH24120SE**	6025
	36"	914	4	36	136	61.7	OB3036SE	2494	142	64.4	CB3036SE	3149	142	64.4	CBH3036SE	3819
	48"	1219	4	49	166	75.3	OB3048SE	2581	173	78.5	CB3048SE	3499	173	78.5	CBH3048SE	3994
	60"	1524	4	63	199	90.3	OB3060SE	2775	219	99.3	CB3060SE	3776	219	99.3	CBH3060SE	4275
	72"	1829	4	72	248	112.5	OB3072SE	2972	261	118.4	CB3072SE	4057	261	118.4	CBH3072SE	4553
	84"	2134	6	83	294	133.4	OB3084SE	3175	312	141.5	CB3084SE**	4564	312	141.5	CBH3084SE**	5054
96"	2438	6	95	340	154.2	OB3096SE	3504	350	158.8	CB3096SE**	4999	350	158.8	CBH3096SE**	5483	
120"	3048	6	105	432	196.0	OB30120SE	4031	450	204.1	CB30120SE**	5782	450	204.1	CBH30120SE**	6259	

\* 20 gauge stainless steel doors. To order optional door locks, add suffix "-L" and \$148 list price; \*\* Tables 84" (2134mm) and longer have two sets of doors.

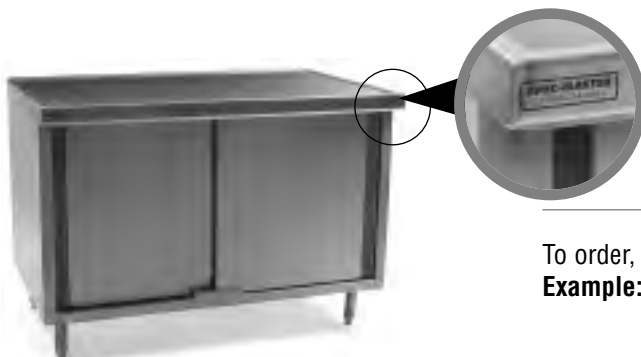

**SPEC-MASTER® Marine Counter Edge Cabinets**

To order, add 20% to list price and add "M" after "SE" in model number. Example: OB2436SEM.

see spec sheet **EG10.33A**





**SPEC-MASTER® Enclosed Worktables with Upturn** 

see spec sheet **EG10.31**



patented  
**uni-lok**  
system  
(Patent #5,165,349)

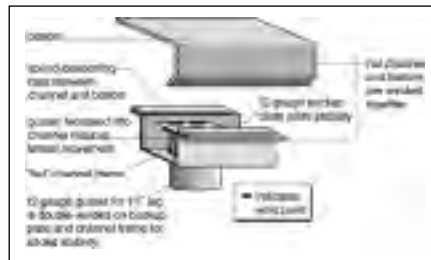

- All-welded cabinet.
- Top mechanically polished to satin finish.
- Top is 14 gauge type 304 stainless steel reinforced with a full length "hat" channel support.
- Body is heavy gauge type 430 stainless steel.
- Sound-deadened between top and frame.
- 1½" (42mm) diameter type 304 stainless legs.
- 1" (25mm) adjustable feet.
- 1½" (38mm) sanitary rolled rim on front, 1½" (38mm) rear upturn, and square edge on ends for flush fit.

**FEATURES:**

**Note:** Full length fixed center shelf available. To order full width, **add 20% to list price** and suffix **"-FCS"**. To order two-thirds width, **add 20% to list price** and suffix **"-CS"**. **Example: UOB2436SE-CS.**

To order table with 4" (102mm) casters, add suffix **"-CA"** and **add to list price \$398** (for tables with four legs) or **\$596** (for tables with six legs). **Example: UOB3036SE-CA.**

To order table with 5" (127mm) casters, add suffix **"-CAH"** and **add to list price \$528** (for tables with four legs) or **\$792** (for tables with six legs). **Example: UOB3036SE-CAH.**

NSF sprayed-on sound deadening available. To order, **add \$680 to list price** and suffix **"-SD"**. **Example: UOB3036SE-SD.**

For enhanced utility, add overselves from page 172.

**Freight class is 125.0.**

					with Open Front				with Sliding Doors*				with Hinged Doors*			
	length		# of legs	cu ft	weight		model #	list	weight		model #	list	weight		model #	list
	in.	mm			lbs.	kg			lbs.	kg			lbs.	kg		
<b>24" width</b> (610mm)	36"	914	4	36	132	59.9	<b>UOB2436SE</b>	2362	138	62.6	<b>UCB2436SE</b>	3015	138	62.6	<b>UCBH2436SE</b>	3695
	48"	1219	4	49	160	72.6	<b>UOB2448SE</b>	2453	170	77.1	<b>UCB2448SE</b>	3372	170	77.1	<b>UCBH2448SE</b>	3868
	60"	1524	4	63	200	90.7	<b>UOB2460SE</b>	2624	212	96.2	<b>UCB2460SE</b>	3623	212	96.2	<b>UCBH2460SE</b>	4125
	72"	1829	4	72	240	108.9	<b>UOB2472SE</b>	2797	254	115.2	<b>UCB2472SE</b>	3885	254	115.2	<b>UCBH2472SE</b>	4378
	84"	2134	6	83	281	127.5	<b>UOB2484SE</b>	3043	299	135.6	<b>UCB2484SE**</b>	4442	299	135.6	<b>UCBH2484SE**</b>	4925
	96"	2438	6	95	322	146.1	<b>UOB2496SE</b>	3198	339	153.8	<b>UCB2496SE**</b>	4798	339	153.8	<b>UCBH2496SE**</b>	5283
<b>30" width</b> (762mm)	120"	3048	6	105	366	166.0	<b>UOB24120SE</b>	3791	384	174.2	<b>UCB24120SE**</b>	5543	384	174.2	<b>UCBH24120SE**</b>	6025
	36"	914	4	36	136	61.7	<b>UOB3036SE</b>	2494	142	64.4	<b>UCB3036SE</b>	3149	142	64.4	<b>UCBH3036SE</b>	3819
	48"	1219	4	49	166	75.3	<b>UOB3048SE</b>	2581	173	78.5	<b>UCB3048SE</b>	3499	173	78.5	<b>UCBH3048SE</b>	3994
	60"	1524	4	63	199	90.3	<b>UOB3060SE</b>	2775	219	99.3	<b>UCB3060SE</b>	3776	219	99.3	<b>UCBH3060SE</b>	4275
	72"	1829	4	72	248	112.5	<b>UOB3072SE</b>	2968	261	118.4	<b>UCB3072SE</b>	4057	261	118.4	<b>UCBH3072SE</b>	4553
	84"	2134	6	83	294	133.4	<b>UOB3084SE</b>	3175	312	141.5	<b>UCB3084SE**</b>	4564	312	141.5	<b>UCBH3084SE**</b>	5054
96"	2438	6	95	340	154.2	<b>UOB3096SE</b>	3504	350	158.8	<b>UCB3096SE**</b>	4999	350	158.8	<b>UCBH3096SE**</b>	5483	
120"	3048	6	105	432	196.0	<b>UOB30120SE</b>	4031	450	204.1	<b>UCB30120SE**</b>	5782	450	204.1	<b>UCBH30120SE**</b>	6259	

\* 20 gauge stainless steel doors. To order optional door locks, add suffix **"-L"** and \$148 list price; \*\* Tables 84" (2134mm) and longer have two sets of doors.

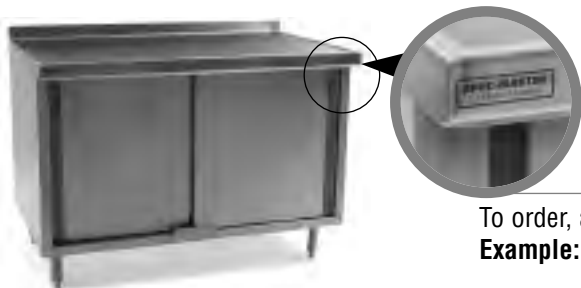

**SPEC-MASTER® Marine Counter Edge Cabinets**

To order, **add 20% to list price** and add **"M"** after **"SE"** in model number. **Example: UOB2436SEM.**

see spec sheet **EG10.33B**



Catalog Section 10

**SPEC-MASTER® Enclosed Worktables with Backsplash** 

see spec sheet **EG10.32**



patented  
**uni-lok**  
system  
(Patent #5,165,349)

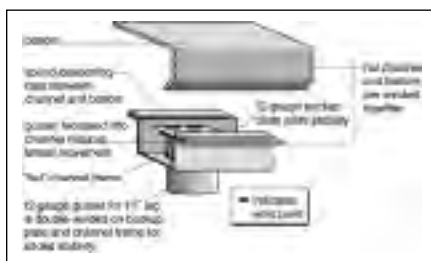

- All-welded cabinet.
- Top mechanically polished to satin finish.
- Top is 14 gauge type 304 stainless steel reinforced with a full length "hat" channel support.
- Body is heavy gauge type 430 stainless steel.
- Sound-deadened between top and frame.
- 1 1/8" (42mm) diameter type 304 stainless legs.
- 1" (25mm) adjustable stainless steel feet.
- 1 1/2" (38mm) sanitary rolled rim on front, 4 1/2" (114mm) backsplash on rear, and square edge on ends for flush fit.

**FEATURES:**

**Note:** Full length fixed center shelf available. To order full width, add 20% to list price and suffix "-FCS". To order two-thirds width, add 20% to list price and suffix "-CS". **Example: UOB2436SE-BS-CS.**

To order table with 4" (102mm) casters, add suffix "-CA" and add to list price \$398 (for tables with four legs) or \$596 (for tables with six legs). **Example: UOB3036SE-BS-CA.**

To order table with 5" (127mm) casters, add suffix "-CAH" and add to list price \$528 (for tables with four legs) or \$792 (for tables with six legs). **Example: UOB3036SE-BS-CAH.**

NSF sprayed-on sound deadening available. To order, add \$680 to list price and suffix "-SD". **Example: UOB3036SE-BS-SD.**

For enhanced utility, add overselves from page 172.

**Freight class is 125.0.**

	with Open Front				with Sliding Doors*				with Hinged Doors*			
	length in. mm	# of legs	cu ft	weight lbs. kg	model #	list	weight lbs. kg	model #	list	weight lbs. kg	model #	list
<b>24"</b> width (610mm)	36" 914	4	36	133 60.3	<b>OB2436SE-BS</b>	2388	139 63.1	<b>CB2436SE-BS</b>	3169	139 63.1	<b>CBH2436SE-BS</b>	3721
	48" 1219	4	49	161 73.0	<b>OB2448SE-BS</b>	2477	171 77.6	<b>CB2448SE-BS</b>	3396	171 77.6	<b>CBH2448SE-BS</b>	3895
	60" 1524	4	63	202 91.6	<b>OB2460SE-BS</b>	2655	214 97.1	<b>CB2460SE-BS</b>	3658	214 97.1	<b>CBH2460SE-BS</b>	4153
	72" 1829	4	72	243 110.2	<b>OB2472SE-BS</b>	2837	256 116.1	<b>CB2472SE-BS</b>	3926	256 116.1	<b>CBH2472SE-BS</b>	4418
	84" 2134	6	83	284 128.8	<b>OB2484SE-BS</b>	3088	304 137.9	<b>CB2484SE-BS**</b>	4484	304 137.9	<b>CBH2484SE-BS**</b>	4973
	96" 2438	6	95	326 147.9	<b>OB2496SE-BS</b>	3247	343 155.6	<b>CB2496SE-BS**</b>	4845	343 155.6	<b>CBH2496SE-BS**</b>	5337
120" 3048	6	105	390 176.9	<b>OB24120SE-BS</b>	3855	390 176.9	<b>CB24120SE-BS**</b>	5606	390 176.9	<b>CBH24120SE-BS**</b>	6085	
<b>30"</b> width (762mm)	36" 914	4	36	137 62.1	<b>OB3036SE-BS</b>	2597	143 64.9	<b>CB3036SE-BS</b>	3274	143 64.9	<b>CBH3036SE-BS</b>	3845
	48" 1219	4	49	167 75.8	<b>OB3048SE-BS</b>	2604	174 78.9	<b>CB3048SE-BS</b>	3521	174 78.9	<b>CBH3048SE-BS</b>	4019
	60" 1524	4	63	201 91.2	<b>OB3060SE-BS</b>	2909	221 100.2	<b>CB3060SE-BS</b>	3813	221 100.2	<b>CBH3060SE-BS</b>	4302
	72" 1829	4	72	251 113.9	<b>OB3072SE-BS</b>	3009	264 119.8	<b>CB3072SE-BS</b>	4095	264 119.8	<b>CBH3072SE-BS</b>	4587
	84" 2134	6	83	299 135.6	<b>OB3084SE-BS</b>	3217	319 144.7	<b>CB3084SE-BS**</b>	4608	319 144.7	<b>CBH3084SE-BS**</b>	5100
	96" 2438	6	95	344 156.0	<b>OB3096SE-BS</b>	3554	355 161.0	<b>CB3096SE-BS**</b>	5045	355 161.0	<b>CBH3096SE-BS**</b>	5863
120" 3048	6	105	438 198.7	<b>OB30120SE-BS</b>	4094	458 207.8	<b>CB30120SE-BS**</b>	5844	458 207.8	<b>CBH30120SE-BS**</b>	6321	

\* 20 gauge stainless steel doors. To order optional door locks, add suffix "-L" and \$148 list price; \*\* Tables 84" (2134mm) and longer have two sets of doors.

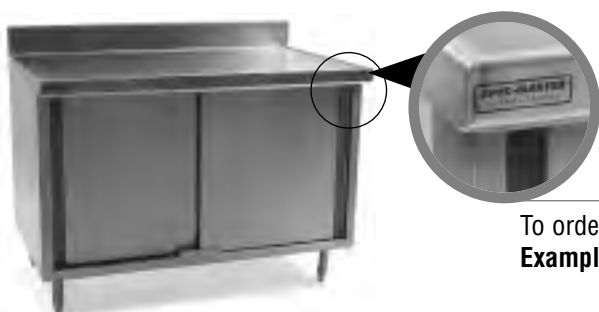

**SPEC-MASTER®**  
**Marine Counter Edge Cabinets**

To order, add 20% to list price and add "M" after "SE" in model number.  
**Example: OB2436SEM-BS.**

see spec sheet **EG10.33C**



adjustable® Work Surface Systems 

see spec sheet **EG10.09**



basic unit

1-tier unit

2-tier unit

**adjustable**

Additional wire undershelves, solid stainless steel undershelves, chrome wire overshelves, or solid stainless steel overshelves make the possibilities almost unlimited.

patented  
**QuadTruss®**  
design  
(Patent #5,390,803)

**Patented QuadTruss® Design**  
makes shelves up to 25% stronger and provides a retaining ledge for increased strength and product retention.

- Unit can be further expanded and customized by adding optional shelving accessories (pages 46-52).
- Custom configurations available, including alternate finishes and solid shelving. Contact factory to configure your custom workstation.
- Optional drawers available (see pages 174-177).

**CUSTOM:**

**Note:** To order table with 5" (127mm) resilient tread casters, add suffix "-CAH" and **add to list price \$528** (for tables with four legs) or **\$792** (for tables with six legs).  
**Example: T3036EBW-1-CAH.**

To order table with 5" (127mm) poly tread casters, add suffix "-CAHP" and **add to list price \$457** (for tables with four legs) or **\$686** (for tables with six legs).  
**Example: T3036EBW-1-CAHP.**

For Post Clamps for 1-tier and 2-tier unit, see page 45.  
For Keyboard stations, see page 45.

**Freight class is 70.0.**

**Basic Units** — 33½" (851mm) overall height.

	length		cu ft	weight		16/304		14/304	
	in.	mm		lbs.	kg	model #	list	model #	list
<b>24" width</b> (610mm)	36"	914	4.5	65	29.5	<b>T2436EBW</b>	833	<b>T2436EW</b>	913
	48"	1219	5.7	81	36.7	<b>T2448EBW</b>	905	<b>T2448EW</b>	1048
	60"	1524	7.1	99	44.9	<b>T2460EBW</b>	1059	<b>T2460EW</b>	1205
<b>30" width</b> (762mm)	36"	914	4.5	75	34.0	<b>T3036EBW</b>	923	<b>T3036EW</b>	1034
	48"	1219	5.7	94	42.6	<b>T3048EBW</b>	1041	<b>T3048EW</b>	1187
	60"	1524	7.1	115	52.2	<b>T3060EBW</b>	1205	<b>T3060EW</b>	1372

CONSISTS OF:

- Stainless steel table top/work surface with hat channel supports.
- Four 33" (838mm) chrome posts.
- Two chrome wire undershelves.\*

**1-tier Units** — 54½" (1384mm) overall height.

	length		cu ft	weight		16/304		14/304	
	in.	mm		lbs.	kg	model #	list	model #	list
<b>24" width</b> (610mm)	36"	914	4.5	73	33.1	<b>T2436EBW-1</b>	1037	<b>T2436EW-1</b>	1116
	48"	1219	5.7	91	41.3	<b>T2448EBW-1</b>	1162	<b>T2448EW-1</b>	1271
	60"	1524	7.1	113	51.3	<b>T2460EBW-1</b>	1312	<b>T2460EW-1</b>	1436
<b>30" width</b> (762mm)	36"	914	4.5	83	37.6	<b>T3036EBW-1</b>	1126	<b>T3036EW-1</b>	1241
	48"	1219	5.7	104	47.2	<b>T3048EBW-1</b>	1264	<b>T3048EW-1</b>	1405
	60"	1524	7.1	129	58.5	<b>T3060EBW-1</b>	1436	<b>T3060EW-1</b>	1605

CONSISTS OF:

- Stainless steel table top/work surface with hat channel supports.
- Two 54" (1372mm) rear chrome posts.
- Two 33" (838mm) front chrome posts.
- Two 21" (533mm) front chrome posts for overshelf.
- One 14" (356mm) wide chrome wire overshelf.
- Two chrome wire undershelves.\*

**2-tier Units** — 62½" (1588mm) overall height.

	length		cu ft	weight		16/304		14/304	
	in.	mm		lbs.	kg	model #	list	model #	list
<b>24" width</b> (610mm)	36"	914	4.5	81	36.7	<b>T2436EBW-2</b>	1137	<b>T2436EW-2</b>	1218
	48"	1219	5.7	101	45.8	<b>T2448EBW-2</b>	1282	<b>T2448EW-2</b>	1392
	60"	1524	7.1	127	57.6	<b>T2460EBW-2</b>	1442	<b>T2460EW-2</b>	1567
<b>30" width</b> (762mm)	36"	914	4.5	91	41.3	<b>T3036EBW-2</b>	1225	<b>T3036EW-2</b>	1341
	48"	1219	5.7	114	51.7	<b>T3048EBW-2</b>	1382	<b>T3048EW-2</b>	1532
	60"	1524	7.1	143	64.9	<b>T3060EBW-2</b>	1566	<b>T3060EW-2</b>	1738

CONSISTS OF:

- Stainless steel table top/work surface with hat channel supports.
- Two 63" (1600mm) rear chrome posts.
- Two 33" (838mm) front chrome posts.
- Two 29" (737mm) front chrome posts for overshelves.
- Two 14" (356mm) wide chrome wire overshelves.
- Two chrome wire undershelves.\*

\* 18" (457mm) wide undershelves used for 24" (610mm) wide tables; 24" (610mm) wide undershelves used for 30" (762mm) wide tables.



## Catalog Section 10

### Utility Stands

see spec sheet **EG10.26A**



FEATURES:

- Highly polished 16 gauge, 300 series stainless steel flat top.
- Adjustable undershelf or adjustable crossbracing.
- 24" (610mm) working height.

WEIGHT CAPACITIES:

- 600 lb. (272.2 kg) weight capacity of top.
- 150 lb. (68.0 kg) weight capacity of undershelf. - evenly distributed static load.

**Freight class is 70.0.**

(•) MTS (made to stock) / ( ) MTO (made to order)

patented  
**uni-lok**  
system

(Patent #5,165,349)

...with Undershelf

...with Tubular Base

width	length		weight		cubic feet	galvanized legs		stainless steel legs		galvanized legs		stainless steel legs	
	in.	mm	lbs.	kg		model #	list	model #	list	model #	list	model #	list
24" (610mm)	24"	610	42	19.1	3.5	MS2424	• 841	MS2424S	1022	TMS2424	841	TMS2424S	1022
	24"	610	47	21.3	3.8	MS3024	• 877	MS3024S	1072	TMS3024	877	TMS3024S	1072
30" (762mm)	30"	762	49	22.2	3.8	MS3030	• 977	MS3030S	1216	TMS3030	977	TMS3030S	1216
	36"	914	51	23.1	4.0	MS3036	• 1003	MS3036S	1236	TMS3036	1003	TMS3036S	1236
36" (914mm)	36"	914	53	24.0	4.2	MS3636	1052	MS3636S	1294	TMS3636	1052	TMS3636S	1294



caster      caster with brake

### Optional Casters for Utility Stands

### Optional Utensil Rack for Utility Stands

- Stainless steel.
- 54" (1371mm) height.

weight lbs.	kg	cubic feet	add to model #	unit list
23	10.4	5.3	UR-501	682



utility stand with undershelf and optional utensil rack

description	wt. cap. per caster		model #		list
	lbs.	kg	model #	list	
4" (102mm) dia., set of four (two swivel, two w/brake)	115	52.2	CA4-SB	• 398	
4" (102mm) dia., set of six (three swivel, three w/brake)	115	52.2	CA6-SB	596	
5" (127mm) dia., set of four (two swivel, two w/brake)	200	90.7	CAH4-SB	• 528	
5" (127mm) dia., set of six (three swivel, three w/brake)	200	90.7	CAH6-SB	792	

Note: See page 177 for **NEW** optional caster stabilizers.

## **NEW** ADA/Ergonomic Height Adjustable Tables

see product announcement **EG8205**

Adjusts from 32" to 40" height!



patented  
**uni-lok**  
system

(Patent #5,165,349)

...with Flat Top

...with 4" Backsplash

width	length		weight cap.		16/304 top		14/304 top		16/304 top		14/304 top	
	in.	mm	lbs.	kg	model #	list	model #	list	model #	list	model #	list
24" (610mm)	48"	1219	575	260.8	T2448SEB-HA	4549	T2448SE-HA	4656	T2448SEB-BS-HA	4871	T2448SE-BS-HA	5277
	60"	1524	550	249.5	T2460SEB-HA	4653	T2460SE-HA	4771	T2460SEB-BS-HA	4982	T2460SE-BS-HA	5397
	72"	1829	525	238.1	T2472SEB-HA	4755	T2472SE-HA	4889	T2472SEB-BS-HA	5095	T2472SE-BS-HA	5523
30" (762mm)	48"	1219	575	260.8	T3048SEB-HA	4635	T3048SE-HA	4754	T3048SEB-BS-HA	4953	T3048SE-BS-HA	5367
	60"	1524	550	249.5	T3060SEB-HA	4765	T3060SE-HA	4892	T3060SEB-BS-HA	5093	T3060SE-BS-HA	5517
	72"	1829	525	238.1	T3072SEB-HA	4889	T3072SE-HA	5037	T3072SEB-BS-HA	5226	T3072SE-BS-HA	5669

To indicate location of crank case, add suffix "L" (left end), "R" (right end), or "C" (center) at end of model number. Example: T2448-SE-HA-L



100 Industrial Boulevard, Clayton, DE 19938-8903 U.S.A.  
Phone: 800-637-5100 or 302-653-3000. Fax: 302-653-2065  
<http://www.eaglegrp.com>

Mobile Utility Stands

see spec sheet **EG10.26B**



patented  
**uni-lok**  
system  
(Patent #5,165,349)

Note: See page 177 for **NEW** optional caster stabilizers.

FEATURES:

- 34" (864mm) working height.
- 14 gauge 300 series stainless steel top with no-drip marine counter edge.
- Stainless steel crossbracing on three sides.
- Four 4" (102mm) casters (two with brakes).
- Pan rack slide holds six 18" x 26" (457 x 660mm) pans.
- 400 lb. (181.4 kg) total weight capacity (top and slides) - evenly distributed static load.

**Freight class is 70.0.**

(•) MTS (made to stock) / ( ) MTO (made to order)

	length		weight		cubic feet	galvanized		stainless steel	
	in.	mm	lbs.	kg		model #	list	model #	list
30" width (762mm)	30"	762	55	24.9	3.8	MMT3030G	2151	MMT3030S •	2400
	36"	914	60	27.2	4.1	MMT3036G	2200	MMT3036S	2471

Mobile Utility Stand with Undershef

see spec sheet **EG10.26B**



patented  
**uni-lok**  
system  
(Patent #5,165,349)

FEATURES:

- Top is 14 gauge 300 series stainless steel with no-drip marine counter edge.
- Stainless steel undershef.
- Two 4" (102mm) casters with brake.

Note: See page 177 for **NEW** optional caster stabilizers.

**Freight class is 70.0.**

width	length		weight		cubic feet	model #	list
	in.	mm	lbs.	kg			
24" (610mm)	30"	762	47	21.3	3.8	MET2430S	1876

Stainless Steel Lok-n-Fold™ Tables

see spec sheet **EG10.57**



with removable undershef

FEATURES:

- Heavy gauge type 430 stainless steel top.
- Folding legs constructed of heavy gauge painted mild steel.
- Locking dimples, a safety mechanism, ensure legs are locked in place.
- 30% (784mm) non-adjustable height.

**Freight class is 70.0.**

	length		weight capacity		cu ft	WITH OPEN BASE				WITH REMOVABLE GALVANIZED UNDERSHELF				WITH REMOVABLE STAINLESS STEEL UNDERSHELF			
	in.	mm	lbs.	kg		weight		model #	list	weight		model #	list	weight		model #	list
						lbs.	kg			lbs.	kg			lbs.	kg		
24" width (610mm)	48"	1219	360	163.3	6.0	44	20.0	T2448F	613	61	27.7	T2448F-US	739	61	27.7	T2448F-USS	802
	60"	1524	450	204.1	7.5	48	21.8	T2460F	646	65	29.5	T2460F-US	798	65	29.5	T2460F-USS	872
	72"	1829	540	244.9	8.9	52	23.6	T2472F	737	70	31.8	T2472F-US	846	70	31.8	T2472F-USS	936
30" width (762mm)	48"	1219	450	204.1	7.4	46	20.9	T3048F	673	63	28.6	T3048F-US	760	63	28.6	T3048F-USS	818
	60"	1524	562	254.9	9.2	50	22.7	T3060F	721	69	31.3	T3060F-US	820	69	31.3	T3060F-USS	886
	72"	1829	675	306.2	11.0	56	25.4	T3072F	764	75	34.0	T3072F-US	874	75	34.0	T3072F-USS	954

## Catalog Section 10

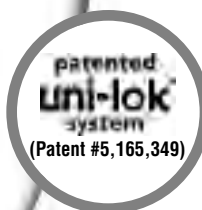
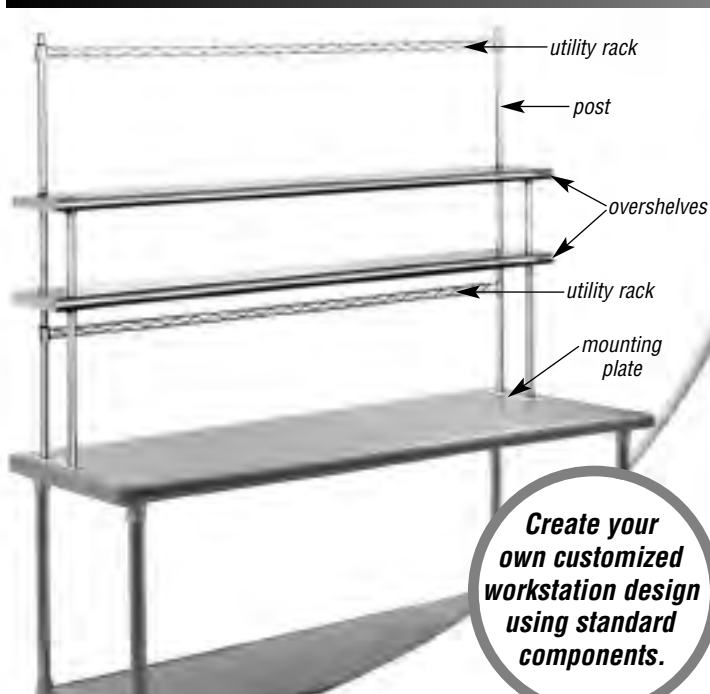

### Features:

- Any table can be customized with overshelves of the same length.
- System can easily be changed or expanded as needed.
- Tables are caster-capable for workstation mobility.
- Overshelves' height adjustable in 1" (25mm) increments for flexible and accurate placement.
- 10" and 12" (254 and 305mm) shelf widths can be intermixed on same posts.
- Split sleeve.
- Tapered collar for easy assembly.
- Overshelves shipped knocked-down.
- All shipping weights and cubic feet are approximate.

## FLEX-MASTER® Overshelf System NSF

Continued on pages 170 & 171

### Overshelves

see spec sheet **EG10.08**

**Note:** 15" and 18" (381 and 457mm) wide shelves available. To order, replace "12" in model number with a "15" or "18" indicating desired shelf width (example: 411584). For 15" (381mm) wide shelves, add 15% to list price of 12" (305mm) wide models. For 18" (457mm) wide shelves, add 30% to list price of 12" (305mm) shelves.



- 14 gauge, type 304 shelves available upon request.
- Priced per shelf.

#### FEATURES:

Freight class is 70.0.

(\*) MTS (made to stock) / ( ) MTO (made to order)

	length		weight		cubic feet	16/430		16/304	
	in.	mm	lbs.	kg		model #	list ea	model #	list ea
10" width (254mm)	30"	762	10.1	4.6	0.5	411030	316	421030	345
	36"	915	12.1	5.5	0.6	411036	320	421036	356
	48"	1219	13.1	6.0	0.8	411048	345	421048	392
	60"	1524	15.2	6.9	1.0	411060	376	421060	441
	72"	1829	17.2	7.8	1.2	411072	426	421072	492
	84"	2133	19.3	8.8	1.5	411084	476	421084	541
	96"	2438	21.3	9.7	1.7	411096	524	421096	612
	108"	2743	23.4	10.6	1.9	411010	568	421010	657
	120"	3048	25.4	11.5	2.1	411012	613	421012	699
	132"	3353	27.4	12.5	2.3	411013	664	421013	751
	144"	3658	29.4	13.4	2.5	411014	712	421014	816
12" width (305mm)	30"	762	11.1	5.1	0.6	411230	320	421230	356
	36"	915	12.3	5.6	0.8	411236	335	421236	397
	48"	1219	14.8	6.7	1.0	411248	364	421248	416
	60"	1524	17.2	7.8	1.3	411260	391	421260	462
	72"	1829	19.7	9.1	1.5	411272	448	421272	523
	84"	2133	22.1	10.0	1.8	411284	499	421284	587
	96"	2438	24.6	11.2	2.0	411296	540	421296	656
	108"	2743	27.0	12.3	2.3	411210	601	421210	704
	120"	3048	29.5	13.4	2.5	411212	669	421212	756
	132"	3353	31.5	14.3	2.7	411213	717	421213	804
	144"	3658	33.5	15.2	2.9	411214	764	421214	852



## Posts - FLEX-MASTER® Overshelf System

see spec sheet **EG10.08**

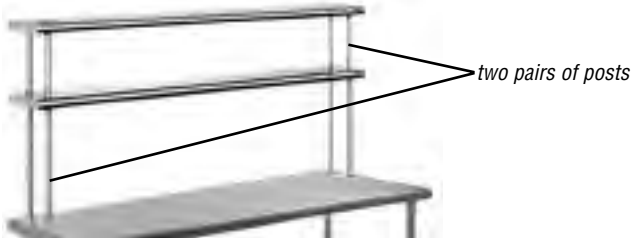

- Sold in pairs.
- Each pair includes mounting plate.
- For 30" to 72" (762 to 1829mm) shelves: two pairs.
- For 84" to 120" (2134 to 3048mm) shelves: three pairs required.
- For 132" and 144" (3353 and 3658mm) shelves: four pairs required.

ORDERING:

**Freight class is 50.0.**

(•) MTS (made to stock) / ( ) MTO (made to order)

height		weight		cubic feet	chrome		stainless steel	
in.	mm	lbs.	kg		model #	list	model #	list
18"	457	1.7	0.8	0.1	<b>418202</b> •	138	<b>418002</b> •	160
30"	762	2.4	1.1	0.2	<b>430202</b> •	151	<b>430002</b> •	205
48"	1219	5.6	2.5	0.2	<b>448202</b> •	183	<b>448002</b> •	271

## Utility Racks

see spec sheet **EG10.08**



- Chrome plated.

FEATURES:

**Freight class is 50.0.**

(•) MTS (made to stock) / ( ) MTO (made to order)

for overshelf length						for overshelf length							
in.	mm	lbs.	kg	cubic feet	model #	list	in.	mm	lbs.	kg	cubic feet	model #	list
30"	762	1.7	0.8	0.2	<b>PRT30-C</b>	74	84"	2133	4.1	1.9	0.4	<b>PRT84-C *</b>	152
36"	915	1.9	0.9	0.2	<b>PRT36-C</b>	86	96"	2438	4.9	2.2	0.4	<b>PRT96-C *</b>	178
48"	1219	2.1	1.0	0.2	<b>PRT48-C</b>	95	108"	2743	5.6	2.5	0.5	<b>PRT108-C *</b>	180
60"	1524	2.5	1.1	0.3	<b>PRT60-C</b>	111	120"	3048	6.2	2.8	0.5	<b>PRT120-C *</b>	186
72"	1829	2.9	1.3	0.4	<b>PRT72-C •</b>	131	132"	3353	6.9	3.1	0.6	<b>PRT132-C **</b>	202
							144"	3658	7.6	3.5	0.6	<b>PRT144-C **</b>	219

\* Utility racks 84" to 120" (2133 to 3048mm) come in two pieces.

\*\*132" and 144" (3353 and 3658mm) racks come in three pieces.

## Mounting Plate

see spec sheet **EG10.08**



model #	list each
<b>311915</b> •	24

- Aluminum.
- Designed to accommodate both 10" and 12" (254 and 305mm) wide shelves.

FEATURES:

**Freight class is 70.0.**

(•) MTS (made to stock) / ( ) MTO (made to order)

## Double-Prong Hook

see spec sheet **EG10.08**

weight lbs.	kg	cubic feet	model #	list each
0.2	0.1	0.1	<b>300696</b> •	26



- Stainless steel.
- Slips over utility racks.
- 2¼" (57mm) prongs.

FEATURES:

**Freight class is 70.0.**

(•) MTS (made to stock) / ( ) MTO (made to order)

## Catalog Section 10

### FLEX-MASTER® Kits for All Stainless Steel Worktables

see spec sheet **EG10.08**

#### Kit A

description	for Budget tables* add to list	for all other tables add to list
fits 36" (914mm) long worktables	1318	1442
fits 48" (1219mm) long worktables	1394	1498
fits 60" (1524mm) long worktables	1480	1622
fits 72" (1829mm) long worktables	1634	1784

\* Note: Kits for "Budget" worktables include 16 gauge type 430 shelves and stainless steel posts.

#### Kit B

description	for Budget tables* add to list	for all other tables add to list
fits 36" (914mm) long worktables	1080	1204
fits 48" (1219mm) long worktables	1138	1242
fits 60" (1524mm) long worktables	1192	1334
fits 72" (1829mm) long worktables	1306	1456

\* Note: Kits for "Budget" worktables include 16 gauge type 430 shelves and stainless steel posts.

Kit A  
INCLUDES:

- Two 12" (305mm) wide 16 gauge type 304 shelves.
  - Two 30" (762mm) stainless steel front posts.
  - Two 48" (1219mm) stainless steel rear posts.
  - Two chrome utility racks.
- To order, add suffix "-FM-PL" to model number.  
**Example: T3060SE-FM-PL.**

**Tabletops are predrilled for rear mounting of posts and shelves.**

Kit B  
INCLUDES:

- Two 12" (305mm) wide 16 gauge type 304 shelves.
  - Four 30" (762mm) stainless steel posts.
- To order, add suffix "-FM" to model number.  
**Example: T3060SE-FM.**

**Freight class is 70.0.**

### Stainless Steel Bins

see spec sheet **EG10.59**



width x length x height in. mm		weight lbs. kg	cubic feet	model #	list
6½" x 5½" x 6"	165 x 140 x 152	1.5 0.7	0.1	SB-1	291

FEATURES:

- Designed for either overshef or wall shelf applications.
- 22 gauge stainless steel with fully covered deep-drawn construction, complete with label holders.
- Removable bin must be allowed 7¼" (197mm) space and slides on stainless steel angle supports secured to underside of shelf.

Note: Shipping weight and cubic feet are approximate.

**Freight class is 85.0.**

### Wall Cabinets

see spec sheet **EG02.07**

length in. mm	weight lbs. kg		cu ft	Open Front		Hinged Doors		Sliding Doors	
				model #	list	model #	list	model #	list
24"	610	95 43.1	13.5	WCO-24	3293	WCH-24	4468	WCS-24	3725
30"	762	115 52.2	17.3	WCO-30	3297	WCH-30	4952	WCS-30	4539
36"	914	125 56.7	18.0	WCO-36	3419	WCH-36	5038	WCS-36	4679
42"	1067	145 65.8	18.2	-	-	WCH-42	5294	WCS-42	4702
48"	1219	165 74.8	18.3	WCO-48	3938	WCH-48	5458	WCS-48	5126
54"	1372	180 81.6	25.4	-	-	WCH-54	5580	WCS-54	5221
60"	1524	195 88.5	22.6	WCO-60	4309	WCH-60	6258	WCS-60	5928
66"	1676	210 95.3	30.6	-	-	WCH-66	6303	-	-
72"	1829	225 102.0	26.8	WCO-72	4573	WCH-72	7011	WCS-72	6639
84"	2134	255 115.7	38.5	WCO-84	4825	WCH-84*	7209	WCS-84*	6811
90"	2286	267 121.1	41.7	-	-	WCH-90*	7618	WCS-90*	7213
96"	2438	260 117.9	35.2	WCO-96	5403	WCH-96*	7854	WCS-96*	7436
120"	3048	360 163.3	55.8	-	-	-	-	WCS-120*	8960

\* Features two pairs of doors.

FEATURES:

- Heavy gauge stainless steel.
- Back is recessed with full-length concealed mounting plate for easy installation.
- Fixed center shelf.
- Hinged doors provided with lift-off pin hinges.
- 15" (381mm) width. 28" (711mm) overall height.

**Freight class is 100.0.**



wall cabinet with hinged doors



100 Industrial Boulevard, Clayton, DE 19938-8903 U.S.A.  
Phone: 800-637-5100 or 302-653-3000. Fax: 302-653-2065  
<http://www.eaglegrp.com>



Overshelves, Non-Adjustable 

see spec sheet **EG10.28**

- Mounted on four stainless steel, 1" (25mm) diameter tubular base legs.
- Special width shelves available.

FEATURES:

**Note:** Recommended that overshelves be ordered when ordering tables. Specify choice of centered or rear-mounted on table. Otherwise, table must be field-drilled for mounting overshelves.



single deck overshelf



double deck overshelf

Freight class is 70.0.

Optional heat lamp brackets available. Standard 12" (305mm) shorter than overshelf. To order, add suffix "-HLB" to model number (example: OS1236-16/4-HLB) and \$203 per pair. Two pairs required for lengths 84" (2133mm) and over.

Single Deck Overshelves, Non-Adjustable - Shipped knocked-down.

	length		# of legs	weight		cu ft	16 gauge, type 430		16 gauge, type 304		14 gauge, type 304	
	in.	mm		lbs.	kg		model #	list	model #	list	model #	list
10" width (254mm)	36"	915	4	15	6.8	0.9	OS1036-16/4	574	OS1036-16/3	694	OS1036-14/3	767
	48"	1219	4	19	8.6	1.3	OS1048-16/4	611	OS1048-16/3	759	OS1048-14/3	843
	60"	1524	4	24	10.9	1.6	OS1060-16/4	648	OS1060-16/3	833	OS1060-14/3	925
	72"	1829	4	29	13.2	1.9	OS1072-16/4	694	OS1072-16/3	909	OS1072-14/3	1008
	84"	2133	6	34	15.4	2.2	OS1084-16/4	734	OS1084-16/3	981	OS1084-14/3	1089
	96"	2438	6	37	16.8	2.5	OS1096-16/4	897	OS1096-16/3	1168	OS1096-14/3	1299
	108"	2743	6	38	17.2	2.8	OS10108-16/4	919	OS10108-16/3	1203	OS10108-14/3	1333
	120"	3048	6	39	17.6	3.1	OS10120-16/4	953	OS10120-16/3	1304	OS10120-14/3	1453
	132"	3353	8	42	19.1	3.7	OS10132-16/4	997	OS10132-16/3	1384	OS10132-14/3	1540
	144"	3658	8	46	20.9	4.2	OS10144-16/4	1034	OS10144-16/3	1455	OS10144-14/3	1618
12" width (305mm)	36"	915	4	16	7.3	0.9	OS1236-16/4	607	OS1236-16/3	724	OS1236-14/3	804
	48"	1219	4	20	9.0	1.3	OS1248-16/4	643	OS1248-16/3	795	OS1248-14/3	883
	60"	1524	4	25	11.3	1.6	OS1260-16/4	687	OS1260-16/3	871	OS1260-14/3	968
	72"	1829	4	30	13.6	1.9	OS1272-16/4	735	OS1272-16/3	953	OS1272-14/3	1059
	84"	2133	6	35	15.9	2.2	OS1284-16/4	781	OS1284-16/3	1029	OS1284-14/3	1146
	96"	2438	6	38	17.2	2.5	OS1296-16/4	953	OS1296-16/3	1241	OS1296-14/3	1381
	108"	2743	6	39	17.6	2.5	OS12108-16/4	1013	OS12108-16/3	1333	OS12108-14/3	1484
	120"	3048	6	40	18.1	3.1	OS12120-16/4	1047	OS12120-16/3	1402	OS12120-14/3	1557
	132"	3353	8	43	19.5	3.7	OS12132-16/4	1107	OS12132-16/3	1497	OS12132-14/3	1665
	144"	3658	8	47	21.3	4.2	OS12144-16/4	1142	OS12144-16/3	1566	OS12144-14/3	1739

Double Deck Overshelves, Non-Adjustable - All welded construction, shipped assembled.

	length		# of legs	weight		cu ft	16 gauge, type 430		16 gauge, type 304		14 gauge, type 304	
	in.	mm		lbs.	kg		model #	list	model #	list	model #	list
10" width (254mm)	36"	915	4	31	14.1	8.6	DOS1036-16/4	1126	DOS1036-16/3	1261	DOS1036-14/3	1387
	48"	1219	4	39	17.6	11.4	DOS1048-16/4	1162	DOS1048-16/3	1326	DOS1048-14/3	1461
	60"	1524	4	48	21.8	14.2	DOS1060-16/4	1249	DOS1060-16/3	1447	DOS1060-14/3	1593
	72"	1829	4	59	26.8	17.0	DOS1072-16/4	1326	DOS1072-16/3	1565	DOS1072-14/3	1719
	84"	2134	6	69	31.3	19.8	DOS1084-16/4	1404	DOS1084-16/3	1675	DOS1084-14/3	1843
	96"	2438	6	75	34.0	22.6	DOS1096-16/4	1715	DOS1096-16/3	2026	DOS1096-14/3	2229
	108"	2743	6	77	34.9	25.4	DOS10108-16/4	1836	DOS10108-16/3	2188	DOS10108-14/3	2405
	120"	3048	6	79	35.8	28.2	DOS10120-16/4	1874	DOS10120-16/3	2257	DOS10120-14/3	2482
	132"	3353	8	85	38.6	35.8	DOS10132-16/4	1998	DOS10132-16/3	2422	DOS10132-14/3	2664
	144"	3658	8	92	41.7	41.8	DOS10144-16/4	2034	DOS10144-16/3	2484	DOS10144-14/3	2734
12" width (305mm)	36"	915	4	32	14.5	8.6	DOS1236-16/4	1191	DOS1236-16/3	1325	DOS1236-14/3	1538
	48"	1219	4	40	18.1	11.4	DOS1248-16/4	1224	DOS1248-16/3	1426	DOS1248-14/3	1651
	60"	1524	4	48	21.8	14.2	DOS1260-16/4	1320	DOS1260-16/3	1532	DOS1260-14/3	1776
	72"	1829	4	60	27.2	17.0	DOS1272-16/4	1414	DOS1272-16/3	1641	DOS1272-14/3	1907
	84"	2134	6	70	31.8	19.8	DOS1284-16/4	1504	DOS1284-16/3	1798	DOS1284-14/3	2049
	96"	2438	6	76	34.5	22.6	DOS1296-16/4	1827	DOS1296-16/3	2128	DOS1296-14/3	2271
	108"	2743	6	78	35.4	25.4	DOS12108-16/4	1978	DOS12108-16/3	2219	DOS12108-14/3	2440
	120"	3048	6	80	36.3	28.3	DOS12120-16/4	2015	DOS12120-16/3	2329	DOS12120-14/3	2564
	132"	3353	8	87	39.5	35.9	DOS12132-16/4	2163	DOS12132-16/3	2589	DOS12132-14/3	2849
	144"	3658	8	95	43.1	42.0	DOS12144-16/4	2198	DOS12144-16/3	2660	DOS12144-14/3	2924



**Catalog Section 10**

**Extra Undershelves**

see spec sheet **EG10.59**



- For tables with uni-lok® hat channel frame.
- Designed for storage of shorter, smaller items under worktable where only one undershelf might not suffice.
- Available in galvanized or stainless steel.

**FEATURES:**

**Note:** When ordering an extra or replacement undershelf, please order per the size of your tabletop. Please note the "for table size" column in chart.

**Freight class is 70.0.**

(•) MTS (made to stock) / ( ) MTO (made to order)

	for table size *		weight		cu ft	galvanized (adjustable)		stainless steel (adjustable)				
	length in.	mm	lbs.	kg		model #	list	model #	list	model #	list	
<b>24" width (610mm)</b>	24"	610	15	6.6	1.6	2424GADJUS	177	2424SADJUS-18/4	395	2424SADJUS-18/3	434	
	30"	762	18	8.2	1.9	2430GADJUS	211	2430SADJUS-18/4	433	2430SADJUS-18/3	475	
	36"	915	21	9.6	2.3	2436GADJUS	215	2436SADJUS-18/4	456	2436SADJUS-18/3	498	
	48"	1219	27	12.2	3.0	2448GADJUS	224	2448SADJUS-18/4	500	2448SADJUS-18/3	547	
	60"	1524	33	15.0	3.7	2460GADJUS	232	2460SADJUS-18/4	563	2460SADJUS-18/3	615	
	72"	1829	39	17.6	4.5	2472GADJUS	235	2472SADJUS-18/4	631	2472SADJUS-18/3	692	
	84"	2134	45	20.4	5.2	2484GADJUS	237	2484SADJUS-18/4	703	2484SADJUS-18/3	767	
	96"	2438	51	23.1	5.9	2496GADJUS	252	2496SADJUS-18/4	758	2496SADJUS-18/3	829	
	108"	2743	57	25.9	6.6	24108GADJUS	261	24108SADJUS-18/4	864	24108SADJUS-18/3	937	
	120"	3048	63	28.6	7.3	24120GADJUS	281	24120SADJUS-18/4	869	24120SADJUS-18/3	946	
	132"	3353	69	31.3	8.1	24132GADJUS	314	24132SADJUS-18/4	928	24132SADJUS-18/3	1012	
	144"	3658	75	34.0	8.8	24144GADJUS	347	24144SADJUS-18/4	1101	24144SADJUS-18/3	1194	
	<b>30" width (762mm)</b>	24"	610	17	7.5	1.9	3024GADJUS	183	3024SADJUS-18/4	461	3024SADJUS-18/3	502
		30"	762	21	9.5	2.4	3030GADJUS	224	3030SADJUS-18/4	495	3030SADJUS-18/3	542
36"		915	24	10.7	2.8	3036GADJUS	226	3036SADJUS-18/4	524	3036SADJUS-18/3	572	
48"		1219	30	13.6	3.7	3048GADJUS •	232	3048SADJUS-18/4	571	3048SADJUS-18/3	626	
60"		1524	36	16.3	4.6	3060GADJUS •	237	3060SADJUS-18/4	654	3060SADJUS-18/3	716	
72"		1829	42	19.1	5.5	3072GADJUS	252	3072SADJUS-18/4	731	3072SADJUS-18/3	799	
84"		2134	48	21.8	6.4	3084GADJUS	259	3084SADJUS-18/4	809	3084SADJUS-18/3	884	
96"		2438	54	24.5	7.3	3096GADJUS	261	3096SADJUS-18/4	899	3096SADJUS-18/3	983	
108"		2743	60	27.2	8.2	30108GADJUS	299	30108SADJUS-18/4	993	30108SADJUS-18/3	1107	
120"		3048	66	29.9	9.0	30120GADJUS	318	30120SADJUS-18/4	1103	30120SADJUS-18/3	1168	
132"		3353	72	32.7	9.9	30132GADJUS	342	30132SADJUS-18/4	1222	30132SADJUS-18/3	1287	
144"		3658	78	35.4	10.8	30144GADJUS	378	30144SADJUS-18/4	1323	30144SADJUS-18/3	1438	

\* Undershelves for 30" (762mm) wide tables listed above also fit 36" (915mm) wide tables.

**Table Mounted Microwave Shelves**

see spec sheet **EG10.25**



- 16 gauge type 304 stainless steel.
- 24" x 24" (610 x 610mm) microwave area.
- 16 1/2" (422mm) clearance above tabletop.
- Six stainless steel posts.

**FEATURES:**

**Freight class is 70.0.**

	length		weight		cu ft	Left Side		Right Side		Center				
	in.	mm	lbs.	kg		model #	list	model #	list	weight lbs.	kg	cu ft	model #	list
	<b>12" width (305mm)</b>	60"	1524	30	13.6	1.9	MOS1260L	1074	MOS1260R	1074	32	14.5	2.1	MOS1260C
	72"	1829	35	15.9	2.4	MOS1272L	1217	MOS1272R	1217	38	17.2	2.6	MOS1272C	1361
	84"	2133	40	18.1	3.0	MOS1284L	1317	MOS1284R	1317	43	19.5	3.2	MOS1284C	1458
	96"	2438	45	20.4	3.4	MOS1296L	1458	MOS1296R	1458	48	21.8	3.7	MOS1296C	1519



100 Industrial Boulevard, Clayton, DE 19938-8903 U.S.A.  
 Phone: 800-637-5100 or 302-653-3000. Fax: 302-653-2065  
<http://www.eaglegrp.com>

Drawers

- For stainless steel and hardwood tables.
- Type 430 stainless steel.

**Note:** To specify drawer assemblies for hardwood tables (page 161), you must order model #605500 mounting kit (at no additional charge) along with drawer selected.

To specify drawer assemblies for custom equipment (fabricated through SpecFAB®) which requires angle frame construction, you must order model #605499 (at no additional charge) mounting kit along with drawer selected.

Drawer Capacity Per Table

Drawers can be centered, left or right. Holes are predrilled for 20" x 20" drawers only.

table length in. mm	15" x 20" (381 x 508mm) drawer capacity per table	20" x 20" (508 x 508mm) drawer capacity per table
24" 610	0	0
30" 762	1 centered	0
36" 914	1 centered	1 centered
48" 1219	1 centered; or 1 left & 1 right	1 centered
60" 1524	1 centered; or 1 left & 1 right	1 centered; or 1 left & 1 right
72" 1829	3 (1 centered, 1 left, 1 right)	1 centered; or 1 left & 1 right
84" 2134	4	1 centered; or 1 left & 1 right
96" 2438	4 (2 left, 2 right)	2 (1 left, 1 right)
108" 2743	4 (2 left, 2 right)	4 (2 left, 2 right)
120" 3048	4 (2 left, 2 right)	4 (2 left, 2 right)
132" 3353	6 (3 left, 3 right)	4 (2 left, 2 right)
144" 3658	6 (3 left, 3 right)	4 (2 left, 2 right)

Drawers with Polymer Slides

see spec sheet **EG10.13A**



**Note:** For use on standard worktables only, not for equipment using angle frame construction.

No locks are available for these drawers.



- 1/2" (13mm) thick polycarbonate grooved friction slides.
- To specify drawer assemblies for tabletops with box marine edge, you must order one of the following based on the table width, along with drawer selected:
  - #611383 for 24"-wide tables
  - #611384 for 30"-wide tables
  - For tables 36" and wider, consult factory.

FEATURES:

Freight class is 85.0.

(\*) MTS (made to stock) / ( ) MTO (made to order)

width x length x height in. mm		cu ft	weight lbs. kg	model #	list	For ALL 24" STANDARD tables		For ALL 30" & 36" STANDARD tables		For 36" tables with FRAMING specified AT 30% CENTER LINES								
width	length	height	in.	mm	cu	ft	weight	lbs.	kg	model #	list	weight	lbs.	kg	model #	list		
20"	15"	5"	508	381	127	1.4	13	5.8	502976*	• 178	13	5.8	503007*	• 178	13	5.8	503011*	178
20"	20"	5"	508	508	127	1.4	13	5.8	502975**	• 211	13	5.8	503006	• 211	13	5.8	503010	211

\* Tables must be field drilled for mounting; \*\* #502975 will protrude past tabletop width.

Drawers with Pull Flange

see spec sheet **EG10.13A**



FEATURES:

- Includes full-extension zinc-plated steel slides with rubber stops.

**Note:** No locks are available for these drawers.

Freight class is 85.0.

(\*) MTS (made to stock) / ( ) MTO (made to order)

width x length x height in. mm	weight lbs. kg	cubic feet	model #	list
20" x 15" x 5"	13 5.8	1.4	502941* •	242
20" x 20" x 5"	13 5.8	1.4	500772 •	279

\* Tables must be field drilled for mounting.



**Catalog Section 10**

**Drawers with Pull Flange & Full Front**

see spec sheet **EG10.13A**



- Includes full-extension zinc-plated steel slides with rubber stops.
- Hemmed safety pull handle.

**FEATURES:**

**Note:** No locks are available for these drawers.

**Freight class is 85.0.**

(•) MTS (made to stock) / ( ) MTO (made to order)

width x length x height		weight		cubic	model #	list
in.	mm	lbs.	kg	feet		
20" x 15" x 5"	508 x 381 x 127	25	11.3	3.0	<b>502942</b> *•	360
20" x 20" x 5"	508 x 508 x 127	25	11.3	3.0	<b>501571</b> •	394

\* Tables must be field drilled for mounting.

**Tier Drawers - Regular**

see spec sheet **EG10.13B**



tier drawer



tier drawer with legs

- Heavy gauge type 430 stainless steel cabinet with three roller-track drawers.
- With or without legs.
- Guides.
- Full-extension zinc-plated steel slides.
- Stainless steel drawer.
- Hemmed safety pull handle on each drawer.

**FEATURES:**

**Note:** All shipping weights and cubic feet are approximate.

**Freight class is 85.0.**

(•) MTS (made to stock) / ( ) MTO (made to order)

width x length x height		description	weight		cubic	model #	list
inches	mm		lbs.	kg	feet		
22½" x 24" x 22"	572 x 610 x 559	3 drawers, nylon feet	75	34.0	9.8	<b>TD3</b> •	2425
22½" x 24" x 34½"	572 x 610 x 876	3 drawers, with legs	78	35.4	9.8	<b>TD3L</b>	2737

**NSF-Approved Tier Drawers** 

see spec sheet **EG10.13B**



model #NTD3L  
with NSF-certified drawer

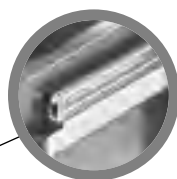

removable NSF  
drawer slide

- Utilizes totally removable drawer slides certified by the National Sanitation Foundation.
- Otherwise, design and features are the same as tier drawers mentioned above.
- Hemmed safety pull handle on each drawer.

**FEATURES:**

**Notes:** These drawers can be integrated into a table.

**Model #NTD3I. \$3509 list.**

Optional Pan Replacement available.

**Model #608120. \$133 list.**

**Freight class is 85.0.**

width x length x height		description	weight		cubic	model #	list
inches	mm		lbs.	kg	feet		
22½" x 24" x 22"	572 x 610 x 559	3 drawers, nylon feet	75	34.0	9.8	<b>NTD3</b>	2598
22½" x 24" x 34½"	572 x 610 x 876	3 drawers, with legs	78	35.4	9.8	<b>NTD3L</b>	2741



Drawer Assemblies

see spec sheet **EG10.13B**



enclosed drawer assembly



SPEC-MASTER® heavy duty drawer assembly

For Stainless Steel and Hardwood Tables!

FEATURES:

- Removable drawer pan.

**Note:** All shipping weights and cubic feet are approximate. Lock available. **\$148 list.** To order, add suffix “-L”. **Example: 502972-L.**

To determine number of drawers per table, see chart on page 174.

**Freight class is 85.0.**

(•) MTS (made to stock) / ( ) MTO (made to order)

Enclosed Assemblies

Type 430 stainless steel, front with hemmed safety pull handle, and full-extension zinc-plated steel slides.

SPEC-MASTER® Heavy Duty Assemblies

Type 304 stainless steel, insulated front and self-closing drawer slides that fully extend from housing. **THESE ASSEMBLIES ARE STACKABLE!!**

width x length x height		cu ft	weight		model #		OPTIONAL PAN REPLACEMENT		weight lbs. kg	model #		OPTIONAL PAN REPLACEMENT		
in.	mm		lbs.	kg			model #	list		model #	list	model #	list	
20" x 15" x 5"	508 x 381 x 127	3.0	35	15.9	<b>502943</b> •	689	<b>608115</b>	191	40	18.1	<b>502972</b> •	1114	<b>608117</b>	232
20" x 20" x 5"	508 x 508 x 127	3.0	35	15.9	<b>501572</b> •	717	<b>608118</b> **	201	40	18.1	<b>502971</b> •	1152	<b>606826</b>	240

\* Tables must be field drilled for mounting.

\*\* Pan replacement #608118 does NOT fit drawer assembly #501572 with optional lock (#501572-L). Drawer assembly #501572-L only accepts pan replacement #608119, list \$269.

Drawer Assemblies With NSF-Approved Slides

see spec sheet **EG10.13B**

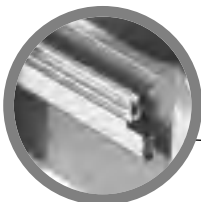

removable NSF drawer slide



#502946 or 502947 drawer assembly

FEATURES:

- Type 430 stainless steel.
- Utilizes a totally removable drawer slide, making it easy to clean for complete sanitation.
- Requires no tools.
- All-stainless steel housing, frame, drawer front complete with full-length front pull flange, and removable drawer pan with large radius corners.
- Hemmed safety pull handle.

**Note:** To determine number of drawers per table, see chart on page 174. Optional lock available. **\$148 list.** To order, add suffix “-L”. **Example: 502946-L.**

**Freight class is 85.0.**

(•) MTS (made to stock) / ( ) MTO (made to order)

width x length x height		weight		cubic feet	model #		OPTIONAL PAN REPLACEMENT	
in.	mm	lbs.	kg				model #	list
20" x 15" x 5"	508 x 381 x 127	35	15.9	3.0	<b>502947</b> •	708	<b>608115</b>	191
20" x 20" x 5"	508 x 508 x 127	35	15.9	3.0	<b>502946</b> •	743	<b>608116</b> **	191

\* Tables must be field drilled for mounting.

\*\* Pan replacement #608116 does NOT fit drawer assembly #502946 with optional lock (#502946-L). Drawer assembly #502946-L only accepts pan replacement #608119, list \$269.



**Catalog Section 10**

**Polymer Drawers** 

see spec sheet **EG10.13A**

FEATURES:

- Made of heavy gauge polymer.
- With pull flange and built-in drawer stop.

**Freight class is 85.0.**



width x length x depth		weight		cubic feet	model #	list
in.	mm	lbs.	kg			
13 3/8" x 19" x 3"	352 x 483 x 76	9	4.1	1.4	<b>502948</b>	286
13 3/8" x 19" x 6"	352 x 483 x 152	13	5.8	3.0	<b>502949</b>	343
13 3/8" x 19" x 9"	352 x 483 x 229	18	8.2	4.5	<b>502950</b>	417

**Drawer Kits for All Stainless Steel Worktables**

see spec sheet **EG10.13A**

**Freight class is 70.0.**

description	add * suffix #	add to list
20" x 20" x 5" (508 x 508 x 127mm) enclosed drawer assembly (#501572)	<b>-D1</b>	717
20" x 20" x 5" (508 x 508 x 127mm) drawer with pull flange and full front (#501571)	<b>-D2</b>	394
20" x 20" x 5" (508 x 508 x 127mm) drawer with pull flange (#500772)	<b>-D3</b>	279

\* Example: T3060SB-D3



**Stainless Steel Caster Cradle®**

see product announcement **EG8108M**

FEATURES:

- The only caster stabilizing device with a patented uniform circular design (patent #US 8,678,335 B2) that allows for approach from any angle.
- Units are secured to the floor where the casters are to be centered.

**Freight class is 85.0.**



**PATENTED!**  
(patent #US 8,678,335 B2)

description	model #	list/pkg
quantity of 2 per package	<b>CC-S-2</b>	83
quantity of 10 per package	<b>CC-S-10</b>	329
quantity of 60 per package	<b>CC-S-60</b>	1847

**The Benefits of Broadline Manufacturing from EAGLE.**

**Call Your EAGLE GROUP Representative Now To Place Your Order.**



100 Industrial Boulevard, Clayton, DE 19938-8903 U.S.A.  
Phone: 800-637-5100 or 302-653-3000. Fax: 302-653-2065  
<http://www.eaglegrp.com>

Table Mounted Utility Tool Racks 

see spec sheet **EG10.12**



- Furnished with 1 1/2" (41mm) stainless steel tubular supports extending through table top and fastened securely to adjustable undershelf.
- Racks are triple-bar type made of 3/8" x 2" (5 x 51mm), aluminum or type 304 stainless steel bars bolted together and fitted with one two-prong sliding hook per foot.

FEATURES:

**NOTE:** All shipping weights and cubic feet are approximate. Worktables with Utility Tool Rack not recommended for use with casters.

**Freight class is 70.0.**

(•) MTS (made to stock) / ( ) MTO (made to order)

fits table length		rack length		weight		cu	Aluminum		Stainless Steel		weight		cu		
in.	mm	in.	mm	lbs.	kg	ft	model #	list	lbs.	kg	ft	model #	list		
36"	914	28"	711	38	17.2	1.7	<b>TM36APR</b>	920	50	22.7	1.7	<b>TM36PR</b>	1100		
48"	1219	40"	1016	42	19.1	1.9	<b>TM48APR</b>	956	57	25.9	1.9	<b>TM48PR</b>	1162		
60"	1524	52"	1321	46	20.9	1.9	<b>TM60APR</b>	989	64	29.0	1.9	<b>TM60PR</b>	1224		
72"	1829	64"	1626	50	22.7	1.9	<b>TM72APR</b>	1036	70	31.8	1.9	<b>TM72PR •</b>	1288		
84"	2134	76"	1930	54	24.5	1.9	<b>TM84APR</b>	1235	77	34.9	1.9	<b>TM84PR</b>	1523		
96"	2438	88"	2235	58	26.3	2.1	<b>TM96APR</b>	1273	83	37.6	2.1	<b>TM96PR</b>	1586		
108"	2743	100"	2540	62	28.1	2.3	<b>TM108APR*</b>	1544	89	40.4	2.3	<b>TM108PR*</b>	1918		
120"	3048	112"	2845	66	29.9	2.5	<b>TM120APR*</b>	1591	95	43.1	2.5	<b>TM120PR*</b>	1998		
132"	3353	124"	3150	71	32.2	2.8	<b>TM132APR*</b>	1638	102	46.3	2.8	<b>TM132PR*</b>	2097		
144"	3658	136"	3454	76	34.5	3.1	<b>TM144APR*</b>	1692	109	49.4	3.1	<b>TM144PR*</b>	2137		

\* These racks include center tubular support.

Optional Adjustable Shelves for Table Mounted Pan/Pot Racks

12" (305mm) wide. 16 gauge, type 304 stainless steel.

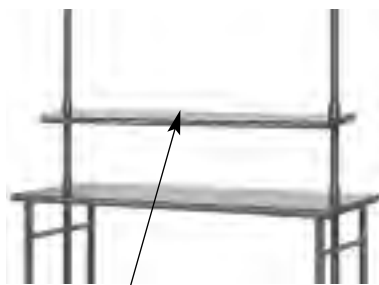

optional adjustable shelf for table mounted pot/pan racks

shelf length		weight		cubic		
in.	mm	lbs.	kg	feet	model #	list
36"	914	16	7.3	0.9	<b>TM36PRS</b>	448
48"	1219	20	9.0	1.3	<b>TM48PRS</b>	484
60"	1524	25	11.3	1.6	<b>TM60PRS</b>	519
72"	1829	30	13.6	1.9	<b>TM72PRS</b>	560
84"	2134	35	15.9	2.2	<b>TM84PRS</b>	601
96"	2438	39	17.6	2.5	<b>TM96PRS</b>	665
108"	2743	41	18.6	3.1	<b>TM108PRS</b>	1661
120"	3048	45	20.4	3.6	<b>TM120PRS</b>	1678
132"	3353	49	22.2	4.1	<b>TM132PRS</b>	1753
144"	3658	53	24.0	4.7	<b>TM144PRS</b>	1772

Single Bar Utility Racks

see spec sheet **EG10.06**

	ALUMINUM				STAINLESS STEEL					
	length in.	length mm	weight lbs.	weight kg	weight lbs.	weight kg	model #	list		
8 1/2" width (216mm)	24"	610	5	2.3	<b>SBPR-24-A</b>	412	9	4.1	<b>SBPR-24-S</b>	548
	36"	915	6	2.7	<b>SBPR-36-A</b>	433	12	5.4	<b>SBPR-36-S</b>	577
	48"	1219	7	3.2	<b>SBPR-48-A</b>	446	15	6.8	<b>SBPR-48-S</b>	593
	60"	1524	9	4.1	<b>SBPR-60-A</b>	458	18	8.2	<b>SBPR-60-S</b>	611
	72"	1829	11	5.0	<b>SBPR-72-A</b>	473	21	9.5	<b>SBPR-72-S</b>	629
	84"	2134	13	5.9	<b>SBPR-84-A</b>	484	25	11.3	<b>SBPR-84-S</b>	645
	96"	2438	15	6.8	<b>SBPR-96-A</b>	534	29	13.2	<b>SBPR-96-S</b>	711
	108"	2743	17	7.7	<b>SBPR-108-A</b>	587	34	15.4	<b>SBPR-108-S</b>	779
	120"	3048	20	9.0	<b>SBPR-120-A</b>	637	39	17.6	<b>SBPR-120-S</b>	849

- Flat 3/16" (5mm)-thick, 2" (51mm)-wide solid bar.
- 24" (610mm) racks are one-piece, all others come with support brackets.
- Includes one two-prong hook per foot.

FEATURES:

**Freight class is 70.0.**

(•) MTS (made to stock) / ( ) MTO (made to order)

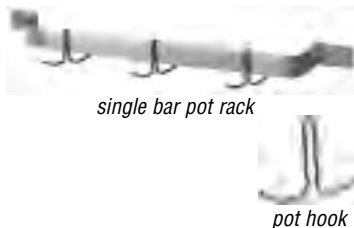

Additional Hook for Single Bar Pot Racks

- Stainless steel.

weight lbs.	weight kg	cu ft	model #	list ea.
0.2	0.1	0.1	<b>300696 •</b>	26



Catalog Section 10

Ceiling Mounted Utility Tool Racks

see spec sheet **EG10.12**

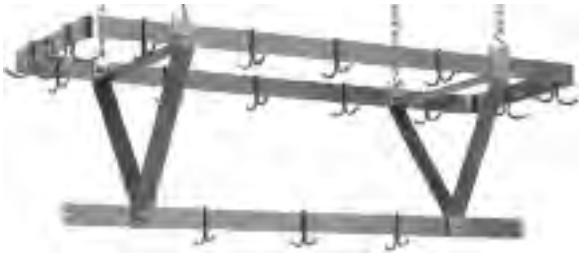

- Furnished with chain hangers for ceiling suspension.
- Racks are triple-bar type made of 3/16" x 2" (5 x 51mm), aluminum or type 304 stainless steel bars bolted together, and fitted with one two-prong sliding hook per foot.

FEATURES:

**Note:** All shipping weights and cubic feet are approximate.

**Freight class is 70.0.**

(•) MTS (made to stock) / ( ) MTO (made to order)

rack length		Aluminum					Stainless Steel				
in.	mm	weight lbs.	weight kg	cu ft	model #	list	weight lbs.	weight kg	cu ft	model #	list
28"	711	28	12.7	0.7	CM36APR	740	41	18.6	0.7	CM36PR	946
40"	1016	32	14.5	0.9	CM48APR •	778	48	21.8	0.9	CM48PR •	988
52"	1321	36	16.3	1.2	CM60APR •	813	54	24.5	1.2	CM60PR •	1055
64"	1626	40	18.1	1.6	CM72APR •	859	60	27.2	1.6	CM72PR •	1116
76"	1930	44	20.0	1.9	CM84APR	1063	67	30.4	1.8	CM84PR	1358
88"	2235	48	21.8	2.1	CM96APR	1097	74	33.6	2.1	CM96PR	1418
100"	2540	53	24.0	2.5	CM108APR	1283	81	36.7	2.5	CM108PR	1786
112"	2845	58	26.3	2.9	CM120APR	1298	87	39.5	2.9	CM120PR	1884
124"	3150	63	28.6	3.3	CM132APR	1366	94	42.6	3.3	CM132PR	1909
136"	3454	68	30.8	3.7	CM144APR	1394	101	45.8	3.7	CM144PR	2179

Wall Mounted Utility Tool Racks

see spec sheet **EG10.12**



- Racks are double-bar type made of 3/16" x 2" (5 x 51mm), aluminum or type 304 stainless steel bars bolted together, and fitted with one two-prong sliding hook per foot.
- Stainless steel brackets.

FEATURES:

**Freight class is 70.0.**

(•) MTS (made to stock) / ( ) MTO (made to order)

rack length		Aluminum					Stainless Steel				
in.	mm	weight lbs.	weight kg	cu ft	model #	list	weight lbs.	weight kg	cu ft	model #	list
36"	914	13	5.8	1.0	WM36APR •	267	18	8.2	1.0	WM36PR •	308
48"	1219	15	6.8	1.2	WM48APR •	279	22	10.0	1.2	WM48PR •	372
60"	1524	17	7.7	1.4	WM60APR •	319	26	11.8	1.4	WM60PR •	397
72"	1829	19	8.6	1.8	WM72APR •	408	29	13.2	1.8	WM72PR •	505
84"	2134	21	9.5	2.0	WM84APR •	429	33	15.0	2.0	WM84PR •	548
96"	2438	23	10.4	2.3	WM96APR •	527	37	16.8	2.3	WM96PR •	779
108"	2743	25	11.3	2.6	WM108APR	636	41	18.6	2.6	WM108PR	874
120"	3048	28	12.7	2.9	WM120APR	644	45	20.4	2.9	WM120PR	925
132"	3353	31	14.1	3.2	WM132APR	746	50	22.7	3.3	WM132PR	940
144"	3658	34	15.4	3.5	WM144APR	801	55	24.9	3.5	WM144PR	1181

Corner Guards

see spec sheet **EG10.14**

- Adheres to corner of adjacent wall(s).
- Heavy gauge stainless steel.
- Adhesive tape backing.

height		2" x 2" Inner Corner Guards		2" x 2" Outer Corner Guards	
in.	mm	model #	list	model #	list
36"	914	CG-I-36	107	CG-O-36	107
48"	1219	CG-I-48	125	CG-O-48	125
60"	1524	CG-I-60	142	CG-O-60	142
72"	1829	CG-I-72	157	CG-O-72	157





- Options / Accessories / Replacements -

see spec sheet **EG10.50** NSF

Please allow six to eight weeks shipping cycle for custom fabrication after receipt of approved drawings. Add 10% upcharge to expedite 4-week shipping cycle.



model #	description	unit	list	model #	description	unit	list
E10	Square edge table - front and/or rear	per table	212	300720	Lever drains - 1.5" I.P.S. (38mm)	each	232
E11	Marine counter edge	per table	457	300721	Lever drains - 2" I.P.S. (51mm)	each	232
E12	"V" type marine edge	per table	457	300722	Lever drains - 2" I.P.S. (51mm) with overflow	each	476
E13	Bullnose edge	per table	434	341189 ***	Twist handle drains - 1.5" I.P.S. (38mm)	each	244
E15	Vertical tray dividers - 4-section assembly, 3" on centers	each	675	336002 ***	Twist handle drains - 2" I.P.S. (51mm)	each	244
300698	Casters - 4" (102mm)-diameter with brake	each	104	341190 ***	Twist handle drains - 2" I.P.S. (51mm) with overflow	each	553
300699	Casters - 4" (102mm)-diameter without brake	each	99	E27	Top cutout - square or round (Specify location)	each	286
317635	Casters - 5" (127mm)-diameter with brake	each	135	E28	Angle slides for pans, up to six pairs Specify location and pan size.	set	592
317636	Casters - 5" (127mm)-diameter without brake	each	135	E29	Urn trough, 4.5" wide x 1.25" deep (114 x 32mm) with 1.5" (38mm) drain, complete with louvered grate. (Length must be maximum of 6" shorter than table. Specify location.)	lin. ft	144
313835	Stainless steel flanged bullet feet	each	26	E30	End splash — per end (Specify end), all heights	each	312
300692	Bullet feet - stainless steel	each	18	E31	1.5" (38mm) rear upturn for undershelf	table	125
301036	Bullet feet - white metal	each	9	E32	Can opener hole with under table support (Specify location)		203
300293	Bullet feet - plastic	each	2	E33	Sink splashes — single thickness 4" tall (102mm)	each	322
E17	Special height legs	per table	159	E34	Column cutout (Send floor plan/sketch)	each	666
E18 *	Duplex receptacle and mounting plate (under table)	each	400	<b>NOT PICTURED</b>			
E18.1 *	Duplex receptacle in splash (requires at least 6"-high splash)	each	387	model #	description	unit	list
E18.2 *	Pedestal duplex receptacle (top of table or overshelf)	each	446	606329	Scrap chute, 6" (152mm)-diameter	each	225
E19	Stainless steel gussets	each	35	606331	Knife rack (fits rolled rim, poly, and square edge tables)	each	326
E20	Sinks — complete with faucet and basket drain (Specify location)	each	1078	E35	16 gauge s/s apron in front of sinks or cutouts	lin. ft	157
E21	- 10" x 14" x 9.5" bowl (254 x 356 x 241mm)	each	1132	E36	Fully welded - top, undershelf & legs	each	504
E22 **	- 14" x 16" x 9.5" bowl (356 x 406 x 241mm)	each	1207	E36A	Welded base only - undershelf & legs	each	339
E23 **	- 16" x 20" x 8" bowl (406 x 508 x 203mm)	each	1339	E37	NSF sprayed-on sound deadening up to 12' (3658mm)	table	680
E24 **	- 16" x 20" x 14" bowl (406 x 508 x 356mm)	each	1468	E37A	- for each additional foot	lin. ft	54
E24A **	- 18" x 20" x 14" bowl (457 x 508 x 356mm)	each	1468	E38-6****	Cantilever mount up to 6' (1829mm) - add to wall shelf price	each	395
E25	- 20" x 20" x 14" (508 x 508 x 356mm)	each	1478	E38-12****	Cantilever mount up to 12' (3658mm) - add to wall shelf price	each	591
E25	- 24" x 24" x 14" (610 x 610 x 356mm)	each	2001	E39	Enclosed backsplash	lin. ft	84
313304	T&S faucet upgrade - deck mount 4" (102mm) centers	each	599				

\* For GFI receptacle, add "-GFI" to E number (example: E18.1-GFI) and \$40 to list price.  
 \*\* These sink bowls will not fit in a table any less than 30" (762mm) wide.  
 \*\*\* Optional twist drain brackets available for use with twist handle drains.  
 \*\*\*\* Applicable to wall mount shelves and pot racks.

Optional Sinks Built Into Tables – Standard Locations

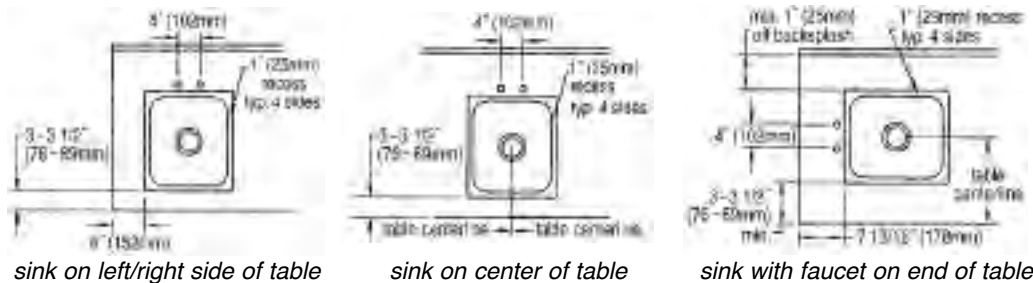

Optional Table Edges

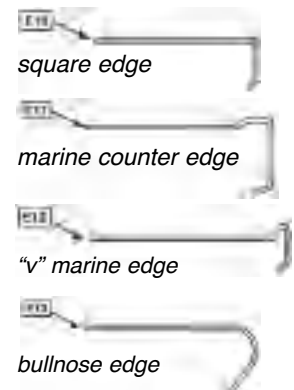

## Accessories/Replacements

Hand Sinks .....	193-195
All Other Sinks.....	197, 215-220

## Custom Options .....217

### 412, 414, and 314 Series Sinks

One-Compartment .....	198
Two-Compartment .....	199
Three-Compartment .....	200
Four-Compartment .....	201

### Cool Trough® Water Tempering Systems .....223-224

Portable Cool Trough® .....	226
-----------------------------	-----

## Counter Drop-In Sinks ....212-213

## Floor Drains/Troughs .....221-225

## Hand Sinks.....182-196

Accessories .....	193-195
Electronic.....	185-186
HFL-5000 Handwashing System.....	182
Physically Challenged / ADA.....	189
With Waste Receptacle .....	192

## Specialty Sinks

314 Series Corner .....	209
310 / 312 Series Specialty Use.....	210
Lavatory .....	196
Mop Sink Storage Cabinets .....	211
Mop Sinks.....	210

## SPEC-MASTER® FN Series Heavy Duty Sinks

One-Compartment .....	202
Two-Compartment .....	203
Three-Compartment .....	204
Four-Compartment .....	205
FFN Series Flush Front .....	208
Specialty Use/Parts Cleaning.....	209

## Undermount Sink Bowls ..214-216

## Utility Sinks .....206-208

## EAGLE HAND SINKS WITH MICROGARD® Antimicrobial Protection.

**THE  
INDUSTRY'S  
CLEAN  
LEADER.**

### **NOW HERE'S A GREAT IDEA:**

making your handwashing stations more convenient and accessible by integrating them into your work sequence. What better way to attain more frequent handwashing. Let the industry's clean leader help by giving you the widest range of hand sink choices – many available with exclusive MICROGARD® Antimicrobial Protection. More models, configurations and accessories mean more design options for you... so you'll have more efficient work areas along with improved hygiene.

For all the details on how EAGLE hand sinks add up to better sanitation, **visit [www.eaglegrp.com](http://www.eaglegrp.com).**



# Stainless Steel Fabricated Sinks

see spec sheets **EG20.14** **EG20.15**

- 14"-deep (356mm) bowls with 3/4" (19mm) radius corners.
- 8" (203mm)-high backsplash with 3/4" (19mm) upturn and tile edge.

FEATURES:

Freight class is 100.0.

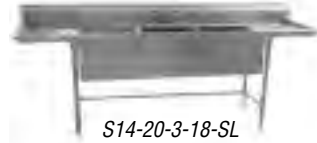

S14-20-3-18-SL



S16-20-3-18

### S14 Series

Stainless steel legs, crossbracing, gussets and bullet feet.

### S16 Series

Galvanized legs, crossbracing and gussets, and plastic bullet feet.

# of bowls	drainboard length		# of drbds	overall length		14 gauge type 304 stainless steel construction		16 gauge type 304 stainless steel construction	
	in.	mm		in.	mm	model #	list	model #	list
1	n/a		0	29"	737	<b>S14-20-1-SL</b>	1619	<b>S16-20-1</b>	1425
2	18"	457	1	67½"	1715	<b>S14-20-2-18R-SL</b>	2812	<b>S16-20-2-18R</b>	2475
	18"	457	1	67½"	1715	<b>S14-20-2-18L-SL</b>	2812	<b>S16-20-2-18L</b>	2475
2	18"	457	2	81"	2057	<b>S14-20-2-18-SL</b>	2959	<b>S16-20-2-18</b>	2604
	18"	457	1	89½"	2273	<b>S14-20-3-18R-SL</b>	3709	<b>S16-20-3-18R</b>	3263
2	18"	457	1	89½"	2273	<b>S14-20-3-18L-SL</b>	3709	<b>S16-20-3-18L</b>	3263
	18"	457	2	103"	2616	<b>S14-20-3-18-SL</b>	3903	<b>S16-20-3-18</b>	3435
3	24"	610	1	95½"	2426	<b>S14-20-3-24R-SL</b>	3867	<b>S16-20-3-24R</b>	3404
	24"	610	1	95½"	2426	<b>S14-20-3-24L-SL</b>	3867	<b>S16-20-3-24L</b>	3404
3	24"	610	2	115"	2921	<b>S14-20-3-24-SL</b>	4073	<b>S16-20-3-24</b>	3583
	18"	457	2	103"	2616	<b>S14-28-3-18-SL *</b>	4945	<b>S16-28-3-18 *</b>	4348

\* #S14-28-3-18-SL and #S16-28-3-18 sinks feature 28"-wide x 20"-long (711 x 508mm) sink bowls and two sets of faucet holes.

## HFL-5000 Touch-Free Handwashing Systems

see spec sheet **EG20.55**

- EAGLE hand sink with MICROGARD® antimicrobial protection.
- Kimberly-Clark touchless towel dispenser. EAGLE part #377454. Use Kleenex #50606 or Scott #02000 towel roll.
- T&S electronic eye faucet, splash mounted with battery-saving hydro-generator power source. A LEED-friendly combination with the flow of water creating its own power source. EAGLE part #369865.
- Purell/LTX hand sanitizing dispenser. EAGLE part #377455.
- Gojo/LTX hand soap dispenser. EAGLE part #377456.
- FoodHandler glove rack with single service gloves. Model #11-0012. EAGLE part #352855.
- Tucel soft bristle white nail brush. Model #1832. EAGLE part #348602



### Optional MICROGARD®<sup>+</sup> for Hand Sinks!

(See pages 183-192 for applicable hand sinks.)

- MICROGARD® is an antimicrobial agent which contains built-in protection to retard the growth of a broad range of bacteria, mold and mildew on the surface that cause stains, odors and degradation.
- MICROGARD® combines inorganic antimicrobial silver ions with a patented delivery system. The patented delivery system triggers the release of silver ions which react with bacteria in three ways:
  - 1) Suffocates the cell.
  - 2) Stops the cell reproduction system.
  - 3) Stops the cell from growing.
- MICROGARD® is a second line of defense. In keeping with good hygiene practices, clean this product as usual. The protection will not wash out, while organic bactericides may.\*\*
- MICROGARD® is applied onto top and underside of sink deck, backsplash, and inside & outside of sink bowl (excludes faucets, drains, towel/soap dispensers, waste receptacle, skirt, pedal valves, and nail brush holder).

\* MICROGARD® does not protect users or others against bacteria, viruses, germs or other disease organisms. Always clean this product thoroughly after each use.

\*\* Note: To clean, use mild soap and water, rinse, and wipe entire surface dry. Soft non-abrasive cleaners may be used when necessary. Strong abrasive cleaners will scratch and dull the surface.

description of hand sink included	model #	list
with waste receptacle	<b>HFL-5000</b>	3987
with skirt (no waste receptacle)	<b>HFL-5000-S</b>	3829
with waste receptacle and end splashes	<b>HFL-5000-LRS</b>	4446



## Catalog Section 20

### Traditional Hand Sinks

see spec sheet **EG20.40**

#### MICROGARD®

an antimicrobial agent which contains built-in protection to retard the growth of a broad range of bacteria, mold and mildew that causes stains, odors and degradation.

- All sinks are wall mountable.
- Deep-drawn seamless design.
- Positive drain, included on all models.
- All type 304 stainless steel.
- Splash mount gooseneck faucet included on all models except HSA-10.

#### FEATURES:

**Freight class is 85.0.**

(•) MTS (made to stock) / ( ) MTO (made to order)

**Cleanest sinks in the industry!**

HSA-10* •		list:	512
	bowl size:	9¼" x 13½" x 6¼" (248 x 343 x 173mm)	
	overall size:	14¼" x 18½" x 12¼" (376 x 480 x 324mm)	
	weight:	10 lbs. (4.5 kg)	
	cubic feet:	3.0	
<b>MICROGARD® available:</b> To order, add suffix "-MG" to model # / add \$116 to list price.		includes:	4" (102mm) centerline faucet holes, basket drain.

HSA-10-FAW •		list:	805
	bowl size:	9¼" x 13½" x 6¼" (248 x 343 x 173mm)	
	overall size:	14¼" x 18½" x 12¼" (376 x 480 x 324mm)	
	weight:	14 lbs. (6.4 kg)	
	cubic feet:	2.8	
<b>MICROGARD® available:</b> To order, add suffix "-MG" to model # / add \$116 to list price.		includes:	Faucet with wrist handles, p-trap, tail piece, basket drain.

HSA-10-F •		list:	599
	bowl size:	9¼" x 13½" x 6¼" (248 x 343 x 173mm)	
	overall size:	14¼" x 18½" x 12¼" (376 x 480 x 324mm)	
	weight:	12 lbs. (5.2 kg)	
	cubic feet:	2.8	
<b>MICROGARD® available:</b> To order, add suffix "-MG" to model # / add \$116 to list price.		includes:	Faucet, basket drain.

HSA-10-FL •		list:	856
	bowl size:	10" x 14" x 5" (254 x 356 x 127mm)	
	overall size:	14¼" x 18½" x 12¼" (376 x 480 x 318mm)	
	weight:	15 lbs. (6.6 kg)	
	cubic feet:	3.0	
		includes:	Faucet, polymer lever drain.

HSA-10-FA •		list:	633
	bowl size:	9¼" x 13½" x 6¼" (248 x 343 x 173mm)	
	overall size:	14¼" x 18½" x 12¼" (376 x 480 x 324mm)	
	weight:	14 lbs. (6.4 kg)	
	cubic feet:	3.0	
<b>MICROGARD® available:</b> To order, add suffix "-MG" to model # / add \$116 to list price.		includes:	Faucet, p-trap, tail piece, basket drain.

HSA-10-FO •		list:	709
	bowl size:	10" x 14" x 5" (254 x 356 x 127mm)	
	overall size:	14¼" x 18½" x 12¼" (376 x 480 x 318mm)	
	weight:	13 lbs. (5.6 kg)	
	cubic feet:	3.0	
		includes:	Faucet, polymer lever drain w/overflow.

\* To order hand sink with no faucet holes, add suffix "-NH" to model number (example: HSA-10-NH). \$149 upcharge.



100 Industrial Boulevard, Clayton, DE 19938-8903 U.S.A.  
Phone: 800-637-5100 or 302-653-3000. Fax: 302-653-2065  
http://www.eaglegrp.com

## Hand Sinks with Standard Towel Dispenser and/or Soap Dispenser

see spec sheets **EG20.05** **EG20.41**

### MICROGARD®

an antimicrobial agent which contains built-in protection to retard the growth of a broad range of bacteria, mold and mildew that causes stains, odors and degradation.

- Deep-drawn positive drain and splash mount gooseneck faucet included on all models.
- All 304 series stainless steel, including towel dispenser.
- Soap dispenser on all models holds 16 ounces.
- Towel dispenser holds 4" x 10" (102 x 254mm) C-fold disposable paper towels.

**FEATURES:**

**Freight class is 85.0.**

<b>HSA-10-FDP</b>		<b>list: 1260</b>
	<b>bowl size:</b>	9 3/4" x 13 1/2" x 6 3/4" (248 x 343 x 173mm)
	<b>overall size:</b>	14 3/4" x 19 1/4" x 28 3/4" (376 x 489 x 718mm)
	<b>weight:</b>	29 lbs. (13.2 kg)
	<b>cubic feet:</b>	6.2
<b>MICROGARD® available:</b> To order, add suffix "-MG" to model # / add \$116 to list price.		<b>includes:</b> Faucet, towel dispenser, soap dispenser, basket drain.

<b>HSA-10-FODP</b>		<b>list: 1547</b>
	<b>bowl size:</b>	10" x 14" x 5" (254 x 356 x 127mm)
	<b>overall size:</b>	14 3/4" x 19 1/4" x 28" (376 x 489 x 711mm)
	<b>weight:</b>	30 lbs. (13.6 kg)
	<b>cubic feet:</b>	6.2
<b>MICROGARD® available:</b> To order, add suffix "-MG" to model # / add \$116 to list price.		<b>includes:</b> Faucet, towel dispenser, soap dispenser, polymer lever drain w/overflow.

<b>HSA-10-FDPS</b>		<b>list: 1924</b>
	<b>bowl size:</b>	9 3/4" x 13 1/2" x 6 3/4" (248 x 343 x 173mm)
	<b>overall size:</b>	14 3/4" x 19 1/4" x 30" (376 x 489 x 762mm)
	<b>weight:</b>	29 lbs. (13.2 kg)
	<b>cubic feet:</b>	6.2
<b>MICROGARD® available:</b> To order, add suffix "-MG" to model # / add \$116 to list price.		<b>includes:</b> Faucet, towel dispenser, soap dispenser, skirt, basket drain.

<b>HSA-10-F-DS*</b>		<b>list: 788</b>
	<b>bowl size:</b>	9 3/4" x 13 1/2" x 6 1/2" (248 x 343 x 165mm)
	<b>overall size:</b>	14 13/16" x 18 1/8" x 12 3/4" (376 x 480 x 324mm)
	<b>weight:</b>	12 lbs. (5.2 kg)
	<b>cubic feet:</b>	2.8
<i>(see page 159 for #HSAN-10-F-DS)</i> <b>MICROGARD® available:</b> To order, add suffix "-MG" to model # / add \$116 to list price.		<b>includes:</b> Faucet, 16-oz deck-mt soap dispenser, basket drain.

<b>HSA-10-FLDP</b>		<b>list: 1513</b>
	<b>bowl size:</b>	10" x 14" x 5" (254 x 356 x 127mm)
	<b>overall size:</b>	14 3/4" x 19 1/4" x 28" (376 x 489 x 711mm)
	<b>weight:</b>	32 lbs. (14.5 kg)
	<b>cubic feet:</b>	6.2
<b>MICROGARD® available:</b> To order, add suffix "-MG" to model # / add \$116 to list price.		<b>includes:</b> Faucet, towel dispenser, soap dispenser, polymer lever drain.

<b>HSA-10-FWLDP-LRS</b>		<b>list: 2042</b>
	<b>bowl size:</b>	10" x 14" x 5" (254 x 356 x 127mm)
	<b>overall size:</b>	14 3/4" x 19 1/4" x 28" (376 x 489 x 711mm)
	<b>weight:</b>	30 lbs. (13.6 kg)
	<b>cubic feet:</b>	6.2
<b>MICROGARD® available:</b> To order, add suffix "-MG" to model # / add \$116 to list price.		<b>includes:</b> Faucet with wrist handles, towel dispenser, soap dispenser, polymer lever drain, and side splashes.

\* Overall height does not include soap dispenser bottle. See page 191 for "Space-Saver" hand sink with deck-mount soap dispenser.

## Catalog Section 20

### Electronic Eye Hand Sinks - AC POWER

see spec sheet **EG20.42**

**Note:** For regulating water temperature, Temperature Adjustment Valve (see page 194) is required.

#### MICROGARD®

an antimicrobial agent which contains built-in protection to retard the growth of a broad range of bacteria, mold and mildew that causes stains, odors and degradation.

- Electronic “eye” sensor beam activates water flow and adjusts from 3” to 12” (76 to 305mm).
- Requires 120-volt, 15-amp electricity.
- 120-volt AC adapter.
- Splash mount gooseneck spout.
- Lever or basket drain.
- Y-Inlet Non-Adjustable Mixing Valve.

#### FEATURES:

**Freight class is 85.0.**

(•) MTS (made to stock) / ( ) MTO (made to order)

<b>HSA-10-FE*•</b>		<b>list: 2179</b>
	<b>bowl size:</b>	9¼" x 13½" x 6¼" (248 x 343 x 173mm)
	<b>overall size:</b>	14¾" x 18¾" x 12¾" (376 x 480 x 324mm)
	<b>weight:</b>	14 lbs. (6.3 kg)
	<b>cubic feet:</b>	3.0
<b>MICROGARD® available:</b> To order, add suffix “-MG” to model # / add \$116 to list price.		<b>includes:</b> Spout, electronic eye, and basket drain.

<b>HSA-10-FDPE*</b>		<b>list: 3119</b>
	<b>bowl size:</b>	9¼" x 13½" x 6¼" (248 x 343 x 173mm)
	<b>overall size:</b>	14¾" x 19¼" x 28¼" (376 x 489 x 718mm)
	<b>weight:</b>	31 lbs. (14.1 kg)
	<b>cubic feet:</b>	6.2
<b>MICROGARD® available:</b> To order, add suffix “-MG” to model # / add \$116 to list price.		<b>includes:</b> Spout, electronic eye, soap dispenser, towel dispenser, and basket drain.

<b>HSA-10-FOE</b>		<b>list: 2291</b>
	<b>bowl size:</b>	10" x 14" x 5" (254 x 356 x 127mm)
	<b>overall size:</b>	14¾" x 18¾" x 12½" (376 x 480 x 318mm)
	<b>weight:</b>	13 lbs. (5.7 kg)
	<b>cubic feet:</b>	3.0
		<b>includes:</b> Spout, electronic eye, and polymer lever drain with overflow.

<b>HSA-10-FODPE</b>		<b>list: 3132</b>
	<b>bowl size:</b>	10" x 14" x 5" (254 x 356 x 127mm)
	<b>overall size:</b>	14¾" x 19¼" x 28" (376 x 489 x 711mm)
	<b>weight:</b>	30 lbs. (13.6 kg)
	<b>cubic feet:</b>	6.2
		<b>includes:</b> Spout, electronic eye, soap dispenser, towel dispenser, and polymer lever drain with overflow.

<b>HSA-10-FA-PE</b>		<b>list: 2901</b>
	<b>bowl size:</b>	9¼" x 13½" x 6¼" (248 x 343 x 173mm)
	<b>overall size:</b>	14¾" x 18¾" x 40¼" (376 x 480 x 1036mm)
	<b>weight:</b>	28 lbs. (12.7 kg)
	<b>cubic feet:</b>	9.5
<b>MICROGARD® available:</b> To order, add suffix “-MG” to model # / add \$116 to list price.		<b>includes:</b> Spout, electronic eye, soap dispenser, P-trap, tail piece, and basket drain.

<b>HSA-10-FDPEE</b>		<b>list: 3417</b>
	<b>bowl size:</b>	9¼" x 13½" x 6¼" (248 x 343 x 173mm)
	<b>overall size:</b>	14¾" x 19¼" x 31¼" (376 x 489 x 794mm)
	<b>weight:</b>	30 lbs. (13.6 kg)
	<b>cubic feet:</b>	6.2
<b>MICROGARD® available:</b> To order, add suffix “-MG” to model # / add \$116 to list price.		<b>includes:</b> Spout, electronic eye, towel dispenser, electronic soap dispenser, and basket drain.

\* Optional waste receptacle available for models HSA-10-FE, HSA-10-FDPE, and HSA-10-FDPEE. See page 195.



100 Industrial Boulevard, Clayton, DE 19938-8903 U.S.A.  
Phone: 800-637-5100 or 302-653-3000. Fax: 302-653-2065  
<http://www.eaglegrp.com>

## Electronic Hand Sinks - Battery Power

see spec sheets **EG20.07** **EG20.49**

### MICROGARD®

an antimicrobial agent which contains built-in protection to retard the growth of a broad range of bacteria, mold and mildew that causes stains, odors and degradation.

- Battery-powered electronic-eye faucet which operates on four "AA" batteries (included).
- Y-Inlet Non-Adjustable Mixing Valve.
- "Low battery" indicator light.

**FEATURES:**

**Freight class is 85.0.**

<b>HSA-10-FDPEE-B-T</b>		<b>list: 4795</b>
	<b>bowl size:</b>	9¼" x 13½" x 6¾" (248 x 343 x 173mm)
	<b>overall size:</b>	14¾" x 19¼" x 47½" (376 x 489 x 1207mm)
	<b>weight:</b>	54 lbs. (24.5 kg)
	<b>cubic feet:</b>	9.8
<b>MICROGARD® available:</b> To order, add suffix "-MG" to model # / add \$116 to list price.		<b>includes:</b> Battery-powered electronic eye faucet, towel dispenser, electronic soap dispenser, waste receptacle & skirt, and basket drain.

<b>HSAP-14-ADA-FE-B</b>		<b>list: 4781</b>
	<b>bowl size:</b>	16" x 14" x 5" (406 x 356 x 127mm)
	<b>overall size:</b>	24" x 22" x 24½" (610 x 559 x 623mm)
	<b>weight:</b>	65 lbs. (29.5 kg)
	<b>cubic feet:</b>	19.2
<b>MICROGARD® available:</b> To order, add suffix "-MG" to model # / add \$116 to list price.		<b>includes:</b> Battery-powered electronic eye faucet, basket drain, c-fold towel dispenser in front, deck-mount soap dispenser, skirt.

<b>HSA-10-FE-B-DS*</b>		<b>list: 2707</b>
	<b>bowl size:</b>	9¼" x 13½" x 6¾" (248 x 343 x 173mm)
	<b>overall size:</b>	14¼" x 18" x 12¼" (376 x 480 x 324mm)
	<b>weight:</b>	16 lbs. (7.3 kg)
	<b>cubic feet:</b>	3.0
<b>MICROGARD® available:</b> To order, add suffix "-MG" to model # / add \$116 to list price.		<b>includes:</b> Battery-powered electronic eye faucet, deck-mount soap dispenser, basket drain.

<b>HSA-10-FE-B-NB-MG</b>		<b>list: 2760</b>
	<b>bowl size:</b>	9¼" x 13½" x 6¾" (248 x 343 x 173mm)
	<b>overall size:</b>	14¼" x 18" x 12¼" (376 x 480 x 324mm)
	<b>weight:</b>	26 lbs. (11.8 kg)
	<b>cubic feet:</b>	3.0
<b>MICROGARD® Standard</b>		<b>includes:</b> Battery-powered electronic eye faucet, splash-mount nail brush holder, nail brush, MICROGARD®, basket drain.

<b>HSAN-10-FE-B-DS*</b>		<b>list: 3033</b>
	<b>bowl size:</b>	13½" x 9¼" x 6¾" (343 x 248 x 171mm)
	<b>overall size:</b>	17¼" x 12¼" x 14¼" (457 x 308 x 362mm)
	<b>weight:</b>	16 lbs. (7.3 kg)
	<b>cubic feet:</b>	2.8
<b>MICROGARD® available:</b> To order, add suffix "-MG" to model # / add \$116 to list price.		<b>includes:</b> Battery-powered electronic eye faucet, deck-mount soap dispenser, basket drain.

<b>HSA-10-FE-B-T-NB-MG</b>		<b>list: 3401</b>
	<b>bowl size:</b>	9¼" x 13½" x 6¾" (248 x 343 x 173mm)
	<b>overall size:</b>	14¼" x 18" x 29" (376 x 480 x 740mm)
	<b>weight:</b>	25 lbs. (11.3 kg)
	<b>cubic feet:</b>	8.1
<b>MICROGARD® Standard</b>		<b>includes:</b> Battery-powered electronic eye faucet, splash-mount nail brush holder, nail brush, MICROGARD®, waste receptacle & skirt, basket drain.

\* Overall height does not include soap dispenser bottle.

## Catalog Section 20

### Miscellaneous Hand Sinks

see spec sheets **EG20.21** **EG20.44**

Freight class is 85.0.

(•) MTS (made to stock) / ( ) MTO (made to order)

#### MICROGARD®

an antimicrobial agent which contains built-in protection to retard the growth of a broad range of bacteria, mold and mildew that causes stains, odors and degradation.

#### HSA-10-FKP list: 1447

 <p>single knee pedal valve</p>	<b>bowl size:</b>	9¼" x 13½" x 6¼" (248 x 343 x 173mm)
	<b>overall size:</b>	14¾" x 18⅞" x 17½" (376 x 480 x 445mm)
	<b>weight:</b>	26 lbs. (11.8 kg)
	<b>cubic feet:</b>	6.0
<b>MICROGARD® available:</b> To order, add suffix "-MG" to model # / add \$116 to list price.		<b>includes:</b> Spout, single pedal knee valve, skirt, basket drain.

#### HSA-10-FA-P• list: 1324

 <p>with Foot Valve Operation</p>	<b>bowl size:</b>	9¼" x 13½" x 6¼" (248 x 343 x 173mm)
	<b>overall size:</b>	14¾" x 18⅞" x 39¼" (376 x 480 x 997mm)
	<b>weight:</b>	32 lbs. (14.5 kg)
	<b>cubic feet:</b>	7.4
<b>MICROGARD® available:</b> To order, add suffix "-MG" to model # / add \$116 to list price.		<b>includes:</b> Spout, foot pedal valves, P-trap, tail piece, basket drain.

#### HSA-10-1FK\*• list: 1298

 <p>with Knee Valve Operation</p>	<b>bowl size:</b>	9¼" x 13½" x 6¼" (248 x 343 x 173mm)
	<b>overall size:</b>	14¾" x 18⅞" x 17½" (376 x 480 x 445mm)
	<b>weight:</b>	27 lbs. (12.2 kg)
	<b>cubic feet:</b>	4.0
<b>MICROGARD® available:</b> To order, add suffix "-MG" to model # / add \$116 to list price.		<b>includes:</b> Spout, single knee pedal, skirt, and basket drain.

#### HSA-10-FA-1P• list: 1324

 <p>with Foot Valve Operation</p>	<b>bowl size:</b>	9¼" x 13½" x 6¼" (248 x 343 x 173mm)
	<b>overall size:</b>	14¾" x 18⅞" x 39¼" (376 x 480 x 997mm)
	<b>weight:</b>	32 lbs. (14.5 kg)
	<b>cubic feet:</b>	10.2
<b>MICROGARD® available:</b> To order, add suffix "-MG" to model # / add \$116 to list price.		<b>includes:</b> Spout, single foot pedal valve, P-trap, tail piece, basket drain.

#### HSA-10-FDPK\* list: 1988

 <p>with Knee Valve Operation</p>	<b>bowl size:</b>	9¼" x 13½" x 6¼" (248 x 343 x 173mm)
	<b>overall size:</b>	14¾" x 19¼" x 33" (376 x 489 x 838mm)
	<b>weight:</b>	44 lbs. (20.0 kg)
	<b>cubic feet:</b>	6.2
<b>MICROGARD® available:</b> To order, add suffix "-MG" to model # / add \$116 to list price.		<b>includes:</b> Spout, knee pedals, skirt, soap dispenser, towel dispenser, basket drain.

#### HSA-10-FK\*• list: 1298

 <p>with Knee Valve Operation</p>	<b>bowl size:</b>	9¼" x 13½" x 6¼" (248 x 343 x 173mm)
	<b>overall size:</b>	14¾" x 18⅞" x 17½" (376 x 480 x 445mm)
	<b>weight:</b>	27 lbs. (12.2 kg)
	<b>cubic feet:</b>	3.9
<b>MICROGARD® available:</b> To order, add suffix "-MG" to model # / add \$116 to list price.		<b>includes:</b> Spout, knee pedals, skirt, and basket drain.

#### HSA-10-FW• list: 692

 <p>with Standard Wrist Handles</p>	<b>bowl size:</b>	9¼" x 13½" x 6¼" (248 x 343 x 173mm)
	<b>overall size:</b>	14¾" x 18⅞" x 12¼" (376 x 480 x 324mm)
	<b>weight:</b>	14 lbs. (6.4 kg)
	<b>cubic feet:</b>	3.0
<b>MICROGARD® available:</b> To order, add suffix "-MG" to model # / add \$116 to list price.		<b>includes:</b> Faucet with wrist handles, basket drain.

\* Overall height does not include skirt and knee valves.



100 Industrial Boulevard, Clayton, DE 19938-8903 U.S.A.  
 Phone: 800-637-5100 or 302-653-3000. Fax: 302-653-2065  
<http://www.eaglegrp.com>



## Portable Hand Sinks

see product announcements **EG8120** **EG8132**



portable hand sink with stainless steel cabinet and single sink bowl



portable hand sink with laminated cabinet and removable water plate.

**FEATURES:**

- Stainless steel top features box marine edge and rear backsplash.
- 5-gallon fresh water tank, 7-gallon gray water tank.
- Deck mount faucet with 1/4-turn handles.
- Towel rack and trash chute included.
- NEMA 5-15 plug & cord.

**Notes:** Optional Poly Cutting Board available. 3/4"-thick. Green color. Model #376509, list \$175.

Custom portable hand sinks available through SpecFAB®.

**Freight class is 85.0.**

**Sinks with Stainless Steel Cabinet**—Comes with 4" (102mm) swivel casters (two with brake).

description	bowl size		overall size		WITH COLD WATER ONLY			WITH HOT & COLD WATER								
	width in.	length x depth mm	width in.	length x height mm	weight* lbs.	kg	model #	list	lbs.	kg	model #	list				
with single S/S bowl	14"	10" x 5"	356	254 x 127	24"	26" x 44 1/2"	610	660 x 1130	232	105.2	<b>PHS-S-C</b>	5089	204	92.5	<b>PHS-S-H</b>	6283
with 3-compartment bowl	11 1/2"	6 1/2" x 5"	295	156 x 127	24"	26" x 44 1/2"	610	660 x 1130	232	105.2	<b>PHS-S3-C</b>	5254	251	113.9	<b>PHS-S3-H</b>	6614
with acrylic water plate**	12 1/2"	16"	32	406	24"	26" x 44 1/2"	610	660 x 1130	232	105.2	<b>PHS-A-C</b>	6103	251	113.9	<b>PHS-A-H</b>	7237

**Sinks with Laminated Cabinet**—Features Wilsonart® "Biltmore Cherry." Comes with 3" (76mm) swivel casters (two with brake).

description	bowl size		overall size		WITH COLD WATER ONLY			WITH HOT & COLD WATER								
	width in.	length x depth mm	width in.	length x height mm	weight* lbs.	kg	model #	list	lbs.	kg	model #	list				
with single S/S bowl	14"	10" x 5"	356	254 x 127	25"	28" x 44 1/2"	635	711 x 1130	237	107.5	<b>PHS-S-C-LB</b>	5699	214	97.1	<b>PHS-S-H-LB</b>	6383
with 3-compartment bowl	11 1/2"	6 1/2" x 5"	295	156 x 127	25"	28" x 44 1/2"	635	711 x 1130	237	107.5	<b>PHS-S3-C-LB</b>	5779	262	118.8	<b>PHS-S3-H-LB</b>	7519
with acrylic water plate**	12 1/2"	16"	32	406	25"	28" x 44 1/2"	635	711 x 1130	237	107.5	<b>PHS-A-C-LB</b>	6713	237	107.5	<b>PHS-A-H-LB</b>	7961

\* Weights shown reflect empty tanks.

\*\* Features 12 1/2" x 16" (32 x 406mm) removable polycarbonate water plate which drains into a stainless steel trough, and deck-mount faucet.

## Hand Wash Sinks

see spec sheet **EG20.47**



Model # HWC-E



Model # HWB-E

**FEATURES:**

- Type 304 stainless steel all-welded construction.
- 1 1/2" (38mm) bull nose front edge.
- Hinged door with pull handle and magnetic catch.
- Pump-action soap dispenser on rear deck.
- Built-in front-loading C-fold towel dispenser located in front of sink bowl.
- Deck-mounted faucet.
- Basket drain.
- Crumb cup.

**Freight class is 85.0.**

**Space-Saver Models**—Wall-mountable. Furnished with Z-clips to secure to wall.

bowl size	overall size	WITH STANDARD FAUCET			WITH T&S FAUCET								
		width in.	length x depth mm	weight lbs.	kg	model #	list	weight lbs.	kg	model #	list		
9 1/4" x 11 1/2" x 6"	235 x 292 x 152	16 5/8"	14" x 21 1/4"	421	356 x 540	36	16.3	<b>HWC-E</b>	2402	37	16.8	<b>HWC-T</b>	2622

## Drop-In Models

bowl size	overall size	cutout dimensions		WITH STANDARD FAUCET			WITH T&S FAUCET									
		width in.	length mm	weight lbs.	kg	model #	list	weight lbs.	kg	model #	list					
9 1/4" x 11 1/2" x 6"	235 x 292 x 152	17 1/2"	16 1/2" x 17 1/4"	445	419 x 438	16"	14 1/4"	406 x 378	32	14.5	<b>HWB-E</b>	2513	33	15.0	<b>HWB-T</b>	2731

## Catalog Section 20

### Physically Challenged Hand Sinks

see spec sheet **EG20.45**

*Designed for unique applications!*

FEATURES: • Standard with faucet and basket drain.

**Freight class is 85.0.**

(•) MTS (made to stock) / ( ) MTO (made to order)

HSAP-14-FW•		list: 1723
	<b>bowl size:</b>	16" x 14" x 5" (406 x 356 x 127mm)
	<b>overall size:</b>	24½" x 19" x 16½" (613 x 483 x 419mm)
	<b>weight:</b>	26 lbs. (11.8 kg)
	<b>cubic feet:</b>	6.5
<b>includes:</b>		Faucet, basket drain, and wall brackets.

HSAP-14-ADA-FE-B		list: 4781
	<b>bowl size:</b>	16" x 14" x 5" (406 x 356 x 127mm)
	<b>overall size:</b>	24" x 22" x 24½" (610 x 559 x 623mm)
	<b>weight:</b>	65 lbs. (29.5 kg)
	<b>cubic feet:</b>	19.2
<b>includes:</b>		Battery-powered electronic eye splash-mount faucet, c-fold towel dispenser in front, deck mount soap dispenser, skirt, basket drain.

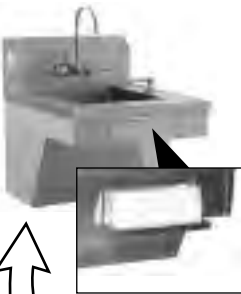
HSAP-14-ADA-FW		list: 4089
	<b>bowl size:</b>	16" x 14" x 5" (406 x 356 x 127mm)
	<b>overall size:</b>	24" x 22" x 24½" (610 x 559 x 623mm)
	<b>weight:</b>	55 lbs. (24.9 kg)
	<b>cubic feet:</b>	14.1
<b>includes:</b>		Splash-mount faucet w/wrist handles, c-fold towel dispenser in front, deck mount soap dispenser, skirt, basket drain.

EAGLE introduces...



**ELECTROPOLISHED FINISH**

(Consult factory for applicable models and availability)

- Increased resistance to corrosion.
- Improved surface finish.
- Deburring.
- Reduced product adhesion.
- Ease of cleaning.
- Attractive appearance.

To order, add suffix "-EP"  
(Example: HSA-10-F-EP).  
Add \$140 to list price of hand sink, except for pedestal sinks (add \$200).

#### Replacement T&S Faucets for HSAP-14-ADA-FW

Top quality splash-mount faucets. 4" center.

features	model #	list
gooseneck spout	<b>306134</b>	535
wrist handles, gooseneck spout	<b>313305</b>	533



#313305

*Service for over 60 years.*

**1 Source +  
1 Purchase Order +  
1 Delivery =**

**High Profits!**



100 Industrial Boulevard, Clayton, DE 19938-8903 U.S.A.  
Phone: 800-637-5100 or 302-653-3000. Fax: 302-653-2065  
<http://www.eaglegrp.com>

## Hand Sinks with Side Splashes NSF

see spec sheet **EG20.56**

FEATURES: • Standard with faucet and basket drain.

**Freight class is 85.0.**

(•) MTS (made to stock) / ( ) MTO (made to order)

<b>HSA-10-F-LRS •</b>		<b>list: 1058</b>
	<b>bowl size:</b>	9 $\frac{3}{4}$ " x 13 $\frac{1}{2}$ " x 6 $\frac{3}{4}$ " (248 x 343 x 173mm)
	<b>overall size:</b>	14 $\frac{3}{4}$ " x 18 $\frac{1}{8}$ " x 12 $\frac{3}{4}$ " (376 x 480 x 324mm)
	<b>weight:</b>	14 lbs. (6.4 kg)
	<b>cubic feet:</b>	3.9
<b>includes:</b> Faucet, basket drain, and side splashes.		

<b>HSAN-10-F-LRS •</b>		<b>list: 1171</b>
	<b>bowl size:</b>	13 $\frac{1}{2}$ " x 9 $\frac{3}{4}$ " x 6 $\frac{3}{4}$ " (343 x 248 x 173mm)
	<b>overall size:</b>	18" x 12" x 14 $\frac{1}{4}$ " (457 x 305 x 362mm)
	<b>weight:</b>	13 lbs. (5.9 kg)
	<b>cubic feet:</b>	2.8
<b>includes:</b> 12" (305mm) side-to-side, faucet, basket drain, and side splashes.		

<b>HSA-10-FTWS-LRS</b>		<b>list: 1404</b>
	<b>bowl size:</b>	9 $\frac{3}{4}$ " x 13 $\frac{1}{2}$ " x 6 $\frac{3}{4}$ " (248 x 343 x 173mm)
	<b>overall size:</b>	14 $\frac{3}{4}$ " x 18 $\frac{1}{8}$ " x 12 $\frac{3}{4}$ " (376 x 480 x 324mm)
	<b>weight:</b>	21 lbs. (9.5 kg)
	<b>cubic feet:</b>	3.5
<b>includes:</b> Faucet, tubular wall brackets, basket drain, and side splashes.		

<b>HSA-10-FDPE-LRS</b>		<b>list: 3578</b>
	<b>bowl size:</b>	9 $\frac{3}{4}$ " x 13 $\frac{1}{2}$ " x 6 $\frac{3}{4}$ " (248 x 343 x 173mm)
	<b>overall size:</b>	14 $\frac{3}{4}$ " x 19 $\frac{1}{4}$ " x 28 $\frac{1}{4}$ " (376 x 489 x 718mm)
	<b>weight:</b>	31 lbs. (14.1 kg)
	<b>cubic feet:</b>	2.8
<b>includes:</b> Spout with electronic eye, towel dispenser, soap dispenser, basket drain, and side splashes.		

## Miscellaneous Hand Sinks NSF

see spec sheet **EG20.31**

**Freight class is 85.0.**

(•) MTS (made to stock) / ( ) MTO (made to order)

### MICROGARD®

an antimicrobial agent which contains built-in protection to retard the growth of a broad range of bacteria, mold and mildew that causes stains, odors and degradation.

<b>HSA-10-FAW •</b>		<b>list: 805</b>
	<b>bowl size:</b>	9 $\frac{3}{4}$ " x 13 $\frac{1}{2}$ " x 6 $\frac{3}{4}$ " (248 x 343 x 173mm)
	<b>overall size:</b>	14 $\frac{3}{4}$ " x 18 $\frac{1}{8}$ " x 12 $\frac{3}{4}$ " (376 x 480 x 324mm)
	<b>weight:</b>	14 lbs. (6.4 kg)
	<b>cubic feet:</b>	2.8
<b>MICROGARD® available:</b> Faucet with wrist handles, P-trap, tail piece, basket drain.		
To order, add suffix "-MG" to model # / add \$116 to list price.		

<b>HSA-10-FTWS</b>		<b>list: 945</b>
	<b>bowl size:</b>	9 $\frac{3}{4}$ " x 13 $\frac{1}{2}$ " x 6 $\frac{3}{4}$ " (248 x 343 x 173mm)
	<b>overall size:</b>	14 $\frac{3}{4}$ " x 18 $\frac{1}{8}$ " x 12 $\frac{3}{4}$ " (376 x 480 x 324mm)
	<b>weight:</b>	20 lbs. (9.0 kg)
	<b>cubic feet:</b>	3.0
<b>MICROGARD® available:</b> Faucet, tubular wall brackets, basket drain.		
To order, add suffix "-MG" to model # / add \$116 to list price.		

## Catalog Section 20

### Space-Saver Series Hand Sinks

see spec sheets **EG20.05** **EG20.43**

#### MICROGARD®

an antimicrobial agent which contains built-in protection to retard the growth of a broad range of bacteria, mold and mildew that causes stains, odors and degradation.

FEATURES: • Standard with faucet and basket drain.

**Freight class is 85.0.**

(•) MTS (made to stock) / ( ) MTO (made to order)

HSAN-10-F•		list:	712
	<b>bowl size:</b>	13½" x 9¼" x 6¼" (343 x 248 x 171mm)	
	<b>overall size:</b>	18" x 12" x 14¼" (457 x 305 x 362mm)	
	<b>weight:</b>	12 lbs. (5.2 kg)	
	<b>cubic feet:</b>	2.8	
<p><i>Only 12" (305mm) side-to-side to maximum space efficiency.</i></p> <p><b>MICROGARD® available:</b> To order, add suffix "-MG" to model # / add \$116 to list price.</p>		<b>includes:</b>	Splash mount faucet, basket drain.

HSAND-10-F•		list:	594
	<b>bowl size:</b>	13½" x 9¼" x 6¼" (343 x 248 x 171mm)	
	<b>overall size:</b>	19⅞" x 12" x 14¼" (498 x 305 x 362mm)	
	<b>weight:</b>	12 lbs. (5.2 kg)	
	<b>cubic feet:</b>	2.8	
<p><i>Only 12" (305mm) side-to-side to maximum space efficiency.</i></p>		<b>includes:</b>	Deck mount faucet, basket drain.

HSANT-FS		list:	841
	<b>bowl size:</b>	13½" x 9¼" x 6¼" (343 x 248 x 171mm)	
	<b>overall size:</b>	18" x 12" x 26½" (457 x 305 x 673mm)	
	<b>weight:</b>	26 lbs. (11.8 kg)	
	<b>cubic feet:</b>	6.5	
<p><i>19½" (495mm) backsplash and skirt</i></p>		<b>includes:</b>	Faucet, 19½" (495mm) high backsplash, basket drain.

HSAN-10-F-DS*		list:	909
	<b>bowl size:</b>	13½" x 9¼" x 6¼" (343 x 248 x 165mm)	
	<b>overall size:</b>	17⅞" x 12" x 14¼" (457 x 308 x 362mm)	
	<b>weight:</b>	12 lbs., 5.2 kg	
	<b>cubic feet:</b>	2.8	
		<b>includes:</b>	Faucet, deck-mount soap dispenser, basket drain.

\* Overall height does not include soap dispenser globe.

### Stainless Steel Cleaner & Polish

- Cleans and polishes in one step.
- Does not streak or leave fingerprints.
- Leaves a protective invisible coating.

weight		model #	list
oz.	kg		
15	0.4	004026	18

### EAGLE introduces...

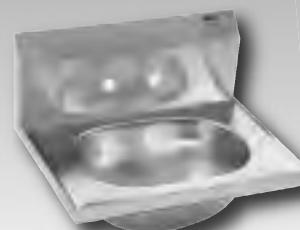

#### ELECTROPOLISHED FINISH

(Consult factory for applicable models and availability)

- Increased resistance to corrosion.
- Improved surface finish.
- Deburring.
- Reduced product adhesion.
- Ease of cleaning.
- Attractive appearance.

To order, add suffix "-EP"  
(Example: HSA-10-F-EP).  
Add \$140 to list price of hand sink, except for pedestal sinks (add \$200).



100 Industrial Boulevard, Clayton, DE 19938-8903 U.S.A.  
Phone: 800-637-5100 or 302-653-3000. Fax: 302-653-2065  
<http://www.eaglegrp.com>

## Special Purpose Hand Sinks

see spec sheets **EG20.20** **EG20.36** **EG20.37** **EG20.48**

### Hand Sink with Deck Mount Faucet

<b>HSAD-10-F •</b>		<b>list: 553</b>
	<b>bowl size:</b>	9¼" x 13½" x 6¾" (249 x 343 x 171mm)
	<b>overall size:</b>	16½" x 18¾" x 12¼" (419 x 479 x 324mm)
	<b>weight:</b>	14 lbs. (6.4 kg)
	<b>cubic feet:</b>	3.0
	<b>includes:</b>	Faucet and basket drain.

### Economical Hand Sink

- Faucet is deck mounted gooseneck.

<b>HSAE-10-FA •</b>		<b>list: 666</b>
	<b>bowl size:</b>	10" x 14" x 5" (254 x 356 x 127mm)
	<b>overall size:</b>	15" x 16¾" x 9" (381 x 425 x 229mm)
	<b>weight:</b>	10 lbs. (4.5 kg)
	<b>cubic feet:</b>	3.0
	<b>includes:</b>	Faucet, p-trap, tail piece, basket drain, wall brackets, 4" (102mm) high backsplash.

### Hand Sink with 8" (203mm) Centerline Faucet Holes

- Accommodates splash-mount faucet with 8" (203mm) centerline.

<b>HSA-10-8</b>		<b>list: 496</b>
	<b>bowl size:</b>	9¼" x 13½" x 6¾" (248 x 343 x 173mm)
	<b>overall size:</b>	14¾" x 18¾" x 12¼" (376 x 480 x 324mm)
	<b>weight:</b>	10 lbs. (4.5 kg)
	<b>cubic feet:</b>	3.0
	<b>includes:</b>	8" (203mm) centerline faucet holes (no faucet), basket drain
<b>MICROGARD® available:</b> To order, add suffix "-MG" to model # / add \$116 to list price.		

- FEATURES:** • Standard with faucet and basket drain.

**Freight class is 85.0.**

(•) MTS (made to stock) / ( ) MTO (made to order)

**Designed for unique applications!**

### MICROGARD®

an antimicrobial agent which contains built-in protection to retard the growth of a broad range of bacteria, mold and mildew that causes stains, odors and degradation.

### Hand Sink with Waste Receptacle-Patent protected

- U.S. Patent #5,732,422.
- Faucet is splash mounted gooseneck.

<b>HSA-10-FDP-T</b>		<b>list: 1837</b>
	<b>bowl size:</b>	9¼" x 13½" x 6¾" (248 x 343 x 173mm)
	<b>overall size:</b>	14¾" x 19¼" x 44¾" (376 x 480 x 1133mm)
	<b>weight:</b>	29 lbs. (13.2 kg)
	<b>cubic feet:</b>	6.2
	<b>includes:</b>	Faucet, basket drain, 12-oz soap dispenser, towel dispenser, waste skirt, and waste receptacle.
<b>MICROGARD® available:</b> To order, add suffix "-MG" to model # / add \$116 to list price.		

### Hand Sink with 8" (203mm) Centerline Faucet

- Faucet is splash mounted gooseneck.

<b>HSA-10-8F</b>		<b>list: 637</b>
	<b>bowl size:</b>	9¼" x 13½" x 6¾" (248 x 343 x 173mm)
	<b>overall size:</b>	14¾" x 18¾" x 12¼" (376 x 480 x 324mm)
	<b>weight:</b>	12 lbs. (5.2 kg)
	<b>cubic feet:</b>	3.0
	<b>includes:</b>	Faucet on 8" (203mm) center, basket drain.
<b>MICROGARD® available:</b> To order, add suffix "-MG" to model # / add \$116 to list price.		

## Catalog Section 20

### Hand Sink Accessories -Faucets & Valves

see spec sheet **EG20.52A**

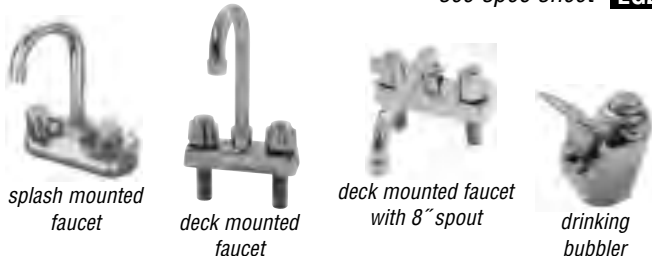

#### Standard Faucets

- With 4" (102mm) center, except #313075.

description	model #	list
splash mounted, gooseneck spout	<b>303987</b>	166
wrist handles for faucet #303987	<b>307120</b>	104
splash mounted with wrist handles, gooseneck spout	<b>306495</b>	344
deck mounted, gooseneck spout, 1/4-turn handles	<b>302004</b>	182
deck mounted, 8" (203mm) spout, 1/4-turn handles	<b>301248</b>	164
drinking bubbler	<b>318495</b>	580
splash mounted, gooseneck spout, 8" (203mm) center	<b>313075</b>	161

#### Repair Kit for Standard Faucets

- For faucets #303987, 302004, and 301248 only.

description	model #	list
hot/cold ceramic cartridge	<b>368421</b>	29

#### Faucet-Mount Emergency Eyewash Units

- Fits in place of standard aerator on spout.

description	model #	list
pull valve activation, includes two dust covers, chrome finish	<b>326272</b>	471
rotate to activate, polished stainless finish, "eye-pod" design	<b>377563</b>	941

**IMPORTANT NOTE:** If anti-scald valve (see below) is needed, order #373848 only.

#### Anti-Scald Valve for Faucet-Mount Emergency Eyewash Units

- This is the only anti-scald valve to be used with faucet-mount emergency eyewash units (above).
- Meets ANSI Z358.1 and ASSE 1071 standards.

description	model #	list
1/2" (13mm) NPT, 65 - 95°F	<b>373848</b>	2125

#### FEATURES:

- All faucets below feature 4" (102mm) centers, except where noted.

**Note:** Faucets listed are lead-free AB1953-compliant.

**Can be shipped UPS.**

#### Battery-Powered Electronic-Eye Faucets

- Used as a replacement to sinks on page 185 (by adding suffix "-B"), or as a replacement faucet for sinks on page 186 via the model number below.



description	model #	list
Splash mount. Comes with four "AA" batteries and built-in low-battery indicator	<b>326014</b>	1566
Upgrade: T&S electric-eye faucet, splash-mtd with batteries and AC adapter for dual operation. With AC adapter plugged in, faucet automatically switches to AC power to conserve batteries.	<b>356128</b>	1676

#### Short 90° for Splash Mount Faucets

description	model #	list
set of two, 1/2" NPT female x male	<b>376740</b>	55

#### Spouts/Spout Assemblies

description	model #	list
splash-mount replacement gooseneck for knee/foot valve-operated models	<b>312162</b>	335

#### Shut-Off Valve

- Antibacterial surface.
- Screws onto faucet aerator.
- Polished chrome finish.

description	model #	list
shut-off push bar	<b>349921</b>	69

#### Anti-Scald Valve

- Automatic shutdown with either hot or cold water failure.
- ASSE 1016 and 1017 listed.

**IMPORTANT: Not for use with Faucet-Mount Emergency Eyewash Units.**

description	model #	list
1/2" (13mm) NPT, 100 - 145°F	<b>326696</b>	626



**Hand Sink Accessories - Valves**

see spec sheet **EG20.52A**

**Can be shipped UPS.**

(\*) MTS (made to stock) / ( ) MTO (made to order)

**Temperature Adjustment Valve ("Mixing Valve")**

- For hand sinks with AC-powered electronic faucet or hand sinks with single pedal valves.
- Cast brass body.
- 3/8" (10mm) all connections.



description	model #	list
built-in check valves to prevent backflow and adjustment screw valves to mix hot and cold	<b>326015</b>	108

**Non-Adjustable Y-Inlet Mixing Valve**

- For electronic hand sinks and hand sinks with single pedal valves only.
- "Y" shaped single-piece component. Chrome-plated brass body.



description	model #	list
Male connections; threads are 3/8"-24 UNEF	<b>342938</b>	32

**Tempering Valve**

- Maximum output of 120°F.
- Maximum pressure of 150 psi.
- ASSE 1016 and 1070 listed.



description	model #	list
thermoplastic body, 3/8" (10mm) male compression fittings, 80°F-120°F, 0.5-2.5 gpm, built-in check valve	<b>375612</b>	338



single foot pedal valve



double foot pedal valve



knee pedal valve

**Pedal Valves**

description	DOUBLE PEDALS		SINGLE PEDALS	
	model #	list	model #	list
foot pedal valve, floor mount	<b>300604</b>	373	<b>355994</b>	373
knee pedal valve	<b>313481</b>	499	<b>351738</b>	499

Replacement Cartridge for all Pedal Valves: **Model # 374955. List: \$35**

**Hand Sink Accessories - Miscellaneous**

see spec sheet **EG20.52B**

**Can be shipped UPS.**

(\*) MTS (made to stock) / ( ) MTO (made to order)



#318496 towel dispenser



#DP-10 towel dispenser



#377454 towel dispenser

**Towel/Soap Dispensers**

description	model #	list
type 304 with conventional soap dispenser	<b>DP-10 *●</b>	820
type 304 stainless, with electric eye soap dispenser	<b>DP-20 *</b>	1705
type 304 stainless, wall mounted	<b>318496</b>	286
break-resistant plastic, touchless, wall mounted	<b>377454</b>	204

\* Fits all HSA hand sinks except Space Saver models.

**Hand Sanitizing Dispenser**

description	model #	list
Purell/LTX, wall mounted	<b>377455</b>	262



hand sanitizing dispenser

**Plumbing**

description	model #	list
tail piece, nickel-plated	<b>300791</b>	16
P-trap, nickel-plated	<b>300789</b>	91



tail piece



P-trap



conventional soap dispenser



soap dispenser with electric eye



deck mount soap dispenser

**Soap Dispensers**

description	model #	list
soap dispenser, conventional, 12-oz	<b>300602</b>	31
soap dispenser, wall mounted with electric eye	<b>377456</b>	262
soap dispenser, deck-mount, 16-oz	<b>324074</b>	120

nail brush

nail brush holder

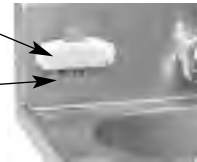

**Nail Brush and Nail Brush Holder**

- To order nail brush and nail brush holder, add suffix "-NB" to hand sink model number. **Example: HSA-10-F-NB .**

description	model #	list each
infectious-control nail brush made of FDA-approved material, splash-mount stainless steel nail brush holder	add suffix "-NB"	111

## Catalog Section 20

### Hand Sink Accessories - Miscellaneous

see spec sheet **EG20.52B**

Can be shipped UPS.

(•) MTS (made to stock) / ( ) MTO (made to order)

#### Waste Receptacle

- U.S. Patent #5,732,422.
- 20 gauge stainless steel.
- Removable.
- Comes with skirt.
- Must be factory installed.

**Note:** To order, add suffix “-T” to hand sink model number.

**Example:** HSA-10-F-T.

**PATENTED DESIGN**



HSA-10-FDP-T  
hand sink with waste receptacle

for models:	model #	list
HSA-10; HSA-10-F; HSA-10-FA; HSA-10-FDP; HSA-10-FE; HSA-10-FDPE; HSA-10-FDPEE; and HSA-10-FW	add suffix “-T”	620

#### Electropolished Finish

(Consult factory for applicable models and availability.)

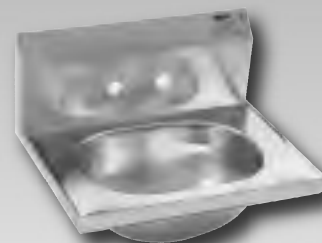

- Increased resistance to corrosion.
- Improved surface finish.
- Deburring.
- Reduced product adhesion.
- Ease of cleaning.
- Attractive appearance.

**To order, add suffix “-EP”**

(Example: HSA-10-F-EP)

**Add \$140 to list price of hand sink, except pedestal sinks (add \$200).**

#### End Splashes...

- Type 304 stainless steel.

**Note:** Will not work with Space Saver Hand Sinks (page 191) that have faucets with wrist handles.

#### ...Factory-installed

**Notes:** To order, add suffix “-LS” (left end splash), “-RS” (right end splash), or “-LRS” (both end splashes). **Example:** HSA-10-F-LRS.

MICROGARD® cannot be put on hand sinks with end splashes.



hand sink with optional end splashes

descriptions	model #	list
left end splash only	add suffix “-LS”	231
right end splash only	add suffix “-RS”	231
left and right end splash	add suffix “-LRS”	459

#### ...for Field-installation

descriptions	model #	list each
one self-adhesive side splash, can be used for right or left application	HSA-SSK •	146
same as above, but fits only on Physically Challenged sinks (page 189)	HSAP-SSK	178



pair of end splashes for field installation



polymer lever drain

#### Wall Brackets

- 14 gauge type 304 stainless steel.

descriptions	model #	list
side mounting, one pair, does not fit Space Saver models	606396 •	215



wall bracket

#### Skirt Assembly

- Type 304 stainless steel.

fits models:	model #	list
HSA-10; HSA-10-F; HSA-10-FA; HSA-10-FDP; HSA-10-FE; HSA-10-FDPE; HSA-10-FDPEE; and HSA-10-FW.	606215 •	484
HSAN-10-F	607560	343



#### Drains

description	maximum flow rate		model #	list
	gallons per minute	gallons per hour		
polymer lever drain fits 3½" (89mm) diameter holes	11	660	319931	78
overflow assembly for lever drain #319931 (above)	-	-	319932	36
1½" (38mm) drain assembly, fits 2" (51mm) dia. hole	12	720	300886	13
mini crumb cup for 1½" (38mm) drain	-	-	300966	5
s/s basket drain assembly fits 3½" (89mm) diameter holes w/crumb cups	18	1080	300287	21
cast metal lever drain with overflow assembly, with 7¼" (185mm) long lever, fits 3½" (89mm) diameter holes	-	-	347771	220





## Hot Water Heater

see spec sheet **EG20.52B**



**with TANKLESS WATER HEATER**

**99% EFFICIENT!**  
**Flow switch activates heater only on demand—no standby heat loss.**

**No temperature/pressure relief valve needed (check local codes), reducing installation cost.**

applicable hand sinks include:	add suffix #	list each
HSA-10; HSA-10-F; HSA-10-FA; HSA-10-FDP; HSA-10-FE; HSA-10-FDPE; HSA-10-FDPEE; HSA-10-FW; HSA-10-FA-P; and HSAD-10-F.	“-WH”	2284

**FEATURES:**

- For EAGLE hand sinks with 10" x 14" (254 x 356mm) rounded bowl.
- Stainless steel pedestal base features notches for electrical wiring and front access panel.
- Unit comes equipped with an energy-saving tankless water heater. 120V 29A electricity. 0.5 GPM. 150 PSI maximum operating pressure (minimum 25 PSI).
- Water is heated instantaneously when faucet is on.
- To order, add suffix “-WH” to model number and **add \$2284 to list price** of hand sink.  
**Example: HSA-10-FDPEE-WH**

**Note:** Must be field-wired.

**Freight class is 70.0.**

(•) MTS (made to stock) / ( ) MTO (made to order)

## Lavatory Sinks

see spec sheet **EG20.12**

### Replacements for Lavatory Sinks

description	to fit process sink model #	model #	list
splash mount spout	P1916, P1916FE, W1916	<b>300600</b>	188
drain assembly	P1916, P1916FE, W1916,	<b>300287</b>	21
temperature adjustment valve, or “mixing valve”	P1916FE	<b>326015</b>	108

**FEATURES:**

- A marine edge.
- Type 304 stainless steel sink bowl.
- Gooseneck spout.
- Soap dispenser.
- Basket drain.
- Wall mount and pedestal models available.

**Freight class is 85.0.**

(•) MTS (made to stock) / ( ) MTO (made to order)

<b>W1916-FA •</b>		<b>list: 1469</b>
	<b>bowl size:</b>	15 $\frac{3}{4}$ " x 19 $\frac{3}{4}$ " x 8 $\frac{7}{8}$ " (400 x 500 x 225mm)
	<b>overall size:</b>	23" x 24 $\frac{5}{16}$ " (584 x 618mm)
	<b>shipping wt:</b>	35 lbs., 15.9 kg
	<b>cubic feet:</b>	1.6
<b>includes:</b> Gooseneck faucet, soap dispenser, basket drain.		
<i>wall mounted</i>		

<b>P1916 •</b>		<b>list: 2477</b>
	<b>bowl size:</b>	15 $\frac{3}{4}$ " x 19 $\frac{3}{4}$ " x 8 $\frac{7}{8}$ " (400 x 500 x 225mm)
	<b>overall size:</b>	23" x 24 $\frac{5}{16}$ " (571 x 618mm)
	<b>shipping wt:</b>	48 lbs., 21.8 kg
	<b>cubic feet:</b>	1.6
<b>includes:</b> Gooseneck spout, soap dispenser, pedestal with foot valves, basket drain.		
<i>pedestal mounted, foot pedal valve</i>		

<b>W1916</b>		<b>list: 2814</b>
	<b>bowl size:</b>	15 $\frac{3}{4}$ " x 19 $\frac{3}{4}$ " x 8 $\frac{7}{8}$ " (400 x 500 x 225mm)
	<b>overall size:</b>	23" x 24 $\frac{5}{16}$ " (571 x 618mm)
	<b>shipping wt:</b>	43 lbs., 19.5 kg
	<b>cubic feet:</b>	1.6
<b>includes:</b> Gooseneck spout, soap dispenser, knee valves, basket drain.		
<i>wall mounted, knee valve operation</i>		

<b>P1916FE</b>		<b>list: 3317</b>
	<b>bowl size:</b>	15 $\frac{3}{4}$ " x 19 $\frac{3}{4}$ " x 8 $\frac{7}{8}$ " (400 x 500 x 225mm)
	<b>overall size:</b>	23" x 24 $\frac{5}{16}$ " (571 x 618mm)
	<b>shipping wt:</b>	48 lbs., 21.8 kg
	<b>cubic feet:</b>	1.6
<b>includes:</b> Gooseneck spout with electronic-eye operation, soap dispenser, pedestal, basket drain.		
<i>pedestal mounted, electronic-eye operation</i>		



*Euro-style edging on front and sides.*

### Sink Kits for 314, 412, and 414 Series Sinks

see spec sheet **EG20.51A**

#### Standard Sink Kit components:

- Stainless steel gussets
- Stainless steel crossbraced legs
- Stainless steel feet
- T&S faucet #313293

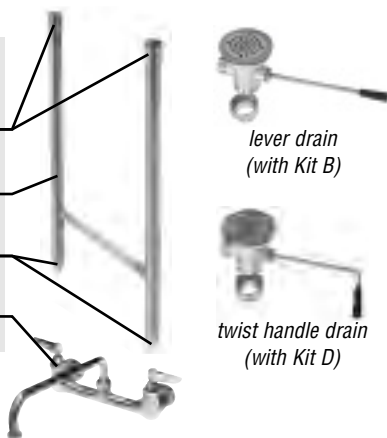

#### Kit A

Add suffix “-CLF” to sink model number.

description	add to list price
1 faucet	1203
2 faucets	1804

#### Kit B

Standard sink kit components plus lever drain. Add suffix “-CLFD” to sink model number.

description	add to list price
1 faucet	1203
2 faucets	1804
per lever drain	232

#### Kit C

Standard sink kit components plus lever drain with overflow. Add suffix “-CLFDO” to sink model number.

description	add to list price
1 faucet	1203
2 faucets	1804
per lever drain with overflow	476

#### Kit D

Standard sink kit components plus twist handle drain and twist handle bracket. Add suffix “-CLFDT” to sink model number.

description	add to list price
1 faucet	1203
2 faucets	1804
per twist handle drain	244

#### Kit E

Standard sink kit components plus twist handle drain with overflow and twist handle bracket. Add suffix “-CLFDOT” to sink model number.

description	add to list price
1 faucet	1203
2 faucets	1804
per twist handle drain with overflow	553

### 412, 414, and 314 Series Sinks Deep Drawn Construction

- Deep drawn seamless covered corner sink bowls of all units have a generous radius and are rectangular for maximum capacity.
- Legs are galvanized, 1½” (41mm) diameter.
- Crossbraced front-to-back with 1” (25mm) diameter galvanized tubing.
- Leg gussets are welded to a die-cut heavy-gauge reinforcing plate, and welded adjacent to sink bowl for maximum stability and support.
- 9½” (241mm) standard backsplash includes 1” (25mm) upturn and tile edge for easy installation and feathering to wall/splash surface.
- Basket-type waste drains are included to fit sink bowl's 3½” (89mm) opening and feature 1½” (38mm) outlet.
- 30” and 36” (762 and 914mm) drainboards available upon request.

**Note:** Stainless steel legs with front-to-back crossbracing available (does not include stainless steel feet).

To order, add \$359 to list price and suffix “-SL” to model number (example: 414-16-1-SL).

To order stainless steel legs and gussets, add \$498 to list price and suffix “-SLG” to model number (example: 414-16-1-SLG).

**Adjustable front-to-back crossbracing available.**

Add suffix “-ACB” to model number, and add \$168 to list price. Example: 414-16-1-ACB

**Left-to-right crossbracing available.**

For galvanized, add 5% to list price and suffix “-CBG” to model number.

For stainless steel (does not include stainless steel legs), add 10% to list price and suffix “-CBS” to model number (example: 414-16-1-CBS).

**Twist drain brackets available.**

Works in conjunction with optional twist handle drains (not included – see page 219). To order, add \$29 per compartment to list price and suffix “-TB” to model number. Example: 414-16-1-TB.

For overflow hole (does not include drain), add \$43 per compartment to list price and suffix “-OF” to model number (example: 414-16-1-OF).

Sink accessories, see pages 217-220.

All shipping weights and cubic feet are approximate.

**ALL SINKS SHIPPED FULLY CRATED.**

**Freight class is 150.0.**



## 412, 414, and 314 Series Sinks One-Compartment Sinks

see spec sheets **EG20.03** **EG20.23** **EG20.27**



one-compartment sink with double drainboards

one-compartment sink with one drainboard

- 412 SERIES:
  - All heavy gauge type 430 construction.
  - 10½" (267mm) deep sink bowl.
  - 44" (1118mm) overall height.
- 414 SERIES:
  - 14" (356mm) deep heavy gauge type 304 sink bowl with type 430 drainboards, and backsplash.
  - 44" (1118mm) overall height.
- 314 SERIES:
  - All heavy gauge type 304 construction.
  - 14" (356mm) deep sink bowl.
  - 44" (1118mm) overall height.

**Freight class is 150.0.**

(•) MTS (made to stock) / ( ) MTO (made to order)

					<b>GOOD</b>	<b>BETTER</b>	<b>BEST</b>							
					412 Series	414 Series	314 Series							
					- see spec sheet - <b>EG20.03</b>	- see spec sheet - <b>EG20.23</b>	- see spec sheet - <b>EG20.27</b>							
bowl size width x length		drainboard length		weight	cu	overall size width x length		model #	list	model #	list	model #	list	
in.	mm	in.	mm	lbs.	kg	ft	in.	mm				in.	mm	
20" x 16"	508 x 406	-	-	40	18.1	10.5	27½" x 23¼"	699 x 591	412-16-1•	1673	414-16-1•	1924	314-16-1•	2176
24" x 18"	610 x 457	-	-	45	20.4	10.0	31¼" x 25½"	807 x 648	n/a	n/a	414-18-1•	2253	314-18-1	2519
22" x 22"	559 x 559	-	-	55	24.9	14.5	29¾" x 29¾"	756 x 749	n/a	n/a	414-22-1•	2395	314-22-1	2533
24" x 24"	610 x 610	-	-	60	27.2	16.5	31¼" x 31¼"	807 x 800	412-24-1•	2236	414-24-1•	2429	314-24-1	2705

					<b>GOOD</b>	<b>BETTER</b>	<b>BEST</b>							
					412 Series	414 Series	314 Series							
					- see spec sheet - <b>EG20.03</b>	- see spec sheet - <b>EG20.23</b>	- see spec sheet - <b>EG20.27</b>							
bowl size width x length		drainboard length		weight	cu	overall size width x length		model #	list	model #	list	model #	list	
in.	mm	in.	mm	lbs.	kg	ft	in.	mm				in.	mm	
20" x 16"	508 x 406	18"	457	59	26.8	18.1	27½" x 38¾"	699 x 987	412-16-1-18R or L	2347	414-16-1-18R or L	2636	314-16-1-18R or L	2922
		24"	610	65	29.5	19.5	27½" x 44¾"	699 x 1140	412-16-1-24R or L	2366	414-16-1-24R or L	2668	314-16-1-24R or L	2958
24" x 18"	610 x 457	18"	457	64	29.0	22.0	31¼" x 40¾"	807 x 1035	n/a	n/a	414-18-1-18R or L	2901	314-18-1-18R or L	3191
		24"	610	70	31.8	22.9	31¼" x 46¾"	807 x 1188	n/a	n/a	414-18-1-24R or L	2922	314-18-1-24R or L	3213
22" x 22"	559 x 559	18"	457	74	33.6	23.0	29¾" x 45"	756 x 1143	n/a	n/a	414-22-1-18R or L	3169	314-22-1-18R or L	3284
		24"	610	80	36.3	26.0	29¾" x 51"	756 x 1295	n/a	n/a	414-22-1-24R or L	3190	314-22-1-24R or L	3306
24" x 24"	610 x 610	18"	457	79	35.8	25.0	31¼" x 46¾"	807 x 1188	412-24-1-18R or L	3177	414-24-1-18R or L	3501	314-24-1-18R or L	3811
		24"	610	85	38.6	28.6	31¼" x 52¾"	787 x 1340	412-24-1-24R or L	3241	414-24-1-24R or L	3538	314-24-1-24R or L	3866

					<b>GOOD</b>	<b>BETTER</b>	<b>BEST</b>							
					412 Series	414 Series	314 Series							
					- see spec sheet - <b>EG20.03</b>	- see spec sheet - <b>EG20.23</b>	- see spec sheet - <b>EG20.27</b>							
bowl size width x length		drainboard length		weight	cu	overall size width x length		model #	list	model #	list	model #	list	
in.	mm	in.	mm	lbs.	kg	ft	in.	mm				in.	mm	
20" x 16"	508 x 406	18"	457	78	35.4	25.7	27½" x 54¾"	699 x 1384	412-16-1-18 •	2489	414-16-1-18	2760	314-16-1-18	3054
		24"	610	90	40.8	30.8	27½" x 66¾"	699 x 1689	412-16-1-24	2496	414-16-1-24	2849	314-16-1-24	3146
24" x 18"	610 x 457	18"	457	83	37.6	29.6	31¼" x 56"	807 x 1422	n/a	n/a	414-18-1-18	3153	314-18-1-18	3464
		24"	610	95	43.1	38.1	31¼" x 68"	807 x 1727	n/a	n/a	414-18-1-24	3182	314-18-1-24	3494
22" x 22"	559 x 559	18"	457	93	42.2	30.3	29¾" x 60¾"	756 x 1537	n/a	n/a	414-22-1-18	3452	314-22-1-18	3573
		24"	610	105	47.6	37.1	29¾" x 72¾"	756 x 1842	n/a	n/a	414-22-1-24	3481	314-22-1-24	3602
24" x 24"	610 x 610	18"	457	98	44.5	32.5	31¼" x 62"	807 x 1575	412-24-1-18	3383	414-24-1-18	3644	314-24-1-18	3899
		24"	610	110	49.9	40.6	31¼" x 74"	807 x 1880	412-24-1-24	3452	414-24-1-24	3699	314-24-1-24	4038

## Catalog Section 20

### 412, 414, and 314 Series Sinks Two-Compartment Sinks

see spec sheets **EG20.03** **EG20.24** **EG20.28**

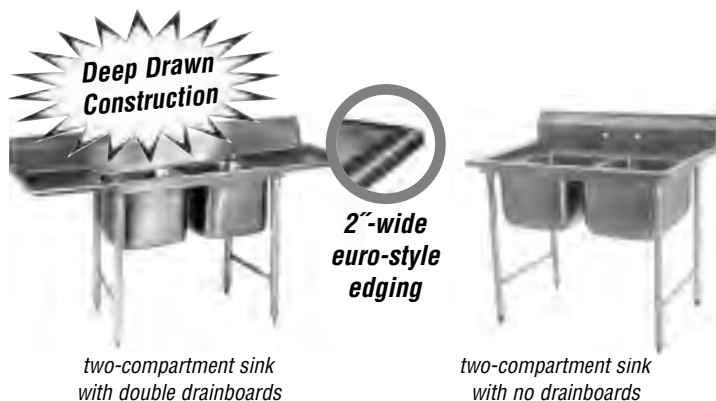

two-compartment sink  
with double drainboards

two-compartment sink  
with no drainboards

- All heavy gauge type 430 construction.
- 10½" (267mm) deep sink bowls.
- 44" (1118mm) overall height.

412 SERIES:

- 14" (356mm) deep heavy gauge type 304 sink bowls with type 430 drainboards, and backsplash.
- 44" (1118mm) overall height.

414 SERIES:

- All heavy gauge type 304 construction.
- 14" (356mm) deep sink bowls.
- 44" (1118mm) overall height.

314 SERIES:

**Freight class is 150.0.**

(•) MTS (made to stock) / ( ) MTO (made to order)

#### Two Compartments, No Drainboards

bowl size width x length in. mm		drainboard length in. mm		weight lbs. kg		cu ft	overall size width x length in. mm		GOOD 412 Series - see spec sheet - <b>EG20.03</b> model # list		BETTER 414 Series - see spec sheet - <b>EG20.24</b> model # list		BEST 314 Series - see spec sheet - <b>EG20.28</b> model # list	
20" x 16"	508 x 406	-	-	64	29.0	18.1	27½" x 41"	699 x 1041	<b>412-16-2</b> •	2288	<b>414-16-2</b> •	2635	<b>314-16-2</b> •	2921
24" x 18"	610 x 457	-	-	75	33.8	24.0	31¼" x 45½"	807 x 1156	n/a	n/a	<b>414-18-2</b> •	3032	<b>314-18-2</b>	3502
22" x 22"	559 x 559	-	-	80	36.3	25.8	29¾" x 53½"	756 x 1359	n/a	n/a	<b>414-22-2</b>	3308	<b>314-22-2</b>	3607
24" x 24"	610 x 610	-	-	90	40.8	29.6	31¼" x 57½"	807 x 1461	<b>412-24-2</b>	3365	<b>414-24-2</b> •	3656	<b>314-24-2</b> •	4154

#### Two Compartments, One Drainboard (right or left)

bowl size width x length in. mm		drainboard length in. mm		weight lbs. kg		cu ft	overall size width x length in. mm		GOOD 412 Series - see spec sheet - <b>EG20.03</b> model # list		BETTER 414 Series - see spec sheet - <b>EG20.24</b> model # list		BEST 314 Series - see spec sheet - <b>EG20.28</b> model # list	
20" x 16"	508 x 406	18"	457	83	37.6	25.7	27½" x 56½"	699 x 1438	<b>412-16-2-18R or L</b> •	3034	<b>414-16-2-18R or L</b> •	3486	<b>314-16-2-18R or L</b>	3814
		24"	610	89	40.4	28.3	27½" x 62½"	699 x 1591	<b>412-16-2-24R or L</b>	3064	<b>414-16-2-24R or L</b> •	3540	<b>314-16-2-24R or L</b>	4032
24" x 18"	610 x 457	18"	457	94	42.6	33.0	31¼" x 60¾"	807 x 1543	n/a	n/a	<b>414-18-2-18R or L</b>	4072	<b>314-18-2-18R or L</b>	4588
		24"	610	100	45.4	35.0	31¼" x 66¾"	807 x 1696	n/a	n/a	<b>414-18-2-24R or L</b>	4097	<b>314-18-2-24R or L</b>	4615
22" x 22"	559 x 559	18"	457	99	44.9	34.0	29¾" x 69"	756 x 1753	n/a	n/a	<b>414-22-2-18R or L</b>	4532	<b>314-22-2-18R or L</b>	4812
		24"	610	105	47.6	37.1	29¾" x 75"	756 x 1905	n/a	n/a	<b>414-22-2-24R or L</b>	4557	<b>314-22-2-24R or L</b>	4837
24" x 24"	610 x 610	18"	457	109	49.4	38.0	31¼" x 72¾"	807 x 1847	<b>412-24-2-18R or L</b>	4515	<b>414-24-2-18R or L</b>	4918	<b>314-24-2-18R or L</b>	5344
		24"	610	115	52.2	41.6	31¼" x 78¾"	807 x 2000	<b>412-24-2-24R or L</b>	4606	<b>414-24-2-24R or L</b> •	5025	<b>314-24-2-24R or L</b>	5700

#### Two Compartments, Double Drainboards

bowl size width x length in. mm		drainboard length in. mm		weight lbs. kg		cu ft	overall size width x length in. mm		GOOD 412 Series - see spec sheet - <b>EG20.03</b> model # list		BETTER 414 Series - see spec sheet - <b>EG20.24</b> model # list		BEST 314 Series - see spec sheet - <b>EG20.28</b> model # list	
20" x 16"	508 x 406	18"	457	102	46.3	32.8	27½" x 72¾"	699 x 1848	<b>412-16-2-18</b> •	3134	<b>414-16-2-18</b> •	3622	<b>314-16-2-18</b>	4117
		24"	610	114	51.7	38.5	27½" x 84¾"	660 x 2140	<b>412-16-2-24</b>	3183	<b>414-16-2-24</b> •	3688	<b>314-16-2-24</b>	4186
24" x 18"	610 x 457	18"	457	113	51.3	43.8	31¼" x 76"	807 x 1930	n/a	n/a	<b>414-18-2-18</b>	4194	<b>314-18-2-18</b>	4717
		24"	610	125	56.7	48.7	31¼" x 88"	807 x 2235	n/a	n/a	<b>414-18-2-24</b>	4240	<b>314-18-2-24</b>	4766
22" x 22"	559 x 559	18"	457	118	53.5	42.0	29¾" x 84¾"	756 x 2146	n/a	n/a	<b>414-22-2-18</b>	4675	<b>314-22-2-18</b>	4955
		24"	610	130	59.0	48.5	29¾" x 96½"	756 x 2451	n/a	n/a	<b>414-22-2-24</b>	4729	<b>314-22-2-24</b>	5007
24" x 24"	610 x 610	18"	457	128	58.1	47.0	31¼" x 88"	807 x 2235	<b>412-24-2-18</b>	4672	<b>414-24-2-18</b>	5081	<b>314-24-2-18</b>	5566
		24"	610	140	63.5	53.6	31¼" x 100"	807 x 2540	<b>412-24-2-24</b>	4767	<b>414-24-2-24</b> •	5239	<b>314-24-2-24</b>	5812



100 Industrial Boulevard, Clayton, DE 19938-8903 U.S.A.  
Phone: 800-637-5100 or 302-653-3000. Fax: 302-653-2065  
<http://www.eaglegrp.com>

## 412, 414, and 314 Series Sinks Three-Compartment Sinks

see spec sheets **EG20.03** **EG20.25** **EG20.29**

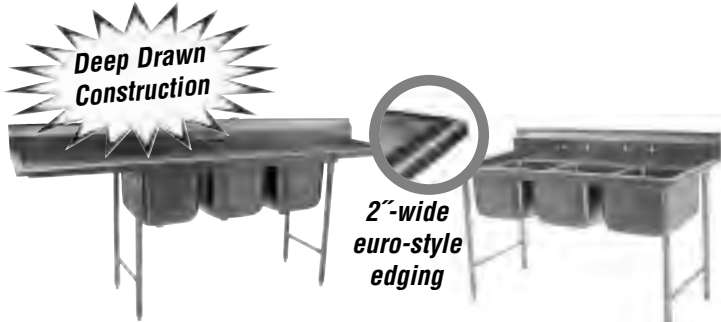

three-compartment sink with double drainboards (faucet not included)

three-compartment sink with no drainboards

- 412 SERIES:
  - All heavy gauge type 430 construction.
  - 10½" (267mm) deep sink bowls.
  - 44" (1118mm) overall height.
- 414 SERIES:
  - 14" (356mm) deep heavy gauge type 304 sink bowls with type 430 drainboards, and backsplash.
  - 44" (1118mm) overall height.
- 314 SERIES:
  - All heavy gauge type 304 construction.
  - 14" (356mm) deep sink bowls.
  - 44" (1118mm) overall height.

**Freight class is 150.0.**

(•) MTS (made to stock) / ( ) MTO (made to order)

### Three Compartments, No Drainboards

bowl size		drainboard length		weight		cu ft	overall size		GOOD 412 Series		BETTER 414 Series		BEST 314 Series	
width in.	length mm	in.	mm	lbs.	kg		width in.	length mm	model #	list	model #	list	model #	list
20" x 16"	508 x 406	-	-	85	38.6	25.7	27½" x 58¾"	699 x 1492	- see spec sheet - <b>EG20.03</b>		- see spec sheet - <b>EG20.25</b>		- see spec sheet - <b>EG20.29</b>	
24" x 18"	610 x 457	-	-	114	51.7	33.0	31¼" x 65½"	807 x 1664	n/a	n/a	414-18-3 •	3194	314-18-3 •	3654
22" x 22"	559 x 559	-	-	120	54.4	37.1	29¾" x 77½"	756 x 1969	n/a	n/a	414-22-3 *	4385	314-22-3 *	4842
24" x 24"	610 x 610	-	-	125	56.7	41.5	31¼" x 83½"	807 x 2121	412-24-3 *	4408	414-24-3 ••	4786	314-24-3 *	5398

\* Features two sets of faucet holes.

### Three Compartments, One Drainboard (right or left)

bowl size		drainboard length		weight		cu ft	overall size		GOOD 412 Series		BETTER 414 Series		BEST 314 Series	
width in.	length mm	in.	mm	lbs.	kg		width in.	length mm	model #	list	model #	list	model #	list
20" x 16"	508 x 406	18"	457	104	47.2	33.3	27½" x 74½"	699 x 1889	- see spec sheet - <b>EG20.03</b>		- see spec sheet - <b>EG20.25</b>		- see spec sheet - <b>EG20.29</b>	
		24"	610	110	49.9	35.8	27½" x 80½"	699 x 2042	412-16-3-18R or L •	3066	414-16-3-18R or L •	4040	314-16-3-18R or L	4906
24" x 18"	610 x 457	18"	457	133	60.3	42.0	31¼" x 80¾"	807 x 2051	n/a	n/a	414-16-3-24R or L	4071	314-16-3-24R or L	4939
		24"	610	139	63.1	68.0	31¼" x 86¾"	807 x 2203	n/a	n/a	414-18-3-18R or L *	5075	314-18-3-18R or L *	5801
22" x 22"	559 x 559	18"	457	139	63.1	45.0	29¾" x 93"	756 x 2362	n/a	n/a	414-18-3-24R or L *	5095	314-18-3-24R or L *	5821
		24"	610	145	65.8	48.4	29¾" x 99"	756 x 2515	n/a	n/a	414-22-3-18R or L *	5711	314-22-3-18R or L *	6147
24" x 24"	610 x 610	18"	457	144	65.3	50.0	31¼" x 98¾"	807 x 2508	412-24-3-18R or L *	5758	414-22-3-24R or L *	5732	314-22-3-24R or L *	6172
		24"	610	150	68.0	54.6	31¼" x 104¾"	807 x 2661	412-24-3-24R or L *	5876	414-24-3-18R or L *	6311	314-24-3-18R or L *	6900
										414-24-3-24R or L ••	6399	314-24-3-24R or L *	7188	

\* Features two sets of faucet holes.

### Three Compartments, Double Drainboards

bowl size		drainboard length		weight		cu ft	overall size		GOOD 412 Series		BETTER 414 Series		BEST 314 Series	
width in.	length mm	in.	mm	lbs.	kg		width in.	length mm	model #	list	model #	list	model #	list
20" x 16"	508 x 406	18"	457	123	55.8	40.9	27½" x 90"	699 x 2286	- see spec sheet - <b>EG20.03</b>		- see spec sheet - <b>EG20.25</b>		- see spec sheet - <b>EG20.29</b>	
		24"	610	135	61.2	46.0	27½" x 102"	699 x 2591	412-16-3-18 •	3174	414-16-3-18 •	4149	314-16-3-18 •	5025
24" x 18"	610 x 457	18"	457	152	68.9	50.5	31¼" x 96"	807 x 2438	412-16-3-24 •	3067	414-16-3-24 •	4002	314-16-3-24 •	4841
		24"	610	164	74.4	57.0	31¼" x 108"	807 x 2743	n/a	n/a	414-18-3-18 ••	5206	314-18-3-18 ••	5941
22" x 22"	559 x 559	18"	457	158	71.6	54.0	29¾" x 108½"	756 x 2756	n/a	n/a	414-18-3-24 ••	5336	314-18-3-24 ••	6073
		24"	610	170	77.1	59.6	29¾" x 120½"	756 x 3061	n/a	n/a	414-22-3-18 ••	5866	314-22-3-18 *	6301
24" x 24"	610 x 610	18"	457	163	73.9	60.0	31¼" x 114"	807 x 2896	n/a	n/a	414-22-3-24 ••	6017	314-22-3-24 ••	6452
		24"	610	175	79.4	65.2	31¼" x 126"	807 x 3200	412-24-3-18 *	5887	414-24-3-18 ••	6315	314-24-3-18 *	6839
								412-24-3-24 ••	6007	414-24-3-24 ••	6594	314-24-3-24 *	7393	

\* Features two sets of faucet holes.



## Catalog Section 20

### 414 and 314 Series Sinks Four-Compartment Sinks

see spec sheets **EG20.26** **EG20.30**



four-compartment sink  
with double drainboards

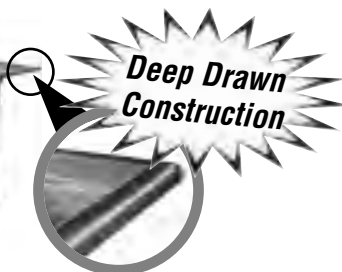

**2"-wide  
euro-style edging**

- 14" (356mm) deep heavy gauge type 304 sink bowls with type 430 drainboards, and backsplash.
- 44" (1118mm) overall height.
- Two sets of faucet holes.

414 SERIES:

- All heavy gauge type 304 construction.
- 14" (356mm) deep sink bowls.
- 44" (1118mm) overall height.
- Two sets of faucet holes.

314 SERIES:

**Freight class is 150.0.**

(•) MTS (made to stock) / ( ) MTO (made to order)

#### Four Compartments, No Drainboards

bowl size		drainboard length		weight		cu ft	overall size		<b>BETTER</b> 414 Series		<b>BEST</b> 314 Series	
width	length	width	length	lbs.	kg		width	length	- see spec sheet - <b>EG20.26</b>		- see spec sheet - <b>EG20.30</b>	
in.	mm	in.	mm			in.	mm	model #	list	model #	list	
20" x 16"	508 x 406	n/a	n/a	125	56.7	33.3	27½" x 76½"	699 x 1943	<b>414-16-4</b>	4312	<b>314-16-4</b>	5164
24" x 18"	610 x 457	n/a	n/a	135	61.2	48.4	31¾" x 85½"	807 x 2172	<b>414-18-4</b>	4983	<b>314-18-4</b>	5866
24" x 24"	610 x 610	n/a	n/a	153	69.4	55.6	31¾" x 109½"	807 x 2783	<b>414-24-4</b>	6143	<b>314-24-4</b>	7082

#### Four Compartments, One Drainboard (right or left)

bowl size		drainboard length		weight		cu ft	overall size		<b>BETTER</b> 414 Series		<b>BEST</b> 314 Series	
width	length	width	length	lbs.	kg		width	length	- see spec sheet - <b>EG20.26</b>		- see spec sheet - <b>EG20.30</b>	
in.	mm	in.	mm			in.	mm	model #	list	model #	list	
20" x 16"	508 x 406	18"	457	144	65.3	41.0	27½" x 92½"	699 x 2340	<b>414-16-4-18R or L</b>	5240	<b>314-16-4-18R or L</b>	6140
		24"	610	150	68.0	43.4	27½" x 98½"	699 x 2492	<b>414-16-4-24R or L</b>	5274	<b>314-16-4-24R or L</b>	6177
24" x 18"	610 x 457	18"	457	154	69.9	49.0	31¾" x 100½"	807 x 2559	<b>414-18-4-18R or L</b>	6293	<b>314-18-4-18R or L</b>	7214
		24"	610	160	72.6	59.6	31¾" x 106½"	807 x 2711	<b>414-18-4-24R or L</b>	6455	<b>314-18-4-24R or L</b>	7237
24" x 24"	610 x 610	18"	457	172	78.0	61.0	31¾" x 124½"	807 x 3169	<b>414-24-4-18R or L</b>	7548	<b>314-24-4-18R or L</b>	8727
		24"	610	178	80.7	67.7	31¾" x 130½"	807 x 3321	<b>414-24-4-24R or L</b>	8121	<b>314-24-4-24R or L</b>	9155

#### Four Compartments, Double Drainboards

bowl size		drainboard length		weight		cu ft	overall size		<b>BETTER</b> 414 Series		<b>BEST</b> 314 Series	
width	length	width	length	lbs.	kg		width	length	- see spec sheet - <b>EG20.26</b>		- see spec sheet - <b>EG20.30</b>	
in.	mm	in.	mm			in.	mm	model #	list	model #	list	
20" x 16"	508 x 406	18"	457	163	73.9	48.5	27½" x 107½"	699 x 2737	<b>414-16-4-18</b> •	5457	<b>314-16-4-18</b>	6363
		24"	610	175	79.5	53.6	27½" x 119½"	699 x 3042	<b>414-16-4-24</b>	5539	<b>314-16-4-24</b>	6452
24" x 18"	610 x 457	18"	457	173	78.5	65.0	31¾" x 116"	807 x 2946	<b>414-18-4-18</b>	6395	<b>314-18-4-18</b>	7343
		24"	610	185	83.9	70.9	31¾" x 128"	807 x 3251	<b>414-18-4-24</b>	6469	<b>314-18-4-24</b>	7425
24" x 24"	610 x 610	18"	457	191	86.6	73.0	31¾" x 140"	807 x 3556	<b>414-24-4-18</b>	7943	<b>314-24-4-18</b>	8912
		24"	610	203	92.1	79.7	31¾" x 152"	807 x 3861	<b>414-24-4-24</b> •	8305	<b>314-24-4-24</b>	9344

### Stainless Steel Cleaner & Polish



weight	oz.	kg	model #	list
	15	0.4	<b>004026</b>	18



FEATURES:

- Cleans and polishes in one step.
- Does not streak or leave fingerprints.
- Leaves a protective invisible coating.



100 Industrial Boulevard, Clayton, DE 19938-8903 U.S.A.  
Phone: 800-637-5100 or 302-653-3000. Fax: 302-653-2065  
<http://www.eaglegrp.com>

## SPEC-MASTER® FN Series Coved Corner Sinks One-Compartment Sinks

see spec sheet **EG20.32**



**Notes: Twist drain bracket available.**

Works in conjunction with optional twist handle drain (*not included* – see page 219). To order, add \$29 per compartment to list price and suffix “-TB” to model number (example: FN2016-1-14/3-TB).

For overflow hole (*does not include drain*), add \$43 per compartment to list price and suffix “-OF” to model number (example: FN2016-1-14/3-OF).

- 14 gauge type 304 18-8 stainless steel.
- All bowls are 14” (356mm) deep and have 5/8” (16mm) radius corners, both vertical and horizontal.
- Stainless steel gussets, feet, legs and crossbracing.
- Adjustable crossbracing front-to-back and side-to-side for increased stability.
- 9 1/2” (241mm) standard backsplash includes 1” (25mm) upturn and tile edge.
- Basket-type waste drains are included to fit sink bowl's 3 1/2” (89mm) opening and feature 1 1/2” (38mm) outlet.
- 30” and 36” (762 and 914mm) drainboards\* available upon request.

**FEATURES:**

\* On sinks with drainboard(s) 30” and 36”, legs are under the outer end of the drainboard(s).

**Note:** All shipping weights and cubic feet are approximate. **ALL SINKS SHIPPED FULLY CRATED.**

For sink accessories, see pages 219-220.

For sink kits, see page 218.

**Freight class is 150.0.**

(•) MTS (*made to stock*) / ( ) MTO (*made to order*)

### One Compartment, No Drainboards

bowl size width x length in. mm		drainboard length in. mm		weight lbs. kg		cubic feet	overall size width x length in. mm		model #	list
20” x 16”	508 x 406	–	–	55	24.9	10.1	27” x 21”	686 x 533	FN2016-1-14/3	2886
20” x 18”	508 x 457	–	–	58	26.3	11.9	27” x 23”	686 x 584	FN2018-1-14/3 •	3252
20” x 20”	508 x 508	–	–	60	27.2	12.9	27” x 25”	686 x 635	FN2020-1-14/3	3252
24” x 24”	610 x 610	–	–	69	31.2	17.8	31” x 29”	787 x 737	FN2424-1-14/3	3482
28” x 20”	711 x 508	–	–	79	35.8	16.7	35” x 25”	889 x 635	FN2820-1-14/3	3840



### One Compartment, One Drainboard (right or left)

bowl size width x length in. mm		drainboard length in. mm		weight lbs. kg		cubic feet	overall size width x length in. mm		model #	list
20” x 16”	508 x 406	18”	457	74	30.8	18.7	27” x 37 1/2”	686 x 953	FN2016-1-18R or L-14/3	3073
		24”	610	80	33.1	21.5	27” x 43 1/2”	686 x 1105	FN2016-1-24R or L-14/3	2968
20” x 18”	508 x 457	18”	457	76	34.4	20.3	27” x 39 1/2”	686 x 1003	FN2018-1-18R or L-14/3	3369
		24”	610	81	36.7	22.4	27” x 45 1/2”	686 x 1156	FN2018-1-24R or L-14/3	3427
20” x 20”	508 x 508	24”	610	85	37.2	23.4	27” x 47 1/2”	686 x 1207	FN2020-1-24R or L-14/3	3427
24” x 24”	610 x 610	24”	610	88	37.6	30.5	31” x 51 1/2”	787 x 1308	FN2424-1-24R or L-14/3	3920
28” x 20”	711 x 508	24”	610	104	43.1	30.2	35” x 47 1/2”	889 x 1207	FN2820-1-24R or L-14/3	4005



### One Compartment, Double Drainboards

bowl size width x length in. mm		drainboard length in. mm		weight lbs. kg		cubic feet	overall size width x length in. mm		model #	list
20” x 16”	508 x 406	18”	457	93	37.6	26.3	27” x 54”	686 x 1372	FN2016-1-18-14/3	3193
		24”	610	105	42.1	32.0	27” x 66”	686 x 1676	FN2016-1-24-14/3	3319
20” x 18”	508 x 457	18”	457	96	43.5	28.7	27” x 56”	686 x 1422	FN2018-1-18-14/3	3506
		24”	610	106	48.1	32.9	27” x 68”	686 x 1727	FN2018-1-24-14/3	3617
20” x 20”	508 x 508	24”	610	110	48.5	33.9	27” x 70”	686 x 1778	FN2020-1-24-14/3	3617
24” x 24”	610 x 610	24”	610	119	49.0	43.9	31” x 74”	787 x 1880	FN2424-1-24-14/3	4148
28” x 20”	711 x 508	24”	610	129	55.3	43.8	35” x 70”	889 x 1778	FN2820-1-24-14/3	4189



## Catalog Section 20

### SPEC-MASTER® FN Series Coved Corner Sinks Two-Compartment Sinks

see spec sheet **EG20.33**



(faucet not included)

**Notes:** Twist drain brackets available.

Works in conjunction with optional twist handle drains (*not included* – see page 219). To order, add **\$29 per compartment** to list price and suffix “-TB” to model number (example: FN2032-2-14/3-TB).

For overflow hole (*does not include drain*), add **\$43 per compartment** to list price and suffix “-OF” to model number (example: FN2032-2-14/3-OF).

- 14 gauge type 304 18-8 stainless steel.
- All bowls are 14" (356mm) deep and have 3/8" (16mm) radius corners, both vertical and horizontal.
- Stainless steel gussets, feet, legs and crossbracing.
- Adjustable crossbracing front-to-back and side-to-side for increased stability.
- 9 1/2" (241mm) standard backsplash includes 1" (25mm) upturn and tile edge.
- Basket-type waste drains are included to fit sink bowl's 3 1/2" (89mm) opening and feature 1 1/2" (38mm) outlet.
- 30" and 36" (762 and 914mm) drainboards\* available upon request.

**FEATURES:**

\* On sinks with drainboard(s) 30" and 36", legs are under the outer end of the drainboard(s).

**Note:** All shipping weights and cubic feet are approximate.

**ALL SINKS SHIPPED FULLY CRATED.**

For sink accessories, see pages 219-220.

For sink kits, see page 218.

**Freight class is 150.0.**

(•) MTS (*made to stock*) / ( ) MTO (*made to order*)

#### Two Compartments, No Drainboards

bowl size width x length in. mm		drainboard length in. mm		weight lbs. kg		cubic feet	overall size width x length in. mm		model #	list
20" x 16"	508 x 406	–	–	77	34.9	20.4	27" x 39"	686 x 991	FN2032-2-14/3	3860
20" x 18"	508 x 457	–	–	82	37.2	22.4	27" x 43"	686 x 1092	FN2036-2-14/3	4238
20" x 20"	508 x 508	–	–	86	39.0	23.9	27" x 47"	686 x 1194	FN2040-2-14/3	4238
24" x 24"	610 x 610	–	–	91	41.3	32.2	31" x 55"	787 x 1397	FN2448-2-14/3	5040
28" x 20"	711 x 508	–	–	96	43.6	31.3	35" x 47"	889 x 1194	FN2840-2-14/3	5048



#### Two Compartments, One Drainboard (right or left)

bowl size width x length in. mm		drainboard length in. mm		weight lbs. kg		cubic feet	overall size width x length in. mm		model #	list
20" x 16"	508 x 406	18"	457	96	43.6	28.2	27" x 55 1/2"	686 x 1410	FN2032-2-18R or L-14/3	4148
		24"	610	102	46.3	31.1	27" x 61 1/2"	686 x 1562	FN2032-2-24R or L-14/3	4220
20" x 18"	508 x 457	18"	457	101	45.8	30.6	27" x 59 1/2"	686 x 1511	FN2036-2-18R or L-14/3	4693
		24"	610	107	48.5	33.1	27" x 65 1/2"	686 x 1664	FN2036-2-24R or L-14/3	4751
20" x 20"	508 x 508	24"	610	111	50.3	35.0	27" x 69 1/2"	686 x 1763	FN2040-2-24R or L-14/3	4751
24" x 24"	610 x 610	24"	610	116	52.6	45.0	31" x 77 1/2"	787 x 1969	FN2448-2-24R or L-14/3	5715
28" x 20"	711 x 508	24"	610	121	54.9	45.0	35" x 69 1/2"	889 x 1763	FN2840-2-24R or L-14/3	5715



#### Two Compartments, Double Drainboards

bowl size width x length in. mm		drainboard length in. mm		weight lbs. kg		cubic feet	overall size width x length in. mm		model #	list
20" x 16"	508 x 406	18"	457	115	52.2	36.0	27" x 72"	686 x 1829	FN2032-2-18-14/3	4293
		24"	610	127	57.6	41.8	27" x 84"	686 x 2134	FN2032-2-24-14/3	4397
20" x 18"	508 x 457	18"	457	120	54.4	39.4	27" x 76"	686 x 1930	FN2036-2-18-14/3 •	4601
		24"	610	132	59.9	43.8	27" x 88"	686 x 2235	FN2036-2-24-14/3	4924
20" x 20"	508 x 508	24"	610	136	61.7	45.7	27" x 92"	686 x 2337	FN2040-2-24-14/3	4924
24" x 24"	610 x 610	24"	610	141	64.0	58.4	31" x 100"	787 x 2540	FN2448-2-24-14/3	5919
28" x 20"	711 x 508	24"	610	146	66.2	58.8	35" x 92"	889 x 2337	FN2840-2-24-14/3	5959



100 Industrial Boulevard, Clayton, DE 19938-8903 U.S.A.  
Phone: 800-637-5100 or 302-653-3000. Fax: 302-653-2065  
<http://www.eaglegrp.com>



## SPEC-MASTER® FN Series Coved Corner Sinks Three-Compartment Sinks NSF

see spec sheet **EG20.34**



(faucets not included)



- 14 gauge type 304 18-8 stainless steel.
- All bowls are 14" (356mm) deep and have 5/8" (16mm) radius corners, both vertical and horizontal.
- Stainless steel gussets, feet, legs and crossbracing.
- Adjustable crossbracing front-to-back and side-to-side for increased stability.
- 9 1/2" (241mm) standard backsplash includes 1" (25mm) upturn and tile edge.
- Basket-type waste drains are included to fit sink bowls' 3 1/2" (89mm) opening and feature 1 1/2" (38mm) outlet.
- 30" and 36" (762 and 914mm) drainboards\* available upon request.

**FEATURES:**

\* On sinks with drainboard(s) 30" and 36", legs are under the outer end of the drainboard(s).

**Note:** All shipping weights and cubic feet are approximate.  
**ALL SINKS SHIPPED FULLY CRATED.**  
For sink accessories, see pages 219-220.  
For sink kits, see page 218.

**Freight class is 150.0.**

(•) MTS (made to stock) / ( ) MTO (made to order)

**Notes: Twist drain brackets available.**

Works in conjunction with optional twist handle drains (not included – see page 219). To order, add \$29 per compartment to list price and suffix "-TB" to model number (example: FN2048-3-14/3-TB).

For overflow hole (does not include drain), add \$43 per compartment to list price and suffix "-OF" to model number (example: FN2048-3-14/3-OF).

### Three Compartments, No Drainboards

bowl size width x length in. mm		drainboard length in. mm		weight lbs. kg		cubic feet	overall size width x length in. mm		model #	list
20" x 16"	508 x 406	–	–	99	44.9	29.2	27" x 57"	686 x 1448	FN2048-3-14/3	4772
20" x 18"	508 x 457	–	–	102	46.3	32.1	27" x 63"	686 x 1600	FN2054-3-14/3 *	5455
20" x 20"	508 x 508	–	–	114	51.7	35.0	27" x 69"	686 x 1753	FN2060-3-14/3 *	5455
24" x 24"	610 x 610	–	–	127	57.6	46.7	31" x 81"	787 x 2057	FN2472-3-14/3 *	6345
28" x 20"	711 x 508	–	–	130	59.0	45.0	35" x 69"	889 x 1753	FN2860-3-14/3 *	6535



\* Features two sets of faucet holes.

### Three Compartments, One Drainboard (right or left)

bowl size width x length in. mm		drainboard length in. mm		weight lbs. kg		cubic feet	overall size width x length in. mm		model #	list
20" x 16"	508 x 406	18"	457	118	53.5	36.9	27" x 73 1/2"	686 x 1867	FN2048-3-18R or L-14/3	4971
		24"	610	124	56.2	39.9	27" x 79 1/2"	686 x 2019	FN2048-3-24R or L-14/3	5021
20" x 18"	508 x 457	18"	457	121	54.9	40.4	27" x 79 1/2"	686 x 2019	FN2054-3-18R or L-14/3 *	5862
		24"	610	127	57.6	42.8	27" x 85 1/2"	686 x 2172	FN2054-3-24R or L-14/3 *	5902
20" x 20"	508 x 508	24"	610	139	63.1	45.7	27" x 91 1/2"	686 x 2324	FN2060-3-24R or L-14/3 *	5902
		24"	610	152	68.9	59.5	31" x 103 1/2"	787 x 2629	FN2472-3-24R or L-14/3 *	7175
28" x 20"	711 x 508	24"	610	155	70.3	58.8	35" x 91 1/2"	889 x 2324	FN2860-3-24R or L-14/3 *	7305



\* Features two sets of faucet holes.

### Three Compartments, Double Drainboards

bowl size width x length in. mm		drainboard length in. mm		weight lbs. kg		cubic feet	overall size width x length in. mm		model #	list
20" x 16"	508 x 406	18"	457	137	61.7	44.7	27" x 90"	686 x 2286	FN2048-3-18-14/3	5093
		24"	610	149	67.6	50.6	27" x 102"	686 x 2591	FN2048-3-24-14/3	5196
20" x 18"	508 x 457	18"	457	140	63.5	49.1	27" x 96"	686 x 2438	FN2054-3-18-14/3 •	5998
		24"	610	158	71.6	53.5	27" x 108"	686 x 2743	FN2054-3-24-14/3 *	6173
20" x 20"	508 x 508	24"	610	164	74.4	56.4	27" x 114"	686 x 2896	FN2060-3-24-14/3 *	6173
		24"	610	177	80.3	72.8	31" x 126"	787 x 3200	FN2472-3-24-14/3 *	7364
28" x 20"	711 x 508	24"	610	180	81.6	72.5	35" x 114"	889 x 2896	FN2860-3-24-14/3 *	7559



\* Features two sets of faucet holes.



## Catalog Section 20

### SPEC-MASTER® FN Series Coved Corner Sinks Four-Compartment Sinks

see spec sheet **EG20.35**



all sinks two sets of faucets holes



- 14 gauge type 304 18-8 stainless steel.
- All bowls are 14" (356mm) deep and have 5/8" (16mm) radius corners, both vertical and horizontal.
- Stainless steel gussets, feet, legs and crossbracing.
- Adjustable crossbracing front-to-back and side-to-side for increased stability.
- 9 1/2" (241mm) standard backsplash includes 1" (25mm) upturn and tile edge.
- Basket-type waste drains are included to fit sink bowls' 3 1/2" (89mm) opening and feature 1 1/2" (38mm) outlet.
- 30" and 36" (762 and 914mm) drainboards\* available upon request.

#### FEATURES:

\* On sinks with drainboard(s) 30" and 36", legs are under the outer end of the drainboard(s).

**Note:** All shipping weights and cubic feet are approximate.

**ALL SINKS SHIPPED FULLY CRATED.**

For sink accessories, see pages 219-220.

For sink kits, see page 218.

**Freight class is 150.0.**

(•) MTS (made to stock) / ( ) MTO (made to order)

#### Notes: Twist drain brackets available.

Works in conjunction with optional twist handle drains (not included – see page 219). To order, add \$29 per compartment to list price and suffix "-TB" to model number (example: FN2064-4-14/3-TB).

For overflow hole (does not include drain), add \$43 per compartment to list price and suffix "-OF" to model number (example: FN2064-4-14/3-OF).

#### Four Compartments, No Drainboards

bowl size width x length in. mm		drainboard length in. mm		weight lbs. kg		cubic feet	overall size width x length in. mm		model #	list
20" x 16"	508 x 406	–	–	121	54.9	35.4	27" x 75"	686 x 1905	FN2064-4-14/3	6102
20" x 18"	508 x 457	–	–	132	59.9	39.0	27" x 83"	686 x 2108	FN2072-4-14/3	6855
20" x 20"	508 x 508	–	–	142	64.4	42.7	27" x 91"	686 x 2311	FN2080-4-14/3	6855
24" x 24"	610 x 610	–	–	163	73.9	57.1	31" x 107"	787 x 2718	FN2496-4-14/3	7887
28" x 20"	711 x 508	–	–	170	77.1	54.9	35" x 91"	889 x 2311	FN2880-4-14/3	8342



#### Four Compartments, One Drainboard (right or left)

bowl size width x length in. mm		drainboard length in. mm		weight lbs. kg		cubic feet	overall size width x length in. mm		model #	list
20" x 16"	508 x 406	18"	457	140	63.5	45.7	27" x 91 1/2"	686 x 2324	FN2064-4-18R or L-14/3	6146
		24"	610	146	66.2	48.6	27" x 97 1/2"	686 x 2477	FN2064-4-24R or L-14/3	6202
20" x 18"	508 x 457	18"	457	151	68.5	50.1	27" x 99 1/2"	686 x 2527	FN2072-4-18R or L-14/3	7255
		24"	610	157	71.2	52.5	27" x 105 1/2"	686 x 2680	FN2072-4-24R or L-14/3	7296
20" x 20"	508 x 508	24"	610	167	75.8	56.4	27" x 113 1/2"	686 x 2883	FN2080-4-24R or L-14/3	7296
		24"	610	188	85.3	68.5	31" x 129 1/2"	787 x 3289	FN2496-4-24R or L-14/3	8632
28" x 20"	711 x 508	24"	610	195	88.5	67.7	35" x 113 1/2"	889 x 2883	FN2880-4-24R or L-14/3	8875



#### Four Compartments, Double Drainboards

bowl size width x length in. mm		drainboard length in. mm		weight lbs. kg		cubic feet	overall size width x length in. mm		model #	list
20" x 16"	508 x 406	18"	457	159	72.1	53.5	27" x 108"	686 x 2743	FN2064-4-18-14/3	6373
		24"	610	171	77.6	55.4	27" x 120"	686 x 3048	FN2064-4-24-14/3	6492
20" x 18"	508 x 457	18"	457	170	77.1	54.9	27" x 116"	686 x 2646	FN2072-4-18-14/3 •	7437
		24"	610	182	82.6	59.0	27" x 128"	686 x 3251	FN2072-4-24-14/3	7507
20" x 20"	508 x 508	24"	610	192	87.1	62.6	27" x 136"	686 x 3454	FN2080-4-24-14/3	7507
		24"	610	213	96.6	81.4	31" x 152"	787 x 3861	FN2496-4-24-14/3	8873
28" x 20"	711 x 508	24"	610	220	99.8	110.2	35" x 136"	889 x 3454	FN2880-4-24-14/3	9129



100 Industrial Boulevard, Clayton, DE 19938-8903 U.S.A.  
Phone: 800-637-5100 or 302-653-3000. Fax: 302-653-2065  
<http://www.eaglegrp.com>

## Utility Sinks One- and Two-Compartment Sinks

see spec sheets **EG20.13A** **EG20.13B**



**Note:** Overflow hole available (does not include drain). To order, add \$43 per compartment to list price and suffix “-OF” to model number (example: 1818-1-16/3-OF).

For detachable drainboards, see page 208.

For NSF-approved utility sinks, add 35% to list price and add prefix “N-” to model number. Example: N-2460-2-16/3.

- For numerous applications when NSF construction is not required.
- Square-corner construction.
- 8” (203mm) backsplash.
- Adjustable bullet feet.
- Heavy gauge stainless steel.
- 304 and 430 series construction available.
- Sink compartments are 13 3/8” (340mm) deep.
- Legs are 1 1/8” (41mm) diameter galvanized tubing and are located directly under sink compartments for maximum stability and weight support.

**FEATURES:**

**Freight class is 150.0.**

(•) MTS (made to stock) / ( ) MTO (made to order)

### One Compartment, No Drainboards

bowl size		drainboard		weight		cubic feet	overall size		type 430 stainless steel		type 304 stainless steel	
width	length	length	length	lbs.	kg		width	length	model #	list	model #	list
in.	mm	in.	mm			in.	mm					
18" x 18"	457 x 457	-	-	53	24.0	0.9	22" x 19"	559 x 492	1818-1-16/4 •	945	1818-1-16/3	1102
18" x 24"	457 x 610	-	-	56	25.4	11.6	22" x 25"	559 x 645	1824-1-16/4	952	1824-1-16/3	1153
21" x 18"	533 x 457	-	-	56	25.4	10.5	25" x 19"	635 x 492	2118-1-16/4 •	941	2118-1-16/3	1131
21" x 24"	533 x 610	-	-	59	26.8	13.1	25" x 25"	635 x 645	2124-1-16/4 •	974	2124-1-16/3	1185
21" x 36"	533 x 914	-	-	65	29.5	18.1	25" x 37"	635 x 949	2136-1-16/4	1048	2136-1-16/3	1317
24" x 24"	610 x 610	-	-	60	27.2	14.6	28" x 25"	711 x 645	2424-1-16/4 •	1014	2424-1-16/3	1243
24" x 36"	610 x 914	-	-	68	30.8	20.2	28" x 37"	711 x 949	2436-1-16/4 •	1079	2436-1-16/3	1379

### One Compartment, Double Drainboards

bowl size		drainboard		weight		cubic feet	overall size		type 430 stainless steel		type 304 stainless steel	
width	length	length	length	lbs.	kg		width	length	model #	list	model #	list
in.	mm	in.	mm			in.	mm					
21" x 24"	533 x 610	18"	457	99	44.9	28.3	25" x 60"	635 x 1530	2124-1-18-16/4	2096	2124-1-18-16/3	2556
24" x 24"	610 x 610	24"	610	108	49.0	37.1	28" x 72"	711 x 1835	2424-1-24-16/4	2255	2424-1-24-16/3	2641

### Two Compartments, No Drainboards

bowl size		drainboard		weight		cubic feet	overall size		type 430 stainless steel		type 304 stainless steel	
width	length	length	length	lbs.	kg		width	length	model #	list	model #	list
in.	mm	in.	mm			in.	mm					
18" x 18"	457 x 457	-	-	75	34.0	16.1	22" x 37"	559 x 949	1836-2-16/4 •	1275	1836-2-16/3	1558
18" x 24"	457 x 610	-	-	80	36.3	20.6	22" x 49"	559 x 1254	1848-2-16/4	1336	1848-2-16/3	1679
21" x 18"	533 x 457	-	-	80	36.3	18.1	25" x 37"	635 x 949	2136-2-16/4 •	1304	2136-2-16/3	1604
21" x 24"	533 x 610	-	-	85	38.6	23.2	25" x 49"	635 x 1254	2148-2-16/4	1319	2148-2-16/3	1694
24" x 24"	610 x 610	-	-	89	40.4	25.8	28" x 49"	711 x 1254	2448-2-16/4 •	1446	2448-2-16/3	1800
24" x 30"	610 x 762	-	-	95	43.1	31.5	28" x 61"	711 x 1559	2460-2-16/4	1793	2460-2-16/3	2066

### Two Compartments, Double Drainboards

bowl size		drainboard		weight		cubic feet	overall size		type 430 stainless steel		type 304 stainless steel	
width	length	length	length	lbs.	kg		width	length	model #	list	model #	list
in.	mm	in.	mm			in.	mm					
21" x 18"	533 x 457	18"	457	120	3048	33.3	25" x 72"	635 x 1835	2136-2-18-16/4	2584	2136-2-18-16/3	3146
24" x 24"	610 x 610	24"	610	139	3531	48.4	28" x 96"	711 x 2445	2448-2-24-16/4	2691	2448-2-24-16/3	3231

**Catalog Section 20**

**Utility Sinks  
Three- and Four-Compartment Sinks**

see spec sheets **EG20.13C** **EG20.13D**



**Note:** Overflow hole available (*does not include drain*). To order, add **\$43 per compartment to list price** and suffix “-OF” to model number (example: **1836-3-16/3-OF**).

For detachable drainboards, see page 208.

For NSF-approved utility sinks, add **35% to list price** and add prefix “N-” to model number. Example: **N-1836-3-16/3**.

**Freight class is 150.0.**

(•) MTS (*made to stock*) / ( ) MTO (*made to order*)

**Three Compartments, No Drainboards**

bowl size		drainboard		weight		cubic feet	overall size		type 430 stainless steel		type 304 stainless steel	
width in.	length mm	length in.	length mm	lbs.	kg		width in.	length mm	model #	list	model #	list
18" x 12"	457 x 305	-	-	79	35.8	16.1	22" x 37 3/4"	559 x 949	<b>1836-3-16/4</b> •	1469	<b>1836-3-16/3</b>	1786
18" x 16"	457 x 406	-	-	90	40.8	20.6	22" x 49 3/4"	559 x 1254	<b>1848-3-16/4</b>	1532	<b>1848-3-16/3</b>	1897
18" x 18"	457 x 457	-	-	97	44.0	22.8	22" x 55 3/4"	559 x 1407	<b>1854-3-16/4</b> •	1740	<b>1854-3-16/3</b>	2071
21" x 12"	533 x 305	-	-	85	38.6	18.1	25" x 37 3/4"	635 x 949	<b>2136-3-16/4</b> •	1506	<b>2136-3-16/3</b>	1844
21" x 16"	533 x 406	-	-	87	39.5	23.2	25" x 49 3/4"	635 x 1254	<b>2148-3-16/4</b> •	1572	<b>2148-3-16/3</b>	1958
21" x 18"	533 x 457	-	-	100	45.4	25.7	25" x 55 3/4"	635 x 1407	<b>2154-3-16/4</b> •	1746	<b>2154-3-16/3</b>	2127
21" x 20"	533 x 508	-	-	110	49.9	28.3	25" x 61 3/4"	635 x 1559	<b>2160-3-16/4</b> *	1805	<b>2160-3-16/3</b> *	2211
24" x 16"	610 x 406	-	-	92	41.7	25.8	28" x 49 3/4"	711 x 1254	<b>2448-3-16/4</b>	1652	<b>2448-3-16/3</b>	2047
24" x 20"	610 x 508	-	-	115	52.2	31.5	28" x 61 3/4"	711 x 1559	<b>2460-3-16/4</b> *	1909	<b>2460-3-16/3</b> *	2297
24" x 24"	610 x 610	-	-	125	56.7	37.1	28" x 73 3/4"	711 x 1864	<b>2472-3-16/4</b> *•	1956	<b>2472-3-16/3</b> *	2431

\* Features two sets of faucet holes.

**Three Compartments, Double Drainboards**

bowl size		drainboard		weight		cubic feet	overall size		type 430 stainless steel		type 304 stainless steel	
width in.	length mm	length in.	length mm	lbs.	kg		width in.	length mm	model #	list	model #	list
21" x 12"	533 x 305	18"	457	125	56.7	33.3	25" x 72 1/4"	635 x 1835	<b>2136-3-18-16/4</b>	2640	<b>2136-3-18-16/3</b>	3122
21" x 16"	533 x 406	18"	457	127	57.6	38.4	25" x 84 1/4"	635 x 2140	<b>2148-3-18-16/4</b>	2726	<b>2148-3-18-16/3</b>	3362
21" x 18"	533 x 457	18"	457	140	63.5	40.9	25" x 90 1/4"	635 x 2292	<b>2154-3-18-16/4</b>	2979	<b>2154-3-18-16/3</b>	3572
24" x 24"	610 x 610	24"	610	175	79.4	59.6	28" x 120 1/4"	711 x 3054	<b>2472-3-24-16/4</b> *	3214	<b>2472-3-24-16/3</b> *	4093

\* Features two sets of faucet holes.

**Four Compartments, No Drainboards** (*All sinks feature two sets of faucet holes.*)

bowl size		drainboard		weight		cubic feet	overall size		type 430 stainless steel		type 304 stainless steel	
width in.	length mm	length in.	length mm	lbs.	kg		width in.	length mm	model #	list	model #	list
18" x 18"	457 x 457	-	-	110	49.9	29.5	22" x 73 3/4"	559 x 1864	<b>1872-4-16/4</b>	2002	<b>1872-4-16/3</b>	2495
21" x 18"	533 x 457	-	-	115	52.2	33.3	25" x 73 3/4"	635 x 1864	<b>2172-4-16/4</b>	2096	<b>2172-4-16/3</b>	2534
24" x 18"	610 x 457	-	-	125	56.7	37.1	28" x 73 3/4"	711 x 1864	<b>2472-4-16/4</b>	2154	<b>2472-4-16/3</b>	2652

**Four Compartments, Double Drainboards** - (*All sinks feature two sets of faucet holes.*)

bowl size		drainboard		weight		cubic feet	overall size		type 430 stainless steel		type 304 stainless steel	
width in.	length mm	length in.	length mm	lbs.	kg		width in.	length mm	model #	list	model #	list
21" x 18"	533 x 457	18"	457	155	70.3	48.5	25" x 108 1/4"	635 x 2750	<b>2172-4-18-16/4</b>	3303	<b>2172-4-18-16/3</b>	3855



100 Industrial Boulevard, Clayton, DE 19938-8903 U.S.A.  
 Phone: 800-637-5100 or 302-653-3000. Fax: 302-653-2065  
<http://www.eaglegrp.com>

## Detachable Drainboards for Utility Sinks

see spec sheet **EG20.13E**

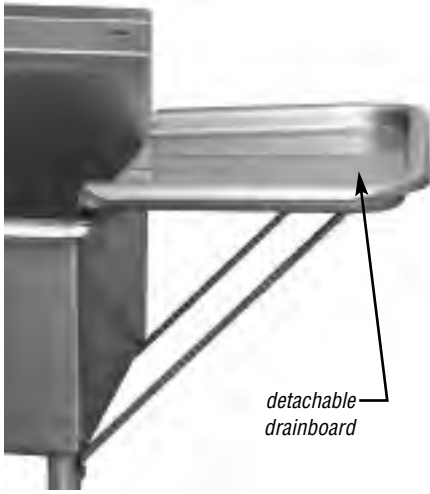

**Drainboards will not work on NSF utility sinks!**

- Unique die-stamped rolled rim construction.
- All drainboards are fully reversible, allowing for left- or right-hand operation.
- “Easy clip-on installation” utilizes two support brackets that bolt to sink gussets.
- Available in 430 or 304 series stainless steel.
- Drainboards 30” (762mm) long are furnished with legs.

FEATURES:

**Freight class is 70.0.**

(•) MTS (made to stock) / ( ) MTO (made to order)

width (front-to-back) x length (side-to-side)		weight		cu	16 gauge type 430 stainless steel		16 gauge type 304 stainless steel	
in.	mm	lbs.	kg	ft	model #	list	model #	list
18" x 18"	457 x 457	19	8.6	1.8	<b>18x18 RRDEDB</b> •	265	<b>18x18 RRDEDB-16/3</b>	444
18" x 24"	457 x 610	23	10.4	1.9	<b>18x24 RRDEDB</b> •	281	<b>18x24 RRDEDB-16/3</b>	467
18" x 30"	457 x 762	27	12.2	2.8	<b>18x30 RRDEDB</b>	479	<b>18x30 RRDEDB-16/3</b>	522
21" x 18"	533 x 457	20	9.0	1.8	<b>21x18 RRDEDB</b> •	265	<b>21x18 RRDEDB-16/3</b>	444
21" x 24"	533 x 610	24	10.9	2.1	<b>21x24 RRDEDB</b> •	285	<b>21x24 RRDEDB-16/3</b>	467
21" x 30"	533 x 762	28	12.7	2.5	<b>21x30 RRDEDB</b>	535	<b>21x30 RRDEDB-16/3</b>	562
24" x 18"	610 x 457	21	9.5	2.3	<b>24x18 RRDEDB</b> •	274	<b>24x18 RRDEDB-16/3</b>	438
24" x 24"	610 x 610	25	11.3	2.4	<b>24x24 RRDEDB</b> •	296	<b>24x24 RRDEDB-16/3</b>	482
24" x 30"	610 x 762	29	13.2	2.7	<b>24x30 RRDEDB</b>	524	<b>24x30 RRDEDB-16/3</b>	553

## SPEC-MASTER® FFN Series Flush Front Sinks

see spec sheet **EG20.54**



- Full front and 10” (254mm) high backsplash are 14 gauge stainless steel.
- 14 gauge double drainboards, rolled rims and sink bowl partitions.
- 1” (25mm) downturn at rear.
- Sink compartments feature ¼” (19mm) coved inside radii.
- Basket-type waste drain fits 3½” (89mm) opening and features 1½” (38mm) outlet.
- Legs are located directly under sink bowls.
- All-welded base constructed of 1½” (41mm) diameter tubular stainless steel.
- Adjustable stainless steel bullet feet.
- 14” (356mm) water level and swirl-away drainage.

FEATURES:

**Freight class is 150.0.**

bowl size width x length		drainboard length		overall size width x length		Two Compartments		Three Compartments *			
in.	mm	in.	mm	in.	mm	model #	list	in.	mm	model #	list
27" x 18"	686 x 457	24"	610	30½" x 85½"	775 x 2216	<b>FFN2736-2-24-14/3</b>	11000	30½" x 105¼"	775 x 2673	<b>FFN2754-3-24-14/3</b>	13269
27" x 18"	686 x 457	30"	762	30½" x 97½"	775 x 2480	<b>FFN2736-2-30-14/3</b>	12311	30½" x 117¼"	775 x 2978	<b>FFN2754-3-30-14/3</b>	14782
27" x 20"	686 x 508	24"	610	30½" x 89½"	775 x 2318	<b>FFN2740-2-24-14/3</b>	11506	30½" x 111¼"	775 x 2826	<b>FFN2760-3-24-14/3</b>	14028
27" x 20"	686 x 508	30"	762	30½" x 101½"	775 x 2581	<b>FFN2740-2-30-14/3</b>	12812	30½" x 123¼"	775 x 3131	<b>FFN2760-3-30-14/3</b>	15542
27" x 24"	686 x 610	24"	610	30½" x 97½"	775 x 2521	<b>FFN2748-2-24-14/3</b>	12514	30½" x 123¼"	775 x 3131	<b>FFN2772-3-24-14/3</b>	15542
27" x 24"	686 x 610	30"	762	30½" x 109½"	775 x 2785	<b>FFN2748-2-30-14/3</b>	13825	30½" x 135¼"	775 x 3435	<b>FFN2772-3-30-14/3</b>	17052
27" x 30"	686 x 762	24"	610	30½" x 109½"	775 x 2826	<b>FFN2760-2-24-14/3</b>	14028	30½" x 141¼"	775 x 3588	<b>FFN2790-3-24-14/3</b>	17811
27" x 30"	686 x 762	30"	762	30½" x 121½"	775 x 3089	<b>FFN2760-2-30-14/3</b>	15334	30½" x 153¼"	775 x 3893	<b>FFN2790-3-30-14/3</b>	19325

\* Three-Compartment sinks feature two sets of faucet holes.

## Catalog Section 20

### SPEC-MASTER® Specialty Use/Parts Cleaning Sinks



see spec sheet **EG20.38**



**FEATURES:**

- All bowls have 14" depth (356mm), 5/8" (16mm) radius corners.
- 14 gauge type 304 18-8 stainless steel construction.
- Available with one, two, or no drainboards.

**Note:** All shipping weights and cubic feet are approximate.

**Freight class is 150.0.**

#### Two Compartments

inside bowl dimensions width x length		overall dimensions width x length		drain boards	weight		cu ft	model #	list
in.	mm	in.	mm		lbs.	kg			
14" x 32"	356 x 813	37" x 37"	902 x 940	none	155	70.3	23	<b>SFN2832-2-14/3</b>	4909
14" x 32"	356 x 813	37" x 53 1/2"	902 x 1359	one 18" (457mm) R or L	175	79.3	26	<b>SFN2832-2-18R or L-14/3</b>	5525
14" x 32"	356 x 813	37" x 70"	902 x 1778	two 18" (457mm) R & L	200	90.7	46	<b>SFN2832-2-18-14/3</b>	6048

#### Three Compartments

inside bowl dimensions width x length		overall dimensions width x length		drain boards	weight		cu ft	model #	list
in.	mm	in.	mm		lbs.	kg			
two 14" x 32" (356 x 813mm) bowls, & one 20" x 30" (508 x 762mm) bowl		37" x 59"	902 x 1499	none	164	74.4	36	<b>SFN3052-3-14/3</b>	6293
		37" x 75 1/2"	902 x 1918	one 18" (457mm) R or L	192	87.1	47	<b>SFN3052-3-18R or L-14/3</b>	6811
		37" x 92"	902 x 2337	two 18" (457mm) R & L	210	95.3	58	<b>SFN3052-3-18-14/3</b>	6985
three 32" x 14" (813 x 356mm) bowls		39" x 51"	991 x 1265	none	160	72.6	32	<b>SFN3242-3-14/3</b>	6558
		39" x 67 1/2"	991 x 1715	one 18" (457mm) R or L	175	79.4	45	<b>SFN3242-3-18R or L-14/3</b>	6760
		39" x 84"	991 x 2134	two 18" (457mm) R & L	200	90.7	56	<b>SFN3242-3-18-14/3</b>	7002

### 314 Series Corner Sinks



see spec sheet **EG20.09**



all sinks have two sets of faucet holes

**FEATURES:**

- Deep-drawn, heavy gauge type 304 construction.
- Poly cutting board/sink cover.

**Note:** All shipping weights and cubic feet are approximate.  
**ALL UNITS SHIPPED FULLY CRATED.**

**Twist drain brackets available.**

Works in conjunction with optional twist handle drains (not included - see page 219). To order, add **\$29 per compartment to list price** and suffix "-TB" to model number. **Example: C314-10-3-12-TB.**

**Freight class is 150.0.**

(•) MTS (made to stock) / ( ) MTO (made to order)

no. bowls	bowl size width x length x depth	drain boards	overall size width x length	shipping weight	cu ft	model #	list
3	10" x 14" x 10" (254 x 355 x 254mm)	two 12" (305mm)	39" x 43" (991 x 1092mm)	80 lbs. (36.3 kg)	27	<b>C314-10-3-12</b>	4993
3	16" x 20" x 14" (406 x 508 x 356mm)	two 18" (457mm)	57 1/4" x 59 1/4" (1454 x 1518mm)	140 lbs. (63.5 kg)	65	<b>C314-16-3-18 •</b>	6568
3	22" x 22" x 14" (558 x 558 x 356mm)	two 18" (457mm)	69" x 69" (1753 x 1753mm)	175 lbs. (79.4 kg)	87	<b>C314-22-3-18</b>	7125
3	24" x 24" x 14" (610 x 610 x 356mm)	two 24" (610mm)	79" x 79" (2007 x 2007mm)	200 lbs. (90.7 kg)	108	<b>C314-24-3-24</b>	7700



100 Industrial Boulevard, Clayton, DE 19938-8903 U.S.A.  
Phone: 800-637-5100 or 302-653-3000. Fax: 302-653-2065  
<http://www.eaglegrp.com>

### 310 and 312 Series Specialty Use Sinks

see spec sheet **EG20.19**



**Euro-style edging  
on 310 series**

#### Faucet for Convenience Store Sinks

description	model #	list
10" (254mm) spout	<b>300489</b>	275

- Heavy gauge type 304 construction.
- Sink bowls are deep-drawn, except where noted.
- 9½" (241mm) backsplash includes 1" (25mm) upturn and tile edge for easy installation and feathering to wall/splash surface.

#### FEATURES:

**Note:** All shipping weights and cubic feet are approximate.

#### Twist drain brackets available.

Works in conjunction with optional twist handle drains (not included – see page 219). To order, add **\$29 per compartment to list price** and suffix “-TB” to model number (example: **310-10-3-12-TB**).

**Freight class is 150.0.**

(\*) MTS (made to stock) / ( ) MTO (made to order)

### 310 Series

no. bowls	bowl size width x length x depth	drain boards	overall size width x length	shipping weight	cu ft	model #	list
3	14" x 10" x 9½" (355 x 254 x 247mm)	two 12" (305mm)	21" x 60" (533 x 1524mm)	71 lbs. (32.2 kg)	23	<b>310-10-3-12 •</b>	2976
3	14" x 10" x 9½" (355 x 254 x 247mm)	two 18" (457mm)	21" x 72" (533 x 1829mm)	78 lbs. (35.4 kg)	27	<b>310-10-3-18 •</b>	3052
3	14" x 10" x 9½" (355 x 254 x 247mm)	two 24" (610mm)	21" x 84" (533 x 2134mm)	87 lbs. (39.5 kg)	32	<b>310-10-3-24</b>	3109

### 312 Series

no. bowls	bowl size width x length x depth	drain boards	overall size width x length	shipping weight	cu ft	model #	list
3	20" x 12" x 12" (508 x 305 x 305mm)	two 12" (305mm)	27" x 66" (686 x 1676mm)	89 lbs. (40.4 kg)	22	<b>312-12-3-12 ••</b>	3157
3	14" x 16" x 12" (356 x 406 x 305mm)	two 12" (305mm)	23" x 72" (584 x 1829mm)	105 lbs. (47.6 kg)	46	<b>312-14-3-12 •</b>	3382

\* #312-12-3-12 features fabricated sink bowls.

### Mop Sinks

see spec sheet **EG20.01**



- 304 18-8 stainless steel construction.
- Sink bowl is heavy gauge with deep-drawn covered corners.
- Drain with flat strainer plate.

#### FEATURES:

**Note:** See page 211 for Mop Storage Cabinets and optional Utility Shelves with Mop Hangers.

**Freight class is 85.0.**

(\*) MTS (made to stock)

( ) MTO (made to order)

bowl width x length x depth in	mm	cu ft	overall width x length x height in.	mm	sh. weight lbs.	kg	model #	list
16" x 20" x 8"	406 x 508 x 203	8.4	21½" x 24½" x 15½"	546 x 625 x 394	35	15.8	<b>F1916 ••</b>	1469
16" x 20" x 12"	406 x 508 x 305	8.4	21½" x 24½" x 19½"	546 x 625 x 495	53	24.0	<b>F1916-12 ••</b>	1522
20" x 28" x 8"	508 x 711 x 203	11.9	25½" x 32½" x 15½"	648 x 829 x 394	68	30.8	<b>F2820 *</b>	1681
20" x 28" x 12"	508 x 711 x 305	11.9	25½" x 32½" x 19½"	648 x 829 x 495	86	39.0	<b>F2820-12 ••</b>	1867

\* Includes 3¼" high backsplash. 12½" deck height; \*\* Includes 3¼" high backsplash. 16½" deck height.

### Optional Accessories for Mop Sink

description	weight		model #	list
	lbs.	kg		
3-pole mop holder	4	1.8	<b>312688</b>	188
4-pole mop holder	4.5	2.0	<b>321561 •</b>	275
30" (762mm) hose & wall mounted bracket	8	3.6	<b>312689</b>	180
service faucet (comes with vacuum breaker)	11	5.0	<b>312690</b>	526



3-pole mop holder



4-pole mop holder



hose & bracket



service faucet

## Catalog Section 20

### Mop Sink Storage Cabinets

see product announcements **EG8104** **EG8112**



(mops shown not included)

- FEATURES:**
- Heavy gauge type 430 stainless steel construction.
  - Overhead shelf (Double-width units feature four shelves).
  - Double-pan 20 gauge stainless steel hinged doors.
  - Transverse rod handles featuring keyed locks.
  - Top is slanted at a 15° angle.
  - Sides are louvered along the top for ventilation.
  - Mop sink holds two mops.
  - Cabinets comes with service faucet, 30" (762mm) hose and wall mounted bracket.

**Freight class is 125.0.**

**Note:** Optional upgrade to type 300 stainless steel cabinet available.  
To order, add 15% to list price and suffix "-SE" to model number (example: F1916-VSCS-SE).

description	width x length x height		weight		cubic feet	model #	list
	in.	mm	lbs.	kg			
single-width cabinet	22¼" x 25" x 84¼"	565 x 635 x 2140	274	124.3	39.0	<b>F1916-VSCS</b>	5463
double-width cabinet, mop sink at left	22¼" x 47½" x 84¼"	565 x 1207 x 2140	544	246.7	81.9	<b>F1916-VSCS-DL</b>	5928
double-width cabinet, mop sink at right	22¼" x 47½" x 84¼"	565 x 1207 x 2140	544	246.7	81.9	<b>F1916-VSCS-DR</b>	5928

### Utility Shelves with Mop Hangers

see spec sheet **EG20.02**



- FEATURES:**
- 16 gauge type 304 stainless steel.
  - Mop hangers. Flat hooks.
  - Hangers and hooks are riveted to front of shelf.

**Note:** Faucets listed are lead-free AB1953-compliant.

**Freight class is 70.0.**

(•) MTS (made to stock) / ( ) MTO (made to order)

width x length		model #	list
in.	mm		
8" x 24"	203 x 610	<b>US0824-16/3*</b>	588
8" x 36"	203 x 914	<b>US0836-16/3</b>	676
8" x 48"	203 x 1219	<b>US0848-16/3</b>	855

## Go Green. Go ECO-Built™ by EAGLE.

The advantages may be invisible. But when you see the tag you'll know the product you purchase has been produced in the EAGLE plant, under the principles that drive the ECO-Built™ program.

For institutions concerned about meeting their own green standards, buying ECO-Built™ is simply the right thing to do.

Look for the ECO-Built™ tag on the bar code 



100 Industrial Boulevard, Clayton, DE 19938-8903 U.S.A.  
Phone: 800-637-5100 or 302-653-3000. Fax: 302-653-2065  
<http://www.eaglegrp.com>



### Countertop Drop-In Sinks with Self Rim Design

Not NSF approved for warewashing and/or food preparation operations. Not intended for NSF installation into stainless steel worksurface. Please consult factory if need arises.

see spec sheet **EG20.39**

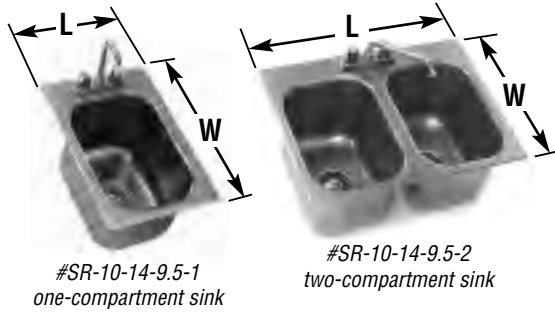

**FEATURES:**

- 304 series stainless steel.
- Faucet and 1½" (38mm) outlet basket drain.

**Freight class is 85.0.**

(•) MTS (made to stock) / ( ) MTO (made to order)

**Note:** Faucet holes are punched on 4" (102mm) centers. To order sinks with faucet holes punched on 8" (203mm) centers, add \$155 to list price and add suffix "-8CL" (example: SR18-24-13.5-2-8CL). Faucets sold separately for "-8CL" sinks. See page 213. All weights and cubic feet in charts are approximate. Recommended for 1"-thick countertops.

**One Compartment** – Furnished with #302004 faucet with gooseneck spout, except where noted. See page 213 for other available faucets.

inside bowl dimensions width x length x depth in. mm		overall width x length in. mm		TOP MOUNT cutout width x length in. mm		BOTTOM MOUNT cutout* width x length in. mm		weight lbs. kg	cu ft	model #	list	
14" x 10" x 5"	356 x 254 x 127	19" x 12¼"	483 x 324	17½" x 11¼"	448 x 286	14½" x 10½"	376 x 275	10	4.5	0.7	SR10-14-5-1•▲	483
14" x 10" x 9½"	356 x 254 x 241	18½" x 12¾"	480 x 324	17½" x 11¼"	445 x 286	14½" x 10½"	376 x 275	12	5.4	1.4	SR10-14-9.5-1•	530
14" x 12" x 9½"	356 x 305 x 241	19" x 14¾"	483 x 375	17" x 13¾"	448 x 337	14" x 12"	365 x 314	14	6.4	1.7	SR12-14-9.5-1•▲	712
10" x 14" x 5"	254 x 356 x 127	15" x 16¾"	381 x 426	13" x 15¼"	346 x 387	10½" x 14½"	275 x 376	10	4.5	0.8	SR14-10-5-1▲	483
10" x 14" x 5"	254 x 356 x 127	15" x 16¾"	381 x 426	13" x 15¼"	346 x 387	n/a	n/a	12	5.4	0.8	SRU14-10-5-1**▲	912
10" x 14" x 9½"	254 x 356 x 241	15" x 16¾"	381 x 422	13" x 15" x 15"	346 x 384	10½" x 14½"	275 x 376	12	5.4	1.6	SR14-10-9.5-1	692
12" x 14" x 9½"	305 x 356 x 241	17" x 16¾"	432 x 426	15" x 15¼"	397 x 387	12" x 14"	314 x 365	14	6.4	1.8	SR14-12-9.5-1▲	705
16" x 14" x 9½"	406 x 356 x 241	21" x 16¾"	533 x 425	19" x 15¼"	499 x 387	16" x 14"	422 x 372	23	10.4	2.1	SR14-16-9.5-1•▲	829
14" x 16" x 9½"	356 x 406 x 241	19" x 18¾"	483 x 476	17" x 17¼"	448 x 448	14" x 16"	372 x 422	23	10.4	2.1	SR16-14-9.5-1▲	829
20" x 16" x 8"	508 x 406 x 203	24¾" x 18½"	629 x 470	23" x 17"	594 x 432	20" x 16"	524 x 422	26	11.8	2.2	SR16-19-8-1	709
20" x 16" x 13½"	508 x 406 x 343	24¾" x 18½"	629 x 470	23" x 17"	594 x 432	20" x 16"	524 x 422	28	12.7	3.9	SR16-19-13.5-1	889
24" x 18" x 13½"	610 x 457 x 343	28¾" x 20½"	730 x 521	27" x 19"	695 x 483	24" x 18"	626 x 473	32	14.5	4.9	SR18-24-13.5-1	942
16" x 20" x 8"	406 x 508 x 203	20¾" x 22½"	527 x 572	19" x 21"	492 x 533	16" x 20"	422 x 524	24	10.9	2.3	SR19-16-8-1■	829
16" x 20" x 13½"	406 x 508 x 343	20¾" x 22½"	527 x 572	19" x 21"	492 x 533	16" x 20"	422 x 524	25	11.3	3.9	SR19-16-13.5-1■	889
12" x 20" x 6½"	305 x 508 x 165	17" x 22¾"	432 x 578	15" x 21¼"	397 x 540	12" x 20"	310 x 511	28	12.7	1.6	SR20-12-6.5-1▲	897
22" x 22" x 13½"	559 x 559 x 343	27" x 24¾"	686 x 629	25" x 23¼"	651 x 591	see template included w/sink	see template included w/sink	34	15.4	5.5	SR22-22-13.5-1■	1056
18" x 24" x 13½"	457 x 610 x 343	22¾" x 26½"	578 x 673	21" x 25"	543 x 635	18" x 24"	473 x 626	32	14.5	5.0	SR24-18-13.5-1	866
24" x 24" x 13½"	610 x 610 x 343	28¾" x 26½"	730 x 673	27" x 25"	695 x 635	24½" x 24½"	627 x 627	36	16.3	6.4	SR24-24-13.5-1	1134

\* See page 213 for Bottom Mount Kit; \*\* #SRU14-10-5-1 features an upturn on sides and rear; ■ These sinks utilize #300490 faucet with 12" (305mm) swivel spout; ▲ 20 gauge stainless steel. All others constructed of 18 gauge stainless steel.

### Optional Deck-Mount Electronic-Eye Faucet for One Compartment Drop-In Sinks only

deck mount electronic-eye faucet



To order, add suffix "-FE" to model #. Example: SR10-14-5-1-FE. Consult factory for list price.

**Two Compartment** – Furnished with #300490 faucet with 12" (203mm) spout, except where noted. See page 213 for other available faucets.

inside bowl dimensions width x length x depth in. mm		overall width x length in. mm		TOP MOUNT cutout width x length in. mm		BOTTOM MOUNT cutout* width x length in. mm		weight lbs. kg	cu ft	model #	list	
14" x 10" x 9½"	356 x 254 x 241	18½" x 24¾"	480 x 629	17½" x 23¼"	445 x 591	14½" x 23"	376 x 584	25	11.3	2.8	SR10-14-9.5-2■•	1122
14" x 12" x 9½"	356 x 305 x 241	19" x 28¾"	483 x 730	17" x 27¼"	448 x 692	14" x 26"	365 x 676	27	12.2	3.2	SR12-14-9.5-2▲	1234
16" x 14" x 9½"	406 x 356 x 241	21" x 32¾"	525 x 832	19" x 31¼"	499 x 794	16" x 30"	422 x 778	42	19.1	4.0	SR14-16-9.5-2▲	1316
20" x 16" x 8"	508 x 406 x 203	24¾" x 36¼"	527 x 921	23" x 34¾"	594 x 883	20" x 34¼"	524 x 870	48	21.8	4.3	SR16-19-8-2	1475
20" x 16" x 13½"	508 x 406 x 343	24¾" x 36¼"	527 x 921	23" x 34¾"	594 x 883	20" x 34¼"	524 x 870	52	23.6	7.5	SR16-19-13.5-2•	1549
24" x 18" x 13½"	610 x 457 x 343	28¾" x 40¼"	578 x 1022	27" x 38¾"	695 x 984	24" x 38½"	626 x 978	56	24.9	9.7	SR18-24-13.5-2	1776
22" x 22" x 13½"	559 x 559 x 343	27" x 48¾"	686 x 1238	25" x 47¼"	651 x 1200	see template included w/sink	see template included w/sink	57	25.9	10.7	SR22-22-13.5-2	1875
24" x 24" x 13½"	610 x 610 x 343	28¾" x 52½"	730 x 1324	27" x 50¾"	695 x 1286	24½" x 50¼"	630 x 1276	64	29.0	12.5	SR24-24-13.5-2	2397

\* See page 213 for Bottom Mount Kit; ■ Model #SR10-14-9.5-2 utilizes #301248 faucet with 8" (203mm) swivel spout; ▲ 20 gauge stainless steel. All others constructed of 18 gauge stainless steel.

## Catalog Section 20

### Countertop Drop-In Sinks with Self Rim Design

see spec sheet **EG20.39**

**Not NSF approved for warewashing and/or food preparation operations. Not intended for NSF installation into stainless steel worksurface. Please consult factory if need arises.**



#SR-10-14-9.5-3  
three-compartment sink

**FEATURES:**

- 304 series stainless steel.
- Faucet and 1½" (38mm) outlet basket drain.

**Freight class is 85.0.**

(•) MTS (made to stock) / ( ) MTO (made to order)

**Note:** Faucet holes are punched on 4" (102mm) centers. To order sinks with faucet holes punched on 8" (203mm) centers, add \$155 to list price and add suffix "-8CL" (example: SR18-24-13.5-3-8CL). Faucets sold separately for "-8CL" sinks. See "T&S Deck Mount Faucets" chart below.  
All weights and cubic feet in charts are approximate. Recommended for 1"-thick countertops.

**Three Compartment** – Furnished with #300490 faucet with 12" (305mm) spout, except where noted. See below for other available faucets.

inside bowl dimensions width x length x depth in. mm		overall width x length in. mm		TOP MOUNT cutout width x length in. mm		BOTTOM MOUNT cutout* width x length in. mm		weight lbs. kg	cu ft	model #	list
14" x 10" x 9½"	356 x 254 x 241	18¾" x 36¾"	480 x 933	17½" x 35¼"	445 x 895	14½" x 35"	376 x 889	37 16.8	4.1	SR10-14-9.5-3•	1500
14" x 12" x 9½"	356 x 305 x 241	19" x 42¾"	483 x 1086	17¾" x 41¼"	448 x 1031	14¾" x 40"	365 x 1032	39 17.6	4.7	SR12-14-9.5-3▲	1811
16" x 14" x 9½"	406 x 356 x 241	21" x 48¾"	533 x 1238	19¾" x 47¼"	498 x 1200	16¾" x 46"	422 x 1184	66 29.9	6.0	SR14-16-9.5-3▲	1847
20" x 16" x 8"	508 x 406 x 203	24¾" x 54"	629 x 1372	23¾" x 52½"	594 x 1334	20¾" x 52¼"	524 x 1327	72 32.7	6.3	SR16-19-8-3	1919
20" x 16" x 13½"	508 x 406 x 343	24¾" x 54"	629 x 1372	23¾" x 52½"	594 x 1334	20¾" x 52¼"	524 x 1327	77 34.9	10.9	SR16-19-13.5-3•	2032
24" x 18" x 13½"	610 x 457 x 343	28¾" x 60"	730 x 1524	27¾" x 58½"	695 x 1486	24¾" x 58¼"	626 x 1480	82 37.2	14.1	SR18-24-13.5-3■	2465

\* See below for Bottom Mount Kit; ■ These sinks utilize #301440 faucet with 14" (356mm) swivel spout; ▲ 20 gauge stainless steel. All others constructed of 18 gauge stainless steel.

### Options for Countertop Drop-In Sinks

see spec sheet **EG20.39**

**Note:** Faucets listed are lead-free AB1953-compliant.

**Faucets can be shipped UPS.**

#### Standard Deck Mount Faucets — with 1/4-turn handles

description	model #	list
gooseneck faucet, 4" (102mm) center, for single bowls	302004	182
8" (203mm) spout, 4" (102mm) centers, for single and double bowls	301248	164
12" (305mm) spout, 4" (102mm) centers, for triple bowls	300490	174
14" (356mm) spout, 4" (102mm) centers, for triple bowls	301440	189



#302004 faucet



#301248 faucet

#### T&S Deck Mount Faucets **OUR BEST**

description	model #	list
gooseneck faucet, 4" (102mm) center, for single bowls	313308	437
8" (203mm) spout, 4" (102mm) center, for single and double bowls	313306	421
8" (203mm) spout, 4" (102mm) center, for single and double bowls, with spray arm	377430 *	434
8" (203mm) spout, 8" (203mm) center, for single and double bowls, with spray arm	303560 *	486
12" (305mm) spout, 4" (102mm) center, for triple bowls	313303	436
12" (305mm) spout, 8" (203mm) center, for triple bowls, with spray arm	303561 *	549
14" (356mm) spout, 4" (102mm) center, for triple bowls	313307	437
14" (356mm) spout, 8" (203mm) center, for triple bowls, with spray arm	303562 *	547

\* Faucets with spray arm require special faucet holes.



#303560 faucet

**Bottom-Mount Kit** — One kit per one-compartment sinks, two kits per two-compartment sink, three kits per three-compartment sink.

description	model #	list
8 undermount clips per kit	362188	25

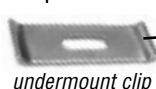

undermount clip

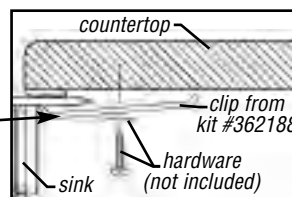

100 Industrial Boulevard, Clayton, DE 19938-8903 U.S.A.  
Phone: 800-637-5100 or 302-653-3000. Fax: 302-653-2065  
http://www.eaglegrp.com

### Undermount Sink Bowls with Drawn Bowl

see spec sheet **EG20.18**



- For NSF-approved welded fabrication.
- Deep-drawn seamless bowls.
- Type 304 stainless steel construction.
- Bowls are provided with drain holes only.

**FEATURES:**

**Note:** All shipping weights and cubic feet are approximate.

**Freight class is 85.0.**

### One Compartment

inside bowl dimensions width x length x depth in. mm		overall dimensions width x length in. mm		gauge	drain hole in. mm		weight lbs. kg		cu ft	model #	list
14" x 10" x 5"	356 x 254 x 127	16" x 12"	406 x 305		20	3½"	89	9			
14" x 10" x 9½"	356 x 254 x 241	16" x 12"	406 x 305	18	3½"	89	11	5.0	1.4	<b>FDI-10-14-9.5-1</b>	354
14" x 12" x 9½"	356 x 305 x 241	16" x 14"	406 x 356	20	3½"	89	13	5.8	2.4	<b>FDI-12-14-9.5-1</b>	369
20" x 12" x 6½"	508 x 305 x 165	22" x 14"	559 x 356	20	2"	51	14	6.4	2.6	<b>FDI-12-20-6.5-1</b>	386
16" x 14" x 6"	406 x 356 x 152	18" x 16"	457 x 406	20	3½"	89	14	6.4	2.5	<b>FDI-14-16-6-1</b>	395
16" x 14" x 9½"	406 x 356 x 241	18" x 16"	457 x 406	20	3½"	89	14	6.4	2.3	<b>FDI-14-16-9.5-1</b>	406
19¼" x 15½" x 8"	502 x 391 x 203	21¼" x 17½"	552 x 441	20	2"	51	15	6.8	2.6	<b>FDI-15 3/8-19 3/4-8-1</b>	409
20" x 16" x 8"	508 x 406 x 203	21¼" x 18"	552 x 457	18	3½"	89	23	10.4	3.7	<b>FDI-16-19-8-1</b>	497
20" x 16" x 13½"	508 x 406 x 343	21¼" x 18"	552 x 457	18	3½"	89	25	11.3	3.7	<b>FDI-16-19-13.5-1</b>	502
24" x 18" x 13½"	610 x 457 x 343	26" x 20"	660 x 508	18	3½"	89	37	16.8	8.6	<b>FDI-18-24-13.5-1</b>	608
20" x 20" x 5"	508 x 508 x 127	22" x 22"	559 x 559	20	3½"	89	19	8.6	1.5	<b>FDI-20-20-5-1</b>	389
22" x 22" x 13½"	559 x 559 x 343	24" x 24"	610 x 610	18	3½"	89	39	17.6	7.3	<b>FDI-22-22-13.5-1</b>	709
24" x 24" x 13½"	610 x 610 x 343	26" x 26"	660 x 660	18	3½"	89	41	18.6	8.3	<b>FDI-24-24-13.5-1</b>	740



### Two Compartment

inside bowl dimensions width x length x depth in. mm		overall dimensions width x length in. mm		gauge	drain hole in. mm		weight lbs. kg		cu ft	model #	list
14" x 10" x 9½"	356 x 254 x 241	16" x 24"	406 x 610		18	3½"	89	19			
14" x 12" x 9½"	356 x 305 x 241	16" x 28"	406 x 711	20	3½"	89	21	9.5	4.5	<b>FDI-12-14-9.5-2</b>	734
16" x 14" x 9½"	406 x 356 x 241	18" x 32"	457 x 813	20	3½"	89	25	11.3	6.2	<b>FDI-14-16-9.5-2</b>	791
20" x 16" x 8"	508 x 406 x 203	21¼" x 36"	552 x 914	18	3½"	89	43	19.5	5.1	<b>FDI-16-19-8-2</b>	961
20" x 16" x 13½"	508 x 406 x 343	21¼" x 36"	552 x 914	18	3½"	89	50	22.7	7.6	<b>FDI-16-19-13.5-2</b>	988
24" x 18" x 13½"	610 x 457 x 343	26" x 40"	660 x 1016	18	3½"	89	73	33.1	15.7	<b>FDI-18-24-13.5-2</b>	1155
22" x 22" x 13½"	559 x 559 x 343	24" x 48"	610 x 1219	18	3½"	89	75	34.0	12.6	<b>FDI-22-22-13.5-2</b>	1369
24" x 24" x 13½"	610 x 610 x 343	26" x 52"	660 x 1321	18	3½"	89	81	36.7	15.0	<b>FDI-24-24-13.5-2</b>	1427

**Catalog Section 20**

**Undermount Sink Bowls with Drawn Bowl** 

see spec sheet **EG20.18**

- For NSF-approved welded fabrication.
- Deep-drawn seamless bowls.
- Type 304 stainless steel construction.
- Bowls are provided with drain holes only.

**FEATURES:**

**Note:** All shipping weights and cubic feet are approximate.

**Freight class is 85.0.**



**Three Compartment**

inside bowl dimensions width x length x depth		overall dimensions width x length		gauge	drain hole		weight		cu ft	model #	list
in.	mm	in.	mm		in.	mm	lbs.	kg			
14" x 10" x 9½"	356 x 254 x 241	16" x 36"	406 x 914	18	3½"	89	27	12.2	4.0	<b>FDI-10-14-9.5-3</b>	1016
14" x 12" x 9½"	356 x 305 x 241	16" x 42"	406 x 1067	20	3½"	89	30	13.6	5.3	<b>FDI-12-14-9.5-3</b>	1026
16" x 14" x 9½"	406 x 356 x 241	18" x 48"	457 x 1219	20	3½"	89	36	16.3	7.2	<b>FDI-14-16-9.5-3</b>	1152
20" x 16" x 8"	508 x 406 x 203	21¼" x 54"	552 x 1372	18	3½"	89	63	28.6	11.3	<b>FDI-16-19-8-3</b>	1387
20" x 16" x 13½"	508 x 406 x 343	21¼" x 54"	552 x 1372	18	3½"	89	75	34.0	15.9	<b>FDI-16-19-13.5-3</b>	1447
24" x 18" x 13½"	610 x 457 x 343	26" x 60"	660 x 1524	18	3½"	89	101	45.8	21.8	<b>FDI-18-24-13.5-3</b>	1677
22" x 22" x 13½"	559 x 559 x 343	24" x 72"	610 x 1829	18	3½"	89	113	51.3	19.8	<b>FDI-22-22-13.5-3</b>	1902
24" x 24" x 13½"	610 x 610 x 343	26" x 78"	660 x 1981	18	3½"	89	123	55.8	21.8	<b>FDI-24-24-13.5-3</b>	1983



**Four Compartment**

inside bowl dimensions width x length x depth		overall dimensions width x length		gauge	drain hole		weight		cu ft	model #	list
in.	mm	in.	mm		in.	mm	lbs.	kg			
14" x 10" x 9½"	356 x 254 x 241	16" x 48"	406 x 1219	18	3½"	89	35	15.9	6.0	<b>FDI-10-14-9.5-4</b>	1222
14" x 12" x 9½"	356 x 305 x 241	16" x 56"	406 x 1422	20	3½"	89	39	17.6	7.2	<b>FDI-12-14-9.5-4</b>	1365
16" x 14" x 9½"	406 x 356 x 241	18" x 64"	457 x 1626	20	3½"	89	47	21.3	9.7	<b>FDI-14-16-9.5-4</b>	1417
20" x 16" x 8"	508 x 406 x 203	21¼" x 72"	552 x 1829	18	3½"	89	83	37.6	16.9	<b>FDI-16-19-8-4</b>	1677
20" x 16" x 13½"	508 x 406 x 343	21¼" x 72"	552 x 1829	18	3½"	89	100	45.4	14.8	<b>FDI-16-19-13.5-4</b>	1731
24" x 18" x 13½"	610 x 457 x 343	26" x 80"	660 x 3032	18	3½"	89	129	58.5	28.4	<b>FDI-18-24-13.5-4</b>	1973
22" x 22" x 13½"	559 x 559 x 343	24" x 96"	610 x 2438	18	3½"	89	151	68.6	23.5	<b>FDI-22-22-13.5-4</b>	2307
24" x 24" x 13½"	610 x 610 x 343	26" x 104"	660 x 2642	18	3½"	89	163	73.9	28.5	<b>FDI-24-24-13.5-4</b>	2401



**Undermount Sink Bowls with Fabricated Wall** 

see spec sheet **EG20.16**

- For NSF-approved welded fabrication.
- Type 304 18-8 stainless steel construction.
- Bowls are tapered to allow for 60% nesting which facilitates shipping and storage.
- 5/8" (16mm) radius corners.
- 3 1/2" (89mm) drain hole with sump.
- Swirl away drainage.

FEATURES:

**Freight class is 85.0.**

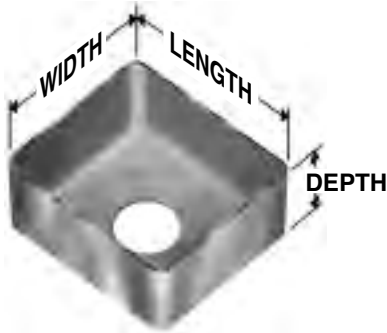

inside bowl dimensions (W x L x D)		gauge	weight		cu ft	model #	list
in.	mm		lbs.	kg			
9" x 12" x 6"	229 x 305 x 432	16	6	2.7	0.4	<b>FNWNF-9-12-6-1</b>	656
9" x 14" x 8"	229 x 356 x 203	16	8	3.6	0.5	<b>FNWNF-9-14-8-1</b>	695
12" x 14" x 8"	305 x 356 x 203	16	11	5.0	0.8	<b>FNWNF-12-14-8-1</b>	716
14" x 16" x 8"	356 x 406 x 203	16	12	5.4	1.0	<b>FNWNF-14-16-8-1</b>	751
18" x 18" x 10"	457 x 457 x 254	14	24	10.9	1.9	<b>FNWNF-18-18-10-1</b>	671
18" x 18" x 12"	457 x 457 x 305	14	27	12.2	2.3	<b>FNWNF-18-18-12-1</b>	680
20" x 20" x 10"	508 x 508 x 254	14	25	11.3	2.3	<b>FNWNF-20-20-10-1</b>	709
20" x 20" x 12"	508 x 508 x 305	14	29	13.2	2.8	<b>FNWNF-20-20-12-1</b>	746
20" x 20" x 14"	508 x 508 x 356	14	32	14.5	3.2	<b>FNWNF-20-20-14-1</b>	786
20" x 27" x 6"	508 x 686 x 432	14	20	9.0	1.5	<b>FNWNF-20-27-6-1</b>	671
20 1/2" x 20 1/2" x 5"	521 x 521 x 127	14	18	8.2	1.2	<b>FNWNF-20.5-20.5-5-1</b>	604
20 1/2" x 20 1/2" x 8"	521 x 521 x 203	14	24	10.9	1.9	<b>FNWNF-20.5-20.5-8-1</b>	663
24" x 24" x 12"	610 x 610 x 305	14	38	17.2	4.0	<b>FNWNF-24-24-12-1</b>	829
24" x 24" x 14"	610 x 610 x 356	14	42	19.1	4.7	<b>FNWNF-24-24-14-1</b>	872



**ECO-Built™ is an important part of The EAGLE Advantage.**

The numbers don't lie. EAGLE's efforts to consume less, emit less and conserve more are beginning to bear fruit. The tree to the left shows just some of what we now accomplish each year.

**Look for the ECO-Built™ tag on the bar code.**



### Custom Sink Modifications

see spec sheet **EG20.50**

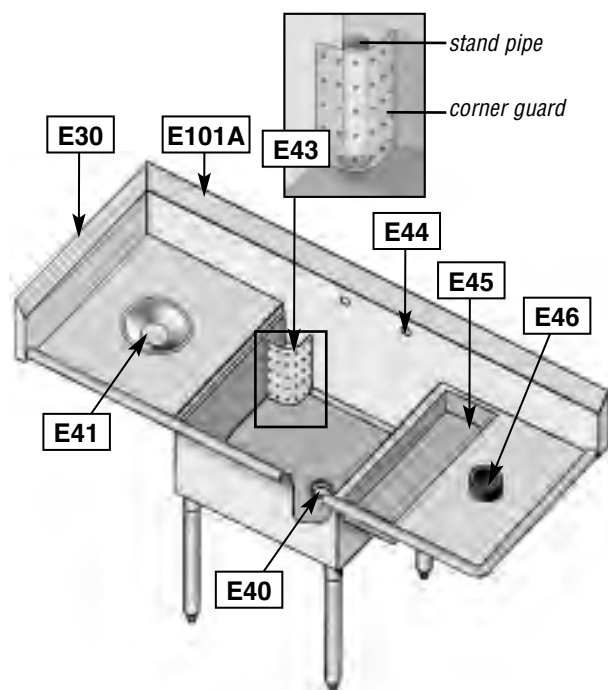

model #	description	list
E30	End splash - per end, all heights	312
E40	Provision for sink heater	177
E41	Disposal provision package—collar	733
E41A	Disposal provision package—cone	733
E43	Stand pipe with corner guard, available only on FN-style and utility sinks	221
E44	Faucet hole revision - adding or moving	165
E45	Trough installed in drainboard - up to 30" (762mm) long	899
E46	Rubber scrap block installed	359
E101A	Turn down backsplash - per sink, includes Z-clips	242

#### Not Pictured

model #	description	list
E37	NSF sprayed-on sound deadening - up to 12' (3658mm)	680
E37A	- for each additional foot	54
E38-6 *	Cantilever mount up to 6' (1829mm) - add to wall shelf price	395
E38-12 *	Cantilever mount up to 12' (3658mm) - add to wall shelf price	591
E39	Enclosed backsplash	84/lin. ft.
E47	Sink cover holders, sized for stainless steel or poly (includes upper and lower track)	675/slot
E48	Stainless steel apron, to cover sink bowls - 2 or 3 compartment	1081
E48A	- for each additional compartment over 3	180
E49	s/s undershelf under drainboards - up to 24" (610mm) w/short legs	581
E49A	- for each additional foot over 24" (610mm)	255
E50	Provision for water pump	1515
E51	Optional size drainboard	335/lin. ft.
E52	High backsplash up to 13" (330mm)	174/lin. ft.
E53	High backsplash up to 18" (457mm)	311/lin. ft.
E54	Working height revision	295/sink
E55	Drainboard corner turn	1363/ea.
E56	overflow hole	43

\* Applicable to wall mount shelves and pot racks.

## Sink Accessories/Replacements

see spec sheet **EG20.51A**

Can be shipped UPS.

## Sink Kits for SPEC-MASTER® FN Series Sinks

- Includes T&S faucet #313293.



lever drain (with sink kits B)

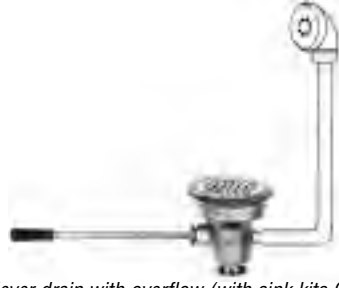

lever drain with overflow (with sink kits C)

Go Green.  
Go EAGLE.

Look for the tag  
on the bar code



### Kit A

- Add suffix “-F” to sink model number.

description	add to list price
1 faucet	601
2 faucets	1202

### Kit B

- T&S faucet plus lever drain. Add suffix “-FD” to sink model number.

description	add to list price
1 faucet	601
2 faucets	1202
per lever drain	232

### Kit C

- T&S faucet plus lever drain with overflow. Add suffix “-FDO” to sink model number.

description	add to list price
1 faucet	601
2 faucets	1202
per lever drain with overflow	476

### Kit D

- T&S faucet plus twist handle drain and twist handle bracket. Add suffix “-FDT” to sink model number.

description	add to list price
1 faucet	601
2 faucets	1202
per twist handle drain	244

### Kit E

- T&S faucet plus twist handle drain with overflow and twist handle bracket. Add suffix “-FDOT” to sink model number.

description	add to list price
1 faucet	601
2 faucets	1202
per twist handle drain with overflow	553

## Plumbing Components

description	model #	list each
P-trap, nickel-plated	300789	91
tail piece for 1.5" (38.1mm) IPS connection, nickel-plated	300791	16
anti-siphon vacuum breaker	313832	176
backflow preventer	313834	205

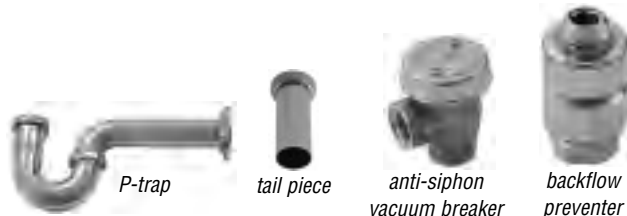

## Catalog Section 20

### Sink Accessories/Replacements

see spec sheet **EG20.51A**

#### Sink Covers...

For 412, 414, 314, and Spec-Master® FN Series Sinks only.

fits sink bowl size	Polyboard		Stainless Steel	
	model #	list	model #	list
14" x 10" (356 x 254mm)	313207	134	321555	166
16" x 20" (483 x 508mm)	351584	152	351585	188
20" x 18" (508 x 457mm)	335377	156	346175	199
20" x 20" (508 x 508mm)	326267	159	305428	201
22" x 22" (559 x 559mm)	313204	164	321557	211
24" x 18" (610 x 457mm)	326268	160	326270	204
24" x 24" (610 x 610mm)	313205	177	321558	258
28" x 20" (711 x 508mm)	326269	176	326271	207

Can be shipped UPS.



polyboard sink cover

stainless steel sink cover



lever handle drain with overflow



crumb cup strainer



twist handle drain



lever handle drain

#### Drains

description	max. flow rate		model #	list
	gal. per minute	gal. per hour		
lever handle drain with 1.5" or 2" (38 or 51mm) NPS connection	27	1620	300720	232
lever handle drain with 2" (51mm) NPS connection	32	1920	300721	232
lever handle drain with 2" (51mm) NPS connection and overflow	32	1920	300722	476
twist handle drain with 1.5" or 2" (38 or 51mm) NPS connection	27	1620	341189 *	244
twist handle drain with 2" (51mm) NPS connection	32	1920	336002 *	244
twist handle drain with 2" (51mm) NPS connection and overflow	32	1920	341190 *	553
nickel-plated brass rotary drain with 1.5" or 2" (38 or 51mm) NPS connection	40	2400	369653	394
crumb cup strainer with 1.5" (38mm) outlet	18	1080	300287	21

\* Twist handle bracket, for use with twist handle drain, should be ordered as sink option "-TB" at time of sink order —or see Sink Kits on page 197 (for 314, 412, or 414 Series sinks) or page 218 (for FN Series sinks).

#### Control Bracket

description	model #	list each
3" x 5" (76 x 127mm), extra heavy duty	309796	69

Note: Requires custom mounting.



stainless steel flanged bullet foot

#### Leg Components

description	model #	list each
19" (483mm) stainless steel leg for utility sinks	300315	32
stainless steel bullet feet	300692	18
stainless steel flanged bullet feet	313835	26
plastic bullet feet	300293	2

### Sink Accessories/Replacements

see spec sheet **EG20.51B**

#### T&S Extra Heavy Duty Faucets

- Top-of-the-line, T&S quality products.
- Splash mounted with 8" (203mm) centers.

description	model #	list
8" (203mm) spout	313920	586
10" (254mm) spout	340380	598
12" (305mm) spout	313293	601
14" (356mm) spout	313294	606



12" (305mm) T&S faucet

**OUR BEST**

**OUR BEST**

#### T&S Extra Heavy Duty Faucet with Wrist Handles

- Top-of-the-line T&S quality.
- Deck mounted with 4" (102mm) centers.
- 4" (102mm) long wrist handles and rigid gooseneck spout.



description	model #	list
extra heavy duty	313304	599





## Sink Accessories/Replacements

see spec sheet **EG20.51B**

**Note:** Faucets listed are lead-free AB1953-compliant.

**Can be shipped UPS.**

### Standard Faucets

- 8" (203mm) centers.
- Splash mounted

description	model #	list
8" (203mm) spout, standard	<b>313918</b>	219
12" (305mm) spout, standard	<b>300716</b>	225
14" (356mm) spout, standard	<b>300804</b>	231
16" (406mm) spout, standard	<b>313919</b>	232
12" (305mm) spout, heavy duty	<b>301001</b>	541
14" (356mm) spout, heavy duty	<b>301002</b>	547
19" (489mm) double-jointed spout	<b>301003</b>	607
gooseneck, 8" (203mm) center	<b>313075</b>	161



19" (483mm)  
double-jointed spout faucet



12" (305mm)  
heavy duty faucet

### Repair Kits for Standard Faucets

description	for faucets #	model #	list
hot/cold stems, handles, seats, bonnet nuts, O-rings	313918, 313919	<b>304146</b>	100
hot/cold ceramic cartridge	300716, 300804	<b>368421</b>	29

### Standard Faucets with Wrist Handles

- Deck mounted with 4" (102mm) centers.
- 4" (102mm) long wrist handles and gooseneck spout.

description	model #	list
standard, rigid gooseneck spout	<b>301005</b>	309
heavy duty, swivel gooseneck spout	<b>301004</b>	504



standard  
wrist handle faucet

## Prerinse Units and Components

### Standard

description	model #	list
splash mounted spray unit	<b>300719</b>	1121
deck mounted spray unit	<b>300718</b>	1117
faucet add-on with 12" (305mm) spout	<b>301189</b>	297
wall bracket	<b>301190</b>	75
prerinse hose, 36" (914mm) length	<b>313116</b>	213
prerinse spray valve assembly for spray units #300718 and 300719	<b>313323</b>	183

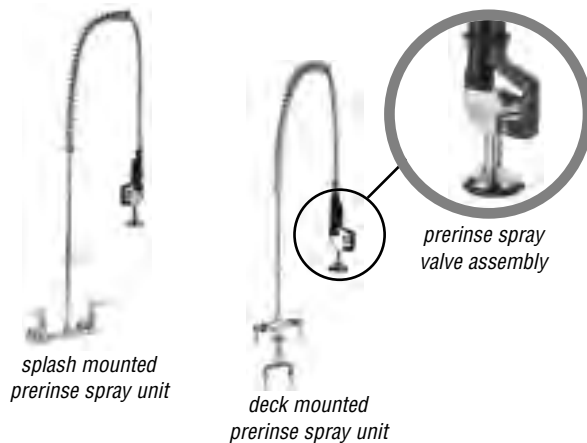

splash mounted  
prerinse spray unit

deck mounted  
prerinse spray unit

prerinse spray  
valve assembly

### T&S Extra Heavy Duty - Top-of-the-line. **OUR BEST**

description	model #	list
splash mounted spray unit with wall bracket	<b>313296</b>	1467
deck mounted spray unit with wall bracket	<b>313295</b>	1381
faucet add-on with 12" (305mm) spout for use with #313296 faucet	<b>313297</b>	365

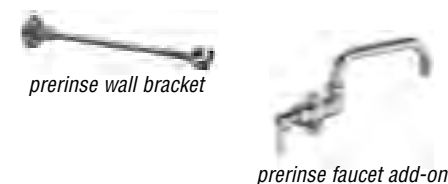

prerinse wall bracket

prerinse faucet add-on

## The EAGLE Advantage

### Can be summed up in two concise points:

Price/Value leadership and Value-Added Service. EAGLE is committed to providing you the highest quality products while maintaining the competitiveness necessary in today's market.

**Visit us at [www.eaglegrp.com](http://www.eaglegrp.com)**

### Floor Troughs

see spec sheet **EG25.00**



floor trough with subway-style grating



(see chart below for dimensions A through F)

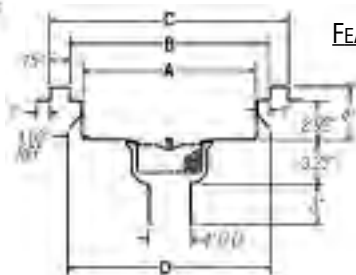

FEATURES:

- Built-in pitch towards drain ensures complete drainage.
- Secured with anchor straps.
- Stainless steel drain accommodates up to a 4" (102mm) diameter pipe, and removable perforated stainless steel basket.
- Stainless steel subway-style grating or fiberglass grating.

**Note:** Custom sizes available. Contact factory for pricing.

**Gray Fiberglass Grating available.**  
To order add suffix "G" to model #.  
**Example FT-1218-FGG.**

**Freight class is 85.0.**

(•) MTS (made to stock) / ( ) MTO (made to order)

### ...with Yellow Fiberglass Grating

**Note:** Wide T-Bar Fiberglass Grating\* available (for fiberglass only). ADA-compliant! Wider T-bar width provides a more solid walking area, and prevents objects from falling through. Resistant to corrosion, skid, fire, chipping and cracking. To order, add 5% to list price and suffix "-ADA". **Example: FT-1224-FG-ADA.**

\* Please note: Wide T-Bar "ADA" option is available only for troughs with fiberglass grating, not for troughs with stainless steel grating.

12" (305mm) WIDE TROUGHs	15" (381mm) WIDE TROUGHs	18" (457mm) WIDE TROUGHs	24" (610mm) WIDE TROUGHs
dimension A: 7" (178mm)	dimension A: 10" (254mm)	dimension A: 13" (330mm)	dimension A: 19" (483mm)
dimension B: 9" (229mm)	dimension B: 12" (305mm)	dimension B: 15" (381mm)	dimension B: 21" (533mm)
dimension C: 12" (305mm)	dimension C: 15" (381mm)	dimension C: 18" (457mm)	dimension C: 24" (610mm)
dimension D: 9.25" (235mm)	dimension D: 12.25" (311mm)	dimension D: 15.25" (387mm)	dimension D: 21.25" (540mm)

dimension E in. mm	dimension F in. mm	model #	list	model #	list	model #	list	model #	list
18" 457	15" 381	FT-1218-FG	1908	n/a	n/a	n/a	n/a	n/a	n/a
24" 610	21" 533	FT-1224-FG	2069	FT-1524-FG	2111	FT-1824-FG	2267	FT-2424-FG	2426
30" 762	27" 686	FT-1230-FG	2271	FT-1530-FG	2293	FT-1830-FG	2502	FT-2430-FG	2734
36" 914	33" 838	FT-1236-FG	2379	FT-1536-FG	2400	FT-1836-FG	2681	FT-2436-FG •	2947
48" 1219	45" 1143	FT-1248-FG	2731	FT-1548-FG	2764	FT-1848-FG	3104	FT-2448-FG	3461
60" 1524	57" 1448	FT-1260-FG	2957	FT-1560-FG	3086	FT-1860-FG	3467	FT-2460-FG	3967
72" 1829	69" 1753	FT-1272-FG	3340	FT-1572-FG	3406	FT-1872-FG	3875	FT-2472-FG	4003
84" 2134	81" 2057	FT-1284-FG	3654	FT-1584-FG	3757	FT-1884-FG	4326	FT-2484-FG	4987
96" 2438	93" 2362	FT-1296-FG	3988	FT-1596-FG	4055	FT-1896-FG	4724	FT-2496-FG	5458
120" 3048	117" 2972	FT-12120-FG	4653	FT-15120-FG	4908	FT-18120-FG	5723	FT-24120-FG	6638

### ...with Subway-Style Stainless Steel Grating

12" (305mm) WIDE TROUGHs	15" (381mm) WIDE TROUGHs	18" (457mm) WIDE TROUGHs	24" (610mm) WIDE TROUGHs
dimension A: 7" (178mm)	dimension A: 10" (254mm)	dimension A: 13" (330mm)	dimension A: 19" (483mm)
dimension B: 9" (229mm)	dimension B: 12" (305mm)	dimension B: 15" (381mm)	dimension B: 21" (533mm)
dimension C: 12" (305mm)	dimension C: 15" (381mm)	dimension C: 18" (457mm)	dimension C: 24" (610mm)
dimension D: 9.25" (235mm)	dimension D: 12.25" (311mm)	dimension D: 15.25" (387mm)	dimension D: 21.25" (540mm)

dimension E in. mm	dimension F in. mm	model #	list	model #	list	model #	list	model #	list
18" 457	15" 381	FT-1218-SG	2653	n/a	n/a	n/a	n/a	n/a	n/a
24" 610	21" 533	FT-1224-SG •	2782	FT-1524-SG	2959	FT-1824-SG •	3129	FT-2424-SG	3788
30" 762	27" 686	FT-1230-SG	2868	FT-1530-SG	3029	FT-1830-SG	3303	FT-2430-SG	3945
36" 914	33" 838	FT-1236-SG •	2956	FT-1536-SG	3442	FT-1836-SG •	3479	FT-2436-SG •	4498
48" 1219	45" 1143	FT-1248-SG •	3653	FT-1548-SG	4189	FT-1848-SG	4136	FT-2448-SG	5208
60" 1524	57" 1448	FT-1260-SG	4381	FT-1560-SG	4906	FT-1860-SG	5103	FT-2460-SG	5840
72" 1829	69" 1753	FT-1272-SG	5034	FT-1572-SG	5642	FT-1872-SG	5586	FT-2472-SG	6787
84" 2134	81" 2057	FT-1284-SG	5916	FT-1584-SG	6380	FT-1884-SG	6784	FT-2484-SG	7419
96" 2438	93" 2362	FT-1296-SG	6086	FT-1596-SG	7072	FT-1896-SG	6958	FT-2496-SG	8208
120" 3048	117" 2972	FT-12120-SG	8001	FT-15120-SG	8613	FT-18120-SG	9221	FT-24120-SG	9943



100 Industrial Boulevard, Clayton, DE 19938-8903 U.S.A.  
Phone: 800-637-5100 or 302-653-3000. Fax: 302-653-2065  
<http://www.eaglegrp.com>

Anti-Splash Floor Troughs

see spec sheet **EG25.01**



**Patent #  
D519,618 S**

"Anti-Splash" design assures complete drainage while preventing splashing back onto the floor.

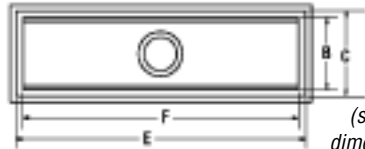
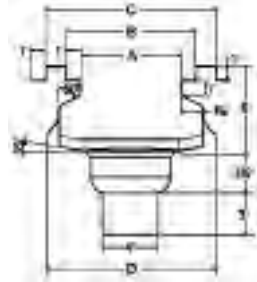

(see chart below for dimensions A through F)

- Built-in pitch towards drain ensures complete drainage.
- Secured with anchor straps.
- Stainless steel drain accommodates up to a 4" (102mm) diameter pipe, and removable perforated stainless steel basket.
- Stainless steel subway-style grating or fiberglass grating.

FEATURES:

**Note:** Custom sizes available. Contact factory for pricing.

**Gray Fiberglass Grating available.**  
To order add suffix "G" to model #.  
**Example ASFT-1218-FGG.**

**Freight class is 85.0.**

...with Yellow Fiberglass Grating

**Note:** Wide T-Bar\* Fiberglass Grating available. ADA-compliant! Wider T-bar width provides a more solid walking area, and prevents objects from falling through. Resistant to corrosion, skid, fire, chipping and cracking. To order, **add 5% to list price** and suffix "-ADA". **Example: ASFT-1218-FG-ADA.**

\* Please note: Wide T-Bar "ADA" option is available only for troughs with fiberglass grating, not for troughs with stainless steel grating.

dimension E		dimension F		12" (305mm) WIDE TROUGHs		15" (381mm) WIDE TROUGHs		18" (457mm) WIDE TROUGHs		24" (610mm) WIDE TROUGHs	
in.	mm	in.	mm	model #	list	model #	list	model #	list	model #	list
18"	457	15"	381	ASFT-1218-FG	2143	n/a	n/a	n/a	n/a	n/a	n/a
24"	610	21"	533	ASFT-1224-FG	2325	ASFT-1524-FG	2372	ASFT-1824-FG	2546	ASFT-2424-FG	2726
30"	762	27"	686	ASFT-1230-FG	2553	ASFT-1530-FG	2574	ASFT-1830-FG	2812	ASFT-2430-FG	3074
36"	914	33"	838	ASFT-1236-FG	2673	ASFT-1536-FG	2696	ASFT-1836-FG	3012	ASFT-2436-FG	3313
48"	1219	45"	1143	ASFT-1248-FG	3067	ASFT-1548-FG	3104	ASFT-1848-FG	3488	ASFT-2448-FG	3889
60"	1524	57"	1448	ASFT-1260-FG	3321	ASFT-1560-FG	3471	ASFT-1860-FG	3895	ASFT-2460-FG	4456
72"	1829	69"	1753	ASFT-1272-FG	3754	ASFT-1572-FG	3828	ASFT-1872-FG	4353	ASFT-2472-FG	4500
84"	2134	81"	2057	ASFT-1284-FG	4107	ASFT-1584-FG	4220	ASFT-1884-FG	4863	ASFT-2484-FG	5605
96"	2438	93"	2362	ASFT-1296-FG	4481	ASFT-1596-FG	4557	ASFT-1896-FG	5307	ASFT-2496-FG	6131
120"	3048	117"	2972	ASFT-12120-FG	5229	ASFT-15120-FG	5515	ASFT-18120-FG	6428	ASFT-24120-FG	7085

...with Subway-Style Stainless Steel Grating

dimension E		dimension F		12" (305mm) WIDE TROUGHs		15" (381mm) WIDE TROUGHs		18" (457mm) WIDE TROUGHs		24" (610mm) WIDE TROUGHs	
in.	mm	in.	mm	model #	list	model #	list	model #	list	model #	list
18"	457	15"	381	ASFT-1218-SG	2971	n/a	n/a	n/a	n/a	n/a	n/a
24"	610	21"	533	ASFT-1224-SG	2985	ASFT-1524-SG	2887	ASFT-1824-SG	3333	ASFT-2424-SG	3991
30"	762	27"	686	ASFT-1230-SG	3121	ASFT-1530-SG	3207	ASFT-1830-SG	3556	ASFT-2430-SG	4623
36"	914	33"	838	ASFT-1236-SG	3259	ASFT-1536-SG	3729	ASFT-1836-SG	3782	ASFT-2436-SG	4801
48"	1219	45"	1143	ASFT-1248-SG	4057	ASFT-1548-SG	4487	ASFT-1848-SG	4538	ASFT-2448-SG	5614
60"	1524	57"	1448	ASFT-1260-SG	4885	ASFT-1560-SG	4960	ASFT-1860-SG	5609	ASFT-2460-SG	6345
72"	1829	69"	1753	ASFT-1272-SG	5640	ASFT-1572-SG	6065	ASFT-1872-SG	6195	ASFT-2472-SG	7395
84"	2134	81"	2057	ASFT-1284-SG	6622	ASFT-1584-SG	6900	ASFT-1884-SG	7493	ASFT-2484-SG	8126
96"	2438	93"	2362	ASFT-1296-SG	6897	ASFT-1596-SG	7608	ASFT-1896-SG	7766	ASFT-2496-SG	9016
120"	3048	117"	2972	ASFT-12120-SG	9012	ASFT-15120-SG	9463	ASFT-18120-SG	10229	ASFT-24120-SG	10955



## Catalog Section 20

### Cool Trough® Water Tempering Systems

see product announcements **EG8138A** **EG8138B**



- Integral mechanical temperature sensor maintains water temperature of 130°F or less.
- Built-in pitch towards drain ensures complete drainage.
- No electrical connection required.

FEATURES:

Freight class is 85.0.



#WTFT-1215-FGG  
Cool Trough®

**PATENT  
PENDING**

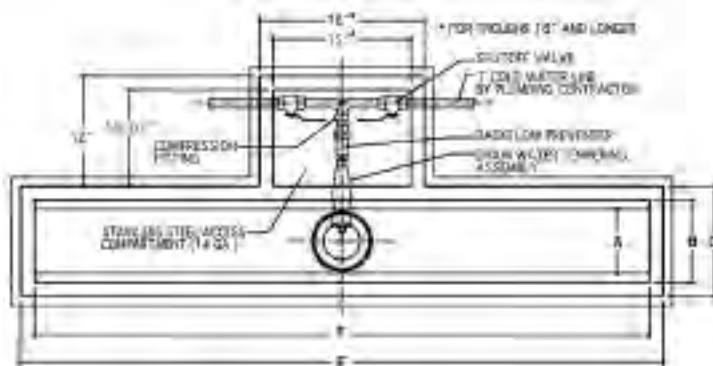
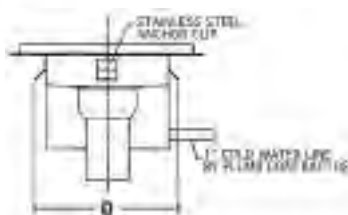

(see chart below for dimensions A through F)

#### ...with Gray Fiberglass Grating

**12" (305mm) WIDE TROUGHS**  
dimension A: 7" (178mm)  
dimension B: 9" (229mm)  
dimension C: 12" (305mm)  
dimension D: 9.25" (235mm)

**15" (381mm) WIDE TROUGHS**  
dimension A: 10" (254mm)  
dimension B: 12" (305mm)  
dimension C: 15" (381mm)  
dimension D: 12.25" (311mm)

**18" (457mm) WIDE TROUGHS**  
dimension A: 13" (330mm)  
dimension B: 15" (381mm)  
dimension C: 18" (457mm)  
dimension D: 15.25" (387mm)

**24" (610mm) WIDE TROUGHS**  
dimension A: 19" (483mm)  
dimension B: 21" (533mm)  
dimension C: 24" (610mm)  
dimension D: 21.25" (540mm)

dimension E in.	dimension F mm	in.	mm	model #	list	model #	list	model #	list	model #	list
15"	381	12"	305	WTFT-1215-FGG	10236	n/a	n/a	n/a	n/a	n/a	n/a
18"	457	15"	381	WTFT-1218-FGG	10752	WTFT-1518-FGG	10461	n/a	n/a	n/a	n/a
24"	610	21"	533	WTFT-1224-FGG	10920	WTFT-1524-FGG	10963	WTFT-1824-FGG	11127	WTFT-2424-FGG	11293
30"	762	27"	686	WTFT-1230-FGG	11130	WTFT-1530-FGG	11153	WTFT-1830-FGG	11372	WTFT-2430-FGG	11614
36"	914	33"	838	WTFT-1236-FGG	11244	WTFT-1536-FGG	11266	WTFT-1836-FGG	11559	WTFT-2436-FGG	11838
48"	1219	45"	1143	WTFT-1248-FGG	11611	WTFT-1548-FGG	11646	WTFT-1848-FGG	12002	WTFT-2448-FGG	12374
60"	1524	57"	1448	WTFT-1260-FGG	11848	WTFT-1560-FGG	11938	WTFT-1860-FGG	12381	WTFT-2460-FGG	12904
72"	1829	69"	1753	WTFT-1272-FGG	12248	WTFT-1572-FGG	12317	WTFT-1872-FGG	13279	WTFT-2472-FGG	12941
84"	2134	81"	2057	WTFT-1284-FGG	12576	WTFT-1584-FGG	12684	WTFT-1884-FGG	13279	WTFT-2484-FGG	13969
96"	2438	93"	2362	WTFT-1296-FGG	12926	WTFT-1596-FGG	12995	WTFT-1896-FGG	13694	WTFT-2496-FGG	14461

#### ...with Subway-Style Stainless Steel Grating

dimension E in.	dimension F mm	in.	mm	model #	list	model #	list	model #	list	model #	list
15"	381	12"	305	WTFT-1215-SG	11279	n/a	n/a	n/a	n/a	n/a	n/a
18"	457	15"	381	WTFT-1218-SG	11530	WTFT-1518-SG	11427	n/a	n/a	n/a	n/a
24"	610	21"	533	WTFT-1224-SG	11665	WTFT-1524-SG	11850	WTFT-1824-SG	12028	WTFT-2424-SG	12717
30"	762	27"	686	WTFT-1230-SG	11755	WTFT-1530-SG	11923	WTFT-1830-SG	12209	WTFT-2430-SG	12880
36"	914	33"	838	WTFT-1236-SG	11846	WTFT-1536-SG	12355	WTFT-1836-SG	12393	WTFT-2436-SG	13458
48"	1219	45"	1143	WTFT-1248-SG	12575	WTFT-1548-SG	13136	WTFT-1848-SG	13622	WTFT-2448-SG	14200
60"	1524	57"	1448	WTFT-1260-SG	13336	WTFT-1560-SG	13885	WTFT-1860-SG	14090	WTFT-2460-SG	14860
72"	1829	69"	1753	WTFT-1272-SG	14018	WTFT-1572-SG	14654	WTFT-1872-SG	15309	WTFT-2472-SG	15850
84"	2134	81"	2057	WTFT-1284-SG	14940	WTFT-1584-SG	15425	WTFT-1884-SG	15847	WTFT-2484-SG	16510
96"	2438	93"	2362	WTFT-1296-SG	15118	WTFT-1596-SG	16147	WTFT-1896-SG	16968	WTFT-2496-SG	17335



100 Industrial Boulevard, Clayton, DE 19938-8903 U.S.A.  
Phone: 800-637-5100 or 302-653-3000. Fax: 302-653-2065  
<http://www.eaglegrp.com>

## Anti-Splash Cool Trough® Water Tempering Systems

see product announcements **EG8138C** **EG8138D**



- Integral mechanical temperature sensor maintains water temperature of 130°F or less.
- Built-in pitch towards drain ensures complete drainage.
- No electrical connection required.

FEATURES:

Freight class is 85.0.



#ASWTFT-1215-FGG  
Cool Trough®

**PATENT  
PENDING**

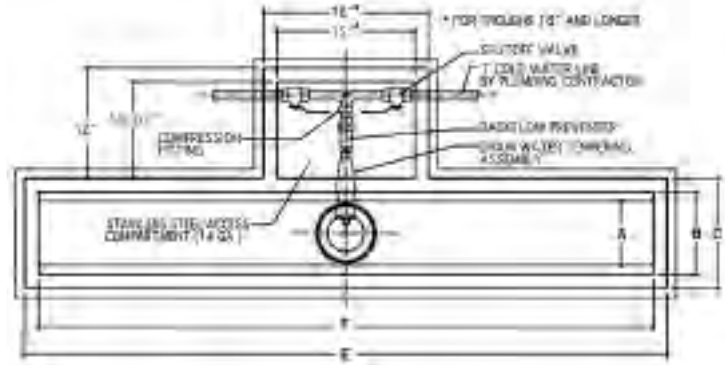
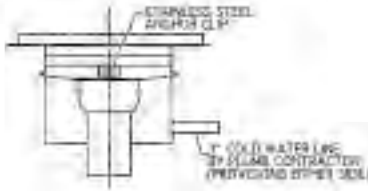

(see chart below for dimensions A through F)

### ...with Gray Fiberglass Grating

12" (305mm) WIDE TROUGHS	15" (381mm) WIDE TROUGHS	18" (457mm) WIDE TROUGHS	24" (610mm) WIDE TROUGHS
dimension A: 7" (178mm)	dimension A: 10" (254mm)	dimension A: 13" (330mm)	dimension A: 19" (483mm)
dimension B: 9" (229mm)	dimension B: 12" (305mm)	dimension B: 15" (381mm)	dimension B: 21" (533mm)
dimension C: 12" (305mm)	dimension C: 15" (381mm)	dimension C: 18" (457mm)	dimension C: 24" (610mm)
dimension D: 9.25" (235mm)	dimension D: 12.25" (311mm)	dimension D: 15.25" (387mm)	dimension D: 21.25" (540mm)

dimension E in. mm	dimension F in. mm	model #	list	model #	list	model #	list	model #	list
15" 381	12" 305	ASWTFT-1215-FGG	10755	n/a	n/a	n/a	n/a	n/a	n/a
18" 457	15" 381	ASWTFT-1218-FGG	10997	ASWTFT-1518-FGG	10972	n/a	n/a	n/a	n/a
24" 610	21" 533	ASWTFT-1224-FGG	11188	ASWTFT-1524-FGG	11236	ASWTFT-1824-FGG	11419	ASWTFT-2424-FGG	11607
30" 762	27" 686	ASWTFT-1230-FGG	11425	ASWTFT-1530-FGG	11447	ASWTFT-1830-FGG	11696	ASWTFT-2430-FGG	11970
36" 914	33" 838	ASWTFT-1236-FGG	11551	ASWTFT-1536-FGG	11575	ASWTFT-1836-FGG	11905	ASWTFT-2436-FGG	12219
48" 1219	45" 1143	ASWTFT-1248-FGG	11963	ASWTFT-1548-FGG	12002	ASWTFT-1848-FGG	12403	ASWTFT-2448-FGG	12822
60" 1524	57" 1448	ASWTFT-1260-FGG	12228	ASWTFT-1560-FGG	12384	ASWTFT-1860-FGG	12828	ASWTFT-2460-FGG	13414
72" 1829	69" 1753	ASWTFT-1272-FGG	12680	ASWTFT-1572-FGG	12758	ASWTFT-1872-FGG	13306	ASWTFT-2472-FGG	13460
84" 2134	81" 2057	ASWTFT-1284-FGG	13050	ASWTFT-1584-FGG	13168	ASWTFT-1884-FGG	13840	ASWTFT-2484-FGG	14615
96" 2438	93" 2362	ASWTFT-1296-FGG	13440	ASWTFT-1596-FGG	13520	ASWTFT-1896-FGG	14304	ASWTFT-2496-FGG	15164

### ...with Subway-Style Stainless Steel Grating

dimension E in. mm	dimension F in. mm	model #	list	model #	list	model #	list	model #	list
15" 381	12" 305	ASWTFT-1215-SG	11786	n/a	n/a	n/a	n/a	n/a	n/a
18" 457	15" 381	ASWTFT-1218-SG	11862	ASWTFT-1518-SG	11236	n/a	n/a	n/a	n/a
24" 610	21" 533	ASWTFT-1224-SG	11877	ASWTFT-1524-SG	11775	ASWTFT-1824-SG	12240	ASWTFT-2424-SG	12928
30" 762	27" 686	ASWTFT-1230-SG	12019	ASWTFT-1530-SG	12109	ASWTFT-1830-SG	12473	ASWTFT-2430-SG	13589
36" 914	33" 838	ASWTFT-1236-SG	12163	ASWTFT-1536-SG	12655	ASWTFT-1836-SG	12710	ASWTFT-2436-SG	13775
48" 1219	45" 1143	ASWTFT-1248-SG	12997	ASWTFT-1548-SG	13447	ASWTFT-1848-SG	13500	ASWTFT-2448-SG	14624
60" 1524	57" 1448	ASWTFT-1260-SG	13863	ASWTFT-1560-SG	13941	ASWTFT-1860-SG	14620	ASWTFT-2460-SG	15388
72" 1829	69" 1753	ASWTFT-1272-SG	14651	ASWTFT-1572-SG	14651	ASWTFT-1872-SG	15231	ASWTFT-2472-SG	16485
84" 2134	81" 2057	ASWTFT-1284-SG	15678	ASWTFT-1584-SG	15986	ASWTFT-1884-SG	16587	ASWTFT-2484-SG	17250
96" 2438	93" 2362	ASWTFT-1296-SG	15965	ASWTFT-1596-SG	16708	ASWTFT-1896-SG	16873	ASWTFT-2496-SG	18179



**Catalog Section 20**

**Replacement Subway-Style Grating for Floor Troughs and Drains**

**Freight class is 85.0.**

see spec sheet **EG25.02**

**Stainless Steel Grating**

- Constructed of 5/16" x 1" (5 x 25mm) vertically positioned bars, spaced 1" (25mm) apart to allow ease of drainage.
- 13/16" (21mm) clearance between bars prevents casters on mobile equipment from wedging in grate.
- Two 5/16" (8mm) rods, set 2 1/4" (57mm) in from each edge, are welded to the bars to eliminate swaying.
- Standard on floor troughs.
- Sizes available fit floor drains up to 24" (610mm) wide.
- Grates 12" and 15" (305 and 381mm) wide feature three rods.
- Grates 21" (533mm) wide feature five rods.



for floor trough widths		grate width x length		model #	list each
in.	mm	in.	mm		
12"	305	9" x 7 1/2"	229 x 191	<b>341169</b>	366
12"	305	9" x 9"	229 x 229	<b>341117</b>	467
12"	305	9" x 12"	229 x 305	<b>341123</b>	509
15"	381	12" x 9"	305 x 229	<b>340992</b>	557
15"	381	12" x 12"	305 x 305	<b>331006</b>	601
18"	457	15" x 6"	381 x 154	<b>341330</b>	516
18"	457	15" x 7 1/2"	381 x 191	<b>341110</b>	548
18"	457	15" x 9"	381 x 229	<b>341113</b>	588
18"	457	15" x 12"	381 x 305	<b>336992</b>	642
18"	457	15" x 15"	381 x 381	<b>345934</b>	698
24"	610	21" x 9"	533 x 229	<b>341109</b>	665
24"	610	21" x 11"	533 x 279	<b>351572</b>	713
24"	610	21" x 12"	533 x 305	<b>336976</b>	735

**Wide "T" Bar Fiberglass Grating — ADA-compliant!**

- Conforms with the Americans with Disabilities Act for use with the physically handicapped.
- Provides a more solid walking area than traditional "T" bar shape, and prevents objects from falling through grating.
- Corrosion-, skid- and fire-resistant.
- High strength, low thermal conductivity.
- Resistant to chipping and cracking.
- Temperature rating of 250°F.



**Fiberglass Grating**

- Constructed of 1" (25mm) high yellow or gray polyester material with a non-slip grit on top surface.
- Tapered "I" beam construction for ease of cleaning and draining.
- Temperature rating of 250°F.
- Other sizes available—consult factory.



**GRAY OR YELLOW**

for floor trough widths		grate width x length		Gray	
in.	mm	in.	mm	model #	list ea
12"	305	9" x 9"	229 x 229	<b>370000</b>	142
12"	305	9" x 12"	229 x 305	<b>370001</b>	174
12"	305	9" x 15"	229 x 381	<b>370002</b>	188
15"	381	12" x 9"	305 x 229	<b>370003</b>	149
15"	381	12" x 12"	305 x 305	<b>370004</b>	182
18"	457	15" x 9"	381 x 229	<b>370005</b>	191
18"	457	15" x 12"	381 x 305	<b>370006</b>	237
18"	457	15" x 15"	381 x 381	<b>370007</b>	294
24"	610	21" x 9"	533 x 229	<b>370008</b>	241
24"	610	21" x 12"	533 x 305	<b>370009</b>	304

for floor trough widths		grate width x length		Yellow		Gray	
in.	mm	in.	mm	model #	list ea	model #	list ea
12"	305	9" x 9"	229 x 229	<b>362648</b>	115	<b>374015</b>	121
12"	305	9" x 12"	229 x 305	<b>362647</b>	138	<b>374018</b>	145
12"	305	9" x 15"	229 x 381	<b>373030</b>	146	<b>374021</b>	154
15"	381	12" x 9"	305 x 229	<b>362650</b>	115	<b>374044</b>	121
15"	381	12" x 12"	305 x 305	<b>362649</b>	138	<b>374047</b>	145
18"	457	15" x 9"	381 x 229	<b>362652</b>	148	<b>374073</b>	156
18"	457	15" x 12"	381 x 305	<b>362651</b>	180	<b>374076</b>	189
18"	457	15" x 15"	381 x 381	<b>373206</b>	223	<b>374079</b>	236
24"	610	21" x 9"	533 x 229	<b>362654</b>	181	<b>374102</b>	191
24"	610	21" x 12"	533 x 305	<b>362653</b>	226	<b>374105</b>	239

**Floor Drains**

see spec sheet **EG25.00**



description	width x length in.	mm	model #	list
with yellow fiberglass grating	12" x 12"	305 x 305	<b>FD-FG</b>	1519
with subway-style grating	12" x 12"	305 x 305	<b>FD-SG</b>	2023

**Note:** Floor opening = 11 1/2" x 11 1/2" (292 x 292)

- Perforated waste cup can be inverted to double as a bee hive strainer.
- Yellow fiberglass grating or subway-style stainless steel grating.

**FEATURES:**

**Note:** Gray Fiberglass Grating available. To order add suffix "G" to model #. Example FD-FGG.

**Freight class is 85.0.**





# SpecFAB<sup>®</sup> Custom Fabrications

Shelf Select<sup>™</sup> .....229  
Shelf Select<sup>™</sup> for Retail .....230  
The SpecFAB<sup>®</sup> Division .....228







**EAGLE's SpecFAB® Division fills the gap between standard equipment and high-cost, highly customized equipment. Depending on the custom need, configurations can be designed from pre-fab pieces by using existing components, or designed completely from scratch to match exacting consultant and architect's plans and details. This flexibility means custom equipment can be delivered faster and at a lower cost directly to the job site.**

## Frequently Asked Questions about Project Quotations:

### How do I request a Quote?

- Standard or modified product using listed 'E' numbers from the catalog:
  - Email requests to the Customer Service Representative for your geographical area or [custserv@eaglegrp.com](mailto:custserv@eaglegrp.com)
  - Telephone (800) 441-8440 and ask for the Customer Service Representative for your city and state.
  - Fax (302) 653-2065
  - Eagle Group, ATTN: Customer Service, 100 Industrial Blvd., Clayton, DE 19938
- Custom products not found in the catalog:
  - Email requests to [quotes@eaglegrp.com](mailto:quotes@eaglegrp.com)
  - Fax (302) 653-2065
  - Eagle Group, ATTN: Project Quotations, 100 Industrial Blvd., Clayton, DE 19938

### What to include with your request?

- Your Name and Dealer Name
- Projected Installation Date and Timeline
- Job or Project Name
- Consultant Name when Applicable
- Required Date for Quote
- Plans and Specs related to the Project
- Bid Date for Project
- Special Considerations

### How long will it take to process my request for a custom quote?

- Typical lead time of 72 hours for most new incoming projects.
- Large scale projects will carry longer lead times. Please be sure to communicate required bid dates.

### How can I find out the status of my custom quote request?

- Customer Service - The Customer Service representative for your area can access information regarding the status of your request via email or call (800) 441-8440.
- SpecFAB® Customer Service.
- SpecFAB® Quote Coordinator - call (800) 441-8440 and ask for the Quote Coordinator, Christina Martin, ext. 2784.
- Outgoing email signatures for quotes sent from SpecFAB® highlight the primary points of contact.

## Frequently Asked Questions about Project Submittals:

### How do I get a Submittal Drawing?

- Submit a purchase order for the project with plans and specifications if not previously provided to the Quotations Department.
- Provide a letter of intent for the project.
- Request quote drawings via [quotes@eaglegrp.com](mailto:quotes@eaglegrp.com).
- Shelf Select™ requests through [quotes@eaglegrp.com](mailto:quotes@eaglegrp.com).

### How long will it take to receive drawings?

- Typical requests for drawings are addressed within 72-hours.
- Large scale projects will carry longer lead times. Please be sure to communicate required bid dates.
- To contact Project Submittals regarding your drawings, contact the Submittals Coordinator, Bruce Moffett at [bmoffett@eaglegrp.com](mailto:bmoffett@eaglegrp.com) or (800) 441-8440, ext. 3158.
- Outgoing email signatures for drawings sent from SpecFAB® highlight the primary points of contact.



# Shelf Select™

**A No-Cost Design & Layout Service for Shelving Products.**



*Typical Shelf Select™ applications include walk-in coolers and freezers; dry storage areas; supermarkets; and department stores.*

## Provide Us With:

- Dimensions of a storage space available.
- Number of shelves per unit.
- Post heights.
- Indicate stationary, mobile or high density shelving.
- Any additional specific or pertinent storage requirements.

## And We'll Provide You With:

- **Plan View**  
Shelving system layout makes the most efficient utilization of your space available.
- **Perspective View\***  
Illustrates the proposed equipment assembled in the available space. A great tool for presentation which reduces field assembly time when provided to your installer.
- **Quote\***  
Includes model numbers, net prices and shipping weights for all components in specified job.

\* Will be provided after plan view is approved.

**For more information about Shelf Select™, request Shelf Select™ service announcement EG8027**

*Simply*

**Email: quotes@eaglegrp.com**

**Fax: 302-653-2065**

in your order and our trained staff will begin planning, layout and quotation upon receipt.

A completed Shelf Select™ custom layout and quotation will be mailed, emailed or faxed back to you within 48 hours.

**See page 230 for Shelf Select™ for Retail**

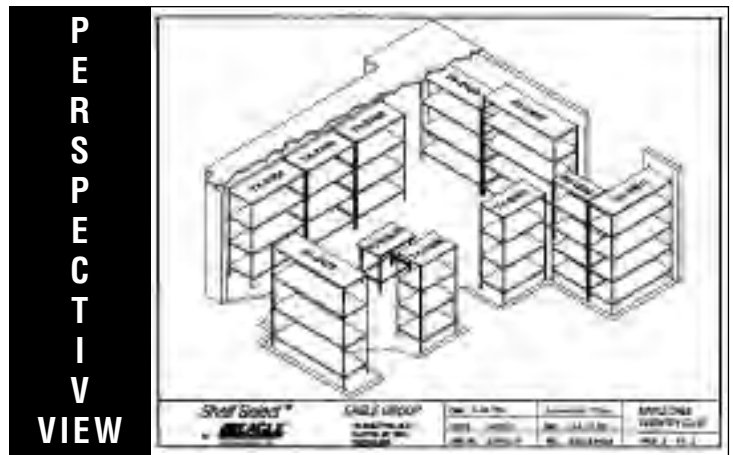

**FINAL OUTCOME!**



# Shelf Select™ for Retail

***A No-Cost Design & Layout Service for Retail Shelving*** by



*Typical Shelf Select™ applications include retail display, floral display, department stores, and point-of-purchase items.*

## Provide Us With:

- Dimensions of display or storage space available.
- Number of shelves per unit.
- Post heights.
- Indicate stationary, mobile or high density shelving.
- Any additional specific or pertinent display or storage requirements.

## And We'll Provide You With:

- **Plan View**  
Shelving system layout makes the most efficient utilization of your space available.
- **Perspective View**  
Illustrates the proposed equipment assembled in the available space.
- **Quote**  
Includes model numbers, net prices and shipping weights for all components in specified job.

***For more information about Shelf Select™ for Retail, request the Shelf Select™ service announcement EG8200***

*Simply*

**Email: [quotes@eaglegrp.com](mailto:quotes@eaglegrp.com)**

**Fax: 302-653-2065**

in your order and our trained staff will begin planning, layout and quotation upon receipt.

A completed Shelf Select™ custom layout and quotation will be mailed, emailed or faxed back to you within 48 hours.

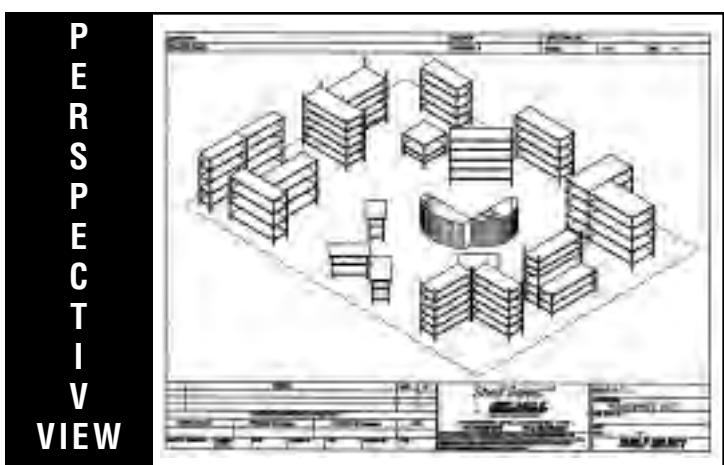
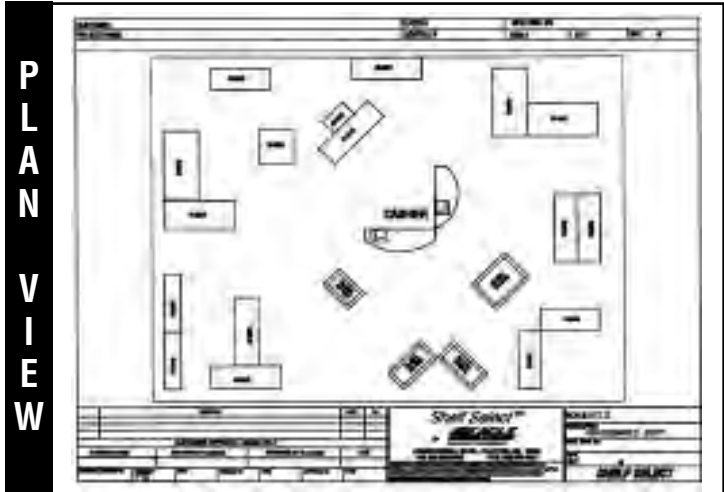

**FINAL OUTCOME!**



Two columns of horizontal lines for taking notes.





# Some of our new products featured inside...



**Caster Cradle®**  
pages 73,  
106 and 117



**Stainless Utility Carts**  
page 25



**Stainless Steel Case Carts**  
page 126

**I.V. Stands**  
page 120



**Cool Trough® Water Tempering Systems**  
pages 223 and 224



**Double-Width Mop Sink Cabinets**  
page 211



**Height Adjustable Tables**  
page 167



Take a look at our...

## HEALTHCARE APPLICATIONS BROCHURE

**CLICK HERE TO VIEW**



100 Industrial Boulevard, Clayton, DE 19938  
Toll Free: 1-800-637-5100 • Fax: 302-653-2065  
www.eaglegrp.com

Rev 07/15 EG9065

© 2015 EAGLE GROUP. Profit From The EAGLE Advantage® is a registered trademark of EAGLE GROUP.

Although every attempt has been made to ensure the accuracy of the data in this publication, we cannot be responsible for printing or typographical errors or omissions.