



North Coast Bearings markets and distributes differential rebuild kits, transmission rebuild kits and related products to the heavy, medium and light duty aftermarkets under the DT Components<sup>®</sup> product line. The brand was created through a strategic alliance with The Timken Company.



Over 2,500 Different Rebuild Kits

After nearly 20 years of success, Timken and North Coast Bearings have extended their strategic alliance to continue providing customers outstanding value into the future.

Our continually growing product line includes rebuild kits for the broadest range of on highway vehicles along with complementing gearing, axle shafts, u-joints and related products. Please visit our website for the latest news, information and literature on all of the North Coast Bearings products.

DT Components is the most recognized and respected brand of differential and transmission rebuild kits in North America. Our mission is to provide the best value in differential and transmission kits and components. Best value means Timken<sup>®</sup> tapered roller bearings, the best order fill, the fastest in-house turn-around time, US manufacturers' product where available, superior quality and personalized service.

North Coast Bearings is a member of the Bearingtech family of companies. These include:

- **Bearing Technologies** – Engineers and manufactures OEM quality wheel end products and OEM center support bearings



- **Micron Metalworks** – Machining division for automotive wheel end products



- **Precision** – Provider of competitively priced line of quality hub assemblies, bearings, seals and related products to automotive warehouse distributors



North Coast Bearings services customers from our 110,000 square foot Avon, Ohio facility along with a distribution center in Sparks, Nevada. The DT Components brand of kits are also available from additional Timken distribution centers throughout the world.



Bearing Technologies engineers, manufactures and services customers from their 119,000 square foot facility in Avon, Ohio.

Snap this QR code with your smartphone app to visit our web site.



# How To Use This Catalog

This catalog is divided into 6 main sections

1. Heavy Duty Differentials
2. Heavy Duty Transmissions and Transfer Cases
3. Light Duty Differentials
4. Light Duty Transmissions
5. Light Duty Transfer Cases
6. Driveshaft, Wheel End Products, Interchanges and Misc. Products

The Indexes for Heavy Duty Differentials, Transmissions and Transfer Cases are divided by the unit manufacturer and model number. Unless noted under the comments column, the rebuild kit services all ratios and variations for the model listed.

The Indexes for Light Duty Differentials, Transmissions and Transfer Cases are divided by vehicle manufacturer and model number/axle size. Make sure you have the correct date the vehicle was manufactured. Most models have evolved over time and there may be several kits for your particular vehicle depending upon when it was made.

Common Light Duty Differentials have their own product page by model number/axle size that lists gearing and other related products that are available.

Common Light Duty Transmissions and Transfer Cases also have their own product page by model number that lists gearing, synchronizers and related products.

We have also reprinted product information from our vendors with their permission on Heavy Duty Axles and Heavy Duty Differentials for your convenience.

Kit Bill Of Materials are listed in numeric sequence in four sections immediately after their related indexes.

# www.dtcomponents.com

View the DT Components E-Catalog for additional product listings by vehicle, the most current application information along with product specifications and images.

Snap this QR code with your smartphone app to view our electronic catalog.



DT Components - Electronic Catalog  
http://catalog.dtcomponents.com/

DT Components Drivetrain Products  
Marketed by The Timken Corporation

PARTS CATALOG

Application Diff/Trans Kits Cross Reference Part Search

Year: 2008 Make: FORD Model: F-150 Product: WHEEL BEARINGS, SEALS Engine: All

Location	Part Number	Part Type	Qty	Comment	Application
FRONT	515079	Axle Bearing and Hub Assembly	2	F150 (8 Stud) From 11/29/04	AWD
FRONT	515079	Axle Bearing and Hub Assembly	2	F150 (6 Stud) From 11/29/04	4WD
FRONT	515080	Axle Bearing and Hub Assembly	2	F150 (7 Stud) From 11/29/04	AWD
FRONT	515080	Axle Bearing and Hub Assembly	2	F150 (7 Stud) From 11/29/04	4WD
FRONT	517014	Wheel Bearing	2		RWD
REAR	100357	Wheel Seal	2	Viton	
REAR	R1561TV	Wheel Bearing	2		
REAR	RP1561FO	Wheel Bearing	2	Optional Repair Bearing; Replaces Brg & Seal	

# What's New In This Catalog

The DT2017 catalog provides the most complete offering of rebuild kits and related products for automotive, light and commercial vehicles. Below are highlights of the most recent additions to our product coverage.

## Heavy Duty Differential

- Dana 170/190 axles (2013 and newer)
- Mack C150 and C151 series of axles
- Meritor RC26-720 transit axle

## Heavy Duty Transmission

- Allison 1000, 2000, 3000 and 4000 models
- Mack T309, T310 and T318 models
- Volvo / Mack I-Shift 2412, 2512, 2612, 2812 and 3112 models
- PTO Kits for Chelsea, 270, 271, 442, 447, 489 and 880 models

## Heavy Duty Transfer Case

- Fabco 38, 200, 237, 270 and 306 models
- Spicer 738, 784, 785, 791 and 792 models

## Light Duty Differential

- Chevrolet Colorado/GMC Canyon with Dana front and rear axles (2015-On)
- Chevy Camaro ZL1 with 250mm axle (2013-On)
- Dodge/Freightliner Sprinters Ring & Pinions and Cases (2003-2007)  
Dodge/Freightliner Sprinters Rebuild Kits (2007-On)
- Ford 9.75" & 10.5" Ring and Pinion Conversion Kits (2000-On)
- Ford Escape with Dana 28 axle (2001-2012)
- Ford Mustang with 8.8" axle (2015-On)
- Ford Transit Vans with 9.75" axle (2015-On)
- Ford Trucks with 8.8", 9.75" and 10.5" axles (2011-On)
- GMC Trucks with the 9.76" axle (2014-On)
- Nissan NV Van with AAM 10.5" axle (2012-On)
- Nissan vehicles with the Dana 44 and Dana 205 axles (2004-On)
- Ram Trucks with ZF 9.25" axle (2011-On)
- RAM Trucks with the AAM 11.5" axle (2014-On)
- Toyota 4Runner and FJ Cruiser with 8" axle (2010-On)
- Toyota Tacoma with 8.75" axle (2016-On)
- Toyota Trucks with 9.5" and 10.5" axles (2007-On)

## Light Duty Transfer Case

- GMC trucks with Magna-Steyr 1222, 1225, 1625, 1626, 3023 and 3024 (2008-On)
- Jeep Grand Cherokee with Magna Steyr MP2010 (2011-On)
- Jeep Wrangler Rubicon with New Venture 241 (2003-On)
- Ram Trucks with Borg Warner 4444/4445 (2012-On)
- Ram Trucks with Borg Warner 4446/4447 (2012-On)
- Transfer Case Chains have been added to the vehicle indexes
- Transfer Case Product pages by transfer case model numbers

## Light Duty Transmission

- Dodge Caliber, Jeep Compass and Patriot vehicles with the T355 transmission. (2007-On)
- Ford Focus (2012-On)
- Ram Trucks with G56 transmissions synchro rings (2005-On)
- G56 Hard Parts are now available

## Center Support Bearings & Driveline Products

- HB210661-1XSA is a self aligning version of the HB210661-1X and allows the bearing to pivot +/- 10° within the rubber cushion for easier alignment during installation.
- Aluminum Center Support Bearings for Ford Trucks (2007-13)
- PTO Yokes Quick reference guide
- U-Joint Quick reference guide

Please link to our electronic catalog through the DT Components website for the most current product listings and additional product lookups by vehicle.

### DT Components Web Catalog

- Product Lookup by Application
- Kit Bill of Materials
- Interchanges
- Product Specifications
- Product Photos



Snap this QR code with your smartphone app to view our electronic catalog.



SECTION	PAGE
<b>NCB/DT Components Introduction</b> .....	<b>Inside Front Cover</b>
<b>How To Use This Catalog</b> .....	<b>i</b>
<b>What's New In This Catalog</b> .....	<b>ii</b>
<b>Legal Disclosure</b> .....	<b>iv</b>
<b>Warning</b> .....	<b>iv</b>
<b>Product Offering</b> .....	<b>v</b>
<b>Heavy Duty Rebuild Kits &amp; Related Products</b> .....	<b>1</b>
<b>Differential Rebuild Kits</b> .....	<b>1</b>
Alliance/Detroit/Freightliner Index .....	2
Dana/Eaton Index.....	2
GMC Index .....	13
International Harvester/Navistar Index.....	13
Mack Index.....	13
Meritor/Rockwell Index.....	15
Volvo Index.....	26
White Index .....	26
Rebuild Kit Bill of Materials .....	27
<b>Tractech NoSPIN Differentials</b> .....	<b>42</b>
<b>Heavy Duty Axle Shafts</b> .....	<b>48</b>
<b>Heavy Duty Transmission Rebuild Kits</b> .....	<b>75</b>
Allison Transmission Products .....	75
Chelsea PTO Products .....	76
Clark/Eaton/Fuller Index.....	77
GMC Index .....	96
International Harvester/Navistar Index.....	96
Mack Index.....	96
Meritor/Rockwell Index.....	96
New Process Index .....	97
Spicer/TTC Index .....	98
Volvo/Mack I-Shift Index.....	102
Warner Index.....	102
Rebuild Kit Bill of Materials .....	106
<b>Heavy Duty Transfer Case Rebuild Kits</b> .....	<b>103</b>
Fabco Index.....	103
Meritor/Rockwell Index.....	103
Spicer Index .....	105
Rebuild Kit Bill of Materials .....	106
<b>Light Duty Differential Rebuild Kits &amp; Related Products</b> .....	<b>150</b>
Identification Help for Axles.....	152
Differential Cover Gaskets .....	153
Differential Applications by Vehicle .....	154
Rebuild Kit Bill of Materials .....	183
Ring & Pinion Sets by Axle Size .....	206
Open Cases & Internal Kits by Axle Size.....	206
Limited Slip Differentials by Axle Size.....	206
Axle Shafts by Axle Size .....	206

<b>SECTION</b>	<b>PAGE</b>
<b>Light Duty Transmission, Transaxle and Transfer Case Rebuild Kits &amp; Related Products .....</b>	<b>237</b>
Transmission & Transaxle Applications by Vehicle .....	237
Rebuild Kit Bill of Materials .....	277
Exploded Transmission Drawings .....	285
Transmission Gearing and Related Parts by Transmission Model .....	285
Identification Help for Transfer Cases .....	303
Transfer Case Applications by Vehicle .....	304
Transmission and Transfer Case Small Parts Kits .....	314
Transfer Case Chains and Related Products by Model .....	315
<b>Additional Product Information and Interchanges .....</b>	<b>334</b>
Rebuild Kits, Bearing and Seal Interchanges .....	334
Center Support Bearings .....	346
Universal Joint Quick Reference .....	355
PTO Products Quick Reference .....	356
EZ Sleeve Repair Sleeves .....	360
Shim Stock Rolls .....	365
Light Duty Wheel Set Interchanges .....	366
Trailer Bearing Kits & Spindle Kits .....	367
Medium/Heavy Duty Wheel Set Interchanges .....	368
Medium/Heavy Duty Wheel Seals & Hub Caps Interchanges .....	370
Permatex Products .....	371
Limited Warranty .....	Inside Back Cover

Every possible effort has been made to ensure that the data in this catalog is correct, but we cannot assume responsibility should there be any error.

References to original equipment part numbers are for cross reference and identification purposes and may not indicate that the actual part is an original equipment part.

## Warning

Follow the manufacturer's installation instructions. Never spin a bearing with compressed air. The rollers may be forcefully expelled, creating a risk of bodily harm. Failure to follow all instructions and to properly lubricate the bearing can cause equipment failure, creating a risk of serious bodily harm.

## Heavy & Medium Duty Differential Products

- Bearing & Seal Rebuild Kits
- Tractech No Spin Differentials
- Axle Shafts
- Permatex<sup>®</sup> Adhesives & Sealants
- Individual Bearings & Seals
- Coverage for all Dana/Eaton, Detroit, GMC, IH/Navistar, Mack, Meritor/Rockwell, Volvo & White Models



## Heavy & Medium Duty Transmission & Transfer Case Products

- Bearing & Seal Rebuild Kits
- Permatex<sup>®</sup> Adhesives & Sealants
- Individual Bearings & Seals
- Coverage for all Allison, Chelsea, Clark, Eaton/Fuller, Fabco, Mack, Meritor/Rockwell, New Process, Spicer/TTC, Volvo & ZF Models

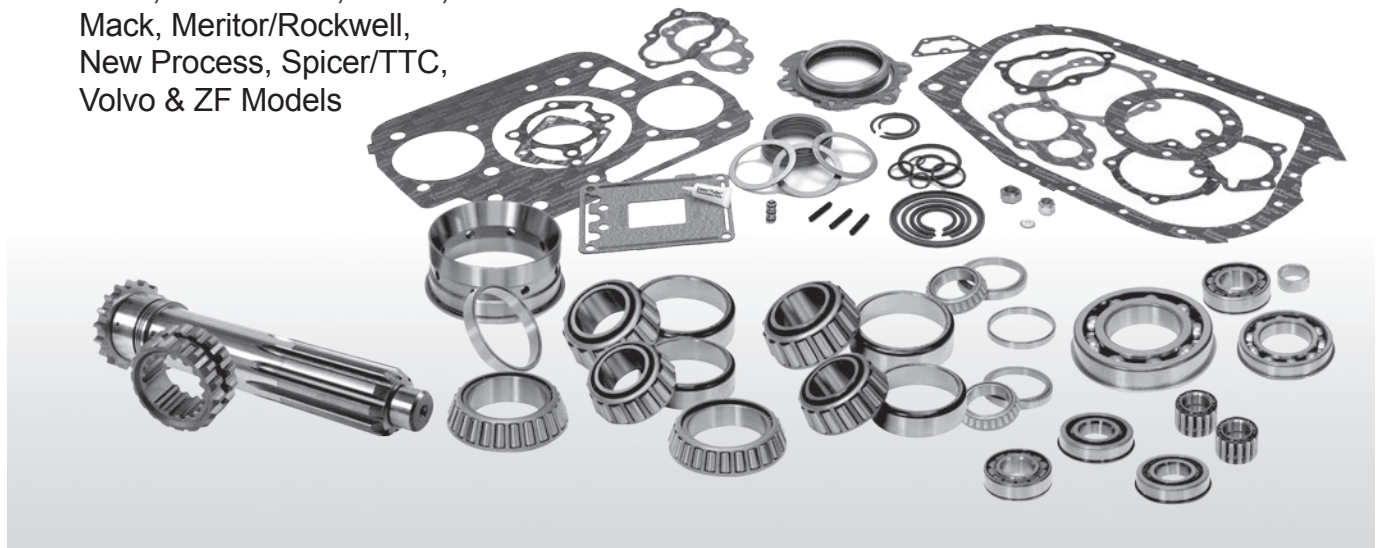

## Light Duty Differential Products

- Bearing & Seal Rebuild Kits
- Ring & Pinion Sets
- Differential Cases & Internal Kits
- Auburn, Detroit Locker & Eaton Limited Slip & Locking Differentials
- Axle Shafts
- Axle Shaft Repair Bearings
- Permatex<sup>®</sup> Adhesives & Sealants
- Individual Bearings & Seals
- Coverage for all AMC, Chrysler, Ford, GM, Jeep, Nissan & Toyota Vehicles



## Light Duty Transmission & Transfer Case Products

- Bearing & Seal Rebuild Kits
- Synchronizer Rings & Assemblies
- Input Shafts & Counter Shafts
- Transfer Case & Automatic Transmission Chains
- Permatex<sup>®</sup> Adhesives & Sealants
- Individual Bearings & Seals
- Coverage for all Acura, AMC, Chrysler, Ford, GM, Honda, Hummer, Hyundai, Infiniti, Isuzu, Jeep, KIA, Lexus, Mazda, Mitsubishi, Nissan, Saturn, Suzuki & Toyota Vehicles

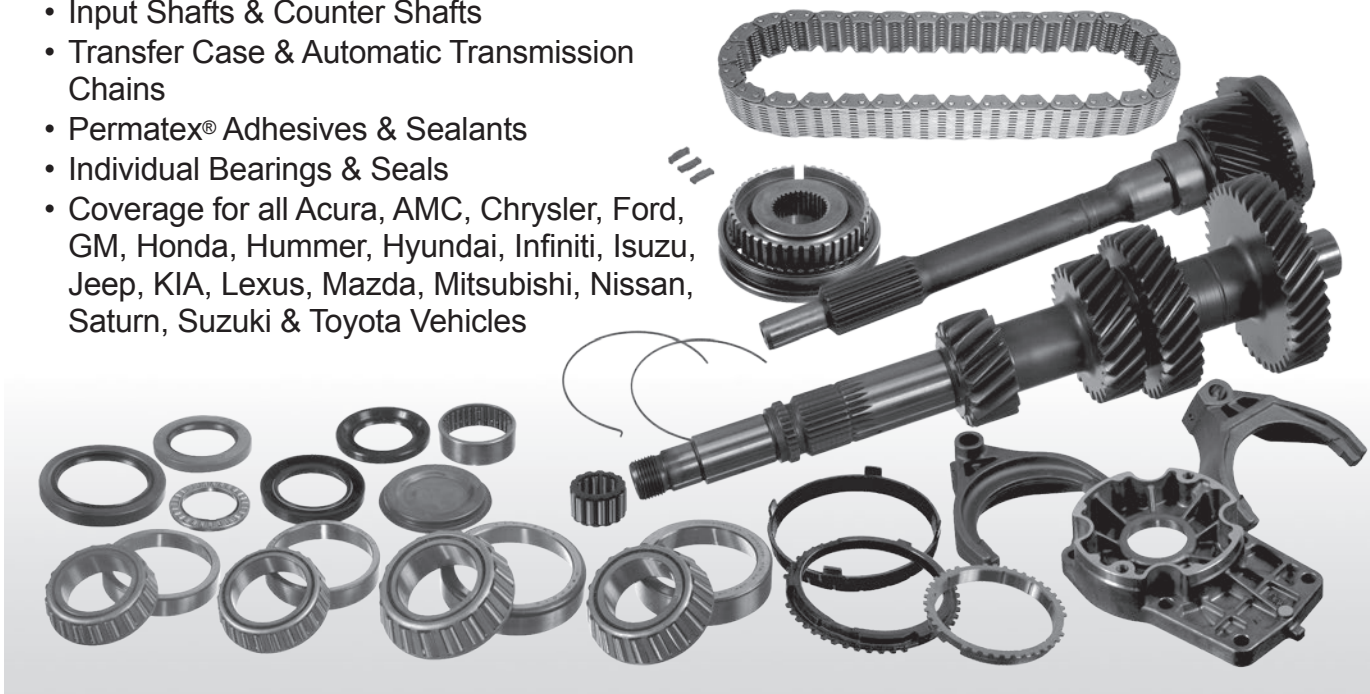



## Driveline & Clutch Products

- Driveshaft Center Support Bearings
- Universal Joints
- PTO Yokes
- Clutch Release Bearings
- Pilot Bearings
- EZ Sleeves®
- Individual Bearings & Seals
- Coverage for all Acura, AMC, Chrysler, Ford, GM, Honda, Hummer, Hyundai, Infiniti, Isuzu, Jeep, KIA, Lexus, Mazda, Mitsubishi, Nissan, Saturn, Suzuki, Volkswagen & Toyota Vehicles & Agricultural Applications



## Heavy Duty, Light Truck & Automotive Wheel End Products

- Wheel Bearings & Sets
- Hand Installed Wheel Seals
- Tool Installed Wheel Seals
- ABS & Non-ABS Hub Assemblies
- Axle Bearings, Axle Repair Bearings & Spindle Bearings
- Axle Seals & Wheel Seals



While this catalog is as current as possible at the time it was printed, it is quickly outdated due to our continued efforts of adding rebuild kits and related products for additional models and newer vehicles.

We also offer many additional products such as axle bearings, wheel hub assemblies, wheel seals, clutch release bearings, automatic transmission and engine seals that are not contained in this catalog.

Our E-Catalog also contains images and specifications on many of our products along with over 330,000 part number interchanges.

Please access our E-catalog via [www.dtcomponents.com](http://www.dtcomponents.com) to look up information on these additional products and for models and years not included in this catalog.



### DT Components Web Site

The redesigned and more informative DT Components web site contains product information, literature, customer login, and a link to our web catalog.



Snap this QR code with your smartphone app to visit our web site.

### DT Components Web Catalog

- Product Lookup by Application
- Kit Bill of Materials
- Interchanges
- Product Specifications
- Product Photos

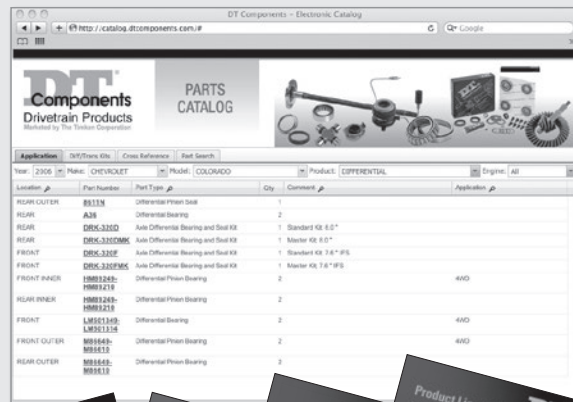

Snap this QR code with your smartphone app to view our electronic catalog.

# Heavy Duty Differential Index

## Dana Axle Identification

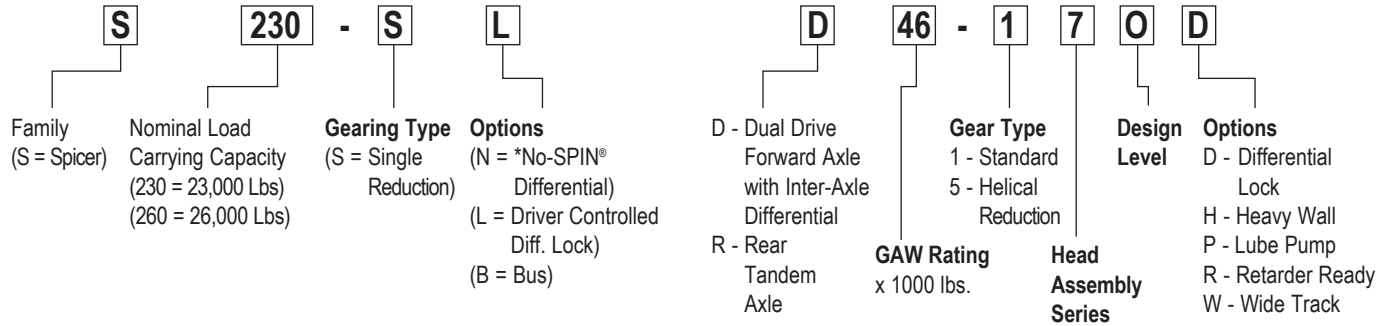

## Eaton Axle Identification

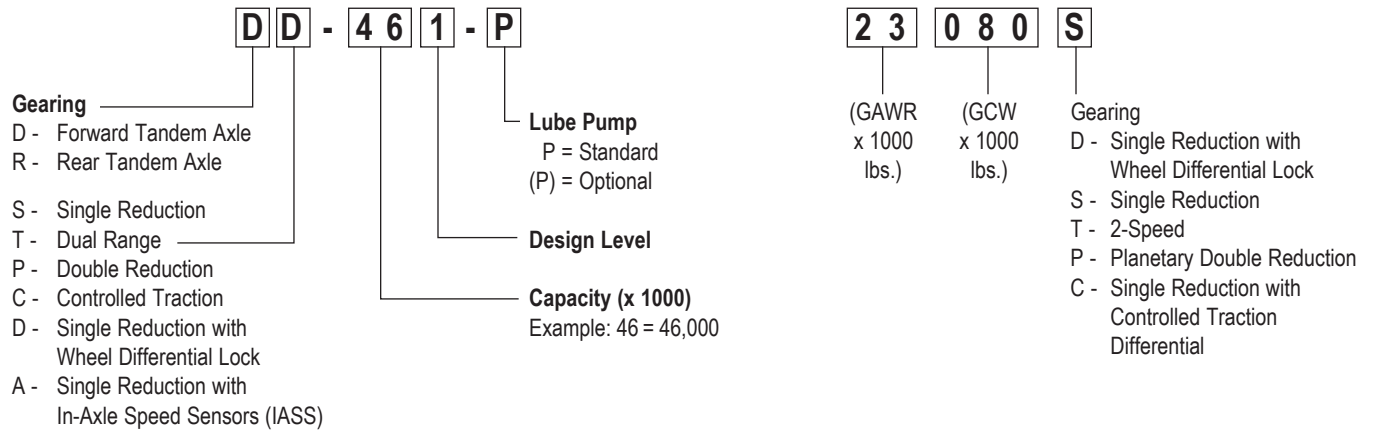

# Heavy Duty Differential Index

HD Differential

## Alliance / Detroit / Freightliner Index

Axle Model	Type/Cap.	Comments	Kit
ARS13-2	R-13,000		DRK-651
ARS15-2	R-15,000		DRK-651
ARS17.5-2	R-17,500		DRK-651
ARS17.5-4	R-17,500		DRK-650R
ARS19-2	R-19,000		DRK-651
ARS19-4	R-19,000		DRK-650R
ARS20-4	R-20,000		DRK-650R
ARS21-2	R-21,000		DRK-651
ARS23-4	R-23,000		DRK-650R
ART34-4	RF-34,000	Before 2008	DRK-650F
	RF-34,000	After 2008	DRK-650FA
	RR-34,000		DRK-650R
ART40-4	RF-44,000	Before 2008	DRK-650F
	RF-44,000	After 2008	DRK-650FA
	RR-44,000		DRK-650R
ART44-4	RF-44,000	Before 2008	DRK-650F
	RF-44,000	After 2008	DRK-650FA
	RR-44,000		DRK-650R

## Dana Index

Axle Model	Type/Cap.	Comments	Kit
S14-110	R-14,500		DRK-434
S14-111	R-14,500		DRK-434
S16-130	R-16,500		DRK-434
S16-132	R-16,500		DRK-434
S17-140	R-17,000		DRK-452
S19-140	R-19,000		DRK-452
S21-170	R-21,000	Before 6-10-13 and w/ 2.69-3.91 Ratios	DRK-438
	R-21,000	Before 6-10-13 and w/ 4.10-7.17 Ratios	DRK-439
	R-21,000	After 6-9-13 and w/ 2.69-3.91 Ratios	DRK-438A
	R-21,000	After 6-9-13 and w/ 4.10-7.17 Ratios	DRK-439A
S21-170D	R-21,000	Before 6-10-13 and w/ 2.69-3.91 Ratios	DRK-443
	R-21,000	Before 6-10-13 and w/ 4.10-7.17 Ratios	DRK-444
	R-21,000	After 6-9-13 and w/ 2.69-3.91 Ratios	DRK-443A
	R-21,000	After 6-9-13 and w/ 4.10-7.17 Ratios	DRK-444A
S21-170DE	R-21,000	Before 6-10-13	DRK-454
	R-21,000	After 6-9-13	DRK-454A
S21-170E	R-21,000	Before 6-10-13	DRK-454
	R-21,000	After 6-9-13	DRK-454A
S23-170	R-23,000	Before 6-10-13 and w/ 2.69-3.91 Ratios	DRK-438
	R-23,000	Before 6-10-13 and w/ 4.10-7.17 Ratios	DRK-439

## Dana Index (cont'd)

Axle Model	Type/Cap.	Comments	Kit
	R-23,000	After 6-9-13 and w/ 2.69-3.91 Ratios	DRK-438A
	R-23,000	After 6-9-13 and w/ 4.10-7.17 Ratios	DRK-439A
S23-170D	R-23,000	Before 6-10-13 and w/ 2.69-3.91 Ratios	DRK-443
	R-23,000	Before 6-10-13 and w/ 4.10-7.17 Ratios	DRK-444
	R-23,000	After 6-9-13 and w/ 2.69-3.91 Ratios	DRK-443A
	R-23,000	After 6-9-13 and w/ 4.10-7.17 Ratios	DRK-444A
S23-170DE	R-23,000	Before 6-10-13	DRK-454
	R-23,000	After 6-9-13	DRK-454A
S23-170E	R-23,000	Before 6-10-13	DRK-454
	R-23,000	After 6-9-13	DRK-454A
S25-170	R-25,000	Before 6-10-13 and w/ 2.69-3.91 Ratios	DRK-438
	R-25,000	Before 6-10-13 and w/ 4.10-7.17 Ratios	DRK-439
	R-25,000	After 6-9-13 and w/ 2.69-3.91 Ratios	DRK-438A
	R-25,000	After 6-9-13 and w/ 4.10-7.17 Ratios	DRK-439A
S25-170D	R-25,000	Before 6-10-13 and w/ 2.69-3.91 Ratios	DRK-443
	R-25,000	Before 6-10-13 and w/ 4.10-7.17 Ratios	DRK-444
	R-25,000	After 6-9-13 and w/ 2.69-3.91 Ratios	DRK-443A
	R-25,000	After 6-9-13 and w/ 4.10-7.17 Ratios	DRK-444A
S25-170DE	R-25,000	Before 6-10-13	DRK-454
	R-25,000	After 6-9-13	DRK-454A
S25-170E	R-25,000	Before 6-10-13	DRK-454
	R-25,000	After 6-9-13	DRK-454A
S21-190	R-21,000	Before 6-10-13 and w/ 2.53-4.78 Ratios	DRK-443
	R-21,000	Before 6-10-13 and w/ 5.25-7.83 Ratios	DRK-441
	R-21,000	After 6-9-13 and w/ 2.53-4.78 Ratios	DRK-443A
	R-21,000	After 6-9-13 and w/ 5.25-7.83 Ratios	DRK-441A
S21-190D	R-21,000	Before 6-10-13 and w/ 2.53-4.78 Ratios	DRK-443
	R-21,000	Before 6-10-13 and w/ 5.25-7.83 Ratios	DRK-441
	R-21,000	After 6-9-13 and w/ 2.53-4.78 Ratios	DRK-443A
	R-21,000	After 6-9-13 and w/ 5.25-7.83 Ratios	DRK-441A



# Heavy Duty Differential Index

## Dana Index (cont'd)

Axle Model	Type/Cap.	Comments	Kit
S23-190	R-23,000	Before 6-10-13 and w/ 2.53-4.78 Ratios	DRK-443
	R-23,000	Before 6-10-13 and w/ 5.25-7.83 Ratios	DRK-441
	R-23,000	After 6-9-13 and w/ 2.53-4.78 Ratios	DRK-443A
	R-23,000	After 6-9-13 and w/ 5.25-7.83 Ratios	DRK-441A
S23-190D	R-23,000	Before 6-10-13 and w/ 2.53-4.78 Ratios	DRK-443
	R-23,000	Before 6-10-13 and w/ 5.25-7.83 Ratios	DRK-441
	R-23,000	After 6-9-13 and w/ 2.53-4.78 Ratios	DRK-443A
	R-23,000	After 6-9-13 and w/ 5.25-7.83 Ratios	DRK-441A
S23-190DE	R-23,000	Before 6-10-13	DRK-453
	R-23,000	After 6-9-13	DRK-453A
S23-190E	R-23,000	Before 6-10-13	DRK-453
	R-23,000	After 6-9-13	DRK-453A
S26-190	R-26,000	Before 6-10-13 and w/ 2.53-4.78 Ratios	DRK-443
	R-26,000	Before 6-10-13 and w/ 5.25-7.83 Ratios	DRK-441
	R-26,000	After 6-9-13 and w/ 2.53-4.78 Ratios	DRK-443A
	R-26,000	After 6-9-13 and w/ 5.25-7.83 Ratios	DRK-441A
S26-190D	R-26,000	Before 6-10-13 and w/ 2.53-4.78 Ratios	DRK-443
	R-26,000	Before 6-10-13 and w/ 5.25-7.83 Ratios	DRK-441
	R-26,000	After 6-9-13 and w/ 2.53-4.78 Ratios	DRK-443A
	R-26,000	After 6-9-13 and w/ 5.25-7.83 Ratios	DRK-441A
S26-190DE	R-26,000	Before 6-10-13	DRK-453
	R-26,000	After 6-9-13	DRK-453A
S26-190E	R-26,000	Before 6-10-13	DRK-453
	R-26,000	After 6-9-13	DRK-453A
S30-190	R-30,000	Before 6-10-13 and w/ 2.53-4.78 Ratios	DRK-443
	R-30,000	Before 6-10-13 and w/ 5.25-7.83 Ratios	DRK-441
	R-30,000	After 6-9-13 and w/ 2.53-4.78 Ratios	DRK-443A
	R-30,000	After 6-9-13 and w/ 5.25-7.83 Ratios	DRK-441A
S30-190D	R-30,000	Before 6-10-13 and w/ 2.53-4.78 Ratios	DRK-443
	R-30,000	Before 6-10-13 and w/ 5.25-7.83 Ratios	DRK-441
	R-30,000	After 6-9-13 and w/ 2.53-4.78 Ratios	DRK-443A

## Dana Index (cont'd)

Axle Model	Type/Cap.	Comments	Kit
	R-30,000	After 6-9-13 and w/ 5.25-7.83 Ratios	DRK-441A
S30-190DE	R-30,000	Before 6-10-13	DRK-453
	R-30,000	After 6-9-13	DRK-453A
S30-190E	R-30,000	Before 6-10-13	DRK-453
	R-30,000	After 6-9-13	DRK-453A
S23-590	R-23,000	Before 6-10-13	DRK-453
	R-23,000	After 6-9-13	DRK-453A
S23-590D	R-23,000	Before 6-10-13	DRK-453
	R-23,000	After 6-9-13	DRK-453A
S26-590	R-26,000	Before 6-10-13	DRK-453
	R-26,000	After 6-9-13	DRK-453A
S26-590D	R-26,000	Before 6-10-13	DRK-453
	R-26,000	After 6-9-13	DRK-453A
S30-590	R-30,000	Before 6-10-13	DRK-453
	R-30,000	After 6-9-13	DRK-453A
S30-590D	R-30,000	Before 6-10-13	DRK-453
	R-30,000	After 6-9-13	DRK-453A
S35-590	R-35,000	Before 6-10-13	DRK-453
	R-35,000	After 6-9-13	DRK-453A
S35-590D	R-35,000	Before 6-10-13	DRK-453
	R-35,000	After 6-9-13	DRK-453A
D40-145S	F-40,000		DRK-427A
D40-145X	F-40,000		DRK-427A
R40-145S	R-40,000		DRK-452
D40-170	F-40,000	Before 6-10-13	DRK-442
	F-40,000	After 6-9-13	DRK-442A
D40-170D	F-40,000	Before 6-10-13	DRK-436
	F-40,000	After 6-9-13	DRK-436A
D40-170DP	F-40,000	Before 6-10-13	DRK-436
	F-40,000	After 6-9-13	DRK-436A
D50-170D	F-50,000	Before 6-10-13	DRK-436
	F-50,000	After 6-9-13	DRK-436A
D50-170DP	F-50,000	Before 6-10-13	DRK-436
	F-50,000	After 6-9-13	DRK-436A
D50-170P	F-50,000	Before 6-10-13	DRK-442
	F-50,000	After 6-9-13	DRK-442A
R50-170	R-50,000	Before 6-10-13 and w/ 2.69-3.91 Ratios	DRK-438
	R-50,000	Before 6-10-13 and w/ 4.10-7.17 Ratios	DRK-439
	R-50,000	After 6-9-13 and w/ 2.69-3.91 Ratios	DRK-438A
	R-50,000	After 6-9-13 and w/ 4.10-7.17 Ratios	DRK-439A
R50-170D	R-50,000	Before 6-10-13 and w/ 2.69-3.91 Ratios	DRK-443
	R-50,000	Before 6-10-13 and w/ 4.10-7.17 Ratios	DRK-444
	R-50,000	After 6-9-13 and w/ 2.69-3.91 Ratios	DRK-443A
	R-50,000	After 6-9-13 and w/ 4.10-7.17 Ratios	DRK-444A
D40-170P	F-40,000	Before 6-10-13	DRK-442
	F-40,000	After 6-9-13	DRK-442A

HD Differential

# Heavy Duty Differential Index

HD Differential

## Dana Index (cont'd)

Axle Model	Type/Cap.	Comments	Kit
R40-170	R-40,000	Before 6-10-13 and w/ 2.69-3.91 Ratios	DRK-438
	R-40,000	Before 6-10-13 and w/ 4.10-7.17 Ratios	DRK-439
	R-40,000	After 6-9-13 and w/ 2.69-3.91 Ratios	DRK-438A
	R-40,000	After 6-9-13 and w/ 4.10-7.17 Ratios	DRK-439A
R40-170D	R-40,000	Before 6-10-13 and w/ 2.69-3.91 Ratios	DRK-443
	R-40,000	Before 6-10-13 and w/ 4.10-7.17 Ratios	DRK-444
	R-40,000	After 6-9-13 and w/ 2.69-3.91 Ratios	DRK-443A
	R-40,000	After 6-9-13 and w/ 4.10-7.17 Ratios	DRK-444A
D46-170	F-46,000	Before 6-10-13	DRK-442
	F-46,000	After 6-9-13	DRK-442A
D46-170D	F-46,000	Before 6-10-13	DRK-436
	F-46,000	After 6-9-13	DRK-436A
D46-170DP	F-46,000	Before 6-10-13	DRK-436
	F-46,000	After 6-9-13	DRK-436A
D46-170H	F-46,000	Before 6-10-13	DRK-442
	F-46,000	After 6-9-13	DRK-442A
D46-170HP	F-46,000	Before 6-10-13	DRK-442
	F-46,000	After 6-9-13	DRK-442A
D46-170P	F-46,000	Before 6-10-13	DRK-442
	F-46,000	After 6-9-13	DRK-442A
R46-170	R-46,000	Before 6-10-13 and w/ 2.69-3.91 Ratios	DRK-438
	R-46,000	Before 6-10-13 and w/ 4.10-7.17 Ratios	DRK-439
	R-46,000	After 6-9-13 and w/ 2.69-3.91 Ratios	DRK-438A
	R-46,000	After 6-9-13 and w/ 4.10-7.17 Ratios	DRK-439A
R46-170D	R-46,000	Before 6-10-13 and w/ 2.69-3.91 Ratios	DRK-443
	R-46,000	Before 6-10-13 and w/ 4.10-7.17 Ratios	DRK-444
	R-46,000	After 6-9-13 and w/ 2.69-3.91 Ratios	DRK-443A
	R-46,000	After 6-9-13 and w/ 4.10-7.17 Ratios	DRK-444A
D50-170	F-50,000	Before 6-10-13	DRK-442
	F-50,000	After 6-9-13	DRK-442A
D52-190DP	F-52,000	Before 6-10-13	DRK-437
	F-52,000	After 6-9-13	DRK-437A
D52-190P	F-52,000	Before 6-10-13	DRK-437
	F-52,000	After 6-9-13	DRK-437A
R52-190	R-52,000	Before 6-10-13 and w/ 2.53-4.78 Ratios	DRK-443

## Dana Index (cont'd)

Axle Model	Type/Cap.	Comments	Kit
	R-52,000	Before 6-10-13 and w/ 5.25-7.83 Ratios	DRK-441
	R-52,000	After 6-9-13 and w/ 2.53-4.78 Ratios	DRK-443A
	R-52,000	After 6-9-13 and w/ 5.25-7.83 Ratios	DRK-441A
R52-190D	R-52,000	Before 6-10-13 and w/ 2.53-4.78 Ratios	DRK-443
	R-52,000	Before 6-10-13 and w/ 5.25-7.83 Ratios	DRK-441
	R-52,000	After 6-9-13 and w/ 2.53-4.78 Ratios	DRK-443A
	R-52,000	After 6-9-13 and w/ 5.25-7.83 Ratios	DRK-441A
D60-190DP	F-60,000	Before 6-10-13	DRK-437
	F-60,000	After 6-9-13	DRK-437A
D60-190P	F-60,000	Before 6-10-13	DRK-437
	F-60,000	After 6-9-13	DRK-437A
R60-190	R-60,000	Before 6-10-13 and w/ 2.53-4.78 Ratios	DRK-443
	R-60,000	Before 6-10-13 and w/ 5.25-7.83 Ratios	DRK-441
	R-60,000	After 6-9-13 and w/ 2.53-4.78 Ratios	DRK-443A
	R-60,000	After 6-9-13 and w/ 5.25-7.83 Ratios	DRK-441A
R60-190D	R-60,000	Before 6-10-13 and w/ 2.53-4.78 Ratios	DRK-443
	R-60,000	Before 6-10-13 and w/ 5.25-7.83 Ratios	DRK-441
	R-60,000	After 6-9-13 and w/ 2.53-4.78 Ratios	DRK-443A
	R-60,000	After 6-9-13 and w/ 5.25-7.83 Ratios	DRK-441A
D46-590DHP	F-46,000	Before 6-10-13	DRK-437
	F-46,000	After 6-9-13	DRK-437A
D46-590HP	F-46,000	Before 6-10-13	DRK-437
	F-46,000	After 6-9-13	DRK-437A
R46-590	R-46,000	Before 6-10-13	DRK-453
	R-46,000	After 6-9-13	DRK-453A
R46-590D	R-46,000	Before 6-10-13	DRK-453
	R-46,000	After 6-9-13	DRK-453A
D52-590DP	F-52,000	Before 6-10-13	DRK-437
	F-52,000	After 6-9-13	DRK-437A
D52-590P	F-52,000	Before 6-10-13	DRK-437
	F-52,000	After 6-9-13	DRK-437A
R52-590	R-52,000	Before 6-10-13	DRK-453
	R-52,000	After 6-9-13	DRK-453A
R52-590D	R-52,000	Before 6-10-13	DRK-453
	R-52,000	After 6-9-13	DRK-453A
D60-590DP	F-60,000	Before 6-10-13	DRK-437
	F-60,000	After 6-9-13	DRK-437A
D60-590P	F-60,000	Before 6-10-13	DRK-437
	F-60,000	After 6-9-13	DRK-437A
R60-590	R-60,000	Before 6-10-13	DRK-453

# Heavy Duty Differential Index

## Dana Index (cont'd)

Axle Model	Type/Cap.	Comments	Kit
R60-590	R-60,000	After 6-9-13	DRK-453A
R60-590D	R-60,000	Before 6-10-13	DRK-453
	R-60,000	After 6-9-13	DRK-453A
D70-590DP	F-70,000	Before 6-10-13	DRK-437
	F-70,000	After 6-9-13	DRK-437A
D70-590P	F-70,000	Before 6-10-13	DRK-437
	F-70,000	After 6-9-13	DRK-437A
R70-590	R-70,000	Before 6-10-13	DRK-453
	R-70,000	After 6-9-13	DRK-453A
R70-590D	R-70,000	Before 6-10-13	DRK-453
	R-70,000	After 6-9-13	DRK-453A
S135-S	R-13,500		DRK-414
S150-S	R-15,500		DRK-414
F155-S	R-15,500		DRK-191R
G155-T	R-15,500		DRK-213
G160-D	R-16,000		DRK-213
G160-T	R-16,000		DRK-213
F170-S	R-17,000		DRK-191R
F175-D	R-17,500		DRK-213
G175-R	R-17,500		DRK-213
G175-T	R-17,500		DRK-213
J175-S	R-17,500		DRK-192RB
N175	R-17,500		DRK-223R
G185-S	R-18,500		DRK-213
M185-D	R-18,500		DRK-214
M185-T	R-18,500		DRK-214
G190-S	R-19,000		DRK-213
J190-S	R-19,000		DRK-192RB
M190-T	R-19,000		DRK-214
N190	R-19,000		DRK-223R
M200-D	R-20,000		DRK-214
M200-T	R-20,000		DRK-214
J210-S	R-21,000		DRK-192RB
M210-T	R-21,000		DRK-214
J220-S	R-22,000		DRK-192RB
M220-D	R-22,000		DRK-214
M220-T	R-22,000		DRK-214
J230-S	R-23,000		DRK-192RB
J230-SB	R-23,000		DRK-192RB
M230-T	R-23,000		DRK-214
S230-S	R-23,000		DRK-416
S230-SB	R-23,000		DRK-416
S230-SL	R-23,000		DRK-416
W230-S	R-23,000		DRK-201R
S260-SB	R-26,000		DRK-416
G340-S	F-34,000		DRK-192FB
J340-S	F-34,000		DRK-200FA
	R-34,000		DRK-192RB
N340-S	F-34,000		DRK-223F
	R-34,000		DRK-223R
G380-S	F-38,000		DRK-192FB
J380-S	F-38,000		DRK-200FA
	R-38,000		DRK-192RB
J400-S	F-40,000		DRK-200FA
	R-40,000		DRK-192RB
N400-I	F-40,000		DRK-223F
	R-40,000		DRK-223R

## Dana Index (cont'd)

Axle Model	Type/Cap.	Comments	Kit
S400-S	F-40,000		DRK-411F
	R-40,000		DRK-411R
W440-S	F-44,000		DRK-201FA
	R-44,000		DRK-201R
W460-S	F-46,000		DRK-201FA
	R-46,000		DRK-201R

## Eaton Index

Axle Model	Type/Cap.	Comments	Kit
30R3	R-30,000		DRK-23
30RP	R-30,000		DRK-23
30RS	R-30,000	w/ Ribbed Carrier	DRK-23
	R-30,000	w/ Conical Carrier	DRK-23B
30RT	R-30,000		DRK-23
34D3	F-34,000	w/ Ball Brg. On Input Shaft	DRK-64F
	F-34,000	w/ Taper Brg. On Input Shaft	DRK-64FE
34DP	F-34,000	w/ Ball Brg. On Input Shaft	DRK-64F
	F-34,000	w/ Taper Brg. On Input Shaft	DRK-64FE
34DS	F-34,000	w/ Ribbed Carrier & Ball Brg. On Input Shaft	DRK-64F
	F-34,000	w/ Conical Carrier & Ball Brg. On Input Shaft	DRK-64FC
	F-34,000	w/ Conical Carrier & Taper Brg. On Input Shaft	DRK-64FD
	F-34,000	w/ Ribbed Carrier & Taper Brg. On Input Shaft	DRK-64FE
34DT	F-34,000	w/ Ball Brg. On Input Shaft	DRK-64F
	F-34,000	w/ Taper Brg. On Input Shaft	DRK-64FE
34R3	R-34,000		DRK-1
34RP	R-34,000	w/ Ribbed Carrier	DRK-1
	R-34,000	w/ Conical Carrier	DRK-1A
34RS	R-34,000	w/ Conical Carrier	DRK-1A
34RSB	R-34,000		DRK-1A
34RT	R-34,000		DRK-1
38D3	F-38,000	w/ Ball Brg. On Input Shaft	DRK-64F
	F-38,000	w/ Taper Brg. On Input Shaft	DRK-64FE
38DP	F-38,000	w/ Ball Brg. On Input Shaft	DRK-64F
	F-38,000	w/ Taper Brg. On Input Shaft	DRK-64FE
38DS	F-38,000	w/ Ribbed Carrier & Ball Brg. On Input Shaft	DRK-64F
	F-38,000	w/ Conical Carrier & Ball Brg. On Input Shaft	DRK-64FC
	F-38,000	w/ Conical Carrier & Taper Brg. On Input Shaft	DRK-64FD
	F-38,000	w/ Ribbed Carrier & Taper Brg. On Input Shaft	DRK-64FE
38DT	F-38,000	w/ Ball Brg. On Input Shaft	DRK-64F
	F-38,000	w/ Taper Brg. On Input Shaft	DRK-64FE
38R3	R-38,000		DRK-1
38RP	R-38,000	w/ Ribbed Carrier	DRK-1
	R-38,000	w/ Conical Carrier	DRK-1A
38RS	R-38,000		DRK-1A
38RSB	R-38,000		DRK-1A
38RT	R-38,000		DRK-1
DDH40(P)	F-40,000	Before 6/16/08	DRK-428

# Heavy Duty Differential Index

HD Differential

## Eaton Index (cont'd)

Axle Model	Type/Cap.	Comments	Kit
DDH40(P)	F-40,000	After 6/16/08	DRK-428A
DDP40(P)	F-40,000	Before 6/16/08	DRK-428
	F-40,000	After 6/16/08	DRK-428A
DDS40(P)	F-40,000		DRK-435
DDT40-P	F-40,000	Before 6/16/08	DRK-405F <sup>44</sup>
	F-40,000	After 6/16/08	DRK-405FA <sup>45</sup>
DSH40(P)	F-40,000	Before 6/16/08	DRK-427
	F-40,000	After 6/16/08	DRK-427A
DSP40(P)	F-40,000	Before 6/16/08	DRK-427
	F-40,000	After 6/16/08	DRK-427A
DSS40(P)	F-40,000		DRK-431
DST40(P)	F-40,000	Before 6/16/08	DRK-404F <sup>41</sup>
	F-40,000	After 6/16/08	DRK-404FA <sup>42</sup>
RDH40	R-40,000		DRK-430
RDP40	R-40,000		DRK-430
RDS40	R-40,000		DRK-219R
RDT40	R-40,000		DRK-445
RSH40	R-40,000		DRK-429
RSP40	R-40,000		DRK-429
RSS40	R-40,000		DRK-449
RST40	R-40,000	Before 4/1/05 & 2.64-5.57 Ratios	DRK-445
	R-40,000	Before 4/1/05 & 6.17-7.17 Ratios	DRK-446
	R-40,000	After 4/1/05 & 2.64-5.57 Ratios	DRK-447
	R-40,000	After 4/1/05 & 6.17-7.17 Ratios	DRK-448
DDP41(P)	F-41,000	Before 6/16/08	DRK-428
	F-41,000	After 6/16/08	DRK-428A
DDS41(P)	F-41,000		DRK-435
DDT41(P)	F-41,000	Before 6/16/08	DRK-405F <sup>44</sup>
	F-41,000	After 6/16/08	DRK-405FA <sup>45</sup>
DSP41(P)	F-41,000	Before 6/16/08	DRK-427
	F-41,000	After 6/16/08	DRK-427A
DST41(P)	F-41,000	Before 6/16/08	DRK-404F <sup>41</sup>
	F-41,000	After 6/16/08	DRK-404FA <sup>42</sup>
RDP41	R-41,000		DRK-430
RDT41	R-41,000		DRK-445
RSP41	R-41,000		DRK-429
RST41	R-41,000	Before 4/1/05 & 2.64-5.57 Ratios	DRK-445
	R-41,000	Before 4/1/05 & 6.17-7.17 Ratios	DRK-446
	R-41,000	After 4/1/05 & 2.64-5.57 Ratios	DRK-447
	R-41,000	After 4/1/05 & 6.17-7.17 Ratios	DRK-448
42D3	F-42,000	w/ Ball Brg. On Input Shaft	DRK-64F
	F-42,000	w/ Taper Brg. On Input Shaft	DRK-64FE
42DP	F-42,000	w/ Ball Brg. On Input Shaft	DRK-64F
	F-42,000	w/ Taper Brg. On Input Shaft	DRK-64FE
42DT	F-42,000	w/ Ball Brg. On Input Shaft	DRK-64F
	F-42,000	w/ Taper Brg. On Input Shaft	DRK-64FE
42R3	R-42,000		DRK-1

## Eaton Index (cont'd)

Axle Model	Type/Cap.	Comments	Kit
42RP	R-42,000		DRK-1
42RS	R-42,000		DRK-18D
42RT	R-42,000		DRK-1
44DP	F-44,000		DRK-209A
44DS	F-44,000		DRK-208A
44DSM	F-44,000		DRK-208A
44DT	F-44,000		DRK-72A
	F-44,000		DRK-209A
44RPB	R-44,000		DRK-72A
44RS	R-44,000	w/ Casting # C67854 / Bef. 2-1-79	DRK-413
	R-44,000	w/ Casting # C98493 / Aft. 2-1-79	DRK-219R
44RSM	R-44,000		DRK-413
44RSB	R-44,000	w/ Large Spherical Diff	DRK-18E
44RT	R-44,000	w/ 103537 Case	DRK-72B
	R-44,000	w/o 103537 Case	DRK-72A
44RTB	R-44,000		DRK-72A
DDH44(P)	F-44,000		DRK-427
DSH44(P)	F-44,000		DRK-428
RDH44	R-44,000		DRK-429
RSH44	R-44,000		DRK-429
50DP	F-50,000		DRK-193
50DT	F-50,000		DRK-193
50RP	R-50,000		DRK-1
50RT	R-50,000		DRK-1
190C4	R-19,000		DRK-419
190P4	R-19,000		DRK-419
190S4	R-19,000		DRK-417
190T4	R-19,000		DRK-419
220C4	R-22,000		DRK-419
220P4	R-22,000		DRK-419
220S4	R-22,000		DRK-417
220T4	R-22,000		DRK-419
230C4	R-23,000		DRK-420
230P4	R-23,000		DRK-421
230S4	R-23,000		DRK-418
230T4	R-23,000		DRK-421
260C4	R-26,000		DRK-420
260P4	R-26,000		DRK-421
260S4	R-26,000		DRK-418
260T4	R-26,000		DRK-421
300C4	R-30,000		DRK-420
300P4	R-30,000		DRK-420
300S4	R-30,000		DRK-418
300T4	R-30,000		DRK-421
DP340	F-34,000		DRK-193
DS340	F-34,000	2-Speed Carrier / Bef. 4-30-78	DRK-193
	F-34,000	1-Speed Carrier / Aft 4-30-78	DRK-193A
DT340	F-34,000		DRK-193
RP340	R-34,000		DRK-1
RS340	R-34,000	2-Speed Carrier / Bef. 4-30-78	DRK-1
	R-34,000	1-Speed Carrier / Aft 4-30-78	DRK-1A



# Heavy Duty Differential Index

## Eaton Index (cont'd)

Axle Model	Type/Cap.	Comments	Kit
RT340	R-34,000		DRK-1
DC341(P)	F-34,000		DRK-207
DP341(P)	F-34,000		DRK-207
DS341(P)	F-34,000	Before 4-6-89	DRK-196
	F-34,000	4-6-89 thru 12-31-94	DRK-222F
	F-34,000	After 1-1-95	DRK-196
DT341(P)	F-34,000		DRK-207
RC341	R-34,000		DRK-1
RP341	R-34,000		DRK-1
RS341	R-34,000	Before 4-6-89	DRK-1A
	R-34,000	4-6-89 thru 12-31-94	DRK-222R
	R-34,000	After 1-1-95	DRK-412
RT341	R-34,000		DRK-1
DA344	F-34,000		DRK-404F <sup>41</sup>
DS344	F-34,000	Before 6/16/08	DRK-404F <sup>41</sup>
	F-34,000	After 6/16/08	DRK-404FA <sup>42</sup>
RA344	R-34,000		DRK-404R <sup>43</sup>
RS344	R-34,000		DRK-404R <sup>43</sup>
350C4	R-35,000		DRK-420
350P4	R-35,000		DRK-420
350S4	R-35,000		DRK-418
350T4	R-35,000		DRK-420
DP380-P	F-38,000		DRK-193
DS380(P)	F-38,000	2-Speed Carrier / Bef 4-30-78	DRK-193
	F-38,000	1-Speed Carrier / Aft 4-30-78	DRK-193A
DT380(P)	F-38,000		DRK-193
RP380(P)	R-38,000		DRK-1
RS380	R-38,000	2-Speed Carrier / Bef 4-30-78	DRK-1
	R-38,000	1-Speed Carrier / Aft 4-30-78	DRK-1A
RT380(P)	R-38,000		DRK-1
DC381(P)	F-38,000		DRK-207
DP381(P)	F-38,000		DRK-207
DS381(P)	F-38,000		DRK-196
DT381(P)	F-38,000		DRK-207
RC381	R-38,000		DRK-1
RP381(P)	R-38,000		DRK-1
RS381	R-38,000		DRK-1A
RT381(P)	R-38,000		DRK-1
DS385	F-38,000		DRK-1
DC386-P	F-38,000		DRK-424
DP386-P	F-38,000		DRK-424
DS386-P	F-38,000		DRK-422
DT386-P	F-38,000		DRK-424
RC386	R-38,000		DRK-1
RP386-P	R-38,000		DRK-1
RS386	R-38,000		DRK-1A
RT386-P	R-38,000		DRK-1
DP400(P)	F-40,000		DRK-193
DS400-P	F-40,000	2-Speed Carrier / Bef 4-30-78	DRK-193
	F-40,000	1-Speed Carrier / Aft 4-30-78	DRK-193A
DT400(P)	F-40,000		DRK-193
RP400(P)	R-40,000		DRK-1

## Eaton Index (cont'd)

Axle Model	Type/Cap.	Comments	Kit
RS400	R-40,000	2-Speed Carrier / Bef 4-30-78	DRK-1
	R-40,000	1-Speed Carrier / Aft 4-30-78	DRK-1A
RT400(P)	R-40,000		DRK-1
DC401-P	F-40,000		DRK-207
DP401(P)	F-40,000		DRK-207
DS401-P	F-40,000		DRK-196
DT401(P)	F-40,000		DRK-207
RC401	R-40,000		DRK-1
RP401(P)	R-40,000		DRK-1
RS401	R-40,000		DRK-1A
RT401(P)	R-40,000		DRK-1
DA402(P)	F-40,000	4-6-89 thru 12-31-94	DRK-222F
	F-40,000	After 1-1-95	DRK-196
DC402(P)	F-40,000		DRK-207
DP402(P)	F-40,000		DRK-207
DS402(P)	F-40,000	Before 4-6-89	DRK-196
	F-40,000	4-6-89 thru 12-31-94	DRK-222F
	F-40,000	After 1-1-95	DRK-196
DT402(P)	F-40,000		DRK-207
RA402	R-40,000	4-6-89 thru 12-31-94	DRK-222R
	R-40,000	After 1-1-95	DRK-412
RC402	R-40,000		DRK-1
RP402(P)	R-40,000		DRK-1
RS402	R-40,000	Before 4-6-89	DRK-1A
	R-40,000	4-6-89 thru 12-31-94	DRK-222R
	R-40,000	After 1-1-95	DRK-412
RT402(P)	R-40,000		DRK-1
DS403(P)	F-40,000	Before 4-6-89	DRK-196
	F-40,000	4-6-89 thru 12-31-94	DRK-222F
	F-40,000	After 1-1-95	DRK-196
RS403	R-40,000	Before 4-6-89	DRK-1A
	R-40,000	4-6-89 thru 12-31-94	DRK-222R
	R-40,000	After 1-1-95	DRK-412
DA404(P)	F-40,000	Before 6/16/08	DRK-404F <sup>41</sup>
	F-40,000	After 6/16/08	DRK-404FA <sup>42</sup>
DD404(P)	F-40,000	Before 6/16/08	DRK-405F <sup>44</sup>
	F-40,000	After 6/16/08	DRK-405FA <sup>45</sup>
DS404(P)	F-40,000	Before 6/16/08	DRK-404F <sup>41</sup>
	F-40,000	After 6/16/08	DRK-404FA <sup>42</sup>
RA404	R-40,000		DRK-404R <sup>43</sup>
RD404	R-40,000		DRK-405R <sup>46</sup>
RS404	R-40,000		DRK-404R <sup>43</sup>
DA405(P)	F-40,000	Before 6/16/08	DRK-404F <sup>41</sup>
	F-40,000	After 6/16/08	DRK-404FA <sup>42</sup>
DD405(P)	F-40,000	Before 6/16/08	DRK-405F <sup>44</sup>
	F-40,000	After 6/16/08	DRK-405FA <sup>45</sup>
DS405(P)	F-40,000	Before 6/16/08	DRK-404F <sup>41</sup>
	F-40,000	After 6/16/08	DRK-404FA <sup>42</sup>
RA405	R-40,000		DRK-404R <sup>43</sup>
RD405	R-40,000		DRK-405R <sup>46</sup>
RS405	R-40,000		DRK-404R <sup>43</sup>
DC406-P	F-40,000		DRK-424
DP406-P	F-40,000		DRK-424
DS406-P	F-40,000		DRK-422

<sup>41</sup>Order DRK-404FMK for Master Kit  
<sup>42</sup>Order DRK-404FAMK for Master Kit

<sup>43</sup>Order DRK-404RMK for Master Kit  
<sup>44</sup>Order DRK-405FMK for Master Kit

<sup>45</sup>Order DRK-405FAMK for Master Kit  
<sup>46</sup>Order DRK-405RMK for Master Kit

# Heavy Duty Differential Index

HD Differential

## Eaton Index (cont'd)

Axle Model	Type/Cap.	Comments	Kit
DT406-P	F-40,000		DRK-424
RC406	R-40,000		DRK-1
RP406-P	R-40,000		DRK-1
RS406	R-40,000		DRK-1A
RT406-P	R-40,000		DRK-1
DP440-P	F-44,000	22 Spline & Case # 103530	DRK-209
	F-44,000	36 Spline & Case # 110500	DRK-210
DS440-P	F-44,000	22 Spline & Case # 103530	DRK-208A
	F-44,000	36 Spline & Case # 110500	DRK-208
DT440-P	F-44,000	22 Spline & Case # 103530	DRK-209
	F-44,000	36 Spline & Case # 110500	DRK-210
RP440	R-44,000		DRK-72B
RS440	R-44,000		DRK-18E
RT440	R-44,000		DRK-72B
DP446-P	F-44,000		DRK-426
DS446-P	F-44,000	w/ Traction Control	DRK-426
	F-44,000	w/o Traction Control	DRK-425
DT446-P	F-44,000		DRK-426
RP446-P	R-44,000		DRK-72B
RS446	R-44,000	w/ Traction Control	DRK-72B
	R-44,000	w/o Traction Control	DRK-18E
RT446-P	R-44,000		DRK-72B
DC451-P	F-45,000		DRK-207
DP451-P	F-45,000		DRK-207
DS451-P	F-45,000	Before 4-6-89	DRK-196
	F-45,000	4-6-89 thru 12-31-94	DRK-222F
	F-45,000	After 1-1-95	DRK-196
DT451-P	F-45,000		DRK-207
RC451	R-45,000		DRK-1
RP451-P	R-45,000		DRK-1
RS451	R-45,000	Before 4-6-89	DRK-1A
	R-45,000	4-6-89 thru 12-31-94	DRK-222R
	R-45,000	After 1-1-95	DRK-412
RT451-P	R-45,000		DRK-1
DA454(P)	F-45,000		DRK-404F <sup>41</sup>
DD454(P)	F-45,000		DRK-405F <sup>44</sup>
DS454(P)	F-45,000		DRK-404F <sup>41</sup>
RA454	R-45,000		DRK-404R <sup>43</sup>
RD454	R-45,000		DRK-405R <sup>46</sup>
RS454	R-45,000		DRK-404R <sup>43</sup>
DC460-P	F-46,000		DRK-211F
DP460-P	F-46,000	22 Spline & Case # 103530	DRK-209
	F-46,000	36 Spline & Case # 110500	DRK-210
DS460-P	F-46,000	22 Spline & Case # 103530	DRK-208A
	F-46,000	36 Spline & Case # 110500	DRK-208
DT460-P	F-46,000	22 Spline & Case # 103530	DRK-209
	F-46,000	36 Spline & Case # 110500	DRK-210
RC460	R-46,000		DRK-219R
RP460	R-46,000		DRK-72B
RS460	R-46,000		DRK-18E
RT460	R-46,000		DRK-72B
DC461-P	F-46,000	Prior 2/2000	DRK-211F
	F-46,000	After 2/2000	DRK-432
DD461-P	F-46,000	Prior 2/2000	DRK-211F
	F-46,000	After 2/2000	DRK-432

## Eaton Index (cont'd)

Axle Model	Type/Cap.	Comments	Kit
DP461-P	F-46,000	Prior 2/2000	DRK-211F
	F-46,000	After 2/2000	DRK-432
DS461-P	F-46,000	Prior 2/2000	DRK-208
	F-46,000	After 2/2000	DRK-433
DT461-P	F-46,000	Prior 2/2000	DRK-211F
	F-46,000	After 2/2000	DRK-432
RC461	R-46,000		DRK-219R
RD461	R-46,000		DRK-219R
RP461	R-46,000		DRK-219R
RS461	R-46,000		DRK-449
RT461	R-46,000		DRK-219R
SP461	R-46,000		DRK-220F
TP461	F-46,000		DRK-220F
DC462-P	F-46,000	Prior 2/2000	DRK-211F
	F-46,000	After 2/2000	DRK-432
DD462-P	F-46,000	Prior 2/2000	DRK-211F
	F-46,000	After 2/2000	DRK-432
DP462-P	F-46,000	Prior 2/2000	DRK-211F
	F-46,000	After 2/2000	DRK-432
DS462-P	F-46,000	Prior 2/2000	DRK-208
	F-46,000	After 2/2000	DRK-433
DT462-P	F-46,000	Prior 2/2000	DRK-211F
	F-46,000	After 2/2000	DRK-432
RC462	R-46,000		DRK-219R
RD462	R-46,000		DRK-219R
RP462	R-46,000		DRK-219R
RS462	R-46,000		DRK-449
RT462	R-46,000		DRK-219R
SP462	R-46,000		DRK-220F
TP462	F-46,000		DRK-220F
DC463-P	F-46,000	Prior 2/2000	DRK-211F
	F-46,000	After 2/2000	DRK-432
DD463-P	F-46,000	Prior 2/2000	DRK-211F
	F-46,000	After 2/2000	DRK-432
DP463-P	F-46,000	Prior 2/2000	DRK-211F
	F-46,000	After 2/2000	DRK-432
DS463-P	F-46,000	Prior 2/2000	DRK-208
	F-46,000	After 2/2000	DRK-433
DT463-P	F-46,000	Prior 2/2000	DRK-211F
	F-46,000	After 2/2000	DRK-432
RC463	R-46,000		DRK-219R
RD463	R-46,000		DRK-219R
RP463	R-46,000		DRK-219R
RS463	R-46,000		DRK-449
RT463	R-46,000		DRK-219R
SP463	R-46,000		DRK-220F
TP463	F-46,000		DRK-220F
DP466-P	F-46,000		DRK-426
DS466-P	F-46,000	w/ Traction Control	DRK-426
	F-46,000	w/o Traction Control	DRK-425
DT466-P	F-46,000		DRK-426
RP466-P	R-46,000		DRK-72B
RS466	R-46,000	w/ Traction Control	DRK-72B
	R-46,000	w/o Traction Control	DRK-18E
RT466-P	R-46,000		DRK-72B
DC480-P	F-48,000		DRK-211F

<sup>41</sup>Order DRK-404FMK for Master Kit  
<sup>43</sup>Order DRK-404RMK for Master Kit

<sup>44</sup>Order DRK-405FMK for Master Kit  
<sup>46</sup>Order DRK-405RMK for Master Kit

# Heavy Duty Differential Index

## Eaton Index (cont'd)

Axle Model	Type/Cap.	Comments	Kit
DP480-P	F-48,000	22 Spline & Case # 103530	DRK-209
	F-48,000	36 Spline & Case # 110500	DRK-210
DS480-P	F-48,000	22 Spline & Case # 103530	DRK-208A
	F-48,000	36 Spline & Case # 110500	DRK-208
DT480-P	F-48,000	22 Spline & Case # 103530	DRK-209
	F-48,000	36 Spline & Case # 110500	DRK-210
RC480	R-48,000		DRK-219R
RP480	R-48,000		DRK-72B
RS480	R-48,000		DRK-18E
RT480	R-48,000		DRK-72B
DP485-P	F-48,000		DRK-211F
DT485-P	F-48,000		DRK-211F
RP485	R-48,000		DRK-72B
RT485	R-48,000		DRK-72B
DC521-P	F-52,000	Prior 2/2000	DRK-211F
	F-52,000	After 2/2000	DRK-432
DD521-P	F-52,000	Prior 2/2000	DRK-211F
	F-52,000	After 2/2000	DRK-432
DP521-P	F-52,000	Prior 2/2000	DRK-211F
	F-52,000	After 2/2000	DRK-432
DS521-P	F-52,000	Prior 2/2000	DRK-208
	F-52,000	After 2/2000	DRK-433
DT521-P	F-52,000	Prior 2/2000	DRK-211F
	F-52,000	After 2/2000	DRK-432
RC521	R-52,000		DRK-219R
RD521	R-52,000		DRK-219R
RP521	R-52,000		DRK-219R
RS521	R-52,000		DRK-449
RT521	R-52,000		DRK-219R
SP521	R-52,000		DRK-220F
TP521	F-52,000		DRK-220F
DP550	F-55,000	22 Spline & Case # 103530	DRK-211FA
	F-55,000	36 Spline & Case # 110500	DRK-211F
RP550	R-55,000		DRK-72B
RT550	R-55,000		DRK-72B
SP550	F-55,000		DRK-220FA
TP550	F-55,000		DRK-220FA
DP580-P	F-58,000	22 Spline & Case # 103530	DRK-211FA
	F-58,000	36 Spline & Case # 110500	DRK-211F
DT580-P	F-58,000	22 Spline & Case # 103530	DRK-211FA
	F-58,000	36 Spline & Case # 110500	DRK-211F
RP580	R-58,000		DRK-219R
RS580	R-58,000	w/ Traction Control	DRK-219R
RT580	R-58,000		DRK-219R
SP580	F-58,000		DRK-220FA
TP580	F-58,000		DRK-220FA
DD581-P	F-58,000	Prior 2/2000	DRK-211F
	F-58,000	After 2/2000	DRK-432
DS581-P	F-58,000	Prior 2/2000	DRK-208
	F-58,000	After 2/2000	DRK-433
RD581	R-58,000		DRK-219R
RS581	R-58,000		DRK-449
DD601(P)	F-60,000	Prior 2/2000	DRK-211F
	F-60,000	After 2/2000	DRK-432

## Eaton Index (cont'd)

Axle Model	Type/Cap.	Comments	Kit
DP601-P	F-60,000	Prior 2/2000	DRK-211F
	F-60,000	After 2/2000	DRK-432
DS601(P)	F-60,000	Prior 2/2000	DRK-208
	F-60,000	After 2/2000	DRK-433
DT601-P	F-60,000	Prior 2/2000	DRK-211F
	F-60,000	After 2/2000	DRK-432
RC601	R-60,000		DRK-219R
RP601	R-60,000		DRK-219R
RS601	R-60,000		DRK-449
RT601	R-60,000		DRK-219R
SP601	R-60,000		DRK-220F
TP601	F-60,000		DRK-220F
DP650-P	F-65,000	22 Spline & Case # 103530	DRK-211FA
	F-65,000	36 Spline & Case # 110500	DRK-211F
DT650-P	F-65,000	22 Spline & Case # 103530	DRK-211FA
	F-65,000	36 Spline & Case # 110500	DRK-211F
RP650	R-65,000		DRK-219R
RS650	R-65,000	w/ Traction Control	DRK-219R
RT650	R-65,000		DRK-219R
SP650	F-65,000		DRK-220FA
TP650	F-65,000		DRK-220FA
DD651(P)	F-65,000	Prior 2/2000	DRK-211F
	F-65,000	After 2/2000	DRK-432
DP651-P	F-65,000	Prior 2/2000	DRK-211F
	F-65,000	After 2/2000	DRK-432
DS651-P	F-65,000	Prior 2/2000	DRK-208
	F-65,000	After 2/2000	DRK-433
DT651-P	F-65,000	Prior 2/2000	DRK-211F
	F-65,000	After 2/2000	DRK-432
RC651	R-65,000		DRK-219R
RP651	R-65,000		DRK-219R
RS651	R-65,000		DRK-449
RT651	R-65,000		DRK-219R
SP651	R-65,000		DRK-220F
TP651	F-65,000		DRK-220F
DP652-P	F-65,000	Prior 2/2000	DRK-211F
	F-65,000	After 2/2000	DRK-432
RP652	R-65,000		DRK-219R
DC3416-P	F-34,000		DRK-424
DP3416-P	F-34,000		DRK-424
DS3416-P	F-34,000		DRK-422
DT3416-P	F-34,000		DRK-424
RC3416	R-34,000		DRK-1
RP3416-P	R-34,000		DRK-1
RS3416	R-34,000		DRK-1A
RT3416-P	R-34,000		DRK-1
DC4026-P	F-40,000		DRK-424
DP4026-P	F-40,000		DRK-424
DS4026-P	F-40,000		DRK-422
DT4026-P	F-40,000		DRK-424
RC4026	R-40,000		DRK-1
RP4026-P	R-40,000		DRK-1
RS4026	R-40,000		DRK-1A
RT4026-P	R-40,000		DRK-1
DC4616-P	F-46,000		DRK-426

HD Differential

# Heavy Duty Differential Index

HD Differential

## Eaton Index (cont'd)

Axle Model	Type/Cap.	Comments	Kit
DP4616-P	F-46,000		DRK-426
DS4616-P	F-46,000		DRK-423
DT4616-P	F-46,000		DRK-426
RC4616	R-46,000		DRK-72B
RP4616-P	R-46,000		DRK-219R
RS4616	R-46,000		DRK-449
RT4616-P	R-46,000		DRK-219R
DC5216-P	F-52,000		DRK-426
DP5216-P	F-52,000		DRK-426
DS5216-P	F-52,000		DRK-423
DT5216-P	F-52,000		DRK-426
RC5216	R-52,000		DRK-72B
RP5216-P	R-52,000		DRK-219R
RS5216	R-52,000		DRK-449
RT5216-P	R-52,000		DRK-219R
DP6016-P	F-60,000		DRK-426
DT6016-P	F-60,000		DRK-426
RP6016-P	R-60,000		DRK-219R
RT6016-P	R-60,000		DRK-219R
DP6516-P	F-65,000		DRK-426
DT6516-P	F-65,000		DRK-426
RP6516-P	R-65,000		DRK-219R
RT6516-P	R-65,000		DRK-219R
350	R-		DRK-24
502	R-		DRK-72
503	R-		DRK-72
1350	R-10-15,000	Exc. Dodge 1957-1958	DRK-24
1618	R-16-17,000		DRK-23
1619	R-16-17,000		DRK-23
1880	R-19-22,000		DRK-1
1881	R-19-22,000		DRK-1
3800	R-15,000		DRK-24
3802	R-15,000		DRK-24
6802	R-16,000		DRK-23
6803	R-16,000		DRK-23
7500	F-		DRK-202
7800	R-18,000		DRK-1
7801	R-18,000		DRK-1
7810	R-18,000		DRK-1
8800	R-22,000		DRK-1
8802	R-22,000		DRK-1
8803	R-22,000		DRK-1
9000	F-		DRK-202
9502	R-23,000		DRK-72
9503	R-23,000		DRK-72
9512	R-23,000		DRK-72
10000	F-		DRK-202
12000	F-		DRK-202
13600	R-13,000		DRK-411
13602	R-13,000		DRK-411
13800	R-13,000		DRK-24
13802	R-13,000		DRK-24
13803	R-13,000		DRK-24
15040-P	R-15,000		DRK-24
15040-S	R-15,000		DRK-400

## Eaton Index (cont'd)

Axle Model	Type/Cap.	Comments	Kit
15040-T	R-15,000		DRK-24
15101	R-15,000		DRK-24
15200	R-15,000		DRK-24
15201	R-15,000		DRK-24
15300	R-15,000		DRK-24
15301	R-15,000		DRK-24
16120	R-16,000		DRK-23D
16123	R-16,000		DRK-23D
16220	R-16,000	w/ 15" Ring Gear	DRK-23
	R-16,000	w/ 15-1/2" Ring Gear	DRK-23D
16244	R-16,000		DRK-23D
16247	R-17,500		DRK-23D
16320	R-16,000		DRK-23
16321	R-16,000		DRK-23
16344	R-16,000		DRK-23D
16500	R-16,000		DRK-23
16501	R-16,000		DRK-23
16800	R-16,000		DRK-23
16802	R-16,000		DRK-23
16803	R-16,000		DRK-23
17060-S	R-17,000		DRK-404R <sup>43</sup>
17100	R-17,000		DRK-1A
17101	R-17,000		DRK-1A
17120	R-17,000		DRK-1A
17121	R-17,000		DRK-1A
17123	R-17,000		DRK-1A
17130	R-17,000		DRK-1A
17200	R-17,000		DRK-1
17201	R-17,000		DRK-1
17202	R-17,000		DRK-1
17220	R-17,000		DRK-1
17221	R-17,000		DRK-1
17300	R-17,000		DRK-1
17301	R-17,000		DRK-1
17302	R-17,000		DRK-1
17320	R-17,000		DRK-1
17321	R-17,000		DRK-1
17322	R-17,000		DRK-1
17401	R-17,000		DRK-1
17421	R-17,000		DRK-1
17500	R-17,000		DRK-1
17501	R-17,000		DRK-1
17800	R-17,000		DRK-1
17810	R-17,000		DRK-1
18100	R-18,000		DRK-1A
18101	R-18,000		DRK-1A
18103	R-18,000		DRK-1A
18120	R-18,000		DRK-1A
18121	R-18,000		DRK-1A
18123	R-18,000		DRK-1A
18200	R-18,000		DRK-1
18201	R-18,000		DRK-1
18202	R-18,000		DRK-1
18207	R-18,000		DRK-1
18220	R-18,000		DRK-1



# Heavy Duty Differential Index

## Eaton Index (cont'd)

Axle Model	Type/Cap.	Comments	Kit
18221	R-18,000		DRK-1
18227	R-18,000		DRK-1
18300	R-18,000		DRK-1
18301	R-18,000		DRK-1
18302	R-18,000		DRK-1
18320	R-18,000		DRK-1
18321	R-18,000		DRK-1
18322	R-18,000		DRK-1
18500	R-18,000		DRK-1
18501	R-18,000		DRK-1
18502	R-18,000		DRK-1
18503	R-18,000		DRK-1
18800	R-18,000		DRK-1
18802	R-18,000		DRK-1
18803	R-18,000		DRK-1
18812	R-18,000		DRK-1
18813	R-18,000		DRK-1
19050-D	R-19,000		DRK-221
19050-P	R-19,000		DRK-23D
19050-S	R-19,000		DRK-221
19050-T	R-19,000		DRK-23D
19055-D	R-19,000		DRK-406
19055-P	R-19,000		DRK-403
19055-S	R-19,000		DRK-406
19055-T	R-19,000		DRK-403
19060-D	R-19,000		DRK-405R <sup>46</sup>
19060-S	R-19,000		DRK-404R <sup>43</sup>
19060-T	R-19,000		DRK-1
19100	R-19,000		DRK-415
19120	R-19,000		DRK-18D
19121	R-19,000	Exc. Dodge	DRK-18D
19123	R-19,000		DRK-18D
19200	R-19,000		DRK-72
19201	R-19,000		DRK-72
19202	R-19,000		DRK-72
19220	R-19,000	w/ 103537 Case	DRK-72B
	R-19,000	w/o 103537 Case	DRK-72A
19221	R-19,000	w/ 103537 Case	DRK-72B
	R-19,000	w/o 103537 Case	DRK-72A
19223	R-19,000		DRK-72A
19227	R-19,000	Before 2-1-79	DRK-413
	R-19,000	After 2-1-79	DRK-219R
19237	R-19,000	After 2-1-79	DRK-219R
19300	R-19,000		DRK-72
19301	R-19,000		DRK-72
19320	R-19,000		DRK-72A
19321	R-19,000	w/ 103537 Case	DRK-72B
	R-19,000	w/o 103537 Case	DRK-72A
19323	R-19,000		DRK-72A
19327	R-19,000		DRK-413
19420	R-19,000		DRK-413
19426	R-19,000		DRK-413
19500	R-19,000		DRK-72
19501	R-19,000		DRK-72
19502	R-19,000		DRK-72

## Eaton Index (cont'd)

Axle Model	Type/Cap.	Comments	Kit
19503	R-19,000		DRK-72
19512	R-19,000		DRK-72
19513	R-19,000		DRK-72
19515	R-19,000		DRK-72
20000	R-20,000		DRK-72
P20060-D	R-20,000		DRK-430
P20060-S	R-20,000		DRK-429
20100	R-20,000		DRK-415
20120	R-20,000		DRK-18D
20121	R-20,000		DRK-18D
20123	R-20,000		DRK-18D
20200	R-20,000		DRK-72
20201	R-20,000		DRK-72
20220	R-20,000	w/ 103537 Case	DRK-72B
	R-20,000	w/o 103537 Case	DRK-72A
20221	R-20,000	w/ 103537 Case	DRK-72B
	R-20,000	w/o 103537 Case	DRK-72A
20223	R-20,000		DRK-72A
20300	R-20,000		DRK-72
20301	R-20,000		DRK-72
20320	R-20,000	w/ 103537 Case	DRK-72B
	R-20,000	w/o 103537 Case	DRK-72A
20321	R-20,000	w/ 103537 Case	DRK-72B
	R-20,000	w/o 103537 Case	DRK-72A
20323	R-20,000		DRK-72A
20500	R-20,000		DRK-72
20501	R-20,000		DRK-72
20502	R-20,000		DRK-72
20503	R-20,000		DRK-72
21060-D	R-21,000		DRK-405R <sup>46</sup>
P21060-D	R-21,000		DRK-430
21060-S	R-21,000		DRK-404R <sup>43</sup>
P21060-S	R-21,000		DRK-429
21060-T	R-21,000		DRK-1
21065-D	R-21,000		DRK-406
21065-P	R-21,000		DRK-403
21065-S	R-21,000		DRK-406
21065-T	R-21,000		DRK-403
21065-Y	R-21,000		DRK-403
21080-D	R-21,000	Before 12-99	DRK-410
	R-21,000	After 12-99	DRK-451
21080-S	R-21,000	Before 12-99	DRK-410
	R-21,000	After 12-99	DRK-451
21090-D	R-21,000	Before 12-99	DRK-410
	R-21,000	After 12-99	DRK-451
21080-S	R-21,000	Before 12-99	DRK-410
	R-21,000	After 12-99	DRK-451
21121	R-21,000		DRK-1A
21221	R-21,000		DRK-1
21321	R-21,000		DRK-1
21421	R-21,000		DRK-1
22060-D	R-22,000		DRK-405R <sup>46</sup>
P22060-D	R-22,000		DRK-430
22060-S	R-22,000		DRK-404R <sup>43</sup>
P22060-S	R-22,000		DRK-429

<sup>43</sup>Order DRK-404RMK for Master Kit

<sup>46</sup>Order DRK-405RMK for Master Kit

# Heavy Duty Differential Index

HD Differential

## Eaton Index (cont'd)

Axle Model	Type/Cap.	Comments	Kit
22060-SH	R-22,000		DRK-429
22065-D	R-22,000		DRK-406
22065-P	R-22,000		DRK-403
22065-S	R-22,000		DRK-406
22065-T	R-22,000		DRK-403
22120	R-22,000		DRK-412
22121	R-22,000		DRK-412
22220	R-22,000		DRK-403
22221	R-22,000		DRK-403
22320	R-22,000		DRK-403
22321	R-22,000		DRK-403
22420	R-22,000		DRK-403
22421	R-22,000		DRK-403
22427	R-22,000		DRK-403
23060-SH	R-23,000		DRK-429
23070-D	R-23,000		DRK-407
23070-P	R-23,000		DRK-408
23070-S	R-23,000		DRK-407
23070-T	R-23,000		DRK-408
23080-D	R-23,000	Before 12-99	DRK-410
	R-23,000	After 12-99	DRK-451
23080-P	R-23,000	Before 4-6-88	DRK-72B
	R-23,000	After 4-6-88	DRK-219R
23080-S	R-23,000	Before 12-99	DRK-410
	R-23,000	After 12-99	DRK-451
23080-T	R-23,000	Before 4-6-88	DRK-72B
	R-23,000	After 4-6-88	DRK-219R
23082-P	R-23,000		DRK-219R
23082-T	R-23,000		DRK-219R
23085-C	R-23,000		DRK-219R
23085-D	R-23,000		DRK-410
23085-S	R-23,000		DRK-410
23085-T	R-23,000	After 4-6-88	DRK-219R
23090-D	R-23,000	After 12-99	DRK-451
23090-S	R-23,000	After 12-99	DRK-451
23105-C	R-23,000		DRK-401
23105-D	R-23,000		DRK-409
23105-S	R-23,000		DRK-402
23120	R-23,000	Large Spherical Differential	DRK-18E
23121	R-23,000	GMC Trucks	DRK-415
	R-23,000	Non-GMC Trucks	DRK-18E
23130	R-23,000		DRK-449
23141	R-23,000		DRK-449
23202	R-23,000		DRK-72
23220	R-23,000	w/ 27950 Case	DRK-72A
	R-23,000	w/103537 Case	DRK-72B
23221	R-23,000	w/ 27950 Case	DRK-72A
	R-23,000	w/103537 Case	DRK-72B
23227	R-23,000	Before 2-1-79	DRK-413
	R-23,000	After 2-1-79	DRK-219R
23302	R-23,000		DRK-72
23320	R-23,000	w/ 27950 Case	DRK-72A
	R-23,000	w/103537 Case	DRK-72B
23321	R-23,000	w/ 27950 Case	DRK-72A
	R-23,000	w/103537 Case	DRK-72B

## Eaton Index (cont'd)

Axle Model	Type/Cap.	Comments	Kit
23327	R-23,000	Before 2-1-79	DRK-413
	R-23,000	After 2-1-79	DRK-219R
23420	R-23,000	Before 2-1-79	DRK-413
	R-23,000	After 2-1-79	DRK-219R
23421	R-23,000		DRK-219R
23427	R-23,000		DRK-219R
23430	R-23,000	w/ CTD	DRK-219R
23433	R-23,000		DRK-219R
23437	R-23,000		DRK-219R
26080-D	R-26,000	Before 12-99	DRK-410
	R-26,000	After 12-99	DRK-451
26080-P	R-26,000		DRK-219R
26080-T	R-26,000		DRK-219R
26085-D	R-26,000	Before 12-99	DRK-410
26085-S	R-26,000	Before 12-99	DRK-410
26085-P	R-26,000	Before 4-6-88	DRK-72B
	R-26,000	After 4-6-88	DRK-219R
26085-T	R-26,000	Before 4-6-88	DRK-72B
	R-26,000	After 4-6-88	DRK-219R
26090-D	R-26,000	After 12-99	DRK-451
26090-S	R-26,000	After 12-99	DRK-451
26105-C	R-26,000		DRK-401
26105-S	R-26,000		DRK-402
26120	R-26,000	Large Spherical Differential	DRK-18E
	R-26,000	Small Spherical Differential	DRK-18D
26121	R-26,000	Large Spherical Differential	DRK-18E
	R-26,000	Small Spherical Differential	DRK-18D
26123	R-26,000	Large Spherical Differential	DRK-18E
	R-26,000	Small Spherical Differential	DRK-18D
26220	R-26,000	w/ 27950 Case	DRK-72A
	R-26,000	w/103537 Case	DRK-72B
26221	R-26,000	w/ 27950 Case	DRK-72A
	R-26,000	w/103537 Case	DRK-72B
26223	R-26,000	w/ 27950 Case	DRK-72A
	R-26,000	w/103537 Case	DRK-72B
26320	R-26,000	w/ 27950 Case	DRK-72A
	R-26,000	w/103537 Case	DRK-72B
26321	R-26,000	w/ 27950 Case	DRK-72A
	R-26,000	w/103537 Case	DRK-72B
26323	R-26,000	w/ 27950 Case	DRK-72A
	R-26,000	w/103537 Case	DRK-72B
26420	R-26,000		DRK-413
26421	R-26,000		DRK-219R
26426	R-26,000		DRK-413
30055-P	R-30,000		DRK-219R
30105-C	R-30,000		DRK-401
30105-S	R-30,000		DRK-402
33321	R-33,000	w/ 27950 Case	DRK-72A
	R-33,000	w/103537 Case	DRK-72B
35055-P	R-35,000		DRK-219R
35227	R-35,000	w/ 27950 Case	DRK-413
	R-35,000	w/103537 Case	DRK-219R
35327	R-35,000	w/ 27950 Case	DRK-413
	R-35,000	w/103537 Case	DRK-219R
30427	R-30,000		DRK-1

# Heavy Duty Differential Index

## GMC Index

Axle Model	Type/Cap.	Comments	Kit
H052	R-5,200	1968-On	DRK-700
H072	R-7,200	1968-On	DRK-700
H110	R-11,000	Before 1983	DRK-701
H130	R-13,000	Late Models	DRK-701
H150	R-15,000	Before 1982	DRK-702
T150	R-15,000	1996-1983	DRK-170
H170	R-17,000	Before 1979	DRK-702
T170	R-17,000	1966-On	DRK-170

## International Harvester/ Navistar Index

Axle Model	Type/Cap.	Comments	Kit
RA15	R-6,000		DRK-195
RA25	R-13,500		DRK-202
RA29	R-15,500		DRK-191R
RA30	R-15,000		DRK-202
RA35	R-16,000		DRK-191R
RA39	R-16,000		DRK-191R
RA42	R-	w/ Involute Splines	DRK-192RB
	R-	w/o Involute Splines and Below Serial # 5141	DRK-192RA
	R-	w/o Involute Splines and Serial # 5141 & Above	DRK-192R
RA43	R-18,500	w/ Involute Splines	DRK-192RB
	R-18,500	w/o Involute Splines and Below Serial # 5141	DRK-192RA
	R-18,500	w/o Involute Splines and Serial # 5141 & Above	DRK-192R
RA44	R-18,500	w/ Involute Splines	DRK-192RB
	R-18,500	w/o Involute Splines and Below Serial # 5141	DRK-192RA
	R-18,500	w/o Involute Splines and Serial # 5141 & Above	DRK-192R
RA47	R-18,500	w/ Involute Splines	DRK-192RB
	R-18,500	w/o Involute Splines and Below Serial # 5141	DRK-192RA
	R-18,500	w/o Involute Splines and Serial # 5141 & Above	DRK-192R
RA48	R-18,500	w/ Involute Splines	DRK-192RB
	R-18,500	w/o Involute Splines and Below Serial # 5141	DRK-192RA
	R-18,500	w/o Involute Splines and Serial # 5141 & Above	DRK-192R
RA57	R-23,000	# G261412 & Up	DRK-198
	R-23,000	w/Involute Splines	DRK-201R
RA341	RF-30,000		DRK-191F
	RR-30,000		DRK-191R
RA351	RF-34,000	Below Diff Ser . #21453	DRK-192FC
	RF-34,000	Diff Ser . #21453 & Higher w/Tapered Drive Bearings	DRK-192FB
	RR-34,000	Involute Splines	DRK-192RB
	RR-34,000	Below Serial # 18798	DRK-192RA
	RR-34,000	Serial # 18798 & Above	DRK-192R
RA355	RF-38,000	Below Diff Ser . #21453	DRK-192FC

## International Harvester/ Navistar Index (cont'd)

Axle Model	Type/Cap.	Comments	Kit
	RF-38,000	Diff Ser . #21453 & Higher w/Tapered Drive Bearings	DRK-192FB
	RR-38,000	Involute Splines	DRK-192RB
	RR-38,000	Below Diff Ser. # 18798	DRK-192RA
	RR-38,000	Diff Ser. # 19798 & Up	DRK-192R
RA386	RF-	Below Diff Ser . #21453	DRK-192FC
	RF-	Diff Ser . #21453 & Higher w/Tapered Drive Bearings	DRK-192FB
	RR-	w/Involute Splines	DRK-192RB
	RR-	Below Diff Ser. # 18798	DRK-192RA
	RR-	Diff Ser. # 18798 & Up	DRK-192R
RA387	RF-	Below Diff Ser . #21453	DRK-192FC
	RF-	Diff Ser . #21453 & Higher w/Tapered Drive Bearings	DRK-192FB
	RR-	w/Involute Splines	DRK-192RB
	RR-	Below Diff Ser. # 18798	DRK-192RA
	RR-	Diff Ser. # 18798 & Up	DRK-192R
RA429	RF-		DRK-198
	RR-	w/Involute Splines	DRK-201R
RA472	RF-	Involute Splines	DRK-200F
	RF-	Involute Splines (Late Design)	DRK-200FA
	RR-	Involute Splines	DRK-192RB
RA474	RF-46,000	Involute Splines	DRK-201F
	RF-46,000	Involute Splines (Late Design)	DRK-201FA
	RR-46,000	Involute Splines	DRK-201R

## Mack Index

Axle Model	Type/Cap.	Comments	Kit
RAD23	R-		DRK-117
SW29	RF-& RR-		DRK-205
SW30	RF-& RR-		DRK-205
SW31	RF-& RR-		DRK-205
CRDP32			DRK-504
SWD32	RF-& RR-		DRK-206
CRD33			DRK-505
AWDR48	RF-& RR-		DRK-117
SWS59	RF-		DRK-212F
	RR-		DRK-212R
SWW59	RF-		DRK-212F
	RR-		DRK-212R
SS65	RF-		DRK-212F
	RR-		DRK-212R
SW65	RF-		DRK-212F
	RR-		DRK-212R
SWD69	RF-		DRK-212F
	RR-		DRK-212R
SWW69	RF-		DRK-212F
	RR-		DRK-212R
SWW69W	RF-		DRK-212F
	RR-		DRK-212R
CRD78	R-22,000		DRK-117
SW80	RF-		DRK-212F

# Heavy Duty Differential Index

HD Differential

## Mack Index (cont'd)

Axle Model	Type/Cap.	Comments	Kit
SW80	RR-		DRK-212R
CRDLP92		w/11KH5312, 5313	DRK-206
		w/11KH5313	DRK-206
		w/11KH5316, 5317, 5318, 5319	DRK-206
SWS92	RF-		DRK-212F
	RR-		DRK-212R
CRD93		Non-Current	DRK-502
		w/11KH5326, 5327, 5330	DRK-205
CRD93A			DRK-503
CRDLP93			DRK-205
SWS93	RF-		DRK-212F
	RR-		DRK-212R
CRD94			DRK-117
CRDP95			DRK-212F
SWWP95	RF-		DRK-212F
	RR-		DRK-212R
CRD96			DRK-212R
CRDPC112		w/11KH5333, 5334, 5336	DRK-206
CRD113		Non-Current	DRK-502
		w/11KH5341, 5342	DRK-205
CRD116	R-22,000	Non-Current	DRK-117A
	R-22,000	w/11KHA4165, 4165A	DRK-117
CRD117		Non-Current	DRK-117A
		w/11KHA4159API-AP14	DRK-117
		w/11KHA45159CP12	DRK-117
CRD118			DRK-506
C150	F-		DRK-507
CRD150	F-		DRK-507
CRDPC150	F-		DRK-507
C151	R-		DRK-508
CRD151	R-		DRK-508
CRDP200	F-		DRK-500
CRD201	R-		DRK-501
CRD202	F-		DRK-500
CRD203	R-		DRK-501
RAD303	R-		DRK-117
RAD305	R-		DRK-117
RAD500	R-		DRK-117
RAS500	R-		DRK-117
RAD501	R-		DRK-117
RAD507	R-22,000		DRK-117
RAD508	R-22,000		DRK-117
RAD509	R-22,000		DRK-117
RAD512	R-22,000		DRK-117
RAD529	R-23,000		DRK-117
RAD529CW	R-		DRK-117
RADL529	R-23,000		DRK-117
RAD530	R-23,000		DRK-117
RAD530C	R-		DRK-117
SWS592	RF-		DRK-212F
	RR-		DRK-212R
SWW592	RR-		DRK-212R
	RF-		DRK-212F
RAD606	R-27,000		DRK-117
RAD606C	R-		DRK-117
SWD691	RF-		DRK-212F

## Mack Index (cont'd)

Axle Model	Type/Cap.	Comments	Kit
SWD691	RR-		DRK-212R
RAD705	R-41,000		DRK-117
CRD781	R-22,000		DRK-117
SWP801	RF-		DRK-212F
	RR-		DRK-212R
RADF1000	R-		DRK-117
RADP1000	R-		DRK-117
RADP1001	R-		DRK-117
CRD1161	R-22,000	Non-Current	DRK-117A
	R-22,000	w/11KHA4159, 4159A, 4166, 4166A	DRK-117
CRD1171	R-22,000	Non-Current	DRK-117A
	R-22,000	w/11KHA4159C, 4167B	DRK-117
	R-22,000	w/11KHA4167, 4167A	DRK-117
CRDPC1501	F-		DRK-507
CRD1511	R-		DRK-508
RAD5291	R-23,000		DRK-117
RADL5291	R-23,000		DRK-117



# Heavy Duty Differential Index

## Meritor/Rockwell Axle Identification

**Nominal Axle Load Rating (GAWR):**  
In thousands of pounds. Individual forward and rear axles of a tandem set (**D, N, P, R**) are rated as single axles. A tandem set (**T**) is rated as the combination of the two axles and a tridem set (**Z**) as the combination of the three axles.

**Manufacturing Location**  
A - Australia  
B - Brazil  
C - India  
D - Mexico (Dirona)  
E - Europe (C.V.C.)  
M - Europe (Maudslay)  
N - U.S.A.

**Hub Type**  
A - Aluminum  
F - Ferrous  
N - None

**Brake Type**  
C - Dura-Master® Air Disc Brake  
D - RDA Stopmaster® Wedge Brake (Dual Air Chambers)  
E - RDH Stopmaster® Wedge Brake (Dual Hydraulic Cylinders)  
F - RSH Stopmaster® Wedge Brake (Single Hydraulic Cylinder)  
L - Q Plus Cam Brake  
N - None  
P - Cam-Master® "P" Series Cam Brake  
Q - Cam-Master® "Q" Series Cam Brake  
S - RSA Stopmaster® Wedge Brake (Single Air Chamber)  
T - Cam-Master® "T" Series Cam Brake  
W - Cam-Master® "W" Series Cam Brake

**Gearing Type**  
1 - Single Speed  
2 - Two Speed  
3 - Helical Double Reduction  
4 - Salisbury Single Speed  
5 - Planetary Double Reduction  
6 - Hub Reduction

**Main Differential Nest Type**  
B - Special Differential  
C - Driver Controlled Differential Lock  
F - Standard Differential  
H - High Traction® Differential  
N - NoSPIN™ Differential

**RR 20 1 4 5      N C Q F 123**

**Axle Specification Number**  
Identifies specific customer axle configurations (variations from the original axle design). For information about the variation, see the Bill of Materials for that specific axle model.

**Axle Type**  
C - Single Rear Drive Axle, Coach  
D - Forward-Rear Axle of a Drive Tandem with Inter-Axle Differential  
N - Forward-Rear Axle of a Drive Tandem or Tridem without Inter-Axle Differential  
P - Forward-Rear Axle of a Drive Tandem with Inter-Axle Differential and Pump  
R - Rear-Rear Axle of a Drive Tandem  
S - Single Rear Drive Axle  
T - Tandem Drive Axle Set  
Z - Tridem Drive Axle Set

**Carrier Type**  
Carrier size. Large numbers indicate a higher GCW rated carrier; i.e., larger ring gear, etc.

**Axle Design Variation**  
Indicates axle design level or variation, (e.g., RS 23 161 has a thicker wall housing than the RS 23 160). For information, see the Bill of Materials for that specific axle model.

# Heavy Duty Differential Index

HD Differential

## 14X Series Single Axles

Axle Model	Sub Model	Type/ Cap.#	Carriers	Notes	Kit
MS-17-14X		R-17,000	All	Hypoid w/o Diff Lock Hypoid w/ Diff Lock	DRK-4843 DRK-4844
MS-19-14X		R-17,000	All	Hypoid w/o Diff Lock Hypoid w/ Diff Lock	DRK-4843 DRK-4844
MS-21-14X		R-17,000	All	Hypoid w/o Diff Lock Hypoid w/ Diff Lock	DRK-4843 DRK-4844

## 14X Series Tandem Axles

Axle Model	Sub Model	Type/ Cap.#	Carriers	Notes	Kit
MD-34-14X	MD-17-14X	RF-17,000	All		DRK-4841
	MR-17-14X	RR-17,000	All	Amboid	DRK-4842
	MR-17-14X			Hypoid w/o Diff Lock	DRK-4843
	MR-17-14X			Hypoid w/ Diff Lock	DRK-4844
MD-40-14X	MD-20-14X	RF-20,000	All		DRK-4841
	MR-20-14X	RR-20,000	All	Amboid	DRK-4842
	MR-20-14X			Hypoid w/o Diff Lock	DRK-4843
	MR-20-14X			Hypoid w/ Diff Lock	DRK-4844
MT-44-14X	MD-22-14X	RF-22,000	All		DRK-4841
	MR-22-14X	RR-22,000	All	Hypoid w/o Diff Lock	DRK-4843
	MR-22-14X			Hypoid w/ Diff Lock	DRK-4844

## 113 Series Single Axles

Axle Model	Sub Model	Type/ Cap.#	Carriers	Notes	Kit
MS-10-113		R-10,000	All		DRK-4753
MS-11-113		R-11,000	All		DRK-4753
MS-12-113		R-12,000	All		DRK-4753

## 120, 125 Series Single Axles

Axle Model	Sub Model	Type/ Cap.#	Carriers	Notes	Kit
RS-13-120		R-13,000	All		DRK-218
RS-15-120		R-15,000	All		DRK-218
RS-15-125		R-15,000	All		DRK-218

## 140, 141, 143, 144 & 145 Series Single Axles

Axle Model	Sub Model	Type/ Cap.#	Carriers	Notes	Kit
RS-16-140		R-16,000	L1676 M1547		DRK-4350 DRK-4345
RS-16-141		R-16,000	All		DRK-217R
RS-17-140		R-17,000	L1676 M1547		DRK-4350 DRK-4345
RS-17-141		R-17,000	All		DRK-217R
RS-17-144		R-17,000	D1850 E1851 G1879 L1676 M1885 Q1785 R1500 S1895 X1558		DRK-217R DRK-217R DRK-4390 DRK-217R DRK-217R DRK-217R DRK-224 DRK-217R DRK-4390
RS-17-145		R-17,000	All		DRK-217R
RS-19-144		R-19,000	D1850 E1851 G1879 L1676 M1885		DRK-217R DRK-217R DRK-4390 DRK-217R DRK-217R

## 140, 141, 143, 144 & 145 Series Single Axles

Axle Model	Sub Model	Type/ Cap.#	Carriers	Notes	Kit
RS-19-144			Q1785 R1500 S1895 X1558		DRK-217R DRK-224 DRK-217R DRK-4390
RS-19-145		R-19,000	All		DRK-217R
RS-21-145		R-21,000	D1850 E1851 G1879 L1676 M1885 Q1785 R1500 S1895 X1558		DRK-217R DRK-217R DRK-4390 DRK-217R DRK-217R DRK-217R DRK-224 DRK-217R DRK-4390

## 140, 141, 143, 144 & 145 Series Tandem Axles

Axle Model	Sub Model	Type/ Cap.#	Carriers	Notes	Kit
RT-34-144	RD-17-144	RF-17,000	B1978	Prior to 11/93 w/ Original 39 Spline Input	DRK-217F
	RD-17-144				
	RD-17-144		B1978	Prior to 11/93 w/ New 46 Spline Input	DRK-4395
	RD-17-144		B1978	After 11/93	DRK-4396
	RD-17-144		C1979	Prior to 11/93 w/ Original 39 Spline Input	DRK-217F
	RD-17-144				
	RD-17-144		C1979	Prior to 11/93 w/ New 46 Spline Input	DRK-4395
	RD-17-144		C1979	After 11/93	DRK-4396
	RD-17-144		E1903	Prior to 11/93	DRK-4405
	RD-17-144		E1903	After 11/93	DRK-4406
	RD-17-144		E1981	Prior to 11/93	DRK-4405
	RD-17-144		E1981	After 11/93	DRK-4406
	RD-17-144		F1852	Prior to 11/93 w/ Original 39 Spline Input	DRK-217F
	RD-17-144				
	RD-17-144		F1852	Prior to 11/93 w/ New 46 Spline Input	DRK-4395
	RD-17-144		F1852	After 11/93	DRK-4396
	RD-17-144		G1645	Prior to 11/93 w/ Original 39 Spline Input	DRK-217F
	RD-17-144				
	RD-17-144		G1645	Prior to 11/93 w/ New 46 Spline Input	DRK-4395
	RD-17-144		G1645	After 11/93	DRK-4396
	RD-17-144		M1677	Prior to 11/93	DRK-4405
	RD-17-144		M1677	After 11/93	DRK-4406
	RD-17-144		N1860	Prior to 11/93 w/ Original 39 Spline Input	DRK-217F
	RD-17-144				
	RD-17-144		N1860	Prior to 11/93 w/ New 46 Spline Input	DRK-4395
	RD-17-144		N1860	After 11/93	DRK-4396
	RD-17-144		R1890	Prior to 11/93	DRK-4405
	RD-17-144		R1890	After 11/93	DRK-4406
	RD-17-144		S1917	Prior to 11/93 w/ Original 39 Spline Input	DRK-217F
	RD-17-144				
	RD-17-144		S1917	Prior to 11/93 w/ New 46 Spline Input	DRK-4395
	RD-17-144		S1917	After 11/93	DRK-4396

# Heavy Duty Differential Index

140, 141, 143, 144 & 145 Series Tandem Axles						
Axle Model	Sub Model	Type/ Cap.#	Carriers	Notes	Kit	
RT-34-144	RD-17-144		T1814	Prior to 11/93 w/ Original 39 Spline Input	DRK-217F	
	RD-17-144		T1814	Prior to 11/93 w/ New 46 Spline Input	DRK-4395	
	RD-17-144		T1814	After 11/93	DRK-4396	
	RD-17-144		U1815	Prior to 11/93	DRK-4405	
	RD-17-144		U1815	After 11/93	DRK-4406	
RP-17-144	RF-17,000	D1902	D1902	Prior to 11/93	DRK-4405	
		D1902	D1902	After 11/93	DRK-4406	
		G1853	G1853	Prior to 11/93 w/ Original 39 Spline Input	DRK-217F	
		G1853	G1853	Prior to 11/93 w/ New 46 Spline Input	DRK-4395	
		G1853	G1853	After 11/93	DRK-4396	
		H1984	H1984	Prior to 11/93 w/ Original 39 Spline Input	DRK-217F	
		H1984	H1984	Prior to 11/93 w/ New 46 Spline Input	DRK-4395	
		H1984	H1984	After 11/93	DRK-4396	
		K1987	K1987	Prior to 11/93	DRK-4405	
		K1987	K1987	After 11/93	DRK-4406	
		L1624	L1624	Prior to 11/93	DRK-4405	
		L1624	L1624	After 11/93	DRK-4406	
		P1888	P1888	Prior to 11/93	DRK-4405	
		P1888	P1888	After 11/93	DRK-4406	
		V1816	V1816	Prior to 11/93 w/ Original 39 Spline Input	DRK-217F	
		V1816	V1816	Prior to 11/93 w/ New 46 Spline Input	DRK-4395	
		V1816	V1816	After 11/93	DRK-4396	
		W1817	W1817	Prior to 11/93	DRK-4405	
		W1817	W1817	After 11/93	DRK-4406	
		X1662	X1662	Prior to 11/93 w/ Original 39 Spline Input	DRK-217F	
		X1662	X1662	Prior to 11/93 w/ New 46 Spline Input	DRK-4395	
		X1662	X1662	After 11/93	DRK-4396	
	RR-17-144	RR-17,000	D1850	D1850		DRK-217R
			E1851	E1851		DRK-217R
			G1879	G1879		DRK-4390
			L1676	L1676		DRK-217R
		M1885	M1885		DRK-217R	
		Q1785	Q1785		DRK-217R	
		S1865	S1865		DRK-217R	
		X1558	X1558		DRK-4390	
RT-34-145	RT-34,000	All	All	Prior to 11/93 w/ Original 39 Spline Input	DRK-217F	
RD-17-145	RF-17,000	All	All	Prior to 11/93 w/ New 46 Spline Input	DRK-4395	
RD-17-145		All	All	After 11/93	DRK-4396	
RP-17-145	RF-17,000	All	All	Prior to 11/93	DRK-4395	
RP-17-145		All	All	After 11/93	DRK-4396	
RR-17-145	RR-17,000	All	All		DRK-217R	
RT-38-144	RD-19-144	RF-19,000	B1978	Prior to 11/93 w/ Original 39 Spline Input	DRK-217F	

140, 141, 143, 144 & 145 Series Tandem Axles					
Axle Model	Sub Model	Type/ Cap.#	Carriers	Notes	Kit
RD-19-144			B1978	Prior to 11/93 w/ New 46 Spline Input	DRK-4395
RD-19-144			B1978	After 11/93	DRK-4396
RD-19-144			C1979	Prior to 11/93 w/ Original 39 Spline Input	DRK-217F
RD-19-144			C1979	Prior to 11/93 w/ New 46 Spline Input	DRK-4395
RD-19-144			C1979	After 11/93	DRK-4396
RD-19-144			E1903	Prior to 11/93	DRK-4405
RD-19-144			E1903	After 11/93	DRK-4406
RD-19-144			E1981	Prior to 11/93	DRK-4405
RD-19-144			E1981	After 11/93	DRK-4406
RD-19-144			F1852	Prior to 11/93 w/ Original 39 Spline Input	DRK-217F
RD-19-144			F1852	Prior to 11/93 w/ New 46 Spline Input	DRK-4395
RD-19-144			F1852	After 11/93	DRK-4396
RD-19-144			G1645	Prior to 11/93 w/ Original 39 Spline Input	DRK-217F
RD-19-144			G1645	Prior to 11/93 w/ New 46 Spline Input	DRK-4395
RD-19-144			G1645	After 11/93	DRK-4396
RD-19-144			M1677	Prior to 11/93	DRK-4405
RD-19-144			M1677	After 11/93	DRK-4406
RD-19-144			N1860	Prior to 11/93 w/ Original 39 Spline Input	DRK-217F
RD-19-144			N1860	Prior to 11/93 w/ New 46 Spline Input	DRK-4395
RD-19-144			N1860	After 11/93	DRK-4396
RD-19-144			R1890	Prior to 11/93	DRK-4405
RD-19-144			R1890	After 11/93	DRK-4406
RD-19-144			S1917	Prior to 11/93 w/ Original 39 Spline Input	DRK-217F
RD-19-144			S1917	Prior to 11/93 w/ New 46 Spline Input	DRK-4395
RD-19-144			S1917	After 11/93	DRK-4396
RD-19-144			T1814	Prior to 11/93 w/ Original 39 Spline Input	DRK-217F
RD-19-144			T1814	Prior to 11/93 w/ New 46 Spline Input	DRK-4395
RD-19-144			T1814	After 11/93	DRK-4396
RD-19-144			U1815	Prior to 11/93	DRK-4405
RD-19-144			U1815	After 11/93	DRK-4406
RP-19-144	RF-19,000	D1902	D1902	Prior to 11/93	DRK-4405
RP-19-144		D1902	D1902	After 11/93	DRK-4406
RP-19-144		G1853	G1853	Prior to 11/93 w/ Original 39 Spline Input	DRK-217F
RP-19-144		G1853	G1853	Prior to 11/93 w/ New 46 Spline Input	DRK-4395
RP-19-144		G1853	G1853	After 11/93	DRK-4396
RP-19-144		H1984	H1984	Prior to 11/93 w/ Original 39 Spline Input	DRK-217F
RP-19-144		H1984	H1984	Prior to 11/93 w/ New 46 Spline Input	DRK-4395
RP-19-144		H1984	H1984	After 11/93	DRK-4396
RP-19-144		K1987	K1987	Prior to 11/93	DRK-4405

HD Differential

# Heavy Duty Differential Index



HD Differential

140, 141, 143, 144 & 145 Series Tandem Axles					
Axle Model	Sub Model	Type/ Cap.#	Carriers	Notes	Kit
RT-38-144	RP-19-144		K1987	After 11/93	DRK-4406
	RP-19-144		L1624	Prior to 11/93	DRK-4405
	RP-19-144		L1624	After 11/93	DRK-4406
	RP-19-144		P1888	Prior to 11/93	DRK-4405
	RP-19-144		P1888	After 11/93	DRK-4406
	RP-19-144		V1816	Prior to 11/93 w/ Original 39 Spline Input	DRK-217F
	RP-19-144		V1816	Prior to 11/93 w/ New 46 Spline Input	DRK-4395
	RP-19-144		V1816	After 11/93	DRK-4396
	RP-19-144		W1817	Prior to 11/93	DRK-4405
	RP-19-144		W1817	After 11/93	DRK-4406
	RP-19-144		X1662	Prior to 11/93 w/ Original 39 Spline Input	DRK-217F
	RP-19-144		X1662	Prior to 11/93 w/ New 46 Spline Input	DRK-4395
	RP-19-144		X1662	After 11/93	DRK-4396
	RR-19-144	RR-19,000	D1850		DRK-217R
	RR-19-144		E1851		DRK-217R
	RR-19-144		G1879		DRK-4390
	RR-19-144		L1676		DRK-217R
	RR-19-144		M1885		DRK-217R
	RR-19-144		Q1785		DRK-217R
	RR-19-144		S1865		DRK-217R
RR-19-144		X1558		DRK-4390	
RT-40-140	RD-20-140	RF-20,000	All	Prior to 11/93	DRK-4355
	RD-20-140		All	After 11/93	DRK-4356
	RR-20-140	RR-20,000	All		DRK-217R
MT-40-143	MD-20-143	RF-20,000	B1978	Prior to 11/93 w/ Original 39 Spline Input	DRK-217F
	MD-20-143		B1978	Prior to 11/93 w/ New 46 Spline Input	DRK-4395
	MD-20-143		B1978	After 11/93	DRK-4396
	MD-20-143		C1979	Prior to 11/93 w/ Original 39 Spline Input	DRK-217F
	MD-20-143		C1979	Prior to 11/93 w/ New 46 Spline Input	DRK-4395
	MD-20-143		C1979	After 11/93	DRK-4396
	MD-20-143		E1903	Prior to 11/93	DRK-4405
	MD-20-143		E1903	After 11/93	DRK-4406
	MD-20-143		E1981	Prior to 11/93	DRK-4405
	MD-20-143		E1981	After 11/93	DRK-4406
	MD-20-143		F1852	Prior to 11/93 w/ Original 39 Spline Input	DRK-217F
	MD-20-143		F1852	Prior to 11/93 w/ New 46 Spline Input	DRK-4395
	MD-20-143		F1852	After 11/93	DRK-4396
	MD-20-143		G1645	Prior to 11/93 w/ Original 39 Spline Input	DRK-217F
	MD-20-143		G1645	Prior to 11/93 w/ New 46 Spline Input	DRK-4395
	MD-20-143		G1645	After 11/93	DRK-4396
	MD-20-143		M1677	Prior to 11/93	DRK-4405
	MD-20-143		M1677	After 11/93	DRK-4406
	MD-20-143		N1860	Prior to 11/93 w/ Original 39 Spline Input	DRK-217F

140, 141, 143, 144 & 145 Series Tandem Axles					
Axle Model	Sub Model	Type/ Cap.#	Carriers	Notes	Kit
	MD-20-143		N1860	Prior to 11/93 w/ 46 Spline Input	New DRK-4395
	MD-20-143		N1860	After 11/93	DRK-4396
	MD-20-143		R1890	Prior to 11/93	DRK-4405
	MD-20-143		R1890	After 11/93	DRK-4406
	MD-20-143		S1917	Prior to 11/93 w/ Original 39 Spline Input	DRK-217F
	MD-20-143		S1917	Prior to 11/93 w/ New 46 Spline Input	DRK-4395
	MD-20-143		S1917	After 11/93	DRK-4396
	MD-20-143		T1814	Prior to 11/93 w/ Original 39 Spline Input	DRK-217F
	MD-20-143		T1814	Prior to 11/93 w/ New 46 Spline Input	DRK-4395
	MD-20-143		T1814	After 11/93	DRK-4396
	MD-20-143		U1815	Prior to 11/93	DRK-4405
	MD-20-143		U1815	After 11/93	DRK-4406
	MP-20-143	RF-20,000	D1902	Prior to 11/93	DRK-4405
	MP-20-143		D1902	After 11/93	DRK-4406
	MP-20-143		G1853	Prior to 11/93 w/ Original 39 Spline Input	DRK-217F
	MP-20-143		G1853	Prior to 11/93 w/ New 46 Spline Input	DRK-4395
	MP-20-143		G1853	After 11/93	DRK-4396
	MP-20-143		H1984	Prior to 11/93 w/ Original 39 Spline Input	DRK-217F
	MP-20-143		H1984	Prior to 11/93 w/ New 46 Spline Input	DRK-4395
	MP-20-143		H1984	After 11/93	DRK-4396
	MP-20-143		K1987	Prior to 11/93	DRK-4405
	MP-20-143		K1987	After 11/93	DRK-4406
	MP-20-143		L1624	Prior to 11/93	DRK-4405
	MP-20-143		L1624	After 11/93	DRK-4406
	MP-20-143		P1888	Prior to 11/93	DRK-4405
	MP-20-143		P1888	After 11/93	DRK-4406
	MP-20-143		V1816	Prior to 11/93 w/ Original 39 Spline Input	DRK-217F
	MP-20-143		V1816	Prior to 11/93 w/ New 46 Spline Input	DRK-4395
	MP-20-143		V1816	After 11/93	DRK-4396
	MP-20-143		W1817	Prior to 11/93	DRK-4405
	MP-20-143		W1817	After 11/93	DRK-4406
	MP-20-143		X1662	Prior to 11/93 w/ Original 39 Spline Input	DRK-217F
	MP-20-143		X1662	Prior to 11/93 w/ New 46 Spline Input	DRK-4395
	MP-20-143		X1662	After 11/93	DRK-4396
	MR-20-143	RR-20,000	All		DRK-4461
	MR-20-143M	RR-20,000	All		DRK-4461
RT-40-145	RD-20-145	RF-20,000	B1978	Prior to 11/93 w/ Original 39 Spline Input	DRK-217F
	RD-20-145		B1978	Prior to 11/93 w/ New 46 Spline Input	DRK-4395
	RD-20-145		B1978	After 11/93	DRK-4396
	RD-20-145		C1979	Prior to 11/93 w/ Original 39 Spline Input	DRK-217F
	RD-20-145		C1979	Prior to 11/93 w/ New 46 Spline Input	DRK-4395
	RD-20-145		C1979	After 11/93	DRK-4396
	RD-20-145		C1979	Prior to 11/93 w/ Original 39 Spline Input	DRK-217F

# Heavy Duty Differential Index

140, 141, 143, 144 & 145 Series Tandem Axles					
Axle Model	Sub Model	Type/ Cap.#	Carriers	Notes	Kit
RT-40-145	RD-20-145		C1979	Prior to 11/93 w/ New 46 Spline Input	DRK-4395
	RD-20-145		C1979	After 11/93	DRK-4396
	RD-20-145		E1903	Prior to 11/93	DRK-4405
	RD-20-145		E1903	After 11/93	DRK-4406
	RD-20-145		E1981	Prior to 11/93	DRK-4405
	RD-20-145		E1981	After 11/93	DRK-4406
	RD-20-145		F1852	Prior to 11/93 w/ Original 39 Spline Input	DRK-217F
	RD-20-145		F1852	Prior to 11/93 w/ New 46 Spline Input	DRK-4395
	RD-20-145		F1852	After 11/93	DRK-4396
	RD-20-145		G1645	Prior to 11/93 w/ Original 39 Spline Input	DRK-217F
	RD-20-145		G1645	Prior to 11/93 w/ New 46 Spline Input	DRK-4395
	RD-20-145		G1645	After 11/93	DRK-4396
	RD-20-145		M1677	Prior to 11/93	DRK-4405
	RD-20-145		M1677	After 11/93	DRK-4406
	RD-20-145		N1860	Prior to 11/93 w/ Original 39 Spline Input	DRK-217F
	RD-20-145		N1860	Prior to 11/93 w/ New 46 Spline Input	DRK-4395
	RD-20-145		N1860	After 11/93	DRK-4396
	RD-20-145		R1890	Prior to 11/93	DRK-4405
	RD-20-145		R1890	After 11/93	DRK-4406
	RD-20-145		S1917	Prior to 11/93 w/ Original 39 Spline Input	DRK-217F
	RD-20-145		S1917	Prior to 11/93 w/ New 46 Spline Input	DRK-4395
	RD-20-145		S1917	After 11/93	DRK-4396
	RD-20-145		T1814	Prior to 11/93 w/ Original 39 Spline Input	DRK-217F
	RD-20-145		T1814	Prior to 11/93 w/ New 46 Spline Input	DRK-4395
	RD-20-145		T1814	After 11/93	DRK-4396
	RD-20-145		U1815	Prior to 11/93	DRK-4405
	RD-20-145		U1815	After 11/93	DRK-4406
	RP-20-145	RF-20,000	D1902	Prior to 11/93	DRK-4405
	RP-20-145		D1902	After 11/93	DRK-4406
	RP-20-145		G1853	Prior to 11/93 w/ Original 39 Spline Input	DRK-217F
	RP-20-145		G1853	Prior to 11/93 w/ New 46 Spline Input	DRK-4395
	RP-20-145		G1853	After 11/93	DRK-4396
	RP-20-145		H1984	Prior to 11/93 w/ Original 39 Spline Input	DRK-217F
	RP-20-145		H1984	Prior to 11/93 w/ New 46 Spline Input	DRK-4395
	RP-20-145		H1984	After 11/93	DRK-4396
	RP-20-145		K1987	Prior to 11/93	DRK-4405
	RP-20-145		K1987	After 11/93	DRK-4406
	RP-20-145		L1624	Prior to 11/93	DRK-4405
	RP-20-145		L1624	After 11/93	DRK-4406
	RP-20-145		P1888	Prior to 11/93	DRK-4405
	RP-20-145		P1888	After 11/93	DRK-4406

140, 141, 143, 144 & 145 Series Tandem Axles					
Axle Model	Sub Model	Type/ Cap.#	Carriers	Notes	Kit
	RP-20-145		V1816	Prior to 11/93 w/ Original 39 Spline Input	DRK-217F
	RP-20-145		V1816	Prior to 11/93 w/ New 46 Spline Input	DRK-4395
	RP-20-145		V1816	After 11/93	DRK-4396
	RP-20-145		W1817	Prior to 11/93	DRK-4405
	RP-20-145		W1817	After 11/93	DRK-4406
	RP-20-145		X1662	Prior to 11/93 w/ Original 39 Spline Input	DRK-217F
	RP-20-145		X1662	Prior to 11/93 w/ New 46 Spline Input	DRK-4395
	RP-20-145		X1662	After 11/93	DRK-4396
	RR-20-145	RR-20,000	D1850		DRK-217R
	RR-20-145		E1851		DRK-217R
	RR-20-145		G1879		DRK-4390
	RR-20-145		L1676		DRK-217R
	RR-20-145		M1885		DRK-217R
	RR-20-145		Q1785		DRK-217R
	RR-20-145		S1865		DRK-217R
	RR-20-145		X1558		DRK-4390
RT-44-145	RD-22-145	RF-22,000	B1874	Prior to 11/93 w/ Original 39 Spline Input	DRK-217F
	RD-22-145		B1874	Prior to 11/93 w/ New 46 Spline Input	DRK-4395
	RD-22-145		B1874	After 11/93	DRK-4396
	RD-22-145		C1875	Prior to 11/93	DRK-4405
	RD-22-145		C1875	After 11/93	DRK-4406
	RD-22-145		D1980	Prior to 11/93 w/ Original 39 Spline Input	DRK-217F
	RD-22-145		D1980	Prior to 11/93 w/ New 46 Spline Input	DRK-4395
	RD-22-145		D1980	After 11/93	DRK-4396
	RD-22-145		F1982	Prior to 11/93	DRK-4405
	RD-22-145		F1982	After 11/93	DRK-4406
	RD-22-145		G1905	Prior to 11/93	DRK-4405
	RD-22-145		G1905	After 11/93	DRK-4406
	RP-22-145	RF-22,000	D1876	Prior to 11/93 w/ Original 39 Spline Input	DRK-217F
	RP-22-145		D1876	Prior to 11/93 w/ New 46 Spline Input	DRK-4395
	RP-22-145		D1876	After 11/93	DRK-4396
	RP-22-145		E1877	Prior to 11/93	DRK-4405
	RP-22-145		E1877	After 11/93	DRK-4406
	RP-22-145		H1906	Prior to 11/93	DRK-4405
	RP-22-145		H1906	After 11/93	DRK-4406
	RP-22-145		J1986	Prior to 11/93 w/ Original 39 Spline Input	DRK-217F
	RP-22-145		J1986	Prior to 11/93 w/ New 46 Spline Input	DRK-4395
	RP-22-145		J1986	After 11/93	DRK-4396
	RP-22-145		M1911	Prior to 11/93	DRK-4405
	RP-22-145		M1911	After 11/93	DRK-4406
	RP-22-145		P1914	Prior to 11/93 w/ Original 39 Spline Input	DRK-217F
	RP-22-145		P1914	Prior to 11/93 w/ New 46 Spline Input	DRK-4395
	RP-22-145		P1914	After 11/93	DRK-4396

HD Differential



# Heavy Duty Differential Index

HD Differential

## 140, 141, 143, 144 & 145 Series Tandem Axles

Axle Model	Sub Model	Type/ Cap.#	Carriers	Notes	Kit
RT-44-145	RP-22-145		T1918	Prior to 11/93	DRK-4405
	RP-22-145		T1918	After 11/93	DRK-4406
	RR-22-145	RR-22,000	A1873		DRK-217R
	RR-22-145		F1904		DRK-4390

## 160, 161 & 164 Series Single Axles

Axle Model	Sub Model	Type/ Cap.#	Carriers	Notes	Kit
RC-23-160		R-23,000	A1821		DRK-4426
			C1511		DRK-4415
			C1823		DRK-4428
			D1928		DRK-4428
			E1825		DRK-4428
			E1929		DRK-4428
			H1854		DRK-4426
			J1856		DRK-4426
			P1706		DRK-4426
			R1708		DRK-4428
			T1658		DRK-4415
			T1892		DRK-4428
			V1660		DRK-4415
			V1712		DRK-4428
			Y1897		DRK-4428
Z1560		DRK-4415			
RS-20-160		R-20,000	A1821		DRK-4426
			C1511		DRK-4415
			C1823		DRK-4428
			D1928		DRK-4428
			E1825		DRK-4428
			E1929		DRK-4428
			H1854		DRK-4426
			J1856		DRK-4426
			P1706		DRK-4426
			R1708		DRK-4428
			T1658		DRK-4415
			T1892		DRK-4428
			V1660		DRK-4415
			V1712		DRK-4428
			Y1897		DRK-4428
Z1560		DRK-4415			
RS-21-160		R-21,000	A1821		DRK-4426
			C1511		DRK-4415
			C1823		DRK-4428
			D1928		DRK-4428
			E1825		DRK-4428
			E1929		DRK-4428
			H1854		DRK-4426
			J1856		DRK-4426
			P1706		DRK-4426
			R1708		DRK-4428
			T1658		DRK-4415
			T1892		DRK-4428
			V1660		DRK-4415
			V1712		DRK-4428
			Y1897		DRK-4428
Z1560		DRK-4415			
RS-23-160		R-23,000	A1821		DRK-4426
			C1511		DRK-4415
			C1823		DRK-4428
			D1928		DRK-4428
			E1825		DRK-4428
			E1929		DRK-4428
			H1854		DRK-4426

## 160, 161 & 164 Series Single Axles

Axle Model	Sub Model	Type/ Cap.#	Carriers	Notes	Kit			
RS-23-160			J1856		DRK-4426			
			P1706		DRK-4426			
			R1708		DRK-4428			
			T1658		DRK-4415			
			T1892		DRK-4428			
			V1660		DRK-4415			
			V1712		DRK-4428			
			Y1897		DRK-4428			
			Z1560		DRK-4415			
			RS-23-161		R-23,000	A1821		DRK-4426
						C1511		DRK-4415
C1823		DRK-4428						
D1928		DRK-4428						
E1825		DRK-4428						
E1929		DRK-4428						
H1854		DRK-4426						
J1856		DRK-4426						
P1706		DRK-4426						
R1708		DRK-4428						
T1658		DRK-4415						
T1892		DRK-4428						
V1660		DRK-4415						
V1712		DRK-4428						
Y1897		DRK-4428						
Z1560		DRK-4415						
RS-24-160		R-24,000	A1821		DRK-4426			
			C1511		DRK-4415			
			C1823		DRK-4428			
			D1928		DRK-4428			
			E1825		DRK-4428			
			E1929		DRK-4428			
			H1854		DRK-4426			
			J1856		DRK-4426			
			P1706		DRK-4426			
			R1708		DRK-4428			
			T1658		DRK-4415			
T1892		DRK-4428						
V1660		DRK-4415						
V1712		DRK-4428						
Y1897		DRK-4428						
Z1560		DRK-4415						
RS-25-160		R-25,000	A1821		DRK-4426			
			C1511		DRK-4415			
			C1823		DRK-4428			
			D1928		DRK-4428			
			E1825		DRK-4428			
			E1929		DRK-4428			
			H1854		DRK-4426			
			J1856		DRK-4426			
			P1706		DRK-4426			
			R1708		DRK-4428			
			T1658		DRK-4415			
T1892		DRK-4428						
V1660		DRK-4415						
V1712		DRK-4428						
Y1897		DRK-4428						
Z1560		DRK-4415						
RS-26-160		R-26,000	A1821		DRK-4426			
			C1511		DRK-4415			
			C1823		DRK-4428			
			D1928		DRK-4428			
			E1825		DRK-4428			
			E1929		DRK-4428			
			H1854		DRK-4426			

# Heavy Duty Differential Index

## 160, 161 & 164 Series Single Axles

Axle Model	Sub Model	Type/ Cap.#	Carriers	Notes	Kit
RS-26-160			J1856		DRK-4426
			P1706		DRK-4426
			R1708		DRK-4428
			T1658		DRK-4415
			T1892		DRK-4428
			V1660		DRK-4415
			V1712		DRK-4428
			Y1897		DRK-4428
			Z1560		DRK-4415

## 160, 161 & 164 Series Tandem Axles

Axle Model	Sub Model	Type/ Cap.#	Carriers	Notes	Kit				
RT-40-160	RD-20-160	RF-20,000	J1648		DRK-4420				
			J2116		DRK-4422				
			K1857		DRK-4422				
	RD-20-160	RF-20,000	L2118		DRK-4423				
			M1703		DRK-4422				
			P1628		DRK-4420				
			Q1837		DRK-4422				
			W1713		DRK-4423				
			W1895		DRK-4423				
			X1818		DRK-4422				
			Y1819		DRK-4423				
			RP-20-160	RF-20,000	K1701		DRK-4423		
					K2117		DRK-4423		
					V1894		DRK-4423		
					Z1820		DRK-4423		
					RR-20-160	RR-20,000	A1821		DRK-4426
							C1511		DRK-4415
							C1823		DRK-4428
							D1928		DRK-4428
							E1825		DRK-4428
	E1929						DRK-4428		
	H1854		DRK-4426						
	J1856		DRK-4426						
	P1706		DRK-4426						
	R1708		DRK-4428						
	RR-20-160	RR-20,000	T1658		DRK-4415				
			T1892		DRK-4428				
			V1660		DRK-4415				
			V1712		DRK-4428				
			Y1897		DRK-4428				
Z1560				DRK-4415					
RT-46-160			RD-23-160	RF-23,000	J1648		DRK-4420		
					J2116		DRK-4422		
					K1857		DRK-4422		
					L2118		DRK-4423		
	M1703				DRK-4422				
	P1628				DRK-4420				
	Q1837				DRK-4422				
	W1713				DRK-4423				
	W1895				DRK-4423				
	X1818				DRK-4422				
RD-23-160	RF-23,000	Y1819		DRK-4423					
		K1701		DRK-4423					
		K2117		DRK-4423					
		V1894		DRK-4423					
		Z1820		DRK-4423					
		RR-23-160	RR-23,000	A1821		DRK-4426			
				C1511		DRK-4415			
				C1823		DRK-4428			
				D1928		DRK-4428			
				E1825		DRK-4428			
RR-23-160	RR-23,000	E1929		DRK-4428					
		H1854		DRK-4426					
		J1856		DRK-4426					
		P1706		DRK-4426					
		R1708		DRK-4428					
RR-23-160	RR-23,000	T1658		DRK-4415					
		T1892		DRK-4428					
		V1660		DRK-4415					
		V1712		DRK-4428					
		Y1897		DRK-4428					
RR-23-160	RR-23,000	Z1560		DRK-4415					

## 160, 161 & 164 Series Tandem Axles

Axle Model	Sub Model	Type/ Cap.#	Carriers	Notes	Kit			
RT-46-160	RR-23-160		E1825		DRK-4428			
			E1929		DRK-4428			
			H1854		DRK-4426			
			J1856		DRK-4426			
			P1706		DRK-4426			
			R1708		DRK-4428			
			T1658		DRK-4415			
			T1892		DRK-4428			
			V1660		DRK-4415			
			V1712		DRK-4428			
			Y1897		DRK-4428			
			Z1560		DRK-4415			
			RT-46-164	RD-23-164	RF-23,000	J1648		DRK-4420
						J2116		DRK-4422
						K1857		DRK-4422
L2118		DRK-4423						
M1703		DRK-4422						
P1628		DRK-4420						
Q1837		DRK-4422						
W1713		DRK-4423						
W1895		DRK-4423						
X1818		DRK-4422						
Y1819		DRK-4423						
RP-23-164	RF-23,000					K1701		DRK-4423
						K2117		DRK-4423
						V1894		DRK-4423
						Z1820		DRK-4423
			RR-23-164	RR-23,000		A1821		DRK-4426
C1511		DRK-4415						
C1823		DRK-4428						
D1928		DRK-4428						
E1825		DRK-4428						
E1929		DRK-4428						
H1854		DRK-4426						
J1856		DRK-4426						
P1706		DRK-4426						
R1708		DRK-4428						
RR-23-164	RR-23,000		T1658		DRK-4415			
			T1892		DRK-4428			
			V1660		DRK-4415			
			V1712		DRK-4428			
			Y1897		DRK-4428			
			Z1560		DRK-4415			
			RT-50-160	RD-25-160	RF-25,000	J1648		DRK-4420
						J2116		DRK-4422
						K1857		DRK-4422
						L2118		DRK-4423
M1703		DRK-4422						
P1628		DRK-4420						
Q1837		DRK-4422						
W1713		DRK-4423						
W1895		DRK-4423						
X1818		DRK-4422						
RD-25-160	RF-25,000		Y1819		DRK-4423			
			K1701		DRK-4423			
			K2117		DRK-4423			
			V1894		DRK-4423			
			Z1820		DRK-4423			
RR-25-160	RR-25,000		A1821		DRK-4426			
			C1511		DRK-4415			
			C1823		DRK-4428			
			D1928		DRK-4428			
			E1825		DRK-4428			
RR-25-160	RR-25,000		E1929		DRK-4428			

# Heavy Duty Differential Index

HD Differential

160, 161 & 164 Series Tandem Axles					
Axle Model	Sub Model	Type/ Cap.#	Carriers	Notes	Kit
RT-50-160	RR-25-160		H1854		DRK-4426
	RR-25-160		J1856		DRK-4426
	RR-25-160		P1706		DRK-4426
	RR-25-160		R1708		DRK-4428
	RR-25-160		T1658		DRK-4415
	RR-25-160		T1892		DRK-4428
	RR-25-160		V1660		DRK-4415
	RR-25-160		V1712		DRK-4428
	RR-25-160		Y1897		DRK-4428
	RR-25-160		Z1560		DRK-4415
RT-50-164	RD-25-164	RF-25,000	J1648		DRK-4420
	RD-25-164		J2116		DRK-4422
	RD-25-164		K1857		DRK-4422
	RD-25-164		L2118		DRK-4423
	RD-25-164		M1703		DRK-4422
	RD-25-164		P1628		DRK-4420
	RD-25-164		Q1837		DRK-4422
	RD-25-164		W1713		DRK-4423
	RD-25-164		W1895		DRK-4423
	RD-25-164		X1818		DRK-4422
	RD-25-164		Y1819		DRK-4423
	RP-25-164	RF-25,000	K1701		DRK-4423
	RP-25-164		K2117		DRK-4423
	RP-25-164		V1894		DRK-4423
	RP-25-164		Z1820		DRK-4423
	RR-25-164	RR-25,000	A1821		DRK-4426
	RR-25-164		C1511		DRK-4415
	RR-25-164		C1823		DRK-4428
	RR-25-164		D1928		DRK-4428
	RR-25-164		E1825		DRK-4428
RR-25-164		E1929		DRK-4428	
RR-25-164		H1854		DRK-4426	
RR-25-164		J1856		DRK-4426	
RR-25-164		P1706		DRK-4426	
RR-25-164		R1708		DRK-4428	
RR-25-164		T1658		DRK-4415	
RR-25-164		T1892		DRK-4428	
RR-25-164		V1660		DRK-4415	
RR-25-164		V1712		DRK-4428	
RR-25-164		Y1897		DRK-4428	
RR-25-164		Z1560		DRK-4415	
RT-52-160	RD-26-160	RF-26,000	J1648		DRK-4420
	RD-26-160		J2116		DRK-4422
	RD-26-160		K1857		DRK-4422
	RD-26-160		L2118		DRK-4423
	RD-26-160		M1703		DRK-4422
	RD-26-160		P1628		DRK-4420
	RD-26-160		Q1837		DRK-4422
	RD-26-160		W1713		DRK-4423
	RD-26-160		W1895		DRK-4423
	RD-26-160		X1818		DRK-4422
	RD-26-160		Y1819		DRK-4423
	RP-26-160	RF-26,000	K1701		DRK-4423
	RP-26-160		K2117		DRK-4423
	RP-26-160		V1894		DRK-4423
	RP-26-160		Z1820		DRK-4423
	RR-26-160	RR-26,000	A1821		DRK-4426
	RR-26-160		C1511		DRK-4415
	RR-26-160		C1823		DRK-4428
	RR-26-160		D1928		DRK-4428
	RR-26-160		E1825		DRK-4428
	RR-26-160		E1929		DRK-4428
	RR-26-160		H1854		DRK-4426
	RR-26-160		J1856		DRK-4426
	RR-26-160		P1706		DRK-4426
	RR-26-160		R1708		DRK-4428
	RR-26-160		T1658		DRK-4415
	RR-26-160		T1892		DRK-4428
	RR-26-160		V1660		DRK-4415
	RR-26-160		V1712		DRK-4428
	RR-26-160		Y1897		DRK-4428
RR-26-160		Z1560		DRK-4415	

160, 161 & 164 Series Tandem Axles						
Axle Model	Sub Model	Type/ Cap.#	Carriers	Notes	Kit	
RT-52-160	RR-26-160		P1706		DRK-4426	
	RR-26-160		R1708		DRK-4428	
	RR-26-160		T1658		DRK-4415	
	RR-26-160		T1892		DRK-4428	
	RR-26-160		V1660		DRK-4415	
	RR-26-160		V1712		DRK-4428	
	RR-26-160		Y1897		DRK-4428	
	RR-26-160		Z1560		DRK-4415	
	RT-52-164	RD-26-164	RF-26,000	J1648		DRK-4420
		RD-26-164		J2116		DRK-4422
RD-26-164			K1857		DRK-4422	
RD-26-164			L2118		DRK-4423	
RD-26-164			M1703		DRK-4422	
RD-26-164			P1628		DRK-4420	
RD-26-164			Q1837		DRK-4422	
RD-26-164			W1713		DRK-4423	
RD-26-164			W1895		DRK-4423	
RD-26-164			X1818		DRK-4422	
RD-26-164			Y1819		DRK-4423	
RP-26-164		RF-26,000	K1701		DRK-4423	
RP-26-164			K2117		DRK-4423	
RP-26-164			V1894		DRK-4423	
RP-26-164			Z1820		DRK-4423	
RR-26-164		RR-26,000	A1821		DRK-4426	
RR-26-164			C1511		DRK-4415	
RR-26-164			C1823		DRK-4428	
RR-26-164			D1928		DRK-4428	
RR-26-164			E1825		DRK-4428	
RR-26-164		E1929		DRK-4428		
RR-26-164		H1854		DRK-4426		
RR-26-164		J1856		DRK-4426		
RR-26-164		P1706		DRK-4426		
RR-26-164		R1708		DRK-4428		
RR-26-164		T1658		DRK-4415		
RR-26-164		T1892		DRK-4428		
RR-26-164		V1660		DRK-4415		
RR-26-164		V1712		DRK-4428		
RR-26-164		Y1897		DRK-4428		
RR-26-164		Z1560		DRK-4415		

180, 185, 186 & 380 Series Single Axles					
Axle Model	Sub Model	Type/ Cap.#	Carriers	Notes	Kit
RS-23-180		R-23,000	A1899	6.83, 7.17, 7.40 & 7.83 Ratios	DRK-4438
			A1899	All Other Ratios	DRK-4437
			C1381	6.83, 7.17, 7.40 & 7.83 Ratios	DRK-4436
			C1381	All Other Ratios	DRK-4435
			J1804	6.83, 7.17, 7.40 & 7.83 Ratios	DRK-4438
			J1804	All Other Ratios	DRK-4437
			K1753	6.83, 7.17, 7.40 & 7.83 Ratios	DRK-4436
			K1753	All Other Ratios	DRK-4435
			U1399	6.83, 7.17, 7.40 & 7.83 Ratios	DRK-4436
			U1399	All Other Ratios	DRK-4435
RS-23-185		R-23,000	A1899	6.83, 7.17, 7.40 & 7.83 Ratios	DRK-4438
			A1899	All Other Ratios	DRK-4437
			W1791	6.83, 7.17, 7.40 & 7.83 Ratios	DRK-4438
			W1791	All Other Ratios	DRK-4437

# Heavy Duty Differential Index

## 180, 185, 186 & 380 Series Single Axles

Axle Model	Sub Model	Type/ Cap.#	Carriers	Notes	Kit		
RS-23-185			A1899	All Other Ratios	DRK-4437		
			C1381	6.83, 7.17, 7.40 & 7.83 Ratios	DRK-4436		
			C1381	All Other Ratios	DRK-4435		
			J1804	6.83, 7.17, 7.40 & 7.83 Ratios	DRK-4438		
			J1804	All Other Ratios	DRK-4437		
			K1753	6.83, 7.17, 7.40 & 7.83 Ratios	DRK-4436		
			K1753	All Other Ratios	DRK-4435		
			U1399	6.83, 7.17, 7.40 & 7.83 Ratios	DRK-4436		
			U1399	All Other Ratios	DRK-4435		
			W1791	6.83, 7.17, 7.40 & 7.83 Ratios	DRK-4438		
			W1791	All Other Ratios	DRK-4437		
			RS-23-186	R-23,000	A1899	6.83, 7.17, 7.40 & 7.83 Ratios	DRK-4438
					A1899	All Other Ratios	DRK-4437
					C1381	6.83, 7.17, 7.40 & 7.83 Ratios	DRK-4436
C1381	All Other Ratios	DRK-4435					
J1804	6.83, 7.17, 7.40 & 7.83 Ratios	DRK-4438					
J1804	All Other Ratios	DRK-4437					
K1753	6.83, 7.17, 7.40 & 7.83 Ratios	DRK-4436					
K1753	All Other Ratios	DRK-4435					
U1399	6.83, 7.17, 7.40 & 7.83 Ratios	DRK-4436					
U1399	All Other Ratios	DRK-4435					
W1791	6.83, 7.17, 7.40 & 7.83 Ratios	DRK-4438					
W1791	All Other Ratios	DRK-4437					
RS-23-380	R-23,000	M1625			All Ratios	DRK-4450	
		M1833			6.83, 7.17, 7.40 & 7.83 Ratios	DRK-4442	
		M1833	All Other Ratios	DRK-4441			
RS-26-180	R-26,000	A1899	6.83, 7.17, 7.40 & 7.83 Ratios	DRK-4438			
		A1899	All Other Ratios	DRK-4437			
		C1381	All Other Ratios	DRK-4435			
		J1804	6.83, 7.17, 7.40 & 7.83 Ratios	DRK-4438			
		J1804	All Other Ratios	DRK-4437			
		U1399	6.83, 7.17, 7.40 & 7.83 Ratios	DRK-4436			
		U1399	All Other Ratios	DRK-4435			
		W1791	6.83, 7.17, 7.40 & 7.83 Ratios	DRK-4438			
		W1791	All Other Ratios	DRK-4437			
		RS-26-185	R-26,000	A1899	6.83, 7.17, 7.40 & 7.83 Ratios	DRK-4438	
				A1899	All Other Ratios	DRK-4437	
				C1381	All Other Ratios	DRK-4435	
				J1804	6.83, 7.17, 7.40 & 7.83 Ratios	DRK-4438	
				J1804	All Other Ratios	DRK-4437	
U1399	6.83, 7.17, 7.40 & 7.83 Ratios			DRK-4436			
U1399	All Other Ratios			DRK-4435			
W1791	6.83, 7.17, 7.40 & 7.83 Ratios			DRK-4438			
W1791	All Other Ratios			DRK-4437			

## 180, 185, 186 & 380 Series Single Axles

Axle Model	Sub Model	Type/ Cap.#	Carriers	Notes	Kit	
RS-26-380		R-26,000	M1625	All Ratios	DRK-4450	
			M1833	6.83, 7.17, 7.40 & 7.83 Ratios	DRK-4442	
RS-30-180	R-30,000	M1833	All Other Ratios	DRK-4441		
		A1899	6.83, 7.17, 7.40 & 7.83 Ratios	DRK-4438		
		A1899	All Other Ratios	DRK-4437		
		C1381	6.83, 7.17, 7.40 & 7.83 Ratios	DRK-4436		
		C1381	All Other Ratios	DRK-4435		
		J1804	6.83, 7.17, 7.40 & 7.83 Ratios	DRK-4438		
		J1804	All Other Ratios	DRK-4437		
		K1753	6.83, 7.17, 7.40 & 7.83 Ratios	DRK-4436		
		K1753	All Other Ratios	DRK-4435		
		U1399	6.83, 7.17, 7.40 & 7.83 Ratios	DRK-4436		
		U1399	All Other Ratios	DRK-4435		
		W1791	6.83, 7.17, 7.40 & 7.83 Ratios	DRK-4438		
		W1791	All Other Ratios	DRK-4437		
		RS-30-185	R-30,000	A1899	6.83, 7.17, 7.40 & 7.83 Ratios	DRK-4438
A1899	All Other Ratios			DRK-4437		
C1381	6.83, 7.17, 7.40 & 7.83 Ratios			DRK-4436		
C1381	All Other Ratios			DRK-4435		
J1804	6.83, 7.17, 7.40 & 7.83 Ratios			DRK-4438		
J1804	All Other Ratios			DRK-4437		
K1753	6.83, 7.17, 7.40 & 7.83 Ratios			DRK-4436		
K1753	All Other Ratios			DRK-4435		
U1399	6.83, 7.17, 7.40 & 7.83 Ratios			DRK-4436		
U1399	All Other Ratios			DRK-4435		
W1791	6.83, 7.17, 7.40 & 7.83 Ratios			DRK-4438		
W1791	All Other Ratios			DRK-4437		
RS-30-380	R-30,000			M1625	All Ratios	DRK-4450
				M1833	6.83, 7.17, 7.40 & 7.83 Ratios	DRK-4442
		M1833	All Other Ratios	DRK-4441		

## 180, 185 & 380 Series Tandem Axles

Axle Model	Sub Model	Type/ Cap.#	Carriers	Notes	Kit
RT-48-180	RP-24-180	RF-24,000	M1625	All Ratios	DRK-4440
			M1833	6.83, 7.17, 7.40 & 7.83 Ratios	DRK-4442
RR-24-180	RR-24,000	M1833	All Other Ratios	DRK-4441	
		A1899	6.83, 7.17, 7.40 & 7.83 Ratios	DRK-4438	
		A1899	All Other Ratios	DRK-4437	
		C1381	6.83, 7.17, 7.40 & 7.83 Ratios	DRK-4436	
		C1381	All Other Ratios	DRK-4435	
		J1804	6.83, 7.17, 7.40 & 7.83 Ratios	DRK-4438	
		J1804	All Other Ratios	DRK-4437	
		U1399	6.83, 7.17, 7.40 & 7.83 Ratios	DRK-4436	
		U1399	All Other Ratios	DRK-4435	

# Heavy Duty Differential Index



HD Differential

180, 185 & 380 Series Tandem Axles					
Axle Model	Sub Model	Type/ Cap.#	Carriers	Notes	Kit
RT-48-180	RR-24-180		U1399	All Other Ratios	DRK-4435
	RR-24-180		W1791	6.83, 7.17, 7.40 & 7.83 Ratios	DRK-4438
	RR-24-180		W1791	All Other Ratios	DRK-4437
	RR-24-180		W1791	All Other Ratios	DRK-4437
RT-48-185	RP-24-185	RF-24,000	M1625	All Ratios	DRK-4440
	RP-24-185		M1833	6.83, 7.17, 7.40 & 7.83 Ratios	DRK-4442
	RP-24-185		M1833	All Other Ratios	DRK-4441
	RR-24-185	RR-24,000	A1899	6.83, 7.17, 7.40 & 7.83 Ratios	DRK-4438
	RR-24-185		A1899	All Other Ratios	DRK-4437
	RR-24-185		C1381	6.83, 7.17, 7.40 & 7.83 Ratios	DRK-4436
	RR-24-185		C1381	All Other Ratios	DRK-4435
	RR-24-185		J1804	6.83, 7.17, 7.40 & 7.83 Ratios	DRK-4438
	RR-24-185		J1804	All Other Ratios	DRK-4437
	RR-24-185		U1399	6.83, 7.17, 7.40 & 7.83 Ratios	DRK-4436
	RR-24-185		U1399	All Other Ratios	DRK-4435
	RR-24-185		W1791	6.83, 7.17, 7.40 & 7.83 Ratios	DRK-4438
	RR-24-185		W1791	All Other Ratios	DRK-4437
	RR-24-185		W1791	All Other Ratios	DRK-4437
	RR-24-185		W1791	All Other Ratios	DRK-4437
	RT-48-380	RP-24-380	RF-24,000	All	
RR-24-380		RR-24,000	M1625	All Ratios	DRK-4450
RR-24-380			M1833	6.83, 7.17, 7.40 & 7.83 Ratios	DRK-4442
RR-24-380			M1833	All Other Ratios	DRK-4441
RT-52-180	RP-26-180	RF-26,000	M1625	All Ratios	DRK-4440
	RP-26-180		M1833	6.83, 7.17, 7.40 & 7.83 Ratios	DRK-4442
	RP-26-180		M1833	All Other Ratios	DRK-4441
	RR-26-180	RR-26,000	A1899	6.83, 7.17, 7.40 & 7.83 Ratios	DRK-4438
	RR-26-180		A1899	All Other Ratios	DRK-4437
	RR-26-180		C1381	6.83, 7.17, 7.40 & 7.83 Ratios	DRK-4436
	RR-26-180		C1381	All Other Ratios	DRK-4435
	RR-26-180		J1804	6.83, 7.17, 7.40 & 7.83 Ratios	DRK-4438
	RR-26-180		J1804	All Other Ratios	DRK-4437
	RR-26-180		U1399	6.83, 7.17, 7.40 & 7.83 Ratios	DRK-4436
	RR-26-180		U1399	All Other Ratios	DRK-4435
	RR-26-180		W1791	6.83, 7.17, 7.40 & 7.83 Ratios	DRK-4438
	RR-26-180		W1791	All Other Ratios	DRK-4437
	RR-26-180		W1791	All Other Ratios	DRK-4437
	RR-26-180		W1791	All Other Ratios	DRK-4437
	RT-52-185	RP-26-185	RF-26,000	M1625	All Ratios
RP-26-185			M1833	6.83, 7.17, 7.40 & 7.83 Ratios	DRK-4442
RP-26-185			M1833	All Other Ratios	DRK-4441
RR-26-185		RR-26,000	A1899	6.83, 7.17, 7.40 & 7.83 Ratios	DRK-4438
RR-26-185			A1899	All Other Ratios	DRK-4437
RR-26-185			C1381	6.83, 7.17, 7.40 & 7.83 Ratios	DRK-4436
RR-26-185			C1381	All Other Ratios	DRK-4435
RR-26-185			J1804	6.83, 7.17, 7.40 & 7.83 Ratios	DRK-4438
RR-26-185			J1804	All Other Ratios	DRK-4437
RR-26-185			U1399	6.83, 7.17, 7.40 & 7.83 Ratios	DRK-4436
RR-26-185			U1399	All Other Ratios	DRK-4435
RR-26-185			U1399	All Other Ratios	DRK-4435
RR-26-185			U1399	All Other Ratios	DRK-4435
RR-26-185			U1399	All Other Ratios	DRK-4435
RR-26-185			U1399	All Other Ratios	DRK-4435

180, 185 & 380 Series Tandem Axles					
Axle Model	Sub Model	Type/ Cap.#	Carriers	Notes	Kit
	RR-26-185		W1791	6.83, 7.17, 7.40 & 7.83 Ratios	DRK-4438
	RR-26-185		W1791	All Other Ratios	DRK-4437
RT-52-380	RP-26-380	RF-26,000	All		DRK-4440
	RR-26-380	RR-26,000	M1625	All Ratios	DRK-4450
	RR-26-380		M1833	6.83, 7.17, 7.40 & 7.83 Ratios	DRK-4442
	RR-26-380		M1833	All Other Ratios	DRK-4441
RT-58-180	RP-29-180	RF-29,000	M1625	All Ratios	DRK-4440
	RP-29-180		M1833	6.83, 7.17, 7.40 & 7.83 Ratios	DRK-4442
	RP-29-180		M1833	All Other Ratios	DRK-4441
	RR-29-180	RR-29,000	A1899	6.83, 7.17, 7.40 & 7.83 Ratios	DRK-4438
	RR-29-180		A1899	All Other Ratios	DRK-4437
	RR-29-180		C1381	6.83, 7.17, 7.40 & 7.83 Ratios	DRK-4436
	RR-29-180		C1381	All Other Ratios	DRK-4435
	RR-29-180		J1804	6.83, 7.17, 7.40 & 7.83 Ratios	DRK-4438
	RR-29-180		J1804	All Other Ratios	DRK-4437
	RR-29-180		U1399	6.83, 7.17, 7.40 & 7.83 Ratios	DRK-4436
	RR-29-180		U1399	All Other Ratios	DRK-4435
	RR-29-180		W1791	6.83, 7.17, 7.40 & 7.83 Ratios	DRK-4438
	RR-29-180		W1791	All Other Ratios	DRK-4437
	RR-29-180		W1791	All Other Ratios	DRK-4437
	RR-29-180		W1791	All Other Ratios	DRK-4437
	RT-58-185	RP-29-185	RF-29,000	M1625	All Ratios
RP-29-185			M1833	6.83, 7.17, 7.40 & 7.83 Ratios	DRK-4442
RP-29-185			M1833	All Other Ratios	DRK-4441
RT-70-380	RN-35-380	RF-35,000	M1625	All Ratios	DRK-4440
	RN-35-380		M1833	6.83, 7.17, 7.40 & 7.83 Ratios	DRK-4442
	RN-35-380		M1833	All Other Ratios	DRK-4441
	RP-35-380	RF-35,000	M1625	All Ratios	DRK-4440
	RP-35-380		M1833	6.83, 7.17, 7.40 & 7.83 Ratios	DRK-4442
	RP-35-380		M1833	All Other Ratios	DRK-4441
	RR-35-380	RR-34,000	M1625	All Ratios	DRK-4440
	RR-35-380		M1833	6.83, 7.17, 7.40 & 7.83 Ratios	DRK-4442
	RR-35-380		M1833	All Other Ratios	DRK-4441
	RR-35-380		M1833	All Other Ratios	DRK-4441
	RR-35-380		M1833	All Other Ratios	DRK-4441
	RR-35-380		M1833	All Other Ratios	DRK-4441
	RR-35-380		M1833	All Other Ratios	DRK-4441
	RR-35-380		M1833	All Other Ratios	DRK-4441
	RR-35-380		M1833	All Other Ratios	DRK-4441

210, 220, 224, 230 & 240 Series Single Axles					
Axle Model	Sub Model	Type/ Cap.#	Carriers	Notes	Kit
RS-15-210		R-15,000	All		DRK-4360
RS-15-220		R-15,000	All		DRK-216
RS-17-220		R-17,000	All		DRK-216
RS-17-224		R-17,000	All		DRK-216
RS-19-220		R-19,000	All		DRK-216
RS-19-224		R-19,000	All		DRK-216
RS-21-230		R-21,000	All		DRK-225
RS-23-240		R-23,000	All		DRK-4375

720 Series Single Axles					
Axle Model	Sub Model	Type/ Cap.#	Carriers	Notes	Kit
RC-26-720		R-26,000	All		DRK-601



# Heavy Duty Differential Index

## Out of Production Double Reduction Axles

Axle Model	Sub Model	Type/ Cap.#	Carriers	Notes	Kit
SFDD4640	FDD		3200C122		DRK-4260
	FDD		5		
	FDD		3800F604		DRK-4255
	FDR		3200C122		DRK-4270
	FDR		5		
SQDD	FDR		3800F604		DRK-1910
	QDD		3800E473		DRK-4180
	QDD		3800H554		DRK-4180
SRDD	QDR		3800K557		DRK-11R
	RDD	RF-22,000	3200D122		DRK-4220
	RDD		6		
	RDD		3800A755		DRK-11FA
	RDD		3800H554		DRK-11FA
	RDR	RR-22,000	3200D122		DRK-4190
	RDR		6		
	RDR		3800A755		DRK-11R
	RDR		3800E473		DRK-11R
	RDR		3800H554		DRK-11R
STDD	TDD	RF-25,000	3200D122		DRK-4220
	TDD		6		
	TDD		3800D758		DRK-187F
	TDR	RR-25,000	3200D122		DRK-4190
	TDR		6		
SUDD	TDR		3800D758		DRK-187R
	UDD	RF-29,000	3200E122		DRK-204F
	UDD		7		
	UDD		3800G579		DRK-4245
	UDR	RR-29,000	3800G579		DRK-4240

## Out of Production Single Reduction Single Axles

Axle Model	Sub Model	Type/ Cap.#	Carriers	Notes	Kit
59722					DRK-2108
59723					DRK-2108
59733					DRK-2108
C100					DRK-2111
C102					DRK-2111
C103					DRK-2111
D140		R-13,000	A1093	Prior to 1985	DRK-4290
			A1093	Prior to 1985	DRK-4295
			A1093	After 1985	DRK-4300
			R1110	After 1985	DRK-4300
F105		R-15,000			DRK-4315
F106		R-15,000			DRK-4315
F140		R-15,000			DRK-4310
F145		R-15,000			DRK-4310
F146		R-15,000			DRK-4310
F147		R-15,000			DRK-4310
F149		R-15,000			DRK-4310
H120		R-17,000		3.55 - 4.63 Ratios	DRK-9RC
H140		R-17,000			DRK-1918
H170		R-17,000			DRK-4325
H172		R-17,000			DRK-4330
H173		R-17,000			DRK-4330
L100		R-18,500		3.55 - 4.63 Ratios	DRK-9RC
L100A		R-18,500		3.55 - 4.63 Ratios	DRK-9RC
		R-18,500		Ratios above 4.63	DRK-9RB
L101		R-18,500		3.55 - 4.63 Ratios	DRK-9RC
L110		R-18,500		3.55 - 4.63 Ratios	DRK-9RC
L110A		R-18,500		3.55 - 4.63 Ratios	DRK-9RC
L140		R-18,500			DRK-1926
L145		R-18,500			DRK-1926
L172		R-18,500			DRK-4330

## Out of Production Single Reduction Single Axles

Axle Model	Sub Model	Type/ Cap.#	Carriers	Notes	Kit
L173		R-18,500			DRK-4330
P174		R-20,000			DRK-4330
PL143		R-18,500			DRK-172R
QT140		R-22,000			DRK-600
QT143		R-22,000			DRK-600
QT145		R-22,000			DRK-600
QT148		R-22,000			DRK-600
R100		R-23,000			DRK-172R
R100A		R-23,000			DRK-172R
R110		R-23,000			DRK-172R
R110A		R-23,000			DRK-172R
R112		R-23,000			DRK-172R
R113		R-23,000			DRK-172R
R114		R-23,000			DRK-172R
R115		R-23,000			DRK-172R
R120		R-23,000			DRK-172R
R140		R-23,000			DRK-172R
R141		R-23,000			DRK-172R
R143		R-23,000			DRK-172R
R155		R-23,000			DRK-172R
R162		R-23,000	A1431		DRK-1984
		R-23,000	C679		DRK-1984
		R-23,000	Z1430		DRK-1984
		R-23,000	Z806		DRK-1984
R164		R-23,000	A1431		DRK-1984
		R-23,000	C679		DRK-1984
		R-23,000	Z1430		DRK-1984
		R-23,000	Z806		DRK-1984
R170		R-23,000		Prior to 12/1/83 Exc. 7.40 Ratio	DRK-50
R171		R-23,000			DRK-50A
R173		R-23,000			DRK-50A
R200		R-23,000		Old Style	DRK-1925
		R-23,000		New Style	DRK-1925A
RL170		R-20,000		Prior to 12/1/83 Exc. 7.40 Ratio	DRK-50
RT140		R-23,000			DRK-172R
S162		R-23,000	A1431		DRK-1984
		R-23,000	C679		DRK-1984
		R-23,000	Z1430		DRK-1984
		R-23,000	Z806		DRK-1984
S170		R-26,000		Prior to 12/1/83 Exc. 7.40 Ratio	DRK-50
U140		R-23,000			DRK-172R
U240		R-29,000		Old Style	DRK-1925
		R-29,000		New Style	DRK-1925A
U340		R-29,000		Old Style	DRK-1925
		R-29,000		New Style	DRK-1925A
W170		R-36-38,000			DRK-50

## Out of Production Single Reduction Tandem Axles

Axle Model	Sub Model	Type/ Cap.#	Carriers	Notes	Kit
SL100	LD100	RF-17,000			DRK-194F
	LR100	RR-17,000			DRK-194RB
SL100P	LP100	RF-17,000			DRK-194F
	LR100	RR-17,000			DRK-194RB
SLHD	LHD	RF-17,000		3.55 - 4.63 Ratios	DRK-900F
	LHR	RR-17,000		3.55 - 4.63 Ratios	DRK-9RC
SQ100	QD100	RF-20,000			DRK-194F
	QR100	RR-20,000			DRK-194RB
SQ100P	QP100	RF-20,000			DRK-194F
	QR100	RR-20,000			DRK-194RB

# Heavy Duty Differential Index

HD Differential

Out of Production Single Reduction Tandem Axles					
Axle Model	Sub Model	Type/Cap.#	Carriers	Notes	Kit
SQHD	QHD	RF-20,000		3.55 - 4.63 Ratios	DRK-900F
	QHR	RR-20,000		3.55 - 4.63 Ratios	DRK-9RC
SQHP	QAR	RR-20,000			DRK-194RA
	QHP	RF-20,000			DRK-194F
SQR100	QRD100	RF-22,000			DRK-194F
	QRR100	RR-22,000			DRK-194RB
SQR100P	QRP100	RF-22,000			DRK-194F
	QRR100	RR-22,000			DRK-194RB
SR170	R170		G1255	7.40 Ratio Only	DRK-4125
	R170		G1255	All ratios Exc. 7.40	DRK-203F
	R170		M1625	7.40 Ratio Only	DRK-4145
	R170		M1625	All ratios Exc. 7.40	DRK-4140
	R170		X1324	All ratios Exc. 7.40	DRK-4135
	R170R	RR-24,000		7.40 Ratio Only	DRK-4130
SR270	R270	RF-24,000	G1255	7.40 Ratio Only	DRK-4125
	R270		G1255	All ratios Exc. 7.40	DRK-203F
	R270		J1076	7.40 Ratio Only	DRK-4125
	R270		J1076	All ratios Exc. 7.40	DRK-203F
	R270		M1625	7.40 Ratio Only	DRK-4145
	R270		M1625	All ratios Exc. 7.40	DRK-4140
	R270		X1324	All ratios Exc. 7.40	DRK-4135
	R270R	RR-24,000	M1625	7.40 Ratio Only	DRK-4155A
	R270R		M1625	All ratios Exc. 7.40	DRK-4155
SR280	R280	RF-24,000	G1255	7.40 Ratio Only	DRK-4125
	R280		G1255	All ratios Exc. 7.40	DRK-203F
	R280		J1076	7.40 Ratio Only	DRK-4125
	R280		J1076	All ratios Exc. 7.40	DRK-203F
	R280		M1625	7.40 Ratio Only	DRK-4145
	R280		M1625	All ratios Exc. 7.40	DRK-4140
	R280		X1324	All ratios Exc. 7.40	DRK-4135
	R280R	RR-24,000	M1625	7.40 Ratio Only	DRK-4155A
	R280R		M1625	All ratios Exc. 7.40	DRK-4155
SSHD	SHD	RF-23,000		Ball Bearing Input & Output Shaft	DRK-172F
	SHD				
	SHR	RR-23,000		Early Style Seal	DRK-172R
SSHP	SHP	RF-23,000		Ball Bearing Input & Output Shaft	DRK-172F
	SHP				
	SHP	RF-23,000		Taper Bearing Input Output Shaft w/ Upgraded O/S Seal	DRK-4095
	SHP				
	SHR	RR-23,000		Early Style Seal	DRK-172R
STHD	THD	RF-25,000		Ball Bearing Input & Output Shaft	DRK-172F
	THD				
	THR	RR-25,000		Early Style Seal	DRK-172R
SU170	U170	RF-29,000	G1255	7.40 Ratio Only	DRK-4125
	U170		G1255	All ratios Exc. 7.40	DRK-203F
	U170		M1625	7.40 Ratio Only	DRK-4145
	U170		M1625	All ratios Exc. 7.40	DRK-4140
	U170		X1324	All ratios Exc. 7.40	DRK-4135
	U170R	RR-29,000		7.40 Ratio Only	DRK-4130
SU270	U270	RF-29,000	G1255	7.40 Ratio Only	DRK-4125
	U270		G1255	All ratios Exc. 7.40	DRK-203F
	U270		J1076	7.40 Ratio Only	DRK-4125
	U270		J1076	All ratios Exc. 7.40	DRK-203F
	U270		M1625	7.40 Ratio Only	DRK-4145
	U270		M1625	All ratios Exc. 7.40	DRK-4140
	U270	RF-29,000	X1324	All ratios Exc. 7.40	DRK-4135
	U270R	RR-29,000	M1625	7.40 Ratio Only	DRK-4155A
	U270R		M1625	All ratios Exc. 7.40	DRK-4155
SU280	U280	RF-29,000	G1255	7.40 Ratio Only	DRK-4125
	U280		G1255	All ratios Exc. 7.40	DRK-203F
	U280		J1076	7.40 Ratio Only	DRK-4125
	U280		J1076	All ratios Exc. 7.40	DRK-203F
	U280		M1625	7.40 Ratio Only	DRK-4145

Out of Production Single Reduction Tandem Axles					
Axle Model	Sub Model	Type/Cap.#	Carriers	Notes	Kit
SU280	U280		M1625	All ratios Exc. 7.40	DRK-4140
	U280		X1324	All ratios Exc. 7.40	DRK-4135
	U280R	RR-29,000	M1625	7.40 Ratio Only	DRK-4155A
	U280R		M1625	All ratios Exc. 7.40	DRK-4155
SUHD	UHD	RF-29,000		Ball Bearing Input & Output Shaft	DRK-172F
	UHD				
	UHR	RR-29,000		Early Style Seal	DRK-172R
SW170	W170	RF-35,000	G1255	7.40 Ratio Only	DRK-4125
	W170		G1255	All ratios Exc. 7.40	DRK-203F
	W170		J1076	7.40 Ratio Only	DRK-4125
	W170	RF-35,000	J1076	All ratios Exc. 7.40	DRK-203F
	W170		M1625	7.40 Ratio Only	DRK-4145
	W170		M1625	All ratios Exc. 7.40	DRK-4140
	W170		X1324	All ratios Exc. 7.40	DRK-4135
	W170R	RR-34,000		7.40 Ratio Only	DRK-4130
SW270	W270	RF-35,000	G1255	7.40 Ratio Only	DRK-4125
	W270		G1255	All ratios Exc. 7.40	DRK-203F
	W270		J1076	7.40 Ratio Only	DRK-4125
	W270		J1076	All ratios Exc. 7.40	DRK-203F
	W270		M1625	7.40 Ratio Only	DRK-4145
	W270		M1625	All ratios Exc. 7.40	DRK-4140
	W270		X1324	All ratios Exc. 7.40	DRK-4135
	W270R	RR-34,000	M1625	7.40 Ratio Only	DRK-4155A
	W270R		M1625	All ratios Exc. 7.40	DRK-4155
SW280	W280	RF-35,000	G1255	7.40 Ratio Only	DRK-4125
	W280		G1255	All ratios Exc. 7.40	DRK-203F
	W280		J1076	7.40 Ratio Only	DRK-4125
	W280		J1076	All ratios Exc. 7.40	DRK-203F
	W280		M1625	7.40 Ratio Only	DRK-4145
	W280		M1625	All ratios Exc. 7.40	DRK-4140
	W280		X1324	All ratios Exc. 7.40	DRK-4135
	W280R	RR-34,000	M1625	7.40 Ratio Only	DRK-4155A
	W280R		M1625	All ratios Exc. 7.40	DRK-4155

## Volvo Index

Axle Model	Type/Cap.	Comments	Kit
EV-80	Front		DRK-801
	Rear		DRK-802
EV-87	Front		DRK-801
	Rear		DRK-802

## White Index

Axle Model	Type/Cap.	Comments	Kit
124C	R-21,000		DRK-111
134C	R-23,000		DRK-111

# Differential Rebuild Kits

<b>DRK-1</b>		
Position	Part Number	Qty
Differential Right Brg.	497-493	1
Differential Left Brg.	56425-56650	1
Pinion Head Brg.	55200C-55437	1
Pinion Tail Brg.	55200C-55437	1
Pinion Nose Brg.	MUSB1307UM	1
Electric Shift Brg.	200SL •	1
Pinion Seal	DT7721 (2.625x4.654)	1
Sealer	RTV Silicone	1

<b>DRK-1A</b>		
Position	Part Number	Qty
Differential Right Brg.	497-493	1
Differential Left Brg.	567-563	1
Pinion Head Brg.	55200C-55437	1
Pinion Tail Brg.	55200C-55437	1
Pinion Nose Brg.	MUSB1307UM	1
Pinion Seal	DT7721 (2.625x4.654)	1
Sealer	RTV Silicone	1

<b>DRK-9F</b>		
Position	Part Number	Qty
Differential Right Brg.	496-493	1
Differential Left Brg.	496-493	1
Pinion Head Brg.	72200C-72487	1
Pinion Tail Brg.	72200C-72487	1
Pinion Nose Brg.	MU1306TDM	1
Drive Gear Front Brg.	29675-29630	1
Drive Gear Rear Brg.	29675-29630	1
Idler Gear Brg.	31597-31520	2
Input Shaft Brg.	211B	1
Thrushaft Brg.	209 •	1
Pinion Seal	35949N (2.937x3.937)	1
Thrushaft Seal	475322N (2.750x3.543)	1
Sealer	RTV Silicone	1

<b>DRK-9R</b>		
Position	Part Number	Qty
Differential Right Brg.	496-493	1
Differential Left Brg.	496-493	1
Pinion Head Brg.	72200C-72487	1
Pinion Tail Brg.	72188C-72487	1
Pinion Nose Brg.	MU1306TDM	1
Pinion Seal	35009N (2.750x3.876)	1
Sealer	RTV Silicone	1

<b>DRK-9RB</b>		
Position	Part Number	Qty
Differential Right Brg.	496-493	1
Differential Left Brg.	496-493	1
Pinion Head Brg.	72200C-72487	1
Pinion Tail Brg.	72188C-72487	1
Pinion Nose Brg.	RU1570UM	1
Pinion Seal	35009N (2.750x3.876)	1
Sealer	RTV Silicone	1

<b>DRK-9RC</b>		
Position	Part Number	Qty
Differential Right Brg.	496-493	1
Differential Left Brg.	497-493	1
Pinion Head Brg.	72200C-72487	1
Pinion Tail Brg.	72188C-72487	1
Pinion Nose Brg.	RU1570UM	1
Pinion Seal	35009N (2.750x3.876)	1
Sealer	RTV Silicone	1

<b>DRK-11FA</b>		
Position	Part Number	Qty
Differential Right Brg.	581-572	1
Differential Left Brg.	581-572	1
Pinion Head Brg.	42350-42584	1
Pinion Tail Brg.	497-493	1
Pinion Nose Brg.	MR1212EL	1
Cross Shaft Right Brg.	66225-66462	2
Cross Shaft Left Brg.	MU1218TDHDM	1
Cross Shaft Left Brg.	5212W	1
Thrushaft Brg.	212	1
Input Shaft Seal	415086N (3.000x4.249)	1
Thrushaft Seal	415086N (3.000x4.249)	1
Sealer	RTV Silicone	1

<b>DRK-11R</b>		
Position	Part Number	Qty
Differential Right Brg.	581-572	1
Differential Left Brg.	581-572	1
Pinion Head Brg.	42350-42584	1
Pinion Tail Brg.	497-493	1
Pinion Nose Brg.	MR1212EL	1
Cross Shaft Right Brg.	66225-66462	2
Cross Shaft Left Brg.	MU1218TDHDM	1
Pinion Seal	3592 (3.000x5.501)	1
Pinion Seal	475012N (3.937x4.003)	1
Sealer	RTV Silicone	1

<b>DRK-18D</b>		
Position	Part Number	Qty
Differential Right Brg.	42381-42584	1
Differential Left Brg.	665-653	1
Pinion Head Brg.	78215C-78551	1
Pinion Tail Brg.	72212C-72487	1
Pinion Nose Brg.	MU1309UGM	1
Pinion Seal	712937 (2.937x4.939)	1
Sealer	RTV Silicone	1

<b>DRK-18E</b>		
Position	Part Number	Qty
Differential Right Brg.	42381-42584	1
Differential Left Brg.	665-653	1
Pinion Head Brg.	78215C-78551 <sup>1</sup>	1
Pinion Tail Brg.	72212C-72487	1
Pinion Nose Brg.	MUB1308UM	1
Pinion Seal	712937 (2.937x4.939)	1
Sealer	RTV Silicone	1

<b>DRK-23</b>		
Position	Part Number	Qty
Differential Right Brg.	495A-493	1
Differential Left Brg.	42381-42584	1
Pinion Head Brg.	HM903249-HM903210	1
Pinion Tail Brg.	HM903249-HM903210	1
Pinion Nose Brg.	MUSB1307UM	1
Electric Shift Brg.	200SL •	1
Pinion Seal	712375 (2.375x4.064)	1
Pinion Seal	712625 (2.625x4.064)	1
Sealer	RTV Silicone	1

<b>DRK-23B</b>		
Position	Part Number	Qty
Differential Right Brg.	3994-3920	1
Differential Left Brg.	567-563	1
Pinion Head Brg.	HM903249-HM903210	1
Pinion Tail Brg.	HM903249-HM903210	1
Pinion Nose Brg.	MUSB1307UM	1
Pinion Seal	712375 (2.375x4.064)	1
Pinion Seal	712625 (2.625x4.064)	1
Sealer	RTV Silicone	1

<b>DRK-23D</b>		
Position	Part Number	Qty
Differential Right Brg.	495A-493	1
Differential Left Brg.	42381-42584	1
Pinion Head Brg.	55175C-55437	1
Pinion Tail Brg.	55175C-55437	1
Pinion Nose Brg.	MUSB1307UM	1
Electric Shift Brg.	200SL •	1
Pinion Seal	475095N (2.375x3.500)	1
Pinion Seal	9773 (2.625x4.564)	1
Sealer	RTV Silicone	1

<b>DRK-24</b>		
Position	Part Number	Qty
Differential Right Brg.	33275-33472	1
Differential Left Brg.	498-493 <sup>25</sup>	1
Pinion Head Brg.	HM903249-HM903210	1
Pinion Tail Brg.	HM903249-HM903210	1
Pinion Nose Brg.	MU1305TDM	1
Electric Shift Brg.	200SL •	1
Pinion Seal	470737N (2.250x3.189)	1
Pinion Seal	722250 (2.250x4.064)	1
Pinion Seal	712625 (2.625x4.064)	1
Sealer	RTV Silicone	1

<b>DRK-50</b>		
Position	Part Number	Qty
Differential Right Brg.	598-592A	1
Differential Left Brg.	52387-52618	1
Pinion Head Brg.	H715343-H715311	1
Pinion Tail Brg.	H715334-H715311	1
Pinion Nose Brg.	MUB1309TM	1
Pinion Seal	415086N (3.000x4.249)	1
Sealer	RTV Silicone	1

<b>DRK-50A</b>		
Position	Part Number	Qty
Differential Right Brg.	598-592A	1
Differential Left Brg.	52387-52618	1
Pinion Head Brg.	H715343-H715311	1
Pinion Tail Brg.	HM813843-HM813810	1
Pinion Nose Brg.	MUB1309TM	1
Pinion Seal	415086N (3.000x4.249)	1
Sealer	RTV Silicone	1

<b>DRK-64F</b>		
Position	Part Number	Qty
Differential Right Brg.	56425-56650	1
Differential Left Brg.	497-493	1
Pinion Head Brg.	72200C-72487	1
Pinion Tail Brg.	72200C-72487	1
Pinion Nose Brg.	MUSB1307UM	1
Input Shaft Front Brg.	311	1
Output Shaft Front Brg.	34274-34492A	1
Output Shaft Rear Brg.	MA1209EL	1
Input Shaft Seal	DT7720 (2.625x3.623)	1
Thrushaft Seal	DT7720 (2.625x3.623)	1
Felt Seal	5M867 (654) •	1
Sealer	RTV Silicone	1

<b>DRK-64FC</b>		
Position	Part Number	Qty
Differential Right Brg.	567-563	1
Differential Left Brg.	497-493	1
Pinion Head Brg.	72200C-72487	1
Pinion Tail Brg.	72200C-72487	1
Pinion Nose Brg.	MUSB1307UM	1
Input Shaft Front Brg.	311	1
Output Shaft Front Brg.	34274-34492A	1
Output Shaft Rear Brg.	MA1209EL	1
Input Shaft Seal	DT7720 (2.625x3.623)	1
Thrushaft Seal	DT7720 (2.625x3.623)	1
Felt Seal	5M867 (654) •	1
Sealer	RTV Silicone	1

<sup>1</sup>with GMC (1984 & later) use 72212C - 72487  
<sup>25</sup>with GMC (1986-1987) use 3994-3920

• Not Packed In Kit

# Differential Rebuild Kits

HD Differential

DRK-64FD		
Position	Part Number	Qty
Differential Right Brg.	567-563	1
Differential Left Brg.	497-493	1
Pinion Head Brg.	72200C-72487	1
Pinion Tail Brg.	72200C-72487	1
Pinion Nose Brg.	MUSB1307UM	1
Input Shaft Front Brg.	JM207049-JM207010	1
Output Shaft Front Brg.	34274-34492A	1
Output Shaft Rear Brg.	MA1209EL	1
Input Shaft Seal	DT7720 (2.625x3.623)	1
Thrushaft Seal	DT7720 (2.625x3.623)	1
Felt Seal	5M867 (654) •	1
Sealer	RTV Silicone	1

DRK-64FE		
Position	Part Number	Qty
Differential Right Brg.	56425-56650	1
Differential Left Brg.	497-493	1
Pinion Head Brg.	72200C-72487	1
Pinion Tail Brg.	72200C-72487	1
Pinion Nose Brg.	MUSB1307UM	1
Input Shaft Front Brg.	JM207049-JM207010	1
Output Shaft Front Brg.	34274-34492A	1
Output Shaft Rear Brg.	MA1209EL	1
Input Shaft Seal	DT7720 (2.625x3.623)	1
Thrushaft Seal	DT7720 (2.625x3.623)	1
Felt Seal	5M867 (654) •	1
Sealer	RTV Silicone	1

DRK-72		
Position	Part Number	Qty
Differential Right Brg.	42346-42584	1
Differential Left Brg.	68450-68712 <sup>2</sup>	1
Pinion Head Brg.	72212C-72487	1
Pinion Tail Brg.	72212C-72487	1
Pinion Nose Brg.	MUB1308UM	1
Electric Shift Brg.	200SL •	1
Pinion Seal	475003N (2.625x3.623)	1
Felt Seal	5M867 (654) •	1
Sealer	RTV Silicone	1

DRK-72A		
Position	Part Number	Qty
Differential Right Brg.	42346-42584	1
Differential Left Brg.	68450-68712	1
Pinion Head Brg.	78215C-78551	1
Pinion Tail Brg.	72212C-72487	1
Pinion Nose Brg.	MUB1308UM	1
Pinion Seal	712937 (2.937x4.939)	1
Sealer	RTV Silicone	1

DRK-72B		
Position	Part Number	Qty
Differential Right Brg.	42346-42584	1
Differential Left Brg.	68462-68712	1
Pinion Head Brg.	78215C-78551	1
Pinion Tail Brg.	72212C-72487	1
Pinion Nose Brg.	MUB1308UM	1
Pinion Seal	712937 (2.937x4.939)	1
Sealer	RTV Silicone	1

DRK-111		
Position	Part Number	Qty
Differential Right Brg.	685-672	1
Differential Left Brg.	685-672	1
Pinion Head Brg.	H913842-H913810	1
Pinion Tail Brg.	HM911245-HM911210	1
Pinion Nose Brg.	MUC1309UM	1
Pinion Seal	416470N (3.250x4.249)	1
Sealer	RTV Silicone	1

DRK-117		
Position	Part Number	Qty
Differential Right Brg.	598A-592A	1
Differential Left Brg.	598A-592A	1
Pinion Head Brg.	H715340-H715310	1
Pinion Tail Brg.	65212-65500	1
Cross Shaft Right Brg.	6379-6320	1
Cross Shaft Left Brg.	6379-6320	1
Pinion Seal	35009N (2.750x3.876)	1
Pinion Seal	476283N (2.750x4.249)	1
O-Ring	OR250	1
O-Ring	OR262	1
Sealer	RTV Silicone	1

DRK-117A		
Position	Part Number	Qty
Differential Right Brg.	598-592A	1
Differential Left Brg.	598-592A	1
Pinion Head Brg.	H715340-H715310	1
Pinion Tail Brg.	65212-65500	1
Cross Shaft Right Brg.	6379-6320	1
Cross Shaft Left Brg.	6379-6320	1
Pinion Seal	35009N (2.750x3.876)	1
O-Ring	OR250	1
O-Ring	OR262	1
Sealer	RTV Silicone	1

DRK-170		
Position	Part Number	Qty
Differential Right Brg.	33287-33472	1
Differential Left Brg.	42381-42584	1
Pinion Head Brg.	55200C-55437	1
Pinion Tail Brg.	HM804848-HM804810	1
Pinion Nose Brg.	M5305TV	1
Electric Shift Brg.	200SL •	1
Pinion Seal	712598 (2.598x3.999)	1
Shift Rod Seal	50419 •	1
Sealer	RTV Silicone	1

DRK-172F		
Position	Part Number	Qty
Differential Right Brg.	47890-47820	1
Differential Left Brg.	47890-47820	1
Pinion Head Brg.	H715343-H715311	1
Pinion Tail Brg.	65237-65500	1
Drive Gear Front Brg.	MU1015DCV	1
Input Shaft Brg.	313	1
Thrushaft Brg.	210	1
Input Shaft Seal	415086N (3.000x4.249)	1
Thrushaft Seal	475322N (2.750x3.543)	1
Sealer	RTV Silicone	1

DRK-172FA		
Position	Part Number	Qty
Differential Right Brg.	47890-47820	1
Differential Left Brg.	47890-47820	1
Pinion Head Brg.	H715343-H715311	1
Pinion Tail Brg.	65237-65500	1
Drive Gear Front Brg.	MU1015DCV	1
Input Shaft Brg.	313A	1
Thrushaft Brg.	210	1
Input Shaft Seal	415086N (3.000x4.249)	1
Thrushaft Seal	475322N (2.750x3.543)	1
Sealer	RTV Silicone	1

DRK-172FB		
Position	Part Number	Qty
Differential Right Brg.	47890-47820	1
Differential Left Brg.	47890-47820	1
Pinion Head Brg.	H715343-H715311	1
Pinion Tail Brg.	65237-65500	1
Inter Differential Brg.	JLM714149-JLM714110	1
Input Shaft Brg.	JH211749-JH211710	1
Thrushaft Brg.	LM104949-JLM104910	2
Input Shaft Seal	416470N (3.250x4.249)	1
Thrushaft Seal	475322N (2.750x3.543)	1
Sealer	RTV Silicone	1

DRK-172R		
Position	Part Number	Qty
Differential Right Brg.	47890-47820	1
Differential Left Brg.	47890-47820	1
Pinion Head Brg.	H715343-H715311	1
Pinion Tail Brg.	H715334-H715311	1
Pinion Nose Brg.	MU1308UM	1
Pinion Seal	3591 (2.750x5.501)	1
Pinion Seal	35009N (2.750x3.876) •	1
Sealer	RTV Silicone	1

DRK-187F		
Position	Part Number	Qty
Differential Right Brg.	HM516449C-HM516410	1
Differential Left Brg.	HM516449C-HM516410	1
Pinion Head Brg.	42350-42584	1
Pinion Tail Brg.	497-493	1
Pinion Nose Brg.	MR1212EL	1
Cross Shaft Right Brg.	66225-66462	2
Cross Shaft Left Brg.	MU1218TDHM	1
Input Shaft Brg.	387A-382A	2
Thrushaft Brg.	212	1
Input Shaft Seal	3592 (3.000x5.501)	1
Thrushaft Seal	415086N (3.000x4.249)	2
Sealer	RTV Silicone	1

DRK-187R		
Position	Part Number	Qty
Differential Right Brg.	HM516449C-HM516410	1
Differential Left Brg.	HM516449C-HM516410	1
Pinion Head Brg.	42350-42584	1
Pinion Tail Brg.	497-493	1
Pinion Nose Brg.	MR1212EL	1
Cross Shaft Right Brg.	66225-66462	2
Cross Shaft Left Brg.	MU1218TDHM	1
Input Shaft Seal	3592 (3.000x5.501)	1
Thrushaft Seal	415013N (3.000x4.003)	1
Sealer	RTV Silicone	1

DRK-191F		
Position	Part Number	Qty
Differential Right Brg.	3984-3925	1
Differential Left Brg.	3984-3925	1
Pinion Head Brg.	55175C-55437	1
Pinion Tail Brg.	55175C-55437	1
Pinion Nose Brg.	MUB5206UM	1
Idler Gear Brg.	25877-25821	2
Thrust Brg. Race	W2840	1
Thrust Brg. Race	TRA2840	2
Input Shaft Brg.	122L	1
Output Shaft Brg.	210	1
Drive Gear Brg.	213SL	1
Input Shaft Brg.	310B	1
Input Shaft Seal	415281N (3.000x3.751)	1
Thrushaft Seal	415147N (2.500x3.500)	1
Sealer	RTV Silicone	1

DRK-191R		
Position	Part Number	Qty
Differential Right Brg.	3984-3925	1
Differential Left Brg.	3984-3925	1
Pinion Head Brg.	55175C-55437	1
Pinion Tail Brg.	55175C-55437	1
Pinion Nose Brg.	MUB5206UM	1
Pinion Seal	714512 (2.375x4.498)	1
Sealer	RTV Silicone	1



# Differential Rebuild Kits

DRK-192FB		
Position	Part Number	Qty
Differential Right Brg.	47890-47820	1
Differential Left Brg.	47890-47820	1
Pinion Head Brg.	72225C-72487	1
Pinion Tail Brg.	72225C-72487	1
Pinion Nose Brg.	MUB1307UM	1
Idler Gear Brg.	25877-25821	2
Thrust Brg. Race	W2840	1
Thrust Brg. Race	TRA2840	2
Input Shaft Brg.	122L	1
Output Shaft Brg.	210	1
Driveshaft Brg.	L610549-L610510	2
Input Shaft Brg.	310B	1
Input Shaft Seal	415281N (3.000x3.751)	1
Thrushaft Seal	415147N (2.500x3.500)	1
Sealer	RTV Silicone	1

DRK-192FC		
Position	Part Number	Qty
Differential Right Brg.	47890-47820	1
Differential Left Brg.	47890-47820	1
Pinion Head Brg.	78225C-78551	1
Pinion Tail Brg.	78225C-78551	1
Pinion Nose Brg.	MUB1307UM	1
Idler Gear Brg.	25877-25821	2
Input Shaft Brg.	122SL	1
Output Shaft Brg.	210	1
Input Shaft Brg.	310B	1
Driveshaft Brg.	L610549-L610510	2
Input Shaft Seal	415281N (3.000x3.751)	1
Thrushaft Seal	415147N (2.500x3.500)	1
Sealer	RTV Silicone	1

DRK-192R		
Position	Part Number	Qty
Differential Right Brg.	47890-47820	1
Differential Left Brg.	47890-47820	1
Pinion Head Brg.	72225C-72487	1
Pinion Tail Brg.	72225C-72487	1
Pinion Nose Brg.	MUB1307UM	1
Pinion Seal	415013N (3.000x4.003)	1
Pinion Seal	415147N (2.500x3.500)	1
Sealer	RTV Silicone	1

DRK-192RA		
Position	Part Number	Qty
Differential Right Brg.	47890-47820	1
Differential Left Brg.	47890-47820	1
Pinion Head Brg.	78225C-78551	1
Pinion Tail Brg.	78225C-78551	1
Pinion Nose Brg.	MUB1307UM	1
Pinion Seal	415013N (3.000x4.003)	1
Pinion Seal	415147N (2.500x3.500)	1
Sealer	RTV Silicone	1

DRK-192RB		
Position	Part Number	Qty
Differential Right Brg.	47890-47820	1
Differential Left Brg.	47890-47820	1
Pinion Head Brg.	72225C-72487	1
Pinion Tail Brg.	72225C-72487	1
Pinion Nose Brg.	MUB1307UM	1
Pinion Seal	DTHH102 (3.000x5.751)	1
Sealer	RTV Silicone	1

DRK-193		
Position	Part Number	Qty
Differential Right Brg.	56425-56650	1
Differential Left Brg.	497-493	1
Pinion Head Brg.	72218C-72487 <sup>3</sup>	1
Pinion Tail Brg.	72200C-72487	1
Pinion Nose Brg.	MUSB1307UM	1
Input Shaft Brg.	JH307749-JH307710	1
Output Shaft Front Brg.	34274-34492A	1
Output Shaft Rear Brg.	MA1209EL	1
Input Shaft Seal	DT7719 (2.937x4.003)	1
Thrushaft Seal	DT7720 (2.625x3.623)	1
Sealer	RTV Silicone	1

DRK-193A		
Position	Part Number	Qty
Differential Right Brg.	567-563	1
Differential Left Brg.	497-493	1
Pinion Head Brg.	72218C-72487 <sup>3</sup>	1
Pinion Tail Brg.	72200C-72487	1
Pinion Nose Brg.	MUSB1307UM	1
Input Shaft Front Brg.	JH307749-JH307710	1
Output Shaft Front Brg.	34274-34492A	1
Output Shaft Rear Brg.	MA1209EL	1
Input Shaft Seal	DT7719 (2.937x4.003)	1
Thrushaft Seal	DT7720 (2.625x3.623)	1
Sealer	RTV Silicone	1

DRK-194F		
Position	Part Number	Qty
Differential Right Brg.	JM716649-JM716610	1
Differential Left Brg.	JM716649-JM716610	1
Pinion Head Brg.	72212C-72487	1
Pinion Tail Brg.	72212C-72487	1
Pinion Nose Brg.	RU1570UM	1
Input Shaft Front Brg.	JM511946-JM511910	1
Input Shaft Rear Brg.	JLM710949-JLM710910	1
Thrushaft Brg.	LM603049-LM603011 <sup>•</sup>	2
Input Shaft Seal	DTP2590 (3.000x3.750) <sup>57</sup>	1
Thrushaft Seal	4561V (2.503x3.428)	1
Sealer	RTV Silicone	1

DRK-194R		
Position	Part Number	Qty
Differential Right Brg.	JM716649-JM716610	1
Differential Left Brg.	JM716649-JM716610	1
Pinion Head Brg.	65237-65500	1
Pinion Tail Brg.	72201C-72487	1
Pinion Seal	5603 (2.375x4.938)	1
Sealer	RTV Silicone	1

DRK-194RA		
Position	Part Number	Qty
Differential Right Brg.	JM716649-JM716610	1
Differential Left Brg.	JM716649-JM716610	1
Pinion Head Brg.	65237-65500	1
Pinion Tail Brg.	72225C-72487	1
Pinion Seal	3905 (3.000x4.938)	1
Sealer	RTV Silicone	1

DRK-194RB		
Position	Part Number	Qty
Differential Right Brg.	JM716649-JM716610	1
Differential Left Brg.	JM716649-JM716610	1
Pinion Head Brg.	72212C-72487	1
Pinion Tail Brg.	72212C-72487	1
Pinion Nose Brg.	RU1570UM	1
Pinion Seal	3905 (3.000x4.938)	1
Sealer	RTV Silicone	1

DRK-195		
Position	Part Number	Qty
Differential Right Brg.	28584-28521	1
Differential Left Brg.	28584-28521	1
Pinion Head Brg.	27881-27820	1
Pinion Tail Brg.	27880-27820	1
Pinion Nose Brg.	MUB5204TM	1
Pinion Seal	410085N (2.000x2.996)	1
Pinion Seal	710007 (20136)	1
Felt Seal	5M293 (573)	1
Sealer	RTV Silicone	1

DRK-196		
Position	Part Number	Qty
Differential Right Brg.	567-563	1
Differential Left Brg.	497-493	1
Pinion Head Brg.	72218C-72487 <sup>4</sup>	1
Pinion Tail Brg.	HM807049-HM807010 <sup>4</sup>	1
Pinion Nose Brg.	MUSB1307UM	1
Input Shaft Brg.	3979-JM511910	1
Output Shaft Front Brg.	29675-29620	1
Output Shaft Rear Brg.	MA1209EL	1
Input Shaft Seal	DT7719 (2.937x4.003)	1
Thrushaft Seal	DT7720 (2.625x3.623)	1
Sealer	RTV Silicone	1

DRK-198		
Position	Part Number	Qty
Differential Right Brg.	56425-56650	1
Differential Left Brg.	56425-56650	1
Pinion Head Brg.	H715343-H715311	1
Pinion Tail Brg.	H715343-H715311	1
Pinion Nose Brg.	MU1308UM	1
Pinion Seal	415013N (3.000x4.003)	1
Sealer	RTV Silicone	1

DRK-200F		
Position	Part Number	Qty
Differential Right Brg.	47890-47820	1
Differential Left Brg.	47890-47820	1
Pinion Head Brg.	72225C-72487	1
Pinion Tail Brg.	72225C-72487	1
Pinion Nose Brg.	MUB1307UM	1
Idler Gear Brg.	3877-3820	2
Power Divider Thrust Race	W4860	1
Power Divider Thrust Brg.	TRA4860	2
Power Divider Case Intermediate Brg.	28985-28921	1
Power Divider Brg.	JLM710949-JLM710910	2
Power Divider Rear Brg.	XLS5-1/8AF	1
Output Shaft Brg.	210	1
Input Shaft Seal	415281N (3.000x3.751)	1
Thrushaft Seal	415013N (3.000x4.003)	1
Sealer	RTV Silicone	1

DRK-200FA		
Position	Part Number	Qty
Differential Right Brg.	47890-47820	1
Differential Left Brg.	47890-47820	1
Pinion Head Brg.	72225C-72487	1
Pinion Tail Brg.	72225C-72487	1
Pinion Nose Brg.	MUB1307UM	1
Idler Gear Brg.	M802048-M802011	2
Power Divider Thrust Race	W4860	1
Power Divider Thrust Brg.	TRA4860	2
Power Divider Case Intermediate Brg.	28985-28921	1
Power Divider Brg.	JLM710949-JLM710910	2
Power Divider Rear Brg.	XLS5-1/8AF	1
Output Shaft Brg.	210	1
Input Shaft Seal	415281N (3.000x3.751)	1
Thrushaft Seal	415013N (3.000x4.003)	1
Sealer	RTV Silicone	1

<sup>3</sup>Use 72200C for 3.70 Ratio  
<sup>4</sup>DS341 w/GMC (after 1985) use 55200C - 55437

<sup>57</sup>Order DTY2729 for updated seal  
<sup>•</sup> Not packed in kit



# Differential Rebuild Kits

HD Differential

DRK-201F		
Position	Part Number	Qty
Differential Right Brg.	56425-56650	1
Differential Left Brg.	56425-56650	1
Pinion Head Brg.	H715343-H715311	1
Pinion Tail Brg.	HM813844-HM813810	1
Pinion Nose Brg.	MU1308UM	1
Idler Gear Brg.	3877-3820	2
Power Divider Thrust Race	W4860	1
Power Divider Thrust Brg.	TRA4860	2
Power Divider Case Intermediate Brg.	28985-28921	1
Power Divider Brg.	JLM710949-JLM710910	2
Power Divider Rear Brg.	XLS5-1/8AF	1
Output Shaft Brg.	210	1
Input Shaft Seal	415281N (3.000x3.751)	1
Thrushaft Seal	415013N (3.000x4.003)	1
Sealer	RTV Silicone	1

DRK-201FA		
Position	Part Number	Qty
Differential Right Brg.	56425-56650	1
Differential Left Brg.	56425-56650	1
Pinion Head Brg.	H715343-H715311	1
Pinion Tail Brg.	HM813844-HM813810	1
Pinion Nose Brg.	MU1308UM	1
Idler Gear Brg.	M802048-M802011	2
Power Divider Thrust Race	W4860	1
Power Divider Thrust Brg.	TRA4860	2
Power Divider Case Intermediate Brg.	28985-28921	1
Power Divider Brg.	JLM710949-JLM710910	2
Power Divider Rear Brg.	XLS5-1/8AF	1
Output Shaft Brg.	210	1
Input Shaft Seal	415281N (3.000x3.751)	1
Thrushaft Seal	415013N (3.000x4.003)	1
Sealer	RTV Silicone	1

DRK-201R		
Position	Part Number	Qty
Differential Right Brg.	56425-56650	1
Differential Left Brg.	56425-56650	1
Pinion Head Brg.	H715343-H715311	1
Pinion Tail Brg.	HM813844-HM813810	1
Pinion Nose Brg.	MU1308UM	1
Pinion Seal	DTHH102 (3.000x5.751)	1
Sealer	RTV Silicone	1

DRK-202		
Position	Part Number	Qty
Differential Right Brg.	3984-3925	1
Differential Left Brg.	3984-3925	1
Pinion Head Brg.	HM903249A-HM903210	1
Pinion Tail Brg.	HM903249A-HM903210	1
Pinion Nose Brg.	MUB5205UM	1
Pinion Seal	410686N (2.375x3.483)	1
Pinion Seal	711553 (2.375x3.875)	1
Sealer	RTV Silicone	1

DRK-203F		
Position	Part Number	Qty
Differential Right Brg.	598-592A	1
Differential Left Brg.	52387-52618	1
Pinion Head Brg.	78250AC-78551	1
Pinion Tail Brg.	78250AC-78551	1
Pinion Nose Brg.	MUB1309TM	1
Input Shaft Front Brg.	HM813841-HM813810	1
Input Shaft Rear Brg.	JM515649-JM515610	1
Thrushaft Brg.	385A-382A	2
Oil Pump Idler Gear Brg.	5204K	1
Input Shaft Seal	416470N (3.250x4.249)	1
Input Shaft Seal	3143N (3.000x5.500) •	1
Thrushaft Seal	415013N (3.000x4.003)	1
Sealer	RTV Silicone	1

DRK-204F		
Position	Part Number	Qty
Differential Right Brg.	HM516449C-HM516410	1
Differential Left Brg.	HM516449C-HM516410	1
Pinion Head Brg.	42350-42584	1
Pinion Tail Brg.	42350-42584	1
Pinion Nose Brg.	MR1213EL	1
Cross Shaft Right Brg.	641-632	2
Cross Shaft Left Brg.	MU1221UM	1
Input Shaft Brg.	394A-392	2
Thrushaft Brg.	385A-382A	2
Input Shaft Seal	415137 (3.250x4.499)	1
Thrushaft Seal	415272N (2.750x4.003)	1
Sealer	RTV Silicone	1

DRK-204R		
Position	Part Number	Qty
Differential Right Brg.	HM516449C-HM516410	1
Differential Left Brg.	HM516449C-HM516410	1
Pinion Head Brg.	H715345-H715311	1
Pinion Tail Brg.	HM807046-HM807010	1
Cross Shaft Right Brg.	65237-65500	1
Cross Shaft Left Brg.	65237-65500	1
Pinion Seal	476283N (2.750x4.249)	1
Sealer	RTV Silicone	1

DRK-205		
Position	Part Number	Qty
Differential Right Brg.	47687-47623A	1
Differential Left Brg.	HM516448-HM516414B	1
Pinion Head Brg.	5760-5735	1
Pinion Tail Brg.	557S-552A	1
Cross Shaft Right Brg.	621-612	1
Cross Shaft Left Brg.	H715345-H715313W	1
Pinion Seal	415272N (2.750x4.003)	1
O-Ring Set	OK205	1
Sealer	RTV Silicone	1

DRK-206		
Position	Part Number	Qty
Differential Right Brg.	47687-47623A	1
Differential Left Brg.	HM516448-HM516414B	1
Pinion Head Brg.	497-492A	1
Pinion Tail Brg.	576-572	1
Cross Shaft Right Brg.	621-612	1
Cross Shaft Left Brg.	H715345-H715313W	1
Drive Gear Front Brg.	1211	1
Input Shaft Brg.	1213L	1
Input Shaft Seal	415991N (3.500x4.501)	1
Thrushaft Seal	475322N (2.750x3.543)	1
O-Ring Set	OK206	1
Sealer	RTV Silicone	1

DRK-207		
Position	Part Number	Qty
Differential Right Brg.	56425-56650	1
Differential Left Brg.	497-493	1
Pinion Head Brg.	72218C-72487	1
Pinion Tail Brg.	HM807049-HM807010	1
Pinion Nose Brg.	MUSB1307UM	1
Input Shaft Brg.	3979-JM511910	1
Output Shaft Front Brg.	29675-29620	1
Output Shaft Rear Brg.	MA1209EL	1
Input Shaft Seal	DT7719 (2.937x4.003)	1
Thrushaft Seal	DT7720 (2.625x3.623)	1
Sealer	RTV Silicone	1

DRK-208		
Position	Part Number	Qty
Differential Right Brg.	665-653	1
Differential Left Brg.	42381-42584	1
Pinion Head Brg.	72212C-72487	1
Pinion Tail Brg.	72212C-72487	1
Pinion Nose Brg.	MUB1308UM	1
Output Shaft Front Brg.	33275-33472	1
Input Shaft Brg.	JM511946-JM511910	1
Output Shaft Rear Brg.	MA1211EL	1
Pinion Forward Brg.	MU1309CV	1
Input Shaft Seal	415164N (3.375x4.376)	1
Thrushaft Seal	475012N (3.937x4.003)	1
Sealer	RTV Silicone	1

DRK-208A		
Position	Part Number	Qty
Differential Right Brg.	665-653	1
Differential Left Brg.	42381-42584	1
Pinion Head Brg.	72212C-72487	1
Pinion Tail Brg.	72212C-72487	1
Pinion Nose Brg.	MUB1308UM	1
Output Shaft Front Brg.	33275-33472	1
Input Shaft Brg.	313	1
Output Shaft Rear Brg.	MA1211EL	1
Pinion Forward Brg.	MU1309CV	1
Input Shaft Seal	415164N (3.375x4.376)	1
Thrushaft Seal	475012N (3.937x4.003)	1
Sealer	RTV Silicone	1

DRK-209		
Position	Part Number	Qty
Differential Right Brg.	68462-68712	1
Differential Left Brg.	42346-42584	1
Pinion Head Brg.	72212C-72487	1
Pinion Tail Brg.	72212C-72487	1
Pinion Nose Brg.	MUB1308UM	1
Pinion Forward Brg.	MU1309CV	1
Input Shaft Brg.	313	1
Output Shaft Front Brg.	33275-33472	1
Output Shaft Rear Brg.	MA1211EL	1
Input Shaft Seal	415164N (3.375x4.376)	1
Thrushaft Seal	475012N (3.937x4.003)	1
Sealer	RTV Silicone	1

DRK-209A		
Position	Part Number	Qty
Differential Right Brg.	68450-68712	1
Differential Left Brg.	42346-42584	1
Pinion Head Brg.	72212C-72487	1
Pinion Tail Brg.	72212C-72487	1
Pinion Nose Brg.	MUB1308UM	1
Pinion Forward Brg.	MU1309CV	1
Input Shaft Brg.	313	1
Output Shaft Front Brg.	33275-33472	1
Output Shaft Rear Brg.	MA1211EL	1
Input Shaft Seal	415164N (3.375x4.376)	1
Thrushaft Seal	475012N (3.937x4.003)	1
Sealer	RTV Silicone	1

DRK-210		
Position	Part Number	Qty
Differential Right Brg.	68462-68712	1
Differential Left Brg.	42346-42584	1
Pinion Head Brg.	72212C-72487	1
Pinion Tail Brg.	72212C-72487	1
Pinion Nose Brg.	MUB1308UM	1
Pinion Forward Brg.	MU1309CV	1
Input Shaft Brg.	JM511946-JM511910	1
Output Shaft Front Brg.	33275-33472	1
Output Shaft Rear Brg.	MA1211EL	1
Input Shaft Seal	415894 (3.375x4.376)	1
Thrushaft Seal	475012N (3.937x4.003)	1
Sealer	RTV Silicone	1

# Differential Rebuild Kits

DRK-211F		
Position	Part Number	Qty
Differential Right Brg.	68462-68712	1
Differential Left Brg.	42381-42584	1
Pinion Head Brg.	72212C-72487	1
Pinion Tail Brg.	72212C-72487	1
Pinion Nose Brg.	MUB1308UM	1
Input Shaft Brg.	JM511946-JM511910	1
Pinion Forward Brg.	MU1309CV	1
Output Shaft Front Brg.	33275-33472	1
Output Shaft Rear Brg.	MA1211EL	1
Input Shaft Seal	DT0736 (3.375x4.376)	1
Thrushaft Seal	DT0737 (2.937x4.003)	1
Sealer	RTV Silicone	1

DRK-211FA		
Position	Part Number	Qty
Differential Right Brg.	68450-68712	1
Differential Left Brg.	42381-42584	1
Pinion Head Brg.	72212C-72487	1
Pinion Tail Brg.	72212C-72487	1
Pinion Nose Brg.	MUB1308UM	1
Input Shaft Brg.	JM511946-JM511910	1
Pinion Forward Brg.	MU1309CV	1
Output Shaft Front Brg.	33275-33472	1
Output Shaft Rear Brg.	MA1211EL	1
Input Shaft Seal	DT0736 (3.375x4.376)	1
Thrushaft Seal	DT0737 (2.937x4.003)	1
Sealer	RTV Silicone	1

DRK-212F		
Position	Part Number	Qty
Differential Right Brg.	766-753A	1
Differential Left Brg.	766-752B	1
Pinion Head Brg.	740-742	1
Pinion Tail Brg.	661-653	1
Cross Shaft Left Brg.	H414235-H414210	1
Cross Shaft Right Brg.	6580-6535W	1
Power Divider Brg.	7213BG	2
Output Shaft Brg.	1212	1
Input Shaft Seal	415991N (3.500x4.501)	1
Thrushaft Seal	5578 (3.125x4.125)	1
Power Divider O-Ring	OR247	1
Power Divider O-Ring	OR272	1
Gasket Set	BBK7124-300	1
Sealer	RTV Silicone	1

DRK-212R		
Position	Part Number	Qty
Differential Right Brg.	766-753A	1
Differential Left Brg.	766-752B	1
Pinion Head Brg.	6466-6420	1
Pinion Tail Brg.	65225-65500	1
Cross Shaft Right Brg.	H414235-H414210	1
Cross Shaft Left Brg.	6580-6535W	1
Pinion Seal	5578 (3.125x4.125)	1
Gasket Set	BBK7143-300	1
Sealer	RTV Silicone	1

DRK-213		
Position	Part Number	Qty
Differential Right Brg.	495-493	1
Differential Left Brg.	42381-42584	1
Pinion Head Brg.	55200C-55437	1
Pinion Tail Brg.	55200C-55437	1
Pinion Nose Brg.	MUB1307UM	1
Pinion Seal	455088V (3.000x4.499)	1
Sealer	RTV Silicone	1

DRK-214		
Position	Part Number	Qty
Differential Right Brg.	JM716649-JM716610	1
Differential Left Brg.	JM822049-JM822010	1
Pinion Head Brg.	72225C-72487 <sup>5</sup>	1
Pinion Tail Brg.	55200C-55437	1
Pinion Nose Brg.	MUB1308UM	1
Pinion Seal	455088V (3.000x4.499)	1
Sealer	RTV Silicone	1

DRK-216		
Position	Part Number	Qty
Differential Right Brg.	JLM714149-JLM714110	1
Differential Left Brg.	42381-42584	1
Pinion Head Brg.	55200C-55437	1
Pinion Tail Brg.	M804049-M804010	1
Pinion Nose Brg.	RU1570UM	1
Pinion Seal	415082N (2.500x3.876)	1
Sealer	RTV Silicone	1

DRK-217F		
Position	Part Number	Qty
Differential Right Brg.	JM716649-JM716610	1
Differential Left Brg.	JM716649-JM716610	1
Pinion Head Brg.	H715334-H715311	1
Pinion Tail Brg.	72212C-72487	1
Input Shaft Front Brg.	JM511946-JM511910	1
Input Shaft Rear Brg.	JLM710949-JLM710910	1
Output Shaft Brg.	LM104949-JLM104910	2
Input Shaft Seal	DTP2590 (3.000x3.750) <sup>57</sup>	1
Thrushaft Seal	DTP2590 (3.000x3.750) <sup>57</sup>	1
O-Ring	5X1034	2
Sealer	RTV Silicone	1

DRK-217R		
Position	Part Number	Qty
Differential Right Brg.	JM716649-JM716610	1
Differential Left Brg.	JM716649-JM716610	1
Pinion Head Brg.	72212C-72487	1
Pinion Tail Brg.	55206C-55437	1
Pinion Nose Brg.	RU1570UM	1
Pinion Seal	DTN2588 (3.000x4.937) <sup>58</sup>	1
Sealer	RTV Silicone	1

DRK-218		
Position	Part Number	Qty
Differential Right Brg.	34306-34478	1
Differential Left Brg.	3994-JM511910	1
Pinion Head Brg.	55200C-55437	1
Pinion Tail Brg.	HM804846-HM804810	1
Pinion Nose Brg.	MUB1305UDM	1
Pinion Seal	415082N (2.500x3.876)	1
Sealer	RTV Silicone	1

DRK-219R		
Position	Part Number	Qty
Differential Right Brg.	42381-42584	1
Differential Left Brg.	68462-68712 <sup>6</sup>	1
Pinion Head Brg.	78215C-78551	1
Pinion Tail Brg.	72212C-72487	1
Pinion Nose Brg.	MUB1308UM	1
Pinion Seal	712937 (2.937x4.939)	1
Pinion Seal	DT0724 (2.937x5.046)	1
Sealer	RTV Silicone	1

DRK-220F		
Position	Part Number	Qty
Differential Right Brg.	68450-68712	1
Differential Left Brg.	42381-42584	1
Pinion Head Brg.	72212C-72487	1
Pinion Tail Brg.	72212C-72487	1
Pinion Nose Brg.	MUB1308UM	1
Pinion Forward Brg.	MU1309CV	1
Input Shaft Front Brg.	JM511946-JM511910	1
Input Shaft Rear Brg.	JH211749-JH211710	1
Output Shaft Brg.	MA1211EL	1
Input Shaft Seal	415164N (3.375x4.376)	1
Thrushaft Seal	475012N (3.937x4.003)	1
Sealer	RTV Silicone	1

DRK-220FA		
Position	Part Number	Qty
Differential Right Brg.	68462-68712	1
Differential Left Brg.	42381-42584	1
Pinion Head Brg.	72212C-72487	1
Pinion Tail Brg.	72212C-72487	1
Pinion Nose Brg.	MUB1308UM	1
Pinion Forward Brg.	MU1309CV	1
Input Shaft Front Brg.	JM511946-JM511910	1
Input Shaft Rear Brg.	JH211749-JH211710	1
Output Shaft Brg.	MA1211EL	1
Input Shaft Seal	415164N (3.375x4.376)	1
Thrushaft Seal	475012N (3.937x4.003)	1
Sealer	RTV Silicone	1

DRK-221		
Position	Part Number	Qty
Differential Right Brg.	3994-3920	1
Differential Left Brg.	497-493	1
Pinion Head Brg.	72200C-72487	1
Pinion Tail Brg.	HM903249-HM903210	1
Pinion Nose Brg.	RUB1570UM	1
Pinion Seal	9773 (2.625x4.564)	1
Sealer	RTV Silicone	1

DRK-222F		
Position	Part Number	Qty
Differential Right Brg.	567-563	1
Differential Left Brg.	497-493	1
Pinion Head Brg.	72218C-72487	1
Pinion Tail Brg.	HM807049-HM807010	1
Pinion Nose Brg.	MUSB7307UM	1
Input Shaft Brg.	3979-JM511910	1
Output Shaft Front Brg.	29675-29620	1
Output Shaft Rear Brg.	MA1209EL	1
Input Shaft Seal	DT7719 (2.937x4.003)	1
Thrushaft Seal	DT7720 (2.625x3.623)	1
Sealer	RTV Silicone	1

DRK-222R		
Position	Part Number	Qty
Differential Right Brg.	497-493	1
Differential Left Brg.	567-563	1
Pinion Head Brg.	72200C-72487	1
Pinion Tail Brg.	55200C-55437	1
Pinion Nose Brg.	MUSB7307UM	1
Pinion Seal	DT7721 (2.625x4.654)	1
Sealer	RTV Silicone	1

DRK-223F		
Position	Part Number	Qty
Differential Right Brg.	495-493	1
Differential Left Brg.	495-493	1
Pinion Head Brg.	72225C-72487	1
Pinion Tail Brg.	72225C-72487	1
Pinion Nose Brg.	RU1570UM	1
Input Shaft Brg.	HM807049-HM807010	1
Input Gear Brg.	J3624	1
Inter Axle Brg.	JLM710949-JLM710910	1
Output Shaft Brg.	A1400	1
Input Shaft Seal	415013N (3.000x4.003)	1
Thrushaft Seal	4624V (2.503x3.629)	1
O-Ring	OR230	1
Sealer	RTV Silicone	1

DRK-223R		
Position	Part Number	Qty
Differential Right Brg.	495-493	1
Differential Left Brg.	495-493	1
Pinion Head Brg.	72225C-72487	1
Pinion Tail Brg.	72225C-72487	1
Pinion Nose Brg.	RU1570UM	1
Pinion Seal	DTHH102 (3.000x5.751)	1
Sealer	RTV Silicone	1

<sup>5</sup> For I.H. use 55200C - 55437  
<sup>6</sup> Use 68450 - 68712 w/Support Case 27950

<sup>57</sup>Order DTY2729 for updated seal  
<sup>58</sup>Order DTZ2730 for updated seal

# Differential Rebuild Kits



HD Differential

DRK-224		
Position	Part Number	Qty
Differential Right Brg.	32020X	1
Differential Left Brg.	32020X	1
Pinion Head Brg.	72212C-72487	1
Pinion Tail Brg.	55200C-55437	1
Pinion Nose Brg.	RU1570UM	1
Pinion Seal	DTN2588 (3.000x4.937) <sup>58</sup>	1
Sealer	RTV Silicone	1

DRK-225		
Position	Part Number	Qty
Differential Right Brg.	JM716649-JM716610	1
Differential Left Brg.	52400-52618	1
Pinion Head Brg.	HM804846-HM804810	1
Pinion Tail Brg.	55200C-55437	1
Pinion Nose Brg.	MUB1307UM	1
Pinion Seal	415082N (2.500x3.876)	1
Sealer	RTV Silicone	1

DRK-400		
Position	Part Number	Qty
Differential Right Brg.	3994-3920	1
Differential Left Brg.	497-493	1
Pinion Head Brg.	55175C-55437	1
Pinion Tail Brg.	HM903249-HM903210	1
Pinion Nose Brg.	MUB1305UDM	1
Pinion Seal	9773 (2.625x4.564)	1
Sealer	RTV Silicone	1

DRK-401		
Position	Part Number	Qty
Differential Right Brg.	JM822049-JM822010	1
Differential Left Brg.	32024X	1
Pinion Head Brg.	H914841-H914811	1
Pinion Tail Brg.	HM813841-HM813810	1
Pinion Nose Brg.	MU1309UGM	1
Pinion Seal	DT0724 (2.937x5.046)	1
Shift Fork Seal	119855	1
Sealer	RTV Silicone	1

DRK-402		
Position	Part Number	Qty
Differential Right Brg.	JM822049-JM822010	1
Differential Left Brg.	52400-52618	1
Pinion Head Brg.	H914841-H914811	1
Pinion Tail Brg.	HM813841-HM813810	1
Pinion Nose Brg.	MU1309UGM	1
Pinion Seal	DT0724 (2.937x5.046)	1
Sealer	RTV Silicone	1

DRK-403		
Position	Part Number	Qty
Differential Right Brg.	497-493	1
Differential Left Brg.	56425-56650	1
Pinion Head Brg.	72200C-72487	1
Pinion Tail Brg.	55200C-55437	1
Pinion Nose Brg.	MUSB1307UM	1
Pinion Seal	9773 (2.625x4.564)	1
Shift Fork Seal	119855	1
Sealer	RTV Silicone	1

DRK-404F		
Position	Part Number	Qty
Differential Right Brg.	567-563	1
Differential Left Brg.	497-493	1
Pinion Head Brg.	72218C-72487	1
Pinion Tail Brg.	55212C-55437	1
Pinion Nose Brg.	MUB1307UM	1
Input Shaft Front Brg.	555S-552A	1
Input Shaft Rear Brg.	29675-29630	1
Output Shaft Brg.	LM104949-JLM104910 •	2
Output Shaft O-Ring	OR-232	2
Input Shaft Seal	DT7591 (2.913x4.561)	1
Input Shaft V-Ring	DT8703	1
Thrushaft Seal	DT7592 (2.625x3.620)	1
Sealer	RTV Silicone	1

DRK-404FMK		
Position	Part Number	Qty
Differential Right Brg.	567-563	1
Differential Left Brg.	497-493	1
Pinion Head Brg.	72218C-72487	1
Pinion Tail Brg.	55212C-55437	1
Pinion Nose Brg.	MUB1307UM	1
Input Shaft Front Brg.	555S-552A	1
Input Shaft Rear Brg.	29675-29630	1
Output Shaft Brg.	LM104949-JLM104910 •	2
Output Shaft O-Ring	OR-232	2
Input Shaft Seal	DT7591 (2.913x4.561)	1
Input Shaft V-Ring	DT8703	1
Thrushaft Seal	DT7592 (2.625x3.620)	1
Sealer	RTV Silicone	1
Input Shaft Shim .003"	127595	1
Input Shaft Shim .005"	127596	1
Input Shaft Shim .010"	127597	1
Input Shaft Shim .020"	127598	1
Input Shaft Shim .030"	127599	1
Output Shaft Gear Snap	85997	1
Ring		
Side Gear Thrust	127386	2
Washer		
Pinion Gear Thrust	129305	4
Washer		
Helical Gear Thrust	132439	1
Washer		

DRK-404FA		
Position	Part Number	Qty
Differential Right Brg.	567-563	1
Differential Left Brg.	497-493	1
Pinion Head Brg.	72218C-72487	1
Pinion Tail Brg.	55212C-55437	1
Pinion Nose Brg.	MUB1307UM	1
Input Shaft Front Brg.	555S-552A	1
Input Shaft Rear Brg.	29688-29620	1
Output Shaft Rear Brg.	LM104949-JLM104910 •	2
Output Shaft O-Ring	OR-232	2
Input Shaft Seal	DT7591 (2.913x4.561)	1
Input Shaft V-Ring	DT8703	1
Thrushaft Seal	DT7592 (2.625x3.620)	1
Sealer	RTV Silicone	1

DRK-404FAMK		
Position	Part Number	Qty
Differential Right Brg.	567-563	1
Differential Left Brg.	497-493	1
Pinion Head Brg.	72218C-72487	1
Pinion Tail Brg.	55212C-55437	1
Pinion Nose Brg.	MUB1307UM	1
Input Shaft Front Brg.	555S-552A	1
Input Shaft Rear Brg.	29688-29620	1
Output Shaft Brg.	LM104949-JLM104910 •	2
Output Shaft O-Ring	OR-232	2
Input Shaft Seal	DT7591 (2.913x4.561)	1
Input Shaft V-Ring	DT8703	1
Thrushaft Seal	DT7592 (2.625x3.620)	1
Sealer	RTV Silicone	1
Input Shaft Shim .003"	127595	1
Input Shaft Shim .005"	127596	1
Input Shaft Shim .010"	127597	1
Input Shaft Shim .020"	127598	1
Input Shaft Shim .030"	127599	1
Output Shaft Gear Snap	85997	1
Ring		
Side Gear Thrust	127386	2
Washer		
Pinion Gear Thrust	129305	4
Washer		
Helical Gear Thrust	132439	1
Washer		

DRK-404FMK		
Position	Part Number	Qty
Differential Right Brg.	567-563	1
Differential Left Brg.	497-493	1
Pinion Head Brg.	72218C-72487	1
Pinion Tail Brg.	55212C-55437	1
Pinion Nose Brg.	MUB1307UM	1
Input Shaft Front Brg.	555S-552A	1
Input Shaft Rear Brg.	29688-29620	1
Output Shaft Brg.	LM104949-JLM104910 •	2
Output Shaft O-Ring	OR-232	2
Input Shaft Seal	DT7591 (2.913x4.561)	1
Input Shaft V-Ring	DT8703	1
Thrushaft Seal	DT7592 (2.625x3.620)	1
Sealer	RTV Silicone	1
Input Shaft Shim .003"	127595	1
Input Shaft Shim .005"	127596	1
Input Shaft Shim .010"	127597	1
Input Shaft Shim .020"	127598	1
Input Shaft Shim .030"	127599	1
Output Shaft Gear Snap	85997	1
Ring		
Side Gear Thrust	127386	2
Washer		
Pinion Gear Thrust	129305	4
Washer		
Helical Gear Thrust	132439	1
Washer		

DRK-404R		
Position	Part Number	Qty
Differential Right Brg.	497-493	1
Differential Left Brg.	567-563	1
Pinion Head Brg.	72212C-72487	1
Pinion Tail Brg.	55200C-55437	1
Pinion Nose Brg.	MUB7307UM	1
Pinion Seal	DT7591 (2.913x4.561)	1
Sealer	RTV Silicone	1

DRK-404RMK		
Position	Part Number	Qty
Differential Right Brg.	497-493	1
Differential Left Brg.	567-563	1
Pinion Head Brg.	72212C-72487	1
Pinion Tail Brg.	55200C-55437	1
Pinion Nose Brg.	MUB7307UM	1
Pinion Seal	DT7591 (2.913x4.561)	1
Sealer	RTV Silicone	1
Pinion Shim .003"	127595	1
Pinion Shim .005"	127596	1
Pinion Shim .010"	127597	1
Pinion Shim .020"	127598	1
Pinion Shim .030"	127599	1
Side Gear Thrust	127386	2
Washer		
Pinion Gear Thrust	129305	4
Washer		

DRK-405F		
Position	Part Number	Qty
Differential Right Brg.	567-563	1
Differential Left Brg.	42362-42584	1
Pinion Head Brg.	72218C-72487	1
Pinion Tail Brg.	55212C-55437	1
Pinion Nose Brg.	MUB1307UM	1
Input Shaft Front Brg.	555S-552A	1
Input Shaft Rear Brg.	29675-29630	1
Output Shaft Brg.	LM104949-JLM104910 •	2
Output Shaft O-Ring	OR-232	2
Input Shaft Seal	DT7591 (2.913x4.561)	1
Input Shaft V-Ring	DT8703	1
Thrushaft Seal	DT7592 (2.625x3.620)	1
Sealer	RTV Silicone	1

DRK-405FMK		
Position	Part Number	Qty
Differential Right Brg.	567-563	1
Differential Left Brg.	42362-42584	1
Pinion Head Brg.	72218C-72487	1
Pinion Tail Brg.	55212C-55437	1
Pinion Nose Brg.	MUB1307UM	1
Input Shaft Front Brg.	555S-552A	1
Input Shaft Rear Brg.	29675-29630	1
Thrushaft Brg.	LM104949-JLM104910	2
Output Shaft O-Ring	OR-232	2
Input Shaft Seal	DT7591 (2.913x4.561)	1
Input Shaft V-Ring	DT8703	1
Thrushaft Seal	DT7592 (2.625x3.620)	1
Sealer	RTV Silicone	1
Input Shaft Shim .003"	127595	1
Input Shaft Shim .005"	127596	1
Input Shaft Shim .010"	127597	1
Input Shaft Shim .020"	127598	1
Input Shaft Shim .030"	127599	1
Output Shaft Gear Snap	85997	1
Ring		
Output Shaft Gear Snap	129594	1
Ring		
Side Gear Thrust	127386	2
Washer		
Pinion Gear Thrust	129305	4
Washer		
Helical Gear Thrust	132439	1
Washer		

# Differential Rebuild Kits

DRK-405FA		
Position	Part Number	Qty
Differential Right Brg.	567-563	1
Differential Left Brg.	42362-42584	1
Pinion Head Brg.	72218C-72487	1
Pinion Tail Brg.	55212C-55437	1
Pinion Nose Brg.	MUB1307UM	1
Input Shaft Front Brg.	555S-552A	1
Input Shaft Rear Brg.	29688-29620	1
Output Shaft Brg.	LM104949-JLM104910 *	2
Output Shaft O-Ring	OR-232	2
Input Shaft Seal	DT7591 (2.913x4.561)	1
Input Shaft V-Ring	DT8703	1
Thrushaft Seal	DT7592 (2.625x3.620)	1
Sealer	RTV Silicone	1

DRK-405FAMK		
Position	Part Number	Qty
Differential Right Brg.	567-563	1
Differential Left Brg.	42362-42584	1
Pinion Head Brg.	72218C-72487	1
Pinion Tail Brg.	55212C-55437	1
Pinion Nose Brg.	MUB1307UM	1
Input Shaft Front Brg.	555S-552A	1
Input Shaft Rear Brg.	29688-29620	1
Thrushaft Brg.	LM104949-JLM104910	2
Output Shaft O-Ring	OR-232	2
Input Shaft Seal	DT7591 (2.913x4.561)	1
Input Shaft V-Ring	DT8703	1
Thrushaft Seal	DT7592 (2.625x3.620)	1
Sealer	RTV Silicone	1
Input Shaft Shim .003"	127595	1
Input Shaft Shim .005"	127596	1
Input Shaft Shim .010"	127597	1
Input Shaft Shim .020"	127598	1
Input Shaft Shim .030"	127599	1
Output Shaft Gear Snap Ring	85997	1
Output Shaft Gear Snap Ring	129594	1
Side Gear Thrust Washer	127386	2
Pinion Gear Thrust Washer	129305	4
Helical Gear Thrust Washer	132439	1

DRK-405R		
Position	Part Number	Qty
Differential Right Brg.	42362-42584	1
Differential Left Brg.	567-563	1
Pinion Head Brg.	72212C-72487	1
Pinion Tail Brg.	55200C-55437	1
Pinion Nose Brg.	MUB7307UM	1
Pinion Seal	DT7591 (2.913x4.561)	1
Sealer	RTV Silicone	1

DRK-405RMK		
Position	Part Number	Qty
Differential Right Brg.	42362-42584	1
Differential Left Brg.	567-563	1
Pinion Head Brg.	72212C-72487	1
Pinion Tail Brg.	55200C-55437	1
Pinion Nose Brg.	MUB7307UM	1
Pinion Seal	DT7591 (2.913x4.561)	1
Sealer	RTV Silicone	1
Pinion Shim .003"	127595	1
Pinion Shim .005"	127596	1
Pinion Shim .010"	127597	1
Pinion Shim .020"	127598	1
Pinion Shim .030"	127599	1
Side Gear Thrust Washer	127386	2
Pinion Gear Thrust Washer	129305	4

DRK-406		
Position	Part Number	Qty
Differential Right Brg.	598-592A	1
Differential Left Brg.	497-493	1
Pinion Head Brg.	78215C-78551	1
Pinion Tail Brg.	55200C-55437	1
Pinion Nose Brg.	MUB1308UM	1
Pinion Seal	9773 (2.625x4.564)	1
Sealer	RTV Silicone	1

DRK-407		
Position	Part Number	Qty
Differential Right Brg.	497-493	1
Differential Left Brg.	598-592A	1
Pinion Head Brg.	H913842-H913810	1
Pinion Tail Brg.	72212C-72487	1
Pinion Nose Brg.	MUB1308UM	1
Pinion Seal	DT0724 (2.937x5.046)	1
Sealer	RTV Silicone	1

DRK-408		
Position	Part Number	Qty
Differential Right Brg.	497-493	1
Differential Left Brg.	56425-56650	1
Pinion Head Brg.	78215C-78551	1
Pinion Tail Brg.	72212C-72487	1
Pinion Nose Brg.	MUB5207UM	1
Pinion Seal	DT0724 (2.937x5.046)	1
Shift Shaft Seal	119855	1
Sealer	RTV Silicone	1

DRK-409		
Position	Part Number	Qty
Differential Right Brg.	JM822049-JM822010	1
Differential Left Brg.	56425-56662	1
Pinion Head Brg.	H914841-H914811	1
Pinion Tail Brg.	HM813841-HM813810	1
Pinion Nose Brg.	MU1309UM	1
Pinion Seal	DT0724 (2.937x5.046)	1
Sealer	RTV Silicone	1

DRK-410		
Position	Part Number	Qty
Differential Right Brg.	497-493	1
Differential Left Brg.	598-592A	1
Pinion Head Brg.	H914841-H914811	1
Pinion Tail Brg.	HM813841-HM813810	1
Pinion Nose Brg.	RU9008UM	1
Pinion Seal	DT0724 (2.937x5.046)	1
Sealer	RTV Silicone	1

DRK-411		
Position	Part Number	Qty
Differential Right Brg.	33275-33472	1
Differential Left Brg.	498-493	1
Pinion Head Brg.	5583-5535	1
Pinion Tail Brg.	49576-49520	1
Pinion Seal	410686N (2.375x3.483)	1
Pinion Seal	470737N (2.250x3.189)	1
Sealer	RTV Silicone	1

DRK-411F		
Position	Part Number	Qty
Differential Right Brg.	495-493	1
Differential Left Brg.	495-493	1
Pinion Head Brg.	72225C-72487	1
Pinion Tail Brg.	72225C-72487	1
Pinion Nose Brg.	MUX5207UMV1	1
Input Shaft Brg.	HM807049-HM807010	1
Input Gear Brg.	J3624	1
Inter Axle Brg.	JLM710949-JLM710910	1
Output Shaft Brg.	SC1084C4 *	1
Input Shaft Seal	401HH104	1
Thrushaft Seal	472HH101	1
Sealer	RTV Silicone	1

DRK-411R		
Position	Part Number	Qty
Differential Right Brg.	495-493	1
Differential Left Brg.	495-493	1
Pinion Head Brg.	72225C-72487	1
Pinion Tail Brg.	72225C-72487	1
Pinion Nose Brg.	MUX5207UMV1	1
Pinion Seal	DTHH102 (3.000x5.751)	1
Sealer	RTV Silicone	1

DRK-412		
Position	Part Number	Qty
Differential Right Brg.	497-493	1
Differential Left Brg.	567-563	1
Pinion Head Brg.	72200C-72487	1
Pinion Tail Brg.	55200C-55437	1
Pinion Nose Brg.	MUB1307UM	1
Pinion Seal	DT7721 (2.625x4.654)	1
Sealer	RTV Silicone	1

DRK-413		
Position	Part Number	Qty
Differential Right Brg.	42381-42584	1
Differential Left Brg.	68450-68712	1
Pinion Head Brg.	78215C-78551	1
Pinion Tail Brg.	72212C-72487	1
Pinion Nose Brg.	MUB1308UM	1
Pinion Seal	712937 (2.937x4.939)	1
Sealer	RTV Silicone	1

DRK-414		
Position	Part Number	Qty
Differential Right Brg.	3984-3920	1
Differential Left Brg.	3984-3920	1
Pinion Head Brg.	72225C-72487	1
Pinion Tail Brg.	55175C-55437	1
Pinion Seal	714512 (2.375x4.498)	1
Sealer	RTV Silicone	1

DRK-415		
Position	Part Number	Qty
Differential Right Brg.	42381-42584	1
Differential Left Brg.	665-653	1
Pinion Head Brg.	72212C-72487	1
Pinion Tail Brg.	72212C-72487	1
Pinion Nose Brg.	MU1309UGM	1
Pinion Seal	475003N (2.625x3.623)	1
Felt Seal	5M867 (654)	1
Sealer	RTV Silicone	1

DRK-416		
Position	Part Number	Qty
Differential Right Brg.	56425-56650	1
Differential Left Brg.	56425-56650	1
Pinion Head Brg.	9185-9121	1
Pinion Tail Brg.	H715343-H715311	1
Pinion Nose Brg.	RU9008UM	1
Pinion Seal	300HH100	1
Sealer	RTV Silicone	1

DRK-417		
Position	Part Number	Qty
Differential Right Brg.	567-563	1
Differential Left Brg.	497-493	1
Pinion Head Brg.	72218C-72487	1
Pinion Tail Brg.	HM807049-HM807010	1
Pinion Nose Brg.	MUB1307UM	1
Outer Pinion Support Brg.	MUF1208CBXV1	1
Input Shaft Front Brg.	3979-JM511910	1
Input Shaft Rear Brg.	3979-3920	1
Front Output Shaft Front Brg.	3780-3720	1
Front Output Shaft Rear Brg.	LM501349-LM501310	1
Input Shaft Seal	119429 (2.938x4.003)	1
Front Thrushaft Seal	475003N (2.625x3.623)	1
Sealer	RTV Silicone	1

\* Not packed in kit



# Differential Rebuild Kits

HD Differential

<b>DRK-418</b>		
Position	Part Number	Qty
Differential Right Brg.	665-653	1
Differential Left Brg.	42381-42584	1
Pinion Head Brg.	72212C-72487	1
Pinion Tail Brg.	72212C-72487	1
Pinion Nose Brg.	MUB1308UM	1
Outer Pinion Support Brg.	MU1309CV	1
Input Shaft Front Brg.	JH211749-JH211710	1
Input Shaft Rear Brg.	JM511946-JM511910	1
Front Output Shaft Front Brg.	3979-3920	1
Front Output Shaft Rear Brg.	3872-3820	1
Input Shaft Seal	119430 (3.375x4.376)	1
Front Thrushaft Seal	119429 (2.938x4.003)	1
Sealer	RTV Silicone	1

<b>DRK-419</b>		
Position	Part Number	Qty
Differential Right Brg.	497-493	1
Differential Left Brg.	56425-56650	1
Pinion Head Brg.	72218C-72487	1
Pinion Tail Brg.	HM807049-HM807010	1
Pinion Nose Brg.	MUSB1307UM	1
Outer Pinion Support Brg.	MUF1208CBXV1	1
Input Shaft Front Brg.	3979-JM511910	1
Input Shaft Rear Brg.	3979-3920	1
Front Output Shaft Front Brg.	3780-3720	1
Front Output Shaft Rear Brg.	LM501349-LM501310	1
Input Shaft Seal	119429 (2.938x4.003)	1
Front Thrushaft Seal	475003N (2.625x3.623)	1
Sealer	RTV Silicone	1

<b>DRK-420</b>		
Position	Part Number	Qty
Differential Right Brg.	42381-42584	1
Differential Left Brg.	68462-68712	1
Pinion Head Brg.	72212C-72487	1
Pinion Tail Brg.	72212C-72487	1
Pinion Nose Brg.	MUB1308UM	1
Outer Pinion Support Brg.	MU1309CV	1
Input Shaft Front Brg.	JH211749-JH211710	1
Input Shaft Rear Brg.	JM511946-JM511910	1
Front Output Shaft Front Brg.	3979-3920	1
Front Output Shaft Rear Brg.	3872-3820	1
Input Shaft Seal	119430 (3.375x4.376)	1
Front Thrushaft Seal	119429 (2.938x4.003)	1
Sealer	RTV Silicone	1

<b>DRK-421</b>		
Position	Part Number	Qty
Differential Right Brg.	42346-42584	1
Differential Left Brg.	68462-68712	1
Pinion Head Brg.	72212C-72487	1
Pinion Tail Brg.	72212C-72487	1
Pinion Nose Brg.	MUB1308UM	1
Outer Pinion Support Brg.	MU1309CV	1
Input Shaft Front Brg.	JH211749-JH211710	1
Input Shaft Rear Brg.	JM511946-JM511910	1
Front Output Shaft Front Brg.	3979-3920	1
Front Output Shaft Rear Brg.	3872-3820	1
Input Shaft Seal	119430 (3.375x4.376)	1
Front Thrushaft Seal	119429 (2.938x4.003)	1
Sealer	RTV Silicone	1

<b>DRK-422</b>		
Position	Part Number	Qty
Differential Right Brg.	567-563	1
Differential Left Brg.	497-493	1
Pinion Head Brg.	72218C-72487	1
Pinion Tail Brg.	HM807049-HM807010	1
Pinion Nose Brg.	MUSB1307UM	1
Outer Pinion Support Brg.	MUF1208CBXV1	1
Input Shaft Front Brg.	3979-JM511910	1
Input Shaft Rear Brg.	29675-29620	1
Front Output Shaft Front Brg.	3780-3720	1
Front Output Shaft Rear Brg.	LM501349-LM501310	1
Rear Output Shaft Brg.	MA1209EL	1
Input Shaft Seal	119429 (2.938x4.003)	1
Front Thrushaft Seal	475003N (2.625x3.623)	1
Rear Thrushaft Seal	475003N (2.625x3.623)	1
Sealer	RTV Silicone	1

<b>DRK-423</b>		
Position	Part Number	Qty
Differential Right Brg.	665-653	1
Differential Left Brg.	42381-42584	1
Pinion Head Brg.	72212C-72487	1
Pinion Tail Brg.	72212C-72487	1
Pinion Nose Brg.	MUB1308UM	1
Outer Pinion Support Brg.	MU1309CV	1
Input Shaft Front Brg.	JM511946-JM511910	1
Input Shaft Rear Brg.	33275-33472	1
Front Output Shaft Front Brg.	3979-3920	1
Front Output Shaft Rear Brg.	HM88649-HM88610	1
Rear Output Shaft Brg.	MA1211EL	1
Input Shaft Seal	119430 (3.375x4.376)	1
Front Thrushaft Seal	119429 (2.938x4.003)	1
Rear Thrushaft Seal	119429 (2.938x4.003)	1
Sealer	RTV Silicone	1

<b>DRK-424</b>		
Position	Part Number	Qty
Differential Right Brg.	56425-56650	1
Differential Left Brg.	497-493	1
Pinion Head Brg.	72218C-72487	1
Pinion Tail Brg.	HM807049-HM807010	1
Pinion Nose Brg.	MUSB1307UM	1
Outer Pinion Support Brg.	MUF1208CBXV1	1
Input Shaft Front Brg.	3979-JM511910	1
Input Shaft Rear Brg.	29675-29620	1
Front Output Shaft Front Brg.	3780-3720	1
Front Output Shaft Rear Brg.	LM501349-LM501310	1
Rear Output Shaft Brg.	MA1209EL	1
Input Shaft Seal	119429 (2.938x4.003)	1
Front Thrushaft Seal	475003N (2.625x3.623)	1
Rear Thrushaft Seal	475003N (2.625x3.623)	1
Sealer	RTV Silicone	1

<b>DRK-425</b>		
Position	Part Number	Qty
Differential Right Brg.	42381-42584	1
Differential Left Brg.	68462-68712	1
Pinion Head Brg.	72212C-72487	1
Pinion Tail Brg.	72212C-72487	1
Pinion Nose Brg.	MUB1308UM	1
Outer Pinion Support Brg.	MU1309CV	1
Input Shaft Front Brg.	JM511946-JM511910	1
Input Shaft Rear Brg.	33275-33472	1
Front Output Shaft Front Brg.	3979-3920	1
Front Output Shaft Rear Brg.	HM88649-HM88610	1
Rear Output Shaft Brg.	MA1211EL	1
Input Shaft Seal	119430 (3.375x4.376)	1
Front Thrushaft Seal	119429 (2.938x4.003)	1
Rear Thrushaft Seal	119429 (2.938x4.003)	1
Sealer	RTV Silicone	1

<b>DRK-426</b>		
Position	Part Number	Qty
Differential Right Brg.	42346-42584	1
Differential Left Brg.	68462-68712	1
Pinion Head Brg.	72212C-72487	1
Pinion Tail Brg.	72212C-72487	1
Pinion Nose Brg.	MUB1308UM	1
Outer Pinion Support Brg.	MU1309CV	1
Input Shaft Front Brg.	JM511946-JM511910	1
Input Shaft Rear Brg.	33275-33472	1
Front Output Shaft Front Brg.	3979-3920	1
Front Output Shaft Rear Brg.	HM88649-HM88610	1
Rear Output Shaft Brg.	MA1211EL	1
Input Shaft Seal	119430 (3.375x4.376)	1
Front Thrushaft Seal	119429 (2.938x4.003)	1
Rear Thrushaft Seal	119429 (2.938x4.003)	1
Sealer	RTV Silicone	1

<b>DRK-427</b>		
Position	Part Number	Qty
Differential Right Brg.	NP799449-NP105857	1
Differential Left Brg.	NP380290-NP533133	1
Pinion Head Brg.	NP242732-NP611140	1
Pinion Tail Brg.	55212C-55437	1
Pinion Nose Brg.	MUB1307UM	1
Input Shaft Front Brg.	NP930036-NP193660	1
Input Shaft Rear Brg.	29675-29630	1
Output Shaft Brg.	LM104949-JLM104910	2
Output Shaft O-Ring	OR-232	2
Input Shaft Seal	DT7591 (2.913x4.561)	1
Thrushaft Seal	DT7592 (2.625x3.620)	1
Sealer	RTV Silicone	1

<b>DRK-427A</b>		
Position	Part Number	Qty
Differential Right Brg.	NP799449-NP105857	1
Differential Left Brg.	NP380290-NP533133	1
Pinion Head Brg.	NP242732-NP611140	1
Pinion Tail Brg.	55212C-55437	1
Pinion Nose Brg.	MUB1307UM	1
Input Shaft Front Brg.	NP930036-NP193660	1
Input Shaft Rear Brg.	29688-29620	1
Output Shaft Brg.	LM104949-JLM104910	2
Output Shaft O-Ring	OR-232	2
Input Shaft Seal	DT7591 (2.913x4.561)	1
Thrushaft Seal	DT7592 (2.625x3.620)	1
Sealer	RTV Silicone	1



# Differential Rebuild Kits

DRK-428		
Position	Part Number	Qty
Differential Right Brg.	NP799449-NP105857	1
Differential Left Brg.	42362-42584	1
Pinion Head Brg.	NP242732-NP611140	1
Pinion Tail Brg.	55212C-55437	1
Pinion Nose Brg.	MUB1307UM	1
Input Shaft Front Brg.	NP930036-NP193660	1
Input Shaft Rear Brg.	29675-29630	1
Output Shaft Brg.	LM104949-JLM104910	2
Output Shaft O-Ring	OR-232	2
Input Shaft Seal	DT7591 (2.913x4.561)	1
Thrushaft Seal	DT7592 (2.625x3.620)	1
Sealer	RTV Silicone	1

DRK-428A		
Position	Part Number	Qty
Differential Right Brg.	NP799449-NP105857	1
Differential Left Brg.	42362-42584	1
Pinion Head Brg.	NP242732-NP611140	1
Pinion Tail Brg.	55212C-55437	1
Pinion Nose Brg.	MUB1307UM	1
Input Shaft Front Brg.	NP930036-NP193660	1
Input Shaft Rear Brg.	29688-29620	1
Output Shaft Front Brg.	LM104949-JLM104910	2
Output Shaft O-Ring	OR-232	2
Input Shaft Seal	DT7591 (2.913x4.561)	1
Thrushaft Seal	DT7592 (2.625x3.620)	1
Sealer	RTV Silicone	1

DRK-429		
Position	Part Number	Qty
Differential Right Brg.	NP799449-NP105857	1
Differential Left Brg.	NP380290-NP53133	1
Pinion Head Brg.	NP523912-NP611140	1
Pinion Tail Brg.	55200C-55437	1
Pinion Nose Brg.	MUB7307UM	1
Pinion Seal	DT7591 (2.913x4.561)	1
Sealer	RTV Silicone	1

DRK-430		
Position	Part Number	Qty
Differential Right Brg.	NP799449-NP105857	1
Differential Left Brg.	42362-42584	1
Pinion Head Brg.	NP523912-NP611140	1
Pinion Tail Brg.	55200C-55437	1
Pinion Nose Brg.	MUB7307UM	1
Pinion Seal	DT7591 (2.913x4.561)	1
Sealer	RTV Silicone	1

DRK-431		
Position	Part Number	Qty
Differential Right Brg.	665-653	1
Differential Left Brg.	42381-42584	1
Pinion Head Brg.	NP523912-NP611140	1
Pinion Tail Brg.	NP523912-NP611140	1
Pinion Nose Brg.	MUB1308UM	1
Outer Pinion Support Brg. (Pre 2/2000)	MU1309CV	1
Outer Pinion Support Brg. (Aft 2/2000)	MU1309UGM	1
Input Shaft Front Brg.	JM511946-JM511910	1
Output Shaft Front Brg.	33275-33472	1
Output Shaft Rear Brg.	MA1211EL	1
Input Shaft Seal	DT0736 (3.375x4.376)	1
Thrushaft Seal	DT0737 (2.937x4.003)	1
Sealer	RTV Silicone	1

DRK-432		
Position	Part Number	Qty
Differential Right Brg.	68462-68712	1
Differential Left Brg.	42381-42584	1
Pinion Head Brg.	72212C-72487	1
Pinion Tail Brg.	72212C-72487	1
Pinion Nose Brg.	MUB1308UM	1
Input Shaft Brg.	JM511946-JM511910	1
Outer Pinion Support Brg.	MU1309UGM	1
Output Shaft Front Brg.	33275-33472	1
Output Shaft Rear Brg.	MA1211EL	1
Input Shaft Seal	DT0736 (3.375x4.376)	1
Thrushaft Seal	DT0737 (2.937x4.003)	1
Sealer	RTV Silicone	1

DRK-433		
Position	Part Number	Qty
Differential Right Brg.	665-653	1
Differential Left Brg.	42381-42584	1
Pinion Head Brg.	72212C-72487	1
Pinion Tail Brg.	72212C-72487	1
Pinion Nose Brg.	MUB1308UM	1
Input Shaft Brg.	JM511946-JM511910	1
Output Shaft Front Brg.	33275-33472	1
Output Shaft Rear Brg.	MA1211EL	1
Outer Pinion Support Brg.	MU1309UGM	1
Input Shaft Seal	DT0736 (3.375x4.376)	1
Thrushaft Seal	DT0737 (2.937x4.003)	1
Sealer	RTV Silicone	1

DRK-434		
Position	Part Number	Qty
Differential Right Brg.	3984-3920	1
Differential Left Brg.	3984-3920	1
Pinion Head Brg.	72212C-72487	1
Pinion Tail Brg.	55200C-55437	1
Pinion Seal	DT7591 (2.913x4.561)	1
Sealer	RTV Silicone	1

DRK-435		
Position	Part Number	Qty
Differential Right Brg.	68462-68712	1
Differential Left Brg.	42381-42584	1
Pinion Head Brg.	NP523912-NP611140	1
Pinion Tail Brg.	NP523912-NP611140	1
Pinion Nose Brg.	MUB1308UM	1
Outer Pinion Support Brg. (Pre 2/2000)	MU1309CV	1
Outer Pinion Support Brg. (Aft 2/2000)	MU1309UGM	1
Input Shaft Front Brg.	JM511946-JM511910	1
Output Shaft Front Brg.	33275-33472	1
Output Shaft Rear Brg.	MA1211EL	1
Input Shaft Seal	DT0736 (3.375x4.376)	1
Thrushaft Seal	DT0737 (2.937x4.003)	1
Sealer	RTV Silicone	1

DRK-436		
Position	Part Number	Qty
Differential Right Brg.	NP237087-NP049312.904A4	1
Differential Left Brg.	NP374995-NP120322.904A5	1
Pinion Head Brg.	NP478770-NP547156	1
Pinion Tail Brg.	NP846736-NP166419	1
Input Shaft Front Brg.	HM813844-HM813810	1
Input Shaft Rear Brg.	NP171276-NP943289	1
Input Shaft Seal & Nut Kit	DT131008K (97x162.5)	1
Input Shaft V-Ring	401300	1
Thrushaft Seal	DT0737 (2.937x4.003)	1
Input Shaft Thrust Washer	132440	1
Sealer	RTV Silicone	1

DRK-436A		
Position	Part Number	Qty
Differential Right Brg.	140019-140020	1
Differential Left Brg.	140014-140012	1
Pinion Head Brg.	NP478770-NP547156	1
Pinion Tail Brg.	NP846736-NP166419	1
Input Shaft Front Brg.	HM813844-HM813810	1
Input Shaft Rear Brg.	NP171276-NP943289	1
Output Shaft Brg.	NP197868-NP910345	2
Input Shaft Seal & Nut Kit	DT131008K (97x162.5)	1
Input Shaft V-Ring	401300	1
Thrushaft Seal	DT0737 (2.937x4.003)	1
Input Shaft Thrust Washer	132440	1
Sealer	RTV Silicone	1

DRK-437		
Position	Part Number	Qty
Differential Right Brg.	NP237087-NP049312.904A4	1
Differential Left Brg.	NP374995-NP120322.904A5	1
Pinion Head Brg.	NP478770-NP547156	1
Pinion Tail Brg.	NP846736-NP166419	1
Pinion Nose Brg.	WUB61308UM	1
Input Shaft Front Brg.	HM813844-HM813810	1
Input Shaft Rear Brg.	NP171276-NP943289	1
Input Shaft Seal & Nut Kit	DT131008K (97x162.5)	1
Input Shaft V-Ring	401300	1
Thrushaft Seal	DT0737 (2.937x4.003)	1
Input Shaft Thrust Washer	132440	1
Sealer	RTV Silicone	1

DRK-437A		
Position	Part Number	Qty
Differential Right Brg.	140019-140020	1
Differential Left Brg.	140014-140012	1
Pinion Head Brg.	NP478770-NP547156	1
Pinion Tail Brg.	NP846736-NP166419	1
Pinion Nose Brg.	WUB61308UM	1
Input Shaft Front Brg.	HM813844-HM813810	1
Input Shaft Rear Brg.	NP171276-NP943289	1
Output Shaft Brg.	NP197868-NP910345	2
Input Shaft Seal & Nut Kit	DT131008K (97x162.5)	1
Input Shaft V-Ring	401300	1
Thrushaft Seal	DT0737 (2.937x4.003)	1
Input Shaft Thrust Washer	132440	1
Sealer	RTV Silicone	1

DRK-438		
Position	Part Number	Qty
Differential Right Brg.	NP374995-NP120322.904A5	1
Differential Left Brg.	NP374995-NP120322.904A5	1
Pinion Head Brg.	NP478770-NP547156	1
Pinion Tail Brg.	NP927527-NP547156	1
Pinion Nose Brg.	WUB61308UM	1
Pinion Seal & Nut Kit	DT131008K (97x162.5)	1
Sealer	RTV Silicone	1

DRK-438A		
Position	Part Number	Qty
Differential Right Brg.	140014-140012	1
Differential Left Brg.	140014-140012	1
Pinion Head Brg.	NP478770-NP547156	1
Pinion Tail Brg.	NP927527-NP547156	1
Pinion Nose Brg.	WUB61308UM	1
Pinion Seal & Nut Kit	DT131008K (97x162.5)	1
Sealer	RTV Silicone	1

\* Not packed in kit

# Differential Rebuild Kits

HD Differential

<b>DRK-439</b>		
Position	Part Number	Qty
Differential Right Brg.	NP374995-NP120322.904A5	1
Differential Left Brg.	NP374995-NP120322.904A5	1
Pinion Head Brg.	NP478770-NP547156	1
Pinion Tail Brg.	NP927527-NP547156	1
Pinion Seal & Nut Kit	DT131008K (97x162.5)	1
Sealer	RTV Silicone	1

<b>DRK-439A</b>		
Position	Part Number	Qty
Differential Right Brg.	140014-140012	1
Differential Left Brg.	140014-140012	1
Pinion Head Brg.	NP478770-NP547156	1
Pinion Tail Brg.	NP927527-NP547156	1
Pinion Seal & Nut Kit	DT131008K (97x162.5)	1
Sealer	RTV Silicone	1

<b>DRK-441</b>		
Position	Part Number	Qty
Differential Right Brg.	NP237087-NP049312.904A4	1
Differential Left Brg.	NP374995-NP120322.904A5	1
Pinion Head Brg.	NP478770-NP547156	1
Pinion Tail Brg.	NP927527-NP547156	1
Pinion Nose Brg.	MUB1308UM	1
Pinion Seal & Nut Kit	DT131008K (97x162.5)	1
Sealer	RTV Silicone	1

<b>DRK-441A</b>		
Position	Part Number	Qty
Differential Right Brg.	140019-140020	1
Differential Left Brg.	140014-140012	1
Pinion Head Brg.	NP478770-NP547156	1
Pinion Tail Brg.	NP927527-NP547156	1
Pinion Nose Brg.	MUB1308UM	1
Pinion Seal & Nut Kit	DT131008K (97x162.5)	1
Sealer	RTV Silicone	1

<b>DRK-442</b>		
Position	Part Number	Qty
Differential Right Brg.	NP374995-NP120322.904A5	1
Differential Left Brg.	NP374995-NP120322.904A5	1
Pinion Head Brg.	NP478770-NP547156	1
Pinion Tail Brg.	NP846736-NP166419	1
Input Shaft Front Brg.	HM813844-HM813810	1
Input Shaft Rear Brg.	NP171276-NP943289	1
Input Shaft Seal & Nut Kit	DT131008K (97x162.5)	1
Input Shaft V-Ring	401300	1
Thrushaft Seal	DT0737 (2.937x4.003)	1
Input Shaft Thrust Washer	132440	1
Sealer	RTV Silicone	1

<b>DRK-442A</b>		
Position	Part Number	Qty
Differential Right Brg.	140014-140012	1
Differential Left Brg.	140014-140012	1
Pinion Head Brg.	NP478770-NP547156	1
Pinion Tail Brg.	NP846736-NP166419	1
Input Shaft Front Brg.	HM813844-HM813810	1
Input Shaft Rear Brg.	NP171276-NP943289	1
Output Shaft Brg.	NP197868-NP910345	2
Input Shaft Seal & Nut Kit	DT131008K (97x162.5)	1
Input Shaft V-Ring	401300	1
Thrushaft Seal	DT0737 (2.937x4.003)	1
Input Shaft Thrust Washer	132440	1
Sealer	RTV Silicone	1

<b>DRK-443</b>		
Position	Part Number	Qty
Differential Right Brg.	NP237087-NP049312.904A4	1
Differential Left Brg.	NP374995-NP120322.904A5	1
Pinion Head Brg.	NP478770-NP547156	1
Pinion Tail Brg.	NP927527-NP547156	1
Pinion Nose Brg.	WUB61308UM	1
Pinion Seal & Nut Kit	DT131008K (97x162.5)	1
Sealer	RTV Silicone	1

<b>DRK-443A</b>		
Position	Part Number	Qty
Differential Right Brg.	140019-140020	1
Differential Left Brg.	140014-140012	1
Pinion Head Brg.	NP478770-NP547156	1
Pinion Tail Brg.	NP927527-NP547156	1
Pinion Nose Brg.	WUB61308UM	1
Pinion Seal & Nut Kit	DT131008K (97x162.5)	1
Sealer	RTV Silicone	1

<b>DRK-444</b>		
Position	Part Number	Qty
Differential Right Brg.	NP237087-NP049312.904A4	1
Differential Left Brg.	NP374995-NP120322.904A5	1
Pinion Head Brg.	NP478770-NP547156	1
Pinion Tail Brg.	NP927527-NP547156	1
Pinion Seal & Nut Kit	DT131008K (97x162.5)	1
Sealer	RTV Silicone	1

<b>DRK-444A</b>		
Position	Part Number	Qty
Differential Right Brg.	140019-140020	1
Differential Left Brg.	140014-140012	1
Pinion Head Brg.	NP478770-NP547156	1
Pinion Tail Brg.	NP927527-NP547156	1
Pinion Seal & Nut Kit	DT131008K (97x162.5)	1
Sealer	RTV Silicone	1

<b>DRK-445</b>		
Position	Part Number	Qty
Differential Right Brg.	567-563	1
Differential Left Brg.	NP380290-NP533133	1
Pinion Head Brg.	72200C-NP611140	1
Pinion Tail Brg.	55200C-55437	1
Pinion Nose Brg.	MUB7307UM	1
Pinion Seal	DT7591 (2.913x4.561)	1
Sealer	RTV Silicone	1

<b>DRK-446</b>		
Position	Part Number	Qty
Differential Right Brg.	567-563	1
Differential Left Brg.	NP380290-NP533133	1
Pinion Head Brg.	72200C-NP611140	1
Pinion Tail Brg.	55200C-55437	1
Pinion Nose Brg.	WUB61307UM	1
Pinion Seal	DT7591 (2.913x4.561)	1
Sealer	RTV Silicone	1

<b>DRK-447</b>		
Position	Part Number	Qty
Differential Right Brg.	567-563	1
Differential Left Brg.	NP380290-NP533133	1
Pinion Head Brg.	NP523912-NP611140	1
Pinion Tail Brg.	55200C-55437	1
Pinion Nose Brg.	MUB7307UM	1
Pinion Seal	DT7591 (2.913x4.561)	1
Sealer	RTV Silicone	1

<b>DRK-448</b>		
Position	Part Number	Qty
Differential Right Brg.	567-563	1
Differential Left Brg.	NP380290-NP533133	1
Pinion Head Brg.	NP523912-NP611140	1
Pinion Tail Brg.	55200C-55437	1
Pinion Nose Brg.	WUB61307UM	1
Pinion Seal	DT7591 (2.913x4.561)	1
Sealer	RTV Silicone	1

<b>DRK-449</b>		
Position	Part Number	Qty
Differential Right Brg.	42381-42584	1
Differential Left Brg.	665-653	1
Pinion Head Brg.	78215C-78551	1
Pinion Tail Brg.	72212C-72487	1
Pinion Nose Brg.	MUB1308UM	1
Pinion Seal	DT0724 (2.937x5.046)	1
Sealer	RTV Silicone	1

<b>DRK-451</b>		
Position	Part Number	Qty
Differential Right Brg.	497-493	1
Differential Left Brg.	598-592A	1
Pinion Head Brg.	H715343-H715311	1
Pinion Tail Brg.	HM813841-HM813810	1
Pinion Nose Brg.	WUB61308UM	1
Pinion Seal	DT0724 (2.937x5.046)	1
Sealer	RTV Silicone	1

<b>DRK-452</b>		
Position	Part Number	Qty
Differential Right Brg.	3984-3920	1
Differential Left Brg.	594A-592A	1
Pinion Head Brg.	NP340526-NP420924	1
Pinion Tail Brg.	55200C-55437	1
Pinion Seal	DT7591 (2.913x4.561)	1
Sealer	RTV Silicone	1

<b>DRK-453</b>		
Position	Part Number	Qty
Differential Right Brg.	NP237087-NP049312.904A4	1
Differential Left Brg.	NP374995-NP120322.904A5	1
Pinion Head Brg.	NP478770-NP547156	1
Pinion Tail Brg.	NP846736-NP166419	1
Pinion Nose Brg.	WUB61308UM	1
Input Shaft Front Brg.	HM813844-HM813810	1
Input Shaft Rear Brg.	NP171276-NP943289	1
Input Shaft Seal & Nut Kit	DT131008K (97x162.5)	1
Sealer	RTV Silicone	1

<b>DRK-453A</b>		
Position	Part Number	Qty
Differential Right Brg.	140019-140020	1
Differential Left Brg.	140014-140012	1
Pinion Head Brg.	NP478770-NP547156	1
Pinion Tail Brg.	NP846736-NP166419	1
Pinion Nose Brg.	WUB61308UM	1
Input Shaft Front Brg.	HM813844-HM813810	1
Input Shaft Rear Brg.	NP171276-NP943289	1
Input Shaft Seal & Nut Kit	DT131008K (97x162.5)	1
Sealer	RTV Silicone	1

<b>DRK-454</b>		
Position	Part Number	Qty
Differential Right Brg.	NP374995-NP120322.904A5	1
Differential Left Brg.	NP374995-NP120322.904A5	1
Pinion Head Brg.	NP478770-NP547156	1
Pinion Tail Brg.	NP846736-NP166419	1
Input Shaft Front Brg.	HM813844-HM813810	1
Input Shaft Rear Brg.	NP171276-NP943289	1
Input Shaft Seal & Nut Kit	DT131008K (97x162.5)	1
Sealer	RTV Silicone	1

<b>DRK-454A</b>		
Position	Part Number	Qty
Differential Right Brg.	140014-140012	1
Differential Left Brg.	140014-140012	1
Pinion Head Brg.	NP478770-NP547156	1
Pinion Tail Brg.	NP846736-NP166419	1
Input Shaft Front Brg.	HM813844-HM813810	1
Input Shaft Rear Brg.	NP171276-NP943289	1
Input Shaft Seal & Nut Kit	DT131008K (97x162.5)	1
Sealer	RTV Silicone	1

# Differential Rebuild Kits

DRK-500		
Position	Part Number	Qty
Differential Right Brg.	47687-47623A	1
Differential Left Brg.	HM516448-HM516414B	1
Pinion Head Brg.	596-592A	1
Pinion Tail Brg.	H715348-H715311	1
Cross Shaft Right Brg.	H715334-H715311	1
Cross Shaft Left Brg.	H715345-H715311	1
Input Shaft Brg.	1213L	1
Inter Axle Brg.	1211	1
Input Shaft Seal	4491V (3.500x4.501)	1
Thrushaft Seal	4492V (2.750x3.543)	1
O-Ring	OR256	1
O-Ring	OR260	1
O-Ring	OR270	1
Gasket	GG53916	1
Gasket	GG53917	1
Sealer	RTV Silicone	1

DRK-501		
Position	Part Number	Qty
Differential Right Brg.	47687-47623A	1
Differential Left Brg.	HM516448-HM516414B	1
Pinion Head Brg.	6466-6420	1
Pinion Tail Brg.	H715334-H715311	1
Cross Shaft Right Brg.	H715334-H715311	1
Cross Shaft Left Brg.	H715345-H715311	1
Pinion Seal	4491V (3.500x4.501)	1
O-Ring	OR256	1
O-Ring	OR270	1
Gasket Set	BGK3902	1
Sealer	RTV Silicone	1

DRK-502		
Position	Part Number	Qty
Differential Right Brg.	47681-47623A	1
Differential Left Brg.	47681-47623AB	1
Pinion Head Brg.	5760-5735	1
Pinion Tail Brg.	49585-49520	1
Cross Shaft Right Brg.	624-612	1
Cross Shaft Left Brg.	H414249-H414211W	1
Pinion Seal	35009N (2.750x3.876)	1
Sealer	RTV Silicone	1

DRK-503		
Position	Part Number	Qty
Differential Right Brg.	47687-47623A	1
Differential Left Brg.	HM516448-HM516414B	1
Pinion Head Brg.	5760-5735	1
Pinion Tail Brg.	559-552A	1
Cross Shaft Right Brg.	621-612	1
Cross Shaft Left Brg.	H715345-H715313W	1
Pinion Seal	415991N (3.500x4.501)	1
O-Ring Set	OK205	1
Gasket Set	GT-503	1
Sealer	RTV Silicone	1

DRK-504		
Position	Part Number	Qty
Differential Right Brg.	47681-47622W	1
Differential Left Brg.	47681-47622BW	1
Pinion Head Brg.	643-632	1
Pinion Tail Brg.	559-552A	1
Cross Shaft Right Brg.	624-612	1
Cross Shaft Left Brg.	645X-634W	1
Input Shaft Brg.	310	1
Power Divider Brg.	MU1211CL	1
Inter Axle Brg.	309	1
Input Shaft Seal	415013N (3.000x4.003)	1
Thrushaft Seal	415001N (2.500x3.543)	1
Sealer	RTV Silicone	1

DRK-505		
Position	Part Number	Qty
Differential Right Brg.	47681-47622W	1
Differential Left Brg.	47681-47622BW	1
Pinion Head Brg.	643-632	1
Pinion Tail Brg.	555-552A	1
Cross Shaft Right Brg.	624-612	1
Cross Shaft Left Brg.	645X-634W	1
Input Shaft Seal	415013N (3.000x4.003)	1
Thrushaft Seal	415001N (2.500x3.543)	1
Sealer	RTV Silicone	1

DRK-506		
Position	Part Number	Qty
Differential Right Brg.	77375-77676W	1
Differential Left Brg.	77375-77676BW	1
Pinion Head Brg.	6460-6420	1
Pinion Tail Brg.	65225-65550	1
Cross Shaft Right Brg.	835-833W	1
Cross Shaft Left Brg.	6576-6535W	1
Pinion Seal	415156N (3.125x4.125)	1
Sealer	RTV Silicone	1

DRK-507		
Position	Part Number	Qty
Differential Right Brg.	47687-47623A	1
Differential Left Brg.	HM516448-HM516414B	1
Pinion Head Brg.	HM518437-HM518411	1
Pinion Tail Brg.	495S-492A	1
Cross Shaft Right Brg.	621-612	1
Cross Shaft Left Brg.	HM518437-HM518411W	1
Input Shaft Brg.	1213L	1
Thrushaft Brg.	1211	1
Input Shaft Seal	4491V (3.500x4.501)	1
Thrushaft Seal	4492V (2.750x3.543)	1
Oil Port Seal	21136471	1
O-Ring Set	OK507	1
Sealer	RTV Silicone	1

DRK-508		
Position	Part Number	Qty
Differential Right Brg.	47687-47623A	1
Differential Left Brg.	HM516448-HM516414B	1
Pinion Head Brg.	HM518437-HM518411	1
Pinion Tail Brg.	495S-492A	1
Cross Shaft Right Brg.	621-612	1
Cross Shaft Left Brg.	HM518437-HM518411W	1
Pinion Seal	21126859	1
Oil Port Seal	21136471	1
O-Ring Set	OK508	1
Sealer	RTV Silicone	1

DRK-600		
Position	Part Number	Qty
Differential Right Brg.	495-493	1
Differential Left Brg.	495-493	1
Pinion Tail Brg.	66212-66462	1
Pinion Head Brg.	72225C-72487	1
Pinion Seal	35009N (2.750x3.876)	1
Pinion Nose Brg.	MUB1307UM	1
Sealer	RTV Silicone	1

DRK-601		
Position	Part Number	Qty
Differential Right Brg.	NP547288-NP478159	1
Differential Left Brg.	33214	1
Pinion Head Brg.	NP635208-NP160764	1
Pinion Tail Brg.	NP942787-NP378089	1
Pinion Seal	DTQ2591 (3.250x5.500) <sup>59</sup>	1
Sealer	RTV Silicone	1

DRK-650F		
Position	Part Number	Qty
Differential Right Brg.	32022X	1
Differential Left Brg.	32017X	1
Pinion Head Brg.	805096	1
Pinion Tail Brg.	805097	1
Input Shaft Front Brg.	JM511945-3920	1
Input Shaft Rear Brg.	JLM714149-JLM714110	1
Output Shaft Brg.	LM104949-JLM104910 •	2
Helical Gear Thrust Brg.	ZN1213	1
Helical Gear Needle Brg.	ZN1212	2
Input Shaft Seal	DT76646 (3.250x4.250)	1
Thrushaft Seal	DT76746 (3.000x3.750)	1
Sealer	RTV Silicone	1

DRK-650FA		
Position	Part Number	Qty
Differential Right Brg.	32022X	1
Differential Left Brg.	32017X	1
Pinion Head Brg.	805096	1
Pinion Tail Brg.	805097	1
Input Shaft Front Brg.	32213	1
Input Shaft Rear Brg.	JLM714149-JLM714110	1
Output Shaft Brg.	LM104949-JLM104910 •	2
Helical Gear Thrust Brg.	ZN1213	1
Helical Gear Needle Brg.	ZN1212	2
Input Shaft Seal	DT70746 (3.250x5.550)	1
Thrushaft Seal	DT76746 (3.000x3.750)	1
Sealer	RTV Silicone	1

DRK-650R		
Position	Part Number	Qty
Differential Right Brg.	32022X	1
Differential Left Brg.	32017X	1
Pinion Head Brg.	805096	1
Pinion Tail Brg.	805097	1
Pinion Seal	DT76246 (3.000x5.500)	1
Sealer	RTV Silicone	1

DRK-651		
Position	Part Number	Qty
Differential Right Brg.	32020X	1
Differential Left Brg.	32014X	1
Pinion Head Brg.	JW6049-JW6010	1
Pinion Tail Brg.	JW6049-JW6010	1
Pinion Seal	DT78047 (78x126)	1
Sealer	RTV Silicone	1

DRK-700		
Position	Part Number	Qty
Differential Right Brg.	388A-382	1
Differential Left Brg.	388A-382	1
Pinion Head and Tail Brg.	A1011(55197 Assy 90030) <sup>9</sup>	1
Pinion Nose Brg.	MR5205EL	1
Pinion Seal	411330N (2.598x3.481)	1
Felt Seal	5M89 (528)	1
Sealer	RTV Silicone	1

DRK-701		
Position	Part Number	Qty
Differential Right Brg.	28990-28919	1
Differential Left Brg.	28990-28919	1
Pinion Head Brg.	5310WA	1
Pinion Tail Brg.	MU1306TDM	1
Pinion Seal	411330N (2.598x3.481)	1
Felt Seal	5M89 (528)	1

DRK-702		
Position	Part Number	Qty
Differential Right Brg.	KR12051Z	1
Differential Left Brg.	KR12051Z	1
Pinion Head and Tail Brg.	A1011(55197 Assy 90030) <sup>9</sup>	1
Pinion Nose Brg.	MR5206EL	1
Pinion Seal	411330N (2.598x3.481)	1
Felt Seal	5M89 (528)	1
Sealer	RTV Silicone	1

<sup>9</sup> Replace Entire Assembly

<sup>59</sup> Order DTA2731 for updated seal

• Not packed in kit

# Differential Rebuild Kits

HD Differential

<b>DRK-801</b>		
Position	Part Number	Qty
Differential Right Brg.	594-592A	1
Differential Left Brg.	594-592A	1
Pinion Head Brg.	31315	1
Pinion Tail Brg.	HM911245-HM911210	1
Pinion Nose Brg.	MU1308UM	1
Input Shaft Front Brg.	30214	1
Input Shaft Rear Brg.	JLM714149-JLM714110	1
Input Shaft Front Needle Brg.	183788	1
Input Shaft Rear Needle Brg.	181632	1
Output Shaft Brg.	310	1
Input Shaft Seal	948642	1
Thrushaft Seal	948448	1

<b>DRK-802</b>		
Position	Part Number	Qty
Differential Right Brg.	594-592A	1
Differential Left Brg.	594-592A	1
Pinion Head Brg.	H913843-H913810	1
Pinion Tail Brg.	HM911245-HM911210	1
Pinion Nose Brg.	MU1308UM	1
Pinion Seal	1522895	1

<b>DRK-900F</b>		
Position	Part Number	Qty
Differential Right Brg.	496-493	1
Differential Left Brg.	497-493 <sup>10</sup>	1
Pinion Head Brg.	72200C-72487	1
Pinion Tail Brg.	72200C-72487	1
Pinion Nose Brg.	RU1570UM	1
Drive Gear Front Brg.	29675-29630	1
Drive Gear Rear Brg.	29675-29630	1
Idler Gear Cone	31597	2
Idler Gear Cup	31520 •	2
Input Shaft Brg.	211B	1
Thrushaft Brg.	LM603049-LM603011 •	2
Input Shaft Seal	35949N (2.937x3.937)	1
Thrushaft Seal	475322N (2.750x3.543) •	1
Sealer	RTV Silicone	1

<b>DRK-900FA</b>		
Position	Part Number	Qty
Differential Right Brg.	496-493	1
Differential Left Brg.	497-493 <sup>10</sup>	1
Pinion Head Brg.	72200C-72487	1
Pinion Tail Brg.	72200C-72487	1
Pinion Nose Brg.	RU1570UM	1
Drive Gear Front Brg.	29675-29630	1
Drive Gear Rear Brg.	29675-29630	1
Idler Gear Brg.	31597-31520	2
Input Shaft Brg.	211B	1
Thrushaft Brg.	LM603049-LM603011	2
Input Shaft Seal	35949N (2.937x3.937)	1
Thrushaft Seal	475322N (2.750x3.543) •	1
Sealer	RTV Silicone	1

<b>DRK-1910</b>		
Position	Part Number	Qty
Differential Right Brg.	683-672	1
Differential Left Brg.	683-672	1
Pinion Head Brg.	42350-42584	1
Pinion Tail Brg.	42350-42584	1
Cross Shaft Left Brg.	MU1221UM	1
Cross Shaft Right Brg.	641-632	2
Rear Pinion Brg.	MR1213EL	1
Pinion Seal	415086N (3.000x4.249)	2
Sealer	RTV Silicone	1

<b>DRK-1918</b>		
Position	Part Number	Qty
Differential Right Brg.	33281-33472	1
Differential Left Brg.	33281-33472	1
Pinion Head Brg.	55187C-55443	1
Pinion Tail Brg.	55176C-55443	1
Pinion Nose Brg.	RU1570UM	1
Pinion Seal	410101N (2.375x3.350)	1
Sealer	RTV Silicone	1

<b>DRK-1925</b>		
Position	Part Number	Qty
Differential Right Brg.	47686-47620	1
Differential Left Brg.	47686-47620	1
Pinion Head Brg.	H715345-H715311	1
Pinion Tail Brg.	HM807046-HM807010	1
Cross Shaft Right Brg.	65225-65500	1
Cross Shaft Left Brg.	65225-65500	1
Pinion Seal	476283N (2.750x4.249)	1
Sealer	RTV Silicone	1

<b>DRK-1925A</b>		
Position	Part Number	Qty
Differential Right Brg.	HM516449C-HM516410	1
Differential Left Brg.	HM516449C-HM516410	1
Pinion Head Brg.	H715345-H715311	1
Pinion Tail Brg.	HM807046-HM807010	1
Cross Shaft Right Brg.	65225-65500	1
Cross Shaft Left Brg.	65225-65500	1
Pinion Seal	476283N (2.750x4.249)	1
Sealer	RTV Silicone	1

<b>DRK-1926</b>		
Position	Part Number	Qty
Differential Right Brg.	34301-34500	1
Differential Left Brg.	42688-42620	1
Pinion Head Brg.	55200C-55437	1
Pinion Tail Brg.	55187C-55437	1
Pinion Nose Brg.	RU1570UM	1
Pinion Seal	35009N (2.750x3.876)	1
Sealer	RTV Silicone	1

<b>DRK-1984</b>		
Position	Part Number	Qty
Differential Right Brg.	47890-47820	1
Differential Left Brg.	47890-47820	1
Pinion Head Brg.	H715343-H715311	1
Pinion Tail Brg.	H715343-H715311	1
Pinion Nose Brg.	MU1308UM	1
Input Shaft Front Brg.	3767-3720	1
Input Shaft Rear Brg.	3775-3720	1
Idler Gear Front Brg.	49585-49520	1
Idler Gear Rear Brg.	HM807046-HM807010	1
Input Shaft Seal	4564V (2.748x3.876)	1
Sealer	RTV Silicone	1

<b>DRK-2108</b>		
Position	Part Number	Qty
Differential Right Brg.	687-672	1
Differential Left Brg.	687-672	1
Pinion Head Brg.	HM813844-HM813810	1
Pinion Tail Brg.	H715341-H715311	1
Pinion Nose Brg.	MU5208UM	1
Pinion Seal	6612S (3.500x5.250)	1
Sealer	RTV Silicone	1

<b>DRK-2111</b>		
Position	Part Number	Qty
Differential Right Brg.	395-394A	1
Differential Left Brg.	395-394A	1
Pinion Head Brg.	M903345-M903310	1
Pinion Tail Brg.	44143-44348	1
Pinion Nose Brg.	MU1305TDM	1
Pinion Seal	410308 (2.125x3.061)	1
Pinion Seal	475080N (2.125x3.623)	1
Sealer	RTV Silicone	1

<b>DRK-4095</b>		
Position	Part Number	Qty
Differential Right Brg.	47890-47820	1
Differential Left Brg.	47890-47820	1
Pinion Head Brg.	H715343-H715311	1
Pinion Tail Brg.	65237-65500	1
Input Shaft Front Brg.	JH211749-JH211710	1
Input Shaft Rear Brg.	JLM714149-JLM714110	1
Output Shaft Brg.	LM104949-JLM104910	2
Input Shaft Seal	416470N (3.250x4.249)	1
Thrushaft Seal	4492V (2.750x3.543)	1
Sealer	RTV Silicone	1

<b>DRK-4100</b>		
Position	Part Number	Qty
Differential Right Brg.	47890-47820	1
Differential Left Brg.	47890-47820	1
Pinion Head Brg.	H715343-H715311	1
Pinion Tail Brg.	65237-65500	1
Input Shaft Front Brg.	JH211749-JH211710	1
Input Shaft Rear Brg.	JLM714149-JLM714110	1
Thrushaft Brg.	210	1
Input Shaft Seal	416470N (3.250x4.249)	1
Thrushaft Seal	475322N (2.750x3.543)	1
O-Ring	5X591	1
Sealer	RTV Silicone	1
Threadlocker	TL1	1

<b>DRK-4105</b>		
Position	Part Number	Qty
Differential Right Brg.	47890-47820	1
Differential Left Brg.	47890-47820	1
Pinion Head Brg.	H715343-H715311	1
Pinion Tail Brg.	H715334-H715311	1
Pinion Nose Brg.	MUB1308UM	1
Pinion Seal	4876N (2.748x5.500)	1
Sealer	RTV Silicone	1

<b>DRK-4125</b>		
Position	Part Number	Qty
Differential Right Brg.	598-592A	1
Differential Left Brg.	52387-52618	1
Pinion Head Brg.	78250AC-78551	1
Pinion Tail Brg.	78250AC-78551	1
Pinion Nose Brg.	MUC1309UM	1
Input Shaft Front Brg.	HM813841-HM813810	1
Input Shaft Rear Brg.	JM515649-JM515610	1
Thrushaft Brg.	385A-382A	2
Oil Pump Idler Gear Brg.	5204K	1
Input Shaft Seal	416470N (3.250x4.249)	1
Thrushaft Seal	415013N (3.000x4.003)	1
Sealer	RTV Silicone	1

<b>DRK-4130</b>		
Position	Part Number	Qty
Differential Right Brg.	598-592A	1
Differential Left Brg.	52387-52618	1
Pinion Head Brg.	H715343-H715311	1
Pinion Tail Brg.	H715334-H715311	1
Pinion Nose Brg.	MUC1309UM	1
Pinion Seal	415086N (3.000x4.249)	1
Sealer	RTV Silicone	1

<b>DRK-4135</b>		
Position	Part Number	Qty
Differential Right Brg.	598-592A	1
Differential Left Brg.	52387-52618	1
Pinion Head Brg.	78250AC-78551	1
Pinion Tail Brg.	78250AC-78551	1
Pinion Nose Brg.	MUB1309UM	1
Input Shaft Front Brg.	HM813844-HM813810	1
Input Shaft Rear Brg.	JM515649-JM515610	1
Thrushaft Brg.	385A-382A	2
Oil Pump Idler Gear Brg.	LM11949-90013	1
Input Shaft Seal	416470N (3.250x4.249)	1
Thrushaft Seal	415013N (3.000x4.003)	1
Sealer	RTV Silicone	1



# Differential Rebuild Kits

HD Differential

DRK-4140		
Position	Part Number	Qty
Differential Right Brg.	598-592A	1
Differential Left Brg.	52387-52618	1
Pinion Head Brg.	78250AC-78551	1
Pinion Tail Brg.	78250AC-78551	1
Pinion Nose Brg.	MUB1309UM	1
Input Shaft Front Brg.	HM813844-HM813810	1
Input Shaft Rear Brg.	JM515649-JM515610	1
Thrushaft Brg.	385A-382A	2
Oil Pump Idler Gear Brg.	LM11949-90013	1
Input Shaft Seal	DTR2592 (3.250x4.250) <sup>56</sup>	1
Thrushaft Seal	415013N (3.000x4.003)	1
Sealer	RTV Silicone	1

DRK-4145		
Position	Part Number	Qty
Differential Right Brg.	598-592A	1
Differential Left Brg.	52387-52618	1
Pinion Head Brg.	78250AC-78551	1
Pinion Tail Brg.	78250AC-78551	1
Pinion Nose Brg.	MUC1309UM	1
Input Shaft Front Brg.	HM813844-HM813810	1
Input Shaft Rear Brg.	JM515649-JM515610	1
Thrushaft Brg.	385A-382A	2
Oil Pump Idler Gear Brg.	LM11949-90013	1
Input Shaft Seal	416470N (3.250x4.249)	1
Thrushaft Seal	415013N (3.000x4.003)	1
Sealer	RTV Silicone	1

DRK-4150		
Position	Part Number	Qty
Differential Right Brg.	598-592A	1
Differential Left Brg.	52387-52618	1
Pinion Head Brg.	H715343-H715311	1
Pinion Tail Brg.	H715334-H715311	1
Pinion Nose Brg.	MUB1309TM	1
Pinion Seal	3143N (3.000x5.500)	1
Sealer	RTV Silicone	1

DRK-4155		
Position	Part Number	Qty
Differential Right Brg.	598-592A	1
Differential Left Brg.	52387-52618	1
Pinion Head Brg.	78250AC-78551	1
Pinion Tail Brg.	78250AC-78551	1
Pinion Nose Brg.	MUB1309UM	1
Input Shaft Front Brg.	496-493	1
Input Shaft Rear Brg.	29685-29620	1
Input Shaft Seal	DTP2590 (3.000x3.750) <sup>57</sup>	1
Sealer	RTV Silicone	1

DRK-4155A		
Position	Part Number	Qty
Differential Right Brg.	598-592A	1
Differential Left Brg.	52387-52618	1
Pinion Head Brg.	78250AC-78551	1
Pinion Tail Brg.	78250AC-78551	1
Pinion Nose Brg.	MUC1309UM	1
Input Shaft Front Brg.	496-493	1
Input Shaft Rear Brg.	29685-29620	1
Input Shaft Seal	DTP2590 (3.000x3.750) <sup>57</sup>	1
Sealer	RTV Silicone	1

DRK-4180		
Position	Part Number	Qty
Differential Right Brg.	581-572	1
Differential Left Brg.	581-572	1
Pinion Head Brg.	42350-42584	1
Pinion Tail Brg.	497-493	1
Pinion Nose Brg.	MR1212EL	1
Cross Shaft Right Brg.	66225-66462	2
Cross Shaft Left Brg.	MU1218TDHM	1
Cross Shaft Left Brg.	5211W	1
Thrushaft Brg.	210	1
Input Shaft Seal	475012N (3.937x4.003)	1
Thrushaft Seal	475322N (2.750x3.543)	1
Sealer	RTV Silicone	1

DRK-4190		
Position	Part Number	Qty
Differential Right Brg.	HM516449C-HM516410	1
Differential Left Brg.	HM516449C-HM516410	1
Pinion Head Brg.	42350-42584	1
Pinion Tail Brg.	497-493	1
Pinion Nose Brg.	MR1213EL	1
Cross Shaft Right Brg.	66225-66462	2
Cross Shaft Left Brg.	MU1218TDHM	1
Input Shaft Seal	3591 (2.750x5.501)	1
Thrushaft Seal	415272N (2.750x4.003)	1
Sealer	RTV Silicone	1

DRK-4220		
Position	Part Number	Qty
Differential Right Brg.	HM516449C-HM516410	1
Differential Left Brg.	HM516449C-HM516410	1
Pinion Head Brg.	42350-42584	1
Pinion Tail Brg.	497-493	1
Pinion Nose Brg.	MR1213EL	1
Cross Shaft Right Brg.	66225-66462	2
Cross Shaft Left Brg.	MU1218TDHM	1
Input Shaft Brg.	394A-392	2
Thrushaft Brg.	385A-382A	2
Input Shaft Seal	415137 (3.250x4.499)	1
Thrushaft Seal	415272N (2.750x4.003)	1
Sealer	RTV Silicone	1

DRK-4245		
Position	Part Number	Qty
Differential Right Brg.	HM516449C-HM516410	1
Differential Left Brg.	HM516449C-HM516410	1
Pinion Head Brg.	42350-42584	1
Pinion Tail Brg.	497-493	1
Pinion Nose Brg.	MR1213EL	1
Cross Shaft Right Brg.	641-632	2
Cross Shaft Left Brg.	MU1221UM	1
Input Shaft Brg.	387A-382A	2
Thrushaft Brg.	210	1
Input Shaft Seal	415086N (3.000x4.249)	1
Thrushaft Seal	415004 (2.750x3.751)	1
Sealer	RTV Silicone	1

DRK-4255		
Position	Part Number	Qty
Differential Right Brg.	683-672	1
Differential Left Brg.	683-672	1
Pinion Head Brg.	42350-42584	1
Pinion Tail Brg.	42350-42584	1
Pinion Nose Brg.	MR1213EL	1
Cross Shaft Right Brg.	641-632	2
Cross Shaft Left Brg.	MU1221UM	1
Input Shaft Brg.	5212W	1
Thrushaft Brg.	212	1
Input Shaft Seal	415086N (3.000x4.249)	1
Thrushaft Seal	415004 (2.750x3.751)	1
Sealer	RTV Silicone	1

DRK-4260		
Position	Part Number	Qty
Differential Right Brg.	683-672	1
Differential Left Brg.	683-672	1
Pinion Head Brg.	42350-42584	1
Pinion Tail Brg.	42350-42584	1
Pinion Nose Brg.	MR1213EL	1
Cross Shaft Right Brg.	641-632	2
Cross Shaft Left Brg.	MU1221UM	1
Input Shaft Brg.	394A-392	2
Thrushaft Brg.	385A-382A	2
Input Shaft Seal	415137 (3.250x4.499)	1
Thrushaft Seal	415272N (2.750x4.003)	1
Sealer	RTV Silicone	1

DRK-4270		
Position	Part Number	Qty
Differential Right Brg.	683-672	1
Differential Left Brg.	683-672	1
Pinion Head Brg.	42350-42584	1
Pinion Tail Brg.	497-493	1
Pinion Nose Brg.	MR1213EL	1
Cross Shaft Right Brg.	641-632	2
Cross Shaft Left Brg.	MU1221UM	1
Input Shaft Seal	3591 (2.750x5.501)	1
Thrushaft Seal	415272N (2.750x4.003)	1
Sealer	RTV Silicone	1

DRK-4290		
Position	Part Number	Qty
Differential Right Brg.	3994-JM511910	1
Differential Left Brg.	3994-JM511910	1
Pinion Head Brg.	HM903244-HM903210	1
Pinion Tail Brg.	44143-44348	1
Pinion Nose Brg.	MU1305TDM	1
Pinion Seal	410308 (2.125x3.061)	1
Sealer	RTV Silicone	1

DRK-4295		
Position	Part Number	Qty
Differential Right Brg.	3994-JM511910	1
Differential Left Brg.	3994-JM511910	1
Pinion Head Brg.	HM903244-HM903216	1
Pinion Tail Brg.	44143-44348	1
Pinion Nose Brg.	MU1305TDM	1
Pinion Seal	410308 (2.125x3.061)	1
Sealer	RTV Silicone	1

DRK-4300		
Position	Part Number	Qty
Differential Right Brg.	3994-JM511910	1
Differential Left Brg.	3994-JM511910	1
Pinion Head Brg.	HM803146-HM803110	1
Pinion Tail Brg.	44143-44348	1
Pinion Nose Brg.	MU1305TDM	1
Pinion Seal	475080N (2.125x3.623)	1
Sealer	RTV Silicone	1
Threadlocker	TL1	1

DRK-4310		
Position	Part Number	Qty
Differential Right Brg.	3994-JM511910	1
Differential Left Brg.	3994-JM511910	1
Pinion Head Brg.	HM903249A-HM903216	1
Pinion Tail Brg.	HM903249A-HM903216	1
Pinion Nose Brg.	MUB1305UDM	1
Pinion Seal	470737N (2.250x3.189)	1
Sealer	RTV Silicone	1
Threadlocker	TL1	1

DRK-4315		
Position	Part Number	Qty
Differential Right Brg.	3994-JM511910	1
Differential Left Brg.	3994-JM511910	1
Pinion Head Brg.	HM803149-HM803110	1
Pinion Tail Brg.	HM803149-HM803110	1
Pinion Nose Brg.	MUB1305UDM	1
Pinion Seal	475234N (2.250x3.623)	1
Sealer	RTV Silicone	1
Threadlocker	TL1	1

DRK-4325		
Position	Part Number	Qty
Differential Right Brg.	33275-33472	1
Differential Left Brg.	47490-47420	1
Pinion Head Brg.	HM807044-HM807010	1
Pinion Tail Brg.	M804049-M804010	1
Pinion Nose Brg.	RU1570UM	1
Pinion Seal	470574N (2.375x3.251)	1
Sealer	RTV Silicone	1

<sup>56</sup>Order DTX2728 for updated seal

<sup>57</sup>Order DTY2729 for updated seal



# Differential Rebuild Kits

HD Differential

<b>DRK-4330</b>		
Position	Part Number	Qty
Differential Right Brg.	JLM714149-JLM714110	1
Differential Left Brg.	JLM714149-JLM714110	1
Pinion Head Brg.	55200C-55437	1
Pinion Tail Brg.	HM804846-HM804810	1
Pinion Nose Brg.	RU1570UM	1
Pinion Seal	415082N (2.500x3.876)	1
Sealer	RTV Silicone	1

<b>DRK-4345</b>		
Position	Part Number	Qty
Differential Right Brg.	JP10049-JP10010A	1
Differential Left Brg.	JM716649-JM716610	1
Pinion Head Brg.	55200C-55437	1
Pinion Tail Brg.	M804049-M804010	1
Pinion Nose Brg.	RU1570UM	1
Pinion Seal	415082N (2.500x3.876)	1
Sealer	RTV Silicone	1

<b>DRK-4350</b>		
Position	Part Number	Qty
Differential Right Brg.	JM716649-JM716610	1
Differential Left Brg.	JM716649-JM716610	1
Pinion Head Brg.	55200C-55437	1
Pinion Tail Brg.	M804049-M804010	1
Pinion Nose Brg.	RU1570UM	1
Pinion Seal	415082N (2.500x3.876)	1
Sealer	RTV Silicone	1

<b>DRK-4355</b>		
Position	Part Number	Qty
Differential Right Brg.	JM716649-JM716610	1
Differential Left Brg.	JM716649-JM716610	1
Pinion Head Brg.	H715334-H715311	1
Pinion Tail Brg.	72212C-72487	1
Input Shaft Front Brg.	JM511946-JM511910	1
Input Shaft Rear Brg.	JLM710949-JLM710910	1
Output Shaft Brg.	LM603049-LM603011	2
Input Shaft Seal	4561V (2.503x3.428)	1
Thrushaft Seal	DTP2590 (3.000x3.750) <sup>57</sup>	1
O-Ring	5X1034	1
Sealer	RTV Silicone	1

<b>DRK-4356</b>		
Position	Part Number	Qty
Differential Right Brg.	JM716649-JM716610	1
Differential Left Brg.	JM716649-JM716610	1
Pinion Head Brg.	H715334-H715311	1
Pinion Tail Brg.	72212C-72487	1
Input Shaft Front Brg.	JM511945-JM511910	1
Input Shaft Rear Brg.	JLM710949-JLM710910	1
Output Shaft Brg.	LM603049-LM603011	2
Input Shaft Seal	4561V (2.503x3.428)	1
Thrushaft Seal	DTP2590 (3.000x3.750) <sup>57</sup>	1
O-Ring	5X1034	1
Sealer	RTV Silicone	1

<b>DRK-4360</b>		
Position	Part Number	Qty
Differential Right Brg.	JLM714149-JLM714110	1
Differential Left Brg.	JP10049-JP10010A	1
Pinion Head Brg.	55200C-55437	1
Pinion Tail Brg.	M804049-M804010	1
Pinion Nose Brg.	MUB1305UDM	1
Pinion Seal	415082N (2.500x3.876)	1
Threadlocker	TL1	1
Sealer	RTV Silicone	1

<b>DRK-4375</b>		
Position	Part Number	Qty
Differential Right Brg.	JM716649-JM716610	1
Differential Left Brg.	JP12049-JP12010	1
Pinion Head Brg.	78225C-78551	1
Pinion Tail Brg.	55206C-55437	1
Pinion Nose Brg.	MUB1307UBM	1
Pinion Seal	DTN2588 (3.000x4.937) <sup>58</sup>	1
Sealer	RTV Silicone	1
Threadlocker	TL1	1

<b>DRK-4390</b>		
Position	Part Number	Qty
Differential Right Brg.	JM716649-JM716610	1
Differential Left Brg.	JP10049-JP10010A	1
Pinion Head Brg.	72212C-72487	1
Pinion Tail Brg.	55206C-55437	1
Pinion Nose Brg.	RU1570UM	1
Pinion Seal	DTN2588 (3.000x4.937) <sup>58</sup>	1
Threadlocker	TL1	1
Sealer	RTV Silicone	1

<b>DRK-4395</b>		
Position	Part Number	Qty
Differential Right Brg.	JM716649-JM716610	1
Differential Left Brg.	JM716649-JM716610	1
Pinion Head Brg.	H715334-H715311	1
Pinion Tail Brg.	72212C-72487	1
Input Shaft Front Brg.	JM511946-3920	1
Input Shaft Rear Brg.	JLM710949-JLM710910	1
Output Shaft Brg.	LM104949-JLM104910	2
Input Shaft Seal	DTP2590 (3.000x3.750) <sup>57</sup>	1
Thrushaft Seal	DTP2590 (3.000x3.750) <sup>57</sup>	1
O-Ring	5X1034	2
Threadlocker	TL1	1
Sealer	RTV Silicone	1

<b>DRK-4396</b>		
Position	Part Number	Qty
Differential Right Brg.	JM716649-JM716610	1
Differential Left Brg.	JM716649-JM716610	1
Pinion Head Brg.	H715334-H715311	1
Pinion Tail Brg.	72212C-72487	1
Input Shaft Front Brg.	JM511945-3920	1
Input Shaft Rear Brg.	JLM710949-JLM710910	1
Output Shaft Brg.	LM104949-JLM104910	2
Input Shaft Seal	DTR2592 (3.250x4.250) <sup>56</sup>	1
Thrushaft Seal	DTP2590 (3.000x3.750) <sup>57</sup>	1
O-Ring	5X1034	2
Threadlocker	TL1	1
Sealer	RTV Silicone	1

<b>DRK-4405</b>		
Position	Part Number	Qty
Differential Right Brg.	JM716649-JM716610	1
Differential Left Brg.	JP10049-JP10010A	1
Pinion Head Brg.	H715334-H715311	1
Pinion Tail Brg.	72212C-72487	1
Input Shaft Front Brg.	JM511946-JM511910	1
Input Shaft Front Cup - New	3920	1
Input Shaft Rear Brg.	JLM710949-JLM710910	1
Output Shaft Brg.	LM104949-JLM104910	2
Input Shaft Seal	DTR2592 (3.250x4.250) <sup>56</sup>	1
Thrushaft Seal	DTP2590 (3.000x3.750) <sup>57</sup>	1
Threadlocker	TL1	1
O-Ring	5X1034	2
Sealer	RTV Silicone	1

<b>DRK-4406</b>		
Position	Part Number	Qty
Differential Right Brg.	JM716649-JM716610	1
Differential Left Brg.	JP10049-JP10010A	1
Pinion Head Brg.	H715334-H715311	1
Pinion Tail Brg.	72212C-72487	1
Input Shaft Front Brg.	JM511945-3920	1
Input Shaft Rear Brg.	JLM710949-JLM710910	1
Output Shaft Brg.	LM104949-JLM104910	2
Input Shaft Seal	DTR2592 (3.250x4.250) <sup>56</sup>	1
Thrushaft Seal	DTP2590 (3.000x3.750) <sup>57</sup>	1
O-Ring	5X1034	2
Threadlocker	TL1	1
Sealer	RTV Silicone	1

<b>DRK-4415</b>		
Position	Part Number	Qty
Differential Right Brg.	32021X	1
Differential Left Brg.	32021X	1
Pinion Head Brg.	9278-9220	1
Pinion Tail Brg.	HM813843-HM813810	1
Pinion Nose Brg.	A11228-P1004	1
Pinion Seal	DTQ2591 (3.250x5.500) <sup>59</sup>	1
Threadlocker	TL1	1
Sealer	RTV Silicone	1

<b>DRK-4420</b>		
Position	Part Number	Qty
Differential Right Brg.	32021X	1
Differential Left Brg.	32021X	1
Pinion Head Brg.	H715343-H715311	1
Pinion Tail Brg.	65237-65500	1
Input Shaft Front Brg.	HM813843-HM813810	1
Input Shaft Rear Brg.	JLM714149-JLM714110	1
Output Shaft Brg.	LM104949-JLM104910 <sup>*</sup>	2
Pinion Seal	DTR2592 (3.250x4.250) <sup>56</sup>	1
Thrushaft Seal	DTP2590 (3.000x3.750) <sup>*</sup>	1
O-Ring	5X1034	2
Threadlocker	TL1	1
Sealer	RTV Silicone	1

<b>DRK-4422</b>		
Position	Part Number	Qty
Differential Right Brg.	594A-592A	1
Differential Left Brg.	594A-592A	1
Pinion Head Brg.	H715343-H715311	1
Pinion Tail Brg.	65237-65500	1
Input Shaft Front Brg.	HM813843-HM813810	1
Input Shaft Rear Brg.	JLM714149-JLM714110	1
Output Shaft Brg.	LM104949-JLM104910 <sup>*</sup>	2
Pinion Seal	DTR2592 (3.250x4.250) <sup>56</sup>	1
Thrushaft Seal	DTP2590 (3.000x3.750) <sup>*</sup>	1
O-Ring	5X1034	1
Threadlocker	TL1	1
Sealer	RTV Silicone	1

<b>DRK-4423</b>		
Position	Part Number	Qty
Differential Right Brg.	594A-592A	1
Differential Left Brg.	52400-52618	1
Pinion Head Brg.	H715343-H715311	1
Pinion Tail Brg.	65237-65500	1
Input Shaft Front Brg.	HM813843-HM813810	1
Input Shaft Rear Brg.	JLM714149-JLM714110	1
Output Shaft Brg.	LM104949-JLM104910 <sup>*</sup>	2
Pinion Seal	DTR2592 (3.250x4.250) <sup>56</sup>	1
Thrushaft Seal	DTP2590 (3.000x3.750) <sup>*</sup>	1
O-Ring	5X1034	1
Threadlocker	TL1	1
Sealer	RTV Silicone	1

<b>DRK-4426</b>		
Position	Part Number	Qty
Differential Right Brg.	594A-592A	1
Differential Left Brg.	594A-592A	1
Pinion Head Brg.	9278-9220	1
Pinion Tail Brg.	HM813843-HM813810	1
Pinion Nose Brg.	RU9008UM	1
Pinion Seal	DTQ2591 (3.250x5.500) <sup>59</sup>	1
Threadlocker	TL1	1
Sealer	RTV Silicone	1

<b>DRK-4428</b>		
Position	Part Number	Qty
Differential Right Brg.	594A-592A	1
Differential Left Brg.	52400-52618	1
Pinion Head Brg.	9278-9220	1
Pinion Tail Brg.	HM813843-HM813810	1
Pinion Nose Brg.	RU9008UM	1
Pinion Seal	DTQ2591 (3.250x5.500) <sup>59</sup>	1
Threadlocker	TL1	1
Sealer	RTV Silicone	1

<sup>56</sup>Order DTX2728 for updated seal  
<sup>57</sup>Order DTY2729 for updated seal

<sup>58</sup>Order DTZ2730 for updated seal  
<sup>59</sup> Order DTA2731 for updated seal

\* Not packed in kit

# Differential Rebuild Kits

DRK-4435		
Position	Part Number	Qty
Differential Right Brg.	64450-64700	1
Differential Left Brg.	JHM720249-JHM720210	1
Pinion Head Brg.	9278-9220	1
Pinion Tail Brg.	H715334-H715311	1
Pinion Nose Brg.	MUB7309UM	1
Pinion Seal	DTQ2591 (3.250x5.500) <sup>56</sup>	1
Threadlocker	TL1	1
Sealer	RTV Silicone	1

DRK-4436		
Position	Part Number	Qty
Differential Right Brg.	64450-64700	1
Differential Left Brg.	JHM720249-JHM720210	1
Pinion Head Brg.	9278-9220	1
Pinion Tail Brg.	H715334-H715311	1
Pinion Nose Brg.	MUC1309UM	1
Pinion Seal	DTQ2591 (3.250x5.500) <sup>56</sup>	1
Threadlocker	TL1	1
Sealer	RTV Silicone	1

DRK-4437		
Position	Part Number	Qty
Differential Right Brg.	JM822049-JM822010	1
Differential Left Brg.	NP579116-NP022042	1
Pinion Head Brg.	9278-9220	1
Pinion Tail Brg.	H715334-H715311	1
Pinion Nose Brg.	MUB7309UM	1
Pinion Seal	DTQ2591 (3.250x5.500) <sup>56</sup>	1
Sealer	RTV Silicone	1
Threadlocker	TL1	1

DRK-4438		
Position	Part Number	Qty
Differential Right Brg.	JM822049-JM822010	1
Differential Left Brg.	NP579116-NP022042	1
Pinion Head Brg.	9278-9220	1
Pinion Tail Brg.	H715334-H715311	1
Pinion Nose Brg.	MUC1309UM	1
Pinion Seal	DTQ2591 (3.250x5.500) <sup>56</sup>	1
Sealer	RTV Silicone	1

DRK-4440		
Position	Part Number	Qty
Differential Right Brg.	NP928171-NP718759	1
Differential Left Brg.	52387-52618	1
Pinion Head Brg.	78250AC-78551	1
Pinion Tail Brg.	78250AC-78551	1
Pinion Nose Brg.	MRB7309GEXR	1
Pinion Nose Brg.	MRC7309	1
Input Shaft Brg.	HM813844-HM813810	1
Rear Side Gear Brg.	JM515649-JM515610	1
Output Shaft Brg.	385A-382A	2
Oil Pump Idler Gear Brg.	LM11949-90013	1
Input Shaft Seal	DTR2592 (3.250x4.250) <sup>56</sup>	1
Thrushaft Seal	415013N (3.000x4.003)	1
Snap Ring	1229T4076	1
Sealer	RTV Silicone	1

DRK-4441		
Position	Part Number	Qty
Differential Right Brg.	NP928171-NP718759	1
Differential Left Brg.	52387-52618	1
Pinion Head Brg.	78250AC-78551	1
Pinion Tail Brg.	78250AC-78551	1
Pinion Nose Brg.	MUB7309UM	1
Input Shaft Brg.	HM813844-HM813810	1
Rear Side Gear Brg.	JM515649-JM515610	1
Output Shaft Brg.	385A-382A	2
Oil Pump Idler Gear Brg.	LM11949-90013	1
Input Shaft Seal	DTR2592 (3.250x4.250) <sup>56</sup>	1
Thrushaft Seal	415013N (3.000x4.003)	1
Snap Ring	1229L1624	1
Sealer	RTV Silicone	1

DRK-4442		
Position	Part Number	Qty
Differential Right Brg.	NP928171-NP718759	1
Differential Left Brg.	52387-52618	1
Pinion Head Brg.	78250AC-78551	1
Pinion Tail Brg.	78250AC-78551	1
Pinion Nose Brg.	MUC1309UM	1
Input Shaft Brg.	HM813844-HM813810	1
Rear Side Gear Brg.	JM515649-JM515610	1
Output Shaft Brg.	385A-382A	2
Oil Pump Idler Gear Brg.	LM11949-90013	1
Input Shaft Seal	416470N (3.250x4.249)	1
Thrushaft Seal	415013N (3.000x4.003)	1
Snap Ring	1229K1623	1
Sealer	RTV Silicone	1

DRK-4443		
Position	Part Number	Qty
Differential Right Brg.	NP928171-NP718759	1
Differential Left Brg.	52387-52618	1
Pinion Head Brg.	78250AC-78551	1
Pinion Tail Brg.	78250AC-78551	1
Pinion Nose Brg.	MUB7309UM	1
Input Shaft Front Brg.	496-493	1
Input Shaft Rear Brg.	29685-29620	1
Input Shaft Seal	DTP2590 (3.000x3.750) <sup>57</sup>	1
Snap Ring	1229L1624	1
Sealer	RTV Silicone	1

DRK-4444		
Position	Part Number	Qty
Differential Right Brg.	NP928171-NP718759	1
Differential Left Brg.	52387-52618	1
Pinion Head Brg.	78250AC-78551	1
Pinion Tail Brg.	78250AC-78551	1
Pinion Nose Brg.	MUC1309UM	1
Input Shaft Front Brg.	496-493	1
Input Shaft Rear Brg.	29685-29620	1
Output Shaft Brg.	385A-382A •	2
Input Shaft Seal	DTP2590 (3.000x3.750) <sup>57</sup>	1
Thrushaft Seal	415013N (3.000x4.003) •	1
Snap Ring	1229K1623	1
Sealer	RTV Silicone	1

DRK-4450		
Position	Part Number	Qty
Differential Right Brg.	NP928171-NP718759	1
Differential Left Brg.	52387-52618	1
Pinion Head Brg.	78250AC-78551	1
Pinion Tail Brg.	78250AC-78551	1
Pinion Nose Brg.	MRB7309GEXR	1
Pinion Nose Brg.	MRC7309	1
Input Shaft Front Brg.	496-493	1
Input Shaft Rear Brg.	29685-29620	1
Input Shaft Seal	DTP2590 (3.000x3.750) <sup>57</sup>	1
Snap Ring	1229T4076	1
Sealer	RTV Silicone	1

DRK-4461		
Position	Part Number	Qty
Differential Right Brg.	JM716649-JM716610	1
Differential Left Brg.	JM716649-JM716610	1
Pinion Head Brg.	H715334-H715311	1
Pinion Tail Brg.	72225C-72487	1
Pinion Seal	DTN2588 (3.000x4.937) <sup>58</sup>	1
Sealer	RTV Silicone	1

DRK-4753		
Position	Part Number	Qty
Differential Right Brg.	28682-28622	1
Differential Left Brg.	28682-28622	1
Pinion Head Brg.	HM803149-HM803110	1
Pinion Tail Brg.	M86649-M86610	1
Pinion Seal	415082N (2.500x3.876)	1
Sealer	RTV Silicone	1

DRK-4841		
Position	Part Number	Qty
Differential Right Brg.	594A-592A	1
Differential Left Brg.	594A-592A	1
Pinion Head Brg.	H715334-H715311	1
Pinion Tail Brg.	72212C-72487	1
Input Shaft Front Brg.	JM511945-3920	1
Input Shaft Rear Brg.	JLM714149-JLM714110	1
Output Shaft Brg.	LM104949-JLM104910 •	2
Helical Gear Thrust Brg.	ZN1213	1
Helical Gear Needle Brg.	ZN1212	2
Input Shaft Seal	DTR2592 (3.250x4.250) <sup>56</sup>	1
Thrushaft Seal	DTP2590 (3.000x3.750) •	1
Sealer	RTV Silicone	1

DRK-4842		
Position	Part Number	Qty
Differential Right Brg.	594A-592A	1
Differential Left Brg.	594A-592A	1
Pinion Head Brg.	H715334-H715311	1
Pinion Tail Brg.	72212C-72487	1
Pinion Seal	DTN2588 (3.000x4.937) <sup>58</sup>	1
Sealer	RTV Silicone	1

DRK-4843		
Position	Part Number	Qty
Differential Right Brg.	NP293601-NP934397	1
Differential Left Brg.	NP293601-NP934397	1
Pinion Head Brg.	72212C-72487	1
Pinion Tail Brg.	55206C-55437	1
Pinion Nose Brg.	RU1570UM	1
Pinion Seal	DTN2588 (3.000x4.937) <sup>58</sup>	1
Sealer	RTV Silicone	1

DRK-4844		
Position	Part Number	Qty
Differential Right Brg.	NP970652-NP563664	1
Differential Left Brg.	NP293601-NP934397	1
Pinion Head Brg.	72212C-72487	1
Pinion Tail Brg.	55206C-55437	1
Pinion Nose Brg.	RU1570UM	1
Pinion Seal	DTN2588 (3.000x4.937) <sup>58</sup>	1
Sealer	RTV Silicone	1

<sup>56</sup>Order DTX2728 for updated seal  
<sup>57</sup>Order DTY2729 for updated seal

<sup>58</sup>Order DTZ2730 for updated seal  
<sup>59</sup>Order DTA2731 for updated seal

• Not packed in kit



# NoSPIN<sup>®</sup>

## Heavy Duty Application List

HD Differential

Axle Description	Carrier	Axle Shaft Dia. (2)	# Splines	NoSpin Model Number (1)	Axle Description	Carrier	Axle Shaft Dia. (2)	# Splines	NoSpin Model Number (1)
<b>DANA</b>					<b>Planetary Axles</b>				
<b>Single Rear Axles</b>									
70HD, 70-2U					19060P		2.00"	39	276S-63
4.10 & down gear ratios		1.50"	35	(3) 225SL-58B	21065P, 22065P		2.10"	41	306S-109
4.56 & up gear ratios				(3) 225SL-58A	23080P, 26080P,		2.31"	36	350S-88
80		1.62"	37	225SL-105A	30055P, 35055P				
		1.50"	35	225SL-131A	PR/PS-1200		1.64"	10	250S-34
D135-S		1.55"	36	250S-99			1.64"	32	250S-12
F155-S		1.55"	36	250S-98	PR/PS-1300, 1350, 33R/S40		1.85"	36	250S-99
F170-S		1.55"	36	250S-98	PR-1800		1.75"	19	250S-20
G155-T		1.55"	36	275S-26	PR/PS-7028		1.50"	35	225S-18
G175-S, T, D		1.55"	36	275S-26					
G185-S, D, G190-S		2.00"	39	275S-32	171, 19R		1.16"	13	187S-83
J175-S		1.85"	36	306S-99	172, 22R		1.38"	8	187S-70
J190-S, J210-S, J380-S		2.00"	39	306S-98	<i>See notes on last page.</i>				
J220-S		2.10"	41	306S-100	12D/Sxxxx, 31R38 1230		1.67"	39	225S-102
M185-S, M190-S, T, D		2.00"	39	306S-101	14Txxx 1391		2.00"	39	250S-167
M210-T		2.00"	39	306S-101	14F/D/S/Txxxx, 35R68 1390		2.00"	39	250S-67
M220-S, T, D, M230-T		2.10"	41	306S-117	15Dxxxx 1530		2.00"	39	275S-22
N175-S		1.85"	36	306S-99					
N190-S, N210-S		2.00"	39	306S-98	16D/F/S/Txxxx 1640		2.10"	42	306S-166
S135-S/150-S, 4.63-5.38 gear ratios		1.85"	36	250S-166	42R/F/S/Txxx		2.31"	27 (7)	306S-46
NS/230-S/NS		2.35"	46	350S-106	19D/Txxxx 1850		2.65"	52	350S-21
W230-S		2.35"	46	350S-73	48R/Txxx		2.50"	49	350S-44
15131		1.75"	34	250S-100			2.70"	26	350S-46
16131		1.85"	36	250S-109			2.52"	24	350S-10
17060 S/A, 19060 S/A/T		2.00"	39	275S-63	21Dxxx, 53Rxxx 2050 Conv. Dif.		2.65"	52	450S-133
17131/431		2.00"	39	306S-108	L.S. dif.		2.65"	52	450S-126
21060 S/A, 22060 S/A		2.10"	41	275S-66	PR 1300, 33R40,		1.85"	36	250S-99
21065T, 22065T		2.10"	41	306S-109	PS 1350, 33S40				
21080 S, 22080 S, 23080 S		2.31"	36	350S-86	PR/S-1200		1.64"	10	250S-34
21090 S/A, 23090 S/A		2.31"	36	350S-86	PR-1800		1.75"	19	250S-20
21131/431, 22131/431		2.10"	41	306S-109	PR/S-7028		1.50"	35	225S-18
23080T, 26080T		2.31"	36	350S-88	<i>Service Only</i>				
23105 S/A		2.31"	36	350S-50	D/DS-12/17xxx 1390		2.00"	39	250S-67
23131/431		2.31"	36	306S-110			1.93"	16	250S-14
S-260-SB		2.31"	36	306S-110	D/DS-18/19xxx 1530		2.00"	39	275S-22
26090 S/A		2.31"	36	306S-110			2.06"	24	275S-17
26105 S/A		2.31"	39	350S-40	D/DS-22/23xxx 1640		2.35"	46	306S-73
26131/431		2.31"	36	306S-110	BD-71/91/101xxx		2.31"	27 (7)	306S-46
30105S		2.50"	39	350S-40	D/DS-13xxx 1230		1.67"	39	225S-48
30131/431		2.31"	36	350S-88	D/DS-26/37xxx 1850		2.70"	26	350S-46
							2.52"	24	350S-10
					D/DS-34/75xxx 2050		2.70"	26	450S-125
					Conv. dif.		2.65"	52	450S-133
					L.S. dif.		2.65"	52	450S-126
					D/DS-64/85xxx2500		3.20"	63	550S-34
					D60/65/66,31R/27R		1.59"	10	250S-86
					D80/85		1.93"	16	250S-79
					D90, 39R		2.08"	24	306S-72
					D100		2.22"	26	350S-43
<b>Tandem Axles</b>									
S135, S150, 4.63-5.38 gear ratios		1.85"	36	250S-166					
S230		2.35"	46	350S-106					
G340-S, J340-S, N340-S		2.00"	39	306S-98					
G380-S, J380-S, G400-S,		2.10"	41	306S-100					
J400-S, N-400-S, S400-S									
W440/460-S, (M460-S),									
W230-S/TR-4670		2.35"	46	350S-73					
DS/A 344		2.00"	39	275S-63					
DS 400, DT 401, 451		2.13"	33	306S-56					
D/T 403, DS/A 404, 405, DSS 40		2.10"	41	275S-66					
DP/T 402, 4026, 451		2.10"	41	306S-109					
DS/A 454		2.10"	41	275S-66					
DT460		2.31"	36	306S-110					
		2.30"	22	306S-39					
DS 461 462, 463, 521, 581		2.31"	36	350S-47					
DP/T 461, 463, 521,									
580, 601, 650, 651		2.31"	36	350S-88					



Axle Description	Carrier	Axle Shaft Dia. (2) # Splines	NoSpin Model Number (1)	Axle Description	Carrier	Axle Shaft Dia. (2) # Splines	NoSpin Model Number (1)
<b>DEERE</b>				<b>Tandem Axles</b>			
Series 1	444/A/B/C/D, 544A, 644A	2.06" 18	306S-60	34 RT		2.00" 39 2.00" 16	306S-108 306S-21
Series 2	544/B/C/D, 740, 762	2.08" 32	306S-61	34 DS/T, DP/S/T, 340, 341, 346, DS/T/P 3416		2.00" 39 2.00" 16	306S-108 306S-21
Series 3	644/B/C/D, 646 C	2.30" 22 2.05" 22	306S-62 306S-148	DS/C/T/P-341 DS/A-344		2.00" 39 2.00" 39	306S-108 275S-63
1100/1200		1.50" 23	225S-80	38 DP/S/T, DP/S/T, 380, 381, 4026, 381, 386		2.10" 41 2.12" 16	306S-109 306S-23
1200	544E Front	2.06" 18	306S-167	DS/C/T/P 402, DS/T/P 4036		2.10" 41	306S-109
1400	624/644E Front	2.33" 22	306S-149	DS/P/T 400, 401, 406		2.13" 33	306S-56
1600	744E Front	2.33" 22	306S-173	42 DP		2.12" 16	306S-23
<b>EATON</b>				44 DT/P 440, 446		2.31" 36 2.30" 22	306S-110 306S-39
<b>Single Rear Axles</b>				DS 404/454		2.10" 41	275S-66
13101, 13107, 13802, 15040S/T/P		1.75" 34	250S-100	DS/C/T/P 451		2.10" 41 2.13" 33	306S-109 306S-56
15101, 15107, 15201		1.87" 16	250S-37	DS/T/P 460, 466		2.31" 36	306S-110
15301		1.75" 19	250S-20	DS/C 461, DS 4616		2.31" 36	350S-47
16120, 16121, 16221, 16244		1.85" 36	250S-109	DT/P 461, 4616		2.31" 36	350S-88
16344		1.88" 16	(a) 250S-44	DS-466		2.31" 36	306S-110
		1.88" 16	(b) 250S-45	DS-480, 486		2.31" 36 2.30" 22	350S-47 350S-39
(a) tapered spline (b) parallel spline				DT/P 480		2.31" 36 2.30" 22	306S-110 306S-39
16247		1.80" 30	250S-39	DT/P 485		2.31" 36 (6)	350S-71
17060, 19060		2.00" 39	275S-63	50 DP		2.13" 33	306S-56
17101, 17121, 17201, 17221, 17301, 17321, 17401*, 17421*		2.00" 39 1.98" 16	306S-108 306S-21	DS 520		2.50" 39	350S-40
17201 (Mack)		2.12" 33	306S-56	DT/P 520		2.50" 39	See Note (4)
18101, 18121, 18201, 18221, 18301		2.10" 41 2.12" 16	306S-109 306S-23	DS/C 521, DS 5216		2.31" 36	350S-47
18127 (Mack)		2.12" 33	306S-53	DT/P 521, 5216		2.31" 36	350S-88
185 S4/P4, 190 S4/T4/P4		2.00" 39	306S-108	DP 580, 586		2.50" 39	See Note (4)
19050 S/T/P		1.85" 36	275S-51	DS/C 581		2.31" 36	350S-47
19055 S/T/P		2.00" 39	306S-108	DP 581, 601, 651, 652		2.31" 36	350S-88
19060S		2.00" 39	275S-63			DP 650, 656 2.50" 39	See Note (4)
19101, 19121, 19201		2.31" 36 2.30" 22	306S-110 306S-39	<b>Planetary Axles</b>			
21060 S/D/A		2.10" 41	275S-66	WR 3, 5	13100	1.75" 34	250S-100
21065 S/D/T/P, 21121, 21221, 21321		2.10" 41	306S-109	WR 7	16100	1.85" 36 2.10" 41	250S-109 306S-109
21080 S		2.31" 36	350S-86	WR 10	DS402 Front	2.10" 41	306S-109
22060 S		2.10" 41	275S-66		21065 Rear	2.10" 41	306S-109
22065 T		2.10" 41	306S-109	WR 12	23070	2.12" 33	306S-56
220 S4/P4, 22065 S/D/T/P, 22080 S		2.10" 41 2.31" 36	306S-109 350S-86	WR 31	13000	1.87" 16	250S-37
22121, 22221, 22321		2.12" 16	306S-23	WR 51	15000	1.75" 19 1.87" 16	250S-20 250S-37
23070 S/D		2.31" 36	350S-86	WR 61	17000	1.87" 16	306S-119
23070 T/P		2.12" 33	306S-56	WR 81	18000	2.12" 16	306S-23
23080 S		2.31" 36	350S-86	<b>CHEVROLET/GMC</b>			
23080 T		2.31" 36	350S-88	<b>Single Rear Axles</b>			
23085 S/D		2.31" 36	350S-86	C100	Rockwell	1.62" 32 1.62" 16	225S-52 225S-15
23070S, 23085 T/P		2.31" 36	350S-88	H110	12-1/4" dia. r.g.	1.75" 27	250S-27
23105 S/D		2.50" 39	350S-40	H135	13-7/32" dia. r.g.	1.87" 29	250S-46
(1996 & newer)		2.31" 36	350S-50	H150		1.87" 29	250S-46
230 S4, 23121, 23421		2.31" 36 2.30" 22	350S-47 350S-39	H170		1.87" 29	250S-46
230 P4/T4, 23221, 23321		2.31" 36 2.30" 22	306S-110 306S-39	H175		1.87" 29	250S-46
E2300 S		2.50" 39	350S-40	H175		2.00" 39	306S-79
25100		2.50" 39 2.31" 36 2.30" 22	350S-40 350S-47 350S-19	T150		1.87" 29	275S-12
26080 T		2.31" 36	350S-88	T170		1.87" 29	275S-12
260 S4, 26121		2.30" 36 2.30" 22	350S-47 350S-39	T175	Eaton 16244	1.85" 36	250S-109
260 P4, 26085, 26221, 26321		2.31" 36 2.30" 22	306S-110 306S-39	T185		1.87" 29	275S-12
26105 S/C		2.50" 39	350S-40	See notes on last page.			
260 S4, 26121		2.31" 36 2.30" 22	350S-47 350S-39				
30055-P		2.31" 36	350S-88				
30105 S/C, 30127		2.50" 39	350S-40				
30227, 30327		2.5 39	See Note (4)				
35055-P		2.31" 36	350S-88				
35327		2.50" 39	See Note (4)				

Axle Description	Carrier	Axle Shaft Dia. (2)	# Splines	NoSpin Model Number (1)	Axle Description	Carrier	Axle Shaft Dia. (2)	# Splines	NoSpin Model Number (1)
------------------	---------	------------------------	-----------	----------------------------	------------------	---------	------------------------	-----------	----------------------------

## INTERNATIONAL Single Rear Axles

<b>14Axx</b>				
CA CD DC DD DG		2.00"	39	306S-98
DH DK DW DY NA	I-N190,210			
CE CG DB DL				
DM DV DX GD	I-N175	1.85"	36	306S-99
CB CC DN DP	D-S100,122	1.85"	36	250SL-166
	135,150			
CH DZ	D-W230	2.35"	46	350S-73
CJ EB EJ GH GL GS	D-23090	2.31"	36	350S-86
DA DE DJ	D-F155	1.85"	36	250S-98
DR	I-S230	2.35"	46	350S-106
DT	D-N220	2.10"	41	306S-100
DW DY	D-J210, I-N190	1.86"	36	306S-98
EE GB	E-22065,23080	2.10"	41	306S-109
EG	E-26105	2.31"	36	306S-110
EH	E-19055	2.00"	39	306S-108
EP GK	E-30105	2.50"	39	350S-40
ET EY GG GP	D-21060,22060	2.10"	41	275S-66
GA GE GM GN GT	D-19060	2.01"	39	275S-63
	17060			
RA RG SR SU	R-R S21145	2.10"	41	275S-43
RH SZ TB	R-RS18145,19145	2.00"	39	275S-44
RB RC RD RE				
RK RR RS RV	R-RS23160	2.35"	46	350S-81
	23161, 21162			
SE SG SH SK				
SM SN SP SX SY				
<b>14Cxx</b>				
DA	D-G155	1.85"	36	250S-98
DB DC	D-M230	2.10"	41	306S-117
DD	D-G175	1.85"	36	275S-26
DE DG EH EJ				
EK EL ES ET EU	26080	2.10"	41	306S-109
	23080			
EA	E-23070	2.31	36	350S-86
EB	E-26085	2.31"	36	306S-110
EG EP EV	D-19055	2.00"	39	306S-108
EM EN ER	R-RS23240	2.10"	41	306S-124
VA	R-RS19224/220	1.85"	36	275S-37
VB	R-RS21230	2.00"	39	306S-127
<b>14Exx</b>				
EB	E-26085	2.31"	36	306S-110
RA RB	R-RS26/30380	2.35"	46	350S-93
RC	R-RS38380	2.55"	50	350S-79
<b>140xx, 14xxx</b>				
29 39	D-F155/170	1.85"	36	250S-98
30	D-D135	1.85"	36	250S-99
32	D-G190	2.00"	39	275S-32
33 132	D-M220/230	2.10"	41	306S-117
36 44	D-J210/190	2.00"	39	306S-98
42	D-J175	1.85"	36	306S-99
47	D-J220	2.05"	41	306S-100
51 52	R-RS23160	2.35"	46	350S-81
57	D-W230	2.35"	46	350S-73
72 73 92	R-RS170	2.35"	46	350S-57
77 91	E-23121/26121	2.31"	36	350S-47
97	231055SL	2.50"	39	350S-40
87 186	E17101/202	2.00"	39	306S-108
88 193 194				
197 282 293	E-19/23/26 xxx	2.31"	36	306S-110
118 119 192 292	E-17/18/22 xxx	2.10"	41	306S-109
130	D-G175	1.85"	36	275S-26
131 133	D-M190/210	2.00"	39	306S-101
168 178 277	R-RS R/U xxx	2.38"	24	350S-13
187	E-15201	1.75"	34	250S-100
199	E-16244	1.85"	36	250S-109
298	E-35327	2.50"	39	306S-96

D=Dana/Spicer E=Eaton I=Int'l. R=Rockwell/Meritor

## Tandem Axles

<b>14Gxx</b>				
DA	I-N340	2.00"	39	306S-98
DC DE DG	DKI-N400, D-S400	2.10"	41	306S-100
DL DM EL EN	D-DP/S402/7, DST41	2.10"	41	306S-109
JD/E rear				
EB EH GE GP	D-DC/S461/2/3/521/540	2.31"	36	350S-47
GT GW GZ HZ				
EC ED EW	D-DT 461/3/521, Dp463	2.31"	36	350S-88
EY GU GV				
EE	E-DS 466	2.31"	36	350S-110
EP ER ES ET EX GG	D-DS404/5/54	2.10"	41	275S-66
GJ GL HA HC	DSH 44, DST 41			
JC JD/E front				
HD	D-DS344	2.00"	39	275S-63
RA RX	R-RT34140/145	2.00"	39	275S-44
RB RC RU RW RY SB	R-RT40140/5	2.10"	41	275S-43
SG SX TK TL UD UN UP	44145, 34144			
RD RE/RG/RH rear RP	R-RT23/48/52/	2.35"	46	350S-81
RR SC SD SE SU TA	58180, 46/52160			
TG TM TN UE UM				
RE/RG/RH front	R-RT48/52/58180,	2.35"	46	350S-93
RJ RL RV ST	52/58380			
RK RM	R-RT70380	2.55"	50	350S-79
SY TV	R-RQ100, RC17350	2.10"	41	306S-15
TE TY TZ	R-RS23/46157/8, 44158	2.35"	46	350S-57
UG UH UJ				
UB	R-RS23240	2.10"	41	306S-124
VA	D-BD71000	2.36"	27	306S-46
<b>14Hxx</b>				
RA RB RC RD	R-RT 46160/4	2.35"	46	350S-81
RE RH RJ RL RM				
RN RP	R-RT40145	2.10"	41	275S-43
<b>14xxx</b>				
307, 467	E-DS 480, 44DS	2.31"	36	350S-47
308, 309,	E-DS/DT 402, D 301	2.10"	41	306S-109
494, 496, 497				
328	R-SLHD	2.00"	21	306S-11
333, 334	R-SQHD	2.13"	22	306S-12
337, 369, 431	R-SU270/DD, R170	2.35"	46	350S-57
341	D-FIXX	1.85"	36	250S-98
342	E-DT401	2.13"	33	306S-56
343, 353, 354,				
377, 469	E-DP/S/T460, 44DP	2.31"	36	306S-110
345, 350, 357, 434	R-SQ100, SQHP	2.10"	41	306S-15
351, 475, 476	D-G/J340/380	2.00"	39	306S-98
355, 472*	D-G380, J400	2.10"	41	306S-100
364, 365, 389, 399,	R-SUD/DD	2.35"	46	350S-57
431, 459	SS/STHD, R170			
367, 368	R-STD/DD	2.35"	46	350S-55
372, 373, 382, 383	R-SFD/DD	2.55"	50	350S-79
437, 474*	D-W230/460	2.35"	46	350S-73
464, 502	E-DS401/451	2.13"	33	306S-56
472*	D-J400	2.13"	20	306S-19
474*	D-W460	2.30"	22	350S-72
486, 500	E-DP580/650	2.50"	39	306S-44
488, 493, 498	E=DS/T341	2.00"	39	306S-108
<b>Planetary Axles</b>				
<b>14Exx</b>				
EC ED	E-3505SP	2.31"	36	350S-88
EH	E-26080P	2.10"	41	306S-109
RA RB	RS-26380,30380	2.35"	46	350S-93
RC	Rs38380	2.50"	50	350S-79

\* Count splines to determine correct NoSPIN model. D=Dana/Spicer E=Eaton I=Int'l. R=Rockwell/Meritor See notes on last page.



Axle Description	Carrier	Axle Shaft Dia. (2) # Splines	NoSpin Model Number (1)	Axle Description	Carrier	Axle Shaft Dia. (2) # Splines	NoSpin Model Number (1)
<b>MERITOR</b>							
<b>Single Rear Axles</b>							
RS-13/15-120		1.75" 34	250S-134	RS-38-380		2.55" 50	350S-79
3.31-4.30 ratio				RS-410#		1.45" 29	225S-39A
4.56-7.17 ratio		1.95" 38	250S-128	S-162, 163		2.25" 23	350S-25
RS-15/17/19-220/224		1.85" 36	275S-37	S-164, 165		2.38" 24	350S-13
RS-17/19-144		2.10" 41	275S-43	S-170		2.35" 46	350S-57
RS-17/19-145		2.00" 39	275S-44			2.38" 24	350S-13
RS-19-220/224		1.85" 36	275S-37	SL-100		2.00" 39	306S-79
RS-21-145		2.10" 41	275S-43	SR-170		2.38" 24	350S-13
RS-21/23-160/160A/161/186		2.35" 46	350S-81	SW-170/180, 270/280		2.55" 50	350S-79
RS-21-230		2.00" 39	306S-127	U-170, 180, 240, 340		2.38" 24	350S-13
RS-23-240		2.10" 41	306S-124	U-270, 340		2.35" 46	350S-57
RS-23/26/30-380		2.35" 46	350S-93	W/WP/WR-170		2.55" 50	350S-79
RS-25/26-160/160A/185		2.35" 46	350S-81	W-180, 270, 280		2.55" 50	350S-63
RS-38-380		2.55" 50	350S-79	W-464		2.55" 50 (5)	350S-56
C-100, 102, 200		1.62" 32	225S-52	59732, 59733 (WT)		2.38" 16	350S-29
		1.62" 16	225S-15	59742, 59743 (WT)		2.38" 24	350S-13
D-100, 140		1.75" 34	250S-97	61142, 61143 (WT)		2.35" 46	350S-81
		1.75" 19	250S-13	*Di Rona Mexico #Brazil See notes on last page.			
		1.75" 16	250S-32	<b>Tandem Axles</b>			
F-106, 140, 146		1.75" 34	250S-97	RT-34/40-144/145/149		2.10" 41	275S-43
		1.75" 19	250S-13	RT-40/46/50-160/164/169,		2.25" 44	306S-136
FM-240		2.13" 22	306S-12	RT-40/44-145			
H-140, 145, 340		1.88" 20	275S-11	RT-48/50/52/58/70-185/380		2.35" 46	350S-93
H-140E		2.25" 44	306S-136	RZ-166		2.35" 46	350S-81
H-162		2.00" 21	306S-11	RZ-186 front		2.35" 46	350S-93
H-170, 171		1.85" 36	275S-10	rear		2.35" 46	350S-81
H-172, 173		2.00" 39	306S-79	RZ-188		2.35" 46	350S-93
L-145, 155		2.00" 21	306S-11	R-170/TKN 4670		2.35" 46	350S-57
L-164		1.88" 20	276S-11			2.38" 24	350S-13
L-172		2.00" 39	306S-79	RT 34-140, 145		2.00" 39	275S-44
L-245, 345		2.00" 21	306S-25				
L-362		2.00" 21	306S-25	RT 46/48/52-160		2.55" 50	350S-76
M-172		2.00" 39	306S-79			2.35" 46	350S-81
M/FM-240		2.12" 16	306S-36	RT 48/52/58-180 front		2.35" 46	350S-93
M/MD-240		2.13" 22	306S-12	rear		2.35" 46	350S-81
P-140E		2.25" 44	306S-136	RT 48/52/58-380		2.35" 46	350S-93
P-174		2.10" 41	306S-15	RT 70-180		2.55" 50	350S-76
Q-100		2.10" 41	306S-15	RT 70-380		2.55" 50	350S-79
Q-145		2.13" 22	306S-31	SDH/SDHD		1.75" 16	250S-32
Q-345		2.13" 22	306S-38	SFD (C-240)		1.62" 16	225S-15
R-140		2.25" 23	350S-25	SFD (M-240)		2.12" 16	306S-36
R-140E		2.25" 44	306S-136	SFD/SFDD 4640, 47		2.55" 50 (5)	350S-56
R-140, 155*, 200, 221,						2.50" 16 (5)	350S-52
255*, 270, 300, 355		2.38" 24	350S-13	SFH/SFHD		1.75" 34	250S-97
R-355/356		2.35" 46	350S-57			1.75" 19	250S-13
R-170		2.38" 16	350S-29	SHD, SHR		2.38" 24	350S-13
		2.38" 24	350S-13	SHHD/SJHD		1.87" 20	275S-11
RL-170		2.35" 46	350S-57	SLD/SLDD		2.00" 21	306S-11
		2.38" 24	350S-13			2.00" 16	306S-22
RS-13-120, 15-120/125		1.75" 34	250S-134	SL 100		2.00" 39	306S-79
4.56-7.17 ratio		1.95" 38	250S-128	SLHD		2.00" 21	306S-11
RS-15-210		1.75" 34	250S-139	SLHR/T-3000		2.00" 21	306S-11
RS-17-140		2.00" 39	275S-44	SQHD		2.13" 22	306S-12
		1.85" 36	275S-46			2.00" 21	306S-25
RS-17-144, 145		2.00" 39	275S-44	SQHP, SQ 100		2.10" 41	306S-15
RS-17-220		1.85" 36	275S-37	SQR 100		2.10" 41	306S-15
RS-18-140, 145		2.00" 39	275S-44	SR 170, 270, 280		2.35" 46	350S-57
		1.85" 36	275S-46			2.38" 24	350S-13
RS-19-145		2.00" 39	275S-44	SRD/SRDD		2.35" 46	306S-84
RS-19-220		1.85" 36	275S-37			2.25" 23	306S-35
RS-20-145		2.25" 44	306S-136	SRHD		2.25" 23	306S-35
		2.10" 41	275S-43	SSHD		2.35" 46	350S-57
RS-20-230		2.00" 39	306S-127			2.38" 24	350S-13
RS-21-145		2.10" 41	275S-43			2.25" 23	350S-25
RS-21-230		2.00" 39	306S-127	ST 170		2.38" 24	350S-13
RS-23-160, 180		2.35" 46	350S-81	STD,STDD,STD-DD		2.35" 46	350S-55
		2.55" 50	350S-76			2.38" 24	350S-36
RS-23-240		2.10" 41	306S-124	STHD		2.38" 46	350S-57
RS-23-380		2.35" 46	350S-93			2.38" 24	350S-13
RS-25/26-160, 180		2.35" 46	350S-81	SU 170, SUD/SUDD, SUHD		2.35" 46	350S-57
RS-26-380		2.35" 46	350S-93			2.38" 24	350S-13
RS-30-180		2.35" 46	350S-81	SU 270, 280		2.35" 46	350S-57
RS-30-380		2.35" 46	350S-93			2.38" 24	350S-13
				SW 170, 180, 270, 280		2.55" 50	350S-79
				FLDD, LDD-240		2.13" 22	306S-12

Axle Description	Carrier	Axle Shaft Dia. (2) # Splines	NoSpin Model Number (1)
LDF		2.00" 21	306S-25
LDH/R		2.00" 21	306S-11
QHD/R		2.00" 21	306S-25
RDD/F/R		2.35" 46	306S-84
SHD/R		2.38" 24	350S-13
		2.35" 46	350S-57
TDD/F/R		2.35" 46	350S-55
UDD/F/R		2.38" 24	350S-13
		2.35" 46	350S-57

### Planetary Axles

#### SINGLE - PR

204/5, 265	D/F-140	1.75" 19	250S-13
184, 824	H-172	1.88" 20	306S-42
673	L-172	2.13" 22	306S-12
352/3, 382	PRA Series	1.60" 31	225S-122
1736	QR-100	2.10" 41	306S-15
867	R-155	2.13" 22	350S-15
3805, 4805	R-155	2.38" 24	350S-15
594, 671	RS-120/125	1.75" 34	250S-134
	RS-120/125	1.95" 38	250S-128
416, 425, 673	RS-145	2.00" 39	275S-44
756, 775, 1314			
727, 866, 1206,	RS-145	2.10" 41	275S-43
1735, 1756, 1794			
5225, 7534	RS-186	2.55" 50	350S-76
674	RS-220	1.85" 36	275S-44
134	53500	1.75" 16	250S-23

#### TANDEM-SP

673	RT-145	2.00" 39	275S-44
1927	RT-160	2.35" 46	350S-81
4808	RT-380	2.55" 50	350S-79
1356, 1735	SQHP	2.10" 41	306S-15
1927	SR-170	2.38" 24	350S-15

#### STEER-PS

205, 594	F-140	1.75" 19	250S-13
824/5	H-172	1.88" 20	306S-42
824/5	L-172	2.13" 22	306S-12
1614	Q-100	2.13" 22	306S-31
		2.10" 41	306S-92
1044, 1617, 1794	QR-100	2.10" 41	306S-15
1485, 1875, 4564	R-155	2.13" 22	350S-19
		2.38" 24	350S-15
205, 594	RS-120/125	1.75" 34	250S-134
	RS-120/125	1.95" 38	250S-128
826, 1044, 1614,	RS-145	2.10" 41	275S-43
1794			
1876	RS-160	2.35" 46	350S-81
SVI 5000 series		1.71" 33	
717SV166			

#### SINGLE PR, TANDEM SP, STEER PS

134, 164, 267, 268	53500	1.75" 16	250S-23
274	C-100	1.62" 16	225S-15
203	C-102	1.65" 32	225N-52
165, 166, 175, 176,	D-140/142	1.75" 19	250S-13
204, 205#, 264, 265,	F-140/145		
353, 354, 515, 524			
574, 593, 594#, 595,			
671#, 723, 724, 823			
592, 596*, 614*, 672*	H-140/150/340	1.88" 20	275S-11
674, 824*, 863*, 1103*, 1374*			
184, 577#, 596*, 614*,	H-172	1.88" 20	306S-42
672*, 694#, 726, 824*, 825#,			
834, 863*, 1103*, 1374*			
784, F106		1.77" 19	250S-13
576, 595, 671#,	HHD Front	1.88" 20	275S-11
1743, 1753	H-172 Rear	1.88" 20	306S-42

Axle Description	Carrier	Axle Shaft Dia.(2) #Splines	NoSpin Model Number (1)
<b>Planetary Axles</b>			
150#, 154#, 158#, 202, 235#, 483, 655, 673#, 695#, 825#, 864, 1104	L-172	2.13" 22	306S-12
577#, 615, 673#, 695#, 803, 855	L-172	2.00" 21	306S-11
362	L-172	2.00" 39	306S-79
673	L-345	2.00" 21	306S-11
150, 158#, 202, 235#, 413		2.00" 21	306S-25
5054, 7314#, 10253	PR-700	2.75" 54	450S-146
7314#	PR-700	2.63" 26	450S-129
1756#	Q-100	2.25" 23	306S-35
208, 209, 210	Q-100/145	2.13" 22	306S-31
250, 251, 266			
676, 804, 826, 1044, 1314, 1355, 1614#			
1614#	Q-100	2.10" 41	306S-92
827, 1044, 1105, 1284, 1357, 1617, 1736, 1794#	Q-100	2.10" 41	306S-15
207, 677, 827, 866, 867, 1315, 1485, 1615, 1725, 1757#	R-140/155	2.13" 22	350S-19
1757#, 1875, 1925, 1935, 3795, 3805, 4025, 4564, 4805	R-140/155	2.38" 24	350S-15
1045, 1737, 1757#	R-140/155	2.15" 23	350S-16
258#, 305#, 312#, 1927#, 3796, 4264, 4565, 4807, 4874	R-170	2.38" 24	350S-15
4824, 5814, 5095	R-170/180	2.45" 48	350S-75
677	R-355	2.38" 24	350S-15
205#, 265, 415, 454	RS-120/125	1.75" 34	250S-134
594#, 671#			
755, 775	RS-125	1.95" 38	250S-128
416, 673#, 756#, 1314	RS-140/145	2.00" 39	275S-44
673#, 727, 826, 866, 867, 1044, 1105, 1614, 1735#, 1756, 1794	RS-145	2.10" 41	275S-43
756#	RS-145	1.85" 36	275S-46
1876, 1927#	RS-160	2.35" 46	350S-81
5225, 7534, 10253	RS-180/185/186	2.55" 50	350S-76
674	RS-220	1.85" 36	275S-37
230	RS-230	2.00" 39	306S-127
4808#	RN-380	2.38" 24	350S-15
	RP/RT-380	2.55" 50	350S-79
	RR-380	2.35" 46	350S-93
258#, 305#, 311#, 1927#, 4806	SR-170	2.38" 24	350S-15
1356, 1357, 1616, 1735# 1736	SQHP, SQ-100	2.10" 41	306S-15
1926, 4026	SSHD SSHP	2.38" 24	350S-13
5324	WR-170	2.55" 50	350S-79

\*May have either H-140 or H-172 carrier; check carrier to determine correct NoSPIN differential. #Produced with different axle shafts: count splines to determine correct NoSPIN differential.

Axle Description		Carrier	Axle Shaft Dia. (2) # Splines	NoSpin Model Number (1)	Axle Description		Carrier	Axle Shaft Dia. (2) # Splines	NoSpin Model Number (1)
<b>MERITOR</b>									
<b>Single Rear Axles</b>									
RS-13/15-120			1.75" 34	250S-134	RS-38-380			2.55" 50	350S-79
3.31-4.30 ratio					RS-410#			1.45" 29	225S-39A
4.56-7.17 ratio			1.95" 38	250S-128	S-162, 163			2.25" 23	350S-25
RS-15/17/19-220/224			1.85" 36	275S-37	S-164, 165			2.38" 24	350S-13
RS-17/19-144			2.10" 41	275S-43	S-170			2.35" 46	350S-57
RS-17/19-145			2.00" 39	275S-44				2.38" 24	350S-13
RS-19-220/224			1.85" 36	275S-37	SL-100			2.00" 39	306S-79
RS-21-145			2.10" 41	275S-43	SR-170			2.38" 24	350S-13
RS-21/23-160/160A/161/186			2.35" 46	350S-81	SW-170/180, 270/280			2.55" 50	350S-79
RS-21-230			2.00" 39	306S-127	U-170, 180, 240, 340			2.38" 24	350S-13
RS-23-240			2.10" 41	306S-124	U-270, 340			2.35" 46	350S-57
RS-23/26/30-380			2.35" 46	350S-93	W/WP/WR-170			2.55" 50	350S-79
RS-25/26-160/160A/185			2.35" 46	350S-81	W-180, 270, 280			2.55" 50	350S-63
RS-38-380			2.55" 50	350S-79	W-464			2.55" 50 (5)	350S-56
C-100, 102, 200			1.62" 32	225S-52	59732, 59733 (WT)			2.38" 16	350S-29
			1.62" 16	225S-15	59742, 59743 (WT)			2.38" 24	350S-13
D-100, 140			1.75" 34	250S-97	61142, 61143 (WT)			2.35" 46	350S-81
			1.75" 19	250S-13	*Di Rona Mexico #Brazil See notes on last page.				
			1.75" 16	250S-32	<b>Tandem Axles</b>				
F-106, 140, 146			1.75" 34	250S-97	RT-34/40-144/145/149			2.10" 41	275S-43
			1.75" 19	250S-13	RT-40/46/50-160/164/169,			2.25" 44	306S-136
FM-240			2.13" 22	306S-12	RT-40/44-145				
H-140, 145, 340			1.88" 20	275S-11	RT-48/50/52/58/70-185/380			2.35" 46	350S-93
H-140E			2.25" 44	306S-136	RZ-166			2.35" 46	350S-81
H-162			2.00" 21	306S-11	RZ-186 front			2.35" 46	350S-93
H-170, 171			1.85" 36	275S-10	rear			2.35" 46	350S-81
H-172, 173			2.00" 39	306S-79	RZ-188			2.35" 46	350S-93
L-145, 155			2.00" 21	306S-11	R-170/TKN 4670			2.35" 46	350S-57
L-164			1.88" 20	276S-11				2.38" 24	350S-13
L-172			2.00" 39	306S-79	RT 34-140, 145			2.00" 39	275S-44
L-245, 345			2.00" 21	306S-25					
L-362			2.00" 21	306S-25	RT 46/48/52-160			2.55" 50	350S-76
M-172			2.00" 39	306S-79				2.35" 46	350S-81
M/FM-240			2.12" 16	306S-36	RT 48/52/58-180 front			2.35" 46	350S-93
M/MD-240			2.13" 22	306S-12	rear			2.35" 46	350S-81
P-140E			2.25" 44	306S-136	RT 48/52/58-380			2.35" 46	350S-93
P-174			2.10" 41	306S-15	RT 70-180			2.55" 50	350S-76
Q-100			2.10" 41	306S-15	RT 70-380			2.55" 50	350S-79
Q-145			2.13" 22	306S-31	SDH/SDHD			1.75" 16	250S-32
Q-345			2.13" 22	306S-38	SFD (C-240)			1.62" 16	225S-15
R-140			2.25" 23	350S-25	SFD (M-240)			2.12" 16	306S-36
R-140E			2.25" 44	306S-136	SFD/SFDD 4640, 47			2.55" 50 (5)	350S-56
R-140, 155*, 200, 221,								2.50" 16 (5)	350S-52
255*, 270, 300, 355			2.38" 24	350S-13	SFH/SFHD			1.75" 34	250S-97
R-355/356			2.35" 46	350S-57				1.75" 19	250S-13
R-170			2.38" 16	350S-29	SHD, SHR			2.38" 24	350S-13
			2.38" 24	350S-13	SHHD/SJHD			1.87" 20	275S-11
RL-170			2.35" 46	350S-57	SLD/SLDD			2.00" 21	306S-11
			2.38" 24	350S-13				2.00" 16	306S-22
RS-13-120, 15-120/125			1.75" 34	250S-134	SL 100			2.00" 39	306S-79
4.56-7.17 ratio			1.95" 38	250S-128	SLHD			2.00" 21	306S-11
RS-15-210			1.75" 34	250S-139	SLHR/T-3000			2.00" 21	306S-11
RS-17-140			2.00" 39	275S-44	SQHD			2.13" 22	306S-12
			1.85" 36	275S-46				2.00" 21	306S-25
RS-17-144, 145			2.00" 39	275S-44	SQHP, SQ 100			2.10" 41	306S-15
RS-17-220			1.85" 36	275S-37	SQR 100			2.10" 41	306S-15
RS-18-140, 145			2.00" 39	275S-44	SR 170, 270, 280			2.35" 46	350S-57
			1.85" 36	275S-46				2.38" 24	350S-13
RS-19-145			2.00" 39	275S-44	SRD/SRDD			2.35" 46	306S-84
RS-19-220			1.85" 36	275S-37				2.25" 23	306S-35
RS-20-145			2.25" 44	306S-136	SRHD			2.25" 23	306S-35
			2.10" 41	275S-43	SSHD			2.35" 46	350S-57
RS-20-230			2.00" 39	306S-127				2.38" 24	350S-13
RS-21-145			2.10" 41	275S-43				2.25" 23	350S-25
RS-21-230			2.00" 39	306S-127	ST 170			2.38" 24	350S-13
RS-23-160, 180			2.35" 46	350S-81	STD,STDD,STD-DD			2.35" 46	350S-55
			2.55" 50	350S-76				2.38" 24	350S-36
RS-23-240			2.10" 41	306S-124	STHD			2.38" 46	350S-57
RS-23-380			2.35" 46	350S-93				2.38" 24	350S-13
RS-25/26-160, 180			2.35" 46	350S-81	SU 170, SUD/SUDD, SUHD			2.35" 46	350S-57
RS-26-380			2.35" 46	350S-93				2.38" 24	350S-13
RS-30-180			2.35" 46	350S-81	SU 270, 280			2.35" 46	350S-57
RS-30-380			2.35" 46	350S-93				2.38" 24	350S-13
					SW 170, 180, 270, 280			2.55" 50	350S-79
					FLDD, LDD-240			2.13" 22	306S-12



## TABLE OF CONTENTS

Axle Type Illustration.....	Page49
Eaton to NCB Interchange List.....	Page50
Rockwell to NCB Interchange List.....	Page52
Numerical Listing Rockwell Assemblies.....	Page53
NCB Axle Shaft No. to Original Equipment Mfg. & Specifications.....	Page54
Principal Applications & Approx. Shipping Weights.....	Page71
Sample Identification.....	Page73

### SPECIAL AXLES & SHAFTS

Our Modern equipment and facilities enable us to produce all types of shafts for Trucks and Tractors as well as for other innumerable uses. Submit your drawings and specifications, and quotations will be promptly forwarded.

### GENERAL INFORMATION

Our axles and drive shafts are manufactured for the replacement trade. It is not intended to convey the thoughts that they are original shafts made by the truck or assembly manufacturer. They are sold for use in replacing broken or worn shafts and should be resold by the vendor for such purposes only. Vehicles or assembly manufacturers' part numbers are used to aid in selection of our proper number.

## AXLE-TYPES

The illustrations below classify the principal types of Axles listed in the Catalog. The symbols appear in the alphabetical listing in the column headed "Type and Number of Splines." The letter symbol identifies the type, and the numeral suffix the number of splines. Flanged axles, unless otherwise noted, are measured from inside of flange to end of spline.



TYPE B

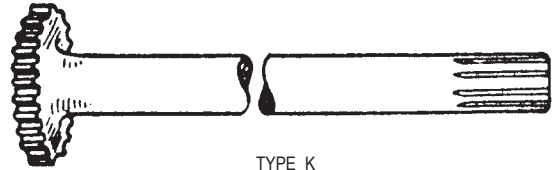

TYPE K

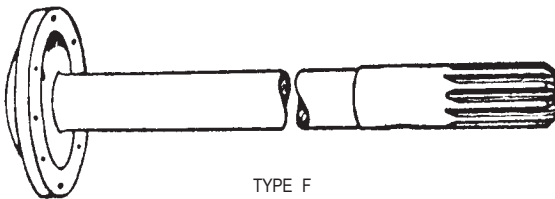

TYPE F  
INTERGRAL FLANGE



TYPE M  
MF-Type M with Press-on Flange



TYPE R

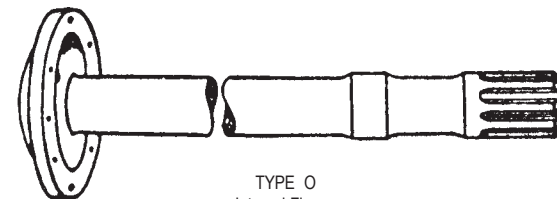

TYPE O  
Integral Flange



TYPE J  
JF-Type with Press-on Flange

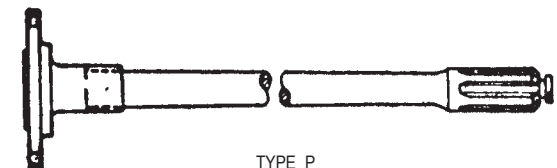

TYPE P

Type "T" same as Type "P", without lock key groove.



# Heavy Duty Axle Shafts

HD Differential

## EATON TO NCB INTERCHANGE LIST

Dana/Eaton Number	NCB Number	Dana/Eaton Assembly Series	Dana/Eaton Number	NCB Number	Dana/Eaton Assembly Series
15461	AS655	IHC	52281	AS1026	30
22586	AS872R	17	53597	AS1051	19-20-23
22619	AS729	19-20	54014	AS1040	19-23-26-44-440-480
22638	AS732A	17-18-34	55293	AS1022L	GMC
27847	AS834	18-38-42	55294	AS1022R	GMC
28429	AS732A	17-18-34	55957	AS1051	19-20-23
29130	AS732A	17-18-34	55987	AS1057	16
29458	AS732A	17-18-34	56203	AS864	18-38
30024	AS834	18-38-42	56979	AS1026	30
30470	AS847	16	56980	AS749	17-34-340
30562	AS864	18-38	56981	AS1052	18-38-380
30687	AS749	17-34-340	58975	AS1053	16
31136	AS855	16	59502	AS1058	16-30
31403	AS758	16-30	62164	AS1048	16-30-34
31673	AS763A	15	62165	AS1049	17-34-340
31928	AS842R	17	62166	AS1087	18-22-38-380
32586	AS846	13-15	62214	AS732A	17-18-34
32686	AS749	17-34-340	64130	AS1063	18-38-380
34689	AS732A	17-18-34	64893	AS732A	17-18-34
35310	AS858	13	64973	AS749	17-34-340
35332	AS866	13-15	65360	AS1054	13-15
37150	AS953	19	67591	AS1049	17-34-340
37303	AS864	18-38	67742	AS834	18-38-42
37311	AS729	19-20	67747	AS1040	19-32-26-44-440-480
37357	AS842R	17	67790	AS842R	17
37396	AS732A	17-18-34	72617	AS1058	16-30
37405	AS732A	17-18-34	76917	AS1104	38-380
37406	AS732A	17-18-34	79005	AS1128	18-23-26-44-440-480
37883	AS732A	17-18-34	79130	AS1131	18
38045	AS953	19	80929	AS1131	18
38208	AS892	18-38-42	81216	AS1083	18-22-38-380
38310	AS834	18-38-42	81683	AS1081	16-30
38928	AS953	19	88192	AS1129	50-400-401-480
40761	AS930	13	88987	AS1098	16
40934	AS732A	17-18-34	91133	AS1144	400
40935	AS729	19-20	99024	AS1114	23-26-34
42681	AS842R	17	110880	AS1137	13-15
42925	AS953	19	110881	AS1133	16
43776	AS846	13-15	110882	AS1134	17-34-340
43981	AS983	18	110883	AS1135	18-22-38-300-381-381P
43982	AS989L	18	110884	AS1135	18-22-38-380-381-381P
43983	AS989R	18	110885	AS1136	23-26
43984	AS985	IHC	110886	AS1140	17-34-340
44006	AS984L	17	110890	AS1138	19-23-26-44-440-480
44007	AS984R	17	111348	AS1132	16
44450	AS864	18-38	111544	AS1141	15
45960	AS866	13-15	111545	AS1142	15-16
46789	AS834	18-38-42	113334	AS1210	401
49934	AS732A	17-18-34	113335	AS1153	440
51084	AS729	19-20	113645	AS1139	16
51264	AS1051	19-20-23	118866	AS1167	13-15

# Heavy Duty Axle Shafts

## EATON TO NCB INTERCHANGE LIST

Dana/Eaton Number	NCB Number	Dana/Eaton Assembly Series
119592	AS1160	15
119593	AS1158	16
119594	AS1150	17-341
119595	AS1207	18-22-381
119596	AS1208	23
119627	AS1200	23105
119949	AS1209	23105
126274	AS1201	19050S
210512	AS1202	19050S
210628	AS1203	19050S
110888	AS1214	38-380-381-402
110889	AS1215	19-23-26-44-440-460-480-461
111788	AS1224	35-580-650
119628	AS1225	35-580-650
127437	AS1226	21060S-404-405-454
127438	AS1227	21060S-404-405-454
128514	AS1228	404-405-454-20606S-21060D-22060S-22060D
128515	AS1229	404-405-454-21060S-22060S
129010	AS1230	344-19060S-19060D
129011	AS1231	344-19060S-17060S-19060L
210654	AS1232	19050S
128112	AS1236	15040S-15040T
128516	AS1237	404-405-454-20606S-21060D-22060S-22060D
128435	AS1252	404-405-454-21060D
129331	AS1253	19050S-19050T
128375	AS1253	19050S-19050T

Dana/Eaton Number	NCB Number	Dana/Eaton Assembly Series
210652	AS1253	19050S-19050T
129000	AS1254	DD/RD 461
129138	AS1255	462-463-23080D-26931-23941
129139	AS1256	461-462-21080D-23080D
129141	AS1257	462-463-23080D
126880	AS1257	23080S
129142	AS1258	23080A
131245	AS1259	170-190
128517	AS1260	404-405-454-20606S-21060L-22060S-22060L
128517HX	AS1260	404-405-454-20606S-21060L-22060S-22060L
128521	AS1261	404-405
128521HX	AS1261	404-405
126878	AS1262	21080S-26080S-23090S
126195	AS1263	26105S
126601	AS1264	23105S-26105S
126877	AS1265	403-451
128516	AS1266	404-405-454-20606S-21060D-22060S-22060D
129332	AS1266	402-403
130911	AS1267	344-17060S-19060S-21060S
129960	AS1268	23090S
130912	AS1269	344-17060S-19060S-21060S

# Heavy Duty Axle Shafts

## ROCKWELL TO NCB INTERCHANGE LIST

Meritor/ Rockwell No.	NCB No.	Meritor/ Rockwell No.	NCB No.	Meritor/ Rockwell No.	NCB No.	Meritor/ Rockwell No.	NCB No.
Z2054	AS649	E8195	AS1015R	F6766	AS1115	H8666	AS1187*
R3710	AS649	N3056	AS1024	F7572	AS1122	Y8917	AS1188
K1779	AS681	L6564	AS1024	T6728	AS1126L	S8937	AS1189
H2686	AS762	Z3120	AS1028	U6729	AS1126S	H9342	AS1190*
N2536	AS863S	X6472	AS1028	S7975	AS1127	F9340	AS1191
Q2539	AS863L	W6549	AS1028	G6793	AS1130	G9341	AS1192
C8193	AS863S	X3508	AS1037	Z8190	AS1130	L9346	AS1193*
D8194	AS863L	Z3718	AS1037	A8191	AS1130	J9344	AS1194
Z2704	AS893	Z3771	AS1037	B8192	AS1130	K9345	AS1195
D2734	AS921	V6730	AS1037	Q8181	AS1143L	Q6361	AS1196
F2736	AS922	A3459	AS1042	R8182	AS1143S	C9519	AS1197
B2706	AS931	V6574	AS1042	Z7384	AS1145L	Y9047	AS1198
T2932	AS932	R3268	AS1043	C7387	AS1145R	X9046	AS1199
D2942	AS933	A3277	AS1043	P8050	AS1146	S6779	AS1204
G2971	AS950	Y4783	AS1043	O8051	AS1147	E9391	AS1205
S2983	AS951	Q5269	AS1043	J8070	AS1148	F9392	AS1206
C2993	AS952	Z3510	AS1044	N8048	AS1149	C8141	AS1211
L3002	AS955	O3423	AS1046	B3512	AS1159L	Q9117	AS1216
Z3692	AS955	B5228	AS1054	V6054	AS1159L	R9118	AS1217
A2513	AS965	K5107	AS1056	X6056	AS1159R	S9119	AS1218
Y3041	AS967L	W5197	AS1056	M8983	AS1166	T9484	AS1219
K3053	AS967L	X5407	AS1057	B8790	AS1170	U9485	AS1220
W3039	AS967R	L2976	AS1060L	Z8788	AS1171	G9393	AS1235
L3054	AS967R	J2974	AS1060R	O8389	AS1172	S9483	AS1238
N3212	AS968	D4450	AS1068	P8362	AS1173	E4555	AS1239
S3035	AS969	B4448	AS1080	F9002	AS1174L	H6768	AS1240
X3742	AS969	Z3666	AS1084L	E9001	AS1174R	H6794	AS1241
H3888	AS969	A3667	AS1084R	J8902	AS1175R	J6796	AS1242
K3911	AS969	N6098	AS1090	L8904	AS1176L	A8191	AS1243
U3921	AS969	P6100	AS1090	B9050	AS1176L	S9041	AS1244
M2873	AS972L	L6356	AS1101S	C9051	AS1176R	C9129	AS1245
Q3943	AS972L	N6358	AS1101L	T9042	AS1177	P9142	AS1246
L2872	AS972R	T7820	AS1106	S9041	AS1178	Q9143	AS1247
P3942	AS972R	E7415	AS1108	U9043	AS1179	P9246	AS1248
J3026	AS995	D6712	AS1109	W8915	AS1180	R9248	AS1249
Z2262	AS999	P7816	AS1110	Q8935	AS1181	S9249	AS1250
S3269	AS1012	F6792	AS1111	G9003	AS1182	N9374	AS1251
D3462	AS1013	Y8189	AS1111	Q8805	AS1183	A9491	AS1252
S2593	AS1015L	G6780	AS1112R	B8816	AS1184*	N9608	AS1253
F8196	AS1015L	W6783	AS1112L	Y8111	AS1185*	Q9611	AS1254
Q2591	AS1015R	G6767	AS1113	F7745	AS1186		

NOTE: ALL ROCKWELL NUMBERS CARRY 3202 AS A PREFIX IN THEIR NUMBERING SYSTEMS

# Heavy Duty Axle Shafts

## NUMERICAL LISTING OF ROCKWELL REAR AXLE ASSEMBLIES FOR WHICH WE CAN SUPPLY REPLACEMENT AXLES

Meritor/Rockwell Assembly Series	NCB No.	Meritor/Rockwell No.	Meritor/Rockwell Assembly Series	NCB No.	Meritor/Rockwell No.
B140	AS932	T2932	RS23-240	AS1188	Y8917
D100-40	AS762	H2686	RT140-240-340	AS952	C2993
F106	AS1054	B5228	RT340	AS1037	X3508
F130	AS1056	K5107-W5197	S170(GMC)	AS1159R-L	X6056-V6054
F140-145-240-340-345	AS933	D2942	S200-300	AS649	Z2054
F140D-147	AS1056	K5107-W5197	SL100	AS1143L-S	Q8181-R8182
G161-341-361	AS968	N3212	SQ100	AS1101L-S	N6358-L6356
G361	AS969	S6065-X3742	SR170-270-380	AS1159R-L	X6056-V6054
H100-110	AS936	CHEV-GMC	T1550	AS1141	GMC
H110	AS1149	N8048	T150-170-185	AS937	CHEV-GMC
H130-150	AS937	CHEV-GMC	T150-170	AS1022R-L	CHEV
H135	AS1146	P8050	T155(GMC)	AS1145R-L	C7387-Z7384
H140-240-340-350-370	AS955	L3002	T185	AS1125	GMC
H141-(DODGE)	AS1080	B4448	U200-300	AS649	Z2054
H150	AS938R-L	CHEV-GMC	D&D D4640	AS1015R-L	Q2591-S2593
H150	AS1022R-L	CHEV	HQDA-QHAR	AS1024	N3056
H150	AS1147	Q8051	LHAR-LHDA	AS1028	Z3120
H170	AS1022R-L	CHEV	SFD154	AS681	K1779
H170(FORD)	AS1090	N6098-P6100	SFD450-60-D461-SFD4600-SFDD4600	AS863L-S	Q2539-N2536
H172	AS1109	D6712	SFD4640	AS1111-1130	F6792-G6793
H172(DODGE)	AS1122	F7572	SFHD	AS995	J3026
H175	AS1148	J8070	SHHD	AS955	L3002-Z3692
L140-145-240-245-340-345	AS950	G2971	SHHD(DODGE)	AS1080	B4448
L162-351-362	AS969	X3742	SHHR	AS995	J3026
L346	AS1028	Z3120	SJHD	AS1040	Z3510
L351	AS969	S3035	SL100	AS1143L-S	Q8181-R8182
L361	AS969	H3888	SLD(21 SPL.)	AS1060R-L	J2974-L2976
Q145-345	AS951	S2983	SLHD	AS950	G2971
Q246P-346P	AS1024	N3056	SLHD(GMC)	AS969	X3742
Q345	AS1043	Q5269	SLHD	AS1143L-S	Q8181-R8182
QT140-240-340-345	AS951	S2983	SLHD(GMC)	AS1028	X6472
QT340	AS1043	R3268	SQS-SQDD	AS921	D2734
R100-101-110-200-201-210-20300-310-330	AS649	Z2054	SQD-SQDD	AS922	F2736
R101-201-301	AS999	Z2262	SQDD(GMC)	AS972R-L	L2872-M2873
R140	AS952	C2993	SQHD	AS951	S2983
R160-390	AS967R-L	L-3054-K3053	SQHD(IHC)	AS1024	N3056
RL170	AS1037	X3508	SQHD(GMC)	AS1012	Q5269-S3269
R2090-1	AS681	K1779	SQHD(GMC)	AS1043	A3277
RS13-120	AS1174R-L	E9001-F9002	SQHD(GMC)	AS1101L-S	N6358-L6356
RS15-120	AS1174R-L	E9001-F9002	SQHD(Wide Track)	AS1046	Q3423
RS15-210	AS1174R-L	E9001-F9002	SQHP	AS1101L-S	N6358-L6356
RS17-140	AS1176R-L	C9051-B9050	SR270-280	AS1159R-L	X6056-V6054
RS17-220	AS1175R-L	J8902-L8904	SRDD	AS1112R-L	T6780-W6783
RS21-145	AS1178	S9041	SSDD	AS1111RH-1130LH	F6792-G6793
RS21-145	AS1177	T9042	SSHD	AS1042-967R	A3459-W3039
RS21-230	AS1180	W8915	SSHD(CHEV-GMC)	AS1084R-L	A3667-Z3666
RS23-160	AS1183	Q8805	SSHD(GMC)	AS1126L-S	T6728-U6729
RS23-160	AS1182	G9003	SSHR	AS955	L3002
RS23-180	AS1183	Q8805	STHD(GMC)	AS1145R-L	C7387-Z7384
RS23-180	AS1185	Y8111	SUD-SUDD	AS1035L-S	P3500-N3498
RS26-180	AS1186	W7745	SUDD	AS1113-1115	G6767-F6766
RS23-180	AS1187	H8666	SUHD	AS1035L-1159L	P3500-V6054

\*Denotes double spline.

# Heavy Duty Axle Shafts



## NCB AXLE SHAFT NUMBER TO ORIGINAL EQUIPMENT MANUFACTURER NUMBER

NCB NO.	TYPE	ROC.	EATON	FORD	CHEVY	NAVISTAR	WHITE	MACK	DODGE
AS649	F16	Z2054		B8QH4234F	208920 2428108	56151R1 51896C1	461403 718416		127750
AS655	F16		15461			54088H 58662H 219891R1			
AS681	F16	K1779					427472		1090629
AS691L	F16								1268811
AS691R	F16								1268810
AS701L	F10				3660093				
AS701R	F10				3660094				
AS729	F16		22619 37311 40935 51084		2426738 2291543		814789		
AS732A	F16		37883 40934 62214 64893		57408R1 57689R1 94050HA 109389R1	718062 879934 879937 879938 294292C1 298187C1 298188C1 875186R1 3237548R1	881220 898001		
AS749	F16		30689 32686 56980 64973	8QH4235 B1QH4235A C3TZ4234N		79951R1	846775 330305008		
AS750L	K16				3685193 3702205 3702227				
AS750R	K16				3685194 3702206 3702228				

## SPECIFICATIONS OF NCB AXLES

NCB No.	Type	Length	Spline O.D.	Flange O.D.	Bolt Circle	STUD BOLT HOLES			
						QTY	SIZE	STR	TAPER
AS649	F16	40-5/8	2.375	8-3/8	7	8	41/64		8
AS655	F16	36	1.812	6-3/8	5-3/8	6	33/64	6	
AS681	F16	40-3/4	1.955	6-1/2	5-1/2	12	17/32	9	3
AS691L	F16	40-1/2	1.375	4-3/4	4	6	29/64	6	
AS691R	F16	29-1/4	1.375	4-3/4	4	6	29/64	6	
AS701L	F10	33	1.638	5-5/16	4-17/32	8	29/64	8	
AS701R	F10	39-5/6	1.638	5-5/16	4-17/32	8	29/64	8	
AS729	F16	40-5/8	2.245	8-1/2	7	8	41/64		8
AS732A	F16	40-11/16	1.975	6-5/8	5-1/2	8	41/64	8	
AS749	F16	40-3/4	1.975	6-1/8	5-1/4	12	17/32		12
†AS750L	K16	36-7/16	1.727	3-3/4		20			TEETH
†AS750R	K16	40-5/8	1.727	3-3/4		20			TEETH



# Heavy Duty Axle Shafts

## NCB AXLE SHAFT NUMBER TO ORIGINAL EQUIPMENT MANUFACTURER NUMBER

NCB NO.	TYPE	ROC.	EATON	FORD	CHEVY	NAVISTAR	WHITE	MACK	DODGE
AS751L	K10				3685191				
AS751R	K10				3685192				
AS755	F16							1194486	
AS758	F16		31403					1196202	
AS762	F16	H2686	31413	7RT4235A					
AS815	F16	N1417 J1466			2108953				
AS834	F16		27847 30024 38310 46789 67742		2486050	111658R1 205490R1 259684C1 305236C1 312075C1	716741 716742 875248	365SP86	
AS837	F16		45961			68932R1 111653R1 205468R1			
AS842R	F16		22586 31928 37357 42681 67790		2120072 2240328 2291542 2479192 3730536Z		861512		
AS843	F16					82778R1			
AS844	F16		45960			69187R1 111651R1 205463R1 229166R1			
AS846	F16		32586 43776			77609R1 108117R1 171093R1	718167		
AS847	F16		30470		2241439		819050		

## SPECIFICATIONS OF NCB AXLES

NCB No.	Type	Length	Spline O.D.	Flange O.D.	Bolt Circle	STUD BOLT HOLES			
						QTY	SIZE	STR	TAPER
†AS751L	K10	34-3/32	1.638	3-3/4		20			TEETH
†AS751R	K10	40-15/32	1.638	3-3/4		20			TEETH
AS755	F16	37-3/32	1.750	5-13/16	5-3/64	8	7/16	8	
AS758	F16	37-9/32	1.875	5-3/4	5-3/64	8	7/16	8	
AS762	F16	36-9/16	1.750	5-1/2	4-3/4	8	29/64		8
AS815	F16	37	1.625	5-3/4	4-7/8	8	29/64		8
AS834	F16	39-3/4	2.125	8-1/2	7	8	49/64	8	
AS837	F16	39-1/12	1.875	6-1/4	5.225	6	41/64	6	
AS842R	F16	40-15/16	1.985	6-1/8	5-1/4	12	33/64		12
AS843	F16	36-3/16	1.510	5-1/4	4-3/8	6	33/64	6	
AS844	F16	36-13/16	1.743	5-3/4	4-7/8	8	33/64	8	
AS846	F16	36-3/4	1.745	5-3/4	4-7/8	8	33/64	8	
AS847	F16	38-1/2	1.875	6-3/16	5-5/16	8	37/64		8

†Dagger denotes length measured overall, NOT under flange.

# Heavy Duty Axle Shafts

HD Differential

## NCB AXLE SHAFT NUMBER TO ORIGINAL EQUIPMENT MANUFACTURER NUMBER

NCB NO.	TYPE	ROC.	EATON	FORD	CHEVY	NAVISTAR	WHITE	MACK	DODGE
AS855	F16		31136			66017R1 108459R1 171628R1 336471C1	861577		
AS863L	F16	Q2539 D8194		C3TZ4234F	2272615	340568C1 698646R1	718873		
AS863S	F16	N2536 C8193		C3TZ4234E	2272614	340569C1 698647R1	718872		
AS864	F16		30562 37303 44450 56203		2290550 2359830 2431537		846681		
AS866	F16		35332 45059			95287R1 101716R1 179882R1			
AS892	F16		38208	TUAA4235A	5727159	205490R1	875248 256011		
AS895L	J17							68KHC356P1	
AS895S	J17							68KHC356P2	
AS921	F16	D2734				138764R1	843670		
AS922	F16	F2736				138765R1	843671		
AS933	F19	D2942		B4T4235A B6T4235A			883520		
AS936	K27				3762916				
AS937	K29				3709890 3762885 3762907				

## SPECIFICATIONS OF NCB AXLES

NCB No.	Type	Length	Spline O.D.	Flange O.D.	Bolt Circle	STUD BOLT HOLES			
						QTY	SIZE	STR	TAPER
AS855	F16	38-1/2	1.875	6-1/4	5.225	6	41/64	6	
AS863L	F16	46-1/16	2.490	8-3/8	7	8	41/64		8
AS863S	F16	37-7/8	2.490	8-3/8	7	8	41/64		8
AS864	F16	40-13/16	2.125	8-1/2	7	8	41/64		8
AS866	F16	38-5/8	1.750	6-1/4	5.225	6	41/64	6	
AS892	F16	39-3/4	2.125	8-1/2	7	8	49/64	8	
†AS895L	J17	50-1/8	2.190						
†AS895S	J17	39-11/16	2.190						
AS921	F16	45-5/8	2.120	7-15/32	6-1/2	12	33/64	6	6
AS922	F16	34-7/16	2.120	7-15/32	6-1/2	12	33/64	6	6
AS933	F19	37-1/2	1.770	6-1/8	5-1/8	8	29/64		8
†AS936	K27	37-7/16	1.730	3-3/4		20			Teeth
†AS937	K29	39-7/16	1.855	4-3/16		40			Teeth

# Heavy Duty Axle Shafts

## NCB AXLE SHAFT NUMBER TO ORIGINAL EQUIPMENT MANUFACTURER NUMBER

NCB NO.	TYPE	ROC.	EATON	FORD	CHEVY	NAVISTAR	WHITE	MACK	DODGE
AS938L	K29				3711457 3762891				
AS938R	K29				3711458 3762892				
AS950	F21	G2971			2468584	172052R1 211626R1	870558		1665635
AS951	F22	S2983				983610R1	871899		1665719
AS952	F23	C2993				168425R1 898212R1	878109		1665822
AS953	F16		37150 38045 38928 42925	B8QH4235		111045R1 123741R1 284147C1	839118A	365SP84	
AS955	F20	L3002 Z3692		C3TZ4234K C7TZ4234B	675889 237286		870562		
AS957L	J17							68KH3129P1	
AS957S	J17							68KH3129P2	
AS959L	J17							68KH358P1-4	
AS959S	J17							68KH358P2-3	
AS960L	F17							68KH3120P3 68KH3121P3	
AS960S	F17							68KH3120P2 68KH3121P2	

## SPECIFICATIONS OF NCB AXLES

NCB No.	Type	Length	Splines O.D.	Flange O.D.	Bolt Circle	STUD BOLT HOLES			
						QTY	SIZE	STR	TAPER
†AS938L	K29	38-1/16	1.855	4-3/16		40			Teeth
†AS938R	K29	40-9/16	1.855	4-3/16		40			Teeth
AS950	F21	40-3/8	1.995	6-3/8	5-11/16	12	15/32		12
AS951	F22	40	2.120	4-15/32	6-1/2	12	33/64	6	6
AS952	F23	40-7/8	2.245	8-3/8	7	8	41/64		8
AS953	F16	39-5/8	2.245	8-1/2	7	8	49/64	8	
AS955	F20	38-3/16	1.872	6-1/4	5-5/16	8	33/64		8
AS957L	J17	50-1/8	2.190						
AS957S	J17	39-11/16	2.190						
AS959L	J17	51-5/8	2.625						
AS959S	J17	40-5/8	2.625						
AS960L	F17	45-1/8	2.190	7-11/32	6-3/8	8	9/16	8	
AS960S	F17	34-3/4	2.190	7-11/32	6-3/8	8	9/16	8	

†Dagger denotes length measured overall, NOT under flange.

# Heavy Duty Axle Shafts

## NCB AXLE SHAFT NUMBER TO ORIGINAL EQUIPMENT MANUFACTURER NUMBER

NCB NO.	TYPE	ROC.	EATON	FORD	CHEVY	NAVISTAR	WHITE	MACK	DODGE
AS965	F16	Q2513					852108		
AS967L	F23	K3053 Y3041				358879C1 983452R1 983717R1	861141 887574		
AS967R	F23	W3039 L3054			2350221 2398830	358880C1 983451R1 983718R1	861142 881632		2560424
AS968	K20	N3212			2358251				
AS969	F21	S3035 X3742 H3888 U3921			2349682 2417717 2431395				
AS972L	F16	Q3943 M2873			2319812 2448043	297337C1	297337C1	3103964	
AS972R	F16	L2872 P3942			2319811 2448042	297338C1	3103965		
AS983	F20		43981			157518R1			
AS984R	F16		44007			175395R1 272120C1			
AS984L	F16		44006			175394R1 272119C1			
AS985	F22		43984			161087R1 892604C1			
AS989L	F20		43982			172714R1			
AS989R	F20		43983			172715R1			
AS991	F16								7922317
AS995	F16	J3026							

## SPECIFICATIONS OF NCB AXLES

NCB No.	Type	Length	Spline O.D.	Flange O.D.	Bolt Circle	STUD BOLT HOLES			
						QTY	SIZE	STR	TAPER
AS965	F16	39-3/16	1.625	6-3/8	5-9/16	8	17/32	8	
AS967L	F23	37-15/16	2.250	8-3/8	7	8	41/64		8
AS967R	F23	43-1/2	2.250	8-3/8	7	8	41/64		8
†AS968	K20	39-1/8	1.875	4-3/16		40			Teeth
AS969	F21	40-11/16	2.000	6-1/8	5-1/4	12	33/64		12
AS972L	F16	46-1/4	2.120	8-3/8	7	8	41/64		8
AS972R	F16	35	2.120	8-3/8	7	8	41/6		8
AS983	F20	39-5/8	2.093	8-1/2	7	8	49/64	8	
AS984R	F16	38	1.980	6-5/8	5-1/2	8	41/64	8	
AS984L	F16	43	1.980	6-5/8	5-1/2	8	41/64	8	
AS985	F22	39-3/8	2.302	8-1/2	7	8	49/64	8	
AS989L	F20	42-1/16	2.093	8-1/2	7	8	49/64	8	
AS989R	F20	37	2.093	8-1/2	7	8	49/64	8	
AS991	F16	33-5/16	1.310	4-3/4	3-31/32	8	29/64		8
AS995	F19	38-3/8	1.770	6-1/4	5-5/16	8	33/64		8



# Heavy Duty Axle Shafts

HD Differential

## NCB AXLE SHAFT NUMBER TO ORIGINAL EQUIPMENT MANUFACTURER NUMBER

NCB NO.	TYPE	ROC.	EATON	FORD	CHEVY	NAVISTAR	WHITE	MACK	DODGE
AS999	F20	Z2262					619787		
AS1012	F22	S3269			2365637 2408387 2472266				
AS1015L	F16	S2593 F8196			2402207	974557R1	877262		
AS1015R	F16	Q2591 E8195			2402206	974558R1	877261		
AS1022L	F29		55293		3796175				
AS1022R	F29		55294		3796176				
AS1024	F22	N3056 L6564		C1TT4235A D5HZ4235A		175542R1 353064R1	027089999		
AS1025	F29				3796177				
AS1026	F16		52281 56979	C1TT4235C C3TZ4234R			887997 1728392		3736653
AS1028	F21	Z3120 X6472 W6549		C1TT4235E D4HZ4234A	2005145	213526R1 579418C91	027075968		
AS1037	F24	X3058 Z3718 Z3771 V6730		D3HZ4234A	2431515 2418918	436422R1 752895C1 257266C1	1715590	365SP87 365SP96	2505729 2560620
AS1040	F22		54014 67747	D8HZ4234A	2428133 2491259		330305003		2239744 2552579
AS1042	F23	A3459 V6574			2398829	242942R1	881633		2560425
AS1043	F22	A3277 R3268 Y4783 Q5269		D7HZ4235A	2366740 2472266	464373C1	027087695 3120157-9		3496241

## SPECIFICATIONS OF NCB AXLES

NCB No.	Type	Length	Splines O.D.	Flange O.D.	Bolt Circle	STUD BOLT HOLES			
						QTY	SIZE	STR	TAPER
AS999	F20	40-5/8	2.375	8-3/8	7	8	41/64		8
AS1012	F22	41	2.125	8-3/8	7	8	41/64		8
AS1015L	F16	49-7/8	2.485	8-3/8	7	8	41/64		8
AS1015R	F16	41-3/4	2.485	8-3/8	7	8	41/64		8
AS1022L	F29	37-1/4	1.860	6-3/16	5-5/16	8	37/64		8
AS1022R	F29	39-3/4	1.860	6-3/16	5-5/16	8	37/64		8
AS1024	F22	39-3/16	2.125	8-1/2	7	8	49/64	8	
AS1025	F29	38-1/2	1.860	6-3/16	5-5/16	8	37/64		8
AS1026	F16	39-1/8	1.883	6-1/4	5-5/6	8	33/64		8
AS1028	F21	40-5/16	2.000	6-1/8	5-1/4	12	33/64		12
AS1037	F24	40-11/16	2.375	8-3/8	7	8	41/64		8
AS1040	F22	41	2.302	8-1/2	7	8	41/64		8
AS1042	F23	38-7/16	2.250	8-3/8	7	8	41/64		8
AS1043	F22	40-9/16	2.125	8-3/8	7	8	41/64		8

†Dagger denotes length measured overall, NOT under flange.

# Heavy Duty Axle Shafts



## NCB AXLE SHAFT NUMBER TO ORIGINAL EQUIPMENT MANUFACTURER NUMBER

NCB NO.	TYPE	ROC.	EATON	FORD	CHEVY	NAVISTAR	WHITE	MACK	DODGE
AS1044	F20	Z3510					864017	365SP85	
AS1046	F22	Q3423				281409C1 333453C1			
AS1048	F16		62164		2457690				
AS1049	F16		62165 67591		2458460 2477769 2477790		V1112035		
AS1051	F22		51264 53597 55957 102560	C4TZ4234A		436957R1	888728		
AS1052	F16		56981	C3TZ4234P		288345C1 352528C1	891918		
AS1053	F16		58675		8QH4235A C3TZ42434S		863905A		
AS1054	F19	B5228	65360	C4TZ24234D		1677097C1	700890		
AS1055	F23			C7TZ4234A C9TZ4234D					2587864
AS1056	F19	K5107							2512525 2512065 2506987 2585378
AS1057	F16	X5406	55987				3101307	365SP94	2808205 2232205
AS1058	F16		59502 72617		2448315 8871758				
AS1060L	F21	L2976				878774			

## SPECIFICATIONS OF NCB AXLES

NCB No.	Type	Length	Spline O.D.	Flange O.D.	Bolt Circle	STUD BOLT HOLES			
						QTY	SIZE	STR	TAPER
AS1044	F20	40-1/4	1.875	6-7/16	5-11/16	12	15/32		12
AS1046	F22	43-1/4	2.125	7-15/32	6-1/2	12	33/64	6	6
AS1048	F16	39	1.875	6-3/16	5-5/16	8	9/16		8
AS1049	F16	41-5/16	1.980	6-1/8	5-1/4	12	9/16		12
AS1051	F22	39-7/8	2.302	8-1/2	7	8	49/64	8	
AS1052	F16	40-1/8	2.125	8-1/2	7	8	49/64	8	
AS1053	F16	38-7/16	1.8756	6-1/4	5-5/16	8	33/64		8
AS1054	F19	38-3/16	1.770	6-1/8	5-1/8	8	29/64		8
AS1055	F23	35-1/16	1.498	4-3/4	3-31/32	8	29/64		8
AS1056	F19	38-1/16	1.770	5-15/16	5-3/64	8	29/64		8
AS1057	F16	38-3/4	1.875	5-15/16	5-3/64	8	29/64		8
AS1058	F16	39-1/2	1.875	6-3/6	5-5/16	8	9/16		8
AS1060L	F21	34-3/4	2.000	6-7/16	5-11/16	12	15/32		12
AS1060R	F21	46	2.000	6-7/16	5-11/16	12	15/32		12

# Heavy Duty Axle Shafts

## NCB AXLE SHAFT NUMBER TO ORIGINAL EQUIPMENT MANUFACTURER NUMBER

NCB NO.	TYPE	ROC.	EATON	FORD	CHEVY	NAVISTAR	WHITE	MACK	DODGE
AS1063	F16		64130	C3TZ4234P		288345C1 352528C1	891918		
AS1068	F16	D4450							2960024
AS1070	F30								3491431 3633824 4036684
AS1076	F35								3633829
AS1077	F35								2910941
AS1078	F35								2952475
AS1080	F20	B4448							2960026
AS1081	F16		81683						2960025
AS1083	F16		81216	D7HZ4234A	669415		330305002		
AS1084L	F24	Z3666		D8HZ4234E	795824	581594C1	893514	365SP91	
AS1084R	F24	A3667		D8HZ4234D	795825		893515	365SP90	
AS1087	F16		62166		2461392		330305037		3496240
AS1088	F16			D3TZ4234N					
AS1089	F16			C9TZ4234C					
AS1090	F36	N6098 P6100		C8TZ4234E					

## SPECIFICATIONS OF NCB AXLES

NCB No.	Type	Length	Splines O.D.	Flange O.D.	Bolt Circle	STUD BOLT HOLES			
						QTY	SIZE	STR	TAPER
AS1063	F16	40-1/8	2.120	8-1/2	7	8	49/64	8	
AS1068	F16	38-5/8	1.875	6-1/4	5-5/16	8	33/64		8
AS1070	F30	34-5/16	1.292	4-3/4	3-31/32	8	29/64		8
AS1076	F35	36-15/16	1.500	4-3/4	3-31/32	8	29/64		8
AS1077	F35	36-1/8	1.500	4-3/4	3-31/32	8	29/64		8
AS1078	F35	36	1.500	5-1/4	4-3/8	6	33/64		6
AS1080	F20	37-15/16	1.875	6-3/16	5-5/16	8	33/64		8
AS1081	F16	39	1.875	6-3/16	5-5/16	8	33/64		8
AS1083	F16	41-11/16	2.125	8-1/2	7	8	41/64		8
AS1084L	F24	43-9/16	2.375	8-3/8	7	8	41/64		8
AS1084R	F24	38-1/16	2.375	8-3/8	7	8	41/64		8
AS1087	F16	41-5/16	2.125	8-1/2	7	8	41/64		8
AS1088	F16	33-5/16	1.310	4-3/4	3-31/32	8	29/64	8	
AS1089	F16	33-5/16	1.310	4-3/4	3-31/32	8	29/64	8	
AS1090	F36	38-7/16	1.835	6-1/4	5-5/16	8	33/64		8

# Heavy Duty Axle Shafts

## NCB AXLE SHAFT NUMBER TO ORIGINAL EQUIPMENT MANUFACTURER NUMBER

NCB NO.	TYPE	ROC.	EATON	FORD	CHEVY	NAVISTAR	WHITE	MACK	DODGE
AS1091	F35			D5UZ4234E					
AS1092	F35			D5UZ4234F					
AS1095	F35			D5TZ4234B					
AS1096	F30			D4TZ4234A					
AS1097	F30			D5TZ4234A					
AS1098	F16		88987						3893152
AS1099	F16					455462C1			
AS1100	F16					455463C1			
AS1101L	F41	N6358		D8HZ4234C	791454	799567C1	Q27075387		
AS1101S	F41	L6356		D8HZ4234B	791453	799568C1	Q27075386		
AS1102	F16					455461C1			
AS1103	F16					455460C1			
AS1104	F16		76917			792886C1	330305056		
AS1105	F16					455464C1			
AS1106	F34	T7820		EOHZ4234D					
AS1107	F36			EOHZ4234A					
AS1108	F19	E7415		D6TZ4235A	793224				
AS1109	F39	D6712		D7HZ4234C		573296C1			
AS1110	F34	P7816		EOHZ4234C					

## SPECIFICATIONS OF NCB AXLES

NCB No.	Type	Length	Spline O.D.	Flange O.D.	Bolt Circle	STUD BOLT HOLES			
						QTY	SIZE	STR	TAPER
AS1091	F35	34-1/8	1.500	4-3/4	3-31/32	8	29/64	8	
AS1092	F35	37-1/2	1.500	4-3/4	3-31/32	8	29/64	8	
AS1095	F35	35-1/8	1.500	4-3/4	3-31/32	8	29/64	8	
AS1096	F30	34-11/16	1.292	4-3/4	3-31/32	8	29/64	8	
AS1097	F30	33-5/16	1.250	4-3/4	3-31/32	8	29/64	8	
AS1098	F16	40-1/2	1.875	6-1/8	5-1/4	12	37/64		12
AS1099	F16	38-5/8	1.745	6-3/16	5.225	8	37/64	8	
AS1100	F16	39-1/12	1.875 Straight	6-3/16	5.225	8	37/64	8	
AS1101L	F41	42-3/8	2.100	8-1/2	7	8	41/64		8
AS1101S	F41	38-3/8	2.100	8-1/2	7	8	41/64		8
AS1102	F16	39-1/12	1.875 Taper	6-3/16	5.225	8	37/64	8	
AS1103	F16	38-5/8	1.750	6-3/16	5.225	8	37/64	8	
AS1104	F16	41-5/16	2.125	8-1/12	7	8	41/64	8	
AS1105	F16	39-15/16	1.875	6-3/16	5.225	8	37/64	8	
AS1106	F34	36-5/16	1.750	5-9/16	4-3/4	8	29/64		8
AS1107	F36	38-11/16	1.835	6-1/4	5-5/16	8	33/64		8
AS1108	F19	36-5/16	1.770	5-9/16	4-3/4	8	29/64		8
AS1109	F39	38-3/4	2.000	6-1/4	5-5/16	8	17/32		8
AS1110	F34	38-3/8	1.750	6-1/8	5-1/8	8	29/64		8



# Heavy Duty Axle Shafts

## NCB AXLE SHAFT NUMBER TO ORIGINAL EQUIPMENT MANUFACTURER NUMBER

NCB NO.	TYPE	ROC.	EATON	FORD	CHEVY	NAVISTAR	WHITE	MACK	DODGE
AS1111	F50	F6792 Y8189		D7HZ4234F		4884418C1			
AS1112L	F46	W6783		D7HZ4234J		496682C1			
AS1112R	F46	G6780		D7HZ4234H		496683C1			
AS1113	F46	G6767		D7HZ4234E		485472C1			
AS1114	F22		99024	D7HZ42348	2010874	577243C1	330305016		
AS1115	F46	F6766		D7HZ4234D		485473C1			
AS1122	F39	F7572		EOHZ4234B E3HZ4234C	2088183		V1111164		4037914 2096038
AS1123L	F41	N6358				799567C1			
AS1123R	F41	L6356				799568C1			
AS1124L	F24				94025968				
AS1124R	F24				94025967				
AS1125	F29				794363				
AS1126L	F24	T6728			2033901	471822C1			
AS1126S	F24	U6729			2033902	471821C1			
AS1127	F39	S7975			2064176				
AS1128	F22		79005				027090062		
AS1129	F33		88192	E1HZ4234A	2014079		027092513		
AS1130	F50	G6793 Z8190		D7HZ4234G		484417C2 484420C2			

## SPECIFICATIONS OF NCB AXLES

NCB No.	Type	Length	Splines O.D.	Flange O.D.	Bolt Circle	STUD BOLT HOLES			
						QTY	SIZE	STR	TAPER
AS1111	F50	37-9/16	2.540	8-3/8	7	8	41/64		8
AS1112L	F46	46-7/16	2.340	8-3/8	7	8	41/64		8
AS1112R	F46	35	2.340	8-3/8	7	8	41/64		8
AS1113	F46	45-1/8	2.340	8-3/8	7	8	41/64		8
AS1114	F22	41-1/4	2.290	8-1/2	7	8	41/64		8
AS1115	F46	37-3/8	2.340	8-3/8	7	8	41/64		8
AS1122	F39	40-13/16	2.000	6-1/4	5-1/4	12	17/32		12
AS1123L	F41	42-1/2	2.100	8-3/8	7	8	41/64		8
AS1123R	F41	38-3/8	2.100	8-3/8	7	8	41/64		8
AS1124L	F24	43-9/16	2.062	6-1/8	5-1/4	12	17/32		12
AS1124R	F24	37-9/16	2.062	6-1/8	5-1/4	12	17/32		12
AS1125	F29	40-11/16	1.860	6-3/16	5-1/4	12	17/32		12
AS1126L	F24	43-3/16	2.370	8-3/8	7	8	41/64		8
AS1126S	F24	38	2.370	8-3/8	7	8	41/64		8
AS1127	F39	38-3/4	2.000	6-1/4	5-1/4	8	33/64		8
AS1128	F22	40-7/8	2.298	8-1/2	7	8	41/64		8
AS1129	F33	41-7/16	2.125	8-1/2	7	8	41/64		8
AS1130	F50	45-5/8	2.540	8-3/8	7	8	41/64		8

# Heavy Duty Axle Shafts



## NCB AXLE SHAFT NUMBER TO ORIGINAL EQUIPMENT MANUFACTURER NUMBER

NCB NO.	TYPE	ROC.	EATON	FORD	CHEVY	NAVISTAR	WHITE	MACK	DODGE
AS1131	F16		79130 80929			792927C1	31109544 027091269		2953172
AS1132	F36		111348		2084246				
AS1133	F36		110881 111347	E1HZ4234B			330305068		
AS1134	F39		110882	E1HZ4234C			330305054		
AS1135	F41		110883 110884	E1HZ4234D	2099148 15585167		330305045 330305046		
AS1136	F36		110885	E1HZ4234E	2095394	592439C1	330305041		
AS1137	F34		110880	E1HZ4234F					
AS1138	F36		110890	E2HZ4234A	2099842				
AS1139	F36		113645	E3HZ4234B			330305075		
AS1140	F39		110886		2093185		330305078		
AS1141	F34		111544		2078076				
AS1142	F36		111545		2078077				
AS1143L	F39	Q8181		E3HZ4234D	15515252	592500C1	330305052		
AS1143S	F39	R8182		C3HZ4234E	55152959	592501C1	330305053		
AS1144	F33		91133						
AS1145L	F24	Z7384			2017542	466122C1	330305001		
AS1145R	F24	C7387			2017541	466121C1	330305000		
AS1146	F34	P8050			2088210				
AS1147	F34	Q8051			2086307				

## SPECIFICATIONS OF NCB AXLES

NCB No.	Type	Length	Spline O.D.	Flange O.D.	Bolt Circle	STUD BOLT HOLES			
						QTY	SIZE	STR	TAPER
AS1131	F16	40-3/4	2.125	7-15/32	6-1/2	12	33/64	6	6
AS1132	F36	38-3/8	1.850	6-1/4	5-5/16	8	33/64		8
AS1133	F36	38-3/8	1.850	6-1/4	5-5/16	8	33/64		8
AS1134	F39	40-7/8	2.000	6-1/8	5-1/4	12	17/32		12
AS1135	F41	41-1/2	2.100	8-1/2	7	8	41/64		8
AS1136	F36	41-1/2	2.312	8-1/2	7	8	41/64		8
AS1137	F34	38-3/16	1.750	6-1/8	5-1/8	8	29/64		8
AS1138	F36	41-1/8	2.312	8-1/2	7	8	41/64		8
AS1139	F36	40-9/16	1.850	6-1/8	5-1/4	12	17/32		12
AS1140	F39	41-5/16	2.000	6-1/8	5-1/4	12	17/32		12
AS1141	F34	38-3/4	1.850	6-1/4	5-5/16	8	33/64		8
AS1142	F36	38-11/16	1.850	6-1/4	5-5/16	8	33/64		8
AS1143L	F39	42-5/16	2.000	6-1/4	5-1/4	12	17/32		12
AS1143S	F39	38-5/16	2.000	6-1/4	5-1/4	12	17/32		12
AS1144	F33	41-7/16	2.125	8-1/2	7	8	41/64	8	
AS1145L	F24	38-3/4	2.375	8-3/8	7	8	41/64		8
AS1145R	F24	44-1/2	2.375	8-3/8	7	8	41/64		8
AS1146	F34	38-1/2	1.750	5-5/8	4-3/4	8	5/8		8
AS1147	F34	38-5/16	1.750	6-1/4	5-5/16	8	5/8		8

# Heavy Duty Axle Shafts

## NCB AXLE SHAFT NUMBER TO ORIGINAL EQUIPMENT MANUFACTURER NUMBER

NCB NO.	TYPE	ROC.	EATON	FORD	CHEVY	NAVISTAR	WHITE	MACK	DODGE
AS1148	F39	J8070			2086366 2099893				
AS1149	F32	N8048			2088185				
AS1150	F39		119594			578778C1 2502177C1			
AS1151	F41		119595			577506C1			
AS1152L	F41					577504C1			
AS1152R	F41					577505C1			
AS1153	F36		113335						
AS1154	F36					571348C1 2502178C1			
AS1155L 1155R	F39 F39					578776C1 578777C1			
AS1156	F41					571350C1			
AS1157	F46					571351C1			
AS1158	F36		119593			577549C1			
AS1159L	F24	B3512 V6054			2095179 793937	574508C1 521710C1	027093212		
AS1159R	F24	X6056			2095180	574507C1	33030522		
AS1160	F34		119592			577548C1			
AS1161	F39					571349C1 2502179C1			

## SPECIFICATIONS OF NCB AXLES

NCB No.	Type	Length	Splines O.D.	Flange O.D.	Bolt Circle	STUD BOLT HOLES			
						QTY	SIZE	STR	TAPER
AS1148	F39	38-3/16	2.000	6-1/4	5-5/16	8	5/8		8
AS1149	F32	38-1/8	1.650	5-5/8	4-3/4	8	5/8		8
AS1150	F39	41	2.000	6-5/8	5-1/2	8	41/64	8	
AS1151	F41	40-3/4	2.100	8-1/2	7	8	49/64	8	
AS1152L	F41	42-3/4	2.100	8-1/2	7	8	49/64	8	
AS1152R	F41	37-3/4	2.100	8-1/2	7	8	49/64	8	
AS1153	F36	40-11/16	2.312	8-1/2	7	8	49/64	8	
AS1154	F36	39-7/8	1.850	6-3/16	5.225	8	37/64	8	
AS1155L	F39	43-1/8	2.000	6-5/8	5-1/2	8	41/64	8	
AS1155R	F39	38-1/8	2.000	6-5/8	5-1/2	8	41/64	8	
AS1156	F41	40-3/16	2.100	8-1/2	7	8	49/64	8	
AS1157	F46	40-1/8	2.350	8-1/2	7	8	49/64	8	
AS1158	F36	39-3/8	1.850	6-3/16	5.225	8	37/64	8	
AS1159L	F24	39-3/8	2.375	8-3/8	7	8	41/64		8
AS1159R	F24	41-5/8	2.375	8-3/8	7	8	41/64		8
AS1160	F34	38-5/8	1.750	6-3/16	5.225	8	37/64	8	
AS1161	F39	40-5/8	2.000	6-5/8	5-1/2	8	41/64	8	

# Heavy Duty Axle Shafts

## NCB AXLE SHAFT NUMBER TO ORIGINAL EQUIPMENT MANUFACTURER NUMBER

NCB NO.	TYPE	ROC.	EATON	FORD	CHEVY	NAVISTAR	WHITE	MACK	DODGE
AS1162L	F30				3977383				
AS1162R	F30				3977384				
AS1163	F36					571347C1			
AS1164	F41			E4HZ4234B	15510267				
AS1165L	F16					463338C1			
AS1165R	F16					463339C1			
AS1166	F39	M8983		E6HZ4234E					
AS1167	F34		118866	E6HZ4234A					
AS1168	F36	101431-5		E6HZ4234A					
AS1169	F39	101437-4		E6HZ4234B					
AS1170	F41	B8790		E6HZ4234C		1648891C1			
AS1171	F41	Z8788		E6HZ4234D		1648890C1			
AS1172	F34	Q8389		EOHZ4234E					
AS1173	F41	P8362							
AS1174L	F34	F9002		E7HZ4234A					
AS1174R	F34	E9001		E7HZ4234B					
AS1175L	F36	L8904		E7HZ4234F					
AS1175R	F36	J8902		E7HZ4234E					
AS1176L	F36	B9050		E7HZ4234D					
AS1176R	F36	C9051		E7HZ4234C					

## SPECIFICATIONS OF NCB AXLES

NCB No.	Type	Length	Spline O.D.	Flange O.D.	Bolt Circle	STUD BOLT HOLES			
						QTY	SIZE	STR	TAPER
AS1162L	F30	31-11/16	1.550	4-1/2	3.562	8	33/64	8	
AS1162R	F30	37-9/16	1.550	4-1/2	3.562	8	33/64	8	
AS1163	F36	39-1/8	1.850	6-3/16	5.225	8	37/64	8	
AS1164	F41	41	2.100	8-1/2	7	8	41/64		8
AS1165L	F16	38	1.745	6-3/16	5.225	8	37/64	8	
AS1165R	F16	39	1.745	6-3/16	5.225	8	37/64	8	
AS1166	F39	39-3/4	2.000	6-1/4	5-1/4	12	17/32		12
AS1167	F34	38-1/4	1.750	6-1/4	5-5/16	8	5/8		8
AS1168	F36	40-11/16	1.850	6-1/4	5-1/4	12	17/32		12
AS1169	F39	41	2.000	8-3/8	7	8	41/64		8
AS1170	F41	41-1/4	2.092	8-3/8	7	8	41/64		8
AS1171	F41	40-3/8	2.092	8-3/8	7	8	41/64		8
AS1172	F34	38-1/4	1.750	6-1/4	5-5/16	8	5/8		8
AS1173	F41	40-7/8	2.100	8-3/8	7	8	41/64		8
AS1174R	F34	38-5/8	1.750	6-1/4	5-5/16	8	33/64		8
AS1174L	F34	37-1/4	1.750	6-1/4	5-5/16	8	33/64		8
AS1175L	F36	40-7/16	1.850	6-1/4	5-1/4	12	17/32		12
AS1175R	F36	41-7/16	1.850	6-1/4	5-1/4	12	17/32		12
AS1176L	F36	38-1/16	1.850	6-1/4	5-1/4	12	17/32		12
AS1176R	F36	44-1/16	1.850	6-1/4	5-1/4	12	17/32		12

# Heavy Duty Axle Shafts

## NCB AXLE SHAFT NUMBER TO ORIGINAL EQUIPMENT MANUFACTURER NUMBER

NCB NO.	TYPE	ROC.	EATON	FORD	CHEVY	NAVISTAR	WHITE	MACK	DODGE
AS1177	F41	T9042		E7HZ4234G	15617637				
AS1178	F41	S9041		E7HZ4234H	15617636				
AS1179	F41	U9043		E8HZ4234A					
AS1180	F39	W8915		E7HZ4234J					
AS1181	F39	Q8935		E9HZ4234G					
AS1182	F46	G9003		E7HZ4234K	15575921	1651230C1			
AS1183	F46	Q8805		E7HZ4234L	15575920	1651231C1			
AS1184	F46	B8816		E8HZ4234B		1651232C1			
AS1185	F46	Y8111		E7HZ4234M	15576035				
AS1186	F46	W7745		E7HZ4234N	15583980				
AS1187	F46	H8666		E8HZ4234C					
AS1188	F41	Y8917		E7HZ4234P					
AS1189	F41	S8937		E9HZ4234H					
AS1190	F41	H9342		E9HZ4234A					
AS1191	F41	F9340		E9HZ4234K		1677098C1			
AS1192	F41	G9341		E9HZ4234J		1677099C1			
AS1193	F46	L9346		E9HZ4234B					
AS1194	F46	J9344		E9HZ4234M					
AS1195	F46	K9345		E9HZ4234L					
AS1196	F41	Q6361		E9HZ4234C					
AS1197	F41	C9519		E9HZ4234D					
AS1198	F39	Y9047		E9HZ4234E					

## SPECIFICATIONS OF NCB AXLES

NCB No.	Type	Length	Splines O.D.	Flange O.D.	Bolt Circle	STUD BOLT HOLES			
						QTY	SIZE	STR	TAPER
AS1177	F41	44-1/16	2.100	8-3/8	7	8	41/64		8
AS1178	F41	38-1/8	2.100	8-3/8	7	8	41/64		8
‡AS1179	F41	44-1/16	2.100	8-3/8	7	8	41/64		8
AS1180	F39	41	2.000	8-3/8	7	8	41/64		8
AS1181	F39	40-3/16	2.000	8-3/8	7	8	41/64		8
AS1182	F46	43-7/8	2.340	8-3/8	7	8	41/64		8
AS1183	F46	37-5/16	2.340	8-3/8	7	8	41/64		8
‡AS1184	F46	44-1/8	2.340	8-3/8	7	8	41/64		8
‡AS1185	F46	42-7/8	2.340	8-3/8	7	8	41/64		8
AS1186	F46	38-3/4	2.340	8-3/8	7	8	41/64		8
‡AS1187	F46	43	2.340	8-3/8	7	8	41/64		8
AS1188	F41	41-1/8	2.100	8-3/8	7	8	41/64		8
AS1189	F41	40-3/8	2.100	8-3/8	7	8	41/64		8
‡AS1190	F41	43-1/4	2.100	8-3/8	7	8	41/64		8
AS1191	F41	37-1/4	2.310	8-3/8	7	8	41/64		8
AS1192	F41	43-1/4	2.100	8-3/8	7	8	41/64		8
‡AS1193	F46	43-1/4	2.340	8-3/8	7	8	41/64		8
AS1194	F46	36-3/4	2.340	8-3/8	7	8	41/64		8
AS1195	F46	43	2.340	8-3/8	7	8	41/64		8
AS1196	F41	41-9/16	2.100	8-3/8	7	8	41/64		8
AS1197	F41	37-7/16	2.100	8-3/8	7	8	41/64		8
AS1198	F39	43-1/2	2.000	6-1/4	5-1/4	12	17/32		12



# Heavy Duty Axle Shafts

## NCB AXLE SHAFT NUMBER TO ORIGINAL EQUIPMENT MANUFACTURER NUMBER

NCB NO.	TYPE	ROC.	EATON	FORD	CHEVY	NAVISTAR	WHITE	MACK	DODGE
AS1199	F39	X9046		E9HZ4234F					
AS1200	F39		119627		15584538		33030-507	4	
AS1201	F36		126274 129331 210652		15601462				
AS1202	F36		210512		15584981				
AS1203	F36		210628		15577003				
AS1204	F46	S6779		E9HZ4234N					
AS1205	F46	E9391		E9HZ4234R					
AS1206	F46	F9392		E9HZ4234P					
AS1207	F41		119595			596737C1			
AS1208	F36		119596			574679C1			
AS1209	F39		113889 119949			1608185C1			
AS1210	F33		113334			577538C1			
AS1211	F24	C8141				574555C1			
AS1212L	J17							68KH316P2	
AS1212S	J17							68KH316P1	
AS1213L	J17							68KH3202P	1
AS1213S	J17							68KH3202P	2
AS1214	F41		110888			512974C1			
AS1215	F36		110889						
AS1216	F41	Q9117				1665497C1			
AS1217	F41	R9118				1665496C1			
AS1218	F41	S9119				1686034C1			

## SPECIFICATIONS OF NCB AXLES

NCB No.	Type	Length	Spline O.D.	Flange O.D.	Bolt Circle	STUD BOLT HOLES			
						QTY	SIZE	STR	TAPER
AS1199	F39	37-5/8	2.000	6-1/4	5-1/4	12	17/32		12
AS1200	F39	41-1/4	2.500	8-1/2	7	8	41/61		8
AS1201	F36	40-15/16	1.850	6-1/8	5-1/4	12	17/32		12
AS1202	F36	41-1/4	1.850	6-1/8	5-1/4	12	17/32		12
AS1203	F36	41-1/4	1.850	6-1/8	5-1/4	12	17/32		12
AS1204	F46	41-7/8	2.340	8-3/8	7	8	41/64		8
AS1205	F46	37-3/4	2.340	8-3/8	7	8	41/64		8
‡AS1206	F46	41-15/16	2.340	8-3/8	7	8	41/64		8
AS1207	F41	40-3/4	2.100	8-3/8	7	8	25/32	8	
AS1208	F36	40-3/4	2.312	8-3/8	7	8	25/32	8	
AS1209	F39	40-9/16	2.500	8-3/8	7	8	25/32	8	
AS1210	F33	40-3/4	2.125	8-3/8	7	8	49/64	8	
AS1211	F24	40-1/16	2.375	8-3/8	7	8	19/64	8	
‡AS1212L	J17	50-3/16	2.375						
‡AS1212S	J17	39-11/16	2.375						
‡AS1213S	J17	39-11/16	2.187						
AS1214	F41	41-5/16	2.100	8.5	7	8	41/64	8	
AS1215	F36	40-7/8	2.310	8.5	7	8	41/64	8	
AS1216	F41	37-3/16	2.100	8.38	7	8	25/32	8	
AS1217	F41	43-9/64	2.100	8.38	7	8	25/32	8	
AS1218	F41	43-9/64	2.100	8.38	7	8	25/32		8

# Heavy Duty Axle Shafts

## NCB AXLE SHAFT NUMBER TO ORIGINAL EQUIPMENT MANUFACTURER NUMBER

NCB NO.	TYPE	ROC.	EATON	FORD	CHEVY	NAVISTAR	WHITE	MACK	DODGE
AS1219	F41	T9484							
AS1220	F41	U9485							
AS1224	F41	111778		E8HZ4234H		1686033C1			
AS1225	F39		119628						
AS1226	F41		127437						
AS1227	F41		127438						
AS1228	F41		128514						
AS1229	F41		128515						
AS1230	F39		129010						
AS1231	F39		129011						
AS1232	F36		210654		15535797				
AS1233	F17							68KH48	i
AS1234	F36					1699568C1			
AS1235	F46	G9393							
AS1236			128112						
AS1237			128516						
AS1238		S9483							
AS1239		E4555							
AS1240		H6768							
AS1241		H6794							

## SPECIFICATIONS OF NCB AXLES

NCB No.	Type	Length	Splines O.D.	Flange O.D.	Bolt Circle	STUD BOLT HOLES			
						QTY	SIZE	STR	TAPER
AS1219	F41	44	2.100	8.38	7	8	41/64	8	
AS1220	F41	44	2.100	8.38	7	8	41/64	8	
AS1224	F41	40-5/8	2.000	7.49	6.5	12	33/24		12
AS1225	F39	41-5/16	2.500	8.5	7	8	41/64	8	
AS1226	F41	39	2.100	8.5	7	8	41/64	8	
AS1227	F41	43-3/8	2.100	8.5	7	8	41/64	8	
AS1228	F41	38-3/32	2.100	8.5	7	8	25/32	8	
AS1229	F41	42-7/16	2.100	8.5	7	8	25/32	8	
AS1230	F39	38-1/2	2.000	6-1/8	5.25	12	17/32		12
AS1231	F39	42-5/8	2.000	6-1/8	5.25	12	17/32		12
AS1232	F36	40.91	1.850	6-1/8	5.25	12	25/32	12	
AS1233	F17	35-9/16	2.367	8.38	7	8	41/64		8
AS1234	F36	40-1/4	1.850	6.62	5-1/2	8	41/64	8	
AS1235	F46	37-3/8	2.350	8.38	7	8	41/64		8
AS1236	F34	40.375	1.750	6.25	5.13	8	19/32		8
AS1237	F41	39.000	2.100	8.5	7	8	41/64		8
AS1238	F41	38 1/16	2.100	8.38	7	8	25/32	8	
AS1239	F41	40 18/25	2.350	6.50	6.50	8	25/32		8
AS1240	F46	41 1/4	2.550	8.38	7	8	25/32		8
AS1241	F50	49 5/8	2.550	8.38	7	8	41/64		8

‡Double dagger denotes double spline.

# Heavy Duty Axle Shafts

## NCB AXLE SHAFT NUMBER TO ORIGINAL EQUIPMENT MANUFACTURER NUMBER

NCB NO.	TYPE	ROC.	EATON	FORD	CHEVY	NAVISTAR	WHITE	MACK	DODGE
AS1242		J6796							
AS1243		A8191							
AS1244		S9041							
AS1245		C9129							
AS1246		P9142							
AS1247		Q9143							
AS1248		P9246							
AS1249		R9248							
AS1250		S9249							
AS1251		N9374							
AS1252		A9491							
AS1253		N9608							
AS1254		Q9611							
AS1255			129138						
AS1256			129139						
AS1257			129141						
AS1257			126880						
AS1258			129142						
AS1259			131245						
AS1260			128517						
AS1260			128517HX						

## SPECIFICATIONS OF NCB AXLES

NCB No.	Type	Length	Spline O.D.	Flange O.D.	Bolt Circle	STUD BOLT HOLES			
						QTY	SIZE	STR	TAPER
AS1242	F50	49-5/8	2.550	8.38	7	8	41/64		8
AS1243	F41	41-1/4	2.550	8.38	7	8	33/24		8
AS1244	F50	38-1/25	2.100	8.38	7	8	41/64		8
AS1245	F46	43-4/57	2.350	8.38	7	8	41/64	8	
AS1246	F46	36-4/7	2.350	8.38	7	8	41/64	8	
AS1247	F50	41-37/50	2.550	8.5 0	7.25	8	25/32		8
AS1248	F50	56-4/19	2.550	8.5 0	7.25	8	25/32		8
AS1249	F50	48-17/50	2.550	8.50	7.25	8	17/32		8
AS1250	F50	45-4/57	2.550	8.50	7.25	8	17/32		8
AS1251	F46	45-21/50	2.350	8.38	7	8	25/32		8
AS1252	F46	42-1/10	2.880	8.38	7	8	41/64	8	
AS1253	F39	40-17/20	2.100	8.38	7	8	41/64		8
AS1254	F41	46-4/5	2.100	8.38	7	8	46/63		8
AS1255	F36	41.375	1.750	8.50	7.000	8	45/64		8
AS1256	F36	41.375	2.100	8.5 0	7.000	8	41/64	8	
AS1257	F36	40.600	2.100	8.38	8.50	8	45/64		8
AS1257	F36	40.600	2.350	6.50	8.50	8	45/64		8
AS1258	F36	41.375	2.550	8.38	7	8	25/32	8	
AS1259	F46	46.000	2.550	8.38	7	8	15/16		8
AS1260	F41	43.307	2.550	8.38	7	8	45/64		8
AS1260	F41	43.307	2.550	8.38	7	8	45/64		8

# Heavy Duty Axle Shafts

## NUMERICAL LISTING PRINCIPAL APPLICATION AND APPROXIMATE SHIPPING WEIGHT TRUCK AND BUS AXLES

Our No.	Application	Weight	Our No.	Application	Weight	Our No.	Application	Weight
AS649	Diamond T Dodge Federal Ford GMC IHC Kenworth Peterbilt Reo White	51		GMC IHC Kenworth Peterbilt Reo White			Reo White Autocar	27
AS655	IHC	26.5	AS864	Diamond T GMC White	42	AS955	Diamond T Ford GMC Reo White	
AS664	IHC	14	AS866	IHC	25	AS957L-S	Mack	L-40 S-32
AS681	Autocar Diamond T dodge Federal Reo White	34	AS892	Autocar Diamond T Dodge Ford GMC IHC Reo White	40	AS959L-S	Mack	L-60.5 S-42.5 L-40.5 S-34.5
AS691	Dodge	15	AS893	Ford	12	AS965	Reo Army White	25
AS691L-R	Dodge	L-12 R-16	AS894	Ford	13	AS967R-L	Dodge GMC	R-53 L-46
AS700	Dodge	22.5	AS895L-S	Mack	L-40 S-32	AS968	Chevrolet GMC	27.5
AS701R-L	Chevrolet	R-22.5 L-19.5 R-24.5 L-19	AS909	IHC	13	AS969	GMC	31
AS703R-L	GMC	R-24.5 L-19	AS917	Chevrolet	22.5	AS972R-L	GMC IHC White	R-37.5 L-46
AS729	GMC White	46	AS921	Autocar Diamond T Federal IHC Kenworth Reo White	43	AS983	IHC	41
AS732A	Diamond T IHC Reo White	34	AS922	Autocar Diamond T Federal IHC Kenworth Reo White	34	AS984R-L	IHC	R-30 L-34
AS749	Dodge Ford IHC White	31	AS932	Ford	17	AS985	IHC	45
AS750R-L	Chevrolet GMC	R-23.5 L-19.5	AS933	Ford Reo White	25	AS989R-L	IHC	R-38 L-42
AS751R-L	Chevrolet GMC	R-20.5 L-17.5	AS936	Chevrolet GMC	19	AS991	Dodge	12
AS754R-L	Dodge	R-11 L-17.5	AS937	Chevrolet GMC	26	AS995	Reo	28
AS755	Dodge	23	AS938R-L	Chevrolet GMC	R-26.5 L-25	AS999	Autocar White	51
AS758	Dodge	20.5	AS950	Autocar Diamond T Dodge Federal IHC Reo White	32	AS1012	GMC	44
AS762	Ford	22.5				AS1015R-L	GMC IHC White	R-67 L-57
AS763A	IHC	27.5	AS951	Autocar Diamond T Dodge Federal IHC Kenworth Peterbilt Reo White	38.5	AS1022R-L	Chevrolet	R-30.5 L-29
AS828	White	39.5				AS1024	Ford IHC White	40
AS834	Diamond T IHC White	40	AS952	Diamond T Dodge Federal IHC Reo White	51	AS1025	Chevrolet	29.5
AS837	IHC	28.5				AS1026	Autocar Diamond T Ford Reo White	29
AS842R	Chevrolet Diamond T GMC Reo White	31	AS953	Diamond T Ford IHC	45	AS1028	Ford GMC IHC White	31
AS843	IHC	18.5				AS1030	Ford	17.5
AS844	IHC	23				AS1037	Dodge Diamond T Ford GMC IHC Kenworth Peterbilt White	51
AS845	IHC	25.5				AS1040	Dodge GMC	46
AS846	IHC	23				AS1042	Dodge GMC IHC Reo White	47
AS847	White Chevrolet GMC White	29.5				AS1043	Dodge Ford	45
AS854	White	49.5						
AS855	IHC	28.5						
AS858	GMC	22						
AS859R-L	Chevrolet GMC	R-23 L-20.5						
AS863L-S	Autocar Diamond T Federal Ford	L-56.5 S-47.5						

HD Differential

# Heavy Duty Axle Shafts

## NUMERICAL LISTING PRINCIPAL APPLICATION AND APPROXIMATE SHIPPING WEIGHT TRUCK AND BUS AXLES

HD Differential

Our No.	Application	Weight	Our No.	Application	Weight	Our No.	Application	Weight
AS1044	GMC White Mack Reo	31	AS1107	Ford	28	AS1161	IHC	35.5
AS1046	White	41	AS1108	Ford	23	AS1162L-R	GMC	L-15 R-17.5
AS1048	IHC Chevrolet GMC	29	AS1109	Ford	33	AS1163	IHC	27.5
AS1049	White Chevrolet GMC	32	AS1110	Ford	25	AS1164	GMC	46
AS1051	Autocar Diamond T Ford IHC Reo White	45	AS1111	Ford	52	AS1165R-L	Ford IHC	R-23 L-22.5
AS1052	Ford IHC White	41	AS1112R-L	Ford	R-47 L-60 58.5	AS1166	Ford	34
AS1053	Ford White	28	AS1113	Ford GMC IHC White		AS1167	Ford	25
AS1054	Ford	25	AS1115	Ford	51	AS1168	Ford	29
AS1055	Dodge Ford	17	AS1122	Dodge Ford GMC White	34.5	AS1169	Ford IHC	40
AS1056	Dodge	25	AS1123L-R	IHC	L-46 R-43	AS1171	Ford IHC	45
AS1057	Dodge White	28	AS1124L-S	GMC	L-33 S-29.5	AS1172	Ford	25
AS1058	White Chevrolet GMC	30	AS1125	GMC	28	AS1173	Ford	46
AS1060R-L	Diamond T White	R-41 L-32	AS1126L-S	GMC	L-53 S-48	AS1174R-L	Ford	R-28 L-27 R
AS1063	Ford IHC White	41	AS1127	GMC	33	AS1175R-L	Ford	L-32 R-33 L-30
AS1068	Dodge	29	AS1128	GMC Freightliner Kenworth Peterbilt	46	AS1176R-L	Ford	48
AS1070	Dodge	15	AS1129	White Ford GMC White	47	AS1177	GMC Ford	43
AS1076	Dodge	18	AS1130	Ford	59	AS1178	GMC Ford	48
AS1077	Dodge	17.5	AS1131	Dodge IHC White	38	AS1179	Ford	41.5
AS1078	Dodge	19	AS1132	GMC	28	AS1180	Ford	41
AS1080	Dodge	28	AS1133	Ford	29	AS1181	Ford	41
AS1081	Dodge	30	AS1134	Ford	31	AS1182	GMC Ford	60
AS1083	Ford GMC White	42.5	AS1135	Ford	42.5	AS1183	GMC Ford IHC	50
AS1084R-L	Ford GMC White	R-48 L-52	AS1136	Ford GMC	48	AS1184	Ford IHC	59
AS1085R-L	Dodge	R-11.5 L-13-12	AS1137	Ford	25	AS1185	GMC Ford	58
AS1087	Dodge GMC White	42.5	AS1138	Ford GMC	47	AS1186	GMC Ford	53
AS1088	Ford	14	AS1139	Ford	29	AS1187	Ford	58
AS1089	Ford	12	AS1140	GMC	32	AS1188	Ford	46
AS1090	Ford	27.5	AS1141	GMC	25.5	AS1189	Ford	45
AS1091	Ford	17.5	AS1142	GMC	28	AS1190	Ford	48
AS1092	Ford	17.5	AS1143L-R	Ford GMC IHC	L-36 R-33	AS1191	Ford IHC	41
AS1095	Ford	17	AS1144	Eaton	47	AS1192	Ford IHC	48
AS1096	Ford	12.5	AS1145R-L	GMC	R-54 L-49	AS1193	Ford	59
AS1097	Ford	13	AS1146	GMC	23	AS1194	Ford	51
AS1098	Ford	19	AS1147	GMC	25	AS1195	Ford	58
AS1099	Dodge	29	AS1148	GMC	33	AS1196	Ford	46
AS1100	IHC	24	AS1149	GMC	23	AS1197	Ford	43
AS1101L-S	Ford GMC Kenworth White	L-46 S-43	AS1150	IHC	35	AS1198	Ford	38
AS1102	IHC	28	AS1151	IHC	42	AS1199	Ford	38
AS1103	IHC	24	AS1152L-R	IHC	L-42.5 R-38-12	AS1200	GMC	57
AS1104	IHC	42	AS1153	IHC	47	AS1201	GMC	34
AS1105	IHC	28	AS1154	IHC	28	AS1202	GMC	37
AS1106	Ford	23	AS1155L-R	IHC	L-37 R-33 40.5	AS1203	Volvo	
			AS1156	IHC	40.5	AS1204	GMC	29
			AS1157	IHC	51	AS1206	Ford	58
			AS1158	IHC	28.5	AS1207	Ford	58
			AS1159L-R	GMC	L-52 R-54.5	AS1208	IHC	42
			AS1160	IHC	24	AS1209	IHC	50
						AS1210	IHC	56
						AS1211	IHC	45
						AS1212L-S	Mack	55
						AS1213L-S	Mack	L-45 S-36 L-40



# Heavy Duty Axle Shafts

To Identify a Heavy Duty Axle Shaft... follow these time saving steps:

## 1 Look for Manufacturers Numbers.

They are stamped as shown with the following codes:

**Foot** =  $\diamond F$  + 3 or 4 digit number

**Eaton** = 5 or 6 digit number

**Rockwell** = Letter + 4 digit number

If you are able to read these numbers clearly, phone your local **NCB** distributor listed below and give them the flange numbers to cross reference in

our catalog. The distributor can quickly give you the interchange number and cost.

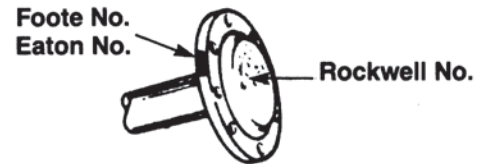

## 2 If numbers are unavailable or illegible.

**Measure** diameter and count number of splines on shaft.

**Measure** diameter of bolt circle. (Center of hole to center of hole on opposite side of flange.)

**Count** the number of straight and the number of tapered holes in flange.

**Measure** length of shaft from inside face of flange to end of spline.

**Note** whether flange is flat or dome shaped.

**Note** whether splines are straight or tapered.

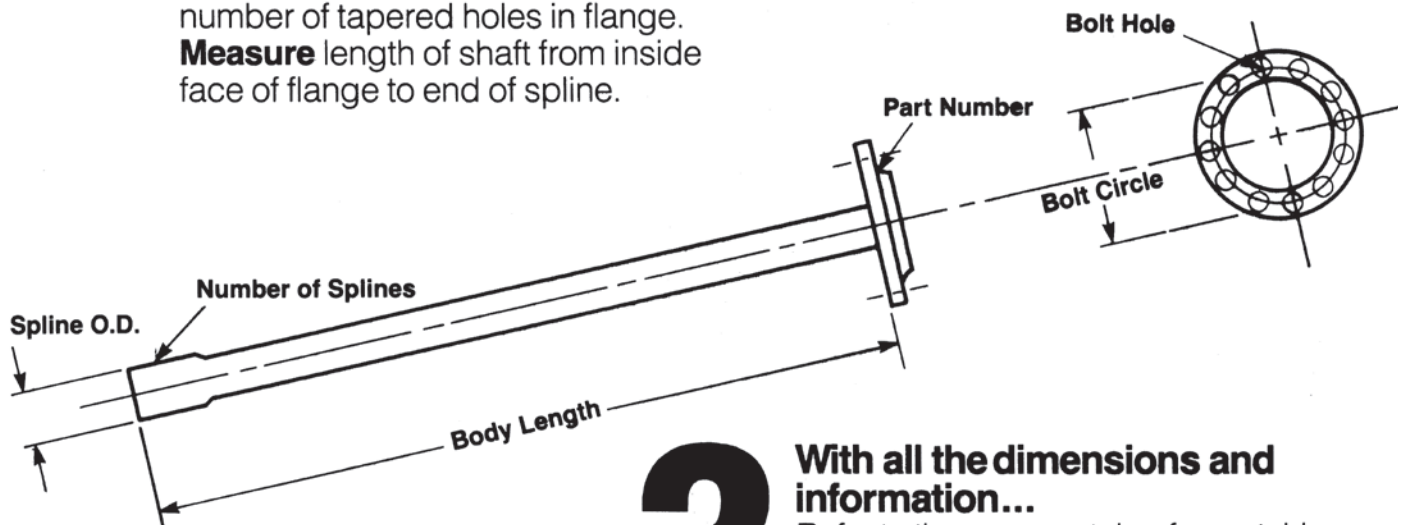

## 3 With all the dimensions and information...

Refer to the **NCB** catalog for matching specifications or call your local **NCB** distributor listed below for assistance and availability. **One phone call is all it takes to cut your downtime.**



# Allison Transmission Products

## 1000/2000 Series

Position	Part #	Comments
Support Assembly Brg.	AT29531013	
Hub Front Thrust Brg.	AT29531089	w/ 29536214 Turbine Assy.
Hub Front Thrust Brg.	AT29539501	w/ 29539501 Turbine Assy.
Hub Front Thrust Brg.	AT29539501	w/ 4th Generation Controls
Hub Rear Thrust Brg.	AT29531090	
P1 Planetary Front Thrust Brg.	AT29531095	
P1 Planetary Rear Thrust Brg.	AT29531106	
P2 Planetary Thrust Brg.	AT29531095	Prior S/N 6310696028
P2 Planetary Thrust Brg.	AT29541702	S/N 6310696028 and later
P3 Planetary Thrust Brg.	AT29531089	w/ 29531121 or 29531218 Sun Gear
P3 Planetary Thrust Brg.	AT29539501	w/o 29531121 or 29531218 Sun Gear
Output Shaft Front Brg.	AT29531151	
Output Shaft Rear Brg.	AT23047970	

## 3000 Series

Position	Part #	Comments
Torque Converter Turbine Front Thrust Brg.	AT23046228	
Torque Converter Turbine Rear Thrust Brg.	AT29500942	1.98, 2.20, 2.35 Stall Ratios
Torque Converter Turbine Rear Thrust Brg.	AT29500768	All other Stall Ratios
Torque Converter Stator Assembly Thrust Brg.	AT23045918	
Support Assembly Thrust Brg.	AT23047834	
Support Assembly Brg.	AT23045816	
Rotating Clutch Front Thrust Brg.	AT23047854	
Rotating Clutch Rear Thrust Brg.	AT23047854	
Hub Front Thrust Brg.	AT23047854	
Hub Rear Thrust Brg.	AT23047854	
P1 Planetary Front Thrust Brg.	AT23047854	
P1 Planetary Rear Thrust Brg.	AT23047854	
Output Shaft Front Cone	AT23046437	
Output Shaft Front Cup	AT23046438	
Output Shaft Rear Cone	AT23046437	
Output Shaft Rear Cup	AT23046438	
Main Shaft Front Thrust Brg.	AT29500768	Close Ratio
Main Shaft Front Thrust Brg.	AT29500713	Wide Ratio
Main Shaft Rear Thrust Brg.	AT29503225	Close Ratio
Main Shaft Rear Thrust Brg.	AT23047854	Close Ratio & Early Lead Unit
Main Shaft Rear Thrust Brg.	AT29503217	Wide Ratio
Main Shaft Rear Thrust Brg.	AT29500953	Wide Ratio & Early Lead Unit

## 4000 Series

Position	Part #	Comments
Torque Converter Turbine Front Thrust Brg.	AT29511436	
Torque Converter Turbine Rear Thrust Brg.	AT29500713	
Torque Converter Stator Assembly Thrust Brg.	AT29503877	
Support Assembly Brg.	AT29505573	
Rotating Clutch Front Thrust Brg.	AT29505572	
Rotating Clutch Rear Thrust Brg.	AT29503225	
Hub Front Thrust Brg.	AT29501221	
Hub Rear Thrust Brg.	AT29501221	
P1 Sun Gear Thrust Brg.	AT29501221	
P1 Planetary Rear Thrust Brg.	AT29514684	
P2 Planetary Thrust Brg.	AT29501197	
Output Shaft Front Cone	AT29505613	
Output Shaft Front Cup	AT29505574	
Output Shaft Rear Cone	AT29505613	
Output Shaft Rear Cup	AT29505574	
Main Shaft Front Thrust Brg.	AT29503225	
Main Shaft Rear Thrust Brg.	AT29514684	
Input Shaft Brg.	AT29542533	
PTO Gear Assembly Front Brg.	AT29501421	
PTO Gear Assembly Rear Brg.	AT29501421	
P4 Sun Gear Brg.	AT29530486	
P4 Front Thrust Brg.	AT29542556	
P4 Rear Thrust Brg.	AT29505572	

## Miscellaneous Bearings

Part #
AT6830333
AT6837146
AT6884434
AT6884835
AT9426916
AT9433392
AT9434057
AT9439704
AT23012921
AT23015799
AT23016866
AT23041147
AT23041452
AT23041458
AT23048030
AT29500063
AT29501299
AT29506196
AT29517123
AT29543992
AT29543993
AT29549505
AT29552652
AT29552707

## Chelsea PTO Rebuild Kits

Model	Comments	Rebuild Kit
442		PTO-489
447		PTO-489
489		PTO-489
270		PTO-270
271		PTO-270
880	Pump Output (M,P,Q,R,T Ratios)	PTO-880A
880	Pump Output (B,D,G,J Ratios)	PTO-880B
880	Standard Output (M,P,Q,R,T Ratios)	PTO-880C
880	Standard Output (B,D,G,J Ratios)	PTO-880D

HD Transmission

### PTO-270

Position	Part Number	Qty
Input Shaft Brg.	WJ162116	2
Input Shaft Thrust Brg.	NTA1625	2
Output Shaft Front Brg.	207	1
Output Shaft Rear Brg.	207	1
Output Gear Brg.	WJ243016	2
Output Seal	471268 (1.375x2.000)	1
Output Seal	410194 (1.625x2.502)	1
Gasket Kit	GT-270	1

### PTO-489

Position	Part Number	Qty
Input Shaft Brg.	21075	2
Output Shaft Front Brg.	15117-15245	1
Output Shaft Rear Brg.	15126-15245	1
Output Seal	471766 (1.250x2.000)	1
Gasket Kit	GT-442	1

### PTO-880A

Position	Part Number	Qty
Input Shaft Brg.	HM88630	2
Output Shaft Front Brg.	LM501349-LM501310	1
Output Shaft Rear Brg.	LM501349-LM501310	1
Output Seal	410194 (1.625x2.502)	1
Gasket Kit	GT-880	1

### PTO-880B

Position	Part Number	Qty
Input Shaft Brg.	M86643	2
Output Shaft Front Brg.	LM501349-LM501310	1
Output Shaft Rear Brg.	LM501349-LM501310	1
Output Seal	410194 (1.625x2.502)	1
Gasket Kit	GT-880	1

### PTO-880C

Position	Part Number	Qty
Input Shaft Brg.	HM88630	2
Output Shaft Front Brg.	LM29749-LM29710	1
Output Shaft Rear Brg.	LM501349-LM501310	1
Output Seal	410085N (2.000x2.996)	1
Gasket Kit	GT-880	1

### PTO-880D

Position	Part Number	Qty
Input Shaft Brg.	M86643	2
Output Shaft Front Brg.	LM29749-LM29710	1
Output Shaft Rear Brg.	LM501349-LM501310	1
Output Seal	410085N (2.000x2.996)	1
Gasket Kit	GT-880	1

## Clark/Eaton/Fuller Transmission Identification

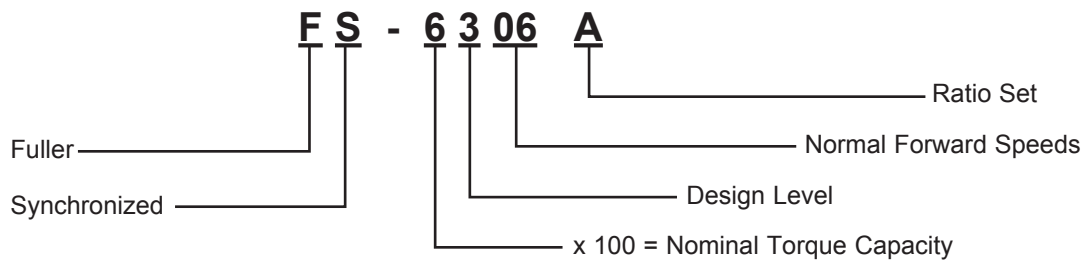
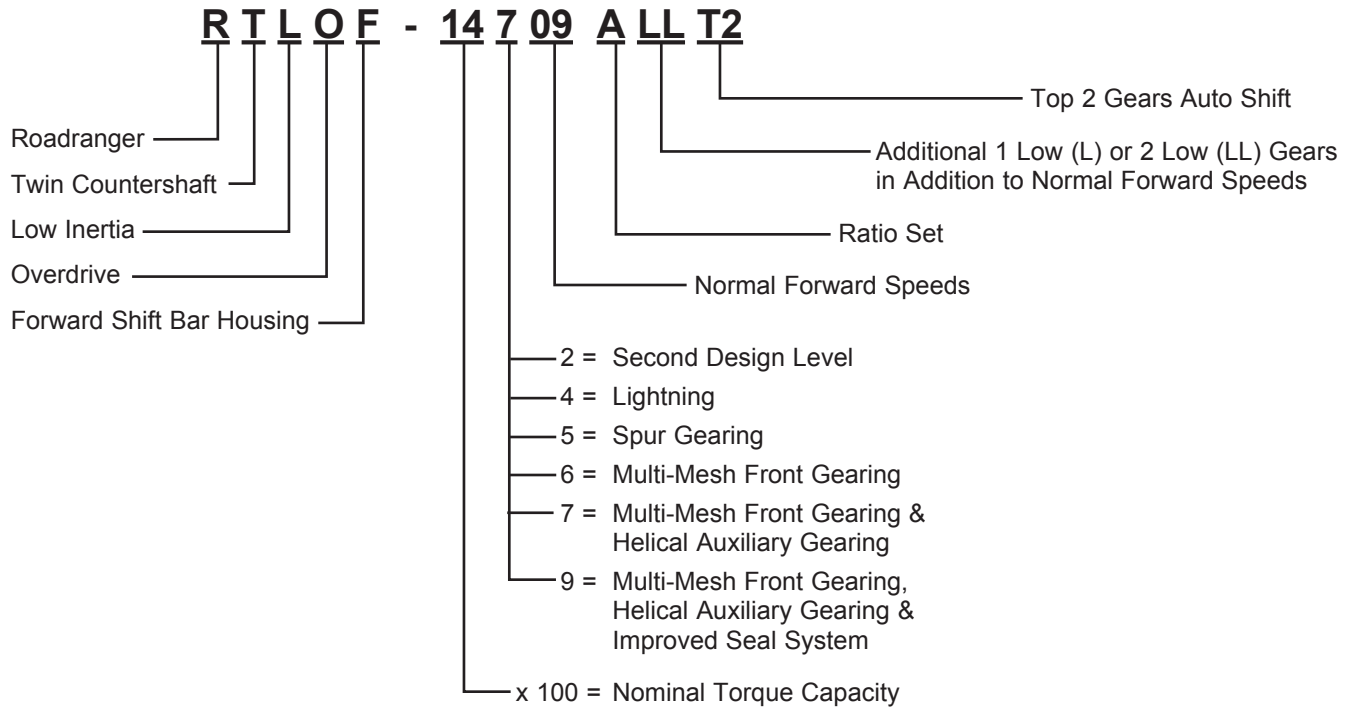



# Heavy Duty Transmission Index

## Clark Medium Duty Models

### Clark 5 Speed Models

Model No.	Comments	Standard Kit	Suitcase Kit	Overhaul Kit	Clutch Install Kit
250-V	1959 & Later	TRK-23			
250-V18		TRK-23B			
250-VO	1959 & Later	TRK-23			
251-V	1959 & Later	TRK-23			
251-VO	1959 & Later	TRK-23			
251-VO18		TRK-23B			
259-V		TRK-23B			
264-V	1959 & Later	TRK-23			
264-VO	1959 & Later	TRK-23			
264-VO48		TRK-23			
264-VO49		TRK-23			
265-V	1959 & Later	TRK-23			
265-VO	1959 & Later	TRK-23			
267-V	1959 & Later	TRK-23			
267-VO	1959 & Later	TRK-23			
268-V	1959 & Later	TRK-23			
269-V	1959 & Later w/ Narrow Output Shaft Brg.	TRK-23B			
269-V	1959 & Later w/o Narrow Output Shaft Brg.	TRK-23			
269-V35	1959 & Later	TRK-23			
280-V	1959 & Later	TRK-148	TRK-2127		
280-VHD	1959 & Later	TRK-190	TRK-2128		
280-VO	1959 & Later	TRK-148	TRK-2127		
280-VO18	1959 & Later	TRK-148	TRK-2127		
280-VO3	1959 & Later	TRK-148	TRK-2127		
280-VO4	1959 & Later	TRK-148	TRK-2127		
282-V		TRK-148	TRK-2127		
282-V11		TRK-148	TRK-2127		
282-V55		TRK-148	TRK-2127		
282-VHD		TRK-190	TRK-2128		
282-VHD12		TRK-190	TRK-2128		
282-VHD13		TRK-190	TRK-2128		
282-VHD2		TRK-190	TRK-2128		
285-V		TRK-148	TRK-2127		
285-V54		TRK-148	TRK-2127		
285-V9		TRK-148	TRK-2127		
285-VHD		TRK-190	TRK-2128		
285-VHD13		TRK-190	TRK-2128		
285-VHD2		TRK-190	TRK-2128		
305-V		TRK-48			
307-V		TRK-48			
315-V		TRK-48			
318-V		TRK-48			
320-V		TRK-132			
325-V		TRK-132			
327-V		TRK-132			
328-V		TRK-132			
380-V		TRK-133			
380-VO		TRK-133			
381-V		TRK-133			
385-V		TRK-133			
387-V		TRK-133			
388-V		TRK-133			
390-V	1-1/2" Input Shaft & 2" Output Shaft	TRK-390F	TRK-2124		
390-V	1-3/4" Input Shaft & 2" Output Shaft	TRK-390G	TRK-2125		
390-V	1-1/2" Input Shaft & 1-3/4" Output Shaft	TRK-390H	TRK-2126		

# Heavy Duty Transmission Index

## Clark Medium Duty Models

### Clark 5 Speed Models (cont.)

Model No.	Comments	Standard Kit	Suitcase Kit	Overhaul Kit	Clutch Install Kit
397-V	1-1/2" Input Shaft & 2" Output Shaft	TRK-390F	TRK-2124		
397-V	1-3/4" Input Shaft & 2" Output Shaft	TRK-390G	TRK-2125		
397-V	1-1/2" Input Shaft & 1-3/4" Output Shaft	TRK-390H	TRK-2126		
2621-V	w/ Narrow Output Shaft Brg.	TRK-23B			
2621-V	w/o Narrow Output Shaft Brg.	TRK-23			
2621-V1	w/ Narrow Output Shaft Brg.	TRK-23B			
2621-V1	w/o Narrow Output Shaft Brg.	TRK-23			
2622-V12		TRK-23B			
2622-V7		TRK-23B			
2651-V	w/ Narrow Output Shaft Brg.	TRK-23B			
2651-V	w/o Narrow Output Shaft Brg.	TRK-23			
2651-V1	w/ Narrow Output Shaft Brg.	TRK-23B			
2651-V1	w/o Narrow Output Shaft Brg.	TRK-23			
2653-V		TRK-23B			
2653-V10		TRK-23B			
2653-V5		TRK-23B			
2653-V9		TRK-23B			
2653-VO		TRK-23B			
CL450	1-1/4" or 1-1/2" Input Shaft	TRK-208	TRK-2120		
CL450	1-3/4" Input Shaft	TRK-208D	TRK-2129		
CL455	1-1/4" or 1-1/2" Input Shaft	TRK-208	TRK-2120		
CL455	1-3/4" Input Shaft	TRK-208D	TRK-2129		
CL457	1-1/4" or 1-1/2" Input Shaft	TRK-208	TRK-2120		
CL457	1-3/4" Input Shaft	TRK-208D	TRK-2129		
CL550	1-1/2" Input Shaft & 2" Output Shaft	TRK-390F	TRK-2124		
CL550	1-3/4" Input Shaft & 2" Output Shaft	TRK-390G	TRK-2125		
CL550	1-1/2" Input Shaft & 1-3/4" Output Shaft	TRK-390H	TRK-2126		
CL551	1-1/2" Input Shaft & 2" Output Shaft	TRK-390F	TRK-2124		
CL551	1-3/4" Input Shaft & 2" Output Shaft	TRK-390G	TRK-2125		
CL551	1-1/2" Input Shaft & 1-3/4" Output Shaft	TRK-390H	TRK-2126		
CL557	1-1/2" Input Shaft & 2" Output Shaft	TRK-390F	TRK-2124		
CL557	1-3/4" Input Shaft & 2" Output Shaft	TRK-390G	TRK-2125		
CL557	1-1/2" Input Shaft & 1-3/4" Output Shaft	TRK-390H	TRK-2126		
CL558	1-1/2" Input Shaft & 2" Output Shaft	TRK-390F	TRK-2124		
CL558	1-3/4" Input Shaft & 2" Output Shaft	TRK-390G	TRK-2125		
CL558	1-1/2" Input Shaft & 1-3/4" Output Shaft	TRK-390H	TRK-2126		

## Eaton/Fuller Medium & Heavy Duty Models

### 2 Speed Auxiliary Models

Model No.	Comments	Standard Kit	Suitcase Kit	Overhaul Kit	Clutch Install Kit
2-A-92			TRK-400		
AT-1202			TRK-401		

### 5 Speed Models

F-5405B-DM3			TRK-3440		
F-5505B-DM3			TRK-3440		
F-6405B-DM3			TRK-3440		
F-6505B-DM3			TRK-3440		
FS-4005A	w/ 1.375" or 1.5" I/S	TRK-208	TRK-2120		
FS-4005A	w/ 1.75" I/S	TRK-208D	TRK-2129		
FS-4005B	w/ 1.375" or 1.5" I/S	TRK-208	TRK-2120		
FS-4005B	w/ 1.75" I/S	TRK-208D	TRK-2129		
FS-4005C	w/ 1.375" or 1.5" I/S	TRK-208	TRK-2120		
FS-4005C	w/ 1.75" I/S	TRK-208D	TRK-2129		
FS-4205A	w/ 1.5" I/S & 2" O/S		TRK-7000		

# Heavy Duty Transmission Index

## Eaton/Fuller Medium & Heavy Duty Models

### 5 Speed Models (cont.)

Model No.	Comments	Standard Kit	Suitcase Kit	Overhaul Kit	Clutch Install Kit
FS-4205A	w/ 1.75" I/S		TRK-7013		
FS-4205B	w/ 1.5" I/S & 2" O/S		TRK-7000		
FS-4205B	w/ 1.75" I/S		TRK-7013		
FS-4205C	w/ 1.5" I/S & 2" O/S		TRK-7000		
FS-4205C	w/ 1.75" I/S		TRK-7013		
FS-5005A	w/ 1.5" I/S & 2" O/S	TRK-395F	TRK-2121		
FS-5005A	w/ 1.5" I/S & 1.75" O/S	TRK-395G	TRK-2122		
FS-5005A	w/ 1.75" I/S & 2" O/S	TRK-395H	TRK-2123		
FS-5005B	w/ 1.5" I/S & 2" O/S	TRK-395F	TRK-2121		
FS-5005B	w/ 1.5" I/S & 1.75" O/S	TRK-395G	TRK-2122		
FS-5005B	w/ 1.75" I/S & 2" O/S	TRK-395H	TRK-2123		
FS-5005C	w/ 1.5" I/S & 2" O/S	TRK-395F	TRK-2121		
FS-5005C	w/ 1.5" I/S & 1.75" O/S	TRK-395G	TRK-2122		
FS-5005C	w/ 1.75" I/S & 2" O/S	TRK-395H	TRK-2123		
FS-5205A	w/ 1.5" I/S		TRK-7032		
FS-5205A	w/ 1.75" I/S		TRK-7033		
FS-5205B	w/ 1.5" I/S		TRK-7032		
FS-5205B	w/ 1.75" I/S		TRK-7033		
FS-5205C	w/ 1.5" I/S		TRK-7032		
FS-5205C	w/ 1.75" I/S		TRK-7033		
FS-6005			TRK-2131		
FS-6105			TRK-2131		
FS-6205A			TRK-7035		
FS-6205B			TRK-7035		
FS-6305A			TRK-7035		
FS-6305B			TRK-7035		
T-11605A	w/ 2" Pull Type I/S	TRK-58A	TRK-1873	TRK-1984	
T-11605B	w/ 2" Pull Type I/S	TRK-58A	TRK-1873	TRK-1984	
T-11605C	w/ 2" Pull Type I/S	TRK-58A	TRK-1873	TRK-1984	
T-11605D	w/ 2" Pull Type I/S	TRK-58A	TRK-1873	TRK-1984	
T-11605F	w/ 2" Pull Type I/S	TRK-58A	TRK-1873	TRK-1984	
T-11605M	w/ 2" Pull Type I/S	TRK-58A	TRK-1873	TRK-1984	
T-905		TRK-58	TRK-1852		
T-955		TRK-1000	TRK-2780		
T-955LL		TRK-1000	TRK-2780		
TO-11605A	w/ 2" Pull Type I/S	TRK-58A	TRK-1873	TRK-1984	
TO-11605B	w/ 2" Pull Type I/S	TRK-58A	TRK-1873	TRK-1984	
TO-11605C	w/ 2" Pull Type I/S	TRK-58A	TRK-1873	TRK-1984	
TO-11605D	w/ 2" Pull Type I/S	TRK-58A	TRK-1873	TRK-1984	
<b>6 Speed Models</b>					
FO-5406B-DM3			TRK-3440		
FO-5506B-DM3			TRK-3440		
FO-6406A-ASX			TRK-3440		
FO-6406B-DM3			TRK-3440		
FO-6506B-DMW			TRK-3440		
FO-8406A-ASX			TRK-3440		
FS-5106A			TRK-2041		
FS-5306A			TRK-7052		
FS-5406A			TRK-3423		
FS-5406N			TRK-3423		
FS-6106			TRK-1766		
FS-6206A			TRK-2041		
FS-6306A			TRK-7052		
FS-6406A			TRK-3423		
FS-6406N			TRK-3423		

# Heavy Duty Transmission Index

## Eaton/Fuller Medium & Heavy Duty Models

### 6 Speed Models (cont.)

Model No.	Comments	Standard Kit	Suitcase Kit	Overhaul Kit	Clutch Install Kit
FS-7206			TRK-2130		
FS-8206A			TRK-2490		
FSB-5406B			TRK-3423		
FSO-6406A			TRK-3423		
FSO-8206			TRK-2464		
FSO-8406A			TRK-3423		
RT-906		TRK-1000	TRK-2780		

### 7 Speed Models

RTO-1157DL		TRK-188	TRK-1859		
RTO-1157DLL		TRK-184	TRK-1860		
RTO-11607L		TRK-201	TRK-1866	TRK-1980	
RTO-11607LL			TRK-1867	TRK-1981	
RTO-11707DLL			TRK-2045	TRK-1986	
RTO-11707LL			TRK-2045	TRK-1986	
RTO-13707DLL			TRK-2855		
RTO-13707MLL			TRK-2855		
RTOF-11607L		TRK-201	TRK-1866	TRK-1980	
RTOF-11607LL			TRK-1867	TRK-1981	
RTOF-11707LL			TRK-2045	TRK-1986	
RTOF-13707DLL			TRK-2855		
RTOF-13707MLL			TRK-2855		
T-11607A			TRK-2771	TRK-1982	
T-11607B			TRK-2771	TRK-1982	
T-14607A			TRK-2771	TRK-1982	
T-14607B			TRK-2771	TRK-1982	
T-8607A			TRK-1877	TRK-1765	
T-8607B			TRK-1877	TRK-1765	
TX-14607B			TRK-2771	TRK-1982	
TX-8607B			TRK-1877	TRK-1765	

### 8 Speed Models

FO-10E308LL-VCS			TRK-3942		
FO-11E308LL-VCS			TRK-3942		
FO-12E308LL-VCS			TRK-3942		
FO-14E308LL-VCS			TRK-3942		
FO-16E308LL-VCS			TRK-3942		
FO-17E308LL-VCS			TRK-3942		
RT-11608	w/ 1.75" Push Type I/S		TRK-2283	TRK-2345	
RT-11608	w/ 2" Pull Type I/S		TRK-2283	TRK-2761	TRK-2468 <sup>55</sup>
RT-7608LL			TRK-2047	TRK-1995	
RT-8608L	w/ 1.75" Push Type I/S		TRK-2283	TRK-2345	
RT-8608L	w/ 2" Pull Type I/S		TRK-2283	TRK-2761	TRK-2468 <sup>55</sup>
RT-8908LL			TRK-3273	TRK-3272	TRK-2468 <sup>55</sup>
RT-9508		TRK-1000	TRK-2780		
RTF-11608	w/ 1.75" Push Type I/S		TRK-2283	TRK-2345	
RTF-11608	w/ 2" Pull Type I/S		TRK-2283	TRK-2761	TRK-2468 <sup>55</sup>
RTF-8608L	w/ 1.75" Push Type I/S		TRK-2283	TRK-2345	
RTF-8608L	w/ 2" Pull Type I/S		TRK-2283	TRK-2761	TRK-2468 <sup>55</sup>
RTF-8908LL			TRK-3273	TRK-3272	TRK-2468 <sup>55</sup>
RTO-11608L	w/ 1.75" Push Type I/S	TRK-203	TRK-3659	TRK-3655	
RTO-11608L	w/ 2" Pull Type I/S	TRK-203	TRK-3659	TRK-3656	TRK-2468 <sup>55</sup>
RTO-11708LL			TRK-3660	TRK-3657	TRK-2468 <sup>55</sup>
RTO-11908LL			TRK-3256	TRK-3258	TRK-2468 <sup>55</sup>
RTO-14608LL		TRK-207	TRK-1872	TRK-1979	TRK-2468 <sup>55</sup>
RTO-14708LL			TRK-2043	TRK-1992	TRK-2468 <sup>55</sup>
RTO-14908LL	w/ 85mm Aux Drive Gear Brg.		TRK-3233	TRK-4092	TRK-2468 <sup>55</sup>

<sup>55</sup> Exc. Hyd. Release

# Heavy Duty Transmission Index

## Eaton/Fuller Medium & Heavy Duty Models

### 8 Speed Models (cont.)

Model No.	Comments	Standard Kit	Suitcase Kit	Overhaul Kit	Clutch Install Kit
RTO-14908LL	w/ 90mm Aux Drive Gear Brg.		TRK-3256	TRK-3258	TRK-2468 <sup>55</sup>
RTO-16908LL			TRK-3233	TRK-4092	TRK-2468 <sup>55</sup>
RTO-9508		TRK-1000	TRK-2780		
RTOF-11608LL	w/ 1.75" Push Type I/S	TRK-203	TRK-3659	TRK-3655	
RTOF-11608LL	w/ 2" Pull Type I/S	TRK-203	TRK-3659	TRK-3656	TRK-2468 <sup>55</sup>
RTOF-11708LL			TRK-3660	TRK-3657	TRK-2468 <sup>55</sup>
RTOF-11908LL			TRK-3256	TRK-3258	TRK-2468 <sup>55</sup>
RTOF-14608LL		TRK-207	TRK-1872	TRK-1979	TRK-2468 <sup>55</sup>
RTOF-14708LL			TRK-2043	TRK-1992	TRK-2468 <sup>55</sup>
RTOF-14908LL	w/ 85mm Aux Drive Gear Brg.		TRK-3233	TRK-4092	TRK-2468 <sup>55</sup>
RTOF-14908LL	w/ 90mm Aux Drive Gear Brg.		TRK-3256	TRK-3258	TRK-2468 <sup>55</sup>
RTOF-16908LL			TRK-3233	TRK-4092	TRK-2468 <sup>55</sup>
RTX-11608LL	w/ 1.75" Push Type I/S	TRK-203	TRK-3659	TRK-3655	
RTX-11608LL	w/ 2" Pull Type I/S	TRK-203	TRK-3659	TRK-3656	TRK-2468 <sup>55</sup>
RTX-11708LL			TRK-3660	TRK-3657	TRK-2468 <sup>55</sup>
RTX-14608LL		TRK-207	TRK-1872	TRK-1979	TRK-2468 <sup>55</sup>
RTX-14708LL			TRK-2043	TRK-1992	TRK-2468 <sup>55</sup>
RTXF-11608LL	w/ 1.75" Push Type I/S	TRK-203	TRK-3659	TRK-3655	
RTXF-11608LL	w/ 2" Pull Type I/S	TRK-203	TRK-3659	TRK-3656	TRK-2468 <sup>55</sup>
RTXF-11708LL			TRK-3660	TRK-3657	TRK-2468 <sup>55</sup>
RTXF-14608LL		TRK-207	TRK-1872	TRK-1979	TRK-2468 <sup>55</sup>
RTXF-14708LL			TRK-2043	TRK-1992	TRK-2468 <sup>55</sup>

### 9 Speed Models

FO-10E309ALL-VMW			TRK-3942		
FO-11309ALL-VMS			TRK-3942		
FO-12E309ALL-VMS			TRK-3942		
FO-14E309ALL-VMS			TRK-3942		
FO-16E309ALL-VMS			TRK-3942		
FO-17E309ALL-VMS			TRK-3942		
RT-11509			TRK-1858	TRK-1063	TRK-2468 <sup>55</sup>
RT-11609A	w/ 1.75" Push Type I/S		TRK-2283	TRK-2345	
RT-11609A	w/ 2" Pull Type I/S		TRK-2283	TRK-2761	TRK-2468 <sup>55</sup>
RT-11709A			TRK-2049	TRK-1996	TRK-2468 <sup>55</sup>
RT-11709H			TRK-2049	TRK-1996	TRK-2468 <sup>55</sup>
RT-12509		TRK-160	TRK-1861	TRK-1064	TRK-2468 <sup>55</sup>
RT-12609A	w/ 1.75" Push Type I/S		TRK-2283	TRK-2345	
RT-12609A	w/ 2" Pull Type I/S		TRK-2283	TRK-2761	TRK-2468 <sup>55</sup>
RT-12709A			TRK-2049	TRK-1996	TRK-2468
RT-12709H			TRK-2049	TRK-1996	TRK-2468
RT-13609A			TRK-2282	TRK-2344	TRK-2468 <sup>55</sup>
RT-13709H			TRK-2284	TRK-2762	TRK-2468 <sup>55</sup>
RT-14609A		TRK-205	TRK-1870	TRK-1971	TRK-2468 <sup>55</sup>
RT-14709A			TRK-2275	TRK-1999	TRK-2468 <sup>55</sup>
RT-14709H			TRK-2275	TRK-1999	TRK-2468 <sup>55</sup>
RT-6609			TRK-2048		
RT-8609			TRK-1876		TRK-2468
RT-8709B			TRK-3322	TRK-3323	TRK-2468 <sup>55</sup>
RT-909		TRK-1000	TRK-2780		
RT-9509		TRK-1000	TRK-2780		
RTF-11509			TRK-1858	TRK-1063	TRK-2468 <sup>55</sup>
RTF-11609A	w/ 1.75" Push Type I/S		TRK-2283	TRK-2345	
RTF-11609A	w/ 2" Pull Type I/S		TRK-2283	TRK-2761	TRK-2468 <sup>55</sup>
RTF-11709H			TRK-2049	TRK-1996	TRK-2468 <sup>55</sup>
RTF-12509		TRK-160	TRK-1861	TRK-1064	TRK-2468 <sup>55</sup>
RTF-12609A	w/ 1.75" Push Type I/S		TRK-2283	TRK-2345	



# Heavy Duty Transmission Index

## Eaton/Fuller Medium & Heavy Duty Models

### 9 Speed Models (cont.)

Model No.	Comments	Standard Kit	Suitcase Kit	Overhaul Kit	Clutch Install Kit
RTF-12609A	w/ 2" Pull Type I/S		TRK-2283	TRK-2761	TRK-2468 <sup>55</sup>
RTF-12709H			TRK-2049	TRK-1996	TRK-2468 <sup>55</sup>
RTF-13609A			TRK-2282	TRK-2344	TRK-2468 <sup>55</sup>
RTF-13709H			TRK-2284	TRK-2762	TRK-2468 <sup>55</sup>
RTF-14609A		TRK-205	TRK-1870	TRK-1971	TRK-2468 <sup>55</sup>
RTF-14709H			TRK-2275	TRK-1999	TRK-2468 <sup>55</sup>
RTF-8709B			TRK-3322	TRK-3323	TRK-2468 <sup>55</sup>
RTLC-16609E			TRK-3586	TRK-3585	TRK-2468 <sup>55</sup>
RTLFC-16609E			TRK-3586	TRK-3585	TRK-2468 <sup>55</sup>
RTLOC-16909A-T2			TRK-3598	TRK-3597	TRK-2468 <sup>55</sup>
RTLOFC-16909A-T2			TRK-3598	TRK-3597	TRK-2468 <sup>55</sup>
RTO-11509			TRK-1858	TRK-1063	TRK-2468 <sup>55</sup>
RTO-11609A	w/ 1.75" Push Type I/S		TRK-2283	TRK-2345	
RTO-11609A	w/ 2" Pull Type I/S		TRK-2283	TRK-2761	TRK-2468 <sup>55</sup>
RTO-11609B	w/ 1.75" Push Type I/S		TRK-2283	TRK-2345	
RTO-11609B	w/ 2" Pull Type I/S		TRK-2283	TRK-2761	TRK-2468 <sup>55</sup>
RTO-11709A			TRK-2284	TRK-2763	TRK-2468 <sup>55</sup>
RTO-11709B			TRK-2284	TRK-2763	TRK-2468 <sup>55</sup>
RTO-11709MLL			TRK-2847	TRK-2848	TRK-2468 <sup>55</sup>
RTO-11909ALL			TRK-3283	TRK-3661	TRK-2468 <sup>55</sup>
RTO-11909MLL			TRK-3283	TRK-3282	TRK-2468 <sup>55</sup>
RTO-12509		TRK-160	TRK-1861	TRK-1064	TRK-2468 <sup>55</sup>
RTO-12609A	w/ 1.75" Push Type I/S		TRK-2283	TRK-2345	
RTO-12609A	w/ 2" Pull Type I/S		TRK-2283	TRK-2761	TRK-2468 <sup>55</sup>
RTO-12609B	w/ 1.75" Push Type I/S		TRK-2283	TRK-2345	
RTO-12609B	w/ 2" Pull Type I/S		TRK-2283	TRK-2761	TRK-2468 <sup>55</sup>
RTO-12709A			TRK-2284	TRK-2763	TRK-2468 <sup>55</sup>
RTO-12709B			TRK-2284	TRK-2763	TRK-2468 <sup>55</sup>
RTO-14609A		TRK-205	TRK-1870	TRK-1971	TRK-2468 <sup>55</sup>
RTO-14609B		TRK-205	TRK-1870	TRK-1971	TRK-2468 <sup>55</sup>
RTO-14709A			TRK-2275	TRK-1999	TRK-2468 <sup>55</sup>
RTO-14709B			TRK-2275	TRK-1999	TRK-2468 <sup>55</sup>
RTO-14709H			TRK-2275	TRK-1999	TRK-2468 <sup>55</sup>
RTO-14709MLL			TRK-2847	TRK-2848	TRK-2468 <sup>55</sup>
RTO-14909ALL	w/ 90mm Aux Drive Gear Brg.		TRK-3283	TRK-3282	TRK-2468 <sup>55</sup>
RTO-14909ALL	w/ 85mm Aux Drive Gear Brg.		TRK-3413	TRK-3414	TRK-2468 <sup>55</sup>
RTO-14909MLL			TRK-3283	TRK-3282	TRK-2468 <sup>55</sup>
RTO-16909ALL			TRK-3413	TRK-3414	TRK-2468 <sup>55</sup>
RTO-909		TRK-1000	TRK-2780		
RTO-9509		TRK-1000	TRK-2780		
RTOC-16709A			TRK-3596	TRK-3595	TRK-2468 <sup>55</sup>
RTOC-16909A			TRK-3598	TRK-3597	TRK-2468 <sup>55</sup>
RTOC-18909A			TRK-4057	TRK-4056	TRK-2468 <sup>55</sup>
RTOCF-16709A			TRK-3596	TRK-3595	TRK-2468 <sup>55</sup>
RTOF-11509			TRK-1858	TRK-1063	TRK-2468 <sup>55</sup>
RTOF-11609A	w/ 1.75" Push Type I/S		TRK-2283	TRK-2345	
RTOF-11609A	w/ 2" Pull Type I/S		TRK-2283	TRK-2761	TRK-2468 <sup>55</sup>
RTOF-11609B	w/ 1.75" Push Type I/S		TRK-2283	TRK-2345	
RTOF-11609B	w/ 2" Pull Type I/S		TRK-2283	TRK-2761	TRK-2468 <sup>55</sup>
RTOF-11709MLL			TRK-2847	TRK-2848	TRK-2468 <sup>55</sup>
RTOF-11909ALL			TRK-3283	TRK-3661	TRK-2468 <sup>55</sup>
RTOF-11909MLL			TRK-3283	TRK-3282	TRK-2468 <sup>55</sup>
RTOF-12509		TRK-160	TRK-1861	TRK-1064	TRK-2468 <sup>55</sup>
RTOF-12609A	w/ 1.75" Push Type I/S		TRK-2283	TRK-2345	
RTOF-12609A	w/ 2" Pull Type I/S		TRK-2283	TRK-2761	TRK-2468 <sup>55</sup>

HD Transmission

# Heavy Duty Transmission Index

## Eaton/Fuller Medium & Heavy Duty Models

### 9 Speed Models (cont.)

Model No.	Comments	Standard Kit	Suitcase Kit	Overhaul Kit	Clutch Install Kit
RTOF-12609B	w/ 1.75" Push Type I/S		TRK-2283	TRK-2345	
RTOF-12609B	w/ 2" Pull Type I/S		TRK-2283	TRK-2761	TRK-2468 <sup>55</sup>
RTOF-14609A		TRK-205	TRK-1870	TRK-1971	TRK-2468 <sup>55</sup>
RTOF-14609B		TRK-205	TRK-1870	TRK-1971	TRK-2468 <sup>55</sup>
RTOF-14709MLL			TRK-2847	TRK-2848	TRK-2468 <sup>55</sup>
RTOF-14909ALL	w/ 90mm Aux Drive Gear Brg.		TRK-3283	TRK-3282	TRK-2468 <sup>55</sup>
RTOF-14909ALL	w/ 85mm Aux Drive Gear Brg.		TRK-3413	TRK-3414	TRK-2468 <sup>55</sup>
RTOF-14909MLL			TRK-3283	TRK-3282	TRK-2468 <sup>55</sup>
RTOF-16909ALL			TRK-3413	TRK-3414	TRK-2468 <sup>55</sup>
RTOFC-16909A			TRK-3598	TRK-3597	TRK-2468 <sup>55</sup>
RTX-11509			TRK-1858	TRK-1063	TRK-2468 <sup>55</sup>
RTX-11609A	w/ 1.75" Push Type I/S		TRK-2283	TRK-2345	
RTX-11609A	w/ 2" Pull Type I/S		TRK-2283	TRK-2761	TRK-2468 <sup>55</sup>
RTX-11609B	w/ 1.75" Push Type I/S		TRK-2283	TRK-2345	
RTX-11609B	w/ 2" Pull Type I/S		TRK-2283	TRK-2761	TRK-2468 <sup>55</sup>
RTX-11609P	w/ 1.75" Push Type I/S		TRK-2283	TRK-2345	
RTX-11609P	w/ 2" Pull Type I/S		TRK-2283	TRK-2761	TRK-2468 <sup>55</sup>
RTX-11609R	w/ 1.75" Push Type I/S		TRK-2283	TRK-2345	
RTX-11609R	w/ 2" Pull Type I/S		TRK-2283	TRK-2761	TRK-2468 <sup>55</sup>
RTX-11709A			TRK-2284	TRK-2763	TRK-2468 <sup>55</sup>
RTX-11709B			TRK-2284	TRK-2763	TRK-2468 <sup>55</sup>
RTX-11709H			TRK-2284	TRK-2763	TRK-2468 <sup>55</sup>
RTX-12509		TRK-160	TRK-1861	TRK-1064	
RTX-12609A	w/ 1.75" Push Type I/S		TRK-2283	TRK-2345	
RTX-12609A	w/ 2" Pull Type I/S		TRK-2283	TRK-2761	TRK-2468 <sup>55</sup>
RTX-12609B	w/ 1.75" Push Type I/S		TRK-2283	TRK-2345	
RTX-12609B	w/ 2" Pull Type I/S		TRK-2283	TRK-2761	TRK-2468 <sup>55</sup>
RTX-12609P	w/ 1.75" Push Type I/S		TRK-2283	TRK-2345	
RTX-12609P	w/ 2" Pull Type I/S		TRK-2283	TRK-2761	TRK-2468 <sup>55</sup>
RTX-12609R	w/ 1.75" Push Type I/S		TRK-2283	TRK-2345	
RTX-12609R	w/ 2" Pull Type I/S		TRK-2283	TRK-2761	TRK-2468 <sup>55</sup>
RTX-12709A			TRK-2284	TRK-2763	TRK-2468 <sup>55</sup>
RTX-12709B			TRK-2284	TRK-2763	TRK-2468 <sup>55</sup>
RTX-12709H			TRK-2284	TRK-2763	TRK-2468 <sup>55</sup>
RTX-13609A			TRK-2282	TRK-2343	TRK-2468 <sup>55</sup>
RTX-13609B			TRK-2282	TRK-2343	TRK-2468 <sup>55</sup>
RTX-13609P			TRK-2282	TRK-2343	TRK-2468 <sup>55</sup>
RTX-13609R			TRK-2282	TRK-2343	TRK-2468 <sup>55</sup>
RTX-13709H			TRK-2284	TRK-2763	TRK-2468 <sup>55</sup>
RTX-14609A		TRK-205	TRK-1870	TRK-1971	TRK-2468 <sup>55</sup>
RTX-14609B		TRK-205	TRK-1870	TRK-1971	TRK-2468 <sup>55</sup>
RTX-14609P		TRK-205	TRK-1870	TRK-1971	TRK-2468 <sup>55</sup>
RTX-14609R		TRK-205	TRK-1870	TRK-1971	TRK-2468 <sup>55</sup>
RTX-16709B			TRK-2275	TRK-1999	TRK-2468 <sup>55</sup>
RTX-16709H			TRK-2275	TRK-1999	TRK-2468 <sup>55</sup>
RTXF-11509			TRK-1858	TRK-1063	TRK-2468 <sup>55</sup>
RTXF-11609A	w/ 1.75" Push Type I/S		TRK-2283	TRK-2345	
RTXF-11609A	w/ 2" Pull Type I/S		TRK-2283	TRK-2761	TRK-2468 <sup>55</sup>
RTXF-11609B	w/ 1.75" Push Type I/S		TRK-2283	TRK-2345	
RTXF-11609B	w/ 2" Pull Type I/S		TRK-2283	TRK-2761	TRK-2468 <sup>55</sup>
RTXF-11609P	w/ 1.75" Push Type I/S		TRK-2283	TRK-2345	
RTXF-11609P	w/ 2" Pull Type I/S		TRK-2283	TRK-2761	TRK-2468 <sup>55</sup>
RTXF-11609R	w/ 1.75" Push Type I/S		TRK-2283	TRK-2345	
RTXF-11609R	w/ 2" Pull Type I/S		TRK-2283	TRK-2761	TRK-2468 <sup>55</sup>
RTXF-11709H			TRK-2284	TRK-2763	TRK-2468 <sup>55</sup>

HD Transmission

# Heavy Duty Transmission Index

## Eaton/Fuller Medium & Heavy Duty Models

### 9 Speed Models (cont.)

Model No.	Comments	Standard Kit	Suitcase Kit	Overhaul Kit	Clutch Install Kit
RTXF-12509		TRK-160	TRK-1861	TRK-1064	TRK-2468 <sup>55</sup>
RTXF-12609A	w/ 1.75" Push Type I/S		TRK-2283	TRK-2345	
RTXF-12609A	w/ 2" Pull Type I/S		TRK-2283	TRK-2761	TRK-2468 <sup>55</sup>
RTXF-12609B	w/ 1.75" Push Type I/S		TRK-2283	TRK-2345	
RTXF-12609B	w/ 2" Pull Type I/S		TRK-2283	TRK-2761	TRK-2468 <sup>55</sup>
RTXF-12609P	w/ 1.75" Push Type I/S		TRK-2283	TRK-2345	
RTXF-12609P	w/ 2" Pull Type I/S		TRK-2283	TRK-2761	TRK-2468 <sup>55</sup>
RTXF-12609R	w/ 1.75" Push Type I/S		TRK-2283	TRK-2345	
RTXF-12609R	w/ 2" Pull Type I/S		TRK-2283	TRK-2761	TRK-2468 <sup>55</sup>
RTXF-12709H			TRK-2284	TRK-2763	TRK-2468 <sup>55</sup>
RTXF-13609A			TRK-2282	TRK-2343	TRK-2468 <sup>55</sup>
RTXF-13609B			TRK-2282	TRK-2343	TRK-2468 <sup>55</sup>
RTXF-13609P			TRK-2282	TRK-2343	TRK-2468 <sup>55</sup>
RTXF-13609R			TRK-2282	TRK-2343	TRK-2468 <sup>55</sup>
RTXF-13709H			TRK-2284	TRK-2763	TRK-2468 <sup>55</sup>
RTXF-14609A		TRK-205	TRK-1870	TRK-1971	TRK-2468 <sup>55</sup>
RTXF-14609B		TRK-205	TRK-1870	TRK-1971	TRK-2468 <sup>55</sup>
RTXF-14609P		TRK-205	TRK-1870	TRK-1971	TRK-2468 <sup>55</sup>
RTXF-14609R		TRK-205	TRK-1870	TRK-1971	TRK-2468 <sup>55</sup>
RTXF-14709H			TRK-2275	TRK-1999	TRK-2468 <sup>55</sup>
RTXF-16709B			TRK-2275	TRK-1999	TRK-2468 <sup>55</sup>
RTXF-16709H			TRK-2275	TRK-1999	TRK-2468 <sup>55</sup>

### 10 Speed Models

FM-14D310B-LST			TRK-3522	TRK-3519	
FM-14E310B-LAS			TRK-4010		
FM-15D310B-LST			TRK-3522	TRK-3519	
FM-15E310B-LAS			TRK-4010		
FO-10E310C-VAS			TRK-4010		
FO-12E310C-VAS			TRK-4010		
FO-14E310C-LAS			TRK-4010		
FO-14E310C-VAS			TRK-4010		
FO-16E310C-LAS			TRK-4010		
FO-16E310C-VAS			TRK-4010		
FOM-14E310C-LAS			TRK-4010		
FOM-14E310C-VAS			TRK-4010		
FOM-15E310C-LAS			TRK-4010		
FOM-15E310C-VAS			TRK-4010		
FOM-16E310C-LAS			TRK-4010		
FOM-16E310C-VAS			TRK-4010		
FR-11210B	w/ Electronic Speedometer		TRK-2924		TRK-3600 <sup>55 60</sup>
FR-11210B	w/ Mechanical Speedometer		TRK-3132		TRK-3600 <sup>55 60</sup>
FR-12210B	w/ Electronic Speedometer		TRK-2924		TRK-3600 <sup>55 60</sup>
FR-12210B	w/ Mechanical Speedometer		TRK-3132		TRK-3600 <sup>55 60</sup>
FR-13210B	w/ Electronic Speedometer		TRK-2924		TRK-3600 <sup>55 60</sup>
FR-13210B	w/ Mechanical Speedometer		TRK-3132		TRK-3600 <sup>55 60</sup>
FR-14210B	w/ Electronic Speedometer		TRK-2924		TRK-3600 <sup>55 60</sup>
FR-14210B	w/ Mechanical Speedometer		TRK-3132		TRK-3600 <sup>55 60</sup>
FR-15210B	w/ Electronic Speedometer		TRK-2924		TRK-3600 <sup>55 60</sup>
FR-15210B	w/ Mechanical Speedometer		TRK-3132		TRK-3600 <sup>55 60</sup>
FR-9210B	w/ Electronic Speedometer		TRK-2924		TRK-3600 <sup>55 60</sup>
FR-9210B	w/ Mechanical Speedometer		TRK-3132		TRK-3600 <sup>55 60</sup>
FRF-11210B	w/ Electronic Speedometer		TRK-2924		TRK-3600 <sup>55 60</sup>
FRF-11210B	w/ Mechanical Speedometer		TRK-3132		TRK-3600 <sup>55 60</sup>
FRF-12210B	w/ Electronic Speedometer		TRK-2924		TRK-3600 <sup>55 60</sup>
FRF-12210B	w/ Mechanical Speedometer		TRK-3132		TRK-3600 <sup>55 60</sup>

# Heavy Duty Transmission Index



## Eaton/Fuller Medium & Heavy Duty Models

### 10 Speed Models (cont.)

Model No.	Comments	Standard Kit	Suitcase Kit	Overhaul Kit	Clutch Install Kit
FRF-13210B	w/ Electronic Speedometer		TRK-2924		TRK-3600 <sup>55 60</sup>
FRF-13210B	w/ Mechanical Speedometer		TRK-3132		TRK-3600 <sup>55 60</sup>
FRF-14210B	w/ Electronic Speedometer		TRK-2924		TRK-3600 <sup>55 60</sup>
FRF-14210B	w/ Mechanical Speedometer		TRK-3132		TRK-3600 <sup>55 60</sup>
FRF-15210B	w/ Electronic Speedometer		TRK-2924		TRK-3600 <sup>55 60</sup>
FRF-15210B	w/ Mechanical Speedometer		TRK-3132		TRK-3600 <sup>55 60</sup>
FRF-9210B	w/ Electronic Speedometer		TRK-2924		TRK-3600 <sup>55 60</sup>
FRF-9210B	w/ Mechanical Speedometer		TRK-3132		TRK-3600 <sup>55 60</sup>
FRO-11210B	w/ Electronic Speedometer		TRK-2924		TRK-3600 <sup>55 60</sup>
FRO-11210B	w/ Mechanical Speedometer		TRK-3132		TRK-3600 <sup>55 60</sup>
FRO-11210C	w/ Electronic Speedometer		TRK-2924		TRK-3600 <sup>55 60</sup>
FRO-11210C	w/ Mechanical Speedometer		TRK-3132		TRK-3600 <sup>55 60</sup>
FRO-12210B	w/ Electronic Speedometer		TRK-2924		TRK-3600 <sup>55 60</sup>
FRO-12210B	w/ Mechanical Speedometer		TRK-3132		TRK-3600 <sup>55 60</sup>
FRO-12210C	w/ Electronic Speedometer		TRK-2924		TRK-3600 <sup>55 60</sup>
FRO-12210C	w/ Mechanical Speedometer		TRK-3132		TRK-3600 <sup>55 60</sup>
FRO-13210B	w/ Electronic Speedometer		TRK-2924		TRK-3600 <sup>55 60</sup>
FRO-13210B	w/ Mechanical Speedometer		TRK-3132		TRK-3600 <sup>55 60</sup>
FRO-13210C	w/ Electronic Speedometer		TRK-2924		TRK-3600 <sup>55 60</sup>
FRO-13210C	w/ Mechanical Speedometer		TRK-3132		TRK-3600 <sup>55 60</sup>
FRO-14210B	w/ Electronic Speedometer		TRK-2924		TRK-3600 <sup>55 60</sup>
FRO-14210B	w/ Mechanical Speedometer		TRK-3132		TRK-3600 <sup>55 60</sup>
FRO-14210C	w/ Electronic Speedometer		TRK-2924		TRK-3600 <sup>55 60</sup>
FRO-14210C	w/ Mechanical Speedometer		TRK-3132		TRK-3600 <sup>55 60</sup>
FRO-15210B	w/ Electronic Speedometer		TRK-2924		TRK-3600 <sup>55 60</sup>
FRO-15210B	w/ Mechanical Speedometer		TRK-3132		TRK-3600 <sup>55 60</sup>
FRO-15210C	w/ Electronic Speedometer		TRK-2924		TRK-3600 <sup>55 60</sup>
FRO-15210C	w/ Mechanical Speedometer		TRK-3132		TRK-3600 <sup>55 60</sup>
FRO-16210B	w/ Electronic Speedometer		TRK-2924		TRK-3600 <sup>55 60</sup>
FRO-16210B	w/ Mechanical Speedometer		TRK-3132		TRK-3600 <sup>55 60</sup>
FRO-16210C	w/ Electronic Speedometer		TRK-2924		TRK-3600 <sup>55 60</sup>
FRO-16210C	w/ Mechanical Speedometer		TRK-3132		TRK-3600 <sup>55 60</sup>
FRO-17210C	w/ Electronic Speedometer		TRK-2924		TRK-3600 <sup>55 60</sup>
FRO-17210C	w/ Mechanical Speedometer		TRK-3132		TRK-3600 <sup>55 60</sup>
FRO-18210C	w/ Electronic Speedometer		TRK-2924		TRK-3600 <sup>55 60</sup>
FRO-18210C	w/ Mechanical Speedometer		TRK-3132		TRK-3600 <sup>55 60</sup>
FROF-11210B	w/ Electronic Speedometer		TRK-2924		TRK-3600 <sup>55 60</sup>
FROF-11210B	w/ Mechanical Speedometer		TRK-3132		TRK-3600 <sup>55 60</sup>
FROF-11210C	w/ Electronic Speedometer		TRK-2924		TRK-3600 <sup>55 60</sup>
FROF-11210C	w/ Mechanical Speedometer		TRK-3132		TRK-3600 <sup>55 60</sup>
FROF-12210B	w/ Electronic Speedometer		TRK-2924		TRK-3600 <sup>55 60</sup>
FROF-12210B	w/ Mechanical Speedometer		TRK-3132		TRK-3600 <sup>55 60</sup>
FROF-12210C	w/ Electronic Speedometer		TRK-2924		TRK-3600 <sup>55 60</sup>
FROF-12210C	w/ Mechanical Speedometer		TRK-3132		TRK-3600 <sup>55 60</sup>
FROF-13210B	w/ Electronic Speedometer		TRK-2924		TRK-3600 <sup>55 60</sup>
FROF-13210B	w/ Mechanical Speedometer		TRK-3132		TRK-3600 <sup>55 60</sup>
FROF-13210C	w/ Electronic Speedometer		TRK-2924		TRK-3600 <sup>55 60</sup>
FROF-13210C	w/ Mechanical Speedometer		TRK-3132		TRK-3600 <sup>55 60</sup>
FROF-14210B	w/ Electronic Speedometer		TRK-2924		TRK-3600 <sup>55 60</sup>
FROF-14210B	w/ Mechanical Speedometer		TRK-3132		TRK-3600 <sup>55 60</sup>
FROF-14210C	w/ Electronic Speedometer		TRK-2924		TRK-3600 <sup>55 60</sup>
FROF-14210C	w/ Mechanical Speedometer		TRK-3132		TRK-3600 <sup>55 60</sup>
FROF-15210B	w/ Electronic Speedometer		TRK-2924		TRK-3600 <sup>55 60</sup>
FROF-15210B	w/ Mechanical Speedometer		TRK-3132		TRK-3600 <sup>55 60</sup>
FROF-15210C	w/ Electronic Speedometer		TRK-2924		TRK-3600 <sup>55 60</sup>

HD Transmission

# Heavy Duty Transmission Index

## Eaton/Fuller Medium & Heavy Duty Models

### 10 Speed Models (cont.)

Model No.	Comments	Standard Kit	Suitcase Kit	Overhaul Kit	Clutch Install Kit
FROF-15210C	w/ Mechanical Speedometer		TRK-3132		TRK-3600 <sup>55 60</sup>
FROF-16210B	w/ Electronic Speedometer		TRK-2924		TRK-3600 <sup>55 60</sup>
FROF-16210B	w/ Mechanical Speedometer		TRK-3132		TRK-3600 <sup>55 60</sup>
FROF-16210C	w/ Electronic Speedometer		TRK-2924		TRK-3600 <sup>55 60</sup>
FROF-16210C	w/ Mechanical Speedometer		TRK-3132		TRK-3600 <sup>55 60</sup>
FRW-15210B			TRK-2924		TRK-3600 <sup>55</sup>
FRWF-15210B			TRK-2924		TRK-3600 <sup>55</sup>
RT-11610	w/ 1.75" Push Type I/S		TRK-2283	TRK-2345	
RT-11610	w/ 2" Pull Type I/S		TRK-2283	TRK-2761	TRK-2468 <sup>55</sup>
RT-11710B			TRK-2049	TRK-1996	TRK-2468 <sup>55</sup>
RT-12510		TRK-160	TRK-1861	TRK-1064	TRK-2468 <sup>55</sup>
RT-12610	w/ 1.75" Push Type I/S		TRK-2283	TRK-2345	
RT-12610	w/ 2" Pull Type I/S			TRK-2761	TRK-2468 <sup>55</sup>
RT-12710B			TRK-2049	TRK-1996	TRK-2468 <sup>55</sup>
RT-13710B			TRK-2284	TRK-2762	TRK-2468 <sup>55</sup>
RT-14610		TRK-205	TRK-1870	TRK-1971	TRK-2468 <sup>55</sup>
RT-14710B			TRK-2277	TRK-2335	TRK-2468 <sup>55</sup>
RT-14910B-AS2			TRK-3522	TRK-3524	TRK-2468 <sup>55</sup>
RT-6610	w/ 25mm Aux C/S Front Brg.	TRK-145			
RT-6610	w/ 30mm Aux C/S Front Brg.	TRK-145A	TRK-1850		
RT-9710B			TRK-3322	TRK-3323	TRK-2468 <sup>55</sup>
RTF-11610	w/ 1.75" Push Type I/S		TRK-2283	TRK-2345	
RTF-11610	w/ 2" Pull Type I/S		TRK-2283	TRK-2761	TRK-2468 <sup>55</sup>
RTF-11710B			TRK-2049	TRK-1996	TRK-2468 <sup>55</sup>
RTF-12510		TRK-160	TRK-1861	TRK-1064	TRK-2468 <sup>55</sup>
RTF-12610			TRK-2283	TRK-2345	TRK-2468 <sup>55</sup>
RTF-12610			TRK-2283	TRK-2761	TRK-2468 <sup>55</sup>
RTF-12710B			TRK-2049	TRK-1996	TRK-2468 <sup>55</sup>
RTF-13710B			TRK-2284	TRK-2762	TRK-2468 <sup>55</sup>
RTF-14610		TRK-205	TRK-1870	TRK-1971	TRK-2468 <sup>55</sup>
RTF-14710B			TRK-2277	TRK-2335	TRK-2468 <sup>55</sup>
RTF-9710B			TRK-3322	TRK-3323	TRK-2468 <sup>55</sup>
RTL-13710B			TRK-2284		TRK-2468 <sup>55</sup>
RTL-14710B			TRK-3553	TRK-3554	TRK-2468 <sup>55</sup>
RTL-13710B			TRK-2284		TRK-2468 <sup>55</sup>
RTL-14710B			TRK-3553	TRK-3554	TRK-2468 <sup>55</sup>
RTLO-11610B			TRK-2772	TRK-2764	TRK-2468 <sup>55</sup>
RTLO-11610B-T2			TRK-2772	TRK-2764	TRK-2468 <sup>55</sup>
RTLO-12610B			TRK-2772	TRK-2764	TRK-2468 <sup>55</sup>
RTLO-12610B-T2			TRK-2772	TRK-2764	TRK-2468 <sup>55</sup>
RTLO-13610B			TRK-2772	TRK-2764	TRK-2468 <sup>55</sup>
RTLO-13610B-T2			TRK-2772	TRK-2764	TRK-2468 <sup>55</sup>
RTLO-14610A			TRK-2998		TRK-2468 <sup>55</sup>
RTLO-14610B			TRK-2773	TRK-2765	TRK-2468 <sup>55</sup>
RTLO-14610B-T2			TRK-2773	TRK-2765	TRK-2468 <sup>55</sup>
RTLO-15610B			TRK-2773	TRK-2765	TRK-2468 <sup>55</sup>
RTLO-15610B-T2			TRK-2773	TRK-2765	
RTLO-16610B			TRK-2773	TRK-2765	TRK-2468 <sup>55</sup>
RTLO-16610B-T2			TRK-2773	TRK-2765	
RTLO-17610B			TRK-2773	TRK-2765	
RTLO-17610B-T2			TRK-2773	TRK-2765	
RTLO-18610B			TRK-2773	TRK-2765	
RTLO-18610B-T2			TRK-2773	TRK-2765	
RTLO-18610B-T2			TRK-3522	TRK-3519	
RTLOF-11610B			TRK-2772	TRK-2764	TRK-2468 <sup>55</sup>

HD Transmission

<sup>55</sup> Exc. Hyd. Release    <sup>60</sup> Exc. Units Built Before 3/1/99



# Heavy Duty Transmission Index



## Eaton/Fuller Medium & Heavy Duty Models

### 10 Speed Models (cont.)

Model No.	Comments	Standard Kit	Suitcase Kit	Overhaul Kit	Clutch Install Kit
RTLOF-11610B-T2			TRK-2772	TRK-2764	TRK-2468 <sup>55</sup>
RTLOF-12610B			TRK-2772	TRK-2764	TRK-2468 <sup>55</sup>
RTLOF-12610B-T2			TRK-2772	TRK-2764	TRK-2468 <sup>55</sup>
RTLOF-13610B			TRK-2772	TRK-2764	TRK-2468 <sup>55</sup>
RTLOF-13610B-T2			TRK-2772	TRK-2764	TRK-2468 <sup>55</sup>
RTLOF-14610B			TRK-2773	TRK-2765	TRK-2468 <sup>55</sup>
RTLOF-14610B-T2			TRK-2773	TRK-2765	
RTLOF-15610B			TRK-2773	TRK-2765	TRK-2468 <sup>55</sup>
RTLOF-15610B-T2			TRK-2773	TRK-2765	
RTLOF-16610B			TRK-2773	TRK-2765	TRK-2468 <sup>55</sup>
RTLOF-16610B-T2			TRK-2773	TRK-2765	
RTLOF-17610B			TRK-2773	TRK-2765	
RTLOF-17610B-T2			TRK-2773	TRK-2765	
RTLOF-18610B			TRK-2773	TRK-2765	
RTO-10710B-AS2			TRK-3488		
RTO-10910B-AS2			TRK-3522	TRK-3524	TRK-2468 <sup>55</sup>
RTO-10910B-AS3			TRK-3522	TRK-3519	
RTO-10910B-DM2			TRK-3522	TRK-3519	
RTO-10910B-DM3			TRK-3522	TRK-3519	
RTO-11610	w/ 1.75" Push Type I/S		TRK-2283	TRK-2345	
RTO-11610	w/ 2" Pull Type I/S		TRK-2283	TRK-2761	TRK-2468 <sup>55</sup>
RTO-12510		TRK-160	TRK-1861	TRK-1064	TRK-2468 <sup>55</sup>
RTO-12610	w/ 1.75" Push Type I/S		TRK-2283	TRK-2345	
RTO-12610	w/ 2" Pull Type I/S		TRK-2283	TRK-2761	TRK-2468 <sup>55</sup>
RTO-12710B-AS2			TRK-3488		TRK-2468 <sup>55</sup>
RTO-12910B-AS2			TRK-3522	TRK-3524	TRK-2468 <sup>55</sup>
RTO-12910B-AS3			TRK-3522	TRK-3519	
RTO-12910B-DM2			TRK-3522	TRK-3519	
RTO-12910B-DM3			TRK-3522	TRK-3519	
RTO-14610		TRK-205	TRK-1870	TRK-1971	TRK-2468 <sup>55</sup>
RTO-14710B-AS2			TRK-3487	TRK-3486	TRK-2468 <sup>55</sup>
RTO-14710C-AS2			TRK-3487	TRK-3486	TRK-2468 <sup>55</sup>
RTO-14910B-AS2			TRK-3522	TRK-3519	TRK-2468 <sup>55</sup>
RTO-14910B-AS3			TRK-3522	TRK-3519	
RTO-14910B-DM2			TRK-3522	TRK-3519	
RTO-14910B-DM3			TRK-3522	TRK-3519	
RTO-14910C-AS2			TRK-3522	TRK-3519	TRK-2468 <sup>55</sup>
RTO-14910C-AS3			TRK-3522	TRK-3519	
RTO-15210C	w/ Electronic Speedometer		TRK-2924		TRK-3600 <sup>55 60</sup>
RTO-15210C	w/ Mechanical Speedometer		TRK-3132		TRK-3600 <sup>55 60</sup>
RTO-16210C	w/ Electronic Speedometer		TRK-2924		TRK-3600 <sup>55 60</sup>
RTO-16210C	w/ Mechanical Speedometer		TRK-3132		TRK-3600 <sup>55 60</sup>
RTO-16710B-AS2			TRK-3487	TRK-3486	TRK-2468 <sup>55</sup>
RTO-16710C-AS2			TRK-3487	TRK-3486	TRK-2468 <sup>55</sup>
RTO-16910B-AS2			TRK-3522	TRK-3519	TRK-2468 <sup>55</sup>
RTO-16910B-AS3			TRK-3522	TRK-3519	
RTO-16910B-DM2			TRK-3522	TRK-3519	
RTO-16910B-DM3			TRK-3522	TRK-3519	
RTO-16910C-AS2			TRK-3522	TRK-3519	TRK-2468 <sup>55</sup>
RTO-16910C-AS3			TRK-3522	TRK-3519	
RTO-18910B-AS2			TRK-3522	TRK-3519	TRK-2468 <sup>55</sup>
RTO-18910B-AS3			TRK-3522	TRK-3519	
RT-6610	w/ 25mm Aux C/S Front Brg.	TRK-145			
RTO-6610	w/ 30mm Aux C/S Front Brg.	TRK-145A	TRK-1850		
RTOF-11610	w/ 1.75" Push Type I/S		TRK-2283	TRK-2345	

HD Transmission

# Heavy Duty Transmission Index

## Eaton/Fuller Medium & Heavy Duty Models

10 Speed Models (cont.)					
Model No.	Comments	Standard Kit	Suitcase Kit	Overhaul Kit	Clutch Install Kit
RTOF-11610	w/ 2" Pull Type I/S		TRK-2283	TRK-2761	TRK-2468 <sup>55</sup>
RTOF-12510		TRK-160	TRK-1861	TRK-1064	TRK-2468 <sup>55</sup>
RTOF-12610	w/ 1.75" Push Type I/S		TRK-2283	TRK-2345	
RTOF-12610	w/ 2" Pull Type I/S		TRK-2283	TRK-2761	TRK-2468 <sup>55</sup>
RTOF-14610		TRK-205	TRK-1870	TRK-1971	TRK-2468 <sup>55</sup>
RTOF-15210C	w/ Electronic Speedometer		TRK-2924		TRK-3600 <sup>55 60</sup>
RTOF-15210C	w/ Mechanical Speedometer		TRK-3132		TRK-3600 <sup>55 60</sup>
RTOF-16210C	w/ Electronic Speedometer		TRK-2924		TRK-3600 <sup>55 60</sup>
RTOF-16210C	w/ Mechanical Speedometer		TRK-3132		TRK-3600 <sup>55 60</sup>
RTOM-16910B-DM3			TRK-3522	TRK-3519	
RTX-11610	w/ 1.75" Push Type I/S		TRK-2283	TRK-2345	
RTX-11610	w/ 2" Pull Type I/S		TRK-2283	TRK-2761	TRK-2468 <sup>55</sup>
RTX-11710B			TRK-2284	TRK-2763	TRK-2468 <sup>55</sup>
RTX-11710C			TRK-2284	TRK-2763	TRK-2468 <sup>55</sup>
RTX-12510		TRK-160	TRK-1861	TRK-1064	
RTX-12610	w/ 1.75" Push Type I/S		TRK-2283	TRK-2345	
RTX-12610	w/ 2" Pull Type I/S		TRK-2283	TRK-2761	TRK-2468 <sup>55</sup>
RTX-12710B			TRK-2284	TRK-2763	TRK-2468 <sup>55</sup>
RTX-12710C			TRK-2284	TRK-2763	TRK-2468 <sup>55</sup>
RTX-13710B			TRK-2284	TRK-2763	TRK-2468 <sup>55</sup>
RTX-13710C			TRK-2284	TRK-2763	TRK-2468 <sup>55</sup>
RTX-14610		TRK-205	TRK-1870	TRK-1971	TRK-2468 <sup>55</sup>
RTX-14710B			TRK-2277	TRK-2336	TRK-2468 <sup>55</sup>
RTX-14710C			TRK-2277	TRK-2336	TRK-2468 <sup>55</sup>
RTX-15710B			TRK-2277	TRK-2336	TRK-2468 <sup>55</sup>
RTX-15710C			TRK-2277	TRK-2336	TRK-2468 <sup>55</sup>
RTX-16710B			TRK-2277	TRK-2336	TRK-2468 <sup>55</sup>
RTX-16710C			TRK-2277	TRK-2336	TRK-2468 <sup>55</sup>
RTXF-11610	w/ 1.75" Push Type I/S		TRK-2283	TRK-2345	
RTXF-11610	w/ 2" Pull Type I/S		TRK-2283	TRK-2761	TRK-2468 <sup>55</sup>
RTXF-11710B			TRK-2284	TRK-2763	TRK-2468 <sup>55</sup>
RTXF-11710C			TRK-2284	TRK-2763	TRK-2468 <sup>55</sup>
RTXF-12510		TRK-160	TRK-1861	TRK-1064	TRK-2468 <sup>55</sup>
RTXF-12610	w/ 1.75" Push Type I/S		TRK-2283	TRK-2345	TRK-2468
RTXF-12610	w/ 2" Pull Type I/S		TRK-2283	TRK-2761	TRK-2468 <sup>55</sup>
RTXF-12710B			TRK-2284	TRK-2763	TRK-2468 <sup>55</sup>
RTXF-12710C			TRK-2284	TRK-2763	TRK-2468 <sup>55</sup>
RTXF-13710B			TRK-2284	TRK-2763	TRK-2468 <sup>55</sup>
RTXF-13710C			TRK-2284	TRK-2763	TRK-2468 <sup>55</sup>
RTXF-14610		TRK-205	TRK-1870	TRK-1971	TRK-2468 <sup>55</sup>
RTXF-14710C			TRK-2277	TRK-2336	TRK-2468 <sup>55</sup>
RTXF-15710B			TRK-2277	TRK-2336	TRK-2468 <sup>55</sup>
RTXF-15710C			TRK-2277	TRK-2336	TRK-2468 <sup>55</sup>
RTXF-16710B			TRK-2277	TRK-2336	TRK-2468 <sup>55</sup>
RTXF-16710C			TRK-2277	TRK-2336	TRK-2468 <sup>55</sup>
13 Speed Models					
FO-14E313A-MHP			TRK-3941		
FO-16D313E-LEP			TRK-3512	TRK-3513	
FO-16E313A-MHP			TRK-3941		
FO-16E313A-VHP			TRK-3941		
FO-18E313A-MHP			TRK-3941		
FO-18E313A-VHP			TRK-3941		
FO-20E313A-MHP			TRK-3941		
FO-20E313A-VHP			TRK-3941		
FOM-16D313E-LEP			TRK-3512	TRK-3513	

# Heavy Duty Transmission Index

## Eaton/Fuller Medium & Heavy Duty Models

### 13 Speed Models (cont.)

Model No.	Comments	Standard Kit	Suitcase Kit	Overhaul Kit	Clutch Install Kit
RT-11613	w/ Tapered Aux. C/S Brgs.		TRK-2281	TRK-2342	TRK-2468 <sup>55</sup>
RT-11613	w/ 1.75" Push Type I/S & w/o Tapered Aux. C/S Brgs.		TRK-2283	TRK-2345	
RT-11613	w/ 2" Pull Type I/S & w/o Tapered Aux. C/S Brgs.		TRK-2283	TRK-2761	TRK-2468 <sup>55</sup>
RT-14613	w/o Tapered Aux. C/S Brgs.	TRK-206	TRK-1871	TRK-1972	TRK-2468 <sup>55</sup>
RT-14613	w/ Tapered Aux. C/S Brgs.		TRK-2280	TRK-2341	TRK-2468 <sup>55</sup>
RT-15613	w/o Tapered Aux. C/S Brgs.		TRK-1874	TRK-1972	TRK-2468 <sup>55</sup>
RT-15613	w/ Tapered Aux. C/S Brgs.		TRK-2280	TRK-2341	TRK-2468 <sup>55</sup>
RT-6613		TRK-146	TRK-1851		
RT-913		TRK-1000	TRK-2780		
RT-9513		TRK-1000	TRK-2780		
RTF-11613	w/ Tapered Aux. C/S Brgs.		TRK-2281	TRK-2342	TRK-2468 <sup>55</sup>
RTF-11613	w/ 1.75" Push Type I/S & w/o Tapered Aux. C/S Brgs.		TRK-2283	TRK-2345	
RTF-11613	w/ 2" Pull Type I/S & w/o Tapered Aux. C/S Brgs.		TRK-2283	TRK-2761	TRK-2468 <sup>55</sup>
RTF-12513		TRK-149	TRK-1862		
RTF-14613	w/o Tapered Aux. C/S Brgs.	TRK-206	TRK-1871	TRK-1972	TRK-2468 <sup>55</sup>
RTF-14613	w/ Tapered Aux. C/S Brgs.		TRK-2280	TRK-2341	TRK-2468 <sup>55</sup>
RTF-15613	w/o Tapered Aux. C/S Brgs.		TRK-1874	TRK-1972	TRK-2468 <sup>55</sup>
RTF-15613	w/ Tapered Aux. C/S Brgs.		TRK-2280	TRK-2341	TRK-2468 <sup>55</sup>
RTLO-12713A			TRK-2285	TRK-2767	TRK-2468 <sup>55</sup>
RTLO-12913A	w/ Forced Lubrication		TRK-3343	TRK-3342	TRK-2468 <sup>55</sup>
RTLO-12913A	w/o Forced Lubrication		TRK-3351	TRK-3350	TRK-2468 <sup>55</sup>
RTLO-14613B			TRK-2996	TRK-2993	TRK-2468 <sup>55</sup>
RTLO-14713A			TRK-2286	TRK-2758	TRK-2468 <sup>55</sup>
RTLO-14913A	w/ Forced Lubrication		TRK-3343	TRK-3342	TRK-2468 <sup>55</sup>
RTLO-14913A	w/o Forced Lubrication		TRK-3348	TRK-3347	TRK-2468 <sup>55</sup>
RTLO-16713A	w/ Serial # 51126220 & Lower		TRK-2287	TRK-2770	TRK-2468 <sup>55</sup>
RTLO-16713A	w/ Serial # 51126221 & Higher or Beginning with a Letter		TRK-3346	TRK-3345	TRK-2468 <sup>55</sup>
RTLO-16713A-T2			TRK-3596	TRK-3595	TRK-2468 <sup>55</sup>
RTLO-16913A			TRK-3343	TRK-3342	TRK-2468 <sup>55</sup>
RTLO-16913A-T2			TRK-3426	TRK-3425	TRK-2468 <sup>55</sup>
RTLO-16913L-DM3			TRK-3512	TRK-3513	
RTLO-18913A	w/ Serial # 51126220 & Lower		TRK-3286	TRK-3287	TRK-2468 <sup>55</sup>
RTLO-18913A	w/ Serial # 51126221 & Higher or Beginning with a Letter		TRK-3343	TRK-3342	TRK-2468 <sup>55</sup>
RTLO-18913A-T2	w/ Serial # 51126220 & Lower		TRK-3286	TRK-3287	TRK-2468 <sup>55</sup>
RTLO-18913A-T2	w/ Serial # 51126221 & Higher or Beginning with a Letter		TRK-3426	TRK-3425	TRK-2468 <sup>55</sup>
RTLO-20913A			TRK-3460	TRK-3459	TRK-2468 <sup>55</sup>
RTLOF-12713A			TRK-2285	TRK-2767	TRK-2468 <sup>55</sup>
RTLOF-12913A	w/ Forced Lubrication		TRK-3343	TRK-3342	TRK-2468 <sup>55</sup>
RTLOF-12913A	w/o Forced Lubrication		TRK-3351	TRK-3350	TRK-2468 <sup>55</sup>
RTLOF-14613B			TRK-2996	TRK-2993	TRK-2468 <sup>55</sup>
RTLOF-14713A			TRK-2286	TRK-2758	TRK-2468 <sup>55</sup>
RTLOF-14913A	w/ Forced Lubrication		TRK-3343	TRK-3342	TRK-2468 <sup>55</sup>
RTLOF-14913A	w/o Forced Lubrication		TRK-3348	TRK-3347	TRK-2468 <sup>55</sup>
RTLOF-16713A	w/ Serial # 51126220 & Lower		TRK-2287	TRK-2770	TRK-2468 <sup>55</sup>
RTLOF-16713A	w/ Serial # 51126221 & Higher or Beginning with a Letter		TRK-3346	TRK-3345	TRK-2468 <sup>55</sup>
RTLOF-16713A-T2			TRK-3596	TRK-3595	TRK-2468 <sup>55</sup>
RTLOF-16913A			TRK-3343	TRK-3342	TRK-2468 <sup>55</sup>
RTLOF-16913A-T2			TRK-3426	TRK-3425	TRK-2468 <sup>55</sup>
RTLOF-18913A	w/ Serial # 51126220 & Lower		TRK-3286	TRK-3287	TRK-2468 <sup>55</sup>

# Heavy Duty Transmission Index

## Eaton/Fuller Medium & Heavy Duty Models

### 13 Speed Models (cont.)

Model No.	Comments	Standard Kit	Suitcase Kit	Overhaul Kit	Clutch Install Kit
RTLOF-18913A	w/ Serial # 51126221 & Higher or Beginning with a Letter		TRK-3343	TRK-3342	TRK-2468 <sup>55</sup>
RTLOF-18913A-T2	w/ Serial # 51126220 & Lower		TRK-3286	TRK-3287	TRK-2468 <sup>55</sup>
RTLOF-18913A-T2	w/ Serial # 51126221 & Higher or Beginning with a Letter		TRK-3426	TRK-3425	TRK-2468 <sup>55</sup>
RTLOF-20913A			TRK-3460	TRK-3459	TRK-2468 <sup>55</sup>
RTL0M-16913L-DM3			TRK-3512	TRK-3513	TRK-2468 <sup>55</sup>
RTO-11613	w/ Tapered Aux. C/S Brgs.		TRK-2281	TRK-2342	TRK-2468 <sup>55</sup>
RTO-11613	w/ 1.75" Push Type I/S & w/o Tapered Aux. C/S Brgs.		TRK-2283	TRK-2345	
RTO-11613	w/ 2" Pull Type I/S & w/o Tapered Aux. C/S Brgs.		TRK-2283	TRK-2761	TRK-2468 <sup>55</sup>
RTO-11813	w/ Tapered Aux. C/S Brgs.		TRK-2281	TRK-2342	TRK-2468 <sup>55</sup>
RTO-11813	w/ 1.75" Push Type I/S & w/o Tapered Aux. C/S Brgs.		TRK-2283	TRK-2345	
RTO-11813	w/ 2" Pull Type I/S & w/o Tapered Aux. C/S Brgs.		TRK-2283	TRK-2761	TRK-2468 <sup>55</sup>
RTO-12513		TRK-149	TRK-1862		
RTO-14613	w/o Tapered Aux. C/S Brgs.	TRK-206	TRK-1871	TRK-1972	TRK-2468 <sup>55</sup>
RTO-14613	w/ Tapered Aux. C/S Brgs.		TRK-2280	TRK-2341	TRK-2468 <sup>55</sup>
RTO-14813	w/o Tapered Aux. C/S Brgs.	TRK-206	TRK-1871	TRK-1972	TRK-2468 <sup>55</sup>
RTO-14813	w/ Tapered Aux. C/S Brgs.		TRK-2280	TRK-2341	TRK-2468 <sup>55</sup>
RTO-15613	w/o Tapered Aux. C/S Brgs.		TRK-1874	TRK-1972	TRK-2468 <sup>55</sup>
RTO-15613	w/ Tapered Aux. C/S Brgs.		TRK-2280	TRK-2341	TRK-2468 <sup>55</sup>
RTO-15813	w/o Tapered Aux. C/S Brgs.		TRK-1874	TRK-1972	TRK-2468 <sup>55</sup>
RTO-15813	w/ Tapered Aux. C/S Brgs.		TRK-2280	TRK-2341	TRK-2468 <sup>55</sup>
RTO-6613		TRK-146	TRK-1851		
RTO-913		TRK-1000			
RTO-9513		TRK-1000	TRK-2780		
RTOF-11613	w/ Tapered Aux. C/S Brgs.		TRK-2281	TRK-2342	TRK-2468 <sup>55</sup>
RTOF-11613	w/ 1.75" Push Type I/S & w/o Tapered Aux. C/S Brgs.		TRK-2283	TRK-2345	
RTOF-11613	w/ 2" Pull Type I/S & w/o Tapered Aux. C/S Brgs.		TRK-2283	TRK-2761	TRK-2468 <sup>55</sup>
RTOF-11813	w/ Tapered Aux. C/S Brgs.		TRK-2281	TRK-2342	TRK-2468 <sup>55</sup>
RTOF-11813	w/ 1.75" Push Type I/S & w/o Tapered Aux. C/S Brgs.		TRK-2283	TRK-2345	
RTOF-11813	w/ 2" Pull Type I/S & w/o Tapered Aux. C/S Brgs.		TRK-2283	TRK-2761	TRK-2468 <sup>55</sup>
RTOF-12513		TRK-149	TRK-1862		
RTOF-14613	w/o Tapered Aux. C/S Brgs.	TRK-206	TRK-1871	TRK-1972	TRK-2468 <sup>55</sup>
RTOF-14613	w/ Tapered Aux. C/S Brgs.		TRK-2280	TRK-2341	TRK-2468 <sup>55</sup>
RTOF-14813	w/o Tapered Aux. C/S Brgs.	TRK-206	TRK-1871	TRK-1972	TRK-2468 <sup>55</sup>
RTOF-14813	w/ Tapered Aux. C/S Brgs.		TRK-2280	TRK-2341	TRK-2468 <sup>55</sup>
RTOF-15613	w/o Tapered Aux. C/S Brgs.		TRK-1874	TRK-1972	TRK-2468 <sup>55</sup>
RTOF-15613	w/ Tapered Aux. C/S Brgs.		TRK-2280	TRK-2341	TRK-2468 <sup>55</sup>
RTOF-15813	w/o Tapered Aux. C/S Brgs.		TRK-1874	TRK-1972	TRK-2468 <sup>55</sup>
RTOF-15813	w/ Tapered Aux. C/S Brgs.		TRK-2280	TRK-2341	TRK-2468 <sup>55</sup>
RTOO-11613	w/ Tapered Aux. C/S Brgs.		TRK-2281	TRK-2342	
RTOO-11613	w/ 1.75" Push Type I/S & w/o Tapered Aux. C/S Brgs.		TRK-2283	TRK-2345	
RTOO-11613	w/ 2" Pull Type I/S & w/o Tapered Aux. C/S Brgs.		TRK-2283	TRK-2761	
RTOO-14613	w/o Tapered Aux. C/S Brgs.	TRK-206	TRK-1871	TRK-1972	TRK-2468 <sup>55</sup>
RTOO-14613	w/ Tapered Aux. C/S Brgs.		TRK-2280	TRK-2341	TRK-2468 <sup>55</sup>
RTOOF-11613	w/ Tapered Aux. C/S Brgs.		TRK-2281	TRK-2342	TRK-2468 <sup>55</sup>
RTOOF-11613	w/ 1.75" Push Type I/S & w/o Tapered Aux. C/S Brgs.		TRK-2283	TRK-2345	
RTOOF-11613	w/ 2" Pull Type I/S & w/o Tapered Aux. C/S Brgs.		TRK-2283	TRK-2761	TRK-2468 <sup>55</sup>
RTOOF-14613	w/o Tapered Aux. C/S Brgs.	TRK-206	TRK-1871	TRK-1972	TRK-2468 <sup>55</sup>

<sup>55</sup> Exc. Hyd. Release

# Heavy Duty Transmission Index

## Eaton/Fuller Medium & Heavy Duty Models

### 13 Speed Models (cont.)

Model No.	Comments	Standard Kit	Suitcase Kit	Overhaul Kit	Clutch Install Kit
RTOOF-14613	w/ Tapered Aux. C/S Brgs.		TRK-2280	TRK-2341	TRK-2468 <sup>55</sup>
RTOX-11613	w/ Tapered Aux. C/S Brgs.		TRK-2281	TRK-2342	TRK-2468 <sup>55</sup>
RTOX-11613	w/ 1.75" Push Type I/S & w/o Tapered Aux. C/S Brgs.		TRK-2283	TRK-2345	
RTOX-11613	w/ 2" Pull Type I/S & w/o Tapered Aux. C/S Brgs.		TRK-2283	TRK-2761	TRK-2468 <sup>55</sup>
RTOX-14613	w/o Tapered Aux. C/S Brgs.	TRK-206	TRK-1871	TRK-1972	TRK-2468 <sup>55</sup>
RTOX-14613	w/ Tapered Aux. C/S Brgs.		TRK-2280	TRK-2341	TRK-2468 <sup>55</sup>
RTOXF-11613	w/ Tapered Aux. C/S Brgs.		TRK-2281	TRK-2342	TRK-2468 <sup>55</sup>
RTOXF-11613	w/ 1.75" Push Type I/S & w/o Tapered Aux. C/S Brgs.		TRK-2283	TRK-2345	
RTOXF-11613	w/ 2" Pull Type I/S & w/o Tapered Aux. C/S Brgs.		TRK-2283	TRK-2761	TRK-2468 <sup>55</sup>
RTOXF-14613	w/o Tapered Aux. C/S Brgs.	TRK-206	TRK-1871	TRK-1972	TRK-2468 <sup>55</sup>
RTOXF-14613	w/ Tapered Aux. C/S Brgs.		TRK-2280	TRK-2341	TRK-2468 <sup>55</sup>

### 13 Speed Models Aux Section Only

RT-11613 AUX		TRK-1000AUX	TRK-1555		
RT-14613 AUX	w/o Tapered Aux. C/S Brgs.	TRK-149AUX	TRK-1554		
RT-14613 AUX	w/ Tapered Aux. C/S Brgs.		TRK-2340		
RT-15613 AUX	w/o Tapered Aux. C/S Brgs.	TRK-149AUX	TRK-1554		
RT-15613 AUX	w/ Tapered Aux. C/S Brgs.		TRK-2340		
RTF-11613 AUX		TRK-1000AUX	TRK-1555		
RTF-14613 AUX	w/o Tapered Aux. C/S Brgs.	TRK-149AUX	TRK-1554		
RTF-14613 AUX	w/ Tapered Aux. C/S Brgs.		TRK-2340		
RTF-15613 AUX	w/o Tapered Aux. C/S Brgs.	TRK-149AUX	TRK-1554		
RTF-15613 AUX	w/ Tapered Aux. C/S Brgs.		TRK-2340		
RTLO-12713A AUX			TRK-2768		
RTLO-14613B AUX			TRK-2338		
RTLO-14713A AUX			TRK-2759		
RTLO-16713A AUX	w/ Serial # 51126220 & Lower		TRK-2769		
RTLO-16713A AUX	w/ Serial # 51126221 & Higher or Beginning with a Letter		TRK-3344		
RTLOF-12713A AUX			TRK-2768		
RTLOF-14613B AUX			TRK-2338		
RTLOF-14713A AUX			TRK-2759		
RTLOF-16713A AUX	w/ Serial # 51126220 & Lower		TRK-2769		
RTLOF-16713A AUX	w/ Serial # 51126221 & Higher or Beginning with a Letter		TRK-3344		
RTO-11613 AUX			TRK-1555		
RTO-11813 AUX			TRK-1555		
RTO-14613 AUX	w/o Tapered Aux. C/S Brgs.	TRK-149AUX	TRK-1554		
RTO-14613 AUX	w/ Tapered Aux. C/S Brgs.		TRK-2340		
RTO-14813 AUX	w/o Tapered Aux. C/S Brgs.	TRK-149AUX	TRK-1554		
RTO-14813 AUX	w/ Tapered Aux. C/S Brgs.		TRK-2340		
RTO-15613 AUX	w/o Tapered Aux. C/S Brgs.	TRK-149AUX	TRK-1554		
RTO-15613 AUX	w/ Tapered Aux. C/S Brgs.		TRK-2340		
RTO-15813 AUX	w/o Tapered Aux. C/S Brgs.	TRK-149AUX	TRK-1554		
RTO-15813 AUX	w/ Tapered Aux. C/S Brgs.		TRK-2340		
RTOF-11613 AUX		TRK-1000AUX	TRK-1555		
RTOF-11813 AUX		TRK-1000AUX	TRK-1555		
RTOF-14613 AUX	w/o Tapered Aux. C/S Brgs.	TRK-149AUX	TRK-1554		
RTOF-14613 AUX	w/ Tapered Aux. C/S Brgs.		TRK-2340		
RTOF-14813 AUX	w/o Tapered Aux. C/S Brgs.	TRK-149AUX	TRK-1554		
RTOF-14813 AUX	w/ Tapered Aux. C/S Brgs.		TRK-2340		
RTOF-15613 AUX	w/o Tapered Aux. C/S Brgs.	TRK-149AUX	TRK-1554		
RTOF-15613 AUX	w/ Tapered Aux. C/S Brgs.		TRK-2340		
RTOF-15813 AUX	w/o Tapered Aux. C/S Brgs.	TRK-149AUX	TRK-1554		



# Heavy Duty Transmission Index

## Eaton/Fuller Medium & Heavy Duty Models

### 13 Speed Models Aux Section Only (cont.)

Model No.	Comments	Standard Kit	Suitcase Kit	Overhaul Kit	Clutch Install Kit
RTOF-15813 AUX	w/ Tapered Aux. C/S Brgs.		TRK-2340		
RTOO-11613 AUX		TRK-1000AUX	TRK-1555		
RTOO-14613 AUX	w/o Tapered Aux. C/S Brgs.	TRK-149AUX	TRK-1554		
RTOO-14613 AUX	w/ Tapered Aux. C/S Brgs.		TRK-2340		
RTOOF-11613 AUX		TRK-1000AUX	TRK-1555		
RTOOF-14613 AUX	w/o Tapered Aux. C/S Brgs.	TRK-149AUX	TRK-1554		
RTOOF-14613 AUX	w/ Tapered Aux. C/S Brgs.		TRK-2340		
RTOX-11613 AUX		TRK-1000AUX	TRK-1555		
RTOX-14613 AUX	w/o Tapered Aux. C/S Brgs.	TRK-149AUX	TRK-1554		
RTOX-14613 AUX	w/ Tapered Aux. C/S Brgs.		TRK-2340		
RTOXF-11613 AUX		TRK-1000AUX	TRK-1555		
RTOXF-14613 AUX	w/o Tapered Aux. C/S Brgs.	TRK-149AUX	TRK-1554		
RTOXF-14613 AUX	w/ Tapered Aux. C/S Brgs.		TRK-2340		

### 15 Speed Models

RT-11615	w/ 1.75" Push Type I/S	TRK-203	TRK-3659	TRK-3655	
RT-11615	w/ 2" Pull Type I/S	TRK-203	TRK-3659	TRK-3656	TRK-2468 <sup>55</sup>
RT-11715			TRK-3660	TRK-3658	TRK-2468 <sup>55</sup>
RT-12515	w/ 45mm Front Countershaft Brgs.	TRK-159A	TRK-1863	TRK-1079	TRK-2468 <sup>55</sup>
RT-12515	w/ 55mm Front Countershaft Brgs.	TRK-159			TRK-2468 <sup>55</sup>
RT-14615		TRK-207	TRK-1872	TRK-1979	TRK-2468 <sup>55</sup>
RT-14715			TRK-2043	TRK-1991	TRK-2468 <sup>55</sup>
RT-14915			TRK-3256	TRK-3257	TRK-2468 <sup>55</sup>
RT-15615			TRK-1875	TRK-1763	TRK-2468 <sup>55</sup>
RT-15715			TRK-2043	TRK-1991	TRK-2468 <sup>55</sup>
RT-915		TRK-1000	TRK-2780		
RTF-11615	w/ 1.75" Push Type I/S	TRK-203	TRK-3659	TRK-3655	
RTF-11615	w/ 2" Pull Type I/S	TRK-203	TRK-3659	TRK-3656	TRK-2468 <sup>55</sup>
RTF-11715			TRK-3660	TRK-3658	TRK-2468 <sup>55</sup>
RTF-12515	w/ 45mm Front Countershaft Brgs.	TRK-159A	TRK-1863	TRK-1079	TRK-2468 <sup>55</sup>
RTF-12515	w/ 55mm Front Countershaft Brgs.	TRK-159			TRK-2468 <sup>55</sup>
RTF-14615		TRK-207	TRK-1872	TRK-1979	TRK-2468 <sup>55</sup>
RTF-14715			TRK-2043	TRK-1991	TRK-2468 <sup>55</sup>
RTF-14915			TRK-3256	TRK-3257	TRK-2468 <sup>55</sup>
RTF-15615			TRK-1875	TRK-1763	TRK-2468 <sup>55</sup>
RTF-15715			TRK-2043	TRK-1991	TRK-2468 <sup>55</sup>
RTO-11615	w/ 1.75" Push Type I/S	TRK-203	TRK-3659	TRK-3655	
RTO-11615	w/ 2" Pull Type I/S	TRK-203	TRK-3659	TRK-3656	TRK-2468 <sup>55</sup>
RTO-11715			TRK-3660	TRK-3657	TRK-2468 <sup>55</sup>
RTO-12515	w/ 45mm Front Countershaft Brgs.	TRK-159A	TRK-1863	TRK-1079	TRK-2468 <sup>55</sup>
RTO-12515	w/ 55mm Front Countershaft Brgs.	TRK-159			TRK-2468 <sup>55</sup>
RTO-14615		TRK-207	TRK-1872	TRK-1979	TRK-2468 <sup>55</sup>
RTO-14715			TRK-2043	TRK-1991	TRK-2468 <sup>55</sup>
RTO-14915	w/ 85mm Aux Drive Gear Brg.		TRK-3233	TRK-3234	TRK-2468 <sup>55</sup>
RTO-14915	w/ 90mm Aux Drive Gear Brg.		TRK-3256	TRK-3258	TRK-2468 <sup>55</sup>
RTO-15615			TRK-1875	TRK-1763	TRK-2468 <sup>55</sup>
RTO-15715			TRK-2043	TRK-1991	TRK-2468 <sup>55</sup>
RTO-16915			TRK-3233	TRK-3234	TRK-2468 <sup>55</sup>
RTO-915		TRK-1000	TRK-2780		
RTOF-11615	w/ 1.75" Push Type I/S	TRK-203	TRK-3659	TRK-3655	
RTOF-11615	w/ 2" Pull Type I/S	TRK-203	TRK-3659	TRK-3656	TRK-2468 <sup>55</sup>
RTOF-11715			TRK-3660	TRK-3657	TRK-2468 <sup>55</sup>
RTOF-12515	w/ 45mm Front Countershaft Brgs.	TRK-159A	TRK-1863	TRK-1079	TRK-2468 <sup>55</sup>
RTOF-12515	w/ 55mm Front Countershaft Brgs.	TRK-159			TRK-2468 <sup>55</sup>
RTOF-14615		TRK-207	TRK-1872	TRK-1979	TRK-2468 <sup>55</sup>
RTOF-14715			TRK-2043	TRK-1991	TRK-2468 <sup>55</sup>

<sup>55</sup> Exc. Hyd. Release

# Heavy Duty Transmission Index

## Eaton/Fuller Medium & Heavy Duty Models

### 15 Speed Models (cont.)

Model No.	Comments	Standard Kit	Suitcase Kit	Overhaul Kit	Clutch Install Kit
RTOF-14915	w/ 85mm Aux Drive Gear Brg.		TRK-3233	TRK-3234	TRK-2468 <sup>55</sup>
RTOF-14915	w/ 90mm Aux Drive Gear Brg.		TRK-3256	TRK-3258	TRK-2468 <sup>55</sup>
RTOF-15615			TRK-1875	TRK-1763	TRK-2468 <sup>55</sup>
RTOF-15715			TRK-2043	TRK-1992	TRK-2468 <sup>55</sup>
RTOF-16915			TRK-3233	TRK-3234	TRK-2468 <sup>55</sup>
RTX-11615	w/ 1.75" Push Type I/S	TRK-203	TRK-3659	TRK-3655	
RTX-11615	w/ 2" Pull Type I/S	TRK-203	TRK-3659	TRK-3656	TRK-2468 <sup>55</sup>
RTX-11715			TRK-3660	TRK-3657	TRK-2468 <sup>55</sup>
RTX-12515		TRK-159A	TRK-1863	TRK-1079	TRK-2468 <sup>55</sup>
RTX-14615		TRK-207	TRK-1872	TRK-1979	TRK-2468 <sup>55</sup>
RTX-14715			TRK-2043	TRK-1992	TRK-2468 <sup>55</sup>
RTX-15615			TRK-1875	TRK-1763	TRK-2468 <sup>55</sup>
RTX-15715			TRK-2043	TRK-1992	TRK-2468 <sup>55</sup>
RTXF-11615	w/ 1.75" Push Type I/S	TRK-203	TRK-3659	TRK-3655	
RTXF-11615	w/ 2" Pull Type I/S	TRK-203	TRK-3659	TRK-3656	TRK-2468 <sup>55</sup>
RTXF-11715			TRK-3660	TRK-3657	TRK-2468 <sup>55</sup>
RTXF-12515		TRK-159A	TRK-1863	TRK-1079	TRK-2468 <sup>55</sup>
RTXF-14615		TRK-207	TRK-1872	TRK-1979	TRK-2468 <sup>55</sup>
RTXF-14715			TRK-2043	TRK-1992	TRK-2468 <sup>55</sup>
RTXF-15615			TRK-1875	TRK-1763	TRK-2468 <sup>55</sup>
RTXF-15715			TRK-2043	TRK-1992	TRK-2468 <sup>55</sup>

### 18 Speed Models

FO-14E318B-MXP			TRK-3941		
FO-14E318B-VXP			TRK-3941		
FO-16E318B-MXP			TRK-3941		
FO-16E318B-VXP			TRK-3941		
FO-18E318B-MXP			TRK-3941		
FO-18E318B-VXP			TRK-3941		
FO-20E318B-MXP			TRK-3941		
FO-20E318B-VXP			TRK-3941		
FO-22E318B-MXP			TRK-3941		
FO-22E318B-VXP			TRK-3941		
RTLO-14618A			TRK-2996	TRK-2993	TRK-2468 <sup>55</sup>
RTLO-14718B			TRK-2288	TRK-2779	TRK-2468 <sup>55</sup>
RTLO-14918A-AS2			TRK-3512	TRK-3513	
RTLO-14918A-AS3			TRK-3512	TRK-3513	
RTLO-14918B	w/ Forced Lubrication		TRK-3340	TRK-3339	TRK-2468 <sup>55</sup>
RTLO-14918B	w/o Forced Lubrication		TRK-3355	TRK-3354	TRK-2468 <sup>55</sup>
RTLO-14918B-AS			TRK-3534	TRK-3533	
RTLO-14918B-T2			TRK-3355	TRK-3354	TRK-2468 <sup>55</sup>
RTLO-16618A			TRK-2996	TRK-2993	TRK-2468 <sup>55</sup>
RTLO-16718B			TRK-2288	TRK-2779	TRK-2468 <sup>55</sup>
RTLO-16918A-AS2			TRK-3512	TRK-3513	
RTLO-16918A-AS3			TRK-3512	TRK-3513	
RTLO-16918B			TRK-3340	TRK-3339	TRK-2468 <sup>55</sup>
RTLO-16918B-AS			TRK-3534	TRK-3533	
RTLO-16918B-T2			TRK-3340	TRK-3339	TRK-2468 <sup>55</sup>
RTLO-18718B			TRK-2865	TRK-2866	TRK-2468 <sup>55</sup>
RTLO-18718B-T2			TRK-2865	TRK-2866	TRK-2468 <sup>55</sup>
RTLO-18918A-AS2			TRK-3512	TRK-3513	
RTLO-18918A-AS3			TRK-3512	TRK-3513	
RTLO-18918B			TRK-3340	TRK-3339	TRK-2468 <sup>55</sup>
RTLO-18918B-AS			TRK-3534	TRK-3533	
RTLO-18918B-T2			TRK-3340	TRK-3339	TRK-2468 <sup>55</sup>
RTLO-20918A-AS2			TRK-3512	TRK-3513	

# Heavy Duty Transmission Index

## Eaton/Fuller Medium & Heavy Duty Models

### 18 Speed Models (cont.)

Model No.	Comments	Standard Kit	Suitcase Kit	Overhaul Kit	Clutch Install Kit
RTLO-20918A-AS3			TRK-3512	TRK-3513	
RTLO-20918B			TRK-3340	TRK-3339	TRK-2468 <sup>55</sup>
RTLO-20918B-AS			TRK-3534	TRK-3533	
RTLO-20918B-T2			TRK-3340	TRK-3339	TRK-2468 <sup>55</sup>
RTLO-22918A-AS2			TRK-3514	TRK-3515	
RTLO-22918A-AS3			TRK-3514	TRK-3515	
RTLO-22918B			TRK-3462	TRK-3461	
RTLOF-14618A			TRK-2996	TRK-2993	TRK-2468 <sup>55</sup>
RTLOF-14718B			TRK-2288	TRK-2779	TRK-2468 <sup>55</sup>
RTLOF-14918B	w/ Forced Lubrication		TRK-3340	TRK-3339	TRK-2468 <sup>55</sup>
RTLOF-14918B	w/o Forced Lubrication		TRK-3355	TRK-3354	TRK-2468 <sup>55</sup>
RTLOF-14918B-T2			TRK-3355	TRK-3354	TRK-2468 <sup>55</sup>
RTLOF-16618A			TRK-2996	TRK-2993	TRK-2468 <sup>55</sup>
RTLOF-16718B			TRK-2288	TRK-2779	TRK-2468 <sup>55</sup>
RTLOF-16918B			TRK-3340	TRK-3339	TRK-2468 <sup>55</sup>
RTLOF-16918B-T2			TRK-3340	TRK-3339	TRK-2468 <sup>55</sup>
RTLOF-18718B			TRK-2865	TRK-2866	TRK-2468 <sup>55</sup>
RTLOF-18718B-T2			TRK-2865	TRK-2866	TRK-2468 <sup>55</sup>
RTLOF-18918B			TRK-3340	TRK-3339	TRK-2468 <sup>55</sup>
RTLOF-18918B-T2			TRK-3340	TRK-3339	TRK-2468 <sup>55</sup>
RTLOF-20918B			TRK-3340	TRK-3339	TRK-2468 <sup>55</sup>
RTLOF-20918B-T2			TRK-3340	TRK-3339	TRK-2468 <sup>55</sup>
RTLOF-22918B			TRK-3462	TRK-3461	
RTO-15618			TRK-2997	TRK-2994	TRK-2468 <sup>55</sup>
RTOF-15618			TRK-2997	TRK-2994	TRK-2468 <sup>55</sup>
<b>18 Speed Models Aux Section Only</b>					
RTLO-14618A AUX			TRK-2338		
RTLO-14718B AUX			TRK-2769		
RTLO-16618A AUX			TRK-2338		
RTLO-16718B AUX			TRK-2769		
RTLO-18718B AUX			TRK-2769		
RTLOF-14618A AUX			TRK-2338		
RTLOF-14718B AUX			TRK-2769		
RTLOF-16618A AUX			TRK-2338		
RTLOF-16718B AUX			TRK-2769		
RTLOF-18718B AUX			TRK-2769		
RTO-15618 AUX			TRK-1993		
RTOF-15618 AUX			TRK-1993		

# Heavy Duty Transmission Index

## GMC Index

Model No.	Speeds	Comments	Kit No.	Kit No. With Rings
CH465	4	Early/Late	TRK-157A	TRK-157AWS
CH465	4	1979 - 1990	TRK-157L	TRK-157LWS
CH465	4	1990 and Later	TRK-157B	TRK-157BWS
SM465	4	Early/Late	TRK-157A	TRK-157AWS
SM465	4	1979 - 1990	TRK-157L	TRK-157LWS
SM465	4	1990 and Later	TRK-157B	TRK-157BWS

## International Harvester/Navistar Index

Model No.	Speeds	Comments	Kit
T32	5		TRK-156
T33	5		TRK-156
T34	5		TRK-156
T35	5		TRK-156
T36	5		TRK-156
T494	5		TRK-156
T495	5		TRK-156
T496	5		TRK-156
T698	5		TRK-183
T699	5		TRK-183

## Mack Index

Model No.	Speeds	Comments	Kit
TRQP72	20	w/o Clutch Brake	TRK-65
TR107	5		TRK-185
TRDXL107	6		TRK-500
TRTXL107	12	Super Duty	TRK-213SD
TRXL107	6		TRK-187
TRXL107A	6		TRK-187
TC150	-	Transfer Case	TRK-504
T309L	9		TRK-505
	9	Master Kit	TRK-505MK
T310	10		TRK-506
	10	Master Kit	TRK-506MK
T318	18		TRK-507
	18	Master Kit	TRK-507MK
TRQ720	20	w/o Clutch Brake	TRK-65
TRQP720	20	w/o Clutch Brake	TRK-65
TRDL1070	10		TRK-187
TRTXL1070	12	Super Duty	TRK-213SD
	12		TRK-213
TRXL1070	-		TRK-502
TRTXL1070	12		TRK-213
TRXL1071	6		TRK-187
TRXL1071A	6		TRK-187
TRL1076	5		TRK-185
TRL1078	5		TRK-185
T2090	9		TRK-214
T2050	5		TRK-503
	5	Master Kit	TRK-503MK
T2060	6		TRK-214
	6	Master Kit	TRK-214MK
T2070	7		TRK-214
	7	Master Kit	TRK-214MK

## Mack Index

Model No.	Speeds	Comments	Kit
T2080	8		TRK-214
T2090	9		TRK-214
	9	Master Kit	TRK-214MK
T2100	10		TRK-214
	10	Master Kit	TRK-214MK
T2130	13		TRK-214
	13	Master Kit	TRK-214MK
T2180	18		TRK-214
	18	Master Kit	TRK-214MK1
TRQ7210	20	w/o Clutch Brake	TRK-65
TRQL7220	20	w/o Clutch Brake	TRK-65
TRXL10710	-		TRK-502
TRL10760	-		TRK-501
TRL10780	-		TRK-501

## Meritor/Rockwell

Model No.	Speeds	Comments	Suitcase Kit	Clutch Install Kit
RM9-115	9		TRK-5356 <sup>61</sup>	TRK-5000CK
RM9-125	9		TRK-5356 <sup>61</sup>	TRK-5000CK
RM9-135	9		TRK-5357 <sup>61</sup>	TRK-5000CK
RM9-145	9		TRK-5357 <sup>61</sup>	TRK-5000CK
RM9-155	9		TRK-5357 <sup>61</sup>	TRK-5000CK
RM10-115	10		TRK-5356 <sup>61</sup>	TRK-5000CK
RM10-125	10		TRK-5356 <sup>61</sup>	TRK-5000CK
RM10-135	10		TRK-5357 <sup>61</sup>	TRK-5000CK
RM10-145	10		TRK-5357 <sup>61</sup>	TRK-5000CK
RM10-155	10		TRK-5357 <sup>61</sup>	TRK-5000CK
RM10-165	10		TRK-5357 <sup>61</sup>	TRK-5000CK
RM13-145	10		TRK-5358 <sup>61</sup>	TRK-5000CK
M-15G9	9		TRK-5406	TRK-5000CK
M-15G10	10		TRK-5406	TRK-5000CK
MO-14G9	9		TRK-5406	TRK-5000CK
MO-15G9	9		TRK-5406	TRK-5000CK
MO-16G10	10		TRK-5406	TRK-5000CK

# Heavy Duty Transmission Index

## New Process Transmissions

Model No.	Speeds	Comments	Kit
435	4	w/ Tapered Bearing on Drive Shaft	TRK-127
	4	Ford only w/ Tapered Bearing on Drive Shaft	TRK-127F
	4	w/ Ball Bearing on Drive Shaft	TRK-127G
435FE	4	w/ Tapered Bearing on Drive Shaft	TRK-127
435FL	4	w/ Tapered Bearing on Drive Shaft	TRK-127
435GL	4	w/ Tapered Bearing on Drive Shaft	TRK-127
436	4	w/ Tapered Bearing on Drive Shaft	TRK-127
	4	Ford only w/ Tapered Bearing on Drive Shaft	TRK-127F
	4	w/ Ball Bearing on Drive Shaft	TRK-127G
540	5		TRK-27
540C	5		TRK-27
540D	5		TRK-27
540G	5		TRK-27
540GD	5		TRK-27
540GL	5		TRK-27
540GO	5		TRK-27
541	5	Early	TRK-27
	5	Late (Exc. Ford)	TRK-29
541DD11	5		TRK-29
541DD12	5		TRK-29
541DD13	5		TRK-29
541DD14	5		TRK-29
541DD15	5		TRK-29
541DD16	5		TRK-29
541DD17	5		TRK-29
541FD	5	Early	TRK-27
	5	Late	TRK-29
541FL	5	Early	TRK-27
	5	Late	TRK-29
541FO	5	Early	TRK-27
	5	Late	TRK-29
541G	5	Early	TRK-27
	5	Late	TRK-29
541GD	5	Early	TRK-27
	5	Late	TRK-29
541GD24	5	Early	TRK-27
	5	Late	TRK-29
541GL	5	Early	TRK-27
	5	Late	TRK-29
541GO	5	Early	TRK-27
	5	Late	TRK-29
541GO-11	5	Early	TRK-27
	5	Late	TRK-29
542	5	Early	TRK-27

## New Process Transmissions

Model No.	Speeds	Comments	Kit
542	5	Late (Exc. Ford)	TRK-29
	5	Late (w/Ford)	TRK-29B
542D	5	w/GMC	TRK-29
542FD	5	Early	TRK-27
	5	Late (Exc. Ford)	TRK-29
	5	Late (w/Ford)	TRK-29B
542FL	5	Early	TRK-27
	5	Late (Exc. Ford)	TRK-29
	5	Late (w/Ford)	TRK-29B
542FO	5	Early	TRK-27
	5	Late (Exc. Ford)	TRK-29
	5	Late (w/Ford)	TRK-29B
542GD	5	w/GMC	TRK-29
542GL	5	w/GMC	TRK-29
542L	5	w/GMC	TRK-29
4590(IH)	4		TRK-174
7531	5		TRK-177
7550	5		TRK-177
7551	5		TRK-177
7590	5		TRK-177
7591	5		TRK-177

HD Transmission



# Heavy Duty Transmission Index

## Spicer/TTC Transmissions

Model No.	Speeds	Comments	Standard Kit	Suitcase Kit
1007	7		TRK-189	
1010	10		TRK-152	
1020	20		TRK-189	
1052	5		TRK-147	TRK-313432-25X
1062	6		TRK-147	TRK-313432-25X
1064	6		TRK-147	
1107	7		TRK-181	
1207	7		TRK-191	
1214	14		TRK-189	
1252	5		TRK-147	TRK-313432-25X
1253	5		TRK-147	TRK-313432-25X
1262	6		TRK-147	
1263	6		TRK-147	TRK-313432-25X
1272	7		TRK-189	
1352	5		TRK-192	TRK-313432-1X
1362	6		TRK-192	TRK-313432-1X
1364	6		TRK-192	TRK-313432-1X
1372	7		TRK-193	TRK-313432-2X
1412	12		TRK-194	
1414	14		TRK-194	
1420	20		TRK-194	
1452	5		TRK-192	TRK-313432-1X
1453	5		TRK-192	TRK-313432-1X
1463	6		TRK-192	TRK-313432-1X
4054	5		TRK-210	TRK-313432-11X
4652	5		TRK-28	
4752	5		TRK-28	
4753	5		TRK-28	
4756	5		TRK-28	
4852	5		TRK-28	
4853	5		TRK-28	
4954	5		TRK-221	TRK-313432-30X
5052	5		TRK-180	TRK-313432-10X
5252	5		TRK-180	TRK-313432-10X
5552	5		TRK-180	TRK-313432-10X
5650	5		TRK-28	
5652	5		TRK-28	
5750	5		TRK-28	
5752	5		TRK-28	
5753	5		TRK-28	
5756	5		TRK-28	
5850	5		TRK-28	
5852	5		TRK-180	TRK-313432-10X
5853	5		TRK-28	
6052	5		TRK-186	TRK-313432-20X
6252	5		TRK-186	TRK-313432-20X
6253	5		TRK-186	TRK-313432-20X
6350	5		TRK-72	
6352	5		TRK-72	
6354	5		TRK-72	
6450	5		TRK-72	
6452	5		TRK-72	
6453	5		TRK-72	
6454	5		TRK-72	
6455	5		TRK-72	
6456	5		TRK-72	
6458	5		TRK-72	

HD Transmission

# Heavy Duty Transmission Index

## Spicer/TTC Transmissions

Model No.	Speeds	Comments	Standard Kit	Suitcase Kit
6850	5		TRK-72	
6852	5		TRK-72	
6853	5		TRK-72	
6854	5		TRK-72	
6855	5		TRK-72	
7041	4		TRK-73	TRK-313432-21X
8012	12		TRK-74	
8016	16		TRK-74	
8051	5	w/ Spherical Pilot Brg., exc. some late models	TRK-2	
	5	w/ Cylindrical Pilot Brg., exc. some late models	TRK-2A	
8055	5	w/ Spherical Pilot Brg., exc. some late models	TRK-2	
	5	w/ Cylindrical Pilot Brg., exc. some late models	TRK-2A	
8212	12		TRK-74	
8216	16		TRK-74	
8251	5	w/ Spherical Pilot Brg., exc. some late models	TRK-2	
	5	w/ Cylindrical Pilot Brg., exc. some late models	TRK-2A	
8255	5	w/ Spherical Pilot Brg., exc. some late models	TRK-2	
	5	w/ Cylindrical Pilot Brg., exc. some late models	TRK-2A	
8516	16		TRK-130	
8542	4		TRK-139	
8544	4		TRK-139	
8552	5		TRK-140	
8553	5		TRK-141	
8554	5		TRK-140	
8555	5		TRK-141	
8716	16		TRK-130	
8742	4		TRK-139	
8744	4		TRK-139	
8753	5		TRK-141	
8755	5		TRK-141	
8842	4		TRK-139	
8844	4		TRK-139	
CM40	5		TRK-210	TRK-313432-11X
CM49	5		TRK-221	TRK-313432-30X
CM50	5		TRK-180	TRK-313432-10X
CM55	5		TRK-180	TRK-313432-10X
CM60	5		TRK-186	TRK-313432-20X
CM62	5		TRK-186	TRK-313432-20X
CM4054	5		TRK-210	TRK-313432-11X
CM4954	5		TRK-221	TRK-313432-30X
CM5052	5		TRK-180	TRK-313432-10X
CM5252	5		TRK-180	TRK-313432-10X
CM5552	5		TRK-180	TRK-313432-10X
CM5852	5		TRK-180	TRK-313432-10X
CM5952	5		TRK-180	TRK-313432-10X
CM6052	5		TRK-186	TRK-313432-20X
CM6253	5		TRK-186	TRK-313432-20X
ES066-7B	7		TRK-222	TRK-101-432-1X
ES42-5	5		TRK-219	TRK-313432-34X
ES43-5	5		TRK-221	TRK-313432-46X
ES46-5A	5		TRK-704	TRK-56-432-1X
ES52-5	5		TRK-221	TRK-313432-30X
ES52-7	7		TRK-222	TRK-101-432-1X
ES53-5	5		TRK-221	TRK-313432-46X
ES56-5A	5		TRK-704	TRK-56-432-1X
ES56-7	7		TRK-222	TRK-101-432-1X
ES60-5	5		TRK-180	TRK-313432-10X

# Heavy Duty Transmission Index

## Spicer/TTC Transmissions

Model No.	Speeds	Comments	Standard Kit	Suitcase Kit
ES62-5	5		TRK-180	TRK-313432-31X
ES65-5	5		TRK-186	TRK-313432-20X
ES65-7	7		TRK-222	TRK-101-432-1X
ESO66-7	7		TRK-222	TRK-101-432-1X
ES70-5	5		TRK-186	TRK-313432-20X
LLPS145-10	10		TRK-700	TRK-313432-33X
LLPSO140-10	10		TRK-700	TRK-313432-33X
LLPSO150-10	10		TRK-700	TRK-313432-33X
LPS100-10	10		TRK-700	TRK-313432-33X
LPS125-10	10		TRK-700	TRK-313432-33X
PS125-9	9		TRK-700	TRK-313432-33X
LPS135-10	10		TRK-700	TRK-313432-33X
LPS145-10	10		TRK-700	TRK-313432-33X
LPSO125-10	10		TRK-700	TRK-313432-33X
LPSO140-10	10		TRK-700	TRK-313432-33X
LPSO150-10	10		TRK-700	TRK-313432-33X
PS100-10	10		TRK-700	TRK-313432-33X
PS105-7LL	7		TRK-705	
PS110-7	7		TRK-702	TRK-313432-35X
PS125-9	9		TRK-700	TRK-313432-33X
PS130-6L	6		TRK-705	
PS135-10	10		TRK-700	TRK-313432-33X
PS145-10	10		TRK-700	TRK-313432-33X
PS145-7	7		TRK-702	TRK-313432-35X
PS95-9	9		TRK-700	TRK-313432-33X
PS97-7	7		TRK-706	TRK-313432-14X
PSO100-10	10		TRK-700	TRK-313432-33X
PSO125-10	10		TRK-700	TRK-313432-33X
PSO140-10	10		TRK-700	TRK-313432-33X
PSO140-9	9		TRK-700	TRK-313432-33X
PSO150-10	10		TRK-700	TRK-313432-33X
PSO150-16	16		TRK-194	
PSO150-9	9		TRK-700	TRK-313432-33X
PSO165-10	10		TRK-700	TRK-313432-33X
PSO165-16	16		TRK-194	
PSO175-16	16		TRK-194	
SST5	5	Old Version	TRK-147	
SST6	6	Old Version	TRK-147	
	6	New Version	TRK-192	
SST6+1	7	New Version	TRK-191	
SST7	7	Old Version	TRK-181	
	7	New Version	TRK-193	
SST10	10	Old Version	TRK-152	
SST12	12	New Version	TRK-194	
SST14	14	Old Version	TRK-189	
	14	New Version	TRK-194	
SST20	20		TRK-189	

HD Transmission

# Heavy Duty Transmission Index

## Spicer/TTC Auxiliary Transmissions

Model No.	Speeds	Comments	Standard Kit	Suitcase Kit
1241	4		TRK-158	TRK-98-432-1X
6041	4		TRK-70	
7041	4		TRK-73	TRK-313432-21X
7231	3		TRK-86	
8031	3	w/ Steel Caged Brgs.	TRK-3	
	3	w/ Bronze Caged Brgs.	TRK-4	
8035	3	w/ Steel Caged Brgs.	TRK-3	
	3	w/ Bronze Caged Brgs.	TRK-4	
8341	4	w/ Steel Caged Brgs.	TRK-3	
	4	w/ Bronze Caged Brgs.	TRK-4	
8341L	4		TRK-155	
8345	4	w/ Steel Caged Brgs.	TRK-3	
	4	w/ Bronze Caged Brgs.	TRK-4	
AMO1000	4		TRK-703	TRK-98-432-1X
AMO1750	4		TRK-703	TRK-98-432-1X
APO1000	4		TRK-703	TRK-98-432-1X
APO1750	4		TRK-703	TRK-98-432-1X
R8341C	4		TRK-155	
R8341L	4		TRK-155	
RP8341	4		TRK-155	

## Spicer/TTC Power Take Offs for Auxiliary Transmissions

Model No.	Speeds	Comments	Standard Kit	Suitcase Kit
1241		Tapered Output Bearings	TRK-707	
		Cylindrical Output Bearings	TRK-226	TRK-312476-22X
7041		Tapered Output Bearings	TRK-708	
		Cylindrical Output Bearings	TRK-709	
8031		Tapered Output Bearings	TRK-708	
		Cylindrical Output Bearings	TRK-709	
8341		Tapered Output Bearings	TRK-708	
		Cylindrical Output Bearings	TRK-709	
AMO1000		Tapered Output Brgs.	TRK-707	
		Cylindrical Output Brgs.	TRK-226	TRK-312476-22X
AMO1750		Tapered Output Brgs.	TRK-707	
		Cylindrical Output Brgs.	TRK-226	TRK-312476-22X
APO1000		Tapered Output Brgs.	TRK-707	
		Cylindrical Output Brgs.	TRK-226	TRK-312476-22X
APO1750		Tapered Output Brgs.	TRK-707	
		Cylindrical Output Brgs.	TRK-226	TRK-312476-22X
R8031		Tapered Output Brgs.	TRK-708	
		Cylindrical Output Brgs.	TRK-709	
R8341		Tapered Output Brgs.	TRK-708	
		Cylindrical Output Brgs.	TRK-709	

# Heavy Duty Transmission Index

## Volvo/Mack I/M Shift

Model No.	Speeds	Comments	Kit
AT2412C	12	Early Planet (70mm O/S Brg.)	TRK-510
	12	Late Planet (80mm O/S Brg.)	TRK-510A
AT2412D	12	Early Planet (70mm O/S Brg.)	TRK-510
	12	Late Planet (80mm O/S Brg.)	TRK-510A
AT2512C	12	Early Planet (70mm O/S Brg.)	TRK-511
	12	Late Planet (80mm O/S Brg.)	TRK-511A
ATO2512C	12	Early Planet (70mm O/S Brg.)	TRK-510
	12	Late Planet (80mm O/S Brg.)	TRK-510A
AT2612D	12	Early Planet (70mm O/S Brg.)	TRK-511
	12	Late Planet (80mm O/S Brg.)	TRK-511A
ATO2612D	12	Early Planet (70mm O/S Brg.)	TRK-510
	12	Late Planet (80mm O/S Brg.)	TRK-510A
AT2812C	12	Early Planet (70mm O/S Brg.)	TRK-511
	12	Late Planet (80mm O/S Brg.)	TRK-511A
AT2812D	12	Early Planet (70mm O/S Brg.)	TRK-511
	12	Late Planet (80mm O/S Brg.)	TRK-511A
ATO3112C	12	Early Planet (70mm O/S Brg.)	TRK-511
	12	Late Planet (80mm O/S Brg.)	TRK-511A
ATO3112D	12	Early Planet (70mm O/S Brg.)	TRK-511
	12	Late Planet (80mm O/S Brg.)	TRK-511A

## Warner Index

Model No.	Speeds	Comments	Kit
T18	4	w/Willys Jeep	TRK-82F
	4	w/Ford	TRK-82F
T184	4	w/I.H.	TRK-82D
T18A	4	w/Willys Jeep	TRK-82F
	4	w/Ford	TRK-82F
	4	w/I.H.	TRK-82D
T18B	4	w/Willys Jeep	TRK-82F
	4	w/Ford	TRK-82F
	4	w/I.H.	TRK-82D
T18C	4	w/Willys Jeep	TRK-82F
	4	w/Ford	TRK-82F
	4	w/I.H.	TRK-82D
T19	4	w/Ford (Gas)	TRK-82F
	4	w/Ford (Diesel)	TRK-82FD
	4	w/I.H.	TRK-82D
T19A	4	w/Ford (Gas)	TRK-82F
	4	w/Ford (Diesel)	TRK-82FD
	4	w/I.H.	TRK-82D
T98	4	w/.9055" Wide Driveshaft Bearing	TRK-82
T98A	4	w/.9055" Wide Driveshaft Bearing w/LH PTO	TRK-82
T98B	4	w/.9055" Wide Driveshaft Bearing	TRK-82
T98D	4	w/.9055" Wide Driveshaft Bearing	TRK-82



# Heavy Duty Transfer Case Index

## Fabco

Model No.	Comments	Kit
TC-38		TCRK-38
TC-170	Upper Shaft w/ PTO	TCRK-170A1
	Intermediate Shaft w/ & w/o Lube Pump	TCRK-170B
	Lower Shaft w/ Neutral	TCRK-170C
	Lower Shaft w/o Neutral	TCRK-170C1
	Upper Shaft w/o PTO	TCRK-170A
TC-170PD	Upper Shaft w/ PTO	TCRK-170A1
	Intermediate Shaft w/ & w/o Lube Pump	TCRK-170B
	Lower Shaft w/ Proportional Differential	TCRK-170C2
	Upper Shaft w/o PTO	TCRK-170A
TC-200	w/o PTO	TCRK-200
	w/ PTO	TCRK-200A
TC-237		TCRK-237
TC-270	w/o PTO	TCRK-270
TC-306		TCRK-306

## Meritor/Rockwell

Model No.	Comments	Kit
MTC-4208		TCRK-929
MTC-4210		TCRK-929
MTC-4213		TCRK-930
T-2120-D		TCRK-926
T-221-A1		TCRK-221
T-221-M6		TCRK-221
T-221-M7		TCRK-221
T-221-N4		TCRK-221
T-223-A102		TCRK-903
T-223-A103		TCRK-900
T-223-A104		TCRK-900
T-223-A105		TCRK-900
T-223-A84		TCRK-900
T-223-A88		TCRK-900
T-223-A89		TCRK-900
T-223-A90		TCRK-900
T-223-A92		TCRK-900
T-223-A94		TCRK-900
T-223-C22		TCRK-900
T-223-C35		TCRK-903
T-223-C41		TCRK-901
T-223-C42		TCRK-903
T-223-C43		TCRK-901
T-223-C44		TCRK-901
T-223-E22		TCRK-900
T-223-E23		TCRK-900
T-223-H29		TCRK-903
T-223-H31		TCRK-903
T-223-H33		TCRK-903
T-223-H39		TCRK-902
T-223-H40		TCRK-903
T-223-H41		TCRK-903
T-223-H42		TCRK-903
T-223-H43		TCRK-903
T-223-H44		TCRK-902
T-223-H45		TCRK-903
T-223-H52		TCRK-903
T-223-H53		TCRK-903
T-223-H54		TCRK-903
T-223-H55		TCRK-903
T-223-H56		TCRK-903
T-223-H57		TCRK-903

## Meritor/Rockwell

Model No.	Comments	Kit
T-223-M4		TCRK-900
T-226-103		TCRK-907
T-226-118		TCRK-906
T-226-132		TCRK-909
T-226-133		TCRK-908
T-226-136		TCRK-906
T-226-138		TCRK-907
T-226-139		TCRK-906
T-226-140		TCRK-906
T-226-148		TCRK-908
T-226-149		TCRK-909
T-226-155		TCRK-906
T-226-156		TCRK-906
T-226-159		TCRK-913
T-226-160		TCRK-906
T-226-161		TCRK-907
T-226-163		TCRK-906
T-226-164		TCRK-906
T-226-166		TCRK-906
T-226-167		TCRK-913
T-226-168		TCRK-907
T-226-169		TCRK-907
T-226-170		TCRK-906
T-226-171		TCRK-907
T-226-172		TCRK-908
T-226-173		TCRK-907
T-226-174		TCRK-906
T-226-175		TCRK-906
T-226-176		TCRK-913
T-226-177		TCRK-906
T-226-26		TCRK-906
T-226-28		TCRK-906
T-226-41		TCRK-906
T-226-65		TCRK-906
T-226-69		TCRK-906
T-226-80		TCRK-906
T-226-83		TCRK-906
T-226-85		TCRK-906
T-226-86		TCRK-906
T-226-A1		TCRK-904
T-226-A12		TCRK-904
T-226-A13		TCRK-904
T-226-A16		TCRK-904
T-226-A22		TCRK-905
T-226-A23		TCRK-904
T-226-AB1		TCRK-904
T-226-AB3		TCRK-904
T-226-AB5		TCRK-905
T-226-B28		TCRK-906
T-226-B30		TCRK-906
T-226-B48		TCRK-906
T-226-B67		TCRK-906
T-226-B68		TCRK-906
T-226-B70		TCRK-906
T-226-B73		TCRK-906
T-226-B74		TCRK-906
T-226-B76		TCRK-906
T-226-B77		TCRK-906
T-226-B78		TCRK-906
T-226-B79		TCRK-906
T-226-B80		TCRK-906
T-226-C17		TCRK-904

# Heavy Duty Transfer Case Index

HD Transmission

## Meritor/Rockwell

Model No.	Comments	Kit
T-226-C3		TCRK-904
T-226-CB12		TCRK-904
T-226-CB13		TCRK-905
T-226-CB4		TCRK-904
T-226-CB9		TCRK-905
T-226-D4		TCRK-906
T-226-D6		TCRK-907
T-226-E26		TCRK-917
T-226-E33		TCRK-917
T-226-E38		TCRK-910
T-226-E43		TCRK-917
T-226-E45		TCRK-910
T-226-E49		TCRK-917
T-226-E50		TCRK-910
T-226-E51		TCRK-910
T-226-E7		TCRK-917
T-226-F		TCRK-916
T-226-F19		TCRK-916
T-226-F2		TCRK-916
T-226-F20		TCRK-916
T-226-F25		TCRK-916
T-226-F26		TCRK-916
T-226-F31		TCRK-916
T-226-F33		TCRK-916
T-226-F34		TCRK-915
T-226-G		TCRK-906
T-226-G1		TCRK-906
T-226-G3		TCRK-906
T-226-H		TCRK-913
T-226-H3		TCRK-913
T-226-HB		TCRK-913
T-226-HB1		TCRK-913
T-226-J		TCRK-911
T-226-K4		TCRK-913
T-226-K7		TCRK-913
T-226-L		TCRK-913
T-226-L1		TCRK-913
T-226-L10		TCRK-913
T-226-L19		TCRK-913
T-226-L30		TCRK-913
T-226-L35		TCRK-913
T-226-L37		TCRK-914
T-226-L4		TCRK-913
T-226-L40		TCRK-914
T-226-L42		TCRK-913
T-226-L43		TCRK-913
T-226-L45		TCRK-913
T-226-L46		TCRK-913
T-226-L47		TCRK-913
T-226-L48		TCRK-913
T-226-L49		TCRK-913
T-226-L50		TCRK-913
T-226-L51		TCRK-913
T-226-L52		TCRK-914
T-226-L53		TCRK-913
T-226-L54		TCRK-913
T-226-L8		TCRK-913
T-226-M		TCRK-913
T-226-M1		TCRK-913
T-226-M3		TCRK-913
T-226-M4		TCRK-913
T-226-M5		TCRK-913

## Meritor/Rockwell

Model No.	Comments	Kit
T-226-N		TCRK-911
T-226-N1		TCRK-912
T-226-N2		TCRK-912
T-226-P4		TCRK-913
T-226-P7		TCRK-913
T-226-Q		TCRK-913
T-226-Q1		TCRK-913
T-226-Q2		TCRK-914
T-226-R10		TCRK-918
T-226-R11		TCRK-918
T-226-R8		TCRK-918
T-226-S		TCRK-913
T-226-S1		TCRK-913
T-226-T		TCRK-911
T-226-T1		TCRK-911
T-226-W		TCRK-904
T-228-12		TCRK-919
T-228-19		TCRK-922
T-228-36		TCRK-919
T-228-37		TCRK-922
T-228-D100		TCRK-921
T-228-D101		TCRK-920
T-228-D102		TCRK-920
T-228-D103		TCRK-920
T-228-D104		TCRK-920
T-228-D106		TCRK-921
T-228-D107		TCRK-920
T-228-D108		TCRK-920
T-228-D109		TCRK-920
T-228-D25		TCRK-920
T-228-D27		TCRK-920
T-228-D31		TCRK-920
T-228-D38		TCRK-920
T-228-D58		TCRK-920
T-228-D60		TCRK-920
T-228-D77		TCRK-920
T-228-D81		TCRK-920
T-228-D82		TCRK-920
T-228-D85		TCRK-921
T-228-D88		TCRK-921
T-228-D89		TCRK-920
T-228-D90		TCRK-920
T-228-D92		TCRK-920
T-228-D93		TCRK-920
T-228-D94		TCRK-920
T-228-D95		TCRK-920
T-228-D97		TCRK-920
T-228-D98		TCRK-920
T-228-D99		TCRK-920
T-228-E		TCRK-925
T-228-E1		TCRK-925
T-228-F		TCRK-920
T-228-F1		TCRK-921
T-228-F2		TCRK-920
T-228-PD16		TCRK-923
T-228-PD37		TCRK-923
T-228-PD38		TCRK-924
T-32-42		TCRK-933
T-32-43		TCRK-933
T-32-46		TCRK-931
T-32-47		TCRK-933
T-32-57		TCRK-933

# Heavy Duty Transfer Case Index

## Meritor/Rockwell

Model No.	Comments	Kit
T-32-63		TCRK-933
T-32-65		TCRK-932
T-32-69		TCRK-933
T-32-70		TCRK-933
T-32-75		TCRK-931
T-32-78		TCRK-931
T-32-79		TCRK-933
T-32-80		TCRK-933
T-32-83		TCRK-932
T-32-84		TCRK-931
T-32-85		TCRK-931
T-32-86		TCRK-931
T-32-87		TCRK-931
T-32-88		TCRK-931
TG-2213	Built 6/01 & Prior	TCRK-927
	Built After 6/01	TCRK-928

## Spicer

Model No.	Comments	Kit
738	Direct Mount	TCRK-738
	Remote Mount	TCRK-738A
784		TCRK-784
785		TCRK-792
791		TCRK-791
792		TCRK-792

# Heavy Duty Transfer Case Rebuild Kits



HD Transmission

TCRK-38		
Position	Part Number	Qty
Input Shaft Front Brg.	59201-59425	1
Input Shaft Rear Brg.	455-453X	1
Input Gear Brg.	389A-382A	2
Intermediate Shaft Front Brg.	455-453X	1
Intermediate Shaft Rear Brg.	JH307749-JH307710	1
Intermediate Gear Brg.	389A-382A	2
Front Output Shaft Front Brg.	59201-59412	1
Front Output Shaft Rear Brg.	455-453X	1
Front Output Gear Brg.	389A-382A	2
Rear Output Shaft Front Brg.	HM804846-HM804810	1
Rear Output Shaft Rear Brg.	4595-4535	1
Input Shaft Seal	416664V (2.750x3.500)	1
Front Output Shaft Seal	416664V (2.750x3.500)	1
Rear Output Shaft Seal	417316V (2.750x3.751)	1
O-Ring Kit	OK38	1
Gasket Kit	GTC38	1

TCRK-170A		
Position	Part Number	Qty
Input Shaft Front Brg.	639-633	1
Input Shaft Rear Brg.	576-572	1
Input Shaft Seal	415991N (3.500x4.501)	1

TCRK-170A1		
Position	Part Number	Qty
Input Shaft Front Brg.	639-633	1
Input Shaft Rear Brg.	576-572	1
PTO Output Shaft Front Brg.	33212	1
PTO Output Shaft Rear Brg.	33212	1
Input Shaft Seal	415991N (3.500x4.501)	1
PTO Output Shaft Seal	415027N (3.500x4.999)	1

TCRK-170B		
Position	Part Number	Qty
Intermediate Shaft Brg.	643-633	2

TCRK-170C		
Position	Part Number	Qty
Front Output Shaft Front Brg.	JH211749-JH211710	1
Front Output Shaft Rear Brg.	JH211749-JH211710	1
Rear Output Shaft Front Brg.	576-572	1
Rear Output Shaft Rear Brg.	5584-5535	1
Front Output Shaft Seal	415027N (3.500x4.999)	1
Rear Output Shaft Seal	415991N (3.500x4.501)	1
O-Ring (Shifter Shaft)	OR316	1
O-Ring (Piston to Shaft)	OR012	2
O-Ring (Piston)	OR326	2
O-Ring (Cap)	OR032	1
O-Ring (Shift Cylinder)	OR224	3
Felt Wiper	339-0223	2

TCRK-170C1		
Position	Part Number	Qty
Front Output Shaft Front Brg.	JH211749-JH211710	1
Front Output Shaft Rear Brg.	JH211749-JH211710	1
Rear Output Shaft Front Brg.	576-572	1
Rear Output Shaft Rear Brg.	639-633	1
Front Output Shaft Seal	415027N (3.500x4.999)	1
Rear Output Shaft Seal	415991N (3.500x4.501)	1
O-Ring (Shifter Shaft)	OR316	1
O-Ring (Piston to Shaft)	OR012	2
O-Ring (Piston)	OR326	2
O-Ring (Cap)	OR032	1
O-Ring (Shift Cylinder)	OR224	3
Felt Wiper	339-0223	2

TCRK-170C2		
Position	Part Number	Qty
Front Output Shaft Brg.	5310KL	1
Differential Front Brg.	575-572	1
Differential Rear Brg.	580-572	1
Rear Output Shaft Front Brg.	32213	1
Rear Output Shaft Rear Brg.	32213	1
Front Output Shaft Seal	413248 (2.625x3.371)	1
Rear Output Shaft Seal	415027N (3.500x4.999)	1
O-Ring (Shifter Shaft)	OR316	1
O-Ring (Piston to Shaft)	OR012	2
O-Ring (Piston)	OR326	2
O-Ring (Cap)	OR032	1
O-Ring (Shift Cylinder)	OR224	3
Felt Wiper	339-0223	2

TCRK-200		
Position	Part Number	Qty
Input Shaft Front Brg.	65225-65500	1
Input Shaft Rear Brg.	JH211749-JH211710	1
Input Gear Brg.	JLM710949-JLM710910	2
Intermediate Shaft Front Brg.	JH211749-JH211710	1
Intermediate Shaft Rear Brg.	JH415647-JH415610	1
Intermediate Gear Brg.	JLM710949-JLM710910	2
Front Output Shaft Front Brg.	39578-39520	1
Front Output Shaft Rear Brg.	JH211749-JH211710	1
Front Output Gear Brg.	JLM710949-JLM710910	2
Rear Output Shaft Front Brg.	39580-39520	1
Rear Output Shaft Rear Brg.	639-632	1
Rear Output Gear Brg.	JLM710949-JLM710910	2
Input Shaft Seal	455088V (3.000x4.499)	1
Front Output Shaft Seal	455088V (3.000x4.499)	1
Rear Output Shaft Seal	455088V (3.000x4.499)	1
O-Ring Kit	OK200	1
Gasket Kit	GTC200	1

TCRK-200A		
Position	Part Number	Qty
Input Shaft Front Brg.	65225-65500	1
Input Shaft Rear Brg.	JH211749-JH211710	1
Input Gear Brg.	JLM710949-JLM710910	2
Intermediate Shaft Front Brg.	JH211749-JH211710	1
Intermediate Shaft Rear Brg.	JH415647-JH415610	1
Intermediate Gear Brg.	JLM710949-JLM710910	2
Front Output Shaft Front Brg.	39578-39520	1
Front Output Shaft Rear Brg.	JH211749-JH211710	1
Front Output Gear Brg.	JLM710949-JLM710910	2
Rear Output Shaft Front Brg.	39580-39520	1
Rear Output Shaft Rear Brg.	639-632	1
Rear Output Gear Brg.	JLM710949-JLM710910	2
PTO Front Brg.	462-453X	1
PTO Rear Brg.	462-453X	1
Input Shaft Seal	455088V (3.000x4.499)	1
Front Output Shaft Seal	455088V (3.000x4.499)	1
Rear Output Shaft Seal	455088V (3.000x4.499)	1
PTO Shaft Seal	417488 (3.000x4.376)	1
O-Ring Kit	OK200A	1
Gasket Kit	GTC200A	1

TCRK-221		
Position	Part Number	Qty
Input Shaft Front Brg.	207S	1
Input Shaft Rear Brg.	206S	1
Front Output Shaft Front Brg.	207L	1
Front Output Shaft Rear Brg.	209L	1
Rear Output Shaft Front Brg.	15126-15245	1
Rear Output Shaft Rear Brg.	15126-15245	1
Idler Shaft Front Brg.	02476-02420	1
Idler Shaft Rear Brg.	15126-15245	1
Input Shaft Seal	482164N (1.750x2.502)	1
Front Output Shaft Seal	482164N (1.750x2.502)	1
Rear Output Shaft Seal	482164N (1.750x2.502)	1
Shift Shaft Seal	6835S (.750x1.250)	2
PTO Shaft Seal	471424 (2.000x2.623)	2

TCRK-237		
Position	Part Number	Qty
Input Shaft Front Brg.	59201-59425	1
Input Shaft Rear Brg.	455-453X	1
Input Gear Brg.	389A-382A	2
Intermediate Shaft Front Brg.	455-453X	1
Intermediate Shaft Rear Brg.	JH307749-JH307710	1
Intermediate Gear Brg.	389A-382A	2
Front Output Shaft Front Brg.	33212	1
Front Output Shaft Rear Brg.	33212	1
Rear Output Shaft Front Brg.	575-572	1
Rear Output Shaft Rear Brg.	4595-4535	1
Input Shaft Seal	416664V (2.750x3.500)	1
Front Output Shaft Seal	415027V (3.500x4.999)	1
Rear Output Shaft Seal	417316V (2.750x3.751)	1
O-Ring Kit	OK237	1
Gasket Kit	GTC237	1

# Heavy Duty Transfer Case Rebuild Kits



TCRK-270		
Position	Part Number	Qty
Input Shaft Front Brg.	639-632	1
Input Shaft Rear Brg.	576-572	1
Intermediate Shaft Front Brg.	JF7049A-JF7010	1
Intermediate Shaft Rear Brg.	JF7049A-JF7010	1
Front Output Shaft Front Brg.	47487-47420	1
Front Output Shaft Rear Brg.	47487-47420	1
Rear Output Shaft Front Brg.	748S-742	1
Rear Output Shaft Rear Brg.	575-572	1
Lower Direct Drive Gear Brg.	JM716649-JM716610	2
Lower Overdrive Gear Brg.	JM716649-JM716610	2
Input Shaft Seal	415991V (3.500x4.501)	1
Front Output Shaft Seal	415027V (3.500x4.999)	1
Rear Output Shaft Seal	415559 (3.500x5.251)	1
O-Ring Kit	OK270	1
Gasket Kit	GTC270	1

TCRK-306		
Position	Part Number	Qty
Input Shaft Front Brg.	JM612949-JM612910	1
Input Shaft Rear Brg.	JM612949-JM612910	1
Output Shaft Front Brg.	47487-47420	1
Output Shaft Rear Brg.	47487-47420	1
Output Shaft High Gear Brg.	33275-33475	2
Output Shaft Low Gear Brg.	NJ214ECP	2
Output Shaft Disconnect Brg.	214	1
Input Shaft Seal	415983N (3.750x4.499)	1
Front Output Shaft Seal	415027V (3.500x4.999)	1
Rear Output Shaft Seal	415304 (3.250x4.249)	1
O-Ring Kit	OK306	1
Gasket Kit	GTC306	1

TCRK-738		
Position	Part Number	Qty
Input Shaft Brg.	122	1
Intermediate Shaft Front Brg.	315	1
Intermediate Shaft Rear Brg.	315	1
Mainshaft Front Brg.	1314	1
Mainshaft Rear Brg.	312	1
Lower Front Output Shaf Brg.	312	1
Lower Front Output Shaf Disconnect Brg.	J401648	1
Upper Front Output Shaf Brg.	217	1
Input Shaft Seal	415013N (3.000x4.003)	1
Lower Front Output Shaf Seal	415013N (3.000x4.003)	1
Lower Rear Output Shaf Seal	415013N (3.000x4.003)	1
Upper Rear Output Shaf Seal	415013N (3.000x4.003)	1
Shift Shaft Seal	6835S (.750x1.250)	1
O-Ring Kit	OK700	1
Gasket Kit	GT700	1

TCRK-738A		
Position	Part Number	Qty
Input Shaft Front Brg.	312	1
Input Shaft Rear Brg.	312	1
Intermediate Shaft Front Brg.	315	1
Intermediate Shaft Rear Brg.	315	1
Mainshaft Front Brg.	1314	1
Mainshaft Rear Brg.	312	1
Lower Front Output Shaf Brg.	312	1
Lower Front Output Shaf Disconnect Brg.	J401648	1
Input Shaft Seal	415013N (3.000x4.003)	1
Lower Front Output Shaf Seal	415013N (3.000x4.003)	1
Lower Rear Output Shaf Seal	415013N (3.000x4.003)	1
Upper Rear Output Shaf Seal	415013N (3.000x4.003)	1
Shift Shaft Seal	6835S (.750x1.250)	1
O-Ring Kit	OK700	1
Gasket Kit	GT700	1

TCRK-784		
Position	Part Number	Qty
Input Shaft Front Brg.	312	1
Input Shaft Rear Brg.	312	1
Intermediate Shaft Front Brg.	315	1
Intermediate Shaft Rear Brg.	315	1
Mainshaft Front Brg.	1314	1
Mainshaft Rear Brg.	312	1
Lower Rear Output Shaf Brg.	312	1
Lower Rear Output Shaf Disconnect Brg.	J401648	1
Upper Rear Output Shaf Brg.	1314	1
Upper Rear Output Shaf Disconnect Brg.	J401648	1
Input Shaft Seal	415013N (3.000x4.003)	1
Lower Front Output Shaf Seal	415013N (3.000x4.003)	1
Lower Rear Output Shaf Seal	415013N (3.000x4.003)	1
Upper Rear Output Shaf Seal	415013N (3.000x4.003)	1
Shift Shaft Seal	6835S (.750x1.250)	1
O-Ring Kit	OK700	1
Gasket Kit	GT700	1

TCRK-791		
Position	Part Number	Qty
Input Shaft Front Brg.	312	1
Input Shaft Rear Brg.	1314	1
Intermediate Shaft Front Brg.	315	1
Intermediate Shaft Rear Brg.	315	1
Mainshaft Front Brg.	312	1
Mainshaft Rear Brg.	1314	1
Lower Front Output Shaf Brg.	312	1
Lower Front Output Shaf Disconnect Brg.	J401648	1
Upper Rear Output Shaf Brg.	312	1
Upper Rear Output Shaf Disconnect Brg.	WJ162116	1
Input Shaft Seal	415013N (3.000x4.003)	1
Lower Front Output Shaf Seal	415013N (3.000x4.003)	1
Lower Rear Output Shaf Seal	415013N (3.000x4.003)	1
Upper Rear Output Shaf Seal	415013N (3.000x4.003)	1
Shift Shaft Seal	6835S (.750x1.250)	1
O-Ring Kit	OK700	1
Gasket Kit	GT700	1

TCRK-792		
Position	Part Number	Qty
Input Shaft Front Brg.	312	1
Input Shaft Rear Brg.	1314	1
Intermediate Shaft Front Brg.	315	1
Intermediate Shaft Rear Brg.	315	1
Mainshaft Front Brg.	1314	1
Mainshaft Rear Brg.	312	1
Lower Front Output Shaf Brg.	312	1
Lower Front Output Shaf Disconnect Brg.	J401648	1
Upper Front Output Shaf Brg.	312	1
Upper Front Output Shaf Disconnect Brg.	J401648	1
Upper Rear Output Shaf Brg.	312	1
Upper Rear Output Shaf Disconnect Brg.	WJ162116	1
Input Shaft Seal	415013N (3.000x4.003)	1
Lower Front Output Shaf Seal	415013N (3.000x4.003)	1
Lower Rear Output Shaf Seal	415013N (3.000x4.003)	1
Upper Rear Output Shaf Seal	415013N (3.000x4.003)	1
Shift Shaft Seal	6835S (.750x1.250)	1
O-Ring Kit	OK700	1
Gasket Kit	GT700	1

HD Transmission



# Heavy Duty Transfer Case Rebuild Kits



HD Transmission

TCRK-900		
Position	Part Number	Qty
Input Shaft Front Brg.	357-353	1
Input Shaft Rear Brg.	339-332	1
Idler Shaft Front Brg.	31597-31521	1
Idler Shaft Rear Brg.	31597-31521	1
Front Output Shaft Front 208L Brg.		1
Front Output Shaft Rear 211L Brg.		1
Front Output Shaft B2414-IR2016 Needle Brg.		1
Rear Output Shaft Front 25878-25821 Brg.		1
Rear Output Shaft Rear 25584-25520 Brg.		1
Input Shaft Seal 45031S (3.750x4.999)		1
Front Output Shaft Front 45031S (3.750x4.999) Seal		1
Front Output Shaft Rear 415483 (2.625x3.500) Seal		1
Rear Output Shaft Seal 471341N (2.250x2.996)		1
Transfer Shift Seal 470954 (.750x1.250)		2

TCRK-901		
Position	Part Number	Qty
Input Shaft Front Brg.	376-372	1
Input Shaft Rear Brg.	339-332	1
Idler Shaft Front Brg.	31597-31521	1
Idler Shaft Rear Brg.	31597-31521	1
Front Output Shaft Front 208L Brg.		1
Front Output Shaft Rear 211L Brg.		1
Front Output Shaft B2414-IR2016 Needle Brg.		1
Rear Output Shaft Front 25878-25821 Brg.		1
Rear Output Shaft Rear 25584-25520 Brg.		1
Input Shaft Seal A1205T1242		1
Input Shaft Seal 471341N (2.250x2.996)		1
Front Output Shaft Front 45031S (3.750x4.999) Seal		1
Front Output Shaft Rear 415483 (2.625x3.500) Seal		1
Rear Output Shaft Seal 471341N (2.250x2.996)		1
Transfer Shift Seal 470954 (.750x1.250)		2

TCRK-902		
Position	Part Number	Qty
Input Shaft Front Brg.	376-372	1
Input Shaft Rear Brg.	339-332	1
Idler Shaft Front Brg.	HM89449-HM89411	1
Idler Shaft Rear Brg.	31597-31521	1
Front Output Shaft Front 208L Brg.		1
Front Output Shaft Rear 211L Brg.		1
Front Output Shaft B2414-IR2016 Needle Brg.		1
Rear Output Shaft Front 25878-25821 Brg.		1
Rear Output Shaft Rear 25584-25520 Brg.		1
Declutch Front Brg.	385A-382A	1
Declutch Rear Brg.	385A-382A	1
PTO Front Brg.	335-332	1
PTO Rear Brg.	335-332	1
Input Shaft Seal A1205T1242		1
Input Shaft Seal 471341N (2.250x2.996)		1
Front Output Shaft Front 45031S (3.750x4.999) Seal		1
Front Output Shaft Rear 415483 (2.625x3.500) Seal		1
Rear Output Shaft Seal 471341N (2.250x2.996)		1
PTO Output Shaft Seal 473445 (1.687x2.437)		1
Transfer Shift Seal 470954 (.750x1.250)		2
PTO Shift Shaft Seal 455151 (2.687x3.751)		1

TCRK-903		
Position	Part Number	Qty
Input Shaft Front Brg.	376-372	1
Input Shaft Rear Brg.	339-332	1
Idler Shaft Front Brg.	HM89449-HM89411	1
Idler Shaft Rear Brg.	31597-31521	1
Front Output Shaft Front 208L Brg.		1
Front Output Shaft Rear 211L Brg.		1
Front Output Shaft B2414-IR2016 Needle Brg.		1
Rear Output Shaft Front 25878-25821 Brg.		1
Rear Output Shaft Rear 25584-25520 Brg.		1
Declutch Front Brg.	385A-382A	1
Declutch Rear Brg.	385A-382A	1
Input Shaft Seal A1205T1242		1
Input Shaft Seal 471341N (2.250x2.996)		1
Front Output Shaft Front 45031S (3.750x4.999) Seal		1
Front Output Shaft Rear 415483 (2.625x3.500) Seal		1
Rear Output Shaft Seal 471341N (2.250x2.996)		1
Transfer Shift Seal 470954 (.750x1.250)		2

TCRK-904		
Position	Part Number	Qty
Mainshaft Front Brg.	59201-59412	1
Mainshaft Rear Brg.	3782-3732	1
Driving Idler Gear Brg.	1209A	2
Idler Shaft Front Brg.	59201-59412	1
Idler Shaft Rear Brg.	3767-3732	1
Front Output Shaft Brg.	33225-33472	1
Rear Output Shaft Brg.	59201-59412	1
Input Shaft Seal 416654 (2.937x4.003)		1
Front Output Shaft Seal 416654 (2.937x4.003)		1
Rear Output Shaft Seal 416654 (2.937x4.003)		1
Transfer Shift Seal 340483 (.875x1.250)		1

TCRK-905		
Position	Part Number	Qty
Mainshaft Front Brg.	59201-59412	1
Mainshaft Rear Brg.	3782-3732	1
Driving Idler Gear Brg.	1209A	2
Idler Shaft Front Brg.	59201-59412	1
Idler Shaft Rear Brg.	3767-3732	1
Front Output Shaft Brg.	33225-33472	1
Rear Output Shaft Brg.	59201-59412	1
PTO Front Brg.	342S-332	1
PTO Rear Brg.	342S-332	1
Input Shaft Seal 416654 (2.937x4.003)		1
Front Output Shaft Seal 416654 (2.937x4.003)		1
Rear Output Shaft Seal 416654 (2.937x4.003)		1
PTO Output Shaft Seal 473228 (1.500x2.502)		1
PTO Output Shaft Seal 450352 (1.750x2.502)		1
Transfer Shift Seal 340483 (.875x1.250)		1
PTO Shift Shaft Seal 330699 (.500x.875)		1

TCRK-906		
Position	Part Number	Qty
Mainshaft Front Brg.	59201-59412	1
Mainshaft Rear Brg.	3782-3732	1
Driving Idler Gear Brg.	1209A	2
Idler Shaft Front Brg.	59201-59412	1
Idler Shaft Rear Brg.	3767-3732	1
Front Output Shaft Brg.	33225-33472	1
Rear Output Shaft Brg.	59201-59412	1
Declutch Front Brg.	385A-382A	1
Declutch Rear Brg.	385A-382A	1
Input Shaft Seal 416654 (2.937x4.003)		1
Input Shaft Seal 456105 (3.187x4.249)		1
Front Output Shaft Seal 416654 (2.937x4.003)		1
Rear Output Shaft Seal 416654 (2.937x4.003)		1
Transfer Shift Seal 340483 (.875x1.250)		1
Declutch Shift Seal 7750 (.750x1.124)		1

TCRK-907		
Position	Part Number	Qty
Mainshaft Front Brg.	59201-59412	1
Mainshaft Rear Brg.	3782-3732	1
Driving Idler Gear Brg.	1209A	2
Idler Shaft Front Brg.	59201-59412	1
Idler Shaft Rear Brg.	3767-3732	1
Front Output Shaft Brg.	33225-33472	1
Rear Output Shaft Brg.	59201-59412	1
Declutch Front Brg.	385A-382A	1
Declutch Rear Brg.	385A-382A	1
PTO Front Brg.	342S-332	1
PTO Rear Brg.	342S-332	1
Input Shaft Seal 416654 (2.937x4.003)		1
Front Output Shaft Seal 416654 (2.937x4.003)		1
Rear Output Shaft Seal 416654 (2.937x4.003)		1
PTO Output Shaft Seal 473228 (1.500x2.502)		1
PTO Output Shaft Seal 450352 (1.750x2.502)		1
Transfer Shift Seal 340483 (.875x1.250)		1
Declutch Shift Seal 7750 (.750x1.124)		1
PTO Shift Shaft Seal 330699 (.500x.875)		1

TCRK-908		
Position	Part Number	Qty
Mainshaft Front Brg.	59201-59412	1
Mainshaft Rear Brg.	3782-3732	1
Driving Idler Gear Brg.	1209A	2
Idler Shaft Front Brg.	HM807046-HM807010	1
Idler Shaft Rear Brg.	39578-39528	1
Front Output Shaft Brg.	33225-33472	1
Rear Output Shaft Brg.	59201-59412	1
Declutch Front Brg.	385A-382A	1
Declutch Rear Brg.	385A-382A	1
Input Shaft Seal 456105 (3.187x4.249)		1
Front Output Shaft Seal 416654 (2.937x4.003)		1
Rear Output Shaft Seal 416654 (2.937x4.003)		1
Transfer Shift Seal 340483 (.875x1.250)		1
Declutch Shift Seal 543351		1

# Heavy Duty Transfer Case Rebuild Kits



TCRK-909		
Position	Part Number	Qty
Mainshaft Front Brg.	59201-59412	1
Mainshaft Rear Brg.	3782-3732	1
Driving Idler Gear Brg.	1209A	2
Idler Shaft Front Brg.	HM807046-HM807010	1
Idler Shaft Rear Brg.	39578-39528	1
Front Output Shaft Brg.	33225-33472	1
Rear Output Shaft Brg.	59201-59412	1
Declutch Front Brg.	385A-382A	1
Declutch Rear Brg.	385A-382A	1
PTO Front Brg.	342S-332	1
PTO Rear Brg.	342S-332	1
Input Shaft Seal	456105 (3.187x4.249)	1
Front Output Shaft Seal	416654 (2.937x4.003)	1
Rear Output Shaft Seal	416654 (2.937x4.003)	1
PTO Output Shaft Seal	450352 (1.750x2.502)	1
Transfer Shift Seal	340483 (.875x1.250)	1
Declutch Shift Seal	543351	1
PTO Shift Shaft Seal	330699 (.500x.875)	1

TCRK-910		
Position	Part Number	Qty
Mainshaft Front Brg.	59201-59412	1
Mainshaft Rear Brg.	3782-3732	1
Driving Idler Gear Brg.	1209A	2
Idler Shaft Front Brg.	HM807046-HM807010	1
Idler Shaft Rear Brg.	39578-39528	1
Front Output Shaft Brg.	211B	1
Rear Output Shaft Brg.	211B	1
Differential Front Brg.	33287-33472	1
Differential Rear Brg.	42688-42620	1
Declutch Front Brg.	385A-382A	1
Declutch Rear Brg.	385A-382A	1
Input Shaft Seal	416654 (2.937x4.003)	1
Input Shaft Seal	456105 (3.187x4.249)	1
Front Output Shaft Seal	416654 (2.937x4.003)	1
Rear Output Shaft Seal	416654 (2.937x4.003)	1
Transfer Shift Seal	340483 (.875x1.250)	1
Declutch Shift Seal	543351	1
Declutch Shift Seal	7750 (.750x1.124)	1
Differential Shift Shaft Seal	471570 (.875x1.499)	1

TCRK-911		
Position	Part Number	Qty
Mainshaft Front Brg.	59201-59412	1
Mainshaft Rear Brg.	3782-3732	1
Driving Idler Gear Brg.	1209A	2
Idler Shaft Front Brg.	HM807046-HM807010	1
Idler Shaft Rear Brg.	39578-39528	1
Front Output Shaft Brg.	211B	1
Rear Output Shaft Brg.	211B	1
Differential Front Brg.	33287-33472	1
Differential Rear Brg.	42688-42620	1
Declutch Front Brg.	385A-382A	1
Declutch Rear Brg.	385A-382A	1
PTO Front Brg.	342S-332	1
PTO Rear Brg.	342S-332	1
Input Shaft Seal	456105 (3.187x4.249)	1
Front Output Shaft Seal	416654 (2.937x4.003)	1
Rear Output Shaft Seal	416654 (2.937x4.003)	1
PTO Output Shaft Seal	473228 (1.500x2.502)	1
PTO Output Shaft Seal	450352 (1.750x2.502)	1
Transfer Shift Seal	340483 (.875x1.250)	1
Declutch Shift Seal	543351	1
Differential Shift Shaft Seal	471570 (.875x1.499)	1
PTO Shift Shaft Seal	330699 (.500x.875)	1

TCRK-912		
Position	Part Number	Qty
Mainshaft Front Brg.	59201-59412	1
Mainshaft Rear Brg.	3782-3732	1
Driving Idler Gear Brg.	1209A	2
Idler Shaft Front Brg.	HM807046-HM807010	1
Idler Shaft Rear Brg.	45287-45220	1
Front Output Shaft Brg.	33225-33472	1
Rear Output Shaft Brg.	59201-59412	1
Input Shaft Seal	416654 (2.937x4.003)	1
Front Output Shaft Seal	416654 (2.937x4.003)	1
Rear Output Shaft Seal	416654 (2.937x4.003)	1
Transfer Shift Seal	340483 (.875x1.250)	1

TCRK-913		
Position	Part Number	Qty
Mainshaft Front Brg.	59201-59412	1
Mainshaft Rear Brg.	3782-3732	1
Driving Idler Gear Brg.	1209A	2
Idler Shaft Front Brg.	HM807046-HM807010	1
Idler Shaft Rear Brg.	45287-45220	1
Front Output Shaft Brg.	33225-33472	1
Rear Output Shaft Brg.	59201-59412	1
PTO Front Brg.	342S-332	1
PTO Rear Brg.	342S-332	1
Input Shaft Seal	416654 (2.937x4.003)	1
Front Output Shaft Seal	416654 (2.937x4.003)	1
Rear Output Shaft Seal	416654 (2.937x4.003)	1
PTO Output Shaft Seal	473228 (1.500x2.502)	1
PTO Output Shaft Seal	450352 (1.750x2.502)	1
Transfer Shift Seal	340483 (.875x1.250)	1
PTO Shift Shaft Seal	330699 (.500x.875)	1

TCRK-914		
Position	Part Number	Qty
Mainshaft Front Brg.	59201-59412	1
Mainshaft Rear Brg.	3782-3732	1
Driving Idler Gear Brg.	1209A	2
Idler Shaft Front Brg.	HM807046-HM807010	1
Idler Shaft Rear Brg.	45287-45220	1
Front Output Shaft Brg.	33225-33472	1
Rear Output Shaft Brg.	59201-59412	1
Declutch Front Brg.	385A-382A	1
Declutch Rear Brg.	385A-382A	1
Input Shaft Seal	416654 (2.937x4.003)	1
Input Shaft Seal	456105 (3.187x4.249)	1
Front Output Shaft Seal	416654 (2.937x4.003)	1
Rear Output Shaft Seal	416654 (2.937x4.003)	1
Transfer Shift Seal	340483 (.875x1.250)	1
Declutch Shift Seal	543351	1
Declutch Shift Seal	7750 (.750x1.124)	1

TCRK-915		
Position	Part Number	Qty
Mainshaft Front Brg.	59201-59412	1
Mainshaft Rear Brg.	3782-3732	1
Driving Idler Gear Brg.	1209A	2
Idler Shaft Front Brg.	HM807046-HM807010	1
Idler Shaft Rear Brg.	45287-45220	1
Front Output Shaft Brg.	33225-33472	1
Rear Output Shaft Brg.	59201-59412	1
Declutch Front Brg.	385A-382A	1
Declutch Rear Brg.	385A-382A	1
PTO Front Brg.	342S-332	1
PTO Rear Brg.	342S-332	1
Input Shaft Seal	416654 (2.937x4.003)	1
Input Shaft Seal	456105 (3.187x4.249)	1
Front Output Shaft Seal	416654 (2.937x4.003)	1
Rear Output Shaft Seal	416654 (2.937x4.003)	1
PTO Output Shaft Seal	473228 (1.500x2.502)	1
Transfer Shift Seal	340483 (.875x1.250)	1
Declutch Shift Seal	7750 (.750x1.124)	1
PTO Shift Shaft Seal	330699 (.500x.875)	1

TCRK-916		
Position	Part Number	Qty
Mainshaft Front Brg.	59201-59412	1
Mainshaft Rear Brg.	3782-3732	1
Driving Idler Gear Brg.	1209A	2
Idler Shaft Front Brg.	HM807046-HM807010	1
Idler Shaft Rear Brg.	45287-45220	1
Front Output Shaft Brg.	211B	1
Rear Output Shaft Brg.	211B	1
Differential Front Brg.	33287-33472	1
Differential Rear Brg.	42688-42620	1
Input Shaft Seal	416654 (2.937x4.003)	1
Front Output Shaft Seal	416654 (2.937x4.003)	1
Rear Output Shaft Seal	415984 (2.750x3.623)	1
Rear Output Shaft Seal	416654 (2.937x4.003)	1
Transfer Shift Seal	340483 (.875x1.250)	1
Differential Shift Shaft Seal	471570 (.875x1.499)	1

TCRK-917		
Position	Part Number	Qty
Mainshaft Front Brg.	59201-59412	1
Mainshaft Rear Brg.	3782-3732	1
Driving Idler Gear Brg.	1209A	2
Idler Shaft Front Brg.	HM807046-HM807010	1
Idler Shaft Rear Brg.	45287-45220	1
Front Output Shaft Brg.	211B	1
Rear Output Shaft Brg.	211B	1
Differential Front Brg.	33287-33472	1
Differential Rear Brg.	42688-42620	1
Declutch Front Brg.	385A-382A	1
Declutch Rear Brg.	385A-382A	1
Input Shaft Seal	416654 (2.937x4.003)	1
Input Shaft Seal	456105 (3.187x4.249)	1
Front Output Shaft Seal	416654 (2.937x4.003)	1
Rear Output Shaft Seal	416654 (2.937x4.003)	1
Transfer Shift Seal	340483 (.875x1.250)	1
Differential Shift Shaft Seal	471570 (.875x1.499)	1
Declutch Shift Seal	7750 (.750x1.124)	1

TCRK-918		
Position	Part Number	Qty
Mainshaft Front Brg.	59201-59412	1
Mainshaft Rear Brg.	3782-3732	1
Idler Shaft Front Brg.	59201-59412	1
Idler Shaft Rear Brg.	3767-3732	1
Front Output Shaft Brg.	33225-33472	1
Rear Output Shaft Brg.	59201-59412	1
Declutch Front Brg.	385A-382A	1
Declutch Rear Brg.	385A-382A	1
Input Shaft Seal	416654 (2.937x4.003)	1
Mainshaft Rear Seal	415147 (2.500x3.500)	1
Rear Output Shaft Seal	416654 (2.937x4.003)	1
Transfer Shift Seal	340483 (.875x1.250)	1
Declutch Shift Seal	7750 (.750x1.124)	1

TCRK-919		
Position	Part Number	Qty
Mainshaft Front Brg.	HM212044-HM212011	1
Mainshaft Rear Brg.	28682-28622	1
Idler Shaft Front Brg.	5584-5535	1
Idler Shaft Rear Brg.	HM212046-HM212011	1
Front Output Shaft Brg.	594-592A	1
Rear Output Shaft Front Brg.	1828U307	1
Rear Output Shaft Rear Brg.	590A-592A	1
Input Shaft Seal	417487 (3.000x4.249)	1
Rear Output Shaft Inner Seal	416130 (4.000x5.376)	1
Rear Output Shaft Outer Seal	A1205W2415	1
Transfer Shift Seal	471570 (.875x1.499)	1

HD Transmission

# Heavy Duty Transfer Case Rebuild Kits



HD Transmission

TCRK-920		
Position	Part Number	Qty
Mainshaft Front Brg.	HM212044-HM212011	1
Mainshaft Rear Brg.	28682-28622	1
Idler Shaft Front Brg.	5584-5535	1
Idler Shaft Rear Brg.	HM212046-HM212011	1
Front Output Shaft Rear Brg.	594-592A	1
Rear Output Shaft Front Brg.	1828U307	1
Rear Output Shaft Rear Brg.	590A-592A	1
Declutch Brg.	1311L	1
Input Shaft Seal	417487 (3.000x4.249)	1
Input Shaft Seal	A1205W2415	1
Rear Output Shaft Inner Seal	416130 (4.000x5.376)	1
Rear Output Shaft Outer Seal	A1205W2415	1
Declutch Seal	416654 (2.937x4.003)	1
Transfer Shift Seal	471570 (.875x1.499)	1
Declutch Shift Seal	470954 (.750x1.250)	1

TCRK-921		
Position	Part Number	Qty
Mainshaft Front Brg.	HM212044-HM212011	1
Mainshaft Rear Brg.	28682-28622	1
Idler Shaft Front Brg.	5584-5535	1
Idler Shaft Rear Brg.	HM212046-HM212011	1
Front Output Shaft Rear Brg.	594-592A	1
Rear Output Shaft Front Brg.	1828U307	1
Rear Output Shaft Rear Brg.	590A-592A	1
Declutch Brg.	1311L	1
PTO Front Brg.	1311L	1
PTO Rear Brg.	211B	1
Input Shaft Seal	417487 (3.000x4.249)	1
Input Shaft Seal	A1205W2415	1
Rear Output Shaft Inner Seal	416130 (4.000x5.376)	1
Rear Output Shaft Outer Seal	A1205W2415	1
Declutch Seal	416654 (2.937x4.003)	1
PTO Input Shaft Seal	470737N (2.250x3.189)	1
PTO Output Shaft Seal	416654 (2.937x4.003)	1
Transfer Shift Seal	471570 (.875x1.499)	1
Declutch Shift Seal	470954 (.750x1.250)	1
PTO Shift Shaft Seal	470954 (.750x1.250)	1

TCRK-922		
Position	Part Number	Qty
Mainshaft Front Brg.	HM212044-HM212011	1
Mainshaft Rear Brg.	28682-28622	1
Idler Shaft Front Brg.	5584-5535	1
Idler Shaft Rear Brg.	HM212046-HM212011	1
Front Output Shaft Rear Brg.	594-592A	1
Rear Output Shaft Front Brg.	1828U307	1
Rear Output Shaft Rear Brg.	590A-592A	1
PTO Front Brg.	1311L	1
PTO Rear Brg.	211B	1
Input Shaft Seal	417487 (3.000x4.249)	1
Rear Output Shaft Inner Seal	416130 (4.000x5.376)	1
Rear Output Shaft Outer Seal	A1205W2415	1
PTO Input Shaft Seal	470737N (2.250x3.189)	1
PTO Output Shaft Seal	416654 (2.937x4.003)	1
Transfer Shift Seal	471570 (.875x1.499)	1
PTO Shift Shaft Seal	470954 (.750x1.250)	1

TCRK-923		
Position	Part Number	Qty
Mainshaft Front Brg.	HM212044-HM212011	1
Mainshaft Rear Brg.	28682-28622	1
Idler Shaft Front Brg.	5584-5535	1
Idler Shaft Rear Brg.	HM212046-HM212011	1
Front Output Shaft Front Brg.	1311L	1
Front Output Shaft Rear Brg.	594-592A	1
Rear Output Shaft Front Brg.	1828U307	1
Rear Output Shaft Rear Brg.	590A-592A	1
Input Shaft Seal	417487 (3.000x4.249)	1
Front Output Shaft Seal	416654 (2.937x4.003)	1
Rear Output Shaft Seal	A1205W2415	1
Transfer Shift Seal	471570 (.875x1.499)	1

TCRK-924		
Position	Part Number	Qty
Mainshaft Front Brg.	HM212044-HM212011	1
Mainshaft Rear Brg.	28682-28622	1
Idler Shaft Front Brg.	5584-5535	1
Idler Shaft Rear Brg.	HM212046-HM212011	1
Front Output Shaft Front Brg.	1311L	1
Front Output Shaft Rear Brg.	594-592A	1
Rear Output Shaft Front Brg.	1828U307	1
Rear Output Shaft Rear Brg.	590A-592A	1
PTO Front Brg.	1311L	1
PTO Rear Brg.	211B	1
Input Shaft Seal	417487 (3.000x4.249)	1
Front Output Shaft Seal	416654 (2.937x4.003)	1
Rear Output Shaft Seal	A1205W2415	1
PTO Input Shaft Seal	470737N (2.250x3.189)	1
PTO Output Shaft Seal	416654 (2.937x4.003)	1
Transfer Shift Seal	471570 (.875x1.499)	1
PTO Shift Shaft Seal	470954 (.750x1.250)	1

TCRK-925		
Position	Part Number	Qty
Mainshaft Front Brg.	HM212044-HM212011	1
Mainshaft Rear Brg.	28682-28622	1
Idler Shaft Front Brg.	5584-5535	1
Idler Shaft Rear Brg.	HM212046-HM212011	1
Declutch Brg.	1311L	1
Front Output Shaft Rear Brg.	594-592A	1
Rear Output Shaft Rear Brg.	590A-592A	1
Input Shaft Seal	417487 (3.000x4.249)	1
Mainshaft Rear Seal	55563	1
Rear Output Shaft Seal	415995 (3.000x4.003)	1
Declutch Seal	416654 (2.937x4.003)	1
Declutch Shift Seal	470954 (.750x1.250)	1

TCRK-926		
Position	Part Number	Qty
Input Shaft Front Brg.	835-832	1
Input Shaft Rear Brg.	835-832	1
Idler Gear Front Brg.	835-832	1
Idler Gear Rear Brg.	835-832	1
Output Shaft Front Brg.	843-832	1
Output Shaft Rear Brg.	843-832	1
Declutch Brg.	1228N1262	1
Input Shaft Seal	A1205D2422	2
Rear Output Shaft Seal	A1205D2422	2
Declutch Inner Seal	45013S (3.000x4.003)	1
Declutch Outer Seal	416654 (2.937x4.003)	1

TCRK-927		
Position	Part Number	Qty
Input Shaft Front Brg.	H715334-H715311	1
Input Shaft Rear Brg.	H715334-H715311	1
Output Shaft Front Brg.	H715334-H715311	1
Output Shaft Rear Brg.	H715334-H715311	1
Declutch Brg.	212	1
Declutch Pilot Brg.	1228Z1222	1
Input Shaft Seal	DTR2592 (3.250x4.250)	1
Output Shaft Seal	DTR2592 (3.250x4.250)	1
Declutch Seal	DTR2592 (3.250x4.250)	1

TCRK-928		
Position	Part Number	Qty
Input Shaft Front Brg.	H715334-H715311	1
Input Shaft Rear Brg.	H715334-H715311	1
Output Shaft Front Brg.	H715334-H715311	1
Output Shaft Rear Brg.	H715334-H715311	1
Declutch Brg.	JLM506849-JLM506810	2
Input Shaft Seal	DTR2592 (3.250x4.250)	1
Output Shaft Seal	DTR2592 (3.250x4.250)	1
Declutch Seal	DTP2590 (3.000x3.750)	1

TCRK-929		
Position	Part Number	Qty
Input Shaft Front Brg.	HM813843	1
Input Shaft Rear Brg.	HM813843-HM813810	1
Idler Gear Front Brg.	HM212049-HM212011	1
Idler Gear Rear Brg.	HM212049-HM212011	1
Front Output Shaft Front Brg.	HM212049-HM212011	1
Front Output Shaft Rear Brg.	HM813843-HM813810	1
Rear Output Shaft Front Brg.	HM212049-HM212011	1
Rear Output Shaft Rear Brg.	HM212049-HM212011	1
Input Shaft Seal	R945007	1
Front Output Shaft Seal	DTR2592 (3.250x4.250)	1
Rear Output Shaft Seal	DTR2592 (3.250x4.250)	1
PTO Output Shaft Seal	DTP2590 (3.000x3.750)	1

TCRK-930		
Position	Part Number	Qty
Input Shaft Front Brg.	HM813843	1
Input Shaft Rear Brg.	NP674708-NP682041	1
Idler Gear Front Brg.	HM212049-HM212011	1
Idler Gear Rear Brg.	HM212049-HM212011	1
Transfer Gear Front Brg.	HM212049-HM212011	1
Transfer Gear Rear Brg.	HM212049-HM212011	1
Front Output Shaft Front Brg.	HM212049-HM212011	1
Front Output Shaft Rear Brg.	HM813843-HM813810	1
Rear Output Shaft Front Brg.	HM212049-HM212011	1
Rear Output Shaft Rear Brg.	HM212049-HM212011	1
Input Shaft Seal	R945007	1
Front Output Shaft Seal	DTR2592 (3.250x4.250)	1
Rear Output Shaft Seal	DTQ2591 (3.250x5.500)	1

# Heavy Duty Transfer Case Rebuild Kits



TCRK-931		
Position	Part Number	Qty
Mainshaft Front Brg.	1307S	1
Mainshaft Rear Brg.	1307S	1
Idler Shaft Front Brg.	339-332	1
Idler Shaft Rear Brg.	339-332	1
Output Shaft Front Brg.	342S-332	1
Output Shaft Rear Brg.	339-332	1
Declutch Front Brg.	14137A-14274	1
Declutch Rear Brg.	14137A-14274	1
Input Shaft Seal	472394 (1.937x3.000)	1
Mainshaft Rear Seal	472394 (1.937x3.000)	1
Declutch Seal	472394 (1.937x3.000)	1
Rear Output Shaft Seal	415281N (3.000x3.751)	1
Rear Output Shaft Seal	472394 (1.937x3.000)	1
Transfer Shift Seal	340483 (.875x1.250)	1
Declutch Shift Seal	455151 (2.687x3.751)	1

TCRK-932		
Position	Part Number	Qty
Mainshaft Front Brg.	1307S	1
Mainshaft Rear Brg.	1307S	1
Idler Shaft Front Brg.	339-332	1
Idler Shaft Rear Brg.	339-332	1
Output Shaft Front Brg.	342S-332	1
Output Shaft Rear Brg.	339-332	1
PTO Front Brg.	335-332	1
PTO Rear Brg.	335-332	1
Input Shaft Seal	472394 (1.937x3.000)	1
Mainshaft Rear Seal	472394 (1.937x3.000)	1
Front Output Shaft Seal	472394 (1.937x3.000)	1
Rear Output Shaft Seal	415281N (3.000x3.751)	1
Rear Output Shaft Seal	472394 (1.937x3.000)	1
PTO Output Shaft Seal	473445 (1.687x2.437)	1
Transfer Shift Seal	340483 (.875x1.250)	1
PTO Shift Shaft Seal	455151 (2.687x3.751)	1

TCRK-933		
Position	Part Number	Qty
Mainshaft Front Brg.	1307S	1
Mainshaft Rear Brg.	1307S	1
Idler Shaft Front Brg.	339-332	1
Idler Shaft Rear Brg.	339-332	1
Output Shaft Front Brg.	339-332	1
Output Shaft Rear Brg.	339-332	1
Input Shaft Seal	472394 (1.937x3.000)	1
Mainshaft Rear Seal	472394 (1.937x3.000)	1
Front Output Shaft Seal	472394 (1.937x3.000)	1
Rear Output Shaft Seal	415281N (3.000x3.751)	1
Rear Output Shaft Seal	472394 (1.937x3.000)	1
Transfer Shift Seal	340483 (.875x1.250)	1

TRK-2		
Position	Part Number	Qty
Input Shaft Brg.	1313S	1
Input Shaft Pilot Brg.	22207	1
Output Shaft Center Brg.	MU1312TM	1
Output Shaft Rear Brg.	5215WL	1
Countershaft Front Brg.	MR1309EAL	1
Countershaft Rear Brg.	MSN1311GELR	1
Rev. Idler Gear Brg.	J402480	2
	F53539 <sup>11</sup>	1
2nd Gear Brg.	F53540 <sup>11</sup>	1
3rd Gear Brg.	F53540 <sup>11</sup>	1
Input Shaft Seal	455995N (3.000x4.003)	1
Output Shaft Seal	415013N (3.000x4.003)	1
Remote Control Seal	350567 (.875x1.375) •	2
Sealer	RTV Silicone	1

TRK-2A		
Position	Part Number	Qty
Input Shaft Brg.	1313S	1
Input Shaft Pilot Brg.	MU5207UM	1
Output Shaft Center Brg.	MU1312TM	1
Output Shaft Rear Brg.	5215WL	1
Countershaft Front Brg.	MR1309EAL	1
Countershaft Rear Brg.	MSN1311GELR	1
Rev. Idler Gear Brg.	J402480	2
1st Gear Brg.	F53539	1
2nd Gear Brg.	F53540	1
3rd Gear Brg.	F53540	1
Input Shaft Seal	455995N (3.000x4.003)	1
Output Shaft Seal	415013N (3.000x4.003)	1
Remote Control Seal	350567 (.875x1.375)	2
Sealer	RTV Silicone	1

TRK-3		
Position	Part Number	Qty
Input Shaft Front Brg.	5212W	1
Input Shaft Rear Brg.	MR1313EL	1
Input Shaft Pilot Brg.	MR1308TV	1
Output Shaft Brg.	1412L	1
Countershaft Front Brg.	MSN1311GELR	1
Countershaft Rear Brg.	MR1311EAHL	1
	F53543-S444Q <sup>12</sup>	1
2nd Gear Brg.	F53543-S444Q <sup>12</sup>	1
3rd Gear Brg.	F53542-S444Q <sup>12</sup>	1
Input Shaft Seal	415281N (3.000x3.751)	1
Output Shaft Seal	415281N (3.000x3.751)	1
Output Shaft Seal	415013N (3.000x4.003)	1
Remote Control Seal	450680 (.875x1.499) •	2
Gasket Set	GT155	1

TRK-4		
Position	Part Number	Qty
Input Shaft Front Brg.	5212W	1
Input Shaft Rear Brg.	MR1313EJ	1
Input Shaft Pilot Brg.	MR1308EJ	1
Output Shaft Brg.	1412L	1
Countershaft Front Brg.	MSN1311GELR	1
Countershaft Rear Brg.	MR1311EAHL	1
	F53543-S444Q <sup>12</sup>	1
2nd Gear Brg.	F53543-S444Q <sup>12</sup>	1
3rd Gear Brg.	F53542-S444Q <sup>12</sup>	1
Input Shaft Seal	415281N (3.000x3.751)	1
Output Shaft Seal	415281N (3.000x3.751)	1
Output Shaft Seal	415013N (3.000x4.003)	1
Remote Control Seal	450032 (.875x1.499) •	2
Gasket Set	GT155	1

TRK-23		
Position	Part Number	Qty
Input Shaft Brg.	211SL	1
Input Shaft Pilot Brg.	SRA5304	1
Output Shaft Brg.	309L	1
Countershaft Front Brg.	M28161	1
Countershaft Rear Brg.	308SL	1
Rev. Idler Gear Brg.	F54970	2
Output Shaft Seal	471271 (2.500x3.251)	1
Output Shaft Seal	450867 (2.125x2.875)	1
Gasket Set	GT23	1

TRK-23B		
Position	Part Number	Qty
Input Shaft Brg.	1211SL	1
Input Shaft Pilot Brg.	SRA5304	1
Output Shaft Brg.	N309L	1
Countershaft Front Brg.	M28161	1
Countershaft Rear Brg.	1308SL	1
Rev. Idler Gear Brg.	F54970	2
Output Shaft Seal	450519 (2.500x3.251)	1
Output Shaft Seal	450867 (2.125x2.875)	1
Gasket Set	GT23	1

TRK-27		
Position	Part Number	Qty
Input Shaft Brg.	1211SL	1
Input Shaft Pilot Brg.	Q15902-F	1
Output Shaft Brg.	1308L	1
Countershaft Front Brg.	1207L	1
Countershaft Rear Brg.	B2816	1
Input Shaft Seal	7412S (1.250x1.750)	1
Output Shaft Seal	6879H (2.125x2.875)	1
Remote Control Seal	6835S (.750x1.250)	1
Gasket Set	GT26	1

TRK-28		
Position	Part Number	Qty
Input Shaft Brg.	1213SL	1
Input Shaft Pilot Brg.	0513Q	1
Output Shaft Brg.	1310L	1
Countershaft Front Brg.	M1208EL	1
Countershaft Rear Brg.	1308SL	1
Rev. Idler Gear Brg.	J322064	2
Input Shaft Seal	481181N (1.625x2.125)	1
Input Shaft Seal	452742 (1.781x2.502) •	1
Output Shaft Seal	471271 (2.500x3.251)	1
Remote Control Seal	350567 (.875x1.375) •	2
Gasket Set	GT28	1

TRK-29		
Position	Part Number	Qty
Input Shaft Brg.	1211SL	1
Input Shaft Pilot Brg.	Q15902-F	1
Output Shaft Brg.	1308L	1
Countershaft Front Brg.	1208L	1
Countershaft Rear Brg.	Q15902-F	2
Rev. Idler Front Brg.	B1412	1
Rev. Idler Rear Brg.	B1816	1
Rev. Idler Thrust Brg.	NTA815	1
Input Shaft Seal	481181N (1.625x2.125) <sup>13</sup>	1
Output Shaft Seal	6879H (2.125x2.875)	1
Output Shaft Seal	471271 (2.500x3.251)	1
Remote Control Seal	350679 (.750x1.250) •	1
Gasket Set	GT26	1

TRK-29B		
Position	Part Number	Qty
Input Shaft Brg.	1211SL	1
Input Shaft Pilot Brg.	Q15902-F	1
Output Shaft Brg.	309L	1
Countershaft Front Brg.	1208L	1
Countershaft Rear Brg.	Q15902-F	2
Rev. Idler Front Brg.	B1412	1
Rev. Idler Rear Brg.	B1816	1
Rev. Idler Thrust Brg.	NTA815	1
Output Shaft Seal	471271 (2.500x3.251)	1
Remote Control Seal	350679 (.750x1.250) •	1
Gasket Set	GT26	1

TRK-48		
Position	Part Number	Qty
Input Shaft Brg.	1212SL	1
Input Shaft Pilot Brg.	J401652	1
Output Shaft Brg.	1310L	1
Countershaft Front Brg.	M32161	1
Countershaft Rear Brg.	1309SL	1
Rev. Idler Gear Brg.	J401652	2
Output Shaft Seal	450316 (2.250x3.251)	1
Output Shaft Seal	471271 (2.500x3.251)	1
Remote Control Seal	6835S (.750x1.250)	1
Gasket Set	GT133	1

<sup>11</sup>Some Models will use S456Q Loose Needles instead of F53539 or F53540 Caged Needles. S456Q not packed in kit.  
<sup>12</sup>Optional for 8341 & 8345; S444Q (186) for 1st Gear & (124) each for 2nd & 3rd Gears(included in kit)

<sup>13</sup>Some Models use 7412S  
 • Not Packed In Kit



# Heavy Duty Transmission Rebuild Kits



HD Transmission

TRK-58		
Position	Part Number	Qty
Input Shaft Brg.	212SLV	1
Input Shaft Pilot Bushing	BS59 <sup>26</sup>	1
Output Shaft Center Brg.	118L	1
Output Shaft Rear Brg.	213	1
Countershaft Front Brg.	MSN1211REX	2
Countershaft Rear Brg.	MU1308TVWS	2
Rev. Idler Gear Brg.	HJ223020-IR1820OH	2
Input Shaft Nut	CN1 (8997)	1
Output Shaft Seal	415991N (3.500x4.501)	1
Output Shaft Seal	415013N (3.000x4.003) •	1
Shift Rod Seal	350567 (.875x1.375) •	1
Snap Ring Set	SR58	1
Gasket Set	GT58	1

TRK-58A		
Position	Part Number	Qty
Input Shaft Brg.	212SLV	1
Input Shaft Pilot Bushing	BS59	1
Output Shaft Center Brg.	118L	1
Output Shaft Rear Brg.	213	1
Countershaft Front Brg.	BS500192SX	2
Countershaft Rear Brg.	MU1308TVWS	2
Rev. Idler Gear Brg.	HJ223020-IR1820OH	2
Mainshaft Rear Seal	415991N (3.500x4.501)	1
Snap Ring Set	SR58	1
Gasket Set	GT58	1

TRK-65		
Position	Part Number	Qty
Input Shaft Brg.	1313SL	1
Input Shaft Pilot Brg.	MRB1308EL	1
Mainshaft Brg.	496-493	2
Mainshaft Pilot Brg.	MA1308TV	1
Output Shaft Brg.	66589-66521DB <sup>15</sup>	1
Countershaft Front Brg.	MR1309EL	1
Countershaft Rear Brg.	621-613B	1
Rear Countershaft Front Brg.	621-612	1
Rear Countershaft Rear Brg.	621-612	1
Rev. Idler Gear Brg.	J482064	2
Output Shaft Seal	416470N (3.250x4.249)	1
Remote Control Seal	41224S (1.000x1.499) •	1
Shift Rail Seal	471570 (.875x1.499)	2
Sealer	RTV Silicone	1

TRK-70		
Position	Part Number	Qty
Input Shaft Front Brg.	28580-28521	1
Input Shaft Rear Brg.	28580-28521	1
Input Shaft Pilot Brg.	1209A	1
Output Shaft Brg.	1310	1
Countershaft Front Brg.	3479-3420	1
Countershaft Rear Brg.	3479-3420	1
Input Shaft Seal	475322N (2.750x3.543)	1
Output Shaft Seal	475322N (2.750x3.543)	1
Remote Control Seal	450680 (.875x1.499) •	2
Gasket Set	GT70	1

TRK-72		
Position	Part Number	Qty
Input Shaft Brg.	1216SL	1
Input Shaft Pilot Brg.	0513Q	1
Output Shaft Brg.	1311L	1
Countershaft Front Brg.	MR1209EL	1
Countershaft Rear Brg.	1310SL	1
Rev. Idler Gear Brg.	J402464	2
Input Shaft Seal	475322N (2.750x3.543)	1
Output Shaft Seal	452742 (1.781x2.502)	1
Output Shaft Seal	415004 (2.750x3.751)	1
Remote Control Seal	450567 (.875x1.375) •	2
Shift Rod Seal	450032 (.875x1.499) •	2
Shift Rod Seal	6835S (.750x1.250) •	4
Shift Solenoid Seal	450009 (.625x1.124) •	1
Input Shaft Seal	475012N (3.937x4.003) •	1
Gasket Set	GT72	1

TRK-73		
Position	Part Number	Qty
Input Shaft Front Brg.	1210	1
Input Shaft Rear Brg.	MSN1312EL	1
Input Shaft Pilot Brg.	MU1209TV	1
Output Shaft Brg.	1312L	1
Countershaft Front Brg.	3877-3820	1
Countershaft Rear Brg.	462-453A	1
Speed Gear Brg.	F54540	1
Input Shaft Seal	415004 (2.750x3.751)	1
Input Shaft Seal	475322N (2.750x3.543)	1
Output Shaft Seal	415013N (3.000x4.003)	1
Output Shaft Seal	415281N (3.000x3.751)	1
Output Shaft Seal	475322N (2.750x3.543) •	1
Remote Control Seal	471570 (.875x1.499)	2
Shift Rod Seal	350567 (.875x1.375) •	4
Gasket Set	GT73	1

TRK-74		
Position	Part Number	Qty
Input Shaft Brg.	1313S	1
Input Shaft Pilot Brg.	22207	1
Mainshaft Front Brg.	WSN61219EV	1
Mainshaft Rear Brg.	MR1308EJ	1
Output Shaft Brg.	1412L	1
Countershaft Front Brg.	MR1309EAL	1
Countershaft Rear Brg.	MSN1311GELR	1
Rev. Idler Gear Brg.	J402480	2
1st Gear Brg.	F53541	1
2nd Gear Brg.	S456Q	1
3rd Gear Brg.	F53540	1
Aux. Countershaft Front Brg.	MSN1311GELR	1
Aux. Countershaft Rear Brg.	MR1311EAHL	1
Aux. 1st Gear Brg.	F53543 <sup>16</sup>	1
Aux. 2nd Gear Brg.	F53543 <sup>16</sup>	1
Aux. 3rd Gear Brg.	F53542 <sup>16</sup>	1
Input Shaft Seal	415013N (3.000x4.003)	1
Output Shaft Seal	415281N (3.000x3.751)	1
Remote Control Seal	350567 (.875x1.375) •	2
Sealer	RTV Silicone	1

TRK-82		
Position	Part Number	Qty
Input Shaft Brg.	1308L	1
Input Shaft Pilot Brg.	W1590Q	1
Output Shaft Brg.	308L	1
Countershaft Front Brg.	C436Q	1
Countershaft Rear Brg.	C436Q	1
Rev. Idler Gear Brg.	B1316Q	2
2nd Gear Brg.	Q6086	1
Input Shaft Seal	471413 (1.250x1.752)	1
Output Shaft Seal	473463 (2.000x3.062)	1
Gasket Set	GT82D	1

TRK-82D		
Position	Part Number	Qty
Driveshaft Rear Brg.	308L1	1
Input Shaft Brg.	C436Q	1
Input Shaft Pilot Brg.	1308L	1
Output Shaft Brg.	C436Q	1
Countershaft Rear Brg.	C436Q	1
Rev. Idler Gear Brg.	B1316Q	2
Input Shaft Seal	471413 (1.250x1.752)	1
Output Shaft Seal	473463 (2.000x3.062)	1
Output Shaft Seal	450308 (2.125x3.061)	1
Output Shaft Seal	470380 (1.500x2.375)	1
O-Ring	OR111	1
Gasket Set	GT82D	1

TRK-82F		
Position	Part Number	Qty
Input Shaft Brg.	308L1	1
Input Shaft Pilot Brg.	C436Q	1
Output Shaft Brg.	1308L	1
Countershaft Front Brg.	C436Q	1
Countershaft Rear Brg.	C436Q	1
Rev. Idler Gear Brg.	B1316Q	2
Input Shaft Seal	51083 (1.250x1.752)	1
Output Shaft Seal	450308 (2.125x3.061)	1
Output Shaft Seal	470380 (1.500x2.375)	1
Output Shaft Seal	473442 (1.562x2.875)	1
Output Shaft Seal	471271 (2.500x3.251)	1
Gasket Set	GT82D	1

TRK-82FD		
Position	Part Number	Qty
Input Shaft Brg.	M802048-M802011	1
Input Shaft Pilot Brg.	C436Q	1
Output Shaft Brg.	1308L	1
Countershaft Front Brg.	C436Q	1
Countershaft Rear Brg.	C436Q	1
Rev. Idler Gear Brg.	B1316Q	2
Input Shaft Seal	51083 (1.250x1.752)	1
Output Shaft Seal	471271 (2.500x3.251)	1
Output Shaft Seal	472189A (1.500x2.377)	1
Gasket Set	GT82D	1

TRK-86		
Position	Part Number	Qty
Input Shaft Front Brg.	210	1
Input Shaft Rear Brg.	1311L	1
Input Shaft Pilot Brg.	MU1209TV	1
Output Shaft Brg.	1311L	1
Countershaft Front Brg.	3479-3420	1
Countershaft Rear Brg.	3479-3420	1
Input Shaft Seal	415004 (2.750x3.751)	1
Output Shaft Seal	415004 (2.750x3.751)	1
Output Shaft Seal	475322N (2.750x3.543)	1
Remote Control Seal	471570 (.875x1.499)	2
Gasket Set	GT86	1

TRK-127		
Position	Part Number	Qty
Input Shaft Brg.	HM88649-HM88610	1
Input Shaft Pilot Brg.	Q15902-F	1
Output Shaft Brg.	1308L	1
Countershaft Front Brg.	M24161X1	1
Countershaft Rear Brg.	B3216	1
Countershaft Rear Thrus Brg.	NTA2031	1
Synchro Hub Thrust Brg.(3rd & 4th Gears)	FA35688	1
Rev. Idler Gear Brg.	C407Q •	1
Input Shaft Seal	470380 (1.500x2.375)	1
Input Shaft Seal	482163N (1.375x1.983)	1
Input Shaft Seal	450140N (1.250x1.752) •	1
Input Shaft Seal	470898 (2.125x2.875)	1
Output Shaft Seal	471271 (2.500x3.251)	1
Output Shaft Seal	473243 (2.125x3.251) •	1
Remote Control Seal	350679 (.750x1.250) •	1
Gasket Set	GT127	1

TRK-127F		
Position	Part Number	Qty
Input Shaft Brg.	HM88649-HM88610	1
Input Shaft Pilot Brg.	Q15902-F	1
Output Shaft Brg.	1308L	1
Countershaft Front Brg.	M24161X1	1
Countershaft Rear Brg.	B3216	1
Countershaft Rear Thrus Brg.	NTA2031	1
Synchro Hub Thrust Brg.(3rd & 4th Gears)	FA35688	1
Input Shaft Seal	482163N (1.375x1.983)	1
Output Shaft Seal	471271 (2.500x3.251)	1
Gasket Set	GT127	1

<sup>13</sup>Some Models use 7412S  
<sup>26</sup>Early Models use BR717

<sup>16</sup>Some Models will use S456Q Loose Needles instead of F53542 or F53543 Caged Needles. S456Q not packed  
• Not Packed In Kit

# Heavy Duty Transmission Rebuild Kits

TRK-127G		
Position	Part Number	Qty
Input Shaft Brg.	1308L	1
Input Shaft Pilot Brg.	Q15902-F	1
Output Shaft Brg.	1308L	1
Countershaft Front Brg.	M24161X1	1
Countershaft Rear Brg.	B3216	1
Countershaft Rear Thrus Brg.	NTA2031	1
Synchro Hub Thrust Brg.(3rd & 4th Gears)	FA35688	1
Output Shaft Seal	471271 (2.500x3.251)	1
Input Shaft Seal	470380 (1.500x2.375)	1
Input Shaft Seal	470898 (2.125x2.875)	1
Gasket Set	GT127	1

TRK-130		
Position	Part Number	Qty
Input Shaft Brg.	MSN1314GELR	1
Input Shaft Pilot Brg.	MU7308L	1
Mainshaft Front Brg.	WSN61219EV	1
Mainshaft Rear Brg.	MR1308TV	1
Output Shaft Brg.	1412L	1
Countershaft Front Brg.	25590-25520	2
Countershaft Rear Brg.	MR1311GTAVR	1
Rev. Idler Gear Brg.	J402480	2
1st Gear Brg.	F53541	1
2nd Gear Brg.	F53540	1
3rd Gear Brg.	F53540	1
Aux. Countershaft Front Brg.	MSN1311GELR	1
Aux. Countershaft Rear Brg.	MR1311EAHL	1
Aux. 1st Gear Brg.	F53543 <sup>16</sup>	1
Aux. 2nd Gear Brg.	F53543 <sup>16</sup>	1
Aux. 3rd Gear Brg.	F53542 <sup>16</sup>	1
Input Shaft Seal	456744N (3.625x4.375)	1
Output Shaft Seal	415281N (3.000x3.751)	1
Output Shaft Seal	415013N (3.000x4.003)	1
Output Shaft Seal	415147 (24989)	1
Remote Control Seal	471267 (.875x1.375) •	2
Gasket Set	GT130	1

TRK-132		
Position	Part Number	Qty
Input Shaft Brg.	213SL	1
Input Shaft Pilot Brg.	R5206SK20	1
Output Shaft Brg.	N310L	1
Countershaft Front Brg.	M32161	1
Countershaft Rear Brg.	1310SL	1
Rev. Idler Gear Brg.	J401652	2
Input Shaft Seal	7412S (1.250x1.750)	1
Output Shaft Seal	450316 (2.250x3.251)	1
Remote Control Seal	6835S (.750x1.250)	1
Gasket Set	GT133	1

TRK-133		
Position	Part Number	Qty
Input Shaft Brg.	213SLV	1
Input Shaft Pilot Brg.	R5206SK20	1
Output Shaft Brg.	1311L	1
Countershaft Front Brg.	M32161	1
Countershaft Rear Brg.	1310SL	1
Rev. Idler Gear Brg.	J401652	2
Input Shaft Seal	450494 (1.750x2.502) •	1
Output Shaft Seal	415483 (2.625x3.500)	1
Output Shaft Seal	475322N (2.750x3.543)	1
Gasket Set	GT133	1

TRK-139		
Position	Part Number	Qty
Input Shaft Brg.	MSN1314GELR	1
Input Shaft Pilot Brg.	MU7308L	1
Output Shaft Brg.	1312L	1
Countershaft Front Brg.	25590-25520	2
Countershaft Rear Brg.	MR1311GTAVR	1
Rev. Idler Gear Brg.	J402480	2
1st Gear Brg.	F53541	1
2nd Gear Brg.	F53540	1
3rd Gear Brg.	F53540	1
Input Shaft Seal	456744N (3.625x4.375)	1
Output Shaft Seal	415013N (3.000x4.003)	1
Remote Control Seal	350567 (.875x1.375) •	2
Gasket Set	GT141	1
Gasket Set	GT141A <sup>17</sup>	1

TRK-140		
Position	Part Number	Qty
Input Shaft Brg.	MSN1314GELR	1
Input Shaft Pilot Brg.	MU7308L	1
Output Shaft Front Brg.	MU1312UM	1
Output Shaft Rear Brg.	MSNB1312GELR	1
Countershaft Front Brg.	25590-25520	2
Countershaft Rear Brg.	MR1312GEALR	1
Rev. Idler Gear Brg.	J402480	2
1st Gear Brg.	F53539	1
2nd Gear Brg.	F53539	1
3rd Gear Brg.	F53540	1
4th Gear Brg.	F53540	1
Input Shaft Seal	456744N (3.625x4.375)	1
Output Shaft Seal	415013N (3.000x4.003)	1
Remote Control Seal	350567 (.875x1.375)	2
Gasket Set	GT141	1

TRK-141		
Position	Part Number	Qty
Input Shaft Brg.	MSN1314GELR	1
Input Shaft Pilot Brg.	MU7308L	1
Output Shaft Front Brg.	MU1312UM	1
Output Shaft Rear Brg.	MSNB1312GELR	1
Countershaft Front Brg.	25590-25520	2
Countershaft Rear Brg.	MR1311GTAVR	1
Rev. Idler Gear Brg.	J402480	2
1st Gear Brg.	F53541	1
2nd Gear Brg.	F53540	1
3rd Gear Brg.	F53540	1
Input Shaft Seal	456744N (3.625x4.375)	1
Output Shaft Seal	415013N (3.000x4.003)	1
Remote Control Seal	350567 (.875x1.375) •	2
Gasket Set	GT141	1

TRK-145		
Position	Part Number	Qty
Input Shaft Brg.	209SLV	1
Input Shaft Pilot Bushing	BS61	1
Aux. Drive Gear Brg.	117L	1
Aux. Mainshaft Front Brg.	MU1307V	1
Aux. Mainshaft Rear Brg	1212L	1
Countershaft Front Brg.	MU1207UGV	2
Countershaft Rear Brg.	MU1306UGV	2
Aux. Countershaft Front Brg.	M1305GGTV	2
Aux. Countershaft Rear Brg.	MU1308TVVWS	2
Rev. Idler Gear Brg.	WJ162116	2
Input Shaft Seal	452554N (1.500x1.983)	1
Output Shaft Seal	455088V (3.000x4.499)	1
Aux. Output Shaft Seal	415991N (3.500x4.501)	1
Snap Ring Set	SR145	1
Gasket Set	GT131A	1

TRK-145A		
Position	Part Number	Qty
Input Shaft Brg.	MU1209UGMR	1
Input Shaft Pilot Bushing	BS61	1
Aux. Drive Gear Brg.	117L	1
Aux. Mainshaft Front Brg.	MU1307V	1
Aux. Mainshaft Rear Brg	1212L	1
Countershaft Front Brg.	MU1207UGV	2
Countershaft Rear Brg.	MU1306UGV	2
Aux. Countershaft Front Brg.	MR1206RUGV	2
Aux. Countershaft Rear Brg.	MR1308TV	2
Rev. Idler Gear Brg.	WJ162116	2
Input Shaft Seal	452554N (1.500x1.983) •	1
Output Shaft Seal	455088V (3.000x4.499)	1
Aux. Output Shaft Seal	415991N (3.500x4.501)	1
O-Ring	OK15092	1
O-Ring	OK15093	1
Snap Ring Set	SR145A	1
Gasket Set	GT131A	1

TRK-146		
Position	Part Number	Qty
Input Shaft Brg.	MU1209UGMR	1
Input Shaft Pilot Bushing	BS61	1
Aux. Drive Gear Brg.	117L	1
Aux. Mainshaft Brg.	390A Assy 902A2 (A3071)	1
Countershaft Front Brg.	MU1207UGV	2
Countershaft Rear Brg.	MU1306UGV	2
Aux. Countershaft Front Brg.	MU1306UV	2
Aux. Countershaft Rear Brg.	1310L	2
Rev. Idler Gear Brg.	WJ162116	2
Input Shaft Seal	452554N (1.500x1.983)	1
Output Shaft Seal	455088V (3.000x4.499)	1
Aux. Output Shaft Seal	415983N (3.750x4.499)	1
O-Ring Set	OK1000V	1
Snap Ring Set	SR146	1
Snap Ring	15980	1
Gasket Set	GT146	1

TRK-147		
Position	Part Number	Qty
Input Shaft Brg.	217SLE	1
Input Shaft Pilot Brg.	JH1812	1
Output Shaft Brg.	312LE	1
Countershaft Front Brg.	311L	2
Countershaft Rear Brg.	WR61209EX	2
Rev. Idler Gear Brg.	WJ162116	4
Countershaft Rear Snap Rings	SR348-1	2
Input Shaft Seal	412015V (2.125x3.000)	1
Output Shaft Seal	3893V (3.750x4.750)	1
Remote Control Seal	350567 (.875x1.375) •	2
Gasket Set	GT-147	1

TRK-148		
Position	Part Number	Qty
Input Shaft Brg.	N309L	1
Input Shaft Pilot Brg.	SRA5304	1
Output Shaft Brg.	N309L	1
Countershaft Front Brg.	M28161	1
Countershaft Rear Brg.	N309L	1
Rev. Idler Gear Brg.	F54970	2
Input Shaft Seal	7412S (1.250x1.750) •	1
Input Shaft Seal	472164(1.750x2.502)	1
Output Shaft Seal	471271 (2.500x3.251)	1
Output Shaft Seal	450316 (2.250x3.251)	1
Output Shaft Seal	411143N (2.625x3.251)	1
Remote Control Seal	471267 (.875x1.375) •	1
Gasket Set	GT148	1

<sup>16</sup>Some Models will use S456Q Loose Needles instead of F53542 or F53543 Caged Needles. S456Q not packed  
<sup>17</sup>For Spicer Model 8844-A application only (Not packed in kit) • Not Packed In Kit



# Heavy Duty Transmission Rebuild Kits



HD Transmission

TRK-149		
Position	Part Number	Qty
Input Shaft Brg.	212SLV	1
Input Shaft Pilot Bushing	BS59	1
Aux. Drive Gear Brg.	118L	1
Aux. Mainshaft Brg.	29675 Assy 902A8 (A2892)	1
Countershaft Front Brg.	MSN1211REX	2
Countershaft Rear Brg.	MU1308TVWS	2
Aux. Countershaft Front Brg.	MU61307GUM <sup>18</sup>	2
Aux. Countershaft Rear Brg.	1310SLV	2
Rev. Idler Gear Brg.	HJ223020-IR1820OH	2
Aux. Range Shaft Quill Front Brg.	204	1
Aux. Range Shaft Quill Rear Bushing	BS60	1
Input Shaft Nut	CN1 (8997)	1
Output Shaft Seal	415983N (3.750x4.499)	1
Aux. Output Shaft Seal	415991N (3.500x4.501)	1
O-Ring Set	OK1000V	1
O-Ring Set	OK17453	1
Snap Ring Set	SR149	1
Gasket Set	GT200N	1
O-Ring	OR217V	1
O-Ring	OR221V	1

TRK-149/2		
Position	Part Number	Qty
Input Shaft Brg.	212SLV	1
Input Shaft Pilot Bushing	BS59	1
Aux. Drive Gear Brg.	118L	1
Aux. Mainshaft Brg.	29675 Assy 902A8 (A2892)	1
Countershaft Front Brg.	MSN1211REX	2
Countershaft Rear Brg.	MU1308TVWS	2
Aux. Countershaft Front Brg.	MR1307EX <sup>18</sup>	2
Aux. Countershaft Rear Brg.	1310SLV	2
Rev. Idler Gear Brg.	HJ223020-IR1820OH	2
Aux. Range Shaft Quill Front Brg.	204	1
Aux. Range Shaft Quill Rear Bushing	BS60	1
Input Shaft Nut	CN1 (8997)	1
Output Shaft Seal	415983N (3.750x4.499)	1
Aux. Output Shaft Seal	415991N (3.500x4.501)	1
O-Ring Set	OK1000V	1
O-Ring Set	OK17453	1
O-Ring	OR217V	1
O-Ring	OR221V	1
Snap Ring Set	SR149	1
Gasket Set	GT200N	1

TRK-149AUX		
Position	Part Number	Qty
Aux. Mainshaft Brg.	29675 Assy 902A8 (A2892)	1
Aux. Countershaft Front Brg.	MU61307GUM <sup>18</sup>	2
Aux. Countershaft Rear Brg.	1310SLV	2
Aux. Range Shaft Quill Front Brg.	204	1
Aux. Range Shaft Quill Rear Bushing	BS60	1
Aux. Output Shaft Seal	415983N (3.750x4.499)	1
O-Ring Set	OK1000V	1
O-Ring	OR217V	1
O-Ring	OR221V	1
Snap Ring Set	SR1000	1
Gasket Set	GT200N	1

TRK-149AUX/2		
Position	Part Number	Qty
Aux. Mainshaft Brg.	29675 Assy 902A8 (A2892)	1
Aux. Countershaft Front Brg.	MR1307EX <sup>18</sup>	2
Aux. Countershaft Rear Brg.	1310SLV	2
Aux. Range Shaft Quill Front Brg.	204	1
Aux. Range Shaft Quill Rear Bushing	BS60	1
Aux. Output Shaft Seal	415983N (3.750x4.499)	1
O-Ring Set	OK1000V	1
O-Ring	OR217V	1
O-Ring	OR221V	1
Snap Ring Set	SR1000	1
Gasket Set	GT200N	1

TRK-152		
Position	Part Number	Qty
Input Shaft Front Brg.	217SLE	1
Input Shaft Rear Brg.	1911S	1
Input Shaft Pilot Brg.	JH1812	1
Output Shaft Brg.	312LE	1
Countershaft Front Brg.	311L	2
Countershaft Rear Brg.	WR61209EX	2
Rev. Idler Gear Brg.	WJ162116	4
Countershaft Rear Snap Rings	SR348-1	2
Input Shaft Seal	412015V (2.125x3.000)	1
Output Shaft Seal	3893V (3.750x4.750)	1
Gasket Set	GT147	1

TRK-155		
Position	Part Number	Qty
Input Shaft Front Brg.	MR1212EL	1
Input Shaft Rear Brg.	MRB1313EL	1
Input Shaft Pilot Brg.	MR1308TV	1
Output Shaft Brg.	1412L	1
Countershaft Front Brg.	MR1311EAHL	1
Countershaft Rear Brg.	MR1311EAHL	1
Mainshaft 1st Gear Brg.	F53543	1
Mainshaft 2nd Gear Brg.	F53543	1
Mainshaft 3rd Gear Brg.	F53542	1
Input Shaft Seal	415281N (3.000x3.751)	1
Output Shaft Seal	415281N (3.000x3.751)	1
Shift Shaft Seal	350567 (.875x1.375)	4
Shift Shaft Seal	450680 (.875x1.499)	2
Gasket Set	GT155	1

TRK-156		
Position	Part Number	Qty
Input Shaft Brg.	212ASLB	1
Input Shaft Pilot Brg.	J362048	1
Input Shaft Pilot Brg. (T-495/T-496 Models)	WJ182420	1
Output Shaft Brg.	309L	1
Countershaft Front Brg.	M1207EL	1
Countershaft Rear Brg.	1308SL	1
Rev. Idler Gear Brg.	J361652	2
Input Shaft Seal	471413 (1.250x1.752)	1
Input Shaft Seal	452554N (1.500x1.983)	1
Output Shaft Seal	411143N (2.625x3.251)	1
Remote Control Seal	6835S (.750x1.250)	1
Shift Shaft Seal	240735 (.750x1.000)	1
Gasket Set	GT156	1

TRK-157A		
Position	Part Number	Qty
Input Shaft Brg.	N1211L	1
Input Shaft Pilot Brg.	QAR34604	1
Output Shaft Brg.	1308L	1
Countershaft Front Brg. (1978 & Earlier)	M1305GGTV	1
Countershaft Front Brg. (1979 & Later)	R1563TAV	1
Countershaft Rear Brg.	1308L	1
Input Shaft Seal	481181N (1.625x2.125)	1
Output Shaft Seal	410085N (2.000x2.996)	1
Gasket Set	GT157	1

TRK-157AWS		
Position	Part Number	Qty
Input Shaft Brg.	N1211L	1
Input Shaft Pilot Brg.	QAR34604	1
Output Shaft Brg.	1308L	1
Countershaft Front Brg. (1978 & Earlier)	M1305GGTV	1
Countershaft Front Brg. (1979 & Later)	R1563TAV	1
Countershaft Rear Brg.	1308L	1
Input Shaft Seal	481181N (1.625x2.125)	1
Output Shaft Seal	410085N (2.000x2.996)	1
Gasket Set	GT157	1
2nd Gear Synchro Ring	ZSY1001	1
3rd Gear Synchro Ring	ZSY1000	1
4th Gear Synchro Ring	ZSY1000	1

TRK-157B		
Position	Part Number	Qty
Input Shaft Brg.	211FFLE	1
Input Shaft Pilot Brg.	QAR34604	1
Output Shaft Brg.	1308L	1
Countershaft Front Brg. (1979 & Later)	R1563TAV	1
Countershaft Rear Brg.	1308L	1
Input Shaft Seal	481181N (1.625x2.125)	1
Output Shaft Seal	410085N (2.000x2.996)	1
Gasket Set	GT157	1

TRK-157BWS		
Position	Part Number	Qty
Input Shaft Brg.	211FFLE	1
Input Shaft Pilot Brg.	QAR34604	1
Output Shaft Brg.	1308L	1
Countershaft Front Brg.	R1563TAV	1
Countershaft Rear Brg.	1308L	1
Input Shaft Seal	481181N (1.625x2.125)	1
Output Shaft Seal	410085N (2.000x2.996)	1
Gasket Set	GT157	1
2nd Gear Synchro Ring	ZSY1001	1
3rd Gear Synchro Ring	ZSY1000	1
4th Gear Synchro Ring	ZSY1000	1

TRK-157L		
Position	Part Number	Qty
Input Shaft Brg.	N1211L	1
Input Shaft Pilot Brg.	QAR34604	1
Output Shaft Brg.	1308L	1
Countershaft Front Brg. (1979 & Later)	R1563TAV	1
Countershaft Rear Brg.	1308L	1
Input Shaft Seal	481181N (1.625x2.125)	1
Output Shaft Seal	410085N (2.000x2.996)	1
Gasket Set	GT157	1

# Heavy Duty Transmission Rebuild Kits

TRK-157LWS		
Position	Part Number	Qty
Input Shaft Brg.	N1211L	1
Input Shaft Pilot Brg.	QAR34604	1
Output Shaft Brg.	1308L	1
Countershaft Front Brg.	R1563TAV	1
Countershaft Rear Brg.	1308L	1
Input Shaft Seal	481181N (1.625x2.125)	1
Output Shaft Seal	410085N (2.000x2.996)	1
Gasket Set	GT157	1
2nd Gear Synchro Ring	ZSY1001	1
3rd Gear Synchro Ring	ZSY1000	1
4th Gear Synchro Ring	ZSY1000	1

TRK-158		
Position	Part Number	Qty
Input Shaft Front Brg.	212	1
Input Shaft Rear Brg.	MR1213EL	1
Input Shaft Pilot Brg.	JH1812	1
Output Shaft Brg.	214LH	1
Countershaft Front Brg.	MU1311UGMR	2
Countershaft Rear Brg.	MR1309EAL	2
Input Shaft Seal	415281N (3.000x3.751)	1
Output Shaft Seal	415035 (4.000x4.999)	1
Shift Rail Seal	471570 (.875x1.499)	2
Gasket Set	GT158	1

TRK-159		
Position	Part Number	Qty
Input Shaft Brg.	212SLV	1
Input Shaft Pilot Bushing	BS59	1
Aux. Drive Gear Brg.	118L	1
Aux. Mainshaft Brg.	29675 Assy 902A8 (A2892)	1
Countershaft Front Brg.	MSN1211REX	2
Countershaft Rear Brg.	MU1308TVWS	2
Aux. Countershaft Front Brg.	MR1307EL <sup>18</sup>	2
Aux. Countershaft Rear Brg.	5310WL	2
Rev. Idler Gear Brg.	HJ223020-IR1820OH	2
Range Shaft Quill Front Brg.	204	1
Range Shaft Quill Rear Bushing	BS60	1
Input Shaft Nut	CN1 (8997)	1
Output Shaft Seal	415983N (3.750x4.499)	1
Aux. Mainshaft Rear Seal	415991N (3.500x4.501) •	1
O-Ring Set	OK1000V	1
Snap Ring Set	SR159	1
Gasket Set	GT200N	1

TRK-159A		
Position	Part Number	Qty
Input Shaft Brg.	212SLV	1
Input Shaft Pilot Bushing	BS59 •	1
Aux. Drive Gear Brg.	118L	1
Aux. Mainshaft Brg.	29675 Assy 902A8 (A2892)	1
Countershaft Front Brg.	BS500192SX	2
Countershaft Rear Brg.	MU1308TVWS	2
Rev. Idler Gear Brg.	HJ223020-IR1820OH	2
Aux. Countershaft Brg.	MR1307EL	2
Aux. Countershaft Rear Brg.	5310WL	2
Range Shaft Quill Front Brg.	204	1
Range Shaft Quill Rear Bushing	BS60	1
Input Shaft Nut	CN1 (8997)	1
Output Shaft Seal	415983N (3.750x4.499)	1
Aux. Mainshaft Rear Seal	415991N (3.500x4.501) •	1
O-Ring Set	OK1000V	1
Snap Ring Set	SR159	1
Gasket Set	GT200N	1

TRK-160		
Position	Part Number	Qty
Input Shaft Brg.	212SLV	1
Input Shaft Pilot Bushing	BS59 •	1
Aux. Drive Gear Brg.	118L	1
Aux. Mainshaft Brg.	29675 Assy 902A8 (A2892)	1
Countershaft Front Brg.	MSN1211REX	2
Countershaft Rear Brg.	MU1308TVWS	2
Rev. Idler Gear Brg.	HJ223020-IR1820OH	2
Aux. Countershaft Front Brg.	MR1307EL <sup>18</sup>	2
Aux. Countershaft Rear Brg.	1311L	2
Input Shaft Nut	CN1 (8997)	1
Aux. Output Shaft Seal	415991N (3.500x4.501)	1
Output Shaft Seal	415983N (3.750x4.499)	1
O-Ring Set	OK1000V	1
Snap Ring Set	SR160	1
Gasket Set	GT200N	1

TRK-174		
Position	Part Number	Qty
Input Shaft Brg.	HM88649-HM88610	1
Input Shaft Pilot Brg.	QBR42536	1
Output Shaft Brg.	25581-25520	1
Countershaft Front Brg.	M24161X1	1
Countershaft Rear Brg.	B3216	1
Rev. Idler Gear Brg.	Q8324	1
Rev. Idler Thrust Brg.	FA35688	1
Input Shaft Seal	471413 (1.250x1.752)	1
Output Shaft Seal	470898 (2.125x2.875)	1
Output Shaft Seal	473243 (2.125x3.251)	1
Gasket Set	GT172	1

TRK-177		
Position	Part Number	Qty
Input Shaft Brg.	1213SL	1
Input Shaft Pilot Brg.	QBR35171	1
Output Shaft Brg.	1310L1	1
Countershaft Front Brg.	M28161	1
Countershaft Rear Brg.	MU1209UBM	1
Rev. Idler Gear Brg.	Q8321	4
Input Shaft Seal	481181N (1.625x2.125)	1
Output Shaft Seal	450329 (2.625x3.350)	1
Sealer	RTV Silicone	1

TRK-180		
Position	Part Number	Qty
Input Shaft Brg.	JM511946-JM511910	1
Input Shaft Pilot Brg.	2580	1
Output Shaft Brg.	JM511946-JM511910	1
Countershaft Front Brg.	25584-25520	1
Countershaft Rear Brg.	25584-25520	1
Rev. Idler Gear Brg.	WJ162116	2
Mainshaft 1st Gear Brg.	F81205	1
Mainshaft 2nd Gear Brg.	C437Q	1
Mainshaft Rev. Gear Brg.	F81205	1
Input Shaft Seal	452742 (1.781x2.502)	1
Output Shaft Seal	471271 (2.500x3.251)	1
Output Shaft Seal	415004 (2.750x3.751)	1
Output Shaft Seal	475322N (2.750x3.543) •	1
Remote Control Seal	350567 (.875x1.375) •	2
Gasket Set	GT180	1

TRK-181		
Position	Part Number	Qty
Input Shaft Brg.	217SLE	1
Input Shaft Pilot Brg.	JH1812	1
Output Shaft Brg.	312L	1
Countershaft Front Brg.	311L	2
Countershaft Rear Brg.	WR61209EX	2
Rev. Idler Gear Brg.	WJ162116	4
Output Shaft Rear Brg.	214L	1
Countershaft Rear Snap Rings	SR348-1	2
Input Shaft Seal	412015V (2.125x3.000)	1
Output Shaft Seal	3893V (3.750x4.750)	1
Gasket Set	GT181	1

TRK-183		
Position	Part Number	Qty
Input Shaft Brg.	212ASLB	1
Input Shaft Pilot Brg.	WJ182420	1
Output Shaft Brg.	309L	1
Countershaft Front Brg.	M1207EL	1
Countershaft Rear Brg.	1308SL	1
Rev. Idler Gear Brg.	J361652	4
1st Gear Brg.	Q8308	1
2nd Gear Brg.	Q8371	1
Rev. Gear Brg.	Q8308	1
1st Gear Thrust Brg.	RA53421 •	1
Rev. Gear Thrust Brg.	RA53422 •	1
Thrust Brg. Spacer	JB53851	1
Input Shaft Seal	471413 (1.250x1.752)	1
Input Shaft Seal	452554N (1.500x1.983)	1
Output Shaft Seal	411143N (2.625x3.251)	1
Gasket Set	GT156	1

TRK-184		
Position	Part Number	Qty
Input Shaft Brg.	212SLV	1
Input Shaft Pilot Bushing	BS59 •	1
Aux. Drive Gear Brg.	117L	1
Aux. Mainshaft Brg.	29675 Assy 902A8 (A2892)	1
Countershaft Front Brg.	MSN1211REX	2
Rev. Idler Gear Brg.	HJ223020-IR1820OH	2
Countershaft Rear Brg.	MU1308TVWS	2
Aux. Countershaft Front Brg.	MR1307EL	2
Aux. Countershaft Rear Brg.	5310WL	2
Range Shaft Quill Front Brg.	204	1
Range Shaft Quill Rear Bushing	BS60	1
Input Shaft Nut	CN1 (8997)	1
Output Shaft Seal	415983N (3.750x4.499)	1
O-Ring Set	OK1000V	1
Snap Ring Set	SR184	1
Gasket Set	GT200N	1

TRK-185		
Position	Part Number	Qty
Input Shaft Brg.	214L	1
Input Shaft Pilot Brg.	MA1205EL	1
Output Shaft Brg.	214L	1
Countershaft Front Brg.	308L	3
Countershaft Rear Brg.	MA1209EL	3
Rear Countershaft Rear Brg.	1208L <sup>19</sup>	2
Rev. Idler Gear Brg.	J361648	3
Shift Rail Brg.	SCE2014P	3
Input Shaft Seal	2822V (2.062x3.000)	1
Output Shaft Seal	415991N (3.500x4.501)	1
Clutch Release Seal	343186 (1.250x1.500)	1
Shift Rail Seal	7750 (.750x1.124)	2
O-Ring	OK6561	1
Snap Ring Set	SR185	1
Gasket Set	GT213	1

<sup>18</sup>Models before 1973; use MR5208EL <sup>19</sup>Model TRL1078 requires 1 additional 1208L not packed in kit  
• Not Packed In Kit

# Heavy Duty Transmission Rebuild Kits



HD Transmission

TRK-186		
Position	Part Number	Qty
Input Shaft Brg.	JM511946-JM511910	1
Input Shaft Pilot Brg.	25877-25821	1
Output Shaft Brg.	3979-JM511910	1
Countershaft Front Brg.	M804049-M804010	1
Countershaft Rear Brg.	JLM506849-JLM506810	1
Rev. Idler Gear Brg.	WJ162116	2
Mainshaft 1st & Rev. Gear Brg.	F56619	2
Input Shaft Seal	452742 (1.781x2.502)	1
Output Shaft Seal	415004 (2.750x3.751)	1
Output Shaft Seal	475322N (2.750x3.543)	1
Gasket Set	GT186	1

TRK-187		
Position	Part Number	Qty
Input Shaft Brg.	214SL	1
Input Shaft Pilot Brg.	7205TA	1
Output Shaft Pilot Brg.	IR2016-B2416	1
Output Shaft Front Brg.	214L	1
Output Shaft Rear Brg.	MA1213EL	1
Countershaft Front Brg.	308L	3
Countershaft Rear Brg.	MAR5209-M5209EL	3
Rear Countershaft Front Brg.	MAR5209-M1209EL	3
Rear Countershaft Rear Brg.	1208L	3
Rev. Idler Gear Brg.	J361648	3
Shift Rail Brg.	SCE2014P	3
Input Shaft Seal	415027N (3.500x4.999)	1
Output Shaft Seal	2822V (2.062x3.000)	1
Clutch Release Seal	343186 (1.250x1.500)	1
Shift Rail Seal	7750 (.750x1.124)	2
O-Ring	OK6561	1
Snap Ring Set	SR187	1
Gasket Set	GT213	1

TRK-188		
Position	Part Number	Qty
Input Shaft Brg.	212SLV	1
Input Shaft Pilot Bushing	BS59	1
Aux. Drive Gear Brg.	117L	1
Aux. Mainshaft Brg.	29675 Assy 902A8 (A2892)	1
Countershaft Front Brg.	MSN1211REX	2
Countershaft Rear Brg.	MU1308TVWS	2
Rev. Idler Gear Brg.	HJ223020-IR1820OH	2
Aux. Countershaft Front Brg.	MR1307EL	2
Aux. Countershaft Rear Brg.	1311L	2
Input Shaft Nut	CN1 (8997)	1
Output Shaft Seal	415983N (3.750x4.499)	1
O-Ring Set	OK1000V	1
Snap Ring Set	SR188	1
Gasket Set	GT200N	1

TRK-189		
Position	Part Number	Qty
Input Shaft Brg.	217SLE	1
Input Shaft Pilot Brg.	JH1812	1
Mainshaft Rear Brg.	312L	1
Aux. Mainshaft Pilot Brg.	1911S	1
Aux. Mainshaft Rear Brg	214L	1
Countershaft Front Brg.	MSN1311GELR	2
Countershaft Rear Brg.	WR61209EX	2
Rev. Idler Gear Brg.	WJ162116	4
Output Shaft Brg.	MU1207UGV	1
Aux. Countershaft Front Brg.	JLM104948-JLM104910	2
Aux. Countershaft Rear Brg.	JLM104948-JLM104910	2
Input Shaft Seal	415013N (3.000x4.003)	1
Input Shaft Seal	412015V (2.125x3.000)	1
Output Shaft Seal	3893V (3.750x4.750)	1
Countershaft Rear Snap Rings	SR348-1	2
Gasket Set	GT189	1

TRK-190		
Position	Part Number	Qty
Input Shaft Brg.	M802048-M802011	1
Input Shaft Pilot Brg.	QBR49845	1
Output Shaft Brg.	25584-25547RB	1
Countershaft Front Brg.	M28161	1
Countershaft Rear Brg.	MU1309SGNV	1
Rev. Idler Gear Brg.	J361644 <sup>20</sup>	2
4th & 5th Shift Hub Brg.	FA35688	1
4th & 5th Shift Hub Race	TR235383	1
Input Shaft Seal	473010N (1.625x2.502)	1
Output Shaft Seal	471271 (2.500x3.251)	1
Output Shaft Seal	475322N (2.750x3.543)	1
Gasket Set	GT148	1

TRK-191		
Position	Part Number	Qty
Input Shaft Brg.	MR1211GEL	1
Input Shaft Pilot Brg.	MR1205EL	1
Mainshaft Rear Brg.	214L	1
Aux. Mainshaft Pilot Brg.	MU1207TV	1
Aux. Mainshaft Rear Brg	214L	1
Countershaft Front Brg.	1311L	2
Countershaft Rear Brg.	WR61209EX	2
Rev. Idler Gear Brg.	WJ162116	4
Aux. Countershaft Front Brg.	JLM104948-JLM104910	2
Aux. Countershaft Rear Brg.	JLM506849-JLM506810	2
Input Shaft Seal	412015V (2.125x3.000)	1
Output Shaft Seal	3893V (3.750x4.750)	1
Countershaft Rear Snap Rings	SR348-1	2
Gasket Set	GT191	1

TRK-192		
Position	Part Number	Qty
Input Shaft Brg.	MR1211GEL	1
Input Shaft Pilot Brg.	MR1205EL	1
Output Shaft Brg.	214L	1
Countershaft Front Brg.	1311L	2
Countershaft Rear Brg.	WR61209EX	2
Countershaft Rear Brg.	MU1209TM	2
(GMC Models)		
Rev. Idler Gear Brg.	WJ162116	4
Input Shaft Seal	412015V (2.125x3.000)	1
Input Shaft Seal	473010N (1.625x2.502)	1
Mainshaft Rear Seal	3893V (3.750x4.750)	1
Countershaft Rear Snap Rings	SR348-1	2
Gasket Set	GT192	1

TRK-193		
Position	Part Number	Qty
Input Shaft Brg.	217SLE <sup>21</sup>	1
Input Shaft Pilot Brg.	JH1812	1
Output Shaft Brg.	214LH	1
Countershaft Front Brg.	1311L	2
Countershaft Rear Brg.	WR61209EX	2
Countershaft Rear Brg.	MU1209TM	2
(GMC Models)		
Rev. Idler Gear Brg.	WJ162116	4
Input Shaft Seal	412015V (2.125x3.000)	1
Mainshaft Rear Seal	455379V (3.750x4.751)	1
Countershaft Rear Snap Rings	SR348-1	2
Gasket Set	GT193	1

TRK-194		
Position	Part Number	Qty
Input Shaft Brg.	MR1211GEL	1
Input Shaft Pilot Brg.	JH1812	1
Mainshaft Rear Brg.	214L	1
Aux. Mainshaft Pilot Brg.	MU1207UGV	1
Aux. Mainshaft Rear Brg	214L	1
Countershaft Front Brg.	MU1311UGMR	2
Countershaft Rear Brg.	WR61209EX	2
Countershaft Rear Brg.	MU1209TM	2
(GMC Models)		
Rev. Idler Gear Brg.	WJ162116	4
Aux. Countershaft Front Brg.	JLM104948-JLM104910	2
Aux. Countershaft Rear Brg.	JLM506849-JLM506810	2
Input Shaft Seal	412015V (2.125x3.000)	1
Output Shaft Seal	3893V (3.750x4.750)	1
Countershaft Rear Snap Rings	SR348-1	2
Gasket Set	GT191	1

TRK-201		
Position	Part Number	Qty
Input Shaft Brg.	212SLV	1
Input Shaft Pilot Bushing	BS59	1
Aux. Drive Gear Brg.	118L	1
Aux. Mainshaft Brg.	29675 Assy 902A8 (A2892)	1
Countershaft Front Brg.	BS500192SX	2
Countershaft Rear Brg.	MU1308TVWS	2
Rev. Idler Gear Brg.	HJ223020-IR1820OH	2
Aux. Countershaft Front Brg.	MR1307EL	2
Aux. Countershaft Rear Brg.	1311L	2
Input Shaft Nut	CN1 (8997)	1
Output Shaft Seal	415983N (3.750x4.499)	1
O-Ring Set	OK1000V	1
O-Ring Set	OK17453	1
Snap Ring Set	SR201	1
Gasket Set	GT200N	1

<sup>20</sup>Some Late GMC may use F54970  
• Not Packed In Kit

<sup>21</sup>For 1986 & Later Models; use MR1211GEL (Not packed in kit)

# Heavy Duty Transmission Rebuild Kits

TRK-203		
Position	Part Number	Qty
Input Shaft Brg.	212SLV	1
Input Shaft Pilot Bushing	BS59	1
Aux. Drive Gear Brg.	118L	1
Aux. Mainshaft Brg.	390A Assy 902A2 (A3071)	1
Countershaft Front Brg.	BS500192SX	2
Countershaft Rear Brg.	MU1308TVWS	2
Countershaft Rear Brg.	MR1308TV <sup>22</sup>	2
Rev. Idler Gear Brg.	HJ223020-IR1820OH	2
Aux. Countershaft Front Brg.	MR1307EL	2
Aux. Countershaft Rear Brg.	1310L	2
Range Shaft Quill Front Brg.	204	1
Range Shaft Quill Rear Bushing	BS60	1
Input Shaft Nut	CN1 (8997)	1
Aux. Mainshaft Rear Seal	415983N (3.750x4.499)	1
O-Ring Set	OK1000V	1
O-Ring Set	OK17453	1
Snap Ring Set	SR159	1
Gasket Set	GT200N	1

TRK-205		
Position	Part Number	Qty
Input Shaft Brg.	212SLV	1
Input Shaft Pilot Bushing	BS59	1
Aux. Drive Gear Brg.	118L	1
Aux. Mainshaft Brg.	29675 Assy 902A8 (A2892)	1
Countershaft Front Brg.	BS500192SX	2
Countershaft Rear Brg.	MU1308TVWS	2
Rev. Idler Gear Brg.	HJ223020-IR1820OH	2
Aux. Countershaft Front Brg.	MR1307EL	2
Aux. Countershaft Rear Brg.	1311L	2
Input Shaft Nut	CN1 (8997)	1
Aux. Mainshaft Rear Seal	415983N (3.750x4.499)	1
O-Ring Set	OK1000V	1
O-Ring Set	OK17453	1
Snap Ring Set	SR160	1
Gasket Set	GT200N	1

TRK-206		
Position	Part Number	Qty
Input Shaft Brg.	212SLV	1
Input Shaft Pilot Bushing	BS59	1
Aux. Drive Gear Brg.	118L	1
Aux. Mainshaft Brg.	29675 Assy 902A8 (A2892)	1
Countershaft Front Brg.	BS500192SX	2
Countershaft Rear Brg.	MU1308TVWS	2
Rev. Idler Gear Brg.	HJ223020-IR1820OH	2
Aux. Countershaft Front Brg.	MU61307GUM	2
Aux. Countershaft Rear Brg.	1310SLV	2
Range Shaft Quill Front Brg.	204	1
Range Shaft Quill Rear Bushing	BS60	1
Input Shaft Nut	CN1 (8997)	1
Aux. Mainshaft Rear Seal	415983N (3.750x4.499)	1
O-Ring Set	OK1000V	1
O-Ring Set	OK17453	1
O-Ring	OR217V	1
O-Ring	OR221V	1
Snap Ring Set	SR159	1
Gasket Set	GT200N	1

TRK-206/2		
Position	Part Number	Qty
Input Shaft Brg.	212SLV	1
Input Shaft Pilot Bushing	BS59	1
Aux. Drive Gear Brg.	118L	1
Aux. Mainshaft Brg.	29675 Assy 902A8 (A2892)	1
Countershaft Front Brg.	BS500192SX	2
Countershaft Rear Brg.	MU1308TVWS	2
Rev. Idler Gear Brg.	HJ223020-IR1820OH	2
Aux. Countershaft Front Brg.	MR1307EX	2
Aux. Countershaft Rear Brg.	1310SLV	2
Range Shaft Quill Front Brg.	204	1
Range Shaft Quill Rear Bushing	BS60	1
Input Shaft Nut	CN1 (8997)	1
Aux. Mainshaft Rear Seal	415983N (3.750x4.499)	1
O-Ring Set	OK1000V	1
O-Ring Set	OK17453	1
O-Ring	OR217V	1
O-Ring	OR221V	1
Snap Ring Set	SR159	1
Gasket Set	GT200N	1

TRK-207		
Position	Part Number	Qty
Input Shaft Brg.	212SLV	1
Input Shaft Pilot Bushing	BS59	1
Aux. Drive Gear Brg.	118L	1
Aux. Mainshaft Brg.	29675 Assy 902A8 (A2892)	1
Countershaft Front Brg.	BS500192SX	2
Countershaft Rear Brg.	MU1308TVWS	2
Rev. Idler Gear Brg.	HJ223020-IR1820OH	2
Aux. Countershaft Front Brg.	MR1307EL	2
Aux. Countershaft Rear Brg.	5310WLB	2
Range Shaft Quill Front Brg.	204	1
Range Shaft Quill Rear Bushing	BS60	1
Input Shaft Nut	CN1 (8997)	1
Aux. Mainshaft Rear Seal	415983N (3.750x4.499)	1
O-Ring Set	OK1000V	1
O-Ring Set	OK17453	1
Snap Ring Set	SR207	1
Gasket Set	GT200N	1

TRK-208		
Position	Part Number	Qty
Input Shaft Brg.	M802048-M802011	1
Input Shaft Pilot Brg.	QBR49845	1
Output Shaft Brg.	25581-25520	1
Countershaft Front Brg.	25877-25821	1
Countershaft Rear Brg.	2689-2631	1
Rev. Idler Gear Brg.	QA48181A	1
Mainshaft 1st & 2nd Gear Brg.	F94490	2
Mainshaft 3rd & Rev. Gear Brg.	F84003	2
Mainshaft 4th Gear Brg.	F94488	1
4th & 5th Shift Hub Brg.	FA35688	1
4th & 5th Shift Hub Race	TR235383	1
Input Shaft Seal	473010N (1.625x2.502)	1
Output Shaft Seal	471271 (2.500x3.251)	1
Output Shaft Seal	712512 (2.250x3.252)	1
Gasket Set	GT208	1

TRK-208D		
Position	Part Number	Qty
Input Shaft Brg.	M804049-M804010	1
Input Shaft Pilot Brg.	QBR49845	1
Output Shaft Brg.	25581-25520	1
Countershaft Front Brg.	25877-25821	1
Countershaft Rear Brg.	2689-2631	1
4th & 5th Shift Hub Brg.	FA35688	1
4th & 5th Shift Hub Race	TR235383	1
Mainshaft 1st & 2nd Gear Brg.	F94490	2
Mainshaft 3rd & Rev. Gear Brg.	F84003	2
Mainshaft 4th Gear Brg.	F94488	1
Rev. Idler Gear Brg.	QA48181A	1
Input Shaft Seal	710211 (1.875x2.677)	1
Output Shaft Seal	712512 (2.250x3.252)	1
Gasket Set	GT208	1

TRK-210		
Position	Part Number	Qty
Input Shaft Brg.	7211HL	1
Input Shaft Pilot Brg.	SCE2420	1
Output Shaft Brg.	7211HL	1
Countershaft Front Brg.	LM48548-LM48510	1
Countershaft Rear Brg.	LM102949-LM102910	1
Mainshaft 1st and Rev. Gear Brg.	F93290	2
Mainshaft 2nd Gear Brg.	F95407	1
Rev. Idler Gear Brg.	WJ162116	2
Drive Gear Seal	330749V (1.562x2.062)	1
Drive Gear Seal	5133 (1.812x2.562)	1
Output Shaft Seal	415322V (2.750x3.543)	1
Gasket Set	GT210	1

TRK-213		
Position	Part Number	Qty
Input Shaft Brg.	214SL	1
Input Shaft Pilot Brg.	MA1205EL	1
Main Drive Gear Brg.	214L	1
Main Drive Gear Pilot Brg.	7205TA	1
Output Shaft Pilot Brg.	IR2016-B2416	1
Output Shaft Front Brg.	214L	1
Output Shaft Rear Brg.	MA1213EL	1
Compound Case Countershaft Front Brg.	308L	3
Compound Case Countershaft Rear Brg.	206	3
Countershaft Front Brg.	308LH	3
Countershaft Rear Brg.	MAR5209-M5209EL	3
Rear Countershaft Front Brg.	MAR5209-M1209EL	3
Rear Countershaft Rear Brg.	1208L	3
Rev. Idler Gear Brg.	J361648	3
Shift Rail Brg.	SCE2014P	2
Input Shaft Seal	2822V (2.062x3.000)	1
Output Shaft Seal	415027N (3.500x4.999)	1
Clutch Release Shaft Seal	343186 (1.250x1.500)	1
Shift Rail Seal	7750 (.750x1.124)	1
O-Ring Set	OK213	1
Snap Ring Set	SR213	1
Gasket Set	GT213	1

HD Transmission

<sup>22</sup>For RT-11613 Series only Use (2) pieces MR1308TV (Not packed in kit)



# Heavy Duty Transmission Rebuild Kits



HD Transmission

TRK-213SD		
Position	Part Number	Qty
Input Shaft Brg.	214SL	1
Input Shaft Pilot Brg.	MA1205EL	1
Main Drive Gear Brg.	214L	1
Main Drive Gear Pilot Brg.	7205TA	1
Output Shaft Pilot Brg.	IR2016-B2416	1
Output Shaft Front Brg.	214L	1
Output Shaft Rear Brg.	MA1213EL	1
Compound Case	MU1308RUMW3	3
Countershaft Front Brg.	Compound Case	206
Countershaft Rear Brg.	MU1308RUMW789	3
Countershaft Rear Brg.	MAR5209-M5209EL	3
Rear Countershaft Front Brg.	MAR5209-M1209EL	3
Rear Countershaft Rear Brg.	MU1208RUMW3	3
Rev. Idler Gear Brg.	J361648	3
Shift Rail Brg.	SCE2014P	2
Input Shaft Seal	2822V (2.062x3.000)	1
Output Shaft Seal	415027N (3.500x4.999)	1
Clutch Release Shaft Seal	343186 (1.250x1.500)	1
Shift Rail Seal	7750 (.750x1.124)	1
O-Ring Set	OK213	1
Snap Ring Set	SR213	1
Gasket Set	GT213	1

TRK-214		
Position	Part Number	Qty
Input Shaft Brg.	214S	1
Input Shaft Pilot Brg.	MA1205EL	1
Output Shaft Pilot Brg.	IR1816-SCH2216	1
Output Shaft Front Brg.	118L	1
Output Shaft Rear Brg.	83B043C3	1
Countershaft Front Brg.	JLM104948-JLM104910	3
Countershaft Rear Brg.	LM501349-LM501310	3
Rear Countershaft Front Brg.	LM501349-LM501310	3
Rear Countershaft Rear Brg.	3780-3720	3
Rev. Idler Gear Brg.	JH1818	3
Countershaft Rear Brg.	IR1816	1
Shift Rail Brg.	B1612	2
Input Shaft Seal	2822V (2.062x3.000)	1
Output Shaft Seal	415983N (3.750x4.499)	1
Shift Rail Seal	240731 (1.000x1.250)	1
Snap Ring Set	SR214	1
Gasket Set	GT214	1

TRK-214MK		
Position	Part Number	Qty
Input Shaft Brg.	214S	1
Input Shaft Pilot Brg.	MA1205EL	1
Output Shaft Pilot Brg.	IR1816-SCH2216	1
Output Shaft Front Brg.	118L	1
Output Shaft Rear Brg.	83B043C3	1
Countershaft Front Brg.	JLM104948-JLM104910	3
Countershaft Rear Brg.	LM501349-LM501310	3
Rear Countershaft Front Brg.	LM501349-LM501310	3
Rear Countershaft Rear Brg.	3780-3720	3
Rev. Idler Gear Brg.	JH1818	3
Countershaft Rear Brg.	IR1816	1
Shift Rail Brg.	B1612	2
Input Shaft Seal	2822V (2.062x3.000)	1
Output Shaft Seal	415983N (3.750x4.499)	1
Shift Rail Seal	240731 (1.000x1.250)	1
Snap Ring Set	SR214	1
Gasket Set	GT214	1
Washer Set	WK214	1
Shim Set	SH214	1
Small Parts Kit	SPK214	1

TRK-214MK1		
Position	Part Number	Qty
Input Shaft Brg.	214S	1
Input Shaft Pilot Brg.	MA1205EL	1
Output Shaft Pilot Brg.	IR1816-SCH2216	1
Output Shaft Front Brg.	118L	1
Output Shaft Rear Brg.	83B043C3	1
Countershaft Front Brg.	JLM104948-JLM104910	3
Countershaft Rear Brg.	LM501349-LM501310	3
Rear Countershaft Front Brg.	LM501349-LM501310	3
Rear Countershaft Rear Brg.	3780-3720	3
Rev. Idler Gear Brg.	JH1818	3
Countershaft Rear Brg.	IR1816	1
Shift Rail Brg.	B1612	2
Input Shaft Seal	2822V (2.062x3.000)	1
Output Shaft Seal	415983N (3.750x4.499)	1
Shift Rail Seal	240731 (1.000x1.250)	1
Snap Ring Set	SR214	1
Gasket Set	GT214	1
Washer Set	WK214-1	1
Shim Set	SH214	1
Small Parts Kit	SPK214-1	1

TRK-219		
Position	Part Number	Qty
Input Shaft Brg.	7211HFL	1
Input Shaft Pilot Brg.	MU5206L	1
Output Shaft Brg.	7211HL	1
Countershaft Front Brg.	LM48548-LM48510	1
Countershaft Rear Brg.	LM102949-LM102910	1
1st Gear Brg.	F93290	1
2nd Gear Brg.	F95407	1
3rd Gear Brg.	FW505520	2
4th Gear Brg.	FW455017	2
Rev. Gear Brg.	F93290	1
Rev. Idler Gear Brg.	WJ162116	2
Input Shaft Seal	39920 (1.562x2.062)	1
Input Shaft Seal	39930 (1.812x2.562)	1
Output Shaft Seal	415322V (2.750x3.543)	1
Snap Ring Set	SR219	1
Gasket Set	GT210	1

TRK-221		
Position	Part Number	Qty
Input Shaft Brg.	7211HFL	1
Input Shaft Pilot Brg.	MU5206L	1
Output Shaft Brg.	7211HL	1
Countershaft Front Brg.	LM48548-LM48510	1
Countershaft Rear Brg.	2788A-2729	1
Rev. Idler Gear Brg.	WJ162116	2
1st Gear Brg.	F208323	1
2nd Gear Brg.	F93290	2
3rd Gear Brg.	F95407	1
4th Gear Brg.	F209348	1
Input Shaft Seal	39920 (1.562x2.062)	1
Input Shaft Seal	39930 (1.812x2.562)	1
Output Shaft Seal	415322V (2.750x3.543)	1
Snap Ring Set	SR220	1
Gasket Set	GT221	1

TRK-222		
Position	Part Number	Qty
Input Shaft Brg.	1213L	1
Input Shaft Pilot Brg.	MU5206L	1
Output Shaft Center Brg.	1213L	1
Output Shaft Rear Brg.	7211HL	1
Countershaft Front Brg.	2788A-2729	1
Countershaft Ctr. Brg.	MB1212GEXR	1
Countershaft Rear Brg.	2788A-2729	1
Rev. Idler Gear Brg.	WJ162116	2
1st Gear Brg.	F208323	1
2nd Gear Brg.	F208323	1
3rd Gear Brg.	F208323	1
4th Gear Brg.	FW657020	1
4th Gear Brg.	FW657030	1
4th/5th Shift Hub Brg.	FWH556320	2
6th Gear Brg.	FW475325	2
Rev. Gear Brg.	F208323	1
Input Shaft Seal	39925 (1.781x2.502)	1
Output Shaft Seal	415322V (2.750x3.543)	1
Snap Ring Set	SR221	1
Gasket Set	GT221	1

TRK-226		
Position	Part Number	Qty
Intermediate Shaft Front Brg.	2788-2720	1
Intermediate Shaft Rear Brg.	25877-25821	1
Output Shaft Brg.	MR1307EX	2
Rev. Shaft Brg.	MR1307EXW927	2
Shift Rod Seal	471570 (.875x1.499)	4
Output Shaft Seal	472015 (2.125x3.000)	1
Gasket Set	GT226	1

TRK-390F		
Position	Part Number	Qty
Input Shaft Brg.	M802048-M802011	1
Input Shaft Pilot Brg.	QBR49845	1
Output Shaft Brg.	28580-28527RB	1
Countershaft Front Brg.	DD46386	1
Countershaft Rear Brg.	MU1309UGM	1
Rev. Idler Gear Brg.	QA47838	1
Mainshaft Gear Brg.	QA48181A	1
4th & 5th Shift Hub Brg.	FA35688	1
4th & 5th Shift Hub Race	TR235383	1
Input Shaft Seal	473010N (1.625x2.502)	1
Mainshaft Rear Seal	475322N (2.750x3.543)	1
Mainshaft 4th Gear Brg.	F94488	1
Mainshaft 2nd, 3rd & Rev. Gear Brg.	F94490	3
Gasket Set	GT390FGH	1

TRK-390G		
Position	Part Number	Qty
Input Shaft Brg.	M802048-M802011	1
Input Shaft Pilot Brg.	QBR49845	1
Output Shaft Brg.	25584-25547RB	1
Countershaft Front Brg.	DD46386	1
Countershaft Rear Brg.	MU1309UGM	1
Rev. Idler Gear Brg.	QA47838	1
Mainshaft Gear Brg.	QA48181A	1
4th & 5th Shift Hub Brg.	FA35688	1
4th & 5th Shift Hub Race	TR235383	1
Input Shaft Seal	473010N (1.625x2.502)	1
Input Shaft Seal	482041N (1.875x2.502)	1
Output Shaft Seal	485364N (2.750x3.500)	1
Output Shaft Seal	471271 (2.500x3.251)	1
Mainshaft 4th Gear Brg.	F94488	1
Mainshaft 2nd, 3rd & Rev. Gear Brg.	F94490	3
Gasket Set	GT390FGH	1



# Heavy Duty Transmission Rebuild Kits

TRK-390H		
Position	Part Number	Qty
Input Shaft Brg.	M804049-M804010	1
Input Shaft Pilot Brg.	QBR49845	1
Output Shaft Brg.	28580-28527RB	1
Countershaft Front Brg.	DD46386	1
Countershaft Rear Brg.	MU1309UGM	1
Rev. Idler Gear Brg.	QA47838	1
Mainshaft Gear Brg.	QA48181A	1
4th & 5th Shift Hub Brg.	FA35688	1
4th & 5th Shift Hub Race	TR235383	1
Input Shaft Seal	482041N (1.875x2.502)	1
Output Shaft Seal	485364N (2.750x3.500)	1
Output Shaft Seal	411143N (2.625x3.251)	1
Mainshaft 4th Gear Brg.	F94488	1
Mainshaft 2nd, 3rd & Rev. Gear Brg.	F94490	3
Gasket Set	GT390FGH	1

TRK-395F		
Position	Part Number	Qty
Input Shaft Brg.	M802048-M802011	1
Input Shaft Pilot Brg.	QBR49845	1
Output Shaft Brg.	28580-28527RB	1
Countershaft Front & Rear Brg.	25590-25520	2
4th & 5th Shift Hub Brg.	FA35688	1
4th & 5th Shift Hub Race	TR235383	1
Mainshaft 1st Gear Brg.	QA48181A	2
Mainshaft 2nd, 3rd & Rev. Gear Brg.	F94490	3
Mainshaft 4th Gear Brg.	F94488	1
Rev. Idler Gear Brg.	QA47838	1
Input Shaft Seal	473010N (1.625x2.502)	1
Output Shaft Seal	475322N (2.750x3.543)	1
Gasket Set	GT390FGH	1

TRK-395G		
Position	Part Number	Qty
Input Shaft Brg.	M802048-M802011	1
Input Shaft Pilot Brg.	QBR49845	1
Output Shaft Brg.	25584-25547RB	1
Countershaft Front & Rear Brg.	25590-25520	2
4th & 5th Shift Hub Brg.	FA35688	1
4th & 5th Shift Hub Race	TR235383	1
Mainshaft 1st Gear Brg.	QA48181A	2
Mainshaft 2nd, 3rd & Rev. Gear Brg.	F94490	3
Mainshaft 4th Gear Brg.	F94488	1
Rev. Idler Gear Brg.	QA47838	1
Input Shaft Seal	473010N (1.625x2.502)	1
Output Shaft Seal	712512 (2.250x3.252)	1
Gasket Set	GT390FGH	1

TRK-395H		
Position	Part Number	Qty
Input Shaft Brg.	M804049-M804010	1
Input Shaft Pilot Brg.	QBR49845	1
Output Shaft Brg.	28580-28527RB	1
Countershaft Front & Rear Brg.	25590-25520	2
4th & 5th Shift Hub Brg.	FA35688	1
4th & 5th Shift Hub Race	TR235383	1
Mainshaft 1st Gear Brg.	QA48181A	2
Mainshaft 2nd, 3rd & Rev. Gear Brg.	F94490	3
Mainshaft 4th Gear Brg.	F94488	1
Rev. Idler Gear Brg.	QA47838	1
Input Shaft Seal	482041N (1.875x2.502)	1
Output Shaft Seal	411143N (2.625x3.251)	1
Output Shaft Seal	475322N (2.750x3.543)	1
Gasket Set	GT390FGH	1

TRK-400		
Position	Part Number	Qty
Input Shaft Brg.	1212S	1
Input Shaft Rear Brg.	MU1313RUMW3	1
Mainshaft Front Brg.	308	1
Mainshaft Rear Brg.	MU1313RUMW3	1
Countershaft Front Brg.	MU1308UM	1
Countershaft Rear Brg.	MU1312RUMW3	1
Input Shaft Seal	20920 (3.500x4.500)	1
Output Shaft Seal	20920 (3.500x4.500)	1
Shift Shaft Seal	340483 (.875x1.250)	1
Gasket Set	K-1568	1

TRK-401		
Position	Part Number	Qty
Input Shaft Brg.	MU1214UMW3	1
Aux. Drive Gear Brg.	117L	1
Aux. Mainshaft Front Brg.	17406	1
Aux. Mainshaft Rear Brg	29675 Assy 902A8 (A2892)	1
Aux. Countershaft Front Brg.	MU1309UV	2
Aux. Countershaft Rear Brg.	1311L	2
Input Shaft Seal	415027N (3.500x4.999)	1
Input Shaft Seal	416339 (3.750x4.999)	1
Output Shaft Seal Kit	K-2256	1
Output Shaft Seal Kit	K-2262	1
O-Ring Kit	K-1552	1
Gasket Kit	K-1479	1

TRK-500		
Position	Part Number	Qty
Clutch Release Brg.	2756T	1
Input Shaft Brg.	214SL	1
Input Shaft Pilot Brg.	MA1205EL	1
Main Drive Gear Brg.	214L	1
Main Drive Gear Pilot Brg.	MA1205EL	1
Output Shaft Brg.	214L	1
Compound Case	308L	3
Countershaft Front Brg.	206	3
Compound Case	206	3
Countershaft Rear Brg.	308L	3
Countershaft Front Brg.	308L	3
Countershaft Rear Brg.	MA1209EL	3
Rear Countershaft Brg.	1208L	3
Rev. Idler Gear Brg.	J361648	3
Shift Rail Brg.	SCE2014P	3
Input Shaft Seal	332134 (2.062x2.561)	1
Output Shaft Seal	415991N (3.500x4.501)	1
Output Shaft Seal	410312N (2.125x3.125)	1
Clutch Release Seal	343186 (1.250x1.500)	4
Shift Rail Seal	7750 (.750x1.124)	2
Gasket Set	GT213	1

TRK-501		
Position	Part Number	Qty
Input Shaft Brg.	218L	1
Input Shaft Pilot Brg.	MA1305EL	1
Output Shaft Brg.	214L	1
Countershaft Front Brg.	308L	3
Countershaft Rear Brg.	MA1209EL	3
Rear Countershaft Rear Brg.	1208L	3
Rev. Idler Gear Brg.	J361648	3
Shift Rail Brg.	SCE2014P	2
Input Shaft Seal	2822V (2.062x3.000)	1
Output Shaft Seal	415991N (3.500x4.501)	1
Clutch Release Seal	343186 (1.250x1.500)	1
Shift Rail Seal	7750 (.750x1.124)	3
Snap Ring Set	SR501	1
O-Ring Set	OK501	1
Bushing	BS52	1
Gasket Set	GT501	1

TRK-502		
Position	Part Number	Qty
Input Shaft Brg.	218L	1
Input Shaft Pilot Brg.	SCE2014P	2
Countershaft Front Brg.	308L	3
Countershaft Rear Brg.	MAR5209-M5209EL	3
Rear Countershaft Front Brg.	MAR5209-M1209EL	3
Rear Countershaft Rear Brg.	1208L	3
Rev. Idler Gear Brg.	J361648	3
Input Shaft Seal	2822V (2.062x3.000)	1
Output Shaft Seal	332134 (2.062x2.561)	2
Clutch Release Seal	343186 (1.250x1.500)	1
Shift Rail Seal	7750 (.750x1.124)	3
Snap Ring Set	SR502	1
O-Ring Set	OK502	1
Gasket Set	GT502	1

TRK-503		
Position	Part Number	Qty
Input Shaft Brg.	214L	1
Input Shaft Pilot Brg.	MA1205EL	1
Output Shaft Brg.	1213A	1
Countershaft Front Brg.	JLM104948-JLM104910	3
Countershaft Rear Brg.	LM501349-LM501310	3
Rev. Idler Gear Brg.	JH1818	3
Clutch Release Shaft Brg.	B1612	2
Bushing	BS52	1
Input Shaft Seal	2822V (2.062x3.000)	1
Output Shaft Seal	713750 (3.750x4.500)	1
Snap Ring Set	SR503	1
O-Ring Set	OK503	1
Gasket Set	GT503	1

TRK-503MK		
Position	Part Number	Qty
Input Shaft Brg.	214L	1
Input Shaft Pilot Brg.	MA1205EL	1
Output Shaft Brg.	1213A	1
Countershaft Front Brg.	JLM104948-JLM104910	3
Countershaft Rear Brg.	LM501349-LM501310	3
Rev. Idler Gear Brg.	JH1818	3
Clutch Release Shaft Brg.	B1612	2
Bushing	BS52	1
Input Shaft Seal	2822V (2.062x3.000)	1
Output Shaft Seal	713750 (3.750x4.500)	1
Snap Ring Set	SR503	1
O-Ring Set	OK503	1
Gasket Set	GT503	1
Washer Set	WK503	1
Small Parts Kit	SPK503	1
Shim Set	SH503	1

HD Transmission

# Heavy Duty Transmission Rebuild Kits



HD Transmission

TRK-504		
Position	Part Number	Qty
Input Shaft Front Brg.	H715341-H715311	1
Input Shaft Rear Brg.	H715341-H715311	1
Countershaft Front Brg.	H715341-H715311	1
Countershaft Rear Brg.	H715341-H715311	1
Countershaft High - Low Range Brg.	WJ485424	4
Front Driveshaft Front Brg.	458S-453X	1
Front Driveshaft Rear Brg.	4559-4535	1
Rear Driveshaft Front Brg.	6461A-JH415610	1
Rear Driveshaft Rear Brg.	HM516449C-HM516410	1
Rear Output Shaft Front Brg.	570-563	1
Rear Output Shaft Rear Brg.	570-563	1
Front Output Shaft Front Brg.	JH307749-JH307710	1
Front Output Shaft Rear Brg.	JH307749-JH307710	1
Gasket Kit	GT-504	1

TRK-505		
Position	Part Number	Qty
Input Shaft Brg.	214S	1
Input Shaft Pilot Brg.	MA1205EL	1
Output Shaft Pilot Brg.	IR1816-SCH2216	1
Output Shaft Front Brg.	118L	1
Output Shaft Rear Brg.	83B043C3	1
Countershaft Front Brg.	JLM104948-JLM104910	3
Countershaft Rear Brg.	LM501349-LM501310	3
Rear Countershaft Front Brg.	LM501349-LM501310	3
Rear Countershaft Rear Brg.	3780-3720	3
Rev. Idler Gear Brg.	JH1818	3
Countershaft Rear Brg.	IR1816	1
Shift Rail Brg.	B1612	2
Input Shaft Seal	2822V (2.062x3.000)	1
Output Shaft Seal	713750 (3.750x4.500)	1
Shift Rail Seal	240731 (1.000x1.250)	1
Snap Ring Set	SR505	1
O-Ring Kit	OK214A	1
Gasket Set	GT505	1

TRK-505MK		
Position	Part Number	Qty
Input Shaft Brg.	214S	1
Input Shaft Pilot Brg.	MA1205EL	1
Output Shaft Pilot Brg.	IR1816-SCH2216	1
Output Shaft Front Brg.	118L	1
Output Shaft Rear Brg.	83B043C3	1
Countershaft Front Brg.	JLM104948-JLM104910	3
Countershaft Rear Brg.	LM501349-LM501310	3
Rear Countershaft Front Brg.	LM501349-LM501310	3
Rear Countershaft Rear Brg.	3780-3720	3
Rev. Idler Gear Brg.	JH1818	3
Countershaft Rear Brg.	IR1816	1
Shift Rail Brg.	B1612	2
Input Shaft Seal	2822V (2.062x3.000)	1
Output Shaft Seal	713750 (3.750x4.500)	1
Shift Rail Seal	240731 (1.000x1.250)	1
Snap Ring Set	SR505	1
O-Ring Kit	OK214A	1
Gasket Set	GT505	1
Washer Set	WK505	1
Shim Set	SH505	1
Small Parts Kit	SPK505	1

TRK-506		
Position	Part Number	Qty
Input Shaft Brg.	214L	1
Input Shaft Pilot Brg.	MA1205EL	1
Output Shaft Pilot Brg.	IR1816-SCH2216	1
Output Shaft Front Brg.	118L	1
Output Shaft Rear Brg.	83B043C3	1
Countershaft Front Brg.	JLM104948-JLM104910	3
Countershaft Rear Brg.	LM501349-LM501310	3
Rear Countershaft Front Brg.	LM501349-LM501310	3
Rear Countershaft Rear Brg.	3780-3720	3
Rev. Idler Gear Brg.	HJ182620	3
Countershaft Rear Brg.	IR1816	1
High-Low Hub Brg.	6912	1
Shift Rail Brg.	B1612	2
Input Shaft Seal	2822V (2.062x3.000)	1
Output Shaft Seal	713750 (3.750x4.500)	1
Shift Rail Seal	240731 (1.000x1.250)	1
Snap Ring Set	SR506	1
O-Ring Kit	OK214A	1
Gasket Set	GT505	1

TRK-506MK		
Position	Part Number	Qty
Input Shaft Brg.	214L	1
Input Shaft Pilot Brg.	MA1205EL	1
Output Shaft Pilot Brg.	IR1816-SCH2216	1
Output Shaft Front Brg.	118L	1
Output Shaft Rear Brg.	83B043C3	1
Countershaft Front Brg.	JLM104948-JLM104910	3
Countershaft Rear Brg.	LM501349-LM501310	3
Rear Countershaft Front Brg.	LM501349-LM501310	3
Rear Countershaft Rear Brg.	3780-3720	3
Rev. Idler Gear Brg.	HJ182620	3
Countershaft Rear Brg.	IR1816	1
High-Low Hub Brg.	6912	1
Shift Rail Brg.	B1612	2
Input Shaft Seal	2822V (2.062x3.000)	1
Output Shaft Seal	713750 (3.750x4.500)	1
Shift Rail Seal	240731 (1.000x1.250)	1
Snap Ring Set	SR506	1
O-Ring Kit	OK214A	1
Gasket Set	GT505	1
Washer Set	WK506	1
Shim Set	SH214	1
Small Parts Kit	SPK506	1

TRK-507		
Position	Part Number	Qty
Input Shaft Brg.	214L	1
Input Shaft Pilot Brg.	MA1205EL	1
Output Shaft Pilot Brg.	IR1816-SCH2216	1
Output Shaft Front Brg.	118L	1
Output Shaft Rear Brg.	83B043C3	1
Countershaft Front Brg.	JLM104948-JLM104910	3
Countershaft Rear Brg.	LM501349-LM501310	3
Rear Countershaft Front Brg.	LM501349-LM501310	3
Rear Countershaft Rear Brg.	3780-3720	3
Rev. Idler Gear Brg.	JH1818	3
Countershaft Rear Brg.	IR1816	1
High-Low Hub Brg.	6912	1
Shift Rail Brg.	B1612	2
Input Shaft Seal	2822V (2.062x3.000)	1
Output Shaft Seal	713750 (3.750x4.500)	1
Shift Rail Seal	240731 (1.000x1.250)	1
Snap Ring Set	SR505	1
O-Ring Kit	OK214A	1
Gasket Set	GT505	1

TRK-507MK		
Position	Part Number	Qty
Input Shaft Brg.	214L	1
Input Shaft Pilot Brg.	MA1205EL	1
Output Shaft Pilot Brg.	IR1816-SCH2216	1
Output Shaft Front Brg.	118L	1
Output Shaft Rear Brg.	83B043C3	1
Countershaft Front Brg.	JLM104948-JLM104910	3
Countershaft Rear Brg.	LM501349-LM501310	3
Rear Countershaft Front Brg.	LM501349-LM501310	3
Rear Countershaft Rear Brg.	3780-3720	3
Rev. Idler Gear Brg.	JH1818	3
Countershaft Rear Brg.	IR1816	1
High-Low Hub Brg.	6912	1
Shift Rail Brg.	B1612	2
Input Shaft Seal	2822V (2.062x3.000)	1
Output Shaft Seal	713750 (3.750x4.500)	1
Shift Rail Seal	240731 (1.000x1.250)	1
Snap Ring Set	SR505	1
O-Ring Kit	OK214A	1
Gasket Set	GT505	1
Washer Set	WK507	1
Shim Set	SH214	1
Small Parts Kit	SPK507	1

TRK-510		
Position	Part Number	Qty
Input Shaft Brg.	21626063	1
Constant Gear Brg.	1654088	1
Input Shaft Pilot Brg.	1656116	1
Output Shaft Front Brg.	21626057	1
Output Shaft Rear Brg.	21170624	1
Countershaft Front Brg.	21626061	1
Countershaft Rear Brg.	22283632	1
1st Gear Brg.	1521452	1
2nd Gear Brg.	1652575	1
Rev. Gear Brg.	1652575	1
Rev. Idler Gear Brg.	20483574	2
Input Shaft Seal	20483426	1
Output Shaft Seal	1652776	1
Output Shaft Sealing Ring	1652622	1
Gasket Kit	20785252	1
Top Cover Gasket	8171137	1
Oil Pump O-Ring	949656	2

TRK-510A		
Position	Part Number	Qty
Input Shaft Brg.	21626063	1
Constant Gear Brg.	1654088	1
Input Shaft Pilot Brg.	1656116	1
Output Shaft Front Brg.	21626057	1
Output Shaft Rear Brg.	20785448	1
Countershaft Front Brg.	21626061	1
Countershaft Rear Brg.	22283632	1
1st Gear Brg.	1521452	1
2nd Gear Brg.	1652575	1
Rev. Gear Brg.	1652575	1
Rev. Idler Gear Brg.	20483574	2
Input Shaft Seal	20483426	1
Output Shaft Seal	20791305	1
Output Shaft Sealing Ring	20791222	1
Gasket Kit	20785252	1
Top Cover Gasket	8171137	1
Oil Pump O-Ring	949656	2

# Heavy Duty Transmission Rebuild Kits

TRK-511		
Position	Part Number	Qty
Input Shaft Brg.	21626057	1
Constant Gear Brg.	1654088	1
Input Shaft Pilot Brg.	1656116	1
Output Shaft Front Brg.	21626057	1
Output Shaft Rear Brg.	21170624	1
Countershaft Front Brg.	21627792	1
Countershaft Rear Brg.	22283632	1
1st Gear Brg.	1521452	1
2nd Gear Brg.	1652575	1
Rev. Gear Brg.	1652575	1
Rev. Idler Gear Brg.	20483574	2
Input Shaft Seal	20483426	1
Output Shaft Seal	1652776	1
Output Shaft Sealing Ring	1652622	1
Gasket Kit	20785252	1
Top Cover Gasket	8171137	1
Oil Pump O-Ring	949656	2

TRK-511A		
Position	Part Number	Qty
Input Shaft Brg.	21626057	1
Constant Gear Brg.	1654088	1
Input Shaft Pilot Brg.	1656116	1
Output Shaft Front Brg.	21626057	1
Output Shaft Rear Brg.	20785448	1
Countershaft Front Brg.	21627792	1
Countershaft Rear Brg.	22283632	1
1st Gear Brg.	1521452	1
2nd Gear Brg.	1652575	1
Rev. Gear Brg.	1652575	1
Rev. Idler Gear Brg.	20483574	2
Input Shaft Seal	20483426	1
Output Shaft Seal	20791305	1
Output Shaft Sealing Ring	20791222	1
Gasket Kit	20785252	1
Top Cover Gasket	8171137	1
Oil Pump O-Ring	949656	2

TRK-700		
Position	Part Number	Qty
Input Shaft Brg.	BS500262R	1
Countershaft Front Brg.	25581-25520	2
Countershaft Rear Brg.	25590-25520	2
Aux. Countershaft Front Brg.	MR1307EX	2
Aux. Countershaft Rear Brg.	MR1309UV	2
Aux. Mainshaft Brg.	JLM710949C (90KA3)	1
Rev. Idler Gear Brg.	K55X63X25A	2
Low Range Brg.	K73X79X20B	2
Input Shaft Seal	97-463-36-1X	1
Output Shaft Seal	37410 (3.750x4.750)	1
Snap Ring	201-381-1	1
Snap Ring	201-381-3	1
Shim Kit	313667X	1
Gasket Set	312475-45X	1

TRK-702		
Position	Part Number	Qty
Input Shaft Brg.	MU1211GUM	1
Input Shaft Pilot Brg.	JH1416	1
Output Shaft Brg.	214LH	1
Countershaft Front Brg.	1311L	2
Countershaft Rear Brg.	MU1209UGMR	2
Rev. Idler Gear Brg.	WJ162116	2
Input Shaft Seal	97-463-36-1X	1
Output Shaft Seal	714713 (4.000x4.999)	1
Gasket Set	GT193	1

TRK-703		
Position	Part Number	Qty
Input Shaft Front Brg.	114	1
Input Shaft Rear Brg.	MU1215TV	1
Input Shaft Pilot Brg.	JH1812	1
Output Shaft Brg.	214LH	1
Countershaft Front Brg.	MU1311UGMR	2
Countershaft Rear Brg.	MR1309EAL	2
Input Shaft Seal	415281N (3.000x3.751)	1
Output Shaft Seal	415035 (4.000x4.999)	1
Shift Rod Seal	471570 (.875x1.499)	2
Gasket Set	GT158	1

TRK-704		
Position	Part Number	Qty
Input Shaft Brg.	1213L	1
Input Shaft Pilot Brg.	MU5206L	1
Output Shaft Brg.	7211HL	1
Countershaft Front Brg.	2788A-2729	1
Countershaft Rear Brg.	2788A-2729	1
1st Gear Brg.	F208323	1
2nd Gear Brg.	F93290	1
3rd Gear Brg.	F95407	1
4th Gear Brg.	F209348	1
Rev. Gear Brg.	F93290	1
Rev. Idler Gear Brg.	WJ162116	2
Input Shaft Seal	39925 (1.781x2.502)	1
Output Shaft Seal	415322V (2.750x3.543)	1
Shift Fork Clip	101-486-1-1X	3
Gasket Set	312475-47X	1

TRK-705		
Position	Part Number	Qty
Input Shaft Brg.	MR1211GEL	1
Input Shaft Pilot Brg.	MR1205EL	1
Mainshaft Rear Brg.	214LH	1
Output Shaft Front Brg.	MU1207UGV	1
Output Shaft Rear Brg.	214LH	1
Countershaft Front Brg.	1311L	2
Countershaft Rear Brg.	WR61209EX	2
Aux. Countershaft Front Brg.	JLM104948-JLM104910	2
Aux. Countershaft Rear Brg.	JLM506849-JLM506810	2
Rev. Idler Gear Brg.	WJ162116	4
Range Gear Brg.	F81205	1
Input Shaft Seal	412015V (2.125x3.000)	1
Output Shaft Seal	3893V (3.750x4.750)	1
Snap Ring Set	SR705	1
Gasket Set	GT705	1

TRK-706		
Position	Part Number	Qty
Input Shaft Front Brg.	MU1211GUM	1
Input Shaft Pilot Brg.	JH1416	1
Output Shaft Brg.	214LH	1
Countershaft Front Brg.	MU1209UGMR	2
Countershaft Rear Brg.	MU1209UGMR	2
Rev. Idler Gear Brg.	WJ162116	4
Input Shaft Seal	97-463-36-1X	1
Output Shaft Seal	3893V (3.750x4.750)	1
Gasket Set	GT192	1

TRK-707		
Position	Part Number	Qty
Intermediate Shaft Front Brg.	2788-2720	1
Intermediate Shaft Rear Brg.	25877-25821	1
Output Shaft Brg.	23691-23620	2
Rev. Shaft Brg.	26883-26824	2
Shift Rod Seal	471570 (.875x1.499)	4
Output Shaft Seal	472015 (2.125x3.000)	1
Gasket Set	GT226	1

TRK-708		
Position	Part Number	Qty
Intermediate Shaft Front Brg.	MR1308TV	1
Intermediate Shaft Rear Brg.	5306W	1
Output Shaft Brg.	23691-23620	2
Rev. Shaft Brg.	26883-26824	2
Shift Rod Seal	471570 (.875x1.499)	4
Output Shaft Seal	472015 (2.125x3.000)	1
Gasket Set	GT226	1

TRK-709		
Position	Part Number	Qty
Intermediate Shaft Front Brg.	MR1308TV	1
Intermediate Shaft Rear Brg.	5306W	1
Output Shaft Brg.	MR1307EX	2
Rev. Shaft Brg.	MR1307EXW927	2
Shift Rod Seal	471570 (.875x1.499)	4
Output Shaft Seal	472015 (2.125x3.000)	1
Gasket Set	GT226	1

TRK-1000		
Position	Part Number	Qty
Input Shaft Brg.	212SLV	1
Input Shaft Pilot Bushing	BS59	1
Aux. Drive Gear Brg.	117L	1
Aux. Mainshaft Brg.	390A Assy 902A2 (A3071)	1
Countershaft Front Brg.	MSN1211REX	2
Countershaft Rear Brg.	MU1308TVVWS	2
Aux. Countershaft Front Brg.	MR1307EL <sup>18</sup>	2
Aux. Countershaft Rear Brg.	1310L	2
Rev. Idler Gear Brg.	HJ223020-IR1820OH	2
Aux. Range Shaft Quill Front Brg.	204	1
Aux. Range Shaft Quill Rear Bushing	BS60	1
Aux. Output Shaft Seal	415983N (3.750x4.499)	1
Auxiliary Drive Gear Brg Retainer Seal	452554N (1.500x1.983)	1
Input Shaft Nut	CN1 (8997)	1
O-Ring Set	OK1000V	1
Snap Ring Set	SR1000	1
Gasket Set	GT200N	1

TRK-1000AUX		
Position	Part Number	Qty
Aux. Mainshaft Brg.	390A Assy 902A2 (A3071)	1
Aux. Countershaft Front Brg.	MR1307EL <sup>18</sup>	2
Aux. Countershaft Rear Brg.	1310L	2
Aux. Range Shaft Quill Front Brg.	204	1
Aux. Range Shaft Quill Rear Bushing	BS60	1
Aux. Output Shaft Seal	415983N (3.750x4.499)	1
O-Ring Set	OK1000V	1
Snap Ring Set	SR1000	1
Gasket Set	GT200N	1

<sup>18</sup>Models before 1973; use MR5208EL

# Heavy Duty Transmission Rebuild Kits



HD Transmission

TRK-1063		
Position	Part Number	Qty
Input Shaft Brg.	212SLV	1
Input Shaft Pilot Bushing	BS59	1
Aux. Drive Gear Brg.	5566507	1
Aux. Mainshaft Brg.	390A Assy 902A2 (A3071)	1
Countershaft Front Brg.	MSN1211REX	2
Countershaft Rear Brg.	MU1308TVWS	2
Rev. Idler Gear Brg.	HJ223020-IR1820OH	2
Aux. Countershaft Front Brg.	MR1307EL	2
Aux. Countershaft Rear Brg.	1310L	2
Spring	14897	3
Output Shaft Seal Kit	K-2256	1
O-Ring Kit	K-1450	1
Snap Ring	14317	2
Snap Ring	14750	1
Snap Ring	16723	2
Snap Ring	16763	2
Gasket Kit	K-2199	1
Spring	15918	3
Input Shaft Nut	CN1 (8997)	1
Sliding Clutch	16118	1
Collet	83001	4
Connector	84002	2
Connector	85002	1
Sealer	LC54505	1
Input Shaft	S1128	1

TRK-1064		
Position	Part Number	Qty
Input Shaft Brg.	212SLV	1
Input Shaft Pilot Bushing	BS59	1
Aux. Drive Gear Brg.	5566507	1
Aux. Mainshaft Brg.	29675 Assy 902A8 (A2892)	1
Countershaft Front Brg.	MSN1211REX	2
Countershaft Rear Brg.	MU1308TVWS	2
Rev. Idler Gear Brg.	HJ223020-IR1820OH	2
Aux. Countershaft Front Brg.	MR1307EL	2
Aux. Countershaft Rear Brg.	1311L	2
Spring	14897	3
Output Shaft Seal Kit	K-2256	1
O-Ring Kit	K-1450	1
Snap Ring	11364	2
Snap Ring	14317	2
Snap Ring	14750	1
Snap Ring	16763	2
Gasket Kit	K-2199	1
Spring	15918	3
Input Shaft Nut	CN1 (8997)	1
Sliding Clutch	16118	1
Collet	83001	4
Connector	84002	2
Connector	85002	1
Sealer	LC54505	1
Input Shaft	S1128	1

TRK-1079		
Position	Part Number	Qty
Input Shaft Brg.	MU1212RUMW3	1
Aux. Drive Gear Brg.	5566507	1
Aux. Mainshaft Brg.	29675 Assy 902A8 (A2892)	1
Countershaft Front Brg.	BS500192SX	2
Countershaft Rear Brg.	MU1308TVWS	2
Rev. Idler Gear Brg.	HJ223020-IR1820OH	2
Aux. Countershaft Front Brg.	MR1307EL	2
Aux. Countershaft Rear Brg.	5310WL	2
Aux. Range Shaft Quill Front Brg.	204	1
Aux. Range Shaft Quill Rear Bushing	BS60	1
Spring	14897	3
Output Shaft Seal Kit	K-2256	1
O-Ring Kit	K-1447	1
Snap Ring	14291	1
Snap Ring	14317	2
Snap Ring	14750	1
Snap Ring	16723	2
Snap Ring	16763	2
Gasket Kit	K-2199	1
Spring	15918	3
Input Shaft Nut	CN1 (8997)	1
Sliding Clutch	16118	1
Collet	83001	4
Connector	84002	2
Connector	85002	1
Sealer	LC54505	1
Input Shaft	S1228	1

TRK-1554		
Position	Part Number	Qty
Aux. Mainshaft Brg.	29675 Assy 902A8 (A2892)	1
Aux. Countershaft Front Brg.	MU61307GUM	2
Aux. Countershaft Rear Brg.	1310SLV	2
Aux. Range Shaft Quill Front Brg.	204	1
Output Shaft Seal Kit	K-2256	1
O-Ring Set	K-1447	1
O-Ring	OR217V	1
O-Ring	OR221V	1
Snap Ring	14291	1
Snap Ring	16723	2
Key Assembly	A3697	1
Spring	14897	3
Insert Valve	19974	1
Connector	85002	1
Gasket Set	K-1603	1
Threadlocker	TL1	1

TRK-1555		
Position	Part Number	Qty
Aux. Mainshaft Brg.	390A Assy 902A2 (A3071)	1
Aux. Countershaft Front Brg.	MR1307EL <sup>18</sup>	2
Aux. Countershaft Rear Brg.	1310L	2
Aux. Range Shaft Quill Front Brg.	204	1
Output Shaft Seal Kit	K-2256	1
O-Ring Set	K-1447	1
O-Ring	OR217V	1
O-Ring	OR221V	1
Snap Ring	14291	1
Snap Ring	16723	2
Key Assembly	A3697	1
Spring	14897	3
Insert Valve	19974	1
Connector	85002	1
Gasket Set	K-1603	1

TRK-1763		
Position	Part Number	Qty
Input Shaft Brg.	MU1212RUMW3	1
Aux. Drive Gear Brg.	5566507	1
Aux. Mainshaft Brg.	29675 Assy 902A8 (A2892)	1
Aux. Mainshaft Front Brg.	BS500192SX	1
Aux. Mainshaft Rear Brg.	MU1308TVWS	1
Rev. Idler Gear Brg.	HJ223020-IR1820OH	2
Aux. Countershaft Front Brg.	MR1307EL	2
Aux. Countershaft Rear Brg.	5310WLB	2
Aux. Range Shaft Quill Front Brg.	204	1
Aux. Range Shaft Quill Rear Bushing	BS60	1
Spring	14897	3
Output Shaft Seal Kit	K-2256	1
Oil Seal	16977 (2.250x3.189)	1
O-Ring Kit	K-1447	1
O-Ring Kit	OK17453	1
O-Ring	OR217V	1
O-Ring	OR221V	1
Snap Ring	14291	1
Snap Ring	14317	2
Snap Ring	14750	1
Snap Ring	15253	1
Snap Ring	16763	2
Snap Ring	16980	1
Gasket Kit	K-2199	1
Spring	15918	3
Sliding Clutch	16118	1
Collet	83001	4
Connector	85002	1
Input Shaft	S1409	1

TRK-1765		
Position	Part Number	Qty
Input Shaft Brg.	212SLV	1
Output Shaft Brg.	1212L	1
Countershaft Front Brg.	1309L	2
Countershaft Rear Brg.	1309L	2
Aux. Countershaft Brg.	MU1213UMW3	2
Rev. Idler Gear Brg.	WJ162116	4
Output Shaft Seal Kit	K-2256	1
Snap Ring	14289	1
Snap Ring	15253	4
Snap Ring	16798	3
O-Ring	OK20128	1
Gasket Kit	K-1846	1
Spring	15918	4
Sliding Clutch	18747	1
Sealer	LC54505	1
Threadlocker	TL1	1
Input Shaft	S1661	1

TRK-1766		
Position	Part Number	Qty
Input Shaft Brg.	MSN1212REXW619	1
Input Shaft Pilot Brg.	20702	1
Output Shaft Brg.	MSN1212REXW619	1
Countershaft Front Brg.	MSN1309REXW619	1
Countershaft Rear Brg.	MU1309UV	1
1st, 2nd, 3rd & Rev. Gear Brg.	FW808840	4
4th Gear Brg.	FW687430	1
5th Gear Brg.	F206252	1
Rev. Idler Gear Brg.	F11739	2
Detent Shaft	20770	1
Pin	20772	1
Spring	8774	1
Input Shaft Seal	470625V (1.500x2.250)	1
Output Shaft Seal	415004V (2.750x3.751)	1
Shift Rail Seal	472311V (1.000x1.437)	2
O-Ring	OR123	1
Gasket Set	K-1955	1

<sup>18</sup>Models before 1973; use MR5208EL



# Heavy Duty Transmission Rebuild Kits



TRK-1850		
Position	Part Number	Qty
Input Shaft Brg.	MU1209UGMR	1
Input Shaft Pilot Bushing	BS61	1
Aux. Drive Gear Brg.	117L	1
Aux. Mainshaft Front Brg.	MU1307V	1
Aux. Mainshaft Rear Brg.	1212L	1
Countershaft Front Brg.	MU1207UGV	2
Countershaft Rear Brg.	MU1306UGV	2
Rev. Idler Gear Brg.	WJ162116	2
Aux. Countershaft Front Brg.	MR1206RUGV	2
Aux. Countershaft Rear Brg.	MR1308TV	2
Spring	14897	3
Oil Seal	20920 (3.500x4.500)	1
Oil Seal	15095	1
O-Ring	OK15092	1
O-Ring	OK15093	1
Snap Ring	14993	1
Snap Ring	15046	1
Snap Ring	15253	1
Snap Ring	15973	1
Snap Ring	15980	1
Snap Ring	15994	1
Lock Washer	15748	2
Gasket Kit	K-1931	1

TRK-1851		
Position	Part Number	Qty
Input Shaft Brg.	MU1209UGMR	1
Input Shaft Pilot Bushing	BS61	1
Aux. Drive Gear Brg.	117L	1
Aux. Mainshaft Brg.	390A Assy 902A2 (A3071)	1
Countershaft Front Brg.	MU1207UGV	2
Countershaft Rear Brg.	MU1306UGV	2
Rev. Idler Gear Brg.	WJ162116	2
Aux. Countershaft Front Brg.	MU1306UV	2
Aux. Countershaft Rear Brg.	1310L	2
Spring	14897	3
Insert Valve	19974	1
Output Shaft Seal Kit	K-2256	1
O-Ring Kit	K-1447	1
Snap Ring Set	SR146	1
Lock Washer	15748	2
Gasket Kit	K-2110	1

TRK-1852		
Position	Part Number	Qty
Input Shaft Brg.	212SLV	1
Input Shaft Pilot Bushing	BS59	1
Output Shaft Front Brg.	5566507	1
Output Shaft Rear Brg.	213	1
Countershaft Front Brg.	MSN1211REX	2
Countershaft Rear Brg.	MU1308TVWS	2
Rev. Idler Gear Brg.	HJ223020-IR1820OH	2
Input Shaft Nut	14754	1
Oil Seal	20920 (3.500x4.500)	1
Snap Ring Set	SR1852	1
Snap Ring	15011	1
Gasket Kit	K-1782	1

TRK-1858		
Position	Part Number	Qty
Input Shaft Brg.	212SLV	1
Input Shaft Pilot Bushing	BS59	1
Aux. Drive Gear Brg.	5566507	1
Aux. Mainshaft Brg.	390A Assy 902A2 (A3071)	1
Countershaft Front Brg.	MSN1211REX	2
Countershaft Rear Brg.	MU1308TVWS	2
Rev. Idler Gear Brg.	HJ223020-IR1820OH	2
Aux. Countershaft Front Brg.	MR1307EL	2
Aux. Countershaft Rear Brg.	1310L	2
Spring	14897	3
Output Shaft Seal Kit	K-2256	1
O-Ring Kit	K-1450	1
Snap Ring	14317	2
Snap Ring	14750	1
Snap Ring	16723	2
Snap Ring	16763	2
Gasket Kit	K-2199	1

TRK-1859		
Position	Part Number	Qty
Input Shaft Brg.	212SLV	1
Input Shaft Pilot Bushing	BS59	1
Aux. Drive Gear Brg.	117L	1
Aux. Mainshaft Brg.	29675 Assy 902A8 (A2892)	1
Countershaft Front Brg.	MSN1211REX	2
Countershaft Rear Brg.	MU1308TVWS	2
Rev. Idler Gear Brg.	HJ223020-IR1820OH	2
Aux. Countershaft Front Brg.	MR1307EL	2
Aux. Countershaft Rear Brg.	1311L	2
Input Shaft Nut	CN1 (8997)	1
Spring	14897	3
Output Shaft Seal Kit	K-2256	1
O-Ring Kit	K-1450	1
Snap Ring Set	SR188	1
Gasket Kit	K-2199	1

TRK-1860		
Position	Part Number	Qty
Input Shaft Brg.	212SLV	1
Input Shaft Pilot Bushing	BS59	1
Aux. Drive Gear Brg.	117L	1
Aux. Mainshaft Brg.	29675 Assy 902A8 (A2892)	1
Countershaft Front Brg.	MSN1211REX	2
Countershaft Rear Brg.	MU1308TVWS	2
Rev. Idler Gear Brg.	HJ223020-IR1820OH	2
Aux. Countershaft Front Brg.	MR1307EL	2
Aux. Countershaft Rear Brg.	5310WL	2
Aux. Range Shaft Quill Front Brg.	204	1
Aux. Range Shaft Quill Rear Bushing	BS60	1
Spring	14897	3
Output Shaft Seal Kit	K-2256	1
O-Ring Kit	K-1447	1
Snap Ring Set	SR1860	1
Gasket Kit	K-2199	1

TRK-1861		
Position	Part Number	Qty
Input Shaft Brg.	212SLV	1
Input Shaft Pilot Bushing	BS59	1
Aux. Drive Gear Brg.	5566507	1
Aux. Mainshaft Brg.	29675 Assy 902A8 (A2892)	1
Countershaft Front Brg.	MSN1211REX	2
Countershaft Rear Brg.	MU1308TVWS	2
Rev. Idler Gear Brg.	HJ223020-IR1820OH	2
Aux. Countershaft Front Brg.	MR1307EL	2
Aux. Countershaft Rear Brg.	1311L	2
Spring	14897	3
Output Shaft Seal Kit	K-2256	1
O-Ring Kit	K-1450	1
Snap Ring	11364	2
Snap Ring	14317	2
Snap Ring	14750	1
Snap Ring	16763	2
Gasket Kit	K-2199	1

TRK-1862		
Position	Part Number	Qty
Input Shaft Brg.	212SLV	1
Input Shaft Pilot Bushing	BS59	1
Aux. Drive Gear Brg.	5566507	1
Aux. Mainshaft Brg.	29675 Assy 902A8 (A2892)	1
Countershaft Front Brg.	MSN1211REX	2
Countershaft Rear Brg.	MU1308TVWS	2
Rev. Idler Gear Brg.	HJ223020-IR1820OH	2
Aux. Countershaft Front Brg.	MU61307GUM	2
Aux. Countershaft Rear Brg.	1310SLV	2
Aux. Range Shaft Quill Front Brg.	204	1
Aux. Range Shaft Quill Rear Bushing	BS60	1
Spring	14897	3
Insert Valve	19974	1
Output Shaft Seal Kit	K-2256	1
O-Ring Kit	K-1447	1
O-Ring Kit	OK17453	1
Snap Ring Set	SR159	1
Gasket Kit	K-2199	1
Threadlocker	TL1	1

TRK-1863		
Position	Part Number	Qty
Input Shaft Brg.	MU1212RUMW3	1
Input Shaft Pilot Bushing	BS59	1
Aux. Drive Gear Brg.	5566507	1
Aux. Mainshaft Brg.	29675 Assy 902A8 (A2892)	1
Countershaft Front Brg.	BS500192SX	2
Countershaft Rear Brg.	MU1308TVWS	2
Rev. Idler Gear Brg.	HJ223020-IR1820OH	2
Aux. Countershaft Front Brg.	MR1307EL	2
Aux. Countershaft Rear Brg.	5310WL	2
Aux. Range Shaft Quill Front Brg.	204	1
Aux. Range Shaft Quill Rear Bushing	BS60	1
Spring	14897	3
Output Shaft Seal Kit	K-2256	1
O-Ring Kit	K-1447	1
Snap Ring	14291	1
Snap Ring	14317	2
Snap Ring	14750	1
Snap Ring	16723	2
Snap Ring	16763	2
Gasket Kit	K-2199	1

• Not Packed In Kit

HD Transmission



# Heavy Duty Transmission Rebuild Kits



HD Transmission

TRK-1866		
Position	Part Number	Qty
Input Shaft Brg.	212SLV	1
Input Shaft Pilot Bushing	BS59 •	1
Aux. Drive Gear Brg.	5566507	1
Aux. Mainshaft Brg.	29675 Assy 902A8 (A2892)	1
Countershaft Front Brg.	1309L	2
Countershaft Rear Brg.	MU1308TVWS	2
Rev. Idler Gear Brg.	HJ223020-IR1820OH	2
Aux. Countershaft Front Brg.	MR1307EL	2
Aux. Countershaft Rear Brg.	1311L	2
Spring	14897	3
Output Shaft Seal Kit	K-2256	1
O-Ring Kit	K-1450	1
O-Ring Kit	OK17453	1
Snap Ring	11364	2
Snap Ring	14289	1
Snap Ring	14317	2
Snap Ring	15253	2
Snap Ring	16763	2
Snap Ring	20085	2
Gasket Kit	K-2199	1

TRK-1867		
Position	Part Number	Qty
Input Shaft Brg.	212SLV	1
Input Shaft Pilot Bushing	BS59 •	1
Aux. Drive Gear Brg.	5566507	1
Aux. Mainshaft Brg.	29675 Assy 902A8 (A2892)	1
Countershaft Front Brg.	1309L	2
Countershaft Rear Brg.	MU1308TVWS	2
Rev. Idler Gear Brg.	HJ223020-IR1820OH	2
Aux. Countershaft Front Brg.	MR1307EL	2
Aux. Countershaft Rear Brg.	5310WLB	2
Aux. Range Shaft Quill Front Brg.	204	1
Aux. Range Shaft Quill Rear Bushing	BS60	1
Spring	14897	3
Output Shaft Seal Kit	K-2256	1
O-Ring Kit	K-1447	1
O-Ring Kit	OK17453	1
O-Ring	OR217V	1
O-Ring	OR221V	1
Snap Ring	14289	1
Snap Ring	14291	1
Snap Ring	14317	2
Snap Ring	15253	4
Snap Ring	16763	2
Snap Ring	20085	2
Gasket Kit	K-2199	1

TRK-1870		
Position	Part Number	Qty
Input Shaft Brg.	212SLV	1
Input Shaft Pilot Bushing	BS59	1
Aux. Drive Gear Brg.	5566507	1
Aux. Mainshaft Brg.	29675 Assy 902A8 (A2892)	1
Countershaft Front Brg.	BS500192SX	2
Countershaft Rear Brg.	MU1308TVWS	2
Rev. Idler Gear Brg.	HJ223020-IR1820OH	2
Aux. Countershaft Front Brg.	MR1307EL	2
Aux. Countershaft Rear Brg.	1311L	2
Spring	14897	3
Output Shaft Seal Kit	K-2256	1
O-Ring Kit	K-1450	1
O-Ring Kit	OK17453	1
Snap Ring	11364	2
Snap Ring	14317	2
Snap Ring	14750	1
Snap Ring	16763	2
Gasket Kit	K-2199	1

TRK-1871		
Position	Part Number	Qty
Input Shaft Brg.	212SLV	1
Input Shaft Pilot Bushing	BS59	1
Aux. Drive Gear Brg.	5566507	1
Aux. Mainshaft Brg.	29675 Assy 902A8 (A2892)	1
Countershaft Front Brg.	BS500192SX	2
Countershaft Rear Brg.	MU1308TVWS	2
Rev. Idler Gear Brg.	HJ223020-IR1820OH	2
Aux. Countershaft Front Brg.	MU61307GUM	2
Aux. Countershaft Rear Brg.	1310SLV	2
Aux. Range Shaft Quill Front Brg.	204	1
Aux. Range Shaft Quill Rear Bushing	BS60	1
Spring	14897	3
Insert Valve	19974	1
Output Shaft Seal Kit	K-2256	1
O-Ring Kit	K-1447	1
O-Ring Kit	OK17453	1
O-Ring	OR217V	1
O-Ring	OR221V	1
Snap Ring	14291	1
Snap Ring	14317	2
Snap Ring	14750	1
Snap Ring	16723	2
Snap Ring	16763	2
Gasket Kit	K-2199	1
Threadlocker	TL1	1

TRK-1872		
Position	Part Number	Qty
Input Shaft Brg.	MU1212RUMW3	1
Aux. Drive Gear Brg.	5566507	1
Aux. Mainshaft Brg.	29675 Assy 902A8 (A2892)	1
Countershaft Front Brg.	BS500192SX	2
Countershaft Rear Brg.	MU1308TVWS	2
Rev. Idler Gear Brg.	HJ223020-IR1820OH	2
Aux. Countershaft Front Brg.	MR1307EL	2
Aux. Countershaft Rear Brg.	5310WLB	2
Aux. Range Shaft Quill Front Brg.	204	1
Aux. Range Shaft Quill Rear Bushing	BS60	1
Spring	14897	3
Insert Valve	19974	1
Output Shaft Seal Kit	K-2256	1
O-Ring Kit	K-1447	1
O-Ring Kit	OK17453	1
O-Ring	OR217V	1
O-Ring	OR221V	1
Snap Ring	14291	1
Snap Ring	14317	2
Snap Ring	14750	1
Snap Ring	16723	2
Snap Ring	16763	2
Gasket Kit	K-2199	1
Threadlocker	TL1	1

TRK-1873		
Position	Part Number	Qty
Input Shaft Brg.	212SLV	1
Input Shaft Pilot Bushing	BS59	1
Output Shaft Front Brg.	5566507	1
Output Shaft Rear Brg.	213	1
Countershaft Front Brg.	1309L	2
Countershaft Rear Brg.	MU1308TVWS	2
Rev. Idler Gear Brg.	HJ223020-IR1820OH	2
Oil Seal	20920 (3.500x4.500)	1
Snap Ring	14289	1
Snap Ring	15253	2
Snap Ring	16763	1
Snap Ring	20085	2
Input Shaft Nut	14754	1
Gasket Kit	K-1782	1

# Heavy Duty Transmission Rebuild Kits



TRK-1874		
Position	Part Number	Qty
Input Shaft Brg.	212SLV	1
Input Shaft Pilot Bushing	BS59	1
Aux. Drive Gear Brg.	5566507	1
Aux. Mainshaft Brg.	29675 Assy 902A8 (A2892)	1
Countershaft Front Brg.	BS500192SX	2
Countershaft Rear Brg.	MU1308TVWS	2
Rev. Idler Gear Brg.	HJ223020-IR1820OH	2
Aux. Countershaft Front Brg.	MU61307GUM	2
Aux. Countershaft Rear Brg.	1310SLV	2
Aux. Range Shaft Quill Front Brg.	204	1
Aux. Range Shaft Quill Rear Bushing	BS60	1
Spring	14897	3
Insert Valve	19974	1
Output Shaft Seal Kit	K-2256	1
Oil Seal	16977 (2.250x3.189)	1
O-Ring Kit	K-1447	1
O-Ring Kit	OK17453	1
O-Ring	OR217V	1
O-Ring	OR221V	1
Snap Ring	14291	1
Snap Ring	14317	2
Snap Ring	14750	1
Snap Ring	16723	1
Snap Ring	16763	2
Snap Ring	16980	1
Gasket Kit	K-2199	1
Threadlocker	TL1	1

TRK-1875		
Position	Part Number	Qty
Input Shaft Brg.	MU1212RUMW3	1
Input Shaft Pilot Bushing	BS59	1
Aux. Drive Gear Brg.	5566507	1
Aux. Mainshaft Brg.	29675 Assy 902A8 (A2892)	1
Aux. Mainshaft Front Brg.	BS500192SX	1
Aux. Mainshaft Rear Brg.	MU1308TVWS	1
Rev. Idler Gear Brg.	HJ223020-IR1820OH	2
Aux. Countershaft Front Brg.	MR1307EL	2
Aux. Countershaft Rear Brg.	5310WLB	2
Aux. Range Shaft Quill Front Brg.	204	1
Aux. Range Shaft Quill Rear Bushing	BS60	1
Spring	14897	3
Output Shaft Seal Kit	K-2256	1
Oil Seal	16977 (2.250x3.189)	1
O-Ring Kit	K-1447	1
O-Ring Kit	OK17453	1
O-Ring	OR217V	1
O-Ring	OR221V	1
Snap Ring	14291	1
Snap Ring	14317	2
Snap Ring	14750	1
Snap Ring	15253	1
Snap Ring	16763	2
Snap Ring	16980	1
Gasket Kit	K-2199	1

TRK-1876		
Position	Part Number	Qty
Input Shaft Brg.	MU1210RUMW772	1
Input Shaft Pilot Bushing	BS61	1
Aux. Drive Gear Brg.	117L	1
Aux. Mainshaft Front Brg.	MU1307V	1
Aux. Mainshaft Rear Brg.	212SLV	1
Rev. Idler Gear Brg.	WJ162116	2
Countershaft Front Brg.	MU1307GUM	2
Countershaft Rear Brg.	MU1307GUM	2
Aux. Countershaft Front Brg.	MR1306RUGVW140	2
Aux. Countershaft Rear Brg.	MU1308UM	2
Spring	14897	3
Oil Seal	15095	1
Oil Seal	20920 (3.500x4.500)	1
Oil Seal	415991N (3.500x4.501)	1
O-Ring Kit	OK15092	1
O-Ring Kit	OK15093	1
Snap Ring	14993	1
Snap Ring	15973	1
Snap Ring	15994	1
Snap Ring	16723	1
Gasket Kit	K-1931	1
Lock Screw Kit	K-2425	1

TRK-1877		
Position	Part Number	Qty
Input Shaft Brg.	212SLV	1
Input Shaft Pilot Bushing	BS59	1
Output Shaft Brg.	1212L	1
Countershaft Front Brg.	1309L	2
Countershaft Rear Brg.	1309L	2
Aux. Countershaft Brg.	MU1213UMW3	2
Rev. Idler Gear Brg.	WJ162116	4
Output Shaft Seal Kit	K-2256	1
Snap Ring	14289	1
Snap Ring	15253	4
Snap Ring	16798	3
O-Ring	OK20128	1
Gasket Kit	K-1846	1

TRK-1971		
Position	Part Number	Qty
Input Shaft Brg.	212SLV	1
Aux. Drive Gear Brg.	5566507	1
Aux. Mainshaft Brg.	29675 Assy 902A8 (A2892)	1
Countershaft Front Brg.	BS500192SX	2
Countershaft Rear Brg.	MU1308TVWS	2
Rev. Idler Gear Brg.	HJ223020-IR1820OH	2
Aux. Countershaft Front Brg.	MR1307EL	2
Aux. Countershaft Rear Brg.	1311L	2
Spring	14897	3
Output Shaft Seal Kit	K-2256	1
O-Ring Kit	K-1450	1
O-Ring Kit	OK17453	1
Snap Ring	11364	2
Snap Ring	14317	2
Snap Ring	14750	1
Snap Ring	16763	2
Gasket Kit	K-2199	1
Spring	15918	3
Front Brg. Cover	20550	1
Sliding Clutch	4306648	1
Collet	83001	4
Connector	84002	2
Connector	85002	1
Sealer	LC54505	1
Input Shaft	S1659	1

TRK-1972		
Position	Part Number	Qty
Input Shaft Brg.	212SLV	1
Aux. Drive Gear Brg.	5566507	1
Aux. Mainshaft Brg.	29675 Assy 902A8 (A2892)	1
Countershaft Front Brg.	BS500192SX	2
Countershaft Rear Brg.	MU1308TVWS	2
Rev. Idler Gear Brg.	HJ223020-IR1820OH	2
Aux. Countershaft Front Brg.	MU61307GUM	2
Aux. Countershaft Rear Brg.	1310SLV	2
Aux. Range Shaft Quill Front Brg.	204	1
Aux. Range Shaft Quill Rear Bushing	BS60	1
Spring	14897	3
Insert Valve	19974	1
Output Shaft Seal Kit	K-2256	1
O-Ring Kit	K-1447	1
O-Ring Kit	OK17453	1
O-Ring	OR217V	1
O-Ring	OR221V	1
Snap Ring	14291	1
Snap Ring	14317	2
Snap Ring	14750	1
Snap Ring	16723	2
Snap Ring	16763	2
Gasket Kit	K-2199	1
Threadlocker	TL1	1
Spring	15918	3
Snap Ring	16980	1
Front Brg. Cover	20550	1
Sliding Clutch	4306648	1
Collet	83001	4
Connector	84002	2
Connector	85002	1
Sealer	LC54505	1
Input Shaft	S1659	1

TRK-1979		
Position	Part Number	Qty
Input Shaft Brg.	MU1212RUMW3	1
Aux. Drive Gear Brg.	5566507	1
Aux. Mainshaft Brg.	29675 Assy 902A8 (A2892)	1
Countershaft Front Brg.	BS500192SX	2
Countershaft Rear Brg.	MU1308TVWS	2
Rev. Idler Gear Brg.	HJ223020-IR1820OH	2
Aux. Countershaft Front Brg.	MR1307EL	2
Aux. Countershaft Rear Brg.	5310WLB	2
Aux. Range Shaft Quill Front Brg.	204	1
Spring	14897	3
Insert Valve	19974	1
Output Shaft Seal Kit	K-2256	1
O-Ring Kit	K-1447	1
O-Ring Kit	OK17453	1
O-Ring	OR217V	1
O-Ring	OR221V	1
Snap Ring	14291	1
Snap Ring	14317	2
Snap Ring	14750	1
Snap Ring	16723	2
Snap Ring	16763	2
Gasket Kit	K-2199	1
Threadlocker	TL1	1
Spring	15918	3
Sliding Clutch	16118	1
Snap Ring	16980	1
Collet	83001	4
Connector	84002	2
Connector	85002	1
Sealer	LC54505	1
Input Shaft	S1659	1

HD Transmission

# Heavy Duty Transmission Rebuild Kits



HD Transmission

TRK-1980		
Position	Part Number	Qty
Input Shaft Brg.	212SLV	1
Input Shaft Pilot Bushing	BS59	1
Aux. Drive Gear Brg.	5566507	1
Aux. Mainshaft Brg.	29675 Assy 902A8 (A2892)	1
Countershaft Front Brg.	1309L	2
Countershaft Rear Brg.	MU1308TVWS	2
Rev. Idler Gear Brg.	HJ223020-IR1820OH	2
Aux. Countershaft Front Brg.	MR1307EL	2
Aux. Countershaft Rear Brg.	1311L	2
Spring	14897	3
Output Shaft Seal Kit	K-2256	1
O-Ring Kit	K-1450	1
O-Ring Kit	OK17453	1
Snap Ring	11364	2
Snap Ring	14289	1
Snap Ring	14317	2
Snap Ring	15253	2
Snap Ring	16763	2
Snap Ring	16980	1
Snap Ring	20085	2
Gasket Kit	K-2199	1
Spring	15918	3
Front Brg. Cover	20550	1
Sliding Clutch	14654	1
Collet	83001	4
Connector	84002	1
Connector	85002	1
Input Shaft	S1661	1

TRK-1981		
Position	Part Number	Qty
Input Shaft Brg.	212SLV	1
Input Shaft Pilot Bushing	BS59	1
Aux. Drive Gear Brg.	5566507	1
Aux. Mainshaft Brg.	29675 Assy 902A8 (A2892)	1
Countershaft Front Brg.	1309L	2
Countershaft Rear Brg.	MU1308TVWS	2
Rev. Idler Gear Brg.	HJ223020-IR1820OH	2
Aux. Countershaft Front Brg.	MR1307EL	2
Aux. Countershaft Rear Brg.	5310WLB	2
Aux. Range Shaft Quill Front Brg.	204	1
Aux. Range Shaft Quill Rear Bushing	BS60	1
Spring	14897	3
Output Shaft Seal Kit	K-2256	1
O-Ring Kit	K-1447	1
O-Ring Kit	OK17453	1
O-Ring	OR217V	1
O-Ring	OR221V	1
Snap Ring	14289	1
Snap Ring	14291	1
Snap Ring	14317	2
Snap Ring	15253	4
Snap Ring	16763	2
Snap Ring	16980	1
Snap Ring	20085	2
Gasket Kit	K-2199	1
Spring	15918	3
Front Brg. Cover	20550	1
Sliding Clutch	14654	1
Collet	83001	4
Connector	84002	1
Connector	85002	1
Input Shaft	S1661	1

TRK-1982		
Position	Part Number	Qty
Input Shaft Brg.	212SLV	1
Output Shaft Brg.	214LB	1
Countershaft Front Brg.	1309L	2
Countershaft Rear Brg.	1309L	2
Aux. Countershaft Brg.	MU1213UMW3	2
Rev. Idler Gear Brg.	WJ162116	4
Output Shaft Seal Kit	K-2262	1
Snap Ring	14289	1
Snap Ring	15253	4
Snap Ring	16798	3
Snap Ring	16980	1
O-Ring	OK20128	2
Gasket Kit	K-1846	1
Sliding Clutch	18747	1
Front Brg. Cover	20550	1
Sealer	LC54505	1
Input Shaft	S1661	1

TRK-1984		
Position	Part Number	Qty
Input Shaft Brg.	212SLV	1
Output Shaft Front Brg.	5566507	1
Output Shaft Rear Brg.	213	1
Countershaft Front Brg.	1309L	2
Countershaft Rear Brg.	MU1308TVWS	2
Rev. Idler Gear Brg.	HJ223020-IR1820OH	2
Oil Seal	20920 (3.500x4.500)	1
Snap Ring	14289	1
Snap Ring	15253	2
Snap Ring	16763	1
Snap Ring	16980	1
Snap Ring	20085	2
Input Shaft Nut	14754	1
Gasket Kit	K-1782	1
Sliding Clutch	14654	1
Nut	14754	1
Front Brg. Cover	20550	1
Input Shaft	S1661	1

TRK-1986		
Position	Part Number	Qty
Input Shaft Brg.	212SLV	1
Aux. Drive Gear Brg.	5566507	1
Aux. Mainshaft Bushing	AA1512-12	2
Aux. Mainshaft Brg.	21356	1
Countershaft Front Brg.	1309L	2
Countershaft Rear Brg.	MU1308TVWS	2
Rev. Idler Gear Brg.	HJ223020-IR1820OH	2
Aux. Countershaft Front Brg.	4302074	2
Aux. Countershaft Rear Brg.	4302074	2
Snap Ring Retainer	21320	1
Spring	14897	3
Insert Valve	19974	1
Output Shaft Seal Kit	K-2262	1
O-Ring Kit	K-2054	1
Snap Ring	14289	1
Snap Ring	14317	2
Snap Ring	15253	2
Snap Ring	16763	2
Snap Ring	20085	2
Shim Kit	K-2805	1
Gasket Kit	K-2061	1
Sliding Clutch	14654	1
Spring	15918	3
Snap Ring	16980	1
Collet	83002	4
Connector	84004	1
Connector	85001	1
Sealer	LC54505	1
Input Shaft	S1661	1

TRK-1991		
Position	Part Number	Qty
Input Shaft Brg.	MU1212RUMW3	1
Aux. Drive Gear Brg.	5566507	1
Aux. Mainshaft Bushing	AA1512-12	2
Aux. Mainshaft Brg.	21356	1
Countershaft Front Brg.	BS500192SX	2
Countershaft Rear Brg.	MU1308TVWS	2
Rev. Idler Gear Brg.	HJ223020-IR1820OH	2
Aux. Countershaft Front Brg.	4302074	2
Aux. Countershaft Rear Brg.	4302074	2
Spring	14897	3
Insert Valve	19974	1
Output Shaft Seal Kit	K-2262	1
O-Ring Kit	K-2054	1
Snap Ring	14317	2
Snap Ring	14750	1
Snap Ring	16763	2
Shim Kit	K-2805	1
Gasket Kit	K-2061	1
Spring	15918	3
Sliding Clutch	16118	1
Snap Ring	16980	1
Collet	83002	4
Connector	84004	2
Connector	85001	1
Sealer	LC54505	1
Input Shaft	S1659	1

TRK-1992		
Position	Part Number	Qty
Input Shaft Brg.	MU1212RUMW3	1
Aux. Drive Gear Brg.	5566507	1
Aux. Mainshaft Bushing	AA1512-12	2
Aux. Mainshaft Brg.	21356	1
Countershaft Front Brg.	BS500192SX	2
Countershaft Rear Brg.	MU1308TVWS	2
Rev. Idler Gear Brg.	HJ223020-IR1820OH	2
Aux. Countershaft Front Brg.	4302074	2
Aux. Countershaft Rear Brg.	4302074	2
Spring	14897	3
Insert Valve	19974	1
Output Shaft Seal Kit	K-2262	1
O-Ring Kit	K-2054	1
Snap Ring	14317	2
Snap Ring	14750	1
Snap Ring	16763	2
Shim Kit	K-2805	1
Gasket Kit	K-2061	1
Spring	15918	3
Snap Ring	16980	1
Sliding Clutch	4304317	1
Collet	83002	4
Connector	84004	2
Connector	85001	1
Sealer	LC54505	1
Input Shaft	S1659	1

TRK-1993		
Position	Part Number	Qty
Aux. Mainshaft Brg.	29675 Assy 902A8 (A2892)	1
Aux. Countershaft Front Brg.	MU61307GUM	2
Aux. Countershaft Rear Brg.	1310SLV	2
Insert Valve	19974	1
Connector	85001	1
Spring	14897	3
Gasket Kit	K-1603	1
Output Shaft Seal Kit	K-2262	1
O-Ring Kit	K-2002	1

# Heavy Duty Transmission Rebuild Kits



TRK-1995		
Position	Part Number	Qty
Input Shaft Brg.	MU1210RUMW772	1
Aux. Drive Gear Brg.	117L	1
Aux. Mainshaft Brg.	390A Assy 902A2 (A3071)	1
Countershaft Front Brg.	MU1307GUM	2
Countershaft Rear Brg.	MU1307GUM	2
Rev. Idler Gear Brg.	WJ162116	2
Aux. Countershaft Front Brg.	MR1306UVW745	2
Aux. Countershaft Rear Brg.	1310L	2
Range Shaft Quill Front Brg.	204	1
Range Shaft Quill Rear Bushing	BS60	1
Spring	14897	3
Insert Valve	19974	1
Output Shaft Seal Kit	K-2256	1
O-Ring Kit	K-2002	1
Snap Ring	14291	1
Snap Ring	14993	1
Snap Ring	15973	1
Snap Ring	15980	1
Snap Ring	16723	2
Lock Screw Kit	K-2425	1
Gasket Kit	K-2110	1
Spring	1064	3
Snap Ring	15980	1
Sliding Clutch	21662	1
Input Shaft	A5022	1
Sealer	LC54505	1

TRK-1996		
Position	Part Number	Qty
Input Shaft Brg.	212SLV	1
Aux. Drive Gear Brg.	5566507	1
Aux. Mainshaft Brg.	21356	1
Countershaft Front Brg.	BS500192SX	2
Countershaft Rear Brg.	MU1308TVWS	2
Rev. Idler Gear Brg.	HJ223020-IR1820OH	2
Aux. Countershaft Front Brg.	4302074	2
Aux. Countershaft Rear Brg.	4302074	2
Spring	14897	3
Output Shaft Seal Kit	K-2262	1
O-Ring Kit	K-1450	1
Snap Ring	14317	2
Snap Ring	14750	1
Snap Ring	16763	2
Snap Ring	16980	1
Gasket Kit	K-2061	1
Spring	15918	3
Sliding Clutch	4306648	1
Collet	83001	4
Connector	84002	1
Connector	85002	1
Input Shaft	S1659	1

TRK-1999		
Position	Part Number	Qty
Input Shaft Brg.	212SLV	1
Aux. Drive Gear Brg.	5566507	1
Aux. Mainshaft Brg.	21356	1
Countershaft Front Brg.	BS500192SX	2
Countershaft Rear Brg.	MU1308TVWS	2
Rev. Idler Gear Brg.	HJ223020-IR1820OH	2
Aux. Countershaft Front Brg.	4302074	2
Aux. Countershaft Rear Brg.	4302074	2
Spring	14897	3
Output Shaft Seal Kit	K-2262	1
O-Ring Kit	K-1450	1
Snap Ring	14317	2
Snap Ring	14750	1
Snap Ring	16763	2
Snap Ring	16980	1
Shim Kit	K-2805	1
Gasket Kit	K-2061	1
Spring	15918	3
Sliding Clutch	4306647	1
Collet	83001	4
Connector	84002	1
Connector	85002	1
Sealer	LC54505	1
Input Shaft	S1659	1

TRK-2041		
Position	Part Number	Qty
Input Shaft Brg.	39590-39520	1
Mainshaft Pilot Brg.	31594	1
Output Shaft Brg.	45284-45220	1
Countershaft Front Brg.	25590-25522	1
Countershaft Rear Brg.	3782-3720	1
1st, 2nd & Rev. Gear Brg.	FW707620	6
3rd Gear Brg.	FW657020	2
4th Gear Brg.	FW556020	2
5th Gear Brg.	FW505520	2
Rev. Idler Gear Brg.	FW404820	2
Countershaft Plug	3315679	1
Spring	3315765	4
Snap Ring	3313798	1
Snap Ring	3315686	1
Snap Ring	3315725	1
Input Shaft Seal	710211 (1.875x2.677)	1
Output Shaft Seal	4300119	1
Shim Kit	K-2183	1
Gasket Set	K-2181	1

TRK-2043		
Position	Part Number	Qty
Input Shaft Brg.	MU1212RUMW3	1
Input Shaft Pilot Bushing	BS59	1
Aux. Drive Gear Brg.	5566507	1
Aux. Mainshaft Bushing	AA1512-12	2
Aux. Mainshaft Brg.	21356	1
Countershaft Front Brg.	BS500192SX	2
Countershaft Rear Brg.	MU1308TVWS	2
Rev. Idler Gear Brg.	HJ223020-IR1820OH	2
Aux. Countershaft Front Brg.	4302074	2
Aux. Countershaft Rear Brg.	4302074	2
Spring	14897	3
Insert Valve	19974	1
Output Shaft Seal Kit	K-2262	1
O-Ring Kit	K-2054	1
Snap Ring	14317	2
Snap Ring	14750	1
Snap Ring	16763	2
Shim Kit	K-2805	1
Gasket Kit	K-2061	1

TRK-2045		
Position	Part Number	Qty
Input Shaft Brg.	212SLV	1
Input Shaft Pilot Bushing	BS59	1
Aux. Drive Gear Brg.	5566507	1
Aux. Mainshaft Bushing	AA1512-12	2
Aux. Mainshaft Brg.	21356	1
Countershaft Front Brg.	1309L	2
Countershaft Rear Brg.	MU1308TVWS	2
Rev. Idler Gear Brg.	HJ223020-IR1820OH	2
Aux. Countershaft Front Brg.	4302074	2
Aux. Countershaft Rear Brg.	4302074	2
Snap Ring Retainer	21320	1
Spring	14897	3
Insert Valve	19974	1
Output Shaft Seal Kit	K-2262	1
O-Ring Kit	K-2054	1
Snap Ring	14289	1
Snap Ring	14317	2
Snap Ring	15253	2
Snap Ring	16763	2
Snap Ring	20085	2
Shim Kit	K-2805	1
Gasket Kit	K-2061	1

TRK-2047		
Position	Part Number	Qty
Input Shaft Brg.	MU1210RUMW772	1
Input Shaft Pilot Bushing	BS61	1
Aux. Drive Gear Brg.	117L	1
Aux. Mainshaft Brg.	390A Assy 902A2 (A3071)	1
Countershaft Front Brg.	MU1307GUM	2
Countershaft Rear Brg.	MU1307GUM	2
Rev. Idler Gear Brg.	WJ162116	2
Aux. Countershaft Front Brg.	MR1306UVW745	2
Aux. Countershaft Rear Brg.	1310L	2
Range Shaft Quill Front Brg.	204	1
Range Shaft Quill Rear Bushing	BS60	1
Spring	14897	3
Insert Valve	19974	1
Output Shaft Seal Kit	K-2256	1
O-Ring Kit	K-2002	1
Snap Ring	14291	1
Snap Ring	14993	1
Snap Ring	15973	1
Snap Ring	15980	1
Snap Ring	16723	2
Lock Screw Kit	K-2425	1
Gasket Kit	K-2110	1

HD Transmission

# Heavy Duty Transmission Rebuild Kits



HD Transmission

TRK-2048		
Position	Part Number	Qty
Input Shaft Brg.	MU1209UGMR	1
Input Shaft Pilot Bushing	BS61	1
Mainshaft Rear Brg.	117L	1
Aux. Mainshaft Pilot Brg.	MU1307V	1
Aux. Mainshaft Rear Brg	MU1212RUMW3	1
Countershaft Front Brg.	MU1306UGV	2
Countershaft Rear Brg.	MU1306UGV	2
Rev. Idler Gear Brg.	WJ162116	2
Aux. Countershaft Front Brg.	MR1206RUGV	2
Aux. Countershaft Rear Brg.	MR1308TV	2
Spring	14897	3
Oil Seal	20920 (3.500x4.500)	1
Oil Seal	15095	1
O-Ring	OK15092	1
O-Ring	OK15093	1
O-Ring	OR016V	1
Snap Ring	14993	1
Snap Ring	15253	1
Snap Ring	15973	1
Snap Ring	15980	1
Snap Ring	15994	1
Lock Washer	15748	2
Silicone Lubricant	SL1	1
Gasket Kit	K-1931	1

TRK-2049		
Position	Part Number	Qty
Input Shaft Brg.	212SLV	1
Input Shaft Pilot Bushing	BS59	1
Aux. Drive Gear Brg.	5566507	1
Aux. Mainshaft Brg.	21355	1
Countershaft Front Brg.	BS500192SX	2
Countershaft Rear Brg.	MU1308TVWS	2
Rev. Idler Gear Brg.	HJ223020-IR1820OH	2
Aux. Countershaft Front Brg.	4302074	2
Aux. Countershaft Rear Brg.	4302074	2
Spring	14897	3
Output Shaft Seal Kit	K-2262	1
O-Ring Kit	K-1450	1
Snap Ring	14317	2
Snap Ring	14750	1
Snap Ring	16763	2
Snap Ring	16980	1
Gasket Kit	K-2061	1

TRK-2120		
Position	Part Number	Qty
Input Shaft Brg.	M802048-M802011	1
Input Shaft Pilot Brg.	QBR49845	1
Output Shaft Brg.	25581-25520	1
Countershaft Front Brg.	25877-25821	1
Countershaft Rear Brg.	2689-2631	1
Rev. Idler Gear Brg.	QA48181A	1
Mainshaft 1st & 2nd Gear Brg.	F94490	2
Mainshaft 3rd & Rev. Gear Brg.	F84003	2
Mainshaft 4th Gear Brg.	F94488	1
4th & 5th Shift Hub Brg.	FA35688	1
4th & 5th Shift Hub Race	TR235383	1
Input Shaft Seal	473010N (1.625x2.502)	1
Output Shaft Seal	471271 (2.500x3.251)	1
Output Shaft Seal	712512 (2.250x3.252)	1
Threadlocker	TL1	1
Gasket Set	K-2143	1

TRK-2121		
Position	Part Number	Qty
Input Shaft Brg.	M802048-M802011	1
Input Shaft Pilot Brg.	QBR49845	1
Output Shaft Brg.	28580A-28527RB	1
Countershaft Front & Rear Brg.	25590-25520	2
4th & 5th Shift Hub Brg.	FA35688	1
4th & 5th Shift Hub Race	TR235383	1
Mainshaft 1st Gear Brg.	QA48181A	2
Mainshaft 2nd, 3rd & Rev. Gear Brg.	F94490	3
Mainshaft 4th Gear Brg.	F94488	1
Rev. Idler Gear Brg.	QA47838	1
Input Shaft Seal	473010N (1.625x2.502)	1
Output Shaft Seal	4300119	1
Output Shaft Seal	485364N (2.750x3.500)	1
Snap Ring	226331	1
Threadlocker	TL1	1
Gasket Set	K-2085	1

TRK-2122		
Position	Part Number	Qty
Input Shaft Brg.	M802048-M802011	1
Input Shaft Pilot Brg.	QBR49845	1
Output Shaft Brg.	25584-25547RB	1
Countershaft Front & Rear Brg.	25590-25520	2
4th & 5th Shift Hub Brg.	FA35688	1
4th & 5th Shift Hub Race	TR235383	1
Mainshaft 1st Gear Brg.	QA48181A	2
Mainshaft 2nd, 3rd & Rev. Gear Brg.	F94490	3
Mainshaft 4th Gear Brg.	F94488	1
Rev. Idler Gear Brg.	QA47838	1
Input Shaft Seal	473010N (1.625x2.502)	1
Output Shaft Seal	712512 (2.250x3.252)	1
Snap Ring	226331	1
Threadlocker	TL1	1
Gasket Set	K-2085	1

TRK-2123		
Position	Part Number	Qty
Input Shaft Brg.	M804049-M804010	1
Input Shaft Pilot Brg.	QBR49845	1
Output Shaft Brg.	28580A-28527RB	1
Countershaft Front & Rear Brg.	25590-25520	2
4th & 5th Shift Hub Brg.	FA35688	1
4th & 5th Shift Hub Race	TR235383	1
Mainshaft 1st Gear Brg.	QA48181A	2
Mainshaft 2nd, 3rd & Rev. Gear Brg.	F94490	3
Mainshaft 4th Gear Brg.	F94488	1
Rev. Idler Gear Brg.	QA47838	1
Snap Ring	226331	1
Input Shaft Seal	4300204 (1.875x2.502)	1
Input Shaft Seal	710211 (1.875x2.677)	1
Output Shaft Seal	411143N (2.625x3.251)	1
Output Shaft Seal	485364N (2.750x3.500)	1
Output Shaft Seal	4300119	1
Snap Ring	226331	1
Threadlocker	TL1	1
Gasket Set	K-2085	1

TRK-2124		
Position	Part Number	Qty
Input Shaft Brg.	M802048-M802011	1
Input Shaft Pilot Brg.	QBR49845	1
Output Shaft Brg.	28580A-28527RB	1
Countershaft Front Brg.	DD46386	1
Countershaft Rear Brg.	MU1309UGM	1
Rev. Idler Gear Brg.	QA47838	1
Mainshaft Gear Brg.	QA48181A	2
4th & 5th Shift Hub Brg.	FA35688	1
4th & 5th Shift Hub Race	TR235383	1
Mainshaft 2nd, 3rd & Rev. Gear Brg.	F94490	3
Mainshaft 4th Gear Brg.	F94488	1
Input Shaft Seal	473010N (1.625x2.502)	1
Output Shaft Seal	411143N (2.625x3.251)	1
Output Shaft Seal	416664 (2.750x3.500)	1
Output Shaft Seal	471271 (2.500x3.251)	1
Output Shaft Seal	475322N (2.750x3.543)	1
Threadlocker	TL1	1
Gasket Set	K-2085	1

TRK-2125		
Position	Part Number	Qty
Input Shaft Brg.	M804049-M804010	1
Input Shaft Pilot Brg.	QBR49845	1
Output Shaft Brg.	28580A-28527RB	1
Countershaft Front Brg.	DD46386	1
Countershaft Rear Brg.	MU1309UGM	1
Rev. Idler Gear Brg.	QA47838	1
Mainshaft Gear Brg.	QA48181A	2
4th & 5th Shift Hub Brg.	FA35688	1
4th & 5th Shift Hub Race	TR235383	1
Mainshaft 2nd, 3rd & Rev. Gear Brg.	F94490	3
Mainshaft 4th Gear Brg.	F94488	1
Input Shaft Seal	482041N (1.875x2.502)	1
Output Shaft Seal	411143N (2.625x3.251)	1
Output Shaft Seal	4300119	1
Threadlocker	TL1	1
Gasket Set	K-2085	1

TRK-2126		
Position	Part Number	Qty
Input Shaft Brg.	M802048-M802011	1
Input Shaft Pilot Brg.	QBR49845	1
Output Shaft Brg.	25584-25547RB	1
Countershaft Front Brg.	DD46386	1
Countershaft Rear Brg.	MU1309UGM	1
Rev. Idler Gear Brg.	QA47838	1
Mainshaft Gear Brg.	QA48181A	2
4th & 5th Shift Hub Brg.	FA35688	1
4th & 5th Shift Hub Race	TR235383	1
Mainshaft 2nd, 3rd & Rev. Gear Brg.	F94490	3
Mainshaft 4th Gear Brg.	F94488	1
Input Shaft Seal	473010N (1.625x2.502)	1
Output Shaft Seal	416664 (2.750x3.500)	1
Output Shaft Seal	471271 (2.500x3.251)	1
Threadlocker	TL1	1
Gasket Set	K-2085	1

TRK-2127		
Position	Part Number	Qty
Input Shaft Brg.	N309L	1
Input Shaft Pilot Brg.	SRA5304	1
Output Shaft Brg.	N309L	1
Countershaft Front Brg.	M28161	1
Countershaft Rear Brg.	N309L	1
Rev. Idler Gear Brg.	F54970	2
Input Shaft Seal	472164 (1.750x2.502)	1
Output Shaft Seal	471271 (2.500x3.251)	1
Output Shaft Seal	450316 (2.250x3.251)	1
Output Shaft Seal	411143N (2.625x3.251)	1
Output Shaft Seal	471271 (2.500x3.251)	1
Gasket Set	K-2136	1



# Heavy Duty Transmission Rebuild Kits



TRK-2128		
Position	Part Number	Qty
Input Shaft Brg.	M802048-M802011	1
Input Shaft Pilot Brg.	QBR49845	1
Output Shaft Brg.	25584-25547RB	1
Countershaft Front Brg.	M28161	1
Countershaft Rear Brg.	MU1309SGNV	1
Rev. Idler Gear Brg.	J361644	2
4th & 5th Shift Hub Brg.	FA35688	1
4th & 5th Shift Hub Race	TR235383	1
Input Shaft Seal	473010N (1.625x2.502)	1
Output Shaft Seal	471271 (2.500x3.251)	1
Output Shaft Seal	482041N (1.875x2.502)	1
Output Shaft Seal	411143N (2.625x3.251)	1
Output Shaft Seal	471271 (2.500x3.251)	1
Gasket Set	K-2138	1

TRK-2129		
Position	Part Number	Qty
Input Shaft Brg.	M804049-M804010	1
Input Shaft Pilot Brg.	QBR49845	1
Output Shaft Brg.	25581-25520	1
Countershaft Front Brg.	25877-25821	1
Countershaft Rear Brg.	2689-2631	1
4th & 5th Shift Hub Brg.	FA35688	1
4th & 5th Shift Hub Race	TR235383	1
Rev. Idler Gear Brg.	QA48181A	1
Mainshaft 1st & 2nd Gear Brg.	F94490	2
Mainshaft 3rd & Rev. Gear Brg.	F84003	2
Mainshaft 4th Gear Brg.	F94488	1
Input Shaft Seal	710211 (1.875x2.677)	1
Output Shaft Seal	471271 (2.500x3.251)	1
Output Shaft Seal	712512 (2.250x3.252)	1
Gasket Set	K2143	1
Threadlocker	TL1	1

TRK-2130		
Position	Part Number	Qty
Input Shaft Brg.	39590-39520	1
Input Shaft Pilot Brg.	31594	1
Output Shaft Brg.	45284-45220	1
Countershaft Front Brg.	25590-25522	1
Countershaft Rear Brg.	3782-3720	1
1st, 2nd, 3rd & Rev. Gear Brg.	FW808840	4
4th Gear Brg.	FW687430	1
5th Gear Brg.	F206252	1
Rev. Idler Gear Brg.	F11739	2
Countershaft Plug	3315679	1
Spring	1064	4
Snap Ring	20712	1
Snap Ring	3313798	1
Snap Ring	3315686	1
Rev. Idler O-Ring	OR123	1
Input Shaft Seal	22329	1
Input Shaft Seal	4300119	1
Output Shaft Seal	4300119	1
Shim Kit	K-2183	1
Gasket Set	K-2181	1

TRK-2131		
Position	Part Number	Qty
Input Shaft Brg.	39590-39520	1
Input Shaft Pilot Brg.	31594	1
Output Shaft Brg.	45284-45220	1
Countershaft Front Brg.	25590-25522	1
Countershaft Rear Brg.	3782-3720	1
1st & Rev. Gear Brg.	FW707620	4
2nd Gear Brg.	FW657020	2
3rd Gear Brg.	FW556020	2
4th Gear Brg.	FW505520	2
Rev. Idler Gear Brg.	FW404820	2
Countershaft Plug	3315679	1
Spring	3315765	4
Snap Ring	3313798	1
Snap Ring	3315686	1
Snap Ring	3315725	1
Input Shaft Seal	710211 (1.875x2.677)	1
Output Shaft Seal	475322N (2.750x3.543)	1
Shim Kit	K-2183	1
Gasket Set	K-2181	1

TRK-2275		
Position	Part Number	Qty
Input Shaft Brg.	212SLV	1
Input Shaft Pilot Bushing	BS59	1
Aux. Drive Gear Brg.	5566507	1
Aux. Mainshaft Brg.	21356	1
Countershaft Front Brg.	BS500192SX	2
Countershaft Rear Brg.	MU1308TVWS	2
Rev. Idler Gear Brg.	HJ223020-IR1820OH	2
Aux. Countershaft Front Brg.	4302074	2
Aux. Countershaft Rear Brg.	4302074	2
Spring	14897	3
Output Shaft Seal Kit	K-2262	1
O-Ring Kit	K-1450	1
Snap Ring	14317	2
Snap Ring	14750	1
Snap Ring	16763	2
Snap Ring	16980	1
Shim Kit	K-2805	1
Gasket Kit	K-2061	1

TRK-2277		
Position	Part Number	Qty
Input Shaft Brg.	212SLV	1
Input Shaft Pilot Bushing	BS59	1
Aux. Drive Gear Brg.	5566507	1
Aux. Mainshaft Brg.	21356	1
Countershaft Front Brg.	BS500192SX	2
Countershaft Rear Brg.	MU1308TVWS	2
Rev. Idler Gear Brg.	HJ223020-IR1820OH	2
Aux. Countershaft Front Brg.	4302074	2
Aux. Countershaft Rear Brg.	4302074	2
Spring	14897	3
Output Shaft Seal Kit	K-2262	1
O-Ring Kit	K-1450	1
Snap Ring	14317	2
Snap Ring	14750	1
Snap Ring	16763	2
Shim Kit	K-2805	1
Gasket Kit	K-2061	1

TRK-2280		
Position	Part Number	Qty
Input Shaft Brg.	212SLV	1
Input Shaft Pilot Bushing	BS59	1
Aux. Drive Gear Brg.	5566507	1
Aux. Mainshaft Brg.	29675 Assy 902A8 (A2892)	1
Countershaft Front Brg.	BS500192SX	2
Countershaft Rear Brg.	MU1308TVWS	2
Rev. Idler Gear Brg.	HJ223020-IR1820OH	2
Range Shaft Quill Front Brg.	204	1
Range Shaft Quill Rear Bushing	BS60	1
Aux. Countershaft Front Brg.	4302074	2
Aux. Countershaft Rear Brg.	4302074	2
Spring	14897	3
Insert Valve	19974	1
Output Shaft Seal Kit	K-2262	1
O-Ring Kit	K-1447	1
O-Ring	OR217V	1
O-Ring	OR221V	1
Snap Ring	14291	1
Snap Ring	14317	2
Snap Ring	14750	1
Snap Ring	16763	2
Snap Ring	16980	1
Shim Kit	K-2430	1
Gasket Kit	K-2199	1

TRK-2281		
Position	Part Number	Qty
Input Shaft Brg.	212SLV	1
Input Shaft Pilot Bushing	BS59	1
Aux. Drive Gear Brg.	118L	1
Aux. Mainshaft Brg.	390A Assy 902A2 (A3071)	1
Countershaft Front Brg.	BS500192SX	2
Countershaft Front Retainer	4304605	2
Countershaft Rear Brg.	MU1308TVWS	2
Rev. Idler Gear Brg.	HJ223020-IR1820OH	2
Range Shaft Quill Front Brg.	204	1
Range Shaft Quill Rear Bushing	BS60	1
Aux. Countershaft Front Brg.	4302074	2
Aux. Countershaft Rear Brg.	4302074	2
Spring	14897	3
Insert Valve	19974	1
Output Shaft Seal Kit	K-2262	1
O-Ring Kit	K-1447	1
O-Ring Kit	OK1000V	1
O-Ring Kit	OK17453	1
O-Ring	OR217V	1
O-Ring	OR221V	1
Snap Ring	14291	1
Snap Ring	14317	2
Snap Ring	14750	1
Snap Ring	16763	2
Shim Kit	K-2430	1
Gasket Kit	K-2199	1

HD Transmission

# Heavy Duty Transmission Rebuild Kits



HD Transmission

TRK-2282		
Position	Part Number	Qty
Input Shaft Brg.	212SLV	1
Input Shaft Pilot Bushing	BS59	1
Aux. Drive Gear Brg.	5566507	1
Aux. Mainshaft Brg.	390A Assy 902A2 (A3071)	1
Countershaft Front Brg.	BS500192SX	2
Countershaft Rear Brg.	MU1308TVWS	2
Rev. Idler Gear Brg.	HJ223020-IR1820OH	2
Aux. Countershaft Front Brg.	MR1307EL	2
Aux. Countershaft Rear Brg.	1310SLV	2
Spring	14897	3
Output Shaft Seal Kit	K-2262	1
O-Ring Kit	K-1450	1
O-Ring Kit	OK17453	1
Snap Ring	14317	2
Snap Ring	14750	1
Snap Ring	16723	2
Snap Ring	16763	2
Gasket Kit	K-2199	1

TRK-2283		
Position	Part Number	Qty
Input Shaft Brg.	212SLV	1
Input Shaft Pilot Bushing	BS59	1
Aux. Drive Gear Brg.	5566507	1
Aux. Mainshaft Brg.	390A Assy 902A2 (A3071)	1
Countershaft Front Brg.	BS500192SX	2
Countershaft Front Retainer	4304605	2
Countershaft Rear Brg.	MU1308TVWS	2
Rev. Idler Gear Brg.	HJ223020-IR1820OH	2
Range Shaft Quill Front Brg.	204	1
Range Shaft Quill Rear Bushing	BS60	1
Aux. Countershaft Front Brg.	MR1307EL	2
Aux. Countershaft Rear Brg.	1310L	2
Spring	14897	3
Insert Valve	19974	1
Output Shaft Seal Kit	K-2256	1
O-Ring Kit	K-1447	1
O-Ring Kit	OK17453	1
O-Ring	OR217V	1
O-Ring	OR221V	1
Snap Ring	14291	1
Snap Ring	14317	2
Snap Ring	14750	1
Snap Ring	16723	2
Snap Ring	16763	2
Gasket Kit	K-2199	1

TRK-2284		
Position	Part Number	Qty
Input Shaft Brg.	212SLV	1
Input Shaft Pilot Bushing	BS59	1
Aux. Drive Gear Brg.	5566507	1
Aux. Mainshaft Brg.	21355	1
Countershaft Front Brg.	BS500192SX	2
Countershaft Rear Brg.	MU1308TVWS	2
Rev. Idler Gear Brg.	HJ223020-IR1820OH	2
Aux. Countershaft Front Brg.	4302074	2
Aux. Countershaft Rear Brg.	4302074	2
Retainer Assembly	4304605	2
Spring	14897	3
Insert Valve	19974	1
Output Shaft Seal Kit	K-2262	1
O-Ring Kit	K-2054	1
Snap Ring	14317	2
Snap Ring	14750	1
Snap Ring	16763	2
Snap Ring	16980	1
Snap Ring Retainer	21320	1
Shim Kit	K-2805	1
Gasket Kit	K-2061	1

TRK-2285		
Position	Part Number	Qty
Input Shaft Brg.	212SLV	1
Input Shaft Pilot Bushing	BS59	1
Aux. Drive Gear Brg.	5566508	1
Aux. Mainshaft Brg.	21355	1
Countershaft Front Brg.	BS500192SX	2
Countershaft Rear Brg.	MU1308TVWS	2
Rev. Idler Gear Brg.	HJ223020-IR1820OH	2
Aux. Countershaft Front Brg.	4302074	2
Aux. Countershaft Rear Brg.	4302074	2
Spring	14897	3
Insert Valve	19974	1
Output Shaft Seal Kit	K-2262	1
O-Ring Kit	K-2804	1
Snap Ring	14317	2
Snap Ring	14750	1
Snap Ring	16980	1
Snap Ring	4301254	2
Shim Kit	K-2805	1
Gasket Kit	K-2199	1

TRK-2286		
Position	Part Number	Qty
Input Shaft Brg.	212SLV	1
Input Shaft Pilot Bushing	BS59	1
Aux. Drive Gear Brg.	5566508	1
Aux. Mainshaft Brg.	21356	1
Countershaft Front Brg.	BS500192SX	2
Countershaft Rear Brg.	MU1308TVWS	2
Rev. Idler Gear Brg.	HJ223020-IR1820OH	2
Aux. Countershaft Front Brg.	4302074	2
Aux. Countershaft Rear Brg.	4302074	2
Spring	14897	3
Insert Valve	19974	1
Output Shaft Seal Kit	K-2262	1
O-Ring Kit	K-2804	1
Snap Ring	14317	2
Snap Ring	14750	1
Snap Ring	16980	1
Snap Ring	4301254	2
Shim Kit	K-2805	1
Gasket Kit	K-2199	1

TRK-2287		
Position	Part Number	Qty
Input Shaft Brg.	212SLV	1
Input Shaft Pilot Bushing	BS59	1
Aux. Drive Gear Brg.	5566508	1
Aux. Mainshaft Brg.	21356	1
Countershaft Front Brg.	BS500192SX	2
Countershaft Rear Brg.	MU1308TVWS	2
Rev. Idler Gear Brg.	HJ223020-IR1820OH	2
Aux. Countershaft Front Brg.	NP656227-NP896049	2
Aux. Countershaft Rear Brg.	NP656227-NP896049	2
Spring	14897	3
Insert Valve	19974	1
Output Shaft Seal Kit	K-2262	1
O-Ring Kit	K-2804	1
Snap Ring	14317	2
Snap Ring	14750	1
Snap Ring	16980	1
Snap Ring	4301254	1
Shim Kit	K-2805	1
Gasket Kit	K-2199	1

TRK-2288		
Position	Part Number	Qty
Input Shaft Brg.	212SLV	1
Input Shaft Pilot Bushing	BS59	1
Aux. Drive Gear Brg.	5566508	1
Aux. Mainshaft Brg.	21356	1
Splitter Gear Brg.	4300902	1
Countershaft Front Brg.	BS500192SX	2
Countershaft Rear Brg.	MU1308TVWS	2
Rev. Idler Gear Brg.	HJ223020-IR1820OH	2
Aux. Countershaft Front Brg.	NP656227-NP896049	2
Aux. Countershaft Rear Brg.	NP656227-NP896049	2
Spring	14897	3
Insert Valve	19974	1
Output Shaft Seal Kit	K-2262	1
O-Ring Kit	K-2804	1
Snap Ring	14317	2
Snap Ring	14750	1
Snap Ring	16980	1
Snap Ring	4301254	1
Snap Ring	4303424	1
Shim Kit	K-2805	1
Gasket Kit	K-2199	1

# Heavy Duty Transmission Rebuild Kits



TRK-2335		
Position	Part Number	Qty
Input Shaft Brg.	212SLV	1
Aux. Drive Gear Brg.	5566507	1
Aux. Mainshaft Brg.	21356	1
Countershaft Front Brg.	BS500192SX	2
Countershaft Rear Brg.	MU1308TVWS	2
Rev. Idler Gear Brg.	HJ223020-IR1820OH	2
Aux. Countershaft Front Brg.	4302074	2
Aux. Countershaft Rear Brg.	4302074	2
Spring	14897	3
Output Shaft Seal Kit	K-2262	1
O-Ring Kit	K-1450	1
Snap Ring	14317	2
Snap Ring	14750	1
Snap Ring	16763	2
Snap Ring	16980	1
Shim Kit	K-2805	1
Gasket Kit	K-2061	1
Spring	15918	3
Sliding Clutch	16118	1
Collet	83002	4
Connector	84004	2
Connector	85001	1
Sealer	LC54505	1
Input Shaft	S1659	1

TRK-2336		
Position	Part Number	Qty
Input Shaft Brg.	212SLV	1
Aux. Drive Gear Brg.	5566507	1
Aux. Mainshaft Brg.	21356	1
Countershaft Front Brg.	BS500192SX	2
Countershaft Rear Brg.	MU1308TVWS	2
Rev. Idler Gear Brg.	HJ223020-IR1820OH	2
Aux. Countershaft Front Brg.	4302074	2
Aux. Countershaft Rear Brg.	4302074	2
Spring	14897	3
Output Shaft Seal Kit	K-2262	1
O-Ring Kit	K-1450	1
Snap Ring	14317	2
Snap Ring	14750	1
Snap Ring	16763	2
Shim Kit	K-2805	1
Gasket Kit	K-2061	1
Spring	15918	3
Snap Ring	16980	1
Sliding Clutch	4304317	1
Collet	83002	4
Connector	84004	2
Connector	85001	1
Sealer	LC54505	1
Input Shaft	S1659	1

TRK-2338		
Position	Part Number	Qty
Aux. Mainshaft Brg.	29675 Assy 902A8 (A2892)	1
Aux. Countershaft Front Brg.	4302074	2
Aux. Countershaft Rear Brg.	4302074	2
Spring	14897	3
Insert Valve	19974	1
Output Shaft Seal Kit	K-2262	1
O-Ring Kit	K-2002	1
Shim Kit	K-2805	1
Gasket Kit	K-1603	1
Threadlocker	TL1	1
Connector	85001	1

TRK-2340		
Position	Part Number	Qty
Aux. Mainshaft Brg.	29675 Assy 902A8 (A2892)	1
Aux. Countershaft Front Brg.	4302074	2
Aux. Countershaft Rear Brg.	4302074	2
Aux. Range Shaft Quill Front Brg.	204	1
Spring	14897	3
Insert Valve	19974	1
Output Shaft Seal Kit	K-2262	1
O-Ring Kit	K-1447	1
O-Ring	OR217V	1
O-Ring	OR221V	1
Snap Ring	14291	1
Key Assembly	A3697	1
Connector	85002	1
Shim Kit	K-2430	1
Gasket Kit	K-1603	1
Threadlocker	TL1	1

TRK-2341		
Position	Part Number	Qty
Input Shaft Brg.	212SLV	1
Aux. Drive Gear Brg.	5566507	1
Aux. Mainshaft Brg.	29675 Assy 902A8 (A2892)	1
Countershaft Front Brg.	BS500192SX	2
Countershaft Rear Brg.	MU1308TVWS	2
Rev. Idler Gear Brg.	HJ223020-IR1820OH	2
Range Shaft Quill Front Brg.	204	1
Range Shaft Quill Rear Brg.	BS60	1
Aux. Countershaft Front Brg.	4302074	2
Aux. Countershaft Rear Brg.	4302074	2
Spring	14897	3
Insert Valve	19974	1
Output Shaft Seal Kit	K-2262	1
O-Ring Kit	K-1447	1
O-Ring	OR217V	1
O-Ring	OR221V	1
Snap Ring	14291	1
Snap Ring	14317	2
Snap Ring	14750	1
Snap Ring	16763	2
Snap Ring	16980	1
Shim Kit	K-2430	1
Gasket Kit	K-2199	1
Spring	15918	3
Sliding Clutch	4306648	1
Collet	83001	4
Connector	84002	2
Connector	85002	1
Sealer	LC54505	1
Input Shaft	S1659	1

TRK-2342		
Position	Part Number	Qty
Input Shaft Brg.	212SLV	1
Aux. Drive Gear Brg.	118L	1
Aux. Mainshaft Brg.	390A Assy 902A2 (A3071)	1
Countershaft Front Brg.	BS500192SX	2
Countershaft Front Retainer	4304605	2
Countershaft Rear Brg.	MU1308TVWS	2
Rev. Idler Gear Brg.	HJ223020-IR1820OH	2
Range Shaft Quill Front Brg.	204	1
Range Shaft Quill Rear Brg.	BS60	1
Aux. Countershaft Front Brg.	4302074	2
Aux. Countershaft Rear Brg.	4302074	2
Spring	14897	3
Insert Valve	19974	1
Output Shaft Seal Kit	K-2262	1
O-Ring Kit	K-1447	1
O-Ring Kit	OK1000V	1
O-Ring Kit	OK17453	1
O-Ring	OR217V	1
O-Ring	OR221V	1
Snap Ring	14291	1
Snap Ring	14317	2
Snap Ring	14750	1
Snap Ring	16763	2
Snap Ring	16980	1
Shim Kit	K-2430	1
Gasket Kit	K-2199	1
Spring	15918	3
Sliding Clutch	4306648	1
Collet	83001	4
Connector	84002	1
Connector	85002	1
Sealer	LC54505	1
Input Shaft	S1659	1

TRK-2343		
Position	Part Number	Qty
Input Shaft Brg.	212SLV	1
Aux. Drive Gear Brg.	5566507	1
Aux. Mainshaft Brg.	390A Assy 902A2 (A3071)	1
Countershaft Front Brg.	BS500192SX	2
Countershaft Rear Brg.	MU1308TVWS	2
Rev. Idler Gear Brg.	HJ223020-IR1820OH	2
Aux. Countershaft Front Brg.	MR1307EL	2
Aux. Countershaft Rear Brg.	1310SLV	2
Spring	14897	3
Output Shaft Seal Kit	K-2262	1
O-Ring Kit	K-1450	1
O-Ring Kit	OK17453	1
Snap Ring	14317	2
Snap Ring	14750	1
Snap Ring	16723	2
Snap Ring	16763	2
Gasket Kit	K-2199	1
Spring	15918	3
Snap Ring	16980	1
Sliding Clutch	4306647	1
Connector	85001	2
Sealer	LC54505	1
Input Shaft	S1659	1

HD Transmission

# Heavy Duty Transmission Rebuild Kits



HD Transmission

TRK-2344		
Position	Part Number	Qty
Input Shaft Brg.	212SLV	1
Aux. Drive Gear Brg.	5566507	1
Aux. Mainshaft Brg.	390A Assy 902A2 (A3071)	1
Countershaft Front Brg.	BS500192SX	2
Countershaft Rear Brg.	MU1308TVWS	2
Rev. Idler Gear Brg.	HJ223020-IR1820OH	2
Aux. Countershaft Front Brg.	MR1307EL	2
Aux. Countershaft Rear Brg.	1310SLV	2
Spring	14897	3
Output Shaft Seal Kit	K-2262	1
O-Ring Kit	K-1450	1
O-Ring Kit	OK17453	1
Snap Ring	14317	2
Snap Ring	14750	1
Snap Ring	16723	2
Snap Ring	16763	2
Snap Ring	16980	1
Gasket Kit	K-2199	1
Spring	15918	3
Sliding Clutch Connector	4306648	1
Connector	85001	2
Sealer	LC54505	1
Input Shaft	S1659	1

TRK-2345		
Position	Part Number	Qty
Input Shaft Brg.	212SLV	1
Aux. Drive Gear Brg.	5566507	1
Aux. Mainshaft Brg.	390A Assy 902A2 (A3071)	1
Countershaft Front Brg.	BS500192SX	2
Countershaft Front Retainer	4304605	2
Countershaft Rear Brg.	MU1308TVWS	2
Rev. Idler Gear Brg.	HJ223020-IR1820OH	2
Range Shaft Quill Front Brg.	204	1
Range Shaft Quill Rear Bushing	BS60	1
Aux. Countershaft Front Brg.	MR1307EL	2
Aux. Countershaft Rear Brg.	1310L	2
Spring	14897	3
Insert Valve	19974	1
Output Shaft Seal Kit	K-2256	1
O-Ring Kit	K-1447	1
O-Ring Kit	OK17453	1
O-Ring	OR217V	1
O-Ring	OR221V	1
Snap Ring	14291	1
Snap Ring	14317	2
Snap Ring	14750	1
Snap Ring	16723	2
Snap Ring	16763	2
Snap Ring	16980	1
Gasket Kit	K-2199	1
Spring	15918	3
Front Brg. Cover	20552	1
Sliding Clutch Collet	4306648	1
Collet	83001	4
Connector	84002	1
Connector	85002	1
Sealer	LC54505	1
Input Shaft	S2928	1

TRK-2464		
Position	Part Number	Qty
Input Shaft Brg.	39590-39520	1
Input Shaft Pilot Brg.	31594	1
Output Shaft Brg.	39585-39520	1
Countershaft Front Brg.	25590-25522	1
Countershaft Rear Brg.	3782-3720	1
1st, 2nd, 3rd & Rev. Gear Brg.	FW808840	4
4th Gear Brg.	FW687430	1
5th Gear Brg.	FW505520	2
Rev. Idler Gear Brg.	F11739	2
Countershaft Plug	3315679	1
Input Shaft Seal	19110	1
Output Shaft Seal Kit	K-2256	1
Threadlocker	TL1	1
Shim Kit	K-2183	1
Gasket Set	K-2465	1

TRK-2468		
Position	Part Number	Qty
Clutch Pilot Brg.	306VV	1
Input Shaft Brg.	212SLV	1
Front Brg. Cover	20550	1
Clutch Yoke	85533	1
Clutch Yoke Bushing	12815	4
Clutch Brake Disc	85541	1
Input Shaft	S1659	1
Snap Ring	14750	1
Snap Ring	16980	1
Gasket	14311	1
Gasket	4305294	1
Gasket	4306584	1

TRK-2490		
Position	Part Number	Qty
Input Shaft Brg.	39590-39520	1
Input Shaft Pilot Brg.	31594	1
Output Shaft Brg.	39585-39520	1
Countershaft Front Brg.	25590-25522	1
Countershaft Rear Brg.	3782-3720	1
1st, 2nd, 3rd & Rev. Gear Brg.	FW808840	4
4th Gear Brg.	FW687430	1
5th Gear Brg.	F206252	1
Rev. Idler Gear Brg.	F11739	2
Countershaft Plug	3315679	1
Spring	1064	4
Snap Ring	17399	1
Snap Ring	20712	1
Snap Ring	22328	1
Snap Ring	22360	1
Snap Ring	3315686	1
Input Shaft Seal	22329	1
Output Shaft Seal Kit	K-2256	1
Threadlocker	TL1	1
Shim Kit	K-2183	1
Gasket Set	K-2465	1

TRK-2758		
Position	Part Number	Qty
Input Shaft Brg.	212SLV	1
Aux. Drive Gear Brg.	5566508	1
Aux. Mainshaft Brg.	21356	1
Countershaft Front Brg.	BS500192SX	2
Countershaft Rear Brg.	MU1308TVWS	2
Rev. Idler Gear Brg.	HJ223020-IR1820OH	2
Aux. Countershaft Front Brg.	4302074	2
Aux. Countershaft Rear Brg.	4302074	2
Spring	14897	3
Insert Valve	19974	1
Output Shaft Seal Kit	K-2262	1
O-Ring Kit	K-2804	1
Snap Ring	14317	2
Snap Ring	14750	1
Snap Ring	16980	1
Snap Ring	4301254	2
Shim Kit	K-2805	1
Gasket Kit	K-2199	1
Spring	15918	3
Sliding Clutch Connector	4304317	1
Connector	84005	2
Connector	85003	1
Sealer	LC54505	1
Input Shaft	S1659	1

TRK-2759		
Position	Part Number	Qty
Aux. Mainshaft Brg.	21356	1
Aux. Countershaft Front Brg.	4302074	2
Aux. Countershaft Rear Brg.	4302074	2
Spring	14897	3
Insert Valve	19974	1
Output Shaft Seal Kit	K-2262	1
O-Ring Kit	K-2804	1
Gasket Kit	K-1603	1
Connector	85003	1
Shim Kit	K-2805	1

# Heavy Duty Transmission Rebuild Kits



TRK-2761		
Position	Part Number	Qty
Input Shaft Brg.	212SLV	1
Aux. Drive Gear Brg.	5566507	1
Aux. Mainshaft Brg.	390A Assy 902A2 (A3071)	1
Countershaft Front Brg.	BS500192SX	2
Countershaft Front Retainer	4304605	2
Countershaft Rear Brg.	MU1308TVWS	2
Rev. Idler Gear Brg.	HJ223020-IR1820OH	2
Range Shaft Quill Front Brg.	204	1
Range Shaft Quill Rear Bushing	BS60	1
Aux. Countershaft Front Brg.	MR1307EL	2
Aux. Countershaft Rear Brg.	1310L	2
Spring	14897	3
Insert Valve	19974	1
Output Shaft Seal Kit	K-2256	1
O-Ring Kit	K-1447	1
O-Ring Kit	OK17453	1
O-Ring	OR217V	1
O-Ring	OR221V	1
Snap Ring	14291	1
Snap Ring	14317	2
Snap Ring	14750	1
Snap Ring	16723	2
Snap Ring	16763	2
Gasket Kit	K-2199	1
Spring	15918	3
Snap Ring	16980	1
Front Brg. Cover	20550	1
Sliding Clutch	4306648	1
Collet	83001	4
Connector	84002	1
Connector	85002	1
Input Shaft	S1659	1

TRK-2762		
Position	Part Number	Qty
Input Shaft Brg.	212SLV	1
Aux. Drive Gear Brg.	5566507	1
Aux. Mainshaft Brg.	21355	1
Countershaft Front Brg.	BS500192SX	2
Countershaft Rear Brg.	MU1308TVWS	2
Rev. Idler Gear Brg.	HJ223020-IR1820OH	2
Aux. Countershaft Front Brg.	4302074	2
Aux. Countershaft Rear Brg.	4302074	2
Retainer Assembly	4304605	2
Spring	14897	3
Insert Valve	19974	1
Output Shaft Seal Kit	K-2262	1
O-Ring Kit	K-2054	1
Snap Ring	14317	2
Snap Ring	14750	1
Snap Ring	16763	2
Snap Ring	16980	1
Snap Ring Retainer	21320	1
Shim Kit	K-2805	1
Gasket Kit	K-2061	1
Spring	15918	3
Sliding Clutch	4306648	1
Collet	83002	4
Connector	84004	1
Connector	85001	1
Sealer	LC54505	1
Input Shaft	S1659	1

TRK-2763		
Position	Part Number	Qty
Input Shaft Brg.	212SLV	1
Aux. Drive Gear Brg.	5566507	1
Aux. Mainshaft Brg.	21355	1
Countershaft Front Brg.	BS500192SX	2
Countershaft Rear Brg.	MU1308TVWS	2
Rev. Idler Gear Brg.	HJ223020-IR1820OH	2
Aux. Countershaft Front Brg.	4302074	2
Aux. Countershaft Rear Brg.	4302074	2
Retainer Assembly	4304605	2
Spring	14897	3
Insert Valve	19974	1
Output Shaft Seal Kit	K-2262	1
O-Ring Kit	K-2054	1
Snap Ring	14317	2
Snap Ring	14750	1
Snap Ring	16763	2
Snap Ring	16980	1
Snap Ring Retainer	21320	1
Shim Kit	K-2805	1
Gasket Kit	K-2061	1
Sliding Clutch	4306647	1
Collet	83002	4
Connector	84004	1
Connector	85001	1
Sealer	LC54505	1
Input Shaft	S1659	1

TRK-2764		
Position	Part Number	Qty
Input Shaft Brg.	212SLV	1
Aux. Drive Gear Brg.	5566507	1
Aux. Mainshaft Brg.	390A Assy 902A2 (A3071)	1
Aux. Mainshaft Thrust Brg.	AXK5070	2
Countershaft Front Brg.	BS500192SX	2
Countershaft Rear Brg.	MU1308TVWS	2
Rev. Idler Gear Brg.	HJ223020-IR1820OH	2
Aux. Countershaft Front Brg.	4302074	2
Aux. Countershaft Rear Brg.	4302074	2
Spring	14897	3
Insert Valve	19974	1
Insert Valve	4300810	2
Output Shaft Seal Kit	K-2262	1
O-Ring Kit	K-2298	1
O-Ring Kit	OK17453	1
Snap Ring	14317	2
Snap Ring	14750	1
Snap Ring	16763	2
Snap Ring	16980	1
Retainer Assembly	A-6340	1
Shim Kit	K-2430	1
Gasket Kit	K-2295	1
Spring	15918	2
Sliding Clutch	16118	1
Connector	84005	2
Connector	85003	1
Sealer	LC54505	1
Input Shaft	S1659	1

TRK-2765		
Position	Part Number	Qty
Input Shaft Brg.	212SLV	1
Aux. Drive Gear Brg.	5566507	1
Aux. Mainshaft Brg.	29675 Assy 902A8 (A2892)	1
Aux. Mainshaft Thrust Brg.	AXK5070	2
Countershaft Front Brg.	BS500192SX	2
Countershaft Rear Brg.	MU1308TVWS	2
Rev. Idler Gear Brg.	HJ223020-IR1820OH	2
Aux. Countershaft Front Brg.	4302074	4
Spring	14897	3
Insert Valve	19974	1
Insert Valve	4300810	2
Output Shaft Seal Kit	K-2262	1
O-Ring Kit	K-2298	1
O-Ring Kit	OK17453	1
Snap Ring	14317	2
Snap Ring	14750	1
Snap Ring	16763	2
Snap Ring	16980	1
Retainer Assembly	A-6340	1
Shim Kit	K-2430	1
Gasket Kit	K-2295	1
Spring	15918	2
Sliding Clutch	16118	1
Connector	84005	2
Connector	85003	1
Sealer	LC54505	1
Input Shaft	S1659	1

TRK-2767		
Position	Part Number	Qty
Input Shaft Brg.	212SLV	1
Aux. Drive Gear Brg.	5566508	1
Aux. Mainshaft Brg.	21355	1
Countershaft Front Brg.	BS500192SX	2
Countershaft Rear Brg.	MU1308TVWS	2
Rev. Idler Gear Brg.	HJ223020-IR1820OH	2
Aux. Countershaft Front Brg.	4302074	2
Aux. Countershaft Rear Brg.	4302074	2
Spring	14897	3
Insert Valve	19974	1
Output Shaft Seal Kit	K-2262	1
O-Ring Kit	K-2804	1
Snap Ring	14317	2
Snap Ring	14750	1
Snap Ring	16980	1
Snap Ring	4301254	2
Shim Kit	K-2805	1
Gasket Kit	K-2199	1
Spring	15918	3
Sliding Clutch	16118	1
Connector	84005	2
Connector	85003	1
Sealer	LC54505	1
Input Shaft	S1659	1

TRK-2768		
Position	Part Number	Qty
Aux. Mainshaft Brg.	21355	1
Aux. Countershaft Front Brg.	4302074	2
Aux. Countershaft Rear Brg.	4302074	2
Insert Valve	19974	1
Connector	85003	1
Spring	14897	3
Gasket Kit	K-1603	1
Output Shaft Seal Kit	K-2262	1
O-Ring Kit	K-2804	1
Shim Kit	K-2805	1

HD Transmission



# Heavy Duty Transmission Rebuild Kits



HD Transmission

TRK-2769		
Position	Part Number	Qty
Aux. Mainshaft Brg.	21356	1
Aux. Countershaft Front Brg.	NP896049-NP656227	2
Aux. Countershaft Rear Brg.	NP896049-NP656227	2
Spring	14897	3
Insert Valve	19974	1
Output Shaft Seal Kit	K-2262	1
O-Ring Kit	K-2804	1
Gasket Kit	K-1603	1
Connector	85003	1
Shim Kit	K-2805	1

TRK-2770		
Position	Part Number	Qty
Input Shaft Brg.	212SLV	1
Aux. Drive Gear Brg.	5566508	1
Aux. Mainshaft Brg.	21356	1
Countershaft Front Brg.	BS500192SX	2
Countershaft Rear Brg.	MU1308TVWS	2
Rev. Idler Gear Brg.	HJ223020-IR1820OH	2
Aux. Countershaft Front Brg.	NP656227-NP896049	2
Aux. Countershaft Rear Brg.	NP656227-NP896049	2
Spring	14897	3
Insert Valve	19974	1
Output Shaft Seal Kit	K-2262	1
O-Ring Kit	K-2804	1
Snap Ring	14317	2
Snap Ring	14750	1
Snap Ring	16980	1
Snap Ring	4301254	1
Shim Kit	K-2805	1
Gasket Kit	K-2199	1
Sliding Clutch	4304317	1
Connector	84005	2
Connector	85003	1
Sealer	LC54505	1
Input Shaft	S1659	1

TRK-2771		
Position	Part Number	Qty
Input Shaft Brg.	212SLV	1
Input Shaft Pilot Bushing	BS59	1
Output Shaft Brg.	214LB	1
Countershaft Front Brg.	1309L	2
Countershaft Rear Brg.	1309L	2
Aux. Countershaft Brg.	MU1213UMW3	2
Rev. Idler Gear Brg.	WJ162116	4
Output Shaft Seal Kit	K-2262	1
Snap Ring	14289	1
Snap Ring	15253	4
Snap Ring	16798	3
O-Ring	OK20128	2
Gasket Kit	K-1846	1
Sealer	LC54505	1

TRK-2772		
Position	Part Number	Qty
Input Shaft Brg.	212SLV	1
Input Shaft Pilot Bushing	BS59	1
Aux. Drive Gear Brg.	5566507	1
Aux. Mainshaft Brg.	390A Assy 902A2 (A3071)	1
Aux. Mainshaft Thrust Brg.	AXK5070	2
Countershaft Front Brg.	BS500192SX	2
Countershaft Rear Brg.	MU1308TVWS	2
Rev. Idler Gear Brg.	HJ223020-IR1820OH	2
Aux. Countershaft Front Brg.	4302074	2
Aux. Countershaft Rear Brg.	4302074	2
Spring	14897	3
Insert Valve	19974	1
Insert Valve	4300810	2
Output Shaft Seal Kit	K-2262	1
O-Ring Kit	K-2298	1
O-Ring Kit	OK17453	1
Snap Ring	14317	2
Snap Ring	14750	1
Snap Ring	16763	2
Snap Ring	16980	1
Retainer Assembly	A-6340	1
Shim Kit	K-2430	1
Gasket Kit	K-2295	1

TRK-2773		
Position	Part Number	Qty
Input Shaft Brg.	212SLV	1
Input Shaft Pilot Bushing	BS59	1
Aux. Drive Gear Brg.	5566507	1
Aux. Mainshaft Brg.	29675 Assy 902A8 (A2892)	1
Aux. Mainshaft Thrust Brg.	AXK5070	2
Countershaft Front Brg.	BS500192SX	2
Countershaft Rear Brg.	MU1308TVWS	2
Rev. Idler Gear Brg.	HJ223020-IR1820OH	2
Aux. Countershaft Brg.	4302074	4
Spring	14897	3
Insert Valve	19974	1
Insert Valve	4300810	2
Output Shaft Seal Kit	K-2262	1
O-Ring Kit	K-2298	1
O-Ring Kit	OK17453	1
Snap Ring	14317	2
Snap Ring	14750	1
Snap Ring	16763	2
Snap Ring	16980	1
Retainer Assembly	A-6340	1
Shim Kit	K-2430	1
Gasket Kit	K-2295	1

TRK-2779		
Position	Part Number	Qty
Input Shaft Brg.	212SLV	1
Aux. Drive Gear Brg.	5566508	1
Aux. Mainshaft Brg.	21356	1
Splitter Gear Brg.	4300902	1
Countershaft Front Brg.	BS500192SX	2
Countershaft Rear Brg.	MU1308TVWS	2
Rev. Idler Gear Brg.	HJ223020-IR1820OH	2
Aux. Countershaft Front Brg.	NP656227-NP896049	2
Aux. Countershaft Rear Brg.	NP656227-NP896049	2
Spring	14897	3
Insert Valve	19974	1
Output Shaft Seal Kit	K-2262	1
O-Ring Kit	K-2804	1
Snap Ring	14317	2
Snap Ring	14750	1
Snap Ring	16980	1
Snap Ring	4301254	1
Snap Ring	4303424	1
Shim Kit	K-2805	1
Gasket Kit	K-2199	1
Spring	15918	3
Sliding Clutch	4304317	1
Connector	84005	2
Connector	85003	1
Sealer	LC54505	1
Input Shaft	S1659	1

TRK-2780		
Position	Part Number	Qty
Input Shaft Brg.	212SLV	1
Input Shaft Pilot Bushing	BS59	1
Aux. Drive Gear Brg.	117L	1
Aux. Mainshaft Brg.	390A Assy 902A2 (A3071)	1
Countershaft Front Brg.	MSN1211REX	2
Countershaft Rear Brg.	MU1308TVWS	2
Rev. Idler Gear Brg.	HJ223020-IR1820OH	2
Aux. Countershaft Front Brg.	MR1307EL	2
Aux. Countershaft Rear Brg.	1310L	2
Aux. Range Shaft Quill Front Brg.	204	1
Aux. Range Shaft Quill Rear Bushing	BS60	1
Spring	14897	3
Insert Valve	19974	1
Output Shaft Seal Kit	K-2256	1
O-Ring Kit	K-1447	1
Snap Ring Set	SR1000	1
Gasket Kit	K-2199	1

TRK-2847		
Position	Part Number	Qty
Input Shaft Brg.	212SLV	1
Input Shaft Pilot Bushing	BS59	1
Aux. Drive Gear Brg.	5566507	1
Aux. Mainshaft Brg.	21356	1
Countershaft Front Brg.	BS500192SX	2
Countershaft Rear Brg.	MU1308TVWS	2
Rev. Idler Gear Brg.	HJ223020-IR1820OH	2
Aux. Countershaft Front Brg.	4302074	2
Aux. Countershaft Rear Brg.	4302074	2
Spring	14897	3
Output Shaft Seal Kit	K-2262	1
O-Ring Kit	K-2846	1
Snap Ring	14317	2
Snap Ring	14750	1
Snap Ring	16763	2
Snap Ring	16980	1
Shim Kit	K-2805	1
Gasket Kit	K-2061	1

# Heavy Duty Transmission Rebuild Kits



TRK-2848			TRK-2865			TRK-2924		
Position	Part Number	Qty	Position	Part Number	Qty	Position	Part Number	Qty
Input Shaft Brg.	212SLV	1	Input Shaft Brg.	212SLV	1	Input Shaft Brg.	MU1212RUMW3	1
Aux. Drive Gear Brg.	5566507	1	Input Shaft Pilot Bushing	BS59	1	Input Shaft Pilot Bushing	BS59	1
Aux. Mainshaft Brg.	21356	1	Aux. Drive Gear Brg.	5566508	1	Aux. Drive Gear Brg.	5566507	1
Countershaft Front Brg.	BS500192SX	2	Aux. Mainshaft Brg.	21356	1	Aux. Mainshaft Brg.	5566503	1
Countershaft Rear Brg.	MU1308TVWS	2	Splitter Gear Brg.	4300902	1	Countershaft Front Brg.	BS226539V	2
Rev. Idler Gear Brg.	HJ223020-IR1820OH	2	Countershaft Front Brg.	BS500192SX	2	Countershaft Rear Brg.	BS226539V	2
Aux. Countershaft Front Brg.	4302074	2	Countershaft Rear Brg.	BS500052V	2	Rev. Idler Gear Brg.	HJ223020-IR1820OH	2
Aux. Countershaft Rear Brg.	4302074	2	Rev. Idler Gear Brg.	HJ223020-IR1820OH	2	Aux. Countershaft Front Brg.	4302074	2
Spring	14897	3	Aux. Countershaft Front Brg.	NP656227-NP896049	2	Aux. Countershaft Rear Brg.	4302074	2
Output Shaft Seal Kit	K-2262	1	Aux. Countershaft Rear Brg.	NP656227-NP896049	2	Spring	14897	3
O-Ring Kit	K-2846	1	Spring	14897	3	Output Shaft Seal Kit	K-2918	1
Snap Ring	14317	2	Insert Valve	19974	1	Snap Ring	16980	1
Snap Ring	14750	1	Output Shaft Seal Kit	K-2262	1	Snap Ring	17399	1
Snap Ring	16763	2	O-Ring Kit	K-2804	1	Snap Ring	4302082	2
Snap Ring	16980	1	Snap Ring	14750	1	Snap Ring	4303362	2
Shim Kit	K-2805	1	Snap Ring	16980	1	Shim Kit	K-2805	1
Gasket Kit	K-2061	1	Snap Ring	4301254	1	Piston Range Kit	K-2923	1
Spring	15918	3	Snap Ring	4303424	2	Gasket Kit	K-2921	1
Sliding Clutch	4304317	1	Snap Ring	4302082	2	<b>TRK-2993</b>		
Connector	84006	1	Snap Ring	4302082	2	Position	Part Number	Qty
Connector	85003	1	Shim Kit	K-2805	1	Input Shaft Brg.	212SLV	1
Sealer	LC54505	1	Gasket Kit	K-2199	1	Aux. Drive Gear Brg.	5566507	1
Input Shaft	S1659	1	<b>TRK-2866</b>			Aux. Mainshaft Brg.	29675 Assy 902A8 (A2892)	1
<b>TRK-2855</b>			Position	Part Number	Qty	Aux. Mainshaft Thrust	AXK5070	2
Position	Part Number	Qty	Input Shaft Brg.	212SLV	1	Brg.		
Input Shaft Brg.	212SLV	1	Aux. Drive Gear Brg.	5566508	1	Countershaft Front Brg.	BS500192SX	2
Input Shaft Pilot Bushing	BS59	1	Aux. Mainshaft Brg.	21356	1	Countershaft Rear Brg.	MU1308TVWS	2
Aux. Drive Gear Brg.	5566507	1	Splitter Gear Brg.	4300902	1	Rev. Idler Gear Brg.	HJ223020-IR1820OH	2
Aux. Mainshaft Brg.	21356	1	Countershaft Front Brg.	BS500192SX	2	Aux. Countershaft Front Brg.	4302074	2
Aux. Mainshaft Bushing	AA1512-12	2	Countershaft Rear Brg.	BS500052V	2	Brg.		
Countershaft Front Brg.	1309L	2	Rev. Idler Gear Brg.	HJ223020-IR1820OH	2	Aux. Countershaft Rear Brg.	4302074	2
Countershaft Rear Brg.	MU1308TVWS	2	Aux. Countershaft Front Brg.	NP656227-NP896049	2	Spring	14897	3
Rev. Idler Gear Brg.	HJ223020-IR1820OH	2	Brg.		Insert Valve	19974	1	
Aux. Countershaft Front Brg.	4302074	2	Aux. Countershaft Rear Brg.	NP656227-NP896049	2	Retainer Assembly	A-6340	1
Aux. Countershaft Rear Brg.	4302074	2	Spring	14897	3	Output Shaft Seal Kit	K-2262	1
Insert Valve	19974	1	Insert Valve	19974	1	O-Ring Kit	K-2002	1
Spring	14897	3	Output Shaft Seal Kit	K-2262	1	O-Ring Kit	OK17453	1
Output Shaft Seal Kit	K-2262	1	O-Ring Kit	K-2804	1	Snap Ring	14317	2
O-Ring Kit	K-2846	1	Snap Ring	14750	1	Snap Ring	14750	1
Snap Ring	14289	1	Snap Ring	4301254	1	Snap Ring	16763	2
Snap Ring	14317	2	Snap Ring	4303424	2	Snap Ring	16980	1
Snap Ring	15253	2	Snap Ring	4302082	2	Shim Kit	K-2430	1
Snap Ring	16763	2	Shim Kit	K-2805	1	Gasket Kit	K-2199	1
Snap Ring	20085	2	Gasket Kit	K-2199	1	Threadlocker	TL1	1
Snap Ring	21320	1	Spring	15918	3	Spring	15918	3
Shim Kit	K-2805	1	Sliding Clutch	4304317	1	Sliding Clutch	16118	1
Gasket Kit	K-2061	1	Connector	84005	2	Collet	83002	4
			Connector	85003	1	Connector	84003	2
			Sealer	LC54505	1	Connector	85001	1
			Input Shaft	S1659	1	Sealer	LC54505	1
						Input Shaft	S1659	1

HD Transmission

# Heavy Duty Transmission Rebuild Kits



HD Transmission

TRK-2994		
Position	Part Number	Qty
Input Shaft Brg.	212SLV	1
Aux. Drive Gear Brg.	5566507	1
Aux. Mainshaft Brg.	29675 Assy 902A8 (A2892)	1
Aux. Mainshaft Thrust Brg.	AXK5070	2
Countershaft Front Brg.	BS500192SX	2
Countershaft Rear Brg.	MU1308TVWS	2
Rev. Idler Gear Brg.	HJ223020-IR1820OH	2
Aux. Countershaft Front Brg.	MU61307GUM	2
Aux. Countershaft Rear Brg.	1310SLV	2
Spring	14897	3
Insert Valve	19974	1
Retainer Assembly	A6340	1
Output Shaft Seal Kit	K-2262	1
O-Ring Kit	K-2002	1
O-Ring Kit	OK17453	1
Snap Ring	14317	2
Snap Ring	14750	1
Snap Ring	16723	1
Snap Ring	16763	2
Snap Ring	16980	1
Gasket Kit	K-2199	1
Threadlocker	TL1	1
Spring	15918	3
Sliding Clutch	16118	1
Collet	83002	4
Connector	84003	2
Connector	85001	1
Input Shaft	S1659	1

TRK-2996		
Position	Part Number	Qty
Input Shaft Brg.	212SLV	1
Input Shaft Pilot Bushing	BS59	1
Aux. Drive Gear Brg.	5566507	1
Aux. Mainshaft Brg.	29675 Assy 902A8 (A2892)	1
Aux. Mainshaft Thrust Brg.	AXK5070	2
Countershaft Front Brg.	BS500192SX	2
Countershaft Rear Brg.	MU1308TVWS	2
Rev. Idler Gear Brg.	HJ223020-IR1820OH	2
Aux. Countershaft Front Brg.	4302074	2
Aux. Countershaft Rear Brg.	4302074	2
Spring	14897	3
Insert Valve	19974	1
Retainer Assembly	A-6340	1
Output Shaft Seal Kit	K-2262	1
O-Ring Kit	K-2002	1
O-Ring Kit	OK17453	1
Snap Ring	14317	2
Snap Ring	14750	1
Snap Ring	16763	2
Snap Ring	16980	1
Shim Kit	K-2430	1
Gasket Kit	K-2199	1
Threadlocker	TL1	1

TRK-2997		
Position	Part Number	Qty
Input Shaft Brg.	212SLV	1
Input Shaft Pilot Bushing	BS59	1
Aux. Drive Gear Brg.	5566507	1
Aux. Mainshaft Brg.	29675 Assy 902A8 (A2892)	1
Aux. Mainshaft Thrust Brg.	AXK5070	2
Countershaft Front Brg.	BS500192SX	2
Countershaft Rear Brg.	MU1308TVWS	2
Rev. Idler Gear Brg.	HJ223020-IR1820OH	2
Aux. Countershaft Front Brg.	MU61307GUM	2
Aux. Countershaft Rear Brg.	1310SLV	2
Spring	14897	3
Insert Valve	19974	1
Retainer Assembly	A-6340	1
Output Shaft Seal Kit	K-2262	1
O-Ring Kit	K-2002	1
O-Ring Kit	OK17453	1
Snap Ring	14317	2
Snap Ring	14750	1
Snap Ring	16723	1
Snap Ring	16763	2
Snap Ring	16980	1
Gasket Kit	K-2199	1
Threadlocker	TL1	1

TRK-2998		
Position	Part Number	Qty
Input Shaft Brg.	212SLV	1
Input Shaft Pilot Bushing	BS59	1
Aux. Drive Gear Brg.	5566507	1
Aux. Mainshaft Brg.	29675 Assy 902A8 (A2892)	1
Aux. Mainshaft Thrust Brg.	AXK5070	2
Countershaft Front Brg.	BS500192SX	2
Countershaft Rear Brg.	MU1308TVWS	2
Rev. Idler Gear Brg.	HJ223020-IR1820OH	2
Aux. Countershaft Front Brg.	MR1307EX	2
Aux. Countershaft Rear Brg.	1310SLV	2
Spring	14897	3
Insert Valve	19974	1
Insert Valve	4300810	2
Retainer Assembly	A-6340	1
Output Shaft Seal Kit	K-2262	1
O-Ring Kit	K-2298	1
O-Ring Kit	OK17453	1
Snap Ring	14317	2
Snap Ring	14750	1
Snap Ring	16763	2
Snap Ring	16980	1
Gasket Kit	K-2295	1
Threadlocker	TL1	1

TRK-3132		
Position	Part Number	Qty
Input Shaft Brg.	MU1212RUMW3	1
Input Shaft Pilot Bushing	BS59	1
Aux. Drive Gear Brg.	5566507	1
Aux. Mainshaft Brg.	5566503	1
Countershaft Front Brg.	BS226539V	2
Countershaft Rear Brg.	BS226539V	2
Rev. Idler Gear Brg.	HJ223020-IR1820OH	2
Aux. Countershaft Front Brg.	4302074	2
Aux. Countershaft Rear Brg.	4302074	2
Spring	14897	3
Output Shaft Seal Kit	K-2262	1
Snap Ring	16980	1
Snap Ring	17399	1
Snap Ring	4302082	2
Snap Ring	4303362	1
Shim Kit	K-2805	1
Piston Range Kit	K-2923	1
Gasket Kit	K-2921	1

TRK-3233		
Position	Part Number	Qty
Input Shaft Brg.	MU1212RUMW3	1
Input Shaft Pilot Bushing	BS59	1
Aux. Drive Gear Brg.	5566508	1
Aux. Mainshaft Brg.	5566503	1
Aux. Mainshaft Bushing	AA1512-12	2
Countershaft Front Brg.	BS500192SX	2
Countershaft Rear Brg.	MU1308TVWS	2
Rev. Idler Gear Brg.	HJ223020-IR1820OH	2
Aux. Countershaft Front Brg.	4302074	2
Aux. Countershaft Rear Brg.	4302074	2
Spring	14897	3
Insert Valve	19974	1
O-Ring Kit	K-2054	1
Output Shaft Seal Kit	K-2918	1
Snap Ring	14317	2
Snap Ring	14750	1
Snap Ring	16763	1
Shim Kit	K-2805	1
Gasket Kit	K-2061	1

TRK-3234		
Position	Part Number	Qty
Input Shaft Brg.	MU1212RUMW3	1
Aux. Drive Gear Brg.	5566508	1
Aux. Mainshaft Brg.	5566503	1
Aux. Mainshaft Bushing	AA1512-12	2
Countershaft Front Brg.	BS500192SX	2
Countershaft Rear Brg.	MU1308TVWS	2
Rev. Idler Gear Brg.	HJ223020-IR1820OH	2
Aux. Countershaft Front Brg.	4302074	2
Aux. Countershaft Rear Brg.	4302074	2
Spring	14897	3
Insert Valve	19974	1
O-Ring Kit	K-2054	1
Output Shaft Seal Kit	K-2918	1
Snap Ring	14317	2
Snap Ring	14750	1
Snap Ring	16763	1
Snap Ring	16980	1
Shim Kit	K-2805	1
Gasket Kit	K-2061	1
Spring	15918	3
Sliding Clutch	4306647	1
Collet	83002	4
Connector	84004	2
Connector	85001	1
Sealer	LC54505	1
Input Shaft	S1659	1

# Heavy Duty Transmission Rebuild Kits



TRK-3256		
Position	Part Number	Qty
Input Shaft Brg.	MU1212RUMW3	1
Input Shaft Pilot Bushing	BS59	1
Aux. Drive Gear Brg.	5566507	1
Aux. Mainshaft Brg.	5566503	1
Aux. Mainshaft Bushing	AA1512-12	2
Countershaft Front Brg.	BS500192SX	2
Countershaft Rear Brg.	MU1308TVWS	2
Rev. Idler Gear Brg.	HJ223020-IR1820OH	2
Aux. Countershaft Front Brg.	4302074	2
Aux. Countershaft Rear Brg.	4302074	2
Spring	14897	3
Insert Valve	19974	1
O-Ring Kit	K-2054	1
Output Shaft Seal Kit	K-2918	1
Snap Ring	14317	2
Snap Ring	14750	1
Snap Ring	16763	1
Shim Kit	K-2805	1
Gasket Kit	K-2061	1

TRK-3257		
Position	Part Number	Qty
Input Shaft Brg.	MU1212RUMW3	1
Aux. Drive Gear Brg.	5566507	1
Aux. Mainshaft Brg.	5566503	1
Aux. Mainshaft Bushing	AA1512-12	2
Countershaft Front Brg.	BS500192SX	2
Countershaft Rear Brg.	MU1308TVWS	2
Rev. Idler Gear Brg.	HJ223020-IR1820OH	2
Aux. Countershaft Front Brg.	4302074	2
Aux. Countershaft Rear Brg.	4302074	2
Spring	14897	3
Insert Valve	19974	1
O-Ring Kit	K-2054	1
Output Shaft Seal Kit	K-2918	1
Snap Ring	14317	2
Snap Ring	14750	1
Snap Ring	16763	1
Snap Ring	16980	1
Shim Kit	K-2805	1
Gasket Kit	K-2061	1
Spring	15918	3
Sliding Clutch	4306648	1
Collet	83002	4
Connector	84004	2
Connector	85001	1
Sealer	LC54505	1
Input Shaft	S1659	1

TRK-3258		
Position	Part Number	Qty
Input Shaft Brg.	MU1212RUMW3	1
Aux. Drive Gear Brg.	5566507	1
Aux. Mainshaft Brg.	5566503	1
Aux. Mainshaft Bushing	AA1512-12	2
Countershaft Front Brg.	BS500192SX	2
Countershaft Rear Brg.	MU1308TVWS	2
Rev. Idler Gear Brg.	HJ223020-IR1820OH	2
Aux. Countershaft Front Brg.	4302074	2
Aux. Countershaft Rear Brg.	4302074	2
Spring	14897	3
Insert Valve	19974	1
O-Ring Kit	K-2054	1
Output Shaft Seal Kit	K-2918	1
Snap Ring	14317	2
Snap Ring	14750	1
Snap Ring	16763	1
Shim Kit	K-2805	1
Gasket Kit	K-2061	1
Snap Ring	16980	1
Sliding Clutch	4306647	1
Collet	83002	4
Connector	84004	2
Connector	85001	1
Sealer	LC54505	1
Input Shaft	S1659	1

TRK-3272		
Position	Part Number	Qty
Input Shaft Brg.	MU1212RUMW3	1
Aux. Drive Gear Brg.	5566507	1
Aux. Mainshaft Brg.	5566503	1
Aux. Mainshaft Bushing	AA1512-12	2
Countershaft Front Brg.	BS500192SX	2
Countershaft Rear Brg.	MU1308TVWS	2
Rev. Idler Gear Brg.	HJ223020-IR1820OH	2
Aux. Countershaft Front Brg.	4302074	2
Aux. Countershaft Rear Brg.	4302074	2
Spring	14897	3
Insert Valve	19974	1
O-Ring Kit	K-2054	1
Output Shaft Seal Kit	K-2918	1
Snap Ring	14317	2
Snap Ring	14750	1
Snap Ring	16763	1
Snap Ring	16980	1
Shim Kit	K-2805	1
Gasket Kit	K-2061	1
Spring	15918	3
Sliding Clutch	4306648	1
Collet	83002	4
Connector	84004	2
Connector	85001	1
Sealer	LC54505	1
Input Shaft	S1659	1

TRK-3273		
Position	Part Number	Qty
Input Shaft Brg.	MU1212RUMW3	1
Input Shaft Pilot Bushing	BS59	1
Aux. Drive Gear Brg.	5566507	1
Aux. Mainshaft Brg.	5566503	1
Aux. Mainshaft Bushing	AA1512-12	2
Countershaft Front Brg.	BS500192SX	2
Countershaft Rear Brg.	MU1308TVWS	2
Rev. Idler Gear Brg.	HJ223020-IR1820OH	2
Aux. Countershaft Front Brg.	4302074	2
Aux. Countershaft Rear Brg.	4302074	2
Spring	14897	3
Insert Valve	19974	1
O-Ring Kit	K-2054	1
Output Shaft Seal Kit	K-2918	1
Snap Ring	14317	2
Snap Ring	14750	1
Snap Ring	16763	1
Shim Kit	K-2805	1
Gasket Kit	K-2061	1

TRK-3282		
Position	Part Number	Qty
Input Shaft Brg.	MU1212RUMW3	1
Aux. Drive Gear Brg.	5566507	1
Aux. Mainshaft Brg.	5566503	1
Aux. Mainshaft Bushing	AA1512-12	2
Countershaft Front Brg.	BS500192SX	2
Countershaft Rear Brg.	MU1308TVWS	2
Rev. Idler Gear Brg.	HJ223020-IR1820OH	2
Aux. Countershaft Front Brg.	4302074	2
Aux. Countershaft Rear Brg.	4302074	2
Spring	14897	3
Insert Valve	19974	1
O-Ring Kit	K-2846	1
Output Shaft Seal Kit	K-2918	1
Snap Ring	14317	2
Snap Ring	14750	1
Snap Ring	16763	1
Shim Kit	K-2805	1
Gasket Kit	K-2061	1
Spring	15918	3
Snap Ring	16980	1
Sliding Clutch	4306647	1
Connector	84006	1
Connector	85003	1
Sealer	LC54505	1
Input Shaft	S1659	1

TRK-3283		
Position	Part Number	Qty
Input Shaft Brg.	MU1212RUMW3	1
Input Shaft Pilot Bushing	BS59	1
Aux. Drive Gear Brg.	5566507	1
Aux. Mainshaft Brg.	5566503	1
Aux. Mainshaft Bushing	AA1512-12	2
Countershaft Front Brg.	BS500192SX	2
Countershaft Rear Brg.	MU1308TVWS	2
Rev. Idler Gear Brg.	HJ223020-IR1820OH	2
Aux. Countershaft Front Brg.	4302074	2
Aux. Countershaft Rear Brg.	4302074	2
Spring	14897	3
Insert Valve	19974	1
O-Ring Kit	K-2846	1
Output Shaft Seal Kit	K-2918	1
Snap Ring	14317	2
Snap Ring	14750	1
Snap Ring	16763	1
Shim Kit	K-2805	1
Gasket Kit	K-2061	1

HD Transmission

# Heavy Duty Transmission Rebuild Kits



HD Transmission

TRK-3286		
Position	Part Number	Qty
Input Shaft Brg.	212SLV	1
Input Shaft Pilot Bushing	BS59	1
Aux. Drive Gear Brg.	5566508	1
Aux. Mainshaft Brg.	5566503	1
Splitter Gear Brg.	4300902	1
Countershaft Front Brg.	BS500192SX	2
Countershaft Rear Brg.	MU1308TMWS	2
Rev. Idler Gear Brg.	HJ223020-IR1820OH	2
Aux. Countershaft Front Brg.	4302074	2
Aux. Countershaft Rear Brg.	4302074	2
Spring	14897	3
Insert Valve	19974	1
O-Ring Kit	K-2804	1
Output Shaft Seal Kit	K-2918	1
Snap Ring	14317	2
Snap Ring	14750	1
Snap Ring	16980	1
Snap Ring	4301254	1
Snap Ring	4303424	1
Shim Kit	K-2805	1
Gasket Kit	K-3288	1

TRK-3287		
Position	Part Number	Qty
Input Shaft Brg.	212SLV	1
Aux. Drive Gear Brg.	5566508	1
Aux. Mainshaft Brg.	5566503	1
Splitter Gear Brg.	4300902	1
Countershaft Front Brg.	BS500192SX	2
Countershaft Rear Brg.	MU1308TMWS	2
Rev. Idler Gear Brg.	HJ223020-IR1820OH	2
Aux. Countershaft Front Brg.	4302074	2
Aux. Countershaft Rear Brg.	4302074	2
Spring	14897	3
Insert Valve	19974	1
O-Ring Kit	K-2804	1
Output Shaft Seal Kit	K-2918	1
Snap Ring	14317	2
Snap Ring	14750	1
Snap Ring	16980	1
Snap Ring	4301254	1
Snap Ring	4303424	1
Shim Kit	K-2805	1
Gasket Kit	K-3288	1
Spring	15918	3
Sliding Clutch	4304317	1
Connector	84006	2
Connector	85003	1
Sealer	LC54505	1
Input Shaft	S1659	1

TRK-3322		
Position	Part Number	Qty
Input Shaft Brg.	MU1212RUMW3	1
Input Shaft Pilot Bushing	BS59	1
Aux. Drive Gear Brg.	5566507	1
Aux. Mainshaft Brg.	21355	1
Countershaft Front Brg.	BS500192SX	2
Countershaft Rear Brg.	MU1308TVWS	2
Rev. Idler Gear Brg.	HJ223020-IR1820OH	2
Aux. Countershaft Front Brg.	4302074	2
Aux. Countershaft Rear Brg.	4302074	2
Spring	14897	3
O-Ring Kit	K-1450	1
Output Shaft Seal Kit	K-2262	1
Snap Ring	14317	2
Snap Ring	14750	1
Snap Ring	16763	2
Snap Ring	16980	1
Shim Kit	K-2805	1
Gasket Kit	K-2061	1

TRK-3323		
Position	Part Number	Qty
Input Shaft Brg.	MU1212RUMW3	1
Aux. Drive Gear Brg.	5566507	1
Aux. Mainshaft Brg.	21355	1
Countershaft Front Brg.	BS500192SX	2
Countershaft Rear Brg.	MU1308TVWS	2
Rev. Idler Gear Brg.	HJ223020-IR1820OH	2
Aux. Countershaft Front Brg.	4302074	2
Aux. Countershaft Rear Brg.	4302074	2
Spring	14897	3
O-Ring Kit	K-1450	1
Output Shaft Seal Kit	K-2262	1
Snap Ring	14317	2
Snap Ring	14750	1
Snap Ring	16763	2
Snap Ring	16980	1
Shim Kit	K-2805	1
Gasket Kit	K-2061	1
Spring	15918	3
Sliding Clutch	4306648	1
Collet	83001	4
Connector	84002	1
Connector	85002	1
Sealer	LC54505	1
Input Shaft	S1659	1

TRK-3339		
Position	Part Number	Qty
Input Shaft Brg.	212SLV	1
Aux. Drive Gear Brg.	5566510	1
Aux. Mainshaft Brg.	5566503	1
Splitter Gear Brg.	4300902	1
Countershaft Front Brg.	BS500192SX	2
Countershaft Rear Brg.	BS500052V	2
Rev. Idler Gear Brg.	HJ223020-IR1820OH	2
Aux. Countershaft Front Brg.	NP656227-NP896049	2
Aux. Countershaft Rear Brg.	NP656227-NP896049	2
Spring	14897	3
O-Ring Kit	K-3341	1
Output Shaft Seal Kit	K-2918	1
Snap Ring	14750	1
Snap Ring	16980	1
Snap Ring	4301254	1
Snap Ring	4302082	2
Snap Ring	4303424	1
Shim Kit	K-2805	1
Gasket Kit	K-3288	1
Spring	15918	3
Sliding Clutch	4304317	1
Connector	84006	2
Connector	85003	1
Sealer	LC54505	1
Input Shaft	S1659	1

TRK-3340		
Position	Part Number	Qty
Input Shaft Brg.	212SLV	1
Input Shaft Pilot Bushing	BS59	1
Aux. Drive Gear Brg.	5566510	1
Aux. Mainshaft Brg.	5566503	1
Splitter Gear Brg.	4300902	1
Countershaft Front Brg.	BS500192SX	2
Countershaft Rear Brg.	BS500052V	2
Rev. Idler Gear Brg.	HJ223020-IR1820OH	2
Aux. Countershaft Front Brg.	NP656227-NP896049	2
Aux. Countershaft Rear Brg.	NP656227-NP896049	2
Spring	14897	3
O-Ring Kit	K-3341	1
Output Shaft Seal Kit	K-2918	1
Snap Ring	14750	1
Snap Ring	16980	1
Snap Ring	4301254	1
Snap Ring	4302082	2
Snap Ring	4303424	1
Shim Kit	K-2805	1
Gasket Kit	K-3288	1



# Heavy Duty Transmission Rebuild Kits



HD Transmission

<b>TRK-3342</b>		
Position	Part Number	Qty
Input Shaft Brg.	212SLV	1
Aux. Drive Gear Brg.	5566508	1
Aux. Mainshaft Brg.	5556503	1
Countershaft Front Brg.	BS500192SX	2
Countershaft Rear Brg.	BS500052V	2
Rev. Idler Gear Brg.	HJ223020-IR1820OH	2
Aux. Countershaft Front Brg.	4302074	2
Aux. Countershaft Rear Brg.	4302074	2
Spring	14897	3
Output Shaft Seal Kit	K-2918	1
O-Ring Kit	K-3341	1
Snap Ring Set	SR3340	1
Snap Ring	4302082	2
Shim Kit	K-2805	1
Gasket Kit	K-3288	1
Spring	15918	3
Sliding Clutch	4304317	1
Connector	84006	2
Connector	85003	1
Sealer	LC54505	1
Input Shaft	S1659	1

<b>TRK-3343</b>		
Position	Part Number	Qty
Input Shaft Brg.	212SLV	1
Input Shaft Pilot Bushing	BS59	1
Aux. Drive Gear Brg.	5566508	1
Aux. Mainshaft Brg.	5556503	1
Countershaft Front Brg.	BS500192SX	2
Countershaft Rear Brg.	BS500052V	2
Rev. Idler Gear Brg.	HJ223020-IR1820OH	2
Aux. Countershaft Front Brg.	4302074	2
Aux. Countershaft Rear Brg.	4302074	2
Spring	14897	3
Output Shaft Seal Kit	K-2918	1
O-Ring Kit	K-3341	1
Snap Ring Set	SR3340	1
Snap Ring	4302082	2
Shim Kit	K-2805	1
Gasket Kit	K-3288	1

<b>TRK-3344</b>		
Position	Part Number	Qty
Aux. Mainshaft Brg.	21356	1
Aux. Countershaft Front Brg.	4302074	2
Aux. Countershaft Rear Brg.	4302074	2
Spring	14897	3
Insert Valve	19974	1
Output Shaft Seal Kit	K-2262	1
O-Ring Kit	K-2804	1
Connector	85003	1
Shim Kit	K-2805	1
Gasket Kit	K-1603	1

<b>TRK-3345</b>		
Position	Part Number	Qty
Input Shaft Brg.	212SLV	1
Aux. Drive Gear Brg.	5566508	1
Aux. Mainshaft Brg.	21356	1
Countershaft Front Brg.	BS500192SX	2
Countershaft Rear Brg.	MU1308TVWS	2
Rev. Idler Gear Brg.	HJ223020-IR1820OH	2
Aux. Countershaft Front Brg.	4302074	2
Aux. Countershaft Rear Brg.	4302074	2
Spring	14897	3
Insert Valve	19974	1
Output Shaft Seal Kit	K-2262	1
O-Ring Kit	K-2804	1
Snap Ring	14317	2
Snap Ring	14750	1
Snap Ring	16980	1
Snap Ring	4301254	2
Shim Kit	K-2805	1
Gasket Kit	K-2199	1
Spring	15918	3
Sliding Clutch	4304317	1
Connector	84005	2
Connector	85003	1
Sealer	LC54505	1
Input Shaft	S1659	1

<b>TRK-3346</b>		
Position	Part Number	Qty
Input Shaft Brg.	212SLV	1
Input Shaft Pilot Bushing	BS59	1
Aux. Drive Gear Brg.	5566508	1
Aux. Mainshaft Brg.	21356	1
Countershaft Front Brg.	BS500192SX	2
Countershaft Rear Brg.	MU1308TVWS	2
Rev. Idler Gear Brg.	HJ223020-IR1820OH	2
Aux. Countershaft Front Brg.	4302074	2
Aux. Countershaft Rear Brg.	4302074	2
Spring	14897	3
Insert Valve	19974	1
Output Shaft Seal Kit	K-2262	1
O-Ring Kit	K-2804	1
Snap Ring	14317	2
Snap Ring	14750	1
Snap Ring	16980	1
Snap Ring	4301254	2
Shim Kit	K-2805	1
Gasket Kit	K-2199	1

<b>TRK-3347</b>		
Position	Part Number	Qty
Input Shaft Brg.	212SLV	1
Aux. Drive Gear Brg.	5566508	1
Aux. Mainshaft Brg.	5556503	1
Countershaft Front Brg.	BS500192SX	2
Countershaft Rear Brg.	MU1308TVWS	2
Rev. Idler Gear Brg.	HJ223020-IR1820OH	2
Aux. Countershaft Front Brg.	4302074	2
Aux. Countershaft Rear Brg.	4302074	2
Spring	14897	3
Output Shaft Seal Kit	K-2918	1
O-Ring Kit	K-3341	1
Snap Ring	14317	2
Snap Ring	14750	1
Snap Ring	16980	1
Snap Ring	4301254	1
Shim Kit	K-2805	1
Gasket Kit	K-3288	1
Spring	15918	3
Sliding Clutch	4304317	1
Connector	84006	2
Connector	85003	1
Sealer	LC54505	1
Input Shaft	S1659	1

<b>TRK-3348</b>		
Position	Part Number	Qty
Input Shaft Brg.	212SLV	1
Input Shaft Pilot Bushing	BS59	1
Aux. Drive Gear Brg.	5566508	1
Aux. Mainshaft Brg.	5556503	1
Countershaft Front Brg.	BS500192SX	2
Countershaft Rear Brg.	MU1308TVWS	2
Rev. Idler Gear Brg.	HJ223020-IR1820OH	2
Aux. Countershaft Front Brg.	4302074	2
Aux. Countershaft Rear Brg.	4302074	2
Spring	14897	3
Output Shaft Seal Kit	K-2918	1
O-Ring Kit	K-3341	1
Snap Ring	14317	2
Snap Ring	14750	1
Snap Ring	16980	1
Snap Ring	4301254	1
Shim Kit	K-2805	1
Gasket Kit	K-3288	1

# Heavy Duty Transmission Rebuild Kits



HD Transmission

TRK-3350		
Position	Part Number	Qty
Input Shaft Brg.	212SLV	1
Aux. Drive Gear Brg.	5566508	1
Aux. Mainshaft Brg.	5556503	1
Countershaft Front Brg.	BS500192SX	2
Countershaft Rear Brg.	MU1308TVWS	2
Rev. Idler Gear Brg.	HJ223020-IR1820OH	2
Aux. Countershaft Front Brg.	4302074	2
Aux. Countershaft Rear Brg.	4302074	2
Spring	14897	3
Output Shaft Seal Kit	K-2918	1
O-Ring Kit	K-3341	1
Snap Ring	14317	2
Snap Ring	14750	1
Snap Ring	16980	1
Snap Ring	4301254	1
Shim Kit	K-2805	1
Gasket Kit	K-3288	1
Spring	15918	3
Sliding Clutch	4304317	1
Connector	84006	2
Connector	85003	1
Sealer	LC54505	1
Input Shaft	S1659	1

TRK-3351		
Position	Part Number	Qty
Input Shaft Brg.	212SLV	1
Input Shaft Pilot Bushing	BS59	1
Aux. Drive Gear Brg.	5566508	1
Aux. Mainshaft Brg.	5556503	1
Countershaft Front Brg.	BS500192SX	2
Countershaft Rear Brg.	MU1308TVWS	2
Rev. Idler Gear Brg.	HJ223020-IR1820OH	2
Aux. Countershaft Front Brg.	4302074	2
Aux. Countershaft Rear Brg.	4302074	2
Spring	14897	3
Output Shaft Seal Kit	K-2918	1
O-Ring Kit	K-3341	1
Snap Ring	14317	2
Snap Ring	14750	1
Snap Ring	16980	1
Snap Ring	4301254	1
Shim Kit	K-2805	1
Gasket Kit	K-3288	1

TRK-3354		
Position	Part Number	Qty
Input Shaft Brg.	212SLV	1
Aux. Drive Gear Brg.	5566508	1
Aux. Mainshaft Brg.	5556503	1
Splitter Gear Brg.	4300902	1
Countershaft Front Brg.	BS500192SX	2
Countershaft Rear Brg.	MU1308TVWS	2
Rev. Idler Gear Brg.	HJ223020-IR1820OH	2
Aux. Countershaft Front Brg.	NP656227-NP896049	2
Aux. Countershaft Rear Brg.	NP656227-NP896049	2
Spring	14897	3
Output Shaft Seal Kit	K-2918	1
O-Ring Kit	K-3341	1
Snap Ring	14317	2
Snap Ring	14750	1
Snap Ring	16980	1
Snap Ring	4301254	1
Snap Ring	4303424	1
Shim Kit	K-2805	1
Gasket Kit	K-3288	1
Spring	15918	3
Connector	84006	2
Connector	85003	1
Sliding Clutch	4304317	1
Input Shaft	S1659	1

TRK-3355		
Position	Part Number	Qty
Input Shaft Brg.	212SLV	1
Input Shaft Pilot Bushing	BS59	1
Aux. Drive Gear Brg.	5566508	1
Aux. Mainshaft Brg.	5556503	1
Splitter Gear Brg.	4300902	1
Countershaft Front Brg.	BS500192SX	2
Countershaft Rear Brg.	MU1308TVWS	2
Rev. Idler Gear Brg.	HJ223020-IR1820OH	2
Aux. Countershaft Front Brg.	NP656227-NP896049	2
Aux. Countershaft Rear Brg.	NP656227-NP896049	2
Spring	14897	3
Output Shaft Seal Kit	K-2918	1
O-Ring Kit	K-3341	1
Snap Ring	14317	2
Snap Ring	14750	1
Snap Ring	16980	1
Snap Ring	4301254	1
Snap Ring	4303424	1
Shim Kit	K-2805	1
Gasket Kit	K-3288	1

TRK-3413		
Position	Part Number	Qty
Input Shaft Brg.	MU1212RUMW3	1
Input Shaft Pilot Bushing	BS59	1
Aux. Drive Gear Brg.	5566508	1
Aux. Mainshaft Bushing	AA1512-12	2
Aux. Mainshaft Brg.	5556503	1
Countershaft Front Brg.	BS500192SX	2
Countershaft Rear Brg.	MU1308TVWS	2
Rev. Idler Gear Brg.	HJ223020-IR1820OH	2
Aux. Countershaft Front Brg.	4302074	2
Aux. Countershaft Rear Brg.	4302074	2
Spring	14897	3
Insert Valve	19974	1
Output Shaft Seal Kit	K-2918	1
O-Ring Kit	K-2846	1
Snap Ring	14317	2
Snap Ring	14750	1
Snap Ring	16763	1
Shim Kit	K-2805	1
Gasket Kit	K-2061	1

TRK-3414		
Position	Part Number	Qty
Input Shaft Brg.	MU1212RUMW3	1
Aux. Drive Gear Brg.	5566508	1
Aux. Mainshaft Bushing	AA1512-12	2
Aux. Mainshaft Brg.	5556503	1
Countershaft Front Brg.	BS500192SX	2
Countershaft Rear Brg.	MU1308TVWS	2
Rev. Idler Gear Brg.	HJ223020-IR1820OH	2
Aux. Countershaft Front Brg.	4302074	2
Aux. Countershaft Rear Brg.	4302074	2
Spring	14897	3
Insert Valve	19974	1
Output Shaft Seal Kit	K-2918	1
O-Ring Kit	K-2846	1
Snap Ring	14317	2
Snap Ring	14750	1
Snap Ring	16763	1
Shim Kit	K-2805	1
Gasket Kit	K-2061	1
Spring	15918	3
Sliding Clutch	4306647	1
Connector	84006	1
Connector	85003	1
Sealer	LC54505	1
Input Shaft	S1659	1

TRK-3423		
Position	Part Number	Qty
Input Shaft Brg.	39590-39520	1
Input Shaft Pilot Brg.	31594	1
Output Shaft Brg.	45285A-45220	1
Mainshaft 6th Gear Brg.	FW505520	2
Mainshaft 4th Gear Brg.	FW556020	2
Mainshaft 3rd Gear Brg.	FW657020	2
Mainshaft 2nd Gear Brg.	FW707620	2
Mainshaft 1st Gear Brg.	FW707620	2
Mainshaft Rev. Gear Brg.	4304555	1
Countershaft Front Brg.	25590-25522	1
Countershaft Rear Brg.	3782-3720	1
Rev. Idler Gear Brg.	FW404820	2
Snap Ring	3315686	1
Snap Ring	3315725	2
Spring	3315765	4
Plug	3315679	1
Shim Kit	K-2183	1
Output Shaft Seal	4300119	1
Input Shaft Seal	710211 (1.875x2.677)	1
Gasket Kit	K-7028	1

# Heavy Duty Transmission Rebuild Kits



HD Transmission

TRK-3425		
Position	Part Number	Qty
Input Shaft Brg.	212SLV	1
Aux. Drive Gear Brg.	5566508	1
Aux. Mainshaft Brg.	5566503	1
Splitter Gear Brg.	4300902	1
Countershaft Front Brg.	BS500192SX	2
Countershaft Rear Brg.	BS500052V	2
Rev. Idler Gear Brg.	HJ223020-IR1820OH	2
Aux. Countershaft Front Brg.	4302074	2
Aux. Countershaft Rear Brg.	4302074	2
Spring	14897	3
Output Shaft Seal Kit	K-2918	1
O-Ring Kit	K-3341	1
Snap Ring	14750	1
Snap Ring	16980	1
Snap Ring	4301254	1
Snap Ring	4302082	2
Snap Ring	4303424	2
Gasket Kit	K-3288	1
Shim Kit	K-2805	1
Spring	15918	3
Sliding Clutch	4304317	1
Connector	84006	2
Connector	85003	1
Sealer	LC54505	1
Input Shaft	S1659	1

TRK-3426		
Position	Part Number	Qty
Input Shaft Brg.	212SLV	1
Input Shaft Pilot Bushing	BS59	1
Aux. Drive Gear Brg.	5566508	1
Aux. Mainshaft Brg.	5566503	1
Splitter Gear Brg.	4300902	1
Countershaft Front Brg.	BS500192SX	2
Countershaft Rear Brg.	BS500052V	2
Rev. Idler Gear Brg.	HJ223020-IR1820OH	2
Aux. Countershaft Front Brg.	4302074	2
Aux. Countershaft Rear Brg.	4302074	2
Spring	14897	3
Output Shaft Seal Kit	K-2918	1
O-Ring Kit	K-3341	1
Snap Ring	14750	1
Snap Ring	16980	1
Snap Ring	4301254	1
Snap Ring	4302082	2
Snap Ring	4303424	2
Gasket Kit	K-3288	1
Shim Kit	K-2805	1

TRK-3440		
Position	Part Number	Qty
Input Shaft Brg.	39590-39520	1
Input Shaft Pilot Brg.	31594	1
Output Shaft Brg.	45285A-45220	1
Countershaft Front Brg.	25590-25522	1
Countershaft Rear Brg.	3782-3720	1
1st Gear Brg.	FW707620	2
2nd Gear Brg.	FW707620	2
3rd Gear Brg.	FW657020	2
4th Gear Brg.	FW556020	2
5th Gear Brg.	FW505520	2
Rev. Gear Brg.	FW556020	2
Rev. Idler Gear Brg.	FW404820	2
Countershaft Plug	3315679	1
Spring	691644	4
Snap Ring	3315686	1
Snap Ring	3315725	2
Input Shaft Seal	710211 (1.875x2.677)	1
Output Shaft Seal	4300119	1
Shim Kit	K-2183	1
Gasket Set	K-3738	1

TRK-3459		
Position	Part Number	Qty
Input Shaft Brg.	212SLV	1
Aux. Drive Gear Brg.	5566510	1
Aux. Mainshaft Brg.	5566503	1
Countershaft Front Brg.	BS500192SX	2
Countershaft Rear Brg.	BS500052V	2
Rev. Idler Gear Brg.	HJ223020-IR1820OH	2
Aux. Countershaft Front Brg.	NP656227-NP896049	2
Aux. Countershaft Rear Brg.	NP656227-NP896049	2
Spring	14897	3
Output Shaft Seal Kit	K-2918	1
O-Ring Kit	K-3341	1
Snap Ring	14750	1
Snap Ring	16980	1
Snap Ring	4301254	1
Snap Ring	4302082	2
Shim Kit	K-2805	1
Gasket Kit	K-3458	1
Spring	15918	3
Sliding Clutch	4304317	1
Connector	84006	2
Connector	85003	1
Sealer	LC54505	1
Input Shaft	S1659	1

TRK-3460		
Position	Part Number	Qty
Input Shaft Brg.	212SLV	1
Input Shaft Pilot Bushing	BS59	1
Aux. Drive Gear Brg.	5566510	1
Aux. Mainshaft Brg.	5566503	1
Countershaft Front Brg.	BS500192SX	2
Countershaft Rear Brg.	BS500052V	2
Rev. Idler Gear Brg.	HJ223020-IR1820OH	2
Aux. Countershaft Front Brg.	NP656227-NP896049	2
Aux. Countershaft Rear Brg.	NP656227-NP896049	2
Spring	14897	3
Output Shaft Seal Kit	K-2918	1
O-Ring Kit	K-3341	1
Snap Ring	14750	1
Snap Ring	16980	1
Snap Ring	4301254	1
Snap Ring	4302082	2
Shim Kit	K-2805	1
Gasket Kit	K-3458	1

TRK-3461		
Position	Part Number	Qty
Input Shaft Brg.	MU1212RUMW3	1
Aux. Drive Gear Brg.	5566510	1
Aux. Mainshaft Brg.	5566503	1
Splitter Gear Brg.	4300902	1
Countershaft Front Brg.	BS500192SX	2
Countershaft Rear Brg.	BS500052V	2
Rev. Idler Gear Brg.	HJ223020-IR1820OH	2
Aux. Countershaft Front Brg.	NP656227-NP896049	2
Aux. Countershaft Rear Brg.	NP656227-NP896049	2
Spring	14897	3
Output Shaft Seal Kit	K-2918	1
O-Ring Kit	K-3341	1
Snap Ring	14750	1
Snap Ring	16980	1
Snap Ring	4301254	1
Snap Ring	4302082	1
Snap Ring	4303424	1
Shim Kit	K-2805	1
Gasket Kit	K-3458	1
Spring	15918	3
Sliding Clutch	4304317	1
Connector	85003	3
Sealer	LC54505	1
Input Shaft	S2890	1

TRK-3462		
Position	Part Number	Qty
Input Shaft Brg.	MU1212RUMW3	1
Input Shaft Pilot Bushing	BS59	1
Aux. Drive Gear Brg.	5566510	1
Aux. Mainshaft Brg.	5566503	1
Splitter Gear Brg.	4300902	1
Countershaft Front Brg.	BS500192SX	2
Countershaft Rear Brg.	BS500052V	2
Rev. Idler Gear Brg.	HJ223020-IR1820OH	2
Aux. Countershaft Front Brg.	NP656227-NP896049	2
Aux. Countershaft Rear Brg.	NP656227-NP896049	2
Spring	14897	3
Output Shaft Seal Kit	K-2918	1
O-Ring Kit	K-3341	1
Snap Ring	14750	1
Snap Ring	16980	1
Snap Ring	4301254	1
Snap Ring	4302082	1
Snap Ring	4303424	1
Shim Kit	K-2805	1
Gasket Kit	K-3458	1

# Heavy Duty Transmission Rebuild Kits



HD Transmission

TRK-3486		
Position	Part Number	Qty
Input Shaft Brg.	212SLV	1
Aux. Drive Gear Brg.	5566507	1
Aux. Mainshaft Brg.	21356	1
Countershaft Front Brg.	BS500192SX	2
Countershaft Rear Brg.	MU1308TVWS	2
Rev. Idler Gear Brg.	HJ223020-IR1820OH	2
Aux. Countershaft Front Brg.	4302074	2
Aux. Countershaft Rear Brg.	4302074	2
Spring	14897	3
Output Shaft Seal Kit	K-2262	1
O-Ring Kit	K-3484	1
Snap Ring	14317	2
Snap Ring	14750	1
Snap Ring	16763	2
Snap Ring	16980	1
Snap Ring Retainer	21320	1
Shim Kit	K-2805	1
Gasket Kit	K-3485	1
Sliding Clutch	4305996	1
Sealer	LC54505	1
Input Shaft	S1659	1

TRK-3487		
Position	Part Number	Qty
Input Shaft Brg.	212SLV	1
Input Shaft Pilot Bushing	BS59	1
Aux. Drive Gear Brg.	5566507	1
Aux. Mainshaft Brg.	21356	1
Countershaft Front Brg.	BS500192SX	2
Countershaft Rear Brg.	MU1308TVWS	2
Rev. Idler Gear Brg.	HJ223020-IR1820OH	2
Aux. Countershaft Front Brg.	4302074	2
Aux. Countershaft Rear Brg.	4302074	2
Spring	14897	3
Output Shaft Seal Kit	K-2262	1
O-Ring Kit	K-3484	1
Snap Ring	14317	2
Snap Ring	14750	1
Snap Ring	16763	2
Snap Ring Retainer	21320	1
Shim Kit	K-2805	1
Gasket Kit	K-3485	1

TRK-3488		
Position	Part Number	Qty
Input Shaft Brg.	212SLV	1
Input Shaft Pilot Bushing	BS59	1
Aux. Drive Gear Brg.	5566507	1
Aux. Mainshaft Brg.	21355	1
Countershaft Front Brg.	BS500192SX	2
Countershaft Rear Brg.	MU1308TVWS	2
Rev. Idler Gear Brg.	HJ223020-IR1820OH	2
Aux. Countershaft Front Brg.	4302074	2
Aux. Countershaft Rear Brg.	4302074	2
Spring	14897	3
Output Shaft Seal Kit	K-2262	1
O-Ring Kit	K-3484	1
Snap Ring	14317	2
Snap Ring	14750	1
Snap Ring	16763	2
Snap Ring Retainer	21320	1
Shim Kit	K-2805	1
Gasket Kit	K-3485	1

TRK-3512		
Position	Part Number	Qty
Input Shaft Brg.	212SLV	1
Input Shaft Pilot Bushing	BS59	1
Aux. Drive Gear Brg.	5566510	1
Aux. Mainshaft Brg.	5556503	1
Splitter Gear Brg.	4300902	1
Countershaft Front Brg.	BS500192SX	2
Countershaft Rear Brg.	BS500052V	2
Rev. Idler Gear Brg.	HJ223020-IR1820OH	2
Aux. Countershaft Front Brg.	NP656227-NP896049	2
Aux. Countershaft Rear Brg.	NP656227-NP896049	2
Spring	14897	3
O-Ring Kit	K-3510	1
Output Shaft Seal Kit	K-2918	1
Snap Ring	14750	1
Snap Ring	16980	1
Snap Ring	4301254	1
Snap Ring	4302082	2
Snap Ring	4303424	1
Shim Kit	K-2805	1
Gasket Kit	K-3509	1

TRK-3513		
Position	Part Number	Qty
Input Shaft Brg.	212SLV	1
Aux. Drive Gear Brg.	5566510	1
Aux. Mainshaft Brg.	5556503	1
Splitter Gear Brg.	4300902	1
Countershaft Front Brg.	BS500192SX	2
Countershaft Rear Brg.	BS500052V	2
Rev. Idler Gear Brg.	HJ223020-IR1820OH	2
Aux. Countershaft Front Brg.	NP656227-NP896049	2
Aux. Countershaft Rear Brg.	NP656227-NP896049	2
Spring	14897	3
O-Ring Kit	K-3510	1
Output Shaft Seal Kit	K-2918	1
Snap Ring	14750	1
Snap Ring	16980	1
Snap Ring	4301254	1
Snap Ring	4302082	2
Snap Ring	4303424	1
Shim Kit	K-2805	1
Gasket Kit	K-3509	1
Spring	691661	3
Sliding Clutch	4305996	1
Sealer	LC54505	1
Input Shaft	S1659	1

TRK-3514		
Position	Part Number	Qty
Input Shaft Brg.	MU1212RUMW3	1
Input Shaft Pilot Bushing	BS59	1
Aux. Drive Gear Brg.	5566510	1
Aux. Mainshaft Brg.	5556503	1
Splitter Gear Brg.	4300902	1
Countershaft Front Brg.	BS500192SX	2
Countershaft Rear Brg.	BS500052V	2
Rev. Idler Gear Brg.	HJ223020-IR1820OH	2
Aux. Countershaft Front Brg.	NP656227-NP896049	2
Aux. Countershaft Rear Brg.	NP656227-NP896049	2
Spring	14897	3
O-Ring Kit	K-3510	1
Output Shaft Seal Kit	K-2918	1
Snap Ring	14750	1
Snap Ring	16980	1
Snap Ring	4301254	1
Snap Ring	4302082	2
Snap Ring	4303424	1
Shim Kit	K-2805	1
Gasket Kit	K-3509	1

TRK-3515		
Position	Part Number	Qty
Input Shaft Brg.	MU1212RUMW3	1
Aux. Drive Gear Brg.	5566510	1
Aux. Mainshaft Brg.	5556503	1
Splitter Gear Brg.	4300902	1
Countershaft Front Brg.	BS500192SX	2
Countershaft Rear Brg.	BS500052V	2
Rev. Idler Gear Brg.	HJ223020-IR1820OH	2
Aux. Countershaft Front Brg.	NP656227-NP896049	2
Aux. Countershaft Rear Brg.	NP656227-NP896049	2
Spring	14897	3
O-Ring Kit	K-3510	1
Output Shaft Seal Kit	K-2918	1
Snap Ring	14750	1
Snap Ring	16980	1
Snap Ring	4301254	1
Snap Ring	4302082	2
Snap Ring	4303424	1
Shim Kit	K-2805	1
Gasket Kit	K-3509	1
Spring	691661	3
Sliding Clutch	4305996	1
Sealer	LC54505	1
Input Shaft	S2890	1

TRK-3519		
Position	Part Number	Qty
Input Shaft Brg.	212SLV	1
Aux. Drive Gear Brg.	5566507	1
Aux. Mainshaft Brg.	5556503	1
Countershaft Front Brg.	BS500192SX	2
Countershaft Rear Brg.	MU1308TVWS	2
Rev. Idler Gear Brg.	HJ223020-IR1820OH	2
Aux. Countershaft Front Brg.	4302074	4
Spring	14897	3
Output Shaft Seal Kit	K-2918	1
O-Ring Kit	K-3484	1
O-Ring Kit	OK17453	1
Snap Ring	14317	2
Snap Ring	14750	1
Snap Ring	16763	2
Snap Ring	16980	1
Snap Ring Retainer	21320	1
Shim Kit	K-2805	1
Gasket Kit	K-3518	1
Sliding Clutch	4305996	1
Sealer	LC54505	1
Input Shaft	S1659	1

TRK-3522		
Position	Part Number	Qty
Input Shaft Brg.	212SLV	1
Input Shaft Pilot Bushing	BS59	1
Aux. Drive Gear Brg.	5566507	1
Aux. Mainshaft Brg.	5556503	1
Countershaft Front Brg.	BS500192SX	2
Countershaft Rear Brg.	MU1308TVWS	2
Rev. Idler Gear Brg.	HJ223020-IR1820OH	2
Aux. Countershaft Front Brg.	4302074	4
Spring	14897	3
Output Shaft Seal Kit	K-2918	1
O-Ring Kit	K-3484	1
O-Ring Kit	OK17453	1
Snap Ring	14317	2
Snap Ring	14750	1
Snap Ring	16763	2
Snap Ring Retainer	21320	1
Shim Kit	K-2805	1
Gasket Kit	K-3518	1

# Heavy Duty Transmission Rebuild Kits

<b>TRK-3524</b>			<b>TRK-3553</b>			<b>TRK-3585</b>		
Position	Part Number	Qty	Position	Part Number	Qty	Position	Part Number	Qty
Input Shaft Brg.	212SLV	1	Input Shaft Brg.	212SLV	1	Input Shaft Brg.	212SLV	1
Aux. Drive Gear Brg.	5566507	1	Input Shaft Pilot Bushing	BS59	1	Aux. Drive Gear Brg.	5566507	1
Aux. Mainshaft Brg.	5556503	1	Aux. Drive Gear Brg.	5566507	1	Aux. Mainshaft Brg.	29675 Assy 902A8 (A2892)	1
Countershaft Front Brg.	BS500192SX	2	Aux. Mainshaft Brg.	21356	1	Aux. Mainshaft Thrust Brg.	AXK5070	2
Countershaft Rear Brg.	MU1308TVWS	2	Splitter Gear Brg.	4300902	1	Countershaft Front Brg.	BS500192SX	2
Rev. Idler Gear Brg.	HJ223020-IR1820OH	2	Countershaft Front Brg.	BS500192SX	2	Countershaft Rear Brg.	MU1308TVWS	2
Aux. Countershaft Brg.	4302074	4	Countershaft Rear Brg.	MU1308TVWS	2	Rev. Idler Gear Brg.	HJ223020-IR1820OH	2
Spring	14897	3	Rev. Idler Gear Brg.	HJ223020-IR1820OH	2	Aux. Countershaft Front Brg.	4302074	2
Output Shaft Seal Kit	K-2918	1	Aux. Countershaft Front Brg.	4302074	2	Aux. Countershaft Rear Brg.	4302074	2
O-Ring Kit	K-3484	1	Aux. Countershaft Rear Brg.	4302074	2	Spring	14897	3
O-Ring Kit	OK17453	1	Spring	14897	3	Output Shaft Seal Kit	K-2262	1
Snap Ring	14317	2	Insert Valve	19974	1	O-Ring Kit	K-3583	1
Snap Ring	14750	1	Insert Valve	4300810	2	O-Ring Kit	OK17453	1
Snap Ring	16763	2	Output Shaft Seal Kit	K-2262	1	Snap Ring	14317	2
Snap Ring	16980	1	O-Ring Kit	K-2298	1	Snap Ring	14750	1
Snap Ring Retainer	21320	1	Snap Ring	14317	2	Snap Ring	16763	2
Shim Kit	K-2805	1	Snap Ring	14750	1	Snap Ring	16980	1
Gasket Kit	K-3518	1	Snap Ring	16980	1	Retainer Assembly	A-6340	1
Sliding Clutch	4305997	1	Shim Kit	K-2805	1	Shim Kit	K-2430	1
Sealer	LC54505	1	Gasket Kit	K-3552	1	Gasket Kit	K-3584	1
Input Shaft	S1659	1				Spring	15918	3
						Sliding Clutch	16118	1
<b>TRK-3533</b>			<b>TRK-3554</b>			<b>TRK-3586</b>		
Position	Part Number	Qty	Position	Part Number	Qty	Position	Part Number	Qty
Input Shaft Brg.	212SLV	1	Input Shaft Brg.	212SLV	1	Input Shaft Brg.	212SLV	1
Aux. Drive Gear Brg.	5566510	1	Aux. Drive Gear Brg.	5566507	1	Input Shaft Pilot Bushing	BS59	1
Aux. Mainshaft Brg.	5556503	1	Aux. Mainshaft Brg.	21356	1	Aux. Drive Gear Brg.	5566507	1
Splitter Gear Brg.	4300902	1	Splitter Gear Brg.	4300902	1	Aux. Mainshaft Brg.	29675 Assy 902A8 (A2892)	1
Countershaft Front Brg.	BS500192SX	2	Countershaft Front Brg.	BS500192SX	2	Aux. Mainshaft Thrust Brg.	AXK5070	2
Countershaft Rear Brg.	BS500052V	2	Countershaft Rear Brg.	MU1308TVWS	2	Countershaft Front Brg.	BS500192SX	2
Rev. Idler Gear Brg.	HJ223020-IR1820OH	2	Rev. Idler Gear Brg.	HJ223020-IR1820OH	2	Countershaft Rear Brg.	MU1308TVWS	2
Aux. Countershaft Front Brg.	4302074	2	Aux. Countershaft Front Brg.	4302074	2	Rev. Idler Gear Brg.	HJ223020-IR1820OH	2
Aux. Countershaft Rear Brg.	4302074	2	Aux. Countershaft Rear Brg.	4302074	2	Aux. Countershaft Front Brg.	4302074	2
Spring	14897	3	Spring	14897	3	Aux. Countershaft Rear Brg.	4302074	2
O-Ring Kit	K-3510	1	Insert Valve	19974	1	Spring	14897	3
Output Shaft Seal Kit	K-2918	1	Insert Valve	4300810	2	Output Shaft Seal Kit	K-2262	1
Snap Ring	14750	1	Output Shaft Seal Kit	K-2262	1	O-Ring Kit	K-3583	1
Snap Ring	16980	1	O-Ring Kit	K-2298	1	O-Ring Kit	OK17453	1
Snap Ring	4301254	1	Snap Ring	14317	2	Snap Ring	14317	2
Snap Ring	4302082	2	Snap Ring	14750	1	Snap Ring	14750	1
Snap Ring	4303424	1	Snap Ring	16980	1	Snap Ring	16763	2
Shim Kit	K-2805	1	Shim Kit	K-2805	1	Snap Ring	16980	1
Gasket Kit	K-3532	1	Gasket Kit	K-3552	1	Retainer Assembly	A-6340	1
Spring	1069	3	Spring	15918	2	Shim Kit	K-2430	1
Sliding Clutch	4305996	1	Sliding Clutch	16118	1	Gasket Kit	K-3584	1
Sealer	LC54505	1	Connector	84005	2			
Input Shaft	S1659	1	Connector	85003	1			
			Sealer	LC54505	1			
			Input Shaft	S1659	1			
<b>TRK-3534</b>								
Position	Part Number	Qty						
Input Shaft Brg.	212SLV	1						
Input Shaft Pilot Bushing	BS59	1						
Aux. Drive Gear Brg.	5566510	1						
Aux. Mainshaft Brg.	5556503	1						
Splitter Gear Brg.	4300902	1						
Countershaft Front Brg.	BS500192SX	2						
Countershaft Rear Brg.	BS500052V	2						
Rev. Idler Gear Brg.	HJ223020-IR1820OH	2						
Aux. Countershaft Front Brg.	4302074	2						
Aux. Countershaft Rear Brg.	4302074	2						
Spring	14897	3						
O-Ring Kit	K-3510	1						
Output Shaft Seal Kit	K-2918	1						
Snap Ring	14750	1						
Snap Ring	16980	1						
Snap Ring	4301254	1						
Snap Ring	4302082	2						
Snap Ring	4303424	1						
Shim Kit	K-2805	1						
Gasket Kit	K-3532	1						



# Heavy Duty Transmission Rebuild Kits



HD Transmission

TRK-3595		
Position	Part Number	Qty
Input Shaft Brg.	212SLV	1
Aux. Drive Gear Brg.	5566508	1
Aux. Mainshaft Brg.	21356	1
Splitter Gear Brg.	4300902	1
Countershaft Front Brg.	BS500192SX	2
Countershaft Rear Brg.	MU1308TVWS	2
Rev. Idler Gear Brg.	HJ223020-IR1820OH	2
Aux. Countershaft Front Brg.	4302074	2
Aux. Countershaft Rear Brg.	4302074	2
Spring	14897	3
Output Shaft Seal Kit	K-2262	1
O-Ring Kit	K-3594	1
Snap Ring	14317	2
Snap Ring	14750	1
Snap Ring	16980	1
Shim Kit	K-2805	1
Gasket Kit	K-3593	1
Spring	15918	3
Sliding Clutch	16118	1
Connector	84005	2
Connector	85003	1
Input Shaft	S1659	1

TRK-3596		
Position	Part Number	Qty
Input Shaft Brg.	212SLV	1
Input Shaft Pilot Bushing	BS59	1
Aux. Drive Gear Brg.	5566508	1
Aux. Mainshaft Brg.	21356	1
Splitter Gear Brg.	4300902	1
Countershaft Front Brg.	BS500192SX	2
Countershaft Rear Brg.	MU1308TVWS	2
Rev. Idler Gear Brg.	HJ223020-IR1820OH	2
Aux. Countershaft Front Brg.	4302074	2
Aux. Countershaft Rear Brg.	4302074	2
Spring	14897	3
Output Shaft Seal Kit	K-2262	1
O-Ring Kit	K-3594	1
Snap Ring	14317	2
Snap Ring	14750	1
Snap Ring	16980	1
Shim Kit	K-2805	1
Gasket Kit	K-3593	1

TRK-3597		
Position	Part Number	Qty
Input Shaft Brg.	212SLV	1
Aux. Drive Gear Brg.	5566508	1
Aux. Mainshaft Brg.	556503	1
Splitter Gear Brg.	4300902	1
Countershaft Front Brg.	BS500192SX	2
Countershaft Rear Brg.	BS500052V	2
Rev. Idler Gear Brg.	HJ223020-IR1820OH	2
Aux. Countershaft Front Brg.	4302074	2
Aux. Countershaft Rear Brg.	4302074	2
Spring	14897	3
Output Shaft Seal Kit	K-2918	1
O-Ring Kit	K-3341	1
Snap Ring	14750	1
Snap Ring	16980	1
Snap Ring	4301254	1
Snap Ring	4302082	2
Shim Kit	K-2805	1
Gasket Kit	K-3458	1
Spring	15918	3
Sliding Clutch	4306647	1
Connector	84005	2
Connector	85003	1
Input Shaft	S1659	1

TRK-3598		
Position	Part Number	Qty
Input Shaft Brg.	212SLV	1
Input Shaft Pilot Bushing	BS59	1
Aux. Drive Gear Brg.	5566508	1
Aux. Mainshaft Brg.	556503	1
Splitter Gear Brg.	4300902	1
Countershaft Front Brg.	BS500192SX	2
Countershaft Rear Brg.	BS500052V	2
Rev. Idler Gear Brg.	HJ223020-IR1820OH	2
Aux. Countershaft Front Brg.	4302074	2
Aux. Countershaft Rear Brg.	4302074	2
Spring	14897	3
Output Shaft Seal Kit	K-2918	1
O-Ring Kit	K-3341	1
Snap Ring	14750	1
Snap Ring	16980	1
Snap Ring	4301254	1
Snap Ring	4302082	2
Shim Kit	K-2805	1
Gasket Kit	K-3458	1

TRK-3599		
Position	Part Number	Qty
Clutch Pilot Brg.	306VVL	1
Input Shaft Brg.	212SLV	1
Front Brg. Cover	20550	1
Clutch Yoke	85533	1
Clutch Yoke Bushing	12815	4
Clutch Brake Disc	85541	1
Input Shaft	S1659	1
Snap Ring	14750	1
Snap Ring	16980	1
Gasket	14311	1
Gasket	4305294	1
Gasket	4306584	1

TRK-3600		
Position	Part Number	Qty
Clutch Pilot Brg.	306VV	1
Input Shaft Brg.	MU1212RUMW3	1
Front Brg. Cover	20550	1
Clutch Yoke	85533	1
Clutch Yoke Bushing	12815	4
Clutch Brake Disc	85541	1
Input Shaft	S2822	1
Snap Ring	16980	1
Snap Ring	4303362	1
Gasket	14311	1
Gasket	4305294	1
Gasket	4306584	1

TRK-3601		
Position	Part Number	Qty
Clutch Pilot Brg.	306VVL	1
Input Shaft Brg.	MU1212RUMW3	1
Front Brg. Cover	20550	1
Clutch Yoke	85533	1
Clutch Yoke Bushing	12815	4
Clutch Brake Disc	85541	1
Input Shaft	S2822	1
Snap Ring	16980	1
Snap Ring	4303362	1
Gasket	14311	1
Gasket	4305294	1
Gasket	4306584	1

TRK-3655		
Position	Part Number	Qty
Input Shaft Brg.	MU1212RUMW3	1
Aux. Drive Gear Brg.	5566507	1
Aux. Mainshaft Brg.	390A Assy 902A2 (A3071)	1
Countershaft Front Brg.	BS500192SX	2
Countershaft Front Retainer	4304605	2
Countershaft Rear Brg.	MU1308TVWS	2
Rev. Idler Gear Brg.	HJ223020-IR1820OH	2
Range Shaft Quill Front Brg.	204	1
Range Shaft Quill Rear Bushing	BS60	1
Aux. Countershaft Front Brg.	MR1307EL	2
Aux. Countershaft Rear Brg.	1310L	2
Spring	14897	3
Insert Valve	19974	1
Output Shaft Seal Kit	K-2256	1
O-Ring Kit	K-1447	1
O-Ring Kit	OK17453	1
O-Ring	OR217V	1
O-Ring	OR221V	1
Snap Ring	14291	1
Snap Ring	14317	2
Snap Ring	14750	1
Snap Ring	16723	2
Snap Ring	16763	2
Snap Ring	16980	1
Gasket Kit	K-2199	1
Spring	15918	3
Front Brg. Cover	20552	1
Sliding Clutch	16118	1
Collet	83001	4
Connector	84002	1
Connector	85002	1
Sealer	LC54505	1
Input Shaft	S2928	1

# Heavy Duty Transmission Rebuild Kits



TRK-3656		
Position	Part Number	Qty
Input Shaft Brg.	MU1212RUMW3	1
Aux. Drive Gear Brg.	5566507	1
Aux. Mainshaft Brg.	390A Assy 902A2 (A3071)	1
Countershaft Front Brg.	BS500192SX	2
Countershaft Front Retainer	4304605	2
Countershaft Rear Brg.	MU1308TVWS	2
Rev. Idler Gear Brg.	HJ223020-IR1820OH	2
Range Shaft Quill Front Brg.	204	1
Range Shaft Quill Rear Bushing	BS60	1
Aux. Countershaft Front Brg.	MR1307EL	2
Aux. Countershaft Rear Brg.	1310L	2
Spring	14897	3
Insert Valve	19974	1
Output Shaft Seal Kit	K-2256	1
O-Ring Kit	K-1447	1
O-Ring Kit	OK17453	1
O-Ring	OR217V	1
O-Ring	OR221V	1
Snap Ring	14291	1
Snap Ring	14317	2
Snap Ring	14750	1
Snap Ring	16723	2
Snap Ring	16763	2
Snap Ring	16980	1
Gasket Kit	K-2199	1
Spring	15918	3
Front Brg. Cover	20550	1
Sliding Clutch	16118	1
Collet	83001	4
Connector	84002	1
Connector	85002	1
Sealer	LC54505	1
Input Shaft	S1659	1

TRK-3657		
Position	Part Number	Qty
Input Shaft Brg.	MU1212RUMW3	1
Aux. Drive Gear Brg.	5566507	1
Aux. Mainshaft Brg.	21355	1
Countershaft Front Brg.	BS500192SX	2
Countershaft Rear Brg.	MU1308TVWS	2
Rev. Idler Gear Brg.	HJ223020-IR1820OH	2
Aux. Countershaft Front Brg.	4302074	2
Aux. Countershaft Rear Brg.	4302074	2
Spring	14897	3
Insert Valve	19974	1
Output Shaft Seal Kit	K-2262	1
O-Ring Kit	K-2054	1
Snap Ring	14317	2
Snap Ring	14750	1
Snap Ring	16763	2
Snap Ring	16980	1
Shim Kit	K-2805	1
Gasket Kit	K-2061	1
Spring	15918	3
Collet	83002	4
Connector	84004	1
Connector	85001	1
Sliding Clutch	4304317	1
Sealer	LC54505	1
Input Shaft	S1659	1

TRK-3658		
Position	Part Number	Qty
Input Shaft Brg.	MU1212RUMW3	1
Aux. Drive Gear Brg.	5566507	1
Aux. Mainshaft Brg.	21355	1
Countershaft Front Brg.	BS500192SX	2
Countershaft Front Retainer	4304605	2
Countershaft Rear Brg.	MU1308TVWS	2
Rev. Idler Gear Brg.	HJ223020-IR1820OH	2
Aux. Countershaft Front Brg.	4302074	2
Aux. Countershaft Rear Brg.	4302074	2
Spring	14897	3
Insert Valve	19974	1
Output Shaft Seal Kit	K-2262	1
O-Ring Kit	K-2054	1
Snap Ring	14317	2
Snap Ring	14750	1
Snap Ring	16763	2
Snap Ring	16980	1
Shim Kit	K-2805	1
Gasket Kit	K-2061	1
Spring	15918	3
Sliding Clutch	16118	1
Collet	83002	4
Connector	84004	1
Connector	85001	1
Sealer	LC54505	1
Input Shaft	S1659	1

TRK-3659		
Position	Part Number	Qty
Input Shaft Brg.	MU1212RUMW3	1
Input Shaft Pilot Bushing	BS59	1
Aux. Drive Gear Brg.	5566507	1
Aux. Mainshaft Brg.	390A Assy 902A2 (A3071)	1
Countershaft Front Brg.	BS500192SX	2
Countershaft Front Retainer	4304605	2
Countershaft Rear Brg.	MU1308TVWS	2
Rev. Idler Gear Brg.	HJ223020-IR1820OH	2
Range Shaft Quill Front Brg.	204	1
Range Shaft Quill Rear Bushing	BS60	1
Aux. Countershaft Front Brg.	MR1307EL	2
Aux. Countershaft Rear Brg.	1310L	2
Spring	14897	3
Insert Valve	19974	1
Output Shaft Seal Kit	K-2256	1
O-Ring Kit	K-1447	1
O-Ring Kit	OK17453	1
O-Ring	OR217V	1
O-Ring	OR221V	1
Snap Ring	14291	1
Snap Ring	14317	2
Snap Ring	14750	1
Snap Ring	16723	2
Snap Ring	16763	2
Gasket Kit	K-2199	1

TRK-3660		
Position	Part Number	Qty
Input Shaft Brg.	MU1212RUMW3	1
Input Shaft Pilot Bushing	BS59	1
Aux. Drive Gear Brg.	5566507	1
Aux. Mainshaft Brg.	21355	1
Countershaft Front Brg.	BS500192SX	2
Countershaft Front Retainer	4304605	2
Countershaft Rear Brg.	MU1308TVWS	2
Rev. Idler Gear Brg.	HJ223020-IR1820OH	2
Aux. Countershaft Front Brg.	4302074	2
Aux. Countershaft Rear Brg.	4302074	2
Spring	14897	3
Insert Valve	19974	1
Output Shaft Seal Kit	K-2262	1
O-Ring Kit	K-2054	1
Snap Ring	14317	2
Snap Ring	14750	1
Snap Ring	16763	2
Snap Ring	16980	1
Shim Kit	K-2805	1
Gasket Kit	K-2061	1

TRK-3661		
Position	Part Number	Qty
Input Shaft Brg.	MU1212RUMW3	1
Aux. Drive Gear Brg.	5566507	1
Aux. Mainshaft Brg.	5556503	1
Aux. Mainshaft Bushing	AA1512-12	2
Countershaft Front Brg.	BS500192SX	2
Countershaft Rear Brg.	MU1308TVWS	2
Rev. Idler Gear Brg.	HJ223020-IR1820OH	2
Aux. Countershaft Front Brg.	4302074	2
Aux. Countershaft Rear Brg.	4302074	2
Spring	14897	3
Insert Valve	19974	1
O-Ring Kit	K-2846	1
Output Shaft Seal Kit	K-2918	1
Snap Ring	14317	2
Snap Ring	14750	1
Snap Ring	16763	1
Snap Ring	16980	1
Shim Kit	K-2805	1
Gasket Kit	K-2061	1
Spring	15918	3
Sliding Clutch	4306647	1
Connector	84006	1
Connector	85003	1
Sealer	LC54505	1
Input Shaft	S1659	1

TRK-3762		
Position	Part Number	Qty
Clutch Pilot Brg.	306VV	1
Input Shaft Brg.	MU1212RUMW3	1
Front Brg. Cover	20550	1
Clutch Yoke	85533	1
Clutch Yoke Bushing	12815	4
Clutch Brake Disc	85541	1
Input Shaft	S1659	1
Snap Ring	14750	1
Snap Ring	16980	1
Gasket	14311	1
Gasket	4305294	1
Gasket	4306584	1

HD Transmission

# Heavy Duty Transmission Rebuild Kits



HD Transmission

TRK-3941		
Position	Part Number	Qty
Input Shaft Brg.	BS500419	1
Input Shaft Pilot Bushing	BS59	1
Aux. Drive Gear Brg.	5566510	1
Aux. Mainshaft Brg.	5566507	1
Splitter Gear Brg.	4300902	1
Splitter Gear Brg.	4301844	1
Sleeve		
Countershaft Front Brg.	BS500192SX	2
Countershaft Rear Brg.	BS500052V	2
Rev. Idler Gear Brg.	HJ223020-IR1820OH	2
Aux. Countershaft Front Brg.	NP656227-NP896049	2
Aux. Countershaft Rear Brg.	NP656227-NP896049	2
Spring	14897	3
O-Ring Kit	K-3510	1
Output Shaft Seal Kit	K-2918	1
Snap Ring	14750	1
Snap Ring	16980	1
Snap Ring	19198	2
Snap Ring	4301254	1
Snap Ring	4302082	2
Snap Ring	4306308	1
Shim Kit	K-2805	1
Gasket Kit	K-3939	1

TRK-3942		
Position	Part Number	Qty
Input Shaft Brg.	BS500419	1
Input Shaft Pilot Bushing	BS59	1
Aux. Drive Gear Brg.	5566508	1
Aux. Mainshaft Brg.	5566507	1
Aux. Mainshaft Bushing	AA1512-12	1
Countershaft Front Brg.	BS500192SX	2
Countershaft Rear Brg.	MU1308TVWS	2
Rev. Idler Gear Brg.	HJ223020-IR1820OH	2
Aux. Countershaft Front Brg.	4302074	2
Aux. Countershaft Rear Brg.	4302074	2
Spring	14897	3
O-Ring Kit	K-2846	1
Output Shaft Seal Kit	K-2918	1
Snap Ring	14317	2
Snap Ring	14750	1
Snap Ring	16763	1
Snap Ring	16980	1
Snap Ring	19198	2
Snap Ring	4306308	1
Shim Kit	K-2805	1
Gasket Kit	K-3940	1

TRK-4010		
Position	Part Number	Qty
Input Shaft Brg.	BS500419	1
Input Shaft Pilot Bushing	BS59	1
Aux. Drive Gear Brg.	5566508	1
Aux. Mainshaft Brg.	5566507	1
Countershaft Front Brg.	BS500192SX	2
Countershaft Rear Brg.	BS500052V	2
Rev. Idler Gear Brg.	HJ223020-IR1820OH	2
Aux. Countershaft Front Brg.	4302074	2
Aux. Countershaft Rear Brg.	4302074	2
Spring	14897	3
O-Ring Kit	K-3484	1
Output Shaft Seal Kit	K-2918	1
Snap Ring	14750	1
Snap Ring	16763	1
Snap Ring	16980	1
Snap Ring	19198	2
Snap Ring	4302082	1
Shim Kit	K-2805	1
Gasket Kit	K-4011	1

TRK-4056		
Position	Part Number	Qty
Input Shaft Brg.	MU1212RUMW3	1
Aux. Drive Gear Brg.	5566508	1
Aux. Mainshaft Brg.	5566503	1
Splitter Gear Brg.	4300902	1
Countershaft Front Brg.	BS500192SX	2
Countershaft Rear Brg.	BS500052V	2
Rev. Idler Gear Brg.	HJ223020-IR1820OH	2
Aux. Countershaft Front Brg.	4302074	2
Aux. Countershaft Rear Brg.	4302074	2
Spring	14897	3
O-Ring Kit	K-3341	1
Output Shaft Seal Kit	K-2918	1
Snap Ring	14750	1
Snap Ring	16980	1
Snap Ring	4301254	1
Snap Ring	4302082	2
Shim Kit	K-2805	1
Gasket Kit	K-3458	1
Spring	15918	3
Sliding Clutch	4306647	1
Connector	84005	2
Connector	85003	1
Sealer	LC54505	1
Input Shaft	S1659	1

TRK-4057		
Position	Part Number	Qty
Input Shaft Brg.	MU1212RUMW3	1
Input Shaft Pilot Bushing	BS59	1
Aux. Drive Gear Brg.	5566508	1
Aux. Mainshaft Brg.	5566503	1
Splitter Gear Brg.	4300902	1
Countershaft Front Brg.	BS500192SX	2
Countershaft Rear Brg.	BS500052V	2
Rev. Idler Gear Brg.	HJ223020-IR1820OH	2
Aux. Countershaft Front Brg.	4302074	2
Aux. Countershaft Rear Brg.	4302074	2
Spring	14897	3
O-Ring Kit	K-3341	1
Output Shaft Seal Kit	K-2918	1
Snap Ring	14750	1
Snap Ring	16980	1
Snap Ring	4301254	1
Snap Ring	4302082	2
Shim Kit	K-2805	1
Gasket Kit	K-3458	1

TRK-4092		
Position	Part Number	Qty
Input Shaft Brg.	MU1212RUMW3	1
Aux. Drive Gear Brg.	5566508	1
Aux. Mainshaft Brg.	5566503	1
Aux. Mainshaft Bushing	AA1512-12	2
Countershaft Front Brg.	BS500192SX	2
Countershaft Rear Brg.	MU1308TVWS	2
Rev. Idler Gear Brg.	HJ223020-IR1820OH	2
Aux. Countershaft Front Brg.	4302074	2
Aux. Countershaft Rear Brg.	4302074	2
Spring	14897	3
Insert Valve	19974	1
O-Ring Kit	K-2054	1
Output Shaft Seal Kit	K-2918	1
Snap Ring	14317	2
Snap Ring	14750	1
Snap Ring	16763	1
Snap Ring	16980	1
Shim Kit	K-2805	1
Gasket Kit	K-2061	1
Spring	15918	3
Sliding Clutch	4306647	1
Collet	83002	4
Connector	84004	2
Connector	85001	1
Sealer	LC54505	1
Input Shaft	S1659	1

TRK-500CK		
Position	Part Number	Qty
Clutch Pilot Brg.	306VV	1
Input Shaft Brg.	212SLV	1
Front Brg. Cover	3105K1155	1
Clutch Yoke	85533	1
Clutch Yoke Bushing	12815	4
Clutch Brake Disc	85541	1
Input Shaft	KIT5367	1
Gasket	3208N1080	1

TRK-5356		
Position	Part Number	Qty
Input Shaft Brg.	212SLV	1
Input Shaft Pilot Brg.	1225A1171	1
Aux. Drive Gear Brg.	119L	1
Aux. Mainshaft Brg.	390A Assy 902B1	1
Countershaft Front Brg.	NP418109-NP525386	2
Countershaft Rear Brg.	NP449281-NP357215	2
Rev. Idler Gear Brg.	A1228E1175	2
Aux. Countershaft Front Brg.	NP449281-NP357215	2
Aux. Countershaft Rear Brg.	3782-3720	2
Spring	2258Z1144	3
Output Shaft Seal Kit	KIT5389 (3.753x4.720)	1
O-Ring	1205T1268	3
O-Ring	OR014V	1
O-Ring	OR017V	1
O-Ring	OR119	3
O-Ring	OR316V	1
O-Ring	OR334V	1
O-Ring	OR340V	2
Lock Nut	NL17-1	1
Lock Nut	NL25-1	1
Lock Nut	NL110-1	2
Snap Ring Set	KIT5452	1
Spacer Kit	KIT5331	1
Shim Kit	KIT5364	1
Small Parts Kit	KIT5291	1
Gasket	2208K1051	1
Output Shaft Nut	1227T1554	1

# Heavy Duty Transmission Rebuild Kits

TRK-5357		
Position	Part Number	Qty
Input Shaft Brg.	212SLV	1
Input Shaft Pilot Brg.	1225A1171	1
Aux. Drive Gear Brg.	119L	1
Aux. Mainshaft Brg.	29675 Assy 902B7	1
Countershaft Front Brg.	NP418109-NP525386	2
Countershaft Rear Brg.	NP449281-NP357215	2
Rev. Idler Gear Brg.	A1228E1175	2
Aux. Countershaft Front Brg.	NP449281-NP357215	2
Aux. Countershaft Rear Brg.	3782-3720	2
Spring	2258Z1144	3
Output Shaft Seal Kit	KIT5389 (3.753x4.720)	1
O-Ring	1205T1268	3
O-Ring	OR014V	1
O-Ring	OR017V	1
O-Ring	OR119	3
O-Ring	OR316V	1
O-Ring	OR334V	1
O-Ring	OR340V	2
Lock Nut	NL17-1	1
Lock Nut	NL25-1	1
Lock Nut	NL110-1	2
Snap Ring Set	KIT5452	1
Spacer Kit	KIT5331	1
Shim Kit	KIT5364	1
Small Parts Kit	KIT5291	1
Gasket	2208K1051	1
Output Shaft Nut	1227T1554	1

TRK-5358		
Position	Part Number	Qty
Input Shaft Brg.	212SLV	1
Input Shaft Pilot Brg.	1225A1171	1
Aux. Drive Gear Brg.	119L	1
Aux. Mainshaft Brg.	29675 Assy 902B7	1
Countershaft Front Brg.	NP418109-NP525386	2
Countershaft Rear Brg.	NP449281-NP357215	2
Rev. Idler Gear Brg.	A1228E1175	2
Aux. Countershaft Front Brg.	NP449281-NP357215	2
Aux. Countershaft Rear Brg.	3782-3720	2
Spring	2258Z1144	3
Output Shaft Seal Kit	KIT5389 (3.753x4.720)	1
O-Ring	1205T1268	3
O-Ring	OR009V	1
O-Ring	OR014V	1
O-Ring	OR017V	1
O-Ring	OR119	3
O-Ring	OR316V	1
O-Ring	OR320V	1
O-Ring	OR323V	1
O-Ring	OR334V	1
O-Ring	OR340V	2
O-Ring	5X889	1
Lock Nut	NL17-1	1
Lock Nut	NL25-1	1
Lock Nut	NL110-1	2
Snap Ring Set	KIT5452	1
Snap Ring	1229V4234	1
Spacer Kit	KIT5331	1
Shim Kit	KIT5364	1
Small Parts Kit	KIT5291	1
Gasket	3208S1059	1
Output Shaft Nut	1227T1554	1
Nut	1227A1405	1
Valve Assembly	A2297K5965	1

TRK-5406		
Position	Part Number	Qty
Input Shaft Brg.	212SLV	1
Input Shaft Pilot Brg.	1225A1171	1
Aux. Drive Gear Brg.	119L	1
Aux. Mainshaft Brg.	NP301337 Assy 902A2	1
Countershaft Front Brg.	NP418109-NP525386	2
Countershaft Rear Brg.	NP449281-NP357215	2
Rev. Idler Gear Brg.	A1228E1175	2
Aux. Countershaft Front Brg.	NP449281-NP357215	2
Aux. Countershaft Rear Brg.	NP449281-NP357215	2
Spring	2258Z1144	3
Spring	2258F1332	1
Ball	2297R6986	1
Snap Ring Set	KIT5452	1
Snap Ring	16980	1
Output Shaft Seal Kit	KIT5389 (3.753x4.720)	1
O-Ring	OR016V	2
O-Ring	OR119	3
O-Ring	OR340V	2
Lock Nut	NL25-1	1
Lock Nut	NL110-1	2
Spacer Kit	KIT5404	1
Shim Kit	KIT5364	1
Output Shaft Nut	1227T1554	1
Piston Seal Kit	KIT5401	1

TRK-7000		
Position	Part Number	Qty
Input Shaft Brg.	M802048-M802011	1
Input Shaft Pilot Brg.	QBR49845	1
Output Shaft Brg.	25581-25520	1
Countershaft Front Brg.	25877-25821	1
Countershaft Rear Brg.	2689-2631	1
Rev. Idler Gear Brg.	QA48181A	1
Mainshaft 1st & 2nd Gear Brg.	F94490	2
Mainshaft 3rd & Rev. Gear Brg.	F84003	2
Mainshaft 4th Gear Brg.	F94488	1
4th & 5th Shift Hub Brg.	FA35688	1
4th & 5th Shift Hub Race	TR235383	1
Input Shaft Seal	473010N (1.625x2.502)	1
Output Shaft Seal	471271V (2.500x3.251)	1
Output Shaft Seal	712512 (2.250x3.252)	1
Countershaft Case Plug	239783	1
Threadlocker	TL1	1
Gasket Set	K-7001	1

TRK-7013		
Position	Part Number	Qty
Input Shaft Brg.	M804049-M804010	1
Input Shaft Pilot Brg.	QBR49845	1
Output Shaft Brg.	25581-25520	1
Countershaft Front Brg.	25877-25821	1
Countershaft Rear Brg.	2689-2631	1
Rev. Idler Gear Brg.	QA48181A	1
Mainshaft 1st & 2nd Gear Brg.	F94490	2
Mainshaft 3rd & Rev. Gear Brg.	F84003	2
Mainshaft 4th Gear Brg.	F94488	1
4th & 5th Shift Hub Brg.	FA35688	1
4th & 5th Shift Hub Race	TR235383	1
Input Shaft Seal	473010N (1.625x2.502)	1
Output Shaft Seal	471271V (2.500x3.251)	1
Output Shaft Seal	712512 (2.250x3.252)	1
Countershaft Case Plug	239783	1
Threadlocker	TL1	1
Gasket Set	K-7001	1

TRK-7032		
Position	Part Number	Qty
Input Shaft Brg.	M802048-M802011	1
Input Shaft Pilot Brg.	QBR49845	1
Output Shaft Brg.	28580A-28527RB	1
Countershaft Front & Rear Brg.	25590-25520	2
4th & 5th Shift Hub Brg.	FA35688	1
4th & 5th Shift Hub Race	TR235383	1
Mainshaft 1st Gear Brg.	F84003	1
Mainshaft 2nd, 3rd & Rev. Gear Brg.	F94490	3
Mainshaft 4th Gear Brg.	F94488	1
Rev. Idler Gear Brg.	QA47838	1
Input Shaft Seal	473010N (1.625x2.502)	1
Input Shaft Seal	4300204 (1.875x2.502)	1
Input Shaft Seal	710211 (1.875x2.677)	1
Output Shaft Seal	4300119	1
Output Shaft Seal	416664 (27269)	1
Output Shaft Seal	415001N (2.500x3.543)	1
Threadlocker	TL1	1
Gasket Set	K-7030	1
Snap Ring	226331	1

TRK-7033		
Position	Part Number	Qty
Input Shaft Brg.	M804049-M804010	1
Input Shaft Pilot Brg.	QBR49845	1
Output Shaft Brg.	28580A-28527RB	1
Countershaft Front & Rear Brg.	25590-25520	2
4th & 5th Shift Hub Brg.	FA35688	1
4th & 5th Shift Hub Race	TR235383	1
Mainshaft 1st Gear Brg.	F84003	1
Mainshaft 2nd, 3rd & Rev. Gear Brg.	F94490	3
Mainshaft 4th Gear Brg.	F94488	1
Rev. Idler Gear Brg.	QA47838	1
Snap Ring	226331	1
Input Shaft Seal	473010N (1.625x2.502)	1
Input Shaft Seal	4300204 (1.875x2.502)	1
Input Shaft Seal	710211 (1.875x2.677)	1
Output Shaft Seal	4300119	1
Output Shaft Seal	416664 (27269)	1
Output Shaft Seal	415001N (2.500x3.543)	1
Threadlocker	TL1	1
Gasket Set	K-7030	1

TRK-7035		
Position	Part Number	Qty
Input Shaft Brg.	39590-39520	1
Input Shaft Pilot Brg.	31594	1
Output Shaft Brg.	45285A-45220	1
Countershaft Front Brg.	25590-25522	1
Countershaft Rear Brg.	3782-3720	1
1st & Rev. Gear Brg.	FW707620	4
2nd Gear Brg.	FW657020	2
3rd Gear Brg.	FW556020	2
4th Gear Brg.	FW505520	2
Rev. Idler Gear Brg.	FW404820	2
Countershaft Plug	3315679	1
Spring	3315765	4
Snap Ring	3315686	1
Snap Ring	3315725	1
Input Shaft Seal	710211 (1.875x2.677)	1
Output Shaft Seal	4300119	1
Shim Kit	K-2183	1
Gasket Set	K-7028	1

HD Transmission

# Heavy Duty Transmission Rebuild Kits



HD Transmission

TRK-7052		
Position	Part Number	Qty
Input Shaft Brg. 1.750"	39590-39520	1
Input Shaft Brg. 1.500"	45284-45220	1
Input Shaft Pilot Brg.	31594	1
Output Shaft Brg.	45285A-45220	1
Countershaft Front Brg.	25590-25522	1
Countershaft Rear Brg.	3782-3720	1
1st & 2nd Gear Brg.	FW707620	4
3rd Gear Brg.	FW657020	2
4th & Rev. Gear Brg.	FW556020	2
5th Gear Brg.	FW505520	2
Rev. Idler Gear Brg.	FW404820	2
Countershaft Plug	3315679	1
Spring	3315765	4
Snap Ring	3315686	1
Snap Ring	3315725	2
Snap Ring	3315752	1
Input Shaft Seal	710211 (1.875x2.677)	1
Output Shaft Seal	4300119	1
Shim Kit	K-2183	1
Gasket Set	K-7028	1

TRK-312476-22X		
Position	Part Number	Qty
Intermediate Shaft Front Brg.	2788-2720	1
Intermediate Shaft Rear Brg.	25877-25821	1
Output Shaft Brg.	MR1307EX	2
Rev. Shaft Brg.	MR1307EXW927	2

TRK-313432-1X		
Position	Part Number	Qty
Input Shaft Brg.	MR1211GEL	1
Input Shaft Pilot Brg.	MR1205EL	1
Output Shaft Brg.	214LH	1
Countershaft Front Brg.	1311L	2
Countershaft Rear Brg.	WR61209EX	2
Rev. Idler Gear Brg.	WJ162116	4
Input Shaft Seal	412015V (2.125x3.000)	1
Mainshaft Rear Seal	3893V (3.750x4.750)	1
Countershaft Rear Snap Rings	SR348-1	2
Snap Ring Set	313024-6X	1
Gasket Set	GT192	1

TRK-313432-2X		
Position	Part Number	Qty
Input Shaft Brg.	217SLE	1
Input Shaft Pilot Brg.	JH1812	1
Output Shaft Brg.	214LH	1
Countershaft Front Brg.	1311L	2
Countershaft Rear Brg.	MU1209UGMR	2
Rev. Idler Gear Brg.	WJ162116	4
Input Shaft Seal	412015V (2.125x3.000)	1
Mainshaft Rear Seal	3893V (3.750x4.750)	1
Countershaft Rear Snap Rings	SR348-1	2
Snap Ring Set	313024-11X	1
Gasket Set	GT193	1

TRK-313432-10X		
Position	Part Number	Qty
Input Shaft Brg.	JM511946-JM511910	1
Input Shaft Pilot Brg.	2580	1
Output Shaft Brg.	JM511946-JM511910	1
Countershaft Front Brg.	25584-25520	1
Countershaft Rear Brg.	25584-25520	1
Rev. Idler Gear Brg.	WJ162116	2
Mainshaft 1st Gear Brg.	F81205	1
Mainshaft 2nd Gear Brg.	C437Q	1
Mainshaft Rev. Gear Brg.	F81205	1
Input Shaft Seal	39925 (1.781x2.502)	1
Output Shaft Seal	471271 (2.500x3.251)	1
Output Shaft Seal	415004 (2.750x3.751)	1
Output Shaft Seal	415322V (2.750x3.543)	1
Snap Ring Set	313024-13X	1
Shim Kit	SK18	3
Shim Kit	SK47	1
Threadlocker	TL1	1
Gasket Set	GT180	1

TRK-313432-11X		
Position	Part Number	Qty
Input Shaft Brg.	7211HL	1
Input Shaft Pilot Brg.	SCE2420	1
Output Shaft Brg.	7211HL	1
Countershaft Front Brg.	LM48548-LM48510	1
Countershaft Rear Brg.	LM102949-LM102910	1
Mainshaft 1st and Rev. Gear Brg.	F93290	2
Mainshaft 2nd Gear Brg.	F95407	1
Rev. Idler Gear Brg.	WJ162116	2
Drive Gear Seal	330749V (1.562x2.062)	1
Drive Gear Seal	5133 (1.812x2.562)	1
Output Shaft Seal	415322V (2.750x3.543)	1
Snap Ring Set	313024-14X	1
Shim Kit	SK54	1
Shift Fork Clip	40-486-1	4
Shift Fork Clip	46-486-2	2
Shift Shoe Set	49-486-2	2
Flange Sealant	PE51531	1
Threadlocker	TL1	1
Gasket Set	GT210	1

TRK-313432-14X		
Position	Part Number	Qty
Input Shaft Front Brg.	MU1211GUM	1
Input Shaft Pilot Brg.	JH1416	1
Output Shaft Brg.	214LH	1
Countershaft Front Brg.	MU1209UGMR	2
Countershaft Rear Brg.	MU1209UGMR	2
Rev. Idler Gear Brg.	WJ162116	4
Input Shaft Seal	97-463-36-1X	1
Output Shaft Seal	3893V (3.750x4.750)	1
Output Shaft Seal	714713 (4.000x4.999)	1
Snap Ring Set	313024-16X	1
Threadlocker	TL1	1
Gasket Set	GT192	1

TRK-313432-20X		
Position	Part Number	Qty
Input Shaft Brg.	JM511946-JM511910	1
Input Shaft Pilot Brg.	25877-25821	1
Output Shaft Brg.	3979-JM511910	1
Countershaft Front Brg.	M804049-M804010	1
Countershaft Rear Brg.	JLM506849-JLM506810	1
Rev. Idler Gear Brg.	WJ162116	2
Mainshaft 1st & Rev. Gear Brg.	F56619	2
Mainshaft 2nd Gear Needle Brg.	F87946	1
Input Shaft Seal	39925 (1.781x2.502)	1
Output Shaft Seal	415004V (2.750x3.751)	1
Snap Ring Set	313024-22X	1
Shim Kit	SK18	3
Shim Kit	SK15	1
Threadlocker	TL1	1
Gasket Set	GT186	1

TRK-313432-21X		
Position	Part Number	Qty
Input Shaft Front Brg.	1210	1
Input Shaft Rear Brg.	MSN1312EL	1
Input Shaft Pilot Brg.	MU1209TV	1
Output Shaft Brg.	1312L	1
Countershaft Front Brg.	3877-3820	1
Countershaft Rear Brg.	462-453A	1
Speed Gear Brg.	F54540	1
Input Shaft Seal	415004V (2.750x3.751)	1
Input Shaft Seal	475322N (2.750x3.543)	1
Output Shaft Seal	415013N (3.000x4.003)	1
Output Shaft Seal	415281N (3.000x3.751)	1
Output Shaft Seal	475322N (2.750x3.543)	1
Remote Control Seal	471570 (0.875x1.499)	2
Snap Ring	60-381-7	1
Snap Ring	60-381-8	1
Snap Ring	60-381-9	1
Snap Ring	82-381-1	1
Gasket Set	GT73	1

TRK-313432-25X		
Position	Part Number	Qty
Input Shaft Brg.	217SLE	1
Input Shaft Pilot Brg.	JH1812	1
Output Shaft Brg.	312LE	1
Countershaft Front Brg.	311L	2
Countershaft Rear Brg.	WR61209EX	2
Rev. Idler Gear Brg.	WJ162116	4
Countershaft Rear Snap Rings	SR348-1	2
Input Shaft Seal	412015V (2.125x3.000)	1
Output Shaft Seal	3893V (3.750x4.750)	1
Snap Ring Set	313024-2X	1
Spacer	330737	1
Flange Sealant	PE51531	1
Threadlocker	TL1	1
Gasket Set	GT-147	1



# Heavy Duty Transmission Rebuild Kits



TRK-313432-30X		
Position	Part Number	Qty
Input Shaft Brg.	7211HFL	1
Input Shaft Pilot Brg.	MU5206L	1
Output Shaft Brg.	7211HL	1
Countershaft Front Brg.	LM48548-LM48510	1
Countershaft Rear Brg.	2788A-2729	1
Rev. Idler Gear Brg.	WJ162116	2
1st Gear Brg.	F208323	1
2nd Gear Brg.	F93290	2
3rd Gear Brg.	F95407	1
4th Gear Brg.	F209348	1
Input Shaft Seal	39920 (1.562x2.062)	1
Input Shaft Seal	39930 (1.812x2.562)	1
Output Shaft Seal	415322V (2.750x3.543)	1
Snap Ring Set	SR220	1
Shim Kit	313438-3X	1
Shift Fork Clip	40-486-1	2
Shift Fork Clip	49-486-3	2
Shift Fork Clip	101-486-1-1X	3
Shift Shoe Set	49-486-2	2
Flange Sealant	PE51531	1
Gasket Set	GT210	1

TRK-313432-31X		
Position	Part Number	Qty
Input Shaft Brg.	JM511946-JM511910	1
Input Shaft Pilot Brg.	2580	1
Output Shaft Brg.	JM511946-JM511910	1
Countershaft Front Brg.	25584-25520	1
Countershaft Rear Brg.	25584-25520	1
Rev. Idler Gear Brg.	WJ162116	2
Mainshaft 1st Gear Brg.	F81205	1
Mainshaft 2nd Gear Brg.	C437Q	1
Mainshaft Rev. Gear Brg.	F81205	1
Input Shaft Seal	39925 (1.781x2.502)	1
Output Shaft Seal	415004 (2.750x3.751)	1
Output Shaft Seal	415322V (2.750x3.543)	1
Snap Ring Set	313024-18X	1
Shim Kit	SK47	1
Shim Kit	SK18	3
Threadlocker	TL1	1
Gasket Set	GT180	1

TRK-313432-33X		
Position	Part Number	Qty
Input Shaft Brg.	BS500262R	1
Countershaft Front Brg. (Early)	LM501349-LM501310	2
Countershaft Front Brg. (Late)	25581-25520	2
Countershaft Rear Brg.	25590-25520	2
Aux. Countershaft Front Brg.	MR1307EX	2
Aux. Countershaft Rear Brg.	MR1309UV	2
Aux. Mainshaft Brg.	JLM710949C (90KA3)	1
Rev. Idler Gear Brg.	K55X63X25A	2
Low Range Brg.	K73X79X20B	2
Input Shaft Seal	97-463-36-1X	1
Output Shaft Seal	37410 (3.750x4.750)	1
Snap Ring	201-381-1	1
Snap Ring	201-381-3	1
Shim Kit	313667X	1
Gasket Set	312475-45X	1

TRK-313432-34X		
Position	Part Number	Qty
Input Shaft Brg.	7211HFL	1
Input Shaft Pilot Brg.	MU5206L	1
Output Shaft Brg.	7211HL	1
Countershaft Front Brg.	LM48548-LM48510	1
Countershaft Rear Brg.	LM102949-LM102910	1
1st Gear Brg.	F93290	1
2nd Gear Brg.	F95407	1
3rd Gear Brg.	FW505520	2
4th Gear Brg.	FW455017	2
Rev. Gear Brg.	F93290	1
Rev. Idler Gear Brg.	WJ162116	2
Input Shaft Seal	39920 (1.562x2.062)	1
Input Shaft Seal	39930 (1.812x2.562)	1
Output Shaft Seal	415322V (2.750x3.543)	1
Snap Ring Set	313024-14X	1
Shim Kit	SK54	1
Shift Fork Clip	40-486-1	4
Shift Fork Clip	49-486-3	2
Shift Fork Clip	101-486-1-1X	2
Flange Sealant	PE51531	1
Threadlocker	TL1	1
Gasket Set	GT210	1

TRK-313432-35X		
Position	Part Number	Qty
Input Shaft Brg.	MU1211GUM	1
Input Shaft Pilot Brg.	JH1416	1
Output Shaft Brg.	214LH	1
Countershaft Front Brg.	1311L	2
Countershaft Rear Brg.	MU1209UGMR	2
Rev. Idler Gear Brg.	WJ162116	2
Input Shaft Seal	97-463-36-1X	1
Output Shaft Seal	714713 (4.000x4.999)	1
Snap Ring Set	313024-27X	1
Flange Sealant	PE51531	1
Threadlocker	TL1	1
Gasket Set	GT193	1

TRK-313432-46X		
Position	Part Number	Qty
Input Shaft Brg.	7211HFL	1
Input Shaft Pilot Brg.	MU5206L	1
Output Shaft Brg.	7211HL	1
Countershaft Front Brg.	LM48548-LM48510	1
Countershaft Rear Brg.	2788A-2729	1
Rev. Idler Gear Brg.	WJ162116	2
1st Gear Brg.	F208323	1
2nd Gear Brg.	F93290	2
3rd Gear Brg.	F95407	1
4th Gear Brg.	F209348	1
Input Shaft Seal	39920 (1.562x2.062)	1
Input Shaft Seal	39930 (1.812x2.562)	1
Output Shaft Seal	415322V (2.750x3.543)	1
Snap Ring Set	SR220	1
Shim Kit	313438-3X	1
Shift Fork Clip	101-486-1-1X	3
Flange Sealant	PE51531	1
Gasket Set	GT221	1

TRK-56-432-1X		
Position	Part Number	Qty
Input Shaft Brg.	1213L	1
Input Shaft Pilot Brg.	MU5206L	1
Output Shaft Brg.	7211HL	1
Countershaft Front Brg.	2788A-2729	1
Countershaft Rear Brg.	2788A-2729	1
1st Gear Brg.	F208323	1
2nd Gear Brg.	F93290	1
3rd Gear Brg.	F95407	1
4th Gear Brg.	F209348	1
Rev. Gear Brg.	F93290	1
Rev. Idler Gear Brg.	WJ162116	2
Input Shaft Seal	39925 (1.781x2.502)	1
Output Shaft Seal	415322V (2.750x3.543)	1
Shift Fork Clip	101-486-1-1X	3
Snap Ring Set	56-381-2X	1
Shim Kit	313438-3X	1
Flange Sealant	PE51531	1
Threadlocker	TL1	1
Gasket Set	GT221	1

TRK-98-432-1X		
Position	Part Number	Qty
Input Shaft Front Brg.	114	1
Input Shaft Front Brg.	212	1
Input Shaft Rear Brg.	MU1215TV	1
Input Shaft Pilot Brg.	MR1213EL	1
Input Shaft Pilot Brg.	JH1812	1
Output Shaft Brg.	214LH	1
Countershaft Front Brg.	MU1311UGMR	2
Countershaft Rear Brg.	MR1309EAL	2
Input Shaft Seal	415281N (3.000x3.751)	1
Output Shaft Seal	415035 (4.000x4.999)	1
Snap Ring Set	313024-24X	1
Flange Sealant	PE51531	1
Threadlocker	TL1	1
Gasket Set	GT158	1

TRK-101-432-1X		
Position	Part Number	Qty
Input Shaft Brg.	1213L	1
Input Shaft Pilot Brg.	MU5206L	1
Output Shaft Center Brg.	1213L	1
Output Shaft Rear Brg.	7211HL	1
Countershaft Front Brg.	2788A-2729	1
Countershaft Ctr. Brg.	MB1212GEXR	1
Countershaft Rear Brg.	2788A-2729	1
Rev. Idler Gear Brg.	WJ162116	2
1st Gear Brg.	F208323	1
2nd Gear Brg.	F208323	1
3rd Gear Brg.	F208323	1
4th Gear Brg.	FW657020	1
4th Gear Brg.	FW657030	1
4th/5th Shift Hub Brg.	FWH556320	2
6th Gear Brg.	FW475325	2
Rev. Gear Brg.	F208323	1
Input Shaft Seal	39925 (1.781x2.502)	1
Output Shaft Seal	415322V (2.750x3.543)	1
Snap Ring Set	SR221	1
Shim Kit	313438-3X	1
Shift Fork Clip	101-486-1-1X	4
Shift Shoe Set	101-486-4-1X	1
Flange Sealant	PE51531	1
Threadlocker	TL1	1
Gasket Set	GT221	1

HD Transmission

# Light Duty Differential Rebuild Kits

DT Components Differential Rebuild Kits are available in four kit types; Standard Kit, Master Kit, Standard Kit Plus and Master Kit Plus. Each kit type has a different level of kit content.

Axle bearings and seals are available individually and within an Axle Kit (both sides) and a Wheel Kit (single side).

These four kit types allows you to choose what level of kit content you stock and enables you to easily stock the axle bearings and seals as an add on kit.

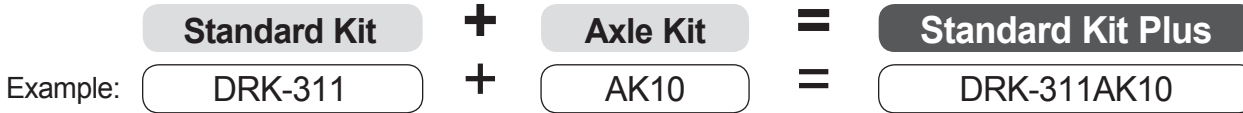

Below is a typical semi-floating rear axle and what is contained within the Standard Kit type.

## Standard Kit DRK-311 Shown

- Differential Brgs.
- Pinion Head Brg.
- Pinion Tail Brg.
- Pinion Seal
- Crush Sleeve
- Pinion Nut
- Gear Marking Compound & Brush
- Threadlocker
- Sealer



+

## Axle Kit AK10 Shown

- Axle Brgs.
- Axle Seals



=

## Standard Kit Plus DRK-311AK10 Shown

Contains entire contents from both Standard and Axle kits



# Light Duty Differential Rebuild Kits



Below is a typical semi-floating rear axle and what is contained within the Master Kit type.

### Master Kit DRK-311MK Shown

- Differential Brgs.
- Pinion Head Brg.
- Pinion Tail Brg.
- Pinion Seal
- Crush Sleeve
- Pinion Nut
- Gear Marking Compound & Brush
- Threadlocker
- Sealer
- Pinion Depth Shims
- Differential Shims
- Ring Gear Bolts



+

### Axle Kit AK10 Shown

- Axle Brgs.
- Axle Seals



=

### Master Kit Plus DRK-311MKAK10 Shown

Contains entire contents from both Master and Axle kits



## Axle Identification

Accurate axle identification is critical when ordering repair parts for rear axles in car, truck & SUV applications as well as for front axles used in four wheel drive truck & SUV applications. The axles used in each individual vehicle can vary based on vehicle options. For example, a typical GM ½-ton truck will be equipped with the GM 8.5" axle, but this same truck may be built with a larger GM 9.5" axle if optioned with a larger engine, heavy duty chassis or towing packages. Therefore, the axle must be identified by the vehicle owner or mechanic prior to ordering parts.

Vehicles can be equipped with either corporate axles (built by the vehicle manufacturer) or Dana axles. Corporate axles from Chrysler, Ford & GM are identified by the ring gear diameter and are frequently referred to as a "Ford 8.8" or "GM 8.5". Ford axles may have an identification tag that specifies ring gear diameter and ratio.

Most corporate axles can be easily identified by the bolt pattern on the differential cover when you have more than one axle option for your vehicle. The following illustrations show the typical bolt pattern for the common corporate axles. You may still need to measure the ring gear diameter in order to positively identify the corporate axle.

### To Determine Ring Gear Diameter

you need to measure the outside diameter of the ring gear.

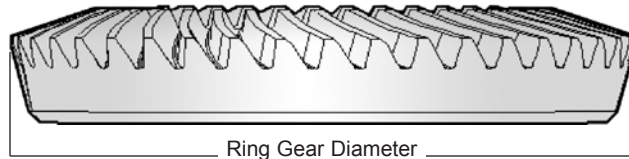

**Dana axles** are identified by model number. The model number (i.e. "44") is usually cast into the webbing of the axle center housing as shown in the illustration below.

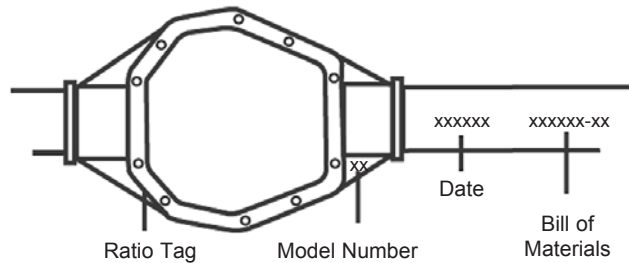

LD Differential

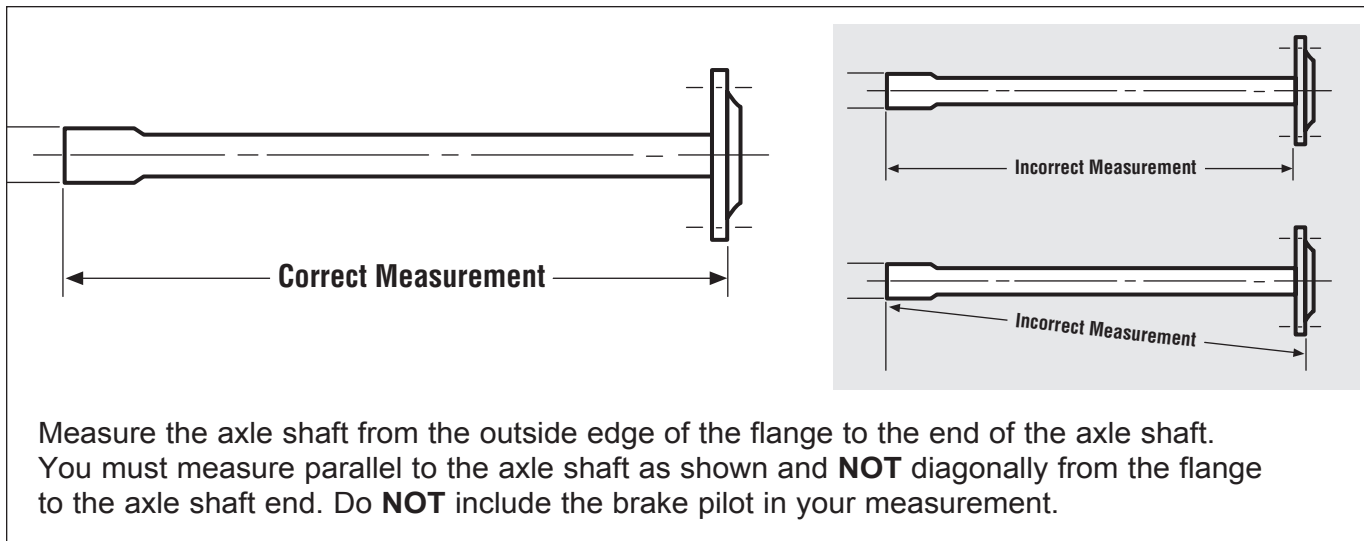

Measure the axle shaft from the outside edge of the flange to the end of the axle shaft. You must measure parallel to the axle shaft as shown and **NOT** diagonally from the flange to the axle shaft end. Do **NOT** include the brake pilot in your measurement.

# Differential Gaskets

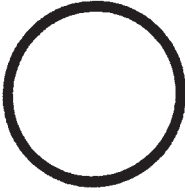
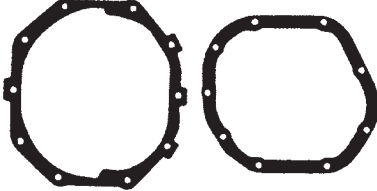
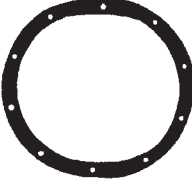
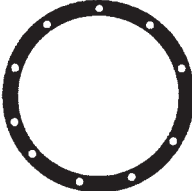
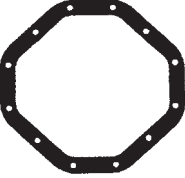
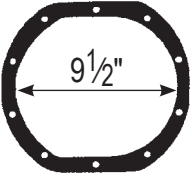
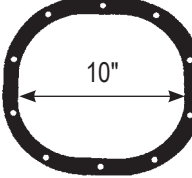
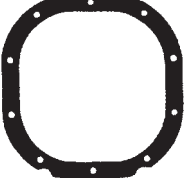
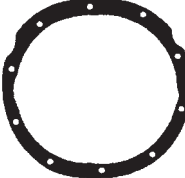
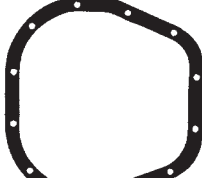
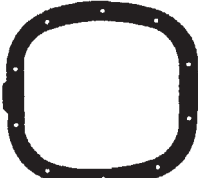
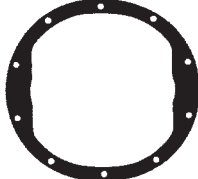
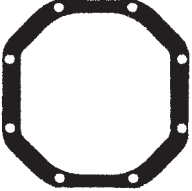
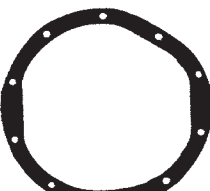
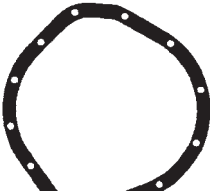
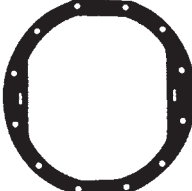
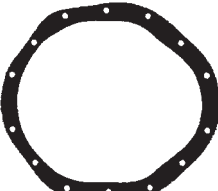
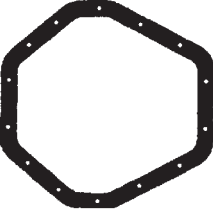
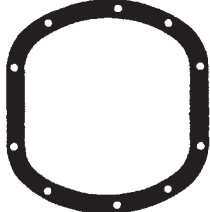
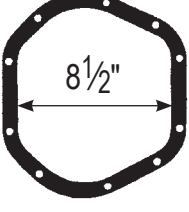
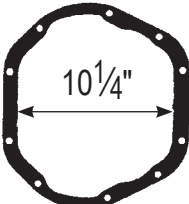
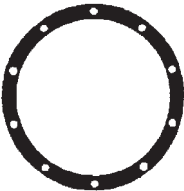
<p>AMC 20 NO HOLES 10½" DIA.</p> 	<p>CHRYSLER 7.25" 10 HOLES      9 HOLES (2 GASKETS IN SET)</p> 	<p>CHRYSLER 8.25" 10 HOLES OVAL</p> 	<p>CHRYSLER 8.75" 10 HOLES ROUND</p> 	
<p>CHRYSLER 9.25" 12 HOLES</p> 	<p>FORD 7.5" 10 HOLES</p> <p>9½"</p> 	<p>FORD 8" 10 HOLES</p> <p>10"</p> 	<p>FORD 8.8" 10 HOLES</p> 	
<p>FORD 9" 10 HOLES</p> 	<p>FORD 10.25" &amp; 10.5" 12 HOLES</p> 	<p>GM 7.5" 10 HOLES</p> 	<p>GM 8.5" 10 HOLES All Exc. Corvette &amp; 80-81 Truck</p> 	
<p>GM 8.5" CORVETTE 8 HOLES CORVETTE</p> 	<p>GM 8.5" TRUCK 10 HOLES TRUCK (80-81)</p> 	<p>GM 8.875" TRUCK 12 HOLES TRUCK</p> 	<p>GM 8.875" AUTO 12 HOLES CAR</p> 	<p>GM 9.5" 14 HOLES</p> 
<p>GM 10.5" 14 HOLES</p> 	<p>DANA 30, 36-ICA 10 HOLES</p> 	<p>DANA 44 10 HOLES</p> <p>8½"</p> 	<p>DANA 60, 70 10 HOLES DANA 60,70</p> <p>10¼"</p> 	<p>TOYOTA 7.5", 8" V6/TURBO 10 HOLES</p> 



# Light Duty Differential Applications



Make/Model	Year	Position/ Ring Gear Size	Standard Kit	Master Kit	Axle Kit	Standard Kit Plus	Master Kit Plus
------------	------	-----------------------------	-----------------	---------------	-------------	----------------------	--------------------

<b>AM GENERAL</b>							
Hummer	01-92	Front - AMC 20	DRK-311H	DRK-311HMK	AK27	DRK-311HAK27	DRK-311HMKAK27
Hummer	01-92	Rear - AMC 20	DRK-311H	DRK-311HMK	AK27	DRK-311HAK27	DRK-311HMKAK27

<b>AMC</b>							
AMX	1970	Rear - AMC 20	DRK-311J	DRK-311JMK ▲			
Concord	88-80	Rear - Dana 35	DRK-335	DRK-335MK ▲	AK49	DRK-335AK49	DRK-335MKAK49 ▲
Concord	79-78	Rear - AMC 20	DRK-311J	DRK-311JMK ▲			
Eagle	88-80	Rear - Dana 35	DRK-335	DRK-335MK ▲	AK49	DRK-335AK49	DRK-335MKAK49 ▲
Gremlin V8	76-72	Rear - AMC 20	DRK-311J	DRK-311JMK ▲			
Hornet V8	75-70	Rear - AMC 20	DRK-311J	DRK-311JMK ▲			
Javelin	1970	Rear - AMC 20	DRK-311J	DRK-311JMK ▲			
Rambler	1969	Rear - AMC 20	DRK-311J	DRK-311JMK ▲			
Rebel	70-67	Rear - AMC 20	DRK-311J	DRK-311JMK ▲			
Spirit	88-80	Rear - Dana 35	DRK-335	DRK-335MK ▲	AK49	DRK-335AK49	DRK-335MKAK49 ▲
Spirit V8	1979	Rear - AMC 20	DRK-311J	DRK-311JMK ▲			

<b>BUICK</b>							
Apollo	75-73	Rear - 8.5"/8.6"	DRK-321R	DRK-321RMK ▲	AK11	DRK-321RAK11	DRK-321RMKAK11 ▲
Century	81-77	Rear - 7.5"/7.6"	DRK-320B	DRK-320BMK ▲	AK11	DRK-320BAK11	DRK-320BMKAK11 ▲
Century	77-73	Rear - 8.5"/8.6"	DRK-321R	DRK-321RMK ▲	AK11	DRK-321RAK11	DRK-321RMKAK11 ▲
Electra	84-73	Rear - 8.5"/8.6"	DRK-321R	DRK-321RMK ▲	AK11	DRK-321RAK11	DRK-321RMKAK11 ▲
Electra	72-65	Rear - 8.875"	DRK-323A	DRK-323AMK ▲			
Estate Wagon	83-82	Rear - 7.5"/7.6"	DRK-320	DRK-320MK ▲	AK11	DRK-320AK11	DRK-320MKAK11 ▲
Estate Wagon	83-80	Rear - 8.5"/8.6"	DRK-321R	DRK-321RMK ▲	AK10	DRK-321RAK10	DRK-321RMKAK10 ▲
Estate Wagon	81-80	Rear - 7.5"/7.6"	DRK-320B	DRK-320BMK ▲	AK11	DRK-320BAK11	DRK-320BMKAK11 ▲
Estate Wagon	79-73	Rear - 8.5"/8.6"	DRK-321R	DRK-321RMK ▲	AK10	DRK-321RAK10	DRK-321RMKAK10 ▲
Estate Wagon	72-71	Rear - 8.875"	DRK-323A	DRK-323AMK ▲			
Lesabre	85-82	Rear - 8.5"/8.6"	DRK-321R	DRK-321RMK ▲	AK10	DRK-321RAK10	DRK-321RMKAK10 ▲
Lesabre	85-82	Rear - 7.5"/7.6"	DRK-320	DRK-320MK ▲	AK10	DRK-320AK10	DRK-320MKAK10 ▲
Lesabre	81-77	Rear - 7.5"/7.6"	DRK-320B	DRK-320BMK ▲	AK11	DRK-320BAK11	DRK-320BMKAK11 ▲
Lesabre	81-73	Rear - 8.5"/8.6"	DRK-321R	DRK-321RMK ▲	AK10	DRK-321RAK10	DRK-321RMKAK10 ▲
Ranier	07-04	Front - 7.25"	DRK-320K	DRK-320KMK	AK87	DRK-320KAK87	DRK-320KMKAK87
Ranier	07-04	Rear - 8"	DRK-320D	DRK-320DMK ▲	AK12	DRK-320DAK12	DRK-320DMKAK12 ▲
Ranier	07-04	Rear - 8.5"/8.6"	DRK-321C	DRK-321CMK ▲	AK12	DRK-321CAK12	DRK-321CMKAK12 ▲
Regal	87-82	Rear - 7.5"/7.6"	DRK-320	DRK-320MK ▲	AK11	DRK-320AK11	DRK-320MKAK11 ▲
Regal	87-78	Rear - 8.5"/8.6"	DRK-321R	DRK-321RMK ▲	AK11	DRK-321RAK11	DRK-321RMKAK11 ▲
Regal	81-78	Rear - 7.5"/7.6"	DRK-320B	DRK-320BMK ▲	AK11	DRK-320BAK11	DRK-320BMKAK11 ▲
Regal	77-73	Rear - 8.5"/8.6"	DRK-321R	DRK-321RMK ▲	AK11	DRK-321RAK11	DRK-321RMKAK11 ▲
Roadmaster	96-91	Rear - 8.5"/8.6"	DRK-321R	DRK-321RMK ▲	AK10	DRK-321RAK10	DRK-321RMKAK10 ▲
Roadmaster	96-91	Rear - 8.5"/8.6" w/ Limited Slip Differential	DRK-321D	DRK-321DMK ▲	AK10	DRK-321DAK10	DRK-321DMKAK10 ▲
Roadmaster	96-91	Rear - 7.5"/7.6"	DRK-320	DRK-320MK ▲	AK10	DRK-320AK10	DRK-320MKAK10 ▲
Skyhawk	80-75	Rear - 7.5"/7.6"	DRK-320B	DRK-320BMK ▲	AK11	DRK-320BAK11	DRK-320BMKAK11 ▲
Skylark	79-76	Rear - 7.5"/7.6"	DRK-320B	DRK-320BMK ▲	AK11	DRK-320BAK11	DRK-320BMKAK11 ▲
Skylark	79-71	Rear - 8.5"/8.6"	DRK-321R	DRK-321RMK ▲	AK11	DRK-321RAK11	DRK-321RMKAK11 ▲

<b>CADILLAC</b>							
Brougham	92-87	Rear - 8.5"/8.6"	DRK-321R	DRK-321RMK ▲	AK11	DRK-321RAK11	DRK-321RMKAK11 ▲
DeVille	84-77	Rear - 8.5"/8.6"	DRK-321R	DRK-321RMK ▲	AK10	DRK-321RAK10	DRK-321RMKAK10 ▲
Escalade	16-99	Front - 8.25"	DRK-321T	DRK-321TMK	AK83	DRK-321TAK83	DRK-321TMKAK83
Escalade	16-15	Rear - 9.5"	DRK-324E	DRK-324EMK ▲	AK12	DRK-324EAK12	DRK-324EMKAK12 ▲

# Light Duty Differential Applications

Make/Model	Year	Position/ Ring Gear Size	Standard Kit	Master Kit	Axle Kit	Standard Kit Plus	Master Kit Plus
<b>CADILLAC (cont'd)</b>							
Escalade	16-15	Rear - 9.76"	DRK-324H	DRK-324HMK ▲	AK12	DRK-324HAK12	DRK-324HMKAK12 ▲
Escalade	14-09	Rear - 8.5"/8.6"	DRK-321Q	DRK-321QMK ▲	AK12	DRK-321QAK12	DRK-321QMKAK12 ▲
Escalade	08-02	Rear - 8.5"/8.6"	DRK-321C	DRK-321CMK ▲	AK12	DRK-321CAK12	DRK-321CMKAK12 ▲
Escalade	00-99	Rear - 8.5"/8.6"	DRK-321R	DRK-321RMK ▲	AK12	DRK-321RAK12	DRK-321RMKAK12 ▲
Escalade ESV	16-03	Front - 8.25"	DRK-321T	DRK-321TMK	AK83	DRK-321TAK83	DRK-321TMKAK83
Escalade ESV	16-15	Rear - 9.5"	DRK-324E	DRK-324EMK ▲	AK12	DRK-324EAK12	DRK-324EMKAK12 ▲
Escalade ESV	16-15	Rear - 9.76"	DRK-324H	DRK-324HMK ▲	AK12	DRK-324HAK12	DRK-324HMKAK12 ▲
Escalade ESV	14-09	Rear - 8.5"/8.6"	DRK-321Q	DRK-321QMK ▲	AK12	DRK-321QAK12	DRK-321QMKAK12 ▲
Escalade ESV	08-03	Rear - 8.5"/8.6"	DRK-321C	DRK-321CMK ▲	AK12	DRK-321CAK12	DRK-321CMKAK12 ▲
Escalade EXT	13-02	Front - 8.25"	DRK-321T	DRK-321TMK	AK83	DRK-321TAK83	DRK-321TMKAK83
Escalade EXT	13-09	Rear - 8.5"/8.6"	DRK-321Q	DRK-321QMK ▲	AK12	DRK-321QAK12	DRK-321QMKAK12 ▲
Escalade EXT	08-02	Rear - 8.5"/8.6"	DRK-321C	DRK-321CMK ▲	AK12	DRK-321CAK12	DRK-321CMKAK12 ▲
Fleetwood	96-94	Rear - 9.5"	DRK-324	DRK-324MK ▲	AK16	DRK-324AK16	DRK-324MKAK16 ▲
Fleetwood	96-77	Rear - 8.5"/8.6"	DRK-321R	DRK-321RMK ▲	AK10	DRK-321RAK10	DRK-321RMKAK10 ▲
<b>CHEVROLET</b>							
150 Series	57-55	Rear - 8.2" Axle Shaft w/1.781" Differential Brgs.	DRK-321G	DRK-321GMK			
210 Series	57-55	Rear - 8.2" Axle Shaft w/1.781" Differential Brgs.	DRK-321G	DRK-321GMK			
Astro	05-90	Front - 7.25"	DRK-320A	DRK-320AMK	AK86	DRK-320AAK86	DRK-320AMKAK86
Astro	05-03	Rear - 7.5"/7.6"	DRK-320C	DRK-320CMK ▲	AK12	DRK-320CAK12	DRK-320CMKAK12 ▲
Astro	02-99	Rear - 7.5"/7.6"	DRK-320C	DRK-320CMK ▲	AK14	DRK-320CAK14	DRK-320CMKAK14 ▲
Astro	98-85	Rear - 7.5"/7.6"	DRK-320	DRK-320MK ▲	AK14	DRK-320AK14	DRK-320MKAK14 ▲
Avalanche 1500	14-02	Front - 8.25"	DRK-321T	DRK-321TMK	AK83	DRK-321TAK83	DRK-321TMKAK83
Avalanche 1500	13-09	Rear - 8.5"/8.6"	DRK-321Q	DRK-321QMK ▲	AK12	DRK-321QAK12	DRK-321QMKAK12 ▲
Avalanche 1500	11-02	Rear - 9.5"	DRK-324B	DRK-324BMK	AK16	DRK-324BAK16	DRK-324BMKAK16
Avalanche 1500	08-02	Rear - 8.5"/8.6"	DRK-321C	DRK-321CMK ▲	AK12	DRK-321CAK12	DRK-321CMKAK12 ▲
Avalanche 2500	06-02	Front - 9.25"	DRK-324C	DRK-324CMK ▲	AK92	DRK-324CAK92	DRK-324CMKAK92 ▲
Avalanche 2500	06-02	Rear - 10.5"	DRK-325B	DRK-325BMK	AK29	DRK-325BAK29	DRK-325BMKAK29
Belair	64-55	Rear - 8.2" Axle Shaft w/1.781" Differential Brgs.	DRK-321G	DRK-321GMK			
Biscayne	72-71	Rear - 8.5"/8.6"	DRK-321R	DRK-321RMK ▲	AK10	DRK-321RAK10	DRK-321RMKAK10 ▲
Biscayne	64-58	Rear - 8.2" Axle Shaft w/1.781" Differential Brgs.	DRK-321G	DRK-321GMK			
Blazer Full Size	94-92	Front - 8.25"	DRK-321A	DRK-321AMK	AK95	DRK-321AAK95	DRK-321AMKAK95
Blazer Full Size	91-80	Front - 8.5"/8.6"	DRK-321R	DRK-321RMK ▲			
Blazer Full Size	79-69	Front - Dana 44	DRK-339B	DRK-339BMK			
Blazer Full Size	94-82	Rear - 8.5"/8.6"	DRK-321R	DRK-321RMK ▲	AK10	DRK-321RAK10	DRK-321RMKAK10 ▲
Blazer Full Size	91-82	Rear - 8.5"/8.6"	DRK-321R	DRK-321RMK ▲	AK10	DRK-321RAK10	DRK-321RMKAK10 ▲
Blazer Full Size	81-69	Rear - 8.875"	DRK-322	DRK-322MK ▲	AK10	DRK-322AK10	DRK-322MKAK10 ▲
Blazer S10 Size	05-83	Front - 7.25"	DRK-320A	DRK-320AMK	AK86	DRK-320AAK86	DRK-320AMKAK86
Blazer S10 Size	05-99	Rear - 7.5"/7.6"	DRK-320C	DRK-320CMK ▲	AK11	DRK-320CAK11	DRK-320CMKAK11 ▲
Blazer S10 Size	05-99	Rear - 8.5"/8.6"	DRK-321C	DRK-321CMK ▲	AK10	DRK-321CAK10	DRK-321CMKAK10 ▲
Blazer S10 Size	98-95	Rear - 8.5"/8.6"	DRK-321R	DRK-321RMK ▲	AK10	DRK-321RAK10	DRK-321RMKAK10 ▲
Blazer S10 Size	98-83	Rear - 7.5"/7.6"	DRK-320	DRK-320MK ▲	AK11	DRK-320AK11	DRK-320MKAK11 ▲
Camaro	15-13	Rear - 250MM Ring Gear ZL1	DRK-325C	DRK-325CMK ▲			
Camaro	15-10	Rear - 195MM Ring Gear	DRK-320J	DRK-320JMK ▲	AK55	DRK-320JAK55	DRK-320JMKAK55
Camaro	15-10	Rear - 218MM Ring Gear	DRK-321S	DRK-321SMK ▲	AK54	DRK-321SAK54	DRK-321SMKAK54 ▲

▲ Add "S" suffix to kit number to receive stackable differential shims in kit.

LD Differential

# Light Duty Differential Applications

Make/Model	Year	Position/ Ring Gear Size	Standard Kit	Master Kit	Axle Kit	Standard Kit Plus	Master Kit Plus
<b>CHEVROLET (cont'd)</b>							
Camaro	02-99	Rear - 7.5"/7.6"	DRK-320C	DRK-320CMK	▲ AK11	DRK-320CAK11	DRK-320CMKAK11 ▲
Camaro	98-82	Rear - 7.5"/7.6"	DRK-320	DRK-320MK	▲ AK11	DRK-320AK11	DRK-320MKAK11 ▲
Camaro	90-87	Rear - Borg Warner 7.75"	DRK-326	DRK-326MK			
Camaro	81-70	Rear - 8.5"/8.6"	DRK-321R	DRK-321RMK	▲ AK11	DRK-321RAK11	DRK-321RMKAK11 ▲
Camaro	72-67	Rear - 8.875"	DRK-323A	DRK-323AMK	▲ AK11		
Camaro	70-67	Rear - 8.2" Axle Shaft w/1.781" Differential Brgs.	DRK-321B	DRK-321BMK	▲ AK11	DRK-321BAK11	DRK-321BMKAK11 ▲
Caprice	16-11	Rear - 8.25"	DRK-326B	DRK-326BMK	AK56	DRK-326BAK56	DRK-326BMKAK56
Caprice	96-81	Rear - 7.5"/7.6"	DRK-320	DRK-320MK	▲ AK11	DRK-320AK11	DRK-320MKAK11 ▲
Caprice	96-73	Rear - 8.5"/8.6"	DRK-321R	DRK-321RMK	▲ AK10	DRK-321RAK10	DRK-321RMKAK10 ▲
Caprice	81-77	Rear - 7.5"/7.6"	DRK-320B	DRK-320BMK	▲ AK11	DRK-320BAK11	DRK-320BMKAK11 ▲
Caprice	72-66	Rear - 8.875"	DRK-323A	DRK-323AMK	▲ AK10	DRK-323AAK10	DRK-323AMKAK10 ▲
Caprice	71-66	Rear - 8.2" Axle Shaft w/1.781" Differential Brgs.	DRK-321B	DRK-321BMK	▲ AK10	DRK-321BAK11	DRK-321BMKAK11 ▲
Chevelle	73-64	Rear - 8.2" Axle Shaft w/1.781" Differential Brgs.	DRK-321B	DRK-321BMK	▲ AK11	DRK-321BAK11	DRK-321BMKAK11 ▲
Chevelle	73-64	Rear - 8.875"	DRK-323A	DRK-323AMK	▲		
Chevy II	68-65	Rear - 8.875"	DRK-323A	DRK-323AMK	▲		
Chevy II	68-64	Rear - 8.2" Axle Shaft w/1.625" Differential Brgs.	DRK-321B	DRK-321BMK	▲ AK11	DRK-321BAK11	DRK-321BMKAK11 ▲
Chevy II	1964	Rear - 8.2" Axle Shaft w/1.781" Differential Brgs.	DRK-321G	DRK-321GMK			
Colorado	16-15	Front - All	DRK-369	DRK-369MK			
Colorado	12-04	Front - 7.6" IFS	DRK-320L	DRK-320LMK	▲ AK85	DRK-320LAK85	DRK-320LMKAK85 ▲
Colorado	16-15	Rear - Dana M200	DRK-367	DRK-367MK	AK58	DRK-367AK58	DRK-367MKAK58
Colorado	16-15	Rear - Dana M220	DRK-368	DRK-368MK	AK58	DRK-368AK58	DRK-368MKAK58
Colorado	12-09	Rear - 8.5"/8.6"	DRK-321Q	DRK-321QMK	▲ AK12	DRK-321QAK12	DRK-321QMKAK12 ▲
Colorado	12-04	Rear - 8.0"	DRK-320D	DRK-320DMK	▲ AK12	DRK-320DAK12	DRK-320DMKAK12 ▲
Corvette	11-97	Rear - Getrag	DRK-328				
Corvette	96-85	Rear - Dana 36, w/ Auto Trans	DRK-338	DRK-338MK			
Corvette	96-85	Rear - Dana 44, w/ Man Trans	DRK-339A	DRK-339AMK	▲		
Corvette	1984	Rear - Dana 44	DRK-339A	DRK-339AMK	▲		
Corvette	82-80	Rear - Dana 44	DRK-339	DRK-339MK	▲		
Corvette	79-63	Rear - 8.5"/8.6"	DRK-323	DRK-323MK	▲ AK39	DRK-323AK39	DRK-323MKAK39 ▲
Corvette	62-55	Rear - 8.2" Axle Shaft w/1.781" Differential Brgs.	DRK-321G	DRK-321GMK			
El Camino	87-82	Rear - 7.5"/7.6"	DRK-320	DRK-320MK	▲ AK11	DRK-320AK11	DRK-320MKAK11 ▲
El Camino	87-77	Rear - 8.5"/8.6"	DRK-321R	DRK-321RMK	▲ AK10	DRK-321RAK10	DRK-321RMKAK10 ▲
El Camino	81-77	Rear - 7.5"/7.6"	DRK-320B	DRK-320BMK	▲ AK11	DRK-320BAK11	DRK-320BMKAK11 ▲
El Camino	76-71	Rear - 8.5"/8.6"	DRK-321R	DRK-321RMK	▲ AK10	DRK-321RAK10	DRK-321RMKAK10 ▲
El Camino	72-65	Rear - 8.875"	DRK-323A	DRK-323AMK	▲		
El Camino	71-64	Rear - 8.2" Axle Shaft w/1.625" Differential Brgs.	DRK-321B	DRK-321BMK	▲ AK11	DRK-321BAK11	DRK-321BMKAK11 ▲
El Camino	64-59	Rear - 8.2" Axle Shaft w/1.781" Differential Brgs.	DRK-321G	DRK-321GMK			

LD Differential

# Light Duty Differential Applications

Make/Model	Year	Position/ Ring Gear Size	Standard Kit	Master Kit	Axle Kit	Standard Kit Plus	Master Kit Plus
<b>CHEVROLET (cont'd)</b>							
Impala	96-82	Rear - 7.5"/7.6"	DRK-320	DRK-320MK ▲	AK11	DRK-320AK11	DRK-320MKAK11 ▲
Impala	96-73	Rear - 8.5"/8.6"	DRK-321R	DRK-321RMK ▲	AK11	DRK-321RAK11	DRK-321RMKAK11 ▲
Impala	81-77	Rear - 7.5"/7.6"	DRK-320B	DRK-320BMK ▲	AK11	DRK-320BAK11	DRK-320BMKAK11 ▲
Impala	72-65	Rear - 8.2" Axle Shaft w/1.781" Differential Brgs.	DRK-321B	DRK-321BMK ▲	AK11	DRK-321BAK11	DRK-321BMKAK11 ▲
Impala	72-65	Rear - 8.875"	DRK-323A	DRK-323AMK ▲	AK11		
Impala	64-59	Rear - 8.2" Axle Shaft w/1.781" Differential Brgs.	DRK-321G	DRK-321GMK			
Malibu	83-82	Rear - 7.5"/7.6"	DRK-320	DRK-320MK ▲	AK11	DRK-320AK11	DRK-320MKAK11 ▲
Malibu	81-77	Rear - 7.5"/7.6"	DRK-320B	DRK-320BMK ▲	AK11	DRK-320BAK11	DRK-320BMKAK11 ▲
Monte Carlo	88-82	Rear - 7.5"/7.6"	DRK-320	DRK-320MK ▲	AK11	DRK-320AK11	DRK-320MKAK11 ▲
Monte Carlo	81-77	Rear - 7.5"/7.6"	DRK-320B	DRK-320BMK ▲	AK11	DRK-320BAK11	DRK-320BMKAK11 ▲
Monte Carlo	77-71	Rear - 8.5"/8.6"	DRK-321R	DRK-321RMK ▲	AK11	DRK-321RAK11	DRK-321RMKAK11 ▲
Monte Carlo	72-70	Rear - 8.2" Axle Shaft w/1.781" Differential Brgs.	DRK-321B	DRK-321BMK ▲			
Monte Carlo	72-70	Rear - 8.875"	DRK-323A	DRK-323AMK ▲			
Monza	80-75	Rear - 7.5"/7.6"	DRK-320B	DRK-320BMK ▲	AK11	DRK-320BAK11	DRK-320BMKAK11 ▲
Nova	79-70	Rear - 8.5"/8.6"	DRK-321R	DRK-321RMK ▲	AK11	DRK-321RAK11	DRK-321RMKAK11 ▲
Nova	72-70	Rear - 8.875"	DRK-323A	DRK-323AMK ▲	AK11		
Nova	72-69	Rear - 8.2"	DRK-321B	DRK-321BMK ▲	AK11	DRK-321BAK11	DRK-321BMKAK11 ▲
S10	04-97	Front - 7.25"	DRK-320A	DRK-320AMK	AK86	DRK-320AAK86	DRK-320AMKAK86
S10	96-83	Front - 7.25"	DRK-320A	DRK-320AMK	AK86	DRK-320AAK86	DRK-320AMKAK86
S10	04-99	Rear - 7.5"/7.6"	DRK-320C	DRK-320CMK ▲	AK11	DRK-320CAK11	DRK-320CMKAK11 ▲
S10	04-99	Rear - 8.5"/8.6"	DRK-321C	DRK-321CMK ▲	AK10	DRK-321CAK10	DRK-321CMKAK10 ▲
S10	98-94	Rear - 8.5"/8.6"	DRK-321R	DRK-321RMK ▲	AK10	DRK-321RAK10	DRK-321RMKAK10 ▲
S10	98-82	Rear - 7.5"/7.6"	DRK-320	DRK-320MK ▲	AK11	DRK-320AK11	DRK-320MKAK11 ▲
SS	16-14	Rear - 8.25"	DRK-326B	DRK-326BMK	AK56	DRK-326BAK56	DRK-326BMKAK56
SSR	06-03	Rear - 8.5"/8.6"	DRK-321C	DRK-321CMK ▲	AK12	DRK-321CAK12	DRK-321CMKAK12 ▲
SSR	06-03	Rear - 9.5"	DRK-324B	DRK-324BMK	AK12	DRK-324BAK12	DRK-324BMKAK12
Suburban	16-15	Front - 8.25"	DRK-321T	DRK-321TMK	AK83	DRK-321TAK83	DRK-321TMKAK83
Suburban	16-15	Rear - 9.5"	DRK-324E	DRK-324EMK ▲	AK12	DRK-324EAK12	DRK-324EMKAK12 ▲
Suburban	16-15	Rear - 9.76"	DRK-324H	DRK-324HMK ▲	AK12	DRK-324HAK12	DRK-324HMKAK12 ▲
Suburban 1500	14-98	Front - 8.25"	DRK-321T	DRK-321TMK	AK83	DRK-321TAK83	DRK-321TMKAK83
Suburban 1500	97-90	Front - 8.25"	DRK-321A	DRK-321AMK	AK95	DRK-321AAK95	DRK-321AMKAK95
Suburban 1500	91-77	Front - 8.5"/8.6"	DRK-321	DRK-321MK ▲			
Suburban 1500	80-73	Front - Dana 44	DRK-339B	DRK-339BMK			
Suburban 1500	14-09	Rear - 8.5"/8.6"	DRK-321Q	DRK-321QMK ▲	AK12	DRK-321QAK12	DRK-321QMKAK12 ▲
Suburban 1500	08-00	Rear - 8.5"/8.6"	DRK-321C	DRK-321CMK ▲	AK12	DRK-321CAK12	DRK-321CMKAK12 ▲
Suburban 1500	08-98	Rear - 9.5"	DRK-324B	DRK-324BMK	AK16	DRK-324BAK16	DRK-324BMKAK16
Suburban 1500	99-82	Rear - 8.5"/8.6"	DRK-321R	DRK-321RMK ▲	AK12	DRK-321RAK12	DRK-321RMKAK12 ▲
Suburban 1500	81-73	Rear - 8.875"	DRK-322	DRK-322MK ▲	AK17	DRK-322AK17	DRK-322MKAK17 ▲
Suburban 2500	13-11	Front - 9.25"	DRK-324D	DRK-324DMK ▲	AK92	DRK-324DAK92	DRK-324DMKAK92 ▲
Suburban 2500	10-98	Front - 9.25"	DRK-324C	DRK-324CMK ▲	AK92	DRK-324CAK92	DRK-324CMKAK92 ▲
Suburban 2500	97-92	Front - 9.25"	DRK-324A	DRK-324AMK ▲	AK92	DRK-324AAK92	DRK-324AMKAK92
Suburban 2500	91-77	Front - 8.5"/8.6"	DRK-321	DRK-321MK ▲			
Suburban 2500	80-73	Front - Dana 44	DRK-339B	DRK-339BMK			
Suburban 2500	13-11	Rear - 10.5"	DRK-325B	DRK-325BMK	AK44	DRK-325BAK44	DRK-325BMKAK44
Suburban 2500	13-98	Rear - 9.5"	DRK-324B	DRK-324BMK	AK16	DRK-324BAK16	DRK-324BMKAK16
Suburban 2500	10-08	Rear - 10.5"	DRK-325B	DRK-325BMK	AK29	DRK-325BAK29	DRK-325BMKAK29
Suburban 2500	05-02	Rear - Dana 60 Quadrasteer	DRK-331C	DRK-331CMK			
Suburban 2500	97-81	Rear - 9.5"	DRK-324	DRK-324MK ▲	AK16	DRK-324AK16	DRK-324MKAK16 ▲

LD Differential

▲ Add "S" suffix to kit number to receive stackable differential shims in kit.

# Light Duty Differential Applications



Make/Model	Year	Position/ Ring Gear Size	Standard Kit	Master Kit	Axle Kit	Standard Kit Plus	Master Kit Plus
<b>CHEVROLET (cont'd)</b>							
Suburban 2500	81-73	Rear - 8.875"	DRK-322	DRK-322MK ▲	AK17	DRK-322AK17	DRK-322MKAK17 ▲
Tahoe	16-98	Front - 8.25"	DRK-321T	DRK-321TMK	AK83	DRK-321TAK83	DRK-321TMKAK83
Tahoe	97-95	Front - 8.25"	DRK-321A	DRK-321AMK	AK95	DRK-321AAK95	DRK-321AMKAK95
Tahoe	16-15	Rear - 9.5"	DRK-324E	DRK-324EMK ▲	AK12	DRK-324EAK12	DRK-324EMKAK12 ▲
Tahoe	16-15	Rear - 9.76"	DRK-324H	DRK-324HMK ▲	AK12	DRK-324HAK12	DRK-324HMKAK12 ▲
Tahoe	14-09	Rear - 8.5"/8.6"	DRK-321Q	DRK-321QMK ▲	AK12	DRK-321QAK12	DRK-321QMKAK12 ▲
Tahoe	08-00	Rear - 8.5"/8.6"	DRK-321C	DRK-321CMK ▲	AK12	DRK-321CAK12	DRK-321CMKAK12 ▲
Tahoe	99-95	Rear - 8.5"/8.6"	DRK-321R	DRK-321RMK ▲	AK12	DRK-321RAK12	DRK-321RMKAK12 ▲
Trailblazer	09-02	Front - 7.25"	DRK-320K	DRK-320KMK	AK87	DRK-320KAK87	DRK-320KMKAK87
Trailblazer	09-06	Rear - 9.5"	DRK-324B	DRK-324BMK	AK12	DRK-324BAK12	DRK-324BMKAK12
Trailblazer	09-02	Rear - 8"	DRK-320D	DRK-320DMK ▲	AK12	DRK-320DAK12	DRK-320DMKAK12 ▲
Trailblazer	08-02	Rear - 8.5"/8.6"	DRK-321C	DRK-321CMK ▲	AK12	DRK-321CAK12	DRK-321CMKAK12 ▲
Truck 1/2 Ton	16-98	Front - 8.25"	DRK-321T	DRK-321TMK	AK83	DRK-321TAK83	DRK-321TMKAK83
Truck 1/2 Ton	97-88	Front - 8.25"	DRK-321A	DRK-321AMK	AK95	DRK-321AAK95	DRK-321AMKAK95
Truck 1/2 Ton	87-77	Front - 8.5"/8.6"	DRK-321	DRK-321MK ▲			
Truck 1/2 Ton	80-69	Front - Dana 44	DRK-339B	DRK-339BMK			
Truck 1/2 Ton	16-14	Rear - 9.5"	DRK-324E	DRK-324EMK ▲	AK12	DRK-324EAK12	DRK-324EMKAK12 ▲
Truck 1/2 Ton	16-14	Rear - 9.76"	DRK-324H	DRK-324HMK ▲	AK12	DRK-324HAK12	DRK-324HMKAK12 ▲
Truck 1/2 Ton	15-09	Rear - 8.5"/8.6"	DRK-321Q	DRK-321QMK ▲	AK12	DRK-321QAK12	DRK-321QMKAK12 ▲
Truck 1/2 Ton	13-98	Rear - 9.5"	DRK-324B	DRK-324BMK	AK16	DRK-324BAK16	DRK-324BMKAK16
Truck 1/2 Ton	08-00	Rear - 8.5"/8.6"	DRK-321C	DRK-321CMK ▲	AK12	DRK-321CAK12	DRK-321CMKAK12 ▲
Truck 1/2 Ton	05-02	Rear - Dana 60 Quadrasteer	DRK-331C	DRK-331CMK			
Truck 1/2 Ton	99-88	Rear - 8.5"/8.6"	DRK-321R	DRK-321RMK ▲	AK12	DRK-321RAK12	DRK-321RMKAK12 ▲
Truck 1/2 Ton	99-88	Rear - 8.5"/8.6" w/ Limited Slip Differential	DRK-321D	DRK-321DMK ▲	AK12	DRK-321DAK12	DRK-321DMKAK12 ▲
Truck 1/2 Ton	97-88	Rear - 9.5"	DRK-324	DRK-324MK ▲	AK16	DRK-324AK16	DRK-324MKAK16 ▲
Truck 1/2 Ton	87-80	Rear - 8.5"/8.6"	DRK-321R	DRK-321RMK ▲	AK10	DRK-321RAK10	DRK-321RMKAK10 ▲
Truck 1/2 Ton	87-70	Rear - 8.5"/8.6" w/ Limited Slip Differential	DRK-321D	DRK-321DMK ▲	AK10	DRK-321DAK10	DRK-321DMKAK10 ▲
Truck 1/2 Ton	82-80	Rear - 8.875"	DRK-322	DRK-322MK ▲	AK10	DRK-322AK10	DRK-322MKAK10 ▲
Truck 1/2 Ton	81-80	Rear - 8.75"	DRK-323	DRK-323MK ▲			
Truck 1/2 Ton	79-71	Rear - 8.5"/8.6"	DRK-321R	DRK-321RMK ▲	AK10	DRK-321RAK10	DRK-321RMKAK10 ▲
Truck 1/2 Ton	79-64	Rear - 8.875"	DRK-322	DRK-322MK ▲	AK10	DRK-322AK10	DRK-322MKAK10 ▲
Truck 1/2 Ton	72-65	Rear - Dana 44	DRK-339B	DRK-339BMK			
Truck 3/4 Ton	16-11	Front - 9.25"	DRK-324D	DRK-324DMK ▲	AK92	DRK-324DAK92	DRK-324DMKAK92 ▲
Truck 3/4 Ton	10-98	Front - 9.25"	DRK-324C	DRK-324CMK ▲	AK92	DRK-324CAK92	DRK-324CMKAK92 ▲
Truck 3/4 Ton	97-88	Front - 9.25"	DRK-324A	DRK-324AMK ▲	AK92	DRK-324AAK92	DRK-324AMKAK92
Truck 3/4 Ton	91-77	Front - 8.5"/8.6"	DRK-321	DRK-321MK ▲			
Truck 3/4 Ton	80-68	Front - Dana 44	DRK-339B	DRK-339BMK			
Truck 3/4 Ton	16-14	Rear - 9.5"	DRK-324E	DRK-324EMK ▲	AK12	DRK-324EAK12	DRK-324EMKAK12 ▲
Truck 3/4 Ton	16-11	Rear - 11.5" 2nd Design w/4.375" Pinion Brg.	DRK-327A	DRK-327AMK	AK44	DRK-327AAK44	DRK-327AMKAK44
Truck 3/4 Ton	15-11	Rear - 10.5"	DRK-325B	DRK-325BMK	AK44	DRK-325BAK44	DRK-325BMKAK44
Truck 3/4 Ton	13-11	Rear - 9.5"	DRK-324B	DRK-324BMK	AK16	DRK-324BAK16	DRK-324BMKAK16
Truck 3/4 Ton	11-01	Rear - 11.5" 1st Design w/4.125" Pinion Brg.	DRK-327	DRK-327MK	AK29	DRK-327AK29	DRK-327MKAK29
Truck 3/4 Ton	10-00	Rear - 10.5"	DRK-325B	DRK-325BMK	AK29	DRK-325BAK29	DRK-325BMKAK29
Truck 3/4 Ton	10-98	Rear - 9.5"	DRK-324B	DRK-324BMK	AK16	DRK-324BAK16	DRK-324BMKAK16
Truck 3/4 Ton	05-02	Rear - Dana 60 Quadrasteer	DRK-331C	DRK-331CMK			
Truck 3/4 Ton	99-98	Rear - 10.5"	DRK-325B	DRK-325BMK	AK21	DRK-325BAK21	DRK-325BMKAK21
Truck 3/4 Ton	97-89	Rear - 10.5"	DRK-325A	DRK-325AMK	AK21	DRK-325AAK21	DRK-325AMKAK21
Truck 3/4 Ton	97-81	Rear - 9.5"	DRK-324	DRK-324MK ▲	AK16	DRK-324AK16	DRK-324MKAK16 ▲

LD Differential



# Light Duty Differential Applications

Make/Model	Year	Position/ Ring Gear Size	Standard Kit	Master Kit	Axle Kit	Standard Kit Plus	Master Kit Plus
<b>CHEVROLET (cont'd)</b>							
Truck 3/4 Ton	1988	Rear - 10.5" 1st Design	DRK-325	DRK-325MK	AK21	DRK-325AK21	DRK-325MKAK21
Truck 3/4 Ton	1988	Rear - 10.5" 2nd Design	DRK-325A	DRK-325AMK	AK21	DRK-325AAK21	DRK-325AMKAK21
Truck 3/4 Ton	87-73	Rear - 10.5"	DRK-325	DRK-325MK	AK21	DRK-325AK21	DRK-325MKAK21
Truck 3/4 Ton	81-80	Rear - 8.5"/8.6"	DRK-323	DRK-323MK	AK17	DRK-323AK17	DRK-323MKAK17 ▲
Truck 3/4 Ton	81-69	Rear - 8.875"	DRK-322	DRK-322MK	AK10	DRK-322AK10	DRK-322MKAK10 ▲
Truck 3/4 Ton	72-67	Rear - Dana 60	DRK-331	DRK-331MK			
Truck 1 Ton	16-11	Front - 9.25"	DRK-324D	DRK-324DMK	AK92	DRK-324DAK92	DRK-324DMKAK92 ▲
Truck 1 Ton	10-98	Front - 9.25"	DRK-324C	DRK-324CMK	AK92	DRK-324CAK92	DRK-324CMKAK92 ▲
Truck 1 Ton	97-88	Front - 9.25"	DRK-324A	DRK-324AMK	AK92	DRK-324AAK92	DRK-324AMKAK92
Truck 1 Ton	91-77	Front - Dana 60	DRK-331	DRK-331MK	AK42	DRK-331AK42	DRK-331MKAK42
Truck 1 Ton	16-11	Rear - 11.5" 2nd Design w/4.375" Pinion Brg.	DRK-327A	DRK-327AMK	AK44	DRK-327AAK44	DRK-327AMKAK44
Truck 1 Ton	15-11	Rear - 10.5"	DRK-325B	DRK-325BMK	AK44	DRK-325BAK44	DRK-325BMKAK44
Truck 1 Ton	11-01	Rear - 11.5" 1st Design w/4.125" Pinion Brg.	DRK-327	DRK-327MK	AK29 <sup>49</sup>	DRK-327AK29 <sup>49</sup>	DRK-327MKAK29 <sup>49</sup>
Truck 1 Ton	11-01	Rear - 11.5" 1st Design w/4.125" Pinion Brg.	DRK-327	DRK-327MK	AK45 <sup>48</sup>	DRK-327AK45 <sup>48</sup>	DRK-327MKAK45 <sup>48</sup>
Truck 1 Ton	00-98	Rear - 10.5"	DRK-325B	DRK-325BMK	AK21	DRK-325BAK21	DRK-325BMKAK21
Truck 1 Ton	99-91	Rear - Dana 80	DRK-337	DRK-337MK			
Truck 1 Ton	97-89	Rear - 10.5"	DRK-325A	DRK-325AMK	AK21	DRK-325AAK21	DRK-325AMKAK21
Truck 1 Ton	95-83	Rear - 9.5"	DRK-324	DRK-324MK	AK16	DRK-324AK16	DRK-324MKAK16 ▲
Truck 1 Ton	94-73	Rear - Dana 70HD	DRK-332HD	DRK-332HDMK			
Truck 1 Ton	91-84	Rear - Dana 70U	DRK-332U	DRK-332UMK			
Truck 1 Ton	91-73	Rear - Dana 60	DRK-331	DRK-331MK			
Truck 1 Ton	90-73	Rear - Dana 70	DRK-332	DRK-332MK			
Truck 1 Ton	1988	Rear - 10.5" 1st Design	DRK-325	DRK-325MK	AK21	DRK-325AK21	DRK-325MKAK21
Truck 1 Ton	1988	Rear - 10.5" 2nd Design	DRK-325A	DRK-325AMK	AK21	DRK-325AAK21	DRK-325AMKAK21
Truck 1 Ton	87-72	Rear - 10.5"	DRK-325	DRK-325MK	AK21	DRK-325AK21	DRK-325MKAK21
C4500 Kodiak	09-03	Front - Dana 70	DRK-332HD	DRK-332HDMK			
C4500 Kodiak	09-03	Rear - Dana S110	DRK-434				
C5500 Kodiak	09-03	Front - Dana 70	DRK-332HD	DRK-332HDMK			
C5500 Kodiak	09-03	Rear - Dana S110	DRK-434				
Van 1/2 Ton	14-03	Front - 7.25"	DRK-320A	DRK-320AMK	AK86	DRK-320AAK86	DRK-320AMKAK86
Van 1/2 Ton	14-09	Rear - 8.5"/8.6"	DRK-321Q	DRK-321QMK	AK12	DRK-321QAK12	DRK-321QMKAK12 ▲
Van 1/2 Ton	08-99	Rear - 8.5"/8.6"	DRK-321C	DRK-321CMK	AK12	DRK-321CAK12	DRK-321CMKAK12 ▲
Van 1/2 Ton	08-98	Rear - 9.5"	DRK-324B	DRK-324BMK	AK16	DRK-324BAK16	DRK-324BMKAK16
Van 1/2 Ton	98-96	Rear - 8.5"/8.6"	DRK-321R	DRK-321RMK	AK12	DRK-321RAK12	DRK-321RMKAK12 ▲
Van 1/2 Ton	97-81	Rear - 9.5"	DRK-324	DRK-324MK	AK16	DRK-324AK16	DRK-324MKAK16 ▲
Van 1/2 Ton	95-77	Rear - 8.5"/8.6"	DRK-321R	DRK-321RMK	AK10	DRK-321RAK10	DRK-321RMKAK10 ▲
Van 1/2 Ton	81-64	Rear - 8.875"	DRK-322	DRK-322MK	AK10	DRK-322AK10	DRK-322MKAK10 ▲
Van 3/4 Ton	05-03	Front - 7.25"	DRK-320A	DRK-320AMK	AK86	DRK-320AAK86	DRK-320AMKAK86
Van 3/4 Ton	16-11	Rear - 10.5" SRW	DRK-325B	DRK-325BMK	AK44	DRK-325BAK44	DRK-325BMKAK44
Van 3/4 Ton	16-11	Rear - 11.5"	DRK-327A	DRK-327AMK	AK44	DRK-327AAK44	DRK-327AMKAK44
Van 3/4 Ton	16-03	Rear - 10.5"	DRK-325B	DRK-325BMK	AK59	DRK-325BAK59	DRK-325BMKAK59
Van 3/4 Ton	14-98	Rear - 9.5"	DRK-324B	DRK-324BMK	AK16	DRK-324BAK16	DRK-324BMKAK16
Van 3/4 Ton	13-04	Rear - Dana 60/61	DRK-331B	DRK-331BMK	AK22	DRK-331BAK22	DRK-331BMKAK22
Van 3/4 Ton	10-01	Rear - 10.5"	DRK-325B	DRK-325BMK	AK29	DRK-325BAK29	DRK-325BMKAK29
Van 3/4 Ton	10-01	Rear - 11.5"	DRK-327	DRK-327MK	AK29	DRK-327AK29	DRK-327MKAK29
Van 3/4 Ton	10-01	Rear - 11.5"	DRK-327	DRK-327MK	AK45 <sup>48</sup>	DRK-327AK45 <sup>48</sup>	DRK-327MKAK45 <sup>48</sup>
Van 3/4 Ton	00-98	Rear - 10.5"	DRK-325B	DRK-325BMK	AK21	DRK-325BAK21	DRK-325BMKAK21
Van 3/4 Ton	97-89	Rear - 10.5"	DRK-325A	DRK-325AMK	AK21	DRK-325AAK21	DRK-325AMKAK21
Van 3/4 Ton	97-80	Rear - 9.5"	DRK-324	DRK-324MK	AK16	DRK-324AK16	DRK-324MKAK16 ▲
Van 3/4 Ton	1988	Rear - 10.5" 1st Design	DRK-325	DRK-325MK	AK21	DRK-325AK21	DRK-325MKAK21
Van 3/4 Ton	1988	Rear - 10.5" 2nd Design	DRK-325A	DRK-325AMK	AK21	DRK-325AAK21	DRK-325AMKAK21

LD Differential

<sup>48</sup>With Dual Rear Wheels

<sup>49</sup>With Single Rear Wheels

▲ Add "S" suffix to kit number to receive stackable differential shims in kit.

# Light Duty Differential Applications



Make/Model	Year	Position/ Ring Gear Size	Standard Kit	Master Kit	Axle Kit	Standard Kit Plus	Master Kit Plus
------------	------	-----------------------------	-----------------	---------------	-------------	----------------------	--------------------

<b>CHEVROLET (cont'd)</b>							
Van 3/4 Ton	87-73	Rear - 10.5"	DRK-325	DRK-325MK	AK21	DRK-325AK21	DRK-325MKAK21
Van 3/4 Ton	81-69	Rear - 8.875"	DRK-322	DRK-322MK ▲	AK10	DRK-322AK10	DRK-322MKAK10 ▲
Van 1 Ton	16-11	Rear - 10.5"	DRK-325B	DRK-325BMK	AK44	DRK-325BAK44	DRK-325BMKAK44
Van 1 Ton	16-11	Rear - 11.5"	DRK-327A	DRK-327AMK	AK44	DRK-327AAK44	DRK-327AMKAK44
Van 1 Ton	16-03	Rear - 10.5"	DRK-325B	DRK-325BMK	AK59	DRK-325BAK59	DRK-325BMKAK59
Van 1 Ton	14-98	Rear - 9.5"	DRK-324B	DRK-324BMK	AK16	DRK-324BAK16	DRK-324BMKAK16
Van 1 Ton	10-04	Rear - Dana 60/61	DRK-331B	DRK-331BMK	AK22	DRK-331BAK22	DRK-331BMKAK22
Van 1 Ton	10-01	Rear - 11.5"	DRK-327	DRK-327MK	AK29 <sup>49</sup>	DRK-327AK29 <sup>49</sup>	DRK-327MKAK29 <sup>49</sup>
Van 1 Ton	10-01	Rear - 11.5"	DRK-327	DRK-327MK	AK45 <sup>48</sup>	DRK-327AK45 <sup>48</sup>	DRK-327MKAK45 <sup>48</sup>
Van 1 Ton	10-98	Rear - 10.5"	DRK-325B	DRK-325BMK	AK29	DRK-325BAK29	DRK-325BMKAK29
Van 1 Ton	09-02	Rear - Dana 70	DRK-332G	DRK-332GMK	AK23	DRK-332GAK23	DRK-332GMKAK23
Van 1 Ton	97-89	Rear - 10.5"	DRK-325A	DRK-325AMK	AK21	DRK-325AAK21	DRK-325AMKAK21
Van 1 Ton	91-80	Rear - Dana 60	DRK-331	DRK-331MK			
Van 1 Ton	1988	Rear - 10.5" 1st Design	DRK-325	DRK-325MK	AK21	DRK-325AK21	DRK-325MKAK21
Van 1 Ton	1988	Rear - 10.5" 2nd Design	DRK-325A	DRK-325AMK	AK21	DRK-325AAK21	DRK-325AMKAK21
Van 1 Ton	87-73	Rear - 10.5"	DRK-325	DRK-325MK	AK21	DRK-325AK21	DRK-325MKAK21

## CHRYSLER

300	10-05	Rear - H226 SRT-8	DRK-370	DRK-370MK			
300	71-69	Rear - 8.75" w/1.875" Pin. Shaft O.D.	DRK-301	DRK-301MK			
300	68-57	Rear - 8.75" w/1.75" Pin. Shaft O.D.	DRK-300	DRK-300MK			
Aspen	09-07	Front - 8"	DRK-305	DRK-305MK			
Aspen	09-07	Rear - 8.25"	DRK-303B	DRK-303BMK	AK26	DRK-303BAK26	DRK-303BMKAK26
Aspen	09-07	Rear - 9.25"	DRK-304A	DRK-304AMK	AK26	DRK-304AAK26	DRK-304AMKAK26
Cordoba	83-80	Rear - 7.25"	DRK-302	DRK-302MK			
Cordoba	83-75	Rear - 8.25"/8.375"	DRK-303	DRK-303MK	AK10	DRK-303AK10	DRK-303MKAK10
Cordoba	79-75	Rear - 9.25"	DRK-304	DRK-304MK	AK10	DRK-304AK10	DRK-304MKAK10
Fifth Avenue	89-83	Rear - 7.25"	DRK-302	DRK-302MK			
Fifth Avenue	89-83	Rear - 8.25"/8.375"	DRK-303	DRK-303MK	AK10	DRK-303AK10	DRK-303MKAK10
Imperial	83-81	Rear - 8.25"/8.375"	DRK-303	DRK-303MK	AK10	DRK-303AK10	DRK-303MKAK10
Imperial	75-74	Rear - 9.25"	DRK-304	DRK-304MK	AK10	DRK-304AK10	DRK-304MKAK10
Imperial	75-71	Rear - 8.25"/8.375"	DRK-303	DRK-303MK	AK10	DRK-303AK10	DRK-303MKAK10
Imperial	73-69	Rear - 8.75" w/1.875" Pin. Shaft O.D.	DRK-301	DRK-301MK			
Imperial	68-57	Rear - 8.75" w/1.75" Pin. Shaft O.D.	DRK-300	DRK-300MK			
LeBaron	81-77	Rear - 7.25"	DRK-302	DRK-302MK			
LeBaron	81-77	Rear - 8.25"/8.375"	DRK-303	DRK-303MK	AK10	DRK-303AK10	DRK-303MKAK10
New Yorker	83-82	Rear - 7.25"	DRK-302	DRK-302MK			
New Yorker	83-82	Rear - 8.25"/8.375"	DRK-303	DRK-303MK	AK10	DRK-303AK10	DRK-303MKAK10
New Yorker	81-75	Rear - 8.25"/8.375"	DRK-303	DRK-303MK	AK10	DRK-303AK10	DRK-303MKAK10
New Yorker	81-75	Rear - 9.25"	DRK-304	DRK-304MK	AK10	DRK-304AK10	DRK-304MKAK10
New Yorker	74-72	Rear - 8.25"/8.375"	DRK-303	DRK-303MK	AK10	DRK-303AK10	DRK-303MKAK10
New Yorker	74-72	Rear - 8.75" w/1.875" Pin. Shaft O.D.	DRK-301	DRK-301MK			
New Yorker	74-72	Rear - 9.25"	DRK-304	DRK-304MK	AK10	DRK-304AK10	DRK-304MKAK10
New Yorker	71-69	Rear - 8.75" w/1.875" Pin. Shaft O.D.	DRK-301	DRK-301MK			
New Yorker	68-57	Rear - 8.75" w/1.75" Pin. Shaft O.D.	DRK-300	DRK-300MK			
Newport	81-75	Rear - 8.25"/8.375"	DRK-303	DRK-303MK	AK10	DRK-303AK10	DRK-303MKAK10
Newport	81-75	Rear - 9.25"	DRK-304	DRK-304MK	AK10	DRK-304AK10	DRK-304MKAK10
Newport	74-72	Rear - 8.25"/8.375"	DRK-303	DRK-303MK	AK10	DRK-303AK10	DRK-303MKAK10

LD Differential

# Light Duty Differential Applications

Make/Model	Year	Position/ Ring Gear Size	Standard Kit	Master Kit	Axle Kit	Standard Kit Plus	Master Kit Plus
<b>CHRYSLER (cont'd)</b>							
Newport	74-72	Rear - 8.75" w/1.875" Pin. Shaft O.D.	DRK-301	DRK-301MK			
Newport	71-69	Rear - 8.75" w/1.875" Pin. Shaft O.D.	DRK-301	DRK-301MK			
Newport	68-57	Rear - 8.75" w/1.75" Pin. Shaft O.D.	DRK-300	DRK-300MK			
Town & Country	81-78	Rear - 8.25"/8.375"	DRK-303	DRK-303MK	AK10	DRK-303AK10	DRK-303MKAK10
Town & Country	77-69	Rear - 8.75" w/1.875" Pin. Shaft O.D.	DRK-301	DRK-301MK			
Town & Country	68-57	Rear - 8.75" w/1.75" Pin. Shaft O.D.	DRK-300	DRK-300MK			
<b>DODGE</b>							
Aspen	1980	Rear - 8.25"/8.375"	DRK-303	DRK-303MK	AK10	DRK-303AK10	DRK-303MKAK10
Aspen	79-76	Rear - 7.25"	DRK-302	DRK-302MK			
Challenger	10-08	Rear - H226	DRK-370	DRK-370MK			
Challenger	74-70	Rear - 8.75" w/1.875" Pin. Shaft O.D.	DRK-301	DRK-301MK			
Challenger	71-70	Rear - 7.25"	DRK-302	DRK-302MK			
Challenger	71-70	Rear - Dana 60	DRK-331	DRK-331MK			
Charger	10-06	Rear - H226 SRT-8	DRK-370	DRK-370MK			
Charger	78-74	Rear - 8.25"/8.375"	DRK-303	DRK-303MK	AK10	DRK-303AK10	DRK-303MKAK10
Charger	78-74	Rear - 9.25"	DRK-304	DRK-304MK	AK10	DRK-304AK10	DRK-304MKAK10
Charger	1974	Rear - 8.75" w/1.875" Pin. Shaft O.D.	DRK-301	DRK-301MK			
Charger	73-69	Rear - 8.25"/8.375"	DRK-303	DRK-303MK	AK10	DRK-303AK10	DRK-303MKAK10
Charger	73-69	Rear - 8.75" w/1.875" Pin. Shaft O.D.	DRK-301	DRK-301MK			
Charger	71-69	Rear - 7.25"	DRK-302	DRK-302MK			
Charger	1968	Rear - 7.25"	DRK-302	DRK-302MK			
Charger	1968	Rear - 8.75" w/1.75" Pin. Shaft O.D.	DRK-300	DRK-300MK			
Charger	1968	Rear - Dana 60	DRK-331	DRK-331MK			
Charger	67-66	Rear - 8.75" w/1.75" Pin. Shaft O.D.	DRK-300	DRK-300MK			
Charger	67-66	Rear - Dana 60	DRK-331	DRK-331MK			
Coronet	76-74	Rear - 8.25"/8.375"	DRK-303	DRK-303MK	AK10	DRK-303AK10	DRK-303MKAK10
Coronet	76-73	Rear - 9.25"	DRK-304	DRK-304MK	AK10	DRK-304AK10	DRK-304MKAK10
Coronet	74-73	Rear - 8.75" w/1.875" Pin. Shaft O.D.	DRK-301	DRK-301MK			
Coronet	73-69	Rear - 8.25"/8.375"	DRK-303	DRK-303MK	AK10	DRK-303AK10	DRK-303MKAK10
Coronet	72-69	Rear - 8.75" w/1.875" Pin. Shaft O.D.	DRK-301	DRK-301MK			
Coronet	71-66	Rear - 7.25"	DRK-302	DRK-302MK			
Coronet	68-66	Rear - 8.75" w/1.75" Pin. Shaft O.D.	DRK-300	DRK-300MK			
Coronet	1966	Rear - Dana 60	DRK-331	DRK-331MK			
Coronet	1965	Rear - 8.75" w/1.75" Pin. Shaft O.D.	DRK-300	DRK-300MK			
Dakota	11-00	Front - 8"	DRK-305	DRK-305MK			
Dakota	99-97	Front - Dana 35	DRK-335	DRK-335MK ▲			
Dakota	96-87	Front - 7.25"	DRK-302	DRK-302MK			
Dakota	11-01	Rear - 9.25"	DRK-304A	DRK-304AMK	AK10	DRK-304AAK10	DRK-304AMKAK10
Dakota	11-00	Rear - 8.25"	DRK-303B	DRK-303BMK	AK10	DRK-303BAK10	DRK-303BMKAK10
Dakota	00-98	Rear - 9.25"	DRK-304	DRK-304MK	AK10	DRK-304AK10	DRK-304MKAK10

▲ Add "S" suffix to kit number to receive stackable differential shims in kit.

# Light Duty Differential Applications



Make/Model	Year	Position/ Ring Gear Size	Standard Kit	Master Kit	Axle Kit	Standard Kit Plus	Master Kit Plus
<b>DODGE (cont'd)</b>							
Dakota	99-87	Rear - 8.25"	DRK-303	DRK-303MK	AK10	DRK-303AK10	DRK-303MKAK10
Dakota	96-87	Rear - 7.25"	DRK-302	DRK-302MK	AK10	DRK-302AK10	DRK-302MKAK10
Dart	76-73	Rear - 8.25"/8.375"	DRK-303	DRK-303MK	AK10	DRK-303AK10	DRK-303MKAK10
Dart	1972	Rear - 7.25"	DRK-302	DRK-302MK			
Dart	1972	Rear - 8.25"/8.375"	DRK-303	DRK-303MK	AK10	DRK-303AK10	DRK-303MKAK10
Dart	1972	Rear - 8.75" w/1.875" Pin. Shaft O.D.	DRK-301	DRK-301MK			
Dart	71-69	Rear - 7.25"	DRK-302	DRK-302MK			
Dart	71-69	Rear - 8.75" w/1.875" Pin. Shaft O.D.	DRK-301	DRK-301MK			
Dart	68-66	Rear - 7.25"	DRK-302	DRK-302MK			
Dart	68-66	Rear - 8.75" w/1.75" Pin. Shaft O.D.	DRK-300	DRK-300MK			
Dart	65-63	Rear - 7.25"	DRK-302	DRK-302MK			
Diplomat	89-77	Rear - 7.25"	DRK-302	DRK-302MK			
Diplomat	89-77	Rear - 8.25"/8.375"	DRK-303	DRK-303MK	AK10	DRK-303AK10	DRK-303MKAK10
Durango	09-00	Front - 8"	DRK-305	DRK-305MK			
Durango	99-98	Front - Dana 35	DRK-335	DRK-335MK ▲			
Durango	09-04	Rear - 8.25"	DRK-303B	DRK-303BMK	AK26	DRK-303BAK26	DRK-303BMKAK26
Durango	09-04	Rear - 9.25"	DRK-304A	DRK-304AMK	AK26	DRK-304AAK26	DRK-304AMKAK26
Durango	03-01	Rear - 9.25"	DRK-304A	DRK-304AMK	AK10	DRK-304AAK10	DRK-304AMKAK10
Durango	03-00	Rear - 8.25"	DRK-303B	DRK-303BMK	AK10	DRK-303BAK10	DRK-303BMKAK10
Durango	00-98	Rear - 9.25"	DRK-304	DRK-304MK	AK10	DRK-304AK10	DRK-304MKAK10
Durango	99-98	Rear - 8.25"	DRK-303	DRK-303MK	AK10	DRK-303AK10	DRK-303MKAK10
Magnum	08-06	Rear - H226 SRT-8	DRK-370	DRK-370MK			
Magnum	79-78	Rear - 8.25"/8.375"	DRK-303	DRK-303MK	AK10	DRK-303AK10	DRK-303MKAK10
Magnum	79-78	Rear - 9.25"	DRK-304	DRK-304MK	AK10	DRK-304AK10	DRK-304MKAK10
Mirada	83-80	Rear - 7.25"	DRK-302	DRK-302MK			
Mirada	83-80	Rear - 8.25"/8.375"	DRK-303	DRK-303MK	AK10	DRK-303AK10	DRK-303MKAK10
Monaco	78-74	Rear - 9.25"	DRK-304	DRK-304MK	AK10	DRK-304AK10	DRK-304MKAK10
Monaco	78-71	Rear - 8.25"/8.375"	DRK-303	DRK-303MK	AK10	DRK-303AK10	DRK-303MKAK10
Monaco	73-69	Rear - 8.75" w/1.875" Pin. Shaft O.D.	DRK-301	DRK-301MK			
Monaco	68-67	Rear - 9.25"	DRK-304	DRK-304MK	AK10	DRK-304AK10	DRK-304MKAK10
Monaco	68-65	Rear - 8.75" w/1.75" Pin. Shaft O.D.	DRK-300	DRK-300MK			
Nitro	11-07	Front - Dana 30	DRK-340	DRK-340MK ▲			
Nitro	11-09	Rear - 8.25"	DRK-303B	DRK-303BMK	AK26	DRK-303BAK26	DRK-303BMKAK26
Nitro	08-07	Rear - 8.25"	DRK-303B	DRK-303BMK	AK10	DRK-303BAK10	DRK-303BMKAK10
Polara	73-71	Rear - 8.25"/8.375"	DRK-303	DRK-303MK	AK10	DRK-303AK10	DRK-303MKAK10
Polara	73-69	Rear - 8.75" w/1.875" Pin. Shaft O.D.	DRK-301	DRK-301MK			
Polara	68-67	Rear - 9.25"	DRK-304	DRK-304MK	AK10	DRK-304AK10	DRK-304MKAK10
Polara	68-63	Rear - 8.75" w/1.75" Pin. Shaft O.D.	DRK-300	DRK-300MK			
Ramcharger	93-74	Front - Dana 44	DRK-339B	DRK-339BMK			
Ramcharger	93-74	Rear - 9.25"	DRK-304	DRK-304MK	AK10	DRK-304AK10	DRK-304MKAK10
Sprinter 2500	12-07	Rear - All	DRK-307A	DRK-307AMK ▲			
Sprinter 2500	06-04	Rear - All From March 2004 Production	DRK-307	DRK-307MK ▲			
Sprinter 2500	2004	Rear - All Up to Feb 2004 Production Date	DRK-307B	DRK-307BMK ▲			
Sprinter 2500	2003	Rear - All	DRK-307B	DRK-307BMK ▲			
Sprinter 3500	12-07	Rear - All	DRK-307A	DRK-307AMK ▲			

LD Differential

# Light Duty Differential Applications

Make/Model	Year	Position/ Ring Gear Size	Standard Kit	Master Kit	Axle Kit	Standard Kit Plus	Master Kit Plus
<b>DODGE (cont'd)</b>							
Sprinter 3500	06-04	Rear - From March 2004 Production Date	DRK-307	DRK-307MK ▲			
Sprinter 3500	2004	Rear - All Up to Feb 2004 Production Date	DRK-307B	DRK-307BMK ▲			
Sprinter 3500	2003	Rear - All	DRK-307B	DRK-307BMK ▲			
St. Regis	81-79	Rear - 7.25"	DRK-302	DRK-302MK			
St. Regis	81-79	Rear - 8.25"/8.375"	DRK-303	DRK-303MK	AK10	DRK-303AK10	DRK-303MKAK10
St. Regis	81-79	Rear - 9.25"	DRK-304	DRK-304MK	AK10	DRK-304AK10	DRK-304MKAK10
Truck 1/2 Ton	10-06	Front - 8"	DRK-305A	DRK-305AMK ▲			
Truck 1/2 Ton	08-94	Front - Dana 44	DRK-339C	DRK-339CMK			
Truck 1/2 Ton	05-02	Front - 8"	DRK-305B	DRK-305BMK ▲			
Truck 1/2 Ton	93-69	Front - Dana 44	DRK-339B	DRK-339BMK			
Truck 1/2 Ton	10-07	Rear - 9.25" Corporate Axle w/ 5 Lugs	DRK-304A	DRK-304AMK	AK26	DRK-304AAK26	DRK-304AMKAK26
Truck 1/2 Ton	10-07	Rear - 9.25" Corporate Axle w/ 8 Lugs	DRK-304A	DRK-304AMK	AK22	DRK-304AAK22	DRK-304AMKAK22
Truck 1/2 Ton	10-06	Rear - 11.5"	DRK-327	DRK-327MK	AK30	DRK-327AK30	DRK-327MKAK30
Truck 1/2 Ton	09-06	Rear - 10.5"	DRK-306	DRK-306MK	AK30	DRK-306AK30	DRK-306MKAK30
Truck 1/2 Ton	06-01	Rear - 9.25" Light Duty Axle w/ 5 Lugs	DRK-304A	DRK-304AMK	AK10	DRK-304AAK10	DRK-304AMKAK10
Truck 1/2 Ton	06-01	Rear - 9.25" Heavy Duty Axle w/ 8 Lugs	DRK-304A	DRK-304AMK	AK22	DRK-304AAK22	DRK-304AMKAK22
Truck 1/2 Ton	06-00	Rear - 8.25"	DRK-303B	DRK-303BMK	AK10	DRK-303BAK10	DRK-303BMKAK10
Truck 1/2 Ton	00-74	Rear - 9.25" Light Duty Axle w/ 5 Lugs	DRK-304	DRK-304MK	AK10	DRK-304AK10	DRK-304MKAK10
Truck 1/2 Ton	00-74	Rear - 9.25" Heavy Duty Axle w/ 8 Lugs	DRK-304	DRK-304MK	AK22	DRK-304AK22	DRK-304MKAK22
Truck 1/2 Ton	99-69	Rear - 8.25"	DRK-303	DRK-303MK	AK10	DRK-303AK10	DRK-303MKAK10
Truck 1/2 Ton	74-68	Rear - 8.75" w/1.875" Pin. Shaft O.D.	DRK-301	DRK-301MK			
Truck 1/2 Ton	68-60	Rear - 8.75" w/1.75" Pin. Shaft O.D.	DRK-300	DRK-300MK			
Truck 3/4 Ton	10-03	Front - 9.25" AAM axle	DRK-324G	DRK-324GMK ▲	AK57	DRK-324GAK57	DRK-324GMKAK57 ▲
Truck 3/4 Ton	08-94	Front - Dana 44	DRK-339C	DRK-339CMK			
Truck 3/4 Ton	08-94	Front - Dana 60	DRK-331	DRK-331MK			
Truck 3/4 Ton	93-75	Front - Dana 60	DRK-331	DRK-331MK	AK42	DRK-331AK42	DRK-331MKAK42
Truck 3/4 Ton	84-69	Front - Dana 44	DRK-339B	DRK-339BMK			
Truck 3/4 Ton	10-03	Rear - 10.5"	DRK-306	DRK-306MK	AK30	DRK-306AK30	DRK-306MKAK30
Truck 3/4 Ton	10-03	Rear - 11.5"	DRK-327	DRK-327MK	AK30	DRK-327AK30	DRK-327MKAK30
Truck 3/4 Ton	10-01	Rear - 9.25" Light Duty Axle w/ 5 Lugs	DRK-304A	DRK-304AMK	AK10	DRK-304AAK10	DRK-304AMKAK10
Truck 3/4 Ton	10-01	Rear - 9.25" Heavy Duty Axle w/ 8 Lugs	DRK-304A	DRK-304AMK	AK22	DRK-304AAK22	DRK-304AMKAK22
Truck 3/4 Ton	08-03	Rear - Dana 60	DRK-331A	DRK-331AMK	AK30	DRK-331AAK30	DRK-331AMKAK30
Truck 3/4 Ton	08-94	Rear - Dana 70U	DRK-332U	DRK-332UMK	AK6	DRK-332UAK6	DRK-332UMKAK6
Truck 3/4 Ton	02-94	Rear - Dana 60	DRK-331A	DRK-331AMK	AK6	DRK-331AAK6	DRK-331AMKAK6
Truck 3/4 Ton	02-94	Rear - Dana 80	DRK-337	DRK-337MK			
Truck 3/4 Ton	00-74	Rear - 9.25" Light Duty Axle w/ 5 Lugs	DRK-304	DRK-304MK	AK10	DRK-304AK10	DRK-304MKAK10
Truck 3/4 Ton	00-74	Rear - 9.25" Heavy Duty Axle w/ 8 Lugs	DRK-304	DRK-304MK	AK22	DRK-304AK22	DRK-304MKAK22
Truck 3/4 Ton	93-61	Rear - Dana 60	DRK-331	DRK-331MK			
Truck 3/4 Ton	74-69	Rear - 8.75" w/1.875" Pin. Shaft O.D.	DRK-301	DRK-301MK			
Truck 3/4 Ton	68-65	Rear - 8.75" w/1.75" Pin. Shaft O.D.	DRK-300	DRK-300MK			



# Light Duty Differential Applications

Make/Model	Year	Position/ Ring Gear Size	Standard Kit	Master Kit	Axle Kit	Standard Kit Plus	Master Kit Plus
<b>DODGE (cont'd)</b>							
Truck 1 Ton	10-03	Front - 9.25" AAM axle	DRK-324G	DRK-324GMK <sup>▲</sup>	AK57	DRK-324GAK57	DRK-324GMKAK57 <sup>▲</sup>
Truck 1 Ton	08-94	Front - Dana 60	DRK-331	DRK-331MK			
Truck 1 Ton	93-75	Front - Dana 60	DRK-331	DRK-331MK	AK42	DRK-331AK42	DRK-331MKAK42
Truck 1 Ton	10-03	Rear - 11.5"	DRK-327	DRK-327MK	AK30 <sup>49</sup>	DRK-327AK30 <sup>49</sup>	DRK-327MKAK30 <sup>49</sup>
Truck 1 Ton	10-03	Rear - 11.5"	DRK-327	DRK-327MK	AK13 <sup>48</sup>	DRK-327AK13 <sup>48</sup>	DRK-327MKAK13 <sup>48</sup>
Truck 1 Ton	08-60	Rear - Dana 60	DRK-331	DRK-331MK			
Truck 1 Ton	02-94	Rear - Dana 80	DRK-337	DRK-337MK			
Truck 1 Ton	00-74	Rear - 9.25" Light Duty Axle w/ 5 Lugs	DRK-304	DRK-304MK	AK10	DRK-304AK10	DRK-304MKAK10
Truck 1 Ton	00-74	Rear - 9.25" Heavy Duty Axle w/ 8 Lugs	DRK-304	DRK-304MK	AK22	DRK-304AK22	DRK-304MKAK22
Truck 1 Ton	93-84	Rear - Dana 70U	DRK-332U	DRK-332UMK			
Truck 1 Ton	84-60	Rear - Dana 70	DRK-332	DRK-332MK			
Ram 4500	10-08	Front - Magna Steyr 275mm	DRK-365				
Ram 4500	10-08	Rear - Dana S111	DRK-434				
Ram 5500	10-08	Front - Magna Steyr 275mm	DRK-365				
Ram 5500	10-08	Rear - Dana S111	DRK-434				
Van 1/2 Ton	03-00	Rear - 8.25"	DRK-303B	DRK-303BMK	AK10	DRK-303BAK10	DRK-303BMKAK10
Van 1/2 Ton	03-00	Rear - 9.25"	DRK-304A	DRK-304AMK	AK10	DRK-304AK10	DRK-304MKAK10
Van 1/2 Ton	99-74	Rear - 9.25"	DRK-304	DRK-304MK	AK10	DRK-304AK10	DRK-304MKAK10
Van 1/2 Ton	99-71	Rear - 8.25"	DRK-303	DRK-303MK	AK10	DRK-303AK10	DRK-303MKAK10
Van 1/2 Ton	74-64	Rear - 8.75"	DRK-301	DRK-301MK			
Van 3/4 Ton	03-00	Rear - 9.25"	DRK-304A	DRK-304AMK	AK10	DRK-304AK10	DRK-304MKAK10
Van 3/4 Ton	03-98	Rear - Dana 60	DRK-331A	DRK-331AMK			
Van 3/4 Ton	99-90	Rear - 8.25"	DRK-303	DRK-303MK	AK10	DRK-303AK10	DRK-303MKAK10
Van 3/4 Ton	99-74	Rear - 9.25"	DRK-304	DRK-304MK	AK10	DRK-304AK10	DRK-304MKAK10
Van 3/4 Ton	74-71	Rear - 8.75"	DRK-301	DRK-301MK			
Van 1 Ton	08-71	Rear - Dana 60	DRK-331	DRK-331MK			
Van 1 Ton	03-00	Rear - 9.25"	DRK-304A	DRK-304AMK	AK10	DRK-304AK10	DRK-304MKAK10
Van 1 Ton	99-74	Rear - 9.25"	DRK-304	DRK-304MK	AK10	DRK-304AK10	DRK-304MKAK10
Viper	00-93	Rear - Dana 44	DRK-339A	DRK-339AMK <sup>▲</sup>			
<b>FORD</b>							
Aerostar	97-90	Front - Dana 28	DRK-333	DRK-333MK			
Aerostar	97-90	Rear - 7.5"	DRK-315	DRK-315MK <sup>▲</sup>	AK11	DRK-315AK11	DRK-315MKAK11 <sup>▲</sup>
Aerostar	97-90	Rear - 8.8"	DRK-311	DRK-311MK <sup>▲</sup>	AK10	DRK-311AK10	DRK-311MKAK10 <sup>▲</sup>
Aerostar	89-86	Rear - Dana 30, To 1989-1/2 Model	DRK-339	DRK-339MK <sup>▲</sup>			
Bronco	96-80	Front - Dana 44	DRK-339B	DRK-339BMK	AK41	DRK-339BAK41	DRK-339BMKAK41
Bronco	79-67	Front - Dana 44	DRK-339B	DRK-339BMK			
Bronco	96-83	Rear - 8.8"	DRK-311	DRK-311MK <sup>▲</sup>	AK10	DRK-311AK10	DRK-311MKAK10 <sup>▲</sup>
Bronco	86-70	Rear - 9" 31 spline From 05/11/70	DRK-313	DRK-313MK			
Bronco	70-67	Rear - 9" 28 spline To 5/10/70	DRK-312	DRK-312MK			
Bronco II	1990	Front - Dana 35	DRK-335	DRK-335MK <sup>▲</sup>			
Bronco II	89-84	Front - Dana 28	DRK-333	DRK-333MK			
Bronco II	90-84	Rear - 7.5"	DRK-315	DRK-315MK <sup>▲</sup>	AK11	DRK-315AK11	DRK-315MKAK11 <sup>▲</sup>
Country Squire	91-81	Rear - 8.8"	DRK-311	DRK-311MK <sup>▲</sup>	AK11	DRK-311AK11	DRK-311MKAK11 <sup>▲</sup>
Country Squire	80-73	Rear - 9" 31 spline From 05/11/70	DRK-313	DRK-313MK			
Crown Victoria	11-92	Rear - 8.8"	DRK-311	DRK-311MK <sup>▲</sup>	AK11	DRK-311AK11	DRK-311MKAK11 <sup>▲</sup>

# Light Duty Differential Applications

Make/Model	Year	Position/ Ring Gear Size	Standard Kit	Master Kit	Axle Kit	Standard Kit Plus	Master Kit Plus
<b>FORD (cont'd)</b>							
Escape	12-01	Rear - Dana 28	DRK-333A <sup>110</sup>	DRK-333AMK <sup>110</sup>	AK89	DRK-333AAK89 <sup>110</sup>	DRK-333AMKAK89 <sup>110</sup>
Excursion	05-00	Front - Dana 50	DRK-336A	DRK-336AMK			
Excursion	05-00	Rear - 10.5"	DRK-317 <sup>50</sup>	DRK-317MK <sup>50</sup> ▲			
Expedition	16-09	Front - 8.8"	DRK-311	DRK-311MK ▲	AK91	DRK-311AK91	DRK-311MKAK91 ▲
Expedition	08-97	Front - 8.8"	DRK-311	DRK-311MK ▲	AK88	DRK-311AK88	DRK-311MKAK88 ▲
Expedition	16-11	Rear - 9.75" from 04/30/2011	DRK-316D	DRK-316DMK ▲	AK36	DRK-316DAK36	DRK-316DMKAK36 ▲
Expedition	11-07	Rear - 9.75" To 04/29/2011	DRK-316B	DRK-316BMK ▲	AK36	DRK-316BAK36	DRK-316BMKAK36 ▲
Expedition	06-03	Rear - 9.75"	DRK-316A	DRK-316AMK ▲	AK36	DRK-316AAK36	DRK-316AMKAK36 ▲
Expedition	05-03	Rear - 8.8" IRS	DRK-311	DRK-311MK ▲	AK36	DRK-311AK36	DRK-311MKAK36 ▲
Expedition	02-00	Rear - 9.75"	DRK-316A	DRK-316AMK ▲	AK15	DRK-316AAK15	DRK-316AMKAK15 ▲
Expedition	02-97	Rear - 8.8"	DRK-311	DRK-311MK ▲	AK15	DRK-311AK15	DRK-311MKAK15 ▲
Expedition	1999	Rear - 9.75" w/ 2.68" Pinion Brg.	DRK-316	DRK-316MK ▲	AK15	DRK-316AK15	DRK-316MKAK15 ▲
Expedition	1999	Rear - 9.75" w/ 3.00" Pinion Brg.	DRK-316A	DRK-316AMK ▲	AK15	DRK-316AAK15	DRK-316AMKAK15 ▲
Expedition	98-97	Rear - 9.75"	DRK-316	DRK-316MK ▲	AK15	DRK-316AK15	DRK-316MKAK15 ▲
Explorer	10-06	Front - Dana 30	DRK-334E	DRK-334EMK ▲	AK93	DRK-334EAK93	DRK-334EMKAK93
Explorer	05-01	Front - Dana 30	DRK-334B	DRK-334BMK	AK93	DRK-334BAK93	DRK-334BMKAK93
Explorer	04-95	Front - Dana 35	DRK-335B	DRK-335BMK ▲			
Explorer	94-91	Front - Dana 35	DRK-335	DRK-335MK ▲			
Explorer	10-08	Rear - 8.8" IRS	DRK-311L	DRK-311LMK ▲	AK36	DRK-311LAK36	DRK-311LMKAK36 ▲
Explorer	07-06	Rear - 8.8" IRS	DRK-311K	DRK-311KMK ▲	AK36	DRK-311KAK36	DRK-311KMKAK36 ▲
Explorer	05-02	Rear - 8.8" IRS	DRK-311	DRK-311MK ▲	AK36	DRK-311AK36	DRK-311MKAK36 ▲
Explorer	01-91	Rear - 8.8"	DRK-311	DRK-311MK ▲	AK10	DRK-311AK10	DRK-311MKAK10 ▲
Explorer	97-91	Rear - 7.5"	DRK-315	DRK-315MK ▲	AK10	DRK-315AK10	DRK-315MKAK10 ▲
Explorer Sport Trac	10-07	Front - Dana 30	DRK-334E	DRK-334EMK ▲	AK93	DRK-334EAK93	DRK-334EMKAK93
Explorer Sport Trac	06-01	Front - Dana 35	DRK-335B	DRK-335BMK ▲	AK93		
Explorer Sport Trac	10-08	Rear - 8.8" IRS	DRK-311L	DRK-311LMK ▲	AK36	DRK-311LAK36	DRK-311LMKAK36 ▲
Explorer Sport Trac	2007	Rear - 8.8" IRS	DRK-311K	DRK-311KMK ▲	AK36	DRK-311KAK36	DRK-311KMKAK36 ▲
Explorer Sport Trac	05-01	Rear - 8.8"	DRK-311	DRK-311MK ▲	AK10	DRK-311AK10	DRK-311MKAK10 ▲
Fairlane	1970	Rear - 9" 31 spline From 05/11/70	DRK-313	DRK-313MK			
Fairlane	70-62	Rear - 8"	DRK-310	DRK-310MK			
Fairlane	70-62	Rear - 9" 28 spline To 5/10/70	DRK-312	DRK-312MK			
Fairmont	83-78	Rear - 7.5"	DRK-315	DRK-315MK ▲	AK11	DRK-315AK11	DRK-315MKAK11 ▲
Falcon	70-62	Rear - 8"	DRK-310	DRK-310MK			
Granada	82-81	Rear - 7.5"	DRK-315	DRK-315MK ▲	AK11	DRK-315AK11	DRK-315MKAK11 ▲
Granada	80-75	Rear - 8"	DRK-310	DRK-310MK			
Granada	80-75	Rear - 9"	DRK-313	DRK-313MK	AK11	DRK-313AK11	DRK-313MKAK11
LTD	86-83	Rear - 7.5"	DRK-315	DRK-315MK ▲	AK11	DRK-315AK11	DRK-315MKAK11 ▲
LTD	82-81	Rear - 8.8"	DRK-311	DRK-311MK ▲	AK11	DRK-311AK11	DRK-311MKAK11 ▲
LTD	80-73	Rear - 9" 31 spline From 05/11/70	DRK-313	DRK-313MK	AK11	DRK-313AK11	DRK-313MKAK11
LTD II	79-77	Rear - 9"	DRK-313	DRK-313MK			
LTD Crown Victoria	91-87	Rear - 8.8"	DRK-311	DRK-311MK ▲	AK11	DRK-311AK11	DRK-311MKAK11 ▲
Maverick	77-71	Rear - 8"	DRK-310	DRK-310MK			
Mustang	16-15	Rear - 8.8" w/ 3.15, 3.31, 3.55 ratios	DRK-311S	DRK-311SMK ▲	AK36	DRK-311SAK36	DRK-311SMKAK36 ▲
Mustang	16-15	Rear - 8.8" w/ 3.73 ratio	DRK-311Q	DRK-311QMK ▲	AK36	DRK-311QAK36	DRK-311QMKAK36 ▲
Mustang	14-05	Rear - 8.8"	DRK-311E	DRK-311EMK ▲	AK10	DRK-311EAK10	DRK-311EMKAK10 ▲
Mustang	10-79	Rear - 7.5"	DRK-315	DRK-315MK ▲	AK11	DRK-315AK11	DRK-315MKAK11 ▲
Mustang	04-86	Rear - 8.8"	DRK-311	DRK-311MK ▲	AK11	DRK-311AK11	DRK-311MKAK11 ▲

<sup>50</sup>For use with OEM 10.5" R/P only-use kit DRK-314AMK if using aftermarket 10.25" R/P <sup>110</sup>Original Pinion Nut Must be Re-used

▲ Add "S" suffix to kit number to receive stackable differential shims in kit.

# Light Duty Differential Applications

Make/Model	Year	Position/ Ring Gear Size	Standard Kit	Master Kit	Axle Kit	Standard Kit Plus	Master Kit Plus
<b>FORD (cont'd)</b>							
Mustang	78-64	Rear - 8"	DRK-310	DRK-310MK			
Mustang	73-70	Rear - 9" 31 spline From 05/11/70	DRK-313	DRK-313MK			
Mustang	70-65	Rear - 9" 28 spline To 5/10/70	DRK-312	DRK-312MK			
Pinto	80-71	Rear - 8"	DRK-310	DRK-310MK			
Ranger	11-98	Front - Dana 35	DRK-335B	DRK-335BMK ▲			
Ranger	97-90	Front - Dana 35 W/4.0L V-6 Engine	DRK-335	DRK-335MK ▲			
Ranger	97-83	Front - Dana 28	DRK-333	DRK-333MK			
Ranger	11-10	Rear - 7.5"	DRK-315	DRK-315MK ▲	AK10	DRK-315AK10	DRK-315MKAK10 ▲
Ranger	11-07	Rear - 8.8" W/4.0L V-6 Engine	DRK-311G	DRK-311GMK ▲	AK10	DRK-311GAK10	DRK-311GMKAK10 ▲
Ranger	09-83	Rear - 7.5"	DRK-315	DRK-315MK ▲	AK11	DRK-315AK11	DRK-315MKAK11 ▲
Ranger	06-90	Rear - 8.8" W/4.0L V-6 Engine	DRK-311	DRK-311MK ▲	AK10	DRK-311AK10	DRK-311MKAK10 ▲
Thunderbird	05-02	Rear - 8.0"	DRK-311N	DRK-311NMK ▲	AK90	DRK-311NAK90	DRK-311NMKAK90 ▲
Thunderbird	97-89	Rear - 7.5"	DRK-315	DRK-315MK ▲			
Thunderbird	97-89	Rear - 8.8"	DRK-311	DRK-311MK ▲	AK90	DRK-311AK90	DRK-311MKAK90 ▲
Thunderbird	1988	Rear - 8.8"	DRK-311	DRK-311MK ▲	AK11	DRK-311AK11	DRK-311MKAK11 ▲
Thunderbird	88-80	Rear - 7.5"	DRK-315	DRK-315MK ▲	AK11	DRK-315AK11	DRK-315MKAK11 ▲
Thunderbird	79-70	Rear - 9" 31 spline From 05/11/70	DRK-313	DRK-313MK			
Thunderbird	70-57	Rear - 9" 28 spline To 5/10/70	DRK-312	DRK-312MK			
Torino	76-68	Rear - 9"	DRK-313	DRK-313MK			
Torino	74-71	Rear - 8"	DRK-310	DRK-310MK			
Transit 150	16-15	Rear - 9.75"	DRK-316E	DRK-316EMK ▲	AK46 <sup>49</sup>	DRK-316EAK46	DRK-316EMKAK46 ▲
Transit 250	16-15	Rear - 9.75"	DRK-316E	DRK-316EMK ▲	AK46 <sup>49</sup>	DRK-316EAK46	DRK-316EMKAK46 ▲
Transit 350	16-15	Rear - 9.75"	DRK-316E	DRK-316EMK ▲	AK46 <sup>49</sup>	DRK-316EAK46	DRK-316EMKAK46 ▲
Transit 350 HD	16-15	Rear - 9.75"	DRK-316E	DRK-316EMK ▲	AK46 <sup>49</sup>	DRK-316EAK46	DRK-316EMKAK46 ▲
Truck 1/2 Ton	16-09	Front - 8.8"	DRK-311	DRK-311MK ▲	AK91	DRK-311AK91	DRK-311MKAK91 ▲
Truck 1/2 Ton	08-97	Front - 8.8"	DRK-311	DRK-311MK ▲	AK88	DRK-311AK88	DRK-311MKAK88 ▲
Truck 1/2 Ton	96-92	Front - Dana 44 w/2.84" Pinion Brg.	DRK-339D	DRK-339DMK	AK41	DRK-339DAK41	DRK-339DMKAK41
Truck 1/2 Ton	92-83	Front - Dana 44 w/3.00" Pinion Brg.	DRK-339B	DRK-339BMK	AK41	DRK-339BAK41	DRK-339BMKAK41
Truck 1/2 Ton	82-67	Front - Dana 44 w/3.00" Pinion Brg.	DRK-339B	DRK-339BMK			
Truck 1/2 Ton	16-15	Rear - 9.75"	DRK-316F	DRK-316FMK	AK15	DRK-316FAK15	DRK-316FMKAK15 ▲
Truck 1/2 Ton	15-11	Rear - 8.8"	DRK-311L	DRK-311LMK ▲	AK15	DRK-311LAK15	DRK-311LMKAK15 ▲
Truck 1/2 Ton	14-12	Rear - 9.75"	DRK-316C	DRK-316CMK ▲	AK15	DRK-316CAK15	DRK-316CMKAK15 ▲
Truck 1/2 Ton	2011	Rear - 9.75" From 12/20/10	DRK-316C	DRK-316CMK ▲	AK15	DRK-316CAK15	DRK-316CMKAK15 ▲
Truck 1/2 Ton	2011	Rear - 9.75" To 12/19/2010	DRK-316B	DRK-316BMK ▲	AK15	DRK-316BAK15	DRK-316BMKAK15 ▲
Truck 1/2 Ton	10-09	Rear - 8.8"	DRK-311L	DRK-311LMK ▲	AK15	DRK-311LAK15	DRK-311LMKAK15 ▲
Truck 1/2 Ton	10-08	Rear - 10.5"	DRK-317A <sup>50</sup>	DRK-317AMK <sup>50</sup> ▲	AK48	DRK-317AAK48 <sup>50</sup>	DRK-317AMKAK48 <sup>50</sup> ▲
Truck 1/2 Ton	10-07	Rear - 9.75"	DRK-316B	DRK-316BMK ▲	AK15	DRK-316BAK15	DRK-316BMKAK15 ▲
Truck 1/2 Ton	08-07	Rear - 8.8"	DRK-311G	DRK-311GMK ▲	AK15	DRK-311GAK15	DRK-311GMKAK15 ▲
Truck 1/2 Ton	07-04	Rear - 10.5"	DRK-317 <sup>50</sup>	DRK-317MK <sup>50</sup> ▲	AK48	DRK-317AK48 <sup>50</sup>	DRK-317MKAK48 ▲
Truck 1/2 Ton	06-04	Rear - 8.8"	DRK-311	DRK-311MK ▲	AK15	DRK-311AK15	DRK-311MKAK15 ▲
Truck 1/2 Ton	06-00	Rear - 9.75"	DRK-316A	DRK-316AMK ▲	AK15	DRK-316AAK15	DRK-316AMKAK15 ▲
Truck 1/2 Ton	03-00	Rear - 8.8"	DRK-311	DRK-311MK ▲	AK10	DRK-311AK10	DRK-311MKAK10 ▲

LD Differential

# Light Duty Differential Applications

Make/Model	Year	Position/ Ring Gear Size	Standard Kit	Master Kit	Axle Kit	Standard Kit Plus	Master Kit Plus
<b>FORD (cont'd)</b>							
Truck 1/2 Ton	1999	Rear - 9.75" w/ 2.68" Pinion Brg.	DRK-316	DRK-316MK ▲	AK15	DRK-316AK15	DRK-316MKAK15 ▲
Truck 1/2 Ton	1999	Rear - 9.75" w/ 3.00" Pinion Brg.	DRK-316A	DRK-316AMK ▲	AK15	DRK-316AAK15	DRK-316AMKAK15 ▲
Truck 1/2 Ton	99-97	Rear - 8.8"	DRK-311	DRK-311MK ▲	AK10	DRK-311AK10	DRK-311MKAK10 ▲
Truck 1/2 Ton	98-97	Rear - 9.75"	DRK-316	DRK-316MK ▲	AK15	DRK-316AK15	DRK-316MKAK15 ▲
Truck 1/2 Ton	96-83	Rear - 8.8"	DRK-311	DRK-311MK ▲	AK10	DRK-311AK10	DRK-311MKAK10 ▲
Truck 1/2 Ton	86-71	Rear - 9" 31 spline	DRK-313	DRK-313MK			
Truck 1/2 Ton	79-70	Rear - Dana 44	DRK-339B	DRK-339BMK			
Truck 1/2 Ton	1970	Rear - 9" 28 spline To 5/10/70	DRK-312	DRK-312MK			
Truck 1/2 Ton	1970	Rear - 9" 31 spline From 05/11/70	DRK-313	DRK-313MK			
Truck 1/2 Ton	69-67	Rear - Dana 44	DRK-339B	DRK-339BMK			
Truck 1/2 Ton	69-57	Rear - 9" 28 spline	DRK-312	DRK-312MK			
Truck 3/4 Ton	16-99	Front - Dana 60	DRK-331A	DRK-331AMK			
Truck 3/4 Ton	02-99	Front - Dana 50	DRK-336A	DRK-336AMK	AK94	DRK-336AAK94	DRK-336AMKAK94
Truck 3/4 Ton	98-80	Front - Dana 50	DRK-336A	DRK-336AMK	AK41	DRK-336AAK41	DRK-336AMKAK41
Truck 3/4 Ton	88-67	Front - Dana 44	DRK-339B	DRK-339BMK			
Truck 3/4 Ton	79-73	Front - Dana 60	DRK-331	DRK-331MK			
Truck 3/4 Ton	16-11	Rear - 10.5"	DRK-317B	DRK-317BMK ▲	AK48	DRK-317BAK48	DRK-317BMKAK48 ▲
Truck 3/4 Ton	10-08	Rear - 10.5"	DRK-317A <sup>50</sup>	DRK-317AMK <sup>50</sup> ▲	AK48	DRK-317AAK48 <sup>50</sup>	DRK-317AMKAK48 ▲ <sup>50</sup>
Truck 3/4 Ton	08-98	Rear - Dana 60/61	DRK-331B	DRK-331BMK			
Truck 3/4 Ton	07-99	Rear - 10.5"	DRK-317 <sup>50</sup>	DRK-317MK <sup>50</sup> ▲	AK48	DRK-317AK48	DRK-317MKAK48 ▲
Truck 3/4 Ton	99-85	Rear - 10.25"	DRK-314	DRK-314MK ▲	AK22	DRK-314AK22	DRK-314MKAK22 ▲
Truck 3/4 Ton	97-54	Rear - Dana 60/61	DRK-331	DRK-331MK			
Truck 3/4 Ton	89-83	Rear - 8.8"	DRK-311	DRK-311MK ▲	AK10	DRK-311AK10	DRK-311MKAK10 ▲
Truck 3/4 Ton	85-83	Rear - Dana 70U	DRK-332U	DRK-332UMK	AK23	DRK-332UAK23	DRK-332UMKAK23
Truck 3/4 Ton	85-80	Rear - Dana 60/61	DRK-331	DRK-331MK	AK22	DRK-331AK22	DRK-331MKAK22
Truck 3/4 Ton	74-70	Rear - 9" 31 spline From 05/11/70	DRK-313	DRK-313MK			
Truck 3/4 Ton	70-69	Rear - 9" 28 spline To 5/10/70	DRK-312	DRK-312MK			
Truck 1 Ton	16-99	Front - Dana 60	DRK-331A	DRK-331AMK			
Truck 1 Ton	02-99	Front - Dana 50	DRK-336A	DRK-336AMK	AK94	DRK-336AAK94	DRK-336AMKAK94
Truck 1 Ton	98-86	Front - Dana 50	DRK-336A	DRK-336AMK	AK41	DRK-336AAK41	DRK-336AMKAK41
Truck 1 Ton	97-92	Front - Dana 60	DRK-331	DRK-331MK			
Truck 1 Ton	91-79	Front - Dana 60	DRK-331	DRK-331MK	AK42	DRK-331AK42	DRK-331MKAK42
Truck 1 Ton	85-81	Front - Dana 44	DRK-339B	DRK-339BMK			
Truck 1 Ton	85-80	Front - Dana 50	DRK-336A	DRK-336AMK	AK41	DRK-336AAK41	DRK-336AMKAK41
Truck 1 Ton	16-11	Rear - 10.5"	DRK-317B	DRK-317BMK ▲	AK48	DRK-317BAK48	DRK-317BMKAK48 ▲
Truck 1 Ton	16-99	Rear - Dana 80	DRK-337A	DRK-337AMK	AK23	DRK-337AAK23	DRK-337AMKAK23
Truck 1 Ton	10-08	Rear - 10.5"	DRK-317A <sup>50</sup>	DRK-317AMK <sup>50</sup> ▲	AK48	DRK-317AAK48 <sup>50</sup>	DRK-317AMKAK48 ▲ <sup>50</sup>
Truck 1 Ton	08-98	Rear - Dana 60/61	DRK-331B	DRK-331BMK			
Truck 1 Ton	08-98	Rear - Dana 70U	DRK-332A	DRK-332AMK	AK23	DRK-332AAK23	DRK-332AMKAK23
Truck 1 Ton	08-72	Rear - Dana 70HD	DRK-332HD	DRK-332HDMK	AK23	DRK-332HDAK23	DRK-332HDMKAK23
Truck 1 Ton	07-99	Rear - 10.5"	DRK-317 <sup>50</sup>	DRK-317MK <sup>50</sup> ▲	AK48	DRK-317AK48	DRK-317MKAK48 ▲
Truck 1 Ton	99-85	Rear - 10.25"	DRK-314	DRK-314MK ▲	AK22	DRK-314AK22	DRK-314MKAK22 ▲
Truck 1 Ton	98-88	Rear - Dana 80	DRK-337	DRK-337MK			
Truck 1 Ton	98-54	Rear - Dana 60/61	DRK-331	DRK-331MK			
Truck 1 Ton	97-82	Rear - Dana 70U	DRK-332U	DRK-332UMK	AK23	DRK-332UAK23	DRK-332UMKAK23
Truck 1 Ton	85-80	Rear - Dana 60/61	DRK-331	DRK-331MK	AK22	DRK-331AK22	DRK-331MKAK22
Truck 1 Ton	83-61	Rear - Dana 70	DRK-332	DRK-332MK			
F-450 Super Duty	16-99	Front - Dana 60	DRK-331A	DRK-331AMK			
F-450 Super Duty	16-99	Rear - Dana S14	DRK-434				
F-450 Super Duty	14-99	Rear - Dana 80	DRK-337A	DRK-337AMK			

LD Differential

<sup>50</sup>For use with OEM 10.5" R/P only-use kit DRK-314AMK if using aftermarket 10.25" R/P

▲ Add "S" suffix to kit number to receive stackable differential shims in kit.

# Light Duty Differential Applications



Make/Model	Year	Position/ Ring Gear Size	Standard Kit	Master Kit	Axle Kit	Standard Kit Plus	Master Kit Plus
<b>FORD (cont'd)</b>							
F-550 Super Duty	16-99	Front - Dana 60	DRK-331A	DRK-331AMK			
F-550 Super Duty	16-99	Rear - Dana S14	DRK-434				
F-650 Super Duty	16-11	Rear - Dana S17-140	DRK-452				
F-650 Super Duty	16-11	Rear - Dana S19-140	DRK-452				
F-650 Super Duty	10-09	Rear - Dana S14	DRK-434				
F-750 Super Duty	16-11	Rear - Dana S17-140	DRK-452				
F-750 Super Duty	16-11	Rear - Dana S19-140	DRK-452				
F-750 Super Duty	10-09	Rear - Dana S14	DRK-434				
Van 1/2 Ton	14-01	Rear - Dana 60/61	DRK-331	DRK-331MK	AK22	DRK-331AK22	DRK-331MKAK22
Van 1/2 Ton	10-07	Rear - 9.75"	DRK-316B	DRK-316BMK ▲	AK15	DRK-316BAK15	DRK-316BMKAK15 ▲
Van 1/2 Ton	08-87	Rear - 8.8"	DRK-311	DRK-311MK ▲	AK10	DRK-311AK10	DRK-311MKAK10 ▲
Van 1/2 Ton	06-00	Rear - 9.75"	DRK-316A	DRK-316AMK ▲	AK10	DRK-316AAK10	DRK-316AMKAK10 ▲
Van 1/2 Ton	1999	Rear - 9.75" w/ 2.68" Pinion Brg.	DRK-316	DRK-316MK ▲	AK10	DRK-316AK10	DRK-316MKAK10 ▲
Van 1/2 Ton	1999	Rear - 9.75" w/ 3.00" Pinion Brg.	DRK-316A	DRK-316AMK ▲	AK10	DRK-316AAK10	DRK-316AMKAK10 ▲
Van 1/2 Ton	98-97	Rear - 9.75"	DRK-316	DRK-316MK ▲	AK10	DRK-316AK10	DRK-316MKAK10 ▲
Van 3/4 Ton	14-75	Rear - Dana 60/61	DRK-331	DRK-331MK	AK22	DRK-331AK22	DRK-331MKAK22
Van 1 Ton	16-98	Rear - Dana 70U	DRK-332A	DRK-332AMK	AK23	DRK-332AAK23	DRK-332AMKAK23
Van 1 Ton	16-79	Rear - Dana 70HD	DRK-332HD	DRK-332HDMK	AK23	DRK-332HDAK23	DRK-332HDMKAK23
Van 1 Ton	14-81	Rear - Dana 60/61	DRK-331	DRK-331MK	AK22	DRK-331AK22	DRK-331MKAK22
Van 1 Ton	01-98	Rear - Dana 80 w/4.375" Pinion Bearing	DRK-337A	DRK-337AMK			
Van 1 Ton	98-96	Rear - Dana 80 w/4.125" Pinion Bearing	DRK-337	DRK-337MK			
Van 1 Ton	97-82	Rear - Dana 70U	DRK-332U	DRK-332UMK	AK23	DRK-332UAK23	DRK-332UMKAK23
Van 1 Ton	83-79	Rear - Dana 70	DRK-332	DRK-332MK	AK23	DRK-332AK23	DRK-332MKAK23
E 450 Super Duty	16-01	Rear - Dana 70HD	DRK-332HD	DRK-332HDMK	AK23	DRK-332HDAK23	DRK-332HDMKAK23
<b>GMC</b>							
Caballero	87-82	Rear - 7.5"/7.6"	DRK-320	DRK-320MK ▲	AK11	DRK-320AK11	DRK-320MKAK11 ▲
Caballero	87-78	Rear - 8.5"/8.6"	DRK-321R	DRK-321RMK ▲	AK10	DRK-321RAK10	DRK-321RMKAK10 ▲
Caballero	81-78	Rear - 7.5"/7.6"	DRK-320B	DRK-320BMK ▲	AK11	DRK-320BAK11	DRK-320BMKAK11 ▲
Canyon	16-15	Front - All	DRK-369	DRK-369MK			
Canyon	12-04	Front - 7.6" IFS	DRK-320L	DRK-320LMK ▲	AK85	DRK-320LAK85	DRK-320LMKAK85 ▲
Canyon	16-15	Rear - Dana M200	DRK-367	DRK-367MK	AK58	DRK-367AK58	DRK-367MKAK58
Canyon	16-15	Rear - Dana M220	DRK-368	DRK-368MK	AK58	DRK-368AK58	DRK-368MKAK58
Canyon	12-09	Rear - 8.5"/8.6"	DRK-321Q	DRK-321QMK ▲	AK12	DRK-321QAK12	DRK-321QMKAK12 ▲
Canyon	12-04	Rear - 8.0"	DRK-320D	DRK-320DMK ▲	AK12	DRK-320DAK12	DRK-320DMKAK12 ▲
Envoy	09-02	Front - 7.25"	DRK-320K	DRK-320KMK	AK87	DRK-320KAK87	DRK-320KMKAK87
Envoy	2009	Rear - 8.5"/8.6"	DRK-321Q	DRK-321QMK ▲	AK12	DRK-321QAK12	DRK-321QMKAK12 ▲
Envoy	09-02	Rear - 8"	DRK-320D	DRK-320DMK ▲	AK12	DRK-320DAK12	DRK-320DMKAK12 ▲
Envoy	08-02	Rear - 8.5"/8.6"	DRK-321C	DRK-321CMK ▲	AK12	DRK-321CAK12	DRK-321CMKAK12 ▲
Jimmy Full Size	91-80	Front - 8.5"/8.6"	DRK-321R	DRK-321RMK ▲			
Jimmy Full Size	79-70	Front - Dana 44	DRK-339B	DRK-339BMK			
Jimmy Full Size	91-82	Rear - 8.5"/8.6"	DRK-321R	DRK-321RMK ▲	AK10	DRK-321RAK10	DRK-321RMKAK10 ▲
Jimmy Full Size	81-70	Rear - 8.875"	DRK-322	DRK-322MK ▲	AK10	DRK-322AK10	DRK-322MKAK10 ▲
Jimmy S15 Size	05-83	Front - 7.25"	DRK-320A	DRK-320AMK	AK86	DRK-320AAK86	DRK-320AMKAK86
Jimmy S15 Size	05-99	Rear - 7.5"/7.6"	DRK-320C	DRK-320CMK ▲	AK11	DRK-320CAK11	DRK-320CMKAK11 ▲
Jimmy S15 Size	05-99	Rear - 8.5"/8.6"	DRK-321C	DRK-321CMK ▲	AK10	DRK-321CAK10	DRK-321CMKAK10 ▲
Jimmy S15 Size	98-95	Rear - 8.5"/8.6"	DRK-321R	DRK-321RMK ▲	AK10	DRK-321RAK10	DRK-321RMKAK10 ▲
Jimmy S15 Size	98-83	Rear - 7.5"/7.6"	DRK-320	DRK-320MK ▲	AK11	DRK-320AK11	DRK-320MKAK11 ▲

LD Differential



# Light Duty Differential Applications

Make/Model	Year	Position/ Ring Gear Size	Standard Kit	Master Kit	Axle Kit	Standard Kit Plus	Master Kit Plus
<b>GMC (cont'd)</b>							
S15	90-83	Front - 7.25"	DRK-320A	DRK-320AMK	AK86	DRK-320AAK86	DRK-320AMKAK86
S15	90-82	Rear - 7.5"/7.6"	DRK-320	DRK-320MK ▲	AK11	DRK-320AK11	DRK-320MKAK11 ▲
Safari	05-90	Front - 7.25"	DRK-320A	DRK-320AMK	AK86	DRK-320AAK86	DRK-320AMKAK86
Safari	05-03	Rear - 7.5"/7.6"	DRK-320C	DRK-320CMK ▲	AK12	DRK-320CAK12	DRK-320CMKAK12 ▲
Safari	02-99	Rear - 7.5"/7.6"	DRK-320C	DRK-320CMK ▲	AK14	DRK-320CAK14	DRK-320CMKAK14 ▲
Safari	98-85	Rear - 7.5"/7.6"	DRK-320	DRK-320MK ▲	AK14	DRK-320AK14	DRK-320MKAK14 ▲
Sonoma	04-97	Front - 7.25"	DRK-320A	DRK-320AMK	AK86	DRK-320AAK86	DRK-320AMKAK86
Sonoma	96-91	Front - 7.25"	DRK-320A	DRK-320AMK	AK86	DRK-320AAK86	DRK-320AMKAK86
Sonoma	04-99	Rear - 7.5"/7.6"	DRK-320C	DRK-320CMK ▲	AK11	DRK-320CAK11	DRK-320CMKAK11 ▲
Sonoma	04-99	Rear - 8.5"/8.6"	DRK-321C	DRK-321CMK ▲	AK10	DRK-321CAK10	DRK-321CMKAK10 ▲
Sonoma	98-94	Rear - 8.5"/8.6"	DRK-321R	DRK-321RMK ▲	AK10	DRK-321RAK10	DRK-321RMKAK10 ▲
Sonoma	98-91	Rear - 7.5"/7.6"	DRK-320	DRK-320MK ▲	AK11	DRK-320AK11	DRK-320MKAK11 ▲
Syclone	1991	Front - 7.25"	DRK-320A	DRK-320AMK	AK86	DRK-320AAK86	DRK-320AMKAK86
Syclone	1991	Rear - 7.5"/7.6"	DRK-320	DRK-320MK ▲	AK11	DRK-320AK11	DRK-320MKAK11 ▲
Truck 1/2 Ton	16-98	Front - 8.25"	DRK-321T	DRK-321TMK	AK83	DRK-321TAK83	DRK-321TMKAK83
Truck 1/2 Ton	97-88	Front - 8.25"	DRK-321A	DRK-321AMK	AK95	DRK-321AAK95	DRK-321AMKAK95
Truck 1/2 Ton	87-77	Front - 8.5"/8.6"	DRK-321	DRK-321MK ▲			
Truck 1/2 Ton	80-69	Front - Dana 44	DRK-339B	DRK-339BMK			
Truck 1/2 Ton	16-14	Rear - 9.5"	DRK-324E	DRK-324EMK ▲	AK12	DRK-324EAK12	DRK-324EMKAK12 ▲
Truck 1/2 Ton	16-14	Rear - 9.76"	DRK-324H	DRK-324HMK ▲	AK12	DRK-324HAK12	DRK-324HMKAK12 ▲
Truck 1/2 Ton	15-09	Rear - 8.5"/8.6"	DRK-321Q	DRK-321QMK ▲	AK12	DRK-321QAK12	DRK-321QMKAK12 ▲
Truck 1/2 Ton	13-98	Rear - 9.5"	DRK-324B	DRK-324BMK	AK16	DRK-324BAK16	DRK-324BMKAK16
Truck 1/2 Ton	08-00	Rear - 8.5"/8.6"	DRK-321C	DRK-321CMK ▲	AK12	DRK-321CAK12	DRK-321CMKAK12 ▲
Truck 1/2 Ton	05-02	Rear - Dana 60	DRK-331C	DRK-331CMK			
		Quadrasteer Denali					
Truck 1/2 Ton	99-88	Rear - 8.5"/8.6"	DRK-321R	DRK-321RMK ▲	AK12	DRK-321RAK12	DRK-321RMKAK12 ▲
Truck 1/2 Ton	99-88	Rear - 8.5"/8.6" w/ Limited Slip Differential	DRK-321D	DRK-321DMK ▲	AK12	DRK-321DAK12	DRK-321DMKAK12 ▲
Truck 1/2 Ton	97-88	Rear - 9.5"	DRK-324	DRK-324MK ▲	AK16	DRK-324AK16	DRK-324MKAK16 ▲
Truck 1/2 Ton	87-80	Rear - 8.5"/8.6"	DRK-321R	DRK-321RMK ▲	AK10	DRK-321RAK10	DRK-321RMKAK10 ▲
Truck 1/2 Ton	87-70	Rear - 8.5"/8.6" w/ Limited Slip Differential	DRK-321D	DRK-321DMK ▲	AK10	DRK-321DAK10	DRK-321DMKAK10 ▲
Truck 1/2 Ton	82-80	Rear - 8.875"	DRK-322	DRK-322MK ▲			
Truck 1/2 Ton	81-80	Rear - 8.75"	DRK-323	DRK-323MK ▲			
Truck 1/2 Ton	79-71	Rear - 8.5"/8.6"	DRK-321R	DRK-321RMK ▲	AK10	DRK-321RAK10	DRK-321RMKAK10 ▲
Truck 1/2 Ton	79-64	Rear - 8.875"	DRK-322	DRK-322MK ▲	AK10	DRK-322AK10	DRK-322MKAK10 ▲
Truck 1/2 Ton	72-65	Rear - Dana 44	DRK-339B	DRK-339BMK			
Truck 3/4 Ton	16-11	Front - 9.25"	DRK-324D	DRK-324DMK ▲	AK92	DRK-324DAK92	DRK-324DMKAK92 ▲
Truck 3/4 Ton	10-98	Front - 9.25"	DRK-324C	DRK-324CMK ▲	AK92	DRK-324CAK92	DRK-324CMKAK92 ▲
Truck 3/4 Ton	97-88	Front - 9.25"	DRK-324A	DRK-324AMK ▲	AK92	DRK-324AAK92	DRK-324AMKAK92
Truck 3/4 Ton	91-77	Front - 8.5"/8.6"	DRK-321	DRK-321MK ▲			
Truck 3/4 Ton	80-68	Front - Dana 44	DRK-339B	DRK-339BMK			
Truck 3/4 Ton	16-11	Rear - 11.5" 2nd Design w/4.375" Pinion Brg.	DRK-327A	DRK-327AMK	AK44	DRK-327AAK44	DRK-327AMKAK44
Truck 3/4 Ton	15-14	Rear - 9.5"	DRK-324E	DRK-324EMK ▲	AK12	DRK-324EAK12	DRK-324EMKAK12 ▲
Truck 3/4 Ton	15-11	Rear - 10.5"	DRK-325B	DRK-325BMK	AK44	DRK-325BAK44	DRK-325BMKAK44
Truck 3/4 Ton	13-11	Rear - 9.5"	DRK-324B	DRK-324BMK	AK16	DRK-324BAK16	DRK-324BMKAK16
Truck 3/4 Ton	11-01	Rear - 11.5" 1st Design w/4.125" Pinion Brg.	DRK-327	DRK-327MK	AK29	DRK-327AK29	DRK-327MKAK29
Truck 3/4 Ton	10-00	Rear - 10.5"	DRK-325B	DRK-325BMK	AK29	DRK-325BAK29	DRK-325BMKAK29
Truck 3/4 Ton	10-98	Rear - 9.5"	DRK-324B	DRK-324BMK	AK16	DRK-324BAK16	DRK-324BMKAK16
Truck 3/4 Ton	05-02	Rear - Dana 60	DRK-331C	DRK-331CMK			
		Quadrasteer					
Truck 3/4 Ton	99-98	Rear - 10.5"	DRK-325B	DRK-325BMK	AK21	DRK-325BAK21	DRK-325BMKAK21

LD Differential

▲ Add "S" suffix to kit number to receive stackable differential shims in kit.

# Light Duty Differential Applications

Make/Model	Year	Position/ Ring Gear Size	Standard Kit	Master Kit	Axle Kit	Standard Kit Plus	Master Kit Plus
<b>GMC (cont'd)</b>							
Truck 3/4 Ton	97-89	Rear - 10.5"	DRK-325A	DRK-325AMK	AK21	DRK-325AAK21	DRK-325AMKAK21
Truck 3/4 Ton	97-81	Rear - 9.5"	DRK-324	DRK-324MK ▲	AK16	DRK-324AK16	DRK-324MKAK16 ▲
Truck 3/4 Ton	1988	Rear - 10.5" 1st Design	DRK-325	DRK-325MK	AK21	DRK-325AK21	DRK-325MKAK21
Truck 3/4 Ton	1988	Rear - 10.5" 2nd Design	DRK-325A	DRK-325AMK	AK21	DRK-325AAK21	DRK-325AMKAK21
Truck 3/4 Ton	87-73	Rear - 10.5"	DRK-325	DRK-325MK	AK21	DRK-325AK21	DRK-325MKAK21
Truck 3/4 Ton	81-80	Rear - 8.5"/8.6"	DRK-323	DRK-323MK ▲	AK17	DRK-323AK17	DRK-323MKAK17 ▲
Truck 3/4 Ton	81-69	Rear - 8.875"	DRK-322	DRK-322MK ▲	AK10	DRK-322AK10	DRK-322MKAK10 ▲
Truck 3/4 Ton	72-67	Rear - Dana 60	DRK-331	DRK-331MK			
Truck 1 Ton	16-11	Front - 9.25"	DRK-324D	DRK-324DMK ▲	AK92	DRK-324DAK92	DRK-324DMKAK92 ▲
Truck 1 Ton	10-98	Front - 9.25"	DRK-324C	DRK-324CMK ▲	AK92	DRK-324CAK92	DRK-324CMKAK92 ▲
Truck 1 Ton	97-88	Front - 9.25"	DRK-324A	DRK-324AMK ▲	AK92	DRK-324AAK92	DRK-324AMKAK92
Truck 1 Ton	91-77	Front - Dana 60	DRK-331	DRK-331MK	AK42	DRK-331AK42	DRK-331MKAK42
Truck 1 Ton	16-11	Rear - 11.5" 2nd Design w/4.375" Pinion Brg.	DRK-327A	DRK-327AMK	AK44	DRK-327AAK44	DRK-327AMKAK44
Truck 1 Ton	15-11	Rear - 10.5"	DRK-325B	DRK-325BMK	AK44	DRK-325BAK44	DRK-325BMKAK44
Truck 1 Ton	11-01	Rear - 11.5" 1st Design w/4.125" Pinion Brg.	DRK-327	DRK-327MK	AK29 <sup>49</sup>	DRK-327AK29 <sup>49</sup>	DRK-327MKAK29 <sup>49</sup>
Truck 1 Ton	11-01	Rear - 11.5" 1st Design w/4.125" Pinion Brg.	DRK-327	DRK-327MK	AK45 <sup>48</sup>	DRK-327AK45 <sup>48</sup>	DRK-327MKAK45 <sup>48</sup>
Truck 1 Ton	00-98	Rear - 10.5"	DRK-325B	DRK-325BMK	AK21	DRK-325BAK21	DRK-325BMKAK21
Truck 1 Ton	99-91	Rear - Dana 80	DRK-337	DRK-337MK			
Truck 1 Ton	97-89	Rear - 10.5"	DRK-325A	DRK-325AMK	AK21	DRK-325AAK21	DRK-325AMKAK21
Truck 1 Ton	95-83	Rear - 9.5"	DRK-324	DRK-324MK ▲	AK16	DRK-324AK16	DRK-324MKAK16 ▲
Truck 1 Ton	94-73	Rear - Dana 70HD	DRK-332HD	DRK-332HDMK			
Truck 1 Ton	91-84	Rear - Dana 70U	DRK-332U	DRK-332UMK			
Truck 1 Ton	91-73	Rear - Dana 60	DRK-331	DRK-331MK			
Truck 1 Ton	90-73	Rear - Dana 70	DRK-332	DRK-332MK			
Truck 1 Ton	1988	Rear - 10.5" 1st Design	DRK-325	DRK-325MK	AK21	DRK-325AK21	DRK-325MKAK21
Truck 1 Ton	1988	Rear - 10.5" 2nd Design	DRK-325A	DRK-325AMK	AK21	DRK-325AAK21	DRK-325AMKAK21
Truck 1 Ton	87-72	Rear - 10.5"	DRK-325	DRK-325MK	AK21	DRK-325AK21	DRK-325MKAK21
C4500 Topkick	09-03	Front - Dana 70	DRK-332HD	DRK-332HDMK			
C4500 Topkick	09-03	Rear - Dana S110	DRK-434				
C5500 Topkick	09-03	Front - Dana 70	DRK-332HD	DRK-332HDMK			
C5500 Topkick	09-03	Rear - Dana S110	DRK-434				
Typhoon	93-92	Front - 7.25"	DRK-320A	DRK-320AMK	AK86	DRK-320AAK86	DRK-320AMKAK86
Typhoon	93-92	Rear - 7.5"/7.6"	DRK-320	DRK-320MK ▲	AK11	DRK-320AK11	DRK-320MKAK11 ▲
Van 1/2 Ton	14-03	Front - 7.25"	DRK-320A	DRK-320AMK	AK86	DRK-320AAK86	DRK-320AMKAK86
Van 1/2 Ton	14-09	Rear - 8.5"/8.6"	DRK-321Q	DRK-321QMK ▲	AK12	DRK-321QAK12	DRK-321QMKAK12 ▲
Van 1/2 Ton	08-99	Rear - 8.5"/8.6"	DRK-321C	DRK-321CMK ▲	AK12	DRK-321CAK12	DRK-321CMKAK12 ▲
Van 1/2 Ton	08-98	Rear - 9.5"	DRK-324B	DRK-324BMK	AK16	DRK-324BAK16	DRK-324BMKAK16
Van 1/2 Ton	98-96	Rear - 8.5"/8.6"	DRK-321R	DRK-321RMK ▲	AK12	DRK-321RAK12	DRK-321RMKAK12 ▲
Van 1/2 Ton	97-81	Rear - 9.5"	DRK-324	DRK-324MK ▲	AK16	DRK-324AK16	DRK-324MKAK16 ▲
Van 1/2 Ton	95-77	Rear - 8.5"/8.6"	DRK-321R	DRK-321RMK ▲	AK10	DRK-321RAK10	DRK-321RMKAK10 ▲
Van 1/2 Ton	81-64	Rear - 8.875"	DRK-322	DRK-322MK ▲	AK10	DRK-322AK10	DRK-322MKAK10 ▲
Van 3/4 Ton	05-03	Front - 7.25"	DRK-320A	DRK-320AMK	AK86	DRK-320AAK86	DRK-320AMKAK86
Van 3/4 Ton	16-11	Rear - 10.5"	DRK-325B	DRK-325BMK	AK44	DRK-325BAK44	DRK-325BMKAK44
Van 3/4 Ton	16-11	Rear - 11.5"	DRK-327A	DRK-327AMK	AK44	DRK-327AAK44	DRK-327AMKAK44
Van 3/4 Ton	16-03	Rear - 10.5"	DRK-325B	DRK-325BMK	AK59	DRK-325BAK59	DRK-325BMKAK59
Van 3/4 Ton	14-98	Rear - 9.5"	DRK-324B	DRK-324BMK	AK16	DRK-324BAK16	DRK-324BMKAK16
Van 3/4 Ton	13-04	Rear - Dana 60/61	DRK-331B	DRK-331BMK	AK22	DRK-331BAK22	DRK-331BMKAK22
Van 3/4 Ton	10-01	Rear - 11.5"	DRK-327	DRK-327MK	AK29	DRK-327AK29	DRK-327MKAK29
Van 3/4 Ton	10-01	Rear - 11.5"	DRK-327	DRK-327MK	AK45 <sup>48</sup>	DRK-327AK45 <sup>48</sup>	DRK-327MKAK45 <sup>48</sup>
Van 3/4 Ton	10-98	Rear - 10.5"	DRK-325B	DRK-325BMK	AK29	DRK-325BAK29	DRK-325BMKAK29
Van 3/4 Ton	97-89	Rear - 10.5"	DRK-325A	DRK-325AMK	AK21	DRK-325AAK21	DRK-325AMKAK21

LD Differential

# Light Duty Differential Applications

Make/Model	Year	Position/ Ring Gear Size	Standard Kit	Master Kit	Axle Kit	Standard Kit Plus	Master Kit Plus
<b>GMC (cont'd)</b>							
Van 3/4 Ton	97-80	Rear - 9.5"	DRK-324	DRK-324MK ▲	AK16	DRK-324AK16	DRK-324MKAK16 ▲
Van 3/4 Ton	1988	Rear - 10.5" 1st Design	DRK-325	DRK-325MK	AK21	DRK-325AK21	DRK-325MKAK21
Van 3/4 Ton	1988	Rear - 10.5" 2nd Design	DRK-325A	DRK-325AMK	AK21	DRK-325AAK21	DRK-325AMKAK21
Van 3/4 Ton	87-73	Rear - 10.5"	DRK-325	DRK-325MK	AK21	DRK-325AK21	DRK-325MKAK21
Van 3/4 Ton	81-69	Rear - 8.875"	DRK-322	DRK-322MK ▲	AK10	DRK-322AK10	DRK-322MKAK10 ▲
Van 1 Ton	16-11	Rear - 10.5"	DRK-325B	DRK-325BMK	AK44	DRK-325BAK44	DRK-325BMKAK44
Van 1 Ton	16-11	Rear - 11.5"	DRK-327A	DRK-327AMK	AK44	DRK-327AAK44	DRK-327AMKAK44
Van 1 Ton	16-03	Rear - 10.5"	DRK-325B	DRK-325BMK	AK59	DRK-325BAK59	DRK-325BMKAK59
Van 1 Ton	14-98	Rear - 9.5"	DRK-324B	DRK-324BMK	AK16	DRK-324BAK16	DRK-324BMKAK16
Van 1 Ton	10-04	Rear - Dana 60/61	DRK-331B	DRK-331BMK	AK22	DRK-331BAK22	DRK-331BMKAK22
Van 1 Ton	10-01	Rear - 11.5"	DRK-327	DRK-327MK	AK29 <sup>49</sup>	DRK-327AK29 <sup>49</sup>	DRK-327MKAK29 <sup>49</sup>
Van 1 Ton	10-01	Rear - 11.5"	DRK-327	DRK-327MK	AK45 <sup>48</sup>	DRK-327AK45 <sup>48</sup>	DRK-327MKAK45 <sup>48</sup>
Van 1 Ton	10-98	Rear - 10.5"	DRK-325B	DRK-325BMK	AK29	DRK-325BAK29	DRK-325BMKAK29
Van 1 Ton	09-02	Rear - Dana 70	DRK-332G	DRK-332GMK	AK23	DRK-332GAK23	DRK-332GMKAK23
Van 1 Ton	97-89	Rear - 10.5"	DRK-325A	DRK-325AMK	AK21	DRK-325AAK21	DRK-325AMKAK21
Van 1 Ton	91-80	Rear - Dana 60	DRK-331	DRK-331MK			
Van 1 Ton	1988	Rear - 10.5" 1st Design	DRK-325	DRK-325MK	AK21	DRK-325AK21	DRK-325MKAK21
Van 1 Ton	1988	Rear - 10.5" 2nd Design	DRK-325A	DRK-325AMK	AK21	DRK-325AAK21	DRK-325AMKAK21
Van 1 Ton	87-73	Rear - 10.5"	DRK-325	DRK-325MK	AK21	DRK-325AK21	DRK-325MKAK21
Yukon	16-98	Front - 8.25"	DRK-321T	DRK-321TMK	AK83	DRK-321TAK83	DRK-321TMKAK83
Yukon	97-92	Front - 8.25"	DRK-321A	DRK-321AMK	AK95	DRK-321AAK95	DRK-321AMKAK95
Yukon	16-15	Rear - 9.5"	DRK-324E	DRK-324EMK ▲	AK12	DRK-324EAK12	DRK-324EMKAK12 ▲
Yukon	16-15	Rear - 9.76"	DRK-324H	DRK-324HMK ▲	AK12	DRK-324HAK12	DRK-324HMKAK12 ▲
Yukon	14-09	Rear - 8.5"/8.6"	DRK-321Q	DRK-321QMK ▲	AK12	DRK-321QAK12	DRK-321QMKAK12 ▲
Yukon	08-01	Rear - 8.5"/8.6"	DRK-321C	DRK-321CMK ▲	AK12	DRK-321CAK12	DRK-321CMKAK12 ▲
Yukon	00-92	Rear - 8.5"/8.6"	DRK-321R	DRK-321RMK ▲	AK12	DRK-321RAK12	DRK-321RMKAK12 ▲
Yukon XL	16-15	Front - 8.25"	DRK-321T	DRK-321TMK	AK83	DRK-321TAK83	DRK-321TMKAK83
Yukon XL	16-15	Rear - 9.5"	DRK-324E	DRK-324EMK ▲	AK12	DRK-324EAK12	DRK-324EMKAK12 ▲
Yukon XL	16-15	Rear - 9.76"	DRK-324H	DRK-324HMK ▲	AK12	DRK-324HAK12	DRK-324HMKAK12 ▲
Yukon XL 1500	14-00	Front - 8.25"	DRK-321T	DRK-321TMK	AK83	DRK-321TAK83	DRK-321TMKAK83
Yukon XL 1500	14-09	Rear - 8.5"/8.6"	DRK-321Q	DRK-321QMK ▲	AK12	DRK-321QAK12	DRK-321QMKAK12 ▲
Yukon XL 1500	08-01	Rear - 8.5"/8.6"	DRK-321C	DRK-321CMK ▲	AK12	DRK-321CAK12	DRK-321CMKAK12 ▲
Yukon XL 1500	08-00	Rear - 9.5"	DRK-324B	DRK-324BMK	AK16	DRK-324BAK16	DRK-324BMKAK16
Yukon XL 1500	2000	Rear - 8.5"/8.6"	DRK-321R	DRK-321RMK ▲	AK12	DRK-321RAK12	DRK-321RMKAK12 ▲
Yukon XL 2500	13-11	Front - 9.25"	DRK-324D	DRK-324DMK ▲	AK92	DRK-324DAK92	DRK-324DMKAK92 ▲
Yukon XL 2500	10-00	Front - 9.25"	DRK-324C	DRK-324CMK ▲	AK92	DRK-324CAK92	DRK-324CMKAK92 ▲
Yukon XL 2500	13-11	Rear - 10.5"	DRK-325B	DRK-325BMK	AK44	DRK-325BAK44	DRK-325BMKAK44
Yukon XL 2500	13-00	Rear - 9.5"	DRK-324B	DRK-324BMK	AK16	DRK-324BAK16	DRK-324BMKAK16
Yukon XL 2500	10-08	Rear - 10.5"	DRK-325B	DRK-325BMK	AK29	DRK-325BAK29	DRK-325BMKAK29
Yukon XL 2500	05-02	Rear - Dana 60 Quadrasteer	DRK-331C	DRK-331CMK			

## HUMMER

H1	06-02	Front - AMC 20	DRK-311H	DRK-311HMK	AK27	DRK-311HAK27	DRK-311HMKAK27
H1	06-02	Rear - AMC 20	DRK-311H	DRK-311HMK	AK27	DRK-311HAK27	DRK-311HMKAK27
H2	09-03	Front - 9.25"	DRK-324C	DRK-324CMK ▲	AK92	DRK-324CAK92	DRK-324CMKAK92 ▲
H2	09-03	Rear - 9.5"	DRK-324B	DRK-324BMK	AK16	DRK-324BAK16	DRK-324BMKAK16
H3	10-06	Front - 7.6" IFS	DRK-320L	DRK-320LMK ▲	AK85	DRK-320LAK85	DRK-320LMKAK85 ▲
H3	10-09	Rear - 8.5"/8.6"	DRK-321C	DRK-321CMK ▲	AK12	DRK-321CAK12	DRK-321CMKAK12 ▲
H3	10-06	Rear - 8.0"	DRK-320D	DRK-320DMK ▲	AK12	DRK-320DAK12	DRK-320DMKAK12 ▲
H3T	10-09	Front - 7.6" IFS	DRK-320L	DRK-320LMK ▲	AK85	DRK-320LAK85	DRK-320LMKAK85 ▲
H3T	10-09	Rear - 8.0"	DRK-320D	DRK-320DMK ▲	AK12	DRK-320DAK12	DRK-320DMKAK12 ▲
H3T	10-09	Rear - 8.5"/8.6"	DRK-321C	DRK-321CMK ▲	AK12	DRK-321CAK12	DRK-321CMKAK12 ▲

<sup>48</sup>With Dual Rear Wheels

<sup>49</sup>With Single Rear Wheels

▲ Add "S" suffix to kit number to receive stackable differential shims in kit.

# Light Duty Differential Applications

Make/Model	Year	Position/ Ring Gear Size	Standard Kit	Master Kit	Axle Kit	Standard Kit Plus	Master Kit Plus
<b>ISUZU</b>							
Ascender	08-03	Front - 7.25"	DRK-320K	DRK-320KMK	AK87	DRK-320KAK87	DRK-320KMKAK87
Ascender	08-03	Rear - 8"	DRK-320D	DRK-320DMK ▲	AK12	DRK-320DAK12	DRK-320DMKAK12 ▲
Ascender	08-03	Rear - 8.5"/8.6"	DRK-321C	DRK-321CMK ▲	AK12	DRK-321CAK12	DRK-321CMKAK12 ▲
Hombre	00-96	Front - 7.25"	DRK-320A	DRK-320AMK	AK86	DRK-320AAK86	DRK-320AMKAK86
Hombre	00-99	Rear - 7.5"/7.6"	DRK-320C	DRK-320CMK ▲	AK11	DRK-320CAK11	DRK-320CMKAK11 ▲
Hombre	00-99	Rear - 8.5"/8.6"	DRK-321C	DRK-321CMK ▲	AK10	DRK-321CAK10	DRK-321CMKAK10 ▲
Hombre	98-96	Rear - 7.5"/7.6"	DRK-320	DRK-320MK ▲	AK11	DRK-320AK11	DRK-320MKAK11 ▲
Hombre	98-96	Rear - 8.5"/8.6"	DRK-321R	DRK-321RMK ▲	AK10	DRK-321RAK10	DRK-321RMKAK10 ▲
i-280	2006	Rear - 8.0"	DRK-320D	DRK-320DMK ▲	AK12	DRK-320DAK12	DRK-320DMKAK12 ▲
i-290	08-07	Rear - 8.0"	DRK-320D	DRK-320DMK ▲	AK12	DRK-320DAK12	DRK-320DMKAK12 ▲
i-350	2006	Front - 7.6" IFS	DRK-320L	DRK-320LMK ▲	AK85	DRK-320LAK85	DRK-320LMKAK85 ▲
i-350	2006	Rear - 8.0"	DRK-320D	DRK-320DMK ▲	AK12	DRK-320DAK12	DRK-320DMKAK12 ▲
i-370	08-07	Front - 7.6" IFS	DRK-320L	DRK-320LMK ▲	AK85	DRK-320LAK85	DRK-320LMKAK85 ▲
i-370	08-07	Rear - 8.0"	DRK-320D	DRK-320DMK ▲	AK12	DRK-320DAK12	DRK-320DMKAK12 ▲
Rodeo	93-91	Rear - 7.5"	DRK-320	DRK-320MK ▲	AK14	DRK-320AK14	DRK-320MKAK14 ▲
<b>JEEP</b>							
Cherokee SJ	83-74	Front - Dana 44	DRK-339B	DRK-339BMK			
Cherokee SJ	83-80	Rear - AMC 20	DRK-311J	DRK-311JMK ▲			
Cherokee SJ	79-74	Rear - Dana 44	DRK-339B	DRK-339BMK			
Cherokee XJ	01-00	Front - Dana 30 Low Pinion	DRK-334TJ	DRK-334TJMK	AK52	DRK-334TJAK52	DRK-334TJMKAK52
Cherokee XJ	2000	Front - Dana 30 High Pinion	DRK-334	DRK-334MK	AK52	DRK-334AK52	DRK-334MKAK52
Cherokee XJ	99-90	Front - Dana 30	DRK-334	DRK-334MK	AK52	DRK-334AK52	DRK-334MKAK52
Cherokee XJ	89-84	Front - Dana 30	DRK-334	DRK-334MK	AK40	DRK-334AK40	DRK-334MKAK40
Cherokee XJ	85-84	Front - Dana 44	DRK-339B	DRK-339BMK			
Cherokee XJ	01-97	Rear - 8.25"	DRK-303A	DRK-303AMK	AK10	DRK-303AAK10	DRK-303AMKAK10
Cherokee XJ	01-90	Rear - Dana 35	DRK-335	DRK-335MK ▲	AK11	DRK-335AK11	DRK-335MKAK11 ▲
Cherokee XJ	96-91	Rear - 8.25"	DRK-303	DRK-303MK	AK10	DRK-303AK10	DRK-303MKAK10
Cherokee XJ	89-88	Rear - Dana 35	DRK-335	DRK-335MK ▲	AK49	DRK-335AK49	DRK-335MKAK49 ▲
Cherokee XJ	1987	Rear - Dana 35	DRK-335	DRK-335MK ▲	AK49	DRK-335AK49	DRK-335MKAK49 ▲
Cherokee XJ	1987	Rear - Dana 44	DRK-339B	DRK-339BMK	AK47	DRK-339BAK47	DRK-339BMKAK47
Cherokee XJ	86-84	Rear - Dana 35	DRK-335	DRK-335MK ▲	AK49	DRK-335AK49	DRK-335MKAK49 ▲
CJ5	83-71	Front - Dana 30	DRK-334	DRK-334MK			
CJ5	83-76	Rear - AMC 20	DRK-311J	DRK-311JMK ▲			
CJ5	75-67	Rear - Dana 44	DRK-339B	DRK-339BMK			
CJ7	86-76	Front - Dana 30	DRK-334	DRK-334MK			
CJ7	1986	Rear - Dana 44	DRK-339B	DRK-339BMK			
CJ7	86-76	Rear - AMC 20	DRK-311J	DRK-311JMK ▲			
Comanche	92-90	Front - Dana 30	DRK-334	DRK-334MK			
Comanche	89-86	Front - Dana 30	DRK-334	DRK-334MK	AK40	DRK-334AK40	DRK-334MKAK40
Comanche	92-90	Rear - Dana 35	DRK-335	DRK-335MK ▲	AK11	DRK-335AK11	DRK-335MKAK11 ▲
Comanche	92-90	Rear - Dana 44	DRK-339B	DRK-339BMK	AK47	DRK-339BAK47	DRK-339BMKAK47
Comanche	89-86	Rear - Dana 35	DRK-335	DRK-335MK ▲	AK49	DRK-335AK49	DRK-335MKAK49 ▲
Comanche	89-86	Rear - Dana 44	DRK-339B	DRK-339BMK	AK47	DRK-339BAK47	DRK-339BMKAK47
Commander	10-06	Front - C200 IFS	DRK-308				
Commander	10-06	Rear - 8.25"	DRK-303B	DRK-303BMK			
Commander	10-06	Rear - Dana 44	DRK-339J	DRK-339JMK			
Grand Cherokee	10-05	Front - C200 IFS	DRK-308				
Grand Cherokee	04-99	Front - Dana 30	DRK-334C	DRK-334CMK			
Grand Cherokee	98-97	Front - Dana 30	DRK-334TJ	DRK-334TJMK	AK52	DRK-334TJAK52	DRK-334TJMKAK52
Grand Cherokee	96-93	Front - Dana 30	DRK-334A	DRK-334AMK	AK52	DRK-334AAK52	DRK-334AMKAK52
Grand Cherokee	10-06	Rear - Dana 44	DRK-339J	DRK-339JMK			

LD Differential

# Light Duty Differential Applications

Make/Model	Year	Position/ Ring Gear Size	Standard Kit	Master Kit	Axle Kit	Standard Kit Plus	Master Kit Plus
<b>JEEP (cont'd)</b>							
Grand Cherokee	10-05	Rear - 8.25"	DRK-303B	DRK-303BMK			
Grand Cherokee	04-99	Rear - Dana 35	DRK-335C	DRK-335CMK ▲			
Grand Cherokee	04-99	Rear - Dana 44	DRK-339A	DRK-339AMK ▲			
Grand Cherokee	98-96	Rear - Dana 44	DRK-339A	DRK-339AMK ▲			
Grand Cherokee	98-93	Rear - Dana 35	DRK-335	DRK-335MK ▲	AK11	DRK-335AK11	DRK-335MKAK11 ▲
Grand Wagoneer	91-84	Front - Dana 44	DRK-339B	DRK-339BMK			
Grand Wagoneer	91-87	Rear - Dana 44	DRK-339B	DRK-339BMK	AK47	DRK-339BAK47	DRK-339BMKAK47
Grand Wagoneer	86-84	Rear - AMC 20	DRK-311J	DRK-311JMK ▲			
J10	88-70	Front - Dana 44	DRK-339B	DRK-339BMK			
J10	86-80	Rear - AMC 20	DRK-311J	DRK-311JMK ▲			
J20	88-70	Front - Dana 44	DRK-339B	DRK-339BMK			
J20	88-70	Rear - Dana 60	DRK-331	DRK-331MK			
Jeepster	73-71	Front - Dana 30	DRK-334	DRK-334MK			
Jeepster	73-67	Rear - Dana 44	DRK-339B	DRK-339BMK			
Liberty	12-02	Front - Dana 30	DRK-340	DRK-340MK ▲			
Liberty	12-09	Rear - 8.25"	DRK-303B	DRK-303BMK	AK26	DRK-303BAK26	DRK-303BMKAK26
Liberty	08-02	Rear - 8.25"	DRK-303B	DRK-303BMK	AK10	DRK-303BAK10	DRK-303BMKAK10
Liberty	08-02	Rear - Dana 35	DRK-335C	DRK-335CMK ▲			
Scrambler CJ8	85-81	Front - Dana 30	DRK-334	DRK-334MK			
Scrambler CJ8	85-81	Rear - AMC 20	DRK-311J	DRK-311JMK ▲			
Wagoneer SJ	83-74	Front - Dana 44	DRK-339B	DRK-339BMK			
Wagoneer SJ	73-71	Front - Dana 30	DRK-334	DRK-334MK			
Wagoneer SJ	83-80	Rear - AMC 20	DRK-311J	DRK-311JMK ▲			
Wagoneer SJ	79-72	Rear - Dana 44	DRK-339B	DRK-339BMK			
Wagoneer XJ	89-84	Front - Dana 30	DRK-334	DRK-334MK	AK40	DRK-334AK40	DRK-334MKAK40
Wagoneer XJ	85-84	Front - Dana 44	DRK-339B	DRK-339BMK			
Wagoneer XJ	89-88	Rear - Dana 35	DRK-335	DRK-335MK ▲	AK49	DRK-335AK49	DRK-335MKAK49 ▲
Wagoneer XJ	1987	Rear - Dana 35	DRK-335	DRK-335MK ▲	AK49	DRK-335AK49	DRK-335MKAK49 ▲
Wagoneer XJ	1987	Rear - Dana 44	DRK-339B	DRK-339BMK	AK47	DRK-339BAK47	DRK-339BMKAK47
Wagoneer XJ	86-84	Rear - Dana 35	DRK-335	DRK-335MK ▲	AK49	DRK-335AK49	DRK-335MKAK49 ▲
Wrangler YJ	95-90	Front - Dana 30	DRK-334	DRK-334MK	AK52	DRK-334AK52	DRK-334MKAK52
Wrangler YJ	89-87	Front - Dana 30	DRK-334	DRK-334MK	AK40	DRK-334AK40	DRK-334MKAK40
Wrangler YJ	95-94	Rear - Dana 44	DRK-339B	DRK-339BMK	AK47	DRK-339BAK47	DRK-339BMKAK47
Wrangler YJ	93-90	Rear - Dana 35	DRK-335	DRK-335MK ▲	AK11	DRK-335AK11	DRK-335MKAK11 ▲
Wrangler YJ	93-87	Rear - Dana 44	DRK-339B	DRK-339BMK	AK47	DRK-339BAK47	DRK-339BMKAK47
Wrangler YJ	89-87	Rear - Dana 35	DRK-335	DRK-335MK ▲			
Wrangler TJ	06-97	Front - Dana 30	DRK-334TJ	DRK-334TJMK	AK52	DRK-334TJAK52	DRK-334TJMKAK52
Wrangler TJ	06-01	Rear - Dana 44	DRK-339E	DRK-339EMK	AK47	DRK-339EAK47	DRK-339EMKAK47
Wrangler TJ	06-97	Rear - Dana 35	DRK-335	DRK-335MK ▲	AK43	DRK-335AK43	DRK-335MKAK43 ▲
Wrangler TJ	00-97	Rear - Dana 44	DRK-339B	DRK-339BMK	AK47	DRK-339BAK47	DRK-339BMKAK47
Wrangler TJ Rubicon	06-03	Front - Dana 44	DRK-339E	DRK-339EMK	AK53	DRK-339EAK53	DRK-339EMKAK53
Wrangler TJ Rubicon	06-03	Rear - Dana 44	DRK-339E	DRK-339EMK	AK47	DRK-339EAK47	DRK-339EMKAK47
Wrangler JK	17-07	Front - Dana 30	DRK-334D	DRK-334DMK	AK53	DRK-334DAK53	DRK-334DMKAK53
Wrangler JK	17-07	Front - Dana 44	DRK-339F	DRK-339FMK	AK53	DRK-339FAK53	DRK-339FMKAK53
Wrangler JK	17-07	Rear - Dana 44	DRK-339H	DRK-339HMK	AK47	DRK-339HAK47	DRK-339HMKAK47
Wrangler JK	17-07	Rear - Dana 44 w/ E-Loc	DRK-339G	DRK-339GMK	AK47	DRK-339GAK47	DRK-339GMKAK47
Wrangler JK Rubicon	17-07	Front - Dana 44	DRK-339F	DRK-339FMK	AK53	DRK-339FAK53	DRK-339FMKAK53
Wrangler JK Rubicon	17-07	Rear - Dana 44 w/ E-Loc	DRK-339G	DRK-339GMK	AK47	DRK-339GAK47	DRK-339GMKAK47
<b>LINCOLN</b>							
Aviator	05-03	Front - Dana 30	DRK-334B	DRK-334BMK			
Aviator	05-03	Front - Dana 35	DRK-335B	DRK-335BMK ▲			
Aviator	05-03	Rear - 8.8" IRS	DRK-311	DRK-311MK ▲	AK36	DRK-311AK36	DRK-311MKAK36 ▲
Blackwood	2002	Rear - 9.75"	DRK-316A	DRK-316AMK ▲	AK15	DRK-316AAK15	DRK-316AMKAK15 ▲

▲ Add "S" suffix to kit number to receive stackable differential shims in kit.



# Light Duty Differential Applications

Make/Model	Year	Position/ Ring Gear Size	Standard Kit	Master Kit	Axle Kit	Standard Kit Plus	Master Kit Plus
------------	------	-----------------------------	-----------------	---------------	-------------	----------------------	--------------------

<b>LINCOLN (cont'd)</b>							
Continental	87-80	Rear - 8.8"	DRK-311	DRK-311MK ▲	AK11	DRK-311AK11	DRK-311MKAK11 ▲
Continental	79-70	Rear - 9" 31 spline From 05/11/70	DRK-313	DRK-313MK			
LS	06-00	Rear - 8.0"	DRK-311N	DRK-311NMK ▲	AK90	DRK-311NAK90	DRK-311NMKAK90 ▲
Mark LT	08-06	Front - 8.8"	DRK-311	DRK-311MK ▲	AK88	DRK-311AK88	DRK-311MKAK88 ▲
Mark LT	08-07	Rear - 9.75"	DRK-316B	DRK-316BMK ▲	AK15	DRK-316BAK15	DRK-316BMKAK15 ▲
Mark LT	2006	Rear - 9.75"	DRK-316A	DRK-316AMK ▲	AK15	DRK-316AAK15	DRK-316AMKAK15 ▲
Mark III	71-68	Rear - 9" 28 spline	DRK-312	DRK-312MK			
Mark III	71-68	Rear - 9" 31 spline	DRK-313	DRK-313MK			
Mark VI	83-80	Rear - 8.8"	DRK-311	DRK-311MK ▲	AK11	DRK-311AK11	DRK-311MKAK11 ▲
Mark VII	92-84	Rear - 8.8"	DRK-311	DRK-311MK ▲	AK11	DRK-311AK11	DRK-311MKAK11 ▲
Mark VII	87-84	Rear - 7.5"	DRK-315	DRK-315MK ▲	AK11	DRK-315AK11	DRK-315MKAK11 ▲
Mark VIII	98-93	Rear - 8.8"	DRK-311	DRK-311MK ▲	AK90	DRK-311AK90	DRK-311MKAK90 ▲
Navigator	16-09	Front - 8.8"	DRK-311	DRK-311MK ▲	AK91	DRK-311AK91	DRK-311MKAK91 ▲
Navigator	08-98	Front - 8.8"	DRK-311	DRK-311MK ▲	AK88	DRK-311AK88	DRK-311MKAK88 ▲
Navigator	16-11	Rear - 9.75" from 04/30/2011	DRK-316D	DRK-316DMK ▲	AK36	DRK-316DAK36	DRK-316DMKAK36 ▲
Navigator	11-07	Rear - 9.75" To 04/29/2011	DRK-316B	DRK-316BMK ▲	AK36	DRK-316BAK36	DRK-316BMKAK36 ▲
Navigator	06-03	Rear - 9.75"	DRK-316A	DRK-316AMK ▲	AK36	DRK-316AAK36	DRK-316AMKAK36 ▲
Navigator	02-00	Rear - 9.75"	DRK-316A	DRK-316AMK ▲	AK15	DRK-316AAK15	DRK-316AMKAK15 ▲
Navigator	1999	Rear - 9.75" w/ 2.68" Pinion Brg.	DRK-316	DRK-316MK ▲	AK15	DRK-316AK15	DRK-316MKAK15 ▲
Navigator	1999	Rear - 9.75" w/ 3.00" Pinion Brg.	DRK-316A	DRK-316AMK ▲	AK15	DRK-316AAK15	DRK-316AMKAK15 ▲
Navigator	1998	Rear - 9.75"	DRK-316	DRK-316MK ▲	AK15	DRK-316AK15	DRK-316MKAK15 ▲
Town Car	11-81	Rear - 8.8"	DRK-311	DRK-311MK ▲	AK11	DRK-311AK11	DRK-311MKAK11 ▲
Versailles	80-77	Rear - 9"	DRK-313	DRK-313MK			
Zephyr	83-78	Rear - 7.5"	DRK-315	DRK-315MK ▲			
Zephyr	1978	Rear - 8"	DRK-310	DRK-310MK			

## MAZDA

B2300	10-01	Front - Dana 35	DRK-335B	DRK-335BMK ▲			
B2300	2010	Rear - 7.5"	DRK-315	DRK-315MK ▲	AK10	DRK-315AK10	DRK-315MKAK10 ▲
B2300	09-01	Rear - 7.5"	DRK-315	DRK-315MK ▲	AK11	DRK-315AK11	DRK-315MKAK11 ▲
B2500	01-98	Front - Dana 35	DRK-335B	DRK-335BMK ▲			
B2500	01-98	Rear - 7.5"	DRK-315	DRK-315MK ▲	AK11	DRK-315AK11	DRK-315MKAK11 ▲
B3000	08-98	Front - Dana 35	DRK-335B	DRK-335BMK ▲			
B3000	97-94	Front - Dana 35	DRK-335	DRK-335MK ▲			
B3000	08-07	Rear - 8.8"	DRK-311G	DRK-311GMK ▲	AK10	DRK-311GAK10	DRK-311GMKAK10 ▲
B3000	08-94	Rear - 7.5"	DRK-315	DRK-315MK ▲	AK11	DRK-315AK11	DRK-315MKAK11 ▲
B3000	06-94	Rear - 8.8"	DRK-311	DRK-311MK ▲	AK10	DRK-311AK10	DRK-311MKAK10 ▲
B4000	10-98	Front - Dana 35	DRK-335B	DRK-335BMK ▲			
B4000	97-94	Front - Dana 35	DRK-335	DRK-335MK ▲			
B4000	10-07	Rear - 8.8"	DRK-311G	DRK-311GMK ▲	AK10	DRK-311GAK10	DRK-311GMKAK10 ▲
B4000	06-94	Rear - 8.8"	DRK-311	DRK-311MK ▲	AK10	DRK-311AK10	DRK-311MKAK10 ▲
Navajo	94-91	Front - Dana 35	DRK-335	DRK-335MK ▲			
Navajo	01-91	Rear - 8.8"	DRK-311	DRK-311MK ▲	AK10	DRK-311AK10	DRK-311MKAK10 ▲
Navajo	97-91	Rear - 7.5"	DRK-315	DRK-315MK ▲	AK10	DRK-315AK10	DRK-315MKAK10 ▲
Tribute	11-01	Rear - Dana 28	DRK-333A <sup>110</sup>	DRK-333AMK <sup>110</sup>	AK89	DRK-333AAK89 <sup>110</sup>	DRK-333AMKAK89 <sup>110</sup>

# Light Duty Differential Applications

Make/Model	Year	Position/ Ring Gear Size	Standard Kit	Master Kit	Axle Kit	Standard Kit Plus	Master Kit Plus
<b>MERCURY</b>							
Bobcat	80-75	Rear - 8"	DRK-310	DRK-310MK			
Capri	1986	Rear - 8.8"	DRK-311	DRK-311MK	▲ AK11	DRK-311AK11	DRK-311MKAK11 ▲
Capri	86-79	Rear - 7.5"	DRK-315	DRK-315MK	▲ AK11	DRK-315AK11	DRK-315MKAK11 ▲
Colony Park	91-81	Rear - 8.8"	DRK-311	DRK-311MK	▲ AK11	DRK-311AK11	DRK-311MKAK11 ▲
Colony Park	80-73	Rear - 9" 31 spline From 05/11/70	DRK-313	DRK-313MK			
Comet	72-64	Rear - 8"	DRK-310	DRK-310MK			
Cougar	97-89	Rear - 7.5"	DRK-315	DRK-315MK	▲		
Cougar	97-89	Rear - 8.8"	DRK-311	DRK-311MK	▲ AK90	DRK-311AK90	DRK-311MKAK90 ▲
Cougar	88-80	Rear - 7.5"	DRK-315	DRK-315MK	▲ AK11	DRK-315AK11	DRK-315MKAK11 ▲
Cougar	79-70	Rear - 9" 31 spline From 05/11/70	DRK-313	DRK-313MK			
Cougar	70-67	Rear - 9" 28 spline To 5/10/70	DRK-312	DRK-312MK			
Cougar	68-67	Rear - 8"	DRK-310	DRK-310MK			
Grand Marquis	11-83	Rear - 8.8"	DRK-311	DRK-311MK	▲ AK11	DRK-311AK11	DRK-311MKAK11 ▲
Marauder	04-03	Rear - 8.8"	DRK-311	DRK-311MK	▲ AK11	DRK-311AK11	DRK-311MKAK11 ▲
Mariner	10-05	Rear - Dana 28	DRK-333A <sup>110</sup>	DRK-333AMK <sup>110</sup>	AK89	DRK-333AAK89 <sup>110</sup>	DRK-333AMKAK89 <sup>110</sup>
Marquis	86-81	Rear - 7.5"	DRK-315	DRK-315MK	▲		
Marquis	82-81	Rear - 8.8"	DRK-311	DRK-311MK	▲ AK11	DRK-311AK11	DRK-311MKAK11 ▲
Marquis	80-73	Rear - 9" 31 spline From 05/11/70	DRK-313	DRK-313MK			
Monarch	80-75	Rear - 8"	DRK-310	DRK-310MK			
Monarch	80-75	Rear - 9"	DRK-313	DRK-313MK			
Montego	76-70	Rear - 9" 31 spline From 05/11/70	DRK-313	DRK-313MK			
Montego	70-68	Rear - 9" 28 spline To 5/10/70	DRK-312	DRK-312MK			
Mountaineer	10-06	Front - Dana 30	DRK-334E	DRK-334EMK	▲		
Mountaineer	05-01	Front - Dana 30	DRK-334B	DRK-334BMK			
Mountaineer	05-97	Front - Dana 35	DRK-335B	DRK-335BMK	▲		
Mountaineer	10-08	Rear - 8.8" IRS	DRK-311L	DRK-311LMK	▲ AK36	DRK-311LAK36	DRK-311LMKAK36 ▲
Mountaineer	07-06	Rear - 8.8" IRS	DRK-311K	DRK-311KMK	▲ AK36	DRK-311KAK36	DRK-311KMKAK36 ▲
Mountaineer	05-02	Rear - 8.8" IRS	DRK-311	DRK-311MK	▲ AK36	DRK-311AK36	DRK-311MKAK36 ▲
Mountaineer	01-97	Rear - 8.8"	DRK-311	DRK-311MK	▲ AK10	DRK-311AK10	DRK-311MKAK10 ▲
<b>MITSUBISHI</b>							
Raider	09-06	Front - 8.0"	DRK-305	DRK-305MK			
Raider	09-06	Rear - 8.25"	DRK-303B	DRK-303BMK	AK10	DRK-303BAK10	DRK-303BMKAK10
Raider	09-06	Rear - 9.25"	DRK-304A	DRK-304AMK	AK10	DRK-304AAK10	DRK-304AMKAK10
<b>NISSAN</b>							
Armada	15-05	Front - Dana 205	DRK-339T	DRK-339TMK			
Armada	15-09	Rear - Dana 44	DRK-339N	DRK-339NMK	AK51	DRK-339NAK51	DRK-339NMKAK51
Armada	08-05	Rear - Dana 44	DRK-339N	DRK-339NMK	AK47	DRK-339NAK47	DRK-339NMKAK47
Frontier	12-03	Rear - Dana 44 w/ 12 Bolt Cover	DRK-339N	DRK-339NMK	AK47	DRK-339NAK47	DRK-339NMKAK47
NV1500	16-12	Rear - 10.5" AAM Axle	DRK-339V	DRK-339VMK			
NV2500	16-12	Rear - 10.5" AAM Axle	DRK-339V	DRK-339VMK			
NV3500	16-12	Rear - 10.5" AAM Axle	DRK-339V	DRK-339VMK			
Pathfinder	12-06	Front - Dana 205	DRK-339T	DRK-339TMK			
Pathfinder	12-09	Rear - Dana 44 w/ 12 Bolt Cover	DRK-339N	DRK-339NMK	AK51	DRK-339NAK51	DRK-339NMKAK51

<sup>110</sup>Original Pinion Nut Must be Re-used

▲ Add "S" suffix to kit number to receive stackable differential shims in kit.

# Light Duty Differential Applications



Make/Model	Year	Position/ Ring Gear Size	Standard Kit	Master Kit	Axle Kit	Standard Kit Plus	Master Kit Plus
------------	------	-----------------------------	-----------------	---------------	-------------	----------------------	--------------------

**NISSAN (cont'd)**

Pathfinder	08-03	Rear - Dana 44 w/ 12 Bolt Cover	DRK-339N	DRK-339NMK	AK47	DRK-339NAK47	DRK-339NMKAK47
Titan	15-04	Front - Dana 205	DRK-339T	DRK-339TMK			
Titan	15-09	Rear - Dana 44	DRK-339N	DRK-339NMK	AK51	DRK-339NAK51	DRK-339NMKAK51
Titan	08-04	Rear - Dana 44	DRK-339N	DRK-339NMK	AK47	DRK-339NAK47	DRK-339NMKAK47
Xterra	15-03	Rear - Dana 44 w/ 12 Bolt Cover	DRK-339N	DRK-339NMK	AK47	DRK-339NAK47	DRK-339NMKAK47

**OLDSMOBILE**

88	1957	Rear - 9.3" C axle	DRK-329	DRK-329MK			
98	84-82	Rear - 7.5"/7.6"	DRK-320	DRK-320MK	▲	AK11	DRK-320AK11
98	84-73	Rear - 8.5"/8.6"	DRK-321R	DRK-321RMK	▲		
98	81-77	Rear - 7.5"/7.6"	DRK-320B	DRK-320BMK	▲	AK11	DRK-320BAK11
98	72-65	Rear - 8.875"	DRK-323A	DRK-323AMK	▲		
98	62-58	Rear - 9.3" C axle	DRK-329	DRK-329MK			
442	70-68	Rear - 8.5" "O"	DRK-321N	DRK-321NMK	▲		
Bravada	04-97	Front - 7.25"	DRK-320K	DRK-320KMK		AK87	DRK-320KAK87
Bravada	96-91	Front - 7.25"	DRK-320A	DRK-320AMK		AK86	DRK-320AAK86
Bravada	04-02	Rear - 8"	DRK-320D	DRK-320DMK	▲	AK12	DRK-320DAK12
Bravada	01-99	Rear - 7.5"/7.6"	DRK-320C	DRK-320CMK	▲	AK11	DRK-320CAK11
Bravada	98-91	Rear - 7.5"/7.6"	DRK-320	DRK-320MK	▲	AK11	DRK-320AK11
Custom Cruiser	92-80	Rear - 8.5"/8.6"	DRK-321R	DRK-321RMK	▲	AK10	DRK-321RAK10
Cutlass	81-78	Rear - 7.5"/7.6"	DRK-320	DRK-320MK	▲	AK11	DRK-320AK11
Cutlass	77-71	Rear - 8.5"/8.6"	DRK-321R	DRK-321RMK	▲	AK10	DRK-321RAK10
Cutlass	70-68	Rear - 8.5" "O"	DRK-321N	DRK-321NMK	▲		
Cutlass	1962	Rear - 9.3" C axle	DRK-329	DRK-329MK			
Cutlass Cruiser	83-82	Rear - 7.5"/7.6"	DRK-320	DRK-320MK	▲	AK11	DRK-320AK11
Cutlass Cruiser	81-80	Rear - 7.5"/7.6"	DRK-320B	DRK-320BMK	▲	AK11	DRK-320BAK11
Cutlass Supreme	88-82	Rear - 7.5"/7.6"	DRK-320	DRK-320MK	▲	AK11	DRK-320AK11
Cutlass Supreme	81-77	Rear - 7.5"/7.6"	DRK-320B	DRK-320BMK	▲	AK11	DRK-320BAK11
Cutlass Supreme	77-71	Rear - 8.5"/8.6"	DRK-321R	DRK-321RMK	▲	AK10	DRK-321RAK10
Cutlass Supreme	70-68	Rear - 8.5" "O"	DRK-321N	DRK-321NMK	▲		
Delta 88	85-82	Rear - 7.5"/7.6"	DRK-320	DRK-320MK	▲	AK10	DRK-320AK10
Delta 88	85-73	Rear - 8.5"/8.6"	DRK-321R	DRK-321RMK	▲	AK10	DRK-321RAK10
Delta 88	81-77	Rear - 7.5"/7.6"	DRK-320B	DRK-320BMK	▲	AK11	DRK-320BAK11
Delta 88	72-65	Rear - 8.875"	DRK-323A	DRK-323AMK	▲		
Dynamic	62-58	Rear - 9.3" C axle	DRK-329	DRK-329MK			
F85	72-70	Rear - 8.5"/8.6"	DRK-321R	DRK-321RMK	▲		
F85	70-68	Rear - 8.875"	DRK-323A	DRK-323AMK	▲		
F85	70-64	Rear - 8.2" B-O-P	DRK-321H	DRK-321HMK	▲		
F85	62-61	Rear - 9.3" C axle	DRK-329	DRK-329MK			
Omega	81-75	Rear - 7.5"/7.6"	DRK-320B	DRK-320BMK	▲		
Omega	79-73	Rear - 8.5"/8.6"	DRK-321R	DRK-321RMK	▲		
Starfire	80-75	Rear - 7.5"/7.6"	DRK-320B	DRK-320BMK	▲		
Starfire	62-61	Rear - 9.3" C axle	DRK-329	DRK-329MK			
Super 88	62-57	Rear - 9.3" C axle	DRK-329	DRK-329MK			

**PLYMOUTH**

Barracuda	74-72	Rear - 8.25"/8.375"	DRK-303	DRK-303MK		AK10	DRK-303AK10
Barracuda	74-72	Rear - 8.75" w/1.875" Pin. Shaft O.D.	DRK-301	DRK-301MK			
Barracuda	71-70	Rear - 7.25"	DRK-302	DRK-302MK			
Barracuda	71-70	Rear - 8.25"/8.375"	DRK-303	DRK-303MK		AK10	DRK-303AK10

# Light Duty Differential Applications

Make/Model	Year	Position/ Ring Gear Size	Standard Kit	Master Kit	Axle Kit	Standard Kit Plus	Master Kit Plus
<b>PLYMOUTH (cont'd)</b>							
Barracuda	71-70	Rear - 8.75" w/1.875" Pin. Shaft O.D.	DRK-301	DRK-301MK			
Barracuda	71-70	Rear - Dana 60	DRK-331	DRK-331MK			
Barracuda	1969	Rear - 7.25"	DRK-302	DRK-302MK			
Barracuda	1969	Rear - 8.75" w/1.875" Pin. Shaft O.D.	DRK-301	DRK-301MK			
Barracuda	68-64	Rear - 7.25"	DRK-302	DRK-302MK			
Barracuda	68-64	Rear - 8.75" w/1.75" Pin. Shaft O.D.	DRK-300	DRK-300MK			
Belvedere	70-69	Rear - 7.25"	DRK-302	DRK-302MK			
Belvedere	70-69	Rear - 8.25"/8.375"	DRK-303	DRK-303MK	AK10	DRK-303AK10	DRK-303MKAK10
Belvedere	70-69	Rear - 8.75" w/1.875" Pin. Shaft O.D.	DRK-301	DRK-301MK			
Belvedere	70-66	Rear - 7.25"	DRK-302	DRK-302MK			
Belvedere	68-67	Rear - 8.75" w/1.75" Pin. Shaft O.D.	DRK-300	DRK-300MK			
Belvedere	1966	Rear - Dana 60	DRK-331	DRK-331MK			
Belvedere	65-57	Rear - 8.75" w/1.75" Pin. Shaft O.D.	DRK-300	DRK-300MK			
Duster	76-73	Rear - 8.25"/8.375"	DRK-303	DRK-303MK	AK10	DRK-303AK10	DRK-303MKAK10
Duster	74-70	Rear - 8.75" w/1.875" Pin. Shaft O.D.	DRK-301	DRK-301MK			
Fury	78-74	Rear - 9.25"	DRK-304	DRK-304MK			
Fury	78-70	Rear - 8.25"/8.375"	DRK-303	DRK-303MK	AK10	DRK-303AK10	DRK-303MKAK10
Fury	73-69	Rear - 8.75" w/1.875" Pin. Shaft O.D.	DRK-301	DRK-301MK			
Fury	68-57	Rear - 8.75" w/1.75" Pin. Shaft O.D.	DRK-300	DRK-300MK			
Gran Fury	89-82	Rear - 7.25"	DRK-302	DRK-302MK			
Gran Fury	89-75	Rear - 8.25"/8.375"	DRK-303	DRK-303MK	AK10	DRK-303AK10	DRK-303MKAK10
Gran Fury	81-75	Rear - 9.25"	DRK-304	DRK-304MK	AK10	DRK-304AK10	DRK-304MKAK10
GTX	71-69	Rear - 8.75" w/1.875" Pin. Shaft O.D.	DRK-301	DRK-301MK			
GTX	71-67	Rear - Dana 60	DRK-331	DRK-331MK			
GTX	68-67	Rear - 8.75" w/1.75" Pin. Shaft O.D.	DRK-300	DRK-300MK			
Road Runner	75-74	Rear - 9.25"	DRK-304	DRK-304MK	AK10	DRK-304AK10	DRK-304MKAK10
Road Runner	75-73	Rear - 8.25"/8.375"	DRK-303	DRK-303MK	AK10	DRK-303AK10	DRK-303MKAK10
Road Runner	74-69	Rear - 8.75" w/1.875" Pin. Shaft O.D.	DRK-301	DRK-301MK			
Road Runner	72-69	Rear - Dana 60	DRK-331	DRK-331MK			
Road Runner	1968	Rear - Dana 60	DRK-331	DRK-331MK			
Road Runner	1968	Rear - 8.75" w/1.75" Pin. Shaft O.D.	DRK-300	DRK-300MK			
Satellite	74-73	Rear - 9.25"	DRK-304	DRK-304MK	AK10	DRK-304AK10	DRK-304MKAK10
Satellite	74-69	Rear - 8.25"/8.375"	DRK-303	DRK-303MK	AK10	DRK-303AK10	DRK-303MKAK10
Satellite	74-69	Rear - 8.75" w/1.875" Pin. Shaft O.D.	DRK-301	DRK-301MK			
Satellite	71-68	Rear - 7.25"	DRK-302	DRK-302MK			
Satellite	1968	Rear - 8.75" w/1.75" Pin. Shaft O.D.	DRK-300	DRK-300MK			
Satellite	67-66	Rear - 7.25"	DRK-302	DRK-302MK			
Satellite	1966	Rear - Dana 60	DRK-331	DRK-331MK			
Trailduster	81-74	Front - Dana 44	DRK-339B	DRK-339BMK			
Trailduster	81-74	Rear - 9.25"	DRK-304	DRK-304MK	AK10	DRK-304AK10	DRK-304MKAK10
Valiant	76-73	Rear - 8.25"/8.375"	DRK-303	DRK-303MK	AK10	DRK-303AK10	DRK-303MKAK10

# Light Duty Differential Applications



Make/Model	Year	Position/ Ring Gear Size	Standard Kit	Master Kit	Axle Kit	Standard Kit Plus	Master Kit Plus	
<b>PLYMOUTH (cont'd)</b>								
Valiant	76-69	Rear - 7.25"	DRK-302	DRK-302MK				
Valiant	72-69	Rear - 8.75" w/1.875" Pin. Shaft O.D.	DRK-301	DRK-301MK				
Valiant	68-60	Rear - 7.25"	DRK-302	DRK-302MK				
Valiant	68-60	Rear - 8.75" w/1.75" Pin. Shaft O.D.	DRK-300	DRK-300MK				
Volare	80-76	Rear - 7.25"	DRK-302	DRK-302MK				
Volare	80-76	Rear - 8.25"/8.375"	DRK-303	DRK-303MK	AK10	DRK-303AK10	DRK-303MKAK10	
<b>PONTIAC</b>								
Bonneville	86-82	Rear - 7.5"/7.6"	DRK-320	DRK-320MK	▲	AK11	DRK-320AK11	DRK-320MKAK11 ▲
Bonneville	81-77	Rear - 7.5"/7.6"	DRK-320B	DRK-320BMK	▲	AK11	DRK-320BAK11	DRK-320BMKAK11 ▲
Bonneville	81-73	Rear - 8.5"/8.6"	DRK-321R	DRK-321RMK	▲			
Bonneville	72-65	Rear - 8.875"	DRK-323A	DRK-323AMK	▲	AK10	DRK-323AAK10	DRK-323AMKAK10 ▲
Bonneville	62-57	Rear - 9.3" C axle	DRK-329	DRK-329MK				
Catalina	81-77	Rear - 7.5"/7.6"	DRK-320B	DRK-320BMK	▲	AK11	DRK-320BAK11	DRK-320BMKAK11 ▲
Catalina	81-73	Rear - 8.5"/8.6"	DRK-321R	DRK-321RMK	▲	AK10	DRK-321RAK10	DRK-321RMKAK10 ▲
Catalina	72-65	Rear - 8.2" Axle Shaft w/1.781" Differential Brgs.	DRK-321B	DRK-321BMK	▲			
Catalina	72-65	Rear - 8.875"	DRK-323A	DRK-323AMK	▲			
Catalina	62-57	Rear - 9.3" C axle	DRK-329	DRK-329MK				
Chieftain	58-57	Rear - 9.3" C axle	DRK-329	DRK-329MK				
Firebird	02-99	Rear - 7.5"/7.6"	DRK-320C	DRK-320CMK	▲	AK11	DRK-320CAK11	DRK-320CMKAK11 ▲
Firebird	98-82	Rear - 7.5"/7.6"	DRK-320	DRK-320MK	▲	AK11	DRK-320AK11	DRK-320MKAK11 ▲
Firebird	81-71	Rear - 8.5"/8.6"	DRK-321R	DRK-321RMK	▲	AK11	DRK-321RAK11	DRK-321RMKAK11 ▲
Firebird	81-67	Rear - 8.2" B-O-P	DRK-321H	DRK-321HMK	▲			
Firebird	72-67	Rear - 8.875"	DRK-323A	DRK-323AMK	▲	AK11		
Firebird Trans Am	02-99	Rear - 7.5"/7.6"	DRK-320C	DRK-320CMK	▲	AK11	DRK-320CAK11	DRK-320CMKAK11 ▲
Firebird Trans Am	98-82	Rear - 7.5"/7.6"	DRK-320	DRK-320MK	▲	AK11	DRK-320AK11	DRK-320MKAK11 ▲
Firebird Trans Am	90-85	Rear - Borg Warner 7.75"	DRK-326	DRK-326MK				
Firebird Trans Am	81-71	Rear - 8.5"/8.6"	DRK-321R	DRK-321RMK	▲	AK11	DRK-321RAK11	DRK-321RMKAK11 ▲
Firebird Trans Am	72-67	Rear - 8.875"	DRK-323A	DRK-323AMK	▲	AK11		
Firebird Trans Am	71-67	Rear - 8.2" B-O-P	DRK-321H	DRK-321HMK	▲			
G8	09-08	Rear - 8.25"	DRK-326B	DRK-326BMK		AK56	DRK-326BAK56	DRK-326BMKAK56
GTO	06-04	Rear - 8"	DRK-326A	DRK-326AMK				
GTO	72-65	Rear - 8.875"	DRK-323A	DRK-323AMK	▲			
GTO	71-64	Rear - 8.2" B-O-P	DRK-321H	DRK-321HMK	▲			
Grand Am	80-78	Rear - 7.5"/7.6"	DRK-320	DRK-320MK	▲	AK11	DRK-320AK11	DRK-320MKAK11 ▲
Grand Am	80-73	Rear - 8.5"/8.6"	DRK-321R	DRK-321RMK	▲			
Grand Prix	87-82	Rear - 7.5"/7.6"	DRK-320	DRK-320MK	▲	AK11	DRK-320AK11	DRK-320MKAK11 ▲
Grand Prix	81-78	Rear - 7.5"/7.6"	DRK-320B	DRK-320BMK	▲	AK11	DRK-320BAK11	DRK-320BMKAK11 ▲
Grand Prix	77-71	Rear - 8.5"/8.6"	DRK-321R	DRK-321RMK	▲	AK11	DRK-321RAK11	DRK-321RMKAK11 ▲
Grand Prix	72-70	Rear - 8.875"	DRK-323A	DRK-323AMK	▲			
Grand Prix	1962	Rear - 9.3" C axle	DRK-329	DRK-329MK				
LeMans	81-78	Rear - 7.5"/7.6"	DRK-320B	DRK-320BMK	▲	AK11	DRK-320BAK11	DRK-320BMKAK11 ▲
LeMans	77-71	Rear - 8.5"/8.6"	DRK-321R	DRK-321RMK	▲	AK11	DRK-321RAK11	DRK-321RMKAK11 ▲
LeMans	72-65	Rear - 8.875"	DRK-323A	DRK-323AMK	▲			
Parisienne	86-83	Rear - 7.5"/7.6"	DRK-320	DRK-320MK	▲	AK11	DRK-320AK11	DRK-320MKAK11 ▲
Parisienne	86-83	Rear - 8.5"/8.6"	DRK-321R	DRK-321RMK	▲	AK11	DRK-321RAK11	DRK-321RMKAK11 ▲
Phoenix	79-77	Rear - 7.5"/7.6"	DRK-320B	DRK-320BMK	▲			
Star Chief	62-57	Rear - 9.3" C axle	DRK-329	DRK-329MK				
Safari	89-87	Rear - 7.5"/7.6"	DRK-320	DRK-320MK	▲	AK10	DRK-320AK10	DRK-320MKAK10 ▲

LD Differential



# Light Duty Differential Applications

Make/Model	Year	Position/ Ring Gear Size	Standard Kit	Master Kit	Axle Kit	Standard Kit Plus	Master Kit Plus
------------	------	-----------------------------	-----------------	---------------	-------------	----------------------	--------------------

## PONTIAC (cont'd)

Sunbird	80-76	Rear - 7.5"/7.6"	DRK-320B	DRK-320BMK ▲			
Super Chief	58-57	Rear - 9.3" C axle	DRK-329	DRK-329MK			
Tempest	70-64	Rear - 8.2" B-O-P	DRK-321H	DRK-321HMK ▲			
Tempest	62-61	Rear - 9.3" C axle	DRK-329	DRK-329MK			
Ventura	77-71	Rear - 8.5"/8.6"	DRK-321R	DRK-321RMK ▲	AK11	DRK-321RAK11	DRK-321RMKAK11 ▲
Ventura	61-60	Rear - 9.3" C axle	DRK-329	DRK-329MK			

## RAM

1500	2011	Front - 8"	DRK-305A	DRK-305AMK ▲			
1500	16-11	Rear - 9.25" ZF Axle	DRK-366		AK26	DRK-366AK26	
2500	16-11	Front - 9.25" AAM axle	DRK-324G	DRK-324GMK ▲	AK57	DRK-324GAK57	DRK-324GMKAK57 ▲
2500	16-14	Rear - 11.5" w/ 2.125" ID Pinion Brg.	DRK-327B	DRK-327BMK	AK30	DRK-327BAK30	DRK-327BMKAK30
2500	14-11	Rear - 11.5" w/ 2.000" ID Pinion Brg.	DRK-327A	DRK-327AMK	AK30	DRK-327AAK30	DRK-327AMKAK30
2500	13-11	Rear - 10.5"	DRK-306	DRK-306MK	AK30	DRK-306AK30	DRK-306MKAK30
3500	16-11	Front - 9.25" AAM axle	DRK-324G	DRK-324GMK ▲	AK57	DRK-324GAK57	DRK-324GMKAK57 ▲
3500	16-14	Rear - 11.5" w/ 2.125" ID Pinion Brg.	DRK-327B	DRK-327BMK	AK30 <sup>49</sup>	DRK-327BAK30 <sup>49</sup>	DRK-327BMKAK30 <sup>49</sup>
3500	16-14	Rear - 11.5" w/ 2.125" ID Pinion Brg.	DRK-327B	DRK-327BMK	AK13 <sup>48</sup>	DRK-327BAK13 <sup>48</sup>	DRK-327BMKAK13 <sup>48</sup>
3500	16-14	Rear - 11.8" AAM	DRK-327B	DRK-327BMK	AK30 <sup>49</sup>	DRK-327BAK30 <sup>49</sup>	DRK-327BMKAK30 <sup>49</sup>
3500	16-14	Rear - 11.8" AAM	DRK-327B	DRK-327BMK	AK13 <sup>48</sup>	DRK-327BAK13 <sup>48</sup>	DRK-327BMKAK13 <sup>48</sup>
3500	14-11	Rear - 11.5" w/ 2.000" ID Pinion Brg.	DRK-327A	DRK-327AMK	AK30 <sup>49</sup>	DRK-327AAK30 <sup>49</sup>	DRK-327AMKAK30 <sup>49</sup>
3500	14-11	Rear - 11.5" w/ 2.000" ID Pinion Brg.	DRK-327A	DRK-327AMK	AK13 <sup>48</sup>	DRK-327AAK13 <sup>48</sup>	DRK-327AMKAK13 <sup>48</sup>
4500	16-11	Front - Magna Steyr 275mm	DRK-365				
4500	16-11	Rear - Dana S111	DRK-434				
5500	16-11	Front - Magna Steyr 275mm	DRK-365				
5500	16-11	Rear - Dana S111	DRK-434				
Dakota	2011	Front - 8.0"	DRK-305	DRK-305MK			
Dakota	2011	Rear - 8.25"	DRK-303B	DRK-303BMK	AK10	DRK-303BAK10	DRK-303BMKAK10
Dakota	2011	Rear - 9.25"	DRK-304A	DRK-304AMK	AK10	DRK-304AAK10	DRK-304AMKAK10

## SAAB

9-7X	09-05	Front - 7.25"	DRK-320K	DRK-320KMK	AK87	DRK-320KAK87	DRK-320KMKAK87
9-7X	2009	Rear - 8.5"/8.6"	DRK-321Q	DRK-321QMK ▲	AK12	DRK-321QAK12	DRK-321QMKAK12 ▲
9-7X	2008	Rear - 9.5"	DRK-324B	DRK-324BMK	AK12	DRK-324BAK12	DRK-324BMKAK12
9-7X	08-05	Rear - 8"	DRK-320D	DRK-320DMK ▲	AK12	DRK-320DAK12	DRK-320DMKAK12 ▲
9-7X	08-05	Rear - 8.5"/8.6"	DRK-321C	DRK-321CMK ▲	AK12	DRK-321CAK12	DRK-321CMKAK12 ▲

## SUZUKI

Equator RMZ-4	12-09	Rear - Dana 44 w/ 12 Bolt Cover	DRK-339N	DRK-339NMK	AK47	DRK-339NAK47	DRK-339NMKAK47
Samurai	95-85	Front - All	DRK-360	DRK-360MK			
Samurai	95-85	Rear - All	DRK-360	DRK-360MK			

<sup>48</sup>With Dual Rear Wheels

<sup>49</sup>With Single Rear Wheels

▲ Add "S" suffix to kit number to receive stackable differential shims in kit.

# Light Duty Differential Applications

Make/Model	Year	Position/ Ring Gear Size	Standard Kit	Master Kit	Axle Kit	Standard Kit Plus	Master Kit Plus
<b>TOYOTA</b>							
4 Runner	15-03	Front - 7.5"	DRK-359	DRK-359MK			
4 Runner	02-96	Front - 7.5"	DRK-350A	DRK-350AMK ▲			
4 Runner	95-88	Front - 7.5" IFS	DRK-350A	DRK-350AMK ▲			
4 Runner	87-86	Front - 7.5" IFS	DRK-350	DRK-350MK			
4 Runner	85-84	Front - 8" Solid Axle	DRK-351	DRK-351MK			
4 Runner	15-10	Rear - 8.2" w/ Locking Diff	DRK-383A	DRK-383AMK			
4 Runner	15-10	Rear - 8.2" w/o Locking Diff	DRK-383	DRK-383MK			
4 Runner	09-03	Rear - 8"	DRK-352A	DRK-352AMK			
4 Runner	02-01	Rear - 8"	DRK-352	DRK-352MK	AK35	DRK-352AK35	DRK-352MKAK35
4 Runner	00-96	Rear - 8" 4 Cyl. w/ABS	DRK-352	DRK-352MK	AK34	DRK-352AK34	DRK-352MKAK34
4 Runner	00-96	Rear - 8" 4 Cyl. w/o ABS	DRK-352	DRK-352MK	AK33	DRK-352AK33	DRK-352MKAK33
4 Runner	00-96	Rear - 8" V6 & w/ Locking Diff w/o ABS	DRK-354A	DRK-354AMK	AK33	DRK-354AAK33	DRK-354AMKAK33
4 Runner	00-96	Rear - 8" V6 & w/ Locking Diff w/ABS	DRK-354A	DRK-354AMK	AK34	DRK-354AAK34	DRK-354AMKAK34
4 Runner	00-96	Rear - 8" V6 & w/o Locking Diff w/o ABS	DRK-352	DRK-352MK	AK33	DRK-352AK33	DRK-352MKAK33
4 Runner	00-96	Rear - 8" V6 & w/o Locking Diff w/ABS	DRK-352	DRK-352MK	AK34	DRK-352AK34	DRK-352MKAK34
4 Runner	95-90	Rear - 7.5" 4 Cyl. 2WD w/ABS	DRK-350	DRK-350MK	AK34	DRK-350AK34	DRK-350MKAK34
4 Runner	95-90	Rear - 8" 4 Cyl. 4WD w/ABS	DRK-353	DRK-353MK	AK34	DRK-353AK34	DRK-353MKAK34
4 Runner	95-90	Rear - 8" V6 w/ABS	DRK-352	DRK-352MK	AK34	DRK-352AK34	DRK-352MKAK34
4 Runner	95-88	Rear - 7.5" 4 Cyl. 2WD w/o ABS	DRK-350	DRK-350MK	AK33	DRK-350AK33	DRK-350MKAK33
4 Runner	95-88	Rear - 8" 4 Cyl. 4WD w/o ABS	DRK-353	DRK-353MK	AK33	DRK-353AK33	DRK-353MKAK33
4 Runner	95-88	Rear - 8" V6 w/o ABS	DRK-352	DRK-352MK	AK33	DRK-352AK33	DRK-352MKAK33
4 Runner	87-86	Rear - 7.5" 4 Cyl. Non Turbo 2WD	DRK-350	DRK-350MK	AK33	DRK-350AK33	DRK-350MKAK33
4 Runner	87-86	Rear - 8" 4 Cyl. Non Turbo 4WD	DRK-353	DRK-353MK	AK33	DRK-353AK33	DRK-353MKAK33
4 Runner	87-86	Rear - 8" 4 Cyl. Turbo 4WD	DRK-352	DRK-352MK	AK33	DRK-352AK33	DRK-352MKAK33
4 Runner	85-84	Rear - 7.5" 2WD	DRK-350	DRK-350MK	AK33	DRK-350AK33	DRK-350MKAK33
4 Runner	85-84	Rear - 8" 4WD	DRK-351	DRK-351MK	AK33	DRK-351AK33	DRK-351MKAK33
FJ Cruiser	14-07	Front - 8" IFS	DRK-359	DRK-359MK			
FJ Cruiser	14-09	Rear - 8" w/ Locking Diff	DRK-383A	DRK-383AMK			
FJ Cruiser	14-09	Rear - 8" w/o Locking Diff	DRK-383	DRK-383MK			
FJ Cruiser	08-07	Rear - 8" w/ Locking Diff	DRK-354A	DRK-354AMK			
FJ Cruiser	08-07	Rear - 8" w/o Locking Diff	DRK-352A	DRK-352AMK			
Landcruiser	15-08	Front - 9"	DRK-380	DRK-380MK ▲			
Landcruiser	97-91	Front - FJ80 w/Locking Differential	DRK-356	DRK-356MK			
Landcruiser	97-91	Front - FJ80 w/Open Differential	DRK-356A	DRK-356AMK			
Landcruiser	90-75	Front - FJ40/60/62 w/ Open Differential	DRK-358	DRK-358MK			
Landcruiser	15-08	Rear - 9.5"	DRK-381	DRK-381MK			
Landcruiser	97-91	Rear - FJ80 w/Locking Differential	DRK-357	DRK-357MK			
Landcruiser	97-91	Rear - FJ80 w/Open Differential	DRK-357A	DRK-357AMK			

LD Differential

# Light Duty Differential Applications

Make/Model	Year	Position/ Ring Gear Size	Standard Kit	Master Kit	Axle Kit	Standard Kit Plus	Master Kit Plus
<b>TOYOTA (cont'd)</b>							
Landcruiser	90-75	Rear - FJ40/60/62 w/ Open Differential	DRK-358	DRK-358MK			
Pickup	95-88	Front - 7.5" IFS	DRK-350A	DRK-350AMK ▲			
Pickup	88-86	Front - 7.5" IFS	DRK-350	DRK-350MK			
Pickup	85-84	Front - 8" Solid Axle	DRK-351	DRK-351MK			
Pickup	95-90	Rear - 7.5" 4 Cyl. Non Turbo 2WD w/ABS	DRK-350	DRK-350MK	AK34	DRK-350AK34	DRK-350MKAK34
Pickup	95-90	Rear - 8" 4 Cyl. 4WD w/ABS	DRK-353	DRK-353MK	AK34	DRK-353AK34	DRK-353MKAK34
Pickup	95-90	Rear - 8" V6 w/ABS	DRK-352	DRK-352MK	AK34	DRK-352AK34	DRK-352MKAK34
Pickup	95-89	Rear - 7.5" 4 Cyl. Non Turbo 2WD w/o ABS	DRK-350	DRK-350MK	AK33	DRK-350AK33	DRK-350MKAK33
Pickup	95-89	Rear - 8" 4 Cyl. 4WD w/o ABS	DRK-353	DRK-353MK	AK33	DRK-353AK33	DRK-353MKAK33
Pickup	95-89	Rear - 8" V6 w/o ABS	DRK-352	DRK-352MK	AK33	DRK-352AK33	DRK-352MKAK33
Pickup	1988	Rear - 7.5" 4 Cyl. Non Turbo 2WD	DRK-350	DRK-350MK	AK33	DRK-350AK33	DRK-350MKAK33
Pickup	1988	Rear - 8" 4 Cyl. Non Turbo 4WD	DRK-353	DRK-353MK	AK33	DRK-353AK33	DRK-353MKAK33
Pickup	1988	Rear - 8" 4 Cyl. Turbo 4WD	DRK-352	DRK-352MK	AK33	DRK-352AK33	DRK-352MKAK33
Pickup	1988	Rear - 8" V6	DRK-352	DRK-352MK	AK33	DRK-352AK33	DRK-352MKAK33
Pickup	87-86	Rear - 7.5" 4 Cyl. Non Turbo 2WD	DRK-350	DRK-350MK	AK33	DRK-350AK33	DRK-350MKAK33
Pickup	87-86	Rear - 8" 4 Cyl. Non Turbo 4WD	DRK-353	DRK-353MK	AK33	DRK-353AK33	DRK-353MKAK33
Pickup	87-86	Rear - 8" 4 Cyl. Turbo 4WD	DRK-352	DRK-352MK	AK33	DRK-352AK33	DRK-352MKAK33
Pickup	85-84	Rear - 7.5" 2WD	DRK-350	DRK-350MK	AK33	DRK-350AK33	DRK-350MKAK33
Pickup	85-84	Rear - 8" 4WD	DRK-351	DRK-351MK	AK33	DRK-351AK33	DRK-351MKAK33
Pickup	83-79	Rear - 7.5"	DRK-350	DRK-350MK	AK33	DRK-350AK33	DRK-350MKAK33
Sequoia	15-08	Front - 9"	DRK-380	DRK-380MK ▲			
Sequoia	07-01	Front - 7.5" IFS	DRK-350A	DRK-350AMK ▲			
Sequoia	15-08	Rear - 10.5"	DRK-382A	DRK-382AMK ▲			
Sequoia	07-01	Rear - 8.4"	DRK-355	DRK-355MK			
Supra	95-87	Rear - 7.5" w/o Turbo	DRK-350	DRK-350MK			
T100	98-93	Front - 7.5" IFS	DRK-350A	DRK-350AMK ▲			
T100	98-93	Rear - 8.4" w/ABS	DRK-355	DRK-355MK	AK34	DRK-355AK34	DRK-355MKAK34
T100	98-93	Rear - 8.4" w/o ABS	DRK-355	DRK-355MK	AK33	DRK-355AK33	DRK-355MKAK33
Tacoma	15-05	Front - 8" IFS	DRK-359	DRK-359MK			
Tacoma	04-95	Front - 7.5" IFS	DRK-350A	DRK-350AMK ▲			
Tacoma	17-16	Rear - 8.2" w/ Locking Diff	DRK-383A	DRK-383AMK			
Tacoma	17-16	Rear - 8.2" w/o Locking Diff	DRK-383	DRK-383MK			
Tacoma	17-16	Rear - 8.75" w/ Locking Diff	DRK-384A	DRK-384AMK			
Tacoma	17-16	Rear - 8.75" w/o Locking Diff	DRK-384	DRK-384MK			
Tacoma	15-10	Rear - 8" w/ Locking Diff	DRK-354B	DRK-354BMK			
Tacoma	15-05	Rear - 8.4" w/o Locking Diff	DRK-355	DRK-355MK			
Tacoma	09-02	Rear - 8" w/ Locking Diff	DRK-354A	DRK-354AMK	AK35	DRK-354AAK35	DRK-354AMKAK35
Tacoma	06-95	Rear - 7.5"	DRK-350	DRK-350MK	AK34	DRK-350AK34	DRK-350MKAK34
Tacoma	04-03	Rear - 8.4" w/o Locking Diff	DRK-355	DRK-355MK	AK35	DRK-355AK35	DRK-355MKAK35

▲ Add "S" suffix to kit number to receive stackable differential shims in kit.

# Light Duty Differential Applications



Make/Model	Year	Position/ Ring Gear Size	Standard Kit	Master Kit	Axle Kit	Standard Kit Plus	Master Kit Plus
<b>TOYOTA (cont'd)</b>							
Tacoma	2001	Rear - 8" w/ Locking Diff	DRK-354A	DRK-354AMK	AK35	DRK-354AAK35	DRK-354AMKAK35
Tacoma	2001	Rear - 8.4" w/o Locking Diff	DRK-355	DRK-355MK	AK35	DRK-355AK35	DRK-355MKAK35
Tacoma	00-96	Rear - 8" w/ Locking Diff w/ABS	DRK-354A	DRK-354AMK	AK34	DRK-354AAK34	DRK-354AMKAK34
Tacoma	00-96	Rear - 8" w/ Locking Diff w/o ABS	DRK-354A	DRK-354AMK	AK33	DRK-354AAK33	DRK-354AMKAK33
Tacoma	00-96	Rear - 8.4" w/o Locking Diff w/o ABS	DRK-355	DRK-355MK	AK33	DRK-355AK33	DRK-355MKAK33
Tacoma	00-96	Rear - 8.4" w/o Locking Diff w/ABS	DRK-355	DRK-355MK	AK34	DRK-355AK34	DRK-355MKAK34
Tacoma	1995	Rear - 8.4" w/o Locking Diff w/o ABS	DRK-355	DRK-355MK	AK33	DRK-355AK33	DRK-355MKAK33
Tacoma	1995	Rear - 8.4" w/o Locking Diff w/ABS	DRK-355	DRK-355MK	AK34	DRK-355AK34	DRK-355MKAK34
Tundra	15-07	Front - 9"	DRK-380	DRK-380MK ▲			
Tundra	06-00	Front - 7.5" IFS	DRK-350A	DRK-350AMK ▲			
Tundra	15-07	Rear - 10.5"	DRK-382	DRK-382MK ▲			
Tundra	15-07	Rear - 9.5"	DRK-381	DRK-381MK			
Tundra	06-00	Rear - 8.4"	DRK-355	DRK-355MK	AK35	DRK-355AK35	DRK-355MKAK35

LD Differential

# Light Duty Differential Rebuild Kits

<b>AK6</b>		
Position	Part Number	Qty
Axle Shaft Brg. (Inner)	28682-28622	2
Axle Shaft Brg. (Outer)	LM104949-LM104911	2
Axle Shaft Seal	417158 (2.875x3.876)	2
Axle Shaft Seal	455086 (3.000x4.250)	2

<b>AK10</b>		
Position	Part Number	Qty
Axle Shaft Brg.	R1559TV	2
Axle Shaft Seal	8835S (1.618x2.575)	2

<b>AK11</b>		
Position	Part Number	Qty
Axle Shaft Brg.	R1563TAV	2
Axle Shaft Seal	8660S (1.399x2.292)	2

<b>AK12</b>		
Position	Part Number	Qty
Axle Shaft Brg.	513067	2
Axle Shaft Seal	4762N (1.618x2.841)	2

<b>AK13</b>		
Position	Part Number	Qty
Axle Shaft Brg. (Inner)	45291-45220	2
Axle Shaft Brg. (Outer)	LM104949-LM104911	2
Axle Shaft Seal	710563 (72.5x108)	2

<b>AK14</b>		
Position	Part Number	Qty
Axle Shaft Brg.	513023	2
Axle Shaft Seal	4795V (1.399x2.482)	2

<b>AK15</b>		
Position	Part Number	Qty
Axle Shaft Brg.	R1561TV	2
Axle Shaft Seal	100357 (1.705x3.034)	2

<b>AK16</b>		
Position	Part Number	Qty
Axle Shaft Brg.	R1561TV	2
Axle Shaft Seal	710105 (1.705x3.080)	2

<b>AK17</b>		
Position	Part Number	Qty
Axle Shaft Brg.	R1561TV	2
Axle Shaft Seal	8835S (1.618x2.575)	2

<b>AK18</b>		
Position	Part Number	Qty
Axle Shaft Brg.	LM104949-LM104911	4
Axle Shaft Seal	4250 (2.500x3.303)	2

<b>AK21</b>		
Position	Part Number	Qty
Axle Shaft Brg. (Inner)	387AS-382A	2
Axle Shaft Brg. (Outer)	LM104949-LM104911	2
Axle Shaft Seal	2081 (2.843x3.939)	2

<b>AK22</b>		
Position	Part Number	Qty
Axle Shaft Brg.	R1561TV	2
Axle Shaft Seal	710067 (1.703x3.030)	2

<b>AK23</b>		
Position	Part Number	Qty
Axle Shaft Brg. (Inner)	387AS-382A	2
Axle Shaft Brg. (Outer)	LM104949-LM104911	2
Axle Shaft Seal	9864S (2.875x3.875)	2

<b>AK24</b>		
Position	Part Number	Qty
Axle Shaft Brg.	A9	2
Axle Shaft Seal	710179 (42x64.8)	2

<b>AK25</b>		
Position	Part Number	Qty
Axle Shaft Brg.	R1563TAV	2
Axle Shaft Seal (With Axle Code "C")	710166 (1.399x2.290)	2
Axle Shaft Seal (With Axle Code "K")	8660S (1.399x2.292)	2

<b>AK26</b>		
Position	Part Number	Qty
Axle Shaft Brg.	6410	2
Axle Shaft Seal	710498 (1.700x2.559)	2

<b>AK27</b>		
Position	Part Number	Qty
Axle Shaft Brg.	207	2
Axle Shaft Seal	DS48675	2

<b>AK29</b>		
Position	Part Number	Qty
Axle Shaft Brg. (Inner)	387AS-382A	2
Axle Shaft Brg. (Outer)	LM104949-LM104911	2
Axle Shaft Seal	710568 (2.854x3.932)	2

<b>AK30</b>		
Position	Part Number	Qty
Axle Shaft Brg. (Inner)	28682-28622	2
Axle Shaft Brg. (Outer)	LM104949-LM104911	2
Axle Shaft Seal	710564 (72.5x98.5)	2

<b>AK33</b>		
Position	Part Number	Qty
Axle Shaft Brg.	RW130R	2
Axle Shaft Seal (Outer)	1956 (48x62)	2
Axle Shaft Seal (Inner)	1960 (50x70)	2

<b>AK34</b>		
Position	Part Number	Qty
Axle Shaft Brg.	511021	2
Axle Shaft Seal (Outer)	1956 (48x62)	2
Axle Shaft Seal (Inner)	1960 (50x70)	2

<b>AK35</b>		
Position	Part Number	Qty
Axle Shaft Brg.	511031	2
Axle Shaft Seal (Inner)	1960 (50x70)	2
Axle Shaft Seal (Outer)	710574 (54x64)	2

<b>AK36</b>		
Position	Part Number	Qty
Axle Shaft Brg.	FC66998	2
Axle Shaft Seal	100537V (46x73)	2

<b>AK37</b>		
Position	Part Number	Qty
Axle Shaft Brg.	A9	2
Axle Shaft Seal	712146 (1.687x2.560)	2

<b>AK38</b>		
Position	Part Number	Qty
Axle Shaft Brg.	513067	2
Axle Shaft Seal	8835S (1.618x2.575)	2

<b>AK39</b>		
Position	Part Number	Qty
Axle Shaft Brg.	BH2212	2
Axle Shaft Seal	5872S (1.375x2.000)	2

<b>AK40</b>		
Position	Part Number	Qty
Axle Shaft Brg.	JLM603048F-JLM603013Z	4
Axle Shaft Seal (Inner)	470547 (2.882x3.431)	2
Axle Shaft Seal (Outer)	3942 (2.500x3.226)	2

<b>AK41</b>		
Position	Part Number	Qty
Axle Shaft Brg.	R1563TAV	1
Axle Shaft Seal (Left)	710043 (1.301x2.620)	1
Axle Shaft Seal (Right)	DS40773 (1.399x2.250)	1

<b>AK42</b>		
Position	Part Number	Qty
Axle Shaft Brg. (Inner)	387AS-382A	2
Axle Shaft Brg. (Outer)	LM104949-LM104911	2
Axle Shaft Seal	35009N (2.750x3.876)	2

<b>AK43</b>		
Position	Part Number	Qty
Axle Shaft Brg.	R1563TAV	2
Axle Shaft Seal	4857 (1.400x2.282)	2

<b>AK44</b>		
Position	Part Number	Qty
Axle Shaft Brg. (Inner)	NP080525-NP543803	2
Axle Shaft Brg. (Outer)	NP622157-NP382209	2
Axle Shaft Seal	SL260069	2

<b>AK45</b>		
Position	Part Number	Qty
Axle Shaft Brg. (Inner)	NP706218-NP910345	2
Axle Shaft Brg. (Outer)	NP706218-NP910345	2
Axle Shaft Seal	710568 (2.854x3.932)	2
Hub Gasket For Full Float	40000014	2

<b>AK46</b>		
Position	Part Number	Qty
Axle Shaft Brg. (Inner)	382A-387AS	2
Axle Shaft Brg. (Outer)	LM104949-LM104911	2
Axle Shaft Seal	370247A (2.955x3.875)	2

<b>AK47</b>		
Position	Part Number	Qty
Axle Shaft Brg.	A10	2
Axle Shaft Seal (Inner)	51098 (1.500x2.502)	2
Axle Shaft Seal (Outer)	9912 (1.875x2.877)	2

<b>AK48</b>		
Position	Part Number	Qty
Axle Shaft Brg. (Inner)	NP064306-NP114036	2
Axle Shaft Brg. (Outer)	LM104949-LM104911	2
Axle Shaft Seal	370247-A	2

<b>AK49</b>		
Position	Part Number	Qty
Axle Shaft Brg.	A9	2
Axle Shaft Seal (Inner)	473214 (1.375x2.250)	2
Axle Shaft Seal (Outer)	2146 (1.687x2.560)	2

<b>AK51</b>		
Position	Part Number	Qty
Axle Shaft Brg.	SET80	2
Axle Shaft Seal	710851 (54x80)	2

<b>AK52</b>		
Position	Part Number	Qty
Axle Shaft Seal	710068 (1.190x2.122)	2

<b>AK53</b>		
Position	Part Number	Qty
Axle Shaft Seal	DS54381 (1.223x2.128)	2

<b>AK54</b>		
Position	Part Number	Qty
Axle Shaft Seal	710888 (50x75)	2

<b>AK55</b>		
Position	Part Number	Qty
Axle Shaft Seal	92230620	2

<b>AK56</b>		
Position	Part Number	Qty
Axle Shaft Seal (Left)	92191956	1
Axle Shaft Seal (Right)	92191957	1

<b>AK57</b>		
Position	Part Number	Qty
Axle Shaft Seal	40011965	2

<b>AK58</b>		
Position	Part Number	Qty
Axle Shaft Brg.	513067	2
Axle Shaft Seal	23490372	2

<b>AK59</b>		
Position	Part Number	Qty
Axle Shaft Brg. (Outer)	NP706218-NP910345	2
Axle Shaft Brg. (Outer)	NP145100-NP913325	2
Axle Shaft Seal	710568 (2.854x3.932)	2

LD Differential



# Light Duty Differential Rebuild Kits



LD Differential

<b>AK81</b>		
Position	Part Number	Qty
Axle Shaft Brg.	SCH78	1
Axle Shaft Brg.	BH208	1
Axle Shaft Brg.	J2010	2
Axle Shaft Seal	710101 (1.250x2.398)	2

<b>AK83</b>		
Position	Part Number	Qty
Front Axle Clutch Shaft Brg.	SCH78	1
Front Axle Shaft Outer Brg.	BH208	1
Front Axle Shaft Inner Brg.	J2010	2
Axle Shaft Seal	710475	2

<b>AK84</b>		
Position	Part Number	Qty
Front Axle Shaft Inner Brg.	J2010	1
Front Axle Shaft Outer Brg.	BH208	1
Axle Shaft Seal	710475	2

<b>AK85</b>		
Position	Part Number	Qty
Axle Shaft Brg.	HK4012	2
Axle Shaft Seal	710548 (40x69)	2

<b>AK86</b>		
Position	Part Number	Qty
Front Axle Clutch Shaft Brg.	SCH78	2
Front Axle Shaft Inner Brg.	J2010	1
Front Axle Shaft Outer Brg.	HK4012	2
Axle Shaft Seal	710491 (40x69)	2

<b>AK87</b>		
Position	Part Number	Qty
Axle Shaft Brg. (Inner)	BH208	1
Axle Shaft Brg. (Outer)	HK4012	4
Axle Shaft Seal (Left)	40050495	1
Axle Shaft Seal (Right)	710688 (31.6x75)	1
Output Shaft Seal	710475	1
Disconnect Seal	710686 (40x69)	1

<b>AK88</b>		
Position	Part Number	Qty
Axle Shaft Brg.	FC66998	2
Front Axle Shaft Inner Brg.	HK1816B	1
Front Axle Shaft Outer Brg.	HK4012	1
Axle Shaft Seal	SL260030	2

<b>AK89</b>		
Position	Part Number	Qty
Axle Shaft Brg.	BH2212	2
Axle Shaft Seal	710429 (1.380x2.288)	2

<b>AK90</b>		
Position	Part Number	Qty
Axle Shaft Brg.	FC66998	2
Axle Shaft Seal	714569 (1.574x2.410)	2

<b>AK91</b>		
Position	Part Number	Qty
Axle Shaft Brg.	FC66998	2
Front Axle Shaft Inner Brg.	HK1816B	1
Front Axle Shaft Outer Brg.	HK4012	1
Axle Shaft Seal	100537V (46x73)	1

<b>AK92</b>		
Position	Part Number	Qty
Front Axle Shaft Pilot Brg.	SCH78	1
Front Axle Shaft Inner Brg.	B2610	2
Front Axle Shaft Outer Brg.	B2410	1
Axle Shaft Seal	710497 (41x61)	2
Axle Shaft Seal	710102 (1.625x2.400)	2

<b>AK93</b>		
Position	Part Number	Qty
Axle Shaft Brg. (Right)	R1563TAV	1
Axle Shaft Brg. (Left)	B268	1
Axle Shaft Seal (Left)	710429 (1.380x2.288)	1
Axle Shaft Seal (Right)	710428 (1.750x2.621)	1

<b>AK94</b>		
Position	Part Number	Qty
Axle Shaft Brg.	B2110	2
Axle Shaft Seal (Inner)	710492 (1.551x2.628)	2
Axle Shaft Seal (Outer)	710493 (2.750x4.500)	2

<b>AK95</b>		
Position	Part Number	Qty
Front Axle Clutch Shaft Brg.	SCH78	1
Axle Shaft Brg. (Left)	B2012	1
Axle Shaft Brg. (Right)	B2012	1
Axle Shaft Brg. (Inner)	B2012	1
Axle Shaft Seal	710101 (1.250x2.398)	2

<b>WK6</b>		
Position	Part Number	Qty
Axle Shaft Brg. (Inner)	28682-28622	1
Axle Shaft Brg. (Outer)	LM104949-LM104911	1
Axle Shaft Seal	417158(2.875x3.876)	1
Axle Shaft Seal	455086 (3.000x4.250)	1

<b>WK10</b>		
Position	Part Number	Qty
Axle Shaft Brg.	R1559TV	1
Axle Shaft Seal	8835S (1.618x2.575)	1

<b>WK11</b>		
Position	Part Number	Qty
Axle Shaft Brg.	R1563TAV	1
Axle Shaft Seal	8660S (1.399x2.292)	1

<b>WK12</b>		
Position	Part Number	Qty
Axle Shaft Brg.	513067	1
Axle Shaft Seal	4762N (1.618x2.841)	1

<b>WK13</b>		
Position	Part Number	Qty
Axle Shaft Brg. (Inner)	45291-45220	1
Axle Shaft Brg. (Outer)	LM104949-LM104911	1
Axle Shaft Seal	710563 (72.5x108)	1

<b>WK14</b>		
Position	Part Number	Qty
Axle Shaft Brg.	513023	1
Axle Shaft Seal	4795V (1.399x2.482)	1

<b>WK15</b>		
Position	Part Number	Qty
Axle Shaft Brg.	R1561TV	1
Axle Shaft Seal	100357 (1.705x3.034)	1

<b>WK16</b>		
Position	Part Number	Qty
Axle Shaft Brg.	R1561TV	1
Axle Shaft Seal	710105 (1.705x3.080)	1

<b>WK17</b>		
Position	Part Number	Qty
Axle Shaft Brg.	R1561TV	1
Axle Shaft Seal	8835S (1.618x2.575)	1

<b>WK18</b>		
Position	Part Number	Qty
Axle Shaft Brg.	LM104949-LM104911	2
Axle Shaft Seal	4250 (2.500x3.303)	1

<b>WK21</b>		
Position	Part Number	Qty
Axle Shaft Brg. (Inner)	387AS-387A	1
Axle Shaft Brg. (Outer)	LM104949-LM104911	1
Axle Shaft Seal	2081 (2.843x3.939)	1

<b>WK22</b>		
Position	Part Number	Qty
Axle Shaft Brg.	R1561TV	1
Axle Shaft Seal	710067 (1.703x3.030)	1

<b>WK23</b>		
Position	Part Number	Qty
Axle Shaft Brg. (Inner)	387AS-382A	1
Axle Shaft Brg. (Outer)	LM104949-LM104911	1
Axle Shaft Seal	9864S (2.875S3.875)	1

<b>WK24</b>		
Position	Part Number	Qty
Axle Shaft Brg.	A9	1
Axle Shaft Seal	710179 (42x64.8)	1

<b>WK25</b>		
Position	Part Number	Qty
Axle Shaft Brg.	R1563TAV	1
Axle Shaft Seal (With Axle Code "C")	710166 (1.399x2.290)	1
Axle Shaft Seal (With Axle Code "K")	8660S (1.399x2.292)	1

<b>WK26</b>		
Position	Part Number	Qty
Axle Shaft Brg.	6410	1
Axle Shaft Seal	710498 (1.700x2.559)	1

<b>WK27</b>		
Position	Part Number	Qty
Axle Shaft Brg.	207	1
Axle Shaft Seal	DS48675	1

<b>WK29</b>		
Position	Part Number	Qty
Axle Shaft Brg. (Inner)	387AS-382A	1
Axle Shaft Brg. (Outer)	LM104949-LM104911	1
Axle Shaft Seal	710568 (2.854x3.932)	1

<b>WK30</b>		
Position	Part Number	Qty
Axle Shaft Brg. (Outer)	LM104949-LM104911	1
Axle Shaft Brg. (Inner)	28682-28622	1
Axle Shaft Seal	710564 (72.5x98.5)	1

<b>WK33</b>		
Position	Part Number	Qty
Axle Shaft Brg.	RW130R	1
Axle Shaft Seal (Outer)	1956 (48x62)	1
Axle Shaft Seal (Inner)	1960 (50x70)	1

<b>WK34</b>		
Position	Part Number	Qty
Axle Shaft Brg.	511021	1
Axle Shaft Seal (Outer)	1956 (48x62)	1
Axle Shaft Seal (Inner)	1960 (50x70)	1

<b>WK35</b>		
Position	Part Number	Qty
Axle Shaft Brg.	511031	1
Axle Shaft Seal (Inner)	1960 (50x70)	1
Axle Shaft Seal (Outer)	710574 (54x64)	1

<b>WK36</b>		
Position	Part Number	Qty
Axle Shaft Brg.	FC66998	1
Axle Shaft Seal	100537V (46x73)	2

# Light Duty Differential Rebuild Kits

<b>WK37</b>		
Position	Part Number	Qty
Axle Shaft Brg.	A9	1
Axle Shaft Seal	712146 (1.687x2.560)	1

<b>WK38</b>		
Position	Part Number	Qty
Axle Shaft Brg.	513067	1
Axle Shaft Seal	8835S (1.618x2.575)	1

<b>WK40</b>		
Position	Part Number	Qty
Axle Shaft Brg.	JLM603048F-JLM603013Z	2
Axle Shaft Seal (Inner)	470547 (2.882x3.431)	1
Axle Shaft Seal (Outer)	3942 (2.500x3.226)	1

<b>WK42</b>		
Position	Part Number	Qty
Axle Shaft Brg. (Inner)	387AS-382A	1
Axle Shaft Brg. (Outer)	LM104949-LM104911	1
Axle Shaft Seal	35009N (2.750x3.876)	1

<b>WK43</b>		
Position	Part Number	Qty
Axle Shaft Brg.	R1563TAV	1
Axle Shaft Seal	4857 (1.400x2.282)	1

<b>WK44</b>		
Position	Part Number	Qty
Axle Shaft Brg. (Inner)	NP080525-NP543803	1
Axle Shaft Brg. (Outer)	NP622157-NP382209	1
Axle Shaft Seal	SL260069	1

<b>WK45</b>		
Position	Part Number	Qty
Axle Shaft Brg. (Inner)	NP706218-NP910345	1
Axle Shaft Brg. (Outer)	NP706218-NP910345	1
Axle Shaft Seal	710568 (2.854x3.932)	1
Hub Gasket For Full Float	40000014	1

<b>WK46</b>		
Position	Part Number	Qty
Axle Shaft Brg. (Inner)	382A-387AS	1
Axle Shaft Brg. (Outer)	LM104949-LM104911	1
Axle Shaft Seal	370247A (2.955x3.875)	1

<b>WK47</b>		
Position	Part Number	Qty
Axle Shaft Brg.	A10	1
Axle Shaft Seal (Inner)	51098 (1.500x2.502)	1
Axle Shaft Seal (Outer)	9912 (1.875x2.877)	1

<b>WK48</b>		
Position	Part Number	Qty
Axle Shaft Brg. (Inner)	NP064306-NP114036	1
Axle Shaft Brg. (Outer)	LM104949-LM104911	1
Axle Shaft Seal	370247-A	1

<b>WK49</b>		
Position	Part Number	Qty
Axle Shaft Brg.	A9	1
Axle Shaft Seal (Inner)	473214 (1.375x2.250)	1
Axle Shaft Seal (Outer)	2146 (1.687x2.560)	1

<b>WK51</b>		
Position	Part Number	Qty
Axle Shaft Brg.	SET80	1
Axle Shaft Seal	710851 (54x80)	1

<b>WK58</b>		
Position	Part Number	Qty
Axle Shaft Brg.	513067	1
Axle Shaft Seal	23490372	1

<b>WK59</b>		
Position	Part Number	Qty
Axle Shaft Brg. (Outer)	NP706218-NP910345	1
Axle Shaft Brg. (Outer)	NP145100-NP913325	1
Axle Shaft Seal	710568 (2.854x3.932)	1

<b>DRK-300</b>		
Position	Part Number	Qty
Differential Brg.	25590-25520	2
Pinion Head Brg.	HM803149-HM803110	1
Pinion Tail Brg.	HM89443-HM89410	1
Pinion Seal	7216 (1.875x3.105)	1
Pinion Nut	PN8-F	1
Gear Marking & Brush	GMC1-BR1	1
Threadlocker	TL1	1
Sealer	RTV Silicone	1

<b>DRK-300MK</b>		
Position	Part Number	Qty
Differential Brg.	25590-25520	2
Pinion Head Brg.	HM803149-HM803110	1
Pinion Tail Brg.	HM89443-HM89410	1
Pinion Seal	7216 (1.875x3.105)	1
Pinion Nut	PN8-F	1
Gear Marking & Brush	GMC1-BR1	1
Threadlocker	TL1	1
Sealer	RTV Silicone	1
Pinion Brg. Shims	SK2	1
Pinion Depth Shims	SK1	1
Ring Gear Bolts	RGB1	12

<b>DRK-301</b>		
Position	Part Number	Qty
Differential Brg.	LM104949-LM104912	2
Pinion Head Brg.	M804049-M804010	1
Pinion Tail Brg.	M88048-M88010	1
Pinion Seal	5126 (1.875x2.813)	1
Crush Sleeve	CS301	1
Pinion Nut	PN8-F	1
Pinion Nut	PN3	1
Gear Marking & Brush	GMC1-BR1	1
Threadlocker	TL1	1
Sealer	RTV Silicone	1

<b>DRK-301MK</b>		
Position	Part Number	Qty
Differential Brg.	LM104949-LM104912	2
Pinion Head Brg.	M804049-M804010	1
Pinion Tail Brg.	M88048-M88010	1
Pinion Seal	5126 (1.875x2.813)	1
Crush Sleeve	CS301	1
Pinion Nut	PN8-F	1
Pinion Nut	PN3	1
Gear Marking & Brush	GMC1-BR1	1
Threadlocker	TL1	1
Sealer	RTV Silicone	1
Pinion Depth Shims	SK3	1
Ring Gear Bolts	RGB1	12

<b>DRK-301A</b>		
Position	Part Number	Qty
Differential Brg.	LM104949-LM104912	2
Pinion Head Brg.	HM89446-HM89410	1
Pinion Tail Brg.	M88048-M88010	1
Pinion Seal	5126 (1.875x2.813)	1
Crush Sleeve	CS301	1
Pinion Nut	PN8-F	1
Pinion Nut	PN3	1
Gear Marking & Brush	GMC1-BR1	1
Threadlocker	TL1	1
Sealer	RTV Silicone	1

<b>DRK-301AMK</b>		
Position	Part Number	Qty
Differential Brg.	LM104949-LM104912	2
Pinion Head Brg.	HM89446-HM89410	1
Pinion Tail Brg.	M88048-M88010	1
Pinion Seal	5126 (1.875x2.813)	1
Crush Sleeve	CS301	1
Pinion Nut	PN8-F	1
Pinion Nut	PN3	1
Gear Marking & Brush	GMC1-BR1	1
Threadlocker	TL1	1
Sealer	RTV Silicone	1
Pinion Depth Shims	SK3	1
Ring Gear Bolts	RGB1	12

<b>DRK-302</b>		
Position	Part Number	Qty
Differential Brg.	LM501349-LM501310	2
Pinion Head Brg.	HM88649-HM88610	1
Pinion Tail Brg.	M86649-M86610	1
Pinion Seal	8516N (1.687x2.623)	1
Crush Sleeve	CS310	1
Pinion Nut	PN3	1
Gear Marking & Brush	GMC1-BR1	1
Threadlocker	TL1	1
Sealer	RTV Silicone	1

<b>DRK-302MK</b>		
Position	Part Number	Qty
Differential Brg.	LM501349-LM501310	2
Pinion Head Brg.	HM88649-HM88610	1
Pinion Tail Brg.	M86649-M86610	1
Pinion Seal	8516N (1.687x2.623)	1
Crush Sleeve	CS310	1
Pinion Nut	PN3	1
Gear Marking & Brush	GMC1-BR1	1
Threadlocker	TL1	1
Sealer	RTV Silicone	1
Pinion Depth Shims	SK12	1
Ring Gear Bolts	RGB1	8

<b>DRK-303</b>		
Position	Part Number	Qty
Differential Brg.	LM603049-LM603012	2
Pinion Head Brg.	M802048-M802011	1
Pinion Tail Brg.	M86649-M86610	1
Pinion Seal	8516N (1.687x2.623)	1
Crush Sleeve	CS310	1
Pinion Nut	PN3	1
Gear Marking & Brush	GMC1-BR1	1
Threadlocker	TL1	1
Sealer	RTV Silicone	1

<b>DRK-303MK</b>		
Position	Part Number	Qty
Differential Brg.	LM603049-LM603012	2
Pinion Head Brg.	M802048-M802011	1
Pinion Tail Brg.	M86649-M86610	1
Pinion Seal	8516N (1.687x2.623)	1
Crush Sleeve	CS310	1
Pinion Nut	PN3	1
Gear Marking & Brush	GMC1-BR1	1
Threadlocker	TL1	1
Sealer	RTV Silicone	1
Pinion Depth Shims	SK4	1
Ring Gear Bolts	RGB1	10

<b>DRK-303A</b>		
Position	Part Number	Qty
Differential Brg.	LM603049-LM603012	2
Pinion Head Brg.	M802048-M802011	1
Pinion Tail Brg.	M86649-M86610	1
Pinion Seal	5126 (1.875x2.813)	1
Crush Sleeve	CS310	1
Pinion Nut	PN3	1
Gear Marking & Brush	GMC1-BR1	1
Threadlocker	TL1	1
Sealer	RTV Silicone	1

LD Differential

# Light Duty Differential Rebuild Kits



DRK-303AMK		
Position	Part Number	Qty
Differential Brg.	LM603049-LM603012	2
Pinion Head Brg.	M802048-M802011	1
Pinion Tail Brg.	M86649-M86610	1
Pinion Seal	5126 (1.875x2.813)	1
Crush Sleeve	CS310	1
Pinion Nut	PN3	1
Gear Marking & Brush	GMC1-BR1	1
Threadlocker	TL1	1
Sealer	RTV Silicone	1
Pinion Depth Shims	SK4	1
Ring Gear Bolts	RGB1	10

DRK-303B		
Position	Part Number	Qty
Differential Brg.	LM603049-LM603012	2
Pinion Head Brg.	M802048-M802011	1
Pinion Tail Brg.	M86649-M86610	1
Pinion Seal	710480 (44x66.4)	1
Crush Sleeve	CS310	1
Pinion Nut	PN3	1
Gear Marking & Brush	GMC1-BR1	1
Threadlocker	TL1	1
Sealer	RTV Silicone	1

DRK-303BMK		
Position	Part Number	Qty
Differential Brg.	LM603049-LM603012	2
Pinion Head Brg.	M802048-M802011	1
Pinion Tail Brg.	M86649-M86610	1
Pinion Seal	710480 (44x66.4)	1
Crush Sleeve	CS310	1
Pinion Nut	PN3	1
Gear Marking & Brush	GMC1-BR1	1
Threadlocker	TL1	1
Sealer	RTV Silicone	1
Pinion Depth Shims	SK4	1
Ring Gear Bolts	RGB1	10

DRK-304		
Position	Part Number	Qty
Differential Brg.	JLM704649-JLM704610	2
Pinion Head Brg.	M804049-M804010	1
Pinion Tail Brg.	M88048-M88010	1
Pinion Seal	5126 (1.875x2.813)	1
Crush Sleeve	CS303	1
Pinion Nut	PN3	1
Gear Marking & Brush	GMC1-BR1	1
Threadlocker	TL1	1
Sealer	RTV Silicone	1

DRK-304MK		
Position	Part Number	Qty
Differential Brg.	JLM704649-JLM704610	2
Pinion Head Brg.	M804049-M804010	1
Pinion Tail Brg.	M88048-M88010	1
Pinion Seal	5126 (1.875x2.813)	1
Crush Sleeve	CS303	1
Pinion Nut	PN3	1
Gear Marking & Brush	GMC1-BR1	1
Threadlocker	TL1	1
Sealer	RTV Silicone	1
Pinion Depth Shims	SK3	1
Ring Gear Bolts	RGB2	12

DRK-304A		
Position	Part Number	Qty
Differential Brg.	JLM704649-JLM704610	2
Pinion Head Brg.	NP524102-NP912904	1
Pinion Tail Brg.	M88048-M88010	1
Pinion Seal	710481 (1.893x2.811)	1
Crush Sleeve	CS303	1
Pinion Nut	PN3	1
Gear Marking & Brush	GMC1-BR1	1
Threadlocker	TL1	1
Sealer	RTV Silicone	1

DRK-304AMK		
Position	Part Number	Qty
Differential Brg.	JLM704649-JLM704610	2
Pinion Head Brg.	NP524102-NP912904	1
Pinion Tail Brg.	M88048-M88010	1
Pinion Seal	710481 (1.893x2.811)	1
Crush Sleeve	CS303	1
Pinion Nut	PN3	1
Gear Marking & Brush	GMC1-BR1	1
Threadlocker	TL1	1
Sealer	RTV Silicone	1
Pinion Depth Shims	SK3	1
Ring Gear Bolts	RGB2	12

DRK-305		
Position	Part Number	Qty
Differential Brg.	LM102949-LM102911	2
Pinion Head Brg.	NP722065-NP013743	1
Pinion Tail Brg.	M88048-M88010	1
Pinion Seal	710476 (1.720x2.921)	1
Crush Sleeve	CS303	1
Pinion Nut	PN3	1
Gear Marking & Brush	GMC1-BR1	1
Threadlocker	TL1	1
Sealer	RTV Silicone	1

DRK-305MK		
Position	Part Number	Qty
Differential Brg.	LM102949-LM102911	2
Pinion Head Brg.	NP722065-NP013743	1
Pinion Tail Brg.	M88048-M88010	1
Pinion Seal	710476 (1.720x2.921)	1
Crush Sleeve	CS303	1
Pinion Nut	PN3	1
Gear Marking & Brush	GMC1-BR1	1
Threadlocker	TL1	1
Sealer	RTV Silicone	1
Pinion Depth Shims	SK20	1
Differential Shims	SK11 <sup>28</sup>	1
Ring Gear Bolts	RGB1	10

DRK-305A		
Position	Part Number	Qty
Differential Brg.	LM102949-LM102911	2
Pinion Head Brg.	NP682887-NP307044	1
Pinion Tail Brg.	NP270758-NP378971	1
Pinion Seal	710836 (43x77)	1
Crush Sleeve	CS303	1
Pinion Nut	PN3	1
Gear Marking & Brush	GMC1-BR1	1
Threadlocker	TL1	1
Sealer	RTV Silicone	1

DRK-305AMK		
Position	Part Number	Qty
Differential Brg.	LM102949-LM102911	2
Pinion Head Brg.	NP682887-NP307044	1
Pinion Tail Brg.	NP270758-NP378971	1
Pinion Seal	710836 (43x77)	1
Crush Sleeve	CS303	1
Pinion Nut	PN3	1
Gear Marking & Brush	GMC1-BR1	1
Threadlocker	TL1	1
Sealer	RTV Silicone	1
Pinion Depth Shims	SK20	1
Differential Shims	SK11 <sup>28</sup>	1
Ring Gear Bolts	RGB1	10

DRK-305B		
Position	Part Number	Qty
Differential Brg.	LM102949-LM102911	2
Pinion Head Brg.	NP682887-NP013743	1
Pinion Tail Brg.	M88048-M88010	1
Pinion Seal	710476 (1.720x2.921)	1
Crush Sleeve	CS303	1
Pinion Nut	PN3	1
Gear Marking & Brush	GMC1-BR1	1
Threadlocker	TL1	1
Sealer	RTV Silicone	1

DRK-305BMK		
Position	Part Number	Qty
Differential Brg.	LM102949-LM102911	2
Pinion Head Brg.	NP682887-NP013743	1
Pinion Tail Brg.	M88048-M88010	1
Pinion Seal	710476 (1.720x2.921)	1
Crush Sleeve	CS303	1
Pinion Nut	PN3	1
Gear Marking & Brush	GMC1-BR1	1
Threadlocker	TL1	1
Sealer	RTV Silicone	1
Pinion Depth Shims	SK20	1
Differential Shims	SK11 <sup>28</sup>	1
Ring Gear Bolts	RGB1	10

DRK-306		
Position	Part Number	Qty
Differential Brg.	387AS-382A	2
Pinion Head Brg.	NP598002-NP284552	1
Pinion Tail Brg.	M802048-M802011	1
Pinion Seal	710508 (2.324x3.541)	1
Crush Sleeve	CS347	1
Pinion Nut	PN17	1
Gear Marking & Brush	GMC1-BR1	1
Threadlocker	TL1	1
Sealer	RTV Silicone	1

DRK-306MK		
Position	Part Number	Qty
Differential Brg.	387AS-382A	2
Pinion Head Brg.	NP598002-NP284552	1
Pinion Tail Brg.	M802048-M802011	1
Pinion Seal	710508 (2.324x3.541)	1
Crush Sleeve	CS347	1
Pinion Nut	PN17	1
Gear Marking & Brush	GMC1-BR1	1
Threadlocker	TL1	1
Sealer	RTV Silicone	1
Pinion Depth Shims	SK3	1
Ring Gear Bolts	RGB21	12

DRK-307		
Position	Part Number	Qty
Differential Brg.	LM806649-LM806610	2
Pinion Head Brg.	HM803146-HM803110	1
Pinion Tail Brg.	M88043-M88010	1
Pinion Seal	5103900AA	1
Crush Sleeve	CS352	1
Pinion Nut	PN19	1
Gear Marking & Brush	GMC1-BR1	1
Threadlocker	TL1	1
Sealer	RTV Silicone	1

LD Differential

# Light Duty Differential Rebuild Kits

DRK-307MK		
Position	Part Number	Qty
Differential Brg.	LM806649-LM806610	2
Pinion Head Brg.	HM803146-HM803110	1
Pinion Tail Brg.	M88043-M88010	1
Pinion Seal	5103900AA	1
Crush Sleeve	CS352	1
Pinion Nut	PN19	1
Gear Marking & Brush	GMC1-BR1	1
Threadlocker	TL1	1
Sealer	RTV Silicone	1
Pinion Depth Shims	SK1	1
Differential Shims	SK13 <sup>54</sup>	1
Ring Gear Bolts	RGB26	10

DRK-307A		
Position	Part Number	Qty
Differential Brg.	32012-JR/1B	2
Pinion Head Brg.	T7FC045	1
Pinion Tail Brg.	30307-DJR	1
Pinion Seal	68019031AB	1
Crush Sleeve	CS354	1
Pinion Nut	PN21	1
Gear Marking & Brush	GMC1-BR1	1
Threadlocker	TL1	1
Sealer	RTV Silicone	1

DRK-307AMK		
Position	Part Number	Qty
Differential Brg.	32012-JR/1B	2
Pinion Head Brg.	T7FC045	1
Pinion Tail Brg.	30307-DJR	1
Pinion Seal	68019031AB	1
Crush Sleeve	CS354	1
Pinion Nut	PN21	1
Gear Marking & Brush	GMC1-BR1	1
Threadlocker	TL1	1
Sealer	RTV Silicone	1
Pinion Depth Shims	SK1	1
Differential Shims	SK13 <sup>54</sup>	1

DRK-307B		
Position	Part Number	Qty
Differential Brg.	LM806649-LM806610	2
Pinion Head Brg.	HM803146-HM803110	1
Pinion Tail Brg.	M88043-M88010	1
Pinion Seal	5103900AA	1
Crush Sleeve	CS363	1
Pinion Nut	PN19	1
Gear Marking & Brush	GMC1-BR1	1
Threadlocker	TL1	1
Sealer	RTV Silicone	1

DRK-307BMK		
Position	Part Number	Qty
Differential Brg.	LM806649-LM806610	2
Pinion Head Brg.	HM803146-HM803110	1
Pinion Tail Brg.	M88043-M88010	1
Pinion Seal	5103900AA	1
Crush Sleeve	CS363	1
Pinion Nut	PN19	1
Gear Marking & Brush	GMC1-BR1	1
Threadlocker	TL1	1
Sealer	RTV Silicone	1
Pinion Depth Shims	SK1	1
Differential Shims	SK13 <sup>54</sup>	1
Ring Gear Bolts	RGB26	10

DRK-308		
Position	Part Number	Qty
Differential Brg.	LM603049-LM603012/2DYR1	2
Pinion Head Brg.	HM803146-HM803110	1
Pinion Tail Brg.	M88043-M88010	1
Pinion Seal	710839 (40x72)	1
Crush Sleeve	CS304	1
Pinion Nut	PN19	1
Gear Marking & Brush	GMC1-BR1	1
Threadlocker	TL1	1
Sealer	RTV Silicone	1

DRK-310		
Position	Part Number	Qty
Differential Brg.	LM501349-LM501310	2
Pinion Head Brg.	M86649-M86610	1
Pinion Tail Brg.	M86649-M86610	1
Pinion Nose Brg.	R1558TAV	1
Pinion Seal	8181NA (1.812x2.623)	1
Crush Sleeve	CS310	1
Pinion Nut	PN2	1
Gear Marking & Brush	GMC1-BR1	1
Threadlocker	TL1	1
Sealer	RTV Silicone	1
O-Ring	OR241	1

DRK-310MK		
Position	Part Number	Qty
Differential Brg.	LM501349-LM501310	2
Pinion Head Brg.	M86649-M86610	1
Pinion Tail Brg.	M86649-M86610	1
Pinion Nose Brg.	R1558TAV	1
Pinion Seal	8181NA (1.812x2.623)	1
Crush Sleeve	CS310	1
Pinion Nut	PN2	1
Gear Marking & Brush	GMC1-BR1	1
Threadlocker	TL1	1
Sealer	RTV Silicone	1
Pinion Depth Shims	SK6	1
Ring Gear Bolts	RGB3	10
O-Ring	OR241	1

DRK-311		
Position	Part Number	Qty
Differential Brg.	LM603049-LM603012	2
Pinion Head Brg.	M802048-M802011	1
Pinion Tail Brg.	M88048-M88010	1
Pinion Seal	3604 (1.812x2.777)	1
Crush Sleeve	CS311	1
Pinion Nut	PN2	1
Gear Marking & Brush	GMC1-BR1	1
Threadlocker	TL1	1
Sealer	RTV Silicone	1

DRK-311MK		
Position	Part Number	Qty
Differential Brg.	LM603049-LM603012	2
Pinion Head Brg.	M802048-M802011	1
Pinion Tail Brg.	M88048-M88010	1
Pinion Seal	3604 (1.812x2.777)	1
Crush Sleeve	CS311	1
Pinion Nut	PN2	1
Gear Marking & Brush	GMC1-BR1	1
Threadlocker	TL1	1
Sealer	RTV Silicone	1
Pinion Depth Shims	SK4	1
Differential Shims	SK7 <sup>27</sup>	1
Ring Gear Bolts	RGB3	10

DRK-311E		
Position	Part Number	Qty
Differential Brg.	LM603049-LM603012	2
Pinion Head Brg.	STD4183KELFT	1
Pinion Tail Brg.	M88048-M88010	1
Pinion Seal	3604 (1.812x2.777)	1
Crush Sleeve	CS311	1
Pinion Nut	PN2	1
Gear Marking & Brush	GMC1-BR1	1
Threadlocker	TL1	1
Sealer	RTV Silicone	1

DRK-311EMK		
Position	Part Number	Qty
Differential Brg.	LM603049-LM603012	2
Pinion Head Brg.	STD4183KELFT	1
Pinion Tail Brg.	M88048-M88010	1
Pinion Seal	3604 (1.812x2.777)	1
Crush Sleeve	CS311	1
Pinion Nut	PN2	1
Gear Marking & Brush	GMC1-BR1	1
Threadlocker	TL1	1
Sealer	RTV Silicone	1
Pinion Depth Shims	SK4	1
Differential Shims	SK7 <sup>27</sup>	1
Ring Gear Bolts	RGB3	10

DRK-311G		
Position	Part Number	Qty
Differential Brg.	LM603049-LM603012	2
Pinion Head Brg.	STD4183KELFT	1
Pinion Tail Brg.	NP966883-NP759177	1
Pinion Seal	3604 (1.812x2.777)	1
Crush Sleeve	CS311	1
Pinion Nut	PN2	1
Gear Marking & Brush	GMC1-BR1	1
Threadlocker	TL1	1
Sealer	RTV Silicone	1

DRK-311GMK		
Position	Part Number	Qty
Differential Brg.	LM603049-LM603012	2
Pinion Head Brg.	STD4183KELFT	1
Pinion Tail Brg.	NP966883-NP759177	1
Pinion Seal	3604 (1.812x2.777)	1
Crush Sleeve	CS311	1
Pinion Nut	PN2	1
Gear Marking & Brush	GMC1-BR1	1
Threadlocker	TL1	1
Sealer	RTV Silicone	1
Pinion Depth Shims	SK4	1
Differential Shims	SK7 <sup>27</sup>	1
Ring Gear Bolts	RGB3	10

DRK-311H		
Position	Part Number	Qty
Differential Brg.	LM603049-LM603012	2
Pinion Head Brg.	M802048-M802011	1
Pinion Tail Brg.	M88048-M88010	1
Pinion Seal	714675 (1.843x2.748)	1
Crush Sleeve	CS311	1
Pinion Nut	PN6	1
Gear Marking & Brush	GMC1-BR1	1
Threadlocker	TL1	1
Sealer	RTV Silicone	1
O-Ring	OR-213S	6

LD Differential

<sup>27</sup> Order SSK7 for stackable differential shims. <sup>54</sup> Order SSK13 for stackable differential shims.



# Light Duty Differential Rebuild Kits



DRK-311HMK		
Position	Part Number	Qty
Differential Brg.	LM603049-LM603012	2
Pinion Head Brg.	M802048-M802011	1
Pinion Tail Brg.	M88048-M88010	1
Pinion Seal	714675 (1.843x2.748)	1
Crush Sleeve	CS311	1
Pinion Nut	PN6	1
Gear Marking & Brush	GMC1-BR1	1
Threadlocker	TL1	1
Sealer	RTV Silicone	1
Differential Shims	SK21	2
Pinion Brg. Shims	SK4	1
Ring Gear Bolts	RGB2	8
O-Ring	OR-213S	6

DRK-311J		
Position	Part Number	Qty
Differential Brg.	LM603049-LM603012	2
Pinion Head Brg.	M802048-M802011	1
Pinion Tail Brg.	M88048-M88010	1
Pinion Seal	470331N (1.843x2.750)	1
Crush Sleeve	CS311	1
Pinion Nut	PN6	1
Gear Marking & Brush	GMC1-BR1	1
Threadlocker	TL1	1
Sealer	RTV Silicone	1

DRK-311JMK		
Position	Part Number	Qty
Differential Brg.	LM603049-LM603012	2
Pinion Head Brg.	M802048-M802011	1
Pinion Tail Brg.	M88048-M88010	1
Pinion Seal	470331N (1.843x2.750)	1
Crush Sleeve	CS311	1
Pinion Nut	PN6	1
Gear Marking & Brush	GMC1-BR1	1
Threadlocker	TL1	1
Sealer	RTV Silicone	1
Pinion Depth Shims	SK4	1
Differential Shims	SK7 <sup>27</sup>	1
Ring Gear Bolts	RGB3	8

DRK-311K		
Position	Part Number	Qty
Differential Brg.	LM603049-LM603012	2
Pinion Head Brg.	ST4190LFT	1
Pinion Tail Brg.	M88048-M88010	1
Pinion Seal	3604 (1.812x2.777)	1
Crush Sleeve	CS311	1
Pinion Nut	PN2	1
Gear Marking & Brush	GMC1-BR1	1
Threadlocker	TL1	1
Sealer	RTV Silicone	1

DRK-311KMK		
Position	Part Number	Qty
Differential Brg.	LM603049-LM603012	2
Pinion Head Brg.	ST4190LFT	1
Pinion Tail Brg.	M88048-M88010	1
Pinion Seal	3604 (1.812x2.777)	1
Crush Sleeve	CS311	1
Pinion Nut	PN2	1
Gear Marking & Brush	GMC1-BR1	1
Threadlocker	TL1	1
Sealer	RTV Silicone	1
Pinion Depth Shims	SK4	1
Differential Shims	SK7 <sup>27</sup>	1
Ring Gear Bolts	RGB3	10

DRK-311L		
Position	Part Number	Qty
Differential Brg.	LM603049-LM603012	2
Pinion Head Brg.	ST4190LFT	1
Pinion Tail Brg.	NP966883-NP759177	1
Pinion Seal	3604 (1.812x2.777)	1
Crush Sleeve	CS311	1
Pinion Nut	PN2	1
Gear Marking & Brush	GMC1-BR1	1
Threadlocker	TL1	1
Sealer	RTV Silicone	1

DRK-311LMK		
Position	Part Number	Qty
Differential Brg.	LM603049-LM603012	2
Pinion Head Brg.	ST4190LFT	1
Pinion Tail Brg.	NP966883-NP759177	1
Pinion Seal	3604 (1.812x2.777)	1
Crush Sleeve	CS311	1
Pinion Nut	PN2	1
Gear Marking & Brush	GMC1-BR1	1
Threadlocker	TL1	1
Sealer	RTV Silicone	1
Pinion Depth Shims	SK4	1
Differential Shims	SK7 <sup>27</sup>	1
Ring Gear Bolts	RGB3	10

DRK-311N		
Position	Part Number	Qty
Differential Brg.	LM603049-LM603012	2
Pinion Head Brg.	NP559445-NP945727	1
Pinion Tail Brg.	M88048-M88010	1
Pinion Seal	3604 (1.812x2.777)	1
Crush Sleeve	CS311	1
Pinion Nut	PN2	1
Gear Marking & Brush	GMC1-BR1	1
Threadlocker	TL1	1
Sealer	RTV Silicone	1

DRK-311NMK		
Position	Part Number	Qty
Differential Brg.	LM603049-LM603012	2
Pinion Head Brg.	NP559445-NP945727	1
Pinion Tail Brg.	M88048-M88010	1
Pinion Seal	3604 (1.812x2.777)	1
Crush Sleeve	CS311	1
Pinion Nut	PN2	1
Gear Marking & Brush	GMC1-BR1	1
Threadlocker	TL1	1
Sealer	RTV Silicone	1
Pinion Depth Shims	SK4	1
Differential Shims	SK7 <sup>27</sup>	1
Ring Gear Bolts	RGB3	10

DRK-311Q		
Position	Part Number	Qty
Differential Brg.	ST5183	2
Pinion Head Brg.	KEST5195LFT	1
Pinion Tail Brg.	STD3776-2	1
Pinion Seal	4278 (1.812x3.091)	1
Crush Sleeve	CS316C	1
Pinion Nut	PN13	1
Pinion Depth Shims	SK41	1
Differential Shims	SK42 <sup>52</sup>	1
Gear Marking & Brush	GMC1-BR1	1
Threadlocker	TL1	1
Sealer	RTV Silicone	1
Ring Gear Bolts	RGB3	10

DRK-311S		
Position	Part Number	Qty
Differential Brg.	ST5183	2
Pinion Head Brg.	KEST5195LFT	1
Pinion Tail Brg.	HM89448-HM89411	1
Pinion Seal	4278 (1.812x3.091)	1
Crush Sleeve	CS316C	1
Pinion Nut	PN13	1
Gear Marking & Brush	GMC1-BR1	1
Threadlocker	TL1	1
Sealer	RTV Silicone	1

DRK-311SMK		
Position	Part Number	Qty
Differential Brg.	ST5183	2
Pinion Head Brg.	KEST5195LFT	1
Pinion Tail Brg.	HM89448-HM89411	1
Pinion Seal	4278 (1.812x3.091)	1
Crush Sleeve	CS316C	1
Pinion Nut	PN13	1
Pinion Depth Shims	SK41	1
Differential Shims	SK42 <sup>52</sup>	1
Gear Marking & Brush	GMC1-BR1	1
Threadlocker	TL1	1
Sealer	RTV Silicone	1
Ring Gear Bolts	RGB3	10

DRK-312		
Position	Part Number	Qty
Differential Brg.	LM501349-LM501310	2
Pinion Head Brg.	M88048-M88010	1
Pinion Tail Brg.	M88048-M88010	1
Pinion Nose Brg.	R1535TAV	1
Pinion Nose Brg.	R1535-CLIP	1
Retainer		
Pinion Seal	7044NA (1.812x3.000)	1
Crush Sleeve	CS311	1
Pinion Nut	PN2	1
Gear Marking & Brush	GMC1-BR1	1
Threadlocker	TL1	1
Sealer	RTV Silicone	1
O-Ring	OR248	1

DRK-312MK		
Position	Part Number	Qty
Differential Brg.	LM501349-LM501310	2
Pinion Head Brg.	M88048-M88010	1
Pinion Tail Brg.	M88048-M88010	1
Pinion Nose Brg.	R1535TAV	1
Pinion Nose Brg.	R1535-CLIP	1
Retainer		
Pinion Seal	7044NA (1.812x3.000)	1
Crush Sleeve	CS311	1
Pinion Nut	PN2	1
Gear Marking & Brush	GMC1-BR1	1
Threadlocker	TL1	1
Sealer	RTV Silicone	1
Pinion Depth Shims	SK8	1
Ring Gear Bolts	RGB4	10
O-Ring	OR248	1

DRK-313		
Position	Part Number	Qty
Differential Brg.	LM102949-LM102910	2
Pinion Head Brg.	M88048-M88010	1
Pinion Tail Brg.	M88048-M88010	1
Pinion Nose Brg.	R1535TAV	1
Pinion Nose Brg.	R1535-CLIP	1
Retainer		
Pinion Seal	7044NA (1.812x3.000)	1
Pinion Seal	3604 (1.812x2.777)	1
Crush Sleeve	CS311	1
Pinion Nut	PN2	1
Gear Marking & Brush	GMC1-BR1	1
Threadlocker	TL1	1
Sealer	RTV Silicone	1
O-Ring	OR248	1

LD Differential



# Light Duty Differential Rebuild Kits

DRK-313MK			DRK-313BMK			DRK-313DMK		
Position	Part Number	Qty	Position	Part Number	Qty	Position	Part Number	Qty
Differential Brg.	LM102949-LM102910	2	Differential Brg.	LM104949-LM104911	2	Differential Brg.	LM104949-LM104911	2
Pinion Head Brg.	M88048-M88010	1	Pinion Head Brg.	HM89443-HM89410	1	Pinion Head Brg.	HM89444-HM89410	1
Pinion Tail Brg.	M88048-M88010	1	Pinion Tail Brg.	M88048-M88010	1	Pinion Tail Brg.	M88048-M88010	1
Pinion Nose Brg.	R1535TAV	1	Pinion Nose Brg.	R1535TAV	1	Pinion Nose Brg.	R1535TAV	1
Pinion Nose Brg.	R1535-CLIP	1	Pinion Nose Brg.	R1535-CLIP	1	Pinion Nose Brg.	R1535-CLIP	1
Retainer			Retainer			Retainer		
Pinion Seal	7044NA (1.812x3.000)	1	Pinion Seal	7044NA (1.812x3.000)	1	Pinion Seal	7044NA (1.812x3.000)	1
Pinion Seal	3604 (1.812x2.777)	1	Solid Spacer Kit	SS9	1	Solid Spacer Kit	SS9	1
Crush Sleeve	CS311	1	Pinion Nut	PN2	1	Pinion Nut	PN2	1
Pinion Nut	PN2	1	Gear Marking & Brush	GMC1-BR1	1	Gear Marking & Brush	GMC1-BR1	1
Gear Marking & Brush	GMC1-BR1	1	Threadlocker	TL1	1	Threadlocker	TL1	1
Threadlocker	TL1	1	Sealer	GR-F900	1	Sealer	RTV Silicone	1
Sealer	RTV Silicone	1	Pinion Depth Shims	SK8	1	O-Ring	OR248	1
Pinion Depth Shims	SK8	1	Ring Gear Bolts	RGB4	10	Pinion Depth Shims	SK8	1
Ring Gear Bolts	RGB4	10	O-Ring	OR248	1	Ring Gear Bolts	RGB4	10
O-Ring	OR248	1	Washer	5138	1			
DRK-313A			DRK-313C			DRK-928SP		
Position	Part Number	Qty	Position	Part Number	Qty	Position	Part Number	Qty
Differential Brg.	LM603049-LM603011	2	Differential Brg.	LM603049-LM603011	2	Differential Brg.	LM104949-LM104911	2
Pinion Head Brg.	HM89443-HM89410	1	Pinion Head Brg.	M88048-M88010	1	Pinion Head Brg.	HM804846-HM804810	1
Pinion Tail Brg.	M88048-M88010	1	Pinion Tail Brg.	M88048-M88010	1	Pinion Tail Brg.	2790-2729	1
Pinion Nose Brg.	R1535TAV	1	Pinion Nose Brg.	R1535TAV	1	Pinion Nose Brg.	R1535TAV	1
Pinion Nose Brg.	R1535-CLIP	1	Pinion Nose Brg.	R1535-CLIP	1	Pinion Nose Brg.	R1535-CLIP	1
Retainer			Retainer			Retainer		
Pinion Seal	7044NA (1.812x3.000)	1	Pinion Seal	7044NA (1.812x3.000)	1	Pinion Seal	7044NA (1.812x3.000)	1
Solid Spacer Kit	SS9	1	Crush Sleeve	CS311	1	Solid Spacer	SS9	1
Pinion Nut	PN2	1	Pinion Nut	PN2	1	Pinion Nut	PN2	1
Gear Marking & Brush	GMC1-BR1	1	Gear Marking & Brush	GMC1-BR1	1	Gear Marking & Brush	GMC1-BR1	1
Threadlocker	TL1	1	Threadlocker	TL1	1	Threadlocker	TL1	1
Sealer	RTV Silicone	1	Sealer	RTV Silicone	1	Sealer	RTV Silicone	1
O-Ring	OR248	1	O-Ring	OR248	1	O-Ring	OR248	1
DRK-313AMK			DRK-313CMK			DRK-935SP		
Position	Part Number	Qty	Position	Part Number	Qty	Position	Part Number	Qty
Differential Brg.	LM603049-LM603011	2	Differential Brg.	LM603049-LM603011	2	Differential Brg.	LM104949-LM104911	2
Pinion Head Brg.	HM89443-HM89410	1	Pinion Head Brg.	M88048-M88010	1	Pinion Head Brg.	HM804846-HM804810	1
Pinion Tail Brg.	M88048-M88010	1	Pinion Tail Brg.	M88048-M88010	1	Pinion Tail Brg.	2788-2729	1
Pinion Nose Brg.	R1535TAV	1	Pinion Nose Brg.	R1535TAV	1	Pinion Nose Brg.	R1535TAV	1
Pinion Nose Brg.	R1535-CLIP	1	Pinion Nose Brg.	R1535-CLIP	1	Pinion Nose Brg.	R1535-CLIP	1
Retainer			Retainer			Retainer		
Pinion Seal	7044NA (1.812x3.000)	1	Pinion Seal	7044NA (1.812x3.000)	1	Pinion Seal	472015 (2.125x3.000)	1
Solid Spacer Kit	SS9	1	Crush Sleeve	CS311	1	Solid Spacer	SS9HD	1
Pinion Nut	PN2	1	Pinion Nut	PN2	1	Pinion Nut	PN2	1
Gear Marking & Brush	GMC1-BR1	1	Gear Marking & Brush	GMC1-BR1	1	Gear Marking & Brush	GMC1-BR1	1
Threadlocker	TL1	1	Threadlocker	TL1	1	Threadlocker	TL1	1
Sealer	RTV Silicone	1	Sealer	RTV Silicone	1	Sealer	RTV Silicone	1
Pinion Depth Shims	SK8	1	Pinion Depth Shims	SK8	1	O-Ring	OR248	1
Ring Gear Bolts	RGB4	10	Ring Gear Bolts	RGB4	10			
O-Ring	OR248	1	O-Ring	OR248	1			
DRK-313B			DRK-313D			DRK-314		
Position	Part Number	Qty	Position	Part Number	Qty	Position	Part Number	Qty
Differential Brg.	LM104949-LM104911	2	Differential Brg.	LM104949-LM104911	2	Differential Brg.	469-453X	2
Pinion Head Brg.	HM89443-HM89410	1	Pinion Head Brg.	HM89444-HM89410	1	Pinion Head Brg.	HM807044-HM807010	1
Pinion Tail Brg.	M88048-M88010	1	Pinion Tail Brg.	M88048-M88010	1	Pinion Tail Brg.	HM89443-HM89411	1
Pinion Nose Brg.	R1535TAV	1	Pinion Nose Brg.	R1535TAV	1	Pinion Seal	4278 (1.812x3.091)	1
Pinion Nose Brg.	R1535-CLIP	1	Pinion Nose Brg.	R1535-CLIP	1	Crush Sleeve	CS311	1
Retainer			Retainer			Pinion Nut	PN6	1
Pinion Seal	7044NA (1.812x3.000)	1	Pinion Seal	7044NA (1.812x3.000)	1	Gear Marking & Brush	GMC1-BR1	1
Solid Spacer Kit	SS9	1	Solid Spacer Kit	SS9	1	Threadlocker	TL1	1
Pinion Nut	PN2	1	Pinion Nut	PN2	1	Sealer	RTV Silicone	1
Gear Marking & Brush	GMC1-BR1	1	Gear Marking & Brush	GMC1-BR1	1			
Threadlocker	TL1	1	Threadlocker	TL1	1	DRK-314MK		
Sealer	GR-F900	1	Sealer	RTV Silicone	1	Position	Part Number	Qty
O-Ring	OR248	1	O-Ring	OR248	1	Differential Brg.	469-453X	2
Washer	5138	1				Pinion Head Brg.	HM807044-HM807010	1
						Pinion Tail Brg.	HM89443-HM89411	1
						Pinion Seal	4278 (1.812x3.091)	1
						Crush Sleeve	CS311	1
						Pinion Nut	PN6	1
						Gear Marking & Brush	GMC1-BR1	1
						Threadlocker	TL1	1
						Sealer	RTV Silicone	1
						Pinion Depth Shims	SK3	1
						Differential Shims	SK10 <sup>53</sup>	1
						Ring Gear Bolts	RGB6	12

LD Differential

<sup>53</sup> Order SSK10 for stackable differential shims.

# Light Duty Differential Rebuild Kits



DRK-314AMK		
Position	Part Number	Qty
Differential Brg.	469-453X	2
Pinion Head Brg.	HM807044-HM807010	1
Pinion Tail Brg.	HM89443-HM89411	1
Pinion Seal	4278 (1.812x3.091)	1
Crush Sleeve	CS311	1
Pinion Nut	PN6	1
Gear Marking & Brush	GMC1-BR1	1
Threadlocker	TL1	1
Sealer	RTV Silicone	1
Pinion Depth Shims	SK7	1
Differential Shims	SK10 <sup>53</sup>	1
Ring Gear Bolts	RGB6	12
Pinion Nut Washer	DS30275	1

DRK-315		
Position	Part Number	Qty
Differential Brg.	LM501349-LM501314	2
Pinion Head Brg.	M802048-M802011	1
Pinion Tail Brg.	M88048-M88010	1
Pinion Seal	3604 (1.812x2.777)	1
Crush Sleeve	CS311	1
Pinion Nut	PN2	1
Gear Marking & Brush	GMC1-BR1	1
Threadlocker	TL1	1
Sealer	RTV Silicone	1

DRK-315MK		
Position	Part Number	Qty
Differential Brg.	LM501349-LM501314	2
Pinion Head Brg.	M802048-M802011	1
Pinion Tail Brg.	M88048-M88010	1
Pinion Seal	3604 (1.812x2.777)	1
Crush Sleeve	CS311	1
Pinion Nut	PN2	1
Gear Marking & Brush	GMC1-BR1	1
Threadlocker	TL1	1
Sealer	RTV Silicone	1
Pinion Depth Shims	SK4	1
Differential Shims	SK11 <sup>28</sup>	1
Ring Gear Bolts	RGB3	10

DRK-316		
Position	Part Number	Qty
Differential Brg.	NP343847-NP372019	2
Pinion Head Brg.	NP576375-NP434567	1
Pinion Tail Brg.	M88048-M88010	1
Pinion Seal	3604 (1.812x2.777)	1
Crush Sleeve	CS311	1
Pinion Nut	PN13	1
Gear Marking & Brush	GMC1-BR1	1
Threadlocker	TL1	1
Sealer	RTV Silicone	1

DRK-316MK		
Position	Part Number	Qty
Differential Brg.	NP343847-NP372019	2
Pinion Head Brg.	NP576375-NP434567	1
Pinion Tail Brg.	M88048-M88010	1
Pinion Seal	3604 (1.812x2.777)	1
Crush Sleeve	CS311	1
Pinion Nut	PN13	1
Gear Marking & Brush	GMC1-BR1	1
Threadlocker	TL1	1
Sealer	RTV Silicone	1
Pinion Depth Shims	SK41	1
Differential Shims	SK42 <sup>52</sup>	1
Ring Gear Bolts	RGB18	12

DRK-316A		
Position	Part Number	Qty
Differential Brg.	NP343847-NP372019	2
Pinion Head Brg.	NP576375-NP434567	1
Pinion Tail Brg.	HM89443-HM89411	1
Pinion Seal	4278 (1.812x3.091)	1
Crush Sleeve	CS311	1
Pinion Nut	PN6	1
Gear Marking & Brush	GMC1-BR1	1
Threadlocker	TL1	1
Sealer	RTV Silicone	1

DRK-316AMK		
Position	Part Number	Qty
Differential Brg.	NP343847-NP372019	2
Pinion Head Brg.	NP576375-NP434567	1
Pinion Tail Brg.	HM89443-HM89411	1
Pinion Seal	4278 (1.812x3.091)	1
Crush Sleeve	CS311	1
Pinion Nut	PN6	1
Gear Marking & Brush	GMC1-BR1	1
Threadlocker	TL1	1
Sealer	RTV Silicone	1
Pinion Depth Shims	SK41	1
Differential Shims	SK42 <sup>52</sup>	1
Ring Gear Bolts	RGB18	12

DRK-316B		
Position	Part Number	Qty
Differential Brg.	NP912771-NP847706	2
Pinion Head Brg.	NP665996-NP244986	1
Pinion Tail Brg.	HM89443-HM89411	1
Pinion Seal	4278 (1.812x3.091)	1
Crush Sleeve	CS311	1
Pinion Nut	PN6	1
Gear Marking & Brush	GMC1-BR1	1
Threadlocker	TL1	1
Sealer	RTV Silicone	1

DRK-316BMK		
Position	Part Number	Qty
Differential Brg.	NP912771-NP847706	2
Pinion Head Brg.	NP665996-NP244986	1
Pinion Tail Brg.	HM89443-HM89411	1
Pinion Seal	4278 (1.812x3.091)	1
Crush Sleeve	CS311	1
Pinion Nut	PN6	1
Gear Marking & Brush	GMC1-BR1	1
Threadlocker	TL1	1
Sealer	RTV Silicone	1
Pinion Depth Shims	SK41	1
Differential Shims	SK42 <sup>52</sup>	1
Ring Gear Bolts	RGB18	12

DRK-316C		
Position	Part Number	Qty
Differential Brg.	NP912771-NP847706	2
Pinion Head Brg.	TRD101004UR4	1
Pinion Tail Brg.	HM89448-HM89411	1
Pinion Seal	4278 (1.812x3.091)	1
Crush Sleeve	CS355	1
Pinion Nut	PN6	1
Gear Marking & Brush	GMC1-BR1	1
Threadlocker	TL1	1
Sealer	RTV Silicone	1

DRK-316CMK		
Position	Part Number	Qty
Differential Brg.	NP912771-NP847706	2
Pinion Head Brg.	TRD101004UR4	1
Pinion Tail Brg.	HM89448-HM89411	1
Pinion Seal	4278 (1.812x3.091)	1
Crush Sleeve	CS355	1
Pinion Nut	PN6	1
Gear Marking & Brush	GMC1-BR1	1
Threadlocker	TL1	1
Sealer	RTV Silicone	1
Pinion Depth Shims	SK41	1
Differential Shims	SK42 <sup>52</sup>	1
Ring Gear Bolts	RGB18	12

DRK-316D		
Position	Part Number	Qty
Differential Brg.	NP912771-NP847706	2
Pinion Head Brg.	KEST5195LFT	1
Pinion Tail Brg.	HM89448-HM89411	1
Pinion Seal	4278 (1.812x3.091)	1
Crush Sleeve	CS355	1
Pinion Nut	PN6	1
Gear Marking & Brush	GMC1-BR1	1
Threadlocker	TL1	1
Sealer	RTV Silicone	1

DRK-316DMK		
Position	Part Number	Qty
Differential Brg.	NP912771-NP847706	2
Pinion Head Brg.	KEST5195LFT	1
Pinion Tail Brg.	HM89448-HM89411	1
Pinion Seal	4278 (1.812x3.091)	1
Crush Sleeve	CS355	1
Pinion Depth Shims	SK41	1
Differential Shims	SK42 <sup>52</sup>	1
Pinion Nut	PN6	1
Ring Gear Bolts	RGB18	12
Gear Marking & Brush	GMC1-BR1	1
Threadlocker	TL1	1
Sealer	RTV Silicone	1

DRK-316E		
Position	Part Number	Qty
Differential Brg.	NP912771-NP847706	2
Pinion Head Brg.	TRD101004UR4	1
Pinion Tail Brg.	STD3776-2	1
Pinion Seal	4278 (1.812x3.091)	1
Crush Sleeve	CS355	1
Pinion Nut	PN6	1
Gear Marking & Brush	GMC1-BR1	1
Threadlocker	TL1	1
Sealer	RTV Silicone	1

DRK-316EMK		
Position	Part Number	Qty
Differential Brg.	NP912771-NP847706	2
Pinion Head Brg.	TRD101004UR4	1
Pinion Tail Brg.	STD3776-2	1
Pinion Seal	4278 (1.812x3.091)	1
Crush Sleeve	CS355	1
Pinion Depth Shims	SK41	1
Differential Shims	SK42 <sup>52</sup>	1
Pinion Nut	PN6	1
Ring Gear Bolts	RGB18	12
Gear Marking & Brush	GMC1-BR1	1
Threadlocker	TL1	1
Sealer	RTV Silicone	1

LD Differential

190 28 Order SSK11 for stackable differential shims. 52 Order SSK42 for stackable differential shims.  
53 Order SSK10 for stackable differential shims.

# Light Duty Differential Rebuild Kits

<b>DRK-316F</b>			<b>DRK-316-CONVBMK</b>			<b>DRK-317B</b>		
Position	Part Number	Qty	Position	Part Number	Qty	Position	Part Number	Qty
Differential Brg.	NP912771-NP847706	2	Differential Brg.	NP343847-NP372019	2	Differential Brg.	469-453X	2
Pinion Head Brg.	KEST5195LFT	1	Pinion Head Brg.	JHM807045-HM807010	1	Pinion Head Brg.	M802047-M802011	1
Pinion Tail Brg.	TRD101004UR4	1	Pinion Tail Brg.	HM89443-HM89410	1	Pinion Tail Brg.	TRD101004UR4	1
Pinion Seal	4278 (1.812x3.091)	1	Pinion Seal	3604 (1.812x2.777)	1	Pinion Seal	BC3Z4676A	1
Crush Sleeve	CS355	1	Pinion Seal	4278 (1.812x3.091)	1	Crush Sleeve	CS317K	1
Pinion Nut	PN6	1	Crush Sleeve	CS311	1	Gear Marking & Brush	GMC1-BR1	1
Gear Marking & Brush	GMC1-BR1	1	Pinion Nut	PN6	1	Threadlocker	TL1	1
Threadlocker	TL1	1	Gear Marking & Brush	GMC1-BR1	1	Sealer	RTV Silicone	1
Sealer	RTV Silicone	1	Threadlocker	TL1	1	<b>DRK-317BMK</b>		
<b>DRK-316FMK</b>			Sealer	RTV Silicone	1	<b>Position</b>	<b>Part Number</b>	<b>Qty</b>
<b>Position</b>	<b>Part Number</b>	<b>Qty</b>	Pinion Depth Shims	SK41	1	Differential Brg.	469-453X	2
Differential Brg.	NP912771-NP847706	2	Differential Shims	SK42	1	Pinion Head Brg.	M802047-M802011	1
Pinion Head Brg.	KEST5195LFT	1	Ring Gear Bolts	RGB18	12	Pinion Tail Brg.	TRD101004UR4	1
Pinion Tail Brg.	TRD101004UR4	1	<b>DRK-317</b>			Pinion Seal	BC3Z4676A	1
Pinion Seal	4278 (1.812x3.091)	1	<b>Position</b>	<b>Part Number</b>	<b>Qty</b>	Crush Sleeve	CS317K	1
Crush Sleeve	CS355	1	Differential Brg.	469-453X	2	Gear Marking & Brush	GMC1-BR1	1
Pinion Nut	PN6	1	Pinion Head Brg.	NP504493-NP949481	1	Threadlocker	TL1	1
Gear Marking & Brush	GMC1-BR1	1	Pinion Tail Brg.	HM89443-HM89411	1	Sealer	RTV Silicone	1
Threadlocker	TL1	1	Pinion Seal	4278 (1.812x3.091)	1	Pinion Depth Shims	SK41	1
Sealer	RTV Silicone	1	Crush Sleeve	CS311	1	Differential Shims	SK10 <sup>53</sup>	1
Pinion Depth Shims	SK41	1	Pinion Nut	PN6	1	Ring Gear Bolts	RGB32	12
Differential Shims	SK42	1	Gear Marking & Brush	GMC1-BR1	1	<b>DRK-320</b>		
Ring Gear Bolts	RGB18	12	Threadlocker	TL1	1	<b>Position</b>	<b>Part Number</b>	<b>Qty</b>
<b>DRK-316-CONVA</b>			Sealer	RTV Silicone	1	Differential Brg.	LM501349-LM501314	2
<b>Position</b>	<b>Part Number</b>	<b>Qty</b>	<b>DRK-317MK</b>			Pinion Head Brg.	HM89249-HM89210	1
Differential Brg.	NP343847-NP372019	2	<b>Position</b>	<b>Part Number</b>	<b>Qty</b>	Pinion Tail Brg.	M86649-M86610	1
Pinion Head Brg.	KEST5195LFT	1	Differential Brg.	469-453X	2	Pinion Seal	8610 (1.521x2.656)	1
Pinion Tail Brg.	HM89448-HM89411	1	Pinion Head Brg.	NP504493-NP949481	1	Crush Sleeve	CS320	1
Pinion Seal	3604 (1.812x2.777)	1	Pinion Tail Brg.	HM89443-HM89411	1	Pinion Nut	PN3	1
Pinion Seal	4278 (1.812x3.091)	1	Pinion Seal	4278 (1.812x3.091)	1	Gear Marking & Brush	GMC1-BR1	1
Crush Sleeve	CS316A	1	Crush Sleeve	CS311	1	Threadlocker	TL1	1
Pinion Nut	PN6	1	Pinion Nut	PN6	1	Sealer	RTV Silicone	1
Gear Marking & Brush	GMC1-BR1	1	Gear Marking & Brush	GMC1-BR1	1	<b>DRK-320MK</b>		
Threadlocker	TL1	1	Threadlocker	TL1	1	<b>Position</b>	<b>Part Number</b>	<b>Qty</b>
Sealer	RTV Silicone	1	Sealer	RTV Silicone	1	Differential Brg.	LM501349-LM501314	2
<b>DRK-316-CONVAMK</b>			Pinion Depth Shims	SK3	1	Pinion Head Brg.	HM89249-HM89210	1
<b>Position</b>	<b>Part Number</b>	<b>Qty</b>	Differential Shims	SK10 <sup>53</sup>	1	Pinion Tail Brg.	M86649-M86610	1
Differential Brg.	NP343847-NP372019	2	Ring Gear Bolts	RGB6	12	Pinion Seal	8610 (1.521x2.656)	1
Pinion Head Brg.	KEST5195LFT	1	<b>DRK-317A</b>			Crush Sleeve	CS320	1
Pinion Tail Brg.	HM89448-HM89411	1	<b>Position</b>	<b>Part Number</b>	<b>Qty</b>	Pinion Nut	PN3	1
Pinion Seal	3604 (1.812x2.777)	1	Differential Brg.	469-453X	2	Gear Marking & Brush	GMC1-BR1	1
Pinion Seal	4278 (1.812x3.091)	1	Pinion Head Brg.	NP761271-NP998236	1	Threadlocker	TL1	1
Crush Sleeve	CS316A	1	Pinion Tail Brg.	HM89443-HM89411	1	Sealer	RTV Silicone	1
Pinion Nut	PN6	1	Pinion Seal	4278 (1.812x3.091)	1	Pinion Depth Shims	SK12	1
Gear Marking & Brush	GMC1-BR1	1	Crush Sleeve	CS311	1	Differential Shims	SK11 <sup>28</sup>	1
Threadlocker	TL1	1	Pinion Nut	PN6	1	Ring Gear Bolts	RGB2	10
Sealer	RTV Silicone	1	Gear Marking & Brush	GMC1-BR1	1	<b>DRK-320A</b>		
Pinion Depth Shims	SK41	1	Threadlocker	TL1	1	<b>Position</b>	<b>Part Number</b>	<b>Qty</b>
Differential Shims	SK42	1	Sealer	RTV Silicone	1	Differential Brg.	JL69349-JL69310	2
Ring Gear Bolts	RGB18	12	<b>DRK-317AMK</b>			Pinion Head Brg.	M88048S-M88010	1
<b>DRK-316-CONVB</b>			<b>Position</b>	<b>Part Number</b>	<b>Qty</b>	Pinion Tail Brg.	M86649-M86610	1
<b>Position</b>	<b>Part Number</b>	<b>Qty</b>	Differential Brg.	469-453X	2	Pinion Seal	8610 (1.521x2.656)	1
Differential Brg.	NP343847-NP372019	2	Pinion Head Brg.	NP761271-NP998236	1	Crush Sleeve	CS326	1
Pinion Head Brg.	JHM807045-HM807010	1	Pinion Tail Brg.	HM89443-HM89411	1	Pinion Nut	PN3	1
Pinion Tail Brg.	HM89443-HM89410	1	Pinion Seal	4278 (1.812x3.091)	1	Gear Marking & Brush	GMC1-BR1	1
Pinion Seal	3604 (1.812x2.777)	1	Crush Sleeve	CS311	1	Threadlocker	TL1	1
Pinion Seal	4278 (1.812x3.091)	1	Pinion Nut	PN6	1	Sealer	RTV Silicone	1
Crush Sleeve	CS311	1	Gear Marking & Brush	GMC1-BR1	1	<b>DRK-320AMK</b>		
Pinion Nut	PN6	1	Threadlocker	TL1	1	<b>Position</b>	<b>Part Number</b>	<b>Qty</b>
Gear Marking & Brush	GMC1-BR1	1	Sealer	RTV Silicone	1	Differential Brg.	JL69349-JL69310	2
Threadlocker	TL1	1	Pinion Depth Shims	SK3	1	Pinion Head Brg.	M88048S-M88010	1
Sealer	RTV Silicone	1	Differential Shims	SK10 <sup>53</sup>	1	Pinion Tail Brg.	M86649-M86610	1
<b>DRK-316-CONVBMK</b>			Ring Gear Bolts	RGB6	12	Pinion Seal	8610 (1.521x2.656)	1
<b>Position</b>	<b>Part Number</b>	<b>Qty</b>	<b>DRK-317B</b>			Crush Sleeve	CS326	1
Differential Brg.	NP343847-NP372019	2	<b>Position</b>	<b>Part Number</b>	<b>Qty</b>	Pinion Nut	PN3	1
Pinion Head Brg.	JHM807045-HM807010	1	Differential Brg.	469-453X	2	Gear Marking & Brush	GMC1-BR1	1
Pinion Tail Brg.	HM89443-HM89410	1	Pinion Head Brg.	M802047-M802011	1	Threadlocker	TL1	1
Pinion Seal	3604 (1.812x2.777)	1	Pinion Tail Brg.	TRD101004UR4	1	Sealer	RTV Silicone	1
Pinion Seal	4278 (1.812x3.091)	1	Pinion Seal	BC3Z4676A	1	Pinion Depth Shims	SK12	1
Crush Sleeve	CS311	1	Crush Sleeve	CS317K	1	Ring Gear Bolts	RGB2	10
Pinion Nut	PN6	1	Gear Marking & Brush	GMC1-BR1	1			
Gear Marking & Brush	GMC1-BR1	1	Threadlocker	TL1	1			
Threadlocker	TL1	1	Sealer	RTV Silicone	1			
Sealer	RTV Silicone	1	Pinion Depth Shims	SK41	1			
			Differential Shims	SK10 <sup>53</sup>	1			
			Ring Gear Bolts	RGB18	12			

LD Differential

<sup>28</sup> Order SSK11 for stackable differential shims. <sup>53</sup> Order SSK10 for stackable differential shims.

# Light Duty Differential Rebuild Kits



DRK-320B		
Position	Part Number	Qty
Differential Brg.	LM501349-LM501314	2
Pinion Head Brg.	HM89449-HM89410	1
Pinion Tail Brg.	M86649-M86610	1
Pinion Seal	8610 (1.521x2.656)	1
Crush Sleeve	CS320	1
Pinion Nut	PN3	1
Gear Marking & Brush	GMC1-BR1	1
Threadlocker	TL1	1
Sealer	RTV Silicone	1

DRK-320BMK		
Position	Part Number	Qty
Differential Brg.	LM501349-LM501314	2
Pinion Head Brg.	HM89449-HM89410	1
Pinion Tail Brg.	M86649-M86610	1
Pinion Seal	8610 (1.521x2.656)	1
Crush Sleeve	CS320	1
Pinion Nut	PN3	1
Gear Marking & Brush	GMC1-BR1	1
Threadlocker	TL1	1
Sealer	RTV Silicone	1
Pinion Depth Shims	SK12	1
Differential Shims	SK11 <sup>28</sup>	1
Ring Gear Bolts	RGB2	10

DRK-320C		
Position	Part Number	Qty
Differential Brg.	LM501349-LM501314	2
Pinion Head Brg.	HM89249-HM89210	1
Pinion Tail Brg.	M86649-M86610	1
Pinion Seal	710474 (1.732x2.653)	1
Crush Sleeve	CS320	1
Pinion Nut	PN3	1
Gear Marking & Brush	GMC1-BR1	1
Threadlocker	TL1	1
Sealer	RTV Silicone	1

DRK-320CMK		
Position	Part Number	Qty
Differential Brg.	LM501349-LM501314	2
Pinion Head Brg.	HM89249-HM89210	1
Pinion Tail Brg.	M86649-M86610	1
Pinion Seal	710474 (1.732x2.653)	1
Crush Sleeve	CS320	1
Pinion Nut	PN3	1
Gear Marking & Brush	GMC1-BR1	1
Threadlocker	TL1	1
Sealer	RTV Silicone	1
Pinion Depth Shims	SK12	1
Differential Shims	SK11 <sup>28</sup>	1
Ring Gear Bolts	RGB2	10

DRK-320D		
Position	Part Number	Qty
Differential Brg.	LM603049-LM603012	2
Pinion Head Brg.	NP457992-NP926068	1
Pinion Tail Brg.	M86649-M86610	1
Pinion Seal	710474 (1.732x2.653)	1
Crush Sleeve	CS320	1
Pinion Nut	PN3	1
Gear Marking & Brush	GMC1-BR1	1
Threadlocker	TL1	1
Sealer	RTV Silicone	1

DRK-320DMK		
Position	Part Number	Qty
Differential Brg.	LM603049-LM603012	2
Pinion Head Brg.	NP457992-NP926068	1
Pinion Tail Brg.	M86649-M86610	1
Pinion Seal	710474 (1.732x2.653)	1
Crush Sleeve	CS320	1
Pinion Nut	PN3	1
Gear Marking & Brush	GMC1-BR1	1
Threadlocker	TL1	1
Sealer	RTV Silicone	1
Pinion Depth Shims	SK4	1
Differential Shims	SK7 <sup>27</sup>	1
Ring Gear Bolts	RGB22	10

DRK-320J		
Position	Part Number	Qty
Differential Brg.	LM501349-LM501314	2
Pinion Head Brg.	HM89249-HM89210	1
Pinion Tail Brg.	M86649-M86610	1
Pinion Seal	710864	1
Crush Sleeve	CS320	1
Pinion Nut	PN13	1
Gear Marking & Brush	GMC1-BR1	1
Threadlocker	TL1	1
Sealer	RTV Silicone	1

DRK-320JMK		
Position	Part Number	Qty
Differential Brg.	LM501349-LM501314	2
Pinion Head Brg.	HM89249-HM89210	1
Pinion Tail Brg.	M86649-M86610	1
Pinion Seal	710864	1
Crush Sleeve	CS320	1
Pinion Nut	PN13	1
Gear Marking & Brush	GMC1-BR1	1
Threadlocker	TL1	1
Sealer	RTV Silicone	1
Pinion Depth Shims	SK12	1
Differential Shims	SK11 <sup>28</sup>	1
Ring Gear Bolts	RGB2	10

DRK-320K		
Position	Part Number	Qty
Differential Brg.	JL69349-JL69310	2
Pinion Head Brg.	M88048S-M88010	1
Pinion Tail Brg.	M86649-M86610	1
Pinion Seal	710547 (1.521x2.661)	1
Crush Sleeve	CS326	1
Pinion Nut	PN3	1
Gear Marking & Brush	GMC1-BR1	1
Threadlocker	TL1	1
Sealer	RTV Silicone	1

DRK-320KMK		
Position	Part Number	Qty
Differential Brg.	JL69349-JL69310	2
Pinion Head Brg.	M88048S-M88010	1
Pinion Tail Brg.	M86649-M86610	1
Pinion Seal	710547 (1.521x2.661)	1
Crush Sleeve	CS326	1
Pinion Nut	PN3	1
Gear Marking & Brush	GMC1-BR1	1
Threadlocker	TL1	1
Sealer	RTV Silicone	1
Pinion Depth Shims	SK12	1
Ring Gear Bolts	RGB2	10

DRK-320L		
Position	Part Number	Qty
Differential Brg.	LM501349-LM501314	2
Pinion Head Brg.	HM89249-HM89210	1
Pinion Tail Brg.	M86649-M86610	1
Pinion Seal	710549 (1.682x2.660)	1
Crush Sleeve	CS320	1
Pinion Nut	PN3	1
Gear Marking & Brush	GMC1-BR1	1
Threadlocker	TL1	1
Sealer	RTV Silicone	1

DRK-320LMK		
Position	Part Number	Qty
Differential Brg.	LM501349-LM501314	2
Pinion Head Brg.	HM89249-HM89210	1
Pinion Tail Brg.	M86649-M86610	1
Pinion Seal	710549 (1.682x2.660)	1
Crush Sleeve	CS320	1
Pinion Nut	PN3	1
Gear Marking & Brush	GMC1-BR1	1
Threadlocker	TL1	1
Sealer	RTV Silicone	1
Pinion Depth Shims	SK12	1
Differential Shims	SK11 <sup>28</sup>	1
Ring Gear Bolts	RGB2	10

DRK-321		
Position	Part Number	Qty
Differential Brg.	LM501349-LM501314	2
Pinion Head Brg.	M802048-M802011	1
Pinion Tail Brg.	M88048-M88010	1
Pinion Seal	2043 (1.940x2.762)	1
Pinion Seal	8622 (1.940x2.813)	1
Crush Sleeve	CS321	1
Pinion Nut	PN3	1
Gear Marking & Brush	GMC1-BR1	1
Threadlocker	TL1	1
Sealer	RTV Silicone	1

DRK-321MK		
Position	Part Number	Qty
Differential Brg.	LM501349-LM501314	2
Pinion Head Brg.	M802048-M802011	1
Pinion Tail Brg.	M88048-M88010	1
Pinion Seal	2043 (1.940x2.762)	1
Pinion Seal	8622 (1.940x2.813)	1
Crush Sleeve	CS321	1
Pinion Nut	PN3	1
Gear Marking & Brush	GMC1-BR1	1
Threadlocker	TL1	1
Sealer	RTV Silicone	1
Pinion Depth Shims	SK4	1
Differential Shims	SK11 <sup>28</sup>	1
Ring Gear Bolts	RGB2	10

DRK-321A		
Position	Part Number	Qty
Differential Brg.	LM501349-LM501314	2
Pinion Head Brg.	M802048-M802011	1
Pinion Tail Brg.	M88048-M88010	1
Pinion Seal	710281 (1.940x2.900)	1
Crush Sleeve	CS321	1
Pinion Nut	PN3	1
Gear Marking & Brush	GMC1-BR1	1
Threadlocker	TL1	1
Sealer	RTV Silicone	1

LD Differential

# Light Duty Differential Rebuild Kits

DRK-321AMK		
Position	Part Number	Qty
Differential Brg.	LM501349-LM501314	2
Pinion Head Brg.	M802048-M802011	1
Pinion Tail Brg.	M88048-M88010	1
Pinion Seal	710281 (1.940x2.900)	1
Crush Sleeve	CS321	1
Pinion Nut	PN3	1
Gear Marking & Brush	GMC1-BR1	1
Threadlocker	TL1	1
Sealer	RTV Silicone	1
Pinion Depth Shims	SK4	1
Ring Gear Bolts	RGB2	10

DRK-321B		
Position	Part Number	Qty
Differential Brg.	LM501349-LM501314	2
Pinion Head Brg.	HM89449-HM89410	1
Pinion Tail Brg.	M86649-M86610	1
Pinion Seal	8610 (1.521x2.656)	1
Crush Sleeve	CS320 <sup>7</sup>	1
Pinion Nut	PN4	1
Gear Marking & Brush	GMC1-BR1	1
Threadlocker	TL1	1
Sealer	RTV Silicone	1

DRK-321BMK		
Position	Part Number	Qty
Differential Brg.	LM501349-LM501314	2
Pinion Head Brg.	HM89449-HM89410	1
Pinion Tail Brg.	M86649-M86610	1
Pinion Seal	8610 (1.521x2.656)	1
Crush Sleeve	CS320 <sup>7</sup>	1
Pinion Nut	PN4	1
Gear Marking & Brush	GMC1-BR1	1
Threadlocker	TL1	1
Sealer	RTV Silicone	1
Pinion Depth Shims	SK12	1
Differential Shims	SK11 <sup>28</sup>	1
Ring Gear Bolts	RGB5	10

DRK-321C		
Position	Part Number	Qty
Differential Brg.	LM603049-LM603012	2
Pinion Head Brg.	STD4183KELFT	1
Pinion Tail Brg.	M88048-M88010	1
Pinion Seal	710506 (2.088x2.763)	1
Crush Sleeve	CS321	1
Pinion Nut	PN3	1
Gear Marking & Brush	GMC1-BR1	1
Threadlocker	TL1	1
Sealer	RTV Silicone	1

DRK-321CMK		
Position	Part Number	Qty
Differential Brg.	LM603049-LM603012	2
Pinion Head Brg.	STD4183KELFT	1
Pinion Tail Brg.	M88048-M88010	1
Pinion Seal	710506 (2.088x2.763)	1
Crush Sleeve	CS321	1
Pinion Nut	PN3	1
Gear Marking & Brush	GMC1-BR1	1
Threadlocker	TL1	1
Sealer	RTV Silicone	1
Pinion Depth Shims	SK4	1
Differential Shims	SK7 <sup>27</sup>	1
Ring Gear Bolts	RGB2	10

DRK-321D		
Position	Part Number	Qty
Differential Brg.	LM102949-LM102911	2
Pinion Head Brg.	M802048-M802011	1
Pinion Tail Brg.	M88048-M88010	1
Pinion Seal	2043 (1.940x2.762)	1
Crush Sleeve	CS321	1
Pinion Nut	PN3	1
Gear Marking & Brush	GMC1-BR1	1
Threadlocker	TL1	1
Sealer	RTV Silicone	1

DRK-321DMK		
Position	Part Number	Qty
Differential Brg.	LM102949-LM102911	2
Pinion Head Brg.	M802048-M802011	1
Pinion Tail Brg.	M88048-M88010	1
Pinion Seal	2043 (1.940x2.762)	1
Crush Sleeve	CS321	1
Pinion Nut	PN3	1
Gear Marking & Brush	GMC1-BR1	1
Threadlocker	TL1	1
Sealer	RTV Silicone	1
Pinion Depth Shims	SK4	1
Differential Shims	SK11 <sup>28</sup>	1
Ring Gear Bolts	RGB2	10

DRK-321G		
Position	Part Number	Qty
Differential Brg.	LM603049-LM603014	2
Pinion Head Brg.	HM89449-HM89410	1
Pinion Tail Brg.	HM88547-HM88510	1
Pinion Seal	6818 (1.739x3.000)	1
Crush Sleeve	CS331	1
Pinion Nut	PN4	1
Gear Marking & Brush	GMC1-BR1	1
Threadlocker	TL1	1
Sealer	RTV Silicone	1

DRK-321GMK		
Position	Part Number	Qty
Differential Brg.	LM603049-LM603014	2
Pinion Head Brg.	HM89449-HM89410	1
Pinion Tail Brg.	HM88547-HM88510	1
Pinion Seal	6818 (1.739x3.000)	1
Crush Sleeve	CS331	1
Pinion Nut	PN4	1
Gear Marking & Brush	GMC1-BR1	1
Threadlocker	TL1	1
Sealer	RTV Silicone	1
Pinion Depth Shims	SK12	1
Ring Gear Bolts	RGB5	10

DRK-321H		
Position	Part Number	Qty
Differential Brg.	LM501349-LM501314	2
Pinion Head Brg.	HM89449-HM89410	1
Pinion Tail Brg.	M86649-M86610	1
Pinion Seal	2043 (1.940x2.762)	1
Crush Sleeve	CS320	1
Pinion Nut	PN3	1
Gear Marking & Brush	GMC1-BR1	1
Threadlocker	TL1	1
Sealer	RTV Silicone	1

DRK-321HMK		
Position	Part Number	Qty
Differential Brg.	LM501349-LM501314	2
Pinion Head Brg.	HM89449-HM89410	1
Pinion Tail Brg.	M86649-M86610	1
Pinion Seal	2043 (1.940x2.762)	1
Crush Sleeve	CS320	1
Pinion Nut	PN3	1
Gear Marking & Brush	GMC1-BR1	1
Threadlocker	TL1	1
Sealer	RTV Silicone	1
Pinion Depth Shims	SK12	1
Differential Shims	SK11 <sup>28</sup>	1
Ring Gear Bolts	RGB5	10

DRK-321N		
Position	Part Number	Qty
Differential Brg.	LM501349-LM501314	2
Pinion Head Brg.	M802048-M802011	1
Pinion Tail Brg.	M86649-M86610	1
Pinion Seal	2043 (1.94x2.762)	1
Crush Sleeve	CS348	1
Pinion Nut	PN3	1
Gear Marking & Brush	GMC1-BR1	1
Threadlocker	TL1	1
Sealer	RTV Silicone	1

DRK-321NMK		
Position	Part Number	Qty
Differential Brg.	LM501349-LM501314	2
Pinion Head Brg.	M802048-M802011	1
Pinion Tail Brg.	M86649-M86610	1
Pinion Seal	2043 (1.94x2.762)	1
Crush Sleeve	CS348	1
Pinion Nut	PN3	1
Gear Marking & Brush	GMC1-BR1	1
Threadlocker	TL1	1
Sealer	RTV Silicone	1
Pinion Depth Shims	SK4	1
Differential Shims	SK11 <sup>28</sup>	1
Ring Gear Bolts	RGB2	10

DRK-321Q		
Position	Part Number	Qty
Differential Brg.	LM603049-LM603012	2
Pinion Head Brg.	STA4195	1
Pinion Tail Brg.	STB3372	1
Pinion Seal	710507 (2.088x2.911)	1
Crush Sleeve	CS321	1
Pinion Nut	PN3	1
Gear Marking & Brush	GMC1-BR1	1
Threadlocker	TL1	1
Sealer	RTV Silicone	1

DRK-321QMK		
Position	Part Number	Qty
Differential Brg.	LM603049-LM603012	2
Pinion Head Brg.	STA4195	1
Pinion Tail Brg.	STB3372	1
Pinion Seal	710507 (2.088x2.911)	1
Crush Sleeve	CS321	1
Pinion Nut	PN3	1
Gear Marking & Brush	GMC1-BR1	1
Threadlocker	TL1	1
Sealer	RTV Silicone	1
Pinion Depth Shims	SK4	1
Differential Shims	SK7 <sup>27</sup>	1
Ring Gear Bolts	RGB2	10

<sup>7</sup> Order CS322 if using OEM Ring & Pinion Set . <sup>27</sup> Order SSK7 for stackable differential shims.  
<sup>28</sup> Order SSK11 for stackable differential shims.

LD Differential



# Light Duty Differential Rebuild Kits



DRK-321R		
Position	Part Number	Qty
Differential Brg.	LM501349-LM501314	2
Pinion Head Brg.	M802048-M802011	1
Pinion Tail Brg.	M88048-M88010	1
Pinion Seal	2043 (1.940x2.762)	1
Crush Sleeve	CS321	1
Pinion Nut	PN3	1
Gear Marking & Brush	GMC1-BR1	1
Threadlocker	TL1	1
Sealer	RTV Silicone	1

DRK-321RMK		
Position	Part Number	Qty
Differential Brg.	LM501349-LM501314	2
Pinion Head Brg.	M802048-M802011	1
Pinion Tail Brg.	M88048-M88010	1
Pinion Seal	2043 (1.940x2.762)	1
Crush Sleeve	CS321	1
Pinion Nut	PN3	1
Gear Marking & Brush	GMC1-BR1	1
Threadlocker	TL1	1
Sealer	RTV Silicone	1
Pinion Depth Shims	SK4	1
Differential Shims	SK11 <sup>28</sup>	1
Ring Gear Bolts	RGB2	10

DRK-321S		
Position	Part Number	Qty
Differential Brg.	KETR100802A/STA0Z	2
Pinion Head Brg.	HM804846-HM804810	1
Pinion Tail Brg.	32207	1
Pinion Seal	710866 (2.125x2.909)	1
Crush Sleeve	CS324	1
Pinion Nut	PN13	1
Gear Marking & Brush	GMC1-BR1	1
Threadlocker	TL1	1
Sealer	RTV Silicone	1

DRK-321SMK		
Position	Part Number	Qty
Differential Brg.	KETR100802A/STA0Z	2
Pinion Head Brg.	HM804846-HM804810	1
Pinion Tail Brg.	32207	1
Pinion Seal	710866 (2.125x2.909)	1
Crush Sleeve	CS324	1
Pinion Nut	PN13	1
Gear Marking & Brush	GMC1-BR1	1
Threadlocker	TL1	1
Sealer	RTV Silicone	1
Pinion Depth Shims	SK3	1
Differential Shims	SK7 <sup>27</sup>	1
Ring Gear Bolts	RGB2	10

DRK-321T		
Position	Part Number	Qty
Differential Brg.	LM501349-LM501314	2
Pinion Head Brg.	M802048-M802011	1
Pinion Tail Brg.	M88048-M88010	1
Pinion Seal	710536 (49x74)	1
Crush Sleeve	CS321	1
Pinion Nut	PN3	1
Gear Marking & Brush	GMC1-BR1	1
Threadlocker	TL1	1
Sealer	RTV Silicone	1

DRK-321TMK		
Position	Part Number	Qty
Differential Brg.	LM501349-LM501314	2
Pinion Head Brg.	M802048-M802011	1
Pinion Tail Brg.	M88048-M88010	1
Pinion Seal	710536 (49x74)	1
Crush Sleeve	CS321	1
Pinion Nut	PN3	1
Gear Marking & Brush	GMC1-BR1	1
Threadlocker	TL1	1
Sealer	RTV Silicone	1
Pinion Depth Shims	SK4	1
Ring Gear Bolts	RGB2	10

DRK-322		
Position	Part Number	Qty
Differential Brg.	LM603049-LM603012	2
Pinion Head Brg.	HM89449-HM89410	1
Pinion Tail Brg.	M88048-M88010	1
Pinion Seal	8460N (1.739x2.812)	1
Crush Sleeve	CS322	1
Pinion Nut	PN4	1
Gear Marking & Brush	GMC1-BR1	1
Threadlocker	TL1	1
Sealer	RTV Silicone	1

DRK-322MK		
Position	Part Number	Qty
Differential Brg.	LM603049-LM603012	2
Pinion Head Brg.	HM89449-HM89410	1
Pinion Tail Brg.	M88048-M88010	1
Pinion Seal	8460N (1.739x2.812)	1
Crush Sleeve	CS322	1
Pinion Nut	PN4	1
Gear Marking & Brush	GMC1-BR1	1
Threadlocker	TL1	1
Sealer	RTV Silicone	1
Pinion Depth Shims	SK12	1
Differential Shims	SK7 <sup>27</sup>	1
Ring Gear Bolts	RGB5	12

DRK-323		
Position	Part Number	Qty
Differential Brg.	LM603049-LM603012	2
Pinion Head Brg.	M802048-M802011	1
Pinion Tail Brg.	M88048-M88010	1
Pinion Seal	6109 (1.675x2.820)	1
Pinion Seal	2043 (1.940x2.762)	1
Crush Sleeve	CS321	1
Crush Sleeve (Corvette)	CS323C	1
Pinion Nut	PN4	1
Gear Marking & Brush	GMC1-BR1	1
Threadlocker	TL1	1
Sealer	RTV Silicone	1

DRK-323MK		
Position	Part Number	Qty
Differential Brg.	LM603049-LM603012	2
Pinion Head Brg.	M802048-M802011	1
Pinion Tail Brg.	M88048-M88010	1
Pinion Seal	6109 (1.675x2.820)	1
Pinion Seal	2043 (1.940x2.762)	1
Crush Sleeve	CS321	1
Crush Sleeve (Corvette)	CS323C	1
Pinion Nut	PN4	1
Gear Marking & Brush	GMC1-BR1	1
Threadlocker	TL1	1
Sealer	RTV Silicone	1
Pinion Depth Shims	SK4	1
Differential Shims	SK7 <sup>27</sup>	1
Ring Gear Bolts	RGB5	12
Pinion Seal - Corvette	6109	1

DRK-323A		
Position	Part Number	Qty
Differential Brg.	LM603049-LM603012	2
Pinion Head Brg.	M802048-M802011	1
Pinion Tail Brg.	M88048-M88010	1
Pinion Seal	8460N (1.739x2.812)	1
Crush Sleeve	CS323	1
Pinion Nut	PN4	1
Gear Marking & Brush	GMC1-BR1	1
Threadlocker	TL1	1
Sealer	RTV Silicone	1

DRK-323AMK		
Position	Part Number	Qty
Differential Brg.	LM603049-LM603012	2
Pinion Head Brg.	M802048-M802011	1
Pinion Tail Brg.	M88048-M88010	1
Pinion Seal	8460N (1.739x2.812)	1
Crush Sleeve	CS323	1
Pinion Nut	PN4	1
Gear Marking & Brush	GMC1-BR1	1
Threadlocker	TL1	1
Sealer	RTV Silicone	1
Pinion Depth Shims	SK4	1
Differential Shims	SK7 <sup>27</sup>	1
Ring Gear Bolts	RGB5	12

DRK-324		
Position	Part Number	Qty
Differential Brg.	JLM506849A-JLM506811	2
Pinion Head Brg.	HM804846-HM804810	1
Pinion Tail Brg.	HM88649-HM88610	1
Pinion Seal	3896 (1.940x2.909)	1
Crush Sleeve	CS324	1
Pinion Nut	PN3	1
Gear Marking & Brush	GMC1-BR1	1
Threadlocker	TL1	1
Sealer	RTV Silicone	1

DRK-324MK		
Position	Part Number	Qty
Differential Brg.	JLM506849A-JLM506811	2
Pinion Head Brg.	HM804846-HM804810	1
Pinion Tail Brg.	HM88649-HM88610	1
Pinion Seal	3896 (1.940x2.909)	1
Crush Sleeve	CS324	1
Pinion Nut	PN3	1
Gear Marking & Brush	GMC1-BR1	1
Threadlocker	TL1	1
Sealer	RTV Silicone	1
Pinion Depth Shims	SK3	1
Differential Shims	SK13 <sup>54</sup>	1
Ring Gear Bolts	RGB8	12

DRK-324A		
Position	Part Number	Qty
Differential Brg.	JLM506849A-JLM506811	2
Pinion Head Brg.	HM804846-HM804810	1
Pinion Tail Brg.	HM88649-HM88610	1
Pinion Seal	710281 (1.940x2.900)	1
Crush Sleeve	CS324	1
Pinion Nut	PN3	1
Gear Marking & Brush	GMC1-BR1	1
Threadlocker	TL1	1
Sealer	RTV Silicone	1

LD Differential

194 <sup>27</sup> Order SSK7 for stackable differential shims. <sup>28</sup> Order SSK11 for stackable differential shims.  
<sup>54</sup> Order SSK13 for stackable differential shims.

# Light Duty Differential Rebuild Kits

DRK-324AMK		
Position	Part Number	Qty
Differential Brg.	JLM506849A-JLM506811	2
Pinion Head Brg.	HM804846-HM804810	1
Pinion Tail Brg.	HM88649-HM88610	1
Pinion Seal	710281 (1.940x2.900)	1
Crush Sleeve	CS324	1
Pinion Nut	PN3	1
Gear Marking & Brush	GMC1-BR1	1
Threadlocker	TL1	1
Sealer	RTV Silicone	1
Pinion Depth Shims	SK3	1
Differential Shims	SK13 <sup>54</sup>	1
Ring Gear Bolts	RGB8	12

DRK-324B		
Position	Part Number	Qty
Differential Brg.	JLM506849A-JLM506811	2
Pinion Head Brg.	HM804846-HM804810	1
Pinion Tail Brg.	HM88649-HM88610	1
Pinion Seal	710507 (2.088x2.911)	1
Crush Sleeve	CS324	1
Pinion Nut	PN3	1
Gear Marking & Brush	GMC1-BR1	1
Threadlocker	TL1	1
Sealer	RTV Silicone	1

DRK-324BMK		
Position	Part Number	Qty
Differential Brg.	JLM506849A-JLM506811	2
Pinion Head Brg.	HM804846-HM804810	1
Pinion Tail Brg.	HM88649-HM88610	1
Pinion Seal	710507 (2.088x2.911)	1
Crush Sleeve	CS324	1
Pinion Nut	PN3	1
Gear Marking & Brush	GMC1-BR1	1
Threadlocker	TL1	1
Sealer	RTV Silicone	1
Pinion Depth Shims	SK13	1
Differential Shims	SK3	1
Ring Gear Bolts	RGB8	12

DRK-324C		
Position	Part Number	Qty
Differential Brg.	JLM506849A-JLM506811	2
Pinion Head Brg.	HM804846-HM804810	1
Pinion Tail Brg.	HM88649-HM88610	1
Pinion Seal	710536 (49x74)	1
Crush Sleeve	CS324	1
Pinion Nut	PN3	1
Gear Marking & Brush	GMC1-BR1	1
Threadlocker	TL1	1
Sealer	RTV Silicone	1

DRK-324CMK		
Position	Part Number	Qty
Differential Brg.	JLM506849A-JLM506811	2
Pinion Head Brg.	HM804846-HM804810	1
Pinion Tail Brg.	HM88649-HM88610	1
Pinion Seal	710536 (49x74)	1
Crush Sleeve	CS324	1
Pinion Nut	PN3	1
Gear Marking & Brush	GMC1-BR1	1
Threadlocker	TL1	1
Sealer	RTV Silicone	1
Pinion Depth Shims	SK3	1
Differential Shims	SK13 <sup>54</sup>	1
Ring Gear Bolts	RGB8	12

DRK-324D		
Position	Part Number	Qty
Differential Brg.	JLM506849A-JLM506811	2
Pinion Head Brg.	NP256771-NP468253	1
Pinion Tail Brg.	HM88649-HM88610	1
Pinion Seal	710536 (49x74)	1
Crush Sleeve	CS324	1
Pinion Nut	PN3	1
Gear Marking & Brush	GMC1-BR1	1
Threadlocker	TL1	1
Sealer	RTV Silicone	1

DRK-324DMK		
Position	Part Number	Qty
Differential Brg.	JLM506849A-JLM506811	2
Pinion Head Brg.	NP256771-NP468253	1
Pinion Tail Brg.	HM88649-HM88610	1
Pinion Seal	710536 (49x74)	1
Crush Sleeve	CS324	1
Pinion Nut	PN3	1
Gear Marking & Brush	GMC1-BR1	1
Threadlocker	TL1	1
Sealer	RTV Silicone	1
Pinion Depth Shims	SK3	1
Differential Shims	SK13 <sup>54</sup>	1
Ring Gear Bolts	RGB8	12

DRK-324E		
Position	Part Number	Qty
Differential Brg.	JLM506849A-JLM506811	2
Pinion Head Brg.	STA4895-1	1
Pinion Tail Brg.	HM88649-HM88610	1
Pinion Seal	22943111	1
Crush Sleeve	CS361	1
Pinion Nut	PN13	1
Gear Marking & Brush	GMC1-BR1	1
Threadlocker	TL1	1
Sealer	RTV Silicone	1

DRK-324EMK		
Position	Part Number	Qty
Differential Brg.	JLM506849A-JLM506811	2
Pinion Head Brg.	STA4895-1	1
Pinion Tail Brg.	HM88649-HM88610	1
Pinion Seal	22943111	1
Crush Sleeve	CS361	1
Pinion Nut	PN13	1
Pinion Depth Shims	SK3	1
Differential Shims	SK13 <sup>54</sup>	1
Gear Marking & Brush	GMC1-BR1	1
Threadlocker	TL1	1
Sealer	RTV Silicone	1
Ring Gear Bolts	RGB8	12

DRK-324G		
Position	Part Number	Qty
Differential Brg.	JLM506849A-JLM506811	2
Pinion Head Brg.	HM804846-HM804810	1
Pinion Tail Brg.	HM88649-HM88610	1
Pinion Seal	710558 (2.125x2.914)	1
Crush Sleeve	CS324	1
Pinion Nut	PN3	1
Gear Marking & Brush	GMC1-BR1	1
Threadlocker	TL1	1
Sealer	RTV Silicone	1

DRK-324GMK		
Position	Part Number	Qty
Differential Brg.	JLM506849A-JLM506811	2
Pinion Head Brg.	HM804846-HM804810	1
Pinion Tail Brg.	HM88649-HM88610	1
Pinion Seal	710558 (2.125x2.914)	1
Crush Sleeve	CS324	1
Pinion Nut	PN3	1
Gear Marking & Brush	GMC1-BR1	1
Threadlocker	TL1	1
Sealer	RTV Silicone	1
Pinion Depth Shims	SK3	1
Differential Shims	SK13 <sup>54</sup>	1
Ring Gear Bolts	RGB8	12

DRK-324H		
Position	Part Number	Qty
Differential Brg.	JLM506849A-JLM506811	2
Pinion Head Brg.	F580408.RTR-F580408.LTR	1
Pinion Tail Brg.	HM89249-HM89210	1
Pinion Seal	22943111	1
Crush Sleeve	CS313	1
Pinion Nut	PN13	1
Gear Marking & Brush	GMC1-BR1	1
Threadlocker	TL1	1
Sealer	RTV Silicone	1

DRK-324HMK		
Position	Part Number	Qty
Differential Brg.	JLM506849A-JLM506811	2
Pinion Head Brg.	F580408.RTR-F580408.LTR	1
Pinion Tail Brg.	HM89249-HM89210	1
Pinion Seal	22943111	1
Crush Sleeve	CS313	1
Pinion Nut	PN13	1
Gear Marking & Brush	GMC1-BR1	1
Threadlocker	TL1	1
Sealer	RTV Silicone	1
Pinion Depth Shims	SK22	1
Differential Shims	SK13 <sup>54</sup>	1
Ring Gear Bolts	RGB8	12

DRK-325		
Position	Part Number	Qty
Differential Brg.	387AS-382A	2
Pinion Head Brg.	HM803149-HM803110	1
Pinion Tail Brg.	M802048-M802011	1
Pinion Nose Brg.	R1581TV	1
Pinion Seal	2286 (2.201x3.519)	1
Crush Sleeve	CS325	1
Pinion Nut	PN7	1
Gear Marking & Brush	GMC1-BR1	1
Threadlocker	TL1	1
Sealer	RTV Silicone	1

DRK-325MK		
Position	Part Number	Qty
Differential Brg.	387AS-382A	2
Pinion Head Brg.	HM803149-HM803110	1
Pinion Tail Brg.	M802048-M802011	1
Pinion Nose Brg.	R1581TV	1
Pinion Seal	2286 (2.201x3.519)	1
Crush Sleeve	CS325	1
Pinion Nut	PN7	1
Gear Marking & Brush	GMC1-BR1	1
Threadlocker	TL1	1
Sealer	RTV Silicone	1
Pinion Depth Shims	SK14	1
Ring Gear Bolts	RGB9 <sup>8</sup>	12

<sup>8</sup> Order RGB10 for ratios 4.56 and higher.

<sup>54</sup> Order SSK13 for stackable differential shims.

# Light Duty Differential Rebuild Kits



DRK-325A		
Position	Part Number	Qty
Differential Brg.	387AS-382A	2
Pinion Head Brg.	HM903249-HM903210	1
Pinion Tail Brg.	M802048-M802011	1
Pinion Nose Brg.	R1581TV	1
Pinion Seal	2286 (2.201x3.519)	1
Crush Sleeve	CS325A	1
Pinion Nut	PN7	1
Gear Marking & Brush	GMC1-BR1	1
Threadlocker	TL1	1
Sealer	RTV Silicone	1

DRK-325AMK		
Position	Part Number	Qty
Differential Brg.	387AS-382A	2
Pinion Head Brg.	HM903249-HM903210	1
Pinion Tail Brg.	M802048-M802011	1
Pinion Nose Brg.	R1581TV	1
Pinion Seal	2286 (2.201x3.519)	1
Crush Sleeve	CS325A	1
Pinion Nut	PN7	1
Gear Marking & Brush	GMC1-BR1	1
Threadlocker	TL1	1
Sealer	RTV Silicone	1
Pinion Depth Shims	SK14	1
Ring Gear Bolts	RGB9 <sup>8</sup>	12

DRK-325B		
Position	Part Number	Qty
Differential Brg.	387AS-382A	2
Pinion Head Brg.	HM903249-HM903210	1
Pinion Tail Brg.	M802048-M802011	1
Pinion Nose Brg.	R1581TV	1
Pinion Seal	710508 (2.324x3.541)	1
Crush Sleeve	CS325A	1
Pinion Nut	PN7	1
Gear Marking & Brush	GMC1-BR1	1
Threadlocker	TL1	1
Sealer	RTV Silicone	1

DRK-325BMK		
Position	Part Number	Qty
Differential Brg.	387AS-382A	2
Pinion Head Brg.	HM903249-HM903210	1
Pinion Tail Brg.	M802048-M802011	1
Pinion Nose Brg.	R1581TV	1
Pinion Seal	710508 (2.324x3.541)	1
Crush Sleeve	CS325A	1
Pinion Nut	PN7	1
Gear Marking & Brush	GMC1-BR1	1
Threadlocker	TL1	1
Sealer	RTV Silicone	1
Pinion Depth Shims	SK14	1
Ring Gear Bolts	RGB9	12

DRK-325C		
Position	Part Number	Qty
Differential Brg.	JLM506849A-JLM506811	2
Pinion Head Brg.	HM807046-HM807010	1
Pinion Tail Brg.	STD4183KELFT	1
Pinion Seal	20964040	1
Crush Sleeve	CS312	1
Pinion Nut	PN25	1
Gear Marking & Brush	GMC1-BR1	1
Threadlocker	TL1	1
Sealer	RTV Silicone	1

DRK-325CMK		
Position	Part Number	Qty
Differential Brg.	JLM506849A-JLM506811	2
Pinion Head Brg.	HM807046-HM807010	1
Pinion Tail Brg.	STD4183KELFT	1
Pinion Seal	20964040	1
Crush Sleeve	CS312	1
Pinion Nut	PN25	1
Gear Marking & Brush	GMC1-BR1	1
Threadlocker	TL1	1
Sealer	RTV Silicone	1
Pinion Depth Shims	SK54	1
Differential Shims	SK13 <sup>54</sup>	1
Ring Gear Bolts	RGB34	12

DRK-326		
Position	Part Number	Qty
Differential Brg.	LM102949-LM102911	2
Pinion Head Brg.	HM89446-HM89410	1
Pinion Tail Brg.	M86649-M86610	1
Pinion Seal	7457N (1.656x2.623)	1
Crush Sleeve	CS310	1
Pinion Nut	PN12	1
Gear Marking & Brush	GMC1-BR1	1
Threadlocker	TL1	1
Sealer	RTV Silicone	1

DRK-326MK		
Position	Part Number	Qty
Differential Brg.	LM102949-LM102911	2
Pinion Head Brg.	HM89446-HM89410	1
Pinion Tail Brg.	M86649-M86610	1
Pinion Seal	7457N (1.656x2.623)	1
Crush Sleeve	CS310	1
Pinion Nut	PN12	1
Gear Marking & Brush	GMC1-BR1	1
Threadlocker	TL1	1
Sealer	RTV Silicone	1
Pinion Depth Shims	SK12	1
Differential Shims	SK11 <sup>28</sup>	1
Ring Gear Bolts	RGB2	8

DRK-326A		
Position	Part Number	Qty
Differential Brg.	LM102949-LM102910	2
Pinion Head Brg.	HM89446-HM89410	1
Pinion Tail Brg.	M86649-M86610	1
Pinion Seal	7457N (1.656x2.623)	1
Crush Sleeve	CS310	1
Pinion Nut	PN13	1
Gear Marking & Brush	GMC1-BR1	1
Threadlocker	TL1	1
Sealer	RTV Silicone	1
Axle Shaft Seal	1174	2

DRK-326AMK		
Position	Part Number	Qty
Axle Shaft Seal	1174	100
Differential Brg.	LM102949-LM102910	2
Pinion Head Brg.	HM89446-HM89410	1
Pinion Tail Brg.	M86649-M86610	1
Pinion Seal	7457N (1.656x2.623)	1
Crush Sleeve	CS310	1
Pinion Nut	PN13	1
Gear Marking & Brush	GMC1-BR1	1
Threadlocker	TL1	1
Sealer	RTV Silicone	1
Pinion Depth Shims	SK12	1
Differential Shims	SK25	1
Ring Gear Bolts	RGB2	8

DRK-326B		
Position	Part Number	Qty
Differential Brg.	JLM104948-9X147	2
Pinion Head Brg.	HM803149-HM803110	1
Pinion Tail Brg.	HM89449-HM89410	1
Pinion Seal	92191954	1
Crush Sleeve	CS353	1
Pinion Nut	PN20	1
Gear Marking & Brush	GMC1-BR1	1
Threadlocker	TL1	1
Sealer	RTV Silicone	1

DRK-326BMK		
Position	Part Number	Qty
Differential Brg.	JLM104948-9X147	2
Pinion Head Brg.	HM803149-HM803110	1
Pinion Tail Brg.	HM89449-HM89410	1
Pinion Seal	92191954	1
Crush Sleeve	CS353	1
Pinion Nut	PN20	1
Pinion Depth Shims	SK1	1
Differential Shims	SK50	1
Ring Gear Bolts	RGB30	10
Gear Marking & Brush	GMC1-BR1	1
Threadlocker	TL1	1
Sealer	RTV Silicone	1

DRK-327		
Position	Part Number	Qty
Differential Brg.	3984-3920	2
Pinion Head Brg.	HM807046-HM807010	1
Pinion Tail Brg.	M802048-M802011	1
Pinion Seal	710508 (2.324x3.541)	1
Crush Sleeve	CS341	1
Pinion Nut	PN17	1
Gear Marking & Brush	GMC1-BR1	1
Threadlocker	TL1	1
Sealer	RTV Silicone	1

DRK-327MK		
Position	Part Number	Qty
Differential Brg.	3984-3920	2
Pinion Head Brg.	HM807046-HM807010	1
Pinion Tail Brg.	M802048-M802011	1
Pinion Seal	710508 (2.324x3.541)	1
Crush Sleeve	CS341	1
Pinion Nut	PN17	1
Gear Marking & Brush	GMC1-BR1	1
Threadlocker	TL1	1
Sealer	RTV Silicone	1
Pinion Depth Shims	SK54	1
Ring Gear Bolts	RGB21	12
Pinion Seal Sleeve	26060977	1

DRK-327A		
Position	Part Number	Qty
Differential Brg.	3984-3920	2
Pinion Head Brg.	NP516549-NP673386	1
Pinion Tail Brg.	M802048-M802011	1
Pinion Seal	710508 (2.324x3.541)	1
Crush Sleeve	CS341	1
Pinion Nut	PN17	1
Gear Marking & Brush	GMC1-BR1	1
Threadlocker	TL1	1
Sealer	RTV Silicone	1

LD Differential

196 <sup>8</sup> Order RGB10 for ratios 4.56 and higher. <sup>28</sup> Order SSK11 for stackable differential shims.  
<sup>54</sup> Order SSK13 for stackable differential shims.

# Light Duty Differential Rebuild Kits

DRK-327AMK		
Position	Part Number	Qty
Differential Brg.	3984-3920	2
Pinion Head Brg.	NP516549-NP673386	1
Pinion Tail Brg.	M802048-M802011	1
Pinion Seal	710508 (2.324x3.541)	1
Crush Sleeve	CS341	1
Pinion Nut	PN17	1
Gear Marking & Brush	GMC1-BR1	1
Threadlocker	TL1	1
Sealer	RTV Silicone	1
Pinion Depth Shims	SK54	1
Ring Gear Bolts	RGB21	12
Pinion Seal Sleeve	26060977	1

DRK-327B		
Position	Part Number	Qty
Differential Brg.	3984-3920	2
Pinion Head Brg.	NP848872-NP673386	1
Pinion Tail Brg.	HM807046-HM807010	1
Pinion Seal	68237720AA	1
Crush Sleeve	CS356	1
Pinion Nut	PN17	1
Gear Marking & Brush	GMC1-BR1	1
Threadlocker	TL1	1
Sealer	RTV Silicone	1

DRK-327BMK		
Position	Part Number	Qty
Differential Brg.	3984-3920	2
Pinion Head Brg.	NP848872-NP673386	1
Pinion Tail Brg.	HM807046-HM807010	1
Pinion Seal	68237720AA	1
Crush Sleeve	CS356	1
Pinion Nut	PN17	1
Gear Marking & Brush	GMC1-BR1	1
Threadlocker	TL1	1
Sealer	RTV Silicone	1
Pinion Depth Shims	SK54	1
Ring Gear Bolts	RGB21	16
Pinion Seal Sleeve	26060977	1

DRK-328		
Position	Part Number	Qty
Differential Brg.	387A-382A	2
Pinion Head Brg.	NP201062-NP101912	1
Pinion Tail Brg.	NP568415-NP908986	1
Output Shaft Seal	12369460	2
Gear Marking & Brush	GMC1-BR1	1
Threadlocker	TL1	1
Sealer	RTV Silicone	1
Needle Brg.	HK4020	1
O-Ring	OR162	1
O-Ring	OR170X2	1
O-Ring	5X1034	2

DRK-329		
Position	Part Number	Qty
Differential Brg.	25584-25520	2
Pinion Head Brg.	HM804846-HM804810	1
Pinion Tail Brg.	HM89446-HM89410	1
Pinion Seal	473461 (1.937x3.061)	1
Crush Sleeve	CS329	1
Pinion Nut	PN3	1
Gear Marking & Brush	GMC1-BR1	1
Threadlocker	TL1	1
Sealer	RTV Silicone	1

DRK-329MK		
Position	Part Number	Qty
Differential Brg.	25584-25520	2
Pinion Head Brg.	HM804846-HM804810	1
Pinion Tail Brg.	HM89446-HM89410	1
Pinion Seal	473461 (1.937x3.061)	1
Crush Sleeve	CS329	1
Pinion Nut	PN3	1
Gear Marking & Brush	GMC1-BR1	1
Threadlocker	TL1	1
Sealer	RTV Silicone	1
Pinion Depth Shims	SK3	1
Differential Shims	SK23	1
Ring Gear Bolts	RGB5	10

DRK-331		
Position	Part Number	Qty
Differential Brg.	387A-382S	2
Pinion Head Brg.	HM803146-HM803110	1
Pinion Tail Brg.	HM88542-HM88510	1
Pinion Seal	6808N (1.875x3.160)	1
Pinion Seal	9316 (1.875x3.160)	1
Pinion Nut	PN5	1
Gear Marking & Brush	GMC1-BR1	1
Threadlocker	TL1	1
Sealer	RTV Silicone	1
Pinion Brg. Shims	SK17	1
Pinion Depth Shims	SK15	1
Differential Shims	SK54	1

DRK-331MK		
Position	Part Number	Qty
Differential Brg.	387A-382S	2
Pinion Head Brg.	HM803146-HM803110	1
Pinion Tail Brg.	HM88542-HM88510	1
Pinion Seal	6808N (1.875x3.160)	1
Pinion Seal	9316 (1.875x3.160)	1
Pinion Nut	PN5	1
Gear Marking & Brush	GMC1-BR1	1
Threadlocker	TL1	1
Sealer	RTV Silicone	1
Pinion Brg. Shims	SK17	1
Pinion Depth Shims	SK15	1
Differential Shims	SK54	1
Ring Gear Bolts	RGB6	12

DRK-331A		
Position	Part Number	Qty
Differential Brg.	387A-382S	2
Pinion Head Brg.	HM803146-HM803110	1
Pinion Tail Brg.	HM88542-HM88510	1
Pinion Seal	9316 (1.875x3.160)	1
Pinion Seal	100712V (1.874x3.159)	1
Crush Sleeve	CS342	1
Pinion Nut	PN5	1
Gear Marking & Brush	GMC1-BR1	1
Threadlocker	TL1	1
Sealer	RTV Silicone	1
Pinion Depth Shims	SK15	1
Differential Shims	SK54	1

DRK-331AMK		
Position	Part Number	Qty
Differential Brg.	387A-382S	2
Pinion Head Brg.	HM803146-HM803110	1
Pinion Tail Brg.	HM88542-HM88510	1
Pinion Seal	9316 (1.875x3.160)	1
Pinion Seal	100712V (1.874x3.159)	1
Crush Sleeve	CS342	1
Pinion Nut	PN5	1
Gear Marking & Brush	GMC1-BR1	1
Threadlocker	TL1	1
Sealer	RTV Silicone	1
Pinion Depth Shims	SK15	1
Differential Shims	SK54	1
Ring Gear Bolts	RGB6	12

DRK-331B		
Position	Part Number	Qty
Differential Brg.	NP197868-NP802507	2
Pinion Head Brg.	HM803146-HM803110	1
Pinion Tail Brg.	HM88542-HM88510	1
Pinion Seal	719316 (1.875x3.160)	1
Pinion Seal	DS50637 (1.874x3.159)	1
Pinion Nut	PN5	1
Gear Marking & Brush	GMC1-BR1	1
Threadlocker	TL1	1
Sealer	RTV Silicone	1

DRK-331BMK		
Position	Part Number	Qty
Differential Brg.	NP197868-NP802507	2
Pinion Head Brg.	HM803146-HM803110	1
Pinion Tail Brg.	HM88542-HM88510	1
Pinion Seal	719316 (1.875x3.160)	1
Pinion Seal	DS50637 (1.874x3.159)	1
Pinion Nut	PN5	1
Gear Marking & Brush	GMC1-BR1	1
Threadlocker	TL1	1
Sealer	RTV Silicone	1
Pinion Brg. Shims	SK17	1
Pinion Depth Shims	SK15	1
Differential Shims	SK54	1
Ring Gear Bolts	RGB6	12

DRK-331C		
Position	Part Number	Qty
Differential Brg.	NP197868-NP802507	2
Pinion Head Brg.	HM803146-HM803110	1
Pinion Tail Brg.	HM88542-HM88510	1
Pinion Seal	DS2001243	1
Pinion Nut	PN5	1
Gear Marking & Brush	GMC1-BR1	1
Threadlocker	TL1	1
Sealer	RTV Silicone	1

DRK-331CMK		
Position	Part Number	Qty
Differential Brg.	NP197868-NP802507	2
Pinion Head Brg.	HM803146-HM803110	1
Pinion Tail Brg.	HM88542-HM88510	1
Pinion Seal	DS2001243	1
Pinion Nut	PN5	1
Gear Marking & Brush	GMC1-BR1	1
Threadlocker	TL1	1
Sealer	RTV Silicone	1
Pinion Brg. Shims	SK17	1
Pinion Depth Shims	SK15	1
Differential Shims	SK54	3
Ring Gear Bolts	RGB6	12

DRK-332		
Position	Part Number	Qty
Differential Brg.	387A-382S	2
Pinion Head Brg.	HM807040-HM807010	1
Pinion Tail Brg.	HM88542-HM88510	1
Pinion Seal	6808N (1.875x3.160)	1
Pinion Seal	9316 (1.875x3.160)	1
Pinion Nut	PN5	1
Gear Marking & Brush	GMC1-BR1	1
Threadlocker	TL1	1
Sealer	RTV Silicone	1
Pinion Brg. Shims	SK17	1
Pinion Depth Shims	SK18	1
Differential Shims	SK54	1

LD Differential

# Light Duty Differential Rebuild Kits



DRK-332MK		
Position	Part Number	Qty
Differential Brg.	387A-382S	2
Pinion Head Brg.	HM807040-HM807010	1
Pinion Tail Brg.	HM88542-HM88510	1
Pinion Seal	6808N (1.875x3.160)	1
Pinion Seal	9316 (1.875x3.160)	1
Pinion Nut	PN5	1
Gear Marking & Brush	GMC1-BR1	1
Threadlocker	TL1	1
Sealer	RTV Silicone	1
Pinion Brg. Shims	SK17	1
Pinion Depth Shims	SK18	1
Differential Shims	SK54	1
Ring Gear Bolts	RGB12	12

DRK-332A		
Position	Part Number	Qty
Differential Brg.	NP197868-NP802507	2
Pinion Head Brg.	HM803149-HM803110	1
Pinion Tail Brg.	HM88542-HM88510	1
Pinion Seal	719316 (1.875x3.160)	1
Pinion Nut	PN5	1
Gear Marking & Brush	GMC1-BR1	1
Threadlocker	TL1	1
Sealer	RTV Silicone	1
Pinion Brg. Shims	SK17	1
Pinion Depth Shims	SK15	1
Differential Shims	SK54	1
Spacer	DS46176	1

DRK-332AMK		
Position	Part Number	Qty
Differential Brg.	NP197868-NP802507	2
Pinion Head Brg.	HM803149-HM803110	1
Pinion Tail Brg.	HM88542-HM88510	1
Pinion Seal	719316 (1.875x3.160)	1
Pinion Nut	PN5	1
Gear Marking & Brush	GMC1-BR1	1
Threadlocker	TL1	1
Sealer	RTV Silicone	1
Pinion Brg. Shims	SK17	1
Pinion Depth Shims	SK15	1
Differential Shims	SK54	1
Ring Gear Bolts	RGB12	12
Spacer	DS46176	1

DRK-332G		
Position	Part Number	Qty
Differential Brg.	469-453X	2
Pinion Head Brg.	HM807040-HM807010	1
Pinion Tail Brg.	HM88542-HM88510	1
Pinion Seal	DS50637 (1.874x3.159)	1
Pinion Nut	PN5D	1
Pinion Nut Washer	DS30275	1
Gear Marking & Brush	GMC1-BR1	1
Threadlocker	TL1	1
Sealer	RTV Silicone	1
Pinion Brg. Shims	SK17	1
Pinion Depth Shims	SK18	1
Differential Shims	SK54	1

DRK-332GMK		
Position	Part Number	Qty
Differential Brg.	469-453X	2
Pinion Head Brg.	HM807040-HM807010	1
Pinion Tail Brg.	HM88542-HM88510	1
Pinion Seal	DS50637 (1.874x3.159)	1
Pinion Nut	PN5D	1
Pinion Nut Washer	DS30275	1
Gear Marking & Brush	GMC1-BR1	1
Threadlocker	TL1	1
Sealer	RTV Silicone	1
Pinion Brg. Shims	SK17	1
Pinion Depth Shims	SK18	1
Differential Shims	SK54	1
Ring Gear Bolts	RGB12	12

DRK-332HD		
Position	Part Number	Qty
Differential Brg.	469-453X	2
Pinion Head Brg.	HM807040-HM807010	1
Pinion Tail Brg.	HM88542-HM88510	1
Pinion Seal	9316 (1.875x3.160)	1
Pinion Nut	PN5	1
Gear Marking & Brush	GMC1-BR1	1
Threadlocker	TL1	1
Sealer	RTV Silicone	1
Pinion Brg. Shims	SK17	1
Pinion Depth Shims	SK18	1
Differential Shims	SK54	1

DRK-332HDMK		
Position	Part Number	Qty
Differential Brg.	469-453X	2
Pinion Head Brg.	HM807040-HM807010	1
Pinion Tail Brg.	HM88542-HM88510	1
Pinion Seal	9316 (1.875x3.160)	1
Pinion Nut	PN5	1
Gear Marking & Brush	GMC1-BR1	1
Threadlocker	TL1	1
Sealer	RTV Silicone	1
Pinion Brg. Shims	SK17	1
Pinion Depth Shims	SK18	1
Differential Shims	SK54	1
Ring Gear Bolts	RGB12	12

DRK-332U		
Position	Part Number	Qty
Differential Brg.	387A-382S	2
Pinion Head Brg.	HM803149-HM803110	1
Pinion Tail Brg.	HM88542-HM88510	1
Pinion Seal	9316 (1.875x3.160)	1
Pinion Nut	PN5	1
Gear Marking & Brush	GMC1-BR1	1
Threadlocker	TL1	1
Sealer	RTV Silicone	1
Pinion Brg. Shims	SK17	1
Pinion Depth Shims	SK15	1
Differential Shims	SK54	1
Pinion Nut Washer	DS30275	1

DRK-332UMK		
Position	Part Number	Qty
Differential Brg.	387A-382S	2
Pinion Head Brg.	HM803149-HM803110	1
Pinion Tail Brg.	HM88542-HM88510	1
Pinion Seal	9316 (1.875x3.160)	1
Pinion Nut	PN5	1
Gear Marking & Brush	GMC1-BR1	1
Threadlocker	TL1	1
Sealer	RTV Silicone	1
Pinion Brg. Shims	SK17	1
Pinion Depth Shims	SK15	1
Differential Shims	SK54	1
Ring Gear Bolts	RGB12	12
Pinion Nut Washer	DS30275	1

DRK-333		
Position	Part Number	Qty
Differential Brg.	LM29749-LM29710	2
Pinion Head Brg.	M88048-M88010	1
Pinion Tail Brg.	M86649-M86610	1
Pinion Seal	4244 (1.552x2.750)	1
Crush Sleeve	CS330	1
Pinion Nut	PN8-F	1
Gear Marking & Brush	GMC1-BR1	1
Threadlocker	TL1	1
Sealer	RTV Silicone	1

DRK-333MK		
Position	Part Number	Qty
Differential Brg.	LM29749-LM29710	2
Pinion Head Brg.	M88048-M88010	1
Pinion Tail Brg.	M86649-M86610	1
Pinion Seal	4244 (1.552x2.750)	1
Crush Sleeve	CS330	1
Pinion Nut	PN8-F	1
Gear Marking & Brush	GMC1-BR1	1
Threadlocker	TL1	1
Sealer	RTV Silicone	1
Pinion Depth Shims	SK24	1
Differential Shims	SK25	1
Ring Gear Bolts	RGB5-D	10

DRK-333A		
Position	Part Number	Qty
Pinion Nose Brg.	207	1
Differential Brg.	LM29749-LM29710	2
Pinion Head Brg.	M86649-M86610	1
Pinion Tail Brg.	M88048-M88010	1
Pinion Seal	100552 (1.844x2.865)	1
Crush Sleeve	CS335 <sup>110</sup>	1
Gear Marking & Brush	GMC1-BR1	1
Threadlocker	TL1	1
Sealer	RTV Silicone	1

DRK-333AMK		
Position	Part Number	Qty
Pinion Nose Brg.	207	1
Differential Brg.	LM29749-LM29710	2
Pinion Head Brg.	M86649-M86610	1
Pinion Tail Brg.	M88048-M88010	1
Pinion Seal	100552 (1.844x2.865)	1
Crush Sleeve	CS335 <sup>110</sup>	1
Gear Marking & Brush	GMC1-BR1	1
Threadlocker	TL1	1
Sealer	RTV Silicone	1
Pinion Depth Shims	SK24	1
Differential Shims	SK25	1
Ring Gear Bolts	RGB5-D	10

DRK-334		
Position	Part Number	Qty
Differential Brg.	LM501349-LM501314	2
Pinion Head Brg.	HM88649-HM88610	1
Pinion Tail Brg.	02872-02820	1
Pinion Seal	5778 (1.552x3.160)	1
Pinion Nut	PN8-F	1
Gear Marking & Brush	GMC1-BR1	1
Threadlocker	TL1	1
Sealer	RTV Silicone	1

DRK-334MK		
Position	Part Number	Qty
Differential Brg.	LM501349-LM501314	2
Pinion Head Brg.	HM88649-HM88610	1
Pinion Tail Brg.	02872-02820	1
Pinion Seal	5778 (1.552x3.160)	1
Pinion Nut	PN8-F	1
Gear Marking & Brush	GMC1-BR1	1
Threadlocker	TL1	1
Sealer	RTV Silicone	1
Pinion Brg. Shims	SK5	1
Pinion Depth Shims	SK54	1
Differential Shims	SK20	1
Ring Gear Bolts	RGB5	10



# Light Duty Differential Rebuild Kits

<b>DRK-334A</b>		
Position	Part Number	Qty
Differential Brg.	LM501349-LM501314	2
Pinion Head Brg.	HM88649-HM88610	1
Pinion Tail Brg.	M86649-M86610	1
Pinion Seal	5778 (1.552x3.160)	1
Crush Sleeve	CS328	1
Pinion Nut	PN8-F	1
Gear Marking & Brush	GMC1-BR1	1
Threadlocker	TL1	1
Sealer	RTV Silicone	1

<b>DRK-334AMK</b>		
Position	Part Number	Qty
Differential Brg.	LM501349-LM501314	2
Pinion Head Brg.	HM88649-HM88610	1
Pinion Tail Brg.	M86649-M86610	1
Pinion Seal	5778 (1.552x3.160)	1
Crush Sleeve	CS328	1
Pinion Nut	PN8-F	1
Gear Marking & Brush	GMC1-BR1	1
Threadlocker	TL1	1
Sealer	RTV Silicone	1
Pinion Depth Shims	SK54	1
Differential Shims	SK20	1
Ring Gear Bolts	RGB5	10
Slinger	13575	1

<b>DRK-334B</b>		
Position	Part Number	Qty
Differential Brg.	LM501349-LM501314	2
Pinion Head Brg.	HM88649-HM88610	1
Pinion Tail Brg.	M86649-M86610	1
Pinion Seal	714675 (1.843x2.748)	1
Crush Sleeve	CS328	1
Pinion Nut	PN8-F	1
Gear Marking & Brush	GMC1-BR1	1
Threadlocker	TL1	1
Sealer	RTV Silicone	1

<b>DRK-334BMK</b>		
Position	Part Number	Qty
Differential Brg.	LM501349-LM501314	2
Pinion Head Brg.	HM88649-HM88610	1
Pinion Tail Brg.	M86649-M86610	1
Pinion Seal	714675 (1.843x2.748)	1
Crush Sleeve	CS328	1
Pinion Nut	PN8-F	1
Gear Marking & Brush	GMC1-BR1	1
Threadlocker	TL1	1
Sealer	RTV Silicone	1
Pinion Depth Shims	SK54	1
Differential Shims	SK20	1
Ring Gear Bolts	RGB5-D	10

<b>DRK-334C</b>		
Position	Part Number	Qty
Differential Brg.	LM501349-LM501314	2
Pinion Head Brg.	HM88649-HM88610	1
Pinion Tail Brg.	M86649-M86610	1
Pinion Seal	5778 (1.552x3.160)	1
Pinion Seal	DS50531 (1.552x3.160)	1
Crush Sleeve	CS335	1
Pinion Nut	PN8-F	1
Gear Marking & Brush	GMC1-BR1	1
Threadlocker	TL1	1
Sealer	RTV Silicone	1

<b>DRK-334CMK</b>		
Position	Part Number	Qty
Differential Brg.	LM501349-LM501314	2
Pinion Head Brg.	HM88649-HM88610	1
Pinion Tail Brg.	M86649-M86610	1
Pinion Seal	5778 (1.552x3.160)	1
Pinion Seal	DS50531 (1.552x3.160)	1
Crush Sleeve	CS335	1
Pinion Nut	PN8-F	1
Gear Marking & Brush	GMC1-BR1	1
Threadlocker	TL1	1
Sealer	RTV Silicone	1
Pinion Depth Shims	SK54	1
Differential Shims	SK20	1
Ring Gear Bolts	RGB5	10
Slinger	13575	1

<b>DRK-334D</b>		
Position	Part Number	Qty
Differential Brg.	LM501349-LM501314	2
Pinion Head Brg.	M802048-M802011	1
Pinion Tail Brg.	HM88649-HM88610	1
Pinion Seal	710741 (1.844x3.063)	1
Crush Sleeve	CS345	1
Pinion Nut	PN6	1
Gear Marking & Brush	GMC1-BR1	1
Threadlocker	TL1	1
Sealer	RTV Silicone	1

<b>DRK-334DMK</b>		
Position	Part Number	Qty
Differential Brg.	LM501349-LM501314	2
Pinion Head Brg.	M802048-M802011	1
Pinion Tail Brg.	HM88649-HM88610	1
Pinion Seal	710741 (1.844x3.063)	1
Crush Sleeve	CS345	1
Pinion Nut	PN6	1
Gear Marking & Brush	GMC1-BR1	1
Threadlocker	TL1	1
Sealer	RTV Silicone	1
Pinion Depth Shims	SK4	1
Differential Shims	SK20	1
Ring Gear Bolts	RGB5	10
Slinger	DS48741-3	1

<b>DRK-334E</b>		
Position	Part Number	Qty
Differential Brg.	LM501349-LM501314	2
Pinion Head Brg.	NP310800-NP312191	1
Pinion Tail Brg.	NP748236-NP283244	1
Pinion Seal	714675 (1.843x2.748)	1
Crush Sleeve	CS328	1
Crush Sleeve	CS331	1
Pinion Nut	PN8-F	1
Gear Marking & Brush	GMC1-BR1	1
Threadlocker	TL1	1
Sealer	RTV Silicone	1

<b>DRK-334EMK</b>		
Position	Part Number	Qty
Differential Brg.	LM501349-LM501314	2
Pinion Head Brg.	NP310800-NP312191	1
Pinion Tail Brg.	NP748236-NP283244	1
Pinion Seal	714675 (1.843x2.748)	1
Crush Sleeve	CS328	1
Crush Sleeve	CS331	1
Pinion Nut	PN8-F	1
Pinion Depth Shims	SK54	1
Differential Shims	SK28 <sup>51</sup>	1
Gear Marking & Brush	GMC1-BR1	1
Threadlocker	TL1	1
Sealer	RTV Silicone	1
Ring Gear Bolts	RGB5-D	10

<b>DRK-334TJ</b>		
Position	Part Number	Qty
Differential Brg.	LM501349-LM501314	2
Pinion Head Brg.	HM88649-HM88610	1
Pinion Tail Brg.	M86649-M86610	1
Pinion Seal	5778 (1.552x3.160)	1
Pinion Seal	DS50660 (1.552x3.160)	1
Crush Sleeve	CS335	1
Pinion Nut	PN8-F	1
Gear Marking & Brush	GMC1-BR1	1
Threadlocker	TL1	1
Sealer	RTV Silicone	1

<b>DRK-334TJMK</b>		
Position	Part Number	Qty
Differential Brg.	LM501349-LM501314	2
Pinion Head Brg.	HM88649-HM88610	1
Pinion Tail Brg.	M86649-M86610	1
Pinion Seal	5778 (1.552x3.160)	1
Pinion Seal	DS50660 (1.552x3.160)	1
Crush Sleeve	CS335	1
Pinion Nut	PN8-F	1
Gear Marking & Brush	GMC1-BR1	1
Threadlocker	TL1	1
Sealer	RTV Silicone	1
Pinion Depth Shims	SK54	1
Differential Shims	SK20	1
Ring Gear Bolts	RGB5	10
Slinger	13575	1

<b>DRK-335</b>		
Position	Part Number	Qty
Differential Brg.	LM501349-LM501314	2
Pinion Head Brg.	HM88648-HM88610	1
Pinion Tail Brg.	M86649-M86610	1
Pinion Seal	714675 (1.843x2.748)	1
Crush Sleeve	CS310	1
Pinion Nut	PN6	1
Gear Marking & Brush	GMC1-BR1	1
Threadlocker	TL1	1
Sealer	RTV Silicone	1

<b>DRK-335MK</b>		
Position	Part Number	Qty
Differential Brg.	LM501349-LM501314	2
Pinion Head Brg.	HM88648-HM88610	1
Pinion Tail Brg.	M86649-M86610	1
Pinion Seal	714675 (1.843x2.748)	1
Crush Sleeve	CS310	1
Pinion Nut	PN6	1
Gear Marking & Brush	GMC1-BR1	1
Threadlocker	TL1	1
Sealer	RTV Silicone	1
Pinion Depth Shims	SK54	1
Differential Shims	SK28 <sup>51</sup>	1
Ring Gear Bolts	RGB5	8

<b>DRK-335B</b>		
Position	Part Number	Qty
Differential Brg.	LM501349-LM501310	2
Pinion Head Brg.	HM88648-HM88610	1
Pinion Tail Brg.	M86649-M86610	1
Pinion Seal	DS51501 (1.843x2.748)	1
Crush Sleeve	CS310	1
Pinion Nut	PN6	1
Gear Marking & Brush	GMC1-BR1	1
Threadlocker	TL1	1
Sealer	RTV Silicone	1

<sup>51</sup> Order SSK28 for stackable differential shims.

# Light Duty Differential Rebuild Kits



DRK-335BMK		
Position	Part Number	Qty
Differential Brg.	LM501349-LM501310	2
Pinion Head Brg.	HM88648-HM88610	1
Pinion Tail Brg.	M86649-M86610	1
Pinion Seal	DS51501 (1.843x2.748)	1
Crush Sleeve	CS310	1
Pinion Nut	PN6	1
Gear Marking & Brush	GMC1-BR1	1
Threadlocker	TL1	1
Sealer	RTV Silicone	1
Pinion Depth Shims	SK54	1
Differential Shims	SK28 <sup>51</sup>	1
Ring Gear Bolts	RGB5-D	8

DRK-335C		
Position	Part Number	Qty
Differential Brg.	LM501349-LM501314	2
Pinion Head Brg.	HM88648-HM88610	1
Pinion Tail Brg.	M86649-M86610	1
Pinion Seal	DS49153 (1.843x2.748)	1
Crush Sleeve	CS344	1
Pinion Nut	PN6	1
Gear Marking & Brush	GMC1-BR1	1
Threadlocker	TL1	1
Sealer	RTV Silicone	1

DRK-335CMK		
Position	Part Number	Qty
Differential Brg.	LM501349-LM501314	2
Pinion Head Brg.	HM88648-HM88610	1
Pinion Tail Brg.	M86649-M86610	1
Pinion Seal	DS49153 (1.843x2.748)	1
Crush Sleeve	CS344	1
Pinion Nut	PN6	1
Gear Marking & Brush	GMC1-BR1	1
Threadlocker	TL1	1
Sealer	RTV Silicone	1
Pinion Depth Shims	SK54	1
Differential Shims	SK28 <sup>51</sup>	1
Ring Gear Bolts	RGB5	8

DRK-336A		
Position	Part Number	Qty
Differential Brg.	JLM104948-LM104911A	2
Pinion Head Brg.	HM88649-HM88610	1
Pinion Tail Brg.	02872-02820	1
Pinion Seal	5778 (1.552x3.160)	1
Pinion Seal	DS50531 (1.552x3.160)	1
Crush Sleeve	CS338	1
Pinion Brg. Shims	SK5	1
Pinion Nut	PN8-F	1
Gear Marking & Brush	GMC1-BR1	1
Threadlocker	TL1	1
Sealer	RTV Silicone	1

DRK-336AMK		
Position	Part Number	Qty
Differential Brg.	JLM104948-LM104911A	2
Pinion Head Brg.	HM88649-HM88610	1
Pinion Tail Brg.	02872-02820	1
Pinion Seal	5778 (1.552x3.160)	1
Pinion Seal	DS50531 (1.552x3.160)	1
Crush Sleeve	CS338	1
Pinion Brg. Shims	SK5	1
Pinion Nut	PN8-F	1
Gear Marking & Brush	GMC1-BR1	1
Threadlocker	TL1	1
Sealer	RTV Silicone	1
Pinion Depth Shims	SK54	1
Differential Shims	SK21	1
Ring Gear Bolts	RGB14	10
Pinion Nut Washer	30186	1

DRK-337		
Position	Part Number	Qty
Differential Brg.	469-453X	2
Pinion Head Brg.	HM807046-HM807010	1
Pinion Tail Brg.	M802048-M802011	1
Pinion Seal	4525V (2.500x4.035)	1
Pinion Nut	PN10	1
Gear Marking & Brush	GMC1-BR1	1
Threadlocker	TL1	1
Sealer	RTV Silicone	1
Pinion Nut Washer	DS37104	1

DRK-337MK		
Position	Part Number	Qty
Differential Brg.	469-453X	2
Pinion Head Brg.	HM807046-HM807010	1
Pinion Tail Brg.	M802048-M802011	1
Pinion Seal	4525V (2.500x4.035)	1
Pinion Nut	PN10	1
Gear Marking & Brush	GMC1-BR1	1
Threadlocker	TL1	1
Sealer	RTV Silicone	1
Pinion Brg. Shims	SK44	1
Pinion Depth Shims	SK43	1
Differential Shims	SK54	1
Ring Gear Bolts	RGB13	12
Pinion Nut Washer	DS37104	1

DRK-337A		
Position	Part Number	Qty
Differential Brg.	469-453X	2
Pinion Head Brg.	NP516549-NP673386	1
Pinion Tail Brg.	M802048-M802011	1
Pinion Seal	DS51180 (2.500x4.035)	1
Pinion Nut	PN10	1
Gear Marking & Brush	GMC1-BR1	1
Threadlocker	TL1	1
Sealer	RTV Silicone	1
Pinion Nut Washer	DS37104	1

DRK-337AMK		
Position	Part Number	Qty
Differential Brg.	469-453X	2
Pinion Head Brg.	NP516549-NP673386	1
Pinion Tail Brg.	M802048-M802011	1
Pinion Seal	DS51180 (2.500x4.035)	1
Pinion Nut	PN10	1
Gear Marking & Brush	GMC1-BR1	1
Threadlocker	TL1	1
Sealer	RTV Silicone	1
Pinion Brg. Shims	SK44	1
Pinion Depth Shims	SK43	1
Differential Shims	SK54	1
Ring Gear Bolts	RGB13	12
Pinion Nut Washer	DS37104	1

DRK-338		
Position	Part Number	Qty
Differential Brg.	LM501349-LM501314	2
Pinion Head Brg.	HM88649-HM88610	1
Pinion Tail Brg.	M86647-M86610	1
Pinion Seal	5778 (1.552x3.160)	1
Pinion Nut	PN8-F	1
Gear Marking & Brush	GMC1-BR1	1
Threadlocker	TL1	1
Sealer	RTV Silicone	1

DRK-338MK		
Position	Part Number	Qty
Differential Brg.	LM501349-LM501314	2
Pinion Head Brg.	HM88649-HM88610	1
Pinion Tail Brg.	M86647-M86610	1
Pinion Seal	5778 (1.552x3.160)	1
Pinion Nut	PN8-F	1
Gear Marking & Brush	GMC1-BR1	1
Threadlocker	TL1	1
Sealer	RTV Silicone	1
Pinion Brg. Shims	SK5	1
Pinion Depth Shims	SK54	1
Differential Shims	SK20	1
Ring Gear Bolts	RGB5	10

DRK-339		
Position	Part Number	Qty
Differential Brg.	LM603049-LM603011	2
Pinion Head Brg.	HM88649-HM88610	1
Pinion Tail Brg.	M86647-M86610	1
Pinion Seal	5778 (1.552x3.160)	1
Pinion Nut	PN8-F	1
Gear Marking & Brush	GMC1-BR1	1
Threadlocker	TL1	1
Sealer	RTV Silicone	1

DRK-339MK		
Position	Part Number	Qty
Differential Brg.	LM603049-LM603011	2
Pinion Head Brg.	HM88649-HM88610	1
Pinion Tail Brg.	M86647-M86610	1
Pinion Seal	5778 (1.552x3.160)	1
Pinion Nut	PN8-F	1
Gear Marking & Brush	GMC1-BR1	1
Threadlocker	TL1	1
Sealer	RTV Silicone	1
Pinion Brg. Shims	SK5	1
Pinion Depth Shims	SK4	1
Differential Shims	SK7 <sup>27</sup>	1

DRK-339A		
Position	Part Number	Qty
Differential Brg.	LM603049-LM603012	2
Pinion Head Brg.	M802048-M802011	1
Pinion Tail Brg.	M88048-M88010	1
Pinion Seal	719316 (1.870x3.160)	1
Crush Sleeve	CS333	1
Pinion Nut	PN5	1
Gear Marking & Brush	GMC1-BR1	1
Threadlocker	TL1	1
Sealer	RTV Silicone	1

DRK-339AMK		
Position	Part Number	Qty
Differential Brg.	LM603049-LM603012	2
Pinion Head Brg.	M802048-M802011	1
Pinion Tail Brg.	M88048-M88010	1
Pinion Seal	719316 (1.870x3.160)	1
Crush Sleeve	CS333	1
Pinion Nut	PN5	1
Gear Marking & Brush	GMC1-BR1	1
Threadlocker	TL1	1
Sealer	RTV Silicone	1
Pinion Depth Shims	SK4	1
Differential Shims	SK7 <sup>27</sup>	1
Ring Gear Bolts	RGB5	10

DRK-339B		
Position	Part Number	Qty
Differential Brg.	25590-25523	2
Pinion Head Brg.	31594-31520	1
Pinion Tail Brg.	02872-02820	1
Pinion Seal	5778 (1.552x3.160)	1
Pinion Nut	PN8-F	1
Gear Marking & Brush	GMC1-BR1	1
Threadlocker	TL1	1
Sealer	RTV Silicone	1

LD Differential

# Light Duty Differential Rebuild Kits

DRK-339BMK		
Position	Part Number	Qty
Differential Brg.	25590-25523	2
Pinion Head Brg.	31594-31520	1
Pinion Tail Brg.	02872-02820	1
Pinion Seal	5778 (1.552x3.160)	1
Pinion Nut	PN8-F	1
Gear Marking & Brush	GMC1-BR1	1
Threadlocker	TL1	1
Sealer	RTV Silicone	1
Pinion Brg. Shims	SK5	1
Pinion Depth Shims	SK22	1
Differential Shims	SK23	1
Ring Gear Bolts	RGB5	10

DRK-339C		
Position	Part Number	Qty
Differential Brg.	25590-25523	2
Pinion Head Brg.	HM88649-HM88610	1
Pinion Tail Brg.	02872-02820	1
Pinion Seal	5778 (1.552x3.160)	1
Crush Sleeve	CS338	1
Pinion Nut	PN8-F	1
Gear Marking & Brush	GMC1-BR1	1
Threadlocker	TL1	1
Sealer	RTV Silicone	1
Pinion Nut Washer	30186	1

DRK-339CMK		
Position	Part Number	Qty
Differential Brg.	25590-25523	2
Pinion Head Brg.	HM88649-HM88610	1
Pinion Tail Brg.	02872-02820	1
Pinion Seal	5778 (1.552x3.160)	1
Crush Sleeve	CS338	1
Pinion Nut	PN8-F	1
Gear Marking & Brush	GMC1-BR1	1
Threadlocker	TL1	1
Sealer	RTV Silicone	1
Pinion Depth Shims	SK38	1
Differential Shims	SK23	1
Ring Gear Bolts	RGB5	10
Pinion Nut Washer	30186	1

DRK-339D		
Position	Part Number	Qty
Differential Brg.	25590-25523	2
Pinion Head Brg.	HM88649-HM88610	1
Pinion Tail Brg.	02872-02820	1
Pinion Seal	5778 (1.552x3.160)	1
Pinion Nut	PN8-F	1
Gear Marking & Brush	GMC1-BR1	1
Threadlocker	TL1	1
Sealer	RTV Silicone	1
Pinion Nut Washer	30186	1

DRK-339DMK		
Position	Part Number	Qty
Differential Brg.	25590-25523	2
Pinion Head Brg.	HM88649-HM88610	1
Pinion Tail Brg.	02872-02820	1
Pinion Seal	5778 (1.552x3.160)	1
Pinion Nut	PN8-F	1
Gear Marking & Brush	GMC1-BR1	1
Threadlocker	TL1	1
Sealer	RTV Silicone	1
Pinion Shims	SK38	1
Differential Shims	SK23	1
Ring Gear Bolts	RGB5	10
Pinion Nut Washer	30186	1

DRK-339E		
Position	Part Number	Qty
Differential Brg.	25590-25523	2
Pinion Head Brg.	31594-31520	1
Pinion Tail Brg.	02872-02820	1
Pinion Seal	DS50660 (1.552x3.160)	1
Pinion Nut	PN8-F	1
Gear Marking & Brush	GMC1-BR1	1
Threadlocker	TL1	1
Sealer	RTV Silicone	1

DRK-339EMK		
Position	Part Number	Qty
Differential Brg.	25590-25523	2
Pinion Head Brg.	31594-31520	1
Pinion Tail Brg.	02872-02820	1
Pinion Seal	DS50660 (1.552x3.160)	1
Pinion Nut	PN8-F	1
Gear Marking & Brush	GMC1-BR1	1
Threadlocker	TL1	1
Sealer	RTV Silicone	1
Pinion Brg. Shims	SK5	1
Pinion Depth Shims	SK22	1
Differential Shims	SK47	1
Ring Gear Bolts	RGB14	10

DRK-339F		
Position	Part Number	Qty
Differential Brg.	JLM704649-JLM704610	2
Pinion Head Brg.	M802048-M802011	1
Pinion Tail Brg.	HM88649-HM88610	1
Pinion Seal	710741 (1.844x3.063)	1
Crush Sleeve	CS345	1
Pinion Nut	PN6	1
Gear Marking & Brush	GMC1-BR1	1
Threadlocker	TL1	1
Sealer	RTV Silicone	1

DRK-339FMK		
Position	Part Number	Qty
Differential Brg.	JLM704649-JLM704610	2
Pinion Head Brg.	M802048-M802011	1
Pinion Tail Brg.	HM88649-HM88610	1
Pinion Seal	710741 (1.844x3.063)	1
Crush Sleeve	CS345	1
Pinion Nut	PN6	1
Gear Marking & Brush	GMC1-BR1	1
Threadlocker	TL1	1
Sealer	RTV Silicone	1
Pinion Depth Shims	SK4	1
Differential Shims	SK47	1
Ring Gear Bolts	RGB24	10
Slinger	DS48741-3	1

DRK-339G		
Position	Part Number	Qty
Differential Brg.	JLM704649-JLM704610	2
Pinion Head Brg.	M802048-M802011	1
Pinion Tail Brg.	M88048-M88010	1
Pinion Seal	DT04101 (1.875x3.156)	1
Crush Sleeve	CS349	1
Pinion Nut	PN5	1
Gear Marking & Brush	GMC1-BR1	1
Threadlocker	TL1	1
Sealer	RTV Silicone	1

DRK-339GMK		
Position	Part Number	Qty
Differential Brg.	JLM704649-JLM704610	2
Pinion Head Brg.	M802048-M802011	1
Pinion Tail Brg.	M88048-M88010	1
Pinion Seal	DT04101 (1.875x3.156)	1
Crush Sleeve	CS349	1
Pinion Nut	PN5	1
Gear Marking & Brush	GMC1-BR1	1
Threadlocker	TL1	1
Sealer	RTV Silicone	1
Pinion Depth Shims	SK4	1
Differential Shims	SK47	1
Ring Gear Bolts	RGB27	10
Slinger	DS48741-3	1

DRK-339H		
Position	Part Number	Qty
Differential Brg.	25590-25523	2
Pinion Head Brg.	M802048-M802011	1
Pinion Tail Brg.	M88048-M88010	1
Pinion Seal	DT04101 (1.875x3.156)	1
Crush Sleeve	CS349	1
Pinion Nut	PN5	1
Gear Marking & Brush	GMC1-BR1	1
Threadlocker	TL1	1
Sealer	RTV Silicone	1

DRK-339HMK		
Position	Part Number	Qty
Differential Brg.	25590-25523	2
Pinion Head Brg.	M802048-M802011	1
Pinion Tail Brg.	M88048-M88010	1
Pinion Seal	DT04101 (1.875x3.156)	1
Crush Sleeve	CS349	1
Pinion Nut	PN5	1
Gear Marking & Brush	GMC1-BR1	1
Threadlocker	TL1	1
Sealer	RTV Silicone	1
Pinion Depth Shims	SK4	1
Differential Shims	SK23	1
Ring Gear Bolts	RGB24	10
Slinger	DS48741-3	1

DRK-339J		
Position	Part Number	Qty
Differential Brg.	JLM104948-JLM104910	2
Pinion Head Brg.	NP784953-NP396414	1
Pinion Tail Brg.	M88048-M88010	1
Pinion Seal	DT04101 (1.875x3.156)	1
Crush Sleeve	CS349	1
Pinion Nut	PN5D	1
Gear Marking & Brush	GMC1-BR1	1
Threadlocker	TL1	1
Sealer	RTV Silicone	1

DRK-339JMK		
Position	Part Number	Qty
Differential Brg.	JLM104948-JLM104910	2
Pinion Head Brg.	NP784953-NP396414	1
Pinion Tail Brg.	M88048-M88010	1
Pinion Seal	DT04101 (1.875x3.156)	1
Crush Sleeve	CS349	1
Pinion Nut	PN5D	1
Pinion Depth Shims	SK4	1
Differential Shims	SK21	1
Gear Marking & Brush	GMC1-BR1	1
Threadlocker	TL1	1
Sealer	RTV Silicone	1
Ring Gear Bolts	RGB24	10

LD Differential

# Light Duty Differential Rebuild Kits



DRK-339N		
Position	Part Number	Qty
Differential Brg.	JLM704649-JLM704610	2
Pinion Head Brg.	HM803146-HM803110	1
Pinion Tail Brg.	M88048-M88010	1
Pinion Seal	100712V (1.874x3.159)	1
Crush Sleeve	CS349	1
Pinion Nut	PN5	1
Gear Marking & Brush	GMC1-BR1	1
Threadlocker	TL1	1
Sealer	RTV Silicone	1
Washer	DS30275	1

DRK-339NMK		
Position	Part Number	Qty
Differential Brg.	JLM704649-JLM704610	2
Pinion Head Brg.	HM803146-HM803110	1
Pinion Tail Brg.	M88048-M88010	1
Pinion Seal	100712V (1.874x3.159)	1
Crush Sleeve	CS349	1
Pinion Nut	PN5	1
Gear Marking & Brush	GMC1-BR1	1
Threadlocker	TL1	1
Sealer	RTV Silicone	1
Pinion Depth Shims	SK4	1
Differential Shims	SK47	1
Ring Gear Bolts	RGB25	10
Washer	DS30275	1

DRK-339T		
Position	Part Number	Qty
Differential Brg.	LM603049-LM603011	2
Pinion Head Brg.	M88048-M88010	1
Pinion Tail Brg.	M802048-802011	1
Pinion Seal	38189-8S110	1
Crush Sleeve	CS339	1
Pinion Nut	PN26	1
Gear Marking & Brush	GMC1-BR1	1
Threadlocker	TL1	1
Sealer	RTV Silicone	1

DRK-339TMK		
Position	Part Number	Qty
Differential Brg.	LM603049-LM603011	2
Pinion Head Brg.	M88048-M88010	1
Pinion Tail Brg.	M802048-802011	1
Pinion Seal	38189-8S110	1
Crush Sleeve	CS339	1
Pinion Nut	PN26	1
Gear Marking & Brush	GMC1-BR1	1
Threadlocker	TL1	1
Sealer	RTV Silicone	1
Pinion Depth Shims	SK4	1
Ring Gear Bolts	RGB24	10

DRK-340		
Position	Part Number	Qty
Differential Brg.	LM501349-LM501314	2
Pinion Head Brg.	M802048-M802011	1
Pinion Tail Brg.	HM88649-HM88610	1
Pinion Seal	DS50619 (1.803x3.067)	1
Crush Sleeve	CS345	1
Pinion Nut	PN6	1
Gear Marking & Brush	GMC1-BR1	1
Threadlocker	TL1	1
Sealer	RTV Silicone	1

DRK-340MK		
Position	Part Number	Qty
Differential Brg.	LM501349-LM501314	2
Pinion Head Brg.	M802048-M802011	1
Pinion Tail Brg.	HM88649-HM88610	1
Pinion Seal	DS50619 (1.803x3.067)	1
Crush Sleeve	CS345	1
Pinion Nut	PN6	1
Gear Marking & Brush	GMC1-BR1	1
Threadlocker	TL1	1
Sealer	RTV Silicone	1
Pinion Depth Shims	SK4	1
Differential Shims	SK28 <sup>51</sup>	1
Ring Gear Bolts	RGB5-D	10

DRK-350		
Position	Part Number	Qty
Differential Brg.	LM603049-LM603014	2
Pinion Head Brg.	32307C	1
Pinion Tail Brg.	30306	1
Pinion Seal	1177 (38x74)	1
Crush Sleeve	CS332	1
Pinion Nut	PN11	1
Gear Marking & Brush	GMC1-BR1	1
Threadlocker	TL1	1
Sealer	RTV Silicone	1

DRK-350MK		
Position	Part Number	Qty
Differential Brg.	LM603049-LM603014	2
Pinion Head Brg.	32307C	1
Pinion Tail Brg.	30306	1
Pinion Seal	1177 (38x74)	1
Crush Sleeve	CS332	1
Pinion Nut	PN11	1
Gear Marking & Brush	GMC1-BR1	1
Threadlocker	TL1	1
Sealer	RTV Silicone	1
Pinion Depth Shims	SK32	1
Ring Gear Bolts	RGB15	10

DRK-350A		
Position	Part Number	Qty
Differential Brg.	90368-50006	2
Pinion Head Brg.	32307C	1
Pinion Tail Brg.	30306	1
Pinion Seal	1177 (38x74)	1
Crush Sleeve	CS332	1
Pinion Nut	PN11	1
Gear Marking & Brush	GMC1-BR1	1
Threadlocker	TL1	1
Sealer	RTV Silicone	1

DRK-350AMK		
Position	Part Number	Qty
Differential Brg.	90368-50006	2
Pinion Head Brg.	32307C	1
Pinion Tail Brg.	30306	1
Pinion Seal	1177 (38x74)	1
Crush Sleeve	CS332	1
Pinion Nut	PN11	1
Gear Marking & Brush	GMC1-BR1	1
Threadlocker	TL1	1
Sealer	RTV Silicone	1
Pinion Depth Shims	SK32	1
Differential Shims	SK7 <sup>27</sup>	1
Ring Gear Bolts	RGB15	10

DRK-351		
Position	Part Number	Qty
Differential Brg.	LM603049-LM603014	2
Pinion Head Brg.	32307C	1
Pinion Tail Brg.	30306	1
Pinion Seal	1177 (38x74)	1
Crush Sleeve	CS331	1
Pinion Nut	PN9	1
Gear Marking & Brush	GMC1-BR1	1
Threadlocker	TL1	1
Sealer	RTV Silicone	1

DRK-351MK		
Position	Part Number	Qty
Differential Brg.	LM603049-LM603014	2
Pinion Head Brg.	32307C	1
Pinion Tail Brg.	30306	1
Pinion Seal	1177 (38x74)	1
Crush Sleeve	CS331	1
Pinion Nut	PN9	1
Gear Marking & Brush	GMC1-BR1	1
Threadlocker	TL1	1
Sealer	RTV Silicone	1
Pinion Depth Shims	SK32	1
Ring Gear Bolts	RGB15	10

DRK-352		
Position	Part Number	Qty
Differential Brg.	JLM104948-LM104912	2
Pinion Head Brg.	90366-35028	1
Pinion Tail Brg.	90366-30067	1
Pinion Seal	1177 (38x74)	1
Crush Sleeve	CS334	1
Pinion Nut	PN9	1
Gear Marking & Brush	GMC1-BR1	1
Threadlocker	TL1	1
Sealer	RTV Silicone	1

DRK-352MK		
Position	Part Number	Qty
Differential Brg.	JLM104948-LM104912	2
Pinion Head Brg.	90366-35028	1
Pinion Tail Brg.	90366-30067	1
Pinion Seal	1177 (38x74)	1
Crush Sleeve	CS334	1
Pinion Nut	PN9	1
Gear Marking & Brush	GMC1-BR1	1
Threadlocker	TL1	1
Sealer	RTV Silicone	1
Pinion Depth Shims	SK32	1
Ring Gear Bolts	RGB15	10
Spacer	SP2043	1

DRK-352A		
Position	Part Number	Qty
Differential Brg.	JLM104948-LM104912	2
Pinion Head Brg.	90366-35028	1
Pinion Tail Brg.	90366-30067	1
Pinion Seal	90311-41009	1
Crush Sleeve	CS334	1
Pinion Nut	PN18	1
Gear Marking & Brush	GMC1-BR1	1
Threadlocker	TL1	1
Sealer	RTV Silicone	1
Spacer	SP2043	1

LD Differential

# Light Duty Differential Rebuild Kits

<b>DRK-352AMK</b>		
Position	Part Number	Qty
Differential Brg.	JLM104948-LM104912	2
Pinion Head Brg.	90366-35028	1
Pinion Tail Brg.	90366-30067	1
Pinion Seal	90311-41009	1
Crush Sleeve	CS334	1
Pinion Nut	PN18	1
Gear Marking & Brush	GMC1-BR1	1
Threadlocker	TL1	1
Sealer	RTV Silicone	1
Pinion Depth Shims	SK32	1
Ring Gear Bolts	RGB15	10
Spacer	SP2043	1

<b>DRK-353</b>		
Position	Part Number	Qty
Differential Brg.	LM603049-LM603014	2
Pinion Head Brg.	30306	1
Pinion Tail Brg.	90366-35044-77	1
Pinion Seal	1177 (38x74)	1
Crush Sleeve	CS331	1
Pinion Nut	PN9	1
Gear Marking & Brush	GMC1-BR1	1
Threadlocker	TL1	1
Sealer	RTV Silicone	1

<b>DRK-353MK</b>		
Position	Part Number	Qty
Differential Brg.	LM603049-LM603014	2
Pinion Head Brg.	30306	1
Pinion Tail Brg.	90366-35044-77	1
Pinion Seal	1177 (38x74)	1
Crush Sleeve	CS331	1
Pinion Nut	PN9	1
Gear Marking & Brush	GMC1-BR1	1
Threadlocker	TL1	1
Sealer	RTV Silicone	1
Pinion Depth Shims	SK32	1
Ring Gear Bolts	RGB15	10

<b>DRK-354A</b>		
Position	Part Number	Qty
Differential Left Brg.	90366-75001	1
Differential Right Brg.	90366-50007	1
Pinion Head Brg.	90366-30025	1
Pinion Tail Brg.	90366-35028	1
Pinion Seal	1177 (38x74)	1
Crush Sleeve	CS334	1
Pinion Nut	PN14	1
Gear Marking & Brush	GMC1-BR1	1
Threadlocker	TL1	1
Sealer	RTV Silicone	1

<b>DRK-354AMK</b>		
Position	Part Number	Qty
Differential Left Brg.	90366-75001	1
Differential Right Brg.	90366-50007	1
Pinion Head Brg.	90366-30025	1
Pinion Tail Brg.	90366-35028	1
Pinion Seal	1177 (38x74)	1
Crush Sleeve	CS334	1
Pinion Nut	PN14	1
Gear Marking & Brush	GMC1-BR1	1
Threadlocker	TL1	1
Sealer	RTV Silicone	1
Pinion Depth Shims	SK32	1
Ring Gear Bolts	RGB19	12

<b>DRK-355</b>		
Position	Part Number	Qty
Differential Brg.	90366-51001	2
Pinion Head Brg.	HM88649-HM88610	1
Pinion Tail Brg.	90366-40068	1
Pinion Seal	90311-44007	1
Crush Sleeve	CS327	1
Pinion Nut	PN15	1
Gear Marking & Brush	GMC1-BR1	1
Threadlocker	TL1	1
Sealer	RTV Silicone	1

<b>DRK-355MK</b>		
Position	Part Number	Qty
Differential Brg.	90366-51001	2
Pinion Head Brg.	HM88649-HM88610	1
Pinion Tail Brg.	90366-40068	1
Pinion Seal	90311-44007	1
Crush Sleeve	CS327	1
Pinion Nut	PN15	1
Gear Marking & Brush	GMC1-BR1	1
Threadlocker	TL1	1
Sealer	RTV Silicone	1
Pinion Depth Shims	SK49	1
Ring Gear Bolts	RGB19	12

<b>DRK-356</b>		
Position	Part Number	Qty
Differential Left Brg.	90366-75001	1
Differential Right Brg.	90366-50007	1
Pinion Head Brg.	90366-30025	1
Pinion Tail Brg.	90366-35028	1
Pinion Seal	1177 (38x74)	1
Crush Sleeve	CS334	1
Pinion Nut	PN9	1
Gear Marking & Brush	GMC1-BR1	1
Threadlocker	TL1	1
Sealer	RTV Silicone	1
Gasket	GR-TFJ80F	1

<b>DRK-356MK</b>		
Position	Part Number	Qty
Differential Left Brg.	90366-75001	1
Differential Right Brg.	90366-50007	1
Pinion Head Brg.	90366-30025	1
Pinion Tail Brg.	90366-35028	1
Pinion Seal	1177 (38x74)	1
Crush Sleeve	CS334	1
Pinion Nut	PN9	1
Gear Marking & Brush	GMC1-BR1	1
Threadlocker	TL1	1
Sealer	RTV Silicone	1
Pinion Depth Shims	SK32	1
Ring Gear Bolts	RGB20	12
Gasket	GR-TFJ80F	1

<b>DRK-356A</b>		
Position	Part Number	Qty
Differential Brg.	90366-50007	2
Pinion Head Brg.	90366-30025	1
Pinion Tail Brg.	90366-35028	1
Pinion Seal	1177 (38x74)	1
Crush Sleeve	CS334	1
Pinion Nut	PN9	1
Gear Marking & Brush	GMC1-BR1	1
Threadlocker	TL1	1
Gasket	GR-TFJ80F	1
Sealer	RTV Silicone	1

<b>DRK-356AMK</b>		
Position	Part Number	Qty
Differential Brg.	90366-50007	2
Pinion Head Brg.	90366-30025	1
Pinion Tail Brg.	90366-35028	1
Pinion Seal	1177 (38x74)	1
Crush Sleeve	CS334	1
Pinion Nut	PN9	1
Gear Marking & Brush	GMC1-BR1	1
Threadlocker	TL1	1
Gasket	GR-TFJ80F	1
Sealer	RTV Silicone	1
Pinion Depth Shims	SK32	1
Ring Gear Bolts	RGB20	12

<b>DRK-357</b>		
Position	Part Number	Qty
Differential Brg.	32012X	2
Pinion Head Brg.	30308	1
Pinion Tail Brg.	30306	1
Pinion Seal	1177 (38x74)	1
Crush Sleeve	CS340	1
Pinion Nut	PN16	1
Gear Marking & Brush	GMC1-BR1	1
Threadlocker	TL1	1
Sealer	RTV Silicone	1

<b>DRK-357MK</b>		
Position	Part Number	Qty
Differential Brg.	32012X	2
Pinion Head Brg.	30308	1
Pinion Tail Brg.	30306	1
Pinion Seal	1177 (38x74)	1
Crush Sleeve	CS340	1
Pinion Nut	PN16	1
Gear Marking & Brush	GMC1-BR1	1
Threadlocker	TL1	1
Sealer	RTV Silicone	1
Pinion Depth Shims	SK15	1
Ring Gear Bolts	RGB20	12

<b>DRK-357A</b>		
Position	Part Number	Qty
Differential Brg.	32010X	2
Pinion Head Brg.	30308	1
Pinion Tail Brg.	30306	1
Pinion Seal	1177 (38x74)	1
Crush Sleeve	CS340	1
Pinion Nut	PN16	1
Gear Marking & Brush	GMC1-BR1	1
Threadlocker	TL1	1
Sealer	RTV Silicone	1

<b>DRK-357AMK</b>		
Position	Part Number	Qty
Differential Brg.	32010X	2
Pinion Head Brg.	30308	1
Pinion Tail Brg.	30306	1
Pinion Seal	1177 (38x74)	1
Crush Sleeve	CS340	1
Pinion Nut	PN16	1
Gear Marking & Brush	GMC1-BR1	1
Threadlocker	TL1	1
Sealer	RTV Silicone	1
Pinion Depth Shims	SK15	1
Ring Gear Bolts	RGB20	12

<b>DRK-358</b>		
Position	Part Number	Qty
Differential Brg.	LM603049-LM603014	2
Pinion Head Brg.	30308	1
Pinion Tail Brg.	30306	1
Pinion Seal	1177 (38x74)	1
Crush Sleeve	CS340	1
Pinion Nut	PN16	1
Gear Marking & Brush	GMC1-BR1	1
Threadlocker	TL1	1
Sealer	RTV Silicone	1

LD Differential



# Light Duty Differential Rebuild Kits



LD Differential

DRK-358MK		
Position	Part Number	Qty
Differential Brg.	LM603049-LM603014	2
Pinion Head Brg.	30308	1
Pinion Tail Brg.	30306	1
Pinion Seal	1177 (38x74)	1
Crush Sleeve	CS340	1
Pinion Nut	PN16	1
Gear Marking & Brush	GMC1-BR1	1
Threadlocker	TL1	1
Sealer	RTV Silicone	1
Pinion Depth Shims	SK15	1
Ring Gear Bolts	RGB20	12

DRK-359		
Position	Part Number	Qty
Differential Brg.	90366-53004	2
Pinion Head Brg.	90366-35028	1
Pinion Tail Brg.	90366-30067	1
Pinion Seal	90311-41009	1
Crush Sleeve	CS351	1
Pinion Nut	PN18	1
Gear Marking & Brush	GMC1-BR1	1
Threadlocker	TL1	1
Sealer	RTV Silicone	1

DRK-359MK		
Position	Part Number	Qty
Differential Brg.	90366-53004	2
Pinion Head Brg.	90366-35028	1
Pinion Tail Brg.	90366-30067	1
Pinion Seal	90311-41009	1
Crush Sleeve	CS351	1
Pinion Nut	PN18	1
Gear Marking & Brush	GMC1-BR1	1
Threadlocker	TL1	1
Sealer	RTV Silicone	1
Pinion Depth Shims	SK32	1
Differential Shims	SK47	1
Ring Gear Bolts	RGB19	12

DRK-360		
Position	Part Number	Qty
Differential Brg.	LM603049-LM603014	2
Pinion Head Brg.	30307	1
Pinion Tail Brg.	30306	1
Pinion Seal	710523 (40x72)	1
Crush Sleeve	CS332	1
Pinion Nut	PN9	1
Gear Marking & Brush	GMC1-BR1	1
Threadlocker	TL1	1
Sealer	RTV Silicone	1

DRK-360MK		
Position	Part Number	Qty
Differential Brg.	LM603049-LM603014	2
Pinion Head Brg.	30307	1
Pinion Tail Brg.	30306	1
Pinion Seal	710523 (40x72)	1
Crush Sleeve	CS332	1
Pinion Nut	PN9	1
Gear Marking & Brush	GMC1-BR1	1
Threadlocker	TL1	1
Sealer	RTV Silicone	1
Pinion Depth Shims	SK32	1
Ring Gear Bolts	RGB28	10

DRK-365		
Position	Part Number	Qty
Differential Right Brg.	32012X	1
Differential Left Brg.	32017X	1
Pinion Head Brg.	805177	1
Pinion Tail Brg.	805177	1
Pinion Seal	68034401AA	1
Pinion Nut	PN22	1
Gear Marking & Brush	GMC1-BR1	1
Threadlocker	TL1	1
Sealer	RTV Silicone	1

DRK-366		
Position	Part Number	Qty
Differential Brg.	JLM704649-JLM704610	2
Pinion Head Brg.	NP524102-NP912904	1
Pinion Tail Brg.	M88048-M88010	1
Pinion Seal	710481 (1.893x2.811)	1
Crush Sleeve	CS303	1
Pinion Nut	PN19	1
Pinion Nut	PN5D	1
Gear Marking & Brush	GMC1-BR1	1
Threadlocker	TL1	1
Sealer	RTV Silicone	1

DRK-367		
Position	Part Number	Qty
Differential Brg.	23471878	2
Pinion Head Brg.	STD4183KELFT	1
Pinion Tail Brg.	23471880	1
Pinion Seal	23490373	1
Crush Sleeve	CS364	1
Pinion Nut	23493140	1
Gear Marking & Brush	GMC1-BR1	1
Threadlocker	TL1	1
Sealer	RTV Silicone	1

DRK-367MK		
Position	Part Number	Qty
Differential Brg.	23471878	2
Pinion Head Brg.	STD4183KELFT	1
Pinion Tail Brg.	23471880	1
Pinion Seal	23490373	1
Crush Sleeve	CS364	1
Pinion Nut	23493140	1
Gear Marking & Brush	GMC1-BR1	1
Threadlocker	TL1	1
Sealer	RTV Silicone	1
Differential Shims	SK54	1
Pinion Depth Shims	SK3	1
Ring Gear Bolts	RGB18	10

DRK-368		
Position	Part Number	Qty
Differential Brg.	387A-382S	2
Pinion Head Brg.	23490334	1
Pinion Tail Brg.	23471879	1
Pinion Seal	23490373	1
Crush Sleeve	CS365	1
Pinion Nut	23493140	1
Gear Marking & Brush	GMC1-BR1	1
Threadlocker	TL1	1
Sealer	RTV Silicone	1

DRK-368MK		
Position	Part Number	Qty
Differential Brg.	387A-382S	2
Pinion Head Brg.	23490334	1
Pinion Tail Brg.	23471879	1
Pinion Seal	23490373	1
Crush Sleeve	CS365	1
Pinion Nut	23493140	1
Gear Marking & Brush	GMC1-BR1	1
Threadlocker	TL1	1
Sealer	RTV Silicone	1
Differential Shims	SK54	1
Pinion Depth Shims	SK3	1
Ring Gear Bolts	RGB18	1

DRK-370		
Position	Part Number	Qty
Differential Brg.	32010X	2
Pinion Head Brg.	M802048-M802011	1
Pinion Tail Brg.	NP922169-NP2330028	1
Pinion Seal	68049798AA	1
Gear Marking & Brush	GMC1-BR1	1
Threadlocker	TL1	1
Sealer	RTV Silicone	1

DRK-370MK		
Position	Part Number	Qty
Differential Brg.	32010X	2
Pinion Head Brg.	M802048-M802011	1
Pinion Tail Brg.	NP922169-NP2330028	1
Pinion Seal	68049798AA	1
Gear Marking & Brush	GMC1-BR1	1
Threadlocker	TL1	1
Sealer	RTV Silicone	1
Pinion Brg. Shims	SK3	1
Differential Shims	SK52	1
Spacer	SK53	1

DRK-380		
Position	Part Number	Qty
Differential Brg.	90366-58013	2
Pinion Head Brg.	90366-40114	1
Pinion Tail Brg.	90363-35063	1
Pinion Seal	90311-46006	1
Crush Sleeve	CS357	1
Pinion Nut	PN24	1
Gear Marking & Brush	GMC1-BR1	1
Threadlocker	TL1	1
Sealer	RTV Silicone	1

DRK-380MK		
Position	Part Number	Qty
Differential Brg.	90366-58013	2
Pinion Head Brg.	90366-40114	1
Pinion Tail Brg.	90363-35063	1
Pinion Seal	90311-46006	1
Crush Sleeve	CS357	1
Pinion Nut	PN24	1
Gear Marking & Brush	GMC1-BR1	1
Threadlocker	TL1	1
Sealer	RTV Silicone	1
Pinion Depth Shims	SK47	1
Differential Shims	SK13 <sup>54</sup>	1

DRK-381		
Position	Part Number	Qty
Differential Brg.	32010X	2
Pinion Head Brg.	90366-A0011	1
Pinion Tail Brg.	90366-A0014	1
Pinion Seal	90311-A0007	1
Crush Sleeve	CS358	1
Pinion Nut	PN24	1
Gear Marking & Brush	GMC1-BR1	1
Threadlocker	TL1	1
Sealer	RTV Silicone	1

DRK-381MK		
Position	Part Number	Qty
Differential Brg.	32010X	2
Pinion Head Brg.	90366-A0011	1
Pinion Tail Brg.	90366-A0014	1
Pinion Seal	90311-A0007	1
Crush Sleeve	CS358	1
Pinion Nut	PN24	1
Gear Marking & Brush	GMC1-BR1	1
Threadlocker	TL1	1
Sealer	RTV Silicone	1
Pinion Depth Shims	SK4	1

DRK-382		
Position	Part Number	Qty
Differential Brg.	90366-A0020	2
Pinion Head Brg.	90366-A0017	1
Pinion Tail Brg.	90366-A0023	1
Pinion Seal	710734 (52x87)	1
Solid Spacer	SS105	1
Pinion Nut	PN24	1
Gear Marking & Brush	GMC1-BR1	1
Threadlocker	TL1	1
Sealer	RTV Silicone	1

# Light Duty Differential Rebuild Kits

<b>DRK-382MK</b>			<b>DRK-383A</b>			<b>DRK-384AMK</b>		
Position	Part Number	Qty	Position	Part Number	Qty	Position	Part Number	Qty
Differential Brg.	90366-A0020	2	Differential Right Brg.	JLM104948-LM104912	1	Differential Left Brg.	90366-T0068	1
Pinion Head Brg.	90366-A0017	1	Differential Left Brg.	90366-75001	1	Differential Right Left Brg.	90366-T0071	1
Pinion Tail Brg.	90366-A0023	1	Pinion Head Brg.	90366-40132	1	Pinion Head Brg.	90366-50130	1
Pinion Seal	710734 (52x87)	1	Pinion Tail Brg.	90366-35157	1	Pinion Tail Brg.	90366-T0062	1
Solid Spacer	SS105	1	Pinion Seal	710697 (41x74)	1	Pinion Seal	90311-T0068	1
Pinion Nut	PN24	1	Crush Sleeve	CS362	1	Pinion Seal	90311-T0065	1
Gear Marking & Brush	GMC1-BR1	1	Pinion Nut	PN24	1	Crush Sleeve	CS367	1
Threadlocker	TL1	1	Gear Marking & Brush	GMC1-BR1	1	Pinion Nut	PN28	1
Sealer	RTV Silicone	1	Threadlocker	TL1	1	Gear Marking & Brush	GMC1-BR1	1
Pinion Depth Shims	SK23	1	Sealer	RTV Silicone	1	Threadlocker	TL1	1
Pinion Brg. Shims	SK44	2	<b>DRK-383AMK</b>			Sealer	RTV Silicone	1
Differential Shims	SK13 <sup>54</sup>	1	Position	Part Number	Qty	Pinion Depth Shims	SK23	1
<b>DRK-382A</b>			Ring Gear Bolts	RGB38	12	<b>DRK-434</b>		
Position	Part Number	Qty	Differential Right Brg.	JLM104948-LM104912	1	Position	Part Number	Qty
Differential Brg.	90366-60021	2	Differential Left Brg.	90366-75001	1	Differential Right Brg.	3984-3920	1
Pinion Head Brg.	90366-45044	1	Pinion Head Brg.	90366-40132	1	Differential Left Brg.	3984-3920	1
Pinion Tail Brg.	90366-40123	1	Pinion Tail Brg.	90366-35157	1	Pinion Head Brg.	72212C-72487	1
Pinion Seal	710734 (52x87)	1	Pinion Seal	710697 (41x74)	1	Pinion Tail Brg.	55200C-55437	1
Crush Sleeve	CS360	1	Crush Sleeve	CS362	1	Pinion Seal	DT7591 (2.913x4.561)	1
Pinion Nut	PN24	1	Pinion Nut	PN24	1	Sealer	RTV Silicone	1
Gear Marking & Brush	GMC1-BR1	1	Pinion Depth Shims	SK23	1	<b>DRK-452</b>		
Threadlocker	TL1	1	Gear Marking & Brush	GMC1-BR1	1	Position	Part Number	Qty
Sealer	RTV Silicone	1	Threadlocker	TL1	1	Differential Right Brg.	3984-3920	1
<b>DRK-382AMK</b>			Sealer	RTV Silicone	1	Differential Left Brg.	594A-592A	1
Position	Part Number	Qty	Ring Gear Bolts	RGB15	12	Pinion Head Brg.	NP340526-NP420924	1
Differential Brg.	90366-60021	2	<b>DRK-384</b>			Pinion Tail Brg.	55200C-55437	1
Pinion Head Brg.	90366-45044	1	Position	Part Number	Qty	Pinion Seal	DT7591 (2.913x4.561)	1
Pinion Tail Brg.	90366-40123	1	Differential Brg.	90366-T0010	2	Sealer	RTV Silicone	1
Pinion Seal	710734 (52x87)	1	Pinion Head Brg.	90366-50130	1	<b>DRK-383</b>		
Crush Sleeve	CS360	1	Pinion Tail Brg.	90366-T0062	1	Position	Part Number	Qty
Pinion Nut	PN24	1	Pinion Seal	90311-T0068	1	Differential Brg.	90366-50130	2
Gear Marking & Brush	GMC1-BR1	1	Pinion Seal	90311-T0065	1	Pinion Head Brg.	90366-40132	1
Threadlocker	TL1	1	Crush Sleeve	CS367	1	Pinion Tail Brg.	90366-35157	1
Sealer	RTV Silicone	1	Pinion Nut	PN27	1	Pinion Seal	710697 (41x74)	1
Pinion Depth Shims	SK10	1	Gear Marking & Brush	GMC1-BR1	1	Crush Sleeve	CS362	1
Differential Shims	SK42 <sup>52</sup>	1	Threadlocker	TL1	1	Pinion Nut	PN24	1
<b>DRK-383</b>			Sealer	RTV Silicone	1	Gear Marking & Brush	GMC1-BR1	1
Position	Part Number	Qty	Pinion Depth Shims	SK23	1	Threadlocker	TL1	1
Differential Brg.	90366-50130	2	Ring Gear Bolts	RGB37	12	Sealer	RTV Silicone	1
Pinion Head Brg.	90366-40132	1	<b>DRK-384MK</b>			Pinion Seal	90311-T0068	1
Pinion Tail Brg.	90366-35157	1	Position	Part Number	Qty	Pinion Seal	90311-T0065	1
Pinion Seal	710697 (41x74)	1	Differential Brg.	90366-T0010	2	Crush Sleeve	CS367	1
Crush Sleeve	CS362	1	Pinion Head Brg.	90366-50130	1	Pinion Nut	PN27	1
Pinion Nut	PN24	1	Pinion Tail Brg.	90366-T0062	1	Gear Marking & Brush	GMC1-BR1	1
Gear Marking & Brush	GMC1-BR1	1	Pinion Seal	90311-T0068	1	Threadlocker	TL1	1
Threadlocker	TL1	1	Pinion Seal	90311-T0065	1	Sealer	RTV Silicone	1
Sealer	RTV Silicone	1	Crush Sleeve	CS367	1	Pinion Depth Shims	SK23	1
<b>DRK-383MK</b>			Pinion Nut	PN28	1	Ring Gear Bolts	RGB15	12
Position	Part Number	Qty	Gear Marking & Brush	GMC1-BR1	1	<b>DRK-384A</b>		
Differential Brg.	90366-50130	2	Threadlocker	TL1	1	Position	Part Number	Qty
Pinion Head Brg.	90366-40132	1	Sealer	RTV Silicone	1	Differential Left Brg.	90366-T0068	1
Pinion Tail Brg.	90366-35157	1	<b>DRK-384</b>			Differential Right Brg.	90366-T0071	1
Pinion Seal	710697 (41x74)	1	Position	Part Number	Qty	Pinion Head Brg.	90366-50130	1
Crush Sleeve	CS362	1	Differential Left Brg.	90366-T0068	1	Pinion Tail Brg.	90366-T0062	1
Pinion Nut	PN24	1	Differential Right Brg.	90366-T0071	1	Pinion Seal	90311-T0068	1
Pinion Depth Shims	SK23	1	Pinion Head Brg.	90366-50130	1	Pinion Seal	90311-T0065	1
Gear Marking & Brush	GMC1-BR1	1	Pinion Tail Brg.	90366-T0062	1	Crush Sleeve	CS367	1
Threadlocker	TL1	1	Pinion Seal	90311-T0068	1	Pinion Nut	PN28	1
Sealer	RTV Silicone	1	Pinion Seal	90311-T0065	1	Gear Marking & Brush	GMC1-BR1	1
Ring Gear Bolts	RGB15	12	Crush Sleeve	CS367	1	Threadlocker	TL1	1
			Pinion Nut	PN28	1	Sealer	RTV Silicone	1
			Gear Marking & Brush	GMC1-BR1	1			
			Threadlocker	TL1	1			
			Sealer	RTV Silicone	1			

LD Differential

<sup>52</sup> Order SSK42 for stackable differential shims. <sup>54</sup> Order SSK13 for stackable differential shims.

# Axle Product by Axle Size

## AMC Model 20 Axle (12 Bolt Cover)

<u>Rebuild Kit</u>	<u>Comments</u>
DRK-311J	Standard Kit
DRK-311JMK	Master Kit

<u>Open Case</u>	<u>Comments</u>
AMC20-CASE	3.08-4.88 Ratios

<u>Internal Kit</u>	<u>Comments</u>
AMC20-IK	

<u>Ring &amp; Pinion</u>	<u>Ratio</u>
AMC273	2.73 (41-15)
AMC308	3.08 (40-14)
AMC331	3.31 (43-13)
AMC354	3.54 (39-11)
AMC373	3.73 (41-11)
AMC410	4.10 (41-10)
AMC456	4.56 (41-9)
AMC488	4.88 (39-8)

<u>Differential</u>	<u>Comments</u>
542081	Auburn Pro 3.07 & Higher, 29 Spline (66-86)

## Chrysler 7.25" Axle (9 or 10 Bolt Cover)

<u>Rebuild Kit</u>	<u>Comments</u>
DRK-302	Standard Kit
DRK-302MK	Master Kit

<u>Open Case</u>	<u>Comments</u>
C725-CASE	2.76 & Higher

<u>Internal Kit</u>	<u>Comments</u>
C725-IK	25 Spline

<u>Ring &amp; Pinion</u>	<u>Ratio</u>
C725293	2.93 (41-11)
C725323	3.23 (42-13)
C725355	3.55 (39-11)
C725391	3.91 (39-10)

Application	Years	2WD/		Comments	Length	Studs	Spline	Side
		4WD	Axle Shaft					
Dakota	91-96	2	AS4506147		30-1/4"	6	25	R/L
Dakota	91-96	2	AS4348511		30-1/4"	5	25	R/L

Call for other applications or dimensions.

## Chrysler 8.25" Axle (10 Bolt Cover)

### **Rebuild Kit**      **Comments**

DRK-303 Kit Series

Refer to the vehicle index for proper kit selection

### **Open Case**      **Comments**

C825-CASE

### **Internal Kit**      **Comments**

C825-IK                      27 Spline

C825-IKB                    29 Spline

### **Ring & Pinion**      **Ratio**

C825321                    3.21 (45-14)

C825323                    3.23 (42-13)

C825355                    3.55 (39-11)

C825390                    3.90 (43-11)

C825410                    4.10 (41-10)

C825456                    4.56 (41-9)

### **Differential**      **Comments**

542072                      Auburn HP 2.71 & Higher, 27 Spline (66-96)

542074                      Auburn HP 2.71 & Higher, 29 Spline (97-On)

187C151A                    Detroit Locker 2.73 & Higher, 27 Spline (69-96)

187C179A                    Detroit Locker 2.73 & Higher, 29 Spline (97-09)

912A553                      Detroit Truetrac 2.73 & Higher, 29 Spline (97-09)

<b>Application</b>	<b>Years</b>	<b>2WD/</b>		<b>Comments</b>	<b>Length</b>	<b>Studs</b>	<b>Spline</b>	<b>Side</b>
		<b>4WD</b>	<b>Axle Shaft</b>					
Dakota	87-90	2/4	AS4348510		30-3/4	5	27	R/L
Dakota	91-96	2/4	AS4506115		30-3/4"	6	27	R/L
Jeep Cherokee	91-96	2/4	AS53008134		29-3/4"	5	27	R/L
Jeep Cherokee	97-01	4	AS5018393		29-3/4"	5	29	R/L
Van 1/2 Ton	85-96	2/4	AS4137670		32-9/16"	5	27	R/L
Van 3/4 Ton	85-96	2/4	AS4137670		32-9/16"	5	27	R/L

Call for other applications or dimensions.

# Axle Product by Axle Size

## Chrysler 8.75" Axle Early 1.75" Pinion (12 Bolt Cover)

<u>Rebuild Kit</u>	<u>Comments</u>
--------------------	-----------------

DRK-300	Standard Kit
DRK-300MK	Master Kit

<u>Ring &amp; Pinion</u>	<u>Ratio</u>
--------------------------	--------------

C875391E	3.90 (43-11)
C875410E	4.10 (41-10)
C875430E	4.30 (43-10)
C875457E	4.57 (32-7)
C875486E	4.86 (34-7)
C875513E	5.13 (41-8)
C875538E	5.38 (43-8)
C875557E	5.57 (39-7)

<u>Differential</u>	<u>Comments</u>
---------------------	-----------------

542051	Auburn Pro 30 Spline (57-74)
--------	------------------------------

## Chrysler 8.75" Axle Late 1.875" Pinion (12 Bolt Cover)

<u>Rebuild Kit</u>	<u>Comments</u>
--------------------	-----------------

DRK-301	Standard Kit
DRK-301MK	Master Kit

<u>Ring &amp; Pinion</u>	<u>Ratio</u>
--------------------------	--------------

C875355L	3.55 (39-11)
C875390L	3.90 (43-11)
C875410L	4.10 (41-10)
C875430L	4.30 (43-10)
C875457L	4.57 (32-7)
C875486L	4.86 (34-7)
C875513L	5.13 (41-8)
C875538L	5.38 (43-8)

<u>Differential</u>	<u>Comments</u>
---------------------	-----------------

542051	Auburn Pro 30 Spline (57-74)
187SL14A	Detroit Locker 2.76-4.56, 30 Spline (69-74)
913A572	Detroit Truetrac 2.76-4.56, 30 Spline (69-74)



## Chrysler 9.25" Axle-Corporate (12 Bolt Cover)

<b>Rebuild Kit</b>	<b>Comments</b>
DRK-304	Standard Kit (69-00)
DRK-304MK	Master Kit (69-00)
DRK-304A	Standard Kit (01-10)
DRK-304AMK	Master Kit (01-10)

<b>Open Case</b>	<b>Comments</b>
C925-CASE	

<b>Internal Kit</b>	<b>Comments</b>
C925-IK	31 Spline

<b>Ring &amp; Pinion</b>	<b>Ratio</b>
C925323	3.21 (45-14) Fits 69-10
C925355	3.55 (39-11) Fits 69-10
C925390	3.90 (43-11) Fits 69-10
C925410	4.10 (41-10) Fits 69-10
C925456	4.56 (41-9) Fits 69-10

<b>Differential</b>	<b>Comments</b>
542071	Auburn HP 2.71 / Higher, 31 Spline (68-83)
542070-AG1	Auburn HP 2.71 / Higher, 31 Spline (84-10)
5420142-AG1	Auburn HP 2.71 / Higher, 31 Spline (10-On)
187C172A	Detroit Locker 2.76-4.56, 31 Spline (74-10)
913A368	Detroit Truetrac 2.76-4.56, 31 Spline (74-10)

<b>Application</b>	<b>Years</b>	<b>2WD/</b>		<b>Comments</b>	<b>Length</b>	<b>Studs</b>	<b>Spline</b>	<b>Side</b>
		<b>4WD</b>	<b>Axle Shaft</b>					
Passenger Car	73-78	2	AS3723824		31-11/16"	5	31	R/L
Ram Charger	74-82	2	AS3723824		31-11/16"	5	31	R/L
Ram Charger	85 -93	2	AS4137429		31-5.8"	5	31	R/L
Ram Charger	74-79	4	AS3723824		31-11/16"	5	31	R/L
Ram Charger	80-84	4	AS4037726	Thru 4/2/84	31-5.8"	5	31	R/L
Ram Charger	84 -93	4	AS4137429	After 4/3/84	31-5.8"	5	31	R/L
Trail Duster	74-81	2	AS3723824		31-11/16"	5	31	R/L
Trail Duster	74-79	4	AS3723824		31-11/16"	5	31	R/L
Trail Duster	80-81	4	AS4037726		31-5.8"	5	31	R/L
Truck 1/2 Ton	74-83	2	AS3723824		31-11/16"	5	31	R/L
Truck 1/2 Ton	85 -93	2	AS4137429		31-5.8"	5	31	R/L
Truck 1/2 Ton	75-79	4	AS3723824		31-11/16"	5	31	R/L
Truck 1/2 Ton	80-84	4	AS4037726	Thru 4/2/84	31-5.8"	5	31	R/L
Truck 1/2 Ton	84 -93	4	AS4137429	After 4/3/84	31-5.8"	5	31	R/L
Truck 1/2 Ton	94-05	2/4	AS52067614		34"	5	31	R/L
Van 1/2 Ton	98-03	2	AS52067708AB		32-9/16"	5	31	R/L
Van 3/4 Ton	92-99	2	AS52067708AB		32-9/16"	5	31	R/L
Van 1 Ton	92-94	2	AS52067708AB		32-9/16"	5	31	R/L

Call for other applications or dimensions.

# Axle Product by Axle Size

## Chrysler 9.25" Axle-Front-AAM (14 Bolt Cover)

### Rebuild Kit

DRK-324G Standard Kit (03-16)  
 DRK-324GMK Master Kit (03-16)

### Comments

### Open Case

GM95-CASE-LOAD 2003-06  
 C925-CASEB 2007-13 (Includes Internals)  
 C925-CASEC 2014-16, (Includes Internals)

### Comments

### Internal Kit

GM95-IK 2003-06  
 AAM-C925-IK-SP 2007-14

### Comments

### Ring & Pinion

### Ratio

C925373F 3.73 Fits 03-13  
 C925410F 4.10 Fits 03-13  
 C925342GS-1 3.42 Fits 14-16  
 C925373GS-2 3.73 Fits 14-16  
 C925410GS-2 4.10 Fits 14-16  
 CPW925410GS 4.10 Fits 14-16 Powerwagon Only

### Differential

### Comments

914A643 Detroit Truetrac, 33 Spline (03-10)\*  
 \*2007 and newer vehicles must use 03-06 Ring & Pinion

### 2WD/

Application	Years	4WD	Axle Shaft	Comments	Length	Studs	Spline	Side
Truck 3/4 and 1 Ton	14-16	4	AS40104193					L
Truck 3/4 and 1 Ton	14-16	4	AS40104194					R

LD Differential

## Chrysler 10.5" Rear Axle-AAM (14 Bolt Cover)

### **Rebuild Kit**

DRK-306

DRK-306MK

### **Comments**

Standard Kit (03-13)

Master Kit (03-13)

### **Open Case**

C105-CASE (03-09)

### **Comments**

2003-13 (Includes Internals)

### **Internal Kit**

C105-IK (03-09)

### **Comments**

2003-13

### **Ring & Pinion**

C105373

C105410

### **Ratio**

3.73

4.10

## Chrysler 11.5" Rear Axle-AAM (14 Bolt Cover)

### Rebuild Kit

### Comments

DRK-327	Standard Kit (03-10)
DRK-327MK	Master Kit (03-10)
DRK-327A	Standard Kit (11-14)
DRK-327AMK	Master Kit (11-14)
DRK-327B	Standard Kit (14-16)
DRK-327BMK	Master Kit (14-16)

### Open Case

### Comments

GM115-CASE-LOAD	3.73, 4.10 & 4.63 Gear Ratios (Includes Internals)
-----------------	--

### Ring & Pinion

### Ratio

GM115342	3.42-Fits 2003-13
GM115373	3.73 (41-11) Fits 2003-13
GM115410	4.10 (41-10) Fits 2003-13
GM115444	4.44 Fits 2003-13
GM115456	4.56 Fits 2003-13
GM115463	4.63 (37-8) Fits 2003-13
GM115513	5.13 Fits 2003-13
C115342GSK	3.42-Fits 2014-2016
C115373GSK	3.73-Fits 2014-2016
C115410GSK	4.10-Fits 2014-2016

### Differential

### Comments

40099548	Locking Differential - Original OE
250SL195A	Detroit Locker 30 Spline (03-09)
915A568	Detroit Truetrac 30 Spline (03-09)

### 2WD/

Application	Years	4WD	Axle Shaft	Comments	Length	Studs	Spline	Side
Truck 3/4 Ton	03-10	All	AS40022279	Single Rear Wheel				R/L
Truck 1 Ton	03-10	All	AS40022280	Dual Rear Wheel				R/L

# Axle Product by Axle Size

## Ford 7.5" Axle (10 Bolt Cover)

**Rebuild Kit**      **Comments**

DRK-315                  Standard Kit  
DRK-315MK             Master Kit

**Open Case**      **Comments**

FD75-CASE

**Internal Kit**      **Comments**

FD75-IK                  78-On (28 Spline)

**Ring & Pinion**   **Ratio**

FD75308                3.08 (37-12)  
FD75345                3.45 (38-11)  
FD75373†              3.73 (41-11)  
FD75410†              4.10 (41-10)  
FD75456†              4.56 (41-9)

†Ratios 3.73-4.56 require milled cross shaft FD75CS for Auburn Limited Slip Units Only

**Differential**      **Comments**

542023                  Auburn HP, 28 Spline  
542048                  Auburn Pro, 28 Spline  
162C57A                Detroit Locker, 28 Spline (75-09)  
912A316                Detroit Truetrac, 28 Spline (75-09)

Application	Years	2WD/		Comments	Length	Studs	Spline	Side
		4WD	Axle Shaft					
Aerostar	86-97	2/4	ASE3TZ4234C		29-1/8"	5	28	R
Aerostar	86-97	2/4	ASE69Z4234A		32-1/4"	5	28	L
Bronco II	84-90	2/4	ASE4TZ4234A		27-11/16"	5	28	R
Bronco II	84-90	2/4	ASE3TZ4234C		29-1/8"	5	28	L
Mazda B-Series	98-09	2/4	ASF87Z4234AC		27-1/4"	5	28	R
Mazda B-Series	98-09	2/4	ASF87Z4234AD		30-1/4"	5	28	L
Ranger	90-94	2	ASE3TZ4324A		28"	5	28	R/L
Ranger	85-92	2	ASE3TZ4234B		26-1/4"	5	28	R
Ranger	85-92	2	ASE3TZ4234C		29-1/8"	5	28	L
Ranger	83-92	4	ASE3TZ4234B		26-1/4"	5	28	R
Ranger	83-92	4	ASE3TZ4234C		29-1/8"	5	28	L
Ranger	93-97	2/4	ASF37Z4234A		27-1/4"	5	28	R
Ranger	93-97	2/4	ASF37Z4234B		30-1/8"	5	28	L
Ranger	98-09	2/4	ASF87Z4234AC		27-1/4"	5	28	R
Ranger	98-09	2/4	ASF87Z4234AD		30-1/4"	5	28	L



# Axle Product by Axle Size

## Ford 8" Axle (10 Bolt Cover)

### Rebuild Kit      Comments

DRK-310	Standard Kit
DRK-310MK	Master Kit

### Ring & Pinion      Ratio

FD8300	3.00 (39-13)
FD8325	3.25 (39-12)
FD8340	3.40 (34-10)
FD8355	3.55 (39-11)
FD8380	3.80 (38-10)
FD8411	4.11 (37-9)

### Differential      Comments

542059†	Auburn Pro, 28 Spline
5420115†	Auburn Pro, 31 Spline
187S13D	Detroit Locker, 28 Spline (63-71)
912A616	Detroit Truetrac, 28 Spline (63-71)

†Requires two LM102949-LM102910 Brgs.

## Ford 8.8" IFS Axle

### Rebuild Kit      Comments

DRK-311	Standard Kit (97-16)
DRK-311MK	Master Kit (97-16)

### Internal Kit      Comments

FD88-IKIFS	
------------	--

### Ring & Pinion      Ratio

FD88331IFS	3.31
FD88355IFS	3.55
FD88373IFS	3.73

### Differential      Comments

187C147A	Detroit Locker, 28 Spline (97-08)
912A563	Detroit Truetrac, 28 Spline (97-08)

# Axle Product by Axle Size

## Ford 8.8" Solid Axle & IRS (10 Bolt Cover)

### Rebuild Kit

DRK-311 Kit Series  
Refer to the vehicle index for proper kit selection

### Internal Kit

FD88-IK

### Ring & Pinion

	<b>Comments</b>
FD88308	3.08 (40-13)
FD88327	3.27 (36-11)
FD88331	3.31 (43-13)
FD88355	3.55 (39-11)
FD88373	3.73 (41-11)
FD88390	3.90 (43-11)
FD88410	4.10 (41-10)
FD88430	4.30 (43-10)
FD88456	4.56 (41-9)
FD88488	4.88 (39-8)

### Comments

87-14 (31 Spline)

### Ratio

### Differential

	<b>Comments</b>
542079-AG1	Auburn HP, 28 Spline (79-15)
542025-AG1	Auburn HP, 31 Spline (83-15)
542080	Auburn Pro, 28 Spline (79-14)
542054	Auburn Pro, 31 Spline (83-14)
5420116	Auburn Pro, 33 Spline (83-14)
545001	Auburn ECTED, 28 Spline (78-14)
545002	Auburn ECTED, 31 Spline - Non-IRS (83-14)
545005	Auburn ECTED, 31 Spline - IRS (83-14)
19605-010	Eaton, 28 Spline (82-11)
19558-010	Eaton, 31 Spline (83-86)
19660-010	Eaton E-locker, 31 Spline (83-86)
187C147A	Detroit Locker, 28 Spline (82-11)
187C145A†	Detroit Locker, 31 Spline (86-11)
912A562	Detroit Truetrac, 28 Spline (82-11)
913A561†‡	Detroit Truetrac, 31 Spline (86-11)
FD88-CPK	OEM Limited Slip Clutch Pack Replacement Kit

† Fits 1987 & Later Models  
‡ 2005 & Later Mustangs Require Axle Spacer Modification

### 2WD/

Truck Application	Years	4WD	Axle Shaft	Comments	Length	Studs	Spline
Aerostar	86-97	2/4	ASE3TZ4234C		29-1/8"	5	28
Aerostar	86-97	2/4	ASE69Z4234A		32-1/4"	5	28
Bronco	83-86	2/4	ASE3TZ4234D		31-1/16"	5	31
Bronco	83-86	2/4	ASE3TZ4234E		33-3/16"	5	31
Bronco	87-96	2/4	ASE7TZ4234A		31-1/16"	5	31
Bronco	87-96	2/4	ASE7TZ4234B		33-3/16"	5	31
Expedition	97-02	2/4	ASF75Z4234AA	w/ 1.620" Brg. Surface	31-3/4"	5	31
Expedition	97-02	2/4	ASF75Z4234AB	w/ 1.620" Brg. Surface	33-3/8"	5	31
Expedition	97-02	2/4	ASF75Z4234KA	w/ 1.705" Brg. Surface	31-3/4"	5	31
Expedition	97-02	2/4	ASF75Z4234KB	w/ 1.705" Brg. Surface	33-3/8"	5	31
Explorer	91-94	2/4	ASF1TZ4234A		27-3/4"	5	31
Explorer	91-94	2/4	ASF1TZ4234B		30-5/8"	5	31
Explorer	95-01	2/4	ASF5TZ4234A		27-5/8"	5	31
Explorer	95-01	2/4	ASF5TZ4234B		30-1/2"	5	31
Explorer Sport Trac	01-05	2/4	ASF5TZ4234A		27-5/8"	5	31
Explorer Sport Trac	01-05	2/4	ASF5TZ4234B		30-1/2"	5	31
Explorer Sport	02-03	2/4	ASF5TZ4234A		27-5/8"	5	31
Explorer Sport	02-03	2/4	ASF5TZ4234B		30-1/2"	5	31
Mazda B-Series	98-01	2/4	ASF87Z4234AC		27-1/4"	5	28
Mazda B-Series	98-01	2/4	ASF87Z4234AD		30-1/4"	5	28
Mazda Navajo	91-94	2/4	ASF1TZ4234A		27-3/4"	5	31
Mazda Navajo	91-94	2/4	ASF1TZ4234B		30-5/8"	5	31
Mountaineer	97-01	2/4	ASF5TZ4234A		27-5/8"	5	31
Mountaineer	97-01	2/4	ASF5TZ4234B		30-1/2"	5	31
Ranger	83-84	2	ASE3TZ4234A		28"	5	28
Ranger	85-92	2	ASE3TZ4234B		26-1/4"	5	28
Ranger	85-92	2	ASE3TZ4234C		29-1/8"	5	28
Ranger	83-92	4	ASE3TZ4234B		26-1/4"	5	28
Ranger	83-92	4	ASE3TZ4234C		29-1/8"	5	28

# Axle Product by Axle Size

## Ford 8.8" Solid Axle & IRS (10 Bolt Cover) Continued

Truck Application	Years	2WD/		Comments	Length	Studs	Spline
		4WD	Axle Shaft				
Ranger	93-97	2/4	ASF37Z4234A		27-1/4"	5	28
Ranger	93-97	2/4	ASF37Z4234B		30-1/8"	5	28
Ranger	98-09	2/4	ASF87Z4234AC		27-1/4"	5	28
Ranger	98-09	2/4	ASF87Z4234AD		30-1/4"	5	28
Ranger	98-09	2/4	ASF87Z4234BA		27-1/4"	5	31
Ranger	98-09	2/4	ASF87Z4234BB		30-1/4"	5	31
Truck 1/2 Ton	83-86	2/4	ASE3TZ4234D		31-1/16"	5	31
Truck 1/2 Ton	83-86	2/4	ASE3TZ4234E		33-3/16"	5	31
Truck 1/2 Ton	87-96	2/4	ASE7TZ4234A		31-1/16"	5	31
Truck 1/2 Ton	87-96	2/4	ASE7TZ4234B		33-3/16"	5	31
Truck 1/2 Ton	97-04	2/4	ASF75Z4234AA	2004 Heritage	31-3/4"	5	31
Truck 1/2 Ton	97-04	2/4	ASF75Z4234AB	2004 Heritage	33-3/8"	5	31
Truck 1/2 Ton	04-08	2/4	AS7L3Z4234A	2004 Non-Heritage	33-3/4"	5	31
Truck 1/2 Ton	04-08	2/4	AS7L3Z4234C	2004 Non-Heritage	35-7/16"	5	31
Van 1/2 Ton	88-96	2	ASE7TZ4234A		31-1/16"	5	31
Van 1/2 Ton	88-96	2	ASE7UZ4234E		35-5/8"	5	31
Van 1/2 Ton	97-99	2	ASF75Z4234BA		31-1/16"	5	31
Van 1/2 Ton	97-99	2	ASF75Z4234BB		35-5/8"	5	31

Call for other applications or dimensions.

Car Application	Years	2WD/		Comments	Length	Studs	Spline
		4WD	Axle Shaft				
Capri	80-86	2	ASD9BZ4234C		29"	4	28
Capri	80-86	2	ASE3TZ4234C		29-1/8"	5	28
Cougar	86-88	2	ASE5SZ4234A		30"	4	28
Crown Victoria	92-95	2	ASF2AZ4234C	w/o ABS	31-3/4"	5	28
Crown Victoria	92-97	2	ASF2AZ4234B	w/ABS	31-3/4"	5	28
Crown Victoria	98-02	2	ASF8AZ4234DA	w/ABS	32-7/16"	5	28
Crown Victoria	03-06	2	AS3W1Z4234A		34-7/16"	5	28
Crown Victoria	03-10	2	AS6W1Z4234A		35-1/4"	5	31
Ford Full Size	79-89	2	ASD9AZ4234A		30-7/8"	5	28
Grand Marquis	92-95	2	ASF2AZ4234C	w/o ABS	31-3/4"	5	28
Grand Marquis	92-97	2	ASF2AZ4234B	w/ABS	31-3/4"	5	28
Grand Marquis	98-02	2	ASF8AZ4234DA	w/ABS	32-7/16"	5	28
Grand Marquis	03-05	2	AS3W1Z4234A		34-7/16"	5	28
Grand Marquis	05-10	2	AS6W1Z4234A		35-1/4"	5	31
Marauder	03-04	2	AS3W1Z4234A		34-7/16"	5	28
Mercury Full Size	79-89	2	ASD9AZ4234A		30-7/8"	5	28
Lincoln Mark VI	80-83	2	ASD9AZ4234A		30-7/8"	5	28
Lincoln Town Car	81-89	2	ASD9AZ4234A		30-7/8"	5	28
Lincoln Town Car	92-95	2	ASF2AZ4234C	w/o ABS	31-3/4"	5	28
Lincoln Town Car	92-97	2	ASF2AZ4234B	w/ABS	31-3/4"	5	28
Lincoln Town Car	98-02	2	ASF8AZ4234DA	w/ABS	32-7/16"	5	28
Lincoln Town Car	03-04	2	AS3W1Z4234A		34-7/16"	5	28
Lincoln Town Car	05-10	2	AS6W1Z4234A		35-1/4"	5	31
Mustang	79-93	2	ASD9BZ4234C		29"	4	28
Mustang	94-98	2	ASF4ZZ4234A	w/o ABS	29-15/16"	5	28
Mustang	94-98	2	ASF4ZZ4234B	w/ABS	29-15/16"	5	28
Mustang	99-04	2	ASXR3Z4234AA	Exc. Cobra	31-5/8"	5	28
Thunderbird	86-88	2	ASE5SZ4234A		30"	4	28
Thunderbird	87-88	2	ASE7SZ4234A	w/ABS	30"	4	28

Call for other applications or dimensions.

# Axle Product by Axle Size

## Ford 9"

### Rebuild Kit

<u>Rebuild Kit</u>	<u>Comments</u>
DRK-312	Standard Kit (57-70)
DRK-312MK	Master Kit (57-70)
DRK-313	Standard Kit (70-86)
DRK-313MK	Master Kit (70-86)
DRK-313C	with 3.062" Carrier Brgs. Standard Kit
DRK-313CMK	with 3.062" Carrier Brgs. Master Kit
DRK-313D	with 3.250" Carrier Brgs. Standard Kit
DRK-313DMK	with 3.250" Carrier Brgs. Master Kit
DRK-928SP	HRW Aftermarket Stock Pinion, 3.250" Carrier Brgs.
DRK-935SP	HRW Aftermarket Large Pinion, 3.250" Carrier Brgs.

### Open Case

<u>Open Case</u>	<u>Comments</u>
FD9-CASE	28 & 31 Spline, 2 and 4 Pinion

### Internal Kit

<u>Internal Kit</u>	<u>Comments</u>
FD9-IK31-2	2 Pinion, 31 Spline
FD9-IK31-4	4 Pinion, 31 Spline
FD9-IK28-2	2 Pinion, 28 Spline
FD9-IK28-4	4 Pinion, 28 Spline

### Differential

<u>Differential</u>	<u>Comments</u>
542043	Auburn Pro (28 Spline)
542036	Auburn Pro (31 Spline)

### Ring & Pinion Ratio

<u>Ring &amp; Pinion</u>	<u>Ratio</u>
FD9280	2.80 (42-15)
FD9286	2.86 (40-14)
FD9294	2.94 (47-16)
FD9300	3.00 (39-13)
FD9315	3.15 (41-13)
FD9325	3.25 (39-12)
FD9350	3.50 (35-10)
FD9355	3.55 (39-11)
FD9360	3.60 (36-10)
FD9370	3.70 (37-10)
FD9375	3.75 (45-12)
FD9382	3.82 (42-11)
FD9389	3.89 (35-9)
FD9400	4.00 (36-9)
FD9411	4.11 (37-9)
FD9422	4.22 (38-9)
FD9430	4.30 (43-10)
FD9433	4.33 (39-9)
FD9444	4.44 (40-9)
FD9456	4.56 (41-9)
FD9457	4.57 (32-7)
FD9463	4.63 (37-8)
FD9471	4.71 (33-7)
FD9486	4.86 (34-7)
FD9500	5.00 (35-7)
FD9514	5.14 (36-7)
FD9529	5.29 (37-7)
FD9633	6.33 (38-6)
FD9650	6.50 (39-6)

LD Differential

<u>Application</u>	<u>Years</u>	<u>2WD/</u>		<u>Comments</u>	<u>Length</u>	<u>Studs</u>	<u>Spline</u>	<u>Side</u>
		<u>4WD</u>	<u>Axle Shaft</u>					
Bronco	66-75	2/4	AS5781L	w/ RW207CCRA Brg.	27-1 /4"	5	28	L
Bronco	66-75	2/4	AS5781R	w/ RW207CCRA Brg.	29-5 /8"	5	28	R
Bronco	66-75	2/4	AS5783L	w/ 514003 Brg.	26-15 /16"	5	28	L
Bronco	66-75	2/4	AS5783R	w/ 514003 Brg.	29-5 /16"	5	28	R
Bronco	74-75	2/4	AS5785L	w/ 514003 Brg.	27-1 /4"	5	28	L
Bronco	74-75	2/4	AS5785R	w/ 514003 Brg.	29-3 /4"	5	28	R
Bronco	76-77	2/4	AS5787L	w/ 514003 Brg.	27-1 /4"	5	28	L
Bronco	76-77	2/4	AS5787R	w/ 514003 Brg.	29-11 /16"	5	28	R
Fairlane	63	2/4	AS6070A		26"	5	31	L
Mustang	64-66	2/4	AS6070A		26"	5	31	L
Fairlane	63	2/4	AS6070B		30-1 /8"	5	31	R
Mustang	64-66	2/4	AS6070B		30-1 /8"	5	31	R
Mustang/Cougar	66-70	2/4	ASC90Z4234D		27-1 /8"	5	31	L
Mustang/Cougar	66-70	2/4	ASC90Z4234C		31-1 /4"	5	31	R
Mustang/Cougar	71-72	2/4	ASD1ZZ4234B		27-7 /8"	5	31	L
Mustang/Cougar	71-72	2/4	ASD1ZZ4234A		31-7 /8"	5	31	R
1/2 Ton Truck/Van	74-86	2/4	ASD6TZ4234A	w/ RW207CCRA Brg.	31-27 /32"	5	31	R/L
1/2 Ton Truck/Van	74-86	2/4	ASD6TZ4234A	w/ RW207CCRA Brg.	31-27 /32"	5	31	R/L

Call for other applications or dimensions.

# Axle Product by Axle Size

## Ford 9.75" Axle (12 Bolt Cover)

### Rebuild Kit

### Comments

DRK-316 Kit Series

Refer to the vehicle index for proper kit selection

### Internal Kit

### Comments

FD975-IK

97-15

### Ring & Pinion

### Ratio

FD975355	3.55 (39-11) Fits 97-2010
FD975373	3.73 (41-11) Fits 97-2010
FD975410	4.10 (41-10) Fits 97-2010
FD975430	4.30 (43-10) Fits 97-2010
FD975456	4.56 (41-9) Fits 97-2010
FD975488	4.88 (39-8) Fits 97-2010

### Conversion Kits

### Comments

DRK-316-CONVA	Standard Kit-Use when installing a later (2011-On) R/P into an earlier (2000-10) Housing
DRK-316-CONVB	Standard Kit-Use when installing an earlier (2000-10) R/P into an later (2011-On) Housing
DRK-316-CONVAMK	Master Kit-Use when installing a later (2011-On) R/P into an earlier (2000-10) Housing
DRK-316-CONVBMK	Master Kit-Use when installing an earlier (2000-10) R/P into an later (2011-On) Housing

### Conversion Brgs.

### Comments

KEST5195LFT	Pinion Brg. when installing a later (2011-On) R/P into an earlier (2000-10) Housing
JHM807045-HM807010	Pinion Brg. when installing an earlier (2000-10) R/P into an later (2011-On) Housing

### Differential

### Comments

542090	Auburn HP, 34 Spline (97-14)
225C194A	Detroit Locker, 34 Spline (97-12)
913A477	Detroit Truetrac, 34 Spline (97-12)

LD Differential

Application	Years	2WD/ 4WD	Axle Shaft	Comments	Length	Studs	Spline	Side
Blackwood†	2002	2	ASYL1Z4234CA		31-3/4"	5	34	R
Blackwood†	2002	2	ASYL1Z4234CB		33-3/8"	5	34	L
Expedition‡	97-00	2/4	ASF75Z4234LA		31-3/4"	5	34	R
Expedition‡	97-00	2/4	ASF75Z4234LB		33-3/8"	5	34	L
Expedition†	00-02	2/4	ASYL1Z4234CA		31-3/4"	5	34	R
Expedition†	00-02	2/4	ASYL1Z4234CB		33-3/8"	5	34	L
Mark LT 1/2 Ton	06-08	2/4	AS7L3Z4234B		33-3/4"	6	34	R
Mark LT 1/2 Ton	06-08	2/4	AS7L3Z4234D		35-3/8"	6	34	L
Navigator‡	98-99	2/4	ASF75Z4234LA		31-3/4"	5	34	R
Navigator‡	98-99	2/4	ASF75Z4234LB		33-3/8"	5	34	L
Navigator†	99-02	2/4	ASYL1Z4234CA		31-3/4"	5	34	R
Navigator†	99-02	2/4	ASYL1Z4234CB		33-3/8"	5	34	L
Truck 1/2 Ton!	97-00	2/4	ASF75Z4234MA		31-3/4"	5	34	R
Truck 1/2 Ton!	97-00	2/4	ASF75Z4234MB		33-3/8"	5	34	L
Truck 1/2 Ton‡	1999	2/4	ASF75Z4234LA		31-3/4"	5	34	R
Truck 1/2 Ton‡	1999	2/4	ASF75Z4234LB		33-3/8"	5	34	L
Truck 1/2 Ton†	00-04	2/4	ASYL1Z4234CA		31-3/4"	5	34	R
Truck 1/2 Ton†	00-04	2/4	ASYL1Z4234CB		33-3/8"	5	34	L
Truck 1/2 Ton	04-08	2/4	AS7L3Z4234B		33-3/4"	6	34	R
Truck 1/2 Ton	04-08	2/4	AS7L3Z4234D		35-3/8"	6	34	L
Truck 1/2 Ton	09-14	2/4	AS9L3Z4234C		33-3/4"	6	34	R
Truck 1/2 Ton	09-14	2/4	AS9L3Z4234D		35-3/8"	6	34	L

† w/ 1.705" Wheel Brg. & .610" Wheel Stud Hole

‡ w/ 1.705" Wheel Brg. & .568" Wheel Stud Hole

! w/ 1.618" Wheel Brg.

Call for all other applications or dimensions.



# Axle Product by Axle Size

## Ford 10.25" Axle (12 Bolt Cover)

<u>Rebuild Kit</u>	<u>Comments</u>	<u>Ring &amp; Pinion</u>	<u>Ratio</u>
DRK-314	Standard Kit (85-03)	FD10355	3.55 (39-11) – fits 83-92
DRK-314MK	Master Kit (85-03)	FD10355-A	3.55 (39-11) – fits 93-99
		FD10373	3.73 (41-11) – fits 83-92
		FD10373-A	3.73 (41-11) – fits 93-99
		FD10410	4.10 (41-10) – fits 83-92
		FD10410-A	4.10 (41-10) – fits 93-99
		FD10456	4.56 (41-9) – fits 83-92
		FD10456-A	4.56 (41-9) – fits 93-99
		FD10488-A	4.88 (41-8) – fits 93-99
<u>Open Case</u>	<u>Ratio</u>		
FD1025-CASE	83-99 (2 Pinion)		
<u>Internal Kit</u>	<u>Comments</u>		
FD1025-IK	83-99 (2 Pinion)		
		<u>Differential</u>	<u>Comments</u>
		542089	Auburn HP (83-14)
		19694-010†	Eaton (85-12)
		225SL56A†	Detroit Locker (85-12)
		915A550†	Detroit Truetrac (85-12)
		† Full-Float Style Axle Only	

## Ford 10.5" Axle (12 Bolt Cover)

<u>Rebuild Kit</u>	<u>Comments</u>	<u>Conversion Kits</u>	<u>Comments</u>
DRK-317	Standard Kit (99-07)	DRK-314AMK	Conversion kit 10.5" R/P to 10.25" R/P
DRK-317MK	Master Kit (99-07)		
DRK-317A	Standard Kit (08-10)	<u>Differential</u>	<u>Comments</u>
DRK-317AMK	Master Kit (08-10)	542089	Auburn HP
DRK-317B	Standard Kit (11-16)	19694-010†	Eaton
DRK-317BMK	Master Kit (11-16)	225SL56A†	Detroit Locker
		915A550†	Detroit Truetrac
		† Full-Float Style Axle Only	
<u>Ring &amp; Pinion</u>	<u>Ratio</u>		
FD10355-A	3.55 (39-11)		
FD10373-A	3.73 (41-11)		
FD10410-A	4.10 (41-10)		
FD10456-A	4.56 (41-9)		
FD10488-A	4.88 (41-8)		

*Above Ring & Pinion Sets are Aftermarket 10.25" sets that will work in place of OE 10.5" sets. When using these Ring & Pinion Sets, you will need to use the DRK-314AMK kit instead of DRK-317 kit.*

# Axle Product by Axle Size

## GM 7.25" IFS Axle

### **Rebuild Kit**

### **Comments**

DRK-320 Kit Series

Refer to the vehicle index for proper kit selection

### **Open Case**

### **Ratio**

GM725-CASE

### **Internal Kit**

### **Comments**

GM725-IK

### **Ring & Pinion**

### **Ratio**

GM725308

3.08 (40-13)

GM725342

3.42 (41-12)

GM725373

3.73 (41-11)

# Axle Product by Axle Size

## GM 7.5"/7.6" Axle

### **Rebuild Kit**

### **Comments**

DRK-320 Kit Series

Refer to the vehicle index for proper kit selection

### **Open Case**

### **Ratio**

GM75-CASE	3.23 & higher 26 spline (89-04)
GM76-CASEL	3.08 & lower 28 spline (89-04)
GM76-CASEH	3.23 & higher 28 spline (89-04)

### **Internal Kit**

### **Comments**

GM75-IK	7.5" (89-Earlier, 26 Spline)
GM76-IK	7.6" (89-04, 28 Spline)

### **Ring & Pinion**

### **Ratio**

GM75273	2.73 (41-15)
GM75308	3.08 (40-13)
GM75323	3.23 (42-13)
GM75342	3.42 (41-12)
GM75373	3.73 (41-11)
GM75410	4.10 (41-10)
GM75456	4.56 (41-9)

### **Differential**

### **Comments**

542044	Auburn Pro 3.23 & Higher, 26 Spline (76-88)
542045	Auburn Pro 3.08 & Lower, 26 Spline (76-88)
542046	Auburn Pro 3.23 & Higher, 28 Spline (88-04)
542047	Auburn Pro 3.08 & Lower, 28 Spline (88-04)
542057	Auburn HP 3.23 & Higher, 26 Spline (76-88)
542058	Auburn HP 3.08 & Lower, 26 Spline (76-88)
542040	Auburn HP 3.23 & Higher, 28 Spline (88-04)
542041	Auburn HP 3.08 & Lower, 28 Spline (88-04)
19663-010	Eaton 3.23 & Higher, 26 Spline (76-88)
19599-010	Eaton 3.23 & Higher, 28 Spline (88-04)
40004010	AAM Trac-Rite Torsen Limited Slip
40004011	AAM Trac-Rite Torsen Limited Slip
162C58A	Detroit Locker 3.23 & Higher, 26 Spline
162C59A	Detroit Locker 3.23 & Higher, 28 Spline
911A415	Detroit Truetrac 3.08 & Lower, 26 Spline
911A319	Detroit Truetrac 3.23 & Higher, 26 Spline
912A317	Detroit Truetrac 3.23 & Higher, 28 Spline

# Axle Product by Axle Size

## GM 7.5"/7.6" Axle Continued

Application	Years	4WD	Axle Shaft	Comments	Length	Studs	Spline	Side
Astro Van	85-89	2	AS14074822		30-5/16"	5	26	R
Astro Van	85-89	2	AS14074821		34-3/4"	5	26	L
Astro Van	90-98	2/4	AS26011055		30-5/16"	5	28	R
Astro Van	90-98	2/4	AS26011054		34-13/16"	5	28	L
Astro Van	03-04	4	AS12479211		31"	6	28	R
Astro Van	03-04	4	AS12479210		35-1/2"	6	28	L
Bravada	93-96	4	AS26013882		29"	5	28	R/L
Bravada	91-93	4	AS26015260		29"	5	28	R/L
Camaro	90-92	2	AS26031252		30-5/16"	5	28	R/L
Camaro	93-96	2	AS26027588		32"	5	28	R/L
Camaro	98-02	2	AS26059972		32"	5	28	R/L
Firebird	90-92	2	AS26031252		30-5/16"	5	28	R/L
Firebird	93-96	2	AS26027588		32"	5	28	R/L
Firebird	98-02	2	AS26059972		32"	5	28	R/L
Jimmy	83-90	2	AS14030355		26-9/16"	5	26	R/L
Jimmy	88-97	2	AS26015759		26-5/8"	5	28	R/L
Jimmy	98-01	2	AS26058696		26-5/16"	5	28	R/L
Jimmy	83-89	4	AS14035368		29"	5	26	R/L
Jimmy	88-97	4	AS26013882		29"	5	28	R/L
Jimmy	91-93	4	AS26015260		29"	5	28	R/L
Jimmy	98-01	4	AS26050549		28-13/16"	5	28	R/L
S10/S15 Pick-Up	82-93	2	AS14030355		26-9/16"	5	26	R/L
S10/S15 Pick-Up	88-97	2	AS26015759		26-5/8"	5	28	R/L
S10 Pick-Up	98-03	2	AS26064388		26-5/8"	5	28	R/L
S10/S15 Pick-Up	83-89	4	AS14035368		29"	5	26	R/L
S10/S15 Pick-Up	88-97	4	AS26013882		29"	5	28	R/L
S10 Pick-Up	98-04	4	AS26050549		28-13/16"	5	28	R/L
S10 Blazer	83-90	2	AS14030355		26-9/16"	5	26	R/L
S10 Blazer	88-97	2	AS26015759		26-5/8"	5	28	R/L
S10 Blazer	98-05	2	AS26058696		26-5/16"	5	28	R/L
S10 Blazer	83-89	4	AS14035368		29"	5	26	R/L
S10 Blazer	88-97	4	AS26013882		29"	5	28	R/L
S10 Blazer	91-93	4	AS26015260		29"	5	28	R/L
S10 Blazer	98-05	4	AS26050549		28-13/16"	5	28	R/L
Safari Van	85-89	2	AS14074822		30-5/16"	5	26	R
Safari Van	85-89	2	AS14074821		34-3/4"	5	26	L
Safari Van	90-98	2/4	AS26011055		30-5/16"	5	28	R
Safari Van	90-98	2/4	AS26011054		34-13/16"	5	28	L
Safari Van	03-04	4	AS12479211		31"	6	28	R
Safari Van	03-04	4	AS12479210		35-1/2"	6	28	L
Sonoma	91-93	2	AS14030355		26-9/16"	5	26	R/L
Sonoma	91-97	2	AS26015759		26-5/8"	5	28	R/L
Sonoma	98-03	2	AS26064388		26-5/8"	5	28	R/L
Sonoma	91-97	4	AS26013882		29"	5	28	R/L
Sonoma	98-04	4	AS26050549		28-13/16"	5	28	R/L

LD Differential

# Axle Product by Axle Size

## GM 8" Axle

**Rebuild Kit**      **Comments**

DRK-320D      Standard Kit  
DRK-320DMK      Master Kit

**Open Case**      **Ratio**

GM8-CASE

**Internal Kit**      **Comments**

GM8-IK      28 Spline

**Ring & Pinion**      **Ratio**

GM8342      3.42  
GM8373      3.73  
GM8410      4.10

**Differential**      **Comments**

912A654      Detroit True Trac 28 Spline (02-10)

Application	Years	2WD/		Comments	Length	Studs	Spline	Side
		4WD	Axle Shaft					
Bravada	02-04	4	AS12479017		31-1 /2"	6	28	R
Bravada	02-04	4	AS12479016		33-3 /8"	6	28	L
Canyon	04-12	4	AS12479337		30-3 /4"	6	28	L
Colorado	04-12	4	AS12479337		30-3 /4"	6	28	L
Envoy	02-08	4	AS12479017		31-1 /2"	6	28	R
Envoy	02-08	4	AS12479016		33-3 /8"	6	28	L
Rainier	04-07	4	AS12479017		31-1 /2"	6	28	R
Rainier	04-07	4	AS12479016		33-3 /8"	6	28	L
Trailblazer	02-08	4	AS12479017		31-1 /2"	6	28	R
Trailblazer	02-08	4	AS12479016		33-3 /8"	6	28	L

LD Differential



# Axle Product by Axle Size

## GM 8.2" Axle (10 Bolt Cover)

<b>Rebuild Kit</b>	<b>Comments</b>
DRK-321B	Standard Kit (64-72)
DRK-321BMK	Master Kit (64-72)
DRK-321G	Standard Kit (55-64)
DRK-321GMK	Master Kit (55-64)
DRK-321H	Standard Kit (64-71) Buick, Olds & Pontiac
DRK-321HMK	Master Kit (64-71) Buick, Olds & Pontiac

<b>Ring &amp; Pinion</b>	<b>Ratio</b>
GM82308	3.08 (40-13)
GM82336	3.36 (37-11)
GM82355	3.55 (39-11)
GM82355-BOP	3.55 (39-11)
GM82373	3.73 (41-11)
GM82390-BOP	3.90 (39-10)
GM82410	4.10 (41-10)
GM82411-BOP	4.11 (37-9)
GM82456	4.56 (41-9)
GM82456-BOP	4.56 (41-9)
GM82488	4.88 (39-8)
GM82513	5.13 (41-8)

<b>Differential</b>	<b>Comments</b>
542061	Auburn Pro-Chevrolet 3.08 & Higher, 25 Spline (64-72)
542099	Auburn Pro-Buick, Olds, Pontiac 2.93-3.23, & Higher, 27 Spline (64-71)
542060	Auburn Pro-Buick, Olds, Pontiac 3.36 & Higher, 27 Spline (64-71)
5420108	Auburn HP-Chevrolet 3.08 & Higher, 25 Spline (64-72)
5420114	Auburn HP-Buick, Olds, Pontiac 2.93-3.23 & Higher, 27 Spline (64-71)
5420113	Auburn HP-Buick, Olds, Pontiac 3.36 & Higher, 27 Spline (64-71)
19674-010	Eaton Buick, Oldsmobile & Pontiac 3.36 & Higher
19603-010	Eaton Chevy 3.08 & Higher (64-72)
19686-010	Eaton Chevy 3.90 & Higher (55-64)

<b>Application</b>	<b>Years</b>	<b>2WD/</b>		<b>Comments</b>	<b>Length</b>	<b>Studs</b>	<b>Spline</b>	<b>Side</b>
		<b>4WD</b>	<b>Axle Shaft</b>					
Camaro	67-69	2WD	AS1255803		29-5 /8"	5	28	R/L
Camaro	70-81	2WD	AS1255802		30-1 /8"	5	28	R/L
Chevelle	65-67	2WD	AS1255803		29-5 /8"	5	28	R/L
Chevelle	68-72	2WD	AS1255802		30-1 /8"	5	28	R/L
El Camino	68-72	2WD	AS1255802		30-1 /8"	5	28	R/L
Nova	65-67	2WD	AS3863726		28-5 /8"	5	28	R/L
Nova	70-75	2WD	AS1255803		29-5 /8"	5	28	R/L

# Axle Product by Axle Size

## GM 8.25 IFS" Axle

### **Rebuild Kit**

### **Comments**

DRK-321 Kit Series

Refer to the vehicle index for proper kit selection

### **Open Case**

### **Ratio**

GM825-CASE

### **Internal Kit**

### **Comments**

GM825-IK

### **Ring & Pinion**

### **Ratio**

GM825342 3.42 (41-12)

GM825373 3.73 (41-11)

GM825410 4.10 (41-10)

GM825456 4.56 (41-9)

# Axle Product by Axle Size

## GM 8.5"/8.6" Axle (10 Bolt Cover)

Application	Years	2WD/		Comments	Length	Studs	Spline	Side
		4WD	Axle Shaft					
Avalanche	02-04	2/4	AS12471369	w/o active brake control	33-5/8"	6	30	R/L
Blazer	79-89	2	AS14035542		31-3/8"	5	28	R/L
Blazer	88-91	2	AS26010415		31-3/8"	5	30	R/L
Blazer	82-88	4	AS14039547		31-5/16"	6	28	R/L
Blazer	88-91	4	AS26010414	Non-IFS	31-5/16"	6	30	R/L
Blazer	92-94	2/4	AS26010416		33"	6	30	R/L
Caprice	91-96	2	AS26018080	w/Disc Brake	30-7/16"	5	30	R/L
Camaro	67-69	2	AS1255803		29-5/8"	5	28	R/L
Camaro	70-81	2	AS1255802		30-1/8"	5	28	R/L
Chevelle	65-67	2	AS1255803		29-5/8"	5	28	R/L
Chevelle	68-72	2	AS1255802		30-1/8"	5	28	R/L
Chevelle	63-77	2	AS1255801		30-7/16"	5	28	R/L
Denali	00	4	AS26010416		33"	6	30	R/L
El Camino	68-72	2	AS1255802		30-1/8"	5	28	R/L
El Camino	73-77	2	AS1255801		30-7/16"	5	28	R/L
Envoy	02-08	4	AS12479161		31-3/4"	6	30	R
Envoy	02-08	4	AS12479160		33-1/4"	6	30	L
Escalade	99-00	4	AS26010416		33"	6	30	R/L
Escalade	02	2/4	AS12471369		33-5/8"	6	30	R/L
Escalade EXT	02	2/4	AS12471369		33-5/8"	6	30	R/L
Jimmy	79-89	2	AS14035542		31-3/8"	5	28	R/L
Jimmy	88-91	2	AS26010415		31-3/8"	5	30	R/L
Jimmy	82-88	4	AS14039547		31-5/16"	6	28	R/L
Jimmy	88-91	4	AS26010414	Non-IFS	31-5/16"	6	30	R/L
Nova	70-75	2	AS1255803		29-5/8"	5	28	R/L
Ranier	04-07	4	AS12479161		31-3/4"	6	30	R
Ranier	04-07	4	AS12479160		33-1/4"	6	30	L
SSR	03-06	2	AS12479161		31-3/4"	6	30	R
SSR	03-06	2	AS12479160		33-1/4"	6	30	L
Suburban	78-88	2	AS14035542		31-3/8"	5	28	R/L
Suburban	88-91	2	AS26010415		31-3/8"	5	30	R/L
Suburban	92-99	2	AS26010417		31-13/16"	5	30	R/L
Suburban	81-88	4	AS14039547		31-5/16"	6	28	R/L
Suburban	88-91	4	AS26010414	Non-IFS	31-5/16"	6	30	R/L
Suburban	92-99	4	AS26010416		33"	6	30	R/L
Suburban	00-04	2/4	AS12471369	w/o active brake control	33-5/8"	6	30	R/L
Tahoe	95-00	2	AS26010417	2000 Classic only	31-13/16"	5	30	R/L
Tahoe	95-00	4	AS26010416	2000 Classic only	33"	6	30	R/L
Tahoe	00-04	2/4	AS12471369		33-5/8"	6	30	R/L
Yukon	92-94	2/4	AS26010416		33"	6	30	R/L
Yukon	95-99	4	AS26010416		33"	6	30	R/L
Yukon	95-99	2	AS26010417		31-13/16"	5	30	R/L
Yukon	00	2/4	AS12471369	Exc. Denali	33-5/8"	6	30	R/L
Yukon	01-04	2/4	AS12471369	w/o active brake control	33-5/8"	6	30	R/L
Yukon XL	00-04	2/4	AS12471369	w/o active brake control	33-5/8"	6	30	R/L
Trailblazer	02-08	4	AS12479161		31-3/4"	6	30	R
Trailblazer	02-08	4	AS12479160		33-1/4"	6	30	L
Truck 1/2 Ton	78-87	2	AS14035542		31-3/8"	5	28	R/L
Truck 1/2 Ton	88-99	2	AS26010417	1999 Classic only	31-13/16"	5	30	R/L
Truck 1/2 Ton	88-99	4	AS26010416	1999 Classic only	33"	6	30	R/L
Truck 1/2 Ton	88	4	AS15521892	IFS; Standard Cab	33"	6	28	R/L
Truck 1/2 Ton	99-00	2/4	AS12471369		33-5/8"	6	30	R/L
Truck 1/2 Ton	01-02	2/4	AS12471369	Exc.01-02 Crew Cab 4x4	33-5/8"	6	30	R/L
Truck 1/2 Ton	03-04	2/4	AS12471369	w/o active brake control	33-5/8"	6	30	R/L
Truck 1/2 Ton	81-87	4	AS14039547		31-5/16"	6	28	R/L
Van 1/2 Ton	75-88	2	AS14042690		33-5/16"	5	28	R/L
Van 1/2 Ton	88-95	2	AS26013313		33-5/16"	5	30	R/L
Van 1/2 Ton	96-02	2	AS26042818		33-1/4"	5	30	R/L
Van 1/2 Ton	03-10	2	AS12479175	w/o active brake control	34-1/2"	5	30	R/L
Van 3/4 Ton	75-88	2	AS14042690		33-5/16"	5	28	R/L
Van 3/4 Ton	88-95	2	AS26013313		33-5/16"	5	30	R/L

Call for all other applications or dimensions.

# Axle Product by Axle Size

## GM 8.5"/8.6" Axle (10 Bolt Cover)

### **Rebuild Kit**

DRK-321 Kit Series

Refer to the vehicle index for proper kit selection

### **Comments**

### **Open Case**

GM85-Case

(98-Earlier)

GM85-Case†

(99-001/2) (Case Open Both Sides)

GM85-CASEC-LOAD

(001/2-14) (Case Closed One Side)

†GM85-CaseB is OBSOLETE -Replaced by GM85-CaseC but you must update internals to GM85-IKC.

### **Comments**

### **Internal Kit**

GM85-IK28

(89-Earlier) (28 Spl.)

GM85-IK30

(89-98) (30 Spl.)

GM85-IKB

(99-001/2) (30 Spl.)

GM85-IKC

(001/2-08) (30 Spl.)

GM85-IKD

(09-14) (30 Spl.)

### **Comments**

### **Ring & Pinion**

### **Ratio**

GM85308

3.08 (40-13)

GM85308-V

3.08 (40-13)

GM85323

3.23 (42-13) 1986-96

GM85323-V

3.23 (42-13) 1986-96

GM85342

3.42 (41-12)

GM85355-V

3.55 (39-11)

GM85370

3.70 (37-10)

GM85373

3.73 (41-11)

GM85390

3.90 (39-10)

GM85390-V

3.90 (39-10)

GM85410

4.10 (41-10)

GM85411-V

4.11 (37-9)

GM85456

4.56 (41-9)

GM85488

4.88 (39-08)

GM85513

5.13 (41-08)

GM85538‡

5.38 (43-08)

GM85557‡

5.57 (39-07)

‡Requires a modified cross shaft for installation.

\*V Are for Corvette only.

### **Differential**

### **Comments**

40135974

AAM Trac-Rite Torsen Limited Slip

542050

Auburn Pro 2.73 & Higher, 28 Spline (71-88)

542052

Auburn Pro 2.73 & Higher, 30 Spline (89-14)

542062

Auburn Pro-Corvette Only 2.41-3.70, 17 Spline (63-79)

542063

Auburn Pro-Corvette Only 4.10 & Higher, 17 Spline (63-79)

542018

Auburn HP 2.73 & Higher, 28 Spline (71-88)

542022

Auburn HP 2.73 & Higher, 30 Spline (89-98)

542097

Auburn HP 2.73 & Higher, 30 Spline (99-14)

19557-010

Eaton 2.73 & Higher, 28 Spline (71-89)

19559-010

Eaton 2.73 & Higher, 30 Spline (88-09)

19670-010

Eaton-Corvette Only 3.08-3.70 Ratios (63-79)

19659-010

Eaton E-Locker 2.73 & Higher, 30 Spline (88-09)

187C149A

Detroit Locker 2.73 & Higher, 28 Spline (72-89)

187C148A

Detroit Locker 2.73 & Higher, 30 Spline (88-09)

912A557

Detroit Truetrac-Front 2.73 & Lower, 28 Spline (77-88)

913A481

Detroit Truetrac 2.73 & Higher, 30 Spline (88-09)

## GM 8.875" Axle (12 Bolt Cover) Car

### Rebuild Kit      Comments

DRK-323A      Standard Kit  
DRK-323AMK      Master Kit

### Internal Kit      Comments

GM12-1K

<u>Ring &amp; Pinion</u>	<u>Ratio</u>	<u>Differential</u>	<u>Comments</u>
GM12308-C	3.08 (40-13)	542031	Auburn Pro 4.10 & Higher, 30 Spline (64-72)
GM12342-C	3.42 (41-12)	5420117	Auburn Pro 4.10 & Higher, 33 Spline (64-72)!
GM12355-C	3.55 (39-11)	5420104	Auburn HP 4.10 & Higher, 30 Spline (64-72)
GM12373-C	3.73 (41-11)	19554-010	Eaton 3.08-3.90, 30 Spline
GM12373-XC*	3.73 (41-11)	19555-010	Eaton 4.10 & Higher, 30 Spline
GM12390-C	3.90 (39-10)	187C197A	Detroit Locker 3.08-3.90, 30 Spline
GM12410-C	4.10 (41-10)	187C198A	Detroit Locker 3.08-3.90, 33 Spline
GM12410-XC**	4.10 (41-10)	187S196A	Detroit Locker 3.08-3.90, 35 Spline w/ 3.25" bearing
GM12430-C	4.30 (43-10)	913A555	Detroit Truetrac 3.08-3.90, 33 Spline
GM12433-C	4.33 (39-9)	914A576	Detroit Truetrac 3.08-3.90, 35 Spline
GM12456-C	4.56 (41-9)	914A575	Detroit Truetrac 4.10 & Higher, 33 Spline
GM12456-XC**	4.56 (41-9)		!Fits axles with 45 degree pressure angle.
GM12488-C	4.88 (39-8)		
GM12488-XC**	4.88 (39-8)		
GM12514-C	5.14 (36-7)		
GM12538-C	5.38 (43-8)		
GM12557-C	5.57 (39-7)		
GM12586-C	5.86 (41-7)		
GM12614-C	6.14 (43-7)		

\*Fits 3.90 ratio and numerically higher carrier

\*\*Fits 3.07-3.73 ratio carrier

<u>Application</u>	<u>Years</u>	<u>2WD/</u>		<u>Comments</u>	<u>Length</u>	<u>Studs</u>	<u>Spline</u>	<u>Side</u>
		<u>4WD</u>	<u>Axle Shaft</u>					
Camaro	67-69	2	AS3969349		29-9 /16"	5	30	R/L
Camaro	70-72	2	AS3969285		30-1 /16"	5	30	R/L
Chevelle	65-67	2	AS3969349		29-9 /16"	5	30	R/L
Chevelle	68-72	2	AS3969285		30-1 /16"	5	30	R/L
Chevy II	68-72	2	AS3969349		29-9 /16"	5	30	R/L
El Camino	68-72	2	AS3969285		30-1 /16"	5	30	R/L

LD Differential



# Axle Product by Axle Size

## GM 8.875" Axle (12 Bolt Cover) Truck

### Rebuild Kit      Comments

DRK-322              Standard Kit  
DRK-322MK        Master Kit

### Internal Kit      Comments

GM12-1K

### Ring & Pinion   Ratio

GM12308            3.08 (40-13)  
GM12342            3.42 (41-12)  
GM12373            3.73 (41-11)  
GM12410            4.10 (41-10)  
GM12456            4.56 (41-9)  
GM12488            4.88 (39-8)  
GM12513\*\*         5.13 (41-8)  
GM12538\*\*         5.38 (43-8)

\*\*Requires a modified cross shaft

### Differential      Comments

542034              Auburn Pro 2.76-3.42, 30 Spline (64-82)  
542032              Auburn Pro 3.73 & Higher, 30 Spline (64-82)  
5420107             Auburn HP 2.76-3.42, 30 Spline (64-82)  
5420105             Auburn HP 3.73 & Higher, 30 Spline (64-82)  
19587-010          Eaton 2.76-3.42, 30 Spline  
19556-010          Eaton 3.73 & Higher, 30 Spline  
187C150A          Detroit Locker 3.73 & Higher, 30 Spline  
916A315             Detroit Truetrac 3.73 & Higher, 30 Spline

### **2WD/**

<b>Application</b>	<b>Years</b>	<b>4WD</b>	<b>Axle Shaft</b>	<b>Comments</b>	<b>Length</b>	<b>Studs</b>	<b>Spline</b>	<b>Side</b>
Truck	65-69	2/4	AS3893605		30-3 /4"	5/6	30	R/L
Truck	65-69	2/4	AS5855	6 Lug to 5 Lug Conversion	30-3 /4"	5	30	R/L
Truck	70-81	2	AS14071751		31-5 /16"	5	30	R/L
Truck	70-81	4	AS14071750		31-9 /132"	6	30	R/L

# Axle Product by Axle Size

## GM 9.25" IFS Axle

<b>Rebuild Kit</b>	<b>Comments</b>
DRK-324A	Standard Kit (88-97)
DRK-324AMK	Master Kit (88-97)
DRK-324C	Standard Kit (98-10)
DRK-324CMK	Master Kit (98-10)
DRK-324D	Standard Kit (11-16)
DRK-324DMK	Master Kit (11-16)

<b>Open Case</b>	<b>Ratio</b>
GM95-CASE	1988-13

<b>Internal Kit</b>	<b>Comments</b>
GM95-IK	1988-15

<b>Ring &amp; Pinion</b>	<b>Ratio</b>
GM925342	3.42 (41-12)
GM925373	3.73 (41-11)
GM925410	4.10 (41-10)
GM925456	4.56 (41-9)

## GM 9.3" "C" Axle

<b>Rebuild Kit</b>	<b>Comments</b>
DRK-329	Standard Kit
DRK-329MK	Master Kit

<b>Ring &amp; Pinion</b>	<b>Ratio</b>
GM93410	4.10 (41-10)
GM93456	4.56 (41-9)
GM93488	4.88 (39-8)

# Axle Product by Axle Size

## GM 9.5" Axle (14 Bolt Cover)

<b><u>Rebuild Kit</u></b>	<b><u>Comments</u></b>
DRK-324	Standard Kit (81-97)
DRK-324MK	Master Kit (81-97)
DRK-324B	Standard Kit (98-13)
DRK-324BMK	Master Kit (98-13)

<b><u>Open Case</u></b>	<b><u>Ratio</u></b>
GM95-CASE-LOAD	

<b><u>Internal Kit</u></b>	<b><u>Comments</u></b>
GM95-IK	1988-13

<b><u>Ring &amp; Pinion</u></b>	<b><u>Ratio</u></b>
GM95342	3.42 (41-12) 1988-13
GM95373	3.73 (41-11) 1988-13
GM95410	4.10 (41-10) 1988-13
GM95456	4.56 (41-9) 1988-13

<b><u>Differential</u></b>	<b><u>Comments</u></b>
542087	Auburn HP 33 Spline (81-13)
19590-010	Eaton 33 Spline (81-09)
19684-010	Eaton E-Locker 33 Spline (81-09)
225C135A	Detroit Locker 33 Spline (81-09)
914A538	Detroit Truetrac 33 Spline (81-09)

### 2WD/

<b>Application</b>	<b>Years</b>	<b>4WD</b>	<b>Axle Shaft</b>	<b>Comments</b>	<b>Length</b>	<b>Studs</b>	<b>Spline</b>	<b>Side</b>
Suburban	81-96	2/4	AS14035395	Semi-float style	32-9/16"	8	33	R/L
Suburban	92-99	2/4	AS15522070	Semi-float style	31-13/16"	8	33	R/L
Truck 1/2 Ton	88-99	4	AS15521928	1999 Classic models only	33-1/8"	6	33	R/L
Truck 3/4 Ton	88-98	2	AS15522068		31-9/16"	6	33	R/L
Truck 3/4 Ton	88-95	4	AS15521928		33-1/8"	6	33	R/L
Truck 3/4 Ton	81-96	2/4	AS14035395	Semi-float style	32-9/16"	8	33	R/L
Truck 3/4 Ton	89-00	2/4	AS15522070	Semi-float style	31-13/16"	8	33	R/L
Truck 1 Ton	88-89	2/4	AS15522070	Semi-float style	31-13/16"	8	33	R/L
Van 1 Ton	86-96	2	AS14035395	Semi-floating, Exc. Van	32-9/16"	8	33	R/L

Call for all other applications or dimensions.

# Axle Product by Axle Size

## GM 9.5" Axle (12 Bolt Cover, 2014-On)

### Rebuild Kit

DRK-324E  
DRK-324EMK

### Comments

Standard Kit (14-16)  
Master Kit (14-16)

### Open Case

GM976-CASE-LOAD  
GM976-CASEB-LOAD

### Ratio

3.23 and Lower  
3.42 and Higher

### Ring & Pinion

GM95K2308  
GM95K2342  
GM95K2410

### Ratio

3.08  
3.42  
4.10

### 2WD/

Application	Years	4WD	Axle Shaft	Comments	Length	Studs	Spline	Side
Truck 1/2 Ton	14-15	2/4	AS40103091					R/L
Suburban,Tahoe,Yukon,Escalade	14-15	2/4	AS40103092					R/L

LD Differential

## GM 9.76" Axle (12 Bolt Cover, 2014-On)

### Rebuild Kit

DRK-324H  
DRK-324HMK

### Comments

Standard Kit (14-16)  
Master Kit (14-16)

### Open Case

GM976-CASE-LOAD  
GM976-CASEB-LOAD

### Ratio

3.23 and Lower  
3.42 and Higher

### Ring & Pinion

GM976323  
GM976342  
GM976373

### Ratio

3.23  
3.42  
3.73

### 2WD/

Application	Years	4WD	Axle Shaft	Comments	Length	Studs	Spline	Side
Truck 1/2 Ton	14-15	2/4	AS40103091					R/L
Suburban,Tahoe,Yukon,Escalade	14-15	2/4	AS40103092					R/L

# Axle Product by Axle Size

## GM 10.5" Axle (14 Bolt Cover)

### Rebuild Kit

DRK-325	Standard Kit (72-88) 1st design
DRK-325MK	Master Kit (72-88) 1st design
DRK-325A	Standard Kit (88-97) 2nd design
DRK-325AMK	Master Kit (88-97) 2nd design
DRK-325B	Standard Kit (98-16)
DRK-325BMK	Master Kit (98-16)

### Comments

### Open Case

GM105-CASEL	4.10 & Lower Ratios
GM105-CASE	4.56 & Higher Ratios

### Ratio

### Internal Kit

GM105-IK

### Comments

### Ring & Pinion

GM105342	3.42 (41-12)
GM105373	3.73 (41-11)
GM105410	4.10 (41-10)
GM105456	4.56 (41-9)
GM105456X†	4.56 (41-9)
GM105488	4.88 (39-8)
GM105488X†	4.88 (39-8)

### Ratio

†Fits 4.10 and down case.

### Differential

19689-010	Eaton 4.10 & Lower, 30 Spline (72-11)
19610-010	Eaton 4.56 & Higher, 30 Spline (73-09)

### Comments

### **2WD/**

<b>Application</b>	<b>Years</b>	<b>4WD</b>	<b>Axle Shaft</b>	<b>Comments</b>	<b>Length</b>	<b>Studs</b>	<b>Spline</b>	<b>Side</b>
Truck 3/4 Ton	73-89	2/4	AS3977384	Full-float style	37-9/16"	8	30	R
Truck 3/4 Ton	73-00	2/4	AS3977383	Full-float style	31-11/16"	8	30	L
Truck 1 Ton	73-91	2/4	AS3977384	Full-float style	37-9/16"	8	30	R
Truck 1 Ton	73-91	2/4	AS3977383	Full-float style	31-11/16"	8	30	L
Suburban	73-91	2/4	AS3977384	Full-float style	37-9/16"	8	30	R
Suburban	73-91	2/4	AS3977383	Full-float style	31-11/16"	8	30	L
Van 1 Ton	93-96	2/4	AS3977384	Full-float , Exc. Van	37-9/16"	8	30	R
Van 1 Ton	93-96	2/4	AS3977383	Full-float , Exc. Van	31-11/16"	8	30	L

Call for all other applications or dimensions.



# Axle Product by Axle Size

## GM 11.5" Axle (14 Bolt Cover)

### Rebuild Kit

### Comments

DRK-327	Standard Kit (01-11)
DRK-327MK	Master Kit (01-11)
DRK-327A	Standard Kit (11-16)
DRK-327AMK	Master Kit (11-16)

### Open Case

### Ratio

GM115-CASE-LOAD	3.73, 4.10 & 4.63 Gear Ratios
-----------------	-------------------------------

### Ring & Pinion

### Ratio

GM115342	3.42
GM115373	3.73 (41-11)
GM115410	4.10 (41-10)
GM115444	4.44
GM115456	4.56
GM115463	4.63 (37-8)
GM115513	5.13

### Differential

### Comments

250SL195A	Detroit Locker 30 Spline (01-12)
915A568	Detroit Truetrac 30 Spline (01-12)
40025134	AAM Trac-Rite Torsen Limited Slip

### **2WD/**

<b>Application</b>	<b>Years</b>	<b>4WD</b>	<b>Axle Shaft</b>	<b>Comments</b>	<b>Length</b>	<b>Studs</b>	<b>Spline</b>	<b>Side</b>
Truck 3/4 Ton	01-02	2/4	AS40003202	Semi-float style	39-3 /4"	8	30	R/L
Truck 3/4 Ton	01-10	2/4	AS40003201	Full-float style	35-1 /2"	8	30	R/L
Truck 1 Ton	14-16	2/4	AS40086785	Full-float style	N/A	8	30	R/L
Truck 1 Ton	08-13	2/4	AS40042353	Full-float style	913 MM	8	30	R/L
Truck 1 Ton	11-13	2/4	AS40051861	Full-float style	947 MM	8	30	R/L
Truck 1 Ton	11-13	2/4	AS40051863	Full-float style	1023 MM	8	30	R/L
Truck 1 Ton	11-13	2/4	AS40051859	Full-float style	932 MM	8	30	R/L
Truck 1 Ton	01-02	2/4	AS40003202	Verify axle length	39-3 /4"	8	30	R/L
Truck 1 Ton	04-10	2/4	AS40003201	Verify axle length	35-1 /2"	8	30	R/L
Truck 1 Ton	01-02	2/4	AS40003204	Verify axle length	35-3 /4"	8	30	R/L

## Dodge Sprinter

### **Rebuild Kit**

DRK-307A	Standard Kit (07-12)
DRK-307AMK	Master Kit (07-12)
DRK-307	Standard Kit (March 2004-06)
DRK-307MK	Master Kit (March 2004-06)
DRK-307B	Standard Kit (03-Feb. 2004)
DRK-307BMK	Master Kit (03-Feb. 2004)

### **Comments**

### **Open Case**

Sprinter-CaseLoaded	Case with Internal Kit (01-06)
---------------------	--------------------------------

### **Comments**

### **Internal Kit**

Sprinter-IK	Internal Kit (01-06)
-------------	----------------------

### **Comments**

### **Ring & Pinion**

Sprinter-373	3.73 (01-06)
--------------	--------------

### **Ratio**

### **Center Support Bearings**

HB5104574	Center Support Bearings (01-06)
HB68088	Center Support Bearings (07-10) Must also use HB68088K for 3 piece driveshafts
HB68088K	Center Support Bearings (07-10) Boot Kit for 3 piece driveshafts

### **Comments**

# Axle Product by Axle Size

## Toyota 7.5" Axle (8 Bolt Cover)

### Rebuild Kit

#### Front Axle

DRK-350  
DRK-350MK  
DRK-350A  
DRK-350AMK

### Comments

Standard Kit (86-88 IFS Front Axle)  
Master Kit (86-88 IFS Front Axle)  
Standard Kit (88-95 IFS Front Axle)  
Master Kit (88-95 IFS Front Axle)

### Rear Axle

DRK-350  
DRK-350MK

### Comments

Standard Kit (79-95) 4 Cyl. Non Turbo 2WD  
Master Kit (79-95) 4 Cyl. Non Turbo 2WD

### Ring & Pinion

T75410  
T75456  
T75488  
T75529

### Ratio

4.10 (41-10)  
4.56 (41-9)  
4.88 (39-8)  
5.29 (37-7)

## Toyota 8" Axle (8 Bolt Cover)

### Rebuild Kit

DRK-351  
DRK-351MK  
DRK-352  
DRK-352MK  
DRK-353  
DRK-353MK  
DRK-354A  
DRK-354AMK

### Comments

Standard Kit (84-85)  
Master Kit (84-85)  
Standard Kit (86-95 4 Cyl. Turbo and V6)  
Master Kit (86-95 4 Cyl. Turbo and V6)  
Standard Kit (86-95 4 Cyl. 4WD)  
Master Kit (86-95 4 Cyl. 4WD)  
Standard Kit (96-02 w/locking diff)  
Master Kit (96-02 w/locking diff)

### Internal Kit

TOY8-IK

### Comments

### Ring & Pinion

TOY411  
TOY488  
TOY529  
TOY571

### Ratio

4.11 (37-9)  
4.88 (39-8)  
5.29 (37-7)  
5.71 (40-7)

# Light Duty Transmission Applications

Year	Engine	Speed	Model#	Notes	Kit	w/Synchro Rings
<b>AMC/Eagle</b>						
<b>All Car Models (82 &amp; Earlier)</b>						
85-82	All	5	T5		TRK-5	TRK-5WS
84-82	All	4	T4		TRK-4J	TRK-4JWS
82-78	All	4	SR4		TRK-BWSR4J	TRK-BWSR4JWS
81-76	All	4	SR4		TRK-BWSR4	TRK-BWSR4WS
79-74	All	3	T150		TRK-150A	TRK-150AWS
78-67	All	3	T86		TRK-BW86JA	TRK-BW86JAWS
78-67	All	3w/OD	T86		TRK-BW86JB	TRK-BW86JBWS
76-68	All	3	T14		TRK-BW14	TRK-BW14WS
76-68	All	3w/OD	T14		TRK-BW14A	TRK-BW14AWS
74-65	All	4	T10		TRK-10W	TRK-10WWS
72-68	All	3	T15		TRK-BW15	TRK-BW15WS
72-68	All	3w/OD	T15		TRK-BW15A	TRK-BW15AWS
72-67	199	3	T96		TRK-BW96A	TRK-BW96AWS
72-67	199	3w/OD	T96		TRK-BW96B	TRK-BW96BWS
72-67	232	3	T96		TRK-BW96C	TRK-BW96CWS
72-67	232	3w/OD	T96		TRK-BW96D	TRK-BW96DWS
<b>Summit</b>						
96-95	1.8L	5	F5M22/KM206		TRK-FM150	TRK-FM150WS1
96-94	2.4L	5	F5M31	Taper Diff Brg.	TRK-FM360	TRK-FM360WS
96-94	2.4L	5	W5M33/KM201	4WD	TRK-FM160	TRK-FM160WS1
96-93	1.5L	5	F5M21/KM201	3-4 Synchro Rings 36 Teeth	TRK-FM100	TRK-FM100WS2
94-89	1.8L	5	F5M22/KM206	Taper Diff Brg.	TRK-FM150	TRK-FM150WS
93-92	2.4L	5	W5M33/KM201	4WD	TRK-FM160	TRK-FM160WS
92-89	1.5L	5	F5M21/KM201	3-4 Synchro Rings 30 Teeth	TRK-FM100	TRK-FM100WS
90-89	1.6L	5	F5M22/KM206	Taper Diff Brg.	TRK-FM150	TRK-FM150WS
1993	2.4L	5	F5M31	Taper Diff Brg.	TRK-FM360	TRK-FM360WS1
1992	1.5L	4	F4M21/KM200	Ball Diff Brg.	TRK-FM100	TRK-FM100WS1
<b>Talon</b>						
98-95	2.0L	5	F5MC1/NVT350/A578	3 Pc. 1-2 Synchro Rings.	TRK-350	TRK-350WS
98-94	2.0L Turbo	5	F5M33	FWD, Brass 1-2 Synchro Rings, Synchro Rev.	TRK-FM180	TRK-FM180WS4
98-93	2.0L Turbo	5	W5M33	4WD, 39 Teeth 3-4 Synchro Rings	TRK-FM160	TRK-FM160WS3
98-90	2.0L Turbo		KM272	Transfer Case Section Only	TRK-FM350	N/A
94-93	1.8L, 2.0L	5	F5M22	FWD, 3-4 Synchro Rings, 36 Teeth, Synchro Rev.	TRK-FM150	TRK-FM150WS2
5/93-6/93	2.0L Turbo	5	W5M33	4WD, 24 Teeth 3-4 Synchro Rings	TRK-FM160	TRK-FM160WS2
93-90	2.0L Turbo	5	F5M33	Fiber Lined 1-2 Synchro Rings, Synchro Rev.	TRK-FM180	TRK-FM180WS
92-90	1.8L	5	F5M22	3-4 Synchro Rings 30 Teeth	TRK-FM150	TRK-FM150WS
92-90	2.0L	5	F5M22	3-4 Synchro Rings 30 Teeth, Synchro Rev.	TRK-FM150	TRK-FM150WS1
4/91-5/91	2.0L Turbo	5	W5M33	4WD, Fiber Lined Rings	TRK-FM160	TRK-FM160WS
<b>Acura</b>						
<b>2.2CL</b>						
1997	2.2L	5	S2A4		TRK-FH180	TRK-FH180WS
<b>2.3CL</b>						
99-98	2.3L	5	S2A8		TRK-FH180	TRK-FH180WS1
<b>3.2CL</b>						
2003	3.2L	6	YZC6		TRK-FH410	N/A
<b>Integra</b>						
01-98	1.8L V-Tech	5	Y80, S80	Ball Diff Brg.	TRK-FH400	TRK-FH400WS
01-94	1.8L	5	Y80, S80	Ball Diff Brg.	TRK-FH260	TRK-FH260WS
98-94	1.8L V-Tech	5	Y80, S80	Taper Diff Brg.	TRK-FH220	TRK-FH220WS
93-92	1.7L V-Tech	5	YS1	3 Pc. 2nd Synchro Ring	TRK-FH260	TRK-FH260WS1

# Light Duty Transmission Applications

Year	Engine	Speed	Model#	Notes	Kit	w/Synchro Rings
<b>Acura (cont.)</b>						
<b>Integra (cont.)</b>						
93-92	1.8L	5	SSO		TRK-FH260	TRK-FH260WS
93-92	1.8L	5	YS1		TRK-FH260	TRK-FH260WS
1991	1.8L	5	A1		TRK-FH280	TRK-FH280WS1
1990	1.8L	5	S1		TRK-FH280	TRK-FH280WS
89-86	1.6L	5	CG		TRK-FH120	TRK-FH120WS
<b>Legend</b>						
95-93	3.2L	6	K4F6		TRK-FH230	TRK-FH230WS
95-91	3.2L	5	K4A6		TRK-FH230	TRK-FH230WS
90-89	2.7L	5	G3T4		TRK-FH190	TRK-FH190WS
88-86	2.7L	5	C3P4		TRK-FH190	TRK-FH190WS
<b>RSX</b>						
05-02	2.0L	5	W2M5		TRK-FH420	N/A
05-02	2.0L	6	X2M5		TRK-FH420	N/A
<b>Buick</b>						
<b>All Car Models (82 &amp; Earlier)</b>						
85-66	All	3	Saginaw		TRK-301	TRK-301WS1
82-81	All	5	T5	Cylindrical C/S Brgs.	TRK-5	TRK-5WS
1982	All	4	T4		TRK-5	TRK-5WS1
82-80	All	4	MR2		TRK-FG110	Obsolete
82-74	All	4	T10W	6307 I/S Brg., 1" C/S	TRK-10WA	TRK-10WAWS
82-74	All	4	T10W	6307 I/S Brg., 1" C/S, Max-Type Ball Brgs.	TRK-10WAHD	TRK-10WAHDWS
82-66	All	4	Saginaw		TRK-301	TRK-301WS
74-68	All	3	Tremec		TRK-150F	TRK-150FWS
74-66	All	4	M21	1" Countershaft	TRK-297A	TRK-297AWS
74-66	All	4	M21	1" Countershaft and Max-Type Brgs.	TRK-297AHD	TRK-297AHDWS
73-66	All	4	T10W	6307 I/S Brg., 7/8" C/S, w/o Thrust Brg. Between 2nd & 3rd Gears	TRK-10W	TRK-10WWS
72-66	All	3w/OD	Saginaw		TRK-301A	TRK-301AWS
71-67	All	4	M22	1" Countershaft	TRK-297A	TRK-297AWS
71-67	All	4	M22	1" Countershaft and Max-Type Brgs.	TRK-297AHD	TRK-297AHDWS
66-62	All	4	T10	6307 I/S Brg., 7/8" C/S, w/ Thrust Brg. Between 2nd & 3rd Gears	TRK-10E	TRK-10EWS
66-57	All	4	T10	6207 I/S Brg.	TRK-10A	TRK-10AWS
65-63	All	4	M20	7/8" Countershaft	TRK-297	TRK-297WS
65-63	All	4	M20	7/8" Countershaft and Max-Type Brgs.	TRK-297HD	TRK-297HDWS
63-62	All	4	M20	6207 I/S Brg.	TRK-297B	TRK-297BWS
<b>Skyhawk</b>						
89-88	2.0L	5	76mm Isuzu	3 Pc. 1-2 Synchro Rings	TRK-FI120	TRK-FI120WS1
87-83	1.8L	4	MR2		TRK-FG110	Obsolete
87-83	2.0L	5	76mm Isuzu		TRK-FI120	TRK-FI120WS
<b>Skylark</b>						
87-86	All	5	76mm Isuzu		TRK-FI120	TRK-FI120WS
85-83	All	4	MR2		TRK-FG110	Obsolete
<b>Somerset</b>						
87-86	All	5	76mm Isuzu		TRK-FI120	TRK-FI120WS
<b>Cadillac</b>						
<b>All Car Models (82 &amp; Earlier)</b>						
85-66	All	3	Saginaw		TRK-301	TRK-301WS1
82-81	All	5	T5	Cylindrical C/S Brgs.	TRK-5	TRK-5WS
1982	All	4	T4		TRK-5	TRK-5WS1

LD Transmission

# Light Duty Transmission Applications

Year	Engine	Speed	Model#	Notes	Kit	w/Synchro Rings
<b>Cadillac (cont.)</b>						
<b>All Car Models (82 &amp; Earlier) (cont.)</b>						
82-80	All	4	MR2		TRK-FG110	Obsolete
82-74	All	4	T10W	6307 I/S Brg., 1" C/S	TRK-10WA	TRK-10WAWS
82-74	All	4	T10W	6307 I/S Brg., 1" C/S, Max-Type Ball Brgs.	TRK-10WAHD	TRK-10WAHDWS
82-66	All	4	Saginaw		TRK-301	TRK-301WS
74-68	All	3	Tremec		TRK-150F	TRK-150FWS
74-66	All	4	M21	1" Countershaft	TRK-297A	TRK-297AWS
74-66	All	4	M21	1" Countershaft and Max-Type Brgs.	TRK-297AHD	TRK-297AHDWS
73-66	All	4	T10W	6307 I/S Brg., 7/8" C/S, w/o Thrust Brg. Between 2nd & 3rd Gears	TRK-10W	TRK-10WWS
72-66	All	3w/OD	Saginaw		TRK-301A	TRK-301AWS
71-67	All	4	M22	1" Countershaft	TRK-297A	TRK-297AWS
71-67	All	4	M22	1" Countershaft and Max-Type Brgs.	TRK-297AHD	TRK-297AHDWS
68-55	All	3w/OD	319		TRK-G110	N/A
66-62	All	4	T10	6307 I/S Brg., 7/8" C/S, w/ Thrust Brg. Between 2nd & 3rd Gears	TRK-10E	TRK-10EWS
66-57	All	4	T10	6207 I/S Brg.	TRK-10A	TRK-10AWS
65-63	All	4	M20	7/8" Countershaft	TRK-297	TRK-297WS
65-63	All	4	M20	7/8" Countershaft and Max-Type Brgs.	TRK-297HD	TRK-297HDWS
63-62	All	4	M20	6207 I/S Brg.	TRK-297B	TRK-297BWS
54-40	All	3	Muncie 318		TRK-G100	N/A
<b>Cimarron</b>						
88-87	2.8L	5	NVT550/HM282		TRK-550	TRK-550WS
86-85	2.0L	4	MR2		TRK-FG110	Obsolete
86-83	2.0L	5	76mm Isuzu		TRK-FI120	TRK-FI120WS
<b>CTS</b>						
07-04	6.0L	6	T56		TRK-56	TRK-56WS1
<b>Chevrolet</b>						
<b>All Car Models (82 &amp; Earlier)</b>						
85-66	All	3	Saginaw		TRK-301	TRK-301WS1
82-81	All	5	T5	Cylindrical C/S Brgs.	TRK-5	TRK-5WS
1982	All	4	T4		TRK-5	TRK-5WS1
82-80	All	4	MR2		TRK-FG110	Obsolete
82-74	All	4	T10W	6307 I/S Brg., 1" C/S	TRK-10WA	TRK-10WAWS
82-74	All	4	T10W	6307 I/S Brg., 1" C/S, Max-Type Ball Brgs.	TRK-10WAHD	TRK-10WAHDWS
82-66	All	4	Saginaw		TRK-301	TRK-301WS
74-68	All	3	Tremec		TRK-150F	TRK-150FWS
74-66	All	4	M21	1" Countershaft	TRK-297A	TRK-297AWS
74-66	All	4	M21	1" Countershaft and Max-Type Brgs.	TRK-297AHD	TRK-297AHDWS
73-66	All	4	T10W	6307 I/S Brg., 7/8" C/S, w/o Thrust Brg. Between 2nd & 3rd Gears	TRK-10W	TRK-10WWS
72-66	All	3w/OD	Saginaw		TRK-301A	TRK-301AWS
71-67	All	4	M22	1" Countershaft	TRK-297A	TRK-297AWS
71-67	All	4	M22	1" Countershaft and Max-Type Brgs.	TRK-297AHD	TRK-297AHDWS
68-55	All	3w/OD	319		TRK-G110	N/A
66-62	All	4	T10	6307 I/S Brg., 7/8" C/S, w/ Thrust Brg. Between 2nd & 3rd Gears	TRK-10E	TRK-10EWS
66-57	All	4	T10	6207 I/S Brg.	TRK-10A	TRK-10AWS



# Light Duty Transmission Applications

Year	Engine	Speed	Model#	Notes	Kit	w/Synchro Rings
<b>Chevrolet (cont.)</b>						
<b>All Car Models (82 &amp; Earlier) (cont.)</b>						
65-63	All	4	M20	7/8" Countershaft	TRK-297	TRK-297WS
65-63	All	4	M20	7/8" Countershaft and Max-Type Brgs.	TRK-297HD	TRK-297HDWS
63-62	All	4	M20	6207 I/S Brg.	TRK-297B	TRK-297BWS
54-40	All	3	Muncie 318		TRK-G100	N/A
<b>Astro</b>						
89-85	2.5L	5	T5 World Class	Taper C/S Brgs.	TRK-5W	TRK-5WWS
<b>Beretta</b>						
96-88	2.0L, 2.2L	5	76mm Isuzu	3 Pc. 1-2 Synchro Rings	TRK-FI120	TRK-FI120WS1
93-87	2.8L, 3.1L	5	NVT550/HM282		TRK-550	TRK-550WS
1987	2.0L	5	76mm Isuzu		TRK-FI120	TRK-FI120WS
<b>Blazer (Full Size)</b>						
1994	5.7L	5	HM290/MG5/NV3500	Standard I/S & O/S Brgs. Includes M/S Needle Brgs.	TRK-235BN1	TRK-235BN1WS
94-92	5.7L	5	HM290/MG5/NV3500	Standard I/S & O/S Brgs.	TRK-235B	TRK-235BWS
93-92	5.7L	5	HM290/MG5/NV3500	Standard I/S & O/S Brgs. Includes M/S Needle Brgs.	TRK-235BN	TRK-235BNWS
91-90	All	4	SM465	211FFLE I/S Brg.	TRK-157B	TRK-157BWS
90-79	All	4	SM465	Contains R1563TAV Front C/S Brg.	TRK-157L	TRK-157LWS
90-68	All	4	SM465	Contains M1305GGTV & R1563TAV Front C/S Brg.	TRK-157A	TRK-157AWS
90-68	All	4	SM465	w/ Small Parts Kit, Keys, & Spring	TRK-157ASPK	TRK-157ASPKWS
87-81	All	4	NP833		TRK-833	TRK-833WS
81-77	All	3	Saginaw		TRK-301	TRK-301WS1
<b>Blazer (S10 Size)</b>						
05-96	4.3L	5	HM290/MG5/NV3500	Standard I/S & O/S Brgs. 3 Pc. 1-2 Synchro Rings & 1.18 ID C/S Brgs	TRK-235B	TRK-235BWS1
05-96	4.3L	5	NV3500	Standard I/S & O/S Brgs. 3 Pc. 1-2 Synchro Rings & 1.30 ID C/S Brgs	TRK-235E	TRK-235EWS
03-96	2.2L	5	NV1500	6306 I/S Brg.	TRK-1500GM	TRK-1500GMWS
96-95	4.3L	5	HM290/MG5/NV3500	Standard I/S & O/S Brgs. Includes M/S Needle Brgs.	TRK-235BN2	TRK-235BN2WS
1995	4.3L	5	HM290/MG5/NV3500	Standard I/S & O/S Brgs. 3 Pc. 1-2 Synchro Rings	TRK-235B	TRK-235BWS1
1994	4.3L	5	HM290/MG5/NV3500	Standard I/S & O/S Brgs. Includes M/S Needle Brgs.	TRK-235BN1	TRK-235BN1WS
94-91	4.3L	5	HM290/MG5/NV3500	Standard I/S & O/S Brgs.	TRK-235B	TRK-235BWS
93-91	4.3L	5	HM290/MG5/NV3500	Standard I/S & O/S Brgs. Includes M/S Needle Brgs.	TRK-235BN	TRK-235BNWS
91-90	4.3L	5	HM290/MG5	3 Pc. I/S & Standard Ball O/S Brgs	TRK-235A	TRK-235AWS
91-90	4.3L	5	HM290/MG5	3 Pc. I/S & Standard Ball O/S Brgs Includes M/S Needle Brgs.	TRK-235AN	TRK-235ANWS
90-88	2.8L	5	T5 World Class	Taper C/S Brgs.	TRK-5W	TRK-5WWS
87-85	2.0L	4	T4	Taper I/S & O/S Brgs.	TRK-5	TRK-5WS1
87-83	2.8L	5	T5	Cylindrical C/S Brgs.	TRK-5	TRK-5WS
85-83	1.9L	4	S101		TRK-FI240	TRK-FI240WS
84-83	2.0L	4	T4C	Ball I/S & O/S Brgs.	TRK-4C	TRK-4CWS
<b>Camaro</b>						
02-93	3.4L, 3.8L	5	T5 World Class	Taper C/S Brgs.	TRK-5W	TRK-5WWS
02-93	5.7L	6	T56		TRK-56	TRK-56WS
92-88	5.0L, 5.7L	5	T5 World Class	Taper C/S Brgs.	TRK-5W	TRK-5WWS
87-83	5.0L	5	T5	Cylindrical C/S Brgs.	TRK-5	TRK-5WS
84-83	2.5L	4	Saginaw		TRK-301	TRK-301WS

# Light Duty Transmission Applications

Year	Engine	Speed	Model#	Notes	Kit	w/Synchro Rings
<b>Chevrolet (cont.)</b>						
<b>Cavalier</b>						
04-00	2.2L, 2.4L	5			TRK-FG140	TRK-FG140WS
99-95	2.2L, 2.3L	5	76mm Isuzu		TRK-FI210	TRK-FI210WS2
94-88	2.0L	5	76mm Isuzu	3 Pc. 1-2 Synchro Rings	TRK-FI120	TRK-FI120WS1
94-84	2.8L, 3.1L	5	NVT550/HM282		TRK-550	TRK-550WS
87-83	1.8L	4	MR2		TRK-FG110	Obsolete
87-83	2.0L	5	76mm Isuzu		TRK-FI120	TRK-FI120WS
<b>Celebrity</b>						
88-87	2.8L	5	NVT550/HM282		TRK-550	TRK-550WS
<b>Chevette</b>						
87-83	1.8L	5	T5	DC51932 Front C/S Brg.	TRK-5A	TRK-5AWS
87-76	1.6L	4	70mm		TRK-G120	TRK-G120WS
86-83	Diesel	5	MSG-5K		TRK-FI110	TRK-FI110WS
<b>Citation</b>						
85-83	2.5L	4	MR2		TRK-FG110	Obsolete
<b>Corsica</b>						
93-88	2.0L	5	76mm Isuzu	3 Pc. 1-2 Synchro Rings	TRK-FI120	TRK-FI120WS1
92-87	2.8L, 3.1L	5	NVT550/HM282		TRK-550	TRK-550WS
1987	2.0L	5	76mm Isuzu		TRK-FI120	TRK-FI120WS
<b>Corvette</b>						
04-97	5.7L	6	T56	3 Pc. 1-6 Synchro Ring	TRK-56A	TRK-56AWS
96-89	5.7L	6	S6-40		TRK-S6-40	TRK-S6-40WS
87-84	5.7L	4	T10		TRK-10WB	TRK-10WBWS
84-83	5.7L	4	Saginaw		TRK-301	TRK-301WS
<b>LUV</b>						
1982	All	5	MSG-5ET	4WD	TRK-FI100	TRK-FI100WS
82-81	All	4	MSG-4ET	4WD	TRK-FI180	TRK-FI180WS
82-81	All	5	MSG-5K		TRK-FI110	TRK-FI110WS
82-76	All	4	MSG-4K		TRK-FI140	TRK-FI140WS
80-76	All	4	MSG-4ET	4WD	TRK-FI150	TRK-FI150WS
75-71	All	4	MSG-4E		TRK-FI230	TRK-FI230WS
<b>Metro</b>						
01-89	1.0L	5	MV3		TRK-FS110	TRK-FS110WS
<b>Nova</b>						
88-85	1.6L	5	C51		TRK-FT270	TRK-FT270WS
<b>Prizm</b>						
02-88	1.8L DOHC	5	C51		TRK-FT320	TRK-FT320WS3
<b>S10 Pickup</b>						
03-96	4.3L	5	HM290/MG5/NV3500	Standard I/S & O/S Brgs. 3 Pc. 1-2 Synchro Rings & 1.18 ID C/S Brgs	TRK-235B	TRK-235BWS1
03-96	4.3L	5	NV3500	Standard I/S & O/S Brgs. 3 Pc. 1-2 Synchro Rings & 1.30 ID C/S Brgs	TRK-235E	TRK-235EWS
03-96	2.2L	5	NV1500	6306 I/S Brg.	TRK-1500GM	TRK-1500GMWS
96-95	4.3L	5	HM290/MG5/NV3500	Standard I/S & O/S Brgs. Includes M/S Needle Brgs.	TRK-235BN2	TRK-235BN2WS
1995	4.3L	5	HM290/MG5/NV3500	Standard I/S & O/S Brgs. 3 Pc. 1-2 Synchro Rings	TRK-235B	TRK-235BWS1
95-88	All	5	T5 World Class	Taper C/S Brgs.	TRK-5W	TRK-5WWS
1994	4.3L	5	HM290/MG5/NV3500	Standard I/S & O/S Brgs. Includes M/S Needle Brgs.	TRK-235BN1	TRK-235BN1WS
94-91	4.3L	5	HM290/MG5/NV3500	Standard I/S & O/S Brgs.	TRK-235B	TRK-235BWS
93-91	4.3L	5	HM290/MG5/NV3500	Standard I/S & O/S Brgs. Includes M/S Needle Brgs.	TRK-235BN	TRK-235BNWS
91-90	4.3L	5	HM290/MG5	3 Pc. I/S & Standard Ball O/S Brgs	TRK-235A	TRK-235AWS
91-90	4.3L	5	HM290/MG5	3 Pc. I/S & Standard Ball O/S Brgs Includes M/S Needle Brgs.	TRK-235AN	TRK-235ANWS

# Light Duty Transmission Applications

Year	Engine	Speed	Model#	Notes	Kit	w/Synchro Rings
<b>Chevrolet (cont.)</b>						
<b>S10 Pickup (cont.)</b>						
87-85	2.0L	4	T4	Taper I/S & O/S Brgs.	TRK-5	TRK-5WS1
87-82	2.8L	5	T5	Cylindrical C/S Brgs.	TRK-5	TRK-5WS
85-82	1.9L	4	S101		TRK-FI240	TRK-FI240WS
84-82	2.0L	4	T4C	Ball I/S & O/S Brgs.	TRK-4C	TRK-4CWS
<b>Spectrum</b>						
1988	1.5L	5	76mm Isuzu	3 Pc. 1-2 Synchro Rings	TRK-FI120	TRK-FI120WS1
87-85	1.5L	5	76mm Isuzu		TRK-FI120	TRK-FI120WS
<b>SSR</b>						
06-05	6.0L	6	T56		TRK-56	TRK-56WS1
<b>Suburban</b>						
1990	All	4	SM465	211FFLE I/S Brg.	TRK-157B	TRK-157BWS
90-83	All	4	SM465	N1211-L I/S Brg.	TRK-157L	TRK-157LWS
90-68	All	4	SM465	Contains M1305GGTV & R1563TAV Front C/S Brg.	TRK-157A	TRK-157AWS
90-68	All	4	SM465	w/ Small Parts Kit, Keys, & Spring	TRK-157ASPK	TRK-157ASPKWS
72-67	All	4	NP435	Ball I/S Brg.	TRK-127G	TRK-127GWS
72-67	All	4	NP435	Taper I/S Brg.	TRK-127SPK	TRK-127WS
<b>Tahoe</b>						
96-95	5.7L	5	HM290/MG5/NV3500		TRK-235B	TRK-235BWS1
96-95	5.7L	5	HM290/MG5/NV3500	Includes M/S Needle Brgs.	TRK-235BN2	TRK-235BN2WS
<b>Tracker</b>						
04-98	2.0L	5	All		TRK-FS150	TRK-FS150WS
<b>Trucks, Vans &amp; SUV's (82 &amp; Earlier)</b>						
86-80	All	4	NP833		TRK-833	TRK-833WS
84-70	All	5	NP542		TRK-29	N/A
82-79	All	5	Clark 280HD	Taper I/S Brg.	TRK-190	N/A
82-76	All	5	Clark 390		TRK-390G	N/A
82-68	All	5	Clark 280		TRK-148	N/A
82-66	All	3	Saginaw		TRK-301	TRK-301WS1
82-65	All	3	Tremec		TRK-150F	TRK-150FWS1
78-60	All	5	NP540		TRK-27	N/A
75-68	All	5	Clark 320		TRK-132	N/A
75-68	All	5	Clark 380		TRK-133	N/A
74-68	All	3	SM330		TRK-G140	Obsolete
69-60	All	5	Clark 300		TRK-48	N/A
69-60	All	5	NP541		TRK-29	N/A
68-55	All	3	318		TRK-G110	N/A
68-55	All	3w/OD	319		TRK-G110	N/A
67-60	All	5	Clark 260		TRK-23	N/A
67-48	All	4	SM420		TRK-G160	N/A
54-40	All	3	318		TRK-G100	N/A
54-40	All	3w/OD	319		TRK-G100	N/A
47-40	All	4	185		TRK-G150	N/A
<b>Truck 1/2 Ton</b>						
07-96	All	5	NV3500	Standard I/S & O/S Brgs. 3 Pc. 1-2 Synchro Rings & 1.30 ID C/S Brgs	TRK-235E	TRK-235EWS
07-96	All	5	HM290/MG5/NV3500	Standard I/S & O/S Brgs. 3 Pc. 1-2 Synchro Rings & 1.18 ID C/S Brgs	TRK-235B	TRK-235BWS1
98-97	All	5	NV4500	Includes M/S Needles & Small Parts Kit	TRK-4500GM1N1SPK	TRK-4500GM1N1SPKWS
98-97	All	5	NV4500	Includes M/S Needle Brgs.	TRK-4500GM1N1	TRK-4500GM1N1WS
98-96	All	5	NV4500	Includes Small Parts Kit	TRK-4500GM1SPK	TRK-4500GM1SPKWS
98-96	All	5	NV4500		TRK-4500GM1	TRK-4500GM1WS
1996	All	5	NV4500	Includes M/S Needles & Small Parts Kit	TRK-4500GM1NSPK	TRK-4500GM1NSPKWS

# Light Duty Transmission Applications

Year	Engine	Speed	Model#	Notes	Kit	w/Synchro Rings
<b>Chevrolet (cont.)</b>						
<b>Truck 1/2 Ton (cont.)</b>						
1996	All	5	NV4500	Includes M/S Needle Brgs.	TRK-4500GM1N	TRK-4500GM1NWS
96-95	All	5	HM290/MG5/NV3500	Standard I/S & O/S Brgs. Includes M/S Needle Brgs.	TRK-235BN2	TRK-235BN2WS
1995	All	5	HM290/MG5/NV3500	Standard I/S & O/S Brgs.	TRK-235B	TRK-235BWS1
95-92	All	5	NV4500	Includes M/S Needle Brgs.	TRK-4500GMSPK	TRK-4500GMSPKWS
95-92	All	5	NV4500	Includes M/S Needle Brgs.	TRK-4500GMNSPK	TRK-4500GMNSPKWS
95-92	All	5	NV4500	Includes M/S Needle Brgs.	TRK-4500GMN	TRK-4500GMNWS
95-92	All	5	NV4500		TRK-4500GM	TRK-4500GMWS
1994	All	5	HM290/MG5/NV3500	Standard I/S & O/S Brgs. Includes M/S Needle Brgs.	TRK-235BN1	TRK-235BN1WS
94-91	All	5	HM290/MG5/NV3500	3 Pc. I/S & Standard Ball O/S Brgs	TRK-235B	TRK-235BWS
93-91	All	5	HM290/MG5/NV3500	Includes M/S Needle Brgs.	TRK-235BN	TRK-235BNWS
91-90	All	4	SM465	211FFLE I/S Brg.	TRK-157B	TRK-157BWS
91-90	All	5	HM290/MG5	3 Pc. I/S & Standard Ball O/S Brgs Includes M/S Needle Brgs.	TRK-235AN	TRK-235ANWS
91-90	All	5	HM290/MG5	3 Pc. I/S & O/S Brgs. Includes M/S Needle Brgs.	TRK-235A	TRK-235AWS
90-79	All	4	SM465	Contains R1563TAV Front C/S Brg.	TRK-157L	TRK-157LWS
90-68	All	4	SM465		TRK-157A	TRK-157AWS
90-68	All	4	SM465	Contains M1305GGTV & R1563TAV Front C/S Brg.	TRK-157ASP	TRK-157ASPWS
89-88	All	5	HM290/MG5	3 Pc. I/S & O/S Brgs.	TRK-235N	TRK-235NWS
89-88	All	5	HM290/MG5	Contains R1563TAV Front C/S Brg. & 211FFLE I/S Brg.	TRK-235	TRK-235WS
87-82	All	4	NP833		TRK-833	TRK-833WS
87-77	All	3	Saginaw		TRK-301	TRK-301WS1
72-67	All	4	NP435	Includes M/S Needle Brgs.; Taper I/S Brg.	TRK-127SPK	TRK-127WS
72-67	All	4	NP435	Ball I/S Brg.	TRK-127G	TRK-127GWS
<b>Truck 3/4 Ton</b>						
07-01	All	6	S6-650	4WD	TRK-S6-650ZFC	TRK-S6-650ZFCWS
07-01	All	6	S6-650	4WD, Includes M/S Needle Brgs.	TRK-S6-650ZFCN	TRK-S6-650ZFCNWS
07-01	All	6	S6-650	2WD	TRK-S6-650ZFA	TRK-S6-650ZFAWS
07-01	All	6	S6-650	2WD, Includes M/S Needle Brgs.	TRK-S6-650ZFAN	TRK-S6-650ZFANWS
07-97	All	5	NV4500	Includes M/S Needle Brgs.	TRK-4500GM1N1	TRK-4500GM1N1WS
07-97	All	5	NV4500	Includes M/S Needles & Small Parts Kit	TRK-4500GM1N1SPK	TRK-4500GM1N1SPKWS
07-96	All	5	NV4500		TRK-4500GM1	TRK-4500GM1WS
07-96	All	5	NV4500	Includes Small Parts Kit	TRK-4500GM1SPK	TRK-4500GM1SPKWS
98-96	All	5	NV3500	Standard I/S & O/S Brgs. 3 Pc. 1-2 Synchro Rings & 1.30 ID C/S Brgs	TRK-235E	TRK-235EWS
98-96	All	5	HM290/MG5/NV3500	Standard I/S & O/S Brgs. 3 Pc. 1-2 Synchro Rings & 1.18 ID C/S Brgs	TRK-235B	TRK-235BWS1
1996	All	5	NV4500	Includes M/S Needle Brgs.	TRK-4500GM1N	TRK-4500GM1NWS
1996	All	5	NV4500	Includes M/S Needles & Small Parts Kit	TRK-4500GM1NSPK	TRK-4500GM1NSPKWS
96-95	All	5	HM290/MG5/NV3500	Standard I/S & O/S Brgs. Includes M/S Needle Brgs.	TRK-235BN2	TRK-235BN2WS
1995	All	5	HM290/MG5/NV3500	Standard I/S & O/S Brgs.	TRK-235B	TRK-235BWS1
95-91	All	5	NV4500		TRK-4500GM	TRK-4500GMWS
95-91	All	5	NV4500	Includes M/S Needle Brgs.	TRK-4500GMN	TRK-4500GMNWS
95-91	All	5	NV4500	Includes M/S Needle Brgs.	TRK-4500GMNSPK	TRK-4500GMNSPKWS
95-91	All	5	NV4500	Includes M/S Needle Brgs.	TRK-4500GMSPK	TRK-4500GMSPKWS
1994	All	5	HM290/MG5/NV3500	Standard I/S & O/S Brgs. Includes M/S Needle Brgs.	TRK-235BN1	TRK-235BN1WS

# Light Duty Transmission Applications

Year	Engine	Speed	Model#	Notes	Kit	w/Synchro Rings
<b>Chevrolet (cont.)</b>						
<b>Truck 3/4 Ton (cont.)</b>						
94-91	All	5	HM290/MG5/NV3500	3 Pc. I/S & Standard Ball O/S Brgs	TRK-235B	TRK-235BWS
93-91	All	5	HM290/MG5/NV3500	Includes M/S Needle Brgs.	TRK-235BN	TRK-235BNWS
91-90	All	4	SM465	211FFLE I/S Brg.	TRK-157B	TRK-157BWS
91-90	All	5	HM290/MG5	3 Pc. I/S & Standard Ball O/S Brgs Includes M/S Needle Brgs.	TRK-235AN	TRK-235ANWS
91-90	All	5	HM290/MG5	3 Pc. I/S & O/S Brgs. Includes M/S Needle Brgs.	TRK-235A	TRK-235AWS
90-79	All	4	SM465	Contains R1563TAV Front C/S Brg.	TRK-157L	TRK-157LWS
90-68	All	4	SM465		TRK-157A	TRK-157AWS
90-68	All	4	SM465	Contains M1305GGTV & R1563TAV Front C/S Brg.	TRK-157ASPK	TRK-157ASPKWS
89-88	All	5	HM290/MG5	3 Pc. I/S & O/S Brgs.	TRK-235N	TRK-235NWS
89-88	All	5	HM290/MG5	Contains R1563TAV Front C/S Brg. & 211FFLE I/S Brg.	TRK-235	TRK-235WS
87-82	All	4	NP833		TRK-833	TRK-833WS
87-77	All	3	Saginaw		TRK-301	TRK-301WS1
72-67	All	4	NP435	Taper I/S Brg.	TRK-127SPK	TRK-127WS
72-67	All	4	NP435	Ball I/S Brg.	TRK-127G	TRK-127GWS
<b>Truck 1 Ton</b>						
07-01	All	6	S6-650	4WD	TRK-S6-650ZFC	TRK-S6-650ZFCWS
07-01	All	6	S6-650	4WD, Includes M/S Needle Brgs.	TRK-S6-650ZFCN	TRK-S6-650ZFCNWS
07-01	All	6	S6-650	2WD	TRK-S6-650ZFA	TRK-S6-650ZFAWS
07-01	All	6	S6-650	2WD, Includes M/S Needle Brgs.	TRK-S6-650ZFAN	TRK-S6-650ZFANWS
07-97	All	5	NV4500	Includes M/S Needle Brgs.	TRK-4500GM1N1	TRK-4500GM1N1WS
07-97	All	5	NV4500	Includes M/S Needles & Small Parts Kit	TRK-4500GM1N1SPK	TRK-4500GM1N1SPKWS
07-96	All	5	NV4500		TRK-4500GM1	TRK-4500GM1WS
07-96	All	5	NV4500	Includes Small Parts Kit	TRK-4500GM1SPK	TRK-4500GM1SPKWS
1996	All	5	NV4500	Includes M/S Needle Brgs.	TRK-4500GM1N	TRK-4500GM1NWS
1996	All	5	NV4500	Includes M/S Needles & Small Parts Kit	TRK-4500GM1NSPK	TRK-4500GM1NSPKWS
95-91	All	5	NV4500		TRK-4500GM	TRK-4500GMWS
95-91	All	5	NV4500	Includes M/S Needle Brgs.	TRK-4500GMN	TRK-4500GMNWS
95-91	All	5	NV4500	Includes M/S Needle Brgs.	TRK-4500GMNSPK	TRK-4500GMNSPKWS
95-91	All	5	NV4500	Includes M/S Needle Brgs.	TRK-4500GMSPK	TRK-4500GMSPKWS
91-90	All	4	SM465	211FFLE I/S Brg.	TRK-157B	TRK-157BWS
90-79	All	4	SM465	Contains R1563TAV Front C/S Brg.	TRK-157L	TRK-157LWS
90-68	All	4	SM465		TRK-157A	TRK-157AWS
90-68	All	4	SM465	Contains M1305GGTV & R1563TAV Front C/S Brg.	TRK-157ASPK	TRK-157ASPKWS
72-67	All	4	NP435	Taper I/S Brg.	TRK-127	TRK-127WS
72-67	All	4	NP435	Ball I/S Brg.	TRK-127G	TRK-127GWS
<b>Van 1/2 Ton</b>						
87-79	All	4	SM465	Contains R1563TAV Front C/S Brg.	TRK-157L	TRK-157LWS
87-71	All	4	SM465		TRK-157A	TRK-157AWS
87-71	All	4	SM465	Contains M1305GGTV & R1563TAV Front C/S Brg.	TRK-157ASPK	TRK-157ASPKWS
72-67	All	4	NP435	Taper I/S Brg.	TRK-127	TRK-127WS
72-67	All	4	NP435	Ball I/S Brg.	TRK-127G	TRK-127GWS

LD Transmission

# Light Duty Transmission Applications

Year	Engine	Speed	Model#	Notes	Kit	w/Synchro Rings
<b>Chevrolet (cont.)</b>						
<b>Van 3/4 Ton</b>						
87-79	All	4	SM465	Contains R1563TAV Front C/S Brg.	TRK-157L	TRK-157LWS
87-71	All	4	SM465		TRK-157A	TRK-157AWS
87-71	All	4	SM465	Contains M1305GGTV & R1563TAV Front C/S Brg.	TRK-157ASPK	TRK-157ASPKWS
72-67	All	4	NP435	Taper I/S Brg.	TRK-127	TRK-127WS
72-67	All	4	NP435	Ball I/S Brg.	TRK-127G	TRK-127GWS
<b>Van 1 Ton</b>						
87-79	All	4	SM465	Contains R1563TAV Front C/S Brg.	TRK-157L	TRK-157LWS
87-71	All	4	SM465		TRK-157A	TRK-157AWS
87-71	All	4	SM465	Contains M1305GGTV & R1563TAV Front C/S Brg.	TRK-157ASPK	TRK-157ASPKWS
72-67	All	4	NP435	Taper I/S Brg.	TRK-127SPK	TRK-127WS
72-67	All	4	NP435	Ball I/S Brg.	TRK-127G	TRK-127GWS
<b>Chrysler</b>						
<b>All Car Models (82 &amp; Earlier)</b>						
82-81	All	4	NP460	1-4 Synchro Rings Same Size	TRK-465	TRK-465WS2
80-75	All	4	NP833		TRK-833B	TRK-833BWS
80-70	All	3	NP230	35x80x21 I/S & O/S Brgs.	TRK-NP100	TRK-NP100WS
80-70	All	3	NP230	35x90x21 I/S & O/S Brgs.	TRK-NP100A	TRK-NP100AWS
76-74	All	3	390		TRK-150A	TRK-150AWS
74-72	All	3	NP250	14mm Wide O/S Brg.	TRK-NP110A	TRK-NP110AWS
74-72	All	3	NP250	17mm Wide O/S Brg.	TRK-NP110	TRK-NP110WS
72-64	All	4	NP833		TRK-833A	TRK-833AWS
<b>Cirrus</b>						
00-99	2.0L	5	F5MC1/NVT350/A578		TRK-350	TRK-350WS
<b>Laser</b>						
86-84	2.2L, 2.5L	5	NP525		TRK-465	TRK-465WS
<b>LeBaron</b>						
93-90	All	5			TRK-568	TRK-568WS
89-87	All	5	NP520		TRK-520	TRK-520WS
89-87	All	5	NP520	3 Pc. 2nd Synchro Ring	TRK-520	TRK-520WS1
86-84	All	5	NP525		TRK-465	TRK-465WS
83-82	All	4	NP460	1-4 Synchro Rings Same Size	TRK-465	TRK-465WS2
<b>Sebring</b>						
04-03	2.4L	5	F5M42		TRK-FM450	TRK-FM450WS
04-03	2.7L	5	F5M51		TRK-FM440	TRK-FM440WS
00-95	2.0L	5	F5MC1/NVT350/A578		TRK-350	TRK-350WS
<b>Dodge</b>						
<b>All Car Models (82 &amp; Earlier)</b>						
82-81	All	4	NP460	1-4 Synchro Rings Same Size	TRK-465	TRK-465WS2
80-75	All	4	NP833		TRK-833B	TRK-833BWS
80-70	All	3	NP230	35x80x21 I/S & O/S Brgs.	TRK-NP100	TRK-NP100WS
80-70	All	3	NP230	35x90x21 I/S & O/S Brgs.	TRK-NP100A	TRK-NP100AWS
76-74	All	3	390		TRK-150A	TRK-150AWS
74-72	All	3	NP250	14mm Wide O/S Brg.	TRK-NP110A	TRK-NP110AWS
74-72	All	3	NP250	17mm Wide O/S Brg.	TRK-NP110	TRK-NP110WS
72-64	All	4	NP833		TRK-833A	TRK-833AWS
72-70	All	3	NP903		TRK-NP150	TRK-NP150WS
<b>400</b>						
1983	2.2L, 2.6L	5	NP465		TRK-465	TRK-465WS1
1982	2.2L, 2.6L	4	NP460	1-4 Synchro Rings Same Size	TRK-465	TRK-465WS2



# Light Duty Transmission Applications

Year	Engine	Speed	Model#	Notes	Kit	w/Synchro Rings
<b>Dodge (cont.)</b>						
<b>600</b>						
1984	2.2L, 2.6L	5	NP525		TRK-465	TRK-465WS
1983	2.2L, 2.6L	5	NP465		TRK-465	TRK-465WS1
<b>Aries</b>						
89-87	2.2L, 2.6L	5	NP520		TRK-520	TRK-520WS
89-87	2.2L, 2.6L	5	NP520	3 Pc. 2nd Synchro Ring	TRK-520	TRK-520WS1
86-84	2.2L, 2.6L	5	NP525		TRK-465	TRK-465WS
85-84	2.2L, 2.6L	4	NP460		TRK-465	TRK-465WS3
83-81	2.2L, 2.6L	4	NP460	1-4 Synchro Rings Same Size	TRK-465	TRK-465WS2
1983	2.2L, 2.6L	5	NP465		TRK-465	TRK-465WS1
<b>Avenger</b>						
00-95	2.0L	5	F5MC1/NVT350/A578		TRK-350	TRK-350WS
<b>Caliber</b>						
12-07	All	5	T355		TRK-355	N/A
<b>Challenger</b>						
83-79	2.0L	5	KM131	6207-N M/S Front Brg.	TRK-FM140	TRK-FM140WS
83-79	2.6L	5	KM131	35BVV072 M/S Front Brg.	TRK-FM110	TRK-FM110WS
<b>Charger</b>						
87-84	2.2L, 2.6L	5	NP525		TRK-465	TRK-465WS
86-84	2.2L, 2.6L	4	NP460		TRK-465	TRK-465WS3
1983	2.2L, 2.6L	4	NP460	1-4 Synchro Rings Same Size	TRK-465	TRK-465WS2
1983	2.2L, 2.6L	5	NP465	1-5 Synchro Rings Same Size	TRK-465	TRK-465WS1
<b>Colt</b>						
94-93	1.8L	5	F5M22	Taper Diff Brg.	TRK-FM150	TRK-FM150WS
94-92	1.5L	5	F5M21	3-4 Synchro Rings 36 Teeth	TRK-FM100	TRK-FM100WS2
92-90	1.6L	4	F4M21	Ball Diff Brg.	TRK-FM100	TRK-FM100WS1
91-90	1.5L	5	F5M21	3-4 Synchro Rings 30 Teeth	TRK-FM100	TRK-FM100WS
89-87	1.5L	4	KM200	Ball Diff Brgs. & Ball Int.Shaft Brgs	TRK-FM340	TRK-FM340WS
89-87	1.5L	5	KM201	Small 30T 3-4 Synchro Rings	TRK-FM100	TRK-FM100WS
89-87	1.6L	5	KM206	Taper Diff Brgs. & Taper Int.Shaft Brgs.	TRK-FM150	TRK-FM150WS
86-85	1.5L	4	KM161	Ball Diff Brgs. & Taper Int.Shaft Brgs.	TRK-FM390	TRK-FM390WS
86-85	1.5L	5	KM162	Ball Diff Brg.	TRK-FC110	TRK-FC110WS
86-85	1.6L	5	KM163	Taper Diff Brg.	TRK-FM170	TRK-FM170WS
84-83	1.6L	8	KM166	Taper Diff Brg.	TRK-FM170	TRK-FM170WS
84-82	1.4L	4	KM160	Ball Diff Brgs. & Taper Int.Shaft Brgs.	TRK-FC110	TRK-FC110WS1
84-82	1.4L	8	KM165	Ball Diff Brg.	TRK-FC110	TRK-FC110WS
1990	1.6L	5	F5M22	Taper Diff Brg.	TRK-FM150	TRK-FM150WS
1989	1.6L Turbo	5	KM210	Taper Diff Brg.	TRK-FM210	TRK-FM210WS
<b>Colt Vista</b>						
94-92	2.4L	5	F5M31	FWD	TRK-FM210	TRK-FM210WS
94-92	2.4L	5	W5M33	4WD	TRK-FM290	TRK-FM290WS
94-90	1.8L, 2.0L	5	F5M22	Taper Diff Brg.	TRK-FM150	TRK-FM150WS
93-90	1.8L	5	W5M31	4WD	TRK-FM240	TRK-FM240WS
91-87	2.0L	5	KM182	4WD	TRK-FC100	TRK-FC100WS1
89-11/86	1.5L	5	KM201	Small 30T 3-4 Synchro Rings	TRK-FM100	TRK-FM100WS
89-86	2.0L	5	KM206	Taper Diff Brgs. & Taper Int.Shaft Brgs.	TRK-FM150	TRK-FM150WS
10/87	2.0L	5	KM182	4WD	TRK-FC100	TRK-FC100WS
11/86-84	2.0L	5	KM163	FWD	TRK-FM170	TRK-FM170WS
1990	1.5L	5	F5M21	3-4 Synchro Rings 30 Teeth	TRK-FM100	TRK-FM100WS
1989	1.8L	5	KM221	4WD	TRK-FM240	TRK-FM240WS
1984	2.0L	8	KM166	Taper Diff Brg.	TRK-FM170	TRK-FM170WS

LD Transmission

# Light Duty Transmission Applications

Year	Engine	Speed	Model#	Notes	Kit	w/Synchro Rings
<b>Dodge (cont.)</b>						
<b>Conquest</b>						
86-85	2.6L Turbo	5	KM132-N	w/ Intercooler, TMSC07887 I/S Brg.	TRK-FM310	TRK-FM310WS
86-84	2.6L Turbo	5	KM132-M	w/o Intercooler	TRK-FM300	TRK-FM300WS
<b>Dakota</b>						
09-05	3.7L	5	Getrag 238		Obsolete	Obsolete
04-00	3.9L	5	NV3500		TRK-235C	TRK-235CWS1
04-97	5.2L, 5.9L	5	NV3500		TRK-235C	TRK-235CWS1
02-99	2.5L	5	NV1500	30mm ID Input Shaft Brg.	TRK-1500D	TRK-1500DWS
99-92	2.5L, 3.9L	5	AX15		TRK-FT420	TRK-FT420WS
96-94	5.2L	5	NV3500		TRK-235C	TRK-235CWS
93-92	2.5L	5	NV2500/535	35mm ID Input Shaft Brg.	TRK-535	TRK-535WS
91-87	2.2L, 2.5L	5	NV2500/535	35mm ID Input Shaft Brg.	TRK-535	TRK-535WS
<b>Dart</b>						
72-66	All	3	NP903		TRK-NP150	TRK-NP150WS
<b>Daytona</b>						
93-90	2.2L, 2.5L	5	NP523		TRK-568	TRK-568WS
93-90	3.0L	5	NP568		TRK-568	TRK-568WS
89-87	2.2L, 2.5L	5	NP520		TRK-520	TRK-520WS
89-87	2.2L, 2.5L	5	NP520	3 Pc. 2nd Synchro Ring	TRK-520	TRK-520WS1
89-87	2.2L Turbo	5	NP555		TRK-520	TRK-520WS
89-87	2.2L Turbo	5	NP555	3 Pc. 2nd Synchro Ring	TRK-520	TRK-520WS1
86-84	2.2L, 2.5L	5	NP525		TRK-465	TRK-465WS
<b>Lancer</b>						
89-87	2.2L, 2.5L	5	NP520		TRK-520	TRK-520WS
86-85	2.2L, 2.5L	5	NP525		TRK-465	TRK-465WS
<b>Neon</b>						
05-03	2.4L	5	T850		TRK-850	TRK-850WS
04-00	2.0L	5	F5MC1/NVT350/A578	66mm O.D. Rear Input/Pinion Brgs.	TRK-350A	TRK-350AWS
00-95	2.0L	5	F5MC1/NVT350/A578	63mm O.D. Rear Input/Pinion Brgs.	TRK-350	TRK-350WS
<b>Nitro</b>						
09-07	3.7L	6	NSG370		TRK-FC120	TRK-FC120WS
<b>Omni</b>						
90-84	All	5	NP525		TRK-465	TRK-465WS
86-84	All	4	NP460		TRK-465	TRK-465WS3
83-81	All	4	NP460	1-4 Synchro Rings Same Size	TRK-465	TRK-465WS2
1983	All	5	NP465	1-5 Synchro Rings Same Size	TRK-465	TRK-465WS1
<b>Ramcharger</b>						
1992	5.2L, 5.9L	5	NV4500		TRK-4500D	TRK-4500DWS
91-86	All	4	435	Ball I/S Brg.	TRK-127G	TRK-127GWS
86-74	All	4	435	Taper I/S Brg.	TRK-127B	TRK-127BWS
79-74	All	3	NP230		TRK-NP100A	TRK-NP100AWS
<b>Rampage</b>						
84-82	2.2L, 2.6L	4	NP460		TRK-465	TRK-465WS2
<b>Shadow</b>						
94-90	2.2L, 2.5L	5	NP523		TRK-568	TRK-568WS
91-90	3.0L	5	NP568		TRK-568	TRK-568WS
89-87	2.2L, 2.5L	5	NP520		TRK-520	TRK-520WS
89-87	2.2L, 2.5L	5	NP520	3 Pc. 2nd Synchro Ring	TRK-520	TRK-520WS1
1987	2.2L, 2.5L	5	NP525		TRK-465	TRK-465WS

# Light Duty Transmission Applications

Year	Engine	Speed	Model#	Notes	Kit	w/Synchro Rings
<b>Dodge (cont.)</b>						
<b>Spirit</b>						
94-90	2.2L, 2.5L	5	NP523		TRK-568	TRK-568WS
93-91	3.0L	5	NP568		TRK-568	TRK-568WS
1989	2.2L, 2.5L	5	NP520		TRK-520	TRK-520WS
1989	2.2L, 2.5L	5	NP520	3 Pc. 2nd Synchro Ring	TRK-520	TRK-520WS1
<b>Stealth</b>						
96-94	3.0L Turbo	6	W6MG1	4WD	TRK-FM530	TRK-FM530WS
96-93	3.0L	5	F5M33	3 Pc. 2nd Synchro Ring	TRK-FM180	TRK-FM180WS4
4/93-5/93	3.0L	5	F5M33	3 Pc. 2nd Synchro Ring	TRK-FM180	TRK-FM180WS3
93-91	3.0L Turbo	5	W5MG1	4WD	TRK-FM250	TRK-FM250WS
5/92-6/92	3.0L	5	F5M33	3 Pc. 2nd Synchro Ring	TRK-FM180	TRK-FM180WS2
4/91-5/91	3.0L	5	F5M33		TRK-FM180	TRK-FM180WS1
11/90-12/90	3.0L	5	F5M33		TRK-FM180	TRK-FM180WS
<b>Stratus</b>						
06-02	3.0L	5	T850		TRK-850	TRK-850WS
04-01	2.4L	5	F5M42		TRK-FM450	TRK-FM450WS
04-01	3.0L	5	F5M51		TRK-FM440	TRK-FM440WS
00-95	2.0L	5	F5MC1/ NVT350/A578		TRK-350	TRK-350WS
<b>Truck 1/2 Ton</b>						
04-97	All	5	NV3500	Synchronized Rev., 3 Pc. 2nd Synchro Ring	TRK-235C	TRK-235CWS1
04-97	All	5	NV4500/MT8	Includes M/S Needle Brgs.	TRK-4500DN1	TRK-4500DN1WS
04-97	All	5	NV4500/MT8	Includes M/S Needles & Small Parts Kit	TRK-4500DN1SPK	TRK-4500DN1SPKWS
04-92	All	5	NV4500/MT8		TRK-4500D	TRK-4500DWS
04-92	All	5	NV4500/MT8	Includes M/S Needle Brgs.	TRK-4500DSPK	TRK-4500DSPKWS
96-94		5	NV3500	Synchronized Rev.	TRK-235C	TRK-235CWS
96-92	All	5	NV4500/MT8	Includes M/S Needle Brgs.	TRK-4500DN	TRK-4500DNWS
96-92	All	5	NV4500/MT8	Includes M/S Needles & Small Parts Kit	TRK-4500DNSPK	TRK-4500DNSPKWS
91-88	3.9L	5	NV2500/535	35mm ID Input Shaft Brg.	TRK-535	TRK-535WS
91-86	All	4	NP435		TRK-127G	TRK-127GWS
90-76	All	4	NP833		TRK-833	TRK-833WS
79-75	All	3	390		TRK-150A	TRK-150AWS
79-70	All	3	NP230		TRK-NP100A	TRK-NP100AWS
86-65	All	4	NP435	Taper I/S Brg.	TRK-127B	TRK-127BWS
86-65	All	4	NP435	Ball I/S Brg.	TRK-127G	TRK-127GWS
<b>Truck 3/4 Ton</b>						
10-05	6.7L	6	G56		TRK-FC200	TRK-FC200WS
05-01	Diesel	6	NV5600		TRK-5600	TRK-5600WS
05-97	All	5	NV4500/MT8	Includes M/S Needles & Small Parts Kit	TRK-4500DN1SPK	TRK-4500DN1SPKWS
05-97	All	5	NV4500/MT8	Includes M/S Needle Brgs.	TRK-4500DN1	TRK-4500DN1WS
05-92	All	5	NV4500/MT8	Includes M/S Needle Brgs.	TRK-4500DSPK	TRK-4500DSPKWS
05-92	All	5	NV4500/MT8		TRK-4500D	TRK-4500DWS
00-98	Diesel	6	NV5600		TRK-5600	Obsolete
96-94	All	5	NV3500	Synchronized Rev.	TRK-235C	TRK-235CWS
96-92	All	5	NV4500/MT8	Includes M/S Needles & Small Parts Kit	TRK-4500DNSPK	TRK-4500DNSPKWS
96-92	All	5	NV4500/MT8	Includes M/S Needle Brgs.	TRK-4500DN	TRK-4500DNWS
93-89	Diesel	5	G360	Includes M/S Needle Brgs.	TRK-261N	TRK-261NWS
93-89	Diesel	5	G360		TRK-261	TRK-261WS
91-86	All	4	NP435		TRK-127G	TRK-127GWS
79-75	All	3	NP230		TRK-NP100A	TRK-NP100AWS
79-70	All	3	390		TRK-150A	TRK-150AWS

LD Transmission

# Light Duty Transmission Applications

Year	Engine	Speed	Model#	Notes	Kit	w/Synchro Rings
<b>Dodge (cont.)</b>						
<b>Truck 3/4 Ton (cont.)</b>						
86-65	All	4	NP435	Taper I/S Brg.	TRK-127B	TRK-127BWS
86-65	All	4	NP435	Ball I/S Brg.	TRK-127G	TRK-127GWS
<b>Truck 1 Ton</b>						
10-05	6.7L	6	G56		TRK-FC200	TRK-FC200WS
05-01	Diesel	6	NV5600		TRK-5600	TRK-5600WS
05-97	All	5	NV4500/MT8	Includes M/S Needles & Small Parts Kit	TRK-4500DN1SPK	TRK-4500DN1SPKWS
05-97	All	5	NV4500/MT8	Includes M/S Needle Brgs.	TRK-4500DN1	TRK-4500DN1WS
05-92	All	5	NV4500/MT8	Includes M/S Needle Brgs.	TRK-4500DSPK	TRK-4500DSPKWS
05-92	All	5	NV4500/MT8		TRK-4500D	TRK-4500DWS
00-98	Diesel	6	NV5600		TRK-5600	Obsolete
96-92	All	5	NV4500/MT8	Includes M/S Needles & Small Parts Kit	TRK-4500DNSPK	TRK-4500DNSPKWS
96-92	All	5	NV4500/MT8	Includes M/S Needle Brgs.	TRK-4500DN	TRK-4500DNWS
93-89	Diesel	5	G360		TRK-261	TRK-261WS
93-89	Diesel	5	G360	Includes M/S Needle Brgs.	TRK-261N	TRK-261NWS
91-65	All	4	NP435	Taper I/S Brg.	TRK-127B	TRK-127BWS
91-65	All	4	NP435	Ball I/S Brg.	TRK-127G	TRK-127GWS
<b>Truck 1-1/2 Ton</b>						
81-78	All	4	NP435		TRK-127B	TRK-127BWS
<b>Ram 4500</b>						
10-08	6.7L	6	G56		TRK-FC200	TRK-FC200WS
<b>Ram 5500</b>						
10-08	6.7L	6	G56		TRK-FC200	TRK-FC200WS
<b>Van (1/2 &amp; 3/4 Ton)</b>						
93-92	3.9L	5	AX15		TRK-FT420	TRK-FT420WS
91-88	3.9L	5	NV2500/535	35mm ID Input Shaft Brg.	TRK-535	TRK-535WS
89-88	5.2L, 5.9L	4	NP833		TRK-833	TRK-833WS
87-76	All	4	NP833		TRK-833	TRK-833WS
<b>Viper</b>						
08-92	8.0L	6	T56		TRK-56	TRK-56WS
<b>Ford</b>						
<b>All Car Models (82 &amp; Earlier)</b>						
82-81	All	4	SROD		TRK-170	TRK-170WS1
82-80	All	4	MTX4		TRK-FMZ160	TRK-FMZ160WS
82-65	All	3	Tremec	1st Synchro Ring Larger than 2nd & 3rd	TRK-150F	TRK-150FWS
82-65	All	3	Tremec		TRK-150F	TRK-150FWS1
81-78	All	4	RUG		TRK-170	TRK-170WS
76-71	All	4	ENG		TRK-F150	N/A
73-64	All	4	RUG/HED		TRK-170A	TRK-170AWS
73-64	All	4	RUG/HED	Max-Type Brgs.	TRK-170AHD	TRK-170AHDWS
70-64	All	3	T86		TRK-BW86	N/A
69-66	All	4	T10	w/o Thrust Brg. Between 2nd-3rd Gear	TRK-10W	TRK-10WWS
68-63	All	4	DAG	Includes Small Parts Kit	TRK-F140	TRK-F140WS
68-63	All	4	DAG	M/S & C/S Needles Not Included	TRK-F140A	TRK-F140AWS
67-64	All	3	HED		TRK-F130	TRK-F130WS
65-57	All	4	T10	w/ Thrust Brg. Between 2nd-3rd Gear	TRK-10E	TRK-10EWS
64-48	All	3	259		TRK-259	N/A
64-48	All	3w/OD	259		TRK-259A	N/A

# Light Duty Transmission Applications

Year	Engine	Speed	Model#	Notes	Kit	w/Synchro Rings
<b>Ford (cont.)</b>						
<b>Aerostar</b>						
95-90	3.0L	5	M5R1	Updated 30 Tooth 5th Synchro Ring	TRK-247	TRK-247WS1
1/90	3.0L	5	M5R1		TRK-247	TRK-247WS
87-86	All	5	TK5L	42 Teeth Synchro Rings	TRK-12	TRK-12WS1
<b>Aspire</b>						
97-94	1.3L	5			TRK-FF100	Obsolete
<b>Bronco</b>						
96-90	5.0L	5	M5R2	Updated 33 Tooth 5th Synchro Ring	TRK-248	TRK-248WS1
92-87	All	4	T18	23mm Wide I/S Brg.	TRK-BW18A	TRK-BW18AWS1
1/90	5.0L	5	M5R2		TRK-248	TRK-248WS
90-79	All	4	T18	20mm Wide I/S Brg.	TRK-BW18	TRK-BW18WS
87-85	All	4	RTS		TRK-174F	TRK-174FWS1
87-78	All	4	NP435		TRK-127F	TRK-127FWS
1983	All	4	RUG		TRK-174F	TRK-174FWS
<b>Bronco II</b>						
1990	2.9L	5	M5R1	Updated 30 Tooth 5th Synchro Ring	TRK-247	TRK-247WS1
90-88	2.9L	5	FM146	Synchronized Rev.	TRK-50	TRK-50WS1
90-88	2.9L	5	M5R1		TRK-247	TRK-247WS
87-86	2.3L	5	FM145		TRK-50	TRK-50WS
87-86	2.9L	5	TK5L	42 Teeth Synchro Rings	TRK-12	TRK-12WS1
85-84	2.8L	5	TK5	30 Teeth Synchro Rings	TRK-12	TRK-12WS
1984	2.8L	4	TK4		TRK-12C	TRK-12CWS
<b>Contour</b>						
00-95	2.0L	5	MTX5		Obsolete	Obsolete
<b>EXP</b>						
83-82	1.6L	4	MTX4		TRK-FMZ160	TRK-FMZ160WS
<b>Escort</b>						
00-98	2.0L	5	MTX5		TRK-FMZ150	TRK-FMZ150WS
96-93	1.9L	5	MTX5	I/S Ball Brg. Has 25.0mm I.D.	TRK-FMZ260	TRK-FMZ260WS
96-91	1.8L	5	MTX5	Taper I/S Brg.	TRK-FMZ150	TRK-FMZ150WS
11/93	1.9L	5	MTX5	I/S Ball Brg. Has 25.4mm I.D.	TRK-FMZ130	TRK-FMZ130WS
90-85	All	4	MTX4		TRK-FMZ330	TRK-FMZ330WS
84-81	All	4	MTX4		TRK-FMZ160	TRK-FMZ160WS
<b>Explorer</b>						
03-02	4.0L	5	M5R4		TRK-FMZ360	TRK-FMZ360WS
01-91	4.0L	5	M5R1	Updated 30 Tooth 5th Synchro Ring	TRK-247	TRK-247WS1
01-91	4.0L	5	M5R1	Includes M/S Needle Brgs.	TRK-247N	TRK-247NWS1
<b>Explorer Sport / Trac</b>						
03-01	4.0L	5	M5R1	Updated 5th Synchro Ring	TRK-247	TRK-247WS1
<b>Festiva</b>						
93-89	1.3L	5	All		TRK-FF100	Obsolete
89-88	1.3L	4	All		TRK-FF100	Obsolete
<b>Focus</b>						
15-12	2.3L	5	MTX75		TRK-FMZ420A	N/A
11-04	2.0L SOHC	5	MTX75		TRK-FMZ420	N/A
04-00	2.0L SOHC	5	IB5		TRK-FMZ370	TRK-FMZ370WS
03-00	2.3L	5	MTX75		TRK-FMZ350	Obsolete
<b>Granada</b>						
84-81	All	4	SROD		TRK-170	TRK-170WS1
81-78	All	4	RUG		TRK-170	TRK-170WS

LD Transmission

# Light Duty Transmission Applications

Year	Engine	Speed	Model#	Notes	Kit	w/Synchro Rings
<b>Ford (cont.)</b>						
<b>Mustang</b>						
10-01	4.6L	5	TR-3650		TRK-3650	TRK-3650WS
08-94	3.8L, 4.0L	5	T5 World Class	LM48548/10 I/S Brg. Rev Synchro	TRK-5W	TRK-5WWS1
04-03	4.6L	6	T56		TRK-56	TRK-56WS
02-96	4.6L	5	T45		TRK-BW45	TRK-BW45WS
95-93	5.0L	5	T5 World Class	LM48548/10 I/S Brg. Rev Synchro, Taper Pilot Brg.	TRK-5WC	TRK-5WCWS
95-92	5.0L	5	T5 World Class	LM48548/10 I/S Brg. Rev Synchro	TRK-5W	TRK-5WWS1
93-87	2.3L	5	T5 World Class	M88048/10 I/S Brg.	TRK-5WA	TRK-5AWWS
91-85	All	5	T5 World Class	LM48548/10 I/S Brg. & Taper C/S Brgs.	TRK-5W	TRK-5WWS
84-83	All	5	T5	LM48548/10 I/S Brg. & Cylindrical C/S Brgs.	TRK-5	TRK-5WS
1983	All	4	RUG		TRK-170	TRK-170WS
1983	All	5	RAP		TRK-F190	Obsolete
<b>Pinto</b>						
81-78	All	4	RUG		TRK-170	TRK-170WS
<b>Probe</b>						
97-93	2.0L & 2.5L	5	PR5		TRK-FMZ150	TRK-FMZ150WS
92-89	2.2L Turbo	5	PR5		TRK-FMZ170	TRK-FMZ170WS
92-88	2.2L, 3.0L	5	PR5		TRK-FMZ150	TRK-FMZ150WS
<b>Ranger</b>						
11-90	All	5	M5R1	Updated 30 Tooth 5th Synchro Ring	TRK-247	TRK-247WS1
11-90	All	5	M5R1	Includes M/S Needle Brgs.	TRK-247N	TRK-247NWS1
92-88	All	5	FM146	Synchronized Rev.	TRK-50	TRK-50WS1
92-85	All	5	FM132		TRK-50A	TRK-50AWS
90-87	All	5	M5R1		TRK-247	TRK-247WS
1/90	All	5	M5R1	Includes M/S Needle Brgs.	TRK-247N	TRK-247NWS
87-86	All	5	FM145		TRK-50	TRK-50WS
87-86	Gas	5	TK5L	42 Teeth Synchro Rings	TRK-12	TRK-12WS1
85-83	Gas	5	TK5	30 Teeth Synchro Rings	TRK-12	TRK-12WS
84-83	Diesel	4	TK4D		TRK-12A	TRK-12AWS
84-83	Diesel	5	TK5D		TRK-12B	TRK-12BWS
84-83	Gas	4	TK4		TRK-12C	TRK-12CWS
<b>Taurus</b>						
88-86	2.5L	5	MTX5		TRK-FMZ140	Obsolete
<b>Taurus SHO</b>						
95-89	3.0L	5	MTX5		TRK-FMZ190	Obsolete
<b>Tempo</b>						
94-92	3.0L	5	MTX5		TRK-FMZ190	Obsolete
94-84	2.3L	5	MTX5		TRK-FMZ140	Obsolete
85-84	2.0L	4	MTX4		TRK-FMZ160	TRK-FMZ160WS
<b>Thunderbird</b>						
95-89	3.8L S/C	5	M5R2		TRK-248B	Obsolete
88-85	2.3L	5	T5 World Class	LM48548/10 I/S Brg. & Taper C/S Brgs.	TRK-5W	TRK-5WWS
84-83	2.3L	5	T5	LM48548/10 I/S Brg. & Cylindrical C/S Brgs.	TRK-5	TRK-5WS
<b>Trucks, Vans &amp; SUV's (82 &amp; Earlier)</b>						
82-81	All	4	SROD		TRK-174F	TRK-174FWS1
82-80	All	4	T19D	Taper I/S Brg.	TRK-BW19B	TRK-BW19BWS
82-77	All	4	RUG		TRK-174F	TRK-174FWS
82-72	All	4	CR1		TRK-F100	TRK-F100WS
82-68	All	4	T19	20mm Wide I/S Brg.	TRK-BW19	TRK-BW19WS



# Light Duty Transmission Applications

Year	Engine	Speed	Model#	Notes	Kit	w/Synchro Rings
<b>Ford (cont.)</b>						
<b>Trucks, Vans &amp; SUV's (82 &amp; Earlier) (cont.)</b>						
82-68	All	4	T19	23mm Wide I/S Brg.	TRK-BW19A	TRK-BW19AWS
82-65	All	3	Tremec	1st Synchro Ring Larger than 2nd & 3rd	TRK-150F	TRK-150FWS
82-65	All	3	Tremec	All Rings Same Size	TRK-150F	TRK-150FWS1
82-65	All	4	T18	20mm Wide I/S Brg.	TRK-BW18	TRK-BW18WS
82-65	All	4	T18	23mm Wide I/S Brg.	TRK-BW18A	TRK-BW18AWS1
81-76	All	5	CR2		TRK-F110	TRK-F110WS
71-67	All	3	T89		TRK-BW85	TRK-BW85WS
71-66	All	3	T87		TRK-BW87	TRK-BW87WS
71-56	All	3	T85		TRK-BW85	TRK-BW85WS
70-62	All	3	T86		TRK-BW86	TRK-BW86WS
64-48	All	3	259		TRK-259	Obsolete
64-48	All	3w/OD	259A		TRK-259A	Obsolete
64-48	All	4	T98		TRK-BW98	TRK-BW98WS
55-40	All	4	T8		TRK-F120	Obsolete
55-40	All	4	T9		TRK-F120	Obsolete
<b>Truck 1/2 Ton</b>						
08-99	All	5	M5R2	3 Pc. 2nd Synchro Ring	TRK-248	Obsolete
08-99	All	5	M5R2	Includes M/S Needle Brgs.	TRK-248N	Obsolete
98-90	All	5	M5R2	Updated 33 Tooth 5th Synchro Ring	TRK-248	TRK-248WS1
98-90	All	5	M5R2	Includes M/S Needle Brgs.	TRK-248N	TRK-248NWS1
96-88	All	5	S5-42		TRK-300ZF/1	TRK-300ZF/1WS
96-88	All	5	S5-42	Includes M/S Needle Brgs.	TRK-300ZF	TRK-300ZFWS
94-83	All	4	T18	23mm Wide I/S Brg.	TRK-BW18A	TRK-BW18AWS1
92-65	All	4	T18	20mm Wide I/S Brg.	TRK-BW18	TRK-BW18WS
90-87	All	5	M5R2		TRK-248	TRK-248WS
1/90	All	5	M5R2	Includes M/S Needle Brgs.	TRK-248N	TRK-248NWS
87-83	All	4	RUG		TRK-174F	TRK-174FWS
87-83	All	4	RTS		TRK-174F	TRK-174FWS1
87-65	All	4	NP435		TRK-127F	TRK-127FWS
86-83	All	3	Tremec	1st Synchro Ring Larger than 2nd & 3rd	TRK-150F	TRK-150FWS
86-83	All	3	Tremec	All Rings Same Size	TRK-150F	TRK-150FWS1
64-60	All	4	T98		TRK-BW98	TRK-BW98WS
<b>Truck 3/4 Ton</b>						
10-99	All	6	S6-650		TRK-S6-650ZF	TRK-S6-650ZFWS
10-99	All	6	S6-650	Includes M/S Needle Brgs.	TRK-S6-650ZFN	TRK-S6-650ZFNWS
08-99	All	6	S6-650	Brake Drum Section	TRK-300ZFBDL	N/A
07-03	All	6	S6-750		TRK-S6-650ZFB	TRK-S6-650ZFBWS
01-99	All	5	S5-47M		TRK-300ZF/1	TRK-300ZF/1WS1
01-99	All	5	S5-47M	Includes M/S Needle Brgs.	TRK-300ZF	TRK-300ZFWS1
01-88	All	5	S5-42/47M	Brake Drum Section	TRK-300ZFB	N/A
1999	All	5	M5R2	3 Pc. 2nd Synchro Ring	TRK-248	Obsolete
1999	All	5	M5R2	Includes M/S Needle Brgs.	TRK-248N	Obsolete
98-96	All	5	S5-47		TRK-300ZF/1	TRK-300ZF/1WS1
98-96	All	5	S5-47	Includes M/S Needle Brgs.	TRK-300ZF	TRK-300ZFWS1
98-90	All	5	M5R2	Updated 33 Tooth 5th Synchro Ring	TRK-248	TRK-248WS1
98-90	All	5	M5R2	Includes M/S Needle Brgs.	TRK-248N	TRK-248NWS1
95-88	All	5	S5-42		TRK-300ZF/1	TRK-300ZF/1WS
95-88	All	5	S5-42	Includes M/S Needle Brgs.	TRK-300ZF	TRK-300ZFWS
94-83	All	4	T18	23mm Wide I/S Brg.	TRK-BW18A	TRK-BW18AWS1
93-83	All	4	T19	20mm Wide I/S Brg.	TRK-BW19	TRK-BW19WS

LD Transmission

# Light Duty Transmission Applications

Year	Engine	Speed	Model#	Notes	Kit	w/Synchro Rings
<b>Ford (cont.)</b>						
<b>Truck 3/4 Ton (cont.)</b>						
93-83	All	4	T19	23mm Wide I/S Brg.	TRK-BW19A	TRK-BW19AWS
93-83	All	4	T19D	Taper I/S Brg.	TRK-BW19B	TRK-BW19BWS
92-65	All	4	T18	20mm Wide I/S Brg.	TRK-BW18	TRK-BW18WS
90-87	All	5	M5R2		TRK-248	TRK-248WS
1/90	All	5	M5R2	Includes M/S Needle Brgs.	TRK-248N	TRK-248NWS
87-65	All	4	NP435		TRK-127F	TRK-127FWS
86-83	All	3	Tremec	1st Synchro Ring Larger than 2nd & 3rd	TRK-150F	TRK-150FWS
86-83	All	3	Tremec	All Rings Same Size	TRK-150F	TRK-150FWS1
<b>Truck 1 Ton</b>						
10-99	All	6	S6-650		TRK-S6-650ZF	TRK-S6-650ZFWS
10-99	All	6	S6-650	Includes M/S Needle Brgs.	TRK-S6-650ZFN	TRK-S6-650ZFNWS
10-03	All	6	S6-750		TRK-S6-650ZFB	TRK-S6-650ZFBWS
01-99	All	5	S5-47M		TRK-300ZF/1	TRK-300ZF/1WS1
01-99	All	5	S5-47M	Includes M/S Needle Brgs.	TRK-300ZF	TRK-300ZFWS1
97-96	All	5	S5-47		TRK-300ZF/1	TRK-300ZF/1WS1
97-96	All	5	S5-47	Includes M/S Needle Brgs.	TRK-300ZF	TRK-300ZFWS1
95-88	All	5	S5-42		TRK-300ZF/1	TRK-300ZF/1WS
95-88	All	5	S5-42	Includes M/S Needle Brgs.	TRK-300ZF	TRK-300ZFWS
94-83	All	4	T18	23mm Wide I/S Brg.	TRK-BW18A	TRK-BW18AWS1
93-83	All	4	T19	20mm Wide I/S Brg.	TRK-BW19	TRK-BW19WS
93-83	All	4	T19	23mm Wide I/S Brg.	TRK-BW19A	TRK-BW19AWS
93-83	All	4	T19D	Taper I/S Brg.	TRK-BW19B	TRK-BW19BWS
87-65	All	4	NP435		TRK-127F	TRK-127FWS
87-65	All	4	T18	20mm Wide I/S Brg.	TRK-BW18	TRK-BW18WS
84-83	All	3	Tremec	1st Synchro Ring Larger than 2nd & 3rd	TRK-150F	TRK-150FWS
84-83	All	3	Tremec	All Rings Same Size	TRK-150F	TRK-150FWS1
<b>Van 1 Ton</b>						
87-84	All	4	NP435		TRK-127F	TRK-127FWS
<b>Geo</b>						
<b>Metro</b>						
01-89	1.0L	5	MV3		TRK-FS110	TRK-FS110WS
<b>Prizm</b>						
97-89	All	5	C51		TRK-FT320	TRK-FT320WS3
<b>Spectrum</b>						
1989	1.5L	5	76mm Isuzu	3 Pc. 1-2 Synchro Rings	TRK-FI120	TRK-FI120WS1
<b>Storm</b>						
93-90	All	5	MV4	3 Pc. 1-2 Synchro Rings	TRK-FI120	TRK-FI120WS1
<b>Tracker</b>						
97-89	2.0L	5	All		TRK-FS130	TRK-FS130WS
<b>GMC</b>						
<b>Jimmy (Full Size)</b>						
91-90	All	4	SM465	211FFLE I/S Brg.	TRK-157B	TRK-157BWS
90-79	All	4	SM465	Contains R1563TAV Front C/S Brg.	TRK-157L	TRK-157LWS
90-70	All	4	SM465	Contains M1305GGTV & R1563TAV Front C/S Brg.	TRK-157A	TRK-157AWS
90-70	All	4	SM465	w/ Small Parts Kit, Keys, & Spring	TRK-157ASPK	TRK-157ASPKWS
87-81	All	4	NP833		TRK-833	TRK-833WS
81-77	All	3	Saginaw		TRK-301	TRK-301WS1

# Light Duty Transmission Applications

Year	Engine	Speed	Model#	Notes	Kit	w/Synchro Rings
<b>GMC (cont.)</b>						
<b>Jimmy (S15 Size)</b>						
05-96	4.3L	5	HM290/MG5/NV3500	Standard I/S & O/S Brgs. 3 Pc. 1-2 Synchro Rings & 1.18 ID C/S Brgs	TRK-235B	TRK-235BWS1
05-96	4.3L	5	NV3500	Standard I/S & O/S Brgs. 3 Pc. 1-2 Synchro Rings & 1.30 ID C/S Brgs	TRK-235E	TRK-235EWS
03-96	2.2L	5	NV1500	6306 I/S Brg.	TRK-1500GM	TRK-1500GMWS
96-95	4.3L	5	HM290/MG5/NV3500	Standard I/S & O/S Brgs. Includes M/S Needle Brgs.	TRK-235BN2	TRK-235BN2WS
1995	4.3L	5	HM290/MG5/NV3500	Standard I/S & O/S Brgs. 3 Pc. 1-2 Synchro Rings	TRK-235B	TRK-235BWS1
1994	4.3L	5	HM290/MG5/NV3500	Standard I/S & O/S Brgs. Includes M/S Needle Brgs.	TRK-235BN1	TRK-235BN1WS
94-91	4.3L	5	HM290/MG5/NV3500	Standard I/S & O/S Brgs.	TRK-235B	TRK-235BWS
93-91	4.3L	5	HM290/MG5/NV3500	Standard I/S & O/S Brgs. Includes M/S Needle Brgs.	TRK-235BN	TRK-235BNWS
91-90	4.3L	5	HM290/MG5	3 Pc. I/S & Standard Ball O/S Brgs	TRK-235A	TRK-235AWS
91-90	4.3L	5	HM290/MG5	3 Pc. I/S & Standard Ball O/S Brgs Includes M/S Needle Brgs.	TRK-235AN	TRK-235ANWS
90-88	2.8L	5	T5 World Class	Taper C/S Brgs.	TRK-5W	TRK-5WWS
87-85	2.0L	4	T4	Taper I/S & O/S Brgs.	TRK-5	TRK-5WS1
87-83	2.8L	5	T5	Cylindrical C/S Brgs.	TRK-5	TRK-5WS
85-83	1.9L	4	S101		TRK-FI240	TRK-FI240WS
84-83	2.0L	4	T4C	Ball I/S & O/S Brgs.	TRK-4C	TRK-4CWS
<b>S15, Sonoma Pickup</b>						
03-96	4.3L	5	HM290/MG5/NV3500	Standard I/S & O/S Brgs. 3 Pc. 1-2 Synchro Rings & 1.18 ID C/S Brgs	TRK-235B	TRK-235BWS1
03-96	4.3L	5	NV3500	Standard I/S & O/S Brgs. 3 Pc. 1-2 Synchro Rings & 1.30 ID C/S Brgs	TRK-235E	TRK-235EWS
03-96	2.2L	5	NV1500	6306 I/S Brg.	TRK-1500GM	TRK-1500GMWS
96-95	4.3L	5	HM290/MG5/NV3500	Standard I/S & O/S Brgs. Includes M/S Needle Brgs.	TRK-235BN2	TRK-235BN2WS
1995	4.3L	5	HM290/MG5/NV3500	Standard I/S & O/S Brgs. 3 Pc. 1-2 Synchro Rings	TRK-235B	TRK-235BWS1
95-88	All	5	T5 World Class	Taper C/S Brgs.	TRK-5W	TRK-5WWS
1994	4.3L	5	HM290/MG5/NV3500	Standard I/S & O/S Brgs. Includes M/S Needle Brgs.	TRK-235BN1	TRK-235BN1WS
94-91	4.3L	5	HM290/MG5/NV3500	Standard I/S & O/S Brgs.	TRK-235B	TRK-235BWS
93-91	4.3L	5	HM290/MG5/NV3500	Standard I/S & O/S Brgs. Includes M/S Needle Brgs.	TRK-235BN	TRK-235BNWS
91-90	4.3L	5	HM290/MG5	3 Pc. I/S & Standard Ball O/S Brgs	TRK-235A	TRK-235AWS
91-90	4.3L	5	HM290/MG5	3 Pc. I/S & Standard Ball O/S Brgs Includes M/S Needle Brgs.	TRK-235AN	TRK-235ANWS
87-85	2.0L	4	T4	Taper I/S & O/S Brgs.	TRK-5	TRK-5WS1
87-82	2.8L	5	T5	Cylindrical C/S Brgs.	TRK-5	TRK-5WS
85-82	1.9L	4	S101		TRK-FI240	TRK-FI240WS
84-82	2.0L	4	T4C	Ball I/S & O/S Brgs.	TRK-4C	TRK-4CWS
<b>Suburban</b>						
1990	All	4	SM465	211FFLE I/S Brg.	TRK-157B	TRK-157BWS
90-83	All	4	SM465	N1211-L I/S Brg.	TRK-157L	TRK-157LWS
90-68	All	4	SM465	Contains M1305GGTV & R1563TAV Front C/S Brg.	TRK-157A	TRK-157AWS
90-68	All	4	SM465	w/ Small Parts Kit, Keys, & Spring	TRK-157ASPK	TRK-157ASPKWS
72-67	All	4	NP435	Ball I/S Brg.	TRK-127G	TRK-127GWS
72-67	All	4	NP435	Taper I/S Brg.	TRK-127SPK	TRK-127WS

# Light Duty Transmission Applications

Year	Engine	Speed	Model#	Notes	Kit	w/Synchro Rings
<b>GMC (cont.)</b>						
<b>Trucks, Vans &amp; SUV's (82 &amp; Earlier)</b>						
86-80	All	4	NP833		TRK-833	TRK-833WS
84-70	All	5	NP542		TRK-29	N/A
82-79	All	5	Clark 280HD	Taper I/S Brg.	TRK-190	N/A
82-76	All	5	Clark 390		TRK-390G	N/A
82-68	All	5	Clark 280		TRK-148	N/A
82-66	All	3	Saginaw		TRK-301	TRK-301WS1
82-65	All	3	Tremec		TRK-150F	TRK-150FWS1
78-60	All	5	NP540		TRK-27	N/A
75-68	All	5	Clark 320		TRK-132	N/A
75-68	All	5	Clark 380		TRK-133	N/A
74-68	All	3	SM330		TRK-G140	Obsolete
69-60	All	5	Clark 300		TRK-48	N/A
69-60	All	5	NP541		TRK-29	N/A
68-55	All	3	318		TRK-G110	N/A
68-55	All	3w/OD	319		TRK-G110	N/A
67-60	All	5	Clark 260		TRK-23	N/A
67-48	All	4	SM420		TRK-G160	N/A
54-40	All	3	318		TRK-G100	N/A
54-40	All	3w/OD	319		TRK-G100	N/A
47-40	All	4	185		TRK-G150	N/A
<b>Truck 1/2 Ton</b>						
07-96	All	5	NV3500	Standard I/S & O/S Brgs. 3 Pc. 1-2 Synchro Rings & 1.30 ID C/S Brgs	TRK-235E	TRK-235EWS
07-96	All	5	HM290/MG5/NV3500	Standard I/S & O/S Brgs. 3 Pc. 1-2 Synchro Rings & 1.18 ID C/S Brgs	TRK-235B	TRK-235BWS1
98-97	All	5	NV4500	Includes M/S Needles & Small Parts Kit	TRK-4500GM1N1SPK	TRK-4500GM1N1SPKWS
98-97	All	5	NV4500	Includes M/S Needle Brgs.	TRK-4500GM1N1	TRK-4500GM1N1WS
98-96	All	5	NV4500	Includes Small Parts Kit	TRK-4500GM1SPK	TRK-4500GM1SPKWS
98-96	All	5	NV4500		TRK-4500GM1	TRK-4500GM1WS
1996	All	5	NV4500	Includes M/S Needles & Small Parts Kit	TRK-4500GM1NSPK	TRK-4500GM1NSPKWS
1996	All	5	NV4500	Includes M/S Needle Brgs.	TRK-4500GM1N	TRK-4500GM1NWS
96-95	All	5	HM290/MG5/NV3500	Standard I/S & O/S Brgs. Includes M/S Needle Brgs.	TRK-235BN2	TRK-235BN2WS
1995	All	5	HM290/MG5/NV3500	Standard I/S & O/S Brgs.	TRK-235B	TRK-235BWS1
95-92	All	5	NV4500	Includes M/S Needle Brgs.	TRK-4500GMSPK	TRK-4500GMSPKWS
95-92	All	5	NV4500	Includes M/S Needle Brgs.	TRK-4500GMNSPK	TRK-4500GMNSPKWS
95-92	All	5	NV4500	Includes M/S Needle Brgs.	TRK-4500GMN	TRK-4500GMNWS
95-92	All	5	NV4500		TRK-4500GM	TRK-4500GMWS
1994	All	5	HM290/MG5/NV3500	Standard I/S & O/S Brgs. Includes M/S Needle Brgs.	TRK-235BN1	TRK-235BN1WS
94-91	All	5	HM290/MG5/NV3500	3 Pc. I/S & Standard Ball O/S Brgs	TRK-235B	TRK-235BWS
93-91	All	5	HM290/MG5/NV3500	Includes M/S Needle Brgs.	TRK-235BN	TRK-235BNWS
91-90	All	4	SM465	211FFLE I/S Brg.	TRK-157B	TRK-157BWS
91-90	All	5	HM290/MG5	3 Pc. I/S & Standard Ball O/S Brgs Includes M/S Needle Brgs.	TRK-235AN	TRK-235ANWS
91-90	All	5	HM290/MG5	3 Pc. I/S & O/S Brgs. Includes M/S Needle Brgs.	TRK-235A	TRK-235AWS
90-79	All	4	SM465	Contains R1563TAV Front C/S Brg.	TRK-157L	TRK-157LWS
90-68	All	4	SM465		TRK-157A	TRK-157AWS
90-68	All	4	SM465	Contains M1305GGTV & R1563TAV Front C/S Brg.	TRK-157ASPK	TRK-157ASPKWS
89-88	All	5	HM290/MG5	3 Pc. I/S & O/S Brgs.	TRK-235N	TRK-235NWS

# Light Duty Transmission Applications



Year	Engine	Speed	Model#	Notes	Kit	w/Synchro Rings
<b>GMC (cont.)</b>						
<b>Truck 1/2 Ton (cont.)</b>						
89-88	All	5	HM290/MG5	Contains R1563TAV Front C/S Brg. & 211FFLE I/S Brg.	TRK-235	TRK-235WS
87-82	All	4	NP833		TRK-833	TRK-833WS
87-77	All	3	Saginaw		TRK-301	TRK-301WS1
72-67	All	4	NP435	Taper I/S Brg.	TRK-127SPK	TRK-127WS
72-67	All	4	NP435	Ball I/S Brg.	TRK-127G	TRK-127GWS
<b>Truck 3/4 Ton</b>						
07-01	All	6	S6-650	4WD	TRK-S6-650ZFC	TRK-S6-650ZFCWS
07-01	All	6	S6-650	4WD, Includes M/S Needle Brgs.	TRK-S6-650ZFCN	TRK-S6-650ZFCNWS
07-01	All	6	S6-650	2WD	TRK-S6-650ZFA	TRK-S6-650ZFAWS
07-01	All	6	S6-650	2WD, Includes M/S Needle Brgs.	TRK-S6-650ZFAN	TRK-S6-650ZFANWS
07-97	All	5	NV4500	Includes M/S Needle Brgs.	TRK-4500GM1N1	TRK-4500GM1N1WS
07-97	All	5	NV4500	Includes M/S Needles & Small Parts Kit	TRK-4500GM1N1SPK	TRK-4500GM1N1SPKWS
07-96	All	5	NV4500		TRK-4500GM1	TRK-4500GM1WS
07-96	All	5	NV4500	Includes Small Parts Kit	TRK-4500GM1SPK	TRK-4500GM1SPKWS
98-96	All	5	NV3500	Standard I/S & O/S Brgs. 3 Pc. 1-2 Synchro Rings & 1.30 ID C/S Brgs	TRK-235E	TRK-235EWS
98-96	All	5	HM290/MG5/NV3500	Standard I/S & O/S Brgs. 3 Pc. 1-2 Synchro Rings & 1.18 ID C/S Brgs	TRK-235B	TRK-235BWS1
1996	All	5	NV4500	Includes M/S Needle Brgs.	TRK-4500GM1N	TRK-4500GM1NWS
1996	All	5	NV4500	Includes M/S Needles & Small Parts Kit	TRK-4500GM1NSPK	TRK-4500GM1NSPKWS
96-95	All	5	HM290/MG5/NV3500	Standard I/S & O/S Brgs. Includes M/S Needle Brgs.	TRK-235BN2	TRK-235BN2WS
1995	All	5	HM290/MG5/NV3500	Standard I/S & O/S Brgs.	TRK-235B	TRK-235BWS1
95-91	All	5	NV4500		TRK-4500GM	TRK-4500GMWS
95-91	All	5	NV4500	Includes M/S Needle Brgs.	TRK-4500GMN	TRK-4500GMNWS
95-91	All	5	NV4500	Includes M/S Needle Brgs.	TRK-4500GMNSPK	TRK-4500GMNSPKWS
95-91	All	5	NV4500	Includes M/S Needle Brgs.	TRK-4500GMSPK	TRK-4500GMSPKWS
1994	All	5	HM290/MG5/NV3500	Standard I/S & O/S Brgs. Includes M/S Needle Brgs.	TRK-235BN1	TRK-235BN1WS
94-91	All	5	HM290/MG5/NV3500	3 Pc. I/S & Standard Ball O/S Brgs	TRK-235B	TRK-235BWS
93-91	All	5	HM290/MG5/NV3500	Includes M/S Needle Brgs.	TRK-235BN	TRK-235BNWS
91-90	All	4	SM465	211FFLE I/S Brg.	TRK-157B	TRK-157BWS
91-90	All	5	HM290/MG5	3 Pc. I/S & Standard Ball O/S Brgs Includes M/S Needle Brgs.	TRK-235AN	TRK-235ANWS
91-90	All	5	HM290/MG5	3 Pc. I/S & O/S Brgs. Includes M/S Needle Brgs.	TRK-235A	TRK-235AWS
90-79	All	4	SM465	Contains R1563TAV Front C/S Brg.	TRK-157L	TRK-157LWS
90-68	All	4	SM465		TRK-157A	TRK-157AWS
90-68	All	4	SM465	Contains M1305GGTV & R1563TAV Front C/S Brg.	TRK-157ASPK	TRK-157ASPKWS
89-88	All	5	HM290/MG5	3 Pc. I/S & O/S Brgs.	TRK-235N	TRK-235NWS
89-88	All	5	HM290/MG5	Contains R1563TAV Front C/S Brg. & 211FFLE I/S Brg.	TRK-235	TRK-235WS
87-82	All	4	NP833		TRK-833	TRK-833WS
87-77	All	3	Saginaw		TRK-301	TRK-301WS1
72-67	All	4	NP435	Taper I/S Brg.	TRK-127SPK	TRK-127WS
72-67	All	4	NP435	Ball I/S Brg.	TRK-127G	TRK-127GWS

LD Transmission

# Light Duty Transmission Applications

Year	Engine	Speed	Model#	Notes	Kit	w/Synchro Rings
<b>GMC (cont.)</b>						
<b>Truck 1 Ton</b>						
07-01	All	6	S6-650	4WD	TRK-S6-650ZFC	TRK-S6-650ZFCWS
07-01	All	6	S6-650	4WD, Includes M/S Needle Brgs.	TRK-S6-650ZFCN	TRK-S6-650ZFCNWS
07-01	All	6	S6-650	2WD	TRK-S6-650ZFA	TRK-S6-650ZFAWS
07-01	All	6	S6-650	2WD, Includes M/S Needle Brgs.	TRK-S6-650ZFAN	TRK-S6-650ZFANWS
07-97	All	5	NV4500	Includes M/S Needle Brgs.	TRK-4500GM1N1	TRK-4500GM1N1WS
07-97	All	5	NV4500	Includes M/S Needles & Small Parts Kit	TRK-4500GM1N1SPK	TRK-4500GM1N1SPKWS
07-96	All	5	NV4500		TRK-4500GM1	TRK-4500GM1WS
07-96	All	5	NV4500	Includes Small Parts Kit	TRK-4500GM1SPK	TRK-4500GM1SPKWS
1996	All	5	NV4500	Includes M/S Needle Brgs.	TRK-4500GM1N	TRK-4500GM1NWS
1996	All	5	NV4500	Includes M/S Needles & Small Parts Kit	TRK-4500GM1NSPK	TRK-4500GM1NSPKWS
95-91	All	5	NV4500		TRK-4500GM	TRK-4500GMWS
95-91	All	5	NV4500	Includes M/S Needle Brgs.	TRK-4500GMN	TRK-4500GMNWS
95-91	All	5	NV4500	Includes M/S Needle Brgs.	TRK-4500GMNSPK	TRK-4500GMNSPKWS
95-91	All	5	NV4500	Includes M/S Needle Brgs.	TRK-4500GMSPK	TRK-4500GMSPKWS
91-90	All	4	SM465	211FFLE I/S Brg.	TRK-157B	TRK-157BWS
90-79	All	4	SM465	Contains R1563TAV Front C/S Brg.	TRK-157L	TRK-157LWS
90-68	All	4	SM465		TRK-157A	TRK-157AWS
90-68	All	4	SM465	Contains M1305GGTV & R1563TAV Front C/S Brg.	TRK-157ASPK	TRK-157ASPKWS
72-67	All	4	NP435	Taper I/S Brg.	TRK-127SPK	TRK-127WS
72-67	All	4	NP435	Ball I/S Brg.	TRK-127G	TRK-127GWS
<b>Van 1/2 Ton</b>						
87-79	All	4	SM465	Contains R1563TAV Front C/S Brg.	TRK-157L	TRK-157LWS
87-71	All	4	SM465		TRK-157A	TRK-157AWS
87-71	All	4	SM465	Contains M1305GGTV & R1563TAV Front C/S Brg.	TRK-157ASPK	TRK-157ASPKWS
72-67	All	4	NP435	Taper I/S Brg.	TRK-127	TRK-127WS
72-67	All	4	NP435	Ball I/S Brg.	TRK-127G	TRK-127GWS
<b>Van 3/4 Ton</b>						
87-79	All	4	SM465	Contains R1563TAV Front C/S Brg.	TRK-157L	TRK-157LWS
87-71	All	4	SM465		TRK-157A	TRK-157AWS
87-71	All	4	SM465	Contains M1305GGTV & R1563TAV Front C/S Brg.	TRK-157ASPK	TRK-157ASPKWS
72-67	All	4	NP435	Taper I/S Brg.	TRK-127	TRK-127WS
72-67	All	4	NP435	Ball I/S Brg.	TRK-127G	TRK-127GWS
<b>Van 1 Ton</b>						
87-79	All	4	SM465	Contains R1563TAV Front C/S Brg.	TRK-157L	TRK-157LWS
87-71	All	4	SM465		TRK-157A	TRK-157AWS
87-71	All	4	SM465	Contains M1305GGTV & R1563TAV Front C/S Brg.	TRK-157ASPK	TRK-157ASPKWS
72-67	All	4	NP435	Taper I/S Brg.	TRK-127	TRK-127WS
72-67	All	4	NP435	Ball I/S Brg.	TRK-127G	TRK-127GWS
<b>Yukon</b>						
96-95	5.7L	5	HM290/MG5/NV3500	Standard I/S & O/S Brgs. Includes M/S Needle Brgs.	TRK-235BN2	TRK-235BN2WS
96-95	5.7L	5	HM290/MG5/NV3500	Standard I/S & O/S Brgs. 3 Pc. 1-2 Synchro Rings	TRK-235B	TRK-235BWS1
1994	5.7L	5	HM290/MG5/NV3500	Standard I/S & O/S Brgs. Includes M/S Needle Brgs.	TRK-235BN1	TRK-235BN1WS



# Light Duty Transmission Applications



Year	Engine	Speed	Model#	Notes	Kit	w/Synchro Rings
<b>GMC (cont.)</b>						
Yukon (cont.)						
94-92	5.7L	5	HM290/MG5/NV3500	Standard I/S & O/S Brgs.	TRK-235B	TRK-235BWS
93-92	5.7L	5	HM290/MG5/NV3500	Standard I/S & O/S Brgs. Includes M/S Needle Brgs.	TRK-235BN	TRK-235BNWS
<b>Honda</b>						
Accord						
05-03	2.3L	5	APG6		TRK-FH370	TRK-FH370WS
05-03	3.0L	5	ATC6		TRK-FH380	TRK-FH380WS
02-98	2.3L	5	P2A5		TRK-FH180	TRK-FH180WS1
02-98	2.3L	5	P2A8		TRK-FH180	TRK-FH180WS1
02-98	2.3L	5	P2U5		TRK-FH180	TRK-FH180WS2
97-94	2.2L	5	P2A4		TRK-FH180	TRK-FH180WS
97-94	2.2L	5	P2A5		TRK-FH180	TRK-FH180WS
97-94	2.2L	5	P2U5		TRK-FH180	TRK-FH180WS
93-92	2.2L	5	H2A5		TRK-FH180	TRK-FH180WS
93-92	2.2L	5	H2C4		TRK-FH180	TRK-FH180WS
93-92	2.2L	5	H2U4		TRK-FH180	TRK-FH180WS
93-92	2.2L	5	H2U5		TRK-FH180	TRK-FH180WS
93-92	2.2L	5	HWU4		TRK-FH180	TRK-FH180WS
91-90	2.2L	5	H2A5		TRK-FH170	TRK-FH170WS
91-90	2.2L	5	H2C4		TRK-FH170	TRK-FH170WS
91-90	2.2L	5	H2U4		TRK-FH170	TRK-FH170WS
91-90	2.2L	5	H2U5		TRK-FH170	TRK-FH170WS
91-90	2.2L	5	HWU4		TRK-FH170	TRK-FH170WS
89-86	2.0L	5	A2Q5		TRK-FH120	TRK-FH120WS
89-86	2.0L	5	A2Q6		TRK-FH120	TRK-FH120WS
89-86	2.0L	5	All		TRK-FH120	TRK-FH120WS
89-86	2.0L	5	All		TRK-FH120	TRK-FH120WS
89-86	2.0L	5	All		TRK-FH120	TRK-FH120WS
89-86	2.0L	5	All		TRK-FH120	TRK-FH120WS
85-84	1.8L	5	GS		TRK-FH140	TRK-FH140WS
85-84	1.8L	5	GY		TRK-FH140	TRK-FH140WS
83-79	1.8L	5	All		TRK-FH100	TRK-FH100WS
78-75	1.6L	5	All		Obsolete	Obsolete
<b>CR-V</b>						
01-97	2.0L	5	SBXM	4WD	TRK-FH340	N/A
<b>CRX</b>						
91-88	1.5L	5	L3	6207 Diff Brgs.	TRK-FH150	TRK-FH150WS
91-88	1.6L	5	L3	6208 Diff Brgs.	TRK-FH130	TRK-FH130WS
87-84	1.3L	5	GV		TRK-FH110	TRK-FH110WS
87-84	1.5L	5	GW		TRK-FH110	TRK-FH110WS
<b>Civic</b>						
15-12	2.4L	6	SY1M		TRK-FH500	N/A
15-06	1.8L	5	SPFM		TRK-FH490	N/A
11-06	2.0L	6	PNN3		TRK-FH500	N/A
05-02	2.0L	5	NRH3		TRK-FH460	N/A
05-02	1.3L	5	SZB		TRK-FH470	N/A
05-01	1.7L	5	SLW		TRK-FH390	N/A
00-99	1.6L DOHC	5	S4C	6208 Diff Brgs., 28x60x15 I/S Brg.	TRK-FH260	TRK-FH260WS1
00-96	1.6L SOHC	5	S40	6207 Diff Brgs.	TRK-FH150	TRK-FH150WS
00-96	1.6L SOHC	5	S40	6208 Diff Brgs., 26x58x15 I/S Brg.	TRK-FH200	TRK-FH200WS
95-92	1.5L	5	S20	6207 Diff Brgs.	TRK-FH150	TRK-FH150WS
95-92	1.6L	5	S20	6208 Diff Brgs.	TRK-FH200	TRK-FH200WS
91-88	1.5L	4	L3	6207 Diff Brgs.	TRK-FH150	TRK-FH150WS
91-88	1.5L	5	L3	6207 Diff Brgs.	TRK-FH150	TRK-FH150WS

LD Transmission

# Light Duty Transmission Applications

Year	Engine	Speed	Model#	Notes	Kit	w/Synchro Rings
<b>Honda (cont.)</b>						
<b>Civic (cont.)</b>						
91-88	1.6L	5	L3	6208 Diff Brgs.	TRK-FH130	TRK-FH130WS
87-84	1.5L	6	L3-SL	4WD	TRK-FH290	TRK-FH290WS
83-80	All	5	GM		TRK-FH160	Obsolete
79-73	All	5	GB		Obsolete	Obsolete
79-73	All	5	GC		Obsolete	Obsolete
79-73	All	5	GD		Obsolete	Obsolete
79-73	All	5	GE		Obsolete	Obsolete
79-73	All	5	All		Obsolete	Obsolete
<b>Civic del Sol</b>						
97-93	1.6L SOHC	5	S20	6208 Diff Brgs., 26x58x15 I/S Brg.	TRK-FH200	TRK-FH200WS
97-94	1.6L DOHC	5	S21	6208 Diff Brgs., 28x60x15 I/S Brg.	TRK-FH260	TRK-FH260WS1
95-93	1.5L	5	S20	6207 Diff Brgs.	TRK-FH150	TRK-FH150WS
<b>Passport</b>						
02-94	3.2L	5	MSG-5	4WD, Includes Transfer Case Parts	TRK-FI160	TRK-FI160WS
02-94	3.2L	5	MSG-5	2WD	TRK-FI200	TRK-FI200WS
96-94	2.6L	5	T5 World Class		TRK-5W	TRK-5WWS1
<b>Prelude</b>						
01-97	2.2L	5	M2U4		TRK-FH350	TRK-FH350WS
01-97	2.2L	5	M2Y4		TRK-FH360	TRK-FH360WS
96-92	2.2L SOHC	5	M2L5		TRK-FH180	TRK-FH180WS1
96-92	2.3L DOHC	5	M2S4		TRK-FH180	TRK-FH180WS1
91-90	2.0L	5	All		TRK-FH210	TRK-FH210WS
89-88	2.0L	5	All		TRK-FH240	TRK-FH240WS
89-88	2.0L	5	All		TRK-FH240	TRK-FH240WS
89-88	2.0L	5	All		TRK-FH240	TRK-FH240WS
89-88	2.0L	5	All		TRK-FH240	TRK-FH240WS
87-85	2.0L	5	A1B5		TRK-FH120	TRK-FH120WS
87-85	2.0L	5	A2K5		TRK-FH120	TRK-FH120WS
85-83	1.8L	5	GM		TRK-FH140	TRK-FH140WS
82-79	1.8L	5	All		TRK-FH100	TRK-FH100WS
<b>Hyundai</b>						
<b>Accent</b>						
99-11/95	1.5L	5	KM302		TRK-FM420	TRK-FM420WS
10/95-8/94	1.5L	5	KM302		TRK-FM260	TRK-FM260WS
<b>Elantra</b>						
00-12/95	1.6L, 1.8L	5	M5AF3		TRK-FM400	TRK-FM400WS
11/95-6/93	1.6L	5	KM303		TRK-FM150	TRK-FM150WS3
93-91	1.6L	5	KM303		TRK-FM150	TRK-FM150WS1
<b>Excel</b>						
94-89	1.5L	5	KM206		TRK-FM100	TRK-FM100WS
93-89	1.5L	4	KM200		TRK-FM100	TRK-FM100WS1
4/89-12/85	1.5L	4	KM160		TRK-FC110	TRK-FC110WS1
4/89-12/85	1.5L	5	KM162		TRK-FC110	TRK-FC110WS
<b>Scoupe</b>						
95-92	1.5L	5	KM301		TRK-FM380	TRK-FM380WS
7/92-5/90	1.5L	5	KM210		TRK-FM100	TRK-FM100WS
<b>Sonata</b>						
98-92	2.4L	5	KM212		TRK-FM210	TRK-FM210WS
91-89	2.0L	5	KM208		TRK-FM150	TRK-FM150WS

# Light Duty Transmission Applications

Year	Engine	Speed	Model#	Notes	Kit	w/Synchro Rings
<b>Infiniti</b>						
<b>G20</b>						
02-90	2.0L	5	RS5F32A	Standard Differential	TRK-FN360	TRK-FN360WS
02-90	2.0L	5	RS5F32V	Limited Slip Differential	TRK-FN200	TRK-FN200WS
<b>I30</b>						
01-11/95	3.0L	5	RS5F50A	Standard Differential	TRK-FN370	TRK-FN370WS
01-11/95	3.0L	5	RS5F50A	Limited Slip Differential	TRK-FN380	TRK-FN380WS
<b>International</b>						
<b>Truck</b>						
85-80	All	5	T698		TRK-183	N/A
85-74	All	4	T19		TRK-BW19I	TRK-BW19IWS
80-74	All	3	T15		TRK-BW15I	TRK-BW15IWS
78-70	All	4	NP445		TRK-NP140I	N/A
75-62	All	5	T33		TRK-156	N/A
73-65	All	4	T18		TRK-BW18I	TRK-BW18IWS
73-61	All	3	T90		TRK-BW90I	TRK-BW90IWS
69-56	All	4	T98		TRK-BW98I	TRK-BW98IWS
<b>Isuzu</b>						
<b>Amigo</b>						
00-98	3.2L	5	MSG-5G		TRK-FI200	TRK-FI200WS
00-91	2.2L	5	MSG-5	4WD, 3 Pc. 1-2 Synchro Rings	TRK-FI160	TRK-FI160WS
<b>Hombre</b>						
00-96	2.2L	5	NV1500		TRK-1500GM	TRK-1500GMWS
<b>I-Mark</b>						
89-85	1.5L	5	MSG-5G		TRK-FI120	TRK-FI120WS
89-85	1.5L	5	MSG-5G	3 Pc. 1-2 Synchro Rings	TRK-FI120	TRK-FI120WS1
85-81	1.8L	4	MSG-4K		TRK-FI220	TRK-FI220WS
85-81	1.8L	5	MSG-5K		TRK-FI110	TRK-FI110WS
<b>Impulse</b>						
92-90	1.6L	5	MSG-5G		TRK-FI120	TRK-FI120WS
92-90	1.6L	5	MSG-5G	3 Pc. 1-2 Synchro Rings	TRK-FI120	TRK-FI120WS1
90-12/87	1.9L	5	MSG-5T	1-2 Synchro Rings 45 Teeth	TRK-FI110	TRK-FI110WS1
12/87-83	1.9L	5	MSG-5T	1-2 Synchro Rings 36 Teeth	TRK-FI110	TRK-FI110WS
<b>Pickup</b>						
95-91	All	5	MSG-5F	3 Pc. 1-2 Synchro Rings	TRK-FI160	TRK-FI160WS
95-91	All	5	MSG-5G	2WD	TRK-FI200	TRK-FI200WS
5/91-7/87	All	5	MSG-5F	4WD	TRK-FI130	TRK-FI130WS
87-84	All	5	MSG-5ET	4WD	TRK-FI100	TRK-FI100WS
87-81	All	4	MSG-4ET	4WD	TRK-FI180	TRK-FI180WS
87-81	All	4	MSG-4K	2WD	TRK-FI220	TRK-FI220WS
87-81	All	5	MSG-5K	1-2 Synchro Rings 36 Teeth	TRK-FI110	TRK-FI110WS
87-81	All	5	MSG-5K	1-2 Synchro Rings 45 Teeth	TRK-FI110	TRK-FI110WS1
81-76	All	4	MSG-4K	2WD	TRK-FI140	TRK-FI140WS
<b>Rodeo</b>						
04-91	All	5	MSG-5F	3 Pc. 1-2 Synchro Rings	TRK-FI160	TRK-FI160WS
04-91	3.1L	5	MSG-5G	2WD	TRK-FI200	TRK-FI200WS
98-91	2.2L, 2.6L	5	T5 World Class	2WD	TRK-5W	TRK-5WWS
<b>Stylus</b>						
93-91	1.6L	5	MSG-5G		TRK-FI120	TRK-FI120WS
93-91	1.6L	5	MSG-5G	3 Pc. 1-2 Synchro Rings	TRK-FI120	TRK-FI120WS1
<b>Trooper</b>						
97-91	All	5	MSG-5F	3 Pc. 1-2 Synchro Rings	TRK-FI160	TRK-FI160WS
5/91-7/87	All	5	MSG-5F		TRK-FI130	TRK-FI130WS
87-84	All	5	MSG-5ET		TRK-FI100	TRK-FI100WS

LD Transmission

# Light Duty Transmission Applications

Year	Engine	Speed	Model#	Notes	Kit	w/Synchro Rings
<b>Jeep</b>						
<b>All Models (82 &amp; Earlier)</b>						
86-82	All	4	T4J	Taper I/S Brg.	TRK-4J	TRK-4JWS
86-65	All	4	T18J		TRK-BW18J	TRK-BW18JWSO
84-80	All	4	T176		TRK-175	TRK-175WS
84-80	All	4	T177		TRK-175	TRK-175WS
84-80	All	4	T178		TRK-175	TRK-175WS
81-79	All	4	SR4J	Ball I/S Brg	TRK-BWSR4J	TRK-BWSR4JWS
80-75	All	3	T150		TRK-150J	TRK-150JWS
79-67	All	3	T15		TRK-BW15J	TRK-BW15JWS
76-68	All	3	T14		TRK-BW14J	TRK-BW14JWS
73-55	All	4	T98J		TRK-BW98J	TRK-BW98JWS
72-46	All	3	T90		TRK-BW90	TRK-BW90WS
71-65	All	3	T86		TRK-BW86JA	TRK-BW86JAWS
64-54	All	3	T86		TRK-BW86J	TRK-BW86JWS
64-52	All	3	T85		TRK-BW85	TRK-BW85WS
45-41	All	3	T84		TRK-BW84	TRK-BW84WS
<b>Cherokee</b>						
01-00	4.0L	5	NV3550		TRK-NV3550	TRK-NV3550WS
00-11/5/88	2.5L	5	AX5		TRK-FT160	TRK-FT160WS
99-90	4.0L	5	AX15	Serial # 00705123 and higher	TRK-FT300	TRK-FT300WS1
90-89	4.0L	5	AX15	Serial # 00705122 and lower	TRK-FT300	TRK-FT300WS
90-11/5/88	2.5L	4	AX4	23mm Wide I/S Brg.	TRK-FT170	TRK-FT170WS
89-87	4.0L	5	BA10/AX18		TRK-FP100	TRK-FP100WS
11/4/88-86	All	5	AX5	23mm Wide I/S Brg.	TRK-FT170	TRK-FT170WS
11/4/88-84	All	4	AX4	23mm Wide I/S Brg.	TRK-FT170	TRK-FT170WS
85-84	All	4	T4J	Taper I/S Brg.	TRK-4J	TRK-4JWS
85-84	All	5	T5J		TRK-5	TRK-5WS
85-84	All	4	AX4	20mm Wide I/S Brg.	TRK-FT180	TRK-FT180WS
85-84	All	5	AX5	20mm Wide I/S Brg.	TRK-FT180	TRK-FT180WS
79-74	All	4	T18		TRK-BW18J	TRK-BW18JWS
<b>CJ Series</b>						
86-82	All	5	T5J		TRK-5	TRK-5WS
86-81	All	4	T177		TRK-175	TRK-175WS
1981	2.5L, 4.2L	4	SR4J	Ball I/S Brg	TRK-BWSR4J	TRK-BWSR4JWS
79-70	All	4	T18	20mm Wide I/S Brg.	TRK-BW18	TRK-BW18WS
71-57	All	4	T98		TRK-BW98	TRK-BW98WS
<b>Comanche/ MJ</b>						
93-90	4.0L	5	AX15	Serial # 00705123 and higher	TRK-FT300	TRK-FT300WS1
92-11/5/88	2.5L	5	AX5		TRK-FT160	TRK-FT160WS
90-89	4.0L	5	AX15	Serial # 00705122 and lower	TRK-FT300	TRK-FT300WS
90-11/5/88	2.5L	4	AX4	23mm Wide I/S Brg.	TRK-FT170	TRK-FT170WS
89-87	4.0L	5	BA10/AX18		TRK-FP100	TRK-FP100WS
11/4/88-86	All	5	AX5	23mm Wide I/S Brg.	TRK-FT170	TRK-FT170WS
<b>Compass</b>						
17-07	All	5	T355		TRK-355	N/A
<b>Grand Cherokee</b>						
94-93	4.0L	5	AX15	4WD	TRK-FT300	TRK-FT300WS1
<b>Liberty</b>						
09-05	3.7L	6	NSG370		TRK-FC120	TRK-FC120WS
04-02	2.4L	5	NV1500		TRK-1500D	TRK-1500DWS
04-02	3.7L	5	NV3550		TRK-235C	TRK-235CWS1
<b>Patriot</b>						
17-07	All	5	T355		TRK-355	N/A

# Light Duty Transmission Applications

Year	Engine	Speed	Model#	Notes	Kit	w/Synchro Rings
<b>Jeep (cont.)</b>						
<b>Truck J10 / J20</b>						
87-81	4.2L	4	T177		TRK-175	TRK-175WS
87-81	5.9L	4	T176		TRK-175	TRK-175WS
83-82	All	5	T5J		TRK-5	TRK-5WS
83-65	All	4	T18		TRK-BW18J	TRK-BW18JWS
64-63	All	4	T98J		TRK-BW98J	TRK-BW98JWS
<b>Wagoneer</b>						
79-71	All	4	T18		TRK-BW18J	TRK-BW18JWS
<b>Wrangler</b>						
17-05	3.8L, 4.0L	6	NSG370		TRK-FC120	TRK-FC120WS
04-01	4.0L	5	NV3550		TRK-235C	TRK-235CWS1
01-00	4.0L	5	NV3550		TRK-NV3550	TRK-NV3550WS
99-90	4.0L	5	AX15	Serial # 00705123 and higher	TRK-FT300	TRK-FT300WS1
92-11/5/88	2.5L	5	AX5		TRK-FT160	TRK-FT160WS
90-89	4.0L	5	AX15	Serial # 00705122 and lower	TRK-FT300	TRK-FT300WS
89-87	4.0L	5	BA10/AX18		TRK-FP100	TRK-FP100WS
11/4/88-87	All	5	AX5	23mm Wide I/S Brq.	TRK-FT170	TRK-FT170WS
<b>Kia</b>						
<b>Sephia</b>						
01-95	1.8L	5	All		TRK-FMZ150	TRK-FMZ150WS
97-94	1.6L	5	All		TRK-FMZ130	TRK-FMZ130WS
<b>Sportage</b>						
02-95	2.0L	5	All	4WD	TRK-FK110	TRK-FK110WS
<b>Lexus</b>						
<b>ES250</b>						
91-89	2.5L	5	E52		TRK-FT520	Obsolete
<b>ES300</b>						
93-91	3.0L	5	E53		TRK-FT520	TRK-FT520WS1
<b>SC300</b>						
97-11/91	3.0L	5	W58		TRK-FT210	TRK-FT210WS5
<b>Lincoln</b>						
<b>All Car Models (82 &amp; Earlier)</b>						
82-81	All	4	SROD		TRK-170	TRK-170WS1
82-80	All	4	MTX4		TRK-FMZ160	TRK-FMZ160WS
82-65	All	3	Tremec	1st Synchro Ring Larger than 2nd & 3rd	TRK-150F	TRK-150FWS
82-65	All	3	Tremec		TRK-150F	TRK-150FWS1
81-78	All	4	RUG		TRK-170	TRK-170WS
76-71	All	4	ENG		TRK-F150	N/A
73-64	All	4	RUG/HED		TRK-170A	TRK-170AWS
73-64	All	4	RUG/HED	Max-Type Brgs.	TRK-170AHD	TRK-170AHDWS
70-64	All	3	T86		TRK-BW86	N/A
69-66	All	4	T10	w/o Thrust Brg. Between 2nd-3rd Gear	TRK-10W	TRK-10WWS
68-63	All	4	DAG	Includes Small Parts Kit	TRK-F140	TRK-F140WS
68-63	All	4	DAG	M/S & C/S Needles Not Included	TRK-F140A	TRK-F140AWS
67-64	All	3	HED		TRK-F130	TRK-F130WS
65-57	All	4	T10	w/ Thrust Brg. Between 2nd-3rd Gear	TRK-10E	TRK-10EWS
64-48	All	3	259		TRK-259	N/A
64-48	All	3w/OD	259		TRK-259A	N/A

LD Transmission

# Light Duty Transmission Applications

Year	Engine	Speed	Model#	Notes	Kit	w/Synchro Rings
<b>Mazda</b>						
<b>323</b>						
94-89	1.6L SOHC	5	G5M-R		TRK-FMZ130	TRK-FMZ130WS
94-89	1.8L DOHC	5	F5M-R		TRK-FMZ150	TRK-FMZ150WS
89-88	1.6L Turbo	5	F5M-R		TRK-FMZ150	TRK-FMZ150WS
89-88	1.6L	5	G5MX-R	4WD	Obsolete	Obsolete
88-86	1.6L	4	All		TRK-FMZ180	TRK-FMZ180WS1
88-86	1.6L	5	All		TRK-FMZ180	TRK-FMZ180WS
<b>626</b>						
02-88	2.0L, 2.2L	5	F5M-R, G25M-R, H5M-R		TRK-FMZ150	TRK-FMZ150WS
91-88	2.0L Turbo	5	F5M-R, G25M-R, H5M-R		TRK-FMZ170	TRK-FMZ170WS
87-83	2.0L	5	All		TRK-FMZ150	TRK-FMZ150WS
87-86	2.0L Turbo	5	F5M-R		TRK-FMZ150	TRK-FMZ150WS
82-76	All	5	All		TRK-FMZ100	TRK-FMZ100WS
<b>929</b>						
89-88	3.0L	5	All		TRK-FMZ210	TRK-FMZ210WS
<b>GLC</b>						
85-83	All	4	All		TRK-FMZ180	TRK-FMZ180WS1
85-83	All	5	All		TRK-FMZ180	TRK-FMZ180WS
82-77	All	4	All		TRK-FMZ240	TRK-FMZ240WS
82-77	All	5	All		TRK-FMZ250	TRK-FMZ250WS
<b>MX-3</b>						
95-93	1.6L	5	F25M-R		TRK-FMZ130	TRK-FMZ130WS
95-93	1.8L	5	G25M-R		TRK-FMZ150	TRK-FMZ150WS
1992	1.6L	5	F5M-R		TRK-FMZ130	TRK-FMZ130WS
1992	1.8L	5	G5M-R		TRK-FMZ150	TRK-FMZ150WS
<b>MX-6</b>						
97-88	2.2L	5	All		TRK-FMZ150	TRK-FMZ150WS
92-88	2.2L Turbo	5	All		TRK-FMZ170	TRK-FMZ170WS
<b>Miata</b>						
05-99	1.8L	6	Y16M-D		TRK-FMZ400	TRK-FMZ400WS
05-95	1.8L	5	M15M-D	3 Pc. 2nd Synchro Ring	TRK-FMZ300	TRK-FMZ300WS1
94-90	All	5	M15M-D		TRK-FMZ300	TRK-FMZ300WS
<b>MPV</b>						
91-89	2.6L	5	All		TRK-FMZ210	TRK-FMZ210WS
<b>Navajo</b>						
94-91	4.0L	5	M5R1		TRK-247	TRK-247WS1
<b>Protege</b>						
03-3/16/02	2.0L	5	G15M-R		TRK-FMZ390	TRK-FMZ390WS
03-95	1.5L, 1.6L SOHC	5	F25M-R		TRK-FMZ130	TRK-FMZ130WS
3/15/02-01	2.0L	5	G15M-R		TRK-FMZ380	TRK-FMZ380WS
98-92	1.8L DOHC	5	G25M-R		TRK-FMZ150	TRK-FMZ150WS
<b>RX-7</b>						
95-93	1.3L Turbo	5	R15M-D		TRK-FMZ210	TRK-FMZ210WS1
91-89	1.3L	5	R5M-D	Single Ball Front C/S Brg.	TRK-FMZ120	TRK-FMZ120WS2
91-87	1.3L Turbo	5	R5M-D		TRK-FMZ210	TRK-FMZ210WS
88-86	All	5	All	Single Ball Front C/S Brg.	TRK-FMZ120	TRK-FMZ120WS1
88-86	All	5	All	Double Ball Front C/S Brg.	TRK-FMZ200	TRK-FMZ200WS1
85-81	All	5	All	Single Ball Front C/S Brg.	TRK-FMZ120	TRK-FMZ120WS
85-81	All	5	All	Double Ball Front C/S Brg.	TRK-FMZ200	TRK-FMZ200WS
80-79	All	5	All	Single Ball Front C/S Brg.	TRK-FMZ100	TRK-FMZ100WS
84-79	All	4	B4		TRK-FMZ290	TRK-FMZ290WS
80-79	All	5	All	Double Ball Front C/S Brg.	TRK-FMZ110	TRK-FMZ110WS



# Light Duty Transmission Applications

Year	Engine	Speed	Model#	Notes	Kit	w/Synchro Rings
<b>Mazda (cont.)</b>						
<b>Truck B2000</b>						
84-79	2.0L	4	B4		TRK-FMZ290	TRK-FMZ290WS
84-79	2.0L	5	All	Single Ball Front C/S Brg.	TRK-FMZ100	TRK-FMZ100WS
84-79	2.0L	5	All	Double Ball Front C/S Brg.	TRK-FMZ110	TRK-FMZ110WS
<b>Truck B2200</b>						
93-90	2.2L	5	All	Double Ball Front C/S Brg.	TRK-FMZ200	TRK-FMZ200WS2
90-86	2.2L	5	All	Single Ball Front C/S Brg.	TRK-FMZ120	TRK-FMZ120WS
90-86	2.2L	5	All	Double Ball Front C/S Brg.	TRK-FMZ200	TRK-FMZ200WS
<b>Truck B2300</b>						
10-94	2.3L	5	M5R1		TRK-247	TRK-247WS1
<b>Truck B2600</b>						
93-87	2.6L	5	All		TRK-FMZ210	TRK-FMZ210WS
<b>Truck B3000</b>						
08-94	3.0L	5	M5R1		TRK-247	TRK-247WS1
<b>Truck B4000</b>						
10-94	4.0L	5	M5R1		TRK-247	TRK-247WS1
<b>Mercury</b>						
<b>All Car Models (82 &amp; Earlier)</b>						
82-81	All	4	SROD		TRK-170	TRK-170WS1
82-80	All	4	MTX4		TRK-FMZ160	TRK-FMZ160WS
82-65	All	3	Tremec	1st Synchro Ring Larger than 2nd & 3rd	TRK-150F	TRK-150FWS
82-65	All	3	Tremec		TRK-150F	TRK-150FWS1
81-78	All	4	RUG		TRK-170	TRK-170WS
76-71	All	4	ENG		TRK-F150	N/A
73-64	All	4	RUG/HED		TRK-170A	TRK-170AWS
73-64	All	4	RUG/HED	Max-Type Brgs.	TRK-170AHD	TRK-170AHDWS
70-64	All	3	T86		TRK-BW86	N/A
69-66	All	4	T10	w/o Thrust Brg. Between 2nd-3rd Gear	TRK-10W	TRK-10WWS
68-63	All	4	DAG	Includes Small Parts Kit	TRK-F140	TRK-F140WS
68-63	All	4	DAG	M/S & C/S Needles Not Included	TRK-F140A	TRK-F140AWS
67-64	All	3	HED		TRK-F130	TRK-F130WS
65-57	All	4	T10	w/ Thrust Brg. Between 2nd-3rd Gear	TRK-10E	TRK-10EWS
64-48	All	3	259		TRK-259	N/A
64-48	All	3w/OD	259		TRK-259A	N/A
<b>Capri</b>						
94-91	1.6L	5	CAP5		TRK-FMZ130	TRK-FMZ130WS
94-91	1.6L Turbo	5	CAP5		TRK-FMZ150	TRK-FMZ150WS
84-83	All	5	T5	LM48548/10 I/S Brg. & Cylindrical C/S Brgs.	TRK-5	TRK-5WS
83-81	All	5	RAP		TRK-F190	Obsolete
83-80	All	4	RUG		TRK-170	TRK-170WS
<b>Cougar</b>						
02-99	2.0L	5	MTX5		TRK-FMZ350	Obsolete
86-85	2.3L	5	T5 World Class		TRK-5W	TRK-5WWS
1984	2.3L	5	T5		TRK-5	TRK-5WS
<b>LN7</b>						
1983	All	4	MTX4		TRK-FMZ160	TRK-FMZ160WS
<b>Lynx</b>						
87-86	All	4	MTX4		TRK-FMZ330	TRK-FMZ330WS
84-83	All	4	MTX4		TRK-FMZ160	TRK-FMZ160WS
1985	1.6L, 1.9L	4	MTX4		TRK-FMZ160	TRK-FMZ160WS
1985	1.9L	4	MTX4		TRK-FMZ330	TRK-FMZ330WS

LD Transmission

# Light Duty Transmission Applications

Year	Engine	Speed	Model#	Notes	Kit	w/Synchro Rings
<b>Mercury (cont.)</b>						
<b>Mystique</b>						
00-95	2.0L	5	MTX5		Obsolete	Obsolete
<b>Topaz</b>						
94-92	3.0L	5	MTX5		TRK-FMZ340	Obsolete
94-84	2.3L	5	MTX5	2 Pinion Differential	TRK-FMZ140	Obsolete
94-84	2.3L	5	MTX5	4 Pinion Differential	TRK-FMZ190	Obsolete
1984	2.0L	4	MTX4		TRK-FMZ160	TRK-FMZ160WS
<b>Tracer</b>						
99-97	2.0L	5	TR5C		TRK-FMZ150	TRK-FMZ150WS
96-91	1.8L	5	TR5A		TRK-FMZ150	TRK-FMZ150WS
96-91	1.9L	5	TR5B		TRK-FMZ130	TRK-FMZ130WS
89-88	1.6L	5	TR5		TRK-FMZ180	TRK-FMZ180WS
<b>Mitsubishi</b>						
<b>3000GT</b>						
99-94	3.0L Turbo	6	W6MG1	4WD	TRK-FM530	TRK-FM530WS
12/99-5/93	3.0L	5	F5M33	3 Pc. 2nd Synchro Ring	TRK-FM180	TRK-FM180WS4
4/93-6/92	3.0L	5	F5M33	3 Pc. 2nd Synchro Ring	TRK-FM180	TRK-FM180WS3
93-91	3.0L Turbo	5	W5MG1	4WD	TRK-FM250	TRK-FM250WS
5/92-5/91	3.0L	5	F5M33	3 Pc. 2nd Synchro Ring	TRK-FM180	TRK-FM180WS2
4/91-12/90	3.0L	5	F5M33		TRK-FM180	TRK-FM180WS1
<b>Cordia</b>						
88-83	1.8L	4	KM165	Ball Diff Brg.	TRK-FC110	TRK-FC110WS1
88-83	1.8L	5	KM162	Ball Diff Brg.	TRK-FC110	TRK-FC110WS
88-83	2.0L	5	KM163	Taper Diff Brg.	TRK-FM170	TRK-FM170WS
88-83	2.0L	8	KM166	Taper Diff Brg.	TRK-FM170	TRK-FM170WS
11/86-6/83	1.8L Turbo	5	KM163	Taper Diff Brg.	TRK-FM170	TRK-FM170WS
<b>Eclipse</b>						
12-00	2.4L	5	F5M42		TRK-FM450	TRK-FM450WS
04-00	3.0L	5	F5M51		TRK-FM440	TRK-FM440WS
99-96	2.4L	5	F5M31	3 Pc. 2nd Synchro Ring	TRK-FM180	TRK-FM180WS4
99-95	2.0L	5	F5MC1/NVT350/A578	FWD	TRK-350	TRK-350WS
99-94	2.0L Turbo	5	F5M33	FWD, 3 Pc. 2nd Synchro Ring	TRK-FM180	TRK-FM180WS4
99-93	2.0L Turbo	5	W5M33	4WD, 39 Teeth 3-4 Synchro Rings	TRK-FM160	TRK-FM160WS3
99-90	2.0L Turbo		KM272	Transfer Case Section Only	TRK-FM350	N/A
94-93	1.8L, 2.0L	5	F5M22	FWD, 3-4 Synchro Rings, 36 Teeth, Synchro Rev.	TRK-FM150	TRK-FM150WS2
5/93-6/92	2.0L Turbo	5	W5M33	4WD, 24 Teeth 3-4 Synchro Rings	TRK-FM160	TRK-FM160WS2
93-88	2.0L Turbo	5	F5M33	FWD, Fiber Lined 1-2 Synchro Rings, Synchro. Rev.	TRK-FM180	TRK-FM180WS
5/92-5/91	2.0L Turbo	5	W5M33	4WD, Brass Rings	TRK-FM160	TRK-FM160WS1
92-90	1.8L, 2.0L	5	F5M22	3-4 Synchro Rings 30 Teeth	TRK-FM150	TRK-FM150WS1
<b>Expo</b>						
94-93	1.8L	5	F5M22	FWD	TRK-FM150	TRK-FM150WS3
94-91	1.8L	5	W5M31	4WD	TRK-FM240	TRK-FM240WS
94-91	2.4L	5	F5M31	FWD	TRK-FM210	TRK-FM210WS
92-91	1.8L	5	F5M22		TRK-FM150	TRK-FM150WS1
92-91	2.4L	5	W5M33	4WD	TRK-FM290	TRK-FM290WS
<b>Galant</b>						
98-94	2.4L	5	F5M31	FWD	TRK-FM500	TRK-FM500WS
93-88	2.0L	5	F5M22	FWD	TRK-FM150	TRK-FM150WS1
92-91	2.0L	5	W5M33	4WD	TRK-FM160	TRK-FM160WS
92-90	2.0L	5	W5M31	4WD, Taper Diff Brg.	TRK-FM240	TRK-FM240WS
92-90	2.0L Turbo	5	F5M22	FWD	TRK-FM150	TRK-FM150WS1
92-88	2.0L Turbo	5	F5M33	FWD	TRK-FM210	TRK-FM210WS1

# Light Duty Transmission Applications

Year	Engine	Speed	Model#	Notes	Kit	w/Synchro Rings
<b>Mitsubishi (cont.)</b>						
<b>Lancer</b>						
06-02	2.0L	5	F5M42		TRK-FM490	TRK-FM490WS1
<b>Mirage</b>						
02-97	1.5L	5	F5M41		TRK-FM480	TRK-FM480WS
02-97	1.8L	5	F5M42		TRK-FM490	TRK-FM490WS
96-93	1.5L	5	F5M21		TRK-FM460	TRK-FM460WS
96-93	1.8L	5	F5M22		TRK-FM470	TRK-FM470WS
92-89	1.6L Turbo	5	KM210		TRK-FM210	TRK-FM210WS
92-86	1.5L	4	KM200		TRK-FM100	TRK-FM100WS1
92-86	1.5L	5	KM201		TRK-FM100	TRK-FM100WS
88-86	1.6L Turbo	5	KM206		TRK-FM150	TRK-FM150WS
86-85	1.5L	4	KM161		TRK-FM390	TRK-FM390WS
86-85	1.5L	5	KM162		TRK-FC110	TRK-FC110WS
86-85	1.6L Turbo	5	KM163		TRK-FM170	TRK-FM170WS
<b>Mighty Max</b>						
96-87	All	5	KM145-8	4WD	TRK-FM120	TRK-FM120WS
94-90	3.0L	5	V5MT2	4WD	TRK-FM200	TRK-FM200WS
89-87	2.6L	5	KM132-9	2WD, F6307X1-1 I/S Brg	TRK-FM120	TRK-FM120WS
88-83	2.0L	5	KM132-8	2WD	TRK-FM140	TRK-FM140WS
88-83	2.0L, 2.6L	5	KM132-E	2WD	TRK-FM110	TRK-FM110WS
86-83	2.0L, 2.6L	5	KM145-1	4WD	TRK-FM110	TRK-FM110WS
86-83	2.3L Diesel	5	KM145-2	4WD	TRK-FM110	TRK-FM110WS
85-83	2.0L, 2.6L	4	KM144	4WD	TRK-FM190	TRK-FM190WS
85-81	All	4	KM130	2WD	TRK-FM190	TRK-FM190WS
<b>Montero</b>						
97-10/91	3.0L	5	V5MT2	4WD	TRK-FM200	TRK-FM200WS2
96-86	2.6L	5	LD42GL	2WD	TRK-FM130	TRK-FM130WS
9/91-5/89	3.0L	5	V5MT2	Fiber Lined 1-4 Gear Synchro Rings	TRK-FM200	TRK-FM200WS1
4/89-5/88	3.0L	5	V5MT2	4WD	TRK-FM200	TRK-FM200WS
3/86-1/83	2.6L	5	LD42G	6307 I/S Brg.	TRK-FM110	TRK-FM110WS
<b>Montero Sport</b>						
99-98	2.4L	5	R5M21		TRK-FM510	TRK-FM510WS
00-97	3.0L	5	V5MT1		TRK-FM520	TRK-FM520WS
98-97	2.4L	5	R5M21		TRK-FM500	TRK-FM500WS
<b>Precis</b>						
92-88	1.5L	4	KM200		TRK-FM100	TRK-FM100WS1
92-88	1.5L	5	KM201		TRK-FM100	TRK-FM100WS
4/89-1/87	1.8L	5	KM162		TRK-FC110	TRK-FC110WS
<b>Raider</b>						
09-06	3.7L	5	Getrag 238		Obsolete	Obsolete
<b>Starion</b>						
89-88	2.6L Turbo	5	KM132-M	w/ Intercooler	TRK-FM320	TRK-FM320WS
87-85	2.6L Turbo	5	KM132-G	w/ Intercooler, TMSC0788 I/S Brg.	TRK-FM310	TRK-FM310WS
87-84	2.6L Turbo	5	KM132-B	w/o Intercooler	TRK-FM300	TRK-FM300WS
<b>Tredia</b>						
88-83	1.8L	4	KM165	Ball Diff Brg.	TRK-FC110	TRK-FC110WS1
88-83	1.8L	5	KM162	Ball Diff Brg.	TRK-FC110	TRK-FC110WS
88-83	2.0L	5	KM163	Taper Diff Brg.	TRK-FM170	TRK-FM170WS
88-83	2.0L	8	KM166	Taper Diff Brg.	TRK-FM170	TRK-FM170WS
11/86-6/83	1.8L Turbo	5	KM163	Taper Diff Brg.	TRK-FM170	TRK-FM170WS

# Light Duty Transmission Applications

Year	Engine	Speed	Model#	Notes	Kit	w/Synchro Rings
<b>Nissan</b>						
<b>1200</b>						
77-71	All	4	F4W56A		TRK-FN310	N/A
<b>200SX</b>						
88-87	All	5	FS5W71S	3 Pc. 2nd Synchro Ring	TRK-FN110	TRK-FN110WS2
8/87-7/84	All	5	FS5W71M	2.440" O.D. Front C/S Ball Brg.	TRK-FN110	TRK-FN110WS1
84-80	All	5	FS5W71C	2.200" O.D. Front C/S Ball Brg.	TRK-FN100	TRK-FN100WS
79-77	All	5	FS5W63A	Taper C/S Brgs.	TRK-FN350	TRK-FN350WS
<b>210</b>						
93-88	All	5	FS5W71H	2 Pc. 2nd Synchro Ring	TRK-FN110	TRK-FN110WS2
82-79	All	5	FS5W60A		TRK-FN330	TRK-FN330WS
82-75	All	4	F4W60		TRK-FN320	N/A
79-76	All	5	FS5W60L		TRK-FN340	N/A
<b>240Z</b>						
73-70	All	4	F4W70B		TRK-FN280	TRK-FN280WS
<b>260Z</b>						
80-74	All	4	F4W71B		TRK-FN230	TRK-FN230WS
80-74	All	5	FS5W71A		TRK-FN100	TRK-FN100WS
<b>280Z</b>						
80-74	All	4	F4W71B		TRK-FN230	TRK-FN230WS
80-74	All	5	FS5W71A		TRK-FN100	TRK-FN100WS
<b>280ZX</b>						
83-81	2.8L	5	FS5W71C		TRK-FN100	TRK-FN100WS
1983	2.8L Turbo	5	FS5R90A/T-5		TRK-5NA	TRK-5NAWS
<b>300ZX</b>						
96-91	All	5	FS5R30A	3 Pc. 2nd & 3rd Synchro Rings	TRK-FN150	TRK-FN150WS1
2/89-8/87	3.0L	5	FS5W71N	2 Pc. 2nd Synchro Ring	TRK-FN110	TRK-FN110WS2
2/89-9/86	3.0L Turbo	5	FS5R30A		TRK-FN150	TRK-FN150WS2
8/87-7/83	3.0L	5	FS5W71N		TRK-FN110	TRK-FN110WS1
86-84	3.0L Turbo	5	FS5R90A/T-5		TRK-5N	TRK-5NWS
<b>310</b>						
1/84-2/82	All	4	RN4F30A		TRK-FN130	TRK-FN130WS
1/84-2/82	All	5	RS5F30A		TRK-FN130	TRK-FN130WS
<b>510, 610, 710</b>						
81-70	All	4	F4W63		TRK-FN260	TRK-FN260WS
<b>521/620/720 Pickup</b>						
86-84	All	5	FS5W71C	4WD	TRK-FN110	TRK-FN110WS13
84-81	All	5	FS5W71C	2WD	TRK-FN100	TRK-FN100WS
84-81	All	5	FS5W71C	4WD	TRK-FN100	TRK-FN100WS
83-80	All	4	F4W71B	4WD	TRK-FN270	TRK-FN270WS
83-74	All	4	F4W71B	2WD	TRK-FN230	TRK-FN230WS
80-74	All	5	FS5W71A	2WD, 5th Synchro Ring Not Included	TRK-FN100	TRK-FN100WS
73-67	All	4	F4W63	2WD	TRK-FN260	TRK-FN260WS
<b>Altima</b>						
01-93	2.4L DOHC	5	RS5F50A		TRK-FN220	TRK-FN220WS
01-93	2.4L DOHC	5	RS5F50V	Limited Slip Differential	TRK-FN470	TRK-FN470WS
<b>Axxess</b>						
1990	2.4L	5	RS5F50A	Two 32008 Diff Brgs.	TRK-FN120	TRKFN120WS1
1990	2.4L	5	RS5F50A	One 32008 & One 32008J/1D-57407N Diff Brgs.	TRK-FN210	TRK-FN210WS
1990	2.4L	5	RS5F50V	4WD	TRK-FN250	TRK-FN250WS
1990	2.4L		TY10B	Transfer Case Section Only	TRK-FN500	N/A

# Light Duty Transmission Applications

Year	Engine	Speed	Model#	Notes	Kit	w/Synchro Rings
<b>Nissan (cont.)</b>						
<b>D21 Pickup</b>						
3/97-1/93	2.4L	5	FS5W71C	4WD	TRK-FN190	TRK-FN190WS2
1/96-8/94	2.4L	5	FS5W71C	2WD	TRK-FN110	TRK-FN110WS11
1/96-1/92	3.0L	5	FS5R30A	2WD&4WD	TRK-FN150	TRK-FN150WS11
8/94-7/93	2.4L	5	FS5W71C	2WD	TRK-FN110	TRK-FN110WS10
1/93-1/92	2.4L	5	FS5W71C	4WD	TRK-FN190	TRK-FN190WS1
1/93-1/92	2.4L	5	FS5W71C	4WD	TRK-FN190	TRK-FN190WS1
7/93-8/89	2.4L	5	FS5W71C	2WD	TRK-FN110	TRK-FN110WS9
1/92-3/87	3.0L	5	FS5R30A	2WD&4WD	TRK-FN150	TRK-FN150WS8
1/92-6/86	2.4L	5	FS5W71C	4WD	TRK-FN190	TRK-FN190WS
89-86	All	4	F4W71C	2WD	TRK-FN270	TRK-FN110WS5
89-84	2.4L	5	FS5W71C	2WD	TRK-FN110	TRK-FN110WS8
3/87-11/85	3.0L	5	FS5R30A	2WD&4WD	TRK-FN150	TRK-FN150WS7
<b>Frontier</b>						
03-99	3.0L	5	FS5R30A		TRK-FN150	TRK-FN150WS11
04-01	2.4L	5	FS5W71C	2WD	TRK-FN530	TRK-FN530WS
00-98	2.4L	5	FS5W71C	4WD	TRK-FN540	TRK-FN540WS
<b>Maxima</b>						
06-02	3.5L	6	RS6F51A		TRK-FN580	TRK-FN580WS
00-93	3.0L	5	RS5F50A		TRK-FN370	TRK-FN370WS
00-93	3.0L	5	RS5F50V	Limited Slip Differential	TRK-FN380	TRK-FN380WS
92-91	3.0L	5	RS5F50A	Two 32008J/1D-57407N Diff Brgs.	TRK-FN220	TRK-FN220WS
90-88	3.0L	5	RS5F50A	Two 32008 Diff Brgs. Synchronized Rev.	TRK-FN120	TRK-FN120WS1
90-85	3.0L	5	RS5F50A	One 32008 & One 32008J/1D-57407N Diff Brgs.	TRK-FN210	TRK-FN210WS
86-85	3.0L	5	RS5F50A	Two 32008 Diff Brgs.	TRK-FN120	TRK-FN120WS
85-81	2.4L	5	FS5W71C		TRK-FN100	TRK-FN100WS
<b>Pathfinder</b>						
02-12/98	3.3L, 3.5L	5	FS5R30A		TRK-FN150	TRK-FN150WS11
12/98-10/97	3.3L	5	FS5R30A		TRK-FN150	TRK-FN150WS10
10/97-5/97	3.3L	5	FS5R30A		TRK-FN150	TRK-FN150WS9
5/97-7/92	3.0L, 3.3L	5	FS5R30A		TRK-FN150	TRK-FN150WS8
7/92-3/87	3.0L	5	FS5R30A		TRK-FN150	TRK-FN150WS7
1987	3.0L	5	FS5R30A		TRK-FN150	TRK-FN150WS6
1987	2.4L	5	FS5W71C	4WD	TRK-FN160	TRK-FN160WS
<b>Pulsar</b>						
90-88	1.8L	5	RS5F50A		TRK-FN120	TRK-FN120WS
90-87	1.6L SOHC	5	RS5F31A		TRK-FN140	TRK-FN140WS
88-87	1.6L DOHC	5	RS5F31A		TRK-FN440	TRK-FN440WS
86-83	1.6L SOHC	5	RS5F30A		TRK-FN130	TRK-FN130WS
85-83	1.5L Turbo	5	RS5F31A		TRK-FN140	TRK-FN140WS
<b>Sentra</b>						
06-02	2.5L	5	RS5F51A	SE-R	TRK-FN570	TRK-FN570WS
06-02	2.5L	6	RS6F51A	SE-R Spec V	TRK-FN580	TRK-FN580WS
02-00	1.8L DOHC	5	RS5F70A		TRK-FN550	TRK-FN550WS
01-00	2.0L DOHC	5	RS5F70A		TRK-FN550	TRK-FN550WS
01-00	2.0L DOHC	5	RS5F70V		TRK-FN560	TRK-FN560WS
99-91	1.6L DOHC	5	RS5F31A	Two 32010 Differential Brgs.	TRK-FN170	TRK-FN170WS
99-91	2.0L DOHC	5	RS5F32V	Uses One 32010 & One R8018 Differential Brg.	TRK-FN200	TRK-FN200WS
99-91	2.0L DOHC	5	RS5F32V	Uses Two 32010 Differential Brgs.	TRK-FN520	TRK-FN520WS
92-91	1.6L	4	RN4F31A		TRK-FN170	TRK-FN170WS
90-88	1.6L	4	RN4F31A		TRK-FN140	TRK-FN140WS
90-86	1.6L	5	RS5F31A		TRK-FN140	TRK-FN140WS

LD Transmission

# Light Duty Transmission Applications

Year	Engine	Speed	Model#	Notes	Kit	w/Synchro Rings
<b>Nissan (cont.)</b>						
<b>Sentra (cont.)</b>						
89-87	1.6L	5	RS5F31E	4WD	TRK-FN420	TRK-FN420WS
89-87	1.6L		TY10A	Transfer Case Section Only	TRK-FN430	N/A
87-82	All	4	RN4F30A		TRK-FN130	TRK-FN130WS
87-82	Diesel	4	All		TRK-FN130	TRK-FN130WS
86-82	All	5	RS5F30A		TRK-FN130	TRK-FN130WS
<b>Stanza</b>						
92-91	2.4L	5	RS5F50A		TRK-FN220	TRK-FN220WS
92-91	2.4L	5	RS5F50V	Limited Slip Differential	TRK-FN470	TRK-FN470WS
90-86	2.0L	5	RS5F50A		TRK-FN120	TRK-FN120WS
88-86	2.0L		TY10		Obsolete	Obsolete
88-86	2.0L	5	RS5F50A	4WD	TRK-FN450	TRK-FN450WS
86-82	2.0L	5	RS5F31A		TRK-FN140	TRK-FN140WS
<b>Van</b>						
88-86	2.4L	5	FS5W71V		TRK-FN110	TRK-FN110WS1
<b>X-Terra</b>						
07-02	2.4L	5	FS5W71C	2WD, 1Pc. 2-3 Synchro Rings	TRK-FN590	TRK-FN590WS
03-00	3.0L	5	FS5R30A		TRK-FN150	TRK-FN150WS11
9/02-10/00	2.4L	5	FS5W71C	2WD, 3Pc. 2-3 Synchro Rings	TRK-FN590	TRK-FN590WS1
10/00-5/99	2.4L	5	FS5W71C	2WD, Cylindrical Rear C/S Brg.	TRK-FN530	TRK-FN530WS
<b>Oldsmobile</b>						
<b>All Car Models (82 &amp; Earlier)</b>						
85-66	All	3	Saginaw		TRK-301	TRK-301WS1
82-81	All	5	T5	Cylindrical C/S Brgs.	TRK-5	TRK-5WS
1982	All	4	T4		TRK-5	TRK-5WS1
82-80	All	4	MR2		TRK-FG110	Obsolete
82-74	All	4	T10W	6307 I/S Brg., 1" C/S	TRK-10WA	TRK-10WAWS
82-74	All	4	T10W	6307 I/S Brg., 1" C/S, Max-Type Ball Brgs.	TRK-10WAHD	TRK-10WAHDWS
82-66	All	4	Saginaw		TRK-301	TRK-301WS
74-68	All	3	Tremec		TRK-150F	TRK-150FWS
74-66	All	4	M21	1" Countershaft	TRK-297A	TRK-297AWS
74-66	All	4	M21	1" Countershaft and Max-Type Brgs.	TRK-297AHD	TRK-297AHDWS
73-66	All	4	T10W	6307 I/S Brg., 7/8" C/S, w/o Thrust Brg. Between 2nd & 3rd Gears	TRK-10W	TRK-10WWS
72-66	All	3w/OD	Saginaw		TRK-301A	TRK-301AWS
71-67	All	4	M22	1" Countershaft	TRK-297A	TRK-297AWS
71-67	All	4	M22	1" Countershaft and Max-Type Brgs.	TRK-297AHD	TRK-297AHDWS
68-55	All	3w/OD	319		TRK-G110	N/A
66-62	All	4	T10	6307 I/S Brg., 7/8" C/S, w/ Thrust Brg. Between 2nd & 3rd Gears	TRK-10E	TRK-10EWS
66-57	All	4	T10	6207 I/S Brg.	TRK-10A	TRK-10AWS
65-63	All	4	M20	7/8" Countershaft	TRK-297	TRK-297WS
65-63	All	4	M20	7/8" Countershaft and Max-Type Brgs.	TRK-297HD	TRK-297HDWS
63-62	All	4	M20	6207 I/S Brg.	TRK-297B	TRK-297BWS
54-40	All	3	Muncie 318		TRK-G100	N/A
<b>Achieva</b>						
97-95	2.3L, 2.4L	5	76mm Isuzu		TRK-FI210	TRK-FI210WS2
94-92	2.3L	5	76mm Isuzu	3 Pc. 1-2 Synchro Rings	TRK-FI120	TRK-FI120WS1
94-92	2.3L DOHC	5	NVT550/HM282		TRK-550	TRK-550WS



# Light Duty Transmission Applications



Year	Engine	Speed	Model#	Notes	Kit	w/Synchro Rings
<b>Oldsmobile (cont.)</b>						
<b>Alero</b>						
04-00	2.2L, 2.4L	5	All		TRK-FG140	TRK-FG140WS
<b>Calais</b>						
87-85	2.5L	5	76mm Isuzu		TRK-FI120	TRK-FI120WS
<b>Cutlass Calais</b>						
91-88	2.5L	5	76mm Isuzu	3 Pc. 1-2 Synchro Rings	TRK-FI120	TRK-FI120WS1
91-88	2.3L	5	NVT550/HM282		TRK-550	TRK-550WS
<b>Cutlass Supreme</b>						
90-88	All	5	NVT550/HM282		TRK-550	TRK-550WS
<b>Firenza</b>						
1988	2.0L	5	76mm Isuzu	3 Pc. 1-2 Synchro Rings	TRK-FI120	TRK-FI120WS1
87-83	All	4	MR2		TRK-FG110	Obsolete
87-83	All	5	76mm Isuzu		TRK-FI120	TRK-FI120WS
1987	2.8L	5	NVT550/HM282		TRK-550	TRK-550WS
<b>Omega</b>						
84-83	All	4	MR2		TRK-FG110	Obsolete
<b>Plymouth</b>						
<b>All Car Models (82 &amp; Earlier)</b>						
82-81	All	4	NP460	1-4 Synchro Rings Same Size	TRK-465	TRK-465WS2
80-75	All	4	NP833		TRK-833B	TRK-833BWS
80-70	All	3	NP230	35x80x21 I/S & O/S Brgs.	TRK-NP100	TRK-NP100WS
80-70	All	3	NP230	35x90x21 I/S & O/S Brgs.	TRK-NP100A	TRK-NP100AWS
76-74	All	3	390		TRK-150A	TRK-150AWS
74-72	All	3	NP250	14mm Wide O/S Brg.	TRK-NP110A	TRK-NP110AWS
74-72	All	3	NP250	17mm Wide O/S Brg.	TRK-NP110	TRK-NP110WS
72-64	All	4	NP833		TRK-833A	TRK-833AWS
<b>Acclaim</b>						
94-90	2.5L	5	NP523		TRK-568	TRK-568WS
93-91	3.0L	5	NP568		TRK-568	TRK-568WS
1989	2.5L	5	NP520		TRK-520	TRK-520WS
1989	2.5L	5	NP520	3 Pc. 2nd Synchro Ring	TRK-520	TRK-520WS1
<b>Barracuda</b>						
69-66		3	NP903		TRK-NP150	TRK-NP150WS
<b>Breeze</b>						
00-96	2.0L	5	F5M31/NVT350/A578		TRK-350	TRK-350WS
<b>Horizon</b>						
90-84	All	5	NP525		TRK-465	TRK-465WS
86-84	All	4	NP460		TRK-465	TRK-465WS3
83-81	All	4	NP460	1-4 Synchro Rings Same Size	TRK-465	TRK-465WS2
1983	All	5	NP465	1-5 Synchro Rings Same Size	TRK-465	TRK-465WS1
<b>Laser</b>						
94-93	1.8L, 2.0L	5	F5M22	3-4 Synchro Rings 36 Teeth, Synchro Rev.	TRK-FM150	TRK-FM150WS2
94-90			KM272	Transfer Case Section Only	TRK-FM350	N/A
94-90	2.0L Turbo	5	F5M33	Fiber Lined 1-2 Synchro Rings, Synchro Rev.	TRK-FM180	TRK-FM180WS
94-90	2.0L Turbo	5	W5M33	4WD, Fiber Lined Rings	TRK-FM160	TRK-FM160WS
92-90	1.8L	5	F5M22	3-4 Synchro Rings 30 Teeth	TRK-FM150	TRK-FM150WS
92-90	2.0L	5	F5M22	3-4 Synchro Rings 30 Teeth, Synchro Rev.	TRK-FM150	TRK-FM150WS1
<b>Neon</b>						
01-00	2.0L	5	F5M31/NVT350/A578	66mm O.D. Rear Input/Pinion Brgs.	TRK-350A	TRK-350AWS
00-95	2.0L	5	F5M31/NVT350/A578	63mm O.D. Rear Input/Pinion Brgs.	TRK-350	TRK-350WS

LD Transmission

# Light Duty Transmission Applications

Year	Engine	Speed	Model#	Notes	Kit	w/Synchro Rings
<b>Plymouth (cont.)</b>						
<b>Reliant</b>						
89-87	2.2L, 2.6L	5	NP520		TRK-520	TRK-520WS
89-87	2.2L, 2.6L	5	NP520	3 Pc. 2nd Synchro Ring	TRK-520	TRK-520WS1
86-84	2.2L, 2.6L	5	NP525		TRK-465	TRK-465WS
85-84	2.2L, 2.6L	4	NP460		TRK-465	TRK-465WS3
83-81	2.2L, 2.6L	4	NP460		TRK-465	TRK-465WS2
1983	2.2L, 2.6L	5	NP465		TRK-465	TRK-465WS1
<b>Sapporo</b>						
83-79	2.0L	5	KM131	6207-N M/S Front Brg.	TRK-FM140	TRK-FM140WS
83-79	2.6L	5	KM131	35BVV072 M/S Front Brg.	TRK-FM110	TRK-FM110WS
<b>Scamp</b>						
1983	2.2L	4	NP460		TRK-465	TRK-465WS2
<b>Sundance</b>						
94-90	2.2L, 2.5L	5	NP523		TRK-568	TRK-568WS
91-90	3.0L	5	NP568		TRK-568	TRK-568WS
89-87	2.2L, 2.5L	5	NP520		TRK-520	TRK-520WS
89-87	2.2L, 2.5L	5	NP520	3 Pc. 2nd Synchro Ring	TRK-520	TRK-520WS1
1987	2.2L, 2.5L	5	NP525		TRK-465	TRK-465WS
<b>Trailduster</b>						
81-74	All	4	NP435		TRK-127B	TRK-127BWS
79-74	All	3	NP230		TRK-NP100A	TRK-NP100AWS
<b>Turismo</b>						
87-84	All	5	NP525		TRK-465	TRK-465WS
86-84	All	4	NP460		TRK-465	TRK-465WS3
1983	All	4	NP460	1-4 Synchro Rings Same Size	TRK-465	TRK-465WS2
1983	All	5	NP465	1-5 Synchro Rings Same Size	TRK-465	TRK-465WS1
<b>Valiant</b>						
72-66	All	3	NP903		TRK-NP150	TRK-NP150WS
<b>Pontiac</b>						
<b>All Car Models (82 &amp; Earlier)</b>						
85-66	All	3	Saginaw		TRK-301	TRK-301WS1
82-81	All	5	T5	Cylindrical C/S Brgs.	TRK-5	TRK-5WS
1982	All	4	T4		TRK-5	TRK-5WS1
82-80	All	4	MR2		TRK-FG110	Obsolete
82-74	All	4	T10W	6307 I/S Brg., 1" C/S	TRK-10WA	TRK-10WAWS
82-74	All	4	T10W	6307 I/S Brg., 1" C/S, Max-Type Ball Brgs.	TRK-10WAHD	TRK-10WAHDWS
82-66	All	4	Saginaw		TRK-301	TRK-301WS
74-68	All	3	Tremec		TRK-150F	TRK-150FWS
74-66	All	4	M21	1" Countershaft	TRK-297A	TRK-297AWS
74-66	All	4	M21	1" Countershaft and Max-Type Brgs.	TRK-297AHD	TRK-297AHDWS
73-66	All	4	T10W	6307 I/S Brg., 7/8" C/S, w/o Thrust Brg. Between 2nd & 3rd Gears	TRK-10W	TRK-10WWS
72-66	All	3w/OD	Saginaw		TRK-301A	TRK-301AWS
71-67	All	4	M22	1" Countershaft	TRK-297A	TRK-297AWS
71-67	All	4	M22	1" Countershaft and Max-Type Brgs.	TRK-297AHD	TRK-297AHDWS
68-55	All	3w/OD	319		TRK-G110	N/A
66-62	All	4	T10	6307 I/S Brg., 7/8" C/S, w/ Thrust Brg. Between 2nd & 3rd Gears	TRK-10E	TRK-10EWS
66-57	All	4	T10	6207 I/S Brg.	TRK-10A	TRK-10AWS
65-63	All	4	M20	7/8" Countershaft	TRK-297	TRK-297WS
65-63	All	4	M20	7/8" Countershaft and Max-Type Brgs.	TRK-297HD	TRK-297HDWS

# Light Duty Transmission Applications

Year	Engine	Speed	Model#	Notes	Kit	w/Synchro Rings
<b>Pontiac (cont.)</b>						
<b>All Car Models (82 &amp; Earlier) (cont.)</b>						
63-62	All	4	M20	6207 I/S Brg.	TRK-297B	TRK-297BWS
54-40	All	3	Muncie 318		TRK-G100	N/A
<b>6000</b>						
91-87	2.8L, 3.1L	5	NVT550/HM282		TRK-550	TRK-550WS
<b>Fiero</b>						
87-84	2.5L	5	76mm Isuzu		TRK-FI120	TRK-FI120WS
86-85	All	4	MR2		TRK-FG110	Obsolete
1988	2.5L	5	76mm Isuzu	3 Pc. 1-2 Synchro Rings	TRK-FI120	TRK-FI120WS1
<b>Firebird</b>						
02-93	3.4L, 3.8L	5	T5 World Class	Taper C/S Brgs.	TRK-5W	TRK-5WWS
02-93	5.7L	6	T56		TRK-56	TRK-56WS
92-88	5.0L, 5.7L	5	T5 World Class	Taper C/S Brgs.	TRK-5W	TRK-5WWS
87-83	5.0L	5	T5	Cylindrical C/S Brgs.	TRK-5	TRK-5WS
84-83	2.5L	4	T4		TRK-5	TRK-5WS1
<b>Grand Am</b>						
04-00	2.2L, 2.4L	5	All		TRK-FG140	TRK-FG140WS
99-95	2.3L, 2.4L	5	76mm Isuzu		TRK-FI210	TRK-FI210WS2
94-88	2.0L	5	76mm Isuzu	3 Pc. 1-2 Synchro Rings	TRK-FI120	TRK-FI120WS1
87-85	3.0L	5	NVT550/HM282		TRK-550	TRK-550WS
87-83	2.0L	5	76mm Isuzu		TRK-FI120	TRK-FI120WS
<b>GTO</b>						
06-04	6.0L	6	T56		TRK-56	TRK-56WS1
<b>Phoenix</b>						
84-83	All	4	MR2		TRK-FG110	Obsolete
<b>Sunbird</b>						
94-88	2.0L	5	76mm Isuzu	3 Pc. 1-2 Synchro Rings	TRK-FI120	TRK-FI120WS1
94-87	2.8L, 3.1L	5	NVT550/HM282		TRK-550	TRK-550WS
87-85	2.0L	5	76mm Isuzu		TRK-FI120	TRK-FI120WS
84-80	1.8L	4	MR2		TRK-FG110	Obsolete
<b>Sunfire</b>						
05-00	2.2L, 2.4L	5	All		TRK-FG140	TRK-FG140WS
99-95	2.2L, 2.3L	5	76mm Isuzu		TRK-FI210	TRK-FI210WS2
<b>T1000</b>						
88-81	Diesel	5	MSG-5K		TRK-FI110	TRK-FI110WS
86-76	1.6L	4	70mm		TRK-G120	TRK-G120WS
85-82	1.8L	5	T5	DC51932 Front C/S Brg.	TRK-5A	TRK-5AWS
<b>Vibe</b>						
10-03	1.8L	5	C59		TRK-FT900	TRK-FT900WS1
05-03	1.8L	6	C60		TRK-FT790	TRK-FT790WS
1/03-03	1.8L	5	C59		TRK-FT900	TRK-FT900WS
<b>RAM</b>						
<b>2500</b>						
15-11	6.7L	6	G56		TRK-FC200	TRK-FC200WS
<b>3500</b>						
15-11	6.7L	6	G56		TRK-FC200	TRK-FC200WS
<b>4500</b>						
15-11	6.7L	6	G56		TRK-FC200	TRK-FC200WS
<b>5500</b>						
15-11	6.7L	6	G56		TRK-FC200	TRK-FC200WS

# Light Duty Transmission Applications

Year	Engine	Speed	Model#	Notes	Kit	w/Synchro Rings
<b>Saturn</b>						
<b>Ion</b>						
04-03/04	2.2L	5	F23/M86		TRK-FG140	TRK-FG140WS
<b>S Series</b>						
02-91	All	5	All		TRK-FG120	TRK-FG120WS
<b>Vue</b>						
04-02/04	2.2L	5	MG3		TRK-FG140	TRK-FG140WS
<b>Sterling</b>						
<b>825, 827</b>						
91-87	All	5	C3		TRK-FH190	TRK-FH190WS
<b>Suzuki</b>						
<b>Esteem</b>						
02-99	1.8L	5	EST		TRK-FS160	TRK-FS160WS
99-96	1.6L	5	EST		TRK-FS110	TRK-FS110WS
<b>Samurai</b>						
95-86	1.3L	5	All		TRK-FS100	TRK-FS100WS
<b>Sidekick</b>						
98-89	All	5	All		TRK-FS130	TRK-FS130WS
<b>Swift</b>						
01-89	1.3L	5	All		TRK-FS110	TRK-FS110WS
<b>Vitara</b>						
03-99	All	5	All		TRK-FS150	TRK-FS150WS
<b>X-90</b>						
98-96	1.6L	5	All		TRK-FS130	TRK-FS130WS
<b>Toyota</b>						
<b>4-Runner</b>						
8/00-10/96	2.7L	5	W59		TRK-FT210	TRK-FT210WS7
8/00-11/95	3.4L	5	R150	3 Pc. 2nd Synchro Ring	TRK-FT340	TRK-FT340WS5
1/98-11/95	3.0L	5	R150	1 Pc. 2nd Synchro Ring	TRK-FT340	TRK-FT340WS3
10/96-11/95	2.4L, 2.7L	5	W59		TRK-FT210	TRK-FT210WS6
11/95-5/94	3.0L	5	R150	Changes to 30T 5th Synchro Ring	TRK-FT340	N/A
11/95-8/92	2.4L	5	W56		TRK-FT210	TRK-FT210WS5
4/94-3/94	3.0L	5	R150	Changes to Triangular Teeth on 3rd Synchro Ring	TRK-FT200	TRK-FT200WS4
5/94-4/94	3.0L	5	R150	Changes to Anti-Rotation Tabs on 1-2 Synchro Ring	TRK-FT200	N/A
3/94-4/89	3.0L	5	R150		TRK-FT200	TRK-FT200WS3
8/92-10/91	2.4L	5	W56		TRK-FT210	TRK-FT210WS4
10/91-8/84	2.4L	5	W56		TRK-FT150	TRK-FT150WS
10/91-8/84	2.4L	5	W56	I/S Brg has 21mm wide outer race and 23mm wide inner race	TRK-FT230	TRK-FT230WS
8/90-8/88	All	5	G58	Snap Ring On End of C/S	TRK-FT190	TRK-FT190WS
88-84	All	5	G52	Nut On End of C/S	TRK-FT140	TRK-FT140WS
88-84	All	5	G52	32TM03 I/S Brg,	TRK-FT130	TRK-FT130WS
<b>Camry</b>						
05-02	2.4L		5		TRK-FT840	TRK-FT840WS
01-00	3.0L	5	E153		TRK-FT830	TRK-FT830WS1
01-97	2.2L	5	S51		TRK-FT880	TRK-FT880WS
99-97	3.0L	5	E153		TRK-FT830	TRK-FT830WS
96-92	2.2L	5	S51		TRK-FT330	TRK-FT330WS1
93-93	3.0L	5	E52		TRK-FT520	TRK-FT520WS1
8/93-6/91	2.5L	5	E52		TRK-FT520	Obsolete
8/92-6/91	2.0L, 2.2L	5	S51		TRK-FT330	TRK-FT330WS
6/91-2/88	2.5L	5	E52		TRK-FT530	TRK-FT530WS
91-88	2.0L	5	E50	4WD	TRK-FT540	TRK-FT540WS
6/91-4/84	2.0L, 2.2L	5	S51		TRK-FT280	TRK-FT280WS

LD Transmission

# Light Duty Transmission Applications



Year	Engine	Speed	Model#	Notes	Kit	w/Synchro Rings
<b>Toyota (cont.)</b>						
<b>Camry (cont.)</b>						
4/84-1/83	All	5	S51		TRK-FT560	TRK-FT560WS
<b>Celica</b>						
05-00	1.8L	6	C60		TRK-FT790	TRK-FT790WS
01-1/2/01	1.8L	5	C56		TRK-FT810	TRK-FT810WS
03-00	1.8L	5	C56		TRK-FT810	TRK-FT810WS1
99-93	1.8L	5	C52		TRK-FT570	TRK-FT570WS
99-93	2.2L	5	S54		TRK-FT580	TRK-FT580WS
8/93-4/91	1.6L	5	C52		TRK-FT320	TRK-FT320WS2
9/93-9/89	2.2L	5	S53		TRK-FT330	TRK-FT330WS
4/91-9/89	1.6L	5	C52		TRK-FT320	TRK-FT320WS1
93-88	2.0L	5	E50	4WD	TRK-FT610	TRK-FT610WS
89-85	2.0L	5	S53		TRK-FT280	TRK-FT280WS
84-81	2.4L, 2.8L	5	W55		TRK-FT150	TRK-FT150WS
80-72	2.2L	4	W40		TRK-FT370	TRK-FT370WS
80-72	2.6L	5	W50		TRK-FT100	TRK-FT100WS
<b>Corolla</b>						
10-04	1.8L	5	C59		TRK-FT900	TRK-FT900WS1
2003	1.8L	5	C59		TRK-FT900	TRK-FT900WS
02-00	1.8L	5	C59		TRK-FT780	TRK-FT780WS
99-98	1.8L	5	C59		TRK-FT780	TRK-FT780WS1
97-95	1.6L, 1.8L	5	C50,C51,C52		TRK-FT590	TRK-FT590WS1
94-93	1.6L, 1.8L	5	C50,C51,C52		TRK-FT590	TRK-FT590WS
92-88	1.6L	5	E57	4WD	TRK-FT410	TRK-FT410WS
6/92-8/86	1.6L	5	C50, C51, C52		TRK-FT320	TRK-FT320WS
8/86-8/83	1.6L	5	C50, C51, C52		TRK-FT270	TRK-FT270WS
86-83	1.6L	5	T51		TRK-FT670	TRK-FT670WS
8/85-4/84	Diesel	5	C50, C51, C52		TRK-FT280	TRK-FT280WS
4/84-8/83	Diesel	5	C50, C51, C52		TRK-FT620	TRK-FT620WS
4/83-6/81	All	5	T50A		TRK-FT250	TRK-FT250WS
81-75	All	4	All		TRK-FT640	TRK-FT640WS1
81-75	All	5	K50		TRK-FT640	TRK-FT640WS
81-72	All	5	T50		TRK-FT660	TRK-FT660WS
81-71	All	4	T40		TRK-FT650	TRK-FT650WS
81-71	All	4	T41		TRK-FT650	TRK-FT650WS
75-70	All	4	All		TRK-FT630	TRK-FT630WS1
75-70	All	5	K50		TRK-FT630	TRK-FT630WS
<b>Corona</b>						
82-80	All	5	W55		TRK-FT150	TRK-FT150WS
80-72	All	4	W40		TRK-FT370	TRK-FT370WS
80-72	All	5	W50		TRK-FT100	TRK-FT100WS
<b>Cressida</b>						
87-82	All	5	W58		TRK-FT150	TRK-FT150WS
82-78	All	5	W50		TRK-FT100	TRK-FT100WS
<b>Echo</b>						
05-00	1.5L	5	C150		TRK-FT850	TRK-FT850WS
<b>Landcruiser</b>						
87-86	4.2L	4	H42		TRK-FT470	N/A
86-81	4.2L	4	H42		TRK-FT310	N/A
80-74	All	4	H41		TRK-FT290	N/A
73-58	All	3	J30		TRK-FT480	N/A
<b>MR2</b>						
03-00	1.8L	5	C56		TRK-FT810	TRK-FT810WS1
95-93	2.0L Turbo	5	E153		TRK-FT520	TRK-FT520WS2
95-92	2.2L	5	S54		TRK-FT330	TRK-FT330WS1

# Light Duty Transmission Applications

Year	Engine	Speed	Model#	Notes	Kit	w/Synchro Rings
<b>Toyota (cont.)</b>						
<b>MR2 (cont.)</b>						
8/93-1/92	2.0L Turbo	5	E153		TRK-FT520	TRK-FT520WS1
8/92-1/90	2.2L	5	S54		TRK-FT330	TRK-FT330WS
1/92-1/90	2.0L Turbo	5	E153		TRK-FT520	Obsolete
1/90-4/88	1.6L	5	E51		TRK-FT550	TRK-FT550WS
1/90-3/88	1.6L S/C	5	E51		TRK-FT870	TRK-FT870WS
1/90-8/86	1.6L	5	C52		TRK-FT320	TRK-FT320WS
2/28/88-88	1.6L S/C	5	E51		TRK-FT870	TRK-FT870WS1
3/88-8/87	1.6L	5	E51		TRK-FT510	TRK-FT510WS
8/86-8/83	1.6L	5	C52		TRK-FT270	TRK-FT270WS
<b>MR2 Spyder</b>						
05-04	1.8L	6	C65		TRK-FT790	TRK-FT790WS
02-04	1.8L	5	C56M		TRK-FT810	TRK-FT810WS2
05-03	1.8L	5	C56		TRK-FT810	TRK-FT810WS
<b>Matrix</b>						
10-04	1.8L	5	C59		TRK-FT900	TRK-FT900WS1
05-03	1.8L	6	C60		TRK-FT790	TRK-FT790WS
2003	1.8L	5	C59		TRK-FT900	TRK-FT900WS
<b>Paseo</b>						
97-92	1.5L	5	C150		TRK-FT430	TRK-FT430WS2
<b>Pickup</b>						
12/94-8/92	2.4L	5	W55		TRK-FT210	TRK-FT210WS5
12/94-8/92	2.4L	5	W56		TRK-FT210	TRK-FT210WS5
12/94-8/88	3.0L	5	R150		TRK-FT200	TRK-FT200WS3
8/92-10/91	2.4L	5	W55		TRK-FT210	TRK-FT210WS4
8/92-10/91	2.4L	5	W56		TRK-FT210	TRK-FT210WS4
10/91-8/85	2.4L	5	W55		TRK-FT150	TRK-FT150WS
10/91-8/85	2.4L	5	W55	I/S Brg has 21mm wide outer race and 23mm wide inner race	TRK-FT230	TRK-FT230WS
10/91-84	2.4L	5	W56		TRK-FT150	TRK-FT150WS
10/91-84	2.4L	5	W56	I/S Brg has 21mm wide outer race and 23mm wide inner race	TRK-FT230	TRK-FT230WS
8/90-8/88	All	5	G58	Snap Ring On End of C/S	TRK-FT190	TRK-FT190WS
8/88-8/85	2.4L Turbo, 3.0L	5	R150		TRK-FT200	TRK-FT200WS2
8/88-8/85	2.4L Turbo, 3.0L	5	R151		TRK-FT200	TRK-FT200WS2
8/88-8/82	2.4L	5	G52	Nut On End of C/S	TRK-FT140	TRK-FT140WS
8/88-8/82	2.4L	5	G52	32TM03 I/S Brg,	TRK-FT130	TRK-FT130WS
86-74	All	5	W50		TRK-FT100	TRK-FT100WS
86-71	All	4	W40		TRK-FT370	TRK-FT370WS
84-80	All	4	L45		TRK-FT120	TRK-FT120WS
84-80	All	4	L45	032-2 I/S Brg	TRK-FT220	TRK-FT220WS
84-80	All	4	L45	63/32 I/S Brg.	TRK-FT110	TRK-FT110WS
84-80	All	5	L52		TRK-FT120	TRK-FT120WS
84-80	All	5	L52	032-2 I/S Brg	TRK-FT220	TRK-FT220WS
84-80	All	5	L52	63/32 I/S Brg.	TRK-FT110	TRK-FT110WS
80-74	All	4	L43	0.75" Countershaft	TRK-FT350	TRK-FT350WS
74-72	All	4	L42	0.69" Countershaft	TRK-FT450	TRK-FT450WS
11/71-69	All	4	L40	C/S Needles Not Included	TRK-FT460	TRK-FT460WS
<b>Previa</b>						
97-90	2.4L	5			TRK-FT190	TRK-FT190WS



# Light Duty Transmission Applications

Year	Engine	Speed	Model#	Notes	Kit	w/Synchro Rings
<b>Toyota (cont.)</b>						
<b>RAV4</b>						
05-01	2.0L	5	E352	FWD	TRK-FT890	TRK-FT890WS
05-01	2.0L	5	E352F	4WD	TRK-FT800	TRK-FT800WS
00-96	2.0L	5	All	4WD	TRK-FT410	TRK-FT410WS1
<b>Solara</b>						
08-04	2.4L	5	All		TRK-FT840	TRK-FT840WS
01-99	2.2L	5	S51		TRK-FT880	TRK-FT880WS
1999	3.0L	5	E153		TRK-FT830	TRK-FT830WS
<b>Starlet</b>						
84-83	1.3L	4	All		TRK-FT710	TRK-FT710WS1
84-81	1.3L	5	K50		TRK-FT710	TRK-FT710WS
<b>Supra</b>						
98-93	3.0L	5	W58	21mm Wide M/S Front Brg.	TRK-FT210	TRK-FT210WS4
93-85	3.0L Turbo	5	R154	23mm Wide M/S Front Brg.	TRK-FT200	TRK-FT200WS
93-86	3.0L	5	W58		TRK-FT150	TRK-FT150WS
<b>T100</b>						
96-94	3.4L	5	R150		TRK-FT340	TRK-FT340WS3
95-10/93	2.7L	5	W56		TRK-FT210	TRK-FT210WS6
8/94-4/94	3.0L	5	R150		TRK-FT200	TRK-FT200WS5
4/94-3/93	3.0L	5	R150		TRK-FT200	TRK-FT200WS4
93-93	3.0L	5	R150		TRK-FT200	TRK-FT200WS3
<b>Tacoma</b>						
04-00	3.4L	5	R150		TRK-FT340	TRK-FT340WS6
7/01-10/96	2.4L, 2.7L	5	W59		TRK-FT210	TRK-FT210WS7
01-95	2.4L, 2.7L	5	W59		TRK-FT210	TRK-FT210WS5
04-95	3.4L	5	R150		TRK-FT340	TRK-FT340WS7
9/00-4/96	3.4L	5	R150		TRK-FT340	TRK-FT340WS5
10/96-95	2.4L, 2.7L	5	W59		TRK-FT210	TRK-FT210WS6
96-95	3.4L	5	R150		TRK-FT340	TRK-FT340WS4
98-6/30/98	2.4L, 2.7L	5	W59	2WD	TRK-FT210	TRK-FT210WS9
98-6/30/98	2.4L, 2.7L	5	W59	4WD	TRK-FT210	TRK-FT210WS8
<b>Tercel</b>						
98-94	1.5L	5	C151		TRK-FT430	TRK-FT430WS2
96-86	1.5L	4	C140		TRK-FT430	TRK-FT430WS1
9/94-8/86	1.5L	5	C150		TRK-FT430	TRK-FT430WS
88-83	1.5L	6	Z52F, Z54F	4WD	TRK-FT700	TRK-FT700WS
88-10/82	1.5L	5	Z51, Z52, Z53		TRK-FT690	TRK-FT690WS1
88-80	1.5L		Front Diff. Section	FWD	TRK-FT730	N/A
86-80	1.5L	4	Z41, Z44, Z46		TRK-FT680	TRK-FT680WS
82-80	1.5L	5	Z51, Z52, Z53	4WD	TRK-FT690	TRK-FT690WS
<b>Tundra</b>						
04-99	3.4L	5	R150	2WD	TRK-FT340	TRK-FT340WS6
<b>Van</b>						
89-83	All	5	G53	Nut On End of C/S	TRK-FT440	TRK-FT440WS

LD Transmission

# Light Duty Transmission Rebuild Kits



## TRK-247

Position	Part Number	Qty
Input Shaft Brg.	ZT1047	1
Mainshaft Pilot Brg.	ZN1044	1
Mainshaft Thrust Brg.	ZN1028	1
Mainshaft Front Brg.	30207	1
Mainshaft Rear Brg.	ZB1060	1
Countershaft Front Brg.	ZC1021	1
Countershaft Ctr. Brg.	ZC1033	1
Countershaft Rear Brg.	304L	1
Input Shaft Seal	1990 (27x43)	1
Input Shaft Oil Ring	BZ3541E	1
Input Shaft Oil Baffle	ZM1014	1
Output Shaft Seal	14900 (1.500x2.372)	1
Output Shaft Seal	1981 (30x45)	1
Expansion Plug	ZM1013	3
Shift Socket	ZM1008	2
Gasket Set	GT247	1
Top Cover Pins	M50P1	2
Top Cover Gasket	GT247R	1

## TRK-247WS

Position	Part Number	Qty
Input Shaft Brg.	ZT1047	1
Mainshaft Pilot Brg.	ZN1044	1
Mainshaft Thrust Brg.	ZN1028	1
Mainshaft Front Brg.	30207	1
Mainshaft Rear Brg.	ZB1060	1
Countershaft Front Brg.	ZC1021	1
Countershaft Ctr. Brg.	ZC1033	1
Countershaft Rear Brg.	304L	1
Input Shaft Seal	1990 (27x43)	1
Input Shaft Oil Ring	BZ3541E	1
Input Shaft Oil Baffle	ZM1014	1
Output Shaft Seal	14900 (1.500x2.372)	1
Output Shaft Seal	1981 (30x45)	1
Expansion Plug	ZM1013	3
Shift Socket	ZM1008	2
Gasket Set	GT247	1
Top Cover Pins	M50P1	2
Top Cover Gasket	GT247R	1
1st, 2nd, 3rd & 4th Gear	ZSY1054	4
Synchro Ring		
5th Gear Synchro Ring	ZSY1055	1
Rev. Gear Synchro Ring	ZSY1077	1

## TRK-247WS1

Position	Part Number	Qty
Input Shaft Brg.	ZT1047	1
Mainshaft Pilot Brg.	ZN1044	1
Mainshaft Thrust Brg.	ZN1028	1
Mainshaft Front Brg.	30207	1
Mainshaft Rear Brg.	ZB1060	1
Countershaft Front Brg.	ZC1021	1
Countershaft Ctr. Brg.	ZC1033	1
Countershaft Rear Brg.	304L	1
Input Shaft Seal	1990 (27x43)	1
Input Shaft Oil Ring	BZ3541E	1
Input Shaft Oil Baffle	ZM1014	1
Output Shaft Seal	14900 (1.500x2.372)	1
Output Shaft Seal	1981 (30x45)	1
Expansion Plug	ZM1013	3
Shift Socket	ZM1008	2
Gasket Set	GT247	1
Top Cover Pins	M50P1	2
Top Cover Gasket	GT247R	1
1st, 2nd, 3rd & 4th Gear	ZSY1054	4
Synchro Ring		
5th Gear Synchro Ring	ZSY1057	1
Rev. Gear Synchro Ring	ZSY1058	1

## TRK-248

Position	Part Number	Qty
Input Shaft Brg.	ZT1087	1
Mainshaft Pilot Brg.	ZN1034	1
Mainshaft Thrust Brg.	ZN1035	1
Mainshaft Center Brg.	ZT1088	1
Mainshaft Rear Brg.	ZB1061	1
Countershaft Front Brg.	ZC1010	1
Countershaft Ctr. Brg.	ZC1023	1
Countershaft Rear Brg.	304L	1
Input Shaft Seal	223012 (30x44)	1
Input Shaft Oil Baffle	ZM1015	1
Input Shaft Oil Ring	BZ3421E	1
Output Shaft Seal	14900 (1.500x2.372)	1
Output Shaft Seal	223608 (36x42)	1
Gasket Set	GT248	1
Top Cover Gasket	GT248R	1
Top Cover Pins	M50P1	2
Expansion Plug	ZM1013	4
Shift Socket	ZM1008	2

## TRK-248WS

Position	Part Number	Qty
Input Shaft Brg.	ZT1087	1
Mainshaft Pilot Brg.	ZN1034	1
Mainshaft Thrust Brg.	ZN1035	1
Mainshaft Center Brg.	ZT1088	1
Mainshaft Rear Brg.	ZB1061	1
Countershaft Front Brg.	ZC1010	1
Countershaft Ctr. Brg.	ZC1023	1
Countershaft Rear Brg.	304L	1
Input Shaft Seal	223012 (30x44)	1
Input Shaft Oil Baffle	ZM1015	1
Input Shaft Oil Ring	BZ3421E	1
Output Shaft Seal	14900 (1.500x2.372)	1
Output Shaft Seal	223608 (36x42)	1
Gasket Set	GT248	1
Top Cover Gasket	GT248R	1
Top Cover Pins	M50P1	2
Expansion Plug	ZM1013	4
Shift Socket	ZM1008	2
1st, 2nd, 3rd & 4th Gear	ZSY1059	4
Synchro Ring		
5th Gear Synchro Ring	ZSY1054	1
Rev. Gear Synchro Ring	ZSY1056	1

## TRK-248WS1

Position	Part Number	Qty
Input Shaft Brg.	ZT1087	1
Mainshaft Pilot Brg.	ZN1034	1
Mainshaft Thrust Brg.	ZN1035	1
Mainshaft Center Brg.	ZT1088	1
Mainshaft Rear Brg.	ZB1061	1
Countershaft Front Brg.	ZC1010	1
Countershaft Ctr. Brg.	ZC1023	1
Countershaft Rear Brg.	304L	1
Input Shaft Seal	223012 (30x44)	1
Input Shaft Oil Baffle	ZM1015	1
Input Shaft Oil Ring	BZ3421E	1
Output Shaft Seal	14900 (1.500x2.372)	1
Output Shaft Seal	223608 (36x42)	1
Gasket Set	GT248	1
Top Cover Gasket	GT248R	1
Top Cover Pins	M50P1	2
Expansion Plug	ZM1013	4
Shift Socket	ZM1008	2
1st, 2nd, 3rd & 4th Gear	ZSY1059	4
Synchro Ring		
5th Gear Synchro Ring	ZSY1060	1
Rev. Gear Synchro Ring	ZSY1061	1

## TRK-300ZF

Position	Part Number	Qty
Input Shaft Brg.	28580-28521	1
Mainshaft Pilot Brg.	JH13349	1
Output Shaft Brg.	J28573-28521	1
Countershaft Front Brg.	2580-2520	1
Countershaft Rear Brg.	2580-2520	1
Front Brg. Retainer	ZM1004	1
O-Ring		
Input Shaft Seal	3771 (35x50)	1
Input Shaft Seal	14703	1
Oil Baffle	E7T27040A	1
Oil Ring	F4T27046A	1
Output Shaft Seal	225010 (50x65)	1
Output Shaft Seal	15803 (40x52)	1
Gasket Set	GT300ZF	1
Sealing Cap (Small)	ZM1035	4
Sealing Cap (Large)	ZM1036	3
Mainshaft 1st Gear Brg.	ZN1055	1
Mainshaft 3rd Gear Brg.	ZN1057	1
Mainshaft 3rd Gear Brg.	ZN1056	1
Inner Race		
Mainshaft 2nd Gear Brg.	ZN1057	1
Mainshaft 5th Gear Brg.	ZN1058	1
Mainshaft Rev. Gear	ZN1055	1
Needle Brg.		
Rev. Idler Gear Brg.	ZN1059	2
Shift Rail Brg.	ZN1060	2

## TRK-300ZF/1

Position	Part Number	Qty
Input Shaft Brg.	28580-28521	1
Mainshaft Pilot Brg.	JH13349	1
Output Shaft Brg.	J28573-28521	1
Countershaft Front Brg.	2580-2520	1
Countershaft Rear Brg.	2580-2520	1
Front Brg. Retainer	ZM1004	1
O-Ring		
Input Shaft Seal	3771 (35x50)	1
Input Shaft Seal	14703	1
Oil Baffle	E7T27040A	1
Oil Ring	F4T27046A	1
Output Shaft Seal	225010 (50x65)	1
Output Shaft Seal	15803 (40x52)	1
Gasket Set	GT300ZF	1
Sealing Cap (Small)	ZM1035	4
Sealing Cap (Large)	ZM1036	3

## TRK-300ZF/1WS

Position	Part Number	Qty
Input Shaft Brg.	28580-28521	1
Mainshaft Pilot Brg.	JH13349	1
Output Shaft Brg.	J28573-28521	1
Countershaft Front Brg.	2580-2520	1
Countershaft Rear Brg.	2580-2520	1
Front Brg. Retainer	ZM1004	1
O-Ring		
Input Shaft Seal	3771 (35x50)	1
Input Shaft Seal	14703	1
Oil Baffle	E7T27040A	1
Oil Ring	F4T27046A	1
Output Shaft Seal	225010 (50x65)	1
Output Shaft Seal	15803 (40x52)	1
Gasket Set	GT300ZF	1
Sealing Cap (Small)	ZM1035	4
Sealing Cap (Large)	ZM1036	3
1st Gear Synchro Ring	ZSY1198	1
2nd Gear Synchro Ring	ZSY1198	1
3rd Gear Synchro Ring	ZSY1199	1
4th Gear Synchro Ring	ZSY1199	1
5th Gear Synchro Ring	ZSY1199	1
Rev. Gear Synchro Ring	ZSY1200	1

LD Transmission

# Light Duty Transmission Rebuild Kits



## TRK-300ZF/1WS1

Position	Part Number	Qty
Input Shaft Brg.	28580-28521	1
Mainshaft Pilot Brg.	JH13349	1
Output Shaft Brg.	J28573-28521	1
Countershaft Front Brg.	2580-2520	1
Countershaft Rear Brg.	2580-2520	1
Front Brg. Retainer	ZM1004	1
O-Ring		
Input Shaft Seal	3771 (35x50)	1
Input Shaft Seal	14703	1
Oil Baffle	E7TZ7040A	1
Oil Ring	F4TZ7046A	1
Output Shaft Seal	225010 (50x65)	1
Output Shaft Seal	15803 (40x52)	1
Gasket Set	GT300ZF	1
Sealing Cap (Small)	ZM1035	4
Sealing Cap (Large)	ZM1036	3
1st Gear Synchro Ring	ZSY1203	1
2nd Gear Synchro Ring	ZSY1203	1
3rd Gear Synchro Ring	ZSY1204	1
4th Gear Synchro Ring	ZSY1204	1
5th Gear Synchro Ring	ZSY1204	1
Rev. Gear Synchro Ring	ZSY1205	1

## TRK-300ZFB

Position	Part Number	Qty
Input Shaft Brg.	JLM704649-JLM704610	1
Output Shaft Brg.	NP043905-NP547779	1
Input Shaft Seal	226530 (65x90)	1
Output Shaft Seal	75X100X12	1
O-Ring	ZM1004	1
Adapter Gasket	GTCNP1	1

## TRK-300ZBDL

Position	Part Number	Qty
Input Shaft Brg.	JLM506849-JLM506811	1
Output Shaft Brg.	NP043905-NP547779	1
Input Shaft Seal	75X100X12	1
Output Shaft Seal	75X100X12	1
O-Ring	ZM1004	1
Adapter Gasket	GTCNP1	1

## TRK-300ZFW

Position	Part Number	Qty
Input Shaft Brg.	28580-28521	1
Mainshaft Pilot Brg.	JH13349	1
Output Shaft Brg.	J28573-28521	1
Countershaft Front Brg.	2580-2520	1
Countershaft Rear Brg.	2580-2520	1
Front Brg. Retainer	ZM1004	1
O-Ring		
Input Shaft Seal	3771 (35x50)	1
Input Shaft Seal	14703	1
Oil Baffle	E7TZ7040A	1
Oil Ring	F4TZ7046A	1
Output Shaft Seal	225010 (50x65)	1
Output Shaft Seal	15803 (40x52)	1
Gasket Set	GT300ZF	1
Sealing Cap (Small)	ZM1035	4
Sealing Cap (Large)	ZM1036	3
Mainshaft 1st Gear Brg.	ZN1055	1
Mainshaft 3rd Gear Brg.	ZN1057	1
Mainshaft 3rd Gear Brg.	ZN1056	1
Inner Race		
Mainshaft 2nd Gear Brg.	ZN1057	1
Mainshaft 5th Gear Brg.	ZN1058	1
Mainshaft Rev. Gear	ZN1055	1
Needle Brg.		
Rev. Idler Gear Brg.	ZN1059	2
Shift Rail Brg.	ZN1060	2
1st Gear Synchro Ring	ZSY1198	1
2nd Gear Synchro Ring	ZSY1198	1
3rd Gear Synchro Ring	ZSY1199	1
4th Gear Synchro Ring	ZSY1199	1
5th Gear Synchro Ring	ZSY1199	1
Rev. Gear Synchro Ring	ZSY1200	1

## TRK-300ZFW1

Position	Part Number	Qty
Input Shaft Brg.	28580-28521	1
Mainshaft Pilot Brg.	JH13349	1
Output Shaft Brg.	J28573-28521	1
Countershaft Front Brg.	2580-2520	1
Countershaft Rear Brg.	2580-2520	1
Front Brg. Retainer	ZM1004	1
O-Ring		
Input Shaft Seal	3771 (35x50)	1
Input Shaft Seal	14703	1
Oil Baffle	E7TZ7040A	1
Oil Ring	F4TZ7046A	1
Output Shaft Seal	225010 (50x65)	1
Output Shaft Seal	15803 (40x52)	1
Gasket Set	GT300ZF	1
Sealing Cap (Small)	ZM1035	4
Sealing Cap (Large)	ZM1036	3
Mainshaft 1st Gear Brg.	ZN1055	1
Mainshaft 3rd Gear Brg.	ZN1057	1
Mainshaft 3rd Gear Brg.	ZN1056	1
Inner Race		
Mainshaft 2nd Gear Brg.	ZN1057	1
Mainshaft 5th Gear Brg.	ZN1058	1
Mainshaft Rev. Gear	ZN1055	1
Needle Brg.		
Rev. Idler Gear Brg.	ZN1059	2
Shift Rail Brg.	ZN1060	2
1st Gear Synchro Ring	ZSY1203	1
2nd Gear Synchro Ring	ZSY1203	1
3rd Gear Synchro Ring	ZSY1204	1
4th Gear Synchro Ring	ZSY1204	1
5th Gear Synchro Ring	ZSY1204	1
Rev. Gear Synchro Ring	ZSY1205	1

## TRK-4500D

Position	Part Number	Qty
Input Shaft Brg.	ZT1010-ZT1009	1
Mainshaft Pilot Brg.	ZN1003	1
Mainshaft Thrust Brg.	ZN1013	1
Mainshaft Rear Brg.	M804049-M804010	1
Ext. Housing Brg.	B5020	1
Countershaft Front Brg.	ZT1006-ZT1005	1
Countershaft Rear Brg.	ZT1008-ZT1007	1
Input Shaft Seal	714655 (1.375x1.981)	1
Output Shaft Seal	7300S (1.685x2.500)	1
Output Shaft Seal	4741 (2.200x3.022)	1
Output Shaft Seal	710058 (1.937x2.562)	1
Countershaft Plug	ZM1005	1
Fork Pads	4219073	1
Fork Pads	4167969	2
Transfer Case Adapter	GTCNP1	1
Gasket		
PTO Cover Gasket	GTPTO55	2

## TRK-4500DN

Position	Part Number	Qty
Input Shaft Brg.	ZT1010-ZT1009	1
Mainshaft Pilot Brg.	ZN1003	1
Mainshaft Thrust Brg.	ZN1013	1
Mainshaft Rear Brg.	M804049-M804010	1
Ext. Housing Brg.	B5020	1
Countershaft Front Brg.	ZT1006-ZT1005	1
Countershaft Rear Brg.	ZT1008-ZT1007	1
Input Shaft Seal	714655 (1.375x1.981)	1
Output Shaft Seal	7300S (1.685x2.500)	1
Output Shaft Seal	4741 (2.200x3.022)	1
Output Shaft Seal	710058 (1.937x2.562)	1
Countershaft Plug	ZM1005	1
Fork Pads	4219073	1
Fork Pads	4167969	2
Transfer Case Adapter	GTCNP1	1
Gasket		
PTO Cover Gasket	GTPTO55	2
Mainshaft 1st & 2nd Gear Needle Brg.	ZN1005	2
Mainshaft 3rd Gear Needle Brg.	ZN1006	1
Mainshaft Rev. Gear Needle Brg.	ZN1004	1
Countershaft 5th Gear Needle Brg.	ZN1010	1
Idler Gear Brg.	ZN1007	2

## TRK-4500DN1

Position	Part Number	Qty
Input Shaft Brg.	ZT1010-ZT1009	1
Mainshaft Pilot Brg.	ZN1003	1
Mainshaft Thrust Brg.	ZN1013	1
Mainshaft Rear Brg.	M804049-M804010	1
Ext. Housing Brg.	B5020	1
Countershaft Front Brg.	ZT1006-ZT1005	1
Countershaft Rear Brg.	ZT1008-ZT1007	1
Input Shaft Seal	714655 (1.375x1.981)	1
Output Shaft Seal	7300S (1.685x2.500)	1
Output Shaft Seal	4741 (2.200x3.022)	1
Output Shaft Seal	710058 (1.937x2.562)	1
Countershaft Plug	ZM1005	1
Fork Pads	4219073	1
Fork Pads	4167969	2
Transfer Case Adapter	GTCNP1	1
Gasket		
PTO Cover Gasket	GTPTO55	2
Mainshaft 1st & 2nd Gear Needle Brg.	ZN1005	2
Mainshaft 3rd Gear Needle Brg.	ZN1006	1
Mainshaft Rev. Gear Needle Brg.	ZN1004	1
Countershaft 5th Gear Needle Brg.	ZN1010	1
Idler Gear Brg.	ZN1214	1

LD Transmission

# Light Duty Transmission Rebuild Kits



<b>TRK-4500DN1SPK</b>			<b>TRK-4500DN1WS</b>			<b>TRK-4500DN1SPKWS</b>		
Position	Part Number	Qty	Position	Part Number	Qty	Position	Part Number	Qty
Input Shaft Brg.	ZT1010-ZT1009	1	Input Shaft Brg.	ZT1010-ZT1009	1	Input Shaft Brg.	ZT1010-ZT1009	1
Mainshaft Pilot Brg.	ZN1003	1	Mainshaft Pilot Brg.	ZN1003	1	Mainshaft Pilot Brg.	ZN1003	1
Mainshaft Thrust Brg.	ZN1013	1	Mainshaft Thrust Brg.	ZN1013	1	Mainshaft Thrust Brg.	ZN1013	1
Mainshaft Rear Brg.	M804049-M804010	1	Mainshaft Rear Brg.	M804049-M804010	1	Mainshaft Rear Brg.	M804049-M804010	1
Ext. Housing Brg.	B5020	1	Ext. Housing Brg.	B5020	1	Ext. Housing Brg.	B5020	1
Countershaft Front Brg.	ZT1006-ZT1005	1	Countershaft Front Brg.	ZT1006-ZT1005	1	Countershaft Front Brg.	ZT1006-ZT1005	1
Countershaft Rear Brg.	ZT1008-ZT1007	1	Countershaft Rear Brg.	ZT1008-ZT1007	1	Countershaft Rear Brg.	ZT1008-ZT1007	1
Input Shaft Seal	714655 (1.375x1.981)	1	Input Shaft Seal	714655 (1.375x1.981)	1	Input Shaft Seal	714655 (1.375x1.981)	1
Output Shaft Seal	7300S (1.685x2.500)	1	Output Shaft Seal	7300S (1.685x2.500)	1	Output Shaft Seal	7300S (1.685x2.500)	1
Output Shaft Seal	4741 (2.200x3.022)	1	Output Shaft Seal	4741 (2.200x3.022)	1	Output Shaft Seal	4741 (2.200x3.022)	1
Output Shaft Seal	710058 (1.937x2.562)	1	Output Shaft Seal	710058 (1.937x2.562)	1	Output Shaft Seal	710058 (1.937x2.562)	1
Countershaft Plug	ZM1005	1	Countershaft Plug	ZM1005	1	Countershaft Plug	ZM1005	1
Fork Pads	4219073	1	Fork Pads	4219073	1	Fork Pads	4219073	1
Fork Pads	4167969	2	Fork Pads	4167969	2	Fork Pads	4167969	2
Transfer Case Adapter Gasket	GTCNP1	1	Transfer Case Adapter Gasket	GTCNP1	1	Transfer Case Adapter Gasket	GTCNP1	1
PTO Cover Gasket	GTPTO55	2	PTO Cover Gasket	GTPTO55	2	PTO Cover Gasket	GTPTO55	2
Mainshaft 1st & 2nd Gear Needle Brg.	ZN1005	2	Mainshaft 1st & 2nd Gear Needle Brg.	ZN1005	2	Mainshaft 1st & 2nd Gear Needle Brg.	ZN1005	2
Mainshaft 3rd Gear Needle Brg.	ZN1006	1	Mainshaft 3rd Gear Needle Brg.	ZN1006	1	Mainshaft 3rd Gear Needle Brg.	ZN1006	1
Mainshaft Rev. Gear Needle Brg.	ZN1004	1	Mainshaft Rev. Gear Needle Brg.	ZN1004	1	Mainshaft Rev. Gear Needle Brg.	ZN1004	1
Countershaft 5th Gear Needle Brg.	ZN1010	1	Countershaft 5th Gear Needle Brg.	ZN1010	1	Countershaft 5th Gear Needle Brg.	ZN1010	1
Idler Gear Brg.	ZN1214	1	Idler Gear Brg.	ZN1214	1	Idler Gear Brg.	ZN1007	2
Small Parts Kit	SPK4500	1	1st & 2nd Gear Synchro Ring	ZSY1115	2	1st & 2nd Gear Synchro Ring	ZSY1115	2
<b>TRK-4500DN1SPKWS</b>			<b>TRK-4500DN1WS</b>			<b>TRK-4500DN1SPKWS</b>		
Position	Part Number	Qty	Position	Part Number	Qty	Position	Part Number	Qty
Input Shaft Brg.	ZT1010-ZT1009	1	3rd & 4th Gear Synchro Ring	ZSY1116	2	3rd & 4th Gear Synchro Ring	ZSY1116	2
Mainshaft Pilot Brg.	ZN1003	1	5th & Rev Gear Synchro Ring	ZSY1114	2	5th & Rev Gear Synchro Ring	ZSY1114	2
Mainshaft Thrust Brg.	ZN1013	1	<b>TRK-4500DN1SPK</b>			<b>TRK-4500DNWS</b>		
Mainshaft Rear Brg.	M804049-M804010	1	Position	Part Number	Qty	Position	Part Number	Qty
Ext. Housing Brg.	B5020	1	Input Shaft Brg.	ZT1010-ZT1009	1	Input Shaft Brg.	ZT1010-ZT1009	1
Countershaft Front Brg.	ZT1006-ZT1005	1	Mainshaft Pilot Brg.	ZN1003	1	Mainshaft Pilot Brg.	ZN1003	1
Countershaft Rear Brg.	ZT1008-ZT1007	1	Mainshaft Thrust Brg.	ZN1013	1	Mainshaft Thrust Brg.	ZN1013	1
Input Shaft Seal	714655 (1.375x1.981)	1	Mainshaft Rear Brg.	M804049-M804010	1	Mainshaft Rear Brg.	M804049-M804010	1
Output Shaft Seal	7300S (1.685x2.500)	1	Ext. Housing Brg.	B5020	1	Ext. Housing Brg.	B5020	1
Output Shaft Seal	4741 (2.200x3.022)	1	Countershaft Front Brg.	ZT1006-ZT1005	1	Countershaft Front Brg.	ZT1006-ZT1005	1
Output Shaft Seal	710058 (1.937x2.562)	1	Countershaft Rear Brg.	ZT1008-ZT1007	1	Countershaft Front Brg.	ZT1006-ZT1005	1
Countershaft Plug	ZM1005	1	Input Shaft Seal	714655 (1.375x1.981)	1	Countershaft Rear Brg.	ZT1008-ZT1007	1
Fork Pads	4219073	1	Output Shaft Seal	7300S (1.685x2.500)	1	Countershaft Rear Brg.	ZT1008-ZT1007	1
Fork Pads	4167969	2	Output Shaft Seal	4741 (2.200x3.022)	1	Input Shaft Seal	714655 (1.375x1.981)	1
Transfer Case Adapter Gasket	GTCNP1	1	Output Shaft Seal	710058 (1.937x2.562)	1	Output Shaft Seal	7300S (1.685x2.500)	1
PTO Cover Gasket	GTPTO55	2	Countershaft Plug	ZM1005	1	Output Shaft Seal	4741 (2.200x3.022)	1
Mainshaft 1st & 2nd Gear Needle Brg.	ZN1005	2	Fork Pads	4219073	1	Output Shaft Seal	710058 (1.937x2.562)	1
Mainshaft 3rd Gear Needle Brg.	ZN1006	1	Fork Pads	4167969	2	Countershaft Plug	ZM1005	1
Mainshaft Rev. Gear Needle Brg.	ZN1004	1	Transfer Case Adapter Gasket	GTCNP1	1	Fork Pads	4219073	1
Countershaft 5th Gear Needle Brg.	ZN1010	1	PTO Cover Gasket	GTPTO55	2	Fork Pads	4167969	2
Idler Gear Brg.	ZN1214	1	Mainshaft 1st & 2nd Gear Needle Brg.	ZN1005	2	Transfer Case Adapter Gasket	GTCNP1	1
1st & 2nd Gear Synchro Ring	ZSY1115	2	Mainshaft 3rd Gear Needle Brg.	ZN1006	1	PTO Cover Gasket	GTPTO55	2
3rd & 4th Gear Synchro Ring	ZSY1116	2	Mainshaft Rev. Gear Needle Brg.	ZN1004	1	Mainshaft 1st & 2nd Gear Needle Brg.	ZN1005	2
5th & Rev Gear Synchro Ring	ZSY1114	2	Countershaft 5th Gear Needle Brg.	ZN1010	1	Mainshaft 3rd Gear Needle Brg.	ZN1006	1
Small Parts Kit	SPK4500	1	Idler Gear Brg.	ZN1007	2	Mainshaft Rev. Gear Needle Brg.	ZN1004	1
			Small Parts Kit	SPK4500	1	Countershaft 5th Gear Needle Brg.	ZN1010	1
						Idler Gear Brg.	ZN1007	2
						1st & 2nd Gear Synchro Ring	ZSY1115	2
						3rd & 4th Gear Synchro Ring	ZSY1116	2
						5th & Rev Gear Synchro Ring	ZSY1114	2

LD Transmission

# Light Duty Transmission Rebuild Kits



TRK-4500DSPK		
Position	Part Number	Qty
Input Shaft Brg.	ZT1010-ZT1009	1
Mainshaft Pilot Brg.	ZN1003	1
Mainshaft Thrust Brg.	ZN1013	1
Mainshaft Rear Brg.	M804049-M804010	1
Ext. Housing Brg.	B5020	1
Countershaft Front Brg.	ZT1006-ZT1005	1
Countershaft Rear Brg.	ZT1008-ZT1007	1
Input Shaft Seal	714655 (1.375x1.981)	1
Output Shaft Seal	7300S (1.685x2.500)	1
Output Shaft Seal	4741 (2.200x3.022)	1
Output Shaft Seal	710058 (1.937x2.562)	1
Countershaft Plug	ZM1005	1
Fork Pads	4219073	1
Fork Pads	4167969	2
Transfer Case Adapter	GTCNP1	1
Gasket		
PTO Cover Gasket	GTPTO55	2
Small Parts Kit	SPK4500	1

TRK-4500DSPKWS		
Position	Part Number	Qty
Input Shaft Brg.	ZT1010-ZT1009	1
Mainshaft Pilot Brg.	ZN1003	1
Mainshaft Thrust Brg.	ZN1013	1
Mainshaft Rear Brg.	M804049-M804010	1
Ext. Housing Brg.	B5020	1
Countershaft Front Brg.	ZT1006-ZT1005	1
Countershaft Rear Brg.	ZT1008-ZT1007	1
Input Shaft Seal	714655 (1.375x1.981)	1
Output Shaft Seal	7300S (1.685x2.500)	1
Output Shaft Seal	4741 (2.200x3.022)	1
Output Shaft Seal	710058 (1.937x2.562)	1
Countershaft Plug	ZM1005	1
Fork Pads	4219073	1
Fork Pads	4167969	2
Transfer Case Adapter	GTCNP1	1
Gasket		
PTO Cover Gasket	GTPTO55	2
1st & 2nd Gear Synchro	ZSY1115	2
Ring		
3rd & 4th Gear Synchro	ZSY1116	2
Ring		
5th & Rev Gear Synchro	ZSY1114	2
Ring		
Small Parts Kit	SPK4500	1

TRK-4500DWS		
Position	Part Number	Qty
Input Shaft Brg.	ZT1010-ZT1009	1
Mainshaft Pilot Brg.	ZN1003	1
Mainshaft Thrust Brg.	ZN1013	1
Mainshaft Rear Brg.	M804049-M804010	1
Ext. Housing Brg.	B5020	1
Countershaft Front Brg.	ZT1006-ZT1005	1
Countershaft Rear Brg.	ZT1008-ZT1007	1
Input Shaft Seal	714655 (1.375x1.981)	1
Output Shaft Seal	7300S (1.685x2.500)	1
Output Shaft Seal	4741 (2.200x3.022)	1
Output Shaft Seal	710058 (1.937x2.562)	1
Countershaft Plug	ZM1005	1
Fork Pads	4219073	1
Fork Pads	4167969	2
Transfer Case Adapter	GTCNP1	1
Gasket		
PTO Cover Gasket	GTPTO55	2
1st & 2nd Gear Synchro	ZSY1115	2
Ring		
3rd & 4th Gear Synchro	ZSY1116	2
Ring		
5th & Rev Gear Synchro	ZSY1114	2
Ring		

TRK-4500GM		
Position	Part Number	Qty
Input Shaft Brg.	ZT1010-ZT1009	1
Mainshaft Pilot Brg.	ZN1003	1
Mainshaft Thrust Brg.	ZN1013	1
Mainshaft Rear Brg.	M804049-M804010	1
Ext. Housing Brg.	B5020	1
Countershaft Front Brg.	ZT1006-ZT1005	1
Countershaft Rear Brg.	ZT1008-ZT1007	1
Input Shaft Seal	714655 (1.375x1.981)	1
Output Shaft Seal	4670N (2.503x3.500)	1
Output Shaft Seal	410085N (2.000x2.996)	1
Output Shaft Seal	1943 (45x72.2)	1
Output Shaft Seal	224850 (48x72)	1
Countershaft Plug	ZM1005	1
Fork Pads	4219073	1
Fork Pads	4167969	2
Transfer Case Adapter	GTCNP1	1
Gasket		
PTO Cover Gasket	GTPTO55	2

TRK-4500GM1		
Position	Part Number	Qty
Input Shaft Brg.	ZT1010-NP728109	1
Mainshaft Pilot Brg.	ZN1003	1
Mainshaft Thrust Brg.	ZN1013	1
Mainshaft Rear Brg.	M804049-M804010	1
Ext. Housing Brg.	B5020	1
Countershaft Front Brg.	ZT1006-ZT1005	1
Countershaft Rear Brg.	ZT1008-ZT1007	1
Input Shaft Seal	4638N (1.375x1.982)	1
Output Shaft Seal	4670N (2.503x3.500)	1
Output Shaft Seal	410085N (2.000x2.996)	1
Output Shaft Seal	1943 (45x72.2)	1
Output Shaft Seal	224850 (48x72)	1
Countershaft Plug	ZM1005	1
Fork Pads	4219073	1
Fork Pads	4167969	2
Transfer Case Adapter	GTCNP1	1
Gasket		
PTO Cover Gasket	GTPTO55	2

TRK-4500GM1N		
Position	Part Number	Qty
Input Shaft Brg.	ZT1010-NP728109	1
Mainshaft Pilot Brg.	ZN1003	1
Mainshaft Thrust Brg.	ZN1013	1
Mainshaft Rear Brg.	M804049-M804010	1
Ext. Housing Brg.	B5020	1
Countershaft Front Brg.	ZT1006-ZT1005	1
Countershaft Rear Brg.	ZT1008-ZT1007	1
Input Shaft Seal	4638N (1.375x1.982)	1
Output Shaft Seal	4670N (2.503x3.500)	1
Output Shaft Seal	410085N (2.000x2.996)	1
Output Shaft Seal	1943 (45x72.2)	1
Output Shaft Seal	224850 (48x72)	1
Countershaft Plug	ZM1005	1
Fork Pads	4219073	1
Fork Pads	4167969	2
Transfer Case Adapter	GTCNP1	1
Gasket		
PTO Cover Gasket	GTPTO55	2
Mainshaft 1st & 2nd	ZN1005	2
Gear Needle Brg.		
Mainshaft 3rd Gear	ZN1006	1
Needle Brg.		
Mainshaft Rev. Gear	ZN1004	1
Needle Brg.		
Countershaft 5th Gear	ZN1010	1
Needle Brg.		
Idler Gear Brg.	ZN1007	2

TRK-4500GM1N1		
Position	Part Number	Qty
Input Shaft Brg.	ZT1010-NP728109	1
Mainshaft Pilot Brg.	ZN1003	1
Mainshaft Thrust Brg.	ZN1013	1
Mainshaft Rear Brg.	M804049-M804010	1
Ext. Housing Brg.	B5020	1
Countershaft Front Brg.	ZT1006-ZT1005	1
Countershaft Rear Brg.	ZT1008-ZT1007	1
Input Shaft Seal	4638N (1.375x1.982)	1
Output Shaft Seal	4670N (2.503x3.500)	1
Output Shaft Seal	410085N (2.000x2.996)	1
Output Shaft Seal	1943 (45x72.2)	1
Output Shaft Seal	224850 (48x72)	1
Countershaft Plug	ZM1005	1
Fork Pads	4219073	1
Fork Pads	4167969	2
Transfer Case Adapter	GTCNP1	1
Gasket		
PTO Cover Gasket	GTPTO55	2
Mainshaft 1st & 2nd	ZN1005	2
Gear Needle Brg.		
Mainshaft 3rd Gear	ZN1006	1
Needle Brg.		
Mainshaft Rev. Gear	ZN1004	1
Needle Brg.		
Countershaft 5th Gear	ZN1010	1
Needle Brg.		
Idler Gear Brg.	ZN1214	1

TRK-4500GM1N1SPK		
Position	Part Number	Qty
Input Shaft Brg.	ZT1010-NP728109	1
Mainshaft Pilot Brg.	ZN1003	1
Mainshaft Thrust Brg.	ZN1013	1
Mainshaft Rear Brg.	M804049-M804010	1
Ext. Housing Brg.	B5020	1
Countershaft Front Brg.	ZT1006-ZT1005	1
Countershaft Rear Brg.	ZT1008-ZT1007	1
Input Shaft Seal	4638N (1.375x1.982)	1
Output Shaft Seal	4670N (2.503x3.500)	1
Output Shaft Seal	410085N (2.000x2.996)	1
Output Shaft Seal	1943 (45x72.2)	1
Output Shaft Seal	224850 (48x72)	1
Countershaft Plug	ZM1005	1
Fork Pads	4219073	1
Fork Pads	4167969	2
Transfer Case Adapter	GTCNP1	1
Gasket		
PTO Cover Gasket	GTPTO55	2
Mainshaft 1st & 2nd	ZN1005	2
Gear Needle Brg.		
Mainshaft 3rd Gear	ZN1006	1
Needle Brg.		
Mainshaft Rev. Gear	ZN1004	1
Needle Brg.		
Countershaft 5th Gear	ZN1010	1
Needle Brg.		
Idler Gear Brg.	ZN1214	1
Small Parts Kit	SPK4500	1

LD Transmission



# Light Duty Transmission Rebuild Kits



TRK-4500GM1N1SPKWS			TRK-4500GM1NSPK			TRK-4500GM1NWS		
Position	Part Number	Qty	Position	Part Number	Qty	Position	Part Number	Qty
Input Shaft Brg.	ZT1010-NP728109	1	Input Shaft Brg.	ZT1010-NP728109	1	Input Shaft Brg.	ZT1010-NP728109	1
Mainshaft Pilot Brg.	ZN1003	1	Mainshaft Pilot Brg.	ZN1003	1	Mainshaft Pilot Brg.	ZN1003	1
Mainshaft Thrust Brg.	ZN1013	1	Mainshaft Thrust Brg.	ZN1013	1	Mainshaft Thrust Brg.	ZN1013	1
Mainshaft Rear Brg.	M804049-M804010	1	Mainshaft Rear Brg.	M804049-M804010	1	Mainshaft Rear Brg.	M804049-M804010	1
Ext. Housing Brg.	B5020	1	Ext. Housing Brg.	B5020	1	Ext. Housing Brg.	B5020	1
Countershaft Front Brg.	ZT1006-ZT1005	1	Countershaft Front Brg.	ZT1006-ZT1005	1	Countershaft Front Brg.	ZT1006-ZT1005	1
Countershaft Rear Brg.	ZT1008-ZT1007	1	Countershaft Rear Brg.	ZT1008-ZT1007	1	Countershaft Rear Brg.	ZT1008-ZT1007	1
Input Shaft Seal	4638N (1.375x1.982)	1	Input Shaft Seal	4638N (1.375x1.982)	1	Input Shaft Seal	4638N (1.375x1.982)	1
Output Shaft Seal	4670N (2.503x3.500)	1	Output Shaft Seal	4670N (2.503x3.500)	1	Output Shaft Seal	4670N (2.503x3.500)	1
Output Shaft Seal	410085N (2.000x2.996)	1	Output Shaft Seal	410085N (2.000x2.996)	1	Output Shaft Seal	410085N (2.000x2.996)	1
Output Shaft Seal	1943 (45x72.2)	1	Output Shaft Seal	1943 (45x72.2)	1	Output Shaft Seal	1943 (45x72.2)	1
Output Shaft Seal	224850 (48x72)	1	Output Shaft Seal	224850 (48x72)	1	Output Shaft Seal	224850 (48x72)	1
Countershaft Plug	ZM1005	1	Countershaft Plug	ZM1005	1	Countershaft Plug	ZM1005	1
Fork Pads	4219073	1	Fork Pads	4219073	1	Fork Pads	4219073	1
Fork Pads	4167969	2	Fork Pads	4167969	2	Fork Pads	4167969	2
Transfer Case Adapter Gasket	GTCNP1	1	Transfer Case Adapter Gasket	GTCNP1	1	Transfer Case Adapter Gasket	GTCNP1	1
PTO Cover Gasket	GTPTO55	2	PTO Cover Gasket	GTPTO55	2	PTO Cover Gasket	GTPTO55	2
Mainshaft 1st & 2nd Gear Needle Brg.	ZN1005	2	Mainshaft 1st & 2nd Gear Needle Brg.	ZN1005	2	Mainshaft 1st & 2nd Gear Needle Brg.	ZN1005	2
Mainshaft 3rd Gear Needle Brg.	ZN1006	1	Mainshaft 3rd Gear Needle Brg.	ZN1006	1	Mainshaft 3rd Gear Needle Brg.	ZN1006	1
Mainshaft Rev. Gear Needle Brg.	ZN1004	1	Mainshaft Rev. Gear Needle Brg.	ZN1004	1	Mainshaft Rev. Gear Needle Brg.	ZN1004	1
Countershaft 5th Gear Needle Brg.	ZN1010	1	Countershaft 5th Gear Needle Brg.	ZN1010	1	Countershaft 5th Gear Needle Brg.	ZN1010	1
Idler Gear Brg.	ZN1214	1	Idler Gear Brg.	ZN1007	2	Idler Gear Brg.	ZN1007	2
1st & 2nd Gear Synchro Ring	ZSY1115	2	Small Parts Kit	SPK4500	1	1st & 2nd Gear Synchro Ring	ZSY1115	2
3rd & 4th Gear Synchro Ring	ZSY1116	2	<b>TRK-4500GM1NSPKWS</b>			3rd & 4th Gear Synchro Ring	ZSY1116	2
5th Gear Synchro Ring	ZSY1114	1	<b>Position</b>	<b>Part Number</b>	<b>Qty</b>	5th Gear Synchro Ring	ZSY1114	1
Small Parts Kit	SPK4500	1	Input Shaft Brg.	ZT1010-NP728109	1	<b>TRK-4500GM1SPK</b>		
<b>TRK-4500GM1N1WS</b>			Mainshaft Pilot Brg.	ZN1003	1	<b>Position</b>	<b>Part Number</b>	<b>Qty</b>
Input Shaft Brg.	ZT1010-NP728109	1	Mainshaft Thrust Brg.	ZN1013	1	Input Shaft Brg.	ZT1010-NP728109	1
Mainshaft Pilot Brg.	ZN1003	1	Mainshaft Rear Brg.	M804049-M804010	1	Mainshaft Pilot Brg.	ZN1003	1
Mainshaft Thrust Brg.	ZN1013	1	Ext. Housing Brg.	B5020	1	Mainshaft Thrust Brg.	ZN1013	1
Mainshaft Rear Brg.	M804049-M804010	1	Countershaft Front Brg.	ZT1006-ZT1005	1	Mainshaft Rear Brg.	M804049-M804010	1
Ext. Housing Brg.	B5020	1	Countershaft Rear Brg.	ZT1008-ZT1007	1	Ext. Housing Brg.	B5020	1
Countershaft Front Brg.	ZT1006-ZT1005	1	Input Shaft Seal	4638N (1.375x1.982)	1	Countershaft Front Brg.	ZT1006-ZT1005	1
Countershaft Rear Brg.	ZT1008-ZT1007	1	Output Shaft Seal	4670N (2.503x3.500)	1	Countershaft Rear Brg.	ZT1008-ZT1007	1
Input Shaft Seal	4638N (1.375x1.982)	1	Output Shaft Seal	410085N (2.000x2.996)	1	Input Shaft Seal	4638N (1.375x1.982)	1
Output Shaft Seal	4670N (2.503x3.500)	1	Output Shaft Seal	1943 (45x72.2)	1	Output Shaft Seal	4670N (2.503x3.500)	1
Output Shaft Seal	410085N (2.000x2.996)	1	Output Shaft Seal	224850 (48x72)	1	Output Shaft Seal	410085N (2.000x2.996)	1
Output Shaft Seal	1943 (45x72.2)	1	Countershaft Plug	ZM1005	1	Output Shaft Seal	1943 (45x72.2)	1
Output Shaft Seal	224850 (48x72)	1	Fork Pads	4219073	1	Output Shaft Seal	224850 (48x72)	1
Countershaft Plug	ZM1005	1	Fork Pads	4167969	2	Countershaft Plug	ZM1005	1
Fork Pads	4219073	1	Transfer Case Adapter Gasket	GTCNP1	1	Fork Pads	4219073	1
Fork Pads	4167969	2	PTO Cover Gasket	GTPTO55	2	Fork Pads	4167969	2
Transfer Case Adapter Gasket	GTCNP1	1	Mainshaft 1st & 2nd Gear Needle Brg.	ZN1005	2	Transfer Case Adapter Gasket	GTCNP1	1
PTO Cover Gasket	GTPTO55	2	Mainshaft 3rd Gear Needle Brg.	ZN1006	1	PTO Cover Gasket	GTPTO55	2
Mainshaft 1st & 2nd Gear Needle Brg.	ZN1005	2	Mainshaft Rev. Gear Needle Brg.	ZN1004	1	Small Parts Kit	SPK4500	1
Mainshaft 3rd Gear Needle Brg.	ZN1006	1	Countershaft 5th Gear Needle Brg.	ZN1010	1			
Mainshaft Rev. Gear Needle Brg.	ZN1004	1	Idler Gear Brg.	ZN1007	2			
Countershaft 5th Gear Needle Brg.	ZN1010	1	1st & 2nd Gear Synchro Ring	ZSY1115	2			
Idler Gear Brg.	ZN1214	1	3rd & 4th Gear Synchro Ring	ZSY1116	2			
1st & 2nd Gear Synchro Ring	ZSY1115	2	5th Gear Synchro Ring	ZSY1114	1			
3rd & 4th Gear Synchro Ring	ZSY1116	2	Small Parts Kit	SPK4500	1			
5th Gear Synchro Ring	ZSY1114	1						

LD Transmission



# Light Duty Transmission Rebuild Kits



TRK-4500GM1SPKWS			TRK-4500GMN			TRK-4500GMNSPKWS		
Position	Part Number	Qty	Position	Part Number	Qty	Position	Part Number	Qty
Input Shaft Brg.	ZT1010-NP728109	1	Input Shaft Brg.	ZT1010-ZT1009	1	Input Shaft Brg.	ZT1010-ZT1009	1
Mainshaft Pilot Brg.	ZN1003	1	Mainshaft Pilot Brg.	ZN1003	1	Mainshaft Pilot Brg.	ZN1003	1
Mainshaft Thrust Brg.	ZN1013	1	Mainshaft Thrust Brg.	ZN1013	1	Mainshaft Thrust Brg.	ZN1013	1
Mainshaft Rear Brg.	M804049-M804010	1	Mainshaft Rear Brg.	M804049-M804010	1	Mainshaft Rear Brg.	M804049-M804010	1
Ext. Housing Brg.	B5020	1	Ext. Housing Brg.	B5020	1	Ext. Housing Brg.	B5020	1
Countershaft Front Brg.	ZT1006-ZT1005	1	Countershaft Front Brg.	ZT1006-ZT1005	1	Countershaft Front Brg.	ZT1006-ZT1005	1
Countershaft Rear Brg.	ZT1008-ZT1007	1	Countershaft Rear Brg.	ZT1008-ZT1007	1	Countershaft Rear Brg.	ZT1008-ZT1007	1
Input Shaft Seal	4638N (1.375x1.982)	1	Input Shaft Seal	714655 (1.375x1.981)	1	Input Shaft Seal	714655 (1.375x1.981)	1
Output Shaft Seal	4670N (2.503x3.500)	1	Output Shaft Seal	4670N (2.503x3.500)	1	Output Shaft Seal	4670N (2.503x3.500)	1
Output Shaft Seal	410085N (2.000x2.996)	1	Output Shaft Seal	410085N (2.000x2.996)	1	Output Shaft Seal	410085N (2.000x2.996)	1
Output Shaft Seal	1943 (45x72.2)	1	Output Shaft Seal	1943 (45x72.2)	1	Output Shaft Seal	1943 (45x72.2)	1
Output Shaft Seal	224850 (48x72)	1	Output Shaft Seal	224850 (48x72)	1	Output Shaft Seal	224850 (48x72)	1
Countershaft Plug	ZM1005	1	Countershaft Plug	ZM1005	1	Countershaft Plug	ZM1005	1
Fork Pads	4219073	1	Fork Pads	4219073	1	Fork Pads	4219073	1
Fork Pads	4167969	2	Fork Pads	4167969	2	Fork Pads	4167969	2
Transfer Case Adapter	GTCNP1	1	Transfer Case Adapter	GTCNP1	1	Transfer Case Adapter	GTCNP1	1
Gasket			Gasket			Gasket		
PTO Cover Gasket	GTPTO55	2	PTO Cover Gasket	GTPTO55	2	PTO Cover Gasket	GTPTO55	2
1st & 2nd Gear Synchro Ring	ZSY1115	2	Mainshaft 1st & 2nd Gear Needle Brg.	ZN1005	2	Mainshaft 1st & 2nd Gear Needle Brg.	ZN1005	2
3rd & 4th Gear Synchro Ring	ZSY1116	2	Mainshaft 3rd Gear Needle Brg.	ZN1006	1	Mainshaft 3rd Gear Needle Brg.	ZN1006	1
5th Gear Synchro Ring	ZSY1114	1	Mainshaft Rev. Gear Needle Brg.	ZN1004	1	Mainshaft Rev. Gear Needle Brg.	ZN1004	1
Small Parts Kit	SPK4500	1	Countershaft 5th Gear Needle Brg.	ZN1010	1	Countershaft 5th Gear Needle Brg.	ZN1010	1
<b>TRK-4500GM1WS</b>			<b>TRK-4500GMNSPK</b>			<b>TRK-4500GMNWS</b>		
Position	Part Number	Qty	Position	Part Number	Qty	Position	Part Number	Qty
Input Shaft Brg.	ZT1010-NP728109	1	Input Shaft Brg.	ZT1010-ZT1009	1	Input Shaft Brg.	ZT1010-ZT1009	1
Mainshaft Pilot Brg.	ZN1003	1	Mainshaft Pilot Brg.	ZN1003	1	Mainshaft Pilot Brg.	ZN1003	1
Mainshaft Thrust Brg.	ZN1013	1	Mainshaft Thrust Brg.	ZN1013	1	Mainshaft Thrust Brg.	ZN1013	1
Mainshaft Rear Brg.	M804049-M804010	1	Mainshaft Rear Brg.	M804049-M804010	1	Mainshaft Rear Brg.	M804049-M804010	1
Ext. Housing Brg.	B5020	1	Ext. Housing Brg.	B5020	1	Ext. Housing Brg.	B5020	1
Countershaft Front Brg.	ZT1006-ZT1005	1	Countershaft Front Brg.	ZT1006-ZT1005	1	Countershaft Front Brg.	ZT1006-ZT1005	1
Countershaft Rear Brg.	ZT1008-ZT1007	1	Countershaft Rear Brg.	ZT1008-ZT1007	1	Countershaft Rear Brg.	ZT1008-ZT1007	1
Input Shaft Seal	4638N (1.375x1.982)	1	Input Shaft Seal	714655 (1.375x1.981)	1	Input Shaft Seal	714655 (1.375x1.981)	1
Output Shaft Seal	4670N (2.503x3.500)	1	Output Shaft Seal	4670N (2.503x3.500)	1	Output Shaft Seal	4670N (2.503x3.500)	1
Output Shaft Seal	410085N (2.000x2.996)	1	Output Shaft Seal	410085N (2.000x2.996)	1	Output Shaft Seal	410085N (2.000x2.996)	1
Output Shaft Seal	1943 (45x72.2)	1	Output Shaft Seal	1943 (45x72.2)	1	Output Shaft Seal	1943 (45x72.2)	1
Output Shaft Seal	224850 (48x72)	1	Output Shaft Seal	224850 (48x72)	1	Output Shaft Seal	224850 (48x72)	1
Countershaft Plug	ZM1005	1	Countershaft Plug	ZM1005	1	Countershaft Plug	ZM1005	1
Fork Pads	4219073	1	Fork Pads	4219073	1	Fork Pads	4219073	1
Fork Pads	4167969	2	Fork Pads	4167969	2	Fork Pads	4167969	2
Transfer Case Adapter	GTCNP1	1	Transfer Case Adapter	GTCNP1	1	Transfer Case Adapter	GTCNP1	1
Gasket			Gasket			Gasket		
PTO Cover Gasket	GTPTO55	2	PTO Cover Gasket	GTPTO55	2	PTO Cover Gasket	GTPTO55	2
1st & 2nd Gear Synchro Ring	ZSY1115	2	Mainshaft 1st & 2nd Gear Needle Brg.	ZN1005	2	Mainshaft 1st & 2nd Gear Needle Brg.	ZN1005	2
3rd & 4th Gear Synchro Ring	ZSY1116	2	Mainshaft 3rd Gear Needle Brg.	ZN1006	1	Mainshaft 3rd Gear Needle Brg.	ZN1006	1
5th Gear Synchro Ring	ZSY1114	1	Mainshaft Rev. Gear Needle Brg.	ZN1004	1	Mainshaft Rev. Gear Needle Brg.	ZN1004	1
<b>LD Transmission</b>			<b>Small Parts Kit</b>			<b>Small Parts Kit</b>		
				SPK4500	1			

# Light Duty Transmission Rebuild Kits



TRK-4500GMSPK		
Position	Part Number	Qty
Input Shaft Brg.	ZT1010-ZT1009	1
Mainshaft Pilot Brg.	ZN1003	1
Mainshaft Thrust Brg.	ZN1013	1
Mainshaft Rear Brg.	M804049-M804010	1
Ext. Housing Brg.	B5020	1
Countershaft Front Brg.	ZT1006-ZT1005	1
Countershaft Rear Brg.	ZT1008-ZT1007	1
Input Shaft Seal	714655 (1.375x1.981)	1
Output Shaft Seal	4670N (2.503x3.500)	1
Output Shaft Seal	410085N (2.000x2.996)	1
Output Shaft Seal	1943 (45x72.2)	1
Output Shaft Seal	224850 (48x72)	1
Countershaft Plug	ZM1005	1
Fork Pads	4219073	1
Fork Pads	4167969	2
Transfer Case Adapter	GTCNP1	1
Gasket		
PTO Cover Gasket	GTPTO55	2
Small Parts Kit	SPK4500	1

TRK-4500GMSPKWS		
Position	Part Number	Qty
Input Shaft Brg.	ZT1010-ZT1009	1
Mainshaft Pilot Brg.	ZN1003	1
Mainshaft Thrust Brg.	ZN1013	1
Mainshaft Rear Brg.	M804049-M804010	1
Ext. Housing Brg.	B5020	1
Countershaft Front Brg.	ZT1006-ZT1005	1
Countershaft Rear Brg.	ZT1008-ZT1007	1
Input Shaft Seal	714655 (1.375x1.981)	1
Output Shaft Seal	4670N (2.503x3.500)	1
Output Shaft Seal	410085N (2.000x2.996)	1
Output Shaft Seal	1943 (45x72.2)	1
Output Shaft Seal	224850 (48x72)	1
Countershaft Plug	ZM1005	1
Fork Pads	4219073	1
Fork Pads	4167969	2
Transfer Case Adapter	GTCNP1	1
Gasket		
PTO Cover Gasket	GTPTO55	2
1st & 2nd Gear Synchro	ZSY1115	2
Ring		
3rd & 4th Gear Synchro	ZSY1116	2
Ring		
5th Gear Synchro Ring	ZSY1114	1
Small Parts Kit	SPK4500	1

TRK-4500GMWS		
Position	Part Number	Qty
Input Shaft Brg.	ZT1010-ZT1009	1
Mainshaft Pilot Brg.	ZN1003	1
Mainshaft Thrust Brg.	ZN1013	1
Mainshaft Rear Brg.	M804049-M804010	1
Ext. Housing Brg.	B5020	1
Countershaft Front Brg.	ZT1006-ZT1005	1
Countershaft Rear Brg.	ZT1008-ZT1007	1
Input Shaft Seal	714655 (1.375x1.981)	1
Output Shaft Seal	4670N (2.503x3.500)	1
Output Shaft Seal	410085N (2.000x2.996)	1
Output Shaft Seal	1943 (45x72.2)	1
Output Shaft Seal	224850 (48x72)	1
Countershaft Plug	ZM1005	1
Fork Pads	4219073	1
Fork Pads	4167969	2
Transfer Case Adapter	GTCNP1	1
Gasket		
PTO Cover Gasket	GTPTO55	2
1st & 2nd Gear Synchro	ZSY1115	2
Ring		
3rd & 4th Gear Synchro	ZSY1116	2
Ring		
5th Gear Synchro Ring	ZSY1114	1

TRK-5600		
Position	Part Number	Qty
Input Shaft Brg.	HM804849-HM804810	1
Mainshaft Pilot Brg.	32305	1
Mainshaft Front Brg.	45290-45220	1
Mainshaft Rear Brg.	209	1
Countershaft Front Brg.	LM102949-LM102910	1
Countershaft Ctr. Brg.	25590-25520	1
Countershaft Rear Brg.	LM48548-LM48510	1
Input Shaft Seal	4638N (1.375x1.982)	1
Input Shaft Seal	14703 (38x50)	1
Output Shaft Seal	4741 (2.200x3.022)	1
Output Shaft Seal	710058 (1.937x2.562)	1

TRK-5600N		
Position	Part Number	Qty
Input Shaft Brg.	HM804849-HM804810	1
Mainshaft Pilot Brg.	32305	1
Mainshaft Front Brg.	45290-45220	1
Mainshaft Rear Brg.	209	1
Countershaft Front Brg.	LM102949-LM102910	1
Countershaft Ctr. Brg.	25590-25520	1
Countershaft Rear Brg.	LM48548-LM48510	1
Mainshaft 1st Gear	ZN1142	1
Needle Brg.		
Mainshaft 2nd Gear	ZN1142	1
Needle Brg.		
Mainshaft 3rd Gear	ZN1005	1
Needle Brg.		
Mainshaft 4th Gear	ZN1005	1
Needle Brg.		
Mainshaft 6th Gear	ZN1141	1
Needle Brg.		
Mainshaft Rev. Gear	ZN1004	1
Needle Brg.		
Rev. Idler Gear Brg.	ZN1143	2
Input Shaft Seal	4638N (1.375x1.982)	1
Input Shaft Seal	14703 (38x50)	1
Output Shaft Seal	4741 (2.200x3.022)	1
Output Shaft Seal	710058 (1.937x2.562)	1

TRK-5600NS		
Position	Part Number	Qty
Input Shaft Brg.	HM804849-HM804810	1
Mainshaft Pilot Brg.	32305	1
Mainshaft Front Brg.	45290-45220	1
Mainshaft Rear Brg.	209	1
Countershaft Front Brg.	LM102949-LM102910	1
Countershaft Ctr. Brg.	25590-25520	1
Countershaft Rear Brg.	LM48548-LM48510	1
Mainshaft 1st Gear	ZN1142	1
Needle Brg.		
Mainshaft 2nd Gear	ZN1142	1
Needle Brg.		
Mainshaft 3rd Gear	ZN1005	1
Needle Brg.		
Mainshaft 4th Gear	ZN1005	1
Needle Brg.		
Mainshaft 6th Gear	ZN1141	1
Needle Brg.		
Mainshaft Rev. Gear	ZN1004	1
Needle Brg.		
Rev. Idler Gear Brg.	ZN1143	2
Input Shaft Seal	4638N (1.375x1.982)	1
Input Shaft Seal	14703 (38x50)	1
Output Shaft Seal	4741 (2.200x3.022)	1
Output Shaft Seal	710058 (1.937x2.562)	1
1st,2nd,3rd,4th,5th,6th&	ZSY1216	7
Rev.Synchro Ring		

TRK-5600WS		
Position	Part Number	Qty
Input Shaft Brg.	HM804849-HM804810	1
Mainshaft Pilot Brg.	32305	1
Mainshaft Front Brg.	45290-45220	1
Mainshaft Rear Brg.	209	1
Countershaft Front Brg.	LM102949-LM102910	1
Countershaft Ctr. Brg.	25590-25520	1
Countershaft Rear Brg.	LM48548-LM48510	1
Input Shaft Seal	4638N (1.375x1.982)	1
Input Shaft Seal	14703 (38x50)	1
Output Shaft Seal	4741 (2.200x3.022)	1
Output Shaft Seal	710058 (1.937x2.562)	1
1st,2nd,3rd,4th,5th,6th&	ZSY1216	7
Rev.Synchro Ring		

TRK-FC200		
Position	Part Number	Qty
Input Shaft Brg.	32210	1
Input Shaft Pilot Brg.	33206	1
Output Shaft Rear Brg.	32210	1
Countershaft Front Brg.	30307	1
Countershaft Rear Brg.	32208	1
Input Shaft Seal	710904 (39.8x62)	1
Output Shaft Seal	710906 (62x78)	1
Output Shaft Seal	710905 (49.9x78)	1

TRK-FC200WS		
Position	Part Number	Qty
Input Shaft Brg.	32210	1
Input Shaft Pilot Brg.	33206	1
Output Shaft Rear Brg.	32210	1
Countershaft Front Brg.	30307	1
Countershaft Rear Brg.	32208	1
Input Shaft Seal	710904 (39.8x62)	1
Output Shaft Seal	710906 (62x78)	1
Output Shaft Seal	710905 (49.9x78)	1
1st & 2nd Gear Synchro	ZSY1412	2
Ring		
3rd & 4th Gear Synchro	ZSY1413	2
Ring		
5th & 6th Gear Synchro	ZSY1414	2
Ring		
Rev. Gear Synchro Ring	ZSY1415	1

TRK-S6-650ZF		
Position	Part Number	Qty
Input Shaft Brg.	45285-45220	1
Mainshaft Pilot Brg.	JH13349	1
Mainshaft Center Brg.	NP957859-NP771105	1
Mainshaft Rear Brg.	309L	1
Countershaft Front Brg.	4302074	1
Countershaft Ctr. Brg.	JLM508748-JLM508710	1
Countershaft Rear Brg.	FC69178	1
Input Shaft Seal	UH5019E0 (40x55)	1
Output Shaft Seal	UH5020G0 (57x73)	1
Output Shaft Seal	710719 (42x55)	1
Oil Baffle	F81Z7046AA	1
Oil Ring	F4TZ7046A	1
Sealing Cap (Large)	ZM1036	4

TRK-S6-650ZFA		
Position	Part Number	Qty
Input Shaft Brg.	45285-45220	1
Mainshaft Pilot Brg.	JH13349	1
Mainshaft Center Brg.	NP957859-NP771105	1
Mainshaft Rear Brg.	309L	1
Countershaft Front Brg.	4302074	1
Countershaft Ctr. Brg.	JLM508748-JLM508710	1
Countershaft Rear Brg.	FC69178	1
Input Shaft Seal	UH5019E0 (40x55)	1
Output Shaft Seal	UH5020G0 (57x73)	1
Oil Baffle	F81Z7046AA	1
Oil Ring	F4TZ7046A	1
Sealing Cap (Large)	ZM1036	4

LD Transmission

# Light Duty Transmission Rebuild Kits



## TRK-S6-650ZFAWS

Position	Part Number	Qty
Input Shaft Brg.	45285-45220	1
Mainshaft Pilot Brg.	JH13349	1
Mainshaft Center Brg.	NP957859-NP771105	1
Mainshaft Rear Brg.	309L	1
Countershaft Front Brg.	4302074	1
Countershaft Ctr. Brg.	JLM508748-JLM508710	1
Countershaft Rear Brg.	FC69178	1
Input Shaft Seal	UH5019E0 (40x55)	1
Output Shaft Seal	UH5020G0 (57x73)	1
Oil Baffle	F81Z7046AA	1
Oil Ring	F4TZ7046A	1
Sealing Cap (Large)	ZM1036	4
1st & 2nd Gear Synchro Ring	ZSY1230	2
3rd, 4th & 5th Gear Synchro Ring	ZSY1204	3
Rev. & Creeper Gear Synchro Ring	ZSY1203	2

## TRK-S6-650ZFB

Position	Part Number	Qty
Input Shaft Brg.	45285-45220	1
Mainshaft Pilot Brg.	JH13349	1
Mainshaft Center Brg.	NP957859-NP771105	1
Mainshaft Rear Brg.	309L	1
Countershaft Front Brg.	4302074	1
Countershaft Ctr. Brg.	JLM508748-JLM508710	1
Countershaft Rear Brg.	R1563TAV	1
Input Shaft Seal	UH5019E0 (40x55)	1
Output Shaft Seal	UH5020G0 (57x73)	1
Output Shaft Seal	710719 (42x55)	1
Oil Baffle	F81Z7046AA	1
Oil Ring	F4TZ7046A	1
Sealing Cap (Large)	ZM1036	4

## TRK-S6-650ZFBWS

Position	Part Number	Qty
Input Shaft Brg.	45285-45220	1
Mainshaft Pilot Brg.	JH13349	1
Mainshaft Center Brg.	NP957859-NP771105	1
Mainshaft Rear Brg.	309L	1
Countershaft Front Brg.	4302074	1
Countershaft Ctr. Brg.	JLM508748-JLM508710	1
Countershaft Rear Brg.	R1563TAV	1
Input Shaft Seal	UH5019E0 (40x55)	1
Output Shaft Seal	UH5020G0 (57x73)	1
Output Shaft Seal	710719 (42x55)	1
Oil Baffle	F81Z7046AA	1
Oil Ring	F4TZ7046A	1
Sealing Cap (Large)	ZM1036	4
1st & 2nd Gear Synchro Ring	ZSY1230	2
3rd, 4th & 5th Gear Synchro Ring	ZSY1204	3
Rev. & Creeper Gear Synchro Ring	ZSY1203	2

## TRK-S6-650ZFC

Position	Part Number	Qty
Input Shaft Brg.	45285-45220	1
Mainshaft Pilot Brg.	JH13349	1
Mainshaft Center Brg.	NP957859-NP771105	1
Mainshaft Rear Brg.	ZB1181	1
Countershaft Front Brg.	4302074	1
Countershaft Ctr. Brg.	JLM508748-JLM508710	1
Countershaft Rear Brg.	R1563TAV	1
Input Shaft Seal	UH5019E0 (40x55)	1
Output Shaft Seal	UH5020G0 (57x73)	1
Oil Baffle	F81Z7046AA	1
Oil Ring	F4TZ7046A	1
Sealing Cap (Large)	ZM1036	4
O-Ring	OR-100X3V	1

## TRK-S6-650ZFCWS

Position	Part Number	Qty
Input Shaft Brg.	45285-45220	1
Mainshaft Pilot Brg.	JH13349	1
Mainshaft Center Brg.	NP957859-NP771105	1
Mainshaft Rear Brg.	ZB1181	1
Countershaft Front Brg.	4302074	1
Countershaft Ctr. Brg.	JLM508748-JLM508710	1
Countershaft Rear Brg.	R1563TAV	1
Input Shaft Seal	UH5019E0 (40x55)	1
Output Shaft Seal	UH5020G0 (57x73)	1
Oil Baffle	F81Z7046AA	1
Oil Ring	F4TZ7046A	1
Sealing Cap (Large)	ZM1036	4
O-Ring	OR-100X3V	1
1st & 2nd Gear Synchro Ring	ZSY1230	2
3rd, 4th & 5th Gear Synchro Ring	ZSY1204	3
Rev. & Creeper Gear Synchro Ring	ZSY1203	2

## TRK-S6-650ZFN

Position	Part Number	Qty
Input Shaft Brg.	45285-45220	1
Mainshaft Pilot Brg.	JH13349	1
Mainshaft Center Brg.	NP957859-NP771105	1
Mainshaft Rear Brg.	309L	1
Countershaft Front Brg.	4302074	1
Countershaft Ctr. Brg.	JLM508748-JLM508710	1
Countershaft Rear Brg.	FC69178	1
Input Shaft Seal	UH5019E0 (40x55)	1
Output Shaft Seal	UH5020G0 (57x73)	1
Output Shaft Seal	710719 (42x55)	1
Oil Baffle	F81Z7046AA	1
Oil Ring	F4TZ7046A	1
Sealing Cap (Large)	ZM1036	4
1st Gear Brg.	ZN1189	1
2nd Gear Brg.	ZN1189	1
2nd Gear Brg. Inner Race	ZN1190	1
3rd Gear Brg.	ZN1189	1
3rd Gear Inner Brg. Rac	ZN1190	1
5th Gear Brg.	ZN1191	1
5th Gear Inner Brg. Rac	ZN1192	1
5th Gear Thrust Washer	ZN1193	1
Creeper Gear Brg.	ZN1194	2
Rev. Gear Brg.	ZN1194	2
Rev. Gear Brg. Inner Race	ZN1195	1
Rev. Idler Gear Brg.	ZN1196	2
Shift Shaft Brg.	ZN1160	3
2nd/3rd Gear Thrust Washer	ZN1197	1
Rev. Gear Thrust Brg.	ZN1198	1

## TRK-S6-650ZFNWS

Position	Part Number	Qty
Input Shaft Brg.	45285-45220	1
Mainshaft Pilot Brg.	JH13349	1
Mainshaft Center Brg.	NP957859-NP771105	1
Mainshaft Rear Brg.	309L	1
Countershaft Front Brg.	4302074	1
Countershaft Ctr. Brg.	JLM508748-JLM508710	1
Countershaft Rear Brg.	FC69178	1
Input Shaft Seal	UH5019E0 (40x55)	1
Output Shaft Seal	UH5020G0 (57x73)	1
Output Shaft Seal	710719 (42x55)	1
Oil Baffle	F81Z7046AA	1
Oil Ring	F4TZ7046A	1
1st & 2nd Gear Synchro Ring	ZSY1230	2
3rd, 4th & 5th Gear Synchro Ring	ZSY1204	3
Rev. & Creeper Gear Synchro Ring	ZSY1203	2
Sealing Cap (Large)	ZM1036	4
1st Gear Brg.	ZN1189	1
2nd Gear Brg.	ZN1189	1
2nd Gear Brg. Inner Race	ZN1190	1
3rd Gear Brg.	ZN1189	1
3rd Gear Inner Brg. Rac	ZN1190	1
5th Gear Brg.	ZN1191	1
5th Gear Inner Brg. Rac	ZN1192	1
5th Gear Thrust Washer	ZN1193	1
Creeper Gear Brg.	ZN1194	2
Rev. Gear Brg.	ZN1194	2
Rev. Gear Brg. Inner Race	ZN1195	1
Rev. Idler Gear Brg.	ZN1196	2
Shift Shaft Brg.	ZN1160	3
2nd/3rd Gear Thrust Washer	ZN1197	1
Rev. Gear Thrust Brg.	ZN1198	1

## TRK-S6-650ZFW

Position	Part Number	Qty
Input Shaft Brg.	45285-45220	1
Mainshaft Pilot Brg.	JH13349	1
Mainshaft Center Brg.	NP957859-NP771105	1
Mainshaft Rear Brg.	309L	1
Countershaft Front Brg.	4302074	1
Countershaft Ctr. Brg.	JLM508748-JLM508710	1
Countershaft Rear Brg.	FC69178	1
Input Shaft Seal	UH5019E0 (40x55)	1
Output Shaft Seal	UH5020G0 (57x73)	1
Output Shaft Seal	710719 (42x55)	1
Oil Baffle	F81Z7046AA	1
Oil Ring	F4TZ7046A	1
Sealing Cap (Large)	ZM1036	4
1st & 2nd Gear Synchro Ring	ZSY1230	2
3rd, 4th & 5th Gear Synchro Ring	ZSY1204	3
Rev. & Creeper Gear Synchro Ring	ZSY1203	2

LD Transmission

# Transmission Gearing & Related Parts

## Aisin Warner AX5 and AX15

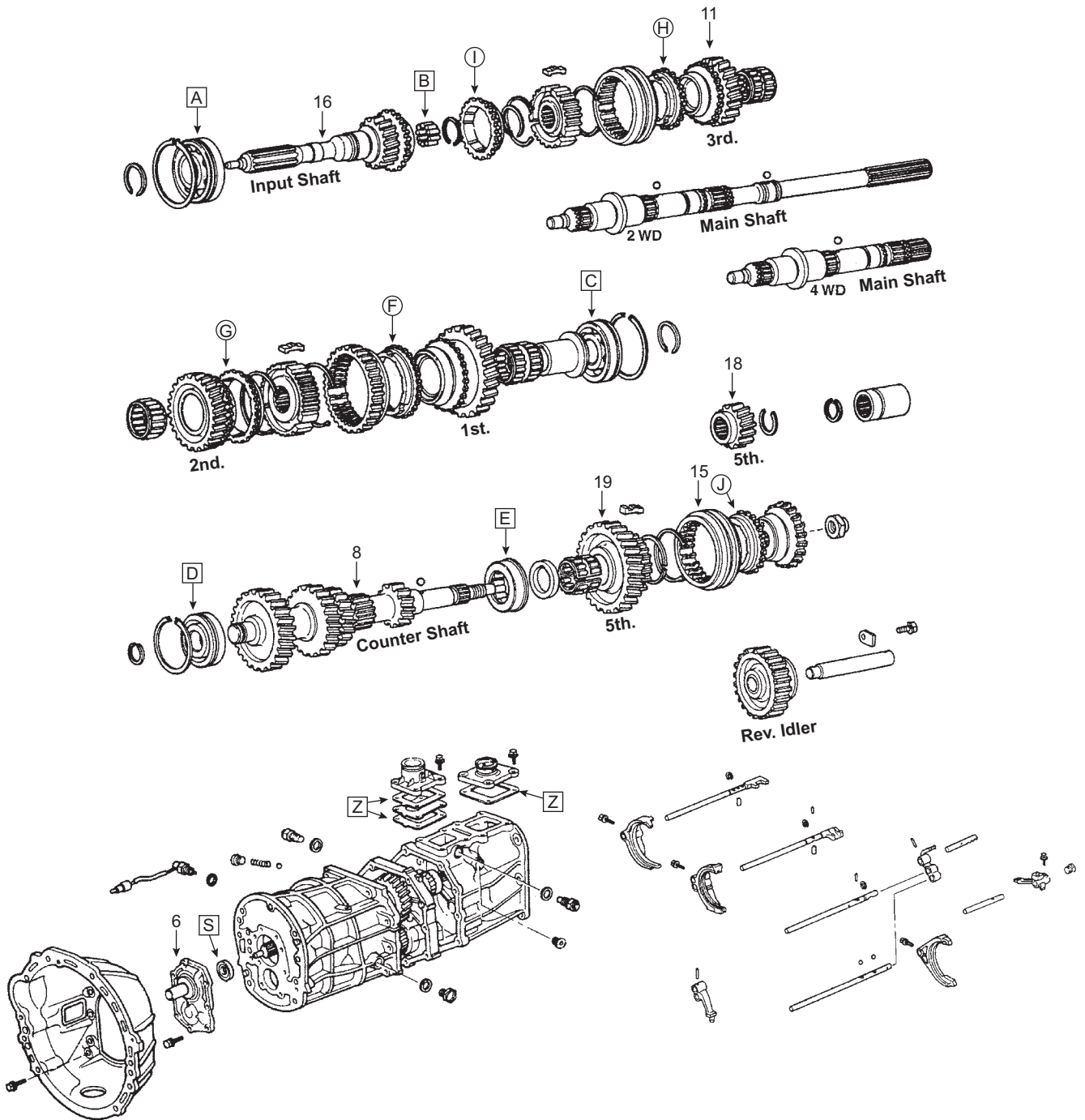

□ = Contained in all kits.

○ = Contained in WS (With Synchros) kits.

△ = Contained in N (With Needle Brgs.) kits

References to original equipment part numbers are for cross reference and identification purpose only.

# Transmission Gearing & Related Parts

## Aisin Warner AX5

Position	Description	Specifications	Applications	Part Number
6	Front Bearing Retainer	w/Snout		83502685
6	Front Bearing Retainer	w/o Snout		83503112
8	Counter Shaft	Uses Nut	84-10/88	AX5-8
8	Counter Shaft	Uses Snap Ring	10/88-On	AX5-8A
11	3rd Gear	27T		G52-11
15	Slider, 5th/Reverse Gear	For Aluminum Fork Only		G52-15
16	Input Shaft	Uses 20mm Wide I/S Brg.	84-87	AX5-16
16	Input Shaft	Uses 23mm Wide I/S Brg.	84-10/88	AX5-16A
16	Input Shaft	Uses 23mm Wide I/S Brg.	10/88-On	AX5-16B
18 & 19	5th Gear Kit	Includes M/S (24T) & C/S (45T)		G52-5
	5th Gear Needle Brg.			83500644
A	Input Shaft Brg.	20mm Wide I/S Brg.	84-87	ZB1043
A	Input Shaft Brg.	23mm Wide I/S Brg.	84-On	ZB1049
B	Main Shaft Pilot Brg.			N6X17-13
C	Main Shaft Rear Brg.	20mm Wide	84-87	ZB1044
C	Main Shaft Rear Brg.	21mm Wide	87-On	ZB1048
D	Countershaft Front Brg.			ZC1027
E	Countershaft Rear Brg.	18mm Wide	84-87	ZC1015
E	Countershaft Rear Brg.	20mm Wide	87-On	ZC1016
F	1st Gear Synchro Ring			ZSY1052
G	2nd Gear Synchro Ring			ZSY1052
H	3rd Gear Synchro Ring			ZSY1053
I	4th Gear Synchro Ring			ZSY1053
J	5th Gear Synchro Ring			ZSY1053
S	Input Shaft Seal			1981
S	Output Shaft Seal		2WD	223840
S	Output Shaft Seal		4x4	225010
Z	Gasket			Part of GT-FT130
Z	Adapter Gasket			GTC-NP1

## Aisin Warner AX15

Position	Description	Specifications	Applications	Part Number
8	Counter Shaft		86-On	AX15-8
16	Input Shaft	29T, 10 spl., 10½ OAL	86-91	AX15-16
16	Input Shaft		92-On	AX15-16A
19	5th Gear (Counter Shaft)	47T, Includes Keys & Springs		AX15-19
A	Input Shaft Brg.			
B	Main Shaft Pilot Brg.			ZN1025
C	Main Shaft Rear Brg.			ZB1053
D	Countershaft Front Brg.			ZC1002
E	Countershaft Rear Brg.			ZC1017
F	1st Gear Synchro Ring			ZSY1096
G	2nd Gear Synchro Ring			ZSY1096
H	3rd Gear Synchro Ring			ZSY1097
I	4th Gear Synchro Ring			ZSY1097
J	5th Gear Synchro Ring	36T		ZSY1097
J	5th Gear Synchro Ring	33T		ZSY1098
S	Input Shaft Seal			223253
S	Output Shaft Seal		2WD	223840
S	Output Shaft Seal		4x4	225010
Z	Adapter Gasket			GTC-NP1



# Transmission Gearing & Related Parts

## M5R1 and M5R2

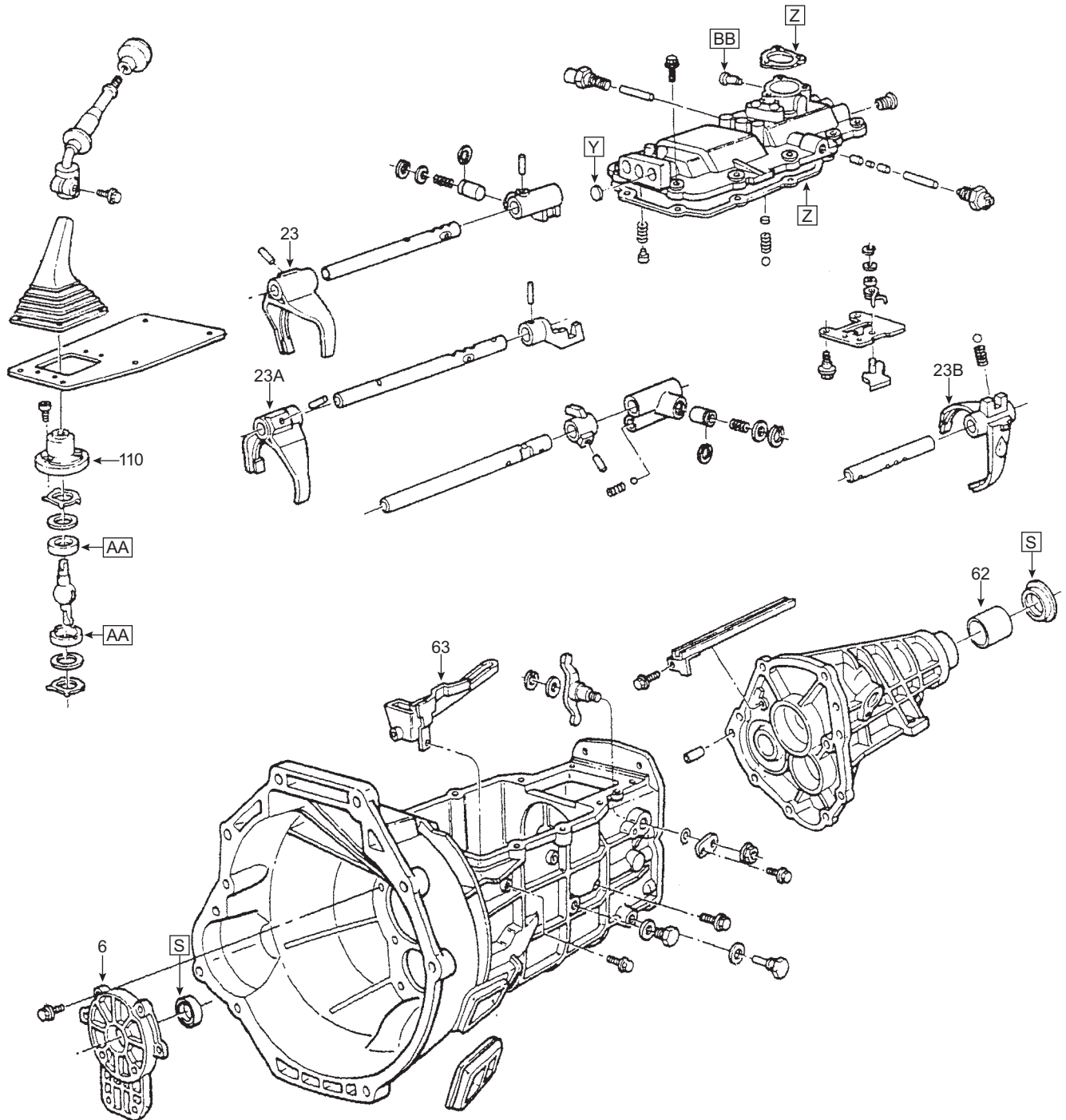

□ = Contained in all kits.

○ = Contained in WS (With Synchros) kits.

△ = Contained in N (With Needle Brgs.) kits

References to original equipment part numbers are for cross reference and identification purpose only.



# Transmission Gearing & Related Parts

## M5R1 and M5R2

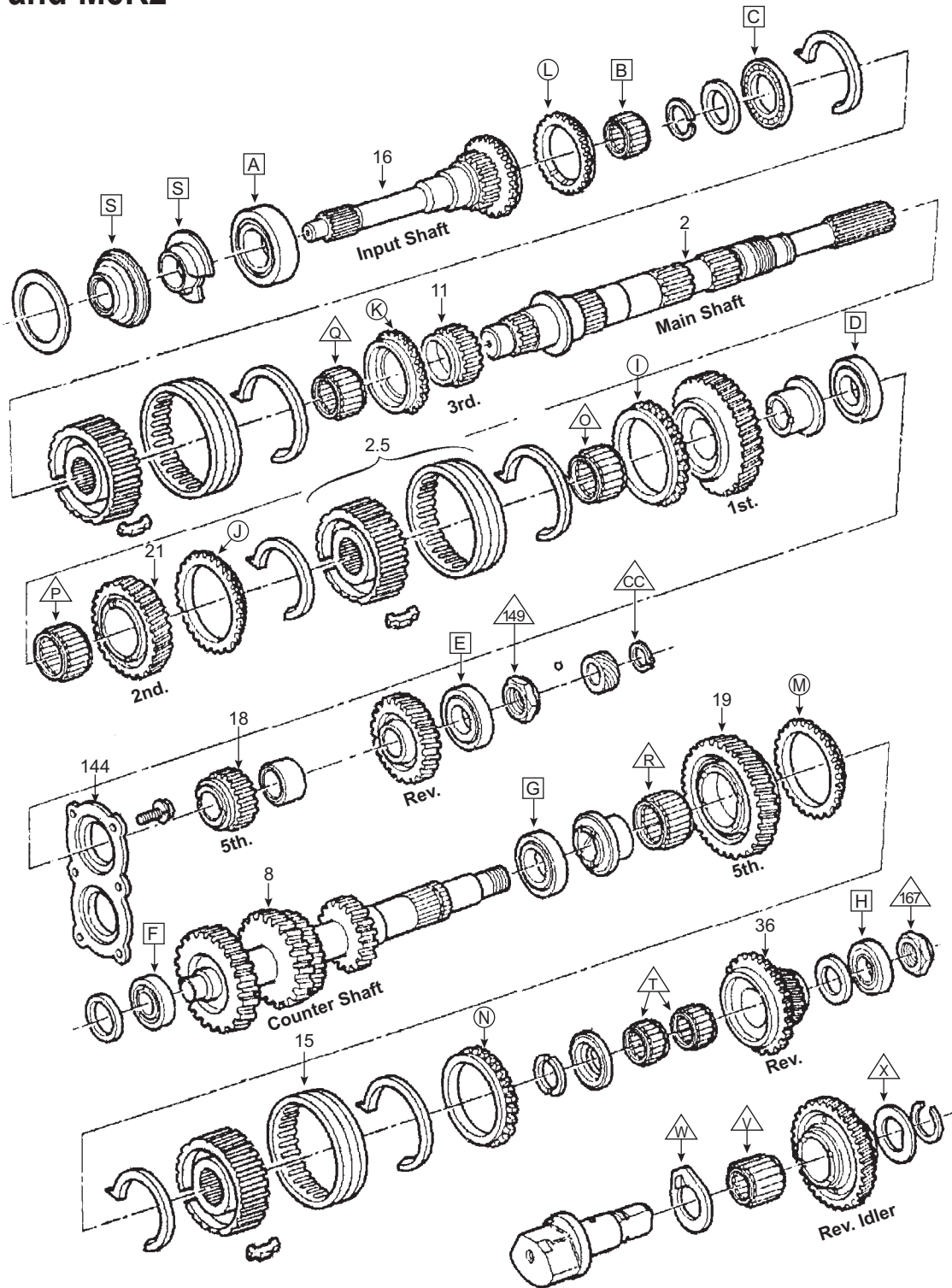

□ = Contained in all kits.

○ = Contained in WS (With Synchros) kits.

△ = Contained in N (With Needle Brgs.) kits

# Transmission Gearing & Related Parts



## M5R1

Position	Description	Specifications	Applications	Part Number
2	Main Shaft	28 Spl. (Yoke End) 21-1/2" OAL	2WD	M5R1-2A
2	Main Shaft	25 Spl. (Yoke End) 20" OAL	4x4	M5R1-2
2.5	Synchro Assy. (3rd-4th)	Hub, Slider, Springs & Keys and Synchro Ring		M5R1-2.5A
6	Front Bearing Retainer			M5R1-6
8	Counter Shaft	38-32-24-16	2.3L, 2.9L & 3.0L	M5R1-8
8	Counter Shaft	38-34-25-17	4.0L	M5R1-8A
11	3rd Gear	29T		M5R1-11
11	3rd Gear	27T		M5R1-11A
15	Slider	5th-Rev. Non-Updated 36T	87-/1/90	M5R1-15
15	Slider	5th-Rev. Updated 30T	1/90-On	M5R1-15A
16	Input Shaft	23T, 23 Spline	2.3L, 2.9L & 3.0L	M5R1-16
16	Input Shaft	23T, 23 Spline	4.0L	M5R1-16A
18	5th Gear (Main Shaft)	Updated w/Spacer	1/90-On	M5R1-18A
19	5th Gear (Counter Shaft)	48T, Updated	1/90-On	M5R1-19A
21	2nd Gear	32T		M5R1-21
21	2nd Gear	31T		M5R1-21A
23	Shift Fork	1st-2nd Gear		M5R1-23
23A	Shift Fork	3rd-4th Gear		M5R1-23A
36	Rev. Gear	Non-Updated 17T, 36 Synchro Teeth	87-/1/90	M5R1-36
36	Rev. Gear	Updated 17T, 30 Synchro Teeth	1/90-On	M5R1-36A
62	Ext. Housing Bushing			M5R1-62
63	Oil Trough			M5R1-63
110	Shift Stick Rubber Retainer			E8TZ7277A-R
144	Rear Retainer Plate			M5R1-144
149	Main Shaft Nut			ZM1027
167	Counter Shaft Nut			ZM1029
15, 36 & N	Rev. Gear Kit	Rev. Gear, Slider and Synchro Ring (Non-Updated)	87-/1/90	M5R1-RK
15, 36 & N	Rev. Gear Kit	Rev. Gear, Slider and Synchro Ring (Updated)	1/90-On	M5R1-RKL
	Spring & Key Kit	1st-2nd & 3rd-4th Gear		M5R1-K3
A	Input Shaft Brg.			ZT1047
B	Main Shaft Pilot Brg.			ZN1044
C	Main Shaft Thrust Brg.			ZN1028
D	Main Shaft Front Brg.			ZT1036
E	Main Shaft Rear Brg.			ZB1060
F	Countershaft Front Brg.			ZC1021
G	Countershaft Center Brg.			ZC1033
H	Countershaft Rear Brg.			ZB1034
I	1st Gear Synchro Ring			ZSY1054
J	2nd Gear Synchro Ring			ZSY1054
K	3rd Gear Synchro Ring			ZSY1054
L	4th Gear Synchro Ring			ZSY1054
M	5th Gear Synchro Ring	36T Non-Updated	87-/1/90	ZSY1055
M	5th Gear Synchro Ring	30T Updated	1/90-On	ZSY1057
N	Rev. Gear Synchro Ring	30T Non-Updated	87-/1/90	ZSY1077
N	Rev. Gear Synchro Ring	24T Updated	1/90-On	ZSY1058
O	1st Gear Needle Brg.			ZN1124
P	2nd Gear Needle Brg.			ZN1124
Q	3rd Gear Needle Brg.			ZN1133
R	5th Gear Needle Brg.			ZN1126
S	Input Shaft Seal			1990
S	Input Shaft Oil Ring			BZ3541E
S	Input Shaft Oil Baffle			ZM1014
S	Output Shaft Seal		2WD	14900
S	Output Shaft Seal		4x4	1981
T	Rev. Gear Needle Brg.			ZN1134
U	Rev. Gear Thrust Washer			ZN1128
V	Rev. Idler Gear Needle Brg.			ZN1125
W	Rev. Idler Gear Thrust Washer			ZN1135
X	Rev. Idler Gear Thrust Washer			ZN1129
Y	Expansion Plug			ZM1013
Z	Gasket Set			GT-247
Z	Top Cover Gasket			GT-247R
AA	Shift Socket			ZM1008
BB	Shift Pin			M50-P1
CC	Main Shaft Snap Ring			ZM1028

References to original equipment part numbers are for cross reference and identification purpose only.

# Transmission Gearing & Related Parts

## M5R2

Position	Description	Specifications	Applications	Part Number
2	Main Shaft		4x4	M5R2-2
2.5	Synchro Assy. (3rd-4th)	Hub & Slider		M5R2-2.5
2.5	Synchro Assy. (3rd-4th)	Hub, Slider, Keys & Springs		M5R2-2.5A
8	Counter Shaft	37-31-24-15		M5R2-8
11	3rd Gear	30T		M5R2-11
15	Slider	5th-Rev. Non-Updated 42T	87-/1/90	M5R2-15
15	Slider	5th-Rev. Updated 33T	1/90-On	M5R2-15A
16	Input Shaft	24T, 10 Spl, 11" OAL	88-95	M5R2-16
16	Input Shaft	24T, 10 Spl, 11-5/8" OAL	96-On	M5R2-16A
18	5th Gear (Main Shaft)	27T		M5R2-18
19	5th Gear (Counter Shaft)	Non-Updated	87-/1/90	M5R2-19
19	5th Gear (Counter Shaft)	52T, 33 Synchro Teeth, Updated	1/90-On	M5R2-19A
23	Shift Fork	1st-2nd Gear	88-95	M5R2-23
23	Shift Fork	1st-2nd Gear	96-On	M5R2-23AA
23A	Shift Fork	3rd-4th Gear	88-95	M5R2-23A
23A	Shift Fork	3rd-4th Gear	96-On	M5R2-23AB
23B	Shift Fork	5th-Rev. Gear Updated	1/90-On	M5R2-23B
36	Rev. Gear	15T Non-Updated	87-/1/90	M5R2-36
36	Rev. Gear	15T, 33 Synchro Teeth, Updated	1/90-On	M5R2-36A
62	Ext. Housing Bushing			M5R1-62
63	Oil Trough			M5R2-63
110	Shift Stick Rubber Retainer			E8TZ7277A-R
144	Rear Retainer Plate			M5R2-144
149	Main Shaft Nut			M5R2-149
167	Counter Shaft Nut			ZM1029
15, 36 & N	Rev. Gear Kit	Rev. Gear, Slider and Synchro Ring (Non-Updated)	87-/1/90	M5R2-RK
15, 36 & N	Rev. Gear Kit	Rev. Gear, Slider and Synchro Ring (Updated)	1/90-On	M5R2-RKL
	Spring & Key Kit	1st-2nd & 3rd-4th Gear		M5R2-K3
A	Input Shaft Brg.			ZT1087
B	Main Shaft Pilot Brg.			ZN1034
C	Main Shaft Thrust Brg.			ZN1035
D	Main Shaft Front Brg.			ZT1088
E	Main Shaft Rear Brg.			ZB1061
F	Countershaft Front Brg.			ZC1010
G	Countershaft Center Brg.			ZC1023
H	Countershaft Rear Brg.			ZB1034
I	1st Gear Synchro Ring			ZSY1059
J	2nd Gear Synchro Ring			ZSY1059
K	3rd Gear Synchro Ring			ZSY1059
L	4th Gear Synchro Ring			ZSY1059
M	5th Gear Synchro Ring	42T Non-Updated	87-/1/90	ZSY1054
M	5th Gear Synchro Ring	33T Updated	1/90-On	ZSY1060
N	Rev. Gear Synchro Ring	36T Non-Updated	87-/1/90	ZSY1056
N	Rev. Gear Synchro Ring	30T Updated	1/90-On	ZSY1061
O	1st Gear Needle Brg.			ZN1124
P	2nd Gear Needle Brg.			ZN1124
Q	3rd Gear Needle Brg.			ZN1123
R	5th Gear Needle Brg.			ZN1126
S	Input Shaft Seal			223012
S	Input Shaft Oil Ring			ZM1015
S	Input Shaft Oil Baffle			BZ3421E
S	Output Shaft Seal		2WD	14900
S	Output Shaft Seal		4x4	223608
T	Rev. Gear Needle Brg.			ZN1071
U	Rev. Gear Thrust Washer			ZN1128
V	Rev. Idler Gear Needle Brg.			ZN1132
W	Rev. Idler Gear Thrust Washer			ZN1130
X	Rev. Idler Gear Thrust Washer			ZN1131
Y	Expansion Plug			ZM1013
Z	Gasket Set			GT-248
Z	Top Cover Gasket			GT-248R
AA	Shift Socket			ZM1008
BB	Shift Pin			M50-P1
CC	Main Shaft Snap Ring			ZM1028

References to original equipment part numbers are for cross reference and identification purpose only.

# Transmission Gearing & Related Parts

## New Venture 3500/Getrag HM290/5LM60

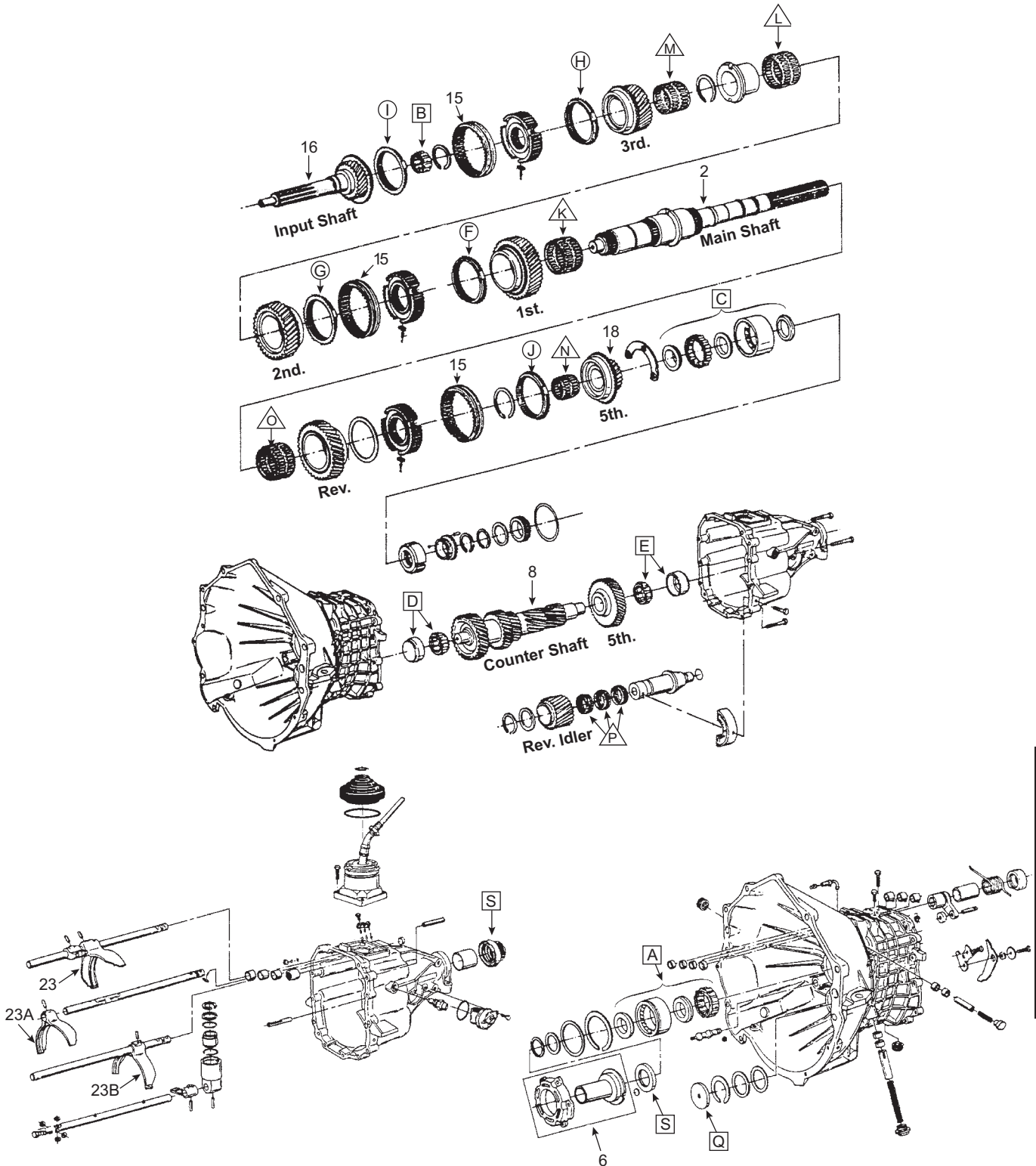

□ = Contained in all kits.

○ = Contained in WS (With Synchros) kits.

△ = Contained in N (With Needle Brgs.) kits

References to original equipment part numbers are for cross reference and identification purpose only.

LD Transmission

# Transmission Gearing & Related Parts



## New Venture 3500/Getrag HM290/5LM60

Position	Description	Specifications	Applications	Part Number
2	Main Shaft	Fits 1st & 2nd Design	4x4, 88-91	290-2
2	Main Shaft	Fits 3rd Design	4x4, 91-On	290-2A
6	Front Bearing Retainer	Fits 1st & 2nd Design	88-91	290-6N
6	Front Bearing Retainer	Fits 3rd Design	91-On	290-6A
8	Counter Shaft	34-28-22-14-43, 1" Journal	88-91, GM	290-8R
8	Counter Shaft	34-28-22-14-14, 1.18" Journal	91-93, GM	290-8AR
8	Counter Shaft	34-28-22-14(Long), 1.18" Journal	94-On, GM & Dodge	290-8BR
8	Counter Shaft	34-28-23-15-14(1.2" wide)-37, 1.18" Journal	96-On, GM S-10	290-8CR
8	Counter Shaft	34-28-23-15-14(2.4" wide)-37, 1.18" Journal	94-On, GM & Dodge	290-8DR
8	Counter Shaft	34-28-23-15-14-43, 1.31" Journal	96-On, GM	290-8ER
8	Counter Shaft	46-37-22-14(Long)-52, 1.18" Journal	97-On Dodge	290-8FR
15	Slider	42T, 1st-2nd Gear		290-15
15	Slider	42T, 3rd-4th Gear		290-15
15	Slider	42T, 5th-Rev. Gear		290-15
16	Input Shaft	26T, 10 Spl, 9-5/8" OAL (w/Step, Fits 1st & 2nd Design)	88-91, GM	290-16R
16	Input Shaft	26T, 10 Spl, 9-5/8" OAL (w/o Step, Fits 3rd Design)	91-95, GM	290-16AR
16	Input Shaft	26T, 10 Spl, 10-5/8" OAL	94-On, Dodge	290-16BR
16	Input Shaft	26T, w/o Step, 3 id Rings	96-On, GM	290-16CR
16	Input Shaft	35T, 10 Spl, 10-1/2" OAL	97-On, Dodge	290-16FR
18	5th Gear (Main Shaft)	24T, Fits 1st & 2nd Design	88-91, GM	290-18
23	Shift Fork	1st-2nd Gear	88-92, GM	290-23
23A	Shift Fork	3rd-4th Gear	88-92, GM	290-23A
23B	Shift Fork	5th-Rev. Gear	88-92, GM	290-23B
A	Input Shaft Brg.	3 Piece Brg., 1st & 2nd Design	88-91	ZB1024
A	Input Shaft Brg.	Ball Brg., 3rd Design	91-On	ZB1055
B	Main Shaft Pilot Brg.	Fits 1" Pilot Journal		ZN1036
B	Main Shaft Pilot Brg.	Fits 1.18" Pilot Journal	96-On GM	ZN1037
C	Main Shaft Brg.	3 Piece Brg., 1st Design	88-89	ZB1024
C	Main Shaft Brg.	Ball Brg., 2nd & 3rd Design	90-On	ZB1055
D	Countershaft Front Brg.	1st & 2nd Design, Fits 1" Journal	88-91	ZN1036
D	Countershaft Front Brg.	3rd Design, Fits 1.18" Journal	91-On	ZN1037
D	Countershaft Front Brg.	Fits 1.31" Journal	96-On GM	ZN1114
E	Countershaft Rear Brg.	1st & 2nd Design, Fits 1" Journal	88-91	ZN1036
E	Countershaft Rear Brg.	3rd Design, Fits 1.18" Journal	91-On	ZN1037
E	Countershaft Rear Brg.	Fits 1.31" Journal	96-On GM	ZN1114
F	1st Gear Synchro Ring	1-Piece Ring		ZSY1076
F	1st Gear Synchro Ring	3-Piece Ring		ZSY1173
G	2nd Gear Synchro Ring	1-Piece Ring		ZSY1076
G	2nd Gear Synchro Ring	3-Piece Ring		ZSY1173
H	3rd Gear Synchro Ring			ZSY1076
I	4th Gear Synchro Ring			ZSY1076
J	5th Gear Synchro Ring			ZSY1076
	Rev. Gear Synchro Ring			ZSY1210
K	1st Gear Needle Brg.		88-94	ZN1115
K	1st Gear Needle Brg.		95	ZN1117
L	2nd Gear Needle Brg.		88-94	ZN1115
L	2nd Gear Needle Brg.		95	ZN1116
M	3rd Gear Needle Brg.		88-95	ZN1118
N	5th Gear Needle Brg.		88-93	ZN1120
N	5th Gear Needle Brg.		94-95	ZN1119
O	Rev. Gear Needle Brg.		88-95	ZN1115
P	Rev. Idler Needle Brg.		88-89	FW404820
P	Rev. Idler Needle Brg.		89-93	ZN1122
P	Rev. Idler Needle Brg.		94-95	ZN1121
Q	Countershaft Plug			AD2285
S	Input Shaft Seal			4529-N
S	Output Shaft Seal		2WD Full Size GM	4528-N
S	Output Shaft Seal		2WD S-10	4530
S	Output Shaft Seal		4x4 GM	4532-N
S	Output Shaft Seal		2WD Dodge	7300-S
S	Output Shaft Seal		4x4 Dodge	4528-N
	Small Parts Kit			SPK-235

LD Transmission

References to original equipment part numbers are for cross reference and identification purpose only.



# Transmission Gearing & Related Parts

## New Venture 4500

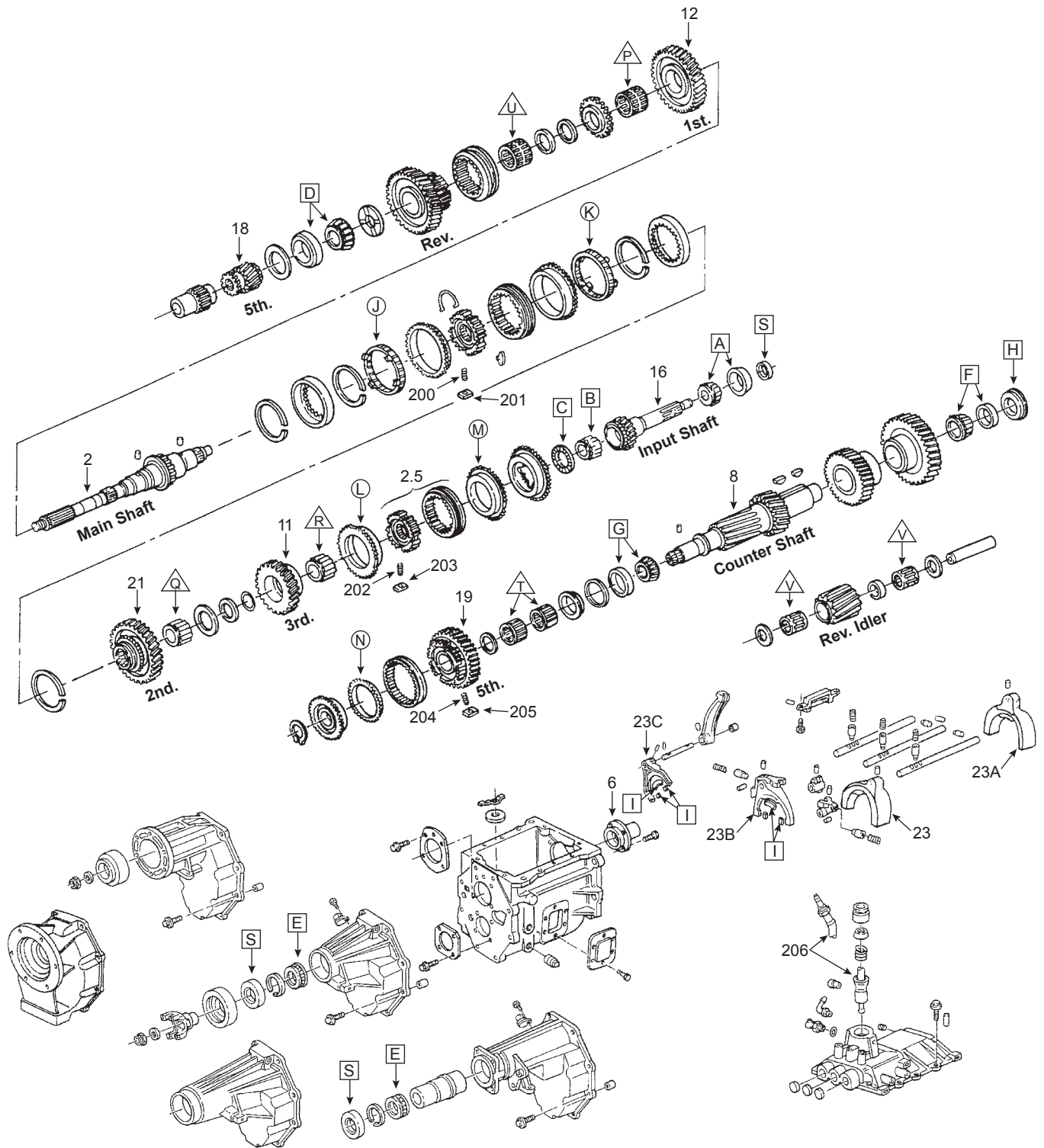

- = Contained in all kits.
- = Contained in WS (With Synchros) kits.
- △ = Contained in N (With Needle Brgs.) kits

LD Transmission



# Transmission Gearing & Related Parts

## New Venture 4500

Position	Description	Specifications	Applications	GMC Reference #	Dodge Reference #	Part Number
2	Main Shaft		GMC 2WD (91-93)	15637463		NV17276
2	Main Shaft	20-1/4" OAL	GMC 2WD (94-00) w/o Parking Brake	12382817		NV25330
2	Main Shaft		GMC 2WD (94-00) w/Parking Brake	12382819		NV25332
2	Main Shaft		GMC 2WD (01-02)	12382892		NV33308
2	Main Shaft		GMC 4x4 (91-00)	12382861		NV27170
2	Main Shaft		GMC 4x4 (01-02)	12382891		NV33290
2	Main Shaft		Dodge 2WD (92-93)		4637711	NV17281
2	Main Shaft		Dodge 4x4 (92-93)		4637714	NV17280
2	Main Shaft		Dodge 2WD (94-99) 5.9L Gas		5003037AA	NV27174
2	Main Shaft		Dodge 2WD (94-99) 5.9L Diesel, 8.0L		5003038AA	NV27175
2	Main Shaft		Dodge 4x4 (94-99) 5.9L Gas		5003215AA	NV27171
2	Main Shaft		Dodge 4x4 (94-99) 5.9L Diesel, 8.0L		5003218AA	NV27173(-R)
2	Main Shaft		Dodge 2WD (00-02) 5.9L Gas		5016383AA	NV33293
2	Main Shaft		Dodge 2WD (00-02) 5.9L Diesel, 8.0L		5016384AA	NV33294
2	Main Shaft		Dodge 4x4 (00-02) 5.9L Gas		5016385AA	NV33291
2	Main Shaft		Dodge 4x4 (00-02) 5.9L Diesel, 8.0L		5016386AA	NV33292
2	Main Shaft	31 Spl, 24-5/16" OAL	Dodge 2WD Diesel			NV27176(-R)
2	Main Shaft		Dodge 4x4 Gas			NV27171
2	Main Shaft	29 Spl, 14-1/2" OAL	Dodge 4x4 Diesel			NV27173(-R)
2.5	Synchro Assy. (3rd-4th)		GMC (91-93)	15637287		NV17301
2.5	Synchro Assy. (3rd-4th)		GMC (94-03)	12542865		NV18412
2.5	Synchro Assy. (3rd-4th)		Dodge (94-03)		4740824	NV18412
6	Front Bearing Retainer		GMC (91-96)	15665238		NV17507(-R)
6	Front Bearing Retainer		GMC (97-02)	12549369		NV22414
6	Front Bearing Retainer		Dodge (92-93)		4713787	NV17508
6	Front Bearing Retainer		Dodge (94-02) 5.2L, 5.9L Gas		4741542	NV18347
6	Front Bearing Retainer		Dodge (94-02) 5.9L Diesel, 8.0L		4741543	NV18161
8	Counter Shaft		Dodge (92-11/95)		4637700	NV14015
8	Counter Shaft		Dodge (11/95-96)		4856072	NV22415
8	Counter Shaft	38-30-21-12	Dodge (97-02)		4882367	NV22657
8	Counter Shaft		GMC (91-95)	12542557		NV18317
8	Counter Shaft	38-30-21-12	GMC (96-03)	12382834		NV22657
11	3rd Gear		Dodge (92-93)		4637735	NV17296
11	3rd Gear		Dodge (94-96)		4773011	NV18918
11	3rd Gear		Dodge (97-02)		4874369	NV23712
11	3rd Gear		GMC (91-94)	12547205		NV18922
11	3rd Gear	29T	GMC (95-03)	12382792		NV23712
12	1st Gear		Dodge (92-02)	15637279	4637728	NV17290
12	1st Gear		GMC (91-03)	15637279		NV17290
16	Input Shaft		Dodge (92-93)	4637756	NV17303	4637772
16	Input Shaft		Dodge (94-96) 5.2L, 5.9L Gas		4741540	NV18358
16	Input Shaft		Dodge (94-96) 5.9L Diesel, 8.0L		4741541	NV18160
16	Input Shaft	22T 10 Spl, 10" OAL (1.104" Clutch Spline Diameter)	Dodge (97-02) 5.9L Gas		4882357	NV25354
16	Input Shaft	22T 10 Spl, 10" OAL (1.205" Clutch Spline Diameter)	Dodge (97-02) 5.9L Diesel, 8.0L		4882358	NV25356
16	Input Shaft	20T 10 Spl, 9" OAL	GMC (91-94)	15637293		NV17310
16	Input Shaft	20T 10 Spl, 9" OAL	GMC (95)	15637293		NV17310
16	Input Shaft		GMC (95)	12382877		NV26205
16	Input Shaft		GMC (96-03)	12382877		NV26205
18	5th Gear (Main Shaft)		Dodge (92-93)		4637798	NV16999(-R)
18	5th Gear (Main Shaft)		Dodge (94-00) 5.2L, 5.9L Gas		4637798	NV16999(-R)

LD Transmission

References to original equipment part numbers are for cross reference and identification purpose only.

# Transmission Gearing & Related Parts

## New Venture 4500 Continued

Position	Description	Specifications	Applications	GMC Reference #	Dodge Reference #	Part Number
18	5th Gear (Main Shaft)		Dodge (01-02) 5.9L Gas	4741551	NV18164	4637798
18	5th Gear (Main Shaft)		Dodge (94-02) 5.9L Diesel, 8.0L		4741551	NV18164(-R)
18	5th Gear (Main Shaft)		GMC (91-93)	15635278		NV16799
18	5th Gear (Main Shaft)		GMC (94-03)	12548339		NV16999(-R)
19	5th Gear (Counter Shaft)	51T	Dodge (92-02)		4637786	NV17318
19	5th Gear (Counter Shaft)		GMC (91-94)	15637296		NV17317
19	5th Gear (Counter Shaft)		GMC (95)	12548338		NV17318
19	5th Gear (Counter Shaft)	50T with Slider and Keys	GMC (96-03)	12548337		NV17582(-R)
21	2nd Gear		Dodge (92-02)		4637730	NV17293(-R)
21	2nd Gear		GMC (91-03)	15637281		NV17293(-R)
A	Input Shaft Brg.		Dodge (92-02)			ZT1010-ZT1009
A	Input Shaft Brg.		GMC (91-95)			ZT1010-ZT1009
A	Input Shaft Brg.		GMC (96-03)			ZT1010-NP728109
B	Main Shaft Pilot Brg.					ZN1003
C	Main Shaft Thrust Brg.					ZN1013
D	Main Shaft Brg.					ZT1084-ZT1083
E	Extension Housing Brg.					ZN1030
F	Countershaft Front Brg.					ZT1006-ZT1005
G	Countershaft Rear Brg.					ZT1008-ZT1007
H	Countershaft Plug					ZM1005
I	Fork Pads		Center			ZM1007
I	Fork Pads		Tip			ZM1006
J	1st Gear Synchro Ring					ZSY1115
K	2nd Gear Synchro Ring					ZSY1115
L	3rd Gear Synchro Ring					ZSY1116
M	4th Gear Synchro Ring					ZSY1116
N	5th Gear Synchro Ring					ZSY1114
O	Rev. Gear Synchro Ring		Req'd for Dodge Only			ZSY1114
P	1st Gear Needle Brg.					ZN1005
Q	2nd Gear Needle Brg.					ZN1005
R	3rd Gear Needle Brg.					ZN1006
S	Input Shaft Seal		Dodge (92-02)			714655
S	Input Shaft Seal		GMC (91-95)			714655
S	Input Shaft Seal		GMC (96-02)			21901
S	Output Shaft Seal		Dodge (2WD)			7300-S
S	Output Shaft Seal		Dodge (2WD-V10)			4741
S	Output Shaft Seal		Dodge (4x4)			710058
S	Output Shaft Seal		GMC (With Parking Brake)			4670-N
S	Output Shaft Seal		GMC (Without Parking Brake)			410085-N
S	Output Shaft Seal		GMC (P Series With Parking Brake)			1943
S	Output Shaft Seal		GMC (P Series Without Parking Brake)			224850
T	5th Gear Needle Brg.					ZN1010
U	Rev. Gear Needle Brg.					ZN1004
V	Rev. Idler Needle Brg.		(91-96)			ZN1007
V	Rev. Idler Needle Brg.		(97-0n)			ZN1109
	Small Parts Kit					5PK-4500

References to original equipment part numbers are for cross reference and identification purpose only.

# Transmission Gearing & Related Parts

ZF S5-42, S5-47, S5-47M

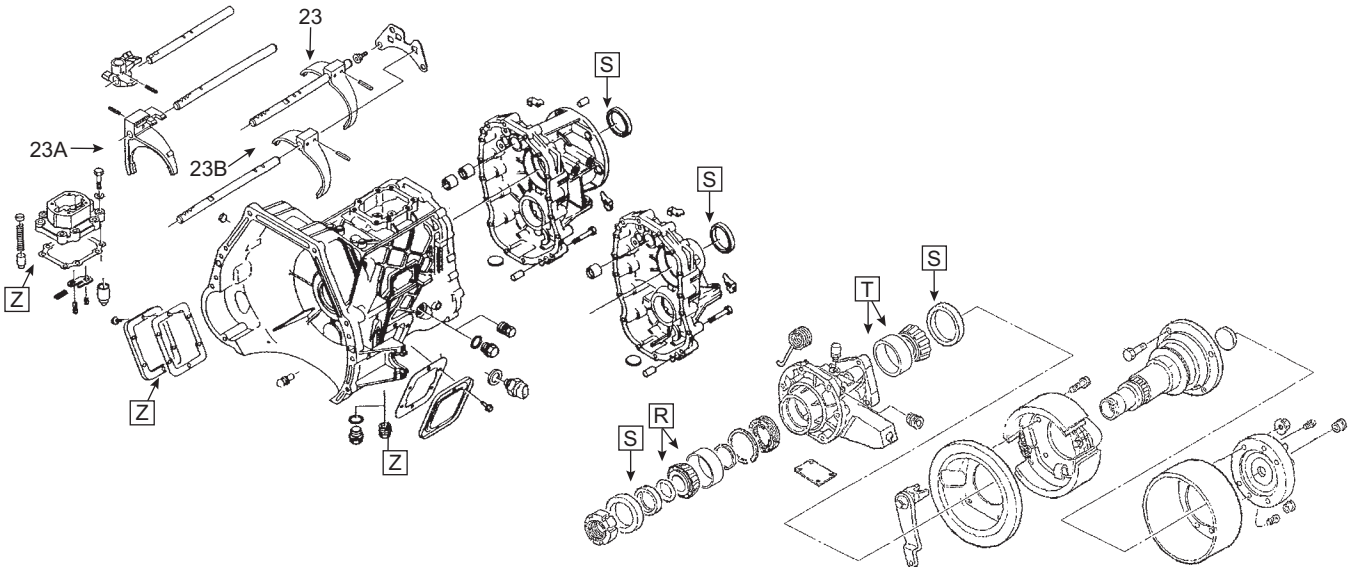
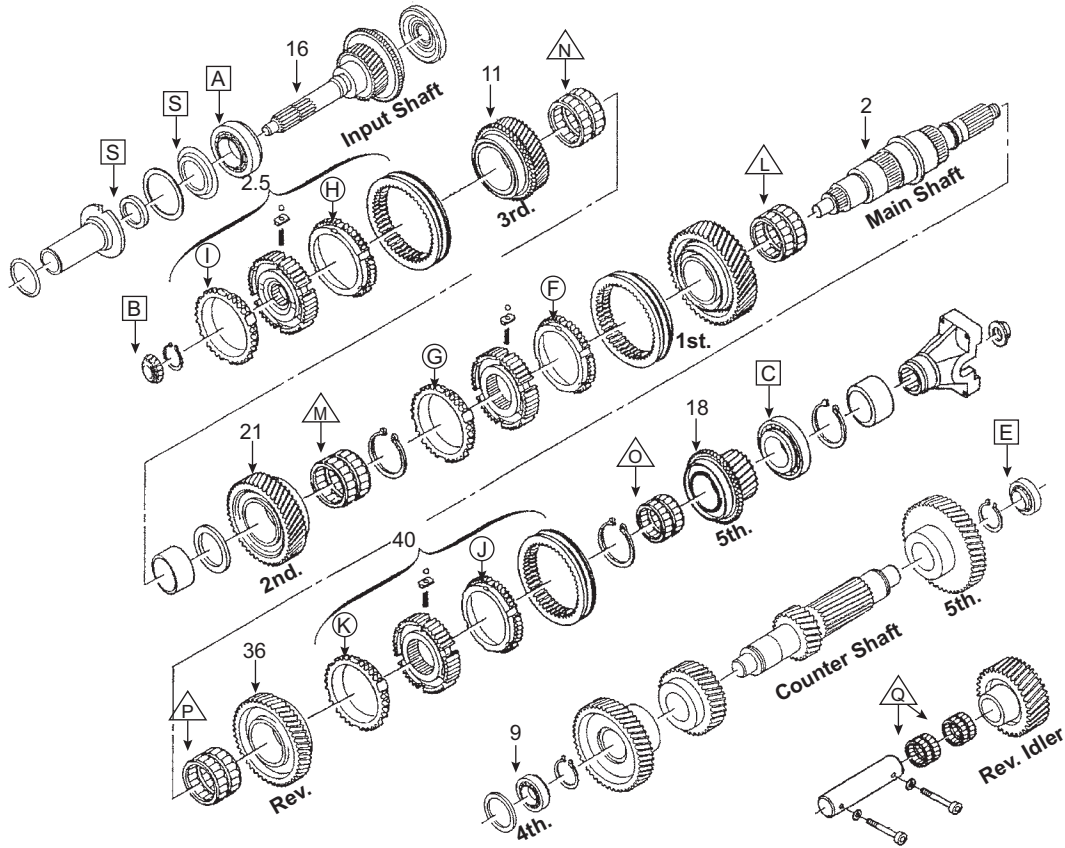

- = Contained in all kits.
- = Contained in WS (With Synchros) kits.
- △ = Contained in N (With Needle Brgs.) kits

# Transmission Gearing & Related Parts

## ZF S5-42, S5-47 & S5-47M

Position	Description	Specifications	Applications	Part Number	Model#’s	Assembly#’s
2	Mainshaft	20" Length	4x4	1307-304-353	S5-42	118
2	Mainshaft	20" Length	4x4	1307-304-353	S5-47	002
2	Mainshaft	18 3/4" Length	4x4	ZF42-2	S5-42	100, 102, 103, 109, 111, 120
2	Mainshaft	16 3/8" Length	4x2	ZF42-2A	S5-42	050, 051, 053, 054, 056, 057, 059, 064, 108, 110
2	Mainshaft	18 3/4" Length	4x4	ZF42-2	S5-47/S5-47M	004, 007, 012, 013, 008, 016, 020
2	Mainshaft	16 3/8" Length	4x2	ZF42-2A	S5-47/S5-47M	001, 003, 006, 014, 016, 020
2.5	3rd/4th Gear Synchro. Assy.			ZF42-2.5	S5-42	All
2.5	3rd/4th Gear Synchro. Assy.- Includes Synchro. Rings			ZF42-2.5A	S5-42	All
2.5	3rd/4th Gear Synchro. Assy.			ZF47-2.5	S5-47/S5-47M	All
2.5	3rd/4th Gear Synchro. Assy.- Includes Synchro. Rings			ZF47-2.5A	S5-47/S5-47M	All
3	Countershaft (w/o press on gears) 1st,2nd,Rev.	21T/14T		ZF42-3	S5-42	All
3	Countershaft (w/o press on gears) 1st,2nd,Rev.	26T/14T		ZF42-3A	S5-42	All
6	Bearing Retainer			ZF42-6	S5-42	All
6	Bearing Retainer	1317-302-041		ZF47-6	S5-47/S5-47M	003/004/006/007/012/013
9	Countershaft 4th Gear	45T		ZF42-9	S5-42	050, 051, 053, 054, 059, 064, 102, 110, 111, 118, 120
9	Countershaft 4th Gear	45T		ZF42-9	S5-47/S5-47M	001, 002, 006, 007, 013, All S5-47M
9	Countershaft 4th Gear	41T		ZF42-9A	S5-42	056, 057, 100, 103, 108, 109
9	Countershaft 4th Gear	43T		ZF47-9B	S5-47	003, 004, 012
11	3rd Gear	30T		ZF42-11	S5-42	050, 051, 053, 054, 059, 064, 102, 110, 111, 118, 120
11	3rd Gear	40T		ZF42-11A	S5-42	056, 057, 100, 103, 108, 109
11	3rd Gear	31T		ZF47-11	S5-47	3,004,012
11	3rd Gear	1317-204-006, 30T		ZF47-11A	S5-47/S5-47M	001, 002, 006, 007, 013, All S5-47M
12	1st Gear	48T		ZF42-12	S5-42	All
12	1st Gear	48T		1317-204-032	S5-47/S5-47M	All
16	Input Shaft	27T, 10 Spl, 11-3/4" OAL		ZF42-16B	S5-42	050, 051, 064, 118
16	Input Shaft	27T 9-1/2" OAL		ZF42-16	S5-42	053, 054, 059, 102, 110, 111, 120
16	Input Shaft	34T, 10 Spl, 9-5/8" OAL		ZF42-16A	S5-42	056, 057, 100, 103, 108, 109
16	Input Shaft	1317-202-016, 29T, 9-1/2" OAL		ZF47-16B	S5-47	003, 004, 012
16	Input Shaft	27T, 11-3/4" OAL		1317-202-015	S5-47	001, 002
16	Input Shaft	27T, 9-1/2" OAL		1317-202-017	S5-47	006, 007, 013
16	Input Shaft	1317-202-033, 27T, 12-3/8" OAL		ZF47-16C	S5-47M	All
18	Mainshaft 5th Gear	26T		ZF42-18	S5-42	050, 051, 053, 054, 059, 064, 102,
18	Mainshaft 5th Gear	30T		ZF42-18A	S5-42	056, 057, 100, 103, 108, 109
18	Mainshaft 5th Gear	25T		ZF47-18	S5-47	30,040,120
18	Mainshaft 5th Gear	25T		1317-204-018	S5-47/S5-47M	001, 002, 006, 007, 013, All S5-47M
19	Countershaft 5th Gear	57T		ZF42-19	S5-42	050/051/053/054/059/064/102/110/111/118/120

# Transmission Gearing & Related Parts

## ZF S5-42, S5-47 & S5-47M

Continued

Position	Description	Specifications	Applications	Part Number	Model#s	Assembly#s
19	Countershaft 5th Gear	47T		ZF42-19A	S5-42	056/057/100/103/108/109
19	Countershaft 5th Gear	1317-303-016, 48T		N/A	S5-47/S5-47M	003/004/012
21	2nd Gear	37T		ZF42-21A	S5-42	050, 051, 053, 054, 059, 064, 102,
21	2nd Gear	51T		ZF42-21	S5-42	056, 057, 100, 103, 108, 109
21	2nd Gear	37T		ZF47-21	S5-47/S5-47M	All
23	1st/2nd Gear Shift	1307-298-933	Fork Only, No Rail Included, Fits only S5-42 and S5-47	ZF42-23	S5-42/S5-47/S5-47M	All
23	1st/2nd Gear Shift		Fork Only, No Rail Included, Fits only S5-47	ZF47-23	S5-47/S5-47M	All
23A	3rd/4th Gear Shift Fork	1307-206-003		ZF42-23A	S5-42/S5-47/S5-47M	All
23B	5th/Rev. Gear Shift Fork	1307-306-019		ZF42-23B	S5-42/S5-47/S5-47M	All
34	Countershaft 3rd gear	34T		ZF42-34	S5-42	All
34	Countershaft 3rd gear	31T		ZF42-34A	S5-42	All
34	Countershaft 3rd gear	1317-303-013, 30T		N/A	S5-47/S5-47M	All
34	Countershaft 3rd gear	31T		1317-303-012	S5-47/S5-47M	All
36	Mainshaft Rev. Gear	1307-304-590, 44T		ZF42-36	S5-42	All
36	Mainshaft Rev. Gear	44T		ZF47-36A	S5-47/S5-47M	All
40	5th/Rev. Gear Synchro. Assy.	1307-204-239		ZF42-40	S5-42	All
40	5th/Rev. Gear Synchro. Assy.- Includes Synchro. Rings			ZF47-40A	S5-47/S5-47M	All
40	5th/Rev. Gear Synchro. Assy.- Includes Synchro. Rings			ZF42-40A	S5-42	All
40	5th/Rev. Gear Synchro. Assy.			ZF47-40	S5-47/S5-47M	All
80	1-2 Hub and Slider			ZF42-80	S5-42	All
80	1-2 Hub and Slider-Includes Synchro. Rings			1307-204-243	S5-47/S5-47M	All
80	1-2 Hub and Slider			ZF47-80	S5-47/S5-47M	All
80	1-2 Hub and Slider-Includes Synchro. Rings			ZF47-80A	S5-47/S5-47M	All
111	3-4 Synchro.. Hub			ZF42-111	S5-42	All
111	3-4 Synchro.. Hub			ZF47-111	S5-47/S5-47M	All
116	3-4, 5th-Rev. Slider			ZF42-116	S5-42	All
128	1-2 Slider			ZF47-128	S5-47/S5-47M	All
128	1-2 Slider			ZF42-128	S5-42	All
131	5th-Rev. Synchro. Hub			ZF42-131	S5-42	All
131	5th-Rev. Synchro. Hub			ZF47-131	S5-47/S5-47M	All
136	3-4, 5th-Rev. Slider	1307-304-372		ZF42-136	S5-42	All
136	3-4, 5th-Rev. Slider	1317-304-158		ZF47-136A	S5-47/S5-47M	All
	Key, Spring and Ball Kit			ZF42-K	S5-42/47/47M	All
	Synchro. Ring Kit			SK-ZF1A	S5-42	All
	Synchro. Ring Kit			SK-ZF2A	S5-47/S5-47M	All
	Input Shim Kit			ZF42-SMK	S5-42/47/47M	All
	Snap Ring Kit	SRK1307		1052-SRK		

# Transmission Gearing & Related Parts



## ZF S5-42, S5-47 & S5-47M Continued

Position	Description	Applications	Part Number	Models
A	Input Shaft Brg.		ZT1096-ZT1097	S5-42/S5-47/S5-47M
B	Mainshaft Pilot Brg.		ZT1101	S5-42/S5-47/S5-47M
C	Mainshaft Rear Brg.		ZT1098-ZT1097	S5-42/S5-47/S5-47M
D	Countershaft Front Brg.		ZT1099-ZT1100	S5-42/S5-47/S5-47M
E	Countershaft Rear Brg.		ZT1099-ZT1100	S5-42/S5-47/S5-47M
F	1st Gear Synchro. Ring		ZSY1198	S5-42
F	1st Gear Synchro. Ring		ZSY1203	S5-47/S5-47M
G	2nd Gear Synchro. Ring		ZSY1198	S5-42
G	2nd Gear Synchro. Ring		ZSY1203	S5-47/S5-47M
H	3rd Gear Synchro. Ring		ZSY1199	S5-42
H	3rd Gear Synchro. Ring		ZSY1204	S5-47/S5-47M
I	4th Gear Synchro. Ring		ZSY1199	S5-42
I	4th Gear Synchro. Ring		ZSY1204	S5-47/S5-47M
J	Mainshaft 5th Gear Synchro. Ring		ZSY1199	S5-42
J	Mainshaft 5th Gear Synchro. Ring		ZSY1204	S5-47/S5-47M
K	Mainshaft Rev. Gear Synchro. Ring		ZSY1200	S5-42
K	Mainshaft Rev. Gear Synchro. Ring		ZSY1205	S5-47/S5-47M
L	1st Gear Brg.		ZN1055	S5-42/S5-47/S5-47M
M	2nd Gear Brg.		ZN1057	S5-42/S5-47/S5-47M
N	3rd Gear Brg.		ZN1057	S5-42/S5-47/S5-47M
N	3rd Gear Brg. Inner Race		ZN1056	S5-42/S5-47/S5-47M
O	Mainshaft 5th Gear Brg.		ZN1058	S5-42/S5-47/S5-47M
P	Mainshaft Rev. Gear Brg.		ZN1055	S5-42/S5-47/S5-47M
Q	Rev. Idler Gear Brg.		ZN1059	S5-42/S5-47/S5-47M
R	Shift Lever Brg.		ZN1060	S5-42/S5-47/S5-47M
S	Input Shaft Seal	35x50x7	3771	S5-42/S5-47
S	Input Shaft Seal	38x50x7	14703	S5-47M
S	Ext. Housing Seal	4x4	15803	S5-42/S5-47/S5-47M
S	Ext. Housing Seal	2WD	225010	S5-42/S5-47/S5-47M
S	Oil Baffle		E7TZ7040A	S5-42/S5-47/S5-47M
S	Oil Ring		F4TZ7046A	S5-42/S5-47/S5-47M
S	Front Brg. Retainer O-Ring		ZM1004	S5-42/S5-47/S5-47M
S	Detent Pin Plug		ZM1035	S5-42/S5-47/S5-47M
S	Detent Pin Plug		ZM1036	S5-42/S5-47/S5-47M
S	Sealing Plug		ZM1035	S5-42/S5-47/S5-47M
Z	Gear Shift Gasket		Part of GT-300ZF	S5-42
Z	PTO Cover Gasket		Part of GT-300ZF	S5-42
	Needle Bearing Kit		NK-ZF1	S5-42/S5-47/S5-47M

LD Transmission



# Transmission Gearing & Related Parts

## ZF S6-650/750 Continued

Description	Specifications	Applications	Part Number	Model#’s	Assembly#’s
Mainshaft	1319-304-069	2WD	ZFS6-2	S6-650	004/005/022
Mainshaft	1319-304-094, High Torque	4WD	ZFS6-2B	S6-650	025/036/044/046
Mainshaft	1319-304-099	2WD	1319-304-099	S6-750	001/004/006
Mainshaft	1319-304-070	4WD	ZFS6-2A	S6-750	
Mainshaft	1319-304-108	4WD	ZFS6-2E	S6-750	003/005/007
3-4 Synchro. Assy.	1319-304-125		ZFS6-2.5	S6-650	All
3-4 Synchro. Assy.	1319-204-039		1319-204-039	S6-750	All
Countershaft 3rd Gear	1319-303-050		ZFS6-34	S6-650/S6-750	All
Front Bearing Retainer	1319-302-009	Ford Only	ZFS6-6	S6-650/S6-750	All
Input Shim			ZFS6-SMK	S6-650	All
Cluster Gear	1319-203-024, 39-35-25-19-12 Tooth Counts		ZFS6-8	S6-650/S6-750	001/003/004/005/006/007 008/009/010/011-does not fit 083/084/085/086
4th Gear	1319-303-049, 39T		ZFS6-9	S6-650/S6-750	001/003/004/005/006/007 008/009/010/011-does not fit 083/084/085/086
3rd Gear	1319-204-011, 27T		ZFS6-11	S6-650/S6-750	All
1st Gear	1319-307-044, 37T		ZFS6-12	S6-650/S6-750	
Input Shaft	1319-202-026, 23T, 10 3/8” Length	Ford Only	ZFS6-16	S6-650	004/005/006/022/023/024/0 25/036/037/045/046/049/
Input Shaft	1319-202-017	GM	N/A	N/A	N/A
Input Shaft	1319-202-024, 23T, 11.375”Length, .970” Pilot	Ford Only	ZFS6-16B	S6-750	001/003/004/005/006/007
Input Shaft	1319-202-018, 23T, 14.5” Length, 1.5” Clutch splines	GM	N/A	S6-650	
Input Shaft	1319-202-023		N/A	S6-650	043/044/053/054/061/062/0 65/66/081/082
5th Gear	1319-303-052, 54T		ZFS6-18	S6-650/S6-750	All
2nd-3rd Gear Inner Bearing Race	0730-162-812		ZN1190	S6-650/S6-750	All
2nd Gear	1319-204-013, 31T		ZFS6-21	S6-650	004/005/006/022/023/02 4/025/036/037/043/044/0 45/046
2nd Gear	1319-204-042		1319-204-042	S6-750	All
2nd-3rd Thrust Washer	0730-162-813		ZN1197	S6-650	All
2nd-3rd Thrust Washer	0730-112-261		ZFS6-22A	S6-750	All
Low-Rev Shift Fork	1319-306-045		ZFS6-23	S6-650/S6-750	All
1-2 Slider	1319-204-056, 1319 304 092		ZFS6-28	S6-650/S6-750	All
1-2 Hub	1319-304-088, High Torque, .675” Splines		1319-304-088	S6-650	All
1-2 Synchro. Hub	1317-304-125		ZFS6-37	S6-650/S6-750	All
Reverse Gear	1319-204-026, 37T		ZFS6-36	S6-650/S6-750	All
Creeper Rev. Synchro. Assembly	1319-204-040		ZFS6-40	S6-650/S6-750	All
Creeper Gear	1319-204-056, 41T		ZFS6-48	S6-650/S6-750	All
5th Synchro. Hub and Slider	1319-203-029		ZFS6-50	S6-650/S6-750	All
5th Synchro. Hub and Slider	1319-203-029- Includes Synchro. Rings		ZFS6-50A	S6-650/S6-750	All
3rd Gear C-S	1319-303-050		ZFS6-34	S6-650/S6-750	All
5th Synchro. Hub	1319-303-047		1319-303-047	S6-650/S6-750	All
1-2 Synchro. Assembly	1319-204-045		ZFS6-80A	S6-650	004/005/006/022/023
1-2 Gear Hub and Slider	1319-204-045		ZFS6-80	S6-650/S6-750	All
1-2 Synchro. Assembly	1319-204-050		1319-204-050	S6-750	All
Low and Reverse Gear Slider	1317-304-157		ZF47-128	S6-650/S6-750	All

LD Transmission

# Transmission Gearing & Related Parts

## ZF S6-650/750 Continued

Description	Specifications	Applications	Part Number	Model#s	Assembly#s
3-4,5th Gear Slider	1317-304-158		ZF47-136A	S6-650	All
3-4, 5th Gear Slider	1317-304-125		N/A	S6-750	All
5th Shift Fork	1319-306-047		1319-306-047	S6-650/S6-750	All
1-2, 3-4 Shift Fork	1307-306-019		ZF42-23B	S6-650/S6-750	All
Synchro. Key and Spring Kit			ZFS6-K1	S6-650/S6-750	All
Pump Housing	1319-220-008		1319-220-008	S6-650/S6-750	S6-650/S6-750
Snap Ring Kit	1319SRK		1319SRK	S6-650/S6-750	All
Input Shaft Brg.			45285-45220	S6-650/S6-750	
Mainshaft Pilot Brg.			JH13349	S6-650/S6-750	
Mainshaft Center Brg.			NP957859- NP771105	S6-650/S6-750	
Mainshaft Rear Brg.			309-L	S6-650/S6-750	
Mainshaft Rear Brg.		4WD GM Applications	ZB1181	S6-650/S6-750	
Countershaft Front Brg.			DTP2074	S6-650	
Countershaft Front Brg.			1319-203-032	S6-750	
Countershaft Center Brg.			NP043905- NP547779	S6-650/S6-750	
Countershaft Rear Brg.		Ford Applications	FC69178	S6-650	
Countershaft Rear Brg.		GM Applications	R1563TAV	S6-650	
Countershaft Rear Brg.			N/A	S6-750	
Input Shaft Seal			UH5019-E0	S6-650/S6-750	
Output Shaft Seal		2WD All	UH5020-G0	S6-650/S6-750	
Output Shaft Seal		4WD Ford Applications	UH5021-E0	S6-650/S6-750	
Rear O ring		4WD GM Applciations	OR-100X3V	S6-650/S6-750	
Oil Baffle			F81Z7046AA	S6-650/S6-750	
Oil Ring			F4TZ7046A	S6-650/S6-750	
Sealing Cap (Large)			ZM1036	S6-650/S6-750	
1st Gear Brg.			ZN1189	S6-650/S6-750	
2nd Gear Brg.			ZN1189	S6-650/S6-750	
2nd Gear Brg. Inner Race			ZN1190	S6-650/S6-750	
3rd Gear Brg.			ZN1189	S6-650/S6-750	
3rd Gear Inner Brg. Race			ZN1190	S6-650/S6-750	
5th Gear Brg.			ZN1191	S6-650/S6-750	
5th Gear Inner Brg. Race			ZN1192	S6-650/S6-750	
5th Gear Thrust Washer			ZN1193	S6-650/S6-750	
Creep Gear Brg.			ZN1194	S6-650/S6-750	
Rev. Gear Brg.			ZN1194	S6-650/S6-750	
Rev. Gear Brg. Inner Race			ZN1195	S6-650/S6-750	
Rev. Idler Gear Brg.			ZN1196	S6-650/S6-750	
Shift Shaft Brg.			ZN1160	S6-650/S6-750	
2nd-3rd Gear Thrust Washer			ZN1197	S6-650/S6-750	
Rev. Gear Thrust Brg.			ZN1198	S6-650/S6-750	
Gasket Kit			GT-PTO55	S6-650/S6-750	
Synchro. Ring Kit			SK-ZF4A	S6-650/S6-750	
Needle Bearing Kit			NK-ZF2	S6-650/S6-750	

# Transmission Gearing & Related Parts

## Dodge/Mercedes G56

Description	Specifications	Applications	Part Number	Model#’s	Assembly#’s
Mainshaft		4WD	G56-2		
3-4 Hub and Slider			G56-2.5		
3-4 Synchro. Assembly			G56-2.5A		
Bearing Retainer	Cast Iron		G56-6C		
5-6 Gear, Countershaft	52&48 Tooth		G56-9		
5-6 Gear, Countershaft	52&47 Tooth		G56-9A		
1-2 Synchro. Ring- 3 Piece Set			G56-14A		
1-2 Synchro. Ring- Center			ZSY1412		
3-4 Synchro. Ring- 3 Piece Set			G56-14B		
3-4 Synchro. Ring- Center			ZSY1413		
5-6 Synchro. Ring			ZSY1414		
Reverse Synchro. Ring- 3 Piece Set			ZSY1415		
3-4 Slider			G56-15		
Input Shaft	27 Tooth		G56-16		
Input Shaft	28 Tooth, 3 ID Grooves		G56-16A		
6th Gear (Mainshaft)	23 Tooth		G56-18		
1-2 Clutch Gear			G56-28		
1-2 Hub			G56-37		
Reverse Hub and Slider			G56-40		
Reverse Synchro. Assembly			G56-40A		
Input Bearing Sleeve			G56-41		
5-6 Hub and Slider			G56-50		
5-6 Synchro, Assembly			G56-50A		
Synchro. Keys			G56-77		
Synchro. Springs			G56-78		
1-2 Hub and Slider			G56-80		
1-2 Synchro. Assembly			G56-80A		
Shifter Boot			G56-86		
3-4 Hub			G56-111		
5-6 Hub			G56-131		
5-6 Slider			G56-136		
Synchro. Key and Spring Kit			G56-K1		
Synchro. Ring Kit			SK-G56		
1-2 Slider			N/A		
Input Shaft Brg.			32210		
Input Shaft Pilot Brg.			33206		
Output Shaft Rear Brg.			32210		
Countershaft Front Brg.			30307		
Countershaft Rear Brg.			32208		
Input Shaft Seal			5179736AA		
Output Shaft Seal		2WD	5142723AA		
Output Shaft Seal		4WD	5142724AA		

# Transfer Case Identification

## GM Magna Steyr Transfer Case Identification:

GM RPO Code*	Magna Model#	Part Time/Full Time	Shift Type	Operation Modes	Compatible Transmissions
NQG	1222	Part Time	Manual	2High, 4High, 4Low, N	4L60, 4L70
NQG	1225	Part Time	Manual	2High, 4High, 4Low, N	6L80, 6L90
NQG	1226	Part Time	Manual	2High, 4High, 4Low, N	6L90 and Allison
NQF	1625	Part Time	Electric	2High, 4High, 4Low, N	6L80, 6L90
NQF	1626	Part Time	Electric	2High, 4High, 4Low, N	6L90 and Allison
NQH	3023	Part Time/Full Time	Electric	2High, Auto, 4High, 4Low, N	4L60, 4L70, M99 Hybrid
NQH	3024	Part Time/Full Time	Electric	2High, Auto, 4High, 4Low, N	6L80, 6L90

\*Note-There is no external ID tag on these transfer cases, you must use the RPO code located in the glove box.

## New Process Transfer Case Identification:

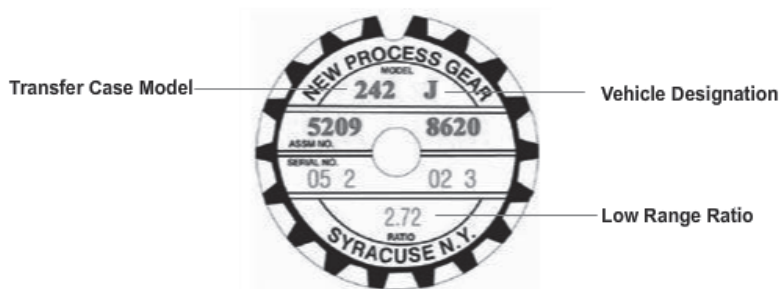

### Vehicle Designation Codes:

C=Chevrolet/GM

J=Jeep

D=Dodge

## Borg Warner Transfer Case Identification:

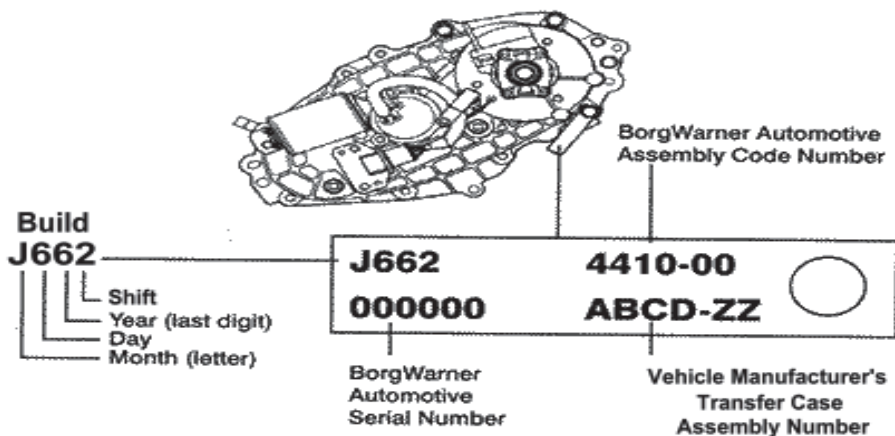

LD Transmission

# Light Duty Transfer Case Applications



Vehicle	Model #	Years	Notes	Bearing, Seal & Gasket Kit	Seal & Gasket Kit	Chain Kit
<b>Chrysler (Dodge, Plymouth)</b>						
1/2, 3/4 & 1 Ton Truck	3010	2010		TCRK-3010	DTK-3010	HV084
1/2, 3/4 & 1 Ton Truck	271	10-08		TCRK-271BB	DTK-271BB	HV064
1/2, 3/4 & 1 Ton Truck	273	10-08		TCRK-271CC	DTK-271CC	HV064
1/2, 3/4 & 1 Ton Truck	246	10-06		TCRK-246AA	DTK-246AA	HV072
1/2, 3/4 & 1 Ton Truck	271	07-03		TCRK-271AA	DTK-271AA	HV064
1/2, 3/4 & 1 Ton Truck	273	07-03		TCRK-271AA	DTK-271AA	HV064
1/2, 3/4 & 1 Ton Truck	243	10-02		TCRK-243D	DTK-243D	HV072
1/2, 3/4 & 1 Ton Truck	244	05-04	Electric Shift	TCRK-242EE	DTK-242EE	HV084
1/2, 3/4 & 1 Ton Truck	241	05-02		TCRK-241LL	DTK-241LL	HV081
1/2, 3/4 & 1 Ton Truck	241	05-00	241 DHD (Heavy Duty)	TCRK-241DD	DTK-241	HV031
1/2, 3/4 & 1 Ton Truck	231	01-97		TCRK-231EE	DTK-231EE	HV027
1/2, 3/4 & 1 Ton Truck	241	99-97		TCRK-241EE	DTK-241	HV025
1/2, 3/4 & 1 Ton Truck	241	99-97	241 DHD (Heavy Duty)	TCRK-241FF	DTK-241	HV031
1/2, 3/4 & 1 Ton Truck	241	96-95		TCRK-241BB	DTK-241	HV025
1/2, 3/4 & 1 Ton Truck	241	1994		TCRK-241	DTK-241	HV025
1/2, 3/4 & 1 Ton Truck	231	96-94		TCRK-231DD	DTK-231DD	HV027
1/2, 3/4 & 1 Ton Truck	205	93-88	w/ 6210N Input Bearing	TCRK-205D	DTK-205D	N/A
1/2, 3/4 & 1 Ton Truck	241	93-88		TCRK-241AA	DTK-241	HV025
1/2, 3/4 & 1 Ton Truck	208	87-80	Includes Small Parts Kit	TCRK-208SPK	DTK-208	HV025
1/2, 3/4 & 1 Ton Truck	205	87-69	w/ 6307N Input Bearing	TCRK-205G	DTK-205G	N/A
1/2, 3/4 & 1 Ton Truck	203	79-73		TCRK-203G	DTK-203G	Obsolete
1/2, 3/4 & 1 Ton Truck	201	68-60		TCRK-201	DTK-201	N/A
Aspen	243	09-07		TCRK-243D	DTK-243D	HV072
Dakota	243	11-06		TCRK-243D	DTK-243D	HV072
Dakota	233	11-01		TCRK-233AA	DTK-233AA	HV027
Dakota	244	08-01	Electric Shift	TCRK-242EE	DTK-242EE	HV072
Dakota	242	2000	w/ BD50-8 I/S Brg	TCRK-242EE	DTK-242EE	HV063
Dakota	231	00-94	w/ 6010N I/S Brg	TCRK-231EE	DTK-231EE	HV027
Dakota	242	99-98	w/ 6010N I/S Brg	TCRK-242DD	DTK-242DD	HV063
Dakota	231	93-88	w/ BD50-8 I/S Brg	TCRK-231	DTK-231	HV027
Dakota	207	1987		TCRK-207	DTK-207	HV022
Durango	3023	15-11		TCRK-3023	DTK-3023A	HVMS1 <sup>70</sup>
Durango	243	15-02		TCRK-243D	DTK-243D	HV084
Durango	140	09-08		TCRK-140	DTK-140	HV089
Durango	244	09-01	Electric Shift	TCRK-242EE	DTK-242EE	HV072
Durango	233	03-01	Electric Shift	TCRK-233AA	DTK-233AA	HV027
Durango	242	2000	w/ BD50-8 I/S Brg	TCRK-242EE	DTK-242EE	HV063
Durango	231	00-98		TCRK-231EE	DTK-231EE	HV027
Durango	242	99-98	w/ 6010N I/S Brg	TCRK-242DD	DTK-242DD	HV063
Nitro	1522	12-08		TCRK-1522	DTK-1522	N/A
Ramcharger	241	93-88		TCRK-241AA	DTK-241	HV025
Ramcharger	208	87-80	Includes Small Parts Kit	TCRK-208SPK	DTK-208	HV025
Ramcharger	203	79-74		TCRK-203G	DTK-203G	Obsolete
Ram 4500	271	10-08		TCRK-271BB	DTK-271BB	HV064
Ram 4500	273	10-08		TCRK-271CC	DTK-271CC	HV064
Ram 5500	273	10-08		TCRK-271CC	DTK-271CC	HV064
Ram 5500	271	10-08		TCRK-271BB	DTK-271BB	HV064
Trailduster	208	81-80	Includes Small Parts Kit	TCRK-208SPK	DTK-208	HV025
Trailduster	203	79-74		TCRK-203G	DTK-203G	Obsolete
<b>Daihatsu</b>						
Rocky		92-88		TCRK-FD120	DTK-FD120	N/A

LD Transmission

# Light Duty Transfer Case Applications

Vehicle	Model #	Years	Notes	Bearing, Seal & Gasket Kit	Seal & Gasket Kit	Chain Kit
<b>Ford (Lincoln, Mercury)</b>						
Aerostar	Dana 28	97-90		TCRK-28	DTK-28	HV048
Aviator	4410	05-03		TCRK-4410	DTK-4410	HV067
Bronco	1356	96-92	Electric Shift	TCRK-1356	DTK-1356	HV012
Bronco	1356	96-87	Manual Shift	TCRK-1356	DTK-1356	HV012
Bronco	1345	86-81		TCRK-1345	DTK-1345	Obsolete
Bronco	208	86-80	Includes Small Parts Kit	TCRK-208SPK	DTK-208	HV026
Bronco	205	79-78	Direct Mount	TCRK-205F	DTK-205F	N/A
Bronco	203	79-78	Direct Mount	TCRK-203F	DTK-203F	Obsolete
Bronco	Dana 20	77-73		TCRK-20C	DTK-20F	N/A
Bronco	Dana 20	72-66		TCRK-20B	DTK-20F	N/A
Bronco II	1354	1990	Manual Shift or Electric Shift	TCRK-1354	DTK-1354	HV022
Bronco II	1359	90-84	Dummy Case used in 2WD Applications	TCRK-1359	DTK-1359	N/A
Bronco II	1359					
Bronco II	1350	90-84	Manual Shift or Electric Shift	TCRK-1350	DTK-1350	HV022
Excursion	273	05-00	Electric Shift	TCRK-271	DTK-271	HV064
Expedition	4417	15-07		TCRK-4417	DTK-4417	HV076
Expedition	4416	06-03		TCRK-4416	DTK-4416	HV053
Expedition	4406	02-97	Torque on Demand	TCRK-4406	DTK-4406	HV053
Explorer	4412 w/ 6 Spd. Auto Trans.	10-06		TCRK-4412A	DTK-4412A	HV067
Explorer	4414 w/ 5 Spd. Auto Trans.	10-06		TCRK-4412	DTK-4412	HV067
Explorer	4411	05-02	V-6	TCRK-4411	DTK-4411	HV067
Explorer	4410	05-02	V-8	TCRK-4410	DTK-4410	HV078
Explorer	4403	01-99	AWD	TCRK-4403	DTK-4403	HV051
Explorer	4405	01-97	V-6 w/ Electric Shift	TCRK-4405AA	DTK-4405	HV067
Explorer	4404	01-96	V-8 w/ TOD	TCRK-4404	DTK-4404	HV070
Explorer	4405	96-95	V-6 w/ Electric Shift	TCRK-4405	DTK-4405	HV051
Explorer	1354	95-91	Manual Shift or Electric Shift	TCRK-1354	DTK-1354	HV022
Explorer Sport	1354	03-01	Manual Shift or Electric Shift	TCRK-1354	DTK-1354	HV068
Explorer Sport Trac	4412 w/ 6 Spd. Auto Trans.	10-06		TCRK-4412A	DTK-4412A	HV067
Explorer Sport Trac	4414 w/ 5 Spd. Auto Trans.	10-06		TCRK-4412	DTK-4412	HV067
Explorer Sport Trac	1354	10-05	Electric Shift	TCRK-1354	DTK-1354	HV505
Explorer Sport Trac	1354	04-01	Electric Shift	TCRK-1354	DTK-1354	HV068
F-150	4417	15-10		TCRK-4417	DTK-4417	HV076
F-150	4419	15-09		TCRK-4419	DTK-4419	HV076
F-150	4418	11-09		TCRK-4418	DTK-4418	HV076
F-150	4406	08-96	Manual Shift, Electric Shift & Torque on Demand	TCRK-4406	DTK-4406	HV053
F-150	4406					
F-150	1356	97-92	Electric Shift	TCRK-1356	DTK-1356	HV012
F-150	1356	97-87	Manual Shift	TCRK-1356	DTK-1356	HV012
F-150	1345	92-82		TCRK-1345	DTK-1345	Obsolete
F-150	205	89-71	Direct Mount	TCRK-205F	DTK-205F	N/A
F-150	208	86-80	Includes Small Parts Kit	TCRK-208SPK	DTK-208	HV026
F-150	203	79-73	Direct Mount	TCRK-203F	DTK-203F	Obsolete
F-150	203	77-74	Remote Mount	TCRK-203FA	DTK-203FA	Obsolete
F-150	205	77-73	Remote Mount	TCRK-205FA	DTK-205R	N/A
F-150	Dana 21	76-65		TCRK-21	DTK-21	N/A
F-150	Dana 24	1965		TCRK-24	DTK-24	N/A
F-250	271	15-11		TCRK-271DD	DTK-271DD	HV064
F-250	271	10-99		TCRK-271	DTK-271	HV064
F-250	273	15-11	Electric Shift	TCRK-271DD	DTK-271DD	HV064
F-250	273	10-99	Electric Shift	TCRK-271	DTK-271	HV064



# Light Duty Transfer Case Applications



Vehicle	Model #	Years	Notes	Bearing, Seal & Gasket Kit	Seal & Gasket Kit	Chain
<b>Ford (Lincoln, Mercury) (cont.)</b>						
F-250	4406	99-96	Manual Shift, Electric Shift & Torque on Demand	TCRK-4406	DTK-4406	HV053
F-250	4406					
F-250	4407	97-96		TCRK-4407	DTK-4407	HV054
F-250	1356	97-87	Manual Shift	TCRK-1356	DTK-1356	HV012
F-250	1345	92-81		TCRK-1345	DTK-1345	Obsolete
F-250	208	86-80	Includes Small Parts Kit	TCRK-208SPK	DTK-208	HV012
F-250	203	79-74	Direct Mount	TCRK-203F	DTK-203F	Obsolete
F-250	205	79-73	Direct Mount	TCRK-205F	DTK-205F	N/A
F-250	205	77-73	Remote Mount	TCRK-205FA	DTK-205R	N/A
F-250	203	75-74	Remote Mount	TCRK-203FA	DTK-203FA	Obsolete
F-250	Dana 24	72-65		TCRK-24	DTK-24	N/A
F-350	271	15-11		TCRK-271DD	DTK-271DD	HV064
F-350	273	15-11	Electric Shift	TCRK-271DD	DTK-271DD	HV064
F-350	271	10-99		TCRK-271	DTK-271	HV064
F-350	273	10-99	Electric Shift	TCRK-271	DTK-271	HV064
F-350	1356	97-87	Manual Shift	TCRK-1356	DTK-1356	HV012
F-350	1345	87-80		TCRK-1345	DTK-1345	Obsolete
F-350	208	86-84	Includes Small Parts Kit	TCRK-208SPK	DTK-208	HV012
F-350	203	79-72	Direct Mount	TCRK-203F	DTK-203F	Obsolete
F-350	205	79-71	Direct Mount	TCRK-205F	DTK-205F	N/A
F-350	205	77-71	Remote Mount	TCRK-205FA	DTK-205R	N/A
F-350	203	75-72	Remote Mount	TCRK-203FA	DTK-203FA	Obsolete
F-350	Dana 21	74-65		TCRK-21	DTK-21	N/A
F-350	Dana 24	72-62		TCRK-24	DTK-24	N/A
Mark LT	4406	08-06	Manual Shift, Electric Shift & Torque on Demand	TCRK-4406	DTK-4406	HV053
Mark LT	4406					
Mountaineer	4414 w/ 5 Spd. Auto Trans.	10-06		TCRK-4412	DTK-4412	HV067
Mountaineer	4412 w/ 6 Spd. Auto Trans.	10-06		TCRK-4412A	DTK-4412A	HV067
Mountaineer	4410	05-02	V-8	TCRK-4410	DTK-4410	HV078
Mountaineer	4403	01-99	AWD	TCRK-4403	DTK-4403	HV051
Mountaineer	4405	01-98	V-6 w/ Electric Shift	TCRK-4405AA	DTK-4405	HV051
Mountaineer	4404	01-97	V-8 w/ TOD	TCRK-4404	DTK-4404	HV070
Navigator	4417	15-07		TCRK-4417	DTK-4417	HV076
Navigator	4416	06-03		TCRK-4416	DTK-4416	HV053
Navigator	4406	02-98	Torque on Demand	TCRK-4406	DTK-4406	HV053
Ranger	1354	11-91	Electric Shift	TCRK-1354	DTK-1354	HV022
Ranger	1354	98-90	Manual Shift	TCRK-1354	DTK-1354	HV022
Ranger	4405	1997	V-6 w/ Electric Shift	TCRK-4405AA	DTK-4405	HV051
Ranger	4405	96-95	V-6 w/ Electric Shift	TCRK-4405	DTK-4405	HV051
Ranger	1350	93-83	Manual Shift or Electric Shift	TCRK-1350	DTK-1350	HV022
<b>GM (Chevrolet, GMC, Buick, Cadillac, Oldsmobile, Hummer, Geo)</b>						
1/2 Ton Truck	1222	16-07		TCRK-1222	DTK-1222	HV501
1/2 Ton Truck	3023, RPO Code NQH	16-07		TCRK-3023	DTK-3023	HVMS1 <sup>70</sup>
1/2 Ton Truck	4485	14-07	One Speed	TCRK-4485	DTK-4485	HV502
1/2 Ton Truck	149	07-01	One Speed	TCRK-149	DTK-149	HV072
1/2 Ton Truck	246	07-98		TCRK-246	DTK-246	HVMS1 <sup>70</sup>
1/2 Ton Truck	261HD	07-01	Heavy Duty	TCRK-261AA	DTK-261	HV069
1/2 Ton Truck	261	07-99		TCRK-261	DTK-261	HV072
1/2 Ton Truck	241	99-94	w/ 6010N I/S Brg	TCRK-241BB	DTK-241	HV025
1/2 Ton Truck	243	99-91	Electric Shift	TCRK-241BB	DTK-241	HV025
1/2 Ton Truck	241	94-88	w/ BD50-8 I/S Brg	TCRK-241	DTK-241	HV025
1/2 Ton Truck	208	87-81	Includes Small Parts Kit	TCRK-208SPK	DTK-208	HV025
1/2 Ton Truck	205	80-70	w/ G307N Input Bearing	TCRK-205G	DTK-205G	N/A
1/2 Ton Truck	205	80-70	w/ G210N Input Bearing	TCRK-205GDM4	DTK-205G	N/A

LD Transmission

# Light Duty Transfer Case Applications

Vehicle	Model #	Years	Notes	Bearing, Seal & Gasket Kit	Seal & Gasket Kit	Chain
<b>GM (Chevrolet, GMC, Buick, Cadillac, Oldsmobile, Hummer, Geo) (cont.)</b>						
1/2 Ton Truck	203	79-73		TCRK-203G	DTK-203G	Obsolete
1/2 Ton Truck	Dana 20 w/ 1.3125" ID Front Output Cones	75-73		TCRK-20A		N/A
1/2 Ton Truck	Dana 20 w/ 1.1875" ID Front Output Cones	73-69		TCRK-20		N/A
1/2 Ton Truck	4481	2003	AWD, One Speed	TCRK-4481	DTK-4481	HV076
1/2 Ton Truck	4482	2003	AWD, Two Speed	TCRK-4482	DTK-4482	HV076
3/4 Ton Truck	3024, RPO Code NQH	16-08		TCRK-3024	DTK-3024	HVMS1 <sup>70</sup>
3/4 Ton Truck	1225 w/ 29 Tooth Input Shaft, RPO Code NQG	16-07		TCRK-1225	DTK-1225	HVMS1 <sup>70</sup>
3/4 Ton Truck	1225 w/ 33 Tooth Input Shaft, RPO Code NQG	16-07		TCRK-1225A	DTK-1225A	HVMS1 <sup>70</sup>
3/4 Ton Truck	1226 w/ 29 Tooth Input Shaft, RPO Code NQG	16-07		TCRK-1225	DTK-1225	HVMS1 <sup>70</sup>
3/4 Ton Truck	1226 w/ 33 Tooth Input Shaft, RPO Code NQG	16-07		TCRK-1225A	DTK-1225A	HVMS1 <sup>70</sup>
3/4 Ton Truck	1625 w/ 29 Tooth Input Shaft, RPO Code NQF	16-07		TCRK-1625	DTK-1625	HVMS1 <sup>70</sup>
3/4 Ton Truck	1625 w/ 33 Tooth Input Shaft, RPO Code NQF	16-07		TCRK-1625A	DTK-1625A	HVMS1 <sup>70</sup>
3/4 Ton Truck	1626 w/ 29 Tooth Input Shaft, RPO Code NQF	16-07		TCRK-1625	DTK-1625	HVMS1 <sup>70</sup>
3/4 Ton Truck	1626 w/ 33 Tooth Input Shaft, RPO Code NQF	16-07		TCRK-1625A	DTK-1625A	HVMS1 <sup>70</sup>
3/4 Ton Truck	246	07-98		TCRK-246	DTK-246	HVMS1 <sup>70</sup>
3/4 Ton Truck	261SHD	07-01	Super Heavy Duty	TCRK-261BB	DTK-261	HV074
3/4 Ton Truck	263XHD	07-01	Extreme Heavy Duty	TCRK-261BB	DTK-261	HV074
3/4 Ton Truck	261HD	07-99	Heavy Duty	TCRK-261AA	DTK-261	HV069
3/4 Ton Truck	263HD	07-99	Heavy Duty	TCRK-261AA	DTK-261	HV069
3/4 Ton Truck	261	06-99		TCRK-261	DTK-261	HV072
3/4 Ton Truck	241	99-94	w/ 6010N I/S Brg	TCRK-241BB	DTK-241	HV025
3/4 Ton Truck	243	99-91	Electric Shift	TCRK-241BB	DTK-241	HV025
3/4 Ton Truck	241	94-88	w/ BD50-8 I/S Brg	TCRK-241	DTK-241	HV025
3/4 Ton Truck	208	87-81	Includes Small Parts Kit	TCRK-208SPK	DTK-208	HV025
3/4 Ton Truck	205	80-70	w/ 6307N Input Bearing	TCRK-205G	DTK-205G	N/A
3/4 Ton Truck	205	80-70	w/ 6210N Input Bearing	TCRK-205GDM4	DTK-205G	N/A
3/4 Ton Truck	203	79-73		TCRK-203G	DTK-203G	Obsolete
3/4 Ton Truck	Dana 20 w/ 1.3125" ID Front Output Cones	75-73		TCRK-20A		N/A
3/4 Ton Truck	Dana 20 w/ 1.1875" ID Front Output Cones	73-69		TCRK-20		N/A
1 Ton Truck	1226 w/ 29 Tooth Input Shaft, RPO Code NQG	16-07		TCRK-1225	DTK-1225	HVMS1 <sup>70</sup>
1 Ton Truck	1226 w/ 33 Tooth Input Shaft, RPO Code NQG	16-07		TCRK-1225A	DTK-1225A	HVMS1 <sup>70</sup>
1 Ton Truck	1626 w/ 29 Tooth Input Shaft, RPO Code NQF	16-07		TCRK-1625	DTK-1625	HVMS1 <sup>70</sup>
1 Ton Truck	1626 w/ 33 Tooth Input Shaft, RPO Code NQF	16-07		TCRK-1625A	DTK-1625A	HVMS1 <sup>70</sup>
1 Ton Truck	261HD	07-01	Heavy Duty	TCRK-261AA	DTK-261	HV069
1 Ton Truck	263HD	07-01	Heavy Duty	TCRK-261AA	DTK-261	HV069
1 Ton Truck	261SHD	07-01	Super Heavy Duty	TCRK-261BB	DTK-261	HV074
1 Ton Truck	263XHD	07-01	Extreme Heavy Duty	TCRK-261BB	DTK-261	HV074
1 Ton Truck	4401	00-94		TCRK-1356	DTK-1356	HV025
1 Ton Truck	4470	00-90		TCRK-4470	DTK-1356	HV031
1 Ton Truck	1370	93-89		TCRK-1356	DTK-1356	HV025

LD Transmission

<sup>70</sup>Use dimensions on T/C product page to identify correct chain.

# Light Duty Transfer Case Applications



Vehicle	Model #	Years	Notes	Bearing, Seal & Gasket Kit	Seal & Gasket Kit	Chain
<b>GM (Chevrolet, GMC, Buick, Cadillac, Oldsmobile, Hummer, Geo) (cont.)</b>						
1 Ton Truck	241	91-88	w/ BD50-8 I/S Brg	TCRK-241	DTK-241	HV025
1 Ton Truck	205	87-70	w/ 6307N Input Bearing	TCRK-205G	DTK-205G	N/A
1 Ton Truck	205	87-70	w/ 6210N Input Bearing	TCRK-205GDM4	DTK-205G	N/A
1 Ton Truck	203	79-73		TCRK-203G	DTK-203G	Obsolete
1 Ton Truck	Dana 20 w/ 1.3125" ID Front Output Cones	75-73		TCRK-20A		N/A
1 Ton Truck	Dana 20 w/ 1.1875" ID Front Output Cones	73-69		TCRK-20		N/A
Astro	136	05-98	One Speed	TCRK-236	DTK-236	HV062
Astro	4472	98-90		TCRK-1372	DTK-4472	Obsolete
Avalanche	3023, RPO Code NQH	13-08		TCRK-3023	DTK-3023	HVMS1 <sup>70</sup>
Avalanche	4485	13-07		TCRK-4485	DTK-4485	HV502
Avalanche	246	07-02		TCRK-246	DTK-246	HVMS1 <sup>70</sup>
Bravada	126	04-02		TCRK-226	DTK-226	HV059
Bravada	136	01-98	One Speed	TCRK-236	DTK-236	HV062
Bravada	4472	97-91		TCRK-1372	DTK-4472	Obsolete
Envoy	226	09-02		TCRK-226	DTK-226	HV059
Escalade EXT	4485	13-07	One Speed	TCRK-4485	DTK-4485	HV502
Escalade EXT	4481	06-03	AWD, One Speed	TCRK-4481	DTK-4481	HV076
Escalade ESV	1222	16-09		TCRK-1222	DTK-1222	HV501
Escalade ESV	4485	14-07	One Speed	TCRK-4485	DTK-4485	HV502
Escalade ESV	4481	06-03	AWD, One Speed	TCRK-4481	DTK-4481	HV076
Escalade	1222	16-09		TCRK-1222	DTK-1222	HV501
Escalade	4485	14-07	One Speed	TCRK-4485	DTK-4485	HV502
Escalade	4481	06-03	AWD, One Speed	TCRK-4481	DTK-4481	HV076
Escalade	149	2002	One Speed	TCRK-149	DTK-149	HV072
Escalade	246	00-99		TCRK-246	DTK-246	HVMS1 <sup>70</sup>
Express 1500	4473	14-03		TCRK-4473	DTK-4473	HV076
Express 2500	4473	05-03		TCRK-4473	DTK-4473	HV076
Hummer H-1	242	08-92		TCRK-242AA	DTK-242	HV060
Hummer H-1	218	99-92		TCRK-218	DTK-218	Obsolete
Hummer H-2	4484	09-03	AWD, Two Speed	TCRK-4484	DTK-4484	HV502
Hummer H3	4493	10-06				HV055
Hummer H3T	4493	10-09				HV055
Jimmy	241	91-89		TCRK-241	DTK-241	HV025
Jimmy	208	88-81	Includes Small Parts Kit	TCRK-208SPK	DTK-208	HV025
Jimmy	205	80-70	w/6307N Input Bearing	TCRK-205G	DTK-205G	N/A
Jimmy	205	80-70	w/6210N Input Bearing	TCRK-205GDM4	DTK-205G	N/A
Jimmy	203	79-73		TCRK-203G	DTK-203G	Obsolete
Jimmy	Dana 20 w/ 1.3125" ID Front Output Cones	75-73		TCRK-20A		N/A
Jimmy	Dana 20 w/ 1.1875" ID Front Output Cones	73-70		TCRK-20		N/A
K5 Blazer	241	94-89		TCRK-241	DTK-241	HV025
K5 Blazer	208	88-81	Includes Small Parts Kit	TCRK-208SPK	DTK-208	HV025
K5 Blazer	205	80-69	w/ 6307N Input Bearing	TCRK-205G	DTK-205G	N/A
K5 Blazer	205	80-69	w/ 6210N Input Bearing	TCRK-205GDM4	DTK-205G	N/A
K5 Blazer	203	79-73		TCRK-203G	DTK-203G	Obsolete
K5 Blazer	Dana 20 w/ 1.3125" ID Front Output Cones	75-73		TCRK-20A		N/A
K5 Blazer	Dana 20 w/ 1.1875" ID Front Output Cones	73-69		TCRK-20		N/A
Rainier	126	07-04		TRK-226	DTK-226	HV059
S10 Blazer	236	05-99	Two Speed	TCRK-236	DTK-236	HV062
S10 Blazer	233	05-94	Electric Shift	TCRK-231CC	DTK-231CC	HV022
S10 Blazer	136	01-98	One Speed	TCRK-236	DTK-236	HV062

LD Transmission

# Light Duty Transfer Case Applications

Vehicle	Model #	Years	Notes	Bearing, Seal & Gasket Kit	Seal & Gasket Kit	Chain Kit
<b>GM (Chevrolet, GMC, Buick, Cadillac, Oldsmobile, Hummer, Geo) (cont.)</b>						
S10 Blazer	231	97-95		TCRK-231CC	DTK-231CC	HV022
S10 Blazer	4472	97-95		TCRK-1372	DTK-4472	Obsolete
S10 Blazer	231	94-92		TCRK-231BB	DTK-231	HV022
S10 Blazer	233	93-92	Electric Shift	TCRK-231BB	DTK-231	HV022
S10 Blazer	231	91-89		TCRK-231	DTK-231	HV022
S10 Blazer	207	88-83		TCRK-207	DTK-207	HV022
S-10/S-15 Pick-Up	233	04-94	Electric Shift, All	TCRK-231CC	DTK-231CC	HV022
S-10/S-15 Pick-Up	236	1999	Two Speed	TCRK-236	DTK-236	HV062
S-10/S-15 Pick-Up	231	97-95	All	TCRK-231CC	DTK-231CC	HV022
S-10/S-15 Pick-Up	231	1994	All	TCRK-231BB	DTK-231	HV022
S-10/S-15 Pick-Up	231	93-92	Extended Cab	TCRK-231	DTK-231	HV022
S-10/S-15 Pick-Up	231	93-92	Standard Cab	TCRK-231BB	DTK-231	HV022
S-10/S-15 Pick-Up	233	93-92	Electric Shift, Extended Cab	TCRK-231	DTK-231	HV022
S-10/S-15 Pick-Up	233	93-92	Electric Shift, Standard Cab	TCRK-231BB	DTK-231	HV022
S-10/S-15 Pick-Up	231	91-89	All	TCRK-231	DTK-231	HV022
S-10/S-15 Pick-Up	207	88-83	All	TCRK-207	DTK-207	HV022
S15 Jimmy	236	05-99	Two Speed	TCRK-236	DTK-236	HV062
S15 Jimmy	231	05-95		TCRK-231CC	DTK-231CC	HV022
S15 Jimmy	233	05-94	Electric Shift	TCRK-231CC	DTK-231CC	HV022
S15 Jimmy	136	01-98	One Speed	TCRK-236	DTK-236	HV062
S15 Jimmy	4472	97-95		TCRK-1372	DTK-4472	Obsolete
S15 Jimmy	231	94-92		TCRK-231BB	DTK-231	HV022
S15 Jimmy	233	93-92	Electric Shift	TCRK-231BB	DTK-231	HV022
S15 Jimmy	231	91-89		TCRK-231	DTK-231	HV022
S15 Jimmy	207	88-83		TCRK-207	DTK-207	HV022
Safari	136	05-99	One Speed	TCRK-236	DTK-236	HV062
Safari	4472	98-90		TCRK-1372	DTK-4472	Obsolete
Savana 1500	4473	14-03		TCRK-4473	DTK-4473	HV076
Savana 2500	4473	05-03		TCRK-4473	DTK-4473	HV076
Sonoma	233	04-94	Electric Shift, All	TCRK-231CC	DTK-231CC	HV022
Sonoma	236	1999	Two Speed	TCRK-236	DTK-236	HV062
Sonoma	231	97-95	All	TCRK-231CC	DTK-231CC	HV022
Sonoma	231	1994	All	TCRK-231BB	DTK-231	HV022
Sonoma	231	93-92	Extended Cab	TCRK-231	DTK-231	HV022
Sonoma	231	93-92	Standard Cab	TCRK-231BB	DTK-231	HV022
Sonoma	233	93-92	Electric Shift, Standard Cab	TCRK-231BB	DTK-231	HV022
Sonoma	233	93-92	Electric Shift, Extended Cab	TCRK-231	DTK-231	HV022
Suburban	1225, RPO Code NQG	16-12		TCRK-1225A	DTK-1225A	HVMS1 <sup>70</sup>
Suburban	1226, RPO Code NQG	16-12		TCRK-1225A	DTK-1225A	HVMS1 <sup>70</sup>
Suburban	1222	16-09	One Speed	TCRK-1222	DTK-1222	HV501
Suburban	3024, RPO Code NQH	16-09		TCRK-3024	DTK-3024	HVMS1 <sup>70</sup>
Suburban	3023, RPO Code NQH	16-08		TCRK-3023	DTK-3023	HVMS1 <sup>70</sup>
Suburban	4485	14-07	One Speed	TCRK-4485	DTK-4485	HV502
Suburban	1225 w/ 29 Tooth Input Shaft, RPO Code NQG	11-09		TCRK-1225	DTK-1225	HVMS1 <sup>70</sup>
Suburban	1225 w/ 33 Tooth Input Shaft, RPO Code NQG	11-09		TCRK-1225A	DTK-1225A	HVMS1 <sup>70</sup>
Suburban	1226 w/ 29 Tooth Input Shaft, RPO Code NQG	11-09		TCRK-1225	DTK-1225	HVMS1 <sup>70</sup>
Suburban	1226 w/ 33 Tooth Input Shaft, RPO Code NQG	11-09		TCRK-1225A	DTK-1225A	HVMS1 <sup>70</sup>
Suburban	4481	08-03	AWD, One Speed	TCRK-4481	DTK-4481	HV076
Suburban	4482	08-03	AWD, Two Speed	TCRK-4482	DTK-4482	HV076
Suburban	246	07-98		TCRK-246	DTK-246	HVMS1 <sup>70</sup>
Suburban	243	99-96	Electric Shift	TCRK-241BB	DTK-241	HV025
Suburban	241	99-94	w/ 6010N I/S Brg	TCRK-241BB	DTK-241	HV025

<sup>70</sup>Use dimensions on T/C product page to identify correct chain.

# Light Duty Transfer Case Applications



Vehicle	Model #	Years	Notes	Bearing, Seal & Gasket Kit	Seal & Gasket Kit	Chain
<b>GM (Chevrolet, GMC, Buick, Cadillac, Oldsmobile, Hummer, Geo) (cont.)</b>						
Suburban	241	94-89	w/ BD50-8 I/S Brg	TCRK-241	DTK-241	HV025
Suburban	208	88-81	Includes Small Parts Kit	TCRK-208SPK	DTK-208	HV025
Suburban	205	80-70	w/ 6307N Input Bearing	TCRK-205G	DTK-205G	N/A
Suburban	205	80-70	w/ 6210N Input Bearing	TCRK-205GDM4	DTK-205G	N/A
Suburban	203	79-73		TCRK-203G	DTK-203G	Obsolete
Suburban	Dana 20 w/ 1.3125" ID Front Output Cones	75-73		TCRK-20A		N/A
Suburban	Dana 20 w/ 1.1875" ID Front Output Cones	1973		TCRK-20		N/A
Syclone	4472	1991		TCRK-1372	DTK-4472	Obsolete
Tahoe	1222	16-09		TCRK-1222	DTK-1222	HV501
Tahoe	3023, RPO Code NQH	16-08		TCRK-3023	DTK-3023	HVMS1 <sup>70</sup>
Tahoe	4485	14-07	One Speed	TCRK-4485	DTK-4485	HV502
Tahoe	246	07-98		TCRK-246	DTK-246	HVMS1 <sup>70</sup>
Tahoe	241	00-95		TCRK-241BB	DTK-241	HV025
Tahoe	243	99-96	Electric Shift	TCRK-241BB	DTK-241	HV025
Tracker	G130	97-87		TCRK-FS140	DTK-FS140	HV10-110
Trailblazer	226	09-02		TCRK-226	DTK-226	HV059
Typhoon	4472	93-92		TCRK-1372	DTK-4472	Obsolete
Yukon XL	1222	14-09		TCRK-1222	DTK-1222	HV501
Yukon XL	3023, RPO Code NQH	14-08		TCRK-3023	DTK-3023	HVMS1 <sup>70</sup>
Yukon XL	3024, RPO Code NQH	14-08		TCRK-3024	DTK-3024	HVMS1 <sup>70</sup>
Yukon XL	4485	14-07	One Speed	TCRK-4485	DTK-4485	HV502
Yukon XL	1225 w/ 33 Tooth Input Shaft, RPO Code NQG	11-09		TCRK-1225A	DTK-1225A	HVMS1 <sup>70</sup>
Yukon XL	1225 w/ 29 Tooth Input Shaft, RPO Code NQG	11-09		TCRK-1225	DTK-1225	HVMS1 <sup>70</sup>
Yukon XL	1226 w/ 29 Tooth Input Shaft, RPO Code NQG	11-09		TCRK-1225	DTK-1225	HVMS1 <sup>70</sup>
Yukon XL	1226 w/ 33 Tooth Input Shaft, RPO Code NQG	11-09		TCRK-1225A	DTK-1225A	HVMS1 <sup>70</sup>
Yukon XL	246	07-00		TCRK-246	DTK-246	HVMS1 <sup>70</sup>
Yukon XL	149	05-01	One Speed	TCRK-149	DTK-149	HV072
Yukon XL	4481	04-03	AWD, One Speed	TCRK-4481	DTK-4481	HV076
Yukon	1222	16-09		TCRK-1222	DTK-1222	HV501
Yukon	3023, RPO Code NQH	16-08		TCRK-3023	DTK-3023	HVMS1 <sup>70</sup>
Yukon	4485	14-07	One Speed	TCRK-4485	DTK-4485	HV502
Yukon	246	07-98		TCRK-246	DTK-246	HVMS1 <sup>70</sup>
Yukon	243	97-96	Electric Shift	TCRK-241BB	DTK-241	HV025
Yukon	241	97-94	w/ 6010N I/S Brg	TCRK-241BB	DTK-241	HV025
Yukon	241	94-92	w/ BD50-8 I/S Brg	TCRK-241	DTK-241	HV025
<b>Isuzu</b>						
i-370	T150	08-07		TCRK-T150	DTK-T150	N/A
i-350	T150	2006		TCRK-T150	DTK-T150	N/A
<b>Jeep</b>						
CJ	Dana 300	86-80		TCRK-300	DTK-300	N/A
CJ	1305	79-76	Quadra-Trac	TCRK-1305	DTK-1305	Obsolete
CJ	1339	79-76	Quadra-Trac	TCRK-1305	DTK-1305	Obsolete
CJ	Dana 20	79-74		TCRK-20A	DTK-20J	N/A
CJ	Dana 20	73-72		TCRK-20	DTK-20J	N/A
CJ	Dana 18	71-61		TCRK-18	DTK-18	N/A
CJ	Dana 18	60-46		TCRK-18B	DTK-18	N/A
CJ	Dana 18	45-41		TCRK-18A	DTK-18	N/A
Cherokee	231	01-94	w/ 6010N I/S Brg	TCRK-231FF	DTK-231FF	HV027
Cherokee	242	01-94	w/ 6010N I/S Brg	TCRK-242BB	DTK-242BB	HV028
Cherokee	231	94-87	w/ BD50-8 I/S Brg	TCRK-231	DTK-231	HV027

LD Transmission

# Light Duty Transfer Case Applications

Vehicle	Model #	Years	Notes	Bearing, Seal & Gasket Kit	Seal & Gasket Kit	Chain
<b>Jeep (cont.)</b>						
Cherokee	242	93-87	w/ BD50-8 I/S Brg	TCRK-242	DTK-242	HV028
Cherokee	228	1986		TCRK-229	DTK-208	HV015
Cherokee	207	86-84		TCRK-207	DTK-207	HV022
Cherokee	229	85-82		TCRK-229	DTK-208	HV015
Cherokee	208	83-80	Includes Small Parts Kit	TCRK-208SPK	DTK-208	HV025
Cherokee	219	82-80		TCRK-229	DTK-208	HV015
Cherokee	Dana 20	79-74		TCRK-20A	DTK-20J	N/A
Cherokee	1305	79-74	Quadra-Trac	TCRK-1305	DTK-1305	Obsolete
Cherokee	1339	79-74	Quadra-Trac	TCRK-1305	DTK-1305	Obsolete
Comanche	231	92-87		TCRK-231	DTK-231	HV027
Comanche	242	92-87		TCRK-242	DTK-242	HV028
Comanche	207	86-84		TCRK-207	DTK-207	HV022
Comanche	228	1986		TCRK-229	DTK-208	HV015
Grand Cherokee	3023	16-11		TCRK-3023A	DTK-3023A	HVMS1 <sup>70</sup>
Grand Cherokee	2010	16-11		TCRK-2010	DTK-2010	
Grand Cherokee	146	10-06		TCRK-146	DTK-146	
Grand Cherokee	245	10-05		TCRK-245	DTK-245	HV090
Grand Cherokee	140	10-05		TCRK-140	DTK-140	HV089
Grand Cherokee	247	08-99		TCRK-247	DTK-247	HV071
Grand Cherokee	242	08-94	w/ 6010N I/S Brg	TCRK-242BB	DTK-242BB	HV028
Grand Cherokee	249	98-94	w/ 6010N I/S Brg	TCRK-249JA	DTK-249	HV034
Grand Cherokee	249	94-93	w/ BD50-8 I/S Brg	TCRK-249J	DTK-249	HV034
Grand Cherokee	242	1993	w/ BD50-8 I/S Brg	TCRK-242	DTK-242	HV028
Grand Wagoneer	249	1993	w/ BD50-8 I/S Brg	TCRK-249J	DTK-249	HV034
Grand Wagoneer	229	91-84		TCRK-229	DTK-208	HV015
Grand Wagoneer	208	88-84	Includes Small Parts Kit	TCRK-208SPK	DTK-208	HV025
Liberty	1522	12-08		TCRK-1522	DTK-1522	N/A
Liberty	231	07-02		TCRK-231GG	DTK-231GG	HV027
Liberty	242	08-02		TCRK-242CC	DTK-242CC	HV062
SJ	229	88-82		TCRK-229	DTK-208	HV015
SJ	208	88-80	Includes Small Parts Kit	TCRK-208SPK	DTK-208	HV025
SJ	228	1986		TCRK-229	DTK-208	HV015
SJ	119	82-80		TCRK-229	DTK-208	HV015
SJ	219	82-80		TCRK-229	DTK-208	HV015
SJ	Dana 20	79-74		TCRK-20A	DTK-20J	N/A
SJ	1305	79-74	Quadra-Trac	TCRK-1305	DTK-1305	Obsolete
SJ	1339	79-74	Quadra-Trac	TCRK-1305	DTK-1305	Obsolete
SJ	Dana 20	73-62		TCRK-20	DTK-20J	N/A
SJ	Dana 18	65-61		TCRK-18	DTK-18	N/A
Wagoneer	231	90-87		TCRK-231	DTK-231	HV027
Wagoneer	242	90-87		TCRK-242	DTK-242	HV028
Wagoneer	228	1986		TCRK-229	DTK-208	HV015
Wagoneer	207	86-84		TCRK-207	DTK-207	HV022
Wagoneer	229	85-82		TCRK-229	DTK-208	HV015
Wagoneer	208	83-80	Includes Small Parts Kit	TCRK-208SPK	DTK-208	HV025
Wagoneer	219	82-80		TCRK-229	DTK-208	HV015
Wagoneer	1305	79-74	Quadra-Trac	TCRK-1305	DTK-1305	Obsolete
Wagoneer	1339	79-74	Quadra-Trac	TCRK-1305	DTK-1305	Obsolete
Wagoneer	Dana 20	79-74		TCRK-20A	DTK-20J	N/A
Wagoneer	Dana 20	73-62		TCRK-20	DTK-20J	N/A
Wrangler	241	17-12	Non-Rubicon	TCRK-241JJ	DTK-241HH	HV027
Wrangler	241	17-03	Rubicon	TCRK-241GG	DTK-241GG	HV081
Wrangler	241	11-07	Non-Rubicon	TCRK-241HH	DTK-241HH	HV027
Wrangler	231	06-94	w/ 6010N I/S Brg	TCRK-231FF	DTK-231FF	HV027
Wrangler	242	08-94	w/ 6010N I/S Brg	TCRK-242BB	DTK-242BB	HV028
Wrangler	231	94-87	w/ BD50-8 I/S Brg	TCRK-231	DTK-231	HV027

LD Transmission

<sup>70</sup>Use dimensions on T/C product page to identify correct chain.



# Light Duty Transfer Case Applications



Vehicle	Model #	Years	Notes	Bearing, Seal & Gasket Kit	Seal & Gasket Kit	Chain
<b>Jeep (cont.)</b>						
Wrangler	242	93-87	w/ BD50-8 I/S Brg	TCRK-242	DTK-242	HV028
<b>Kia</b>						
Sportage		02-95		TCRK-FK100	DTK-FK100	N/A
<b>Land Rover</b>						
Range Rover	BW1361	95-89		TCRK-1361	DTK-1361	HV049
<b>Lexus</b>						
LX470	LEXTR	07-98		TRK-FT500	DTK-FT500	N/A
LX450	LEXTR	97-96		TRK-FT500	DTK-FT500	N/A
<b>Mazda</b>						
B2000		87-86		TCRK-FMZ220	DTK-FMZ220	HV10-105
B2200		93-87		TCRK-FMZ220	DTK-FMZ220	HV10-105
B2300	1354	10-01	Manual Shift or Electric Shift	TCRK-1354	DTK-1354	HV022
B2500	1354	01-98	Manual Shift or Electric Shift	TCRK-1354	DTK-1354	HV022
B2600		93-87		TCRK-FMZ220	DTK-FMZ220	HV10-105
B3000	1354	08-94	Manual Shift or Electric Shift	TCRK-1354	DTK-1354	HV022
B3000	4405	1997	Electric Shift	TCRK-4405AA	DTK-4405	HV051
B3000	4405	96-95	Electric Shift	TCRK-4405	DTK-4405	HV051
B4000	1354	10-94	Manual Shift or Electric Shift	TCRK-1354	DTK-1354	HV022
B4000	4405	1997	Electric Shift	TCRK-4405AA	DTK-4405	HV051
B4000	4405	96-95	Electric Shift	TCRK-4405	DTK-4405	HV051
MPV Van		98-91		TCRK-FMZ230	DTK-FMZ230	N/A
Navajo	1354	94-91	Manual Shift or Electric Shift	TCRK-1354	DTK-1354	HV022
<b>Mitsubishi</b>						
Montero	KM120	06-92		TCRK-FM220	DTK-FM220	N/A
Raider	243	09-06		TCRK-243D	DTK-243D	HV072
Raider	233	09-06	Electric Shift	TCRK-233AA	DTK-233AA	HV027
Raider	244	08-06	Electric Shift	TCRK-242EE	DTK-242EE	HV072
Truck	KM100	96-80		TCRK-FM230	DTK-FM230	N/A
<b>Nissan</b>						
Truck	TY10B	95-90		TCRK-FN500	DTK-FN500	N/A
Truck	TX10	04-86	Direct Mount Transfer Case	TCRK-FN240	DTK-FN240	N/A
Truck	TY10	08-86		TCRK-FN460	DTK-FN460	N/A
Truck	TY10A	08-85		TCRK-FN430	DTK-FN430	N/A
Truck	T100L	86-81	Remote Transfer Case	TCRK-FN180	DTK-FN180	N/A
<b>Ram</b>						
Dakota	243	11-10		TCRK-243D	DTK-243D	HV072
Dakota	233	11-10	Electric Shift	TCRK-233AA	DTK-233AA	HV027
1500	4445	15-12		TCRK-4444	DTK-4444	HV076
1500	4444	15-11		TCRK-4444	DTK-4444	HV076
1500	3010	12-11		TCRK-3010	DTK-3010	HV084
2500	4446	15-12		TCRK-4446A	DTK-4446A	HV064
2500	4447	15-12		TCRK-4446A	DTK-4446A	HV064
2500	271	12-11		TCRK-271BB	DTK-271BB	HV064
2500	273	12-11		TCRK-271CC	DTK-271CC	HV064
3500	4447	15-12		TCRK-4446A	DTK-4446A	HV064
3500	4446	15-12		TCRK-4446A	DTK-4446A	HV064
3500	271	12-11		TCRK-271BB	DTK-271BB	HV064
3500	273	12-11		TCRK-271CC	DTK-271CC	HV064
4500	4447	15-12		TCRK-4446	DTK-4446	HV064
4500	4446	15-12		TCRK-4446	DTK-4446	HV064
4500	271	12-11		TCRK-271BB	DTK-271BB	HV064
4500	273	12-11		TCRK-271CC	DTK-271CC	HV064
5500	4447	15-12		TCRK-4446	DTK-4446	HV064
5500	4446	15-12		TCRK-4446	DTK-4446	HV064
5500	271	12-11		TCRK-271BB	DTK-271BB	HV064

LD Transmission

# Light Duty Transfer Case Applications

Vehicle	Model #	Years	Notes	Bearing, Seal & Gasket Kit	Seal & Gasket Kit	Chain
<b>Ram (cont.)</b>						
5500	273	12-11		TCRK-271CC	DTK-271CC	HV064
<b>Saab</b>						
9-7x	126	08-05		TCRK-226	DTK-226	HV059
<b>Suzuki</b>						
Samurai	TS45	90-85	Remote Transfer Case	TCRK-FS120	DTK-FS120	N/A
Sidekick	G130	98-87		TCRK-FS140	DTK-FS140	HV10-110
<b>Toyota</b>						
Camry	S110; From 10/87	91-87		TCRK-FT740	DTK-FT740	N/A
Camry	S120; From 10/87	91-87		TCRK-FT750	DTK-FT750	N/A
Celica	S100	93-89		TCRK-FT740	DTK-FT740	N/A
Landcruiser	LC18; From 2/90	08-90		TRK-FT500	DTK-FT500	N/A
Landcruiser	LC16; To 1/90	90-87		TCRK-FT400	DTK-FT400	N/A
Landcruiser	LC14; From 8/80	87-80		TCRK-FT240	DTK-FT240	N/A
Landcruiser	LC12; To 7/80	80-73		TCRK-FT360	DTK-FT360	N/A
Landcruiser	LC10	75-69		TRK-FT490	DTK-FT490	N/A
Truck	R100	08-86	Chain Driven, Manual T/M Only	TCRK-FT390	DTK-FT390	HV10-102
Truck	W100	86-78	Gear Driven, Manual T/M Only	TCRK-FT260	DTK-FT260	N/A
Van	T100	97-90	Chain Driven, Manual T/M Only	TCRK-FT770	DTK-FT770	HV10-103

# Transmission & Transfer Case Small Parts Kits

Part No.	Industry Part No.	Application	Years
SPK-4C	SP1104-50C	Warner T4 GM Truck Only	1982-1988
SPK-5	SP1105-50	Warner T4 & T5	1982-1985
SPK-5W	SP1105-50A	Warner T5 World Class	1985-On
SPK-10	SP10-50	Warner T10	1957-1966
SPK-10W	SP10W-50	Warner Super T10	1974-1982
SPK-14	SP14-50	Warner T14	1967-1975
SPK-15	SP15-50	Warner T15	1967-1979
SPK-18	SP18-50	Warner T18	1965-
SPK-19	SP19-50	Warner T19	1968-
SPK-27	SP277-50	New Process 540, 541	1966-1969
SPK-29	SP310-50	New Process 542	1970-1984
SPK-127	SP291-50	New Process 435, 436	1963-
SPK-150F	SP287-50	Tremec RAB, RAN, RAT	1965-1982
SPK-150J	SP150-50B	Tremec T150 Jeep	1975-1980
SPK-170	SP170-50	Warner T170	1978-1985
SPK-170A	SP296-50	Ford 3 Speed HEH	1964-1973
SPK-205	SP205-50	New Process 205	1983-1987
SPK-208	SP208-50	New Process 208	1980-1986
SPK-231	SP231-50	New Process 231 & 241	1988-On
SPK-235	SP3500-50A	NVG3500, 5LM60, HM290	1988-1996
SPK-259	SP259-50B	Ford 3 Speed 259	1951-1962
SPK-280	SP280-50	Ford 3 Speed HED	1960-1967
SPK-285	SP305-50	Clark 280V, 282V, 285V	1968-1982
SPK-297	SP297-50	Muncie 4 Speed M22, Small Bore	1963-1965
SPK-297A	SP297-50A	Muncie 4 Speed M22, Large Bore	1966-1974
SPK-301	SP301-50	Saginaw SM326	1966-1985
SPK-318/319	SP266-50B	Muncie 318/319	1955-1968
SPK-318/319A	SP242-50B	Muncie 318/319	1940-1954
SPK-833	SP294-50	New Process 833	1975-1980
SPK-4500	SP4500-50	NVG 4500 Dodge & GM	1992-
SPK-AX5	SPAX5-50	Aisan Warner AX5, G52 Toyota	1985-
SPK-BW90	SP90A-50	Warner T90A, T90B	1946-1971
SPK-M465	SP304-50	Muncie CH465, SM465, M20	1968-1982

# Transfer Case Chain Information

## Link and Pin Nomenclature

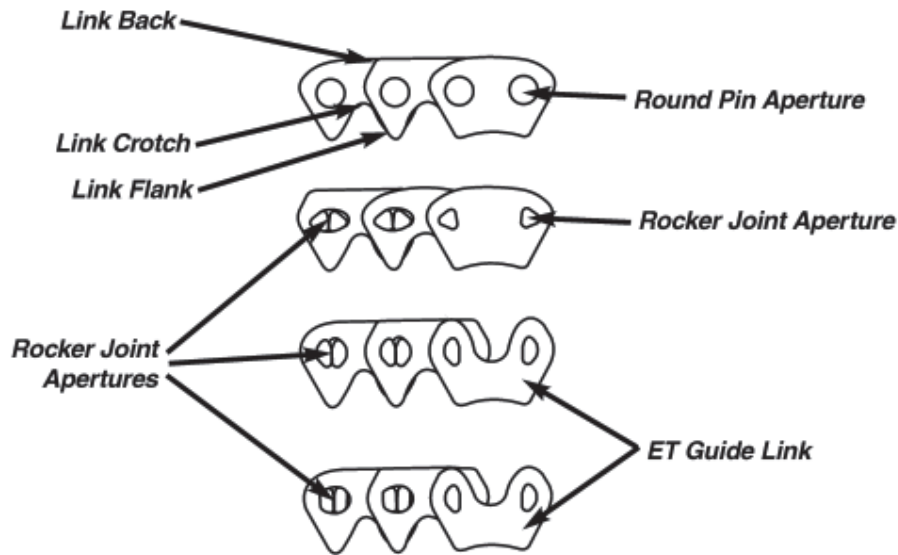

### Chain Component Identification

- Link Apertures: Holes in links either round or Rocker Joint shaped to match the connecting pins. This is the area of articulation in the chain.
- Guide Link: Link plate positioned on the outside of the chain. This pilots the chain on the sprocket.
- Link Flank: Lower portion of link which engages the sprocket teeth.
- Link Crotch: Space between link flanks which clear the sprocket tooth tip.
- Link Back: The outside curvature of the link design to provide strength and operating smoothness. Some are designed flat rather than curved.
- Round Pin: Singular round pin used to articulate the chain.
- Rocker Joint Pin: Two pins are utilized to articulate the chain.

A round pin chain can be rolled into a ball. A rocker pin chain cannot be. Round and rocker pin chains are not interchangeable.

### Chain Identification Terms

- Pitch: Effective length between the center points of the apertures, which are the points of joint movement.
- Width: The approximate dimension between the inside and outside guide links.
- Random Chain: Patterns which are interlaced in a random link pattern utilizing two different link styles in rows across the chain.
- Chain measurement example: 3/8" Pitch x 1-1/4" Width x 72 Pitches — 72 pitches would be 36 total guide plates per side

# Transfer Case Products

## New Process 203

### Bearings/Seals

Part#	Position	Specifications
QAR29523	Output Shaft Pilot Brg.	Loose Needles (15 per pack)
1210-L	Input Shaft Brg.	50x90x20 N/R
307-L	Front Output Shaft Front Brg.	35x80x21 N/R
M28161	Front Output Shaft Rear Brg.	1.750x2.125x1.000
C1086-Q	Output Shaft Brg.	Loose Needles (23 per pack)
J3616	Rear Output Shaft Front Brg.	2.250x2.625x1.000
Q8113	Planetary Needles	Loose Needles (132 per pack)
19255	Input Shaft Seal	1.938x2.680x.500 (2 Spring)
473214	Input Shaft Seal	1.375x2.250x.312
410308	Front Output Shaft Seal	2.125x3.061x.500
710005	Front Output Shaft Seal	1.750x3.062x.485
2043	Rear Output Shaft Seal	1.940x2.762x.500
473204	Rear Output Shaft Seal	2.125x2.750x.375
3946	Rear Output Shaft Seal	1.875x2.750x.500
471424	Rear Output Shaft Seal	2.000x2.623x.312
6835-S	Shift Shaft Seal	.750x1.250x.312
3821370	Lube Washer	
GTK-203U	Gasket Set	

Chains	Position	Specifications
HV005	Obsolete	.3750 Pitch x 2 1/2" Width x 98 Pitches-RJ
HV009		.5033 Pitch x 2" Width x 72 Pitches-RJ

Input Shafts	Position	Specifications
NV13343		27 Spline (With TH350 Transmission)

# Transfer Case Products

## New Process 205

### Bearings/Seals

Part#	Position	Specifications
QAR29523	Output Shaft Pilot Brg.	Loose Needles (15 per pack)
210-L	Input Shaft Brg.	50x90x20 N/R
307-L	Front Output Shaft Front Brg.	35x80x21 N/R
M28161	Front Output Shaft Rear Brg.	1.750x2.125x1.000
B3216	Rear Output Shaft Front Brg.	2.000x2.375x1.000
2793-2720	Idler Shaft Brg.	1.375x3.000x.937
QBR23549	Low Gear Brg.	Loose Needles (16 per pack)
19255	Input Shaft Seal	1.938x2.680x.500 (2 Spring, Diesel & Manual Trans.)
19255	Input Shaft Seal	1.938x2.680x.500 (2 Spring)
482163-N	Input Shaft Seal	1.375x1.983x.312 (Gas or Diesel w/ Auto. Trans.)
710005	Front Output Shaft Seal	1.750x3.062x.485
410308	Rear Output Shaft Seal	2.125x3.061x.500
473457	Rear Output Shaft Seal	1.875x3.061x.375
9449	Rear Output Shaft Seal	1.887x2.704x.582
6835-S	Shift Shaft Seal	.750x1.250x.312
2287	Shift Shaft Seal	.750x1.250x.280
OR-216	O-Ring	
GTK-205STAR	Yoke Washer	
GTK105-901C	Gasket Set	Ford and Dodge with Remote Mount Transfer Case
GTK-205	Gasket Set	GM and Dodge except Cummins Diesel
GTK-205-1	Gasket Set	Dodge with Cummins Diesel
GTK-205GDM	Gasket Set	GM and Dodge with Direct Mount Transfer Case
SPK-205	Small Parts Kit	

Input Shafts	Position	Specifications
NV99646		10 Spline
NV11401		27 Spline
NV16615		29 Spline
NV11656		31 Spline
NV13929		32 Spline, 7 1/2" Length

Output Shafts	Position	Specifications
NV99653	Front	32 Spline

Sliders	Position	Specifications
2954116-R	Range and Mode	

Synchronizers	Position	Specifications
AWT275-2.5B	Front Output Mode Assembly	

Misc.	Position	Specifications
6259656	Coupling Sleeve	10 Spline, 4 1/4"



# Transfer Case Products

## New Process 208

<b>Bearings/Seals</b>		
<b>Part#</b>	<b>Position</b>	<b>Specifications</b>
B5020	Input Shaft Brg.	1.990x2.283x.783
AXK5070	Input Shaft Thrust Brg.	1.970x2.750x.1181
NTA2435	Main Shaft Thrust Brg.	1.502x2.177x.078
TRA2435	Main Shaft Thrust Race	1.500x2.165x.028
B2012	Main Shaft Pilot Brg.	1.250x1.500x.750
1207	Main Shaft Front Brg.	35x72x17 N/R
B2816	Front Output Shaft Front Brg.	1.750x2.125x1.000
NTA2840	Front Output Shaft Front Thrust Brg.	1.752x2.500x.0781
TRA2840	Front Output Shaft Front Thrust Race	1.762x2.470x.029
B2416	Front Output Shaft Rear Brg.	1.500x1.876x.995
NTA2840	Front Output Shaft Rear Thrust Brg.	1.752x2.500x.0781
TRA2840	Front Output Shaft Rear Thrust Race	1.762x2.470x.029
TRC3244	Thrust Race	2.000x2.735x.009
C1086-Q*	Sprocket Brg.	Loose Needles (23 per pack)
19255	Input Shaft Seal	1.938x2.680x.500 (2 Spring)
3946	Front Output Shaft Seal	1.875x2.750x.500
9449	Rear Output Shaft Seal	1.887x2.704x.582
3946	Rear Output Shaft Seal	1.875x2.750x.500
341022	Oil Pump Seal	2.250x2.625x.187
472572	Rear Output Shaft Seal	1.875x2.750x.312
GTK-208	Gasket Set	
4219073	Fork Pads	
4167969	Fork Pads	
4167970	Fork Pads	
SPK-208	Small Parts Kit	

<b>Chains</b>	<b>Position</b>	<b>Specifications</b>
HV012	Ford Applications	.5033 Pitch x 1 1/4" Width x 84 Pitches-RP
HV025	GM and Dodge Applications	.5033 Pitch x 1 1/4" Width x 72 Pitches-RP

<b>Forks</b>	<b>Position</b>	<b>Specifications</b>
NV15380	Range Fork	Ford Applications, Non-Updated
NV15111	Range Fork	Ford Applications, Updated
4219070	Mode Fork	GM Applications
4167966R	Range Fork	GM Applications

<b>Input Shafts</b>	<b>Position</b>	<b>Specifications</b>
NV15786		23 Spline, Dodge Applications
NV13948		27 Spline, GM Applications
NV13779		31 Spline, Ford Applications
NV15112		32 Spline, GM Applications

<b>Planetary Sets</b>	<b>Position</b>	<b>Specifications</b>
4329198R		

<b>Pumps</b>	<b>Position</b>	<b>Specifications</b>
NV15486	Pump Housing	
NV11801	Pump Gear	

<b>Synchronizers</b>	<b>Position</b>	<b>Specifications</b>
NV15210	GM Applications	
NP208-K	Key and Spring Kit	

# Transfer Case Products

## New Process 231

### Bearings/Seals

Part#	Position	Specifications
ZN1065	Input Shaft Pilot Brg.	1.215x1.507/1.233x.882
BD50-8	Input Shaft Brg.	50x80x23.75 w/snap ring on edge
110-L	Input Shaft Brg.	50x80x16 N/R
B2416	Front Output Shaft Rear Brg.	1.500x1.876x.995
206-L	Front Output Shaft Front Brg.	30x62x16
207	Rear Output Shaft Rear Brg.	35x72x17
BB1-1015	Rear Output Shaft Rear Brg.	35x72x17
B5020	Drive Sprocket Brg.	1.990x2.283x.783
J1212	Shift Shaft Brg.	20x25.4x19
19255	Input Shaft Seal	1.938x2.680x.500 (2 Spring)
710046	Front Output Shaft Seal	1.552x2.447x.500
4813-V	Front Output Shaft Seal	1.177x2.448x.500
NV31219	Front Output Shaft Seal	1.552x2.460x.500
2506	Rear Output Shaft Seal	1.558x2.372x1.500 (Dodge)
9613-S	Rear Output Shaft Seal	1.500x2.377x.470 (Jeep & Chevy)
9449	Rear Output Shaft Seal	1.890x2.700x.582
NV19129	Rear Output Shaft Seal	1.177x2.572x.433/.638 Extending Lip.
NV31808	Rear Output Shaft Seal	1.448x3.083x.433
341022	Oil Pump Seal	2.250x2.625x.187
727410	Shift Shaft Seal	.750x1.000x.125
ZM1001	Planetary Thrust Washer	2.625x3.885x.065
OR-116	Shift Shaft O-Ring	
OR-109	Oil Pump O-Ring	
OR-014	O-Ring	
OR-013	O-Ring	
OR-015	O-Ring	
GTK-207STAR	Yoke Washer	
4167969	Fork Pads	
4219073	Fork Pads	
4167970	Fork Pads	
GTK-207-1	Adapter Gasket	
GT-243	Adapter Gasket	

Chains	Position	Specifications
HV022		.5033 Pitch x 1 1/4" Width x 62 Pitches-RP
HV027		.5033 Pitch x 1" Width x 62 Pitches-RP

Chain Sprockets	Position	Specifications
NV19043	Drive Sprocket	Used with 1 1/4" Chain
NV16619	Driven Sprocket	Used with 1 1/4" Chain

Forks	Position	Specifications
-------	----------	----------------

# Transfer Case Products

## New Process 231 Continued

Forks	Position	Specifications
NV16267	Mode Fork	Casting#16196
NV17790	Mode Fork	Casting#17769
NV17833	Range Fork	Casting#17833

Input Shafts	Position	Specifications
NV16758		21 Spline, used with BD50-8 Input Brg., 4.30" Length
NV17822		23 Spline, used with BD50-8 Input Brg., 5.30" Length
NV17449		23 Spline, used with BD50-8 Input Brg., 4.30" Length
NV17949		23 Spline, used with 110-L Input Brg., 5.30" Length

Planetary Sets	Position	Specifications
NV17869		Used with 110-L Input Brg.

Pumps	Position	Specifications
NV16209	Pump Assembly	

Sliders	Position	Specifications
241-15	Mode Slider	48 Tooth
NV17773	Mode Slider	60 Tooth
NV19114	Range Slider/Hub Assembly	

Synchronizers	Position	Specifications
NV17915	Mode Synchro. Assembly	48 Tooth
241-14	Mode Synchro. Ring	48 Tooth, Narrow Teeth, used with 110-L Input Brg.
NV17779	Mode Synchro. Ring	60 Tooth
NP208-K	Key and Spring Kit	48 Tooth
NV16217	Pump Screen	

# Transfer Case Products

## New Process 241

### Bearings and Seals

Part#	Position	Specifications
ZN1065	Input Shaft Pilot Brg.	1.215x1.507/1.233x.882
B2110	Input Shaft Pilot Brg.	1.312x1.625x.625
ZN1174	Input Shaft Pilot Brg.	34.2x39/41.3x25
BD50-8	Input Shaft Brg.	50x80x23.75 w/snap ring on edge
110-L	Input Shaft Brg.	50x80x16 N/R
ZB1180	Input Shaft Brg.	50x80x23.75 w/snap ring in middle
307-L	Front Output Shaft Front Brg.	35x80x21 N/R
B3612	Rear Output Shaft Front Brg.	58x66.75x19
B2416	Front Output Shaft Rear Brg.	1.500x1.876x.995
BB1-1015	Rear Output Shaft Rear Brg.	35x72x17
112L	Output Gear Brg.	60x95x18 N/R
J2416	Output Shaft Rear Brg.	1.500x1.875x1.000
207	Rear Output Shaft Rear Brg.	35x72x17
B5020	Drive Sprocket Brg.	1.990x2.283x.783
19255	Input Shaft Seal	1.938x2.680x.500 (2 Spring)
710627	Input Shaft Seal	49x68.5x9.5
3946	Front Output Shaft Seal	1.875x2.750x.500
4741	Rear Output Shaft Seal	2.200x3.022x.422
3946	Rear Output Shaft Seal	1.875x2.750x.500
5013019AA	Rear Output Shaft Seal	49x70x11.5
9449	Rear Output Shaft Seal	1.890x2.700x.582
341022	Oil Pump Seal	2.250x2.625x.187
727410	Shift Shaft Seal	.750x1.000x.125
NV27024	Shifter Seal	1.500x2.260x.006
710597	Shift Shaft Seal	.750x1.000x.225
NV29133	Planetary Thrust Washer	2.280x3.115x.050
ZM1001	Planetary Thrust Washer	2.625x3.885x.065
297-62	Extension Housing Bushing	2.010" OD
NV16428	Shift Rail Bushing	.630x.720x.500
NV48698	Shift Shaft Bushing	.765x.825x.645
OR-015	O-Ring	
OR-013	Oil Pump O-Ring	
OR-117	Speed Sensor O-Ring	
OR-012	O-Ring	
OR-014	O-Ring	
OR-109	Oil Pump O-Ring	
OR-116	Shift Shaft O-Ring	
GTK-205STAR	Yoke Washer	
4167969	Fork Pad	
4219073	Fork Pad	
ZM1000	Fork Pad	
GT-243	Adapter Gasket	

Chains	Position	Specifications
HV031		.5033 Pitch x 1 1/2" Width x 72 Pitches-RP
HV025		.5033 Pitch x 1 1/4" Width x 72 Pitches-RP
HV072		.3750 Pitch x 1 1/4" Width x 98 Pitches-RJ
HV081		.4346 Pitch x 1 1/4" Width x 84 Pitches-RJ

# Transfer Case Products

## New Process 241 Continued

Chain Sprockets	Position	Specifications
NV17813	Mode Sprocket	1 3/8" Wide (241DHD Only)
NV17814	Mode Sprocket	1 1/8" Wide (241DHD Only)
241-235	Mode Sprocket	All except 241DHD

Forks	Position	Specifications
NV16267	Mode Fork	Casting#16196
NV17025	Mode Fork	Casting#16342-B
NV17790	Mode Fork	Casting#17769
NV17833	Range Fork	Casting#17833, Aluminum
NV17543	Range Fork	Casting#17524

Input Shafts	Position	Specifications
NV19019		32 Spline with 110-L Input Brg.
NV17118		32 Spline with BD50-8 Input Brg.
NV22409		29 Spline with 110-L Input Brg.
NV19020		27 Spline with 110-L Input Brg.
NV16959		27 Spline with BD50-8 Input Brg.
NV21288		23 Spline with 110-L Input Brg.
NV22390		23 Spline with 110-L Input Brg., Wide Teeth
NV17949		23 Spline with 110-L Input Brg., Narrow Teeth
NV17822		23 Spline with BD50-8 Input Brg., Wide Teeth
NV17953		23 Spline with BD50-8 Input Brg., Narrow Teeth
NV17954		29 Spline with 110-L Input Brg., 5" Length

Output Shafts	Position	Specifications
NV20482		32 Spline, 18 1/2" Length
NV20480		32 Spline, 19 7/16" Length

Planetary Sets	Position	Specifications
NV17869		Narrow Teeth, used with 110-L Input Brg.

Pumps	Position	Specifications
NV24956	Pump Assembly	31 Spline
NV16209	Pump Assembly	32 Spline

Sliders	Position	Specifications
241-15	Mode Slider	48 Tooth
NV17773	Mode Slider	60 Tooth
NV19114	Range Slider	All except 241DHD

Synchronizers	Position	Specifications
NV17915	Mode Synchro. Assembly	48 Tooth
241-14	Mode Synchro. Ring	48 Tooth
NV17779	Mode Synchro. Ring	60 Tooth
NP208-K	Key and Spring Kit	48 Tooth
NP241-K	Key and Spring Kit	60 Tooth

Misc.	Position	Specifications
NV16754	Poppet Plunger	
NV16217	Pump Screen	
1300-139-027	Output Bearing Retainer Snap Ring	

# Transfer Case Products

## New Process 242

### Bearings and Seals

Part#	Position	Specifications
ZN1065	Input Shaft Pilot Brg.	1.215x1.507/1.233x.882
BD50-8	Input Shaft Brg.	50x80x23.75 w/snap ring on edge
110-L	Input Shaft Brg.	50x80x16 N/R
NV19129	Rear Output Shaft Seal	1.177x2.572x.433/.638 Extending Lip
207	Front Output Shaft Front Brg.	35x72x17
B2416	Front Output Shaft Rear Brg.	1.500x1.876x.995
206-L	Rear Output Shaft Rear Brg.	30x62x16
BB1-1015	Rear Output Shaft Rear Brg.	35x72x17
J1212	Shift Shaft Brg.	20x25.4x19
J2416	Needle Brg.	1.500x1.875x1.000
Q8308	Drive Sprocket Brg.	Loose Needles (116 per pack)
19255	Input Shaft Seal	1.938x2.680x.500 (2 Spring)
3946	Front Output Shaft Seal	1.875x2.750x.500
714503	Front Output Shaft Seal	1.875x2.750x.500
18758	Front Output Shaft Seal	1.875x2.750x.500
9613-S	Rear Output Shaft Seal	1.500x2.377x.470
4333-N	Rear Output Shaft Seal	1.886x2.699x.350
UH0911-E	Rear Output Shaft Seal	1.850x2.750x.460 (Slip Yoke)
NV30138	Rear Output Shaft Seal	1.800x2.880x.650
NV22507	Rear Output Shaft Seal	1.835x2.700x1.325
710046	Rear Output Shaft Seal	1.552x2.447x.500
341022	Oil Pump Seal	2.250x2.625x.187
727410	Shift Shaft Seal	.750x1.000x.125
ZM1001	Planetary Thrust Washer	2.625x3.885x.065
OR-014	O-Ring	
OR-109	Oil Pump O-Ring	
OR-116	Shift Shaft O-Ring	
OR-115	O-Ring	
GTK-205STAR	Yoke Washer	
4167969	Fork Pad	
4167970	Fork Pad	
ZM1000	Fork Pad	
GT-243	Adapter Gasket	

Chains	Position	Specifications
HV028		.5033 Pitch x 1" Width x 72 Pitches-RP
HV061		.5033 Pitch x 1" Width x 72 Pitches-RJ
HV062		.3750" Pitch x 1" Width x 98 Pitches-RJ
HV063		.3750" Pitch x 1 1/4" Width x 98 Pitches-RJ

Chain Sprockets	Position	Specifications
NV16365	Driven Sprocket	Removable



# Transfer Case Products

## New Process 242 Continued

<b>Forks</b>	<b>Position</b>	<b>Specifications</b>
NV21222	Range Fork	Casting#16448, Iron
NV17833	Range Fork	Casting#17833, Aluminum

<b>Input Shafts</b>	<b>Position</b>	<b>Specifications</b>
NV19061	Input Shaft	23 Spline with 110-L Input Brg., 4.25" Length
NV17449	Input Shaft	23 Spline with BD50-8 Input Brg., 4.25" Length

<b>Planetary Sets</b>	<b>Position</b>	<b>Specifications</b>
NV17869		Narrow Teeth, used with 110-L Input Brg.

<b>Pumps</b>	<b>Position</b>	<b>Specifications</b>
NV16209	Pump Assembly	

<b>Sliders</b>	<b>Position</b>	<b>Specifications</b>
NV16662	Range Slider	Used with Iron Fork
NV19068	Range Slider	Used with Aluminum Fork

<b>Misc.</b>	<b>Position</b>	<b>Specifications</b>
NV16754	Poppet Plunger	
NV16217	Pump Screen	

# Transfer Case Products

## New Process 246

### Bearings and Seals

Part#	Position	Specifications
110	Input Shaft Brg.	50x80x16
ZN1065	Input Shaft Pilot Brg.	1.215x1.507/1.233x.882
111	Rear Output Shaft Center Brg.	55x90x18
ZB1055	Rear Output Shaft Rear Brg.	35x80x23 N/R
B5020	Front Output Shaft Rear Brg.	1.990x2.283x.783
B2416	Front Output Shaft Rear Brg.	1.500x1.876x.995
ZN1146	Clutch Housing Brg.	50x58x38
ZN1147	Shift Shaft Brg.	19.5x26x11
NV22441	Input Shaft Seal	1.875x2.700x.500
NV22507	Rear Output Shaft Seal	1.835x2.700x1.325
NV30138	Front Output Shaft Seal	1.800x2.880x.650
NV22452	Front Output Shaft Seal	1.325x2.565x.385
341022	Oil Pump Seal	2.250x2.625x.187
ZM1001	Planetary Thrust Washer	2.625x3.885x.065
OR-015	O-Ring	
OR-109	Oil Pump O-Ring	
OR-116	Shift Shaft O-Ring	
4167969	Fork Pads	
ZM1000	Fork Pads	
GT-243	Adapter Gasket	
ZM1048	Fork Pads	

Chains	Position	Specifications
HV063		.3750 Pitch x 1 1/4" Width x 98 Pitches-RJ (One Blue Guide Link)
HV072		.3750 Pitch x 1 1/4" Width x 98 Pitches-RJ (Three Blue Guide Links)

Chain Sprockets	Position	Specifications
NV31269	Drive/Driven	

Forks	Position	Specifications
NV40966	Apply Fork	2003 and Newer Models
NV26542	Range Fork	

Input Shafts	Position	Specifications
NV19019	Input Shaft	27 Spline
NV19020	Input Shaft	32 Spline

Planetary Sets	Position	Specifications
NV17869		6 Pinion, used with 110 Input Brg.

# Transfer Case Products

## New Process 246 Continued

<b>Pump</b>	<b>Position</b>	<b>Specifications</b>
NV16686		38 Spline

<b>Sliders</b>	<b>Position</b>	<b>Specifications</b>
NV17982	Range Slider and Hub	

<b>Misc.</b>	<b>Position</b>	<b>Specifications</b>
NV16754	Poppet Plunger	
NV16217	Pump Screen	

# Transfer Case Products

## New Process 261/263

Bearings and Seals	Position	Specifications
ZN1174	Input Shaft Pilot Brg.	34.2x39/41.3x25
110	Input Shaft Brg.	50x80x16
BD50-8	Input Shaft Brg.	50x80x23.75 w/snap ring on edge
B5020	Front Output Shaft Rear Brg.	1.990x2.283x.783
208-L	Rear Output Shaft Rear Brg.	40x80x18 N/R
ZB1151	Rear Output Shaft Rear Brg.	41x80x18 N/R
NV22441	Input Shaft Seal	1.854x2.677x.511
B126	Shift Detent Brg.	15x27.8x18.4
ZN1147	Shift Detent Brg.	19.5x26x11
NV30138	Front Output Shaft Seal	1.800x2.880x.650
NV22507	Rear Output Shaft Seal	1.835x2.700x1.325
4741	Rear Output Shaft Seal	2.200x3.022x.422
727410	Shift Shaft Seal	.750x1.000x.125
ZM1001	Planetary Thrust Washer	2.625x3.885x.065
OR-012	Pick-Up Tube O-Ring	
OR-015	Shift Detent O-Ring	
OR-109	Oil Pump O-Ring	
OR-116	Shift Shaft & VSS O-Ring	
OR-220	Oil Pump O-Ring	
GTK-205STAR	Yoke Washer	
ZM1048	Fork Pads	
GT-243	Adapter Gasket	

Chains	Position	Specifications
HV069		.3750 Pitch x 1 1/2" Width x 98 Pitches-RJ 3 Blue Guide Links
HV072		.3750 Pitch x 1 1/4" Width x 98 Pitches-RJ
HV074		.4346 Pitch x 1 1/2" Width x 84 Pitches-RP

Chain Sprockets	Position	Specifications
NV21965	Drive and Driven	Used with 1 1/2" Chain (261)
NV31269	Drive and Driven	Used with 1 1/4" Chain (261)
NV40910	Drive and Driven	Used with 1 1/2" Chain (261XHD)

Forks	Position	Specifications
NV17833	Range Fork	Casting#17833, Aluminum
NV27756	Mode Fork	Casting#28624, Aluminum

Input Shafts	Position	Specifications
NV25890		27 Spline
NV42740		32 Spline
NV43996		29 Spline

# Transfer Case Products

## New Process 261/263 Continued

Output Shafts	Position	Specifications
NV27718		38 Spline Pump
NV48714		49 Spline Pump (261)
NV47936		49 Spline Pump (261XHD)

Planetary Sets	Position	Specifications
NV17869		6 Pinion used with 110-L Input Brg.

Pumps	Position	Specifications
NV16686		38 Spline
NV25904		49 Spline

Sliders	Position	Specifications
NV26082	Mode Slider	
NV27761	Range Slider	261
NV43350	Range Slider	261XHD
NV43681	Range Slider	263XHD
NV27721	Drive Hub	

Synchronizers	Position	Specifications
NV27722	Mode Synchro Inner	
NV21635	Mode Synchro Middle Friction	
NV26081	Mode Synchro Outer	

Misc.	Position	Specifications
NV54319		Anti-Wear Case Protector Clip
NV26162		Vent Tube
NP208-K		Key and Spring Kit
NV16217	Pump Screen	38 Spline
NV25502	Pump Screen	49 Spline

# Transfer Case Products

## New Process 271/273

Bearings and Seals	Position	Specifications
NV24260	Input Shaft Pilot Brg.	35x36.9/41.3x20.5
211-B	Input Shaft Brg.	55x100x21
111	Front Output Shaft Front Brg.	55x90x18
B2416	Front Output Shaft Rear Brg.	1.500x1.876x.995
212	Rear Output Shaft Rear Brg.	60x110x22
J3416	Extension Housing Brg.	2.165x2.500x1.000
NV25626	Input Shaft Seal	2.125x2.889x.401
BC3Z7B215A	Input Shaft Seal	2.30x3.16x.410
NV24288	Rear Output Shaft Seal	2.122x3.040x.430
NV38249	Rear Output Shaft Seal	2.300x3.335x.433
341022	Oil Pump Seal	2.250x2.625x.187
B353	Shift Shaft Seal	19x23.5x6
ZM1001	Planetary Thrust Washer	2.625x3.885x.065
OR-116	Shift Shaft O-Ring	
OR-109	Oil Pump O-Ring	
4167969	Fork Pads	
4219073	Fork Pads	
ZM1000	Fork Pads	
ZM1048	Fork Pads	
GTC-NP1	Adapter Gasket	

Chains	Position	Specifications
HV064		.4346 Pitch x 1 1/2" Width x 98 Pitches-RP

Chain Sprockets	Position	Specifications
NV21966	Drive and Driven	

Forks	Position	Specifications
NV17543	Range Fork	Casting#17524, Non-Updated
NV41113	Range Fork	Casting#38356, Updated
NV41815	Range Fork	Casting#41816
NV27885	Range Fork	Updated

Input Shafts	Position	Specifications
NV26605		24 Spline
NV24257		29 Spline
NV44631		34 Spline

Output Shafts	Position	Specifications
NV42757		Ford, Updated

Planetary Sets	Position	Specifications
NV17869		6 Pinion used with 110-L Input Brg.



# Transfer Case Products

## New Process 271/273 Continued

<b>Pumps</b>	<b>Position</b>	<b>Specifications</b>
NV25519		

<b>Sliders</b>	<b>Position</b>	<b>Specifications</b>
241-15	Mode Slider	24 Teeth
NV26948	Range Slider	Non-Updated
NV38304	Range Slider	Updated

<b>Synchronizers</b>	<b>Position</b>	<b>Specifications</b>
NV26549	Inner	
NV30130	Middle	
NV30131	Outer	
NP208-K	Key and Spring Kit	

<b>Misc.</b>	<b>Position</b>	<b>Specifications</b>
NV16754	Poppet Plunger	
NV16217	Pump Screen	

# Transfer Case Products

## Borg Warner 1356

Bearings and Seals	Position	Specifications
110	Input Shaft Brg.	50x80x16
BK3026	Main Shaft Pilot Brg.	30x37x26
AA1512-12	Input Shaft Pilot Bushing	1.250x1.500x.500
207	Front Output Shaft Front Brg.	35x72x17
B2012	Front Output Shaft Rear Brg.	1.250x1.500x.750
207	Rear Output Shaft Brg.	35x72x17
714503	Input Shaft Seal	1.886x2.756x.823
714503	Front Output Shaft Seal	1.886x2.756x.823
714503	Rear Output Shaft Seal	1.886x2.756x.823 (Fixed Yoke)
UH0911-E	Rear Output Shaft Seal	1.850x2.750x.460 (Slip Yoke)
7399-S	Shift Shaft Seal	.625x.937x.187 (Manual Shift)
330385	Shift Shaft Seal	.375x.750x.250 (Electric Shift)
ZM1023	Yoke Seal	.750x1.380x.160
1356-235-001	Fork Pads	Range
1345-235-001	Fork Pads	Mode
OR-014	O-Ring	Magnetic Sensor
GTC-NP1	Adapter Gasket	
GT-PTO55	PTO Gasket	

Chains	Position	Specifications
HV012		.5033 Pitch x 1 1/4" Width x 84 Pitches-RP

Chain Sprockets	Position	Specifications
1356-144-003	Drive Sprocket	
1356-144-002	Driven Sprocket	

Forks	Position	Specifications
4400-596-002	Mode Fork	
4400-596-001	Range/Reduction Fork	

Output Shafts	Position	Specifications
1356-171-007R	With Slip Yoke and Long Shaft	
1356-171-013	With Bolt On Flange and Long Shaft	
1356-171-009	With Bolt On Yoke and Long Shaft	

Planetary Sets	Position	Specifications
1356-410-004	Updated Kit with Planet, Ring Gear, and Range Slider	

Pumps	Position	Specifications
PK1356	Pump Kit	

Sliders	Position	Specifications
1356-089-002	Mode Slider, Lockup	
4400-055-001	Mode Slider Flange, Electric Shift	
1356-089-001	Range Slider, 38 Teeth, Non Updated	
1356-089-003	Range Slider, 31 Teeth, Updated	

Misc.	Position	Specifications
1356-034-001	Hose	

# Transfer Case Products

## Borg Warner 4405

Bearings and Seals	Position	Specifications
209-L	Input Shaft Brg.	45x85x19 N/R
M18161	Main Shaft Pilot Brg.	1.125x1.374x1.00
AA1512-12	Main Shaft Pilot Bushing	1.250x1.500x.500
306-L	Front Output Shaft Front Brg.	30x72x19
206-L	Front Output Shaft Rear Brg.	30x62x16 N/R
207	Front Output Shaft Rear Brg.	35x72x17
306-L	Rear Output Shaft Rear Brg.	30x72x19
4143	Input Shaft Seal	1.625x2.440x.472
4143	Front/Rear Output Shaft Seal	1.625x2.440x.472
330385	Shift Shaft Seal	.375x.750x.250
ZM1043	Yoke Washer	
1356-235-001	Ford Pad	
GT-1350	Gasket Set	

Chains	Position	Specifications
HV051		.4346 Pitch x 1 1/4" Width x 74 Pitches-RJ
HV067		.4346 Pitch x 1" Width x 74 Pitches-RJ
HV070		.4346 Pitch x 1 1/4" Width x 74 Pitches-RJ 2 Blue Links

Chain Sprockets	Position	Specifications
4405-644-002	Drive Sprocket, with HV067 Chain	
4405-144-008	Driven Sprocket, with HV067 Chain	

Forks	Position	Specifications
4405-596-002	Range Fork	

Input Shafts	Position	Specifications
4405-189-002		

Pumps	Position	Specifications
4400-508-004		

Sliders	Position	Specifications
1354-089-002	Range Slider	

Misc.	Position	Specifications
4405-099-009	Electric Shift Cam	
4405-625-003	Clutch Pack	

# Transfer Case Products

## Magna Steyr 1225/1226-RPO NQG

<b>Chains</b>	<b>Specifications</b>
HV074	.4346 Pitch x 1-1/2" Width x 84 Pitches-RP
HV501	.4346 Pitch x 1-1/4" Width x 84 Pitches-RJ
HV502	.4346 Pitch x 1-1/2" Width x 84 Pitches-RJ

## Magna Steyr 1625/1626-RPO NQF

<b>Chains</b>	<b>Specifications</b>
HV074	.4346 Pitch x 1-1/2" Width x 84 Pitches-RP
HV502	.4346 Pitch x 1-1/2" Width x 84 Pitches-RJ

## Magna Steyr 3023/3024-RPO NQH

<b>Chains</b>	<b>Specifications</b>
HV501	.4346 Pitch x 1-1/4" Width x 84 Pitches-RJ
HV502	.4346 Pitch x 1-1/2" Width x 84 Pitches-RJ

# Rebuild Kits and Components Interchanges



Manufacturer Part #	Manufacturer	NCB Part #
029HH100	Dana	714512
10043617	Dana	DRK-334MK
10043618	Dana	DRK-334
10043619	Dana	DRK-334TJMK
10043620	Dana	DRK-334TJ
10043621	Dana	DRK-335MK
10043622	Dana	DRK-335
10043624	Dana	DRK-339E
10043627	Dana	DRK-339EMK
10043629	Dana	DRK-339BMK
10043630	Dana	DRK-339B
10043631	Dana	DRK-336AMK
10043632	Dana	DRK-336A
10043633	Dana	DRK-331MK
10043634	Dana	DRK-331
10043635	Dana	DRK-332HD
10043637	Dana	DRK-332HDMK
10043638	Dana	DRK-332
10043639	Dana	DRK-332MK
10043640	Dana	DRK-332U
10043641	Dana	DRK-332UMK
10043642	Dana	DRK-337A
10043643	Dana	DRK-337AMK
10043644	Dana	DRK-337
10043645	Dana	DRK-337MK
1008360	Dana	T1910
1008585	Dana	HM212049
1008586	Dana	3782
1008911	Dana	HM212011
101-432-1X	TTC	TRK-101-432-1X
101-482-1	TTC	1213-L
101-486-1-1X	TTC	101-486-1-1X
101-486-4-1X	TTC	101-486-4-1X
102611	Dana	102611
102620	Dana	OR-146
102660	Dana	68462
10-3-122X	Dana	S10-3-122X
10-3-162X	Dana	S10-3-162X
10-3-163X	Dana	S10-3-163X
10-3-18KX	Dana	S10-3-18KX
10-3-22X	Dana	S10-3-22X
10-3-32X	Dana	S10-3-32X
10-3-33X	Dana	S10-3-33X
10-3-83X	Dana	S10-3-83X
10-4-103	Dana	S10-4-103
10-4-113	Dana	S10-4-113
10-4-12	Dana	S10-4-12
10-4-123	Dana	S10-4-123
10-4-183	Dana	S10-4-183
10-4-193	Dana	S10-4-193
10-4-22	Dana	S10-4-22
10-4-223	Dana	S10-4-23
10-4-282	Dana	S10-4-282
10-4-32	Dana	S10-4-32
10-4-43	Dana	S10-4-43
10-4-481	Dana	S10-4-481
10-4-52	Dana	S10-4-52
10-4-63	Dana	S10-4-63
10-4-93	Dana	S10-4-93
105C-137	TTC	85533
1064	Eaton	1064
1069	Eaton	1069
107276S	Dana	3OZRTVGREY
10737	Dana	3820
107567	Dana	107567
107568	Dana	107568
107569	Dana	107569
107570	Dana	107570
107670	Dana	DRK-72B

Manufacturer Part #	Manufacturer	NCB Part #
108145	Dana	108145
110555	Dana	DRK-1AMK
110811	Dana	29620
110812	Dana	29675
110846	Dana	HM807049
111355	Dana	HM88610
111356	Dana	HM88649
111374	Dana	3872
113130	Dana	113130
11364	Eaton	11364
113866	Dana	DT0724
113868	Dana	HM813841
113869	Dana	HM813810
114394	Dana	DRK-196
114399	Dana	DRK-196MK
115125	Dana	DRK-207
118787	Dana	MA1211
118788	Dana	M1211EL
119427	Dana	119427
119429	Dana	119429
119430	Dana	119430
119681	Dana	33262
119855	Dana	119855
120080	Dana	MU1309UM
120098	Dana	772
122421	Dana	DRK-211FMK1
122437	Dana	DRK-208MK
122448	Dana	DRK-219RMK
122657	Dana	DRK-211FMK2
1228A183	Meritor	B2414
1228A261	Meritor	MUC1309UM
1228B1042	Meritor	RU9008UM
1228B262	Meritor	MUB1309UM
1228C3	Meritor	1209-A
1228C55	Meritor	MU1305TDM
1228E1045	Meritor	MUB1307UBM
1228F136	Meritor	MU1307TM
1228F1722	Meritor	ZN1213
1228F552	Meritor	RU1570UM
1228G1203	Meritor	212-SLV
1228G1723	Meritor	ZN1212
1228H190	Meritor	MR1213EL
1228H580	Meritor	MUB1305UDM
1228J192	Meritor	210
1228K1545	Meritor	JLM104910
1228L1130	Meritor	JP10010
1228L1728	Meritor	NP934397
1228L194	Meritor	212
1228M1547	Meritor	JLM506810
1228N1262	Meritor	1211
1228N1548	Meritor	JLM506849
1228N1938	Meritor	JLM714110
1228P250	Meritor	313
1228Q1473	Meritor	592-A
1228S1267	Meritor	MUB7309UM
1228U1217	Meritor	3920
1228U645	Meritor	55437
1228V204	Meritor	211-B
1228V594	Meritor	9278
1228W179	Meritor	MU1221UM
1228X154	Meritor	MU1308UM
1228Z1716	Meritor	H715311
1228Z52	Meritor	MU1306TDM
1229K1623	Meritor	1229K1623
1229L1624	Meritor	1229L1624
1229T4076	Meritor	1229T4076
12303	Meritor	12303
123297	Dana	DRK-409MK
124487	Dana	DRK-222FMK

Manufacturer Part #	Manufacturer	NCB Part #
12479126	AAM	S3147
12495	Dana	55437
12496	Dana	55200-C
12500	Dana	52618
12501	Dana	52400
126003	Dana	126003
126004	Dana	126004
126180	Dana	126180
126187	Dana	MUB1308UM
126242	Dana	126242
126286	Dana	H914841
126287	Dana	H914811
126924	Dana	56662
126987	Dana	6580
126988	Dana	6535
127051	Dana	MUSB7307UM
127386	Dana	127386
127484	Dana	MUB1307UM
127485	Dana	MUB7307UM
127536	Dana	29630
127539	Dana	JLM104910
127540	Dana	LM104949
127545	Dana	OR-232
127589	Dana	127589
127591	Dana	DT7591
127592	Dana	DT7592
127595	Dana	127595
127596	Dana	127596
127597	Dana	127597
127598	Dana	127598
127599	Dana	127599
127719	Dana	DT7719
127720	Meritor	DT7720
127721	Dana	DT7721
12815	Eaton	12815
128700	Dana	128700
128703	Dana	DT8703
129293	Dana	LC27105
129305	Dana	129305
129374	Dana	NP975161
129375	Dana	NP577914
129377	Dana	NP107783
129378	Dana	NP568900
129380	Dana	NP720703
129381	Dana	NP431952
129383	Dana	NP378092
129384	Dana	NP555065
129561	Dana	NP611140
129562	Dana	NP523912
129594	Dana	129594
129847	Dana	NP723977
129848	Dana	NP751735
129947	Dana	WUB61308UM
131008K	Dana	DT131008K
131041	Dana	NP374995
131042	Dana	NP237087
131044	Dana	NP120322.904A5
131048	Dana	NP049312.904A4
131052	Dana	NP927527
131095	Dana	131095
131095K	Dana	131095
131211	Dana	NP197868
131212	Dana	NP802507
131333	Dana	401300
132060	Dana	29688
13224	Dana	MU1305UBM
132439	Dana	132439
133897	Dana	NP340526
133898	Dana	NP420924

Additional Info

# Rebuild Kits and Components Interchanges



Manufacturer			Manufacturer			Manufacturer		
Part #	Manufacturer	NCB Part #	Part #	Manufacturer	NCB Part #	Part #	Manufacturer	NCB Part #
134291	Dana	NP242732	16516	Eaton	BS60	20537032	Mack	20537032
134292	Dana	NP611140	1652575	Mack	1652575	20537032	Volvo	20537032
134294	Dana	55212-C	1652575	Volvo	1652575	20550	Eaton	20550
134295	Dana	55437	1652578	Mack	1652578	20552	Eaton	20552
134297	Dana	NP799449	1652578	Volvo	1652578	20606	Eaton	MR1306RUGVW140
134298	Dana	NP105857	1652622	Mack	1652622	20607	Eaton	MU1308UM
134300	Dana	NP380290	1652622	Volvo	1652622	20674	Eaton	OR-123
134301	Dana	NP533133	1652776	Mack	1652776	20701	Eaton	MSN1212REXW619
134303	Dana	NP930036	1652776	Volvo	1652776	20703	Eaton	MSN1309REXW619
134304	Dana	NP193660	1654088	Mack	1654088	20704	Eaton	F206252
134306	Dana	NP523912	1654088	Volvo	1654088	20705	Eaton	FW687430
134308	Dana	55200-C	1656116	Mack	1656116	20706	Eaton	FW808840
134322	Dana	42584	1656116	Volvo	1656116	20707	Eaton	F11739
134323	Dana	DT134323	16566	Eaton	BS59	20712	Eaton	20712
13575	Dana	13575	16723	Eaton	16723	20715	Eaton	415004-V
139968	Dana	NP478770	16763	Eaton	16763	20716	Eaton	470625-V
139969	Dana	NP547156	16798	Eaton	16798	20762	Eaton	472311-V
139970	Dana	NP927527	16817	Eaton	MU1306UV	20770	Eaton	20770
139971	Dana	NP846736	16977	Eaton	470737-N	20771311	Mack	20771311
139972	Dana	NP166419	16980	Eaton	16980	20771311	Volvo	20771311
139973	Dana	HM813844	17399	Eaton	17399	20772	Eaton	20772
139974	Dana	HM813810	17406	Eaton	17406	20785252	Mack	20785252
139975	Dana	NP171276	17425	Eaton	415027-N	20785252	Volvo	20785252
139976	Dana	NP943289	17453	Eaton	OK-17453	20785448	Mack	20785448
139977	Dana	NP197868	17553	Eaton	MR1206RUGV	20785448	Volvo	20785448
139978	Dana	NP802507	1828K219	Meritor	1311-L	20791222	Mack	20791222
139980	Dana	NP910345	1828P68	Meritor	MR1212EL	20791222	Volvo	20791222
14039577	AAM	223255	1828S149	Meritor	211-L	20791305	Mack	20791305
14276	Meritor	14276	1828S201	Meritor	1309-S	20791305	Volvo	20791305
14287	Eaton	HJ223020/IR1820	1828Z234	Meritor	307-S	20832	Eaton	MU1307GUM
14289	Eaton	14289	18408	Eaton	416339	208385	Eaton	450316
14291	Eaton	14291	18657	Eaton	MU1207UGV	20899	Eaton	MSN1211REX
14311	Eaton	14311	18658	Eaton	MU1306UGV	20920	Eaton	20920
14317	Eaton	14317	18720	Meritor	18720	210084-2X	Dana	HB210084-2X
14354	Eaton	127831	18747	Eaton	18747	210088-1X	Dana	HB210088-1X
14366	Eaton	MU1308TV	19110	Eaton	19110	210090-1X	Dana	HB210090-1X
14367	Eaton	A3071	19129	New Venture	NV19129	210111	Dana	RUB1570UM
14654	Eaton	14654	19198	Eaton	19198	210121-1X	Dana	HB210121-1X
14750	Eaton	14750	19256728	AAM	S3208	210140-1X	Dana	HB210140-1X
14754	Eaton	14754	19529	Dana	653	210144-1X	Dana	HB210144-1X
14897	Eaton	14897	19974	Eaton	19974	210207-1X	Dana	HB210207-1X
14993	Eaton	14993	20015	Eaton	MR1307EX	210353	Dana	MUB1305UDM
15011	Eaton	15011	2001855	Dana	PN10	210367-1X	Dana	HB210367-1X
15045	Eaton	WJ162116	2002749	Dana	PN6	210370-1X	Dana	HB210370-1X
15046	Eaton	15046	2002806	Dana	S268	210391-1X	Dana	HB210391-1X
15092	Dana	42584	2003431	Dana	RGB25	210433-1X	Dana	HB210433-1X
15093	Eaton	OK-15093	2004101	Dana	DS2004101	210527X	Dana	HB210527X
15094	Dana	495-A	2004670	Dana	DS2004670	210588	Dana	MUB5207UM
15095	Eaton	15095	2005082	Dana	JLM104948-JLM104910 (2)	210661-1X	Dana	HB210661-1X
15101	Meritor	15101	2005899	Dana	NP784953-NP396414	210724	Dana	DT0724
15117	Meritor	15117	2007293	Dana	JLM704649-JLM704610	210736	Dana	DT0736
15126	Meritor	15126	20085	Eaton	20085	210737	Dana	DT0737
1521452	Mack	1521452	2009802	Dana	DS50574	21075	Meritor	21075
1521452	Volvo	1521452	201-210-4-1	TTC	201-210-4-1	210865-1X	Dana	HB108
15243	Meritor	15243	201-210-4-2	TTC	201-210-4-2	210866-1X	Dana	HB210866-1X
15245	Meritor	15245	201-210-4-3	TTC	201-210-4-3	210873-1X	Dana	HB210873-1X
15253	Eaton	15253	20128	Eaton	OK-20128	210875-1X	Dana	HB210875-1X
15260	Eaton	A2892	201-381-1	TTC	201-381-1	210881-1X	Dana	HB210881-1X
15571	Eaton	340483	201-381-3	TTC	201-381-3	210969-1X	Dana	HB88509
15748	Eaton	15748	201-463-26	TTC	OR-340V	211016X	Dana	HB88508-A
15823962	AAM	710568	201-463-8	TTC	37410.1	211019-1XV	Dana	HB25775162UJ
15918	Eaton	15918	201-47-4	TTC	201-47-4	211020-1XV	Dana	HB83065
15973	Eaton	15973	201-47-6	TTC	201-47-6	211098-1X	Dana	HB88508
15977	Eaton	BS61	20171	Eaton	BS59	211130X	Dana	HB88107-A
15980	Eaton	15980	201989	Eaton	J361644	211175X	Dana	HB211175X
15982	Eaton	MU1307V	20483426	Mack	20483426	211218	Dana	DRK-222RMK
15994	Eaton	15994	20483426	Volvo	20483426	211222	Dana	DRK-222F
16118	Eaton	16118	20483574	Mack	20483574	211223	Dana	DRK-222R
16244	Eaton	MR1308TV	20483574	Volvo	20483574	211260X	Dana	HB88508-A

Additional Info



# Rebuild Kits and Components Interchanges



Manufacturer Part #	Manufacturer	NCB Part #
211359X	Dana	HB211359X
211431X	Dana	HB211431-X
211499X	Dana	HB211499X
211502X	Dana	HB13
211589-1X	Dana	HB32
211590-1X	Dana	HB211590-1X
21170624	Mack	21170624
21170624	Volvo	21170624
211735-3X	Dana	HB211793-1X
211750-1X	Dana	HB26
211793-1X	Dana	HB211793-1X
211848-1X	Dana	HB211848-1X
211985X	Dana	HB211985-X
212028-1X	Dana	HB212028-1X
212030-1X	Dana	HB212030-1X
212032-1X	Dana	HB212032-1X
212053-1X	Dana	HB212053-1X
212066-1X	Dana	HB210661-1X
21208	Eaton	OR-217V
21209	Eaton	OR-221V
212093-1X	Dana	HB212093-1X
212134-1X	Dana	HB212134-1X
212135-1X	Dana	HB212135-1X
212187-1X	Dana	HB212187-1X
212235X	Dana	HB211499X
212258-1X	Dana	HB212030-1X
21320	Eaton	21320
21352	Eaton	AA1512-12
21355	Eaton	NCB355
21356	Eaton	NCB356
216220	Dana	DRK-404FMK/1
216221	Dana	DRK-404RMK
216234	Dana	DRK-404F
216248	Dana	DRK-404R
21626057	Mack	21626057
21626057	Volvo	21626057
21626061	Mack	21626061
21626061	Volvo	21626061
21626063	Mack	21626063
21626063	Volvo	21626063
21627792	Mack	21627792
21627792	Volvo	21627792
21632	Dana	68712
21633	Dana	68450
21635	Dana	42346
21662	Eaton	21662
217463	Dana	DRK-405FMK
217464	Dana	DRK-405RMK
217621	Dana	DRK-211FMK
217622	Dana	DRK-219RMK1
22283632	Mack	22283632
22283632	Volvo	22283632
22328	Eaton	22328
22329	Eaton	22329
22360	Eaton	22360
22441	New Venture	NV22441
22452	New Venture	NV22452
22-463-13	TTC	472015
2-2-479	Dana	S2-2-479
22507	New Venture	NV22507
226331	Eaton	226331
227080	Eaton	N309-L
227081	Eaton	SRA5304
228285	Eaton	M28161
2-28-357	Dana	S2-28-357
2-28-437	Dana	S2-28-437
229367	Eaton	472164
23012921	Allison	AT23012921
23015799	Allison	AT23015799

Manufacturer Part #	Manufacturer	NCB Part #
23016866	Allison	AT23016866
23041147	Allison	AT23041147
23041452	Allison	AT23041452
23041458	Allison	AT23041458
23045816	Allison	AT23045816
23045918	Allison	AT23045918
23046228	Allison	AT23046228
23046437	Allison	AT23046437
23046438	Allison	AT23046438
23047834	Allison	AT23047834
23047854	Allison	AT23047854
23047970	Allison	AT23047970
23048030	Allison	AT23048030
232-0376	Fabco	5310-KL
23261	Eaton	MR1306UVW745
233-0274	Fabco	382A
233-0375	Fabco	572
233-0376	Fabco	JH307710
233-0377	Fabco	JH307749
233-0443	Fabco	JH211749
233-0444	Fabco	JH211710
233-0455	Fabco	HM804846
233-0456	Fabco	HM804810
233-0457	Fabco	4595
233-0458	Fabco	4535
233-0474	Fabco	5584
233-0475	Fabco	535
233-0475	Fabco	5535
233-0479	Fabco	59425
233-0485	Fabco	389-A
233-0487	Fabco	59201
233-0489	Fabco	576
233-0492	Fabco	633
233-0493	Fabco	639
233-0494	Fabco	643
233-0497	Fabco	575
233-0498	Fabco	580
233-0499	Fabco	32213
233-0523	Fabco	33212
233-0527	Fabco	JM716610
233-0528	Fabco	JM716649
233-0545	Fabco	453-X
233-0546	Fabco	462
233-0547	Fabco	59412
233-0548	Fabco	455
233-0554	Fabco	742
233-0556	Fabco	748S
233-0569	Fabco	47420
233-0572	Fabco	47487
233-0586	Fabco	JF7010
233-0587	Fabco	JF7049A
23484	Eaton	415001-N
235130	Eaton	MU1309SGNV
235376	Eaton	QA48181-A
235402	Eaton	DD46386
235411	Eaton	MU1309UGM
235412	Eaton	QA47838
235414	Eaton	QBR49845
235655	Eaton	416664
23613	Eaton	MU1310RUMW3
237919	Eaton	411143-N
2-3-8001KX	Dana	S2-3-8001KX
239651	Eaton	F94488
239653	Eaton	F94490
239783	Eaton	239783
239818	Eaton	F84003
24288	New Venture	NV24288
24328	Dana	33472
24330	Dana	33275

Manufacturer Part #	Manufacturer	NCB Part #
2-4-533	Dana	S2-4-533
25520	Meritor	25520
25523	Meritor	25523
25580	Meritor	25580
25584	Meritor	25584
25626	New Venture	NV25626
2580	Meritor	2580
25820	Meritor	25820
25821	Meritor	25821
258452C1	Dana	28921
258453C91	Dana	28985
25877	Meritor	25877
25878	Meritor	25878
25880	Meritor	25880
25952	New Venture	NV25952
26057167	AAM	710105
26064028	AAM	710506
26064029	AAM	710507
26064030	AAM	710508
26067390	AAM	HB26067390
2720	Meritor	2720
27238	Dana	78551
27239	Dana	78215
27666	Dana	665
27810	Dana	27810
27813	Dana	497
27816	Dana	56650
27817	Dana	56425
27876	Dana	42381
28521	Meritor	28521
28580	Meritor	28580
28622	Meritor	28622
28682	Meritor	28682
28921	Meritor	28921
28985	Meritor	28985
28995	Meritor	28995
28-P-191	Chelsea	OR-113V
28-P-211	Chelsea	410085V
28-P-216	Chelsea	470163V
28-P-218	Chelsea	471231V
28-P-219	Chelsea	410194V
28-P-225	Chelsea	471268V
28-P-228	Chelsea	470442V
28-P-237	Chelsea	415983V
28-P-261	Chelsea	412015V
29500063	Allison	AT29500063
29500713	Allison	AT29500713
29500768	Allison	AT29500768
29500942	Allison	AT29500942
29500953	Allison	AT29500953
29501197	Allison	AT29501197
29501221	Allison	AT29501221
29501299	Allison	AT29501299
29501421	Allison	AT29501421
29503217	Allison	AT29503217
29503225	Allison	AT29503225
29503877	Allison	AT29503877
29505572	Allison	AT29505572
29505573	Allison	AT29505573
29505574	Allison	AT29505574
29505613	Allison	AT29505613
29506196	Allison	AT29506196
29511436	Allison	AT29511436
29514684	Allison	AT29514684
29517123	Allison	AT29517123
29530486	Allison	AT29530486
29531013	Allison	AT29531013
29531089	Allison	AT29531089
29531090	Allison	AT29531090

Additional Info

# Rebuild Kits and Components Interchanges



Manufacturer			Manufacturer			Manufacturer		
Part #	Manufacturer	NCB Part #	Part #	Manufacturer	NCB Part #	Part #	Manufacturer	NCB Part #
29531095	Allison	AT29531095	313628X	TTC	JLM710949C90KA3	387	Meritor	387
29531106	Allison	AT29531106	313645X	TTC	BS500262R	3877	Meritor	3877
29531151	Allison	AT29531151	313667X	TTC	313667X	387A	Meritor	387-A
29539501	Allison	AT29539501	313668X	TTC	K73X79X20B	387AS	Meritor	387-AS
29541702	Allison	AT29541702	31520	Meritor	31520	390	Meritor	390
29542533	Allison	AT29542533	31521	Meritor	31521	390A	Meritor	390-A
29542556	Allison	AT29542556	31594	Meritor	31594	390HA100	Dana	JLM710910
29543992	Allison	AT29543992	31597	Meritor	31597	390HA101	Dana	NP692588
29543993	Allison	AT29543993	31808	New Venture	NV31808	390HB101	Dana	JLM710949
29549505	Allison	AT29549505	31824	Dana	592-A	390HB102	Dana	NP064206
29552652	Allison	AT29552652	31825	Dana	598	390HD100	Dana	MUX5207UMV1
29552707	Allison	AT29552707	32210	Meritor	32210	390HD103	Dana	SC1084C4
29620	Meritor	29620	32739	New Venture	NV32739	390KS105X	Dana	DRK-411F
29630	Meritor	29630	330734	TTC	330734	392	Meritor	392
29675	Meritor	29675	330810	TTC	330810	3920	Meritor	3920
29685	Meritor	29685	330869	TTC	330869	3925	Meritor	3925
29869	New Venture	NV29869	3313798	Eaton	3313798	394A	Meritor	394-A
29870	New Venture	NV29870	3315624	Eaton	712512	394AS	Meritor	394-AS
300HA100	Dana	9121	3315674	Eaton	FW404820	394CS	Meritor	394-CS
300HB100	Dana	9185	3315679	Eaton	3315679	395	Meritor	395
300HD100	Dana	RJ9008UM	3315686	Eaton	3315686	39520	Meritor	39520
300HH100	Dana	300HH100	3315703	Eaton	FW707620	39578	Meritor	39578
30138	New Venture	NV30138	3315722	Eaton	FW657020	39580	Meritor	39580
30185	Dana	PN8-F	3315725	Eaton	3315725	39581	Meritor	39581
30271	Dana	PN5D	3315737	Eaton	FW505520	39585	Meritor	39585
30275	Dana	DS30275	3315765	Eaton	3315765	39590	Meritor	39590
30316	Dana	782	332	Meritor	332	395A	Meritor	395-A
30-463-6	Dana	6835-S	33208	Meritor	33208	396	Meritor	396
30689	Dana	39590	33211	Meritor	33211	3979	Meritor	3979
30692	Dana	47686	33212	Meritor	33212	3982	Meritor	3982
30703	Dana	30703	33225	Meritor	33225	3984	Meritor	3984
31219	New Venture	NV31219	33275	Meritor	33275	3992	Meritor	3992
312475-16X	TTC	GT-147	33281	Meritor	33281	3994	Meritor	3994
312475-25X	TTC	GT-158	33287	Meritor	33287	399A	Meritor	399-A
312475-28X	TTC	GT-180	33462	Meritor	33462	40001710	AAM	4762N
312475-29X	TTC	GT-186	33472	Meritor	33472	40006689	AAM	710474
312475-33X	TTC	GT-193	33699	Dana	55175	40007020	AAM	HB12471505
312475-35X	TTC	312475-35X	339	Meritor	339	40007042	AAM	HB12479237
312475-40X	TTC	GT-210	341KS101	Dana	DRK-191R	40007630	AAM	710491
312475-45X	TTC	312475-45X	34279	Dana	RGB5	40007712	AAM	710536
312475-46X	TTC	GT-221	34306	Meritor	34306	40012061	AAM	40012061
312475-47X	TTC	GT-221	34368	Dana	580	40015029	AAM	40015029
312476-22X	TTC	TRK-312476-22X	34478	Meritor	34478	40017140	AAM	710558
313024-17X	TTC	313024-17X	34539	Dana	749	40021317	AAM	HB40021334
313024-18X	TTC	313024-18X	3520	Meritor	3520	40021334	AAM	HB40021334
313024-24X	TTC	313024-24X	35239	Dana	9912	40021934	AAM	HB40120951
313024-27X	TTC	313024-27X	3525	Meritor	3525	40022855	AAM	710508
313024-28X	TTC	SR-221	353	Meritor	353	40024017	AAM	HB40024017
313240-3X	TTC	313240-3X	35502	Dana	HM807010	40024218	AAM	40024218
313401-13X	TTC	313401-13X	3585	Meritor	3585	40024349	AAM	710686
313401-33X	TTC	313401-33X	360HA100	Dana	72487	40033576	AAM	HB40048725
313401-34X	TTC	313401-34X	360HB100	Dana	72225-C	40033577	AAM	HB40048725
313429-21X	TTC	313429-21X	3620	Meritor	3620	40038875	AAM	710475
313429-23X	TTC	313429-23X	36487	Dana	DS36487	40041711	AAM	HB40048725
313429-25X	TTC	313429-25X	3720	Meritor	3720	40043559	AAM	HB40120951
313429-26X	TTC	313429-26X	3732	Meritor	3732	40048725	AAM	HB40048725
313429-6X	TTC	313429-6X	37625	Meritor	37625	40048726	AAM	HB40048725
313432-10X	TTC	TRK-313432-10X	3767	Meritor	3767	40051283	AAM	40014744
313432-1X	TTC	TRK-192	3775	Meritor	3775	40069374	AAM	HB40120951
313432-20X	TTC	TRK-313432-20X	3782	Meritor	3782	40088808	AAM	22943111
313432-25X	TTC	TRK-313432-25X	382	Meritor	382	40120951	AAM	HB40120951
313432-30X	TTC	TRK-313432-30X	3820	Meritor	3820	401HA100	Dana	HM807010
313432-31X	TTC	TRK-313432-31X	38249	New Venture	NV38249	401HC101	Dana	A1400
313432-33X	TTC	TRK-313432-33X	382A	Meritor	382-A	401HD101	Dana	B3624
313432-34X	TTC	TRK-313432-34X	382S	Meritor	382-S	401HH102	Dana	DTHH102
313432-35X	TTC	TRK-313432-35X	383271C91	Dana	MUB5206UM	401HH103	Dana	4624-V
313432-46X	TTC	TRK-313432-46X	385	Meritor	385	401HH104	Dana	401HH104
313438-3X	TTC	313438-3X	385A	Meritor	385-A	40-463-4-1X	TTC	39930
313438X	TTC	SK47	38615	Dana	30ZRTVGREY	40-463-6-1X	TTC	39920

Additional Info

# Rebuild Kits and Components Interchanges



Manufacturer Part #	Manufacturer	NCB Part #
40-486-1	TTC	40-486-1
40638	Dana	RGB12
40679	Dana	3994
40773	Dana	DS40773
41221	Dana	RGB5
4124075	Eaton	FW556020
42102	Dana	CS310
42346	Meritor	42346
42350	Meritor	42350
42381	Meritor	42381
42433	Dana	RGB13
42449	Dana	719316
42584	Meritor	42584
425-SP	TTC	425-SP
42620	Meritor	42620
42687	Meritor	42687
42688	Meritor	42688
4300119	Eaton	4300119
4300121	Eaton	710211
4300203	Eaton	471271-V
4300204	Eaton	4300204
4300329	Eaton	4300329
4300798	Eaton	473010-N
4300810	Eaton	4300810
4300828	Eaton	MU61307GUM
4300902	Eaton	NCB0902
4301254	Eaton	4301254
4301417	Eaton	MU1212RUMW3
4301844	Eaton	4301844
4301851	Eaton	NP656227-NP896049
4301855	Eaton	MU1210RUMW772
4301863	Eaton	MU1209UGMR
4302058	Eaton	AXK5070
4302074	Eaton	NCB2074
4302082	Eaton	4302082
4302712	Eaton	BS500052V
4303031	Eaton	MU1308TVWS
4303362	Eaton	4303362
4303424	Eaton	4303424
4303667	Eaton	MU1308TMWS
4303920	Eaton	MU1214UMW3
4303921	Eaton	MU1213UMW3
4304080	Eaton	BS226539V
4304101	Eaton	4304101
4304113	Eaton	4304113
4304184	Eaton	MR61014W617
4304185	Eaton	M61014GEVW617
4304189	Eaton	4304189
4304202	Eaton	K25X33X20B
4304211	Eaton	BS500156
4304212	Eaton	BS5001563
4304214	Eaton	M5206VW603
4304217	Eaton	4304217
4304317	Eaton	4304317
4304555	Eaton	4304555
4304599	Eaton	BS500192SX
4304600	Eaton	MU1313RUMW3
4304601	Eaton	MU1312RUMW3
4304605	Eaton	4304605
4305294	Eaton	4305294
4305625	Eaton	4305625
4305996	Eaton	4305996
4305997	Eaton	4305997
4306308	Eaton	4306308
4306584	Eaton	4306584
4306647	Eaton	4306647
4306648	Eaton	4306648
4308161	Eaton	BS500419
4308403	Eaton	HJ223020/IR1820

Manufacturer Part #	Manufacturer	NCB Part #
43085	Dana	714675
4327	Dana	4327
43270	Dana	43270
43916	Dana	CS333
44143	Meritor	44143
44189	Dana	PN6
44228	Dana	CS328
44348	Meritor	44348
44895	Dana	5778-V
44896	Dana	CS338
45220	Meritor	45220
45280	Meritor	45280
45282	Meritor	45282
45284	Meritor	45284
45285	Meritor	45285
45287	Meritor	45287
45290	Meritor	45290
45291	Meritor	45291
4535	Meritor	4535
453X	Meritor	453-X
454	Meritor	454
45460	Dana	72200-C
45461	Dana	45461
45462	Dana	45462
45463	Dana	45463
45478	Dana	45478
45498	Dana	45498
45499	Dana	45499
45516	Dana	45516
45658	Dana	CS342
45784	Dana	RGB14
46065	Dana	710429
46176	Dana	DS46176
462	Meritor	462
46485	Dana	4857
46-486-2	TTC	46-486-2
46526	Dana	46526
46584	Dana	MA1209EL
46720	Meritor	46720
469	Meritor	469
46925	Dana	CS349
47-210-1	TTC	47-210-1
472KS101	Dana	DRK-192RB
472KS113	Dana	DRK-200FA
47420	Meritor	47420
47490	Meritor	47490
474KS101	Dana	DRK-201R
474KS102	Dana	DRK-201FA
47620	Meritor	47620
47623A	Meritor	47623-A
47679	Meritor	47679
47686	Meritor	47686
47687	Meritor	47687
47820	Meritor	47820
47890	Meritor	47890
47896	Meritor	47896
48220	Meritor	48220
48286	Meritor	48286
48290	Meritor	48290
483067C91	Dana	HM813844
483068C1	Dana	HM813810
48488	Dana	710241
48717	Dana	CS344
49153	Dana	714675
492A	Meritor	492-A
493	Meritor	493
49-486-2	TTC	49-486-2
49-486-3	TTC	49-486-3
49489	Dana	710566

Manufacturer Part #	Manufacturer	NCB Part #
495	Meritor	495
495A	Meritor	495-A
495AX	Meritor	495-AX
496	Meritor	496
497	Meritor	497
49848	Dana	HM903249
49849	Dana	HM903210
500008-37	TTC	500008-37
500010-8	TTC	500010-8
5001874	Dana	HB5001874
5003684	Dana	HB5003684
5008025	Dana	HB5008025
500898	TTC	500898
5009385	Dana	HB5009385
501200	TTC	501200
50313	Dana	CS339
50366	Dana	PN26
50381	Dana	710413
504030	Dana	DRK-427AMK
504031	Dana	DRK-405FAMK
504033	Dana	DRK-427AMK/1
504034	Dana	DRK-405FAMK/1
504117	Dana	DRK-405F
504118	Dana	DRK-404FMK
504119	Dana	DRK-404R
504120	Dana	DRK-404F
504121	Dana	DRK-404RMK
504126	Dana	DRK-442A
504127	Dana	DRK-436A
504128	Dana	DRK-437A
504129	Dana	DRK-438A
504130	Dana	DRK-439A
504131	Dana	DRK-443A
504132	Dana	DRK-444A
504133	Dana	DRK-441A
50491	Dana	710493
50531	Dana	DS50531
50531	Dana	DS50531
50560	Dana	PN8-F
50608	Dana	710624
50614	Dana	CS345
50619	Dana	DS50619
50619	Dana	DS50619
50637	Dana	DS50637
50660	Dana	DS50660
509689	Dana	DRK-412
5-101X	Dana	S102
510393	Dana	DRK-427MK
510398	Dana	DRK-429MK
510399	Dana	DRK-428MK
510400	Dana	DRK-430MK
5-105X	Dana	S105
5-110X	Dana	S110
51180	Dana	DS51180
511891	Dana	DRK-451MK
5-1200X	Dana	S1200
5-1203X	Dana	S1203
5-1204X	Dana	S1204
51232	Dana	34492-A
51233	Dana	34274
512800	Dana	DRK-428
512805	Dana	DRK-430
512806	Dana	DRK-429
512812	Dana	DRK-427
512814	Dana	DRK-449
512828	Dana	DRK-445
512829	Dana	DRK-446
5-129X	Dana	S129
5-1301X	Dana	S1301

Additional Info

# Rebuild Kits and Components Interchanges

Manufacturer		
Part #	Manufacturer	NCB Part #
5-134X	Dana	S134
514011	Dana	DRK-436
514012	Dana	DRK-437
514013	Dana	DRK-438
514014	Dana	DRK-439
514015	Dana	DRK-443
514016	Dana	DRK-441
514059	Dana	DRK-447
514238	Dana	DRK-442
514240	Dana	DRK-444
5-1500X	Dana	S1500
5-1501X	Dana	S1501
5-1503X	Dana	S1503
5-1505X	Dana	S1505
5-1508X	Dana	S1508
5-1510X	Dana	S1306-1
5-1514X	Dana	S1514
5-1515X	Dana	S1515
5-160X	Dana	S160
5-188X	Dana	S188
5-2031X	Dana	S2031
52148	Dana	DS52148
522	Meritor	522
52375	Meritor	52375
52387	Meritor	52387
52387P	Meritor	52387-P
52400	Meritor	52400
5-242X	Dana	S242
5-243X	Dana	S243
5-260X	Dana	S260
52618	Meritor	52618
52618P	Meritor	52618-P
52637	Meritor	52637
5-279X	Dana	S279
528	Meritor	528
5-280X	Dana	S280
5-281X	Dana	S281
5-28-627	Dana	S5-28-627
5-3147X	Dana	S3147
53-205-1	TTC	53-205-1
5-3206X	Dana	S3206
5-3207X	Dana	S3207
5-3208X	Dana	S3208
5-3-2261KX	Dana	S5-3-2261KX
5-324X	Dana	S324
5-326X	Dana	S326
5-328X	Dana	S328
5-357X	Dana	S357
5-407X	Dana	S407
5-431X	Dana	S431
54381	Dana	DS54381
5-443X	Dana	S443
545021	TTC	545021
545047	TTC	545047
545065	TTC	545065
545132	TTC	SN13
5-460X	Dana	S460
550010	Chelsea	207
550026	Chelsea	453X
550031	TTC	311-L
550033	Dana	312
550038	Chelsea	1209A
550055	Chelsea	1309L
5-5015X	Dana	S5015
550182	TTC	25590
550218	Chelsea	14276
550221	Chelsea	15245
550225	Dana	25523
550228	TTC	25821

Manufacturer		
Part #	Manufacturer	NCB Part #
550311	Chelsea	209
550348	Dana	39520
550375	TTC	25520
550397	Chelsea	15126
550437	Chelsea	14124
550439	Chelsea	21075
550509	Chelsea	112
550532	Chelsea	15117
550671	Chelsea	M1206EL
550697	Chelsea	1206
550711	Dana	315
550712	Dana	122
550713	Dana	217
550714	Dana	1314
550715	Dana	J401648
550720	TTC	MR1309EAL
550868	TTC	2788-A
550886	Chelsea	WJ162116
550886	Dana	WJ162116
550886	TTC	WJ162116
550889	TTC	JH1812
550895	Chelsea	B2012
550900	TTC	JLM104948
550908	TTC	212
550914	TTC	MR1213EL
550921	TTC	MU1207TV
550924	TTC	217-SLE
550925	TTC	214-LH
550927	TTC	25584
550929	TTC	JM511910
550930	TTC	JM511946
550931	TTC	2580
550932	TTC	F81205
550940	TTC	MR1307EX
550941	TTC	MR1307EBX
550952	TTC	MU1311UGMR
550953	TTC	JH1416
550963	TTC	F93290
550978	TTC	2729
550981	TTC	MU1215TV
550982	TTC	114
550988	TTC	7211-HFL
550989	TTC	7211-HL
550991	TTC	F208323
550992	TTC	MU1211GUM
550996	TTC	MR1307EX
550998	TTC	MR1309UV
551003	TTC	K47X53X25A
551004	TTC	K55X63X20B
551005	TTC	K65X70X30A
551006	TTC	FW657020
551007	TTC	MB1212GEXR
551013	TTC	25581
55175C	Meritor	55175-C
55176C	Meritor	55176-C
55187C	Meritor	55187-C
55200C	Meritor	55200-C
55206C	Meritor	55206-C
552A	Meritor	552-A
55437	Meritor	55437
55443	Meritor	55443
5556503	Eaton	NCB6503
5556507	Eaton	5556507
5556509	Eaton	39590
5556510	Eaton	3782
5556511	Eaton	3720
5557003	Eaton	45285A
5557005	Eaton	NP317848
5557008	Eaton	25590

Manufacturer		
Part #	Manufacturer	NCB Part #
5557502	Eaton	39520
5557503	Eaton	NP525140
5557506	Eaton	25522
555S	Meritor	555-S
5566505	Eaton	306-VV
5566507	Eaton	DTP6507
5566508	Eaton	DTP6508
5566510	Eaton	DTP6510
5566511	Eaton	306-VVL
557S	Meritor	557-S
560918	Chelsea	WJ243016
560920	Chelsea	NTA1625
560976	Chelsea	LM501349
560977	Chelsea	LM501310
560978	Chelsea	M86643
560982	Chelsea	LM29710
560986	Chelsea	LM29749
560987	Chelsea	HM88630
563	Meritor	563
56-381-2X	TTC	56-381-2X
56-429-1X	TTC	56-429-1X
56-429-3X	TTC	56-429-3X
56-432-1X	TTC	TRK-56-432-1X
56-482-1	TTC	MU5206L
5-648X	Dana	S648
565903	Dana	A10
565904	Dana	SET80
566	Meritor	566
566008	Dana	710565
566071	Dana	33281
566117	Dana	R1561TV
56650	Meritor	56650
567	Meritor	567
5-674X	Dana	S674
5-675X	Dana	S675
5-676X	Dana	S676
5-70-28X	Dana	S5-70-28
5-7111X	Dana	S7105
572	Meritor	572
572A	Meritor	572-A
5735	Meritor	5735
575	Meritor	575
576	Meritor	576
5760	Meritor	5760
580	Meritor	580
581	Meritor	581
5-8105X	Dana	S8105
582	Meritor	582
592	Meritor	592
59201	Meritor	59201
592A	Meritor	592-A
5-92X	Dana	S92
593	Meritor	593
593A	Meritor	593-A
593X	Meritor	593-X
594	Meritor	594
59412	Meritor	59412
59-482-1-1X	TTC	C437-Q
594A	Meritor	594-A
595	Meritor	595
596	Meritor	596
598	Meritor	598
598A	Meritor	598-A
5C32-4800-B	Ford	HB5003684
5X1034	Meritor	5X1034
5X591	Meritor	5X591
6.5-70-18X	Dana	S6.5-70-18
60-463-10-1X	TTC	39925
60-463-8	TTC	415004-V

Additional Info

# Rebuild Kits and Components Interchanges



Manufacturer Part #	Manufacturer	NCB Part #
6082	Dana	567
612	Meritor	612
61-463-4	TTC	471570
620216	Dana	710566
621	Meritor	621
62829	Dana	62829
62830	Dana	62830
632	Meritor	632
6320	Meritor	6320
633	Meritor	633
63-463-1	TTC	415322-V
6379	Meritor	6379
6389	Meritor	6389
641	Meritor	641
6420	Meritor	6420
643	Meritor	643
64450	Meritor	64450
6461	Meritor	6461
6461A	Meritor	6461-A
64700	Meritor	64700
6488	Eaton	MU1309UV
652	Meritor	652
65225	Meritor	65225
65237	Meritor	65237
653	Meritor	653
6535	Meritor	6535
65390	Meritor	65390
65500	Meritor	65500
6580	Meritor	6580
663	Meritor	663
665	Meritor	665
665A	Meritor	665-A
672	Meritor	672
672-0229	Fabco	OR-032
673-0229	Fabco	OR-032
67322	Meritor	67322
67388	Meritor	67388
67390	Meritor	67390
67391	Meritor	67391
675-0224	Fabco	OR-224
675-0316	Fabco	OR-316
675-0326	Fabco	OR-326
67720	Meritor	67720
67782	Meritor	67782
67787	Meritor	67787
681A	Meritor	681-A
683	Meritor	683
6830333	Allison	AT6830333
6837146	Allison	AT6837146
68462	Meritor	68462
687	Meritor	687
68712	Meritor	68712
6884434	Allison	AT6884434
6884835	Allison	AT6884835
691644	Eaton	691644
691661	Eaton	691661
6984	Eaton	MU1308TM
701071-14	Dana	RGB24
706003X	Dana	DS706003X
706015X	Dana	HM88649-HM88610
706016X	Dana	LM501349-LM501314 (2)
706030X	Dana	02872-02820
706031X	Dana	31594-31520
706032X	Dana	25590-25523 (2)
706045X	Dana	HM88542-HM88510
706046X	Dana	HM803146-HM803110
706047X	Dana	387A-382S (2)
706060X	Dana	HM807040-HM807010
706070X	Dana	469-453X (2)

Manufacturer Part #	Manufacturer	NCB Part #
706123X	Dana	M88048-M88010
706861X	Dana	HM803149-HM803110
706894X	Dana	M86649-M86610
707065X	Dana	M802048-M802011
707066X	Dana	HM807046-HM807010
70709	Dana	70709
707162X	Dana	HM88648-HM88610
707447X	Dana	NP516549-NP673386
707489X	Dana	NP197868-NP802507 (2)
710787	Eaton	31594
711123	Eaton	45220
71204	Eaton	TL1
71205	Eaton	LC54505
71206	Eaton	SL1
71450	Meritor	71450
71750	Meritor	71750
72188C	Meritor	72188-C
72200C	Meritor	72200-C
72212C	Meritor	72212-C
72218C	Meritor	72218-C
72225C	Meritor	72225-C
72487	Meritor	72487
732-0333	Fabco	415027V
732-0355	Fabco	415991V
732-0358	Fabco	413248
732-0372	Fabco	417316V
732-0384	Fabco	416664V
732-0396	Fabco	455088V
732-0397	Fabco	417488
732-0428	Fabco	415559
740	Meritor	740
74001315	AAM	710475
74001710	AAM	4762N
74001965	AAM	450094
74002006	AAM	710547
74002024	AAM	46002024
74004028	AAM	710506
74004029	AAM	710507
74004030	AAM	710508
74004218	AAM	710549
74004349	AAM	710686
74004744	AAM	710497
74006689	AAM	710474
74007140	AAM	710558
74007167	AAM	710105
74007630	AAM	710491
74007656	AAM	40037764
74007712	AAM	710536
74009402	AAM	40014744
74050001	AAM	AK87
74050002	AAM	AK86
74050003	AAM	AK85
74050005	AAM	AK92
74050006	AAM	AK92
74050007	AAM	AK11
74050008	AAM	AK14
74050009	AAM	AK11
74050010	AAM	AK12
74050011	AAM	AK12
74050012	AAM	AK16
74050013	AAM	AK16
74050014	AAM	AK16
74050016	AAM	AK57
74067003	AAM	DRK-320A
74067004	AAM	DRK-321A
74067005	AAM	DRK-324
74067006	AAM	DRK-320
74067007	AAM	DRK-321
74067008	AAM	DRK-321C

Manufacturer Part #	Manufacturer	NCB Part #
74067009	AAM	DRK-325A
74067010	AAM	DRK-325B
74067011	AAM	DRK-327
74067013	AAM	DRK-320D
74067018	AAM	DRK-327A
74067020	AAM	DRK-324E
74067021	AAM	DRK-324H
74067022	AAM	DRK-327B
74070001	AAM	WK29
74070002	AAM	WK45
74070003	AAM	WK44
74070004	AAM	WK44
74070005	AAM	WK30
74070006	AAM	WK13
74081334	AAM	HB40021334
74081485	AAM	S3206
74085339	AAM	S3207
74087020	AAM	HB12471505
74087042	AAM	HB12479237
74087390	AAM	HB26067390
742	Meritor	742
747-D	TTC	747-D
749	Meritor	749
749A	Meritor	749-A
752	Meritor	752
759	Meritor	759
760	Meritor	760
772	Meritor	772
780	Meritor	780
782	Meritor	782
782-0288	Fabco	OR-012
78214C	Meritor	78214-C
78215C	Meritor	78215-C
78225C	Meritor	78225-C
78250AC	Meritor	78250-AC
78551	Meritor	78551
787	Meritor	787
78904	Dana	78904
78909	Dana	78909
78930	Dana	313
78931	Dana	OR-331
78936	Dana	MA1211EL
78937	Dana	78937
7C3Z4800C	Ford	HB5008025
7C3Z-4800-N	Ford	HB88527
7L8Z-4800A	Ford	HB5009385
7L8Z-4R602B	Ford	HB5009385
81012	Eaton	1311-L
81017	Eaton	1212-S
81022	Eaton	1309-L
81029	Eaton	1212-L
81052	Eaton	1310-L
81057	Eaton	1310-SLV
81058	Eaton	309-MG5
811523	Dana	T189
81504	Eaton	212-SLV
81505	Eaton	117-L
81511	Eaton	308
81547	Eaton	204
81549	Eaton	213
81557	Eaton	5310-WL
81559	Eaton	117
81566	Eaton	5310-WLB
81567	Eaton	214-LB
8171137	Mack	8171137
8171137	Volvo	8171137
820642	Dana	6461-A
82-463-4	TTC	415281-N
83001	Eaton	83001

Additional Info



# Rebuild Kits and Components Interchanges



Manufacturer			Manufacturer			Manufacturer		
Part #	Manufacturer	NCB Part #	Part #	Manufacturer	NCB Part #	Part #	Manufacturer	NCB Part #
83002	Eaton	83002	A11205X2728	Meritor	DTX2728	A1805R408	Meritor	45031-S
830398	Dana	WUB61307UM	A11205Y2729	Meritor	DTY2729	A1805S149	Meritor	476283-N
83726	Dana	83726	A11205Z2730	Meritor	DTZ2730	A1805S279	Meritor	471570
83824	Dana	JM822010	A11228B600	Meritor	32021-X	A1805T488	Meritor	415984
83825	Dana	JM822049	A11228J1414	Meritor	NP301337.902A2	A1805X466	Meritor	456105
84002	Eaton	84002	A11228R486	Meritor	MU1218TDHM	A1805Z26	Meritor	340483
84003	Eaton	84003	A11805S149	Meritor	3591	A-3697	Eaton	A3697
84004	Eaton	84004	A1199S1917	Meritor	502234	A-5022	Eaton	A5022
84005	Eaton	84005	A1205A1925	Meritor	4492-V	A-6340	Eaton	A6340
84006	Eaton	84006	A1205A2107	Meritor	45013S	ABG-9121	PAI	45280
85001	Eaton	85001	A1205B1198	Meritor	410101-N	ABG-9122	PAI	555-S
85002	Eaton	85002	A1205B1328	Meritor	3136-N	ABG-9130	PAI	HM212049
85003	Eaton	85003	A1205C1927	Meritor	A1205C1927	ABG-9131	PAI	6461-A
854	Meritor	854	A1205D1928	Meritor	415082-N	ACU-9041	PAI	432
85404	Dana	85404	A1205D706	Meritor	6612-S	ACU-9061	PAI	563
85406	Dana	85406	A1205E1227	Meritor	476023-N	BBG-6039	PAI	LM104949
85425	Dana	JH307749	A1205E1929	Meritor	475234-N	BBG-6149	PAI	495
85429	Dana	85429	A1205G2425	Meritor	4561-V	BBG-7070	PAI	310
85437	Dana	85437	A1205G683	Meritor	470308-N	BBG-7090	PAI	559
85439	Dana	72218-C	A1205J1544	Meritor	415082-N	BBG-7150	PAI	643
85533	Eaton	85533	A1205J1934	Meritor	4564-V	BBG-7159	PAI	3979
85541	Eaton	85541	A1205K1779	Meritor	475322-N	BBG-7160	PAI	309
85991	Dana	85991	A1205K401	Meritor	417316	BBG-7180	PAI	624
85994	Dana	85994	A1205K635	Meritor	470737-N	BBG-7190	PAI	645-X
85997	Dana	85997	A1205K713	Meritor	3592	BBG-7257	PAI	64450
864	Meritor	864	A1205L714	Meritor	4563-V	BBG-7280	PAI	47681
8774	Eaton	8774	A1205M325	Meritor	415137	BBG-7320	PAI	1213-L
8879	Eaton	MR1307EL	A1205N1132	Meritor	470954	BBG-7330	PAI	HM516448
8997	Eaton	CN1	A1205N1496	Meritor	415013-N	BBG-7336	PAI	JH211749
90943	Dana	563	A1205N612	Meritor	5406	BBG-7340	PAI	47687
90951	Dana	3920	A1205P1758	Meritor	471224	BBG-7341	PAI	47686
90954	Dana	575	A1205P1914	Meritor	4876-N	BBG-7343	PAI	47890
90955	Dana	572	A1205Q1915	Meritor	3143-N	BBG-7372	PAI	567
91136	Dana	3979	A1205S1527	Meritor	475080-N	BBG-7373	PAI	52387
917217R1	Dana	HM903210	A1205S1761	Meritor	410101-N	BBG-7400	PAI	557-S
9220	Meritor	9220	A1205U1529	Meritor	416654	BBG-7419	PAI	55206-C
92230584	AAM	DT53191	A1205U1685	Meritor	3905	BBG-7421	PAI	598-A
9278	Meritor	9278	A1205U1737	Meritor	475012-N	BBG-7430	PAI	5760
932	Meritor	932	A1205V1374	Meritor	473274-N	BBG-7435	PAI	H715334
936	Meritor	936	A1205V1686	Meritor	CR543351	BBG-7436	PAI	H715343
938	Meritor	938	A1205W1349	Meritor	370023-A	BBG-7469	PAI	H715348
9426916	Allison	AT9426916	A1205Y727	Meritor	475012-N	BBG-7470	PAI	H715345
9433392	Allison	AT9433392	A1228A1717	Meritor	H715334	BBG-7490	PAI	497
9434057	Allison	AT9434057	A1228E1175	Meritor	A1228E1175	BBG-7510	PAI	576
9439704	Allison	AT9439704	A1228G1307	Meritor	390A-902B1	BBG-7511	PAI	65237
949656	Mack	949656	A1228H1204	Meritor	119-L	BBG-7623	PAI	HM813843
949656	Volvo	949656	A1228H1308	Meritor	29675-902B7	BBG-7634	PAI	42362
95215	Dana	95215	A1228K1207	Meritor	390A-902A8	BBG-7640	PAI	1211
97-381-4	TTC	SR348-1	A1228L1130	Meritor	JP10049	BBG-7642	PAI	1213-A
97-463-32	TTC	412015-V	A1228L1546	Meritor	LM104949	BBG-7750	PAI	555
97-463-33	TTC	455379-V	A1228M1209	Meritor	29675-902B4	BBG-8941	PAI	28985
97-463-36-1X	TTC	97-463-36-1X	A1228M1729	Meritor	NP293601	BBG-8943	PAI	3877
97-463-39	TTC	714713	A1228N2068	Meritor	55206-C	BBK-7119	PAI	DRK-500
9797	Dana	9797	A1228N326	Meritor	MU1015DCV	BBK-7121	PAI	DRK-206
9803	Dana	493	A1228P1940	Meritor	JLM714149	BBK-7124	PAI	DRK-212F
9804	Dana	498	A1228R1474	Meritor	594-A	BBK-7124-100	PAI	DRK-212F
98-210-2	TTC	98-210-2	A1228S1345	Meritor	NP449281-NP357215	BBK-7125	PAI	DRK-206
98384	Dana	JH211749	A1228T1346	Meritor	NP418109-NP525386	BBK-7139	PAI	DRK-501
98385	Dana	JH211710	A1228U1347	Meritor	3782-3720	BBK-7141	PAI	DRK-205
98387	Dana	JM511946	A1228W1713	Meritor	JM511945	BBK-7142	PAI	DRK-502
98388	Dana	JM511910	A1228Z572	Meritor	LM11949-90013	BBK-7143	PAI	DRK-212R
98-432-1X	TTC	TRK-98-432-1X	A1805A157	Meritor	473228	BBK-7144	PAI	DRK-117
98-463-1	TTC	415953	A1805A261	Meritor	415272-N	BBK-7145	PAI	DRK-117A
99041	Dana	DRK-1A	A1805A573	Meritor	471341-N	BBK-7153	PAI	DRK-503
99050	Dana	DRK-23D	A1805B522	Meritor	CR540636	BC3Z-4800-B	Ford	HB88551
99051	Dana	DRK-1	A1805B80	Meritor	35009-N	BC3Z-4800-D	Ford	HB88525
99053	Dana	DRK-72A	A1805D212	Meritor	475322-N	BC3Z-4800-E	Ford	HB88553
99906	Dana	594-A	A1805F162	Meritor	417487	BC3Z-4800-HB	Ford	HB88549
A11205A2731	Meritor	DTA2731	A1805P536	Meritor	415483	BC3Z-4800-J	Ford	HB88529

Additional Info



# Rebuild Kits and Components Interchanges



Manufacturer Part #	Manufacturer	NCB Part #
BC3Z-4800-P	Ford	HB88557
BCU-7112	PAI	HM807010
BCU-7120	PAI	552-A
BCU-7140	PAI	632
BCU-7170	PAI	612
BCU-7256	PAI	64700
BCU-7318	PAI	66462
BCU-7335	PAI	JH1711710
BCU-7342	PAI	47820
BCU-7350	PAI	HM516414-B
BCU-7353	PAI	592-A
BCU-7356	PAI	56650
BCU-7390	PAI	47623-A
BCU-7480	PAI	572
BCU-7481	PAI	6420
BCU-7500	PAI	492-A
BCU-7501	PAI	65500
BCU-7502	PAI	653
BCU-7622	PAI	HM813810
BCU-7820	PAI	H715313-W
BCU-8942	PAI	28921
BCU-8944	PAI	3820
BCU-8973	PAI	25821
BOS-7695	PAI	4492-V
BOS-7696	PAI	4490-V
BOS-7697	PAI	4491-V
BSR-0385	PAI	3OZRTVBL
CP20RPLS	Meritor	RPL20
CP25RPLS	Meritor	RPL25
EBG-8639	PAI	306-DDL
EE60770	PAI	313.4
EE71140	PAI	DRK-222F
EE71360	PAI	DRK-222R
EE74520	PAI	H414210.4
EE90610	PAI	563.4
EF10880	PAI	21320
EF16640	PAI	1064
EF19970	PAI	15748
EF25380	PAI	14897
EF27410	PAI	14750
EF27470	PAI	16980
EF27510	PAI	14289
EF27520	PAI	14291
EF27530	PAI	14993
EF27540	PAI	16723
EF27550	PAI	16763
EF27830	PAI	11364
EF28020	PAI	15253
EF28030	PAI	20085
EF28050	PAI	15973
EF28370	PAI	17399
EF36610	PAI	19974
EF38710	PAI	204.4
EM31040	PAI	IR1816.4
EM38700	PAI	204-F.4
EM47800	PAI	780.4
EM47900	PAI	752.4
EM48000	PAI	772.4
EM48080	PAI	864.4
EM48120	PAI	687.4
EM48140	PAI	HM518410.4
EM48150	PAI	582.4
EM48160	PAI	HM518445.4
EM48170	PAI	594-A.4
EM48190	PAI	854.4
EM48500	PAI	594.4
EM48700	PAI	45220.4
EM48790	PAI	HM212011.4
EM48800	PAI	HM212010.4

Manufacturer Part #	Manufacturer	NCB Part #
EM49600	PAI	652.4
EM49690	PAI	740.4
EM49700	PAI	742.4
EM50100	PAI	47620.4
EM50200	PAI	HM516410.4
EM60120	PAI	IR2016.4
EM60290	PAI	3782.4
EM60330	PAI	3780.4
EM60340	PAI	3720.4
EM60350	PAI	JLM104948.4
EM60370	PAI	LM501349.4
EM60380	PAI	LM501310.4
EM60400	PAI	621.4
EM61320	PAI	M5209EL.4
EM61470	PAI	1212-SLV.4
EM61630	PAI	205-FF.4
EM65800	PAI	308-L.4
EM65900	PAI	214-SL.4
EM65930	PAI	214-L.4
EM65940	PAI	214-S.4
EM66010	PAI	206.4
EM66100	PAI	1208-L.4
EM66200	PAI	MA1205EL.4
EM66550	PAI	6912.4
EM67200	PAI	2822-V
EM69010	PAI	HB210661-1X
EM69020	PAI	HB210121-1X
EM69030	PAI	HB210084-2X
EM69040	PAI	HB210391-1X
EM69050	PAI	HB210875-1X
EM69060	PAI	HB210088-1X
EM69070	PAI	HB210881-1X
EM69080	PAI	HB210207-1X
EM71200	PAI	552-A.4
EM71210	PAI	DRK-206.V
EM71250	PAI	DRK-206.V
EM71410	PAI	DRK-205.V
EM71500	PAI	643.4
EM71670	PAI	3920.4
EM71700	PAI	612.4
EM71750	PAI	39590.4
EM72560	PAI	64700.4
EM72570	PAI	64450.4
EM73190	PAI	DTP043
EM73200	PAI	1213-L.4
EM73300	PAI	HM516448.4
EM73400	PAI	47687.4
EM73500	PAI	HM516414-B
EM73700	PAI	575.4
EM73710	PAI	52400.4
EM73900	PAI	47623-A.4
EM74000	PAI	557-S.4
EM74100	PAI	5735.4
EM74300	PAI	5760.4
EM74700	PAI	H715345
EM74740	PAI	H414235
EM75000	PAI	492-A.4
EM75020	PAI	653.4
EM75100	PAI	576.4
EM75200	PAI	663.4
EM75500	PAI	47679.4
EM75700	PAI	HM516449.4
EM75710	PAI	HM516449-A.4
EM76220	PAI	HM813810.4
EM76230	PAI	HM813843.4
EM76400	PAI	1211.4
EM76900	PAI	417484N / 4492
EM77400	PAI	415272-N
EM78200	PAI	H715313-W.4

Manufacturer Part #	Manufacturer	NCB Part #
EM89680	PAI	399-A.4
EM89690	PAI	394-A.4
EM91210	PAI	45280.4
EM91270	PAI	HM218248.4
EM91280	PAI	HM218210.4
EM91300	PAI	HM212049.4
EM91310	PAI	6461-A
ER60200	PAI	493.4
ER60360	PAI	JLM104910.4
ER70870	PAI	DRK-217R
ER74350	PAI	H715334.4
ER74360	PAI	H715343.4
ER74530	PAI	H715311.4
ER74900	PAI	497.4
GBG-6011	PAI	J2416
GBG-6033	PAI	3780
GBG-6035	PAI	JLM104948
GBG-6040	PAI	621
GBG-6071	PAI	JH1818
GBG-6087	PAI	212-SLV
GBG-6089	PAI	HJ223020/IR1820
GBG-6100	PAI	SCE2014P
GBG-6102	PAI	B1612
GBG-6133	PAI	SCH2216
GBG-6590	PAI	214-SL
GBG-6593	PAI	214-L
GBG-6594	PAI	214-S
GBG-6610	PAI	1208-L
GBG-6620	PAI	MA1205EL
GBG-6621	PAI	205
GBG-6630	PAI	MA1209EL
GBG-6631	PAI	M1209EL
GBG-6640	PAI	J361648
GBG-6655	PAI	6912
GBG-7319	PAI	DTP043
GBG-7321	PAI	MA1213EL
GBG-8967	PAI	390-A
GBG-8968	PAI	399-A
GBK-6560	PAI	TRK-185
GBK-6561	PAI	TRK-187
GBK-6562	PAI	TRK-213
GBK-6563	PAI	TRK-185
GBK-6564	PAI	TRK-500
GBK-6565	PAI	TRK-214MK
GBK-6565-400	PAI	GBK6565-400
GBK-6571	PAI	TRK-501
GBK-6572	PAI	TRK-502
GBK-6573	PAI	TRK-503
GBK-6574	PAI	TRK-213SD
GBK-6605	PAI	TRK-504
GBK-6637	PAI	TRK-214MK1
GCU-6020	PAI	493
GCU-6034	PAI	3720
GCU-6036	PAI	JLM104910
GCU-7453	PAI	H715311
GDB-1566	PAI	GDB1566
GDB-1665	PAI	GDB1665
GDB-1666	PAI	GDB1666
GGAHA100	Dana	42584
GGAHA101	Dana	493
GGAHA109	Dana	M802011
GGAHB100	Dana	42381
GGAHB101	Dana	495
GGAHB102	Dana	39590
GGAHB104	Dana	555-S
GGAHB105	Dana	HM807049
GGAHB106	Dana	M802048
GOS-6720	PAI	2822-V
GRI-2735	PAI	GRI2735

Additional Info

# Rebuild Kits and Components Interchanges



Manufacturer		
Part #	Manufacturer	NCB Part #
GSP-1672	PAI	GSP1672
GSP-1673	PAI	GSP1673
GSP-5988	PAI	GSP5988
GTW-1021	PAI	GTW1021
GTW-1022	PAI	GTW1022
GTW-5998	PAI	GTW5998
GWA-5919	PAI	GWA5919
GWA-5972	PAI	GWA5972
H500445	Dana	3782
H60-463-7	Dana	415013N
H715311	Meritor	H715311
H715313W	Meritor	H715313-W
H715334	Meritor	H715334
H715341	Meritor	H715341
H715343	Meritor	H715343
H715345	Meritor	H715345
HA100	Dana	H715311
HA101	Dana	56650
HA102	Dana	3920
HA105	Dana	6420
HB102	Dana	56425
HB103	Dana	H715343
HB104	Dana	55175-C
HB105	Dana	3984
HBG-4815	PAI	582
HBG-4817	PAI	594-A
HBG-4840	PAI	596
HBG-4850	PAI	594
HBG-4860	PAI	580
HBG-6029	PAI	3782
HBG-6031	PAI	3582
HBG-7163	PAI	28682
HBG-7174	PAI	39581
HBG-7175	PAI	39590
HBG-7371	PAI	52400
HBG-7520	PAI	663
HBG-7550	PAI	47679
HBG-7570	PAI	HM516449
HBG-7571	PAI	HM516449-A
HBG-9065	PAI	560
HBG-9129	PAI	HM212047
HCU-4830	PAI	592
HCU-4880	PAI	HM212010
HCU-5010	PAI	47620
HCU-5020	PAI	HM516410
HCU-7162	PAI	28622
HD100	Dana	XLS5-1/8-AF
HH221410	Meritor	HH221410
HH221442	Meritor	HH221442
HH506310	Meritor	HH506310
HH506348	Meritor	HH506348
HM212010	Meritor	HM212010
HM212011	Meritor	HM212011
HM212044	Meritor	HM212044
HM212047	Meritor	HM212047
HM212049	Meritor	HM212049
HM212049X	Meritor	HM212049-X
HM218210	Meritor	HM218210
HM218248	Meritor	HM218248
HM516410	Meritor	HM516410
HM516414B	Meritor	HM516414-B
HM516448	Meritor	HM516448
HM516449A	Meritor	HM516449-A
HM516449C	Meritor	HM516449-C
HM518410	Meritor	HM518410
HM518445	Meritor	HM518445
HM617010	Meritor	HM617010
HM617049	Meritor	HM617049
HM801310	Meritor	HM801310

Manufacturer		
Part #	Manufacturer	NCB Part #
HM801346X	Meritor	HM801346-X
HM803110	Meritor	HM803110
HM803146	Meritor	HM803146
HM803149	Meritor	HM803149
HM804810	Meritor	HM804810
HM804840	Meritor	HM804840
HM804846	Meritor	HM804846
HM807010	Meritor	HM807010
HM807040	Meritor	HM807040
HM807046	Meritor	HM807046
HM807049	Meritor	HM807049
HM813810	Meritor	HM813810
HM813843	Meritor	HM813843
HM813844	Meritor	HM813844
HM88510	Meritor	HM88510
HM88542	Meritor	HM88542
HM88610	Meritor	HM88610
HM88649	Meritor	HM88649
HM89411	Meritor	HM89411
HM89449	Meritor	HM89449
HM903210	Meritor	HM903210
HM903216	Meritor	HM903216
HM903249	Meritor	HM903249
HM911210	Meritor	HM911210
HM911242	Meritor	HM911242
HM911245	Meritor	HM911245
JCB-6895	PAI	HB210370-1X
JCB-6896	PAI	HB210140-1X
JCB-6897	PAI	HB210144-1X
JCB-6898	PAI	HB210433-1X
JCB-6899	PAI	HB210866-1X
JF7049A	Meritor	JF7049-A
JH211710	Meritor	JH211710
JH211749	Meritor	JH211749
JH217210	Meritor	JH217210
JH217249	Meritor	JH217249
JH307710	Meritor	JH307710
JH307749	Meritor	JH307749
JH415610	Meritor	JH415610
JH415647	Meritor	JH415647
JHM720210	Meritor	JHM720210
JHM720249	Meritor	JHM720249
JL69310	Meritor	JL69310
JL69349	Meritor	JL69349
JLM104910	Meritor	JLM104910
JLM104948	Meritor	JLM104948
JLM506810	Meritor	JLM506810
JLM506849	Meritor	JLM506849
JLM508748	Meritor	JLM508748
JLM710910	Meritor	JLM710910
JLM710949C	Meritor	JLM710949
JLM714110	Meritor	JLM714110
JLM714149	Meritor	JLM714149
JM205110	Meritor	JM205110
JM205149A	Meritor	JM205149A
JM207010	Meritor	JM207010
JM207049	Meritor	JM207049
JM207049A	Meritor	JM207049-A
JM511910	Meritor	JM511910
JM511945	Meritor	JM511945
JM511946	Meritor	JM511946
JM515610	Meritor	JM515610
JM515649	Meritor	JM515649
JM612910	Meritor	JM612910
JM612949	Meritor	JM612949
JM716610	Meritor	JM716610
JM716648	Meritor	JM716648
JM716649	Meritor	JM716649
JM720210	Meritor	JM720210

Manufacturer		
Part #	Manufacturer	NCB Part #
JM822010	Meritor	JM822010
JM822049	Meritor	JM822049
JP12010	Meritor	JP12010
JP12049	Meritor	JP12049
JRM3535	Meritor	JRM3535
K-1063	Eaton	TRK-1063
K-1064	Eaton	TRK-1064
K-1079	Eaton	TRK-1079
K-1447	Eaton	K-1447
K-1450	Eaton	K-1450
K-1479	Eaton	K-1479
K-1552	Eaton	K-1552
K-1554	Eaton	TRK-1554
K-1555	Eaton	TRK-1555
K-1568	Eaton	k-1568
K-1603	Eaton	K-1603
K-1763	Eaton	TRK-1763
K-1765	Eaton	TRK-1765
K-1782	Eaton	K-1782
K-1846	Eaton	K-1846
K-1850	Eaton	TRK-1850
K-1851	Eaton	TRK-1851
K-1852	Eaton	TRK-1852
K-1858	Eaton	TRK-1858
K-1859	Eaton	TRK-1859
K-1860	Eaton	TRK-1860
K-1861	Eaton	TRK-1861
K-1862	Eaton	TRK-1862
K-1863	Eaton	TRK-1863
K-1866	Eaton	TRK-1866
K-1867	Eaton	TRK-1867
K-1870	Eaton	TRK-1870
K-1871	Eaton	TRK-1871
K-1872	Eaton	TRK-1872
K-1873	Eaton	TRK-1873
K-1874	Eaton	TRK-1874
K-1875	Eaton	TRK-1875
K-1876	Eaton	TRK-1876
K-1877	Eaton	TRK-1877
K-1931	Eaton	K-1931
K-1955	Eaton	K-1955
K-1971	Eaton	TRK-1971
K-1972	Eaton	TRK-1972
K-1979	Eaton	TRK-1979
K-1980	Eaton	TRK-1980
K-1981	Eaton	TRK-1981
K-1982	Eaton	TRK-1982
K-1984	Eaton	TRK-1984
K-1986	Eaton	TRK-1986
K-1991	Eaton	TRK-1991
K-1992	Eaton	TRK-1992
K-1993	Eaton	TRK-1993
K-1995	Eaton	TRK-1995
K-1996	Eaton	TRK-1996
K-1999	Eaton	TRK-1999
K-2002	Eaton	K-2002
K-2041	Eaton	TRK-2041
K-2043	Eaton	TRK-2043
K-2045	Eaton	TRK-2045
K-2047	Eaton	TRK-2047
K-2048	Eaton	TRK-2048
K-2049	Eaton	TRK-2049
K-2054	Eaton	K-2054
K-2061	Eaton	K-2061
K-2085	Eaton	K-2085
K-2110	Eaton	K-2110
K-2120	Eaton	TRK-2120
K-2121	Eaton	TRK-2121
K-2122	Eaton	TRK-2122

Additional Info

# Rebuild Kits and Components Interchanges



Manufacturer Part #	Manufacturer	NCB Part #
K-2123	Eaton	TRK-2123
K-2124	Eaton	TRK-2124
K-2125	Eaton	TRK-2125
K-2126	Eaton	TRK-2126
K-2127	Eaton	TRK-2127
K-2128	Eaton	TRK-2128
K-2129	Eaton	TRK-2129
K-2130	Eaton	TRK-2130
K-2131	Eaton	TRK-2131
K-2136	Eaton	K-2136
K-2138	Eaton	K-2138
K-2143	Eaton	K-2143
K-2144	Eaton	K-2144
K-2181	Eaton	K-2181
K-2183	Eaton	K-2183
K-2199	Eaton	K-2199
K-2256	Eaton	DTK2256
K-2262	Eaton	DTK2262
K-2275	Eaton	TRK-2275
K-2277	Eaton	TRK-2277
K-2280	Eaton	TRK-2280
K-2281	Eaton	TRK-2281
K-2282	Eaton	TRK-2282
K-2283	Eaton	TRK-2283
K-2284	Eaton	TRK-2284
K-2285	Eaton	TRK-2285
K-2286	Eaton	TRK-2286
K-2287	Eaton	TRK-2287
K-2288	Eaton	TRK-2288
K-2295	Eaton	K-2295
K-2298	Eaton	K-2298
K-2335	Eaton	TRK-2335
K-2336	Eaton	TRK-2336
K-2338	Eaton	TRK-2338
K-2340	Eaton	TRK-2340
K-2341	Eaton	TRK-2341
K-2342	Eaton	TRK-2342
K-2343	Eaton	TRK-2343
K-2344	Eaton	TRK-2344
K-2345	Eaton	TRK-2345
K-2425	Eaton	K-2425
K-2430	Eaton	K-2430
K-2465	Eaton	K-2465
K-2468	Eaton	TRK-2468
K-2490	Eaton	TRK-2490
K-2758	Eaton	TRK-2758
K-2759	Eaton	TRK-2759
K-2761	Eaton	TRK-2761
K-2762	Eaton	TRK-2762
K-2763	Eaton	TRK-2763
K-2764	Eaton	TRK-2764
K-2765	Eaton	TRK-2765
K-2767	Eaton	TRK-2767
K-2768	Eaton	TRK-2768
K-2769	Eaton	TRK-2769
K-2770	Eaton	TRK-2770
K-2771	Eaton	TRK-2771
K-2772	Eaton	TRK-2772
K-2773	Eaton	TRK-2773
K-2779	Eaton	TRK-2779
K-2780	Eaton	TRK-2780
K-2802	Eaton	K-2802
K-2804	Eaton	K-2804
K-2805	Eaton	K-2805
K-2838	Eaton	TRK-2838
K-2839	Eaton	K-2839
K-2846	Eaton	K-2846
K-2847	Eaton	TRK-2847

Manufacturer Part #	Manufacturer	NCB Part #
K-2848	Eaton	TRK-2848
K-2855	Eaton	TRK-2855
K-2860	Eaton	K-2860
K-2865	Eaton	TRK-2865
K-2866	Eaton	TRK-2866
K-2918	Eaton	DTK2918
K-2921	Eaton	K-2921
K-2923	Eaton	K-2923
K-2924	Eaton	TRK-2924
K-2993	Eaton	TRK-2993
K-2994	Eaton	TRK-2994
K-2996	Eaton	TRK-2996
K-2997	Eaton	TRK-2997
K-3132	Eaton	TRK-3132
K-3233	Eaton	TRK-3233
K-3234	Eaton	TRK-3234
K-3256	Eaton	TRK-3256
K-3257	Eaton	TRK-3257
K-3258	Eaton	TRK-3258
K-3272	Eaton	TRK-3272
K-3273	Eaton	TRK-3273
K-3282	Eaton	TRK-3282
K-3283	Eaton	TRK-3283
K-3286	Eaton	TRK-3286
K-3287	Eaton	TRK-3287
K-3288	Eaton	K-3288
K-3322	Eaton	TRK-3322
K-3323	Eaton	TRK-3323
K-3339	Eaton	TRK-3339
K-3340	Eaton	TRK-3340
K-3341	Eaton	K-3341
K-3342	Eaton	TRK-3342
K-3343	Eaton	TRK-3343
K-3344	Eaton	TRK-3344
K-3345	Eaton	TRK-3345
K-3346	Eaton	TRK-3346
K-3347	Eaton	TRK-3347
K-3348	Eaton	TRK-3348
K-3350	Eaton	TRK-3350
K-3351	Eaton	TRK-3351
K-3354	Eaton	TRK-3354
K-3355	Eaton	TRK-3355
K-3413	Eaton	TRK-3413
K-3414	Eaton	TRK-3414
K-3423	Eaton	TRK-3423
K-3425	Eaton	TRK-3425
K-3426	Eaton	TRK-3426
K-3440	Eaton	TRK-3440
K-3458	Eaton	K-3458
K-3459	Eaton	TRK-3459
K-3460	Eaton	TRK-3460
K-3461	Eaton	TRK-3461
K-3462	Eaton	TRK-3462
K-3484	Eaton	K-3484
K-3485	Eaton	K-3485
K-3486	Eaton	TRK-3486
K-3487	Eaton	TRK-3487
K-3488	Eaton	TRK-3488
K-3509	Eaton	K-3509
K-3510	Eaton	K-3510
K-3512	Eaton	TRK-3512
K-3513	Eaton	TRK-3513
K-3514	Eaton	TRK-3514
K-3515	Eaton	TRK-3515
K-3518	Eaton	K-3518
K-3519	Eaton	TRK-3519
K-3522	Eaton	TRK-3522
K-3524	Eaton	TRK-3524

Manufacturer Part #	Manufacturer	NCB Part #
K-3532	Eaton	K-3532
K-3533	Eaton	TRK-3533
K-3534	Eaton	TRK-3534
K-3552	Eaton	K-3552
K-3553	Eaton	TRK-3553
K-3554	Eaton	TRK-3554
K-3583	Eaton	K-3583
K-3584	Eaton	K-3584
K-3585	Eaton	TRK-3585
K-3586	Eaton	TRK-3586
K-3593	Eaton	K-3593
K-3594	Eaton	K-3594
K-3595	Eaton	TRK-3595
K-3596	Eaton	TRK-3596
K-3597	Eaton	TRK-3597
K-3598	Eaton	TRK-3598
K-3600	Eaton	TRK-3600
K-3655	Eaton	TRK-3655
K-3656	Eaton	TRK-3656
K-3657	Eaton	TRK-3657
K-3658	Eaton	TRK-3658
K-3659	Eaton	TRK-3659
K-3660	Eaton	TRK-3660
K-3661	Eaton	TRK-3661
K-3738	Eaton	K-3738
K-3795	Eaton	25590-25522
K-3919	Eaton	25581-25520
K-3939	Eaton	K-3939
K-3940	Eaton	K-3940
K-3941	Eaton	TRK-3941
K-3942	Eaton	TRK-3942
K-4010	Eaton	TRK-4010
K-4011	Eaton	TRK-4011
K-4056	Eaton	TRK-4056
K-4057	Eaton	TRK-4057
K-4092	Eaton	TRK-4092
K-4152	Eaton	39590-39520
K-4154	Eaton	M802048-M802011
K-4155	Eaton	3782-3720
K-4158	Eaton	25584-25547RB
K-4160	Eaton	45285A-45220
K-7000	Eaton	TRK-7000
K-7001	Eaton	K-7001
K-7013	Eaton	TRK-7013
K-7028	Eaton	K-7028
K-7030	Eaton	K-7030
K-7032	Eaton	TRK-7032
K-7033	Eaton	TRK-7033
K-7035	Eaton	TRK-7035
K-7052	Eaton	TRK-7052
KBG-4816	PAI	HM518445
KBG-9127	PAI	HM218248
KCU-4814	PAI	HM518410
KCU-9128	PAI	HM218210
KIT2108	Meritor	DRK-2108
KIT4005	Meritor	DRK-9RC
KIT4010	Meritor	DRK-9RB
KIT4015	Meritor	DRK-900F
KIT4035	Meritor	DRK-194F
KIT4055	Meritor	DRK-194F
KIT4060	Meritor	DRK-194RB
KIT4065	Meritor	DRK-194RB
KIT4075	Meritor	DRK-172R
KIT4080	Meritor	DRK-172FB
KIT4095	Meritor	DRK-4095
KIT4100	Meritor	DRK-4100
KIT4105	Meritor	DRK-4105
KIT4110	Meritor	DRK-50

Additional Info

# Rebuild Kits and Components Interchanges



Manufacturer			Manufacturer			Manufacturer		
Part #	Manufacturer	NCB Part #	Part #	Manufacturer	NCB Part #	Part #	Manufacturer	NCB Part #
KIT4135	Meritor	DRK-4135	LM48548	Meritor	LM48548	SET402	Meritor	SET402
KIT4140	Meritor	DRK-4140	LM48548A	Meritor	LM48548-A	SET403	Meritor	SET403
KIT4145	Meritor	DRK-4145	LM501310	Meritor	LM501310	SET404	Meritor	SET404
KIT4150	Meritor	DRK-4150	LM501314	Meritor	LM501314	SET405	Meritor	SET405
KIT4155	Meritor	DRK-4155	LM501349	Meritor	LM501349	SET406	Meritor	SET406
KIT4190	Meritor	DRK-4190	LM522510	Meritor	LM522510	SET407	Meritor	SET407
KIT4220	Meritor	DRK-4220	LM522548	Meritor	LM522548	SET408	Meritor	SET408
KIT4235	Meritor	DRK-204R	LM603011	Meritor	LM603011	SET409	Meritor	SET409
KIT4270	Meritor	DRK-4270	LM603049	Meritor	LM603049	SET410	Meritor	SET410
KIT4300	Meritor	DRK-4300	LM67010	Meritor	LM67010	SET411	Meritor	SET411
KIT4315	Meritor	DRK-4315	LM67048	Meritor	LM67048	SET412	Meritor	SET412
KIT4330	Meritor	DRK-4330	M10HB109	Dana	787	SET413	Meritor	SET413
KIT4340	Meritor	DRK-218	M802011	Meritor	M802011	SET414	Meritor	SET414
KIT4345	Meritor	DRK-4345	M802048	Meritor	M802048	SET415	Meritor	SET415
KIT4350	Meritor	DRK-4350	M804010	Meritor	M804010	SET416	Meritor	SET416
KIT4356	Meritor	DRK-4356	M804049	Meritor	M804049	SET417	Meritor	SET417
KIT4360	Meritor	DRK-4360	M86610	Meritor	M86610	SET418	Meritor	SET418
KIT4365	Meritor	DRK-216	M86649	Meritor	M86649	SET419	Meritor	SET419
KIT4370	Meritor	DRK-225	M88010	Meritor	M88010	SET420	Meritor	SET420
KIT4375	Meritor	DRK-4375	M88048	Meritor	M88048	SET421	Meritor	SET421
KIT4385	Meritor	DRK-224	M903345	Meritor	M903345	SET422	Meritor	SET422
KIT4390	Meritor	DRK-4390	MER0103	Meritor	TM350	SET423	Meritor	SET423
KIT4395	Meritor	DRK-4395	MER0104	Meritor	TM318	SET424	Meritor	SET424
KIT4396	Meritor	DRK-4396	MER0112	Meritor	TM309	SET425	Meritor	SET425
KIT4400	Meritor	DRK-217R	MER0113	Meritor	TM329	SET426	Meritor	SET426
KIT4405	Meritor	DRK-4405	MER0123	Meritor	TM302	SET427	Meritor	SET427
KIT4406	Meritor	DRK-4406	MER0136	Meritor	TM312	SET428	Meritor	SET428
KIT4415	Meritor	DRK-4415	MER0143	Meritor	TM305	SET429	Meritor	SET429
KIT4420	Meritor	DRK-4420	MER0164	Meritor	TM315	SET430	Meritor	SET430
KIT4422	Meritor	DRK-4422	MER0173	Meritor	TM333	SET431	Meritor	SET431
KIT4423	Meritor	DRK-4423	MJAJA100	Dana	JM822010	SET432	Meritor	SET432
KIT4426	Meritor	DRK-4426	MJAJA103	Dana	JM716610	SET433	Meritor	SET433
KIT4428	Meritor	DRK-4428	MJAHB100	Dana	JM822049	SET434	Meritor	SET434
KIT4437	Meritor	DRK-4437	MJAHB103	Dana	JM716649	SET437	Meritor	SET437
KIT4438	Meritor	DRK-4438	NP160764	Meritor	NP160764	SET45	Meritor	A35
KIT4440	Meritor	DRK-4440	NP293601	Meritor	NP293601	SET6	Meritor	A6
KIT4441	Meritor	DRK-4441	NP378089	Meritor	NP378089	SPL140X	Dana	SP140
KIT4442	Meritor	DRK-4442	NP414535	Meritor	NP414535	ST2161	Dana	47820
KIT4443	Meritor	DRK-4443	NP478159	Meritor	NP478159	ST2162	Dana	47890
KIT4444	Meritor	DRK-4444	NP528108	Meritor	NP528108	ST264	Dana	210
KIT4445	Meritor	KIT4445	NP547288	Meritor	NP547288	ST741	Dana	122-L
KIT4446	Meritor	KIT4446	NP563664	Meritor	NP563664	ST791	Dana	3877
KIT4450	Meritor	DRK-4450	NP621196	Meritor	NP621196	ST951	Dana	3820
KIT4459	Meritor	DRK-4435	NP635208	Meritor	NP635208			
KIT4460	Meritor	DRK-4436	NP655898	Meritor	NP655898			
KIT4461	Meritor	DRK-4461	NP674708	Meritor	NP674708			
KIT4753	Meritor	DRK-4753	NP682041	Meritor	NP682041			
KIT4841	Meritor	DRK-4841	NP934397	Meritor	NP934397			
KIT4842	Meritor	DRK-4842	NP942787	Meritor	NP942787			
KIT4843	Meritor	DRK-4843	NP970652	Meritor	NP970652			
KIT4844	Meritor	DRK-4844	PAP806869	PAI	TRK-505MK			
KIT5356	Meritor	TRK-5356	PAP806870	PAI	TRK-506MK			
KIT5357	Meritor	TRK-5357	PAP806871	PAI	TRK-507MK			
KIT5389	Meritor	KIT5389	PAP806929	PAI	932			
KIT5406	Meritor	TRK-5406	PAP806930	PAI	27820			
L44610	Meritor	L44610	PAP806933	PAI	382-A			
L44643	Meritor	L44643	PAP806989	PAI	938			
L44649	Meritor	L44649	PAP806994	PAI	385-A			
L68111	Meritor	L68111	PAP806995	PAI	78250-AC			
L68149	Meritor	L68149	S-1128	Eaton	S1128			
L812148	Meritor	L812148	S-1409	Eaton	S1409			
LM102910	Meritor	LM102910	S-1659	Eaton	S1659			
LM102949	Meritor	LM102949	S-1661	Eaton	S-1661			
LM104911A	Meritor	LM104911-A	S-2822	Eaton	S2822			
LM11910	Meritor	LM11910	S-2838	Eaton	S-1661			
LM11949	Meritor	LM11949	S-2890	Eaton	S2890			
LM12710	Meritor	LM12710	S-2928	Eaton	S2928			
LM48510	Meritor	LM48510	SET401	Meritor	SET401			

Additional Info

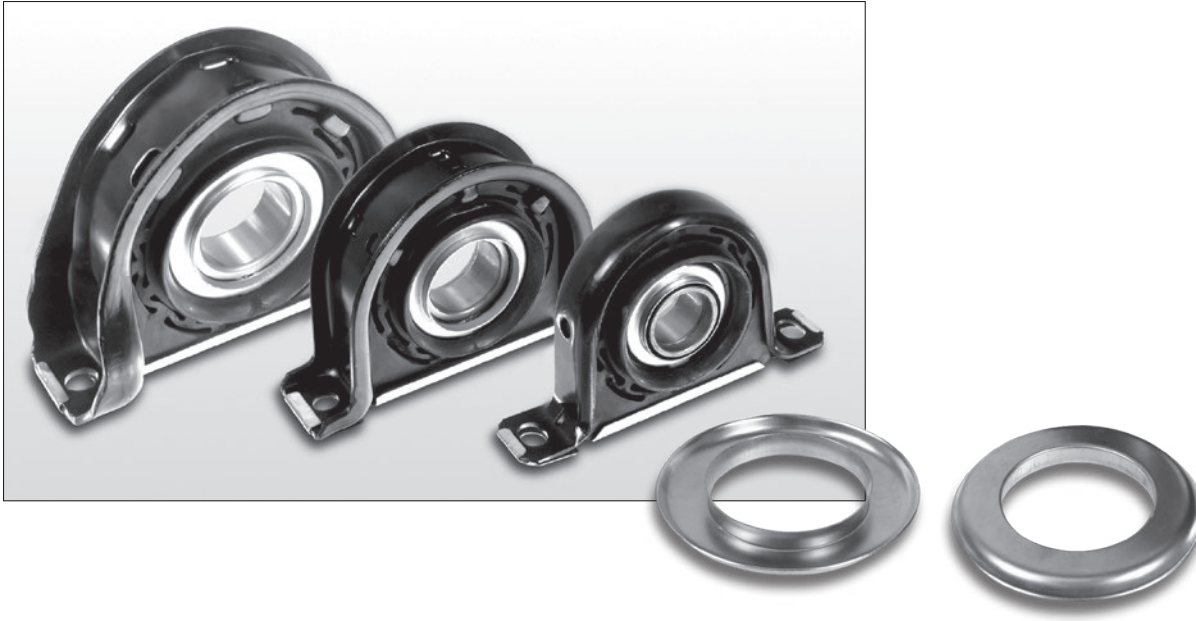

## Center Support Bearings

DT Components center support bearings are available for a broad range of domestic and foreign passenger cars, SUV's, pickup trucks as well as medium and heavy duty truck applications. Each center support bearing is engineered and constructed for the specific vehicle application ensuring precise driveshaft alignment and support. All center support bearing components are manufactured at ISO9001 certified or higher factories and go through rigorous testing throughout the manufacturing process to ensure the highest possible quality is built into every unit.

The bearings contained within the center supports are designed to provide smooth and quiet operation under the harshest conditions. Every bearing is pre-lubricated for life and sealed with metal reinforced seals preventing moisture and contaminants from entering the bearing. The center support rubber cushions are manufactured using a special formula that blends the highest quality materials into a rubber compound that provides support while absorbing and isolating vibrations that could damage the driveline.

Center support frames are constructed from cold rolled steel for additional strength and feature a protective corrosion resistant coating to protect it from the elements and road salt. DT Components center support bearings are available with and without flingers where applicable.

This DT Components catalog is organized by U-Joint series and vehicle specific applications. Photos of each center support bearing are arranged in numeric order so customers can visually confirm the correct part identification before ordering. Complete interchange and vehicle application information is located in our electronic catalog that is accessible through the DT Components website.



# Center Support Bearings

## Assembly Style

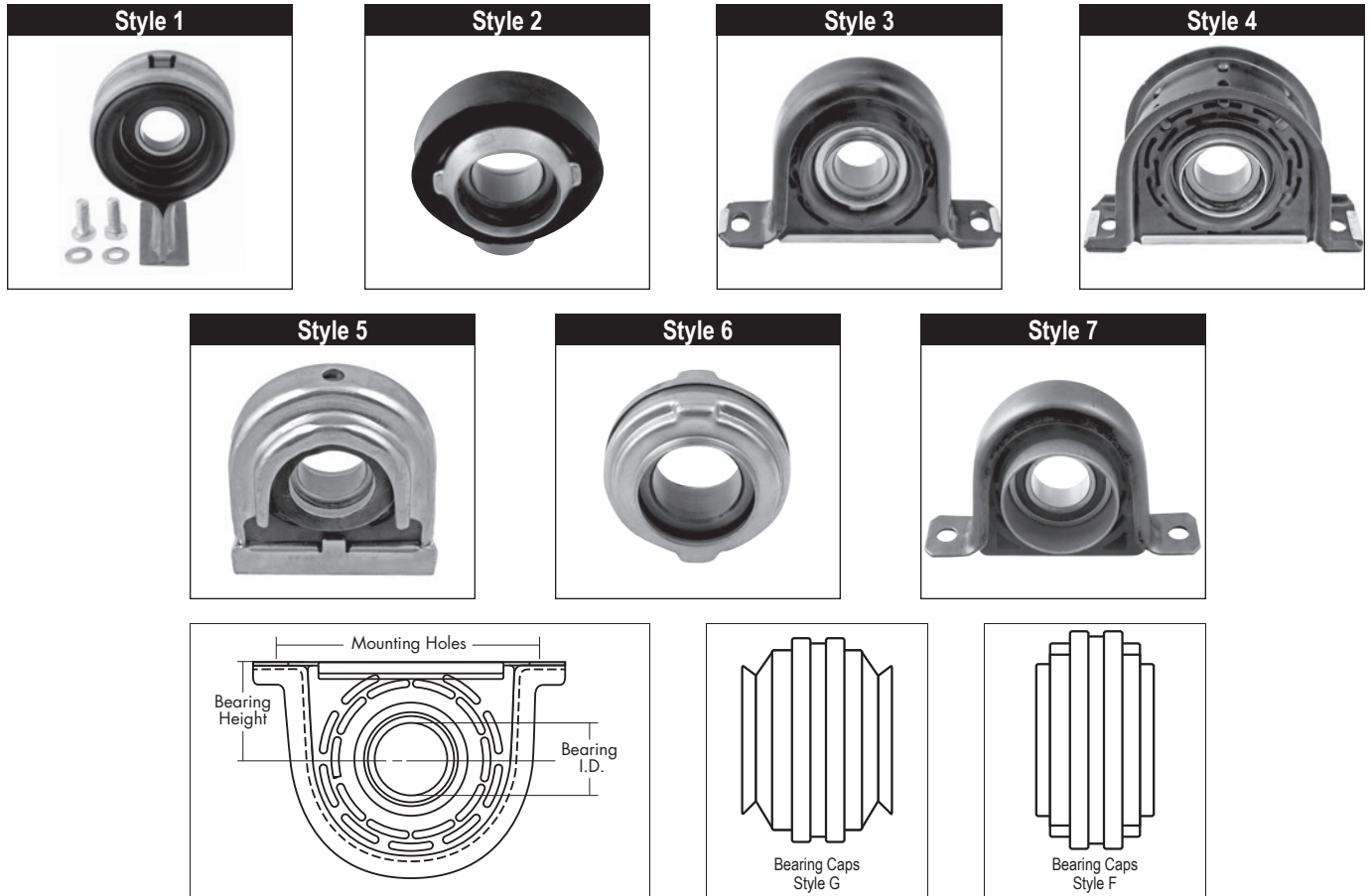

## Flinger Specifications

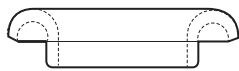

1

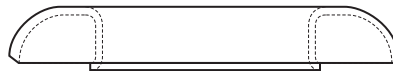

2

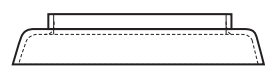

3

Part Number	Type	I.D.	O.D.	Width
230104	1	1.375"	2.562"	0.750"
230118	2	2.057"	4.000"	0.562"
230121	1	1.374"	2.437"	0.625"
230124	2	2.306"	4.375"	0.562"
230141	2	1.757"	4.000"	0.828"
230151	2	2.556"	4.562"	0.562"
230166	2	2.807"	4.812"	0.562"
230192	2	2.370"	4.625"	1.190"
230193	3	2.370"	3.125"	0.560"
230207	2	2.525"	4.375"	0.875"
230208	1	1.569"	2.875"	0.938"

Part Number	Type	I.D.	O.D.	Width
230209	1	1.569"	2.625"	0.594"
230363	1	1.765"	2.875"	0.594"
230746	2	3.312"	5.562"	0.578"
231000	1	1.569"	2.437"	0.562"
231004	2	2.149"	4.000"	0.440"
231217	2	2.057"	3.687"	0.300"
231256	1	1.374"	2.093"	0.470"
231286	2	2.055"	3.701"	0.299"
231696	2	1.692"	3.012"	0.472"
98-1473	3	1.747"	2.500"	0.500"

Additional Info



## Center Support Bearing by U-Joint Series

Center Support w/Flingers	Center Support w/o Flingers	Style	Center Height	Mounting Holes	Cap Style	Flingers
<b>1210 Series 1.259" (32mm) Bearing I.D.</b>						
HB211431-X	N/A	3	1.940"	5.880"	F	231669 (2)
<b>1310 Series 1.181" (30mm) Bearing I.D.</b>						
HB211590-1X	N/A	3	1.940"	5.880"	F	231669 (2)
<b>1280 thru 1310 Series 1.181" (30mm) Bearing I.D.</b>						
	HB210527X	1	3.560"	1.500"	N/A	N/A
<b>1280 thru 1330 Series 1.378" (35mm) Bearing I.D.</b>						
	HB5	2	N/A	N/A	N/A	N/A
<b>1280 thru 1410 Series 1.378" (35mm) Bearing I.D.</b>						
HB210088-1X	88107-AF	3	2.250"	6.620"	F	230121, 230217
HB210090-1X	88107-AF	3	2.250"	6.620"	F	230217 (2)
HB210367-1X	88107-AG	3	2.250"	6.620"	G	230141, 98-1473 (2)
HB210370-1X	88107-AG	3	2.250"	6.620"	G	230104, 230141, 98-1473
HB211175X	N/A	Special	2.250"	6.620"	F	231286, 231256
HB211187-X	HB88107-A	3	2.250"	6.625"	F	231217, 231256
	HB211985X	7	2.750"	6.620"	N/A	N/A
HB212053-1X	N/A	Special	2.250"	6.620"	F	231286
<b>1310 thru 1550 Series 1.575" (40mm) Bearing I.D. (*Includes Balancing Ring)</b>						
HB210140-1X	HB88508-G	4	2.440"	6.620"	G	230207, 230208
HB210144-1X	HB88508-G	4	2.440"	6.620"	G	230207 (2)
HB210391-1X	HB88508	4	2.440"	6.620"	F	230124 (2)
HB210433-1X	HB88508	4	2.440"	6.620"	F	230124, 230209
HB210866-1X	HB88508-A	4	2.250"	6.620"	F	231000, 231004
HB210873-1X	HB88508-A	4	2.250"	6.620"	F	231004 (2)
HB211793-1X		Special	2.250"	6.620"	F	231286, 231000
HB211359X		Special	2.250"	6.620"	F	231286, 231000
HB211499X		Special	2.250"	6.620"	F	231286, 231834
HB211848-1X	N/A	5	3.250"	3.380"	F	231286, 232662
HB211963-1X	N/A	5	3.250"	3.380"	F	231286, 232662
HB212093-1X	N/A	4	2.250"	6.620"	F	231000, 231286
	HB108	6			F	N/A
	HB212028-1X*	7	2.250"	6.620"	N/A	N/A
	HB212030-1X*	7	2.250"	6.620"	N/A	N/A
	HB212032-1X*	7	2.630"	6.620"	N/A	N/A

Additional Info

# Center Support Bearings

## Center Support Bearing by U-Joint Series

Center Support w/Fingers	Center Support w/o Fingers	Style	Center Height	Mounting Holes	Cap Style	Fingers
<b>SPL70 Series</b>						
HB212134-1X		Special	2.689"	7.622"	N/A	N/A
HB212135-1X		Special	2.689"	7.622"	N/A	232930
<b>1410 thru 1650/SPL90 Series 1.772" (45mm) Bearing I.D.</b>						
HB210084-2X	HB88509	4	2.690"	7.620"	F	230151 (2)
HB210130-1X	HB88509-G	4	2.690"	7.620"	G	230151, 230363
HB210207-1X	HB88509	4	2.690"	7.620"	F	230151, 230363
HB210209-1X	HB88509-G	4	2.690"	7.620"	G	230192, 230193, 230380
HB211172-1X		4	2.690"	7.620"		230151, 230163
<b>1700 thru 1710/SPL140 Series 1.969" (50mm) Bearing I.D.</b>						
HB210121-1X	N/A	4	2.780"	7.620"	F	230166 (2)
HB210881-1X	N/A	4	2.780"	7.620"	F	230166 (2)
<b>1760 thru 1810/SPL140 thru SPL250 Series 2.362" (60mm) Bearing I.D.</b>						
HB210661-1X	N/A	4	3.380"	8.620"	F	230746 (2)
HB210661-1XSA	N/A	Self Aligning	3.380"	8.620"	F	230746 (2)
HB210875-1X	N/A	4	3.380"	8.620"	F	230746 (2)
<b>1850 thru 1880 Series 2.756" (70mm) Bearing I.D.</b>						
HB210748-1X	N/A	4	3.380"	8.620"	F	230746 (2)

## Center Support Bearings by Vehicle

### Chrysler Vehicles

Application	Years	ID	Bearing Height	Part Number
300	05-13	30mm	N/A	HB83065
Challenger w/Auto. Trans.	08-13	30mm	N/A	HB83065
Charger w/Auto. Trans.	05-13	30mm	N/A	HB83065
Dakota	00-02	35mm	57.2mm	HB5001874
Dakota, includes Flingers	00-02	35mm	57.2mm	HB12479237
Magnum w/Auto. Trans.	05-08	30mm	N/A	HB83065
Ram 2500 ,3500	06-10	40mm	115.7mm	HB40048725
Ram 2500,3500 Quad Cab	04-05	40mm	117.5mm	HB40021334
Sprinter Van	03-06	45mm	67mm	HB5104574
Sprinter Van	07-10	47mm	68.5mm	HB68088
Sprinter Van Boot Kit	07-10	N/A	N/A	HB68088K

### Ford Vehicles

Application	Years	ID	Bearing Height	Part Number
Escape AWD, Mariner AWD	05-12	30mm	36.5mm	HB5009385
F-250 w/158" Wheel Base	05-10	40mm	57.2mm	HB5008025
F-250 Super Duty	07-10	40mm	68.5mm	HB5003684
F-250 Super Duty	07-12	40mm	70.6mm	HB88525
F-250 Super Duty	07-13	40mm	57.5mm	HB88550
F-250 Super Duty w/142" Wheel Base	08-10	40mm	37.5mm	HB88527
F-250 Super Duty	08-11	40mm	70.6mm	HB88551
F-250 Super Duty	08-13	40mm	37.5mm	HB88529
F-250 Super Duty	11-13	40mm	37.5mm	HB88549
F-250 Super Duty	11-13	40mm	63.3mm	HB88553
F-350 w/158" Wheel Base	05-10	40mm	57.2mm	HB5008025
F-350 Super Duty	07-10	40mm	68.5mm	HB5003684
F-350 Super Duty	07-12	40mm	70.6mm	HB88525
F-350 Super Duty	07-13	40mm	57.5mm	HB88550
F-350 Super Duty	08-10	40mm	57.5mm	HB88552
F-350 Super Duty w/142" Wheel Base	08-10	40mm	37.5mm	HB88527
F-350 Super Duty	08-11	40mm	70.6mm	HB88551
F-350 Super Duty	08-13	40mm	37.5mm	HB88529
F-350 Super Duty w/SRW	10-15	40mm	63.3mm	HB88557
F-350 Super Duty	11-13	40mm	37.5mm	HB88549
F-350 Super Duty	11-13	40mm	63.3mm	HB88553

### GM Vehicles

Application	Years	ID	Bearing Height	Part Number
Cadillac CTS, STS	03-11	30mm	N/A	HB83074
Cadillac Escalade, ESV, EXT	08-12	40mm	55mm	HB40120951
Chevrolet Camaro w/2 Pc. Driveshaft	93-99	35mm	37mm	HB26067390
GMC Canyon 2WD	04-12	30mm	99mm	HB212187-1X
Chevrolet Colorado 2WD	04-12	30mm	99mm	HB212187-1X
Chevrolet Equinox AWD	05-06	30mm	26mm	HB25775162
Chevrolet Equinox AWD w/ U-Joint	05-06	30mm	26mm	HB25775162UJ
Chevrolet, GMC Trucks and SUV's	88-11	35mm	57mm	HB40024017
Chevrolet Full Size Van, Camaro, Firebird with 2 Pc. Driveshaft	93-99	35mm	37mm	HB26067390
Chevrolet, GMC 1/2 Ton Truck	02-04	35mm	56mm	HB12471505
Chevrolet, GMC 3/4 and 1 Ton Truck and Vans; w/o Mtg. Studs	00-04	40mm	58mm	HB88505
Chevrolet Full Size Van	93-99	35mm	37mm	HB26067390
Pontiac Torrent AWD	05-06	30mm	26mm	HB25775162
Pontiac Torrent AWD w/ U-Joint	05-06	30mm	26mm	HB25775162UJ
Pontiac Firebird w/2 Pc. Driveshaft	93-99	35mm	37mm	HB26067390
Saturn Vue AWD	05-06	30mm	26mm	HB25775162
Saturn Vue AWD w/ U-Joint	05-06	30mm	26mm	HB25775162UJ

### Import Vehicles

Application	Years	ID	Bearing Height	Part Number
Honda CR-V	97-01	25mm	11mm	HB10003
Kia Sorento RWD & 4 Spd Auto. Trans.	03-06	28mm	21mm	HB49100
Kia Sorento RWD & 5 Spd Manual Trans.	03-06	30mm	22mm	HB49200
Kia Sorento RWD & 5 Spd Auto. Trans.	03-06	30mm	22mm	HB49300
Mazda Tribute AWD	01-11	30mm	36.5mm	HB5009385
Nissan Frontier 4WD	98-04	31mm	N/A	HB1009
Toyota Highlander, Front	01-10	30mm	N/A	HB1820-10
Toyota Highlander, Rear	01-10	30mm	N/A	HB1850-10
Toyota Pick Up 2WD	89-95	30mm	N/A	HB27
Toyota Pick Up 4WD	89-95	30mm	N/A	HB24
Toyota T100	93-98	30mm	N/A	HB2020-10
Toyota T100 2WD	93-98	30mm	9mm	HB26
Toyota T100 4WD	93-98	30mm	9mm	HB28
Toyota Tacoma	96-04	30mm	9mm	HB26
Toyota Tacoma	96-04	30mm	9mm	HB31
Toyota Tacoma	96-12	30mm	N/A	HB2020-10
Toyota Tundra	00-04	30mm	9mm	HB26
Toyota Tundra	00-12	30mm	N/A	HB2020-10
Toyota RAV4	96-00	30mm	76mm	HB1600-10

# Center Support Bearings

## Product Images

HB5

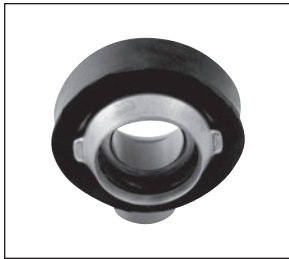

HB24



HB26



HB27



HB28



HB31



HB108



HB1009



HB1600-10



HB1820-10



HB1850-10



HB2020-10



HB10003



HB49100



HB49200



HB49300



HB68088



HB83065



HB88107-A



88107-AF



# Center Support Bearings

## Product Images (continued)

88107-AG

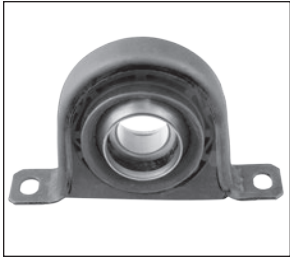

HB88508



HB88508-A



HB88508-G

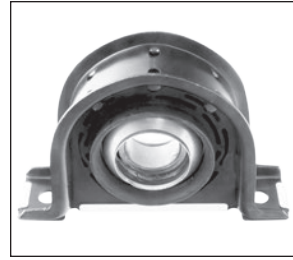

HB88509

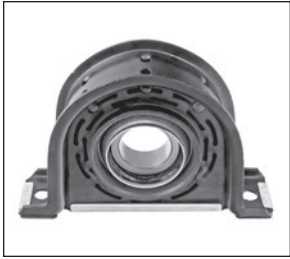

HB88509-G

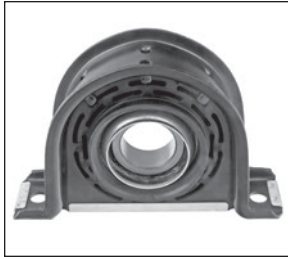

HB88527

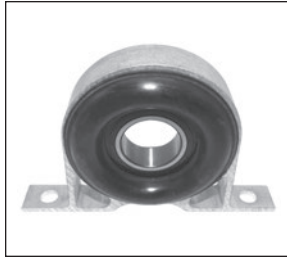

HB88528

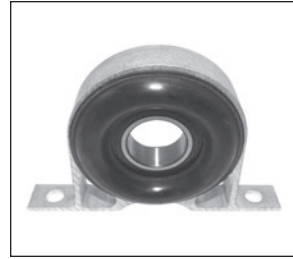

HB88529

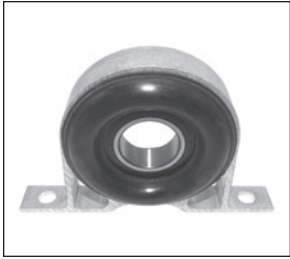

HB88549

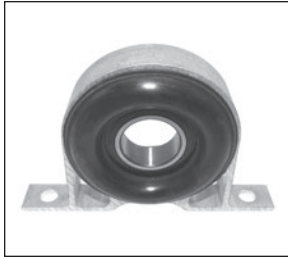

HB88550

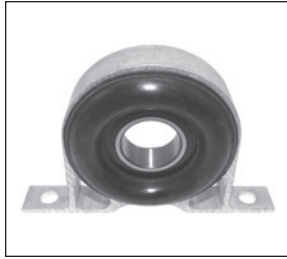

HB88551

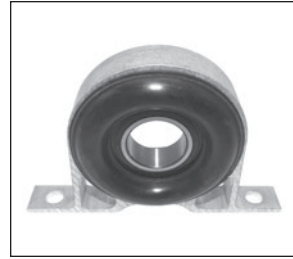

HB88552

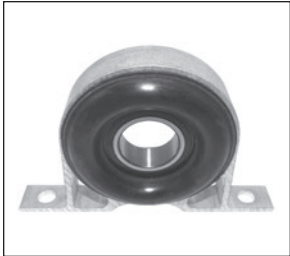

HB88553

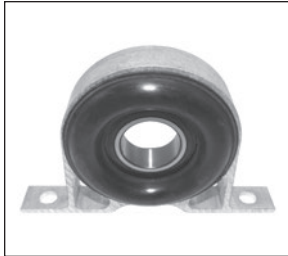

HB88557

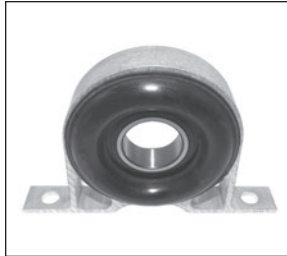

HB210121-1X



HB210527X



HB210661-1X

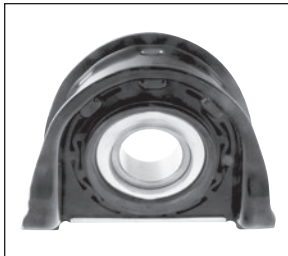

HB210661-1XSA



HB210748-1X





# Center Support Bearings

## Product Images (continued)

HB210875-1X



HB210881-1X

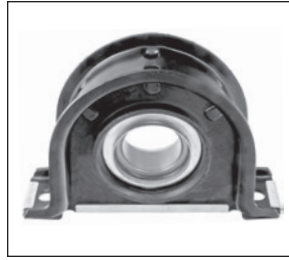

HB211175X



HB211359X



HB211431-X



HB211499X



HB211590-1X

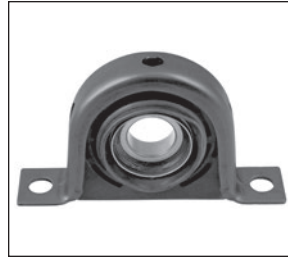

HB211793-1X



HB211848-1X



HB211963-1X



HB211985X

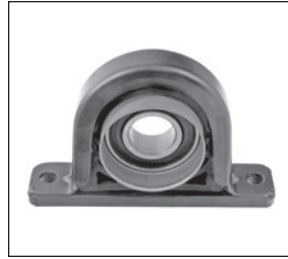

HB212028-1X

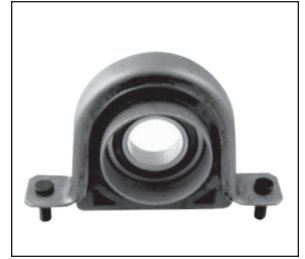

HB212030-1X

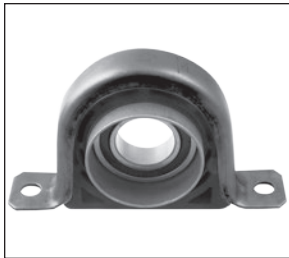

HB212032-1X



HB212053-1X



HB212093-1X



HB212134-1X

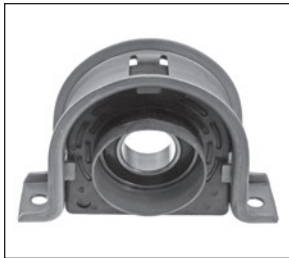

HB212135-1X

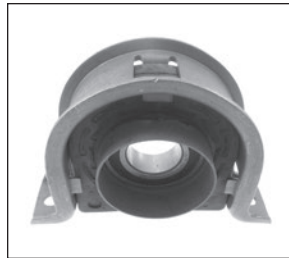

HB212187-1X



HB5001874





# Center Support Bearings

## Product Images (continued)

HB5003684

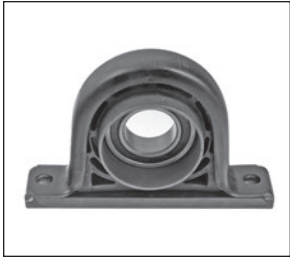

HB5008025

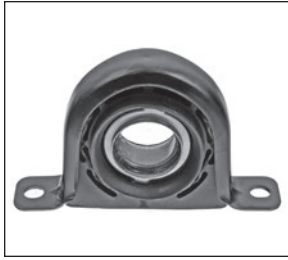

HB5009385

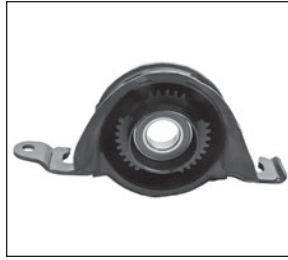

HB5104574



HB12471505



HB12479237

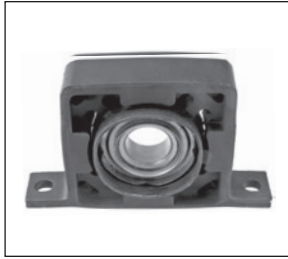

HB25775162



HB25775162UJ

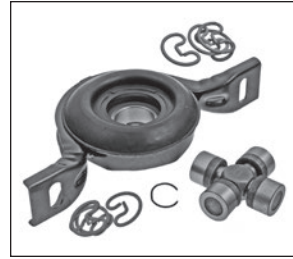

HB26067390



HB40021334

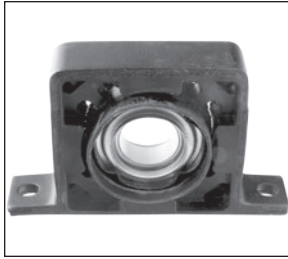

HB40024017



HB40048725

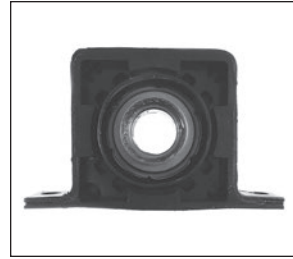

HB40120951



# Universal Joint Quick Reference

Driveline Series	Part Number	Bearing Cap Diameter	Overall Length	Strap Kit Part Number	U-Bolt Kit Part Number
1210	S443	1.062"	2.438"	S2-70-28	
1310	S153	1.062"	3.219"	S2-70-28	S2-94-28
1310/7260	S353	1.062"/1.078"	3.219"	S2-70-38	
1330	S213	1.062"	3.625"	S2-70-28	S2-94-28
1330 Special	S1204	1.062"/1.125"	3.625"		
1330/S44	S212	1.062"/1.125"	3.625"	S2-70-48	
1350	S178	1.188"	3.625"	S3-70-28	S3-94-18
1410	S160	1.188"	4.188"	S3-70-28	S3-94-18
1480/SPL55	S188	1.375"	4.188"	S3-70-38	S3-94-28
1550/SPL70	S155	1.375"	4.964"	S3-70-38	S3-94-28
7260	S1306	1.078"	2.125"	S2-70-38	
7290	S1309	1.125"	2.625"		
S44	S3147	1.125"	2.556"	S2-70-48	
SPL90/SPL100	SP100	1.625"	4.957"		
SPL140	SP140	1.937"	5.461"		
SPL170	SP170	2.165"	6.456"		
SPL250	SP250	2.362"	6.417"		
1610 (Full Round)	S279	1.875"	5.312"		
1610 (Half Round)	S674	1.875"	5.312"	S5-70-28	
1650	S165	1.625"	5.590"		
1710 (Full Round)	S280	1.938"	6.094"		
1710 (Half Round)	S675	1.938"	6.094"	S6.5-70-18	
1760 (Full Round)	S407	1.938"	7.000"		
1760 (Half Round)	S677	1.938"	7.000"	S6.5-70-18	
1800 (Full Round)	S124	2.312"	6.594"		
1810 (Full Round)	S281	1.938"	7.547"		
1810 (Half Round)	S676	1.938"	7.547"	S6.5-70-18	
1880 (Full Round)	S308	2.188"	8.094"		
AAM 1355	S3208	1.188"	3.622"		
AAM 1415	S3207	1.188"	4.181"		
AAM 1485	S3206	1.374"	4.181"		
Meritor 20R	RPL20	2.060"	6.880"		
Meritor 25R	RPL25	2.060"	8.200"		

## 1000 Series PTO Parts

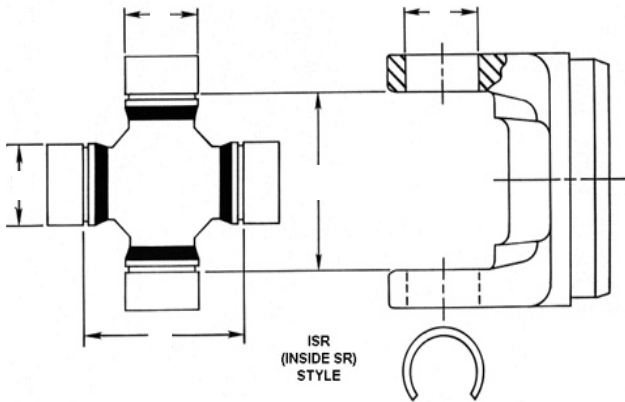

Spicer Part Number	NCB Part Number	Cap Diameter	Snap Ring Diameter	Snap Ring Style
5-170X	S170X	15/16"	1-1/2"	ISR

## End Yokes

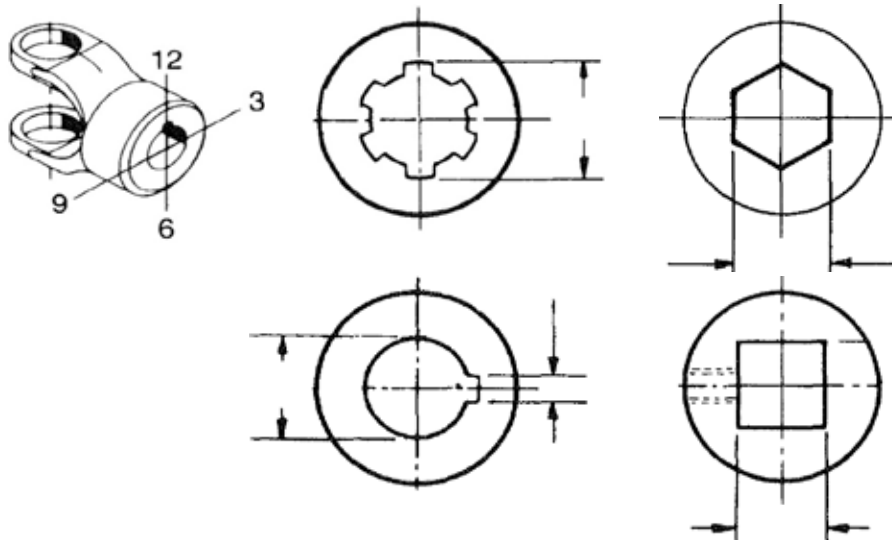

Spicer Part Number	NCB Part Number	I.D. Type	I. D. Diameter	Keyway Location	Keyway Width	Set Screw Location
10-4-481	S10-4-481	Spline 13 Inv.	7/8"	n/a	n/a	6 or 12
10-4-282	S10-4-282	Hex	7/8"	n/a	n/a	3 or 9
10-4-32	S10-4-32	Hex	1-1/8"	n/a	n/a	3 or 9
10-4-23	S10-4-23	Round	3/4"	3	1/4"	6
10-4-43	S10-4-43	Round	13/16"	3	1/4"	6
10-4-63	S10-4-63	Round	7/8"	3	1/4"	6
10-4-93	S10-4-93	Round	1"	3	1/4"	6
10-4-103	S10-4-103	Round	1-1/8"	3	1/4"	6
10-4-113	S10-4-113	Round	1-1/8"	3	3/8"	6
10-4-183	S10-4-183	Round	1-1/4"	3	1/4"	9
10-4-123	S10-4-123	Round	1-1/4"	3	3/8"	6
10-4-193	S10-4-193	Round	1-1/4"	3	3/8"	9
10-4-22	S10-4-22	Square	3/4"	n/a	n/a	3 or 9
10-4-12	S10-4-12	Square	7/8"	n/a	n/a	3 or 9
10-4-52	S10-4-52	Square	1"	n/a	n/a	3 or 9

Additional Info

## Slip Yoke Assemblies

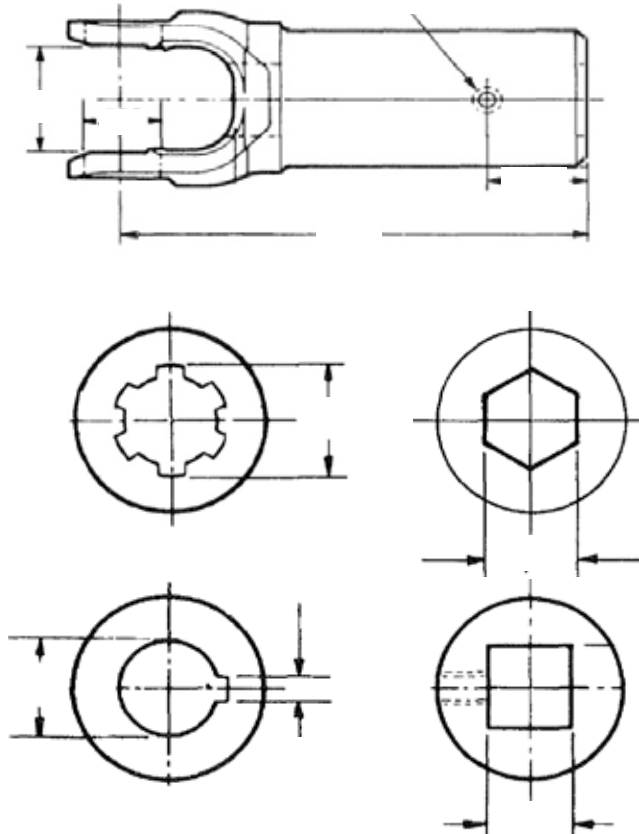

Spicer Part Number	NCB Part Number	I. D. Type	I. D. Diameter	Keyway Location	Keyway Width	Set Screw Location
10-3-18KX	S10-3-18KX	Spline 16	1-1/4"	n/a	n/a	n/a
10-3-162X	S10-3-162X	Hex	7/8"	n/a	n/a	n/a
10-3-32X	S10-3-32X	Hex	1-1/8"	n/a	n/a	n/a
10-3-33X	S10-3-33X	Round	7/8"	3	1/4"	n/a
10-3-83X	S10-3-83X	Round	1"	3	1/4"	n/a
10-3-163X	S10-3-163X	Round	1-1/4"	3	1/4"	n/a
10-3-22X	S10-3-22X	Square	7/8"	n/a	n/a	n/a
10-3-122X	S10-3-122X	Square	1"	n/a	n/a	n/a

## 1280/1310 Series PTO Parts

### U-Joint

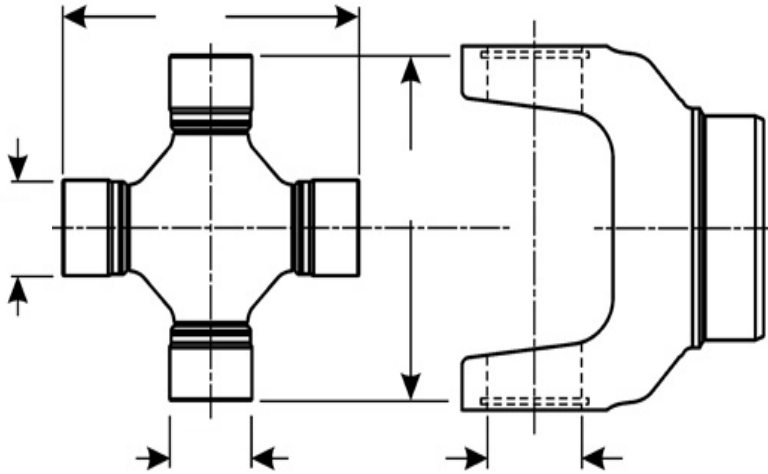

Spicer Part Number	NCB Part Number	Cap Diameter	Snap Ring Diameter	Snap Ring Style
5-153X	S153X	1-1/16"	3-7/32"	OSR

### End Yokes

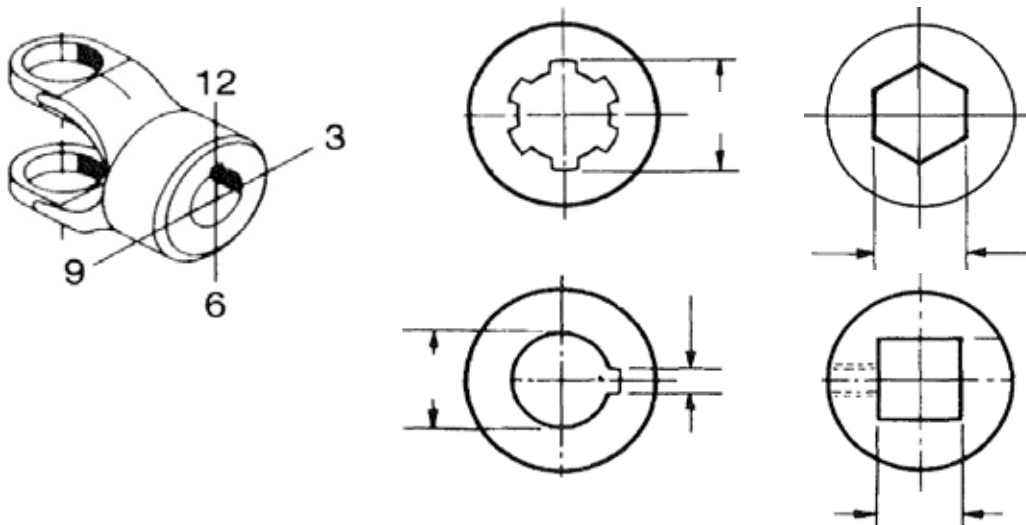

Spicer Part Number	NCB Part Number	I. D. Type	I. D. Diameter	Keyway Location	Set Screw Location
2-4-533	S2-4-533	Round	1-1/4"	12	6

## Slip Yokes

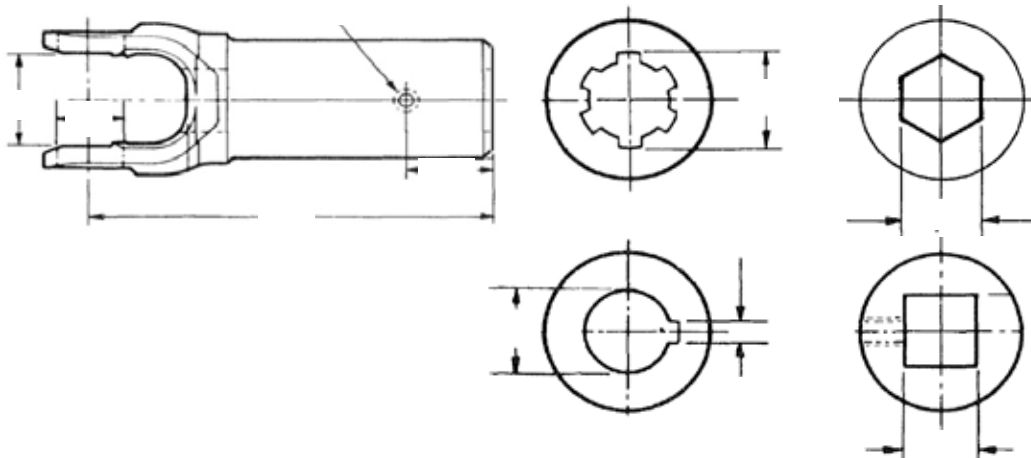

Spicer Part Number	NCB Part Number	I. D. Type	I. D. Diameter	Keyway Location	Set Screw Location
2-3-8001KX	S2-3-8001KX	Spline 16	1-3/8"	n/a	n/a

## Flange Yokes

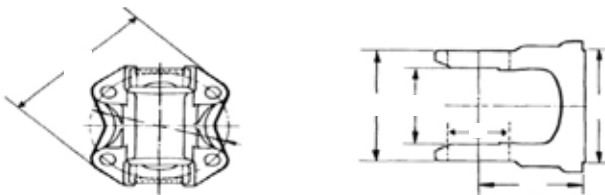

Spicer Part Number	NCB Part Number	Number of Bolt Holes	Bolt Hole Diameter	Bolt Circle Diameter	Flange Diameter
2-2-479	S2-2-479	4	7/16"	3-3/4"	4-5/8"

## Tube Yokes

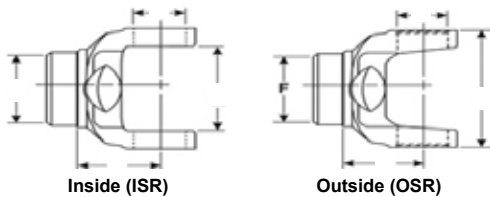

Spicer Part Number	NCB Part Number	Snap Ring Style	Fits Tube Diameter
2-28-357	S2-28-357	OSR	2"
2-28-437	S2-28-437	OSR	3"





## FOR WORN YOKES & SHAFTS RESLEEVEING

E-Z SLEEVE restores your worn yokes and shafts to give them new life. E-Z SLEEVE is so hard, wear resistant and friction free, it will set new standards for trouble free sleeving.

The concept of a thin wall flanged sleeve is very popular for fast sleeving of shafts and yokes. However the results often fall short of expectations. The soft sleeves lack durability and operate with too much resistance (resulting in excessive heat and failures).

E-Z SLEEVE eliminates these problems and provides a long life sleeve at an affordable price.

E-Z SLEEVE's innovative technology will set the new standard in the industry.

### What sets E-Z SLEEVE apart from other sleeves?

- **HARD CHROME COATING**  
E-Z SLEEVE stainless steel sleeves are hard chromed to a hardness of 68RC.
- **LOWER COEFFICIENT OF FRICTION**  
Hard chrome provides a smoother surface and has a lower coefficient of friction that reduces heat and seal wear.
- **BETTER SEAL FIT**  
E-Z SLEEVE minimize the change to the original shaft diameter. This provides a better fit between the repaired shaft and the seal.



# E-Z Sleeve Repair Sleeves

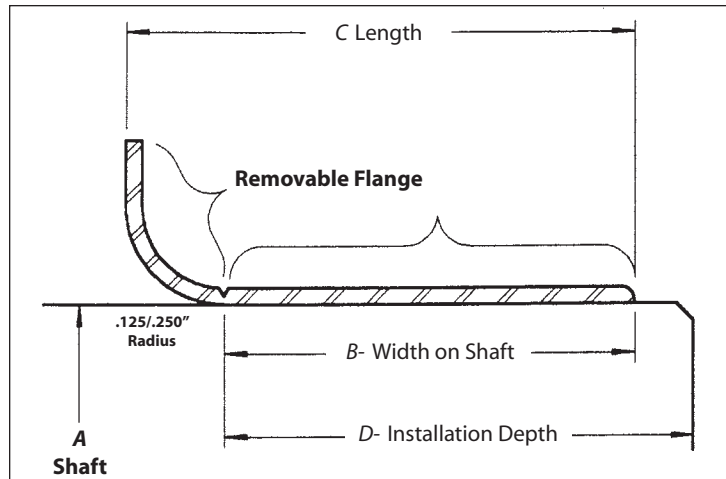

## E-Z SLEEVE SPECIFICATIONS

Part Number	A Shaft Diameter Range		B Width	C Length	D Installation Tool Depth
	Minimum	Maximum			
99058	0.624	0.630	0.315	0.437	2.032
99062	0.621	0.627	0.312	0.406	2.032
99076	0.746	0.752	0.312	0.437	2.032
99078	0.785	0.789	0.312	0.437	2.032
99087	0.871	0.877	0.312	0.437	2.032
99098	0.980	0.986	0.312	0.437	2.032
99100	0.995	1.002	0.312	0.437	2.032
99101	0.995	1.002	0.312	0.437	2.032
99112	1.123	1.127	0.312	0.438	0.688
99116	1.123	1.127	0.375	0.500	0.688
99125	1.245	1.253	0.312	0.437	0.875
99128	1.254	1.263	0.312	0.437	0.875
99131	1.310	1.316	0.500	0.625	0.813
99138	1.368	1.374	0.500	0.625	1.000
99139	1.372	1.378	0.500	0.063	1.000
99143	1.432	1.438	0.563	0.688	1.016
99144	1.435	1.441	0.375	0.500	1.016
99149	1.496	1.503	0.562	0.688	1.016
99150	1.497	1.503	0.375	0.500	1.016
99152	1.519	1.526	0.438	0.563	1.016
99155	1.549	1.555	0.438	0.563	1.016
99156	1.559	1.565	0.563	0.688	1.016
99157	1.572	1.578	0.512	0.630	1.023
99162	1.622	1.628	0.562	0.688	0.812
99168	1.684	1.690	0.563	0.688	0.875
99169	1.647	1.653	0.563	0.689	0.827
99170	1.735	1.742	0.375	0.500	1.032
99172	1.745	1.753	0.375	0.500	1.032

Additional Info

# E-Z Sleeve Repair Sleeves

Part Number	A Shaft Diameter Range		B	C	D
	Minimum	Maximum	Width	Length	Installation Tool Depth
99173	1.745	1.753	0.875	1.000	1.032
99174	1.745	1.753	0.562	0.688	1.032
99175	1.745	1.753	0.750	0.875	1.032
99176	1.759	1.767	0.562	0.688	1.032
99177	1.767	1.775	0.550	0.669	1.032
99181	1.807	1.815	0.562	0.688	1.250
99187	1.869	1.878	0.562	0.688	1.250
99189	1.887	1.893	0.550	0.668	0.984
99192	1.909	1.915	0.375	0.500	1.000
99193	1.932	1.940	0.562	0.688	1.250
99196	1.965	1.971	0.550	0.668	0.984
99199	1.996	2.003	0.562	0.688	2.060
99200	1.996	2.003	0.875	1.000	2.060
99205	2.057	2.063	0.813	0.938	1.375
99210	2.123	2.128	0.500	0.750	1.280
99212	2.122	2.130	0.780	0.937	1.375
99215	2.162	2.168	0.787	0.905	1.375
99218	2.185	2.192	0.781	0.938	1.312
99220	2.198	2.205	0.500	0.625	1.312
99225	2.248	2.255	0.780	0.937	1.375
99227	2.249	2.255	0.303	0.438	1.312
99235	2.359	2.365	0.787	0.905	1.375
99237	2.372	2.378	0.780	0.937	1.375
99238	2.372	2.378	0.594	0.750	1.375
99240	2.374	2.380	0.526	0.683	1.375
99241	2.359	2.365	0.370	0.450	1.375
99242	2.435	2.441	0.500	0.625	1.425
99243	2.434	2.440	0.781	0.938	1.393
99244	2.433	2.441	0.500	0.625	1.425
99248	2.497	2.506	0.500	0.656	1.393
99249	2.487	2.506	0.780	0.937	1.393
99250	2.497	2.506	0.780	0.937	1.375
99251	2.509	2.516	0.780	0.906	1.375
99253	2.497	2.506	0.555	0.650	0.890
99254	2.554	2.562	0.787	0.905	1.375
99256	2.559	2.566	0.781	0.938	1.375
99259	2.595	2.601	0.781	0.938	1.250
99261	2.618	2.624	0.781	0.938	1.375
99262	2.623	2.631	0.780	0.937	1.500
99264	2.620	2.627	0.780	0.906	1.500
99272	2.748	2.756	0.406	0.563	1.250
99274	2.743	2.751	0.780	0.937	1.375
99275	2.748	2.756	0.780	0.937	1.375

# E-Z Sleeve Repair Sleeves

Part Number	A Shaft Diameter Range		B	C	D
	Minimum	Maximum	Width	Length	Installation Tool Depth
99276	2.750	2.759	0.787	0.945	1.375
99282	2.837	2.844	0.500	0.656	1.250
99284	2.826	2.836	0.748	0.868	1.339
99287	2.871	2.879	0.780	0.937	1.375
99289	2.949	2.956	0.594	0.689	1.102
99290	2.935	2.943	0.500	0.640	1.331
99291	2.987	2.996	0.484	0.625	1.331
99293	2.935	2.943	0.780	0.938	1.500
99294	2.949	2.956	0.866	1.024	1.312
99296	2.997	3.005	0.812	0.938	1.281
99298	2.987	2.996	0.563	0.688	1.375
99299	2.987	2.996	0.812	1.000	1.250
99300	2.998	3.006	0.812	1.000	1.281
99303	2.998	3.006	0.625	0.812	1.063
99307	3.123	3.132	0.550	0.709	2.031
99311	3.119	3.126	0.688	0.813	2.000
99312	3.119	3.126	0.812	1.000	2.000
99313	3.141	3.150	0.750	0.886	1.375
99315	3.145	3.153	0.827	0.945	1.375
99317	3.145	3.153	0.433	0.591	1.375
99322	3.246	3.253	0.812	1.000	1.375
99324	3.248	3.256	0.595	0.720	1.500
99325	3.248	3.256	0.812	1.000	1.500
99332	3.337	3.347	0.669	0.827	1.378
99333	3.337	3.347	0.827	0.894	1.378
99337	3.371	3.379	0.812	1.000	1.500
99346	3.495	3.503	0.625	0.812	1.348
99347	3.498	3.506	0.312	0.500	1.348
99349	3.499	3.507	0.625	0.812	1.348
99350	3.498	3.506	0.812	1.000	1.347
99351	3.540	3.546	0.710	0.906	1.812
99353	3.540	3.546	0.526	0.667	1.750
99354	3.540	3.546	0.906	1.102	1.750
99356	3.560	3.566	0.812	1.000	1.750
99360	3.618	3.629	0.812	1.000	1.750
99362	3.622	3.629	0.812	1.000	1.750
99363	3.622	3.629	0.500	0.625	1.750
99364	3.739	3.746	0.469	0.594	1.750
99367	3.748	3.756	0.344	0.500	1.750
99369	3.736	3.743	0.827	0.945	1.750
99372	3.748	3.756	0.688	0.875	1.875
99374	3.739	3.746	0.344	0.500	1.750
99376	3.745	3.752	0.563	0.688	1.750
99387	3.873	3.879	0.812	1.000	1.875

# E-Z Sleeve Repair Sleeves

Part Number	A Shaft Diameter Range		B	C	D
	Minimum	Maximum	Width	Length	Installation Tool Depth
99393	3.935	3.491	0.812	1.000	2.050
99395	3.995	4.006	0.600	0.725	2.125
99399	3.995	4.006	0.812	1.000	2.125
99400	3.995	4.006	0.650	0.775	2.125
99401	3.995	4.006	0.500	0.625	2.125
99424	4.248	4.256	0.812	1.000	1.438
99437	4.370	4.378	0.812	1.000	1.650
99450	4.496	4.504	0.813	1.000	1.250
99452	4.523	4.531	0.813	0.938	1.250
99492	4.916	4.925	1.024	1.260	1.438
99498	4.998	5.006	0.688	0.875	1.438
99499	4.998	5.006	0.813	1.000	1.438
99525	5.246	5.254	0.812	1.000	1.250
99549	5.498	5.506	0.812	1.000	1.250
99550	5.498	5.506	0.578	0.705	1.250
99552	5.508	5.516	0.807	1.000	1.250
99599	5.995	6.004	1.000	1.250	1.750
99601	5.995	6.004	0.500	0.750	1.750
99650	6.495	6.505	1.000	1.250	1.375
99700	6.994	7.005	1.000	1.250	1.688

# Shim Stock Rolls

Size	Cold Rolled Steel Part Number	Brass Part Number	Stainless Steel Part Number
.001	001CRS	001BR	001SS
.0015	0015CRS	0015BR	0015SS
.002	002CRS	002BR	002SS
.003	003CRS	003BR	003SS
.004	004CRS	004BR	004SS
.005	005CRS	005BR	005SS
.006	006CRS	006BR	006SS
.007	007CRS	007BR	007SS
.008	008CRS	008BR	008SS
.009	009CRS	009BR	009SS
.010	010CRS	010BR	010SS
.012	012CRS	012BR	012SS
.015	015CRS	015BR	015SS
.020	020CRS	020BR	020SS

	Width	Length
Cold Rolled Steel Rolls	6"	100"
Brass Rolls	6"	100"
Stainless Steel Rolls	6"	50"



# Light Duty Wheel Set Interchanges

Part Number	Timken Number	Federal Mogul Number	SKF Number	Cone-Cup Numbers
A1	SET1	A-1	BR1	LM11749-LM11710
A2	SET2	A-2	BR2	LM11949-LM11910
A3	SET3	A-3	BR3	M12649-M12610
A4	SET4	A-4	BR4	L44649-L44610
A5	SET5	A-5	BR5	LM48548-LM48510
A6	SET6	A-6	BR6	LM67048-LM67010
A7	SET7	A-7	BR7	M201047-M201011 w/locking collar
A9	SET9	A-9	BR9	U298-U261L w/locking collar**
A10	SET10	A-10	BR10	U399-U360L w/locking collar**
A12	SET12	A-12	BR12	LM12749-LM12710
A13	SET13	A-13	BR13	L68149-L68110
A14	SET14	A-14	BR14	L44643-L44610
A15	SET8	A-15	BR8	L45449-L45410
A16	SET16	A-16	BR16	LM12749-LM12711
A17	SET17	A-17	BR17	L68149-L68111
A18	SET11	A-18	BR11	JL69349-JL69310
A19	SET15	A-19	BR15	07100-07196
A20	SET20	A-20	BR20	0399A-U365L w/locking collar**
A21	SET21	A-21	BR21	1988-1922
A22	SET25	A-22	BR25	JLM506848E-90K02
A23	SET23	A-23	BR23	LM104949E-904A2
A24	SET27	A-24	BR31	LM67048-LM67010BCE**
A28	SET28	A-28	BR28	J15585-15520**
A29	SET22	A-29	BR22	2 of LM67045-LM67010Z
A30	SET30	A-30	BR30	JLM67042-LM67010**
A31	SET24	A-31	BR24	JL68145-JL68111-Z**
A32	SET32	A-32	BR32	320-28X**
A33	SET33	A-33	BR33	320-32X**
A34	SET34	A-34	BR34	LM12748F-LM12710
A35	SET45	A-35	BR35	LM501349-LM501310
A36	SET36	A-36	BR36	LM603049-LM603012
A37	SET37	A-37	BR37	LM603049-LM603011
A38	SET38	A-38	BR38	LM104949-LM104911
A39	SET46	A-39	BR39	JL26749F-JL26710
A40	SET26	A-40	BR26	JLM104946-JLM104910Z
A41	SET41	A-41	BR41	574106-LM29710S**
A42	SET42	A-42	BR42	JLM506849A-JLM506811
A43	SET43	A-43	BR43	32307
A44	SET449	A-44	N/A	3578A-3525
A45	N/A	A-45	N/A	R35-24**
A46	N/A	A-46	BR46	NP706218-NP910345**
A47	N/A	A-47	BR47	NP145100-NP913325**
A48	SET251	A-48	N/A	15103S-15243
A49	N/A	A-49	BR103	NP182140-904A1**
A50	N/A	A-50	N/A	NP197868-NP802507**
A51	N/A	A-51	BR14585-525	14585-14525**
A53	N/A	A-53	N/A	NP114036-NP064306
A54	N/A	A-54	N/A	M38549H-M38510**
A55	SET702	A-55	N/A	NP123221-NP787333
A56	N/A	A-56	N/A	NP903590-NP640324
A66	SET80	A-66	BR27	U497-U460L**
A70	N/A	A-70	N/A	387AS-382A
A80	SET47	A-80	BR50	LM102949-LM102910
A81	N/A	A-81	BR51	LM29748-LM29710
A82	N/A	A-82	BR52	M88048-M88010
A140	A140	A-140	32008-X	32008
A149	A149	A-149	GRW250	**

\*\*Not sold separately

# Repair Bearings

Part Number	Description
RP1561-FO	Replaces R1561TV Brg. And Seal used on Ford and Dodge 1.700" Axles
RP1561-GM	Replaces R1561TV Brg. And Seal used on GM 1.700" Axles
RP-513023	Replaces 513023 Brg. And Seal used on GM Axles
RP-1559	Replaces R1559TV Brg. And Seal used on Various Manufacturers with 1.399" Axles
RP-5707	Replaces R1563TV Brg. And Seal used on Various Manufacturers with 1.399" Axles
RP-513067	Replaces 513067 Brg. And Seal used on GM 8.5" Axles

# Trailer Bearings Kits

Part Number	Timken Number	Federal Mogul Number	SKF Number	Inner Set Number	Outer Set Number	Seal Number
FM001	BT134	FM-001	22	A2	A2	204020
NAT002	BT100	NAT-002	21	A14	A14	203025
FM003	BT101	FM-003	N/A	A19	A19	203012
FM004	BT114	FM-004	23	A6	A6	203013
FM005	N/A	FM-005	N/A	A5	A5	205015
TH545K5	N/A	N/A	N/A	A17	A4	N/A
TH440K6	N/A	N/A	N/A	A4	A4	N/A

# Spindle Kits

Part Number	Timken Number	Federal Mogul Number	SKF Number	Bearing Number
SBK1	SBK1	SBK-1	BK1	B2110
SBK2	SBK2	SBK-2	BK4	SCE188
SBK3	SBK3	SBK-3	BK3	B2414
SBK4	SBK4	SBK-4	BK1	**
SBK5	SBK5	SBK-5	BK6	B2414

\*\*Not sold separately

# New Departure-Hyatt Barrel Style Roller Bearings

Part Number	Timken Number	Federal Mogul Number	SKF Number	Cone-Cup Numbers
KC11445Y	KC11445Y	KC-11445-Y	KC11445-Y	17887-17831
KB11630Z	KB11630Z	KB-11630-Z	KB11630-Z	368S-362
KB11786Y	KB11786Y	KB-11786-Y	KB11786-Y	387-382
KD11786Y	KD11786Y	KD-11786-Y	KD11786-Y	388A-382
KA11820Z	KA11820Z	KA-11820-Z	KA11820-Z	28990-28919
KA11950Z	KA11950Z	KA-11950-Z	KA11950-Z	M111048-M111012
KD12051Z	KD12051Z	KD-12051-Z	KD12051-Z	395CS-394CS
KR12051Z**	KR12051Z	KR-12051-Z	KR12051-Z	395ES-394CS

\*\*Not sold separately

# Medium/Heavy Duty Wheel Set Interchanges



Part Number	Timken Number	Federal Mogul Number	SKF Number	Cone-Cup Number
SET401	SET401	HD206	SET401	580-572
SET402	SET402	HD211	SET402	582-572
SET403	SET403	HD203	SET403	594A-592A
SET404	SET404	HD204	SET404	598A-592A
SET405	SET405	HD207	SET405	663-653
SET406	SET406	HD205	SET406	3782-3720
SET407	SET407	HD213	SET407	28682-28622
SET408	SET408	HD210	SET408	39590-39520
SET409	SET409	HD219	SET409	45280-45220
SET410	SET410		SET410	45284-45220
SET411	SET411	HD209	SET411	47686-47620
SET412	SET412	HD202	SET412	HM212047-HM212011
SET413	SET413	HD200	SET413	HM212049-HM212011
SET414	SET414	HD201	SET414	HM218248-HM218210
SET415	SET415	HD208	SET415	HM518445-HM518410
SET416	SET416		SET416	45291-45220
SET417	SET417		SET417	47890-47820
SET418	SET418		SET418	H715334-H715311
SET419	SET419		SET419	H715343-H715311
SET420	SET420		SET420	H715345-H715311
SET421	SET421	HD214	SET421	HM516449A-HM516410
SET422	SET422	HD212	SET422	HM516449C-HM516410
SET423	SET423	HD218	SET423	6461A-6420
SET424	SET424	HD217	SET424	555S-552A
SET425	SET425	HD216	SET425	567-563
SET426	SET426	HD215	SET426	47679-47620
SET427	SET427	HD427	SET427	NP899357-NP026773
SET428	SET428	HD428	SET428	NP874005-NP435398
SET429	SET429	HD429	SET429	NP034946-NP363298
SET430	SET430	HD430	SET430	NP840302-NP053874
SET431	SET431	HD431	SET431	NP965350-NP503727
SET432	SET432	HD432	SET432	NP174964-NP593561
SET433	SET433		SET433	NP431952-NP378092
SET434	SET434		SET434	NP555065-NP720703
SET435	SET435		SET435	NP568900-NP107783
SET436	SET436		SET436	NP577914-NP975161
SET437	SET437		SET437	NP022333-NP250023
SET438	SET438			NP417549-NP156827
SET439	SET439		SET439	HM212049X-HM212011
SET440	SET440			NP454049-NP454011
SET441	SET441			NP454248-NP454210
SET442	SET442			NP454580-NP454572
SET443	SET443			NP454594-NP454592
SET444	SET444			NP454445-NP454410
SET445	SET445			NP294109-NP039695
SET446	SET446			NP107091-NP183330
SET600	SET600			NP454946-NP454298
SET601	SET601			NP454302-NP454874
SET602	SET602			NP454350-NP454727

Additional Info

# Medium/Heavy Duty Wheel Set Interchanges

Part Number	Timken Number	Federal Mogul Number	SKF Number	Cone-Cup Number
SET603	SET603			NP454357-NP454773
SET604	SET604			NP454964-NP454561
SET605	SET605			NP454005-NP454398
SET700	SET700			JM205149AS-JM205110
SET701	SET701			28680-28622
SET702	SET702	A55		NP123221-NP797333
SET703	SET703	A56		NP903590-NP640324
SET704	SET704			39250-39412
SET705	SET705			29586-29520
SET709	SET709			H414245X-H414210
SET710	SET710			594A-592
SET711	SET711			4388-4335
SET712	SET712			29586-29522
SET713	SET713			3778-3720
SET714	SET714			462-453X
SET715	SET715			26878-26820
SET716	SET716			JM205149A-JM205110
SET718	SET718			387S-382A

# Oil Bath Seals

Tool Installed Number	Tool Installed Number	Hand Installed Number	National Number	SKF Scotseal Number	SKF Scotseal Plus Number	Stemco Grit Guard Number	Stemco Guardian Number
P370001-A	P35066	TM312	370001-A	35066	35059	382-8036	308-0836
P370003-A	P47697	TM333	370003-A	47697	47695	392-9131	309-0973
P370022-A		TM350	370022-A	45099	45097	392-9094	309-0903
P370023-A		TM309	370023-A	38780	38779	392-9099	309-0912
P370025-A	P46305	TM305	370025-A	46305	46304	372-7097	307-0743
P370031-A		TM318	370031-A	42672	42671	392-9112	309-0904
P370036-A		TM329	370036-A	40136	40133	372-7098	307-0713
P370047-A		TM301	370047-A	34387	34384	392-9035	309-0935
P370048-A		TM315	370048-A	43764	43763	382-8064	308-0864
P370065-A	P42623	TM302	370065-A	42623	42622	372-7099	307-0723
P370131-A		TM317	370131-A	45103	45102	382-8056	308-0856

# Hub Caps

Number	Stemco Number
P359-5990	359-5990
P340-4009	340-4009
P340-4024	340-4024
P340-4075	340-4075
P340-4195	340-4195
P340-4249	340-4249
P340-4975	340-4975
P343-4009	343-4009
P343-4024	343-4024
P343-4195	343-4195
P343-4249	343-4249

# Gasket Maker

## Permatex® High Strength Threadlocker RED

OEM specified. High strength threadlocker for heavy-duty applications 3/8 inch to 1 inch (10mm to 25mm). Especially well-suited for permanently locking studs and press fits. Adds 3,000 PSI holding power on slip and press fit assemblies. Replaces set screws and snap rings. Locks against vibration loosening. May require heat or special tools for removal.

Available in 1 ml individual pouches, 6 ml carded tubes, 36 ml carded bottles and 90 ml bottles. Large diameter threadlocker for bolts larger than 1 inch in diameter is available in 36 ml carded bottles. High temperature, high strength threadlockers suited for temperatures up to 450°F is available in 6 ml carded tubes, 10 ml carded bottles and 36 ml carded bottles. High temperature, permanent strength threadlocker for high vibration and heavy shock applications is available in 6 ml carded tubes and 36 ml carded bottles.



## Permatex® Medium Strength Threadlocker BLUE

OEM specified. All-purpose, medium strength threadlocker. Ideal for all nut and bolt applications 1/4" to 3/4" (6mm to 20mm). Eliminates need for stocking expensive lock nuts and lock washers. Locks and seals while preventing parts loosening due to vibration. Protects threads from corrosion. Removable with hand tools for easy disassembly.

Available in 1 ml individual pouches, 2.5 ml carded bottles, 6 ml carded tubes, 36 ml carded bottles and 90 ml bottles.



## Permatex® Low Strength Threadlocker PURPLE

OEM specified. Low strength threadlocker designed for fasteners under 1/4" (6mm) that require occasional adjustment. Removable with hand tools for easy disassembly. Noncorrosive. Conforms to ASTM D 5363 AN0311 (Mil-S-46163A, Type II, Grade M).

Available in 6 ml carded tubes.





# Gasket Maker

## Permatex® Anaerobic Gasket Maker

OEM specified. Noncorrosive gasketing material designed primarily for use on aluminum, iron, and steel flanged mating surfaces. Ideal for on-the-spot and emergency repairs, or when a conventional gasket is unavailable. Fills gaps up to .015" and cures to a solvent-resistant seal that will not tear or decay during service. Parts disassemble easily even after extended service and old gasket material can be removed in minutes with a simple putty knife.

Available in 6 ml carded tubes, 50 ml carded tubes and 300 ml cartridges.



## Permatex® Ultra Blue® Multipurpose RTV Silicone Gasket Maker

OEM specified. Permatex® Ultra silicones were developed to meet today's technology changes. Sensor-safe, low odor, noncorrosive. Outstanding oil resistance and joint movement values. Eight times more flexible than cork/composite gaskets; three times more oil resistant than conventional silicones. Temperature range -65°F to 500°F (-54°C to 260°C) intermittent; resists auto and shop fluids and vibration.

Available in 3.35 oz carded tubes, 9.5 oz Powerbead cans and 13 oz cartridges.



## Permatex® Ultra Black® Maximum Oil Resistance RTV Silicone Gasket Maker

OEM specified. For dealership warranty requirements, ensures extended drivetrain warranty compliance. Fast-curing formula. Sensor safe, low odor, noncorrosive. Meets performance specs of OE silicone gaskets. Retains high flexibility, oil resistance properties through use of a patented adhesion system. Temperature range -65°F to 500°F (-54°C to 260°C) intermittent; resists auto and shop fluids and vibration.

Available in 3.35 oz carded tubes, 8.75 oz Automatic Tubes, 9.5 oz Powerbead cans and 13 oz cartridges.



## Gasket Maker

### Permatex® Ultra Grey® Rigid High-Torque RTV Silicone Gasket Maker

OEM specified. Designed specially for high-torque and high vibration applications, like those common in import engines, this premium RTV gasket maker exceeds manufacturers' performance requirements. Noncorrosive and low-odor. Maximum vibration resistance, with outstanding resistance to oils, cooling and shop fluids. Guaranteed not to leak. Temperature range -65°F to 500°F (-54°C to 260°C) intermittent.

Available in 3.35 oz carded tubes, 9.5 oz Powerbead cans and 13 oz cartridges.



### Permatex® High-Temp Red RTV Silicone Gasket

OEM specified. Formulated for hi-temp applications, or heavy-duty use (such as towing, etc.). Replaces almost any cut gasket by making reliable "formed-in-place" gaskets that resist cracking, shrinking and migrating caused by thermal cycling. Coats pre-cut gaskets to increase reliability. Temperature range -65°F to 650°F (-54°C to 343°C) intermittent; resists auto and shop fluids. First generation 1970-1980 gasket maker.

Available in 3 oz carded tubes, 7.25 oz Automatic Tubes, 7.25 oz Powerbead cans and 11 oz cartridges.



### Permatex® the Right Stuff® Gasket Maker

Return equipment to service immediately when you make leak-proof gaskets in just one minute with the Right Stuff.® This latest elastomeric rubber gasket technology is blowout resistant and outperforms pre-cut gaskets. Specified on production lines by GM, Ford, DaimlerChrysler and Mercedes-Benz. Temperature range -75°F to 450°F (-59°C to 232°C) continuous, 500°F (260°C) intermittent.; resists ATF, coolant, oil and other shop fluids. Protects against leaks caused by vibration and thermal expansion. Sensor-safe

Available in 4 & 7 oz Automatic Tubes, 7.5 oz Powerbead cans and 5 & 10.1 oz cartridges.



## Gasket Maker

### Permatex® Bearing Mount for Close Fits



OEM specified. A low viscosity, rapid-curing anaerobic adhesive that augments the strength of press fit assemblies or slip fit assemblies up to .005" in diameter. Adds up to 3,000 PSI holding power.

Available in 36 ml carded bottles.

### Permatex® Bearing Mount for Relaxed Fits

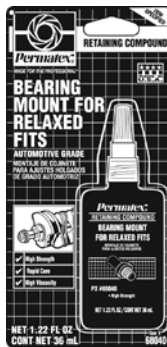

OEM specified. High strength, medium viscosity anaerobic adhesive for slip fit assemblies. Provides 2,800 PSI shear strength on steel. Fixes in 10 minutes at room temperature.

Available in 36 ml carded bottles.

### Permatex® High Temperature Sleeve Retainer



OEM specified. High temperature (up to 400°F / 204°C) anaerobic adhesive that secures slip and press fit assemblies. Adds up to 3,000 PSI holding power. Restores fit to worn or out-of-tolerance assemblies. Prevents surface corrosion.

Available in 6 ml carded tubes and 36 ml carded bottles.

### Permatex® Prussian Blue



Aids precision-fitting of machined surfaces. Locates high spots on bearings, valves, gears and other close-to-tolerance components. Nondrying. Easy clean-up.

Available in .75 oz tubes.

### Permatex® Anaerobic Flange Sealant



Flexible, gasketing material for use on rigid machined flanges with less than .015" gap. OEM approved – use where OE's specify "anaerobic" gasket (cures in the absence of air). Withstands temperatures to 300°F (149°C). Eliminates preformed, pre-cut, paper, rubber and cork gaskets. Flexes with flanges that move in service.

Available in 50 ml carded tubes and 300 ml cartridges.

### Permatex® High Temperature Anaerobic Flange Sealant



A high temperature sealant specially engineered for making or dressing gaskets in rigid assemblies. Able to withstand temperatures to 400°F (204°C), fills gaps up to 0.020" (primed) and permits clamping loads to be maintained for strong, leakproof assemblies.

Available in 50 ml carded tubes.





---

## Limited Warranty

---

Merchandise purchased from NORTH COAST BEARINGS, LLC (“NCB”) is warranted against defects in material and workmanship for a period expiring one (1) year after purchase from NCB by the original purchaser, which purchase date is set forth on NCB invoice. If a breach of this warranty, then NCB shall, at NCB’s option, either replace the defective merchandise or refund in full, without interest or abatement, the purchase price actually paid by the original purchaser to NCB. In order to avail itself of relief from NCB under this warranty, the claimant must return the defective merchandise at claimant’s own cost and expense to NCB, and NCB shall be entitled to make its own inspection to determine whether the warranty claim is valid. NCB shall have no responsibility in the event that written notice of such claim is not made within the one (1) year period aforesaid; nor shall NCB be responsible for labor charges involved in the replacement of any merchandise. NCB shall not be liable in the event of alteration, misuse, overload, negligence or damage caused by others or if the merchandise shall have been damaged by flood, fire or other events not within its control.

THIS EXCLUSIVE WARRANTY IS EXPRESSLY MADE IN PLACE OF AND IS SUPERIOR TO ANY AND ALL OTHER WARRANTIES OF ANY NATURE WHATSOEVER, INCLUDING IMPLIED WARRANTIES, WARRANTIES OF MERCHANTABILITY OR FITNESS FOR ANY PARTICULAR PURPOSE, AND OF ALL OTHER OBLIGATIONS IN CONNECTION WITH THE SALE OF THE MERCHANDISE BY NORTH COAST BEARINGS UNDER NO CIRCUMSTANCES SHALL NORTH COAST BEARINGS BE LIABLE TO THE PURCHASER OR ANY OTHER PARTY FOR LOSS OF PROFIT, INCIDENTAL OR CONSEQUENTIAL DAMAGES OF ANY TYPE.



## Light, Medium & Heavy Duty Products for Domestic & Foreign Applications

- Differential Rebuild Kits
- Transmission / Transaxle Rebuild Kits
- Transfer Case Rebuild Kits
- Timken® Tapered Roller Bearings
- MileMate® Matched Wheel Bearing Sets
- DT Components Wheel Seals
- Ring & Pinion Sets
- Eaton Limited Slip Differentials and Service Kits
- Detroit Locker Locking Differentials and Detroit Truetrac Limited Slip Differentials
- Tractech No Spin Heavy Duty Differentials
- Differential Internal Kits & Cases
- Axle Shafts
- Center Support Bearings
- U-Joints & Yokes
- EZ Sleeve™ Repair Sleeves
- Seal & Gasket Kits
- Input Shafts & Counter Shafts
- Transmission Gears & Related Parts
- Synchronizer Rings & Assemblies
- Synchronizer Ring Kits
- Transfer Case & Automatic Transmission Chains
- Ball Bearings
- Clutch Installation Kits
- Clutch Release & Pilot Bearings
- Cylindrical & Needle Roller Bearings
- Shim Stock Rolls
- Small Parts Kits
- Permatex® Adhesives & Sealants
- Hub Assemblies

**DT**<sup>®</sup>  
**Components**  
**Drivetrain Products**  
Marketed by The Timken Corporation



Snap this QR code with your smartphone app to visit our web site.

For order placement contact:  
North Coast Bearings

Toll Free: 800-627-0700

Toll Free Fax: 800-627-9401

[www.dtcomponents.com](http://www.dtcomponents.com)

Timken, DT Components and MileMate are registered trademarks of The Timken Company.  
North Coast Bearings and EZ Sleeve are trademarks of North Coast Bearings, LLC

© 2017 North Coast Bearings, LLC

Printed in the U.S.A.

DT2017 5M 1-17