



TE'S CROMPTON INSTRUMENTS CURRENT TRANSFORMERS

Table of contents

I. Tape Wound Measuring and Protection Current Transformers



MR Series Measuring Range.....	6-7
PR Series Measuring Range.....	8
Class PX Current Transformer.....	9
Miniature Measuring Range.....	10
Miniature Moulded Case.....	11

II. Split Core Current Transformers



Split Core Current Transformers.....	14-15
Miniature Split Core Current Transformers.....	16-17

III. 3-in-1 Current Transformers



3-in-1 Current Transformers.....	20
Din-Rail Enclosure 3-in-1 Current Transformers.....	21
Dual Load 3-in-1 Current Transformers.....	22
Q2C 3-in-1 Current Transformers.....	23

IV. Moulded Current Transformers



Ebony Current Transformers.....	26-35
CS Range.....	36-39
AS Range.....	40-43
RS Range.....	44

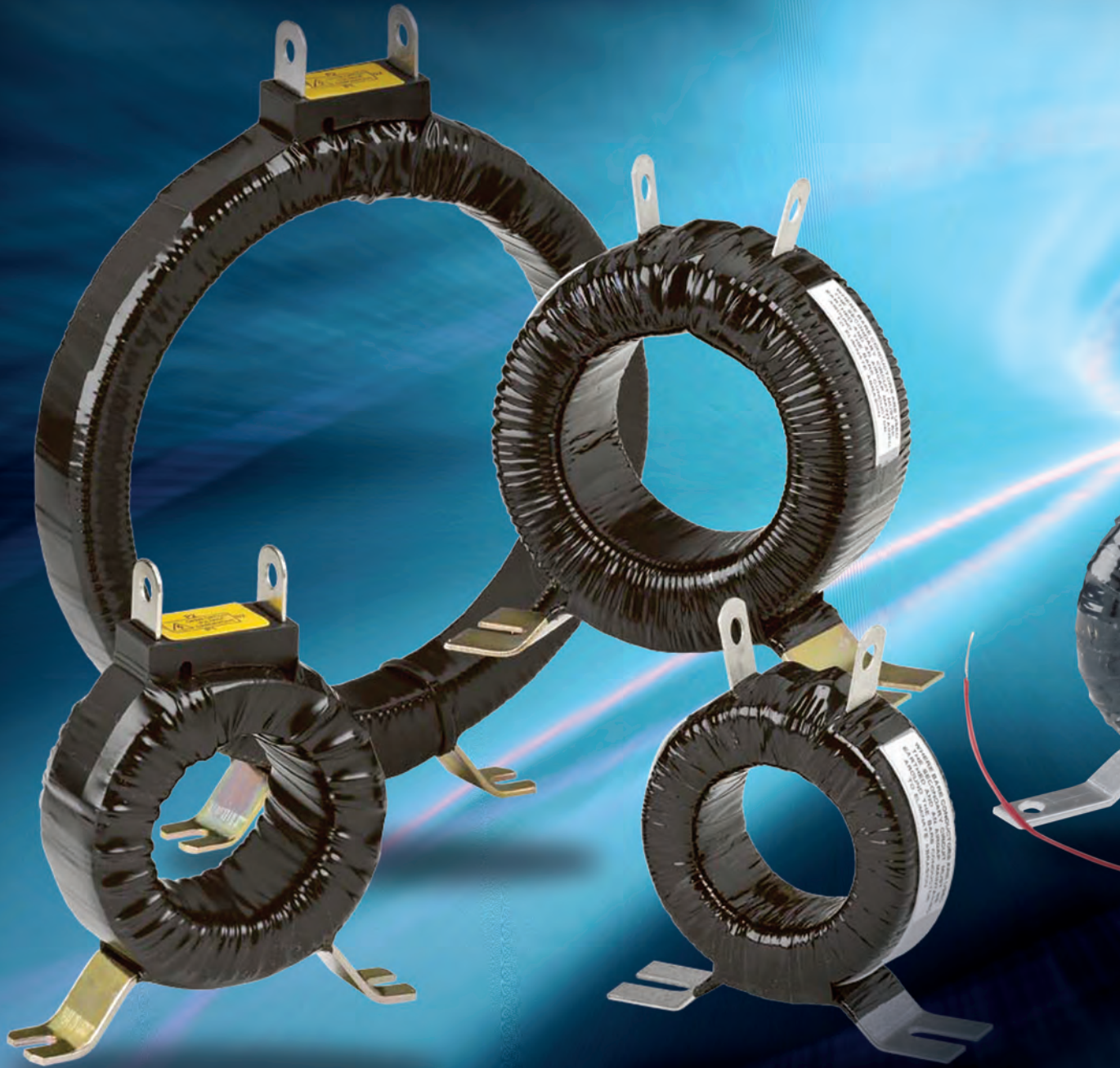

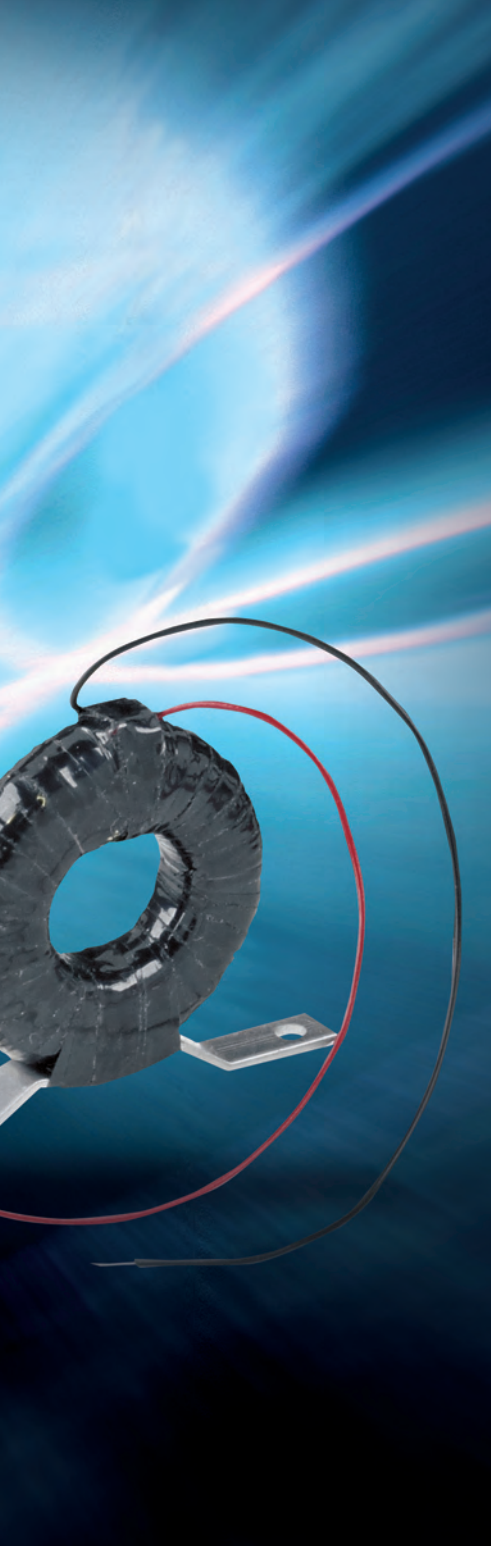

Chapter I

Tape Wound Measuring and Protection Current Transformers

MR Series Measuring Range.....	6-7
PR Series Measuring Range.....	8
Class PX Current Transformer.....	9
Miniature Measuring Range.....	10
Miniature Moulded Case.....	11

MR Series Measuring Range

FEATURES

- Available in a wide range of transformer ratings
- Accuracy up to Class 0.5
- Measuring or protective types

APPLICATIONS

- Switchgear
- Control panels
- Overload protection
- Control devices

BENEFITS

- Long product life



A comprehensive range of measuring ring current transformers for installation where reliability, accuracy and quality are required.

CONSTRUCTION

High grade silicon iron cores are carefully selected, then insulated and protected by a polypropylene covering on which the secondary winding is toroidally wound by precision winding machines. Multi layers of polyester and PVC are then applied to provide a tough moisture resistant coating.

SPECIFICATIONS

System voltage:	720V maximum
Test voltage:	3kV for 1 minute
System frequency:	50/60Hz
Overload withstand:	1.2 x rated current continuously
Short circuit thermal:	60 x rated primary current for 1 second current (Ith)*:
Dynamic current (Idyn)*:	= 2.55 x Ith
Service temperature:	-20°C to 70°C
Secondary current:	5A or 1A
Complies with:	IEC60044-1, BS EN60044-1
Saturation coefficient:	<6
Humidity:	Up to 95% RH (non condensing)
Insulation class:	BS EN60085 Class Y
Mounting hardware:	Foot mounted

Loss in copper wires between instrument and CT for 5A secondary

Wire section in mm ²	Loss in VA (for both wires)					
	1 m	2 m	4 m	6 m	8 m	10 m
1.5	0.60	1.19	2.38	3.57	4.76	5.95
2.5	0.36	0.71	1.43	2.14	2.86	3.57
4	0.22	0.45	0.89	1.34	1.79	2.23
6	0.15	0.30	0.60	0.89	1.19	1.49
10	0.09	0.18	0.36	0.54	0.71	0.89

Loss in copper wires between instrument and CT for 1A secondary

Wire section in mm ²	Loss in VA (for both wires)					
	10m	20m	40m	60m	80m	100m
1	0.36	0.71	1.43	2.14	2.86	3.57
1.5	0.24	0.48	0.95	1.43	1.90	2.38
2.5	0.14	0.29	0.57	0.86	1.14	1.43
4	0.09	0.18	0.36	0.54	0.71	0.89
6	0.06	0.12	0.24	0.36	0.48	0.60
10	0.04	0.07	0.14	0.21	0.29	0.36

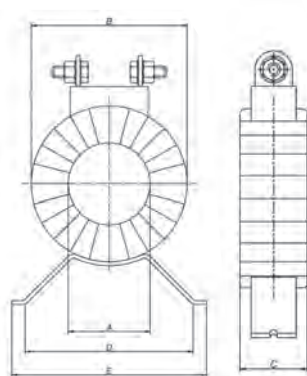

* THERMAL CURRENT (ITH) & DYNAMIC CURRENT (LDYN).
LTH IS THE HIGHEST PRIMARY CURRENT (EFFECTIVE VALUE), THE LDYN IS THE HIGHEST PRIMARY CURRENT (PEAK VALUE) THAT THE CT CAN SUPPORT FOR 1 SECOND WITHOUT DAMAGE, OWING TO EXCESSIVE OVERLOADS WITH SECONDARY SHORT CIRCUITS.

MR Series Measuring Range

MR transformers are used to accurately measure high alternating primary currents, converting the primary current into a proportional secondary current as required for measurement and instrumentation. They are available in 5 amp or 1 amp secondary versions.

Part number	Ratio range	Class 3	Class 1	Class 0.5	A	B	C	D	Approx. weight
MR-28-40/5A	40/5	1.5	-	-	28	70	40	77.5	0.5
MR-28-50/5A	50/5	2	-	-	28	70	40	77.5	0.5
MR-28-60/5A	60/5	2.5	-	-	28	70	40	77.5	0.5
MR-28-40/1A	40/1	1.5	-	-	22	60	50	70	0.5
MR-28-50/1A	50/1	2	-	-	22	60	40	70	0.5
MR-28-60/1A	60/1	2.5	-	-	22	60	40	70	0.5
MR-42-80/5A	80/5	1.5	-	-	42	80	30	86	0.5
MR-42-100/5A	100/5	3.75	1.25	-	42	80	30	86	0.5
MR-42-150/5A	150/5	5	2.5	1	42	80	30	86	0.5
MR-42-200/5A	200/5	7.5	5	2.5	42	80	30	86	0.5
MR-42-250/5A	250/5	10	5	2.5	42	80	30	86	0.5
MR-42-80/1A	80/1	1.5	-	-	40	72	26	70	0.5
MR-42-100/1A	100/1	5	1.5	-	40	72	45	70	0.5
MR-42-150/1A	150/1	5	3	-	40	72	40	70	0.5
MR-42-200/1A	200/1	7.5	5	3	40	72	40	70	0.5
MR-42-250/1A	250/1	10	7.5	2.5	40	72	40	70	0.5
MR-45-300/5A	300/5	10	7.5	3.75	45	80	30	86	0.5
MR-45-400/5A	400/5	15	7.5	5	45	80	30	86	0.5
MR-45-300/1A	300/1	10	10	5	45	83	32	100	0.5
MR-45-400/1A	400/1	15	10	5	45	83	32	100	0.5
MR-60-400/5A	400/5	15	7.5	5	60	100	30	86	0.5
MR-60-500/5A	500/5	15	10	5	60	100	30	86	0.5
MR-60-600/5A	600/5	20	10	7.5	60	100	30	86	0.5
MR-60-400/1A	400/1	15	7.5	5	58	100	30	100	0.5
MR-60-500/1A	500/1	20	15	5	58	100	32	100	0.5
MR-60-600/1A	600/1	20	15	10	58	100	32	100	0.5
MR-85-800/5A	800/5	20	10	7.5	85	124	30	86	0.5
MR-85-1000/5A	1000/5	30	15	10	85	124	30	86	1
MR-85-1200/5A	1200/5	30	15	10	85	124	30	86	1
MR-85-1500/5A	1500/5	30	15	10	85	124	30	86	1
MR-85-1600/5A	1600/5	30	15	10	85	124	30	86	1
MR-85-800/1A	800/1	20	15	10	84	122	30	100	0.5
MR-85-1000/1A	1000/1	25	20	15	94	135	30	100	1
MR-85-1200/1A	1200/1	25	20	15	94	135	30	100	1
MR-85-1500/1A	1500/1	25	20	15	94	135	30	100	1
MR-85-1600/1A	1600/1	25	20	15	94	135	30	100	1
MR-125-2000/5A	2000/5	30	20	15	125	160	30	86	1
MR-125-2500/5A	2500/5	30	20	15	125	160	30	86	-
MR-125-3000/5A	3000/5	30	20	15	125	160	30	86	1
MR-125-4000/5A	4000/5	30	20	15	125	160	30	86	1
MR-125-2000/1A	2000/1	25	20	15	132	175	30	150	1.5
MR-125-2500/1A	2500/1	25	20	15	132	175	30	150	1.5
MR-125-3000/1A	3000/1	25	20	15	125	180	32	150	1.5
MR-125-4000/1A	4000/1	25	20	15	140	215	45	150	4.5

PR Series Protection Range



IEC60044-1/BS EN60044-1 commonly define protection current transformers in terms of composite error at an accuracy limit factor. In simple terms this means how accurate the current transformer will remain when the primary current flowing is many times higher than in normal conditions i.e. in a fault situation.

The classification of protection current transformers follows the following simple formula:

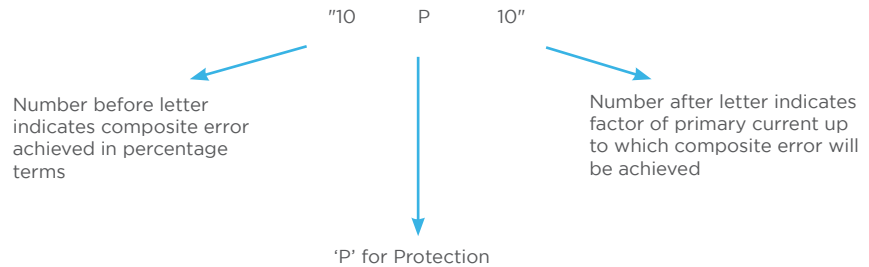

Manufacturers of protection devices will normally specify the classification for the protection current transformer intended to operate the particular protection device concerned.

In addition the classification of protection current transformers indicates accuracy class: 5P – current transformer will have a ratio error of 1% and phase error not exceeding 60 minutes. 10P – current transformer will have a ratio error of 3% (no level of phase error specified).

The PR series is a range of two of the most popular classifications of protection current transformers, 5P10 and 10P10. Other classifications are possible (such as 5P20 or 10P20). Please consult factory for a quotation should you require an alternative classification or a current transformer with dimensions different to those set out below.

Part number	Ratio range	VA burden	Accuracy class	A	B	C	D	Approx. weight
PR-35-100/5A-2.5	100/5	2.5	10P10	35	98	60	100	2
PR-35-100/5A-5	100/5	5	10P10	35	98	90	100	3
PR-35-120/5A-2.5	120/5	2.5	10P10	35	98	55	100	2
PR-35-120/5A-5	120/5	5	10P10	35	98	85	100	3
PR-35-150/5A-2.5	150/5	2.5	5P10 & 10P10	35	98	50	100	1.5
PR-35-150/5A-5	150/5	5	5P10 & 10P10	35	98	70	100	2.5
PR-35-200/5A-2.5	200/5	2.5	5P10 & 10P10	35	98	40	100	1
PR-35-200/5A-5	200/5	5	5P10 & 10P10	35	98	60	100	2
PR-35-250/5A-2.5	250/5	2.5	5P10 & 10P10	35	98	35	100	1
PR-35-250/5A-5	250/5	5	5P10 & 10P10	35	98	55	100	1.5
PR-55-300/5A-5	300/5	5	5P10 & 10P10	55	98	75	100	1.5
PR-55-300/5A-15	300/5	15	5P10 & 10P10	55	125	90	100	4
PR-55-400/5A-5	400/5	5	5P10 & 10P10	55	98	60	100	1.5
PR-55-400/5A-15	400/5	15	5P10 & 10P10	55	125	65	100	3
PR-55-500/5A-5	500/5	5	5P10 & 10P10	55	98	55	100	1
PR-55-500/5A-15	500/5	15	5P10 & 10P10	55	125	60	100	2.5
PR-55-600/5A-5	600/5	5	5P10 & 10P10	55	98	50	100	1
PR-55-600/5A-15	600/5	15	5P10 & 10P10	55	125	55	100	2.5
PR-65-800/5A-5	800/5	5	5P10 & 10P10	65	110	40	100	1
PR-65-800/5A-15	800/5	15	5P10 & 10P10	65	110	80	100	3
PR-80-1000/5A-15	1000/5	15	5P10 & 10P10	80	125	70	100	2
PR-80-1200/5A-15	1200/5	15	5P10 & 10P10	80	125	65	100	2.5
PR-90-1500/5A-15	1500/5	15	5P10 & 10P10	90	140	55	100	2.5
PR-90-1600/5A-15	1600/5	15	5P10 & 10P10	90	140	55	100	2.5
PR-100-2000/5A-15	2000/5	15	5P10 & 10P10	100	155	55	100	3
PR-110-2500/5A-15	2500/5	15	5P10 & 10P10	110	165	45	100	3
PR-120-3000/5A-15	3000/5	15	5P10 & 10P10	120	180	45	150	3

Consult factory for availability and lead time on 1A secondary for protection range. 1A current transformer dimensions may vary by up to 10%.

Class PX Current Transformer



In some balanced protection systems where sensitivity and stability levels required are high, classes 5P10 or 10P10 may not be adequate. In these situations a Class PX current transformer will usually be specified. Class PX as defined in IEC60044-1/BS EN60044-1 allows the manufacturer of a protection device to detail more specific requirements of the current transformer so as to achieve a more sensitive protection scheme. Typically this will involve specifying the following information for the current transformer:

- 1) Turns ratio
- 2) Minimum kneepoint voltage
- 3) Maximum secondary resistance
- 4) Maximum excitation current at the rated minimum kneepoint voltage

To enquire about Class PX current transformers consult the factory with the above information together with any physical limiting dimensions and the aperture size required. If not all the above information is available, details of relay type, lead run from current transformer to relay and the fault current expected to flow through the zone protected by the current transformers will be required in order to provide a quotation.

SPECIFICATIONS

System voltage:	720V maximum
Test voltage:	3kV for 1 minute
System frequency:	50/60Hz
Service temperature:	-20°C to 70°C
Humidity:	Up to 95% RH (non condensing)
Insulation class:	BS2757 Class Y
Compliant with:	Ring Type CT BS EN60044-1:1999

Part number	Ratio	Class	Vk	Ω at 75°C	Dimensions		
					A	B	C
81X-9412-501388	800/5	PX	52	0.35	65	135	65
81X-9412-501795	1000/5	PX	62	0.31	80	150	65
81X-9412-501802	1250/5	PX	85	0.45	90	160	65
81X-9412-501928	1600/5	PX	80	0.44	120	190	50
81X-9412-501386	1600/5	PX	72	0.5	123	188	49
81X-9412-501902	2500/5	PX	112	0.6	120	192	52
81X-9412-216148	2500/5	PX	124	0.78	119	191	52
81X-9412-501384	2500/5	PX	112	0.8	119	191	52
81X-9412-501948	2500/5A	PX	130	0.65	120	205	65
81X-9412-501949	2000/5A	PX	118	0.58	115	195	65
81X-9412-501950	1600/5A	PX	110	0.45	75	185	75

DIMENSIONS

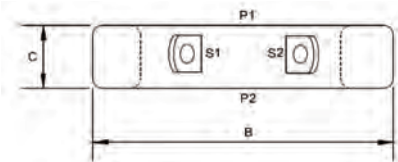
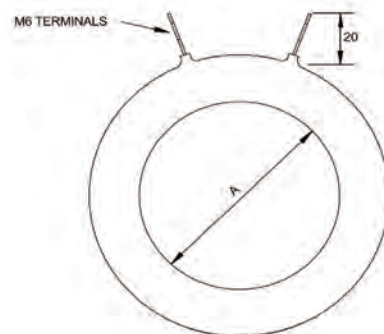

Miniature Measuring Range



A range of Wedding ring Miniature Tape wound current transformers whose size permits PCB mounting. Designed to convert high currents to low level electronic signals. Available in tape wound with ring or foot mounting versions or in a moulded case.

SPECIFICATIONS

Primary current range:	10A-100A
Secondary output:	10mA-100mA
VA output:	0.015VA-0.15VA
System frequency:	50/60Hz
Service temperature:	0°C to + 80°C
Insulation class:	BS EN60085 Class Y
Operating voltage:	720V AC
Operating voltage:	720V AC
Test voltage:	2kV DC
Test voltage:	2kV DC
20-80%:	1.5%
81-120%:	1%

Part number	Ratio range	Type
773-01-P-FL	10A-100A/10mA-100mA	Ring type, flexible lead 150 mm
773-02-P-FL	10A-100A/10mA-100mA	Ring type, flexible lead 450 mm
773-01-F-FL	10A-100A/10mA-100mA	Ring type, foot mounting, flexible lead 150 mm

RING TYPE (P)

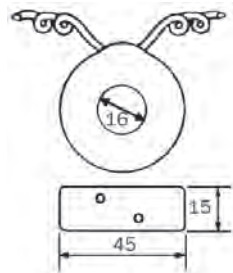

FOOT MOUNTING OPTION (F)

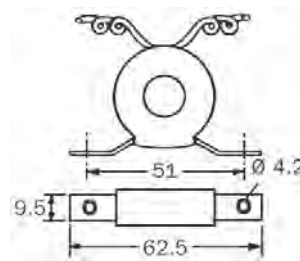

Miniature Molded Case Current Transformer



SPECIFICATIONS

Service temperature:	-20°C to + 85°C
Insulation class:	BS EN60085 Class Y

Part number	Ratio range	Type
773-01-MC	10A-100A/10mA-100mA	Moulded case

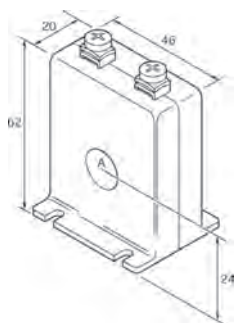

DIMENSIONS

A = 16 mm transformer ratings
 Fixing centres 30 mm x 30 mm
 M3.5 terminal screw and clamp





Chapter 2 Split Core Current Transformers

Split Core Current Transformers.....	14-15
Miniature Split Core Current Transformers.....	16-17

Split Core Current Transformers

FEATURES

- High quality comprehensive measurements
- Available in a wide range of transformer ratings
- Accuracy up to Class 0.5
- Foot or busbar mounted

APPLICATIONS

- Switchgear
- Distribution systems
- Generator sets
- Control panels

BENEFITS

- Faster installation
- Cost effective
- Long product life



A range of split core current transformers that offers a cost effective and efficient method by which the current can be measured without the need to break the conductor, thereby reducing installation and commissioning time.

SPECIFICATIONS

System voltage:	720V (0.72kV) maximum
Test voltage:	3kV for 1 minute
System frequency:	50/60Hz
Insulation class:	E
Overload withstand:	1.2 times rated current continuously
Short circuit thermal:	100 x rated primary for 1 second
Operating temperature:	-20°C to +70°C
Relative humidity:	0-90% (non condensing)
Compliant with:	IEC/EN60044-1, BS7626
Accuracy:	Class 3, 1 & 0.5
Mounting hardware:	Plug-in metal feet for wall or base mounting or moulded busbar mounting
Rated dynamic current:	= 2.55 x I _{ht}
Enclosure:	Flame retardant grade classified UL 94V-O

Model	Case 1	Case 2	Case 3	Case 4	Case 5
A	20	50	80	80	80
B	30	80	80	120	160
C	51	78	108	108	120
D	89	114	144	144	184
E	111	145	145	185	245
F	34	32	32	32	52
G	47	32	32	32	52
H	40	32	32	32	52
I	32	33	33	33	38
Weight (kg)	0.75	0.90	1.05	1.25	4.30

DIMENSIONS

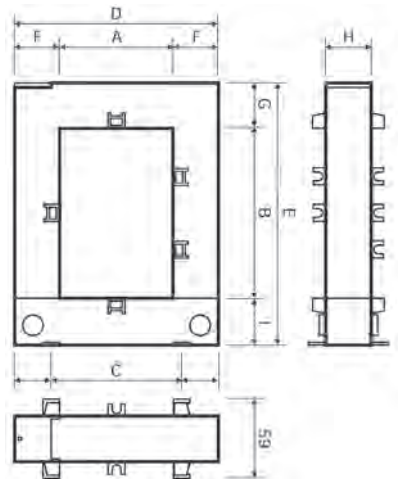

Split Core Current Transformers

PRODUCT CODES

	Part number	Ratio	Burden VA against class index			Aperture (mm)
			0.5	1	3	
Case 1	SC1-100/5A	100/5A	-	-	1.5	20 x 30
	SC1-150/5A	150/5A	-	-	2	20 x 30
	SC1-200/5A	200/5A	-	1.5	2.5	20 x 30
	SC1-250/5A	250/5A	-	2	4	20 x 30
	SC1-300/5A	300/5A	1.5	4	6	20 x 30
	SC1-400/5A	400/5A	2.5	6	10	20 x 30
	SC2-250/5A	250/5A	1	2	4	50 x 80
Case 2	SC2-300/5A	300/5A	1.5	3	6	50 x 80
	SC2-400/5A	400/5A	1.5	3	10	50 x 80
	SC2-500/5A	500/5A	2.5	5	15	50 x 80
	SC2-600/5A	600/5A	2.5	5	15	50 x 80
	SC2-750/5A	750/5A	3	6	20	50 x 80
	SC2-800/5A	800/5A	3	7.5	20	50 x 80
	SC2-1000/5A	1000/5A	5	10	20	50 x 80
	SC3-250/5A	250/5A	1	2	4	80 x 80
Case 3	SC3-300/5A	300/5A	1.5	3	6	80 x 80
	SC3-400/5A	400/5A	1.5	3	10	80 x 80
	SC3-500/5A	500/5A	2.5	5	15	80 x 80
	SC3-600/5A	600/5A	2.5	5	15	80 x 80
	SC3-750/5A	750/5A	3	6	20	80 x 80
	SC3-800/5A	800/5A	3	7.5	20	80 x 80
	SC3-1000/5A	1000/5A	5	10	20	80 x 80
Case 4	SC4-500/5A	500/5A	-	4	12.5	80 x 120
	SC4-600/5A	600/5A	-	5	15	80 x 120
	SC4-750/5A	750/5A	2.5	6	17.5	80 x 120
	SC4-800/5A	800/5A	3	7.5	20	80 x 120
	SC4-1000/5A	1000/5A	5	10	20	80 x 120
	SC4-1200/5A	1200/5A	6	12.5	25	80 x 120
	SC4-1250/5A	1250/5A	7.5	15	30	80 x 120
	SC4-1500/5A	1500/5A	8	17	30	80 x 120
	SC4-1600/5A	1600/5A	8	17	30	80 x 120
Case 5	SC5-1000/5A	1000/5A	10	15	20	80 x 160
	SC5-1250/5A	1250/5A	10	15	20	80 x 160
	SC5-1500/5A	1500/5A	15	20	25	80 x 160
	SC5-2000/5A	2000/5A	15	20	25	80 x 160
	SC5-2500/5A	2500/5A	15	20	25	80 x 160
	SC5-3000/5A	3000/5A	20	25	30	80 x 160
	SC5-4000/5A	4000/5A	20	25	30	80 x 160
	SC5-5000/5A	5000/5A	20	25	30	80 x 160
SC5-6000/5A	6000/5A	20	25	30	80 x 160	

Miniature Split Core Current Transformers



FEATURES

- Cost effective moulded case
- Ratio's ranging from 60/1 to 500/5
- Fast cable clamp connection
- Multiple fixing options
- Safety plug in shorting link

BENEFITS

- Faster installation
- Compact size profile applications

A range of miniature split core current transformers that offers a cost effective and efficient method by which the current can be measured without the need to break the conductor, each current transformer is supplied with colour coded leads up to 3 meters for connection to the monitoring device. The MSC range of current transformers offers primary currents between 60-500A with 1 or 5A secondaries with class 1 accuracy performance. (Class 3 for 60-80A range).

ACCESSORIES



SHORTING LINK FOR SAFE INSTALLATION, (CT WILL NOT OPERATE UNTIL REMOVED).

Fixing kit supplied



SPECIFICATIONS

System voltage:	720V maximum
Test voltage:	3kV for 1 minute
System frequency:	50Hz or 60Hz
Primary ratings:	60A to 500A
Short circuit thermal current:	60 x rated primary current (Ith): for 1 sec
Overload withstand:	1.2 x rated current continuously
Rated dynamic current:	= 2.55 x Iht
Secondary leads:	1A, (length 3m), 5A (length 1m) 2.5 mm wire
Enclosure:	Flame retardant grade classified UL 94V-O
Aperture holes centres:	18 mm up to 250A, 28 mm from 300A - 500A
Operating temperature:	-20°C to +70°C
Accuracy class:	1, 3
Compliant with:	IEC/EN 60044-1

PRODUCT CODES

Part number	Ratio	Class	Burden VA	Aperture	Lead length	Case	Wire colour	Approx. weight
MSC1-60/1	60/1	3	0.1	18 mm	3 m	Size 1	White S1 and Black S2	57.3, 31, 53, 18
MSC1-75/1	75/1	3	0.1	18 mm	3 m	Size 1	White S1 and Black S2	57.3, 31, 53, 18
MSC1-80/1	80/1	3	0.15	18 mm	3 m	Size 1	White S1 and Black S2	57.3, 31, 53, 18
MSC1-100/1	100/1	1	0.2	18 mm	3 m	Size 1	White S1 and Black S2	57.3, 31, 53, 18
MSC2-100/1	100/1	1	1	18 mm	3 m	Size 2	White S1 and Black S2	72.7, 44.5, 61.5, 18
MSC2-100/5	100/5	1	1	18 mm	1 m	Size 2	White S1 and Black S2	72.7, 44.5, 61.5, 18
MSC2-150/1	150/1	1	1	18 mm	3 m	Size 2	White S1 and Black S2	72.7, 44.5, 61.5, 18
MSC2-150/5	150/5	1	1	18 mm	1 m	Size 2	White S1 and Black S2	72.7, 44.5, 61.5, 18
MSC2-200/1	200/1	1	1	18 mm	3 m	Size 2	White S1 and Black S2	72.7, 44.5, 61.5, 18
MSC2-200/5	200/5	1	1	18 mm	1 m	Size 2	White S1 and Black S2	72.7, 44.5, 61.5, 18
MSC2-250/1	250/1	1	1	18 mm	3 m	Size 2	White S1 and Black S2	72.7, 44.5, 61.5, 18
MSC2-250/5	250/5	1	1	18 mm	1 m	Size 2	White S1 and Black S2	72.7, 44.5, 61.5, 18
MSC3-300/1	300/1	1	1.5	28 mm	3 m	Size 3	White S1 and Black S2	71.7, 44.5, 62.2, 28
MSC3-300/5	300/5	1	1.5	28 mm	1 m	Size 3	White S1 and Black S2	71.7, 44.5, 62.2, 28
MSC3-400/1	400/1	1	2.5	28 mm	3 m	Size 3	White S1 and Black S2	71.7, 44.5, 62.2, 28
MSC3-400/5	400/5	1	2.5	28 mm	1 m	Size 3	White S1 and Black S2	71.7, 44.5, 62.2, 28
MSC3-500/1	500/1	1	2.5	28 mm	3 m	Size 3	White S1 and Black S2	71.7, 44.5, 62.2, 28
MSC3-500/5	500/5	1	2.5	28 mm	1 m	Size 3	White S1 and Black S2	71.7, 44.5, 62.2, 28

Miniature Split Core Current Transformers



MSC1

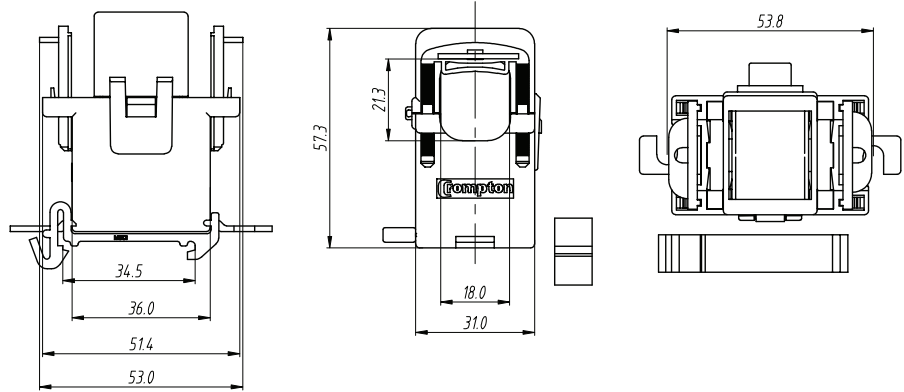

MSC2

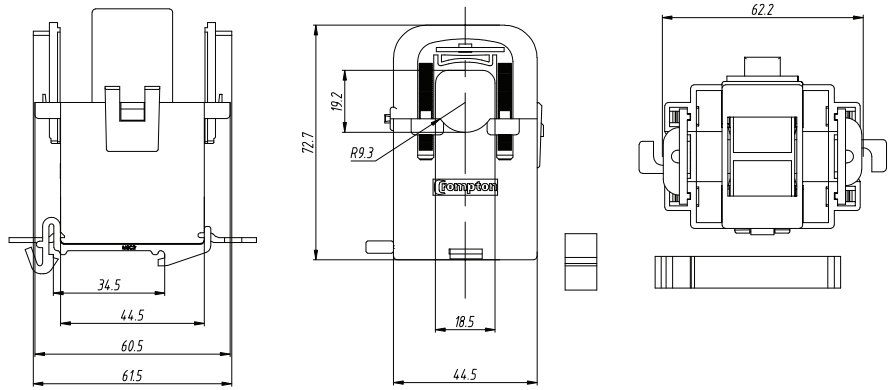

MSC3

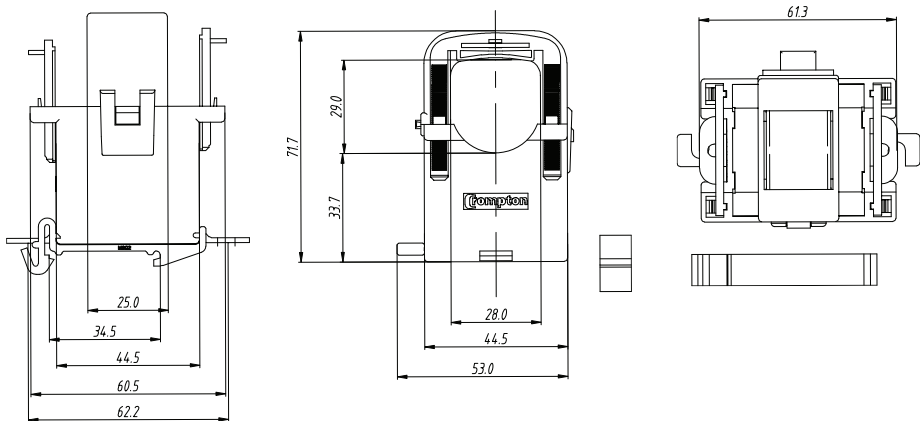





Chapter 3

3-in-1 Current Transformers

3-in-1 Current Transformers.....	20
Din-Rail Enclosure 3-in-1 Current Transformers.....	21
Dual Load 3-in-1 Current Transformers.....	22
Q2C 3-in-1 Current Transformers.....	23

3-in-1 Current Transformers

FEATURES

- Cost effective three-phase moulded case
- Ratio's ranging from 60/5 to 630/5
- Integrated wire sealable terminal cover
- Busbar, DIN-rail and metal feet mounting hardware supplied
- Combined M4 posi/slot screw

APPLICATIONS

- Switchgear
- Distribution systems
- Generator sets
- Control panels

BENEFITS

- Isolated output for safety
- Faster installation
- Compact size
- Ex-stock delivery



A range of 3-in-1 current transformers combine three traditional current transformers in one moulded case. 3-in-1 current transformers can be directly installed next to a three-phase moulded case circuit breaker, thus saving installation time where fitting three standard individual current transformers would be required. The M3N1 range of current transformers offers primary currents between 60-630A with 5A secondaries with up to Class 0.5 accuracy performance.

SPECIFICATIONS

System voltage:	720V maximum
Test voltage:	3kV for 1 minute
System frequency:	50Hz or 60Hz
Primary ratings:	60A to 630A
Short circuit thermal current:	60 x rated primary current (Ith): for 1 sec
Overload withstand:	1.2 x rated current continuously
Rated dynamic current:	= 2.55 x Ith
Secondary terminals:	M4 screw terminals
Enclosure:	Flame retardant grade classified UL 94V-0
Aperture holes centres:	25, 35, 45 mm
Operating temperature:	-20°C to +85°C
Accuracy:	Class 0.5, 1, 3
Mounting hardware:	Plug-in metal feet for wall or base mounting Busbar and DIN-rail mounting
Compliant with:	IEC/EN60044-1

Part number	Ratio	Burden VA against class index			Aperture (mm)
		Class 0.5	Class 1	Class 3	
M3N1-25-60/5	60/5	-	1	2	3@14.5 x 24.5 mm
M3N1-25-100/5	100/5	-	1.5	2.5	3@14.5 x 24.5 mm
M3N1-25-125/5	125/5	-	1.5	2.5	3@14.5 x 24.5 mm
M3N1-25-150/5	150/5	1.5	1.5	2.5	3@14.5 x 24.5 mm
M3N1-25-160/5	160/5	1.5	1.5	2.5	3@14.5 x 24.5 mm
M3N1-35-100/5	100/5	-	1.5	2	3@20.5 x 24.5 mm
M3N1-35-125/5	125/5	-	1.5	2.5	3@20.5 x 24.5 mm
M3N1-35-150/5	150/5	-	1.5	2.5	3@20.5 x 24.5 mm
M3N1-35-160/5	160/5	1.5	1.5	2.5	3@20.5 x 24.5 mm
M3N1-35-200/5	200/5	1.5	1.5	2.5	3@20.5 x 24.5 mm
M3N1-35-250/5	250/5	1.5	1.5	2.5	3@20.5 x 24.5 mm
M3N1-45-250/5	250/5	1.5	1.5	2.5	3@30.5 x 30.5 mm
M3N1-45-300/5	300/5	2.5	2.5	3.75	3@30.5 x 30.5 mm
M3N1-45-400/5	400/5	2.5	2.5	3.75	3@30.5 x 30.5 mm
M3N1-45-500/5	500/5	2.5	2.5	3.75	3@30.5 x 30.5 mm
M3N1-45-600/5	600/5	2.5	2.5	3.75	3@30.5 x 30.5 mm
M3N1-45-630/5	630/5	2.5	2.5	3.75	3@30.5 x 30.5 mm

M3N1-25

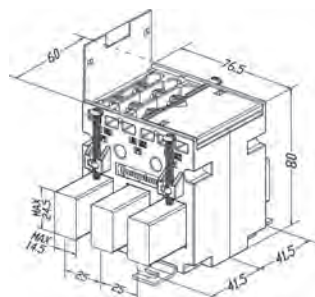

M3N1-35

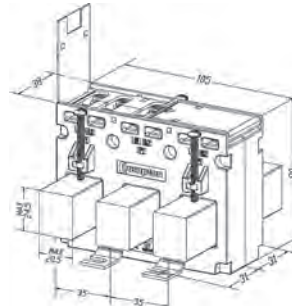

M3N1-45

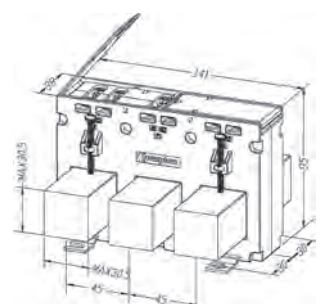

Din-Rail Enclosure 3-in-1 Current Transformers

FEATURES

- Cost effective three-phase moulded case
- Ratio's ranging from 50/5 to 250/5
- Two part connector for fast installation
- Complete with cable assembly

APPLICATIONS

- Switchgear
- Distribution systems
- Generator sets
- Control panels

BENEFITS

- Long product life
- Faster installation
- Compact size



A range of 3-in-1 current transformers combine three traditional current transformers in one Low profile DIN-rail enclosure. 3-in-1 current transformers can be directly mounted onto a DIN-rail, thus saving installation time where fitting three standard individual current transformers would be required. The 3-in-1 range of current transformers offers primary currents between 50-250A with 5A secondaries with up to class 0.5 accuracy performance.

SPECIFICATIONS

System voltage:	720V maximum
Test voltage:	3kV for 1 minute
System frequency:	50Hz or 60Hz
Primary ratings:	50A to 160A
Short circuit thermal current:	60 x rated primary current (Ith): for 1 sec
Overload withstand:	1.2 x rated current continuously
Rated dynamic current:	= 2.55 x Iht
Secondary terminals:	7 way screw clamp connector
Cable assembly:	Open ended loom/harness CT fixed/open at meter connection, 1 mm ² LSZH cable (lengths specified in part number table)
Enclosure:	Flame retardant grade classified UL 94V-O
Aperture holes centres:	31 mm (cable through 13.5 mm) up to 150A, 36 mm (cable through 20 mm) from 160-250A
Operating temperature:	-20°C to +85°C
Accuracy class:	0.5, 1, 3
Compliant with:	IEC/EN 60044-1

DR3N1-50/5A - 150/5A

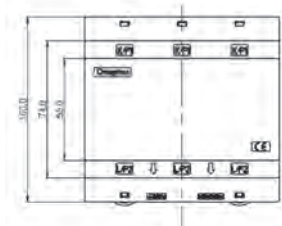
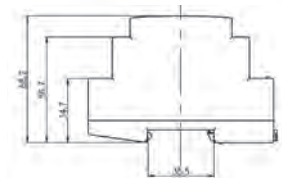
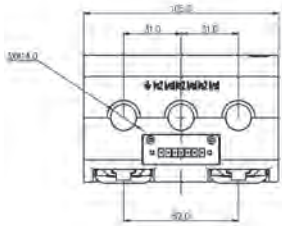

Part number	Ratio	Class 0.5 VA	Class 1 VA	Class 3 VA	Aperture (mm)	No. of modules	Cable length (M)
DR3N1-50/5	50/5A	-	1	1.5	3@13.5 x 31	6	1
DR3N1-60/5	60/5A	-	1	1.5	3@13.5 x 31	6	1
DR3N1-75/5	75/5A	-	1.5	2	3@13.5 x 31	6	1
DR3N1-80/5	80/5A	-	1.5	2.5	3@13.5 x 31	6	1
DR3N1-100/5	100/5A	2.5	3	3.75	3@13.5 x 31	6	2
DR3N1-125/5	125/5A	2.5	3	3.75	3@13.5 x 31	6	2
DR3N1-150/5	150/5A	2.5	3.75	5	3@13.5 x 31	6	2
DR3N1-160/5	160/5A	1.5	2.5	3.75	3@20 x 36	7	2
DR3N1-180/5	180/5A	2.5	3	3.75	3@20 x 36	7	2
DR3N1-200/5	200/5A	2.5	3.75	5	3@20 x 36	7	2
DR3N1-250/5	250/5A	3.75	5	6.25	3@20 x 36	7	2

DIMENSIONS

Part number	Width	Aperture	Mounting	Number of modules (width)
DR3N1-50/5A-150/5A	105 mm	13.5 mm	35 mm DIN-rail	6 (31 mm cable centres)
DR3N1-160/5A-250/5A	120 mm	20 mm	35 mm DIN-rail	7 (36 mm cable centres)

DR3N1-160/5A - 250/5A

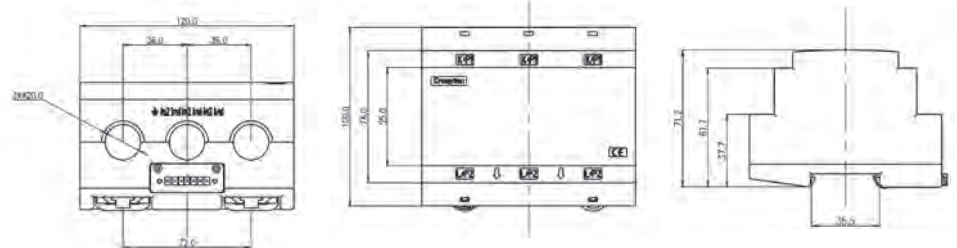

Dual Load 3-in-1 Current Transformers

FEATURES

- Busbar DIN-rail and metal feet (mounting hardware supplied)
- RJ12 socket for fast connection eliminate wiring errors
- Cable included (length 1.5 m)
- Low 60A ratio for more energy efficient loads
- Aperture hole centres 35 mm



The 3-in-1 current transformer range are for use with the Integra DL1 digital metering system which combines three traditional current transformers in one moulding case with a RJ12 connection for simple and easy error free installation.

SPECIFICATIONS

System voltage:	720V maximum
Test voltage:	3kV for 1 minute
System frequency:	50Hz or 60Hz
Primary ratings:	100mA AC rms. per CT
Overload withstand:	1.2 x rated current continuously
Enclosure:	Flame retardant grade classified UL94V-O
Aperture hole centres:	35 mm
Operating temperature:	-20°C to +85°C
Compliant with accuracy:	IEC/EN 60044-1 Class 0.5, Class 1

Product Codes	Primary Current	VA at Class 1	VA at Class 0.5
DL3N1-35-60/0.1	60A	0.25	-
DL3N1-35-125/0.1	125A	0.5	0.25
DL3N1-35-160/0.1	160A	0.35	0.25
DL3N1-35-250/0.1	250A	0.5	0.25
DL3N1-45-250/0.1	250A	0.25	-
DL3N1-45-400/0.1	400A	-	0.25
DL3N1-45-600/0.1	600A	-	0.25
DL3N1-70-400/0.1	400A	-	0.25
DL3N1-70-600/0.1	600A	-	0.25
DL3N1-70-800/0.1	800A	-	0.25



DIMENSIONS

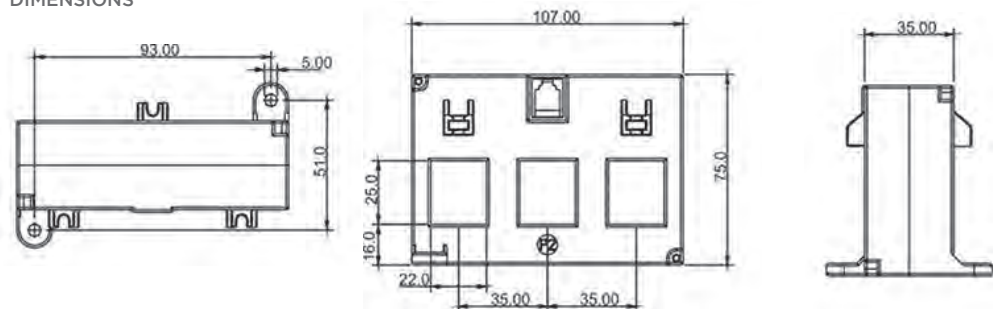

ALL CURRENT TRANSFORMERS ARE SUPPLIED WITH A 1.5M CONNECTING CABLE, WITH RJ12 CONNECTOR TERMINATION AT EACH END.

DUAL LOAD CT PHASE ORIENTATION

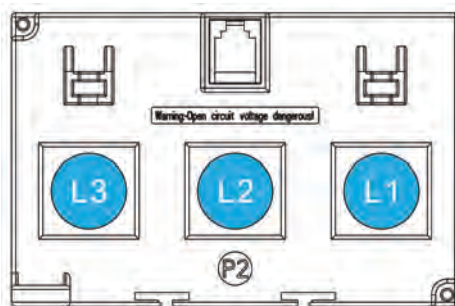

Q2C 3-in-1 Current Transformers

FEATURES

- Reversible mounting LHS and RHS
- Internal grounding/earthing facility
- Supplied with connector

A range of 3-in-1 current transformers for use with or without the Q2C wiring solution. The 3-in-1 current transformers combine three traditional current transformers in one moulded case with a pluggable locking connector for simple and easy installation.

SPECIFICATIONS



Part number	Ratio	Burden VA against class index			Aperture (mm)
		Class 0.5	Class 1	Class 3	
QC3N1-25-60/5	60/5	-	1	2	3 @ 15x25 mm
QC3N1-25-100/5	100/5	-	1.5	2.5	3 @ 15x25 mm
QC3N1-25-160/5	160/5	1.5	1.5	2.5	3 @ 15x25 mm
QC3N1-35-100/5	100/5	-	1.5	2	3 @ 21x25 mm
QC3N1-35-125/5	125/5	-	1.5	2.5	3 @ 21x25 mm
QC3N1-35-160/5	160/5	1.5	1.5	2.5	3 @ 21x25 mm
QC3N1-35-250/5	250/5	1.5	1.5	2.5	3 @ 21x25 mm
QC3N1-45-250/5	250/5	-	2.5VA	-	3 @ 32x27 mm
QC3N1-45-400/5	400/5	-	2.5VA	-	3 @ 32x27 mm
QC3N1-45-600/5	600/5	2.5VA	5VA	-	3 @ 32x27 mm
QC3N1-70-400/5	400/5	-	2.5VA	-	3 @ 52x40 mm
QC3N1-70-600/5	600/5	2.5VA	5VA	-	3 @ 52x40 mm
QC3N1-70-800/5	800/5	2.5VA	5VA	-	3 @ 52x40 mm

DIMENSIONS

QC3N1-25

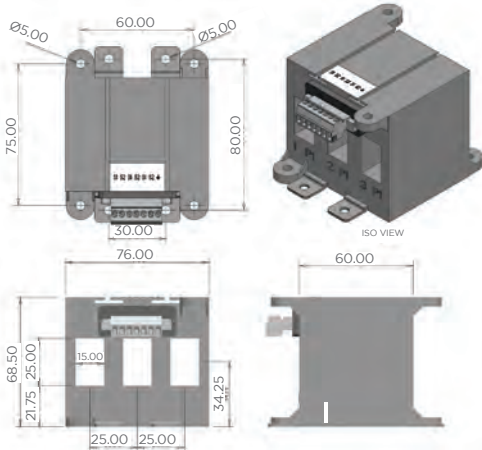

QC3N1-35

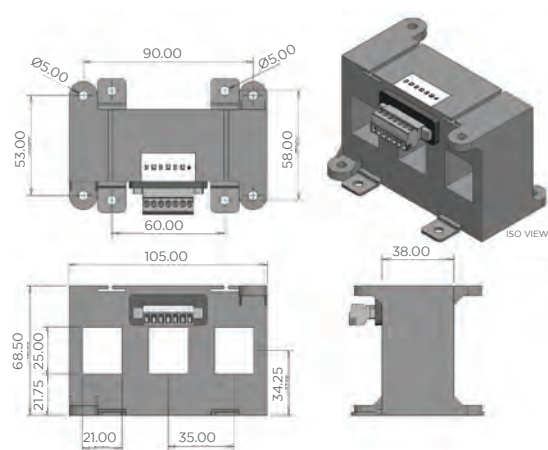

QC3N1-45

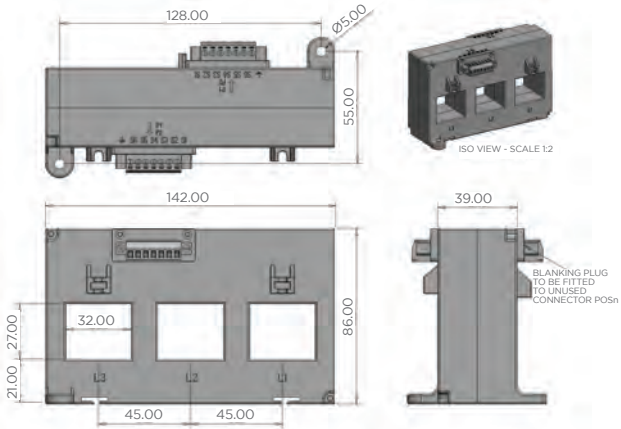

QC3N1-70

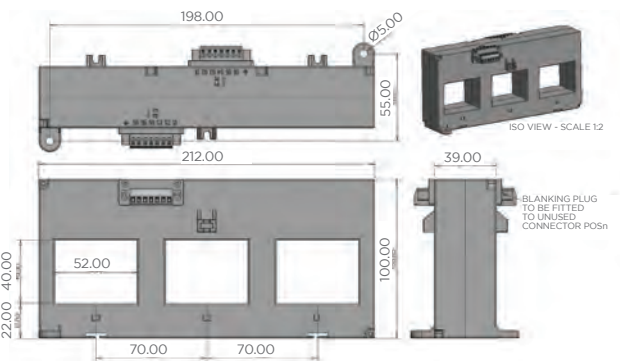



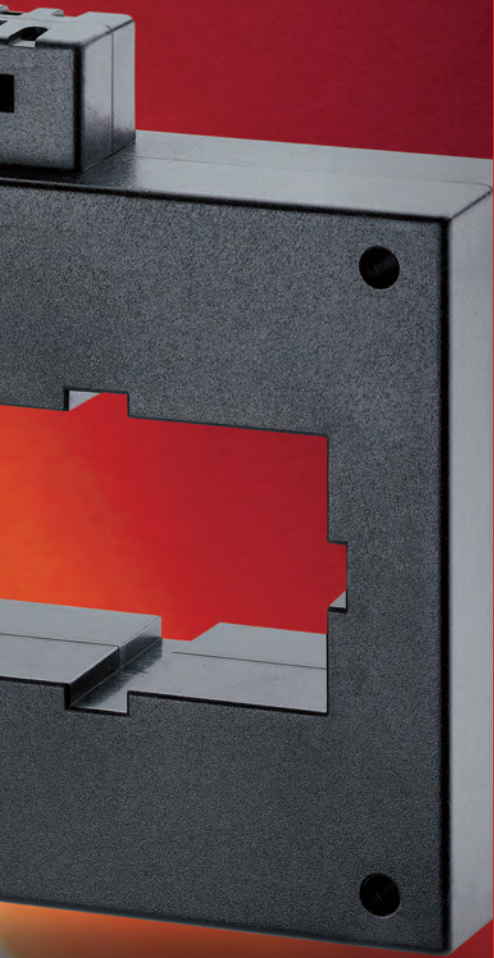

Chapter 4 Moulded Case Current Transformers

Ebony Current Transformers.....	26-35
CS Current Transformers.....	36-39
AS Current Transformers.....	40-43
RS Current Transformers.....	44

Ebony Current Transformers

FEATURES

- CT ratios from 1A to 6000A with 5A and 1A secondaries
- Accuracy up to Class 0.5
- Integral terminal cover
- High impact, flame retardant moulded case
- Busbar, DIN-rail or foot mounting options



* THERMAL CURRENT (I_{TH}) & DYNAMIC CURRENT (I_{LDYN})

I_{TH} IS THE HIGHEST PRIMARY CURRENT (EFFECTIVE VALUE), THE I_{LDYN} IS THE HIGHEST PRIMARY CURRENT (PEAK VALUE) THAT THE CT CAN SUPPORT FOR 1 SECOND WITHOUT DAMAGE, OWING TO EXCESSIVE OVERLOADS WITH SECONDARY SHORT CIRCUITS.

APPLICATIONS

- BS EN61010-1
- EN60044-1
- UL Recognized file no: E257877

BENEFITS

- Wide range of apertures and case sizes
- Reduction of high currents for ease of metering
- Long product life

The range of TE's Crompton Instruments Ebony current transformers offers wide system current ratings, apertures, busbar and case sizes to suit every application. Manufactured to meet EN60044 the range benefits include ratio rating from 1/5 to 6000/5, accuracy up to Class 0.5, integral terminal cover for safety and multiple mounting options.

CONSTRUCTION

The toroidal core and secondary winding is encapsulated by a self-extinguishing polycarbonate moulded case cover providing excellent mechanical strength and electrical insulation. The material is halogen free thus reducing risk of halogen emissions in case of fire. The integral covered secondary terminals offer protection to IP20B and the enclosure is protected to IP40.

INSTALLATION OPTIONS

- Plug-in metal feet for wall or base mounting
- Plastic DIN-rail clips for DIN-rail mounting
- Moulded busbar mounting
- Primary copper busbar mounting
- Multi busbar mounting for two busbars

SPECIFICATIONS

System voltage:	720V maximum
Test voltage:	3kV for 1 minute
System frequency:	50/60Hz
Short circuit thermal current (I _{th})*:	60 x rated primary current for 1 second
Overload withstand:	1.2 x rated current continuously
Dynamic current (I _{ldyn})*:	= 2.55 x I _{th}
Saturation coefficient:	<5 for through aperture models <10 for wound primary
Service temperature:	-20°C to 85°C
Insulation class:	Class E BS2757 IEC85
Enclosure code:	IP40
Integral terminal cover:	IP20B
Complies with:	IEC60044-1:2003
Humidity:	Up to 95% RH (non condensing)
Secondary terminals screw clamp:	Up to 10 mm ² cable
'Fast On':	6.3 mm type

Loss in copper wires between instrument and CT for 5A secondary

Wire section in mm ²	Loss in VA (for both wires)					
	1 m	2 m	4 m	6 m	8 m	10 m
1.5	0.60	1.19	2.38	3.57	4.76	5.95
2.5	0.36	0.71	1.43	2.14	2.86	3.57
4	0.22	0.45	0.89	1.34	1.79	2.23
6	0.15	0.30	0.60	0.89	1.19	1.49
10	0.09	0.18	0.36	0.54	0.71	0.89

Loss in copper wires between instrument and CT for 1A secondary

Wire section in mm ²	Loss in VA (for both wires)					
	10 m	20 m	40 m	60 m	80 m	100 m
1	0.36	0.71	1.43	2.14	2.86	3.57
1.5	0.24	0.48	0.95	1.43	1.90	2.38
2.5	0.14	0.29	0.57	0.86	1.14	1.43
4	0.09	0.18	0.36	0.54	0.71	0.89
6	0.06	0.12	0.24	0.36	0.48	0.60
10	0.04	0.07	0.14	0.21	0.29	0.36

Ebony Current Transformers



M53Q RANGE

Case size: 45 mm wide x 30 mm deep x 65 mm high
 1.8" wide x 1.2" deep x 2.5" high
 Aperture: 20 x 6 mm and 21 mm diameter
 0.8" x 0.2" and 0.8" diameter
 Weight: 0.25kg

DIMENSIONS

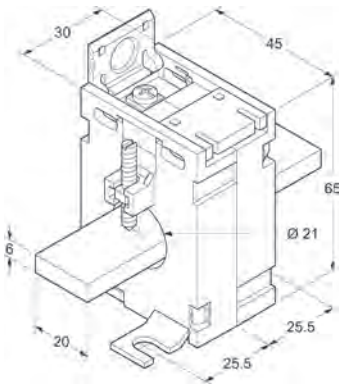

- Mounting feet centres 26 mm x 51 mm

Model type	Primary current	VA at Class 3	VA at Class 1
M53Q-50/5	50	1	-
M53Q-60/5	60	1.25	-
M53Q-75/5	75	1.5	-
M53Q-80/5	80	1.25	-
M53Q-100/5	100	2.5	1.5
M53Q-125/5	125	3	2.5
M53Q-150/5	150	3.75	2.5
M53Q-200/5	200	5	3.75
M53Q-250/5	250	-	5
M53Q-300/5	300	7.5	5

ORDERING CODES

As above	Change end suffix to depict required secondary. For example: M53Q-50/1
M50-DINCLIP	DIN-rail mounting clip for DIN-rail mounting option (2 required)



M55E RANGE

Case size: 50 mm wide x 50 mm deep x 80 mm high
 2" wide x 2" deep x 3.1" high
 Aperture: 15 x 5 mm and 16 mm diameter
 0.6" x 0.2" diameter
 Weight: 0.4kg

DIMENSIONS

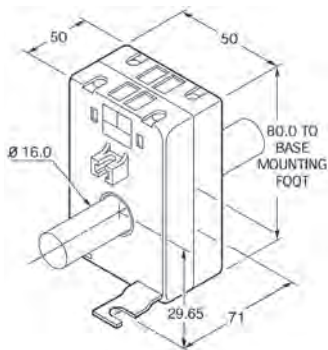

- Mounting feet centres 33 mm x 71 mm

Model type	Primary current	VA at Class 3	VA at Class 1
M55E-30/5	30	1.25	-
M55E-40/5	40	2.5	-
M55E-50/5	50	2.5	-
M55E-60/5	60	3.75	2.5
M55E-75/5	75	5	3.75
M55E-80/5	80	5	3.75
M55E-100/5	100	7.5	5

ORDERING CODES

As above	Change end suffix to depict required secondary. For example: M55E-50/1
M50-DINCLIP	(2 required)

Ebony Current Transformers



M53J RANGE

Case size: 50 mm wide x 30 mm deep x 80 mm high
 2" wide x 1.2" deep x 3.1" high
 Aperture: 30 x 10 mm, 25 x 15 mm and 20 x 20 mm and 25 mm diameter
 1.2" x 0.4", 1" x 0.6" and 0.8" x 0.8" and 1.0" diameter
 Weight: 0.22kg

Model type	Primary current	VA at Class 3	VA at Class 1
M53J-100/5	100	1.25	-
M53J-125/5	125	1.25	-
M53J-150/5	150	2.5	-
M53J-160/5	160	2.5	-
M53J-200/5	200	2.5	2.5
M53J-250/5	250	3.75	2.5
M53J-300/5	300	5	3.75
M53J-400/5	400	7.5	3.75

DIMENSIONS

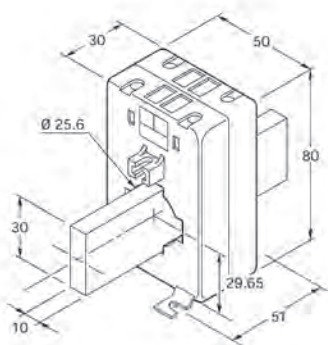

- Mounting feet centres
33 mm x 51 mm

ORDERING CODES

As above Change end suffix to depict required secondary. For example: M53J-150/1
 M50-DINCLIP DIN-rail mounting clip for DIN-rail mounting option (2 required)



M65F RANGE

Case size: 60 mm wide x 50 mm deep x 94 mm high
 2.4" wide x 2" deep x 3.7" high
 Aperture: 20 x 10 mm and 23 mm diameter
 0.8" x 0.4", 0.9" diameter
 Weight: 0.4kg

Model type	Primary current	VA at Class 3	VA at Class 1	VA at Class 0.5
M65F-30/5	30	1.25	-	-
M65F-40/5	40	2.5	-	-
M65F-50/5	50	2.5	-	-
M65F-60/5	60	3.75	-	-
M65F-75/5	75	5	2.5	-
M65F-80/5	80	5	2.5	-
M65F-100/5	100	7.5	5	2.5
M65F-125/5	125	7.5	5	2.5
M65F-150/5	150	15	10	5
M65F-200/5	200	20	15	7.5
M65F-250/5	250	20	20	10
M65F-300/5	300	30	30	10

DIMENSIONS

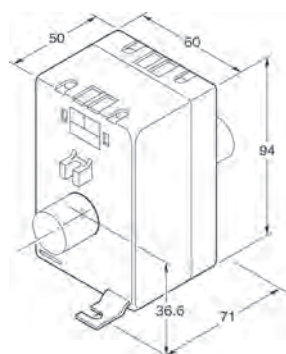

- Mounting feet centres
42 mm x 71 mm

ORDERING CODES

As above Change end suffix to depict required secondary. For example: M65F-150/1
 M50-DINCLIP DIN-rail mounting clip for DIN-rail mounting option (2 required)

Consult factory for availability and lead time on 1A secondary.

Ebony Current Transformers



M63N RANGE

Case size: 60 mm wide x 30 mm deep x 94 mm high
 2.3" wide x 1.2" deep x 3.7" high
 Aperture: 40 x 10 mm and 32 mm diameter
 1.5" x 0.4" and 1.2" diameter
 Weight: 0.3kg

DIMENSIONS

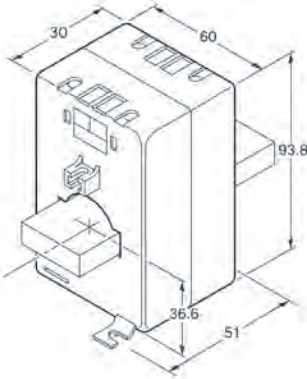

- Mounting feet centres 42 mm x 51 mm

Model type	Primary current	VA at Class 3	VA at Class 1	VA at Class 0.5
M63N-200/5	200	2.5	-	-
M63N-250/5	250	3.75	2.5	-
M63N-300/5	300	5	3.75	-
M63N-400/5	400	7.5	5	-
M63N-500/5	500	10	7.5	3.75
M63N-600/5	600	10	7.5	5
M63N-750/5	750	15	10	7.5
M63N-800/5	800	15	10	7.5

ORDERING CODES

As above	Change end suffix to depict required secondary. For example: M53J-150/1
M50-DINCLIP	DIN-rail mounting clip for DIN-rail mounting option (2 required)



MA5G RANGE

Case size: 77 mm wide x 50 mm deep x 116 mm high
 3" wide x 2" deep x 4.5" high
 Aperture: 40 x 10 mm, 30 x 30 mm and 36 mm diameter
 1.6" x 0.4", 1.2" x 1.2" and 1.4" diameter
 Weight: 0.6kg

DIMENSIONS

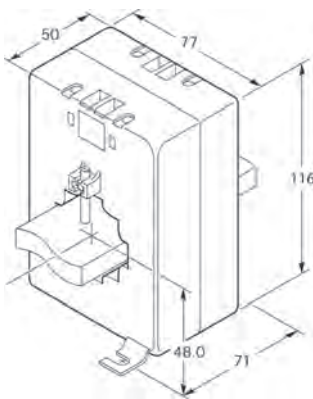

- Mounting feet centres 58.5 mm x 71 mm

Model type	Primary current	VA at Class 3	VA at Class 1	VA at Class 0.5
MA5G-100/5	100	2.5	-	-
MA5G-125/5	125	5	2.5	-
MA5G-150/5	150	5	3.75	-
MA5G-200/5	200	10	5	2.5
MA5G-250/5	250	10	7.5	5
MA5G-300/5	300	10	7.5	5
MA5G-400/5	400	10	7.5	5
MA5G-500/5	500	10	7.5	5
MA5G-600/5	600	10	10	7.5
MA5G-750/5	750	15	10	10
MA5G-800/5	800	15	10	10
MA5G-1000/5	1000	20	15	15

ORDERING CODES

As above	Change end suffix to depict required secondary. For example: MA5G-150/1
M50-DINCLIP	DIN-rail mounting clip for DIN-rail mounting option (2 required)

Consult factory for availability and lead time on 1A secondary.

Ebony Current Transformers



MA5Y RANGE

Case size: 77 mm wide x 50 mm deep x 116 mm high
 3" wide x 2" deep x 4.5" high
 Fixing: M8 stud primary bar
 Weight: 0.45kg

DIMENSIONS

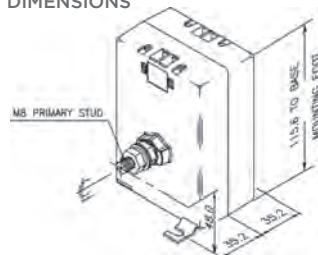

- Mounting feet centres
58.5 mm x 71 mm

Model type	Primary current	VA at Class 3	VA at Class 1
MA5Y-1/5	1	7.5	5
MA5Y-5/5	5	7.5	5
MA5Y-10/5	10	7.5	5
MA5Y-15/5	15	7.5	5
MA5Y-20/5	20	7.5	5
MA5Y-30/5	30	7.5	5
MA5Y-40/5	40	7.5	5

ORDERING CODES

As above	Change end suffix to depict required secondary. For example: MA5Y-1/1
M50-DINCLIP	DIN-rail mounting clip for DIN-rail mounting option (2 required)



M93L RANGE

Case size: 90 mm wide x 30 mm deep x 131 mm high
 3.5" wide x 1.2" deep x 5.1" high
 Aperture: 50 x 10 mm, 40 x 30 mm and 42 mm diameter
 2" x 0.4", 1.5" x 1.2" and 1.6" diameter
 Weight: 0.45kg

DIMENSIONS

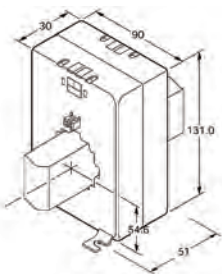

- Mounting feet centres
71.5 mm x 51 mm

Model type	Primary current	VA at Class 3	VA at Class 1	VA at Class 0.5
M93L-400/5	400	15	7.5	3.75
M93L-500/5	500	20	15	5
M93L-600/5	600	30	20	10
M93L-750/5	750	20	15	7.5
M93L-800/5	800	20	15	10
M93L-1000/5	1000	20	20	15
M93L-1200/5	1200	30	30	20
M93L-1250/5	1250	30	30	20
M93L-1500/5	1500	30	30	20
M93L-1600/5	1600	30	30	20

ORDERING CODES

As above	Change end suffix to depict required secondary. For example: M93L-1000/1
M30-DINCLIP	DIN-rail mounting clip for DIN-rail mounting option (2 required)



M93R RANGE

Case size: 90 mm wide x 30 mm deep x 131 mm high
 3.5" wide x 1.2" deep x 5.1" high
 Aperture: 64 x 12.6 mm, 60 x 30 mm
 2.5" x 0.5", 2.4" x 1.2"
 Weight: 0.6kg

DIMENSIONS

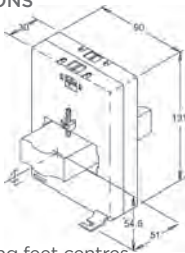

- Mounting feet centres
71.5 mm x 51 mm

Model type	Primary current	VA at Class 3	VA at Class 1	VA at Class 0.5
M93R	800/5	10	10	5
M93R	1000/5	10	10	7.5
M93R	1200/5	10	15	10
M93R	1250/5	10	15	10
M93R	1500/5	10	20	15
M93R	1600/5	10	20	15
M93R	2000/5	10	20	20

ORDERING CODES

As above	Change end suffix to depict required secondary. For example: M93R-1000/1
M30-DINCLIP	DIN-rail mounting clip for DIN-rail mounting option (2 required)

Ebony Current Transformers



M93S RANGE

Case size: 90 mm wide x 30 mm deep x 131 mm high
 3.5" wide x 1.2" deep x 5.1" high
 Aperture: 76.5 x 19 mm, 60 x 30 mm
 3.0" x 0.7", 2.4" x 1.2"
 Weight: 0.7kg

DIMENSIONS

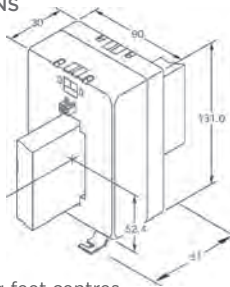

- Mounting feet centres
71.5 mm x 51 mm

Model type	Primary current	VA at Class 3	VA at Class 1	VA at Class 0.5
M93S-800/5A	800	10	10	5
M93S-1000/5A	1000	150	10	7.5
M93S-1200/5A	1200	20	15	10
M93S-1250/5A	1250	20	20	15
M93S-1500/5A	1500	20	20	15
M93S-1600/5A	1600	30	20	15
M93S-2000/5	2000	30	20	15

ORDERING CODES

As above	Change end suffix to depict required secondary. For example: M93S-1000/1
M50-DINCLIP	DIN-rail mounting clip for DIN-rail mounting option (2 required)



S95P RANGE

Case size: 90 mm wide x 50 mm deep x 144 mm high
 3.5" wide x 2" deep x 5.7" high
 Weight: 0.9kg - 1.1kg

DIMENSIONS

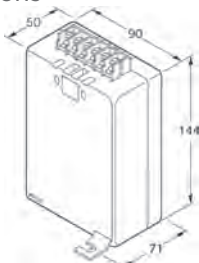

- Mounting feet centres
71.5 mm x 71 mm

Model type	Primary current	VA at Class 1
S95P-5/5	5 + 5 = 5	5
S95P-5/5/5	5 + 5 + 5 = 5	5

ORDERING CODES

As above	Change end suffix to depict required secondary. For example: S95P-1/1
M50-DINCLIP	DIN-rail mounting clip for DIN-rail mounting option (2 required)



S97P RANGE

Case size: 90 mm wide x 50 mm deep x 144 mm high
 3.5" wide x 2" deep x 5.7" high
 Weight: 0.9kg - 1.1kg

DIMENSIONS

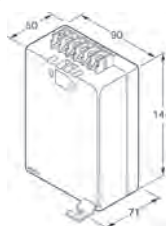

- Mounting feet centres
71.5 mm x 91 mm

Model type	Primary current	VA at Class 1
S97P-5/5/5/5	5 + 5 + 5 + 5 = 5	5
S97P-5/5/5/5/5	5 + 5 + 5 + 5 + 5 = 5	5
S97P-5/5/5/5/5/5	5 + 5 + 5 + 5 + 5 + 5 = 5	5

ORDERING CODES

As above	Change end suffix to depict required secondary. For example: S95P-1/1
----------	-----------------------------------------------------------------------

Consult factory for availability and lead time on 1A secondary.

Ebony Current Transformers



MB5D RANGE

Case size: 134 mm wide x 50 mm deep x 156 mm high
 5.2" wide x 2" deep x 6.1" high
 Aperture: 80 x 30 mm, 60 x 30 mm, 50 X 50 mm and 63 mm diameter
 3.1" x 1.2", 2.3" x 1.2", 2 x 2" and 2.4" diameter
 Weight: 0.5kg

DIMENSIONS

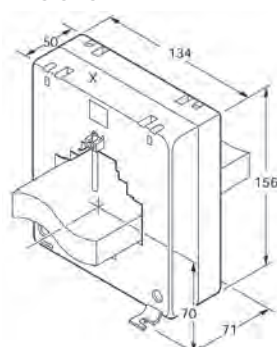

- Mounting feet centres 105 mm x 71 mm
- Mounting hole centres 110 mm x 6.6 mm

Model type	Primary current	VA at Class 3	VA at Class 1	VA at Class 0.5
MB5D-400/5	400	15	10	7.5
MB5D-500/5	500	20	15	10
MB5D-600/5	600	15	10	5
MB5D-750/5	750	15	10	5
MB5D-800/5	800	20	15	7.5
MB5D-1000/5	1000	22.5	20	10
MB5D-1200/5	1200	30	20	15
MB5D-1250/5	1250	30	20	15
MB5D-1500/5	1500	30	20	15
MB5D-1600/5	1600	40	30	20
MB5D-2000/5	2000	50	40	30

ORDERING CODES

As above Change end suffix to depict required secondary. For example: MB5D-1600/1



MB5Z RANGE

Case size: 134 mm wide x 50 mm deep x 156 mm high
 5.2" wide x 2" deep x 6.1" high
 Aperture: 104 x 35 mm, 35 mm diameter
 4" x 1.3" and 1.3" diameter
 Weight: 0.7kg

DIMENSIONS

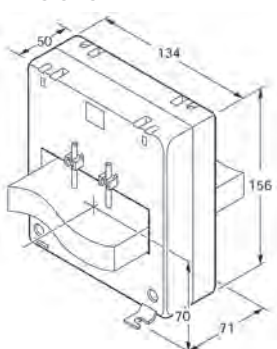

- Mounting feet centres 105 mm x 71 mm
- Mounting hole centres 110 mm x 6.6 mm

Model type	Primary current	VA at Class 3	VA at Class 1	VA at Class 0.5
MB5Z-750/5	750	15	7.5	2.5
MB5Z-800/5	800	20	10	2.5
MB5Z-1000/5	1000	22.5	15	7.5
MB5Z-1200/5	1200	30	20	10
MB5Z-1250/5	1250	30	20	15
MB5Z-1500/5	1500	30	20	15
MB5Z-1600/5	1600	30	20	15
MB5Z-2000/5	2000	30	20	15
MB5Z-2400/5	2400	30	20	15
MB5Z-2500/5	2500	30	20	15
MB5Z-3000/5	3000	30	20	15
MB5Z-4000/5	4000	30	20	15

ORDERING CODES

As above Change end suffix to depict required secondary. For example: MB5Z-1600/1

Consult factory for availability and lead time on 1A secondary.

Ebony Current Transformers



MC5T RANGE

Case size: 140 mm wide x 50 mm deep x 238 mm high
 5.5" wide x 2" deep x 9.3" high
 Aperture: 160 x 50 mm
 6.3" x 2"
 Weight: +/-1.5kg

DIMENSIONS

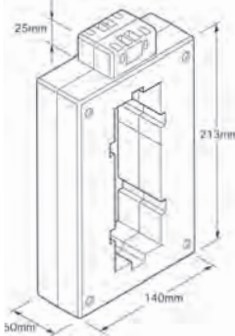

- Hole for M6 diameter screws or busbar mounting

Model type	Primary current	VA at Class 3	VA at Class 1	VA at Class 0.5
MC5T-1600/5	1600	45	30	20
MC5T-2000/5	2000	45	30	20
MC5T-2500/5	2500	60	45	30
MC5T-3000/5	3000	60	45	30
MC5T-3200/5	3200	60	45	30
MC5T-4000/5	4000	60	45	30
MC5T-5000/5	5000	60	45	30
MC5T-6000/5	6000	60	45	30

ORDERING CODES

As above Change end suffix to depict required secondary. For example: MC5T-1600/1

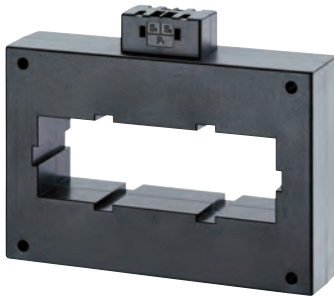

MD5T RANGE

Case size: 213 mm wide x 50 mm deep x 165 mm high
 8.3" wide x 2" deep x 6.5" high
 Aperture: 160 x 50 mm
 6.3" x 2"
 Weight: +/-1.5kg

DIMENSIONS

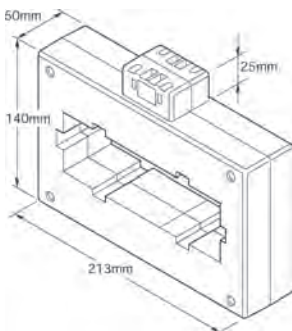

- Hole for M6 diameter screws or busbar mounting

Model type	Primary current	VA at Class 3	VA at Class 1	VA at Class 0.5
MD5T-1600/5	1600	45	30	20
MD5T-2000/5	2000	45	30	20
MD5T-2500/5	2500	60	45	30
MD5T-3000/5	3000	60	45	30
MD5T-3200/5	3200	60	45	30
MD5T-4000/5	4000	60	45	30
MD5T-5000/5	5000	60	45	30
MD5T-6000/5	6000	60	45	30

ORDERING CODES

As above Change end suffix to depict required secondary. For example: MD5T-1600/1

Consult factory for availability and lead time on 1A secondary.

Ebony Current Transformers

Type	MA5Y		M53Q		M55E		M53J		M65F		M63N		MA5G		M93L	
Inside diameter (mm)			21		16.2		25		23		32		36		32	
Busbar	M8 Stud		20x6		15x5		30x10		20x10		40x10		40x10		50x10	
							25x15						30x30		40x30	
							20x20									
Dimensions (mm)																
Height	116		65		80		80		94		94		116		131	
Width	77		45		50		50		60		60		77		90	
Depth	50		30		50		50		50		30		50		30	
DIN-rail mounting	X	X	X	X	X	X	X	X	X	X	X	X	X	X	X	X
Foot mounting	X	X	X	X	X	X	X	X	X	X	X	X	X	X	X	X
Integrated terminal cover	X	X	X	X	X	X	X	X	X	X	X	X	X	X	X	X
Secondary	5	1	5	1	5	1	5	1	5	1	5	1	5	1	5	1
Primary current																
1	X	X														
5	X	X														
10	X	X														
15	X	X														
20	X	X			X	X										
30	X	X			X	X			X	X						
40	X	X			X	X			X	X						
50			X	X	X	X			X	X						
60			X	X	X	X			X	X						
75			X	X	X	X			X	X						
80			X	X	X				X	X						
100			X	X	X	X	X		X	X			X	X		
125			X	X			X		X	X			X	X		
150			X	X			X		X	X			X	X		
160							X									
200			X	X			X		X	X	X	X	X	X		
250			X	X			X		X	X	X	X	X	X		
300			X	X			X		X	X	X	X	X	X		
400							X				X	X	X	X	X	
500											X	X	X	X	X	
600											X	X	X	X	X	
750											X	X	X	X	X	
800											X	X	X	X	X	
1000													X	X	X	
1200															X	
1250																
1500															X	
1600															X	

Consult factory for availability and lead time on 1A secondary.

Ebony Current Transformers

Type	M93S		M93R		MB5D		MB5Z		MC5T		MD5T		S95		S97	
Inside diameter (mm)					63		35									
Busbar	60x30		60x30		80x30		104x35			50x160		160x50				
	76.5x19		64x12.6		60x30											
					50x50											
Dimensions (mm)																
Height	131		131		156		156		238		165		144		144	
Width	90		90		134		134		140		213		90		90	
Depth	30		30		50		50		50		50		50		70	
DIN-rail mounting	X	X	X	X									X	X		
Foot mounting	X	X	X	X	X	X	X	X	X				X	X	X	X
Integrated terminal cover	X	X	X	X	X	X	X	X	X	X	X					
Secondary	5	1	5	1	5	1	5	1	5	1	5	1	5	1	5	1
Primary current																
400					X	X										
500					X	X										
600					X	X										
750					X	X	X	X								
800	X	X	X	X	X	X	X	X	X							
1000	X	X	X	X	X	X	X	X	X							
1200	X	X	X	X	X	X	X	X	X							
1250	X	X	X	X	X	X	X	X	X							
1500	X	X	X	X	X	X	X	X	X							
1600	X	X	X	X	X	X	X	X	X	X	X	X				
2000	X	X	X	X	X	X	X	X	X	X	X	X	X			
2500							X	X	X	X	X	X				
3000							X	X	X	X	X	X				
4000							X	X	X	X	X	X				
5000								X	X	X	X					
6000									X	X	X					
5 + 5 = 5														X		
5 + 5 + 5 = 5														X		
5 + 5 + 5 + 5 = 5															X	
5 + 5 + 5 + 5 + 5 = 5															X	
5 + 5 + 5 + 5 + 5 + 5 = 5															X	
1 + 1 = 1														X		
1 + 1 + 1 = 1														X		
1 + 1 + 1 + 1 = 1															X	
1 + 1 + 1 + 1 + 1 = 1															X	
1 + 1 + 1 + 1 + 1 + 1 = 1															X	

Consult factory for availability and lead time on 1A secondary.

CS Current Transformers

FEATURES

- CT ratios from 5/5 to 5000/5A
- Accuracy class 0.2S
- Integral terminal cover
- Busbar, DIN-rail or foot mounting options
- Sealable terminal covers
- Combined M4 posi/slot screw

APPLICATIONS

- Switchgear
- Distribution systems
- Generator sets
- Control panels

BENEFITS

- Wide range of apertures and case sizes
- Reduction of high currents for ease of metering
- Long product life



The range of TE's Crompton Instruments CS series moulded case current transformers offers wide system current ratings, apertures and case sizes to suit every application. The range benefits include ratio rating from 5 to 5000/5, accuracy up to class 0.2S, integral terminal cover for safety and multiple mounting options.

SPECIFICATIONS

System voltage:	720V maximum
Test voltage:	3kV for 1 minute
System frequency:	50/60Hz
Short circuit thermal current (I _{th}):	60 x rated primary current for 1 second
Overload withstand:	1.2 x rated primary current
Dynamic current (I _{dyn}):	2.5 x I _{th}
Operating temperature:	-20°C to 50°C
Accuracy:	0.2S of reading
Class:	0.2S
Mounting hardware:	Plug-in metal feet for wall or base mounting Busbar and DIN-rail mounting (included as standard)
Compliant with:	IEC 61869-2
Enclosure:	Flame retardant grade classified UL 94V-0
Secondary terminals:	M4 screw terminals



CSO RANGE

Case size: 87 mm wide x 52 mm deep x 103.5 mm high
3.4" wide x 2" deep x 4.1" high
Stub size: M8
Weight: 0.5kg

DIMENSIONS

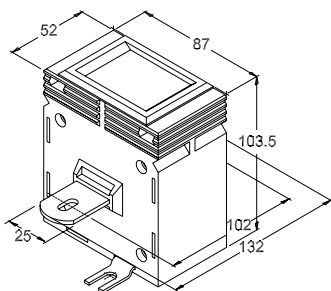

Model number	Ratio (A)	Burden (VA) VA at class 0.2S
CSO-5/5A	5/5	5VA
CSO-10/5A	10/5	5VA
CSO-15/5A	15/5	5VA
CSO-20/5A	20/5	5VA
CSO-30/5A	30/5	5VA
CSO-40/5A	40/5	5VA
CSO-50/5A	50/5	5VA
CSO-60/5A	60/5	5VA
CSO-75/5A	75/5	5VA
CSO-80/5A	80/5	5VA
CSO-100/5A	100/5	5VA
CSO-150/5A	150/5	5VA
CSO-200/5A	200/5	7.5VA
CSO-250/5A	250/5	7.5VA
CSO-300/5A	300/5	7.5VA
CSO-400/5A	400/5	7.5VA
CSO-500/5A	500/5	10VA
CSO-600/5A	600/5	10VA
CSO-800/5A	800/5	10VA
CSO-1000/5A	1000/5	10VA

CS Current Transformers



CS1A RANGE

Case size: 87 mm wide x 52 mm deep x 103.5 mm high
 3.4" wide x 2" deep x 4.1" high
 Aperture: 31.5 x 11 mm, 26 x 21.5 mm and 28 mm diameter
 1.2" x 0.4", 1" x 0.8" and 1.1" diameter
 Weight: 0.5kg

DIMENSIONS

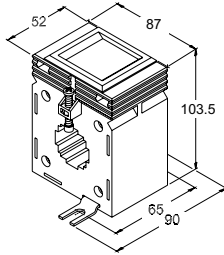

Model number	Ratio (A)	Burden (VA)
		VA at class 0.2S
CS1A-100/5A	100/5	1VA
CS1A-150/5A	150/5	1VA
CS1A-200/5A	200/5	1.5VA
CS1A-250/5A	250/5	1.5VA
CS1A-300/5A	300/5	1.5VA



CS1B RANGE

Case size: 74.5 mm wide x 45 mm deep x 98.5 mm high
 2.9" wide x 1.8" deep x 3.9" high
 Aperture: 31.5 x 11 mm, 26 x 21.5 mm and 28 mm diameter
 1.2" x 0.4", 1" x 0.8" and 1.1" diameter
 Weight: 0.65kg

DIMENSIONS

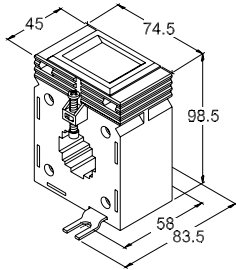

Model number	Ratio (A)	Burden (VA)
		VA at class 0.2S
CS1B-100/5A	100/5	1VA
CS1B-150/5A	150/5	1VA
CS1B-200/5A	200/5	1.5VA
CS1B-250/5A	250/5	1.5VA
CS1B-300/5A	300/5	1.5VA

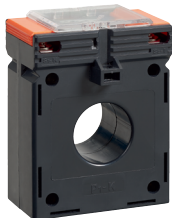

CS1C RANGE

Case size: 74.5 mm wide x 45 mm deep x 98.5 mm high
 2.9" wide x 1.8" deep x 3.9" high
 Aperture: 30 mm diameter
 1.2" diameter
 Weight: 0.5kg

DIMENSIONS

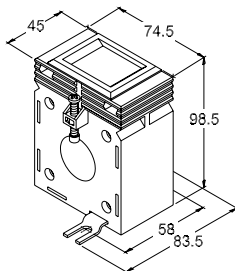

Model number	Ratio (A)	Burden (VA)
		VA at class 0.2S
CS1C-50/5A	50/5	1VA
CS1C-60/5A	60/5	1VA
CS1C-75/5A	75/5	1.5VA
CS1C-80/5A	80/5	1.5VA
CS1C-100/5A	100/5	1.5VA
CS1C-150/5A	150/5	1.5VA
CS1C-200/5A	200/5	1.5VA
CS1C-250/5A	250/5	1.5VA
CS1C-300/5A	300/5	1.5VA

CS Current Transformers



DIMENSIONS

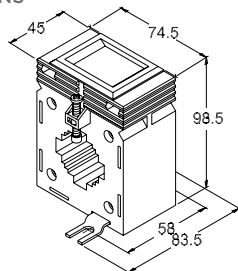

CS2 RANGE

Case size: 74.5 mm wide x 45 mm deep x 98.5 mm high
 2.9" wide x 1.8" deep x 3.9" high
 Aperture: 41.5 x 11 mm, 31.5 x 21 mm, 26.5 x 26.5 mm and 33 mm diameter
 1.6" x 0.4", 1.2" x 0.8", 1" x 1" and 1.3" diameter
 Weight: 0.65kg

Model number	Ratio (A)	Burden (VA) VA at class 0.2S
CS2-100/5A	100/5	2.5VA
CS2-150/5A	150/5	3.75VA
CS2-200/5A	200/5	5VA
CS2-250/5A	250/5	5VA
CS2-300/5A	300/5	5VA
CS2-400/5A	400/5	5VA
CS2-500/5A	500/5	5VA

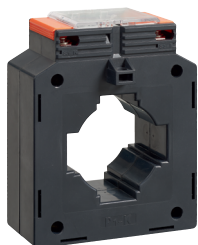

DIMENSIONS

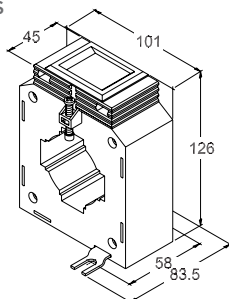

CS3 RANGE

Case size: 101 mm wide x 45 mm deep x 126 mm high
 3.9" wide x 1.8" deep x 4.9" high
 Aperture: 61 x 21 mm, 52 x 25 mm and 52mm diameter
 2.4" x 0.8", 2" x 0.9" and 2" diameter
 Weight: 0.65kg

Model number	Ratio (A)	Burden (VA) VA at class 0.2S
CS3-400/5A	400/5	5VA
CS3-500/5A	500/5	5VA
CS3-600/5A	600/5	5VA
CS3-750/5A	750/5	5VA
CS3-800/5A	800/5	5VA
CS3-1000/5A	1000/5	7.5VA

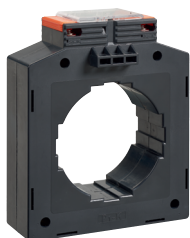

DIMENSIONS

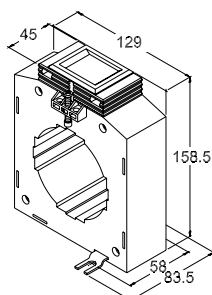

CS4 RANGE

Case size: 129mm wide x 45 mm deep x 158.5 mm high
 5.1" wide x 1.8" deep x 6.2" high
 Aperture: 86 x 11 mm, 82.5 x 32 mm and 82 mm diameter
 3.4" x 0.4", 3.2" x 1.3" and 3.2" diameter
 Weight: 1kg

Model number	Ratio (A)	Burden (VA) VA at class 0.2S
CS4-750/5A	750/5	7.5VA
CS4-800/5A	800/5	7.5VA
CS4-1000/5A	1000/5	7.5VA
CS4-1200/5A	1200/5	10VA
CS4-1500/5A	1500/5	10VA

CS Current Transformers

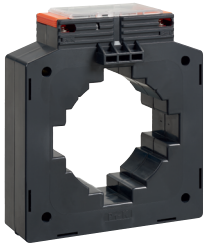

CS5 RANGE

Case size: 144 mm wide x 45 mm deep x 163.5 mm high
 5.7" wide x 1.8" deep x 6.4" high
 Aperture: 101 x 22 mm, 81 x 45 mm and 85.5 mm diameter
 4" x 0.9", 3.2" x 1.8" and 3.4" diameter
 Weight: 1kg

DIMENSIONS

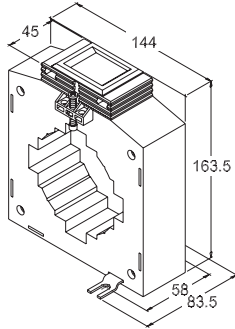

Model number	Ratio (A)	Burden (VA) VA at class 0.2S
CS5-800/5A	800/5	7.5VA
CS5-1000/5A	1000/5	10VA
CS5-1200/5A	1200/5	15VA
CS5-1500/5A	1500/5	15VA
CS5-1600/5A	1600/5	15VA
CS5-2000/5A	2000/5	15VA
CS5-2500/5A	2500/5	20VA
CS5-3000/5A	3000/5	20VA

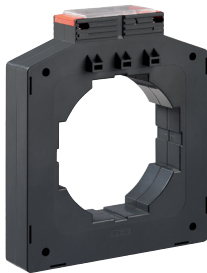

CS6 RANGE

Case size: 192 mm wide x 45 mm deep x 222.5 mm high
 7.6" wide x 1.8" deep x 8.8" high
 Aperture: 130.5 x 11 mm, 126 x 58 mm and 126.5 mm diameter
 5.1" x 0.4", 4.9" x 2.3" and 5.0" diameter
 Weight: 1.2kg

DIMENSIONS

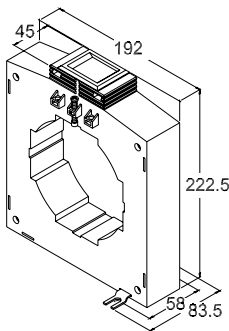

Model number	Ratio (A)	Burden (VA) VA at class 0.2S
CS6-1500/5A	1500/5	15VA
CS6-1600/5A	1600/5	15VA
CS6-2000/5A	2000/5	15VA
CS6-2500/5A	2500/5	15VA
CS6-3000/5A	3000/5	15VA
CS6-4000/5A	4000/5	20VA
CS6-5000/5A	5000/5	20VA

AS Current Transformers

FEATURES

- CT ratios from 5/5 to 5000/5A
- Accuracy class 0.5
- Integral terminal cover
- Busbar, DIN-rail or foot mounting options



APPLICATIONS

- Switchgear
- Distribution systems
- Generator sets
- Control panels

BENEFITS

- Wide range of apertures and case sizes
- Reduction of high currents for ease of metering
- Long product life

The range of TE's Crompton Instruments AS series moulded case current transformers offers wide system current ratings, apertures and case sizes to suit every application. The range benefits include ratio rating from 5 to 5000/5, accuracy up to class 0.25, integral terminal cover for safety and multiple mounting options.

SPECIFICATIONS

System voltage:	720V maximum
Test voltage:	3kV for 1 minute
System frequency:	50/60Hz
Short circuit thermal current (I _{th}):	60 x rated primary current for 1 second
Overload withstand:	1.2 x rated primary current
Dynamic current (I _{dyn}):	2.5 x I _{th}
Operating temperature:	-20C to 50C
Accuracy:	0.25% of reading
Mounting hardware:	Plug-in metal feet for wall or base mounting Busbar and DIN-rail mounting
Compliant with:	IEC/EN 60044-1
Class:	0.25



ASO RANGE

Case size: 87 mm wide x 52 mm deep x 103.5 mm high
Stub size: M8
Weight: 500g

DIMENSIONS

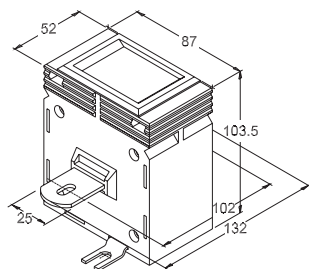

Model number	Ratio (A)	Burden (VA)	
		Class 0.5S	Class 0.5
ASO-5/5A	5/5	5VA	5VA
ASO-10/5A	10/5	5VA	5VA
ASO-15/5A	15/5	5VA	5VA
ASO-20/5A	20/5	5VA	5VA
ASO-30/5A	30/5	5VA	5VA
ASO-40/5A	40/5	5VA	5VA
ASO-50/5A	50/5	5VA	5VA
ASO-60/5A	60/5	5VA	5VA
ASO-75/5A	75/5	5VA	5VA
ASO-80/5A	80/5	5VA	5VA
ASO-100/5A	100/5	5VA	5VA
ASO-150/5A	150/5	5VA	5VA
ASO-200/5A	200/5	5VA	5VA
ASO-250/5A	250/5	5VA	5VA
ASO-300/5A	300/5	5VA	5VA
ASO-400/5A	400/5	5VA	5VA
ASO-500/5A	500/5	5VA	10VA
ASO-600/5A	600/5	5VA	10VA
ASO-800/5A	800/5	5VA	10VA
ASO-1000/5A	1000/5	5VA	10VA

AS Current Transformers



AS1 RANGE

Case size: 74.5 mm wide x 52 mm deep x 98.5 mm high
 Aperture: 31.5 x 11 mm, 26 x 21.5 mm and 28 mm diameter
 Weight: 500g

DIMENSIONS

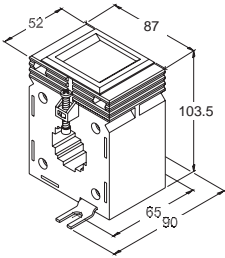

Model number	Ratio (A)	Burden (VA)			
		Class 0.5S	Class 0.5		
AS1A-50/5A	50/5	2.5	2.5		
AS1A-60/5A	60/5	2.5	2.5		
AS1A-75/5A	75/5	3.75	3.75		
AS1A-80/5A	80/5	3.75	3.75		
AS1A-100/5A	100/5	5	5		
AS1A-150/5A	150/5	5	5		
AS1A-200/5A	200/5	5	5		
AS1A-250/5A	250/5	5	5		
AS1A-300/5A	300/5	5	5		



AS1B RANGE

Case size: 74.5 mm wide x 45 mm deep x 98.5 mm high
 Aperture: 31.5 x 11 mm, 26 x 21.5 mm and 28 mm diameter
 Weight: 650g

DIMENSIONS

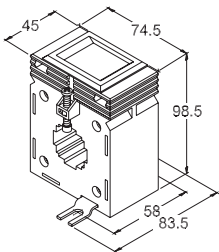

Model number	Ratio (A)	Burden (VA)			
		Class 0.5S	Class 0.5		
AS1B-60/5A	60/5	1.5	1.5		
AS1B-75/5A	75/5	2.5	2.5		
AS1B-80/5A	80/5	2.5	2.5		
AS1B-100/5A	100/5	3.75	3.75		
AS1B-150/5A	150/5	5	5		
AS1B-200/5A	200/5	5	5		
AS1B-250/5A	250/5	5	5		
AS1B-300/5A	300/5	5	5		



AS1C RANGE

Case size: 74.5 mm wide x 45 mm deep x 98.5 mm high
 Aperture: 30 mm diameter
 Weight: 500g

DIMENSIONS

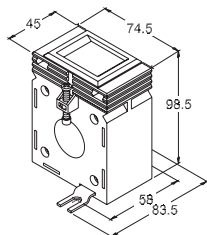

Model number	Ratio (A)	Burden (VA)			
		Class 0.5S	Class 0.5		
AS1C-50/5A	50/5	1.5	1.5		
AS1C-60/5A	60/5	1.5	1.5		
AS1C-75/5A	75/5	2.5	2.5		
AS1C-80/5A	80/5	2.5	2.5		
AS1C-100/5A	100/5	3.75	3.75		
AS1C-150/5A	150/5	5	5		
AS1C-200/5A	200/5	5	5		
AS1C-250/5A	250/5	5	5		
AS1C-300/5A	300/5	5	5		

AS Current Transformers



DIMENSIONS

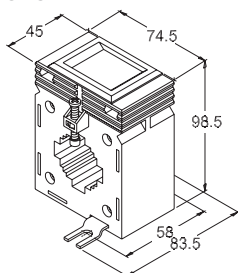

AS2 RANGE

Case size: 74.5 mm wide x 45 mm deep x 98.5 mm high
 Aperture: 41.5 x 11 mm, 31.5 x 21 mm, 26.5 x 26.5 mm and 33 mm diameter
 Weight: 650g

Model number	Ratio (A)	Burden (VA)			
		Class 0.5S	Class 0.5		
AS2-75/5A	75/5	1.5	1.5		
AS2-80/5A	80/5	1.5	1.5		
AS2-100/5A	100/5	2.5	2.5		
AS2-150/5A	150/5	3.75	5		
AS2-200/5A	200/5	5	5		
AS2-250/5A	250/5	5	5		
AS2-300/5A	300/5	5	5		
AS2-400/5A	400/5	5	5		
AS2-500/5A	500/5	5	5		



DIMENSIONS

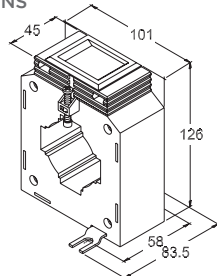

AS3 RANGE

Case size: 101 mm wide x 45 mm deep x 126 mm high
 Aperture: 61 x 21 mm, 52 x 25 mm and 52 mm diameter
 Weight: 650g

Model number	Ratio (A)	Burden (VA)			
		Class 0.5S	Class 0.5		
AS3-200/5A	200/5	5	5		
AS3-250/5A	250/5	5	5		
AS3-300/5A	300/5	5	5		
AS3-400/5A	400/5	5	5		
AS3-500/5A	500/5	5	5		
AS3-600/5A	600/5	5	10		
AS3-750/5A	750/5	5	10		
AS3-800/5A	800/5	5	10		
AS3-1000/5A	1000/5	5	10		



DIMENSIONS

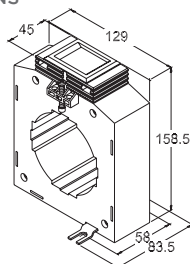

AS4 RANGE

Case size: 129 mm wide x 45 mm deep x 158.5 mm high
 Aperture: 86 x 11 mm, 82.5 x 32 mm and 82 mm diameter
 Weight: 1kg

Model number	Ratio (A)	Burden (VA)			
		Class 0.5S	Class 0.5		
AS4-750/5A	750/5	5	10		
AS4-800/5A	800/5	5	10		
AS4-1000/5A	1000/5	5	10		
AS4-1200/5A	1200/5	5	10		
AS4-1500/5A	1500/5	5	10		

AS Current Transformers



AS5 RANGE

Case size: 144 mm wide x 45 mm deep x 163.5 mm high
 Aperture: 101 x 22 mm, 81 x 45 mm and 85.5 mm diameter
 Weight: 1kg

DIMENSIONS

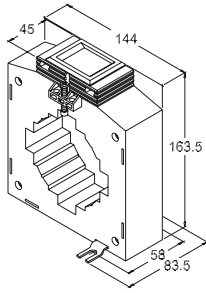

Model number	Ratio (A)	Burden (VA)			
		Class 0.5S	Class 0.5		
AS5-800/5A	800/5	5	10		
AS5-1000/5A	1000/5	5	10		
AS5-1200/5A	1200/5	7.5	10		
AS5-1500/5A	1500/5	7.5	10		
AS5-1600/5A	1600/5	7.5	10		
AS5-2000/5A	2000/5	10	15		
AS5-2500/5A	2500/5	10	15		
AS5-3000/5A	3000/5	10	15		



AS6 RANGE

Case size: 192 mm wide x 45 mm deep x 222.5 mm high
 Aperture: 130.5 x 11 mm, 126 x 58 mm and 126.5 mm diameter
 Weight: 1.2kg

DIMENSIONS

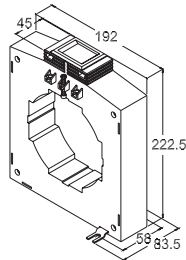

Model number	Ratio (A)	Burden (VA)			
		Class 0.5S	Class 0.5		
AS6-1500/5A	1500/5	7.5	10		
AS6-1600/5A	1600/5	7.5	10		
AS6-2000/5A	2000/5	10	15		
AS6-2500/5A	2500/5	10	15		
AS6-3000/5A	3000/5	10	15		
AS6-4000/5A	4000/5	15	20		
AS6-5000/5A	5000/5	15	20		

RS Current Transformers



BUSBAR MOUNTING RS125

Dimensions: 110 mm wide x 62 mm deep x 182 mm high
4.3" wide x 2.4" deep x 7.2" high

Hole: 126 x 36 mm
5" x 1.4"

Weight: 0.6kg

DIMENSIONS

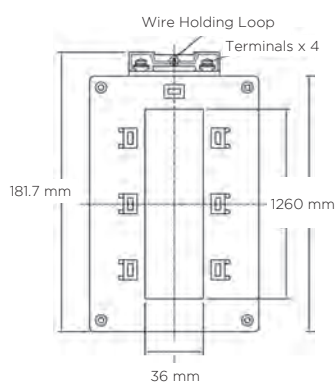

Ratio range	VA at Class 3	VA at Class 1	VA at Class 0.5	Cat no.	Delivery
800/5	-	25	15	RS125-800/5	C
1000/5	-	25	15	RS125-1000/5	C
1200/5	-	25	15	RS125-1200/5	A
1250/5	-	25	15	RS125-1250/5	A
1500/5	-	25	15	RS125-1500/5	A
1600/5	-	25	15	RS125-1600/5	A
2000/5	-	25	15	RS125-2000/5	A
2500/5	-	25	15	RS125-2500/5	A
3000/5	-	25	15	RS125-3000/5	A
3500/5	-	25	15	RS125-3500/5	A
4000/5	-	25	15	RS125-4000/5	A

TE Connectivity Ltd. is a \$13 billion global technology and manufacturing leader creating a safer, sustainable, productive, and connected future. For more than 75 years, our connectivity and sensor solutions, proven in the harshest environments, have enabled advancements in transportation, industrial applications, medical technology, energy, data communications, and the home. With 78,000 employees, including more than 7,000 engineers, working alongside customers in nearly 150 countries, TE ensures that EVERY CONNECTION COUNTS. - www.TE.com.

Generation

- Conventional Power
- Nuclear Power
- Wind/Solar
- Hydro-electric

Transmission & Distribution

- Substation
- Underground
- Overhead
- Street Lighting

Industry

- Mining
- Petrochemical
- Railway
- Shipbuilding

WHEREVER ELECTRICITY FLOWS, YOU'LL FIND TE ENERGY



crompton-instruments.com

FOR MORE INFORMATION:

TE Technical Support Centres

UK: +44 1376 509 401
USA: +1 800 327 6996
Australia: +61 1300 656 090
Singapore: +65 6590 5151
Hong Kong: +852 2790 9609

te.com/energy

© 2018 TE Connectivity Ltd. family of companies. All Rights Reserved. EPP-2044-03/18

TE Connectivity, the TE connectivity (logo) and Crompton Instruments are trademarks of the TE Connectivity Ltd. family of companies. Other logos, product and Company names mentioned herein may be trademarks of their respective owners. While TE has made every reasonable effort to ensure the accuracy of the information in this brochure, TE does not guarantee that it is error-free, nor does TE make any other representation, warranty or guarantee that the information is accurate, correct, reliable or current. TE reserves the right to make any adjustments to the information contained herein at any time without notice. TE expressly disclaims all implied warranties regarding the information contained herein, including, but not limited to, any implied warranties of merchantability or fitness for a particular purpose. The dimensions in this brochure are for reference purposes only and are subject to change without notice. Specifications are subject to change without notice. Consult TE for the latest dimensions and design specifications.