

Eaton power infrastructure solutions & products



Powering Business Worldwide

Energizing a world that demands more.

Discover today's Eaton.

Powering business worldwide

As a global power management company, we help customers worldwide manage the power needed for buildings, aircraft, trucks, cars, machinery and businesses.

Eaton's innovative technologies help customers manage electrical, hydraulic and mechanical power more reliably, efficiently, safely and sustainably.



Powering Business Worldwide



We deliver:

- **Electrical solutions** that use less energy, improve power reliability and make the places we live and work safer and more comfortable
- **Hydraulic and electrical solutions** that enable machines to deliver more productivity without wasting power
- **Aerospace solutions** that make aircraft lighter, safer and less costly to operate, and help airports operate more efficiently
- **Vehicle drivetrain and powertrain solutions** that deliver more power to cars, trucks and buses, while reducing fuel consumption and emissions

We provide integrated solutions that help make energy, in all its forms, more practical and accessible.

With 2012 sales of \$21.8 billion on a pro forma basis, Eaton has approximately 102,000 employees around the world and sells products in more than 175 countries.



Eaton's electrical business

Eaton is a global leader with expertise in:

- Power distribution and circuit protection
- Backup power protection
- Solutions for harsh and hazardous environments
- Lighting and security
- Structural solutions and wiring devices
- Control and automation
- Engineering services

Eaton is positioned through its global solutions to answer today's most critical electrical power management challenges. With 100 years of electrical experience behind us, we're energized by the challenge of powering up a world that demands twice as much energy as today. We're anticipating needs, engineering products and creating solutions to energize our markets today and in the future.

We are dedicated to ensuring that reliable, efficient and safe power is available when it's needed most.

Eaton.com

Intelligent Power Pod

Your Business Live 365



Build your own integrated power management system for your converged infrastructure solution

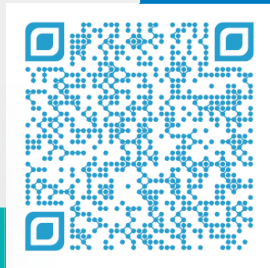

Eaton's Intelligent Power Pod is an integrated power management system for modern IT architectures including converged infrastructure solutions. It does not only reliably house and protect your IT application, but also ensures business continuity and data integrity through full integration with hypervisors and automation of the virtual servers' migration to the cloud or backup site in case of power outage. Your IT application is protected, managed and works non-stop. Your Business Live 365.

EATON

Powering Business Worldwide

www.eaton.eu/live365





10% more
power
18% less
heat

Introducing the new and improved Power Xpert 9395P

The new Power Xpert 9395P from Eaton offers more efficiency, resiliency, scalability and intelligence – providing more power with less heat.

The 96.3% double conversion efficiency of the 9395P reduces losses and energy consumption. When combined with Eaton's proven Variable Module Management and Energy Saver System technologies, you can achieve the highest performance for a lower Total Cost of Ownership.

With a full range of power ratings from 275-1100 kW, the 9395P is highly scalable up to a maximum of 7700 kW.

You can specify the number of power modules per UPS, choose the layout to suit your installation, specify your preferred bypass topology and add modules as the power load increases.

Based on the highly successful Power Xpert 9395, our technologies are proven across a huge range of installations. The power performance and reliability make the new 9395P ideal for mission critical applications from data centres to healthcare institutions, infrastructure projects to telecoms installations, banking and finance.

EATON

Powering Business Worldwide

Learn more at www.eaton.eu/9395P

Eaton's heritage in industry -leading UPS design and production

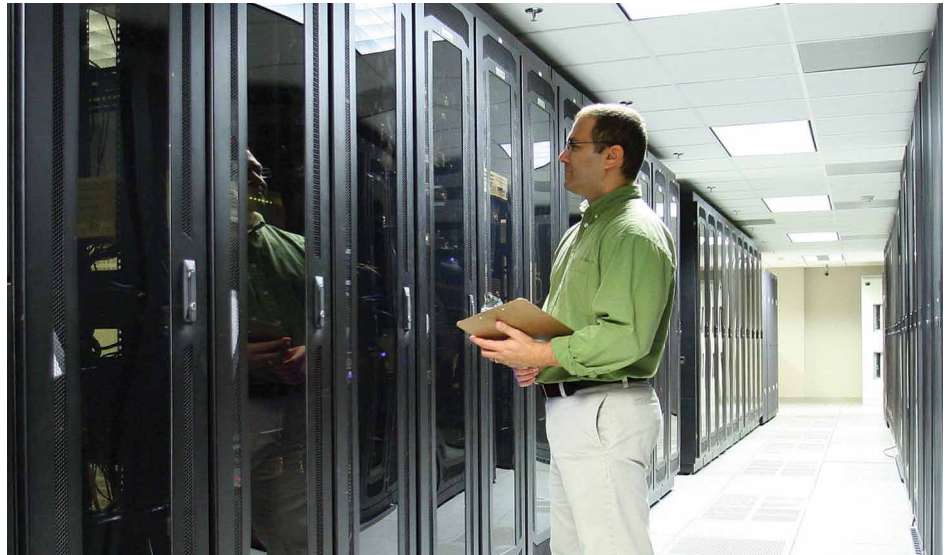

For more than 50 years, Eaton has been safeguarding the critical systems of businesses across the globe. Whether protecting a single desktop or a large data centre, Eaton solutions provide clean, uninterrupted power to keep mission-critical applications working. We offer a comprehensive range of environmentally sensitive, efficient, reliable UPSs, surge protective devices, power distribution units (PDUs), remote monitoring solutions, meters, software, connectivity solutions, enclosures, airflow management and professional services. We work with IT and facilities managers to effectively manage power in virtually every business segment, including data centres, retail outlets, healthcare organisations, governmental agencies, manufacturing firms, broadcasting companies, financial institutions, and a wide variety of other areas. Our solutions provide the power to make a difference, helping you achieve your business goals while maintaining an environmentally sustainable enterprise.

www.eaton.eu/powerquality

Contents

UPS Basics	
Why use UPS?	8
PC, Workstation and Home AV UPS	
Eaton Protection Box	10
Eaton Protection Station	12
Eaton 3S UPS	14
Eaton Ellipse ECO UPS	16
Eaton 5S UPS	18
Eaton Ellipse PRO UPS	20
Network and Server	
Eaton 5SC UPS	22
Eaton 5P UPS	24
Eaton 5PX UPS	26
Eaton 9130 UPS	28
Eaton EX UPS	30
Eaton 9SX UPS	32
Eaton 9PX UPS	34
Data Centre and Facility UPS	
Eaton BladeUPS	36
Eaton 9155 and 9355 UPS	38
Eaton 9355 UPS	40
Eaton 93E UPS	42
Eaton 93PM UPS	44
Power Xpert 9395P UPS	46
IT Racks and Power Distribution Units	
Eaton RP Series IT Rack	48
Eaton REC Series IT Rack	50
Eaton Aisle Containment System	52
Eaton RE Series IT Rack	54
Eaton STS 16	56
Eaton FlexPDU	58
Eaton HotSwap MBP	58
Managed ePDUs	60
Advanced Monitored ePDUs	60
Switched ePDUs	60
ePDU G3 Metered Input	61
ePDU G3 In-Line Metered	61
ePDU G3 Basic	61
Power Management Software & Connectivity	
Intelligent Power Software	62
Intelligent Power Manager	63
Intelligent Power Protector	64
Connectivity Options	65
Green Life Cycle	
Green by design	66
Technology	
Hot Sync Technology	68
ABM Technology	70
Energy Saver System	72
Variable Module Management System	74

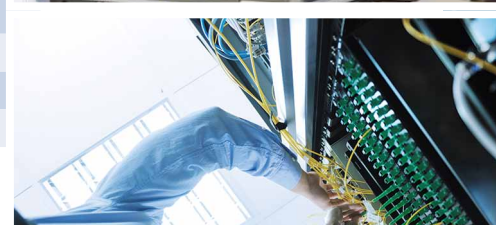
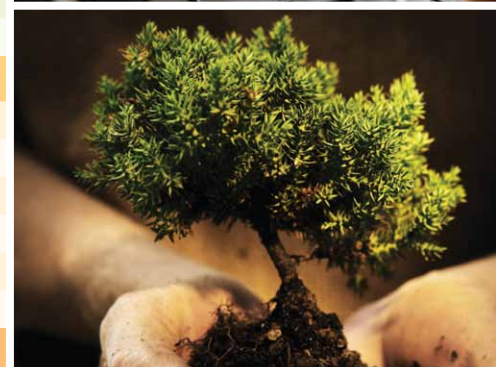

Why use UPS?

An uninterruptible power supply (UPS) protects IT equipment and other electrical loads from problems that can affect the public electricity supply. It performs the following three basic functions:

1. Prevents hardware damage typically caused by surges and spikes. Many UPS models continually condition incoming power as well.
2. Prevents data loss and corruption. Without a UPS, data stored on devices that are subjected to a hard system shutdown may become corrupted or even lost completely. In conjunction with power management software, a UPS can facilitate a graceful system shutdown.
3. Provides availability for networks and other applications while preventing downtime. UPSs can also be paired with generators in order to give the generators sufficient time to power up in the event of a power cut.

Eaton UPSs address all of the nine common power problems below:

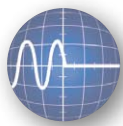

1. Power failure
typically caused by lightning strike or fault with the power company's equipment. Without a UPS, this will cause a hard shutdown, putting data at risk.

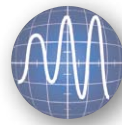

5. Overvoltage
Increased supply voltage lasting from minutes to days. Often triggered by rapid reductions in power demands, overvoltage can damage hardware.

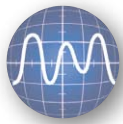

2. Power sag
Short-term voltage reduction, often caused by start-up of nearby large loads. Power sags can cause equipment crashes and hardware damage.

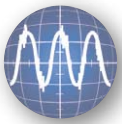

6. Electrical noise
"Interference," typically from radio transmitters, welding equipment etc. Noise can cause hard-to-find intermittent problems.

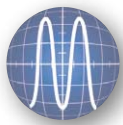

3. Power surge
Short-term high voltage, usually caused by lightning strike nearby. Spikes almost always lead to data loss and/or hardware damage.

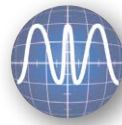

7. Frequency variation
Changes in supply frequency, usually only found on supplies from generators.



4. Undervoltage
Reduced supply voltage lasting from minutes to days. Typically occurs when supply network is overloaded. Can lead to computers behaving unpredictably.

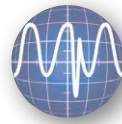

8. Switching transient
Instantaneous undervoltage, typically lasting a few nanoseconds.

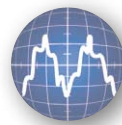

9. Harmonic distortion
Distortion of the normal smooth supply waveform. Can be caused by variable speed drivers and even photocopiers. Can cause communication errors, overheating and hardware damage.

UPS topologies for different needs

Three common UPS topologies described below provide varying degrees of protection for your equipment.

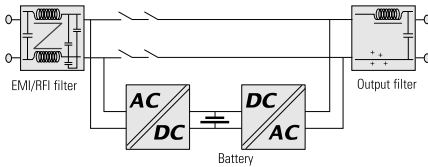

Passive standby topology (off-line) is the most frequently used UPS topology for protecting PCs against power failure, power sag and power surge. In normal mode, the UPS supplies power to the application directly from the mains, filtered but without active conversion. The battery is charged from the mains. In the event of a power cut or fluctuation, the UPS delivers stable power from the battery. The advantages of this topology are low cost and adequacy for office environments. Passive standby topology is not suitable if the power supply is of low quality (industrial sites) or subject to frequent disruptions.

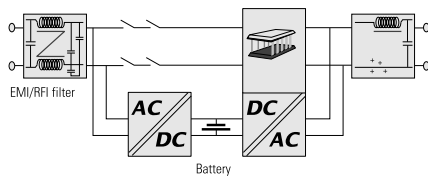

Line interactive topology is used for protecting enterprise networks and IT applications against power failure, power sag, power surge, undervoltage and overvoltage. In normal mode, the device is controlled by a microprocessor that monitors the quality of the supply and reacts to fluctuations. A voltage compensation circuit is enabled to boost or reduce the supply voltage to compensate for the fluctuations. The main advantage of this topology is that it enables compensation of under and overvoltage without using the batteries.

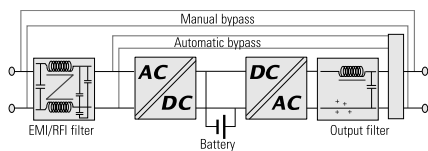

Double conversion topology (on-line) is a basis for UPSs designed for continuous power protection of critical equipment against all nine power problems: power failure, power sag, power surge, undervoltage, overvoltage, switching transient, line noise, frequency variation and harmonic distortion. It ensures a consistent quality of power supply regardless of disturbances in the incoming mains. The output voltage is entirely regenerated by a sequence of AC to DC conversion followed by DC to AC conversion in order to create power supply without any electrical interference. Double conversion UPSs can be used with any type of equipment as there are no transients when changing over to battery power.

Eaton Protection Box



Eaton Protection Box 8



Eaton Protection Box 5



Eaton Protection Box 1

Advanced protection for:

- Computers, peripherals and multimedia
- TV, Video and Hi-Fi equipment: Home cinema, DVD writers, digital decoders, etc.
- Broadband modems (Internet and TV)
- IP telephony
- Household goods, etc.



Surge protection

The Eaton Protection Box multi-way block with high performance surge protection is a simple solution for protecting delicate equipment.

Effective surge protection

The Protection Box is designed to filter the power supply for delicate equipment to protect it against surges, interference and the indirect effects of lightning.

The high performance of the Protection Box is based on an advanced design with surge protection in compliance with IEC 61643-1.

Complete protection

The Protection Box range has models with 1, 5 or 8 sockets. Some models also provide protection for telephone connections that can carry surges to the equipment.

- Tel@ models: with telephone/broadband Internet access protection
- Tel@ + TV models: with telephone/broadband Internet access protection + Audio/Video protection module (surge protection for television and FM radio with TV and F-Type connectors)

Practical and economical: replaceable surge protection module

(Protection Box 5 Tel@, 5 Tel@ + TV and 8 Tel@ + TV)

The surge protective components for these models are grouped into a pluggable module for:

- Easy replacement if the surge protective devices are destroyed by a major surge (no need to disconnect the equipment and the pluggable unit is an Eaton standard replacement part)
- Can be updated (adding functions, changing connectors, etc.)

Warranty for connected equipment

Eaton offers free warranty for the equipment connected (applicable for EU countries and Norway only). This insurance is included in the purchase price of the Protection Box and covers up to 50 000 € for an 8 socket model to cover damage caused by a failure of the surge protection.

And lots of features to simplify life

- Power ON and active protection indicators
- PowerLine Communications compatibility (Protection Box 5/8) for connecting PLC adapters
- Cable ties and cable markers supplied (5 and 8 socket models)
- Sockets arranged to allow blocks to be plugged side by side



Eaton Protection Box

- 1 Power ON indicator
- 2 Active protection indicator
- 3 Telephone / broadband protection
- 4 Replaceable surge protection module



Eaton Protection Box 8



Eaton Protection Box 5

- 5 Widely spaced sockets for transformer units, 1 PLC-ready outlet (for Protection Box 5 and 8)
- 6 All outlets with safety shutters



Audio/Video protection module available (for Protection Box 5 Tel@ + TV and 8 Tel@ + TV only)

TECHNICAL SPECIFICATIONS	1	1 Tel@	5	5 Tel@	5 Tel@+TV	8 Tel@+TV
Rating (A/W)*	16 A / 3 680 W	16 A / 3 680 W	10 A / 2 300 W	10 A / 2 300 W	10 A / 2 300 W	10 A / 2 300 W
Voltage/frequency	220 V – 250 V / 50/60 Hz					
IEC 61643-1 tested	Yes	Yes	Yes	Yes	Yes	Yes
PowerLine compatibility	/	/	Yes	Yes	Yes	Yes
Surge test conditions						
Surge test conditions for IEC 61643-1 with 8/20µs pulse	Uoc = 6.6 kV - Up = 1.5 kV - In = 2.5 kA - Imax = 8 kA					
Protective devices						
Total rating	30 000 A, 3 x MOV 10 000 A					
Response time	<1ns					
Total power absorbed	1110 Joules					
EMI/RFI filter						
52 dB from 100kHz to 100MHz	/	Yes	/	Yes	Yes	Yes
Telephone and audio/video line protection						
RJ11/RJ45 telephone including broadband	/	10 000 A	/	10 000 A	10 000 A	10 000 A
Audio/Video line	/	/	/	/	10 000 A	10 000 A
Marking and standards						
Safety	IEC 60-950, NFC 61-303					
EMC	EN 55082-2, EN 55022 class B, EN 61000-4-4 level 4 IEC 61000-4-5, level X=10kV					
Surge protection	IEC 61 643-1					
Dimensions and weight						
Dimensions H x W x D	67 x 70 x 105 mm	67 x 70 x 105 mm	65 x 120 x 255 mm	65 x 120 x 260 mm	65 x 120 x 260 mm	65 x 150 x 315 mm
Weight	0.160 kg	0.210 kg	0.610 kg	0.770 kg	0.840 kg	0.850 kg
Customer Service & Support						
2 years warranty	Standard product exchange ; warranty for connected equipment up to 50 000 €					
Replaceable surge protection module	Standard exchange free of charge from Eaton aftersales services					

*: Calculated for a nominal voltage at 230 V

Part Numbers	1	1 Tel@	5	5 Tel@	5 Tel@+TV	8 Tel@+TV
French sockets (FR)	66 706	66 707	66 710	66 711	66 934	66 935
“Schuko” sockets (DIN)	66 708	66 709	66 712	66 713	66 936	66 937
French sockets (FR-B) for Belgium	/	/	66 932	66 933	66 938	/



FR DIN

Eaton Protection Station

500/650/800 VA



Eaton Protection Station 800



Multi-position

Advanced protection for:

- Home computing
- Digital leisure equipment



Combined UPS/surge protection/ multiple socket device

Innovative solutions offering total protection for home computers and digital leisure devices.

Connect all your equipment and protect them against power failures and voltage fluctuations...

Eaton Protection Station can do this, offering in a single device:

- Up to 8 standard outlets
- A high performance surge suppressor
- A UPS with 20 to 30 minutes battery back-up for a typical PC

The first UPS in this class with energy saving features

Eaton Protection Station boasts an efficient electrical design with **EcoControl function** that **automatically disables peripherals** when the master device (Computer, HD TV, Home network storage, etc...) is turned off. This will help you **save up to 30% energy** compared to previous generation UPSs.

One model suitable for each application

3 versions (500 VA/250 W, 650 VA/400 W or 800 VA/500 W backup power), to protect an internet PC, a multimedia computer with peripherals or a hardcore gamer configuration. Thanks to its multi-position format Eaton Protection Station can fit anywhere.

Guarantees total peace of mind

- Surge suppressor compatible with IEC 61 643-1 standard (+ status indicator)
- USB port and power management software as standard (650 & 800 models)
- Data line protection to ensure that the internet line (including xDSL) is protected against surges
- Unlimited warranty for the connected computer equipment (EU countries and Norway)
- Periodic test and battery replacement indicator



Eaton Protection Station



- 1 Surge protection status indicator
- 2 Line protection for telephone/Internet ADSL
- 3 Spaced outlets, compatible with local standards
- 4a Outlets with surge protection
- 4b Outlets with surge protection and back-up power
- 4c 2 EcoControl outlets (650 & 800)

- 4d 1 PLC-ready outlet
- 5 Replaceable battery
- 6 Reset button (circuit breaker)
- 7 USB port (650 & 800) with Windows/Linux/Mac software
- 8 Indicator for mains/battery operation, overload, fault + audible alarms

Eaton Protection Station 650 & 800

TECHNICAL SPECIFICATIONS	500	650	800
Technology	High frequency UPS with surge protection		
Application			
Outlets	6 standard outlets (3 with back-up power and surge protection + 3 with surge protection)	8 standard outlets (4 with back-up power and surge protection + 4 with surge protection)	
Performance			
Output power capacity (backup outlets)	500 VA - 250 W	650 VA - 400 W	800 VA - 500 W
Output power capacity (all outlets)	5 A - 1150 VA	10 A - 2300 VA	10 A - 2300 VA
Input voltage range	184 V - 264 V	Up to 160 V - 284 V (adjustable)	Up to 160 V - 284 V (adjustable)
Output voltage and frequency	230 V - 50 / 60 Hz auto-selection		
Protection	Resettable circuit breaker		
Batteries			
Battery type	Replaceable sealed lead-acid batteries		
Battery monitoring	Automatic battery test, battery replacement indicator, protection against deep discharges (4-hour limit)		
Battery operation	Cold-start capable (mobile power source), battery charging even in OFF position		
Typical application	1 internet computer	1 multimedia computer + peripherals	1 computer high graphics power
Backup time with typical application	20 min	30 min	30 min
Features			
User interface	Operation with mains/battery power, surge suppressor status, overload, battery replacement, fault, audible alarms		
EcoControl	/	Save up to 30% energy* (efficient electrical design and automatic deactivation of idle peripherals)	
Surge protection	Complete common and differential mode protection - 3 MOV – Total power: 525 Joules, compatible with IEC 61643-1 standard		
Performance on 8/20 wave	Uoc = 6 kV Up = 1.5 kV In = 2.5 kA I max = 8 kA	Uoc = 6 kV Up = 1.7 kV In = 2.8 kA I max = 8 kA	Uoc = 6 kV Up = 1.7 kV In = 2.8 kA I max = 8 kA
PowerLine compatibility	/	1 PLC-ready outlet	1 PLC-ready outlet
Data line protection	Protection for telephone/fax/modem/Internet ADSL line + Ethernet network		
Installation	Requires earth connection		
Standards			
Standards	IEC 62040-1, IEC 62040-2, IEC 61643-1		
Quality and environment	ISO 9001, ISO 14001		
Dimensions and weight			
Dimensions W x H x D	155 x 304 x 137 mm	185 x 327 x 149 mm	185 x 327 x 149 mm
Weight	2.9 kg	3.8 kg	4 kg
Power Management			
Com port	/	USB port	USB port
Software	/	Eaton UPS Companion software on CD, compatible with Windows 7/Windows Vista/XP/Mac/Linux (power management, Automatic system shutdown, Alarm notification, Events log)	
Customer service & support			
2 years guarantee	Standard product exchange, including the battery ; warranty for the connected computing equipment for an unlimited amount (EU countries)		
Warranty+	Optional 3 years warranty (depending on the country please visit www.eaton.eu/powerquality)		

*compared to UPS from the previous generations

Part Numbers	500	650	800
FR outlets	66 942	61 061	61 081
DIN outlets	66 943	61 062	61 082



FR DIN



An Eaton Green Solution

Eaton 3S UPS

550 – 700 VA



Ideal for protecting:

- Computers and peripherals
- Broadband modems (internet and TV)
- IP telephony equipment
- POS equipment

Power protection for office and home computer equipment

Protection against power problems

- The Eaton 3S UPS helps to protect your computer equipment in case of everyday events such as lightning strikes, storms, over-demand on the utility grid, accidents, and natural disasters knocking out power without warning.
- In the event of a total blackout, the unit provides sufficient battery backup time to last through most power outages.
- The 3S also protects telephone, broadband and Ethernet line from “back door” power surges.
- The shutdown software makes it possible to automatically save your work and shut down your application without losing any data. Once the power is restored, you can continue working exactly where you left off.

Easy integration and installation

- Attractive design and glossy finish make the 3S a perfect fit for the modern office environment.
- The 3S comes with either 6 Schuko (DIN) or 6 French (FR) outlets for easy connection of typical computer configurations with peripherals (IEC model also available with 8 outlets).
- The 3S features a HID-compliant USB port (cable supplied), for automatic integration with common operating systems (Windows/Mac OS/Linux).
- Compact unit fits on or under your desk or can be mounted on a wall.
- Easy-to-replace battery helps to extend UPS service life.



Eaton 3S UPS

- 1 3 Schuko or FR outlets with surge protection
- 2 3 Schuko or FR outlets with battery backup and surge protection
- 3 On / Off button + LED interface
- 4 USB port
- 5 Dataline protection
- 6 Replaceable battery
- 7 Reset button (circuit breaker)
- 8 Wall-mounting system



Eaton 3S 700 DIN



Eaton 3S 700 IEC

- 1 4 IEC outlets with surge protection
- 2 4 IEC outlets with battery backup and surge protection
- 3 On / Off button + LED interface
- 4 USB port
- 5 Dataline protection
- 6 Replaceable battery
- 7 Reset button (circuit breaker)
- 8 Wall-mounting system

TECHNICAL SPECIFICATIONS

	Eaton 3S 550	Eaton 3S 700
Rating (VA/W)	550 VA / 330 W	700 VA / 420 W
Application		
Output connection (FR/DIN models)	3 outlets with battery backup and surge protection + 3 outlets with surge protection	
Output connection (IEC models)	4 outlets with battery backup and surge protection + 4 outlets with surge protection	
Characteristics		
Input voltage	Up to 161-284 V (adjustable)	
Output voltage	230 V (settable to 220 V, 230 V or 240 V)	
Frequency	50-60 Hz autoselect	
Input protection	Resettable circuit breaker	
Battery		
Battery type	Compact, sealed lead-acid (replaceable)	
Battery test	Yes	Yes
Cold start (no mains power)	Yes	Yes
Deep-discharge protection	Yes	Yes
Battery replacement indicators	LED	LED
50% load backup	10 min	9 min
70% load backup	6 min	6 min
Communication		
Communications port	HID-compliant USB port for automatic integration with most common operating systems (Windows XP, Vista and 7, Linux, Mac OS X), cable supplied	
Line protection	Tel/fax/modem/internet/Ethernet	
Standards compliance		
Safety	IEC/EN 62040-1, CE mark	
EMC	IEC 62040-2	
Dimensions, weight and colour		
Dimensions H x W x D	86 x 140 x 335 mm	86 x 170 x 335 mm
Weight	2.9 kg	3.8 kg
Colour	Black	Black
Customer service & support		
2-year warranty	Standard product exchange, including battery	
Warranty+	Optional 3-year warranty (depending on the country please visit www.eaton.eu/powerquality)	

Part numbers

	550	700
French sockets (FR)	3S550FR	3S700FR
Schuko sockets (DIN)	3S550DIN	3S700DIN
IEC sockets	3S550IEC	3S700IEC



FR DIN IEC

Eaton Ellipse ECO

500/650/800/1200/1600 VA



Eaton Ellipse ECO range



Eaton Ellipse ECO easy integration



Energy-efficient power protection for business computers

- With an efficient electrical design and the EcoControl function (USB models), which automatically disables peripherals when the master device is turned off, the Eaton Ellipse ECO helps you make energy savings of up to 25% compared to previous-generation UPSs.
- As well as providing a power supply backed up by a battery to keep equipment operating during a power failure, the Ellipse ECO also provides effective protection against damaging surges.
- The Ellipse ECO includes a high performance surge-protection device that complies with IEC 61643-1; this device also protects data connections such as Ethernet, internet and telephone lines.

Easy integration and installation

- The Ellipse ECO comes with either four (500/650/800 models) or eight outlets (1200/1600 models) with Schuko (DIN) or French (FR) format for easy connection to typical computer configurations with peripherals. IEC models are also available.
- The Ellipse ECO's extra-flat design makes it easy to install in any office environment: installation options include vertical box format, below the desk, horizontally under a monitor, 19" rack-mounted (optional 2U kit) and wall-mounted (optional kit).
- The USB models are designed to be compatible with a wide variety of different computer models. Eaton power management software is delivered as standard (CD and USB cable supplied) and is compatible with all major operating systems (Windows 7, Vista, XP, Linux and Mac OS).

Complete peace of mind

- Unlimited warranty for the connected computer equipment (EU countries and Norway)
- Periodic battery self-test ensures early detection of a battery that needs to be replaced.
- Easy-to-replace battery helps to extend UPS service life.
- Push-button circuit breaker enables easy recovery from an overload or short circuit.



Eaton Ellipse ECO

- 1 4 outlets with surge protection and backup
- 2 4 outlets with surge protection
- 2a 2 EcoControl outlets (1200 & 1600)
- 3 Tel/Internet and Ethernet protection
- 4 USB port
- 5 Replaceable batteries
- 6 Circuit breaker reset button



Eaton Ellipse ECO 1200/1600



Eaton Ellipse ECO 500/650/800

- 1 3 outlets with surge protection and backup, 1 socket with surge protection only
- 1a 1 EcoControl outlet (USB models)
- 2 Tel/Internet and Ethernet protection
- 3 USB port (USB models)
- 4 Replaceable batteries
- 5 Circuit breaker reset button

TECHNICAL SPECIFICATIONS	500	650	650 USB	800 USB	1200 USB	1600 USB
Rating (VA/W)	500 VA / 300 W	650 VA / 400 W	650 VA / 400 W	800 VA / 500 W	1200 VA / 750 W	1600 VA / 1000 W
Application						
Number of outlets	4	4	4	4	8	8
Outlets with surge protection and backup / Outlets with surge protection	3/1	3/1	3/1	3/1	4/4	4/4
Characteristics						
Nominal input voltage	230 V					
Input voltage	184 V - 264 V (adjustable to 161 V - 284 V)					
Output voltage	230 V (adjustable to 220 V, 230 V, 240 V)					
Frequency	50-60 Hz autoselect					
Input protection	Resettable circuit breaker					
Features						
Energy efficient design	Yes	Yes	Yes	Yes	Yes	Yes
EcoControl function	-	-	Yes up to 20% energy saving* (automatic deactivation of idle peripherals)		Yes up to 25% energy saving*	
Surge protection	Surge protection device compliant with IEC 61643-1					
PowerLine compatibility	-	-	1 PLC-ready outlet	1 PLC-ready outlet	1 PLC-ready outlet	1 PLC-ready outlet
Battery						
Battery type	Replaceable sealed lead acid					
Automatic battery test	Yes	Yes	Yes	Yes	Yes	Yes
Cold start (start without mains)	Yes	Yes	Yes	Yes	Yes	Yes
Deep discharge protection	4 hours	4 hours	4 hours	4 hours	4 hours	4 hours
Battery replacement indicators	LED + audible alarm					
Battery runtime at 50% load	9 min	9 min	9 min	11 min	10 min	11 min
Battery runtime at 70% load	5 min	6 min	6 min	6 min	6 min	6 min
Communication						
Communication port	-	-	USB port (cable supplied)	USB port (cable supplied)	USB port (cable supplied)	USB port (cable supplied)
Software	-	-	Eaton Intelligent Power software delivered as standard (compatible with: Windows 7/Vista/XP, Mac OS X, Linux)			
Line protection	Tel/Fax/Modem/Internet and Ethernet					
Standards						
Safety / EMC	IEC 62040-1, IEC 60950-1, IEC 62040-2, CB Report, CE mark					
Surge protection	IEC 61643-1					
Dimensions and weight						
Dimensions H x W x D	263 x 81 x 235 mm	263 x 81 x 235 mm	263 x 81 x 235 mm	263 x 81 x 235 mm	305 x 81 x 312 mm	305 x 81 x 312 mm
Weight	2.9 kg	3.6 kg	3.6 kg	4.1 kg	6.7 kg	7.8 kg
Customer Service & Support						
2 years warranty	Standard product exchange, including the battery; warranty for the connected computing equipment for an unlimited amount (EU countries)					
Warranty+	Optional 3-years warranty (depending on the country please visit www.eaton.eu/powerquality)					

* compared to previous generation UPS.

Part Numbers	500	650	650 USB	800 USB	1200 USB	1600 USB
French outlets (FR)	EL500FR	EL650FR	EL650USBFR	EL800USBFR	EL1200USBFR	EL1600USBFR
Schuko outlets (DIN)	EL500DIN	EL650DIN	EL650USBIN	EL800USBIN	EL1200USBIN	EL1600USBIN
IEC outlets	EL500IEC	EL650IEC	EL650USBIEC	EL800USBIEC	EL1200USBIEC	EL1600USBIEC
Accessories						
19" rack mounting kit (2U)	ELRACK	ELRACK	ELRACK	ELRACK	ELRACK	ELRACK
Wall mounting kit	ELWALL	ELWALL	ELWALL	ELWALL	ELWALL	ELWALL



FR DIN IEC

Eaton 5S UPS

550/700/1000/1500 VA



Eaton 5S UPS product range



Eaton 5S versatility

Ideal for protecting:

- Workstations
- Business Telephony
- Network devices
- Point-of-sale equipment



Affordable power protection for workstations

Performance

- The Eaton 5S UPS provides effective power protection, even in disturbed electrical environments. Voltage fluctuations are automatically corrected using an AVR device (booster/fader), without needing the batteries.
- The 5S not only provides a supply with battery backup to keep equipment operating during power cuts, but also provides effective protection against damaging surges.

Reliability

- The 5S protects networked equipment from “back door” power surges coming through Ethernet, internet or telephone lines.
- The 5S’s periodic automatic battery testing ensures early detection if a battery needs to be replaced.
- The easy-to-replace battery helps to extend the UPS service life.

Versatility

- The 5S can be installed vertically over or under a desk, or horizontally under a screen. Its compact, slimline form factor even allows it to be easily integrated into environments with space constraints.
- The 5S features an HID-compliant USB port, for automatic integration with common operating systems (Windows/ Mac OS/Linux). The 5S is also compatible with Eaton UPS Companion power management software.
- All models come bundled with a USB cable and two IEC-IEC load cables.

Eaton 5S UPS

- 1 LED user interface
- 2 Battery replacement panel
- 3 USB port



- 4 Data line protection
- 5 4 IEC 10 A and 4 surge only IEC 10 A
- 6 Circuit breaker reset button

Eaton 5S 1000i UPS

TECHNICAL SPECIFICATIONS	550	700	1000	1500
Rating (VA/W)	550 VA / 330 W	700 VA / 420 W	1000 VA / 600 W	1500 VA / 900 W
Electrical Characteristics				
Technology	Line-Interactive (AVR with Booster + Fader)			
Input voltage range	175 V-275 V			
Output voltage	230 V			
Frequency	50-60 Hz autoselect			
Connections				
Number of IEC outlets	4	6	8	8
Outlets with surge protection and backup / Outlets with surge protection	3/1	3/3	4/4	4/4
Batteries				
Typical backup times at 50 and 70% load*	10/6 mn	9/5 mn	14/8 mn	11/8 mn
Battery management	Automatic battery test, deep-discharge protection, cold-start capable, replaceable batteries			
Communication				
Communication Port	HID-compliant USB port for automatic integration with most common operating systems (Windows Vista, 7 & 8, Linux, Mac OS X), cable supplied			
Data line protection	Tel/Fax/Modem/Internet and Ethernet			
Standards				
Safety & EMC	IEC/EN 62040-1, IEC/EN 62040 -2, CB Report, CE mark			
Dimensions & Weight				
Dimensions H x W x D	250 x 87 x 260 mm	250 x 87 x 260 mm	250 x 87 x 382 mm	250 x 87 x 382 mm
Weight	4.96 kg	5.98 kg	9.48 kg	11.08 kg
Customer Service & Support				
Warranty	2 years warranty including batteries			

* Backup times are approximate and may vary with equipment, configuration, battery age, temperature, etc.

Part Numbers	550	700	1000	1500
5S	5S550i	5S700i	5S1000i	5S1500i

Eaton Ellipse PRO UPS

650/850/1200/1600 VA



Ellipse Pro range



LCD screen

Advanced protection for:

- Workstations
- Network devices
- Peripherals



Energy-saving power protection for workstations

- The LCD screen on the Eaton Ellipse PRO UPS provides clear information on its status and measurements. It also allows easy configuration of UPS settings.
- The EcoControl function, which automatically disables peripherals when the master device is turned off, can cut energy consumption by as much as 20%.
- Automatic Voltage Regulation (AVR) instantly corrects voltage fluctuations, meaning you can continue working through brownouts and overvoltages without using the batteries.
- The Ellipse PRO includes a high performance surge-protection device that complies with IEC 61643-1. This device also protects data connections such as Ethernet, internet and telephone lines.

Easy integration and installation

- The Ellipse PRO comes with either four (650/850 models) or eight (1200/1600 models) Schuko (DIN) or French (FR) sockets for easy connection to most common computer configurations with peripherals. IEC models are also available.
- The Ellipse PRO's extra-flat design makes it easy to install in any office environment: installation options include vertical box format, below the desk, horizontally under a monitor, 19" rack-mounted (optional 2U kit) and wall-mounted (optional kit).
- The Ellipse PRO is equipped with a USB port and comes complete with a USB cable and Eaton UPS Companion software that enables safe system shutdown, energy usage metering and easy configuration of UPS settings.

Complete peace of mind

- Three-year warranty including batteries.
- Unlimited warranty for connected computer equipment (EU countries and Norway only).
- Battery tests itself automatically at regular intervals, ensuring early detection when it's time for replacement.
- Easy-to-replace battery helps to extend UPS service life.

Eaton Ellipse PRO UPS

- 1 3 sockets with surge protection and backup, one socket with surge protection only
- 2 1 EcoControl socket
- 3 Telephone, internet and Ethernet protection
- 4 USB port
- 5 Replaceable batteries
- 6 Circuit breaker reset button



Eaton Ellipse PRO 650



Eaton Ellipse PRO 1600

- 1 4 sockets with surge protection and backup
- 2 4 sockets with surge protection
- 3 2 EcoControl sockets (1200/1600 models)
- 4 Telephone, internet and Ethernet protection
- 5 USB port
- 6 Replaceable batteries
- 7 Circuit breaker reset button

TECHNICAL SPECIFICATIONS	650	850	1200	1600
Rating (kVA/kW)	650 VA / 400 W	850 VA / 510 W	1200 VA / 750 W	1600 VA / 1000 W
Electrical characteristics				
Technology	Line-interactive (AVR with booster + fader)			
Input voltage range	165 V - 285 V (adjustable to 150 V - 285 V)			
Output voltage	230 V (adjustable to 220 V - 230 V - 240 V)			
Frequency	50-60 Hz autoselect			
Connections				
Number of sockets	4	4	8	8
Sockets with surge protection and backup / Sockets with surge protection	3 / 1	3 / 1	4 / 4	4 / 4
Features				
User interface	LCD (UPS status and measurements, configuration of UPS settings)			
EcoControl (automatic deactivation of idle peripherals)	Yes, up to 15% energy saving	Yes, up to 15% energy saving	Yes, up to 20% energy saving	Yes, up to 20% energy saving
Surge protection	Surge protection device compliant with IEC 61643-1			
Batteries				
Typical backup times at 50 and 70% load*	9 / 5 mn	9 / 5 mn	9 / 5 mn	9 / 5 mn
Battery management	Automatic battery test, deep-discharge protection, cold-start capable, replaceable batteries			
Communication				
Communication port	USB port (cable supplied)	USB port (cable supplied)	USB port (cable supplied)	USB port (cable supplied)
Software	Eaton UPS Companion CD ROM (enables safe system shutdown, energy usage metering and configuration of UPS settings)			
Data line protection	Tel/fax/modem/internet and Ethernet			
Standards				
Safety and EMC	IEC/EN 62040-1, IEC/EN 62040 -2, CB report, CE mark			
Surge protection	IEC 61643-1			
Dimensions H x W x D and weight				
Dimensions H x W x D	260 x 82 x 285 mm	260 x 82 x 285 mm	275 x 82 x 390 mm	275 x 82 x 390 mm
Weight	6.6 kg	7.3 kg	9.9 kg	11.3 kg
Customer service and support				
Warranty	3 years warranty including batteries. Unlimited warranty for connected computer equipment (EU countries and Norway only).			

* Backup times are approximate and may vary with equipment, configuration, battery age, temperature, etc.

Parts Numbers	650	850	1200	1600
French sockets (FR)	ELP650FR	ELP850FR	ELP1200FR	ELP1600FR
Schuko sockets (DIN)	ELP650DIN	ELP850DIN	ELP1200DIN	ELP1600DIN
IEC outlets	ELP650IEC	ELP850IEC	ELP1200IEC	ELP1600IEC
Accessories				
19" rack-mounting kit (2U)	ELRACK	ELRACK	ELRACK	ELRACK
Wall-mounting kit	ELWALL	ELWALL	ELWALL	ELWALL

Eaton 5SC UPS

500/750/1000/1500 VA



5SC Range



LCD interface

Ideal for protecting:

- Tower Servers
- NAS, Network equipment
- ATMs, Ticket machines, Kiosks



Affordable and reliable protection for small business servers

Easily manageable UPS

- The new LCD interface provides clear status of the UPS key parameters such as input and output voltage, load and battery level, and estimated runtime. Configuration capabilities are also offered for output voltage, audible alarm and sensitivity.
- The 5SC offers USB and serial connectivity. USB port is HID compliant for automatic integration into Windows, Mac OS and Linux.
- Eaton Intelligent Power Protector® (IPP) software delivered as standard, can be used as point to point power management (USB/Serial) or Network based using IPP as a proxy.

Reliable power protection

- Pure sinewave output: When operating in battery mode the 5SC provides a high quality output signal for any sensitive equipment connected, such as active PFC (power factor corrected) servers.
- Buck and Boost operation corrects a wide range of input voltage variations through continuous regulation, without the use of batteries, and ensures consistent input voltage to the loads protected.
- Stronger, longer battery life: Eaton ABM® battery management technology uses an innovative three-stage charging system that extends battery life by up to 50%.

Flexible integration

- Small size for easy integration even with space constraints (kiosks, cash machines, ticket machines etc.) and up to eight outlets for better flexibility!
- Adjustable input waveform sensitivity to adapt the UPS to specific environment (like Genset).
- Easy battery replacement from front panel to extend UPS life.

Eaton 5SC UPS

- 1 LCD Interface :
Clear information on
UPS status and measurements



- 2 Panel for batteries replacement
3 1 USB port + 1 serial port
4 8 IEC 10 A sockets

Eaton 5SC 1500i

TECHNICAL SPECIFICATIONS	500	750	1000	1500
Rating (VA/W)	500 VA / 350 W	750 VA / 525 W	1000 VA / 700 W	1500 VA / 1050 W
Format	Tower	Tower	Tower	Tower
Electrical Characteristics				
Technology	Line-Interactive High Frequency (Sinewave, Booster + Fader)			
Input voltage and frequency ranges without using batteries	184 V–276 V, 45–55 Hz (50 Hz system), 55–65 Hz (60 Hz system)			
Output voltage and frequency	230 V (+6/–10%) (Adjustable to 220 V/230 V/240 V), 50/60 Hz +/-0.1% (autosensing)			
Connections				
Input	1 IEC C14 (10 A)			
Outputs	4 IEC C13 (10 A)	6 IEC C13 (10 A)	8 IEC C13 (10 A)	8 IEC C13 (10 A)
Batteries				
Typical backup times at 50 and 70% load*	13/9	13/9	13/9	13/9
Battery management	ABM®, Automatic battery test, deep discharge protection			
Communication				
Communication ports	1 USB port + 1 RS232 serial port (USB and RS232 ports cannot be used simultaneously)			
Operating conditions, Standards and Approvals				
Operating temperature	0–35°C	0–35°C	0–35°C	0–35°C
Noise level	<40 dB	<40 dB	<40 dB	<40 dB
Safety	IEC/EN 62040-1, UL 1778			
EMC, Performance	IEC/EN 62040-2			
Approvals	CE, CB report (TUV)			
Dimensions H x W x D / Weight				
Dimensions	210 x 150 x 240 mm	210 x 150 x 340 mm	210 x 150 x 340 mm	210 x 150 x 410 mm
Weight	6.6 kg	10.4 kg	11.1 kg	15.2 kg
Customer Service & Support				
Warranty	2 years			

* Runtimes are shown at 0.7 power factor. Backup times are approximate and may vary with equipment, configuration, battery age, temperature, etc.

Part Numbers	500	750	1000	1500
5SC	5SC500i	5SC750i	5SC1000i	5SC1500i

Eaton 5P UPS

650/850/1150/1550 VA



Available in tower and rack 1U format



Intuitive LCD

Ideal for protecting:

- Servers
- Networking
- Storage devices



Eaton 5P is an energy efficient line-interactive UPS with advanced LCD and energy metering features.

Manageability

- The new graphical LCD display provides clear information on the UPS's status and measurements on a single screen (in seven languages). Enhanced configuration capabilities are also available with easy-to-use navigation keys.
- The 5P can meter energy consumption providing kWh values through the LCD and Eaton's power management software.
- Load segment control enables prioritised shutdowns of non-essential equipment during outages in order to maximise battery runtime for critical devices. Load segment control can also be used to remotely reboot locked-up network equipment or to manage scheduled shutdowns and sequential start-ups.
- The 5P offers Serial and USB connectivity, plus an extra slot for an optional communication card (including SNMP/Web card or relay contact card). Eaton's Intelligent Power® Software Suite compatible with all major OS including virtualisation software such as VMware and Hyper-V is included with each UPS.

Performance and efficiency

- Energy efficient UPS: With an optimised electrical design, the 5P provides up to 98% efficiency, reducing cooling and utility costs.
- Pure sinewave output: When operating in battery mode the 5P provides a high quality output signal for any sensitive equipment connected, such as active PFC (power factor corrected) servers.
- Adjustable tolerance and sensitivity: Users can maximise useful battery life by widening the input voltage window or adjustable input waveform sensitivity (via the LCD or software) to adapt the UPS to a specific environment (like Genset).

Availability and Flexibility

- The 5P is available in tower or Rack 1U format, providing unmatched energy density with up to 1.1 kW in only 1U.
- Stronger, longer battery life: Eaton ABM® battery management technology uses an innovative three-stage charging technique that extends batteries by up to 50%.
- Batteries can be hot-swapped without ever having to shut down connected equipment. With an optional, hot-swap maintenance bypass module, you can even replace the entire UPS.

Eaton 5P UPS

- 1 Graphical LCD:
 - Clear information on UPS status and measurements
 - Energy metering
 - Enhanced configuration capabilities
 - Available in seven languages
- 2 Panel for batteries replacement (Hot-swappable)



- 3 One USB port + one serial port + remote ON/OFF and remote power OFF connector
- 4 8 IEC 10 A sockets (including two groups of controlled sockets)
- 5 Communication card slot

Eaton 5P 1550i UPS

TECHNICAL SPECIFICATIONS	650	850	1150	1550
Rating (VA/W)	650 VA/420 W	850 VA/600 W	1150 VA/770 W	1550 VA/1100 W
Technology	Tower or Rack 1U	Tower or Rack 1U	Tower or Rack 1U	Tower or Rack 1U
Electrical Characteristics				
Technology	Line-Interactive High Frequency (Pure Sinewave, Booster + Fader)			
Input voltage and frequency ranges without using batteries	160 V-294 V (adjustable to 150 V-294 V) 47 to 70 Hz (50 Hz system), 56.5 to 70 Hz (60 Hz system), 40 Hz in low-sensitivity mode			
Output voltage and frequency	230 V Adjustable to 200V / 208V / 220V / 230V / 240V, 50/60 Hz +/- 0.1 % (autosensing)			
Connections				
Input	1 IEC C14 (10 A)			
Outputs Tower model	4 IEC C13 (10 A)	6 IEC C13 (10 A)	8 IEC C13 (10 A)	8 IEC C13 (10 A)
Outputs Rack 1U model	4 IEC C13 (10 A)	4 IEC C13 (10 A)	6 IEC C13 (10 A)	6 IEC C13 (10 A)
Switched Outlet Group	2 outlet groups			
Battery				
Typical backup times at 50 and 70% load*	9/6 mn	12/7 mn	12/7 mn	13/8 mn
Battery management	ABM® & Temperature compensated charging method (user selectable), Automatic battery test, deep discharge protection			
Communication				
Communication Ports	1 USB port + 1 RS232 serial port and relay contacts (USB and RS232 ports cannot be used simultaneously), 1 mini terminal block for remote ON/OFF and Remote Power Off			
Communication Slot	1 slot for Network-MS card , ModBus-MS or Relay-MS cards			
Operating conditions, standards and approvals				
Operating temperature	0 to 35°C	0 to 35°C	0 to 35°C	0 to 40°C
Noise level	<40 dB	<40 dB	<40 dB	<40 dB
Safety	IEC/EN 62040-1, UL 1778			
EMC, Performance	IEC/EN 62040 -2 , IEC/EN 62040-3 (Performance)			
Approvals	CE, CB report (TUV)			
Dimensions H x W x D / Weight				
Tower models	230*150*345 mm/7.8 kg	230*150*345 mm/10.4 kg	230*150*345 mm/11.1 kg	230*150*445 mm/15.6 kg
Rack 1U models	43.2(1U)*438*364 mm/8.6 kg	43.2(1U)*438*509 mm/13.8 kg	43.2(1U)*438*509 mm/14.6 kg	43.2(1U)*438*554 mm/19.4 kg
Customer Service & Support				
Warranty	3 years on electronics, 2 years on batteries			

* Runtimes are shown at 0.7 power factor. Backup times are approximate and may vary with equipment, configuration, battery age, temperature, etc.

Part Numbers	650	850	1150	1550
Tower	5P650i	5P850i	5P1150i	5P1550i
Rack 1U	5P650iR	5P850iR	5P1150iR	5P1550iR



Eaton 5PX UPS

1500/2200/3000 VA



Rack/Tower versatile



Intuitive LCD display for ease of configuration and management

Advanced protection for:

- Servers
- Switches
- Routers
- Storage devices



Exceptional efficiency, manageability and energy metering capabilities for IT managers

Manageability

- The new graphical LCD display provides clear information on the UPS's status and measurements on a single screen (in seven languages). Enhanced configuration capabilities are also available with easy-to-use navigation keys.
- For the first time in the industry the 5PX can meter energy consumption right down to the managed outlet groups. kWh values can be monitored using the LCD or Eaton's Intelligent Power® Software Suite.
- Load segment control enables prioritised shutdowns of nonessential equipment to maximise battery runtime for critical devices. Load segment control can also be used to remotely reboot locked-up network equipment or to manage scheduled shutdowns and sequential start-ups.
- The 5PX offers Serial and USB connectivity, plus an extra slot for an optional communication card (including SNMP/Web card or relay contact card). Eaton's Intelligent Power® Software Suite compatible with all major OS including virtualization software such as VMware and Hyper-V is included with each UPS.

Performance and Efficiency

- With an optimised electrical design, the 5PX can provide up to 99% efficiency, reducing cooling and utility costs.
- With a power factor of 0.9, the 5PX delivers more real output power. It powers more servers than other UPSs with equivalent VA ratings and lower power factors. The 5PX is compatible with all modern IT equipment.
- When operating in battery mode the 5PX provides a high quality output signal for any sensitive equipment connected, such as active PFC (power factor corrected) servers.

Availability and Flexibility

- The 5PX is available in a rack/tower convertible version—pedestal and rail kits are included with all models at no extra charge.
- Stronger, longer battery life: Eaton ABM® battery management technology uses an innovative three-stage charging technique that only recharges the battery when necessary, so the battery experiences less corrosion and service life is prolonged by up to 50%.
- Batteries can be hot-swapped without ever having to shut down connected equipment. With an optional, hot-swap maintenance bypass module, you can even replace the entire UPS.
- There is also the possibility to add more runtime with up to four external hot-swappable battery modules, able to run systems for hours if necessary. The additional battery modules are automatically recognised by the UPS.

Eaton 5PX UPS

- 1 Graphical LCD display :
 - Clear information on UPS status and measurements
 - Enhanced configuration capabilities
 - Available in 7 languages
- 2 Panel for batteries replacement (Hot-swappable)



- 3 1 USB port + 1 serial port + remote ON/OFF and remote power OFF inputs
- 4 External battery (EBM) connector
- 5 8 IEC 10 A + 1 IEC 16 A sockets with energy metering (including 4 programmable sockets)
- 6 Communication card slot

Eaton 5PX 3000i RT2U

TECHNICAL SPECIFICATIONS	1500	2200	3000
Rating (VA/W)	1500 VA / 1350 W	2200 VA / 1980 W	3000 VA / 2700 W
Format	RT2U (tower / rack 2U)	RT2U (tower / rack 2U)	RT2U & RT3U
Electrical characteristics			
Technology	Line-Interactive High Frequency (Pure Sinewave, Booster + Fader)		
Input voltage and frequency ranges without using batteries	160 V-294 V (adjustable to 150 V-294 V) 47 to 70 Hz (50 Hz system), 56.5 to 70 Hz (60 Hz system), 40 Hz in low-sensitivity mode		
Output voltage and frequency	230 V (+6/-10%) (Adjustable to 200 V / 208 V / 220 V / 230 V / 240 V), 50/60 Hz +/- 0.1% (autosensing)		
Connections			
Input	1 IEC C14 (10 A) socket	1 IEC C20 (16 A) socket	1 IEC C20 (16 A) socket
Outputs	8 IEC C13 (10 A)	8 IEC C13 (10 A) sockets 1 IEC C19 (16 A) socket	8 IEC C13 (10 A) sockets 1 IEC C19 (16 A) socket
Remotely controlled sockets	2 groups of 2 x IEC C13 (10 A)		
Additional outputs with HS MBP	4 FR/Schuko sockets or 3 BS sockets or 6 IEC 10 A sockets or terminal blocks (HW version)		
Additional outputs with FlexPDU	8 FR/Schuko sockets or 6 BS sockets or 12 IEC 10 A sockets		
Batteries			
Typical backup times for 50 and 70% load*			
5PX	19/11 mn	15/8 mn	14/9 mn
5PX + 1 EBM	90/54 mn	60/35 mn	66/38 mn
5PX + 4 EBM	285/180 mn	210/125 mn	213/121 mn
Battery management	ABM® & Temperature compensated charging method (user selectable), Automatic battery test, deep discharge protection, automatic recognition of external battery units		
Interfaces			
Communication ports	1 USB port + 1 RS232 serial port and relay contacts (USB and RS232 ports cannot be used simultaneously) + 1 mini terminal block for remote ON/OFF and Remote Power Off		
Communications card slots	1 slot for NMC Minislot card (included in Netpack versions) or NMC ModBus/JBus or MC Contacts/Serial		
Operating conditions, standards and approvals			
Operating temperature	0 to 40°C		
Noise Level	< 45 dBA	< 45 dBA	< 50 dBA
Performance - Safety - EMC	IEC/EN 62040-1 (Safety), IEC/EN 62040-2 (EMC), IEC/EN 62040-3 (Performance),		
Approvals	CE, CB report, TÜV		
Dimensions W x D x H / Weight			
UPS Dimensions	441 x 522 x 86.2 (2U) mm	441 x 522 x 86.2 (2U) mm	441 x 647 x 86.2 (RT2U) mm 441 x 497 x 130.7 (RT3U) mm
UPS Weight	27.6 kg	28.5 kg	38.08 (RT2U) - 37.33 (RT3U)
Dimensions of EBM	same as UPS		
Weight of the EBM	32.8 kg	32.8 kg	46.39 (RT2U) - 44.26 (RT3U)
Customer Service & Support			
Warranty	3 years on electronics, 2 years on batteries		

* Runtimes are shown at 0.7 power factor. Backup times are approximate and may vary with equipment, configuration, battery age, temperature, etc.

Part Numbers	1500	1500 Netpack*	2200	2200 Netpack*	3000 (RT3U)	3000 Netpack* (RT2U)
UPS	5PX1500iRT	5PX1500iRTN	5PX2200iRT	5PX2200iRTN	5PX3000iRT3U	5PX3000iRTN
EBM	5PXEBM48RT	5PXEBM48RT	5PXEBM48RT	5PXEBM48RT	5PXEBM72RT3U	5PXEBM72RT2U

* Network Management Card included as standard in Netpack versions



Eaton 9130 UPS

700/1000/1500/2000/3000/5000/6000 VA



Multilingual LCD

Advanced power protection for:

- IT and networking environments
- Servers, networking gear
- Telecommunications, VoIP, security systems
- Medical systems
- Diagnostics and medical screening
- Patient record archives
- Manufacturing systems
- Chip fabrication
- Pharmaceutical production
- Chemical processing



Double-conversion UPS

Highest power performance

- Double-conversion topology. The 9130 constantly monitors power conditions and regulates voltage and frequency. Even when presented with the most severe power problems, UPS's output remains within 3% of nominal voltage.
- More real power. High 0.9 output power factor enables the 9130 to provide its full power capability to modern IT equipment.
- Highest efficiency to reduce utility and cooling spending. The 9130 can provide up to 95% efficiency in online double-conversion mode and up to 98% in high-efficiency mode.

Unmatched reliability

- The internal bypass allows service continuity in case of internal fault, a maintenance bypass is also available (as option) for easy replacement of the UPS without powering down critical systems.
- Stronger, longer battery life. Eaton ABM[®] battery management technology uses an innovative three-stage charging technique, that only recharges the battery when necessary, so the battery experiences less corrosion and service life is prolonged by up to 50%.
- Batteries can be hot-swapped without ever having to shut down connected equipment.
- Possibility to add more runtime at any time with up to four external hot-swappable battery modules to run systems for hours if necessary.
- Enables prolonged runtime of essential equipment during power outages by allowing for orderly, remote shutdown of non-critical systems and processes thanks to a capability to control load segments (available up to 3 kVA).

Outstanding versatility

- One platform, two factors, dozens of choices. Up to 3000 VA of UPS power is packed into only 2U of rack space. The tower option is about the size of a modern, compact PC.
- Enhanced configuration capability through easily navigated multilingual graphical display.
- Remote monitoring. The 9130 comes complete with the Eaton Intelligent Power[®] Software CD including SNMP-compatible power management software providing control and visibility over all your UPS systems.
- Connectivity options are available for almost any network environment.

Eaton 9130 UPS



- 1 Multilingual graphical LCD display
- 2 Panel for replacing batteries
- 3 1 USB port + 1 serial port
- 4 1 Relay Output + 1 EPO connector
- 5 EBM battery unit connector
- 6 Load segments
- 7 Communication card slot

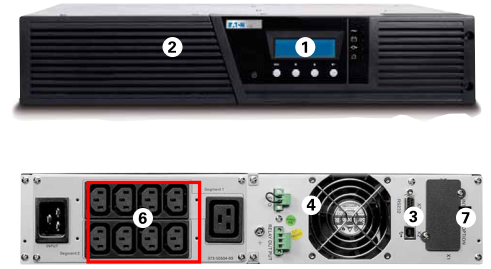

TECHNICAL SPECIFICATIONS

General

User interface	Graphical LCD with blue backlight and text in English, French, German, Russian and Spanish
LEDs	Four status-indicating LEDs
Topology	True online, double-conversion
Diagnostics	Full system self-test
UPS bypass	Automatic bypass
Rail kit	Included with all rackmount units

Electrical Input

Nominal voltage	220–240 V
Voltage range	up to 120–276 VAC (depending on load level)
Frequency range	40–70 Hz (50/60 Hz)

Electrical Output

Power factor	0.9
Voltage	±3% of nominal regulation (on utility and battery)
Frequency regulation	±3 Hz online
Load crest factor	3 to 1

Communications

Ports	RS-232 and USB HID port as standard
Relay output	Common alarm standard
Optional communication cards (BD/MS Slot)	SNMP/Web card for monitoring in SNMP-based networks. Relay card for remote shutdown of IBM AS/400 systems. MODBUS for integration to industrial environment.

Environmental

Safety and EMC markings	IEC/EN 62040-1, IEC/EN 62040-2, CE marking
Audible noise	<50 dB
Ambient operating	0°C to +40°C
Storage temperature	-20°C to +40°C with batteries and -25°C to +55°C without batteries
Relative humidity	5–90% non-condensing

Description	Part number	Rating (VA/Watts)	Input connection	Output receptacles	Dimensions H x W x D, mm	Weight, kg
Tower Models						
PW9130i700T	103006433-6591	700/630	C14	(6) C13	230 x 160 x 350	12.2
PW9130i1000T-XL	103006434-6591	1000/900	C14	(6) C13	230 x 160 x 380	14.5
PW9130i1500T-XL	103006435-6591	1500/1350	C14	(6) C13	230 x 160 x 430	19.0
PW9130i2000T-XL	103006436-6591	2000/1800	C14	(8) C13, (1) C19	325 x 214 x 410	34.5
PW9130i3000T-XL	103006437-6591	3000/2700	C20	(8) C13, (1) C19	325 x 214 x 410	34.5
PW9130i5000T-XL	103007841-6591	5000/4500	Hardwire	Hardwire	574 x 244 x 542	75.5
PW9130i6000T-XL	103007842-6591	6000/5400	Hardwire	Hardwire	574 x 244 x 542	75.5
Tower Extended Battery Modules						
PW9130N1000T-EBM	103006438-6591	NA	NA	NA	230 x 160 x 380	18.5
PW9130N1500T-EBM	103006439-6591	NA	NA	NA	230 x 160 x 430	24.3
PW9130N3000T-EBM	103006440-6591	NA	NA	NA	325 x 214 x 410	50.0
PW9130N6000T-EBM	103007843-6591	NA	NA	NA	574 x 244 x 542	111
Rack Models						
PW9130i1000R-XL2U	103006455-6591	1000/900	C14	(6) C13	86.5 x 438 x 450	16
PW9130i1500R-XL2U	103006456-6591	1500/1350	C14	(6) C13	86.5 x 438 x 450	19
PW9130i2000R-XL2U	103006457-6591	2000/1800	C14	(8) C13, (1) C19	86.5 x 438 x 600	29
PW9130i3000R-XL2U	103006463-6591	3000/2700	C20	(8) C13, (1) C19	86.5 x 438 x 600	29.5
Rack Extended Battery Modules						
PW9130N1000R-EBM2U	103006458-6591	NA	NA	NA	86.5 x 438 x 450	22.1
PW9130N1500R-EBM2U	103006459-6591	NA	NA	NA	86.5 x 438 x 450	28.1
PW9130N3000R-EBM2U	103006460-6591	NA	NA	NA	86.5 x 438 x 600	41.1

BATTERY RUNTIMES*	Internal batteries		+1 EBM		+2 EBMs		+3 EBMs		+4 EBMs	
	75% Load	50% Load	75% Load	50% Load	75% Load	50% Load	75% Load	50% Load	75% Load	50% Load
Rack models										
PW9130i1000R-XL2U	13	22	55	82	103	186	151	250	223	312
PW9130i1500R-XL2U	11	18	47	81	83	143	126	208	195	262
PW9130i2000R-XL2U	13	24	63	95	118	190	170	242	221	345
PW9130i3000R-XL2U	8	14	34	62	70	92	96	156	130	211
Tower models										
PW9130i700T-XL	12	19	N/A	N/A	N/A	N/A	N/A	N/A	N/A	N/A
PW9130i1000T-XL	13	22	55	82	103	186	151	250	223	312
PW9130i1500T-XL	11	18	47	81	83	143	126	208	195	262
PW9130i2000T-XL	21	34	81	130	145	198	184	293	248	431
PW9130i3000T-XL	12	20	49	79	90	143	134	180	165	240
PW9130i5000T-XL	20	34	81	136	153	232	217	328	273	477
PW9130i6000T-XL	16	27	66	107	120	194	178	267	231	372

* Runtimes are shown at a 0.7 power factor. Backup times are approximate and may vary with equipment, configuration, battery age, temperature, etc.

Eaton EX

700/1000/1500/2200/3000 VA



Eaton EX 1500



Eaton EX Rack/Tower versatility

Ideal protection for:

- Servers, data storage and network equipment
- Telephony- VoIP
- Medical equipment- Industrial processes



Double-conversion (on-line)

Maximum availability

- **Topology:** double-conversion on-line UPS with automatic by-pass and power factor correction
- **Powershare:** the Eaton EX output sockets are individually controlled to provide load-shedding to maximise the backup time and provide remote reboot and sequential start-up as standard
- **Continuous power supply:** Hot-swappable batteries. The HotSwap MBP (Maintenance By-Pass) module allows the UPS to be replaced without interrupting the power supply
- **Long backup times:** 1 to 4 EXB battery units can be added to the Eaton EX. The Eaton EX 3000XL has a built-in super charger for extra long backup times

Minimum total cost of ownership

- **Easy operation:** the LCD gives you access to a wide range of measurements and set-up menus
- **Remote supervision:** the Eaton Intelligent Power® Software offers a wide range of communication option including: SNMP and HTML, ModBus/JBus and relay outputs

Total flexibility

Eaton EX has unmatched Flexibility.

- **Format:** EX 700 to 1500 are available in tower format or RT2U convertible rack/tower format (compatible with short-depth rack). EX 2200 & 3000 are available in RT2U format (optimised for rack mounting) or RT3U (for tower or short-depth racks)
- **Connections:** with FlexPDU and HotSwap MBP, the RT2U and RT3U models can be connected by sockets or terminal blocks. They can be installed as required, on the side or on top of the unit
- **Compatible with high power factor loads:** Eaton EX is rated for 0.9 power factor (700 VA/630 W, 1000 VA/900 W, 1500 VA/1350 W, 2200 VA/1980 W and 3000 VA/2700 W)
- **Communication:** the EX includes both serial and USB ports, plus remote On/Off connector and an extra slot for optional communication cards. The UPS comes with a complete Eaton Intelligent Power® Software.

Eaton EX UPS

- 1 LCD Multilingual display
 - 6 languages,
 - displays measurements,
 - displays alarms,
 - access to control and set-up menus.
- 2 Panel for batteries replacement (Hot-swappable)



Eaton EX 3000

- 3 1 USB port + 1 serial port + remote ON/OFF and emergency stop inputs.
- 4 EXB battery unit connector.
- 5 EXB units recognised automatically.
- 6 8 IEC 10 A sockets, including 4 Powershare programmable sockets and 1 IEC 16 A socket.
- 7 Communication card slot.
- 8 Mountings for HotSwap MBP and FlexPDU.

TECHNICAL SPECIFICATIONS	700	1000 - 1000 RT2U	1500 - 1500 RT2U	2200	3000 - 3000 XL
Rating (VA/W)	700 VA / 630 W	1000 VA / 900 W(1)	1500 VA / 1350 W(1)	2200 VA / 1980 W	3000 VA / 2700 W(1)
Format	Mini tower	Mini tower or RT2U (tower/rack 2U)		RT2U (tower/rack 2U) and RT3U (tower/rack 3U)	
Electrical characteristics					
Architecture	On-line double-conversion with automatic by-pass and power factor correction				
Input voltage and frequency ranges without using batteries	100/120/140/160 V to 284 V - 40 to 70 Hz for load level <20% / <33% / <66% / >=66% of rated output			100/120/160/184 V to 284 V - 40 to 70 Hz for load level <20% / <33% / <66% / >=66% of rated output	
Output voltage and frequency	230 V (adjustable to 200/208/220/240/250 V), 50/60 Hz auto-select or frequency converter mode (2)			230 V (adjustable to 200/208/220/240 V), 50/60 Hz auto-select or frequency converter mode	
Connections					
Input	1 IEC C14 (10 A) socket			1 IEC C20 (16 A) or terminal block on HotSwap MBP HW (Hard-Wired)	
Outputs	6 IEC C13 (10 A) sockets			8 IEC C13 (10 A) sockets + 1 IEC C19 (16 A) socket	
Remotely controlled Powershare sockets	2 independent groups: 2 + 1 IEC C13 (10 A) sockets			2 groups of 2 x IEC C13 (10 A) on Eaton EX	
Additional outputs with HotSwap MBP FR/DIN/BS/IEC/HW	4 FR/Schuko sockets or 3 BS sockets or 6 IEC 10 A sockets or terminal blocks (HW version)				
Additional outputs with FlexPDU FR/DIN/BS/IEC	8 FR/Schuko sockets or 6 BS sockets or 12 IEC 10 A sockets				
Battery					
Typical backup times for 50 and 70% load(5) except for Eaton EX 3000 XL(4)					
EX	16 min / 10 min	18 min / 12 min	13 min / 9 min	17 min / 12 min	15 min / 10 min
EX + 1 EXB	/	75 min / 50 min	50 min / 35 min	85 min / 60 min	60 min / 40 min
EX + 4 EXB	/	250 min / 200 min	180 min / 120 min	285 min / 200 min	190 min / 150 min
Battery management	Automatic weekly test (period adjustable using LCD display or in software supplied), automatic recognition of external battery units => continuous maximisation of backup time + deep discharge protection				
Interfaces					
Indicators and display	3 LEDs + adjustable multilingual display: display of measurements, access to control and set-up menus				
Communication ports	1 USB port + 1 RS232 serial port and relay contacts(3) + 1 mini terminal block for remote ON/OFF and emergency stop				
Communications card slots	1 slot for NMC Minislot card (included in Netpack version) or NMC ModBus/JBus or MC Contacts/Serial				
Operating conditions, standards and approvals					
Operating temperature noise level	0°C to 40°C continuous, 45 dBA				
Performance - Safety - EMC	IEC/EN 62 040-1, IEC/EN 62 040-2, IEC/EN 62 040-3 (VFI-SS-113), IEC/EN 60 950-1 (RD)				
Approvals	CE, TÜV GS, CB report, cTÜV-US			CE, TÜV, CB Report, UL CE, TÜV, CB Report, UL	
Dimensions (H x W x D) / Weight					
EX	242 x 153 x 440 mm / 12.5 kg	242 x 153 x 440 mm / 15 kg	242 x 153 x 490 mm / 18 kg	440 x 131 x 490 mm (6) / 30 kg (3000 XL = 18 kg)	
EX (RT2U format)	/	86.5 x 438 x 483 mm / 18 kg	86.5 x 438 x 483 mm / 20.5 kg	86 x 440 x 640 mm / 31 kg	
EX EXB	/	242 x 153 x 440 mm / 21 kg		440 x 131 x 490 mm(6)	
EX EXB (RT2U format)	/	86.5 x 438 x 483 mm / 24.5 kg		/	
Customer Service & Support					
2 years warranty	Standard product exchange, including the battery				
Warranty+	Optional 3-years warranty (depending on the country please visit www.eaton.eu/powerquality)				
1: Maximum rating with EXB battery units: Eaton EX 1000 = 800 W, Eaton EX 1500 =1200 W and Eaton EX 3000=2400 W. 2: Derated by 15% when used as a frequency converter. 3: USB and RS232 serial ports cannot be used simultaneously. 4: Except Eaton EX 3000 XL: UPS with high speed charger, without built-in batteries, for custom configurations: ask us for details. 5: Runtimes are shown at 0.7 power factor. Backup times are approximate and may vary with equipment, configuration, battery age, temperature, etc. 6: compatible with 600 mm deep rack					
Part Numbers					
EX	68 180	68 181	68 183	68 400	68 402 - XL: 68 404
EX (RT2U format, includes rack kit)	/	68 182	68 184	68 401	68 403
EX HotSwap (RT3U format, includes rack kit + HotSwap MBP)	/	/	/	FR: 68406 DIN: 68407 BS: 68408 IEC: 68409 HW: 68410	FR: 68412 DIN: 68413 BS: 68414 IEC: 68415 HW: 68416
EX Netpack (RT2U format, includes rack kit and NMC card)	/	/	/	68 411	68 417
EX EXB	/	68 185	68 185	/	/
EX EXB (RT2U format, includes rack kit)	/	68 186	68 186	/	/
EX EXB (RT3U format, includes rack kit)	/	/	/	68 405	68 405
EX Rack Kit 2U/3U	/	/	/	68 441	68 441

Eaton 9SX UPS

5/6/8/11 kVA



9SX 11 kVA



9SX is an
Energy Star®
qualified UPS



9SX LCD tilts 45° for ease-of-viewing

Advanced protection for:

- Infrastructure, Industrial and Medical
- IT, Networking, Storage and Telecom



High performance Online double-conversion UPS

Performance and Efficiency

- Double-conversion topology. The Eaton 9SX constantly monitors power conditions and regulates voltage and frequency.
- With up to 95% efficiency in online double-conversion mode the 9SX provides the highest efficiency level in its class to reduce energy & cooling costs.
- With a 0.9 power factor the 9SX delivers 28% more power than UPS in its class. It powers more servers than other UPSs with equivalent VA ratings and lower power factors.

Availability and Flexibility

- The internal bypass allows service continuity in case of internal fault. Batteries are hot-swappable from the front panel without powering down critical systems.
- With its rack/tower versatile form factor the 9SX can be installed in any environment (rack kit provided as standard on RT versions).
- Stronger, longer battery life: Eaton ABM® battery management technology uses an innovative three-stage charging technique that extends battery life by up to 50%.
- More runtime can be added with up to 12 external hot-swappable battery modules, able to run systems for hours if necessary. The additional battery modules are automatically recognized by the UPS.

Manageability

- The new graphical LCD provides clear information on the UPS's status and measurements on a single screen (in seven languages). LCD display position can be adjusted to offer the best viewable angle for tower and rack usage.
- The 9SX can meter energy consumption. kWh values can be monitored using the LCD or Eaton's Intelligent Power® Software Suite.
- Load segment control enables prioritised shutdowns of nonessential equipment to maximise battery runtime for critical devices. It can also be used to remotely reboot locked-up equipment or to manage scheduled shutdowns and sequential start-ups.
- The 9SX offers Serial, USB and relay (4 dry contacts) connectivity, plus an extra slot for an optional card (Modbus, Network or Relay). 9SX also provides Remote Power off function. Eaton's Intelligent Power® Software is included with each UPS.

Eaton 9SX UPS

- 1 Remote Off/On and Remote Power Off connectors
- 2 Slot for Network-MS, ModBus-MS or Relay-MS cards
- 3 External battery module (EBM) connector with automatic detection (RJ11)



- 4 DB 9 with output contacts
- 5 USB and serial ports
- 6 Input/Output connections

Eaton 9SX 11 kVA

TECHNICAL SPECIFICATIONS	5 kVA	6 kVA	8 kVA	11 kVA
Rating (kVA/kW)	5 kVA/4.5 kW	6 kVA/5.4 kW	8 kVA/7.2 kW	11 kVA/10 kW
Electrical Characteristics				
Technology	On-line double-conversion with Power Factor Correction (PFC) system			
Nominal voltage	200/208/220/230/240 V		200/208/220/230/240 V/250 V	
Input voltage range	176-276 V without derating (up to 100–276 V with derating)			
Output voltage/THDU	200/208/220/230/240 V +/- 1%; THDU <2%		200/208/220/230/240/250 V +/- 1%; THDU <2%	
Input frequency range/THDI	40-70 Hz, 50/60 Hz autoselection, frequency converter as standard, THDI < 5%			
Efficiency	Up to 94% in Online mode, 98% in Hi-Efficiency mode		Up to 95% in Online mode, 98% in Hi-Efficiency mode	
Crest factor/short circuit current	3:1/90 A	3:1/90 A	3:1/120 A	3:1/150 A
Overload capacity	102–110% : 120 s, 110–125%: 60 s, 125–150%: 10 s, >150%: 500 ms		102–110% : 120 s, 110–125%: 60 s, 125–150%: 10 s, >150%: 900 ms	
Connections				
Input	Terminal block (up to 10 mm ²)		Terminal block (up to 16 mm ²)	
Outputs	Terminal block + 2 controlled groups of 4 IEC C13 (10 A) + 2 IEC C19 (16 A)		Terminal block	
Batteries				
Typical backup times at 50 and 70% load*				
9SX	13/10 min	11/8 min	15/10 min	9/5 min
9SX + 1 EBM	60/40 min	48/34 min	38/25 min	22/15 min
9SX + 4 EBM	220/150 min	170/120 min	120/82 min	80/55 min
Battery management	ABM* and Temperature compensated charging method (user selectable), automatic battery test, deep discharge protection, automatic recognition of external battery units.			
Communication				
Communication ports	1 USB port, 1 RS232 serial port (USB and RS232 ports cannot be used simultaneously), 4 dry contacts (DB9), 1 mini terminal block for remote On/Off and 1 for remote power Off.			
Communication slot	1 slot for Network-MS card, ModBus-MS or Relay-MS cards.			
Operating conditions, standards and approvals				
Operating temperature	0 to 40°C continuous			
Noise level	<45 dB	<45 dB	<48 dB	<50 dB
Safety	IEC/EN 62040-1, UL 1778, CSA 22.2			
EMC, performance	IEC/EN 62040 -2 , FCC Class A, IEC/EN 62040-3 (Performance)			
Approvals	CE, CB report (TUV), UL			
Dimensions H x W x D/Weight				
UPS	440(19 ")*130(3U)*685 mm/48 kg	440(19 ")*130(3U)*685 mm/48 kg	440(19 ")*260(6U)*700 mm/84 kg	440(19 ")*260(6U)*700 mm/86 kg
EBM	440(19 ")*130(3U)*645 mm/68 kg	440(19 ")*130(3U)*645 mm/68 kg	440(19 ")*130(3U)*680 mm/65 kg	440(19 ")*130(3U)*680 mm/65 kg
Power module	–	–	440(19 ")*130(3U)*700 mm/19 kg	440(19 ")*130(3U)*700 mm/21 kg
Customer Service and Support				
Warranty	2 years warranty			

* Runtimes are shown at 0.7 power factor. Backup times are approximate and may vary with equipment, configuration, battery age, temperature, etc

Parts Numbers	9SX 5 kVA	9SX 6 kVA	9SX 8 kVA	9SX 11 kVA
UPS	–	–	9SX8Ki	9SX11Ki
UPS with Rack Kit	9SX5KiRT	9SX6KiRT	9SX8KiRT	9SX11KiRT
EBM	–	–	9SXEBM240	9SXEBM240
EBM with Rack Kit	9SXEBM180RT	9SXEBM180RT	–	–
Power Module	–	–	9SX8KiPM	9SX11KiPM
HotSwap Maintenance ByPass	MBP6Ki	MBP6Ki	MBP11Ki	MBP11Ki
Transformer Module	TFMR11Ki	TFMR11Ki	TFMR11Ki	TFMR11Ki
Supercharger with Rack Kit	–	–	SC240RT	SC240RT
1.8m Battery Connection Cable	EBMCBL180	EBMCBL180	EBMCBL240	EBMCBL240
Battery Integration System	BINTSYS	BINTSYS	BINTSYS	BINTSYS
Rack Kit	9RK	9RK	9RK	9RK



Eaton 9PX UPS

5/6/8/11 kVA



Rack/Tower versatile



9PX 1:1 is an Energy Star® qualified UPS



9PX 11 kVA with maintenance bypass

Advanced protection for:

- Small and Medium Datacentre
- IT, Networking, Storage and Telecom
- Infrastructure, Industrial and Medical

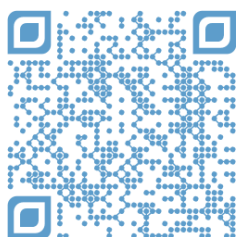

Watch 9PX's video

Energy efficient power protection

Performance and Efficiency

- Double-conversion topology. The Eaton 9PX constantly monitors power conditions and regulates voltage and frequency.
- With up to 95% efficiency in online double-conversion mode and 98% in high-efficiency mode the 9PX provides the highest efficiency level in its class to reduce energy and cooling costs.
- With a 0.9 power factor the 9PX delivers 28% more power than any UPS in its class. It powers more servers than other UPSs with equivalent VA ratings and lower power factors.
- With a RT (Rack/tower) versatile form factor the 9PX is the most compact solution in its class delivering up to 5400 W in only 3U and 10 kW in only 6U.

Manageability

- The new graphical LCD provides clear information on the UPS's status and measurements on a single screen (in seven languages). LCD display position can be adjusted to offer the best viewable angle for tower and rack usage.
- The 9PX can meter energy consumption. kWh values can be monitored using the LCD or Eaton's Intelligent Power® Software.
- Load segment control enables prioritised shutdowns of nonessential equipment to maximise battery runtime for critical devices. It can also be used to remotely reboot locked-up network equipment or to manage scheduled shutdowns and sequential start-ups.
- The 9PX offers Serial, USB and relay connectivity, plus an extra slot for an optional card (Network card delivered as standard on Netpack version). Eaton's Intelligent Power® Software is compatible with all major OS including virtualisation software such as VMware and Hyper-V is included with each UPS.

Availability and Flexibility

- The internal bypass allows service continuity in case of internal fault, a maintenance bypass is also available (as standard on HotSwap version) for easy replacement of the UPS without powering down critical systems.
- The 9PX can be paralleled to achieve twice the power of unitary product using HotSync technology, without extra cost on the initial purchase.
- Stronger, longer battery life: Eaton ABM® battery management technology uses an innovative three-stage charging technique that extends battery life by up to 50%.
- More runtime can be added with up to 12 external hot-swappable battery modules, able to run systems for hours if necessary. The additional battery modules are automatically recognised by the UPS.

Eaton 9PX UPS

- 1 Remote Off/On and Remote Power Off connectors
- 2 Slot for Network-MS, ModBus-MS or Relay-MS cards
- 3 Parallel operation port (DB15)
- 4 External battery module (EBM) connector with automatic detection (RJ11)

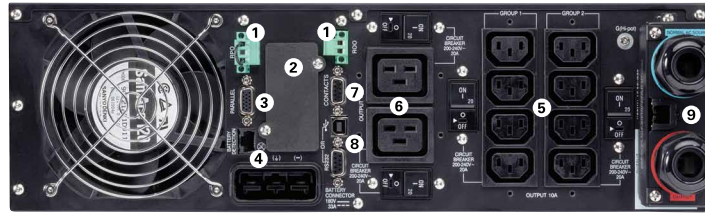

Eaton 9PX 6 kVA 1:1

- 5 8 IEC 10 A sockets (2 groups of 4 manageable sockets) with cable retention system
- 6 2 IEC 16 A sockets with cable retention system
- 7 DB 9 with output contacts
- 8 USB and serial ports
- 9 Input/Output connection

TECHNICAL SPECIFICATIONS	5 kVA 1:1	6 kVA 1:1	6 kVA 3:1	8 kVA 1:1 or 3:1	11 kVA 1:1 or 3:1
Rating (kVA/kW)	5 kVA/4.5 kW	6 kVA/5.4 kW	6 kVA/5.4 kW	8 kVA/7.2 kW	11 kVA/10 kW

Electrical Characteristics	
Technology	On-line double-conversion with Power Factor Correction (PFC) system
Input voltage	200/208/220/230/240 V 1:1, 200/208/220/230/240 V/250 V 1:1, 380/400/415 3:1
Input voltage range	176-276 V without derating (up to 100-276 V with derating) 1:1, 305 V-480 V without derating (up to 175 V-480 V with derating) 3:1
Output voltage/THDU	200/208/220/230/240 V +/- 1%; THDU <2%
Input frequency/THDI	40-70 Hz, 50/60 Hz autoselection, frequency converter as standard, THDI <5%
Efficiency	Up to 94% in Online mode, 98% in Hi-Efficiency mode, Up to 95% in Online mode, 98% in Hi-Efficiency mode
Short circuit current	90 A, 90 A, 90 A, 120 A, 150 A
Overload capacity	102-110%: 120 s, 110-125%: 60 s, 125-150%: 10 s, >150%: 500 ms, 102-110%: 120 s, 110-125%: 60 s, 125-150%: 10 s, >150%: 900 ms

Connections	
Input	Terminal block (up to 10 mm ²)
Outputs	Terminal block + 2 controlled groups of 4 IEC C13 (10 A) + 2 IEC C19 (16 A)
Outputs with HotSwap Maintenance Bypass	Terminal block + 3 IEC C13 (10 A) + 2 IEC C19 (16 A)

Batteries	
Typical backup times at 50 and 70% load*	
9PX	13/10 min, 11/8 min, 30/20 min, 20/15 min, 13/9 min
9PX + 1 EBM	60/40 min, 48/34 min, 70/45 min, 48/32 min, 32/21 min
9PX + 4 EBM	220/150 min, 170/120 min, 210/140 min, 140/100 min, 100/70 min
Battery management	ABM® and Temperature compensated charging method (user selectable), automatic battery test, deep discharge protection, automatic recognition of external battery units.

Communication	
Communication ports	1 USB port, 1 RS232 serial port (USB and RS232 ports cannot be used simultaneously), 4 dry contacts (DB9), 1 mini terminal block for remote On/Off and 1 for remote power Off, 1 DB15 for parallel operation.
Communication slot	1 slot for Network-MS card (included in Netpack versions), ModBus-MS or Relay-MS cards.

Operating conditions, standards and approvals	
Operating temperature	0 to 40°C continuous
Noise level	<45 dB, <45 dB, <48 dB, <48 dB, <50 dB
Safety	IEC/EN 62040-1, UL 1778 (1:1 version)
EMC, performance	IEC/EN 62040-2, FCC Class A (1:1 version), IEC/EN 62040-3 (Performance)
Approvals	CE, CB report (TUV), UL (1:1 version)

Dimensions H x W x D/Weight	
UPS dimensions	440(19")*130(3U)*685 mm, 440(19")*130(3U)*685 mm, 440(19")*260(3U+3U)*700 mm, 440(19")*260(3U+3U)*700 mm, 440(19")*260(3U+3U)*700 mm
UPS weight	48 kg, 48 kg, 88 kg, 84 kg (1:1), 88 kg (3:1), 86 kg (1:1), 88 kg (3:1)
EBM dimensions	440(19")*130(3U)*645 mm, 440(19")*130(3U)*645 mm, 440(19")*130(3U)*680 mm, 440(19")*130(3U)*680 mm, 440(19")*130(3U)*680 mm
EBM weight	68 kg, 68 kg, 65 kg, 65 kg, 65 kg
Power module dimensions	-, -, 440(19")*130(3U)*700 mm, 440(19")*130(3U)*700 mm, 440(19")*130(3U)*700 mm
Power module weight	-, -, 23 kg, 19 kg (1:1), 23 kg (3:1), 21 kg (1:1), 23 kg (3:1)

Customer Service and Support	
Warranty	2 years warranty

* Runtimes are shown at 0.7 power factor. Backup times are approximate and may vary with equipment, configuration, battery age, temperature, etc

Parts Numbers	9PX 5 kVA 1:1	9PX 6 kVA 1:1	9PX 8 kVA 1:1	9PX 11 kVA 1:1	9PX 6 kVA 3:1	9PX 8 kVA 3:1	9PX 11 kVA 3:1
UPS with HotSwap Maintenance Bypass	9PX5KiBP	9PX6KiBP	9PX8KiBP	9PX11KiBP	9PX6KiBP31	9PX8KiBP31	9PX11KiBP31
UPS with Network Card and Rack Kit	9PX5KiRTN	9PX6KiRTN	-	-	-	-	-
UPS with HotSwap MBP, Network Card and Rack Kits	-	-	9PX8KiRTNBP	9PX11KiRTNBP	9PX6KiRTNBP31	9PX8KiRTNBP31	9PX11KiRTNBP31
EBM	9PXEBM180	9PXEBM180	9PXEBM240	9PXEBM240	9PXEBM240	9PXEBM240	9PXEBM240
Power Module	-	-	9PX8KiPM	9PX11KiPM	9PX6KiPM31	9PX8KiPM31	9PX11KiPM31
HotSwap Maintenance Bypass	MBP6Ki	MBP6Ki	MBP11Ki	MBP11Ki	MBP11Ki31	MBP11Ki31	MBP11Ki31
9PX ModularEasy (paralleling kit)	9PXMEZ6Ki	9PXMEZ6Ki	9PXMEZ11Ki	9PXMEZ11Ki	-	-	-
Supercharger with Rack Kit	-	-	SC240RT	SC240RT	SC240RT	SC240RT	SC240RT
1.8m Battery Connection Cable	EBMCBL180	EBMCBL180	EBMCBL240	EBMCBL240	EBMCBL240	EBMCBL240	EBMCBL240
Accessories	Rack kit: 9RK, Transformer (Single Phase): TFM11Ki, Battery Integration System: BINTSYS						

9PX Parallel*	9PX 10 kVA 1:1 (5 kVA redundant)	9PX 12 kVA 1:1 (6 kVA redundant)	9PX 16 kVA 1:1 (8 kVA redundant)	9PX 22 kVA 1:1 (11 kVA redundant)
	9PXM10KiRTN	9PXM12KiRTN	9PXM16KiRTN	9PXM22KiRTN

*9PX Parallel system includes 2 x 9PX, ModularEasy (Parallel kit), rail kits and network cards



Eaton BladeUPS

12/24/36/48/60 kW



An Eaton Green Solution

Due to outstanding green performance, Eaton BladeUPS has earned the "An Eaton Green Solution"™ label

Advanced power protection for:

- Small, medium and large data centres
- Blade servers
- Network environments
- Telephony and VoIP equipment
- Networking applications such as IPTV, security
- Storage devices: RAID, SAN



Designed for data centres – to ensure maximum uptime and efficiency

Simply scalable

- Eaton BladeUPS provides scalable double-conversion backup power
- BladeUPS is designed for the data centre-to work in harmony with your servers and IT equipment to ensure maximum uptime and maximum efficiency
- Scalable architecture enables you to design, scale and grow your data centre as your demand grows.
- BladeUPS provides from 12 kW to 60 kW N+1 mounted in a single IT rack enclosure, with multiple power distribution options
- BladeUPS delivers an industry-leading 98% efficiency across the operating range, resulting in cooler operating conditions and less heat dissipation

Highly flexible

- BladeUPS is extremely flexible and supports multiple configurations including power protection in each rack, centralised protection, zone protection or hybrid as required
- If your needs change or need to move your IT equipment, simply redeploy and reuse BladeUPS as single of parallel units elsewhere
- Multiple external batteries can be added to increase runtime
- BladeUPS has multiple power distribution options including the Rack Power Module (RPM), ePDUs or hardwired. The 3U RPM delivers single-phase power and can be deployed in the same rack as the UPS and IT equipment.

Highly efficient

- Optimize your operational expenditure- Latest high efficiency technologies provide 98% efficiency, with 65% less heat dissipation to minimise your operational costs and reduce your carbon footprint
- A 60 kW N+1 solution could save over 20,000 in 5 years in energy costs alone
- The small footprint of BladeUPS allows extra space for IT equipment in the rack and data centre.
- Due to the low heat dissipation, air conditioning requirements are reduced by up to a third and BladeUPS can be located close to IT equipment.
- Utilises Eaton's Advanced Battery Management system to prolong battery life by up to 50%

TECHNICAL SPECIFICATIONS

General	
Power Rating	12 kW per UPS module
Efficiency	Up to 98.6%
Heat Dissipation	371 W/1266 BTU/hr at 100% rated load
Cooling	Fan cooled, temperature microprocessor monitored; front air entry, rear exhaust
Audible Noise, Normal Operation	<60 dBA at 1 meter
Altitude Before Derating	1000 m (3300 ft ASL)
Input	
Input Voltage	400 Vac
Voltage Range	400 V: 311 to 519 Vac, phase to phase
Frequency Range	50 or 60 Hz, ± 5 Hz
Input Current Distortion	<5% with IT loads (PFC power supplies)
Input Power Factor	>0.99 with IT loads (PFC power supplies)
Inrush Current	Load dependent
Input Requirements	Three-phase, four-wire + ground
Bypass Source	Same as input (single feed)
Generator Compatibility	Fast sync slew rate for generator synchronisation
Output	
Rated Output Voltage	400 V: 180 to 240 Vac, Ph to N
Output Configuration	Three-phase, four-wire + ground
Output Frequency (nominal)	50 or 60 Hz auto-detection on startup
Frequency Regulation	0.1 Hz free running
Load Power Factor Range	Lagging: 0.7 Leading: 0.9
Total Output Voltage Distortion	<3% with IT loads (PFC power supplies) <5% non-linear or non-PFC power supplies
Battery	
Battery Type	VRLA - AGM
Battery Runtime (Internal)	13 minutes at 50% load 4.7 minutes at 100% load
Battery String Voltage	240 Vdc
Battery Test	Automatic battery test standard (remote scheduling capable) Manual battery test from front display
Battery Recharge Profile	ABM three-stage charging technology
Battery Cut-off Voltage	Variable from 1.67 VPC at <5 min. runtime
Battery Low Condition	Announced with alarm
Extended Battery Capability	Yes, add up to four additional 3U battery enclosures (~34 min at 100% load, >1 hour at 50% load)
Physical	
Dimensions (HxWxD) UPS	261 (6U) x 442 x 660 mm
Note: Total Chassis Weight without batteries or electronics	46 kg
Total Chassis Weight with batteries or electronics	140 kg
Total UPS Weight without Batteries	61 kg
Total UPS Weight with Batteries	140 kg
EBM Weight	77 kg

Communications and User Interface	
Software Compatibility	UPS ships with Software Suite CD
X-Slot Bays	Two available for the cards listed below
Control Panel LCD	Two lines by 20 characters Four menu-driven interface buttons Four status at a glance LEDs
Multi-language	English standard; 20 languages available
Configuration Changes	User capable, firmware auto configures
Dry Contact Inputs	Two, user-configurable
Dry Contact Outputs	One, user-configurable
Service	
Installation	User capable, located in the IT racks
Preventative Maintenance	User capable, optional factory service available
Corrective Maintenance	User capable, optional factory service available
Serviceability Features	Hot-swappable batteries Hot-swappable electronics module Automated internal maintenance bypass Auto-configure firmware Flash firmware upgradeable
Certifications	
EMI	IEC 62040
Surge Protection	ANSI C62.41, Cat B-3
Hazardous Materials (RoHS)	EU Directive 2002/95/EC Category 3 (4 of 5)
Warranty	
Standard	12 months
Warranty Repair	Factory depot repair or replace
Options and Accessories	
Detachable input cord	
Detachable input/output cord assembly	
Detachable paralleling cord assembly	
Extended Battery Modules (EBMs)	
3U output sub-distribution module	
0U to 3U rack power strips	
60 kW BladeUPS Parallel Bar	
Four-post rail kit	
Optional X-Slot Communication Cards	
Application	Card
Web SNMP	ConnectUPS-X Web/SNMP Card
Environment Monitoring	EMP Environmental Monitoring Probe (requires Web/SNMP card)
IBM eServer™ (i5™, iSeries™, or AS/400), industrial	Relay Interface Card
Parallel	Hot Sync Card
Remote LCD Display	ViewUPS-X
Recommended ePDU:	
Y032440CD100000	RPM - Rack Power Module (BladeUPS in, 12xC13 + 6xC19 out) 20 ft lead
PW107BA0UC08	ePDU - Basic (0U, Dual 16 A C20 in, 24xC13+ 8xC19 out) use in addition to RPM
PW107MI0UC08	ePDU - IP Monitored (0U, Dual 16 A C20 in, 24xC13+ 8xC19 out) use in addition to RPM

Eaton 9155 and 9355 UPS

8/11/12/15 kVA



Advanced power protection for:

- Banking systems
- Small server and computer rooms
- Healthcare equipment
- Network communications equipment
- Security systems
- Automation systems



Double-conversion UPS

Premium power performance

- Double-conversion topology provides the highest level of protection available by isolating the output power from all input anomalies.
- With a transformer-free design and sophisticated sensing and control circuitry the 9155/9355 delivers an efficiency of up to 92%.
- Active power factor correction (PFC) provides unbeatable 0.99 input power factor and less than 4.5% ITHD, thus eliminating interference with other critical equipment in the same electrical network and enhancing compatibility with generators.
- With 0.9 output power factor, UPS is optimized to protect modern IT equipment without need to oversize.

True reliability

- Patented Powerware HotSync® technology enables paralleling of two or more UPS modules to increase availability or add capacity. The technology enables load sharing without any communication line, thus eliminating single point of failure.
- ABM® technology charges batteries only when necessary, reducing batteries corrosion and prolonging batteries service life by up to 50%.
- Internal batteries in all standard configurations provide an extended runtime with the smallest footprint.

Extensive configurability

- Further runtime extension is possible with external battery cabinets.
- A multilingual graphical LCD display makes possible to monitor the UPS status easily.
- The 9155/9355 can also be integrated into network management, industrial automation and building management systems.
- Bundled Eaton Software Suite provides an orderly network shutdown in an event of extended power outage.

Eaton 9155/9355 UPS 8-15 kVA

TECHNICAL SPECIFICATIONS

UPS output power rating (0.9 p.f.)				
kVA	8	10	12	15
kW	7.2	9	10.8	13.5
General				
Efficiency in double conversion mode (full load)	92%			
Efficiency in double conversion mode (half load)	90%			
Efficiency in high efficiency mode	up to 98%			
Distributed parallelling with Hot Sync technology	4			
Field upgradeable	yes			
Inverter/rectifier topology	transformer-free IGBT with PWM			
Audible noise	<50 dB			
Altitude (max)	1000 m without derating (max 2000 m)			
Input				
Input wiring	1 ph or 3 ph + N + PE			
Nominal voltage rating (configurable)	220/380, 230/400, 240/415 V 50/60 Hz			
Input voltage range	Low -20% at 100% load/-50% at 50% load without battery discharge; High +10% /max +20%			
Input frequency range	45-65 Hz			
Input power factor	0.99			
Input ITHD	less than 4.5%			
Soft start capability	Yes			
Internal backfeed protection	Yes			
Output				
Output wiring	1 ph or 3 ph + N + PE			
Nominal voltage rating (configurable)	220/380, 230/400, 240/415 V 50/60 Hz			

Output UTHD	<3% (100% linear load); <5% (reference non linear load)
Output power factor	0.9 (e.g. 9 kW at 10 kVA)
Permitted load power factor	0.7 lagging - 0.8 leading
Overload on inverter	10 min 100-110%; 1 min 110-125%; 5 sec 125-150%; 300 ms >150%
Overload when bypass available	60 min 100-110%, 10 min 110-125%; 1 min >125-150%

Battery	
Type	Maintenance free VRLA batteries, NiCd
Charging method	ABM technology or Float
Temperature compensation	Optional
Battery nominal voltage (lead-acid)	384 V (32x12 V, 192 cells)
Charging current / Model	Default 3 A *Max 30 A

*May be limited by maximum UPS input current rating

Accessories	
	Isolation transformer, long-life batteries, external battery cabinets, UPS Centre (input, bypass, distribution), X-Slot connectivity (Web/SNMP, ModBus/Jbus, Relay, Hot Sync, ViewUPS-X remote display), Hot Sync parallel tie cabinet, integrated manual bypass, external maintenance bypass switch

Communications	
X-Slot	2 communication bays
Serial ports	1 available
Relay inputs/outputs	2/1 programmable

Compliance with standards	
Safety (CB certified)	IEC 62040-1, IEC 60950-1
EMC	IEC 62040-2
Performance	IEC 62040-3

Stand-alone UPS with 1-phase input

Part number	Description	Rating	Back-up (pf. 0.7)	Dimensions (HxWxD)	Weight
1022532	9155-8-S-10-32x7 Ah	8 kVA / 7.2 kW	10 min	817x305x702 mm	155 kg
1022533	9155-8-S-15-32x9 Ah	8 kVA / 7.2 kW	15 min	817x305x702 mm	160 kg
1022534	9155-8-S-28-64x7 Ah	8 kVA / 7.2 kW	28 min	1214x305x702 mm	250 kg
1022535	9155-8-S-33-64x9 Ah	8 kVA / 7.2 kW	33 min	1214x305x702 mm	275 kg
1022536	9155-10-S-10-32x9 Ah	10 kVA / 9 kW	10 min	817x305x702 mm	160 kg
1022537	9155-10-S-20-64x7 Ah	10 kVA / 9 kW	20 min	1214x305x702 mm	250 kg
1022538	9155-10-S-25-64x9 Ah	10 kVA / 9 kW	25 min	1214x305x702 mm	275 kg

Stand-alone UPS with 3-phase input

Part number 9155/9355	Description	Rating	Back-up (pf. 0.7)	Dimensions (HxWxD)	Weight
1022480	9155-8-N-10-32x7 Ah	8 kVA / 7.2 kW	10 min	817x305x702 mm	155 kg
1022481/1023411	9155/9355-8-N-15-32x9 Ah	8 kVA / 7.2 kW	15 min	817x305x702 mm	160 kg
1022482	9155-8-N-28-64x7 Ah	8 kVA / 7.2 kW	28 min	1214x305x702 mm	250 kg
1022483/1023412	9155/9355-8-N-33-64x9 Ah	8 kVA / 7.2 kW	33 min	1214x305x702 mm	275 kg
1022484/1023413	9155/9355-10-N-10-32x9 Ah	10 kVA / 9 kW	10 min	817x305x702 mm	160 kg
1022485	9155-10-N-20-64x7 Ah	10 kVA / 9 kW	20 min	1214x305x702 mm	250 kg
1022486/1023414	9155/9355-10-N-25-64x9 Ah	10 kVA / 9 kW	25 min	1214x305x702 mm	275 kg
1022487/1023415	9155/9355-12-N-8-32x9 Ah	12 kVA / 10.8 kW	8 min	817x305x702 mm	160 kg
1022488	9155-12-N-15-64x7 Ah	12 kVA / 10.8 kW	15 min	1214x305x702 mm	250 kg
1022489/1023416	9155/9355-12-N-20-64x9 Ah	12 kVA / 10.8 kW	20 min	1214x305x702 mm	275 kg
1022490/1023417	9155/9355-15-N-5-32x9 Ah	15 kVA / 13.5 kW	5 min	817x305x702 mm	160 kg
1022491	9155-15-N-10-64x7 Ah	15 kVA / 13.5 kW	10 min	1214x305x702 mm	250 kg
1022492/1023418	9155/9355-15-N-15-64x9 Ah	15 kVA / 13.5 kW	15 min	1214x305x702 mm	275 kg

External battery cabinets

Part number	Description	Rating	Back-up (pf. 0.7)	Dimensions (HxWxD)	Weight
1022561	9X55-BAT5-64x7 Ah	2x32x7 Ah	Check technical specifications	817x305x699 mm	195 kg
1022562	9X55-BAT5-96x7 Ah	3x32x7 Ah	Check technical specifications	1214x305x699 mm	310 kg

Eaton 9355 UPS

20/30/40 kVA



Advanced power protection for:

- Financial systems
- Medium-sized servers and computers
- ICT equipment
- Critical building infrastructure
- Industrial applications



Double-conversion UPS

Premium power performance

- Double-conversion topology provides the highest level of protection available by isolating the output power from all input anomalies.
- With a transformer-free design and sophisticated sensing and control circuitry the 9355 delivers an efficiency of up to 93%.
- Active power factor correction (PFC) provides unbeatable 0.99 input power factor and less than 4.5% input ITHD, thus enhancing compatibility with generators and eliminating interference with other critical equipment in the same network.
- The UPS enables optimal power protection for modern 0.9 p.f. rated IT equipment without the need to oversize.
- The 9355 design is also available with 1-phase output (9155) at 20-30 kVA power ratings.

True reliability

- Patented Powerware Hot Sync® technology makes possible to parallel two or more UPSs to increase availability or add capacity. The technology enables load sharing without any communication line, thus eliminating single point of failure.
- ABM® technology charges batteries only when necessary, preventing batteries corrosion and prolonging batteries service life by up to 50%.
- Internal batteries in all standard configurations support more runtime than comparable UPS.

Extensive configurability

- Configurable and multilingual LCD control panel with back light and graphical mimic screen monitors the UPS status easily.
- Connectivity options guarantee a smooth integration with various application systems requirements.
- Bundled with Eaton Software Suite the 9355 provides an orderly network shutdown in an event of extended power outage. If required, the 9355 can also be integrated to network management, industrial automation and building management systems.

Eaton 9355 UPS 20-40 kVA

TECHNICAL SPECIFICATIONS

UPS output power rating (0.9 p.f.)

kVA	20	30	40
kW	18	27	36

General

Efficiency in double-conversion mode (full load)	93%
Efficiency in double-conversion mode (half load)	91%
Distributed parallelling with Hot Sync technology	4
Field upgradeable	yes
Inverter/rectifier topology	Transformer-free IGBT with PWM
Audible noise	<50 dB
Altitude (max)	1000 m without derating (max 2000 m)

Input

Input wiring	3 ph + N + PE
Nominal voltage rating (configurable)	220/380, 230/400, 240/415 V 50/60 Hz
Input voltage range	Low -20% at 100% load/-50% at 50% load without battery discharge; High +10%/max +20%
Input frequency range	45-65 Hz
Input power factor	0.99
Input ITHD	less than 4.5%
Soft start capability	Yes
Internal backfeed protection	Yes

Output

Output wiring	1 ph or 3 ph + N + PE
Nominal voltage rating (configurable)	220/380, 230/400, 240/415 V 50/60 Hz
Output UTHD	<3% (100% linear load); <5% (reference non linear load)

Output power factor	0.9 (e.g. 27 kW at 30 kVA)
Permitted load power factor	0.7 lagging - 0.8 leading
Overload on inverter	10 min 100-110%; 1 min 110-125 %; 5 sec 125-150%; 300 ms >150%
Overload when bypass available	60 min 100-110%, 10 min 110-125%; 1 min >125-150%

Battery

Type	Maintenance free VRLA batteries, NiCd
Charging method	ABM technology or Float
Temperature compensation	Optional
Battery nominal voltage (lead-acid)	432 V (36x12 V, 216 cells)
Charging current / Model	Default 3 A *Max 60 A

*May be limited by maximum UPS input current rating

Accessories

Isolation transformer, long-life batteries, external battery cabinets, X-Slot connectivity (Web/SNMP, ModBus/Jbus, Relay, Hot Sync, ViewUPS-X remote display), Hot Sync parallel tie cabinet, integrated manual bypass, external maintenance bypass switch

Communications

X-Slot	2 communication bays
Serial ports	1 available
Relay inputs/outputs	2/1 programmable

Compliance with standards

Safety (CB certified)	IEC 62040-1, IEC 60950-1
EMC	IEC 62040-2
Performance	IEC 62040-3

Standard UPS with 3-phase input

Part number 9355	Description	Rating	Runtime (pf 0.7)	Dimensions (HxWxD)	Weight
1025061/1026598	9355/9155-20-N-5-1x9 Ah-MBS	20 kVA / 18 kW	5 min	1684x494x762 mm	300 kg
1025062/1026599	9355/9155-20-N-13-2x9 Ah-MBS	20 kVA / 18 kW	13 min	1684x494x762 mm	400 kg
1025063/1026600	9355/9155-20-N-22-3x9 Ah-MBS	20 kVA / 18 kW	22 min	1684x494x762 mm	500 kg
1025064/1026601	9355/9155-20-N-31-4x9 Ah-MBS	20 kVA / 18 kW	31 min	1684x494x762 mm	600 kg
1025065/1026602	9355/9155-30-N-7-2x9 Ah-MBS	30 kVA / 27 kW	7 min	1684x494x762 mm	400 kg
1025066/1026603	9355/9155-30-N-13-3x9 Ah-MBS	30 kVA / 27 kW	12 min	1684x494x762 mm	500 kg
1025067/1026604	9355/9155-30-N-20-4x9 Ah-MBS	30 kVA / 27 kW	20 min	1684x494x762 mm	600 kg
1025795	9355-40-N-8-3x9 Ah-MBS	40 kVA / 36 kW	8 min	1684x494x762 mm	517 kg
1025796	9355-40-N-12-4x9 Ah-MBS	40 kVA / 36 kW	12 min	1684x494x762 mm	617 kg

External battery cabinets 9155/9355

Part number	Description	Rating	Runtime	Dimensions (HxWxD)	Weight
1025169	9355-BAT-1x24 Ah	1x36x24 Ah	See separate specification	1684x494x758 mm	510 kg
1025170	9355-BAT-2x24 Ah	2x36x24 Ah		1684x494x758 mm	870 kg

9355 20-40 kVA runtimes

Runtimes for UPS with internal batteries ...p.f. 0.7 (typical IT server/computer load)

Battery	Qty	5	10	15	20	25	30	35	40	kVA
7 Ah 12 V	1 x 36	24	8	5	-	-	-	-	-	min
9 Ah 12 V	1 x 36	30	12	7	5	-	-	-	-	min
7 Ah 12 V	2 x 36	60	24	14	10	6	-	-	-	min
9 Ah 12 V	2 x 36	70	28	18	13	10	7	5	-	min
7 Ah 12 V	3 x 36	103	41	26	17	12	10	7	5	min
9 Ah 12 V	3 x 36	115	46	31	22	16	13	10	8	min
7 Ah 12 V	4 x 36	152	55	40	26	18	15	11	9	min
9 Ah 12 V	4 x 36	158	63	42	31	23	20	15	12	min

Eaton 93E UPS

80/100/120/160/200/300/400 kVA



93E 80-200 kVA

Advanced power protection for:

- Financial services
- Building management
- Telecommunications
- Industrial automation equipment
- Healthcare
- Government
- Data centres



Double-conversion UPS

Simply effective power protection

- Double-conversion provides the highest level of protection available by isolating the output power from all input anomalies.
- With a transformer-free design and sophisticated sensing and control circuitry the 93E UPS delivers an efficiency of up to 98.5%.
- Active power factor correction (PFC) provides unbeatable 0.99 input power and <5% ITHD, thus eliminating interference with other critical equipment in the same network and enhancing compatibility with generators.
- The UPS is optimized for protecting modern 0.9 p.f. rated IT equipment without the need to oversize.

True reliability

- Patented Powerware Hot Sync® technology makes possible to parallel up to 3 UPSs in capacity and up to 4 UPSs in redundancy. The technology enables load sharing without any communication line, thus eliminating single point of failure and increasing power availability.
- ABM testing and charging cycle helps you to prevent battery problems and in addition lessens corrosion prolonging battery service life up to 50%.

Extensive configurability

- The 93E offers over 20% smaller footprint compared to competitive UPS offerings.
- A multilingual graphical LCD display makes possible to monitor the UPS status easily.
- Wide software and connectivity options provide monitoring, management and shutdown capabilities over the network.
- Connectivity options are available to suit nearly any communication requirements, from standard serial communications to secure remote monitoring over the Web.

Cost savings and sustainability

- A new technical platform used in Eaton's three-phase UPS products guarantee easy upgrades, low MTTR, similarity on service trainings and documentation, thus lowering total cost of ownership.
- A range of service agreement options can be easily customized for customers' needs and budget.

TECHNICAL SPECIFICATIONS

General

UPS output power rating (0.9 p.f.)	80 100 120 160 200 300 400 kVA 72 90 108 144 180 270 360 kW
Efficiency in double-conversion mode (full load)	94%
Distributed paralleling with Hot Sync technology	Max 4 units
Maximum system power	1600 kVA
Inverter/rectifier topology	Transformer-free IGBT with PWM
Audible noise	≤65 dB (80-120 kVA), ≤70 dB (160-200 kVA) and ≤73 dB (300-400 kVA) at 1 m, 75% load
Altitude (max)	1000 m without derating (max 2000 m)
Dimensions W x D x H	600 x 800 x 1876 (mm) 80-200 kVA 1600 x 820 x 1880 (mm) 300-400 kVA
UPS ambient service temperature	0°C to +40°C

Input

Input wiring	3 ph + neutral
Nominal voltage rating (configurable)	220/380, 230/400, 240/415 V 50/60 Hz
Input voltage range	+20% / -15% at 100% load +20% / -50% at 50% load
Input frequency range	42-70 Hz
Input Power Factor	0.99
Input ITHD	< 5%
Soft start capability	Yes
Internal backfeed protection	Yes

Battery

Battery type	VRLA
Charging method	ABM technology or Float
Battery nominal voltage (lead-acid)	432 V (36 x 12 V, 216 cells) 456 V (38 x 12 V, 228 cells) 480 V (40 x 12 V, 240 cells)
Charging current / Model	80 100 120 160 200 300 400 kVA
Default	20 20 20 20 20 20 20 A
Max*	40 40 40 80 80 120 160 A

*May be limited by maximum UPS input current rating

Output

Output wiring	3 ph + neutral
Nominal voltage rating (configurable)	220/380, 230/400 (default), 240/415 V 50/60 Hz
Output UTHD	<2% (100% linear load)
Output power factor	0.9
Permitted load power factor	0.7 lagging – 0.9 leading
Overload on inverter	10 min 102-125% load 1 min 126-150% load 150 ms >151% load
Overload when bypass available	Continuous <115% load, 20 ms 1000% peak current. Note! External bypass fuses may limit the overload capability.

Accessories

External battery cabinets, internal manual bypass switch up to 120 kVA, external maintenance bypass switch, MiniSlot connectivity (Web/SNMP, ModBus/Jbus, Relay)

Communications

MiniSlot	2 communication bays
Serial ports	USB, RS232
Relay inputs/outputs	Three Signal inputs

Compliance with standards

Safety (CB certified)	IEC 62040-1
EMC	IEC 62040-2, EMC Category C3
Performance	IEC 62040-3

Due to continuous product improvement programs, specifications are subject to change without notice.



93E 300-400 kVA

Eaton 93PM UPS

30/40/50/80/100/120/150/160/200 kW



An Eaton Green Solution

Due to outstanding green performance, the Eaton 93PM UPS has earned the "An Eaton Green Solution"™ label

Key applications

- Small, medium and large data centres
- Modular and virtualised data centres
- Mission-critical applications
- IT infrastructure

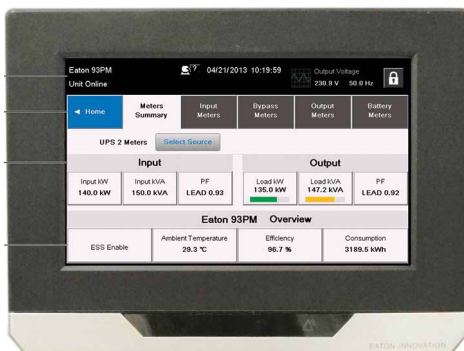

Maximum energy efficiency.
Minimum operating costs.

Lowest total cost of ownership

- The 93PM UPS sets new standards, with an operating level of up to 97% in double-conversion mode resulting in significant savings in operational costs.
- > 99% superior efficiency is delivered in Energy Saver System mode (ESS).
- Maximal power and energy density ensures a compact footprint.

Highly scalable and reliable

- Scalable, modular architecture and 'Pay as you grow' capability minimises CapEx.
- Eaton's unique Hot Sync wireless paralleling and internal redundancy ensures maximum availability and high reliability.

Easy deployment

- Thermal management support allows for flexible installation against the wall, in rows and in hot/cold aisle configurations.
- Easy access allows fast MTTR (mean time to repair).

Easy management

- The 93PM UPS comes with Web and SNMP interfaces as standard.
- Intelligent Power® software integrates with leading virtualisation management systems for monitoring and managing.
- The intuitive user LCD interface and visual data logging provides clear information on the UPS status.

TECHNICAL SPECIFICATIONS

General	
UPS output power rating (1.0 p.f.)	30, 40, 50, 80, 100, 120, 150, 160, 200 kW
Efficiency in double-conversion mode	Up to 97%
Efficiency in Energy Saver System (ESS)	> 99%
Distributed paralleling with Hot Sync technology	Up to 8 units
Maximum system power	1600 kW
Field upgradeable	Yes
Inverter/rectifier topology	Transformer-free IGBT with PWM
Audible noise	30–50 kW: < 60 dBA 80–200 kW: < 65 dBA ESS operation: < 47 dBA
Altitude (max)	1000 m without derating (max 2000 m)
Input	
Input wiring	3 ph + N + PE
Nominal voltage rating (configurable)	220/380, 230/400, 240/415 V 50/60 Hz
Input voltage range	High +20% rectifier input, 10% bypass input. Low –15% at 100% load, –40% at 50% load without battery discharge
Input frequency range	40–72 Hz
Input Power Factor	0.99
Input ITHD	30 kW: < 4.5% 40–200 kW: < 3%
Soft start capability	Yes
Internal backfeed protection	Yes
Battery	
Battery type	VRLA
Charging method	ABM technology or Float
Battery nominal voltage (VRLA)	432 V (36 x 12 V, 216 cells) or 480 V (40 x 12 V, 240 cells) Note: Strings with different battery voltage may not be paralleled!
Charging current maximum	30–50 kW: 16.5 A 80–100 kW: 33 A 120–150 kW: 50 A 160–200 kW: 66 A
Battery start capability	Yes

Output	
Output wiring	3 ph + N + PE
Nominal voltage rating (configurable)	220/380, 230/400, 240/415 V 50/60 Hz
Output UTHD	< 1% (100% linear load). < 5% (reference non-linear load)
Rated output power factor	1.0
Permitted load power factor	0.8 lagging – 0.8 leading
Overload on inverter	10 min 102–110%; 60 sec 111–125%; 10 sec 126–150% 300 ms > 150%. On battery mode 300 ms > 126%
Overload when bypass available	Continuous < 125%, 10 ms 1000% Note: Bypass fuses may limit the overload capability!

Accessories	
External battery cabinets with long-life batteries, External maintenance bypass switch, integrated manual bypass, MiniSlot connectivity (Web/SNMP, ModBus/Jbus, Relay)	

Communications	
MiniSlot	3 communication bays
Network/SNMP interface	Yes, standard
Serial ports	Built-in host and device USB
Relay inputs/outputs	5 relay inputs and dedicated EPO 1 relay output

Compliance with standards	
Safety (CB certified)	IEC 62040-1
EMC	IEC 62040-2
Performance	IEC 62040-3

Due to continuous product improvement programmes, specifications are subject to change without notice.

Part number	Description	Rating	Full load runtime	Dimension (WxDxH)	Weight (with battery)
P-105000007-005	93PM-30(50)-BB-6x9 Ah	30 kW	20 min	560 x 914 x 1876	890 kg
P-105000007-020	93PM-40(50)-BB-6x9 Ah	40 kW	15 min	560 x 914 x 1876	890 kg
P-105000007-034	93PM-50(50)-BB-6x9 Ah	50 kW	10 min	560 x 914 x 1876	890 kg

Part number	Description	Rating	Dimension (WxDxH)	Weight (without batteries)
P-105000011-001	93PM-50(100)-N+1	50 kW N+1	560 x 914 x 1876	338 kg
P-105000011-005	93PM-80(100)	80 kW	560 x 914 x 1876	338 kg
P-105000011-009	93PM-100(100)	100 kW	560 x 914 x 1876	338 kg
P-105000014-001	93PM-100(150)-N+1	100 kW N+1	560 x 914 x 1876	438 kg
P-105000014-005	93PM-120(150)	120 kW	560 x 914 x 1876	438 kg
P-105000014-009	93PM-150(150)	150 kW	560 x 914 x 1876	438 kg
P-105000016-001	93PM-150(200)-N+1	150 kW N+1	760 x 914 x 1876	556 kg
P-105000016-002	93PM-160(200)	160 kW	760 x 914 x 1876	556 kg
P-105000016-003	93PM-200(200)	200 kW	760 x 914 x 1876	556 kg

Power Xpert 9395P UPS

275 – 1100 kW



Power Xpert 9395P UPS

Advanced power protection for:

- Large data centres, infrastructure projects, industrial complexes and other buildings
- Process control equipment
- Healthcare
- Finance and banking infrastructure
- Transportation systems
- Security operations
- Telecommunications installations

Double conversion UPS

10% more power

- 96.3% double conversion efficiency, delivers 10% more power than the previous 9395 UPS.
- Complete isolation of output power from all input power anomalies, to deliver 100% conditioned, perfect sine-wave output – even during severe power disturbance.
- High efficiency even when UPS load levels are low, optimised by Variable Module Management System (VMMS).
- Energy Saver System (ESS) improves efficiency levels to 99% by suspending power modules when double conversion is not required. Switches to double conversion mode in less than 2 milliseconds in event of pre-set input limits being exceeded. Filtering against fast low-energy transients provided by ESS.
- Producing 18% less heat helps reduce the need for cooling. Designed for continuous operation at ambient temperatures up to 40°C without de-rating. Can also deliver safe power in higher temperatures without shutting down.

Ultimate resiliency

- HotSync® patented load-sharing technology enables parallel operating of static converters without communication or load-share signals. Eliminating the communication link eliminates risk of single point of failure.
- One static switch per UPS enables the full bypass capacity to be achieved from day one. Power modules can be added as loads increase.
- Wide power factor range meets rapidly changing load power factor without de-rating.
- Intelligent battery charging through Advanced Battery Management prevents unnecessary charging and significantly retards battery wear rate.

Scalability and flexibility

- Number of power modules per UPS can be specified.
- Layout can be chosen to suit installation: back-to-back, L-shaped etc. Front-accessible design minimises installation costs and saves valuable data centre space.
- Preferred bypass topology can be specified. Additional modules can be added as power load increases.
- Centralised multi-module paralleled 9395P systems are supported by the Eaton System Bypass Module (SBM). Available in ratings from 2000 A to 5000 A as standard, the SBM includes a continuous-duty centralised static switch, backfeed protection device and centralised bypass systems.
- Service disconnect in each power module allows easy maintenance while the UPS is supporting the load in double conversion mode.
- More than 90% of materials used can be recycled, decreasing end-of-life impact.

Power Xpert 9395P UPS

TECHNICAL SPECIFICATIONS

UPS output power rating (0.9 p.f.)	
kVA	300 600 900 1100
kW	275 550 825 1100
General	
Efficiency in double conversion mode (full load)	95.6%
Efficiency in double conversion mode (half load)	96.3%
VMMS (double conversion)	Significantly increased efficiency at low loads
Efficiency in Energy Saver System (ESS)	Up to 99%
Distributed parallelling with Hot Sync technology	5 + 1
Internal N+1 redundance capable	In 600 kVA: 300 kVA In 900 kVA: 600 kVA In 1100 kVA: 900 kVA
Field upgradable	Yes
Inverter/rectifier topology	Transformer-free IGBT with PWM
Audible noise	<78 dB; <81 dB (300 and 600 kVA)
Altitude (max)	1000 m without derating (max 2000 m)
Input	
Input wiring	3 ph + N + PE
Nominal voltage rating (configurable)	220/380, 230/400, 240/415 V 50/60 Hz
Input voltage range	+15% / -15% for 400 V or 415 V +15% / -10% for 380 V +10% / -10% for bypass
Input frequency range	45-65 Hz
Input power factor	0.99
Input ITHD	<3% on nominal load in double conversion mode
Soft start capability	Yes
Internal backfeed protection	Yes, standard
Output	
Output wiring	3 ph + N + PE
Nominal voltage rating (configurable)	220/380, 230/400, 240/415 V 50/60 Hz
Output UTHD	<2% (100% linear load), <5% (non linear load)
Output power factor	0.9 (e.g. 270 kW at 300 kVA)
Permitted load power factor	0.7 lagging - 0.8 leading
Overload on inverter	10 min 100-110%; 30 sec 110-125%; 10 sec 125-150%; 300 ms >150%
Overload when bypass available	Continuous <115%, 20 ms 1000% Note! Bypass fuses may limit the overload capability

Battery	
Type	VRLA, AGM, Gel, Wet Cell
Charging method	Current limited constant voltage charging, or Eaton Advanced Battery Management (ABM)
Temperature compensation	Optional
Battery nominal voltage (lead-acid)	480 V (40 x 12 V, 240 cells)
Charging current / Model	300 600
Max* A	120 240

*Limited by maximum UPS input current rating

Dimensions and weights		
300 kVA	1350 x 880 x 1880 mm (wxdxh)	830 kg
600 kVA	1890 x 880 x 1880 mm	1430 kg
900 kVA	3710 x 880 x 1880 mm	2520 kg
1100 kVA	4450 x 880 x 1880 mm	3120 kg

Accessories	
	External battery cabinets with long-life batteries, X-Slot connectivity (Web/SNMP, ModBus/Jbus, Relay, Hot Sync, ViewUPS-X remote display), integrated manual bypass for 300 kVA model

Communications	
X-Slot	4 communication bays
Serial ports	1 available
Relay inputs/outputs	5/1 programmable

Compliance with standards	
Safety (CB certified)	IEC 62040-1
EMC	IEC 62040-2
Performance	IEC 62040-3

Eaton RP Series IT Rack

42U/48U



Main Features

- Unobstructed front, rear and top cable access, maximises cabling flexibility for demanding network infrastructure
- Four 482 mm (19 inch) EIA-310-E vertical mounting rails with U-markings
- Tool-less adjustable rail positioning reduces set up and refresh time
- 3 point rail mounting gives superior top to bottom rigidity
- Fast, easily removable doors, left or right hinge
- Split rear doors reduce space requirements on rack back side
- Top panel includes two 150 mm wide cable openings allowing removable covers or brush strip options to accommodate all cabling requirements.
- Lockable, split side panels for quick and easy removal and re-installation for stand-alone and end of row racks
- Side dividers with cable pass-through holes for easy cable management between racks on multiple rack models
- Smart, attractive design with black RAL 9005 colour reflects high quality construction
- Designed to accommodate all Eaton enclosure PDUs, rack mounted UPSs
- Highly flexible accessory mounting options

All racks include

- Pre-installed grounding system, eliminating time and installation cost
- Pull handles with key locks; other handle types available upon request
- Starter kit including 20 x M6 cage nuts and screws, 20 x M5 accessory mounting screws
- Levelling feet
- Baying kit for multiple rack applications

Airflow Management

- Zero leakage around the front perimeter guides cool air to IT equipment, significantly increasing cooling efficiency and reducing energy costs
- High flow 75% open perforation doors maximizes airflow, increasing cooling effectiveness of the IT equipment
- Vertical air blanking panels with grommet-covered cable pass-thru on all 800 mm wide models
- Extensive airflow management accessories available

Main Options & Accessories

- Side panels – aesthetic side cover includes security lock. Supplied in two sections for easy installation
- Sided dividers – separate bayed racks for security and airflow management without adding to rack footprint
- Rack top cable management – flexible distribution of power and network cables with simple installation
- Full selection of cable management accessories
- Blanking panels in a variety of sizes
- Casters – easily install and move rack
- Shelves



RP Series rack with 2 installed Eaton ePDUs

Eaton RP Series IT Rack

TECHNICAL SPECIFICATIONS	42U 600x1000	42U 600x1200	42U 800x1000	42U 800x1200	48U 600x1000	48U 600x1200	48U 800x1000	48U 800x1200
Physical								
Equipment Mounting Height	42U	42U	42U	42U	48U	48U	48U	48U
Height	2043 mm	2043 mm	2043 mm	2043 mm	2310 mm	2310 mm	2310 mm	2310 mm
Height (with caster wheels)	2062 mm	2062 mm	2062 mm	2062 mm	2329 mm	2329 mm	2329 mm	2329 mm
Width (with side panels)	638 mm	638 mm	838 mm	838 mm	638 mm	638 mm	838 mm	838 mm
Width (without side panels)	600 mm	600 mm	800 mm	800 mm	600 mm	600 mm	800 mm	800 mm
Depth (with doors)	1057 mm	1257 mm	1057 mm	1257 mm	1057 mm	1257 mm	1057 mm	1257 mm
Depth (without doors)	1000 mm	1200 mm	1000 mm	1200 mm	1000 mm	1200 mm	1000 mm	1200 mm
Weight Capacity (static)	1500 kg	1500 kg	1500 kg	1500 kg	1500 kg	1500 kg	1500 kg	1500 kg
Maximum Rail Mounting Depth	860 mm	1060 mm	860 mm	1060 mm	860 mm	1060 mm	860 mm	1060 mm
Rail Mounting Width	483 mm (19 inch)							
Colour	Black, RAL 9005							
Metal Thickness								
Frame	2.0 mm	2.0 mm	2.0 mm	2.0 mm	2.0 mm	2.0 mm	2.0 mm	2.0 mm
Front Door	1.5 mm	1.5 mm	1.5 mm	1.5 mm	1.5 mm	1.5 mm	1.5 mm	1.5 mm
Rear Door	1.5 mm	1.5 mm	1.5 mm	1.5 mm	1.5 mm	1.5 mm	1.5 mm	1.5 mm
Roof	1.5 mm	1.5 mm	1.5 mm	1.5 mm	1.5 mm	1.5 mm	1.5 mm	1.5 mm
EIA Mounting Rail, 9.5 mm square holes	2.0 mm	2.0 mm	2.0 mm	2.0 mm	2.0 mm	2.0 mm	2.0 mm	2.0 mm
Side Panel	1.0 mm	1.0 mm	1.0 mm	1.0 mm	1.0 mm	1.0 mm	1.0 mm	1.0 mm
Side Divider	1.0 mm	1.0 mm	1.0 mm	1.0 mm	1.0 mm	1.0 mm	1.0 mm	1.0 mm
Airflow								
Open Perforation	75%	75%	75%	75%	75%	75%	75%	75%
Front Door Grill Free Area	6882 sqcm	6882 sqcm	10289 sqcm	10289 sqcm	7960 sqcm	7960 sqcm	11897 sqcm	11897 sqcm
Rear Door Grill Free Area	6165 sqcm	6165 sqcm	9563 sqcm	9563 sqcm	7111 sqcm	7111 sqcm	11058 sqcm	11058 sqcm
Shipping								
Shipping Width	780 mm	780 mm	900 mm	900 mm	780 mm	780 mm	900 mm	900 mm
Shipping Depth	1200 mm	1540 mm	1200 mm	1540 mm	1200 mm	1540 mm	1200 mm	1540 mm
Shipping Height	2250 mm	2250 mm	2250 mm	2250 mm	2420 mm	2420 mm	2420 mm	2420 mm
Shipping Weight	170 kg	190 kg	206 kg	224 kg	185 kg	205 kg	221 kg	239 kg
Conformance								
Regulatory Approvals	IEC/EN 60950							
Standards	EIA-310-E							
Protection Class	IP20 (when configured with Side Panels and top cover plate options)							
Enclosure Power Distribution mounting (ePDU)								
Zero U Frame mount, rear	Qty 4 PDUs, 1700 mm high x 55 mm wide				Qty 4 PDUs, 1966 mm high x 55 mm wide			
Zero U mount with extension bracket	Qty 4 PDUs, 1870 mm high x 88 mm wide				Qty 4 PDUs, 2136 mm high x 88 mm wide			
Mounting options	Key hole, M5 screw, EIA Mounting Rail (multiple options)							
Customer Service and Support								
Warranty	Two-year warranty							

Due to continuous product improvement programs, specifications are subject to change without notice.

Eaton REC Series IT Rack

42U & 47U



Eaton's REC Series IT racks deliver essential storage and protection for critical IT equipment in small, medium and large data center applications.

Designed for fast and easy set-up, the REC Series is provided with features IT specialists need in an affordable, ready-to-go enclosure including casters, lockable side panels, truly step-less rail positioning, U-markings and a grounding kit. A full range of easy-to-use cable management, airflow management and storage accessories are also available. The REC Series can also easily be assembled into aisle containment configurations with pre-fabricated end-of-row doors and horizontal roofs which are simple, fast and easy to install. Importantly, the REC series provides a foundation for larger variations of Eaton's new Intelligent Power Pod™ platform, which includes UPSs, rack PDUs, power management software, services and IT racks. With this full suite of products, integrators can simply install their preferred IT equipment and software and deliver a fully integrated system to their customer.

Standard racks include:

- Fully assembled sturdy rack frame
- Four infinitely adjustable 19" mounting rails, painted steel with U-markings
- Top panel with three large central cover plates for cable and air management, plus 2 additional front-to-back side openings for cable management brush inserts on 800 mm models.
- Split rear doors (800 mm wide models) or single rear door (600 mm wide models)
- Swing handles with key lock
- Lockable sides, no-sides version also available
- Casters and levelling feet
- Grounding kit
- 2 year standard warranty

Technical Specifications

Equipment mounting height Width x Depth (mm)	42U 600x1000	42U 600x1200	42U 800x1000	42U 800x1200	47U 600x1000	47U 600x1200	47U 800x1000	47U 800x1200
Physical								
Equipment mounting height	42U	42U	42U	42U	47U	47U	47U	47U
Height (casters fitted)	2048 mm	2048 mm	2048 mm	2048 mm	2270 mm	2270 mm	2270 mm	2270 mm
Width	600 mm	600 mm	800 mm	800 mm	600 mm	600 mm	800 mm	800 mm
Depth (door-to-door)	1040 mm	1240 mm	1040 mm	1240 mm	1040 mm	1240 mm	1040 mm	1240 mm
Load capacity (static)	1100 kg	1100 kg	1100 kg	1100 kg	1100 kg	1100 kg	1100 kg	1100 kg
Load capacity (dynamic)	200 kg	200 kg	200 kg	200 kg	200 kg	200 kg	200 kg	200 kg
Weight of assembled rack (with sides)	114 kg	116 kg	128 kg	132 kg	116 kg	127 kg	132 kg	143 kg
Front Door - Perforated	Single	Single	Single	Single	Single	Single	Single	Single
Rear Door - perforated (perforated model)	Single	Single	Split	Split	Single	Single	Split	Split
Door opening angle, hinges	180° angle with non-bayed installations, left-hand hinged, field reversible (140° for bayed racks). Doors attached with 3 quick release hinges.							
Door perforation	80%							
Rail mounting width	482.6 mm (19 inch) fully compliant with EIA-310-E. Can be set at 23 inch width or offset to one side on 800 mm models.							
Rail mounting holes	9.5 mm square holes							
Rail mounting depth (maximum)	850 mm	1048 mm	850 mm	1048 mm	850 mm	1048 mm	850 mm	1048 mm
Rail mounting depth - with PDU bracket	725 mm	925 mm	725 mm	925 mm	725 mm	925 mm	725 mm	925 mm
Rail offset	Rails can be offset to either side by 50 mm on 800 mm wide racks.							
Sides	Removable, lockable side panels (2 locks per side on 1200 mm deep models) - on models with sides.							
Colour	Black, RAL 9005							
Regulatory Approvals & Standards	EIA-310-E, IEC / EN 60950, IEC / EN 60297, IEC 529							
Protection Class	IP20 - when configured with doors and side panels							
ePDU maximum length*	42U: 1865 mm, 47U: 2085 mm Note: PDU bracket allows the mounting of 2 rack PDUs side-by-side at the rear of the rack.							

Eaton REC Series IT Rack

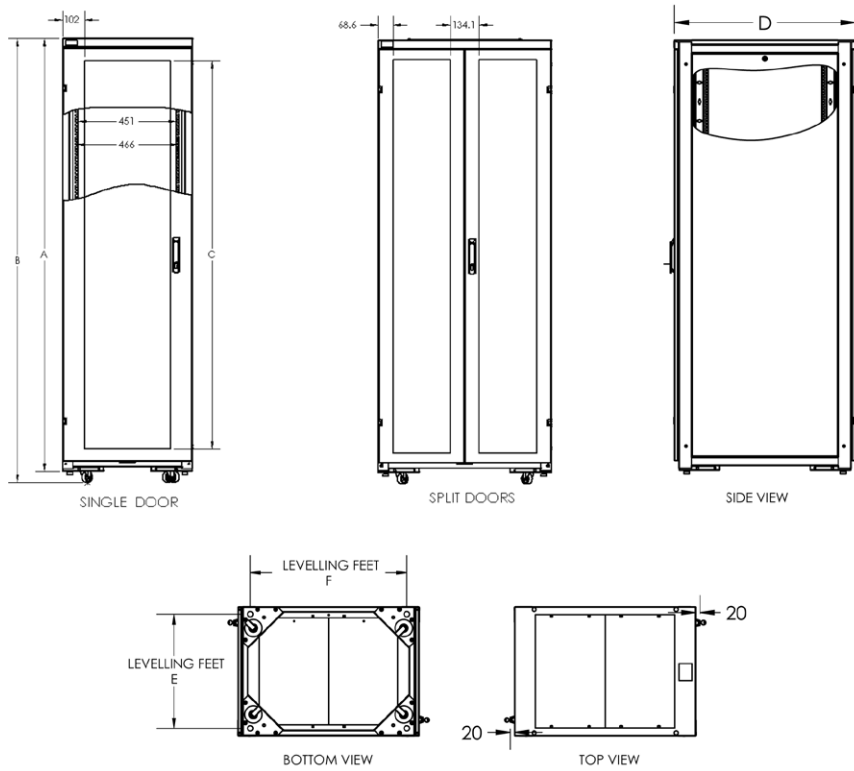

Models	Height	Width (mm)	Dimensions (mm)					
			A	B	C	D	E	F
RCA42610SPBE	42 U	600	1998	2049	1816	1040	529.5	925
RCA42610NPBE	42 U	600	1998	2049	1816	1040	529.5	925
RCA42612SPBE	42 U	600	1998	2049	1816	1240	529.5	1125
RCA42612NPBE	42 U	600	1998	2049	1816	1240	529.5	1125
RCA42810SPBE	42 U	800	1998	2049	1816	1040	729.5	925
RCA42810NPBE	42 U	800	1998	2049	1816	1040	729.5	925
RCA42812SPBE	42 U	800	1998	2049	1816	1240	729.5	1125
RCA42812NPBE	42 U	800	1998	2049	1816	1240	729.5	1125
RCA47610SPBE	47 U	600	2219	2270	2033.5	1040	529.5	925
RCA47610NPBE	47 U	600	2219	2270	2033.5	1040	529.5	925
RCA47612SPBE	47 U	600	2219	2270	2033.5	1240	529.5	1125
RCA47612NPBE	47 U	600	2219	2270	2033.5	1240	529.5	1125
RCA47810SPBE	47 U	800	2219	2270	2033.5	1040	729.5	925
RCA47810NPBE	47 U	800	2219	2270	2033.5	1040	729.5	925
RCA47812SPBE	47 U	800	2219	2270	2033.5	1240	729.5	1125
RCA47812NPBE	47 U	800	2219	2270	2033.5	1240	729.5	1125

Part numbers								
Equipment mounting height	42U	42U	42U	42U	47U	47U	47U	47U
Width x Depth (mm)	600x1000	600x1200	800x1000	800x1200	600x1000	600x1200	800x1000	800x1200
Perforated doors, with sides	RCA42610SPBE	RCA42612SPBE	RCA42810SPBE	RCA42812SPBE	RCA47610SPBE	RCA47612SPBE	RCA47810SPBE	RCA47812SPBE
Perforated doors, no sides	RCA42610NPBE	RCA42612NPBE	RCA42810NPBE	RCA42812NPBE	RCA47610NPBE	RCA47612NPBE	RCA47810NPBE	RCA47812NPBE

Eaton Aisle Containment System

REC Series IT Racks

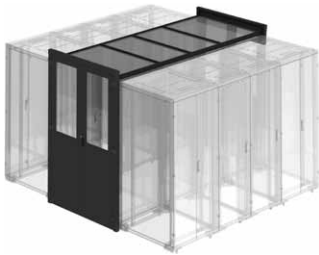

Eaton's Aisle Containment System for the REC Series IT racks delivers energy saving airflow management for small, medium and large data center applications.

Designed for fast and easy installation, the REC aisle containment system provides an affordable solution for energy saving cold aisle containment installations. This completely modular system allows extensions or reconfigurations as a pod changes or expands.

The system attaches to 42U or 47U high Eaton REC Series racks, and spans 1200 mm wide aisles. Roof panels connect to equal-width racks on either side of the aisle, and can be cut to install fire suppression systems.

Importantly, the REC aisle containment system provides an energy saving envelope for Eaton's new Intelligent Power Pod™ platform, which includes UPSs, rack PDUs, power management software, services and IT racks. With this full suite of products, integrators can simply install their preferred IT equipment and software and deliver a fully integrated system to their customer.

End-of-Row door kits include:

- Split, swing-style door pre-assembled with toughened glass window
- Door frame
- All hardware to attach doors to IT racks and floor

Roof panel kits include:

- Acrylic panel
- Panel frame with Velcro™ seal
- All hardware to attach panels to racks and adjacent roof panels

Technical Specifications

Rack Height, Width x Depth (mm)	End-of-Row Doors		Roof Panels	
	42U	47U	600x1200	800x1200
Height	2138 mm	2367 mm	50 mm	50 mm
Width	1316 mm	1316 mm	600 mm	800 mm
Depth	53 mm	53 mm	1200 mm	1200 mm
Aisle Width	1200 mm	1200 mm	1200 mm	1200 mm
Door style	Split swing door	Split swing door		
Door opening angle, hinges	180°, 2 lift-style hinges			
Door window material	Toughened glass, 4 mm			
Roof panels - material	Thickness: 3 mm, Perpex Cast Acrylic, attached with Velcro™			
Roof panels - Standards & Classifications	UL94 HB, NFP 92-307 (dripless), BS 476 Part 7 Class 3			
Rack types	Doors and roof panels designed for Eaton REC series IT racks			
Colour - Door & Frame	Black, RAL 9005			
Estimated installation time	4 hours each	4 hours each	10 minutes each	10 minutes each
Weight	56 kg	62 kg	8.8 kg	11.2 kg
Part Numbers	RCACUHD12KB	RCACUHD12KB	RCACRP0612KB	RCACRP0812KB

Eaton Aisle Containment System

End-of-row door dimensions

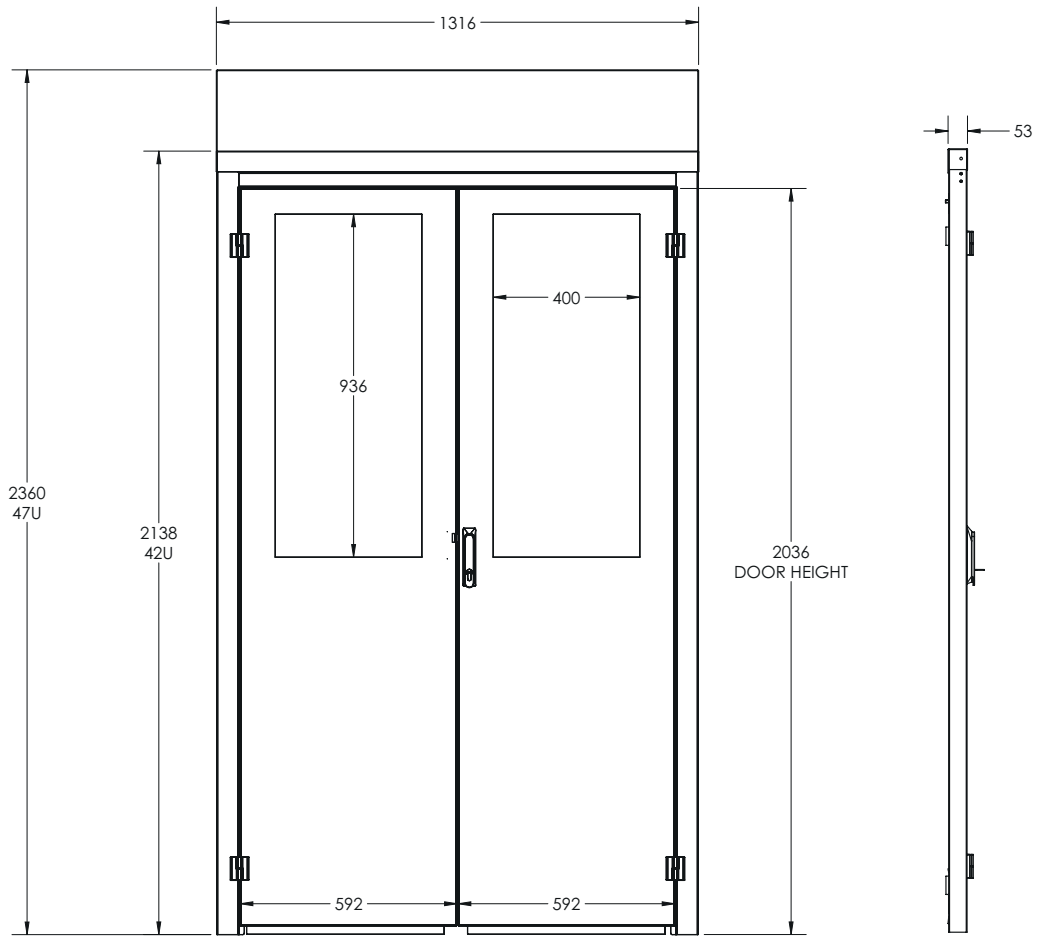

Roof panel dimensions

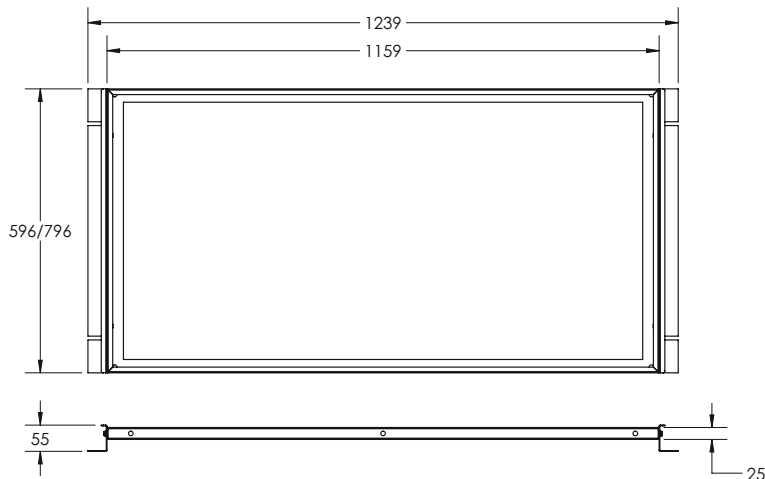

Eaton RE Series IT Rack

27U & 42U



Eaton RE series IT racks deliver essential protection for critical IT equipment in network closet and small server room applications.

Designed for fast and easy set-up, the RE Series is provided with features IT specialists need in an affordable, ready-to-go enclosure including casters, lockable side panels, step-less rail positioning, U-markings and a grounding kit. A full range of easy-to-use cable management, airflow management and storage accessories are available. Importantly, the RE series provides a foundation for Eaton's new Intelligent Power Pod™ platform, which includes UPSs, rack PDUs, power management software, service and the IT rack. With this full suite of products, integrators can simply install their preferred IT equipment and software and deliver a fully integrated system to their customer.

Standard racks include:

- Fully assembled sturdy rack frame
- Four infinitely adjustable 19" mounting rails with U-markings
- Plain top panel with two cover plates for optional airflow or cable management brush inserts
- Perforated steel or glass front door
- Split rear doors (800 mm wide models) or single rear door (600 mm wide models)
- Swing handles with key lock
- Lockable sides, no-sides version also available
- Casters and levelling feet
- Grounding kit
- 2 years standard warranty

Technical Specifications

Equipment mounting height Width & depth (mm)	27U 600x800	27U 600x1000	27U 800x800	27U 800x1000	42U 600x800	42U 600x1000	42U 800x800	42U 800x1000
Physical								
Height (casters fitted)	1382 mm	1382 mm	1382 mm	1382 mm	2048 mm	2048 mm	2048 mm	2048 mm
Width	600 mm	600 mm	800 mm	800 mm	600 mm	600 mm	800 mm	800 mm
Depth	840 mm	1040 mm	840 mm	1040 mm	840 mm	1040 mm	840 mm	1040 mm
Load capacity (static)	800 kg	800 kg	800 kg	800 kg	800 kg	800 kg	800 kg	800 kg
Load capacity (dynamic)	200 kg	200 kg	200 kg	200 kg	200 kg	200 kg	200 kg	200 kg
Weight of assembled rack (with sides)	76 kg	82 kg	80 kg	84.5 kg	102 kg	114 kg	117 kg	128 kg
Front door - perforated	single	single	single	single	single	single	single	single
Front door - glass door model	single		single		single		single	
Glass door specification	4 mm clear toughened glass, conforms with EN 12150							
Rear door - perforated (perforated model)	single	single	split	split	single	single	split	split
Rear door - solid metal (glass door model)	single		single		single		single	
Door opening angle	180° angle with non-bayed installations, left-hand hinged, field reversible (140° for bayed racks)							
Door perforation	80%							
Rail mounting width	482.6 mm (19 inch) fully compliant with EIA-310-E. Can be set at 23 inch width or offset to one side on 800 mm models							
Rail mounting holes	9.5 mm square holes							
Rail mounting depth (maximum)	650 mm	850 mm	650 mm	850 mm	650 mm	850 mm	650 mm	850 mm
Rail mounting depth - with PDU bracket	525 mm	725 mm	525 mm	725 mm	525 mm	725 mm	525 mm	725 mm
Rail offset	Rails can be offset to either side by 50 mm on 800 mm wide racks.							
Sides	Removeable, lockable side panels - on models with sides.							
Colour	Black, RAL 9005							
Heat load suitability - glass door model	< 1.5 kW		< 1.5 kW		< 1.5 kW		< 1.5 kW	
Regulatory approvals & standards	EIA-310-E, IEC / EN 60950, IEC / EN 60297, IEC 529							
Protection class	IP20 - when configured with doors and side panels							
ePDU maximum length	27U: 1200 mm, 42U: 1865 mm. Note: PDU bracket allows the mounting of 2 rack PDUs side-by-side at the rear of the rack.							

Eaton RE Series IT Rack

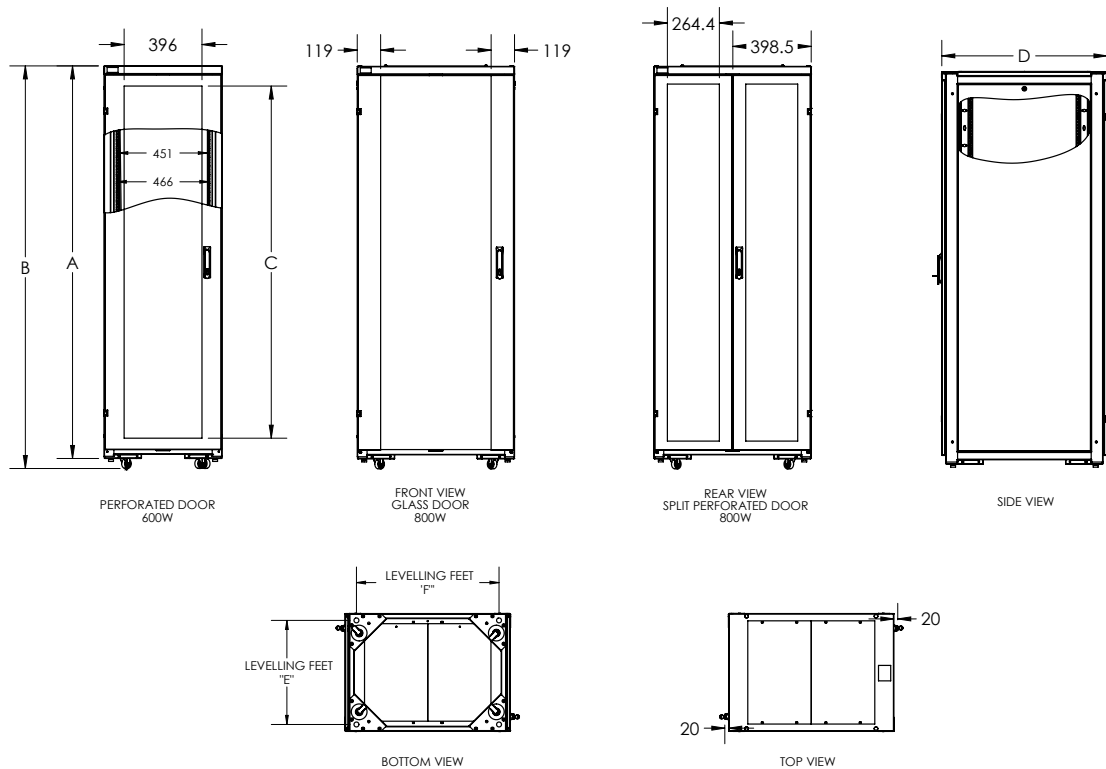

Models	Height	Width (mm)	Dimensions (mm)					
			A	B	C	D	E	F
REA27608SPBE	27 U	600	1332	1383	1034.4	840	529.5	725
REB27608SPBE	27 U	600	1332	1383	n/a	840	529.5	725
REA27610SPBE	27 U	600	1332	1383	1034.4	1040	529.5	925
REA27808SPBE	27 U	800	1332	1383	1034.4	840	729.5	725
REB27808SPBE	27 U	800	1332	1383	n/a	840	729.5	725
REA27810SPBE	27U	800	1332	1383	1034.4	1040	729.5	925
REA42608SPBE	42 U	600	1998	2049	1791	840	529.5	725
REA42608NPBE	42 U	600	1998	2049	1791	840	529.5	725
REB42608SPBE	42 U	600	1998	2049	n/a	840	529.5	725
REA42610SPBE	42 U	600	1998	2049	1791	1040	529.5	925
REA42610NPBE	42 U	600	1998	2049	1791	1040	529.5	925
REA42808SPBE	42 U	800	1998	2049	1791	840	729.5	725
REA42808NPBE	42 U	800	1998	2049	1791	840	729.5	725
REB42808SPBE	42 U	800	1998	2049	n/a	840	729.5	725
REB42808NPBE	42 U	800	1998	2049	n/a	840	729.5	725
REA42810SPBE	42 U	800	1998	2049	1791	1040	729.5	925
REA42810NPBE	42 U	800	1998	2049	1791	1040	729.5	925

Note: n/a indicates 'not applicable' due to glass door model.

Part numbers

Equipment mounting height Width x depth (mm)	27U 600x800	27U 600x1000	27U 800x800	27U 800x1000	42U 600x800	42U 600x1000	42U 800x800	42U 800x1000
Perforated doors, with sides	REA27608SPBE	REA27610SPBE	REA27808SPBE	REA27810SPBE	REA42608SPBE	REA42610SPBE	REA42808SPBE	REA42810SPBE
Perforated doors, no sides					REA42608NPBE	REA42610NPBE	REA42808NPBE	REA42810NPBE
Glass door, with sides	REB27608SPBE		REB27808SPBE		REB42608SPBE		REB42808SPBE	
Glass door, no sides							REB42808NPBE	

Eaton STS 16



Eaton STS 16



Source transfer system

Power supply redundancy for single-connection circuit equipment. With the Eaton STS 16, power from 2 independent sources can be supplied to servers and circuit equipment which only have one input power supply.

Redundancy

Only advanced servers are equipped with a dual electrical power supply. A majority of network devices and entry-level servers are single connection which means that they only have one electrical power input. With the Eaton STS, every critical equipment can be connected to a redundant power supply. Both sources (primary and secondary) are connected, in a very straightforward manner, to the STS in the base of the rack. The Eaton STS then controls the redundancy of this electrical power supply. If the primary source fails, transfer to the secondary source is automatic and instantaneous.

Simple and cost-effective

Considering its advanced design, the price of the Eaton STS is highly competitive compared with the 'dual power supply' options available from suppliers of computer equipment.

1U high, the unit can be installed easily within the rack. Five LEDs indicate the status of the sources and the Eaton STS.

Reliability

Designed to provide redundancy as close as possible to the equipment, the Eaton STS deploys a 'break before make' technology based on relays:

- In the event of a short-circuit, the Eaton STS ensures that the fault cannot affect the alternative source, so that power continues to be supplied to the fault-free equipment
- Power is transferred without overlap of the sources in order to prevent any node of reliability
- Even if it suffers a fault, the Eaton STS continues to supply power to the equipment from the remaining available source

Eaton STS 16

- 1 Buzzer stop
- 2 Fault indicator
- 3 Select primary source



STS 16, front view

- 4 Status of the sources
 - source OK
 - source failed
- 5 Eaton STS output
 - power supplied via the primary source
 - supplied via the secondary source

- 1 Circuit breakers
- 2 Output
- 3 Input



STS 16, rear view

TECHNICAL SPECIFICATIONS	STS 16
Nominal current	16 A
Compatibility	With all uninterruptible power supplies which use on-line double-conversion technology
Input/output	
Voltage/input frequency	208/220/230/240 V +/- 12% ; 50/60 Hz
Output protection	1 thermal cutout per set of IEC 13 connectors
Performance	
Transfer time	6 ms
Technical standards	
Safety	EN 50091-1
EMC	EN 50022/B, IEC 1000-4
Marking	CE, TÜV/GS/UL
Connection	
Inputs	2 connecting cables with IEC C20 connector (16 A male connector)
Outputs	2 set of 3 IEC C13 connectors - 1 set of 1 IEC C19 connector
Dimensions and weight	
Dimensions H x W x D	430 x 43 x 250 mm
Weight	5 kg
Customer Service & Support	
2 years guarantee	Standard exchange of the product
Communications software and hardware	
A simple and complete mimic diagram	Displays the various status of the sources and the Eaton STS
An 'STS COM' communication port	Of the dry contact type indicates the status of the sources and the Eaton STS: primary source, source OK, fault within the Eaton STS

Part Numbers	STS 16
STS 16	66 028
Set of two 16 A connecting cables IEC female connector / USE-DIN male connector length 1.5 m	66 397
1 cable / IEC 10 A male to IEC 16 A female	66 029

Eaton FlexPDU

Eaton HotSwap MBP



FlexPDU range



HotSwap MBP range



Hotswap MBP6Ki & MBP11Ki



Power distribution

The no hassle solution for improving availability and adding flexibility for single phase UPSs.

Eaton FlexPDU

Having the right connectors just where you need them

- FlexPDUs (Power Distribution Units) are flexible mounting multiway socket blocks for easy connection of multiple loads either as free-standing or on rack-mounted UPSs
- FlexPDUs have a large number of sockets (8 French or Schuko sockets, 6 BS sockets or 12 IEC 10 A sockets) which fit into a very compact unit (1U- 19")
- FlexPDUs are easy to implement into any type of installation: they can be rack mounted horizontally (1U) or vertically or directly onto all Eaton RT format (rack/tower) UPSs

Eaton HotSwap MBP

- High availability for all UPSs up to 11 kVA.
- HotSwap MBP provides a maintenance bypass for all UPSs. UPSs can be hot swapped or upgraded without interrupting the power supply.
- HotSwap MBP are available with multiple power ratings: 3000 VA, 6000 VA, 11000 VA, 11000 VA (3 ph Input).
- HotSwap MBP provides compatibility with any UPS now and in the future from Eaton or any other supplier
- The HotSwap MBP 3000 VA is available with different output connectors: French, Schuko, British, IEC or terminal blocks (Hard-Wired version).
- When used with a 9PX or 9SX the HotSwap MBP 6000 VA and above are providing information on the Bypass status through the UPS LCD screen.
- HotSwap MBP units can be installed as required; at the back, side, top of the UPSs, or rack-mounted.

Eaton FlexPDU

Eaton HotSwap MBP

- 1 Flexible system for 19" rack-mounting or on Eaton RT UPSs
 - 2 French/Schuko/British/IEC 10 A sockets
 - 3 IEC 16 A output for cascading
 - 4 IEC 16 A input socket
 - 5 Retaining clip
 - 6 Rotary bypass switch
 - 7 Colour coded input and output sockets for connecting the UPS
- NB: hard-wired version available



HotSwap MBP 3000



HotSwap MBP 11000

- 1 Flexible system for 19" rack-mounting or on Eaton 9PX/SX UPSs
- 2 Input/Output
- 3 4 IEC 16 A sockets with Retaining clip
- 4 Rotary bypass switch

TECHNICAL SPECIFICATIONS

	Eaton FlexPDU	Eaton HotSwap MBP 3000	Eaton HotSwap MBP 6000	Eaton HotSwap MBP 11000
Maximum power	3000 VA	3000 VA	6000 VA	11000 VA
Nominal Voltage	220 - 240 V			200-240 V (350 - 430 V for 3 ph version)
Installation				
Format	1U (except BS) 19" rack-mounting with multi-position mountings	>1U 19" rack-mounting with multi-position mountings	3U 19" rack	3U 19" rack
Installation	19" rack, wall mounting or on Eaton RT UPSs		19" rack, wall mounting or on Eaton 9PX/SX UPSs	
Dimensions H x W x D	44 x 483 x 80 mm (BS: 52 x 483 x 120 mm)	52 x 483 x 120 mm	52 x 483 x 120 mm	89 x 483 x 90 mm
Connection				
Inputs	1 IEC C20 (16 A) connector and 2 cables (1 IEC 16 A - 16 A cable and 1 IEC 10 A - 16 A cable) for connection to any UPS	FR / DIN / BS / IEC models: 1 IEC C20 (16 A) connector and 1 IEC 16 A - 16 A cable (1) HW (Hard-Wired): terminal block	Hardwired terminal block	Hardwired terminal block
Outputs	FR 8 French sockets + 1 IEC 16 A socket DIN 8 Schuko sockets + 1 IEC 16 A socket BS 6 British sockets + 1 IEC 16 A socket (with 2 circuit breakers) IEC 12 IEC 10 A sockets + 1 IEC 16 A socket (with 2 circuit breakers) HW NA	4 French sockets + 1 IEC 16 A socket / 4 Schuko sockets + 1 IEC 16 A socket / 3 British sockets + 1 IEC 16 A socket (with 1 circuit breaker) 6 IEC sockets + 1 IEC 16 A sockets (with 1 circuit breaker)	3 IEC 10 A sockets + 2 IEC 16 A sockets (with 3 circuit breakers) + Terminal blocks	/ / / 4 IEC 16 A sockets (with 4 circuit breakers)+ Terminal blocks
Cascading	Yes, IEC 16 A output socket			
Retaining clips	Retaining clips on the IEC output sockets			
Operating conditions and approvals				
Operating temperature	0°C to 45°C continuous		0°C to 40°C continuous	
Approvals	CE			

1: Use cable kits P/N 66 439 (French/Schuko) or 66 440 (British) for connecting a low power UPS <2.2 kVA (with IEC 10 A outputs) - see below.

Part Numbers	Eaton FlexPDU	Eaton HotSwap MBP 3000	Eaton HotSwap MBP 6000	Eaton HotSwap MBP 11000
FR	FlexPDU 8 FR: 68 435	HotSwap MBP 4 FR: 68 430	/	
DIN	FlexPDU 8 DIN: 68 436	HotSwap MBP 4 DIN: 68 431	/	
BS	FlexPDU 6 BS: 68 437	HotSwap MBP 3 BS: 68 432	/	
IEC	FlexPDU 12 IEC: 68 438	HotSwap MBP 6 IEC: 68 433		
HW (Hard-Wired)	/	HotSwap MBP HW: 68 434	MBP6Ki	1Phase In/Out : MBP11Ki, 3Phase In/1 Phase Out: MBP11Ki31
10 A French/Schuko cable kit for HotSwap MBP	/	68 439		
10 A British cable kit for HotSwap MBP	/	68 440		



FR DIN/ BS IEC C13 IEC C19 IEC C14 IEC C20
Schuko 10 A 16 A 10 A 16 A



Managed ePDUs

Managed ePDUs offer data centre managers maximum functionality and flexibility by providing a complete understanding of, and control over, data centre power distribution.



Advanced Monitored Switched ePDUs

Advanced Monitored ePDUs give data centre managers the detailed, accurate information and understanding needed to run a data centre efficiently and effectively.



Switched ePDUs give control to the data centre managers. They provide the ability to remotely shut off or restart equipment, ensuring that it starts up in the correct sequence with the correct delays, together with overall monitoring for load balancing.

Monitoring

Highly accurate individual outlet, user-defined group of outlets, branch circuit, and full ePDU monitoring for kWhrs, V, W and A (1% accuracy above 2 A). Also temperature and humidity monitoring in the rack via optional sensors.

Highly accurate individual outlet, user-defined group of outlets, branch circuit and full ePDU monitoring for kWhrs, V, W and A (1% accuracy above 2 A). Also temperature and humidity monitoring in the rack via optional sensors.

Highly accurate monitoring of branch circuit and the ePDU as a whole for kWhrs, V, W and A (1% accuracy above 2 A). Also temperature and humidity monitoring in the rack via optional sensors. Monitor over Ethernet or via Advanced LCD screen on the unit.

Switching

Individual outlet, sequencing of outlets with delays or cycling, together with user-defined outlet group or branch circuit, enables remote reboot of equipment. Power Scheduling of outlets or outlet groups also available.

—

On, off and reboot control of individual outlets and user-defined group of outlets, together with cycling and sequencing of outlets and branch circuits. Power Scheduling of outlets or outlet groups also available.

Control

Monitor and control remotely over Ethernet or via Advanced LCD screen on the unit. Communication protocols include HTTP/HTTPS, DHCP, SNMP v1 and v3, SMTP, Telnet, IPv4 and IPv6. Mass configuration and upgrade available.

Includes Eaton's patented flexible mounting system, which ensures ePDUs will fit in any standard 42U IT rack. Eaton Managed ePDUs provide reliable, consistent power distribution at temperatures of up to 50°C.

Cisco EnergyWise compliant.

Monitor and measure key properties and alerts remotely over Ethernet or via Advanced LCD screen on the unit. Communication protocols include HTTP/HTTPS, DHCP, SNMP v1 and v3, SMTP, Telnet, IPv4 and IPv6. Mass configuration and upgrade available.

Includes Eaton's patented flexible mounting system, which ensures ePDUs will fit in any standard 42U IT rack. Eaton Advanced Monitored ePDUs provide reliable, consistent power distribution at temperatures of up to 50°C.

Cisco EnergyWise compliant.

Monitor and Control key properties and alerts remotely over Ethernet. Monitor via Advanced LCD screen on the unit. Communication protocols include HTTP/HTTPS, DHCP, SNMP v1 and v3, SMTP, Telnet, IPv4 and IPv6. Mass configuration and upgrade available.

Includes Eaton's patented flexible mounting system, which ensures ePDUs will fit in any standard 42U IT rack. Eaton switched ePDUs provide reliable, consistent power distribution at temperatures of up to 50°C.

Cisco EnergyWise compliant.



New

ePDU G3 Metered Input

New ePDU G3 Metered Input models feature best-in-class technologies, including $\pm 1\%$ billing grade accuracy, an advanced LCD pixel display showing V, W, A and kWh, a hot-swap meter and the ability to daisy chain four ePDUs to share the same network connection and IP address. Eaton Metered Input ePDUs also provide both rear and side variable button mounting system and Eaton's patented clip foot system.



New

ePDU G3 In-Line Metered

New ePDU G3 In-Line Metered Input models upgrade existing basic installation to include, including $\pm 1\%$ billing grade accuracy, an advanced LCD pixel display showing V, W, A and kWh, a hot-swap meter and the ability to daisy chain four ePDUs to share the same network connection and IP address. Eaton In-line Metered ePDUs also provide both rear and side variable button mounting system and Eaton's patented clip foot system.



New

ePDU G3 Basic

Designed for reliable and cost effective power distribution, the new ePDU G3 Basic models feature Eaton's patented IEC outlet grip plug retention, colour-coded outlet sections, a low-profile form factor and a high operating temperature. Eaton basic ePDUs also provide both rear and side variable button mounting system and Eaton's patented clip foot system.

ePDU G3 Technical Specification

G3 Key technology features	G3 Metered Input	G3 In-Line Metered	G3 Basic
IEC outlet eGrip plug retention	✓	N/A	✓
$\pm 1\%$ IEC class 1 billing grade accuracy	✓	✓	N/A
Colour-coded outlet and breaker sections	✓	✓	✓
Hot-swap eNMC meter with advanced LCD	✓	✓	N/A
Low-profile form factor	✓	✓	✓
High operating temperatures	✓	✓	✓
Daisy-chain network	✓	✓	N/A
Multiple install options	✓	✓	✓
EnergyWise ready	✓	✓	N/A

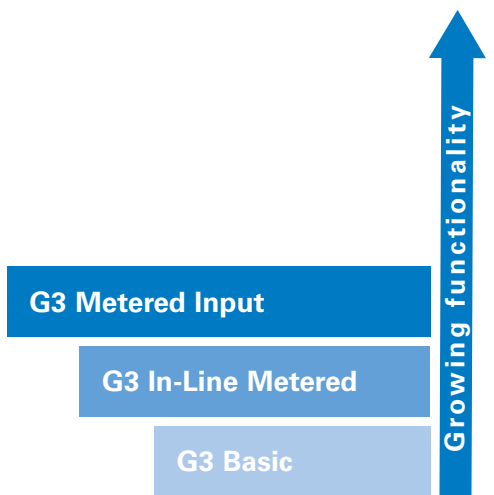

Intelligent Power Software

Intelligent Power™ Software is a suite of productivity tools for power management from Eaton. It greatly simplifies the supervision of power conditions and devices in today's enterprise environment, scaling effortlessly from local area networks with a few UPSs and ePDUs to the most critical virtualised data centres.

Administrators will value the many automatic functions of Intelligent Power Software. Installation requires just a few clicks and a couple of minutes; once the software starts, it will automatically discover manageable equipment.

The Intelligent Power Software architecture makes it very flexible. Completely network-based communications make the server part very suitable for virtualisation, and the web interface allows access from any device with a browser, anywhere in the network. The Dynamic web interface presents the database contents in easy to interpret text, graphs and colours, highlighting the essential points.

The software can take automatic action as well. Events can be set to trigger email sending, notifications and command execution. This way the infrastructure can automatically adapt to extend runtime and alarms with exact data reach the right people in seconds, giving maximum time for action to prevent downtime, reduce mean time to repair and minimise the impact of power events.

Intelligent Power Software incorporates two applications that ensure system uptime and data integrity: **Intelligent Power Manager** and **Intelligent Power Protector**.

Powering Virtualisation

Virtualisation is driving the deployment of many new applications and data centre demands. It changes the way IT facilities are operated, bringing substantial savings and increasing availability and flexibility of IT applications.

Managing the power infrastructure within a virtual platform is vital for increased uptime and reliability of those applications. To facilitate the management of power devices, the Intelligent Power Manager plugs into leading virtual machine management systems, including VMware® vCenter™ and Citrix XenCenter™, and integrates power management functions to these systems so that all UPSs and ePDUs in the virtual network can be viewed within the same application, together with network, physical server and storage information. In case of a local power failure, it can also trigger vCenter's vMotion™, SCVMM's Live Migration and XenCenter's XenMove™ to transparently move virtual machines from a server affected by a power interruption to an available server on the network, ensuring data integrity and enabling zero downtime.

If controlled graceful shutdown of hypervisors and their guests is sufficient in case of a prolonged power outage, Intelligent Power Protector is ideal for the task. Intelligent Power Protector invokes shutdown or hibernation of virtual machines, signals the hypervisor to shut down and powers off the physical server. It supports VMware, Hyper-V, Xen and KVM platforms.

Intelligent Power Software snapshot

- Intelligent Power Manager for monitoring and managing power equipment in IT environments
- Intelligent Power Protector for graceful shutdown of operating systems on physical and virtual machines.
- Intuitive web-based user interface
- Seamlessly integrates with leading virtualisation platforms
- Compatible with Eaton and other manufacturers' UPSs as well as Eaton's ePDU products and environmental sensors
- Generic SNMP driver enables monitoring of practically any SNMP enabled device
- Reduces total cost of ownership for the whole monitoring system

Benefits for virtualised environments

- Intelligent Power Manager integration with VMware's vCenter, Citrix's XenCenter and Microsoft's SCVMM streamlines daily management work and increases productivity.
- View critical power information on UPS, ePDUs and environmental sensors from a virtual machine management dashboard
- Integrate power alarms to vCenter alarm handling and event logging
- Instantly access critical information such as UPS battery status, load levels and alarms
- Intelligent Power Manager can be configured to trigger vCenter's vMotion or Site Recover Manager, XenMove and SCVMM's Live Migration to transparently move virtual machines to a back-up facility.
- Intelligent Power Protector can perform an automatic orderly shutdown of VMware, Hyper-V, Xen and KVM hypervisors and their guest operating systems in case of a prolonged power failure
- Intelligent Power Manager can trigger agentless remote shutdown of hypervisors and NetApp storage.
- Intelligent Power Manager enables IT managers to cap power usage on Cisco UCS servers in order to extend battery runtime during power events.



Intelligent Power Manager

Intelligent Power Manager is a productivity tool for administrators of multiple power devices and shutdown applications. It delivers the big picture and highlights key data by concentrating information from multiple sources and displaying it in a single view. It also centralises alarm propagation making sure that important events are brought to those who need to know.

Intelligent Power Manager simplifies many routine maintenance tasks, including its own updates. It has an automatic update function which will notify the operator of available upgrades, download and install them. In addition to that, it also checks if there are new versions of shutdown software. Mass upgrade and configuration of cards and applications saves a lot of valuable operator time and reduces the chance of human error.

Intelligent Power Manager manages up to 10 devices at no charge.

Simply purchase a full license and enter the corresponding license key to raise this limit and enable management of 100 or more devices.

Features:

- Easily monitor hundreds of power and environmental devices
- Integrates seamlessly with leading virtualization platforms for single pane of glass management
- User-definable tree structure enables grouping, access and management of multiple devices in several locations
- Minimises the effort required in power management system maintenance through mass configuration and firmware management
- Manages all Intelligent Power software instances in the network

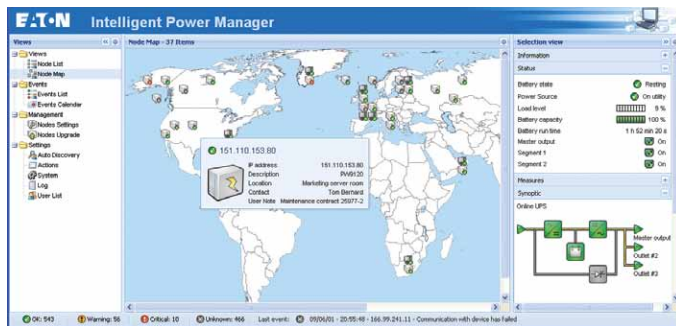

Global view

Intelligent Power Manager scales easily from a local area network to a global view, keeping an eye on power conditions and equipment status. In addition to the default maps, it's possible to upload more maps, floor plans and other images. There can be separate views for multiple geographical areas and buildings.

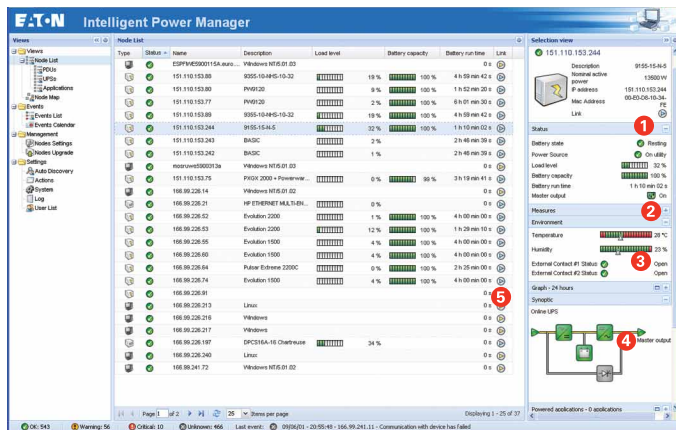

Main list view

With Intelligent Power Manager list view, the key operational parameters of multiple devices can be seen at a glance. Users can create their own views and apply several different filters, such as location, equipment type, function and so forth. Activating an entry provides more detailed data in the information panes:

- 1 Identification of the device, including equipment type, serial number and user-defined information
- 2 Operational status
- 3 Readings from optional environmental probe
- 4 Synoptic view of power flow
- 5 For each node, there is a hyperlink to the web interface of that device



Graphing tools

List and map views give an excellent real-time snapshot of a large number of devices, but very often time series data is needed for analysis, planning and problem mitigation. Intelligent Power Software has powerful graphing tools which help in visualising large amounts of data stored in its database. The user can choose which data is graphed and which timescales are used. Exact values are displayed when the pointer is moved over the graph area.

Intelligent Power Protector

When the power goes out for longer than your available battery runtime, Intelligent Power Protector software facilitates automatic, graceful shutdown of computers, servers and network devices powered by a UPS, saving all work-in-progress and ensuring data integrity (Intelligent Power Protector).

Intelligent Power Protector has also monitoring and alarm handling capabilities making it a complete solution for a single UPS.

Intelligent Power Protector has comprehensive choices for shutdown triggers, timings and modes. User can choose whether the operating system should shut down, hibernate, power off or run a custom script. The start of shutdown can be based on an instant event, delay or the remaining runtime on the UPS.

Features:

- Graceful shutdown of operating systems in case of an extended power failure or other condition that threatens the availability of IT equipment
- Supports Eaton UPS through network, RS232 serial and USB communication
- Supports redundant power supplies and parallel UPS configurations
- Silent unattended installation option
- Manageable with Intelligent Power Manager

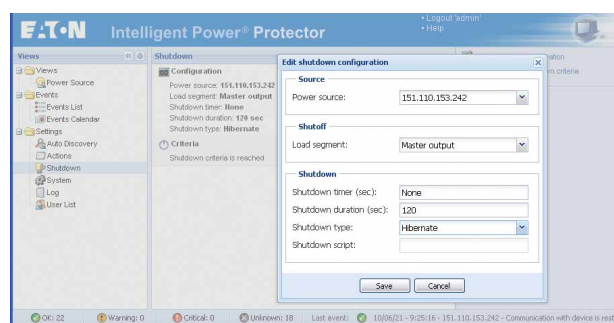

Shut down settings

There could be hundreds of UPSs in a network, each powering multiple servers running shutdown software. Managing that kind of setup could easily become a nightmare, especially because new computers are added and old ones moved all the time. Intelligent Power Manager comes to the rescue by clearly showing which Protectors are connected to a particular UPS.



Connectivity Options

Web/SNMP cards are complete UPS monitoring, control and shutdown solutions in a networked IT environment. In case of alert the Web/SNMP card can notify users and administrators through e-mail and SNMP traps. In case of a prolonged power failure the protected computer systems can be shut down in a graceful manner with Intelligent Power Protector software. The unique three-port switching hub on the X-Slot model provides additional network connections.

ConnectUPS-X

P/N 116750221-001 for Eaton 9155, 9355, 9395P, BladeUPS.

ConnectUPS-E

P/N 116750223-001 is an external model that is connected to a serial port on a UPS. It supports Eaton 9130, 9155, 9355, and 9395P UPS (requires cable 1023247).

Network Card-MS Web/SNMP adapter (P/N Network-MS)

The Eaton Network Card-MS supports SNMP v1 and v3; IPv4 and v6; http, https and SMTP. Works with: 5130, 5PX, 9130, EX, 5SC, 5P, 9PX, 9SX, 93E and 93PM.

Environmental Monitoring Probe (P/N EMP001) adds temperature, humidity and two contact closure monitoring capability to ConnectUPS Web/SNMP cards. It is well suited for monitoring rack temperature and door status, as well as battery temperature. Operating system shutdown can be triggered if user defined thresholds are exceeded or contact closure status changes. EMP works with Network-MS, Network and Modbus – MS, ConnectUPS and PXGX cards as well as network enabled ePDUs.

Relay/AS400 cards are an easy connection to IBM AS/400 series computers as well as industrial and building management systems. P/N 1018460 for Eaton 9155, 9355, 9395P, BladeUPS. P/N 1014018 for Eaton 9130.

C/N RELAY-MS for 5130, 5PX, EX, 5SC, 5P, 9PX, 9SX, 93E and 93PM.

X-Slot ModBus card connects the UPS to industrial and building management systems using ModBus/JBUS RTU protocol. P/N 103005425-5591 for Eaton 9155, 9355, 9395P, BladeUPS.

Network and MODBUS Card-MS (P/N MODBUS-MS) offers ModBus RTU in addition to Web and SNMP for 5130, 5PX, 9130, EX, 5SC, 5P, 9PX, 9SX, 93E and 93PM.

PXGX UPS card (P/N 103007974-5591) offers ModBus TCP as well as Web and SNMP interfaces for 9155, 9355, 9395P and BladeUPS.

ViewUPS-X remote display is an LCD panel that lets users view the status of the UPS from as far as 100 m. ViewUPS-X has also four status LEDs and an alarm sound. The display is bundled with a dedicated X-Slot card that also powers the display through the communication cable. In addition to the remote display connection the card has also a SELV isolated relay port for connection to monitoring systems and AS/400 computers.

P/N 1027020 for 9155, 9355, 9395P and BladeUPS.



ConnectUPS - X



Network Card-MS



Environmental Monitoring Probe



BD relay card (for Eaton 9130 UPS)

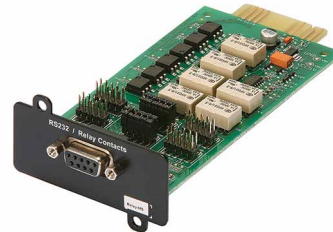

Relay MS



X-Slot relay card



PXGX UPS



X-Slot Modbus card



ViewUPS-X



Modbus MS card



Green by design

Eaton is constantly working with customers to develop solutions that drive sustainable growth around the globe. Our UPS solutions strive for unparalleled energy efficiency, efficient resource use, maximum use of recyclable materials and the reduction of emissions throughout the entire life of the product, from cradle to grave.

Our engineers are constantly developing smarter ways to deliver ecological and economic benefits. This includes the development of energy efficient and environmentally friendly technologies.

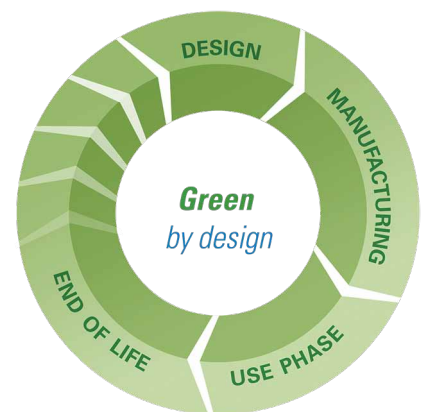

Design

Taking account of the environment is a part of the design process at Eaton. Four characteristics guide the design team during their work: energy efficiency, resource efficiency, recycling and compliance with regulations.

The Life Cycle Assessment (LCA) process is used to gather information about the potential environmental impact of a product.

✉ LCA@Eaton.eu

Eaton is constantly monitoring the use of hazardous substances and material its design and manufacturing processes. Our products do not contain **REACH** SVHCs (Substances of Very High Concern) and Eaton is seeking to comply with the **RoHS Directive** in advance of it becoming a legal requirement to do so.

The Eaton Green Leaf label is our promise to customers, consumers and our communities, of exceptional and documented environmental performance. Eaton 93PM, Power Xpert 9395P UPS, Protection Station, BladeUPS are exceptional Power Quality products that have been certified as Eaton Green solutions.

Manufacturing

Eaton is focused on building sustainable operations and managing Environment, Safety and Health (EHS) through standardisation. Our global Managing Environment, Safety and Health (MESH) programme is a unified system that consolidates existing programmes (ISO 14001, OHSAS 18001, OSHA VPP) into a single integrated management system. All EMEA manufacturing locations are ISO14001 certified.



An Eaton Green Solution

Use Phase

Green technologies

Energy Saver System (ESS)	Enables extremely high energy efficiency and reliability under normal operating conditions	Eaton 93PM and Power Xpert 9395P UPSs
Easy Capacity Test (ECT) technology	Enables testing of entire power train under full load stress without the need for an external load	Eaton 9355, 93E, 93PM and Power Xpert 9395P UPSs
Hot Sync technology	Start from a single module and add power when required	BladeUPS, Eaton 9PX, 9155, 9355, 93E, 93PM and Power Xpert 9395P UPSs
Advanced Battery Management (ABM) technology	Increases the life of batteries by employing a three-stage charging technique	BladeUPS, Eaton 5P, 5PX, 5SC, 9130, 9SX, 9PX, 9155, 9355, 93E, 93PM and Power Xpert 9395P UPSs
Hot-Swappable batteries	Allows batteries to be replaced or removed one string at a time while the equipment is still running	BladeUPS, Eaton 5130, 5P, 5PX, EX, 9130, 9SX and 9PX UPSs
EcoControl technology	Automatically disables peripherals when the master drive is turned off	Eaton Protection Station, Ellipse ECO and Ellipse PRO
Variable Module Management System (VMMS)	Maximises efficiencies at lighter loads without compromising reliability.	Power Xpert 9395P UPSs

End of Life

Eaton takes into account the environmental effects of the packaging and the end-of-life processing of our products and to aid more responsible dismantling, end-of-life instructions are available for recyclers.

We are committed to adhering to the following legislation when applicable:

WEEE (Directive 2002/96/CE)
Waste Electrical and Electronic Equipment

Batteries (Directive 2006/66/CE)
Batteries and accumulators and waste batteries and accumulators

Packaging (Directive 2004/12/CE)
Packaging and packaging waste

To find out more about Green by design, please visit:
www.eaton.eu/green

Hot Sync Technology



Paralleling UPS technology

The number one function of a UPS is to supply continuous conditioned, reliable electricity to a critical load. In case of a single unit, reliability can be increased by modular design, where redundant internal modules can take over each others' tasks, if one of the modules fails.

To further increase reliability, a true parallel configuration can be employed, where two or more units share the load. A failed unit is isolated while the remaining ones continue to support the critical load. Competitive UPS products on the market utilise centralised or distributed load-sharing technology with the master-slave principle, which introduces a risk of single point failure. The absolute reliability of a UPS system can be achieved with patented Powerware Hot Sync® parallel load-sharing technology. **(Figure 1)**

Hot Sync technology is designed for parallel redundant N+1 systems to satisfy 24/7 applications. It can also be used in parallel capacity systems to benefit from scalability for customers' ever-increasing load demands modules can share loads without any communication wiring to the outside world.

User benefits

- Available for both single- and three-phase products to meet any mission-critical need up to 7.7 MW (400 V) systems
- Easy and modular parallel UPS system upgrade with additional capacity or redundancy
- Erases single point of failure, load sharing is not endangered by loss of communication

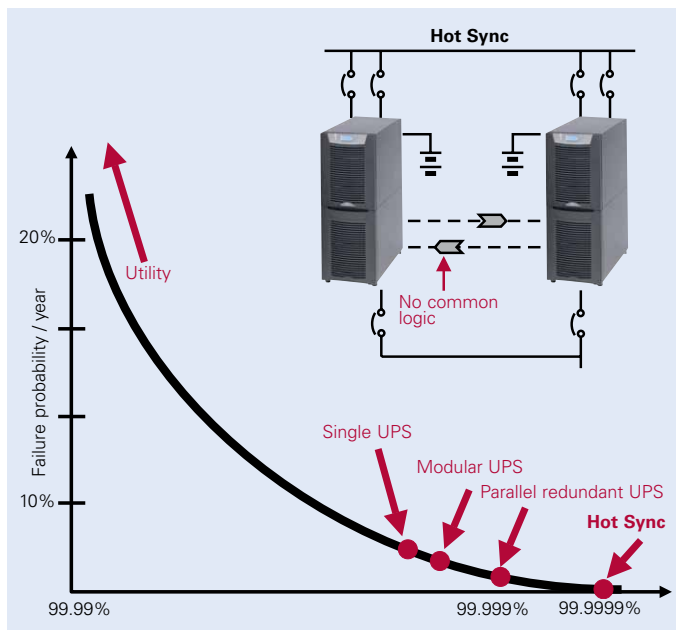

Figure 1. Power availability with various power supply configurations.

Hot Sync Technology

The internal output impedance of a UPS is inherently mainly inductive, i.e. it looks as a small inductor in series with a stiff alternating voltage source. So, if there is any difference between the output voltage phases, it means that there is a power flow from unit to unit, resulting in unequal load sharing. In the

Figure 3, two units have equal output voltages with phase angle displacement.

The voltage V_{diff} and current I_{diff} between units exhibit a 90 degrees phase shift due to the inductive source impedance. The main voltage (V_1 and V_2) and the current between units I_{diff} are in phase resulting in active power flow.

The greater the phase shift, the heavier the power imbalance. If we now introduce a controller to adjust the voltage phase by the output power, the phase difference can be forced to decrease. To adjust the phase difference to zero and to achieve accurate load sharing, we may integrate the measured phase thus arriving at power-controlled frequency. For the purpose of fast frequency locking and to enable synchronisation to external bypass, a term containing the power level change rate is added.

The flow diagram (**Figure 4**) shows how the load sharing proceeds.

The output power is monitored and the new frequency calculated at 3000 times per second. The measurements are also used for fast identification of a failed module. This feature is based on the computation of instantaneous output power. A negative value, even for a single instant, is an indication of an internal failure, e.g. a shorted inverter IGBT. In a response the UPS trips immediately off-line, causing minimal voltage disturbance. This feature is known as 'selective tripping'.

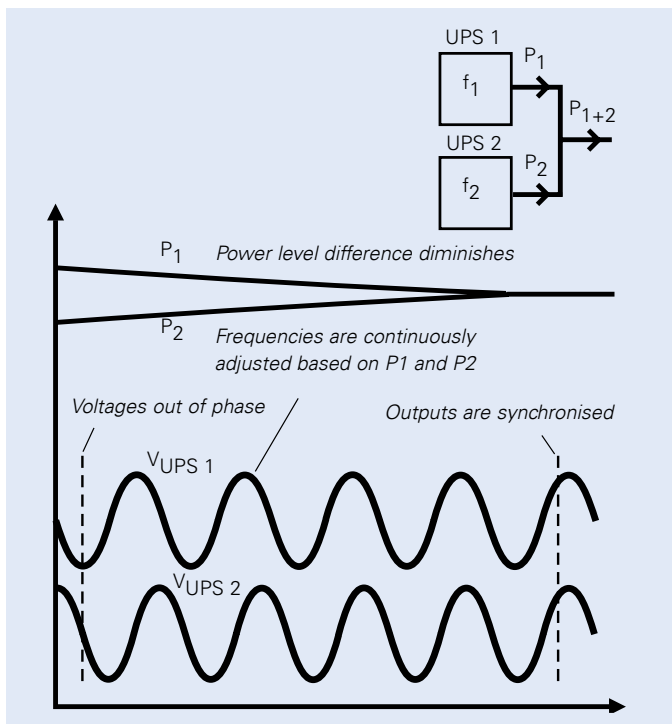

Figure 2. Well-balanced load share is achieved by adjusting output frequencies; thus the phase difference between parallel UPS output voltages is forced to zero.

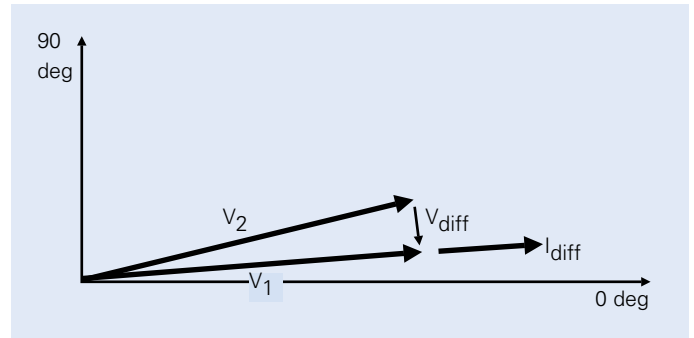

Figure 3. A phase displacement between parallel connected UPS voltages (V_1 and V_2) causes current flow between the units thus imbalances load share.

Hot Sync technology allows full maintenance to be performed one-by-one on redundant UPS modules without an external maintenance bypass switch. The critical load does not need to be disconnected from the conditioned power. Scheduled or unscheduled maintenance can be performed with the load supported continuously by the UPS-grade clean power.

$$F_n = F_{n-1} - K_1(P_n) - K_2(\dot{P}_n)$$

Where:

F_n = frequency

F_{n-1} = previous frequency

P_n = power to load

K_1 = frequency reduction factor

K_2 = power change rate factor

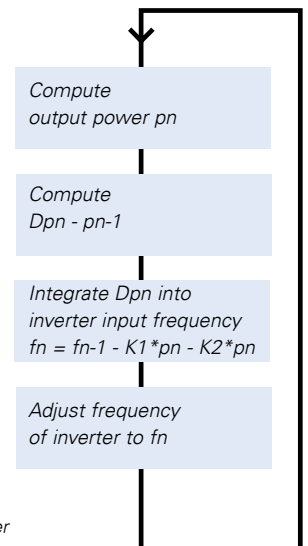

Figure 4. With HotSync algorithm, inverter phase angle is adjusted by output power and its change rate.

Accurate, equal load share is the number one characteristic to determine the integral quality and reliability of the parallel UPS system providing redundancy or increased capacity. With HotSync technology this is achieved without need for additional communications line between UPSs thus no single point of failure is added when introducing parallel modules to a system. From operational and also economical viewpoint, the achieved "close to perfect" reliability returns clear savings in the long run as every downtime incident is costly and might lead to unpredictable consequences.

ABM Technology



ABM technology significantly increases battery service life.

Superior battery management

Battery service life is a major contributor to UPS reliability. Since batteries are electrochemical devices, their performance gradually decreases over time. Premature wear-out means higher costs in terms of replacement labour and shorter service cycle. A worn battery entails a risk of unexpected load loss. In normal UPS operation, backup power is needed only occasionally and the battery 'wearing' rate depends strongly on how the full charge is being maintained. Excess charging is detrimental under any operating circumstances.

Significant extension of battery life

Eaton has created ABM[®] technology to extend the life of valve-regulated lead-acid batteries by applying sophisticated logic to the charging regime. Using the traditional trickle charge method, batteries become subject to electrode corrosion and electrolyte dry-out, especially in standby service use due to continuous float charging. ABM is essentially an addition of intelligence to the charging routine by preventing unnecessary charging, thus significantly retarding wear-out. ABM provides an additional feature for monitoring battery condition and advance warning about the end of battery life upon detection of a weak battery. It also optimises the recharge time, which is advantageous when there may be consecutive power outages within a short period. ABM has been used for over 15 years is now applied in UPSs up to 1100 kW.

User benefits

- Predictive and automatic diagnostics of battery health
- Significant extension of battery life compared to traditional charging method
- Optimisation of battery recharging time with dual mode charging method
- Automatic battery charge voltage compensation within 0 to +50°C temperature range

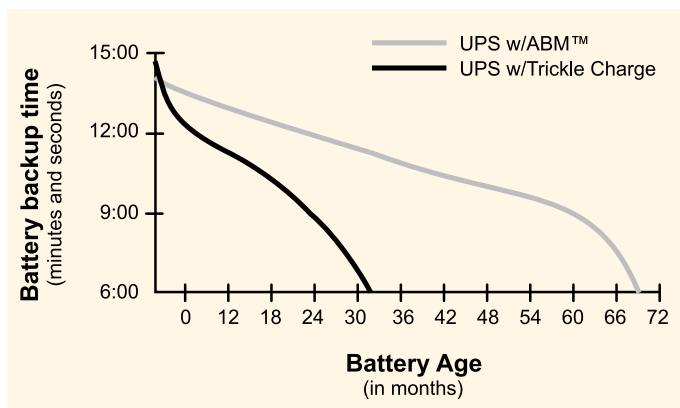

ABM cycle and operation – how does it work?

The basic idea of ABM is to leave a fully charged battery in rest mode for most of the time, and then apply charge current only at certain intervals. Initially, in order to charge up a fully or partly discharged battery, the charger starts at a constant current appropriate for the battery type used. When the battery voltage reaches a set level, the operation is changed to float mode using a constant but lower voltage, thus providing an optimum recharge time. The battery is kept at this voltage for 24 hours until it comes to the first test point. This takes approximately one minute, and during this period voltage drop measurements are taken while loading the battery, giving an indication of battery condition. The float charging is continued for an additional 24 hours, plus a period equal to 1.5 times the constant current charging time, before the rest mode is

initiated. At this point, charging is discontinued for a maximum of 28 days – as if the batteries were disconnected. During the first 10 days the battery voltage is continuously monitored, and if it drops below 2.1 V/cell, the ABM restarts in charge mode and the user gets a notification of improper battery operation. If it drops below this limit after the 10-day period, charging is resumed without an alarm being raised. In short, the algorithm uses three charging stages in its operation. Thus, the batteries experience much less stress than in the case of traditional charging. A typical battery charging cycle without power interruptions is shown in the graph below.

For convenience, the user has the facility to disable the ABM and instead select continuous 'constant voltage' charging whereby

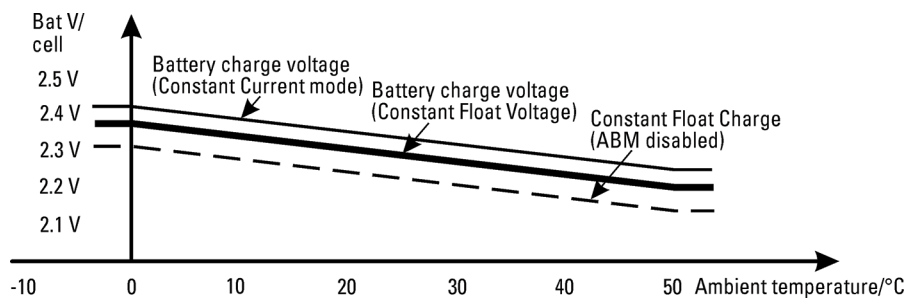

Temperature compensated charger between ±0°C...+50°C internal/external measurements.

the charger uses a constant float voltage. 'ABM enabled' is the default setting. The charger voltage levels are (by default setting) programmed to be dependent on an internal temperature sensor measurement, thus providing further enhancement to battery health. The external batteries can be also provided with temperature dependent charger voltage. For this purpose a Web/SNMP card with Environmental Monitoring Probe (EMP) is required.



Optional Web/SNMP card with EMP probe for temperature measurement of an external battery cabinet or rack.

Energy Saver System

ESS



Energy Saver System

The rising demand for highly available, reliable and efficient power is a continuous challenge for data centre operators. Higher energy efficiency helps to address increasing environmental, regulatory and economic pressures.

Eaton has developed innovative and proprietary technologies that improve system efficiency without compromising on reliability. Energy Saver System (ESS) is one of these technologies.

Maximised energy efficiency

With **85 percent reduction in UPS energy losses**, ESS technology dramatically reduces energy consumption, environmental impact and power costs without compromising load protection. With these outstanding energy savings, it is possible to recover the entire cost of the UPS over a three to five year period.

Applications

Energy Saver System is available for all Eaton 93PM and Power Xpert 9395P UPSs including:

- stand-alone single UPSs
 - parallel systems
- All existing installations can be upgraded with the ESS capability.

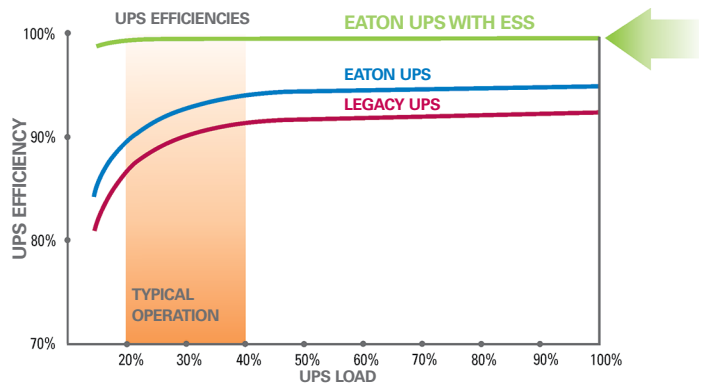

ESS enables market-leading 99 percent efficiency across the entire operating range. Compared to conventional 'eco-mode' capabilities available with legacy products, ESS offers the best possible efficiency and the fastest transition times to double-conversion when power disturbances occur.

Energy Saver System

No compromise on reliability

In ESS mode the UPS safely provides mains current directly to the load when the input is within the acceptable limits by its voltage and frequency. If input power exceeds the predefined limits by frequency or voltage, the UPS switches to double-conversion. If input power is outside the tolerances of the system, the UPS draws power from available battery modules.

Superior detection and control algorithms continuously monitor incoming power quality and allow the UPS to engage power converters in less than two milliseconds when the utility source exceeds predefined limits by its voltage or frequency, thus always providing secured power to the critical load while maximising efficiency. If the UPS detects a fault condition while operating in ESS, it is able to detect and determine whether the fault is caused by the load or if it is upstream from the UPS. A fault at the bypass source results in immediate switchover to the inverter; a fault in the load keeps the UPS in Energy Saver System (ESS).

Proven Eaton technology ensures reliability and continuous load availability without compromising the protection of the supported equipment.

Extensive configurability

Eaton UPS with Energy Saver System features three configurable modes of operation:

- Standard double-conversion mode: the UPS operates as normal, supplying power through the power converters.
- Energy Saver System: the power converters are in ready state and the static bypass switch allows the UPS to supply mains power directly.
- High Alert mode: the UPS automatically transfers from ESS to double-conversion mode and in case of multiple recurring utility line disturbances it stays there for a predefined time (default one hour) until it is safe to return to ESS.

The UPS seamlessly executes transitions through different operating modes as needed. This is only possible with transformer-free topologies.

Availability

ESS is available for all 93PM and Power Xpert 9395P UPSs. Parallel UPS systems also support operation in ESS mode. Existing installations can be upgraded with ESS capability.

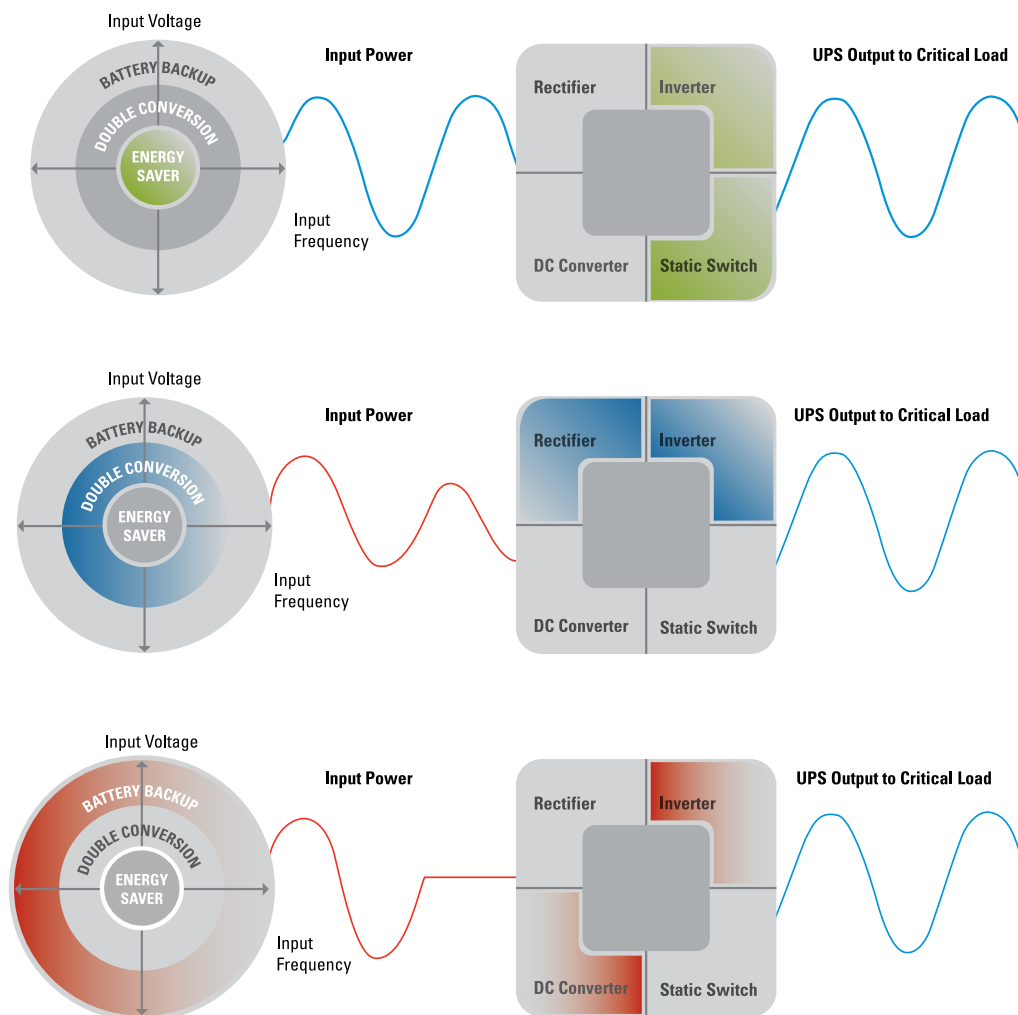

Active components engaged during Energy Saver System mode

Variable Module Management System

VMMS

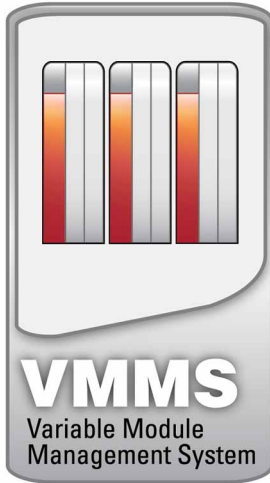

Applications

Typical applications where VMMS is particularly efficient include:

- UPSs in redundant N+1 and 2N systems
 - Lightly loaded: UPSs in these systems typically operate at low loads, < 45% load level
- Data centres, especially when the UPS system feeds dual-corded servers
- Any applications where load is not constant

Variable Module Management System (VMMS)

The rising demand for highly available, reliable and efficient power is a continuous challenge for data centre operators. Higher energy efficiency helps to address increasing environmental, regulatory and economic pressures.

Eaton has developed innovative and proprietary technologies that improve system efficiency without compromising on reliability. Variable Module Management System (VMMS) is one of these technologies.

Typical field operations are usually within low load range, but UPSs do not operate at optimal efficiency when used for lighter loads.

In some multi-UPS parallel systems used with lighter loads, the system maximises the load percentage of the UPSs by putting the UPSs that are not needed to power the load into idle mode. This results in partial energy savings and is limited to multi-UPS systems, with no efficiency improvements for -single-UPS systems.

Variable Module Management System (VMMS) technology maximises efficiencies at lighter loads without compromising reliability.

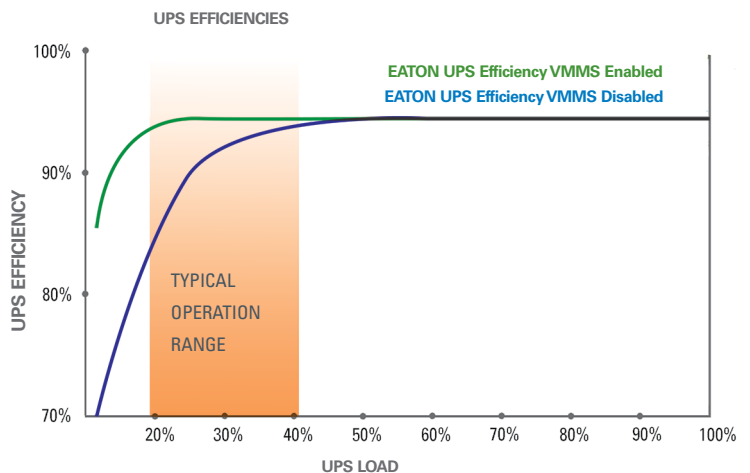

Variable module management technology maximises efficiencies at lighter loads

Variable Module Management System (VMMS)

Maximised energy efficiency

VMMS optimally employs uninterruptible power modules (UPMs) in the UPS to achieve higher efficiencies in double-conversion mode in order to maximise the percentage load level of the remaining active UPMs by switching UPMs that are not needed to ready state*.

This is calculated according to the UPMs' VMMS load threshold – 80% by default – and the system configuration (redundancy requirements). This results in maximised energy savings.

VMMS is only possible thanks to Power Xpert 9395P UPS modularity. VMMS can also be applied in multimodule single-UPS systems.

***In "ready state", the UPM rectifies the DC-link, generates logic level PWM (Pulse Width Modulation) signals and filters EMI and lightning spikes.**

No compromise on reliability

When a disturbance or load increase occurs on a critical bus, all the UPMs in ready state are able to react quickly, immediately switching back to double-conversion mode connecting the existing PWM signals to the IGBT gates.

In VMMS, all UPMs will switch to double-conversion if:

- the output voltage fluctuates by more than 3% for any reason
- any UPM reaches its current limit or discharges its battery
- battery recharge is necessary.

Once the above conditions are resolved, the system switches back to VMMS, after a customer-preset time delay (1 to 60 hours): once the load stabilises, Eaton proprietary design and algorithms allow the system to determine which UPMs to switch back to ready state to maximise efficiency according to the new operating conditions.

Extensive configurability

Customers can decide how to configure their system, establishing the number of redundant UPMs and the max percentage load level per UPM allowed in VMMS setting other UPM's in ready state.

VMMS can be used in all multi-module (multiple-UPM) Power Xpert 9395P systems:

- Single 9395P units from 550 kVA to 1100 kVA
- All parallel 9395P systems

Existing installations can also be upgraded with VMMS capability:

- VMMS maintains redundancy and achieves higher efficiency by intelligently controlling the load levels of UPMs
- Number of redundant UPMs can be selected (N+0, N+1, N+2, N+X)
- UPMs in ready state can be used as redundant units (N+0)

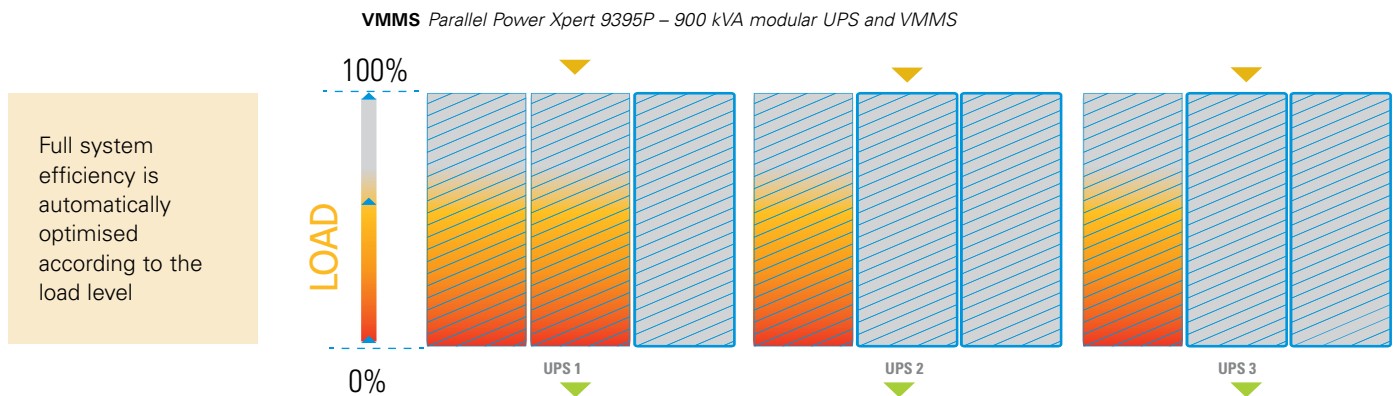

Data centre with dual-corded servers, Power Xpert 9395P-900 kVA UPS on A and B side - 320 kVA load

UPS configuration	Without VMMS	With VMMS
Efficiency @ 320 kVA load	94.6%	96.1%
UPS energy savings	Used as reference for savings calculation	41 MWh / year
UPS energy savings	<ul style="list-style-type: none"> ▣ Industry-leading UPS efficiency in double conversion 	<ul style="list-style-type: none"> ▣ Additional energy savings from reduced cooling in VMMS (typically 30-40% on top of UPS energy savings) ▣ UPMs in VMMS ready state available for redundancy



Eaton is dedicated to ensuring that reliable, efficient and safe power is available when it's needed most. With unparalleled knowledge of electrical power management across industries, experts at Eaton deliver customised, integrated solutions to solve our customers' most critical challenges.

Our focus is on delivering the right solution for the application. But, decision makers demand more than just innovative products. They turn to Eaton for an unwavering commitment to personal support that makes customer success a top priority.

For more information, visit www.eaton.eu/electrical



To contact an Eaton salesperson
or local distributor/agent, please visit
www.eaton.eu/electrical/customer-support

Eaton Industries Manufacturing GmbH
Electrical Sector EMEA
Route de la Longeraie 7
1110 Morges, Switzerland
Eaton.eu

© 2014 Eaton All Rights Reserved
Printed in Europe
Publication No. CA153003EN REVoct/14
Article: Power infrastructure
solutions & products catalogue
October 2014

Changes to the products, to the information contained in this document, and to prices are reserved; so are errors and omissions. Only order confirmations and technical documentation by Eaton is binding. Photos and pictures also do not warrant a specific layout or functionality. Their use in whatever form is subject to prior approval by Eaton. The same applies to Trademarks (especially Eaton, Moeller, and Cutler-Hammer). The Terms and Conditions of Eaton apply, as referenced on Eaton internet pages and Eaton order confirmations.

Eaton is a registered trademark of Eaton.

All other trademarks are property of their respective owners.

Follow us on social media to get the latest product and support information.

