



# TABLE OF CONTENTS

<b>AXLE NUT SOCKETS</b>	<b>40</b>
<b>AXLE SPINDLE NUTS AND WASHERS</b>	<b>44-48</b>
<b>CAST SPOKE WHEEL BOLTS</b>	<b>7</b>
<b>CAST SPOKE WHEEL STUDS</b>	<b>5-6</b>
<b>CLIPPED HEAD WHEEL STUDS</b>	<b>29-30</b>
<b>COMPETITOR INTERCHANGES</b>	<b>50-89</b>
<b>DRIVE FLANGE STUDS</b>	<b>38-39</b>
<b>DRIVE FLANGE WEDGES</b>	<b>38</b>
<b>HEADED WHEEL STUDS</b>	<b>18-29</b>
<b>HUBS CAPS</b>	<b>42-43</b>
<b>INNER NUTS FOR DISC WHEELS</b>	<b>9-10</b>
<b>METRIC WHEEL STUDS</b>	<b>34-37</b>
<b>OUTER NUTS FOR DISC WHEELS</b>	<b>10-12</b>
<b>SHOULDER STUDS FOR DISC WHEELS</b>	<b>31-34</b>
<b>SMALL PARTS DISPLAY RACK</b>	<b>41</b>
<b>SPOKE WHEEL AND LIGHT TRUCK DISC WHEEL NUTS</b>	<b>8</b>
<b>U-BOLT KITS</b>	<b>49</b>
<b>WEDGE HEAD WHEEL STUDS</b>	<b>31</b>
<b>WHEEL CHOCKS</b>	<b>41</b>
<b>WHEEL CLAMPS</b>	<b>2-4</b>
<b>WHEEL FLANGE NUTS</b>	<b>12-14</b>
<b>WHEEL STUDS FOR LIGHT TRUCKS</b>	<b>15-17</b>
<b>DECIMAL-METRIC CONVERSION CHART</b>	<b>96</b>
<b>DIAMETER OUTLINES</b>	<b>96</b>
<b>WORLD AMERICAN INDEX PAGES</b>	<b>90-91</b>
<b>DISCLAIMER</b>	<b>92</b>
<b>WARRANTY</b>	<b>93</b>

PARTS LISTED IN THIS CATALOG ARE NOT NECESSARILY MANUFACTURED BY THE ORIGINAL EQUIPMENT MANUFACTURER AND ANY REFERENCE TO THE TRADEMARKS OR PART NUMBERS OF OTHERS ARE FOR CROSS REFERENCE INFORMATIONAL PURPOSES ONLY. THE PHOTOS PROVIDED HEREIN ARE PROVIDED ONLY FOR ILLUSTRATIVE PURPOSES. THE ACTUAL PRODUCTS SUPPLIED MAY DIFFER. THE TRADEMARKS OF OTHERS REFERRED TO HEREIN ARE OWNED BY THEIR RESPECTIVE COMPANIES AND ARE NOT AFFILIATED IN ANY WAY WITH MIDWEST TRUCK & AUTO PARTS, INC.™. WORLD AMERICAN®, MOTIVE GEAR® AND MOTIVE GEAR PERFORMANCE® ARE REGISTERED TRADEMARKS OF MIDWEST TRUCK & AUTO PARTS, INC.™. USE OF THE ™ IN CONNECTION WITH A MARK OF MIDWEST TRUCK & AUTO PARTS, INC.™ INDICATES THAT THE MARK IS REGISTERED IN AT LEAST THE UNITED STATES. NO REPRESENTATION IS MADE WITH RESPECT TO THE SOURCE OF MANUFACTURE OF ANY PARTICULAR PART. WHILE EVERY EFFORT IS MADE TO PROVIDE ACCURATE INFORMATION, NO GUARANTEE IS PROVIDED AS TO THE ACCURACY OF THE INFORMATION CONTAINED HEREIN. WE ARE NOT RESPONSIBLE FOR TYPOGRAPHICAL ERRORS. © 2011, MIDWEST TRUCK & AUTO PARTS, INC.™ ALL RIGHTS RESERVED.

# WHEEL CLAMPS



USE THESE DIMENSIONS  
FOR MEASURING CLAMPS.



## FOR 1/2" WHEEL STUDS

### GOODYEAR® WHEEL CLAMPS

WA#	REPLACES	A	B	C	D
WA15-5017	GY-562 M-3602	1 1/16"	2 1/8"	1 13/16"	1/2"



## FOR 5/8" WHEEL STUDS

### DAYTON® "F" STYLE WHEEL CLAMPS

WA#	REPLACES	A	B	C	D
WA15-5004	09-541417 M-1 W-90 E-5570	1"	2 7/8"	2 1/2"	5/8"
WA15-5025	09-658417 M-2 W-93 E-5045	1 3/8"	2 7/8"	2 1/2"	5/8"



## FOR 5/8" WHEEL STUDS

### DAYTON® FOR CAST AND ALUMINUM WHEELS

WA#	REPLACES	A	B	C	D
WA15-5029	5414 M-1101 E-5047	1"	2 1/2"	4"	5/8"



## FOR 3/4" WHEEL STUDS

### DAYTON® "F" STYLE WHEEL CLAMPS

WA#	REPLACES	A	B	C	D
WA15-5000	09-612317 M-3 W-96 E-5571A	1 1/8"	2 7/8"	2 1/2"	3/4"
WA15-5006	09-870817 M-1123 W-103 E-5784A	1 1/4"	2 7/8"	2 1/2"	3/4"



# WHEEL CLAMPS continued...



WA#	REPLACES	A	B	C	D
WA15-5001	09-699317 M-8 W-98 E-5040A	1 1/2"	2 7/8"	2 1/2"	3/4"
WA15-5002	09-623517 M-4 W-97 E-5572A	1 3/4"	2 7/8"	2 1/2"	3/4"
WA15-5005	09-851817 M-3600 W-101	1 7/8"	2 7/8"	2 1/2"	3/4"
WA15-5007	09-870917 M-1124 W-104 E-5785	2"	2 7/8"	2 1/2"	3/4"
WA15-5008	09-705317 M-1125 W-99 E-5785A	2 1/8"	2 7/8"	2 1/2"	3/4"

## DAYTON® CLAMPS FOR CAST & ALUMINUM WHEELS

WA#	REPLACES	A	B	C	D
WA15-5026	09-717110 M-5 W-100 E-5046	1"	3"	2 1/2"	3/4"



## DAYTON® CLAMPS FOR DUAL REAR WHEELS

WA#	REPLACES	A	B	C	D
WA15-5009	09-006257 15QJ17P1 M-1142 W-113 E-5828	1 13/16"	6"	2 7/16"	3/4"

## GOODYEAR® WHEEL CLAMPS

WA#	REPLACES	A	B	C	D
WA15-5016	CL-1008 M-1282 E-5885	1 3/16"	2 1/2"	2 7/16"	3/4"
WA15-5018	CL-1022 M-3603	1 3/8"	2 1/2"	3 13/32"	3/4"

# WHEEL CLAMPS continued...



<b>GUNITE® WHEEL CLAMPS</b>					
<b>WA#</b>	<b>REPLACES</b>	<b>A</b>	<b>B</b>	<b>C</b>	<b>D</b>
<b>WA15-5014</b>	W-846 FORGED W-1138 CAST W-242 FORGED W-255 CAST M-1242 E-5904A	1 3/8"	2 7/8"	2 3/8"	3/4"
<b>WA15-5028</b> HEEL TYPE	W-194 WP-383 M-1148 E-5778	1 1/4"	2 5/8"	2 3/8"	3/4"
<b>WA15-5027</b> HEEL LESS	W-228 WP-368 M-1130 E-5755	1 5/16"	2 1/4"	1 13/16"	3/4"
<b>WA15-5011</b> HEEL LESS	W-240 WP-398 M-1135 E-5837	1 3/4"	2 3/8"	1 3/4"	3/4"



<b>MACK® REAR WHEEL CLAMPS</b>					
<b>WA#</b>	<b>REPLACES</b>	<b>A</b>	<b>B</b>	<b>C</b>	<b>D</b>
<b>WA07-6224</b>	15QJ223BP4 15QJ223CP4 M-1246 E-5823	1"	2 1/2"	2 1/2"	3/4"
<b>WA15-5013</b>	15QJ223BP8 15QJ223CP8 M-1175 E-5781	1 7/8"	2 1/2"	2 1/2"	3/4"
<b>WA15-5015</b>	15QJ223BP3 15QJ223CP3 M-1249 E-5821	2"	2 1/2"	2 1/2"	3/4"
<b>WA15-5010</b>	15QJ223BP6 15QJ223CP6 M-1127 E-5783	2 3/8"	2 1/2"	2 1/2"	3/4"



<b>NAVISTAR® (IHC®) REAR WHEEL CLAMPS</b>					
<b>WA#</b>	<b>REPLACES</b>	<b>A</b>	<b>B</b>	<b>C</b>	<b>D</b>
<b>WA15-5027</b>	868368-R1 M-1130 W-228 E-5755 WP-368	1 5/16"	2 1/4"	1 13/16"	3/4"



# CAST SPOKE WHEEL STUDS

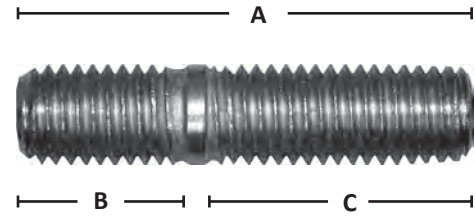

## DAYTON® WHEEL STUDS

WA#	DIA./THREAD	A	B	C	REPLACES
WA07-6049	5/8"-11	2 3/8"	7/8"	1 3/8"	BWP DAYTON EUCLID M-37 08-005148 E-4955
WA07-5150	5/8"-11	2 3/4"	1"	1 1/2"	BWP DAYTON EUCLID M-38 08-006654 E-4958
WA07-5004	3/4"-10	2 13/16"	1 1/16"	1 11/16"	BWP DAYTON EUCLID M-39 08-005715 E-4956A
WA07-5005	3/4"-10	3 1/8"	1"	1 7/8"	BWP DAYTON EUCLID M-1102 08-008411 E-5706
WA07-5151	3/4"-10	3 9/16"	1 5/8"	1 5/8"	BWP DAYTON EUCLID M-40 08-034396 E-4957

## GOODYEAR® WHEEL STUDS

WA#	DIA./THREAD	A	B	C	REPLACES
WA07-6225	5/8"-11	3 1/4"	7/8"	1 7/8"	BWP DAYTON EUCLID GOODYEAR M-1263 13-6012 E-5726 ST-178
WA07-6226	3/4"-10	3 5/8"	1 1/16"	2 3/8"	BWP DAYTON EUCLID GOODYEAR M-1264 13-6014 E-5728 ST-770
WA07-6227	3/4"-10	4"	1 1/16"	2 3/4"	BWP DAYTON EUCLID GOODYEAR M-1265 13-6015 E-5729 ST-570

# CAST SPOKE WHEEL STUDS



## MACK® WHEEL STUDS

WA#	DIA./THREAD	A	B	C	REPLACES
WA07-6051	3/4"-10 3/4"-16"	2 7/8"	7/8"	1 3/8"	BWP® M-35 DAYTON®13-6101 EUCLID® E-4987A MACK® 18-AX-405
WA07-6178	5/8"-18	3"	1 3/16"	13/16"	BWP® M-2462 DAYTON® EUCLID® E-5731 MACK® 18-AX-970
WA07-6181	5/8"-18	3 1/2"	1 7/16"	13/16"	BWP® M-2465 DAYTON®13-7028 EUCLID® E-5751 MACK® 18-AX-971

## GENERAL PURPOSE WHEEL STUDS - HIGH TENSILE

WA#	A LENGTH	B THREAD	B LENGTH	C THREAD	REPLACES
WA07-6018	2 1/2"	1/2"-20	1 1/8"	1/2"-13	BWP® M-960 DAYTON® 13-7002 EUCLID® E-4944
WA07-6136	3 1/4"	3/4"-16	1 7/8"	3/4"-10	BWP® M-980 DAYTON® EUCLID®





# CAST SPOKE WHEEL BOLTS

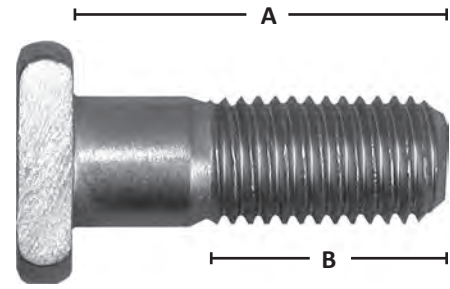

## ERIE®

WA#	DIA./THREAD	A	B	USE WA NUT	REPLACES
WA07-6052	3/4"-10	2 1/4"	1 3/8"	WA07-5153	BWP® M-1144 DAYTON® 13-6502 EUCLID® E-5761 ERIE® 5247

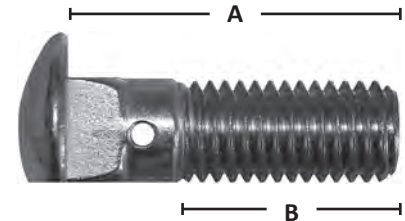

## NAVISTAR®

WA#	DIA./THREAD	A	B	USE WA NUT	REPLACES
WA07-6200	5/8"-11	2"	1 3/16"	WA07-5152	BWP® M-32 DAYTON® EUCLID® E-5712 IHC® 68333H

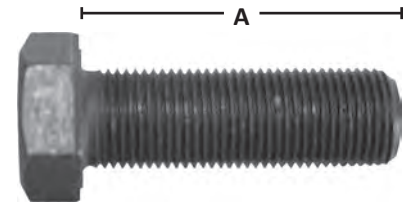

## BRAKE DRUM BOLTS

WA#	DIA./THREAD	A	USE WA NUT	REPLACES
WA07-6006	5/8"-18	2"	WA07-6010	BWP® M-2454 DAYTON® 13-6521 EUCLID® E-5966 GUNITE® WP-185
WA07-6008	3/4"-16	2"	WA07-5040	BWP® M-2456 DAYTON® 13-6523 EUCLID® E-5968 GUNITE® W-845

# SPOKE WHEEL AND LIGHT TRUCK DISC WHEEL NUTS



## DAYTON® STYLE - CHAMFERED SPOKE WHEEL NUTS

WA#	THREAD	HEX	REPLACES
WA07-5152	5/8"-11	1 1/16"	BWP® M-43 DAYTON® 13-8003 EUCLID® E-4962 GUNITE® WP-2 WEBB® 74611
WA07-5018	3/4"-10	1 1/4"	BWP® M-45 DAYTON® 13-8004 EUCLID® E-4963 GUNITE® 74710 WEBB® 74710



## ERIE® STYLE - BALL FACE SPOKE WHEEL NUTS

WA#	THREAD	HEX	REPLACES
WA07-6202	1/2"-13	7/8"	BWP® M-42 DAYTON® 13-8001 EUCLID® E-5006
WA07-6118	5/8"-11	1 1/16"	BWP® M-44 DAYTON® 13-8002 EUCLID® E-4986A ERIE® 538-U
WA07-5153	3/4"-10	1 1/4"	BWP® M-1145 DAYTON® 13-8005 EUCLID® E-5762 ERIE® 5248-U



## LOCK NUTS FOR BRAKE DRUM BOLTS

WA#	THREAD	HEX	HEIGHT	REPLACES
WA07-6010	5/8"-18	15/16"	3/4"	BWP® M-2457 DAYTON® 09-3353 EUCLID® E-1943
WA07-6012	3/4"-10	1 1/8"	3/4"	BWP® M-2458 DAYTON® 09-2343 EUCLID® E-4347
WA07-5040	3/4"-16	1 1/8"	21/32"	BWP® M-2459 DAYTON® 09-3372 EUCLID® E-5964 GUNITE® W-823



## LIGHT TRUCK CAP NUTS, 90° CONICAL TAPER

WA#	THREAD	HEX	HEIGHT	REPLACES
WA07-6135	LH 5/8"-18	1 1/16"	21/32"	BWP® M-249A DAYTON® 13-3042L OEM® B-47148





# INNER NUTS FOR DISC WHEELS



## STANDARD INNER CAP NUT FOR STEEL WHEELS

WA#	OUTER THREAD	INNER THREAD	LENGTH	SQUARE HEAD	GRADE	REPLACES	RH	LH
WA07-5024	RH 1 1/8"-16	3/4"-16	2 1/8"	13/16"	8	BWP®	M-128	M-129
WA07-5025	LH 1 1/8"-16	3/4"-16	2 1/8"	13/16"	8	BUDD®	10708	10709
						DAYTON®	13-3005R	13-3005L
						EUCLID®	E-5549R	E-5549L
						NWRA®	X-1828	X-1829
WA07-5024	RH 1 1/8"-16	3/4"-16	2 1/8"	13/16"	8	BWP®	M-3396	M-3397
WA07-5025	LH 1 1/8"-16	3/4"-16	2 1/8"	13/16"	8	BUDD®	3203403	3203404
						DAYTON®	13-3005R	13-3005L
						EUCLID®	E-7895R	E-7895L

## METRIC INNER DISC WHEEL NUTS

WA#	OUTER	INNER	LENGTH	REPLACES	RH	LH
WA07-5154	M30x1.5	M20x1.5	62mm	BWP®	M-3982	M-3983
RIGHT HAND				DAYTON®	13-3130R	13-3130L
WA07-5155				EUCLID®	E-10253R	E-10253L
LEFT HAND				GMC®	94039630	94039631
				HINO®	9004-23101	9004-24101
				IZUZU®	1-42335-005-0R	1-42335-005-0L
				NAVI®	43212Z5025R	43212Z5025L

## EXTRA LENGTH INNER CAP NUTS FOR STEEL WHEELS

WA#	OUTER THREAD	INNER THREAD	LENGTH	SQUARE HEAD	GRADE	REPLACES	RH	LH
WA07-5026	RH 1 1/8"-16	3/4"-16	2 9/16"	13/16"	8	BWP®	M-130	M-131
WA07-5027	LH 1 1/8"-16	3/4"-16	2 9/16"	13/16"	8	BUDD®	35336	35337
						DAYTON®	13-3028R	13-3028L
						EUCLID®	E-7896R	E-7896L
						NWRA®	X-1835	X-1836
WA07-5028	RH 1 1/8"-16	3/4"-16	3 1/16"	13/16"	8	BWP®	M-132	M-133
WA07-5029	LH 1 1/8"-16	3/4"-16	3 1/16"	13/16"	8	BUDD®	22621	22622
						DAYTON®	13-3029R	13-3029L
						EUCLID®	E-7897R	E-7897L
						NWRA®	X-1407	X-1408

## HEAVY DUTY OFF HIGHWAY INNER NUTS

WA#	OUTER THREAD	INNER THREAD	LENGTH	SQUARE HEAD	GRADE	REPLACES	RH	LH
WA07-6126	RH 1 5/16"-12	15/16"-12	3"	15/16"	8	BWP®	M-140A	M-140B
WA07-6127	LH 1 5/16"-12	15/16"-12	3"	15/16"	8	BUDD®	49414	49415
						DAYTON®	13-3010R	13-3010L
						EUCLID®	E-7898R	E-7898L
						NWRA®	X-1411	X-1412

# INNER NUTS FOR DISC WHEELS *continued...*



## EXTRA LENGTH INNER CAP NUTS FOR ALUMINUM WHEELS

WA#	OUTER THREAD	INNER THREAD	LENGTH	SQUARE HEAD	GRADE	REPLACES	RH	LH
WA07-5032	RH 1 1/8"-16	3/4"-16	2 15/16"	13/16"	8	ALCOA®	5988R	5988L
WA07-5033	LH 1 1/8"-16	3/4"-16	2 15/16"	13/16"	8	BWP®	M-2400	M-2401
						DAYTON®	13-3026R	13-3026L
						EUCLID®	E-5988R	E-5988L
						NWRA®	X-1873	X-1874

## STANDARD INNER CAP NUTS FOR ALUMINUM WHEELS

WA#	OUTER THREAD	INNER THREAD	LENGTH	SQUARE HEAD	GRADE	REPLACES	RH	LH
WA07-5030	RH 1 1/8"-16	3/4"-16	2 5/8"	13/16"	8	BWP®	M-136	M-137
WA07-5031	LH 1 1/8"-16	3/4"-16	2 5/8"	13/16"	8	BUDD®	70611	70612
						DAYTON®	13-3026R	13-3026L
						EUCLID®	E-5548R	E-5548L
						NWRA®	X-1801	X-1802

# OUTER NUTS FOR DISC WHEELS



## DISC WHEEL OUTER AND FRONT NUTS

WA#	THREAD	HEX	HEIGHT	APPLICATION	REPLACES	RH	LH
WA07-5022	RH 1 1/8"-16	1 1/2"	7/8"	Standard for Steel & Aluminum Dual & Single Wheels w/ 1 1/8" Dia Studs	BWP®	M-126	M-127
WA07-5023	LH 1 1/8"-16	1 1/2"	7/8"		BUDD®	37891	37892
					DAYTON®	13-3012R	13-3012L
					EUCLID®	E-5552R	E-5552L
WA07-5022	RH 1 1/8"-16	1 1/2"	7/8"		ALCOA®	5977R	5977L
WA07-5023	LH 1 1/8"-16	1 1/2"	7/8"		BWP®	M-3394	M-3395
					DAYTON®	N/A	N/A
					EUCLID®	E-5977R	E-5977L



# OUTER NUTS FOR DISC WHEELS *continued...*

## METRIC OUTER DISC WHEEL NUTS

WA#	THREAD	HEX	HEIGHT	APPLICATION	REPLACES	RH	LH
WA07-5156 WA07-5157	M30X1.5	M20X1.5	62 mm		BWP® DAYTON® EUCLID® HINO® IZUZU® NAVISTAR®	M-3980 13-3131R E-10254R 9004-2111R 1-42333-023-0R 433241Z5025R	M-3981 13-3131L E-10254L 9004-22104L 1-42333-023-0L 433241Z5025L

## OUTER CAP NUTS - WIDE BASE FOR ALUMINUM WHEELS

WA#	THREAD	HEX	HEIGHT	APPLICATION	REPLACES	RH	LH
WA07-6016 WA07-6017	RH 1 1/8"-16 LH 1 1/8'-16	1 1/2" 1 1/2"	1" 1"		ALCOA® BWP® DAYTON® EUCLID®	5996R M-3210 13-3055R E-5996R	5996L M-3211 13-3055L E-5996L

## OUTER CAP NUTS - WIDE BASE FOR ALUMINUM WHEELS

WA#	THREAD	HEX	HEIGHT	APPLICATION	REPLACES	RH	LH
WA07-6014 WA07-6015	RH 3/4"-16 LH 3/4"-16	1 1/2" 1 1/2"	1 3/8" 1 3/8"		ALCOA® BWP® DAYTON® EUCLID®	5995R M-3208 13-3054R E-5995R	5995L M-3209 13-3054L E-5995L

## STANDARD OUTER CAP NUTS - SINGLE WHEELS

WA#	THREAD	HEX	HEIGHT	APPLICATION	REPLACES	RH	LH
WA07-5020 WA07-5021	RH 3/4"-16 LH 3/4"-16	1 1/2" 1 1/2"	7/8" 7/8"		BWP® BUDD® DAYTON® EUCLID® NWRA®	M-124 37888 13-3013R E-5652R X-1803	M-125 37889 13-3013L E-5652L X-1804

## STANDARD FRONT OR SINGLE REAR ALUMINUM WHEEL NUTS

WA#	THREAD	HEX	HEIGHT	APPLICATION	REPLACES	RH	LH
WA07-6002 WA07-6003	RH 3/4"-16 LH 3/4"-16	1 1/2" 1 1/2"	1" 1"	For Use on Aluminum Wheels	BWP® BUDD® DAYTON® EUCLID® NWRA®	M-134 70613 13-3054R E-5554R X-1807	M-135 70614 13-3054L E-5554L X-1808

# OUTER NUTS FOR DISC WHEELS *continued...*



## HEAVY DUTY OFF-HIGHWAY OUTER CAP NUTS OR SINGLE CAP NUTS

WA#	THREAD	HEX	REPLACES	RH	LH
WA07-6128	RH 1 5/16"-12	1 3/4"	BWP®	M-140E	M-140F
WA07-6129	LH 1 5/16"-12	1 3/4"	BUDD®	49416	49417
			DAYTON®	13-3017R	13-3017L
			EUCLID®	E-5576R	E-5576L
			NWRA®	X-1416	X-1417

## HEAVY DUTY OFF-HIGHWAY OUTER CAP NUTS OR SINGLE CAP NUTS

WA#	THREAD	HEX	REPLACES	RH	LH
WA07-5159	RH 1 1/8"-16	1 3/4"	BWP®	M-140G	M-140H
WA07-5158	LH 1 1/8"-16	1 3/4"	BUDD®	67011	67012
			DAYTON®	13-3019R	13-3019L
			EUCLID®	E-6060R	E-6060L
			NWRA®	X-1362	X-1363

## FLANGED OUTER HEAVY DUTY CAP NUTS

WA#	THREAD	HEX	REPLACES	RH	LH
WA07-5300	RH 1 1/8"-16	1 1/2"	BWP®	M-166	M-167
WA07-5301	LH 1 1/8"-16	1 1/2"	BUDD®	69912	69913
			DAYTON®	13-3016R	13-3016L
			EUCLID®	E-5579R	E-5579L
			NWRA®	X-1420	X-1421

# DISC WHEEL FLANGE NUTS



## FLANGED OUTER CAP NUTS SINGLE WHEELS

WA#	THREAD	HEX	APPLICATION	REPLACES
WA07-6004	RH 3/4"-16	1 1/2"	Heavy Duty Version of WA07-5020 for Severe Service	BWP® M-164 BUDD® 71736 DAYTON® 13-3015R EUCLID® E-5578R
WA07-6005	LH 3/4"-16	1 1/2"	Heavy Duty Version of WA07-5021 for Severe Service	BWP® M-165 BUDD® 71737 DAYTON® 13-3015L EUCLID® E-5578L



# DISC WHEEL FLANGE NUTS *continued...*

## FLANGED NUTS

WA#	THREAD	HEX	HEIGHT	GENERAL INFORMATION	REPLACES
<b>WA07-5511</b>	9/16"-18 RH	7/8"	1/2"	for Chevrolet and GMC 3/4 and 1 ton trucks	BWP® M-1254 DAYTON® 13-3048 EUCLID® E-5892 GMC® 3988631
<b>WA07-5122</b>	5/8"-18 RH	1 1/8"	1 1/16"	for Dodge truck with 1 ton duals	BWP® M-1266 DAYTON® 13-3047R EUCLID® E-9022R
<b>WA07-6149</b>	3/4"-16 RH	1 1/8"	1 1/16"		BWP® M-1153 DAYTON® 13-3002 EUCLID® E-5704 FORD® C3TZ-1120A



## MOTOR WHEEL® CONE LOCK NUTS WITH FLOATING FLANGE

WA#	THREAD	HEX	HEIGHT	GENERAL INFORMATION	REPLACES
<b>WA07-5510</b>	3/4"-16	1 3/16"	1 5/16"	for Single Nut Applications Only	BWP® M-142 DAYTON® 13-3003 EUCLID® E-5708 MW® 08434
<b>WA07-6210</b>	7/8"-14	1 1/2"	7/8"	for Single Nut Applications Only	BWP® M-144 DAYTON® E-5710 EUCLID® 07652 MW®
<b>WA07-5057</b>	7/8"-14	1 1/2"	1 5/16"	for Single Nut Applications Only	BWP® M-145 DAYTON® E-5711 EUCLID® 07669 MW®

## BUDD® METRIC FLANGE NUT

WA#	THREAD	HEX	HEIGHT	GENERAL INFORMATION	REPLACES
<b>WA07-5035</b>	M22X1.5	33MM	31MM	BUDD® Unimount 10 Wheel Studs	BWP® M-3203 BUDD® 106333 DAYTON® 13-3052 EUCLID® E-6000A

# DISC WHEEL FLANGE NUTS continued...



## METFORM® SECUREX™ METRIC FLANGE NUT

WA#	THREAD	HEX	HEIGHT	GENERAL INFORMATION	REPLACES
WA07-5037	M22X1.5	33MM	32MM	ALCOA® Hub Piloted Wheels	ALCOA® 39691, 39949 BWP® M-3979 DAYTON® 13-3057 EUCLID® E-9020 FORD® E6HZ1120A METFORM® 39701/627 NAVISTAR® 1649492C1

## MOTOR WHEEL® METRIC FLANGE NUT

WA#	THREAD	HEX	HEIGHT	GENERAL INFORMATION	REPLACES
WA07-5036	M22X1.5	38MM	34.9MM	Motor Wheel 8 Stud Wheels	BWP® M-3207 DAYTON® 13-3050 EUCLID® E-5991 MW® 88881

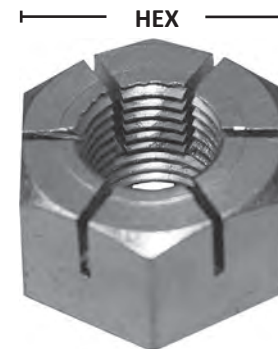

## FLAT WHEEL NUTS

WA#	THREAD	HEX	HEIGHT	GENERAL INFORMATION	REPLACES
WA07-6132	1/2"-20	7/8"	1/2"		BWP® M-220 CHEVROLET® 3726212 DAYTON® EUCLID® E-5007 KELSEY® K43935
WA07-6124	5/8"-18	1 1/16"	39/64"		BWP® M-140 DAYTON® EUCLID® E-5009 GMC® 3724246

[WWW.WORLDAMERICAN.COM](http://WWW.WORLDAMERICAN.COM)



# DISC WHEEL STUDS FOR LIGHT TRUCK

**GMC® - 1/2 - 20  
.560" DIAMETER  
BOTH RIGHT HAND STUDS**

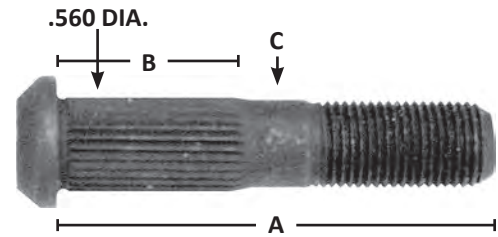

WA#	A	B	C	REPLACES	
WA07-6130 Right Hand Stud	2 1/2"	15/16"	9/16"	BWP® DAYTON® EUCLID® KELSEY® NWRA®	M-214  E-5622 43941 X-1242
WA07-6131 Right Hand Stud	2 7/8"	15/16"	9/16"	BWP® DAYTON® EUCLID® GM®	M-214A  E-5819 3819780

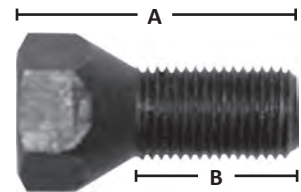

**DODGE® - 3/4" HEX HEAD**

WA#	A	B	THREAD	REPLACES	
WA07-6133 Right Hand Stud	1 1/2"	7/8"	1/2"-20 RH	BWP® DAYTON® DODGE® EUCLID® NWRA®	M-225  393984 E-5591R X-1064
WA07-6218 Left Hand Stud	1 1/2"	7/8"	1/2"-20 LH	BWP® DAYTON® DODGE® EUCLID® NWRA®	M-226  856981 E-5591L X-1065
WA07-6216 Right Hand Stud	1 1/2"	7/8"	9/16"-18 RH	BWP® DAYTON® DODGE® EUCLID® NWRA®	M-200  386985 E-5592R X-1092

# DISC WHEEL STUDS FOR LIGHT TRUCK continued...

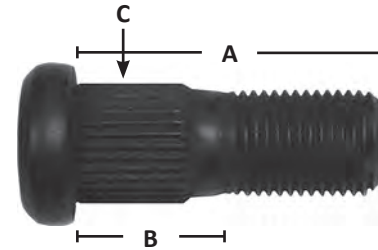

## BUDD®, MOTOR WHEEL® 9/16"-18

WA#	A	B	C	REPLACES
WA07-6151 Right Hand Stud	1 5/8"	5/8"	5/8"	BWP® M-1163 DAYTON® E-5701 EUCLID® 81109 MW® X-1198 NWRA®
WA07-6222 Right Hand Stud	2 5/16"	13/16"	5/8"	BWP® M-1172 DAYTON® EUCLID® MW® 81118 NWRA® X-1196
WA07-6122 Right Hand Stud	3 1/4"	1 19/64"	19/32"	BWP® M-90 BUDD® 31439 DAYTON® 13-1901 EUCLID® E-5724

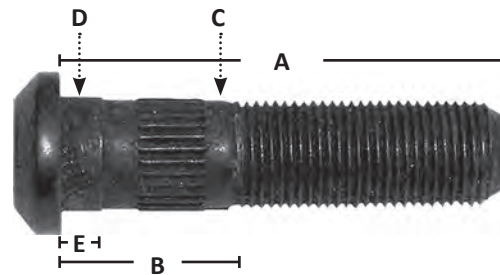

## DODGE® - 5/8"-18

WA#	A	B	C	D	E	REPLACES
WA07-6031 Right Hand Stud	2 9/16"	15/16"	5/8"	21/32"	1/4"	BWP® M-1280 BUDD® 92176 DAYTON® 13-2550R DODGE® 301123 EUCLID® E-8946R
WA07-6320 Left Hand Stud	2 9/16"	15/16"	5/8"	21/32"	1/4"	BWP® M-1281 BUDD® 92177 DAYTON® 13-2550L DODGE® 301124 EUCLID® E-8946L
WA07-6304 Right Hand Stud	2 15/16"	15/16"	5/8"	21/32"	1/4"	BWP® M-1272 BUDD® 98348 DAYTON® 13-2551R DODGE® 3637878 EUCLID® E-8946R
WA07-6229 Left Hand Stud	2 15/16"	15/16"	5/8"	21/32"	1/4"	BWP® M-1273 BUDD® 98349 DAYTON® 13-2551L DODGE® 3637879 EUCLID® E-8946L





# DISC WHEEL STUDS FOR LIGHT TRUCK continued...

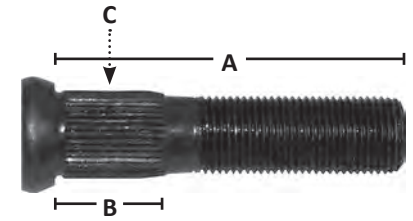

## GMC® 5/8"-18

WA#	A	B	C	REPLACES	
WA07-6205 Right Hand Stud	2"	9/16"	11/16"	BWP® DAYTON® EUCLID® GMC®	M-91 E-5607 3682387
WA07-6206 Right Hand Stud	2 13/16"	7/8"	11/16"	BWP® DAYTON® EUCLID® GMC®	M-96 13-1902 E-5938 3682389
WA07-6209 Right Hand Stud	2 27/32"	1"	11/16"	BWP® DAYTON® EUCLID® GMC®	M-101 E-5625 3707585
WA07-6123 Right Hand Stud	2 15/16"	3/4"	11/16"	BWP® DAYTON® EUCLID® GMC®	M-97 13-1903 E-5938 3694508
WA07-6207 Right Hand Stud	3 3/64"	1 7/64"	11/16"	BWP® DAYTON® EUCLID® GMC®	M-99 13-1904 E-5628 3682153
WA07-5160 Right Hand Stud	3 3/16"	1"	11/16"	BWP® DAYTON® EUCLID® GMC®	M-98 13-1905 E-10230 3697043



## GMC® 11/16"-16

WA#	A	B	C	REPLACES	
WA07-5161 Right Hand Stud	2 5/8"	1"	1 1/8"	BWP® BUDD® DAYTON® EUCLID® GMC®	M-158 82525 13-2001 E-5682 3763619
WA07-5162 Right Hand Stud	3 1/4"	1"	1 27/64"	BWP® BUDD® DAYTON® EUCLID® GMC®	M-159 82526 13-2002 E-5683 3765876
WA07-6231 Right Hand Stud	3 1/4"	1 21/64"	1 3/8"	BWP® BUDD® DAYTON® EUCLID® GMC®	M-1283 83172 13-2003 E-5816 301112-1

# HEADED DISC WHEEL STUDS *continued...*

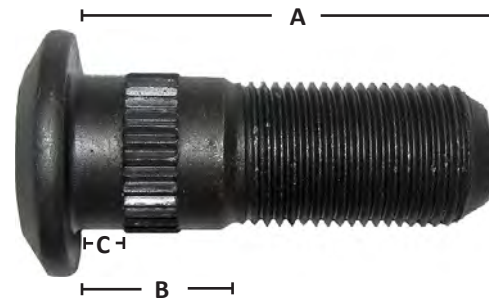

*3/4" - 16 Thread - Serrated Body  
Body Diameter .783-.786  
Serrated Diameter .810-.820  
Grade 8*

WA#	A	B	C	REPLACES	
WA07-6204 Right Hand	2 1/8"	3/4"	1/4"	BWP® BUDD® DAYTON® EUCLID®	M-72 59364 13-1101R E-4964R
WA07-6318 Left Hand	2 1/8"	3/4"	1/4"	BWP® BUDD® DAYTON® EUCLID®	M-73 59365 13-1101L E-4964L
WA07-5163 Right Hand	2 3/8"	1"	1/4"	BWP® BUDD® DAYTON® EUCLID® WEBB®	M-74 59191 13-1102R E-4965R 159190
WA07-5164 Left Hand	2 3/8"	1"	1/4"	BWP® BUDD® DAYTON® EUCLID® WEBB®	M-75 59192 13-1102L E-4965L 159191
WA07-6098 Right Hand	2 1/2"	3/4"	1/4"	BWP® DAYTON® EUCLID® GUNITE®	M-3926 13-1131R E-10202R W1091R
WA07-6311 Left Hand	2 1/2"	3/4"	1/4"	BWP® DAYTON® EUCLID® GUNITE®	M-3927 13-1131L E-10202L W1091L
WA07-5096 Right Hand	2 5/8"	1 1/4"	5/16"	BWP® BUDD® DAYTON® EUCLID® TRAILMOBILE®	M-76 59263 13-1103R E-4966R 50-33A-29
WA07-5097 Left Hand	2 5/8"	1 1/4"	5/16"	BWP® BUDD® DAYTON® EUCLID® TRAILMOBILE®	M-77 59264 13-1103L E-4966L 50-33A-30
WA07-6062 Right Hand	2 25/32"	1 1/16"	1/8"	BWP® CONMET® DAYTON® EUCLID® WEBB®	M-3648 102192 13-1154R 102192
WA07-6063 Left Hand	2 25/32"	1 1/16"	1/8"	BWP® CONMET® DAYTON® EUCLID® WEBB®	M-3649 102191 13-1154L 102191



# HEADED DISC WHEEL STUDS *continued...*

WA#	A	B	C	REPLACES	
WA07-5098 Right Hand	2 7/8"	1 1/2"	1/4"	BWP® BUDD® DAYTON® EUCLID® GM® MERITOR®	M-78 61968 13-1107R E-4967R 3723968 20X1576
WA07-5099 Left Hand	2 7/8"	1 1/2"	1/4"	BWP® BUDD® DAYTON® EUCLID® GM® MERITOR®	M-79 61969 13-1107L E-4967L 3723969 20X1575
WA07-6208 Right Hand	2 29/32"	1 1/16"	1/2"	BWP® DAYTON® EUCLID® MERITOR®	M-3954 13-1143R E-9003R 20X1812
WA07-6099 Left Hand	2 29/32"	1 1/16"	1/2"	BWP® DAYTON® EUCLID® MERITOR®	M-3955 13-1143L E-9003L 20x1811
WA07-6064 Right Hand	2 31/32"	1 13/32"	1/2"	BWP® BUDD® DAYTON® EUCLID® WEBB®	M-3608 100145 13-1122R E-8947R 159184
WA07-6065 Left Hand	2 31/32"	1 13/32"	1/2"	BWP® BUDD® DAYTON® EUCLID® WEBB®	M-3609 100146 13-1122L E-8947L 159183
WA07-6066 Right Hand	2 15/16"	1 5/16"	1/4"	BWP® GM® GUNITE® DAYTON® EUCLID®	M-3610 15580830 W-981R 13-1128R E-8969R
WA07-6067 Left Hand	2 15/16"	1 5/16"	1/4"	BWP® GM® GUNITE® DAYTON® EUCLID®	M-3611 15580833 W-981L 13-1128L E-8969L
WA07-6100 Right Hand	3"	1 21/32"	1/4"	BWP® DAYTON® EUCLID® GUNITE®	M-3932 13-1126R E-10206R W1064R
WA07-6101 Left Hand	3"	1 21/32"	1/4"	BWP® DAYTON® EUCLID® GUNITE®	M-3933 13-1126L E-10206L W1064L
WA07-6068 Right Hand	3 1/8"	1 11/32"	1/4"	BWP® DAYTON® EUCLID® GUNITE®	M-3612 13-1146R E-8982R W-1166R
WA07-6069 Left Hand	3 1/8"	1 11/32"	1/4"	BWP® DAYTON® EUCLID® GUNITE®	M-3613 13-1146L E-8982L W-1166L

CONTINUED>>>

# HEADED DISC WHEEL STUDS continued...



WA#	A	B	C	REPLACES	
WA07-5502 Right Hand	3 5/32"	1 7/16"	1/8"	BWP® CONMET® DAYTON® EUCLID® WEBB®	M-3650 102278 13-1156R E-10209R 102278
WA07-5503 Left Hand	3 5/32"	1 7/16"	1/8"	BWP® CONMET® DAYTON® EUCLID® WEBB®	M-3651 102277 13-1156L E-10209L 102277
WA07-6070 Right Hand	3 3/16"	1 13/32"	1/4"	BWP® DAYTON® EUCLID® GUNITE®	M-3614 13-1135R E-8968R W-980R
WA07-6071 Left Hand	3 3/16"	1 13/32"	1/4"	BWP® DAYTON® EUCLID® GUNITE®	M-3615 13-1135L E-8968L W-980L
WA07-5165 Right Hand	3 11/32"	1 9/32"	1/4"	BWP® DAYTON® EUCLID® GUNITE®	M-3241 13-1129R E-8979R W-992R W-1133R
WA07-5166 Left Hand	3 11/32"	1 9/32"	1/4"	BWP® DAYTON® EUCLID® GUNITE®	M-3242 13-1129L E-8979L W-992L W-1133L
WA07-6072 Right Hand	3 3/8"	1 13/32"	1/2"	BWP® DAYTON® EUCLID® WEBB®	M-3616 13-1140R E-9008R 100164
WA07-6073 Left Hand	3 3/8"	1 13/32"	1/2"	BWP® DAYTON® EUCLID® WEBB®	M-3617 13-1140L E-9008L 100163
WA07-5167 Right Hand	3 13/32"	1 7/16"	1/8"	BWP® CONMET® DAYTON® EUCLID® WEBB®	M-3652 102280 13-1157R E-10208R 102280
WA07-5353 Left Hand	3 13/32"	1 7/16"	1/8"	BWP® CONMET® DAYTON® EUCLID® WEBB®	M-3653 102279 13-1157L E-10208L 102279
WA07-5504 Right Hand	3 25/32"	1 7/16"	1/8"	BWP® CONMET® DAYTON® EUCLID® WEBB®	M-3654 102282 13-1158R E-10210R 102282
WA07-5505 Left Hand	3 25/32"	1 7/16"	1/8"	BWP® CONMET® DAYTON® EUCLID® WEBB®	M-3655 102281 13-1158L E-10210L 102281



# HEADED DISC WHEEL STUDS *continued...*

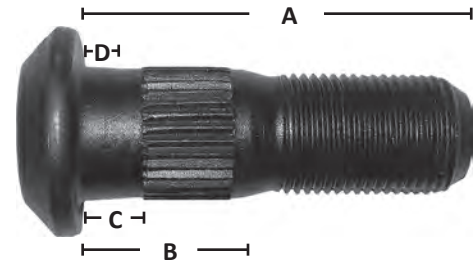

**3/4"-16 Thread - Serrated Body with Raised Shoulder**  
**Body Diameter .783-.786**  
**Serrated Diameter .810-.820**  
**Raised Shoulder Diameter .798-.808**  
**Grade 8**

WA#	A	B	C	D	REPLACES
WA07-6154 Right Hand	2 3/8"	1"	3/8"	3/16"	BWP® BUDD® DAYTON® EUCLID® M-1206 90554 13-1111R E-5764R
WA07-6155 Left Hand	2 3/8"	1"	3/8"	3/16"	BWP® BUDD® DAYTON® EUCLID® M-1207 90554 13-1111L E-5764L
WA07-6156 Right Hand	2 5/8"	1 1/4"	7/16"	3/16"	BWP® BUDD® DAYTON® EUCLID® M-1208 90513 13-1112R E-5870R
WA07-6157 Left Hand	2 5/8"	1 1/4"	7/16"	3/16"	BWP® BUDD® DAYTON® EUCLID® M-1209 90514 13-1112L E-5870L
WA07-6219 Right Hand	2 3/4"	1 3/8"	1/2"	1/4"	BWP® BUDD® DAYTON® EUCLID® FORD® M-1151 85108 13-1150 E-5775 C3T2-1118A
WA07-5100 Right Hand	2 7/8"	1 1/2"	1/2"	5/16"	BWP® BUDD® DAYTON® EUCLID® MERITOR® WEBB® M-80 49851 13-1104R E-4968R 20X996 198510
WA07-5101 Left Hand	2 7/8"	1 1/2"	1/2"	5/16"	BWP® BUDD® DAYTON® EUCLID® MERITOR® WEBB® M-81 49852 13-1104L E-4968L 20X997 198511
WA07-5102 Right Hand	3 1/8"	1 3/4"	9/16"	5/16"	BWP® BUDD® DAYTON® EUCLID® FRUEHAUF® M-82 59183 13-1105R E-4969R 582886
WA07-5103 Left Hand	3 1/8"	1 3/4"	9/16"	5/16"	BWP® BUDD® DAYTON® EUCLID® FRUEHAUF® M-83 59184 13-1105L E-4969L 582887

CONTINUED>>>

# HEADED DISC WHEEL STUDS continued...



WA#	A	B	C	D	REPLACES	
WA07-6220 Right Hand	3 3/8"	1 13/16"	1/2"	5/16"	BWP® BUDD® DAYTON® EUCLID® FORD®	M-1152 85106 13-1151 E-5703 CTZ-1119A
WA07-5169 Right Hand	3 3/8"	2"	3/8"	3/16"	BWP® BUDD® DAYTON® EUCLID®	M-1120 84097 13-1108R E-5765R
WA07-5355 Left Hand	3 3/8"	2"	3/8"	3/16"	BWP® BUDD® DAYTON® EUCLID®	M-1121 84097 13-1108L E-5765L
WA07-6140 Right Hand	3 3/8"	2"	9/16"	5/16"	BWP® BUDD® DAYTON® EUCLID®	M-1110 59066 13-1113R E-5756R
WA07-6141 Left Hand	3 3/8"	2"	9/16"	5/16"	BWP® BUDD® DAYTON® EUCLID®	M-1111 59067 13-1113L E-5756L
WA07-6142 Right Hand	3 5/8"	2 1/4"	9/16"	5/16"	BWP® BUDD® DAYTON® EUCLID®	M-1112 59375 13-1106R E-5757R
WA07-6143 Left Hand	3 5/8"	2 1/4"	9/16"	5/16"	BWP® BUDD® DAYTON® EUCLID®	M-1113 59376 13-1106L E-5757L
WA07-6152 Right Hand	3 7/8"	2 1/2"	9/16"	5/16"	BWP® BUDD® DAYTON® EUCLID®	M-1176 59373 13-1110R E-5766R
WA07-6153 Left Hand	3 7/8"	2 1/2"	9/16"	5/16"	BWP® BUDD® DAYTON® EUCLID®	M-1177 59373 13-1110L E-5766L
WA07-6158 Right Hand	4 1/8"	2 3/4"	9/16"	5/16"	BWP® BUDD® DAYTON® EUCLID®	M-1210 59371 13-1114R E-5869R
WA07-6302 Left Hand	4 1/8"	2 3/4"	9/16"	5/16"	BWP® BUDD® DAYTON® EUCLID®	M-1211 59372 13-1114L E-5869L



# HEADED DISC WHEEL STUDS continued...

**BUDD UNIMOUNT WHEEL STUDS**  
 3/4"-16 Thread - Serrated Body  
 Body Diameter .900-.906  
 Serrated Diameter .935-.942  
 Grade 8

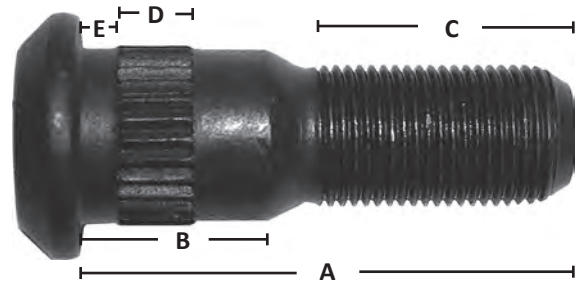

WA#	A	B	C	D	E	REPLACES
<b>WA07-5171</b> Right Hand Stud	2 19/32"	1"	1 1/4"	13/32"	3/16"	BWP® M-3218 BUDD® 106201 DAYTON® 13-1585R EUCLID® E-8949R
<b>WA07-5172</b> Left Hand Stud	2 19/32"	1"	1 1/4"	13/32"	3/16"	BWP® M-3219 BUDD® 106202 DAYTON® 13-1585L EUCLID® E-8949L

**3/4"-16 Thread - "D" Head Studs**  
 for DURA-LIGHT HUBS  
 Body Diameter .888

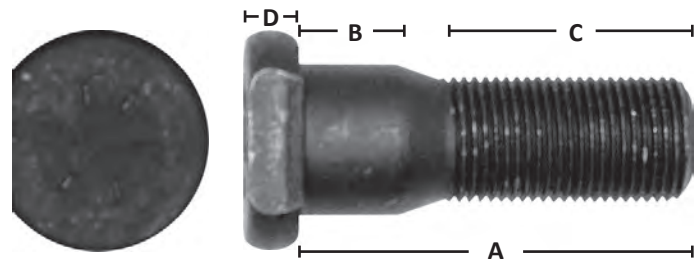

WA#	A	B	C	D	REPLACES
<b>WA07-6104</b> Right Hand Stud	2 11/32"	5/8"	1 3/8"	5/16"	BWP® M-3960 DAYTON® E-10259R EUCLID®
<b>WA07-6316</b> Left Hand Stud	2 11/32"	5/8"	1 3/8"	5/16"	BWP® M-3961 DAYTON® E-10259L EUCLID®

**GMC**  
 11/16"-16 Thread - Serrated Body  
 Body Diameter .747-.749  
 Serrated Diameter .761-.767

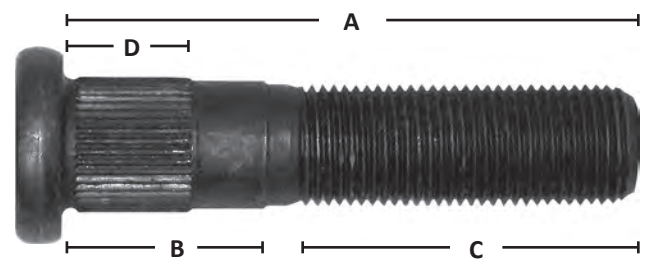

WA#	A	B	C	D	REPLACES
<b>WA07-6102</b> Right Hand Stud	3 1/4"	1 1/8"	1 27/32"	5/8"	BWP® M-3956 GMC® 3874369 DAYTON® 13-2007 EUCLID® E-8962
<b>WA07-6315</b> Left Hand Stud	3 5/8"	1 5/16"	1 32/32"	1/2"	BWP® M-3957 GMC® 704173 DAYTON® 13-2006 EUCLID® E-8961

# HEADED DISC WHEEL STUDS *continued...*

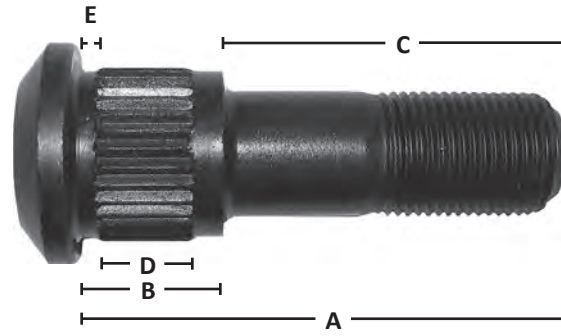

*3/4"-16 Thread - Serrated Body  
Body Diameter .971-.975  
Serrated Diameter .998-.1006  
Grade 8*

WA#	A	B	C	D	E	REPLACES
WA07-5116 Right Hand Stud	2 7/8"	13/16"	1 1/8"	3/8"	1/4"	BWP® M-3618 DAYTON® 13-1273R EUCLID® E-9010R WEBB® 101172
WA07-6193 Left Hand Stud	2 7/8"	13/16"	1 1/8"	3/8"	1/4"	BWP® M-3619 DAYTON® 13-1273L EUCLID® E-9010L WEBB® 101173
WA07-6194 Right Hand Stud	3 3/8"	1 3/8"	1 13/16"	1/2"	1/4"	BWP® M-3620 DAYTON® 13-1259R EUCLID® E-8984R GUNITE® W-1199R
WA07-6195 Left Hand Stud	3 3/8"	1 3/8"	1 13/16"	1/2"	1/4"	BWP® M-3621 DAYTON® 13-1259L EUCLID® E-8984L GUNITE® W-1199L
WA07-6196 Right Hand Stud	3 5/8"	13/16"	1 1/8"	7/16"	1/8"	BWP® M-3622 DAYTON® 13-1208R EUCLID® E-8971R MERITOR® 20X348
WA07-6307 Left Hand Stud	3 5/8"	13/16"	1 1/8"	7/16"	1/8"	BWP® M-3623 DAYTON® 13-1208L EUCLID® E-8971L MERITOR® 20X349
WA07-6198 Right Hand Stud	3 7/16"	1 15/16"	1 5/16"	3/4"	1"	BWP® M-3624 DAYTON® 13-1256R EUCLID® E-8971R GUNITE® W985R
WA07-6308 Left Hand Stud	3 7/16"	1 15/16"	1 5/16"	3/4"	1"	BWP® M-3625 DAYTON® 13-1256L EUCLID® E-8971L GUNITE® W-985L

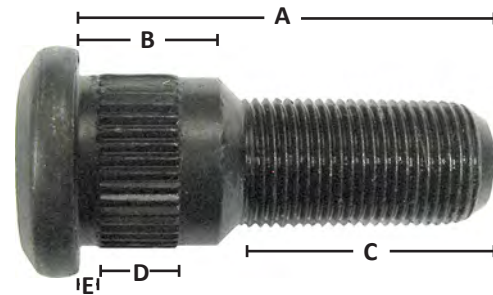

*3/4"-16 Thread - Serrated Body  
Body Diameter .973-.977  
Serrated Diameter .998-.1006  
Grade 8*

WA#	A	B	C	D	E	REPLACES
WA07-6032 Right Hand	2 3/8"	13/16"	1 5/32"	7/16"	1/8"	BWP® M-84 BUDD® 63625-2 DAYTON® 13-1201R EUCLID® E-5718R MERITOR® 20X208





# HEADED DISC WHEEL STUDS continued...

WA#	A	B	C	D	E	REPLACES
WA07-6033 Left Hand	2 3/8"	13/16"	1 5/32"	7/16"	1/8"	BWP® M-85 BUDD® 63626-2 DAYTON® 13-1201L EUCLID® E-5718L MERITOR® 20X209
WA07-6034 Right Hand	2 9/16"	13/16"	1 5/32"	5/8"	1/8"	BWP® M-86 BUDD® 63625-3 DAYTON® 13-1202R EUCLID® E-5719R MERITOR® 20X210
WA07-6035 Left Hand	2 9/16"	13/16"	1 5/32"	5/8"	1/8"	BWP® M-87 BUDD® 63626-3 DAYTON® 13-1202L EUCLID® E-5719L MERITOR® 20X211
WA07-6120 Right Hand	2 23/32"	13/16"	1 5/32"	7/16"	1/8"	BWP® M-88 BUDD® 63625-1 DAYTON® 13-1203R EUCLID® E-5720R MERITOR® 20X206
WA07-6037 Left Hand	2 23/32"	13/16"	1 5/32"	7/16"	1/8"	BWP® M-89 BUDD® 63626-1 DAYTON® 13-1203L EUCLID® E-5720L MERITOR® 20X207
WA07-6170 Right Hand	2 9/16"	15/16"	1 1/4"	7/16"	9/32"	BWP® M-2432 DAYTON® 13-1205R EUCLID® E-5911R MERITOR® 20X402
WA07-6171 Left Hand	2 9/16"	15/16"	1 1/4"	7/16"	9/32"	BWP® M-2433 DAYTON® 13-1205L EUCLID® E-5911L MERITOR® 20X403
WA07-6172 Right Hand	2 11/16"	13/16"	1 7/16"	7/16"	1/8"	BWP® M-2434 DAYTON® 13-1206R EUCLID® E-5900R MERITOR® 20X831
WA07-6173 Left Hand	2 11/16"	13/16"	1 7/16"	7/16"	1/8"	BWP® M-2435 DAYTON 13-1206L EUCLID® E-5900L MERITOR® 20X832
WA07-6138 Right Hand	2 13/16"	1 3/16"	1 3/16"	1/2"	3/8"	BWP® M-1106 BUDD® 82578 DAYTON® 13-1236R EUCLID® E-5721R MERITOR® 20X404
WA07-6139 Left Hand	2 13/16"	1 3/16"	1 3/16"	1/2"	3/8"	BWP® M-1107 BUDD® 82579 DAYTON® 13-1236L EUCLID® E-5721L MERITOR® 20X405
WA07-6232 Right Hand	2 15/16"	1 1/4"	1 1/4"	1"	1/16"	BWP® M-1288 DAYTON® 13-1234R EUCLID® E-5987R NW® 86797 NAVISTAR® 472008C
WA07-6233 Left Hand	2 15/16"	1 1/4"	1 1/4"	1"	1/16"	BWP M-1289 DAYTON 13-1234L EUCLID E-5987L NW 86798 NAVISTAR 472007C1
WA07-5173 Right Hand	3 1/16"	13/16"	1 1/2"	7/16"	1/8"	BWP® M-2436 DAYTON® 13-1204R EUCLID® E-5910R MERITOR® 20X344

# HEADED DISC WHEEL STUDS continued...



WA#	A	B	C	D	E	REPLACES
WA07-5141 Left Hand	3 1/16"	13/16"	1 1/2"	7/16"	1/8"	BWP® M-2437 DAYTON®13-1204L EUCLID E-5910L MERITOR®20X345
WA07-5175 Right Hand	3 3/32"	1 3/8"	1 1/4"	1 1/8"	3/16"	BWP® M-1212 DAYTON®13-1230R EUCLID® E-5871R MERITOR®20X481
WA07-5176 Left Hand	3 3/32"	1 3/8"	1 1/4"	1 1/8"	3/16"	BWP® M-1213 DAYTON®13-1230L EUCLID® E-5871L MERITOR®20X482
WA07-6106 Right Hand	3 3/16"	25-32"	1 19/32"	1/2"	3/8"	BWP® M-3950 DAYTON®13-1274R EUCLID® E-9524R WEBB® 101174
WA07-6313 Left Hand	3 3/16"	25/32"	1 19/32"	1/2"	3/8"	BWP® M-3951 DAYTON®13-1274L EUCLID® E-9524L WEBB® 101175
WA07-6074 Right Hand	3 3/16"	1 3/16"	1 5/32"	1"	1/16"	BWP® M-3626 DAYTON®13-1235R EUCLID® E-6057R MW® 90801
WA07-6075 Left Hand	3 3/16"	1 3/16"	1 5/32"	1"	1/16"	BWP® M-3627 DAYTON®13-1235L EUCLID® E-6057L MW® 90801
WA07-5104 Right Hand	3 5/16"	1 7/16"	1 3/32"	1"	5/16"	BWP® M-2438 DAYTON®13-1231R EUCLID® E-5896R KENWORTH® 233-2871R PETERBILT® 03-02207
WA07-5105 Left Hand	3 5/16"	1 7/16"	1 3/32"	1"	5/16"	BWP® M-2439 DAYTON®13-1231L EUCLID® E-5896L KENWORTH® 233-2871L PETERBILT® 03-02208
WA07-6108 Right Hand	3 11/32"	25/32"	1 27/32"	1/2"	3/8"	BWP® M-3952 DAYTON®13-1275R EUCLID® E-9525R WEBB® 101178
WA07-6314 Left Hand	3 11/32"	25/32"	1 27/32"	1/2"	3/8"	BWP M-3953 DAYTON 13-1275L EUCLID E-9525L WEBB 101178
WA07-6234 Right Hand	3 11/32"	1 27/32"	1 1/4"	1/2"	3/8"	BWP® M-1290 DAYTON®13-1233R EUCLID® E-5909R MERITOR®20X852
WA07-6235 Left Hand	3 11/32"	1 27/32"	1 1/4"	1/2"	3/8"	BWP M-1291 DAYTON 13-1233L EUCLID E-5909L MERITOR 20X853
WA07-5177 Right Hand	3 3/4"	1 3/8"	1 7/8"	1 1/16"	3/16"	BWP M-2466 DAYTON 13-1232R EUCLID E-5983R KENWORTH® 12452-001R PETERBILT® 03-02852
WA07-5178 Left Hand	3 3/4"	1 3/8"	1 7/8"	1 1/16"	3/16"	BWP M-2467 DAYTON 13-1232L EUCLID E-5983L KENWORTH®122452-001L PETERBILT® 03-02853



# HEADED DISC WHEEL STUDS *continued...*

**3/4"-16 Thread - Serrated Body  
Body Diameter .772-.784**

WA#	A	B	C	D	REPLACES	
WA07-6312 Right Hand	3 1/2"	1 25/32"	1 9/32"	1/2"	BWP® DAYTON® EUCLID®	M-3946 13-1171R E-8957R
WA07-5304 Left Hand	3 1/2"	1 25/32"	1 9/32"	1/2"	BWP® DAYTON® EUCLID®	M-3947 13-1171L E-8957L

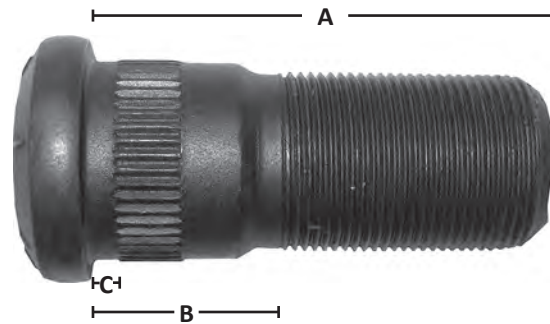

**1 1/8"-16 Thread - Serrated Body  
Body Diameter 1.218-1.222  
Serrated Body Diameter 1.244-1.252  
Grade 8**

WA#	A	B	C	REPLACES	
WA07-6144 Right Hand	2 13/16"	7/8"	3/16"	BWP® BUDD® DAYTON® EUCLID® MERITOR®	M-1116 82575 13-1604R E-5749R 20X372
WA07-6145 Left Hand	2 13/16"	7/8"	3/16"	BWP® BUDD® DAYTON® EUCLID® MERITOR®	M-1117 82576 13-1604L E-5749L 20X371
WA07-6076 Right Hand	2 31/32"	3/4"	1/8"	BWP® DAYTON® EUCLID® MW® WEBB®	M-3630 13-1622R E-5986R 88108 188108
WA07-6309 Left Hand	2 31/32"	3/4"	1/8"	BWP® DAYTON® EUCLID® MW® WEBB®	M-3631 13-1622L E-5986L 88109 188109
WA07-3236 Right Hand	3 1/4"	3/4"	1/8"	BWP® DAYTON® EUCLID® MW®	M-2472 13-1620R E-8996R 88291
WA07-6237 Left Hand	3 1/4"	3/4"	1/8"	BWP® DAYTON® EUCLID® MW®	M-2473 13-1620L E-8996L 88292
WA07-6238 Right Hand	3 15/32"	7/8"	1/8"	BWP® DAYTON® EUCLID® MERITOR®	M-2474 13-1621R E-9001R 20X1356

CONTINUED>>>

# HEADED DISC WHEEL STUDS continued...



WA#	A	B	C	REPLACES	
WA07-6239 Left Hand	3 15/32"	7/8"	1/8"	BWP® DAYTON® EUCLID® MERITOR®	M-2475 13-1621L E-9001L 20X1357
WA07-5179 Right Hand	3 1/2"	1 3/16"	1/4"	BWP® DAYTON® EUCLID® GUNITE®  NAVISTAR®	M-3632 13-1630R E-8972R W-988R W-1118R 593096C1
WA07-5180 Left Hand	3 1/2"	1 3/16"	1/4"	BWP® DAYTON® EUCLID® GUNITE®  NAVISTAR®	M-3633 13-1630L E-8972L W-988L W-1118L 593097C1
WA07-6240 Right Hand	3 1/2"	1 1/2"	5/16"	BWP® DAYTON® EUCLID® MW®	M-2476 13-1617R E-8995R 87142
WA07-6241 Left Hand	3 1/2"	1 1/2"	5/16"	BWP® DAYTON® EUCLID® MW®	M-2477 13-1617L E-8995L 87143
WA07-6110 Right Hand	3 13/16"	1 3/16"	3/16"	BWP® DAYTON® EUCLID® GUNITE®	M-3912 13-1635R E-8985R W1203R
WA07-6111 Left Hand	3 13/16"	1 3/16"	3/16"	BWP® DAYTON® EUCLID® GUNITE®	M-3913 13-1635L E-8985L W1203L
WA07-6168 Right Hand	3 5/8"	1 13/16"	9/16"	BWP® BUDD®  DAYTON® EUCLID® PETERBILT® WEBB®	M-2428 85381 99616 13-1616R E-5868R 02-00573 133610
WA07-6169 Left Hand	3 5/8"	1 13/16"	9/16"	BWP® BUDD®  DAYTON® EUCLID® PETERBILT® WEBB®	M-2429 85382 99617 13-1616L E-5868L 02-00572 133609
WA07-5106 Right Hand	3 3/4"	1 7/32"	1/8"	BWP® DAYTON® EUCLID® KENWORTH® PETERBILT®	M-2430 13-1618R E-5982R 233B359R 02-00772
WA07-5107 Left Hand	3 3/4"	1 7/32"	1/8"	BWP® DAYTON® EUCLID® KENWORTH® PETERBILT®	M-2431 13-1618L E-5982L 233B359L 02-00771
WA07-6242 Right Hand	3 3/4"	1 3/8"	5/8"	BWP® DAYTON® EUCLID® MERITOR®	M-2478 13-1623R E-10249R 20X1476
WA07-6243 Left Hand	3 3/4"	1 3/8"	5/8"	BWP® DAYTON® EUCLID® MERITOR®	M-2479 13-1623L E-10249L 20X1475
WA07-6244 Right Hand	3 25/32"	1 3/8"	7/32"	BWP® DAYTON® EUCLID® MERITOR®	M-2480 13-1609R E-5985R 20X586
WA07-6245 Left Hand	3 25/32"	1 3/8"	7/32"	BWP® DAYTON® EUCLID® MERITOR®	M-2481 13-1609L E-5985L 20X587



# HEADED DISC WHEEL STUDS *continued...*

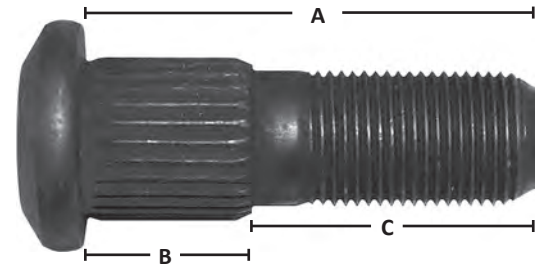

**3/4"-16 THREAD - FULLY SERRATED BODY**  
**BODY DIAMETER .742-.749**  
**SERRATED BODY .875**

WA#	A	B	C	REPLACES
WA07-6211 Right Hand Stud	2 15/32"	29/32"	1 5/32"	BWP® DAYTON® EUCLID® MOTORWHEEL® M-189 13-1182R E-8994R 82017
WA07-6212 Left Hand Stud	2 15/32"	29/32"	1 5/32"	BWP® DAYTON® EUCLID® MOTORWHEEL® M-190 13-1182L E-8994L 82018
WA07-6213 Right Hand Stud	2 5/8"	29/32"	1 5/32"	BWP® DAYTON® EUCLID® MOTORWHEEL® M-191 84155
WA07-6305 Left Hand Stud	2 5/8"	29/32"	1 5/32"	BWP® DAYTON® EUCLID® MOTORWHEEL® M-192 84156
WA07-6215 Right Hand Stud	2 13/16"	29/32"	1 5/32"	BWP® DAYTON® EUCLID® MOTORWHEEL® M-193 84986
WA07-6306 Left Hand Stud	2 13/16"	29/32"	1 5/32"	BWP® DAYTON® EUCLID® MOTORWHEEL® M-194 84987

# CLIPPED HEAD WHEEL STUDS

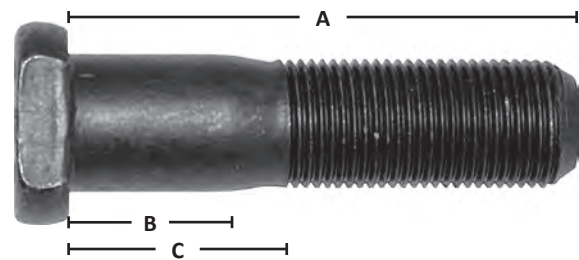

**Trailer Aluminum Hubs**  
**3/4"-16 Thread**  
**Body Diameter .783-.786**  
**Grade 8**

WA#	A	B	C	REPLACES
WA07-6096 Right Hand Stud	2 15/16"	1 1/8"	15/16"	BWP® DAYTON® EUCLID® M-3966 13-1511R E-10213R
WA07-6054 Right Hand Stud	3 5/w32"	1 13/32"	1 23/32"	BWP® DAYTON® EUCLID® M-3220 13-2372R E-6026R
WA07-6056 Right Hand Stud	3 13/32"	1 13/32"	1 3/4"	BWP® DAYTON® EUCLID® M-3224 13-2376R E-6027R
WA07-6057 Left Hand Stud	3 13/32"	1 13/32"	1 3/4"	BWP® DAYTON® EUCLID® M-3225 13-2376L E-6027L

CONTINUED>>>

# CLIPPED HEAD WHEEL STUDS continued...



WA#	A	B	C	REPLACES	
WA07-6058 Right Hand Stud	3 17/32"	1 9/16"	1 29/32"	BWP® DAYTON® EUCLID®	M-3226 13-2375R E-6059R
WA07-6059 Left Hand Stud	3 17/32"	1 9/16"	1 29/32"	BWP® DAYTON® EUCLID®	M-3227 13-2375L E-6059L
WA07-6060 Right Hand Stud	3 25/32"	1 9/16"	1 3/4"	BWP® DAYTON® EUCLID®	M-3228 13-2373R E-6028R
WA07-6061 Left Hand Stud	3 25/32"	1 9/16"	1 3/4"	BWP® DAYTON® EUCLID®	M-3229 13-2373L E-6028L

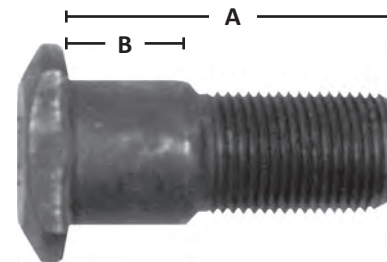

**BUDD**  
3/4"16 Thread  
Body Diameter .875-.879

WA#	A	B	REPLACES	
WA07-5182 Right Hand Stud	2"	3/4"	BWP® BUDD® DAYTON® EUCLID®	M-260 35786 N/A E-5587R
WA07-5181 Left Hand Stud	2"	3/4"	BWP® BUDD® DAYTON® EUCLID®	M-261 35787 N/A E-5587L
WA07-5183 Right Hand Stud	2 1/4"	1 3/64"	BWP® BUDD® DAYTON® EUCLID®	M-102 40336 13-1502R E-4988R
WA07-5184 Left Hand Stud	2 1/4"	1 3/64"	BWP® BUDD® DAYTON® EUCLID®	M-103 40337 13-1502L E-4988L
WA07-5370 Right Hand Stud	2 3/8"	1 3/16"	BWP® BUDD® DAYTON® EUCLID®	M-104 40338 13-1505R E-5588R
WA07-5371 Left Hand Stud	2 3/8"	1 3/16"	BWP® BUDD® DAYTON® EUCLID®	M-105 40339 13-1505L E-5588L
WA07-5187 Right Hand Stud	2 39/64"	1 9/32"	BWP® BUDD® DAYTON® EUCLID®	M-258 59536 13-1506R E-5618R
WA07-5188 Left Hand Stud	2 39/64"	1 9/32"	BWP® BUDD® DAYTON® EUCLID®	M-259 59537 13-1506L E-5618L

USE WORLD AMERICAN® NUTS FOR ABOVE STUDS		
	Right Hand	Left Hand
Single Wheel	WA07-5020	WA07-5021
Dual Wheel Inner Nuts	WA07-5024	WA07-5025
Dual Wheel Outer Nuts	WA07-5022	WA07-5023



# WEDGE HEAD WHEEL STUDS

**MERITOR STUDS FOR ALUMINUM HUBS**  
**3/4"-16 THREAD**  
 Body Diameter .786-.789  
 Underhead Diameter .790-.795  
 Grade 8

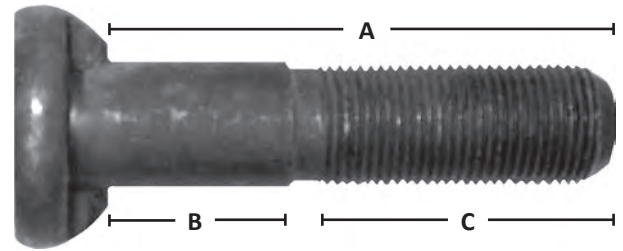

WA#	A	B	C	REPLACES	
WA07-6078 Right Hand Stud	3 1/8"	1 13/32"	1 3/8"	BWP® DAYTON® EUCLID® MERITOR®	M-3636 13-2327R E-9004R 20X1980
WA07-6310 Left Hand Stud	3 1/8"	1 13/32"	1 3/8"	BWP® DAYTON® EUCLID® MERITOR®	M-3637 13-2327L E-9004L 20X1979
WA07-6166 Right Hand Stud	3 3/8"	1 13/32"	1 3/32"	BWP® DAYTON® EUCLID® MERITOR®	M-2420 13-2323R E-5924R 20X1335 20X1464
WA07-6167 Left Hand Stud	3 3/8"	1 13/32"	1 3/32"	BWP® DAYTON® EUCLID® MERITOR®	M-2421 13-2323L E-5924L 20X1334 20X1463

# SHOULDER STUDS FOR DISC WHEELS

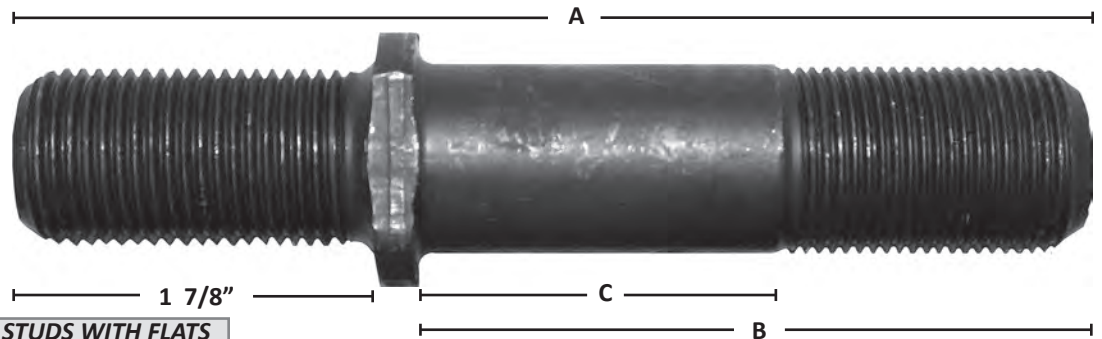

**OFF-HIGHWAY SHOULDER STUDS WITH FLATS**  
 1"-14 Thread Hub End  
 15/16"-12 Thread Wheel End  
 Body Diameter 1.010-1.013  
 Grade 8

WA#	A	B	C	REPLACES	
WA07-6160 Right Hand Stud	5 5/8"	3 1/2"	1 7/8"	BWP® BUDD® DAYTON® EUCLID®	M-1228 63341 13-2204R E-5876R
WA07-6303 Left Hand Stud	5 5/8"	3 1/2"	1 7/8"	BWP® BUDD® DAYTON® EUCLID®	M-1229 63342 13-2204L E-5876L

# SHOULDER STUDS FOR DISC WHEELS *continued...*

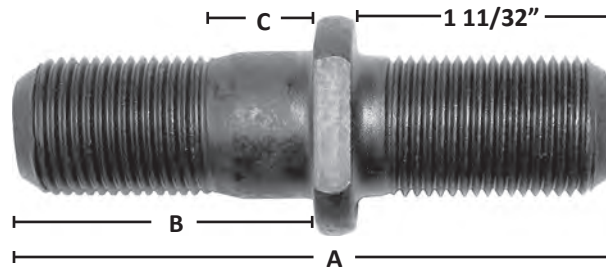

**3/4"-16 Thread Both Ends - Flats on Shoulder**  
**Body Diameter .783-.786**  
**Grade 8**

WA#	A	B	C	REPLACES	
WA07-6038 Right Hand	3 1/8"	1 19/32"	5/8"	BWP® BUDD® DAYTON® EUCLID®	M-46 12247 13-1001R E-5558R
WA07-6039 Left Hand	3 1/8"	1 19/32"	5/8"	BWP® BUDD® DAYTON® EUCLID®	M-47 12248 13-1001L E-5558L
WA07-5189 Right Hand	3 19/32"	2 1/16"	7/8"	BWP® BUDD® DAYTON® EUCLID®	M-48 13096 13-1002R E-5556R
WA07-5190 Left Hand	3 19/32"	2 1/16"	7/8"	BWP® BUDD® DAYTON® EUCLID®	M-49 13097 13-1002L E-5556L
WA07-5191 Right Hand	3 23/32"	2 3/16"	1 1/16"	BWP® BUDD® DAYTON® EUCLID®	M-50 13988 13-1003R E-5559R
WA07-5192 Left Hand	3 23/32"	2 3/16"	1 1/16"	BWP® BUDD® DAYTON® EUCLID®	M-51 13989 13-1003L E-5559L
WA07-5193 Right Hand	3 31/32"	2 7/16"	1 5/32"	BWP® BUDD® DAYTON® EUCLID®	M-52 13990 13-1004R E-5559L
WA07-5194 Left Hand	3 31/32"	2 7/16"	1 5/32"	BWP® BUDD® DAYTON® EUCLID®	M-53 13991 13-1004L E-5561L
WA07-5195 Right Hand	4 1/32"	2 1/2"	1 9/32"	BWP® BUDD® DAYTON® EUCLID®	M-54 19004 13-1005R E-5560R
WA07-5196 Left Hand	4 1/32"	2 1/2"	1 9/32"	BWP® BUDD® DAYTON® EUCLID®	M-55 19005 13-1005L E-5560L
WA07-6044 Right Hand	4 7/32"	2 11/16"	1 7/16"	BWP® BUDD® DAYTON® EUCLID®	M-56 17123 13-1006R E-5551R
WA07-6045 Left Hand	4 7/32"	2 11/16"	1 7/16"	BWP® BUDD® DAYTON® EUCLID®	M-57 17124 13-1006L E-5551L
WA07-5197 Right Hand	4 17/32"	3"	1 29/32"	BWP® BUDD® DAYTON® EUCLID®	M-60 16271 13-1008R E-5553R





# SHOULDER STUDS FOR DISC WHEELS *continued...*

WA#	A	B	C	REPLACES	
WA07-5198 Left Hand	4 17/32"	3"	1 29/32"	BWP® BUDD® DAYTON® EUCLID®	M-61 16272 13-1008L E-5553L
WA07-6080 Right Hand	4 29/32"	3 3/8"	2 1/32"	BWP® CONMET® DAYTON® EUCLID®	M-3644 100525 13-1017R E-5989R
WA07-6081 Left Hand	4 29/32"	3 3/8"	2 1/32"	BWP® CONMET® DAYTON® EUCLID®	M-3645 100524 13-1017L E-5989L
WA07-6048 Right Hand	5 1/32"	3 1/2"	2 15/32"	BWP® BUDD® DAYTON® EUCLID®	M-62 16003 13-1009R E-5557R
WA07-6317 Left Hand	5 1/32"	3 1/2"	2 15/32"	BWP® BUDD® DAYTON® EUCLID®	M-63 16004 13-1009L E-5557L

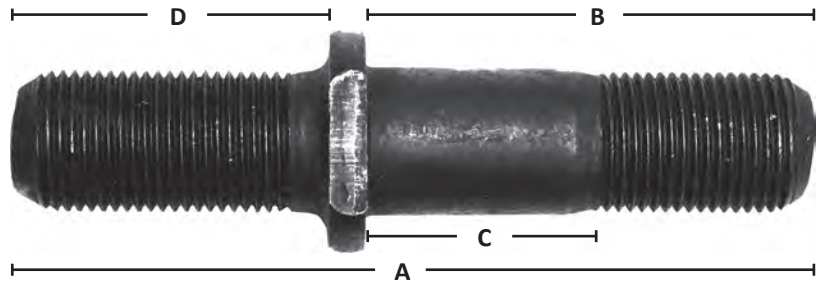

*3/4"-16 Thread - Both Ends - Longer Cap Nut End  
for Alluminum Wheels  
Flats on Shoulder  
Body Diameter .783-.786*

WA#	A	B	C	D	REPLACES	
WA07-6162 Right Hand	4 1/4"	2 3/8"	1 1/16"	1 5/8"	BWP® BUDD® DAYTON® EUCLID® FREIGHTLINER®	M-2402 95693 13-1038R E-5932R 11-9714-3
WA07-6163 Left Hand	4 1/4"	2 3/8"	1 1/16"	1 5/8"	BWP® BUDD® DAYTON® EUCLID® FREIGHTLINER®	M-2403 95694 13-1038L E-5932L 11-9714-2
WA07-6164 Right Hand	4 1/2"	2 3/8"	1 1/32"	1 15/16"	BWP® BUDD® DAYTON® EUCLID® FREIGHTLINER®	M-2404 X-2053 13-1037R E-5931R 11-9714-12
WA07-6165 Left Hand	4 1/2"	2 3/8"	1 1/32"	1 15/16"	BWP® BUDD® DAYTON® EUCLID® FREIGHTLINER®	M-2405 X-2054 13-1037L E-5931L 11-9714-11

# SHOULDER STUDS FOR DISC WHEELS continued...

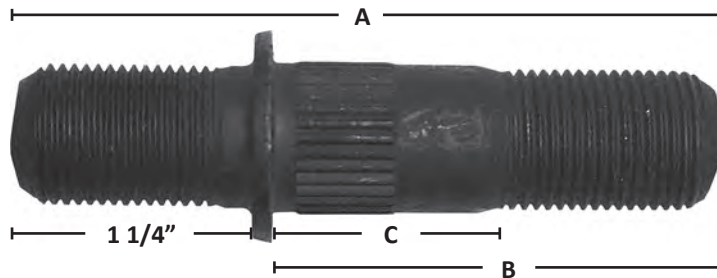

3/4"-16 THREAD - BOTH ENDS,  
SERRATIONS UNDER SHOULDER  
ROUND SHOULDER  
BODY DIAMETER .783-.786

WA#	A	B	C	REPLACES	
WA07-6042 Right Hand	3 5/8"	2 9/32"	1 1/16"	BWP® BUDD® DAYTON® EUCLID®	M-1166 82581 13-1302R E-5714R
WA07-6300 Left Hand	3 5/8"	2 9/32"	1 1/16"	BWP® BUDD® DAYTON® EUCLID®	M-1167 82582 13-1302L E-5714L
WA07-6046 Right Hand	4 5/8"	3 9/32"	2"	BWP® BUDD® DAYTON® EUCLID®	M-1170 83812 13-1305R E-5589R
WA07-6301 Left Hand	4 5/8"	3 9/32"	2"	BWP® BUDD® DAYTON® EUCLID®	M-1171 83813 13-1305L E-5589L
WA07-6246 Right Hand	4 7/8"	3 17/32"	2"	BWP® BUDD® DAYTON® EUCLID®	M-2498 101321 13-1306R E-8948R
WA07-6247 Left Hand	4 7/8"	3 17/32"	2"	BWP® BUDD® DAYTON® EUCLID®	M-2499 101322 13-1306L E-8948L

## METRIC WHEEL STUDS

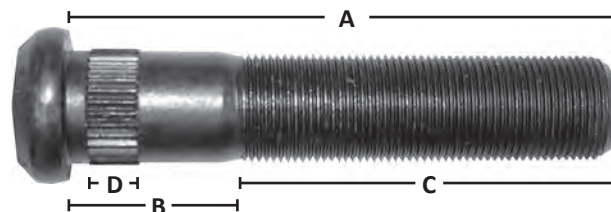

BUDD UNIMOUNT SYSTEM  
METRIC M22X1.5 THREAD - HEADED STUD - SERRATED BODY  
BODY DIAMETER .900-.903 - SERRATED DIAMETER .935-.944  
GRADE 10.9  
USES WA METRIC NUT WA07-5035

WA#	A	B	C	D	REPLACES	
WA07-6188	3 5/32"	1 7/32"	1 5/8"	13/32"	BWP® BUDD® DAYTON® EUCLID®	M-3200 106377 13-1580 E-5998
WA07-5200	3 21/32"	1 7/32"	2 1/8"	13-32"	BWP® BUDD® DAYTON® EUCLID®	M-3201 106216 13-1581 E-5997
WA07-5201	4 29/64"	1 7/32"	2 29/32"	13/32"	BWP® BUDD® DAYTON® EUCLID®	M-3202 106397 13-1582 E-5999



# METRIC WHEEL STUDS continued...

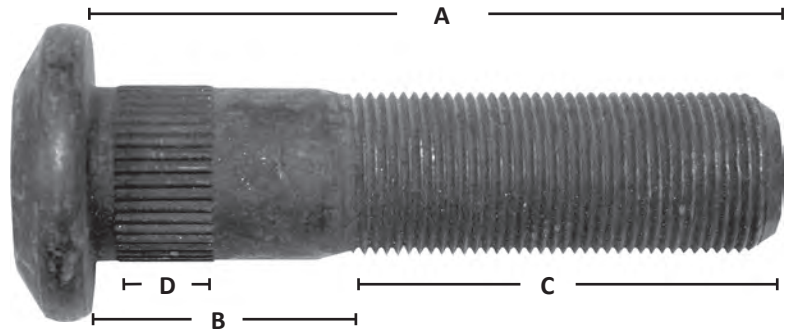

**CON-MET ALLUMINUM HUB**  
**METRIC M22X1.5 THREAD - HEADED STUD - SERRATED BODY**  
**BODY DIAMETER .908-.912 - SERRATED DIAMETER .929-.937**  
**GRADE 10.9**

WA#	A	B	C	D	REPLACES
WA07-6114	3 21/32"	1 7/32"	2 3/32"	1/2"	BWP® CON-MET® DAYTON® EUCLID® M-3972 103193 13-1548 E-10222
WA07-5506	4 3/32"	1 1/16"	2 11/32"	1/2"	BWP® CON-MET® DAYTON® EUCLID® M-3658 102188 13-1544 E-10215
WA07-6083	4 1/2"	1 9/16"	2 19/32"	1/2"	BWP® CON-MET® DAYTON® EUCLID® M-3659 102290 13-1550 E-10219
WA07-5507	4 9/16"	1 1/16"	2 13/16"	1/2"	BWP® CON-MET® DAYTON® EUCLID® M-3660 102189 13-1545 E-10216
WA07-5508	4 15/16"	1 1/16"	3 3/16"	1/2"	BWP® CON-MET® DAYTON® EUCLID® M-3661 102190 13-1546 E-10217
WA07-5509	5"	1 9/16"	3 3/32"	1/2"	BWP® CON-MET® DAYTON® EUCLID® M-3662 102291 13-1552 E-10221
WA07-5202	5 5/16"	1 9/16"	3 13/32"	1/2"	BWP® CON-MET® DAYTON® EUCLID® M-3663 102292 13-1552 E-10221

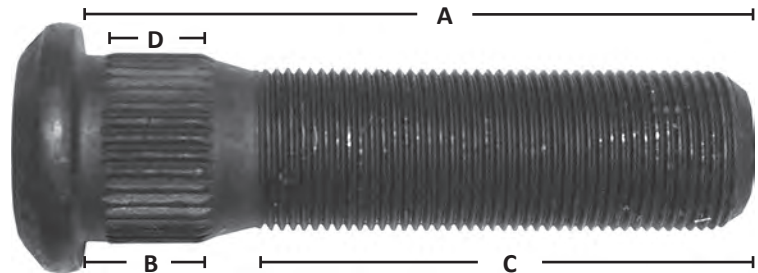

**GUNITE**  
**METRIC M22X1.5 THREAD - HEADED STUD - SERRATED BODY**  
**BODY DIAMETER .971-.975 - SERRATED BODY**  
**GRADE 10.9**

WA#	A	B	C	D	REPLACES
WA07-5203	3 1/2"	21/32"	2 5/8"	1/2"	BWP® DAYTON® EUCLID® GUNITE® M-3664 N/A E-10675 W-1324
WA07-6085	3 11/16"	7/8"	2 11/32"	1/2"	BWP® DAYTON® EUCLID® GUNITE® M-3665 13-1579 E-8988 W-1246
WA07-5204	4"	3/4"	2 7/8"	1/2"	BWP® DAYTON® EUCLID® GUNITE® M-3666 13-1567 E-8981 W-1164

CONTINUED>>>

# METRIC WHEEL STUDS continued...



WA#	A	B	C	D	REPLACES
WA07-6087	4 1/4"	1 1/16"	2 7/8"	1/2"	BWP® DAYTON® EUCLID® GUNITE® M-3667 13-1577 E-8989 W-1249
WA07-6088	4 1/4"	21/32"	3 1/4"	1/2"	BWP® DAYTON® EUCLID® GUNITE® M-3668 N/A E-10676 W-1327
WA07-6116	4 3/8"	1 3/8"	2 3/8"	1"	BWP® DAYTON® EUCLID® GUNITE® M-3976 N/A E-10241 K233-468
WA07-5205	5 3/32"	7/8"	3 3/4"	1/2"	BWP® DAYTON® EUCLID® GUNITE® M-3669 13-1576 E-8980 W-1160
WA07-5114	5 3/16"	1 1/16"	3 23/32"	1/2"	BWP® DAYTON® EUCLID® GUNITE® M-3670 13-1578 E-8987 W-1211

**WEBB**  
METRIC M22X1.5 THREAD - HEADED STUD - SERRATED BODY  
BODY DIAMETER .973-.977 - SERRATED BODY DIAMETER 1.000-1.015  
GRADE 10.9

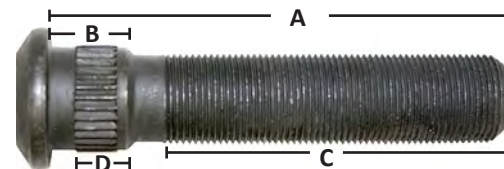

WA#	A	B	C	D	REPLACES
WA07-6089	2 9/16"	23/32"	1 11/16"	3/8"	BWP® DAYTON® EUCLID® WEBB® M-3671 13-1573 E-9009 101166
WA07-5374	3 1/2"	23/32"	2 1/4"	3/8"	BWP® DAYTON® EUCLID® WEBB® M-3215 13-1570 E-6036 101164
WA07-5038	3 15/16"	23/32"	2 11/16"	3/8"	BWP® DAYTON® EUCLID® WEBB® M-3216 13-1571 E-6035 101162
WA07-6090	4 5/16"	23/32"	3 1/16"	3/8"	BWP® DAYTON® EUCLID® WEBB® M-3672 13-1569 E-9526 101161
WA07-5039	4 25/32"	23/32"	3 17/32"	3/8"	BWP® DAYTON® EUCLID® WEBB® M-3217 13-1572 E-6034 101160

**USE METRIC NUT: WA07-5036**

**GUNITE**  
METRIC M22X1.5 THREAD - HEADED STUD - SERRATED BODY  
BODY DIAMETER 1.218-1.222  
SERRATED BODY DIAMETER 1.244-1.252  
GRADE 10.9

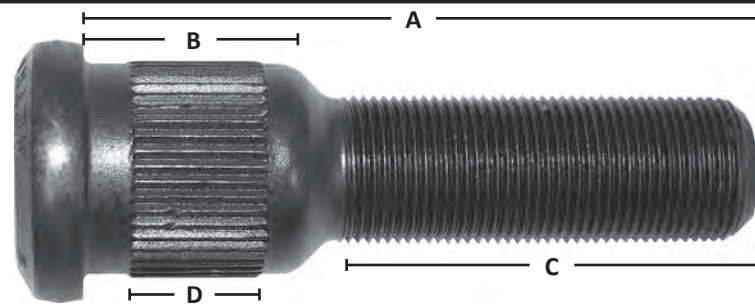

WA#	A	B	C	D	REPLACES
WA07-6091	3 7/8"	1 3/16"	2 11/32"	3/4"	BWP® DAYTON® EUCLID® GUNITE® M-3673 13-1720 N/A W-1202
WA07-6093	4 13/32"	1 3/16"	2 7/8"	3/4"	BWP® DAYTON® EUCLID® GUNITE® M-3677 13-1721 E-8986 W-1205



# METRIC WHEEL STUDS continued...

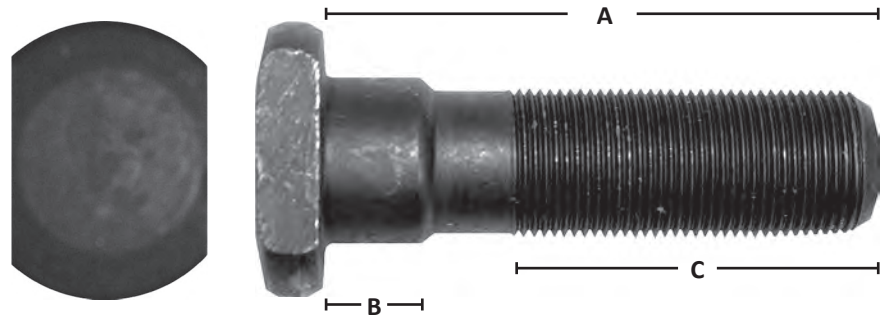

**METRIC CLIPPED HEAD STUDS**  
 M22X1.5 THREAD - BODY DIAMETER .908-.912  
 GRADE 10.9

WA#	A	B	C	REPLACES
WA07-5303	4 3/8"	1 19/64"	2 1/2"	BWP® CONMET® DAYTON® EUCLID® WEBB® M-3679 101151 13-1591 E-6029A 89983
WA07-6094	4 25/32"	5/8"	3 3/4"	BWP® DAYTON® EUCLID® MOTORWHEEL® M-3680 13-1563 E-8997 89620

**MOTOR WHEEL - CLIPPED HEAD STUDS**  
 M22X1.5 THREAD - BODY DIAMETER .980-.983  
 GRADE 10.9

WA#	A	B	C	REPLACES
WA07-6190	3 1/4"	43/64"	2 1/4"	BWP® DAYTON® EUCLID® MOTORWHEEL® M-3204 13-1561 E-5994 88808
WA07-6192	4 1/8"	23/32"	3 1/16"	BWP® DAYTON® EUCLID® MOTORWHEEL® M-3206 13-1560 E-5993 88799

**METRIC "D" HEAD CLIPPED STUD**  
 M22X1.5 THREAD - BODY DIAMETER .888  
 GRADE 10.9

WA#	A	B	C	REPLACES
WA07-6319	4 3/16"	1/2"	3 5/16"	BWP® EUCLID® EMC® M-3978 E-10257 02-00014



# DRIVE FLANGE WEDGES

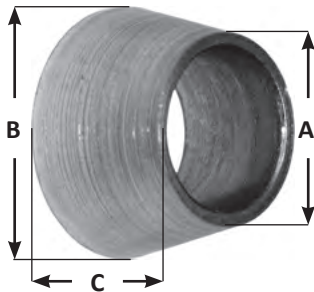

WA#	A	B	C	REPLACES:					
				GMC®	IHC®	MERITOR®	BWP®	DAYTON®	EUCLID®
WA07-5080	7/16"	11/16"	13/32"		72342R1	1246-Z-234	M-2527	13-7204	E-5952
WA07-6319	7/16"	3/4"	5/16"				M-981		E-5736
WA07-5077	7/16"	3/4"	13/32"	2124231	974272R1	1246-X-232	M-982	13-7202	E-5737
WA07-5019	7/16"	13/16"	11/32"	3651372			M-983		E-5738
WA07-6020	1/2"	13/16"	5/16"				M-984		E-5739
WA07-5078	1/2"	13/16"	13/32"		97242R1	1246-T-306	M-985	13-7208	E-5740
WA07-5081	1/2"	7/8"	15/32"	652328	40377-V	1246-B-28	M-2528	13-7210	E-5957
WA07-6021	9/16"	7/8"	3/8"				M-986		E-5742
WA07-5079	5/8"	1"	15/32"	2019573	141316H	1246-Y-233	M-987	13-7216	E-5743
WA07-5082	5/8"	1"	9/16"	2231319	54700R1	1246-D-290	M-2529	13-7218	E-5960

# DRIVE FLANGE STUDS



7/16" DRIVE FLANGE STUDS

WA#	A	B	B LENGTH	C	C LENGTH	REPLACES
WA07-6179	2"	7/16"-20	5/8"	7/16"-14	1/2"	BWP® BUDD® DAYTON® EUCLID® M-2463 18560 N/A E-5792
WA07-6180	2 3/16"	7/16"-20	15/16"	7/16"-14	9/16"	BWP® BUDD® DAYTON® EUCLID® KELSEY® MERITOR® M-2464 42793 13-7001 E-5796 WP-28 SC-718

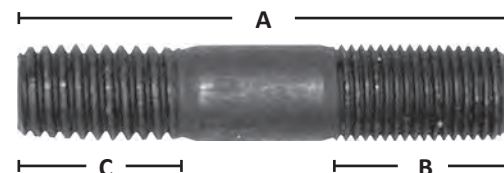

1/2" DRIVE FLANGE STUDS

WA#	A	B	B LENGTH	C	C LENGTH	REPLACES
WA07-6182	2 3/8"	1/2"-20	13/16"	1/2"-13	13/16"	BWP® BUDD® DAYTON® EUCLID® MERITOR® M-2520 37181, 44577 13-7010 E-5798 SC-819
WA07-6183	2 9/16"	1/2"-20	15/16"	1/2"-13	1 1/16"	BWP® DAYTON® EUCLID® KELSEY® WEBB® M-2521 13-7012 E-5799 WP-81 152026
WA07-5206	2 7/8"	1/2"-20	15/16"	1/2"-13	7/8"	BWP® DAYTON® EUCLID® GMC® MW® M-2522 13-7015 N/A 2216914 85521



# DRIVE FLANGE STUDS continued...

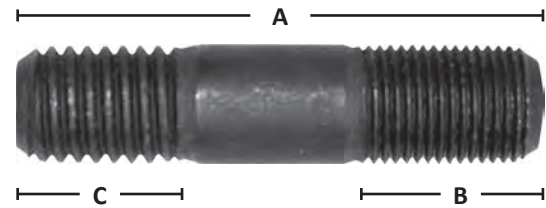

## 5/8" DRIVE FLANGE STUDS

WA#	A	B	B LENGTH	C	C LENGTH	REPLACES
WA07-5207	2 3/4"	5/8"-18	1"	5/8"-11	1"	BWP® BUDD DAYTON® EUCLID® IHC® KELSEY® M-2523 63606 13-7037 E-5800 119345H WP-174
WA07-6178	3"	5/8"-18	7/8"	5/8"-18	1 1/2"	BWP® DAYTON® EUCLID® MACK® M-2462 N/A E-5731 18AX970
WA07-5208	3 1/16"	5/8"-18	1 1/16"	5/8"-11	1 1/8"	BWP® BUDD® DAYTON® EUCLID® M-2509 48966 13-7038 E-5801
WA07-6181	3 1/2"	5/8"-18	7/8"	5/8"-18	1 7/16"	BWP® DAYTON® EUCLID® MACK® M-2465 13-7028 E-5751 18AX971
WA07-5209	3 11/16"	5/8"-18	1 1/8"	5/8"-11	1 9/16"	BWP® DAYTON® EUCLID® MW® MERITOR® M-2524 13-7026 E-5872 86478 4X1027

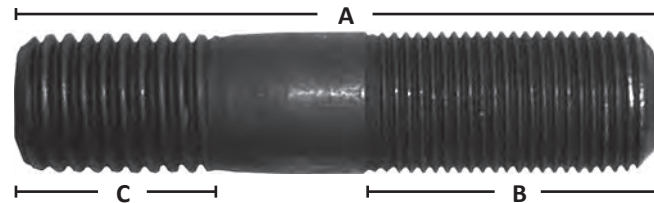

## 3/4" DRIVE FLANGE STUDS

WA#	A	B	B LENGTH	C	C LENGTH	REPLACES
WA07-6185	3 3/16"	3/4"-16	1 1/8"	3/4"-10	1"	BWP® DAYTON® EUCLID® IHC® M-2525 13-7055 E-5955 61142H
WA07-6186	3 3/4"	3/4"-16	1 9/16"	3/4"-10	1 1/8"	BWP® BUDD® DAYTON® EUCLID® IHC® KELSEY® MERITOR® M-2526 37179, 49321 13-7050 E-4960 55585H WP-39 4X1207

[WWW.WORLDAMERICAN.COM](http://WWW.WORLDAMERICAN.COM)

# HEAVY DUTY AXLE NUT SOCKETS



**3/4" DRIVE SQUARE OPENING**  
**ALL SOCKETS MEASURED INSIDE FLAT-TO-FLAT**  
**6 POINT SOCKETS**

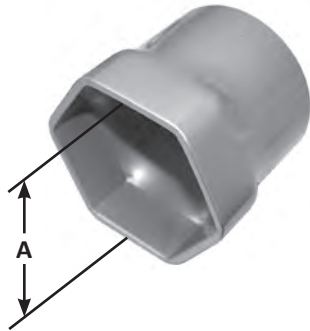

A=OPENING SIZE	WA#	OTC®	BWP®	DAYTON®	EUCLID®
2 3/32"	WA13-1901	1901	M-1901	11-1901	E-1901
2 1/4"	WA13-1920	1920	M-1920	11-1920	E-1920
2 3/8"	WA13-1902	1902	M-1902	11-1902	E-1902
2 1/2"	WA13-1921	1921	M-1921	11-1921	E-1921
2 9/16"	WA13-1904	1904	M-1904	11-1904	E-1904
2 5/8"	WA13-1922	1922	M-1922	11-1922	E-1922
3"	WA13-1906	1906	M-1906	11-1906	E-1906
3 1/4"	WA13-1908	1908	M-1908	11-1908	E-1908
3 1/2"	WA13-1910	1910	M-1910	11-1910	E-1910
3 7/8"	WA13-1912	1912	M-1912	11-1912	E-1912
4"	WA13-1914	1914	M-1914	11-1914	E-1914
4 1/8"	WA13-1915	1915	M-1915	11-1915	E-1915
4 3/8"	WA13-1916	1916	M-1916	11-1916	E-1916
4 7/8"	WA13-1918	1918	M-1918	11-1918	E-1918

**3/4" DRIVE SQUARE OPENING**  
**ALL SOCKETS MEASURED INSIDE FLAT-TO-FLAT**  
**8 POINT SOCKETS**

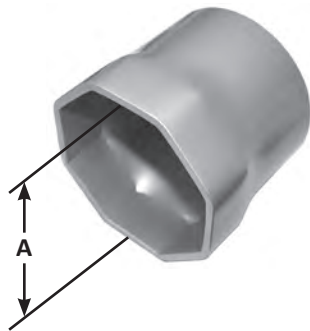

A=OPENING SIZE	WA#	OTC®	BWP®	DAYTON®	EUCLID®
2 3/8"	WA13-1903	1903	M-1903	11-1903	E-1903
2 9/16"	WA13-1905	1905	M-1905	11-1905	E-1905
3"	WA13-1907	1907	M-1907	11-1907	E-1907
3 1/4"	WA13-1909	1909	M-1909	11-1909	E-1909
3 1/2"	WA13-1911	1911	M-1911	11-1911	E-1911
3 13/16"	WA13-1927	1927	M-1927	11-1927	E-1927
3 7/8"	WA13-1913	1913	M-1913	11-1913	E-1913
4 3/8"	WA13-1917	1917	M-1917	11-1917	E-1917
4 7/8"	WA13-1919	1919	M-1919	11-1919	E-1919

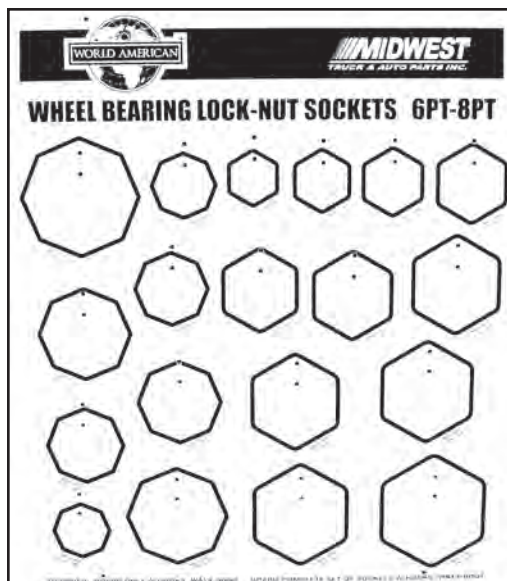

**SOCKET BOARD**  
**INCLUDES HOOKS**

WA#	DESCRIPTION
WA13-0000	BOARD AND HOOKS ONLY
WA13-0001	BOARD, HOOKS AND COMPLETE SET OF SOCKETS.





# DISPLAY RACKS AND WHEEL CHOCKS

## SMALL PARTS DISPLAY RACK

### WA#

### DESCRIPTION

WA07-RACK

- SMALL PARTS DISPLAY RACK:
- SILK SCREENED MIDWEST TRUCK LOGO
- 8 TRAYS
- 48 ADJUSTABLE COMPARTMENTS
- DURABLE BLUE POWDER COAT FINISH
- HEIGHT: 4 1/2'
- WIDTH: 26"
- SHIPPING WEIGHT: 52 lbs.

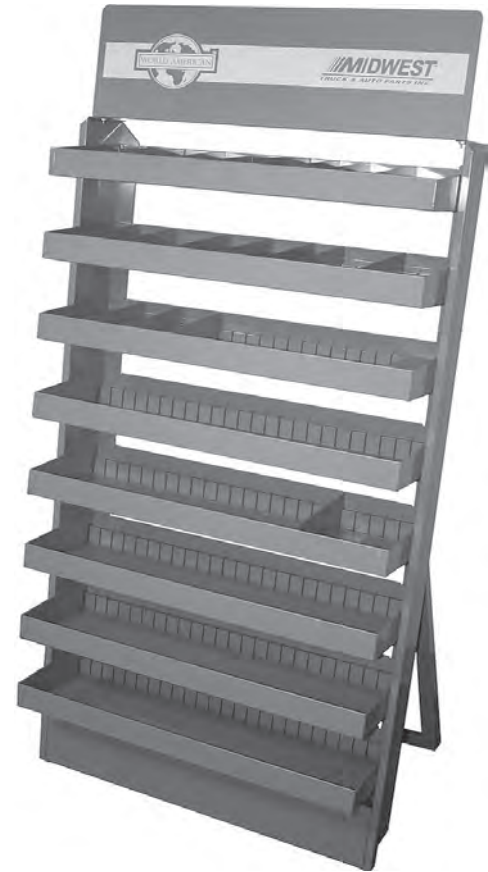

## WHEEL CHOCKS

### WA#

### DESCRIPTION

WA14-5025

- HEAVY DUTY CHOCK, LARGE ZINC-PLATED EYEBOLT,  
NON-SKID BOTTOM (7LBS., 8"D x 10"L x 6"H)

WA14-5026

- HEAVY DUTY CHOCK, LARGE ZINC-PLATED EYEBOLT,  
NON-SKID BOTTOM (9LBS., 8"D x 9 1/2"L x 5 3/4"H)



# HUB CAPS



## HUB CAPS



WA#	REPLACES	THREAD	APPLICATION
WA340-4975	FRUEHAUF® ACC-7538-900 EUCLID® E-04075	6 1/4"-8	



WA#	REPLACES	APPLICATION
WA359-5990	FRUEHAUF® AXA-1005-1 EUCLID® E-04000	STD PLUG FOR ALL CENTER FILL HUB CAPS



WA#	REPLACES	I.D.	O.D.	NOTE
WA14-5001	FRUEHAUF® AXA-0484-1 EUCLID® E-05500	5 1/2"	6"	O-RING



WA#	REPLACES	BOLT CIRCLE	BOLT SIZE	O.D.	I.D.	NOTE
WA330-3009	STEMCO® 330-3009	5 1/2"	5/16"	6 1/4"	4 3/4"	STANDARD GASKET FOR 6-HOLE HUB CAPS. USE WITH WA14-5003 & WA343-009



WA#	REPLACES	BOLT CIRCLE	BOLT SIZE	INSIDE DEPTH	O.D.	I.D.	NOTE
WA14-5003	240-4009	5 1/2"	5/16"	1 15/16"	6 1/4"	4 3/8"	DIE CAST ALUM. TYPE W/WINDOW



WA#	REPLACES	BOLT CIRCLE	BOLT SIZE	INSIDE DEPTH	O.D.	I.D.	NOTE
WA343-009	343-4009	5 1/2"	5/16"	1 15/16"	6 1/4"	4 3/8"	WITH GASKET



WA#	NOTE
WA14-5005	WINDOW KIT FOR WA343-009



WA#	REPLACES	BOLT CIRCLE	BOLT HOLES	HOLE SIZE	O.D.	I.D.	HEIGHT
WA14-5023	343-4025	4.5"	6	.349	6.25"	3.5"	2.609"



# HUB CAPS continued...



**HUB CAP  
6 HOLE METAL - GREASE TYPE**

WA#	REPLACES	BOLT CIRCLE	BOLT HOLES	HOLE SIZE	OD	ID	HT
WA14-5024	E-975 M-767 11-0660 9009G M10HK129 3262-S-45 A-170074	5 1/2"	6	5/16"	6 1/8"	4 1/2"	2 1/8"



**HUB CAP  
6 HOLE W/FITTING**

WA#	REPLACES	BOLT CIRCLE	BOLT HOLES	HOLE SIZE	OD	ID	HT
WA340-4249	340-4249 21017 MST404249 ZCP3404249	5 1/2"	6	5/16"	6 3/16"	4 7/16"	1 13/16"



**HUB CAP  
6 HOLE W/FITTING**

WA#	REPLACES	BOLT CIRCLE	OD	ID	HT
WA343-4075	343-4075 A3262Q407 23004 47550 7843-3434075	6 1/4" X 8	6 7/8"	5 3/4"	2 5/16"

# AXLE SPINDLE NUTS AND WASHERS



WA#	REPLACES	I.D.	O.D.	THICK	APPLICATION
WA07-5090	EUCLID® E-540 DANA® 10284 DANA® M10HN158 EATON® F-1529 MERITOR® 1227-C-549	2 5/8"-16"	3 13/16"	3/8"	STANDARD INNER NUT



WA#	REPLACES	I.D.	O.D.	THICK	APPLICATION
WA07-5091	EUCLID® E-573 DANA® 10287 DANA® M10HN100 EATON® F-1531 MERITOR® 1227-V-1660	2 41/64"	3 15/16"	1/4"	STANDARD LOCK WASHER



WA#	REPLACES	I.D.	O.D.	THICK	APPLICATION
WA07-5092	EUCLID® E-572 DANA® 10286 EATON® F-1530 MERITOR® 1227-B-756	2 5/8"-16"	3 1/4"	3/8"	STANDARD OUTER NUT



WA#	REPLACES	I.D.	O.D.	THICK	APPLICATION
WA07-5093	EUCLID® E-2237 DANA® M10HN151	2 41/64"	4 1/32"	1/16"	POSITION LOCK WASHER INSIDE WA07-5092 NUT BEND TABS TO LOCK NUT



WA#	REPLACES	I.D.	O.D.	THICK	APPLICATION
WA07-5094	EUCLID® E-2250 FRUEHAUF® ACE-8510-1	3 1/2"-12	4 13/16"	1 1/8"	LATE STYLE NUT FULLY THREADED



WA#	REPLACES	I.D.	O.D.	THICK	APPLICATION
WA07-5095	EUCLID® E-1561 FRUEHAUF® AXA-0408-1	3 1/2"	5"	3/16"	HEAT TREATED



# DRIVE AXLE SPINDLE NUTS AND WASHERS

EATON® 32M-MR, 34M-MF, 34D-DT-RP-RT, 17800-1 AXLES				
WA#	REPLACES	I.D. OR THREAD	O.D. OR A.F.	THICKNESS
WA07-5375 OUTER NUT	EATON® 34090 EUCLID® E-2460	2 5/8" - 12THD.	3 3/8" A.F.	1"
WA07-5217 LOCK WASHER	EATON® 30714 EUCLID® E-2461	2 5/8" I.D.	4" O.D.	3/32"
WA07-5382 INNER NUT	EATON® 19186 EUCLID® E-2462	2 5/8" - 12THD.	3 7/16" A.F.	15/32"

EATON® 28R3-RP-RT, 42R3-RP-RT, 18800, 18801-2-3 AXLES				
WA#	REPLACES	I.D. OR THREAD	O.D. OR A.F.	THICKNESS
WA07-5377 OUTER NUT	EATON® 31926 EUCLID® E-2463	3" - 12THD.	3 13/16" A.F.	1"
WA07-5378 LOCK WASHER	EATON® 90180 EATON® E-2464	3" I.D.	4 1/2" O.D.	3/32"
WA07-5379 INNER NUT	EATON® 90229 EUCLID® E-2465	3" - 12THD.	3 13/16" A.F.	1/2"

EATON® 1911-1919, 2011, 20500-1, 19500-1-2 AXLES				
WA#	REPLACES	I.D. OR THREAD	O.D. OR A.F.	THICKNESS
WA07-5380 OUTER NUT	EATON® 31927 EUCLID® E-2466	3 1/4" - 12THD.	4 1/16" A.F.	1"
WA07-5215 LOCK WASHER	EATON® 11245 EUCLID® E-2467	3 1/4" I.D.	4 3/4" O.D.	1/8"
WA07-5381 INNER NUT	EATON® 11249 EUCLID® E-2468	3 1/4" - 12THD.	4 1/8" A.F.	1/2"

FORD® 18,000 LB. REAR AXLES				
WA#	REPLACES	I.D. OR THREAD	O.D. OR A.F.	THICKNESS
WA07-5382 OUTER NUT	FORD® D7HZ-4245A EUCLID® E-2462	2 5/8" - 12THD.	3 7/16" A.F.	15/32"
WA07-5217 LOCK WASHER	FORD® EQH-1124 EUCLID® E-2461	2 5/8" I.D.	4" O.D.	3/32"
WA07-5091 LOCK WASHER	FORD® 7EQ-1124A EUCLID® E-573	2 41/64" I.D.	3 15/16" O.D.	1/4"
WA07-5383 INNER NUT	FORD® D7HZ-4255A EUCLID® E-6142	2 5/8" - 12THD.	3 1/2" A.F.	3/8"

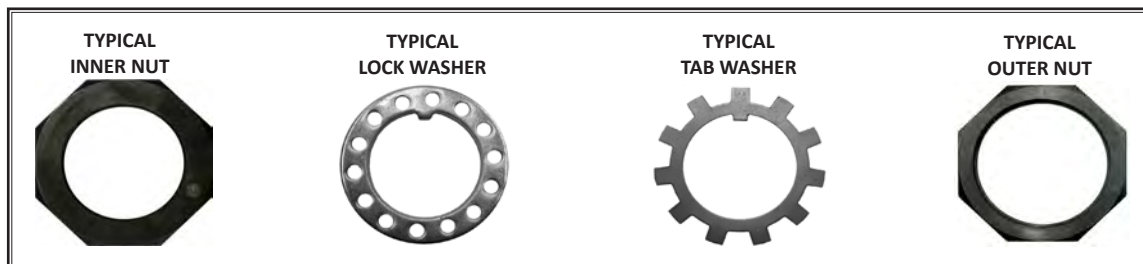



# DRIVE AXLE SPINDLE NUTS & WASHERS (continued)



MACK® 50,000 LB. AXLES				
WA#	REPLACES	I.D. OR THREAD	O.D. OR A.F.	THICKNESS
WA07-5384 OUTER NUT	MACK® 25QJ36 EUCLID® E-2305	3 1/4" - 12THD.	4" A.F.	1"
WA07-5385 LOCK WASHER	MACK® 23QJ201 EUCLID® E-2304	3 1/4" I.D.	4 5/16" O.D.	3/32"
WA07-5386 INNER NUT	MACK® 25QJ35 EUCLID® E-2386	3 1/4" - 12THD.	4" A.F.	3/8"

MACK® SW-56C AXLES				
WA#	REPLACES	I.D. OR THREAD	O.D. OR A.F.	THICKNESS
WA07-5387 OUTER NUT	MACK® 21-AX-626 EUCLID® E-2419	2 7/8" - 12THD.	4 1/8" A.F.	1"
WA07-5388 LOCK WASHER	MACK® 23-QJ-125 ,23-QJ-129 EUCLID® E-3505	2 7/8" I.D.	4 7/16" O.D.	1/8"
WA07-5389 INNER NUT	MACK® 25-QJ-138 EUCLID® E-3504	2 7/8" - 12THD.	4 1/8" A.F.	3/8"

NAVISTAR® 19,000-34,000 LB. AXLES				
APPLICATION: NAVISTAR AXLES: 14044, 14186,14351				
WA#	REPLACES	I.D. OR THREAD	O.D. OR A.F.	THICKNESS
WA07-5382 OUTER NUT	NAVISTAR® 67678R1 EUCLID® E-2462	2 5/8" - 12THD.	3 7/16" A.F.	15/32"
WA07-5391 LOCK WASHER	NAVISTAR® 470422C1 EUCLID® E-4877	2 5/8" I.D.	4 1/16" O.D.	1/8"

MERITOR® DRIVE AXLE - "F" SERIES				
WA#	REPLACES	I.D. OR THREAD	O.D. OR A.F.	THICKNESS
WA07-5392 OUTER NUT	MERITOR® 1227-D-446 EUCLID® E-2419	2 1/2" - 16THD.	3 1/2" A.F.	5/16"
WA07-5393 LOCK WASHER	MERITOR® 1229-C-1459 EUCLID® E-2418	2 1/2" I.D.	3 3/4" O.D.	5/32"
WA07-5394 INNER NUT	MERITOR® 1227-U-515 EUCLID® E-2417	2 1/4" - 16THD.	3 1/2" A.F.	5/16"

MERITOR® DRIVE AXLE - "H" SERIES				
WA#	REPLACES	I.D. OR THREAD	O.D. OR A.F.	THICKNESS
WA07-5395 OUTER NUT	MERITOR® 1227-T-288 EUCLID® E-2422	2 5/8" - 16THD.	3 1/2" A.F.	3/8"
WA07-5396 LOCK WASHER	MERITOR® 1229-G-1021 EUCLID® E-2421	2 5/8" I.D.	3 3/4" O.D.	3/16"
WA07-5397 INNER NUT	MERITOR® A-1227-T-540 EUCLID® E-2420	2 5/8" - 16THD.	3 1/2" A.F.	3/8"



## DRIVE AXLE SPINDLE NUTS & WASHERS (continued)

MERITOR® DRIVE AXLE - SPECIAL "H" SERIES				
WA#	REPLACES	I.D. OR THREAD	O.D. OR A.F.	THICKNESS
WA07-5398 OUTER NUT	MERITOR® 1227-E-1045 EUCLID® E-2462	2 5/8" - 12THD.	3 1/2" A.F.	3/8"
WA07-5396 LOCK WASHER	MERITOR® 1229-G-1021 EUCLID® E-2421	2 5/8" I.D.	3 3/4" O.D.	3/16"
WA07-5383 INNER NUT	MERITOR® 1227-Z-1040 EUCLID® E-6142	2 5/8" - 12THD.	3 1/2" A.F.	3/8"

## DRIVE AXLE SPINDLE NUTS & LOCKS

MERITOR® DRIVE AXLE - "J" AND "L" SERIES				
WA#	REPLACES	I.D. OR THREAD	O.D. OR A.F.	THICKNESS
WA07-5413 OUTER NUT	MERITOR® 1227-H-346 EUCLID® E-2425	3" - 12THD.	4" A.F.	3/8"
WA07-5414 LOCK WASHER	MERITOR® 1229-R-1058 EUCLID® E-2424	3" I.D.	4 1/4" O.D.	3/16"
WA07-5415 INNER NUT	MERITOR® A-1227-V-516 EUCLID® E-2423	3" - 12THD.	4" A.F.	3/8"

MERITOR® DRIVE AXLE - "Q", "R", "S", "T" SERIES				
WA#	REPLACES	I.D. OR THREAD	O.D. OR A.F.	THICKNESS
WA07-5384 OUTER NUT	MERITOR® 1227-R-330 EUCLID® E-2305	3 1/4" - 12THD.	4" A.F.	3/8"
WA07-5385 LOCK WASHER	MERITOR® 1229-V-1009 EUCLID® E-2304	3 1/4" I.D.	4 5/16" O.D.	3/16"
WA07-5386 INNER NUT	MERITOR® 1227-W-517 EUCLID® E-2303	3 1/4" - 12THD.	4" A.F.	3/8"

MERITOR® DRIVE AXLE - "S", "U" AND FU900 SERIES				
WA#	REPLACES	I.D. OR THREAD	O.D. OR A.F.	THICKNESS
WA07-5399 OUTER NUT	MERITOR® 1227-P-328 EUCLID® E-2428	3 3/8" - 12THD.	4 3/8" A.F.	3/8"
WA07-5400 LOCK WASHER	MERITOR® 1229-V-48 EUCLID® E-2427	3 3/8" I.D.	4" O.D.	7/32"
WA07-5401 INNER NUT	MERITOR® 1227-A-547 EUCLID® E-2426	2 5/8" - 12THD.	4 7/8" A.F.	5/16"

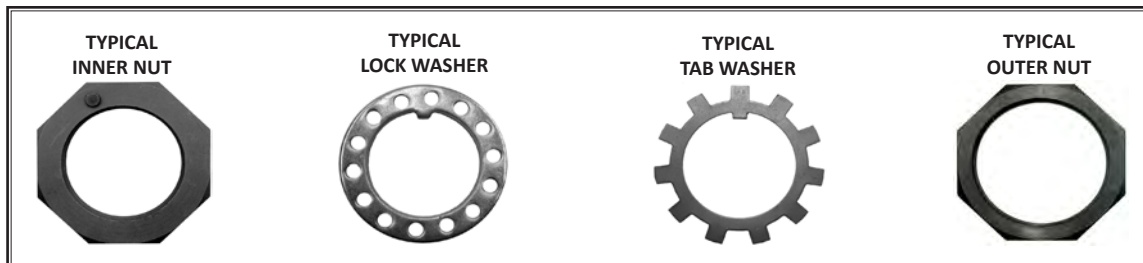



# DRIVE AXLE SPINDLE NUTS & LOCKS (continued)

MERITOR® - FD900, FD901, FD931, FE900, FF901, FF931 AXLES				
WA#	REPLACES	I.D. OR THREAD	O.D. OR A.F.	THICKNESS
WA07-5402 OUTER NUT	ROCKWELL® 1227-B-106 EUCLID® E-2296	1 1/2" - 12THD.	2 1/4" A.F.	7/16"
WA07-5403 OUTER WASHER	ROCKWELL® 1229-F-474 EUCLID® E-2298	1 17/32" I.D.	3" O.D.	1/32"
WA07-5404 LOCK WASHER	ROCKWELL® 1229-G-475 EUCLID® E-2297	1 17/32" I.D.	3" O.D.	3/16"
WA07-5405 INNER NUT	ROCKWELL® 1227-U-541, 1227-L-194, A-1227-A-105 EUCLID® E-2299	1 1/2" - 12THD.	2 5/8" O.D.	3/8"

MERITOR® - FE970 AND "E" SERIES AXLES				
WA#	REPLACES	I.D. OR THREAD	O.D. OR A.F.	THICKNESS
WA07-5406 OUTER NUT	ROCKWELL® 1227-F-162 EUCLID® E-2300	2 1/4" - 16THD.	2 7/8" A.F.	1/4"
WA07-5407 LOCK WASHER	ROCKWELL® 1229-S-721 EUCLID® E-2301	2 1/4" I.D.	3 5/16" O.D.	1/16"
WA07-5408 THRUST WASHER	ROCKWELL® 1229-H-1568 EUCLID® E-2302	2 1/4" I.D.	4 5/16" O.D.	1/4"

MERITOR® - FG900 AXLES				
WA#	REPLACES	I.D. OR THREAD	O.D. OR A.F.	THICKNESS
WA07-5409 OUTER NUT	ROCKWELL® 1227-D-108 EUCLID® E-2658	1 3/4" - 12THD.	2 1/2" A.F.	11/16"
WA07-5410 OUTER WASHER	ROCKWELL® 1229-J-478 EUCLID® E-2659	1 25/32" I.D.	3 1/4" O.D.	1/32"
WA07-5411 LOCK WASHER	ROCKWELL® 1229-H-476 EUCLID® E-2660	1 25/32" I.D.	3 1/4" O.D.	7/32"
WA07-5412 INNER NUT	ROCKWELL® A-1227-C-107 EUCLID® E-3510	1 3/4" - 12THD.	3 5/16" O.D.	7/16"

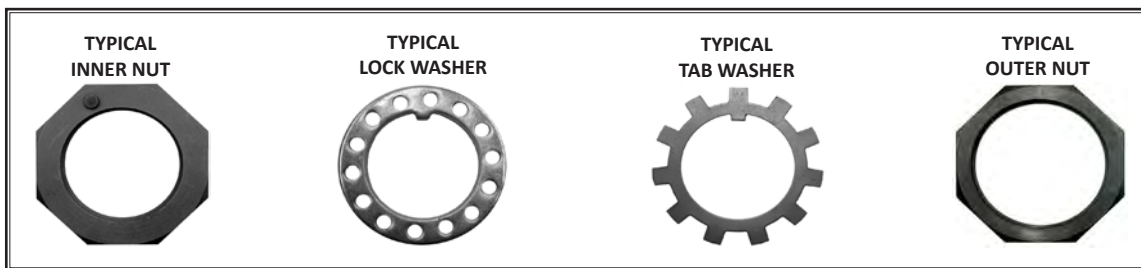





# U-BOLT KITS

ALL U-BOLT KITS CONTAIN: 2 U-BOLTS AND 4 HI-NUTS

## SQUARE BEND U-BOLT KITS



WA#	EUCLID®	DIAM.	LEG LENGTH	BETWEEN LEGS	THREAD LENGTH	THREAD	APPLICATION	GRADE
WA07-5006	E-UB8287-11	1 1/8"	11 3/8"	5 3/4"	3"	1 1/8"-12	NEWAY®STYLE	8
WA07-5007	N/A	1 1/8"	12"	5 3/4"	3"	1 1/8"-12	NEWAY®STYLE	8

## SEMI-ROUND BEND U-BOLT KITS



WA#	EUCLID®	DIAM.	LEG LENGTH	BETWEEN LEGS	THREAD LENGTH	THREAD	APPLICATION	GRADE
WA07-5008	E-UB8351-18	3/4"	18"	3"	8"	3/4"-12	TRK/TRACTOR	8

## FLAT FORGED - ROUND BEND U-BOLT KITS



WA#	EUCLID®	DIAM.	LEG LENGTH	BETWEEN LEGS	THREAD LENGTH	THREAD	APPLICATION	GRADE
WA07-5017	E-UB8479-090	1"	9 1/2"	6 3/8"	3"	1"-14	NEWAY®-STYLE	8

## ROUND BEND U-BOLT KITS



WA#	EUCLID®	DIAM.	LEG LENGTH	BETWEEN LEGS	THREAD LENGTH	THREAD	APPLICATION	GRADE
WA07-5009	E-UB8145-076	5/8"	7 3/4"	5"	3"	5/8"-18	NEWAY® STYLE	8
WA07-5010	E-UB8151-18	3/4"	18"	3"	8"	3/4"-16	TRK/TRACTOR	8
WA07-5011	E-UB8154-18	3/4"	18"	4"	8"	3/4"-16	TRK/TRACTOR	8
WA07-5012	E-UB8161-12	7/8"	12"	3"	8"	7/8"-14	TRK/TRACTOR	5
WA07-5013	E-UB5161-14	7/8"	14"	3"	8"	7/8"-14	TRK/TRACTOR	5
WA07-5014	E-UB5161-16	7/8"	16"	3"	8"	7/8"-14	TRK/TRACTOR	5
WA07-5015	E-UB5161-18	7/8"	18"	3"	8"	7/8"-14	TRK/TRACTOR	5
WA07-5016	E-UB5165-14	7/8"	14"	5"	8"	7/8"-14	TRK/TRACTOR	5

# INTERCHANGE



## ALCOA®

COMPETITOR #	WA#	NOTES	COMPETITOR #	WA#	NOTES
5548-L	WA07-5031		5956-L	WA07-5033	
5548-R	WA07-5030		5956-R	WA07-5032	
5549-L	WA07-5025		5977-L	WA07-5023	
5549-R	WA07-5024		5977-R	WA07-5022	
5552-L	WA07-5023		5978-L	WA07-5033	
5552-R	WA07-5022		5978-R	WA07-5032	
5554-L	WA07-6003		5988-L	WA07-5033	
5554-R	WA07-6002		5988-R	WA07-5032	
5575-L	WA07-6127		5995-L	WA07-6015	
5575-R	WA07-6126		5995-R	WA07-6014	
5735-L	WA07-5027		5996-L	WA07-6017	
5735-R	WA07-5026		5996-R	WA07-6016	
5903-L	WA07-5033		7896-L	WA07-5027	
5903-R	WA07-5032		7896-R	WA07-5026	

## AUTOMANN®

COMPETITOR #	WA#	NOTES	COMPETITOR #	WA#	NOTES
101.0251	WA07-5044	SUSPENSION CATALOG	112.1281	WA04-5007	SUSPENSION CATALOG
101.2072	WA07-5045	SUSPENSION CATALOG	113.1281	WA09-5000	SUSPENSION CATALOG
102.2071	WA07-5051	SUSPENSION CATALOG	113.1282	WA09-5001	SUSPENSION CATALOG
102.2122	WA07-5043	SUSPENSION CATALOG	113.1283	WA09-5003	SUSPENSION CATALOG
103.1084	WA04-5028	SUSPENSION CATALOG	113.2001	WA09-5004	SUSPENSION CATALOG
104.03281	WA10-5006	SUSPENSION CATALOG	113.2023	WA09-5002	SUSPENSION CATALOG
104.05091	WA10-5008	SUSPENSION CATALOG	114.1162	WA07-5136	SUSPENSION CATALOG
104.05161	WA10-5009	SUSPENSION CATALOG	114.1171	WA07-5129	SUSPENSION CATALOG
104.06181	WA10-5021	SUSPENSION CATALOG	114.1172	WA07-5127	SUSPENSION CATALOG
104.07041	WA10-5000	SUSPENSION CATALOG	114.1174	WA07-5128	SUSPENSION CATALOG
104.07061	WA10-5022	SUSPENSION CATALOG	114.1211	WA07-5134	SUSPENSION CATALOG
104.07221	WA10-5001	SUSPENSION CATALOG	115.1161	WA07-5001	SUSPENSION CATALOG
104.08001	WA10-5023	SUSPENSION CATALOG	115.1162	WA07-5003	SUSPENSION CATALOG
105.1002	WA10-5013	SUSPENSION CATALOG	134.1031	WAKN47011	SUSPENSION CATALOG
105.1004	WA10-5014	SUSPENSION CATALOG	134.1041	WAKN47001	SUSPENSION CATALOG
105.2004	WA10-5011	SUSPENSION CATALOG	134.2831	WAKN44061	SUSPENSION CATALOG
110.2002	WA08-5013	SUSPENSION CATALOG	134.2841	WAKN44071	SUSPENSION CATALOG
110.2101	WA08-5005	SUSPENSION CATALOG	134.3741	WAKN44041	SUSPENSION CATALOG
110.2204	WA08-5006	SUSPENSION CATALOG	170.065437	WA65437AIR	VALVE CATALOG
110.2215	WA08-5007	SUSPENSION CATALOG	170.065439	WA65439AIR	VALVE CATALOG
110.2217	WA08-5002	SUSPENSION CATALOG	170.101112	WA101112	AIR VALVE CATALOG
110.2302	WA08-5009	SUSPENSION CATALOG	170.101622	WA101622	AIR VALVE CATALOG
110.2304	WA08-5013	SUSPENSION CATALOG	170.101818	WA101818	AIR VALVE CATALOG
110.2506	WA08-5016	SUSPENSION CATALOG	170.102626	WA102626	AIR VALVE CATALOG
111.0001	WA07-5019	SUSPENSION CATALOG	170.103009	WA103009	AIR VALVE CATALOG
112.1081	WA04-5058	SUSPENSION CATALOG	170.10301	WA103010	AIR VALVE CATALOG
112.1083	WA04-5057	SUSPENSION CATALOG	170.103028	WA103028	AIR VALVE CATALOG
112.1161	WA04-5011	SUSPENSION CATALOG	170.104358	WA104358	AIR VALVE CATALOG
112.11614	WA04-5060	SUSPENSION CATALOG	170.107798	WA107798	AIR VALVE CATALOG
112.11615	WA04-5003	SUSPENSION CATALOG	170.109578	WA109578	AIR VALVE CATALOG
112.11616	WA04-5015	SUSPENSION CATALOG	170.109994	WA109994	AIR VALVE CATALOG
112.1162	WA04-5000	SUSPENSION CATALOG	170.11017	WA110170	AIR VALVE CATALOG
112.1164	WA04-5001	SUSPENSION CATALOG	170.110171	WA110171	AIR VALVE CATALOG
112.1165	WA04-5013	SUSPENSION CATALOG	170.12105	WA12105	AIR VALVE CATALOG
112.1167	WA04-5016	SUSPENSION CATALOG	170.205105	WA205105	AIR VALVE CATALOG
112.1169	WA04-5004	SUSPENSION CATALOG	170.2286	WA228600	AIR VALVE CATALOG
112.1192	WA04-5061	SUSPENSION CATALOG	170.229635	WA229635	AIR VALVE CATALOG
112.1202	WA04-5006	SUSPENSION CATALOG	170.229859	WAKN32005	AIR VALVE CATALOG
112.1203	WA04-5059	SUSPENSION CATALOG	170.22986	WA229860	AIR VALVE CATALOG
112.1206	WA04-5008	SUSPENSION CATALOG	170.248433	WA248433	AIR VALVE CATALOG
112.1241	WA04-5005	SUSPENSION CATALOG	170.275491	WAKN18530	AIR VALVE CATALOG



## AUTOMANN® cont.

COMPETITOR #	WA#	NOTES	COMPETITOR #	WA#	NOTES
170.276566	WA276566	AIR VALVE CATALOG	100.4311.10	WA1887ASHD	SUSPENSION CATALOG
170.276567	WA276567	AIR VALVE CATALOG	100.4515.21	WA2769SHD	SUSPENSION CATALOG
170.277863	WA277863	AIR VALVE CATALOG	100.4515.22	WA2769SHD	SUSPENSION CATALOG
170.27918	WA279180	AIR VALVE CATALOG	100.4515.31	WA3710SHD	SUSPENSION CATALOG
170.281865	WA281865	AIR VALVE CATALOG	100.4515.32	WA3710SHD	SUSPENSION CATALOG
170.284142	WA284142	AIR VALVE CATALOG	100.4524.11	WA08-5019	SUSPENSION CATALOG
170.28476	WA284760	AIR VALVE CATALOG	100.4702.10	WAE9064	SUSPENSION CATALOG
170.286171	WA286171	AIR VALVE CATALOG	100.4709.10	WAE5481A	SUSPENSION CATALOG
170.28637	WA286370	AIR VALVE CATALOG	101.0251.99	WA07-5050	SUSPENSION CATALOG
170.2865	WA286500	AIR VALVE CATALOG	101.2051K	WA07-5047	SUSPENSION CATALOG
170.287376	WA287376	AIR VALVE CATALOG	101.2075K	WA07-5046	SUSPENSION CATALOG
170.288239	WA288239	AIR VALVE CATALOG	104.08001HD	WA10-5024	SUSPENSION CATALOG
170.288241	WA288241	AIR VALVE CATALOG	104.10261HD	WA10-5005	SUSPENSION CATALOG
170.289714	WA289714	AIR VALVE CATALOG	110.2220	WA08-5010	SUSPENSION CATALOG
170.800376	WA800376	AIR VALVE CATALOG	121.371604.01	WA05-5003	SUSPENSION CATALOG
174.6909	A6909	AIR VALVE CATALOG	121.671604.02	WA05-5002	SUSPENSION CATALOG
174.691	A6910	AIR VALVE CATALOG	122.280818.01	WA05-5049	SUSPENSION CATALOG
174.6913	A6913	AIR VALVE CATALOG	122.280818.02	WA05-5048	SUSPENSION CATALOG
174.6915	A6915	AIR VALVE CATALOG	122.280818.03	WA05-5039	SUSPENSION CATALOG
174.6918	A6918	AIR VALVE CATALOG	122.280818.04	WA05-5038	SUSPENSION CATALOG
177.6001	WA11600	SUSPENSION CATALOG	122.281107.01	WA05-5043	SUSPENSION CATALOG
177.6002	WA11602	SUSPENSION CATALOG	122.281107.02	WA05-5042	SUSPENSION CATALOG
177.6005	WA11544	SUSPENSION CATALOG	122.281118.03	WA05-5041	SUSPENSION CATALOG
177.6006	WA11548	SUSPENSION CATALOG	122.281118.04	WA05-5040	SUSPENSION CATALOG
177.7015	WA01-5016	SUSPENSION CATALOG	122.281710.01	WA05-5009	SUSPENSION CATALOG
177.7016	WA01-5017	SUSPENSION CATALOG	122.281710.02	WA05-5008	SUSPENSION CATALOG
177.7017	WA01-5018	SUSPENSION CATALOG	122.281710.03	WA05-5019	SUSPENSION CATALOG
177.7018	WA01-5019	SUSPENSION CATALOG	122.281710.04	WA05-5018	SUSPENSION CATALOG
180.10616	WA14-5024	SUSPENSION CATALOG	122.282013.01	WA05-5011	SUSPENSION CATALOG
180.10617	WA359-5990	SUSPENSION CATALOG	122.282013.02	WA05-5010	SUSPENSION CATALOG
180.10618	WA340-4975	SUSPENSION CATALOG	122.282402.01	WA05-5013	SUSPENSION CATALOG
181.127591	127591	SEAL	122.282402.02	WA05-5012	SUSPENSION CATALOG
181.3591	3591	SEAL	122.282402.03	WA05-5020	SUSPENSION CATALOG
182.372	3720	BEARING	122.282402.04	WA05-5019	SUSPENSION CATALOG
182.3782	3782	BEARING	123.281714.01	WA05-5057	SUSPENSION CATALOG
182.3952	39520	BEARING	123.281714.02	WA05-5056	SUSPENSION CATALOG
182.3959	39590	BEARING	123.282014.01	WA05-5071	SUSPENSION CATALOG
182.4522	45220	BEARING	123.282014.02	WA05-5070	SUSPENSION CATALOG
182.4528	45280	BEARING	123.282014.03	WA05-5077	SUSPENSION CATALOG
182.47679	47679	BEARING	123.282014.04	WA05-5076	SUSPENSION CATALOG
182.47686	47686	BEARING	123.282318.01	WA05-5073	SUSPENSION CATALOG
182.493	493	BEARING	123.282318.02	WA05-5072	SUSPENSION CATALOG
182.497	497	BEARING	123.282318.03	WA05-5017	SUSPENSION CATALOG
182.518	HM518445	BEARING	123.282318.04	WA05-5016	SUSPENSION CATALOG
182.563	563	BEARING	123.282402.03	WA05-5051	SUSPENSION CATALOG
182.567	567	BEARING	123.282402.04	WA05-5050	SUSPENSION CATALOG
182.572	572	BEARING	124.102014.01	WA05-5001	SUSPENSION CATALOG
182.58	580	BEARING	124.102014.02	WA05-5000	SUSPENSION CATALOG
182.582	582	BEARING	124.102228.01	WA05-5053	SUSPENSION CATALOG
182.594	594	BEARING	124.102228.02	WA05-5052	SUSPENSION CATALOG
182.598	598	BEARING	124.102314.01	WA05-5007	SUSPENSION CATALOG
182.642	6420	BEARING	124.102314.02	WA05-5006	SUSPENSION CATALOG
182.653	653	BEARING	125.101100.01	WA05-5037	SUSPENSION CATALOG
182.663	663	BEARING	125.101100.02	WA05-5036	SUSPENSION CATALOG
201.6149	WA07-5374		125.281102.01	WA05-5031	SUSPENSION CATALOG
201.6162	WA07-6192		125.281102.02	WA05-5030	SUSPENSION CATALOG
203.3002	WA07-5018		170.A1000	WAA1000	AIR VALVE CATALOG
100.1308.10	WAE3869	SUSPENSION CATALOG	170.KN20900	WA290655	AIR VALVE CATALOG
100.1308.30	WAE5139	SUSPENSION CATALOG	170.KN23000	WAKN23000	AIR VALVE CATALOG



## AUTOMANN® cont.

COMPETITOR #	WA#	NOTES	COMPETITOR #	WA#	NOTES
170.KN23040	WAKN23040	AIR VALVE CATALOG	181.T65111U	370047A	SEAL
170.KN26000	WAKN26000	AIR VALVE CATALOG	181.T65152U	370023A	SEAL
170.KN28500	WAKN28500	AIR VALVE CATALOG	181.T65156U	370003A	SEAL
170.KN28510	WAKN28510	AIR VALVE CATALOG	181.T65165U	370005A	SEAL
170.KN28520	WAKN28520	AIR VALVE CATALOG	181.T65172U	370021A	SEAL
170.KN30400	WAKN30400	AIR VALVE CATALOG	181.T65261U	370036A	SEAL
170.KN31000	WAKN31000	AIR VALVE CATALOG	181.T65262U	370065A	SEAL
171.H184	WA90054007	AIR VALVE CATALOG	181.T65263U	370001A	SEAL
171.KN27000	WAKN27000	AIR VALVE CATALOG	181.T65270U	370022A	SEAL
171.LV100	WA90054007	AIR VALVE CATALOG	181.T69598	370025A	SEAL
177.7020	WA01-5011	SUSPENSION CATALOG	181.T69699	370001A	SEAL
177.7024	WA01-5022	SUSPENSION CATALOG	181.T69794	370023A	SEAL
179.1001	WA11452	SUSPENSION CATALOG	181.T69799	370003A	SEAL
179.1002	WA11451	SUSPENSION CATALOG	181.T70561	370036A	SEAL
179.1003	WA11450	SUSPENSION CATALOG	181.T70596	370065A	SEAL
179.1010	WA10024	SUSPENSION CATALOG	181.T70796	370022A	SEAL
179.1016	WA15-730	ELECTRICAL CATALOG	181.T70798	370005A	SEAL
179.1017	WA15-720	ELECTRICAL CATALOG	181.T70799	370003A	SEAL
179.3003.15	WA451036N	SUSPENSION CATALOG	182.47620	47620	BEARING
179.3005	WA01-5046	SUSPENSION CATALOG	182.552A	552A	BEARING
179.3010.12	WA22-4621	ELECTRICAL CATALOG	182.555S	555S	BEARING
179.3010.15	WA24-4621	ELECTRICAL CATALOG	182.592A	592A	BEARING
179.3011.15	WA30-4621	ELECTRICAL CATALOG	182.594A	594A	BEARING
179.4013	RB-30PS	AIR VALVE CATALOG	182.598A	598A	BEARING
179.DT12	WAKN18120	SUSPENSION CATALOG	182.6461A	6461A	BEARING
179.DT16	WAKN18160	SUSPENSION CATALOG	182.HM212011	HM212011	BEARING
179.DT20	WAKN18200	SUSPENSION CATALOG	182.HM212047	HM212047	BEARING
179.DT24	WAKN18240	SUSPENSION CATALOG	182.HM212049	HM212049	BEARING
179.DT30	WAKN18300	SUSPENSION CATALOG	182.HM218210	HM218210	BEARING
179.DT9	WAKN18090	SUSPENSION CATALOG	182.HM218248	HM218248	BEARING
179.SB3030	WA3030TC	AIR VALVE CATALOG	182.HM516410	HM516410	BEARING
179.SC16	WA16SC	AIR VALVE CATALOG	182.HM516449C	HM516449C	BEARING
179.SC20	WA20SC	AIR VALVE CATALOG	182.HM518410	HM518410	BEARING
179.SC24	WA24SC	AIR VALVE CATALOG	201.1001L	WA07-5025	
179.SC30	WA30SC	AIR VALVE CATALOG	201.1001R	WA07-5024	
181.370001A	WA370001A	SEAL	201.1002L	WA07-5027	
181.370003A	WA370003A	SEAL	201.1002R	WA07-5026	
181.370005A	370005A	SEAL	201.1003L	WA07-5029	
181.370019A	370019A	SEAL	201.1003R	WA07-5028	
181.370021A	370021A	SEAL	201.1004L	WA07-5155	
181.370022A	370022A	SEAL	201.1004R	WA07-5154	
181.370023A	370023A	SEAL	201.1007L	WA07-5033	
181.370025A	370025A	SEAL	201.1007R	WA07-5032	
181.370031A	370031A	SEAL	201.2001L	WA07-5021	
181.370036A	370036A	SEAL	201.2001R	WA07-5020	
181.370047A	370047A	SEAL	201.2003L	WA07-5023	
181.370048A	370048A	SEAL	201.2003R	WA07-5022	
181.370065A	370065A	SEAL	201.2006L	WA07-5157	
181.370120A	370120A	SEAL	201.2006R	WA07-5156	
181.370131A	370131A	SEAL	201.2009L	WA07-6015	
181.473274N	473274N	SEAL	201.2009R	WA07-6014	
181.475003N	475003N	SEAL	201.3013	WA07-5037	
181.475009N	475009N	SEAL	201.3014	WA07-5035	
181.475012N	475012N	SEAL	201.3015	WA07-5036	
181.476023N	476023N	SEAL	201.3019L	WA07-5301	
181.T65060U	370025A	SEAL	201.3019R	WA07-5300	
181.T65071U	370031A	SEAL	201.6035L	WA07-5164	
181.T65078U	370131A	SEAL	201.6035R	WA07-5163	
181.T65092U	370048A	SEAL	201.6037L	WA07-5097	



## AUTOMANN® cont.

COMPETITOR #	WA#	NOTES	COMPETITOR #	WA#	NOTES
201.6037R	WA07-5096		201.6152	WA07-5204	
201.6042L	WA07-5099		201.6153	WA07-6087	
201.6042R	WA07-5098		201.6157	WA07-5039	
201.6043L	WA07-6067		201.6158	WA07-5205	
201.6043R	WA07-6066		201.6159	WA07-5114	
201.6045L	WA07-6065		201.6172	WA07-6093	
201.6045R	WA07-6064		201.6178R	WA07-6076	
201.6049L	WA07-6069		201.6183L	WA07-6237	
201.6049R	WA07-6068		201.6183R	WA07-3236	
201.6050L	WA07-6071		201.6187L	WA07-5180	
201.6050R	WA07-6070		201.6187R	WA07-5179	
201.6054L	WA07-5166		201.6193L	WA07-5107	
201.6054R	WA07-5165		201.6193R	WA07-5106	
201.6057L	WA07-5353		201.6195L	WA07-6111	
201.6057R	WA07-5167		201.6195R	WA07-6110	
201.6062L	WA07-5505		201.7002L	WA07-5190	
201.6062R	WA07-5504		201.7002R	WA07-5189	
201.6067L	WA07-5101		201.7003L	WA07-5192	
201.6067R	WA07-5100		201.7003R	WA07-5191	
201.6069L	WA07-5103		201.7004L	WA07-5194	
201.6069R	WA07-5102		201.7004R	WA07-5193	
201.6071L	WA07-5355		201.7005L	WA07-5196	
201.6071R	WA07-5169		201.7005R	WA07-5195	
201.6073L	WA07-6143		201.7006L	WA07-6045	
201.6073R	WA07-6142		201.7006R	WA07-6044	
201.6074L	WA07-6153		201.7007L	WA07-6163	
201.6074R	WA07-6152		201.7007R	WA07-6162	
201.6075R	WA07-6158		201.7010L	WA07-5198	
201.6082L	WA07-6059		201.7010R	WA07-5197	
201.6082R	WA07-6058		201.7011L	WA07-6165	
201.6086L	WA07-6167		201.7011R	WA07-6164	
201.6086R	WA07-6166		201.7027R	WA07-6046	
201.6097L	WA07-5172		203.1010	WA15-5003	
201.6097R	WA07-5171		203.2013	WA15-5000	
201.6103L	WA07-6173		203.2014	WA15-5006	
201.6103R	WA07-6172		203.2015	WA15-5001	
201.6104L	WA07-6037		203.2016	WA15-5002	
201.6104R	WA07-6120		203.2023	WA15-5009	
201.6106L	WA07-6193		203.2041	WA15-5015	
201.6106R	WA07-5116		203.2042	WA15-5010	
201.6107L	WA07-6233		203.3001	WA07-5152	
201.6107R	WA07-6232		203.3103	WA07-5153	
201.6108L	WA07-5141		203.4002	WA07-5150	
201.6108R	WA07-5173		203.4005	WA07-5004	
201.6109L	WA07-5176		203.4006	WA07-5005	
201.6109R	WA07-5175		203.4010	WA07-6051	
201.6111L	WA07-6075		209.1110	WA07-5405	
201.6111R	WA07-6074		209.1111	WA07-5402	
201.6113R	WA07-6108		209.1210	WA07-5382	
201.6114L	WA07-5105		209.1215	WA07-5387	
201.6114R	WA07-5104		209.1222	WA07-5386	
201.6119L	WA07-5178		209.1223	WA07-5384	
201.6119R	WA07-5177		209.1225	WA07-5381	
201.6132	WA07-5200		209.1307	WA07-5090	
201.6133	WA07-5201		209.1308	WA07-5092	
201.6141	WA07-6083		209.2109	WA07-5403	
201.6145	WA07-5202		209.2206	WA07-5091	
201.6150	WA07-6085		209.2209	WA07-5391	
201.6151	WA07-5038		209.2210	WA07-5388	



## AUTOMANN® cont.

COMPETITOR #	WA#	NOTES	COMPETITOR #	WA#	NOTES
209.2214	WA07-5385		AB1DK23L-9265	WA01-9265	SUSPENSION CATALOG
209.2215	WA07-5215		AB1DK23L-9394	WA01-9394	SUSPENSION CATALOG
209.2216	WA07-6030		AB1DK23P-8944	WA01-8944	SUSPENSION CATALOG
209.2313	WA07-5093		AB1DK23P-9287	WA01-9287	SUSPENSION CATALOG
462.ES187L	MW187L	SUSPENSION CATALOG	AB1DK23P-9373	WA01-9373	SUSPENSION CATALOG
462.ES187R	MW187R	SUSPENSION CATALOG	AB1DK23P-9921	WA01-9921	SUSPENSION CATALOG
462.ES2035L	MW2035L	SUSPENSION CATALOG	AB1DK28A-8050	WA01-8050	SUSPENSION CATALOG
462.ES2036R	MW2036R	SUSPENSION CATALOG	ABP4	WA12-5013	SUSPENSION CATALOG
462.ES2069R	MW2069R	SUSPENSION CATALOG	ABP5	WA12-5113	SUSPENSION CATALOG
462.ES2070L	MW2070L	SUSPENSION CATALOG	ABP6	WA12-5034	SUSPENSION CATALOG
462.ES2090L	MW2090L	SUSPENSION CATALOG	BP198	WA04-5045	SUSPENSION CATALOG
462.ES2091R	MW2091R	SUSPENSION CATALOG	BP200	WA04-5042	SUSPENSION CATALOG
462.ES3030R	MW3030R	SUSPENSION CATALOG	EQ019	WA12-5027	SUSPENSION CATALOG
462.ES3031L	MW3031L	SUSPENSION CATALOG	EQ022	WA12-5002	SUSPENSION CATALOG
462.ES373L	MW373L	SUSPENSION CATALOG	EQ028	WA12-5028	SUSPENSION CATALOG
462.ES373R	MW373R	SUSPENSION CATALOG	FLN107	WA07-5059	
462.ES411L	MW411L	SUSPENSION CATALOG	KP100	WA15-5050	SUSPENSION CATALOG
462.ES411R	MW411R	SUSPENSION CATALOG	KPL002	WA15-5051	SUSPENSION CATALOG
462.ES423L	MW423L	SUSPENSION CATALOG	M1970	WA04-5030	SUSPENSION CATALOG
462.ES423R	MW423R	SUSPENSION CATALOG	M1972	WA04-5035	SUSPENSION CATALOG
462.ES431L	MW431L	SUSPENSION CATALOG	M1978	WA04-5036	SUSPENSION CATALOG
462.ES431R	MW431R	SUSPENSION CATALOG	M1980	WA04-5037	SUSPENSION CATALOG
750.210084-2X	210084-2X	CENTER SUPPORT BRG	M1988	WA04-5031	SUSPENSION CATALOG
750.210088-1X	210088-1X	CENTER SUPPORT BRG	M8286	WA12-5081	SUSPENSION CATALOG
750.21021-1X	210121-1X	CENTER SUPPORT BRG	M852	WA12-5019	SUSPENSION CATALOG
750.210391-1X	210391-1X	CENTER SUPPORT BRG	MLP466	WA07-5115	SUSPENSION CATALOG
750.210433-1X	210433-1X	CENTER SUPPORT BRG	MN11444	WA12-5024	SUSPENSION CATALOG
750.210661-1X	210661-1X	CENTER SUPPORT BRG	TR004	WA12-5015	SUSPENSION CATALOG
750.210866-1X	210866-1X	CENTER SUPPORT BRG	TR009	WA12-5003	SUSPENSION CATALOG
750.210875-1X	210875-1X	CENTER SUPPORT BRG	TR010	WA12-5033	SUSPENSION CATALOG
750.211590-1X	211590-1X	CENTER SUPPORT BRG	TR061	WA12-5106	SUSPENSION CATALOG
AB1D28C-9122	WA01-9122	SUSPENSION CATALOG	TR062	WA12-5107	SUSPENSION CATALOG
AB1D28G-9121	WA01-9121	SUSPENSION CATALOG	TRB5066	WA04-5025	SUSPENSION CATALOG
AB1DK20D-9422	WA01-9422	SUSPENSION CATALOG	TRB6000	WA04-5019	SUSPENSION CATALOG
AB1DK20F-9293	WA01-9293	SUSPENSION CATALOG	TRB6002	WA04-5023	SUSPENSION CATALOG
AB1DK20F-9295	WA01-9295	SUSPENSION CATALOG	TRB6008	WA04-5024	SUSPENSION CATALOG
AB1DK23F-9039	WA01-9039	SUSPENSION CATALOG	TRB6112	WA12-5096	SUSPENSION CATALOG
AB1DK23H-8204	WA01-8204	SUSPENSION CATALOG	TRB6116	WA12-5093	SUSPENSION CATALOG
AB1DK23H-9105	WA01-9105	SUSPENSION CATALOG	TRB6117	WA12-5094	SUSPENSION CATALOG
AB1DK23I-9069	WA01-9069	SUSPENSION CATALOG	TRB6119	WA12-5095	SUSPENSION CATALOG
AB1DK23I-9270	WA01-9270	SUSPENSION CATALOG	TRB6164	WA12-5005	SUSPENSION CATALOG
AB1DK23K-9082	WA01-9082	SUSPENSION CATALOG	TRB6300	WA04-5021	SUSPENSION CATALOG
AB1DK23K-9213	WA01-9213	SUSPENSION CATALOG	TRB6820	WA12-5006	SUSPENSION CATALOG
AB1DK23K-9219	WA01-9219	SUSPENSION CATALOG	TRK5541	WA04-5062	SUSPENSION CATALOG
AB1DK23K-9296	WA01-9296	SUSPENSION CATALOG	TRK6326	WA07-5060	SUSPENSION CATALOG
AB1DK23K-9648	WA01-9648	SUSPENSION CATALOG	TR56326	WA07-5058	SUSPENSION CATALOG
AB1DK23K-9780	WA01-9780	SUSPENSION CATALOG			



# INTERCHANGE

## BUDD®

COMPETITOR #	WA#	NOTES	COMPETITOR #	WA#	NOTES
10708	WA07-5024		63341	WA07-6160	
10709	WA07-5025		63342	WA07-6303	
12247	WA07-6038		63606	WA07-5207	
12248	WA07-6039		67011	WA07-5159	
13096	WA07-5189		67012	WA07-5158	
13097	WA07-5190		69912	WA07-5300	
13988	WA07-5191		69913	WA07-5301	
13989	WA07-5192		70611	WA07-5030	
13990	WA07-5193		70612	WA07-5031	
13991	WA07-5194		70613	WA07-6002	
16004	WA07-6317		70614	WA07-6003	
16202	WA07-5172		71736	WA07-6004	
16271	WA07-5197		71737	WA07-6005	
16272	WA07-5198		82525	WA07-5161	
17123	WA07-6044		82526	WA07-5162	
17124	WA07-6045		82575	WA07-6144	
18560	WA07-6179		82576	WA07-6145	
19004	WA07-5195		82578	WA07-6138	
19005	WA07-5196		82579	WA07-6139	
22621	WA07-5026		82581	WA07-6042	
22622	WA07-5027		82582	WA07-6300	
35336	WA07-5026		83172	WA07-6231	
35337	WA07-5027		83812	WA07-6046	
35786	WA07-5182		83813	WA07-6301	
35787	WA07-5181		84097	WA07-5169	
37179	WA07-6186		85106	WA07-6220	
37181	WA07-6182		85108	WA07-6219	
37888	WA07-5020		85381	WA07-6168	
37889	WA07-5021		85382	WA07-6169	
37891	WA07-5022		90513	WA07-6156	
37892	WA07-5023		90514	WA07-6157	
40336	WA07-5183		90554	WA07-6155	
40337	WA07-5184		92176	WA07-6031	
40338	WA07-5370		92177	WA07-6320	
40339	WA07-5371		95693	WA07-6162	
42793	WA07-6180		95694	WA07-6163	
44577	WA07-6182		98348	WA07-6304	
48966	WA07-5208		98349	WA07-6229	
49321	WA07-6186		99616	WA07-6168	
49414	WA07-6126		99617	WA07-6169	
49415	WA07-6127		100145	WA07-6064	
49416	WA07-6128		100146	WA07-6065	
49417	WA07-6129		101321	WA07-6246	
49851	WA07-5100		101322	WA07-6247	
49852	WA07-5101		106201	WA07-5171	
59066	WA07-6140		106202	WA07-5172	
59067	WA07-6141		106216	WA07-5200	
59183	WA07-5102		106333	WA07-5035	
59184	WA07-5103		106377	WA07-6188	
59191	WA07-5163		106397	WA07-5201	
59192	WA07-5164		160036	WA07-6048	
59263	WA07-5096		3203403	WA07-5024	
59264	WA07-5097		3203404	WA07-5025	
59365	WA07-6318		41073-7	WA07-5412	
59371	WA07-6158		47693-7	WA07-5412	
59372	WA07-6302		63625-1	WA07-6120	
59373	WA07-6152		63625-2	WA07-6032	
59374	WA07-6153		63625-3	WA07-6034	
59375	WA07-6142		63626-1	WA07-6037	
59376	WA07-6143		63626-2	WA07-6033	
59536	WA07-5187		63626-3	WA07-6035	
59537	WA07-5188		X-2053	WA07-6164	
61968	WA07-5098		X-2054	WA07-6165	
61969	WA07-5099				

# INTERCHANGE



**BWP®**

COMPETITOR #	WA#	NOTES	COMPETITOR #	WA#	NOTES
M-1	WA15-5004		M-104	WA07-5370	
M-2	WA15-5025		M-105	WA07-5371	
M-3	WA15-5000		M-124	WA07-5020	
M-4	WA15-5002		M-125	WA07-5021	
M-5	WA15-5026		M-126	WA07-5022	
M-8	WA15-5001		M-127	WA07-5023	
M-32	WA07-6200		M-128	WA07-5024	
M-35	WA07-6051		M-129	WA07-5025	
M-37	WA07-6049		M-130	WA07-5026	
M-38	WA07-5150		M-131	WA07-5027	
M-39	WA07-5004		M-132	WA07-5028	
M-40	WA07-5151		M-133	WA07-5029	
M-42	WA07-6202		M-134	WA07-6002	
M-43	WA07-5152		M-135	WA07-6003	
M-44	WA07-6118		M-136	WA07-5030	
M-45	WA07-5018		M-137	WA07-5031	
M-46	WA07-6038		M-140	WA07-6124	
M-47	WA07-6039		M-142	WA07-5510	
M-48	WA07-5189		M-144	WA07-6210	
M-49	WA07-5190		M-145	WA07-5057	
M-50	WA07-5191		M-158	WA07-5161	
M-51	WA07-5192		M-159	WA07-5162	
M-52	WA07-5193		M-164	WA07-6004	
M-53	WA07-5194		M-165	WA07-6005	
M-54	WA07-5195		M-166	WA07-5300	
M-55	WA07-5196		M-167	WA07-5301	
M-56	WA07-6044		M-189	WA07-6211	
M-57	WA07-6045		M-190	WA07-6212	
M-60	WA07-5197		M-191	WA07-6213	
M-61	WA07-5198		M-192	WA07-6305	
M-62	WA07-6048		M-193	WA07-6215	
M-63	WA07-6317		M-194	WA07-6306	
M-72	WA07-6204		M-200	WA07-6216	
M-73	WA07-6318		M-214	WA07-6130	
M-74	WA07-5163		M-220	WA07-6132	
M-75	WA07-5164		M-225	WA07-6133	
M-76	WA07-5096		M-226	WA07-6218	
M-77	WA07-5097		M-258	WA07-5187	
M-78	WA07-5098		M-259	WA07-5188	
M-79	WA07-5099		M-260	WA07-5182	
M-80	WA07-5100		M-261	WA07-5181	
M-81	WA07-5101		M-300	WA01-5012	SUSPENSION CATALOG
M-82	WA07-5102		M-301	WA01-5013	SUSPENSION CATALOG
M-83	WA07-5103		M-302	WA01-5014	SUSPENSION CATALOG
M-84	WA07-6032		M-303	WA01-5016	SUSPENSION CATALOG
M-85	WA07-6033		M-304	WA01-5017	SUSPENSION CATALOG
M-86	WA07-6034		M-305	WA01-5018	SUSPENSION CATALOG
M-87	WA07-6035		M-309	WA01-5020	SUSPENSION CATALOG
M-88	WA07-6120		M-312	WA09-5007	SUSPENSION CATALOG
M-89	WA07-6037		M-317	WA01-5024	SUSPENSION CATALOG
M-90	WA07-6122		M-434	WAKN47001	SUSPENSION CATALOG
M-91	WA07-6205		M-444	WA01-5022	SUSPENSION CATALOG
M-97	WA07-6123		M-457	WAKN47011	SUSPENSION CATALOG
M-98	WA07-5160		M-458	WA24SC	SUSPENSION CATALOG
M-99	WA07-6207		M-459	WA30SC	SUSPENSION CATALOG
M-101	WA07-6209		M-460	WAKN18090	SUSPENSION CATALOG
M-102	WA07-5183		M-461	WAKN18120	SUSPENSION CATALOG
M-103	WA07-5184		M-462	WAKN18160	SUSPENSION CATALOG





# INTERCHANGE

## BWP® cont.

COMPETITOR #	WA#	NOTES	COMPETITOR #	WA#	NOTES
M-463	WAKN18200	SUSPENSION CATALOG	M-1050	WA07-5094	
M-464	WAKN18240	SUSPENSION CATALOG	M-1051	WA07-5095	
M-466	WAKN18300	SUSPENSION CATALOG	M-1052	WA340-4975	SUSPENSION CATALOG
M-473	WA11548	SUSPENSION CATALOG	M-1058	WA04-5017	SUSPENSION CATALOG
M-474	WAKN44041	SUSPENSION CATALOG	M-1065	WA14-5001	SUSPENSION CATALOG
M-499	WA451036N	SUSPENSION CATALOG	M-1066	WA359-5990	SUSPENSION CATALOG
M-538	WA04-5026	SUSPENSION CATALOG	M-1068	WA07-5093	
M-548	WA10-5023	SUSPENSION CATALOG	M-1093	WA09-5008	SUSPENSION CATALOG
M-571	WA04-5000	SUSPENSION CATALOG	M-1101	WA15-5029	
M-572	WA04-5015	SUSPENSION CATALOG	M-1102	WA07-5005	
M-579	WA07-5001	SUSPENSION CATALOG	M-1106	WA07-6138	
M-580	WA07-5124	SUSPENSION CATALOG	M-1107	WA07-6139	
M-582	WA04-5013	SUSPENSION CATALOG	M-1110	WA07-6140	
M-583	WA07-5128	SUSPENSION CATALOG	M-1111	WA07-6141	
M-584	WA07-5136	SUSPENSION CATALOG	M-1112	WA07-6142	
M-592	WA07-5044	SUSPENSION CATALOG	M-1113	WA07-6143	
M-596	WA07-5045	SUSPENSION CATALOG	M-1116	WA07-6144	
M-612	WA07-5050	SUSPENSION CATALOG	M-1117	WA07-6145	
M-618	WA07-5416	SUSPENSION CATALOG	M-1120	WA07-5169	
M-638	WAKN44051	SUSPENSION CATALOG	M-1121	WA07-5355	
M-644	WA10-5018	SUSPENSION CATALOG	M-1123	WA15-5006	
M-682	WA07-5090		M-1124	WA15-5007	
M-683	WA07-5091		M-1125	WA15-5008	
M-684	WA07-5092		M-1127	WA15-5010	
M-698	WA15-5050	SUSPENSION CATALOG	M-1130	WA15-5027	
M-701	WA07-5064	SUSPENSION CATALOG	M-1135	WA15-5011	
M-719	WA07-5131	SUSPENSION CATALOG	M-1142	WA15-5009	
M-721	WA10-5020	SUSPENSION CATALOG	M-1144	WA07-6052	
M-737	WA07-5110	SUSPENSION CATALOG	M-1145	WA07-5153	
M-747	WA04-5028	SUSPENSION CATALOG	M-1148	WA15-5028	
M-748	WA07-5108	SUSPENSION CATALOG	M-1151	WA07-6219	
M-756	WA14-5011	SUSPENSION CATALOG	M-1152	WA07-6220	
M-757	WA14-5015	SUSPENSION CATALOG	M-1153	WA07-6149	
M-767	WA14-5024	SUSPENSION CATALOG	M-1163	WA07-6151	
M-770	WA15-5051	SUSPENSION CATALOG	M-1166	WA07-6042	
M-771	WA07-5109	SUSPENSION CATALOG	M-1167	WA07-6300	
M-792	WA10-5024	SUSPENSION CATALOG	M-1170	WA07-6046	
M-824	WA09-5000	SUSPENSION CATALOG	M-1171	WA07-6301	
M-826	WA04-5004	SUSPENSION CATALOG	M-1172	WA07-6222	
M-844	WA10-5007	SUSPENSION CATALOG	M-1175	WA15-5013	
M-847	WA04-5005	SUSPENSION CATALOG	M-1176	WA07-6152	
M-960	WA07-6018		M-1177	WA07-6153	
M-980	WA07-6136		M-1192	WA07-5086	SUSPENSION CATALOG
M-981	WA07-6022		M-1193	WA07-5087	SUSPENSION CATALOG
M-982	WA07-5077	SUSPENSION CATALOG	M-1194	WA07-5088	SUSPENSION CATALOG
M-983	WA07-6019		M-1195	WA07-5083	SUSPENSION CATALOG
M-984	WA07-6020		M-1196	WA07-5084	SUSPENSION CATALOG
M-985	WA07-5078	SUSPENSION CATALOG	M-1197	WA07-5085	SUSPENSION CATALOG
M-986	WA07-6021		M-1199	WA07-5089	SUSPENSION CATALOG
M-987	WA07-5079	SUSPENSION CATALOG	M-1206	WA07-6154	
M-999	WA04-5060	SUSPENSION CATALOG	M-1207	WA07-6155	
M-1009	WA10-5021	SUSPENSION CATALOG	M-1208	WA07-6156	
M-1014	WA10-5005	SUSPENSION CATALOG	M-1209	WA07-6157	
M-1016	WA04-5027	SUSPENSION CATALOG	M-1210	WA07-6158	
M-1045	WA07-5134	SUSPENSION CATALOG	M-1211	WA07-6302	
M-1046	WA07-5003	SUSPENSION CATALOG	M-1212	WA07-5175	
M-1047	WA04-5061	SUSPENSION CATALOG	M-1213	WA07-5176	
M-1049	WA04-5008	SUSPENSION CATALOG	M-1228	WA07-6160	

CONTINUED>>>

# INTERCHANGE



## BWP® cont.

COMPETITOR #	WA#	NOTES	COMPETITOR #	WA#	NOTES
M-1229	WA07-6303		M-1500	WA10-5011	SUSPENSION CATALOG
M-1242	WA15-5014		M-1520	WA04-5064	SUSPENSION CATALOG
M-1246	WA07-6224		M-1521	WA07-5019	SUSPENSION CATALOG
M-1249	WA15-5015		M-1523	WA07-5002	SUSPENSION CATALOG
M-1254	WA07-5511		M-1550	WA04-5011	SUSPENSION CATALOG
M-1263	WA07-6225		M-1551	WA04-5046	SUSPENSION CATALOG
M-1264	WA07-6226		M-1554	WA07-5117	SUSPENSION CATALOG
M-1265	WA07-6227		M-1572	WA07-6250	SUSPENSION CATALOG
M-1266	WA07-5122		M-1670	WA12-5000	SUSPENSION CATALOG
M-1272	WA07-6304		M-1671	WA12-5001	SUSPENSION CATALOG
M-1273	WA07-6229		M-1690	WA12-5002	SUSPENSION CATALOG
M-1280	WA07-6031		M-1691	WA07-5139	SUSPENSION CATALOG
M-1281	WA07-6320		M-1695	WA12-5003	SUSPENSION CATALOG
M-1282	WA15-5016		M-1696	WA12-5033	SUSPENSION CATALOG
M-1283	WA07-6231		M-1701	WA12-5004	SUSPENSION CATALOG
M-1288	WA07-6232		M-1706	WA04-5053	SUSPENSION CATALOG
M-1289	WA07-6233		M-1707	WA04-5052	SUSPENSION CATALOG
M-1290	WA07-6234		M-1711	WA07-5006	SUSPENSION CATALOG
M-1291	WA07-6235		M-1713	WA07-5007	SUSPENSION CATALOG
M-1322	WA12105	SUSPENSION CATALOG	M-1714	WA07-5009	SUSPENSION CATALOG
M-1359	WA01-5044	SUSPENSION CATALOG	M-1718	WA04-5024	SUSPENSION CATALOG
M-1360	WA01-5015	SUSPENSION CATALOG	M-1719	WA04-5025	SUSPENSION CATALOG
M-1362	WA01-5019	SUSPENSION CATALOG	M-1724	WA04-5029	SUSPENSION CATALOG
M-1366	WA01-5021	SUSPENSION CATALOG	M-1725	WA04-5034	SUSPENSION CATALOG
M-1380	WA01-5023	SUSPENSION CATALOG	M-1726	WA04-5030	SUSPENSION CATALOG
M-1385	WA01-5025	SUSPENSION CATALOG	M-1727	WA04-5035	SUSPENSION CATALOG
M-1387	WA01-5026	SUSPENSION CATALOG	M-1763	WA12-5110	SUSPENSION CATALOG
M-1388	WA01-5027	SUSPENSION CATALOG	M-1765	WA12-5112	SUSPENSION CATALOG
M-1389	WA01-5028	SUSPENSION CATALOG	M-1780	WA14-5017	SUSPENSION CATALOG
M-1391	WA01-5029	SUSPENSION CATALOG	M-1781	WA14-5006	SUSPENSION CATALOG
M-1393	WA01-5030	SUSPENSION CATALOG	M-1793	WA04-5036	SUSPENSION CATALOG
M-1396	WA01-5031	SUSPENSION CATALOG	M-1794	WA04-5037	SUSPENSION CATALOG
M-1398	WA01-5032	SUSPENSION CATALOG	M-1797	WA04-5038	SUSPENSION CATALOG
M-1401	WA09-5004	SUSPENSION CATALOG	M-1803	WA12-5038	SUSPENSION CATALOG
M-1403	WA09-5003	SUSPENSION CATALOG	M-1806	WA12-5035	SUSPENSION CATALOG
M-1404	WA04-5006	SUSPENSION CATALOG	M-1808	WA04-5020	SUSPENSION CATALOG
M-1407	WA04-5007	SUSPENSION CATALOG	M-1818	WA04-5021	SUSPENSION CATALOG
M-1413	WA07-5129	SUSPENSION CATALOG	M-1845	WA04-5019	SUSPENSION CATALOG
M-1415	WA07-5113	SUSPENSION CATALOG	M-1846	WA04-5023	SUSPENSION CATALOG
M-1422	WA07-5051	SUSPENSION CATALOG	M-1888	WA04-5022	SUSPENSION CATALOG
M-1423	WA10-5009	SUSPENSION CATALOG	M-1901	WA13-1901	SUSPENSION CATALOG
M-1428	WA10-5013	SUSPENSION CATALOG	M-1902	WA13-1902	SUSPENSION CATALOG
M-1430	WA07-5041	SUSPENSION CATALOG	M-1903	WA13-1903	SUSPENSION CATALOG
M-1433	WA10-5012	SUSPENSION CATALOG	M-1904	WA13-1904	SUSPENSION CATALOG
M-1449	WA04-5018	SUSPENSION CATALOG	M-1905	WA13-1905	SUSPENSION CATALOG
M-1449	WA04-5018	SUSPENSION CATALOG	M-1906	WA13-1906	SUSPENSION CATALOG
M-1452	WA04-5056	SUSPENSION CATALOG	M-1907	WA13-1907	SUSPENSION CATALOG
M-1488	WA04-5050	SUSPENSION CATALOG	M-1908	WA13-1908	SUSPENSION CATALOG
M-1489	WA04-5051	SUSPENSION CATALOG	M-1909	WA13-1909	SUSPENSION CATALOG
M-1490	WA07-5010	SUSPENSION CATALOG	M-1910	WA13-1910	SUSPENSION CATALOG
M-1491	WA07-5008	SUSPENSION CATALOG	M-1911	WA13-1911	SUSPENSION CATALOG
M-1492	WA07-5013	SUSPENSION CATALOG	M-1912	WA13-1912	SUSPENSION CATALOG
M-1493	WA07-5015	SUSPENSION CATALOG	M-1913	WA13-1913	SUSPENSION CATALOG
M-1494	WA07-5016	SUSPENSION CATALOG	M-1914	WA13-1914	SUSPENSION CATALOG
M-1496	WA14-5019	SUSPENSION CATALOG	M-1915	WA13-1915	SUSPENSION CATALOG
M-1497	WA07-5014	SUSPENSION CATALOG	M-1916	WA13-1916	SUSPENSION CATALOG
M-1498	WA07-5011	SUSPENSION CATALOG	M-1917	WA13-1917	SUSPENSION CATALOG
M-1499	WA07-5012	SUSPENSION CATALOG	M-1918	WA13-1918	SUSPENSION CATALOG



## BWP® cont.

COMPETITOR #	WA#	NOTES	COMPETITOR #	WA#	NOTES
M-1919	WA13-1919		M-2097	WA04-5049	SUSPENSION CATALOG
M-1920	WA13-1920		M-2108	WA07-5115	SUSPENSION CATALOG
M-1921	WA13-1921		M-2110	WA12-5012	SUSPENSION CATALOG
M-1922	WA13-1922		M-2111	WA12-5013	SUSPENSION CATALOG
M-1927	WA13-1927		M-2112	WA12-5014	SUSPENSION CATALOG
M-1956	WA07-5402		M-2128	WA07-5017	SUSPENSION CATALOG
M-1957	WA07-5403		M-2141	WA12-5099	SUSPENSION CATALOG
M-1958	WA07-5404		M-2142	WA12-5100	SUSPENSION CATALOG
M-1959	WA07-5405		M-2143	WA12-5015	SUSPENSION CATALOG
M-1960	WA07-5406		M-2144	WA12-5016	SUSPENSION CATALOG
M-1961	WA07-5407		M-2146	WA12-5017	SUSPENSION CATALOG
M-1962	WA07-5408		M-2147	WA12-5018	SUSPENSION CATALOG
M-1965	WA07-5409		M-2148	WA12-5019	SUSPENSION CATALOG
M-1966	WA07-5410		M-2149	WA12-5020	SUSPENSION CATALOG
M-1967	WA07-5411		M-2150	WA12-5022	SUSPENSION CATALOG
M-1969	WA07-5392		M-2151	WA12-5036	SUSPENSION CATALOG
M-1970	WA07-5393		M-2152	WA12-5037	SUSPENSION CATALOG
M-1971	WA07-5394		M-2153	WA04-5031	SUSPENSION CATALOG
M-1972	WA07-5395		M-2159	WA07-5060	SUSPENSION CATALOG
M-1973	WA07-5396		M-2160	WA07-5058	SUSPENSION CATALOG
M-1974	WA07-5397		M-2161	WA07-5059	SUSPENSION CATALOG
M-1975	WA07-5413		M-2204	WA07-5046	SUSPENSION CATALOG
M-1976	WA07-5414		M-2305	WAK450B	SUSPENSION CATALOG
M-1977	WA07-5415		M-2306	WAK463B	SUSPENSION CATALOG
M-1978	WA07-5384		M-2307	WAK466	SUSPENSION CATALOG
M-1979	WA07-5385		M-2307	WAK466B	SUSPENSION CATALOG
M-1980	WA07-5213		M-2308	WAK469A	SUSPENSION CATALOG
M-1981	WA07-5399		M-2310	WAK493	SUSPENSION CATALOG
M-1982	WA07-5400		M-2315	WAK504	SUSPENSION CATALOG
M-1983	WA07-5401		M-2324	WAK517	SUSPENSION CATALOG
M-1984	WA07-5375		M-2334	WAK538B	SUSPENSION CATALOG
M-1985	WA07-5217		M-2335	WAK539D	SUSPENSION CATALOG
M-1986	WA07-5382		M-2336	WAK541B	SUSPENSION CATALOG
M-1987	WA07-5377		M-2339	WAK547	SUSPENSION CATALOG
M-1988	WA07-5378		M-2339	WAK572DC	SUSPENSION CATALOG
M-1989	WA07-5379		M-2340	WAK548BN	SUSPENSION CATALOG
M-1990	WA07-5380		M-2341	WAK549B	SUSPENSION CATALOG
M-1991	WA07-5215		M-2347	WAK562B	SUSPENSION CATALOG
M-1992	WA07-5381		M-2348	WAK563B	SUSPENSION CATALOG
M-1995	WA07-RACK		M-2350	WAK567B	SUSPENSION CATALOG
M-1997	WA07-5387		M-2358	WAK570B	SUSPENSION CATALOG
M-1998	WA07-5388		M-2363	WAK477	SUSPENSION CATALOG
M-1999	WA07-5389		M-2384	WAK591B	SUSPENSION CATALOG
M-2010	WA04-5032	SUSPENSION CATALOG	M-2389	WAK602	SUSPENSION CATALOG
M-2012	WA04-5033	SUSPENSION CATALOG	M-2394	WAK592	SUSPENSION CATALOG
M-2039	WA07-5055	SUSPENSION CATALOG	M-2400	WA07-5032	
M-2040	WA07-5056	SUSPENSION CATALOG	M-2401	WA07-5033	
M-2041	WA07-5054	SUSPENSION CATALOG	M-2402	WA07-6162	
M-2042	WA04-5040	SUSPENSION CATALOG	M-2403	WA07-6163	
M-2043	WA04-5041	SUSPENSION CATALOG	M-2404	WA07-6164	
M-2057	WA07-5121	SUSPENSION CATALOG	M-2405	WA07-6165	
M-2063	WA04-5039	SUSPENSION CATALOG	M-2420	WA07-6166	
M-2069	WA12-5005	SUSPENSION CATALOG	M-2421	WA07-6167	
M-2070	WA12-5006	SUSPENSION CATALOG	M-2428	WA07-6168	
M-2071	WA12-5093	SUSPENSION CATALOG	M-2429	WA07-6169	
M-2072	WA12-5096	SUSPENSION CATALOG	M-2430	WA07-5106	
M-2089	WA12-5094	SUSPENSION CATALOG	M-2431	WA07-5107	
M-2090	WA12-5095	SUSPENSION CATALOG	M-2432	WA07-6170	

# INTERCHANGE



## BWP® cont.

COMPETITOR #	WA#	NOTES	COMPETITOR #	WA#	NOTES
M-2433	WA07-6171		M-2759	WA01-5006	SUSPENSION CATALOG
M-2434	WA07-6172		M-2760	WA01-5007	SUSPENSION CATALOG
M-2435	WA07-6173		M-2761	WA01-5008	SUSPENSION CATALOG
M-2436	WA07-5173		M-2762	WA01-5009	SUSPENSION CATALOG
M-2438	WA07-5104		M-2763	WA01-5010	SUSPENSION CATALOG
M-2439	WA07-5105		M-2768	WA330-3009	SUSPENSION CATALOG
M-2454	WA07-6006		M-2774	WA14-5003	SUSPENSION CATALOG
M-2456	WA07-6008		M-2801	WA12-5105	SUSPENSION CATALOG
M-2457	WA07-6010		M-2813	WA12-5106	SUSPENSION CATALOG
M-2458	WA07-6012		M-2814	WA12-5107	SUSPENSION CATALOG
M-2459	WA07-5040		M-2817	WA12-5108	SUSPENSION CATALOG
M-2462	WA07-6178		M-2818	WA12-5109	SUSPENSION CATALOG
M-2463	WA07-6179		M-2868	WA12-5021	SUSPENSION CATALOG
M-2464	WA07-6180		M-2871	WA12-5098	SUSPENSION CATALOG
M-2465	WA07-6181		M-2872	WA12-5097	SUSPENSION CATALOG
M-2466	WA07-5177		M-2884	WA12-5023	SUSPENSION CATALOG
M-2467	WA07-5178		M-2917	WA12-5043	SUSPENSION CATALOG
M-2472	WA07-3236		M-2919	WA12-5113	SUSPENSION CATALOG
M-2473	WA07-6237		M-2920	WA12-5034	SUSPENSION CATALOG
M-2474	WA07-6238		M-2935	WA12-5024	SUSPENSION CATALOG
M-2475	WA07-6239		M-2936	WA12-5111	SUSPENSION CATALOG
M-2476	WA07-6240		M-2945	WA04-5043	SUSPENSION CATALOG
M-2477	WA07-6241		M-2950	WA04-5048	SUSPENSION CATALOG
M-2478	WA07-6242		M-2973	WA12-5025	SUSPENSION CATALOG
M-2479	WA07-6243		M-2975	WA12-5026	SUSPENSION CATALOG
M-2480	WA07-6244		M-2977	WA07-5065	SUSPENSION CATALOG
M-2481	WA07-6245		M-2978	WA07-5066	SUSPENSION CATALOG
M-2498	WA07-6246		M-2979	WA07-5067	SUSPENSION CATALOG
M-2499	WA07-6247		M-2980	WA07-5068	SUSPENSION CATALOG
M-2509	WA07-5208		M-2981	WA07-5069	SUSPENSION CATALOG
M-2520	WA07-6182		M-2982	WA07-5070	SUSPENSION CATALOG
M-2521	WA07-6183		M-2983	WA07-5071	SUSPENSION CATALOG
M-2522	WA07-5206		M-2984	WA07-5072	SUSPENSION CATALOG
M-2523	WA07-5207		M-2985	WA07-5073	SUSPENSION CATALOG
M-2524	WA07-5209		M-2986	WA07-5074	SUSPENSION CATALOG
M-2525	WA07-6185		M-2987	WA07-5075	SUSPENSION CATALOG
M-2526	WA07-6186		M-2988	WA07-5076	SUSPENSION CATALOG
M-2527	WA07-5080	SUSPENSION CATALOG	M-3055	WA11600	SUSPENSION CATALOG
M-2528	WA07-5081	SUSPENSION CATALOG	M-3056	WA11601	SUSPENSION CATALOG
M-2529	WA07-5082	SUSPENSION CATALOG	M-3057	WA11602	SUSPENSION CATALOG
M-2548	WA04-5002	SUSPENSION CATALOG	M-3065	WA14-0041	SUSPENSION CATALOG
M-2549	WA07-5040		M-3066	WA14-0009	SUSPENSION CATALOG
M-2577	WAKN44061	SUSPENSION CATALOG	M-3067	WA14-0015	SUSPENSION CATALOG
M-2594	WA07-5120	SUSPENSION CATALOG	M-3068	WA14-0021	SUSPENSION CATALOG
M-2618	WA04-5058	SUSPENSION CATALOG	M-3069	WA14-0031	SUSPENSION CATALOG
M-2621	WA04-5059	SUSPENSION CATALOG	M-3200	WA07-6188	
M-2622	WA04-5012	SUSPENSION CATALOG	M-3201	WA07-5200	
M-2623	WA04-5016	SUSPENSION CATALOG	M-3202	WA07-5201	
M-2634	WA07-5137	SUSPENSION CATALOG	M-3203	WA07-5035	
M-2638	WA07-5130	SUSPENSION CATALOG	M-3204	WA07-6190	
M-2645	WA07-5118	SUSPENSION CATALOG	M-3206	WA07-6192	
M-2724	WA07-5049	SUSPENSION CATALOG	M-3207	WA07-5036	
M-2729	WA10-5022	SUSPENSION CATALOG	M-3208	WA07-6014	
M-2732	WA10-5003	SUSPENSION CATALOG	M-3209	WA07-6015	
M-2748	WA07-5052	SUSPENSION CATALOG	M-3210	WA07-6016	
M-2756	WA01-5000	SUSPENSION CATALOG	M-3211	WA07-6017	
M-2757	WA01-5002	SUSPENSION CATALOG	M-3215	WA07-5374	
M-2758	WA01-5004	SUSPENSION CATALOG	M-3218	WA07-5171	



## BWP® cont.

COMPETITOR #	WA#	NOTES	COMPETITOR #	WA#	NOTES
M-3219	WA07-5172		M-3502	WA01-7135	SUSPENSION CATALOG
M-3220	WA07-6054		M-3503	WA01-7136	SUSPENSION CATALOG
M-3224	WA07-6056		M-3506	WA01-7400	SUSPENSION CATALOG
M-3225	WA07-6057		M-3507	WA01-7403	SUSPENSION CATALOG
M-3226	WA07-6058		M-3508	WA01-7410	SUSPENSION CATALOG
M-3227	WA07-6059		M-3509	WA01-7424	SUSPENSION CATALOG
M-3228	WA07-6060		M-3510	WA01-8050	SUSPENSION CATALOG
M-3229	WA07-6061		M-3511	WA01-9039	SUSPENSION CATALOG
M-3240	WA07-5138	SUSPENSION CATALOG	M-3512	WA01-9069	SUSPENSION CATALOG
M-3241	WA07-5165		M-3513	WA01-9082	SUSPENSION CATALOG
M-3242	WA07-5166		M-3515	WA01-9101	SUSPENSION CATALOG
M-3260	WA10-5025	SUSPENSION CATALOG	M-3516	WA01-9105	SUSPENSION CATALOG
M-3263	WA90054007	SUSPENSION CATALOG	M-3517	WA01-9121	SUSPENSION CATALOG
M-3289	WA07-5391		M-3518	WA01-9122	SUSPENSION CATALOG
M-3345	WA10-5006	SUSPENSION CATALOG	M-3522	WA01-9213	SUSPENSION CATALOG
M-3346	WA10-5000	SUSPENSION CATALOG	M-3524	WA01-9265	SUSPENSION CATALOG
M-3347	WA07-5048	SUSPENSION CATALOG	M-3525	WA01-9422	SUSPENSION CATALOG
M-3349	WA07-5000	SUSPENSION CATALOG	M-3526	WA01-9466	SUSPENSION CATALOG
M-3351	WA04-5057	SUSPENSION CATALOG	M-3528	WA01-6897	SUSPENSION CATALOG
M-3353	WA07-5133	SUSPENSION CATALOG	M-3530	WA07-358-0361	SUSPENSION CATALOG
M-3355	WA07-5053	SUSPENSION CATALOG	M-3531	WA01-7555	SUSPENSION CATALOG
M-3356	WA10-5001	SUSPENSION CATALOG	M-3534	WA01-5410	SUSPENSION CATALOG
M-3357	WA10-5008	SUSPENSION CATALOG	M-3538	WA01-9192	SUSPENSION CATALOG
M-3358	WA07-5043	SUSPENSION CATALOG	M-3540	WA01-9219	SUSPENSION CATALOG
M-3359	WA07-5042	SUSPENSION CATALOG	M-3542	WA01-9270	SUSPENSION CATALOG
M-3360	WA07-5047	SUSPENSION CATALOG	M-3543	WA01-9293	SUSPENSION CATALOG
M-3361	WA10-5014	SUSPENSION CATALOG	M-3544	WA01-9265	SUSPENSION CATALOG
M-3362	WA10-5004	SUSPENSION CATALOG	M-3545	WA01-9321	SUSPENSION CATALOG
M-3363	WA24100	SUSPENSION CATALOG	M-3546	WA01-9394	SUSPENSION CATALOG
M-3365	WA25100	SUSPENSION CATALOG	M-3550	WA01-9780	SUSPENSION CATALOG
M-3367	WA21103	SUSPENSION CATALOG	M-3551	WA01-6905	SUSPENSION CATALOG
M-3368	WA22103	SUSPENSION CATALOG	M-3552	WA01-9921	SUSPENSION CATALOG
M-3369	WA21102	SUSPENSION CATALOG	M-3554	WA01-9370	SUSPENSION CATALOG
M-3370	WA22102	SUSPENSION CATALOG	M-3555	WA01-9371	SUSPENSION CATALOG
M-3373	WAKN44071	SUSPENSION CATALOG	M-3560	WA01-8709	SUSPENSION CATALOG
M-3386	WA07-6000	SUSPENSION CATALOG	M-3600	WA15-5005	
M-3391	WA07-5383		M-3602	WA15-5017	
M-3392	WA07-5398		M-3603	WA15-5018	
M-3394	WA07-5022		M-3608	WA07-6064	
M-3395	WA07-5023		M-3609	WA07-6065	
M-3396	WA07-5024		M-3610	WA07-6066	
M-3397	WA07-5025		M-3611	WA07-6067	
M-3454	WA04-5054	SUSPENSION CATALOG	M-3612	WA07-6068	
M-3456	WA04-5055	SUSPENSION CATALOG	M-3613	WA07-6069	
M-3461	WA12-5101	SUSPENSION CATALOG	M-3614	WA07-6070	
M-3462	WA12-5115	SUSPENSION CATALOG	M-3615	WA07-6071	
M-3463	WA12-5116	SUSPENSION CATALOG	M-3616	WA07-6072	
M-3465	WA12-5102	SUSPENSION CATALOG	M-3617	WA07-6073	
M-3482	WA12-5027	SUSPENSION CATALOG	M-3618	WA07-5116	
M-3485	WA12-5061	SUSPENSION CATALOG	M-3619	WA07-6193	
M-3487	WA12-5029	SUSPENSION CATALOG	M-3620	WA07-6194	
M-3488	WA12-5030	SUSPENSION CATALOG	M-3621	WA07-6195	
M-3489	WA12-5031	SUSPENSION CATALOG	M-3622	WA07-6196	
M-3491	WA10-5010	SUSPENSION CATALOG	M-3623	WA07-6307	
M-3495	WA11549	SUSPENSION CATALOG	M-3624	WA07-6198	
M-3497	WA10-5019	SUSPENSION CATALOG	M-3625	WA07-6308	
M-3498	WA10-5017	SUSPENSION CATALOG	M-3626	WA07-6074	
M-3500	WA01-6902	SUSPENSION CATALOG	M-3627	WA07-6075	

# INTERCHANGE



## BWP® cont.

COMPETITOR #	WA#	NOTES	COMPETITOR #	WA#	NOTES
M-3630	WA07-6076		M-3804	WA03-5000	SUSPENSION CATALOG
M-3631	WA07-6309		M-3808	WA03-5001	SUSPENSION CATALOG
M-3632	WA07-5179		M-3824	WA03-5002	SUSPENSION CATALOG
M-3633	WA07-5180		M-3825	WA03-5003	SUSPENSION CATALOG
M-3636	WA07-6078		M-3829	WA03-5004	SUSPENSION CATALOG
M-3637	WA07-6310		M-3830	WA03-5005	SUSPENSION CATALOG
M-3644	WA07-6080		M-3832	WA03-5006	SUSPENSION CATALOG
M-3645	WA07-6081		M-3833	WA03-5007	SUSPENSION CATALOG
M-3648	WA07-6062		M-3838	WA03-5008	SUSPENSION CATALOG
M-3649	WA07-6063		M-3840	WA03-5009	SUSPENSION CATALOG
M-3650	WA07-5502		M-3842	WA03-5010	SUSPENSION CATALOG
M-3651	WA07-5503		M-3858	WA03-5011	SUSPENSION CATALOG
M-3652	WA07-5167		M-3870	WA03-5012	SUSPENSION CATALOG
M-3653	WA07-5353		M-3871	WA03-5013	SUSPENSION CATALOG
M-3654	WA07-5504		M-3874	WA03-5014	SUSPENSION CATALOG
M-3655	WA07-5505		M-3877	WA03-5015	SUSPENSION CATALOG
M-3658	WA07-5506		M-3883	WA03-5018	SUSPENSION CATALOG
M-3659	WA07-6083		M-3888	WA03-5016	SUSPENSION CATALOG
M-3660	WA07-5507		M-3912	WA07-6110	
M-3661	WA07-5508		M-3913	WA07-6111	
M-3662	WA07-5509		M-3926	WA07-6098	
M-3663	WA07-5202		M-3927	WA07-6311	
M-3664	WA07-5203		M-3932	WA07-6100	
M-3665	WA07-6085		M-3933	WA07-6101	
M-3666	WA07-5204		M-3946	WA07-6312	
M-3667	WA07-6087		M-3947	WA07-5304	
M-3668	WA07-6088		M-3950	WA07-6106	
M-3669	WA07-5205		M-3951	WA07-6313	
M-3670	WA07-5114		M-3952	WA07-6108	
M-3671	WA07-6089		M-3953	WA07-6314	
M-3672	WA07-6090		M-3954	WA07-6208	
M-3673	WA07-6091		M-3955	WA07-6099	
M-3677	WA07-6093		M-3956	WA07-6102	
M-3679	WA07-5303		M-3957	WA07-6315	
M-3680	WA07-6094		M-3960	WA07-6104	
M-3707	WA12-5032	SUSPENSION CATALOG	M-3961	WA07-6316	
M-3747	WA04-5009	SUSPENSION CATALOG	M-3966	WA07-6096	
M-3748	WA04-5014	SUSPENSION CATALOG	M-3972	WA07-6114	
M-3749	WA07-5135	SUSPENSION CATALOG	M-3976	WA07-6116	
M-3750	WA07-5123	SUSPENSION CATALOG	M-3978	WA07-6319	
M-3751	WA07-5119	SUSPENSION CATALOG	M-3979	WA07-5037	
M-3752	WA01-5033	SUSPENSION CATALOG	M-3980	WA07-5156	
M-3755	WA01-5034	SUSPENSION CATALOG	M-3981	WA07-5157	
M-3756	WA01-5035	SUSPENSION CATALOG	M-3982	WA07-5154	
M-3757	WA01-5036	SUSPENSION CATALOG	M-3983	WA07-5155	
M-3758	WA01-5037	SUSPENSION CATALOG	M-3988	WA343-009	SUSPENSION CATALOG
M-3759	WA01-5038	SUSPENSION CATALOG	M-3989	WA14-5005	SUSPENSION CATALOG
M-3761	WA01-5039	SUSPENSION CATALOG	M-83207	WA01-83207	SUSPENSION CATALOG
M-3764	WA01-5040	SUSPENSION CATALOG	M-83215	WA01-83215	SUSPENSION CATALOG
M-3766	WA01-5041	SUSPENSION CATALOG	M-83312	WA01-83312	SUSPENSION CATALOG
M-3767	WA01-5047	SUSPENSION CATALOG	M-83318	WA01-83318	SUSPENSION CATALOG
M-3768	WA01-5001	SUSPENSION CATALOG	M-85000	WA01-85000	SUSPENSION CATALOG
M-3769	WA01-5003	SUSPENSION CATALOG	M-85001	WA01-85001	SUSPENSION CATALOG
M-3770	WA01-5005	SUSPENSION CATALOG	M-85006	WA01-85006	SUSPENSION CATALOG
M-3774	WA01-0000	SUSPENSION CATALOG	M-85012	WA01-85012	SUSPENSION CATALOG
M-3777	WAR9017R	SUSPENSION CATALOG	M-85030	WA01-85030	SUSPENSION CATALOG
M-3778	WAR9017B	SUSPENSION CATALOG	M-85303	WA01-85303	SUSPENSION CATALOG
M-3787	WA11543	SUSPENSION CATALOG	M-85305	WA01-85305	SUSPENSION CATALOG



## BWP® cont.

COMPETITOR #	WA#	NOTES	COMPETITOR #	WA#	NOTES
M-85307	WA01-85307	SUSPENSION CATALOG	M-3170L	WA05-5019	SUSPENSION CATALOG
M-85311	WA01-85311	SUSPENSION CATALOG	M-3170R	WA05-5018	SUSPENSION CATALOG
M-85319	WA01-85319	SUSPENSION CATALOG	M-3171L	WA05-5069	SUSPENSION CATALOG
M-85724	WA01-85724	SUSPENSION CATALOG	M-3171R	WA05-5068	SUSPENSION CATALOG
M-89429	WA01-89429	SUSPENSION CATALOG	M-3172L	WA05-5021	SUSPENSION CATALOG
M-1401A	WA09-5005	SUSPENSION CATALOG	M-3172R	WA05-5020	SUSPENSION CATALOG
M-1402A	WA07-5132	SUSPENSION CATALOG	M-3173L	WA05-5053	SUSPENSION CATALOG
M-140A	WA07-6126		M-3173R	WA05-5052	SUSPENSION CATALOG
M-140B	WA07-6127		M-3175L	WA05-5067	SUSPENSION CATALOG
M-140E	WA07-6128		M-3175R	WA05-5066	SUSPENSION CATALOG
M-140F	WA07-6129		M-3181L	WA05-5091	SUSPENSION CATALOG
M-140G	WA07-5159		M-3181R	WA05-5090	SUSPENSION CATALOG
M-140H	WA07-5158		M-3185L	WA05-5103	SUSPENSION CATALOG
M-1424B	WA10-5015	SUSPENSION CATALOG	M-3185R	WA05-5102	SUSPENSION CATALOG
M-214A	WA07-6131		M-3186L	WA05-5055	SUSPENSION CATALOG
M-249A	WA07-6135		M-3186R	WA05-5054	SUSPENSION CATALOG
M-2604L	WA05-5047	SUSPENSION CATALOG	M-3187L	WA05-5057	SUSPENSION CATALOG
M-2604R	WA05-5046	SUSPENSION CATALOG	M-3187R	WA05-5056	SUSPENSION CATALOG
M-2605L	WA05-5049	SUSPENSION CATALOG	M-3188L	WA05-5059	SUSPENSION CATALOG
M-2605R	WA05-5048	SUSPENSION CATALOG	M-3188R	WA05-5058	SUSPENSION CATALOG
M-2606L	WA05-5029	SUSPENSION CATALOG	M-3482C	WA12-5028	SUSPENSION CATALOG
M-2606R	WA05-5028	SUSPENSION CATALOG	M-3682L	WA05-5093	SUSPENSION CATALOG
M-2607L	WA05-5081	SUSPENSION CATALOG	M-3682R	WA05-5092	SUSPENSION CATALOG
M-2607R	WA05-5080	SUSPENSION CATALOG	M-3688L	WA05-5095	SUSPENSION CATALOG
M-2613L	WA05-5043	SUSPENSION CATALOG	M-3688R	WA05-5094	SUSPENSION CATALOG
M-2613R	WA05-5042	SUSPENSION CATALOG	M-3697L	WA05-5077	SUSPENSION CATALOG
M-2614L	WA05-5015	SUSPENSION CATALOG	M-3697R	WA05-5076	SUSPENSION CATALOG
M-2614R	WA05-5014	SUSPENSION CATALOG	M-3699L	WA05-5023	SUSPENSION CATALOG
M-3109L	WA05-5039	SUSPENSION CATALOG	M-3699R	WA05-5022	SUSPENSION CATALOG
M-3109R	WA05-5038	SUSPENSION CATALOG	M-3798L	WA05-5061	SUSPENSION CATALOG
M-3111L	WA05-5041	SUSPENSION CATALOG	M-3798R	WA05-5060	SUSPENSION CATALOG
M-3111R	WA05-5040	SUSPENSION CATALOG	M-3799L	WA05-5063	SUSPENSION CATALOG
M-3112L	WA05-5025	SUSPENSION CATALOG	M-3799R	WA05-5062	SUSPENSION CATALOG
M-3112R	WA05-5024	SUSPENSION CATALOG	M-4009L	WA05-5031	SUSPENSION CATALOG
M-3114L	WA05-5001	SUSPENSION CATALOG	M-4009R	WA05-5030	SUSPENSION CATALOG
M-3114R	WA05-5100	SUSPENSION CATALOG	M-4010L	WA05-5033	SUSPENSION CATALOG
M-311A	WA01-5011	SUSPENSION CATALOG	M-4010R	WA05-5032	SUSPENSION CATALOG
M-3130L	WA05-5065	SUSPENSION CATALOG	M-4012L	WA05-5035	SUSPENSION CATALOG
M-3130R	WA05-5064	SUSPENSION CATALOG	M-4012R	WA05-5034	SUSPENSION CATALOG
M-3131L	WA05-5079	SUSPENSION CATALOG	M-4031L	WA05-5037	SUSPENSION CATALOG
M-3131R	WA05-5078	SUSPENSION CATALOG	M-4031R	WA05-5036	SUSPENSION CATALOG
M-3137L	WA05-5075	SUSPENSION CATALOG	M-478L	WA05-5097	SUSPENSION CATALOG
M-3137R	WA05-5074	SUSPENSION CATALOG	M-478R	WA05-5096	SUSPENSION CATALOG
M-313A	WA11450	SUSPENSION CATALOG	M-560L	WA05-5087	SUSPENSION CATALOG
M-313B	WA11452	SUSPENSION CATALOG	M-560R	WA05-5086	SUSPENSION CATALOG
M-313C	WA11451	SUSPENSION CATALOG	M-561L	WA05-5099	SUSPENSION CATALOG
M-3140L	WA05-5071	SUSPENSION CATALOG	M-561R	WA05-5098	SUSPENSION CATALOG
M-3140R	WA05-5070	SUSPENSION CATALOG	M-562L	WA05-5001	SUSPENSION CATALOG
M-3142L	WA05-5073	SUSPENSION CATALOG	M-562R	WA05-5000	SUSPENSION CATALOG
M-3142R	WA05-5072	SUSPENSION CATALOG	M-563L	WA05-5003	SUSPENSION CATALOG
M-3147L	WA05-5017	SUSPENSION CATALOG	M-563R	WA05-5002	SUSPENSION CATALOG
M-3147R	WA05-5016	SUSPENSION CATALOG	M-566L	WA05-5005	SUSPENSION CATALOG
M-3151L	WA05-5089	SUSPENSION CATALOG	M-566R	WA05-5004	SUSPENSION CATALOG
M-3151R	WA05-5088	SUSPENSION CATALOG	M-571A	WA04-5003	SUSPENSION CATALOG
M-315A	WA01-5042	SUSPENSION CATALOG	M-571B	WA04-5001	SUSPENSION CATALOG
M-315S	WA01-5043	SUSPENSION CATALOG	M-587A	WA09-5002	SUSPENSION CATALOG
M-3169L	WA05-5051	SUSPENSION CATALOG	M-596A	WA07-5045A	SUSPENSION CATALOG
M-3169R	WA05-5050	SUSPENSION CATALOG	M-743L	WA05-5027	SUSPENSION CATALOG

# INTERCHANGE



## BWP® cont.

COMPETITOR #	WA#	NOTES	COMPETITOR #	WA#	NOTES
M-743R	WA05-5026	SUSPENSION CATALOG	M-K16	WA08-5007	SUSPENSION CATALOG
M-744L	WA05-5007	SUSPENSION CATALOG	M-K20	WA08-5005	SUSPENSION CATALOG
M-744R	WA05-5006	SUSPENSION CATALOG	M-K24	WA08-5009	SUSPENSION CATALOG
M-824A	WA09-5001	SUSPENSION CATALOG	M-K39	WA2769SHD	SUSPENSION CATALOG
M-990L	WA05-5009	SUSPENSION CATALOG	M-K39A	WAE3895	SUSPENSION CATALOG
M-990R	WA05-5008	SUSPENSION CATALOG	M-K42	WA3710SHD	SUSPENSION CATALOG
M-991L	WA05-5011	SUSPENSION CATALOG	M-K42	WAKIT4HD	SUSPENSION CATALOG
M-991R	WA05-5010	SUSPENSION CATALOG	M-K61	WA08-5006	SUSPENSION CATALOG
M-992L	WA05-5013	SUSPENSION CATALOG	M-K63	WA08-5012	SUSPENSION CATALOG
M-992R	WA05-5012	SUSPENSION CATALOG	M-K64	WA08-5013	SUSPENSION CATALOG
M-997L	WA05-5045	SUSPENSION CATALOG	M-K72	WA2769SHD	SUSPENSION CATALOG
M-997R	WA05-5044	SUSPENSION CATALOG	M-K77	WAE5139	SUSPENSION CATALOG
M-998L	WA05-5085	SUSPENSION CATALOG	M-K79	WAE3869	SUSPENSION CATALOG
M-998R	WA05-5084	SUSPENSION CATALOG	M-K81	WA08-5008	SUSPENSION CATALOG
M-K10	WA1887ASHD	SUSPENSION CATALOG	M-K84	WAE5481A	SUSPENSION CATALOG
M-K101	WA08-5003	SUSPENSION CATALOG	M-K88	WA08-5001	SUSPENSION CATALOG
M-K103	WA08-5004	SUSPENSION CATALOG	M-K90	WA08-5002	SUSPENSION CATALOG
M-K105	WAE10244	SUSPENSION CATALOG	M-K91	WA08-5015	SUSPENSION CATALOG
M-K106	WA08-5019	SUSPENSION CATALOG	M-K98	WAE9064	SUSPENSION CATALOG
M-K107	WA08-5016	SUSPENSION CATALOG	M-QHD	WA2769SHD	SUSPENSION CATALOG

## CONMET®

COMPETITOR #	WA#	NOTES	COMPETITOR #	WA#	NOTES
100333	WA07-6165		102277	WA07-5503	
100334	WA07-6164		102278	WA07-5502	
100370	WA07-6059		102279	WA07-5353	
100371	WA07-6058		102280	WA07-5167	
100524	WA07-6081		102281	WA07-5505	
100525	WA07-6080		102282	WA07-5504	
101151	WA07-5303		102290	WA07-6083	
102188	WA07-5506		102291	WA07-5509	
102189	WA07-5507		102292	WA07-5202	
102190	WA07-5508		103193	WA07-6114	

## DANA®

COMPETITOR #	WA#	NOTES	COMPETITOR #	WA#	NOTES
10284	WA07-5090		M10HN101	WA07-5090	
10286	WA07-5092		M10HN102	WA07-5092	
10287	WA07-5091		M10HN151	WA07-5093	
M10HM107-4	WA07-6160		M10HN158	WA07-5090	
M10HM108-4	WA07-6303		M12KBH04	WA07-5102	
M10HN100	WA07-5091		M12KBH06	WA07-5100	

WWW.WORLDAMERICAN.COM





# INTERCHANGE

## DAYTON®

COMPETITOR #	WA#	NOTES	COMPETITOR #	WA#	NOTES
08-005148	WA07-6049		13-1006R	WA07-6044	
08-005715	WA07-5004		13-1008L	WA07-5198	
08-006654	WA07-5150		13-1008R	WA07-5197	
08-008411	WA07-5005		13-1009L	WA07-6317	
08-034396	WA07-5151		13-1009R	WA07-6048	
09-006257	WA15-5009		13-1017L	WA07-6081	
09-2343	WA07-6012		13-1017R	WA07-6080	
09-3353	WA07-6010		13-1037L	WA07-6165	
09-3372	WA07-5040		13-1037R	WA07-6164	
09-541417	WA15-5004		13-1038L	WA07-6163	
09-612317	WA15-5000		13-1038R	WA07-6162	
09-623517	WA15-5002		13-1101L	WA07-6318	
09-658417	WA15-5025		13-1101R	WA07-6204	
09-699317	WA15-5001		13-1102L	WA07-5164	
09-705317	WA15-5008		13-1102R	WA07-5163	
09-717110	WA15-5026		13-1103L	WA07-5097	
09-851817	WA15-5005		13-1103R	WA07-5096	
09-870817	WA15-5006		13-1104L	WA07-5101	
09-870917	WA15-5007		13-1104R	WA07-5100	
11-1901	WA13-1901		13-1105L	WA07-5103	
11-1902	WA13-1902		13-1105R	WA07-5102	
11-1903	WA13-1903		13-1106L	WA07-6143	
11-1904	WA13-1904		13-1106R	WA07-6142	
11-1905	WA13-1905		13-1107L	WA07-5099	
11-1906	WA13-1906		13-1107R	WA07-5098	
11-1907	WA13-1907		13-1108L	WA07-5355	
11-1908	WA13-1908		13-1108R	WA07-5169	
11-1909	WA13-1909		13-1110L	WA07-6153	
11-1910	WA13-1910		13-1110R	WA07-6152	
11-1911	WA13-1911		13-1111L	WA07-6155	
11-1912	WA13-1912		13-1111R	WA07-6154	
11-1913	WA13-1913		13-1112L	WA07-6157	
11-1914	WA13-1914		13-1112R	WA07-6156	
11-1915	WA13-1915		13-1113L	WA07-6141	
11-1916	WA13-1916		13-1113R	WA07-6140	
11-1917	WA13-1917		13-1114L	WA07-6302	
11-1918	WA13-1918		13-1114R	WA07-6158	
11-1919	WA13-1919		13-1122L	WA07-6065	
11-1920	WA13-1920		13-1122R	WA07-6064	
11-1921	WA13-1921		13-1126L	WA07-6101	
11-1922	WA13-1922		13-1126R	WA07-6100	
11-1927	WA13-1927		13-1128L	WA07-6067	
13-1001L	WA07-6039		13-1128R	WA07-6066	
13-1001R	WA07-6038		13-1129L	WA07-5166	
13-1002L	WA07-5190		13-1129R	WA07-5165	
13-1002R	WA07-5189		13-1131L	WA07-6311	
13-1003L	WA07-5192		13-1131R	WA07-6098	
13-1003R	WA07-5191		13-1135L	WA07-6071	
13-1004L	WA07-5194		13-1135R	WA07-6070	
13-1004R	WA07-5193		13-1140L	WA07-6073	
13-1005L	WA07-5196		13-1140R	WA07-6072	
13-1005R	WA07-5195		13-1143L	WA07-6099	
13-1006L	WA07-6045		13-1143R	WA07-6208	

CONTINUED>>>

# INTERCHANGE



## DAYTON® cont.

COMPETITOR #	WA#	NOTES	COMPETITOR #	WA#	NOTES
13-1146L	WA07-6069		13-1275R	WA07-6108	
13-1146R	WA07-6068		13-1302L	WA07-6300	
13-1150	WA07-6219		13-1302R	WA07-6042	
13-1151	WA07-6220		13-1305L	WA07-6301	
13-1154L	WA07-6063		13-1305R	WA07-6046	
13-1154R	WA07-6062		13-1306L	WA07-6247	
13-1156L	WA07-5503		13-1306R	WA07-6246	
13-1156R	WA07-5502		13-1502L	WA07-5184	
13-1157L	WA07-5353		13-1502R	WA07-5183	
13-1157R	WA07-5167		13-1505L	WA07-5371	
13-1158L	WA07-5505		13-1505R	WA07-5370	
13-1158R	WA07-5504		13-1506L	WA07-5188	
13-1171L	WA07-5304		13-1506R	WA07-5187	
13-1171R	WA07-6312		13-1511R	WA07-6096	
13-1182L	WA07-6212		13-1544	WA07-5506	
13-1182R	WA07-6211		13-1545	WA07-5507	
13-1201L	WA07-6033		13-1546	WA07-5508	
13-1201R	WA07-6032		13-1548	WA07-6114	
13-1202L	WA07-6035		13-1550	WA07-6083	
13-1202R	WA07-6034		13-1552	WA07-5509	
13-1203L	WA07-6037		13-1552	WA07-5202	
13-1203R	WA07-6120		13-1560	WA07-6192	
13-1204L	WA07-5175		13-1561	WA07-6190	
13-1204R	WA07-5173		13-1563	WA07-6094	
13-1205L	WA07-6171		13-1567	WA07-5204	
13-1205R	WA07-6170		13-1569	WA07-6090	
13-1206L	WA07-6173		13-1570	WA07-5374	
13-1206R	WA07-6172		13-1573	WA07-6089	
13-1208L	WA07-6307		13-1576	WA07-5205	
13-1208R	WA07-6196		13-1577	WA07-6087	
13-1230L	WA07-5176		13-1578	WA07-5114	
13-1230R	WA07-5175		13-1579	WA07-6085	
13-1231L	WA07-5105		13-1580	WA07-6188	
13-1231R	WA07-5104		13-1581	WA07-6200	
13-1232L	WA07-5178		13-1582	WA07-5201	
13-1232R	WA07-5177		13-1585L	WA07-5172	
13-1233L	WA07-6235		13-1585R	WA07-5171	
13-1233R	WA07-6234		13-1591	WA07-5303	
13-1234L	WA07-6233		13-1604L	WA07-6145	
13-1234R	WA07-6232		13-1604R	WA07-6144	
13-1235L	WA07-6075		13-1609L	WA07-6245	
13-1235R	WA07-6074		13-1609R	WA07-6244	
13-1236L	WA07-6139		13-1616L	WA07-6169	
13-1236R	WA07-6138		13-1616R	WA07-6168	
13-1256L	WA07-6308		13-1617L	WA07-6241	
13-1256R	WA07-6198		13-1617R	WA07-6240	
13-1259L	WA07-6195		13-1618L	WA07-5107	
13-1259R	WA07-6194		13-1618R	WA07-5106	
13-1273L	WA07-6193		13-1620L	WA07-6237	
13-1273R	WA07-5116		13-1620R	WA07-3236	
13-1274L	WA07-6313		13-1621L	WA07-6239	
13-1274R	WA07-6106		13-1621R	WA07-6238	
13-1275L	WA07-6314		13-1622L	WA07-6309	



## DAYTON® cont.

COMPETITOR #	WA#	NOTES	COMPETITOR #	WA#	NOTES
13-1622R	WA07-6076		13-3019L	WA07-5158	
13-1623L	WA07-6243		13-3019R	WA07-5159	
13-1623R	WA07-6242		13-3026L	WA07-5033	
13-1630L	WA07-5180		13-3026L	WA07-5031	
13-1630R	WA07-5179		13-3026R	WA07-5032	
13-1635L	WA07-6111		13-3026R	WA07-5030	
13-1635R	WA07-6110		13-3028L	WA07-5027	
13-1720	WA07-6091		13-3028R	WA07-5026	
13-1721	WA07-6093		13-3029L	WA07-5029	
13-1901	WA07-6122		13-3029R	WA07-5028	
13-1902	WA07-6206		13-3042L	WA07-6135	
13-1903	WA07-6123		13-3047R	WA07-5122	
13-1904	WA07-6207		13-3048	WA07-5511	
13-1905	WA07-5160		13-3050	WA07-5036	
13-2001	WA07-5161		13-3052	WA07-5035	
13-2002	WA07-5162		13-3054L	WA07-6015	
13-2003	WA07-6231		13-3054L	WA07-6003	
13-2006	WA07-6315		13-3054R	WA07-6014	
13-2007	WA07-6102		13-3054R	WA07-6002	
13-2204L	WA07-6303		13-3055L	WA07-6017	
13-2204R	WA07-6160		13-3055R	WA07-6016	
13-2323L	WA07-6167		13-3057	WA07-5037	
13-2323R	WA07-6166		13-3130L	WA07-5155	
13-2327L	WA07-6310		13-3130R	WA07-5154	
13-2327R	WA07-6078		13-3131L	WA07-5157	
13-2372R	WA07-6054		13-3131R	WA07-5156	
13-2373L	WA07-6061		13-6012	WA07-6225	
13-2373R	WA07-6060		13-6014	WA07-6226	
13-2375L	WA07-6059		13-6015	WA07-6227	
13-2375R	WA07-6058		13-6101	WA07-6051	
13-2376L	WA07-6057		13-6502	WA07-6052	
13-2376R	WA07-6056		13-6521	WA07-6006	
13-2550L	WA07-6320		13-6523	WA07-6008	
13-2550R	WA07-6031		13-7001	WA07-6180	
13-2551L	WA07-6229		13-7002	WA07-6018	
13-2551R	WA07-6304		13-7010	WA07-6182	
13-3002	WA07-6149		13-7012	WA07-6183	
13-3003	WA07-5510		13-7015	WA07-5206	
13-3005L	WA07-5025		13-7026	WA07-5209	
13-3005R	WA07-5024		13-7028	WA07-6181	
13-3010L	WA07-6127		13-7037	WA07-5207	
13-3010R	WA07-6126		13-7038	WA07-5208	
13-3012L	WA07-5023		13-7050	WA07-6186	
13-3012R	WA07-5022		13-7055	WA07-6185	
13-3013L	WA07-5021		13-7202	WA07-5077	
13-3013R	WA07-5020		13-7204	WA07-5080	
13-3015L	WA07-6005		13-7208	WA07-5078	
13-3015R	WA07-6004		13-7210	WA07-5081	
13-3016L	WA07-5301		13-7216	WA07-5079	
13-3016R	WA07-5300		13-7218	WA07-5082	
13-3017L	WA07-6129		13-8001	WA07-6202	
13-3017R	WA07-6128		13-8002	WA07-6118	
			13-8003	WA07-5152	
			13-8004	WA07-5018	
			13-8005	WA07-5153	

# INTERCHANGE



## DODGE®

COMPETITOR #	WA#	NOTES	COMPETITOR #	WA#	NOTES
503550	WA07-5024		1194126	WA07-5163	
503551	WA07-5025		1194127	WA07-5164	
513796	WA07-5152		1260634	WA07-5183	
531378	WA07-5081		1260635	WA07-5184	
532062	WA07-5189		1261180	WA07-5187	
533063	WA07-5190		1261181	WA07-5188	
568516	WA07-6022		1267752	WA07-5082	
576817	WA15-5029		1272771	WA07-5184	
585192	WA07-5020		1272772	WA07-5183	
585193	WA07-5021		1508989	WA07-5077	
585194	WA07-5022		1920494	WA07-5300	
585195	WA07-5023		1920495	WA07-5301	
856981	WA07-6218		1925790	WA07-5098	
916702	WA07-5182		1925791	WA07-5099	
916703	WA07-5181		1927774	WA15-5000	
1191846	WA07-6032		2153823	WA07-5169	
1191847	WA07-6033		2153824	WA07-5355	
1192558	WA07-6120		2515316	WA07-6031	
1194080	WA07-6049		2515317	WA07-6320	
1194097	WA07-5150		3637719	WA07-5122	
1194103	WA07-5004		11952559	WA07-6037	
1194113	WA07-5018				

## EATON®

COMPETITOR #	WA#	NOTES	COMPETITOR #	WA#	NOTES
11245	WA07-5215		4-2209	WA07-5406	
11249	WA07-5381		4-2210	WA07-5407	
1194080	WA07-6049		4-2211	WA07-5408	
19186	WA07-5382		4-2216	WA07-5397	
30714	WA07-5217		4-2217	WA07-5395	
31926	WA07-5377		4-2218	WA07-5396	
31927	WA07-5380		4-2219	WA07-5415	
34090	WA07-5375		4-2220	WA07-5413	
40X35	WA07-5378		4-2221	WA07-5414	
4-2194	WA07-5092		4-2222	WA07-5213	
4-2196	WA07-5090		4-2223	WA07-5384	
4-2198	WA07-6025		4-2224	WA07-5385	
4-2199	WA07-6024		45X93	WA07-5379	
4-2200	WA07-6026		779321	WA07-5090	
4-2205	WA07-5405		799041	WA07-5091	
4-2206	WA07-5402		F-940	WA07-5090	
4-2207	WA07-5404		F-941	WA07-5092	
4-2208	WA07-5403		F-942	WA07-5091	

## ERIE®

COMPETITOR #	WA#	NOTES	COMPETITOR #	WA#	NOTES
5247	WA07-6052		E-19	WA15-5000	
5259	WA07-5004		E-2	WA15-5002	
5260	WA07-5018		E-20	WA15-5002	
5248U	WA07-5153		E-21	WA15-5001	
538U	WA07-6118		E-22	WA15-5006	
E-1	WA15-5000		E-3	WA15-5001	
E-10	WA15-5029		E-5	WA15-5025	
E-12	WA15-5006		E-6	WA15-5026	



## EUCLID®

COMPETITOR #	WA#	NOTES	COMPETITOR #	WA#	NOTES
E-04000	WA359-5990		E-1428A	WA10-5005	
E-04075	WA340-4975		E-1546	WA04-5038	
E-05500	WA14-5001		E-1559	WA07-5041	
E-10197	WA10-5004		E-1561	WA07-5095	
E-10198	WA10-5010		E-1565	WA07-5134	
E-1020	WA04-5020		E-1567	WA04-5008	
E-10202L	WA07-6311		E-1569	WA07-5003	
E-10202R	WA07-6098		E-1571	WA04-5061	
E-10206L	WA07-6101		E-1574HD	WAKN44041	
E-10206R	WA07-6100		E-1577	WA04-5017	
E-10208L	WA07-5353		E-1594	WA04-5036	
E-10208R	WA07-5167		E-1595	WA04-5037	
E-10209L	WA07-5503		E-1781	WA07-5125	
E-10209R	WA07-5502		E-1782	WA07-5126	
E-10210L	WA07-5505		E-1817	WA07-5055	
E-10210R	WA07-5504		E-1818	WA07-5056	
E-10213R	WA07-6096		E-1819	WA07-5054	
E-10215	WA07-5506		E-1876	WA04-5040	
E-10216	WA07-5507		E-1877	WA04-5041	
E-10217	WA07-5508		E-1880B	WA10-5024	
E-10219	WA07-6083		E-1887ASHD	WA1887ASHD	
E-10220	WA07-5509		E-1893	WA04-5028	
E-10221	WA07-5202		E-1901	WA13-1901	
E-10222	WA07-6114		E-1902	WA13-1902	
E-10229	WA07-6123		E-1903	WA13-1903	
E-10229	WA07-6320		E-1904	WA13-1904	
E-1023	WA12-5038		E-1905	WA13-1905	
E-10230	WA07-5160		E-1906	WA13-1906	
E-1024	WA12-5035		E-1907	WA13-1907	
E-10241	WA07-6116		E-1908	WA13-1908	
E-10244	WAE10244		E-1909	WA13-1909	
E-10249L	WA07-6243		E-1910	WA13-1910	
E-10249R	WA07-6242		E-1911	WA13-1911	
E-1025	WA10-5020		E-1912	WA13-1912	
E-10253L	WA07-5155		E-1913	WA13-1913	
E-10253R	WA07-5154		E-1914	WA13-1914	
E-10254L	WA07-5157		E-1915	WA13-1915	
E-10254R	WA07-5156		E-1916	WA13-1916	
E-10259L	WA07-6316		E-1917	WA13-1917	
E-10259R	WA07-6104		E-1918	WA13-1918	
E-10675	WA07-5203		E-1919	WA13-1919	
E-10676	WA07-6088		E-1920	WA13-1920	
E-11449	WA04-5044		E-1921	WA13-1921	
E-1159	WA04-5025		E-1922	WA13-1922	
E-1160	WA04-5024		E-1927	WA13-1927	
E-1271	WA04-5004		E-1943	WA07-6010	
E-1318A	WA07-5019		E-1946	WA07-5121	
E-1330	WA12-5004		E-1948	WA04-5039	
E-1332	WA04-5053		E-1980	WA04-5018	
E-1333	WA04-5052		E-1981	WA12-5110	
E-1338	WA04-5034		E-1982	WA04-5019	
E-1339	WA04-5035		E-1983	WA12-5110	
E-1340	WA04-5029		E-1999A	WA04-5056	
E-1341A	WA04-5030		E-2003	WA04-5062	
E-1385	WA04-5060		E-2090	WA08-5005	
E-1415	WA14-5017		E-2102	WA04-5013	
E-1416	WA09-5000		E-2104	WA07-5117	
E-1416A	WA09-5001		E-2177	WA07-5046	
E-1418	WA10-5007		E-2225	WA12-5005	

# INTERCHANGE



## EUCLID® cont.

COMPETITOR #	WA#	NOTES	COMPETITOR #	WA#	NOTES
E-2226	WA12-5006		E-2510	WA12-5099	
E-2227	WA12-5093		E-2511	WA12-5015	
E-2228	WA12-5096		E-2512	WA12-5106	
E-2237	WA07-5093		E-2513	WA12-5107	
E-2250	WA07-5094		E-2514	WA12-5037	
E-2287	WA08-5009		E-2515	WA12-5036	
E-2294	WA12-5108		E-2517	WA04-5012	
E-2295	WA12-5109		E-2555	WA04-5049	
E-2296	WA07-5402		E-2558	WA07-5115	
E-2297	WA07-5404		E-2634	WA12-5091	
E-2298	WA07-5403		E-2658	WA07-5409	
E-2299	WA07-5405		E-2659	WA07-5410	
E-2300	WA07-5406		E-2660	WA07-5411	
E-2301	WA07-5407		E-2680	WA08-5013	
E-2302	WA07-5408		E-2690A	WA04-5059	
E-2303	WA07-5213		E-2695	WA04-5016	
E-2304	WA07-5385		E-2696A	WA08-5012	
E-2305	WA07-5384		E-2766	WA07-5051	
E-2361	WA04-5011		E-2767	WA10-5009	
E-2365	WA07-5118		E-2768	WA10-5015	
E-2372	WA04-5032		E-2769SHD	WA2769SHD	
E-2374	WA04-5033		E-2771	WA04-5031	
E-2380	WA04-5005		E-2781A	WA12-5017	
E-2382	WA08-5007		E-2815	WA12-5095	
E-2386	WA07-5213		E-2830	WA12-5022	
E-2389	WA04-5027		E-2841	WA12-5097	
E-2398	WA10-5021		E-2842	WA12-5098	
E-2405	WA09-5004		E-2843	WA12-5001	
E-2406	WA09-5003		E-2846	WA12-5000	
E-2407	WA04-5007		E-2889	WA12-5018	
E-2408	WA04-5006		E-2891	WA07-5058	
E-2409	WA07-5129		E-2892	WA07-5059	
E-2411A	WA07-5133		E-2899	WA12-5016	
E-2417	WA07-5394		E-2907	WA12-5019	
E-2418	WA07-5393		E-2908	WA12-5021	
E-2419	WA07-5387		E-2909	WA12-5020	
E-2419	WA07-5392		E-2910A	WA12-5039	
E-2420	WA07-5397		E-2911	WA12-5040	
E-2421	WA07-5396		E-2913A	WA12-5029	
E-2422	WA07-5395		E-2914	WA12-5030	
E-2423	WA07-5415		E-2915A	WA12-5031	
E-2424	WA07-5414		E-2916	WA12-5094	
E-2425	WA07-5413		E-2917	WA12-5012	
E-2426	WA07-5401		E-2919	WA12-5013	
E-2427	WA07-5400		E-2920	WA12-5014	
E-2428	WA07-5399		E-2935	WA04-5050	
E-2458	WAKN44051		E-2965	WA12-5024	
E-2458HD	WAKN44071		E-3000	WA07-5086	
E-2459HD	WAKN44061		E-3001	WA07-5087	
E-2460	WA07-5375		E-3002A	WA07-5088	
E-2461	WA07-5217		E-3003	WA07-5089	
E-2462	WA07-5382		E-3007A	WA10-5012	
E-2463	WA07-5377		E-3012	WA12-5105	
E-2464	WA07-5378		E-3079	WA07-5060	
E-2465	WA07-5379		E-3188	WA07-5065	
E-2466	WA07-5380		E-3189	WA07-5066	
E-2467	WA07-5215		E-3190	WA07-5067	
E-2468	WA07-5381		E-3191	WA07-5068	
E-2507	WA14-5006		E-3192	WA07-5069	



EUCLID® cont.

COMPETITOR #	WA#	NOTES	COMPETITOR #	WA#	NOTES
E-3193	WA07-5070		E-4877	WA07-5391	
E-3194	WA07-5071		E-4944	WA07-6018	
E-3195	WA07-5072		E-4955	WA07-6049	
E-3196	WA07-5073		E-4956A	WA07-5004	
E-3197	WA07-5074		E-4957	WA07-5151	
E-3198	WA07-5075		E-4958	WA07-5150	
E-3199	WA07-5076		E-4960	WA07-6186	
E-3227	WA10-5013		E-4962	WA07-5152	
E-3276	WA12-5099		E-4963	WA07-5018	
E-3390	WA12-5100		E-4964L	WA07-6318	
E-3414	WA12-5026		E-4964R	WA07-6204	
E-3421A	WA07-5048		E-4965L	WA07-5164	
E-3437	WA10-5022		E-4965R	WA07-5163	
E-3447	WA04-5058		E-4966L	WA07-5097	
E-3478	WA07-5137		E-4966R	WA07-5096	
E-3479	WA07-5130		E-4967L	WA07-5099	
E-3490B	WA10-5003		E-4967R	WA07-5098	
E-3504	WA07-5389		E-4968L	WA07-5101	
E-3505	WA07-5388		E-4968R	WA07-5100	
E-3510	WA07-5412		E-4969L	WA07-5103	
E-3520A	WA08-5006		E-4969R	WA07-5102	
E-3680	WA12-5034		E-4978	WA07-5083	
E-3689	WA12-5043		E-4979	WA07-5084	
E-3710SHD	WA3710SHD		E-4980	WA07-5085	
E-3711	WA07-5043		E-4986A	WA07-6118	
E-3780	WA07-5053		E-4987A	WA07-6051	
E-3869	WAE3869		E-4988L	WA07-5184	
E-3872	WA10-5001		E-4988R	WA07-5183	
E-3873	WA10-5008		E-5006	WA07-6202	
E-3874	WA07-5042		E-5007	WA07-6132	
E-3895	WAE3895		E-5009	WA07-6124	
E-3991	WA09-5005		E-502	WA07-5416	
E-3993B	WA08-5008		E-5040A	WA15-5001	
E-4301	WA12-5101		E-5045	WA15-5025	
E-4302	WA12-5102		E-5046	WA15-5026	
E-4323	WA90054007		E-5047	WA15-5029	
E-4347	WA07-6012		E-5093	WA07-5000	
E-4382A	WA04-5055		E-5122	WA10-5006	
E-4410A	WA04-5054		E-5123	WA10-5000	
E-4587	WA07-5120		E-5127	WA04-5057	
E-4604	MW373R		E-5139	WAE5139	
E-4605	MW373L		E-5228	WA12-5061	
E-4608	MW2070L		E-523	WA07-5045	
E-4609	MW2069R		E-526	WA07-5001	
E-4610	MW187L		E-5325	WA346-189	
E-4611	MW187R		E-535	WA04-5015	
E-4614	MW423L		E-5358	WA346-240	
E-4615	MW423R		E-536	WA04-5000	
E-4616	MW431L		E-5366	WA346-249	
E-4617	MW431R		E-5370	WA346-293	
E-4628	MW2090L		E-539	WA10-5018	
E-4629	MW2091R		E-540	WA07-5090	
E-4630	MW411L		E-541	WA04-5026	
E-4631	MW411R		E-545A	WA10-5023	
E-4813	WA12-5002		E-5477	WA07-5047	
E-4824	WA12-5003		E-5478	WA10-5014	
E-4825	WA12-5033		E-5481A	WAE5481A	
E-4830	WA07-5139		E-5482	WA07-5138	
E-4835	WA12-5025		E-5513	WA08-5017	

# INTERCHANGE



## EUCLID® cont.

COMPETITOR #	WA#	NOTES	COMPETITOR #	WA#	NOTES
E-5548L	WA07-5031		E-5711	WA07-5057	
E-5548R	WA07-5030		E-5712	WA07-6200	
E-5549L	WA07-5025		E-5714L	WA07-6300	
E-5549R	WA07-5024		E-5714R	WA07-6042	
E-5551L	WA07-6045		E-5718L	WA07-6033	
E-5551R	WA07-6044		E-5718R	WA07-6032	
E-5552L	WA07-5023		E-5719L	WA07-6035	
E-5552R	WA07-5022		E-5719R	WA07-6034	
E-5553L	WA07-5198		E-572	WA07-6020	
E-5553R	WA07-5197		E-5720L	WA07-6037	
E-5554L	WA07-6003		E-5720R	WA07-6120	
E-5554R	WA07-6002		E-5721L	WA07-6139	
E-5556L	WA07-5190		E-5721R	WA07-6138	
E-5556R	WA07-5189		E-5724	WA07-6122	
E-5557L	WA07-6317		E-5726	WA07-6225	
E-5557R	WA07-6048		E-5728	WA07-6226	
E-5558L	WA07-6039		E-5729	WA07-6227	
E-5558R	WA07-6038		E-573	WA07-5091	
E-5559L	WA07-5192		E-5731	WA07-6178	
E-5559R	WA07-5191		E-5736	WA07-6022	
E-5560L	WA07-5196		E-5737	WA07-5077	
E-5560R	WA07-5195		E-5738	WA07-6019	
E-5561L	WA07-5194		E-5739	WA07-6020	
E-5561R	WA07-5193		E-5740	WA07-5078	
E-5570	WA15-5004		E-5742	WA07-6021	
E-5571A	WA15-5000		E-5743	WA07-5079	
E-5572A	WA15-5002		E-5749L	WA07-6145	
E-5576L	WA07-6129		E-5749R	WA07-6144	
E-5576R	WA07-6128		E-5751	WA07-6181	
E-5578L	WA07-6005		E-5755	WA15-5027	
E-5578R	WA07-6004		E-5756L	WA07-6141	
E-5579L	WA07-5301		E-5756R	WA07-6140	
E-5579R	WA07-5300		E-5757L	WA07-6143	
E-5587L	WA07-5181		E-5757R	WA07-6142	
E-5587R	WA07-5182		E-5761	WA07-6052	
E-5588L	WA07-5371		E-5762	WA07-5153	
E-5588R	WA07-5370		E-5764L	WA07-6155	
E-5589L	WA07-6301		E-5764R	WA07-6154	
E-5589R	WA07-6046		E-5765L	WA07-5355	
E-5591L	WA07-6218		E-5765R	WA07-5169	
E-5591R	WA07-6133		E-5766L	WA07-6153	
E-5592R	WA07-6216		E-5766R	WA07-6152	
E-5607	WA07-6205		E-5775	WA07-6219	
E-5618L	WA07-5188		E-5778	WA15-5028	
E-5618R	WA07-5187		E-5781	WA15-5013	
E-5622	WA07-6130		E-5783	WA15-5010	
E-5625	WA07-6209		E-5784A	WA15-5006	
E-5628	WA07-6207		E-5785	WA15-5007	
E-564	WA07-5124		E-5785A	WA15-5008	
E-5652L	WA07-5021		E-5792	WA07-6179	
E-5652R	WA07-5020		E-5796	WA07-6180	
E-5682	WA07-5161		E-5798	WA07-6182	
E-5683	WA07-5162		E-5799	WA07-6183	
E-5701	WA07-6151		E-580	WA07-5128	
E-5703	WA07-6220		E-5800	WA07-5207	
E-5704	WA07-6149		E-5801	WA07-5208	
E-5706	WA07-5005		E-581	WA07-5127	
E-5708	WA07-5510		E-5816	WA07-6231	
E-5710	WA07-6210		E-5819	WA07-6131	





EUCLID® cont.

COMPETITOR #	WA#	NOTES	COMPETITOR #	WA#	NOTES
E-5821	WA15-5015		E-5989L	WA07-6081	
E-5823	WA07-6224		E-5989R	WA07-6080	
E-5828	WA15-5009		E-5991	WA07-5036	
E-5837	WA15-5011		E-5993	WA07-6192	
E-5868L	WA07-6169		E-5994	WA07-6190	
E-5868R	WA07-6168		E-5995L	WA07-6015	
E-5869L	WA07-6302		E-5995R	WA07-6014	
E-5869R	WA07-6158		E-5996L	WA07-6017	
E-5870L	WA07-6157		E-5996R	WA07-6016	
E-5870R	WA07-6156		E-5997	WA07-5200	
E-5871L	WA07-5176		E-5998	WA07-6188	
E-5871R	WA07-5175		E-5999	WA07-5201	
E-5872	WA07-5209		E-6000A	WA07-5035	
E-5876L	WA07-6303		E-6026R	WA07-6054	
E-5876R	WA07-6160		E-6027L	WA07-6057	
E-5885	WA15-5016		E-6027R	WA07-6056	
E-5892	WA07-5511		E-6028L	WA07-6061	
E-5896L	WA07-5105		E-6028R	WA07-6060	
E-5896R	WA07-5104		E-6029A	WA07-5303	
E-5900L	WA07-6173		E-603	WA07-6250	
E-5900R	WA07-6172		E-6036	WA07-5374	
E-5902	WA15-5003		E-6057L	WA07-6075	
E-5904A	WA15-5014		E-6057R	WA07-6074	
E-5909L	WA07-6235		E-6059L	WA07-6059	
E-5909R	WA07-6234		E-6059R	WA07-6058	
E-5910L	WA07-5105		E-6060L	WA07-5158	
E-5910R	WA07-5173		E-6060R	WA07-5159	
E-5911L	WA07-6171		E-6078	WA08-5002	
E-5911R	WA07-6170		E-6121	WA04-5063	
E-5924L	WA07-6167		E-612HD	WAKN47001	
E-5924R	WA07-6166		E-6142	WA07-5383	
E-5931L	WA07-6165		E-654	WA09-5002	
E-5931R	WA07-6164		E-656	WA07-5136	
E-5932L	WA07-6163		E-661	WA04-5003	
E-5932R	WA07-6162		E-667	WA04-5046	
E-5938	WA07-6206		E-6685	WA346-196	
E-595	WA07-5044		E-6856	MW3030R	
E-5952	WA07-5080		E-6857	MW3031L	
E-5955	WA07-6185		E-6999S	WAE6999S	
E-5957	WA07-5081		E-700	WA15-5050	
E-5960	WA07-5082		E-702	WA15-5051	
E-5964	WA07-5040		E-719	WA07-5131	
E-5966	WA07-6006		E-7431	WA03-5001	
E-5968	WA07-6008		E-7450	WA03-5002	
E-596A	WA07-5050		E-747	WA10-5011	
E-5977L	WA07-5023		E-7529	WA03-5016	
E-5977R	WA07-5022		E-7532	WA12-5027	
E-5982L	WA07-5107		E-756-43	WA12-5089	
E-5982R	WA07-5106		E-759	WA04-5001	
E-5983L	WA07-5178		E-781	WA07-5045A	
E-5983R	WA07-5177		E-7895L	WA07-5025	
E-5985L	WA07-6245		E-7895R	WA07-5024	
E-5985R	WA07-6244		E-7896L	WA07-5027	
E-5986L	WA07-5309		E-7896R	WA07-5026	
E-5986R	WA07-6076		E-7897L	WA07-5029	
E-5987L	WA07-6233		E-7897R	WA07-5028	
E-5987R	WA07-6232		E-7898L	WA07-6127	
E-5988L	WA07-5033		E-7898R	WA07-6126	
E-5988R	WA07-5032		E-801	WA04-5002	

# INTERCHANGE



## EUCLID® cont.

COMPETITOR #	WA#	NOTES	COMPETITOR #	WA#	NOTES
E-812	WA04-5023		E-8962	WA07-6102	
E-8579-20	WA01-5025		E-8968L	WA07-6071	
E-8579-24	WA01-5026		E-8968R	WA07-6070	
E-8579-26	WA01-5027		E-8969L	WA07-6067	
E-8579-28	WA01-5028		E-8969R	WA07-6066	
E-8579-32	WA01-5029		E-8971L	WA07-6308	
E-8579-36	WA01-5030		E-8971R	WA07-6198	
E-8579-42	WA01-5031		E-8972L	WA07-5180	
E-8579-48	WA01-5032		E-8972R	WA07-5179	
E-8580-18	WA01-5033		E-8979L	WA07-5166	
E-8580-24	WA01-5034		E-8979R	WA07-5165	
E-8580-26	WA01-5035		E-8980	WA07-5205	
E-8580-28	WA01-5036		E-8981	WA07-5204	
E-8580-30	WA01-5037		E-8982L	WA07-6069	
E-8580-32	WA01-5038		E-8982R	WA07-6068	
E-8580-36	WA01-5039		E-8984L	WA07-6195	
E-8580-42	WA01-5040		E-8984R	WA07-6194	
E-8580-48	WA01-5041		E-8985L	WA07-6111	
E-8582-18	WA01-5000		E-8985R	WA07-6110	
E-8582-20	WA01-5047		E-8986	WA07-6093	
E-8582-22	WA01-5001		E-8987	WA07-5114	
E-8582-24	WA01-5002		E-8988	WA07-6085	
E-8582-26	WA01-5003		E-8989	WA07-6087	
E-8582-28	WA01-5004		E-8994L	WA07-6212	
E-8582-30	WA01-5005		E-8994R	WA07-6211	
E-8582-32	WA01-5006		E-8995L	WA07-6241	
E-8582-36	WA01-5007		E-8995R	WA07-6240	
E-8582-40	WA01-5008		E-8996L	WA07-6237	
E-8582-44	WA01-5009		E-8996R	WA07-3236	
E-8582-48	WA01-5010		E-8997	WA07-6094	
E-8590	WA01-5012		E-9001L	WA07-6239	
E-8591	WA01-5013		E-9001R	WA07-6238	
E-8592	WA01-5014		E-9003L	WA07-6099	
E-8593	WA01-5015		E-9003R	WA07-6208	
E-8595	WA01-5016		E-9004L	WA07-6310	
E-8596	WA01-5017		E-9004R	WA07-6078	
E-8597	WA01-5018		E-9008L	WA07-6073	
E-8598	WA01-5019		E-9008R	WA07-6072	
E-8600	WA01-5022		E-9009	WA07-6089	
E-8601	WA01-5023		E-9010L	WA07-6193	
E-8602	WA01-5020		E-9010R	WA07-5116	
E-8603	WA01-5021		E-9020	WA07-5037	
E-8616	WA01-5024		E-9022R	WA07-5122	
E-8757	MW3298L		E-9022R	WA07-5122	
E-8758	MW3297R		E-9037	WA10-5017	
E-8918	WA03-5000		E-9063	WA10-5002	
E-8931	WA12-5023		E-9063	WA10-5025	
E-8946L	WA07-6229		E-9064	WAE9064	
E-8946R	WA07-6031		E-9079HD	WA08-5001	
E-8946R	WA07-6304		E-9107	WA11452	
E-8947L	WA07-6065		E-9108	WA11451	
E-8947R	WA07-6064		E-9109	WA11450	
E-8948L	WA07-6247		E-9110	WA09-5007	
E-8948R	WA07-6246		E-9131	RB-30PS	
E-8949L	WA07-5172		E-9133	WA07-6000	
E-8949R	WA07-5171		E-925	WA14-5015	
E-8957L	WA07-5304		E-926	WA14-5011	
E-8957R	WA07-6312		E-927	WA04-5021	
E-8961	WA07-6315		E-9325	WA04-5045	
			E-9326	WA04-5042	
			E-934	WA04-5022	



EUCLID® cont.

COMPETITOR #	WA#	NOTES	COMPETITOR #	WA#	NOTES
E-940HD	WAKN47011		E-9790A	WA08-5004	
E-9420	WA04-5047		E-9791	WA08-5016	
E-9421	WA04-5048		E-9792	WA04-5014	
E-9471	WA12-5028		E-UB3851-18	WA07-5008	
E-9524L	WA07-6313		E-UB5161-14	WA07-5013	
E-9524R	WA07-6106		E-UB5161-16	WA07-5014	
E-9525L	WA07-6314		E-UB5161-18	WA07-5015	
E-9525R	WA07-6108		E-UB5165-14	WA07-5016	
E-9526	WA07-6090		E-UB8145-076	WA07-5009	
E-957	WA07-5110		E-UB8151-18	WA07-5010	
E-9643	WA10-5019		E-UB8154-18	WA07-5011	
E-9644	WA08-5019		E-UB8287-11	WA07-5006	
E-975	WA14-5024		E-UB8479-090	WA07-5017	
E-9787/E-9788	WA07-5119		KIT4HD	WAKIT4HD	
E-9789	WA04-5009				

HEAVY DUTY AXLES, CLUTCHES, ELECTRICAL, DIFFERENTIAL & TRANSMISSION COMPONENTS, HYDRAULICS, SUSPENSION, BRAKES, VALVES & MORE!

# MIDWEST

TRUCK & AUTO PARTS INC.

**WORLD AMERICAN®**

[WWW.WORLDAMERICAN.COM](http://WWW.WORLDAMERICAN.COM)

Motive Gear

800.934.2727

# INTERCHANGE



## FORD®

COMPETITOR #	WA#	NOTES	COMPETITOR #	WA#	NOTES
863494	WA07-5194		B8QH-1119A	WA07-6045	
872325	WA07-6127		B8QH-1124A	WA07-5215	
872326	WA07-6129		B8QH-1142A	WA07-5082	
872331	WA07-6126		B8QH-1181A	WA07-5380	
876005	WA07-6042		BB-1120	WA07-5020	
876006	WA07-6300		BB-1121	WA07-5021	
1Q-1151A	WA07-6049		BB-1132	WA07-5024	
356085-S8B	WA07-5152		BB-1133	WA07-5025	
51-1107	WA07-5183		BB-1134	WA07-5022	
51-1108	WA07-5184		BB-1135	WA07-5023	
7EQ-1118	WA07-6032		BB-1142A	WA07-6022	
7EQ-1119	WA07-6033		BB-1142B	WA07-5077	
7EQ-1124	WA07-5091		BB-2208	WA07-5020	
7EQ-1124A	WA07-5091		C3T2-1118A	WA07-6219	
7EQ-1142	WA07-5078		C3TZ-1119A	WA07-6220	
7EQH-1118	WA07-5096		C3TZ-1120A	WA07-6149	
7EQH-1119	WA07-5097		C3TZ-4A106A	WA07-5081	
7EQH-1124	WA07-5217		C5TZ-1118C	WA07-5100	
81-T-1118	WA07-6038		C5TZ-1119C	WA07-5101	
81-T-1119	WA07-6039		C7TS-1043	WA15-5001	
8EB-1107	WA07-6120		CTZ-1119A	WA07-6220	
8EB-1108	WA07-6037		D7HZ-4245A	WA07-5382	
8EB-1195	WA07-5403		D7HZ-4255A	WA07-5383	
8EB-3293	WA07-5404		E6HZ1120A	WA07-5037	
8QH-1181	WA07-5375		EQH-1124	WA07-5217	
B-34331X	WA07-5197		F-81-T-1118	WA07-5370	
B-34332X	WA07-5198		F-81-T-1119	WA07-5371	
B-4919X	WA07-5024		SC-352849	WA15-5000	
B-4920X	WA07-5025		TDAA-1118A	WA07-5163	
B-4921X	WA07-6039		TDAA-1119A	WA07-5164	
B-4922X	WA07-6038		TUAA-1118A	WA07-5193	
B4T-1124A	WA07-5393		TUAA-1119A	WA07-5194	
B-6320X	WA07-5191		TUAA-1124A	WA07-5378	
B-6321X	WA07-5192		TUAA-4252A	WA07-5379	
B7TZ-1151A	WA07-6182		TVAA-1181A	WA07-5377	
B8QH-1118A	WA07-6044				

## FREIGHTLINER®

COMPETITOR #	WA#	NOTES	COMPETITOR #	WA#	NOTES
11-9714-11	WA07-6165		11-9714-2	WA07-6163	
11-9714-12	WA07-6164		11-9714-3	WA07-6162	

**FOR ALL YOUR WHEEL ATTACHING NEEDS, CALL:**

**800.934.2727**



# INTERCHANGE

## FRUEHAUF®

COMPETITOR #	WA#	NOTES	COMPETITOR #	WA#	NOTES
202786	WA07-6045		535414	WA15-5002	
298484	WA07-6035		535588	WA15-5000	
298485	WA07-6034		535798	WA07-5018	
334816	WA07-5026		535799	WA07-5004	
334817	WA07-5027		535860	WA07-5150	
502787	WA07-6044		535861	WA07-5152	
507321	WA07-6049		535884	WA15-5000	
508865	WA07-5195		535885	WA07-5018	
509360	WA07-5196		535886	WA07-5004	
534764	WA07-5022		535920	WA07-5197	
534765	WA07-5023		535921	WA07-5198	
534766	WA07-5024		536365	WA07-5184	
534767	WA07-5025		536366	WA07-5183	
534768	WA07-5020		582884	WA07-6046	
534769	WA07-5021		582886	WA07-5102	
534770	WA07-6038		582887	WA07-5103	
534771	WA07-6039		901480	WA07-6049	
534772	WA07-5193		ACA-8587	WA07-5025	
534773	WA07-5194		ACA-8587-1	WA07-5024	
534780	WA07-5189		ACA-8588	WA07-5023	
534781	WA07-5190		ACA-8588-1	WA07-5022	
534782	WA07-5191		ACE-8510-1	WA07-5094	
534783	WA07-5192		AXA-0408-1	WA07-5095	
534784	WA07-6048		AXA-0410-1	WA07-5094	
534907	WA15-5004				

## GREAT DANE®

COMPETITOR #	WA#	NOTES	COMPETITOR #	WA#	NOTES
158	WA14-5020	SUSPENSION CATALOG	BWPM-3057	WA11602	SUSPENSION CATALOG
10450	WA11450	SUSPENSION CATALOG	BWPM-317	WA01-5024	SUSPENSION CATALOG
10708	WA07-5024		BWPM-3170L	WA05-5019	SUSPENSION CATALOG
10709	WA07-5025		BWPM-3170R	WA05-5018	SUSPENSION CATALOG
37891	WA07-5022		BWPM-3171L	WA05-5069	SUSPENSION CATALOG
37892	WA07-5023		BWPM-3171R	WA05-5068	SUSPENSION CATALOG
44185	WA14-5015	SUSPENSION CATALOG	BWPM-3172L	WA05-5021	SUSPENSION CATALOG
44609	WA14-5019	SUSPENSION CATALOG	BWPM-3172R	WA05-5020	SUSPENSION CATALOG
45436	WA12105	AIR VALVE CATALOG	BWPM-39	WA07-5004	
56955	WA01-5045	SUSPENSION CATALOG	BWPM-434	WAKN47001	SUSPENSION CATALOG
1008306	WAE5139	SUSPENSION CATALOG	BWPM-45	WA07-5018	
01-099-010	WA11549	SUSPENSION CATALOG	BWPM-474	WAKN44041	SUSPENSION CATALOG
34020HC	WA11548	SUSPENSION CATALOG	BWPM-548	WA10-5023	SUSPENSION CATALOG
41516MEPH	WA14-5014	SUSPENSION CATALOG	BWPM-579	WA07-5001	SUSPENSION CATALOG
ABA-15-42-57	WA14-5007	SUSPENSION CATALOG	BWPM-582	WA04-5013	SUSPENSION CATALOG
BND229859	WA229859	AIR VALVE CATALOG	BWPM-583	WA07-5128	SUSPENSION CATALOG
BND281865	WA281865	AIR VALVE CATALOG	BWPM-587-A	WA09-5002	SUSPENSION CATALOG
BWPM-1045	WA07-5134	SUSPENSION CATALOG	BWPM-638	WAKN44051	SUSPENSION CATALOG
BWPM-1046	WA07-5003	SUSPENSION CATALOG	BWPM-682	WA07-5090	
BWPM-1049	WA04-5008	SUSPENSION CATALOG	BWPM-684	WA07-5092	
BWPM-1050	WA07-5094		BWPM-748	WA07-5108	SUSPENSION CATALOG
BWPM-1051	WA07-5095		BWPM-80	WA07-5100	
BWPM-1058	WA04-5017	SUSPENSION CATALOG	BWPM-81	WA07-5101	
BWPM-1401	WA09-5004	SUSPENSION CATALOG	BWPM-824	WA09-5000	SUSPENSION CATALOG
BWPM-1422	WA07-5051	SUSPENSION CATALOG	BWPMK-103	WA08-5004	SUSPENSION CATALOG
BWPM-1423	WA10-5009	SUSPENSION CATALOG	BWPMK-61	WA08-5006	SUSPENSION CATALOG
BWPM-1424	WA10-5015	SUSPENSION CATALOG	BWPMK-88	WA08-5001	SUSPENSION CATALOG
BWPM-1521	WA07-5019	SUSPENSION CATALOG	DANM16WKL25-236	WA05-5017	SUSPENSION CATALOG
BWPM-1523	WA07-5002	SUSPENSION CATALOG	DANM16WKR25-236	WA05-5016	SUSPENSION CATALOG
BWPM-1909	WA13-1909		FIR5410	WA01-5410	SUSPENSION CATALOG
BWPM-1927	WA13-1927		FIR6897	WA01-6897	SUSPENSION CATALOG
BWPM-2204	WA07-5046	SUSPENSION CATALOG	FIR6902	WA01-6902	SUSPENSION CATALOG
BWPM-2594	WA07-5120	SUSPENSION CATALOG	FIR6905	WA01-6905	SUSPENSION CATALOG
BWPM-3055	WA11600	SUSPENSION CATALOG	FIR7135	WA01-7135	SUSPENSION CATALOG

CONTINUED>>>

# INTERCHANGE



## GREAT DANE® cont.

COMPETITOR #	WA#	NOTES	COMPETITOR #	WA#	NOTES
FIR7136	WA01-7136	SUSPENSION CATALOG	GD16	WA08-5007	SUSPENSION CATALOG
FIR7400	WA01-7400	SUSPENSION CATALOG	GD20	WA08-5005	SUSPENSION CATALOG
FIR7403	WA01-7403	SUSPENSION CATALOG	GD-21	WA14-0021	SUSPENSION CATALOG
FIR7410	WA01-7410	SUSPENSION CATALOG	GD3/8X24	WA01-5026	SUSPENSION CATALOG
FIR7424	WA01-7424	SUSPENSION CATALOG	GD3/8X36	WA01-5030	SUSPENSION CATALOG
FIR7446	WA01-7446	SUSPENSION CATALOG	GD3/8X42	WA01-5031	SUSPENSION CATALOG
FIR7555	WA01-7555	SUSPENSION CATALOG	GD3/8X48	WA01-5032	SUSPENSION CATALOG
FIR7795	WA01-7795	SUSPENSION CATALOG	GD-31	WA14-0031	SUSPENSION CATALOG
FIR8050	WA01-8050	SUSPENSION CATALOG	GD39	WA2769SHD	SUSPENSION CATALOG
FIR8091	WA01-8091	SUSPENSION CATALOG	GD-41	WA14-0041	SUSPENSION CATALOG
FIR8204	WA01-8204	SUSPENSION CATALOG	GD42	WA1887ASHD	SUSPENSION CATALOG
FIR8708	WA01-8708	SUSPENSION CATALOG	GD55924	WA01-5043	SUSPENSION CATALOG
FIR8709	WA01-8709	SUSPENSION CATALOG	GD562L	WA05-5001	SUSPENSION CATALOG
FIR8713	WA01-8713	SUSPENSION CATALOG	GD562R	WA05-5000	SUSPENSION CATALOG
FIR8729	WA01-8729	SUSPENSION CATALOG	GD563L	WA05-5003	SUSPENSION CATALOG
FIR8829	WA01-8829	SUSPENSION CATALOG	GD563R	WA05-5002	SUSPENSION CATALOG
FIR8852	WA01-8852	SUSPENSION CATALOG	GD566L	WA05-5005	SUSPENSION CATALOG
FIR8944	WA01-8944	SUSPENSION CATALOG	GD566R	WA05-5004	SUSPENSION CATALOG
FIR9026	WA01-9026	SUSPENSION CATALOG	GD56878	WA14-5006	SUSPENSION CATALOG
FIR9039	WA01-9039	SUSPENSION CATALOG	GD56917	WA01-5042	SUSPENSION CATALOG
FIR9069	WA01-9069	SUSPENSION CATALOG	GD761525-15	WA451036N	SUSPENSION CATALOG
FIR9082	WA01-9082	SUSPENSION CATALOG	GD770	WA15-5051	SUSPENSION CATALOG
FIR9101	WA01-9101	SUSPENSION CATALOG	GD990L	WA05-5009	SUSPENSION CATALOG
FIR9105	WA01-9105	SUSPENSION CATALOG	GD990R	WA05-5008	SUSPENSION CATALOG
FIR9121	WA01-9121	SUSPENSION CATALOG	GD991L	WA05-5011	SUSPENSION CATALOG
FIR9122	WA01-9122	SUSPENSION CATALOG	GD991R	WA05-5010	SUSPENSION CATALOG
FIR9192	WA01-9192	SUSPENSION CATALOG	GD992L	WA05-5013	SUSPENSION CATALOG
FIR9213	WA01-9213	SUSPENSION CATALOG	GD992R	WA05-5012	SUSPENSION CATALOG
FIR9219	WA01-9219	SUSPENSION CATALOG	GUNAS1038	WA65174	SUSPENSION CATALOG
FIR9265	WA01-9265	SUSPENSION CATALOG	HAL11543	WA11543	SUSPENSION CATALOG
FIR9270	WA01-9270	SUSPENSION CATALOG	HAL11544	WA11544	SUSPENSION CATALOG
FIR9287	WA01-9287	SUSPENSION CATALOG	HAL11600	WA11600	SUSPENSION CATALOG
FIR9293	WA01-9293	SUSPENSION CATALOG	HAL11601	WA11601	SUSPENSION CATALOG
FIR9295	WA01-9265	SUSPENSION CATALOG	HAL11603	WA11603	SUSPENSION CATALOG
FIR9296	WA01-9296	SUSPENSION CATALOG	HAL40010142	WA10142	SUSPENSION CATALOG
FIR9297	WA01-9297	SUSPENSION CATALOG	HAL40010143	WA10143	SUSPENSION CATALOG
FIR9321	WA01-9321	SUSPENSION CATALOG	HAL40010211	WA10211	SUSPENSION CATALOG
FIR9366	WA01-9366	SUSPENSION CATALOG	HAL40010212	WA10212	SUSPENSION CATALOG
FIR9370	WA01-9370	SUSPENSION CATALOG	HAL90054007	WA90054007	SUSPENSION CATALOG
FIR9371	WA01-9371	SUSPENSION CATALOG	HALBE22040	WA22040	ELECTRICAL CATALOG
FIR9373	WA01-9373	SUSPENSION CATALOG	HALKN26000	WAKN26000	AIR VALVE CATALOG
FIR9375	WA01-9375	SUSPENSION CATALOG	HALKN28500	WAKN28500	AIR VALVE CATALOG
FIR9394	WA01-9394	SUSPENSION CATALOG	HALKN28510	WAKN28510	AIR VALVE CATALOG
FIR9422	WA01-9422	SUSPENSION CATALOG	HALKN28550	WAKN28550	AIR VALVE CATALOG
FIR9466	WA01-9466	SUSPENSION CATALOG	HALKN28600	WAKN28600	AIR VALVE CATALOG
FIR9580	WA01-9580	SUSPENSION CATALOG	HALKN28601	WAKN28601	AIR VALVE CATALOG
FIR9616	WA01-9616	SUSPENSION CATALOG	HALKN30400	WAKN30400	AIR VALVE CATALOG
FIR9622	WA01-9622	SUSPENSION CATALOG	HALKN32005	WAKN32005	AIR VALVE CATALOG
FIR9625	WA01-9625	SUSPENSION CATALOG	HENS-20010	WA01-9270	SUSPENSION CATALOG
FIR9640	WA01-9640	SUSPENSION CATALOG	HENS-20124	WA01-9265	SUSPENSION CATALOG
FIR9648	WA01-9648	SUSPENSION CATALOG	HENS-20127	WA01-9580	SUSPENSION CATALOG
FIR9780	WA01-9780	SUSPENSION CATALOG	HENS-20217	WA01-8944	SUSPENSION CATALOG
FIR9921	WA01-9921	SUSPENSION CATALOG	HENS-20223	WA01-9640	SUSPENSION CATALOG
FIR9935	WA01-9935	SUSPENSION CATALOG	HENS-21800	WA01-8709	SUSPENSION CATALOG
GD0070-02	WA14-5017	SUSPENSION CATALOG	HENS-21966	WA01-8708	SUSPENSION CATALOG
GD1/2X18	WA01-5000	SUSPENSION CATALOG	HENS-22045	WA01-8755	SUSPENSION CATALOG
GD1/2X24	WA01-5002	SUSPENSION CATALOG	HENS-22948	WA01-8713	SUSPENSION CATALOG
GD1/2X28	WA01-5004	SUSPENSION CATALOG	HENS-23974	WA08-5010	SUSPENSION CATALOG
GD1/2X30	WA01-5005	SUSPENSION CATALOG	HENS-23974	WA08-5010	SUSPENSION CATALOG
GD1/2X36	WA01-5007	SUSPENSION CATALOG	HENS-24636-1L	WA05-5031	SUSPENSION CATALOG
GD1/2X40	WA01-5008	SUSPENSION CATALOG	HENS-24636-1R	WA05-5030	SUSPENSION CATALOG
GD1/2X48	WA01-5010	SUSPENSION CATALOG	HENS-2630	WA01-6902	SUSPENSION CATALOG
GD10	WA1887ASHD	SUSPENSION CATALOG	HENS-28890	WA08-5011	SUSPENSION CATALOG
GD-15	WA14-0015	SUSPENSION CATALOG	HENS-6914	WA04-5063	SUSPENSION CATALOG



**GREAT DANE® cont.**

COMPETITOR #	WA#	NOTES	COMPETITOR #	WA#	NOTES
HUT7010-00	WA04-5056	SUSPENSION CATALOG	PNS04-40-56-72	WA14-5008	SUSPENSION CATALOG
HUT710-00	WA12-5020	SUSPENSION CATALOG	PNS05-310	WA14-5016	SUSPENSION CATALOG
HUT715-00	WA12-5016	SUSPENSION CATALOG	PNS06-345	WA14-5018	SUSPENSION CATALOG
HUT722-00	WA04-5022	SUSPENSION CATALOG	RBPRB-D-09	WAKN18090	SUSPENSION CATALOG
HUT750-03	WA12-5017	SUSPENSION CATALOG	RBPRB-D-12	WAKN18120	SUSPENSION CATALOG
HUT7620-00	WA04-5021	SUSPENSION CATALOG	RBPRB-D-16	WAKN18160	SUSPENSION CATALOG
HUT7702-01	WA12-5040	SUSPENSION CATALOG	RBPRB-D-20	WAKN18200	SUSPENSION CATALOG
HUT7702-02	WA12-5030	SUSPENSION CATALOG	RBPRB-D-24	WAKN18240	SUSPENSION CATALOG
KP-T-809-F	WA15-5050	SUSPENSION CATALOG	RBPRB-D-30	WAKN18300	SUSPENSION CATALOG
MER2210-Q-8155	WA05-5008	SUSPENSION CATALOG	REY20018-01	WA01-7555	SUSPENSION CATALOG
MER2210-R-8156	WA05-5009	SUSPENSION CATALOG	SEA110170	WA110170	AIR VALVE CATALOG
PHL12-006	WA11452	SUSPENSION CATALOG	SEA110171	WA110171	AIR VALVE CATALOG
PHL12-008	WA11451	SUSPENSION CATALOG	SEA110191	WA110191	AIR VALVE CATALOG
PHL15-400	WA15-400	ELECTRICAL CATALOG	SEA110197	WA110197	AIR VALVE CATALOG
PHL15-430	WA15-430	ELECTRICAL CATALOG	SEA110200	WA110200	AIR VALVE CATALOG
PHL15-720	WA15-720	ELECTRICAL CATALOG	SEA110380	WA110380	AIR VALVE CATALOG
PHL15-730	WA15-730	ELECTRICAL CATALOG	SEA110415	WA110415	AIR VALVE CATALOG
PHL30-4621	WA30-4621	ELECTRICAL CATALOG	SEA110500	WA110500	AIR VALVE CATALOG
PNS03-215-H	WA14-5013	SUSPENSION CATALOG	SEA110570	WA110370	AIR VALVE CATALOG
PNS03-215-V	WA14-5011	SUSPENSION CATALOG	SEA3100	WA9054107	AIR VALVE CATALOG
PNS03-221-V	WA14-5012	SUSPENSION CATALOG			

**GMC®**

COMPETITOR #	WA#	NOTES	COMPETITOR #	WA#	NOTES
072272	WA07-6049		279673	WA07-5025	
2018596	WA15-5029		3651372	WA07-6019	
2019459	WA07-5510		3682153	WA07-6207	
2022806	WA07-6044		3682387	WA07-6205	
2022807	WA07-6045		3682389	WA07-6206	
2024990	WA07-6118		3694508	WA07-6123	
2066639	WA07-5004		3697043	WA07-5160	
2066640	WA07-5018		3697734	WA07-6130	
2162150	WA07-5150		3705442	WA07-6124	
2201406	WA07-5024		3705785	WA07-6209	
2201407	WA07-5025		3723955	WA07-5163	
2202032	WA07-5020		3723956	WA07-5164	
2202033	WA07-5021		3723967	WA07-5099	
2216914	WA07-5206		3723968	WA07-5098	
2221295	WA07-5396		3724246	WA07-6124	
2227935	WA07-5382		3726212	WA07-6132	
2231319	WA07-5082		3729737	WA07-5021	
2242631	WA07-5217		3729738	WA07-5020	
2266639	WA07-5004		3735550	WA07-5022	
2266640	WA07-5018		3735579	WA07-5023	
234132	WA07-5189		3752789	WA07-5025	
234133	WA07-5190		3752790	WA07-5024	
2392367	WA15-5002		3763619	WA07-5161	
2398446	WA15-5004		3765876	WA07-5162	
2405564	WA07-5164		5667139	WA15-5000	
2405565	WA07-5163		5767140	WA15-5001	
2408341	WA07-5090		659535	WA07-5152	
244626	WA07-5193		688152	WA07-5192	
244627	WA07-5194		688153	WA07-5191	
279670	WA07-5022		702091	WA07-5176	
279671	WA07-5023		702092	WA07-5175	
279672	WA07-5024				

# INTERCHANGE



## GOODYEAR®

COMPETITOR #	WA#	NOTES	COMPETITOR #	WA#	NOTES
CL-1008	WA15-5016		ST-178	WA07-6225	
CL-1022	WA15-5018		ST-570	WA07-6227	
GY-562	WA15-5017		ST-770	WA07-6226	

## GUNITE®

COMPETITOR #	WA#	NOTES	COMPETITOR #	WA#	NOTES
74710	WA07-5018		W-1327	WA07-6087	
W-1053L	WA07-6067		W-823	WA07-5040	
W-1053R	WA07-6066		W-845	WA07-6008	
W-1064L	WA07-6101		W-846	WA15-5014	
W-1064R	WA07-6100		W-980L	WA07-6071	
W-1091L	WA07-6311		W-980R	WA07-6070	
W-1133L	WA07-5166		W-981R	WA07-6066	
W-1133R	WA07-5165		W-988-L	WA07-5180	
W-1133R	WA07-5165		W-988-R	WA07-5179	
W-1138	WA15-5014		W-992L	WA07-5166	
W-1160	WA07-5205		W-992R	WA07-5165	
W-1164	WA07-5204		WP-147	WA07-5004	
W-1166L	WA07-6069		WP-185	WA07-6006	
W-1166R	WA07-6068		WP-2	WA07-5152	
W-1203L	WA07-6111		WP-202	WA07-5005	
W-1203R	WA07-6110		WP-368	WA15-5027	
W-1205	WA07-6093		WP-383	WA15-5028	
W-1211	WA07-5114		WP-398	WA15-5011	
W-1246	WA07-6085		WP-722	WA15-5003	

## HINO®

COMPETITOR #	WA#	NOTES	COMPETITOR #	WA#	NOTES
9004-21112	WA07-5156		9004-23101	WA07-5154	
9004-22104	WA07-5157		9004-24101	WA07-5155	

## IZUZU®

COMPETITOR #	WA#	NOTES	COMPETITOR #	WA#	NOTES
1-42333-023-OL	WA07-5157		1-42335-005-OL	WA07-5155	
1-42333-023-OR	WA07-5156		1-42335-005-OR	WA07-5154	

## KELSEY®

COMPETITOR #	WA#	NOTES	COMPETITOR #	WA#	NOTES
13974	WA07-5028		36162	WA07-5024	
20048	WA07-5183		36163	WA07-5025	
20049	WA07-5184		36707	WA07-5163	
20441	WA07-5029		36708	WA07-5164	
25264	WA07-5020		38605	WA07-6209	
25265	WA07-5021		40338	WA07-5370	
30020	WA07-6205		40339	WA07-5371	
30021	WA07-6206		43935	WA07-6132	
30719	WA07-6118		43939	WA07-5160	
31104	WA07-6207		46009	WA07-5161	
34271	WA07-5022		46010	WA07-5162	
34272	WA07-5023		49748	WA07-6149	
34460	WA07-6123				





**KENWORTH®**

COMPETITOR #	WA#	NOTES	COMPETITOR #	WA#	NOTES
12452-001L	WA07-5178		233-2871L	WA07-5105	
12452-001R	WA07-5177		233-2871R	WA07-5104	

**MACK®**

COMPETITOR #	WA#	NOTES	COMPETITOR #	WA#	NOTES
15QJ17P1	WA15-5009		18-AX-405	WA07-6051	
15QJ223BP3	WA15-5015		18-AX-970	WA07-6178	
15QJ223BP4	WA07-6224		18-AX-971	WA07-6181	
15QJ223BP6	WA15-5010		21-AX-626	WA07-5387	
15QJ223BP8	WA15-5013		23-QJ-125	WA07-5388	
15QJ223CP3	WA15-5015		23QJ201	WA07-5385	
15QJ223CP4	WA07-6224		25-QJ-138	WA07-5389	
15QJ223CP6	WA15-5010		25QJ35	WA07-5213	
15QJ223CP8	WA15-5013		25QJ36	WA07-5384	

**MERITOR®**

COMPETITOR #	WA#	NOTES	COMPETITOR #	WA#	NOTES
1227-A-547	WA07-5401		20X1811	WA07-6099	
1227B106	WA07-5402		20X1812	WA07-6208	
1227-B-756	WA07-5092		20X1977	WA07-6167	
1227-C-549	WA07-5090		20X1978	WA07-6166	
1227-D-446	WA07-5392		20X1979	WA07-6310	
1227-E-1045	WA07-5398		20X1980	WA07-6078	
1227-H-346	WA07-5413		20X206	WA07-6120	
1227-P-328	WA07-5399		20X207	WA07-6037	
1227-R-330	WA07-5384		20X208	WA07-6032	
1227-T-288	WA07-5395		20X209	WA07-6033	
1227-U-515	WA07-5394		20X210	WA07-6034	
1227-V-1660	WA07-5091		20X211	WA07-6035	
1227-W-517	WA07-5386		20X344	WA07-5173	
1227-Z-1040	WA07-5383		20X371	WA07-6145	
1229-C-1459	WA07-5393		20X372	WA07-6144	
1229-G-1021	WA07-5396		20X402	WA07-6170	
1229-R-1058	WA07-5414		20X403	WA07-6171	
1229-V-1009	WA07-5385		20X404	WA07-6138	
1229-V-1660	WA07-5091		20X405	WA07-6139	
1229-V-48	WA07-5400		20X586	WA07-6244	
20X1334	WA07-6167		20X587	WA07-6245	
20X1335	WA07-6166		20X852	WA07-6234	
20X1356	WA07-6238		20X853	WA07-6235	
20X1357	WA07-6239		4X1027	WA07-5209	
20X1463	WA07-6167		4X1207	WA07-6186	
20X1464	WA07-6166		A-1227-T-540	WA07-5397	
20X1475	WA07-6243		A-1227-V-516	WA07-5414	
20X1476	WA07-6242		SC-718	WA07-6180	
20X1575	WA07-5099		SC-819	WA07-6182	
20X1576	WA07-5098				

VISIT US AT:

**WWW.WORLDAMERICAN.COM**

# INTERCHANGE



## MOTORWHEEL®

COMPETITOR #	WA#	NOTES	COMPETITOR #	WA#	NOTES
82017	WA07-6211		86798	WA07-6233	
82018	WA07-6212		88108	WA07-6076	
84155	WA07-6213		88799	WA07-6192	
84156	WA07-6305		88808	WA07-6190	
84986	WA07-6215		89291	WA07-3236	
84987	WA07-6306		89292	WA07-6237	
85521	WA07-5206		89620	WA07-6094	
86797	WA07-6232				

## NAVISTAR®

COMPETITOR #	WA#	NOTES	COMPETITOR #	WA#	NOTES
41419	WA07-5024		472008-R1	WA07-6233	
41420	WA07-5025		48796-H	WA07-6044	
101729-H1	WA07-5189		48797-H	WA07-6045	
101731-H1	WA07-5024		50993-R11	WA07-5380	
101732-H1	WA07-5025		54491-R1	WA07-5018	
102906-H1	WA07-6038		54493-R2	WA15-5000	
102907-H1	WA07-6039		54494-R1	WA07-5004	
110730-H1	WA07-5190		54700-R1	WA07-5082	
121364-H1	WA07-5163		55539-H	WA07-5182	
121365-H1	WA07-5164		55540-H	WA07-5181	
129300-R1	WA07-6003		55575-H	WA07-5191	
129301-R1	WA07-6002		55576-H	WA07-5192	
129302-R1	WA07-5031		55585-H	WA07-6186	
129303-R1	WA07-5030		59684-H	WA07-5198	
1610751-C1	WA07-5036		59790-R1	WA07-5188	
17903-HA	WA07-5379		59791-R1	WA07-5187	
184197-R1	WA07-5097		59863-H	WA07-5197	
184198-R1	WA07-5096		60421-R1	WA07-5209	
189444-R1	WA07-5150		60793-R2	WA07-6182	
189445-R1	WA07-5152		67675-R12	WA07-5375	
195759-R1	WA07-6049		67678-R1	WA07-5382	
212254-R1	WA07-6033		68333-H	WA07-6200	
212255-R1	WA07-6032		69327-R2	WA07-5184	
22422-V	WA07-5189		69328-R2	WA07-5183	
22423-V	WA07-5190		698166-R1	WA07-6127	
224957-R1	WA07-6145		698167-R1	WA07-6128	
224958-R1	WA07-6144		698168-R1	WA07-6129	
253874-C1	WA15-5006		698794-R1	WA07-5191	
260578-C1	WA07-5150		698795-R1	WA07-5192	
292963-C1	WA07-5180		698796-R1	WA07-6048	
292964-C1	WA07-5179		698797-R1	WA07-6317	
304481-R1	WA07-5150		6998165-R1	WA07-6126	
332528-C1	WA07-6155		72169-R1	WA07-6180	
332529-C1	WA07-6154		74342-R1	WA07-5080	
351138-C1	WA07-6235		773433-C1	WA07-6168	
351139-C1	WA07-6234		773434-C1	WA07-6169	
40377-V	WA07-5081		791042-C1	WA07-5176	
41419-V	WA07-5024		791043-C1	WA07-5175	
41420-V	WA07-5025		83155-H	WA07-5022	
425282-R1	WA07-5301		83156-H	WA07-5023	
425283-R1	WA07-5300		84711-H	WA07-5020	
437858-C1	WA07-5122		84712-H	WA07-5021	
443660-C1	WA07-6139		870813-R1	WA07-5090	
443661-C1	WA07-6138		878210-R1	WA07-5163	
446217-R1	WA15-5002		878211-R1	WA07-5164	
44668-H	WA07-6044		89764-R1	WA07-6037	
44669-H	WA07-6045		89765-R1	WA07-6120	
447556-R1	WA07-6147		898375-R1	WA07-5028	
469609-C7	WA07-6168		898376-R1	WA07-5029	
469610-C7	WA07-6169		91872-H	WA07-5150	
472007-R1	WA07-6232		92134-H	WA15-5004	



**NAVISTAR® cont.**

COMPETITOR #	WA#	NOTES	COMPETITOR #	WA#	NOTES
92135-H	WA15-5025		983878-R1	WA07-5097	
94819-R1	WA07-6135		983879-R1	WA07-5096	
973226-R1	WA07-5150		98726-R1	WA07-6139	
973230-R1	WA15-5026		98727-R1	WA07-6138	
974272-R1	WA07-5077		988339-R1	WA15-5006	
974745-R1	WA07-5158		98839-R1	WA15-5006	
974746-R1	WA07-5159				

**NWRA®**

COMPETITOR #	WA#	NOTES	COMPETITOR #	WA#	NOTES
W-100	WA15-5026		X-1407	WA07-5028	
W-101	WA15-5005		X-1408	WA07-5029	
W-103	WA15-5006		X-1411	WA07-6126	
W-104	WA15-5007		X-1412	WA07-6127	
W-113	WA15-5009		X-1416	WA07-6128	
W-228	WA15-5027		X-1417	WA07-6129	
W-90	WA15-5004		X-1420	WA07-5300	
W-93	WA15-5025		X-1421	WA07-5301	
W-96	WA15-5000		X-1801	WA07-5030	
W-97	WA15-5002		X-1802	WA07-5031	
W-98	WA15-5001		X-1803	WA07-5020	
W-99	WA15-5008		X-1804	WA07-5021	
X-1064	WA07-6133		X-1807	WA07-6002	
X-1065	WA07-6218		X-1808	WA07-6003	
X-1092	WA07-6216		X-1828	WA07-5024	
X-1196	WA07-6222		X-1829	WA07-5025	
X-1198	WA07-6151		X-1835	WA07-5026	
X-1242	WA07-6130		X-1836	WA07-5027	
X-1362	WA07-5159		X-1873	WA07-5032	
X-1363	WA07-5158		X-1874	WA07-5033	

**OTC®**

COMPETITOR #	WA#	NOTES	COMPETITOR #	WA#	NOTES
1901	WA13-1901		1913	WA13-1913	
1902	WA13-1902		1914	WA13-1914	
1903	WA13-1903		1915	WA13-1915	
1904	WA13-1904		1916	WA13-1916	
1905	WA13-1905		1917	WA13-1917	
1906	WA13-1906		1918	WA13-1918	
1907	WA13-1907		1919	WA13-1919	
1908	WA13-1908		1920	WA13-1920	
1909	WA13-1909		1921	WA13-1921	
1910	WA13-1910		1922	WA13-1922	
1911	WA13-1911		1927	WA13-1927	
1912	WA13-1912				

**PACCAR®**

COMPETITOR #	WA#	NOTES	COMPETITOR #	WA#	NOTES
PAC-1	WA07-5104		PAC-5R	WA07-6144	
PAC-2	WA07-5105		PAC-5L	WA07-6145	
PAC-3	WA07-5175		PAC-15R	WA07-5106	
PAC-4	WA07-5176		PAC-15L	WA07-5107	

# INTERCHANGE



## PETERBILT®

COMPETITOR #	WA#	NOTES	COMPETITOR #	WA#	NOTES
02-00771	WA07-5107		03-02208	WA07-5105	
02-00772	WA07-5106		03-02852	WA07-5177	
03-02207	WA07-5104		03-02853	WA07-5178	

## SIRCO®

COMPETITOR #	WA#	NOTES	COMPETITOR #	WA#	NOTES
123	WA15-5000		482	WA07-5175	
124	WA07-6044		654	WA07-5150	
125	WA07-6045		676	WA07-6087	
133	WA07-5165		700	WA15-5050	
134	WA07-5166		702	WA15-5051	
138	WA15-5014		708	WA15-5006	
149	WA07-5152		715	WA07-5004	
160	WA07-5039		716	WA07-5018	
162	WA07-5038		722	WA15-5003	
164	WA07-5374		804	WA07-6010	
183	WA07-5102		805	WA07-6012	
184	WA07-5103		851	WA07-5100	
191	WA07-5163		852	WA07-5101	
192	WA07-5164		882	WA07-6190	
205	WA07-6167		884	WA07-6192	
233	WA15-5015		920	WA07-5037	
235	WA15-5002		947	WA07-6065	
236	WA15-5010		948	WA07-6064	
238	WA15-5013		968	WA07-5098	
257	WA15-5009		969	WA07-5099	
263	WA07-5096		988	WA07-5191	
264	WA07-5097		989	WA07-5192	
271	WA07-5197		990	WA07-5193	
272	WA07-5198		991	WA07-5194	
334	WA07-6188		993	WA15-5001	
335	WA07-5200		1904	WA13-1904	
336	WA07-5201		1904	WA13-1904	
373	WA07-6152		1908	WA13-1908	
374	WA07-6153		1909	WA13-1909	
375	WA07-6142		1910	WA13-1910	
376	WA07-6143		1912	WA13-1912	
411	WA07-5005		1913	WA13-1913	
412	WA07-5173		1914	WA13-1914	
413	WA07-5141		1915	WA13-1915	
414	WA07-6232		1917	WA13-1917	
415	WA07-6233		1919	WA13-1919	
416	WA07-6074		1920	WA13-1920	
417	WA07-6075		1921	WA13-1921	
418	WA07-6070		1922	WA13-1922	
419	WA07-6071		1927	WA13-1927	
420	WA07-6066		2296	WA07-5402	
421	WA07-6067		2297	WA07-5404	
422	WA07-5205		2298	WA07-5403	
423	WA07-5204		2299	WA07-5405	
424	WA07-6068		2303	WA07-5386	
425	WA07-6069		2304	WA07-5385	
428	WA07-6072		2305	WA07-5384	
429	WA07-6073		5000	WA13-1940	
430	WA07-5121		5200	WA07-5092	
431	WA07-6193		5210	WA07-5090	
432	WA07-5167		5300	WA07-5091	
433	WA07-5353		5401	WA07-5094	
436	WA07-6083		5402	WA07-5095	
437	WA07-5202		5403	WA07-5041	
481	WA07-5176		5660	WA07-5093	



## SIRCO® cont.

COMPETITOR #	WA#	NOTES	COMPETITOR #	WA#	NOTES
9013	WA340-4975		AS8050	WA01-8050C	SUSPENSION CATALOG
9014	WA14-5001		AS8709	WA01-8709	SUSPENSION CATALOG
9015	WA359-5990		AS8709	WA01-8709C	SUSPENSION CATALOG
004	WA07-5195		AS9069	WA01-9069	SUSPENSION CATALOG
005	WA07-5196		AS9069	WA01-9069C	SUSPENSION CATALOG
008	WA15-5016		AS9082	WA01-9082	SUSPENSION CATALOG
011	WA07-6165		AS9082	WA01-9082C	SUSPENSION CATALOG
012	WA07-6164		AS9265	WA01-9265	SUSPENSION CATALOG
053	WA15-5007		AS9265	WA01-9265C	SUSPENSION CATALOG
066	WA07-6140		AS9270	WA01-9270	SUSPENSION CATALOG
067	WA07-6141		AS9270	WA01-9270C	SUSPENSION CATALOG
073	WA07-5040		AS9422	WA01-9422	SUSPENSION CATALOG
095	WA07-5189		AS9422	WA01-9422C	SUSPENSION CATALOG
096	WA07-5190		AS9580	WA01-9580	SUSPENSION CATALOG
097	WA07-5169		AS9580	WA01-9580C	SUSPENSION CATALOG
098	WA07-5355		AS9648	WA01-9648	SUSPENSION CATALOG
204	WA07-6166		AS9648	WA01-9648C	SUSPENSION CATALOG
287L	WA07-5105		AS9780	WA01-9780	SUSPENSION CATALOG
287R	WA07-5104		AS9780	WA01-9780C	SUSPENSION CATALOG
304L	WA07-5157		AS9781	WA01-9781	SUSPENSION CATALOG
304R	WA07-5156		AS9781	WA01-9781C	SUSPENSION CATALOG
306L	WA07-5155		B052	WA07-5044	SUSPENSION CATALOG
306R	WA07-5154		B120	WA07-5051	SUSPENSION CATALOG
333B	WA07-5035		B151	WA10-5018	SUSPENSION CATALOG
5R783123	WA07-5012		B152	WA07-5050	SUSPENSION CATALOG
5R783146	WA07-5013		B161	WA10-5012	SUSPENSION CATALOG
5R783146	WA07-5013		B211	WA04-5026	SUSPENSION CATALOG
5R783166	WA07-5014		B220	WA10-5009	SUSPENSION CATALOG
5R783186	WA07-5015		B277	WA07-5052	SUSPENSION CATALOG
5R783186	WA07-5015		B302	WA10-5015	SUSPENSION CATALOG
5R785146	WA07-5016		B307	WA10-5021	SUSPENSION CATALOG
5R785146	WA07-5016		B311	WA07-5416	SUSPENSION CATALOG
708AR	WA07-5024		B348	WA10-5019	SUSPENSION CATALOG
709AL	WA07-5025		B349	WA10-5003	SUSPENSION CATALOG
881M	WA07-5036		B362	WA04-5027	SUSPENSION CATALOG
888R	WA07-5020		B423	WA10-5011	SUSPENSION CATALOG
889L	WA07-5021		B430K	WA07-5047	SUSPENSION CATALOG
891AR	WA07-5022		B431	WA10-5014	SUSPENSION CATALOG
892AL	WA07-5023		B432A	WA10-5004	SUSPENSION CATALOG
896L	WA07-5027		B433	WA10-5017	SUSPENSION CATALOG
896R	WA07-5026		B434	WA10-5010	SUSPENSION CATALOG
897L	WA07-5029		B498	WA10-5013	SUSPENSION CATALOG
897R	WA07-5028		B579	WA10-5022	SUSPENSION CATALOG
8R343186	WA07-5010		B611	WA07-5045A	SUSPENSION CATALOG
8R344186	WA07-5011		B667	WA04-5046	SUSPENSION CATALOG
9009G	WA14-5024		B725	WA07-5049	SUSPENSION CATALOG
912R	WA07-5300		B728	WA10-5024	SUSPENSION CATALOG
913L	WA07-5301		B769	WA10-5007	SUSPENSION CATALOG
988L	WA07-5033		B793	WA07-5002	SUSPENSION CATALOG
988R	WA07-5032		B805	WA04-5009	SUSPENSION CATALOG
995L	WA07-6015		B806	WA04-5044	SUSPENSION CATALOG
995R	WA07-6014		B807	WA04-5002	SUSPENSION CATALOG
996L	WA07-6017		B8150L	WA07-5119	SUSPENSION CATALOG
996R	WA07-6016		B8150R	WA07-5119	SUSPENSION CATALOG
A1015	WA451036N	SUSPENSION CATALOG	B8600	WA04-5000	SUSPENSION CATALOG
A1450	WA11450	SUSPENSION CATALOG	B8601	WA04-5003	SUSPENSION CATALOG
A1451	WA11451	SUSPENSION CATALOG	B8602	WA04-5001	SUSPENSION CATALOG
A1452	WA11452	SUSPENSION CATALOG	B8603	WA04-5015	SUSPENSION CATALOG
A1453	WA01-5046	SUSPENSION CATALOG	B8604	WA07-5001	SUSPENSION CATALOG
A2400	WA24SC	SUSPENSION CATALOG	B8605	WA07-5124	SUSPENSION CATALOG
A3000	WA30SC	SUSPENSION CATALOG	B8606	WA04-5013	SUSPENSION CATALOG
A9859	WAKN32005	AIR VALVE CATALOG	B8606A	WA04-5014	SUSPENSION CATALOG
A9860	WAKN32011	AIR VALVE CATALOG	B8607	WA07-5128	SUSPENSION CATALOG
AS8050	WA01-8050	SUSPENSION CATALOG	B8608	WA07-5136	SUSPENSION CATALOG



## SIRCO® cont.

COMPETITOR #	WA#	NOTES	COMPETITOR #	WA#	NOTES
B8609	WA09-5002	SUSPENSION CATALOG	C095L	WA05-5007	SUSPENSION CATALOG
B8611	WA07-5131	SUSPENSION CATALOG	C098L	WA05-5059	SUSPENSION CATALOG
B8612	WA09-5000	SUSPENSION CATALOG	C099R	WA05-5058	SUSPENSION CATALOG
B8612A	WA09-5001	SUSPENSION CATALOG	C100R	WA05-5004	SUSPENSION CATALOG
B8614	WA04-5004	SUSPENSION CATALOG	C101L	WA05-5005	SUSPENSION CATALOG
B8615	WA04-5005	SUSPENSION CATALOG	C102L	WA05-5051	SUSPENSION CATALOG
B8616	WA04-5060	SUSPENSION CATALOG	C103R	WA05-5050	SUSPENSION CATALOG
B8619	WA07-5134	SUSPENSION CATALOG	C147R	WA05-5026	SUSPENSION CATALOG
B8620	WA04-5008	SUSPENSION CATALOG	C148L	WA05-5027	SUSPENSION CATALOG
B8621	WA09-5008	SUSPENSION CATALOG	C349L	WA05-5043	SUSPENSION CATALOG
B8622	WA07-5003	SUSPENSION CATALOG	C350R	WA05-5042	SUSPENSION CATALOG
B8623	WA04-5061	SUSPENSION CATALOG	C351L	WA05-5015	SUSPENSION CATALOG
B8624	WA04-5017	SUSPENSION CATALOG	C352R	WA05-5014	SUSPENSION CATALOG
B8625	WA09-5004	SUSPENSION CATALOG	C424R	WA05-5000	SUSPENSION CATALOG
B8627	WA04-5006	SUSPENSION CATALOG	C425L	WA05-5001	SUSPENSION CATALOG
B8628	WA04-5007	SUSPENSION CATALOG	C426R	WA05-5038	SUSPENSION CATALOG
B8629	WA07-5126	SUSPENSION CATALOG	C427L	WA05-5039	SUSPENSION CATALOG
B8630	WA07-5125	SUSPENSION CATALOG	C441BL	WA05-5019	SUSPENSION CATALOG
B8632	WA07-5129	SUSPENSION CATALOG	C441L	WA05-5009	SUSPENSION CATALOG
B8635	WA04-5064	SUSPENSION CATALOG	C442BR	WA05-5018	SUSPENSION CATALOG
B8636	WA04-5011	SUSPENSION CATALOG	C442R	WA05-5008	SUSPENSION CATALOG
B8645	WA08-5007	SUSPENSION CATALOG	C443BL	WA05-5069	SUSPENSION CATALOG
B8645	WA08-5007	SUSPENSION CATALOG	C443L	WA05-5011	SUSPENSION CATALOG
B8649A	WA08-5005	SUSPENSION CATALOG	C444BR	WA05-5068	SUSPENSION CATALOG
B8663	WA07-5113	SUSPENSION CATALOG	C444R	WA05-5010	SUSPENSION CATALOG
B8683	WA08-5006	SUSPENSION CATALOG	C445BL	WA05-5021	SUSPENSION CATALOG
B8683	WA08-5006	SUSPENSION CATALOG	C445L	WA05-5013	SUSPENSION CATALOG
B8684	WA08-5012	SUSPENSION CATALOG	C446BR	WA05-5020	SUSPENSION CATALOG
B8687	WA08-5003	SUSPENSION CATALOG	C446R	WA05-5012	SUSPENSION CATALOG
B8688	WA04-5016	SUSPENSION CATALOG	C518L	WA05-5057	SUSPENSION CATALOG
B8696	WA07-5019	SUSPENSION CATALOG	C519R	WA05-5056	SUSPENSION CATALOG
B8698	WA04-5059	SUSPENSION CATALOG	C520L	WA05-5071	SUSPENSION CATALOG
B8699	WA04-5012	SUSPENSION CATALOG	C521R	WA05-5070	SUSPENSION CATALOG
B8707	WA08-5008	SUSPENSION CATALOG	C522R	WA05-5040	SUSPENSION CATALOG
B8713	WA07-6250	SUSPENSION CATALOG	C524L	WA05-5041	SUSPENSION CATALOG
B8714	WA07-5117	SUSPENSION CATALOG	C526L	WA05-5073	SUSPENSION CATALOG
B8717	WA07-5118	SUSPENSION CATALOG	C527R	WA05-5072	SUSPENSION CATALOG
B8719	WA07-5130	SUSPENSION CATALOG	C536R	WA05-5024	SUSPENSION CATALOG
B8727A	WA07-5120	SUSPENSION CATALOG	C537L	WA05-5025	SUSPENSION CATALOG
B8750	WA04-5057	SUSPENSION CATALOG	C563L	WA05-5003	SUSPENSION CATALOG
B8752	WA07-5133	SUSPENSION CATALOG	C564R	WA05-5002	SUSPENSION CATALOG
B8754	WA04-5058	SUSPENSION CATALOG	C602R	WA05-5060	SUSPENSION CATALOG
B8763	WA07-5138	SUSPENSION CATALOG	C603L	WA05-5061	SUSPENSION CATALOG
B8764	WA09-5005	SUSPENSION CATALOG	C604R	WA05-5062	SUSPENSION CATALOG
B8766	WA08-5017	SUSPENSION CATALOG	C605L	WA05-5063	SUSPENSION CATALOG
B8773M	WA08-5001	SUSPENSION CATALOG	C708R	WA05-5084	SUSPENSION CATALOG
B8788	WA08-5002	SUSPENSION CATALOG	C709L	WA05-5085	SUSPENSION CATALOG
B8790	WA08-5019	SUSPENSION CATALOG	C720R	WA05-5046	SUSPENSION CATALOG
B8794	WA08-5010	SUSPENSION CATALOG	C721L	WA05-5047	SUSPENSION CATALOG
B8805	WA08-5011	SUSPENSION CATALOG	C728R	WA05-5080	SUSPENSION CATALOG
B887	WA07-5109	SUSPENSION CATALOG	C729L	WA05-5081	SUSPENSION CATALOG
B888	WA04-5028	SUSPENSION CATALOG	C773R	WA05-5044	SUSPENSION CATALOG
B911	WA07-5046	SUSPENSION CATALOG	C774L	WA05-5045	SUSPENSION CATALOG
B941	WA07-5045	SUSPENSION CATALOG	C854L	WA05-5067	SUSPENSION CATALOG
B951	WA07-5043	SUSPENSION CATALOG	C855R	WA05-5066	SUSPENSION CATALOG
B952	WA10-5001	SUSPENSION CATALOG	C856L	WA05-5055	SUSPENSION CATALOG
B956	WA10-5002	SUSPENSION CATALOG	C857R	WA05-5054	SUSPENSION CATALOG
B971	WA10-5023	SUSPENSION CATALOG	C866R	WA05-5018	SUSPENSION CATALOG
B981	WA10-5005	SUSPENSION CATALOG	C867L	WA05-5019	SUSPENSION CATALOG
B988	WA07-5108	SUSPENSION CATALOG	C868L	WA05-5021	SUSPENSION CATALOG
B999	WA10-5006	SUSPENSION CATALOG	C869R	WA05-5020	SUSPENSION CATALOG
C059L	WA05-5079	SUSPENSION CATALOG	C870R	WA05-5068	SUSPENSION CATALOG
C060R	WA05-5078	SUSPENSION CATALOG	C871L	WA05-5069	SUSPENSION CATALOG
C094R	WA05-5006	SUSPENSION CATALOG	C884L	WA05-5053	SUSPENSION CATALOG



**SIRCO® cont.**

COMPETITOR #	WA#	NOTES	COMPETITOR #	WA#	NOTES
C885R	WA05-5052	SUSPENSION CATALOG	SH1023	WA12-5098	SUSPENSION CATALOG
C890L	WA05-5075	SUSPENSION CATALOG	SH1025	WA12-5018	SUSPENSION CATALOG
C891R	WA05-5074	SUSPENSION CATALOG	SH1026	WA07-5058	SUSPENSION CATALOG
C894L	WA05-5029	SUSPENSION CATALOG	SH1027	WA07-5059	SUSPENSION CATALOG
C895R	WA05-5028	SUSPENSION CATALOG	SH1029	WA12-5016	SUSPENSION CATALOG
C896L	WA05-5049	SUSPENSION CATALOG	SH1030	WA12-5019	SUSPENSION CATALOG
C897R	WA05-5048	SUSPENSION CATALOG	SH1030	WA12-5019	SUSPENSION CATALOG
C910L	WA05-5023	SUSPENSION CATALOG	SH1031	WA12-5021	SUSPENSION CATALOG
C911R	WA05-5022	SUSPENSION CATALOG	SH1032	WA12-5020	SUSPENSION CATALOG
C933L	WA05-5077	SUSPENSION CATALOG	SH1033	WA12-5039	SUSPENSION CATALOG
C934R	WA05-5076	SUSPENSION CATALOG	SH1034	WA12-5040	SUSPENSION CATALOG
C935L	WA05-5017	SUSPENSION CATALOG	SH1035	WA12-5042	SUSPENSION CATALOG
C936R	WA05-5016	SUSPENSION CATALOG	SH1036	WA12-5029	SUSPENSION CATALOG
EF-1	WAE5139	SUSPENSION CATALOG	SH1037	WA12-5030	SUSPENSION CATALOG
EK-1HD	WA1887ASHD	SUSPENSION CATALOG	SH1038	WA12-5031	SUSPENSION CATALOG
ES-1	WAE5481A	SUSPENSION CATALOG	SH1039	WA07-5088	SUSPENSION CATALOG
ES-2	WAE10244	SUSPENSION CATALOG	SH1040	WA07-5060	SUSPENSION CATALOG
LB-6	WA08-5014	SUSPENSION CATALOG	SH1041	WA12-5099	SUSPENSION CATALOG
MF-2	WA08-5019	SUSPENSION CATALOG	SH1042	WA12-5015	SUSPENSION CATALOG
QK-1HD	WA2769SHD	SUSPENSION CATALOG	SH1043	WA12-5100	SUSPENSION CATALOG
QK-1HD	WAE6999S	SUSPENSION CATALOG	SH1044	WA12-5026	SUSPENSION CATALOG
RF-3	WAE3869	SUSPENSION CATALOG	SH1048	WA12-5027	SUSPENSION CATALOG
RF-5	WAE9064	SUSPENSION CATALOG	SH1050	WA12-5028	SUSPENSION CATALOG
S2010S	WAKN47001	SUSPENSION CATALOG	SH1057	WA12-5025	SUSPENSION CATALOG
S2011A	WAKN44051	SUSPENSION CATALOG	SH1059	WA12-5041	SUSPENSION CATALOG
S2012A	WAKN44041	SUSPENSION CATALOG	SH1064	WA07-5087	SUSPENSION CATALOG
S2019A	WAKN44061	SUSPENSION CATALOG	SH1064	WA07-5082	SUSPENSION CATALOG
S2020A	WAKN47011	SUSPENSION CATALOG	SH1080	WA07-5085	SUSPENSION CATALOG
S2022A	WAKN44071	SUSPENSION CATALOG	SH1082	WA07-5086	SUSPENSION CATALOG
SB1004	WA04-5018	SUSPENSION CATALOG	SH1083	WA07-5089	SUSPENSION CATALOG
SB1007	WA12-5003	SUSPENSION CATALOG	SH1086	WA07-5083	SUSPENSION CATALOG
SF1000	WA12-5022	SUSPENSION CATALOG	SH1087	WA07-5084	SUSPENSION CATALOG
SF1001	WA12-5023	SUSPENSION CATALOG	SR1000	WA12-5000	SUSPENSION CATALOG
SF1002	WA12-5035	SUSPENSION CATALOG	SR1001	WA12-5111	SUSPENSION CATALOG
SF1004	WA04-5020	SUSPENSION CATALOG	SR1002	WA04-5025	SUSPENSION CATALOG
SF1007	WA12-5036	SUSPENSION CATALOG	SR1007	WA12-5112	SUSPENSION CATALOG
SF1008	WA12-5037	SUSPENSION CATALOG	SR1008	WA04-5024	SUSPENSION CATALOG
SF1009	WA12-5038	SUSPENSION CATALOG	ST1000	WA12-5002	SUSPENSION CATALOG
SF1011	WA04-5021	SUSPENSION CATALOG	ST1001	WA12-5032	SUSPENSION CATALOG
SH1001	WA04-5022	SUSPENSION CATALOG	ST1005	WA12-5033	SUSPENSION CATALOG
SH1008	WA04-5056	SUSPENSION CATALOG	XK-3HD	WA3710SHD	SUSPENSION CATALOG
SH1012	WA04-5062	SUSPENSION CATALOG	XL-1	WA08-5015	SUSPENSION CATALOG
SH1021	WA12-5017	SUSPENSION CATALOG			

**STEMCO®**

COMPETITOR #	WA#	NOTES	COMPETITOR #	WA#	NOTES
240-4009	WA14-5003		343-4009	WA343-009	
330-3009	WA330-3009		343-4025	WA14-5023	
340-4249	WA340-4249		343-4075	WA343-4075	
340-4975	WA340-4975		359-5990	WA359-5990	

# INTERCHANGE



## TRAILMOBILE®

COMPETITOR #	WA#	NOTES	COMPETITOR #	WA#	NOTES
19105	WA07-5092		50-34B-2	WA07-5025	
19107	WA07-5091		50-34B-5	WA07-5030	
50-2A-7C	WA07-5152		50-34B-6	WA07-5031	
50-2Z-69	WA07-6199		50-34C-1	WA07-5022	
50-33A-1	WA07-5189		50-34C-10	WA07-6005	
50-33A-10	WA07-5190		50-34C-2	WA07-5023	
50-33A-15	WA07-5197		50-34C-5	WA07-5300	
50-33A-16	WA07-5198		50-34C-6	WA07-5301	
50-33A-25	WA07-5100		50-34C-9	WA07-6004	
50-33A-26	WA07-5101		6-3-7	WA07-5090	
50-33A-27	WA07-5163		6-4-2	WA07-5092	
50-33A-28	WA07-5164		6-5-8	WA07-5091	
50-33A-29	WA07-5096		8-15-4	WA07-5018	
50-33A-30	WA07-5097		8-16-3	WA07-5152	
50-33A-31	WA07-6154		8-8-3	WA15-5004	
50-33A-32	WA07-6155		8-8-6	WA15-5000	
50-33A-7	WA07-5191		8-9-18	WA07-5151	
50-33A-9	WA07-5192		8-9-36	WA07-6140	
50-34A-1	WA07-5020		8-9-37	WA07-6141	
50-34A-2	WA07-5021		8-9-5	WA07-6049	
50-34B-1	WA07-5024		8-9-7	WA07-5150	
50-34B-11	WA07-6126		8-9-8	WA07-5004	
50-34B-12	WA07-6127				

## WEBB®

COMPETITOR #	WA#	NOTES	COMPETITOR #	WA#	NOTES
74611	WA07-5152		102279	WA07-5353	
74710	WA07-5018		102280	WA07-5167	
89983	WA07-5303		102281	WA07-5505	
100163	WA07-6073		102282	WA07-5504	
100164	WA07-6072		133609	WA07-6169	
101160	WA07-5039		133610	WA07-6168	
101161	WA07-6090		152026	WA07-6183	
101162	WA07-5038		159184	WA07-6064	
101164	WA07-5374		159190	WA07-5163	
101166	WA07-6089		159191	WA07-5164	
101172	WA07-5116		161127	WA07-5150	
101173	WA07-6193		179955	WA07-5036	
101174	WA07-6106		188108	WA07-6076	
101175	WA07-6313		188109	WA07-6309	
101178	WA07-6108		198510	WA07-5100	
102191	WA07-6063		198511	WA07-5101	
102192	WA07-6062		178950R	WA07-6014	
102277	WA07-5503		178951L	WA07-6015	
102278	WA07-5502				

**FOR ALL YOUR WHEEL ATTACHING NEEDS, CALL:**

**800.934.2727**





# INTERCHANGE

## WHITE®

COMPETITOR #	WA#	NOTES	COMPETITOR #	WA#	NOTES
93101	WA07-6048		861634	WA07-5150	
93102	WA07-6317		863493	WA07-5193	
300190	WA07-5021		863494	WA07-5194	
300191	WA07-5020		863694	WA07-5150	
300248	WA07-5023		872325	WA07-6127	
300249	WA07-5022		872331	WA07-6126	
303780	WA07-5378		874603	WA07-5158	
303781	WA07-5379		874608	WA07-5159	
304981	WA07-5077		877578	WA07-5097	
328382	WA07-5152		877579	WA07-5096	
373812	WA07-5403		883558	WA07-5393	
403926	WA07-5079		884232	WA07-5090	
426956	WA07-5004		884822	WA07-5163	
426957	WA15-5000		884823	WA07-5164	
466590	WA07-6033		6043825	WA07-5100	
466591	WA07-6032		116872J	WA07-5209	
466827	WA07-5396		141132H	WA07-5402	
466885	WA07-5078		448888A	WA15-5002	
467129	WA07-6182		451061A	WA15-5001	
467824	WA07-6037		466121A	WA15-5001	
467825	WA07-6120		A-13817X	WA07-5018	
467837	WA07-5080		A-300248X	WA07-5023	
475236	WA07-5510		A-300249X	WA07-5022	
475644	WA07-5217		A-33768X	WA15-5004	
475713	WA07-5375		B-2250X	WA07-6044	
475718	WA07-5194		B-2251X	WA07-6045	
475719	WA07-5193		B-22550X	WA07-6044	
476822	WA07-5196		B-22551X	WA07-6045	
476823	WA07-5195		B-34331X	WA07-5197	
477089	WA07-6002		B-34332X	WA07-5198	
477090	WA07-6003		B-4919X	WA07-5024	
477091	WA07-5030		B-4920X	WA07-5025	
477092	WA07-5031		B-4921X	WA07-6038	
604826	WA07-5101		B-4922X	WA07-6039	
650849	WA07-5215		B-5331X	WA07-5189	
650850	WA07-5381		B-5332X	WA07-5190	
684628	WA15-5006		B-6320X	WA07-5191	
689783	WA07-5004		B-6321X	WA07-5192	
716805	WA07-6186		Y-481084	WA07-5029	
716829	WA07-5380		Y-481085	WA07-5028	
837770	WA07-5195		Y-484442	WA07-5027	
837771	WA07-5196		Y-484443	WA07-5026	
857684	WA07-6138				
857685	WA07-6139				



VISIT US AT:  
[WWW.WORLDAMERICAN.COM](http://WWW.WORLDAMERICAN.COM)

# INDEX



WA07-3236	27	WA07-5114	36	WA07-5303	37	WA07-6002	11
WA07-5004	5	WA07-5116	24	WA07-5304	27	WA07-6003	11
WA07-5005	5	WA07-5122	13	WA07-5353	20	WA07-6004	12
WA07-5006	49	WA07-5141	26	WA07-5355	22	WA07-6005	12
WA07-5007	49	WA07-5150	5	WA07-5370	30	WA07-6006	7
WA07-5008	49	WA07-5151	5	WA07-5371	30	WA07-6008	7
WA07-5009	49	WA07-5152	8	WA07-5374	36	WA07-6010	8
WA07-5010	49	WA07-5153	8	WA07-5375	45	WA07-6012	8
WA07-5011	49	WA07-5154	9	WA07-5377	45	WA07-6014	11
WA07-5012	49	WA07-5155	9	WA07-5378	45	WA07-6015	11
WA07-5013	49	WA07-5156	11	WA07-5379	45	WA07-6016	11
WA07-5014	49	WA07-5157	11	WA07-5380	45	WA07-6017	11
WA07-5015	49	WA07-5158	12	WA07-5381	45	WA07-6018	6
WA07-5016	49	WA07-5159	12	WA07-5382	45	WA07-6020	38
WA07-5017	49	WA07-5160	17	WA07-5382	45	WA07-6021	38
WA07-5018	8	WA07-5161	17	WA07-5382	46	WA07-6031	16
WA07-5019	38	WA07-5162	17	WA07-5383	45	WA07-6032	24
WA07-5020	11	WA07-5163	18	WA07-5383	47	WA07-6033	25
WA07-5021	11	WA07-5164	18	WA07-5384	46	WA07-6034	25
WA07-5022	10	WA07-5165	20	WA07-5384	47	WA07-6035	25
WA07-5023	10	WA07-5166	20	WA07-5385	46	WA07-6037	25
WA07-5024	9	WA07-5167	20	WA07-5385	47	WA07-6038	32
WA07-5025	9	WA07-5169	22	WA07-5386	46	WA07-6039	32
WA07-5026	9	WA07-5171	23	WA07-5386	47	WA07-6042	34
WA07-5027	9	WA07-5172	23	WA07-5387	46	WA07-6044	32
WA07-5028	9	WA07-5173	25	WA07-5388	46	WA07-6045	32
WA07-5029	9	WA07-5175	26	WA07-5389	46	WA07-6046	34
WA07-5030	10	WA07-5176	26	WA07-5391	46	WA07-6048	33
WA07-5031	10	WA07-5177	26	WA07-5392	46	WA07-6049	5
WA07-5032	10	WA07-5178	26	WA07-5393	46	WA07-6051	6
WA07-5033	10	WA07-5179	28	WA07-5394	46	WA07-6052	7
WA07-5035	13	WA07-5180	28	WA07-5395	46	WA07-6054	29
WA07-5036	14	WA07-5181	30	WA07-5396	46	WA07-6056	29
WA07-5037	14	WA07-5182	30	WA07-5396	47	WA07-6057	29
WA07-5038	36	WA07-5183	30	WA07-5397	46	WA07-6058	30
WA07-5039	36	WA07-5184	30	WA07-5398	47	WA07-6059	30
WA07-5040	8	WA07-5187	30	WA07-5399	47	WA07-6060	30
WA07-5057	13	WA07-5188	30	WA07-5400	47	WA07-6061	30
WA07-5077	38	WA07-5189	32	WA07-5401	47	WA07-6062	18
WA07-5078	38	WA07-5190	32	WA07-5402	48	WA07-6063	18
WA07-5079	38	WA07-5191	32	WA07-5403	48	WA07-6064	19
WA07-5080	38	WA07-5192	32	WA07-5404	48	WA07-6065	19
WA07-5081	38	WA07-5193	32	WA07-5405	48	WA07-6066	19
WA07-5082	38	WA07-5194	32	WA07-5406	48	WA07-6067	19
WA07-5090	44	WA07-5195	32	WA07-5407	48	WA07-6068	19
WA07-5091	44	WA07-5196	32	WA07-5408	48	WA07-6069	19
WA07-5091	45	WA07-5197	32	WA07-5409	48	WA07-6070	20
WA07-5092	44	WA07-5198	33	WA07-5410	48	WA07-6071	20
WA07-5093	44	WA07-5200	34	WA07-5411	48	WA07-6072	20
WA07-5094	44	WA07-5201	34	WA07-5412	48	WA07-6073	20
WA07-5095	44	WA07-5202	35	WA07-5413	47	WA07-6074	26
WA07-5096	18	WA07-5203	35	WA07-5414	47	WA07-6075	26
WA07-5097	18	WA07-5204	35	WA07-5415	47	WA07-6076	27
WA07-5098	19	WA07-5205	36	WA07-5502	20	WA07-6078	31
WA07-5099	19	WA07-5206	38	WA07-5503	20	WA07-6080	33
WA07-5100	21	WA07-5207	39	WA07-5504	20	WA07-6081	33
WA07-5101	21	WA07-5208	39	WA07-5505	20	WA07-6083	35
WA07-5102	21	WA07-5209	39	WA07-5506	35	WA07-6085	35
WA07-5103	21	WA07-5215	45	WA07-5507	35	WA07-6087	36
WA07-5104	26	WA07-5217	45	WA07-5508	35	WA07-6088	36
WA07-5105	26	WA07-5217	45	WA07-5509	35	WA07-6089	36
WA07-5106	28	WA07-5300	12	WA07-5510	13	WA07-6090	36
WA07-5107	28	WA07-5301	12	WA07-5511	13	WA07-6091	36



# INDEX

WA07-6093	36	WA07-6180	38	WA07-6309	27	WA15-5025	2
WA07-6094	37	WA07-6181	6	WA07-6310	31	WA15-5026	3
WA07-6096	29	WA07-6181	39	WA07-6311	18	WA15-5027	4
WA07-6098	18	WA07-6182	38	WA07-6312	27	WA15-5028	4
WA07-6099	19	WA07-6183	38	WA07-6313	26	WA15-5029	2
WA07-6100	19	WA07-6185	39	WA07-6314	26	WA330-3009	42
WA07-6101	19	WA07-6186	39	WA07-6315	23	WA340-4249	43
WA07-6102	23	WA07-6188	34	WA07-6316	23	WA340-4975	42
WA07-6104	23	WA07-6190	37	WA07-6317	33	WA343-009	42
WA07-6106	26	WA07-6192	37	WA07-6318	18	WA343-4075	43
WA07-6108	26	WA07-6193	24	WA07-6319	37	WA359-5990	42
WA07-6110	28	WA07-6194	24	WA07-6319	38		
WA07-6111	28	WA07-6195	24	WA07-6320	16		
WA07-6114	35	WA07-6196	24	WA07-RACK	41		
WA07-6116	36	WA07-6198	24	WA13-0000	40		
WA07-6118	8	WA07-6200	7	WA13-0001	40		
WA07-6120	25	WA07-6202	8	WA13-1901	40		
WA07-6122	16	WA07-6204	18	WA13-1902	40		
WA07-6123	17	WA07-6205	17	WA13-1903	40		
WA07-6124	14	WA07-6206	17	WA13-1904	40		
WA07-6126	9	WA07-6207	17	WA13-1905	40		
WA07-6127	9	WA07-6208	19	WA13-1906	40		
WA07-6128	12	WA07-6209	17	WA13-1907	40		
WA07-6129	12	WA07-6210	13	WA13-1908	40		
WA07-6130	15	WA07-6211	29	WA13-1909	40		
WA07-6131	15	WA07-6212	29	WA13-1910	40		
WA07-6132	14	WA07-6213	29	WA13-1911	40		
WA07-6133	15	WA07-6215	29	WA13-1912	40		
WA07-6135	8	WA07-6216	15	WA13-1913	40		
WA07-6136	6	WA07-6218	15	WA13-1914	40		
WA07-6138	25	WA07-6219	21	WA13-1915	40		
WA07-6139	25	WA07-6220	22	WA13-1916	40		
WA07-6140	22	WA07-6222	16	WA13-1917	40		
WA07-6141	22	WA07-6224	4	WA13-1918	40		
WA07-6142	22	WA07-6225	5	WA13-1919	40		
WA07-6143	22	WA07-6226	5	WA13-1920	40		
WA07-6144	27	WA07-6227	5	WA13-1921	40		
WA07-6145	27	WA07-6229	16	WA13-1922	40		
WA07-6149	13	WA07-6231	17	WA13-1927	40		
WA07-6151	16	WA07-6232	25	WA14-5001	42		
WA07-6152	22	WA07-6233	25	WA14-5003	42		
WA07-6153	22	WA07-6234	26	WA14-5005	42		
WA07-6154	21	WA07-6235	26	WA14-5023	42		
WA07-6155	21	WA07-6237	27	WA14-5024	43		
WA07-6156	21	WA07-6238	27	WA14-5025	41		
WA07-6157	21	WA07-6239	28	WA14-5026	41		
WA07-6158	22	WA07-6240	28	WA15-5000	2		
WA07-6160	31	WA07-6241	28	WA15-5001	3		
WA07-6162	33	WA07-6242	28	WA15-5002	3		
WA07-6163	33	WA07-6243	28	WA15-5004	2		
WA07-6164	33	WA07-6244	28	WA15-5005	3		
WA07-6165	33	WA07-6245	28	WA15-5007	3		
WA07-6166	31	WA07-6246	34	WA15-5008	2		
WA07-6167	31	WA07-6247	34	WA15-5008	3		
WA07-6168	28	WA07-6300	34	WA15-5009	3		
WA07-6169	28	WA07-6301	34	WA15-5010	4		
WA07-6170	25	WA07-6302	22	WA15-5011	4		
WA07-6171	25	WA07-6303	31	WA15-5013	4		
WA07-6172	25	WA07-6304	16	WA15-5014	4		
WA07-6173	25	WA07-6305	29	WA15-5015	4		
WA07-6178	6	WA07-6306	29	WA15-5016	3		
WA07-6178	39	WA07-6307	24	WA15-5017	2		
WA07-6179	38	WA07-6308	24	WA15-5018	3		



## DISCLAIMER

PARTS LISTED IN THIS CATALOG ARE NOT NECESSARILY MANUFACTURED BY THE ORIGINAL EQUIPMENT MANUFACTURER AND ANY REFERENCE TO THE TRADEMARKS OR PART NUMBERS OF OTHERS ARE FOR CROSS REFERENCE INFORMATIONAL PURPOSES ONLY. THE PHOTOS PROVIDED HEREIN ARE PROVIDED ONLY FOR ILLUSTRATIVE PURPOSES. THE ACTUAL PRODUCTS SUPPLIED MAY DIFFER. THE TRADEMARKS OF OTHERS REFERRED TO HEREIN ARE OWNED BY THEIR RESPECTIVE COMPANIES AND ARE NOT AFFILIATED IN ANY WAY WITH MIDWEST TRUCK & AUTO PARTS, INC.<sup>TM</sup>. WORLD AMERICAN<sup>®</sup>, MOTIVE GEAR<sup>®</sup> AND MOTIVE GEAR PERFORMANCE<sup>®</sup> ARE REGISTERED TRADEMARKS OF MIDWEST TRUCK & AUTO PARTS, INC.<sup>TM</sup>. USE OF THE '®' IN CONNECTION WITH A MARK OF MIDWEST TRUCK & AUTO PARTS, INC.<sup>TM</sup> INDICATES THAT THE MARK IS REGISTERED IN AT LEAST THE UNITED STATES. NO REPRESENTATION IS MADE WITH RESPECT TO THE SOURCE OF MANUFACTURE OF ANY PARTICULAR PART. WHILE EVERY EFFORT IS MADE TO PROVIDE ACCURATE INFORMATION, NO GUARANTEE IS PROVIDED AS TO THE ACCURACY OF THE INFORMATION CONTAINED HEREIN. WE ARE NOT RESPONSIBLE FOR TYPOGRAPHICAL ERRORS.

© 2011, MIDWEST TRUCK & AUTO PARTS, INC.<sup>TM</sup> ALL RIGHTS RESERVED.



## WARRANTY

MIDWEST TRUCK & AUTO PARTS, INC.™ warrants that all new MIDWEST TRUCK & AUTO PARTS, INC.™, except as otherwise provided herein, will be free from defects in material and workmanship for the first 6 months or 50,000 miles, whichever occurs first, with the sole exception of its heavy duty alternators and starters, the warranty for which shall extend for the first year, with no mileage limit. THIS WARRANTY WILL NOT APPLY IF ANY PART HAS BEEN MODIFIED, DAMAGED OR IS DEFECTIVE AS A RESULT OF ANY ACCIDENT, MISUSE, USE IN COMPETITIVE APPLICATIONS, IMPROPER INSTALLATION, NEGLIGENCE, REPAIR OR ALTERATION.

COMPETITION PARTS ARE SOLD "AS IS", WITHOUT ANY WARRANTY WHATSOEVER. IMPLIED WARRANTIES, INCLUDING WARRANTIES OF MERCHANTABILITY OR FITNESS FOR A PARTICULAR PURPOSE, ARE EXCLUDED. THE ENTIRE RISK AS TO THE QUALITY AND PERFORMANCE OF SUCH PARTS IS WITH THE BUYER. SHOULD SUCH PARTS PROVE DEFECTIVE FOLLOWING THEIR PURCHASE, THE BUYER, AND NOT THE MANUFACTURER, DISTRIBUTOR OR RETAILER, ASSUMES THE ENTIRE COST OF ALL NECESSARY SERVICING OR REPAIR.

The MIDWEST TRUCK & AUTO PARTS, INC.™ parts warranty is voided if the part is used for competition or if it has been modified.

To make a warranty claim on parts used in non-competitive applications, distributors should contact MIDWEST TRUCK & AUTO PARTS, INC.™ distributor for a Return Goods Authorization (RGA) Number. No returns will be accepted without an RGA Number. All parts should be returned to MIDWEST TRUCK & AUTO PARTS, INC.™, freight prepaid. MIDWEST TRUCK & AUTO PARTS, INC.™ will issue a credit equal to the original purchase price for all defective parts covered by this warranty. In the event that a warranty claim cannot be substantiated by MIDWEST TRUCK & AUTO PARTS, INC.™, the parts will be returned to the customer, freight collect.

THIS WARRANTY IS IN LIEU OF ALL OTHER WARRANTIES, EXPRESSED OR IMPLIED, INCLUDING, BUT NOT LIMITED TO, ANY IMPLIED WARRANTY OF MERCHANTABILITY OR FITNESS FOR A PARTICULAR PURPOSE, AND IN NO EVENT WILL MIDWEST BE LIABLE FOR INCIDENTAL, SPECIAL OR CONSEQUENTIAL DAMAGES INCLUDING, BUT NOT LIMITED TO, ANY LABOR COSTS.





# NOTES



A large, empty rectangular box with a thin black border, intended for a student to write their notes.

A series of horizontal lines for writing, consisting of 18 evenly spaced lines that span the width of the page.

# DECIMAL & METRIC SIZE CONVERSION CHARTS

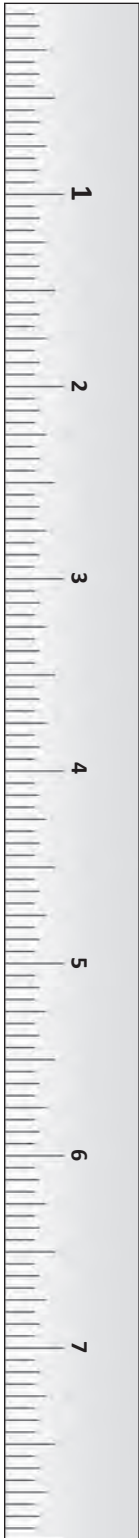

FRACTIONS (INCH)	DECIMAL (INCH)	METRIC (MM)
1/64	.016	0.40
1/32	.031	0.79
3/64	.047	1.19
1/16	.063	1.59
5/64	.078	1.98
3/32	.094	2.38
7/64	.109	2.78
1/8	.125	3.18
5/32	.156	3.97
3/16	.188	4.46
7/32	.219	5.56
1/4	.250	6.35
9/32	.281	7.14
5/16	.313	7.94
11/32	.873	3.44
3/8	.375	9.53
13/32	.406	10.32
7/16	.438	11.11
15/16	.469	11.91
1/2	.500	12.70
17/32	.531	13.49
9/16	.563	14.29
19/32	.594	15.08
5/8	.625	15.88
21/32	.656	16.67
11/16	.688	17.46
23/32	.719	18.26
3/4	.750	19.05
25/32	.781	19.84
13/16	.813	20.64
27/32	.844	21.43
7/8	.875	22.23
29/32	.906	23.02
15/16	.938	23.81
31/32	.969	24.61
1	1.000	25.40

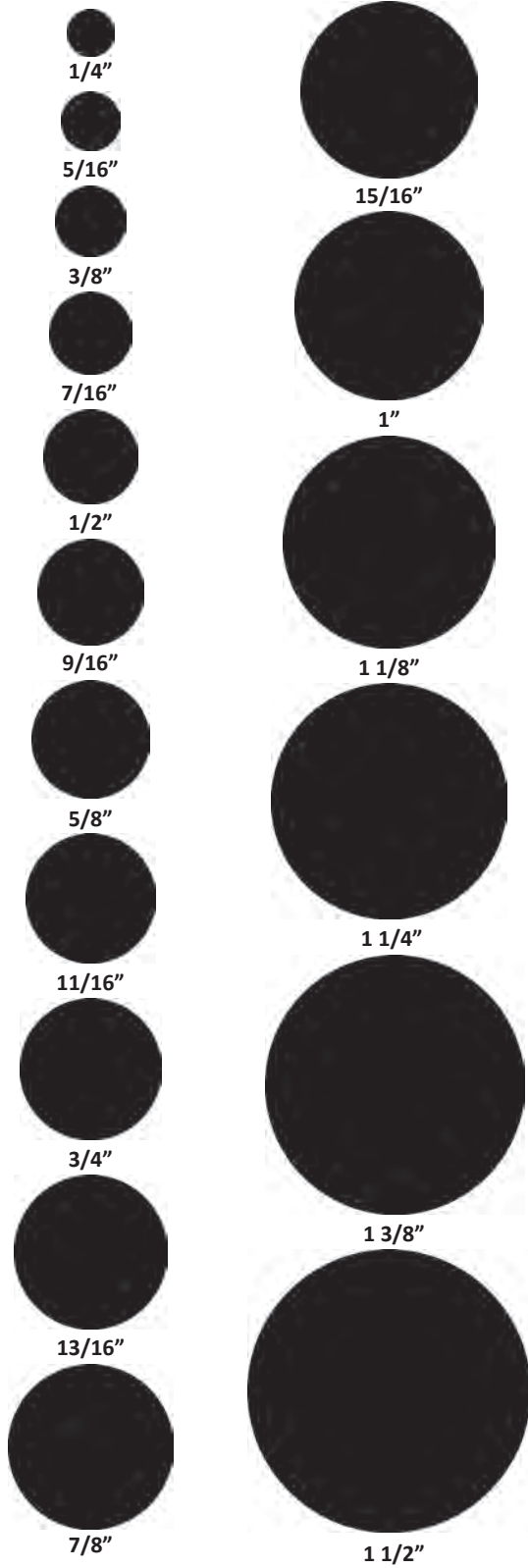

CONVERSION FACTORS		
1 INCH = 25.4MM		
CONVERT FROM	TO	FACTOR
INCHES (IN)	MILLIMETERS (MM)	MULTIPLY INCHES BY 25.4
MILLIMETERS (MM)	INCHES (IN)	DIVIDE MILLIMETERS BY 25.4