

**BEFORE THE  
BOURBON COUNTY JOINT PLANNING COMMISSION**

In the Matter of:

CONSTRUCTION OF A WIRELESS  
COMMUNICATIONS FACILITY IN  
PARIS, BOUBRON COUNTY, KENTUCKY

CASE NO. CT 18-01

SITE NAME: LV PARIS DT

\* \* \* \* \*

**SUPPLEMENT TO APPLICATION FOR  
CONSTRUCTION OF A WIRELESS COMMUNICATIONS FACILITY**

TowerCo 2013, LLC, a Delaware limited liability company (“Applicant”), by counsel, pursuant to the Kentucky Revised Statutes, the City of Paris Zoning Ordinance, and the rules and regulations applicable thereto, and pursuant to the Telecommunications Act of 1996, respectfully submits this Supplement to Its Application requesting approval from the Bourbon County Joint Planning Commission (“Planning Commission”) to construct, maintain, and operate a cellular tower facility (“Facility”) to serve the customers of Verizon Wireless with wireless communications services.

Per the request of the Planning Administrator, the following items are hereby clarified with respect to the instant application:

1. The Applicant has reviewed the potential colocation possibilities mentioned at the Technical Review of this application. All sites mentioned were outside the search ring submitted as a part of the initial application, and thus, will not meet the needs of Verizon Wireless or its customers. Documents reflecting our further evaluation are attached hereto as **Exhibit S-A**.

2. The Notice Signs have been installed on the property, and photographs of the same are attached hereto as **Exhibit S-B**.
3. The engineer responsible for procuring the LOMA has supplemented his information to clearly show the area removed from the floodplain, and the same is attached hereto as **Exhibit S-C**.
4. In clarification, no trees are to be removed as part of this project.
5. The foundation plans have been provided to the Commission's engineering consultant. The same items provided to her are attached hereto as **Exhibit S-D**.
6. As requested, stormwater calculations have been completed, and the same are attached hereto as **Exhibit S-E**.
7. As requested, erosion control has been considered, and an explanation of erosion/runoff calculations is also attached hereto as a part of **Exhibit S-E**.
8. To clarify, no backup generator is currently proposed for this site.
9. A redacted copy of the 2014 Option and Ground Lease Agreement is attached hereto as **Exhibit S-F**.
10. To the extent practicable, the Applicant acknowledges that utilities are to be located underground.
11. Revised site plans indicating a dust-free surface for the drive areas are attached hereto as **Exhibit S-G**.
12. The sanitary sewer lines have been added to the plans, and are also attached here to as **Exhibit S-G**.

WHEREFORE, the Applicant respectfully requests that the Planning Commission accept this Supplement for filing, and having now met all relevant legal requirements, grant all appropriate permissions to construct and operate the Facility at the location described herein.

Respectfully submitted,



---

W. Brent Rice  
Jacob C. Walbourn  
McBrayer, McGinnis, Leslie & Kirkland, PLLC  
201 East Main Street, Suite 900  
Lexington, Kentucky 40507  
(859) 231-8780 (phone)  
(859) 231-6518 (fax)  
[brice@mmlk.com](mailto:brice@mmlk.com)  
[jwalbourn@mmlk.com](mailto:jwalbourn@mmlk.com)

## **LIST OF EXHIBITS**

- Exhibit S-A RF Clarification/Structural Analysis
- Exhibit S-B Notice Sign Photos
- Exhibit S-C Clear Revision Showing LOMA
- Exhibit S-D Foundation Plans
- Exhibit S-E Stormwater/Erosion Calculations
- Exhibit S-F Redacted 2014 Option and Lease Agreement
- Exhibit S-G Revised Site Plans



Tuesday, January 29<sup>th</sup>, 2019

To Whom It May Concern:

This letter is a supplement to my October 19, 2018 letter where I stated the need for a Verizon Wireless site called Paris DT in my capacity as a radio frequency engineer for Verizon Wireless.

Following inquiries from the local jurisdiction, we have conducted a more thorough evaluation of the sites mentioned in my prior letter, and provide the following updated information:

**Crown Castle (FCC ID: 1223175)** – As is shown on the attached map, the Crown Castle tower is located 2.45 miles southeast of the selected site. The selected site is near the center of the demand area for the new tower. A distance of nearly 2 ½ miles is too far to serve customer needs, and thus is not a viable option for colocation.

**Powertel Inc (FCC ID: 999-ASO-376-OE)** – This water tank site is 1.7 miles from the selected site, and 1.2 miles from an existing Verizon tower. As above, this site is too far from the search area to be viable for colocation. Additionally, because it is close to the existing facility, it does not meet the objectives for the project which involves offloading of capacity from the existing tower.

As mentioned in my previous letter, when forced to use sites that are not optimal, additional towers may be required in the near future. Our goal is to provide uninterrupted, consistent service throughout the area. While colocation is generally the most cost-effective means for prompt deployment of new facilities, it is only effective if located at appropriate distances from our existing towers. The sites evaluated here do not meet our needs, as they are too close to our existing facilities, too far from the search area for a new facility, or both.

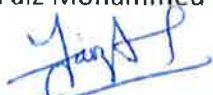
Sincerely,  
Faiz Mohammed  
  
RF Engineer, Verizon Wireless

STATE OF INDIANA

COUNTY OF Hamilton

Subscribed and sworn to before me this 29<sup>th</sup> day of January, 2019.

**Notary Public**

THOMAS D. HERNDON  
Notary Public, State of Indiana  
SEAL  
My Commission Expires 9/2/2019

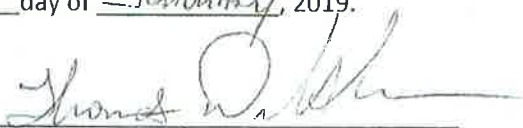
Signature   
Printed Thomas D. Herndon  
County of Residence Hamilton

My Commission expires: 9-2-23



**FAIL**  
(Legs, 173% capacity)



January 16, 2019

**Mr. Stephen Rambeau**  
Director of Engineering  
TowerCo, LLC  
5000 Valleystone Drive  
Cary, NC 27519

**Subject**

**Feasibility Structural Analysis**

**TowerCo Designation**

**Site Number: KY0062-A**  
**Site Name: Paris Municipal Center**

**Engineering Firm Designation**

**Delta Oaks Group Project: STR19-03781-02, Revision 1**

**Site Data**

**525 High St., Paris, Bourbon County, KY 40361**  
**Latitude: N 38.2113°± Longitude: W 84.2518°±**  
**Elevation: 838-ft±, Topography Category: 1; Site Class "D"**  
**Exposure Category: "C"; Structure Class/Risk Category II;**  
**93.3-ft Guyed Mast on 45-ft Rooftop**

Dear Mr. Rambeau,

To your request, we present our feasibility structural analysis. Our work indicates that with the proposed appurtenance configuration, the tower **will not** satisfy the structural strength requirements of ANSI/TIA-222-G-2-2009 / 2013 Kentucky Building Code (2012 IBC) (local building code) / ASCE 7-10 for:

- $V_{ult} = 115\text{-mph} / V_{asd} = 89\text{-mph}$  three-second gust basic wind speed [per Eqn. 16-33 of the 2012 IBC]
- 30-mph three-second gust basic wind speed with 3/4-in radial ice
- Earthquake design parameters and loading, per USGS Ground Motion Parameter Calculator (ASCE 7-10) and industry standard, respectively, including:
  - o  $S_s = 0.196\text{ g}, S_1 = 0.089\text{ g}$

Results published herein are for the existing appurtenance configuration. Computer models would not converge when Verizon equipment loading was considered: 208 ft<sup>2</sup> effective projected area with (12) 1-5/8" lines. We estimate results above 400% of capacity.

**It is not feasible to install or support the Verizon equipment loading on this tower.**

Delta Oaks Group appreciates the opportunity to be of service to TowerCo. Please do not hesitate to contact us if you have any questions or require any additional information.

Sincerely,

Matthew Layden, PE  
Structural Engineer III

Digitally signed by Michael Lassiter  
 Date: 2019.01.16 09:40:45 -05'00'

Michael L. Lassiter, SE, PE  
Chief Structural Engineer  
KY PE License 24895

**Table 1: Existing Appurtenance Configuration**

Elevation (AGL, ft)	Carrier	Mount	Equipment	Feedlines <sup>1</sup>	Location
147.1	Tower [Existing]	--	(1) 19.6' Dipole w/ 4 Elements	(2) 1-1/16"	Legs A & B
130.7		(2) Standoffs	(1) 15.1' Dipole w/ 16 Elements	(1) 5/8"	Leg C
126.8		(2) Standoffs	(1) 21.1' Dipole w/ 4 Elements	(1) 1-1/16"	Leg B
107.2		(2) Standoffs	(1) 21.4' Dipole w/ 4 Elements	(1) 1-1/16"	Leg B
84.2		(2) Standoffs	(1) 20.3' Dipole w/ 4 Elements	(2) 3/8"	Leg C
68		(1) Standoff	(1) 13.3' Omni	(1) 1-1/16"	Leg B
61.7		--	(1) 1.5' Dish	(1) 1/4"	Leg C

1. See Feed Line Plan for locations.
2. Existing tower loading per DOG Site Visit on 01/10/2019.

**Table 2: Twist and Sway Limitations<sup>1</sup>**

Elevation (AGL, ft)	Equipment	Tilt (deg)	Twist (deg)	Resultant (deg)
61.7	1.5' Dish	0.2127	2.1734	2.1838

1. See program output for supporting details.
2. Dish frequencies unknown, Tenant shall coordinate with their RF Engineer with respect to twist and sway results.

**Table 3: Serviceability Requirements: Limit State Deformations<sup>1</sup>**

Elevation (AGL, ft)	Equipment	Twist (deg) <sup>2</sup>	Sway (deg) <sup>2</sup>	Deflection (in)	Deflection Limit (in) <sup>3</sup>	Result
93.3	Structure	8.3868	0.7335	9.152	33.6	N.G.

1. See program output for supporting details.
2. Per TIA-222-G Section 2.8.2.1 rotation about the vertical axis (twist) or any horizontal axis (sway) of the structure shall not exceed 4 degrees.
3. Per TIA-222-G Section 2.8.2.2 horizontal displacement shall not exceed 3% of the height of the structure.

**Table 4: Tower Structure Results Summary, Percent Capacity Utilized<sup>1</sup>**

Component	Percent Capacity	Result
Legs	173	N.G.
Diagonals	83	O.K.
Horizontals	52	O.K.
Girts	32	O.K.
Guys	134	N.G.
Guy Pull-Offs	3	O.K.

1. Detailed results and capacities available in the TNX Tower output attached. Percent utilized less than 105% is considered acceptable.

## ASSUMPTIONS

This structural analysis is based on the theoretical capacity of the members and is not a condition assessment of the tower. This analysis is from information supplied, and therefore, its results are based on and are as accurate as that supplied data. Delta Oaks Group (“DOG”) has made no independent determination, nor is it required to, of its accuracy. The following assumptions were made for this structural analysis.

1. The tower member sizes and shapes are considered accurate as supplied. The material grade is as per data supplied and/or as assumed based on industry standards.
2. The antenna configuration is as supplied and/or as modeled in the analysis. It is assumed to be complete and accurate. All antennas, mounts, coax and waveguides are assumed to be properly installed and supported as per manufacturer requirements.
3. Some assumptions are made regarding antennas and mount sizes and their projected areas based on best interpretation of data supplied and of best knowledge of antenna type and industry practice.
4. All mounts, if applicable, are considered adequate to support the loading. No actual analysis of the mount(s) is performed. This analysis is limited to analyzing the tower only.
5. The soil parameters are as per data supplied or as assumed and stated in the calculations.
6. Foundations are properly designed and constructed to resist the original design loads indicated in the documents provided.
7. The tower and structures have been properly maintained in accordance with TIA Standards and/or with manufacturer’s specifications.
8. All welds and connections are assumed to develop at least the member capacity unless determined otherwise and explicitly stated in this report.
9. All prior structural modifications are assumed to be as per data supplied/available and to have been properly installed.
10. Loading interpreted from photos is accurate to  $\pm 5'$  AGL, antenna size accurate to  $\pm 3.3$  SF, and coax equal to the number of existing antennas without reserve.
11. Unless otherwise noted, documents reviewed and used in this structural analysis were provided by CLIENT.
12. The proposed coax shall be installed per the attached coax layout plan, Feed Line Plan.
13. Leg A is determined per best industry practice.

If any of these assumptions are not valid or have been made in error, this analysis may be affected, and DOG should be allowed to review any new information to determine its effect on the structural integrity of the tower.



## DISCLAIMER OF WARRANTIES

Delta Oaks Group (“DOG”) has not necessarily performed a detailed site visit to the tower to verify the member sizes or antenna/coax loading. Even if a site visit was performed, it is possible that the tower configuration, components, and/or loading has been modified since said site visit. Therefore, if the existing conditions are not as represented on the tower elevation contained in this report, we should be contacted immediately to evaluate the significance of the discrepancy. This is not a condition assessment of the tower or foundation, nor does this report replace a full tower inspection. The tower and foundations are assumed to be in good condition, twist free, and plumb and are also assumed to have been properly fabricated, erected and maintained.

The engineering services rendered by DOG in connection with this Structural Analysis are limited to a computer analysis of the tower structure and theoretical capacity of its main structural members. All tower components have been assumed to only resist dead loads when no other loads are applied. No allowance was made for any damaged, bent, missing, loose, or rusted members (above and below ground). No allowance was made for loose bolts or cracked welds.

This report does not include an analysis of the fabrication of the structure (including welding). As it is not feasible to attain all the detailed information necessary to perform a thorough analysis of every structural sub-component and connection of an existing tower, DOG provides a limited scope of service that does not verify the adequacy of every weld, plate connection detail, etc. Therefore, the purpose of this report is to assess the capacity of the major tower components regarding the addition of appurtenances, usually accompanied by transmission lines, to the structure.

It is the owner’s responsibility to determine the amount of ice accumulation in excess of the specified code recommended amount, if any, that should be considered in the structural analysis.

The attached sketches are a schematic representation of the analyzed tower. If any material is fabricated from these sketches, the contractor shall be responsible for field verifying the existing conditions, proper fit, and clearance in the field. Any mentions of structural modifications are reasonable estimates and should not be used as a precise construction document. Precise modification drawings are obtainable from DOG, but are beyond the scope of this report.

Miscellaneous items such as antenna mounts, etc., have not been designed or detailed as a part of our work.

DOG makes no warranties, expressed and/or implied, in connection with this report and disclaim any liability arising from material, fabrication, and erection of this tower.

**Attachments:**

- Anchor Layout and Tower Elevation Sketch
- Feed Line Plan
- Program Input and Output – Wind

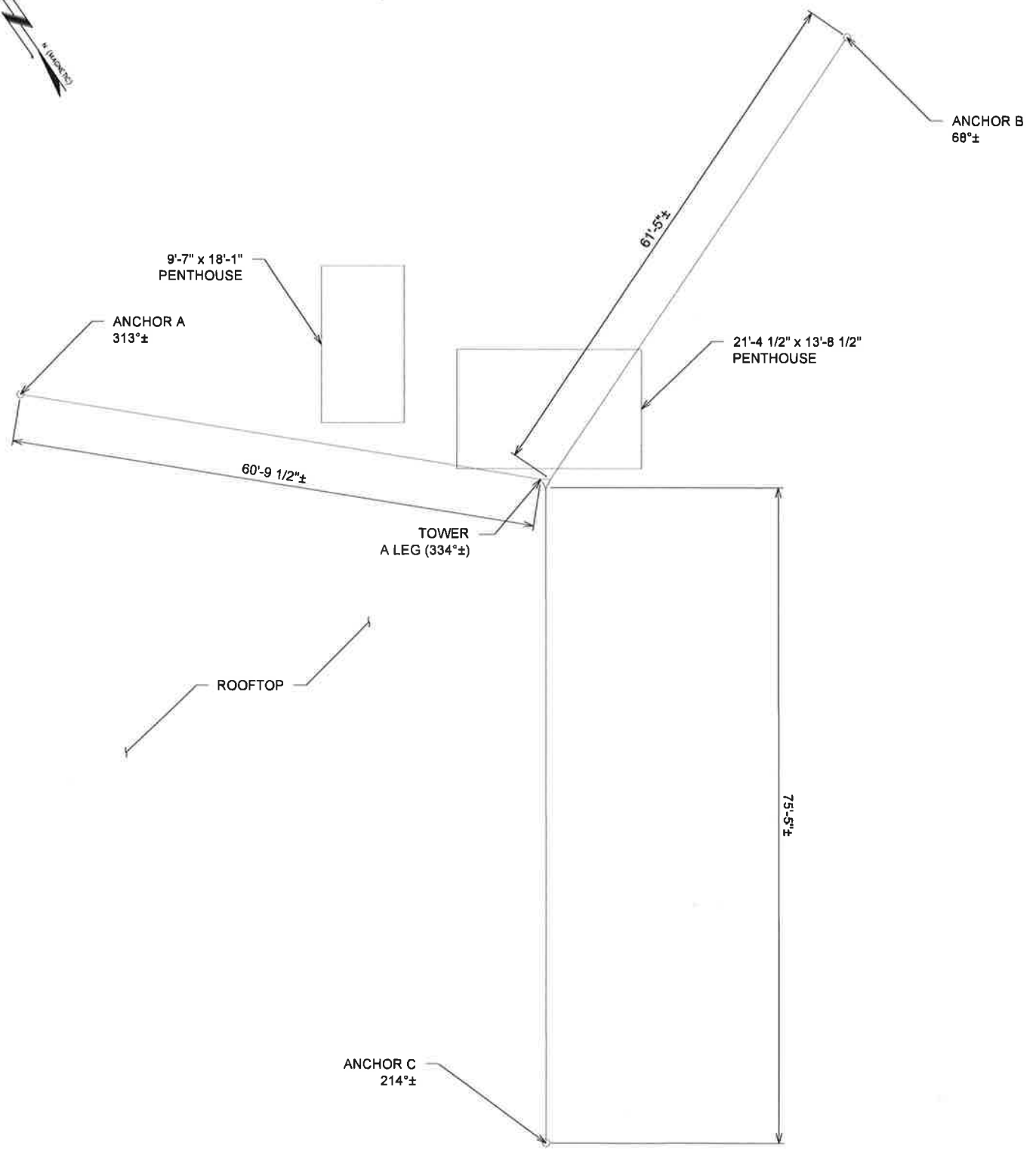

**DELTA OAKS GROUP**  
 CLIENT FOCUSED - EMPLOYEE DRIVEN

Delta Oaks Group  
 4904 Professional Court, Second Floor  
 Raleigh, NC 27609  
 Phone: (919) 342-8247  
 www.deltaoaksgroup.com

Job: <b>KY0062, Paris Municipal Center</b>			
Project: --			
Client: <b>TowerCo</b>	Drawn By: <b>MEA</b>	App'd: <b>MLL</b>	
Code: <b>N/A</b>	Date: <b>01/14/19</b>	Scale: <b>1/16"=1'-0"</b>	
Path: P:\2018 Projects\18-03181 Paris Municipal Center KY0062\ASBTR\CAD\PHYSICALS.dwg			Dwg No.: <b>SP</b>

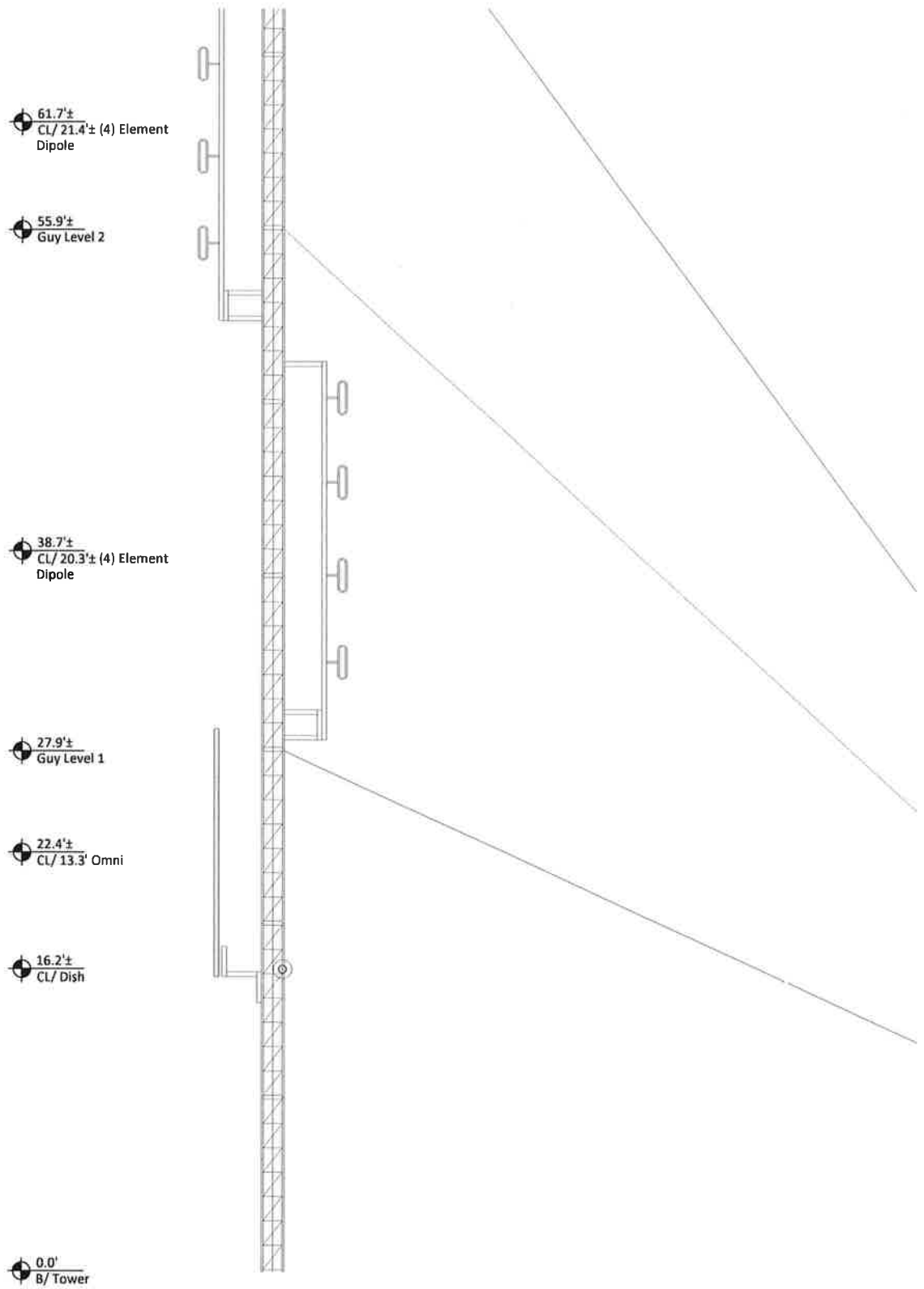

**DELTA OAKS GROUP**  
CLIENT FOCUSED -- EMPLOYEE DRIVEN

Delta Oaks Group  
4904 Professional Court, Second Floor  
Raleigh, NC 27609  
Phone: (919) 342-8247  
www.deltaoaksgroup.com

Job: <b>KY0062, Paris Municipal Center</b>			
Project: --			
Client: TowerCo	Drawn By: MEA	App'd: MLL	
Code: N/A	Date: 01/14/19	Scale: 1/16"=1'-0"	
Path: F:\2018 Projects\18-03751 Paris Municipal Center\KY0062 ABTRCAD\DWG\KY0062A.dwg			Dwg No: TE-1



# Feed Line Plan

Round    
  Flat    
  App In Face    
  App Out Face

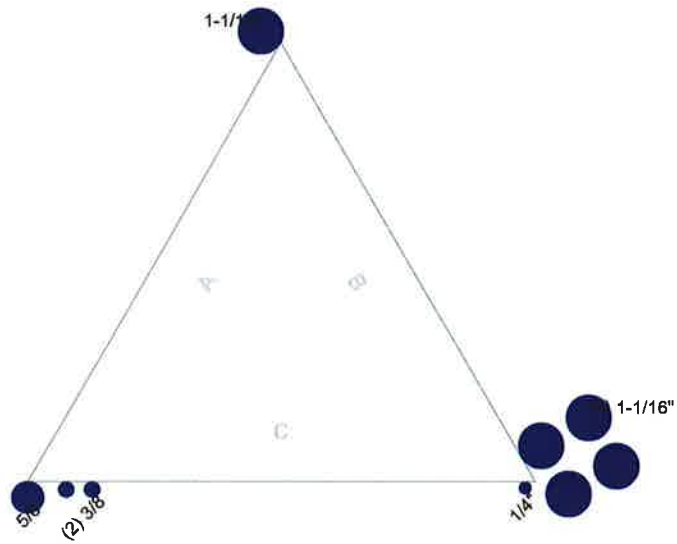

 <p><b>DELTA OAKS GROUP</b> CLIENT FOCUSED - EMPLOYEE DRIVEN</p>	<p><b>Delta Oaks Group</b> 4904 Professional Court, Second Floor Raleigh, NC 27609</p>	<p><b>Job: KY0062-A, Paris Municipal Center</b></p>									
	<p>Phone: FAX:</p>	<p>Project: <b>STR19-03781-02</b></p> <table border="1" style="width: 100%; border-collapse: collapse;"> <tr> <td style="width: 50%;">Client: TowerCo</td> <td style="width: 50%;">Drawn by: MLayden</td> <td style="width: 50%;">App'd:</td> </tr> <tr> <td>Code: TIA-222-G</td> <td>Date: 01/15/19</td> <td>Scale: NTS</td> </tr> <tr> <td>Path:</td> <td colspan="2">Dwg No. E-7</td> </tr> </table>		Client: TowerCo	Drawn by: MLayden	App'd:	Code: TIA-222-G	Date: 01/15/19	Scale: NTS	Path:	Dwg No. E-7
Client: TowerCo	Drawn by: MLayden	App'd:									
Code: TIA-222-G	Date: 01/15/19	Scale: NTS									
Path:	Dwg No. E-7										







<b>tnxTower</b> Delta Oaks Group 4904 Professional Court, Second Floor Raleigh, NC 27609 Phone: (919) 342-8247 FAX:	<b>Job</b>	KY0062-A, Paris Municipal Center	<b>Page</b>	3 of 17
	<b>Project</b>	STR19-03781-02	<b>Date</b>	18:25:34 01/15/19
	<b>Client</b>	TowerCo	<b>Designed by</b>	M Lassiiter

<b>tnxTower</b> Delta Oaks Group 4904 Professional Court, Second Floor Raleigh, NC 27609 Phone: (919) 342-8247 FAX:	<b>Job</b>	KY0062-A, Paris Municipal Center	<b>Page</b>	4 of 17
	<b>Project</b>	STR19-03781-02	<b>Date</b>	18:25:34 01/15/19
	<b>Client</b>	TowerCo	<b>Designed by</b>	M Lassiiter

Tower Section	Tower Elevation ft	Diagonal Spacing ft	Bracing Type	Has	Has	Top Girt	Bottom Girt
				K Brace End Panels	Horizontal	Offset	Offset
				No	Yes	in	in
T1	138.83-129.50	1.30	Z Brace	No	Yes	1.3125	1.3125
T2	129.50-120.16	1.30	Z Brace	No	Yes	1.3125	1.3125
T3	120.16-110.83	1.30	Z Brace	No	Yes	1.3125	1.3125
T4	110.83-101.50	1.30	Z Brace	No	Yes	1.3125	1.3125
T5	101.50-92.17	1.30	Z Brace	No	Yes	1.3125	1.3125
T6	92.17-82.83	1.30	Z Brace	No	Yes	1.3125	1.3125
T7	82.83-73.50	1.30	Z Brace	No	Yes	1.3125	1.3125
T8	73.50-64.17	1.30	Z Brace	No	Yes	1.3125	1.3125
T9	64.17-54.83	1.30	Z Brace	No	Yes	1.3125	1.3125
T10	54.83-45.50	1.30	Z Brace	No	Yes	1.3125	1.3125

Tower Elevation ft	Top Girt Type	Top Girt Size	Top Girt Grade	Bottom Girt Type	Bottom Girt Size	Bottom Girt Grade
T6 92.17-82.83	Solid Round	3/8	A36 (36 ksi)	Solid Round	3/8	A36 (36 ksi)
T7 82.83-73.50	Solid Round	3/8	A36 (36 ksi)	Solid Round	3/8	A36 (36 ksi)
T8 73.50-64.17	Solid Round	3/8	A36 (36 ksi)	Solid Round	3/8	A36 (36 ksi)
T9 64.17-54.83	Solid Round	3/8	A36 (36 ksi)	Solid Round	3/8	A36 (36 ksi)
T10 54.83-45.50	Solid Round	3/8	A36 (36 ksi)	Solid Round	3/8	A36 (36 ksi)

### Tower Section Geometry (cont'd)

Tower Elevation ft	Leg Type	Leg Size	Leg Grade	Diagonal Type	Diagonal Size	Diagonal Grade
T1 138.83-129.50	Pipe	P1.25" x 0.140"	A500-50 (50 ksi)	Solid Round	3/8	A36 (36 ksi)
T2 129.50-120.16	Pipe	P1.25" x 0.140"	A500-50 (50 ksi)	Solid Round	3/8	A36 (36 ksi)
T3 120.16-110.83	Pipe	P1.25" x 0.140"	A500-50 (50 ksi)	Solid Round	3/8	A36 (36 ksi)
T4 110.83-101.50	Pipe	P1.25" x 0.140"	A500-50 (50 ksi)	Solid Round	3/8	A36 (36 ksi)
T5 101.50-92.17	Pipe	P1.25" x 0.140"	A500-50 (50 ksi)	Solid Round	3/8	A36 (36 ksi)
T6 92.17-82.83	Pipe	P1.25" x 0.140"	A500-50 (50 ksi)	Solid Round	3/8	A36 (36 ksi)
T7 82.83-73.50	Pipe	P1.25" x 0.140"	A500-50 (50 ksi)	Solid Round	3/8	A36 (36 ksi)
T8 73.50-64.17	Pipe	P1.25" x 0.140"	A500-50 (50 ksi)	Solid Round	3/8	A36 (36 ksi)
T9 64.17-54.83	Pipe	P1.25" x 0.140"	A500-50 (50 ksi)	Solid Round	3/8	A36 (36 ksi)
T10 54.83-45.50	Pipe	P1.25" x 0.140"	A500-50 (50 ksi)	Solid Round	3/8	A36 (36 ksi)

### Tower Section Geometry (cont'd)

Tower Elevation ft	No. of Mid Girts	Mid Girt Type	Mid Girt Size	Mid Girt Grade	Horizontal Type	Horizontal Size	Horizontal Grade
T1 138.83-129.50	None	Flat Bar		A36 (36 ksi)	Solid Round	3/8	A36 (36 ksi)
T2 129.50-120.16	None	Flat Bar		A36 (36 ksi)	Solid Round	3/8	A36 (36 ksi)
T3 120.16-110.83	None	Flat Bar		A36 (36 ksi)	Solid Round	3/8	A36 (36 ksi)
T4 110.83-101.50	None	Flat Bar		A36 (36 ksi)	Solid Round	3/8	A36 (36 ksi)
T5 101.50-92.17	None	Flat Bar		A36 (36 ksi)	Solid Round	3/8	A36 (36 ksi)
T6 92.17-82.83	None	Flat Bar		A36 (36 ksi)	Solid Round	3/8	A36 (36 ksi)
T7 82.83-73.50	None	Flat Bar		A36 (36 ksi)	Solid Round	3/8	A36 (36 ksi)
T8 73.50-64.17	None	Flat Bar		A36 (36 ksi)	Solid Round	3/8	A36 (36 ksi)
T9 64.17-54.83	None	Flat Bar		A36 (36 ksi)	Solid Round	3/8	A36 (36 ksi)
T10 54.83-45.50	None	Flat Bar		A36 (36 ksi)	Solid Round	3/8	A36 (36 ksi)

### Tower Section Geometry (cont'd)

Tower Elevation ft	Top Girt Type	Top Girt Size	Top Girt Grade	Bottom Girt Type	Bottom Girt Size	Bottom Girt Grade
T1 138.83-129.50	Solid Round	3/8	A36 (36 ksi)	Solid Round	3/8	A36 (36 ksi)
T2 129.50-120.16	Solid Round	3/8	A36 (36 ksi)	Solid Round	3/8	A36 (36 ksi)
T3 120.16-110.83	Solid Round	3/8	A36 (36 ksi)	Solid Round	3/8	A36 (36 ksi)
T4 110.83-101.50	Solid Round	3/8	A36 (36 ksi)	Solid Round	3/8	A36 (36 ksi)
T5 101.50-92.17	Solid Round	3/8	A36 (36 ksi)	Solid Round	3/8	A36 (36 ksi)

### Tower Section Geometry (cont'd)

Tower Elevation ft	Gusset Area (per face) ft <sup>2</sup>	Gusset Thickness in	Gusset Grade	Adjust. Factor A <sub>1</sub>	Adjust. Factor A <sub>2</sub>	Weight Multi.	Double Angle Spacing Diagonals in	Double Angle Spacing Horizontal in	Double Angle Spacing Redundants in
T1 138.83-129.50	0.00	0.0000	A36 (36 ksi)	1	1	1	36.0000	36.0000	36.0000
T2 129.50-120.16	0.00	0.0000	A36 (36 ksi)	1	1	1	36.0000	36.0000	36.0000
T3 120.16-110.83	0.00	0.0000	A36 (36 ksi)	1	1	1	36.0000	36.0000	36.0000

<b>tnxTower</b> Delta Oaks Group 4904 Professional Court, Second Floor Raleigh, NC 27609 Phone: (919) 342-8247 FAX:	<b>Job</b> KY0062-A, Paris Municipal Center	<b>Page</b> 5 of 17
	<b>Project</b> STR19-03781-02	<b>Date</b> 18:25:34 01/15/19
	<b>Client</b> TowerCo	<b>Designed by</b> M Lassiter

<b>tnxTower</b> Delta Oaks Group 4904 Professional Court, Second Floor Raleigh, NC 27609 Phone: (919) 342-8247 FAX:	<b>Job</b> KY0062-A, Paris Municipal Center	<b>Page</b> 6 of 17
	<b>Project</b> STR19-03781-02	<b>Date</b> 18:25:34 01/15/19
	<b>Client</b> TowerCo	<b>Designed by</b> M Lassiter

Tower Elevation	Gusset Area (per face)	Gusset Thickness	Gusset Grade	Adjust. Factor A <sub>J</sub>	Adjust. Factor A <sub>r</sub>	Weight Mult.	Double Angle Spacing Diagonals in	Double Angle Spacing Horizontals in	Double Angle Spacing Redundants in
ft	ft <sup>2</sup>	in							
T4	0.00	0.0000	A36	↓	↓	↓	36.0000	36.0000	36.0000
110.83-101.50			(36 ksi)						
T5	0.00	0.0000	A36	↓	↓	↓	36.0000	36.0000	36.0000
101.50-92.17			(36 ksi)						
T6	0.00	0.0000	A36	↓	↓	↓	36.0000	36.0000	36.0000
92.17-82.83			(36 ksi)						
T7	0.00	0.0000	A36	↓	↓	↓	36.0000	36.0000	36.0000
82.83-73.50			(36 ksi)						
T8	0.00	0.0000	A36	↓	↓	↓	36.0000	36.0000	36.0000
73.50-64.17			(36 ksi)						
T9	0.00	0.0000	A36	↓	↓	↓	36.0000	36.0000	36.0000
64.17-54.83			(36 ksi)						
T10	0.00	0.0000	A36	↓	↓	↓	36.0000	36.0000	36.0000
54.83-45.50			(36 ksi)						

Tower Elevation ft	Leg		Diagonal		Top Girt		Bottom Girt		Mid Girt		Long Horizontal		Short Horizontal	
	Net Width Deduct in	U	Net Width Deduct in	U	Net Width Deduct in	U	Net Width Deduct in	U	Net Width Deduct in	U	Net Width Deduct in	U	Net Width Deduct in	U
T1	0.0000	↓	0.0000	0.75	0.0000	0.75	0.0000	0.75	0.0000	0.75	0.0000	0.75	0.0000	0.75
138.83-129.50														
T2	0.0000	↓	0.0000	0.75	0.0000	0.75	0.0000	0.75	0.0000	0.75	0.0000	0.75	0.0000	0.75
129.50-120.16														
T3	0.0000	↓	0.0000	0.75	0.0000	0.75	0.0000	0.75	0.0000	0.75	0.0000	0.75	0.0000	0.75
120.16-110.83														
T4	0.0000	↓	0.0000	0.75	0.0000	0.75	0.0000	0.75	0.0000	0.75	0.0000	0.75	0.0000	0.75
110.83-101.50														
T5	0.0000	↓	0.0000	0.75	0.0000	0.75	0.0000	0.75	0.0000	0.75	0.0000	0.75	0.0000	0.75
101.50-92.17														
T6	0.0000	↓	0.0000	0.75	0.0000	0.75	0.0000	0.75	0.0000	0.75	0.0000	0.75	0.0000	0.75
92.17-82.83														
T7	0.0000	↓	0.0000	0.75	0.0000	0.75	0.0000	0.75	0.0000	0.75	0.0000	0.75	0.0000	0.75
82.83-73.50														
T8	0.0000	↓	0.0000	0.75	0.0000	0.75	0.0000	0.75	0.0000	0.75	0.0000	0.75	0.0000	0.75
73.50-64.17														
T9	0.0000	↓	0.0000	0.75	0.0000	0.75	0.0000	0.75	0.0000	0.75	0.0000	0.75	0.0000	0.75
64.17-54.83														
T10	0.0000	↓	0.0000	0.75	0.0000	0.75	0.0000	0.75	0.0000	0.75	0.0000	0.75	0.0000	0.75
54.83-45.50														

### Tower Section Geometry (cont'd)

Tower Elevation	Calc K Single Angles	Calc K Solid Rounds	Legs	K Factors <sup>1</sup>								
				X Brace Diags	K Brace Diags	Single Diags	Girts	Horiz.	Sec. Horiz.	Inner Brace		
											X Y	X Y
T1	No	Yes	↓	↓	↓	↓	↓	↓	↓	↓	↓	↓
138.83-129.50												
T2	No	Yes	↓	↓	↓	↓	↓	↓	↓	↓	↓	↓
129.50-120.16												
T3	No	Yes	↓	↓	↓	↓	↓	↓	↓	↓	↓	↓
120.16-110.83												
T4	No	Yes	↓	↓	↓	↓	↓	↓	↓	↓	↓	↓
110.83-101.50												
T5	No	Yes	↓	↓	↓	↓	↓	↓	↓	↓	↓	↓
101.50-92.17												
T6	No	Yes	↓	↓	↓	↓	↓	↓	↓	↓	↓	↓
92.17-82.83												
T7	No	Yes	↓	↓	↓	↓	↓	↓	↓	↓	↓	↓
82.83-73.50												
T8	No	Yes	↓	↓	↓	↓	↓	↓	↓	↓	↓	↓
73.50-64.17												
T9	No	Yes	↓	↓	↓	↓	↓	↓	↓	↓	↓	↓
64.17-54.83												
T10	No	Yes	↓	↓	↓	↓	↓	↓	↓	↓	↓	↓
54.83-45.50												

<sup>1</sup>Note: K factors are applied to member segment lengths. K-braces without inner supporting members will have the K factor in the out-of-plane direction applied to the overall length.

### Tower Section Geometry (cont'd)

### Guy Data

Guy Elevation	Guy Grade	Guy Size	Initial Tension	%	Guy Modulus	Guy Weight	L <sub>w</sub>	Anchor Radius	Anchor Azimuth Adj. °	Anchor Elevation	End Fitting Efficiency
ft			lb		ksi	plf	ft	ft		ft	%
129.606	EHS	A 1/4	665.00	10%	21000	0.129	142.78	60.79	-21.0000	0.00	100%
		B 1/4	665.00	10%	21000	0.129	143.05	61.42	-26.0000	0.00	100%
		C 1/4	665.00	10%	21000	0.129	149.50	75.42	0.0000	0.00	100%
101.389	EHS	A 1/4	665.00	10%	21000	0.129	117.80	60.79	-21.0000	0.00	100%
		B 1/4	665.00	10%	21000	0.129	118.14	61.42	-26.0000	0.00	100%
		C 1/4	665.00	10%	21000	0.129	125.87	75.42	0.0000	0.00	100%
73.3896	EHS	A 1/4	665.00	10%	21000	0.129	94.83	60.79	-21.0000	0.00	100%
		B 1/4	665.00	10%	21000	0.129	95.24	61.42	-26.0000	0.00	100%
		C 1/4	665.00	10%	21000	0.129	104.68	75.42	0.0000	0.00	100%

### Guy Data (cont'd)

Guy Elevation ft	Mount Type	Torque-Arm Spread ft	Torque-Arm Leg Angle °	Torque-Arm Style	Torque-Arm Grade	Torque-Arm Type	Torque-Arm Size
129.606	Corner						
101.389	Corner						
73.3896	Corner						

<b>tnxTower</b> Delta Oaks Group 4904 Professional Court, Second Floor Raleigh, NC 27609 Phone: (919) 342-8247 FAX:	<b>Job</b>	KY0062-A, Paris Municipal Center	<b>Page</b>	7 of 17
	<b>Project</b>	STR19-03781-02	<b>Date</b>	18:25:34 01/15/19
	<b>Client</b>	TowerCo	<b>Designed by</b>	M Lassiiter

<b>tnxTower</b> Delta Oaks Group 4904 Professional Court, Second Floor Raleigh, NC 27609 Phone: (919) 342-8247 FAX:	<b>Job</b>	KY0062-A, Paris Municipal Center	<b>Page</b>	8 of 17
	<b>Project</b>	STR19-03781-02	<b>Date</b>	18:25:34 01/15/19
	<b>Client</b>	TowerCo	<b>Designed by</b>	M Lassiiter

### Guy Data (cont'd)

Guy Elevation ft	Diagonal Grade	Diagonal Type	Upper Diagonal Size	Lower Diagonal Size	Is Strap.	Pull-Off Grade	Pull-Off Type	Pull-Off Size
129.61	A572-50 (50 ksi)	Solid Round			No	A572-50 (50 ksi)	Solid Round	1 1/4
101.39	A572-50 (50 ksi)	Solid Round			No	A572-50 (50 ksi)	Solid Round	1 1/4
73.39	A572-50 (50 ksi)	Solid Round			No	A572-50 (50 ksi)	Solid Round	1 1/4

### Guy Data (cont'd)

Guy Elevation ft	Cable Weight			Tower Intercept		Tower Intercept		Tower Intercept	
	A lb	B lb	C lb	A ft	B ft	C ft	D ft	E ft	F ft
129.606	18.42	18.45	19.29	1.95	1.96	2.14			
101.389	15.20	15.24	16.24	2.4 sec/pulse 1.33	2.4 sec/pulse 1.34	2.5 sec/pulse 1.52			
73.3896	12.23	12.29	13.50	0.87 1.6 sec/pulse	0.87 1.6 sec/pulse	1.06 1.8 sec/pulse			

### Guy Data (cont'd)

Guy Elevation ft	Calc K Single Angles	Calc K Solid Rounds	Torque Arm		Pull Off		Diagonal	
			K <sub>x</sub>	K <sub>y</sub>	K <sub>x</sub>	K <sub>y</sub>	K <sub>x</sub>	K <sub>y</sub>
129.606	No	No			1	1	1	1
101.389	No	No			1	1	1	1
73.3896	No	No			1	1	1	1

### Guy Data (cont'd)

Guy Elevation ft	Torque Arm				Pull Off				Diagonal			
	Bolt Size	Number	Net Width Deduct in	U	Bolt Size	Number	Net Width Deduct in	U	Bolt Size	Number	Net Width Deduct in	U
129.606	0.6250	0	0.0000	0.75	0.6250	0	0.0000	0.75	0.6250	0	0.0000	0.75
101.389	A325N				A325N				A325N			
73.3896	0.6250	0	0.0000	0.75	0.6250	0	0.0000	0.75	0.6250	0	0.0000	0.75
	A325N				A325N				A325N			
	0.6250	0	0.0000	0.75	0.6250	0	0.0000	0.75	0.6250	0	0.0000	0.75
	A325N				A325N				A325N			

### Guy Pressures

Guy Elevation ft	Guy Location	#	q <sub>z</sub> psf	q <sub>s</sub> Ice psf	Ice Thickness in
129.606	A	64.80	20	2	1.6047
	B	64.80	20	2	1.6047
	C	64.80	20	2	1.6047
101.389	A	50.69	19	2	1.5658
	B	50.69	19	2	1.5658
	C	50.69	19	2	1.5658
73.3896	A	36.69	18	2	1.5160
	B	36.69	18	2	1.5160
	C	36.69	18	2	1.5160

### Feed Line/Linear Appurtenances - Entered As Round Or Flat

Description	Face or Leg	Allow Shield	Exclude From Torque Calculation	Component Type	Placement ft	Face Offset in	Lateral Offset (Frac FW)	#	# Per Row	Clear Spacing in	Width or Diameter in	Perimeter in	Weight plf
1-1/16"	A	No	No	Ar (CaAa)	138.83 = 55.50	0.0000	0.5	1	1	0.5000	1.2500		0.58
***													
1-1/16"	B	No	No	Ar (CaAa)	138.83 = 126.80	0.0000	0.5	1	1	0.2500	1.2500		0.58
1-1/16"	B	No	No	Ar (CaAa)	126.80 = 107.20	0.0000	0.5	2	2	0.2500	1.2500		0.58
1-1/16"	B	No	No	Ar (CaAa)	107.20 = 68.00	0.0000	0.5	3	2	0.2500	1.2500		0.58
1-1/16"	B	No	No	Ar (CaAa)	68.00 = 55.50	0.0000	0.5	4	2	0.2500	1.2500		0.58
***													
5/8"	C	No	No	Ar (CaAa)	130.70 = 55.50	0.0000	0.5	1	1	0.5000	0.8700		0.27
***													
3/8"	C	No	No	Ar (CaAa)	84.20 = 55.50	0.0000	0.4	2	2	0.2500	0.4400		0.08
***													
1/4"	C	No	No	Ar (CaAa)	61.70 = 55.50	0.0000	-0.48	1	1	0.2500	0.3450		0.06
***													
***													
***													
***													
***													

### Feed Line/Linear Appurtenances - Entered As Area

Description	Face or Leg	Allow Shield	Exclude From Torque Calculation	Component Type	Placement ft	Total Number	C <sub>d</sub> A <sub>d</sub> ft <sup>2</sup> /ft	Weight plf
-------------	-------------	--------------	---------------------------------	----------------	-----------------	-----------------	--	---------------

<b>tnxTower</b>  <b>Delta Oaks Group</b> 4904 Professional Court, Second Floor Raleigh, NC 27609 Phone: (919) 342-8247 FAX:	<b>Job</b>	KY0062-A, Paris Municipal Center	<b>Page</b>	9 of 17
	<b>Project</b>	STR19-03781-02	<b>Date</b>	18:25:34 01/15/19
	<b>Client</b>	TowerCo	<b>Designed by</b>	M Lassiiter

<b>tnxTower</b>  <b>Delta Oaks Group</b> 4904 Professional Court, Second Floor Raleigh, NC 27609 Phone: (919) 342-8247 FAX:	<b>Job</b>	KY0062-A, Paris Municipal Center	<b>Page</b>	10 of 17
	<b>Project</b>	STR19-03781-02	<b>Date</b>	18:25:34 01/15/19
	<b>Client</b>	TowerCo	<b>Designed by</b>	M Lassiiter

Description	Face or Leg	Allow Shield	Exclude From Torque Calculation	Component Type	Placement ft	Total Number	$C_d A_d$ ft <sup>2</sup> /ft	Weight plf
***								
***								
***								
***								
***								

Tower Section	Tower Elevation ft	Face or Leg	Ice Thickness in	$A_h$ ft <sup>2</sup>	$A_v$ ft <sup>2</sup>	$C_d A_d$ In Face ft <sup>2</sup>	$C_d A_d$ Out Face ft <sup>2</sup>	Weight lb
T3	120.16-110.83	B		0.000	0.000	7.688	0.000	82.10
		C		0.000	0.000	4.010	0.000	52.99
		A	1.700	0.000	0.000	4.340	0.000	62.61
		B		0.000	0.000	8.995	0.000	88.88
		C		0.000	0.000	3.986	0.000	52.35
T4	110.83-101.50	A	1.686	0.000	0.000	4.314	0.000	61.85
		B		0.000	0.000	9.632	0.000	101.48
		C		0.000	0.000	3.959	0.000	51.65
T5	101.50-92.17	A	1.670	0.000	0.000	4.285	0.000	61.04
		B		0.000	0.000	10.049	0.000	108.98
		C		0.000	0.000	3.930	0.000	50.91
T6	92.17-82.83	A	1.654	0.000	0.000	4.253	0.000	60.16
		B		0.000	0.000	9.994	0.000	107.79
		C		0.000	0.000	4.892	0.000	57.40
T7	82.83-73.50	A	1.635	0.000	0.000	4.219	0.000	59.20
		B		0.000	0.000	9.932	0.000	106.48
		C		0.000	0.000	10.579	0.000	98.15
T8	73.50-64.17	A	1.614	0.000	0.000	4.180	0.000	58.14
		B		0.000	0.000	9.864	0.000	110.34
		C		0.000	0.000	10.472	0.000	96.20
T9	64.17-54.83	A	1.591	0.000	0.000	3.841	0.000	52.89
		B		0.000	0.000	9.088	0.000	107.95
		C		0.000	0.000	11.677	0.000	111.02
T10	54.83-45.50	A	1.564	0.000	0.000	0.000	0.000	0.00
		B		0.000	0.000	0.000	0.000	0.00
		C		0.000	0.000	0.000	0.000	0.00

**Feed Line/Linear Appurtenances Section Areas**

Tower Section	Tower Elevation ft	Face	$A_h$ ft <sup>2</sup>	$A_v$ ft <sup>2</sup>	$C_d A_d$ In Face ft <sup>2</sup>	$C_d A_d$ Out Face ft <sup>2</sup>	Weight lb
T1	138.83-129.50	A	0.000	0.000	1.167	0.000	5.41
		B	0.000	0.000	1.167	0.000	5.41
		C	0.000	0.000	0.105	0.000	0.32
T2	129.50-120.16	A	0.000	0.000	1.167	0.000	5.41
		B	0.000	0.000	1.996	0.000	9.26
		C	0.000	0.000	0.812	0.000	2.52
T3	120.16-110.83	A	0.000	0.000	1.167	0.000	5.41
		B	0.000	0.000	2.333	0.000	10.83
		C	0.000	0.000	0.812	0.000	2.52
T4	110.83-101.50	A	0.000	0.000	1.167	0.000	5.41
		B	0.000	0.000	3.046	0.000	14.13
		C	0.000	0.000	0.812	0.000	2.52
T5	101.50-92.17	A	0.000	0.000	1.167	0.000	5.41
		B	0.000	0.000	3.500	0.000	16.24
		C	0.000	0.000	0.812	0.000	2.52
T6	92.17-82.83	A	0.000	0.000	1.167	0.000	5.41
		B	0.000	0.000	3.500	0.000	16.24
		C	0.000	0.000	0.932	0.000	2.74
T7	82.83-73.50	A	0.000	0.000	1.167	0.000	5.41
		B	0.000	0.000	3.500	0.000	16.24
		C	0.000	0.000	1.633	0.000	4.01
T8	73.50-64.17	A	0.000	0.000	1.167	0.000	5.41
		B	0.000	0.000	3.979	0.000	18.46
		C	0.000	0.000	1.633	0.000	4.01
T9	64.17-54.83	A	0.000	0.000	1.083	0.000	5.03
		B	0.000	0.000	4.333	0.000	20.11
		C	0.000	0.000	1.730	0.000	4.10
T10	54.83-45.50	A	0.000	0.000	0.000	0.000	0.00
		B	0.000	0.000	0.000	0.000	0.00
		C	0.000	0.000	0.000	0.000	0.00

**Feed Line Center of Pressure**

Section	Elevation ft	$CP_x$ in	$CP_z$ in	$CP_x$ Ice in	$CP_z$ Ice in
T1	138.83-129.50	0.8259	-0.5529	0.0492	-0.0331
T2	129.50-120.16	0.6310	0.1210	0.0232	0.0085
T3	120.16-110.83	0.7715	0.2332	0.0329	0.0152
T4	110.83-101.50	1.3733	0.3305	0.0585	0.0147
T5	101.50-92.17	1.6908	0.3828	0.0729	0.0136
T6	92.17-82.83	1.6376	0.4124	0.0732	0.0244
T7	82.83-73.50	1.2309	0.5500	-0.0013	0.0779
T8	73.50-64.17	1.2164	0.5434	-0.0007	0.0792
T9	64.17-54.83	1.2801	0.5941	0.0547	0.1204
T10	54.83-45.50	0.0000	0.0000	0.0000	0.0000

**Feed Line/Linear Appurtenances Section Areas - With Ice**

Tower Section	Tower Elevation ft	Face or Leg	Ice Thickness in	$A_h$ ft <sup>2</sup>	$A_v$ ft <sup>2</sup>	$C_d A_d$ In Face ft <sup>2</sup>	$C_d A_d$ Out Face ft <sup>2</sup>	Weight lb
T1	138.83-129.50	A	1.726	0.000	0.000	4.390	0.000	64.00
		B		0.000	0.000	4.390	0.000	64.00
		C		0.000	0.000	0.520	0.000	6.91
T2	129.50-120.16	A	1.713	0.000	0.000	4.365	0.000	63.21

**Shielding Factor Ka**

Tower Section	Feed Line Record No.	Description	Feed Line Segment Elev.	$K_a$ No Ice	$K_a$ Ice
T1	1	1-1/16"	129.50 - 138.83	0.6000	0.0514
T1	3	1-1/16"	129.50 - 138.83	0.6000	0.0514

<b>tnxTower</b> Delta Oaks Group 4904 Professional Court, Second Floor Raleigh, NC 27609 Phone: (919) 342-8247 FAX:	<b>Job</b>	KY0062-A, Paris Municipal Center	<b>Page</b>	11 of 17
	<b>Project</b>	STR19-03781-02	<b>Date</b>	18:25:34 01/15/19
	<b>Client</b>	TowerCo	<b>Designed by</b>	M Lassiiter

<b>tnxTower</b> Delta Oaks Group 4904 Professional Court, Second Floor Raleigh, NC 27609 Phone: (919) 342-8247 FAX:	<b>Job</b>	KY0062-A, Paris Municipal Center	<b>Page</b>	12 of 17
	<b>Project</b>	STR19-03781-02	<b>Date</b>	18:25:34 01/15/19
	<b>Client</b>	TowerCo	<b>Designed by</b>	M Lassiiter

Tower Section	Feed Line Record No.	Description	Feed Line Segment Elev.	F <sub>No Ice</sub>	F <sub>Ice</sub>
T1	8	5/8	129.50 - 130.70	0.6000	0.0514
T2	1	1-1/16"	120.16 - 129.50	0.6000	0.0608
T2	3	1-1/16"	126.80 - 129.50	0.6000	0.0608
T2	4	1-1/16"	120.16 - 126.80	0.6000	0.0608
T2	8	5/8	120.16 - 129.50	0.6000	0.0608
T3	1	1-1/16"	110.83 - 120.16	0.6000	0.0654
T3	4	1-1/16"	110.83 - 120.16	0.6000	0.0654
T3	8	5/8	110.83 - 120.16	0.6000	0.0654
T4	1	1-1/16"	101.50 - 110.83	0.6000	0.0702
T4	4	1-1/16"	107.20 - 110.83	0.6000	0.0702
T4	5	1-1/16"	101.50 - 107.20	0.6000	0.0702
T4	8	5/8	101.50 - 110.83	0.6000	0.0702
T5	1	1-1/16"	92.16 - 101.50	0.6000	0.0703
T5	5	1-1/16"	92.16 - 101.50	0.6000	0.0702
T5	8	5/8	92.16 - 101.50	0.6000	0.0703
T6	1	1-1/16"	82.83 - 92.16	0.6000	0.0814
T6	5	1-1/16"	82.83 - 92.16	0.6000	0.0814
T6	8	5/8	82.83 - 92.16	0.6000	0.0814
T6	10	3/8	82.83 - 84.20	0.6000	0.0814
T7	1	1-1/16"	73.50 - 82.83	0.6000	0.0878
T7	5	1-1/16"	73.50 - 82.83	0.6000	0.0878
T7	8	5/8	73.50 - 82.83	0.6000	0.0878
T7	10	3/8	73.50 - 82.83	0.6000	0.0878
T8	1	1-1/16"	64.17 - 73.50	0.6000	0.0896
T8	5	1-1/16"	68.00 - 73.50	0.6000	0.0896
T8	6	1-1/16"	64.17 - 68.00	0.6000	0.0896
T8	8	5/8	64.17 - 73.50	0.6000	0.0896
T8	10	3/8	64.17 - 73.50	0.6000	0.0896
T9	1	1-1/16"	55.50 - 64.17	0.6000	0.1031
T9	6	1-1/16"	55.50 - 64.17	0.6000	0.1031
T9	8	5/8	55.50 - 64.17	0.6000	0.1031
T9	10	3/8	55.50 - 64.17	0.6000	0.1031
T9	12	1/4"	55.50 - 61.70	0.6000	0.1031

Description	Face or Leg	Offset Type	Offsets: Horiz Lateral Vert	Azimuth Adjustment	Placement	C <sub>dA<sub>s</sub></sub> Front	C <sub>dA<sub>s</sub></sub> Side	Weight	
			ft ft ft	°	ft	ft <sup>2</sup>	ft <sup>2</sup>	lb	
20' 4-Bay Single Dipole	C	None		0.0000	147.10	No Ice 1/2" Ice 1" Ice	4.00 6.00 101.67	6.00 6.00 16.20	6.00 10.00 14.00
***									
15-ft Dipole	A	From Leg	1.00 0.00 0.00	0.0000	130.70	No Ice 1/2" Ice 1" Ice	4.50 6.03 7.58	4.50 6.03 7.58	20.00 32.48 94.58
Side Arm Mount [SO 701-1]	A	From Leg	0.50 0.00 0.00	0.0000	138.20	No Ice 1/2" Ice 1" Ice	0.85 1.14 1.43	0.85 1.14 1.43	21.67 26.33 31.00
Side Arm Mount [SO 701-1]	A	From Leg	0.50 0.00 0.00	0.0000	123.10	No Ice 1/2" Ice 1" Ice	0.85 1.14 1.43	0.85 1.14 1.43	21.67 26.33 31.00
***									
20' 4-Bay Single Dipole	B	From Leg	1.00 0.00 0.00	0.0000	126.80	No Ice 1/2" Ice 1" Ice	4.00 6.00 101.67	4.00 6.00 16.20	6.00 10.00 14.00
Side Arm Mount [SO 701-1]	B	From Leg	0.50 0.00 0.00	0.0000	137.30	No Ice 1/2" Ice 1" Ice	0.85 1.14 1.43	0.85 1.14 1.43	21.67 26.33 31.00
Side Arm Mount [SO 301-1]	B	From Leg	0.50 0.00 0.00	0.0000	116.20	No Ice 1/2" Ice 1" Ice	1.00 1.39 1.78	1.00 1.42 1.94	23.00 32.57 42.14
***									
20' 4-Bay Single Dipole	A	From Leg	1.00 0.00 0.00	0.0000	107.20	No Ice 1/2" Ice 1" Ice	4.00 6.00 101.67	4.00 6.00 16.20	6.00 10.00 14.00
Side Arm Mount [SO 701-1]	A	From Leg	0.50 0.00 0.00	0.0000	117.90	No Ice 1/2" Ice 1" Ice	0.85 1.14 1.43	0.85 1.14 1.43	21.67 26.33 31.00
Side Arm Mount [SO 301-1]	A	From Leg	0.50 0.00 0.00	0.0000	96.50	No Ice 1/2" Ice 1" Ice	1.00 1.39 1.78	1.00 1.42 1.94	23.00 32.57 42.14
***									
20' 4-Bay Single Dipole	C	From Leg	1.00 0.00 0.00	0.0000	84.20	No Ice 1/2" Ice 1" Ice	4.00 6.00 101.67	4.00 6.00 16.20	6.00 10.00 14.00
Side Arm Mount [SO 701-1]	C	From Leg	0.50 0.00 0.00	0.0000	94.30	No Ice 1/2" Ice 1" Ice	0.85 1.14 1.43	0.85 1.14 1.43	21.67 26.33 31.00
Side Arm Mount [SO 301-1]	C	From Leg	0.50 0.00 0.00	0.0000	74.00	No Ice 1/2" Ice 1" Ice	1.00 1.39 1.78	1.00 1.42 1.94	23.00 32.57 42.14
***									
13-ft Ornni	B	From Leg	2.00 0.00 0.00	0.0000	68.00	No Ice 1/2" Ice 1" Ice	3.90 5.23 6.58	3.90 5.23 6.58	25.00 53.20 89.80
Side Arm Mount [SO 301-1]	B	From Leg	1.00 0.00 0.00	0.0000	61.30	No Ice 1/2" Ice 1" Ice	1.00 1.39 1.78	1.00 1.42 1.94	23.00 32.57 42.14
***									
***									
***									
***									
***									

### Discrete Tower Loads

Description	Face or Leg	Offset Type	Offsets: Horiz Lateral Vert	Azimuth Adjustment	Placement	C <sub>dA<sub>s</sub></sub> Front	C <sub>dA<sub>s</sub></sub> Side	Weight
			ft ft ft	°	ft	ft <sup>2</sup>	ft <sup>2</sup>	lb

<b>tnxTower</b>  Delta Oaks Group 4904 Professional Court, Second Floor Raleigh, NC 27609 Phone: (919) 342-8247 FAX:	<b>Job</b>	KY0062-A, Paris Municipal Center	<b>Page</b>	13 of 17
	<b>Project</b>	STR19-03781-02	<b>Date</b>	18:25:34 01/15/19
	<b>Client</b>	TowerCo	<b>Designed by</b>	M Lassiiter

<b>tnxTower</b>  Delta Oaks Group 4904 Professional Court, Second Floor Raleigh, NC 27609 Phone: (919) 342-8247 FAX:	<b>Job</b>	KY0062-A, Paris Municipal Center	<b>Page</b>	14 of 17
	<b>Project</b>	STR19-03781-02	<b>Date</b>	18:25:34 01/15/19
	<b>Client</b>	TowerCo	<b>Designed by</b>	M Lassiiter

### Dishes

Description	Face or Leg	Dish Type	Offset Type	Offsets: Horiz Lateral	Azimuth Adjustment	3 dB Beam Width	Elevation	Outside Diameter	Aperture Area	Weight
				ft	°	ft	ft	ft <sup>2</sup>	lb	
18" Standard Dish	C	Paraboloid w/Shroud (HP)	From Leg	0.50 0.00 0.00	0.0000	*	61.70	1.50	No Ice 1/2" Ice 1" Ice	50.00 50.00 60.00

### Load Combinations

Comb. No.	Description
1	Dead Only
2	1.2 Dead+1.6 Wind 0 deg - No Ice+1.0 Guy
3	1.2 Dead+1.6 Wind 30 deg - No Ice+1.0 Guy
4	1.2 Dead+1.6 Wind 60 deg - No Ice+1.0 Guy
5	1.2 Dead+1.6 Wind 90 deg - No Ice+1.0 Guy
6	1.2 Dead+1.6 Wind 120 deg - No Ice+1.0 Guy
7	1.2 Dead+1.6 Wind 150 deg - No Ice+1.0 Guy
8	1.2 Dead+1.6 Wind 180 deg - No Ice+1.0 Guy
9	1.2 Dead+1.6 Wind 210 deg - No Ice+1.0 Guy
10	1.2 Dead+1.6 Wind 240 deg - No Ice+1.0 Guy
11	1.2 Dead+1.6 Wind 270 deg - No Ice+1.0 Guy
12	1.2 Dead+1.6 Wind 300 deg - No Ice+1.0 Guy
13	1.2 Dead+1.6 Wind 330 deg - No Ice+1.0 Guy
14	1.2 Dead+1.0 Ice+1.0 Temp+Guy
15	1.2 Dead+1.0 Wind 0 deg+1.0 Ice+1.0 Temp+1.0 Guy
16	1.2 Dead+1.0 Wind 30 deg+1.0 Ice+1.0 Temp+1.0 Guy
17	1.2 Dead+1.0 Wind 60 deg+1.0 Ice+1.0 Temp+1.0 Guy
18	1.2 Dead+1.0 Wind 90 deg+1.0 Ice+1.0 Temp+1.0 Guy
19	1.2 Dead+1.0 Wind 120 deg+1.0 Ice+1.0 Temp+1.0 Guy
20	1.2 Dead+1.0 Wind 150 deg+1.0 Ice+1.0 Temp+1.0 Guy
21	1.2 Dead+1.0 Wind 180 deg+1.0 Ice+1.0 Temp+1.0 Guy
22	1.2 Dead+1.0 Wind 210 deg+1.0 Ice+1.0 Temp+1.0 Guy
23	1.2 Dead+1.0 Wind 240 deg+1.0 Ice+1.0 Temp+1.0 Guy
24	1.2 Dead+1.0 Wind 270 deg+1.0 Ice+1.0 Temp+1.0 Guy
25	1.2 Dead+1.0 Wind 300 deg+1.0 Ice+1.0 Temp+1.0 Guy
26	1.2 Dead+1.0 Wind 330 deg+1.0 Ice+1.0 Temp+1.0 Guy
27	Dead+Wind 0 deg - Service+Guy
28	Dead+Wind 30 deg - Service+Guy
29	Dead+Wind 60 deg - Service+Guy
30	Dead+Wind 90 deg - Service+Guy
31	Dead+Wind 120 deg - Service+Guy
32	Dead+Wind 150 deg - Service+Guy
33	Dead+Wind 180 deg - Service+Guy
34	Dead+Wind 210 deg - Service+Guy
35	Dead+Wind 240 deg - Service+Guy
36	Dead+Wind 270 deg - Service+Guy
37	Dead+Wind 300 deg - Service+Guy
38	Dead+Wind 330 deg - Service+Guy

### Maximum Tower Deflections - Service Wind

Section No.	Elevation	Horz. Deflection	Gov. Load Comb.	Tilt	Twist
	ft	in		°	°
T1	138.833 - 129.497	9.152	27	0.7355	8.3868
T2	129.497 - 120.164	7.740	27	0.6978	8.3358
T3	120.164 - 110.831	6.397	27	0.6812	7.8777
T4	110.831 - 101.498	5.083	27	0.6545	7.3821
T5	101.498 - 92.165	3.852	27	0.5803	6.7989
T6	92.165 - 82.832	2.795	27	0.5086	5.8159
T7	82.832 - 73.499	1.862	27	0.4420	4.8283
T8	73.499 - 64.166	1.079	27	0.3405	3.8903
T9	64.166 - 54.833	0.518	27	0.2383	2.5771
T10	54.833 - 45.5	0.146	27	0.1353	1.2878

### Critical Deflections and Radius of Curvature - Service Wind

Elevation	Appurtenance	Gov. Load Comb.	Deflection	Tilt	Twist	Radius of Curvature
ft			in	°	°	ft
147.10	20' 4-Bay Single Dipole	27	9.152	0.7355	8.3868	15447
138.20	Side Arm Mount [SO 701-1]	27	9.055	0.7307	8.3905	15447
137.30	Side Arm Mount [SO 701-1]	27	8.918	0.7268	8.3954	15447
130.70	15-ft Dipole	27	7.919	0.7013	8.3647	10470
129.61	Guy	27	7.756	0.6981	8.3389	10123
126.80	20' 4-Bay Single Dipole	27	7.346	0.6914	8.2362	12080
123.10	Side Arm Mount [SO 701-1]	27	6.815	0.6853	8.0456	27098
117.90	Side Arm Mount [SO 701-1]	27	6.075	0.6778	7.7520	33697
116.20	Side Arm Mount [SO 301-1]	27	5.834	0.6744	7.6607	33654
107.20	20' 4-Bay Single Dipole	27	4.587	0.6294	7.1896	8029
101.39	Guy	27	3.839	0.5794	6.7896	5356
96.50	Side Arm Mount [SO 301-1]	27	3.267	0.5397	6.3044	6812
94.30	Side Arm Mount [SO 701-1]	27	3.024	0.5234	6.0584	8156
84.20	20' 4-Bay Single Dipole	27	1.991	0.4536	4.9620	7942
74.00	Side Arm Mount [SO 301-1]	27	1.115	0.3463	3.9503	4319
73.39	Guy	27	1.071	0.3393	3.8769	4303
68.00	13-ft Omni	27	0.724	0.2790	3.1304	5437
61.70	18" Standard Dish	27	0.400	0.2127	2.2290	5594
61.30	Side Arm Mount [SO 301-1]	27	0.381	0.2085	2.1734	5430

### Maximum Tower Deflections - Design Wind

Section No.	Elevation	Horz. Deflection	Gov. Load Comb.	Tilt	Twist
	ft	in		°	°
T1	138.833 - 129.497	88.685	2	8.5105	16.3799
T2	129.497 - 120.164	74.835	2	8.3243	16.3183
T3	120.164 - 110.831	61.224	2	8.0240	15.4058
T4	110.831 - 101.498	47.985	2	7.3533	14.3048
T5	101.498 - 92.165	35.623	2	6.2745	12.9080
T6	92.165 - 82.832	24.723	2	5.1636	10.7931
T7	82.832 - 73.499	15.525	2	4.2063	8.9797

<b>tnxTower</b> Delta Oaks Group 4904 Professional Court, Second Floor Raleigh, NC 27609 Phone: (919) 342-8247 FAX:	<b>Job</b>	KY0062-A, Paris Municipal Center	<b>Page</b>	15 of 17
	<b>Project</b>	STR19-03781-02	<b>Date</b>	18:25:34 01/15/19
	<b>Client</b>	TowerCo	<b>Designed by</b>	M Lassiiter

<b>tnxTower</b> Delta Oaks Group 4904 Professional Court, Second Floor Raleigh, NC 27609 Phone: (919) 342-8247 FAX:	<b>Job</b>	KY0062-A, Paris Municipal Center	<b>Page</b>	16 of 17
	<b>Project</b>	STR19-03781-02	<b>Date</b>	18:25:34 01/15/19
	<b>Client</b>	TowerCo	<b>Designed by</b>	M Lassiiter

Section No.	Elevation ft	Horz. Deflection in	Gov. Load Comb.	Tilt °	Twist °
T8	73.499 - 64.166	8.364	2	3.0673	7.4023
T9	64.166 - 54.833	3.537	13	1.9264	4.9546
T10	54.833 - 45.5	0.821	13	0.8936	2.4858

### Critical Deflections and Radius of Curvature - Design Wind

Elevation ft	Appurtenance	Gov. Load Comb.	Deflection in	Tilt °	Twist °	Radius of Curvature ft
147.10	20' 4-Bay Single Dipole	2	88.685	8.5105	16.3799	2175
138.20	Side Arm Mount [SO 701-1]	2	87.742	8.4986	16.3903	2175
137.30	Side Arm Mount [SO 701-1]	2	86.403	8.4817	16.4044	2175
130.70	15-ft Dipole	2	76.610	8.3506	16.3717	1391
129.61	Guy	2	74.996	8.3268	16.3240	1272
126.80	20' 4-Bay Single Dipole	2	70.873	8.2693	16.1266	1131
123.10	Side Arm Mount [SO 701-1]	2	65.476	8.1475	15.7486	1076
117.90	Side Arm Mount [SO 701-1]	2	57.965	7.9011	15.1413	1013
116.20	Side Arm Mount [SO 301-1]	2	53.534	7.7921	14.9437	890
107.20	20' 4-Bay Single Dipole	2	43.035	6.9763	13.8331	534
101.39	Guy	2	35.486	6.2599	12.8870	451
96.50	Side Arm Mount [SO 301-1]	2	29.586	5.5729	11.8287	388
94.30	Side Arm Mount [SO 701-1]	2	27.074	5.3578	11.3059	374
84.20	20' 4-Bay Single Dipole	2	16.755	4.3597	9.1914	339
74.00	Side Arm Mount [SO 301-1]	2	8.689	3.1301	7.5086	378
73.39	Guy	2	8.293	3.0536	7.3785	380
68.00	13-ft Omni	13	5.250	2.3869	6.0201	398
61.70	18" Standard Dish	13	2.614	1.6388	4.2866	498
61.30	Side Arm Mount [SO 301-1]	13	2.477	1.5930	4.1800	496

### Section Capacity Table

Section No.	Elevation ft	Component Type	Size	Critical Element	P lb	$oP_{allow}$ lb	% Capacity	Pass Fail
T1	138.833 - 129.497	Leg	P1.25" x 0.140"	3	-6222.52	21951.50	28.3	Pass
T2	129.497 - 120.164	Leg	P1.25" x 0.140"	51	-11351.40	19600.50	57.9	Pass
T3	120.164 - 110.831	Leg	P1.25" x 0.140"	99	-18337.40	19600.50	95.6	Pass
T4	110.831 - 101.498	Leg	P1.25" x 0.140"	147	-26135.00	19600.50	133.3	Fail X
T5	101.498 - 92.165	Leg	P1.25" x 0.140"	195	-32145.60	19600.50	164.0	Fail X
T6	92.165 - 82.832	Leg	P1.25" x 0.140"	243	-38442.80	19600.50	172.7	Fail X
T7	82.832 - 73.499	Leg	P1.25" x 0.140"	291	-33770.50	19600.50	172.3	Fail X
T8	73.499 - 64.166	Leg	P1.25" x 0.140"	339	-32059.30	19600.50	163.6	Fail X
T9	64.166 - 54.833	Leg	P1.25" x 0.140"	387	-25325.10	19600.50	129.2	Fail X
T10	54.833 - 45.5	Leg	P1.25" x 0.140"	435	-23389.40	19600.50	119.3	Fail X
T1	138.833 - 129.497	Diagonal	3/8	11	-715.11	1261.91	56.7	Pass
T2	129.497 - 120.164	Diagonal	3/8	94	-710.38	1262.38	56.3	Pass

Section No.	Elevation ft	Component Type	Size	Critical Element	P lb	$oP_{allow}$ lb	% Capacity	Pass Fail
T3	120.164 - 110.831	Diagonal	3/8	144	-500.92	1262.38	39.7	Pass
T4	110.831 - 101.498	Diagonal	3/8	155	-1048.05	1262.38	83.0	Pass
T5	101.498 - 92.165	Diagonal	3/8	238	-691.16	1262.38	54.8	Pass
T6	92.165 - 82.832	Diagonal	3/8	286	-1475.82	3578.47	41.2	Pass
T7	82.832 - 73.499	Diagonal	3/8	300	-1458.03	3578.47	40.7	Pass
T8	73.499 - 64.166	Diagonal	3/8	348	-1792.79	3578.47	50.1	Pass
T9	64.166 - 54.833	Diagonal	3/8	396	-1934.72	3578.47	54.1	Pass
T10	54.833 - 45.5	Diagonal	3/8	480	-1939.57	3578.47	54.2	Pass
T1	138.833 - 129.497	Horizontal	3/8	14	-328.61	2282.95	14.4	Pass
T2	129.497 - 120.164	Horizontal	3/8	91	-663.91	2282.95	29.1	Pass
T3	120.164 - 110.831	Horizontal	3/8	110	-684.93	2282.95	30.0	Pass
T4	110.831 - 101.498	Horizontal	3/8	158	-1024.18	2282.95	44.9	Pass
T5	101.498 - 92.165	Horizontal	3/8	235	-1021.99	2282.95	44.8	Pass
T6	92.165 - 82.832	Horizontal	3/8	283	-900.08	2282.95	39.4	Pass
T7	82.832 - 73.499	Horizontal	3/8	303	-902.66	2282.95	39.5	Pass
T8	73.499 - 64.166	Horizontal	3/8	379	-1111.04	2282.95	48.7	Pass
T9	64.166 - 54.833	Horizontal	3/8	399	-1172.66	2282.95	51.4	Pass
T10	54.833 - 45.5	Horizontal	3/8	477	-1189.88	2282.95	52.1	Pass
T1	138.833 - 129.497	Top Girt	3/8	6	243.94	3578.47	6.8	Pass
T2	129.497 - 120.164	Top Girt	3/8	52	-297.65	2282.95	13.0	Pass
T3	120.164 - 110.831	Top Girt	3/8	101	-308.50	2282.95	13.5	Pass
T4	110.831 - 101.498	Top Girt	3/8	149	-401.70	2282.95	17.6	Pass
T6	92.165 - 82.832	Top Girt	3/8	244	-487.67	2282.95	21.4	Pass
T7	82.832 - 73.499	Top Girt	3/8	294	-453.45	2282.95	19.9	Pass
T9	64.166 - 54.833	Top Girt	3/8	390	-540.22	2282.95	23.7	Pass
T10	54.833 - 45.5	Top Girt	3/8	438	-551.09	2282.95	24.1	Pass
T2	129.497 - 120.164	Bottom Girt	3/8	56	-241.99	2282.95	10.6	Pass
T3	120.164 - 110.831	Bottom Girt	3/8	104	-352.67	2282.95	15.4	Pass
T4	110.831 - 101.498	Bottom Girt	3/8	152	-448.53	2282.95	19.6	Pass
T5	101.498 - 92.165	Bottom Girt	3/8	199	-496.00	2282.95	21.7	Pass
T6	92.165 - 82.832	Bottom Girt	3/8	248	-444.09	2282.95	19.5	Pass
T7	82.832 - 73.499	Bottom Girt	3/8	296	-415.67	2282.95	18.2	Pass
T8	73.499 - 64.166	Bottom Girt	3/8	345	-661.12	2282.95	29.0	Pass
T9	64.166 - 54.833	Bottom Girt	3/8	393	-721.92	2282.95	31.6	Pass
T10	54.833 - 45.5	Bottom Girt	3/8	441	-411.65	2282.95	18.0	Pass
T1	138.833 - 129.497	Guy A@129.606 (-21 deg)	1/4	483	3065.84	3990.00	76.8	Pass
T5	101.498 - 92.165	Guy A@101.389 (-21 deg)	1/4	486	2432.32	3990.00	61.0	Pass
T8	73.499 - 64.166	Guy A@73.3896 (-21 deg)	1/4	489	1598.51	3990.00	40.1	Pass
T1	138.833 - 129.497	Guy B@129.606 (-21 deg)	1/4	482	5325.79	3990.00	133.5	Fail X
T5	101.498 - 92.165	Guy B@101.389 (-21 deg)	1/4	485	4007.87	3990.00	100.4	Fail X
T8	73.499 - 64.166	Guy B@73.3896 (-21 deg)	1/4	488	2049.63	3990.00	51.4	Pass
T1	138.833 - 129.497	Guy C@129.606 (-26 deg)	1/4	481	4526.50	3990.00	113.4	Fail X

<b>tnxTower</b>  <b>Delta Oaks Group</b> 4904 Professional Court, Second Floor Raleigh, NC 27609 Phone: (919) 342-8247 FAX:	<b>Job</b>	<b>Page</b>	
		KY0062-A, Paris Municipal Center	17 of 17
	<b>Project</b>	STR19-03781-02	<b>Date</b>
		18:25:34 01/15/19	
<b>Client</b>	TowerCo	<b>Designed by</b>	
		M Lassiiter	

Section No.	Elevation ft	Component Type	Size	Critical Element	P lb	$\theta_{P_{allow}}$ lb	% Capacity	Pass Fail
T5	129.497	deg)						
	101.498 - 92.165	Guy C@101.389 (-26 deg)	1/4	484	3404.72	3990.00	85.3	Pass
T8	73.499 - 64.166	Guy C@73.3896 (-26 deg)	1/4	487	1951.06	3990.00	48.9	Pass
T1	138.833 - 129.497	Top Guy Pull-Off@129.606	1 1/4	7	1796.40	55223.30	3.3	Pass
T5	101.498 - 92.165	Top Guy Pull-Off@101.389	1 1/4	196	1569.01	55223.30	2.8	Pass
T8	73.499 - 64.166	Top Guy Pull-Off@73.3896	1 1/4	340	801.25	55223.30	1.5	Pass
Summary								
							172.7	Fail X
							83.0	Pass
							52.1	Pass
							24.1	Pass
							3.6	Pass
							76.8	Pass
							133.5	Fail X
							113.4	Fail X
							3.3	Pass
							<b>RATING =</b>	<b>172.7 Fail X</b>







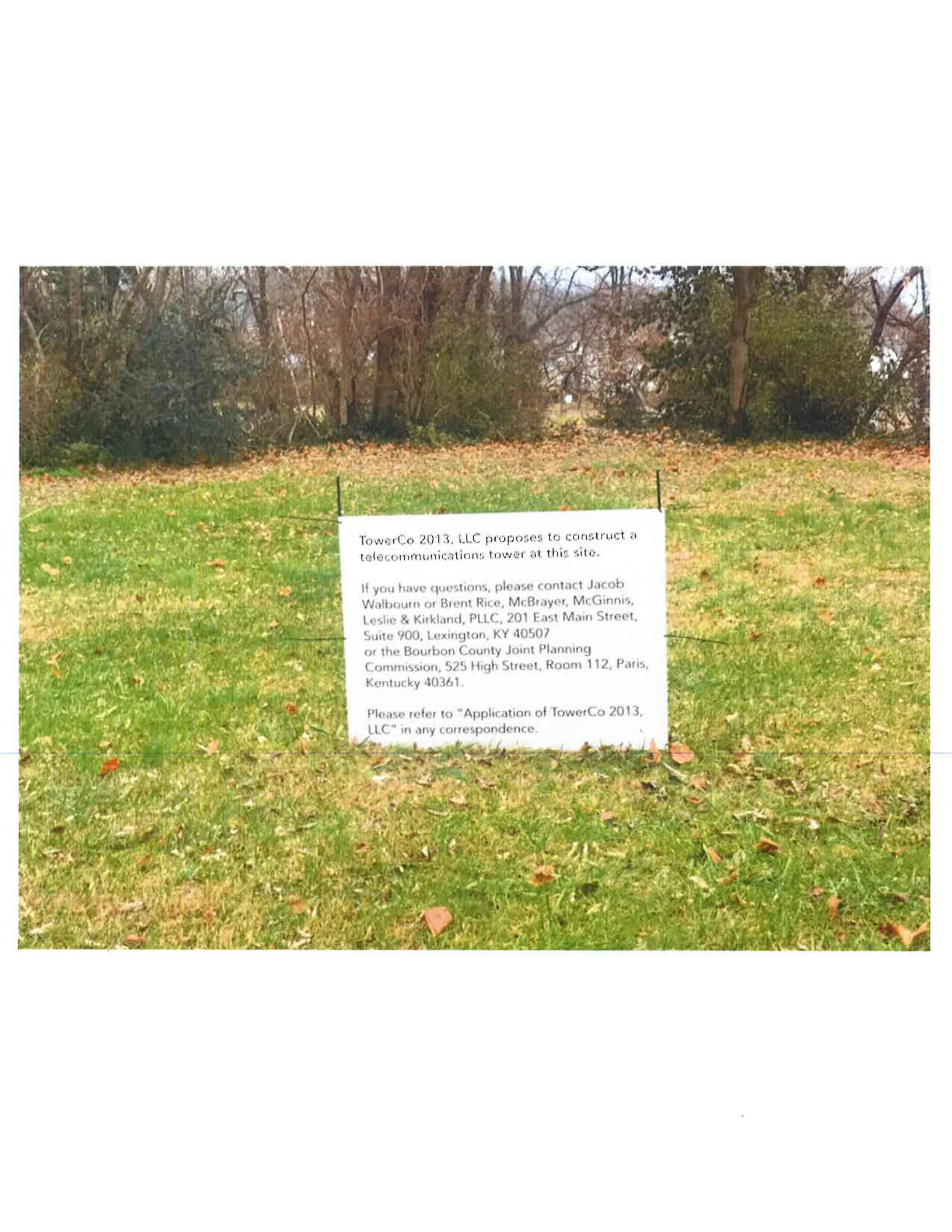

TowerCo 2013, LLC proposes to construct a telecommunications tower at this site.

If you have questions, please contact Jacob Walbourn or Brent Rice, McBrayer, McGinnis, Leslie & Kirkland, PLLC, 201 East Main Street, Suite 900, Lexington, KY 40507 or the Bourbon County Joint Planning Commission, 525 High Street, Room 112, Paris, Kentucky 40361.

Please refer to "Application of TowerCo 2013, LLC" in any correspondence.

**EXHIBIT**  
**S-C**  
 ALL-STATE LEGAL

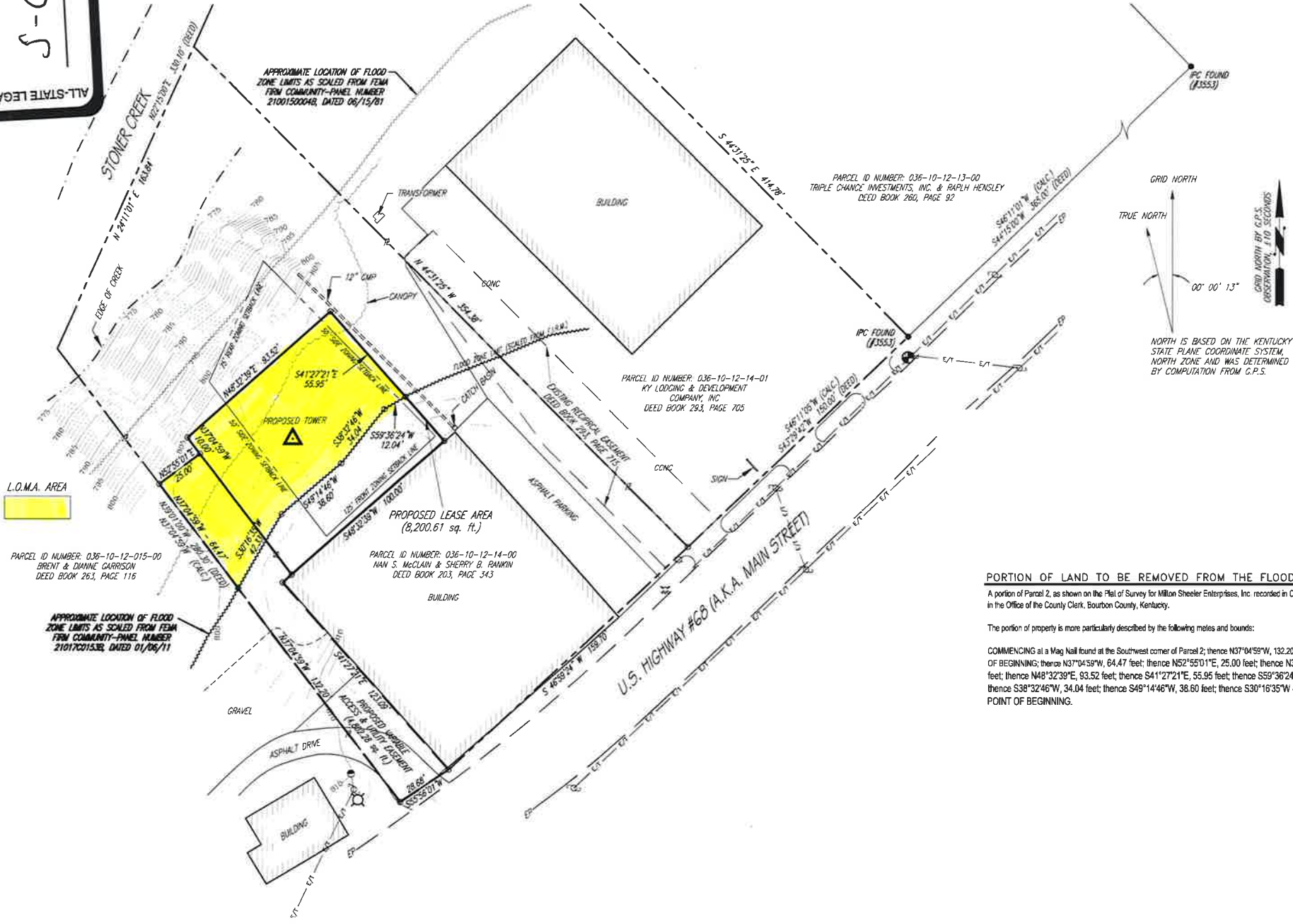

**PORTION OF LAND TO BE REMOVED FROM THE FLOOD ZONE:**

A portion of Parcel 2, as shown on the Plat of Survey for Million Sheeler Enterprises, Inc. recorded in Cabinet C, Page 303, in the Office of the County Clerk, Bourbon County, Kentucky.

The portion of property is more particularly described by the following metes and bounds:

COMMENCING at a Mag Nail found at the Southwest corner of Parcel 2; thence N37°04'59"W, 132.20 feet to the POINT OF BEGINNING; thence N37°04'59"W, 64.47 feet; thence N52°55'01"E, 25.00 feet; thence N37°04'59"W, 10.00 feet; thence N48°32'39"E, 93.52 feet; thence S41°27'21"E, 55.95 feet; thence S59°36'24"W, 12.04 feet; thence S38°32'46"W, 34.04 feet; thence S49°14'46"W, 38.60 feet; thence S30°16'35"W 42.33 feet to the POINT OF BEGINNING.



- SHEET 1**
- VICINITY AND 500' STRUCTURAL MAP
  - ABUTTING PROPERTY OWNERS
  - U.S.G.S. QUAD MAP
- SHEET 2**
- PROPOSED LEASE AREA
  - LEGAL DESCRIPTIONS
  - FLOOD ZONE DATA

**UNDERGROUND UTILITIES**  
CALL 2 WORKING DGS  
**BEFORE YOU DIG**  
KENTUCKY 1-800-382-5564  
KENTUCKY 1-800-753-0007  
UTILITIES PROTECTION SERVICE  
NON-MEMBERS MUST CALL DIRECTLY

The utility information shown on this plan prepared for 2008 was obtained from existing records and/or by field location. It is the contractor's responsibility to verify these conditions and locations, and to contact the appropriate utility company for field location.

**PROJECT POWER POLE**  
UTILITY COMPANY: UNKNOWN  
IDENTIFICATION #: N/A

- SYMBOL LEGEND**
- WOOD POWER POLE
  - CONCRETE POWER POLE
  - METAL TRAFFIC POLE
  - LIGHT POLE
  - GUY POLE
  - TELEPHONE PEDESTAL
  - GUY ANCHOR
  - SANITARY SEWER MANHOLE
  - DEWATER SEWER MANHOLE
  - MANHOLE
  - WATER VALVE
  - METER METER
  - FIRE HYDRANT
  - ELECTRICAL BOX
  - FENCE POST
  - SET BY BEARING (UNLESS OTHERWISE NOTED)
  - EXISTING BY BEARING (UNLESS OTHERWISE NOTED)
- ABBREVIATIONS**
- EP EDGE OF PAVEMENT
  - ROW RIGHT OF WAY
  - E EASEMENT
  - PCP REINFORCED CONCRETE PIPE
  - CONC CONCRETE
  - CMF CORRUGATED METAL PIPE
  - SL SUBJECT PROPERTY LINE
  - TO TOP OF CURB
  - BC BOTTOM OF CURB
  - PSM POINT OF BEGINNING
  - IPC IRON PIN CAPPED

- LINE LEGEND**
- OVERHEAD ELECTRIC
  - UNDERGROUND GAS LINE
  - UNDERGROUND WATER LINE
  - OVERHEAD ELECTRIC & TELEPHONE LINE
  - OVERHEAD TELEPHONE LINE
  - SANITARY SEWER LINE
  - EXISTING FENCE
  - PROPOSED FENCE
  - SUBJECT PROPERTY BOUNDARY
  - RIGHT OF WAY CENTERLINE

NOTE: SYMBOLS, ABBREVIATIONS, OR LINESYLES DO NOT NECESSARILY APPEAR ON DRAWING(S). USE ONLY AS APPLICABLE.

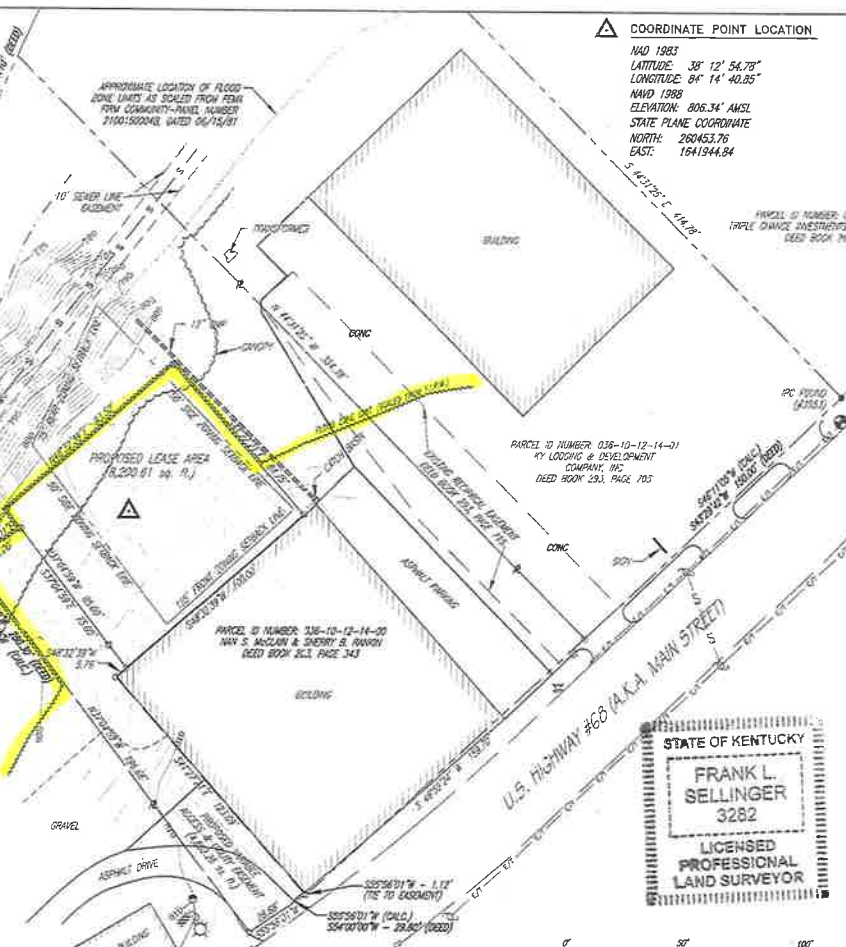

**SURVEYOR'S REVIEW OF "SPECIAL EXCEPTIONS"**

NOTES CONCERNING TO THE U.S. G.S. RECORDS "EXCERPTS OF TITLE", FILE NUMBER: 1908-41760-024 AND REVISIONS: 08/08/02, 08/08/04, 08/08/05, 08/08/06, 08/08/07, 08/08/08, 08/08/09, 08/08/10, 08/08/11, 08/08/12, 08/08/13, 08/08/14, 08/08/15, 08/08/16, 08/08/17, 08/08/18, 08/08/19, 08/08/20, 08/08/21, 08/08/22, 08/08/23, 08/08/24, 08/08/25, 08/08/26, 08/08/27, 08/08/28, 08/08/29, 08/08/30, 08/08/31, 08/08/32, 08/08/33, 08/08/34, 08/08/35, 08/08/36, 08/08/37, 08/08/38, 08/08/39, 08/08/40, 08/08/41, 08/08/42, 08/08/43, 08/08/44, 08/08/45, 08/08/46, 08/08/47, 08/08/48, 08/08/49, 08/08/50, 08/08/51, 08/08/52, 08/08/53, 08/08/54, 08/08/55, 08/08/56, 08/08/57, 08/08/58, 08/08/59, 08/08/60, 08/08/61, 08/08/62, 08/08/63, 08/08/64, 08/08/65, 08/08/66, 08/08/67, 08/08/68, 08/08/69, 08/08/70, 08/08/71, 08/08/72, 08/08/73, 08/08/74, 08/08/75, 08/08/76, 08/08/77, 08/08/78, 08/08/79, 08/08/80, 08/08/81, 08/08/82, 08/08/83, 08/08/84, 08/08/85, 08/08/86, 08/08/87, 08/08/88, 08/08/89, 08/08/90, 08/08/91, 08/08/92, 08/08/93, 08/08/94, 08/08/95, 08/08/96, 08/08/97, 08/08/98, 08/08/99, 08/08/100.

**LAND SURVEYOR'S CERTIFICATE**

Type "A" Survey - Unadjusted linear traverse closure: 1 in 19,000

I TO ALL PARTIES INTERESTED IN TITLE TO PREMISES SURVEYED I hereby certify that this plan and survey were made under my supervision, and that the angular and linear measurements, as witnessed by monuments shown herein, are true and correct to the best of my knowledge and belief.

This survey and plat meets or exceeds the minimum standards of the governing authorities.

This property is subject to any recorded easements or right of ways not shown herein.

Frank L. Sellinger, Jr. Ky. Reg. No. 3282

**PROPOSED LEASE AREA**

**LEGAL DESCRIPTIONS:**

This is a description for TowerCo of an area to be leased from the property of Nan S. McClellan & Sherry B. Rankin, which is further described as follows:

Beginning at an PC with a cap stamped "2005" found on the Northeast right of way of U.S. Highway 400 (AKA, Main Street) of the Southeast corner of the property conveyed to KY Logging & Development Company, INC. in Deed Book 281, Page 228 in the Office of the Clerk of Bourbon County, Kentucky, said PC being S 48°11'01" W - 265.00' from an PC with a cap stamped "2005" found on said Northeast right of way thence with the said right of way line and the south property line of the said KY Logging & Development Company, INC. property S 48°11'01" W - 150.00' to the southeast corner of the said KY Logging & Development Company, INC. property and being the southeast corner of the property conveyed to Nan S. McClellan & Sherry B. Rankin in Deed Book 280, Page 534 in the Office of the Clerk of Bourbon County, Kentucky, thence with said right of way and south line of the said Nan S. McClellan & Sherry B. Rankin property S 48°59'24" W - 138.00' thence S 20°20'11" W - 1.12' to a set of iron rebar with a cap stamped "2004" thence N 47°27'21" W - 123.00' to a set of iron rebar with a cap stamped "2004" thence S 47°27'21" W - 84.00' to a set of iron rebar with a cap stamped "2004" thence S 47°27'21" W - 100.00' to the true point of beginning, containing 8,200.61 square feet as per survey by Frank L. Sellinger, PLS No. 3282 with KY Land Surveyors & Consulting Engineers, dated March 28, 2007, and revised April 5, 2007.

**PROPOSED VARIABLE ACCESS & UTILITY EASEMENT**

Beginning at an PC with a cap stamped "2005" found on the Northeast right of way of U.S. Highway 400 (AKA, Main Street) of the Southeast corner of the property conveyed to KY Logging & Development Company, INC. in Deed Book 281, Page 228 in the Office of the Clerk of Bourbon County, Kentucky, said PC being S 48°11'01" W - 265.00' from an PC with a cap stamped "2005" found on said Northeast right of way thence with the said right of way line and the south property line of the said KY Logging & Development Company, INC. property S 48°11'01" W - 150.00' to the southeast corner of the said KY Logging & Development Company, INC. property and being the southeast corner of the property conveyed to Nan S. McClellan & Sherry B. Rankin in Deed Book 280, Page 534 in the Office of the Clerk of Bourbon County, Kentucky, thence with said right of way and south line of the said Nan S. McClellan & Sherry B. Rankin property S 48°59'24" W - 138.00' thence S 20°20'11" W - 1.12' to a set of iron rebar with a cap stamped "2004" thence N 47°27'21" W - 123.00' to a set of iron rebar with a cap stamped "2004" thence S 47°27'21" W - 84.00' to a set of iron rebar with a cap stamped "2004" thence S 47°27'21" W - 100.00' to the true point of beginning, containing 8,200.61 square feet as per survey by Frank L. Sellinger, PLS No. 3282 with KY Land Surveyors & Consulting Engineers, dated March 28, 2007, and revised April 5, 2007.

**REVISIONS:**

- LEASE AREA - 04.05.07
- NEW FLOOD MAP - 07.24.14
- REVISE OWNERS - 08.18.14
- ADD TITLE NOTES - 08.21.14
- FINAL - 08.21.14
- UPDATE SURVEY - 08.09.18
- UPDATE TITLE - 11.12.18
- SEWER LINE - 1.28.19
- FLOOD LIMIT LOMA - 1.28.19

**REFERENCED AS "EXHIBIT C"**

OWNER APPROVAL: \_\_\_\_\_ DATE: \_\_\_\_\_  
TowerCo APPROVAL: \_\_\_\_\_ DATE: \_\_\_\_\_

I HAVE REVIEWED THE FLOOD INSURANCE RATE MAPS (FIRM) MAP NO. 216102D1018 DATED 01-06-11 AND THE PROPOSED LEASE AREA DOES APPEAR TO BE IN A FLOOD PRONE AREA, THE PROPOSED LEASE AREA IS LOCATED IN ZONE AE. THE BASE FLOOD ELEVATION IS 795.5'

**TowerCo**

**FSI**

Land Surveyors  
1012 S 4th Street, Suite 101  
Louisville, KY 40203  
Phone: (502) 636-5111  
Fax: (502) 636-5263

**"SITE SURVEY"**

SITE NUMBER: RLV1276

SITE NAME: EAST PARS

SITE ADDRESS: EAST MAIN STREET  
PARIS, KY 40361

PROPOSED LEASE AREA: 8,200.61 sq. ft.

PROPERTY OWNER: NAN S. McCLELLAN & SHERRY B. RANKIN  
427 MAIN STREET  
PARIS, KY 40361

PARCEL ID NUMBER: 036-10-12-01-00

SOURCE OF TITLE: DEED BOOK 280, PAGE 534

DWG NO: 016

DWG BY: FSI

DATE: 03.28.07

FSM PROJECT NO.: 07-4384

**REVISIONS:**

- LEASE AREA - 04.05.07
- NEW FLOOD MAP - 07.24.14
- REVISE OWNERS - 08.18.14
- ADD TITLE NOTES - 08.21.14
- FINAL - 08.21.14
- UPDATE SURVEY - 08.09.18
- UPDATE TITLE - 11.12.18
- SEWER LINE - 1.28.19
- FLOOD LIMIT LOMA - 1.28.19

C2

ALL-STATE LEGAL®

EXHIBIT

S-D

PROJECT INFORMATION:

196' SELF-SUPPORTING  
POLE STRUCTURE  
DRILLED SHAFT  
FOUNDATION DESIGN

SITE NAME:  
**EAST PARIS**

SITE NUMBER:  
**KY0062**

SITE LOCATION:  
**93± EAST MAIN STREET  
PARIS, KY 40361  
(BOURBON COUNTY)**

CHECKED: \_\_\_\_\_  
DRAWN BY: MEA  
SHEET NUMBER: **T-1**  
REVISION: **0**  
DOG #: STR. I.B

DATE: \_\_\_\_\_  
REV: \_\_\_\_\_

5000 VALLEYSTONE DRIVE  
CARY, NC 27519  
OFFICE: (919) 469-5559  
WWW.TOWERCO.COM



(D.S.)

**EAST PARIS**

TOWERCO JOB #:

**KY0062**

PREPARED BY:

4904 PROFESSIONAL COURT  
SECOND FLOOR  
RALEIGH, NC 27609  
OFFICE: (919) 342-8247  
WWW.DELTAOKSGROUP.COM

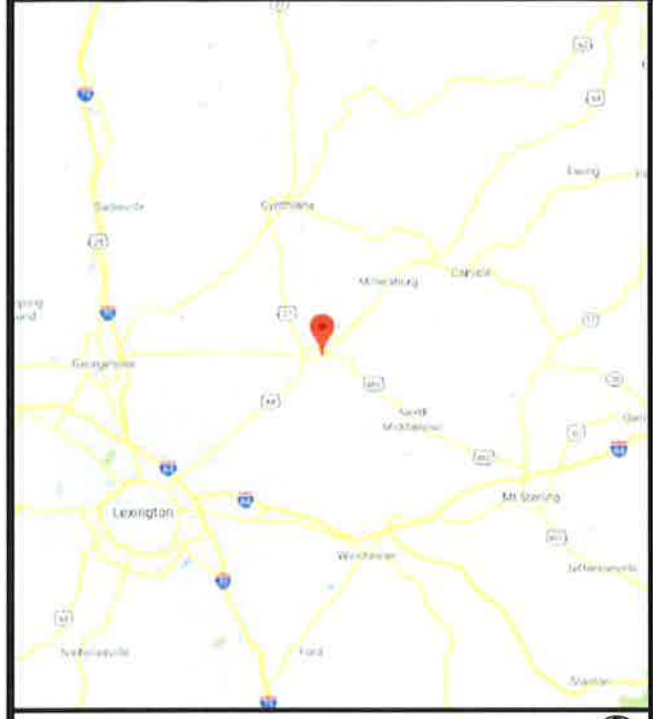

VICINITY MAP

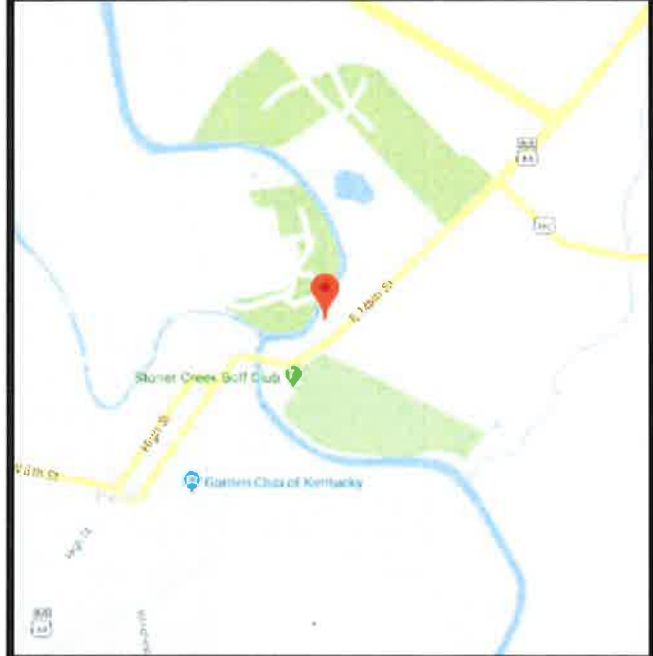

LOCATION MAP



LATITUDE: 38.2162±  
LONGITUDE: -84.2447±

COORDINATES

THE UTILITIES SHOWN HEREON ARE FOR THE CONTRACTORS CONVENIENCE ONLY. THERE MAY BE OTHER UTILITIES NOT SHOWN ON THESE PLANS. THE ENGINEER/SURVEYOR ASSUMES NO RESPONSIBILITY FOR THE LOCATIONS SHOWN AND IT SHALL BE THE CONTRACTOR'S RESPONSIBILITY TO VERIFY ALL UTILITIES WITHIN THE LIMITS OF THE WORK. ALL DAMAGE MADE TO EXISTING UTILITIES BY THE CONTRACTOR SHALL BE THE SOLE RESPONSIBILITY OF THE CONTRACTOR.

UTILITY STATEMENT

SHEET	DESCRIPTION	REV
T-1	TITLE SHEET	0
N-1	PROJECT NOTES	0
PL-1	PARTS LIST	0
F-1	FOUNDATION ELEVATION	0
F-2	SECTION CUTS	0

INDEX OF SHEETS

SEAL:



September 12, 2018

# GENERAL NOTES:

1. FOUNDATION DESIGN(S) ARE BASED ON:
  - A. TOWER DESIGN CALCULATIONS BY SABRE INDUSTRIES TOWERS AND POLES DATED AUGUST 20, 2018, JOB NO.: 19-1271-JDS OPT. 2 WITH DESIGN CRITERIA:
    - i. BASIC WIND SPEED (V3s) OF 89 MPH, NO ICE
    - ii. BASIC WIND SPEED (V3s) OF 30 MPH, 0.75-IN RADIAL ICE
    - iii. WIND IMPORTANCE FACTOR OF 1.00
    - iv. EXPOSURE CATEGORY C
    - v. TOPOGRAPHY CATEGORY 1
  - B. REACTIONS AND ANCHOR BOLT LAYOUT FROM DESIGN DRAWINGS:
    - i. MOMENT = 5,927 KIP-FT (UNFACTORED, DESIGN) 2,410 KIP-FT (UNFACTORED, SERVICE) 9,483 KIP-FT (FACTORED, DESIGN)
    - ii. SHEAR = 37.3 KIP (UNFACTORED, DESIGN) 15.2 KIP (UNFACTORED, SERVICE) 59.7 KIP (FACTORED, DESIGN)
    - iii. AXIAL = 72.9 KIP (UNFACTORED, DESIGN) 72.9 KIP (UNFACTORED, SERVICE) 87.4 KIP (FACTORED, DESIGN)
    - iv. (24) 2.25" Ø X 64" ANCHOR RODS EQUALLY SPACED ON 80.5" B.C. WITH MINIMUM EMBEDMENT OF 72.00".
  - C. GEOTECHNICAL INVESTIGATION BY TOWER ENGINEERING PROFESSIONALS, INC. DATED OCTOBER 29, 2014, PROJECT NO.: 57808.25425.
  - D. 1.50" DEFLECTION LIMIT CRITERIA AT UNFACTORED DESIGN REACTIONS.
  - E. 0.75" DEFLECTION LIMIT CRITERIA AT UNFACTORED SERVICE REACTIONS.
2. ABBREVIATIONS:
  - A. CONC = CONCRETE
  - B. VERT = VERTICAL REINFORCEMENT BAR
  - C. TIE = TIE REINFORCEMENT BAR
  - D. HORIZ = HORIZONTAL REINFORCEMENT BAR
  - E. T&B = TOP AND BOTTOM
  - F, E.W. = EACH WAY
  - G. O/C = ON CENTER
  - H. CY = CUBIC YARDS
  - J. PSI = POUNDS PER SQUARE INCH
3. SEISMIC DESIGN PARAMETERS:
  - A. STRUCTURE CLASS II (COMMERCIAL USE & NON-EMERGENCY COMMUNICATION)
  - B. MAPPED SPECTRAL RESPONSE VALUES
    - i. S<sub>s</sub> = 0.196g
    - ii. S<sub>1</sub> = 0.089g
    - iii. SITE CLASS D
    - iv. F<sub>a</sub> = 1.600
    - v. F<sub>v</sub> = 2.400
    - vi. S(D<sub>s</sub>) = 0.209g
    - vii. S(D<sub>1</sub>) = 0.142g
  - C. SEISMIC DESIGN CATEGORY "C"

# FOUNDATION NOTES:

1. CONCRETE SHALL HAVE A MINIMUM 28-DAY COMPRESSIVE STRENGTH OF 4,500 PSI.
2. REBAR SHALL CONFORM TO ASTM SPECIFICATION A615.
3. ALL REBAR SHALL HAVE 3 INCHES MINIMUM COVER.
4. ALL EXPOSED CONCRETE CORNERS SHALL BE CHAMFERED 1 INCH.
5. SEE GEOTECHNICAL REPORT FOR INSTALLATION REQUIREMENTS.
6. REINFORCEMENT SHALL BE 3 INCHES CLEAR FROM EDGES OF CONCRETE.
7. REFER TO CONCRETE AIR CONTENT TABLE FOR TARGET AIR CONTENT PER MAXIMUM AGGREGATE SIZE.

CONCRETE AIR CONTENT	
NOMINAL MAXIMUM AGGREGATE SIZE (in.)	TARGET AIR CONTENT (%)
3/8	7.5
1/2	7
3/4	6
1	6
1 1/2	5.5
2	5
3	4.5

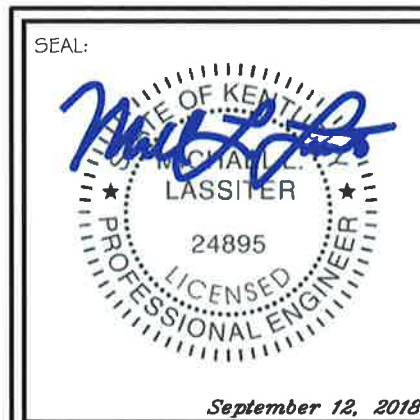

DRAWN BY: MEA	CHECKED BY: MILL	REVISION: 0	DOG #: STR18-03128-08
N-1		SHEET NUMBER:	
0	12 SEP 18	REV	DATE
<p>5000 VALLEYSTONE DRIVE CARY, NC 27519 OFFICE: (919) 468-5559 WWW.TOWERCO.COM</p>			
<p><b>(D.S.)</b></p> <p><b>EAST PARIS</b></p> <p>TOWERCO JOB #: <b>KY0062</b></p>			
<p>PREPARED BY:</p> <p>4804 PROFESSIONAL COURT SECOND FLOOR RALEIGH, NC 27609 OFFICE: (919) 342-8247 WWW.DELTAOKSGROUP.COM</p>			



## PARTS LIST - DRILLED SHAFT

MARK NO.	DESCRIPTION	SIZE	QTY
CONC.	4,500-PSI MIX - LARGEST COARSE AGGREGATE SHALL BE 1/2-IN OR LESS	75.4 CY	1
VERT.	VERTICAL BAR	#10 ASTM A615-60 x 31'-6"	46
TIE	TIE	#5 ASTM A615-60 x 29'-5"	71
HORIZ	HORIZONTAL	#3 ASTM A615-60 X 8'-8" MAX. (CUT TO FIT)	24
PIPE	TEMPORARY STEEL PIPE (SEE NOTE 1)	PL 3/8"	1

**NOTE:**  
1. REFER TO GEOTECHNICAL REPORT FOR CONSTRUCTION RECOMMENDATIONS.

DRAWN BY: MEA	CHECKED BY: MILL	REVISION: 0	PL-1
SHEET NUMBER:		DOG #: STR   8-03   28-08	
REV	0	12 SEP 18	DATE



5000 VALLEYSTONE DRIVE  
CARY, NC 27519  
OFFICE: (919) 468-5558  
WWW.TOWERCO.COM

PROJECT NAME:	<b>(D.S.)</b>
<b>EAST PARIS</b>	
TOWERCO JOB #:	<b>KY0062</b>

SEAL:



*September 12, 2018*

PREPARED BY: 4904 PROFESSIONAL COURT SECOND FLOOR RALEIGH, NC 27609 OFFICE: (919) 342-8247 WWW.DELTADAKSGROUP.COM	
--	---

**NOTES:**

1. REFER TO SHEET PL-1 FOR PARTS LIST.

HORIZ @ 9" MAX. E.W.

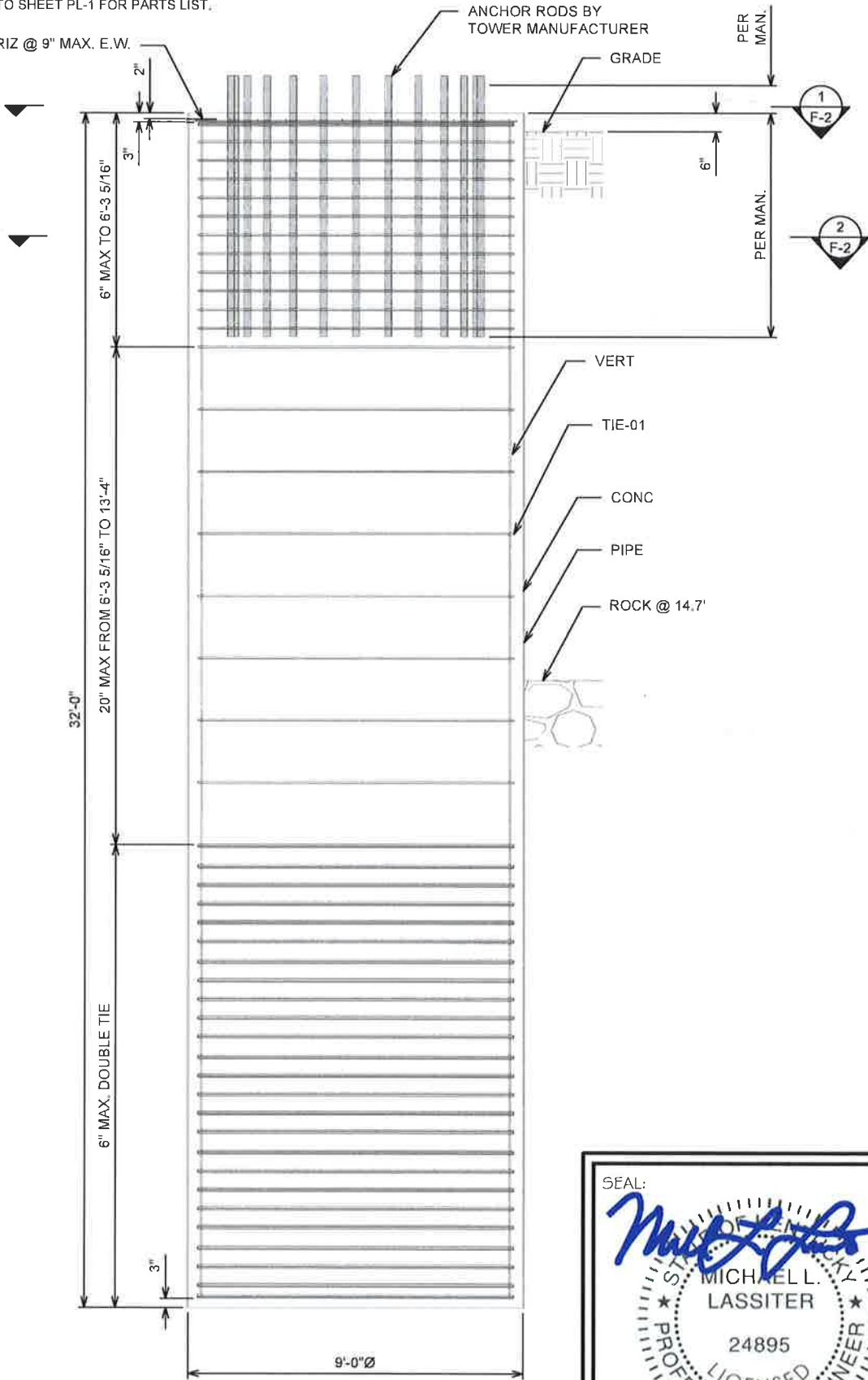

**1**  
**F-1** FOUNDATION ELEVATION  
SCALE: 1/4" = 1'-0"

SEAL:  
*Michael Lassiter*  
MICHAEL LASSITER  
24895  
LICENSED PROFESSIONAL ENGINEER  
September 12, 2018

DRAWN BY: MEA	CHECKED BY: MILL
SHEET NUMBER: <b>F-1</b>	REVISION: 0
REV	DATE
0	12 SEP 18
DOG # : STR 18-03   28-08	

5000 VALLEYSTONE DRIVE CARY, NC 27519 OFFICE: (919) 468-5559 WWW.TOWERCO.COM
---

**TowerCo**

PROJECT NAME: **(D.S.) EAST PARIS**  
TOWERCO JOB #: **KY0062**

PREPARED BY:  
4804 PROFESSIONAL COURT  
SECOND FLOOR  
RALEIGH, NC 27609  
OFFICE: (919) 342-8247  
WWW.DELTAACKSGROUP.COM



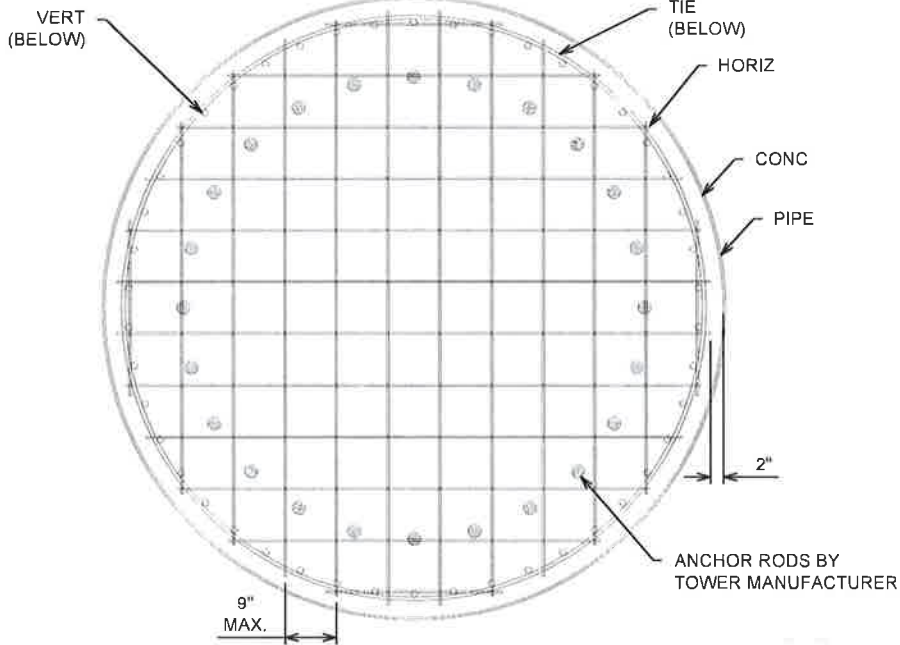

**1**  
**F-2** **FOUNDATION SECTION**  
SCALE: 3/8" = 1'-0"

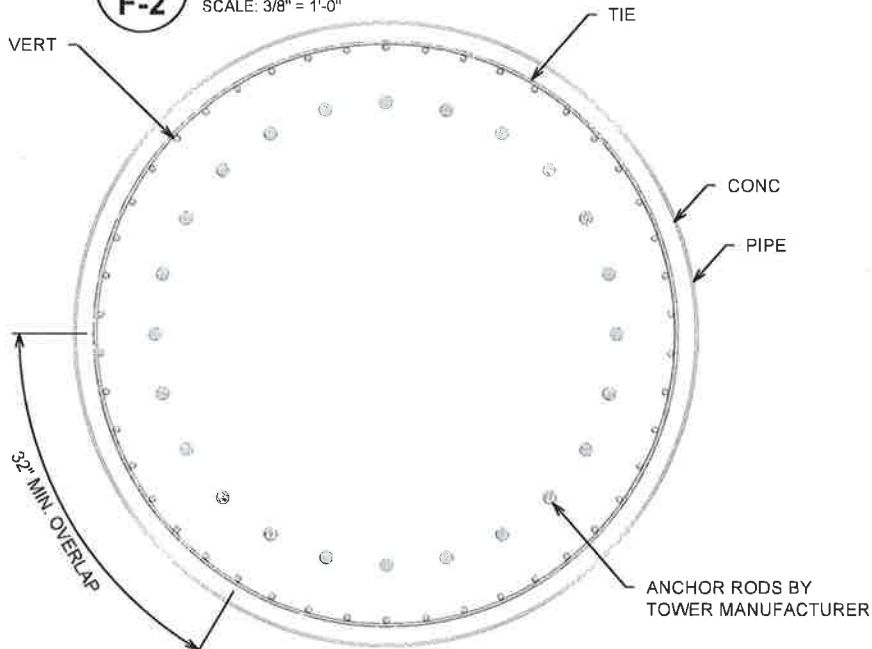

**2**  
**F-2** **FOUNDATION SECTION**  
SCALE: 3/8" = 1'-0"

SEAL:



September 12, 2018

DRAWN BY: MEA	CHECKED BY: MILL
SHEET NUMBER: <b>F-2</b>	REVISION: 0
DOG #: STR18-03128-08	

0	12 SEP 18	DATE
REV		

5000 VALLEYSTONE DRIVE  
CARY, NC 27519  
OFFICE: (919) 469-5559  
WWW.TOWERCO.COM

PROJECT NAME: **(D.S.) EAST PARIS**  
TOWERCO JOB #: **KY0062**

PREPARED BY:

4804 PROFESSIONAL COURT  
SECOND FLOOR  
RALEIGH, NC 27609  
OFFICE: (919) 342-8247  
WWW.DELTAAKSGROUP.COM



September 12, 2018

Mr. Stephen Rambeau  
Director of Engineering  
TowerCo, LLC  
5000 Valleystone Drive  
Cary, NC 27519

**Subject**

**Foundation Design Calculations**

**TowerCo Designation**

**Site Number: KY0062**  
**Site Name: East Paris**  
**JIRA Ticket: [ENG-28089](#)**

**Engineering Firm Designation**

**Delta Oaks Group Project: STR18-03128-08**  
**Delta Oaks Group Site Number: 17-00227**

**Site Data**

**93+/- East Main Street, Paris, Bourbon County KY 40361**  
**Latitude N 38.2152° ±; Longitude: W 84.2446° ±; Elev: 806.3 ft±,**  
**Topography Category I; Site Class “D”;**  
**Exposure Category “C” Structure Class/Risk Category II;**  
**196-ft Self-Supporting Pole Structure**

Dear Mr. Rambeau,

To your request, we present our foundation design calculations. Our work is in conformance ANSI/TIA-222-G-2-2009, *Structural Standard for Antenna Supporting Structures and Antennas* (industry standard) and 2012 *Kentucky Building Code / International Building Code* (local building code) for:

- $V_{ult} = 115\text{-mph} / V_{asd} = 89\text{-mph}$  three-second gust basic wind speed
- 30-mph three-second gust basic wind speed with 3/4-in radial ice
- Earthquake design parameters, per USGS Ground Motion Parameter Calculator (ASCE 7-10):
  - $S_s = 0.196, S_1 = 0.089$
- Seismic Design Category C

We trust you find our work satisfactory. Please contact us should you have questions or comments.

Sincerely,

Michael L. Lassiter, SE, PE  
Chief Structural Engineer  
KY PE License 24895

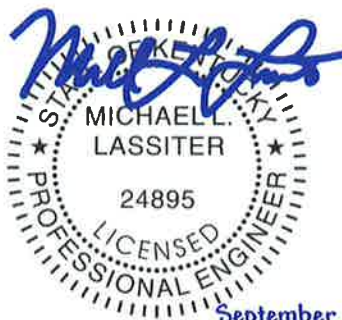

September 12, 2018

Attachments:

Foundation design calculations



DS Design

Job #: STR18-03128-08  
 Date: 9/11/2018  
 Calculated by: N Whetsel  
 Reviewed by: M Lassiter

**DRILLED SHAFT FOUNDATION DESIGN**

Tower Design:

Structure Type = SSPS  
 Code = TIA-222-G  
 V(3s) - Design = 89 mph  
 V(3s) - Service = 60 mph  
  
 BC = 80.50 in  
 AR Diameter = 2.25 in  
 AR Embedment = 72.00 in \*  
 AR Template = 6.0 in \*

Design Notes:

1. Vertical rebar is controlled by LPILE, 58 sq in req'd
2. Static deflection < 1.5" at 30.5-ft length
3. Length required for #5 ties at 20" > 40 ft
4. Length required for #5 ties at 6" = 37 ft
5. Length required (2) #5 ties at 6" < 30.5 ft
6. Final design: 32-ft shaft w/ (46) #10 vert and (2) #5 ties @ 6"

\*Sabre Information

Factored Base Reactions:

Moment = 9483.4 kip-ft  
 Shear = 59.7 kip  
 Axial = 87.4 kip

Drilled Shaft Concrete Properties:

D<sub>MIN</sub> = 9.00 ft  
 D = 9.00 ft #VALUE!  
 L = 32.00 ft  
 f'<sub>c</sub> = 3000 psi  
 Side Cover = 3.00 in (to edge of tie)  
 Top/Bottom Cover = 3.00 in (to end of vertical)  
 Max Agg. Size = 1/2 in

Vertical Rebar Properties:

Vert. Size = #10  
 n<sub>bar</sub> = 46 [min. (37) #10 rebar req'd]  
 Grade = A615-60  
  
 A<sub>t,vert</sub> = 58.42 in<sup>2</sup>  
 ρ = 0.0064 > 0.005 OK  
 h<sub>x</sub> = 5.52 in > 2.50 in OK

Tie / Shear Reinforcement:

Shear Area calc'd per: 0.7\*Ag  
 Tie Size = (2) #5 (#5 min. size recommended)  
 s<sub>tie</sub> = 6.0 in (max spacing req'd: 8.45")  
 clr<sub>tie</sub> = 4.75 in > 2.50 in OK  
 Grade = A615-60  
 Overlap = 2.7 ft  
 # of ties @ 3", TOP = 2  
 # of ties @ 3", BOT = 2  
  
 - Seismic Ties: NO = seismic ties req'd?



LPILE & Caisson I&O

Job #: STR18-03128-08  
 Date: 9/11/2018  
 Calculated by: N Whetsel  
 Reviewed by: M Lassiter

**DRILLED SHAFT FOUNDATION DESIGN**

**- Shaft Dimensions:**

L = 32.0 ft  
 D = 108.0 in

**- Concrete:**

f'<sub>c</sub> = 3000 psi

**- Rebars:**

Vert. Size = #10  
 n<sub>bar</sub> = 46  
 Clr. cover = 3.625 in (to edge of vert)

**PILE-HEAD CONDITIONS**

**- Static Loading:**

Limit State	Condition 1	Condition 2	Axial Load
	lb	lb-in	lb
Structure	79653	151734560	116560
Design Defl.	37338	71125575	72850

**- Cyclic Loading:**

ratio = 0.41

Service Defl.	15183	28923017	72850

**CAISSON LOAD DATA**

Moment = 9483 kip-ft  
 Axial = 87.42 kip  
 Shear = 59.74 kip  
 Add. SF = 1.33

**LPILE RESULTS**

Design % = 100%

**- Design: Flexure**

M<sub>n</sub> = 162895 kip-in  
 φM<sub>n</sub> = 12217 kip-ft  
 M<sub>max</sub> = 1.20E+08 lb-in  
 M<sub>u</sub> = 10000 kip-ft  
 r<sub>M</sub> = 82% OK

**- Design: Deflection**

Δ = 1.160  
 Δ<sub>All</sub> = 1.5  
 r<sub>Δ</sub> = 77% OK

**- Design: Max Shear**

V<sub>max</sub> = 1100213 lb  
 V<sub>u</sub> = 1100.2 kip  
 d = 86.4 in  
 A<sub>c,eff</sub> = 6412.6 in<sup>2</sup>  
  
 V<sub>c</sub> = 705.8 kip  
 V<sub>s</sub> = 1071.4 kip

S<sub>tie, MAX1</sub> = 20.32 in (7.10.5.2 - Vert)

S<sub>tie, MAX2</sub> = 24.00 in (11.5.5.1 - d/2)

S<sub>tie, MAX3</sub> = N/A (11.5.5.3 - d/4)

Min Stirrip Req'd ? YES (11.5.6.1)

S<sub>tie, MAX4</sub> = 40.33 in (11.5.6.3 - A<sub>v,min</sub>)

S<sub>tie, MAX5</sub> = 8.45 in (11.5.7.2 - V<sub>s</sub>)

S<sub>tie, MAX</sub> = 8.45 in > 6.0 in OK

φV<sub>n</sub> = 1332.9 kip  
 r<sub>V</sub> = 83% OK

**- Service: Deflection**

Δ = 0.250  
 Δ<sub>All</sub> = 0.75  
 r<sub>Δ</sub> = 33% OK

**CAISSON RESULTS**

L<sub>req'd</sub> = 26.5 ft  
 r<sub>sail</sub> = 83% OK

A<sub>s,req'd</sub> = 55.0 in<sup>2</sup>  
 A'<sub>s,req'd</sub> = 51.9 in<sup>2</sup>  
 r<sub>As</sub> = 89% OK

**MAX = 89% OK**

CAISSON Version 12.10 4:47:17 PM Tuesday, September 11, 2018

\*\*\*\*\*  
 \*  
 \* CAISSON - Pier Foundations Analysis and Design - Copyright Power Line Systems, Inc. 1993-2011 \*  
 \*  
 \*\*\*\*\*

Project Title: 18-03128 East Paris KY0062  
 Project Notes:

Calculation Method: Full 8CD

\*\*\*\*\* I N P U T D A T A

Pier Properties

Diameter (ft)	Distance of Top of Pier above Ground (ft)	Concrete Strength (ksi)	Steel Yield Strength (ksi)
9.00	0.50	3.00	60.00

Soil Properties

Layer	Type	Thickness (ft)	Depth at Top of Layer (ft)	Density (lbs/ft^3)	CU (psf)	KP	PHI (deg)
1	Clay	1.70	0.00	100.0	50.0		
2	Clay	4.30	1.70	100.0	100.0		
3	Sand	8.70	6.00	105.0		1.420	9.99
4	Sand	10.00	14.70	130.0		5.830	45.01

Design (Factored) Loads at Top of Pier

Moment (ft-k)	Axial Load (kips)	Shear Load (kips)	Additional Safety Factor Against Soil Failure
9483.4	87.4	59.70	1.33

\*\*\*\*\* R E S U L T S

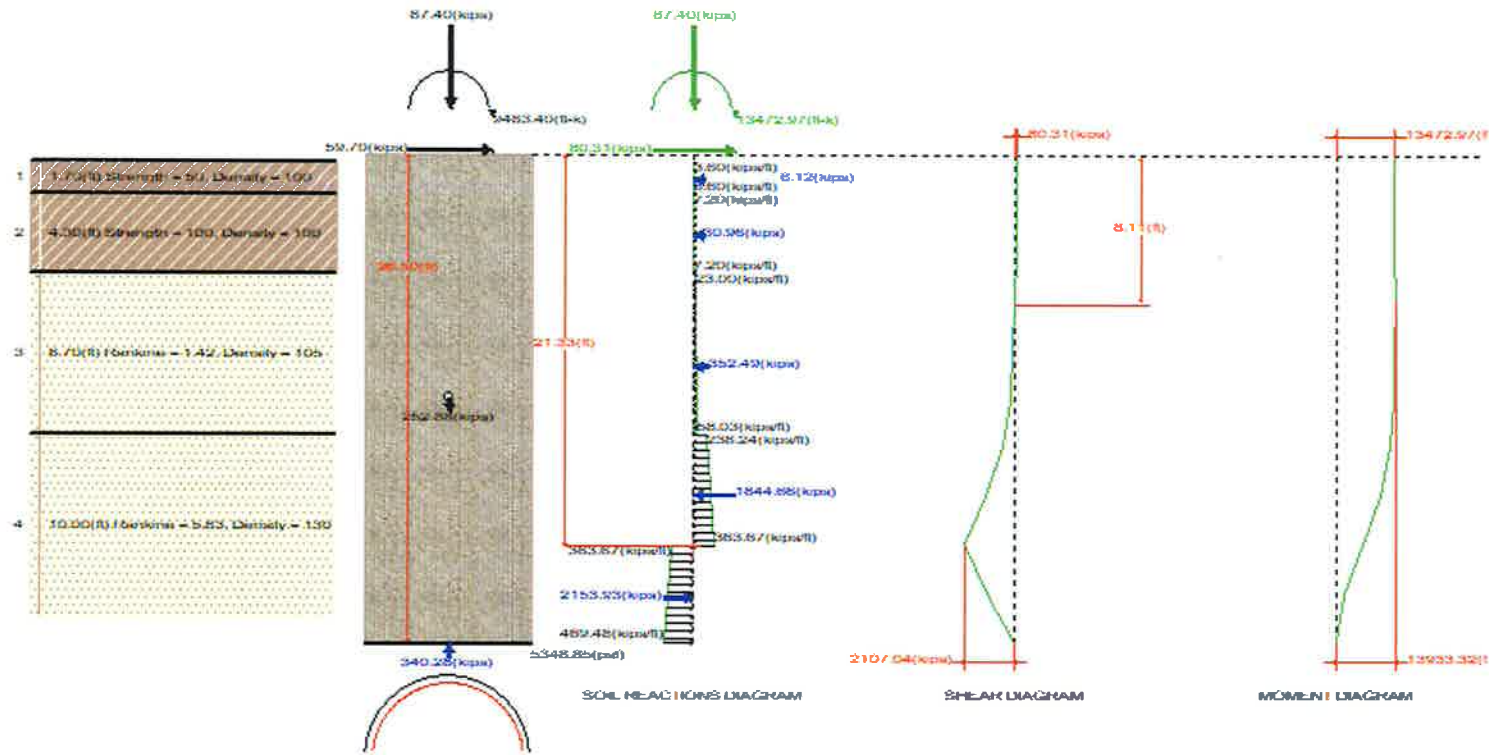

Calculated Pier Properties

Length (ft)	Weight (kips)	Pressure Due To Axial Load (psf)	Pressure Due To Weight (psf)	Total End-Bearing Pressure (psf)
26.500	252.879	1373.8	3975.0	5348.8

Ultimate Resisting Forces Along Pier

Type	Distance of Top of Layer to Top of Pier (ft)	Thickness (ft)	Density (lbs/ft^3)	CU (psf)	KP	Force (kips)	Arm (ft)
Clay	0.50	1.70	100.0	50.0		6.12	1.35
Clay	2.20	4.30	100.0	100.0		30.96	4.35
Sand	6.50	8.70	105.0		1.420	352.49	11.48
Sand	15.20	6.13	130.0		5.830	1844.66	18.48

Sand 21.33 5.17 130.0 5.830 -2153.93 24.02

## Shear and Moments Along Pier

Distance below Top of Pier (ft)	Shear (with Safety Factor) (kips)	Moment (with Safety Factor) (ft-k)	Shear (without Safety Factor) (kips)	Moment (without Safety Factor) (ft-k)
0.00	80.3	13473.0	60.4	10130.1
2.65	70.9	13677.1	53.3	10283.5
5.30	51.9	13839.8	39.0	10405.9
7.95	5.6	13933.3	4.2	10476.2
10.60	-84.9	13834.5	-63.9	10401.9
13.25	-203.8	13458.2	-153.2	10119.0
15.90	-481.0	12684.5	-361.7	9537.2
18.55	-1222.2	10459.5	-918.9	7864.3
21.20	-2107.0	6080.0	-1584.2	4571.4
23.85	-1172.3	1585.0	-881.4	1191.7
26.50	-0.0	0.0	-0.0	0.0

## Reinforcement and Capacity

Total Reinforcement Percent	Reinforcement Area (in <sup>2</sup> )	Usable Axial Capacity (kips)	Usable Moment Capacity (ft-k)
0.60	54.97	87.4	10736.4

## US Standard Re-Bars (Select one of the following)

Quantity	Name	Area (in <sup>2</sup> )	Diameter (in)	Spacing (in)
275	#4	0.20	0.500	1.12
178	#5	0.31	0.625	1.73
125	#6	0.44	0.750	2.45
92	#7	0.60	0.875	3.35
70	#8	0.79	1.000	4.40
55	#9	1.00	1.128	5.60
44	#10	1.27	1.270	7.00
36	#11	1.56	1.410	8.55
25	#14	2.25	1.693	12.32



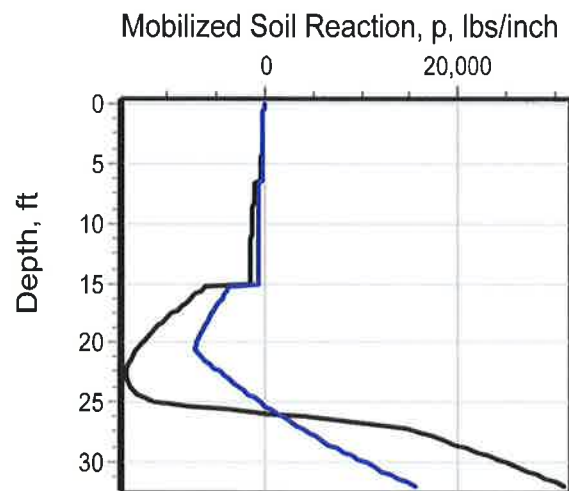
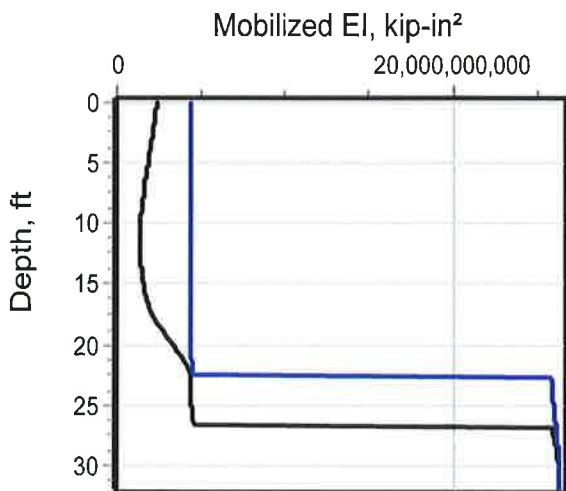
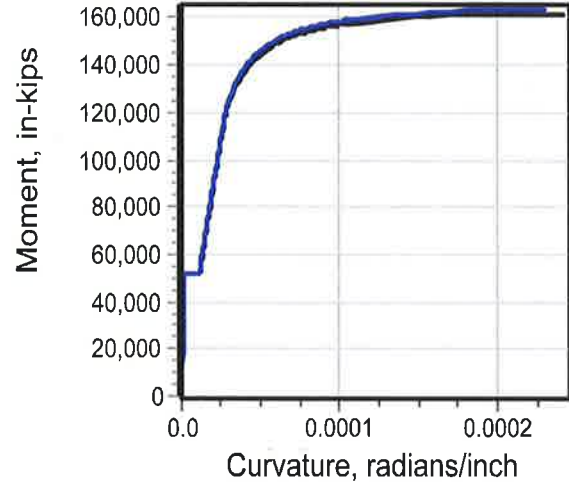
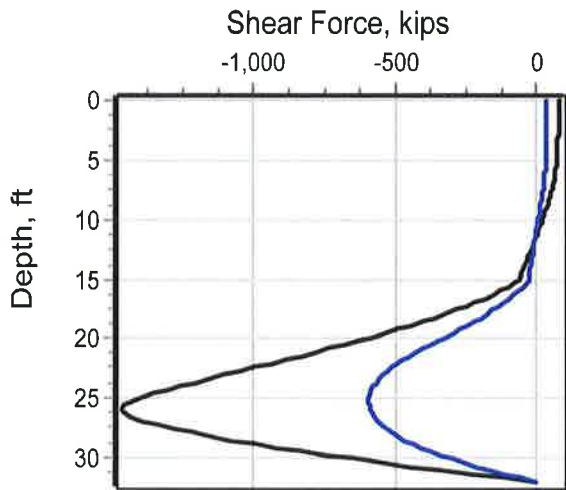
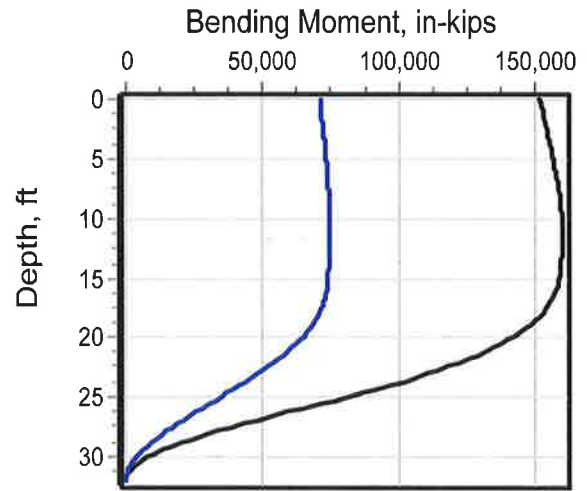



KY0062\_static.lp10o

LFile for Windows, Version 2018-10.004

Analysis of Individual Piles and Drilled Shafts  
 Subjected to Lateral Loading Using the p-y Method  
 © 1985-2018 by Ensoft, Inc.  
 All Rights Reserved

-----  
 This copy of LFile is being used by:

Delta Oaks Group  
 Chapel Hill, NC

Serial Number of Security Device: 139334612

This copy of LFile is licensed for exclusive use by:

Delta Oaks Group, Chapel Hill, N

Use of this program by any entity other than Delta Oaks Group, Chapel Hill, N  
 is a violation of the software license agreement.

-----  
 Files Used for Analysis  
 -----

Path to file locations:  
 \2018 Projects\18-03128 East Paris KY0062\STR\Additional Calculations\SSPS DS\L-Pile - Deflection\MLL\

Name of input data file:  
 KY0062\_static.lp10

Name of output report file:  
 KY0062\_static.lp10

Name of plot output file:  
 KY0062\_static.lp10

Name of runtime message file:  
 KY0062\_static.lp10

-----  
 Date and Time of Analysis  
 -----

Page 1

Date: September 11, 2018

KY0062\_static.lp10o  
 Time: 17:36:39

-----  
 Problem Title  
 -----

18-03128 East Paris KY0062

M Lassiter

-----  
 Program Options and Settings  
 -----

Computational Options:  
 - Use unfactored loads in computations (conventional analysis)  
 Engineering Units Used for Data Input and Computations:  
 - US Customary System Units (pounds, feet, inches)

Analysis Control Options:  
 - Maximum number of iterations allowed = 500  
 - Deflection tolerance for convergence = 1.0000E-05 in  
 - Maximum allowable deflection = 100.0000 in  
 - Number of pile increments = 100

Loading Type and Number of Cycles of Loading:  
 - Static loading specified

- Use of p-y modification factors for p-y curves not selected  
 - Analysis uses layering correction (Method of Georgiadis)  
 - No distributed lateral loads are entered  
 - Loading by lateral soil movements acting on pile not selected  
 - Input of shear resistance at the pile tip not selected  
 - Computation of pile-head foundation stiffness matrix not selected

Page 2

- Push-over analysis of pile not selected
- Buckling analysis of pile not selected

KY0062\_static.lp10o

## Output Options:

- Output files use decimal points to denote decimal symbols.
- Values of pile-head deflection, bending moment, shear force, and soil reaction are printed for full length of pile.
- Printing Increment (nodal spacing of output points) = 1
- No p-y curves to be computed and reported for user-specified depths
- Print using wide report formats

---

 Pile Structural Properties and Geometry
 

---

Number of pile sections defined = 1  
 Total length of pile = 32.0000 ft  
 Depth of ground surface below top of pile = 0.5000 ft

Pile diameters used for p-y curve computations are defined using 2 points.

p-y curves are computed using pile diameter values interpolated with depth over the length of the pile. A summary of values of pile diameter vs. depth follows.

Point No.	Depth Below Pile Head feet	Pile Diameter inches
1	0.000	108.0000
2	32.000	108.0000

---

 Input Structural Properties for Pile Sections:
 

---

## Pile Section No. 1:

Section 1 is a round drilled shaft, bored pile, or CIDH pile  
 Length of section = 32.000000 ft  
 Shaft Diameter = 108.000000 in  
 Shear capacity of section = 0.0000 lbs

---

 Ground Slope and Pile Batter Angles
 

---

Page 3

KY0062\_static.lp10o

Ground Slope Angle = 0.000 degrees  
 = 0.000 radians  
 Pile Batter Angle = 0.000 degrees  
 = 0.000 radians

---

 Soil and Rock Layering Information
 

---

The soil profile is modelled using 4 layers

Layer 1 is soft clay, p-y criteria by Matlock, 1970

Distance from top of pile to top of layer = 0.500000 ft  
 Distance from top of pile to bottom of layer = 2.200000 ft  
 Effective unit weight at top of layer = 100.000000 pcf  
 Effective unit weight at bottom of layer = 100.000000 pcf  
 Undrained cohesion at top of layer = 50.000000 psf  
 Undrained cohesion at bottom of layer = 50.000000 psf  
 Epsilon-50 at top of layer = 0.020000  
 Epsilon-50 at bottom of layer = 0.020000

Layer 2 is soft clay, p-y criteria by Matlock, 1970

Distance from top of pile to top of layer = 2.200000 ft  
 Distance from top of pile to bottom of layer = 6.500000 ft  
 Effective unit weight at top of layer = 100.000000 pcf  
 Effective unit weight at bottom of layer = 100.000000 pcf  
 Undrained cohesion at top of layer = 100.000000 psf  
 Undrained cohesion at bottom of layer = 100.000000 psf  
 Epsilon-50 at top of layer = 0.020000  
 Epsilon-50 at bottom of layer = 0.020000

Layer 3 is sand, p-y criteria by Reese et al., 1974

Distance from top of pile to top of layer = 6.500000 ft  
 Distance from top of pile to bottom of layer = 15.200000 ft  
 Effective unit weight at top of layer = 105.000000 pcf  
 Effective unit weight at bottom of layer = 105.000000 pcf  
 Friction angle at top of layer = 10.000000 deg.  
 Friction angle at bottom of layer = 10.000000 deg.  
 Subgrade k at top of layer = 10.000000 pci  
 Subgrade k at bottom of layer = 10.000000 pci

Page 4

KY0062\_static.lp10o

Layer 4 is sand, p-y criteria by Reese et al., 1974

Distance from top of pile to top of layer = 15.200000 ft  
 Distance from top of pile to bottom of layer = 40.000000 ft  
 Effective unit weight at top of layer = 130.000000 pcf  
 Effective unit weight at bottom of layer = 130.000000 pcf  
 Friction angle at top of layer = 45.000000 deg.  
 Friction angle at bottom of layer = 45.000000 deg.  
 Subgrade k at top of layer = 270.000000 pci  
 Subgrade k at bottom of layer = 270.000000 pci

(Depth of the lowest soil layer extends 8.000 ft below the pile tip)

Summary of Input Soil Properties

Layer Num.	Soil Type Name (p-y Curve Type)	Layer Depth ft	Effective Unit Wt. pcf	Undrained Cohesion psf	Angle of Friction deg.	E50 or krm	kpy pci
1	Soft Clay	0.5000	100.0000	50.0000	--	0.02000	--
2	Soft Clay	2.2000	100.0000	100.0000	--	0.02000	--
3	Sand (Reese, et al.)	6.5000	100.0000	100.0000	--	0.02000	--
4	Sand (Reese, et al.)	15.2000	105.0000	--	10.0000	--	10.0000
		15.2000	130.0000	--	45.0000	--	270.0000
		40.0000	130.0000	--	45.0000	--	270.0000

Static Loading Type

Static loading criteria were used when computing p-y curves for all analyses.

File-head Loading and File-head Fixity Conditions

Number of loads specified = 2

Load Load Condition Condition Axial Thrust Compute Top y

KY0062\_static.lp10o

No.	Type	1	2	Force, lbs	vs. File Length
1	1	V = 79653. lbs	M = 151734560. in-lbs	116560.	No
2	1	V = 37338. lbs	M = 71125575. in-lbs	72850.	No

V = shear force applied normal to pile axis  
 M = bending moment applied to pile head  
 y = lateral deflection normal to pile axis  
 S = pile slope relative to original pile batter angle  
 R = rotational stiffness applied to pile head  
 Values of top y vs. pile lengths can be computed only for load types with specified shear loading (Load Types 1, 2, and 3).  
 Thrust force is assumed to be acting axially for all pile batter angles.

Computations of Nominal Moment Capacity and Nonlinear Bending Stiffness

Axial thrust force values were determined from pile-head loading conditions

Number of File Sections Analyzed = 1

File Section No. 1:

Dimensions and Properties of Drilled Shaft (Bored Pile):

Length of Section = 32.000000 ft  
 Shaft Diameter = 108.000000 in  
 Concrete Cover Thickness = 3.625000 in  
 Number of Reinforcing Bars = 46 bars  
 Yield Stress of Reinforcing Bars = 60000. psi  
 Modulus of Elasticity of Reinforcing Bars = 29000000. psi  
 Gross Area of Shaft = 9161. sq. in.  
 Total Area of Reinforcing Steel = 58.420000 sq. in.  
 Area Ratio of Steel Reinforcement = 0.64 percent  
 Edge-to-Edge Bar Spacing = 5.518755 in  
 Maximum Concrete Aggregate Size = 0.750000 in  
 Ratio of Bar Spacing to Aggregate Size = 7.36  
 Offset of Center of Rebar Cage from Center of Pile = 0.0000 in

Axial Structural Capacities:

Nom. Axial Structural Capacity = 0.85 Fc Ac + Fy As = 26716.494 kips  
 Tensile Load for Cracking of Concrete = -3491.747 kips  
 Nominal Axial Tensile Capacity = -3505.200 kips

KY0062\_static.lp10o

## Reinforcing Bar Dimensions and Positions Used in Computations:

Bar Number	Bar Diam. inches	Bar Area sq. in.	X inches	Y inches
1	1.270000	1.270000	49.740000	0.00000
2	1.270000	1.270000	49.276719	6.772929
3	1.270000	1.270000	47.895506	13.419691
4	1.270000	1.270000	45.622090	19.816470
5	1.270000	1.270000	42.498821	25.844106
6	1.270000	1.270000	38.583880	31.390314
7	1.270000	1.270000	33.950193	36.351781
8	1.270000	1.270000	28.684079	40.636082
9	1.270000	1.270000	22.883635	44.163411
10	1.270000	1.270000	16.656912	46.868058
11	1.270000	1.270000	10.119902	48.699643
12	1.270000	1.270000	3.394378	49.624045
13	1.270000	1.270000	-3.394378	49.624045
14	1.270000	1.270000	-10.119902	48.699643
15	1.270000	1.270000	-16.656912	46.868058
16	1.270000	1.270000	-22.883635	44.163411
17	1.270000	1.270000	-28.684079	40.636082
18	1.270000	1.270000	-33.950193	36.351781
19	1.270000	1.270000	-38.583880	31.390314
20	1.270000	1.270000	-42.498821	25.844106
21	1.270000	1.270000	-45.622090	19.816470
22	1.270000	1.270000	-47.895506	13.419691
23	1.270000	1.270000	-49.276719	6.772929
24	1.270000	1.270000	-49.740000	0.00000
25	1.270000	1.270000	-49.276719	-6.772929
26	1.270000	1.270000	-47.895506	-13.419691
27	1.270000	1.270000	-45.622090	-19.816470
28	1.270000	1.270000	-42.498821	-25.844106
29	1.270000	1.270000	-38.583880	-31.390314
30	1.270000	1.270000	-33.950193	-36.351781
31	1.270000	1.270000	-28.684079	-40.636082
32	1.270000	1.270000	-22.883635	-44.163411
33	1.270000	1.270000	-16.656912	-46.868058
34	1.270000	1.270000	-10.119902	-48.699643
35	1.270000	1.270000	-3.394378	-49.624045
36	1.270000	1.270000	3.394378	-49.624045
37	1.270000	1.270000	10.119902	-48.699643
38	1.270000	1.270000	16.656912	-46.868058
39	1.270000	1.270000	22.883635	-44.163411
40	1.270000	1.270000	28.684079	-40.636082
41	1.270000	1.270000	33.950193	-36.351781
42	1.270000	1.270000	38.583880	-31.390314
43	1.270000	1.270000	42.498821	-25.844106

Page 7

KY0062_static.lp10o				
44	1.270000	1.270000	45.622090	-19.816470
45	1.270000	1.270000	47.895506	-13.419691
46	1.270000	1.270000	49.276719	-6.772929

NOTE: The positions of the above rebars were computed by LPile

Minimum spacing between any two bars not equal to zero = 5.519 inches  
between bars 31 and 32

Ratio of bar spacing to maximum aggregate size = 7.36

## Concrete Properties:

Compressive Strength of Concrete	=	3000. psi
Modulus of Elasticity of Concrete	=	3122019. psi
Modulus of Rupture of Concrete	=	-410.791918 psi
Compression Strain at Peak Stress	=	0.001634
Tensile Strain at Fracture of Concrete	=	-0.0001160
Maximum Coarse Aggregate Size	=	0.750000 in

Number of Axial Thrust Force Values Determined from Pile-head Loadings = 2

Number	Axial Thrust Force kips
1	72.850
2	116.560

## Definitions of Run Messages and Notes:

C = concrete in section has cracked in tension.  
 Y = stress in reinforcing steel has reached yield stress.  
 T = ACI 318 criteria for tension-controlled section met, tensile strain in reinforcement exceeds 0.005 while simultaneously compressive strain in concrete more than 0.003. See ACI 318, Section 10.3.4.  
 Z = depth of tensile zone in concrete section is less than 10 percent of section depth.

Bending Stiffness (EI) = Computed Bending Moment / Curvature.  
 Position of neutral axis is measured from edge of compression side of pile.  
 Compressive stresses and strains are positive in sign.  
 Tensile stresses and strains are negative in sign.

Page 8

Axial Thrust Force = 72.850 kips KY0062\_static.lp10o

Table with 9 columns: Bending Curvature rad/in., Bending Moment in-kip, Bending Stiffness kip-in2, Depth to N Axis in, Max Comp Strain in/in, Max Tens Strain in/in, Max Conc Stress ksi, Max Steel Stress ksi, Run Msg. Contains 42 rows of numerical data.

Table with 9 columns: Bending Curvature rad/in., Bending Moment in-kip, Bending Stiffness kip-in2, Depth to N Axis in, Max Comp Strain in/in, Max Tens Strain in/in, Max Conc Stress ksi, Max Steel Stress ksi, Run Msg. Contains 42 rows of numerical data.

KY0062_static.lp10o									
0.00006175	149639.	2423298048.	21.2109767	0.0013098	-0.0053592	2.8566182	-60.0000000	CY	
0.00006375	150299.	2357624815.	21.0565654	0.0013424	-0.0055426	2.8807952	-60.0000000	CY	
0.00006575	150821.	2293862317.	20.8879817	0.0013734	-0.0057276	2.9017139	-60.0000000	CY	
0.00006775	151336.	2233737139.	20.7306170	0.0014045	-0.0059125	2.9206672	-60.0000000	CY	
0.00006975	151846.	2177000297.	20.5839963	0.0014357	-0.0060973	2.9376558	-60.0000000	CY	
0.00007175	152352.	2123367335.	20.4472467	0.0014671	-0.0062819	2.9526561	-60.0000000	CY	
0.00007375	152853.	2072584626.	20.3195911	0.0014986	-0.0064664	2.9656440	-60.0000000	CY	
0.00007575	153329.	2024140976.	20.1978658	0.0015300	-0.0066510	2.9765340	-60.0000000	CY	
0.00007775	153747.	1977454993.	20.0779306	0.0015611	-0.0068359	2.9852652	-60.0000000	CY	
0.00007975	154085.	1932100925.	19.9547728	0.0015914	-0.0070216	2.9918334	-60.0000000	CY	
0.00008175	154406.	1888763547.	19.8292476	0.0016210	-0.0072080	2.9963905	-60.0000000	CY	
0.00008375	154724.	1847455813.	19.7111287	0.0016508	-0.0073942	2.9991201	-60.0000000	CY	
0.00008575	155039.	1808034500.	19.5999302	0.0016807	-0.0075803	2.9998275	-60.0000000	CY	
0.00008775	155349.	1770357871.	19.4954711	0.0017107	-0.0077663	2.9952522	-60.0000000	CY	
0.00008975	155656.	1734325260.	19.3969476	0.0017409	-0.0079521	2.9983700	-60.0000000	CY	
0.00009175	155959.	1699828486.	19.3039920	0.0017711	-0.0081379	2.9998627	-60.0000000	CY	
0.00009375	156254.	1666707797.	19.2159648	0.0018015	-0.0083235	2.9966634	-60.0000000	CY	
0.00009575	156541.	1634889970.	19.1324072	0.0018319	-0.0085091	2.9959318	-60.0000000	CY	
0.00009775	156777.	1603859033.	19.0468521	0.0018618	-0.0086952	2.9985709	-60.0000000	CY	
0.00009975	156971.	1573648696.	18.9603987	0.0018913	-0.0088817	2.9988491	-60.0000000	CY	
0.0001017	157159.	1544560210.	18.8758863	0.0019206	-0.0090684	2.9974372	-60.0000000	CY	
0.0001037	157335.	1516480292.	18.7883738	0.0019493	-0.0092557	2.9934311	-60.0000000	CY	
0.0001057	157509.	1489448244.	18.7049525	0.0019780	-0.0094430	2.9965689	-60.0000000	CY	
0.0001077	157682.	1463405496.	18.6254050	0.0020069	-0.0096301	2.9987030	-60.0000000	CY	
0.0001097	157853.	1438297720.	18.5495302	0.0020358	-0.0098172	2.9998214	-60.0000000	CY	
0.0001217	158842.	1304658761.	18.1631024	0.0022114	-0.0109376	2.9997826	-60.0000000	CY	
0.0001337	159614.	1193377438.	17.8409508	0.0023862	-0.0120588	2.9980351	-60.0000000	CY	
0.0001457	160136.	1098706407.	17.5200187	0.0025535	-0.0131875	2.9987358	-60.0000000	CY	
0.0001577	160618.	1018180268.	17.2625546	0.0027232	-0.0143138	2.9996440	-60.0000000	CY	
0.0001697	161055.	948780027.	17.0602128	0.0028960	-0.0154370	2.9857558	-60.0000000	CY	
0.0001817	161349.	887750247.	16.9154511	0.0030744	-0.0165546	2.9988951	-60.0000000	CYT	
0.0001937	161549.	833799655.	16.7856113	0.0032522	-0.0176728	2.9897641	-60.0000000	CYT	
0.0002057	161654.	785682347.	16.6535259	0.0034265	-0.0187945	2.9896649	-60.0000000	CYT	
0.0002177	161747.	742809015.	16.5314042	0.0035997	-0.0199173	2.9987912	-60.0000000	CYT	
0.0002297	161785.	704177964.	16.4514942	0.0037797	-0.0210333	2.9923006	-60.0000000	CYT	
0.0002417	161785.	669223939.	16.5412541	0.0039988	-0.0221102	2.9851153	-60.0000000	CYT	

Axial Thrust Force = 116.560 kips

Bending Curvature rad/in.	Bending Moment in-kip	Bending Stiffness kip-in <sup>2</sup>	Depth to N Axis in	Max Comp Strain in/in	Max Tens Strain in/in	Max Conc Stress ksi	Max Steel Stress ksi	Run Msg
2.50000E-07	6571.	2.62843E+10	67.3186471	0.00001683	-0.00001017	0.6210055	0.4841452	
5.00000E-07	13111.	2.62213E+10	60.6813301	0.00003034	-0.00002366	0.1094319	0.8720493	
7.50000E-07	19616.	2.61550E+10	58.4691394	0.00004385	-0.00003715	0.1574566	1.2599588	
0.00000100	26088.	2.60879E+10	57.3631479	0.00005736	-0.00005064	0.2050794	1.6478713	
0.00000125	32526.	2.60205E+10	56.6996233	0.00007087	-0.00006413	0.2523001	2.0357863	
0.00000150	38929.	2.59528E+10	56.2573291	0.00008439	-0.00007761	0.2991189	2.4237038	

Page 11

KY0062_static.lp10o									
0.00000175	45299.	2.58851E+10	55.9414509	0.00009790	-0.00009110	0.3455356	2.8116236		
0.00000200	51635.	2.58173E+10	55.7045830	0.0001114	-0.0001046	0.3915503	3.1995458		
0.00000225	51635.	2.29487E+10	30.0712705	0.00006766	-0.0001753	0.2390879	-5.0496146	C	
0.00000250	51635.	2.06538E+10	29.5134711	0.00007378	-0.0001962	0.2601478	-5.6511233	C	
0.00000275	51635.	1.87762E+10	29.0451760	0.00007987	-0.0002171	0.2810126	-6.2535822	C	
0.00000300	51635.	1.72115E+10	28.6560866	0.00008597	-0.0002380	0.3018096	-6.8559405	C	
0.00000325	51635.	1.58876E+10	28.3149873	0.00009202	-0.0002599	0.3223930	-7.4594175	C	
0.00000350	51635.	1.47527E+10	28.0222541	0.00009808	-0.0002790	0.3428931	-8.0629312	C	
0.00000375	61636.	1.37692E+10	27.7694939	0.0001041	0.0003009	0.3633267	8.6663125	C	
0.00000400	51635.	1.29086E+10	27.5492143	0.0001102	-0.0003218	0.3836935	-9.2696511	C	
0.00000425	51635.	1.21493E+10	27.3471860	0.0001162	-0.0003428	0.4038701	-9.8739043	C	
0.00000450	51635.	1.14743E+10	27.1680349	0.0001223	-0.0003637	0.4239751	-10.4781014	C	
0.00000475	51635.	1.08704E+10	27.0085086	0.0001283	-0.0003847	0.4440144	-11.0821929	C	
0.00000500	51635.	1.03269E+10	26.8656655	0.0001343	-0.0004057	0.4639877	-11.6861785	C	
0.00000525	51635.	9835150169.	26.7371246	0.0001404	-0.0004266	0.4838950	-12.2900578	C	
0.00000550	51635.	9388097889.	26.6209374	0.0001464	-0.0004476	0.5037362	-12.8938305	C	
0.00000575	51635.	8979919720.	26.5154948	0.0001525	-0.0004685	0.5235111	-13.4974962	C	
0.00000600	51635.	8605756398.	26.4174864	0.0001585	-0.0004895	0.5431805	-14.1013973	C	
0.00000625	51635.	8261526142.	26.3254538	0.0001645	-0.0005105	0.5627328	-14.7056365	C	
0.00000650	51635.	7943775137.	26.2410904	0.0001706	-0.0005314	0.5822197	-15.3097644	C	
0.00000675	51635.	7649561243.	26.1635459	0.0001766	-0.0005524	0.6016409	-15.9137809	C	
0.00000700	51635.	7376362627.	26.0920916	0.0001826	-0.0005734	0.6209965	-16.5176854	C	
0.00000725	51635.	7122005295.	26.0260992	0.0001887	-0.0005943	0.6402863	-17.1214776	C	
0.00000750	51635.	6884605119.	25.9650242	0.0001947	-0.0006153	0.6595101	-17.7251572	C	
0.00000775	51635.	6662521082.	25.9083925	0.0002008	-0.0006362	0.6786679	-18.3287238	C	
0.00000800	51635.	6454317299.	25.8557889	0.0002068	-0.0006572	0.6977596	-18.9321769	C	
0.00000825	51635.	6258731926.	25.8068491	0.0002129	-0.0006781	0.7167850	-19.5355163	C	
0.00000850	51635.	6074651575.	25.7612511	0.0002190	-0.0006990	0.7357440	-20.1387416	C	
0.00000875	51635.	5901090102.	25.7187101	0.0002250	-0.0007200	0.7546365	-20.7418523	C	
0.00000900	51635.	5737170932.	25.6789729	0.0002311	-0.0007409	0.7734624	-21.3448481	C	
0.00000925	51635.	5582112258.	25.6418135	0.0002372	-0.0007618	0.7922216	-21.9477285	C	
0.00000950	51635.	5435214567.	25.6070298	0.0002433	-0.0007827	0.8109140	-22.5504933	C	
0.00000975	51635.	5295850091.	25.5744404	0.0002494	-0.0008036	0.8295394	-23.1531419	C	
0.00001025	51635.	5037515940.	25.5152080	0.0002615	-0.0008455	0.8665888	-24.3580894	C	
0.00001075	51635.	4803212873.	25.4629905	0.0002737	-0.0008873	0.9033690	-25.5625677	C	
0.00001125	52112.	4632203408.	25.4166624	0.0002859	-0.0009291	0.9398789	-26.7665736	C	
0.00001175	54249.	4616940898.	25.3785524	0.0002982	-0.0009708	0.9761104	-27.9701733	C	
0.00001225	56384.	4602749799.	25.3378536	0.0003104	-0.0010126	1.0120082	-29.1738925	C	
0.00001275	58516.	4589514730.	25.3041980	0.0003226	-0.0010544	1.0476362	-30.3710777	C	
0.00001325	60647.	4577126497.	25.2744036	0.0003349	-0.0010961	1.0829935	-31.5798154	C	
0.00001375	62776.	4565491775.	25.2480587	0.0003472	-0.0011378	1.1180790	-32.7820116	C	
0.00001425	64902.	4554530329.	25.2248095	0.0003595	-0.0011795	1.1528916	-33.9836924	C	
0.00001475	67027.	4544172789.	25.2043503	0.0003718	-0.0012212	1.1874304	-35.1848541	C	
0.00001525	69149.	4534358874.	25.1864156	0.0003841	-0.0012629	1.2216942	-36.3854927	C	
0.00001575	71269.	4525035745.	25.1707738	0.0003964	-0.0013046	1.2556819	-37.5856045	C	
0.00001625	73388.	4516157678.	25.1572218	0.0004088	-0.0013462	1.2893926	-38.7851846	C	
0.00001675	75504.	4507683751.	25.1455809	0.0004212	-0.0013878	1.3228250	-39.9842293	C	
0.00001725	77618.	4499578002.	25.1356935	0.0004336	-0.0014294	1.3559780	-41.1827345	C	
0.00001775	79730.	4491808510.	25.1274194	0.0004460	-0.0014710	1.3888506	-42.3806960	C	
0.00001825	81839.	4484346842.	25.1206342	0.0004585	-0.0015125	1.4214416	-43.5781094	C	

Page 12

KY0062_static.lp10o							
0.00001875	83947.	4477167588.	25.1152269	0.0004709	-0.0015541	1.4537497	-44.7749704 C
0.00001925	86052.	4470247968.	25.1110980	0.0004834	-0.0015956	1.4857740	-45.9712745 C
0.00001975	88155.	4463567497.	25.1081582	0.0004959	-0.0016371	1.5175131	-47.1670174 C
0.00002025	90256.	4457107704.	25.1063272	0.0005084	-0.0016786	1.5489659	-48.3621943 C
0.00002075	92355.	4450851890.	25.1053266	0.0005209	-0.0017201	1.5801311	-49.5568007 C
0.00002125	94452.	4444784915.	25.1057087	0.0005335	-0.0017615	1.6110076	-50.7508320 C
0.00002175	96546.	4438893023.	25.1067962	0.0005461	-0.0018029	1.6415941	-51.9442832 C
0.00002225	98638.	4433163682.	25.1087412	0.0005587	-0.0018443	1.6718894	-53.1371497 C
0.00002275	100728.	4427585456.	25.1114944	0.0005713	-0.0018857	1.7018921	-54.3294265 C
0.00002325	102815.	4422147879.	25.1150113	0.0005839	-0.0019271	1.7316011	-55.5211086 C
0.00002375	104900.	4416841358.	25.1192508	0.0005966	-0.0019684	1.7610149	-56.7121910 C
0.00002425	106983.	4411657082.	25.1241756	0.0006093	-0.0020097	1.7901323	-57.9026686 C
0.00002475	109063.	4406586940.	25.1297513	0.0006220	-0.0020510	1.8189520	-59.0925360 C
0.00002525	111141.	4401623455.	25.1359467	0.0006347	-0.0020923	1.8474726	-60.0000000 CY
0.00002575	113217.	4396759721.	25.1427327	0.0006474	-0.0021336	1.8756928	-60.0000000 CY
0.00002625	115273.	4391335990.	25.1488060	0.0006602	-0.0021748	1.9035367	-60.0000000 CY
0.00002675	117125.	438514870.	25.14406175	0.0006725	-0.0022165	1.9302081	-60.0000000 CY
0.00002725	118767.	4378408852.	25.1388080	0.0006845	-0.0022585	1.9556863	-60.0000000 CY
0.00002775	120187.	4331046840.	25.0807510	0.0006960	-0.0023010	1.9799303	-60.0000000 CY
0.00002825	121544.	4302459913.	25.0408115	0.0007074	-0.0023436	1.9936544	-60.0000000 CY
0.00002875	122775.	4270449924.	24.9934405	0.0007186	-0.0023864	2.0265688	-60.0000000 CY
0.00002925	123953.	4237707245.	24.9443345	0.0007296	-0.0024294	2.0490138	-60.0000000 CY
0.00002975	125098.	4204970088.	24.8949989	0.0007406	-0.0024724	2.0710827	-60.0000000 CY
0.00003025	126294.	4066140059.	24.6639972	0.0007831	-0.0026459	2.1537229	-60.0000000 CY
0.00003075	132097.	3913983649.	24.4201951	0.0008242	-0.0028208	2.2299927	-60.0000000 CY
0.00003125	134700.	3767822943.	24.1596604	0.0008637	-0.0029973	2.2988724	-60.0000000 CY
0.00003175	137028.	3629892851.	23.9038132	0.0009024	-0.0031746	2.3649674	-60.0000000 CY
0.00003225	138995.	3496735562.	23.6503239	0.0009401	-0.0033529	2.4253935	-60.0000000 CY
0.00003275	140806.	3372596579.	23.4127259	0.0009775	-0.0035315	2.4822645	-60.0000000 CY
0.00003325	142302.	3252625168.	23.1730203	0.0010138	-0.0037112	2.5346656	-60.0000000 CY
0.00003375	143774.	3142602033.	22.9445803	0.0010497	-0.0038913	2.5836650	-60.0000000 CY
0.00003425	145001.	3036659990.	22.7170940	0.0010847	-0.0040723	2.6288183	-60.0000000 CY
0.00003475	146093.	2936538034.	22.4996497	0.0011194	-0.0042536	2.6708815	-60.0000000 CY
0.00003525	147178.	2844024942.	22.3016389	0.0011541	-0.0044349	2.7105710	-60.0000000 CY
0.00003575	148199.	2757187656.	22.1137767	0.0011886	-0.0046164	2.7474485	-60.0000000 CY
0.00003625	148994.	2672544863.	21.9099947	0.0012215	-0.0047995	2.7801874	-60.0000000 CY
0.00003675	149760.	2593242802.	21.7201319	0.0012543	-0.0049827	2.8106440	-60.0000000 CY
0.00003725	150520.	2519160645.	21.5451160	0.0012873	-0.0051657	2.8389391	-60.0000000 CY
0.00003775	151275.	2449789537.	21.3835368	0.0013204	-0.0053486	2.8650467	-60.0000000 CY
0.00003825	151947.	2383483542.	21.2263649	0.0013532	-0.0055318	2.8885888	-60.0000000 CY
0.00003875	152501.	2319411382.	21.0692409	0.0013853	-0.0057157	2.9094774	-60.0000000 CY
0.00003925	153014.	2258510071.	20.9082492	0.0014165	-0.0059005	2.9276925	-60.0000000 CY
0.00003975	153521.	2201024762.	20.7574203	0.0014478	-0.0060852	2.9438961	-60.0000000 CY
0.00004025	154025.	2146684480.	20.6167215	0.0014792	-0.0062698	2.9581006	-60.0000000 CY
0.00004075	154523.	2095232228.	20.4853555	0.0015108	-0.0064542	2.9702812	-60.0000000 CY
0.00004125	155003.	2046238411.	20.3608575	0.0015423	-0.0066387	2.9803734	-60.0000000 CY
0.00004175	155441.	1999240402.	20.2402120	0.0015737	-0.0068233	2.9883341	-60.0000000 CY
0.00004225	155779.	1953346378.	20.1161716	0.0016043	-0.0070087	2.9941138	-60.0000000 CY
0.00004275	156114.	1909651122.	19.9996946	0.0016350	-0.0071940	2.9979475	-60.0000000 CY
0.00004325	156432.	1867845744.	19.8804918	0.0016650	-0.0073800	2.9997861	-60.0000000 CY

Page 13

KY0062_static.lp10o							
0.00008575	156743.	1827910628.	19.7664204	0.0016950	-0.0075660	2.9968621	-60.0000000 CY
0.00008625	157051.	1789752333.	19.6590391	0.0017251	-0.0077519	2.9971179	-60.0000000 CY
0.00008675	157355.	1753259065.	19.5577479	0.0017553	-0.0079377	2.9993714	-60.0000000 CY
0.00008725	157656.	1718318298.	19.4622426	0.0017857	-0.0081233	2.9992798	-60.0000000 CY
0.00008775	157949.	1684794112.	19.3722095	0.0018161	-0.0083089	2.9944062	-60.0000000 CY
0.00008825	158234.	1652574148.	19.2861911	0.0018467	-0.0084943	2.9976797	-60.0000000 CY
0.00008875	158494.	1621420269.	19.2017697	0.0018770	-0.0086800	2.9995271	-60.0000000 CY
0.00008925	158686.	1590832517.	19.1130062	0.0019065	-0.0088665	2.9992442	-60.0000000 CY
0.00010117	158873.	1561409266.	19.0291683	0.0019362	-0.0090528	2.9941976	-60.0000000 CY
0.0001037	159059.	1533101535.	18.9493816	0.0019660	-0.0092390	2.9959885	-60.0000000 CY
0.0001057	159239.	1505808645.	18.8699691	0.0019955	-0.0094255	2.9883842	-60.0000000 CY
0.0001077	159410.	1479444968.	18.7881147	0.0020244	-0.0096126	2.9996964	-60.0000000 CY
0.0001097	159579.	1454023524.	18.7101925	0.0020534	-0.0097996	2.9989552	-60.0000000 CY
0.0001217	160557.	1318742073.	18.3122435	0.0022295	-0.0109195	2.9991168	-60.0000000 CY
0.0001337	161347.	1206330548.	17.9845605	0.0024054	-0.0120396	2.9994259	-60.0000000 CY
0.0001457	161885.	1110700336.	17.6763678	0.0025763	-0.0131647	2.9927341	-60.0000000 CY
0.0001577	162352.	1029172127.	17.4126528	0.0027468	-0.0142902	2.9987781	-60.0000000 CY
0.0001697	162762.	958835856.	17.2099115	0.0029214	-0.0154116	2.9914612	-60.0000000 CY
0.0001817	163065.	897194469.	17.0622472	0.0031011	-0.0165279	2.9999755	-60.0000000 CYT
0.0001937	163257.	842616359.	16.9311756	0.0032804	-0.0176446	2.9839060	-60.0000000 CYT
0.0002057	163374.	794041344.	16.8119553	0.0034591	-0.0187619	2.9954977	-60.0000000 CYT
0.0002177	163453.	750644151.	16.7132537	0.0036393	-0.0198777	2.9985860	-60.0000000 CYT
0.0002297	163484.	711575097.	16.6298104	0.0038207	-0.0209923	2.9837910	-60.0000000 CYT

#### Summary of Results for Nominal (Unfactored) Moment Capacity for Section 1

Moment values interpolated at maximum compressive strain = 0.003  
or maximum developed moment if pile fails at smaller strains.

Load No.	Axial Thrust kips	Nominal Mom. Cap. in-kip	Max. Comp. Strain
1	72.850	161226.368	0.00300000
2	116.560	162894.833	0.00300000

Note that the values of moment capacity in the table above are not factored by a strength reduction factor ( $\phi$ -factor).

In ACI 318, the value of the strength reduction factor depends on whether the transverse reinforcing steel bars are tied hoops (0.65) or spirals (0.70).

The above values should be multiplied by the appropriate strength reduction factor to compute ultimate moment capacity according to ACI 318, Section 9.3.2.2 or the value required by the design standard being followed.

The following table presents factored moment capacities and corresponding bending stiffnesses computed for common resistance factor values used for

Page 14

reinforced concrete sections, KY0062\_static.lp10o

Axial Load No.	Resist. Factor for Moment	Nominal Moment Cap in-kips	Ult. (Fac) Ax. Thrust kips	Ult. (Fac) Moment Cap in-kips	Bend. Stiff. at Ult Mom kip-in <sup>2</sup>
1	0.65	161226.	47.352500	104797.	4.3618E+09
2	0.65	162895.	75.764000	105882.	4.4144E+09
1	0.70	161226.	50.995000	112858.	4.3461E+09
2	0.70	162895.	81.592000	114026.	4.3946E+09
1	0.75	161226.	54.637500	120920.	4.2341E+09
2	0.75	162895.	87.420000	122171.	4.2862E+09

Layering Correction Equivalent Depths of Soil & Rock Layers

Layer No.	Top of Layer Below Pile Head ft	Equivalent Top Depth Below Grnd Surf ft	Same Layer Type As Layer Above	Layer is Rock or is Below Rock Layer	F0 Integral for Layer lbs	F1 Integral for Layer lbs
1	0.5000	0.00	N.A.	No	0.00	3636.
2	2.2000	1.1242	Yes	No	3636.	24975.
3	6.5000	5.5754	No	No	28611.	155803.
4	15.2000	4.3844	Yes	No	184414.	N.A.

Notes: The F0 integral of Layer n+1 equals the sum of the F0 and F1 integrals for Layer n. Layering correction equivalent depths are computed only for soil types with both shallow-depth and deep-depth expressions for peak lateral load transfer. These soil types are soft and stiff clays, non-liquefied sands, and cemented c-phi soil.

Computed Values of Pile Loading and Deflection for Lateral Loading for Load Case Number 1

Pile-head conditions are Shear and Moment (Loading Type 1)

Shear force at pile head = 79653.0 lbs  
Applied moment at pile head = 151734560.0 in-lbs

Axial thrust load on pile head

KY0062\_static.lp10o = 116560.0 lbs

Depth X y feet	Deflect. y inches	Bending Moment in-lbs	Shear Force lbs	Slope S radians	Total Strees psi*	Bending Stiffness in-lb <sup>2</sup>	Soil Res. p lb/inch	Soil Spr. Es*H lb/inch	Distrib. Lat. Load lb/inch
0.00	6.9563	1.52E+08	79653.	-0.03570	0.00	2.40E+12	0.00	0.00	0.00
0.3200	6.8196	1.52E+08	79653.	-0.03545	0.00	2.40E+12	0.00	0.00	0.00
0.6400	6.6040	1.52E+08	79526.	-0.03521	0.00	2.33E+12	-66.1000	30.0260	0.00
0.9600	6.5493	1.53E+08	79247.	-0.03495	0.00	2.30E+12	-78.8938	46.2574	0.00
1.2800	6.4155	1.53E+08	78920.	-0.03470	0.00	2.26E+12	-91.4156	54.7166	0.00
1.6000	6.2828	1.53E+08	78546.	-0.03443	0.00	2.22E+12	-103.7526	63.4128	0.00
1.9200	6.1511	1.54E+08	78124.	-0.03417	0.00	2.19E+12	-115.9030	72.3559	0.00
2.2400	6.0204	1.54E+08	77586.	-0.03389	0.00	2.15E+12	-164.4355	104.8819	0.00
2.5600	5.8908	1.54E+08	76931.	-0.03362	0.00	2.12E+12	-176.2862	114.9147	0.00
2.8800	5.7622	1.55E+08	76232.	-0.03333	0.00	2.09E+12	-187.9382	125.2434	0.00
3.2000	5.6348	1.55E+08	75488.	-0.03305	0.00	2.06E+12	-199.3898	135.8804	0.00
3.5200	5.5084	1.55E+08	74701.	-0.03276	0.00	2.03E+12	-210.6392	146.8392	0.00
3.8400	5.3832	1.55E+08	73871.	-0.03246	0.00	1.99E+12	-221.6844	158.1336	0.00
4.1600	5.2592	1.56E+08	72999.	-0.03216	0.00	1.95E+12	-232.5237	169.7784	0.00
4.4800	5.1363	1.56E+08	72086.	-0.03185	0.00	1.91E+12	-243.1553	181.7889	0.00
4.8000	5.0146	1.56E+08	71132.	-0.03153	0.00	1.88E+12	-253.5775	194.1813	0.00
5.1200	4.8941	1.57E+08	70139.	-0.03121	0.00	1.84E+12	-263.7887	206.9725	0.00
5.4400	4.7749	1.57E+08	69107.	-0.03087	0.00	1.80E+12	-273.7873	220.1801	0.00
5.7600	4.6570	1.57E+08	68036.	-0.03054	0.00	1.77E+12	-283.5716	233.8229	0.00
6.0800	4.5404	1.57E+08	66929.	-0.03019	0.00	1.74E+12	-293.1401	247.9204	0.00
6.4000	4.4251	1.58E+08	65786.	-0.02984	0.00	1.71E+12	-302.4914	262.4932	0.00
6.7200	4.3112	1.58E+08	63483.	-0.02948	0.00	1.68E+12	-896.8192	798.7950	0.00
7.0400	4.1987	1.58E+08	59943.	-0.02912	0.00	1.65E+12	-947.1002	866.1863	0.00
7.3600	4.0876	1.59E+08	56210.	-0.02874	0.00	1.62E+12	-997.0216	936.6262	0.00
7.6800	3.9780	1.59E+08	52303.	-0.02836	0.00	1.58E+12	-1038.	1002.	0.00
8.0000	3.8698	1.59E+08	48252.	-0.02797	0.00	1.55E+12	-1072.	1064.	0.00
8.3200	3.7631	1.59E+08	44071.	-0.02758	0.00	1.52E+12	-1105.	1128.	0.00
8.6400	3.6580	1.59E+08	39766.	-0.02717	0.00	1.50E+12	-1137.	1193.	0.00
8.9600	3.5544	1.59E+08	35343.	-0.02676	0.00	1.47E+12	-1167.	1261.	0.00
9.2800	3.4525	1.60E+08	30809.	-0.02634	0.00	1.45E+12	-1195.	1329.	0.00
9.6000	3.3521	1.60E+08	26168.	-0.02592	0.00	1.43E+12	-1222.	1400.	0.00
9.9200	3.2534	1.60E+08	21426.	-0.02549	0.00	1.42E+12	-1247.	1472.	0.00
10.2400	3.1564	1.60E+08	16589.	-0.02505	0.00	1.41E+12	-1272.	1548.	0.00
10.5600	3.0610	1.60E+08	11659.	-0.02461	0.00	1.40E+12	-1296.	1625.	0.00
10.8800	2.9674	1.60E+08	6642.	-0.02417	0.00	1.39E+12	-1318.	1705.	0.00
11.2000	2.8754	1.60E+08	1543.	-0.02373	0.00	1.39E+12	-1338.	1787.	0.00
11.5200	2.7851	1.60E+08	-3633.	-0.02329	0.00	1.39E+12	-1357.	1872.	0.00
11.8400	2.6966	1.60E+08	-8880.	-0.02284	0.00	1.39E+12	-1375.	1959.	0.00
12.1600	2.6097	1.60E+08	-14193.	-0.02240	0.00	1.39E+12	-1392.	2048.	0.00
12.4800	2.5245	1.60E+08	-19568.	-0.02196	0.00	1.40E+12	-1407.	2141.	0.00
12.8000	2.4410	1.60E+08	-24999.	-0.02152	0.00	1.41E+12	-1421.	2236.	0.00
13.1200	2.3592	1.60E+08	-30481.	-0.02109	0.00	1.43E+12	-1434.	2334.	0.00
13.4400	2.2791	1.60E+08	-36010.	-0.02066	0.00	1.44E+12	-1445.	2435.	0.00
13.7600	2.2005	1.60E+08	-41580.	-0.02024	0.00	1.46E+12	-1456.	2540.	0.00



KY0062\_static.lp10o

14.0800	2.1236	1.59E+08	-47187.	-0.01983	0.00	1.49E+12	-1465.	2648.	0.00
14.4000	2.0483	1.59E+08	-52826.	-0.01942	0.00	1.52E+12	-1472.	2760.	0.00
14.7200	1.9745	1.59E+08	-58500.	-0.01902	0.00	1.55E+12	-1483.	2884.	0.00
15.0400	1.9022	1.59E+08	-64212.	-0.01863	0.00	1.58E+12	-1492.	3013.	0.00
15.3600	1.8314	1.58E+08	-78660.	-0.01825	0.00	1.62E+12	-6033.	12649.	0.00
15.6800	1.7620	1.58E+08	-102771.	-0.01788	0.00	1.66E+12	-6525.	14221.	0.00
16.0000	1.6941	1.58E+08	-128774.	-0.01752	0.00	1.71E+12	-7018.	15908.	0.00
16.3200	1.6275	1.57E+08	-156667.	-0.01717	0.00	1.77E+12	-7509.	17718.	0.00
16.6400	1.5622	1.57E+08	-186439.	-0.01684	0.00	1.86E+12	-7997.	19658.	0.00
16.9600	1.4981	1.56E+08	-218075.	-0.01653	0.00	1.96E+12	-8480.	21736.	0.00
17.2800	1.4352	1.55E+08	-251552.	-0.01623	0.00	2.06E+12	-8956.	23962.	0.00
17.6000	1.3735	1.54E+08	-286841.	-0.01595	0.00	2.17E+12	-9423.	26346.	0.00
17.9200	1.3128	1.53E+08	-323905.	-0.01568	0.00	2.30E+12	-9880.	28902.	0.00
18.2400	1.2530	1.51E+08	-362699.	-0.01544	0.00	2.44E+12	-10325.	31642.	0.00
18.5600	1.1942	1.50E+08	-403173.	-0.01521	0.00	2.58E+12	-10755.	34584.	0.00
18.8800	1.1362	1.48E+08	-445267.	-0.01499	0.00	2.75E+12	-11169.	37746.	0.00
19.2000	1.0791	1.47E+08	-488914.	-0.01479	0.00	2.90E+12	-11564.	41152.	0.00
19.5200	1.0226	1.45E+08	-534038.	-0.01460	0.00	3.07E+12	-11938.	44828.	0.00
19.8400	0.9669	1.42E+08	-580557.	-0.01443	0.00	3.24E+12	-12290.	48810.	0.00
20.1600	0.9118	1.40E+08	-628403.	-0.01427	0.00	3.42E+12	-12630.	53189.	0.00
20.4800	0.8573	1.38E+08	-677501.	-0.01411	0.00	3.59E+12	-12942.	57969.	0.00
20.8000	0.8034	1.35E+08	-727741.	-0.01397	0.00	3.75E+12	-13225.	63210.	0.00
21.1200	0.7500	1.32E+08	-779004.	-0.01384	0.00	3.92E+12	-13474.	68987.	0.00
21.4400	0.6971	1.29E+08	-831155.	-0.01371	0.00	4.06E+12	-13687.	75394.	0.00
21.7600	0.6447	1.26E+08	-884045.	-0.01359	0.00	4.18E+12	-13860.	82552.	0.00
22.0800	0.5927	1.22E+08	-937512.	-0.01348	0.00	4.29E+12	-13987.	90616.	0.00
22.4000	0.5412	1.18E+08	-991370.	-0.01337	0.00	4.36E+12	-14064.	99796.	0.00
22.7200	0.4900	1.15E+08	-1045416.	-0.01327	0.00	4.39E+12	-14084.	110374.	0.00
23.0400	0.4392	1.10E+08	-1099416.	-0.01317	0.00	4.40E+12	-14041.	122748.	0.00
23.3600	0.3888	1.06E+08	-1153105.	-0.01308	0.00	4.41E+12	-13923.	137496.	0.00
23.6800	0.3388	1.02E+08	-1206175.	-0.01299	0.00	4.43E+12	-13718.	155492.	0.00
24.0000	0.2891	9.69E+07	-1258263.	-0.01290	0.00	4.44E+12	-13410.	178141.	0.00
24.3200	0.2397	9.20E+07	-1308922.	-0.01282	0.00	4.45E+12	-12975.	207869.	0.00
24.6400	0.1906	8.68E+07	-1357654.	-0.01275	0.00	4.47E+12	-12406.	249948.	0.00
24.9600	0.1418	8.15E+07	-1403051.	-0.01267	0.00	4.49E+12	-11238.	304322.	0.00
25.2800	0.09327	7.61E+07	-1439006.	-0.01261	0.00	4.51E+12	-7489.	308303.	0.00
25.6000	0.04499	7.05E+07	-1460409.	-0.01254	0.00	4.53E+12	-3659.	312284.	0.00
25.9200	-0.00306	6.49E+07	-1466951.	-0.01249	0.00	4.55E+12	251.8959	316265.	0.00
26.2400	-0.05090	5.92E+07	-1458317.	-0.01243	0.00	4.59E+12	4245.	320247.	0.00
26.5600	-0.09855	5.37E+07	-1434190.	-0.01239	0.00	4.62E+12	8321.	324228.	0.00
26.8800	-0.1460	4.82E+07	-1394250.	-0.01236	0.00	2.59E+13	12481.	328209.	0.00
27.2000	-0.1935	4.30E+07	-1341865.	-0.01235	0.00	2.59E+13	14802.	293780.	0.00
27.5200	-0.2409	3.79E+07	-1282417.	-0.01235	0.00	2.60E+13	16161.	257594.	0.00
27.8400	-0.2883	3.31E+07	-1217951.	-0.01234	0.00	2.60E+13	17415.	231950.	0.00
28.1600	-0.3357	2.86E+07	-1148811.	-0.01234	0.00	2.61E+13	18595.	212704.	0.00
28.4800	-0.3831	2.43E+07	-1075251.	-0.01233	0.00	2.61E+13	19718.	197653.	0.00
28.8000	-0.4304	2.04E+07	-997469.	-0.01233	0.00	2.61E+13	20794.	185510.	0.00
29.1200	-0.4778	1.67E+07	-915510.	-0.01233	0.00	2.62E+13	21893.	175963.	0.00
29.4400	-0.5251	1.33E+07	-829376.	-0.01233	0.00	2.62E+13	22968.	167959.	0.00
29.7600	-0.5724	1.03E+07	-739162.	-0.01232	0.00	2.62E+13	24018.	161119.	0.00

KY0062\_static.lp10o

30.0800	-0.6198	7667153.	-644956.	-0.01232	0.00	2.63E+13	25047.	155190.	0.00
30.4000	-0.6671	5380705.	-546838.	-0.01232	0.00	2.63E+13	26056.	149991.	0.00
30.7200	-0.7144	3478472.	-444880.	-0.01232	0.00	2.63E+13	27047.	145382.	0.00
31.0400	-0.7617	1975060.	-339151.	-0.01232	0.00	2.63E+13	28020.	141257.	0.00
31.3600	-0.8090	884820.	-229719.	-0.01232	0.00	2.63E+13	28976.	137534.	0.00
31.6800	-0.8563	221850.	-116647.	-0.01232	0.00	2.63E+13	29915.	134148.	0.00
32.0000	-0.9036	0.00	0.00	-0.01232	0.00	2.63E+13	30838.	65523.	0.00

\* This analysis computed pile response using nonlinear moment-curvature relationships. Values of total stress due to combined axial and bending stresses are computed only for elastic sections only and do not equal the actual stresses in concrete and steel. Stresses in concrete and steel may be interpolated from the output for nonlinear bending properties relative to the magnitude of bending moment developed in the pile.

Output Summary for Load Case No. 1:

Pile-head deflection = 6.95625620 inches  
 Computed slope at pile head = -0.03569578 radians  
 Maximum bending moment = 160048813. inch-lbs  
 Maximum shear force = -1466951. lbs  
 Depth of maximum bending moment = 11.52000000 feet below pile head  
 Depth of maximum shear force = 25.92000000 feet below pile head  
 Number of iterations = 145  
 Number of zero deflection points = 1

-----  
 Computed Values of Pile Loading and Deflection  
 for Lateral Loading for Load Case Number 2  
 -----

Pile-head conditions are Shear and Moment (Loading Type 1)

Shear force at pile head = 37338.0 lbs  
 Applied moment at pile head = 71125575.0 in-lbs  
 Axial thrust load on pile head = 72850.0 lbs

Depth X feet	Deflect. y inches	Bending Moment in-lbs	Shear Force lbs	Slope S radians	Total Stress psi*	Bending Stiffness in-lb*2	Soil Res. p lb/inch	Soil Spr. Es*h lb/inch	Distrib. Lat. Load lb/inch
0.00	1.1627	7.11E+07	37338.	-0.00630	0.00	4.44E+12	0.00	0.00	0.00
0.3200	1.1386	7.13E+07	37338.	-0.00624	0.00	4.44E+12	0.00	0.00	0.00
0.6400	1.1148	7.14E+07	37268.	-0.00617	0.00	4.44E+12	-36.4341	125.4987	0.00
0.9600	1.0912	7.16E+07	37115.	-0.00611	0.00	4.44E+12	-43.4128	152.7695	0.00
1.2800	1.0679	7.17E+07	36935.	-0.00605	0.00	4.44E+12	-50.2864	180.8272	0.00
1.6000	1.0448	7.18E+07	36729.	-0.00599	0.00	4.44E+12	-57.0542	209.7026	0.00

KY0062_static.lp10o									
1.9200	1.0219	7.20E+07	36497.	-0.00593	0.00	4.44E+12	-63.7156	239.4284	0.00
2.2400	0.9992	7.21E+07	36201.	-0.00586	0.00	4.44E+12	-90.3677	347.2724	0.00
2.5600	0.9769	7.23E+07	35842.	-0.00580	0.00	4.44E+12	-96.8513	380.7205	0.00
2.8800	0.9547	7.24E+07	35457.	-0.00574	0.00	4.44E+12	-103.2228	415.1824	0.00
3.2000	0.9328	7.25E+07	35049.	-0.00568	0.00	4.44E+12	-109.4813	450.7004	0.00
3.5200	0.9111	7.27E+07	34617.	-0.00561	0.00	4.44E+12	-115.6261	487.3190	0.00
3.8400	0.8897	7.28E+07	34161.	-0.00555	0.00	4.44E+12	-121.6564	525.0849	0.00
4.1600	0.8685	7.29E+07	33683.	-0.00549	0.00	4.44E+12	-127.5713	564.0477	0.00
4.4800	0.8476	7.31E+07	33182.	-0.00542	0.00	4.43E+12	-133.3700	604.2595	0.00
4.8000	0.8268	7.32E+07	32659.	-0.00536	0.00	4.43E+12	-139.0517	645.7756	0.00
5.1200	0.8064	7.33E+07	32114.	-0.00530	0.00	4.43E+12	-144.6154	688.6543	0.00
5.4400	0.7862	7.35E+07	31548.	-0.00523	0.00	4.43E+12	-150.0602	732.9573	0.00
5.7600	0.7662	7.36E+07	30962.	-0.00517	0.00	4.43E+12	-155.3853	778.7499	0.00
6.0800	0.7465	7.37E+07	30355.	-0.00511	0.00	4.43E+12	-160.5896	826.1014	0.00
6.4000	0.7270	7.38E+07	29729.	-0.00504	0.00	4.43E+12	-165.6723	875.0853	0.00
6.7200	0.7078	7.39E+07	28442.	-0.00498	0.00	4.43E+12	-504.7437	2739.	0.00
7.0400	0.6888	7.40E+07	26458.	-0.00491	0.00	4.43E+12	-528.1058	2944.	0.00
7.3600	0.6700	7.41E+07	24387.	-0.00485	0.00	4.43E+12	-550.6872	3156.	0.00
7.6800	0.6515	7.42E+07	22252.	-0.00478	0.00	4.43E+12	-561.3557	3309.	0.00
8.0000	0.6333	7.43E+07	20080.	-0.00472	0.00	4.43E+12	-569.9493	3456.	0.00
8.3200	0.6153	7.44E+07	17877.	-0.00466	0.00	4.43E+12	-577.3733	3603.	0.00
8.6400	0.5975	7.44E+07	15648.	-0.00459	0.00	4.43E+12	-583.6565	3751.	0.00
8.9600	0.5800	7.45E+07	13397.	-0.00453	0.00	4.43E+12	-588.8277	3898.	0.00
9.2800	0.5628	7.46E+07	11128.	-0.00446	0.00	4.43E+12	-592.9155	4046.	0.00
9.6000	0.5457	7.46E+07	8845.	-0.00440	0.00	4.43E+12	-595.9487	4193.	0.00
9.9200	0.5290	7.46E+07	6553.	-0.00433	0.00	4.43E+12	-597.9561	4341.	0.00
10.2400	0.5125	7.46E+07	4255.	-0.00427	0.00	4.43E+12	-598.9664	4488.	0.00
10.5600	0.4962	7.47E+07	1955.	-0.00420	0.00	4.43E+12	-599.0082	4636.	0.00
10.8800	0.4802	7.47E+07	-343.8188	-0.00414	0.00	4.43E+12	-598.1103	4783.	0.00
11.2000	0.4644	7.47E+07	-2637.	-0.00407	0.00	4.43E+12	-596.3014	4931.	0.00
11.5200	0.4489	7.46E+07	-4922.	-0.00401	0.00	4.43E+12	-593.6099	5078.	0.00
11.8400	0.4336	7.46E+07	-7194.	-0.00394	0.00	4.43E+12	-590.0645	5225.	0.00
12.1600	0.4186	7.46E+07	-9452.	-0.00388	0.00	4.43E+12	-585.6938	5373.	0.00
12.4800	0.4038	7.46E+07	-11691.	-0.00382	0.00	4.43E+12	-580.5260	5520.	0.00
12.8000	0.3893	7.45E+07	-13909.	-0.00375	0.00	4.43E+12	-574.5897	5668.	0.00
13.1200	0.3750	7.44E+07	-16102.	-0.00369	0.00	4.43E+12	-567.9132	5815.	0.00
13.4400	0.3610	7.44E+07	-18269.	-0.00362	0.00	4.43E+12	-560.5248	5963.	0.00
13.7600	0.3472	7.43E+07	-20406.	-0.00356	0.00	4.43E+12	-552.4525	6110.	0.00
14.0800	0.3337	7.42E+07	-22511.	-0.00349	0.00	4.43E+12	-543.7245	6258.	0.00
14.4000	0.3204	7.41E+07	-24581.	-0.00343	0.00	4.43E+12	-534.3689	6405.	0.00
14.7200	0.3073	7.40E+07	-26613.	-0.00336	0.00	4.43E+12	-524.4135	6553.	0.00
15.0400	0.2945	7.39E+07	-28607.	-0.00330	0.00	4.43E+12	-513.8862	6700.	0.00
15.3600	0.2820	7.38E+07	-30598.	-0.00324	0.00	4.43E+12	-3544.	48266.	0.00
15.6800	0.2697	7.37E+07	-32542.	-0.00317	0.00	4.43E+12	-3822.	54424.	0.00
16.0000	0.2576	7.36E+07	-34447.	-0.00311	0.00	4.43E+12	-4097.	61078.	0.00
16.3200	0.2458	7.32E+07	-36203.	-0.00305	0.00	4.43E+12	-4369.	68262.	0.00
16.6400	0.2342	7.28E+07	-37924.	-0.00298	0.00	4.44E+12	-4637.	76018.	0.00
16.9600	0.2229	7.24E+07	-39602.	-0.00292	0.00	4.44E+12	-4898.	84390.	0.00
17.2800	0.2118	7.19E+07	-41369.	-0.00286	0.00	4.44E+12	-5153.	93429.	0.00
17.6000	0.2009	7.13E+07	-43216.	-0.00280	0.00	4.44E+12	-5400.	103190.	0.00

KY0062_static.lp10o									
17.9200	0.1903	7.07E+07	-45135.	-0.00273	0.00	4.44E+12	-5638.	113741.	0.00
18.2400	0.1800	7.00E+07	-47049.	-0.00267	0.00	4.44E+12	-5855.	125154.	0.00
18.5600	0.1698	6.92E+07	-49003.	-0.00261	0.00	4.45E+12	-6081.	137517.	0.00
18.8800	0.1599	6.83E+07	-51016.	-0.00255	0.00	4.45E+12	-6284.	150930.	0.00
19.2000	0.1502	6.73E+07	-53089.	-0.00249	0.00	4.45E+12	-6474.	165513.	0.00
19.5200	0.1407	6.62E+07	-55222.	-0.00244	0.00	4.46E+12	-6648.	181406.	0.00
19.8400	0.1315	6.50E+07	-57415.	-0.00238	0.00	4.46E+12	-6807.	198803.	0.00
20.1600	0.1224	6.37E+07	-59668.	-0.00233	0.00	4.46E+12	-6958.	218229.	0.00
20.4800	0.1136	6.23E+07	-62081.	0.00227	0.00	4.47E+12	7091.	239686.	0.00
20.8000	0.1050	6.08E+07	-64654.	-0.00222	0.00	4.47E+12	-6906.	252564.	0.00
21.1200	0.09657	5.92E+07	-67287.	-0.00217	0.00	4.48E+12	-6452.	256546.	0.00
21.4400	0.08835	5.75E+07	-70000.	-0.00212	0.00	4.49E+12	-5994.	260527.	0.00
21.7600	0.08031	5.57E+07	-72713.	-0.00207	0.00	4.49E+12	-5532.	264508.	0.00
22.0800	0.07246	5.39E+07	-75426.	-0.00202	0.00	4.50E+12	-5067.	268490.	0.00
22.4000	0.06479	5.19E+07	-78139.	-0.00198	0.00	4.57E+12	-4597.	272471.	0.00
22.7200	0.05728	4.99E+07	-80852.	-0.00195	0.00	2.58E+13	-4124.	276452.	0.00
23.0400	0.04980	4.79E+07	-83565.	-0.00194	0.00	2.59E+13	-3637.	280434.	0.00
23.3600	0.04235	4.58E+07	-86278.	-0.00194	0.00	2.59E+13	-3136.	284415.	0.00
23.6800	0.03492	4.36E+07	-89001.	-0.00193	0.00	2.59E+13	-2623.	288396.	0.00
24.0000	0.02752	4.14E+07	-91724.	-0.00192	0.00	2.59E+13	-2095.	292378.	0.00
24.3200	0.02014	3.91E+07	-94447.	-0.00192	0.00	2.60E+13	-1554.	296359.	0.00
24.6400	0.01278	3.69E+07	-97170.	-0.00191	0.00	2.60E+13	-999.9506	300340.	0.00
24.9600	0.00545	3.46E+07	-99893.	-0.00191	0.00	2.60E+13	-431.9184	304322.	0.00
25.2800	-0.00187	3.23E+07	-102616.	-0.00190	0.00	2.60E+13	149.7470	308303.	0.00
25.6000	-0.00916	3.01E+07	-105339.	-0.00190	0.00	2.60E+13	745.0912	312284.	0.00
25.9200	-0.01644	2.78E+07	-108062.	-0.00189	0.00	2.61E+13	1354.	316265.	0.00
26.2400	-0.02371	2.55E+07	-110785.	-0.00189	0.00	2.61E+13	1977.	320247.	0.00
26.5600	-0.03096	2.33E+07	-113508.	-0.00189	0.00	2.61E+13	2614.	324228.	0.00
26.8800	-0.03819	2.11E+07	-116231.	-0.00188	0.00	2.61E+13	3264.	328209.	0.00
27.2000	-0.04542	1.90E+07	-118954.	-0.00188	0.00	2.62E+13	3929.	332191.	0.00
27.5200	-0.05263	1.69E+07	-121677.	-0.00188	0.00	2.62E+13	4608.	336172.	0.00
27.8400	-0.05984	1.49E+07	-124400.	-0.00188	0.00	2.62E+13	5300.	340153.	0.00
28.1600	-0.06703	1.30E+07	-127123.	-0.00187	0.00	2.62E+13	6007.	344135.	0.00
28.4800	-0.07422	1.12E+07	-129846.	-0.00187	0.00	2.62E+13	6728.	348116.	0.00
28.8000	-0.08140	9437814.	-132569.	-0.00187	0.00	2.63E+13	7464.	352097.	0.00
29.1200	-0.08858	7809225.	-135292.	-0.00187	0.00	2.63E+13	8214.	356079.	0.00
29.4400	-0.09575	6301753.	-138015.	-0.00187	0.00	2.63E+13	8978.	360060.	0.00
29.7600	-0.1029	4926670.	-140738.	-0.00187	0.00	2.63E+13	9757.	364041.	0.00
30.0800	-0.1101	3695461.	-143461.	-0.00187	0.00	2.63E+13	10551.	368023.	0.00
30.4000	-0.1173	2619828.	-146184.	-0.00187	0.00	2.63E+13	11359.	372004.	0.00
30.7200	-0.1244	1711687.	-148907.	-0.00187	0.00	2.63E+13	12182.	375985.	0.00
31.0400	-0.1316	983173.	-151630.	-0.00186	0.00	2.63E+13	13019.	379966.	0.00
31.3600	-0.1387	446638.	-154353.	-0.00186	0.00	2.63E+13	13872.	383948.	0.00
31.6800	-0.1459	114650.	-157076.	-0.00186	0.00	2.63E+13	14739.	387929.	0.00
32.0000	-0.1531	0.00	-159800.	-0.00186	0.00	2.63E+13	15621.	391910.	0.00

\* This analysis computed pile response using nonlinear moment-curvature relationships. Values of total stress due to combined axial and bending stresses are computed only for elastic sections only and do not equal the actual stresses in concrete and steel. Stresses in concrete and steel may be inter-

KY0062\_static.lp10o  
 polated from the output for nonlinear bending properties relative to the  
 magnitude of bending moment developed in the pile.

Output Summary for Load Case No. 2:

Pile-head deflection = 1.16269291 inches  
 Computed slope at pile head = -0.00629679 radians  
 Maximum bending moment = 74661196. inch-lbs  
 Maximum shear force = -593459. lbs  
 Depth of maximum bending moment = 10.88000000 feet below pile head  
 Depth of maximum shear force = 25.28000000 feet below pile head  
 Number of iterations = 247  
 Number of zero deflection points = 1

-----  
 Summary of Pile-head Responses for Conventional Analyses  
 -----

Definitions of Pile-head Loading Conditions:

Load Type 1: Load 1 = Shear, V, lbs, and Load 2 = Moment, M, in-lbs  
 Load Type 2: Load 1 = Shear, V, lbs, and Load 2 = Slope, S, radians  
 Load Type 3: Load 1 = Shear, V, lbs, and Load 2 = Rot. Stiffness, R, in-lbs/rad.  
 Load Type 4: Load 1 = Top Deflection, y, inches, and Load 2 = Moment, M, in-lbs  
 Load Type 5: Load 1 = Top Deflection, y, inches, and Load 2 = Slope, S, radians

Load Case No.	Load Type	Pile-head Load 1	Load Type 2	Pile-head Load 2	Axial Loading lbs	Pile-head Deflection inches	Pile-head Rotation radians	Max Shear in lbs	Max Moment in lbs
1	V, lb	79653.	M, in-lb	1.52E+08	116560.	6.9563	-0.03570	-1466951.	1.60E+08
2	V, lb	37338.	M, in-lb	7.11E+07	72850.	1.1627	-0.00630	-593459.	7.47E+07

Maximum pile-head deflection = 6.9562561999 inches  
 Maximum pile-head rotation = -0.0356957760 radians = -2.045217 deg.

-----  
 Summary of Warning Messages  
 -----

The following warning was reported 6669 times

\*\*\*\* Warning \*\*\*\*

An unreasonable value was input for friction angle has been specified

Page 21

KY0062\_static.lp10o  
 for a soil layer defined using the sand criteria. The input value is  
 either smaller than 20 degrees or higher than 48 degrees. The input  
 data should be checked for correctness.

The analysis ended normally.

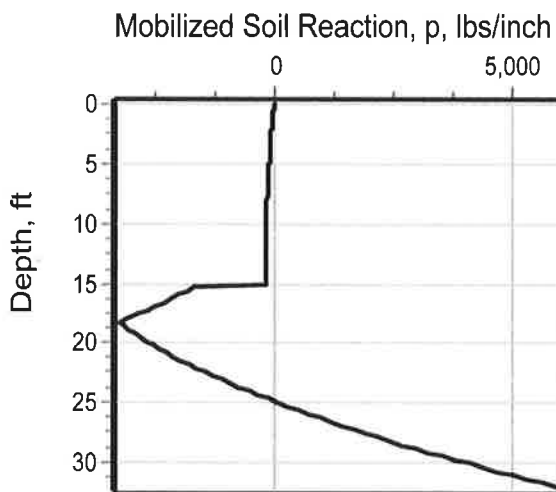
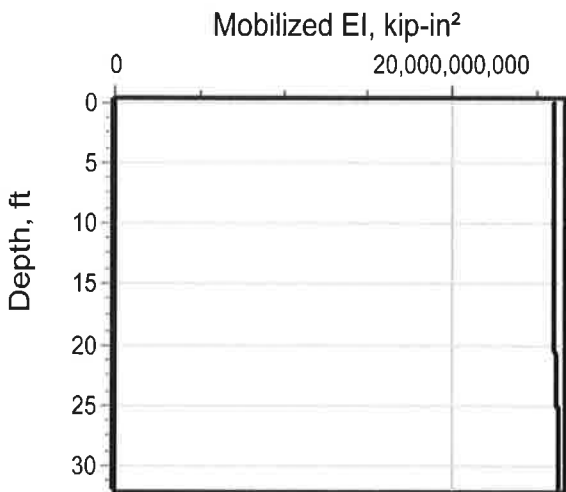
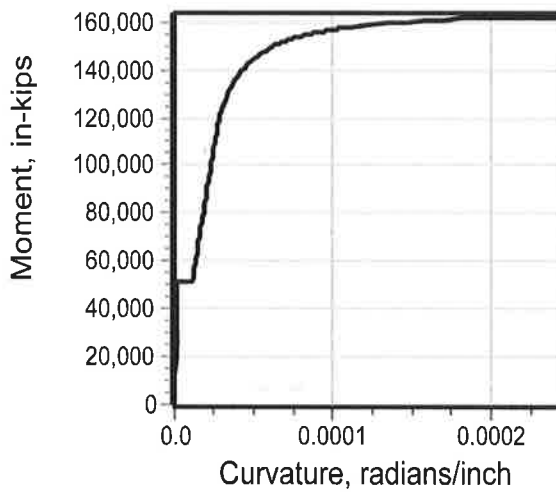
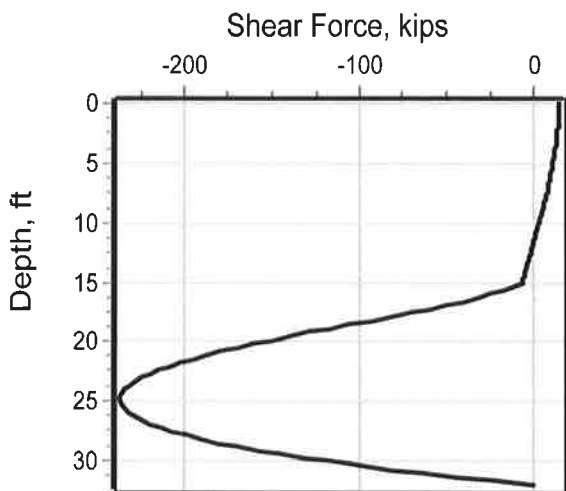
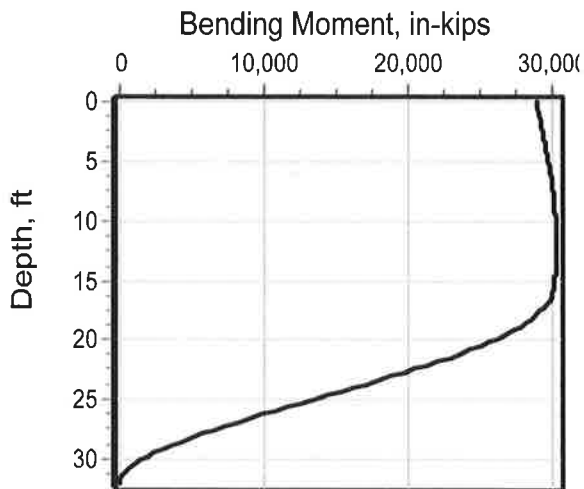
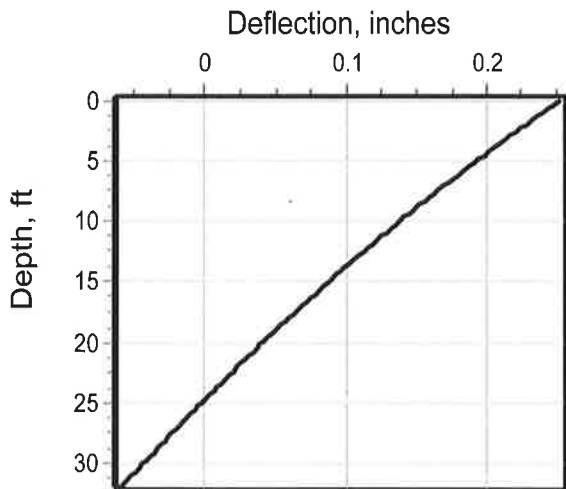

KY0062\_cyclic.lp10o

LFile for Windows, Version 2018-10.004

Analysis of Individual Piles and Drilled Shafts  
 Subjected to Lateral Loading Using the p-y Method  
 © 1985-2018 by Ensoft, Inc.  
 All Rights Reserved

-----  
 This copy of LFile is being used by:

Delta Oaks Group  
 Chapel Hill, NC

Serial Number of Security Device: 139334612

This copy of LFile is licensed for exclusive use by:

Delta Oaks Group, Chapel Hill, N

Use of this program by any entity other than Delta Oaks Group, Chapel Hill, N  
 is a violation of the software license agreement.

-----  
 Files Used for Analysis  
 -----

Path to file locations:  
 \2018 Projects\18-03128 East Paris KY0062\STR\Additional Calculations\SSPS DS\L-File - Deflection\MLL\

Name of input data file:  
 KY0062\_cyclic.lp10

Name of output report file:  
 KY0062\_cyclic.lp10

Name of plot output file:  
 KY0062\_cyclic.lp10

Name of runtime message file:  
 KY0062\_cyclic.lp10

-----  
 Date and Time of Analysis  
 -----

Page 1

Date: September 11, 2018

KY0062\_cyclic.lp10o  
 Time: 17:56:17

-----  
 Problem Title  
 -----

18-03128 East Paris KY0062

M Lassiter

-----  
 Program Options and Settings  
 -----

Computational Options:  
 - Use unfactored loads in computations (conventional analysis)  
 Engineering Units Used for Data Input and Computations:  
 - US Customary System Units (pounds, feet, inches)

Analysis Control Options:  
 - Maximum number of iterations allowed = 500  
 - Deflection tolerance for convergence = 1.0000E-05 in  
 - Maximum allowable deflection = 100.0000 in  
 - Number of pile increments = 100

Loading Type and Number of Cycles of Loading:  
 - Cyclic loading specified = 100 cycles  
 - Number of cycles of loading = 100 cycles  
 - Use of p-y modification factors for p-y curves not selected  
 - Analysis uses layering correction (Method of Georgiadis)  
 - No distributed lateral loads are entered  
 - Loading by lateral soil movements acting on pile not selected  
 - Input of shear resistance at the pile tip not selected  
 - Computation of pile-head foundation stiffness matrix not selected

Page 2

- Push-over analysis of pile not selected
- Buckling analysis of pile not selected

KY0062\_cyclic.lp10o

## Output Options:

- Output files use decimal points to denote decimal symbols.
- Values of pile-head deflection, bending moment, shear force, and soil reaction are printed for full length of pile.
- Printing increment (nodal spacing of output points) = 1
- No p-y curves to be computed and reported for user-specified depths
- Print using wide report formats

---

 File Structural Properties and Geometry
 

---

Number of pile sections defined = 1  
 Total length of pile = 32.000 ft  
 Depth of ground surface below top of pile = 0.5000 ft

Pile diameters used for p-y curve computations are defined using 2 points.

p-y curves are computed using pile diameter values interpolated with depth over the length of the pile. A summary of values of pile diameter vs. depth follows.

Point No.	Depth Below Pile Head feet	Pile Diameter inches
1	0.000	108.0000
2	32.000	108.0000

---

 Input Structural Properties for File Sections:
 

---

## Pile Section No. 1:

Section 1 is a round drilled shaft, bored pile, or CIDH pile  
 Length of section = 32.000000 ft  
 Shaft Diameter = 108.000000 in  
 Shear capacity of section = 0.0000 lbs

---

 Ground Slope and Pile Batter Angles
 

---

Page 3

KY0062\_cyclic.lp10o

Ground Slope Angle = 0.000 degrees  
 = 0.000 radians  
 Pile Batter Angle = 0.000 degrees  
 = 0.000 radians

---

 Soil and Rock Layering Information
 

---

The soil profile is modelled using 4 layers

Layer 1 is soft clay, p-y criteria by Matlock, 1970

Distance from top of pile to top of layer = 0.500000 ft  
 Distance from top of pile to bottom of layer = 2.200000 ft  
 Effective unit weight at top of layer = 100.000000 pcf  
 Effective unit weight at bottom of layer = 100.000000 pcf  
 Undrained cohesion at top of layer = 50.000000 psf  
 Undrained cohesion at bottom of layer = 50.000000 psf  
 Epsilon-50 at top of layer = 0.020000  
 Epsilon-50 at bottom of layer = 0.020000

Layer 2 is soft clay, p-y criteria by Matlock, 1970

Distance from top of pile to top of layer = 2.200000 ft  
 Distance from top of pile to bottom of layer = 6.500000 ft  
 Effective unit weight at top of layer = 100.000000 pcf  
 Effective unit weight at bottom of layer = 100.000000 pcf  
 Undrained cohesion at top of layer = 100.000000 psf  
 Undrained cohesion at bottom of layer = 100.000000 psf  
 Epsilon-50 at top of layer = 0.020000  
 Epsilon-50 at bottom of layer = 0.020000

Layer 3 is sand, p-y criteria by Reese et al., 1974

Distance from top of pile to top of layer = 6.500000 ft  
 Distance from top of pile to bottom of layer = 15.200000 ft  
 Effective unit weight at top of layer = 105.000000 pcf  
 Effective unit weight at bottom of layer = 105.000000 pcf  
 Friction angle at top of layer = 10.000000 deg.  
 Friction angle at bottom of layer = 10.000000 deg.  
 Subgrade k at top of layer = 10.000000 pci  
 Subgrade k at bottom of layer = 10.000000 pci

Page 4

KY0062\_cyclic.lp10o

Layer 4 is sand, p-y criteria by Reese et al., 1974

Distance from top of pile to top of layer = 15.200000 ft  
 Distance from top of pile to bottom of layer = 40.000000 ft  
 Effective unit weight at top of layer = 130.000000 pcf  
 Effective unit weight at bottom of layer = 130.000000 pcf  
 Friction angle at top of layer = 45.000000 deg.  
 Friction angle at bottom of layer = 45.000000 deg.  
 Subgrade k at top of layer = 270.000000 pci  
 Subgrade k at bottom of layer = 270.000000 pci

(Depth of the lowest soil layer extends 8.000 ft below the pile tip)

Summary of Input Soil Properties

Layer Layer Num.	Soil Type Name (p-y Curve Type)	Layer Depth ft	Effective Unit Wt. pcf	Undrained Cohesion psf	Angle of Friction deg.	E50 or krm	kpy pci
1	Soft	0.5000	100.0000	50.0000	--	0.02000	--
	Clay	2.2000	100.0000	50.0000	--	0.02000	--
2	Soft	2.2000	100.0000	100.0000	--	0.02000	--
	Clay	6.5000	100.0000	100.0000	--	0.02000	--
3	Sand	6.5000	105.0000	--	10.0000	--	10.0000
	(Reese, et al.)	15.2000	105.0000	--	10.0000	--	10.0000
4	Sand	15.2000	130.0000	--	45.0000	--	270.0000
	(Reese, et al.)	40.0000	130.0000	--	45.0000	--	270.0000

Cyclic Loading Type

Cyclic loading criteria were used for computation of p-y curves for all analyses.

Number of cycles of loading = 100

Pile-head Loading and Pile-head Fixity Conditions

Number of loads specified = 1

KY0062\_cyclic.lp10o

Load No.	Load Type	Condition 1	Condition 2	Axial Thrust Force, lbs	Compute Top y vs. Pile Length
1	1	V = 15183. lbs	M = 28923017. in-lbs	72850.	No

V = shear force applied normal to pile axis  
 M = bending moment applied to pile head  
 y = lateral deflection normal to pile axis  
 S = pile slope relative to original pile batter angle  
 R = rotational stiffness applied to pile head  
 Values of top y vs. pile lengths can be computed only for load types with specified shear loading (Load Types 1, 2, and 3).  
 Thrust force is assumed to be acting axially for all pile batter angles.

Computations of Nominal Moment Capacity and Nonlinear Bending Stiffness

Axial thrust force values were determined from pile-head loading conditions

Number of Pile Sections Analyzed = 1

File Section No. 1:

Dimensions and Properties of Drilled Shaft (Bored Pile):

Length of Section = 32.000000 ft  
 Shaft Diameter = 108.000000 in  
 Concrete Cover Thickness = 3.625000 in  
 Number of Reinforcing Bars = 46 bars  
 Yield Stress of Reinforcing Bars = 60000. psi  
 Modulus of Elasticity of Reinforcing Bars = 29000000. psi  
 Gross Area of Shaft = 9161. sq. in.  
 Total Area of Reinforcing Steel = 58.420000 sq. in.  
 Area Ratio of Steel Reinforcement = 0.64 percent  
 Edge-to-Edge Bar Spacing = 5.518755 in  
 Maximum Concrete Aggregate Size = 0.750000 in  
 Ratio of Bar Spacing to Aggregate Size = 7.36  
 Offset of Center of Rebar Cage from Center of Pile = 0.0000 in

Axial Structural Capacities:

Nom. Axial Structural Capacity = 0.85 Fc Ac + Fy As = 26716.484 kips  
 Tensile Load for Cracking of Concrete = -3491.747 kips  
 Nominal Axial Tensile Capacity = -3505.200 kips

KY0062\_cyclic.lp10o

## Reinforcing Bar Dimensions and Positions Used in Computations:

Bar Number	Bar Diam. inches	Bar Area sq. in.	X inches	Y inches
1	1.270000	1.270000	49.740000	0.00000
2	1.270000	1.270000	49.276719	6.772929
3	1.270000	1.270000	47.895506	13.419691
4	1.270000	1.270000	45.622090	19.816470
5	1.270000	1.270000	42.498821	25.844106
6	1.270000	1.270000	38.583880	31.390314
7	1.270000	1.270000	33.950193	36.351781
8	1.270000	1.270000	28.684079	40.636082
9	1.270000	1.270000	22.883635	44.163411
10	1.270000	1.270000	16.656912	46.868058
11	1.270000	1.270000	10.119902	48.699643
12	1.270000	1.270000	3.394378	49.624045
13	1.270000	1.270000	-3.394378	49.624045
14	1.270000	1.270000	-10.119902	48.699643
15	1.270000	1.270000	-16.656912	46.868058
16	1.270000	1.270000	-22.883635	44.163411
17	1.270000	1.270000	-28.684079	40.636082
18	1.270000	1.270000	-33.950193	36.351781
19	1.270000	1.270000	-38.583880	31.390314
20	1.270000	1.270000	-42.498821	25.844106
21	1.270000	1.270000	-45.622090	19.816470
22	1.270000	1.270000	-47.895506	13.419691
23	1.270000	1.270000	-49.276719	6.772929
24	1.270000	1.270000	-49.740000	0.00000
25	1.270000	1.270000	-49.276719	-6.772929
26	1.270000	1.270000	-47.895506	-13.419691
27	1.270000	1.270000	-45.622090	-19.816470
28	1.270000	1.270000	-42.498821	-25.844106
29	1.270000	1.270000	-38.583880	-31.390314
30	1.270000	1.270000	-33.950193	-36.351781
31	1.270000	1.270000	-28.684079	-40.636082
32	1.270000	1.270000	-22.883635	-44.163411
33	1.270000	1.270000	-16.656912	-46.868058
34	1.270000	1.270000	-10.119902	-48.699643
35	1.270000	1.270000	-3.394378	-49.624045
36	1.270000	1.270000	3.394378	-49.624045
37	1.270000	1.270000	10.119902	-48.699643
38	1.270000	1.270000	16.656912	-46.868058
39	1.270000	1.270000	22.883635	-44.163411
40	1.270000	1.270000	28.684079	-40.636082
41	1.270000	1.270000	33.950193	-36.351781
42	1.270000	1.270000	38.583880	-31.390314
43	1.270000	1.270000	42.498821	-25.844106

Page 7

KY0062\_cyclic.lp10o

44	1.270000	1.270000	45.622090	-19.816470
45	1.270000	1.270000	47.895506	-13.419691
46	1.270000	1.270000	49.276719	-6.772929

NOTE: The positions of the above rebars were computed by LFile

Minimum spacing between any two bars not equal to zero = 5.519 inches  
between bars 31 and 32.

Ratio of bar spacing to maximum aggregate size = 7.36

## Concrete Properties:

Compressive Strength of Concrete	=	3000. psi
Modulus of Elasticity of Concrete	=	3122019. psi
Modulus of Rupture of Concrete	=	-410.791918 psi
Compression Strain at Peak Stress	=	0.001634
Tensile Strain at Fracture of Concrete	=	-0.0001160
Maximum Coarse Aggregate Size	=	0.750000 in

Number of Axial Thrust Force Values Determined from File-head Loadings = 1

Number	Axial Thrust Force kips
1	72.850

## Definitions of Run Messages and Notes:

C = concrete in section has cracked in tension.  
 Y = stress in reinforcing steel has reached yield stress.  
 T = ACI 318 criteria for tension-controlled section met, tensile strain in reinforcement exceeds 0.005 while simultaneously compressive strain in concrete more than 0.003. See ACI 318, Section 10.3.4.  
 Z = depth of tensile zone in concrete section is less than 10 percent of section depth.

Bending Stiffness (EI) = Computed Bending Moment / Curvature.  
 Position of neutral axis is measured from edge of compression side of pile.  
 Compressive stresses and strains are positive in sign.  
 Tensile stresses and strains are negative in sign.

Axial Thrust Force = 72.850 kips

Page 8



KY0062\_cyclic.lp10o

Bending Curvature rad/in.	Bending Moment in-kip	Bending Stiffness kip-in2	Depth to N Axis in	Max Comp Strain in/in	Max Tens Strain in/in	Max Conc Stress ksi	Max Steel Stress ksi	Run Msg
2.50000E-07	6573.	2.62905E+10	62.3236508	0.00001558	-0.00001142	0.0564641	0.4479315	
5.00000E-07	13112.	2.62245E+10	58.1757126	0.00002909	-0.00002491	0.1049133	0.8357178	
7.50000E-07	19618.	2.61572E+10	56.7931656	0.00004259	-0.00003841	0.1529608	1.2235064	
0.00000100	26090.	2.60895E+10	56.1019464	0.00005610	-0.00005190	0.2006064	1.6112964	
0.00000125	32527.	2.60217E+10	55.6872554	0.00006961	-0.00006539	0.2478501	1.9990880	
0.00000150	38931.	2.59539E+10	55.4108283	0.00008312	-0.00007888	0.2946920	2.3868810	
0.00000175	45301.	2.58860E+10	55.2134085	0.00009662	-0.00009238	0.3411319	2.7746755	
0.00000200	51636.	2.58181E+10	55.0653685	0.00011011	-0.00010509	0.3871700	3.1624714	
0.00000225	51636.	2.29494E+10	27.8554360	0.00006267	-0.0001803	0.2214928	-5.1941978	C
0.00000250	51636.	2.06545E+10	27.4814486	0.00006870	-0.0002013	0.2422873	-5.7984450	C
0.00000275	51636.	1.87768E+10	27.1649744	0.00007470	-0.0002223	0.2629026	-6.4035283	C
0.00000300	51636.	1.72121E+10	26.9024278	0.00008071	-0.0002433	0.2834529	-7.0085088	C
0.00000325	51636.	1.58881E+10	26.6813673	0.00008671	-0.0002643	0.3039361	-7.6133861	C
0.00000350	51636.	1.47532E+10	26.4929059	0.00009273	-0.0002853	0.3243582	-8.2181500	C
0.00000375	51636.	1.37697E+10	26.3243164	0.00009872	-0.0003063	0.3446326	-8.8235056	C
0.00000400	51636.	1.29090E+10	26.1763434	0.0001047	-0.0003273	0.3648236	-9.4289041	C
0.00000425	51636.	1.21497E+10	26.0466498	0.0001107	-0.0003483	0.3849501	-10.0341954	C
0.00000450	51636.	1.14747E+10	25.9321916	0.0001167	-0.0003693	0.4050123	-10.6393790	C
0.00000475	51636.	1.08708E+10	25.8305656	0.0001227	-0.0003903	0.4250098	-11.2444546	C
0.00000500	51636.	1.03272E+10	25.7398495	0.0001287	-0.0004113	0.4449427	-11.8494218	C
0.00000525	51636.	9835465981.	25.6584869	0.0001347	-0.0004323	0.4648107	-12.4542803	C
0.00000550	51636.	9388399345.	25.5852047	0.0001407	-0.0004533	0.4846139	-13.0590298	C
0.00000575	51636.	8980208069.	25.5189508	0.0001467	-0.0004743	0.5043520	-13.6636699	C
0.00000600	51636.	8606032733.	25.4588489	0.0001528	-0.0004952	0.5240250	-14.2682003	C
0.00000625	51636.	8261791424.	25.4041626	0.0001588	-0.0005162	0.5436328	-14.8726205	C
0.00000650	51636.	7944030215.	25.3529761	0.0001648	-0.0005372	0.5631475	-15.4771740	C
0.00000675	51636.	7649806874.	25.3050471	0.0001708	-0.0005582	0.5825724	-16.0818320	C
0.00000700	51636.	7376599485.	25.2611113	0.0001768	-0.0005792	0.6019327	-16.6863744	C
0.00000725	51636.	7122233986.	25.2207575	0.0001829	-0.0006001	0.6212282	-17.2908007	C
0.00000750	51636.	6884826186.	25.1836293	0.0001889	-0.0006211	0.6404589	-17.8951106	C
0.00000775	51636.	6662735019.	25.1494164	0.0001949	-0.0006421	0.6596246	-18.4993036	C
0.00000800	51636.	6454524550.	25.1178472	0.0002009	-0.0006631	0.6787252	-19.1033794	C
0.00000825	51636.	6258932897.	25.0886831	0.0002070	-0.0006840	0.6977606	-19.7073375	C
0.00000850	51636.	6074846635.	25.0617135	0.0002130	-0.0007050	0.7167307	-20.3111776	C
0.00000875	51636.	5901279588.	25.0367520	0.0002191	-0.0007259	0.7356353	-20.9148991	C
0.00000900	51636.	5737355155.	25.0136329	0.0002251	-0.0007469	0.7544744	-21.5185018	C
0.00000925	51636.	5582291503.	24.9922082	0.0002312	-0.0007678	0.7732478	-22.1219851	C
0.00000950	51636.	5435389095.	24.9723459	0.0002372	-0.0007888	0.7919554	-22.7253489	C
0.00000975	51636.	5296020143.	24.9539271	0.0002433	-0.0008097	0.8105971	-23.3285923	C
0.00001000	51636.	5037677697.	24.9210036	0.0002554	-0.0008516	0.8476823	-24.5347166	C
0.00001025	51636.	4803367107.	24.8927013	0.0002676	-0.0008934	0.8845023	-25.7403553	C
0.00001050	51636.	4589884124.	24.8684147	0.0002798	-0.0009352	0.9210563	-26.9455047	C
0.00001075	52956.	4506875163.	24.8476417	0.0002920	-0.0009770	0.9573433	-28.1501611	C
0.00001100	55092.	4497299429.	24.8299621	0.0003042	-0.0010188	0.9933622	-29.3543213	C
0.00001125	57226.	4488318846.	24.8150219	0.0003164	-0.0010606	1.0291120	-30.5579809	C

KY0062\_cyclic.lp10o

0.00001325	59358.	4479864849.	24.8025204	0.0003286	-0.0011024	1.0645918	-31.7611367	C
0.00001350	61488.	4471879064.	24.7922012	0.0003409	-0.0011441	1.0998005	-32.9637849	C
0.00001425	63616.	4464311297.	24.7838436	0.0003532	-0.0011858	1.1347371	-34.1659217	C
0.00001475	65742.	4457118150.	24.7772572	0.0003655	-0.0012275	1.1694004	-35.3675433	C
0.00001525	67866.	4450261903.	24.7722765	0.0003778	-0.0012692	1.2037896	-36.5686457	C
0.00001575	69988.	4443709619.	24.7687573	0.0003901	-0.0013109	1.2379034	-37.7692251	C
0.00001625	72108.	4437432401.	24.7665732	0.0004025	-0.0013525	1.2717409	-38.9692774	C
0.00001675	74226.	4431404792.	24.7656129	0.0004148	-0.0013942	1.3053008	-40.1687985	C
0.00001725	76342.	4425604279.	24.7657704	0.0004272	-0.0014359	1.3385022	-41.3677043	C
0.00001775	78455.	4420010872.	24.7669825	0.0004396	-0.0014774	1.3715839	-42.5662307	C
0.00001825	80567.	4414606764.	24.7691480	0.0004520	-0.0015190	1.4043047	-43.7641334	C
0.00001875	82676.	4409376036.	24.7722058	0.0004645	-0.0015605	1.4367435	-44.9614881	C
0.00001925	84783.	4404304414.	24.7760941	0.0004769	-0.0016021	1.4688992	-46.1582904	C
0.00001975	86888.	4399379057.	24.7807577	0.0004894	-0.0016436	1.5007706	-47.3545360	C
0.00002025	88990.	4394588386.	24.7861468	0.0005019	-0.0016851	1.5323565	-48.5502203	C
0.00002075	91091.	4389921925.	24.7922164	0.0005144	-0.0017266	1.5636557	-49.7453388	C
0.00002125	93189.	4385370177.	24.7989261	0.0005270	-0.0017680	1.5946670	-50.9398869	C
0.00002175	95285.	4380924506.	24.8062391	0.0005395	-0.0018095	1.6253892	-52.1338598	C
0.00002225	97379.	4376577043.	24.8141221	0.0005521	-0.0018509	1.6558210	-53.3272529	C
0.00002275	99470.	4372320602.	24.8225448	0.0005647	-0.0018923	1.6859612	-54.5200613	C
0.00002325	101559.	4368148606.	24.8314798	0.0005773	-0.0019337	1.7158084	-55.7122800	C
0.00002375	103646.	4364055020.	24.8409018	0.0005900	-0.0019750	1.7453615	-56.9039042	C
0.00002425	105731.	4360034298.	24.8507880	0.0006026	-0.0020164	1.7746191	-58.0949287	C
0.00002475	107813.	4356081334.	24.8611173	0.0006153	-0.0020577	1.8035799	-59.2853485	C
0.00002525	109893.	4352191414.	24.8718705	0.0006280	-0.0020990	1.8322426	-60.4753000	CY
0.00002575	111970.	4348360182.	24.8830301	0.0006407	-0.0021403	1.8606058	-61.6645000	CY
0.00002625	114011.	4344267676.	24.8920190	0.0006534	-0.0021816	1.8885179	-62.8525000	CY
0.00002675	115820.	4339711449.	24.8845789	0.0006657	-0.0022233	1.9151332	-64.0390000	CY
0.00002725	117420.	4309002895.	24.8629395	0.0006775	-0.0022655	1.9405653	-65.2235000	CY
0.00002775	118829.	4282109731.	24.8286499	0.0006890	-0.0023080	1.9648919	-66.4050000	CY
0.00002825	120173.	4253900808.	24.7914719	0.0007004	-0.0023506	1.9886888	-67.5825000	CY
0.00002875	121381.	4221937944.	24.7460988	0.0007115	-0.0023935	2.0116340	-68.7550000	CY
0.00002925	122557.	4189967642.	24.7004834	0.0007225	-0.0024365	2.0342066	-69.9200000	CY
0.00002975	123667.	4156873466.	24.6520389	0.0007334	-0.0024796	2.0562511	-71.0800000	CY
0.00003025	124761.	4014505231.	24.4317506	0.0007757	-0.0026533	2.1392770	-72.2300000	CY
0.00003075	130611.	3869955933.	24.1919965	0.0008165	-0.0028285	2.2155945	-73.3700000	CY
0.00003125	133195.	3725722380.	23.9340114	0.0008556	-0.0030054	2.2854855	-74.5000000	CY
0.00003175	135491.	3589152445.	23.6857616	0.0008941	-0.0031829	2.3509812	-75.6200000	CY
0.00003225	137461.	3458130212.	23.4419990	0.0009318	-0.0033612	2.4120051	-76.7300000	CY
0.00003275	139242.	3335126472.	23.2098551	0.0009690	-0.0035400	2.4692601	-77.8300000	CY
0.00003325	140724.	3216556638.	22.9648304	0.0010047	-0.0037203	2.5213965	-78.9200000	CY
0.00003375	142199.	3108177453.	22.7443210	0.0010406	-0.0039004	2.5710346	-80.0000000	CY
0.00003425	143395.	3003030882.	22.5211803	0.0010754	-0.0040816	2.6166338	-81.0700000	CY
0.00003475	144490.	2904319795.	22.3106449	0.0011100	-0.0042630	2.6593429	-82.1300000	CY
0.00003525	145577.	2813072662.	22.1173169	0.0011446	-0.0044444	2.6995866	-83.1800000	CY
0.00003575	146559.	2726681276.	21.9202652	0.0011782	-0.0046268	2.7362424	-84.2200000	CY
0.00003625	147350.	2643051843.	21.7217791	0.0012110	-0.0048100	2.7696312	-85.2500000	CY
0.00003675	148118.	2564818853.	21.5375221	0.0012438	-0.0049932	2.8007877	-86.2700000	CY
0.00003725	148881.	2491734901.	21.3677121	0.0012767	-0.0051763	2.8297918	-87.2800000	CY
0.00003775	149639.	2423298046.	21.2109767	0.0013098	-0.0053592	2.8566182	-88.2800000	CY

KY0062\_cyclic.lp10e

0.00006375	150299.	2357624815.	21.0565654	0.0013424	-0.0055426	2.8807952	-60.0000000	CY
0.00006575	150821.	2293862317.	20.8879817	0.0013734	-0.0057276	2.9017139	-60.0000000	CY
0.00006775	151336.	2233737139.	20.7306170	0.0014045	-0.0059125	2.9206672	-60.0000000	CY
0.00006975	151846.	2177000297.	20.5839963	0.0014357	-0.0060973	2.9376558	-60.0000000	CY
0.00007175	152352.	2123367335.	20.4472467	0.0014671	-0.0062819	2.9526561	-60.0000000	CY
0.00007375	152853.	2072584626.	20.3195911	0.0014986	-0.0064664	2.9656440	-60.0000000	CY
0.00007575	153329.	2024140976.	20.1978658	0.0015300	-0.0066510	2.9765340	-60.0000000	CY
0.00007775	153747.	1977454993.	20.0779306	0.0015611	-0.0068359	2.9852652	-60.0000000	CY
0.00007975	154085.	1932100925.	19.9547728	0.0015914	-0.0070216	2.9918334	-60.0000000	CY
0.00008175	154406.	1888763547.	19.8292476	0.0016210	-0.0072080	2.9963905	-60.0000000	CY
0.00008375	154724.	1847455813.	19.7111287	0.0016508	-0.0073942	2.9991201	-60.0000000	CY
0.00008575	155039.	1808034500.	19.5999302	0.0016807	-0.0075803	2.9998275	-60.0000000	CY
0.00008775	155349.	1770357871.	19.4954711	0.0017107	-0.0077663	2.9952522	-60.0000000	CY
0.00008975	155656.	1734325260.	19.3969476	0.0017409	-0.0079521	2.9883700	-60.0000000	CY
0.00009175	155959.	1699828486.	19.3039920	0.0017711	-0.0081379	2.9998627	-60.0000000	CY
0.00009375	156254.	1666707797.	19.2159648	0.0018015	-0.0083235	2.9966634	-60.0000000	CY
0.00009575	156541.	1634889970.	19.1324072	0.0018319	-0.0085091	2.9959318	-60.0000000	CY
0.00009775	156777.	1603859033.	19.0468521	0.0018618	-0.0086952	2.9985709	-60.0000000	CY
0.00009975	156971.	1573648696.	18.9603987	0.0018913	-0.0088817	2.9998491	-60.0000000	CY
0.0001017	157159.	1544560210.	18.8758863	0.0019206	-0.0090684	2.9974372	-60.0000000	CY
0.0001037	157335.	1516480292.	18.7883738	0.0019493	-0.0092557	2.9934311	-60.0000000	CY
0.0001057	157509.	1489448244.	18.7049525	0.0019780	-0.0094430	2.9965689	-60.0000000	CY
0.0001077	157682.	1463405496.	18.6254050	0.0020069	-0.0096301	2.9987030	-60.0000000	CY
0.0001097	157853.	1438297720.	18.5495302	0.0020358	-0.0098172	2.9998214	-60.0000000	CY
0.0001217	158042.	1304658761.	18.1631024	0.0022114	-0.0109376	2.9997826	-60.0000000	CY
0.0001337	159614.	1193377438.	17.8409508	0.0023862	-0.0120588	2.9980351	-60.0000000	CY
0.0001457	160136.	1098706407.	17.5200187	0.0025535	-0.0131875	2.9887358	-60.0000000	CY
0.0001577	160618.	1018180268.	17.2625546	0.0027232	-0.0143138	2.9996440	-60.0000000	CY
0.0001697	161055.	948780027.	17.0602128	0.0028960	-0.0154370	2.9857558	-60.0000000	CY
0.0001817	161349.	887750247.	16.9154511	0.0030744	-0.0165546	2.9988951	-60.0000000	CYT
0.0001937	161549.	833799655.	16.7856113	0.0032522	-0.0176728	2.9897641	-60.0000000	CYT
0.0002057	161654.	785682347.	16.6535259	0.0034265	-0.0187945	2.9896649	-60.0000000	CYT
0.0002177	161747.	742809015.	16.5314042	0.0035997	-0.0199173	2.9987912	-60.0000000	CYT
0.0002297	161785.	704177964.	16.4514942	0.0037797	-0.0210333	2.9923006	-60.0000000	CYT
0.0002417	161785.	669223939.	16.5412541	0.0039988	-0.0221102	2.9851153	-60.0000000	CYT

Summary of Results for Nominal (Unfactored) Moment Capacity for Section 1

Moment values interpolated at maximum compressive strain = 0.003 or maximum developed moment if pile fails at smaller strains.

Load No.	Axial Thrust kips	Nominal Mom. Cap. in-kip	Max. Comp. Strain
1	72.850	161226.368	0.00300000

Note that the values of moment capacity in the table above are not

KY0062\_cyclic.lp10e  
factored by a strength reduction factor (phi-factor).

In ACI 318, the value of the strength reduction factor depends on whether the transverse reinforcing steel bars are tied hoops (0.65) or spirals (0.70).

The above values should be multiplied by the appropriate strength reduction factor to compute ultimate moment capacity according to ACI 318, Section 9.3.2.2 or the value required by the design standard being followed.

The following table presents factored moment capacities and corresponding bending stiffnesses computed for common resistance factor values used for reinforced concrete sections.

Axial Load No.	Resist. Factor for Moment	Nominal Moment Cap in-kips	Ult. (Fac) Ax. Thrust kips	Ult. (Fac) Moment Cap in-kips	Bend. Stiff. at Ult Mom kip-in <sup>2</sup>
1	0.65	161226.	47.352500	104797.	4.3618E+09
1	0.70	161226.	50.995000	112858.	4.3461E+09
1	0.75	161226.	54.637500	120920.	4.2341E+09

Layering Correction Equivalent Depths of Soil & Rock Layers

Layer No.	Top of Layer Below Pile Head ft	Equivalent Top Depth Below Grnd Surf ft	Same Layer Type As Layer Above	Layer is Rock or is Below Rock Layer	F0 Integral for Layer lbs	F1 Integral for Layer lbs
1	0.5000	0.00	N.A.	No	0.00	855.0452
2	2.2000	1.8637	Yes	No	855.0452	14974.
3	6.5000	6.7374	No	No	15829.	96768.
4	15.2000	5.5676	Yes	No	112597.	N.A.

Notes: The F0 integral of Layer n+1 equals the sum of the F0 and F1 integrals for Layer n. Layering correction equivalent depths are computed only for soil types with both shallow-depth and deep-depth expressions for peak lateral load transfer. These soil types are soft and stiff clays, non-liquefied sands, and cemented c-phi soil.

KY0062\_cyclic.lp100  
Computed Values of Pile Loading and Deflection  
for Lateral Loading for Load Case Number 1

Pile-head conditions are Shear and Moment (Loading Type 1)

Shear force at pile head = 15183.0 lbs  
Applied moment at pile head = 28923017.0 in-lbs  
Axial thrust load on pile head = 72850.0 lbs

Table with 10 columns: Depth X feet, Deflect. y inches, Bending Moment in-lbs, Shear Force lbs, Slope S radians, Total Stress psi\*, Bending Stiffness in-lb\*2, Soil Res. p lb/inch, Soil Spr. Es\*h lb/inch, Distrib. Lat. Load lb/inch. Rows range from 0.00 to 11.2000.

KY0062\_cyclic.lp100

Table with 10 columns: Depth X feet, Deflect. y inches, Bending Moment in-lbs, Shear Force lbs, Slope S radians, Total Stress psi\*, Bending Stiffness in-lb\*2, Soil Res. p lb/inch, Soil Spr. Es\*h lb/inch, Distrib. Lat. Load lb/inch. Rows range from 11.5200 to 27.2000.

KY0062\_cyclic.lp10o

27.5200	-0.02193	6525291.	-206523.	-6.77E-04	0.00	2.63E+13	1919.	336172.	0.00
27.8400	-0.02452	5746584.	-198667.	-6.76E-04	0.00	2.63E+13	2172.	340153.	0.00
28.1600	-0.02712	4999911.	-189829.	-6.76E-04	0.00	2.63E+13	2430.	344135.	0.00
28.4800	-0.02971	4289076.	-179991.	-6.75E-04	0.00	2.63E+13	2694.	348116.	0.00
28.8000	-0.03230	3617960.	-169132.	-6.74E-04	0.00	2.63E+13	2962.	352097.	0.00
29.1200	-0.03489	2990521.	-157233.	-6.74E-04	0.00	2.63E+13	3236.	356079.	0.00
29.4400	-0.03748	2410791.	-144273.	-6.73E-04	0.00	2.63E+13	3514.	360060.	0.00
29.7600	-0.04006	1882861.	-130233.	-6.73E-04	0.00	2.63E+13	3798.	364041.	0.00
30.0800	-0.04265	1410977.	-115093.	-6.73E-04	0.00	2.63E+13	4087.	368023.	0.00
30.4000	-0.04523	999345.	-98831.	-6.73E-04	0.00	2.63E+13	4382.	372004.	0.00
30.7200	-0.04782	652328.	-81429.	-6.73E-04	0.00	2.63E+13	4682.	375985.	0.00
31.0400	-0.05040	374346.	-62865.	-6.73E-04	0.00	2.63E+13	4987.	379966.	0.00
31.3600	-0.05298	169899.	-43119.	-6.73E-04	0.00	2.63E+13	5297.	383948.	0.00
31.6800	-0.05556	43565.	-22171.	-6.72E-04	0.00	2.63E+13	5613.	387929.	0.00
32.0000	-0.05815	0.00	0.00	-6.72E-04	0.00	2.63E+13	5934.	195955.	0.00

\* This analysis computed pile response using nonlinear moment-curvature relationships. Values of total stress due to combined axial and bending stresses are computed only for elastic sections only and do not equal the actual stresses in concrete and steel. Stresses in concrete and steel may be interpolated from the output for nonlinear bending properties relative to the magnitude of bending moment developed in the pile.

Output Summary for Load Case No. 1:

Pile-head deflection = 0.25023506 inches  
 Computed slope at pile head = -0.00100779 radians  
 Maximum bending moment = 30307918. inch-lbs  
 Maximum shear force = -236376. lbs  
 Depth of maximum bending moment = 12.16000000 feet below pile head  
 Depth of maximum shear force = 24.96000000 feet below pile head  
 Number of iterations = 10  
 Number of zero deflection points = 1

Summary of Pile-head Responses for Conventional Analyses

Definitions of Pile-head Loading Conditions:

Load Type 1: Load 1 = Shear, V, lbs, and Load 2 = Moment, M, in-lbs  
 Load Type 2: Load 1 = Shear, V, lbs, and Load 2 = Slope, S, radians  
 Load Type 3: Load 1 = Shear, V, lbs, and Load 2 = Rot. Stiffness, R, in-lbs/rad.  
 Load Type 4: Load 1 = Top Deflection, y, inches, and Load 2 = Moment, M, in-lbs  
 Load Type 5: Load 1 = Top Deflection, y, inches, and Load 2 = Slope, S, radians

Load Load	Load	Axial	Pile-head	Pile-head	Max Shear	Max Moment

Page 15

KY0062\_cyclic.lp10o

Case No.	Type 1	Pile-head Load 1	Type 2	Pile-head Load 2	Loading lbs	Deflection inches	Rotation radians	in Pile lbs	in Pile in-lbs
1	V, lb	15183.	M, in-lb	2.89E+07	72850.	0.2502	-0.00101	-236376.	3.03E+07

Maximum pile-head deflection = 0.2502350557 inches  
 Maximum pile-head rotation = -0.0010077880 radians = -0.057742 deg.

Summary of Warning Messages

The following warning was reported 270 times

\*\*\*\* Warning \*\*\*\*

An unreasonable value was input for friction angle has been specified for a soil layer defined using the sand criteria. The input value is either smaller than 20 degrees or higher than 48 degrees. The input data should be checked for correctness.

The analysis ended normally.



1012 S. Fourth Street  
Louisville, KY 40203



Office: 502.636.5111  
Fax: 502.636.5263

RENAISSANCE DESIGN BUILD, INC.  
502-424-8373  
rdbi@sbcglobal.net

December 20, 2018

Paris – Bourbon County Joint Planning  
301 Main Street  
Paris, KY 40361

Re: Towerco, East Main Street  
Paris, KY 40361  
KY 0062 Site  
FSTANS Project No. 18-10211  
RDBI Job No. 2018-659

Dear Planning Board,

The purpose of this letter is to provide additional information regarding the above referenced site and on previously submitted pre & post drainage calculations. Based on our previously submitted calculations the one and five year rain event increase is 100%, and the 100 year rain event increase is 94% between pre & post conditioning. For the 0.30 acre lease site all runoff goes directly to storm creek on the north and due to the very small size of lease area, should present a negligible affect on any property adjoiners. It's our understanding with this additional information our project can receive any required approvals. If you have any additional questions regarding this project, please contact us.

Sincerely,  
Renaissance Design Build, Inc.

Nathan R. Grimes P.E., P.L.S.





1012 S. Fourth Street  
Louisville, KY 40203



Office: 502.636.5111  
Fax: 502.636.5263

RENAISSANCE DESIGN BUILD, INC.  
502-424-8373  
rdbi@sbcglobal.net

---

December 5, 2018

Drainage Calculations  
Towerco  
East Main Street  
Paris, KY 40361  
KY 0062 Site  
FSTANS Project No. 18-10211  
RDBI Job No. 2018-659

The following design criteria was used for the rational method pre and post drainage run-off calculations.

Time of Concentration	=	Tc = 10 minutes
Total Site Area	=	A = 0.30 Acres (site and easement)
Run-off Coefficients	=	C ASPH/CONC = 0.95 C GRAVEL = 0.70 C GRASS = 0.12
Pre-Site Conditions	=	A ASPH/CONC = 0.04 Acres A GRASS = 0.26 Acres
Post-Site Conditions	=	A ASPH/CONC = 0.05 Acres A GRASS = 0.13 Acres A GRAVEL = 0.12 Acres
Rainfall Intensity	=	I 1 Year = 3.2 In/hour I 10 Year = 5.3 In/hour I 100 Year = 6.9 In/hour

Based on Above Mentioned Design Criteria:

1 Year Pre & Post Drainage Run-off

$$Q \text{ Pre} = CIA = 0.95 (3.2) (0.04) + 0.15 (3.2) (0.26) = 0.24 \text{ CFS}$$

$$Q \text{ Post} = 0.95 (3.2) (0.05) + 0.15 (3.2) (0.13) + 0.70 (3.2) (1.12) = 0.48 \text{ CFS}$$

10 Year Pre & Post Drainage Run-off

$$Q \text{ Pre} = 0.95 (5.3) (0.04) + 0.15 (5.3) (0.26) = 0.40 \text{ CFS}$$

$$Q \text{ Post} = 0.95 (5.3) (0.05) + 0.15 (5.3) (0.13) + 0.70 (5.3) (0.12) = 0.80 \text{ CFS}$$

100 Year Pre & Post Drainage Run-off

$$Q \text{ Pre} = 0.95 (6.9) (0.04) + 0.15 (6.9) (0.26) = 0.53 \text{ CFS}$$

$$Q \text{ Post} = 0.95 (6.9) (0.05) + 0.15 (6.9) (0.13) + 0.70 (6.9) (0.12) = 1.03 \text{ CFS}$$

It's our understanding this is all information required for final approvals on this project. If you have any questions or comments, please call us.

Sincerely,

Renaissance Design Build, Inc.



Nathan R. Grimes P.E., P.L.S.





This instrument was prepared by Jill Harvey  
Prepared by and after recording return to: x Jill Harvey  
TowerCo / Jill Harvey  
Attn: Legal Department  
5000 Valleystone Drive, Suite 200  
Cary, NC 27519

(Recorder's Use Above This Line)

STATE OF KENTUCKY

Parcel No: 036-10-12-014.00

COUNTY OF BOURBON

ASSIGNMENT AND ASSUMPTION OF OPTION AND GROUND LEASE AGREEMENT

Document Date: November 1, 2018

Grantor: TOWERCO IV LLC  
5000 Valleystone Drive, Suite 200  
Cary, NC 27519

Grantee: TOWERCO 2013 LLC  
5000 Valleystone Drive, Suite 200  
Cary, NC 27519

Legal Description of the Land is attached as EXHIBIT A.

Prior Recorded Reference:  
Memorandum of Agreement dated March 25, 2014 and recorded on May 28, 2014 in Book 569 Page 231 of the official records of Bourbon County, Kentucky

NOV 19 2:51 PM  
RECORDED  
CLERK'S OFFICE  
BOURBON COUNTY, KY



ASSIGNMENT AND ASSUMPTION OF OPTION AND GROUND LEASE AGREEMENT

THIS ASSIGNMENT AND ASSUMPTION OF OPTION AND GROUND LEASE AGREEMENT ("Assignment") is made, entered into and effective as of this 1st day of November, 2018 ("Transfer Date"), by TowerCo IV LLC, a Delaware limited liability company, having an address of 5000 Valleystone Drive, Suite 200, Cary, North Carolina 27519 ("Assignor"), to TowerCo 2013 LLC, a Delaware limited liability company, having an address of 5000 Valleystone Drive, Suite 200, Cary, North Carolina 27519 ("Assignee").

RECITALS

WHEREAS, Assignor is a party to that certain Option and Ground Lease Agreement dated March 25, 2014 (the "Lease") by and between Nan S. Kendall and Sherry B. Rankin, as optionor/lessor, and Assignor, as optionee/lessee; and

WHEREAS, pursuant to the Lease, Assignor has certain rights, title and interest in and to a portion of a certain parcel of land in Bourbon County, Kentucky (the "Premises"), as further described on Exhibit B attached hereto, for the construction, maintenance and operation of a communications facility thereon;

WHEREAS, the Premises are a portion of that certain real property described on Exhibit A attached hereto (the "Parent Parcel"); and

WHEREAS, Assignor desires to assign to Assignee, and Assignee desires to assume all of Assignor's rights, title and interest in and to the Lease and the Premises.

ASSIGNMENT

NOW, THEREFORE, for and in consideration of the foregoing, the sum of Ten Dollars (\$10.00) and other good and valuable consideration, the receipt and sufficiency of which is acknowledged, the parties hereto agree as follows:

1. Recitals. The recitals set forth above are incorporated herein by reference and made a part of this Assignment.

2. Incorporation of Exhibits. The Premises are more particularly described on Exhibit B hereto which is incorporated by this reference together with Exhibit A.

3. Assignment and Assumption. Assignor does hereby assign, transfer, set over, and deliver to Assignee, all of Assignor's rights, title and interests in and to the Lease and Premises, including without limitation all related easements, ancillary agreements and other appurtenant rights pertaining to and running with the real property subject to the Lease and the Premises, including the Tenant Leases on Exhibit C, if any. Assignee does hereby accept, assume and agree to be bound by all the terms and conditions which are the responsibility of the lessee or tenant under the Lease, and all the terms and conditions of all related easements and ancillary agreements and other appurtenant rights pertaining to and running with the real property subject to the Lease and the Premises, and which arise, are incurred, or are required to be performed from and after the date of this Assignment, including those within the Tenant Leases on Exhibit C, if any. Assignor will indemnify, defend and hold harmless Assignee, its successors and assigns and their respective agents, employees, directors

and officers from and against any claim, damage, loss, liability, obligation, demand, defense, judgment, suit, proceeding, disbursement or expense, including reasonable attorneys' fees or costs (including those related to appeals) of any nature whatsoever (collectively, "Losses and Liabilities"), that arise from or are in any way related to the Lease as a result of any negligent act or omission or intentional misconduct of Assignor prior to the Transfer Date. Assignee shall indemnify, defend and hold harmless Assignor, its successors and assigns and their respective agents, employees, directors and officers from and against any claim, damage, loss, liability, obligation, demand, defense, judgment, suit, proceeding, disbursement or expense, including reasonable attorneys' fees or costs (including those related to appeals) of any nature whatsoever, that arise from or are in any way related to the Lease as a result of any negligent act or omission or intentional misconduct of Assignee from the Transfer Date forward.

4. Further Assurances. The parties hereby agree to perform, execute and/or deliver or cause to be performed, executed and/or delivered any and all such further acts and assurances as may reasonably be required to confirm the transfers made pursuant to this Assignment.

5. Default. Assignor represents and warrants unto Assignee that as of the Transfer Date, Assignor is not in default under the Lease, and all of the rents payable by Assignor, if any, under the Lease have be duly paid and acknowledged.

6. Counterparts. This Assignment may be executed in two or more counterparts, all of which taken together shall constitute one and the same instrument.

7. Governing Law. This Assignment shall be governed and construed in accordance with the laws of the State of Washington without reference to its conflicts of laws principles. Notwithstanding the foregoing, to the extent that the law of the state in which the real property subject to the Lease is located is mandatory rather than permissive for the issue in question (such as, by way of example only, with respect to possession), the laws of the state in which the real property is located shall govern.

8. Successors and Assigns. The terms and conditions of this Assignment shall run with the Premises and shall be binding on and inure to the benefit of the successors and permitted assignees of the respective parties.

[REMAINDER OF PAGE INTENTIONALLY LEFT BLANK]





**EXHIBIT A**

**DESCRIPTION OF PARENT PARCEL**

Being all of Parcel 2, consisting of 1.248 acres, as shown on that certain Plat of Survey for Milton Sheerer Enterprises, Inc. and being of record in the Office of the Bourbon County Court Clerk in Plat Cabinet C, at Slide 303.

EXHIBIT B

## DESCRIPTION OF PREMISES

An approximately 8,200 square foot portion of the Parent Parcel of the land, including all necessary access and utility easements.

## Lease Description:

*Beginning at an IPC with a cap stamped "#3553" found on the Northwest right of way of U.S. Highway #68 (A.K.A. Main Street) at the Southeast corner of the property conveyed to KY Lodging & Development Company, INC in Deed Book 293, Page 705 in the Office of the Clerk of Bourbon County, Kentucky, said IPC being S 46°11'01" W - 365.00' from an IPC with a cap stamped "#3553" found on said Northwest right of way; thence with the said right of way line and the south property line of the said KY Lodging & Development Company, INC property S 46°11'05" W - 150.00' to the southwest corner of the said KY Lodging & Development Company, INC property and being the southeast corner of the property conveyed to Nan S. McClain & Sherry B. Rankin. in Deed Book 280 Page 534 in the Office of the Clerk of Bourbon County, Kentucky; thence with said right of way and south line of the said Nan S. McClain & Sherry B. Rankin property S 46°59'24" W - 159.70'; thence S 55°56'01" W - 1.12' to a set #5 rebar with a cap stamped "FSTAN #3282"; thence N 41°27'21" W - 123.09' to a set #5 rebar with a cap stamped "FSTAN #3282"; thence N 48°32'39" E - 5.76' to a set #5 rebar with a cap stamped "FSTAN #3282" and the TRUE POINT OF BEGINNING of the Proposed Lease Area; thence N 37°04'59" W - 85.00' to a set #5 rebar with a cap stamped "FSTAN #3282"; thence N 48°32'39" E - 93.52' to a set #5 rebar with a cap stamped "FSTAN #3282"; thence S 41°27'21" E - 84.75' to a set #5 rebar with a cap stamped "FSTAN #3282"; thence S 48°32'39" W - 100.00' to the true point of beginning, containing 8,200.61 square feet as per survey by Frank L. Sellinger, II, PLS No. 3282 with FS/Tan Land Surveyors & Consulting Engineers, dated March 28, 2007, and revised April 5, 2007.*

## Access &amp; Utility Easement Description:

*Beginning at an IPC with a cap stamped "#3553" found on the Northwest right of way of U.S. Highway #68 (A.K.A. Main Street) at the Southeast corner of the property conveyed to KY Lodging & Development Company, INC in Deed Book 293, Page 705 in the Office of the Clerk of Bourbon County, Kentucky, said IPC being S 46°11'01" W - 365.00' from an IPC with a cap stamped "#3553" found on said Northwest right of way; thence with the said right of way line and the south property line of the said KY Lodging & Development Company, INC property S 46°11'05" W - 150.00' to the southwest corner of the said KY Lodging & Development Company, INC property and being the southeast corner of the property conveyed to Nan S. McClain & Sherry B. Rankin. in Deed Book 280 Page 534 in the Office of the Clerk of Bourbon County, Kentucky; thence with said right of way and south line of the said Nan S. McClain & Sherry B. Rankin property S 46°59'24" W - 159.70'; thence S 55°56'01" W - 1.12' to a set #5 rebar with a cap stamped "FSTAN #3282" and the TRUE POINT OF BEGINNING of the Proposed Variable Access & Utility Easement; thence S 55°56'01" W - 28.68' to a set #5 rebar with a cap stamped "FSTAN #3282"; thence N 37°04'59" W - 196.66' to a set #5 rebar with a cap stamped "FSTAN #3282"; thence N 52°55'01" E - 25.00' to a set #5 rebar with a cap stamped "FSTAN #3282"; thence S 37°04'59" E - 75.00' to a set #5 rebar with a cap stamped "FSTAN #3282"; thence S 48°32'39" W - 5.76' to a set #5 rebar with a cap stamped "FSTAN #3282"; thence S 41°27'21" E - 123.09' to the true point of beginning, containing 4,802.28 square feet as per survey by Frank L. Sellinger, PLS No. 3282 with FS/Tan Land Surveyors & Consulting Engineers, dated March 28, 2007, and revised April 5, 2007.*

EXHIBIT C

TENANT LEASES

That certain Tower Lease Agreement dated December 3, 2015, by and between Assignor, as lessor, and Cellco Partnership d/b/a Verizon Wireless, as lessee.

State of Kentucky, County of Bourbon, Sct.  
I, RICHARD STIPP EADS, Clerk of Bourbon County  
Court, do certify that the foregoing  
Assignment & Subscription Agreement  
was, on the 14 day of Nov., 2018  
at 2:57 P. M., lodged in my office for record, and  
that it has been duly recorded in my said office,  
together with this and the certificate thereon endorsed.  
Given under my hand  
Richard Stipp Eads, Sec



775 8018 01163 71  
111 E. 1st St.  
Bourbon, KY 40302  
769-251-1000









**GENERAL NOTES:**

1. ALL EXISTING AND REQUIRED COUNTY RIGHT-OF-WAY AND EASEMENTS ARE SHOWN ON THE CONSTRUCTION PLANS. STRUCTURES SUCH AS WALLS, SIGNS, FENCES, BUILDINGS, ETC. OR PLANTS SUCH AS TREES OR SHRUBS SHALL NOT BE PLACED IN THE RIGHT-OF-WAYS OR EASEMENTS WITHOUT PROPER APPROVAL FROM BOURBON COUNTY.
2. OTHER THAN SHOWN ON APPROVED PLANS, GRADING OPERATIONS INVOLVING CUTTING OR FILLING SHALL NOT BE ALLOWED WITHIN BOURBON COUNTY RIGHT-OF-WAYS AND EASEMENTS.
3. THE OWNER OR DEVELOPER SHALL PROVIDE THE CONTRACTOR WITH EXECUTED PERMITS FOR COMMUNITY IDENTIFICATION SIGNS, (IF REQUIRED) AND LANDSCAPING, (IF REQUIRED) TO BE PLACED IN BOURBON COUNTY RIGHT-OF-WAYS OR EASEMENTS.

**STANDARD SITE DEVELOPMENT NOTES:**

1. ALL CONSTRUCTION TO BE IN ACCORDANCE WITH BOURBON COUNTY REGULATIONS.
2. CONTRACTOR AND/OR DEVELOPER SHALL BE RESPONSIBLE FOR CONSTRUCTION & MAINTENANCE OF EROSION AND SEDIMENTATION CONTROLS DURING CONSTRUCTION FOR PROTECTION OF ADJACENT PROPERTIES, ROADWAYS, AND WATERWAYS.
3. CONTRACTOR AND/OR DEVELOPER ARE RESPONSIBLE FOR PROVIDING SITE FREE OF DRAINAGE PROBLEMS.
4. CONTRACTOR AND/OR DEVELOPER SHALL BE RESPONSIBLE FOR MAINTAINING A PROPER TRAFFIC CONTROL PLAN FOR PUBLIC SAFETY ADJACENT TO CONSTRUCTION SITE. THE TRAFFIC CONTROL PLAN MUST BE IN ACCORDANCE WITH LATEST (MUTCD) EDITION.
5. ALL UTILITIES WITHIN ROADWAY SHALL BE BACKFILLED WITH STONE.

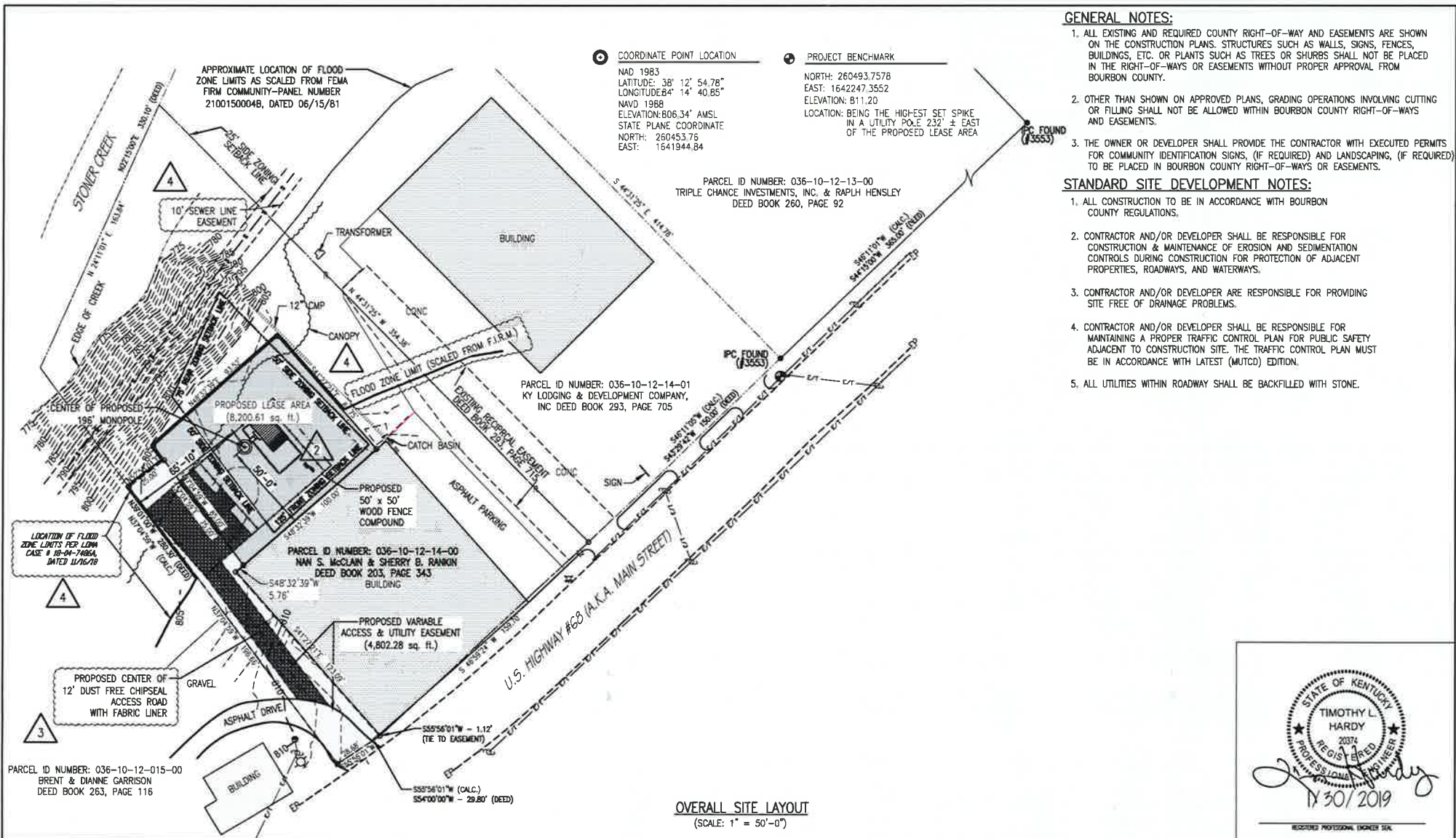

**OVERALL SITE LAYOUT**  
(SCALE: 1" = 50'-0")

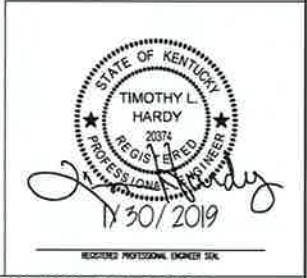

ITEM	REVISIONS	BY	CHK. BY	DATE
1	REVISED VERIZON EQUIPMENT FROM A SHELTER TO A PLATFORM & ADDED A GENERATOR WITH PAD	RMN	TLH	11-1-16
2	REVISED VERIZON EQUIPMENT	RMN	TLH	09-10-18
3	REVISED ACCESS ROAD/PARKING MATERIAL	RMN	TLH	01-30-19
4	ADDED EXISTING SEWER LINE EASEMENT AND REVISED FLOOD ZONE LIMIT LINE	RMN	TLH	01-30-19



DESIGNED BY:	R.M. NACCARI	DATE:	11-1-16
CHECKED BY:	T.L. HARDY	DATE:	11-1-16
APPROVED BY:		DATE:	

**HARDY ENGINEERING, INC.**  
ENGINEERING AND CONSULTING  
209 LINDEN STREET, P.O. BOX 708  
TRUSSVILLE, AL 35173  
PHONE: (205) 655-1427 FAX: (205) 661-9027

<b>OVERALL SITE LAYOUT</b>			
KY0062 SITE: EAST PARIS, KENTUCKY FOR TOWERCO			
DWG NO:	KY0062_C1	SCALE:	AS SHOWN
DWG NO.:		DWG NO.:	C1



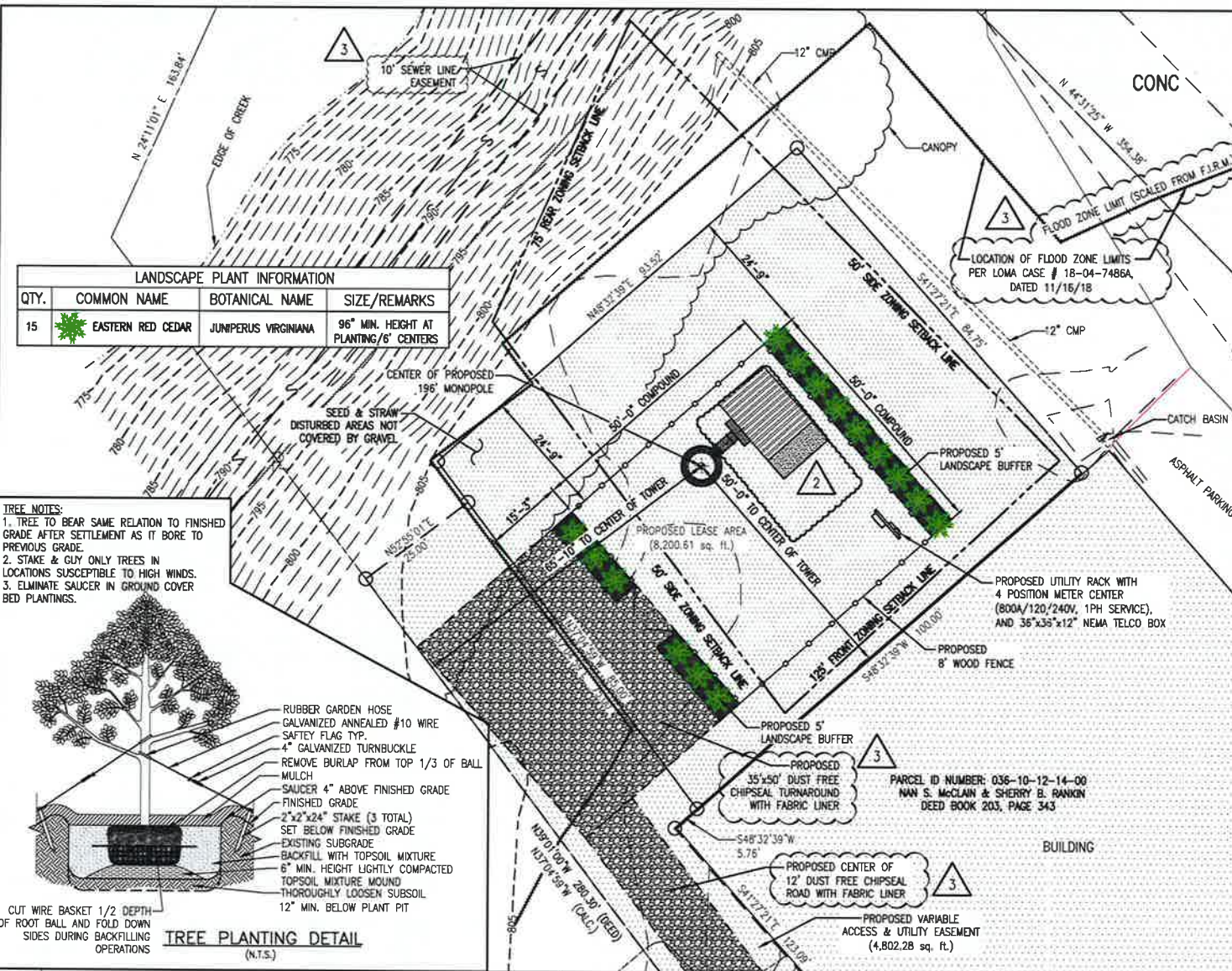

LANDSCAPE PLANT INFORMATION			
QTY.	COMMON NAME	BOTANICAL NAME	SIZE/REMARKS
15	EASTERN RED CEDAR	JUNIPERUS VIRGINIANA	96" MIN. HEIGHT AT PLANTING/6' CENTERS

- TREE NOTES:**
1. TREE TO BEAR SAME RELATION TO FINISHED GRADE AFTER SETTLEMENT AS IT BORE TO PREVIOUS GRADE.
  2. STAKE & GUY ONLY TREES IN LOCATIONS SUSCEPTIBLE TO HIGH WINDS.
  3. ELIMINATE SAUCER IN GROUND COVER BED PLANTINGS.



- RUBBER GARDEN HOSE
- GALVANIZED ANNEALED #10 WIRE
- SAFETY FLAG TYP.
- 4" GALVANIZED TURNBUCKLE
- REMOVE BURLAP FROM TOP 1/3 OF BALL
- MULCH
- SAUCER 4" ABOVE FINISHED GRADE
- FINISHED GRADE
- 2"x2"x24" STAKE (3 TOTAL)
- SET BELOW FINISHED GRADE
- EXISTING SUBGRADE
- BACKFILL WITH TOPSOIL MIXTURE
- 6" MIN. HEIGHT LIGHTLY COMPACTED TOPSOIL MIXTURE MOUND
- THOROUGHLY LOOSEN SUBSOIL
- 12" MIN. BELOW PLANT PIT

**TREE PLANTING DETAIL**  
(N.T.S.)

ITEM	REVISIONS	BY	CHK. BY	DATE
1	REVISED VERIZON EQUIPMENT FROM A SHELTER TO A PLATFORM & ADDED A GENERATOR WITH PAD	SMN	TLH	11-1-16
2	REVISED VERIZON EQUIPMENT	SMN	TLH	09-10-18
3	REVISED ACCESS ROAD & TURNAROUND AREA MATERIAL TYPE/ ADDED SEWER LINE / FLOOD ZONE LIMIT	SMN	TLH	01-30-19



DRAWN BY:	R.M. NACCARI	DATE:	11-1-16
CHECKED BY:	T.L. HARDY	DATE:	11-1-16
APPROVED BY:		DATE:	

**HARDY ENGINEERING, INC.**  
ENGINEERING AND CONSULTING  
209 LINDEN STREET, P.O. BOX 708  
TROSSVILLE, AL 36173  
PHONE: (205) 655-1427 FAX: (205) 661-9027

- NOTES:**
1. BOUNDARY AND PROPOSED SITE FEATURES ARE BASED ON THE SURVEY. CONTRACTOR SHALL IMMEDIATELY NOTIFY THE ENGINEER OF ANY DISCREPANCIES BETWEEN ACTUAL FIELD CONDITIONS AND THIS DRAWING.
  2. CONTRACTOR SHALL FURNISH ALL MATERIALS FOR ELECTRICAL SERVICE AS FOLLOWS:
    - a. 800 AMP INCOMING TO MULTI-TENANT METER CENTER.
    - b. 200 AMP FROM MULTI-METER CENTER TO VERIZON UTILITY RACK.
  3. GROUNDING OF ANTENNAS MOUNTS, COAX, AND EQUIPMENT SHALL BE IN ACCORDANCE WITH T-MOBILE WIRELESS SPECIFICATIONS.
  4. ANY MATERIALS STORED ON SITE SHALL BE STORED IN CLOSED OR COVERED CONTAINERS AND ALL EXCESS WASTE MATERIALS WILL BE PROPERLY DISPOSED OF.
  5. ALL HARDWARE TO BE STAINLESS STEEL, **NO PLATED METAL TO BE USED.**
  6. CONTRACTOR AND/OR DEVELOPER SHALL BE RESPONSIBLE FOR CONSTRUCTION & MAINTENANCE OF EROSION AND SEDIMENTATION CONTROLS DURING CONSTRUCTION FOR PROTECTION OF ADJACENT PROPERTIES, ROADWAYS, AND WATERWAYS.
  7. CONTRACTOR AND/OR DEVELOPER ARE RESPONSIBLE FOR PROVIDING SITE FREE OF DRAINAGE PROBLEMS.
  8. CONTRACTOR IS RESPONSIBLE FOR MAINTAINING A PROPER TRAFFIC CONTROL PLAN FOR PUBLIC SAFETY ADJACENT TO CONSTRUCTION SITE. THE TRAFFIC CONTROL PLAN MUST BE IN ACCORDANCE WITH KYTC DESIGN STANDARDS AND SPECIFICATIONS.
  9. SEEDING & MULCHING OF THE SITE SHALL BE ACCOMPLISHED AS SOON AS POSSIBLE AFTER COMPLETION OF THE SITE DEVELOPMENT. THE CONTRACTOR IS RESPONSIBLE FOR PROVIDING & MAINTAINING AN ADEQUATE COVER OF VEGETATION OVER THE SITE FOR ONE YEAR PERIOD. **ONE YEAR GUARANTEE REQUIRED ON TREES AND SHRUBS.**
  10. SEE SHEET D1.2 FOR DUST FREE CHIPSEAL REQUIREMENTS.

**DETAILED SITE LAYOUT WITH LANDSCAPE**  
(SCALE: 1" = 20'-0")

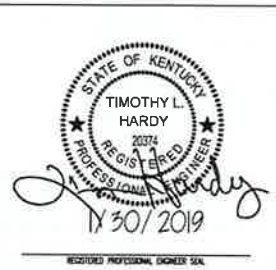

<b>DETAILED SITE LAYOUT W/ LANDSCAPE</b>			
KY0062 SITE: EAST PARIS, KENTUCKY FOR TOWERCO			
DWG. NO. KY0062_C1.1	SCALE: AS SHOWN	SHEET NO. C1.1	



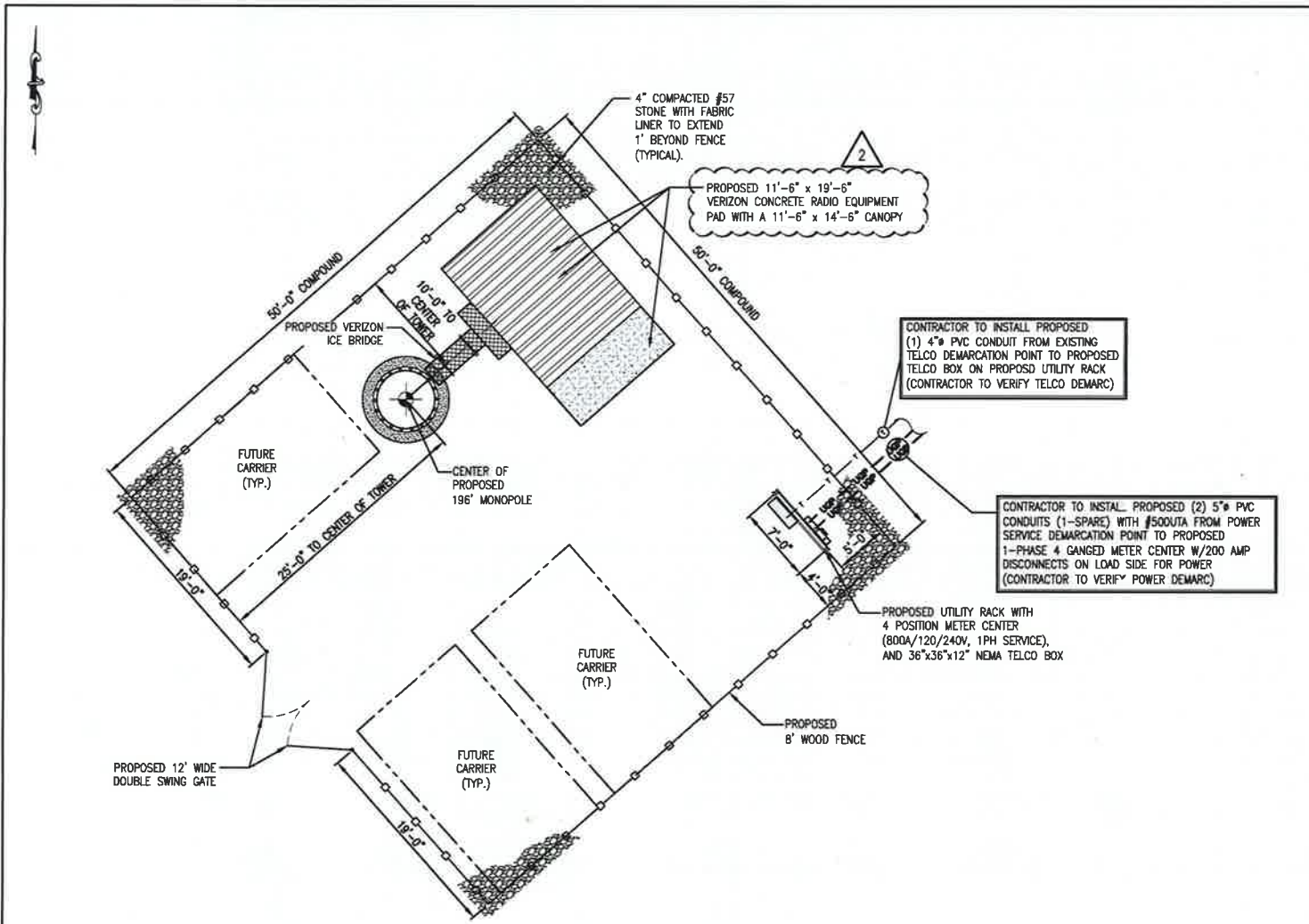

**COMPOUND LAYOUT**  
(SCALE: 1" = 10'-0")

**NOTES:**

1. BOUNDARY AND PROPOSED SITE FEATURES ARE BASED ON THE SURVEY. CONTRACTOR SHALL IMMEDIATELY NOTIFY THE ENGINEER OF ANY DISCREPANCIES BETWEEN ACTUAL FIELD CONDITIONS AND THIS DRAWING.
2. CONTRACTOR SHALL FURNISH ALL MATERIALS FOR ELECTRICAL SERVICE AS FOLLOWS:
  - a. 800 AMP INCOMING TO MULTI-TENANT METER CENTER.
  - b. 200 AMP FROM MULTI-METER CENTER TO VERIZON UTILITY RACK.
3. GROUNDING OF ANTENNAS MOUNTS, COAX, AND EQUIPMENT SHALL BE IN ACCORDANCE WITH T-MOBILE WIRELESS SPECIFICATIONS.
4. ANY MATERIALS STORED ON SITE SHALL BE STORED IN CLOSED OR COVERED CONTAINERS AND ALL EXCESS WASTE MATERIALS WILL BE PROPERLY DISPOSED OF.
5. ALL HARDWARE TO BE STAINLESS STEEL, **NO PLATED METAL TO BE USED.**
6. CONTRACTOR AND/OR DEVELOPER SHALL BE RESPONSIBLE FOR CONSTRUCTION & MAINTENANCE OF EROSION AND SEDIMENTATION CONTROLS DURING CONSTRUCTION FOR PROTECTION OF ADJACENT PROPERTIES, ROADWAYS, AND WATERWAYS.
7. CONTRACTOR AND/OR DEVELOPER ARE RESPONSIBLE FOR PROVIDING SITE FREE OF DRAINAGE PROBLEMS.
8. CONTRACTOR IS RESPONSIBLE FOR MAINTAINING A PROPER TRAFFIC CONTROL PLAN FOR PUBLIC SAFETY ADJACENT TO CONSTRUCTION SITE. THE TRAFFIC CONTROL PLAN MUST BE IN ACCORDANCE WITH KYTC DESIGN STANDARDS AND SPECIFICATIONS.
9. SEEDING & MULCHING OF THE SITE SHALL BE ACCOMPLISHED AS SOON AS POSSIBLE AFTER COMPLETION OF THE SITE DEVELOPMENT. THE CONTRACTOR IS RESPONSIBLE FOR PROVIDING & MAINTAINING AN ADEQUATE COVER OF VEGETATION OVER THE SITE FOR ONE YEAR PERIOD. **ONE YEAR GUARANTEE REQUIRED ON TREES AND SHRUBS.**

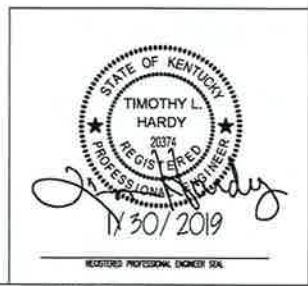

ITEM	REVISIONS	BY	CHK. BY	DATE
1	REVISED VERIZON EQUIPMENT FROM A SHELTER TO A PLATFORM & ADDED A GENERATOR WITH PAD	R/MN	T/LH	11-1-16
2	REVISED VERIZON EQUIPMENT	R/MN	T/LH	09-10-18



DRAWN BY:	R.M. NACCARI	DATE:	11-1-16
CHECKED BY:	T.L. HARDY	DATE:	11-1-16
APPROVED BY:		DATE:	

**HARDY ENGINEERING, INC.**  
ENGINEERING AND CONSULTING  
209 LINDEN STREET, P.O. BOX 708  
TRUSSVILLE, AL 35173  
PHONE: (205) 855-1427 FAX: (205) 861-9027

COMPOUND LAYOUT			
KY0062 SITE: EAST PARIS, KENTUCKY FOR TOWERCO			
DOC NO:	KY0062_C1.2	SCALE:	AS SHOWN
REV. NO.:			C1.2

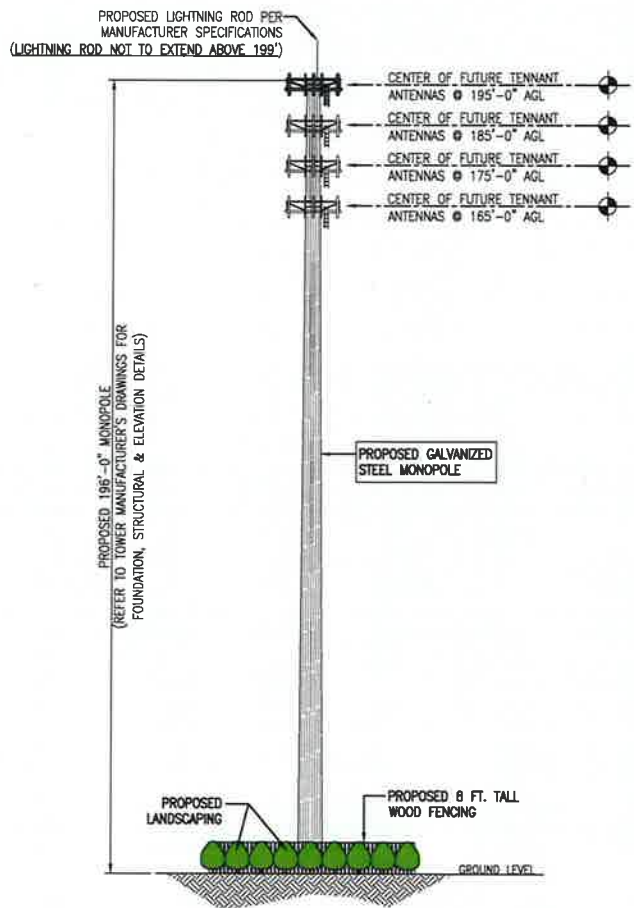

**MONOPOLE ELEVATION**  
(SCALE: 1" = 30'-0")



ITEM	REVISIONS	BY	CHK. BY	DATE



DRAWN BY: R.M. NACCARI	DATE: 11-1-16
CHECKED BY: T.L. HARDY	DATE: 11-1-16
APPROVED BY:	DATE:

**HARDY ENGINEERING, INC.**  
ENGINEERING AND CONSULTING  
209 LINDEN STREET, P.O. BOX 708  
TRUSSVILLE, AL 35173  
PHONE: (205) 656-1427 FAX: (205) 661-9027

<b>TOWER ELEVATION</b>	
KY0062 SITE: EAST PARIS PARIS, KENTUCKY FOR TOWERCO	
DATE: KY0062_C2	SCALE: AS SHOWN
REV. NO: C2	

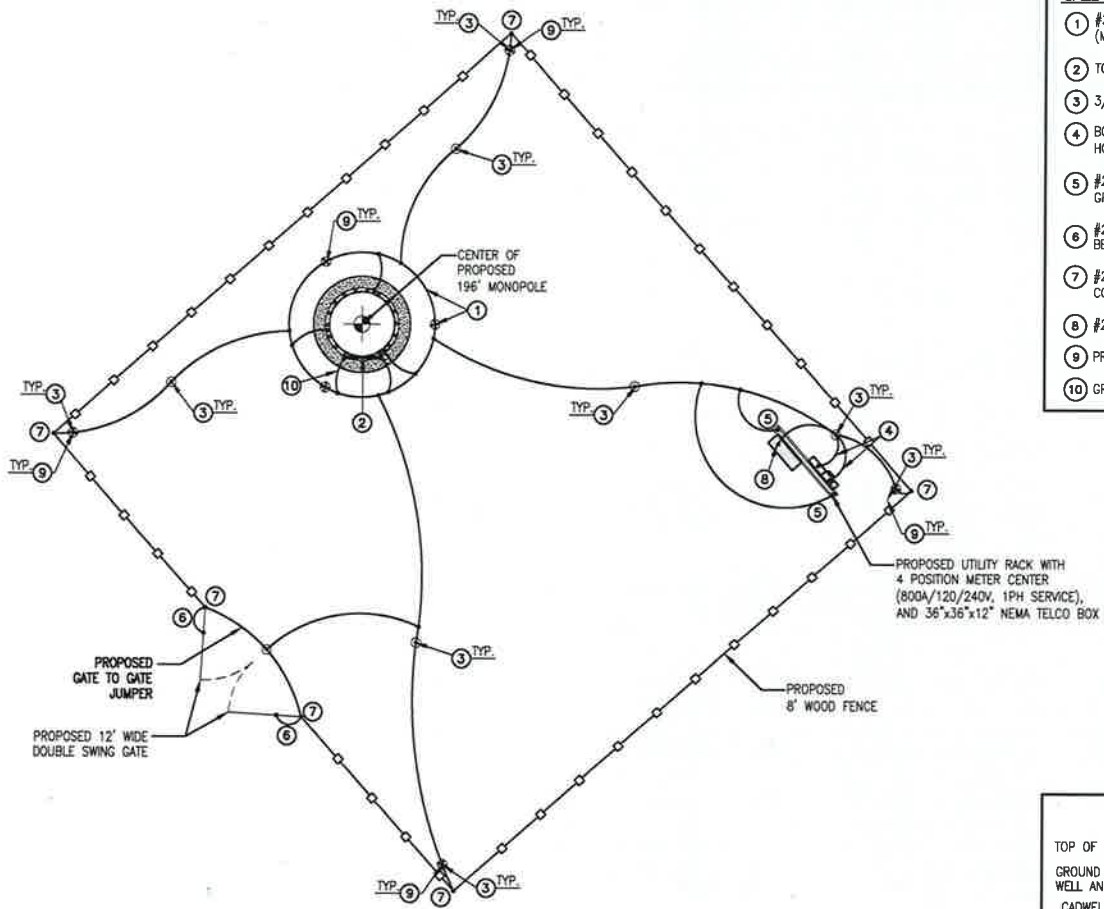

**CALL-OUT NOTES:**

- ① #2 AWG SOLID BARE COPPER TOWER GROUND RING. INSTALL (3) GROUND RODS (MIN.) SPACED 11 FT. (MIN.). MAINTAIN 2 FT. (MIN.) FROM EDGE OF TOWER FOUNDATION.
- ② TOWER BOTTOM GROUND BAR. TOWER GROUND BARS SHALL BE COPPER. (REFER TO SHEET G2 FOR DETAIL)
- ③ 3/4" x 10 FT. COPPER CLAD GROUND ROD(S). GROUND RODS TO BE PLACED APPROX. EVERY 20'.
- ④ BOND GPS ANTENNAS, DISCONNECT SWITCH, MISCELLANEOUS METALLIC EQUIPMENT, CONDUITS AND ANY MISCELLANEOUS LIFTING HOOKS TO GROUND RING W/ #2 AWG SOLID BARE TINNED COPPER WIRE.
- ⑤ #2 AWG SOLID BARE TINNED COPPER WIRE FROM ICE-BRIDGE/H-FRAME SUPPORT POST TO TOWER GROUND RING OR EQUIPMENT GROUND RING (TYP.)
- ⑥ #2 WELDING CABLE JUMPER TO GATE PIPE CONNECTOR. GROUNDING CABLE SHALL BE ATTACHED IN A MANNER WHERE IT WILL NOT BE SUBJECTED TO STRAIN WHICH MAY CAUSE DAMAGE WHEN GATE IS FULLY OPENED.
- ⑦ #2 AWG SOLID BARE TINNED COPPER WIRE FROM TOWER/EQUIPMENT, PAD/PLATFORM GROUND RING TO FENCE POST. BOND CORNER FENCE POST (TYP.)
- ⑧ #2 AWG SOLID BARE TINNED COPPER WIRE TO TELCO DEMARCATON STUB UP LOCATION (ALLOW 6 FT. SLACK)
- ⑨ PROVIDE GROUND RING ACCESS POINT FOR FUTURE CARRIERS (CONTRACTOR TO VERIFY W/ TOWERCO).
- ⑩ GROUND TOWER GROUND RING TO TOWER GROUND BAR (30" BELOW GRADE, TYP.).

**GROUNDING LAYOUT**  
(SCALE: 1" = 10'-0")

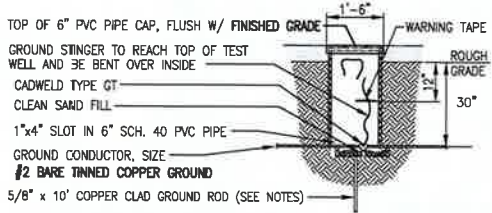

**(GROUND RING ACCESS POINT)**  
VERIFY W/ PROJECT MANAGER FOR NUMBER AND LOCATIONS

NOT TO SCALE

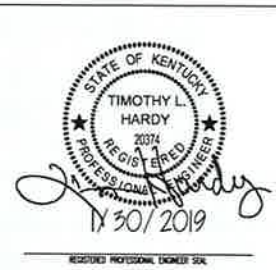

**LEGEND**

⊙	GROUND ROD	—	#2 AWG BARE TINNED COPPER WIRE (SITE/TOWER GROUNDING)	•	CADWELD CONNECTION
⊕	GROUND RING ACCESS POINT	- - -	#2 AWG BARE TINNED COPPER WIRE (SHELTER/EQUIPMENT GROUND RING)	■	COMPRESSION/MECHANICAL CONNECTION

ITEM	REVISIONS	BY	CHK.	BY	DATE



DESIGNED BY:	R.M. NACCARI	DATE:	11-1-16
CHECKED BY:	T.L. HARDY	DATE:	11-1-16
APPROVED BY:		DATE:	

**HARDY ENGINEERING, INC.**  
ENGINEERING AND CONSULTING  
209 LINDEN STREET, P.O. BOX 708  
TRUSSVILLE, AL 35173  
PHONE: (205) 656-1427 FAX: (205) 661-9027

DWG. NO.:	GROUNDING LAYOUT
PROJECT NO.:	KY0062_G1
SCALE:	AS SHOWN
SHEET NO.:	G1



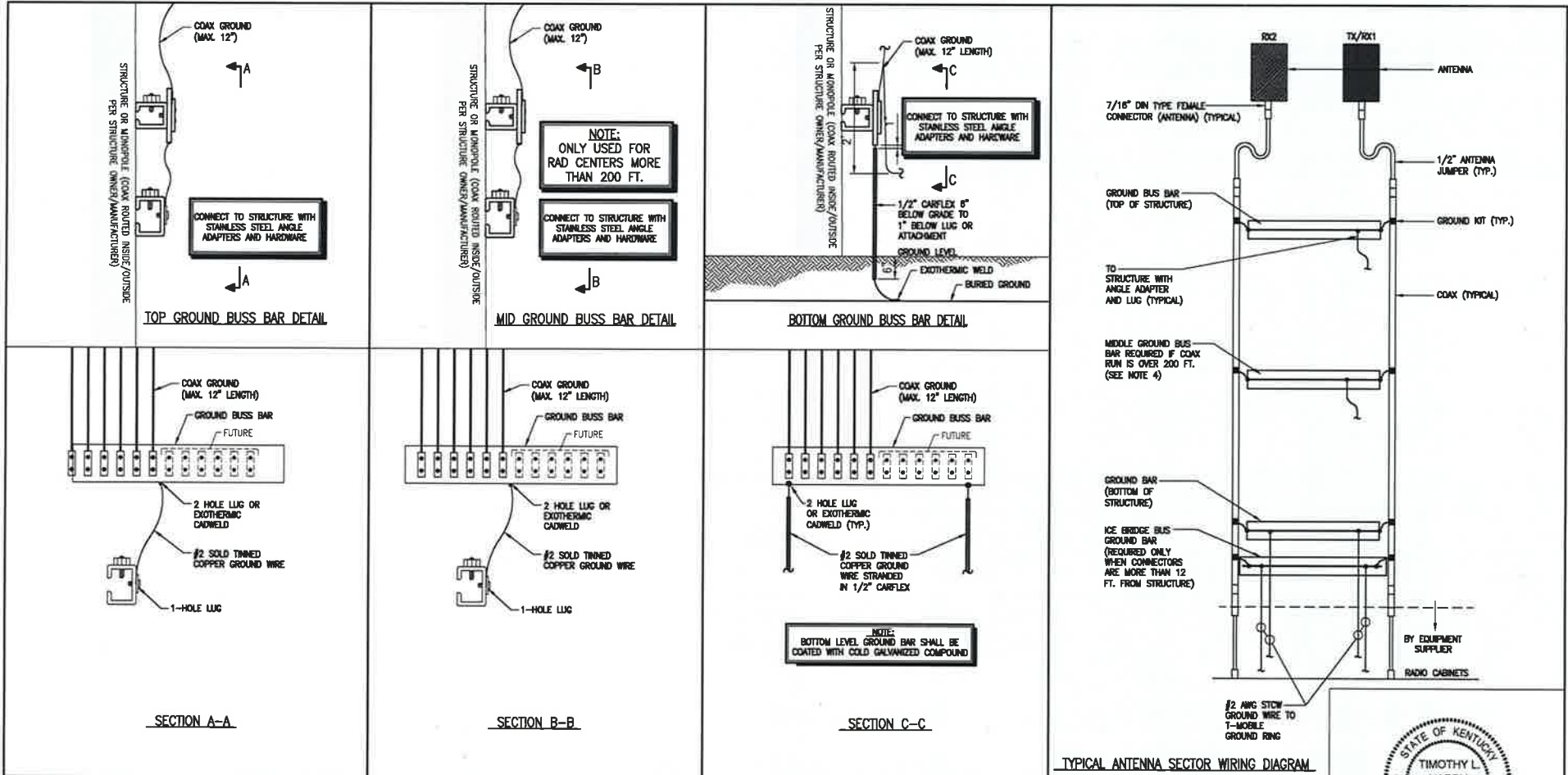

**CELL SITE GROUNDING INSTALLATION NOTES AND DETAILS:**

- ALL METAL CONDUIT FOR GROUNDING DOWN CONDUCTORS SHALL BE BONDED TO THE GROUND SYSTEM AT BOTH ENDS.
- KOPR-SHIELD ANTI-OXIDATION COMPOUND SHALL BE USED ON ALL CONNECTIONS.
- ALL UNDERGROUND GROUNDING CONNECTIONS SHALL BE MADE USING THE CADWELD PROCESS.
- ALL BOLTED GROUNDING CONNECTIONS SHALL BE INSTALLED WITH A 3/4" STAINLESS STEEL FLAT WASHER AND A LOCK WASHER UNDER THE NUT WITH THREADS EXPOSED BEYOND THE NUT. HARDWARE FOR BOLTED CONNECTIONS SHALL BE MINIMUM OF 3/8" DIAMETER AND SHALL BE STAINLESS STEEL.
- MANUFACTURED STANDARD BUS BARS (CGBE AND MGB) SHALL BE FURNISHED BY TOWERCO AND INSTALLED BY THE CONTRACTOR. DO NOT USE SHOP FABRICATED OR FIELD MODIFIED BUS BARS.
- ALL GROUNDING WIRES SHALL BE INSTALLED WITHOUT LOOPS AND SHARP BEND RADII.
- FERRISS METAL CLIPS WHICH COMPLETELY SURROUND THE GROUNDING CONDUCTOR SHALL NOT BE USED. CLIPS OF THE FOLLOWING MATERIALS AND TYPES MAY BE USED TO FASTEN AND SUPPORT GROUNDING CONDUCTORS.

NOT TO SCALE



ITEM	REVISIONS	BY	CHK. BY	DATE



DESIGNED BY: R.M. NACCARI	DATE: 11-1-15
CHECKED BY: T.L. HARDY	DATE: 11-1-15
APPROVED BY:	DATE:

**HARDY ENGINEERING, INC.**  
 ENGINEERING AND CONSULTING  
 209 LINDEN STREET, P.O. BOX 708  
 TRUSSVILLE, AL 35173  
 PHONE: (205) 855-1427 FAX: (205) 861-9027

<b>STRUCTURE GROUND DETAILS</b>			
KY0062 SITE: EAST PARIS, KENTUCKY			
PARIS, KENTUCKY			
FOR TOWERCO			
DWG NO: KY0062_G2	SCALE: AS SHOWN	SHEET NO: G2	

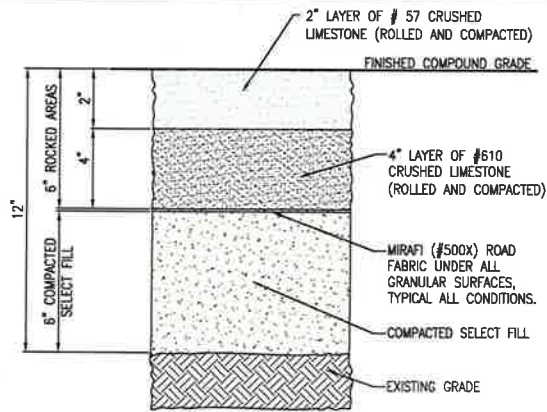

COMPOUND AREA MATERIAL

NOT TO SCALE

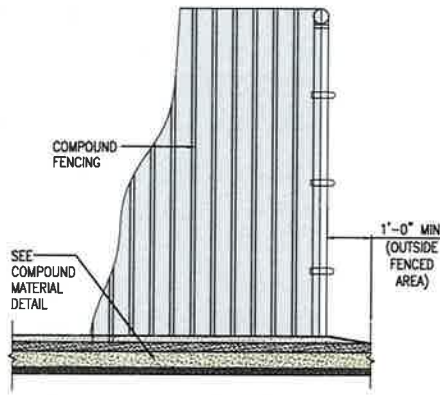

COMPOUND CORNER PROFILE (TYPICAL)

NOT TO SCALE

**COMPOUND MATERIAL NOTES:**

- 1.) ROLL AND COMPACT ALL ROCKED AREAS.
- 2.) SUITABLE FILL MATERIAL SHALL BE COMPACTED IN PLACE AT AN ELEVATION OF 6" ABOVE EXISTING OR SURROUNDING GRADE BEFORE FABRIC AND ROCK IS PUT IN PLACE.

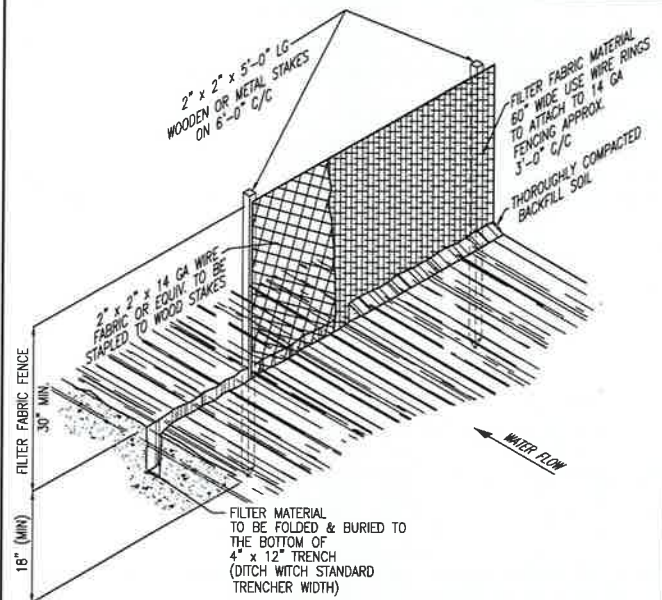

SILT FENCE DETAIL

NOT TO SCALE

- NOTES:**
1. SILT FENCE SHOULD BE INSPECTED AFTER EACH RAINFALL AND SEDIMENT DEPOSITS MUST BE REMOVED WHEN THEY REACH 1/4 THE HEIGHT OF THE FENCE.
  2. FABRIC SHALL RETAIN 85% OF SOIL, BASED ON SIEVE ANALYSIS, BUT NOT TO BE FINER THAN OPENING SIZE 70.

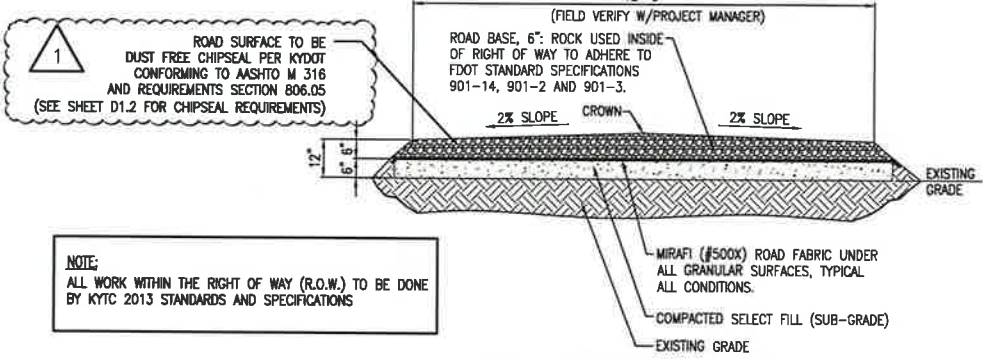

GRAVEL TURNAROUND & ACCESS ROAD

NOT TO SCALE

**NOTE:**  
ALL WORK WITHIN THE RIGHT OF WAY (R.O.W.) TO BE DONE BY KYTC 2013 STANDARDS AND SPECIFICATIONS

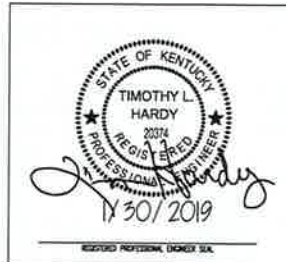

ITEM	REVISIONS	BY	CHK. BY	DATE
1	REVISED ROAD SURFACE MATERIAL FROM ASPHALT TO CHIPSEAL	RMH	TJH	01-30-19



DESIGN BY:	R.M. NACCARI	DATE:	11-1-16
CHECKED BY:	T.L. HARDY	DATE:	11-1-16
APPROVED BY:		DATE:	

**HARDY ENGINEERING, INC.**  
ENGINEERING AND CONSULTING  
209 LINDEN STREET, P.O. BOX 708  
TRUSSVILLE, AL 35173  
PHONE: (205) 655-1427 FAX: (205) 681-8027

<b>SITE DETAILS</b>			
KY0062 SITE: EAST PARIS, KENTUCKY FOR TOWERCO			
PROJECT NO:	KY0062_D1	SCALE:	AS SHOWN
DATE:			









SIGNAGE DETAIL 1

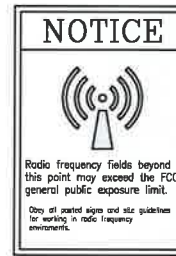

SIGNAGE DETAIL 2

**NOTE:**

SIGNS TO BE MOUNTED ON THE OUTSIDE OF ACCESS GATE TO THE PROPOSED/EXISTING COMPOUND.



SIGNAGE DETAIL 3

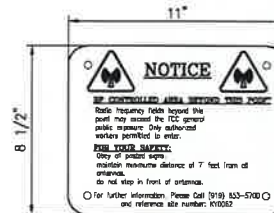

EMERGENCY SIGN  
(WHITE METAL SIGN W/ BLACK LETTERING)  
SIGNAGE DETAIL 4

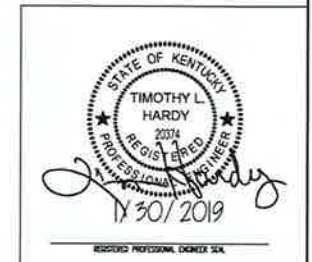

ITEM	REVISIONS	BY	CHK. BY	DATE



DESIGN BY:	R.M. NACCARI	DATE:	11-1-16
CHECKED BY:	T.L. HARDY	DATE:	11-1-16
APPROVED BY:		DATE:	

**HARDY ENGINEERING, INC.**  
ENGINEERING AND CONSULTING  
209 LINDEN STREET, P.O. BOX 708  
TRUSSVILLE, AL 35173  
PHONE: (205) 655-1427 FAX: (205) 661-9027

SIGNAGE DETAILS	
KY0062 SITE- EAST PARIS, KENTUCKY FOR TOWERCO	
DATE: 11/30/2019	SCALE: AS SHOWN
PROJECT NO: KY0062_D2.1	DWG. NO: D2.1

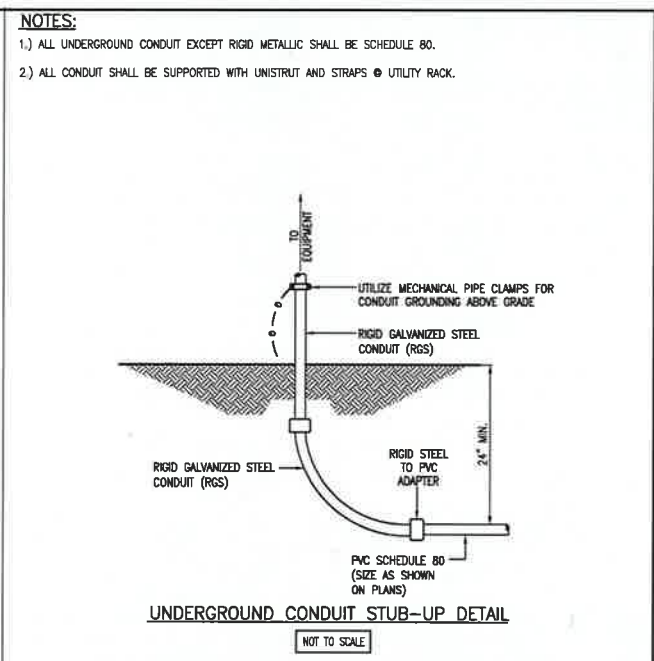
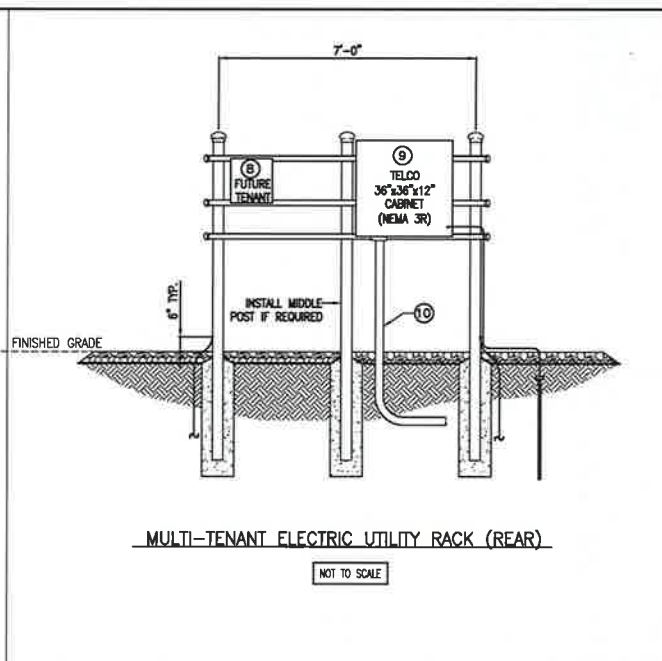
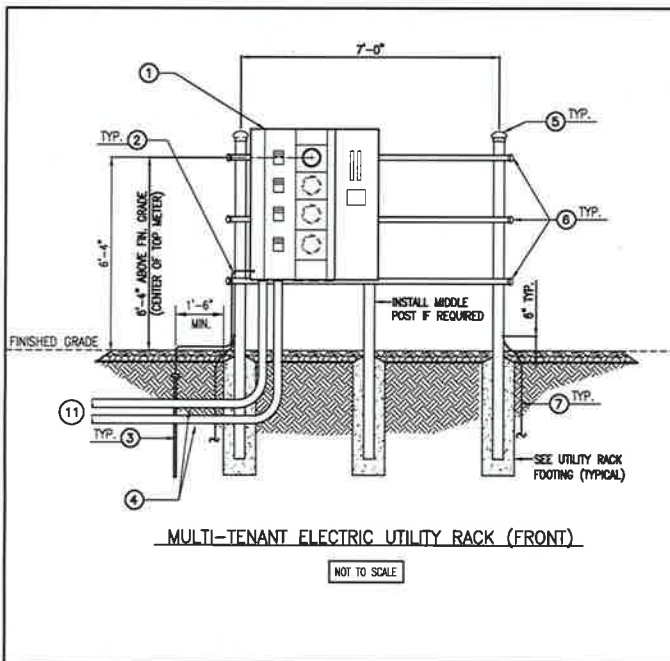

UTILITY RACK & SERVICE POLE LEGEND	
①	4 POSITION METER CENTER (800A/120/240V, 1PH SERVICE)
②	#2 SOLID BARE TINNED COPPER GROUND WIRE IN 1" CONDUIT BETWEEN ELECTRICAL SERVICE ENTRANCE GROUND ROD AND GROUND LUG IN MULTI-TENANT METER CENTER (SERVICE GROUND)
③	3/4" x 10'-0" LONG COPPERCLAD ELECTRICAL STEEL SERVICE ENTRANCE GROUND ROD
④	ELECTRIC SERVICE CONDUCTORS IN (2) 5" CONDUITS TO SERVICE POLE/PAD MOUNTED TRANSFORMER
⑤	3-1/2" O.D. GALVANIZED STEEL POST AND METAL CAP (TYPICAL)
⑥	END CAP ALL ENDS. ZINC COATED "UNISTRUT" HOT DIP GALVANIZED, FIELD DRESS RAW ENDS OF CUT UNISTRUT WITH ZINC COATING, EXTEND PAST POST FOR U-BOLT ATTACHMENT (TYPICAL)
⑦	#2 SOLID BARE TINNED COPPER GROUND WIRE TO TOWER GROUND RING (TYPICAL)
⑧	FUTURE TENANT TELCO BOX (NEMA 3R)
⑨	TELCO 36"x36"x12" CABINET (NEMA 3R)
⑩	4" CONDUIT TO TELCO PEDESTAL/DEMARCATION
⑪	FINAL CONNECTION BY LOCAL POWER COMPANY

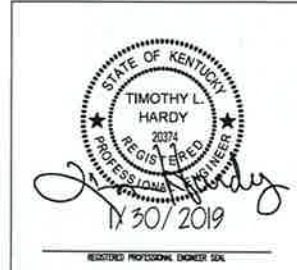
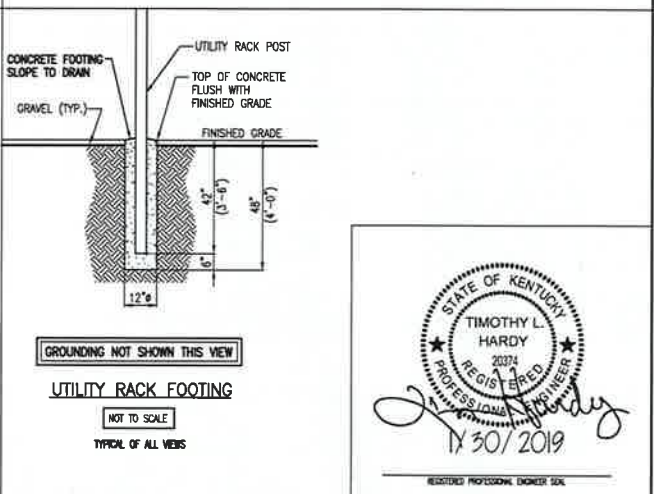
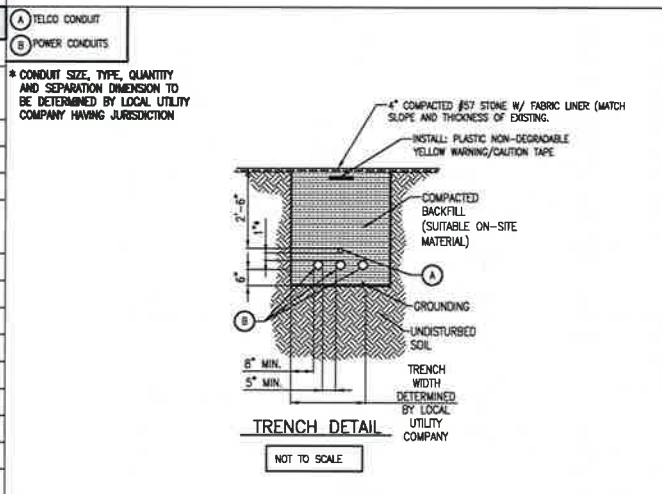

ITEM	REVISIONS	BY	CHK. BY	DATE

<p>5000 VALLESTONE DRIVE CARY, NORTH CAROLINA 27519</p>	DRAWN BY: R.M. NACCARI CHECKED BY: T.L. HARDY APPROVED BY:	DATE: 11-1-16 DATE: 11-1-16 DATE:	<p>ENGINEERING AND CONSULTING 209 LINDEN STREET, P.O. BOX 708 TRUSSVILLE, AL 35173 PHONE: (205) 655-1427 FAX: (205) 861-9027</p>	DRAWING NAME: ELECTRICAL DETAILS KY0062 SITE: EAST PARIS PARIS, KENTUCKY FOR TOWERCO DATE: KY0062_E1 SCALE: AS SHOWN SHEET NO.: E1
---	--	---	--	--



**ELECTRICAL SPECIFICATION NOTES**

**ELECTRICAL AND TELCO SERVICE NOTES:**

- SERVICE POWER TO SITE SHALL BE 800 AMP 120/240VAC, 60HZ, SINGLE PHASE.
- CONTRACTOR SHALL COORDINATE WITH UTILITY COMPANY BEFORE THE START OF CONSTRUCTION. POWER & TELEPHONE CONDUIT SHALL BE PROVIDED AND INSTALLED PER UTILITY REQUIREMENTS.
- REFER TO MANUFACTURER'S DRAWINGS FOR COMPLETE INTERNAL WIRING AND ARRANGEMENT OF POWER PEDESTAL AND INTERNAL TELCO TERMINAL BLOCK.
- ALL SERVICE EQUIPMENT AND INSTALLATIONS SHALL COMPLY WITH THE N.E.C. AND UTILITY COMPANY AND LOCAL CODE REQUIREMENTS.
- ALL CONDUIT ELL'S TO BE 90 RIGID GALVANIZED STEEL (GRS) FOR CONDUITS LARGER THAN 1".
- ALL EXPOSED CONDUIT TO BE GRS OR SCH. 80 PVC UNLESS OTHERWISE NOTED.
- UNLESS NOTED OTHERWISE, USE GRS OR SCHEDULE 80 PVC CONDUIT ABOVE GRADE & GRS OR SCHEDULE 40 PVS CONDUIT BELOW GRADE. TRANSITIONS BETWEEN GRS OR SCH. 80 PVS CONDUIT & GRS OR SCH. 40 PVS CONDUIT SHALL BE MADE W/ GRS CONDUIT ELL'S OR 90'S ALL CONDUITS 1" OR LARGER BELOW GRADE. UNDERGROUND CONDUITS SHALL BE @ A MIN. OF 24" BELOW ROUGH GRADE. (CONDUITS NOT CROSSING ACCESS GATES OR VEHICLE ACCESS ROADS).
- CONNECT NEUTRAL TERMINAL IN DISCONNECTING DEVICE TO GROUND ROD.
- NOALOX IS TO BE USED FOR DISSIMILAR METAL CONNECTIONS. ONLY STAINLESS STEEL OR PLASTIC IS TO BE USED NEXT TO GALVANIZED STEEL.
- ALL UNUSED CONDUIT ENDS WILL BE TURNED UP AND CAPPED TO PREVENT DEBRIS FROM ENTERING THE CONDUIT CAUSING BLOCKAGE TO CABLE.
- CONTRACTOR TO INSTALL PULLSTRINGS IN ANY UNUSED CONDUIT.
- POWER & TELCO:** IN CASES WHERE CONDUIT BENDS EXCEED 360° INSTALL A WEATHERPROOF 13"x24" TRAFFIC RATED PULLBOX W/ LIGHTWEIGHT CONCRETE COVER FLUSH W/ GRADE.
- LABELING:** ALL ENCLOSURES TO BE LABELED "TOWERCO" USING BLACK LETTERING ON WHITE TAPE. TAPE TO BE PERMANENT UV AND WEATHER RESISTANT AND A MIN. OF 3/4" WIDE.
- ALL TRANSITIONS AT ALL CONCRETE PADS OR EQUIPMENT PLATFORMS OR EQUIPMENT PLATFORMS OR EQUIPMENT PLATFORMS OR EQUIPMENT PLATFORMS TO BE MADE WITH METAL LBS.
3. ALL GROUNDING AND ELECTRICAL TRENCHES ARE TO BE COMPACTED TO A FIRM AND STABLE CONDITION.
- CONDUIT ROUTINGS ARE SCHEMATIC, CONTRACTOR SHALL INSTALL CONDUITS SO THAT ACCESS TO EQUIPMENT IS NOT BLOCKED.
- THE CONTRACTOR IS RESPONSIBLE FOR PROPERLY SEQUENCING GROUNDING AND CONDUIT INSTALLATION SO AS TO PREVENT ANY LOSS OF CONTINUITY IN THE GROUNDING SYSTEM OR DAMAGE TO THE CONDUIT.

**GROUNDING NOTES:**

- LUGS SHALL BE ATTACHED TO BUSES USING BOLTS, NUTS AND LOCK/FLAT WASHERS. NO WASHERS ARE TO BE ALLOWED BETWEEN THE ITEMS BEING GROUNDED.
- SURFACE CONNECTIONS SHALL BE MADE TO BARE METAL. PAINTED SURFACES SHALL BE FILED TO ENSURE PROPER CONTACT. APPLY NON-OXIDIZING AGENT TO CONNECTIONS.
- GROUND CONDUCTOR RUNS SHALL BE STRAIGHT AS POSSIBLE, WITH AN 8 INCH MINIMUM RADIUS FOR #6 CONDUCTORS AND 12" FOR #2 AND LARGER CONDUCTORS.
- HARDWARE (I.E. NUTS, BOLTS, WASHERS, ETC.) IS TO BE STAINLESS STEEL.
- GROUND COAXIAL CABLES AT POINT SHOWN ON GROUNDING RISER DIAGRAM WITH MANUFACTURER'S GROUNDING KITS.
- ALL GROUND CONNECTIONS UNDERGROUND SHALL BE EXOTHERMIC WELD; ABOVE GROUND CAN BE MECHANICAL OR EXOTHERMIC CONNECTIONS.
- GROUND RING, COMPRISED OF #2 BARE TINNED SOLID RADIAL COPPER CONDUCTOR, SHALL HAVE A MINIMUM DISTANCE OF 24" FROM THE STRUCTURE AND BE BURIED A MINIMUM OF 30" BELOW GRADE.
- CADWELD GROUND RODS TO GROUND RING. RODS TO BE 3/4" x 10'-0" COPPER CLAD STEEL WITH COPPER JACKET OF NOT LESS TAN 0.01 INCHES THICK. THE TOP OF GROUND ROD SHALL EXTEND NO MORE THAN 6 INCHES ABOVE THE BOTTOM OF THE TRENCH. GROUND ACCESS POINTS SHALL BE PLACED ON TOP OF GROUND ROD (TYP.)
- INTERCONNECT OUTDOOR EQUIPMENT GROUND RING AND TOWER GROUND RING WITH EXOTHERMIC WELD.
- INSTALL GROUNDING KIT. BOND COAXIAL CABLE OUTER CONDUCTOR TO GROUNDING CONDUCTOR.
- INSTALL GROUND RODS ON GROUND RING AT NOT LESS THAN 11' INTERVALS. BOND GROUND RODS TO FENCE POSTS AT CORNER POSTS AND GATE POSTS.
- ALL GROUNDING SHALL COMPLY WITH THE NATIONAL ELECTRICAL CODE (NEC) AND THE LATEST EDITION OF NATIONAL FIRE PROTECTION ASSOCIATION (NFPA) 780, APPROVED BY LOCAL AUTHORITY.
- ALL CONDUCTOR CONNECTIONS SHALL UTILIZE AN ANTI-OXIDANT COMPOUND. A COPPER (COPPER COLORED) BASED COMPOUND SHALL BE USED ON ALL COPPER TO COPPER CONNECTIONS. A ZINC BASED (GRAY COLORED) COMPOUND SHALL BE USED ON ALL COPPER TO STEEL CONNECTIONS.
- GROUND WIRES SHALL BE #2 BARE TINNED SOLID COPPER CONDUCTOR FOR BONDING CONNECTIONS UNLESS OTHERWISE NOTED ON PLANS.
- DOCUMENT GROUND RING INSTALLATION AND CONNECTIONS WITH PHOTOGRAPHS PRIOR TO BACKFILLING SITE. PRESENT PHOTO ARCHIVE AT SITE "PUNCH LIST" WALK TO TOWERCO REPRESENTATIVE.
- THE ENTIRE SYSTEM SHALL BE SOLIDLY GROUNDED USING PROPERLY BONDED GROUND CONDUCTORS. RECEPTACLES AND EQUIPMENT BRANCH CIRCUITS SHALL BE GROUNDED WITH EQUIPMENT GROUNDING CONDUCTOR RUN IN THE CIRCUIT'S CONDUIT.
- PERFORM THE GROUND RESISTANCE TEST ON EACH RING PRIOR TO BONDING THE RINGS TOGETHER IN (2) PLACES USING THE THREE POINT FALL METHOD. TEST AND VERIFY THAT IMPEDANCE DOES NOT EXCEED 5 OHMS TO THE GROUND. THE REPORT SHALL BE SENT TO TOWERCO, LLC REPRESENTATIVE AND INCLUDED IN ALL CLOSE-OUT DOCUMENTS.
- GROUND BUS BARS @ GROUND LEVEL SHALL BE COATED WITH COLD GALVANIZING COMPOUND.
- ENCLOSURE GROUNDS ARE LOCATED ON THE LOWER LEFT SIDE OF THE ENCLOSURE.

**ELECTRICAL NOTES:**

- IF CONDUIT RUNS HAVE MORE THAN (4)-90° TURNS, THEN THE CONTRACTOR MUST INSTALL PULL BOXES AS NEEDED.
- CONTRACTOR SHALL CORE DRILL THROUGH SHELTER WALL AND PROVIDE WEATHERPROOFING FOR ALL CONDUITS THAT DON'T HAVE A PENETRATION.
- ALL EQUIPMENT INSTALLED ON THE H-FRAMES SHALL MAINTAIN A MINIMUM OF 3'-0" CLEARANCE TO ALL FENCES.
- ALL UNDERGROUND CONDUIT INSTALLED UNDER VEHICLE ACCESS ROADS AND CROSSING CONFINES OF ACCESS GATE AREA SHALL BE 42" BELOW ROUGH GRADE.
- MAINTAIN MINIMUM 12" SEPARATION BETWEEN POWER, TELEPHONE AND PIPING. ALL CONDUIT/PIPING SHALL BE BURIED MINIMUM 24" BELOW ROUGH GRADE.
- SIGNAL WIRING SHALL BE CAT-5.
- WIRING DEVICES AND EQUIPMENT SHALL BE UL LISTED AND SPECIFICATION GRADE.
- FUSES ARE NOT ALLOWED; CIRCUIT BREAKERS ONLY.
- ALL CONDUIT CONSTRUCTION SHALL BE IN ACCORDANCE WITH THE NATIONAL ELECTRICAL CODE 2005 (NFPA 70).
- UNLESS THE SERVING UTILITY REQUIRES OTHERWISE: THE SERVICE ENTRANCE HEAD ON THE UTILITY POLE IS TO BE 18 FT. ABOVE FINISHED GRADE W/ 3/4" GALVANIZED EYE-BOLT 1'-0" ABOVE WEATHERHEAD.

**GENERAL NOTES:**

- OBTAIN PERMITS AND PAY FEES RELATED TO ELECTRICAL WORK PERFORMED ON THIS PROJECT. DELIVER COPIES OF ALL PERMITS TO TOWERCO REPRESENTATIVE.
- SCHEDULE AND ATTEND INSPECTIONS RELATED TO ELECTRICAL WORK REQUIRED BY JURISDICTION HAVING AUTHORITY. CORRECT AND PAY FOR ANY WORK REQUIRED TO PASS ANY FAILED INSPECTION.
- REDLINED AS-BUILTS ARE TO BE DELIVERED TO TOWERCO REPRESENTATIVE.
- FURNISH AND INSTALL THE COMPLETE ELECTRICAL SERVICE, CABLE TRAY, TELCO CONDUIT AND GROUNDING SYSTEMS.
- ALL WORK SHALL BE PERFORMED IN STRICT ACCORDANCE WITH ALL APPLICABLE BUILDING CODES AND LOCAL ORDINANCES, INSTALLED IN A NEAT MANNER AND SHALL BE SUBJECT TO APPROVAL BY TOWERCO, LLC REPRESENTATIVE.
- CONDUCT A PRE-CONSTRUCTION SITE VISIT AND VERIFY EXISTING SITE CONDITIONS AFFECTING THIS WORK, REPORT ANY OMISSIONS OR DISCREPANCIES FOR CLARIFICATION PRIOR TO THE START OF CONSTRUCTION.
- PROTECT ADJACENT STRUCTURES AND FINISHES FROM DAMAGE. REPAIR TO ORIGINAL CONDITION ANY DAMAGED AREA.
- REMOVE DEBRIS ON A DAILY BASIS. DEBRIS NOT REMOVED IN A TIMELY FASHION WILL BE REMOVED BY OTHERS AND THE RESPONSIBLE SUBCONTRACTOR SHALL BE CHARGED ACCORDINGLY. REMOVAL OF DEBRIS SHALL BE COORDINATED WITH TOWERCO, LLC'S REPRESENTATIVE. DEBRIS SHALL BE REMOVED FROM THE PROPERTY AND DISPOSED OF LEGALLY. USE OF THE PROPERTY'S DUMPSTER IS PROHIBITED.
- ALL CONSTRUCTION SHALL BE INSPECTED AND APPROVED BY LOCAL AUTHORITIES.
- MATERIALS SHALL BE NEW AND CONFORM TO THE APPLICABLE STANDARDS ESTABLISHED FOR EACH ITEM BY THE ORGANIZATIONS LISTED BELOW:  
 -AMERICAN SOCIETY FOR TESTING AND MATERIALS (ASTM)  
 -UNDERWRITERS LABORATORY (UL)  
 -NATIONAL ELECTRICAL MANUFACTURING ASSOCIATION (NEMA)  
 -AMERICAN STANDARDS ASSOCIATION (ASA).



ITEM	REVISIONS	BY	CHK. BY	DATE



DESIGNED BY:	R.M. NACCARI	DATE:	11-1-15
CHECKED BY:	T.L. HARDY	DATE:	11-1-15
APPROVED BY:		DATE:	

**HARDY ENGINEERING, INC.**  
 ENGINEERING AND CONSULTING  
 209 LINDEN STREET, P.O. BOX 708  
 TRUSSVILLE, AL 35173  
 PHONE: (205) 655-1427 FAX: (205) 661-9027

<b>ELECTRICAL SPECIFICATION NOTES</b>			
KY0062 SITE: EAST PARIS, KENTUCKY			
PARIS, KENTUCKY FOR TOWERCO			
DOC. NO. KY0062.E2	SCALE AS SHOWN	DATE	E2