

Standard extruded Heat Sinks

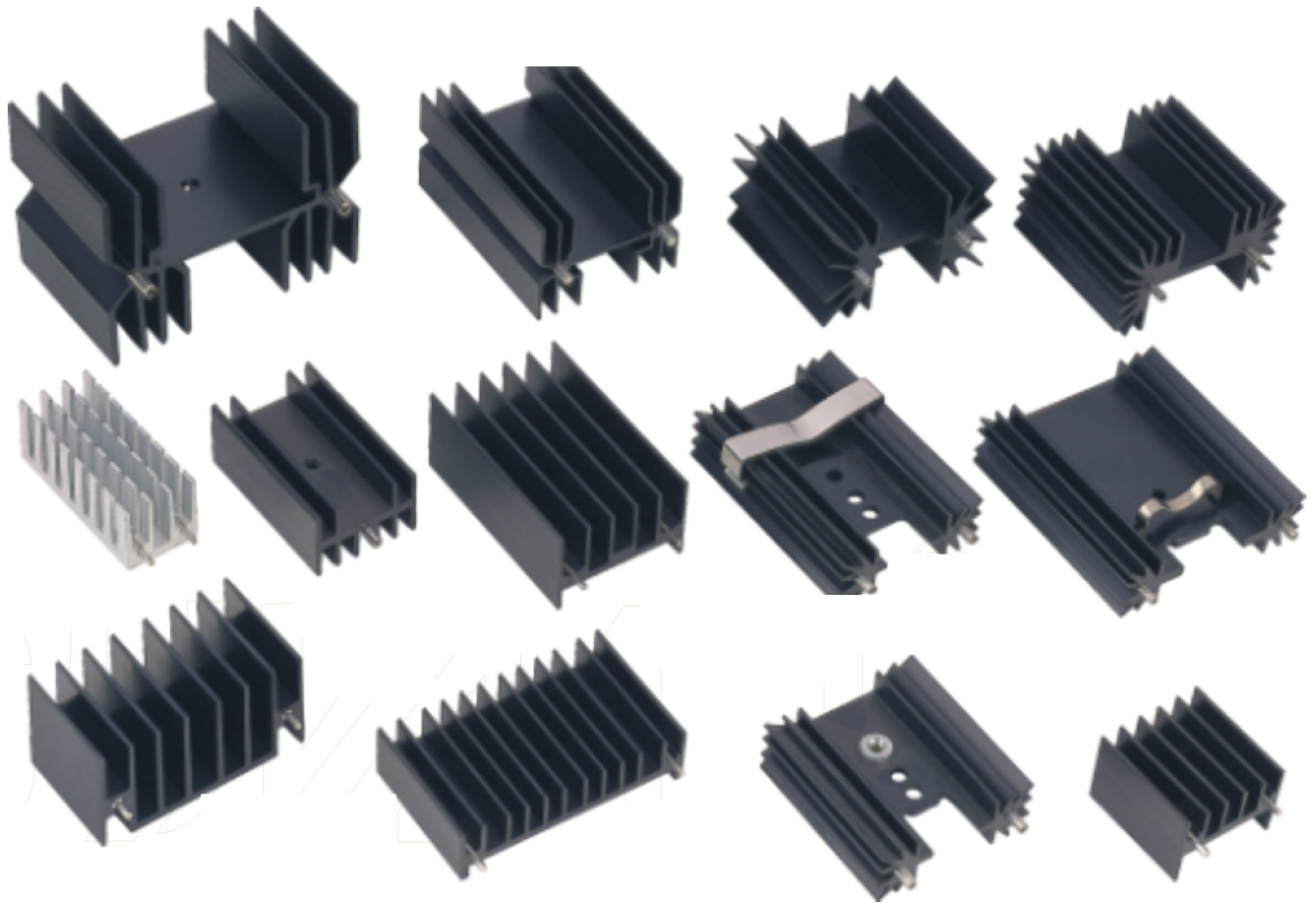

- PC Board Level Standard Heat Sinks
- Standard for TO-220s, TO-3s, to-5s, TO-126s, TO127s, TO-202s, TO-218s ...
- Aluminum anodized or degreased material with solderable tabs
- Clips, Nuts or Thermal pad optional

STANDARD EXTRUDED HEAT SINKS

SE930006A

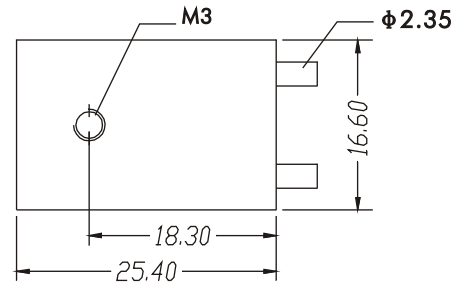
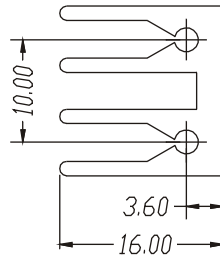
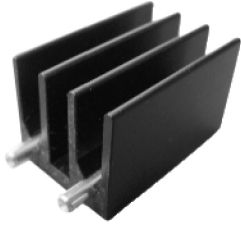

SE930006B

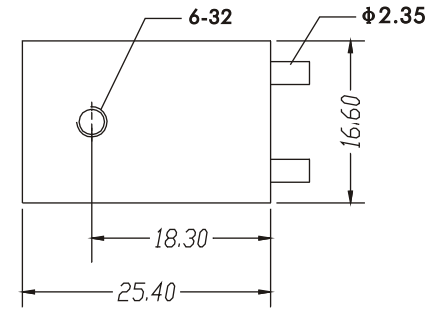
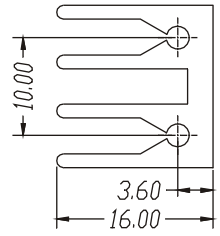
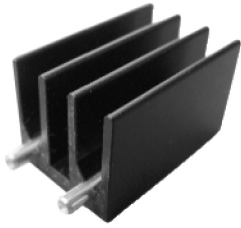

SE930006C

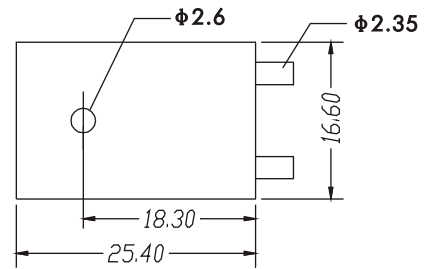
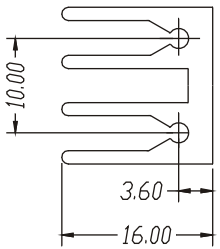
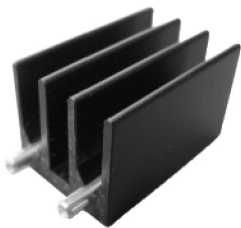

SE930006D

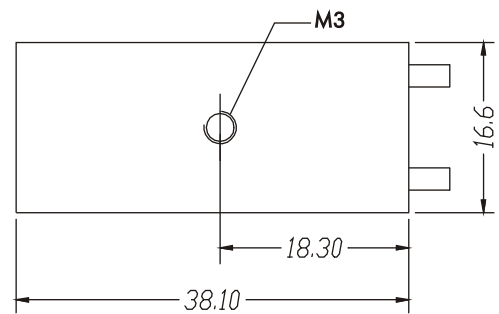
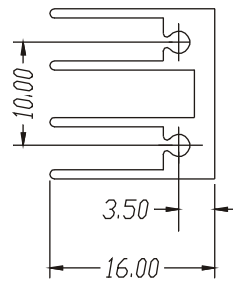
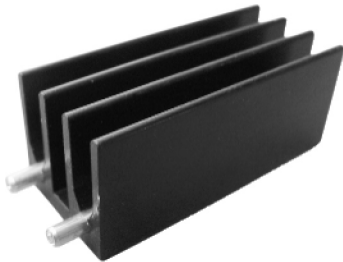

SE930005A

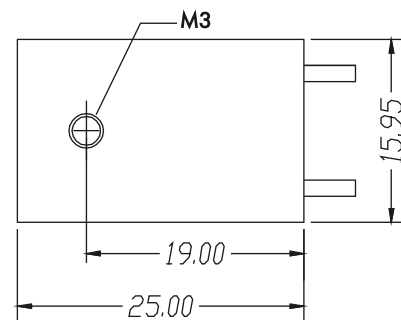
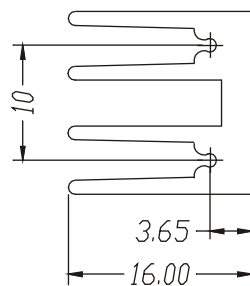
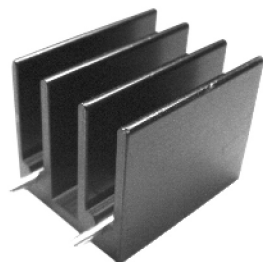

STANDARD EXTRUDED HEAT SINKS

SE930005C

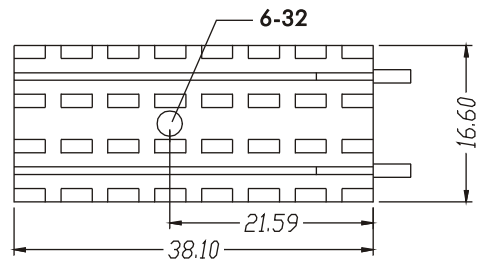
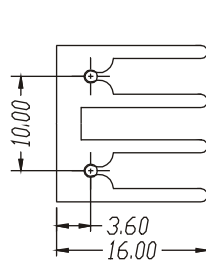
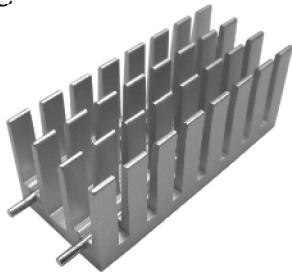

SE932001

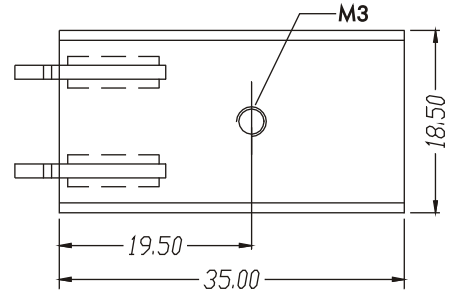
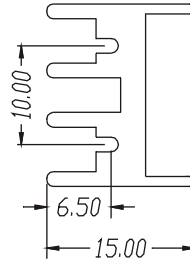

SE932002

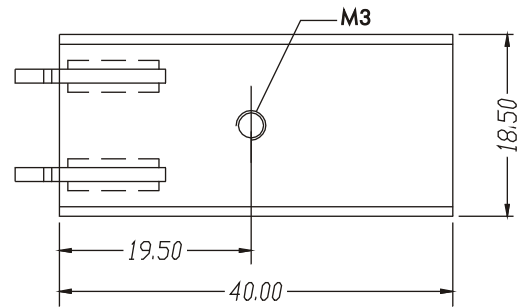
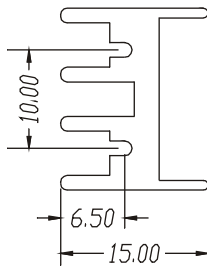

SE930009A

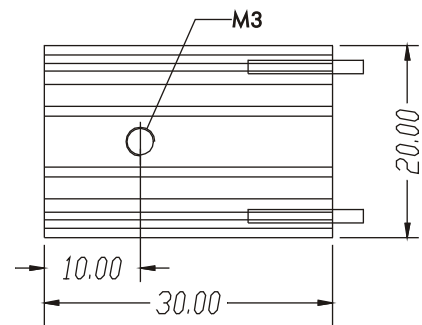
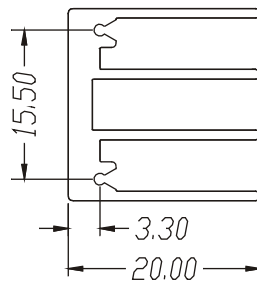
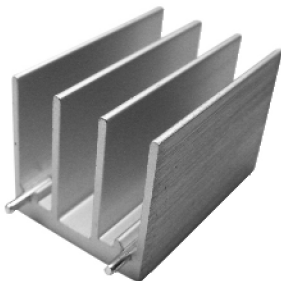

SE930008A

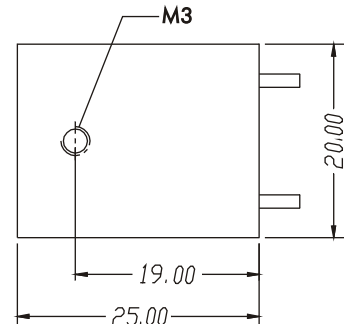
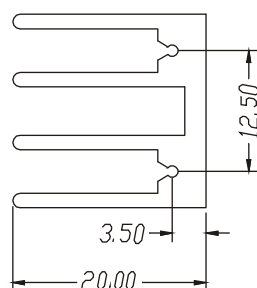
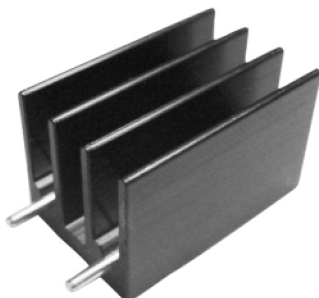

STANDARD EXTRUDED HEAT SINKS

SE930019A

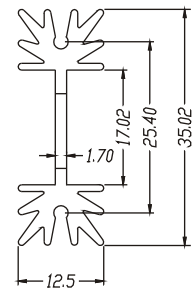
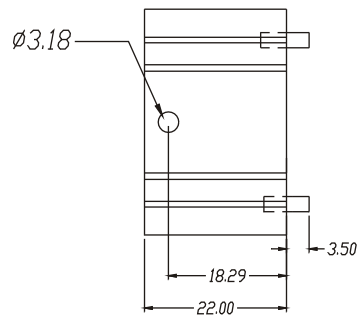
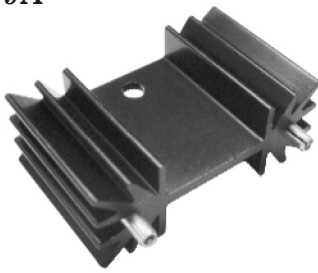

SE930020A

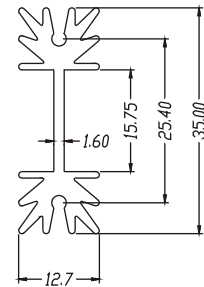
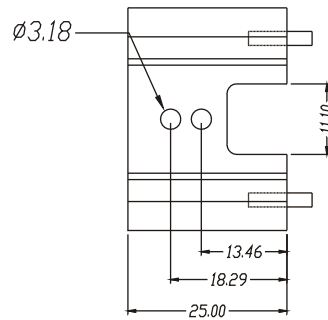
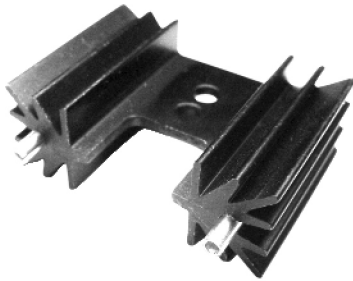

SE930019B

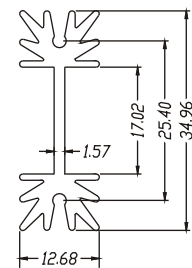
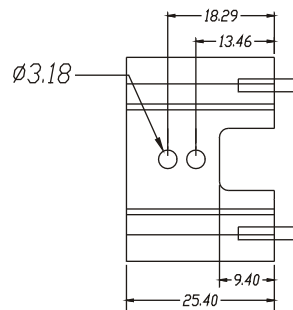

SE930019C

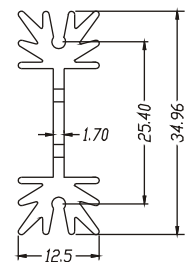
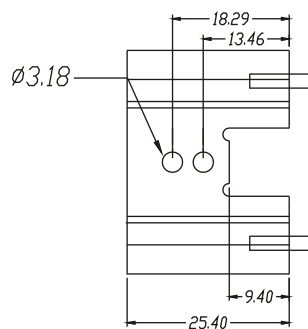

SE930019D

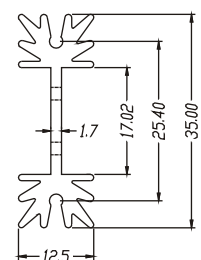
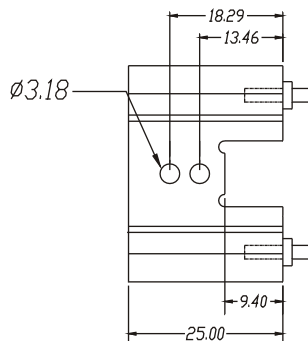
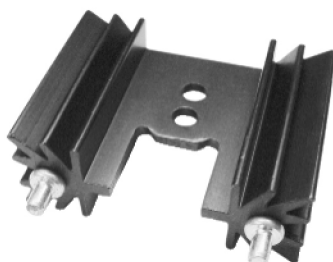

STANDARD EXTRUDED HEAT SINKS

SE930020B

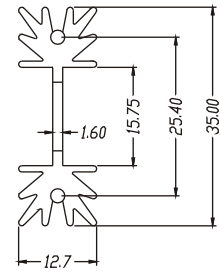
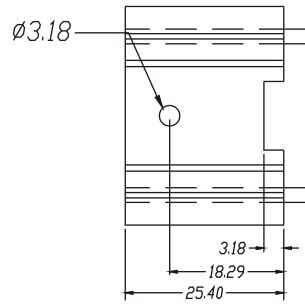
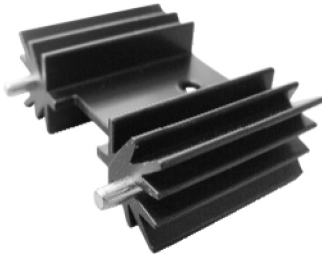

SE930019E

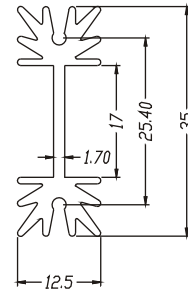
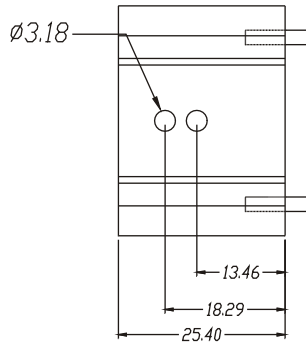
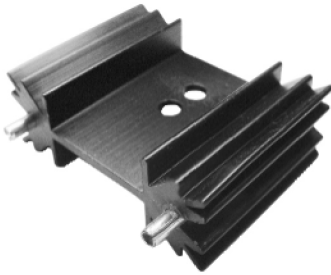

SE932003

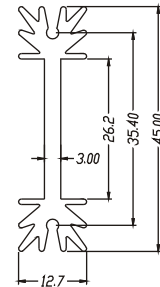
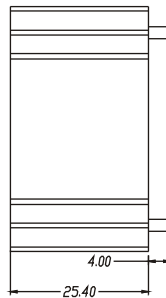
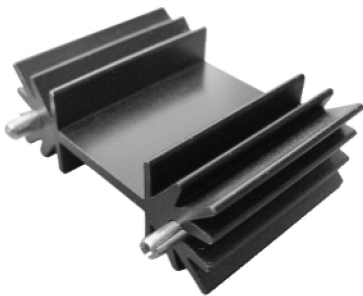

SE930019F

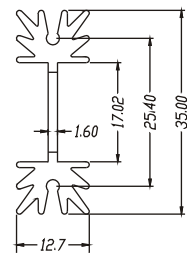
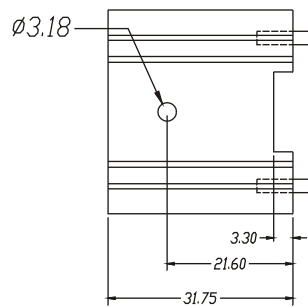
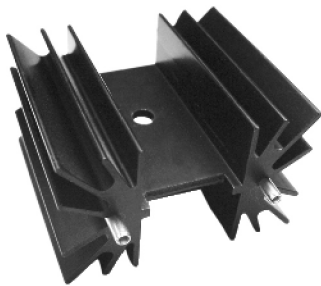

SE930019G

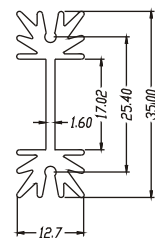
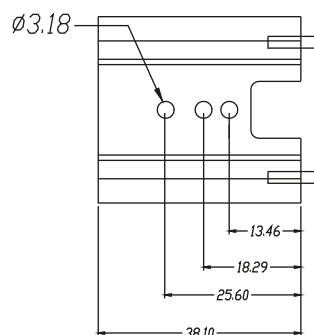
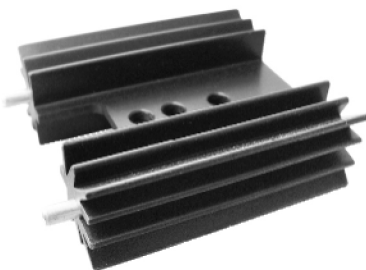

STANDARD EXTRUDED HEAT SINKS

SE930019H

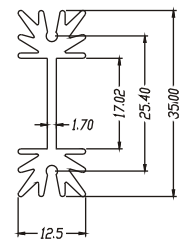
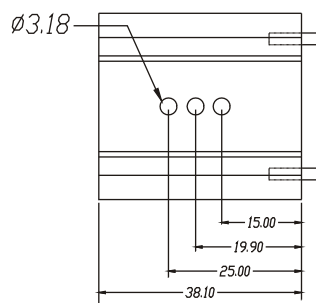
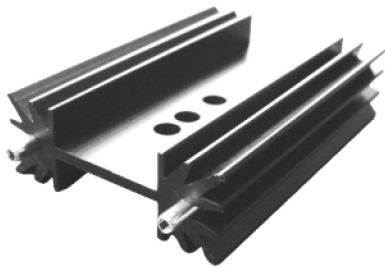

SE932004

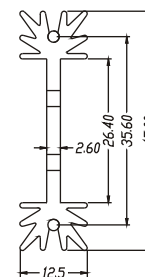
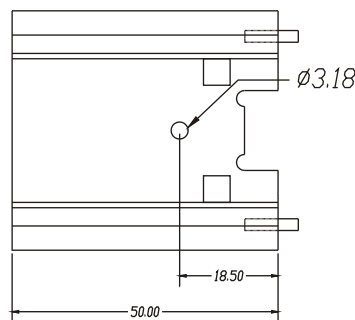
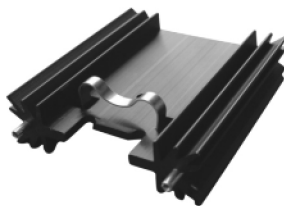

SE930027A

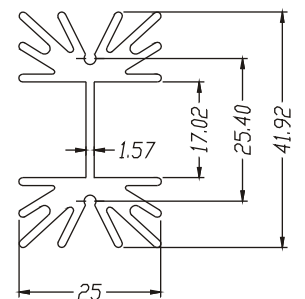
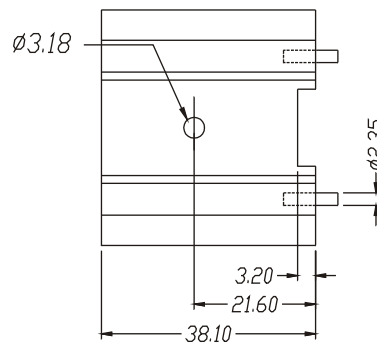
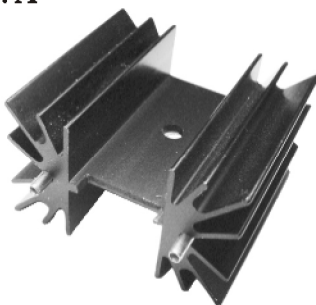

SE930027B

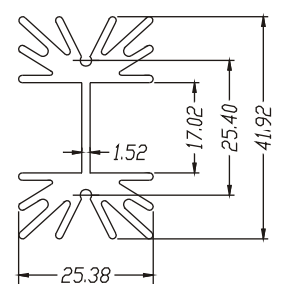
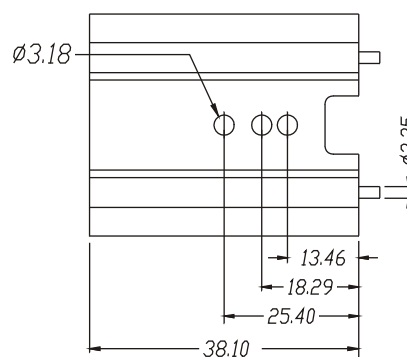
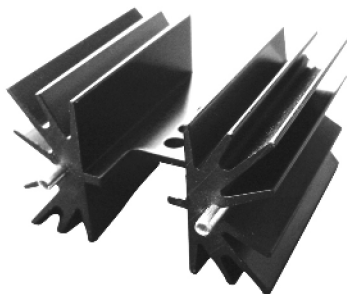

SE930027C

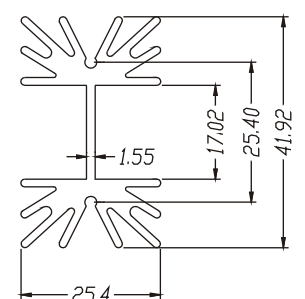
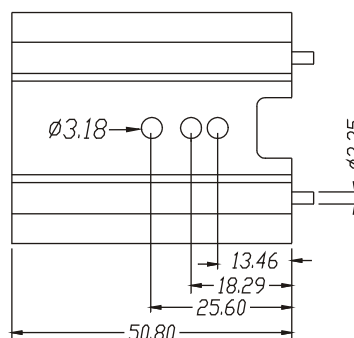
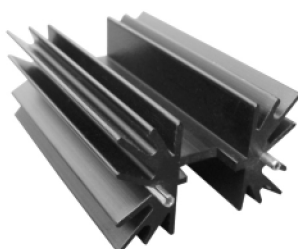

STANDARD EXTRUDED HEAT SINKS

SE930027D

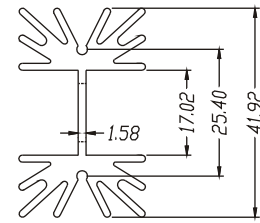
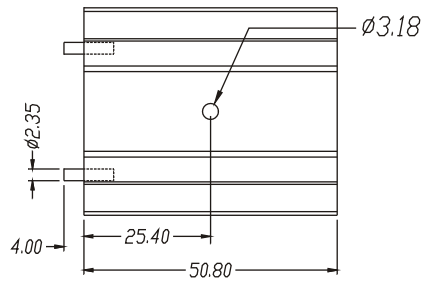
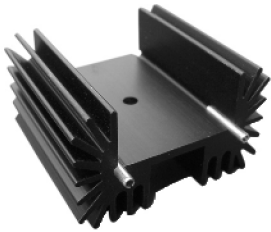

SE930027E

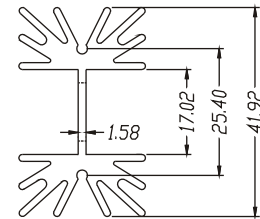
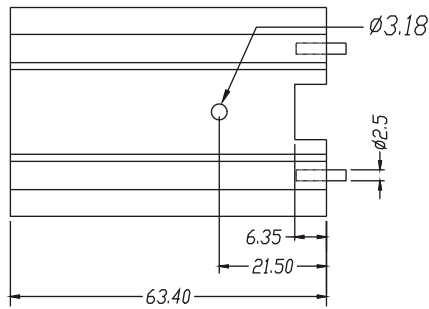
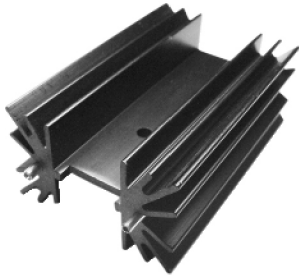

SE930001A

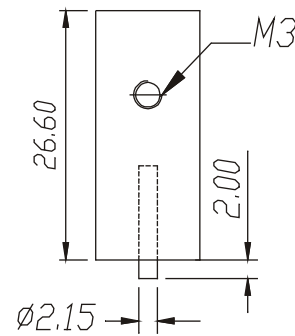
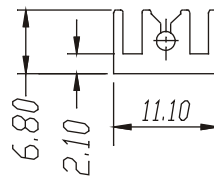

SE932005

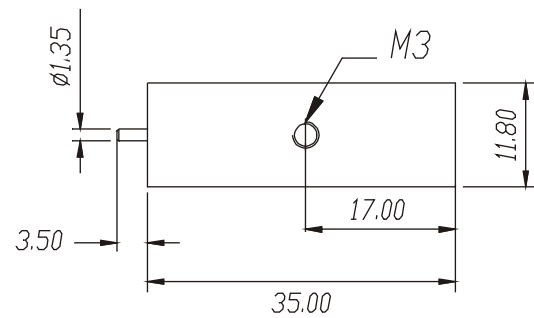
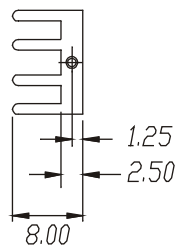
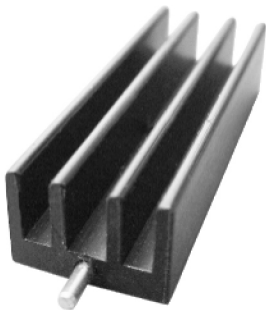

SE932006

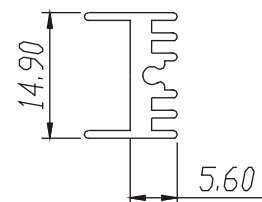
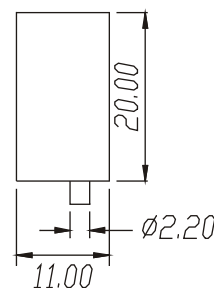
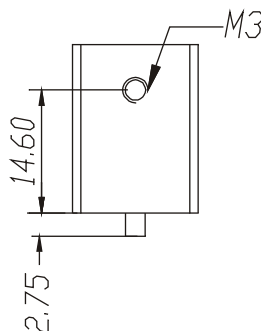

STANDARD EXTRUDED HEAT SINKS

SE932007

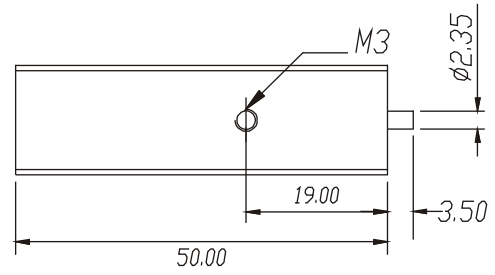
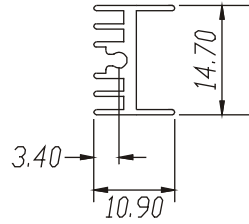
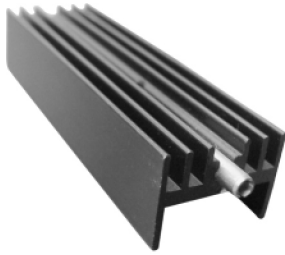

SE932008

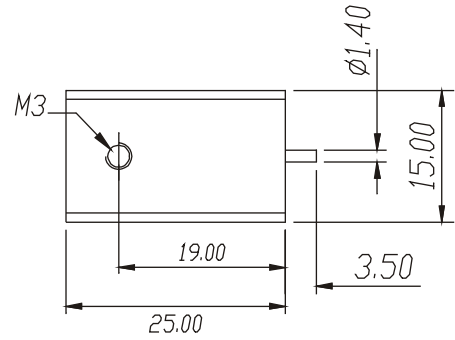
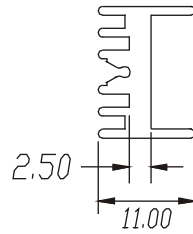

SE932009

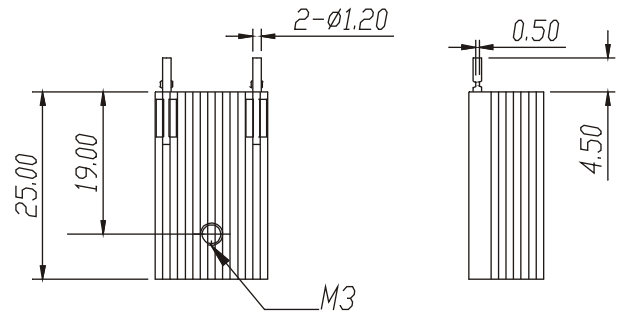
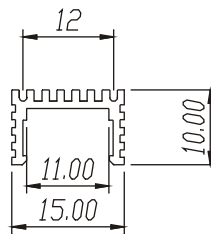

SE930011A

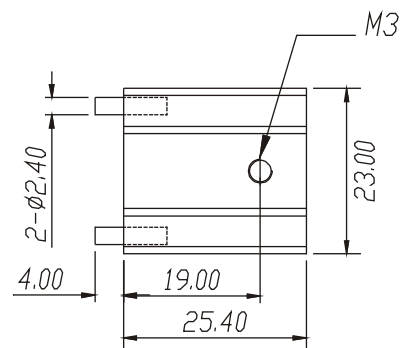
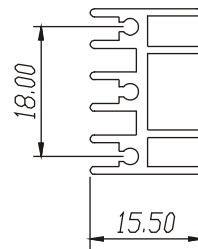
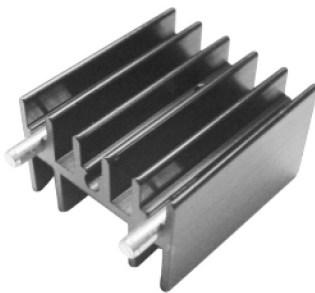

SE930013A

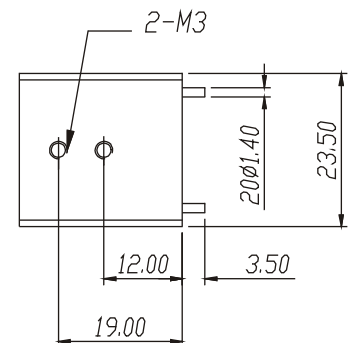
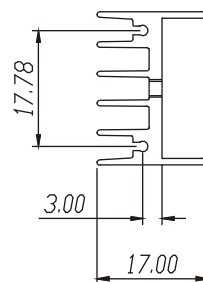
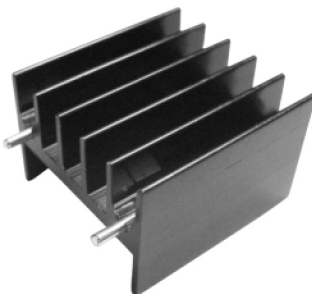

STANDARD EXTRUDED HEAT SINKS

SE930012A

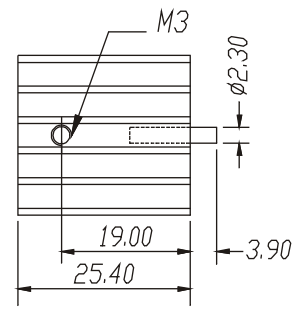
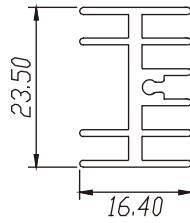
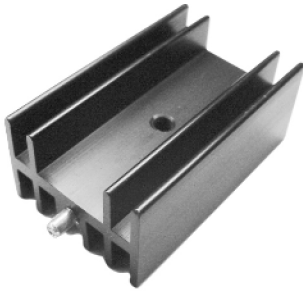

SE930014A

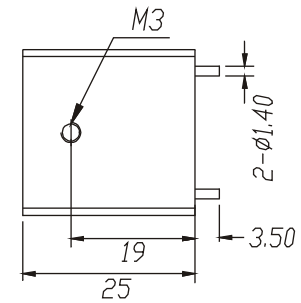
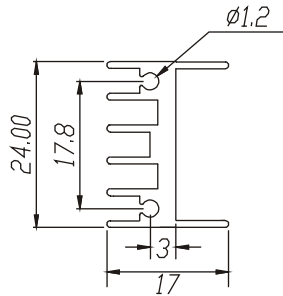
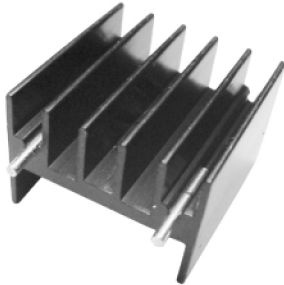

SE930014B

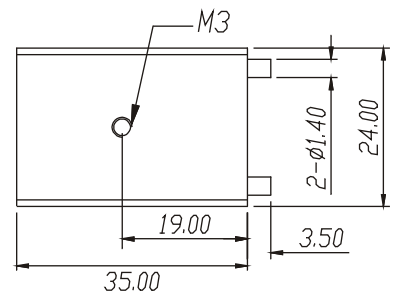
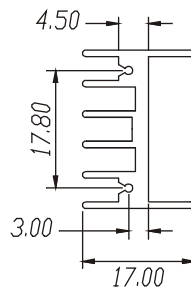
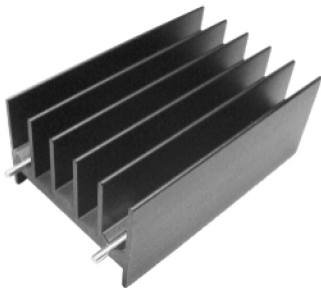

SE930017A

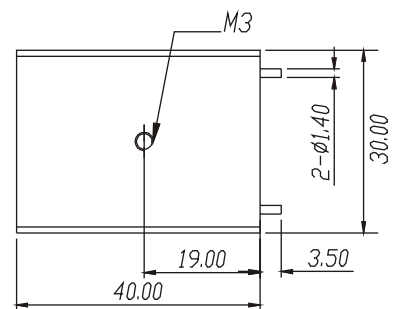
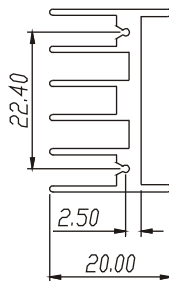
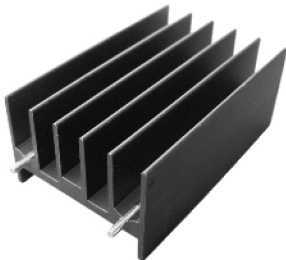

SE930017B

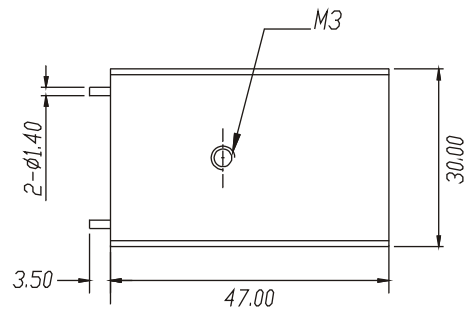
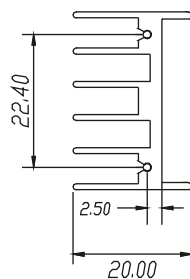
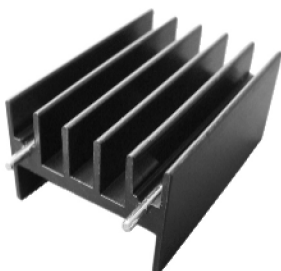

STANDARD EXTRUDED HEAT SINKS

SE932010

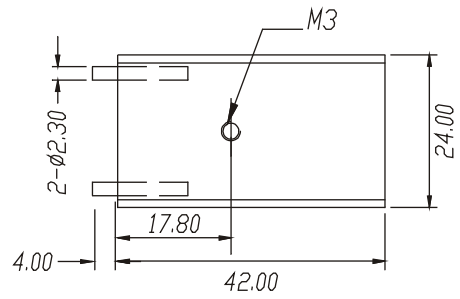
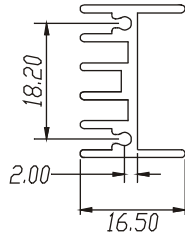
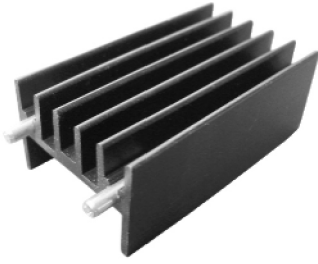

SE930030A

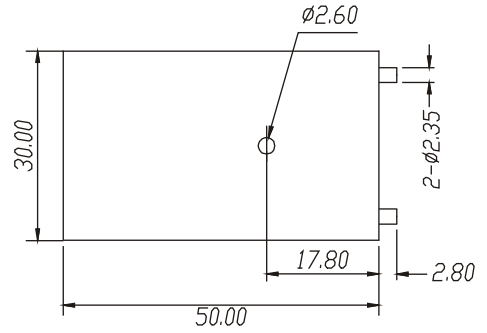
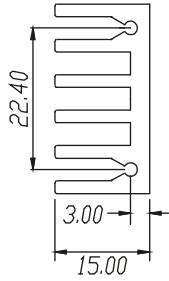
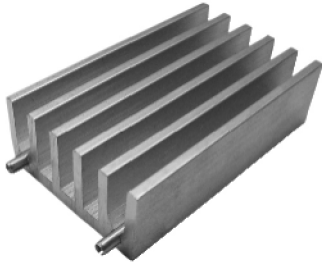

SE932011

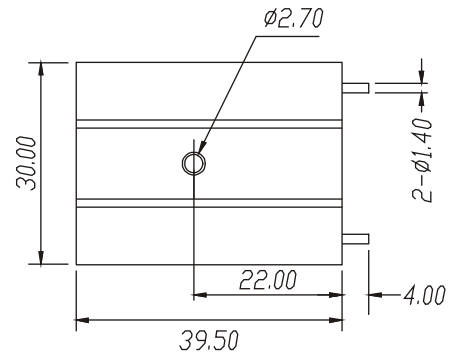
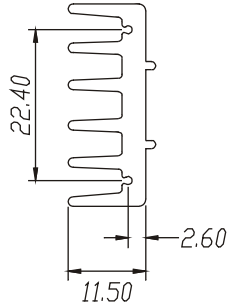

SE932012

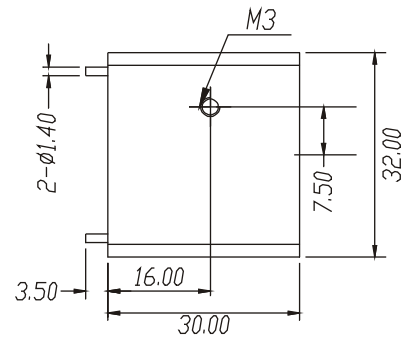
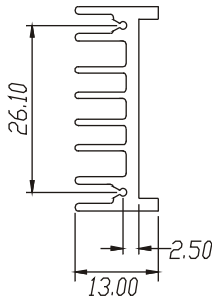
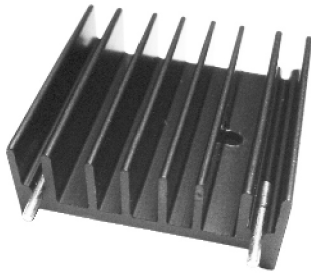

SE932013

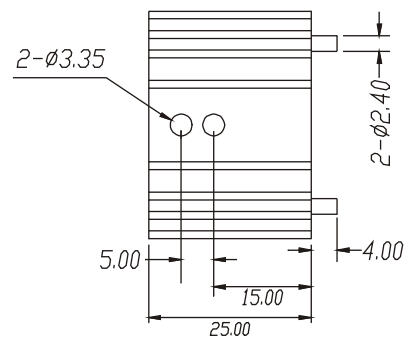
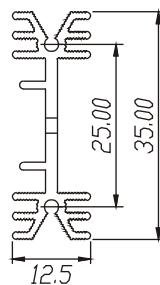
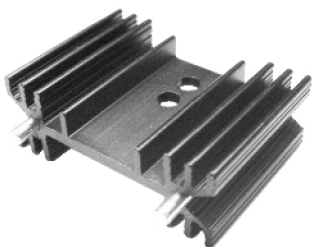

STANDARD EXTRUDED HEAT SINKS

SE932014

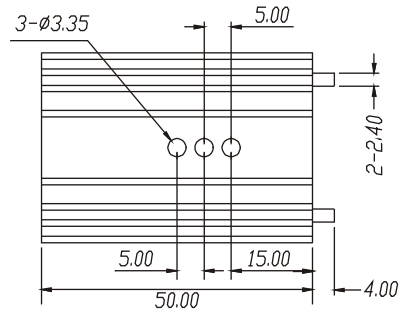
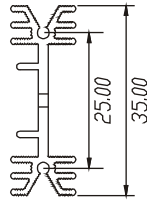
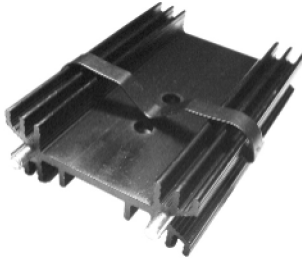

SE932015

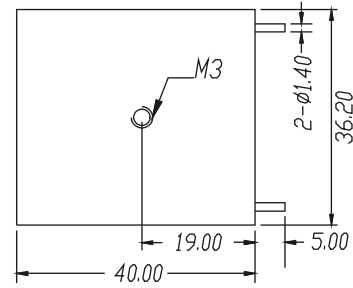
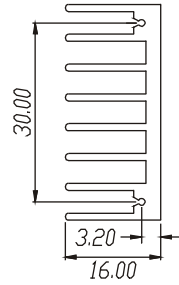
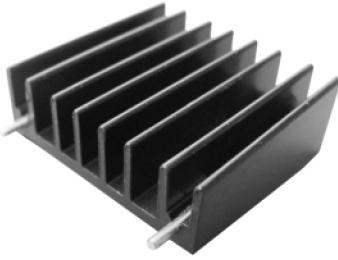

SE930023A

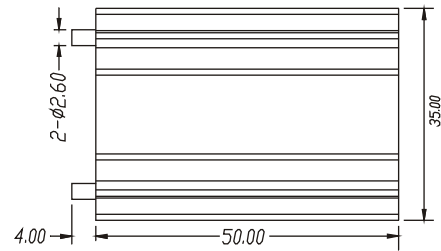
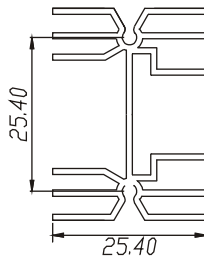
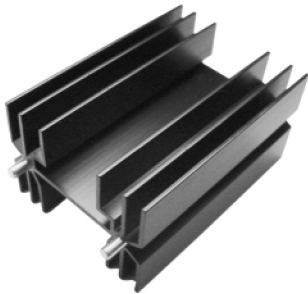

SE932016

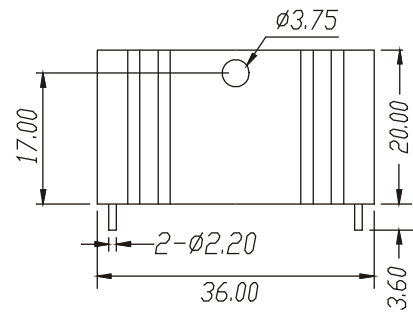
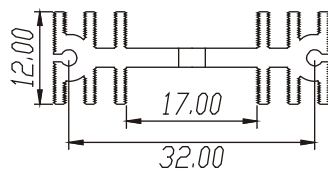
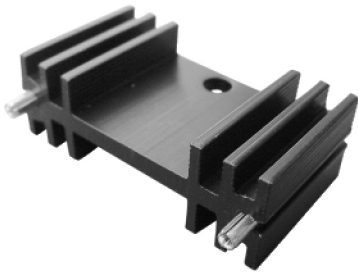

SE932017

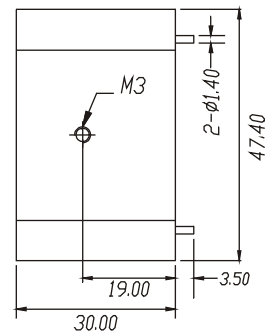
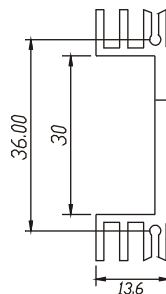

STANDARD EXTRUDED HEAT SINKS

SE930033A

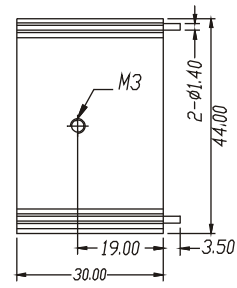
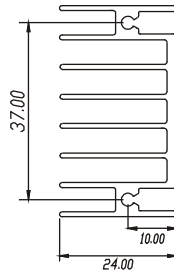
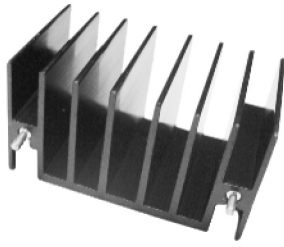

SE932018

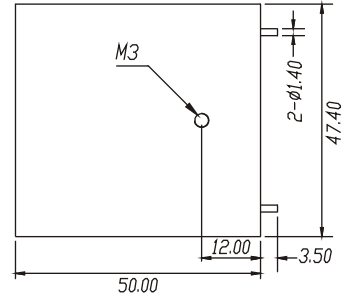
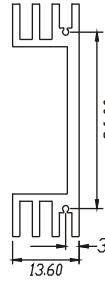
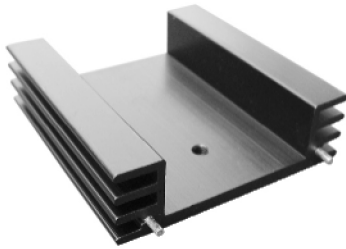

SE932019

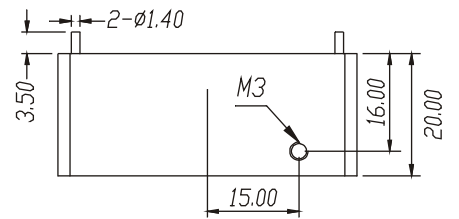
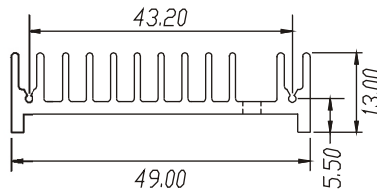
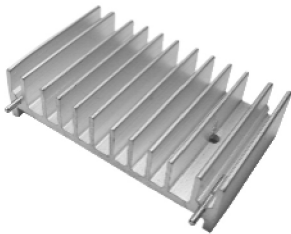

SE932020

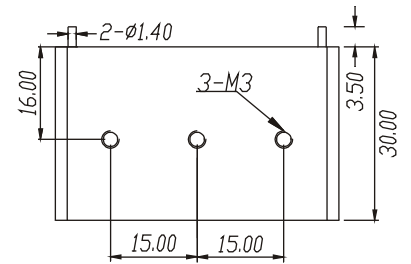
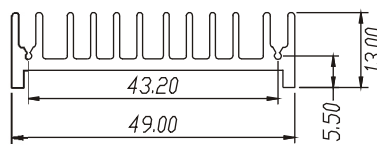

SE930034A

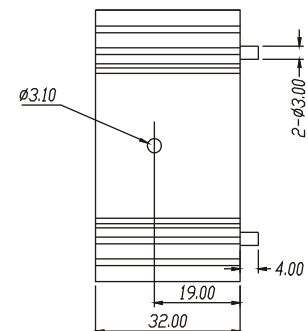
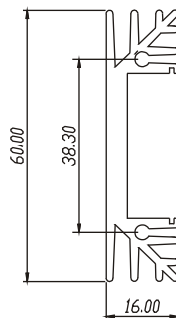
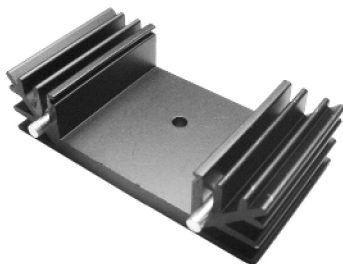

STANDARD EXTRUDED HEAT SINKS

SE932021

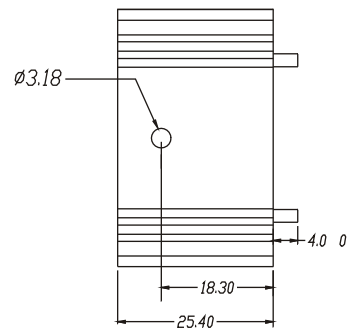
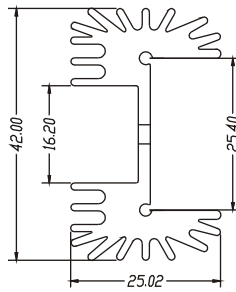
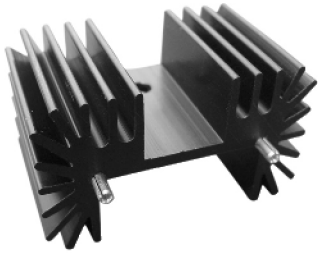

SE932022

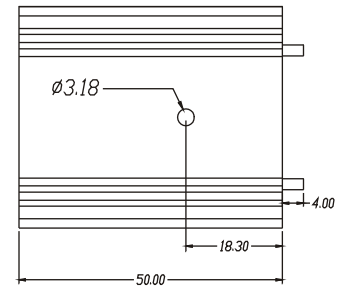
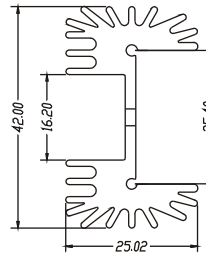
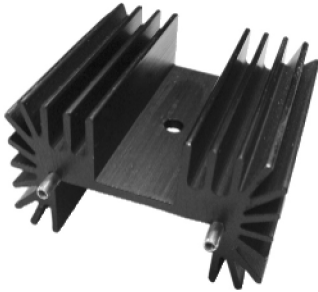

SE930021A

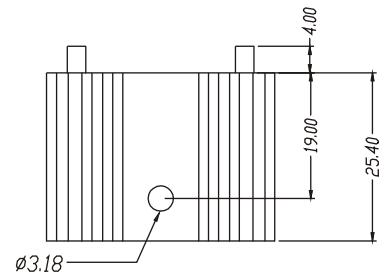
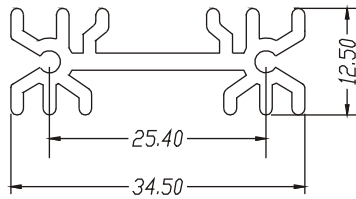

SE930021B

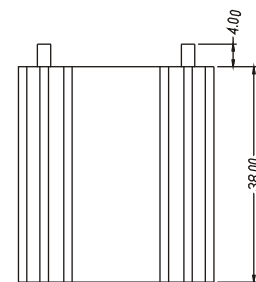
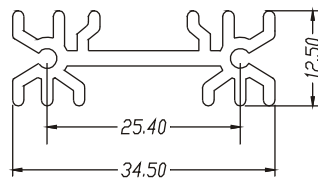

SE930021C

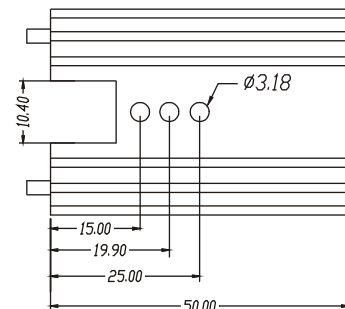
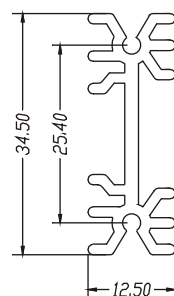

STANDARD EXTRUDED HEAT SINKS

SE932023

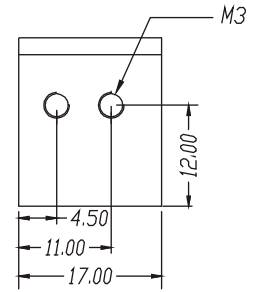
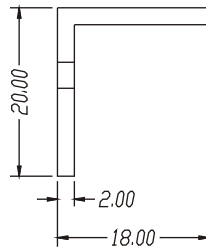

SE930010A

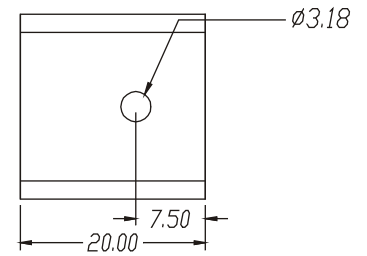
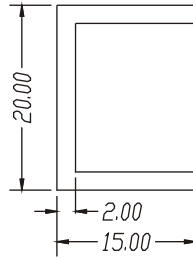

SE932024

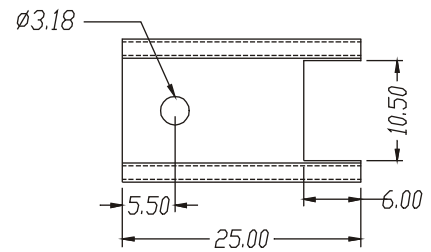
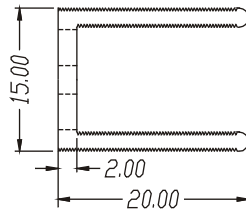
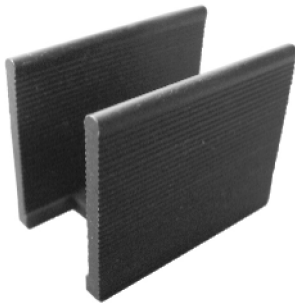

SE930007A

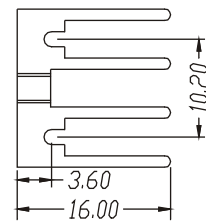
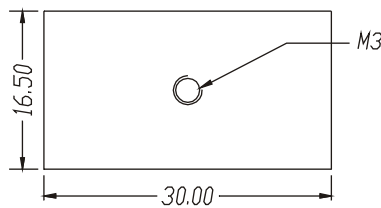

SE930016A

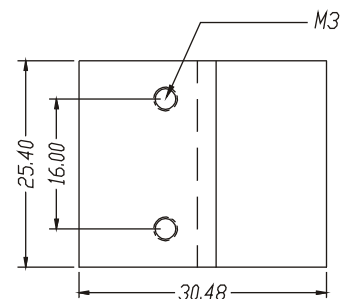
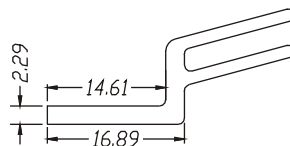
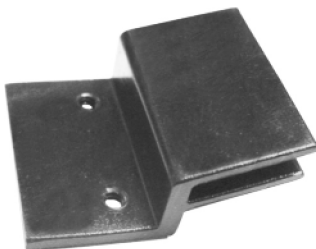

STANDARD EXTRUDED HEAT SINKS

SE932025

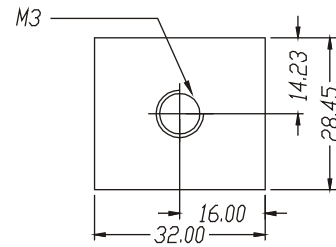
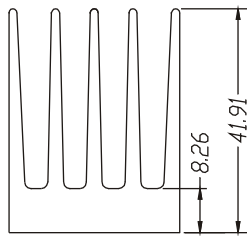
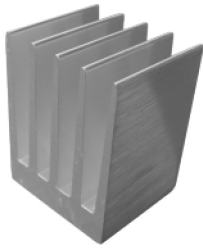

SE932026

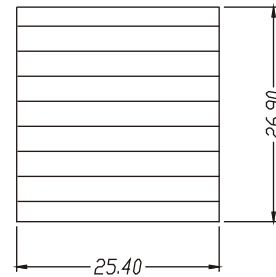
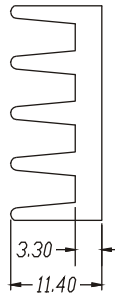

SE930028A

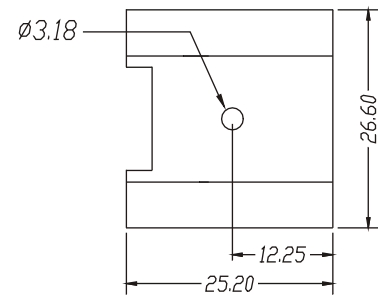
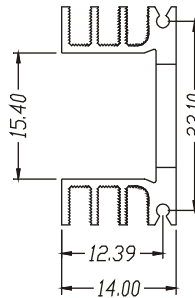
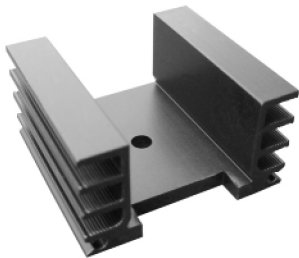

SE930029A

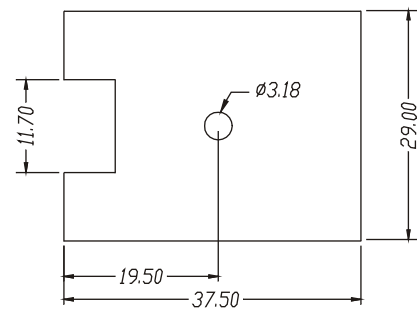
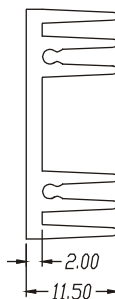
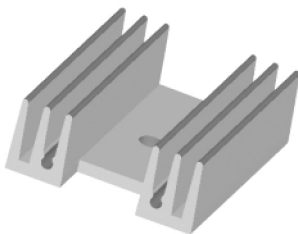

SE930031A

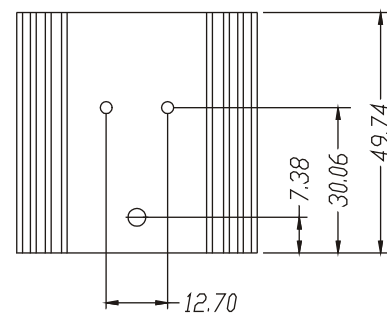
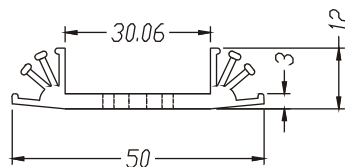

STANDARD EXTRUDED HEAT SINKS

SE932027

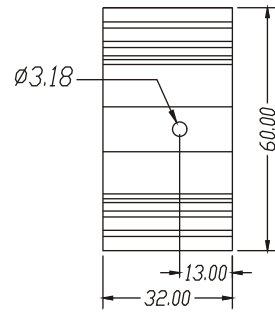
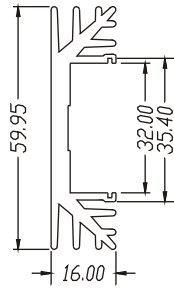
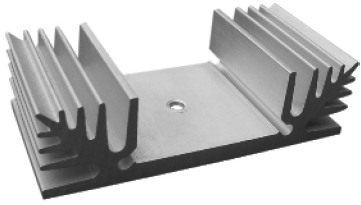

SE932028

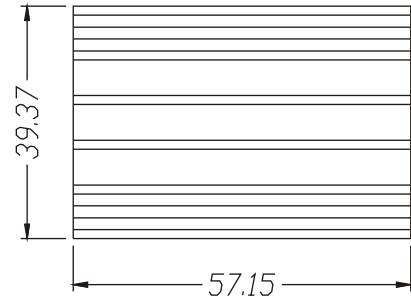
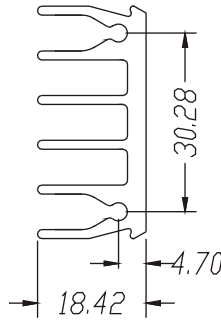

SE932029

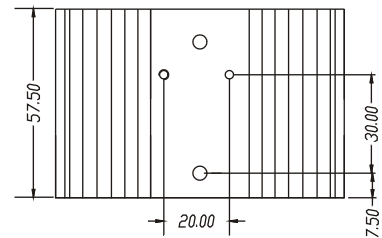
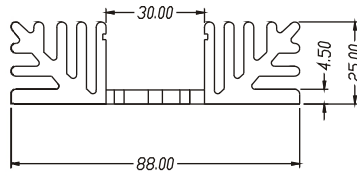
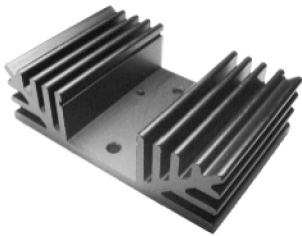

SE932030

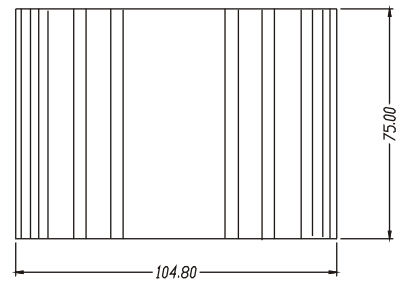
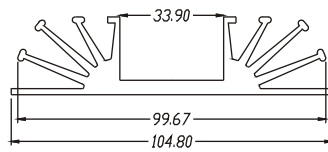
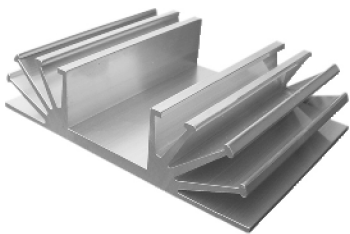

SE932031

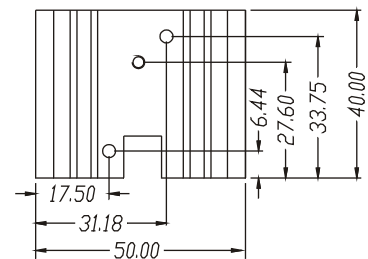
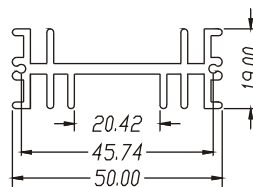
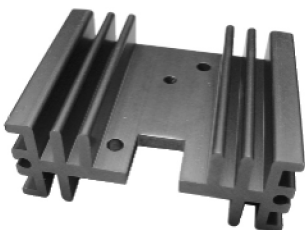

STANDARD EXTRUDED HEAT SINKS

SE932032

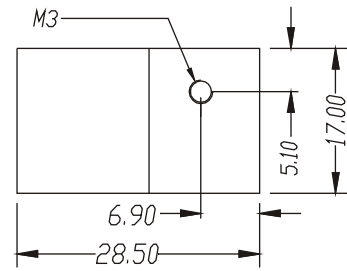
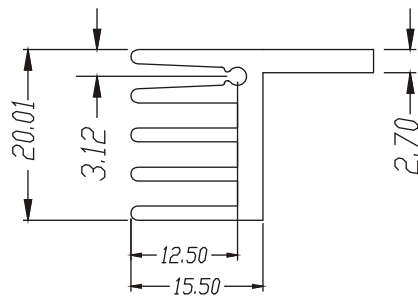
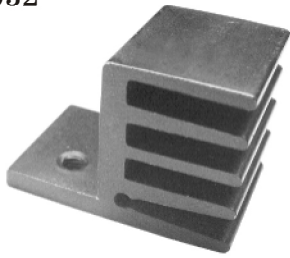

SE932033

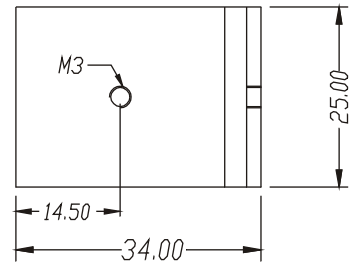
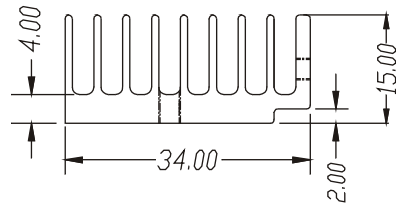
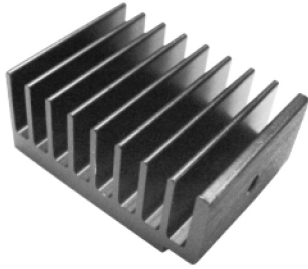

SE932034

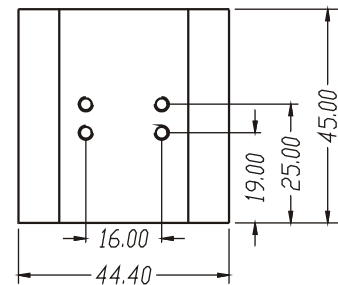
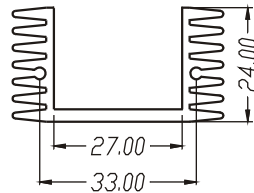
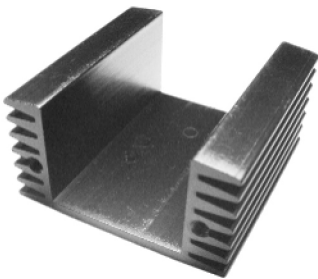

SE932035

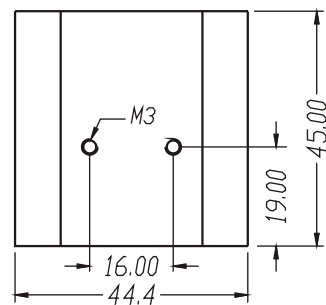
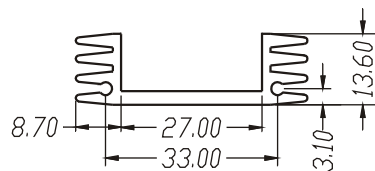
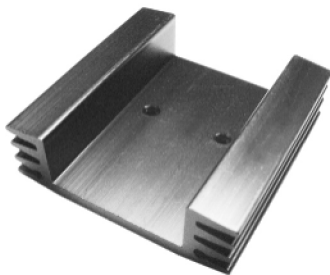

SE932036

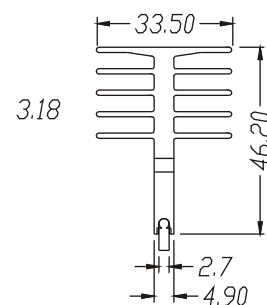
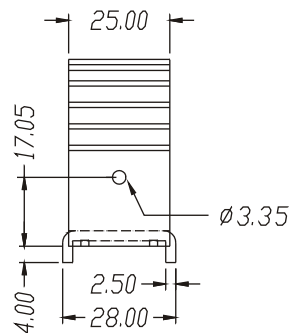
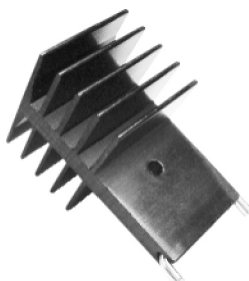

STANDARD EXTRUDED HEAT SINKS

SE932037

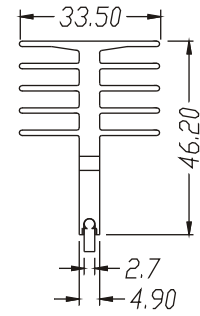
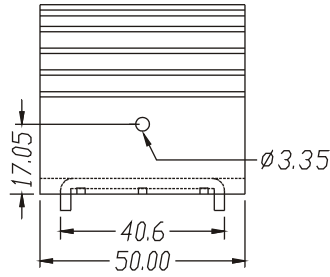
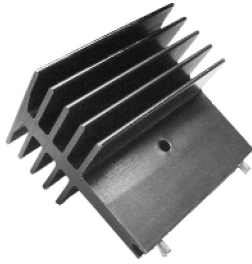

SE932038

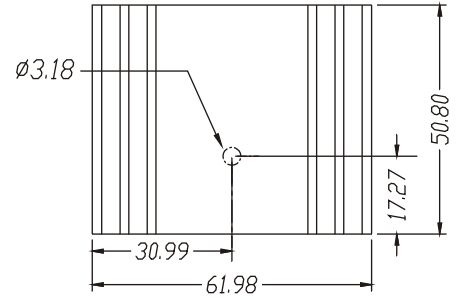
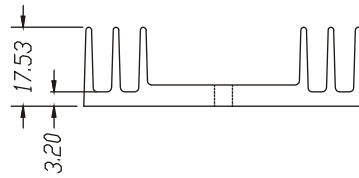

SE932039

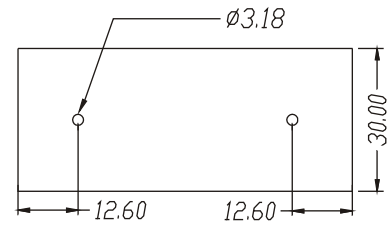
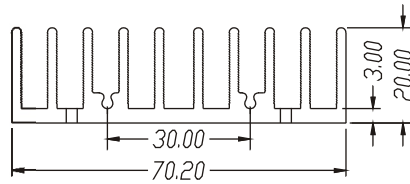
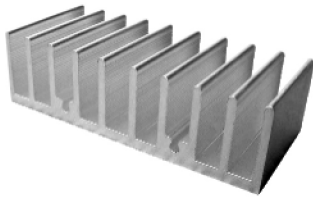

SE932040

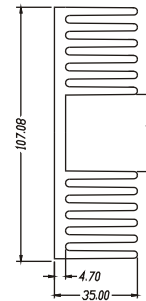
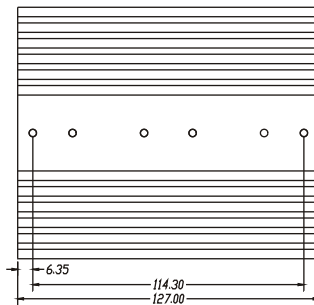

SE932041

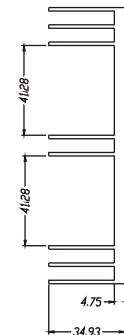
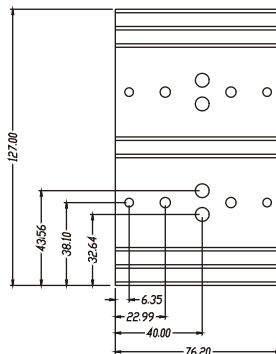
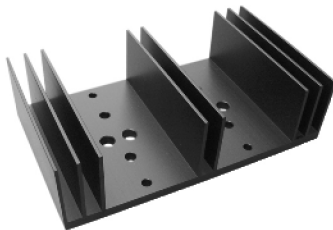

STANDARD EXTRUDED HEAT SINKS

SE932042

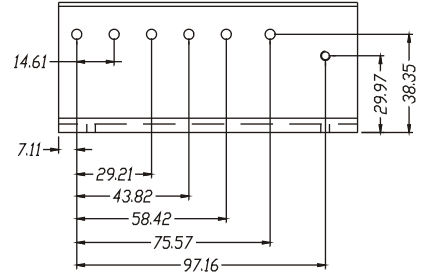
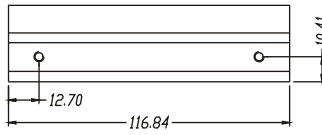
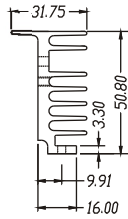

SE932043

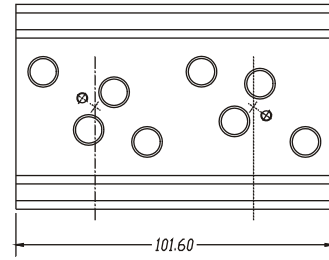
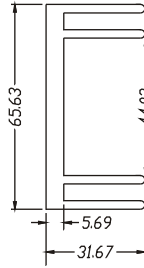

SE932044

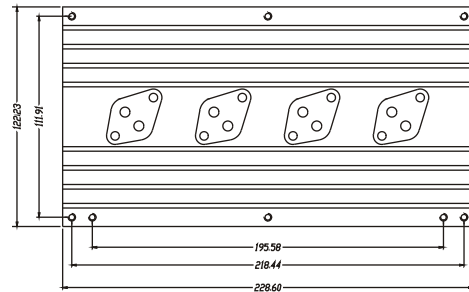
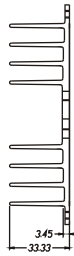

SE932045

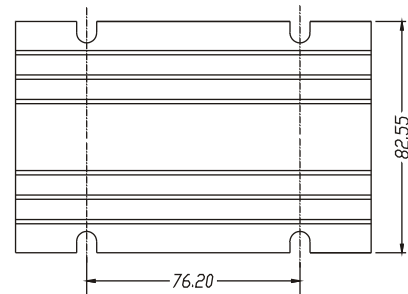
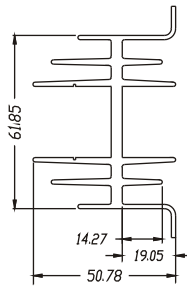
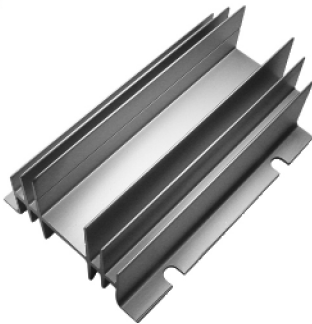

SE932046

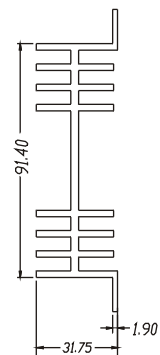
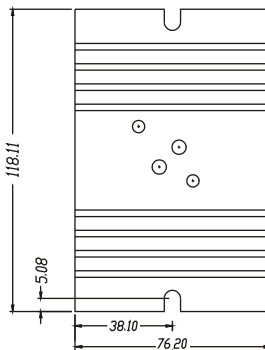
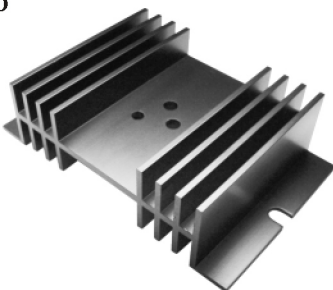

STANDARD EXTRUDED HEAT SINKS

SE932047

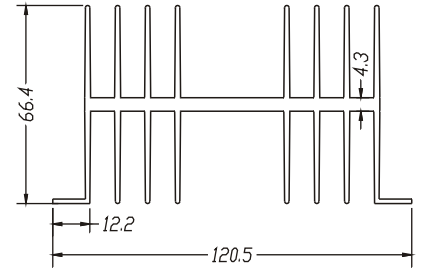
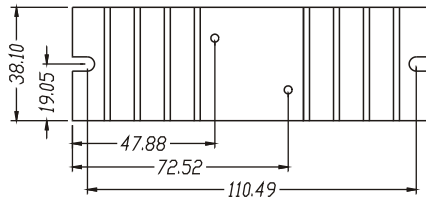
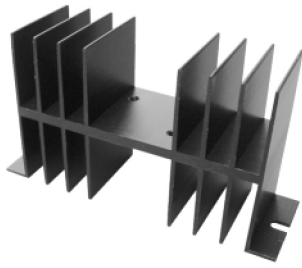

SE932048

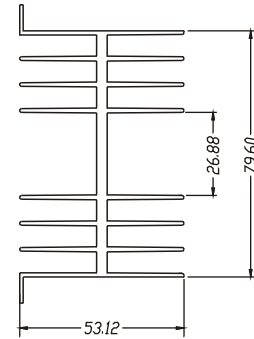
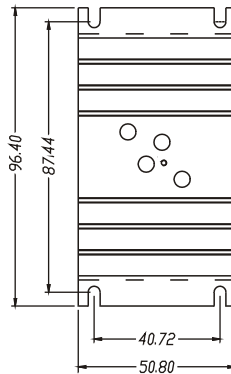
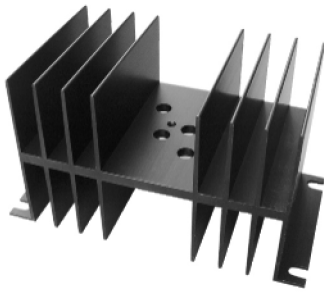

SE932049

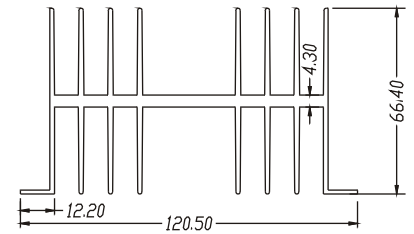
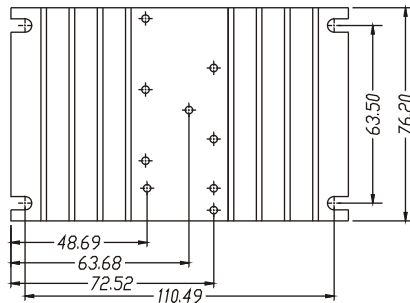
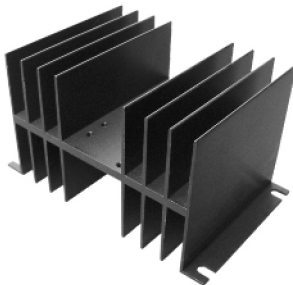

SE932050

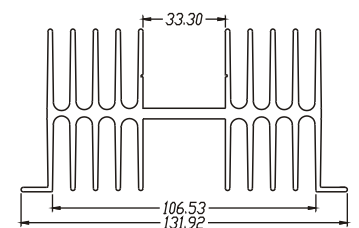
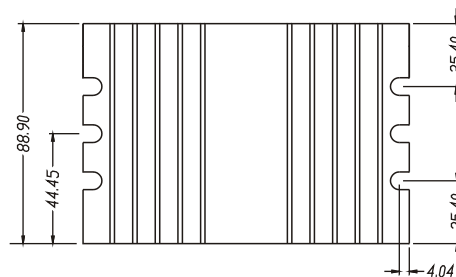
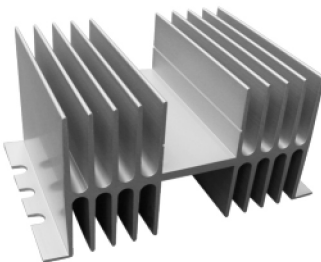

STANDARD EXTRUDED HEAT SINKS

SE932051

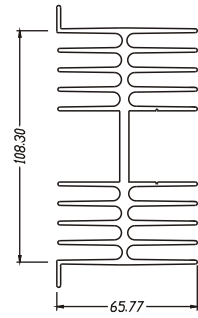
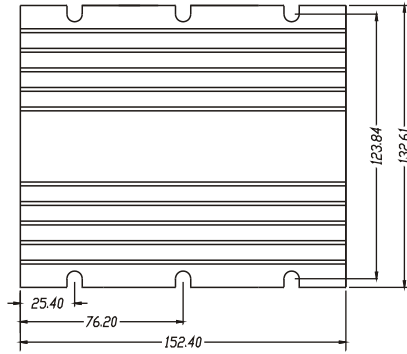
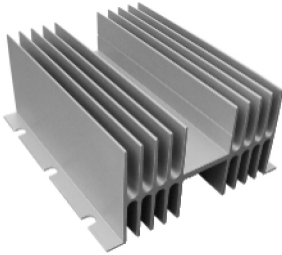

STANDARD EXTRUSION

SE90001

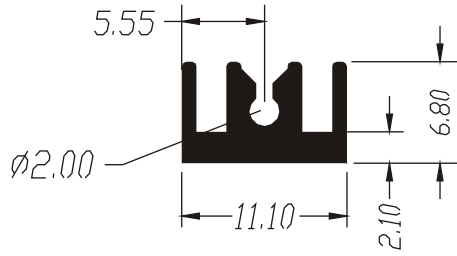

SE930002

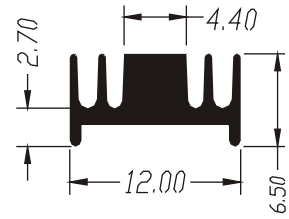

SE930003

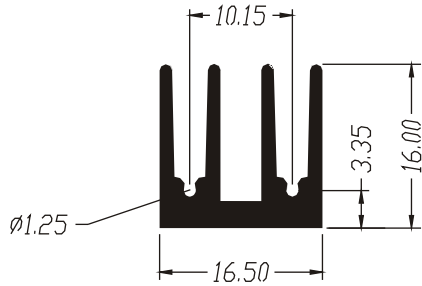

SE930004

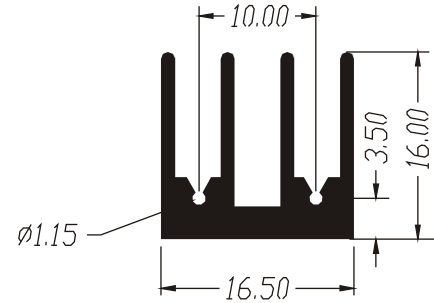

SE930005

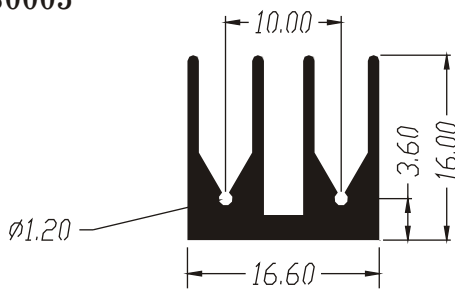

SE930006

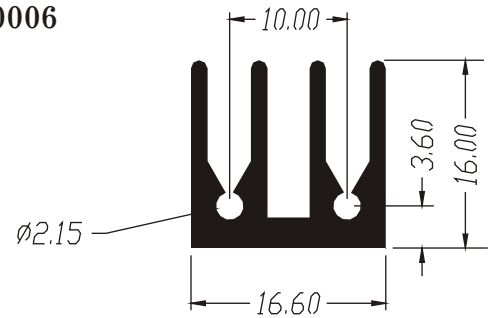

SE930007

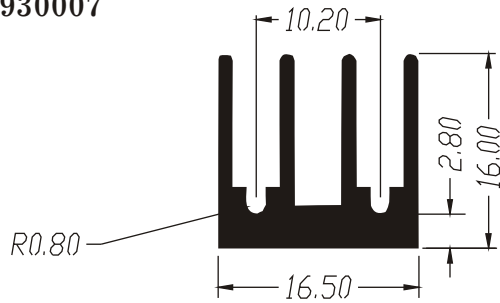

SE930008

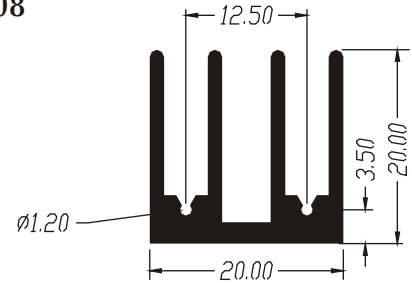

SE930009

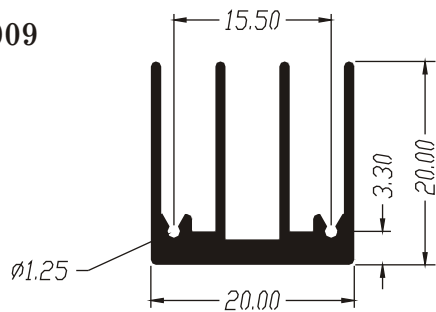

SE930010

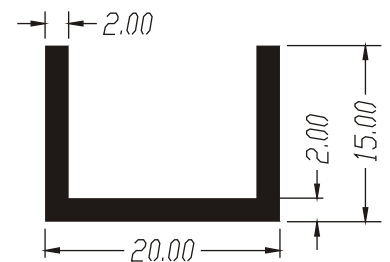

STANDARD EXTRUSION

SE930011

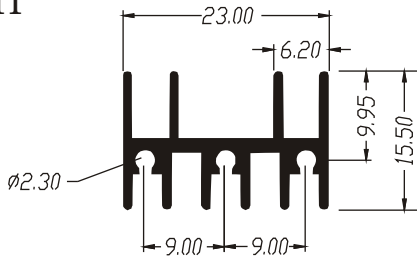

SE930012

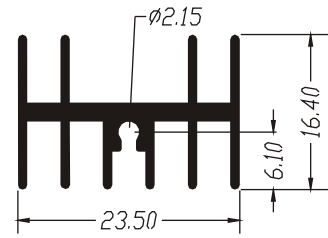

SE930013

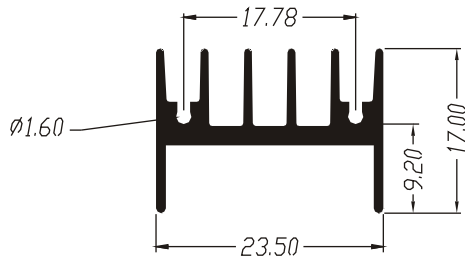

SE930014

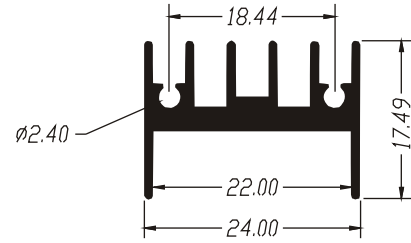

SE930015

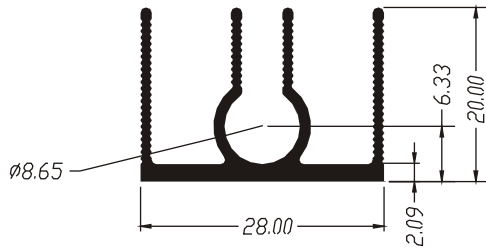

SE930016

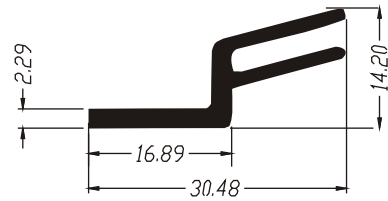

SE930017

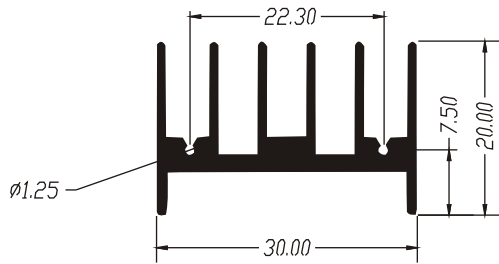

SE930018

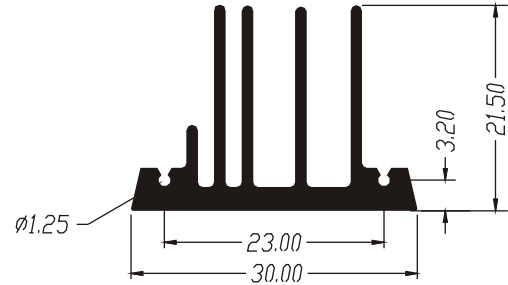

SE930019

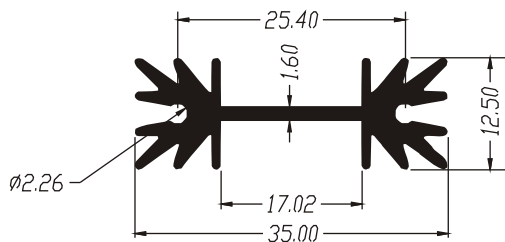

SE930020

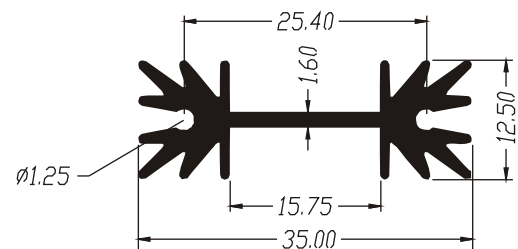

STANDARD EXTRUSION

SE930021

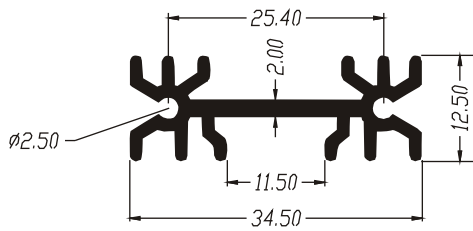

SE930022

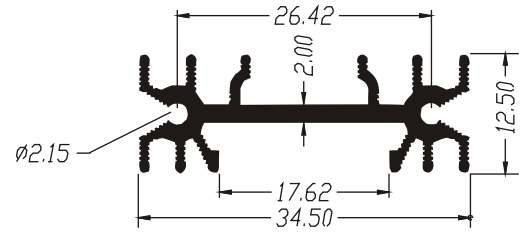

SE930023

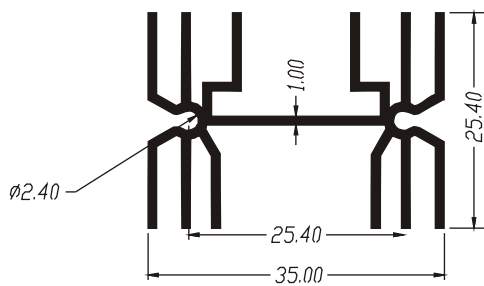

SE930024

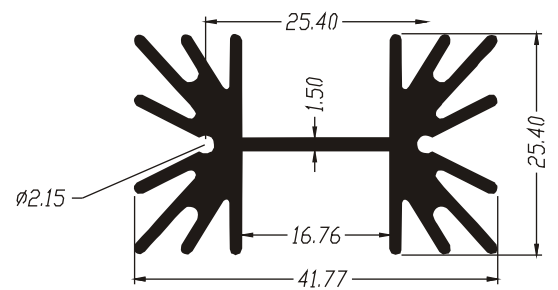

SE930025

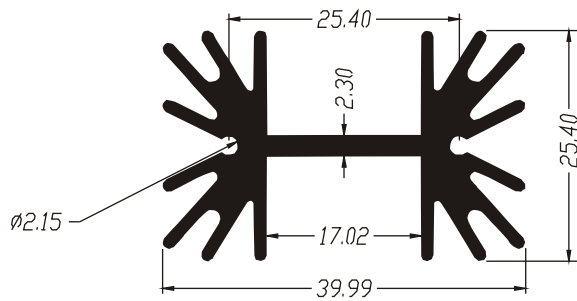

SE930026

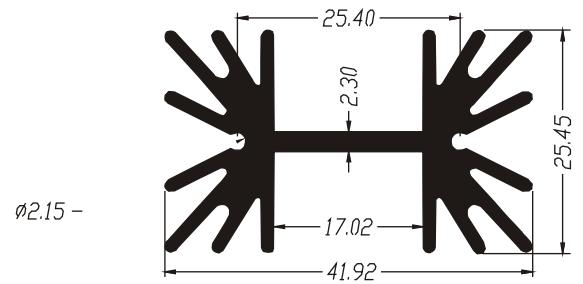

SE930027

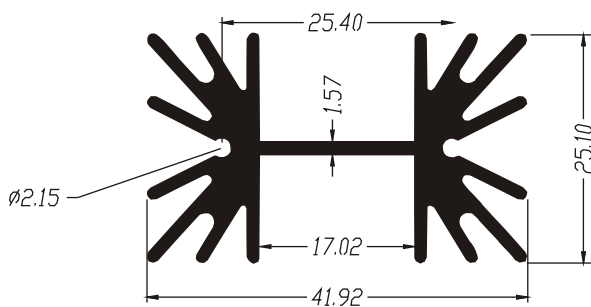

SE930028

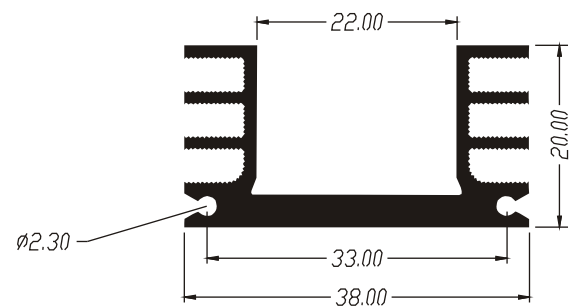

STANDARD EXTRUSION

SE930029

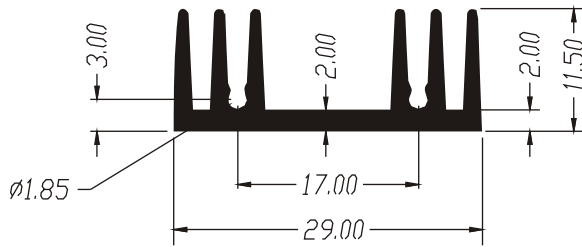

SE930030

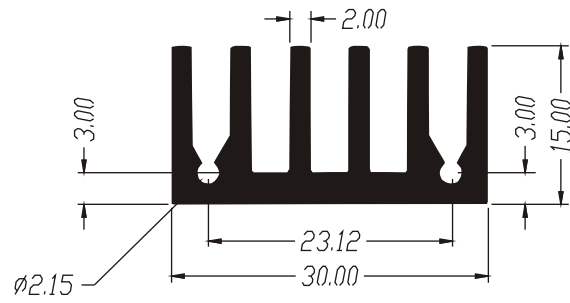

SE930031

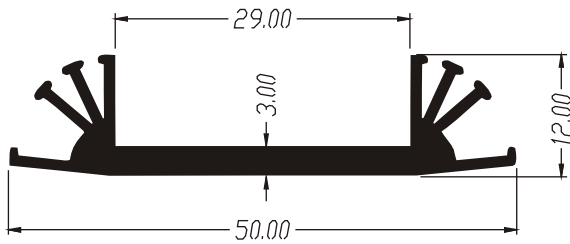

SE930032

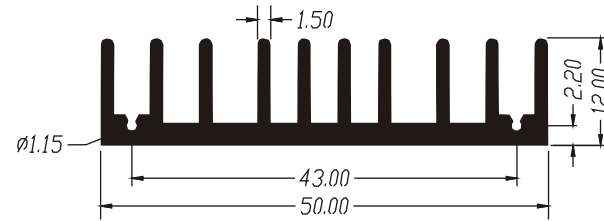

SE930033

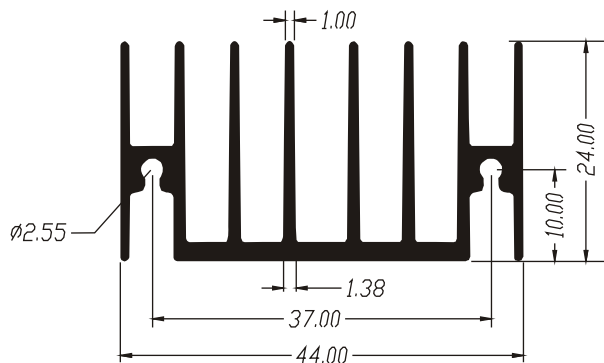

SE930034

