

Sept./Oct. 1987, No. 66, \$3.75

# Fine Woodworking

Plunge Router Test

Rustic Furniture

Wood Dyes

Designing Wall Paneling

Vacuum Jigs



*Mortise-and-Tenon Joinery*



# PERFECT MARRIAGE



## Porter-Cable Unites Joiner Technology With An Affordable Price.

Join forces with the advanced joiner technology of Porter-Cable's Model 555 Plate Joiner. It's a powerful, American designed and manufactured machine that makes joining material faster and easier than ever before. With a unique vertical handle for comfort and speed... a heavy-duty 5 amp motor for smoother cutting... and an industrial-rated belt drive for quieter operation.

Used in Europe for years, this previously expensive technology is now available in a precision engineered American made machine at an affordable price. All of which makes the Porter-Cable Plate Joiner the perfect tool for cabinet workers, furniture makers, and



specialty woodworkers... in any joining application where precise alignment and fit is critical. Porter-Cable also offers joining biscuits in the three standard sizes, now manufactured in the USA to exacting specifications to work with all brands of plate joiners.

So visit your local Porter-Cable distributor today... and join up with the Model 555. You'll find it's one perfect marriage.

America's Working Class  
**PORTER-CABLE**  
PROFESSIONAL POWER TOOLS  
P.O. BOX 2468 • JACKSON, TN 38302

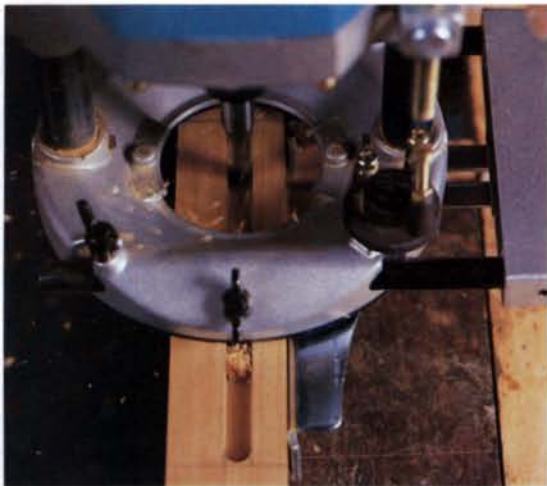

Plunge routers, once the mainstay of the production cabinet shop, are finding their way into the amateur's shop as well. To find out how the top three Japanese machines compare, turn to p. 56. Cover: Michael Podmaniczky demonstrates mortising techniques described in detail on p. 67.

#### Editor

Paul Bertorelli

#### Art Director

Roland Wolf

#### Associate Editors

Jim Cummins, Dick Burrows

#### Assistant Editors

Sandor Nagyszalanczy, Roy Berendsohn

#### Copy Editor

Barbara Hofmann Jennes

#### Assistant Art Director

Kathleen Creston

#### Editorial Secretary

Mary Ann Colbert

#### Contributing Editors

Tage Frid, R. Bruce Hoadley,  
Michael S. Podmaniczky, Graham Blackburn

#### Consulting Editors

George Frank, Otto Heuer, Richard E. Preiss,  
Norman Vandal

#### Methods of Work

Jim Richey

*Fine Woodworking* is a reader-written magazine. We welcome proposals, manuscripts, photographs and ideas from our readers, amateur or professional. We'll acknowledge all submissions and return within six weeks those we can't publish. Send your contributions to *Fine Woodworking*, Box 355, Newtown, Conn. 06470.

*Fine Woodworking* (ISSN 0361-3453) is published bimonthly, January, March, May, July, September and November, by The Taunton Press, Inc., Newtown, CT 06470. Telephone (203) 426-8171. Second-class postage paid at Newtown, CT 06470, and additional mailing offices. Copyright 1987 by The Taunton Press, Inc. No reproduction without permission of The Taunton Press, Inc. *Fine Woodworking*® is a registered trademark of The Taunton Press, Inc. Subscription rates: United States and possessions, \$18 for one year, \$34 for two years; Canada and other countries, \$21 for one year, \$40 for two years (in U.S. dollars, please). Single copy, \$3.75. Single copies outside U.S. and possessions, \$4.25. Send to Subscription Dept., The Taunton Press, PO Box 355, Newtown, CT 06470. Address all correspondence to the appropriate department (Subscription, Editorial, or Advertising), The Taunton Press, 63 South Main Street, PO Box 355, Newtown, CT 06470. U.S. newsstand distribution by Eastern News Distributors, Inc., 1130 Cleveland Road, Sandusky, OH 44870.

## DEPARTMENTS

- 4 **Letters**
- 8 **Methods of Work**  
Blade covers; making long dowels; lubricating sealed bearings
- 14 **Questions & Answers**  
Curing smelly furniture; bending thick stock; router bits for shapers
- 20 **Follow-up**  
Roubo-type holdfasts; staining with lye; moisture meter update
- 106 **Events**
- 110 **Books**
- 114 **Notes and Comment**  
Timberline Lodge; Square It review; Daphne's demise

## ARTICLES

- 38 **Rustic Furniture** by Dick Burrows  
*Crafting with nature's free-form designs*
- 44 **Carved Bowls** by Alan Stirt  
*Texture enriches the basic shape*
- 47 **Carved handles and feet** by Dale Boyce
- 48 **Sharpening Carving Tools** by Ben Bacon  
*The essential steps for a keen edge*
- 51 **Multi-wheel sharpening system** by Russell Orrell
- 52 **Old-Fashioned Wood-Coloring** by George Frank  
*Reviving the dyes of yore*
- 55 **Dyed-in-the-wood pine** by Sandor Nagyszalanczy
- 56 **Plunge Routers** by Bernard Maas  
*A comparison of the top three Japanese imports and a new machine from Europe*
- 60 **Plunge to destruction** by Jim Cummins
- 61 **Coachmakers' Rabbet Plane** by Jeff Lock  
*An ebony beauty for smoothing curves*
- 64 **Cherry** by Jon Arno  
*A rose among woods*
- 67 **Mortise and Tenon** by Michael Podmaniczky  
*Chop the mortise by hand, but a machine's best for the tenon*
- 72 **Vacuum Jigs** by James L. Kassner, Jr.  
*Holding the work with thin air*
- 76 **Wall Paneling** by Graham Blackburn  
*General application and design principles*
- 79 **Laying out Georgian-style paneling**  
by Malcolm MacGregor
- 82 **Brandy Stand** by Carlyle Lynch  
*A lightweight table with a marquetry top*
- 85 **William Robertson** by Jim Cummins  
*Glimpses into a miniaturist's world*

Was I ever excited when I received the latest issue of *Fine Woodworking* and saw Gerrit Rietveld's Red and Blue chair on the cover. I've been interested in Rietveld for many years and have built several of the chairs for my own gratification. I finished the first two in the same colors as the original, but left the third chair natural. I next plan to build a footstool that duplicates the seat portion of the chair.

The chair is surprisingly comfortable, especially when you consider that you're sitting on solid wood.

—Alan R. Stenicka, Louisville, Ky.

Do you know if there's a book or set of plans available for the Red and Blue chair you featured on the cover of *FWW* #65, or for the Zig-Zag chair mentioned in Glenn Gordon's article?

—Herbert Kurtz, Melrose Park, Pa.

EDITOR'S NOTE: We weren't able to locate measured drawings for the Red and Blue chair, but the next best thing is the excellent line drawings featured in *The Furniture of Gerrit Thomas Rietveld*, by Daniele Baroni, Barron's Educational Series, Inc., 113 Crossways Park Drive, Woodbury, N.Y. 11797, \$23.95. No joining details are given, but some of the drawings are superimposed on a metric grid, so dimensions can be readily calculated.

As a subscriber, I date back to your first issue, but now I discover that you must be slipping. Just look at the chair on p. 44 of *FWW* #65—I built one better than that out of crate wood during the Great Depression. My mother wouldn't even let me put it in the backyard. Come on!

—H.C. Conkling, Jr., South Dartmouth, Mass.

I'd like to add to the comments of Scott Landis about the "rough-cut" guitar mentioned in his article about the Guild of American Luthiers convention in *FWW* #61. Although I could not have articulated this at the time I built the instrument, the most important reason for building it was to help discover for myself what quality in craft is. In this case, it was demonstrated that craft is not defined by a "perfect" finish.

The surfaces of the top, sides and back of the body on my rough-cut guitar were left as they came to me, straight off the saw, with only a light coat of lacquer. One can even detect traces of the sawyer's numbers on the book-matched top.

In the "normal" construction of a guitar, the top is first joined together then rough-sanded to thickness, braced, inlaid and assembled into the rest of the instrument. At the last possible minute before applying lacquer, the instrument is finish-sanded to clean up any slight nicks and scratches. With the rough-cut guitar, I have no opportunity to remove out-of-flat spots in the joint, excess glue, miscellaneous marks or minor errors made during the rest of the construction; I have one chance to take my best shot and keep it looking its best. This is a different method of working than the "patch, fill and tinker" style so common in instrument building. Other problems come up, too, such as the impossibility of measuring the effective thickness of the wood. I must rely on my sense of its weight and stiffness.

It generally takes the first-time viewer several minutes to

discover and appreciate this style of instrument building. Part of my intent was to bring the viewer into this recognition of craft via the backdoor of the rough exterior.

—Max Krimmel, Boulder, Colo.

The article in *FWW* #64 on shopmade sash clamps was interesting and beneficial. May I suggest that the threaded cross-member be held in place with a small bolt rather than glue so that short and long bars can be interchanged to suit the job.

—Charles H. Price, Winnsboro, Tex.

I'd like to reply to your recent article (*FWW* #64) regarding the new Freud JS100 plate joiner. Two points were disturbing. First, as a long-time reader of your magazine, I've always agreed with your viewpoint that the cost of a tool, while important, should remain secondary to the tool's quality, reliability and versatility. I gather that you have some strong doubts about the reliability of the Freud machine—yet you suggested that the reader buy two! Now, with a Freud machine in each hand, it's unlikely that this woodworker will be interested in hearing about the added speed and flexibility provided by [the Lamello's] swiveling front plate or, for that matter, the many attachments and accessories which will greatly increase the versatility of a Lamello machine.

Second, I note that, in the same issue, the Lamello Junior (functionally similar to the Freud machine and able to accept Lamello accessories) was advertised for \$299. I suggest woodworkers consider purchasing one Lamello Junior and several boxes of plates, rather than purchasing two complete machines.

As woodworkers, we're all concerned about maintaining high quality in our products and charging accordingly. Are we now being asked to reward lower quality from our tool manufacturers?

—Bob Jardinico, Colonial Saw Co., Inc., Kingston, Mass.

In regard to the Method of Work, "Making tenons on chair rungs," in *FWW* #64, I'm surprised that you would print a drawing of this potentially dangerous jig. If the chair rung slips, either the router bit or the chair rung could easily explode into little pieces. The correct way to build this jig would be to cut out a small piece in the bottom of the V-block to contain the router bit so that the bit projects only as far as the depth of cut. This way, the bit can't grab, even if the dowel slips.

If you design the jig as I suggest, a slipup can be corrected by another pass over the router bit.

—Gerald Bayne, Brackney, Pa.

I don't want to drag out the discussion on bandsaws, but there was one omission which could be of interest to the craftsman who cuts both wood and metal: a converter sold by Sears. The converter is a "little black box" that fits on the motor shaft with a steel strap fastened on the motor mount. Wood-cutting speed is maintained, and a simple slip of the belt to an adjacent pulley reduces the speed.

When the drive pulley is set-screwed to the motor shaft, an adjacent pulley of the same diameter—supported by the motor

## The Taunton Press

Paul Roman, *publisher*; Janice A. Roman, *associate publisher*; Tom Luxeder, *operations manager*; Carol Marotti, *personnel manager*; Lois Beck, *office-services coordinator*; Joyce Moran, *administrative assistant/secretary*; Linda Ballerini, *secretary*. Accounting: Wayne Reynolds, *controller*; Irene Arfaras, *manager*; Mary Ames, Elaine Yamin. Art: Roger Barnes, *design director*; Ben Kann, *art department manager*; Elizabeth Eaton, Anne Feinstein, Heather Brine Lambert, *associate art directors*; Margot Knorr, *art/production technician*. Books: Leslie Carola, *publisher*; Mark Feirer, *managing*

*editor*; Scott Landis, Christine Timmons, *associate editors*; Nancy Stabile, *copy/production editor*. Circulation: Karen Cheh, *circulation coordinator*. Data Processing: Richard Benton, *system operator/programmer*. Fulfillment: Carole E. Ando, *subscription manager*; Terry Thomas, *supervisor customer service/mail processing*; Connie Barczak, Gloria Carson, Dorothy Dreher, Anette Hamerski, Pamela Kaswer, Peggy LeBlanc, Jean Oddo, Denise Pascal, Heather Riccardi, Nancy Schoch, Marchelle Sperling; Ben Warner, *mail-services clerk*. Robert Bruschi, *distribution supervisor*; David Blasko, Mary Ann Costagliola, Timothy Harrington, Linnea Ingram, Alice Saxton. Manufacturing: Kathleen Davis, *director*; Austin E. Starbird, *prepress manager*; Barbara Bahr, David DeFeo, *coordinators*; Rolland Ford, *PC coordinator*; Lisa

Carlson, Mark Coleman, Deborah Cooper, Ellen Olmsted, *production assistants*; Swapan Nandy, *scanner/system operator*; Dinah George, Nancy Knapp, *system operators*; Pamela Smith, *secretary*. Marketing: Dale Brown, *director*; Rosemarie Dowd, *trade sales coordinator*; Barbara Buckalew, *secretary*. Promotion: Jon Miller, *manager*; Philip Allard, *copy/promotion writer*; Claudia Allen, *promotion/circulation assistant*; Pamela Purrone, *copy/production editor*. Video: Rick Mastelli, *producer/director*.

Advertising and Sales: Richard Mulligan and Pamela Sigal, *national accounts managers*; Carole Weckesser, *senior sales coordinator*; Nancy Clark, *sales coordinator*; Jill Turek, *secretary*. Tel. (203) 426-8171.



# FAST • EASY • ACCURATE patent pending Magna-Set

**Everything you need for setting and checking jointer and planer knives and rollers**

Traditional jointer and planer knife changing methods take too long and can be dangerous. One or more of the knives can be reset too high, too low, out of parallel or squirm out of position when tightened in place. Eliminate these miseries... use the MAGNA-SET system! Its patented magnetic design holds each knife in perfect alignment. Great for shifting nicked knives in seconds.

Order by phone or mail. Use VISA, MASTERCARD, check, money order or C.O.D. Add \$2.50 for shipping and handling. Allow four weeks for delivery.

**MAGNA SET Pro Kit... \$374.95**

Kit Contains: Planer jig pair ..... \$149.95 Jointer jig ..... \$ 44.95  
Rotator ..... \$149.95 Wood case and instruction book

Each item may be purchased separately. Jointer and planer jigs are also available in carbide holding capacity.

**UNIQUEST CORP. (FORMERLY QUEST INDUSTRIES)**

585 WEST 3900 SOUTH #6, MURRAY, UT. 84123 • 800 331-1748 or 801 265-1400

## TOOLS ON SALE™ AMERICA'S LOWEST PRICED TOOLS ★PLUS★ •••FREE••• Freight On Every Item

### ••• BRAND NEW BY PORTER CABLE •••

MODEL 555 PLATE BISCUIT JOINTER 5 AMP — 8,000 RPM — WT 6# — 6 TOOTH CARBIDE TIPPED BLADE — COMPLETE WITH/STEEL CARRYING CASE  
LIST PRICE 269.00 —  
SPECIAL INTRODUCTORY SALE PRICE 159.00

### BISCUIT BONANZA — BOX OF 1000

Model	Description	List	Sale	Lots Of Any 2 Boxes
5551	Size "0" 1 3/4" x 5/8"	30	22	40
5552	Size "10" 2 1/8" x 3/4"	30	22	40
5553	Size "20" 2 3/8" x 1"	30	22	40
5554	Asst. Contains "0" - "10" - "20"	30	22	40

PORTER-CABLE BISCUITS ARE MANUFACTURED IN THE U.S.A. AND ARE COMPLETELY INTERCHANGEABLE IN SIZE AND PERFORMANCE WITH FOREIGN-MADE BISCUITS

### ••• BRAND NEW BY PORTER-CABLE •••

THE NEW BOSS IN TOWN ••• MODEL 345 — 6" CIRCULAR SAW CALLED SAW BOSS™ 9 AMP MOTOR — 8,000 R.P.M. CUTS A 2 x 4 AT 45°. THE HEAVY WEIGHT HEAVY DUTY SAW THAT WEIGHS ONLY 8 LBS.  
LIST PRICE 154.50  
SPECIAL INTRODUCTORY SALE PRICE 95.00

**1987 TOOL CATALOG AVAILABLE**  
Call Toll-Free 1-800-328-0457 — In Minnesota Call (612) 224-4859  
SEND CHECK — MONEY ORDER — VISA — MASTERCARD — DISCOVER — ACE  
**SEVEN CORNERS ACE HDW. Inc.**  
216 West 7th St. • St. Paul, MN 55102 • Est. 1933

## Sharpen Your Files

NEW & Innovative Etching Solution  
Sharpen Files in Your Own Shop

Sharpens dull files & maintains a sharpened edge on new files.  
Simply immerse clean file in quart bottle of CP-17 for 30 min. rinse with water & place in rust inhibitor (CP-21) for 10 min.

CP-17 ..... \$18.95  
CP-21 ..... \$ 7.95 Plus shipping & handling

**Money Back Guarantee — Larger Kits Available.**  
Write or Call for more Information (303) 625-5472  
Western Chem-Tech P.O. Box 539 Parachute CO 81635

## BUILD THE SEELY ROUTER TABLE

Convert your old router into a Seely Router Table System

- Plunge capability
- Foot pedal control
- 4 preset depth stops
- Easy depth adjustments
- Accurate depth gauge
- Bit change via insert in top
- Accepts router motors to 4" dia.
- Ideal for dust collector hook-ups
- Pick a table height - 33" to 44"

Complete plans and instructions  
Custom-machined parts included  
Wood, router and standard hardware not included  
\$75 ppd. check or M.O. (N.Y. res. add tax)

**The Seely Workshop** 292 BARRINGTON STREET  
ROCHESTER, N.Y. 14607

## TRUE HARD ARKANSAS SHARPENING STONES

Inventory Reduction Sale  
Satisfaction Guaranteed

10"x2 1/2"x1/2" Black Hard Arkansas \$53<sup>00</sup>  
Slipstones, Files, Carving Tool Stones  
2" and 3" wide bench stones

Free Brochure  
COD or prepaid orders  
Without prior credit

**ARKANSAS WHETSTONE CO.**  
Rt. 7, Box 322  
Hot Springs, AR 71901  
(501) 624-2298

## CABINETMAKERS HAMMER

by Cabinetmaker Thomas Von Fange

- Designed especially for trim carpentry, and finish work.
- It's a fact my Beryllium Copper Hammer drives nails with less slippage than steel hammers.
- Striking face is precision milled almost flat, giving operator better control
- Small edge bevel leaves more hitting area.
- Highly chip resistant, can't rust, won't mushroom, pulls hard to grip finish nails with ease.

Cabinetmaker, 16 oz 45.00 + 2.50 shipping.  
Cabinetmaker, 12 oz 35.00 + 2.50 shipping.

■ Dealer Inquiries Invited

To order Write or Call Von Fange Tool Co.,  
General Delivery, Woodville, Va. 22749  
Virginia 1-703-829-2565

■ FOXON ENT.  
National 1-800-541-0900  
California 1-800-334-3030

shaft, but turning independently at one-tenth of the motor's speed—is driven by a two-belt arrangement in the black box.

I bought my converter from Sears in 1963. The current Sears tool catalog lists a converter that might be an updated version, judging from the scanty description and miniature picture. It's available through the catalog for \$140.

My converter is small but acceptably well-built, with six sealed ball bearings and belts toothed like a timing belt. It came with a chart of speeds obtainable with various sizes of saw pulleys.

—Elmer W. Stecher, Oak Park, Ill.

In the Methods of Work column of *FWW* #62, Bill Amaya had a good design for a sliding tablesaw carriage made of roller-skate wheels. As readers ponder his plans and sketches, the first question that comes to mind is this: where do you buy steel skate wheels? I did a project article incorporating roller-skate wheels for another woodworking magazine, and Carl F. Haeussler, Jr. (Gee Vee Line, Inc., Box 461, Feasterville, Pa. 19047) informed readers in a later issue that his company produces steel or aluminum ball-bearing roller-skate wheels. They can be purchased directly for \$.95 each, postpaid. The minimum order is 20 wheels, and you should specify whether you want aluminum or zinc-plated steel.

—Donald F. Kinnaman, Phoenix, Ariz.

For the last 15 years, I've seen tool catalogs state that the small end of a Warrington Hammer is for driving brads. I've had it! Please be informed that the small end is for setting cap irons on both wooden and metal planes, and also for adjusting the side set of molding-plane irons.

—Eugene Welker, Cornish, N.H.

Like Gary Korneman (Methods of Work, *FWW* #59) I needed drawer pulls and couldn't find what I wanted. An even simpler way to make pulls than the one Korneman describes is to bore a 1-in.-dia. hole through the length of a block of wood about 4 in. long and 1¼ in. square. If you rip this block into quarters along its length, you'll have four drawer pulls. On the sander, you can shape the pulls to suit your taste. You may want to round the corners, and maybe make the front edge thinner than the edge that screws to the drawer front.

—Henry Jaeckel, Nevada City, Calif.

I was delighted to see David Shaw's excellent article on filling open-pore woods in *FWW* #60. I'd like to add a few of my own observations, gleaned from years of doing that rather tedious but necessary task.

Although filling pores with shellac or clear lacquer does indeed offer a different look, it carries with it a drawback. The filler and top coat share the same solvent, so the filler will be redissolved during coating, causing it to swell up initially, then shrink down over a long period of time. Even if such a finish is rubbed out flat initially, it will start to exhibit shrunken pores within two years. The main advantage of fillers such as the plaster Shaw mentions is that they don't share a common solvent, and hence won't move after coating. In the case of silex fillers, they're too dense with solids for any significant effect to occur. One way around this dilemma is to fill the pores with a clear material (such as catalyzed polyester) that won't redissolve with the lacquer top coat. Once the polyester is cured and sanded back, lacquer can safely be applied over it and will adhere, provided the polyester is only in the pores. A barrier coat of vinyl sealer will also help.

With silex fillers, I find that a light coat of vinyl before filling not only makes it easier to rub off the dried filler, but allows you more control in coloring the wood. For example, to get that old, warm, filled look on mahogany, you might want to stain the raw wood first with a light, yellow aniline, seal it

with thinned vinyl, then fill it with a dark cordovan filler. Though the pores would be darkly contrasting, the surrounding wood would not be affected by the stain in the filler, and you could easily attain that golden, aged (but filled) look characteristic of old mahogany. After scuffing the filler, a sealer coat of vinyl envelopes the filler in the pores and reduces the small amount of shrinkage that occurs—even with silex fillers under a lacquer finish.

—Michael M. Dresdner, Spinnerstown, Pa.

I was interested in the Method of Work from John Gallis in *FWW* #61. He described his difficulty in finding a 4-in. PVC angle that didn't have the restriction of the standard 90° elbow, for use in his dust-collection system.

Gallis and your other readers may be interested to try a trick that I learned from plumbers installing a swimming pool. To get the PVC to conform to the irregular shape of the pool wall, they bent the pipe by first allowing the exhaust gas from their truck to pass through the pipe for two or three minutes. They'd made a coupler for the truck tail pipe that allowed the PVC pipe to fit inside the coupler. With the engine at idle, the exhaust gas made the pipe soft enough to bend to any shape. As soon as the PVC cooled, it retained its new shape.

Incidentally, the pickup truck was out in the open, and the heated PVC pipe was handled with insulated gloves.

—Anthony H. Bathurst, Tucson, Ariz.

In "New life for old chisel" in the Q&A section of *FWW* #61, Norm Vandal describes the hardening and tempering procedure, but then adds: "Some workers prefer to heat the metal red and let it cool to straw before quenching." This procedure will not harden the steel. Quenching must be done while the steel is still red-hot. After quenching, tempering can be done by heating the steel to about 450°F, which would result in the straw color mentioned in the article.

One other tip: When quenching, hold the end of the chisel with a pair of tongs and quickly lower it straight down into the water. This way, all surfaces of the steel will be cooled at the same time with less chance of warping, which could result from uneven cooling.

—Lloyd E. Emond, Milwaukee, Wisc.

Annoyed by my sharp chisels being nicked, I found a solution in my increased girth. I have several old leather belts which no longer fit my middle. One was the kind made with two faced pieces of leather, sewn and glued together. Using a pocket knife, I cut a 1-in. section and separated the two pieces of leather along the glue line to form a pocket about ¾-in. deep. The chisel slid easily into this makeshift sheath, and the rough, split leather provided enough grip to keep it in place. No more nicked chisels! And I really prefer leather to plastic against a fine honed edge. I have, alas, enough belt left over to last a lifetime. If I lose a sheath, I just make another when necessary.

—Howard J. McHugh, Raleigh, N.C.

Regarding Ben Erickson's disappointment in his Makita B04510 finishing sander (*FWW* #62): my experience is just the opposite. My Makita sander works just fine. I've found no reason to complain. Placing a drop of silicone lubricant on the clamping arms periodically makes them easy to operate. I bought the Makita after a Speed Bloc rattled itself apart. The Makita also eliminated the need to look for a screwdriver every time I wanted to change paper.

I've had no problems with paper slipping from the clamps, although I can load paper faster if I clip about ¼ in. from the length of the paper after quartering it. I've found it to be a dependable, well-balanced, efficient machine.

—Reese Crispen, Bolton, Mass.

**INTRODUCING:**

## The woodturning equipment from "Down Under". That's about to turn *your* world upside down!

We know how it is! Even after years of trying, you've despaired of ever turning a large bowl, an enclosed form, or hollow vessel with any degree of safety.

Enter **Harry & David Arnall** — woodturners both, from 'way back. *And* the patented, *All-Australian* equipment they have developed, which is setting new standards in ease of operation and downright safety. It is all of the highest quality and has been designed for use, not only on the ARNALL Lathe but also — with universal adapters — on your present lathe.

**John Sainsbury**, one of the world's most respected and revered woodturning authorities, has said of it: "You haven't cut until you've cut with Arnall..."

ARNALL Woodturning Equipment — the wraps are coming off.



**ARNALL MACHINERY**

Lot 3, Enterprise Drive  
Berkeley Vale, NSW 2259, Australia  
Telephone (043) 88 3298

*Like to know more?... Send \$5 (inc. P & H) for ARNALL Catalogue, plus occasional mailings.*



## A Typical Router Bit Can Really Burn You Up.



There are several factors that can cause a router bit to "burn" a workpiece with heat of friction. But the most common is a cutting edge that's just plain dull.

The obvious solution is to use a bit with a sharper cutting edge. And no bit starts out sharper or keeps a usable cutting edge longer than Bosch Super-Sharp

carbide-tipped bits. Honed to a mirror finish with razor-like sharpness using micro-fine diamond abrasives, Super-Sharp bits cut faster and cleaner. And they do it far longer than even other carbide-tipped bits. (Fewer bit changes means less downtime, too.) All of which keeps your routing jobs from going up in smoke.

For the name of your Bosch Distributor, see the Yellow Pages' "Tools—Electric."

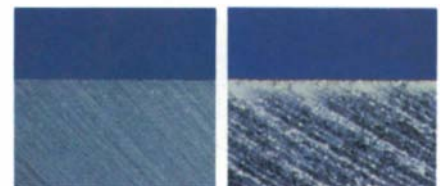

*Bosch Super-Sharp edge compared to conventional edge.*



**BOSCH**

"Quality You Can Hold On To."

©1987 Robert Bosch Power Tool Corporation

### Sawing duplicate pieces on the bandsaw

I had experimented with various bandsaw techniques for sawing duplicate pieces, but I was dissatisfied with the results and the lack of flexibility. As a result, I developed this simple fixture. It lets you duplicate a pattern quickly and accurately, provided the curves aren't too abrupt for the blade to follow. Another advantage of the fixture is that you need only one pattern to produce various-sized duplicates.

The fixture evolved from a common circle-cutting jig that uses an auxiliary table clamped to a bandsaw table. The table is simply a piece of 3/4-in. Formica-covered plywood with a 3/4-in. groove routed in the top (the centerline of the groove is aimed at the cutting edge of the blade). The rest of the fixture consists of a guide pin, a sliding pivot pin and a spacer. The guide pin and the sliding pivot pin are both 1/4-in. dowels pressed into small blocks sized to fit the groove.

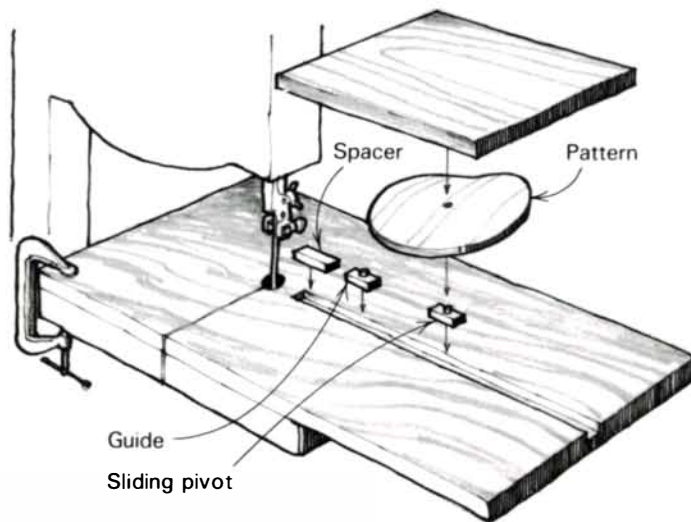

To use the fixture, first cut a pattern an inch or two smaller than the finished size of your workpiece and drill a pivot-pin hole near its center. Next, place the guide pin in the groove at an appropriate distance from the blade. The distance from the guide pin to the blade will determine the enlargement of the finished duplicate over the pattern. Fix the guide pin at this distance by placing one or more spacer blocks between the guide and the end of the groove.

Now, attach a blank to the pattern with brads, two-sided tape or hot-melt glue. Fit the blank/pattern assembly over the pivot pin and cut the duplicate by rotating it while applying gentle pressure toward the guide pin. The pivot pin will slide back and forth in the groove as the pattern follows the guide pin. Generally, the stock is too large to allow the pattern to contact the guide pin at first. In this case, simply turn the pattern and feed the stock into the blade until the pattern touches the pin.

The fixture is useful for many applications. Curved pieces—such as the back of a crowned chair—can be ripped quickly and easily. If the fixture is adapted to a scroll saw, it can be used to cut elliptical picture frames. With minor modifications, the setup can also be used to cut circles.

—Peter J. Cranford, Windsor Junction, Nova Scotia

### Making twelve-sided turning blanks

It's common practice to rip the corners from square turning stock, making it octagonal, in order to reduce the amount of material to be roughed off in the lathe. It's just as easy to produce a twelve-sided turning blank, which requires even less stock removal in the lathe and doesn't require racking the saw blade over to 45°, where my tablesaw, at least, doesn't behave very well.

First, set the tablesaw blade at 30° away from vertical. Set the

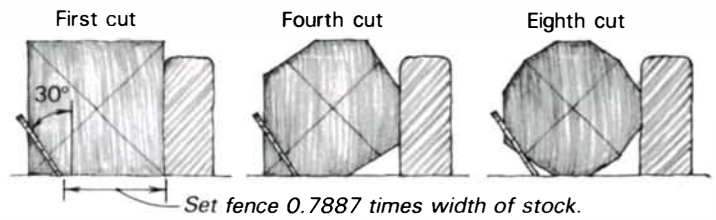

rip fence at 0.7887 of the stock width from the blade. This setting can be approximated accurately by taking 3/4 in. plus 1/32 in. for each inch of face width. Mark both ends of the stock with an X, as shown in the sketch, so as to be able to keep track of which corners to cut off. Rip the corners from the square, turning the stock 90° clockwise each time if your fence is to the right of the blade. Now turn the stock end-for-end and repeat the process keeping the original faces, which are now not the widest ones, against the fence and saw table.

A 10-in. saw will handle a 7 1/2-in.-thick blank. The procedure is inadvisable for stock less than 1 1/2 in. wide, because the faces become too narrow to guide safely against the fence and table.

—Warren Miller, State College, Penn.

**Quick tip:** I make router subbases out of 3/16-in. Plexiglas, to increase visibility.  
—Jerome Crawford, Durham, N.H.

### Powering other tools with a tablesaw

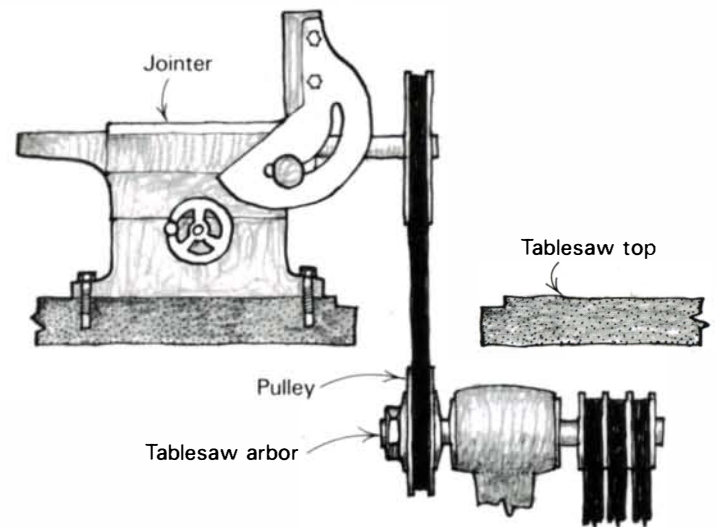

If you work in a small shop as I do and space is at a premium, here's how to drive another tool, a small jointer for example, with your tablesaw's motor. First slip a pulley on the saw's arbor and tighten the arbor nut as you would with a sawblade. As with any tool setup, be sure to size the pulley to drive your tool at the proper speed. Place the jointer on the saw table and clamp or bolt it in place. If you plan to use the arrangement often, you may wish to drill and tap fastening holes for the jointer right into the saw table. Next, slip a belt over the pulleys and lower the saw motor until the belt is tensioned. The whole arrangement takes no longer to set up than any other tablesaw accessory, and you save the price of a motor and gain a little space in your shop as well.

—Luc Mercier, Laval, Que.

### Blade covers

After spending several hours honing a new 3-in.-wide fishtail gouge, I considered fabricating a special blade cover to protect the cutting edge. A better idea came to me as I paged through a mail-order supply catalog and spied a product called Plastic Dip, normally used for coating plier handles.

Here's how I made a blade cover with Plastic Dip. First, I spread some Vaseline on the blade so the plastic wouldn't stick





Build this lovely Spinnet

## THE Early Music Shop of New England

59a Boylston St., Brookline, MA 02146  
Telephone: (617) 277-8690

For information on this & other fine musical instrument kits, write for our free brochure.

### THE CONOVER LIVE CENTER



#### Put a Little Conover Performance in Your Lathe

Any Conover Lathe owner can tell you, "Conover makes a great lathe!" Well, Conover also makes a dandy Live Center and most Conover owners would not consider their great lathe complete without one. Christmas and a Conover Lathe may be a ways off but, why not put a little Conover performance in your present lathe — today? You will be able to tackle a wide variety of work without smoking, burning or runout and because you can put more pressure on the work you can turn better.

The Conover Live Center comes in #1 or #2 Morse taper. is equipped with replaceable double row ball bearings and has four interchangeable points. (L to R) The extended cup point is used for turning tool handles and for getting into such things as goblets and weed pots. The normal cup point is used for the majority of your turning. The core point is inserted into a 3/8" hole, providing secure holding of large items. The 60° point is used for small, delicate turnings. Finally, the body itself can be used with a piece of leather for metal spinning. All this for just \$64.95.

Send me \_\_\_ Live Center/s in #\_\_\_ Morse taper @ \$64.95 ea. and \_\_\_ Extra bearings @ \$17.95 ea. plus \$3.50 shipping. (Ohio res. add 5% sales tax.)

Just send Catalogue @ \$1.  
Print your name, address (UPS) on a clean sheet of paper, send along with check, money order, M.C. or Visa #, exp. dt. and phone #.



Conover Woodcraft Specialties, Inc.  
18125 Madison Road, Dept A48709  
Parkman, OH 44080  
Tel (216) 548-3481

# MOLD, PLANE and TURN

In Your Shop or On the Job

Introductory Discounts and FREE 30-Day Trial from Williams & Hussey.

Join countless professionals and hobbyists who've made W&H woodworking tools part of their workshops. You'll find these unique and rugged 100% American-made machines worth every penny you invest in them.

#### Molder/Planers for Shop and Jobsite

America's most versatile combo-function shop tool molds, planes and edges—and it's so portable, you can bring it out to the site! Available in three models for power infeed/outfeed, power infeed, or manual operation. Molds, planes & edges 15' per minute—even oak! Duplicates virtually any molding between 3/4" deep x 7" wide. Converts from molder to planer in less than two minutes because you change only the blades, not the arbor! Edges boards of any width, thanks to the open-sided design.

Picture Frames • Crown Moldings  
• Raised Panels • Boat Decks  
• Casings • Sashes • Rails

#### 5-YEAR WARRANTY

- 100% American Made
- Weighs Only 85 lbs.
- Molds, Planes & Edges
- Serrated Steel Roller
- 2-Minute Changeover



Free 30-day trial!

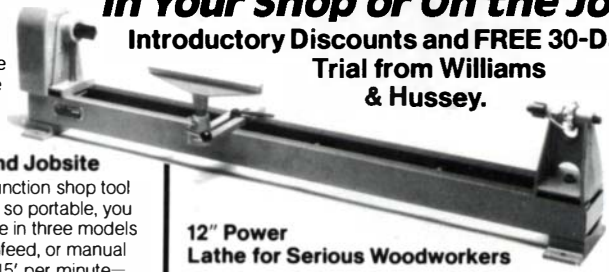

#### 12" Power Lathe for Serious Woodworkers

Built like a battleship, with flat, machined-steel ways that can't sag; massive cast-iron headstock and tailstock — no cheap plastic or thin, stamped-steel housings! Ingenious threadless chuck lets you mount your workpieces, sanding wheels, buffers, and drills inboard or outboard. Four speed operation; 46" between centers. Free 30-day trial!

#### 10-YEAR WARRANTY

- 100% American Made
- Works Inboard & Out
- Machined-Steel Ways
- 46" Between Centers

#### BUILT TO GO THE DISTANCE.



Introductory Offer. Limited Time Only.

WRITE OR CALL FOR FREE LITERATURE!

Please send information about the

MOLDER/PLANERS  LATHE

CALL TOLL FREE

1-800-258-1380

In N.H. (603) 673-3446

Name \_\_\_\_\_

Street \_\_\_\_\_

City \_\_\_\_\_ State \_\_\_\_\_ Zip \_\_\_\_\_

Williams & Hussey Machine Co.  
Elm St., Dept. 1371A, Milford, NH 03055

"I find the HEGNER far superior in all aspects..."

"... does everything I want."

"A pleasure to use."

"Worth every penny."

"Total Satisfaction!"

To find out more about the scroll saw that inspired the above comments, just complete and return the coupon or call for FREE information.

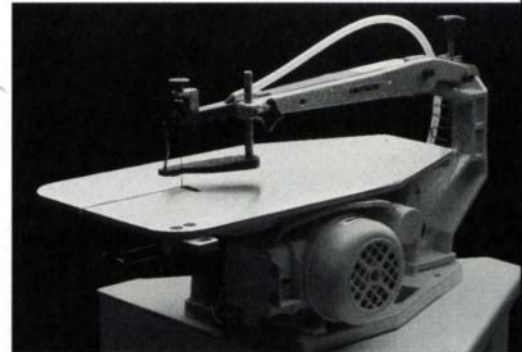

Please send me FREE information on the HEGNER Precision Scroll Saws.

Please send FREE information on HEGNER Lathes and Lathe Duplicators also.

Name \_\_\_\_\_

Address \_\_\_\_\_

City, State, Zip \_\_\_\_\_

Phone ( ) \_\_\_\_\_

ADVANCED MACHINERY IMPORTS LTD.

P.O. Box 312, Dept. 178  
New Castle, DE 19720  
Call 302 • 322 • 2226

to the metal. Then, I dipped the blade in the plastic once a day for four days. After four applications, I trimmed the top of the dip and pulled at it gently. My newly made blade cover came off with a thwack! The dip had molded itself perfectly to the blade, and the Vaseline allowed easy removal. I couldn't ask for a tougher material. Plastic Dip is sold by Leichtung (4944 Commerce Parkway, Cleveland, OH 44128) for about \$8 per can.

—Carl Hungness, Speedway, Ind.

### Improved sharpening-stone box

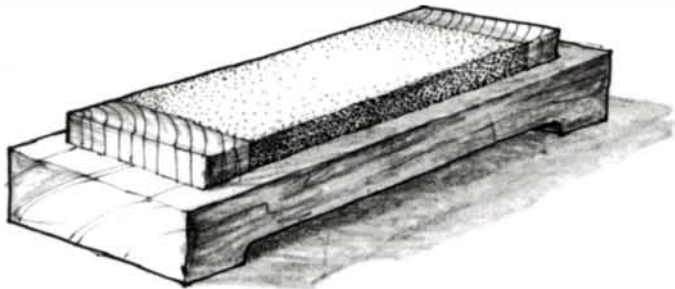

By mortising two endgrain blocks into your sharpening-stone box (one on each end of the stone), you'll provide support for longer sharpening strokes—the tool won't skip abruptly off the edge of the stone at the end of a stroke, nor do you risk catching the edge on the end of the stone at the beginning of a stroke. Longer strokes will reduce wear in the middle of the stone and greatly increase the stone's life.

—James Gauntlett, Boise, Id.

**Quick tip:** Tapping a hole in cast steel, and feeling too lazy to get my tapping fluid, I grabbed a convenient bottle of Teflon-based lubricant. The tap turned in just like a bolt into an already-threaded hole! I've since tested the fluid to both drill and tap holes in mild steel, brass and aluminum, with good results in all.

—Gordon Mulholland, Streator, Ill.

### Making long dowels

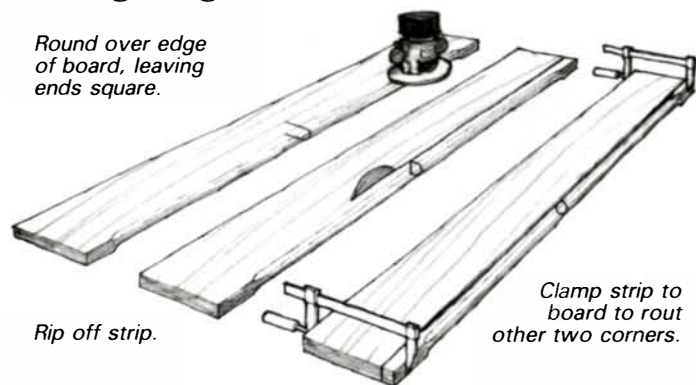

I needed a 3/4-in.-dia. oak dowel more than 6 ft. long to use as a curtain rod. Unable to find a source of supply, I came up with a method to make the dowel in my shop without a lot of effort. First, I rounded the edges of a 7-ft.-long, 3/4-in.-thick oak board with a 3/8-in. corner-round bit in my router. I didn't round over the first and last 6 in. of the board because I knew I'd need the square ends for a clamping surface later. Moving the board to the tablesaw, I set my fence at 3/4 in. and ripped off the rounded edge. I then flipped the stick over, clamped it back to the board with three quick-action clamps (for stability) and rounded the top and bottom edges again to produce a dowel. Of course, I had to reposition the middle clamp to finish the rounding. When I trimmed off the two square ends, I had my long dowel, ready to scrape, sand and finish.

—Phil Lisik, Hemlock, Mich.

### Double bifocal shop glasses



Last year, it finally became necessary for me to begin wearing bifocals. The close-up area of the lens worked fine—as long as the work was below me. But the glasses didn't help at all if I was doing close or detailed work *overhead*. So, I had my optician make me a pair of shop glasses with bifocal areas on both the top and the bottom, as shown above. The particular design is known as Double D28, Occupational Segments. The glasses have greatly improved my enjoyment of woodworking.

—Rod Goettelmann, Vincentown, N.J.

**Quick tip:** Many woodworking glues are strongly fluorescent. If you have an ultraviolet lamp, you can use its ghostly light to spot glue residue that otherwise would come back to haunt you later.

—Allan E. Gilmore, Sacramento, Calif.

### Roller-stand adjustment revisited

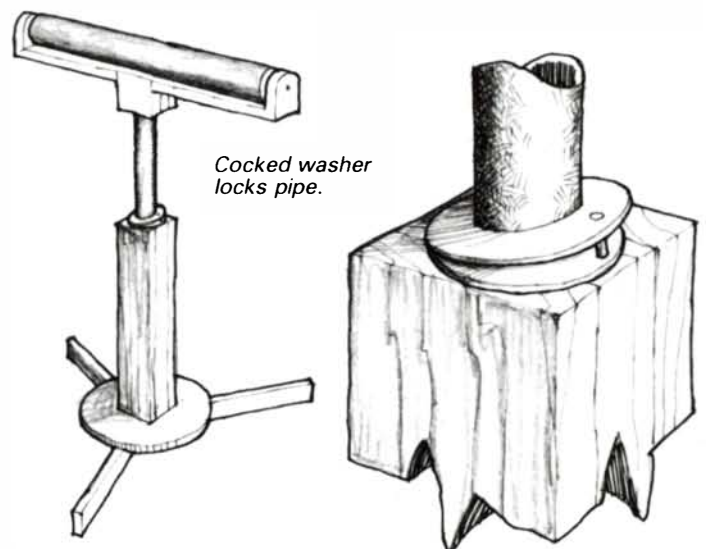

My three-legged roller stands are similar to Tim Anderson's (FWW #60). But I have substituted a 1-in.-dia. steel pipe in place of Anderson's sliding dowel, and I use a cocked washer mechanism for adjustment and locking. It's the same idea found on many pipe and bar clamps. To make the adjustment mechanism, first locate a couple of steel washers with holes about 1/8 in. larger than the outside diameter of the pipe. Rivet a 1/2-in.-long steel bolt to one side of one washer. The bolt will cock the washer against the pipe and automatically lock the roller assembly at any height. The second washer prevents wear on the stand. To release the mechanism, simply lift up on the low side of the top washer.

—Ingwald Wegenke, Montello, Wisc.

### Lubricating sealed bearings

If you ever have a power tool with a noisy sealed bearing, here's an unorthodox but effective way to lubricate it. Place the dry bearing in a can of oil, and place the can inside a bell jar on a vacuum pump. Switch the pump on and watch the air

**BEVELED  
GLASS WORKS**  
Since 1975  
**Custom Glass Beveling  
to Your Pattern**  
Cabinet Doors, Table Tops,  
Front Doors, Side Lights.  
**Your Complete Beveled Glass Shop**  
503-253-8811  
11721 S.E. Taylor  
Portland, Oregon 97216

**MEASURED DRAWINGS**  
by  
**CARLYLE LYNCH**



These 18th and 19th century American furniture plans have been painstakingly prepared by noted cabinetmaker Carlyle Lynch from museum pieces and private collections. Complete with bills of materials and construction notes, \$7.50 ppd. Send \$2 for illustrated list of plans available (refunded with first order).

**CARLYLE LYNCH**  
196 Holly Hill,  
Broadway, VA 22815  
(VA residents add .34')

**RENAISSANCE®**  
*British Museum Formula  
State-of-the-Art Wax Polish*

*Ultra refined acid-free waxes impart a universal protective finish of impeccable quality, performance and stability which cleans, preserves and revitalizes. \$11.95 / 8 fl. oz. (+ \$1.50 shipping).*

Information or order:  
**CEREUS, INC.**  
184 Warburton, Dept. 15  
Hastings-On-Hudson, NY 10706  
(914) 693-8698

**WEST DEAN COLLEGE**  
**The Edward James  
Foundation**

1-Year Diploma Course in Conservation of Antique Furniture in conjunction with The British Antique Dealers' Association  
3-Year Apprenticeship in the Making of Plucked and Bowed Musical Instruments

The College is situated in an Edwardian Mansion in beautiful South of England Country

Further information from:  
**The Principal, West Dean College,**  
West Dean, Chichester,  
West Sussex PO18 0QZ, England.  
Telephone: Singleton (0243 63) 301

**Attack the paint.  
Defend the wood.**



Removing layers of paint from wood is difficult. Removing the paint *without harming the wood* may be one of the world's toughest tasks. Homer Formby has the solution: Formby's® Wood Formula Paint Remover. Independent tests show Formby's Wood Formula Paint Remover is better at removing layers of paint than the most commonly used brands. And it won't raise wood grain or discolor the wood. Formby's Wood Formula Paint Remover is the one to use on wood. Homer has done it again.



**FORMBY'S®**  
WOOD FORMULA  
**PAINT REMOVER**

© 1987 Thompson & Formby Inc.

**only  
79.95**



**Sander / Grinder**

- Great For Sharpening Tools, Polishing, Deburring, and Precision Work
- Weight 8 lbs at 10" High
- Ideal for the Craftsman, Light Industry, Hobbist
- Three FREE Belts are included with Sander.

**VISA & MASTERCARD  
ACCEPTED**  
**1-800-437-4757 Ext. 001**

**THE KEEN-EDGE COMPANY  
INCORPORATED  
PRESENTS**

**Milford™**

**BAND SAW BLADES:**

1/4 x 72"	x	tooth	4.06
1/2 x 72"	x	tooth	4.30
1/4 x 80"	x	tooth	4.37
1/2 x 80"	x	tooth	4.64
1/4 x 93 1/2"	x	tooth	4.70
1/2 x 93 1/2"	x	tooth	5.02

All sizes to order ... & coil stock available in 1/8" to 1 1/2" widths.  
\$20.00 minimum. In U.S., add \$3.75 S&H. Each \$20 add'l, add \$1.00.

**ORDERS & INQUIRES:**  
5879-A New Peachtree Road  
Doraville, Georgia 30340  
**(404) 455-4356**  
CHECK • MO • VISA • MC • DISCOVER  
— SINCE 1940 —



**KEEN-EDGE**  
SAW REPAIRS • KNIFE GRINDING  
GRINDING WHEELS • SANDPAPER • SAWS • KNIVES  
395 EDGEWOOD AVENUE, S.E.  
ATLANTA, GEORGIA 30312

bubbles come to the surface of the oil. When the bubbles stop rising, turn the pump off. Normal air pressure will force the oil into the sealed bearing.

Some of you are probably asking where you can get a vacuum pump and bell jar. Check with the head of your local high school's science department. If you're a tax-paying resident of that town, you'll most likely be allowed to use the school's equipment.

—William Warner, York, Pa.

### Steady rest for baseball bats

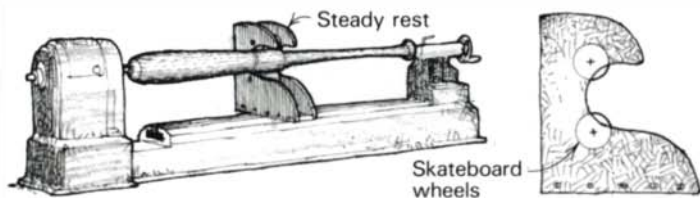

For years, the eighth graders in my woodworking class have wanted to turn baseball bats. I've always put them off because the small diameter of the bat's handle invariably results in whipping and chattering, especially at the hands of an inexperienced turner. I licked the problem by making the steady rest shown here out of skateboard wheels, threaded rod and a couple of scraps of hardwood. The urethane plastic skateboard wheels can be bought for less than \$15 a pair.

To use the steady rest, turn a cylinder, then tighten the steady rest in place with both wheels riding ahead of the handle. Turn the bat to shape, except the area right near the steady rest. My students spokeshave this area off, then sand and finish their bats.

—Paul Damato, Morristown, N.J.

### Fancy eyes for pull toys

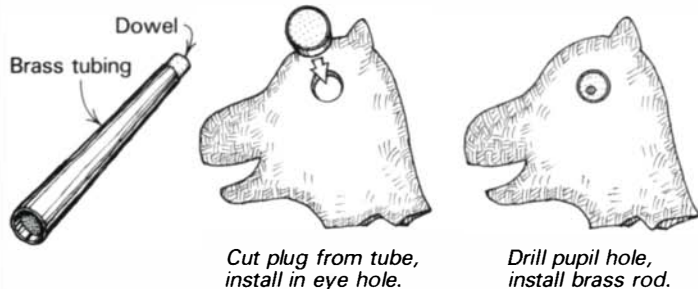

Here's how to make eyes for wooden-animal pull toys that give them an animated and professional touch. First, drive a 3-in. dowel into a 3-in. length of brass tubing with the same outside diameter as you've chosen for the eye. If you round the nose of the dowel and proceed carefully, you should be able to drive the full length of the dowel through.

Next, cut a short plug off the brass-encased dowel and epoxy it into an eye hole you've drilled in the toy's head. When the glue has set, drill an off-center pupil hole near the bottom edge, and tap in a piece of brass rod. Use a file and sandpaper to bring the eye flush with the toy's head. A drop of lacquer over the entire eye will prevent the brass from tarnishing and preserve the gleam. Brass tubing and rods are available in various sizes at most hobby stores.

—Mark DiBona, Kensington, N.H.

Methods of Work buys readers' tips, jigs and tricks. Send details, sketches (we'll redraw them) and photos to Methods, Fine Woodworking, Box 355, Newtown, Conn. 06470. We'll return only those contributions that include an SASE.

## Sand-Rite

### Pneumatic Drum/Brush Head Sander Eliminate Tedious Hand Sanding!

Model No. DB-612  
Made in U.S.A.

**Sand irregular surfaces without loss of shape or detail.**

**Pneumatic sanding drum.** Available in five diameters, 2" to 8". Operator-regulated inflated drum conforms abrasive sleeve to contoured work.

**Cut Costs—Boost Production—  
On Moldings, Furniture And Intricate Carvings!**

Case-hardened steel shaft mounted on McGill self-aligning, flanged ball bearings. Cast zinc pneumatic drums. Ultra-reliable 3/4 H.P. Baldor single phase, capacitor-start motor, one of the finest industrial motors available. Optional stand lets you work at comfortable bench height. Fabricated of heavy gauge steel.

Our nationwide dealer network serves you. To order, call **Toll-Free 1-800-521-2318** for your nearest dealer or a **Free** brochure.

**Sand-Rite MANUFACTURING CO.**  
321 N. JUSTINE ST. ■ CHICAGO, IL 60607

**NEW!  
Plate Joiner**  
Model 555  
List \$269.95  
**SALE \$169.99**  
**Save on Biscuits! \$19.99**

## Jenks & PORTER-CABLE

bring you the latest in power tool technology

**NEW!  
6" SAWBOSS™  
Circular Saw**  
Model 345 List \$154.50  
**SALE \$98.99**

**NEW!  
STAIR-EASE™**  
**2X Stair Template**  
Model 5060 List \$194.00  
**SALE \$147.99**

**Send \$2.00 for our new catalog of woodworking tools, machinery & supplies (Refundable with first order)**

**w.s. JENKS & Son** Established 1866

1933 Montana Ave. NE Washington DC 20002  
**TOLL-FREE 1-800-638-6405**

# SQUARE DRIVE SCREWS



- Square recess drive virtually eliminates driver cam-out
- Heat treated steel for greatest strength
- Optimized thread form for exceptional holding power

**SPECIAL:** 100 each of the following sizes with hex driver bit and hand driver.

6 Heavy Plastic Storage Bins



Size	Length	\$w/o Bins	\$ w/ Bins
#6 x	1/2, 5/8, 3/4, 1, 1-1/4, 1-1/2	13.35	17.35
#8 x	3/4, 1, 1-1/4, 1-1/2, 2, 2-1/2	16.65	20.95
#10 x	1-1/4, 1-3/4, 2, 2-1/4, 2-1/2, 3	23.65	27.90

Square Drive Screws are also available in Solid Brass, Zinc Plated, and Round Washer Head (similar to pen head). Call or write for pricing. (Plus \$2 Shipping / Asst)

QUANTITY DISCOUNTS AVAILABLE - Dealer Inquiries Invited



**McFEELY** Hardwoods and Lumber



P.O. Box 3, 43 Cabell St. • Lynchburg, Virginia 24505  
Toll Free 1-800-443-7937 • In Va. 1-800-542-2023

## Mini Max

T3, Wood Shaper

- 3H.P. 1PH
- Reversing Switch
- 3 speed
- 22" x 37"
- excellent Fence
- Sliding Table
- included

**\$1725.00**  
prepaid freight



**M CHANDLER & CO**

6005 Milwee, Suite #709  
Houston, Texas 77092  
(713) 683-8455

Call us for information on other Mini Max machines  
1-800-247-9213



## MIRRORA - OVALS

PERFECTLY BEVELED MIRROR

- Five sizes of ovals from 2" x 3" to 7" x 9" and 63 other sizes, shapes, and colors available
- 1,000,000 pieces in stock—UPS delivery-ready-to-ship • Highest quality float glass—Double-backed for protection • We fabricate any shape or size of glass & mirror • Call now 1-800-MIRRORA to place orders and get our color catalog

**FLORAL**  
Glass & Mirror, Inc.

895 Motor Parkway  
Hauppauge, New York 11788  
516/234-2200 800-647-7672

## Woodturners

CHOOSE FROM THE FINEST WOODTURNING TOOLS AND SUPPLIES AVAILABLE INCLUDING:

- SORBY
- HENRY TAYLOR
- RUDE OSOLNIK TOOLS

ALSO A WIDE VARIETY OF CHUCKS, BURL WOODS, EXCLUSIVE CUSTOM ACCESSORIES AND DALE NISH WORKSHOPS

Send \$2.00 for our 42-page catalog, refunded with order.



**CRAFT SUPPLIES USA**  
specialists in woodturning tools  
1644 S. State St Provo, UT 84601  
Tel (801) 373-0917

\* not affiliated with Craft Supplies U.K.

# ALS Tool Supply Inc

Alco Tool Supply, Inc. 28235 U.S. 33 West

**ELKHART, IN 46516**

INDIANA WATS 1-800-552-7604 USA WATS 1-800-437-2911

While Quantities Last

### MAKITA

6002DWK	3/8 Cdis drill	178.	89.
6092DW	3/8 Cdis driver & drill	208.	107.
6010DWK	3/8 Cdis drill	174.	87.
6012HDW	Cdis driver & drill	208.	111.
6070DW	3/8 Cdis driver & drill	108.	58.
6800DBV	VS drywall gun	156.	78.
6802BV	VS screwgun	192.	85.
BO4510	fin. sander	92.	53.
BO4550	Dustless fin. sander	92.	48.
DP3720	3/8 Rev. drill	99.	49.
LS1000	10" Mitre saw	396.	228.
JR3000V	Recip. saw	208.	119.
GA7001L	7" angle sander	198.	107.
3620	1 1/4 Router	166.	93.
5007NB	7 1/4 Cir. saw	194.	115.
3700B	Laminate trimmer	162.	82.
6891DW	Cdis drywall gun	204.	117.
4302C	Jig saw	256.	142.
6093DW	CDIs driver & drill	224.	122.
9924DB	3 x 24 belt sander dustless	248.	137.
9401	4 x 24 Belt sander	288.	175.
DP4700	1/2" rev. drill	178.	106.
DA3000DW	Angle drill	206.	115.
JV2000	Jigsaw	198.	110.
1900BW	3 1/4" Planer	198.	112.
LS1430	14" Mitre saw	630.	410.
2708	8 1/4" Table saw	396.	226.
2416s	16" Cutoff saw	368.	221.
2711	10" Tablesaw	698.	483.

**Makita**  
Power Tools

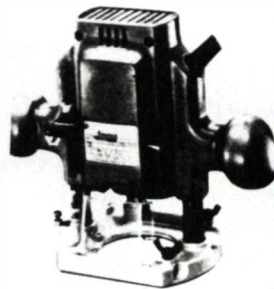

**Model 3620**  
**1 1/4 H.P. ROUTER**



1703



**10" ROTARY TABLE MITER SAW**

### BLACK & DECKER

1179	3/8 VS drill	125.	73.
1311	1/2 VS drill	183.	116.
1703	10" Mitre saw	313.	168.
2046	VS Driver, PC	209.	87.
3027-09 7	1/4 cir. saw	119.	76.
3153	Jig saw	194.	128.
3310	1 1/2 HP router	219.	121.
3328	3 1/2 HP router	500.	330.
3108	Recip. saw	202.	117.
1042	1/4 drill VSR	163.	90.
1321	1/2 drill	232.	132.
3102	Cutsaw	163.	98.
3103	2 Speed cut saw	191.	109.
3140	Cordless jigsaw	192.	118.
3157	Orbital jigsaw	201.	152.
3225	14 Gauge shear	343.	226.
3255	8 Gauge nibbler	1213.	985.
3251	16 Gauge nibbler	324.	214.
3265	Laminate trimmer	199.	131.
3370-10 3	1/4" Planer	177.	109.
4026	3 x 24 Belt sander	232.	159.
4075	5000 RPM sander	198.	130.
4076	6000 RPM sander	198.	130.
4247	4 1/2 10000 RPM grinder	115.	71.
4300	Drill bit sharpener	330.	222.
5014	3/4" Rotary hammer	269.	173.

Write For Free Catalog



**I LOVE MY JOB**

SPONSORED BY ALCO TOOL SUPPLY ELKHART, IN 46516



### Wavering tablesaw cuts

*I couldn't get my tablesaw to track true when I tried to rip 1½-in. by 2¼-in. Sitka spruce laminations for a sailboat mast. My 10-in. Sears tablesaw with carbide-tipped blade would cut a wavering, crooked line for a foot or two, then bind. I had to finish the job with a handsaw. I recently had similar tracking problems cutting Douglas fir plywood for shelves. What's going on?* —J.J. Gibbens, Lafayette, La.

**Harold Payson replies:** The ripping problem with the mast laminations sounds quite familiar. Each time that “binding” problem happens, I look hard at the stick to see if it's twisted. You don't say how long the planks are, but just a small amount of twist over the length of the plank, or trying to saw a plank with the concave curve next to the fence, will bring the best of saws to a roaring halt. What's more, the chance that the rip fence is toeing in a little makes sawing long planks on a table-saw a chancy thing for anyone working alone. Long pieces are best sawn with a helper ready to jam a screwdriver in a closing kerf and help steer the stick.

Even a roller supporting the end of a stick can produce the results you mention. If the roller is slightly askew of the plank's line of travel, the plank will slip sideways and bind. Grain tension can skew the plank, too, but you'd spot that problem quick enough when the kerf started closing on you.

It doesn't sound as if the saw is at fault, but I'd definitely check the fence for misalignment. If the fence opens just a hair from being parallel to the back of the sawblade, that's okay. But a toe-in is a definite fault and must be corrected.

Finishing the cut with a handsaw was your last resort and it would have been mine, too. I would have skipped the hand-saw part and reached for my Skilsaw. Using a Skilsaw with a guide makes sawing long lengths like this a breeze.

I'd suspect your problems with plywood are due to the feed being too fast, the sawblade being set too high or unnoticed toe-in of the fence. I have to assume that your equipment is otherwise in good shape and that your saw sharpener did a good job. Improperly sharpened saws, either hand or power, with teeth longer on one side than on the other (or dull on one side) can get you into the binding problems you describe.

All of these problems can ruin your day and keep you from doing a proper sawing job. Worse yet, they're enough to drive you nuts because they're often almost imperceptible.

[Harold “Dynamite” Payson is a writer and boatbuilder in South Thomaston, Me.]

**Jim Cummins replies:** In addition to the good advice above, let me add a couple of things. First, the saw is underpowered. You can install Sears' 1½-HP motor to good advantage. Second, your blade sounds dull, or perhaps you're trying to rip with a combination blade instead of a blade designed for ripping. Or, maybe you're using a rip blade, but one with too many teeth. What happens with a dull or incorrect blade—especially with an underpowered saw—is that each tooth doesn't have the power behind it to take a full cut. Instead, the blade bogs down and the teeth skid, producing friction and heat. This can actually cause the disc of the blade to buckle slightly from expansion, at which point cutting becomes impossible. When the blade cools off, it flattens out again. I saw this happen once years ago when cutting Plexiglas with an 8-in. plywood blade—the blade began first to bind, then to wander, then it stalled. The blade disc was warped almost an inch out of true. Fifteen minutes later, it was flat again. I suspect that the same thing happens with wood, because the symptoms of a deteriorating cut are the same, even when the kerf appears to be open.

You won't be sorry if you treat yourself to a 10-tooth ripping blade from a good sawshop. I bought one about eight years ago from Winchester (2633 Paper Mill Rd., Winchester, Va. 22601) for \$45. The same blade costs about \$65 today, but

that's inconsequential when you average out the cost over the anticipated life of the blade. Also, it will pay for itself in the wood you don't ruin. I still think, though, that you'll need the larger motor as well. As a last thought, my saw would barely cut a 2x4 when at the end of a 50-ft. extension cord—plug your saw directly into a wall or floor outlet if you can.

[Jim Cummins is an associate editor at *Fine Woodworking*.]

### Staining softwoods to match hardwoods

*Recently, I applied some fruitwood stain to the oak trim in my new home. When I applied the same stain to the new pine windows, the wood turned considerably darker than the oak. Can I lighten the pine without stripping or bleaching the windows?* —Edward J. Stolfa, Palatine, Ill.

**David Shaw replies:** The solution is simple if no finish has been applied over the stain. Just rub the stained pine with a rag that's been lightly moistened with lacquer thinner. The color will rub off slowly, so you'll have enough control to reach the shade you want. Don't use a heavily soaked rag, or you'll risk streaking the color. If the stain streaks no matter what you do, substitute lacquer retarder for lacquer thinner.

If the thinner removes too much color, you have to start from scratch, but this time seal the trim with a thin coat of shellac before applying the stain. A sealer is usually necessary on pine because softwoods absorb more stain than hardwoods. Once the sealer coat dries, apply the stain with the grain. Be careful near joints where the grain direction changes.

If you already applied a finish coat over the stain, the lacquer thinner may eventually work through the finish enough to lighten the color. If the finish is polyurethane, oil-based or just plain thick, you'll probably have to head for the nearest paint-supply store and buy some stripper. The only other alternative is to color the finish with a thick, light-colored pigment and fake the grain. Trust me: stripping is a lot easier.

[David Shaw is a writer and finisher in Kelly Corners, N.Y.]

### A cure for smelly furniture

*Is there any way to remove a foul smell from furniture? We have a 150-year-old chest, and the drawers smell so bad (we think from mothballs) that we can't put anything in them.*

—S.D. Takle, Fridley, Minn.

**R. Bruce Hoadley replies:** Since you don't know exactly what caused the odor, you may have to experiment a bit. First, you should sprinkle ordinary baking soda (bicarbonate of soda) liberally inside the chest, especially on the drawer bottoms. Leave the soda there for a week or more before vacuuming it thoroughly. If the first treatment seems to reduce the odor, repeat the process. I've also heard that ground coffee is as effective as baking soda in removing odors.

If the odors are due to cats, mice or another animal, you might try washing the wood with a weak solution of neutrolem alpha—available from drugstores, vets and pet-supply stores.

[R. Bruce Hoadley is professor of wood science at the University of Massachusetts at Amherst.]

### Furniture panels keep cracking

*I'm trying to repair an antique English chest. The top and side panels have large cracks along the grain, and the cracks are getting worse. What do you recommend for a repair/restoration method? I believe the wood will continue to crack and have advised the owner just to consider the cracks part of the piece's character.* —Ken Hardin, Arlington, Tex.

**Bob Flexner replies:** Whenever furniture is subjected to a change in environmental moisture, as in being moved from a damp climate to a dry climate, the wood will shrink across the grain to adjust to the lower humidity. Though wood may warp when subjected to these changes, it doesn't usually split unless

# Introducing The Multi-Router™

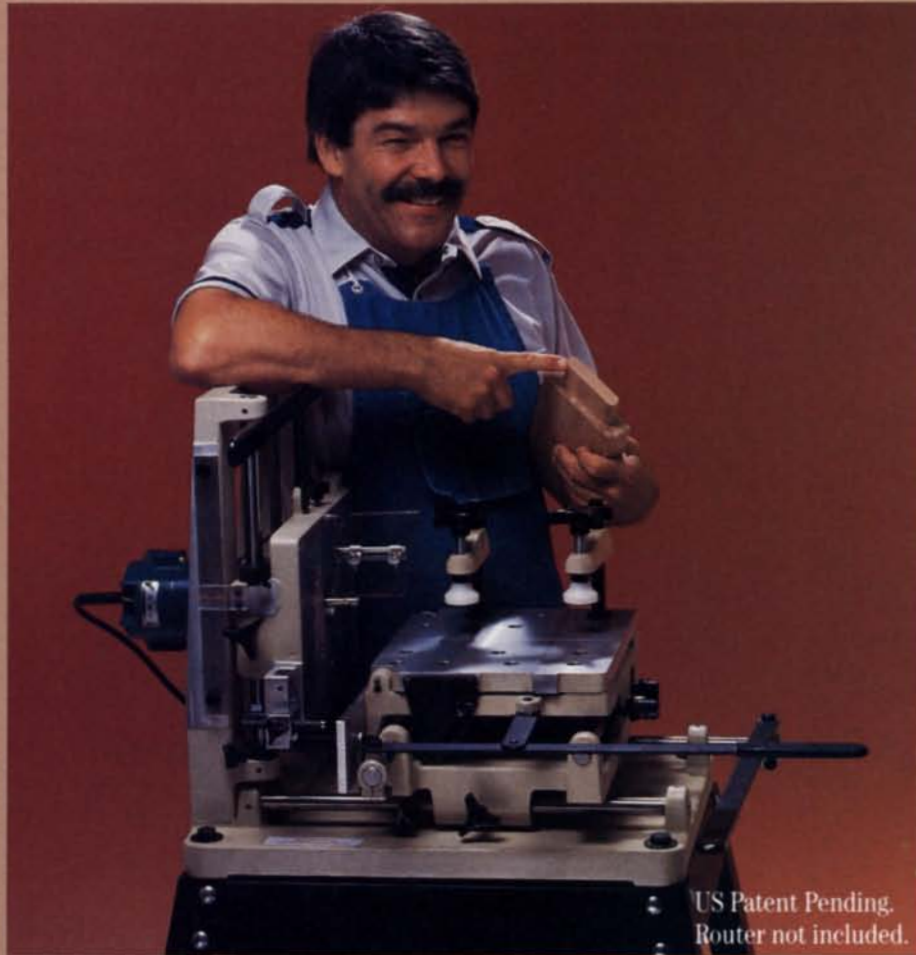

US Patent Pending.  
Router not included.



Here are some of the joints which can be produced using The Multi-Router™.

- Mortise & Tenon
- Compound Angle Tenon
- Dovetail
- Box Joint
- Sliding Dovetail

- Mitre Joint with Floating Stub Tenon
- Round Tenon
- Double Mortise & Tenon
- Decorative Joints

*Call or write for free brochure and price list. Dealer inquiries invited.*

**YOU HAVE TO SEE IT TO BELIEVE IT!** The only way to really appreciate The Multi-Router™ is to see it in action! For a deposit of \$20.00, we will send you a video tape that demonstrates the capabilities of this woodworking wonder. Return the tape and your money will be quickly refunded—even if you don't purchase The Multi-Router™!

JDS COMPANY Suite 200 800 Dutch Square Blvd. Columbia, SC 29210  
**1-803-798-1600**

A new, precision-built woodworking machine designed for the accurate production of wood joints.



Machine & Stand

This unique system of templates and a ball bearing-tipped stylus enable the woodworker to quickly create joints that are right *every* time! The Multi-Router™ is one of the most innovative machines available today. The Multi-Router™ is constructed of heavy cast aluminum. It operates on three axes and the work table tilts a full 45°. Thomson linear bearings and hardened steel rods assure safe, smooth movement. Air Power Clamps are available as original equipment or as an accessory system. Air clamps are valuable time savers.



Power Clamping System

**The  
Multi-Router™**  
**\$1295.**

plus shipping



it's secured to a frame that prevents it from shrinking freely. Frame-and-panel construction is designed to allow for shrinkage by permitting the panel to float inside the grooves in the frame. Chances are, your split panels are glued or frozen into the groove, which would cause them to split when they shrink. The proper repair is to remove the nails or glue immobilizing the panels and, if possible, glue them back together before reinstalling them to float in their frames.

The top repair will probably be more complicated. If the piece is still functional and especially rare or valuable, the owner should try to live with the crack. But the cause of the problem is surely the same—the top is splitting because it is tied to a frame. If it is held down with screws or nails, remove them, glue the splits back together and reattach the top with some system that allows it to float. I'd suggest screws in the front, and brackets with slots instead of holes in the back. If the top is glued to the frame and this is the original construction, you can release it by injecting alcohol into the glue joint with a syringe. This will crystallize the hide glue that would have been used on such an old piece and allow the top to be removed. Then, follow the above procedure to reattach the top. [Bob Flexner restores furniture in Norman, Okla. His videotape, "Repairing Furniture," is available from The Taunton Press, Box 355, 63 South Main St., Newtown, Conn. 06470]

### Bending thick stock

*I recently tried to bend nine feet of 1½-in. by 3½-in. Spanish cedar on a frame with a 49-in. radius. I left the stock in a steamer for seven hours before unsuccessfully trying to bend the wood with two helpers and many bar clamps. The next day, I hooked the steamer to a steam-cleaning machine generating pressurized steam. The only thing I got was three days of harassment from the two flunkies helping me. Why won't it bend?*

—Chuck Leonard, Thibodaux, La.

**William Keyser replies:** My research indicates your Spanish cedar has "moderately good steambending properties." Much of your problem arises from the fact that you're trying to bend 3½-in. stock, and that takes tremendous force—even with stock having the best bending properties. I suggest that you try bending the wood in three pieces, then laminate them together after bending. Bend the inner piece first and allow it to cool and dry. Bend the next layer over the first, with both pieces on the bending form. After that bend has set, repeat with the third layer. After this composite has completely set, remove the three pieces from the form, spread the piece with your favorite waterproof glue (I suggest the West System—Wood Epoxy Saturation Technique—developed by Gougeon Brothers, 7066 Martin St., Bay City, Mich. 48706) and clamp the pieces back on the form. When the glue has cured, proceed with machining the cross-section details.

[William Keyser teaches design and woodworking at the Rochester, N.Y., Institute of Technology.]

### Oil finish for red oak

*I've experimented with many different oil and oil/varnish finishes on red oak, but haven't found one I like. The oil always seeps back out of the porous sections of the wood, which creates an uneven finish. Any suggestions?*

—Kent Korgenski, Salt Lake City, Utah

**Otto Heuer replies:** You should be able to get good results with any oil finish. The one advantage of these finishes is ease of application, but you can only get a good-to-excellent finish by working hard to prepare the surfaces before applying the finish. Scrape the surface to remove any trace of machine marks, then sand with a cork sanding block and 120-grit sandpaper. Always sand in the direction of the grain. Continue the sanding with finer and finer grades until you have a very smooth surface

with 220-grit. Naturally, it's important to remove all the sanding dust. I find vacuuming to be the best method.

Next, dip a rag in water and wring it out so it's damp, not wet, and wipe the wood surface. This will raise the wood grain. After the surface has dried thoroughly, sand again with 220-grit paper. Some people skip the wetting step, saying the first coat of oil will also raise the grain, but I think surfaces treated with water dry faster and are easier to sand.

After cleaning the surface thoroughly, apply a thin coat of finish with a rag or brush. I'd recommend thinning the oil 50/50 with mineral spirits or, better yet, turpentine. Let the first thin coat dry until tacky, then wipe off the excess. Let the finish dry 24 hours before applying a second coat, this time with undiluted oil. Some finishers use 400-grit wet/dry silicon-carbide paper to apply the second coat, but that's a matter of individual preference. The important thing to remember is that the finish must be applied in light coats. If you put on heavy coats, the excess will ooze out of the pores for days.

Normally only two coats are required, but you may want to apply a third after the second coat dries for a week.

[Otto Heuer is a finishing consultant.]

### Router bits for shapers

*I've been considering buying a shaper. It seems to me that the usefulness of this machine depends on the selection of cutters available. Since I always have a reasonable collection of carbide router bits, I was wondering if any shapers accept them. Wouldn't this feature make the machine much more versatile?*

—William S. MacTiernan, Schenectady, N.Y.

**Sven Hanson replies:** You can buy shapers that will run your router bits and spread the economic pain of purchasing a full range of cutters over a longer period of time. This method also allows you greater versatility in choosing patterns, and offers the flexibility of using cheap router cutters for light jobs.

Your initial investment is still going to be steep. All of the shapers I found that would accept router-bit adapters were interchangeable-spindle machines; the most economical of them (a Taiwanese-made model) was \$795. The router-arbor spindles on these machines accept ½-in.-shank router bits, but you'll have to sleeve the spindle down with special adapters to use ⅜-in. or ¼-in. bits. Two companies that offer router-adaptor spindles as an accessory/option on their shapers are Delta International Machinery Corp., (800) 438-2486, and Chang Iron, distributed by Woodworker's Supply of New Mexico, (800) 645-9292.

Bear in mind that router cutters generally are considerably smaller in diameter than shaper cutters. So, a router bit used in a shaper will run at half the speed (or less) of a full-size shaper cutter used in a shaper, or a router bit used in a router. You'll have to compensate for this reduced speed (measured in linear feet per second) by feeding the stock more slowly. The following equation will help you determine the speed of various shaper cutter and router bit combinations:

Speed (linear fps) = [(RPM ÷ 60) × (bit dia. ÷ 12)] × 3.14

[Sven Hanson, founder of the Albuquerque Woodworkers Association, builds custom furniture in Albuquerque, N. Mex.]

### Repairing a guitar bridge

*Shortly after my acoustic guitar went out of warranty, the tension on the strings pulled one corner of the bridge about ¼ in. off the deck of the guitar. How can I repair the bridge?*

—Ed Mikolajczyk, Orange, Calif.

**William Laskin replies:** Bridge lifting, especially on steel-string guitars, is not uncommon. Whether the problem was caused by string tension, a failed glue joint, a warped or shrunken guitar top that allowed the bridge to angle forward or a combination of these problems, the remedy is the same. Essentially, you reattach the bridge with a large clamp and any



## CLAYTON SPINDLE SANDER

Do your contour sanding on a oscillating sander once affordable only to pattern and furniture shops. Now a price for any shop; for information write:

**CLAYTON ENTERPRISES**  
2505 W. Dewey Rd.  
Owosso, MI 44867

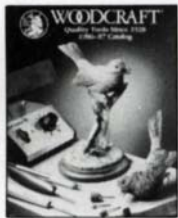

## FREE Tool Catalog

Quality Products For Woodworkers

Send today for your FREE copy of our new colorful catalog. It's fully illustrated with the finest quality tools, supplies, books, components, hardware, and much more. Satisfaction Guaranteed. Write today for your FREE catalog.



**WOODCRAFT SUPPLY CORP.**  
Dept. FW97  
41 Atlantic Avenue, Box 4000  
Woburn, Massachusetts 01888

## Thin HARDWOOD Priced Right

Clear - Kiln Dried - 2 Sides Surfaced  
3" to 10" widths - 3' to 7' lengths  
20 sq. ft. packs - Random widths and lengths

	1/4"	3/8"	1/2"	3/4"
Red Oak	\$32	\$36	\$40	\$55
Pecan	\$28	\$30	\$32	-
Walnut	\$36	\$44	\$48	\$60
Cherry	\$36	\$44	\$48	\$60
Hard Maple	\$32	\$38	\$42	\$48
Basswood	\$30	\$36	\$40	\$45
Poplar	\$29	\$30	\$34	\$38
Honduras Mahogany	\$39	\$50	\$55	\$66

Price includes UPS delivery in Continental U.S.A.  
To order, circle dollar amount above  
Send with check or money order to:

**HARDWOODS OF ILLINOIS**  
R.R. 4 - Box 618 • Mt. Vernon, IL 62864

## Wood-Mizer

**NEW** The World's Largest Mfg. of Quality Portable Bandsaw Mills  
Now with Hydraulic Log Handling

- One Man Loads, Turns, Clamps
- Capacities up to 32" Dia. X 33' Long
- Safe - Precise - Efficient
- More Lumber per Log

FIVE MODELS AVAILABLE

BUY DIRECT - 3 FACTORY SALES LOCATIONS.  
For a 44-Page Catalog on Our Entire Product Line, Send \$1.00.

For the Catalog and a 50 minute 1/2" VHS Video Demonstration Tape of our Product Line, Send \$10.00 to:

Wood-Mizer®, Dept. Z23  
8180W. 10th St., Indpls., IN 46214 - (317) 271-1542

50 MINUTE VIDEO

## HONING GUIDE WITH MICRO-BEVEL ACCURACY

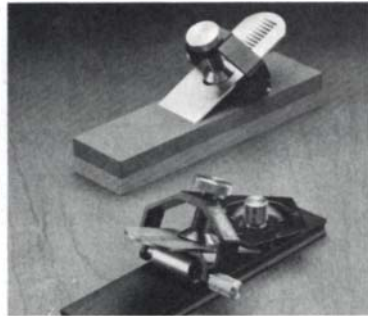

Produce a sharp cutting edge quickly, easily and accurately. Hone a micro-bevel with a turn of the setting knob. The Veritas honing guide and angle jig combination will even tackle the difficult job of sharpening skew blades. For plane, chisel and spokeshave blades.

**05M02.10W** Honing Guide and Angle Jig  
\$25.95. Add \$1.75 for shipping. N.Y. residents include tax.

Send check or money order to:

**Veritas®** Dept. 100  
12 River Street, Ogdensburg, N.Y. 13669

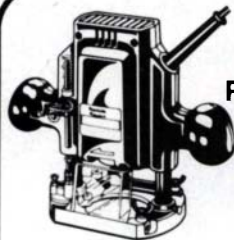

## MAKITA

Model 3620 1 1/4 HP  
Plunge Router

**\$99.95** plus shipping  
(List Price \$166)

7.8 amps. 24,000 rpm.  
Uses 1/4" router bits.

## MAKITA 3 HP Plunge Routers

14 amps. 23,000 rpm. Use 1/4", 3/8" or 1/2" bits.

Either Model

3612B Square Base **\$199.95** plus shipping  
3612BR Round Base (List Price \$338)

## MAKITA

BO4550 Dustless Finishing Sander

1.6 amps. 14,000 opm.  
Uses 1/4 sheet sandpaper.

OUR SALE PRICE **\$49.95** (List \$92)  
Less Makita mail-in Rebate = **5.00**  
Your cost after Rebate **\$44.95** plus shipping

Mastercard/Visa users  
ORDER TOLL FREE  
(800) 241-6748  
(Orders only)

Shipping. On orders up to \$60, add \$3 shipping. Over \$60, add \$6 shipping. Offers valid thru 10-31-87.

highland hardware

1045 N. Highland Avenue, NE  
Atlanta, GA 30306 (404) 872-4466

## TWS MACHINERY

### 3/4" SPINDLE WOOD SHAPER

20x18 table size, under nut 3 1/2", 2 speeds, 6500 and 9000 RPM, with 2 h.p. Baldor motor, fwd/rev, accept cutter to 6"; 3 inserts, 3/8", 5/8", 6/8"

**SPECIAL: US \$499.00**

### TABLE SAW

Outstanding performance, 10" cabinet super precision table saw, 3 hp, 1 phase with mag. switch, 70" long extension, motor cover and dust hood included

**SPECIAL: \$995.00**



### EDGE SANDER

ES-6108, Belt 6"x108", 3600 FPM, 1 1/2 hp Baldor motor with mag. switch overload, adjustable table and auto belt tracking

**SPECIAL: \$995.00**

### BUFFER/SANDER B/S 906

6"x9" pneumatic drum sander, 6"x6" buffer, Baldor 3/4 hp, 115/230 volt

**SPECIAL: \$499.00**



### 15"x6" PLANER

Cutting depth 3/16" auto feed, 3 knife cutter, 3 hp, 230V, shaving hood and stand incl.

**SPECIAL: \$895.00**

### BALDOR 3 H.P.

### RESAW WOOD CUTTING

RS-20 1/2"x2" blade, cap. 12 1/2"x20" with rip fence and miter gauge, safety brake, 3 hp, 230V, 1 phase.

**SPECIAL: \$1895**

### BALDOR 3 H.P.

### 8' STROKE SANDER

3 h.p. Baldor motor, 1 phase with 1/2 hp table lifting motor

**SPECIAL \$2595**

### CARBIDE TIPPED SHAPER CUTTERS

**SPECIAL: Industrial Quality Cabinet Sets**



19-921S  
**\$179.00**

19-922S  
**\$199.00**

19-940S  
**\$149.00**

concave stile and rail set

### RAISED PANELS 6"

32-987  
32-985  
32-986  
32-984

**SPECIAL: \$69.95**

## TWS MACHINERY

All price F.O.B. Seattle, Washington  
Send \$3.00 for catalogue. Refundable with purchase  
P.O. Box 55545 Seattle, Washington, 98155

**1-800-663-1644**

Call toll free USA or Canada

good resin glue, such as the aliphatic or yellow glues.

I'd recommend you first remove the bridge from the guitar using one of three possible methods. First, tune the guitar up to tension and allow a few weeks for the strings' pull to lift the bridge a bit more. As the bridge lifts, it might be easier to slide a thin flexible tool, such as a 1-in. paint scraper, into the gap to pry the bridge off. Prod gently, working a little under one edge of the bridge, then repeating the maneuver under the opposite edge. Mask off the top around the bridge with tape to prevent scratching. Your goal is to shear off the bridge without tearing any wood from the bridge or the top.

If the string tension doesn't lift the bridge, your second option is to go through the prying operation described above using only the present gap in the gluejoint as an entry point for your scraper. Your third choice is to respond to the natural fear of accidentally damaging the guitar and do none of the above. Take the instrument to your local instrument repair shop instead.

If you decide to go ahead and remove the bridge yourself, the next step is to clean the dried glue from both the bottom of the bridge and the top. Then, fit the bridge's underside to mate with the top, either flat or slightly convex if the top curves. Finally, I'd reglue the bridge by clamping it to the top between a wooden support block on the underside of the top and a clamping jig on the bridge. The support block and jig are necessary to spread the gluing pressure. The block going inside the guitar will have to be slotted to avoid the braces and allow it to contact the bridge plate (if there is one) or the top itself. Secure it in place with masking tape. I'd leave the whole thing clamped overnight to let the glue cure.

It might also be possible to reglue only the portion of the bridge that's lifted. To do this, work glue into the opening, then

clamp the bridge between support blocks as described above and hope for the best. The problem here is that you will probably only be regluing the old glue to itself. Without cleaned wood surfaces, adhesion will most likely be short-lived.

[Grit Laskin builds custom guitars in Toronto, Ont., Canada.]

### Finishing both sides of drawers

*One of the first finishing rules I learned was to apply the same finish to both sides of a board—to prevent warping and uneven moisture movement. But Tage Frid's article on drawers (FWW #45) recommends using no finish other than paraffin on the outside of drawer sides or inside of carcasses. Does the paraffin balance the finish on the other side?*

—Steve McGee, Seattle, Wash.

**Tage Frid replies:** If drawers are finished on the outside and the cabinet is finished on the inside, the finish might gum up and glue the drawer to the carcass. The paraffin avoids this problem and also provides an adequate finish for protecting the wood, since the drawers are usually closed and very little air gets inside. If you look at old furniture, you'll notice that the inner sides of the cabinet were left unfinished—as, in many cases, were drawer interiors. Because the case sides are rigidly joined, warpage is not usually a problem. With a large tabletop, however, I'd still finish both sides. A top can't be restrained the way a carcass side is, so it's liable to warp. [Tage Frid is professor emeritus at R.I. School of Design.]

*Send queries, comments and sources of supply to Q&A, Fine Woodworking, Box 355, Newtown, Conn. 06470. We attempt to answer all questions but, due to the great number of requests received, the process can take several months.*

# CLOCKBUILDING SUPPLIES and more...

**W**hether you're a beginner or master craftsman, Mason & Sullivan's unique skill level approach offers you exactly as much of a challenge as you want.

At Mason & Sullivan we've built a foundation of product based on excellence of design and craftsmanship. We have expanded on that base with new reproduction designs, customer service before and after the purchase, and a guarantee that's the best in the industry. We back up what we sell and we have the resources to follow through on that promise.

#### DOUBLE STEEPLE CLOCK

The design of the double steeple (a.k.a. "steeple-on-steeple," "double-decker steeple" or "sharp Gothic-on-frame") was in response to the introduction of the spring driven movement popularized in America in the 1840's. Elias Ingraham is attributed with the original design concept and the clock is considered by some to be the most popular clock ever produced in the United States.



HARDWARE



GLASS



MUSIC MOVEMENTS

Send \$2 to receive a one year subscription to our 56-page clock building supply catalog. Includes clock kits, dials, movements, weather instruments, hardware, tools, books and accessories.

**Mason & Sullivan**

Dept. 2154, W. Yarmouth  
Cape Cod, Massachusetts 02673



# The Leader in Carbide Blade Technology

## LASER CUT BLADE BODIES

The extreme accuracy and consistency of Laser Technology makes it ideal for re-attaching the retina in your eye or producing nearly perfect blade bodies at Freud.

Expansion slots are necessary in a saw blade to allow for the stretching that occurs when the blade is running. Old style saw blades have large slots cut into the blades. With these slots, a "whistling" or ringing noise can be created when the blade is running. Some blade makers fill the holes with lead or copper. This can alter the tensioning of the blade and there is the danger that the plug will come out while the blade is running.



Old Style

The laser technology used by Freud eliminates the need to fill the holes, and makes the expansion slot only .003 inch wide (about the thickness of a human hair). This assures the tensioning strength, a quieter running blade and no danger of the plugs coming out while in use.

The expansion slots are positioned in relationship to the arbor and gullets to minimize blade body distortion. The combination and location is determined by the blade size and application. Most manufacturers use the same number of old style expansion slots for all blade sizes and uses.

With Freud's laser technology, all shoulders and gullets are identical in strength and shape. Arbor holes are perfectly rounded, centered, and ground.

## FREUD'S SPECIAL CARBIDE MIX

Freud produces carbide in their own factory. This assures the high quality level that cannot be obtained by saw blade manufacturers who buy carbide from outside sources.

All of Freud carbide is made from titanium and carbon using cobalt as a binder. This special mixture creates a chemical matrix that is exceptionally resistant to the chemical attack of the glues and resins found in man-made wood building materials. Specific grades of carbide are produced to fit the cutting function of each blade. This means a sharper, longer lasting blade for you. Many other manufacturers use the same purchased carbide on all blades.

The carbide is induction brazed onto Freud's laser cut blade shoulders. This process is controlled by a computer system that assures uniformity of brazing. The hand brazing used by other manufacturers can result in weakened shoulders (due to over heating) and inconsistent bonding.

The blade is finally sharpened with a 400 grit diamond wheel for a razor edge and a mirror finish. Because of the cost of such a fine grinding wheel, many other blade producers use a coarser grade of diamond wheel. This can result in shorter blade life for you.

*By comparing the Freud advantages, you will find the value and quality you want in your tools.*

# freud®

218 Feld Ave., High Point, NC 27264 • For the dealer nearest you call 1-800-334-4107 (In NC: 919-434-3171)

**Holdfasts for the Roubo workbench**—The antique workbench featured in issue #65 prompted blacksmith, machinist and woodworker Norm Peschke to let us know that he's been using hand-wrought holdfasts for years. He says that they're the sort of thing that can be forged by any competent, neighborhood blacksmith. As a guide for those who might be so inclined, Peschke offers the following hints: The steel he uses is some old 3/8-in. rod that he bought as scrap, but any mild steel or even wrought iron can be made to work. Depending on the springiness of the material, thin and flatten the neck of the holdfast so that there is a balance between the wedging action of the holdfast in its hole and the downward spring of the clamp's head against the material. Peschke's own holdfasts fit the end of his shaving horse, and serve to clamp workpieces between it and another low bench similarly equipped. They're a little smaller than the ones shown for the Roubo bench: about 15 in. long, with an 8-in. reach. If you can't find a local blacksmith interested in the job, Peschke himself will make you a holdfast for \$20. You can write him at Rt. 1, Box 160, Marshall, Ind. 47859.

**Chemical staining with lye**—Reader response to Tom Dewey's article, "Unlocking Cherry's Color," which appeared in *FWW* #61, has raised some cautions. These apply not only to using lye, but also to using any of the chemical dyes mentioned in George Frank's article in this issue.

Briefly, Dewey's method calls for using up to six tablespoons of household lye per quart of warm water. When this mixture is sponged or sprayed on cherry, it darkens the heartwood to the color it would naturally achieve with decades of aging.

The first concern is that lye might be left on the surface, thereby making the wood unsafe to use around food. Dewey himself would not use the treatment on a salad bowl, but chemical engineer W.J. Collings, of Cleveland, Ohio, wrote to explain that any lye residue would quickly react with the carbon dioxide in the air to form harmless sodium carbonate. He went on to say that, "It would be impossible to get any lye exposure from a salad bowl unless it was filled with a fresh solution."

Yet the whole story appears to be a lot more complicated, with chemical interrelationships that no chemist we've been able to find can quite explain.

After treatment and drying, the wood surface is left in an alkaline condition. Woodworkers using catalyzed lacquer on chemically dyed cherry have run into serious problems—the first coat appears to adhere, but the second coat peels.

We called Sherwin-Williams, makers of some catalyzed lacquers, to find out what was going on. John Wolfe explained that the catalyst used to harden the lacquer is an acid; applying it to an alkaline surface inhibits the hardening, producing a soft base coat. This soft undercoat doesn't have the resilience to resist the next coat's shrinking and hardening action. Wolfe suspected that the same effect would occur if alkyd ureas or conversion varnishes were used. He went on to advise that he'd apply vinyl sealer as a first coat under any subsequent finish. This turns out to be the sealer Dewey himself has been using for years, followed by nitrocellulose lacquer.

John Grew-Sheridan, of San Francisco, Calif., had a harrowing experience of another kind using the lye treatment on three cherry tables. The job was slated to cost \$4,700—with about \$1,000 worth of wood alone—and the whole thing nearly crashed when the lye went on. "You wouldn't believe the blotches, the overlap marks, the runs and drips," Grew-Sheridan exclaimed. "Despite all our efforts to apply the solution evenly, we knew we were in deep trouble when the surface dried. There was no way the customer could accept modern furniture with such uneven coloring."

Grew-Sheridan had not blindly stumbled into his dilemma; there had been a week of testing lye concentrations, application methods and compatibility with the planned finish (his tests were thorough enough to have discovered the problems with catalyzed lacquer). But chemical finishes are, by their nature, uncertain in their use, because they react with substances in the wood—and no two pieces of wood are exactly alike. Dewey makes mostly period pieces, and some variation in the patina is not objectionable. But Grew-Sheridan had to find a cure.

After Grew-Sheridan's efforts with a belt sander had complicated matters, he finally enlisted the help of Bay Area finisher Hugh Fite, who surveyed the damage and said the job would be easy enough, but would take a little time. Fite applied vinyl sealer, then numerous coats of nitrocellulose, with strategic glazing coats of toner in between to even out the color. By week's end, the tables had a deep, rich gleam, and blood pressure had returned pretty much to normal.

Two weeks ago, we got another letter, this one from Philip N. Werner, of Pavilion, N.Y.:

"I tried Dewey's method of aging cherry on two pieces I built and it produced some beautiful results. Unfortunately, though, these results were short-lived. In less than a month, both pieces, which were finished with lacquer, were covered with white streaks and blotches.

"I assumed that there was still some active lye on the surface, so I removed the finish from one piece, then applied vinegar to neutralize the remaining lye. This proved to be a disaster. The entire piece turned white, and I tried everything I could think of to bring the color back, but nothing worked. As a last resort, I tried some methylene chloride paint stripper on it, and as soon as it touched it, the color returned."

Back we went to a new round of chemists for an explanation. There was a general consensus that the wood surface might have been made more hygroscopic (water-absorbing), and that the excess water in the wood could have caused the finish to whiten. But nobody was sure whether this was due to the chemical condition of the wood or its physical condition after the lye treatment. The only agreement was that the subject was, chemically, a can of worms. Vinegar, indeed, proved to be a bleach, but this surprised everybody we talked to.

Paint chemist Erick Kasner, of North Brunswick, N.J., offered the caution that such unpredictable results aren't uncommon with chemical dyes. He confirmed the advice that vinyl sealer makes the best first coat, and went on to say that he'd use it in subsequent coats as well. "Vinyl sealer is usually pure vinyl pellets dissolved in toluene; you can add 10% to your lacquer top coats and improve moisture resistance by about 50%."

Michael Dresdner, a guitar builder in Zionhill, N.J., apprenticed in the antique-restoration trade. He said he learned about chemical treatments from the "old guys," and went on to add: "You never saw a profession where the old masters were so eager to give up all that alchemy and use stuff right off the shelf. They were all really grateful when anilines came along."

**Shop-built moisture meter update**—Rick Liftig, whose project for a shop-built moisture meter appeared in *FWW* #53 and has since been reprinted in *FWW on Wood and How to Dry It*, has come up with a summary of common problems and some substitutions for the discontinued Radio Shack parts.

Liftig wrote to warn that substitutions for part LM 308 may not work, and that well-meaning salespeople may have been leading woodworkers astray. If necessary, you can replace the part with NTE 909, or order the correct part from Digi-Key Corp., Box 677, Thief River Falls, Minn. 56701, (800) 344-4539.

The black-and-white plans featured in the reprint are a little more difficult to follow than the original color plans (in which, however, the meter polarity in figure 3 was reversed;



## Exotic Hardwoods

Ebony & others. For serious woodworkers & turners.

FREE CATALOGUE

Phone or write:

ART EISENBRAND  
4100 Spencer Street  
Torrance, CA 90503  
(213) 542-3576

**FROG'S GREAT TOOL CATALOG**

Over 100 pages of latest books and quality woodworking hand tools. Bargains galore! Send for FREE FROG CATALOG today.

**FROG TOOL CO. Ltd.**  
P.O. Box 8325 Dept. FW8  
CHICAGO, IL 60680  
Store: 700 W. Jackson  
(312) 648-1270

**SPECIAL OFFER**  
**BRANDING IRON**  
For hard and soft wood

HAND CRAFTED BY YOUR NAME HERE

**\$2600**  
Plus \$2.00 for shipping and handling  
Nebr. residents add correct sales tax  
**SATISFACTION GUARANTEED** or your money back

- Shipped in 1 week
- Solid brass head — Compact Size
- First Line: HAND CRAFTED BY — as above
- 2nd line: Your choice — 20 characters/spaces max.
- As above but with 3rd line — \$37.00 + \$2.00

ORDER TOLL FREE 1-800-826-7606 (except Nebraska)  
In Nebraska 1-402-464-0511

Brochure/Information call (402) 464-0511

Order by mail from: **NOVA TOOL CO.**  
4533 Colfax Circle, Dept. FW87  
P.O. Box 29341, Lincoln, NE 68529

VISA MasterCard

**BAND SAW BLADES**  
WELDED TO YOUR EXACT LENGTH

Complete Band Saw Blade Line Including Saw Mill Blades

We also carry:  
Scroll Saw Blades • Hand Saws  
Circular Saw Blades • Hole Saws  
Hack Saws • Sanding Belts  
Sanding Disks • Router Bits  
Files • Rasps • Scrapers

SEND \$1.00 FOR CATALOG or TO ORDER PHONE OR WRITE TO:

**BUCKEYE SAW COMPANY**  
P.O. BOX 14794  
CINCINNATI, OHIO 45250-0794  
1-800-543-8664 (Except Ohio)  
1-513-621-2159 (In Ohio)

## "A Woodworkers' Show Unlike All Others."



The Fairgrounds - Woodstock, Ontario  
Oct. 2; 10 a.m. - 9 p.m.  
Oct 3 & 4; 10 a.m. - 6 p.m.

★

Seminars by Bob Rosendahl / Jon Eakes  
Pat Godin / Michael Fortune / Jeff Parsons  
Benoi Deschenes / Stuart Roxborough  
Helen James / John Sedgewick  
Andy Poynter

★

Exhibits on Wood, Woodworking, Tools, Equipment & Crafts

★

Upper Canada Juried Woodworking Championship and the Woodworkers Hall of Fame

★

**The Woodstock Wood Show**  
P.O. Box 1272  
Woodstock, Ontario N4S 8R2  
(519) 539-7772

"An Autumn Adventure in Southern Ontario!"

## YES YOU CAN!

- make \$18.00 to \$30.00 an hour!
- work full time or part time, right at home.
- operate a CASH business where 90¢ of every dollar is CASH PROFIT!

We'll send you a FREE Lifetime Security Fact Kit — yours to keep with no obligation — that gives you the details on being your own boss with a Foley-Belsaw Full-service Saw and Tool Sharpening Shop.

YES YOU CAN have independence and make good money. But you have to WRITE NOW to get your FREE Lifetime Security Fact Kit.

Mail the coupon below.



**FREE LIFETIME SECURITY FACT KIT**

Foley-Belsaw Co.  
6301 Equitable Rd., Dept. 20520.  
Kansas City, Mo. 64120

Foley-Belsaw Co.  
6301 Equitable Rd., Dept. 20520.  
Kansas City, Mo. 64120

YES, I want to know more! Please rush my FREE Lifetime Security Fact Kit.

Name \_\_\_\_\_

Address \_\_\_\_\_

City \_\_\_\_\_ State \_\_\_\_\_ Zip \_\_\_\_\_

(Area Code) Phone \_\_\_\_\_



**ANDREOU**

10", 14", 16" TABLE SAWS

37", 25", 12" WIDE BELT SANDERS

1 1/4", 1", 1 1/4", 1/2" SHAPERS  
Options: Sliding Tables, tilting spindles.

15", 16", 20", 24" PLANERS

2HP, 2 Bag, 3HP, 3 Bag DUST COLLECTORS

6", 8", 12", 14", 16" JOINTERS

14" UP TO 36" BANSAWS

MINIMAX JOINTER/PLANER/MORTICE COMB. MACHINE

PNEUMATIC CUT-UP SAW

3, 4, 5 SIDED MOULDER

PNEUMATIC OVERARM ROUTER

8' & 10' STROKE SANDER

OSCILLATING SPINDLE SANDER

9" x 48" OPEN END BELT SANDER

6" x 89" EDGE BELT SANDER (larger models available)

UNITRONEX 24" PLANER

EDGE BANDER

Call for Prices-Many More Machines Available  
Please call or write for information.

Financing Available Send \$2.00 for catalog (refundable) 1 Year Guarantee  
**VISIT OUR SHOWROOM**

**ANDREOU INDUSTRIES, INC.**  
22 69 23rd STREET ASTORIA NEW YORK 11105  
(718) 278-9528 MC / VISA

24 HOURS 7 DAYS A WEEK

rely on figure 1). Be sure that the bands on the diodes are facing the correct way—U1 should have a dot in the upper right-hand corner (or a notch facing right); D1 and D3 should have their bands facing right; D2 should face left. The center lead of transistor Q1 should not be connected—it just acts as a resistor in the meter.

Concerning the discontinued and re-numbered parts: You can use any 0-1 milliamp meter; S1 can be any SPST (on/off) switch; and the phone jack is now listed as Radio Shack part number 274-254, but any two-conductor jack and plug will work. Take special care not to hook up any parts backwards, or you may damage other components. When you switch the meter on, the needle should swing all the way to the right pin (full scale). If you touch the electrodes with your finger, the reading should fall back to zero. Scale E is obtained by turning switch S2 to any of the unconnected positions.

**Mosaic bracelets revisited**—We've had a few questions about where to get dyed veneers to make the laminated bracelets Richard Schneider wrote about in *FWW* #61. One source is Constantine's (2050 Eastchester Rd., Bronx, N.Y. 10461), which sells variety packs of dyed-through veneers for marquetry and other work. These, combined with natural colors from Constantine's other veneer assortments, can produce stunning effects. The author, however, dyes his own veneers according to the following formula:

Use aniline dye on rotary-cut maple veneer that's 0.025 in. to 0.032 in. thick (thicker veneer is very difficult to dye all the way through; rotary-cut veneer doesn't curl up during the dyeing process). The fastest way to ensure complete penetration is to dye the veneer in a 14-qt. pressure cooker. Cut the veneer into

3½-in. by 13½-in. strips and fill the cooker no more than two-thirds full of dye and veneer. Depending on the color, it takes anywhere from half an hour to several hours at 12 to 15 psi for the dye to penetrate.

After a while, cool down the cooker until it loses pressure, open it and move the veneer around to make sure that the dye covers all the pieces. Cook a second time, then remove a piece of veneer, dry it in the oven and cut it across the grain with a sharp knife to see if total penetration has been achieved. Wet veneer will not give a valid test result. Keep the rest of the veneer in the hot dye while you perform the test—allowing it to cool will leave the sheets bent and thus difficult to laminate.

If the test is successful, wash the rest of the veneer to remove any scale and hang the pieces on a line to dry.

**Three more plate joiners**—Paul Bertorelli's article on the new Freud plate joiner (*FWW* #64) aroused the interest of W.S. Jenks & Son (1933 Montana Ave. N.E., Washington, D.C. 20002), who plan to import the Mini 3D "Vario" made by Rudolf Kaiser in Austria. The machine, which has a 600-watt AEG motor, aluminum construction and a non-slip rubber faceplate, will be introduced at \$399. For details, write Jenks at the above address, or call (800) 638-6405 or (202) 529-6020.

Two well-known tool companies, Porter-Cable and Bosch, are introducing their own plate joiners. Porter-Cable's model 555 will retail for \$270, and should be available by the time this issue reaches you. Unlike other designs on the market, the 555's motor is vertically mounted, like a pad sander. Bosch's plate joiner, model number 1607, should be available next summer and is expected to retail for about \$299. It's inevitable, of course, that both machines will be discounted by distributors. □

## U.S. SAW'S NEW WIZARD BLADE IS BETTER THAN ANY BLADE ON THE MARKET...WE GUARANTEE IT!

U.S. Saw's new Wizard blade is a sharp departure from any blade on the market today. We've rethought conventional blade design to correct common cutting flaws and to sharpen the Wizard's capabilities. Here's what's different about our new blade.

### Large Bevel Angles

The Wizard has 30° bevel angles versus 15° angles on a conventional blade tip. These larger bevel angles produce lower cutting pressures, virtually eliminating the tendency to tear out.

### Shallow Side Clearance

The Wizard's side clearance angles

are shallower than most blades, which means you cut with the whole side of the tip rather than just the top. This planing action leaves the wood with a more sanded-like finish.

### Sharper Carbide Teeth

Our new blade's carbide tips

are precision sharpened with a 600 grit diamond wheel. They'll cut soft woods,

hard woods and laminates better than any comparable blade. The Wizard is available in both alternate top bevel (soft woods) and triple chip (hard woods and laminates.)

See for yourself. Call us at

1-800-828-9000 for free sample cuts

(soft woods or hard woods) and the name of your nearest distributor. You'll like what you see. We guarantee it!

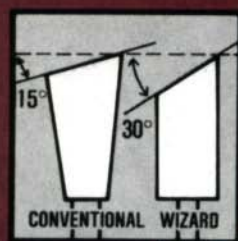

LARGE BEVEL EDGES



SHALLOW SIDE CLEARANCE



*Quality is not Expensive... It's Priceless!*

**UNITED STATES SAW CORP.**

1 Main St., P.O. Box 1  
Burt, N.Y. 14028  
1-800-828-9000  
716-778-8588

# Here's Help!

your help!

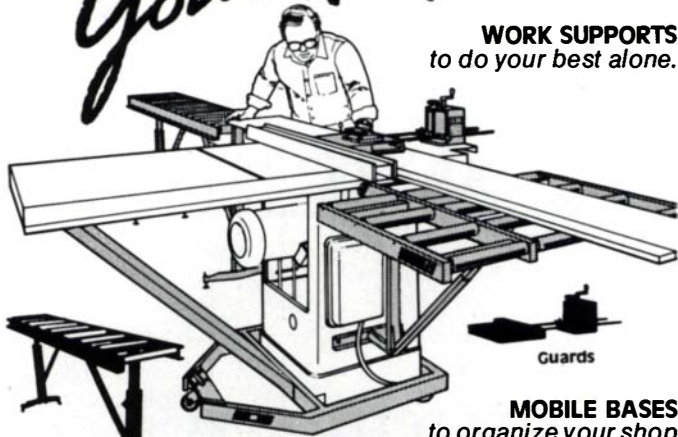

**WORK SUPPORTS**  
to do your best alone.

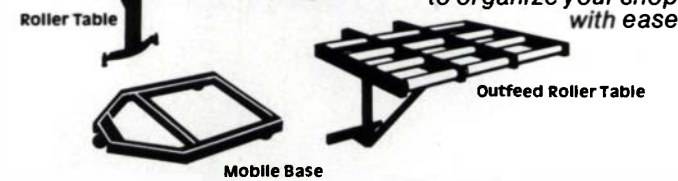

**MOBILE BASES**  
to organize your shop  
with ease



**HTC INNOVATIVE SHOP SOLUTIONS**  
HTC PRODUCTS, INC., 120 E. HUDSON, ROYAL OAK, MI 48067

800-624-2027 / 313-399-6185

**FREE CATALOG**

**SEND \$3.00 for CATALOG**  
SOME QUANTITIES MAY BE LIMITED

**THE SOURCE**  
WOODWORKERS TOOLS & HARDWARE

7305 Boudinot Drive  
Springfield, VA 22150  
703-644-5460

**FREE FREIGHT**

**ORDER TOLL FREE US 800-452-9999 VA 800-468-1778**

<p><b>HITACHI</b></p> <table border="0"> <tr><td>SV125A</td><td>4 1/2" Orb Sander</td><td>49.00</td></tr> <tr><td>PDH15</td><td>4 1/2" Disc Grind</td><td>74.00</td></tr> <tr><td>TR6</td><td>Lam Trimmer</td><td>79.00</td></tr> <tr><td>TR8</td><td>1hp Router</td><td>132.00</td></tr> <tr><td>TR12</td><td>3hp Plunge Rout</td><td>169.00</td></tr> <tr><td>CR10V</td><td>VS Recip Saw/Cs</td><td>118.00</td></tr> <tr><td>F20A</td><td>3 1/2 Hand Planer</td><td>99.00</td></tr> <tr><td>C10FB</td><td>10" Miter Saw</td><td>199.60</td></tr> <tr><td>C10FA</td><td>Delix 10" Mit. Sw</td><td>269.00</td></tr> <tr><td>C15FB</td><td>15" Miter Saw</td><td>389.00</td></tr> <tr><td>C25A</td><td>7 1/2" Circ Saw</td><td>69.00</td></tr> <tr><td>C50A</td><td>6 1/2" Batt Saw</td><td>129.00</td></tr> </table> <p><small>Flammable Gas Solvent</small></p> <table border="0"> <tr><td>A025</td><td>2 1/4" Air Drill</td><td>49.00</td></tr> <tr><td>3801A</td><td>Cutoff Tool</td><td>34.75</td></tr> <tr><td>4501</td><td>3/8" Air Dr(St)</td><td>58.00</td></tr> <tr><td>855</td><td>Orbit Jitterbug</td><td>64.00</td></tr> <tr><td>2000</td><td>Hi Speed Sander</td><td>35.00</td></tr> <tr><td>875</td><td>Qual Act Sander</td><td>76.00</td></tr> </table> <p><b>SENCO</b></p> <table border="0"> <tr><td>SFN 1</td><td>1-3/8" Fin Nailer</td><td>269.00</td></tr> <tr><td>SFN 2</td><td>2 1/2" Fin Nailer</td><td>389.00</td></tr> <tr><td>LS 2</td><td>Pin Nailer</td><td>249.00</td></tr> <tr><td>SN 4</td><td>Framing Nailer</td><td>515.00</td></tr> <tr><td>SNS-L</td><td>Narrow Crwn Stplr</td><td>249.00</td></tr> </table>	SV125A	4 1/2" Orb Sander	49.00	PDH15	4 1/2" Disc Grind	74.00	TR6	Lam Trimmer	79.00	TR8	1hp Router	132.00	TR12	3hp Plunge Rout	169.00	CR10V	VS Recip Saw/Cs	118.00	F20A	3 1/2 Hand Planer	99.00	C10FB	10" Miter Saw	199.60	C10FA	Delix 10" Mit. Sw	269.00	C15FB	15" Miter Saw	389.00	C25A	7 1/2" Circ Saw	69.00	C50A	6 1/2" Batt Saw	129.00	A025	2 1/4" Air Drill	49.00	3801A	Cutoff Tool	34.75	4501	3/8" Air Dr(St)	58.00	855	Orbit Jitterbug	64.00	2000	Hi Speed Sander	35.00	875	Qual Act Sander	76.00	SFN 1	1-3/8" Fin Nailer	269.00	SFN 2	2 1/2" Fin Nailer	389.00	LS 2	Pin Nailer	249.00	SN 4	Framing Nailer	515.00	SNS-L	Narrow Crwn Stplr	249.00	<p><b>RYOBI</b></p> <p><b>RA200</b> 8 1/4" Portable Radial Arm Saw <b>\$225-</b></p> <p><b>EXTRA BLADES \$30-</b></p> <p><b>DUST CHUTE \$19.95</b></p> <p><b>AP-10</b> 10" Portable Planer <b>\$170-</b></p> <p><b>TS-251U</b> Miter Saw with X2000 Accessory Kit <b>\$170-</b></p> <p><b>With AMANA 80 ATB BLADE \$215-</b></p> <p><b>VANDEX</b></p> <p><b>VIRUTEX 0-B1</b> JOINING MACHINE <b>\$279-</b></p> <p><b>SPLINES</b> Sm-Md-Lg 1,000 per CTM. <b>\$27.50</b></p>	<p><b>Milwaukee</b></p> <table border="0"> <tr><td>3300</td><td>Rad Drill</td><td>189.00</td></tr> <tr><td>0328-1</td><td>1 1/4" Reg. Drl 0-850rpm</td><td>112.00</td></tr> <tr><td>0375-1</td><td>3/8" Close Qtr Drl</td><td>118.00</td></tr> <tr><td>1676-1</td><td>Moie Mang w/Case</td><td>235.00</td></tr> <tr><td>5399</td><td>0 Handle Ham Dr Kt</td><td>197.00</td></tr> <tr><td>6507</td><td>Sawzall TSC w/Cs</td><td>139.00</td></tr> <tr><td>6511</td><td>2sp Sawzall w/Cs</td><td>122.00</td></tr> <tr><td>6539-1</td><td>Crldess Scrdrvr</td><td>65.00</td></tr> <tr><td>6565</td><td>7 1/2 Circ Saw</td><td>109.00</td></tr> <tr><td>6750-1</td><td>Dr Over 4.5 Amp</td><td>89.00</td></tr> </table> <p><b>Power Tools</b></p> <table border="0"> <tr><td>1604</td><td>1-3/4 hp Router</td><td>118.00</td></tr> <tr><td>1601</td><td>1hp Router</td><td>89.00</td></tr> <tr><td>9350</td><td>Overarm Router</td><td>950.00</td></tr> <tr><td>90300</td><td>3 1/2hp Router</td><td>329.00</td></tr> <tr><td>12720</td><td>3x2 1/2 Sndr w/Bg</td><td>169.00</td></tr> <tr><td>12730</td><td>4x2 1/2 Sndr w/Bg</td><td>179.00</td></tr> <tr><td>1288</td><td>Orbit Fin Sndr</td><td>99.00</td></tr> <tr><td>1581VS</td><td>Top Andl Jgsw</td><td>123.00</td></tr> <tr><td>1582VS</td><td>Barrel Grip Jgsw</td><td>117.00</td></tr> <tr><td>1652</td><td>8 1/4" Circ Saw</td><td>99.00</td></tr> <tr><td>1651</td><td>7 1/4" Circ Saw</td><td>84.00</td></tr> <tr><td>91064</td><td>3/8" Migdt Drl</td><td>98.00</td></tr> <tr><td>1160VSR</td><td>3/8" VSR Dr 111</td><td>79.00</td></tr> <tr><td>1158VSR</td><td>3/8" VSR Dr 111</td><td>55.00</td></tr> <tr><td>1920RK</td><td>3/8" Batt Dr 111</td><td>59.95</td></tr> <tr><td>1920VSRK</td><td>3/8" VS Bat Drl</td><td>89.00</td></tr> <tr><td>1921VSRK</td><td>3/8" VS Bat Drl</td><td>109.00</td></tr> <tr><td>3268</td><td>Heatgun</td><td>54.00</td></tr> <tr><td>1942</td><td>Heatgun</td><td>69.00</td></tr> <tr><td>3258</td><td>3 1/2" Hand Planer</td><td>109.00</td></tr> <tr><td>1609K</td><td>Trimmer Kit</td><td>169.00</td></tr> </table> <p><b>BLACK &amp; DECKER</b></p> <table border="0"> <tr><td>1179</td><td>3/8 VSR Drill</td><td>69.00</td></tr> <tr><td>1175</td><td>3/8 VSR Drill</td><td>49.95</td></tr> <tr><td>1180</td><td>3/8 VSR Drill</td><td>99.00</td></tr> <tr><td>2034</td><td>VS Screwgun</td><td>79.00</td></tr> <tr><td>2037</td><td>VS Screwgun</td><td>89.00</td></tr> <tr><td>3310</td><td>1 1/2hp Router</td><td>129.00</td></tr> <tr><td>3108</td><td>2sp Tiger Saw</td><td>119.00</td></tr> <tr><td>4008</td><td>Pad Sander</td><td>45.00</td></tr> <tr><td>1910</td><td>Batt Dr 111</td><td>79.00</td></tr> <tr><td>1940</td><td>Extra HD Batt Drl</td><td>95.00</td></tr> <tr><td>1950</td><td>Ext HD Batt Dr w/Cs</td><td>99.00</td></tr> <tr><td>1703</td><td>10" Miter Saw</td><td>159.00</td></tr> <tr><td>3048-9</td><td>8 1/2" Supr Swcat</td><td>159.00</td></tr> <tr><td>3027-9</td><td>7 1/2" Bldrs Swcat</td><td>79.00</td></tr> <tr><td>3034</td><td>Bldrs Swcat</td><td>119.00</td></tr> </table>	3300	Rad Drill	189.00	0328-1	1 1/4" Reg. Drl 0-850rpm	112.00	0375-1	3/8" Close Qtr Drl	118.00	1676-1	Moie Mang w/Case	235.00	5399	0 Handle Ham Dr Kt	197.00	6507	Sawzall TSC w/Cs	139.00	6511	2sp Sawzall w/Cs	122.00	6539-1	Crldess Scrdrvr	65.00	6565	7 1/2 Circ Saw	109.00	6750-1	Dr Over 4.5 Amp	89.00	1604	1-3/4 hp Router	118.00	1601	1hp Router	89.00	9350	Overarm Router	950.00	90300	3 1/2hp Router	329.00	12720	3x2 1/2 Sndr w/Bg	169.00	12730	4x2 1/2 Sndr w/Bg	179.00	1288	Orbit Fin Sndr	99.00	1581VS	Top Andl Jgsw	123.00	1582VS	Barrel Grip Jgsw	117.00	1652	8 1/4" Circ Saw	99.00	1651	7 1/4" Circ Saw	84.00	91064	3/8" Migdt Drl	98.00	1160VSR	3/8" VSR Dr 111	79.00	1158VSR	3/8" VSR Dr 111	55.00	1920RK	3/8" Batt Dr 111	59.95	1920VSRK	3/8" VS Bat Drl	89.00	1921VSRK	3/8" VS Bat Drl	109.00	3268	Heatgun	54.00	1942	Heatgun	69.00	3258	3 1/2" Hand Planer	109.00	1609K	Trimmer Kit	169.00	1179	3/8 VSR Drill	69.00	1175	3/8 VSR Drill	49.95	1180	3/8 VSR Drill	99.00	2034	VS Screwgun	79.00	2037	VS Screwgun	89.00	3310	1 1/2hp Router	129.00	3108	2sp Tiger Saw	119.00	4008	Pad Sander	45.00	1910	Batt Dr 111	79.00	1940	Extra HD Batt Drl	95.00	1950	Ext HD Batt Dr w/Cs	99.00	1703	10" Miter Saw	159.00	3048-9	8 1/2" Supr Swcat	159.00	3027-9	7 1/2" Bldrs Swcat	79.00	3034	Bldrs Swcat	119.00
SV125A	4 1/2" Orb Sander	49.00																																																																																																																																																																																																															
PDH15	4 1/2" Disc Grind	74.00																																																																																																																																																																																																															
TR6	Lam Trimmer	79.00																																																																																																																																																																																																															
TR8	1hp Router	132.00																																																																																																																																																																																																															
TR12	3hp Plunge Rout	169.00																																																																																																																																																																																																															
CR10V	VS Recip Saw/Cs	118.00																																																																																																																																																																																																															
F20A	3 1/2 Hand Planer	99.00																																																																																																																																																																																																															
C10FB	10" Miter Saw	199.60																																																																																																																																																																																																															
C10FA	Delix 10" Mit. Sw	269.00																																																																																																																																																																																																															
C15FB	15" Miter Saw	389.00																																																																																																																																																																																																															
C25A	7 1/2" Circ Saw	69.00																																																																																																																																																																																																															
C50A	6 1/2" Batt Saw	129.00																																																																																																																																																																																																															
A025	2 1/4" Air Drill	49.00																																																																																																																																																																																																															
3801A	Cutoff Tool	34.75																																																																																																																																																																																																															
4501	3/8" Air Dr(St)	58.00																																																																																																																																																																																																															
855	Orbit Jitterbug	64.00																																																																																																																																																																																																															
2000	Hi Speed Sander	35.00																																																																																																																																																																																																															
875	Qual Act Sander	76.00																																																																																																																																																																																																															
SFN 1	1-3/8" Fin Nailer	269.00																																																																																																																																																																																																															
SFN 2	2 1/2" Fin Nailer	389.00																																																																																																																																																																																																															
LS 2	Pin Nailer	249.00																																																																																																																																																																																																															
SN 4	Framing Nailer	515.00																																																																																																																																																																																																															
SNS-L	Narrow Crwn Stplr	249.00																																																																																																																																																																																																															
3300	Rad Drill	189.00																																																																																																																																																																																																															
0328-1	1 1/4" Reg. Drl 0-850rpm	112.00																																																																																																																																																																																																															
0375-1	3/8" Close Qtr Drl	118.00																																																																																																																																																																																																															
1676-1	Moie Mang w/Case	235.00																																																																																																																																																																																																															
5399	0 Handle Ham Dr Kt	197.00																																																																																																																																																																																																															
6507	Sawzall TSC w/Cs	139.00																																																																																																																																																																																																															
6511	2sp Sawzall w/Cs	122.00																																																																																																																																																																																																															
6539-1	Crldess Scrdrvr	65.00																																																																																																																																																																																																															
6565	7 1/2 Circ Saw	109.00																																																																																																																																																																																																															
6750-1	Dr Over 4.5 Amp	89.00																																																																																																																																																																																																															
1604	1-3/4 hp Router	118.00																																																																																																																																																																																																															
1601	1hp Router	89.00																																																																																																																																																																																																															
9350	Overarm Router	950.00																																																																																																																																																																																																															
90300	3 1/2hp Router	329.00																																																																																																																																																																																																															
12720	3x2 1/2 Sndr w/Bg	169.00																																																																																																																																																																																																															
12730	4x2 1/2 Sndr w/Bg	179.00																																																																																																																																																																																																															
1288	Orbit Fin Sndr	99.00																																																																																																																																																																																																															
1581VS	Top Andl Jgsw	123.00																																																																																																																																																																																																															
1582VS	Barrel Grip Jgsw	117.00																																																																																																																																																																																																															
1652	8 1/4" Circ Saw	99.00																																																																																																																																																																																																															
1651	7 1/4" Circ Saw	84.00																																																																																																																																																																																																															
91064	3/8" Migdt Drl	98.00																																																																																																																																																																																																															
1160VSR	3/8" VSR Dr 111	79.00																																																																																																																																																																																																															
1158VSR	3/8" VSR Dr 111	55.00																																																																																																																																																																																																															
1920RK	3/8" Batt Dr 111	59.95																																																																																																																																																																																																															
1920VSRK	3/8" VS Bat Drl	89.00																																																																																																																																																																																																															
1921VSRK	3/8" VS Bat Drl	109.00																																																																																																																																																																																																															
3268	Heatgun	54.00																																																																																																																																																																																																															
1942	Heatgun	69.00																																																																																																																																																																																																															
3258	3 1/2" Hand Planer	109.00																																																																																																																																																																																																															
1609K	Trimmer Kit	169.00																																																																																																																																																																																																															
1179	3/8 VSR Drill	69.00																																																																																																																																																																																																															
1175	3/8 VSR Drill	49.95																																																																																																																																																																																																															
1180	3/8 VSR Drill	99.00																																																																																																																																																																																																															
2034	VS Screwgun	79.00																																																																																																																																																																																																															
2037	VS Screwgun	89.00																																																																																																																																																																																																															
3310	1 1/2hp Router	129.00																																																																																																																																																																																																															
3108	2sp Tiger Saw	119.00																																																																																																																																																																																																															
4008	Pad Sander	45.00																																																																																																																																																																																																															
1910	Batt Dr 111	79.00																																																																																																																																																																																																															
1940	Extra HD Batt Drl	95.00																																																																																																																																																																																																															
1950	Ext HD Batt Dr w/Cs	99.00																																																																																																																																																																																																															
1703	10" Miter Saw	159.00																																																																																																																																																																																																															
3048-9	8 1/2" Supr Swcat	159.00																																																																																																																																																																																																															
3027-9	7 1/2" Bldrs Swcat	79.00																																																																																																																																																																																																															
3034	Bldrs Swcat	119.00																																																																																																																																																																																																															

**CALL FOR OUR PRICE - WE BEAT MOST PRICES**

## SHOWS

**OCT. 9-11, CHICAGO AREA**  
The Metro Center, Rockford, IL

**OCT. 23-25, NEW ENGLAND**  
The Big E, Springfield, MA

**OCT. 30-NOV. 1, CAROLINA**  
Charlotte Civic Center  
Charlotte, NC

**NOV. 6-8, CENTRAL NEW YORK**  
New York State Fairgrounds  
Syracuse, NY

**NOV. 13-15, PHILADELPHIA AREA**  
Hyatt Cherry Hill, Cherry Hill, NJ

**SPECIALS ON MACHINERY, TOOLS, SUPPLIES**

FREE SEMINARS

NEW SPEAKERS

WIN A WORKSHOP

SAVE \$\$\$

**ADMISSION \$5**  
**1-800-521-7623**  
**WANA, P.O. Box 706, Plymouth, NH 03264**

## THE "GREEN MACHINE"

### THE **ROSS 2000** 26" POWER SANDER

AT LAST AMERICAN QUALITY  
AT IMPORT PRICES

This machine has **quality** and **features** not found in any other machine this size, at a price **you won't believe!**

Write or call **today** for **free information** and price list.

**BETTER QUALITY THAN MACHINES COSTING TWICE AS MUCH**

**ROSS**

INDUSTRIES INC.

(417) 223-4031

For Information & Prices  
Write Ross Industries, Inc.  
P.O. Box 637, Pineville, MO 64856

Name \_\_\_\_\_

Street \_\_\_\_\_

City \_\_\_\_\_ State \_\_\_\_\_ Zip \_\_\_\_\_

Famous Ergo design works as good as it feels.

You may have never seen a chisel like this before. Or gripped one like this before. The fact is, its beautiful long handle was ergonomically designed to help make the chisel one with your hand.

Impact resistant polypropylene has a non-slip grooved surface. That means more comfort, even back to

Seven sizes, ranging from 6 mm to 32 mm.



the palm of your hand. The blade, angled low off the handle, works better, accepts more force, without sway or flexure. You get, you feel, more control all the way down to the high-grade Swedish steel cutting edge. The whole blade is hardened and can be resharpened and ground right up to the neck.

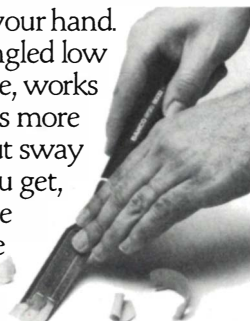

Its honed cutting edge has an angle of 25 degrees.

Imported from Sweden, these fine chisels are available through selected dealers and suppliers. Or write Bahco at the address below.

Just wait'll you get your hands on this!

**BAHCO ergo**

Bahco Tools, P.O. Box 1289, 4099 Landisville Road, Doylestown, PA 18901  
1-800-992-2426 In PA (215) 345-6212

## The Swedish chisel you'd be tempted to buy on looks alone.



*For the Serious Woodworker . . .*  
No more changing blades for rip, miter and crosscut—or for different kinds of material!

**NEW LOW PRICES**

**Why Buy 3 Blades When This ONE DOES IT ALL?**

**RIP-COMBINATION-FINE CROSSCUT**

*Made in America & maintained here in America for your benefit.*  
Keep like-new performance, use our superior micro-edge factory sharpening!

Jim Forrest, President and designer, microscoping cutting edge.

**WOODWORKER I** (For the Radial Saw) This is my *original* Woodworker blade—most desired by the American craftsman. Kerf 3/8", 60 teeth. Modified triple-chip with micro-finish grind. Carbide C4 hard and 40% stronger. Perfect, polished cuts in every direction. The one blade that does it all—for as long as you'll cut wood or plastics. Designed for use primarily on your radial saw, thin kerf gives better pull-control and less bottom splinter on both CROSSCUT and RIPPING. Available in 8", 9" and 10" diameters. Recommended to use with dampener. See below.

**WOODWORKER II** (For the Table Saw) My new **ALL PURPOSE** blade—*primarily* for your table-saw 1/4" kerf. 30 to 40 teeth (see below). Modified alternate-bevel with micro-finish grind. Exclusive Forrest 400 carbide. Designed for super-fast and super-smooth CROSSCUTTING and RIPPING in heavy, solid stock with a **smooth-as-sanded surface**. We rip 2" Red Oak with 1 HP at the shows leaving surface smoother than a jointer, then speed-miter and crosscut soft and hardwoods and PLY-VENEERS with NO BOTTOM SPLINTERING. Generally I recommend 40 teeth. However, if your ripping includes a lot of heavy 1 1/2" to 2" hardwoods, specify 30 teeth. See dampener information. **STOP CHANGING BLADES!** (wastes 2-5 minutes) Just raise for thick woods, lower for thin woods and perfect cut everything!

**AVOID cheap imports! WOODWORKER I and II eliminate scratchy saw cuts for the rest of your life!**

**MULTITOOTH DADO SET** cuts all 1/4"-13/16" flat bottom grooves WITH or CROSSGRAIN all woods and VENEER PLYS. No splintering due to unique 4T and 8T fillers and 24T outside saws. NOTHING LIKE IT IN THE U.S.A.!

**Testimonial "I finally bought one and found all your outrageous claims to be true!"**

**SPECIAL LOW PRICE SALE**

WOODWORKER I Radial Saw		WOODWORKER II Table Saw		All 1/2" holes being up to 1 1/2" \$7.50 extra SHIPPING \$3.50
WAS	NOW 50% OFF	WAS	NOW 50% OFF	
10" 60T	\$162	10" 40T	\$156	
9" 60T	156	9" 30T	135	
8" 60T	150	8" 30T	146	
		7" 30T	125	
		8" 40T	136	
		7" 30T	115	
		7 1/2" 30T	112	
		7" 30T	112	
		8" Dado 24T	13/16" set 299	

Inquire for Larger Industrial Sizes

**DAMPENER-STIFFENER One Side Aids A Smoother, Quieter Cut!!**

- Holds blade rigid and true for better cuts on your machine.
- Dampens out motor and belt vibrations from being transmitted up to the rim of the teeth causing scratchy cuts.
- Greatly reduces cutting noise.
- Helps kill saw scream-whistle from any vibrating blade surface.
- Is hardened and precision ground parallel and flat within .001" to keep your blade true.

• Can be removed instantly if need requires for deep cuts. • One against the outside leaves blade centered in slot of steel table insert. • 6" dampener on 10" blade gives 2" cutdepth. Use 5" dampener if always in 1 1/2-2" deep cuts. Remove or use 4" for 3" cuts. For 8" and 9" blades, figure dampener size accordingly.

**6" Dampener \$23 • 5" Dampener \$22 • 4" Dampener \$20** **ADD \$2 SHIP**

**WE RECOMMEND OUR FACTORY SHARPENING . . . 2-3 DAYS ON THESE AND ALL MAKES OF CARBIDE TIP SAWS. SHIP IN UPS**

10 X 40T \$14.25, 60T \$16.83

Add return UPS \$3 or 2nd Day Air \$5.

We honor Amex, Visa & MasterCard. Money Orders, Personal Checks and COD's.

To order **BY MAIL** clip ad, circle choices and enclose payment. Specify Dept. FW when ordering.

**PHONE TOLL FREE!**  
1-800-526-7852 (In NJ: 201-473-5236)

**SATISFACTION GUARANTEED OR FULL CASH REFUND**  
40 years of fine American saw making & sharpening.  
**FORREST MANUFACTURING COMPANY, INC.**  
250 Delawanna Ave., Clifton, NJ 07014



# freud® Savings in Sets



### 3 SAWBLADE SET

With the purchase of these 3 blades, you will not need to buy any other blades! You have a blade that gives you a glue line rip finish in the LM72M010. Another blade, the LU85M010, cuts with a "glass like" finish when cross cutting or mitering. The third blade, LU84M011, is your combination blade that is used when an extreme cross cut finish or production rate ripping is not needed.

Set of 3 Blades	List	Sale
LM72M010 10 x 24 Flat	\$272.77	\$159.50
LU84M011 10 x 50 Comb	70.69	49.25
LU85M010 10 x 80 ATB	81.22	49.75
	120.86	81.50



### DADO

Freud Carbide Tipped Dado Heads produce a smooth and accurate groove when used running with the grain or across the grain. The standard dado cuts a maximum width of 1 1/16 inch. All blades and chippers are carbide tipped and sharpened to give you a long cutting life. The set contains 2 outside blades of 1/8" kerf, one 1/16" chipper, two 1/8" chippers and one 1/4" chipper.

	List	Sale
DS306 6" x 18 Dado Set	\$160.12	\$125.00
DS308 8" x 18 Dado Set	196.09	135.00



### 94-100

Produce your own cabinet doors with this 5-piece router bit set at a fraction of the cost of shaper heads!! These bits are individually balanced and designed to be used with a 1/2" table mounted router. The bit profiles are: rail and stile lip, raised panel, door, and glue joint.

All bits are precision sharpened for a long cutting life.

	List	Sale
94-100 5 Piece Router Door System	\$248.00	\$199.00



### EC-900

Produce professional quality cabinet doors with this 5 piece set of cutter heads designed for your 3/4" - 1/2" spindle shaper. These heads are sharpened with a 600 grit diamond mounted wheel for an extremely sharp edge. One half inch bushings standard. The shaper head profiles are: Rail & Stile, raised panel, door lip, and glue joint.

	List	Sale
EC-900 5 piece Shaper Set	\$489.41	\$380.00



### 90-100

This 15 piece router bit set offers you a great variety of useful bits from "V" grooving and flush trimming to chamfering and dovetailing. All bits are solid carbide or carbide tipped and are ground to a razor sharp edge. Profile bits have a shear face for an extremely smooth finish. All bits have a 1/4" shank.

	List	Sale
90-100 15 pc. Router Bit Set	\$249.61	\$199.00



### FB-100

These Forstner bits will produce a flat bottom hole and bore any arc of a circle at any angle thus allowing you to make pocket holes. A special heat treated steel is used in their production to assure long lasting edges. The 16 piece set includes bits from 1/4" to 2 1/8" inclusive in 1/8" increments.

	List	Sale
FB-100 16 pc. Forstner Bit Set	\$249.00	\$199.00



### HAND SAWS

These hand saws are made in Sheffield, England out of their finest steel to give you high performance and durability. These high quality blades are flexible but will always return to true. The collection of 5 saws (rip, panel, tenon, dovetail, gent's) will meet all of your hand saw needs. They are precision balanced, thus letting the saw work with you. The lacquered English red beech handles are designed to make your precision sawing comfortable.

	List	Sale
Set of 5 Hand Saws	\$102.51	\$ 73.50
RS024 24" x 7 points	22.21	16.50
PS022 22" x 10 points	20.93	18.25
TS012 12" x 15 points	26.71	21.25
DS008 8" x 20 points	23.46	19.25
GS006 6" x 15 points	9.20	8.25



### DB-050

This 50 piece set consists of: A) 25 high speed steel bits (1/16" - 1/2" in 1/64" increments) B) 4 high speed steel bits for sheet metal (1/4, 3/16, 1/8, 3/32) C) 6 chrome vanadium steel brad point bits for use in wood (1/8, 5/32, 3/16, 1/4, 5/16, 3/8) D) 6 carbide tipped masonry bits with hex shanks (5/32, 3/16, 1/8, 1/4, 5/16, 3/8) E) 1 center punch, 1 Allen key and 6 depth stops. These bits fit any stationary or portable drill using 3/8" or larger chuck.











	List	Sale
DB-050 50 Piece Drill Bit Set	\$ 89.00	\$ 69.00



218 Feld Ave., High Point, NC 27264  
(919) 434-3171  
1570 Corporate Dr., Suite G  
Costa Mesa, CA 92626  
(714) 751-8866

**CALL US TOLL FREE!**  
For the name of your local distributor

- in California 1-800-824-0141
- in This Area 1-800-824-8045
- in This Area 1-800-334-4107

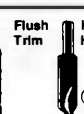
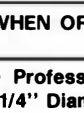
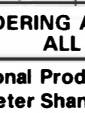
CARBIDE TIPPED ROUTER BITS PROFESSIONAL PRODUCTION QUALITY SPECIAL OFFER — SAVE 50% - 75% BELOW COST						
1000's SOLD TO READERS OF FINE WOODWORKING						
BEST CUT BEST PRICE	ITEM NO.	DESCRIPTION	RADIUS	LARGE DIAM.	CUTTING LENGTH	PRICE
	COVE					
	#01	1/4" R	1/4"	1"	1/2"	\$13.00
	#02	3/8" R	3/8"	1 1/4"	9/16"	14.00
	#03	1/2" R	1/2"	1 1/2"	5/8"	15.00
	ROUND OVER					
	#04	1/4" R	1/4"	1"	1/2"	15.00
	#05	3/8" R	3/8"	1 1/4"	5/8"	16.00
	#06	1/2" R	1/2"	1 1/2"	3/4"	19.00
	ROMAN OGEE					
	#07	5/32" R	5/32"	1 1/4"	15/32"	18.00
	#08	1/4" R	1/4"	1 1/2"	3/4"	20.00
	3/8" RABBETING					
	#11	3/8" R	Deep 3/8"	1 1/4"	1/2"	14.00
	#09	1/8" (KERF) SLOT CUTTER		1 1/4"	1/8"	14.00
	#10	1/4" (KERF) SLOT CUTTER		1 1/4"	1/4"	14.00
	#12	45° CHAMFER	45° Angle	1 1/2"	5/8"	15.00
	#15	RAISED PANEL	20° Angle	1-5/8"	1/2"	25.00
	1/4" V Groove 90°					
	#35		1/4"	1/4"	1/4"	8.00
	#36	3/8" V Groove 90°	3/8"	3/8"	3/8"	9.00
	#37	1/2" V Groove 90°	1/2"	1/2"	11.00	
	3/8" Dovetail 9°					
	#16		3/8"	3/8"	3/8"	7.50
	#17	1/2" Dovetail 14°	1/2"	1/2"	1/2"	8.50
	#18	3/4" Dovetail 14°	3/4"	7/8"	10.50	
	CORE BOX (ROUND NOSE)					
	#19	3/8" Core Box	3/16"	3/8"	3/8"	11.00
	#20	1/2" Core Box	1/4"	1/2"	11/32"	14.00
	#21	3/4" Core Box	3/8"	3/4"	5/8"	18.00
	GROOVE FORMING OGEE					
	#22	1/2" Grooving Ogee		1/2"	3/8"	16.50
	#23	3/4" Grooving Ogee		3/4"	7/16"	21.00
	#24	1/4" Straight Bit		1/4"	3/4"	7.00
	#25	5/16" Straight Bit		5/16"	1"	7.00
	#26	3/8" Straight Bit		3/8"	1"	7.00
	#27	1/2" Straight Bit		1/2"	1"	7.00
	#28	3/4" Straight Bit		3/4"	1"	10.50
	Flush Trim					
	#13	1/2" FLUSH TRIM		1/2"	1"	8.50
	Key Hole					
	#14	3/8" KEY HOLE (This Bit only HSS)	CUTS 3/8" KEY HOLE FOR FLUSH MOUNTING PICTURE FRAMES, ETC.			8.50

WHEN ORDERING ANY 3 OR MORE, DEDUCT \$1.00 EACH  
ALL PRICES POSTAGE PAID

- Professional Production Quality • 1/2" Ball Bearing Pilot
- 1/4" Diameter Shanks x 1 1/4" Long • One Piece Construction
- Two Flute Thick High Quality Tungsten Carbide Tips

To order by Master Charge or Visa Toll Free  
7 Day - 24 Hour Order Service Call  
1-800-533-9298 (In PA 1-800-346-7511 Ext. 56)  
or send check to:

MLCS, P.O. Box 53F, Rydal, PA 19046



## BLUME SUPPLY, INC.

3316 S. BLVD. • CHARLOTTE, N.C. 28209

---



**POWERMATIC**  
MODEL 66 TABLE SAW  
2 H.P., 1 PHASE with  
50" BIESEMEYER FENCE  
**only \$1399<sup>00</sup>!!**

#60 8" JOINTER  
**only \$1395<sup>00</sup>**

#26 H.D. SHAPER  
**only \$1395<sup>00</sup>**

FOB OUR WAREHOUSE  
WHILE SUPPLIES LAST!

---

**PORTER-CABLE**

351 3 x 21 BELT SANDER ..... \$126  
381 3 x 24 BELT SANDER ..... \$179  
383 4 x 24 BELT SANDER ..... \$189  
9100 1 H.P. AMER. CLASSIC ROUTER ..... \$119  
690 1 1/2 H.P. ROUTER-1/2" COLLET ..... \$129  
520 3 H.P. ROUTER-1/2" COLLET ..... \$328  
505 FINISH SANDER-1/2" PAD ..... \$119  
315-1 7/4" CIRCULAR SAW ..... \$101  
5008 DOVETAIL JIG ..... \$ 64  
7548 JIG SAW ..... \$119

330 FINISH SANDER  
**\$5300**

**FREE FREIGHT!!**

---

1920 VSRK CORDLESS  
DRILL KIT  
**ONLY \$77**

**BOSCH**

1604 1 1/4 H.P. ROUTER ..... \$139  
1608 LAMINATE TRIMMER ..... \$ 74  
1609K LAMINATE TRIMMER KIT ..... \$155  
1581VS ORBITAL JIG SAW ..... \$125  
3238VS JIG SAW ..... \$ 93  
1651 7/4" CIRCULAR SAW ..... \$ 95

**LIMITED SUPPLIES!**

---



## DELTA

34-781F 10" UNISAW 1 1/2 H.P. ..... \$1259  
34-783F 10" UNISAW 3 H.P. LVC ..... \$1390  
34-782F 10" UNISAW w/UNIFENCE 3 H.P. \$1573

**FREE — \$350 OF CARBIDE BLADES**

22-851 13" PLANER ..... **\$995**  
2 H.P. w/STAND  
40-801 18" SCROLL  
SAW — 96 FREE BLADES  
**\$675**

**FOB OUR WAREHOUSE**

**CALL STEVE BLUME • 704-523-7811**

## Wood Moisture Meters

**New:**  
Digital Moisture Meter,  
ask for introductory special



**Why waste time and money on wood that is not dry?**

Lignomat has the moisture meter of your choice: From pocket-size Mini-Ligno (only \$110) to moisture meters with analog or digital display, and accessories to monitor air and kiln drying.

Call 800-227-2105 for information and free brochure.

P.O. Box 30145 Iw  
Portland, OR 97230  
503 257-8957

**Lignomat USA Ltd** Tel: 800-227-2105

# The Sawmill

**(800) 345-3103 • NO MINIMUM ORDER**

## EXOTIC AND DOMESTIC HARDWOODS

BUBINGA	ROSEWOODS	CHERRY	WENGE	1/8", 1/4", 1/2"
EBONIES	MAHOGANIES	WALNUT	ZEBRA	4/4, 6/4, 8/4
PADAUK	KINGWOOD	CAPOTE	BOCOTE	Surfaced
SHEDUA	ZIRICOTE	MORADO	& MORE	or Rough

**CUSTOM CUTTING, RESAWING, & ABRASIVE PLANING**

WHOLESALE & RETAIL INQUIRIES WELCOME

ASK FOR: "TELEWOODS" PA RESIDENTS CALL (215) 759-2837

A DIVISION OF THE MARTIN GUITAR COMPANY, NAZARETH, PA 18064



# Good News!



## DML's new adjustable dado

Now, with DML's new Challenger A.D. 8000 adjustable dado, you can say "good-bye!" to the hassle of pulling the blade to change the cut. With the A.D. 8000, you dial the change with the blade on the machine.

## Carbide tipped twin blades

Challenger A.D. 8000 cuts better because of its V-blade design — two blades that sit side-by-side at one edge and apart at the other. Joined at the center by a dial that allows easy adjustment to any width between 1/4" and 3/16". Perfectly balanced. To cut quietly. And to shear away wood like a trim saw, for a smooth finish. Each blade is 8" in diameter: has a 5/8" bore; and has 24 teeth tipped with premium carbide.

## A genuine mahogany box

DML's new Challenger A.D. 8000 blade comes in a mahogany case. With a sliding Plexiglas door. You'd expect nothing less from DML — the premier supplier of tooling to the woodworking industry for over 50 years.

**1-800-233-7297 (SAWS)**

DML, Inc.  
1350 S. 15th Street  
Louisville, KY 40210

**DML**  
America's quality tool maker

## ANTIQUE & USED TOOLS

Quality, older hand tools for collectors and woodworkers. Illustrated lists published 5 times a year.

SUBSCRIPTION > \$5.00  
CURRENT LIST > \$1.25

**BOB KAUNE**

specializing in



buy and sell

511 W. 11th • Port Angeles, WA 98362  
(206) 452-2292

## Delmhorst Model G-30 Wood Moisture Detector

- "One-step" operation • Single four function switch • Temperature stable circuit
- 6-30% range moisture content in wood
- Use with any Delmhorst electrode.

Delmhorst - the name for reliable experience and outstanding service!



Call today toll free  
800-222-0638  
201-334-2557 (NJ)



**DELMHORST**  
Instrument Company  
P.O. Box 220, Dept. 908  
Boonton, NJ 07005

## LEASE

### Your Major Woodworking Machinery Needs

We lease Sunhill, Minimax, SCMI, JET, to name a few.

- \* no down payment
- \* low monthly payments
- \* short or long term
- \* could give you some tax advantages
- \* for more information on a lease for you, please phone or write:

### LYLE'S SHARPENING & SUPPLY COMPANY

1600 A East 4th Street  
Marshfield, WI 54449

In WI call 1-800-472-5680  
Outside WI call 1-800-624-5395

**TOOLMARK**

We offer a complete line of wood lathe accessories including:

SAFETY SHIELDS  
SPINDLE DUPLICATORS  
DUPLICATOR SYSTEMS  
BOWL TURNERS  
STEADY RESTS  
U-TOOL WOODSHAWERS  
UNI-CENTER SYSTEMS

Fortree literature and price list call or write

TOOLMARK CO.  
6840 SHINGLE CREEK PARKWAY  
MINNEAPOLIS, MINNESOTA 55430  
612-561-4210

We offer the best accessories at a good price.



# NOW RING MASTER™ attaches to your:

**NEW!** SHOPSMITH MARK V®  
MODEL 2



Create Any Hollow Cylindrical Shape up to 12" dia. Cut flat wood into straight or angle rings, stack rings, glue, sand, & finish. All on your Ring Master.

**\$199**

CRAFTSMAN® 12" LATHE

**\$199**

ORIGINAL RINGMASTER™  
WITH MOTOR

**\$399**

**CALL** 1-800-854-9815  
**FOR FREE BROCHURE.**

**EASY, FUN  
and  
PROFITABLE  
to  
operate!**

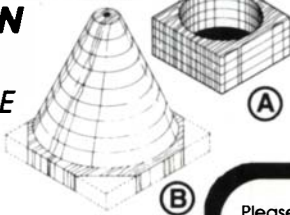

**Project A**  
Using one board foot of wood, a lathe project enclosed 89.06 cubic inches. All enclosed area was wasted wood.

**Project B**  
Using a Ring Master the same amount of wood enclosed 611 cubic inches, with virtually no waste.

**ORDER NOW!**

RING MASTER, INC.  
DEPT. B  
P.O. BOX 8527A  
ORLANDO, FL 32856  
IN FLORIDA CALL (305) 859-2664

Please send me complete facts about the ALL NEW Ring Master.

Name \_\_\_\_\_

Address \_\_\_\_\_

City \_\_\_\_\_ State \_\_\_\_\_ Zip \_\_\_\_\_

Ring Master DEALERS wanted in all areas.

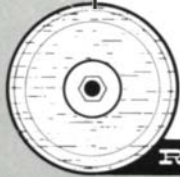

**RING MASTER**

Write or Call  
For Our  
Expanded Catalog

## Cascade Precision Tool Co. Box 848, Mercer Island, WA 98040

PREMIUM QUALITY CARBIDE TIPPED ROUTER BITS AND SHAPER CUTTERS  
Custom Work A Specialty • Send A Profile For A Quotation • Expert Sharpening Service Available

Two Great Shapers at a Sensational Price!  
CAS 15 Wood Shaper/Router Table  
\$395 For A Limited Time Only  
(Plus \$50 Freight)

- Interchangeable 1/2" and 3/4" Spindles
- Collets For 1/2" and 1/4" router bits
- 1-1/2 HP UL motor
- Two spring steel hold down clamps
- 1.2" Vertical spindle travel
- 5" and 3" Inserts in cast iron table
- Reversing switch
- Mitre included

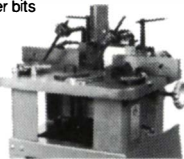

**CMP-2L**  
**\$1095 (plus \$95 Freight)**

- 3 HP
- 2 speed - 7,500/10,000 RPM
- Reversible
- 1", 3/4", and 1/2" spindles included



- Collet for 1/2" and 1/4" shank router bits included
- 4" Vertical spindle travel
- 23-5/8" x 17-3/4" fixed ground cast iron table with dovetailed mitre
- fixed table provides holddown clamps for both side and top control of material
- 18-1/2" x 13-5/8" sliding table includes support arm mitre and holddown clamp
- 15-3/4" sliding table movement
- Steel fence with 4-way micro adjustment
- 33-1/2" table height
- 385 lbs. net

CARBIDE TIPPED SHAPER CUTTER PANEL RAISER-

- 3 Wing, 5 Profiles, 3MM Thick Carbide (Now with 10° Upshear)
- 4 5/8" OD with 3/4" Bore (1/2" Bushing)
- 5 1/2" OD with 1 1/4" Bore (1" Bushing)

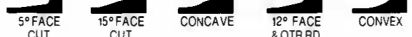

6 PC CARBIDE TIPPED CABINET SETS  
• 3mm CARBIDE • 3/4" BORE W/1/2" BUSHING  
• 13 STOCK PROFILES • \$149<sup>95</sup> To \$179<sup>95</sup>

SY 1280 To SY 1284  
3/4" to 1 1/4" - Thick Material  
3/8" Deep Tongue - \$179<sup>95</sup> ea.  
(1 1/4" Bore with 1" Bushing, \$259<sup>95</sup>)

SY 1272  
3/4" to 1 3/4" Material  
\$179<sup>95</sup>  
(1 1/4" Bore with 1" Bushing \$279<sup>95</sup>)

SY 1269  
\$149<sup>00</sup>  
1/4" Deep Tongue

1/2" SHANK CARBIDE TIPPED CABINET DOOR SET

• BIG 3-1/2" O.D. PANEL RAISER - \$59<sup>95</sup>  
(Choice of 5 Profiles Above)

• RAIL/STILE CUTTER  
• RAIL END CUTTER  
(Choice of 4 Profiles Above)

**BOTH \$119<sup>95</sup>**



ORDER COD BY PHONE OR WITH VISA/MC OR ORDER BY MAIL WITH MO, CHECK, VISA/MC  
Call or Write For New Catalog Featuring Over 300 Carbide Tipped Router Bits and Shaper Cutters  
ORDER TOLL FREE: 1-(800)-235-0272 • IN WASHINGTON STATE CALL 1-236-0272  
10 AM - 7 PM - Monday through Saturday



# tool stop

20" Planer  
By **United**



\$2971.00 - List price  
**SALE PRICE**

**\$1799** 3HP **\$1899** 5HP  
Incl. freight

**YOUR ONE stop FOR BETTER VALUE**

Locations:  
Cupertino Las Vegas Salinas  
Campbell San Jose Santa Maria  
**(800) 247-4468** Outside of Nevada  
**(702) 348-TOOL** Nevada  
3020 Mill St. Reno, NV 89502



CHARGE YOUR ORDER



MADE IN U.S.A. **NEW! POWER-FEED**  
**DRUM SANDER**  
30-DAY FREE TRIAL!

16 in. and 26 in. models  
**FREE DETAILS**

### A Finish Sander... A Thickness Sander

You can use this high-tolerance machine for light dimensioning as well as the finest finish work. Because stock is power-fed at a uniform rate, you'll achieve results impossible to duplicate with hand methods or hand-held sanders. Dimensions remain exact... no more low spots, waves or cross grain marks!

### Improves Results!

Use the Woodmaster to dimension and finish-sand cabinet pieces, resawn stock, paneling, grandfather clocks, toys, tabletops, knees, burls, crotches, and much, much more! You'll soon find it's one of the most valuable tools in your shop!

### 30-Day FREE Trial!

Send for Complete Facts! See how you can use the Woodmaster Drum Sander in your own shop for 30 days completely without risk! Easy terms.

Call Toll-Free Today 1 (800) 538-4200, Ext. 5123

**Woodmaster Tools, Dept. DS23, 2908 Oak  
Kansas City, Mo. 64108**

**YES!** Please rush my FREE Information Kit and details on your 30-Day Free Trial Guarantee.

Name \_\_\_\_\_  
Address \_\_\_\_\_  
City \_\_\_\_\_ State \_\_\_\_\_ Zip \_\_\_\_\_





## "EBAC SMALL SCALE LUMBER DRYER SYSTEMS"

Designed for the Serious Woodworker

"I can't buy better looking, better quality hardwoods than my EBAC Dryer produces."

"My EBAC Dryer has opened up a new business for me."

"For the small operator, it's the only way to go!"

- ★ 100 Board Feet to 10,000 Board Feet — Depending on Model Size.
- ★ Dehumidification PLUS Controlled Heating. YOU Have Control!
- ★ 6% to 8% Furniture Grade Wood.
- ★ Clean, Quiet & Efficient — Typical Drying Costs of 2¢ to 5¢/BF\*
- ★ Rapid Payback — Sometimes on the First Load!!

**FACT:** Hundreds of units in operation in the U.S. & Canada, Thousands in use Worldwide!!

*They're doing it! — So can YOU! — Ask Us!*

CALL or WRITE:



### Ebac Lumber Dryers

8432 E. 33rd St., Dept FW, Indianapolis, IN 46226  
800-433-9011 / 317-897-2100 / FAX 317-898-0766

\*Typical drying costs based on 7¢ per kWh electricity cost  
Larger systems are available

## UNDERSTANDING ORIGINAL HARDWARE

Queen Anne  
1710 . 1735



Graceful lines and delicate carving marked the American furniture of the transitional style that carried the name of Queen Anne. Slow to gain popularity from its inception, production continued into the 1780's, and in fact, did not start here until after Queen Anne's death in 1714. The hardware associated with the style used intricate "openwork" instead of hand-chasing for decoration. The cast post and nut mounting replaced the weaker "snipe." "Spurs," or "ears," replaced the earlier "ball" center as decoration on the bails (the part that you pull). By careful casting, the "openwork" required little finishing, and the backplate size grew as brass became a less precious metal.

Call or write for free mini-catalog, or send \$5.00 for our full 108 page catalog. We now reproduce 15 patterns of the Queen Anne pulls to the finest quality standards.

**BALL and BALL**  
463 W. Lincoln Highway  
Exton, PA 19341  
(215) 363-7330

## PORTER CABLE FALL SIZZLERS

THE FEEL OF YOUR  
WORM DRIVE!  
WITH POWER  
TO SPARE!  
AND 1/2 THE WEIGHT  
OF A WORM DRIVE!



### Model 345 SAW BOSS™ Heavy-Duty 150mm (6") Circular Saw

- Features/Benefits:**
- Cuts 2X lumber at 45° bevel in one pass
  - Left hand blade placement for best view of cutting to a line
  - Dual pick-up bag and vacuum attachment options
  - New compact size and light weight
  - Spindle lock for easy blade changes
  - Rear-mounted handle
  - Sight lines adjustable
  - Powerful 9 amp motor. All ball-and-needle bearing construction.

**Standard Equipment:** Model 345 SAW BOSS™. Thin Kerf 150mm (6") chisel tooth combination blade, 48299 blade wrench, base insert, and operating manual

LIST 154.50 **SPECIAL 97.00 ppd.**

**NEW**

If you've been waiting  
to buy a Plate Joiner  
— Congratulations,  
now you can buy the  
Best For Less.

LIST 269.95  
**SPECIAL  
168.00 ppd.**

### Model No. 555 Plate Joiner



- Easier and faster than doweling
- Unique vertical handle with trigger switch. Machine is designed specifically for plate joining, not adapted from other type of power tools
- Rotating depth adjustment
- Front fence provides easy vertical adjustment for exact placement of cut for biscuits
- Exclusive miter fence locates cutter from outside, or "show" face of joint. Permits precise matching of miter joint corners that show, even when using wood of slightly different thicknesses. The match is on the outside... any mis-match is on the inside angle of the joint. Additionally allows the use of larger biscuits in miter joints for stronger construction
- Dust ejector directs cuttings away from operator standing behind unit
- Plate Joiner, Carbide Tipped blade, and all biscuits are manufactured in USA, to the highest standards of quality for professional woodworking products

**Standard Equipment:** Model 555 Plate Joiner, wrenches, 6 tooth carbide tipped blade, steel carrying case and instruction manual

**PORTER-CABLE**



### Model No. 690 1 1/2 HP Router

Standard equipment includes 1001 base, 6902 motor, 42591 & 4300 collets, 42596 wrench, 42914 wrench and operating manual

LIST 194.00 **SPECIAL \$114.00 ppd.**



### Model No. 691 1 1/2 HP D-Handle Router

Standard equipment includes 6912 motor, 6911 base, 43000 & 42591 collets, 42596 wrench, 42914 wrench and operating manual

LIST 218.00 **SPECIAL \$128.00 ppd.**

ASK ABOUT OUR ROUTER BIT SELECTION AND SPECIAL DISCOUNT PRICING!



### PHILIPPS BROS. SUPPLY, INC.

Construction and Industrial Supplies

"IT'S OUR 60TH ANNIVERSARY YEAR"  
2525 KENSINGTON AVE. • BUFFALO, NY 14226 • 716/839-4800  
CALL TOLL FREE 1-800/544-4466 - IN N.Y.S. 1-800/238-4466

MASTERCARD

VISA

Est 1927

CHECK OR MONEY ORDER

## IF YOU VALUE YOUR FINGERS..... YOU NEED A **RIPSTRATE®**

The RIPSTRATE holds the work tight against the fence with no hands near the blade. Makes perfect, straight cuts. Wheels lock to prevent kickbacks. *Requires no adjustment for stock width or thickness.*

Over 25,000 now in use in amateur, professional, school, government, military, and corporate maintenance shops.

One year guarantee, 30 day money back trial. \$69 prepaid. Check, M.O., Visa or M.C. Free Brochure.

Write or call our toll free number: 800-421-0256.

Fisher Hill Products 1 Fisher Hill Fitzwilliam, NH 03447

Dealer inquiries invited.





# GRIZZLY'S GIANT SUMMER SALE!

SALE PRICES EXTENDED TO OCT. 20, 1987.



**MODEL G1019**  
14" BANDSAW  
Ground Table, Rip  
Fence, 3/4 HP Motor.  
Weights 200 lbs.  
Regularly \$275.00  
**SALE \$225.00**



**MODEL G1131**  
18" BANDSAW  
Ground Table, Rip  
Fence, 2 HP Motor,  
1 1/2" Blade,  
Weights 500 lbs  
Regularly \$595.00  
**SALE \$525.00**



**3 MODELS**  
G1028 1 HP/2 Bag  
**SALE \$265.00**  
G1029 2 HP/2 Bag  
**SALE \$315.00**  
G1030 3 HP/4 Bag  
**SALE \$425.00**



**MODEL G1024**  
SHAPER  
3/4 HP Motor, 1/2"  
Spindle, Weighs  
150 lbs.  
Regularly \$245.00  
**SALE \$225.00**



**MODEL G1026**  
3 HP SHAPER  
3 Spindles,  
2 speeds,  
Weights 500 lbs.  
Introductory Price  
**\$750.00**



**MODEL G1182 6" JOINTER**  
7 x 47" Precision ground bed.  
1 HP. Motor. Weighs 265 lbs.  
Regularly \$325.00  
**SALE \$295.00**



**MODEL G1018 8" JOINTER**  
8 x 65" Precision ground bed. 1 1/2  
HP Motor with magnetic switch.  
Weights 500 lbs.  
Regularly \$575.00  
**SALE \$525.00**



**MODEL G1036 GRINDER**  
Slow Speed. Large 10"x 2" stone  
turns at 60 rpm in water  
container. Small stone turns at  
3000 rpm. Excellent unit for  
sharpening chisels, knives, etc.  
Regularly \$119.50  
**SALE \$99.50 Prepaid to You!**



**MODEL G1021 15" PLANER**  
Precision ground table.  
15 x 6" Automatic drive  
capacity. 2 HP motor with  
magnetic switch. Weighs 500  
lbs. Stand optional.  
Regularly \$795.00  
**SALE \$695.00**



**MODEL G1022 10" TABLESAW**  
Precision ground cast iron table &  
wings. T-slots in table. 1 1/2 HP Motor.  
Weights 235 lbs.  
Regularly \$325.00  
**SALE \$295.00**



**MODEL G1023 10" TABLESAW**  
Precision ground cast iron table and  
wings. T-slots in table. Special fence.  
3 HP motor with magnetic switch.  
Weights 500 lbs.  
Regularly \$795.00  
**SALE \$750.00**



**MODEL G1013 SANDER**  
Combination. 1"x 42"  
belt, 8 disc. 1/2 HP motor.  
Can be used for internal  
sanding. Regularly \$110.00  
**SALE \$99.50**  
**Prepaid to You!**



**MODEL G1033 20" PLANER**  
20 x 8" Capacity. 2 Automatic  
feed speeds. 3 HP motor with  
magnetic switch.  
Weights 960 lbs.  
Introductory Price  
**\$1250.00**

We have fully stocked parts departments and qualified service depts. at both locations — buy with confidence. If you don't have our full color catalog, just call us. Many more items, low, low prices.



**EAST of the MISSISSIPPI:**

(WILLIAMSPORT BRANCH OPEN)  
SATURDAYS TILL 1 PM!

**WEST of the MISSISSIPPI:**

**GRIZZLY IMPORTS PA INC.**

2406 REACH ROAD  
WILLIAMSPORT, PA 17701  
PHONE (717) 326-3806

**GRIZZLY IMPORTS INC.**

P.O. BOX 2069  
BELLINGHAM, WA 98227  
PHONE (206) 647-0801



Unless otherwise specified all prices are FOB BELLINGHAM, WA or WILLIAMSPORT PA.

## PARALOK™ TABLE SAW FENCE SYSTEM

"Well it'll be darned! It's so simple! Why didn't I think of that?"

We at QUINTEC hear that a lot. But it's always nice to hear again.

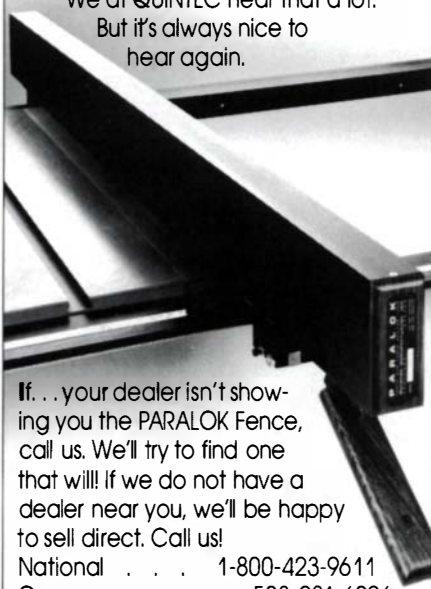

If... your dealer isn't showing you the PARALOK Fence, call us. We'll try to find one that will! If we do not have a dealer near you, we'll be happy to sell direct. Call us!

National . . . . 1-800-423-9611  
Oregon . . . . . 503-281-6096

**QUINTEC**  
MANUFACTURING INC.

5128 N.E. 42nd Portland, OR 97218

## \* SANDPAPER \*

NO GIMMICKS — GREAT PRICES

BELTS: GRITS ASSORTED SHEETS: (9 x 11) PRICE

UNLESS OTHERWISE SPECIFIED		CABINET PAPER	
1 x 30	.69 ea	3 x 24	\$.80 ea
1 x 42	.69 ea	3 x 27	.83 ea
1 x 44	.69 ea	4 x 21 1/4	.91 ea
2 1/2 x 16	.73 ea	4 x 24	.94 ea
3 x 18	.74 ea	4 x 36	1.14 ea
3 x 21	.77 ea	6 x 48	2.98 ea
3 x 23 1/4	.80 ea	2 1/4 x 80	2.47 ea

OTHER SIZES ON REQUEST FINISHING PAPER

NO LOAD PAPER		50 /pk 100 /pk	
80-A	\$ 9 /pk	\$16 /pk	
100 thru 280A	8 /pk	14 /pk	
180-A thru 400-A	\$10 /pk	\$18 /pk	

PRESSURE SENSITIVE ADHESIVE DISCS! 220 thru 600A \$13 /pk \$23 /pk

6"	\$1.06 ea	* OTHER ITEMS *	* JUMBO CLEANING STICK *
8"	1.99 ea	* WIDE BELTS	\$8.80
9"	2.46 ea	* ROLLS	
10"	3.05 ea	* FLAP WHEELS	
12"	4.45 ea	* PUMP SLEEVES	
15"	6.95 ea		

\* MINIMUM ORDER \$25.00  
\* MASTERCARD, VISA OR CHECK  
\* SATISFACTION GUARANTEED!!

SEND MAIL ORDERS TO:  
**ECON-ABRASIVES**  
P. O. BOX B865021  
PLANO, TX 75086  
NATIONAL 1-800-367-4101  
IN TEXAS (214) 377-9779  
\* TEXAS RES. ADD 6% SALES TAX  
\* SHIPPING CHARGES ADD \$4.25



A Small Tidewater Salt Box House  
"SALT SHAKER"  
Main Bldg: 26'-20" Deep, Full Cellar:  
1<sup>st</sup> Fl.: Livg/Ding Area With Fire-  
place And Grill, Kitchen,  
2<sup>nd</sup> Fl.: Bed Rm. With Fire-  
place And Bath  
Rear Wing: 16'-16", Crawl  
Space Betw. 1<sup>st</sup> Fl. Bed  
Rm. With Bath, Side  
Entry And 1/2 Bath.

PLANS \$22<sup>99</sup>



Early American Gambrel, 26'-5"-21'-4"  
"DOUBLE DUTY"  
Studio Apartment With Living-  
Sleeping Area, Kitchen And  
Bath, Over A 2-Bay Garage  
OR  
A Center Chimney, 2-Story  
Residence With 2 Bedrooms,  
2 Baths, Living Dining Area,  
Kitchen, Fireplace, Grill,  
And Woodstove

BOTH Arrangements Included  
PLANS \$18<sup>99</sup>



An Office/Garage Of Early  
American Heritage  
"HOME OFFICE"  
A Two-Car Garage 22' Deep,  
25' Front, With Inside  
Stairs To Second Floor  
Office Space, Studio,  
Work Area, Etc.

Skylights In Rear Roof  
To Upper And Lower  
Floors  
PLANS \$15<sup>99</sup>



A Flexible Early American Design  
"CARRIAGE SHED"  
4 Depths At Side: 20', 21'-4", 22'-6", & 24'  
1, 2, 3, Or More Car Spaces  
3 Door Types, Shop At Side, Etc.  
2<sup>nd</sup> Fl.: Studio, Playroom, Stor-  
age, Skylights In Rear Roof

Complete Construction  
Details For The 4 Depths  
And 4 Optional Front  
Arrangements.  
PLANS \$12<sup>99</sup>

ELI TOWNSEND & SON, INC.  
P.O. BOX 351-W  
CLINTON, CT 06413

Plans Are Repro-  
ducible And By  
Request Profit Entry:  
1 Post Paid

## DOMESTIC & FOREIGN HARDWOODS

Quality stock for  
Cabinet Work

Most all sizes from  
1" up to 4" in thickness

### HARDWOODS

ASH—BASSWOOD  
BIRCH—BUTTERNUT  
CHERRY—CHESTNUT  
EBONY—MAPLE—OAK  
POPLAR—ROSEWOOD  
TEAK—WALNUT  
Also hardwood plywoods

### SOFTWOODS

SUGAR PINE—CYPRESS  
CEDAR—SPRUCE  
DOUGLAS FIR etc.

MAURICE L. CONDON CO., INC.

248 Ferris Avenue  
White Plains, N.Y. 10603  
914-946-4111

Monday through Friday  
8 AM to 4:30 PM

## PORTABLE SAWMILLS

Cut Your Own Lumber  
The Way You  
Want It—  
Without Moving  
The Log

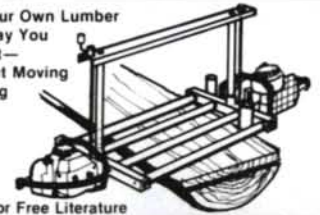

Write for Free Literature

INFORMATION HOTLINE (201) 744-6110  
**SPERBER TOOL WORKS**  
Box 1224E • W. Caldwell • N.J. • 07007

## Make Signs?

If you make or are interested in wood signs, you'll want SignCraft — the magazine for the sign artist. You'll see creative wood signs in every issue — carved, routed and sandblasted — plus how to's, pricing, technical help and more! Your satisfaction is guaranteed.

- 1 yr. (6 issues) . . . \$21
- 1 yr. Outside U.S. (U.S. funds) \$27

**SignCraft Magazine**  
P.O. Box 06031-F, Ft. Myers, FL 33906

## BEST PRICES!



Before you buy  
any 10" saw, call  
1-800-387-9789  
(toll free) and get  
best price ever on

**GENERAL**

J. Philip Humfrey  
International Inc.,  
210 Eighth St. South,  
Lewiston, N.Y. 14092

## JAPANESE HAND TOOLS

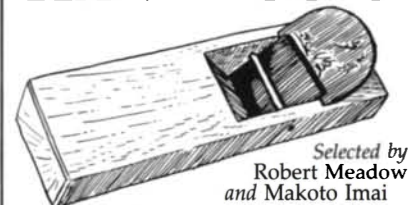

Selected by  
Robert Meadow  
and Makoto Imai  
Catalog: \$3.00 Price List: free  
Also inquire about our school and workshops  
**The Luthierie** (914) 246-5207  
2449 West Saugerties Road • Saugerties, NY 12477

"EVER-LAST" Belts from...

**INDUSTRIAL  
BRASIVES CO.**



Check your size and how many dozen. We will ship assorted grits unless otherwise specified.

- 1" x 30" ..... \$13.70/doz.
- 1" x 42" ..... \$13.75/doz.
- 1" x 44" ..... \$13.80/doz.
- 3" x 18" ..... \$14.75/doz.
- 3" x 21" ..... \$15.25/doz.
- 3" x 23 1/4" ..... \$15.70/doz.
- 3" x 24" ..... \$15.75/doz.
- 3" x 27" ..... \$16.25/doz.
- 4" x 21 3/4" ..... \$17.75/doz.
- 4" x 24" ..... \$18.25/doz.
- 4" x 36" ..... \$21.95/doz.
- 6" x 48" ..... \$27.95/1/2 doz. (3 FREE)

Other size belts on request.

**STIKY DISC, Rugged cloth with PSA backing.**

- 6" diameter .... \$1.00 each
- 8" diameter .... 1.25 each
- 9" diameter .... 1.50 each
- 12" diameter .... 2.00 each

**9" x 11" PAPER SHEETS**  
A/O Cabinet Paper

- |          |                                   |                                   |
|----------|-----------------------------------|-----------------------------------|
|          | <b>50/pk.</b>                     | <b>100/pk.</b>                    |
| 40-D...  | <input type="checkbox"/> \$17/pk. | <input type="checkbox"/> \$31/pk. |
| 50-D...  | <input type="checkbox"/> 16/pk.   | <input type="checkbox"/> 28/pk.   |
| 60-D...  | <input type="checkbox"/> 15/pk.   | <input type="checkbox"/> 26/pk.   |
| 80-D...  | <input type="checkbox"/> 14/pk.   | <input type="checkbox"/> 24/pk.   |
| 100-C... | <input type="checkbox"/> 13/pk.   | <input type="checkbox"/> 22/pk.   |
| 120-C... | <input type="checkbox"/> 13/pk.   | <input type="checkbox"/> 22/pk.   |
| 150-C... | <input type="checkbox"/> 13/pk.   | <input type="checkbox"/> 22/pk.   |

**No Load Finishing Paper**

- |          |                                   |                                   |
|----------|-----------------------------------|-----------------------------------|
|          | <b>50/pk.</b>                     | <b>100/pk.</b>                    |
| 180-A... | <input type="checkbox"/> \$11/pk. | <input type="checkbox"/> \$19/pk. |
| 220-A... | <input type="checkbox"/> 11/pk.   | <input type="checkbox"/> 19/pk.   |
| 280-A... | <input type="checkbox"/> 11/pk.   | <input type="checkbox"/> 19/pk.   |
| 320-A... | <input type="checkbox"/> 11/pk.   | <input type="checkbox"/> 19/pk.   |
| 400-A... | <input type="checkbox"/> 11/pk.   | <input type="checkbox"/> 19/pk.   |

BELT CLEANING STICK  
2" x 2" x 6" ... \$6.95

For Fast Delivery Call Toll Free  
**1-800-428-2222 (U.S.A.)**  
**1-800-222-2292 (PA only)**

**INDUSTRIAL  
BRASIVES CO.**  
644 N. 8th STREET  
READING, PA 19612

SHIPPING CHARGES - Under \$35 add \$2.50. \$35 or more add \$4.00. Over \$100, shipping free. PA residents add 6% sales tax.

- MONEY ORDER     CHECK  
 MASTER CARD     VISA    Exp. Date \_\_\_\_\_

Acct. # \_\_\_\_\_

NAME \_\_\_\_\_

STREET \_\_\_\_\_

CITY \_\_\_\_\_ STATE \_\_\_\_\_

ZIP \_\_\_\_\_ DAYTIME PHONE ( ) \_\_\_\_\_

# Building On Tradition

▲ DELTA ON SALE!

**\$1479** **\$489** **\$879** **\$499** **\$949** **\$1349**

**\$1649** **\$979** **\$178** **\$949** **\$178**

**PORTER-CABLE** **Hitachi**

**Makita** **\$159** **\$1599**

**shop-vac** **DeWALT** **LEI**

**\$159** **\$299** **\$265**

**BLACK & DECKER** **BOSTITCH** **RYOBI**

**\$115** **\$399** **\$338**

**Piranha** **JET** **Makita**

**\$115** **\$529** **\$1599**

**SAN-BLAST** **Jorgensen**

**\$60** **\$11**

**MasterCard** **VISA** **a c m e Electric**

**TOOL CRIB OF THE NORTH SINCE 1948**

★ FULL LINE DIST. ★ FREE SAME DAY SHIPPING. ★ FACTORY AUTH. SERVICE. ★ LIMITED OFFER.

**CALL TOLL FREE FOR MIKE**  
**1-800-358-3096**  
Box 1716 • GRAND FORKS, ND • 58206

# EXPERIENCE NORTHWOOD

The new leader in fine quality woodworking machinery!



NWKL36K 37" wide belt sander  
\$8495 (Good thru Oct. 1)



NW153 pin router  
\$2995



NWDS101 double spindle dowel boring machine  
\$1399



NWGL28 copy shaper  
\$8995



NW660 26" planer  
\$4495



NW4 single end tenoner  
\$3195



NW101 1 1/2" shaper  
\$995

We are a full line manufacturer/distributor and welcome inquiries for anything not listed.

Call or write for free catalog. **Free freight east of Mississippi**



Northwood Industrial Machinery  
11400 Decimal Drive  
Louisville, KY 40299  
Phone (502) 267-5504

## Queen Anne Lowboy Full-Size Professional Plan



You can build this classic piece of furniture. Plan gives construction details of cabriole legs, dove-tailed drawers and chip carving of middle drawer. Overall size: 35 1/4" wide, 20 1/4" deep and 30 1/4" high.

Plan #194 ..... \$13.75

CATALOG 200 full-size professional furniture plans — \$2.00 (catalog free with order)

FURNITURE DESIGNS, INC., Dept. KE-97  
1827 Elmdale Ave., Glenview, IL 60025  
(312) 657-7526

## NEW!

### THE IDEAL CHRISTMAS GIFT

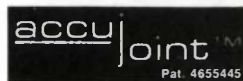

MONEY BACK GUARANTEE



Make precision finger joints on your table saw!

Just set your blade, accujoint will index your work exactly! PERFECT EVERY TIME

Only \$39.95

PLUS \$2 (in U.S.) Shipping & Handling  
Mass. residents add 5% tax

Morse Design, Inc.  
P.O. Box 195  
Boston, MA 02123

TO ORDER — INFO

CALL 1-800-222-8011  
Mass. (617) 262-8436

VISA/MC

## EDLCO

Appalachian Hardwood Specialists

21 species  
Domestic Hardwoods  
Softwoods

Kiln Dried Delivered Prices  
Catalogue \$2.00

Write Today EDLCO  
Box 5373 FW  
Asheville, N.C. 28813  
Phone (704) 255-8765

We Know Our Lumber

EDUCATIONAL LUMBER CO., INC.

## Fine English Made Hinges

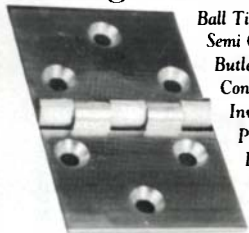

Ball Tip Loose Pin Hinges,  
Semi Concealed Hinges,  
Butler Tray Hinges,  
Continuous Hinges,  
Invisible Hinges  
Pivot Hinges,  
But Hinges,  
H-Hinges,  
and More...

64-Page resource catalog of hard-to-find cabinet hardware \$3.50

PAXTON HARDWARE

7818 Bradshaw Road, Dept. FW13, Upper Falls, MD 21156  
Quick Shipment Free Mini-Catalog

## Sleeveless DRUM SANDER

Uses regular sandpaper — no pre-made sleeves to buy!



Lifetime Guarantee

USE ON:  
Drill press, motor, lathe,  
combo-tools, radial saw, drills.

Twist of key tightens sandpaper to drum. Rubber backing insures long sandpaper wear.

1" x 3" long	\$13.95
2" x 3" long	\$15.95
2 1/2" x 3" long	\$16.95
3" x 3" long	\$17.95
1" and 2 1/4" above	\$27.95
Set of 4 above	\$56.95

3/4" x 3" long	\$14.95
2 1/2" x 4 1/2" long	\$21.95
3" x 4 1/2" long	\$23.95
2 1/2" x 6" long	\$25.95
3" x 6" long	\$27.95

Add \$2.50 per order for shipping.

AVAILABLE WITH:  
1/2" bore with 1/2" or 1/4" shaft  
1/2-20 RH thread (except 3/4" x 3")  
1/4" bore (except 3/4" x 3" and 2" x 3")

MC, Visa, Check or Money order to:  
SINGLEY SPECIALTY CO. INC.  
P.O. BOX 5087F, GREENSBORO, N.C. 27403  
CALL: (919) 852-8581

## CASINGS • BASES • CROWNS • CORNER BLOCKS VICTORIAN ELEGANCE

DOORS • GINGERBREAD • WAINSCOT



LARGEST INVENTORY  
OF VICTORIAN MOULDINGS  
& MILLWORK ANYWHERE

- Specializing in Customer Service
- Buy Direct from Mfr.
- Premium & Commercial Grades
- No Minimum Order
- Rush Orders — No Problem!
- Expert Shipping & Packaging
- Lots of Construction Ideas
- Top Quality Precision Millwork
- High Quality Full Color Catalog with over 60 photos

Send \$4 for Catalog or Phone & use your credit card  
P.O. Box 2987-FW2  
Durango, Colorado 81302  
303-259-5915





## Rustic Furniture

*Crafting with nature's free-form designs*

by Dick Burrows

Long before the turn of the century, guides and caretakers in the Adirondack region of New York State whiled away the winter hours making tables, chairs, bureaus and cupboards with a handful of nails and a few branches harvested from the woods near their homes. In the summer, their winter pastime became a cash crop when city folks with money flocked to the region and began outfitting their camps with local gear, looking for a taste of the primitive life.

The same style of rustic, twig furniture is still being made in the Adirondacks and other parts of the country today, but it's no longer restricted to camps and front porches. Now, rustic furni-

ture is a trendy design item, commanding high prices in shops from Manhattan to Los Angeles.

The whole fad mystified me. I'd seen pictures of the great Adirondack camps, but most of the twig furniture inside the impressive buildings looked heavy, rigidly upright, uncomfortable—much like the campfire stuff we kids used to knock together with hatchets to appease our scoutmaster. Serendipity might occasionally have brought a bunch of branches and twigs together in a pleasing way, but you could hardly have called it craftsmanship.

Once I began looking at some of the old pieces and talking to contemporary makers, though, I began to realize that the only



*Rustic furniture is surprisingly sophisticated, despite its backwoods origins. Barry Gregson created the flowing curves on his modern settee, left, by doweling yellow birch branches together and coping each joint to imitate a natural branch. The 19-century cupboard by Ernest Stowe, above, is equally high style, with split-branch fans and stars nailed to birch-bark sides.*

thing wrong with rustic was my ignorance of it. The early makers were as inventive and sensitive to their materials as any of today's furnituremakers. They had few tools—handsaws, knives, hammers, drawknives, chisels, braces and augers—but they used them expertly. Many had an innate sense of balance, proportion and symmetry. Some makers were carpenters, but it's unclear how they learned about furniture. Their joinery was limited to the nailed butt joint or tenon and socket, but their decorative touches included all the sophistication of high-style furniture—quarter columns, inlay, parquetry and rosettes, like those shown in the photo above. Indeed, the pieces displayed in museums and private collections make it clear that the old-timers worked to high standards.

Except for the furniture, the independent and somewhat reclusive early makers left little to indicate what they were like. Furnituremaking was a sideline, so they didn't keep records. "Rustic is where they turned their creative energies in the winter," says Craig Gilborn, director of the Adirondack Museum in Blue Mountain Lake, N.Y. "They didn't have any tradition of building to follow. . . maybe the skill was in their fingertips because they knew the material and lived outdoors all their lives."

Gilborn, who recently completed a book on his 13-year study of Adirondack furniture, showed me some stunning pieces in the museum's collection and got me thinking about the builders. Traditions of design and technique are important to most of the contemporary woodworkers I know. But the old Adirondack makers apparently had only one tutor: a basic, almost druidic

feeling for wood—not stacks of dimensioned, kiln-dried lumber, but gnarled, knotty, living branches of birch, willow, ash, cedar, ironwood and hickory.

I wondered what the contemporary rustic makers I was soon to meet would be like. Gilborn speculated that the lack of traditions would probably be an asset for them, leaving them free to explore better joinery methods and create furniture that was more comfortable than many of the old pieces.

He was right: Craftsmanship, comfort, durability and beauty are prime concerns of every modern maker I visited. Mostly self-taught, these craftsmen share a love for the forest and the beauty of natural forms. All rely more on their eyes than on squares. And each one seems perfectly suited for life in the turn-of-the-century camps described by Gilborn.

From 1870 until the turn of the century, life at these cottages was rustic and comfortable—not lavish, although people did have servants and guides. This period produced the best furniture. Up to this time, rustic furniture didn't receive much notice, although the guides had always made simple tables and benches for campsites. Gilborn theorizes that the interest in rustic furniture might actually have originated in cities like New York. Central Park played an important role because its designers incorporated so many rustic shelters, benches and other features. "You could make a case where city folks come up in 1850 and asked the locals to build the same kind of thing they saw in a New York park," Gilborn says. Later, the camps became larger and fancier, and people began to get rid of the twig furniture.

Rustic is appealing to Gilborn because of the variety of natural materials and textures used to achieve different designs. "Most of the designs are based on little variations, like jazz—something like just flipping a piece of birch bark to show its back side, or to alternate front and back sides of the bark." Because so little is known about the original makers, Gilborn thinks it's a mistake to read too much into their designs or to call the work sculpture. He sums it up as "intelligence, but no pretense." The resurgence of rustic in recent years is due to this appeal, he believes, as well as to what he considers a city phenomenon. "There's something especially satisfying about rustic furniture to people who live in apartments of glass, plastic and metal," Gilborn says. "The pieces are also relatively inexpensive, and no two are alike."

Ken Heitz, one of the first craftsmen to become involved in the revival of the craft in the Adirondacks, agrees that rustic is often considered an antidote to high-tech environments. A former IBM employee who moved to the Adirondacks from New Jersey in 1970, Heitz thinks rustic's revival is an outgrowth of the back-to-the-land movement of the 1970s and the renewed interest in timber and log homes. He now makes 60 to 80 rustic pieces a year. And while he doesn't advertise, Heitz sells pieces all over the country—mostly to repeat customers, or to people referred by them.

Heitz began making rustic furniture after the sawmill where he worked burned down. Jobs are scarce in the Adirondacks, so he used his free time to build a few rustic pieces for his home. He found the work interesting, and sold several pieces to tourists. The next thing Heitz knew, he was hauling a truckload of his furniture to a Manhattan gallery. Living at the time was pretty rustic: no water, no power, everything done by hand. Good experience, he says, but hard to make a living.

Now his shop off Route 28 in Indian Lake, N.Y., has power for lights, for the homemade lathe shown on the following page, for power drills and other tools—none of which has compromised his sense of craftsmanship. "If it's going to be something I'm



Photo: Ken Heitz



## Ken Heitz

**The ironwood posts on Ken Heitz's chair, above, are bent around a form and dried in a wood-fired kiln until the bend is set. Tenons cut on the ironwood rungs are glued and pinned into holes bored into the posts. The desk panels are made by gluing birch bark to pine. Tenons on the ends of bed rails and other long pieces can be shaped by hand, but Heitz finds it much faster to chuck the piece between centers on the 10-ft. bed of his homemade lathe, left, and turn the tenons and sloping shoulders.**

proud of, it's going to be attractive and it's going to last," Heitz insists. Rather than copy old designs, he aims to make each piece an original, developing one-of-a-kind patterns to please the eye.

"At first, I just nailed pieces together because I didn't have the knowledge or the wherewithal to join them properly," Heitz explains. "The original pieces that survive *were* made properly: socket-and-tenon joinery, aged wood, either air- or kiln-dried." Now he glues tenons into bored holes and secures them with a nail or a wooden peg.

Heitz considers kiln-dried wood a must. He harvests most of his ironwood and white ash in the fall and winter; that way, the bark stays on, unlike wood that's cut when the sap is running. Heitz values the twists and curves that occur naturally in wood, but—like most of the makers I talked to—he doesn't hesitate to bend or shape a piece to achieve the desired effect. His kiln is equipped with braces and ropes for holding bent parts in place while they dry. This helps him get the right angle to pieces—the proper setback for rear chair posts, for example—without searching the woods for branches with just the right bend. The wood is left in the kiln three days to two weeks, which, Heitz says, is equivalent to three to four years of air-drying and long enough to set any bend you need.

After visiting Heitz in the Adirondacks, I decided to head out to Fall City, Washington (just outside Seattle) to talk with Monte Lindsley, a well-known West Coast maker. Lindsley makes his furniture out of willow, bending the pieces into easy-flowing curves. The willow bends easily when green, and doesn't seem to

split as it dries slowly in the relatively damp Seattle air. By using about six of the thirteen varieties of thin-bark willow found in Washington, Lindsley can accent the curves with different tones, textures and colors. "I look at what I do as painting, not furniture-making. You want to bring out the colors, the colors of the earth." If the natural colors don't do the job, Lindsley sprays the willow with fabric dyes (see photo, right). He started dyeing wood after his work sold rather poorly at an Arizona show. Realizing that color is important in sunny climates, Lindsley decided to give his furniture something that would appeal to people unaccustomed to living with the natural color of trees.

For Lindsley, designing a piece means making it comfortable. "It's a challenge to take branches and make functional art pieces that you can sit on and enjoy." To reinforce the shape, he nails in X-braces whenever possible, or threads the curved members over and under each other—in effect, weaving together each piece. On a chair, for example, Lindsley might nail an arm's free-flowing curve to the inside of the lowest crossbrace, to both the front and the back of the seat and, finally, to a back brace. He blunts the nails and predrills the frame pieces to prevent splitting, then leaves the nails proud of the surface. After the pieces season a month or two, he pounds the nails down tight, cuts off the extra length with wire cutters and finishes the furniture with polyurethane varnish.

Lindsley has strong opinions about his work and the craft scene as a whole. He graduated with a forestry degree, but found the work too restrictive and drifted into craft woodworking. He read about willow furniture while working as a landscaper. After making some rustic pieces for his home, he started selling his work. Underlying his transition from forester to maker were his convictions about the environment, conservation and the value of the simple life. With his laid-back view on life, Lindsley is dismayed by craftsmen who become high-pressure mini-manufacturers, complete with computers, agents and employees.

That kind of concern keeps Lindsley a one-man shop, driving all over the country for shows. In recent years, he's done about 30 shows annually, many of them virtual black-tie events of the craft world. Now, he's trying to simplify his schedule, cutting back so he's not away from home for months at a time. But his goal remains unchanged: Lindsley still seeks to make a living by crafting objects that help people stay in touch with their heritage by letting them touch natural things, rather than plastic.

According to Hutch Traver, however, it's not enough just to use natural materials—the quality of work is also essential. "Good craftsmanship is good business," says the rustic maker, who works in Wake Forest, N.C. "People are somewhat suspect of rustic anyway. They have the notion that it's just thrown together. You have to be extra careful to counteract that feeling."

Although he's mastered dovetails and other classical techniques for joining wood into furniture, Traver—who made his first rustic piece as a youth at summer camp—is still drawn to the rustic style and continues to incorporate it in his work. "The main attraction is the shape of the wood," he says. "The forms of the bend give you a starting point. You get an idea from the shape of one piece, then you automatically seem to be led to another idea. The whole thing just seems to flow. Sometimes I concentrate on the wood forms. Other times, I concentrate on the negative space between the branches."

Like the other makers with whom I spoke, Traver relies on hand tools—an adze and a drawknife are his basic tools—but he's also partial to body grinders and heavily padded rubber sanding discs for finish work. The sanding is an important aspect of his



## Monte Lindsley

Rustic furniture is a low-tech, build-as-you-go craft. After stripping the bark from a piece of green willow, Monte Lindsley bends the wet wood into a curve, right, that will become a chair back. He began dyeing willow pieces like the living room set, below, when he realized that people in places like Arizona respond to color more than they do to natural wood forms. The tabletop mosaic is created by nailing patterns of colored willow segments to a plywood base. The photo's background color is from Lindsley's unique photo studio—frozen ice on the pond behind his home near Seattle.

Photo: Monte Lindsley



work. "I go for the smoothness, a very subtle feeling. Touching the wood is almost like touching the limb of a person." The color of red cedar, which Traver frequently uses, is also important to him. He carves off most of the sapwood, but leaves a little to create a harmonious counterpoint to the red of the wood and the scarlet of the knots. (Removing the sapwood also eliminates a hiding place for bugs.)

Traver's finish is linseed oil-based. He applies a couple of coats of linseed oil to clean the wood, resands, then applies a few more coats of linseed oil mixed with japan drier. For the final coats, he adds polyurethane to the linseed/japan drier mixture to produce a harder finish.

I was beginning to take a real liking to rustic furniture, but I still had some nagging questions about its continuing appeal. Tom Phillips, a woods manager in Tupper Lake, N.Y., who's been restoring rustic furniture for about 12 years and building his own for three, had a quick answer. "Wood is warm. People are tired of plastic and also tired of shoddy workmanship."

Primarily, Phillips builds tables and seating like the settee shown on p. 42, but he'll do "anything that the old guys before me did. I have the same philosophy. Anything usable in a camp can be made this way." He studied the old work during his restoration jobs, and spent three years examining chairs before making his first, which ended up in the woodstove. "Nobody is teaching anything about rustic stuff," he says. "If you don't have an aptitude for it, you're in for trouble. Each piece has a multitude of problems. You have to have a natural eye for balance and symmetry."

Construction details are pretty much up to the individual craftsman, but Phillips ticked off a few of his guidelines. The softer

Photo: Hutch Traver



## Hutch Traver

An arching headboard sets off this bed by Hutch Traver. Made of eastern red cedar—what some people call juniper—it was ordered by a man who wanted to incorporate a toy in a bed for his daughter. Traver's solution was to put an abacus with maple and walnut beads in the footboard.



## Tom Phillips

Tom Phillips' yellow birch settee, above, is lighter than many 19th-century rustic pieces, yet strong because of its curved braces. To craft rosettes for embellishing rustic carcasses, Phillips first makes a gently sloping cut into the side of a branch, top right, then twists the branch so the blade leaves the wood at about the same angle as it entered. The ovals are then cut in half with pruning shears and notched with a knife to fit together, right.



## Gilbert Jacques

Gilbert Jacques' attractive little end table, far left, is made entirely from yellow birch, but the figured slab offers a bright contrast to the gnarled base. Makers often use wood harvested at different seasons to create other contrasts. Yellow birch is gray when young, but turns white as it ages. Willow is red in the fall and winter, but turns gray in spring and summer. The desk shown at left has a yellow birch base, white pine top, birch-bark panels and red willow inlays. The top frame is pine, screwed together and braced with angle iron. The legs are notched to accept the frame.

the wood, the thicker the components need to be. Brace as much as possible without spoiling the look of the piece. To prevent splitting, predrill holes for screws and nails. Make sure everything fits together as well as possible before assembly. For fastening veneer, Phillips recommends 1-in., No. 4 hardened and ring-shanked, color-finished nails. As a general rule, root stock or the butt end of the branch goes down and the taper aims toward the top. For contrast, try to include at least two different colors of wood—or wood and splints—in each piece.

Phillips also notes that the color of individual species varies from season to season, with the age of the wood and by the area where the tree grew, so it's important to spend a lot of time in the woods looking for good stock. Phillips relies on a chainsaw, a small bowsaw and pruning shears to cut stock. His finish is

Glidden Ultra-Hide sanding sealer (No. 5035, clear).

When I told Phillips how much I liked the applied rosettes I'd seen on museum pieces, he demonstrated how he makes them (see photos above). The first step is to cut an elongated oval section off the side of a small branch. (Phillips did this freehand on the tablesaw, with a sort of twisting motion of the branch.) Start the cut on one side, sloping into the branch until you reach its midpoint, then move the branch so the cut will slope out of the branch at about the same angle as the entry cut. Cut each oval in half with shears, notch the ends to fit together with a knife and assemble the rosette as shown. Variations in thickness between individual pieces are removed with a sander.

Another Adirondack maker, Gilbert Jacques, embodies the no-pretense attitude I imagine was characteristic of the original rustic



Photo: Barry Gregson

## Barry Gregson

A massive white birch bed by Barry Gregson, above, exemplifies the rugged feeling many people associate with rustic furniture. Like many rustic makers, Gregson harvests wood during the fall and winter months, when the sap is down, to ensure that the bark won't peel off his completed work. The pieces are joined together with dowels fit into holes bored into mating pieces. For a tight fit between the curved members, Gregson copes each joint with carving tools. Hand tools and carving are important parts of the rustic process.



Photo: Dan Mack

## Dan Mack

Daniel Mack lets the wood suggest movement in his functional, yet sculptural, pieces. The maple and red cedar shelving unit above features a favorite Mack device—the foot-like shape on the front leg, which whimsically suggests a mock cabriole.

makers. He says his only formal technique is to gather a bunch of sticks and nail them together. A retired highway superintendent who produces beautiful work, Jacques lives high on a hill in Keene, N.Y., with a spectacular mountain view. When I admired the panorama, Jacques replied, "Yeah, you ought to be here in the winter, when there's snow everywhere, and you can't go anywhere or do anything except watch the thermometer drop."

Jacques began making rustic furniture about five years ago while recovering from a stroke. He got hooked while duplicating an old settee. Now when he's not building, he's looking for good material. "I carry a bowsaw with me all the time. I never know when I'll see a tree I want to cut into. Wood you get that way is a lot better than the stuff you buy."

Relying on wood that catches the eye is an important aspect of Jacques' design approach. Rather than work out proportions or designs beforehand, he simply starts with an eye-appealing branch and builds from there. This approach led to the gnarly little end table shown at bottom left on the facing page. Jacques also does more deliberate work, such as the little desk with bark and split-branch surface decorations, also shown.

Moving east from Jacques' home, I visited Barry Gregson, who began making rustic furniture in Schroon Lake, N.Y., about five years ago. A mason by trade, Gregson was looking to turn a long-time interest in woodworking into a source of winter income. After pricing tablesaws, planers and other tools, he was ready to forget the whole idea. But then a friend suggested he get a hatchet and some chisels and try his hand at making rustic furniture. After studying Roy Underhill's book, *The Woodwright's Shop* (1981, The University of North Carolina Press), Gregson was off to a running start.

Gregson likes the whittled, hand-hewn look obtained with hand tools. He splits out blanks with a froe and shapes them on a shaving horse with a drawknife. Tenons are also shaped with a drawknife, then shaved with a plane.

Gregson's early work was largely symmetrical, made of peeled

wood with joints toe-nailed with pegs. Lately, however, he's turned more to sculptural pieces. There's no limit to design, he says, considering the number of curves you can find on a tree. "I like lots of graceful curves. One of the best places to look for wood is where logs were cut 15 or 20 years ago. New growth is invariably twisted."

Daniel Mack has an unexpected location for a rustic maker—a second-floor shop at 225 West 106th Street, right in the heart of Harlem. Mack likes New York City because of its built-in marketing benefits. He has plenty of visibility, thanks to local news coverage, and is very accessible to potential buyers looking for a natural touch for their city apartments. But there's also a more personal reason. "If I lived in the woods, the natural tree forms might not be as exciting as they are to me every morning. For a while, I thought it was ironic to make rustic furniture in the city. Now, I think the city is why I do it."

Mack made his first rustic chair as a gift for his daughter in 1978; by 1983, he'd given up a career in broadcast journalism to become a full-time maker. Most of his work is commissioned—some of it for store displays, some for the sets of soap operas and other productions. "The style comes out of the wood more than anything," he says. "Looking at old pictures isn't as important as deciding on the symmetry of the piece. Often, I tweak high style with things like mock cabriole legs. I like humor in the work."

Mack's goal is to make objects that are as much sculpture as they are furniture. Many of the makers I spoke to would object to the sculpture label, but they all draw their inspiration from the forest. A copy blurb on Mack's catalog sums it up: "This is a celebration of forest-inspired furniture. The possibilities are as infinite and beautiful as the trees themselves." □

*Dick Burrows is an associate editor of Fine Woodworking. Craig Gilborn's book, Adirondack Furniture and the Rustic Tradition, will be published this fall by Harry N. Abrams, Inc., 120 Woodbine St., Bergenfield, N.J. 07621.*

# Carved Bowls

*Texture enriches the basic shape*

by Alan Stirt

I began carving the outside of my turned bowls about ten years ago after seeing fluted Chinese porcelain bowls. Once I started carving textures, I found all sorts of possibilities. At first, I carved wide flutes like the ones on the big bowl shown below, but later I began experimenting with other textures. The fine-line pattern on the shallow bowl, for instance, was inspired by photos of African masks. Carving the bowls makes them somewhat evocative of the porcelains and masks that inspired them, and the process allows me to create bowls ranging from those with a fragile, delicate quality to others that stress strength and movement.

I originally cut flutes by pressing my bowls against abrasive drum sanders of various diameters mounted in my lathe's Jacobs chuck. I liked the finished pieces, but hated the technique and the dust so much that I switched to a carving gouge. The carved flutes weren't as precise as sanded ones, but they had a wonderful texture and a pleasingly irregular look. To give my sore arms a break, I later bought an electrically powered Rakuda flexible-shaft carver with interchangeable bits (available for about \$200 from Woodline, The Japan Woodworker, 1731 Clement St., Alameda, Calif. 94501). I powered the shaft with a 1/8-HP, 3450-RPM motor equipped with an

on/off foot switch. The tool's reciprocating gouge is easily guided by hand. Less pressure is needed than when using regular carving tools, but the same techniques apply. The Rakuda makes clean cuts.

The basic techniques for carving fluted bowls are the same for both green and dry wood, but I prefer green wood—it's easier to carve and is readily available near my home in northern Vermont. By taking advantage of the drying power of a microwave oven and a heat gun, I can start with a green-wood block in the morning and end up with a carved, dry-enough-to-be-stable bowl in the afternoon.

I begin by roughing out the green blank so the bowl approximates the shape I want, leaving the walls 3/4 in. to 1 in. thick. I like bowls with finished walls about 1/4 in. to 3/8 in. thick, so my roughing out leaves plenty of stock to compensate for any warping that might occur when I zap the piece in the microwave. In designing the bowls, I also leave the areas to be carved about 1/8 in. to 3/16 in. thicker than the rest of the bowl; the exact amount of extra thickness depends on the length and depth of the flutes I have in mind. I often carve flutes from the bottom of the bowl to the rim, but if just a section of the bowl will be fluted, I create a

*Stirt carved the flutes and other textures on his turned bowls with an electric reciprocating gouge. Large flutes were inspired by Chinese porcelain; fine-line patterns by African masks.*



visual boundary for the carving by cutting a cove or by changing the angle of the wall.

After screwing a faceplate to the rim side of the bowl, I shape the outside with  $\frac{1}{2}$ -in. and  $\frac{3}{8}$ -in. high-speed-steel, deep-fluted bowl gouges with their sides ground back and their noses relatively blunt. The long side edges can remove a lot of material quickly, and the blunt nose is good for following sharp concave curves—especially on the inside of bowls. The roughing cuts are made mostly with the sides of the tool, with the bevel rubbing. When I shape the outside of a bowl, the gouge's flute faces away from me and the cutting is done with the left side of the cutting edge, moving from the foot to the rim (the wood cuts more easily this way, as compared to cutting from the rim to the foot). On the inside of the bowl, I cut from the rim toward the center—again with the gouge's flute facing away from me, but cutting now with the right side of the tool's cutting edge.

I've successfully microwave-dried roughed-out 15-in.-dia. bowls, but the process works best for bowls 10 in. in diameter or less. Drying time depends upon the mass, species, moisture content and grain structure of the bowl, so I can't give any exact "recipes." However, there are some general principles that work for me. For example, I do all my drying on a defrost cycle—usually a couple of ten-minute treatments are enough. I never get the bowls too hot to hold in my hand, and I use a turntable stand (built-in on some microwaves or available as an accessory in department stores) to rotate the bowls and ensure even heating. I haven't had much luck microwaving bowls with a moisture content greater than 20-25%, so I let roughed-out bowls that are really wet air dry for a while before I microwave them. If the bowl is too wet, endgrain checking and honeycombing below the surface of the wood are likely to occur.

After microwaving the blank, I remount the bowl on the lathe with a three-jaw chuck (or, with a faceplate and double-face tape) and finish turning it. I employ the same techniques used for roughing out, but take very light cuts to produce the cleanest and smoothest surface possible. On the outside, I sand the areas that won't be carved—sandpaper grit is hard on carving tools. I sand the inside with a foam-backed abrasive disc chucked in an electric drill. If I skip the microwave and go directly from green blank to finished bowl, I usually don't have any problems sanding the outside, but the interior walls may be wet enough to gum up the sandpaper. I get around this by directing a heat gun into the inside of the spinning bowl for a few minutes until the surface is dry enough to be sanded. Salad bowls are then finished with food-safe Livos Kaldet Resin and Oil finish (available from Woodpecker's Tools, Inc., 614 Agua Fria St., Santa Fe, N.M. 87501). Decorative bowls and platters are finished with tung oil.

At this stage, the bowls are ready to be fluted. To draw guidelines for the flutes, I center the bowl on a plywood layout grid with 48 equally spaced lines radiating from a center point, as shown in *FWW* #59, p. 14. (There's nothing magical about having 48 radius lines, by the way—it was simply the number of indexing points on the lathe where I drew my first layout disc. After experimenting with other numbers, I decided I liked the look of 48 flutes best.) I also draw a number of concentric circles from the same center point to help align the bowl on the grid. Then, I center the bowl by eye, rim side down, over the circle that most closely matches the circumference of the bowl and mark the 48 points on the rim before remounting the bowl on the lathe.

To draw guidelines for straight flutes, I substitute my tool's regular tool rest with the wooden guide shown in the top left photo on p. 46. I made the guide by bandsawing a slight curve on a flat piece of scrap; so far, it's fit every bowl I've turned. One end



*Top: The author shapes the outside of bowls from foot to rim with  $\frac{1}{2}$ -in. and  $\frac{3}{8}$ -in. deep-fluted bowl gouges. The tool's flute faces away from him as the left side of the tool shaves the green wood. Above: The right side of the cutting tool cuts the inside of the bowl.*

of the guide is screwed to a post that fits into the lathe's tool-rest holder. The flat surface of the guide keeps the pencil horizontal and locates its writing point at the exact center of the spindle. This ensures that the flutes will be perpendicular to the faceplate—if they're off a little, they just don't look right. Using the points on the rim as starting points, I slide the pencil along the rest of the area to be carved to indicate the flutes.

I use basically the same procedure to make a bowl with spiral flutes, only the scrapwood guide is used to transfer the points on the rim to the bottom of the area to be fluted. The result is 48 evenly spaced points on both borders of the carving area. To draw the spiral flutes, I just connect offset dots with a straight,



*A wooden straightedge on a post fit into the lathe's tool-rest support, above, lays out the lines for flutes. Stirt then carves the flutes with a Rakuda reciprocating gouge, right. The jig shown holding the bowl is constructed from scrapwood, and is large enough to fit bowls of all sizes. The backing board is adjusted to hold the bowl at a comfortable work height. For a smooth flute, Stirt makes several light passes, cutting from the base to the rim, below.*



flexible plastic ruler. I usually skip two or three dots, but you can use any offset that looks good. I've also carved some flutes marked out with a flexible, *curved* piece of plastic. There are many possibilities, so don't hesitate to experiment.

The jig shown for carving the bowl is very simple—a backing board, a plywood base, a shelf to rest the bowl on and a 1-in. by 1½-in. hardwood cleat fastened to the base board with ½-in. threaded rods and wing nuts (see large photo, above). Set the backing board to a height that's comfortable for carving. Lean the base board against a workbench, rest the bowl on the shelf and clamp it in place with the cleat by tightening the wing nuts. I carve from the foot toward the rim, as shown. With the power carver, you just push the gouge into the wood and the blade will begin to cut. The reciprocating action is so slight that you barely notice the back-and-forth motion, although the noise can get a little irritating at times. Usually, I increase the depth of cut slightly as I move up the bowl. Most flutes take about three or four passes with a shallow gouge. The width of the blade generally sets the width of the flute. For a bowl

like the one shown here, I use a 24mm gouge with a #7 or #8 sweep; 16mm and 30mm blades with #7 and #8 sweeps are also handy. After carving the uppermost segment of the bowl, I loosen the wing nuts, rotate the bowl and bring another section to the top.

As you progress around the bowl, the grain orientation constantly changes from endgrain to side grain, then back to endgrain again. Adjust your carving for each flute: the wilder the grain or harder the wood, the slower the movement and lighter the cut. With a little practice, it's relatively easy to judge how fast and deep to carve. If you don't have a power carver, you can hand-carve with a ½-in. to 1¼-in. #7 carving gouge. I recommend that you push the tool by hand, rather than use a mallet and risk cracking the turning.

If you want to try some other textures, substitute a ½-in., 60° V-groove parting tool for the gouge. You can also carve several fine lines by eye between the layout lines on the side of the bowl, experiment with various cross-hatching effects or even carve along the bowl's rim. To carve the rims of bowls, I make a layout guide like the one shown in the top right photo. I cut a



*To lay out the rim design, Stirt bandsaws a piece of scrap to fit the rim, rotates a straightedge from it until he likes the angle (top), then glues the pieces together. The fixture is then moved around the bowl to mark the lines. Above, the thin lines along the rim of a cherry bowl are cut with a ½-in., 60° V-groove parting tool.*

curve in a scrap of wood so it fits snugly against the rim, then play with the angle of the lines by rotating a straight piece of scrap jutting out from the curved piece. When the angle looks right, I Super Glue the two pieces together, then move the guide around the rim and pencil in guidelines at intervals that look right. Next, I carve the lines with the bowl on the lathe.

Once you're done carving, finish the carved areas with the same oil applied to the rest of the bowl previously. I set green-wood bowls aside for a week or so, just to make sure everything is dry and stable. Dry bowls sit for a day or two until the oil sets up.

Finally, the bowls are remounted on the lathe and rotated at the slowest speed—about 200 RPM on my lathe. I oil and wet-sand everything (except the carving) with 400-grit wet-or-dry sandpaper. To remove any rough spots on the flutes, rub them lightly (particularly the ones on the side grain) with grocery-store-variety Scotch-Brite pads. The ridges left by the carving tool remain. □

*Alan Stirt is a professional woodturner in Enosburg Falls, Vt.*



*To carve the handles and feet of this mahogany salad bowl, Boyce followed faceplate turning with gouge work, revealing delicate sections turned into the bowl's sides and bottom.*

## *Carved handles and feet*

by Dale Boyce

Sometimes, the shapes that come directly off the lathe are just a little too round for me, so I've been experimenting with sawing apart or carving my turnings, exposing section profiles that would otherwise be hidden. To add interest to this otherwise featureless round salad bowl, for example, I carved three feet into the bowl's base and shaped a pair of handles from a rib turned around the bowl's circumference.

Here's the basic turning sequence I used to create the bowl. With the blank screwed to a faceplate, I first turned the bottom profile. The center of the bottom should be kept as flat as possible so that the faceplate can be attached to it for remounting the bowl on the lathe.

Next, I wasted the bowl's inside and turned the outside profile and the rib for the handles. To do so, I first glued a scrapwood disc to the bowl's now-flattened bottom. I inserted a piece of newspaper in the glue joint so the disc and bowl could later be separated. An alternative to the paper joint is to use Dexter-Hysol hot-melt glue, applied with the company's 3010 gun (glue and gun are both available from Dexter-Hysol Corporation, 164 Folly Mill Road, Seabrook, N.H. 03874). When the bowl has been turned, the hot-melt glue can be parted with a heat gun, and the bowl's bottom can be cleaned up with a scraper and mineral spirits (a solvent for the glue).

Once the disc is glued down, carefully center and screw the faceplate, then remount the bowl on the lathe.

After turning the outside and inside profiles and the rib, I laid out the handles while the bowl was still on the lathe. For strength, the long grain of the bowl should run into the handles. With the rib turned thin, carving the handles and wasting the unwanted portion of the rib was easy with a ¼-in., No. 3 carving gouge. Before laying out and carving the elliptical cutouts that form the bowl's three feet, I removed the disc by tapping a wide chisel, bevel facing the disc, into the paper joint. Sanding and a coat of walnut oil (see *Fine Woodworking on Faceplate Turning* or "Walnut-oil finish is safe for food," *FWW* #38) completed the bowl. □

*Dale Boyce is an architectural woodworker and turner. He lives in Portland, Me.*

# Sharpening Carving Tools

*The essential steps for a keen edge*

by Ben Bacon

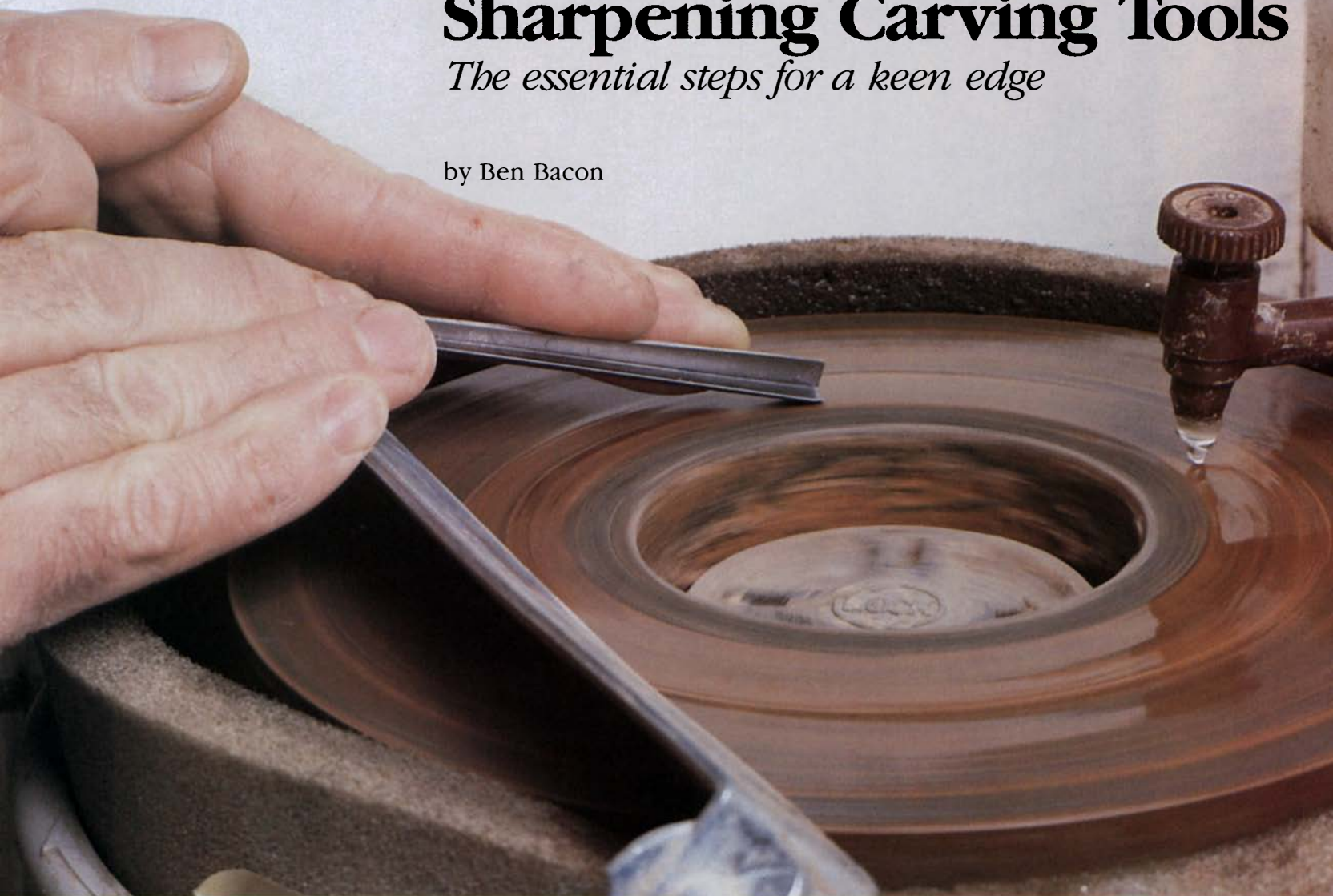

*Author Bacon lays a parting tool on the grinding wheel's tool rest and shapes its bevels by grinding one face, then the other. Depending on the hardness of the wood to be carved, he grinds a bevel angle between 22° and 30°, judging his progress by eye.*

**A**s a professional carver, I maintain a kit of a couple of hundred tools, and often find myself at the sharpening bench twenty times a day. I have to be fast at carving *and* sharpening. After all, I get paid to carve—not fiddle with my tools.

The techniques for sharpening carving gouges and chisels are very similar to those for sharpening other edge tools. First, grind the edge to the proper shape and bevel. Then, hone the bevel on successively finer benchstones to remove the grinding marks and to smooth the edge. The honing will raise a burr on the back of the bevel, which will fall off when the edge is honed on a slip stone. Finally, polish the tool's bevel by lightly stroking it on a leather strop loaded with jewelers' rouge. You can also polish the bevel using a rubberized abrasive wheel.

I'll explain this process in greater detail, but let me add here that sharpening carving tools presents unique difficulties. First, it's critical that you maintain the shape or definition of the tool's edge. The hallmark of good carving is crispness and clearly delineated lines where cuts intersect. You can't cut cleanly if you carve with tools that have had their corners rounded off by careless honing or polishing. If the entire edge of the tool isn't cutting, the intersection of cuts will be left rough and ragged.

Secondly, many carving tools have a curved edge. Sharpening straight-edge and skewed carving tools is a lot like sharpening

chisels or plane irons, but you'll need to practice on tools with curved or multiple edges to gain sharpening proficiency. For this reason, I'll discuss sharpening V-shaped parting tools and gouges, although the same steps apply for all carving tools.

Grind the tool with a bevel angle between 22° and 30°. The harder the wood, the higher the angle. A low angle will give you a very sharp edge, but it will also be delicate and prone to chipping when forced into very hard wood, such as maple. It's better, therefore, to go with a steeper angle—one with more steel behind the edge—when carving hardwoods. As a general rule, you want to use the smallest angle possible. Only experience will teach you just how fine an angle you can get away with. In the beginning, though, it's better to play it safe.

I grind my sharpening tools on a 1000-grit horizontal waterwheel (available from Woodcraft Supply, 41 Atlantic Ave., Woburn, Mass. 01888). The water cools the edge as it's shaped, the horizontal wheel gives a flat and sturdy bevel, and the fine grit often lets me skip honing on a medium stone and go straight to a fine, hard Arkansas—the stone used in final honing.

You can also grind on a standard bench grinder, but this requires a much lighter touch, and honing takes three to four times as long. These wheels spin at a much higher RPM, so there's a greater risk of burning the tool. Quench the tool frequently and



watch the cutting edge carefully for any change in the steel's color. If you see yellow, you can still save the tool's temper by quenching it immediately. A bronze color is borderline. But if you see black or blue discoloration, it's too late—you've overheated the edge.

Regardless of the type of wheel you're grinding with, be careful to maintain the shape of the carving tool's edge. I grind by eye and have achieved consistency in my grinding by practice. On the waterstone, I steady the tool by resting my hand on the tool rest. Then, I lay the back of the bevel against the wheel and tip it forward to achieve the correct angle. Check your progress every so often—the goal is to produce a single true, flat bevel right up to the cutting edge. With a dry grinding wheel, you would aim for a slightly concave bevel. Honing on a benchstone tends to round off the bevel, producing a blunt edge, so the object of both kinds of grinding is to produce a bevel fit for honing.

Grinding a V-shaped parting tool is reasonably simple: grind one bevel, then the other. If you're working with a grindstone as fine as the one I use, round off the point where the two bevels meet by gently rocking the tool back and forth. If you're using a bench grinder, then I suggest you do this on a benchstone where there's less risk of removing too much metal. Even with the waterstone, be careful not to remove too much material—the wheel removes metal quicker than you might think.

If you're not grinding on a very fine wheel, hone the parting tool on a medium India stone (a man-made stone). When honing large tools, you can push and pull the tool across the stone as you please, because the large bevel will give stability on the stone. But smaller, fine tools require a more deliberate touch: Push *or* pull the tool

along the stone, but lift the tool on the return stroke. Then, repeat the process. Hold the tool perpendicular to the long axis of the stone with one bevel flat against it; secondary bevels (small, second bevels right behind the cutting edge) are rarely used on carving tools. The bevel has been sharpened when marks from grinding have been removed, and when a small but even burr has been raised on the inside of the tool. You can see this burr on larger tools or those made of softer steel; on smaller tools, you can feel it with your fingertip. Gently hone the juncture where the two bevels meet by rotating the tool as you move it along the stone. This removes any burr that projects at the intersection of the bevels. The bottom right-hand photo on this page shows what to aim for. Move to a hard Arkansas benchstone and repeat the process, honing the outside bevels.

The next step is to remove the burr raised during honing by rubbing the tool's inside face on a medium slip stone, followed by a rubbing on a fine slip stone. Slip stones are made from the same material as whetstones: bonded, man-made abrasive crystals (such as India and Crystolon stones) or natural crystals (such as white and black hard Arkansas stones). They come in a variety of shapes, including round convex, round concave, triangular and conical. The type you use isn't as important as getting one that matches the shape of your carving tool as closely as possible. Slip stones are available through most major tool catalogs, especially those that sell or specialize in carving tools. On rare occasions, they also turn up in industrial-supply catalogs, so check these, too.

In removing the burr, the slip stone should be parallel to the long axis of the tool. Draw the tool back and forth until you



*To hone a parting tool's bevel, lay one face flat on the benchstone and push or pull the tool along the stone. Lift the tool at the end of each stroke, and repeat the process. Note that the tool is held perpendicular to the length of the stone.*



*Above: Remove the burr that's raised in honing by inverting the parting tool over a slip stone and sliding it gently back and forth. Below: parting tools after sharpening, showing the rounded juncture where the two bevels meet (left), the inside corner, which is left sharp (center) and the bevel after polishing (right).*

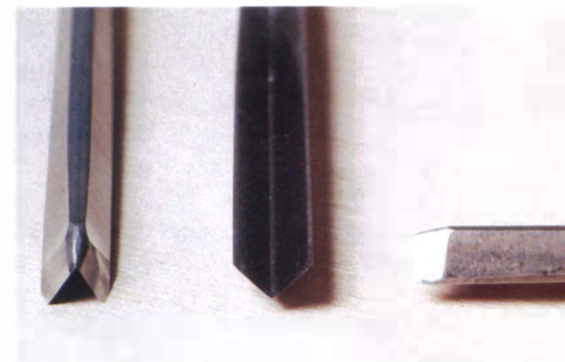



*A gouge is ground similarly to a parting tool, but requires a little extra dexterity. Begin grinding by laying one corner of the bevel on the wheel (top, left) and spinning the tool slowly so the entire bevel is evenly ground. Next, hone the gouge's bevel by starting at one corner and moving the tool down the length of the stone,*

*maintaining the bevel's angle (above, left). Rotate the tool during each pass to hone the entire bevel. When done, a burr should be raised along the edge. To remove the burr, hold the slip stone on the bench, invert the gouge over it and rock the tool back and forth until the burr breaks off (above).*



*Polish the inside face of the gouge on a leather strop rubbed with jewelers' rouge. Flex the strop to match the curve of the gouge (above, left). An alternative to leather-strop polishing is to polish the tool on a rubberized wheel (above, center). The inside*

*face can be polished on the corner of the wheel, the bevel on the face of the wheel. Test a carving tool for sharpness by making parallel cross-grain cuts in a pine block (above, right). The ridges between cuts should be sharp with no tearout.*

see—or feel—that the burr is removed. If the burr proves stubborn and doesn't want to break off, you may have to go back and lightly dress the bevel again on the hard Arkansas benchstone.

A gouge is ground in a similar manner to a parting tool, but the job requires a little extra dexterity. Start grinding with the corner of the bevel against the grindstone. Keeping the bevel against the stone, spin the tool slowly so the entire bevel is evenly ground. It's a little tricky to maintain the bevel's angle as you do this, but—with practice—you'll get the hang of it.

Next, hone the gouge perpendicular to the long axis of a medium India (or hard Arkansas) stone. Place one corner of the curved bevel on the stone and push it down the length of the stone. Pivot the gouge slightly as you do this so the entire bevel is honed when you reach the end of the stone. Repeat these passes until the bevel is properly honed. An alternative is to place a corner of the bevel on the stone and push it along the

stone so that only a portion of the bevel is honed. This technique is useful for removing local high spots in the bevel, but it leaves a faceted edge, and the facets will have to be removed by using the previously mentioned honing technique.

Next, as with the parting tool, hone the inside of the gouge with a slip stone. If you're using a tapered slip stone, be careful not to move the tool up where the stone is wider than the tool's edge—you're sure to round over the cutting edge.

To maintain as much control as possible in sharpening most carving tools, I recommend that you place the slip stone on the bench and move the tool over the stone. With very small or complex carving tools, however, it's sometimes easier to move the stone over the tool.

After honing on the slip stone, polish the edge by stroking both the inside face and the bevel on a leather strop charged with jewelers' rouge. Polish the exterior surface of carving tools by laying

the strop on the bench and moving the tool over it. For the inside of a gouge, I flex the leather to the curvature of the tool. For parting tools, I stroke the tool on the edge of the strop.

You can also polish the tool on a rubber wheel. Proceed carefully, however, as you can burn the tool on one of these wheels. The wheel must be moving away from you; otherwise, the carving tool will cut into it. You can polish the inside surface of flatter carving tools on the corner of the wheel. Polish the bevel in the same manner that you sharpened the tool, but go lightly to avoid rounding off the bevel.

I avoid giving carving tools their final polish on a cloth buffing wheel loaded with polishing compound. These wheels have a tendency to round off corners and round over the bevel behind the cutting edge. This changes the tool's cutting angle and causes the wood to exert more pressure on the tool as it's pushed into the cut. I can, however, see using these buffing wheels with sharpening tools that are used in large sculpture work. Here, great tool definition isn't essential and—because the tools take a greater pounding and have to be sharpened more frequently—you'll need a quick method of restoring the edge.

When sharpening is completed, test the sharpness of the carving tool by making parallel cuts across the grain in a piece of scrap pine. If the ridges between these cuts are sharp and free of tearout, the tool is sharp. If not, go back to the fine benchstone

and take the honing process from there. If the tool still isn't sharp, go back to the medium benchstone and try it again.

I use a lightweight oil as the lubricant in honing, and I clean metal residue from the sharpening stones every so often by brushing them off with gasoline or any fluid that will cut oil and dirt, such as lighter fluid. Obviously, it's important to use powerful solvent with care and to clean the stones outdoors or in a well-ventilated area.

Carving tools have a tendency to wear out the center of a benchstone, so I suggest you get a separate set of stones and reserve them just for these tools. In so doing, you'll preserve the flatness of your other stones so they can be used to hone larger edge tools that require flatness, such as plane irons.

I resharpen a carving tool after about 15 minutes of hard use. It takes me a minute to re-hone a simply shaped carving tool, and three or four minutes to completely regrind and rejuvenate the edge (usually done after about ten sharpenings). At the absolute most, I spend 20 minutes repairing a damaged tool.

Sharpening your carving tools might not be much fun, but once you get good at it, you become so quick that you can get back to the carving in short order. □

*Ben Bacon, formerly a Virginian, now resides in London, where he earns his living in a carving shop.*

## Multi-wheel sharpening system

by Russell Orrell

You could spend a fortune on a bench grinder and numerous gadgets to keep your carving tools sharp, but I believe my homemade system of plywood discs, cloth buffing wheels and grindstones is even better. The system can sharpen all kinds of carving tools, plane irons and chisels. I built it with used materials for \$30 (excluding the 1,000-grit waterstone); made from new parts, it would cost about \$100.

The system is powered by a used two-speed (1,125 and 1,750 RPM) ½-HP motor salvaged from an evaporative cooler. These motors might be hard to come by if you live outside the warmer areas of the country, but check with your local motor shop anyway. If you can't find one, you'll have to use a motor with a different speed (a good motor source is Burden's Surplus Center, 1015 West O St., Box 82209, Lincoln, Neb. 68501-9973) and modify the pulley arrangement.

The motor is wired to a dual-switch three-pole wall switch used to control on/off and high/low speed. The motor's arbor runs a cloth buffing wheel and a 1½-in. pulley. From this pulley, a ½-in. by 38-in. V-belt runs to a 7-in. pulley that drives the gang-wheel assembly.

Mounted to the ⅝-in. axle running through the large pulley are a 1,000-grit

Homemade carving tool sharpener

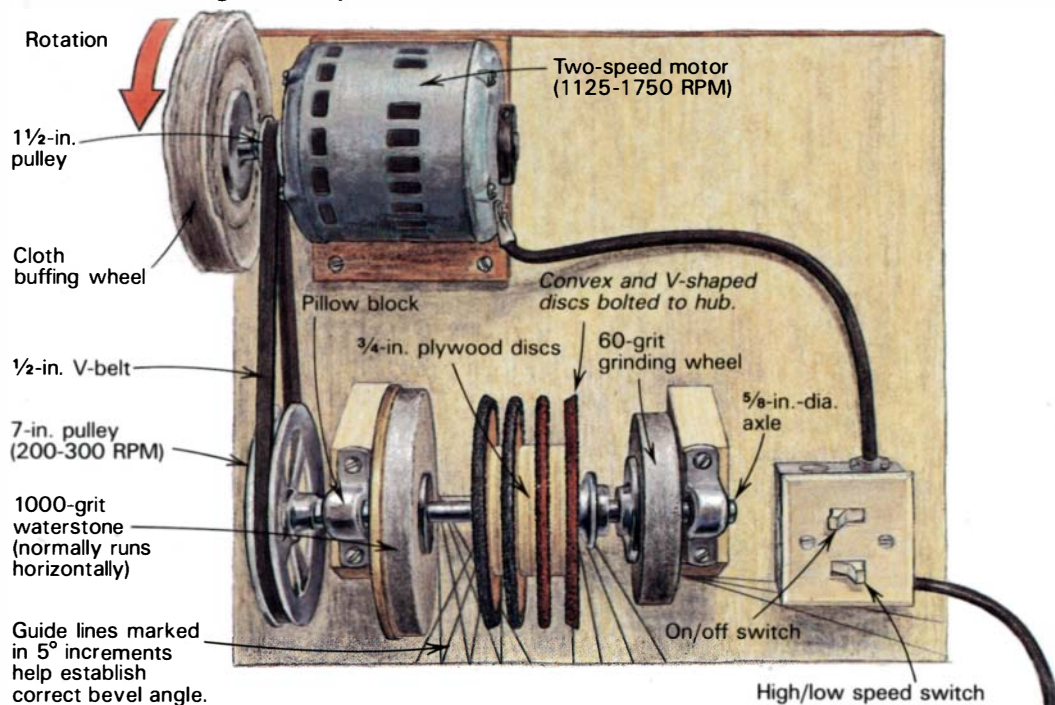

Makita waterstone; four 7-in.-dia., ¼-in. plywood discs loaded with red rouge or emery compound; and a 60-grit grinding wheel. The discs and wheels turn at around 300 RPM at high speed and 200 RPM at low speed. The discs are separated by ¾-in. by 4½-in.-dia. plywood washers. Two discs have a 60° edge angle, and two have a rounded edge to match carving-tool profiles. Sight lines are located beneath the wheels to help me establish the bevel angle (I sharpen freehand). I

modified a hub from the scrapped evaporative cooler and ran two bolts through it to keep the discs and washers clamped together and fixed to the axle. I epoxied another hub to the 60-grit grinding wheel to fasten it to the axle. A V-belt pulley epoxied to the wheel would also have done the job. □

*Russell Orrell is a professional wood-carver and carpenter who lives in Los Angeles, Calif.*

# Old-Fashioned Wood-Coloring

*Reviving the dyes of yore*

by George Frank

There can't be much doubt about the advantages of using modern ready-mixed stains or dyes for coloring wood. They're readily available, easy to apply, reasonably fade-resistant and they yield consistent results. But if you're a one-piece-at-a-time wood artisan interested in obtaining a quality of color you can't get directly out of a can, there are great thrills and advantages to making your own homemade wood-coloring mixtures by following some of the old-fashioned, bygone ways of preparing natural and chemical dyes. I learned about various natural extractive dyes and chemical mordants in Paris in the days following World War I. Although the old woodworking section of Paris has undergone many changes since the unforgettably charming days of the 1920s, and while the old ways of dyeing wood are slowly disappearing, I haven't forgotten what I learned and still depend on many of these techniques today.

Why go to all the trouble of making your own coloring concoctions when you can get reliable, ready-made stains at the corner paint store? First of all, using a dye instead of a stain allows you to color the wood without adding a cloudy layer of pigment that can conceal the grain and cover up the wood's natural beauty. Unlike paint or stain, a dye consists of a liquid medium—usually water or alcohol—in which pigment particles are dissolved, not merely suspended. Thus, the pigment can't settle out. And since these dissolved pigments are less opaque than suspended particles, a dye solution is more transparent than a stain.

Furthermore, many of the techniques I'll describe produce their color by chemical reaction with the wood itself. The effect they achieve has a clarity and vibrant *quality* of color that, in my opinion, far exceeds that of their modern equivalents, such as aniline dyes. The old-fashioned dyes can also be the right way to get an authentic color when refinishing certain antiques.

The use of dyes to change the natural color of a material goes back to textile dyeing—a craft that evolved well before recorded history. Woodworkers undoubtedly gleaned the experience of these textile artisans in developing their own methods for dyeing wood, often to make light, inexpensive woods resemble the darker, more coveted varieties.

The palette of color-creating substances compatible with yarn and fabric is vast, yet relatively few of these materials have been adapted to the wood-dyeing craft. One of the most useful and well-known of these dyestuffs is brewed from the hulls of walnut shells by so simple a means as a pot simmered on the kitchen stove or by extracting the dyestuff with ammonia. This venerable *brou de noix*, which Jon Arno wrote about in *FWW* #58, produces very handsome rich-brown colors when applied to wood.

But allow me to introduce you to the two most versatile stars

for natural wood-dyeing, derived from various species of South American hardwoods: logwood (also known as “campeachy wood”), so called because it is imported from Central America in heavy, dense logs; and brazilwood, frequently referred to simply as “brazil.” In the old days, these logs were reduced to chips or sawdust and marketed as dyestuffs. The product was boiled down, strained, bottled and stored for future use. Since these exotic chips are far from easy to come by these days, we must buy extracts of them (available as powders—see “Sources of supply,” p. 55), ready to be dissolved in water. Yellowwood and catechu are also available as extracts, but they're far less versatile than logwood and brazilwood.

Applied by themselves, these extractive dyes will produce pleasant yellowish and reddish-brown tones. But combine them with chemical mordants and you open the door to a multitude of superb colors (see facing page). Mordants like sodium sulfate also help increase the fade resistance of brazilwood and logwood dyes. Before I provide a how-to on combining dyes and mordants, however, allow me to explain what a mordant is and how it works.

The word “mordant” comes from the French verb, *mordre*—“to bite.” The mordant helps the dye penetrate into the fibers of the wood and bind there. Quite frequently, the chemical combination of dyes and mordants also gives birth to deep, rich, vibrant colors impossible to obtain in any other way. The reason is this: While a dye creates color with dissolved pigment, mordants create or change color by chemically reacting with dyes or other substances found in the wood itself.

Sometimes mordants are used without dyes to create color. For example, untreated oak becomes darker after being exposed to fumes from a heated ammonia solution. By “fuming” the oak in this manner (caution: the use of a vapor respirator with an ammonia cartridge is essential during this process), the natural tannin present in the wood reacts with the ammonia mordant to cause a color change. This effect can also be achieved on other woods lacking tannin by simply applying a tannic acid solution before fuming (see bottom right, facing page).

There are no hard-and-fast rules on how best to combine dyes and mordants. Typically, the dye is applied first, then the mordant when the dye is dry. Sometimes the mordant comes first and the dye follows, but rarely are the two mixed. In some instances, it's unknown which component—dye or mordant—actually creates the color change.

There are countless possible combinations of mordants and dyes, and the key to discovering the magic of brilliant color is experimentation. Experimenting is like creating a play on the stage: The actors are the ingredients; the plot is how you make

**Sample results using various dyes and mordants**

*This white ash sample shows some of the colors obtainable with logwood dye and various chemical mordants. All solutions were mixed in a 15% concentration.*

Ferrous sulfate  
over logwood dye

Logwood dye alone



Alum  
over logwood dye

Potassium dichromate  
over logwood dye

*An interesting range of colors can be created by using mordants in combination—with or without dyes. This entire white ash sample was first coated with tannic acid. Then, various second coats were applied, as indicated.*

Ferrous sulfate  
over tannic acid

Alum  
over tannic acid

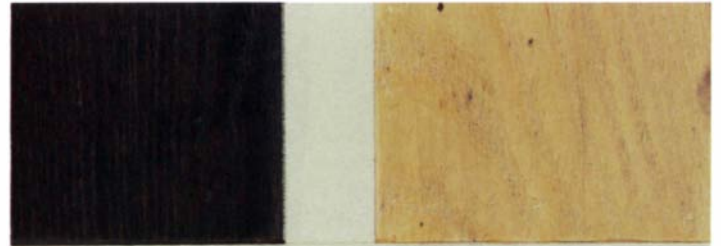

Ferrous sulfate  
over tannic acid with  
logwood dye topcoat

Potassium dichromate  
over tannic acid

*After topcoating this white ash sample with brazilwood dye, different shades and tones were created by varying the concentration of potassium dichromate mordant used.*

Brazilwood dye only

5% solution



20% solution

10% solution

*You can darken woods that have a natural tannin content (such as oak) by exposing them to ammonia fumes. Furthermore, non-tannin woods such as birch and ash can be fume-darkened by first topcoating the wood with a tannin solution.*

Oak

Birch

Ash





Your wood-dyeing experimentation kit needn't make your workbench look like Dr. Frankenstein's laboratory. The most important tools include: disposable mixing cups, mixing sticks and applicators; masks, goggles, gloves and other protective devices; and an accurate scale.

them perform. Here's the chance for you to do for wood-coloring what Shakespeare did for the stage.

The basic tools you need to begin are shown in the photo above. They include: a reliable scale to measure the weight of the powdered dyes and chemicals (mine was made by Kodak—I paid \$15 for it in 1941); a graduated cylinder or beaker to measure the water; disposable plastic cups to mix small sample batches (I use small urine sample cups available from any hospital-supply store); a few dozen Popsicle sticks for stirring each mixture separately; cotton swabs or scraps of old foam rubber for use as disposable applicators; and a notebook for taking notes on the various combi-

nations of mixtures and the results they yield on different woods—so you can reproduce your best results in the future.

Before you do any mixing, however, a word of warning: Most of the chemicals described here are poisonous (see "Mordanting chemicals" below), so treat them with respect. Bottle the chemicals in safe containers, label them properly and store the containers in a locked cabinet or high out of reach. Keep kids and pets out of the shop while you're experimenting (mixed in solution, deadly potassium dichromate looks just like orange soft drink), and avoid all contact with these chemicals by wearing protective goggles, an organic-vapor/acid-gas particulate cartridge (available from MSA, P.O. Box 426, Pittsburgh, Pa. 15239), an apron and rubber gloves. And, most important, concentrate on what you're doing. Add the woodfinisher's most essential ingredient to every mixture: plain horse sense. In six decades of working with these chemicals, neither I nor any of my workers have had a serious mishap.

Start your experiments by cutting and smooth-sanding a number of thin sample boards or strips from whatever wood you plan to work with. Section off several separate areas on each one with masking tape. Now, fill the disposable cups with warm distilled water (or rainwater), and add small amounts of the various dyes and mordants. Use a separate Popsicle stick to stir each mixture (you can write the contents of each mixture on one end of the stick for quick identification). For most general experimenting, I mix dyes and mordants in about a 15% concentration. To speed the process of proportionally combining dry weight with liquid

## Mordanting chemicals

The following is a list of common, readily obtainable chemicals that can serve as mordants in the wood-dyeing process. Please handle, store and use these substances with care.

**Alum**—Usually mined as a mixture of several metallic aluminum sulfates, alum is sold in drugstores as a white, astringent powder or crystal. Relatively non-toxic, it brings out purplish or dark-crimson tones when used over logwood and other dyes.

**Potassium dichromate (potassium bichromate)**—These orange crystals of chrome, available from darkroom-supply stores, are *extremely* poisonous (five grams can kill an adult) and are considered carcinogenic. Avoid all contact with the skin, and use them only in well-ventilated areas. Applied alone, they will darken the natural color of mahogany. When applied over logwood dye, they tend to create rich browns; applied over brazilwood dye, they produce deep reds and browns.

**Copper sulfate**—Also known as blue vitriol. Plumbers use large quantities of this turquoise crystal to kill the tree roots that clog sewer lines. Highly poisonous, copper sulfate can often be purchased at hardware or plumbing-supply stores. When used in conjunction with logwood, it produces dark gray and olive tones.

**Ferrous sulfate**—This toxic form of iron comes in tannish crystals that are poi-

sonous in the amounts used for mordanting, although minute quantities of the chemical are used in iron-supplementing vitamins. Ferrous sulfate will produce an ebony-like black when applied over logwood, or a deep gray over tannic acid.

**Stannous chloride**—A white crystalline form of tin, stannous chloride is moderately poisonous. Toxic fumes are generated when the chemical is mixed with water, so use maximum ventilation, or mix and apply it outdoors. Stannous chloride can be used in combination with alum, potassium dichromate or copper sulfate for color variations. It will produce a nice light red over brazilwood, and a deep yellow over yellowwood. When applied over madder dye (or alizarin, a synthetic replacement for madder), stannous chloride yields a pink color.

**Potassium bitartrate**—The most common form of this white powder can be purchased at the grocery store as cream of tartar. Since it's used in cooking and sauce-making, potassium bitartrate is obviously non-toxic. It will sometimes brighten red or yellow when applied over dyes of those colors. Over logwood dye, it creates a gray-brown; over brazilwood, a reddish-yellow.

**Sodium sulfate**—Also known as Glauber's salt, sodium sulfate is a white or colorless crystal that is thought to assist other mordants and dyes in molecularly bonding colors to the fibers of wood,

yielding better and brighter colors with improved light-fastness.

**Ammonia**—This is a clear liquid with powerful fumes. While the non-sudsing, household-grade ammonia sold in grocery stores will work, a 28% solution called aqueous ammonia (sold by industrial-supply companies) is most effective for darkening the color of oak with fuming. Ammonia will yield a dark violet-brown when applied over logwood dye, a light brown over brazilwood and a yellow-brown over yellowwood dye. It is hazardous to the eyes, skin and respiratory tract, so wear goggles, rubber gloves and an ammonia-cartridge-equipped vapor mask during use.

**Tannic acid**—This slightly toxic chemical can irritate sensitive skin. Tannic acid is naturally present in oak and is the "ingredient" that gives tea an astringent quality. It can be applied to the surface of non-tannic woods to make them susceptible to darkening by fuming, or it can be used in combination with other mordants to produce color—with potassium dichromate, for example, it produces a yellowish-brown.

**Calcium oxide**—Also called quicklime, calcium oxide can be employed by itself to enrich mahogany, walnut or cherry. Slake calcium oxide with warm water and coat the wood with the freshly made paste. Let it dry overnight. The next day, brush off the lime and wash off the residue with rainwater. Neutralize with vinegar. —G.F.

volume, nothing beats the metric system. Since 1 cubic centimeter (cc) of water weighs 1 gram, 15 grams of powder dissolved in 100cc of water automatically yields a 15% solution. Try calculating *that* with liquid and dry ounces!

With a foam applicator, brush on the first coat of dye or mordant. Once dry, remove the raised grain with 400-grit sandpaper, sanding on a slight diagonal to shear the fibers off rather than just pushing them down. Next, brush on an even coating of the mordant solution (or dye, if you used mordant on the first coat). With some applications, the color changes will be rapid; others—ferrous sulfate over logwood dye, for instance—will continue to darken for several hours. If you like the color attained but want to darken it, you can either mix a higher concentration solution of the dye and/or mordant, or you can try a second application of either mixture—or both mixtures.

Once you're satisfied with the hue and intensity of the color, sand the piece lightly and top coat it with the finish of your choice—acknowledging that most finishes will add a slight yellow cast to the color and that some may not adhere to the dyed wood. Although natural-dye colors are reasonably light-fast (particularly when fixed with a mordant), everything in life eventually fades—even the natural color of most woods themselves. These old-timers' dyes, however, will age with dignity.

If you don't get quite the color qualities you're after with the substances I've described, feel free to experiment with others. There are many possible substitutions for the mordanting chemicals discussed here. If you're familiar with safe procedures for using diluted forms of nitric, sulfuric or hydrochloric acid, for example, you might try them in lieu of other mordants. These acids yield a whole range of deep reds, purples or yellows, depending on the dye over which they're applied. Don't be timid in your experiments, but *do* be careful using these materials. And *never* attempt to dilute a concentrated acid by pouring water into it; instead, add the acid to the water gradually, stirring constantly.

There are many other possible sources for dyestuffs. Antique restorers, for instance, achieve a very subtle faded-gold hue in their refinishing by applying final coats of a dye brewed from Chinese black tea (available in brick form from Chinese food and gift shops). In the old days, some finishing masters knew how to use the stone and iron sediment from the bottom of the water trough under a sandstone grinding wheel to make three different color dyes: green, brown and red. They'd boil the mud in vinegar and, over a period of days, skim off liquid at different intervals to produce the three colors. Although I've never tried this formula, I've had success making a grayish-color dye from the aluminum oxide dust and steel particles gathered from below my bench grinder.

Although the old ways of wood-dyeing are usually slower, less predictable and sometimes more dangerous than the modern practice of "finishing by the numbers," they can add valuable tricks to the repertoire of the artistic woodfinisher. □

---

*George Frank is a retired master woodfinisher living in South Venice, Fla., and is the author of Adventures in Wood Finishing (The Taunton Press, 1981).*

## Sources of supply

---

### Dyeing materials and mordanting chemicals:

Olde Mill, R.D.#3, Box 547A, York, PA 17402 (also offers a kit of dyes and mordants).

Woodfinishing Enterprises, 1729 N. 68th St., Wauwatosa, WI 53213.



*By letting a tree's natural circulation system absorb his pigmented solutions, LeRoy Frink is able to create a rainbow of unnaturally colored woods.*

## Dyed-in-the-wood pine

by Sandor Nagyszalanczy

The next time you have trouble getting the stain off your clothing or fingertips, think of LeRoy Frink. About 30 years ago, Frink got the idea that it would be neater and more economical to color wood while it's still in the living tree. It took him 10,000 experiments to perfect his unorthodox method of dyeing: Frink bands each tree near its base with a probe consisting of multiple hollow needles. Through these needles, he pipes a water-based pigment solution (the exact nature of which he's understandably secretive about) fed by a 1/8-in.-dia. hose connected to an oil drum reservoir. The tree's active transport system, which normally circulates water and nutrients through the living portion of the plant, pumps the dye solution into every inch of sapwood and right out into the leaves or needles. A 16-in.-dia. to 20-in.-dia. tree takes about a month to assimilate the color, sucking dry an entire 55-gal. barrel.

Although the process works on all types of trees (including hardwoods), Frink prefers Ponderosa pine since it's fast-growing and consists mostly of sapwood. He once dyed 2,000 aspen trees simultaneously for a production run of colorful paneling, but he rarely colors more than 500 trees "intravenously" at the same time.

Semi-retired at 68, Frink runs a thriving craft business and uses thousands of small pieces of the unnatural-colored woods for making earrings and pendants, which he sells in his shop in Loveland, Colo. In addition to dyeing wood, Frink has explored other applications for his process. With the help and advice of several chemical companies, for example, he has introduced fire retardants, insect repellents and fertilizers into trees. □

---

*Sandor Nagyszalanczy is an assistant editor at FWW.*

**Makita 3612BR**

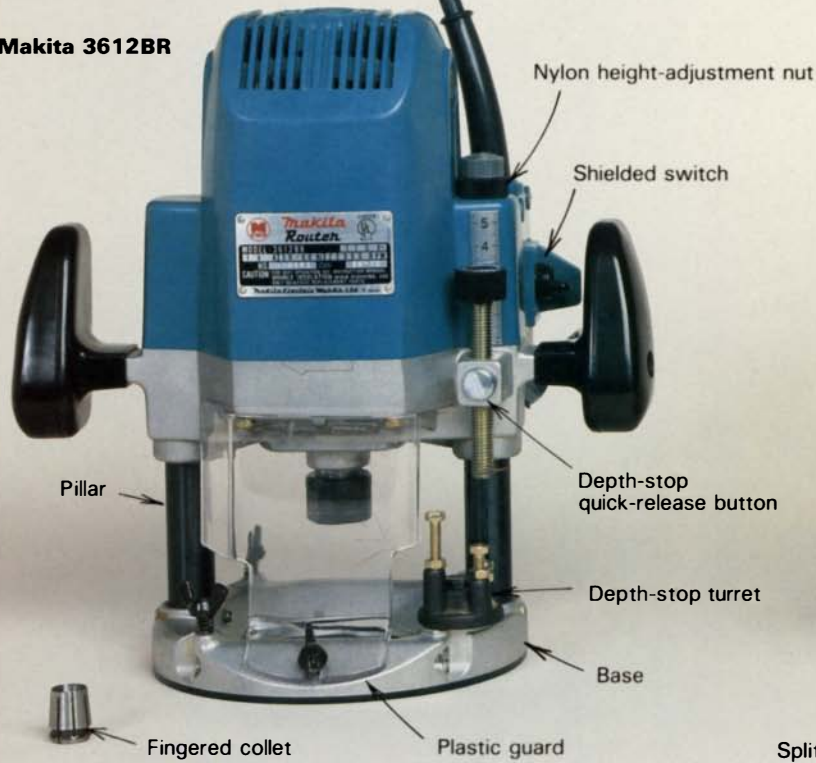

**Ryobi R-500**

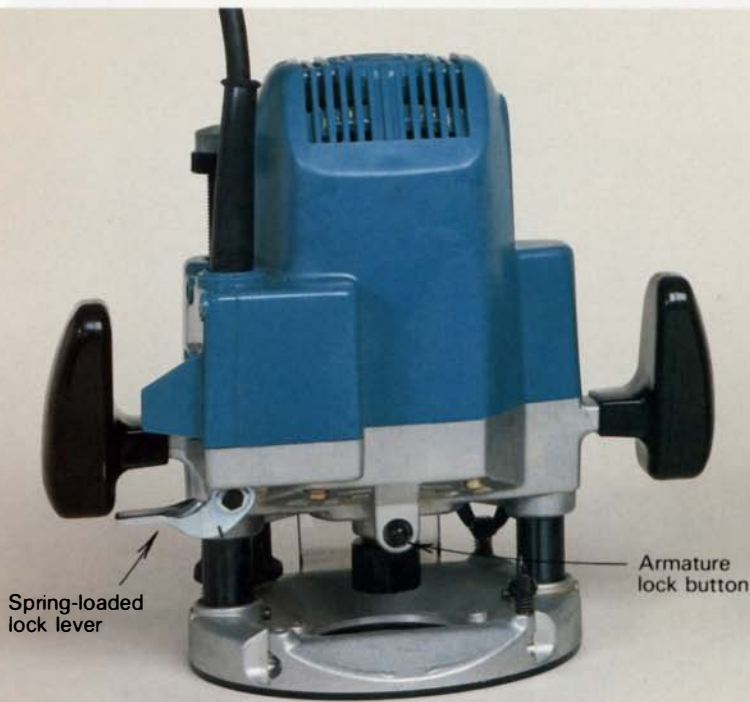
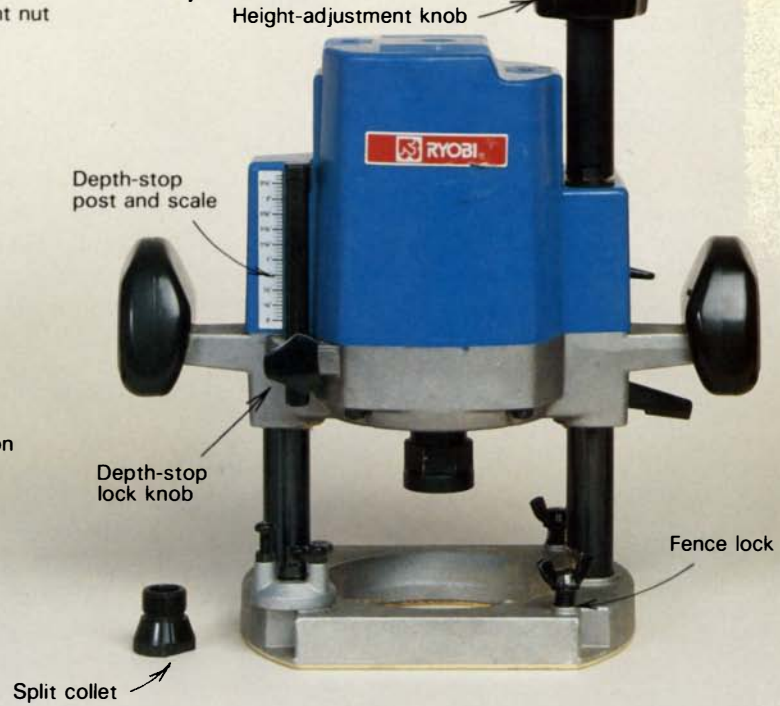

*Husky, versatile plunge routers have become the workhorses of many cabinet shops. The three most popular choices—all imported from Japan—are shown here with their various features labeled. The article explains subtle but significant differences.*

# Plunge Routers

*A comparison of the top three Japanese imports and a new machine from Europe*

by Bernard Maas



Hitachi TR-12

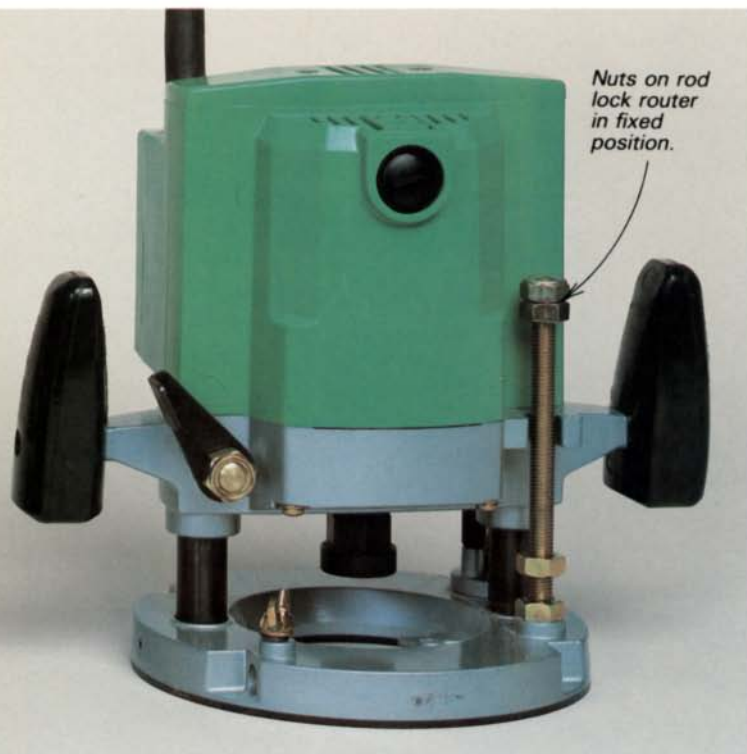

Not too long ago, routers were limited to the arsenals of production shops. But after hiding in the wings for nearly forty years, they've come of age. Today, the 1/4-in.-shank, fixed-base router is commonplace in basement and garage workshops, and the number of brands and models on the market is truly bewildering. Woodworkers without routers wonder if they should buy low-cost, lightweight machines as a means of finding out what routing is all about, while many 1/4-in.-shank router owners I've talked to are impatiently planning to step up to machines that will accept 1/2-in.-shank bits.

In my opinion, 1/2-in.-shank bits have clear advantages over the 1/4-in. variety. First, the beefier shank is more rigid and less sub-

ject to vibration, so its greater mass and momentum make for cleaner cuts. Second, the larger surface of a 1/2-in. shank gives more gripping area to the collet, reducing the chance that a bit will shift position in use. Finally, 1/2-in.-shank bits are available in a more professional selection of shapes, sizes and lengths.

There are two categories of 1/2-in.-shank routers: fixed-base and plunge. In this article, I'll try to show why I prefer a plunger to a fixed-base machine, what you should look for in buying a plunge router and what can go wrong with them. I'll concentrate on the top three Japanese machines, which are the plungers most woodworkers consider. But, first, allow me to give just passing mention to some other makes: The big, old Bosch industrial router is, frankly, in need of a redesign—it's a good machine, but outdated. Black & Decker's big Elu (see p. 59) is an outstanding machine, but so new we barely had time to squeeze any mention of it into this issue at all.

**Why plunge?** The advantage of a plunge router is evident in any joinery/template operation where lots of material must be removed. This includes dadoes, tenons, mortises, grooves and template work. Consider the drawbacks when using a fixed-base machine to start a cut in the middle of a board—it must be tilted and have its bit eased into the work surface. The usual result is kickout, temporary loss of control, ruined lumber and generally unsafe routing. For deep cuts, you have to repeat this business at ever-increasing depth settings—at ever-increasing risk. The plunge router, however, is set over the board and the rotating bit is gently lowered in, much as you'd lower a bit with a drill press. To allow this, the motor rides on two upright pillars and is spring-loaded so it'll retract again when the cut is finished. A lever locks the router body in position at any point on the pillars. This lever is essential to using the machine for plunging (as will be described shortly) and can also be used to convert a plunger into the equivalent of a fixed-base machine.

Most plunge routers employ three built-in, adjustable-height stops, located on a rotating turret. Having these stops can save time in routing work where more than one depth is involved, such as a series of haunched mortises. However, most work requires that only one stop be set—the one for the final depth. Stock removal is accomplished by plunging the bit to take a light cut, then locking the lever and routing. The lever is then unlocked, the bit is plunged a little more, the next increment is routed away and so on. It's easy to develop a rapid-fire rhythm that repeats these steps over and over until the depth stop bottoms out. These tiny, rapid cuts prevent vibration, burning and lugging down. Contrast this with the same operation performed with a fixed-base router where the usual practice is to try to chew off 1/4 in. in one or two laborious shots, usually filling the room with smoke as the overtaxed bit tries to remove too much wood at one pass.

Until recently, two plungers dominated the heavyweight market: Hitachi's TR-12, first marketed here about seven years ago, and Makita's 3612BR, a beefed-up version of the company's pioneering 3600 model, which debuted about 13 years ago. These two workhorses are to be found in countless cabinet shops, either as freehand machines or mounted in router tables. Ryobi's R-500 plunge router is a lesser-known newcomer that, in my opinion, has some nice features the others lack. We also tested two other lightweight plunge routers from Ryobi—the R-150 and the tiny R-50. Both of these machines, however, have 1/4-in. collets, so their utility is limited. Nonetheless, these lightweights are well-suited for shallow plunging jobs, such as letting in hinges or lock strikes.

The machines were tested in my home workshop and by stu-



*The lightest, most nimble plunger available is Ryobi's R-50, which weighs in at about five pounds and turns an amazing 29,000 RPM, resulting in smooth (albeit light-duty) cuts.*

dents at the university where I teach. We ran a multitude of bits, including carbide and steel, dull and sharp. Our tests were fairly extensive, but nothing exotic: average shop conditions and run-of-the-mill project requirements. All in all, we found that all three heavyweight routers performed about the same. The differences boiled down to subtleties in design and personal preferences.

**Studying the specs**—The chart below lists factory specifications, with no attempt on my part to remove hype. I wouldn't place too much weight on the manufacturers' claimed horsepower; amperage is a better indication of a router's power. For example, the Makita 3612BR—rated at 14 amps—draws almost two amps more than the Hitachi TR-12 and turns 1,000 RPM faster. Yet distributor ads usually claim 3 HP for both machines (something nobody

would think of claiming for a 14-amp tablesaw motor). The Ryobi R-500 falls in between yet, as a seat-of-the-pants impression, seems to get to speed a little faster than the others. I'd say that all of these routers are comparably and adequately powered for most woodworking jobs.

Retail price can't be believed, either—buying a router is like buying tires: nobody ever pays list price. In ads run in *FWW* #65, I found the Ryobi at about \$150, the Hitachi at about \$165 and the Makita at about \$175. Price isn't the full story, however—you have to consider standard accessories, too. The Hitachi comes with a full line: a template-guide bushing, a universal-template adapter that accepts Porter-Cable template guides, a router fence, a roller guide and a ½-in.-dia. carbide, two-flute bit. The Ryobi R-500 comes with everything except the universal-template adapter and the bit. But the Makita 3612BR—the most expensive of the three—comes with none of these. If you want a Makita fence, you'll have to shell out about \$20 extra (discount price). Another \$20 will get you a template guide and a roller guide.

I got each router's weight directly from its manufacturer, and the figures quoted are listed in the chart. Like horsepower, however, manufacturers seem to figure weight differently than I do. The Hitachi TR-12's reported weight of 12.3 lb. pretty closely matched the 12.6 lb. I got using a postal scale—the difference might be just that I included the weight of the cord. The Makita weighed 1 lb. more than claimed, and the Ryobi 1.7 lb. more. Why do manufacturers try to out-hype each other on something that's so easy to check? Weight is a matter of compromise anyway: A light router is less fatiguing to use and somewhat easier to move around, but a heavy router is more stable.

My students all preferred the Ryobi R-500, which, un-hyped, is still a pound or two lighter than the others. This model also has the smallest base, making it very maneuverable. A small base might seem like a disadvantage at times, since a large base is inherently more stable. But it's my practice at the school to fit

**Manufacturer specifications**

Plunge router model	RPM X 1000	HP	Amps	Collet lock	Collet size	Retail price	Weight in lb.	Base shape	Plunge depth	Accessories included
Black & Decker/Elu 3303	24	1	6.5	N	¼	\$235	6	OB	1 <sup>5</sup> / <sub>16</sub>	SF,UT
Black & Decker/Elu 3304	8-24*	1	6.5/5	N	¼	\$285	6.2	OB	1 <sup>5</sup> / <sub>16</sub>	SF,UT
Black & Decker/Elu 3337	20	2.25	12	N	½	\$475	11.25	RF	2 <sup>7</sup> / <sub>16</sub>	SF,UT
Black & Decker/Elu 3338	8-20*	2.25	12/10	N	½	\$520	11.5	RF	2 <sup>7</sup> / <sub>16</sub>	SF,UT
Bosch 90303	22	3.25	15	N	½	\$700	19.25	RF	2	CA
Hitachi TR-8	24	NR	6.9	N	¼	\$218	6.6	RE	2 <sup>3</sup> / <sub>8</sub>	SF,TG,UT,CB
Hitachi TR-12	22	NR	12.2	N	½	\$338	12.3	RD	2 <sup>7</sup> / <sub>8</sub>	SF,TG,UT,RG,CA,CB
Makita 3620**	24	1.25	7.8	N	¼	\$166	5.7	OB	1 <sup>3</sup> / <sub>8</sub>	
Makita 3612BR	23	3	14	Y	½	\$338	12.5	RD	2½	CA
Makita 3612B	23	3	14	Y	½	\$338	12.5	S	2½	CA
Ryobi R-50	29	0.75	3.8	N	¼	\$146	5.12	OB	2¼	SF
Ryobi R-150	24	1	6.5	N	¼	\$171	5.9	OB	2	SF
Ryobi R-151**	24	1	6.5	N	¼	\$187	5.9	OB	2	SF
Ryobi R-500	22	2.25	13.3	N	½	\$302	9.7	OB	2 <sup>3</sup> / <sub>8</sub>	SF,TG,RG,CA
Ryobi R-501**	22	2.25	13.3	N	½	\$312	9.7	OB	2 <sup>3</sup> / <sub>8</sub>	SF,TG,RG,CA

Base shapes: OB: oblong; RE: rectangular; RD: round; S: square; RF: round with flat side

Accessories: SF: straight-guide fence; TG: template guide; UT: universal template adapter; RG: roller guide; CA: collet adapters; CB: carbide bit

\* Electronic speed control      \*\* Switch in handle

new special-purpose subbases to most routers anyway, and these can be made any size (see "Router Joinery," *FWW* #57).

All three routers have similar plunge mechanisms—twin pillars in the base slide into bushings in the motor housing. If the plunge mechanism is sticky when you unpack a plunge router, don't panic—this is a common problem. If it doesn't stick new, it likely will after it's been in use for a while. Plungers do need some looking after—tolerances are close, and gunk (primarily sawdust and grease) works its way into the bushings. The solution is to undo the nuts or knob atop the adjustment screw and dismount the motor from the base. Be careful not to lose small parts from the locking lever assembly. With a rag or paper towel, wipe off the posts and bushings. Don't use solvents—they may dry out oil-impregnated bushings. Lubricate the mechanism with silicone spray or a light oil and reassemble. If the plunge is still balky, check the posts—slipped wrenches can dent or ding them. Once such rough spots are filed away, easy plunging should be restored.

A sticky plunge is especially troublesome on the upstroke, because the base can lift off the work, unstick and kick out, jarring the work and possibly ruining the cut. The Makita seems more prone to this than the others, requiring the routine maintenance described above more often.

The plunge mechanisms on all three routers work best if the base is fully supported. They also work fine if the base is supported only on the left side. But none of them plunge correctly when only the right side is supported—a condition that must have something to do with the location of the locking lever. The heavier the router, the worse the jamming. But this is a problem you can work around—by using the router so the base is properly supported, and by maintaining even pressure on the handles.

I found that each router has comfortable grips, and that all of them allow the average hand to reach all the controls—switch, locking lever, depth stops—while the machine is running and on the workpiece. The Makita switch is guarded with a projecting flange, but the Ryobi has no guard. I first thought this was dangerous—that the switch was liable to be bumped accidentally—but I found I couldn't make this happen.

Ryobi makes a model R-501 router, which is basically an R-500 router with the switch installed in the handle. I don't like switches in handles—it's too easy to turn the machine on by accident when picking up the router. Hitachi mounts the switch on the front of the machine, so you have to move your thumb from the handle to reach the switch. The motion seems awkward at first, but you get used to it. Some lefties, in fact, work this router from the back, and reach around to flip the switch with their left index finger.

**Other considerations**—All three routers come with collet adapters for  $\frac{3}{8}$ -in. and  $\frac{1}{4}$ -in. bits (Makita plans to discontinue including its  $\frac{3}{8}$ -in. adapter). Ryobi and Hitachi both use the familiar conical, split-nut collets common to most routers. Makita sports a nicely machined collet with fingers, and is the only router with an armature lock that enables you to change bits using just one wrench. Both of these features are nice to have and give Makita an edge.

Ryobi and Hitachi have similar depth-control setups, and I can't say I like either of them very much. The top center photo on p. 56 shows Ryobi's version of the device: a post slides up and down and measures the depth on a scale. The post is locked in position by a skimpy clamp screw with a plastic knob. This is just the sort of arrangement that loves to vibrate loose, and usually does unless pains are taken to really torque it down. But, as I can attest from experience, you can crack the plastic knob by overtightening it. Makita's solution is better—its depth control is a threaded rod that can

## A new arrival from Europe

While prototypes of new plungers by Swiss power-tool maker, Elu (with whom Black & Decker recently allied in an effort to upgrade its image), arrived too late to be included in the comparison of the three top-rated Japanese machines, they so far surpassed anything else I tested as to redefine the standards.

Basically, B&D/Elu has two plunge router models: the middleweight 3303 and the heavyweight 3337, both available with slow-start/electronic-speed control. The  $\frac{1}{4}$ -in. collet machines incorporate the twist-knob plunge lock of Ryobi's tiny R-50, but use the same old ho-hum stopper-pole depth controls. The monster  $\frac{1}{2}$ -in. models, however, incorporate precise, zero-reference depth adjustments. Magnifying indicators make this feature absolutely outstanding.

I can live without electronic speed control—it's really designed for cutting materials other than wood. But I'd spend more for it just to get the slow-start feature that squelches shotgun-kickback router starts, making them as gentle as turning on a Norelco shaver. Another powerful plus is the double-action collet that won't drop the bit, no matter how tough the cut. It's a great safety feature that also prevents errant bits from ruining work. Such precision doesn't come cheap— $\frac{1}{4}$ -in. and  $\frac{3}{8}$ -in. collets for the  $\frac{1}{2}$ -in. models cost about \$30 each. The bottom line, at discount prices, is that the big plungers will most likely cost more than double the price of a Japanese machine.

Overall, the 3337 offers the smoothest, chatter-free cutting action yet, plus a plunge mechanism you can really count on. Powerful springs ensure positive returns; jamming is a thing of the past. However, this machine requires hefty pressure for plunge spring compression and has a tough-to-twist spring-release plunge lock that can be worked only by large, powerful hands. So unless B&D/Elu remedies this in their current redesign, woodworkers who are slight-of-build or arthritic may miss out on a great machine. —B.M.



*With a proven track record in Europe, the top-of-the-line Elu variable-speed plunger will now be sold here by Black & Decker.*

be turned for fine adjustments; coarse adjustments can be made by pressing a button that releases the threads in the nut so that the threaded rod slides freely. It helps to have three hands, but the arrangement is hefty and will stay put.

Besides the regular locking lever, all three routers have supplemental means to lock the motor in place on the pillars. I like Ryobi's system best: a large plastic knob that sticks up above the router body. You can easily turn the knob up and down to adjust bit projection—just crank the bit out as far as you want it, then lock the lever. For added security when the machine is used for fixed-base work or in a router table, the depth-stop rod can then be locked against one of the stops on the turret.

Hitachi's height-locking system consists of two nuts on a threaded rod. It works well, but requires a metric wrench—something of a nuisance. Another drawback is that these locking nuts fit loosely on the threaded rod. It's a setup that's all right when you have them snugged up to lock the router, but when you want to go back to plunging again, you have to fully unwind the locking nut and jam it against the nut at the top—otherwise, it'll vibrate down when the router runs. You might finish a cut and find that the router won't retract enough to lift the bit from the hole and, with just a little inattention, you might clip the workpiece. Makita's "positive lock" is a nylon nut on a threaded rod. It works on the same principle as Ryobi's, but is much less convenient to reach and turn.

The Makita, incidentally, comes with a plastic safety shield to prevent chips from exiting in the direction of your face—a feature the other two routers lack. The shield is no substitute for safety glasses, however, and in practice it defeated itself—its curved shape caught glare from my workshop lights, and I had to remove it in order to see what I was doing. Nice try, but no points for this one.

With three nearly identical machines, you might wonder about durability. On the Hitachi I bought several years back, the bearings failed during the warranty period due to dust penetration. Rather than losing work time in my shop by sending the router back for evaluation, I just bought new factory parts. The bearings

(shielded, not sealed) soon went again, but when I replaced them with sealed bearings, the problem vanished. Hitachi is somewhat inconsistent in its use of bearings. Sometimes they supply their machines with sealed bearings, sometimes shielded. Apparently, what you get is the luck of the draw. Bearing replacement is not unusual with routers, and bearings are readily available from local suppliers (look under "Bearings" in the Yellow Pages). When it's time to replace your bearings, I suggest that you upgrade the originals (probably grade 4) with grade 7 or higher bearings, at a cost of only about \$10 or \$15 each.

Dust also did in the switch on my original Hitachi, causing it to arc and burn out. When I replaced the switch, I covered it with a shield of modeling clay, and there have been no further problems. To my knowledge, Hitachi still uses the same switch. As soon as a Hitachi comes into the shop, we pull the cover plate off the switch and seal it as preventive maintenance. This wouldn't be a bad idea with any router.

Suspecting that my problems were pretty typical of all plunge routers, I called a major West Coast repair center, unaffiliated with any specific manufacturer. The manager confirmed that troubles with bearings and switches are the most common complaints. "We always replace bearings with sealed ones," he said. "As far as availability of parts goes, all three are about the same. Once in a while a part may be back-ordered, but that can happen with any tool."

As detailed above, all of these routers have some nice features—sometimes in function, sometimes in price. If you don't have the budget to consider the Elu, I don't think you'd make a mistake with any one of the Japanese machines. Of these, my money is on the Ryobi for several reasons: Its smaller base makes it maneuverable on clamp-crowded workpieces; its easy-to-work adjustment knob brings the cutter into line without wrenches; and its light weight makes it easy to use all day long. This is a very nice combination of features to work with, and the price is right. □

---

*Bernie Maas teaches at Edinboro University of Pennsylvania.*

---

## *Plunge to destruction*

by Jim Cummins

How long does it take to wear out a plunge router? Try four to six hours a day for three weeks, routing about 600 monster mortises for huge loose tenons.

What's the result? Chatter, bearings that sound like cornflakes and a plunge that sticks unpredictably and repeatedly, despite hourly disassembly and cleaning toward the end of the run.

Who would put a machine to such a cruel test? The firm of Waxter and Lee, just north of Annapolis, Maryland.

Here's the story. Peter Waxter and John Lee have a 3,000-sq.-ft. shop that's geared for production work. When the order came in for fifty \$4,000 doors, they said, "No problem." They had a shaper for coping and sticking, and an industrial-grade hollow-chisel mortiser for chopping into all the stiles. The rails, howev-

er, required mortises in endgrain—a job for which a hollow-chisel hardly excels—so they shopped for a plunge router.

"If we'd known at the time that Bosch makes a \$700 plunge router, we might have been tempted," says John Lee. "But we wanted to get going quickly, so we bought a Makita, figuring it would be a throwaway. Peter did all the routing, then I'd take each rail and run it through the shaper to cope it. All told, we're pleased with the Makita, and plan to rebuild it for general shop work. It held up at least as well as my partner did. When that last mortise was done, he walked out the door and went straight to Hawaii for a two-week rest." □

---

*Jim Cummins is an associate editor at Fine Woodworking.*

# Coachmakers' Rabbet Plane

*An ebony beauty  
for smoothing curves*

by Jeff Lock



*The author's coachmakers' rabbet plane is a reproduction of those used by 18th- and 19th-century artisans. Made of ebony with a bone sole and wedge, it's used as a finishing tool to clean up the marks left by gouges and chisels on curved surfaces.*

Custom planemaking is ideal for those who find pride and beauty in handworkmanship. It's for the person who understands that patience and concentration are necessary to produce the best work—the person who puts cost effectiveness in its proper place. Those who appreciate the subtle distinctions between a hand-carved pediment and the cold perfection the shaper yields will grasp the essence of this craft.

Our ancestors fully appreciated the spirit of producing things of beauty—including the tools they used to make those products. Coachmakers, violinmakers, cabinetmakers and coopers all had their own specialty planes. Of these, I find the planes used by violinmakers and coachmakers to be the most beautiful.

I started making my own planes because I feel my woodworking and violin restoration warrant the most effective tools possible. Also, many of the planes I need are now available only as high-priced antiques.

The coachmakers' plane shown above is typical of those used by 18th- and 19th-century artisans. Its gently rounded sole allows it to be used to smooth curved surfaces—even the curved rabbets often found in carriages and musical instruments. It can also be made with a sole flat along its length for working straight rabbets. To provide enough clearance for the cutter to clean up the sides of a rabbet, the cutter is 0.005 in. wider than the plane body at the cutting edge, then tapers from the edge to the tang—the long, narrow part of the cutter.

The plane's body is ebony, its sole and wedge are beef bone and its blade is made from a discarded file (see "Making and Modifying Small Tools," *FWW* #50). A cutter from the Stanley No. 75 bullnose plane (available from Highland Hardware, 1034 N. Highland Ave. N.E., Atlanta, Ga. 30306) is thinner and will need some re-grinding, but works well. The plane may look awkward to those accustomed to standard bench planes, but rest assured that its design is efficient, having been refined and streamlined over the centuries. I

never use this tool for rough work, but instead reserve it for finish-planing. I find it invaluable for smoothing the ridges left by chisels and gouges in shaping a violin's top plate, for instance, but there's no reason why the plane couldn't be used to clean up the ogee in a chest's bracket feet, too.

Begin the plane by selecting materials. If exotic woods aren't available, beech, cherry and apple are all traditional plane-body woods. You can make the plane with a wood, bone or ivory sole. You may find it difficult to locate ivory, but if you decide to use it, a good source is antique piano keys for thin soles or billiard balls for thick ones. If you're using an applied sole, dimension the plane accordingly. I usually make an applied sole about  $\frac{3}{16}$  in. thick at its center.

If you plan to use bone, visit your local butcher and get a fresh piece of shinbone from the front leg of a steer. These bones have a thick wall and are ideal for soles and wedges. Saw off the knuckles to expose the marrow on both ends of the bone, and boil it in a large pot for two to four hours. Adding an onion to the water will speed the process, and also helps bleach the bone. After all of the marrow has been cooked away, hang the bone in the sun to dry or place it in a pan on a south-facing roof for a few weeks (bring the bone inside if it starts to rain). The bone is ready when sawing it produces fine, dry powder.

Bone can be worked like dense hardwood. It dulls chisels quickly, so sharpen your tools to a less acute angle than normal—about 30° to 35°. I use resorcinol glue to attach the bone to the plane's sole. Mix the glue to the consistency of a paste; if you mix it to the directions given on the package, it'll be too thin. Also, score both the bone and the mating surface of the wood with the corner of a file or with 40-grit sandpaper. This helps the glue adhere to both surfaces. Be careful to keep all score marks about  $\frac{1}{16}$  in. away from the edges of the sole, lest the marks show on the glue joint after the plane is finished. If you use an exotic

## Coachmakers' rabbet plane

Top view, actual size



Tang mortise one-third width of plane body.

Side view

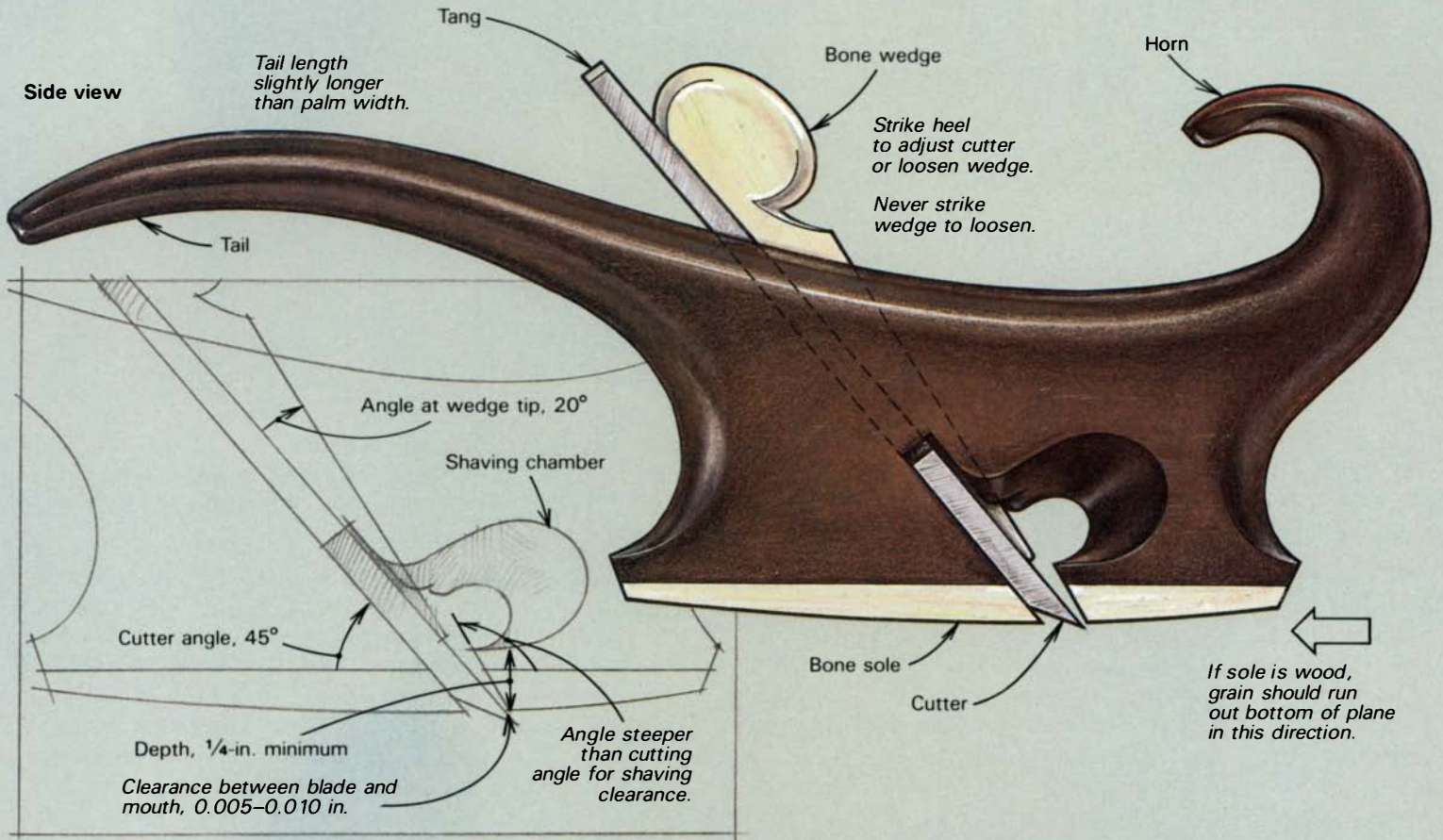

wood, remove traces of resin by wiping the wood's mating surface with lacquer thinner after the scoring is completed.

Now, draw the profile of the plane body on the blank you've selected and cut it out on a bandsaw. If you're making a wooden plane that's self-soling, be sure the grain runs out the bottom of the sole *opposite* to the direction in which the plane will be pushed. (Think of the grain as cat's fur: If you move with the grain, you lay it down; move against the grain, and you raise it up.) Save the outline cutoffs, too—they're ideal for protecting the plane when it's clamped in a vise during shaping (see top left photo, facing page). Now, shape the plane body with chisels, rasps and files.

Next, lay out the  $45^\circ$  angle that beds the blade and the wedge. (Don't mortise for the blade or make the throat cutout until the plane's profile is completely roughed out—the body may crack from the clamping force needed to hold it in the vise during rough-shaping.) Make the tail slightly longer than the width of your palm. Also, your thumb should fit comfortably inside the horn.

Make the first cut for the  $45^\circ$  mouth slot with a fine backsaw, dovetail saw or bandsaw. Don't use a tablesaw—its kerf is too wide. Next, measure the thickness of the blade and make a second cut

that distance from the first. For now, you want the blade tightly seated in the opening. Later, you can pare or file away enough wood to shape the throat opening—the most critical dimension in making the plane. Cut out the shaving chamber with a scroll or coping saw, and bevel the chamber's edge using carving chisels and gouges. The bevel allows shavings to curl out after they enter the chamber. Otherwise, they jam up like an accordion's bellows.

Carefully bore down from the top of the blank to start the mortise for the tang. The wedge bears down mostly on the tang, so the bottom of this mortise must be flat and smooth. Otherwise, the cutter will have a tendency to slip under cutting force. I clamp the plane in a vise and bore the tang mortise hole by eye, judging the angle by the layout lines drawn on the side of the plane. Stay clear of the layout lines to avoid chewing up the final bed surface. I use an extra-long drill bit (also available from Highland Hardware) in an "eggbeater" hand drill for boring this hole. You could make a jig and use an electric drill instead, but I prefer doing this by hand since it allows me to proceed slowly and carefully. The top of the mortise is pared to the wedge angle, and the bottom of the mortise is finished by paring as described later. Make the mortise  $\frac{1}{8}$  in. wider than the tang's width to allow the cutter lateral adjustment.

## Cutter

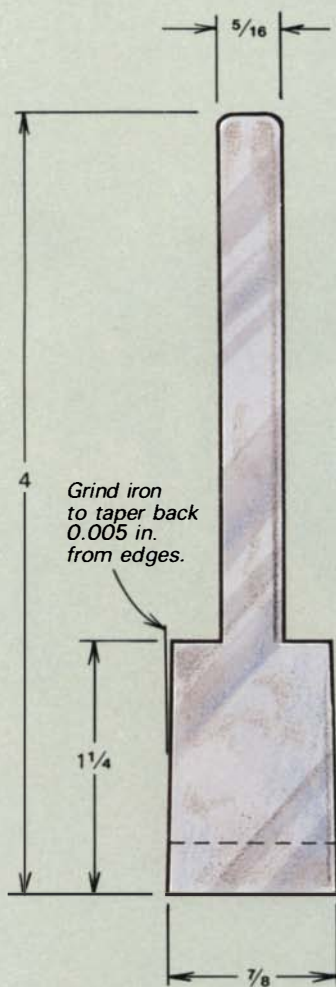

Save the outline scraps from the plane's body to help clamp it in place during shaping (above, left). Flatten the cutter bed after the mouth is cut out by clamping the plane in the vise and filing the bed in line with the top of the vise jaw (above, right). Test fit the cutter after its mortise is completed (below), and hold the plane up to the light to reveal any gap between cutter and bed.



Clamp the plane in a vise with its bed parallel to the vise jaws and extending about  $\frac{1}{2}$  in. above them (see top right photo). Then, flatten the bed with a fine, thin file, using the top of the vise jaw as a guide. Use a mortise chisel to bring the tang mortise in line with the bed. Slip the cutter in place, and hold the plane up to a strong light to check that it fits precisely to the bed. It's critical that the blade bed down accurately. If not, the plane will chatter during use. After making minor adjustments, make a final light check to ensure that the blade beds precisely. Chalk or graphite rubbed on the blade's back will mark any remaining high spots. Be careful not to remove too much material when bedding the iron or you'll risk making the mouth too wide.

Now, bandsaw the wedge and test-fit it. Trim it as needed—with a file if it's made out of bone, with a block plane if it's made out of wood. The wedge should slip easily into place and bear against the top of the tang mortise, not the sides. If it rubs against the sides of the mortise, the wedge won't snug up properly, and you could crack the plane along the mortise trying to tighten the wedge by driving it in place. The wedge should require only a light tap with a small mallet to seat properly.

Now, check the throat opening for chip clearance with the

blade wedged in place. Remove the blade and file or pare the mouth so there's a 0.005-in. to 0.010-in. space ahead of the blade—to allow for chip clearance. Automotive feeler gauges are great for checking this dimension.

Dry-sand the plane, beginning with 120-grit paper and following it with 220, 320, 400 and 600 grit. I also wet-sand the body and the sole, and final-polish with polishing compound, such as jewelers' rouge. I finished my plane with ten coats of Minwax Antique Oil Finish.

Cutter adjustment with these planes is simple, requiring only a light touch. Deepen the cut by gently tapping the back of the tang. Back the cutter out by tipping the plane forward and lightly tapping the plane at the heel. Loosen the wedge by tipping the plane forward and firmly striking the plane's heel (*never* loosen the wedge by striking it directly or working it back and forth).

The plane is demanding to build in that it requires concentration and careful workmanship. But I didn't pay attention to how long it took to build—I was enjoying myself too much to care. For me, one's enjoyment while working is the real bottom line. □

*Jeff Lock is a woodcarver and violin restorer in Tallmadge, Ohio.*



*Pennsylvania stands such as this one produce much of the top-grade cherry available today. Black cherry was the first tree to get a foothold after the region was clear-cut about 100 years ago. The drawing below (actual size) shows cherry blossoms in late May.*



# Cherry

## *A rose among woods*

by Jon Arno

**T**o the American cabinetmaker, there's something special about our domestic black cherry, *Prunus serotina*. It's the second most popular hardwood (after oak) used by furniture manufacturers in this country. And if price is to be taken as a measure of popularity, only black walnut is consistently more expensive than cherry among our major native-grown timbers.

The mystique behind cherry's popularity (and I can't deny it influences me more than it should) is tradition. Cherry was a much-prized wood among Colonial cabinetmakers and also among the magnificently skilled Shaker craftsmen of the 19th century. Certainly, its great working characteristics were important considerations to these old masters at a time when hand tools were the *only* tools. But, I suspect, there was yet another, ulterior motive for its use, at least among the Shakers: Members of that religious sect disdained frills, and the natural beauty of cherry allows a woodworker to create a piece that's exceptionally appealing to the eye—without compromising the functional design with fancy moldings or bric-a-brac.

Cherry is a member of the rose family, *Rosaceae*. This family, with its more than 3,000 species, is one of the most important in the plant kingdom. Were the rose family to vanish tomorrow, it would take with it not only the beauty and fragrance of the rose, cherry wood and cherry pie, but also a host of other flowers and edibles—plums, peaches, apples, raspberries, almonds and many, many more. The so-called "rosewoods" of commerce, by the way, come from tropical species of the genus *Dalbergia*, which is a member of the pea family, *Leguminosae*. None of these

rosewoods is close kin to the true rose. The rose family is well-endowed with woody perennials, shrubs and even trees, some of which—like apple and plum—have been used in cabinetmaking for small items and woodenware since ancient times.

Like apple trees, orchard cherry trees don't produce a lot of usable wood because much of the tree's energy goes into fruit production, rather than toward making timber. Only our wild black cherry is plentiful enough—and energetic enough—to fight for its place in the forest canopy and produce logs of usable dimensions. Black cherry can attain diameters of 4 ft. to 5 ft. and heights of about 100 ft., but seldom in the same tree. A 3-ft.-dia., 80-ft.-tall cherry tree is a mighty respectable specimen. While black cherry is the giant of its family, it's a mere also-ran among the maples, yellow-poplars, oaks and walnuts it competes with in the wild.

Cherry has an average specific gravity of 0.47 (green volume to oven-dry weight), making it hard enough for most furniture and woodworking purposes. On the average, it's 8% to 10% lighter in weight than American black walnut, more than 15% lighter in weight than sugar maple and downright soft in comparison to most of the oaks.

For a wood that's so beautifully figured, cherry is exceptionally easy to cut with reasonably sharp tools. This is a great blessing on those tedious but necessary little jobs, such as mortising for hinges, hand-joining and surface-planing.

Cherry is excellent on the lathe. It's in a class with walnut and,



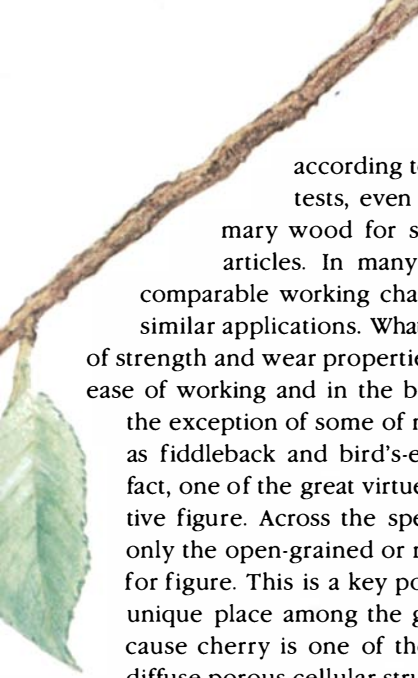

according to USDA Forest Products Laboratory tests, even superior to maple, which is a primary wood for spindles, rollers and other turned articles. In many respects, cherry and maple have comparable working characteristics and are well-suited for similar applications. What cherry gives up to maple in terms of strength and wear properties, it more than makes up for in its ease of working and in the beauty of its color and figure (with the exception of some of maple's special grain patterns, such as fiddleback and bird's-eye, but these are not typical). In fact, one of the great virtues of cherry is its remarkably attractive figure. Across the spectrum of cabinetwoods, generally only the open-grained or ring-porous woods will rival cherry for figure. This is a key point in truly understanding cherry's unique place among the great woods of North America, because cherry is one of the very few woods that combine a diffuse-porous cellular structure with nearly ideal density and a truly beautiful figure. Although fine woods in many applications, other diffuse-porous woods—basswood, yellow-poplar, birch and maple, for example—are either too soft for furniture that will experience hard use, or too bland to produce a finish with real character.

Why cherry captures the important benefits of a diffuse-porous wood while offering a fabulous figure is perhaps best explained by contrasting its cellular arrangement to that of a more typical diffuse-porous wood, maple. The modest, flatsawn figure of typical maple results from thin bands of fibrous tissue along the annual rings that are produced by the tree at the end of each growing season. The pores are of small, uniform diameter and are very evenly dispersed throughout the wood. In cherry, however, the pores—formed early in the growing season—are slightly larger and form a band along the annual ring. This anatomical distinction is quite subtle, but it's significant enough to give cherry's figure far more character than maple and other typical diffuse-porous woods. In effect, cherry is a semi-diffuse-porous wood (see photo, below right), and owes much of its beauty to this feature.

America's other great (and, some would say, finest) timber, black walnut, approaches the other side of the spectrum in that it is semi-ring-porous. This distinction may seem academic—of little interest, except to botanists—but it's important. The size and arrangement of pores—or, more accurately, vessel cells—give cherry a clear advantage over walnut in at least one important furniture application: tabletops. Cherry's grain is so tight that it virtually never needs to be filled in order to achieve a glass-smooth finish. Just an extra coat of a reasonably high-bodied varnish followed by a good rubdown will do the trick. To use this same technique on walnut is possible but, at best, it's a labor of immense love because walnut will drink up the first two or three coats of varnish like an overworked camel.

It's my opinion that, among common domestic hardwoods, only sugar maple is functionally superior to cherry for tabletops. That's due to maple's finer, less-porous texture and greater dent-resisting hardness. Even this conclusion, however, is suspect when the issue of relative stability is brought into consideration. On this feature, maple is adequate, but cherry is outstanding.

Cherry is extremely stable in terms of expansion and contraction when exposed to changes in humidity. This feature made it a favorite species in the printing industry when poured-lead type was the state-of-the-art. A printer could set a page on a cherry-wood block and store it for months without fear of having the block distort the next time it was put on press. But while stability

is indeed a great virtue of cherry, I must confess that when I was a much younger man, my blind faith in wood technology books—which universally extol the stability of cherry—led to one of my most embarrassing woodworking blunders.

I already had plenty of shop experience with cherry, but my first opportunity to get a real “steal” on the stuff came about when some trees had to be cut down to clear a lot in my neighborhood and make way for a new house. After years of paying \$3 a board foot for store-bought stock, I was absolutely ecstatic when the builder told me these cherry trees were mine for the taking—*free!* With abject faith in the renowned stability of the species, I was totally certain that air-drying the wood was going to be a piece of cake. So, to hasten the process, I brought it home green from the mill and stacked it up with stickers in our very hot attic. There, it spent the months of July, August and September, completely undisturbed.

By summer's end, the wood was indeed dry, but as I lifted the attic door and turned on the flashlight, the sight that greeted me had the general dimensional configuration of a curly head of windblown hair, split ends and all. To this day—with the exception of what I fed to my fireplace—the only usable thing I've gotten out of what should have been well over 200 board feet of prime cherry is one Shaker cabinet doorknob. Aside from its potential in providing an occasional 6-in. lathe billet, the cherry that's left is totally worthless. To draw a moral from this story (and perhaps spare others the same experience), cherry is exceedingly stable *once* it's dry, but not necessarily *while* it's drying.

Over the years, I got to know the black cherry species well from many other perspectives. As a firewood, it is superb. When a stick or two of slightly green cherry is laid on the hot coals of a fire, the aroma is unforgettably delightful. The fruit is small, almost black in color and, in my opinion, it'll never replace the commercial Bing for flavor in the raw state. It's bitter to the point of unpalatability when eaten off the tree, but it makes a good wine with a deep purple-red color. In Colonial times, the fruit was packed into jars of rum to produce a potent favorite of the era called “cherry bounce.” That, too, I've experimented with, and it is indeed tasty, but really not substantially different from a modern fruit brandy.

American black cherry is not a reliable producer of fruit—at

Photo: R. Bruce Hoadley

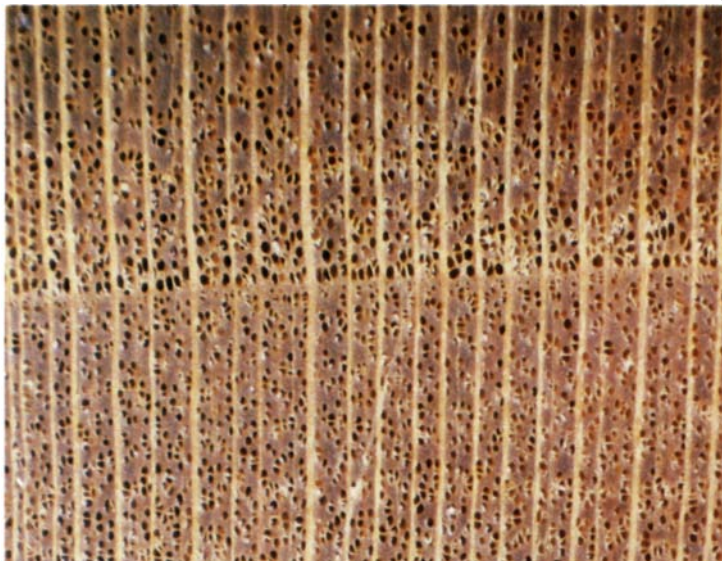

*This ten-power macrophotograph of cherry endgrain shows the slightly larger pores at each annual ring. These give the wood a desirable grain pattern without making the grain hard to fill.*

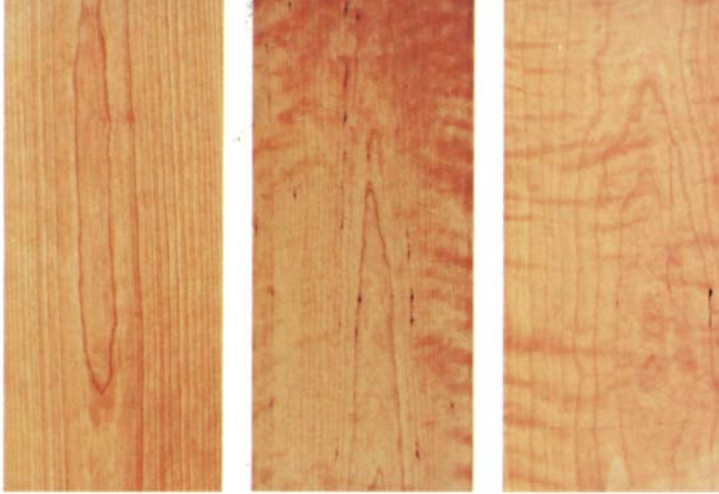

*These three veneer samples show the range of cherry's character, from the very high grade on the left, to gummy (center), to the figured heartwood at right.*

least, not in the harsh climate of northwestern Wisconsin where I cohabited with it. Some years it will hardly set fruit at all; in other, good years, the crop will be plentiful to the point of becoming a nuisance. The cherries litter the lawn, and their dark juice stains clothing. Swarms of birds devour, process and deposit them on cars, sidewalks, roofs and windows. The botanists would call this bird-to-cherry relationship “symbiotic” because it helps to propagate the species—not only to nearby fence rows and under telephone lines, but across considerable distances. As a result, black cherry has a sporadic and yet very extensive range. It's most plentiful in the hardwood forests of the eastern and midwestern United States and southern Canada, but its range extends down through the mountains of Mexico into Central America.

Like most other hardwoods, black cherry grows wild, not in planted stands. As long as there's a supply of seeds from local trees and sufficient sunlight, the trees do well. In fact, experiments over the last 20 years have proven that cherry does best if left alone: Efforts to produce knot-free wood by pruning low branches from selected trees seem to generate more branches.

The heart of cherry's U.S. range, and where it produces timber with maximum vigor, is in the central and Appalachian states. However, latitude, altitude and other macro-geographic and climatic factors are only part of what is important to the tree with respect to habitat. Cherry isn't very shade-tolerant. This, combined with its less than formidable maximum growth potential, makes good cherry lumber dependent on opportunistic natural events. The tree will grow vigorously in full sunlight along a fence row, but it will branch out low, form a broad crown and, over time, pick up a fence staple or two when it happens to be growing right where a post ought to be. All of this, of course, degrades the quality of the wood.

The best source for cherry right now is in the mountainous region running up through Pennsylvania and into New York. That part of the country was almost completely clear-cut about 100 years ago, and cherry—being something of a pioneer species—got off to a good start. Seeds spread by birds were abundant, the saplings were mostly unshaded by older trees and competition between the trees made them reach up for light, promoting tall stems. Foresters in the early 1970s were delighted to discover the maturing resource, just at the time when the trees were reaching their peak. (If left unharvested over the next 100 years, these cherry trees would eventually succumb to the beech and maple growing in the forest's understory.) At the time, the demand for cherry was quite low, because there wasn't enough quality wood available from other parts of the country to promote and maintain much interest. As

recently as the 1950s, cherry was one of the *least* used of our native timbers, having sunk to 28th place in the number of trees harvested. It was so scarce, in fact, that it ranked in price with rosewood and ebony. When the steady supply of Pennsylvania cherry began coming into the marketplace, however, popular demand grew as more and more people began to see the quality of the wood. Today, as mentioned earlier, the demand for cherry is second only to oak.

Cherry has a tendency to be a rather gummy wood, especially trees that have grown under less-than-ideal conditions. This gumminess can be a negative, especially when sanding the end-grain. The surface may quickly burn or darken when belt-sanded, requiring a great deal of tedious hand-sanding to soften the color. The safe approach is to give the endgrain a whisk or two with a sharp scraper, followed by gentle hand-sanding with a fine-grit sandpaper. Personally, I like “gummy” cherry. A certain amount of gum streaks well-dispersed in a slowly grown, wavy-grained piece of heartwood can be very attractive.

In furnituremaking, one of cherry's great attributes is the color it will eventually attain as time and chemistry work together to produce its unmistakable patina. The translucent, warm, amber-orange hue that only old cherry furniture exudes has eluded stain manufacturers to this day, and very likely always will. For starters, I have yet to find a convincing technical explanation of the chemistry of cherry's patina—I doubt if scientists really understand it yet.

Exposure to light definitely affects cherry and might accelerate the patina-building process, but I know from my own otherwise bitter experience in that absolutely pitch-dark attic, one of the few things my stack of cherry did right was to darken. (I think maybe I roasted it.)

The chemistry of cherry is certainly complex and not entirely friendly. Like peaches, almonds and some of its other close relatives in the rose family, cherry produces cyanic acid which, in high enough quantities, is lethal. Although the wood itself is non-toxic, wilted cherry leaves have poisoned livestock. There are traces of the poison in both the bark and the fruit pit. In fact, peach pits are high enough in cyanic acid to have once been an economically viable source for the deadly poison, cyanide.

I have no reservations about working with cherry wood and would do so far more often if it weren't for its price. Cherry is quite plentiful here in Wisconsin, but even here the best price I've found for FAS, kiln-dried stock is \$2.80 per board foot, unsurfaced. I've chased down a few sources of freshly cut green material at well under \$1 per board foot, but I'm understandably a little apprehensive about that alternative. Actually, I *have* successfully air-dried a few pieces of cherry since that disaster years ago (taking the normal care necessary with any wood), and my self-confidence has healed to the point that I would gladly take on the challenge again, but that's not the problem. I simply can't find good, wide pieces of cherry heartwood at the local mills. Demand for this “rose among woods” is intense, and doubtless the best of Wisconsin's production is shipped off to furniture factories and to woodworkers with fatter wallets than mine. What the mills here attempt to pawn off on us locals are narrow widths, slab cuts and sapwood. The art of avoiding that kind of “deal” is a skill the backwoods scavenger soon learns.

You know, come to think of it, it's only about a ten-hour drive from here to the cherry belt in Pennsylvania. □

*Jon Arno is a woodworker and amateur wood technologist who recently moved from Brookfield, Wisc., to Schaumburg, Ill.*

# Mortise and Tenon

*Chop the mortise by hand,  
but a machine's best for the tenon*

by Michael Podmaniczky

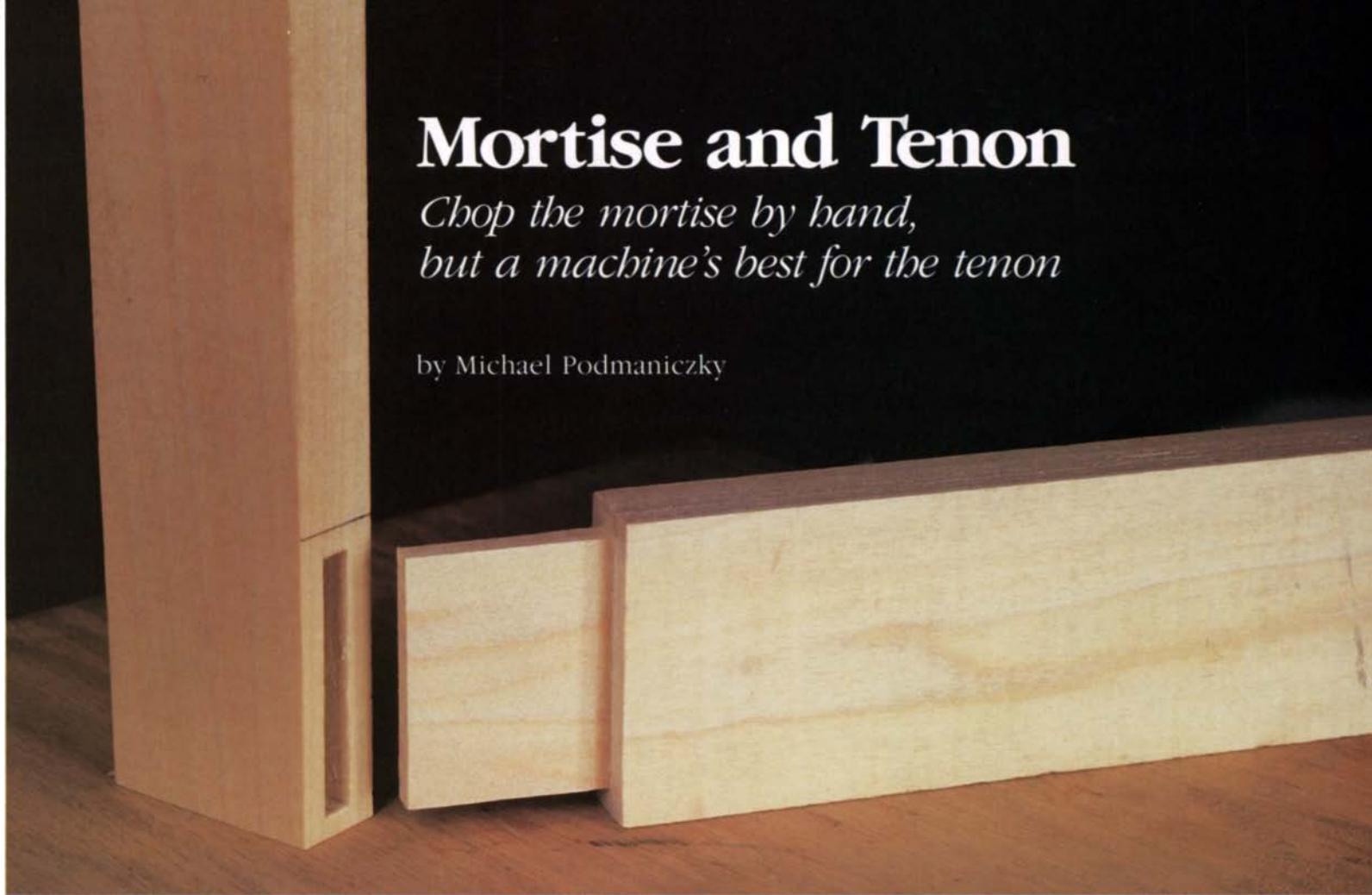

*Easily cut by a combination of hand and machine methods, the mortise and tenon is among the most versatile of all furniture joints.*

I've always considered the basic mortise and tenon the workhorse of joinery and the primary joint to master for most furniture work. Like the dovetail, the mortise and tenon allows wood to "turn the corner." It's also the basic joint we use for frame joinery to join rails and stiles to make doors, join aprons to legs to make tables and join rails to posts for chairs. Marked out and cut in multiples, it's a perfectly acceptable—albeit more time-consuming—alternative to sliding dovetails, miters or lap joints for carcass work, but I'll limit my discussion here to frame joints.

When I grit my teeth and do the very best I can to remain objective, neither falling into the argument that the old ways work best nor advising that nothing really works well in the 20th century unless it does so at deafening decibels, I have to admit that I usually cut my mortises by hand and my tenons by machine. I've arrived at this method after years of working in shops with no proper mortising equipment. Certainly, the router will do a decent job on a shallow mortise, but most furniture work will require a mortise at least 1 in. deep and probably deeper. If you have a slot mortiser or a hollow-chisel setup, you're lucky. Most of us don't have these tools, so it makes sense to learn to mortise by hand. Tenoning is another matter. For just a few rails, sawing tenons by hand is quite reasonable and not all that hard to learn. But one tool that almost all shops have—the tablesaw—is easy and safe to set up for tenoning.

**Chopping a mortise by hand** doesn't require mind-numbing attention to accuracy. Unlike an edge-glued joint, which is jointed straight and then clamped tight, the mortise and tenon needs to be really "tight" only where the tenon shoulder meets the mortise face. It's possible, of course, to achieve a piston-like fit on the tenon, but there's no practical need to do so since modern glues

are more than able to fill minor gaps. In fact, if the fit of the joint was as tight as a clamped edge joint, you'd probably split the mortise apart during assembly. Still, it's a good idea to cut the joint precisely, and I'll describe my procedures for doing so.

But, first, the mortise. You'll need these tools: a combination square, a mortise-marking gauge, a layout knife, a hefty mallet and, of course, a mortise chisel. An accurate square (I like my Starrett combination) is a must for marking both the mortise and the tenon. For marking lines that must be carried completely around the stock, nothing is more annoying than an untrustworthy square that multiplies its error at every turn. For marking out the mortise (and later the tenon), you'll need a mortise-marking gauge—essentially a regular marking gauge, except that it has two spurs instead of one. One spur is fixed to the gauge's beam; the other is adjustable, and both can be moved in relationship to the gauge fence. This allows mortises and tenons of various thicknesses to be marked out and positioned anywhere in the stock thickness.

I realize that some tool catalogs sell what they refer to as "mortise chisels," and there are plenty to pick from. Essentially, a mortise chisel differs from bench and paring chisels in that it has a rectangular section that's deeper than it is wide, with sides that should be parallel to each other (and, with careful sharpening, perpendicular to the cutting edge). I consider the proper mortiser one that can be driven into the side of a utility pole and jumped on by John Madden without breaking or bending. I haven't found a commercial tool that completely fills the bill, so I've taken to making my own by a process described on p. 71.

You can try to sneak by with a paring chisel—I suppose small, shallow joints can be cut this way. But as soon as you start getting into deep mortising, your little paring chisel will twist and there's just no way that the mortise cheeks are going to stay par-



**Fig. 1: Marking out and chopping a mortise**

1. With a knife, mark out shoulders first. All marking should be done with square's blade referenced against face side and face edge.

2. With spurs set to width of mortising chisel, mark out mortise cheeks.

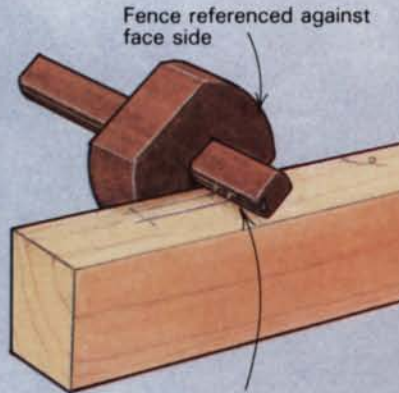
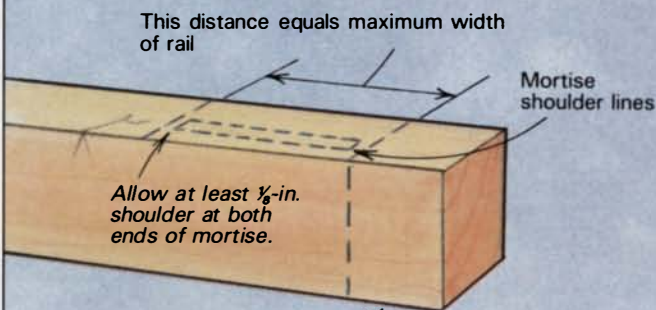

Gauge beam adjusted to position mortise within thickness of stock

Extra length, called *hom*, keeps stile from splitting during chopping. The *hom* is cut off flush after assembly.

3. Begin chopping at far end of mortise, approximately  $\frac{3}{16}$  in. from shoulder line. Chop about  $\frac{3}{16}$  to  $\frac{1}{4}$  in. deep, move bevel forward and chop again.

Lever out the waste with back of bevel, then repeat chop-lever sequence.

When levering waste, take care not to crush wood outside the shoulder line.

With mortise at full depth, pare to the shoulder lines at both ends.

Mortise bottom needn't be perfectly flat, but to clean it up to consistent depth, lever chisel against mortise ends.

Top, marking out a mortise begins with setting the mortise-marking gauge to the width of the mortising chisel. Above, a square stood on the bench aids in keeping the chisel perpendicular to the work during chopping.

allel. So the loose joint is loaded up with gap-filling glue, and the door (chair, table, whatever) lives happily ever after. Best to do it right and buy (or make) a set of mortising chisels.

Mortising chisels are most commonly sold in four widths:  $\frac{1}{4}$  in.,  $\frac{3}{8}$  in.,  $\frac{1}{2}$  in. and  $\frac{3}{4}$  in. If you aren't going to buy a set, choose a size or two most likely to fit your needs. This leads us to the question of sizing the mortise in width, length and depth. To determine mortise width, some woodworkers simply divide the stock thickness by three. Thus,  $\frac{3}{4}$ -in. stock would require a mortise  $\frac{1}{4}$  in. wide with a tenon of matching thickness, less a bit of clearance. Most furniture is, however, frightfully overbuilt and anything reasonably close to this rule is plenty strong.

To begin, cut out your stock to the desired dimensions and make sure you've gotten the faces square to the edges—otherwise your mark-out lines won't align as you carry them around each piece. Allow extra length on the part being mortised (which I'll call the stile), and plan to position the mortise to leave at least 1 in. of additional material between the end of the piece and the edge of the finished joint. This extra length (called the "horn") will keep the stile from splitting out as you chop the mortise. Later, the horn will be cut off flush.

Mark the length of the mortise (allowing for shoulders of at least  $\frac{1}{8}$  in. on both ends) and the horn on the end of the stile. Then, scribe the lines for the mortise with the double spurs on your marking gauge set to the width of your mortising chisel (see top photo, left), and the gauge fence set to roughly center the mortise in the thickness of the stock (unless you want it closer to one edge, as in an apron-to-leg joint for a table). Once I've marked the mortise, I cut the lines a little deeper with my knife. This makes them read well and also allows the first cuts with the chisel to pop waste out without tearing up the edges.

To chop the mortise, clamp the stock to your bench with the joint positioned over a leg so that the shock of your mallet is directly transferred to the floor. You'll be doing some pounding, and even though vises are tough, they really aren't designed for this kind of punishment. The position of your body is critical to hand mortising, so don't try to cheat. With the chisel in your hand, positioned in the marked-out joint, stand in such a way that you can sight down the piece and—with your back straight and arms extended—get the feel of the tool's relationship to the work. This exercise will enable you to develop the skill of perpendicular chopping. To gain confidence, try standing a square on the bench near your work to give yourself a reference to eyeball to keep the chisel perpendicular to the benchtop (see bottom photo, left).

Begin chopping at the far end of the mortise. Start the chisel about  $\frac{3}{8}$  in. in from the line marking the finished edge of the joint (see figure 1) with the bevel toward you. Hold the tool as plumb as you can, and give it a good whack with your mallet. Move the bevel about a  $\frac{1}{4}$  in. closer to you and have at it again. After this shot, lever the chip out of the slot, being very careful to keep the arc of the levering in the same plane as the mortise. Repeat this process until the levering almost crushes your mark-out line at the near end of the mortise. Now, turn the chisel around and march back in the other direction, repeating the process in reverse.

You'll quickly notice how nicely the thick blade of the mortise chisel is jiggled along the waste-levering arc in a single plane by the slot you've already cut. The parallel sides keep the blade from twisting and digging in, so that if you're careful at the start, the blade will virtually follow a straight line, right to the bottom. The deeper you go, the more muscle you'll need to put into levering out the waste, and the more you'll appreciate the extra meat you left on at both ends of the mortise: This provides a

fulcrum so that the crush doesn't encroach on visible wood outside of the joint.

The force you can apply in this process is considerable, and you'll be thankful for the extra length of the horn. Were it not there, you'd probably rip the endgrain right out of the wood with a deep, waste-clearing pry. Check the depth of the mortise from time to time, measuring with a metal rule or a combination square. How deep is deep enough? That depends on the application. A good rule of thumb is to make the mortise as deep as possible, chopping to within  $\frac{1}{4}$  in. to  $\frac{3}{8}$  in. of the backside of the wood. Obviously, if you're mortising into very wide stock—say a 6-in.-wide door stile—you needn't go as deep. The mortise should be slightly deeper than the length of the tenon, and the depth can be checked with the blade of your combo-square set  $\frac{1}{8}$  in. longer than the length of the tenon; after all, you don't want the tenon bottoming out before the shoulder is tight against the mortise face.

Once you're as deep as you want to be, scrape the bottom reasonably flat with levering strokes. Finish up by paring away the material left shy of the line at the ends of the mortise. You can trim up to the final line with shallow paring cuts or with careful, mallet-driven chops, with the chisel's bevel facing into the mortise. Check again that the depth is consistently correct, and the mortise is done.

If you aren't really inclined to doing handwork or if you've got dozens of mortises to chop, there's one method that speeds things along. I have, on occasion, set up a right-angle fence on the drill-press bed, bored out most of the waste and pared to the final line. If the diameter of the drill bit used is the same as the width of the mortise, paring merely involves cleaning off the ridges between overlapping drill holes with a wide paring chisel worked parallel to the mortise length. A reasonably accurate mortise results. I say "reasonably accurate" because any paring of mortise cheeks runs a very high risk of taking them out of parallel.

**I usually cut tenons by machine**, but there are times that hand-cutting makes more sense, is faster and more enjoyable. I'm about to build a reproduction of an 18th-century spice chest, the top case of which is closed with a pair of raised-panel doors. Since everything else is dovetailed together, I'll only have to produce eight mortise-and-tenon joints—hardly a backbreaker. In fact, it's hardly worth the time to set up the jigs and robots to do the job. When I finally succumb to the familial pressure for new kitchen cabinets, however, I plan to defeat that endless army of tenons with the tablesaw. The set-up time will be insignificant relative to the total job, and I can expend my energy on more creative concerns.

Gaining time by machine-jigging exacts a price: There must be absolute uniformity of materials. You don't have to mark out every tenon, nor do you have to concentrate on each jigged cut. But because both edges and/or faces of a rail are used alternately to reference against your jigs, all of the stock must be exactly the same thickness and length, and must also be dead-square. Otherwise, the tenons aren't going to be uniform—they just won't fit right.

Hand-cutting the tenon is demanding in a different sort of way. Each piece must be individually marked, usually from only one reference surface or edge, and cutting is done freehand to the lines, requiring skill with the saw and absolute concentration. A tweak here with a shoulder plane, a trim there with a chisel and the piece goes together the way you want it to.

So, on to hand-cut tenons, beginning with stock preparation. In determining the length of a part to be tenoned, some woodworkers add the length of tenons to the distance between tenon shoulders. They then set a marking gauge to the length of the tenon and, working off the end of the board, mark back to the shoulder. Not

only is this a bit like driving from New York to Boston via Cleveland, it doubles the effort required for accurate shoulders by requiring that the end of the tenon be made perfectly square, which—as far as joint fitting and strength is concerned—it doesn't have to be.

To me, the more sensible approach is to roughly cut the rail to overall length, mark where the shoulders will be (leaving equal lengths of tenon on both ends of the board) and then scribe a crisp line around the stock with your combination square and layout knife. Since there are always at least two rails of the same length in any job, gather them together on the bench after marking shoulder positions on one and knife one edge of each shoulder on all of the pieces simultaneously. The remaining three sides of each tenon can be marked off these initial lines.

The tenon cheeks can now be marked with the gauge set to

the same dimension you used to lay out the width of the mortises. If the rails and stiles are to be flush on the face—as on a cabinet door—the gauge setting doesn't have to be touched. If the stile is to be proud of the rail (as some table legs are proud of the apron face) the depth of the gauge must be reset to reflect this. Strike lines across the ends and edges of each tenon, being careful to always work off the same outside face of each piece.

Figure 2 illustrates how to saw the tenon. A good backsaw will do the job nicely. The cheeks needn't be perfectly smooth and crisp, but the shoulder wants to have a nice, clean edge. So, I knife a second line at a slight angle to the first on the waste side of the line, creating a deeper notch to help guide the saw for the first few strokes. If the shoulders aren't right to the line or if they aren't smooth, true them up with a paring chisel if the tenon is narrow, or

**Fig. 2: Marking and sawing a tenon**

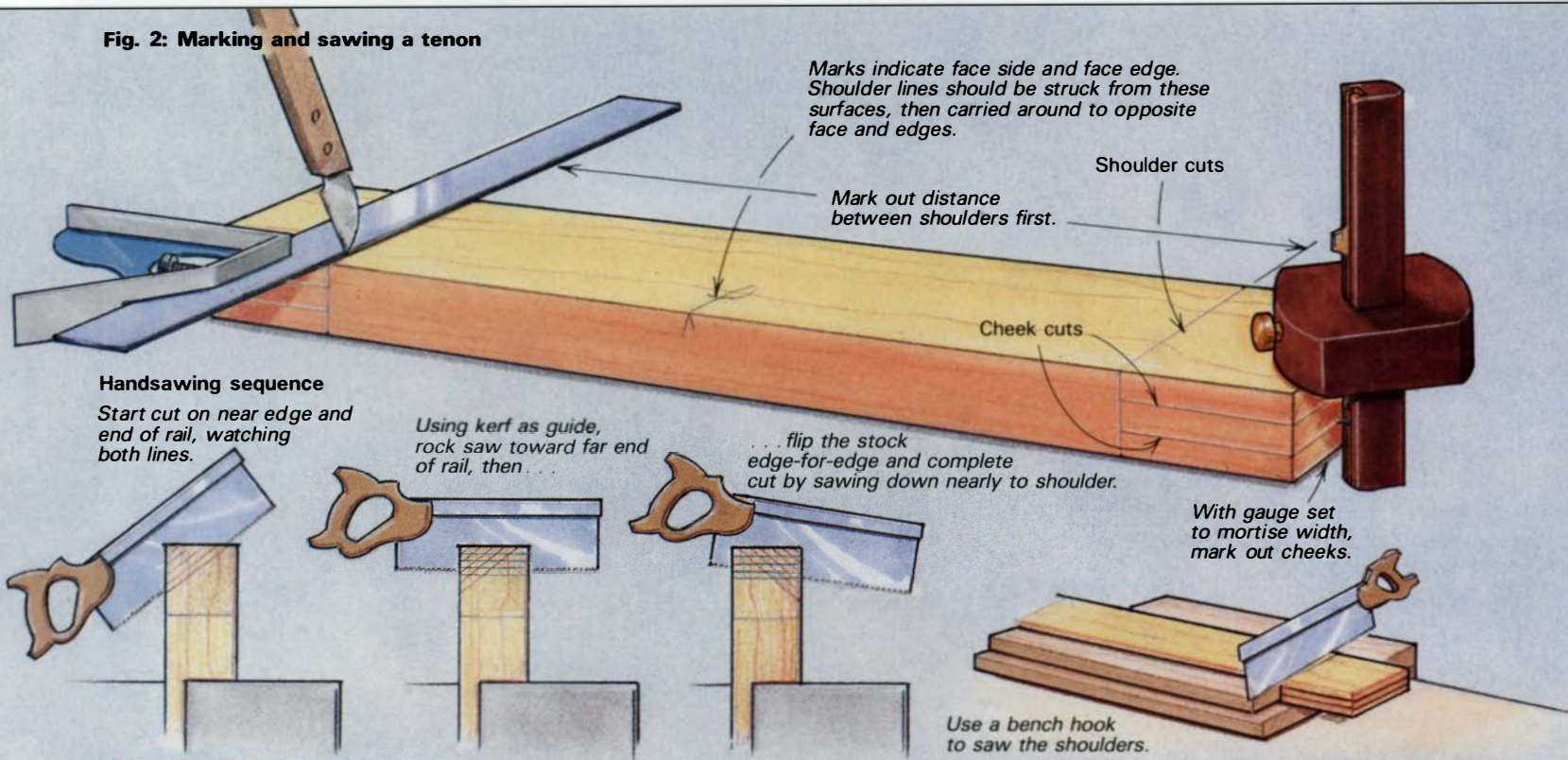

**Fig. 3: Two ways to tablesaw tenons**

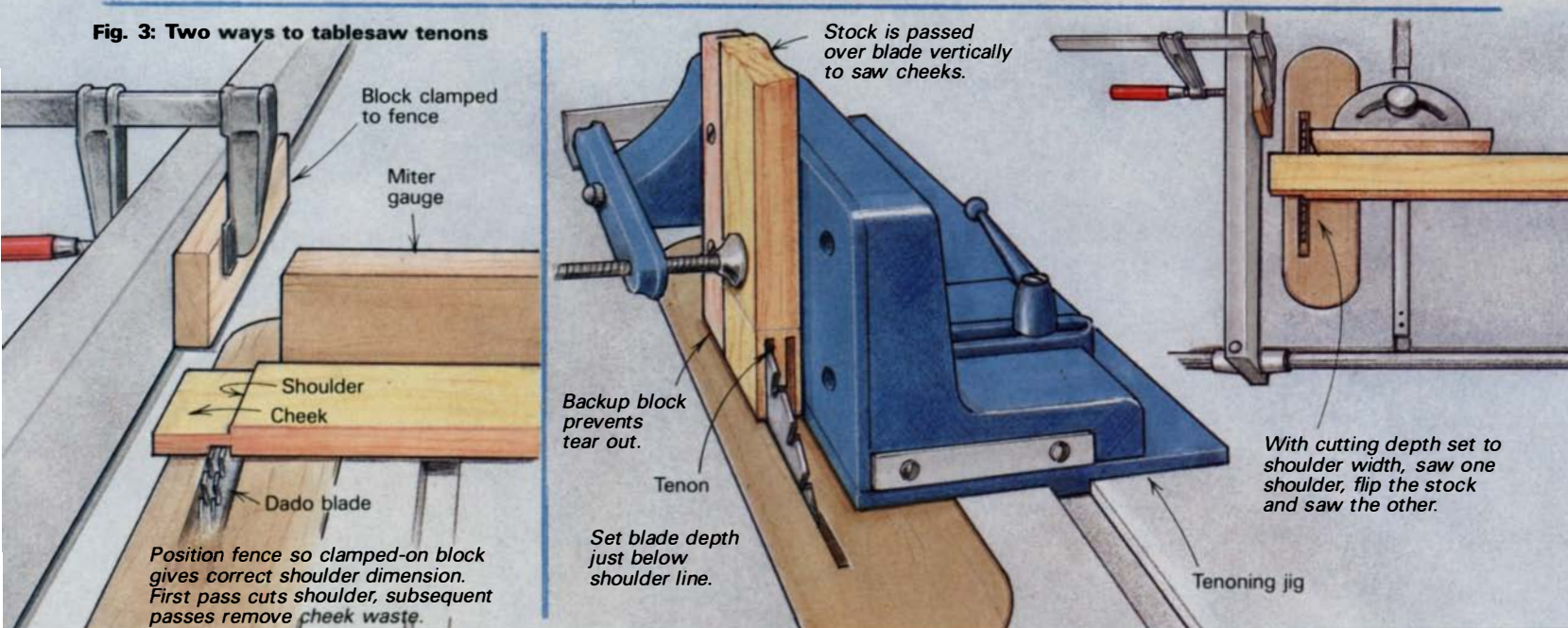

## Making a mortising chisel

I've never been able to find commercially made mortising chisels capable of withstanding the considerable pounding of heavy work, so I designed my own set a few years ago. I know very little about blacksmithing, but I took drawings of what I wanted to a machine shop and asked them to make up a set of three chisel blades, each a different width. The shop used ordinary oil-hardening tool steel, hardening it in an oven after the blades were shaped and then tempering them.

If you don't have a suitably equipped machine shop nearby, you can make the chisels yourself just as well. A good general-purpose oil-hardening tool steel is O-1 (Source: Cardinal Engineering, Route 1, Box 163, Cameron, Ill. 61423). It's available in the annealed (or soft) state, and can be shaped by grinding or with a hacksaw and file. Don't grind too aggressively, however, or else you risk heating the steel and hardening it prematurely. Drill the holes for the scales before heat treating.

To harden O-1, heat it cherry red with a pair of propane torches, then quench it in a bath of clean motor oil. Since there's a lot of



*Author Podmaniczky designed his own mortising chisels and had them made. The chisels are fashioned from oil-hardened tool steel with bronze handles.*

steel in these chisels, small torches may be capable of heating only the lower third or lower half of the blank. As long as the cutting edge is hardened, this will work fine. Tempering can also be done with the torches. (For more information on tempering, see "Making and Modifying Small Tools" in *FWW* #50 or *Fine Woodworking on Hand Tools*.)

At the time I made these chisels, I planned to produce them in quantity, so I shaped patterns for scales out of wood and had them cast in bronze. If you want to make just one set, you can easily shape quarter-hard brass with files and/or a belt sander. I lightly countersunk the holes in the scales, then riveted them on with  $\frac{1}{4}$ -in. brass rod stock (see photo, left).

To ensure that the leading edges of the blade's back were straight and sharply squared, I hollow-ground the blade's length to within  $\frac{1}{4}$  in. of the cutting edge (similar to a Japanese chisel) and stoned it. I then ground the bevel flat and a bit more obtuse than a bench chisel. Finally, I stoned the bevel flat on a fine India. —M.P.

with a shoulder plane if it's wide. To trim a tenon that's too thick for its mortise, pare the cheeks evenly, either with a wide chisel or a rabbeting plane. (See "Paring Chisel Basics," *FWW* #64.)

There are two ways to saw tenons on the tablesaw (see figure 3). The method I prefer is to cut cheeks and shoulders at the same time by multiple passes over a dado blade. The other method is to saw the cheeks in one pass using a rip blade with the part standing vertically, held by a jig or running against the fence. The shoulders are then cut with a cross-cut or planer blade with the rail lying flat and the end of the tenon jiggged against the fence. It's important to clamp a block on the fence. Otherwise, the off-cut cheek can jam and shoot back at you like a cannonball.

If you're really confident at machine setup, you don't have to mark even one tenon, but I always feel better when I have a line to work to. One of the secrets of machine tenoning is to have plenty of waste stock so you can run test pieces for each new setup, making practice tenons that can be tested in the mortise they're intended for before committing actual stock. Knife-in one shoulder on a scrap piece and strike one set of cheeks with the marking gauge you used for the mortises earlier.

You're going to remove cheek material with a cross-cut motion over the blade, so for maximum stock removal per pass, it's expedient to install all of the dado chippers. Set the depth of cut to just less than the depth of the tenon shoulder and, using your miter gauge, make a test cut. If your tenon is centered in the rail, the other cheek can be cut by flipping the stock over and repeating the same procedure. Test the tenon fit and adjust the depth of cut so that the tenon enters the mortise with just the slightest resistance. Better a little loose than too tight. If the tenon isn't centered, every tenon will have the same cheek cut before flipping it over. Then, the depth of cut must be reset to give the correct tenon thickness.

The stand-up method of tenoning requires a shop-built vertical jig or one of the commercial jigs sold for the purpose. Woodcraft Supply sells a lightweight aluminum jig (catalog number 17L21, \$69.50). Delta makes a nice, heavy, cast-iron tenoner that attaches to tablesaws and shapers (catalog number 34-172). For shop-made jigs, see *Fine Woodworking on Proven Shop Tips*, p. 70. All of the jigs do the same thing: They clamp the stock firmly so it can be passed safely through a rip blade on the tablesaw. As with the dado method, set up the tenoning jig using a piece of scrap marked out with shoulder and cheek lines. I cut the cheeks first by setting the saw's depth of cut so the top of the kerf will be just shy of the shoulder line. Saw one cheek on each of the pieces, flip the stock edge-for-edge, readjust the jig (for off-center tenons only) so the tenon thickness is correct, then saw the other cheeks.

Before committing all of your tenons to that second cheek cut, however, it's a good idea to make the second cut on your scrap piece and then saw the shoulder lines so you can test the tenon's fit. Instead of messing around resetting the tablesaw's depth of cut, you can roughly handsaw or bandsaw the cheeks on your scrap to try the fit. If it's satisfactory, complete the second cheek cuts, then set up your miter gauge for the shoulder cuts (see figure 3).

In assembling mortise-and-tenoned parts, clamp just firmly enough to ensure that the shoulder is solidly positioned against the mortise face—don't crush anything with overclamping. Correct for square and true, if necessary, by canting the clamp slightly. When the glue has set up, saw off the horn and you're in business. □

*Michael Podmaniczky is a contributing editor to Fine Woodworking and a furniture conservator at The Winterthur Museum in Winterthur, Del.*



# Vacuum Jigs

*Holding the work with thin air*

by James L. Kassner, Jr.

**F**urniture manufacturers and short-run production shops are constantly searching for new, efficient ways to hold workpieces of all sizes and shapes for machining. Air clamps and lever-lock hold-downs are often slow and clumsy—they frequently get in the way while machining, making it necessary to reclamp the part several times. An alternative that's rapidly gaining wide acceptance in production workshops (although it's still rarely considered in smaller shops) is vacuum-pressure workholding. With these systems, the holding force is sufficient to solidly lock down a piece for routing, shaping or turning. Vacuum systems can be turned on and off quickly for part changes. They also flatten thin, warped material, and leave the top and edges of the workpiece exposed for machining, obstruction-free. Often, you can completely machine a part without reclamping it, thus eliminating a source of error in machining.

Vacuum jigs are fairly simple to make. They're also durable, and can be adapted to a home shop. A typical system (see figure 1) consists of a vacuum pump connected by a hose to a plywood or particleboard jig outfitted with an assortment of holes, grooves

and gaskets. A groove is routed into the face of the jig, just inside the periphery of the area where the workpiece will rest. A special soft-rubber gasket (channel seal) fits into this groove to form an airtight seal between the workpiece and the jig. The workpiece is placed on the jig, and the pump is turned on to suck the air out from under the part. The force exerted by atmospheric pressure on top of the part locks it firmly to the jig.

A vacuum jig usually carries the work into a blade or cutter, or locks the work in place while the cutting tool comes to it. The jigs tend to have low profiles, since the suction is applied to the back of the workpiece. We use vacuum jigs with computerized routers on production runs of wooden clock parts, but the jigs also work well with low-tech machines: shapers, drill presses, lathes or pin routers.

Building a vacuum system is expensive—you need a vacuum pump, plumbing, fittings and related hardware. However, your work volume may be sufficient to justify the expense—especially since the system can be used for other operations, such as vacuum-veneering panels (see *FWW* #16 and #56).



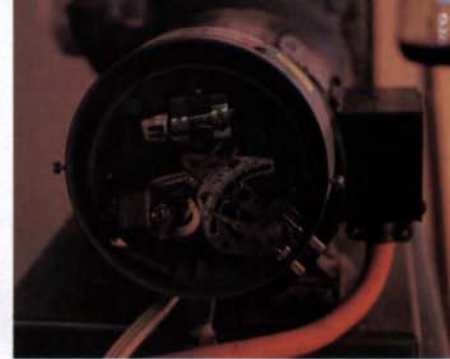

Left, the vacuum system is supplied by a 30-gal. tank and a 6.2 cfm pump driven by a 1½-HP motor. The large Bourdon pressure gauge is seen on the front of the tank, with the vacuum-pressure gauge below it. The inlet filter is mounted near the tank's back, above the pump. The oil lubricator is positioned above the pump, and the exhaust filter is mounted to the right. The check valve is barely visible behind the inlet filter. The vacuum dump valve (above, left) applies or releases vacuum to the jig. The valve connects to both the pump and the jig with ½-in. ID radiator hose. A close-up of the Bourdon gauge (above, right) shows the needles that read the high and low setting for the vacuum pump. The pump is activated and switched off as vacuum rises above and falls below prescribed levels.

**Fig. 1: Schematic of vacuum system**

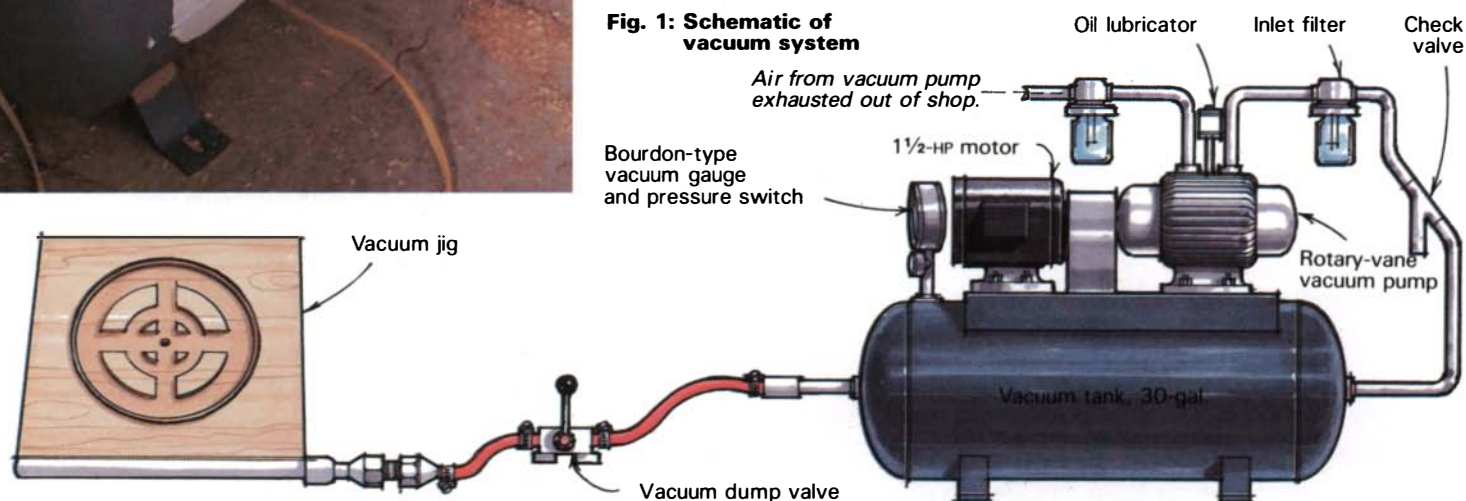

Vacuum pumps are classified by the manner in which they move air: rotary-vane, piston, diaphragm and blower models are common. Rotary-vane pumps—either lubricated or oil-less—are best-suited for vacuum-holding work. All vacuum pumps are rated in two different ways: by the maximum vacuum they can create under zero air flow, and by the vacuum they produce at a specified air flow. The vacuum attainable from any vacuum pump is steadily reduced as the air flow in cubic feet per minute (cfm) increases.

Within the scope of your budget, my advice is to buy a vacuum pump with as high an air-volume-handling capability as possible. Rotary-vane vacuum pumps can range from 1 or 2 cfm to hundreds of cfm. Remember that wood is porous, so air will leak into the vacuum system through the pores in the workpiece. Additional air is drawn through leaks in the jig itself. In order for the pump to sustain a fairly high degree of vacuum under the workpiece in the presence of substantial air leakage, the pump must be rated for a reasonably high vacuum at a substantial air-volume flow rate. Our pump is a Gast, Model 2565, rated at 6.2 cfm at a vacuum pressure of 20 inches of mercury, or about 9.5 psi of vacuum-gauge pressure. This capacity enables us to handle four or more vacuum forms simultaneously on our computerized router. For the average small shop, a pump in the 3-to-6 cfm range should be sufficient. These pumps cost roughly \$400 new, but they can be purchased used for \$50 to \$150 and then be reconditioned.

I think lubricated-type pumps are better than oil-less pumps for woodworking applications because they handle more air and generate slightly higher vacuum pressure. Lubricated pumps are

also better able to handle the dusty air that's inevitably sucked into the vacuum system.

Like air compressors, vacuum systems work better when they're equipped with a tank (see photo, above left) that provides reserve capacity so the pump doesn't have to run full-time. The tank's extra capacity also helps handle the air-flow surge when the vacuum is turned on and the part is sucked down tight. We use a 30-gal. tank, but a smaller tank would undoubtedly work just as well on a less elaborate system.

A word of warning: Ordinary compressor tanks should *not* be used on vacuum systems. Tanks under vacuum may collapse if they're slightly out of round, so they must be made of heavier-gauge metal than compressor tanks. Air tanks rated for 400 psi or more should be suitable for vacuum applications.

Almost any kind of piping can be used to connect the system's components. I've had good results from ¾-in. ID galvanized steel and copper pipe. Seal all of the threaded joints with Teflon tape, which makes the joints easier to disassemble than when standard joint cement is used.

We install an ordinary brass, water-type flapper check valve (available from any plumbing-supply shop) to separate the pump from the reservoir tank. The valve prevents the reservoir from being bled down due to back leakage through the pump when it isn't running. The valve also allows the pressure to equalize across the pump so, once the pump is turned off, it doesn't have to start again under full load. The check valve should be positioned so its flapper hangs vertically. Grease applied around the

**Fig. 2: Vacuum jig**

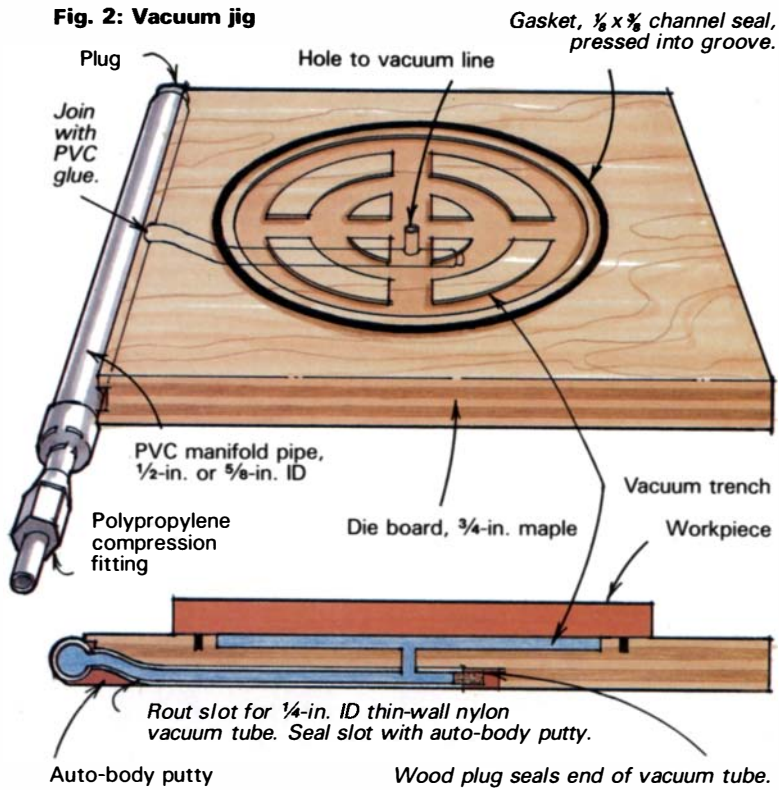

**Fig. 3: Universal vacuum jig**

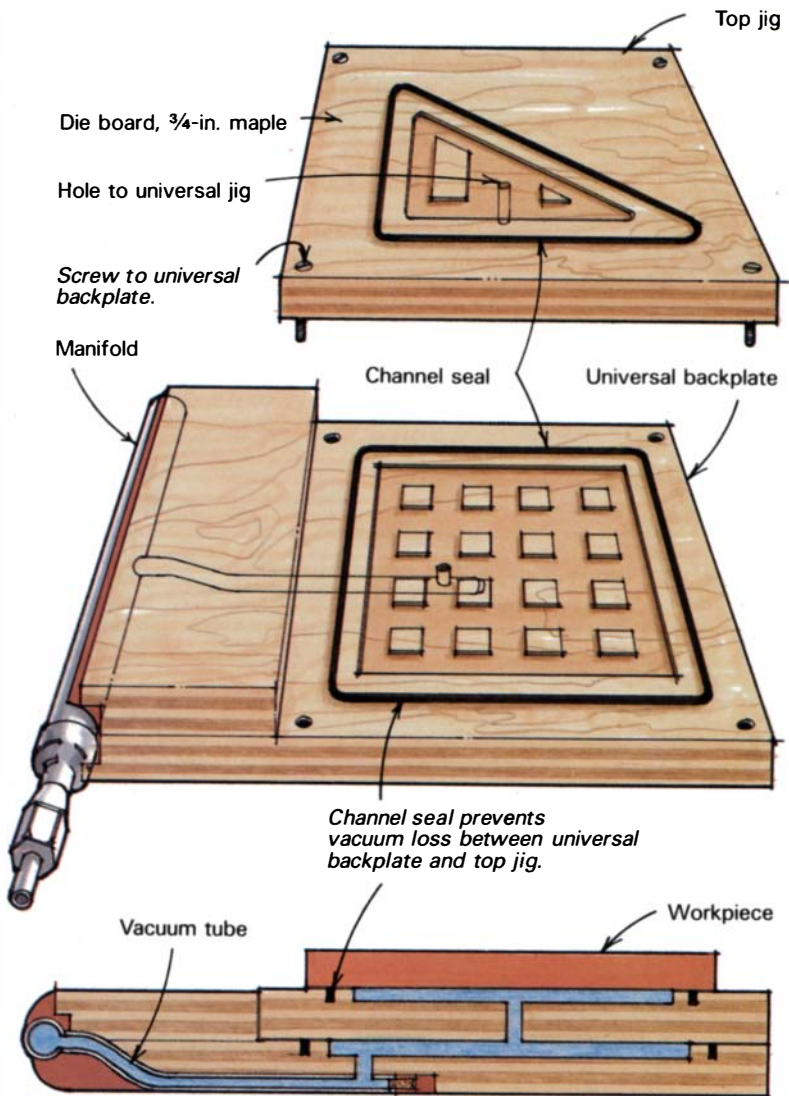

flapper helps seal it against leakage, but also necessitates frequent maintenance, since the grease collects wood dust.

The inlet filter located between the tank and the pump (see figure 1) also helps keep dust out of the pump. Due to the low pressure in the vacuum tank, wood dust that enters the system through pores in the workpiece during machining rapidly settles out in the tank. However, it's advantageous to use different tank outlets for the vacuum pump, the line to the vacuum jig and the pressure control. This gives the dust an even better chance to settle out in the tank, and lets the pressure control do its job more reliably. The filter on the exhaust port or muffler helps trap and collect lubrication oil mist in the glass jar. Venting the muffler's output outdoors via a garden hose keeps oil mist out of the shop air and greatly reduces workshop noise.

The most important routine maintenance item on the lubricated-type vane pump is to maintain the oil level with #10-weight detergent oil in the lubricator. Each filling should last for around 25 to 60 hours of operation. More rapid oil consumption does no harm; it simply exhausts more oil mist into the air.

As woodworking goes, making vacuum jigs is relatively simple. There are two different types of jigs. The simplest—designed to hold a specific workpiece—is shown in figure 2. If you need to hold several types of workpieces, I suggest you build the universal jig shown in figure 3. The beauty of this jig is that you can build one or two of the bases, then make as many custom formboards to fit on top as you want. You remove the formboard by loosening a screw or two, then replace it with another board that's shaped to the requirements of a different workpiece or a different operation. This eliminates the problem of building the more complicated base for each workpiece or operation. If I had to build my jigs over again, I'd build more universals and fewer single-purpose models.

If you were able to create a perfect vacuum under the workpiece (impossible to do, because of inevitable air leakage), the full weight of the atmosphere would bear down on it at 14.7 psi at sea level. The difference in the pressure above and below the work is described as "differential" or "gauge" pressure and is expressed in psi or inches of mercury. Vacuum pumps and gauges are most often rated in inches of mercury, not psi. However, psi is easier to convert into pounds of holding force, using this equation: Holding force (lb.) = area (sq. in.) × gauge pressure (psi). (In preparing your calculations, consider 15 psi roughly equivalent to 30 in. of mercury.)

As an example, assume the air pressure is about 15 psi, which—give or take a pound or two—will be the case in most parts of the world. A typical high-volume vacuum pump will remove enough air from behind the workpiece so that about 9.5 psi of air is bearing down on it. Multiply this gauge pressure by the area inside the gasket sealing the workpiece—let's say 10 sq. in.—and you have about 95 lb. of force holding the workpiece.

A typical jig setup is shown in figure 1. A trench cut into the top of the jig distributes the vacuum over the area of the part, and the vacuum dump valve serves as a "switch" to apply vacuum to the jig or to release it.

I recommend the use of 1/4-in. nylon or rigid PVC tubing on these jigs. Polyethylene, polypropylene, Teflon and Tygon tubing can't be glued to anything, but nylon and PVC can be fastened to the formboard with epoxy, PVC cement or auto-body putty. Before assembly, sand the outside of the tubing so the body filler can grip it. Apply PVC pipe cleaner on the ends of the tubing, on the tubing's connections to the manifold and around the holes bored in the manifold. Then, glue the tubing to the manifold with PVC glue. Build up three or four layers of the glue so that

it forms a substantial connection between the tubing and the manifold. Cement the manifold and the tubing in place with body filler after the glue has dried. The last step is to sand the bottom of the jig to make it as flat as possible. After all, it's the reference surface for your work.

Also, use ½-in. ID (or smaller diameter) automotive radiator hose to connect the jig to the vacuum system. This hose is flexible enough to allow the jig to move freely.

The best materials for jig bodies are Baltic birch plywood, hard maple die board and medium-density fiberboard (MDF). The main requirements are that the material remain flat and be dimensionally stable. This rules out solid wood, which is prone to cross-grain expansion and contraction with the rise and fall of humidity. MDF is suitable for formboards subject to moderate wear and tear. It has relatively little adhesive binding the wood fibers together, so it tends not to retain threaded inserts very well when they're used frequently. Also, intricacies in the formboard tend to crumble with heavy use. MDF is extremely porous. After the vacuum trenches and the gasket grooves are cut, seal the whole jig with shellac to minimize vacuum leakage. Shellac plugs the pores thoroughly, while even multiple coats of other finishes don't. You can also buy ¾-in. MDF that's veneered on both surfaces. The veneered surface is pretty tight, but the interior remains porous.

A word of caution: MDF contains grit that quickly dulls ordinary high-speed steel bits, so cut the gasket grooves in it with a ½-in. solid-carbide bit. Cut the grooves in one pass, moving the bit in one direction. Don't backtrack, or you're liable to make the groove too wide for the gasket. The gasket groove should be at least ⅜ in. from the edge of the vacuum trench. If not, the space between the trench and the groove might crumble.

Finnish or Baltic birch are good choices for jigs because both woods stay flat—even after machining to make the form. These birch plywoods are sold through hardwood supply houses and often through local lumberyards. Die board is a specially laminated hardwood plywood, the bulk of its veneer being hard maple. It's the most expensive, but it's also the most durable and it machines almost as cleanly as aluminum. Use only die board with five or more laminations. Jigs made from die board and most other plywood substrates are relatively nonporous when compared to particleboard. Thus, vacuum loss is less of a problem.

Die board can be drilled and tapped to accept coarse-thread machine screws, largely eliminating the need for threaded inserts. The direction of tapped holes should be perpendicular to the face of the board; threads tend to crumble in the endgrain. Use a standard metalworking tap and blow the chips out of the hole frequently during tapping. The threaded portion of the hole should be two or three times the diameter of the screw in length to provide adequate grip.

Even if vacuum loss in plywood jigs is minimal, it's a good idea to seal them with wood sealer, such as those available through the "Sources of supply" listed at right. These thin sealers penetrate deeply and help harden wood threads, making them more durable (although the hole may need rethreading after the sealer has dried). For ease of operation and to save the threads, wax any screws that will be inserted and removed often. If there's a danger of running a cutting tool into the screw, use brass, nylon or at least unhardened cadmium-plated steel screws. Carbide router bits will cut through unhardened screws, usually without damage. Never use hardened-steel screws or hard-steel dowel pins on formboards. A router bit will shatter if it hits a hardened metal, throwing steel and carbide fragments around the shop at high velocities.

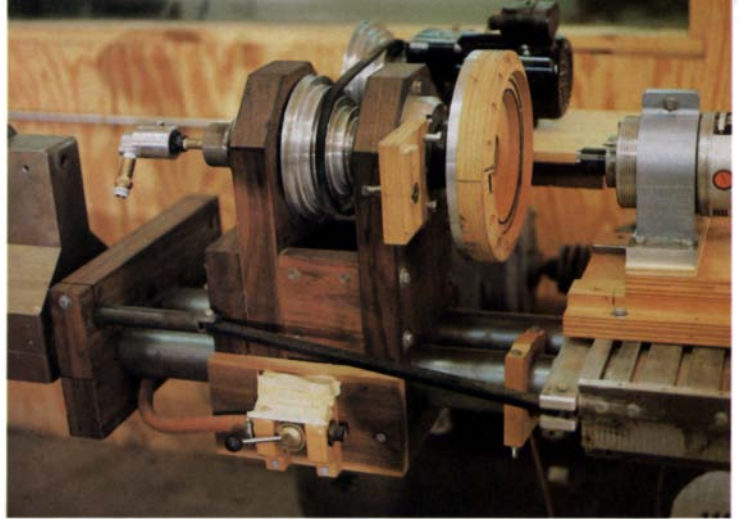

*The author built a lathe and vacuum chuck to handle clock parts that need to be turned. The principle of the chuck is the same as for jigs: sufficient vacuum is applied through it to lock down the workpiece. However, the setup requires a ball-bearing fitting to allow the vacuum line to remain stationary while vacuum is applied through the spinning headstock.*

All stops or components that might easily be damaged or need to be replaced should be held in place with screws. For maximum accuracy, use mild-steel or brass locating pins in addition to the screws. Wax the pins to make them easy to remove. Parts may slide horizontally on the jig when heavy cutting forces are applied by a router or shaper. Prevent this movement by gluing 100-grit, A-weight, open-coat sandpaper to a large area inside the gasket with Titebond glue (contact cement would be too flexible). The sandpaper will grip the part when it's pulled down on the form by the vacuum. If the completed part has one or more holes in it, these can be drilled first, and mating wood dowels can be positioned on the formboard to engage the holes. (It's not usually necessary to install a gasket around the dowel if it fits its hole well.) In addition to preventing slippage, this doweled construction provides accurate location.

Vacuum workholding need not be restricted to flat objects; curved surfaces can also be machined. Holding curved pieces simply requires a bit more ingenuity on the part of the craftsman in designing and making the jig. □

*James Kassner, Jr. builds and sells wooden-clock-movement kits at Kassner Woodcraft, Inc., in Tuscaloosa, Ala.*

## **Sources of supply**

*Occasionally, surplus pumps, vacuum gauges and assorted electrical control relays can be obtained through:*

Arbee Sales, 313 North Morgan St., Chicago, IL 60607.

Herback & Rademan Co., 401 E. Erie Ave., Phila., PA 19134.

*Complete vacuum systems, dump valves, vacuum gauges, rotary couplings and channel seal are available directly from:*

Magna-Lock U.S.A., Box 7012, Rockford, IL 61125.

*Die board:*

Lenderink, Inc., Box 98, Belmont, MI 49306.

*Baltic birch plywood:*

Allied International, Box 56, Charlestown, MA 02129.

*Sealer:*

Nelsonite Chemical Products, Inc., 2320 Oak Industrial Dr. N.E., Grand Rapids, MI 49505.

Prillaman Co., Box 4024, Martinsville, VA 24112.

Guardsman Chemicals, 1350 Steele Ave. S.W., Grand Rapids, MI 49507.

# Wall Paneling

## General application and design principles

by Graham Blackburn

**Fig. 1: Treatments for wainscot and paneling**

*There is no such thing as a typical paneling job, as variations on the theme are practically infinite. These drawings suggest some of the possible treatments at the baseboard.*

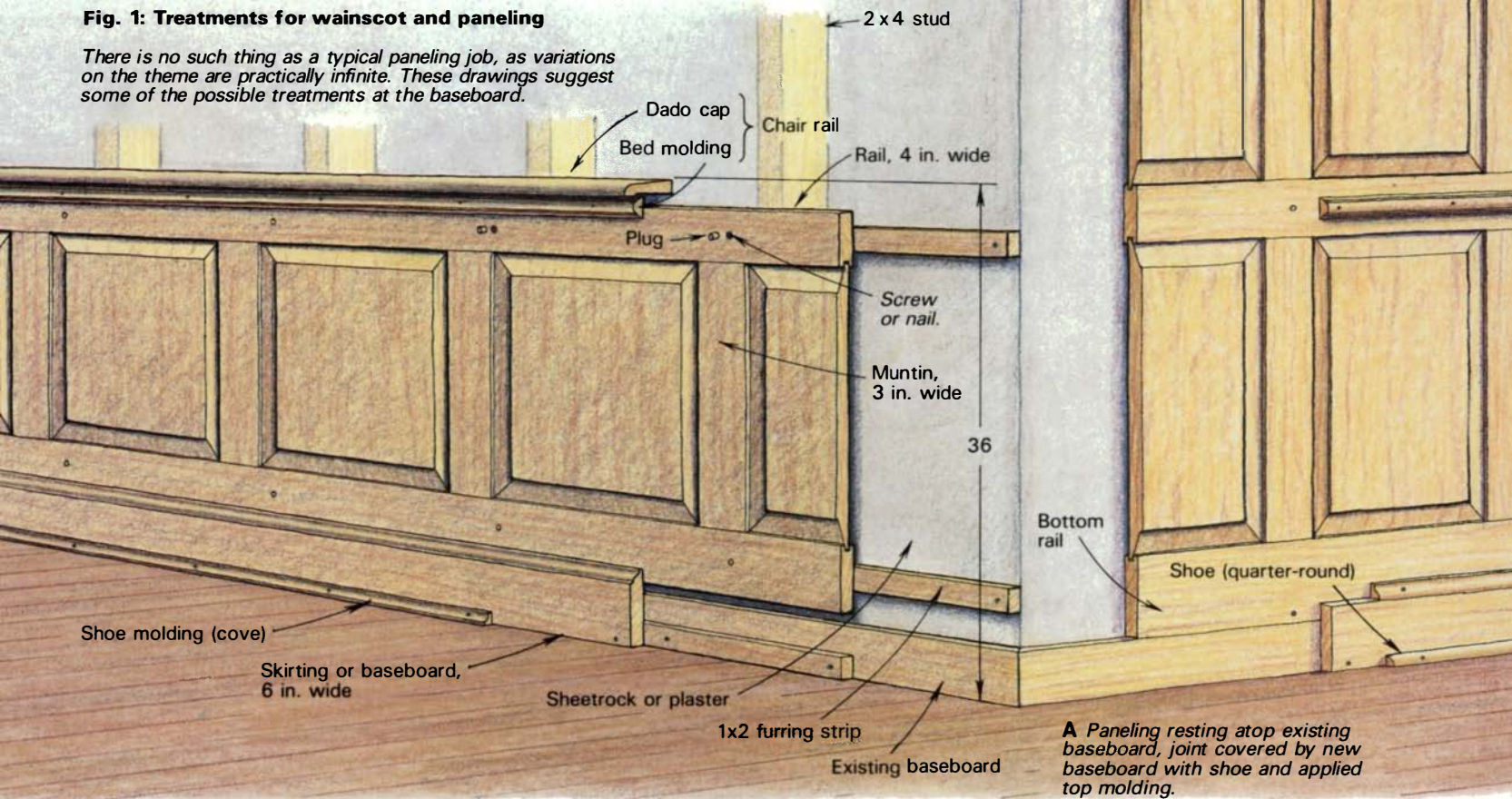

Paneling came into general use as a form of interior decoration for walls during the latter part of the Middle Ages. Because of its infinite adaptability, paneling is a practical form of wall covering even today. Admittedly, one immediately thinks of older architectural styles—Colonial or Georgian, for example—but, used in the right way, paneling can be just as appropriate for the most modern setting, whether it be a boardroom needing tasteful dignity, or a small apartment looking for a way to disguise a Murphy bed.

The elements of a paneled wall—both half-paneling known as “wainscot” and full floor-to-ceiling paneling—are illustrated in drawings throughout this article. Essentially, paneling is a modu-

lar system in which solid-wood panels are held in grooves in a mortised-and-tenoned frame composed of rails (the horizontal members) and stiles (the full-length, vertical ones). The short framing members between rails are called “muntins.” The grooves in the framing allow the panels to expand and contract with changes in relative humidity, and the frame also keeps the panels from warping.

The system is modular because it consists of a series of repeating elements that can be added or subtracted, depending on the space to be covered. These elements needn't be entirely regular—they can be modified in size and shape to conform to fireplaces, windows, beams, doors, etc. as required.

## Turning corners

Although inside corners may simply be butted and covered with molding, a tongue-and-groove joint is more secure and makes assembly alignment easier.

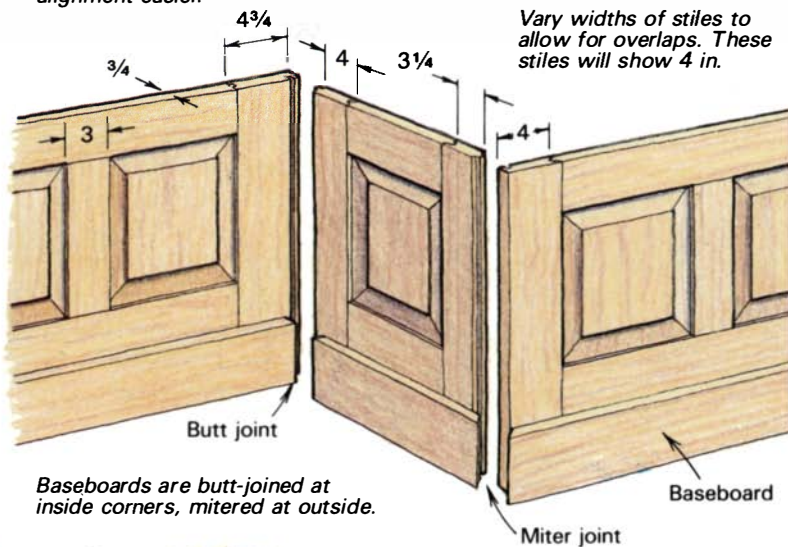

Baseboards are butt-joined at inside corners, mitered at outside.

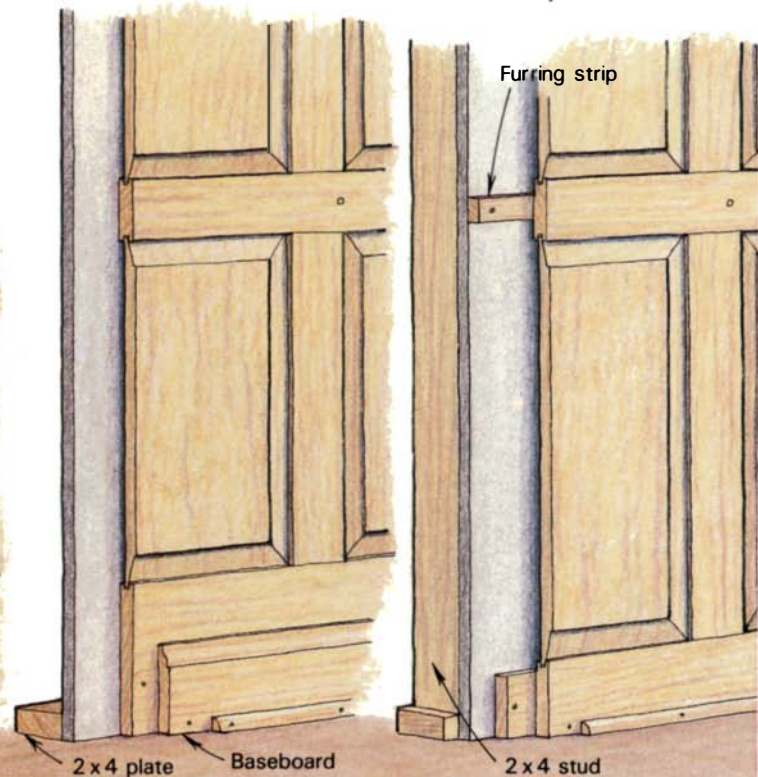

**B** Paneling all the way to floor, trimmed with top-molded baseboard and shoe, and fixed through wall to plate.

**C** Bottom rail fixed over existing baseboard, then trimmed with shoe. Higher rails fixed to furring strips screwed or nailed to wall framing.

Changes in architectural style and interior decoration have dictated the form of paneling in various eras. To mention just a few outstanding styles, there are the distinctive linenfold patterns of the late Gothic, the graduated rectangular panels of the Tudor period, the panels-within-panels of the Jacobean era and the pilastered and classically friezed panels of the 18th century. These characteristic forms may appear to be the dominant element in any particular type of paneling, but all are usually based on certain fundamental principles of design. When you know how to recognize them, these principles constitute the intrinsic “rightness” and success of a paneled wall in any style.

It would be a great pleasure to design a paneled wall of per-

fect proportion and symmetry, and then have a contractor stop by and build the house around it. Such, of course, is seldom the case. Whatever overall plan of design we decide upon, it must usually accommodate existing windows, doors, electrical outlets and switches, plus out-of-plumb and irregular surfaces. In the drawings, I’ve tried to suggest a number of ways of dealing with such things.

Before I go further, there are two points I must emphasize. First, it’s the overall pattern of the paneling that must prevail if the wall is to be successful. If inconsistencies take over a major part of the job, the wall will look disjointed and inharmonious. Second, keep in mind that paneling a wall is a major project, deserving much forethought and preparation. Before beginning construction, produce as detailed a drawing as you can. This will help identify potential problems. If an unusual window presents a great disruption, for example, consider replacing it. The same is true for outlets and switches with inconvenient spacing or height—it may be less work to move them than to force the design around them, and the end result will look far better. This isn’t to say that you must keep the design entirely regular. A wall that is too uniform can look “manufactured,” while a wall with tasteful minor variations looks “tailored” and is all the better for it.

There are several ways to go about setting the proportions of the elements in a paneled wall. In the Middle Ages, craftsmen depended on mathematical theory and geometry to create design systems based on whole numbers and their relationships to straightforward forms, such as the square and the circle. As the guilds became more sophisticated, subtler ideas evolved, such as the ratio of the “golden mean” (or “golden section,” as it’s sometimes called), which I’ll explain in more detail later. The Renaissance saw the reintroduction of classical Greek and Roman proportionalism, and this found its way into the design theory practiced by 18th-century joiners and cabinetmakers in the form of “the five orders of architecture.” Such study can become extremely technical and is beyond the scope of this article, but those interested in pursuing the topic will find references in the books listed in the “Further reading” bibliography, p. 81. The most useful, pragmatic fact to remember about design is that, unless you have an “absolute eye” for what is aesthetically right (like certain musicians have absolute pitch), success will come only if you arrive at your design by way of some rational approach.

Look at the whole space, not just the area to be paneled. Try to imagine what will tie the whole thing together. If a room is broken up by a variety of windows and doors with varying heights and proportions, try designing the paneling so that part of it, such as a visually strong top rail and crown molding, stretches across the entire length of the wall. This molding can then be carried around the entire room, even if the paneling is not. If this isn’t possible, try designing the paneling either with a strong regularity or with one particularly salient member—the wainscot shown in figure 1 is a good example. Its chair rail is a powerful enough feature visually to unify the design. Doors and windows will appear as relatively unimportant interruptions in a predominantly regular plan. Similarly, bookshelves adjacent to a paneled wall can have their shelves aligned with the rails, and may be able to carry unifying moldings.

Of course, if the basic space already possesses its own pleasing rhythm, such as a wall with a fireplace in the middle and two equally spaced windows on either side, then it makes sense to design the paneling around the existing pattern, for the space is already tied together.

The design should look balanced and stable, not as if it were

**Fig. 2: Golden mean**

*Step 1: Construct a right triangle with a base of twice its height.*

*Step 3: Strike an arc as shown across the baseline, which will divide it at the golden mean, 0.61803...*

*Step 2: Strike an arc the length of the height across the hypotenuse.*

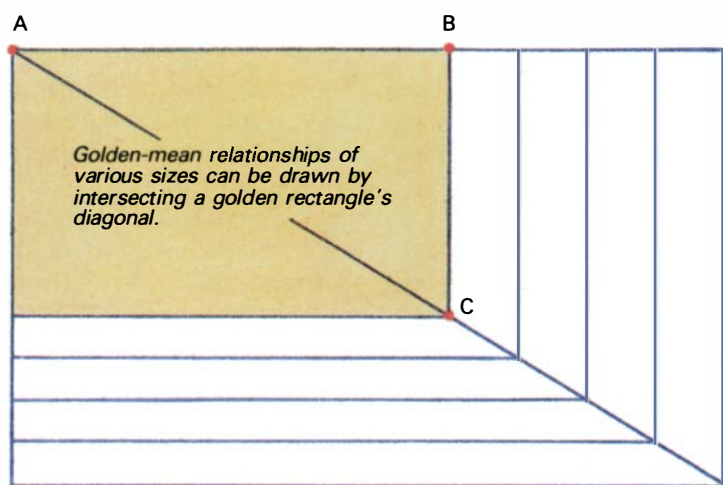
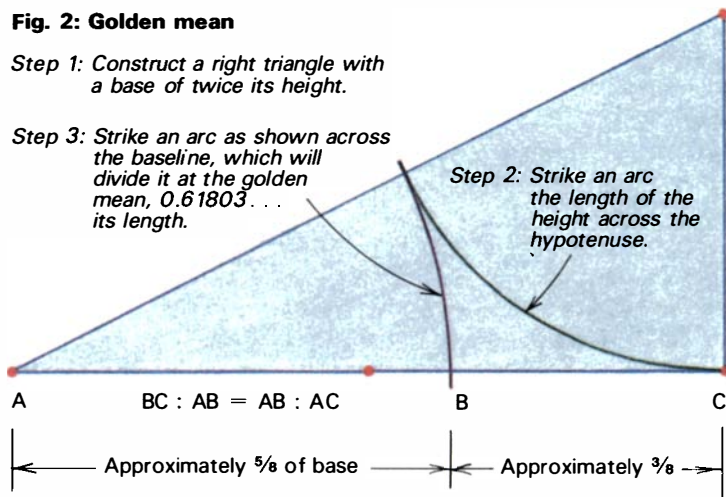

about to topple over. This balance can be achieved by using heavier or bigger parts at or near the bottom. For wall paneling, this means making the skirting (or baseboard) the widest member or, perhaps, designing a chair rail to be visually strong by making it wider or more heavily molded. Chair rails are typically about 36 in. from the floor; their purpose is to protect the paneling from chair backs. Paneling doesn't always require a rail at this height, however, as can be seen in figure 6.

A more sophisticated plan, and one particularly well-suited to the problem of how to divide up an area into the typically smaller parts required by paneling, is to base the arrangement—even loosely—on the golden mean. This is a ratio discovered by the Greeks and used ever since by artists, sculptors and architects as a kind of pattern on which to base their designs. In its basic form, the

golden mean is simply the division of a line at such a point that the smaller part is to the larger part as the larger part is to the whole. This translates into dividing the line at roughly five-eighths of its length. By using one part as the width and the other as the height you will construct a "golden rectangle." There are several ways of arriving at the golden mean of any given line; one of the easiest is shown in figure 2.

Having decided on a general overview of how the area should be divided up (two of the countless possibilities include: a thin row of panels at the top, a wider one in the middle and, perhaps, the widest row at the bottom; or, two narrow columns of panels flanking windows, with a much wider column of panels in the center) it's now necessary to delve into greater detail and decide the relative dimensions of the various framing members. The variations are endless, and the best way to start getting an idea is to study all the examples you can find, both in real life and in pictures in books. Key points to look for are the width of the stiles in relation to the width of the various horizontal pieces; and the width of the horizontal *and* vertical members in relation to the size of the panels themselves.

After a while, you'll begin to notice a few trends, which can be expressed as generalities only (there are always justified exceptions). Stiles tend to be equal in width, while rails are often graduated in width, from the bottommost ones to the top ones. Furthermore, the upper rails are frequently the same width as the stiles, and the panels are usually no narrower than the combined width of two stiles. Outside stiles look best if they are somewhat wider than any inside stiles, and yet at corners—both inside and outside—the width of the stiles may be somewhat reduced, since the combined effect of two regular-width stiles would appear excessive.

I must stress that these proportions are generalizations only. There are also optical "tricks" that can change how things look. For example, the use of molded edges on the framing members creates extra lines of shadow and makes the framing members look narrower. Similarly, overlapping bolection moldings make both the frame members and the panels look narrower. Another extremely potent factor is the design of the panels themselves.

Panels can be simply flat, but it's more common to bevel the edges to produce a central "field." This field can also be "raised" by having a vertical shoulder, as shown in figure 3. Fielded panels can be made to look quite different by changing the width of the beveled areas. Try designing the same size panel with a very wide margin and then a very narrow margin, and observe the difference.

Internal proportions must relate to other features in the room, such as the size of any door panels or window trim. A framing system with very narrow framing members surrounding windows

**Fig. 3: Edge treatments**

*Framing stuck with ovolo molding, panel proud.*

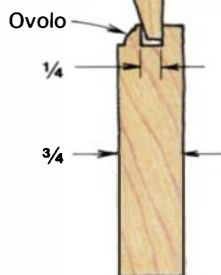

*Framing stuck with ogee molding, panel flush at back.*

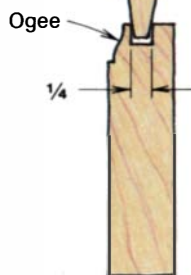

*Framing square-edged, panel feathered both sides.*

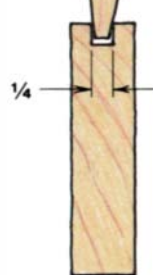

*Bolection molding, panel centered.*

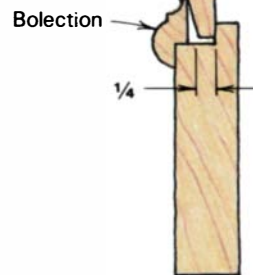

*Bolection molding, panel at front of frame.*

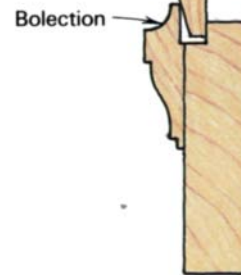

# Laying out Georgian-style paneling

by Malcolm MacGregor

As it was two centuries ago, wall paneling should be considered the focal point of a treasured room, such as a formal parlor or a library. It's possible, of course, to panel an entire room floor to ceiling—and even panel the ceiling itself—but I advise my customers against it. Besides its huge expense, a fully paneled room is too much of a good thing. It's visually overwhelming and not very pleasant to be in. Instead, I prefer to panel only one wall of a room floor to ceiling, then tie it to the rest of the room visually by installing wainscot or a simple chair rail on the adjacent walls and running the cornice around the room.

In the mid-18th-century New England houses I often work in, the Georgian style—with its classically derived moldings and architectural elements—was quite popular, so most of my paneling follows Georgian design principles. As with any period, Georgian spans a stylistic range. At its most modest, a Georgian paneled room might be rather plain, with no architraves and only a simple crown molding topping off the paneled wall. More elaborate walls will include fluted pilasters flanking a formal fireplace, doorways with gabled pediments and the formal double-crown molding shown in the drawing. Typically, New England mid-Georgian design is strongly vertical, with two rectangular panels extending upward from the floor. Sometimes, a squarish median panel separates the two vertical panels. In either case, the baseboard is almost always rather plain.

Paneled walls traditionally have a visual focal point that anchors the design. In Georgian rooms, this is usually a fireplace around which the most complex elements (pilasters, bolection or multi-part moldings forming an elaborate architrave or a complex pediment, for example) are clustered. To either side of this center, the design is deliberately less busy, thus drawing the eye to the most interesting parts of the wall.

I begin a paneling job by very carefully measuring the floor-to-ceiling height at several points along the wall, as well as the side-to-side distance. With a 4-ft. level, I check the walls for plumb and floors for level, recording my findings in a notebook as I go. If the floor is relatively level, I chalk a level reference line on the wall that roughly represents the paneling's center rail. All vertical measurements can then be made from this line to establish the overall height of the panel section and the location of each rail. Similarly, one of the adjacent walls (or a plumb line drawn on it) can serve as a reference plane to lay out the position of various elements in the wall.

If the floor is way off—say 1½ in. in the run of the wall—I adjust my reference line to

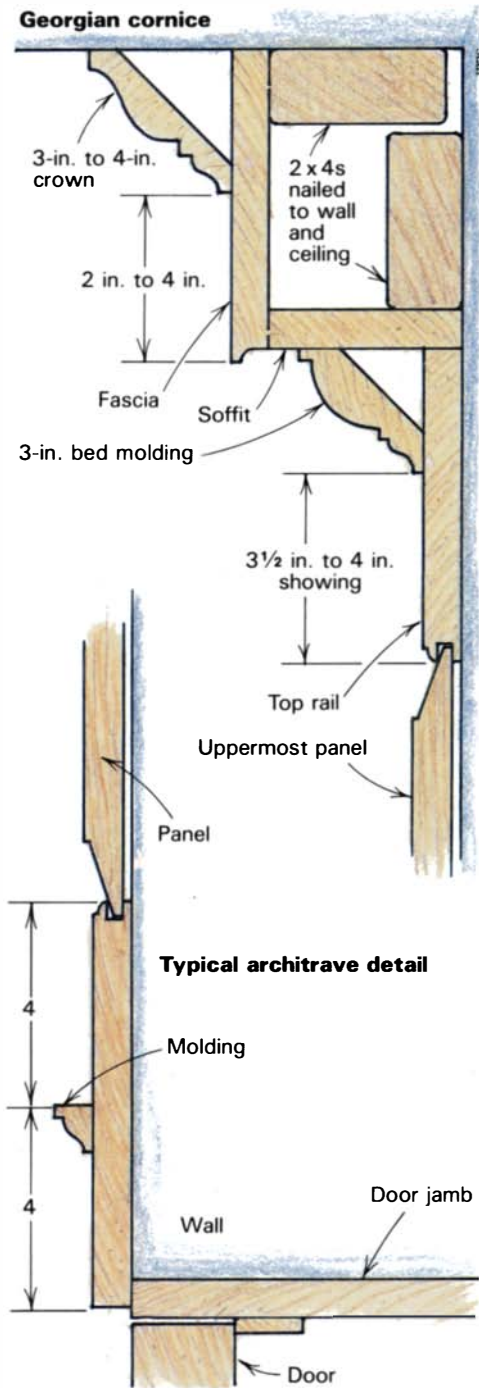

split the difference. It's far more important that the wall be straight and square with the room—minor variations in plumb and level are easily masked by moldings or trim at the paneling's edges. By far the best way to account for structural inaccuracies is to install the paneling *before* the adjacent drywall and floor are installed. This is especially true in Georgian panel systems, because the bottom rail often doubles as the baseboard. It's much easier to lay the floor up to the rail than to scribe the rail to an uneven floor.

I draw my paneling design to scale on graph paper. Before figuring panel sizes and proportions, I decide upon the size and profile of the architraves surrounding the fireplace and/or doors, since the space between these fixed elements determines how much room I'll have for the panels themselves. The drawing shows one way to mate an architrave to the paneling. An architrave can be as simple or elaborate as you like, but in the interest of visual harmony, I try to make the combined width of molded sections closely match the width of the floor-to-ceiling stiles, which are usually about 4 in. to 4½ in. wide. I make the intermediate stiles (also called "muntins") 4 in. wide.

In Georgian walls, there's one critical horizontal alignment that's rarely violated: The paneling's center rail almost always aligns with—and is the same width as—the lock rail on the doors in the room. With this rail and the architraves drawn in as inflexible elements, I begin sketching in the paneling. I rely heavily on books for inspiration, but from the research I've done, I've settled on some favorite designs. Rooms with 7-ft. ceilings look best with two vertical panels, the top panel being about 1½ times the length of the bottom panel. In two-panel walls, I generally make the bottom rail 6 in. to 7 in. wide, the center rail 7½ in. to 8 in. wide (or to match the lock rails) and the top rail 3½ in. to 4 in. wide, exclusive of the crown molding.

Higher ceilings work well with three panels. In this case, what would normally be the center rail is split into two separate rails—the top one about 5 in. wide, the lower about 4 in. wide. A panel that's slightly wider than its length fits between the rails. Horizontal panels, such as the large ones above a fireplace, usually line up with the outer sides of the architrave, not the opening in the wall. Panel widths as narrow as 4½ in. are practical, but I never make them wider than 20 in.; seasonal shrinkage across that much wood can pop the panels out of their grooves.

The rails, stiles and panels are made in the shop, dry-assembled and carried into the room in sections. The sections are tacked to the wall to check for fit. The joints between sections should occur at floor-to-ceiling stiles. There's usually enough give in the paneling so that the tenons between sections can be slipped into their respective mortises as the panels are attached to the wall. Smaller sections of paneling can be assembled face-down on the floor and lifted into position. □

*Mal MacGregor runs Piscataqua Architectural Woodwork in Durham, N.H.*

that have totally different trim proportions and molding treatments will look very uncomfortable, and not at all tied together. One solution would be to remove the existing trim, and bring the edge of the paneling up to the window, as shown in figure 5.

One last but vital consideration in designing the overall plan together with the internal details has to do with how the paneling is secured to the wall. In practice, this usually isn't much of a problem. The overall structural integrity of the paneling makes it very easy to secure with screws—or even nails—at relatively few points. Applied moldings offer a choice of sites at which screws can be used, since they'll later be covered by molding. Screws can also simply be plugged, or—if the wall is to be painted—the paneling can be nailed to the wall and the nails can be set and filled. All

fixing, of course, must be done through the rails, stiles and muntins, because the panels themselves must be left free to expand and contract, unrestrained. The bottom of the paneling can be screwed into the floor, the plaster grounds or to wall-framing plates (see figure 1). Studs in wood-framed houses are spaced closely enough so that stiles or rails can be lined up with them and be screwed or nailed through. Masonry offers even more choices, although a little more work is entailed: holes are drilled wherever you want them, then filled with wood plugs to provide fixings for screws. In brick walls, occasional bricks can be removed and the resulting spaces filled with wood blocks called “noggins.” Should you be working in a stone house constructed of super-hard granite, it's not hard to find a mortar joint that can be drilled out and filled with

**Fig. 4: Top treatments**

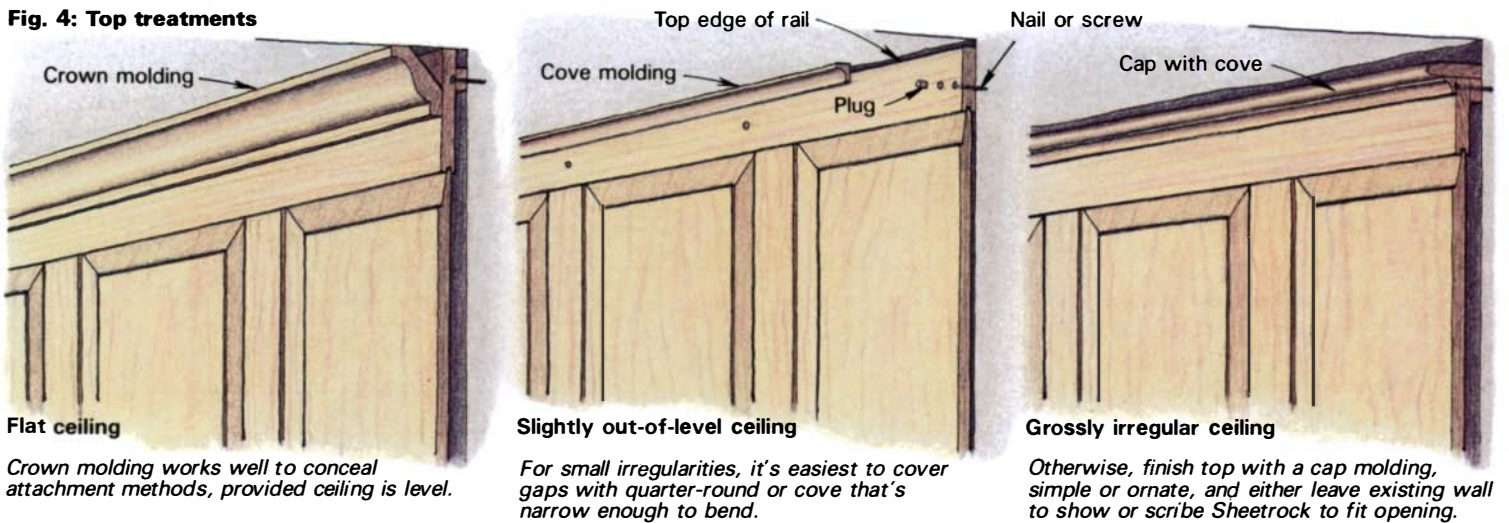

**Fig. 5: Windows**

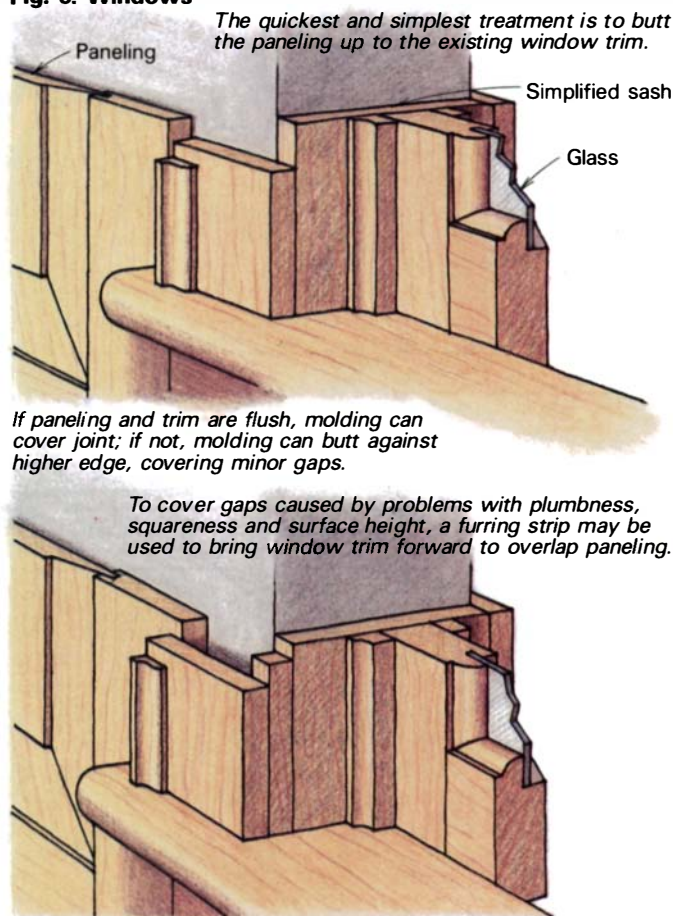

**Fig. 6: Sample wall**

The first design decision was to unify the wall with a visually strong dado rail beneath the windows, with a row of panels of the same height below it. The middle, frieze and top rails would also be kept in continuous horizontal lines as much as possible. Spacings of these higher rails approximate the golden mean (as shown at far right). The unequal spaces caused by the windows were made more uniform by dividing them into two vertical rows of panels each. With these major decisions established, minor difficulties were dealt with as described on the drawing.

Windows not same size: For small difference, widen rail as shown; if this space were much larger, it would be better to install two very narrow horizontal panels, as at top of window.

Old outlets in baseboard: Holes cut in new baseboard over existing outlets. If there had been many more outlets and/or switches, it would have been best to rewire the wall according to code, positioning the electrical boxes so that they would appear in frame members, not in panels.





a wood plug. Instead of these traditional wooden plugs, you can also substitute any type of modern wall anchor in a masonry wall.

By far the biggest difficulty you might encounter is with walls that aren't plumb and floors that aren't level. Occasionally, it may be a good idea to go with the flow, but usually the best rule is to true up the new work rather than attempting to accommodate any irregularities in the building. Nine times out of ten, this will look better and—despite what you may think—be easier to do. The first job is to establish an absolute level at the bottom of the wall (if the floor is uneven or sloping) and work upwards from the highest point of the floor. You have two choices: You can either make the bottom rail perfectly regular and level, covering any resulting gap with a baseboard that's scribed to the uneven floor line along its bottom edge, or you can scribe the bottom framing member itself. The first method is usually the best because it guarantees that at least a part of the bottom of the framing can be made to look consistently wide. By working from the floor's highest point, the baseboard or bottom framing member will never appear too narrow since you started at the point where it was narrowest. A bottom framing member that appears too wide here and there (from accommodating a dip or slope in the floor) looks far better than a bottom framing member that looks too narrow in spots.

An out-of-plumb wall is confronted similarly. Once again, work from the proudest part of the wall, and design the paneling so that gaps at doors and windows can be covered with scribed trim pieces in the same way as using a scribed baseboard at the floor line. If the wall is leaning badly one way or the other, this will entail blocking out some of the fixing points, so plan ahead to ensure that these will remain accessible. Sometimes it's best to plumb and level the wall with graduated furring strips, scribed to the wall and/or

blocked out where necessary before you begin paneling. If the wall undulates badly, say in an old house where settling has taken its toll, it may be wiser to allow a little out of plumbness in favor of a smooth, flat surface. Large humps in the wall's surface make it difficult to achieve tight joints between the framing members.

With this much covered in theory, I'd like to conclude with a concrete example of one way to panel an actual wall, dealing with the sort of peculiarities that theory never quite seems to anticipate. This wall is not imaginary, by the way, but is found in a country farmhouse built around 1840. Figure 6 shows the methods I'd use to get around each problem. More important than the individual solutions, however, is the general approach. First impose the design upon the whole wall and—only then—depart from it judiciously where needed. □

*Graham Blackburn is a contributing editor to FWW, and has written numerous books on woodworking and tools. His shop is in Santa Cruz, Calif.*

## Further reading

*Colonial Architecture of Cape Cod, Nantucket & Martha's Vineyard* by Alfred Easton Poor. Dover Publications, Inc., 31 East 2nd St., Mineola, N.Y. 11501, 1970.

*Early Domestic Architecture of Connecticut* by J. Frederick Kelly. Dover Publications, Inc., 31 East 2nd St., Mineola, N.Y. 11501, 1963.

*Period Details* by Martin and Judith Miller. Crown Publishers, Inc., 34 Engelhard Ave., Avenel, N.J. 07001, 1987.

For general background on classical proportions: *FWW On Making Period Furniture*. The Taunton Press, Box 355, Newtown, Conn. 06470, 1985.

Two ways to accommodate a beam:  
A, with one panel; B, with two panels.

Beams not regularly spaced: Divide panels over windows to match panels under windows, and let any extra space be filled as it will.

Ceiling not level: scribe top rail to fit, cover gap with flexible molding rather than rigid crown molding.



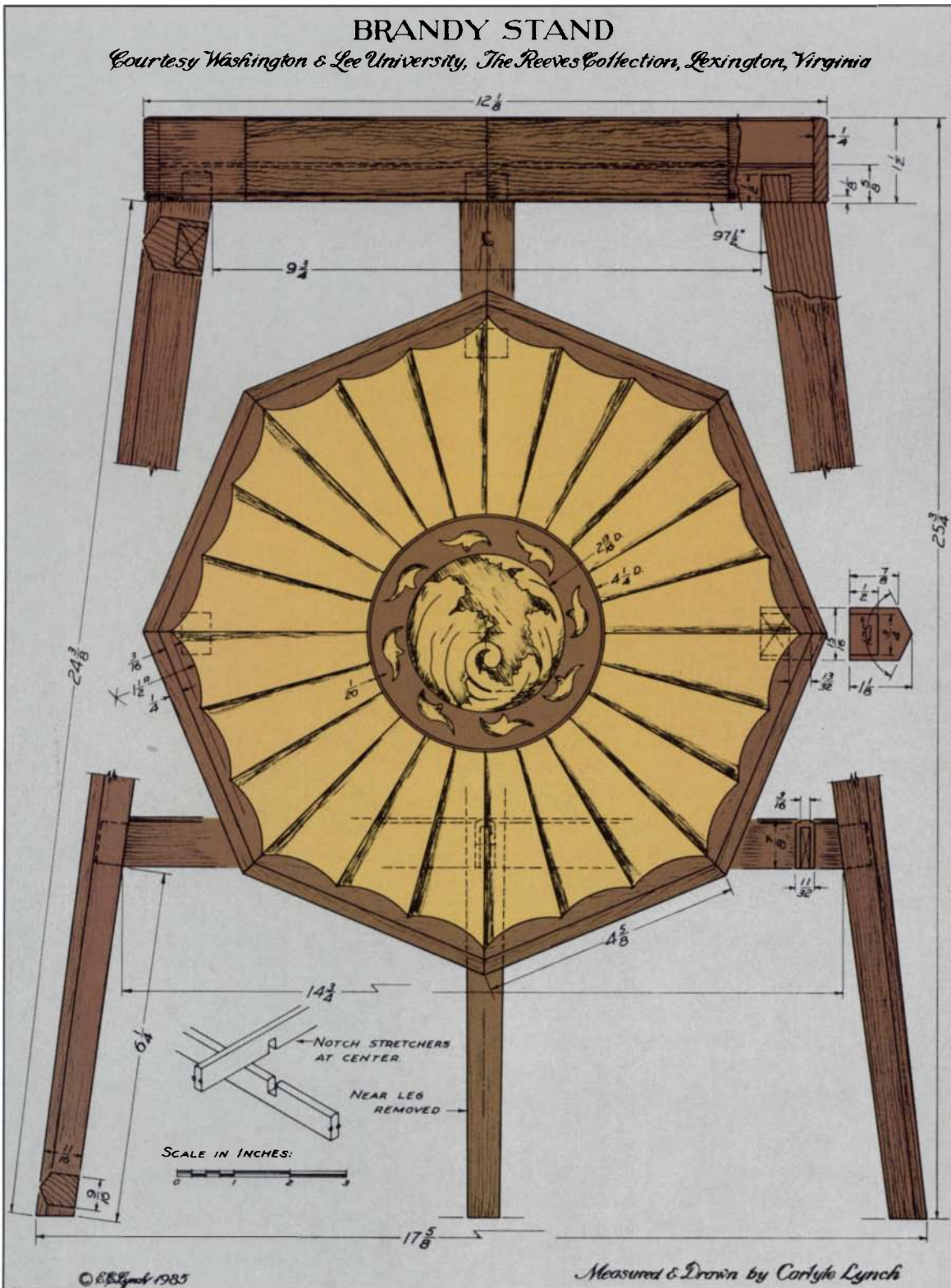

Photo below: Roy Early; other photos: Carlyle Lynch



Lynch's delicate brandy stand, above, is a reproduction of an original pair, probably used as urn stands, from The Reeves Collection at Washington and Lee University.

# Brandy Stand

*A lightweight table with a marquetry top*

by Carlyle Lynch



*The cherry block is grooved and excavated, left, for the inlay. With the block attached to a faceplate, above, a shoulder is cut on the face to the final diameter of the pattern before a thin disc is cut off. The text below describes a safe tablesaw method, in which the block is left square, not turned round.*

Some years ago, Washington and Lee University in Lexington, Va., was given a collection of antique Chinese export porcelain of such beauty and value that a museum was built to display it. This bequest included several pieces of furniture, among them a pair of small mahogany stands with marquetry tops. The exact age of the stands has not been determined, but similar ones, identified as urn stands, appear in George Hepplewhite's 1794 classic, *The Cabinet-Maker & Upholsterer's Guide*.

I was eager to tackle a marquetry project, and the curator at the university museum graciously gave me permission to measure the original stands and make the drawing you see on the facing page. Since the stand is a good height to place by an easy chair to rest one's late-afternoon pick-me-up upon, I think it's appropriate to call it a "brandy stand." The maple, mahogany and greenish-color wood (possibly yellow-poplar heartwood) marquetry on the originals is handsome, but you may prefer to create your own design or substitute other woods. Use your imagination to make a pair of these old and unusual stands, given a new name to suit a new use.

**Construction notes**—Begin with the stand's top, which consists of a substrate covered by the marquetry design. Since solid wood could shrink and swell, damaging the marquetry, I used dimensionally stable  $\frac{3}{4}$ -in. birch plywood with the good side facing down, where it will show. Start by cutting out an octagon from a  $10\frac{3}{4}$ -in. square of the plywood. Use a fine-tooth handsaw and cut close to your lines. Now, draw a  $4\frac{1}{2}$ -in.-dia. circle on the center of the top's top and carry all of the octagon's diagonals through it. These lines will be helpful in aligning the marquetry pieces later. You also need to decide if the mortises for the legs on the underside of the top will be straight or angled. Mark and chop out these mortises before you begin to veneer.

I can't tell how thick the veneer is on the original stands, but it's probably thicker than the commercial veneer available today. I cut all my own  $\frac{3}{32}$ -in.-thick veneer on a tablesaw with a fine-tooth plywood blade projecting through a close-fitting throat plate. You'll need to resaw enough stock (I used maple) to get four  $3\frac{1}{2}$ -in. squares for the pattern in the center disc, as well as the 24 fan leaves and eight small arabesque figures that surround the center design. Also cut eight (or more, for mistakes)  $4\frac{1}{2}$ -in.-long strips of cherry veneer for the scalloped border. Make them  $\frac{1}{2}$  in. wide to allow for trimming after they're glued in place.

The decorative marquetry that forms the center of the disc on my stand is made from the four maple veneer squares with the grain running in different directions and with some of the edges hot-sand-scorched to give the design a three-dimensional quality. To cut the central design, use the patch-pad marquetry method (see *FWW on Marquetry and Veneer*, pp. 32—33). Draw a  $2\frac{3}{16}$ -in. circle on one square and trace the pattern on it. Now, stack the four squares so their grain runs in different directions like a pinwheel, and use a fine-bladed fret or jewelers' saw to cut through all four layers at once. Hold the blade perfectly vertical throughout. Split the line when sawing the curvaceous center portion, but saw to the outside of the line marking the circle. Cut out the rest of the maple and cherry marquetry pieces, and lay them aside for the time being.

For the background of the center scene and the arabesque border, bandsaw a 5-in. square of  $4/4$  stock (cherry is a closed-grain wood that cuts clean for inlays). Use short screws to fasten the block to a faceplate and mount it on the lathe. Face the piece flat and smooth, and cut a  $\frac{3}{32}$ -in.-deep by  $2\frac{3}{16}$ -in.-dia. recess in it for the center design (see photo, above left). Next, use a narrow chisel (I ground one to size from a file tang) to cut a  $4\frac{1}{4}$ -in.-dia. groove  $\frac{1}{16}$  in. deep by  $\frac{1}{20}$  in. wide for a line of holly inlay (available from Dover Inlay, 234 E. 2nd St., P.O. Box 134, Mineola, N.Y. 11501). After removing the faceplate from the lathe, mark the position of the block on it (so it can be remounted in the same position later) and unscrew the block.

Now, arrange the small arabesque pieces in place and draw around each piece with a needle-sharp pencil. Use a carving gouge and a  $\frac{1}{8}$ -in. chisel to excavate a recess  $\frac{3}{32}$  in. deep for each arabesque. Then, loosely assemble the four parts of the center design and trim their outer edges to fit into the recess that was cut on the lathe.

In a saucepan on a hot plate, heat a couple of cups of clean white sand (sandbox sand from a building-supply store is fine) and use it to scorch some of the edges of the marquetry pieces, shown on the drawing as shading. This may distort some of the delicate center pieces but, when cool, most of the distortion will disappear as the pieces regain their lost moisture.

When all of the inlays have been fitted, spread yellow glue in the recesses and press the marquetry pieces in place. Press one end of a 14-in. strip of the narrow holly inlay into the circular groove cut earlier with the file tang. Use the face of a hammer to

## METHOD FOR ANGLED TENONS

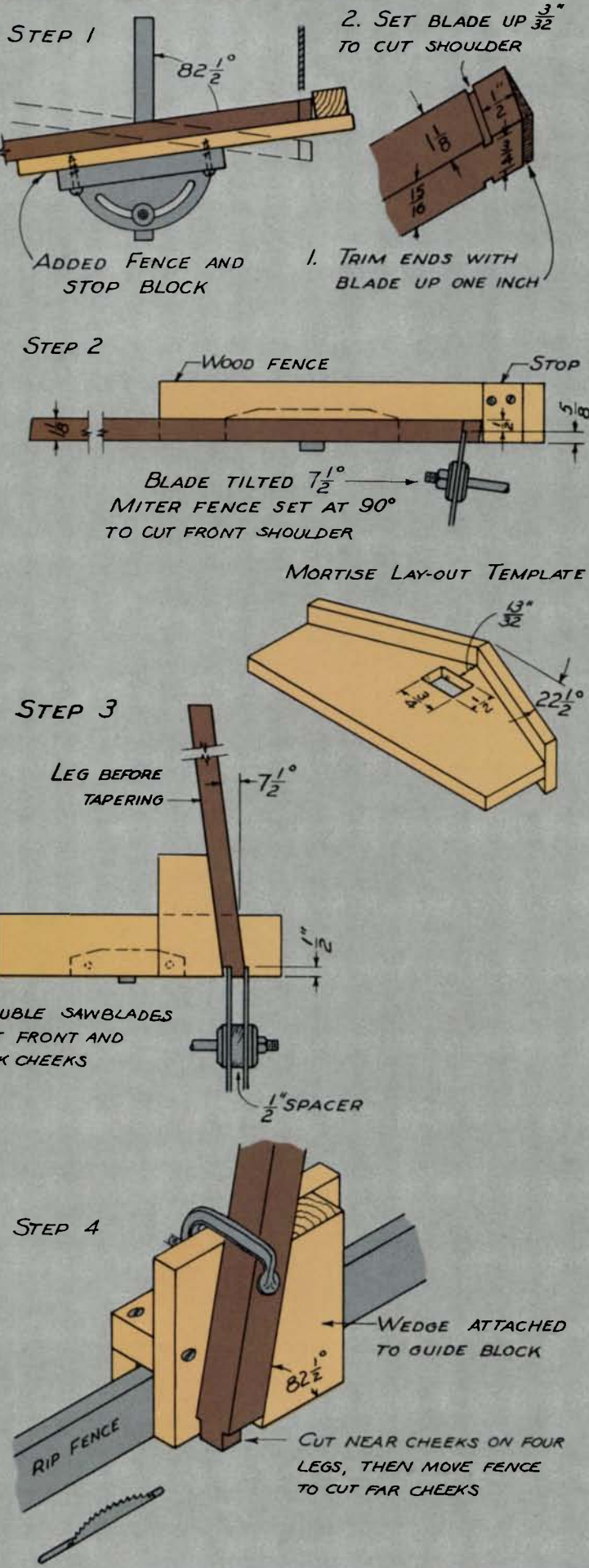

press the holly into the groove. Work your way around the circumference, and trim the strip to length with a sharp knife.

Now, place a scrap of wood over the freshly glued veneer and clamp the surface evenly. Before the glue dries, remove the clamps, wipe off excess glue and reclamp the piece with wax paper positioned between the marquetry and the clamping block.

Once the glue is dry, reattach the block in its original position on the faceplate and mount it on the lathe. With a parting tool, cut a  $\frac{1}{4}$ -in.-deep shoulder  $\frac{1}{16}$  in. outside the holly inlay, and turn the top third of the block's thickness to  $4\frac{1}{2}$  in. in diameter—to avoid ripping out the holly. (Note: This method leaves two-thirds of the block square, and makes the next step—sawing off the inlaid disc—safer and easier than working with a block that has been turned in its entirety, as shown in the top right photo on p. 83.) Now, cut a  $\frac{3}{32}$ -in.-thick wafer from the face of the block by passing it through a tablesaw set to cut the disc off on the left side of a fine-tooth blade. Make the cut in four passes, rotating the block  $90^\circ$  each time.

After gluing the marquetry disc to the center of the plywood top, you're ready to trim the edges of the fan leaves to fit the center disc on one end and the scalloped border pattern on the other. To aid this part of the fitting job and make smooth, accurate concave curves, I made two sanding drums from cylinders turned on the lathe: one with a  $2\frac{1}{4}$ -in. radius for the center curves, another with a  $1\frac{1}{2}$ -in. radius for the border curves.

Next, fit each of the eight sets of three fan leaves in the spaces between the diagonal lines drawn earlier. Be sure to number the leaves in order to avoid a mix-up. When the leaves are all trimmed and fitted, lightly scorch their clockwise edges (see shaded areas of drawing on p. 82) with hot sand. Take care not to overdo the scorching—any charring will result in unwanted ridges when the top is leveled. After gluing the leaves and scalloped border in place, trim the edges of the overhanging border strips with a small handplane, and use a hand scraper to level the marquetry.

The eight pieces that form the top's raised rim are cut from a single 40-in. length of stock that has a small bead along its bottom edge (cut with a scratch stock) and a rounded-over top edge. Miter the ends of each piece to  $22\frac{1}{2}^\circ$  and fit, glue (no nails) and band-clamp them to the plywood top, as well as to each other.

Once the top is completed, construct and assemble the legs and stretchers. Since the legs on my stand are splayed, they join the top at an angle, presenting the dilemma of cutting angled mortises and straight tenons, or vice versa. It's easy enough to cut angled mortises by hand, but I chose to cut angled tenons instead, using the tablesaw jigs shown at left. In either case, the methods illustrated are handy for cutting the angled shoulders.

Before tapering the legs, lay out and cut the mortises for the stretchers and the tenons on the ends of the legs. To lay out the legs, measure from the back side—the one side that will remain untapered. I tapered the legs neatly on the tablesaw using a notched-board tapering jig. Then, I drew a centerline down each leg's front side and planed two  $125^\circ$  chamfers, checking my work with a T-bevel. Although tedious, this made nice-looking legs.

The tenons on the stretchers are cut in the same manner as the ones on the legs, only thinner. Join them with a  $90^\circ$  lap joint where they meet in the center before rounding their top edges.

You can finish the stands any way you like, but the tops should certainly have an alcohol-proof finish—after all, somebody might accidentally knock over a snifter of Courvoisier. □

*Carlyle Lynch is a retired designer, cabinetmaker and teacher. He lives in Broadway, Va. More of his drawings are available from Garrett Wade and Woodcraft Supply.*



*This tiny plane leaves scale-size tool marks on Robertson's miniatures, and is the handiest tool in his shop for truing edges.*

# William Robertson

## *Glimpses into a miniaturist's world*

by Jim Cummins

One of Bill Robertson's dreams—if he ever catches up on orders—is to build an 18th-century tool chest. You may have seen the kind he means—a box resplendent with colorful inlay and intricate compartments. Robertson's dream is to build the chest itself, and then fill it with shopmade replicas of 18th-century hand tools—plow planes, measuring and marking tools, chisels, gouges and bowsaws, all as elegant as the originals. His plan is to use these tools and nothing more to build a piece of Philadelphia high-style furniture from scratch—straight from the log. To get enough lumber, Robertson will need a log at least a foot long and as thick around as his arm.

The world of miniatures may be far from what most of us think of as woodworking. The woods must have super-tight grain and can be as daunting to work as brass. Indeed, most of the measuring and cutting techniques derive from metalworking—a discipline Robertson mastered before he turned to miniatures.

Robertson has been written up in several magazine articles, the authors of which invariably point out that *the boy flunked shop!* In

truth, Robertson was outstanding in shop from seventh grade on. By twelfth grade, he was an accomplished machinist, but he'd had his fill of goof-off fellow students and apathetic teachers, so he cut class 23 times. If that's flunking shop, I'm a monkey.

Robertson's next few years were spent in a patchwork career with but one unifying characteristic: he was good at whatever he tried. His mother, Esther, was the catalyst that hooked her son on miniatures. She'd been interested in miniatures for some time and wanted to make a dollhouse for her granddaughters. Bill was reluctantly lured into helping. In an effort to discourage his mother from proceeding, Robertson hand-cut hundreds of cherry flooring strips, drilling them with 1,500 holes for her to hand-peg. The ploy failed miserably: Descending the stair one morning, Bill found a slipper-clad, bed-robed Esther hard at work, pegging to her heart's content.

Shortly thereafter, Robertson was walking through a miniatures show seeking a gift for his mother when, suddenly, he realized that he could do all the work he saw—better, in fact. His flash of insight proved correct: Before long, he had orders for eight 18th-century



*Left: Robertson's miniature reproductions include an 18th-century Norfolk ladies' writing desk with working drawers; an 18th-century El-nathan Taber clock made of cherry and briarwood with working locks and solid-gold keys; a slipper chair upholstered with 60-mesh Bargello needlepoint; and a piecrust table copied from a Nathan Singer original. All pieces are fully joined as appropriate—even the minuscule candle screen has dovetailed leg joints. Under the desk is a working 77-piece mousetrap crafted from nine woods plus brass. Below: Robertson's handmade and rebuilt tools include router bits for period moldings (left); a combination tablesaw/router table (center); and (right) a 30,000 RPM drill press.*

Photo: Bill Robertson

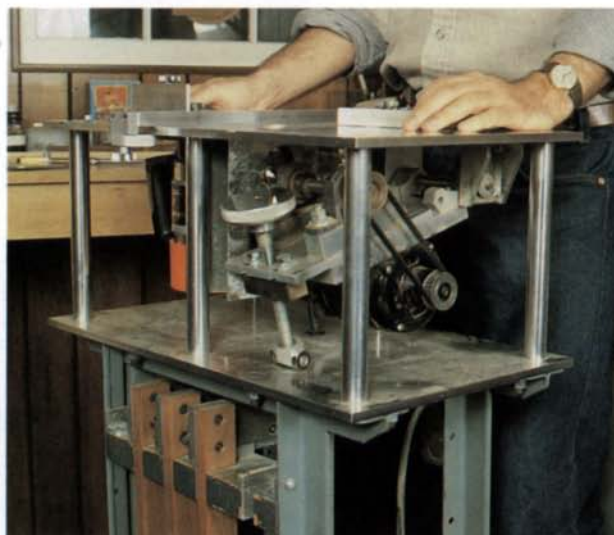

Norfolk ladies' writing desks like the one shown in the top photo, above. He kept one desk for his own collection—a practice he continues today, even on commissions.

His initial miniature venture turned out so well that Robertson cleared out the basement and set up shop. Ten years later, the shop has grown in capability, if not in size. The machines stand shoulder-to-shoulder, as if in a dealers' showroom. There's no need for room to feed long stock—there's no long stock. The lumber pile reminded me of kindling.

Robertson has little regard for modern machine-tool catalogs. "For a long time, most workmen knew how to make what they needed," he notes. "Then, gradually, production shifted to factories, and people stopped making things for themselves. First, the tools disappeared; then, the products started to disappear. You can't find the old molding shapes now, nor the tool to make them."

It seemed like a Catch-22 at first. But then Robertson met an old modelmaker, Paul Runyan, who taught him not to waste time searching for something that can't be found. Instead, he advised, "Teach yourself to make what you need."

Robertson still heeds that advice. He scours salvage dealers and flea markets for pre-World War II machinists' tools and gauges, and

has rebuilt a large number of precision machines—including a lathe that can cut more than 200 threads per inch, with which he makes his own hardware and working locks (with solid-gold keys). Having taught himself heat-treating, Robertson can now make his own router bits for running moldings. Occasionally, he'll modify a standard bit, but he generally gets better results starting with a length of drill rod. He turns the drill rod to the desired profile, then grinds two lengthwise flutes and the necessary relief angle. Some of the longer bits (see photo, above left) have more than one cutting profile ground along their length. By using various parts of bits, Robertson can combine and recombine the profiles to run many different molding shapes. For instance, the 36 bits shown in the photo above can make more than 100 period molding shapes.

In small-scale work, routers often do the jobs of full-scale stationary machines, such as jointers and planers. There are two main routers in Robertson's shop. One is a small drill press that turns at 30,000 RPM. Fitted with an end-mill bit, the drill press can thickness wood down to about 0.004 in.—as thin as paper. To do so, Robertson holds the wood flat against the table, then moves it around under the rotating bit. A series of passes at successively lower heights (checked with a dial indicator) completes the job.

Robertson's other router is part of a combination tablesaw/router table he made from scrap (see middle photo, facing page). In building it, his tool-room experience enabled him to transform other people's junk into precision machinery. For example, the entire drivetrain and arbor of his tablesaw cost him \$8—motor, arbor, bearings, blade-raising tilting carriage and toothed belt and pulleys included.

The tablesaw also has a 4-in.-dia. slotting blade with about ten teeth per inch and no set. When I asked why it didn't burn the wood, Robertson explained that the saw runs at 1,725 RPM—slow enough to cut smoothly without getting hot enough to burn. The tablesaw's miter fence is made of extremely stable, 1-in.-thick Plexiglas. All sliding accessories for the saw table run smoothly on nylon bearings—standard ¼-20 license plate bolts from the hardware store that are run through tapped holes in the jigs so they project a hair and contact the table. Robertson cuts the bolt heads off and saws screwdriver slots in their tops for fine adjustment.

One of Robertson's greatest strengths is his cosmopolitanism. He's interested in everything—particularly anything pertaining to miniatures. His knowledge of the field is expansive. There are all sorts of miniaturists—shipbuilders, dollhouse builders, railroaders, wildlife carvers. Makers tend to pick a category, stick with it and ignore what the rest of the world is up to. As an example, Robertson says, "It's a big thing right now to try to weather and age buildings. Well, model railroaders have been doing that for years; they've got most of the tricks worked out already."

Recently, the National Geographic Society chose Robertson to curate a comprehensive miniatures show, which will run this year from mid-October through January 1 in Explorers Hall at the Society's National Headquarters in Washington, D.C. The show is a follow-up to one Robertson curated two years ago—a ten-week event attended by 64,000 people. Robertson thinks he's mounted the best miniature show ever. In accepting work, he looked for outstanding design and/or daring execution. "One exhibit is the interior of a car on the Orient Express," he says. "It has 85 light bulbs, and when I see how they glisten off the polished varnish and reflect in the windows—wow, that's neat!"

The show coincides with the completion of Robertson's most ambitious project to date—a scale-model American Georgian house with 13 main rooms, not counting attic, basement, back stairwell and all the other nooks and crannies found in ambitious houses. As usual, Robertson is making a duplicate for himself—prompting him to name the dwellings Twin Manors. The rooms will be graced by the best work of other miniature artisans, as well as Robertson's own. The chairs, tables and cabinets will be accompanied by accoutrements of 18th-century gracious living: hand-painted ceramics, embossed silver, paintings in oil—even Oriental carpets handwoven from pure silk. (At a miniatures show I visited last summer, I discovered that, on the average, each of these items costs almost exactly the same as its full-scale counterpart. An upholstered sofa for \$1,500 sounds about right.)

Robertson says that Twin Manors is a high-tech project. He built the structure around a metal frame—both for stability and so the walls can be slid away for viewing. The electrical system is state-of-the-art, and many parts are made from modern casting resins that allow the maker to produce one perfect wooden pattern, then cast the others from it. The finished house, however, will display no high-tech evidence to break the illusion, and Robertson hopes to work on evolving every aspect of the house in years to come—with Esther Robertson's help, of course.

The roof, for example, will proceed in a scene reminiscent of the Robertsons' first flooring job—he'll cut the shingles and begin



*Robertson's most ambitious project to date is a pair of American Georgian houses, entitled Twin Manors. One of the houses was commissioned by The Toy and Miniature Museum of Kansas City (Mo.); the other will remain in Robertson's collection.*

the pattern on the roof, then Esther will step in and finish the job, freeing her son for more complex tasks. Esther doesn't aspire to perfecting the art of miniature carpentry, but she *is* a maker of exquisite needlepoint. The mother-son team once collaborated on a Philadelphia tilt-top gaming table with a stainless steel plate sandwiched in its top to prevent warping. The table's needlepoint insert was a miniature masterpiece containing 33,000 stitches. When it came time for her son to glue the needlepoint down—a delicate, one-chance deal—Esther Robertson was so nervous she had to leave the house.

Esther Robertson is a serious collector. While I was there, she was having doubts about whether a recently acquired lace scarf was of the correct time frame for a room she was composing. One member of her collecting circle is an expert on such matters, and the circle was to meet that evening at the Robertson home. As the time approached, I could feel the tension mounting. But there was to be no answer for me until the next day—on meeting nights, Esther throws the men out. Bill, his father and I wandered over to a nearby hamburger shop, their standard refuge on such occasions, and we all gladly abandoned talk of miniatures for a while.

The next morning, I returned to hear the verdict on the scarf. As feared, the lace pattern was *not* known in America at the time depicted in the model room—it was about ten years off. Esther Robertson was clearly disappointed. She added that the expert had given her one possible "out": The scarf might have been brought to this country by a relative visiting from Scotland, where the pattern was coming into vogue. Mrs. Robertson didn't think this option was quite honest. "What would *you* do?" she asked. I told her I'd buy the relative story and go with the scarf.

Thinking back on it now, I realize that all three Robertsons are made of pretty solid stuff, and that the miniature world I'd peeked into doesn't leave much space for compromise. I'll bet the scarf doesn't end up in the room. Esther's instincts were right all along. I'm as sure of that as I am that, someday, Bill Robertson will build himself a tool chest, fill it and make some furniture by hand. And, like the best of the other woodworkers I've run into over the years, he'll love every minute of it. □

*Jim Cummins is an associate editor at Fine Woodworking.*



# SystiMatic cuts out the racket.

Fine tooth carbide tipped saws must have expansion slots to prevent warping as they heat up. But as we all know, those slots set up a ferocious howl.

SystiMatic has the answer. Our exclusive laser cut "anchor" expansion slots cut the howl down to a whisper. Actually run quieter than saws *without* slots—the quietest running blade in fact that we've ever made.

Ordinary slots are milled out then drilled at the bottom to prevent a crack line from developing (Better blades also have a copper slug swaged into the hole to reduce the noise somewhat. But these slugs can work loose and have been known to fly out and cause serious injury.)

When we bought our big laser press, we experimented with a new improved expansion slot—completely safe and cut

out in one continuous pass of the laser beam. There was no reason to make the bottom of the slot a complete circle, so we worked with an "anchor" profile. Our final design not only prevented cracking, it also turned out to be amazingly quiet. Something about that anchor shape relieves the air pressure, totally eliminating the siren effect.

If you've never seen how smoothly our blades cut—or heard how quietly they run—we think you owe it to your eyes and ears to try a SystiMatic Blade with laser-cut anchor slots. We make our blades in stock sizes from 8" to 20" for every kind of cutting application. Ask your dealer to help you choose the exactly right

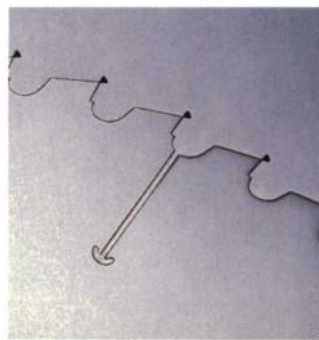

blade or blades for the kind of work you're doing. All SystiMatic blades are manufactured right here in the United States of America. And you can't buy a smoother-cutting, better-made blade anywhere else on the face of the earth.

We guarantee it.







**Now you can get  
Perfect Dovetails  
in Minutes and  
Cash Back with  
the Keller System**

*The easiest, most accurate and foolproof router dovetail system available. Buy your templates between August 20th and November 15th and get up to \$25.00 back direct from the manufacturer. See the dealer nearest you today for details.*

**Action Moulding & Supply, Inc.**  
6140 County Rd. 17  
Helena, AL 35080  
(205) 663-0130

**AAA Wholesale**  
17309 Roscoe Blvd.  
Northridge, CA 91325  
(818) 996-1800

**Henry Electric Tool Company**  
7635-A Auburn Blvd.  
Catus Heights, CA 95610  
(916) 723-1088

**Restoration Hardware**  
417 Second Street  
Eureka, CA 95501  
(707) 443-3152

**Restoration Hardware**  
Alison Street  
Mendocino, CA 95460  
(707) 937-0160

**Tool City**  
14136 E. Firestone Blvd.  
Santa Fe Springs, CA 90670  
1-(800) 423-7899 Outside CA  
1-(800) 826-7819 Inside CA

**Schlusser Tool & Machinery**  
301 Bryant Street  
Denver, CO 80219  
(303) 902-8244

**Brian's Tool Sales**  
9 Moody Rd.  
Enfield, CT 06082  
(203) 623-6282

**Jacksonville Woodworkers  
Supply, Inc.**  
45 Emerson Plaza East  
Jacksonville, FL 32207  
(904) 737-7508

**Wheeler Machinery Co., Inc.**  
16377 N.W. 57th Avenue  
Miami, FL 33014  
1-(800) 624-1594 FL  
(305) 624-3227

**Highland Hardware**  
1045 N. Highland Ave., NE  
Atlanta, GA 30306  
(404) 872-4466

**KLM, Inc.**  
100 Bell Drive  
Kalamazoo, MI 49001  
(269) 726-3180

**The Tool Haus**  
630 North Silverleaf  
Gladwin, MI 49824  
1-(800) 828-0001 MI  
(517) 426-4549

**Wood Works**  
950 N. Rand Rd., (Rt. 12)  
Wauconda, IL 60084  
(312) 526-1411

**Willow Creek Tool Sales**  
Main Street  
Willow Creek, MT 56760  
1-(800) 592-8501 Outside MT  
1-(800) 592-8500 Inside MT

**The Tool Chest**  
45 Emerson Plaza East  
Emerson, NJ 07630  
(201) 261-8665

**Northland Woodworking Supply**  
706 Court Street  
Utica, NY 13502  
(518) 724-1299

**The Wood Workers' Store  
at Brewer's**  
161 F. Boston Post Rd.  
Mamaroneck, NY 10543  
(914) 698-3232

**Lehman Hardware**  
4779 Kidron Road  
Box 41  
Kidron, OH 44636  
(216) 857-5441

**McMaster Power Tools**  
6206 Market Street  
Youngstown, OH 44512  
(216) 783-2130

**Quality Saw and Tool**  
328 South Main Street  
Mansfield, OH 44903  
(419) 526-4221  
1-(800) 523-6927

**Mar-wood Hardwoods**  
406 A Hunnington Pike  
Rockledge, PA 19111  
(215) 663-0446

**Older Mill Cabinet Shoppe**  
RD3, Box 547 A Camp Betty  
Washington Road  
York, PA 17402  
(717) 755-8884

**Cherokee Lumber Co.**  
1410 Sevensville Pike  
Maryville, TN 37802-1256  
(615) 546-0460

**Dallas Wood & Tool Store**  
1936 Record Crossing Rd.  
Dallas, TX 75235  
(214) 631-5478  
1-(800) 826-4965

**Western Woodcraft Supply**  
3149 So. State St  
Salt Lake City, UT 84115  
(801) 485-5823

**The Source**  
7305 Boudinot Avenue  
Springfield, VA 22150  
(703) 644-5460

**Wooden Boat Shop**  
1007 N.E. Boat St.  
Seattle, WA 98105  
(206) 634-3600

For other areas contact: **The Robert Larson Co.** Dealer inquiries welcomed  
82 Dorman Ave., San Francisco, CA 94124 • (415) 821-1021 on your letterhead

**SUNHILL**

1000 Andover Park E.  
Seattle, WA 98188  
(206) 575-4131

**MP-230 Heavy Duty  
Tilting Spindle Shaper**

- 5HP 3PH motor
- 4 speed reversible rotation
- 3" travel spindle tilts to 45°
- 38"x40" table area
- Wt: 1,200 lbs.

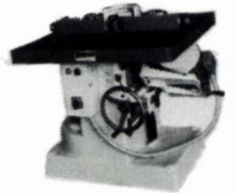

**SALE \$3,500**

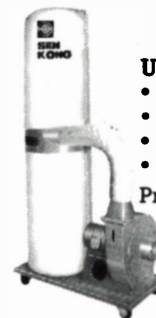

**UFO Dust Collectors**

- UFO-90 1HP 1PH
- UFO-101 2HP 1PH
- UFO-102B 3HP 1PH
- UFO-102B 3HP 3PH

Prices start at **\$249**

**SDM-37 36" Cabinet Shop  
Wide Belt Sander**

- Single Platen Head
  - 37"x60" belt
  - 15HP 3PH main motor
  - 1HP feed motor
  - Wt: 2,000 lbs.
- Rotary Phase Converters available.



**SALE \$8,950**

We stock a full line of Wide Belts from 24" with prices starting at **\$5,950.**

Contact the Dealer in your area or call Sunhill.

CA (209) 455-0189  
CA (916) 343-5937  
CA (213) 749-6441  
CA (707) 725-4742  
CO (303) 469-8013  
IA (319) 232-5434  
IL (815) 758-6009  
IN (219) 353-7551  
KS (316) 942-8475  
KY (502) 898-3740  
MI (715) 384-9998  
MN (715) 384-9998  
NC (919) 977-7988

NH (603) 228-2066  
NY (718) 278-9528  
NV (702) 871-0722  
OH (614) 927-9061  
OK (405) 495-1268  
OR (503) 389-1521  
PA (717) 632-3443  
TX (713) 683-8455  
UT (801) 262-2020  
WA (206) 423-4242  
WA (206) 775-6304  
WI (800) 472-5680

**NEW**  
From  
**Penn State  
Industries** - a  
supplier of quality products  
for over 40 years

Professional quality, precision . . .

**Super 15" Scroll Saw**

Comparable value over \$500

Only **\$139.95** shipped complete ready to run

This versatile machine makes cutting intricate wood patterns easy — great for making toys, jewelry, puzzles, fretwork, etc. The blade is driven on both up and down stroke with a smooth cutting parallel rocker arm system. This system avoids blade breakage and creates a smooth finish that virtually eliminates sanding. Our saw is easy to use and is made with a cast construction that insures durability. We fully support our product with replacement parts and repairs if needed. Thousands of satisfied customers use our saw world-wide.



**SPECIFICATIONS:**

- Cast iron construction
- Throat depth — 15"
- Max. depth of cut — 2"
- Cuts per minute — 1725
- Weight — 43 lbs
- Motor — Heavy duty totally enclosed fan cooled 110V - 120V UL listed, ball bearing — induction motor

**NEW!**

- **Dust Blower (Optional - Add \$15.00)**
- Use standard 5" blades
- Stroke length — 3/4"
- Table Tilt — 0 - 45°
- Table Size — 8" x 17"

30 Day Money Back Guarantee—1 year warranty parts/labor  
**FREE: 12 Blades & Blade Holder Set with purchase**

**PENN STATE INDUSTRIES • F**

2850 Comly Road • Philadelphia, PA 19154  
1-215-676-7609 (Ext. 15)

\* Add \$15.00 for Blower Option • Visa, MasterCard, Check or Money Order Accepted  
Add \$10.00 for shipping in Continental U.S. • Pennsylvania residents add 6% sales tax

## TRANSPOWER



AP650  
15" AUTO PLANNER  
ONLY  
**\$695.00**  
(Free Stand)

- 15"x6" capacity with double belt drive.
- Powerful 3HP motor with 3/16" maximum cutting depth.
- 3 high speed steel blades with 5100 RPM speed.
- Comes with dust hood and extension rollers (not shown).
- Weighs 500 lbs.



HP500  
3/4" SHAPER  
ONLY  
**\$495.00**

- Powerful 2HP motor with reversible speed.
- Milled cast iron table 18"x20".
- Standard 3/4" with 1/2" (optional) interchangeable spindle.
- Spindle travel is 2-1/4", accepts cutters to 6".
- Weighs 275 lbs.



DEALER  
INQUIRY INVITED

11000 E. Rush St., #18, S. El Monte, CA 91733  
1-800-654-7702 • In CA (818) 444-4132

## Makita

freight prepaid

6012 HDW	3/8" C/less Clutch Drill	\$102.00
2708 W	8" Table Saw w/c blade	216.00
3601 B	1 1/2 hp. Router	124.00
9820-2	Blade Sharpener	165.00
5402 A	16" Circular Saw	320.00
1900 BW	3 1/4" Planer	109.00
4301 BV	Var. spd. Jig Saw	140.00
9900 B	3x21 Belt Sander	128.00
9401	4x24 Belt Sander	167.00
5007NBA	7 1/4" Circular Saw	123.00
JR3000V	Recpro Saw	119.00
3705	Offset Lam. Trim	138.00
DP 4700	1/2" Drill	104.00



LS1000  
10" Mitre  
\$225



3612 BR  
3 h.p. Router  
\$185

### Batteries for Cordless

7.2 Volt 28.00  
9.6 Volt 30.00

### ★ NEW ★

Bosch 4x24 1273DVS  
Variable Speed Belt Sander

**\$249** Orders only Call:  
1-800-362-7227  
dial tone then 740  
608-273-0148

## WORKBENCH TOOL CO.

2833 Perry St.  
Madison, WI 53713  
MasterCard and Visa Welcome

# Your home workshop can PAY OFF BIG!



This One Low-Cost Power Tool—

**SAWS** to desired Width...  
**PLANES** to desired Thickness...  
**MOLDS** all popular Patterns...

All at once or separately... All By Power Feed!

TRY THE FOLEY-BELSAW  
IN YOUR OWN SHOP  
**30 DAY FREE  
TRIAL OFFER**

Only 3-in-1-Workshop Tool Of Its Kind!

From the Day It Arrives... Your Planer will make and save you money. With shortages and inflation driving lumber prices sky-high, this versatile power tool easily pays for itself by quickly converting low-cost rough lumber into high value finished stock. In just one pass turn out your own quarter-round, door and window stop, casing, tongue-and-groove... all popular patterns. Other Foley-Belsaw operators are making cases for grandfather clocks, furniture, picture frames, fencing, bee hives, bed slats, surveying stakes... all kinds of millwork.

Built For Pros... Priced For  
the Home Craftsmen

... it is engineered and built to industrial standards, but factory-direct selling keeps the price low. Handles tough oak and walnut as easily as pine, and so simple to operate even beginners with no experience can use it.

## Start Your Own Business Earn Extra Income Right at Home

With just this one low cost power-feed machine in a corner of your garage or basement, you can set up a profitable business by supplying lumberyards, cabinetmakers, carpenters, remodelers, contractors and hobbyists in your area with custom-planed lumber, trim, molding... ALL of their millwork requirements. Supply picture molding to art shops, hardware and department stores, or sell direct to framing shops. All standard patterns in stock... custom knives ground to your design or sample.



**FREE  
BOOKLET!**

Get FREE Book  
with facts and  
full details... RUSH  
COUPON TODAY!

If coupon has been re-  
moved, just send postcard  
with name and  
address to:

Foley-Belsaw Co.  
6301 Equitable Rd., Dept 91134  
Kansas City, Mo. 64120

**NO RISK 100%**  
*Guarantee of Satisfaction*  
"Try the Foley-Belsaw in your own shop for a full 30-Days and put it to work for you. Give it a thorough test and make it prove that it can do everything we say it will... use it as much as you want. Then if you are not completely satisfied, just send it back and we'll return every penny sent with your order. And YOU are the sole judge. There are no questions asked... there are no fine print "use" charges. Our flat guarantee is that YOU must be 100% satisfied or you get your money back."

Does The Foley-Belsaw Pay? **YOU BET!**

READ WHAT OTHER FOLEY-BELSAW OWNERS SAY:

**A Good Investment:** "I believe that the Planer is the best investment I ever made. I've been a planer man for years and am now retired. The Foley-Belsaw has earned me over \$60,000 extra income in the past eleven years."

Robert Sawyer, Roseburg, Oregon

**Pays For Itself:** "I bought a batch of walnut in the rough, and after planing it on the Foley-Belsaw I figured up the money I had saved. It was enough to pay for two-thirds the cost of the Planer. It really does a good job."

R.S. Clark, Springfield, Ohio

**More Than Expected:** "This machine pays for itself by making money out of scrap boards. It is a very well built machine and I confess it is more than I expected for the price. It does everything you say it will."

Stephen Schultz, Orangeville, Penna.

... And Foley-Belsaw Is The Choice Of Professionals: "I recommend Foley-Belsaw's Planer-Molder-Saw as the most useful shop tool that any craftsman could own. We use ours every day in the WORKBENCH model shop, and couldn't get along without it."

JAY HEDDEN — Editor of WORKBENCH Magazine

NO OBLIGATION and  
NO SALESMAN Calls!

SEND FOR  
**FREE  
BOOKLET**



Foley-Belsaw Co.  
6301 Equitable Rd.  
Dept 91134  
Kansas City, Mo. 64120

**YES**, please send me the FREE Booklet that gives me complete facts about your Planer-Molder-Saw and full details on how I can qualify for a 30-Day Free Trial right in my own shop. I understand there is No Obligation and that No Salesman will call.

NAME \_\_\_\_\_

ADDRESS \_\_\_\_\_

CITY \_\_\_\_\_

STATE \_\_\_\_\_

ZIP \_\_\_\_\_

# ULTRASAND™ 2/FXT

## THE ULTRASAND CONCEPT EXTENDED

# 2



ULTRASAND 2/FXT —  
matching functionality to purpose.

For a free brochure and price list on this exciting addition to Kuster Mfg.'s ULTRASAND thickness sander line as well as our other products, write or call today. (201) 359-4680.

Outlining a problem: a small shop creating fine wooden doors has volumes of milled lumber to process and glued-up inset panels to level out, and when the doors are assembled needs to sand the joints smooth and flush. Sanding is time and labor intensive and it's difficult to get high quality results with hand sanders, especially on wide pieces. Bulky pieces like doors require additional handling and support. Adjustable extension tables have to be moved every time the table is raised or lowered. Having the right machine available can have enormous impact on working all of this material and improving overall results.

Understanding these problems led to the solution at the heart of the ULTRASAND 2/FXT thickness sanders: fix the table at a comfortable working height and adjust for material thickness by raising or lowering the sanding drums. Since the table no longer moves up or down, extensions front and back can be permanently attached. These prevent the wood from entering or exiting the machine at an angle, which would cause heavier sanding to occur on the first and last few inches of the work. The thickness sander can then do what it was designed to do: give an even thickness across the width of the workpiece from end to end.

ULTRASAND 2/FXT joins Kuster Mfg.'s original ULTRASAND to provide you with a choice in drum sanders. Features such as dual sanding drums (single drum ULTRASAND models available); conveyor feed; easy abrasive wrapping system; steel frames; and 2-motor drive/feed setup are common to both product lines.



## Powermatic



Model 81  
Band Saw

The Model 81 Band Saw complete with all standard equipment, plus 1" blade capacity, 2 HP, 3 phase motor (or 1 1/2 HP, 1 phase motor), magnetic controls and work lamp. 230 volt.

### WOODSHOP SPECIALTIES

Cold River Industrial Park  
Quality Lane  
Rutland, VT 05701  
(802) 773-3240  
Telex 62946343



Power, precision, versatility put this heavy-duty shaper in a class by itself! Send for free facts on why this low-cost tool outperforms machines costing hundreds of dollars more.

#### CHECK THESE STANDARD FEATURES!

- SLIDING BALL BEARING TABLE for perfect end-grain cuts time after time.
- 3 SPEEDS to cover a wide range of work.
- MASSIVE 3/4" PRECISION GROUND SPINDLE for perfect, chatter-free cuts.
- ACCURATE SPINDLE ELEVATION — Smooth, positive and capable of micro-adjustment.
- VERTICAL AND HORIZONTAL HOLD DOWNS included as standard.
- POWERFUL 2HP MOTOR

Write or call today for complete facts on how you can try this precision tool in your own shop for 30 days without risk!

Call toll free 1 (800) 538-4200, Ext. 5202  
KITTY PRECISION TOOLS, Dept. ME02  
2908 OAK, KANSAS CITY, MO 64108

Yes, please rush complete facts on the KITTY Precision Shaper plus details on your 30-day trial and 2-year warranty.

NAME \_\_\_\_\_  
ADDRESS \_\_\_\_\_  
CITY \_\_\_\_\_ STATE \_\_\_\_\_ ZIP \_\_\_\_\_



### Fine Woodworking

#### Back Issue Slipcases

Bound in dark blue and embossed in gold, each case holds at least 6 issues of *Fine Woodworking* (a year's worth), and costs \$7.95 (\$21.95 for 3, \$39.95 for 6). Add \$1.00 per case for postage and handling. Outside the U.S., add \$2.50 per case (U.S. funds only). PA residents add 6% sales tax.

Send your order and payment to:

Jesse Jones Industries  
Dept. FW, 499 E. Erie Ave.  
Philadelphia, PA 19134.  
Charge orders: Min. \$15.00, call toll free 1-800-972-5858, 7 days, 24 hrs.

**BUY AMERICAN**

**PORTER+CABLE**  
PROFESSIONAL POWER TOOLS

SPECIAL INTRODUCTORY PRICE

Model No. 555

Woodworker's  
Equipment & Supplies  
566 Danbury Rd.  
New Milford, CT 06776

(203)354-2219  
Outside CT.  
(800)848-9663  
Mon.- Fri. 8:30-4:30  
Thurs. til 5:30



**ANDREU**

MAKE ALL YOUR "RAISED PANEL DOORS" WITH THE:

**Lundblom**

3 HEAD VERTICAL CUT WOODSHAPER



World's fastest, safest, most efficient shaper ever made. Can you make the 12 cuts required for a raised panel door in 90 seconds or less, without ever thinking of cutting yourself?

Now you can with the Lundblom Vertical Cut Woodshaper.

- Can cut up to 1 3/4" Cathedral Arches • 3 Machines in One
- UL Listed
- CSA Approved
- 6 ft. of Floor Space
- Can do anything any other shaper can do plus wherever your imagination can take you.
- Safer Than a Hand Drill
- Accepts All Standard 3/4" Bore Cutters
- Easily Maintained, Easily Operated

AVAILABLE IN: • 3hp/Single phase • 5hp/Single phase  
• 3hp/Three phase • 5hp/Three phase

REG. \$3495 SPECIAL INTRODUCTORY SALE PRICE **\$2495**

Video & Brochure Available Sale Ends 10/31/87

In CA: (415) 846-0224 • In FL: (813) 355-8186  
In L.I.: (516) 360-9012 • In NH: (603) 563-8507  
In NJ: (201) 435-7917 • In NC: (919) 427-0637  
In MS: (601) 982-6369

FINANCING AVAILABLE 1 YEAR GUARANTEE

**ANDREU INDUSTRIES, INC.**

22 69 23rd STREET ASTORIA NEW YORK 11105

(718) 278-9528

MC / VISA

24 HOURS / 7 DAYS A WEEK

The professional choice in fine quality joint making. The RBI Joint Machine

Create beautiful practical and decorative wood joints in seconds. Custom furniture building and cabinetry has never been easier! You can make Dovetails, mortises, rabbets, and finger joints effortlessly. Easy enough for the most novice



woodworker to enjoy! Over twice the capabilities of comparable machines at less than half the cost! Don't wait another day to find out how fun and easy joint making can be!

Send Today For Your Free Information Kit!!  
1801 Vine St., P.O. Box 369  
Harrisonville, MO 64701  
1-800-535-8665

YES, please rush me information on the all new RBI Joint Machine.

NAME \_\_\_\_\_

STREET \_\_\_\_\_

CITY \_\_\_\_\_

STATE \_\_\_\_\_ ZIP \_\_\_\_\_

©1987 RBI, INC. (PLEASE PRINT) Dept. FW12

9 SPECIAL SHOWS!  
• Free Workshops  
• 100 Exhibits • Door Prizes

THE WOODWORKING SHOW  
machinery tools - supplies

Widest Variety of Woodworking Products All Under One Roof

- Sept. 4-5-6 Nashville Convention Center Tennessee
- Sept. 11-12-13 Cincinnati Convention Center Cincinnati
- Sept. 25-26-27 Del Mar Fairgrounds San Diego
- Oct. 16-17-18 Minneapolis Auditorium Twin Cities
- Oct. 23-24-25 Pittsburgh Convention Center Pittsburgh
- Oct. 30-Nov. 1 Michigan Fairgrounds, Detroit Metro-Detroit
- Nov. 13-14-15 Portland Memorial Coliseum Oregon
- Nov. 20-21-22 Seattle Center Exhibition Hall W. Washington
- Dec. 4-5-6 L.A. County Fairgrounds, Pomona So. California

Seminars by James Krenov — Ian Kirby — Michael Dunbar — Rude Osolinik — Dale Nish — Roger Cliffe — Bob Rosen-dahl — and other Master Craftsmen  
1-800-826-8257, In Calif. 213-477-8521

Save \$1 OFF reg. \$5 admission with this ad

NEW

Rockingham Community College

OFFERING

Program: Fine and Creative Woodworking  
Degree: 2 year  
Associates of Applied Science  
Instructor: David Keadly

Emphasizes designing and building fine quality, custom furniture, accessories and cabinetry.

Curriculum includes:

- Furniture Construction (Period and Contemporary)
- Finishing
- Wood Turning
- Chair Construction
- Design and Drafting
- Wood Forming and Bending
- Furniture Restoration.

The student will learn design and woodworking skills required to build quality furniture and cabinetry. A balance between the use of handtools and woodworking machinery will provide the knowledge and skills of a well-rounded craftsman.

FOR MORE INFORMATION, CALL ADMISSIONS:  
(919) 342-4261



Rockingham Community College

P.O. Box 38 • Wentworth, NC 27375-0038

Equal Opportunity/Affirmative Action College

Queen Anne Chair

by

Adams Wood Products, Inc.



Ready to assemble  
Prompt delivery  
Any quantity  
Oak, Cherry, Walnut  
Mahogany, etc.

FREE BROCHURE

Dept. Q-2  
974 Forest Dr.  
Morristown, TN 37814  
615/587-2942

RYOBI SU-6200

HEAVY-DUTY 4-1/2" x 9" ORBITAL SANDER

- 120V, 2.9 amp. motor operates at high speed of 10,000 o.p.m.
- All ball bearing construction.
- Water protection cover designed for wet sanding.
- Flush sanding capability on three sides.
- Compact and lightweight.

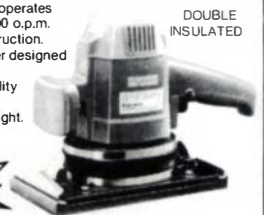

SALE PRICE: \$99.95

Please Call or Write For Information. 1-800-826-4965

DALLAS WOOD AND TOOL STORE

1936 RECORD CROSSING 214 631-5478 DALLAS TEXAS 75235

HORTON BRASSES

Nooks Hill Road, P.O. Box 120F  
Cromwell, CT 06416  
(203) 635-4400



Mfrs. of Fine Hardware for Over 50 Years  
Send \$2.00 for a catalogue

SAVE! BUILD YOUR OWN POWER TOOLS



- 12-IN. BAND SAW
- 18-IN. BAND SAW
- 10-IN. TILT/ARBOR SAW
- COMB. DRILL PRESS-LATHE
- 9-IN. TILT TABLE SAW
- 6-IN. BELT SANDER
- SPINDLE SHAPER
- CIRCULAR SAW TABLE

ONLY \$6.00 PER PLAN

SOLD FOR 40 YEARS

Easy to follow step by step plans. Full scale patterns. Send \$6 per plan or \$24.50 for all 8 plans listed above. Gilbl Metal Parts Kits - made in U.S.A. Satisfaction Guaranteed. Send \$1 for descriptive brochure only.

GILBL MFG. INC., Dept. FW 97  
P.O. Box 1018  
St. Charles, MO 63303



## BOSCH Power Tools

### BOSCH JIG SAWS

only  
**\$125.00**

Model 1581VS



NO TOOL SALE

#### SAWS

1582VS	Orbit. Action Nob Hdle Jig Saw	\$118.00
3238VS	Unv. Shank Mult. Orbit. Jig Saw	79.00
1651	7/4" Cir. Saw, 13 amp	89.00

#### DRILLS

1920VSRK	3/8" Cordless Reversing Drill	99.00
1920RK	3/8" Cordless Reversing Drill	85.00
1158VSR	3/8" Var. Spd. Rev. Drill	54.00
91064	3/8" VSR Mighty Midget Drill	89.00
91066	1/2" VSR Mighty Midget Drill	99.00
1196VSR	3/8" VSR Hornet Hammer Drill	115.50
1198VSR	1/2" VSR 2 spd. Hammer Drill	139.30
1921VSRK	3/8" Var. Spd. Screwdriver	115.00

#### ROUTERS

1601	1 hp Router	89.00
1602	1 1/2 hp Router	129.00
1604	1 3/4 hp Router	118.00
1606	D-Handle, 1 3/4 hp Router	163.00
90300	Fixed Base Router, 3/4 hp	295.00
90303	Plunge Base Router, 3 1/2 hp	449.50
90085	3/4 hp Router	91.00
1608	Trim Router	89.00
1608M	Motor for 1608/1609 Series	83.30
1608L	Laminate Trimmer	94.50
1608T	Tilt Base Trimmer	99.00
1609	Offset Base Trimmer	119.00
1609K	Installers Kit	159.00

#### SANDERS

32700	3x21 Dustless Belt Sander	104.00
1272	3"x24" Belt Sander	159.00
12720	3"x24" Belt Sander w/Dust Collector	149.00
1273	4"x24" Belt Sander	150.00
12730	4"x24" Belt Sander w/Dust Collector	159.00

#### OTHER TOOLS

3268	Heat Gun	48.00
1700	10 Gal. Wet/Dry Vacuum	227.50
3221	18" Professional Hedge Trimmer	94.50
3221L	26" Professional Hedge Trimmer	105.00
1347	4 1/2" Mini Grinder	79.00
1323	9" Grinder	99.00

#### MAKITA-HITACHI

CLOSE OUT ON STATIONARY EQUIPMENT. CALL FOR SALE PRICES AND DETAILS.

Colo. Watts 1-800-523-6285

CALL TOLL FREE  
1-800-525-0750

VISA and MASTERCARD ACCEPTED

AVIATION/INDUSTRIAL SUPPLY  
P.O. Box 38159 • Denver, CO 80238

## The workbench companion

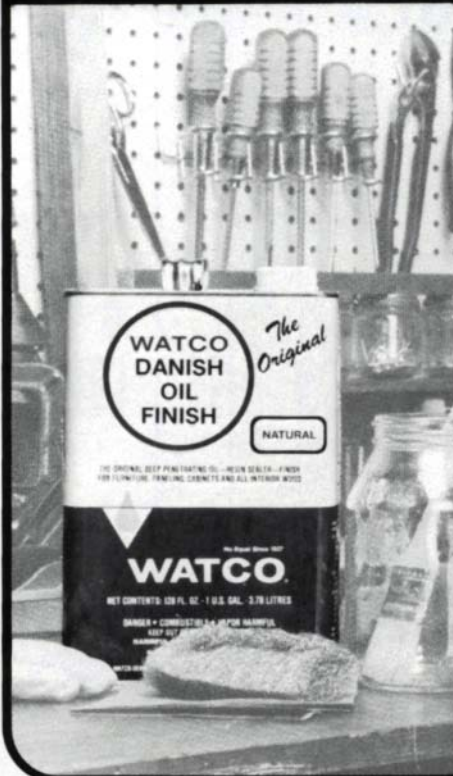

## WATCO®

The Original and Still the Best

### DANISH OIL FINISH

Watco Danish Oil Finish can be your ideal workbench companion for all those wood finishing projects around the house. You'll be amazed at how easy it is to finish wood beautifully with Watco, "The Original Danish Oil". Watco gives wood that natural, hand-rubbed look with long-lasting durability. And because Watco is **IN** the wood... not on it like temporary surface coatings... there is no finish that will wear off. Watco Danish Oil is ideal for furniture, paneling, cabinets, doors, trim-work and even antiques. It's also safe for use on butcher blocks, cutting boards, and children's toys after Watco dries and cures in the wood. Choose from 8 beautiful finishes... Natural and Medium, Dark, and Black Walnut shades, and Cherry, Golden Oak, Fruitwood, and English Oak colors.

Send today for "Free" color booklet "How to Finish Wood Beautifully and Easily" and the name of your nearest Watco distributor.

WATCO-DENNIS CORP., 1433 Santa Monica Blvd., Suite 90, Santa Monica, CA 90404, Dept. FW-S07

Name \_\_\_\_\_  
Street \_\_\_\_\_  
City \_\_\_\_\_  
State \_\_\_\_\_ Zip \_\_\_\_\_

## SQUARE IT™ & DOOR SHOP™ SALE

**Square It™**, the electronic precision square, endorsed by **HOME MECHANIX, INDUSTRIAL EDUCATION, PROGRESSIVE BUILDER, POPULAR SCIENCE** and by **WOOD** magazine as "especially accurate (5/10,000")", amazingly simple to use & a truly revolutionary benchmark tool. **Square It™** fulfills the need of wood workers to square any stationary tool, simply, quickly & accurately. Battery operated & portable, **Square It™** uses precise preset probes & a lit bulb as a go-no-go indicator to assure perfect 90° & 45° settings on the table & radial arm saws, joiner, drill press, band saw, miter box or any stationary tool. Comes ready to use with 17 pg. illustrated manual, alkaline batteries, krypton bulb & a 100% warrantee. **SPECIAL \$49.95**

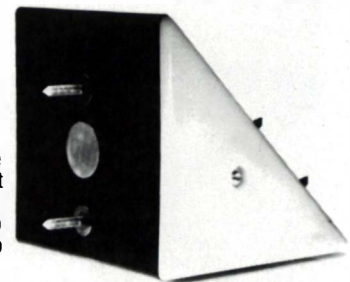

### THE DOOR SHOP™

The original Ogee **DOOR SHOP™** as featured in **WOOD MAGAZINE (MAY/JUNE 85)** is complete with stile & rail, slot & panel raising bits for the 1/4" chuck router. Bits are carbide tipped & BB & will make 3/4" thru 2 1/4" thick raised panel doors. Door Shop™ & Manual \$89.50 ppd. The 1/2" shank Door Shop™ now available. Call about our 5 piece Door Shop™ special.

**COMBINATION SALE \* BOTH SQUARE IT™ & DOOR SHOP™ \$125 ppd.**

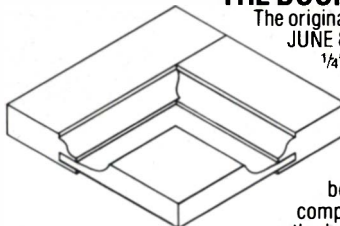

The 37 page **DOOR SHOP™ MANUAL** is clearly written and beautifully illustrated with over 156 detailed drawings covering the complete process of door building. Each section covers proper methods and exact set ups for the router, including how to recognize and correct for errors. There are sections covering Design, Lumber selection, Measuring, Panel Raising, curved & straight Rail and Stile cutting & fitting, Guides, Clamping, Gluing and Finishing. This is the most comprehensive manual out today. When purchasing the **DOOR SHOP™** manual for \$5.00 you also receive Zac's 27 pg. router bit catalog & **SQUARE IT™** manual.

Zac's carbide tipped **PANEL RAISER™** router bits come in 3 styles; **PROVINCIAL**. All 1/2" shank bits are 3 1/2" in diam., with BB & give a \$99 @ or all 3 bits for \$180 ppd. All 1/4" shank bits are 2" in diam. & raised panel cut. \$65 @ ppd. or all 3 bits for \$120 ppd.



TO ORDER CALL  
800-441-0101  
ZAC PRODUCTS INC. 34 Renwick Street NYC, NY 10013

IN NY  
212-645-9494

# "Jorgensen" AND "Pony" CLAMPS

Dependable extra hands for all types of clamping and work-holding jobs: woodworking projects, home maintenance, and furniture repair.

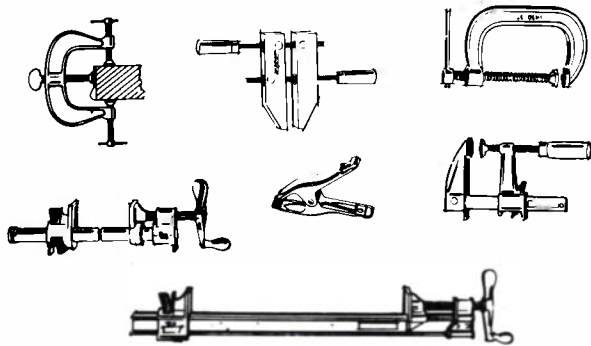

Write for FREE LITERATURE. For big 32-page "how-to-clamp-it" catalog, send 50¢.

ASK YOUR DEALER

ADJUSTABLE CLAMP COMPANY  
THE CLAMP FOLKS

431 N. Ashland Ave. / Chicago, IL 60622

## TOOLS ON SALE™ AMERICA'S LOWEST PRICED TOOLS ★PLUS★...FREE... Freight On Every Item

### 3M BRAND

"THREE-M-ITE" RESIN BOND CLOTH, EXTRA WEIGHT OPEN COAT BELTS

- ✓ CHECK YOUR GRIT • ✓ CHECK YOUR SIZE •
- ✓ LET YOUR SAVINGS BE YOUR PRIZE! •

SIZE 3" x 18"				SIZE 3" x 24"					
120X	Box of 10	9.20	Case of 50	43.70	120X	Box of 10	10.65	Case of 50	50.50
100X	Box of 10	9.20	Case of 50	43.70	100X	Box of 10	10.65	Case of 50	50.50
80X	Box of 10	9.40	Case of 50	44.65	80X	Box of 10	10.80	Case of 50	51.30
60X	Box of 10	9.70	Case of 50	46.00	60X	Box of 10	11.40	Case of 50	54.15
50X	Box of 10	10.15	Case of 50	48.20	50X	Box of 10	11.70	Case of 50	55.50
36X	Box of 10	10.80	Case of 50	51.30	40X	Box of 10	12.20	Case of 50	57.95
					36X	Box of 10	12.70	Case of 50	60.30

SIZE 3" x 21"				SIZE 4" x 24"					
120X	Box of 10	9.90	Case of 50	47.00	120X	Box of 10	16.50	Case of 50	78.35
100X	Box of 10	9.90	Case of 50	47.00	100X	Box of 10	16.50	Case of 50	78.35
80X	Box of 10	10.15	Case of 50	48.20	80X	Box of 10	17.90	Case of 50	85.00
60X	Box of 10	10.65	Case of 50	50.50	60X	Box of 10	18.50	Case of 50	87.85
50X	Box of 10	10.65	Case of 50	50.50	50X	Box of 10	17.10	Case of 50	81.20
40X	Box of 10	11.40	Case of 50	54.15	40X	Box of 10	19.60	Case of 50	93.00
36X	Box of 10	11.70	Case of 50	55.50	36X	Box of 10	20.40	Case of 50	96.90

PORTER CABLE #330 — PALM SANDER LIST 90.00 SALE 52.00  
PORTER CABLE #505 — 1/2 SHEET SANDER LIST 180.00 SALE 100.00

#13599	STIKET®	DISPENSER	LIST 18.50	SALE 14.00
#13608	80 GRIT —	10 YD. ROLL	LIST 13.00	SALE 9.00
#13600	100 GRIT —	10 YD. ROLL	LIST 11.50	SALE 8.40
#13620	120 GRIT —	10 YD. ROLL	LIST 11.50	SALE 8.40
#13618	180 GRIT —	10 YD. ROLL	LIST 11.50	SALE 8.40
#13622	220 GRIT —	10 YD. ROLL	LIST 11.50	SALE 8.40

3M BRAND NON-TOXIC PARTICLE MASK #8500  
BOX OF 50 — 9.50 CASE OF 600 — 85.00

3M BRAND RESPIRATOR — HEAVY DUTY W/2 STRAPS  
BOX OF 15 — 13.00 CASE OF 180 — 130.00

### 1987 TOOL CATALOG AVAILABLE

Call Toll-Free 1-800-328-0457 — In Minnesota Call (612) 224-4859  
SEND CHECK — MONEY ORDER — VISA — MASTERCARD — DISCOVER — ACE

**SEVEN CORNERS ACE HDW. Inc.**  
216 West 7th St. • St. Paul, MN 55102 • Est. 1933



#### North State 10" Cabinet Shop Saw

- 3 or 5HP motor
- Magnetic controls
- Cast iron top
- Motor cover
- Uni-lock fence
- Equal to highest quality machine on the market
- \$1,050.00
- 12" and 14" models

Free Freight

**DELTA "UNISAW"**  
• 1 1/2 HP \$1,275.00  
• 3 to 5HP models  
• \$1,425.00



#### DELTA SHAPER

- Model 43-375
- 3/4" and 1/2" Spindles
- Regularly \$2,195.00

SALE PRICED AT \$1,395.00

14" 1HP Bandsaw \$ 265.00

18" 2HP Bandsaw \$ 595.00

20" Bandsaw \$1495.00

24" Bandsaw \$2465.00

Dust Collectors: 2HP \$315.00 2 bag

3HP \$495.00 4 bag

#### Cabinet Shop Shaper

- 3HP single phase
- 5HP triple phase
- 2 reversible speeds
- 2 spindles, 1", 3/4" 1/2" and 1 1/4" opt.
- Router bit collets available
- Large cast iron table
- 1 year warranty
- Extra heavy duty
- List \$1,600.00
- Sale \$1,095.00
- Free Freight



**Delta 18" Variable Speed Scroll Saw**  
Regularly \$1,117.00  
SALE \$675.00

**Delta Belt/Disc Sander**  
Reg. \$1,479.00  
Sale \$889.00

## LENEAVE-QUALITY

#### Wide Belt Sanders

- variable speed
- Platen head
- Dual motors
- Heavy cast iron & steel plate construction
- 10, 15, & 20 HP
- Best buy in the industry!
- 25" List \$7950.00
- Sale \$5,950.00
- 37" List \$12,000.00
- Sale \$8,695.00
- Free Freight



#### UNIQUE Raised Panel Door Machine

- A Raised Panel Door Machine that machines all five components with only one operator!
- Eliminates Pre-Bandsawing of arches
- Produce a complete door in less than 2 minutes

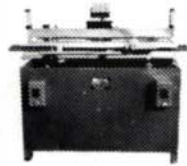

#### 3HP 15" PLANER PRICE BREAKTHROUGH

- Model 310 15" Planer
- Powerful 3HP motor
- Cast iron construction
- Magnetic switch
- 1 year warranty
- Outstanding quality
- Stand included
- Dust hood
- \$725.00

#### 3HP 15" PLANER

- Model 315
- 3HP motor
- Cast iron construction
- Magnetic controls
- 1 year warranty
- Dust hood
- Table extensions
- Anti Kickback
- 2 speeds
- \$795.00



#### 8" Cabinet Shop Jointer

- Heavy cast iron construction
- 2HP Single phase
- 9" x 67" bed
- 3 knife cutterhead
- Dual tilt fence
- Magnetic controls
- List \$1,350.00
- Sale \$750.00
- Free freight
- 6" jointer unit \$325.00
- 12" Jointer \$1695.00
- Delta 8" jointer \$1,150.00



20" Planer \$1,275.00  
24" Planer \$2,375.00  
• 5 HP + 7 1/2 HP



### LENEAVE SUPPLY

305 W. Morehead St.  
Charlotte, NC 28202  
(704) 376-7421



Freiborn and Freud Shaper Cutters available



**PORTER-CABLE**

BOSCH

JORGENSEN

<p>½ H.P. Router</p>  <p><b>\$90.00</b> No. 100</p>	<p>PORTER-CABLE INTRODUCES SAW BOSS™- NEW, COMPACT SAW WITH BIG SAW POWER AND CAPABILITY</p>  <p>Model No. 345 <b>\$95.00</b> <b>SAW BOSS™</b></p>
<p>Variable Speed Bayonet Saw</p>  <p><b>\$99.00</b> No. 7348</p>	<p>PORTER-CABLE INTRODUCES AMERICAN DESIGNED &amp; MADE PLATE JOINER</p>  <p><b>\$165.00</b> Model 555</p>
<p>Laminate Trimmer</p>  <p><b>\$79.00</b> No. 309</p>	<p>3" x 24" Belt Sander</p>  <p><b>\$168.00</b> No. 361</p>
<p>Model 5060 STAIR-EASE™ is for use with standard 2x tread and 1x riser material for most production stair construction jobs</p>  <p><b>\$125.00</b></p>	



**TOOL TOWN**

2800 N.W. 72nd Avenue, Miami, Florida 33122

FLA WATTS 1-800-432-1206  
NATIONAL WATTS 1-800-647-8005



211 E. Oakland Park Blvd.  
Ft. Lauderdale, FL 33334

**MILWAUKEE**

**BIESMEYER**



**ASHMAN TECHNICAL LTD.**  
Machinery • Tools • Shop Equipment  
351 Nash Rd, N., Hamilton, Ont., Can. L8H 7P4  
(416) 560-2400

---

CALL TOLL FREE **1-800-263-4507**

DUTY CHARGES INCLUDED IN ALL PRICES

## SUPER FALL SALE



### GENERAL

3 HP — 10"

Model 350-1 ..... \$1060.  
with Biesemeyer..... \$1200.  
160-2 VS Lathe, 1 HP ..... \$ 925.  
1180-1 6" Jointer, 1HP..... \$ 610.  
480 8" Jointer, 1½ HP ..... \$1220.  
490-1 15" Bandsaw, 1 HP \$ 730.



3 HP-10"- Tilting Arbor Cabinet Saw.....\$1160.  
(formerly Unisaw)

3 HP-10"- Unifence Model .....\$1375.

RT31 10" Scoring Saw.....\$2350.

**—SUPER SPECIAL—**

**20" Delta Planer-RC51-5 HP-\$3775**

U.S. FUNDS — FREIGHT COLLECT — CALL FOR QUOTATION

# Now You Can Solve All Your Feet-Inch Problems Quickly & Simply!

*Now for a limited time  
Only \$79.95—  
You Save \$10.00!*



Now you can save time and cut costly errors by solving all your woodworking problems right in feet, inches and fractions—with the new **Construction Master™** foot-inch calculator.

The perfect tool for cabinet making, design, framing, estimating, stairs, masonry, concrete, square footage, lineal footage, stringers, roof rafters [inc. hips and valleys], squaring-up rooms and much, much more.

Adds, subtracts, multiplies and divides right in feet, inches and any fraction—1/2's, 1/4's, 1/8's, 1/16's, 1/32's, up to 1/64's—or no fraction at all. And you can mix fractions.

Converts between all dimension formats—feet-inch-fraction, decimal (10th's, 100th's), yards, inches and meters—including square and cubic. All with just one button.

Solves diagonals and right triangle instantly and directly in feet and inches. You just enter the two known sides, and press one button to solve for the third. With rafters you can also use "pitch" and 1 side. Solves hips and valleys too!

Figures lumber costs for individual boards, multiple pieces or an entire job with a quick and simple built-in program that keeps track of both total board feet and total dollars.

Also works as a standard math calculator with memory (which also takes dimensions) and battery-saving auto shut-off. Compact (2-3/4 x 5-1/8 x 1/4") and lightweight (4 oz.), includes simple instructions, full 1-Yr. Warranty, 1-Yr. batteries and vinyl case—or an optional custom-fitted, leather case.

To order, simply fill out and return the coupon below, or, call toll-free 24 Hrs. everyday 1-800-854-8075 (in Calif., call 1-800-231-0546) to place your charge-card order by phone.

Save \$10 on the **Construction Master™** with this special offer to readers of *Fine Woodworking*—just \$79.95!

Order yours **Risk Free for 14 days!** If for any reason you're not 100% delighted, return it for a full refund.

Clip & Mail Today!

<b>Calculated Industries, Inc.</b> 2010 N. Tustin Ave., Suite B Orange, CA 92665 • 714-921-1800		Toll Free 24 Hrs. 7 Days <b>1-800-854-8075</b> (CA 1-800-231-0546)		
Please rush me the following order:	Qty	Price (ea.)	Shipping (ea.)	Total
<input type="checkbox"/> Cons. Master	1	\$79.95	\$3.50 each calc.	\$
<input type="checkbox"/> Leather case	1	\$10.00	<input type="checkbox"/> Brown <input type="checkbox"/> Bugundy	\$
<input type="checkbox"/> Gold Initials	1	\$1/init.	Your initials: _____	\$
Qty. Disc. 5-9 \$74.95 • 10+ \$69.95		Calif. residents 6% tax \$		
Plus FREE Shipping		<b>TOTAL \$</b>		
Name _____				
Address _____				
City/St/Zip _____				
<input type="checkbox"/> Check <input type="checkbox"/> VISA <input type="checkbox"/> MasterCard <input type="checkbox"/> Am/Exp				
Account No. _____				Exp Date ____/____/____
Sign Here _____				FW-9/87



# The Taunton Press Books and Videos

from the publishers of *Fine Woodworking*

## Furnituremaking



**Tage Frid Teaches Woodworking Book 3: Furnituremaking**  
Master craftsman Tage Frid offers photographs, step-by-step instructions and complete working drawings for 18 of his most distinctive pieces. There's his well-known workbench, three-legged stool and more. In each case Frid explains how he designed the piece, outlines the steps involved in making it and describes in detail the steps that are most difficult or interesting. Includes a photo gallery.  
**Hardcover, \$18.95 #43**

### Building a Houseful of Furniture

**by Simon Watts**  
Build furniture for any room in your home. Cabinetmaker Simon Watts gives you complete plans for 43 of his favorite pieces: sturdy bed frames, handsome chests, a variety of tables, desks, bureaus, comfortable sofas, chairs and more. Some projects are perfect for beginners, others will challenge even the most experienced woodworker. Throughout the book, Watts covers the difficult spots in construction, and explains his own techniques for overcoming them.  
**Softcover, \$19.95 #22**

### Tage Frid Teaches Woodworking

**Book 1: Joinery**  
Frid shows you step-by-step how to select and make virtually all the joints useful to cabinetmakers, and how to decide which joint is best for a given application.  
**Hardcover, \$18.95 #09**

### Federal Furniture

**by Michael Dunbar**  
Noted period woodworker Michael Dunbar shows you how to make 20 federal pieces from his home, including a card table, candlestand, and Hepplewhite and Windsor chairs. He provides measured drawings and plenty of construction tips. There are also detailed photos, drawings and instructions for reproducing an aspect of the piece that is uniquely federal.  
**Softcover, \$18.95 #41**

### Tage Frid Teaches Woodworking

**Book 2: Shaping, Veneering, Finishing**  
Frid uses hundreds of photos, drawings and step-by-step instructions to teach bending, turning, veneering, carving, inlaying and finishing.  
**Hardcover, \$18.95 #19**

**Frid three-book set: \$44.95 #90**

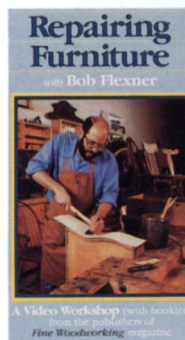

VIDEO

### Repairing Furniture with Bob Flexner

Here's a vast repertoire of straightforward techniques you can use to repair furniture. Expert furniture restorer Bob Flexner explains why wood joints fatigue, how to safely clamp problem pieces like round tabletops, disassemble pieces safely, choose the right glue, mend broken parts, match missing moldings and reglue or replace damaged veneer. By watching Flexner, you'll be able to repair a piece so it won't suffer the same fate again. And Flexner also shows you how to keep the original character of the piece intact. Best of all, you won't need an elaborate shop or extensive experience to perform your repair work. With Flexner's instruction, and the information in the accompanying booklet, those wobbly chairs and battered bureaus are as good as fixed.  
**70 minutes, \$29.95 (Rental: \$14.95) #619 (VHS), #620 (Beta)**

## NEW BOOK

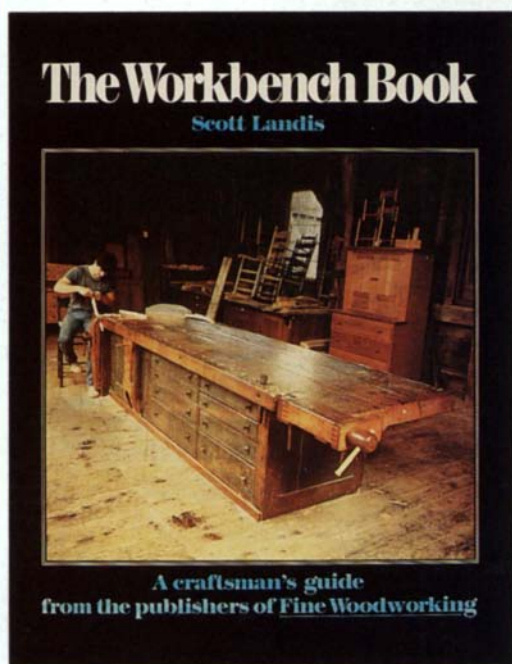

Available October 15

Explore the strengths and weaknesses of the world's great workbenches. Taunton Press editor Scott Landis calls on the insights and discoveries of skilled craftsmen as he examines benches for every kind of woodworking and every kind of shop — from a traditional Shaker bench to a mass-produced Workmate®. Landis shows you how each bench works and leads you through the tough spots in its construction. With 19 pages of measured drawings, more than 100 illustrations, 250 color and black-and-white photographs, two chapters on vises and a list of sources of supply, *The Workbench Book* is sure to become a woodworking classic.  
**Hardcover, color, \$24.95 #61**

### Fine Woodworking on Chairs and Beds

Expert woodworkers show you how to design and make chairs, stools, sofas, cribs and beds in 33 articles collected from the pages of *Fine Woodworking*.  
**Softcover, \$7.95 #45**

### Fine Woodworking on Tables and Desks

In 32 articles from *Fine Woodworking* magazine, skilled craftsmen reveal their methods for making and designing every kind of table and desk.  
**Softcover, \$7.95 #46**

To order from The Taunton Press, use the attached insert or call 1-800-243-7252.

## Small Shop

### Small Shop Tips and Techniques

VIDEO

with Jim Cummins

Jim Cummins lets you in on the tips and tricks he's picked up in his years as associate editor of *Fine Woodworking's* Methods of Work column. He teaches you how to use common tools and machines to achieve uncommon results.

Among the things you'll learn: how to get a home-shop bandsaw to work better, how to expand the role of your drill press, how to make hand tools and machines work together, how to be precise and safe at the tablesaw and how to sharpen dull twist drills. An accompanying booklet includes notes, drawings and supply sources for easy reference.

60 minutes, \$29.95

(Rental: \$14.95)

#625 (VHS), #626 (Beta)

### Fine Woodworking on The Small Workshop

In 41 articles from *Fine Woodworking* magazine, experts share ideas on setting up shop, storing tools, clamping work, controlling dust and more.

Softcover, \$7.95

#33

## NEW BOOK

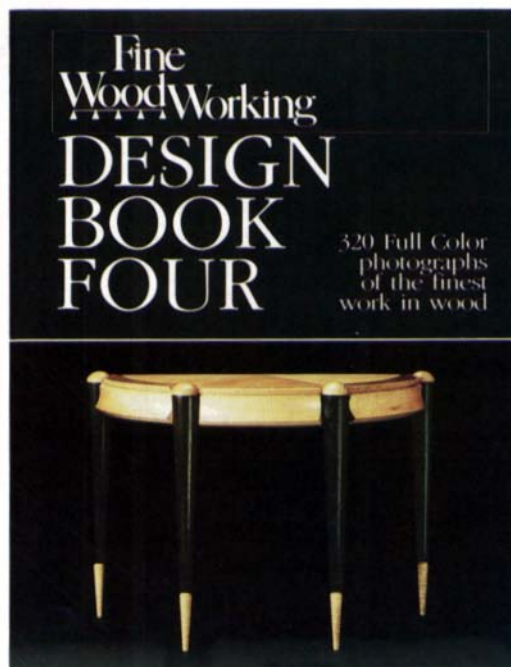

Available September 15

An all-new, full-color look at the best in contemporary woodworking. Selected from some 10,000 photos submitted by *Fine Woodworking* readers, the 320 objects pictured here show just how far the craft has come since we published our first *Biennial Design Book* in 1977.

Woodworking like this takes your breath away, whether it's a beautifully crafted period piece or some playfully painted art furniture. There's a new sense of mastery among woodworkers, and a new fascination with color and materials other than wood. *Design Book Four* captures all the excitement with stunning photographs and essays by seven designer-craftsmen.

Softcover, color, \$16.95

#65

### SALE ON Earlier Design Books

Three volumes of superb woodworking at specially reduced prices. *But only while supplies last.*

#02 Biennial Design Book, Softcover, ~~\$11.95~~ \$10.75

#08 Design Book Two, Hardcover, ~~\$13.95~~ \$12.55

#25 Design Book Three, Softcover, ~~\$13.95~~ \$12.55

#91 Set of three books ~~\$39.95~~ \$31.50

## Machines

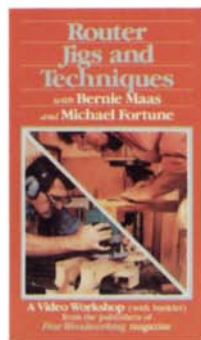

VIDEO

### Fine Woodworking on Making and Modifying Machines

Yes, you can make your own woodworking machines and improve your old favorites. This collection of 29 *Fine Woodworking* articles shows you how. You'll find plans for a tablesaw whose cross-cutting mechanism works better than anything you could buy, a slick long-bed jointer, a way to use a router for thicknessing stock, a boring machine for super-precise joinery, and jointer safety tips.

Softcover, \$7.95

#47

### Fine Woodworking on Woodworking Machines

What machines do you really need in your shop? How can you get the most out of your router? What's the best way to adjust a jointer or a thickness planer? How can you tell whether that old cast-iron bandsaw is worth your rescue efforts? These are just a few of the questions addressed by experienced craftsmen in these 40 articles from *Fine Woodworking*.

Softcover, \$7.95

#37

### Router Jigs and Techniques

with Bernie Maas and Michael Fortune

Experts Bernie Maas and Michael Fortune show you what your router can really do. Maas focuses on basic router joinery, covering spline joints, sliding dovetails and mortise-and-tenons. Fortune shows how the router can work with a series of ingenious jigs to produce the subtle shapes required to create a handsome hand mirror. Plans for the jigs and the hand mirror are in the booklet that accompanies the tape.

60 minutes, \$29.95

(Rental: \$14.95)

#615 (VHS), #616 (Beta)

## Finishing

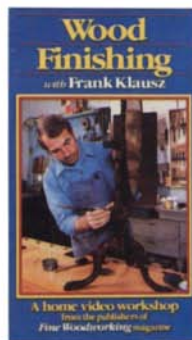

VIDEO

### Adventures in Wood Finishing

A master wood finisher shares the secrets and stories of a lifetime in the trade. During the 1920s and 1930s, George Frank was one of Europe's most sought-after craftsmen, and he tackled an incredible range of finishing jobs for an equally incredible array of customers. To meet these challenges, he developed a vast repertoire of techniques, many of which are recounted here. You'll learn about everything from how old-timers brewed dyes from plant extracts and chemicals, to the culmination of Frank's search for the perfect wax, from a mirror finish that shines to an "antique" finish that fools the experts.

Hardcover, \$10.95

#14

### Wood Finishing with Frank Klausz

Learn finishing directly from a skilled professional—in your own home, at your own pace. Drawing on his 20-plus years as a cabinetmaker, Frank Klausz shows you how to use a smoothing plane, a scraper and sandpaper to prepare an ideal surface for finishing; how to choose between oil, alcohol and water stains; and how to apply tung oil or spar varnish. Also, how to spray lacquer with professional results and French-polish your work to an exquisitely glossy finish.

110 minutes, \$39.95

(Rental: \$14.95)

#603 (VHS), #603 (Beta)

### Fine Woodworking on Finishing and Refinishing

How can you control the shine of varnish or achieve a glossy black finish? Experts explain their formulas and methods in 34 articles from *Fine Woodworking*.

Softcover, \$7.95

#48

To order from The Taunton Press, use the attached insert or call 1-800-243-7252.

## NEW BOOK

### Setting Ceramic Tile

Michael Byrne



Available October 20

At last, a clear, comprehensive book on tiling. Master tilesetter Michael Byrne begins with the basics: the varieties of tile available, setting methods, surface preparation and layout. He then guides you step-by-step through a series of actual home installations—floors, walls and countertops—demonstrating both the popular thinset method and the traditional thick mortar-bed technique. Additional information on repairs, problem installations and sources of supply make this book an invaluable resource for novices and pros alike.

Softcover, color, \$17.95

#53

Companion videos coming in December.

## Wood

### Understanding Wood

A craftsman's guide to wood technology

R. Bruce Hoadley



### Understanding Wood

by R. Bruce Hoadley

A noted wood scientist and woodworker tells you why wood behaves and misbehaves as it does, and how you can work with it, instead of against it. Hoadley shows you how to cut, season, machine, join, bend, fasten and finish wood. Photographs, drawings and charts help explain how a tree's growth influences the wood's figure, and more.

Hardcover, \$21.95

#11

## Magazine Indexes

### Available October 1

#### Fine Woodworking Supplementary Index

(Issues 51-65)

This new, 12-page Index picks up where our larger index leaves off, with listings of articles, letters and photos from issues 51 through 65. There are even entries for the Methods of Work and Questions and Answers sections. Lets you quickly find the issue and page number you're looking for, and the corresponding page in the appropriate *Fine Woodworking on...* and *Techniques* books (up to *Techniques 9*). Prepared by an expert indexer and woodworker, this index features superb cross-referencing and priceless pieces of information that would elude a non-woodworking indexer.

Softcover, \$1.95

#75

### Fine Woodworking Cumulative Index

(Issues 1-50)

Complete listing of articles, photos and columns from the first 50 issues. Covers the first six *Techniques* books and eight *Fine Woodworking on...* books.

Softcover, \$3.95

#71

### Complete Index Set

Both indexes at a special price.

Softcover, \$4.95

#76

*Taunton Press books, videos and magazines make great gifts. And we'll announce any gift you send with a handsome card. Just use our handy order form or call us toll free and use your credit card. Be sure to tell us how you want your gift card signed.*

### Fine Woodworking on: Wood and How to Dry It

Forty-one articles from *Fine Woodworking* tell you how to buy, dry, store and mill lumber. Also how to cope with wood's seasonal swelling and shrinking.

Softcover, \$7.95

#52

## NEW BOOK

### Fine Woodworking TECHNIQUES<sup>9</sup>

Skilled woodworkers write about their techniques, tools, materials and projects in selections from issues 44 through 49 of *Fine Woodworking* magazine



Available October 15

Full-color articles by skilled woodworkers on techniques, tools and materials. *Techniques 9* captures an exciting year's worth of articles from the 1985 issues of *Fine Woodworking* (numbers 50-55). You'll learn about Frank Klausz's classic workbench, how to turn a lidded box, what wood grain really means, how to design with veneer and how to make a Queen Anne handkerchief table. Plus, there are articles on Japanese lacquer, making marionettes and testing chisels.

Hardcover, color, \$19.95

#64

Note: We've reduced the price on *Techniques 8* to match our low price on *Techniques 9*. You'll find the whole series listed on the next page.

To order from The Taunton Press, use the attached insert or call 1-800-243-7252.

## NEW BOOK

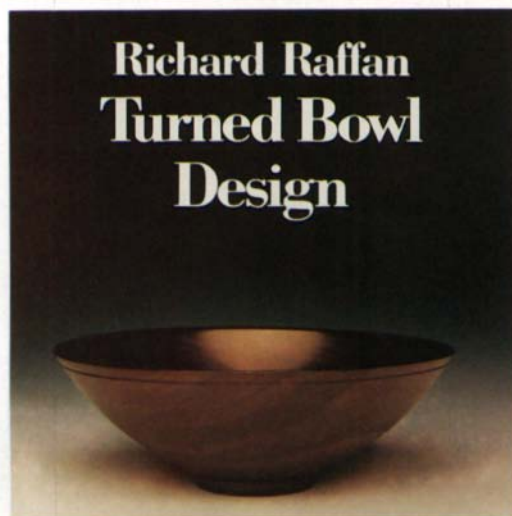

Available December 1

The first in-depth examination of bowl design from a master turner. Richard Raffan takes you beyond the skills he taught in his first book and video, and shows you how to design bowls that remain beautiful after the color and grain have faded. Raffan covers all the steps from timber selection to polished piece. You'll learn how to refine the shape, cut sides, decorate surfaces, analyze curves and more. There are templates and a full-color photo gallery of design ideas.

Softcover, color, \$17.95  
#63

## Also of Interest

### Fine Woodworking Techniques Series

Techniques 8, issues 44-49  
Hardcover, color, \$19.95  
#55

Techniques 7, issues 38-43  
Hardcover, \$17.95  
#42

Techniques 6, issues 32-37  
Hardcover, \$17.95  
#29

Techniques 5, issues 26-31  
Hardcover, \$17.95  
#24

Techniques 4, issues 20-25  
Hardcover, \$17.95  
#17

Techniques 3, issues 14-19  
Hardcover, \$17.95  
#15

Techniques 2, issues 8-13  
Hardcover, \$17.95  
#13

Techniques 1, issues 1-7  
Hardcover, \$17.95  
#03

### Construction

Fine Homebuilding  
Remodeling Ideas  
Softcover, color, \$21.95  
#56

Fine Homebuilding  
Construction Techniques 1  
Hardcover, color \$24.95  
#28

Fine Homebuilding  
Construction Techniques 2  
Hardcover, color, \$24.95  
#44

Building Your Own Kitchen  
Cabinets  
by Jere Cary  
Softcover, \$12.95  
#23

### Carving

How to Carve Wood  
by Richard Bütz  
Softcover, \$13.95  
#30

\*Carving Techniques  
and Projects  
with Sam Bush and  
Mack Headley, Jr.  
90 minutes, \$29.95  
#617 (VHS), #618 (Beta)

\*Carve a Ball-and-Claw Foot  
with Phil Lowe  
115 minutes, \$39.95  
#605 (VHS), #606 (Beta)

Fine Woodworking on  
Carving  
Softcover, \$7.95  
#50

\* VIDEO  
Also available for rent at \$14.95

## Turning

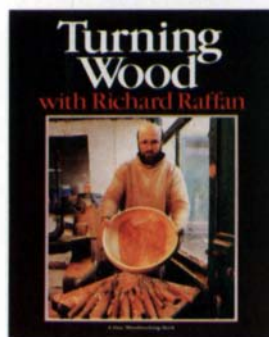

**Turning Wood**  
with Richard Raffan  
Master turner Richard Raffan gives an extensive introduction to turning. The heart of the book is his chapters on centerwork and facework turning, but you'll also learn about setting up your work area, lathe, tools, stock, abrasives and finishes. Raffan gives exercises and projects to help you develop the skills you learn. You'll be able to angle a tool to get the cut and surface you want, position your body to affect the outcome of the finished piece and more. Photos and drawings highlight every detail and a 16-page gallery of Raffan's work shows you how far you can take your skills.  
Softcover, \$17.95  
#39

### Fine Woodworking on Spindle Turning

Explore the variety of things that can be turned between centers. Thirty-nine articles from *Fine Woodworking* cover the turner's gouge, the skew chisel, more.  
Softcover, \$7.95  
#57

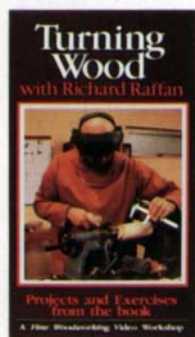

**Turning Wood**  
with Richard Raffan  
Produced and directed to capture the book's dynamic details, this tape lets you experience the sights and sounds of woodturning from a variety of useful perspectives: up close, over Raffan's shoulder and from a distance. Raffan demonstrates his tool-sharpening techniques and a series of gouge and skew exercises. He then takes you through six complete projects: a tool handle, light-pull knob, scoop, box, bowl and breadboard. Page references on the screen refer you to the book.  
117 minutes, \$39.95  
(Rental: \$14.95)  
#611 (VHS), #612 (Beta)  
The Raffan Set  
(book and video), \$49.95,  
#99

*We ship books and videos via UPS, so you can expect them a week to ten days after we receive your order.*

VIDEO

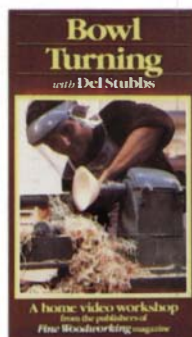

**Bowl Turning**  
with Del Stubbs  
Noted turner Del Stubbs shows you the basics of bowl turning and then some. You'll learn the different ways to lay out and mount a bowl blank, use different gouges and flat tools to shape the outside and excavate the inside of a bowl, evaluate and sharpen your cutting tools and more. You'll even learn how to handle special challenges like turning thin-wall, bark-edge and end-grain bowls. And with the video format, you get up close to see the careful contact of edge on wood, and step back to study the effect of various tool positions, grips and stances.  
120 minutes, \$39.95  
(Rental: \$14.95)  
#607 (VHS), #608 (Beta)

### Fine Woodworking on Faceplate Turning

A rare look at how some of today's best turners create everything from drinking goblets to giant bowls—all from 42 *Fine Woodworking* articles  
Softcover, \$7.95  
#58

VIDEO

To order from The Taunton Press, use the attached insert or call 1-800-243-7252.

# CLASSIFIED

The CLASSIFIED rate is \$ 5.00 per word, minimum ad 15 words. All payments must accompany orders; all are non-commissionable. The WOOD & TOOL EXCHANGE and SITUATIONS WANTED are for private use by individuals only; the rate is \$7 per line. Min. 3 lines, max. 6 lines, limit 2 insertions per yr. DISPLAY CLASSIFIED rates on request. Send to: Fine Woodworking, Advertising Dept., Box 355, Newtown, CT 06470. Deadline for the November/December issues is August 25.

## Busn. Opportunities

**FOR SALE.** Complete comprehensive millwork and woodworking facility. Sale includes: all machinery in place and operating; existing lease; quality A-1 national and local clients. Just north of Boston. A truly turn-key operation \$168,000. The Wood Shop, 315 Main St., Wilmington, MA 01887.

**WOODWORKING SHOP, FULLY EQUIPPED,** office, storage, unfinished apartment Sandusky, OH. 6,400 sq. ft. \$150,000. (419) 625-0663. (419) 627-1999.

**WOODWORKER'S DREAM:** W.V. mountain solar house, 1,500 sq. ft. workshop, solar kiln, greenhouses, lumber nearby. \$95,000. (304) 847-5814.

**ESTABLISHED WOODWORKING SHOP AND BUSINESS** for sale in Greenwich Village, New York City. Excellent reputation for 18 years. Fully-equipped shop. Priced to sell. Call Edwin after September 1. (212) 924-1913.

**SALE: WOODWORKING FACILITY.** 16,000 square feet Philadelphia woodworking facility including one-ton hoist, air system, dust collection, fully-equipped spray room, sprinkler system and security system. \$100,000. (215) 236 3050.

**MILLWORKING BUSINESS WITH VALUABLE REAL ESTATE** located within approximately 60 miles of D.C. Over 2,000 sq. ft. of space. 3 phase electric equipment. \$100,000. Country Heritage Properties. (304) 535-6363.

**WOODWORKING SHOP FOR SALE.** Complete liquidation. 7,000 sq. ft. building with central dust collection, located on primary highway in Western N.C. \$135,000. Equipment also available. Write for more information. Hamilton, 306 W. 100th St., New York, NY 10025.

**DEALER INQUIRIES INVITED**



We are a direct importer stocking all quality hand tools needed for a woodworking tool store or specialty department. Resale only - no enduser sales.

Robe t Larson Company, Inc.  
82 Dorman Avenue  
San Francisco, CA 94124 (415) 821-1021

## Help Wanted

**VIOLIN REPAIR APPRENTICESHIPS** available with finest rare violin shop in the country. Good salary and benefits, excellent training program. Professional woodworking experience required. Must be willing and able to learn. Bein & Fushi Inc., 410 S. Michigan Ave., Chicago, IL 60605.

**INTERIOR SHUTTER INSTALLERS NEEDED!** Custom manufacturer of interior shutters for commercial and residential use needs a network of installers to call on as needed. Particularly popular in resort areas, but new products will increase interest in big cities. Send letters of interest and resumes to President, PO Box 4285, Tampa, FL 33677.

**EXPERIENCED PROTOTYPE MAKER WITH BACKGROUND IN JIG AND FIXTURE DESIGN.** Responsibilities include machine operation and prototype making. Intrex Furniture, 1000 First St., Harrison, NJ 07029. (201) 483-3383.

**EXPERIENCED CABINETMAKER,** custom furniture, salary negotiable, located Mt. Kisco, New York. Designs for Leisure, Ltd., 41 Kensico Dr., Mt. Kisco, NY 10549. (914) 241-4500.

**SKILLED WOODWORKERS** for growing contemporary fine furniture and cabinetry shop. Progressive organization. Jobs are project-oriented, limited production and one-of-a-kind. Wall/Goldfinger, Inc. (Union Woodworks), 7 Belknap Ave., Northfield, VT 05663. (802) 485-6261. EOE.

**FOURTH PERSON IN WELL-EQUIPPED CUSTOM CABINET/WOODWORKING SHOP** catering to the upscale market. Many years' experience and/or degree. The Good Wood Workshop, 1499 S.W. 30 Ave., Boynton Beach, FL 33426. (305) 734-6770.

**HIGHLY-SKILLED ARCHITECTURAL WOODWORKER** wanted for custom millwork firm 30 miles from Boston. Must have firm background in layout and fabrication of doors, sash, stairs, cabinetry, and all other aspects of architectural millwork. Prefer person with 8-10 years experience. Send resume and salary requirements to: Carpenter Associates, Inc., 40 Timber Swamp Road, Hampton, NH 03842.

**SKILLED CABINETMAKER** needed in small NYC shop where excellence and independence are encouraged. (212) 431-9175.

**CABINETMAKERS.** Professional woodworkers for high-end work. Entry level positions also available for trainee. Handmade Furniture Company, Rt. #9, West Creek, NJ 08008. (609) 597-2708.

## Situations Wanted

Furniture conservation, apprenticeship desired, possibly combined with period furniture making. Responsible, intelligent man, 29, with extensive luthier background, willing to relocate anywhere for "museum quality" training. Resume, D. Haney, 222 Ave Del Gado, Oceanside, CA 92056.

Looking for person to share fully-equipped woodworking shop in Weston, MA. Rt. 128 area. Call (617) 893-3887 or 655-6885. Bob Thomason.

## Instruction

**FINE FINISHING & REPAIR** - one week intensive in-shop training. Will give you all the necessary knowledge to start your own business. 3rd generation master finisher. The Hymiller School of Fine Wood Finishing. Visa/MC. (615) 484-9309.

**LEARN TO TURN.** Two-day concentrated course in all aspects of lathe. Workshop located in converted 18th-century spring house. Individualized instruction. Reading and Lancaster nearby. Send for free brochure. James L. Cox Woodworking School, R.D. 2, Box 126, Honey Brook, PA 19344. (215) 273-3840.

**APPRENTICESHIP IN PROFESSIONAL FINE FURNITURE MAKING** with the prominent Jeffrey Greene Design Studio - realistic preparation for an uncompromisingly vital career as an independent artisan designing, making, marketing the very finest furniture in solid walnut/rosewoods. Tuition. New Hope, PA. (215) 862-5530. Call don't write. Monday thru Friday, 9:30-4:00.

**CHICAGO SCHOOL OF VIOLIN MAKING.** Full-time, comprehensive program under direction of master violin maker. Traditional methods of violin construction and repair taught; applications now being accepted for 1988. Write C.S.V.M., 3446 North Albany, Chicago, IL 60618. (312) 478-0505.

**PRESERVATION CARPENTRY** - one year, for experienced woodworkers. Reconstruction of pre-20th century buildings. **CABINET & FURNITURE MAKING** - two years, custom furniture construction. Traditional styles; hand joinery and embellishment. **PIANO TECHNOLOGY** - two years. Tuning, action repairs, and rebuilding. **VIOLIN MAKING & RESTORATION** - three years. Construction and repair of violins, violas, and cellos. Financial aid. Accredited member NATTS. North Bennet Street School, 39 N. Bennet St., Box A, Boston, MA 02113. (617) 227-0155.

**WOODTURNING WORKSHOP.** Intensive two and three-day courses available. Functional and artistic turning. Gallery B, The Marketplace, 11121 N. Rodney Parham Rd., Little Rock, AR 72212. (501) 221-0266.

**Housing Award**

"The Appalachian Center for Crafts is offering 'FREE' housing to students taking 12 hours of Certificate or BFA courses during 1987/88. Study with Trent Whittington at this incredible facility in Tennessee. Courses start mid-Sept. Call: (615) 597-6801 or write Appalachian Center for Crafts, Box 347-A1, Route 3, Smithville, TN 37166."

**RUSS ZIMMERMAN**  
**TURNERS' WORKSHOPS**  
Turn Better With Personal Instruction.

Our 11th year providing:  
SORBY TOOLS & MYFORD LATHES. Also Zimmermann Turning Lathes. Precision Combination Chuck, Double Faced Tape, etc. Please send for FREE BROCHURE.

  
MYFORD  
M.L.A. - 3" & 4"

REF. A, BOX 242, PUTNEY, VT 05546

Now Available In North America!  
**'TEACH YOURSELF TURNING'**  
by Roger Holley  
A Video Woodturning Course - 90 min.  
ONLY \$34.95 (US) ppd VHS or BETA  
MC, Visa, Cheques

**How to do it VIDEO**  
Box 403-FW, Port Credit, Ontario, Canada  
Ltd (416) 278-4300  
Signature required for credit card orders

**WOOD '87**  
June 1 to Dec. 4  
1-2-3 Week Sessions

Brad Smith  
Douglas Sigler  
Douglas B. Prickett  
C.R. "Skip" Johnson  
Lauren McDermott  
Michael Hurwitz  
Michael Pierschalla  
Mitch Ryerson  
Dan Rodriguez  
Randy Shull

PENLAND SCHOOL  
Dept. WS, Penland, NC 28765  
704/765-2359

## Accessories

**SANDPAPER, BELTS, DISCS** - BELOW WHOLESALE. Free catalog with SASE. Redhill, PO Box 500, Biglerville, PA 17307. (215) 295-5406.

**WOOD CRAFTSMEN.** Do more jobs with more precision with Varipro electronic power tool motor speed controllers. Free information. Progressive Controls, Box 768U, Dearborn, MI 48127.

**DUST COLLECTION SYSTEM FILTER BAGS,** fabric (\$10/yd. PPD), free system plans. Barter Enterprises, Box 102B, Prospect Harbor, ME 04669.

**BANDSAW BLADES** - buy from the source - details send stamped envelope. Finnermaster, Box 49191-6, Atlanta, GA 30359.

**DRAFTING INSTRUMENTS, PAPER.** Everything needed to draw professional plans complete in a 15-piece, first-quality outfit (less board). Introductory price, ppd, \$65.00. Californians add 6% tax. List, catalog, \$2. Moneyback guarantee! Earthstar, Box 692, Inverness, CA 94937.

**WHITECHAPEL BRASSES**  
LTD.  
FINE IMPORTED  
ENGLISH HARDWARE  
LARGE SELECTION  
LOW PRICES  
FREE CATALOG  
LOCKS-HANDLES-DRAWN-HINGES (107) \*39-947\*

3850 WEST HWY 22, BOX 106, WILSON, WYO 83014 USA

**CUSTOM BRANDING IRONS**

DRILL PRESS or HANDHELD  
250 to 800 watts  
SEND \$1.00 FOR BROCHURE  
ENGRAVING ARTS (707) 964-8203  
P.O. Box 787  
Lafayette, CA 94554

**STEADY GRIP. FENCE STOP**  
For Your Radial Arm Saw

QUICK RELIABLE  
ACCURATE

\$28.25 ppd  
check or m.o.

Ken Picou  
Design In Wood  
5508 Montview  
Austin, TX 78756

Full Refund  
If Not  
Delighted

## Finishes

**POLYESTER WOOD FINISH.** A complete line of professional products for producing the ultimate piano/high-tech finish. Clears; custom colors. Donald M. Steinert, 800 Messenger Rd., Grants Pass, OR 97527. (503) 846-6835.

**GEORGE FRANK FRENCH POLISH KIT,** natural dye/mordant, aniline dye and earth pigment kits. All your finishing needs. Product booklet/pricelist, \$1, refundable. Olde Mill, R.D. 3, York, PA 17402. (717) 755-8884.

**SPRAY-ON SUEDE LINING.** Finish any project with a soft touch. Free brochure (sample enclosed). Donjer Products, Ilene Court-Bldg. 8F, Belle Mead, NJ 08502. (201) 359-7726

**Swedish Wood**  
Dyes. Beautiful, brilliant  
colors. Inexpensive, non-toxic.  
\$5 for 2 samples. Professionally  
used. T.H.&A., P.O. Box 6004,  
Dept. FW, Rockford, IL 61125

## Miscellaneous

**BRANDING IRONS.** Names, signatures, logos, any size, design. Norcraft Custom Brands, Box 277F, So. Easton, MA 02375. Telephone (617) 238-2163 anytime.

**BRAZE YOUR BAND SAW BLADES USING PROPANE.** Free brochure. Rego, 49 Downing St., Fall River, MA 02723.

**EPOXY:** Five minute glue works even at 30°F. \$30 quart ppd. \$5 sample. Fairfield Resins, Box 1223, Fairfield, IA 52556. (515) 472-8646.

**THE FINE GOLD LEAF PEOPLE™**  
Genuine, Imitation and Variegated  
Sheets & Rolls  
Brushes, Supplies & Technical Books  
IN USA: Three Cross Street  
Suffern, NY 10901-4601  
1-800-772-1212  
(NY-AK 914-368-1100)  
IN CANADA: 454 Lawrence West  
Toronto, Ontario, M5M 1C4  
416-787-7331  
"WORK WITH THE BEST IN THE BUSINESS"

## Musical Supplies

**LUTHIERS' SUPPLIES:** Imported tonewood, tools, varnishes, books, plans, parts, accessories, strings, cases, for violins, violas, cellos, basses and guitars. Assemble-yourself violin and guitar kits. Catalog, \$1.50, includes 10% discount certificate. International Violin Company, Ltd., Dept. WN, 4026 W. Belvedere Ave., Baltimore, MD 21215.

**GUITAR SUPPLIES, KITS AND REPAIR TOOLS.** Hot Stuff™ super glues, finishing supplies. Free 80-page catalog. Stewart-MacDonald, Box 900F, Athens, OH 45701. (614) 592-3021.

**HAMMERED DULCIMER PLANS!** By noted builder Charlie Alm. Best book on subject. \$19.95. Woodworks, Box 218-F, Brookston, IN 47923. (317) 563-3504. Visa/MC or check.

**VIOLIN, GUITAR, banjo, mandolin-making materials, accessories, books.** Catalog \$1. International Luthiers Supply, Box 580397, Tulsa, OK 74158.

## Plans & Kits

**FURNITURE PLANS:** Futon convertible beds, sofa beds, platform beds. Complete details. \$2 brochure. Lachmia Designs. Box 27173, Market Square, Philadelphia, PA 19118.

**WATERBEDS AND BEDROOM FURNITURE CATALOG** of plans, \$2.75. Over 50 beautiful selections! Kraemer Furniture Designs, PO Box 33, 1350 Main St., Plain, WI 53577.

**FULL-SIZE PROFESSIONAL PLANS** - Catalog, \$2. Over 200 professionally-designed plans for building furniture. Traditional, early American. Furniture Designs, Inc., CK-97, 1827 Elmdale Ave., Glenview, IL 60025.

*Create This Elegant Wooden Clock*

in your own workshop with a bandsaw and our full-size 9-sheet plan set and handy 30-page construction book. Moneyback guarantee.

**CLIP AND MAIL TODAY!**

*Saratoga Woodcrafts*

P.O. BOX 3361, DEPT. F1, SARATOGA CA 95070  
Please rush...

Plans and book for only \$16.50 (CA residents add 6% tax) and \$2.40 for postage.

Additional information \$1.00 (refundable).

NAME \_\_\_\_\_  
ADDRESS \_\_\_\_\_  
CITY \_\_\_\_\_ STATE \_\_\_\_\_ ZIP \_\_\_\_\_

## Toy Plans/Kits

**MAKE WOODEN TOYS,** whirligigs, classic autos, swing sets, doll houses, crafts, furniture with our plans, parts, kits, supplies. Color catalog subscription \$1. (614) 484-4363. Cherry Tree Toys, Belmont, OH 43718-0369.

## Publications

**FREE! Decoy & Wood Carvers Wishbook**

Chisels, Gouges, Burs  
Woodturning tools

P.C. English Enterprises, Inc.  
P.O. Box 380 Dept. F107  
Thornburg, VA 22565  
(703) 582-2200

**LEARN FURNITURE REFINISHING**

RESTORERS OF FINE ANTIQUE FURNITURE SHARE THEIR SECRETS IN **ACROSS THE GRAIN** QUARTERLY. SUBSCRIBE NOW! \$15/year.

Florentine Antiques  
320 DON PARK ROAD, UNIT 9  
MARKHAM, ONTARIO, CANADA L3R 1J4

**Machinist**

A bi-monthly magazine with plans/instructions for metal-working projects you can build. \$18.50 per year (Check/M.O.). With charge card - call toll-free.

**THE HOME SHOP Machinist**

1-800-447-7367 or write  
The Home Shop Machinist, Box 1810-D5  
Traverse City, MI 49685

MONEY-BACK GUARANTEE

**LIVE STEAM**

A monthly magazine with plans/instructions for steam-powered machining projects, including locomotives you can ride!

\$26 (USA) per year check or money order  
Charge card call toll-free

1-800-447-7367 or write  
Live Steam, P.O. Box 629-D5  
Traverse City, MI 49685

MONEY-BACK GUARANTEE

## Services

**CURVED CHINA CABINET GLASS MADE TO ORDER,** any size or shape. Send template, dimensions for price to Brant Klippert, P.O. Box 550, East Aurora, NY 14052. (716) 652-1968.

**CUSTOM WOODTURNING.** Reproductions. Limited production runs. Andrew Kencis, 33 Pine Tree Rd., Old Bridge, NJ 08857.

**Consultant for Wood Products**

**Problem Analyses**

**J. Thomas Quirk, Ph.D.**  
Wood Identification a Specialty  
P.O. Box 5086, Madison, WI 53705  
(608) 238-2225

## Tools

**SPECIALS ON EMCO MACHINERY.** You don't have to spend a fortune to have dependable European equipment (mail order only). Hymiller's Woodworkers Shop, Fairfield Glade, TN. (615) 484-9309. Visa/MC.

**ROUTER BITS** - over 600 different shapes and sizes available. Big savings on sale and close-out items. For complete NEW 1987 catalog send \$3 (dealer refundable) to: BYROM International, Dept. FW9, Box 246, Chardon, OH 44024. Dealer inquiries invited.

**RESTORED MACHINERY** - Finest wood-working machines ever made. Oliver, Yates, Northfield. Bandsaws, table saws, wood lathes, etc. Puget Sound Machinery. (206) 857-5088.

**NEW ENGLAND AREA** - Call us about your industrial machinery needs. New, used, rebuilt. Woodshop Machines, 78 Regional Dr., Concord, NH 03301. (603) 228-2066.

**UNBEATABLE PRICES** on Milwaukee, Paslode tools! Visa, MC, Cash. No COD's. 1-800-327-7366 (Calif). 1-800-334-2494 (USA).

**JAPANESE TOOLS SINCE 1888.** Free catalog (sorry delayed). Tashiro's, 1435 S. Jackson, Seattle, WA 98144. (206) 322-2671.

**VISIT WOODCARVERS SUPPLY** - School-established 1955. Chisels, gouges, drawknives, planes, bits, patternmakers - unusual sizes - machinery - books. 3056 Excelsior Blvd., Minneapolis, MN 55416. (612) 927-7491.

**TOOLS - ANTIQUE & USED** - STANLEY. Quality selection, numerous items. Satisfaction guaranteed. Current illustrated list - \$1.25. Subscription - \$5/yr., 5 lists. Bob Kaune, 511 W. 11th, Port Angeles, WA 98362. (206) 452-2292.

**USED MACHINERY:** Oliver, Davis & Wells, Rockwell, Powermatic, Yates, SCM, more. Write for list or call (303) 449-6240. Boulder Machinery, 4640 N. Broadway, Boulder, CO 80302.

**DUST COLLECTION** - Improve the efficiency of your system. Install Windon's Blast Gate Dust Collection Control System. Low voltage gates switch 110 or 220 volt collector. For all your dust collection needs write to Windon, Inc., PO Box 1359, Hillsboro, NH 03244.

**THE BEALL TOOL CO.**

NOW WITH LEFT & RIGHT HAND THREADS

The penultimate wood threading device. Attaches to your router & makes perfect 1/2", 3/4", and 1" threads. For information: Dept. FW, 541 Swans Rd. N.E., Newark, OH, 43055. (614) 345-5045; (800) 331-4718

## Heirloom Quality Tools

Low Angle Jack Plane \$175  
other new items: Brochure \$1

**Lic-Nielsen TOOLWORKS**

West Rockport, Maine 04865

## Sand Door Edges With One Pass

E-Z EDGE SANDER™

Designed by a cabinetmaker for cabinetmakers. Excellent for solid wood or fibrecore doors. Easy to use, precise and sturdy. Call or write for free brochure:  
E-Z Edge Sander, P.O. Box 26157, Shoreview, MN 55126. 1-612-780-8935.

**BUY DIRECT!**

3" lock-notch shaper collars. 3/4"-1-1/4" arbors \$54.95.  
Pattern knives for shapers and Belsaw, Sears, RBL, and Woodmaster type planers. 12" planer blades \$19.95.  
Also shaper & molder tool steel bars. Other patterns available.

**WDR SALES**

9604 Belmont, Kansas City, MO 64134  
1-800-346-3026 Ext. 958

## Save that bench stone!

Restore your dished, worn and glazed stones. Get faster cuts, finer edges, straightest, truest tool blades. Save money, too! EverFlat bench stone lapper. For details, write:

**EverFlat**  
612 Kessler Dr., Neenah, WI 54956

**EDGE JOINING**

NO DOWELING  
NO PLANING  
NO BOWING

STURDY MAPLE STRAIGHT EDGES  
FREE GLUE SHIELDS  
1/2" JACK SCREWS BOTH ENDS

NO OTHER TOOLS NECESSARY!!!

ADD 13¢ EACH FOR SHIPPING

10% DISCOUNT ON TOTAL W/3 OR MORE (ANY SIZE)  
VISA/MSTR CD. ACCEPTED (EXP. DATE REQ'D.) FREE INFO

**IMMEDIATE DELIVERY**

MARK PROD. Box 46143 Dept. FW9  
Bedford, OH 44146 Call: 216-232-1281

**NEW PARKS PLANERS, NORTHFIELD MACHINERY, PROGRESS SANDERS, MINIMAX, LEESON MOTORS, BIESEMEYER FENCES, EXCELLENT PRICES.** Used specials: Northfield 27-in. bandsaw, \$3,000. Newton E30 oscillating edgessander, \$3,000. Rogers stroke, \$2,000. Plaza Machine. (802) 234-9673.

**WE CUSTOM MANUFACTURE CARBIDE SAW BLADES, DADOS AND GROOVERS.** We sharpen carbide router bits and saw blades. Dealer for Systi-matic, DML, Byrom, OCEMCO, Lenox bandsaw blades. Utah Saworks Inc., 427 N. 300 West, Salt Lake City, UT 84103. (801) 364-7146.

**LAMELLO MACHINES,** Lamello Junior/ \$299. Accessories, plates, parts. Hank Koelme, 64-30 Ellwell Crescent, Rego Park, NY 11374. Free brochure. (718) 897-3937. 8am-4pm.

**CARPENTERS MACHINERY COMPANY** THE LARGEST DISTRIBUTOR OF NEW AND USED WOODWORKING EQUIPMENT IN THE COUNTRY announces its relocation sale offering all Bosch router bits, Forrest City tool and Greenlee drill bits, Rockwell shaper cutters, and luxite carbide blades, in stock only, as much as half off. Write to: Carpenters Machinery, PO Box 5086, York, PA 17403 or call (717) 843-2101, ask for Tod Hatterer.

**Precision Combination Chuck**

Designed for woodturners by a woodturner.

The most versatile, the most practical combination chuck ever made. Send \$2 for colour catalogue.  
Craft Supplies, The Mill, Millers Dale Buxton, Derbyshire SK17 8SN, England.

## Wood

**HARDWOOD PLYWOODS.** Ash, Baltic birch, red, white or natural birch, cherry, mahogany, maple, knotty pine, red oak, white oak, walnut, teak. All items 1/4 in. and 3/4 in. thickness. Sheets sizes 4x8, 2x8, 4x4, 2x4 or precision cut (1/16 in. tolerance) to any size, paying for what you order. Edging for all species in hardwood veneer strips or hardwood molding 3/8 in. by 3/4 in. Sheets of hardwood veneer with polyester backing. Wholesale quantity discounts. Call (617) 666-1340 for quotations. Shipping in USA via UPS or a common carrier. Boulter Plywood Corp., 24 Broadway, Somerville, MA 02145.

**EXOTIC AND DOMESTIC HARDWOODS,** veneers, marine plywood, Baltic birch, basswood to 4 in. thick. 90 woods in stock. Northwest Lumber Co., 5035 Lafayette Rd., Indianapolis, IN 46254. Phone (317) 293-1100.

**GENUINE WALNUT FLOORING AND MOLDINGS.** Flooring is tongue and groove, 3/4-in., in various widths. This is the same beautiful walnut used in furniture with interlating character markings. Write Tom McMillan, Frank Purcell Walnut Lumber Co. Inc., Box 5115, Kansas City, KS 66119. (913) 371-3135.

**QUARTERSAWN WHITE OAK AND FIGURED LUMBER**

Curly, Bird's-eye, Quilted, Crotch  
Personalized Service - (215) 755-0400  
RD3, Box 3268, Mohnton, PA 19540-9339

**TALARICO HARDWOODS**

**BIRD'S-EYE MAPLE SPECIALISTS**, heavy figure, large inventory. Chris Pond, 409 Fairway Dr., Lancaster, PA 17603. (717) 393-9687.

**CHESTNUT** - Flooring and molding and wide bubbly maple. Woods of Heavenly Valley, Plymouth, CT 06782. (203) 283-4209.

**EAST MOUNTAIN HARDWOODS**, Rte. 7, Box 31H, Sheffield, MA 01257. Select oak, cherry, maple, ash, butternut, walnut, mahogany, tulip, pine, plank flooring, butcher block, hardwood plywood, custom milling. Toll free: MASS., 1-800-551-5028; Northeast 1-800-521-2019.

**HONDURAS ROSEWOOD** (dalbergia Stevensonii). Logs, precision bandsawn lumber, squares, mill ends. Borderline Trading Co., PO Box 428, Dufur, OR 97021. (503) 467-2533.

**REDWOOD LACE BURL**, OTHER WESTERN SPECIES Squares, slabs, whole. Western lumber, figured lumber, rare woods, sample kits. SASE list. Eureka Hardwood Supply, 3346 D St., Eureka, CA 95501. (701) 445-3371.

**GUARANTEED CLEAR COCOBOLO**. No risk to you! Squares, kants, lumber. Bocote, ebony, koa, lignum, cirocote. Minimum order \$75. Tropical Timber Corporation. (503) 654-5349.

**MAPLE BURL**, lace redwood, and myrtle. Veneer quality. Also madrone and lilac burl, turning stock. Chunks or slab. Bruce Bernson, 2791 Painted Cave, Santa Barbara, CA 93105. (805) 964-5012.

**ATTENTION: FLORIDA WOODWORKERS**

We have Florida's largest selection of exotic and native hard and soft woods, table slabs, veneers, etc. for the professional and novice. Send SASE for list.

**HENEGAN'S WOOD SHED**  
7780 Southern Blvd (F.W.) West Palm Beach, FL 33411  
Call (305) 783-1557



**GILMER WOOD CO.**  
503-274-1271

**Rare & Exotic Woods**

- in logs, planks & squares
- over 50 species in stock
- also cutlery, turning & musical instrument woods

2211 NW St. Helens Rd., Portland, OR 97210



**UNICORN UNIVERSAL WOODS Ltd**

OVER 90 SPECIES IN OUR LARGE INVENTORY OF QUALITY MATERIAL

EXOTICS—DOMESTICS—MILLWORK

VENEER—MAIL ORDER—FREE CATALOG

4190 Steeles Ave. West, Woodbridge Ontario, Canada L4L 3S8  
CALL US AT (416) 851-2308

**ARROYO HARDWOODS**  
Retail-Wholesale-Importers  
Full line of Domestic and Foreign Woods, Lumber, Logs, Turning and Carving Stock, Plywoods, Mouldings and Supplies. Pink Ivory, Rosewoods, Ebonies, Cocobolo, Lignum, Tulipwood, Blackwood, Quilted and Figured Maples, Lilac and other Buris, Snakewood, other species.  
SASE for list.  
2585 Nina Street, Pasadena, CA 91107  
P.O. Box 70781, Tel. (818) 304-0021

**California Woodworkers-Restorers**  
*Your source for: exotic veneers, hardwoods, inlays, tools, hardware, moldings, craft books, finishes, cane, etc. Exclusive supplier of Constantines of New York, quality products.*

**Constantines Wood Products, Inc.**  
5318 W. 144th St., Lawndale, CA. 90260  
(L.A. area) 213-643-9484

**WESTERN PENNSYLVANIA WOODWORKERS**  
50 Domestic & Imported Woods  
Veneers • Finishes • Mouldings • Hardware  
Carving Stock • Inlays & Bandings  
Plans • Books • Magazines • Quality Tools  
Call or Visit Our Store

**WOODCRAFTERS' SUPPLY**  
7703 Perry Hwy. (Rt. 19)  
Pittsburgh, Pa. 15237 (412) 367-4330

**EBONY, ROSEWOOD, AFRICAN BLACKWOOD & CURLY MAPLE**

FOR MUSICAL INSTRUMENTS.  
POOL CUES, KNIFE HANDLES AND INLAYING

For Price List  
**EXOTIC WOODS CO.** Cali. toll free  
Box 532, Dept. FW 1-800-GIDWANI  
Sicklerville, NJ 08081 In N.J. 728-5555



**EXOTIC & DOMESTIC LUMBER • PLYWOOD • VENEERS**

AFRORMOSIA • BUBINGA • IROKO  
PADALUK • PURPLEHEART • TEAK  
ZEBRAWOOD • ETC.

**Wood-Ply Lumber Corp.**  
100 Bennington Ave.  
Freeport, N.Y. 11520  
(516) 378-2612



**Fine kiln-dried hardwoods for the discriminating craftsman.**

- dried to 8% moisture
- all widths & thicknesses

Available Hardwoods

- ASH • BASSWOOD
- BEECH • BIRCH
- BUTTERNUT • CHERRY
- MADRONE • MAPLE (hard or light, (medium or heavy curl) • OAK
- RED OAK • WHITE OAK
- PADALUK • WHITE PINE
- YELLOW POPLAR
- ROSEWOOD • TEAK
- WALNUT

**HARTWOOD** is a division of Hanover Adams Rehabilitation and Training Center.  
P.O. Box 323 • EAST GOLDEN LANE  
NEW OXFORD, PA 17325  
(717) 624-4323 OR (717) 334-9301



FOR SALE, LIMITED AMOUNTS, WIDE WALNUT LUMBER. Gerry Grant, Gettysburg, PA. Call (717) 528-4496 after 6pm.

**VENEER**

- ★ HIGHEST QUALITY ★ FULL LENGTH
- ★ LARGE SELECTION
- ★ LOWEST PRICES

"Let us show you why we're North America's fastest growing veneer supplier."

RETAIL OR WHOLESALE

*certainly wood*

Write for free brochure or call  
11753 Big Tree Road, East Aurora, N.Y. 14052  
(716) 655-0206



**Wood Parts**

SAWMILL DIRECT, cocobolo, Mexican kingwood, bocote, lignum, primavera, granadillo, and more. Defect-free lumber, bowl and turning stock, logs, retail/wholesale, 8 x 8 x 8 box of exotic endcuts \$20 plus shipping. Tropical Exotic Hardwoods of Latin America, PO Box 1806, Carlsbad, CA 92008. (619) 434-3030.

**WOOD PARTS**  
TOY, FURNITURE, CRAFT & GAME  
Wheels • Spindles  
• Balls • Knobs  
• Shaker pegs • And more!

Since 1927! Send \$1.00 for Catalog.

**BROWN WOOD PRODUCTS CO.**  
P.O. Box 8246FW, Northfield, IL 60093 • (312) 446-5200



**DOWELS - PLUGS - PEGS**

Largest & finest selection  
Oak, Walnut, Hickory, Maple, Cherry, Mahogany, Teak, even Treated Dowels.  
Quantity discounts

**MIDWEST DOWEL WORKS, INC.**  
4631 Hutchinson Road  
Cincinnati, Ohio 45248  
(513) 574-8488  
Catalog on request \$1.00

**WOOD & TOOL EXCHANGE**  
Limited to use by individuals only

**For Sale**

Kuster Ultrasander, 7½HP, 36-in. dual drums with less than 5 hrs. use, \$2,650.  
Caesar Verdelli, 32 E. 2nd St., Hummelstown, PA 17036. (717) 566-2234.

Exotic woods from Pacific island cut into bookmatched sets. Burl eucalyptus, mango, koa, lace oak, monkeypod, tropical almond. For information call: (808) 575-2105. PO Box 15-43, Makawao, HI 96768.

Bandsw 36-in., excellent condition, 5HP, 1PH. New enclosed motor, 16-in. resaw, 38-in. by 30-in. table. \$2,500. Russ, Rt. 2, Box 280, Sparta, TN 38583. (615) 738-9006

Kiln-dried walnut, 1,000 board feet, 4/4, No. 1 comm., \$1.35 board foot Butter-nut, 4/4 wide boards, \$1.50 board foot. (615) 621-3382.

Newton double, spindle boring machine No. B-100, ¾HP good \$400. Boice Crane spindle sander 1HP single PH good \$250. Stanley No. 45, \$135. Pattern-maker's vise, Emmert Manufacturing, 7x18-in. jaws opens 15-in. like new, universal action, \$150. Lown (201) 828-0227.

Sicar slot mortise machine (similar to Italian Griggio) 2HP, 1PH American motor, \$2,000. 12-in Unित्रonex joiner 5HP, 3PH \$2,500. 13-in. x 5-in. Bridgewood planer, \$1,200. (603) 934-3241.

*Fine Woodworking* issues 1-65, excellent condition, \$200 plus shipping. R. Deshaies, 106 Severns Bridge Rd., Merrimack, NH 03054.

*Fine Woodworking* complete file '75-'87 excellent condition first \$200, F.O.B. (813) 637-1576.

Amateur's shop, lots of tools one quarter to one-half retail. For list, (813) 637-1576.

Complete set of *Fine Woodworking*, issues 1-65, available for sale. Call Charles Hill, (517) 739-5859.

Castbrass collector's edition lathe duplicator fits most 5-in-1 tools and includes a free auxiliary table, \$200. Standard aluminum model \$100, free with purchase of 500 board feet of walnut or oak lumber. C.B. Trump, (304) 294-8723.

Emmert Patternmakers vise. Good condition. Best offer. Call Bob or Bill, Waynesboro, PA. (717) 762-5056.

Exotic hardwoods. 400 feet of cocobolo 5/4. 400 feet of lingae 5/4. \$5 a foot or best offer. (617) 297-2085.

Kiln dried lumber, 4/4, FAS. Red oak \$1.65 per board foot, black walnut \$2.35 per board foot. (313) 382-8106.

New Paralok table saw fence, 72-in. rails, never uncrated. Will fit Powermatic Model 66 or 28 in. wide table. Best offer. (505) 461-2221.

Sale: 24-in. diameter x 48-in. length, 2HP variable-speed wood lathe, many extras. \$2,200. T. Klapheke, Ft. Wayne, IN. (219) 484-9840.

**Imported European Hardware**

4320 W. Bell Drive  
Las Vegas, Nevada 89118  
(702) 871-0722  
SEND \$1.00 FOR CATALOG





**Two Year Subscription For 22 Cents**

Write us today to start your two year subscription to our full color tool & hardware catalog. We feature well-known brands such as Delta, Freud, Ryobi, Porter-Cable, Bosch, Freeborn and HTC to name a few. We also have many unique and hard-to-find woodworking tools. You'll like our low prices, fast, friendly service and wide selection.

**Woodworker's Supply**  
OF NEW MEXICO

5604-C Alameda Place N.E. • Albuquerque, NM 87113  
505-821-0500

**POWERMATIC SALE**

#66	Saw, 3 hp., 1 ph	\$1,499.00
	for #50 Beisemeyer	add 125.00
NEW ★	for 5 hp., 1 ph	add 99.00
#26	Shaper, 3 hp., 1 ph.	1,475.00
#100	12" Planer, 3 hp.	1,725.00
#60	8" Jointer	1,475.00
#141	14" Bandsaw	1,137.00
#1150A	V.S. Press	999.00
★	24" 15 hp. Planer	only \$9,999.00

Orders only Call:  
1-800-362-7227 dial tone then 740

**WORKBENCH TOOL CO.**  
2833 Perry St., Madison, WI 53713  
MasterCard and Visa Welcome



# BRIDGEWOOD®

## DEPENDABLE HEAVYWEIGHTS!

### WIDE BELT SANDERS... SAVE TIME AND INCREASE PRODUCTION!

AVAILABLE IN SINGLE, DOUBLE AND TRIPLE HEAD MODELS WITH FIXED OR VARIABLE SPEED RATES.

These professionally designed, well-built machines have all the features you want in production sanders: Powerful drive motors. Tension rollers and exclusive air tracking systems. Pneumatic braking systems that stop the sander's belts instantly to avoid belt damage. Serrated rubber drive rollers. Factory adjusted platen, infeed and outfeed pressure bars to assure equal sanding. Adaptable for light or heavy abrasive sanding.

Choose the BRIDGEWOOD® sander for your shop:

BWS-25 . . . . . 25" Fixed speed . . . . .	\$5995.00
BWS-37 . . . . . 37" Fixed speed . . . . .	\$8995.00
BWS-25VS . . . . . 25" Variable speed . . . . .	\$6350.00
BWS-37VS . . . . . 37" Variable speed . . . . .	\$9995.00
BWS-25-2 . . . . . 25" Two head, Variable speed . . . . .	\$12,750.00
BWS-37-2 . . . . . 37" Two head, Variable speed . . . . .	\$16,300.00



**\$200.00 INSTANT CASH REBATE!**  
**ORDER NOW AND DEDUCT \$200.00**  
**FROM THE ALREADY LOW PRICES SHOWN**  
 OFFER EXPIRES DEC. 31, 1987.



### FOUR SIDE MOULDER

BRIDGEWOOD® MODEL BWM462

**COMPACT CABINET SHOP MODEL IDEAL FOR SHORT RUNS AND PRODUCTION.**

**\$8900.00**

LESS CUTTER HEADS\*

\* ACCEPTS CORRUGATED-BACK KNIFE CUTTER HEADS. WE HAVE A VARIETY IN STOCK FOR IMMEDIATE SHIPMENT.



NEW, 52-PAGE CATALOG. Send \$1.00 for your copy. See our wide selection of professional quality BRIDGEWOOD® machinery for discriminating woodworkers and metalworkers.

**FULL ONE YEAR WARRANTY** TO ORDER: TELEPHONE: 717 846-2800 ADDRESS: 120 DERRY COURT, YORK, PA. 17402

ALL MACHINES RUN IN UNDER FULL POWER AND TESTED BEFORE SHIPPING. PRICES SUBJECT TO CHANGE WITHOUT NOTICE. TYPOGRAPHICAL ERRORS SUBJECT TO CORRECTION. ALL PRICES F.O.B., YORK, PA.





## SHAKER FURNITURE

An exciting collection of Shaker dining chairs, tables, beds and other furniture available in Kits or completely finished. All exemplify the simplicity and versatile beauty of Shaker design. Pegs, peg-board, Shaker baskets, oval boxes, and dolls.

Large selection of replacement chair tapes.

New 48 page color catalog and 12 tape samples \$1.00

## SHAKER WORKSHOPS

Box 1028-FW97, Concord, MA 01742



## BAND SAW BLADES

### Buy direct from the manufacturer and save.

- Available in widths ranging from 1/4" wide to 2" wide.
- \$.05 per inch 1/8" through 3/4" plus \$1.75 weld charge.
- Prices for other sizes available on request.
- Specializing in 2" wide x .035" thick x 3/4" T.X. blade for portable band mills.

### Also available:

- Rubber tires for your bandsaw wheels: 10" diameter to 42" diameter. Price list on request.
- \$10.00 minimum order. Add \$2.50 per order for packaging and shipping. Master Card and Visa accepted. Call or write today to order.



**Pennsylvania Saw Co. Inc.**  
P.O. Box 567  
Lancaster, PA 17603

717-764-5989  
or Toll Free:  
1-800-233-9381

## over 20 different Hardwoods!

Direct Mill Savings  
Domestic and exotic.  
Plus pressure-sensitive veneers, carving knives and tools, clamps, buttons and pins and glues.

Send for FREE New Catalog

**American Woodcrafters**  
1025 South Roosevelt  
Piqua, OH 45356  
Phone 513-773-7414 Ext. 263



## WOOD REPAIR

Durham's Rock Hard Water Putty makes lasting repairs in wood. Won't shrink or fall out. Sets quickly, holds tight and can easily be painted. Economical, easy to use. Available at lumber, paint and hardware stores.

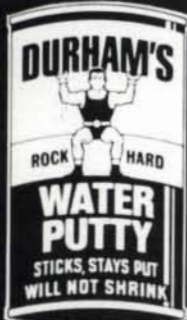

**DONALD DURHAM COMPANY**  
Box 804-FW • Des Moines, IA 50304

# ACC

## INTRODUCING BESSEY ANGLE CLAMPS

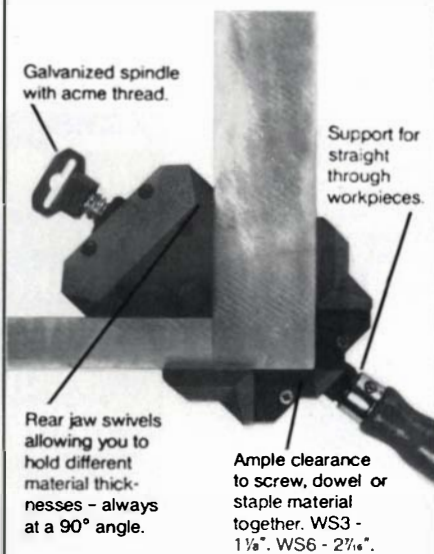

Two sizes available:  
2 table clamps cast in special zinc alloy with steel bolt — included in WS3 display box. Available separately for WS6.

### Other world renowned BESSEY CLAMPS

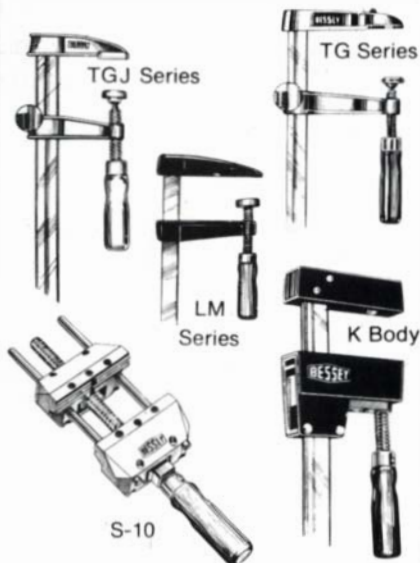

Call us TOLL FREE for the name of your closest distributor:

**American Clamping Corporation**  
50 Franklin St., P.O. Box 399, Batavia, N.Y. 14020

TOLL FREE 1-800-828-1004  
N.Y. STATE 1-800-462-1068  
FAX 716-344-0025

## The most useful furniture joinery tool ever invented!

The amazing Leigh Dovetail jig with infinitely variable spacing is the only jig you will ever need for through and half-blind dovetails.



New attachment now lets you cut Multiple Mortise and Tenons up to 1 1/2 inches deep. No other jig is so versatile! See us soon at a show in your area.

FREE BROCHURE—CALL NOW  
TOLL FREE—1-800-663-8932  
In Canada 604-992-2440 collect  
LEIGH INDUSTRIES LTD.

**LEIGH** P.O. Box 4646-A  
Quesnel, B.C.  
Canada V2J 3J8

## WOODWORKER'S CATALOG



There are over 3,000 money-saving reasons why woodworkers rely on Constantine.

Unique products. Hard-to-find products. **3,000 woodwork items!** Everything important to people who like to **Build-Restore-Repair-Refinish**—and like to save money doing it. Cabinet or furniture wood? Choose from over 200 sizes and kinds. Beat up surface to cover? Choose from 150 richly-grained veneers. Plus 500 plans... cabinet hardware... 96 How-To Books... 118 carving tools and chisels... 76 inlay designs... and lots more for **One-Stop, Right-Price Shopping** without leaving home!

116 Page Catalog—Only \$1.00

**CONSTANTINE** Est. 1812  
2065S Eastchester Road, Bronx, NY 10461

K. Rogers, Texas Forest Products Lab., Box 310, Lufkin, 75901-0310. (409) 639-8180.

**VERMONT: Juried show/sale**—2nd annual Vermont State Crafts Fair, Aug. 21-23. Killington Ski and Summer Resort. Admission: \$4 adults, \$3.50 senior citizens, children under 12 free. Contact Vermont State Craft Center, Mill St., Middlebury, 05753. (802) 388-3177.  
**Juried show/sale**—5th annual crafts fair, Oct. 9-11. Kennedy Bros. Marketplace. Contact Kennedy Bros., 11 Main St., Vergennes, 05491. (802) 877-2975.

**VIRGINIA: Juried show**—7th annual Virginia crafts festival, Sept. 18-20. Prince William County Fairgrounds. For information, send three stamps (66¢) to Deann Verdier, Sugarloaf Mtn. Works, Inc., 20251 Century Blvd., Germantown, MD 20874. (301) 540-0900.  
**Juried show**—12th annual craft show, Nov. 20-22. Richmond Convention Ctr. Contact Hand Workshop, 1812 W. Main St., Richmond, 23220. (804) 353-0094.  
**Juried show**—13th annual woodcarving show, Nov. 28-29. Marymount University, Arlington. Contact

Northern Virginia Carvers, Box 524, Oakton, 22124. (703) 790-1034.

**WASHINGTON: Seminars**—Lofting, Eric Hvalsoe, Sept. 21-25; novice boatbuilding with Simon Watts, Nov. 14-21. Contact The Center for Wooden Boats, 1010 Valley St., Seattle, 98109. (206) 382-2628.  
**Show**—Judith Ames, Hank Hoelzer, Michael Peterson, Sept. 3-27. Northwest Gallery of Fine Wood Working, 202 First Ave. So., Seattle, 98104. (206) 625-0542.  
**Juried show**—Contemporary furniture made in the Northwest, Oct. 1-Nov. 8. Northwest Gallery of Fine Wood Working, 202 First Ave. So., Seattle, 98104. (206) 625-0542.

**WEST VIRGINIA: Exhibition/sale**—Oglebay woodcarvers show, Aug. 29-30. Wheeling Park. Contact Elwood Burris, Peters Run, Wheeling, 26003.

**CANADA: Workshop**—Build a sailing pram with Simon Watts, Aug. 22-29. Sherbrooke Village, Nova Scotia. Fee: \$270. Contact Richard Tyner, 11 Brenton St., Dart-

mouth, Nova Scotia, B2Y 1W2. (902) 466-3306.  
**Workshops**—1987-88 workshop series. Mixed media, business topics. Contact Anne Fox, New Brunswick Craft School, Ecole d'Artisanat du N-B, Box C/P6000, Fredericton, New Brunswick, E3B 5H1. (506) 453-2305.  
**Juried show**—"Explorations in Wood," Nov. 5-Dec. 6. Slide deadline: Sept. 30. Contact Maltwood Art Museum and Gallery, University of Victoria, Box 1700, Victoria, British Columbia, V8W 2Y2. (604) 595-8508.  
**Juried show**—The Southern Alberta Woodworkers Society annual show, Sept. 10-Oct. 3. Muttart Gallery, 1211 2 St. S.W., Calgary, Alberta. (403) 266-2764.  
**Juried show/seminars**—2nd annual Woodstock Wood Show, Oct. 2-4. Woodstock Fairgrounds. Seminars, exhibits. Contact Woodstock Wood Show, Box 1272, Woodstock, Ontario, N4S 8R2. (519) 539-7772.

**ENGLAND: Exhibition/sale**—Annual Chelsea Crafts Fair, Oct. 7-21. Chelsea Old Town Hall, King's Road, London, SW3. A major sales event for contemporary crafts. For information, send a large SASE to the Crafts Council, 12 Waterloo Place, London SW1Y 4AU, England.

**A CLASSIC WORKBENCH**  
 • Kiln-dried Danish Red Beech • Tongue and grooved top • Steel spline vises & dogs • Linseed oil finish • Assembles in minutes • Finger joint construction • Free delivery Continental U.S. •  
 5' Bench—\$450. Other sizes available 7' Bench—\$790



LAGUNA TOOLS VISA/MC (714) 494-7006 (800)345-5952  
 2081 LAGUNA CANYON ROAD, LAGUNA BEACH, CA 92651

**LAGUNA TOOLS**



**NATIONAL WORKING WITH WOOD SHOW**

For the amateur and professional craftsmen.

**INDIANAPOLIS, IN**  
 October 23-25, 1987  
 Indiana State Fairgrounds

**ANAHEIM, CA**  
 November 21-22, 1987  
 Anaheim Convention Center

Machinery • Power & Hand Tools  
 Supplies • Demonstrations  
 Specials Workshops • Free Seminars

ADMISSION \$5.00 (\$1 Off w/ This Ad)  
 For more information call:  
 SHOW OFFICE - (408) 296-0161

**TOOLS ON SALE™**  
 AMERICA'S LOWEST PRICED TOOLS  
 ★PLUS★ ●●FREE●● Freight On Every Item

**BOSCH LAMINATE TRIMMERS**  
 "QUALITY YOU CAN HOLD ON TO"™  
 ALL NEW DESIGNS — INTERCHANGEABLE BASES —  
 NEW MORE POWERFUL MOTORS

Model	Description	List	Sale
1608	5.6 AMP — 3.5# UL Listed	129	75
1608L	Same As Above W/Trim Guide	135	79
1608T	5.6 AMP — Tilt Base UL Listed	149	89
1609	5.6 AMP — Offset Base UL Listed	189	115
1609K	Laminate Installer's Kit Supplied With 1609 Offset Base Laminate Trimmer, Tilt Base, Router Base, Laminate Trimming Guide, 1/4" Collet, Collet Nut, 2 Wrenches, 2 MM Hex Key, 4 MM Hex Key, Steel Case	269.00	159.00

**BOSCH SHOP ROUTERS**

Model	Description	List	Sale
1601	1 H.P. — 790 Watt Motor — 25,500 R.P.M.	149	84
1602	1 1/2 H.P. — 1000 Watt Motor — 25,000 R.P.M.	185	105
1603	1 1/2 H.P. D-Hdle Style 1000 Watt	209	115
1604	1 3/4 H.P. 10 AMP 25,000 R.P.M.	209	115
1606	1 3/4 H.P. D-Hdle Style 1120 Watt	233	128
93940	Overarm Router W/O Motor	1000	795
93950	Overarm Router W/#90300M 3 1/4 H.P. Router Motor	1140	895

COMPLETE STOCK BOSCH ROUTER BITS ANY QUANTITY — 30% OISC. TILL 10-31-87

**1987 TOOL CATALOG AVAILABLE**  
 Call Toll-Free 1-800-328-0457 — In Minnesota Call (612) 224-4869  
 SEND CHECK — MONEY ORDER — VISA — MASTERCARD — DISCOVER — ACE

**SEVEN CORNERS ACE HDW. Inc.**  
 216 West 7th St. • St. Paul, MN 55102 • Est. 1933

**MAKE BEAUTIFUL RAISED PANEL DOORS . . . WITH YOUR ROUTER!**

Professional production quality bit makes it quick and easy to produce matching rails and stiles — the panel raising bit with ball bearing guide makes the raised panel perfect every time.

Regular value over \$180.00  
**SALE PRICE \$79.95** FOR COMPLETE SET  
 ORDER ITEM #154 (Includes all bits shown)

**SAVE 55%**

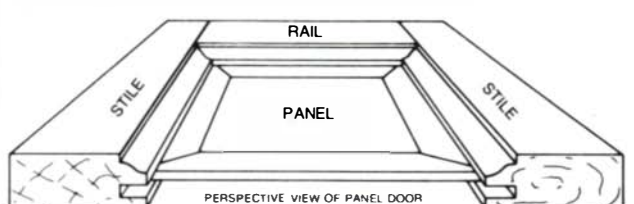

PERSPECTIVE VIEW OF PANEL DOOR (WITH ONE RAIL REMOVED)

**RAISED PANEL BIT**  
 SUPPLIED WITH BALL BEARING  
 1/2" SHANK  
 3-1/4" Large Diameter

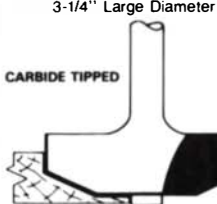

CARBIDE TIPPED

**REVERSIBLE COMBINATION RAIL and STILE BIT**  
 (For making matching rails and stiles in raised panel doors, etc.)  
 Works with stock from 1 1/16" to 7/8" thick

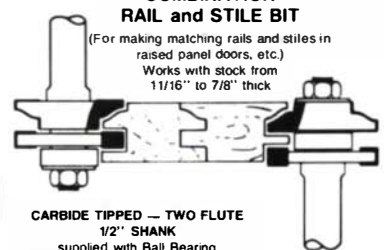

CARBIDE TIPPED — TWO FLUTE  
 1/2" SHANK  
 supplied with Ball Bearing

To order by Master Charge or Visa Toll Free  
 7 Day — 24 Hour Order Service, Call  
 1-800-533-9298, (in PA 1-800-346-7511, Ext. 56)  
 or send check to MLCS, LTD., P.O. Box 53F, Rydal, PA 19046

# Buy 1 tool and get our 212 page tool free.

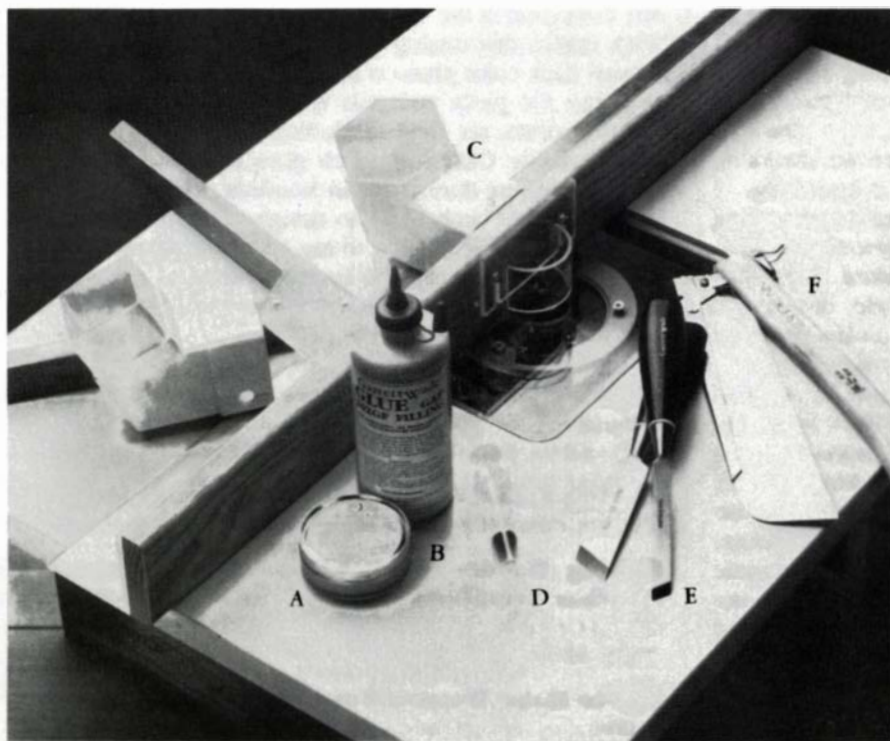

Seven unique woodworking tools of the 3,500 others available from our most versatile tool, the 1988 Garrett Wade Catalog.

The 212 page Catalog, regularly \$4.00, is FREE with any order from this ad. (If you phone in your order, use the Special Code 520.) Or, if you would just like the Catalog, send us \$4.00 with your name and address.

## A / Woodworking Machine Special Wax

Ideal for tables and fences of woodworking machines. Quickly cleans wood resins off the metal surface, leaving a thin coat of non-silicone wax. Helps prevent rust, and most important, your wood will slide smoother, giving you better, more accurate results.

4510.1	4 oz. Waxlit	\$ 7.95
4510.2	24 oz. Waxlit	\$28.00

## B / Our 202GF Gap Filling Glue Has Remarkable Properties

It has a high solids content so that small gaps on your joinery are actually filled - with strength. And the "squeeze-out," where it is not pressed into the wood, beads right up and chips off when dry. No soaking in to ruin finishes. Dries to light tan. Water clean-up.

62J01.01	1 pt. 202 GF	\$ 6.25
62J01.03	1 qt. 202 GF	\$10.95

## C / Turn Your Router Into A Small Scale Shaper

A robust, well designed system that fits any Router, with the size, flexibility and control features found on full-sized Shapers. Tough laminated top is 1 1/16" x 24" x 32". The Standard Set comes with Top; a clear, removable Insert; solid Hardwood Legs; and a fused Switch. Deluxe Set adds a 3" x 3" x 33" Aluminum/Hardwood Fence and Starting Block (both with Bir Guards). For function and quality, a system that is in a class by itself.

		List Price	Special Offer
8200	Standard Set	\$206.95	\$166.90
8210	Deluxe Set	\$325.80	\$265.80

## D / Handy Glue Syringes

Set of three, works with most glues.

62J04.08	3 Glue Syringes	\$3.95
----------	-----------------	--------

## E / Special Cabinetmaker's Skew Ground Chisels Provide A Slicing Finishing Cut

Available in Right and Left Hand pairs. Nothing surpasses these when cleaning up the corners of difficult joints or trimming next to adjacent surfaces.

37S01.01	Pair 1/2" Skew	\$17.65
37S01.02	Pair 3/4" Skew	\$18.65
37S01.03	Pair 1" Skew	\$19.95

**F / Folding Dozuki Protects The Saw Blade**  
Ideal for any toolbox. The deep blade is flexible for flush cuts and the 18 tpi pattern fine enough for trimming out. 9" Blade folds neatly to fully protect the blade.

49116.05	Folding Dozuki	\$22.60
----------	----------------	---------

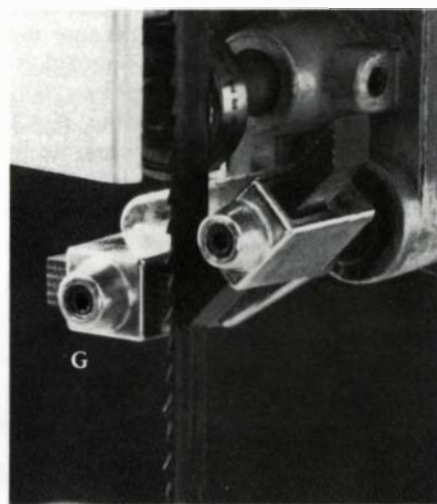

## G / Special Bandsaw "Cool Blocks" Prolong Blade Life And Increase Accuracy

Made of special, composite phenolic resins impregnated with graphite. Set closer to your blades than with conventional soft steel guides. They run much cooler and are more "slippery." Set of 4 Blocks: (A) fits the Delta 14" and Taiwanese copies; (B) Sears 12"; (C) Inca 10 1/2"; and (D) Shopsmith.

33K09.01	4 Cool Blocks (A)	\$9.95
33K09.02	4 Cool Blocks (B)	\$9.95
33K09.03	4 Cool Blocks (C)	\$9.95
33K09.04	4 Cool Blocks (D)	\$9.95

## H / Combination Pocket Knife And Precision Rule

Very slim Knife with 2 Stainless Steel Blades, plus a folding 6" Precision Rule graduated in 64ths. Together in a polished Stainless Steel Case. Overall size 3" x 7/8" closed.

02N01.01	Knife/Rule	\$27.25
----------	------------	---------

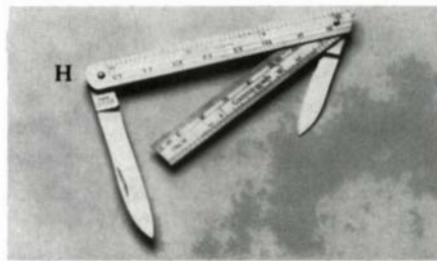

## Garrett Wade Co., Inc.

161 Avenue of the Americas  
New York, NY 10013 Dept. 520  
Call Toll Free 800-221-2942  
(NY, AK & HI 212-807-1757 No Collect Calls Please)



Please send me these Garrett Wade tools and include a FREE 1988 Catalog with my order. (Prices good until December 31, 1987)

Name: \_\_\_\_\_

Address: \_\_\_\_\_

City: \_\_\_\_\_ State: \_\_\_\_\_ Zip: \_\_\_\_\_

Check or Money Order  Card Number

Visa  MasterCard

American Express

Expiration Date: \_\_\_\_\_

STOCK #	QTY.	DESCRIPTION	PRICE		TOTAL
GW	1	1988 Catalog (free with order)	\$4	00	

Sub Total

Shipping: Orders up to \$100 - \$2.50  
Orders over \$100 - \$6.95

Sales Tax

New York Residents add applicable Sales Tax

Shipping

Grand Total

**The Encyclopedia of Furniture Making** by Ernest Joyce, revised by Alan Peters. *Sterling Publishing Co. Inc., Two Park Ave., New York, N.Y. 10016; 1987. \$29.95 (\$42.95 in Canada), hardcover; 520 pp.*

When I was struggling to teach myself woodworking in the early 1970s, the only resource available was the local library. Back then, there was nothing like the saturation of writing on the subject that exists today. With its collection of a dozen woodworking books, our small library was a treasure trove of knowledge. I found two books that formed the foundation of my woodworking learning: Ernest Joyce's *The Encyclopedia of Furniture Making* and John L. Feirer's *Cabinetmaking and Millwork*. These two texts, to my mind, are still landmarks in the field, despite the large number of authors who've written since in greater depth on the same subjects Joyce and Feirer covered only sketchily.

Feirer has periodically revised his book to report on progress in tools and materials, but, until recently, Joyce's book has plugged along in its original version. Frankly, it was looking tired in comparison to the other books on the market. Aware of this, Sterling two years ago hired Alan Peters, an accomplished British designer/craftsman and author of his own book, to revise Joyce.

In his introduction to the revision, Peters admits to some misgivings over tampering with Joyce, and rightfully so—the original is pretty sound stuff. Its real strength is that it's aimed not so much at readers needing step-by-step technical instruction as at those who want to augment basic skills with a reliable reference source to answer tricky questions about building furniture. Joyce was—and remains—a good place to look when you're puzzling out the finer points of carcass or drawer construction, or exploring joinery options for a leg-and-apron table. You'll have to look elsewhere for detailed hand- or power-tool how-to's.

Building upon the sound foundation of Joyce's original text, Peters' chief task was to bring a text published in 1970 into the 1980s. With some help from the editors at Sterling, he managed this by doing three things: reorganizing the chapters in a more sensible order; keying the drawings and photos more closely to the text; and adding new information on the economic and aesthetic concerns of contemporary craftsmen. In the process, Peters has wrung out some of the quasi-industrial tone that bogged down the original and replaced some of the photos of obsolete equipment with those of newer models. Two color sections—one covering wood characteristics, another showing some nice craft-made furniture—have also been added. The text, however, is still tough going in spots, but most of the technical processes are illustrated by good, clear line drawings. And, in deference to American readers, British woodworking terms have been modified, so a clamp is now a cramp/clamp; rebates are now rabbets.

I'm sure hundreds of woodworking books have been published since *The Encyclopedia of Furniture Making* first appeared, but I've yet to encounter one that's as valuable a general reference text for the serious furniture maker. Original Joyce was good, the revision is better. I'll recommend it to my local library, and add a copy to my bookshelf. —Paul Bertorelli

**Late 19th and Early 20th Century Decorative Arts** by Frederick R. Brandt. *Virginia Museum of Fine Arts, Richmond, Va.; distributed by the University of Washington Press, Box 50096, Seattle, Wash. 98145-5096. \$50, hardbound; \$24.95, paperback; 288 pp.*

Students of furniture history often have to look long and hard for good books on the subject, but if their period of interest falls after the mid-19th century, the search can be even more frustrating. Museum catalogs offer some promise but, often, these are wordy, academic tomes more concerned with historical footnoting than useful design discussion. I found *Late 19th and Early*

*20th Century Decorative Arts* to be a delightful exception.

This book covers all of the decorative arts, but 46 of the 100 color plates depict furniture pieces from the Lewis Decorative Arts Collection of the Virginia Museum of Fine Arts in Richmond. What makes this catalog different from others I've seen is its brevity: Each color photo is accompanied by a concise essay that describes the piece and puts its maker into historical context. Some favorites are here, including the Italian designer Carlo Bugatti, Emile Gallé—a French glass craftsman who turned to making furniture during the Art Nouveau period—and Harvey Ellis, an American architect who designed for Gustav Stickley. Yet much of the book was new to me, including furniture by French makers Hector Guimard and Louis Majorelle, as well as a number of others. This is not a master reference work but a good, readable windshield survey of the period. —Paul Bertorelli

**Making Old-Time Folk Toys** by Sharon Pierce. *Sterling Publishing Co. Inc., Two Park Ave., New York, N.Y. 10016; 1986. \$8.95, paperback; 128 pp.*

**Making Folk Toys & Weather Vanes** by Sharon Pierce. *Sterling Publishing Co. Inc.; 1984. \$8.95, paperback; 109pp.*

**Making Wooden Toys: 12 Easy-to-Do Projects with Full-Size Templates** by James T. Stasio. *Dover Publications, Inc., 31 E. 2nd St., Mineola, N.Y. 11501; 1986. \$2.95, paperback; 48 pp.*

**Fun-to-Make Wooden Toys** by Terry Forde. *Sterling Publishing Co., Inc.; 1986. \$9.95, paperback; 136 pp.*

**Making Action Toys in Wood** by Anthony and Judy Peduzzi. *Sterling Publishing Co., Inc.; 1985. \$8.95, paperback; 120 pp.*

Whenever I consider a toy-making project, four factors enter into my decision on which toy to make. First, how will a child enjoy playing with the toy? Next, what about salability—is the toy complex enough to appeal to the *adult* who will buy it? Third, does the project challenge and showcase my toy-making abilities? And, not least, does the toy conform to the fact that—like most woodworkers—I'm a lot better at woodworking than at painting.

Sharon Pierce juggles these factors divinely and comes up with toys well worth the effort for everyone—child, adult and maker. Her two books, *Making Old-Time Folk Toys* and *Making Folk Toys & Weather Vanes*, are possibly the best books for beginning toymakers I've seen. The toys are simple enough to stimulate a child's imagination and attractive enough to sell at craft fairs. Pierce provides detailed instructions on construction, and also on painting—right down to the proportions of paint to mix to obtain the correct colors. Yet while she assumes that the reader knows nothing about toy-making, the construction of the toys themselves is difficult enough to provide a good deal of pleasure. If you're looking for good advice on making toys, invest in *Making Old-Time Folk Toys*, but save money on *Making Folk Toys and Weather Vanes*—borrow it from the library.

In *Making Wooden Toys: 12 Easy-To-Do Projects*, James Stasio goes a little too far down the road to simplicity for most *FWW* readers. These toys are geared for the inexperienced hobbyist, with extremely simple construction and very few details. These are the kinds of toys kids love to play with, but their overriding simplicity (combined with other factors, such as the fact that the proportions are a little off) means most adults won't buy them.

If James Stasio goes too far down the road to simplicity, Terry Forde in *Fun-to-Make Wooden Toys* and Anthony and Judy Peduzzi in *Making Action Toys in Wood* go too far in the other direction. Don't get me wrong: both of these books are full of detailed directions, and the toys depicted would delight the heart and challenge the skills of most woodworkers. Rather, the

# PIN ROUTER

Speed and Precision at a Small Shop Price.

With the Award Winning Onsrud Inverted Router, templates are so simple it is economical to reproduce one part or hundreds.

Call or write for our free literature today.



MODEL 2003

(704) 528-4528

P. O. Box 416, Highway 21 South; Troutman, N.C. 28166

Pink Ivory  
Dagame  
Brazilian Rosewood  
Pear  
Plum  
Burls  
Snakewood  
Bubinga  
Koa  
Satinwood  
Cocobolo  
Padauk  
Rosewood  
Bloodwood  
Ziricote  
Purpleheart  
C. Ebony  
Pau Rosa  
Camphor

## Quality Exotic Wood

» TURNERS «  
Thick Planks for Bowls/Squares

» CABINET MAKERS «  
Individually Selected Lumber  
for  
Furniture/Boxes/Inlays

Over 70 Species

All Inquiries Welcome—Call or Write

Berea Hand Woods Co.

125 Jacqueline Drive  
Berea Ohio 44017

216-243-4452

Pernambuco  
Mac. Ebony  
E.I. Rosewood  
Bocote  
Curly Maple  
Quilted Maple  
Af. Ebony  
Zebrano  
Lacewood  
Lignum Vitae  
Osage  
Tulipwood  
Blackwood  
Mahogany  
Jelutong  
Holly  
Wenge  
Goncalo Alves  
Many More...

"It's a matter of pride for both of us"

"TERRIFIC"

## THE WOODWRIGHT'S WORKBOOK

Further Explorations in Traditional Woodcraft

BY ROY UNDERHILL



## THE WOODWRIGHT'S WORKBOOK

FURTHER EXPLORATIONS  
IN TRADITIONAL WOODCRAFT  
BY ROY UNDERHILL

"This book is terrific—full of wry wit, thorough expertise, charming anecdotes and a far-

reaching consciousness that illuminates not only tools and processes, but also the human condition. I cannot recommend it too highly."—Jim Cummins, *Fine Woodworking*

America's favorite woodwright returns to PBS in October with a new thirteen-week series.

254 pp., 239 illus., \$12.95 paper, \$19.95 cloth

ALSO BY ROY UNDERHILL

**THE WOODWRIGHT'S SHOP**  
A PRACTICAL GUIDE TO TRADITIONAL WOODCRAFT

221 pp., 327 illus., \$12.95 paper

**THE WOODWRIGHT'S COMPANION**  
EXPLORING TRADITIONAL WOODCRAFT

203 pp., 262 illus., \$12.95 paper, \$19.95 cloth

Available at your favorite bookstore or from

**THE UNIVERSITY OF NORTH CAROLINA PRESS**

Post Office Box 2288

Chapel Hill, NC 27514

**Makita** Call 1-800-2-MAKITA for Low Prices on Entire Makita Line • FREE FREIGHT •



2030N  
12 1/2" Planer Jointer  
List \$2580  
SALE \$1566

3612B 3HP  
Round or Square  
Base Plunge  
Router List \$338  
SALE \$188

LS1000  
10" Miter Saw  
List \$396  
SALE \$207  
After \$10.00 rebate

6012HDW  
2 Speed  
Cordless  
Driver Drill  
List \$210  
SALE \$105

Satisfaction Guaranteed  
In all states, call TOLL FREE 1-800-262-5482

B04550  
Dustless  
Palm Sander  
List \$92  
SALE \$43  
After \$5.00 Rebate

2708W 8 1/4" Table Saw  
w/Carbide Blade  
List \$396 SALE \$215



499 WHITEWATER ST., WHITEWATER, WI 53190

## DO IT YOURSELF

Build your own Heavy Duty,  
Industrial Strength Shaper

For less than \$500—Save as much as \$1500.00

Complete set of  
easy-to-follow  
PLANS

for only **\$14.95**

Contains complete set of plans, parts and supplier lists,  
instructions, photographs and drawings

Send \$1 (one dollar) for brochure containing detailed description  
of Shapers and full line of other types of  
woodworking machine plans we have available

**NICHOLS** EQUIPMENT COMPANY

P.O. Box 1381, Wilkes-Barre, PA 18703-1381

"Famous since 1932"

## NEW WOODWORKING BOOKS

Published by the British Guild of Master Craftsmen  
available NOW in the USA



1. Woodworking Plans and Projects \$14.50
2. 40 More Woodworking Plans & Projects \$14.50
3. Sharpening and Care of Woodworking Tools and Equipment \$14.50
4. Woodcarving : A Complete Course \$14.50
5. Pleasure and Profit from Woodturning \$14.50
6. Turning Miniatures in Wood \$14.50

Please send me the following titles  1  2  3  4  5  6

Plus \$1 p&p per book.

Name .....

Street .....

City .....

State .....

Zip .....

My check for \$..... is enclosed and made payable to Garrett Wade Co. Inc.

Debit my  American Express  Access  Mastercharge  Visa

Diners Club Account with \$ .....

My Account No. .... Ex date .....

Signature ..... Send order with remittance to:

**Garrett Wade Company Inc.,**

161 Ave. of the Americas, New York, N.Y. 10013

complexity of these toys rests in the drawing and painting skills required to pull them off. Forde's toys—and, to a much greater extent, the Peduzzis'—require advanced painting abilities. In some cases, the painting alone would consume as much as three-quarters of the total project time. Given that caveat, however, both books offer toy designs that strike an admirable balance between playability and salability. In fact, you might want to make *Fun-to-Make Wooden Toys* the second book you buy—especially if you already have good painting skills. And *Making Action Toys in Wood* is well worth an inter-library loan request, if only for the anecdotes that spice the text. Check it out—especially if you enjoy detailed painting. —Richard Griffin

**Model Sailing Ships: Design and Construction** by Robert F. Brien. *B.T. Batsford Ltd., London; distributed by David & Charles, Inc., North Pomfret, Vt. 05053; 1987. \$22.95, paperback; 119 pp.*

The recent upsurge of interest in ship models has led to the publication of a number of how-to manuals on the subject. This book, a recent addition to the literature, is intended to be a brief introduction to the basic methods and techniques. It follows a logical development, from choosing a model to build, through materials selection, tools and final display. It's illustrated with photos of a variety of models—either in museums or built by the author himself—and contains many drawings.

So, at first glance, *Model Sailing Ships: Design and Construction* might seem ideal for the novice. Unfortunately, much of the information presented—whether describing ship nomenclature, history, seamanship or techniques—is either wrong or misleading. Indeed, I found errors on nearly every

page. For example, tea should never be used to dye sails, as the acid content of the brew will lead to rapid deterioration of the sail material. Also, dry-transfer lettering shouldn't be used on models since it will soon crack and peel. And the idea that the faces of the rudderpost and rudder were flat up until the mid-19th century is a misstatement of historical fact. If this were true, it would be impossible to turn the rudder!

Despite the stated intention of the book to stick to simple construction techniques, there's a section describing a complicated plank-on-frame method known as "dockyard" construction, and the exposition is totally wrong. Obviously, the author lacks a basic understanding of how this kind of model is put together.

The beginner should be able to profit from a book like this, picking up knowledge on construction and absorbing historical knowledge along the way. But, as it is, the novice reader will ingest much that will need to be unlearned. The experienced ship modeler will readily spot Brien's errors and inaccuracies—but this book is intended for beginners.

It may appear that these points are finicky judgments or fine details, not worth worrying about for the first efforts in model-building. But a ship model is the result of all the knowledge, skill and craftsmanship of the builder, and the success of the model reflects the state of mind of the creator. It is just these small matters and points that make a model worthwhile.

—Lloyd McCaffery

*Paul Bertorelli is editor of Fine Woodworking. Richard Griffin is an amateur woodworker, a minister and a former Inter-Library Loan librarian who currently lives in Sumner, Neb. Lloyd McCaffery, a resident of Boulder, Colo., has been making miniature ship models for 29 of his 38 years.*

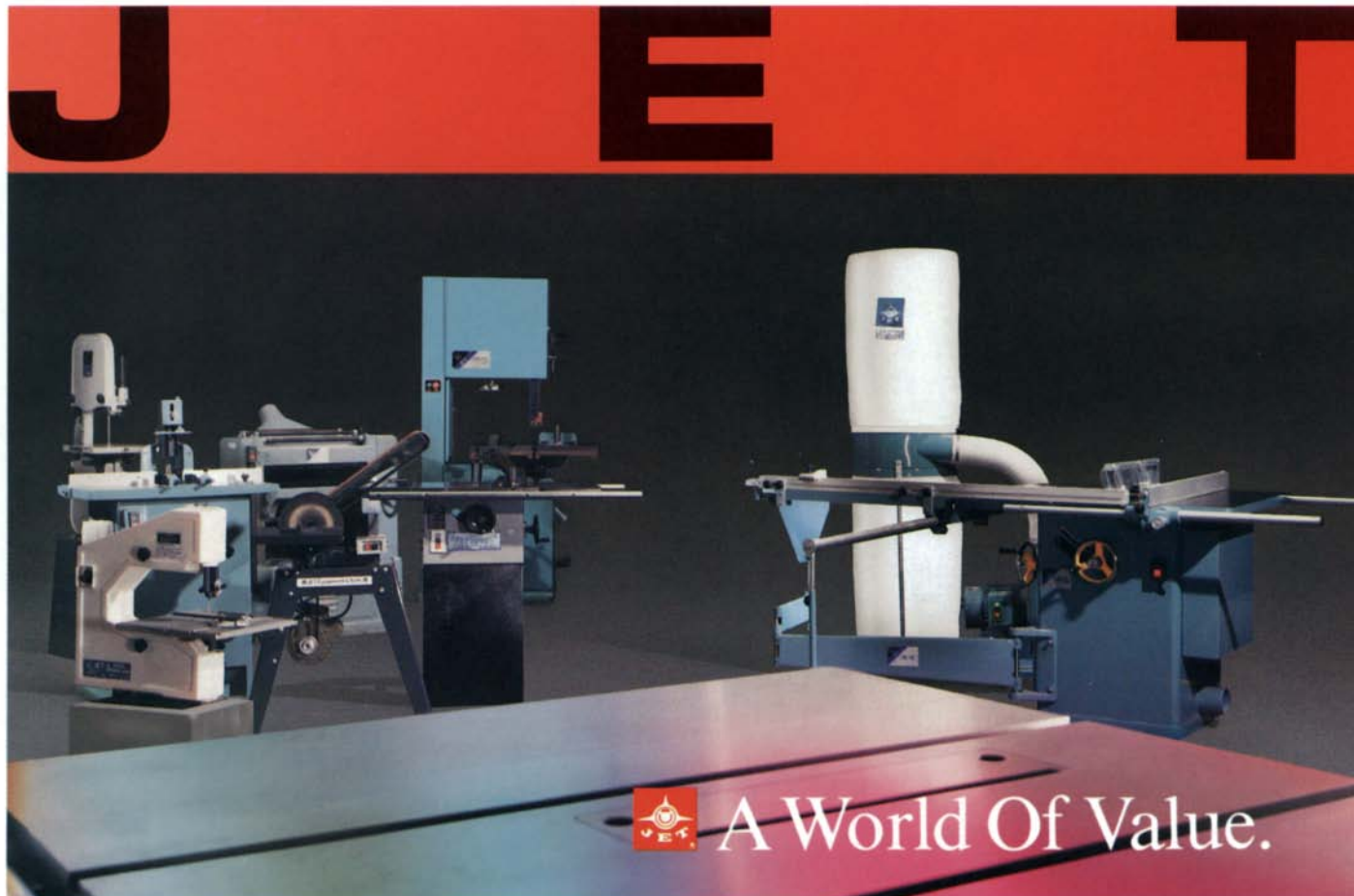

Call or write for free catalog, Jet Equipment and Tools, P.O. Box 1477, Tacoma, WA 98401, Toll-Free (800) 426-8402



**SHAKER PEGS  
CANDLE CUPS  
MUG PEGS**

\$17.95 per 100, prepaid.  
Wide selection of other  
wood products.

Catalog \$2.00 or free with order.

**Benny's Woodworks**

P.O. Box 656, Dept. FW5  
Antioch, TN 37013 615-331-8384  
Out of State 1-800-255-1335

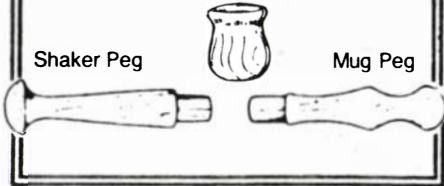

**SUPER SCOOPER**



**BUILD THIS DURABLE SANDPILE BACKHOE.** We offer well illustrated plans and an itemized list of materials. Other components are also available for prompt delivery via UPS. The wood parts are Redwood and Ash. Save \$4.00 and order the complete kit of all items listed below for \$68.00. All prices include shipping.

- Easy to follow plans ..... \$ 4.00
- Welded Steel Bucket ..... 10.50
- Heavy Duty Swivel Bearing ..... 10.50
- Complete set of all screws & fasteners ... 9.00
- All wood parts cut and drilled ..... 39.00

Send check or money order to:

**BALLART DESIGN** 4606 So. 600 East #931  
Salt Lake City, Utah 84107

**Bandit Bander  
Bandsaw Blade Welder**

\* Welds and anneals wood and metal cutting blades up to 1/2" wide.

\* Welder hooks up to 250 - 300 cold cranking amp 12-volt battery.

Regularly \$79.95 now \$69.00

\* Will ship UPS.

\* Accept Mastercard and Visa.

**LYLE'S SHARPENING &  
SUPPLY COMPANY**  
1600 A East 4th Street  
Marshfield, WI 54449

In WI call 1-800-472-5680  
Outside WI call 1-800-624-5395

**A good miter  
is hard to find.**



**Now you  
know where  
to look!**

**POOTATUCK CORPORATION**

P.O. Box 24, Dept. FW879  
Windsor, VT 05089 (802) 674-5984

Name \_\_\_\_\_  
Address \_\_\_\_\_  
City/State/Zip \_\_\_\_\_

**CALL US FOR PRICES  
ON POWERMATIC  
AND DELTA MACHINES**



We offer POWERMATIC  
10' table saw, Model 66  
comp. w/ BIESEMEYER  
fence, 2 HP 230 v. sgl. ph.  
mtr.  
\$1,399 FOB shipping point.

Model 26 shprs w/ 2 HP sgl.  
ph. mtr. \$1,299 FOB shipp pt.  
Miss. residents add 6% tax

**Before you buy, call us toll-free  
for prepaid freight prices:**  
**(800) 821-2750. Ask for Tools Dept.**  
**In Miss. (800) 321-8107.**

**SPECIAL NET PRICES**

Prepaid in U.S.A on

Freud carbide tipped cutters

EC-260 3/4 stock, Stile & Rail Set 173.00

94-100 Router Bit Set 158.75

EC-202, EC-209, EC-210, 86.75

EC-211, EC-212 or EC-213

Raised Panel Cutters 86.75

EC-001 Door Lip Cutter 43.00

EC-044 Quart. Rd. 3/4 + 1/2 49.50

EC-005 Roman Ogee 40.50

EC-031 Rev. Glue Joint 41.75

EC-032 Wedge Tongue 47.00

EC-034 Lock Miter Set 81.00

EC-240 Drawer Lock 44.25

EC-900 Cutters Set 297.50

LM72M010 - 10" x 24T RIP Blade 36.75

LU84M011 - 10" x 50T Comb. Blade 38.75

LU85M010 - 10" x 80T Cut Off Blade 62.75

Call for prices on other FREUD items.



126 E. Amite St., PO Box 102, Jackson, MS 39205

**LIKE OWNING YOUR  
OWN  
LUMBER-  
YARD!**



**VARIABLE  
FEED RATE!**

**FREE  
30-DAY  
TRIAL**

Just a twist of the dial  
gives you from 70 to over  
1,000 cuts-per-inch!

Made in U.S.A.

**Makes you money... saves you money!**

New 3-in-1 power-feed shop planes, molds, sands! Quickly converts low-cost rough lumber into high-value finished stock! Turns out perfect picture frame, quarter-round, casing, tongue & groove ... all popular patterns ... any custom design. Converts in just minutes to a powerfeed drum sanding machine! This one low-cost power-feed shop opens up a truly astonishing range of products you can make and sell. Find out how you can try this versatile tool in your own shop on our 30-day Free Trial! Easy terms.

Call 1-800-538-4200, Ext. 5546

**SEND FOR FREE FACTS TODAY**

Woodmaster Tools, Inc.  
Dept. PE46, 2908 Oak  
Kansas City, MO 64108

YES! Please rush my FREE Information Kit and details on your 30-Day Free Trial Guarantee.

Name \_\_\_\_\_  
Address \_\_\_\_\_  
City/State \_\_\_\_\_ Zip \_\_\_\_\_

**SALE ON BOOKS**



- Contemporary Amer. Woodworkers ..... \$28
  - Encyclo. Furniture-Joyce ..... \$28
  - 4 Books by James Kranov ..... \$55
  - 3 Books by Roy Underhill ..... \$38
  - 2 Books by Dale Nish ..... \$32
  - Soul of a Tree - Nakashima ..... \$58
  - Sam Maloof, Woodworker ..... \$58
  - Table Saw Tech. - Cliff ..... \$13
  - Radial Arm Saw Tech. - Cliff ..... \$13
  - Fine Woodworking Tech. 1-8 ..... \$16 ea
  - Fine Woodworking on ... Series ..... \$ 7 ea
  - Understanding Wood - Hoadley ..... \$20
  - Handtools, Their Ways - Watson ..... \$20
  - Sculpting Wood - M. Lindquist ..... \$26
  - Waterfowl Painting - V. Veasey ..... \$46
  - Scroll Saw Pattern Book ..... \$12
  - Scroll Saw Handbook - Spielman ..... \$12
  - Router Handbook - Spielman ..... \$ 9
  - Tage Frid/Book 1-3 ..... \$17 ea
  - How To Carve Wood - Butz ..... \$13
- ALL PRICES POST PAID**

ORDER TOLL FREE 1 800-243-0713

**Manny's Woodworker's Place**

602 S. Broadway, Lexington, KY 40508  
Hours: 9-5:30 Mon.-Sat. (606) 255-5444  
VISA, MC, Checks, Add \$3 for COD



- 350-1 10" Table Saw 3 HP, 1 ph. 230V Motor Magnetic Control 1,235.00 del.\*
- 1 1/2 HP, 115/230V 1 ph. Motor & Switch 1,175.00 del.\*
- 160-2 Var. Speed Lathe 1 HP 115/230 1,120.00 del.\*
- 260-1 Var. Speed Lathe 1 HP 115/230 Mag. Control 1,899.00 del.\*
- 1180-1 6" Jointer 1 HP, 1 ph. 115/230V Motor 665.00 del.\*
- 480-8" Jointer 1 1/2 HP, 1 ph. 115/230V Motor 1,399.00 del.\*
- 490-1 15" Band Saw w/base 1 HP, 115/230V Motor 875.00 del.\*
- 34-01 15" Floor Model Drill press 1/2 HP. Motor 540.00 del.\*
- 130-1 14" Planer 3 HP, 1 ph. 230V Motor Magnetic Control 2,495.00 del.\*



4050 Williston Rd.  
So. Burlington, VT 05401 802-863-9036  
\*Freight included. Except Alaska & Hawaii

Photo: Larry Montgomery



## The building of Timberline Lodge

On any clear day in Portland, Oregon, the view to the east reveals 11,000-ft. Mount Hood, a dormant volcano looming on the skyline. From Portland, the road to Mount Hood is a serpentine ribbon that winds between dense stands of Douglas fir, Ponderosa pine and hemlock. Occasional breaks in the trees open to the sculpted facets of ice and rock on the rough ridges of the mountain. There, slightly more than halfway up the mountainside between the last line of trees and the open snow fields, is a National Historic Landmark called Timberline Lodge, which celebrates its 50th birthday this September. I recently visited this year-round resort, and discovered that its spectacular alpine setting isn't the only feature that makes it unique.

Timberline Lodge is the only government-owned and sponsored building of its type in America today. Its designers wanted to create an American-Alpine style with a distinct regional identity, so they furnished the building almost entirely with indigenous materials—locally quarried stone, native species of fir and pine, hand-woven fabrics, forged iron—and craft objects characteristic of the 1930s. (The lodge still contains hundreds of the original craft pieces.)

With an architectural character regarded simply as “Cascadian”—a reference to the mountain range that includes Mount Hood—Timberline Lodge was built almost entirely by hand in the depths of the Great Depression, from 1935–1937. Timberline also represented a remarkable collaboration of individuals and agencies: It was proposed by private citizens, funded by Congress, organized and engineered under the auspices of the United States Forest

Service and built by workers hired by the Works Project Administration (WPA).

Margery Hoffman Smith is credited with the consistent integrity of the handcrafted theme carried throughout the lodge's interior. Smith drew her inspiration from the Arts and Crafts Movement popular in this country around the turn of the century—a style typified by simple designs executed in unpretentious materials.

Nowhere is the Arts and Crafts leitmotif more clearly pronounced than in the lodge's furniture and interior woodwork. The lodge contains more than 13 different chair styles, numerous love seats and couches, wall seats and beds. Sturdy plank-and-panel fir cabinets, desks and bookcases reflect a design priority of function and comfort. Ornamental craft pieces include a dozen carved-animal-form newel posts, Indian and forest scene relief carvings and several large marquetry wall panels. Each piece—be it an occasional wooden coat rack or one of the chip-carved chairs in the Blue Ox Bar—stands on its own merits of simple, clean lines and appropriate materials. The fact that much of the furniture has been in daily use for almost 50 years is also a testament to rugged design and the skill of its builders.

Ray Neuffer was the WPA supervisor responsible for the furniture construction and wood carvings at the lodge. Neuffer was a struggling furniture maker in the Portland area when Margery Smith recognized his talent and put him in charge of setting up a 30-man woodworking shop. I went to visit with Ray Neuffer recently at his Clackamas, Ore., home—within view of Mount Hood.

Ray is now 87 years old, but he stood as straight as a plumbline when he rose to

greet me. I shook his hand, rough and hard-callused from the carving he still does, and asked him about the origins of the furniture designs. “We never did have any plans for that furniture. Margery (Smith) would just come in and tell us how many tables and chairs she would need. We had to figure out for ourselves how they should be built. Our first project was the newel posts. They brought us a load of old telephone poles, and we carved them up, trying to give them the feeling of heft and strength.”

I found it quite remarkable that no plans were compiled until *after* the furnishings were built and installed. Perhaps even more surprising is the fact that Ray Neuffer never had the opportunity to visit the lodge site prior to the dedication ceremonies performed by President Roosevelt. Despite his unfamiliarity with the lodge, the talented craftsman conceived and built furnishings that are perfect complements to the building itself. Ray described his inspiration in simple terms: “We hadn't ever been out to the lodge, but the mountain impressed us. We were working for the mountain. That was our scale.”

Throughout the lodge, the unity of architectural scale and furniture design is readily apparent. The hexagonal pattern of the main house, with its 92-ft.-high, free-standing stone chimney and fireplace, is carried over to tabletops and segmented couches. Also, the structure's impressive carved arch-and-beam construction is repeated in mirror frames and chair backs.

I was curious to find out from Neuffer

*Timberline Lodge was built from native timber and stone during the Great Depression. Its furnishings, such as this plank bench and desk, were inspired by turn-of-the-century Arts and Crafts designs.*

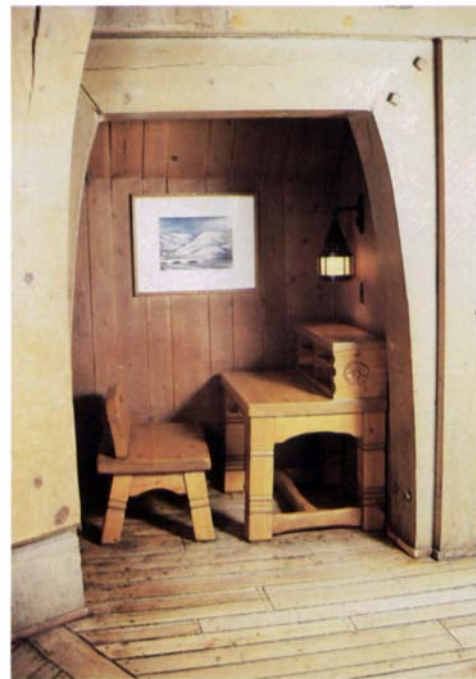

# LEAVE THE COMPETITION IN THE DUST

with  
**PowerStars**

Model 26 Shaper  
(2 HP)



Model 100 Planer  
(2 HP)

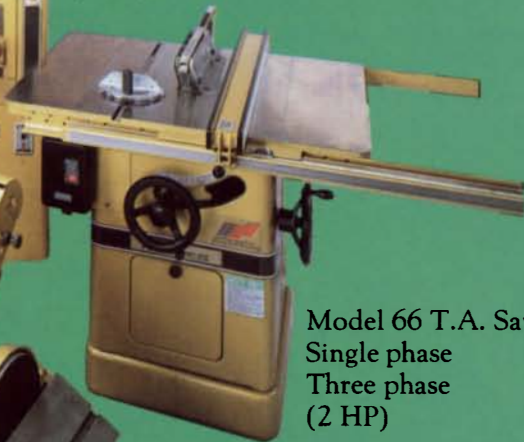

Model 66 T.A. Saw  
Single phase  
Three phase  
(2 HP)

Model 30B Sander  
(1½ HP)



Caught in the quandry of quality vs. price? Home and professional hobbyists, start-up users, and serious craftsmen have had limited choice in outfitting their workshops. That is...until now! Powermatic changes "just gazing at the best" to affordable reality with our new line of **PowerStars**.

Unlike the cheap imports, **PowerStars** maintain the rugged dependability, precision machining, and strict quality standards synonymous with Powermatic's industrial line.

**PowerStars** assure you of superior quality, excellent service and easy-to-get parts. And all at prices that give your expanding business the opportunity to own the best in woodworking machinery.

On all planes, quite frankly, **PowerStars** leave the competition in the dust! Call us today — 615/473-5551.

**POWERMATIC  
FOR THE EIGHTIES™**

**POWERMATIC®** 

POWERMATIC  
McMINNVILLE, TN 37110

Powermatic features only America's best: motors, controls, inspection, parts and service — all across the nation. Rugged cast iron construction. Efficient high torque motors.

why fir was the predominant choice for the furnishings, rather than traditional hardwoods. "A lot of it was used material—local buildings that had been taken down, railroad ties, things like that. I was the one who decided that we should use only fir. . . we didn't have much machinery, most everything was done by hand." Old-growth Douglas fir is prized by builders in the Pacific Northwest for its tight, straight grain and excellent handworking properties. When it's exposed to sunshine, the fir gradually turns the color of good whiskey held up to firelight.

Since Timberline Lodge opened to the public in 1938, an estimated 30 million visitors have visited the Depression-era project. With the same collaborative spirit that led to the creation of Timberline, many organizations have worked to preserve the lodge's handcrafts and numerous buildings. Timberline's curator, Linny Adamson, took me to the Blue Ox Bar to view one of the typical contributions of these dedicated volunteers. She pointed to a new fir bar chair, complete with a chip-carved back. It was such an accurate replica of the originals that I couldn't distinguish it from the others lining the room. "This was donated to us last year," she explained. "It was built by Ray Neuffer when he was 85 years old."

—Larry Montgomery, Portland, Ore.

For information on 50th Anniversary events scheduled at Timberline Lodge, contact the lodge at (503) 272-3311.

Photo: Mats Nordstrom



**Solarium chair**  
*This huge birch-burl chair was made by sculptor David Holzappel, of Marlboro, Vt., to dignify an Italian grotto-style solarium at a corporate headquarters building. It weighs 300 lb. and rides on casters concealed in the base.*

## Product review

**Square It electronic square, \$49.95, Zac Products Inc., 34 Renwick Street, New York, N.Y. 10013.**

If you're tired of fooling around trying to set up fences and blades to a true 90° with an out-of-whack square, there's a new device called Square It that provides a quick, simple way to check squareness or 45°. And the device never leaves you in doubt: it lights up when the setting is correct.

I've been trying out the Square It in my workshop, and despite my skepticism about electronic gadgets, it's proven to be a practical device. The Square It is perfect for jobs like squaring a blade on a table-saw, setting the angle of the jointer fence or checking regular metal squares and bevel gauges for accuracy.

Here's how it works: The Square It has two pairs of factory-calibrated metal pins: one set to check square, the other set to check for 45°. When either set of pins comes in contact with a metal sawblade or fence, an electric circuit is completed and a bulb inside the device lights up. Zac—which claims  $\pm 0.0005$  in. accuracy for the device—calls Square It "electronic," but that's a bit of sales hype. The device is really just a continuity tester.

Once I got the hang of keeping the light plastic triangular case flat while checking adjustments, the Square It was easy to use and consistently accurate. The tool has only one limitation (besides its fairly hefty

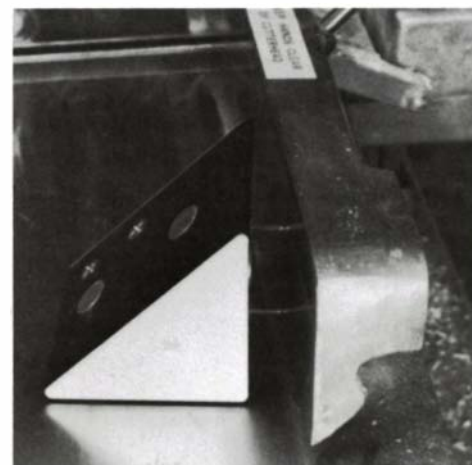

*The Square It lights up when both metal probes touch the 90° fence.*

\$49.95 price tag): It works only on metal surfaces. This means you'll have to remove the belt or disc on a stationary sander before the table angle can be set, or tape a piece of foil to anything wooden you want to check.

Square It can be used on virtually any shop machine with a blade or fence that projects at least  $2\frac{3}{4}$  in. from the table (a special model is available for use on smaller machines). On drill presses and shapers, a length of drill rod provides the smooth surface for the probes to contact.

Unless you want to go to the trouble of making and calibrating your own version of this device, the Square It is a neat, ready-to-use tool. It's earned a place in my shop.

—Richard Preiss, Charlotte, N.C.

## Wanted: Reader comments on lathes

More than any other woodworking machine, a lathe must strike a balance between two mutually exclusive requirements: for spindle work, it needs a robust tailstock riding on a good, solid bed; for faceplate work, it's often best to have no bed at all, to accommodate large bowls and such. Do any manufactured lathes manage the compromise while still being heavy enough to resist the vibration induced by an out-of-balance turning blank spinning at several

hundred RPM? In a future issue, we'll explore that question in an article on how to select a lathe.

In the meantime, we'd like to hear your comments on lathes. What brand do you own? What are its strengths? Its weaknesses? Have you modified it? Would you buy the same machine again?

Send your comments to Lathe Talk, c/o *Fine Woodworking*, Box 355, Newtown, Conn. 06470. If you wish, use the postage-paid envelope bound into this issue. We'll acknowledge your submission and notify you if it will be published in the magazine.

## Daphne's demise

For the last six years, the Daphne Furniture Award competition has recognized and rewarded the furniture-designing talents of industrial designers and small-shop custom woodworkers alike. And while the awards were never as glamorous or well-publicized as the Academy Awards, the Daphne contest was to hardwood furniture design what the Oscar is to the motion-picture industry.

Now, the Hardwood Institute, a division of the National Hardwood Lumber Association and creator of the Daphne, is discontinuing its sponsorship and ending the competition due to lack of support from the industry the awards were intended to promote. Daphne Director Richard Silver explains, "The awards had become too much like the industry patting itself on the back. In order to parlay the promotion into a national event, sales and merchandising needed to extend the prestige and



# ADVANCE NOTICE!

## 25-PIECE BRAD POINT DRILL SET

CREDIT CARD HOLDERS CALL  
TOLL FREE 1-800-533-5305

For the first time, a *complete* Brad Point Drill Set — all 25 sizes from 1/8" to 1/2" in 1/64" increments — for the low price of \$39.95. A similar set is sold elsewhere for \$59.95.

These precision ground, brad point drills make clean, entry holes — even in Oak or curly Maple (A clean entry hole is one that does not splinter or tear the surrounding wood. Then, when you insert your wood plug to cover the counter-bored screw, you can hardly see where you drilled the hole) Moreover, they place the hole exactly where you want it without "skating" — essential for doweling and accurate drilling.

Drill sizes over 3/8" have 3/8" shanks. METAL DRILL INDEX INCLUDED. #200-0025

**ONLY  
\$39.95**

### ADDITIONAL BONUS:

If you place your order for the 25-pc. set you will be eligible to buy . . .

### 4 BIG BRAD POINT DRILLS

5/8", 3/4", 7/8", 1". All with 3/8" shanks.  
Regularly \$19.95.

**ONLY  
\$14.95**

#200-0020



To: The Fine Tool Shops Dept. FW 97  
P.O. Box 7091 170 West Road Portsmouth, NH 03801

Qty #200-0025 25-pc. Brad Point Wood Drill Sets @ \$39.95

Qty #200-0020 4 Bid Brad Point Wood Drills @ \$14.95 with purchase of #200-0025 or \$19.95 separately

Enclosed is  Check  Money Order for \$\_\_\_\_\_ Charge my  Amer. Ex.  Visa  MasterCard

Acct. # \_\_\_\_\_ Exp. \_\_\_\_\_

Signature \_\_\_\_\_

Name \_\_\_\_\_

Street Address \_\_\_\_\_

City \_\_\_\_\_ State \_\_\_\_\_ Zip \_\_\_\_\_

### INDEX TO ADVERTISERS

Abbey Tools	27	Forrest Manufacturing	24	Rockingham	94
Acme Electric	35	Freud	19, 25	Ross Industries	23
Adams Wood Products	94	Frog Tool Ltd.	21	Sand-Rite	12
Addison Hardware	113	Furniture Designs	36	The Sawmill	26
Adjustable Clamp	96	Garrett Wade	109, 111	Seeley Workshop	5
Advanced Machinery Imports	9	Gilliom	94	Seven Corners	5, 37, 96, 108
Alco Tool Supply	13	Grizzly Imports	33	Shaker Workshops	107
American Clamping Corp.	107	Hardwoods of Illinois	17	Signcraft	34
American Woodcrafters	107	Highland Hardware	17	Silverton Victorian Millworks	36
Andreou Industries	21, 94	Home Lumber	111	Singley Specialty	36
Arkansas Whetstone	5	Horton Brasses	94	Sisco Supply	113
Arnall Machinery	7	HTC Products	23	The Source	23
Art Eisenbrand	21	J. Philip Humfrey	34	Sperber Tool Works	34
Ashman Technical	97	Imported European Hardware	104	Sunhill	90
Aviation/Industrial Supply	95	Industrial Abrasives	35	Systi-Matic	88, 89
Bahco Tools	24	JDS Company	15	The Taunton Press	98, 99, 100, 101
Ball & Ball	32	W. S. Jenks & Son	12	Tool City	29
Ballart Design	113	Jet Equipment	112	Tool Stop	30
Benny's Wood	113	Keen-Edge	11	Tool Town	97
Berea Hardwoods	111	Kuster	92	Toolmark	28
Beveled Glass Works	11	Laguna Tools	108	Eli M. Townsend & Son	34
Blume Supply	26	Robert Larson Co.	90	Transpower	91
Bob Kaune	28	Lee Valley Tools	94	TWS Machinery	17
Bosch	7	Leigh Industries	107	Uniquet Corp.	5
Buckeye Saw	21	LeNeave Supply	96	Univ. of N.C. Press	111
Calculated Industries	97	Lignomat USA	26	United States Saw	22
Carlyle Lynch	11	Lyle's Sharpening	28, 113	Vega Enterprises	17
Cascade Precision Tool	30	The Lutherie	34	Veritas	27
M. Chandler & Co.	13	Manny's Woodworker's Place	113	Von Fange Tool Co.	5
Cereus Inc.	11	Mason & Sullivan	18	Watco-Dennis	95
Classified	102, 103, 104	McFeely Hardwoods	13	Wertz	31
Clayton Enterprises	17	MLCS	26, 108	West Dean College	11
Maurice L. Condon	34	Morse Design	36	Western Chem-Tech	5
Conover Woodcraft	9	Nichols Equipment	111	Whole Earth Access	93
Constantine	107	Northwood Industrial Machinery	36	Wilke Machinery	105
Craftsman	117	Nova Tool	21	Williams & Hussey	9
Craft Supplies USA	13	Onsrud	111	Wood-Mizer	17
Dallas Wood & Tool Store	94	Parks Woodworking	27	Woodcraft Supply	17
Delmhorst Instrument	28	Machine	30, 92, 113	Woodmaster Tools	113
Delta	119	Paxton Hardware	36	Woodshop Specialties	92
DML	28	Penn State Industries	90	Woodstock Wood Show	21
Donald Durham	107	Pennsylvania Saw Co.	107	Woodworker's Equip. & Supply	92
Early Music Shop of New England	9	Performax	31	Woodworker's Supply of N.M.	104
Ebac Lumber Dryers	32	Phillips Bros. Supply	32	Woodworkers Tool Works	117
Econ-Abrasives	34	Pootatuck	113	Woodworking Show	92
Educational Lumber	36	Porter Cable	2	Woodworking World	23
Fine Tool Shops	117	Powermatic	115	Workbench Tool	91, 104
Fisher Hill Products	32	Quintec Mfg.	34	Working Wood	108
Floral Glass & Mirror	13	RBI Industries	94	Xylophil's	31
Foley-Belsaw Co.	21, 91	Roger A. Reed, Inc.	27	ZAC Products	95
Formby's	11	Ring Master	30	ZIP	11



### BUILD YOUR OWN WOODWORKING SHAPER

BALL BEARING  
SHAPER MANDREL

SHAFT SIZES  
1/2"-3/4"-1"

PHONE ORDER  
312-640-6420

**WOODWORKERS  
TOOL WORKS, INC.**

2420 E. Oakton - A  
ARLINGTON HEIGHTS, ILLINOIS 60005

### WOODWORKERS

Save on Wood - Tools - Supplies!



Send for  
New 1987  
148 Page  
Money Saving  
CATALOG



Finest Dimensioned  
HARDWOODS and  
Quality VENEERS

42 Varieties 1/64" to 4" Thickness

Fast service on choice kiln dried  
Wood and Veneers, Moldings, Trim,  
Hand and Power Tools, Lamp Parts,  
Upholstery Supplies, Clock Move-  
ments and Kits, Hard-to-Find Hard-  
ware, Finishing Materials, Books  
... over 4000 items in stock! Crafts-  
man—Woodworker's best friend.

FREE with Catalog  
-\$3.00 Discount Coupon  
Good on First Order

**CRAFTSMAN WOOD  
SERVICE**

Dept. A-17 1735 W Cortland Ct., Addison IL 60101  
Please enclose \$1.00 to help pay postage and handling.

uniqueness of Daphne-awarded furniture to the public. As it was, too many Daphnes just ended up in executives' desk drawers."

Though the Daphne award was aimed at promoting the furniture industry, the less conventional work of limited-production makers often received greater visibility in the press and at the Daphne gallery display at High Point, N.C. Last year, Marshall Fields—a prominent Chicago department store—bought and exhibited one of each of the limited-production winners' pieces.

The press coverage received by Daphne winners did produce some recognition for previously unknown designer/craftsmen. Former architect Po Shun Leong's career as a furniture designer took off when his win-

ning dining chair design—the first of three Daphnes he won—was purchased for commercial production. Leong now designs furniture for five companies.

But winning the walnut Daphne trophy, designed by Wendell Castle, was in and of itself hardly a guarantee of furniture-design stardom. For instance, while Jeff Kellar and Judy LaBrasca went through long-term negotiations to contract the design of their Daphne-winning rocking chair, the only thing that came of the award was enough publicity to generate several commissions.

A unique aspect of the Daphne was the criteria employed for selecting winners. Winning pieces were chosen not only for

their aesthetic merit, but for their value, based on the actual selling price of each piece. Finalists' entries in two categories—large-scale manufacture and limited production—were judged by a panel that included trade publication editors, museum curators, design school instructors and representatives of the retail field.

Thomas Moser, a limited-production furnituremaker and recipient of two consecutive Daphnes, says the award was worth winning because, "The whole contest wasn't just an academic exercise. It recognized a designer's ability to make something beautiful that's also marketable in the real world."

—Sandor Nagyszalanczy

## They laughed when he showed the drill

"They laughed at me at Sears," cried the old gaffer as he stood at the bench of his home workshop, holding out a ¼-in. electric drill.

"Best little drill I ever had; bought it right after the war. I've used it to build my house and lots of the furniture that's in it. Never overheated—but it finally wore out its gears. So I took it back to Sears, and this dude held it up and said it must be at least 40

years old and laughed at me. They handed it all around and said the only place I'd find parts for it would be at the Smithsonian.

"I got around those jackanapes at the service counter and found the lady who runs parts. She's good. The nameplate and model number were long gone off that old drill, but I gave her the numbers I had found cast on the inside of the drill.

"With nothing else to go by, she used those numbers and located the series of model numbers for my drill. She let me

look at the screen. 'NIS—not in stock.'" He shook his head sadly. "If Sears was going to make a drill to last 40 years, they ought to have kept parts for it that long."

I told him he sure had a fine-looking shop. On the pegboard wall behind the bench, all his screwdrivers and pliers stood at attention in an orderly manner. Tall ones down to short ones, flat-blade screwdrivers separated from Phillips-head. I said it looked like it must have cost him a fortune.

"Nope. I bought them over the years, one by one. Never borrowed nothin'. When I needed something, I went out and bought it. Then I *kept* it." He reached out and got a small pair of lineman's pliers and a stubby screwdriver with an old-fashioned wooden handle. "These were the first. Bought them right after we got married."

I commented on how good they looked, all with red-painted handles. He chuckled, "Makes them easy to find in the grass—or in somebody else's shop."

He said his son had given him a brand new variable-speed, reversible ¾-in. drill. "But when you've used a tool as long as I used that old ¼-in. drill, it gets to be a part of you." He slipped it back into a box like a mother with a sick baby.

"Someday I'll find somebody with an old drill like mine. We'll swap parts 'til one of us has a good drill." □

—Gordon Baxter, Beaumont, Tex.

This essay first appeared in The Houston Post.

## Inside the bank

This is a drawing of the workings of the bulldog bank on the back cover. The view is from behind, minus the box that surrounds it. In this view, the dog's tongue is sticking out. Push the handle back and the cam-actuated tongue and jaw retract, and the dog's ears droop.

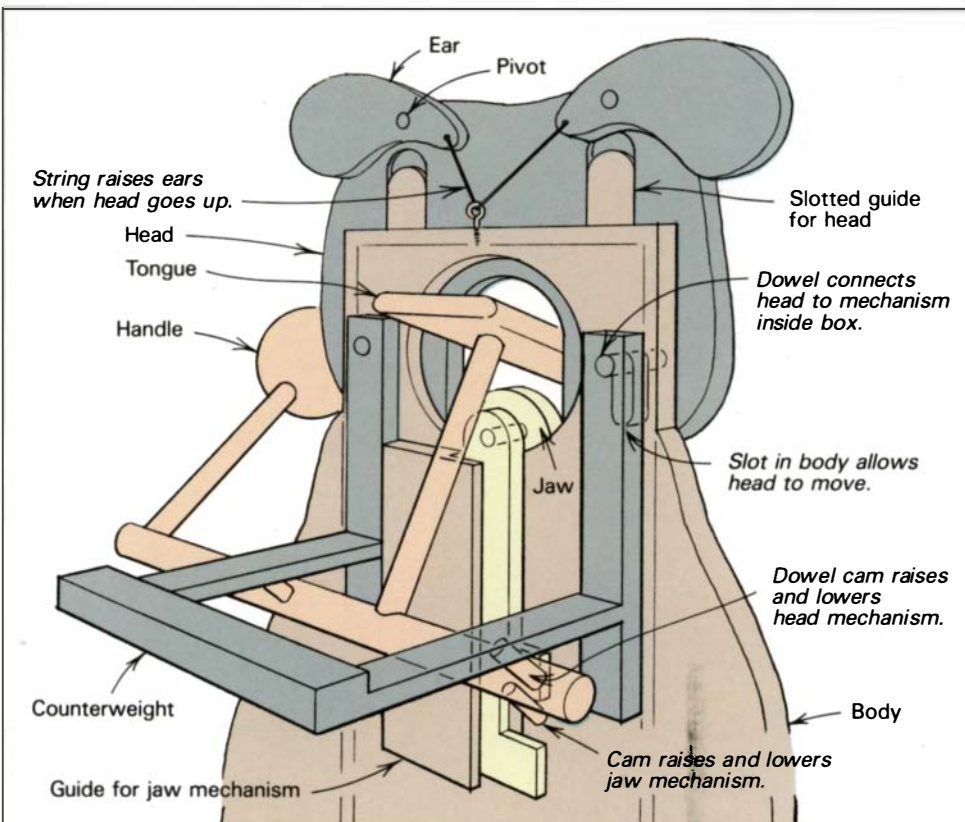

### Notes and Comment

Do you know something we don't about the woodworking scene in your area? Please take a moment to fill us in. Notes and Comment pays for stories, tidbits, commentary and reports on exhibits and events. Send manuscripts and color slides (or, black-and-white photos—preferably with negatives) to Notes and Comment, Fine Woodworking, Box 355, Newtown, Conn. 06470.

# Settle for more.

**DELTA**  
Industrial

**DELTA**  
Industrial Quality

**DELTA**  
Quality

Cat. No. 35-619  
10" x 60 TC&F 5/8" Bore  
9000 Max. RPM

# For less.

You won't find better quality carbide-tipped saw blades than the ones we make. They help your Delta saw — or just about any other saw — perform at peak efficiency. And right now, eight of our most popular carbide-tipped blades are on sale at participating Delta distributors.

#### Sale prices.

#### And a no hassle guarantee.

At prices like these, now you can afford to settle for *more*. Because like our saws, Delta carbide-tipped blades are designed to give you more cutting performance and service life. In fact, we're so sure you'll like them that we're offering this guarantee: if your Delta

Cat. No.	Description	Sug. Price	Sale Price
Combination/Planer			
35-606	9" x 40 ATB&R	\$82.05	<b>\$46.75</b>
35-617	10" x 50 ATB&R	\$87.60	<b>\$46.75</b>
35-657	12" x 60 ATB&R*	\$91.60	<b>\$66.00</b>
Miter Box			
35-619	10" x 60 TC&F	\$105.40	<b>\$49.50</b>
Sawbuck® Frame & Trim Saw			
35-593	8" x 48 TC&F	\$92.20	<b>\$49.50</b>
Special Purpose			
35-611	10" x 18 FT (Rip)	\$74.60	<b>\$43.50</b>
35-614	10" x 48 ATB (Ply & Comp)	\$98.15	<b>\$46.75</b>
35-624	10" x 80 TC&F (Laminates)	\$137.60	<b>\$82.50</b>
*1" arbor hole. Others 5/8" arbor hole.			

carbide-tipped saw blade doesn't perform as well as any blade you've ever used, simply return it to your Delta distributor.

We'll replace it or refund your money. No questions asked.

So hurry. The sale ends December 31, 1987. And if you miss the opportunity to get a Delta carbide-tipped saw blade at these prices — you may have to settle for something less.

For the name of your nearest Delta distributor call toll-free:  
Delta International Machinery Corp.,  
800/438-2486 (in PA, 800/438-2487).  
In Canada call 519/836-2840.

**DELTA**  
Building On Tradition

## BULLDOG BANK



As a child, toymaker David Kirk of King Ferry, N.Y., sharpened his mechanical skills by collecting and fixing toy robots. His know-how came in handy years later when—as an artist—he found his paintings too expensive to sell, so he began building toys. This bulldog bank is one of 30 Kirk designs, ranging from devil banks to jack-in-the-boxes. Made of poplar, mahogany and cherry, the clever canine waits doggedly for a deposit. Pull the lever and her mouth drops open and her tongue pops out. Simultaneously, her ears perk up while she awaits the reward of a coin in lieu of a dog biscuit. Crank the handle back and she gulps the coin down. A sketch of the mechanism for the 12-in.-tall pooch appears on p. 118.