



2017 PROJAHN

Handwerkzeuge
Hand Tools

IMPRESSUM / IMPRINT

| | |
|---|--|
| Herausgeber / <i>Publisher</i> | PROJAHN Präzisionswerkzeuge GmbH · 63128 Dietzenbach · www.projahn.de |
| Verantwortlich / <i>Responsible</i> | Daniel Schneider, Axel Lemmer |
| Gestaltung, Satz & Layout / <i>Design</i> | Aleksandar Agbaba, Laura Salewski |
| Druck / <i>Printing</i> | Druckerei Zeidler GmbH & Co. KG · Fritz-Ullmann-Straße 7 · 55252 Mainz-Kastel · www.zeidler.de |
| Datum / <i>Date</i> | Juli 2016 |

Leistungsangaben, Eigenschaften, Abbildungen, Zusammenstellungen, Abmessungen und Gewichte von Produkten können sich im Zuge der technischen Weiterentwicklung und der Anpassung an Bedürfnisse unserer Kunden ohne Verpflichtung oder vorherige Mitteilung ändern. Es besteht keine Verpflichtung bereits gelieferte Produkte entsprechend zu verändern. Die Herausnahme von Artikeln aus unserem Lieferprogramm behalten wir uns vor. Vertrieb nur über den Fachhandel. Irrtum und Druckfehler sowie Farbabweichungen vorbehalten. © 2016 PROJAHN Präzisionswerkzeuge GmbH Deutschland. Weitere Informationen erhalten Sie unter www.projahn.de

Performance specifications, features, pictures, lists, dimensions and weight of products may change in the course of technical development and adapt to our customers' needs without obligation or prior notice. There is no obligation to change earlier deliveries accordingly. The removal of items from our product range we reserve the right. Sales only through retailers. Errors and misprints, as well as color variations we reserve the right. © 2016 PROJAHN Präzisionswerkzeuge GmbH Germany. Further information you will find at www.projahn.de

Liebe Kunden und geschätzte Geschäftspartner,

unsere beiden Kataloge **Präzisionswerkzeuge** und **Handwerkzeuge** geben Ihnen auf über 500 Seiten einen schnellen und kompakten Überblick über unser Produktprogramm. In unserem Logistikzentrum in Dietzenbach sind über 10.000 verschiedene Lagerartikel sofort für Sie verfügbar.

Auch wenn der Trend zum Online-Marketing ungebrochen ist, hören wir von unseren Kunden immer wieder, dass der gedruckte Katalog einen wesentlichen Mehrwert für sie darstellt. Sowohl bei der schnellen Produktsuche als auch im individuellen Beratungsgespräch mit dem Kunden leistet das „handfeste“ Dokument wertvolle Unterstützung. Die Schnellübersicht aller Neuprodukte auf den ersten Seiten hilft hier genauso wie die Anwendungsempfehlungen und Produktvergleiche zu Beginn der einzelnen Kapitel. Am Ende des Kataloges finden Sie außerdem Artikel- und Stichwortverzeichnisse.

Im Produktbereich **Präzisionswerkzeuge** sind die neuen ROCKET Hammerbohrer besonders hervorzuheben. Das komplett neu entwickelte Design der Hartmetallplatten und die kernverstärkte Spirale bringen große Vorteile in der Anwendung und hinsichtlich der Lebensdauer. Überzeugen Sie sich ab Seite P 13 oder besser – probieren Sie den ROCKET aus!

Im Produktbereich **Handwerkzeuge** finden Sie ab Seite H 58 die vollständige Bandbreite der neuen PROFESSIONAL Industrie-Steckschlüsselkoffer mit 25 Jahren Garantie. Diese stellen die höchste Qualitätsstufe unseres umfangreichen Programms von fast 50 verschiedenen Werkzeugkoffern dar.

Wir wünschen Ihnen viel Erfolg mit Ihrem PROJAHN Werkzeug!

Ihr PROJAHN-Team

Dear customers and valued business partners,

Our two main catalogues **Precision Tools** and **Hand Tools** provide a quick and comprehensive overview of our broad product range on more than 500 pages. In total there are over 10,000 different articles immediately available for you from stock in our logistics centre in Dietzenbach.

While the trend towards online-marketing continues, our customers keep telling us that the printed catalogue constitutes a substantial added value for them. Be it for a quick product search or when advising a customer on a specific application, the tangible printed catalogue proves to be a valuable tool. The quick overview of new products on the first pages provides valuable guidance along with the recommendations for use and the product comparisons at the beginning of each chapter. At the end of the catalogue you will find article and keyword directories.

The product area **Precision Tools** features the innovative ROCKET rotary hammer drill bits which set a new benchmark in hammer drilling. Entirely redesigned carbide tips and head geometry as well as the core reinforced flute provide high durability and substantial user benefits. See for yourself on page P 13 – or better yet – put the ROCKET to the test!

The product area **Hand Tools** includes the complete range of PROFESSIONAL socket sets starting on page H 58. This new line of industrial grade tool cases comes with a 25 year warranty. It covers the highest quality level of our comprehensive offering of nearly 50 different tool cases.

We wish you every success with your PROJAHN tools!

Your PROJAHN-Team

Word cloud terms include: Marke & Werte, Brand & Values, Service & Partnerschaft, Service & Commercial Partnership, Individueller Marketingservice, Sales-boosting Product Portfolio, Personal Support, Immediate Delivery, Individual Marketing Service, E-Commerce, Produkte & Innovationen, Products & Innovations, Quality, Reliability, Betreuung, Personal Care, BMEcat, nexmart, Einzigartiges Produktportfolio, Zuverlässigkeit, Sofortige Lieferung, and Quality.

PROJAHN Präzisionswerkzeuge GmbH

63128 Dietzenbach · Deutschland/Germany · Fon +49 (0) 60 74 / 6 96 66-66 · Fax +49 (0) 60 74 / 6 96 66-99 · verkauf@projahn.de · sales@projahn.de · www.projahn.de
KOSTENLOSE/FREE* Fax-Hotline 0 800 / 22 44 888 *aus dem deutschen Festnetz, Handytarife können abweichen / *from the German fixed network, Mobile phone rates may vary.

Qualität – Service – Zuverlässigkeit

Quality – Service – Reliability



Nachhaltigkeit

Sustainability

PROJAHN hat eine klare Philosophie: Nachhaltigkeit und Kontinuität in der Zusammenarbeit mit Kunden, Lieferanten und Mitarbeitern. Davon profitieren alle. Denn nur durch langfristiges Engagement auf allen Ebenen findet eine starke und enge Bindung statt.

PROJAHN's philosophy: Sustainability and continuity in collaborations with customers, suppliers and employees to generate benefits for all. Only long-term commitment at all levels facilitates close and strong relationships.

Zuverlässigkeit

Reliability

Zuverlässigkeit ist die Grundlage für langfristige Partnerschaften. Genauso wie Ihr Kunde sich auf Sie verlässt, können Sie sich auf PROJAHN verlassen. Bestellungen werden sofort ausgeführt. In der Regel wird Ihre Ware am Tag Ihrer Bestellung versandt. PROJAHN-Kunden können dabei sicher sein, eine gleichbleibend hohe Qualität geliefert zu bekommen. Sie wissen, dass Sie sich auf uns verlassen können!

Reliability is the basis for long-term partnerships. Just as your customer relies on you, you can rely on PROJAHN. Orders will be processed immediately. Usually, the goods will even be dispatched on the same day you placed the order. Furthermore, PROJAHN customers can count on getting goods in a consistently high quality. You know, you can rely on us!

Kompetenz

Expertise

PROJAHN verbindet umfangreiches Produkt-Know-how in einem einzigartigen Sortiment. Für Sie als PROJAHN-Kunde heißt das: Nur die besten Produkte finden Eingang in das breite Produktportfolio für Handwerk und Industrie. Profitieren Sie von dieser Produkt-Bandbreite durch einfache Beschaffungswege bei gleichzeitig konsistenter Qualität und hoher Kompetenz.

PROJAHN combines extensive product know-how with a unique product range. As a PROJAHN customer this means for you: Only the best products will be included into our large portfolio for craft and industry. Benefit from our large product range through easy procurement routes combined with constant quality and high expertise.

Persönliche Betreuung

Personal Support

Eine starke Verbindung zwischen Kunden und Lieferanten wird besonders durch persönliche Betreuung gewährleistet. Das PROJAHN-Team steht für Kontinuität in den persönlichen Kontakten. Sie können sich auf Ihren Partner PROJAHN verlassen.

Personal support ensures a strong alliance between customer and supplier. The PROJAHN team stands for consistency in personal contacts. You know whom to turn to – be it the field staff or the office staff. And you can rely on your contact partners.

Sofortige Lieferung

Immediate Delivery

PROJAHN hält nahezu alle im Katalog aufgeführten Artikel in ausreichender Menge im Logistikzentrum in Deutschland vor. Vom kleinsten Bohrer bis zum größten Werkstattwagen. Für Sie als Kunde heißt das: Sie erhalten fast jeden Artikel aus dem umfangreichen PROJAHN-Sortiment innerhalb von 24 Stunden!

Almost all of PROJAHN's articles which are listed in the catalogue are available in stock at the logistics center in Germany: from the smallest drill bit to the largest roller cabinet. This means for you as specialized dealer: You are able to supply your customers on short notice with the requested tools, even without having high stocks of your own.

Marketingservice

Customized Marketing Support

PROJAHN bietet Ihnen mit der Marketing-Serviceabteilung professionelle Lösungen zu Fragen der Kommunikation: Der vorliegende Katalog zum Beispiel ist nach den Wünschen unserer Partner besonders übersichtlich gestaltet, damit unsere Kunden das finden, was Sie benötigen!

PROJAHN's Marketing Support Department offers you professional communication and marketing: e.g. the new catalogue – which you just hold in your hands – is designed and optimized for ease of use correspond to the feedback of our partners. So our customers don't spend long time to search – they easily find what they need.

Innovationen

Innovations

PROJAHN verfügt über ein großes Kunden- und Lieferantennetzwerk. Die tägliche Arbeit führt häufig zu neuen und besseren Ideen, um innovative Lösungen zu entwickeln. Gemeinsam mit unseren Partnern entstehen daraus professionelle Werkzeuge, die die Arbeit erleichtern, effizienter und effektiver machen.

PROJAHN maintains an extensive customer and supplier network. Daily work often inspires us with new and better ideas, to come up with innovative product solutions. In cooperation with suppliers, we use these ideas to develop professional tools that make daily work easier increasing performance as well as effectiveness.

Qualität

Quality

PROJAHN beliefert professionelle Partner, deren Kundschaft aus Handwerk, Industrie und Gewerbe kommt. Der Qualitätsanspruch unserer Kunden ist hoch. Bei täglichem Einsatz müssen die Werkzeuge wertbeständig sein und stabil funktionieren. Nur mit guten Werkzeugen kann gute Arbeit geleistet werden. Wir liefern professionelle Qualität für professionelle Anwender. Dafür steht PROJAHN.

PROJAHN supplies professional partners from craft, industry and commerce. Our customers ask for high-quality tools. In daily use, tools have to be durable and function reliably. Because only good tools enable you to do a good job! Hence, we offer professional quality for professional users. That is what PROJAHN stands for.

Einzigtiges Produktportfolio

Sales-boosting Product Portfolio

Handwerkzeuge und Präzisionswerkzeuge werden täglich von jedem Handwerker und in der Industrie benötigt. PROJAHN bietet ein sowohl breites als auch tiefes Sortiment in beiden Bereichen, wie kein anderer Anbieter. Profitieren Sie von Synergien und optimierten Beschaffungswegen. Überzeugen Sie sich von der Leistungsfähigkeit eines einzigartigen Produktsortiments.

Hand and precision tools are used by craftsman and in industrial processes on a daily basis. Like no other provider, PROJAHN offers you a broad as well as deep product range out of both product fields. Benefit from synergies and optimized procurement routes. Convince yourself of the efficiency of our unique product range.

Qualität – Service – Zuverlässigkeit

Quality – Service – Reliability



Nachhaltigkeit Experience
Flexibilität Image Tradition
Kundennähe **Sustainability**
Individuality Qualität Erscheinungsbild Flexibility
Confidence **Zuverlässigkeit**
Kompetenz Reliability
Expertise Vertrauen Quality Customer Focus Erfahrung
Tradition Individualität

MARKE & WERTE
BRAND & VALUES



SERVICE & PARTNERSCHAFT
SERVICE & COMMERCIAL PARTNERSHIP

Professionelle Beratung
Flexibilität Customer Relationship **Persönliche Betreuung** Personal Support
Produkterschulungen Online-Competence E-Commerce
Lieferung zum Wunschtermin E-Commerce Online-Kompetenz Delivery on Customer Request nexmart
POS-Material **Sofortige Lieferung** Immediate Delivery
BME cat Flexibility nexmart 24/7 Service Beziehungsmangement BME cat
Individueller Marketingservice Customized Marketing Support
Professional Support Product Training immer erreichbar POS-Material



Produktweiterentwicklung **Neuheiten** New Products
Exklusivität **Innovationen** Innovations Deep Range of Products
Know-how Continuous Product Development Featured Articles Quality Management
Einzigartiges Produktportfolio Sales-boosting Product Portfolio
Sortimentsbreite **Qualität** Quality
Sortimentstiefe Sonderartikel Large Product Range
Exclusiveness

PRODUKTE & INNOVATIONEN
PRODUCTS & INNOVATIONS





Profi-Qualität

Professional Quality

- ▶ **Höchstes Qualitätsniveau für anspruchsvolle Anwender**
- ▶ **Präzision und Belastbarkeit weit über DIN-/ISO-Normen**
- ▶ **Ergonomisch optimiertes Kofferdesign – 2K-Koffergriff und klar strukturierte Anordnung der Werkzeuge**
- ▶ **Optimiert auf Langlebigkeit für höchste Ansprüche**
- ▶ *Highest level of quality for demanding users*
- ▶ *Precision and durability far beyond DIN/ISO standards*
- ▶ *Ergonomically optimized design – 2K-handle and clearly structured arrangement of the tools*
- ▶ *Optimized for durability for highest demands*

Einigartiges Produktportfolio

Unique Product Range

- ▶ **Breites Produktsortiment für verschiedenste Anwendungen**
- ▶ **14 professionelle Werkzeugkoffer optimiert für individuelle Ansprüche**
- ▶ **Innovative, zukunftsorientierte Werkzeugzusammenstellung**
- ▶ *Wide product range enables universal use*
- ▶ *14 professional tool sets optimized for individual requirements*
- ▶ *Innovative and future-oriented assortment of tools*

Exklusive Persönlichkeit

Exclusive Personality

- ▶ **Hochwertige, ausdrucksstarke Premium-Optik**
- ▶ **Langlebige und stabile Design-Metallverschlüsse**
- ▶ **Werkzeuge passgenau eingebettet in Schaumeinlagen mit attraktiver metallischer Oberflächenoptik**
- ▶ *High-quality, expressive premium-look*
- ▶ *Durable and stable design metal locks*
- ▶ *Tools perfectly embedded in foam insert with attractive metallic surface appearance*

Leistungsstarker Service

Powerful Support

- ▶ **PROJAHN Qualitätsversprechen – 25 Jahre Garantie¹**
- ▶ **Alle Einzelteile problemlos nachbestellbar**
- ▶ **Inklusive Servicezertifikat**
- ▶ **Qualifizierte Produktberatung**
- ▶ *PROJAHN's promise of quality – 25 years warranty¹*
- ▶ *All individual parts easily orderable*
- ▶ *Including certificate of service*
- ▶ *Qualified product advice*

¹ Entsprechend unserer allgemeinen Garantiebedingungen
⁴ According to our general warranty conditions





Ergonomisches Design

Ergonomic Design

- ▶ **Sicherer Halt und ermüdungsfreies Arbeiten durch ergonomisch an die Hand angepasste Griffform**
- ▶ **2-Komponentenmaterial – bruchsicherer, stabiler Kern und griffige Ummantelung mit hoher Rutschhemmung**
- ▶ **Hoher Abgleitschutz durch spezielle Daumenmulden**
- ▶ **Geringere Belastung für Gelenke bei gleichzeitig höherem Drehmoment**
- ▶ **Leichte Einhandbedienung durch Schnelllöseknopf und Richtungsumschalter**
- ▶ *Secure grip and fatigue-free working due to ergonomically to the hand designed ratchet handle*
- ▶ *Two-component material – robust core combined with an ergonomic, slip-resistant surface*
- ▶ *High slip protection due to specially adapted thumb grips*
- ▶ *Less strain on joints combined with a higher torque*
- ▶ *Easy one-handed operation because of quick-release button and direction lever*

EINGETRAGENES DESIGN

REGISTERED DESIGN



Profi-Qualität

Professional Quality

- ▶ **Höchstes Qualitätsniveau für anspruchsvolle Anwender**
- ▶ **Präzision und Belastbarkeit weit über DIN-/ISO-Normen**
- ▶ **Hält extremen Drehmomenten bis 650 Nm stand²**
- ▶ **Leichtgängiger, hochpräziser Knarrenmechanismus**
- ▶ **Hohe Öl- und Säurebeständigkeit**
- ▶ *Highest level of quality for demanding users*
- ▶ *Precision and durability far beyond DIN/ISO standards*
- ▶ *Withstands extreme torques up to 650 Nm⁽²⁾*
- ▶ *Smooth-running, high-precision ratchet mechanism*
- ▶ *High oil and acid resistance*

Leistungsstarker Service

Powerful Support

- ▶ **PROJAHN Qualitätsversprechen – 25 Jahre Garantie¹**
- ▶ **Schneller Reparaturservice im Garantiefall**
- ▶ *PROJAHN's promise of quality – 25 years warranty¹*
- ▶ *Fast repair service during warranty time*



¹ Entsprechend unserer allgemeinen Garantiebedingungen / ¹ According to our general warranty conditions
² 1/2" PROJAHN-Umschaltknarre 39012900 / ² PROJAHN ratchet handle 39012900



PROForm-Werkzeugeinlagen

PROForm Tool Inlays

Dieses Produkt finden Sie im Katalog auf Seite **H 43**
*You find this product in the catalogue on page **H 43***

NEU/NEW

Artikel-Gruppe/*Article-Group*: 171



PROFESSIONAL Werkzeugkoffer

PROFESSIONAL Tool Case

Diese Produkte finden Sie im Katalog auf den Seiten **H 60 - H 73**
*You find these products in the catalogue on pages **H 60 - H 73***

NEU/NEW

Artikel-Gruppe/*Article-Group*: 110



PROJAHN Umschaltknarren

PROJAHN Ratchets

Diese Produkte finden Sie im Katalog auf den Seiten **H 93**
*You find these products in the catalogue on pages **H 93***

NEU/NEW

Artikel-Gruppe/*Article-Group*: 120



KOMBI Bit-Box

Bit Box

Dieses Produkt finden Sie im Katalog auf Seite **H 173**
*You find this product in the catalogue on page **H 173***

NEU/NEW

Artikel-Gruppe/*Article-Group*: 131



TORSION Color Bit-Box

TORSION Color Bit Box

Dieses Produkt finden Sie im Katalog auf Seite **H 175**
*You find this product in the catalogue on page **H 175***

NEU/NEW

Artikel-Gruppe/*Article-Group*: 132



Quergriff Schraubendreher-Set

T-Handle Screwdriver Set

Dieses Produkt finden Sie im Katalog auf Seite **H 195**
*You find this product in the catalogue on page **H 195***

NEU/NEW

Artikel-Gruppe/*Article-Group*: 140



TURBALL® Winkelstiftschlüssel-Set

TURBALL® Ball Point Hex Key Set

Dieses Produkt finden Sie im Katalog auf Seite **H 200**
You find this product in the catalogue on page **H 200**

NEU/NEW

Artikel-Gruppe/Article-Group: 141



PROLUMAX Power LED-Universal-Spotlight

PROLUMAX Power LED Universal Spotlight

Dieses Produkt finden Sie im Katalog auf Seite **H 219**
You find this product in the catalogue on page **H 219**

NEU/NEW

Artikel-Gruppe/Article-Group: 184



PROLUMAX Power LED-Werkstattlampe

PROLUMAX Power LED Workshop Lamp

Dieses Produkt finden Sie im Katalog auf Seite **H 220**
You find this product in the catalogue on page **H 220**

NEU/NEW

Artikel-Gruppe/Article-Group: 184



PROFI Stemmeisen-/Stechbeitel-Sets

Professional Wood Chisel Sets

Diese Produkte finden Sie im Katalog auf Seite **H 222**
You find these products in the catalogue on page **H 222**

NEU/NEW

Artikel-Gruppe/Article-Group: 182



90° Winkel-Bohradapter

90° Drill Adapter

Dieses Produkt finden Sie im Katalog auf Seite **H 234**
You find this product in the catalogue on page **H 234**

NEU/NEW

Artikel-Gruppe/Article-Group: 182



TORX® Schraubenausdreher-Set

TORX® Screw Extractor Set

Dieses Produkt finden Sie im Katalog auf Seite **H 236**
You find this product in the catalogue on page **H 236**

NEU/NEW

Artikel-Gruppe/Article-Group: 182

Qualitätsabstufungen im Katalog

Quality Levels in Catalogue

Sehr geehrter Kunde, PROJAHN liefert Ihnen stets eine gleichbleibend hohe Qualität. Um Ihnen die Suche nach dem für Ihre Anforderungen optimalen Werkzeug so einfach wie möglich zu machen, finden Sie über jedem Produkt das PROJAHN-Qualitätssiegel. Folgende Qualitätsstufen gliedern zukünftig das gesamte PROJAHN-Sortiment:

Dear Customer, PROJAHN always provides you with consistently high quality. To make the search for the optimal tool for your needs as easy as possible, you find the PROJAHN Quality Seal on each product. The following grades are dividing the entire PROJAHN range:

Höchste Qualitätsstufe / Highest Quality Level:

PROFESSIONAL PLUS STANDARD

Mittlere Qualitätsstufe / Medium Quality Level:

PROFESSIONAL **PLUS** STANDARD

Standard Qualitätsstufe / Standard Quality Level:

PROFESSIONAL PLUS **STANDARD**

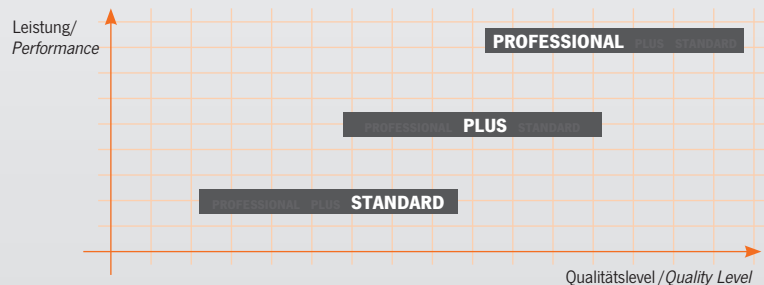
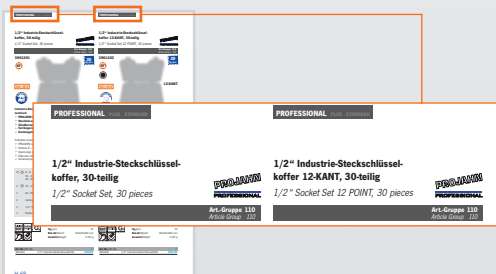

PROFESSIONAL

- ▶ Höchstes Qualitätsniveau für ausgezeichnete Präzision
- ▶ Übertrifft DIN- und ISO-Normen
- ▶ Für härteste Anwendungen bei geringem Verschleiß
- ▶ Sehr lange Lebensdauer
- ▶ Hochwertigste Materialien, professionelles Oberflächen-Finish
- ▶ Kompromisslose Qualität für höchste Ansprüche

PLUS

- ▶ Sehr hohes Qualitätsniveau für präzises Arbeiten
- ▶ Qualität über DIN- und ISO-Normen
- ▶ Werkzeuge für schwierige Anforderungen
- ▶ Für problemlösungsorientierte Anwender
- ▶ Hochwertige Herstellung, ergonomisches Design

STANDARD

- ▶ Gute Markenqualität
- ▶ Sehr attraktiver Preis für Profi-Niveau
- ▶ Qualität für alle Standard-Anwendungen

PROFESSIONAL

- ▶ Highest level of quality for excellent precision
- ▶ Exceeds DIN and ISO standards
- ▶ For the hardest applications by low wear
- ▶ Very long life time
- ▶ High-quality materials, professional finish
- ▶ Uncompromising quality for highest demands

PLUS

- ▶ Very high level of quality for highest precision
- ▶ Quality higher than DIN and ISO standards
- ▶ Tools for difficult requirements
- ▶ For problem-solving users
- ▶ High-quality manufacturing, ergonomic design

STANDARD

- ▶ Good brand quality
- ▶ Attractive price-performance ratio
- ▶ Quality for all standard applications



Werkstattwagen & Zubehör

Roller Cabinets & Accessories



Sätze, Einzelteile und Drehmomentschlüssel

Socket Sets, Accessories and Torque Wrenches



Schraubenschlüssel

Wrenches

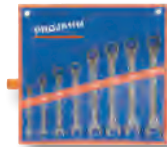

Bit-Programm

Bits



Schraubendreher & Winkelstiftschlüssel

Screwdriver & Hex Keys



Zangen

Pliers



Taschenlampen & Arbeitsleuchten

Flashlights & Working Lamps



Sonstige Werkzeuge

Other Tools



An diesen Zeichen erkennt man die gute PROJAHN-Qualität

You will recognize the good PROJAHN quality by these symbols

► Produktion nach DIN ISO 9001:

Unsere Produktionsstätten sind nach DIN ISO 9001 zertifiziert. Das ist die Basis unserer Qualitätsphilosophie.

► Stahl der höchsten Güteklasse:

Unsere Werkzeuge werden aus qualitativ hochwertigen Chrom-Vanadium- und S2-Stählen gefertigt. Damit ist sichergestellt, dass sämtliche DIN- und ANSI-Spezifikationen weit überschritten werden.

► Gute Werkzeuge sind für uns Ehrensache. Garantiert.

► Alles im Griff:

Optimale Eigenschaften des Griffes durch die Verwendung eines speziellen 'gummiartigen' Materials (TPE*). Im höchsten Maß Säure- und Ölbeständig. Dies garantiert eine lange Lebensdauer und gute Griffbarkeit.

*Thermoplastisches Elastomer

► Auch auf den Koffer kommt es an:

Unsere PE-Koffer sind robust und alltagstauglich. Da kann es schon mal etwas ruppiger zugehen. Unsere Koffer bleiben stabil.

► Eingetragene Warenzeichen

PHILLIPS®, POZIDRIV®, TRIWING®, TORQ® sind eingetragene Markenzeichen der Firma Phillips Screw Co. TORX®, TAMPER TORX® sind eingetragene Markenzeichen der Firma Camcar/Textron, Texas. XZN® ist eingetragenes Markenzeichen der Firma Bauer-Schaurte. RIBE® ist eingetragenes Markenzeichen der Firma Richard Berger. ASSY®, SIT® sind eingetragene Markenzeichen der Firma Adolf Würth GmbH. MultiFit, TOP-CLASS, PROForm, PROMobil, PROline sind eingetragene Markenzeichen der Firma PROJAHN Präzisionswerkzeuge GmbH.

► Größenangaben

1/4" = 6,35 mm | 3/8" = 9,52 mm | 1/2" = 12,70 mm
3/4" = 19,05 mm | 1" = 25,40 mm

DIN ISO
9001

CHROM
VANADIUM



► Manufacture in Accordance with DIN ISO 9001:

Our production centres are certified in accordance with DIN ISO 9001. This is the basis of our quality philosophy.

► Steel of the Highest Quality Standard:

Our tools are manufactured from high quality Chrome Vanadium and S2 steel. This ensures, that all DIN and ANSI specifications are well exceeded.

► Good tools are a matter of honor for us. Guaranteed.

► Everything in Your Hand:

Optimal features of the handle due to the special 'rubber like' material (TPE) used. Resistant to acid and oil to the highest degree. This guarantees a long service life and a good grip.*

**Thermoplastic elastomer*

► The case matters:

Our PE cases are robust and suitable for the working day. Things can become a bit rough sometimes. Our cases stay in shape.

► Registered Trademarks

PHILLIPS®, POZIDRIV®, TRIWING®, TORQ® are registered trademarks of the company Phillips Screw Co. TORX®, TAMPER TORX® are registered trademarks of the company Camcar/Textron. XZN® is a registered trademark of the company Bauer-Schaurte. RIBE® is a registered trademark of the company Richard Berger. ASSY®, SIT® are registered trademarks of the company Adolf Würth GmbH. MultiFit, TOP-CLASS, PROForm, PROMobil are registered trademarks of the company PROJAHN Präzisionswerkzeuge GmbH.

► Sizes

*1/4" = 6,35 mm | 3/8" = 9,52 mm | 1/2" = 12,70 mm
3/4" = 19,05 mm | 1" = 25,40 mm*



**Alle Module aus dem Kapitel
SYSTEMWAND finden Sie unter:**

All System Wall Racks you find at:

www.projahn.de/qr/pos/systemwand



**Alle Produkte aus dem Kapitel
WERBEMITTEL finden Sie unter:**

All Give-Aways you find at:

www.projahn.de/qr/werbemittel

Werkstattwagen & Zubehör

*Roller Cabinets
& Accessories*



PROJAHN Werkstattwagen und Zubehör – Qualität und Vielfalt

PROJAHN Roller Cabinets and Accessories – Quality and Variety

PROFESSIONAL **PLUS** STANDARD

5901, 5901-50, 5901-20

RedLine 7

SuperBlue

BlackLine

Die Profi-Werkstattwagen – Profi-Qualität im hervorragenden Preis-Leistungs-Verhältnis

Professional Roller Cabinets – Professional Quality with the best Value for Money



- ▶ **Hervorragendes PREIS-LEISTUNGS-VERHÄLTNIS:** Profi Qualität, hohe Sicherheit, Langlebigkeit und umfangreiches Zubehör
 - ▶ **LANGLEBIG und STABIL:**
Robuste Doppelwandkonstruktion mit 0,9 mm Materialstärke
 - ▶ **STRAPAZIERFÄHIG:** Hochstabile, kugelgelagerte Schubfachauszüge
 - ▶ **HOHE ARBEITSSICHERHEIT:**
Schubfächer-Sicherheits-Stopp-System (BG-konform)
 - ▶ **HOHES FASSUNGSVERMÖGEN:** 7 Schubfächer mit jeweils einer Belastbarkeit bis zu 40 kg
 - ▶ **HOCH STABIL:** Gesamtbelastbarkeit bis zu 600 kg
 - ▶ **HOHE SICHERHEIT:** Räder mit Roll- und Drehbremse
 - ▶ **STRAPAZIERFÄHIG:** Öl- und säurebeständige Rollen
 - ▶ **MULTIFUNKTIONAL:** Umfangreiches Zubehör
 - ▶ **INDIVIDUELL:** In 3 Farbkombinationen lieferbar
- ▶ *Best value for money: Professional quality, high safety and lots of accessories*
 - ▶ *Excellent stability and torsional stiffness:
Double wall construction with 0,9 mm material thickness*
 - ▶ *For heavy duty: Smooth-running and durable ball bearing slides*
 - ▶ *High work-safety: Only-One-Drawer (OOD) system – only one drawer at a time be opened*
 - ▶ *High capacity: 7 drawers with a capacity of up to 40 kg each*
 - ▶ *High stability: Max. overall capacity of up to 600 kg*
 - ▶ *High safety: Rolls with full break system*
 - ▶ *Hard-wearing: Robust oil and acid-resistant castors*
 - ▶ *Multifunctional: Extensive Range of accessories available*
 - ▶ *Individual: Available in 3 colour-combinations*



PROJAHN Werkstattwagen und Zubehör – Qualität und Vielfalt

PROJAHN Roller Cabinets and Accessories – Quality and Variety

PROFESSIONAL **PLUS** STANDARD

7901-50 **SPACELine**

Der clevere Profi-Werkstattwagen – Profi-Qualität mit cleverem Platzkonzept

The clever professional Roller Cabinet – Professional quality with a clever space concept

- ▶ **RIESIGES FASSUNGSVERMÖGEN:** 7 Schubfächer und zusätzlich 2 seitliche Türen mit diversen Staufächern
- ▶ **HOHE ARBEITSSICHERHEIT:** Schubfächer-Sicherheits-Stopp-System – nur ein Schubfach ausziehbar (BG-konform)
- ▶ **MEHR PLATZ FÜR IHRE WERKZEUGE:** Größere Arbeits- und Ablagefläche
- ▶ **ORDNUNG:** Mehr Übersichtlichkeit beim Arbeiten sowie beim Suchen von Werkzeugen
- ▶ **EXTREM STABIL:** Hohe Stabilität und Verwindungssteifigkeit
- ▶ **EINZIGARTIG und DAUERHAFT:** Öl- und säurebeständige Design-Hochglanzfelgen
- ▶ **PROFESSIONELL und ZEITLOS:** Modernes und durchdachtes Design
- ▶ **ERGONOMISCH:** Längerer Rollenabstand erleichtert das Bewegen des Wagens
- ▶ **EXTREM STABIL:** Gesamtbelastbarkeit bis 500 kg
- ▶ **HOHE SICHERHEIT:** Räder mit Roll- und Drehbremse

- ▶ *Huge capacity: 7 Drawers and additionally 2 side doors with more storage space*
- ▶ *High work-safety: Only-One-Drawer (OOD) System – only one drawer at a time may be openend*
- ▶ *More Space for your tools: Larger work & shelf space*
- ▶ *Organization: More clarity while working and when searching for tools*
- ▶ *Extremely stable: High stability and torsional stiffness*
- ▶ *Unique and durable: Sturdy oil and acid-resistant design mirror finish wheels*
- ▶ *Professional and timeless: Modern and sophisticated design*
- ▶ *Ergonomic: Wider axial distance facilitates the moving of the cabinet*
- ▶ *High stability: Total load up to 500 kg*
- ▶ *High safety: Rolls with full break system*



Katalog-Seite/Catalogue Page
H 16

PROFESSIONAL PLUS **STANDARD**

4901-50 **ECOBlue**

Der ökonomische Profi Werkstattwagen – Gute Qualität und Funktionalität zum fairen Preis!

The Economic Roller Cabinet – Good Quality and High Functionality at a Fair Price!

- ▶ **ÖKONOMISCH:** Gute Qualität, hohe Sicherheit und viele Funktionen zum fairen Preis
- ▶ **GUTE STABILITÄT:** Robuste Wandkonstruktion mit 0,8 mm Materialstärke
- ▶ **HOHE ARBEITSSICHERHEIT:** Schubfächer-Sicherheits-Stopp-System – nur ein Schubfach ausziehbar (BG-konform)
- ▶ **SOLIDE:** Stabile, kugelgelagerte Schubfachauszüge
- ▶ **ANSPRECHENDES FASSUNGSVERMÖGEN:** 6 Schubfächer mit jeweils einer Belastbarkeit bis zu 35 kg
- ▶ **FUNKTIONAL:** Umfangreiches Zubehör
- ▶ **STABIL:** Gesamtbelastbarkeit bis zu 400 kg
- ▶ **HOHE SICHERHEIT:** Räder mit Roll- und Drehbremse

- ▶ *Economic: Good quality, high safety and functionality at a fair price*
- ▶ *Good stability: Robust wall construction with 0,8 mm material thickness*
- ▶ *High work-safety: Only-One-Drawer (OOD) system – only one drawer at a time to be opened*
- ▶ *Smooth-running and durable ball bearing slides*
- ▶ *Good capacity: 6 drawers with a capacity of up to 35 kg each*
- ▶ *Functional: Accessories available*
- ▶ *High stability: Max. overall capacity of up to 400 kg*
- ▶ *High safety: Castors with full break system*



Katalog-Seite/Catalogue Page
H 18

Werkstattwagen

Roller Cabinets

RedLine 7

SuperBlue

BlackLine

Art.-Gruppe 170
Article Group 170

5901, 5901-50, 5901-20 **RedLine 7** **SuperBlue** **BlackLine**

Die Profi-Werkstattwagen – Profi-Qualität im hervorragenden Preis-Leistungs-Verhältnis

Professional Roller Cabinets – Professional Quality with the best value for money

- ▶ **Hohe Stabilität und Verwindungssteifigkeit durch Doppelwandkonstruktion**
- ▶ **Hervorragendes Preis-Leistungs-Verhältnis**
- ▶ **7 Schubfächer (5 x 75 mm , 2 x 154 mm Höhe)**
- ▶ **Leichtgängige und langlebige, kugelgelagerte Schubfächerauszüge mit sehr hoher Belastbarkeit**
- ▶ **Durch Zentral-Sicherheits-Stopp-System max. nur ein Schubfach ausziehbar (BG-konform)**
- ▶ **Schubfächer mit Vollauszug**
- ▶ **Inklusive Handgriff**
- ▶ **In den Farben Blau, Rot und Schwarz lieferbar**
- ▶ **Umfangreiches Zubehör verfügbar**
- ▶ **Zentralverriegelung durch Zylinderschloss reduziert Diebstahl von Werkzeugen**
- ▶ **Robuste, überdimensionierte öl- und säurebeständige Rollen**
- ▶ **Rollen mit Roll- und Drehbremse verhindern das Wegrollen des Werkstattwagens**
- ▶ **Jedes Schubfach kann mit bis zu 3 PROForm Werkzeugeinlagen individuell bestückt werden**



| | |
|---|---|
| Material/Material: | Stahlblech, pulverbeschichtet/Steel plates, powder-coated |
| Materialstärke/Material Thickness: | 0,9 mm |
| Konstruktion/Construction: | Doppelwandkonstruktion/Double wall construction |
| Farbe/Colour: | Blau, Rot, Schwarz/Blue, Red, Black |
| Abmessungen (HxBxD)/Dimensions (HxWxD): | 1.000 x 676 x 459 mm |
| Belastbarkeit pro Schubfach/Max. Capacity per Drawer: | 40 kg |
| Belastbarkeit insgesamt/Max. overall Capacity: | 600 kg |
| Gewicht/Weight: | 63 kg |
| Rollenabmessungen/Roll Dimensions: | Ø 127 x 50 mm |

Weitere technische Details siehe Seite H 22
More technical data please find on page H 22
Zubehör siehe Seiten H 15, H 19 - H 21
Accessories please find on pages H 15, H 19 - H 21
PROForm Werkzeugeinlagen ab Seite H 32
PROForm Tool Sets find from page H 32

- ▶ *High stability and torsional stiffness*
- ▶ *Top value for money*
- ▶ *7 Drawers (5 x 75 mm, 2x 154 mm Height)*
- ▶ *Smooth-running and durable ball bearing slides with high capacity*
- ▶ *Due to Only-One-Drawer (OOD) system - only one drawer at a time may be opened*
- ▶ *Full extension of drawers*
- ▶ *Robust oil and acid-resistant castors*
- ▶ *Full Break System*
- ▶ *One handhold included*
- ▶ *Available in Blue, Red and Black*
- ▶ *Central locking system prevents against larceny of tools*
- ▶ *Extensive range of accessories available*
- ▶ *Customized assembling with up to 3 PROForm inlays*



Kugelgelagerte Schubfächerauszüge
Ball Bearing Slides



Robuste Doppelwandkonstruktion
Robust double wall construction



Öl- und säurebeständige Rollen
Oil and acid resistant castors



Umfangreiches Zubehör
Extensive range of accessories

| Art.-Nr./Art.-No. | Farbe/Color | € |
|-------------------|---------------|---------------|
| 5901-50 | Blau/Blue | 879,00 |
| 5901 | Rot/Red | 879,00 |
| 5901-20 | Schwarz/Black | 879,00 |

Werkstattwagen Zubehör

Accessories for Roller Cabinets

RedLine 7

SuperBlue

BlackLine

Art.-Gruppe 173
Article Group 173

5902, 5902-50, 5902-20

RedLine 7

SuperBlue

BlackLine

Werkzeugkoffer mit 6 Schubfächern, leer

Tool Box with 6 drawers, empty

RedLine



5902

SuperBlue



5902-50

BlackLine



5902-20

- ▶ Der ideale Aufsatz für Ihren »RedLine«, »SuperBlue« oder »BlackLine« Werkstattwagen
- ▶ Schnelle und einfache Kapazitätserweiterung vorhandener Werkstattwagen
- ▶ 3 Schubfächer mit Innenmaß 75 x 269 x 568 mm
- ▶ Weitere 3 schmale Schubfächer für Kleinteile
- ▶ Herausnehmbarer Werkzeugeinsatz im Stauraum des Deckels
- ▶ Leichtgängige und langlebige, kugelgelagerte Schubfachauszüge
- ▶ Zentralverriegelung durch Schließen des Deckels
- ▶ Abschließbar durch Zylinderschloss
- ▶ Alle Schubfächer mit Vollauszug
- ▶ Inklusive 2 stabile Handgriffe
- ▶ Speziell angepasste PROForm Werkzeugeinlagen verfügbar

| | |
|---|---|
| Material/Material: | Stahlblech, pulverbeschichtet/Steel plates, powder-coated |
| Materialstärke/Material Thickness: | 0,9 mm |
| Farbe/Colour: | Blau, Rot, Schwarz/Blue, Red, Black |
| Abmessungen (HxBxT)/Dimensions (HxWxD): | 378 x 660 x 307 mm |
| Belastbarkeit pro Schubfach/Max. Capacity per Drawer: | 30 kg |
| Gewicht/Weight: | 25,5 kg |

- ▶ Ideal for putting on top of the »RedLine«, »SuperBlue« or »BlackLine« roller cabinet
- ▶ Fast and easy possibility to improve the capacity of your roller cabinet
- ▶ 3 Drawers with inside dimensions 75 x 269 x 568 mm
- ▶ 3 additional slim drawers for small parts
- ▶ Mobile tool set inlay inside of the case lid
- ▶ Smooth-running and durable ball bearing slides
- ▶ Locking all drawers by closing the top
- ▶ Full extension of drawers
- ▶ 2 handholds included
- ▶ Specific PROForm tool inlays available

Werkstattwagen »BlackLine«
und Werkzeugkoffer
Roller Cabinet »BlackLine«
and Tool Box

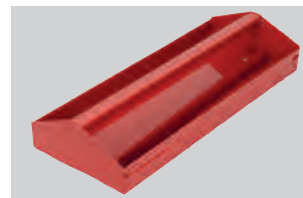

Mobiler Werkzeugeinsatz im Deckel
Removable Tool Set Inlay



Passende Werkzeugeinlagen verfügbar
Tool Inlays available



Weitere PROForm-Werkzeugeinlagen ab Seite /
More PROForm Inlays for Roller Cabinet from Page H 32

| Art.-Nr./Art.-No. | Farbe/Color | € |
|-------------------|---------------|--------|
| 5902 | Rot/Red | 371,00 |
| 5902-50 | Blau/Blue | 371,00 |
| 5902-20 | Schwarz/Black | 371,00 |

Werkstattwagen

Roller Cabinets

SPACE Line

Art.-Gruppe 170
Article Group 170

7901-50 **SPACE Line**

Der clevere Profi-Werkstattwagen – Profi-Qualität mit cleverem Platzkonzept

The clever professional Roller Cabinet – Professional quality with a clever space concept

- ▶ **Hohe Stabilität und Verwindungssteifigkeit durch Doppelwandkonstruktion**
- ▶ **Riesiges Fassungsvermögen durch 7 Schubfächer und zusätzlich 2 seitliche Türen mit diversen Staufächern**
- ▶ **7 Schubfächer (5 x 75 mm, 2 x 154 mm Höhe)**
- ▶ **Leichtgängige und langlebige, kugelgelagerte Schubfächerauszüge mit sehr hoher Belastbarkeit**
- ▶ **Durch Zentral-Sicherheits-Stopp-System max. nur ein Schubfach ausziehbar (BG-konform)**
- ▶ **Schubfächer mit Vollauszug**
- ▶ **Zentralverriegelung durch Zylinderschloss verhindert Diebstahl von Werkzeugen**
- ▶ **Alle Schubfächer und Seitentüren mit gleichem Schlüssel abschließbar**
- ▶ **Strapazierfähige, ölbeständige Design-Hochglanzräder**
- ▶ **Rollen mit Roll- und Drehbremse verhindern das Wegrollen des Werkstattwagens**
- ▶ **Inklusive Handgriff**
- ▶ **Jedes Schubfach kann mit bis zu 3 PROForm Werkzeugeinlagen individuell bestückt werden**



Anwendungsbeispiel/Example of use

| | |
|---|---|
| Material/Material: | Stahlblech, pulverbeschichtet/Steel plates, powder-coated |
| Materialstärke/Material Thickness: | 0,8 – 0,9 mm |
| Konstruktion/Construction: | Doppelwandkonstruktion/Double wall construction |
| Farbe/Colour: | Blau-Anthrazit/Blue-antracite |
| Abmessungen (HxBxT)/Dimensions (HxWxD): | 990 x 910 (990 inkl. Griff) x 475 mm |
| Belastbarkeit pro Schubfach/Max. Capacity per Drawer: | 40 kg |
| Belastbarkeit insgesamt/Max. overall Capacity: | 500 kg |
| Gewicht/Weight: | 72 kg |
| Rollenabmessungen/Roll Dimensions: | Ø 127 x 50 mm |

Weitere Technische Details siehe Seite H 26
More technical data please find on page H 26

Zubehör siehe Seite H 18, H 25
Accessories please find on page H 18, H 25

PROForm Werkzeugeinlagen ab Seite H 36
PROForm Tool Sets find from page H 36

- ▶ High stability and torsional stiffness
- ▶ High capacity because of 7 Drawers and additionally 2 side doors
- ▶ 7 Drawers (5 x 75 mm, 2 x 154 mm Height)
- ▶ Smooth-running and durable ball bearing slides with high capacity
- ▶ Due to Only-One-Drawer (OOD) system – only one drawer at a time may be opened
- ▶ Full extension of drawers
- ▶ Central locking system prevents against larceny of tools
- ▶ All Drawers and side doors lockable with only one key
- ▶ Robust oil and acid-resistant design mirror finish wheels
- ▶ Full Break System
- ▶ One handle included
- ▶ Customized assembling with up to 3 PROForm inlays



Maximaler Stauraum
Maximum storage space



Gasdruckfedern zum Öffnen & Schließen
Gas pressure spring for opening & closing



Design Hochglanzfelgen
Design Mirror Finish Wheels



Kugelgelagerte Schubfächerauszüge
Ball Bearing Slides

| Art.-Nr./Art.-No. | Farbe/Color | € |
|-------------------|--------------------------------|--------|
| 7901-50 | Blau-Anthrazit/Blue-anthracite | 969,00 |

Werkstattwagen – Zubehör und Ersatzteile

Roller Cabinets – Accessories and Spare Parts

SPACE Line

Art.-Gruppe 170
Article Group 170

SPACE Line

Ersatzrollen
Spare Castor



| Art.-Nr./Art.-No. | | € |
|-------------------|----------------------------|--------------|
| 5997-026 | Bockrolle/Fixed castor | 28,65 |
| 5997-027 | Lenkrolle/Dirigible castor | 33,85 |

SPACE Line

Schlösser-Set
Cylinder Lock Set

3 Schließzylinder mit je 2 Schlüsseln
3 Cylinder Locks each with 2 Keys



| Art.-Nr./Art.-No. | | € |
|-------------------|--|--------------|
| 5998-001SPACE | | 65,00 |

SPACE Line

Gasdruckfeder für Seitentür
Gas Pressure Spring for Side Door



| Art.-Nr./Art.-No. | | € |
|-------------------|--|--------------|
| 5997-029 | | 16,40 |

SPACE Line

Handgriff
Handle



| Art.-Nr./Art.-No. | | € |
|-------------------|--|--------------|
| 5997-028 | | 30,70 |



Werkstattwagen

Roller Cabinets

ECOBlue

Art.-Gruppe 170
Article Group 170

4901-50 **ECOBlue**

Der ökonomische Profi-Werkstattwagen – Gute Qualität und hohe Funktionalität zum fairen Preis! Werkstattwagen mit 6 Schubfächern

The economic Roller Cabinet – Good quality and high functionality at a fair price! Roller Cabinet, 6 drawers

- ▶ **Gute Stabilität und Verwindungssteifigkeit**
- ▶ **6 Schubfächer (3 x 75 mm, 3 x 154 mm Höhe)**
- ▶ **Leichtgängige, kugelgelagerte Schubfachauszüge**
- ▶ **Durch Zentral-Sicherheits-Stopp-System max. nur ein Schubfach ausziehbar (BG-konform)**
- ▶ **Zentralverriegelung durch Zylinderschloss**
- ▶ **Rollen: 2 x feststehend, 2 x lenkbar aus Kunststoff**
- ▶ **Rollen mit Roll- und Drehbremse verhindern das Wegrollen des Werkstattwagens**
- ▶ **Inklusive Handgriff zum einfachen Fortbewegen des Wagens und Kunststoffauflagematte**
- ▶ **Jedes Schubfach kann mit bis zu 3 PROForm-Werkzeugeinlagen individuell bestückt werden**



| | |
|---|---|
| Material/Material: | Stahlblech, pulverbeschichtet/ Steel plates, powder-coated |
| Materialstärke/Material Thickness: | 0,8 mm |
| Farbe/Colour: | Blau/Blue |
| Abmessungen (HxBxD)/Dimensions (HxWxD): | 1.010 x 678 x 459 mm |
| Belastbarkeit pro Schubfach/Max. Capacity per Drawer: | 35 kg |
| Belastbarkeit insgesamt/Max. overall Capacity: | 400 kg |
| Gewicht/Weight: | 50 kg |
| Rollenabmessungen/Roll Dimensions: | Ø 127 x 32 mm |

- ▶ *Good stability and torsional stiffness*
- ▶ *6 Drawers (3 x 75 mm, 3 x 154 mm Height)*
- ▶ *Smooth-running ball bearing slides*
- ▶ *Due to Only-One-Drawer (OOD) system – only one drawer at a time may be opened*
- ▶ *Central locking system*
- ▶ *Castors: PVC, 2 x fixed, 2 x dirigible*
- ▶ *Full Break System*
- ▶ *One handhold included*
- ▶ *Customized assembling with up to 3 PROForm inlays*

Weitere Technische Details siehe Seite H 22
More technical data please find on page H 22

Zubehör siehe Seiten H 19 - H 21
Accessories please find on pages H 19 - H 21

PROForm Werkzeugeinlagen ab Seite H 32
PROForm Tool Sets find from page H 32



Kugelgelagerte Schubfachauszüge
Ball Bearing Slides



Rollen mit Roll- und Drehbremse
Full Break System

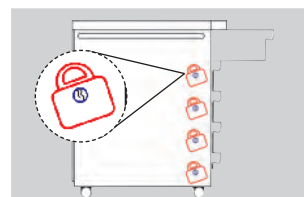

Zentralverriegelung
Central Locking System



Inklusive stabilem Handgriff
Handhold Included

| Art.-Nr./Art.-No. | Farbe/Color | € |
|-------------------|-------------|---------------|
| 4901-50 | Blau/Blue | 584,00 |

Werkstattwagen Zubehör für »RedLine«, »SuperBlue«, »BlackLine« und »ECOBlue«

Roller Cabinet Accessories for »RedLine«, »SuperBlue«, »BlackLine« and »ECOBlue«

Art.-Gruppe 173
Article Group 173

Ablage-Tisch
Side Table

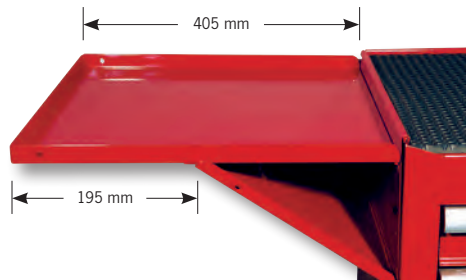

| Art.-Nr./Art.-No. | Farbe/Colour | € |
|-------------------|---------------|-------|
| 5907 | Rot/Red | 54,60 |
| 5907-20 | Schwarz/Black | 54,60 |
| 5907-50 | Blau/Blue | 54,60 |

Arbeitsauflage
aus Kunststoff
Top Table



Arbeitsauflage-
platte aus Holz,
15 mm stark
Wooden Top Table
15 mm



Kannen-/Dosenhalter
Can Holder

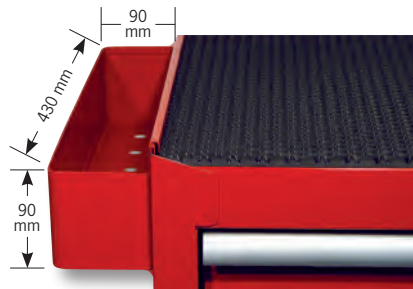

| Art.-Nr./Art.-No. | Farbe/Colour | € |
|-------------------|---------------|-------|
| 5908* | Rot/Red | 32,00 |
| 5908-20* | Schwarz/Black | 32,00 |
| 5908-50* | Blau/Blue | 32,00 |

*nicht passend für »ECOBlue«-Werkstattwagen
*not fitting »ECOBlue« Roller Cabinet

| Art.-Nr./Art.-No. | Beschr./Description | € |
|-------------------|--|-------|
| 5909 | Arbeitsauflage Kunststoff/Top Table | 88,20 |
| 5921 | Arbeitsauflageplatte Holz/Wooden Top Table | 69,50 |
| 5922 | Ersatzauflagematte/Replacement Pad | 20,50 |

Magnetische Lochwand
inkl. 10 Haken, 450 mm,
max. 6 kg

Magnetic Tool Rack with 10 hooks,
450 mm, max. 6 kg



| Art.-Nr./Art.-No. | tlg./pcs. | € |
|-------------------|--|-------|
| 5912 | 11 | 53,50 |
| 5912-10 | Einzelhaken 10er Pack/Single Hooks 10 pieces | 10,60 |

Magnetische Universalablage
Magnetic Tray

310 x 115 x 31 mm



Papierkorb zu Werkstattwagen
Plastic Cask



| Art.-Nr./Art.-No. | Belastbarkeit/Loading Capacity | € |
|-------------------|--------------------------------|-------|
| 5910 | max. 3,5 kg | 39,90 |
| 5911 | max. 4,0 kg | 42,60 |

| Art.-Nr./Art.-No. | Beschr./Description | € |
|-------------------|-------------------------|-------|
| 5913 | Papierkorb/Plastic Cask | 46,70 |

Werkstattwagen Zubehör für »RedLine«, »SuperBlue«, »BlackLine« und »ECOBlue«

Roller Cabinet Accessories for »RedLine«, »SuperBlue«, »BlackLine« and »ECOBlue«

Art.-Gruppe 173
Article Group 173

PROFESSIONAL PLUS STANDARD

5997-001

Handgriff »RedLine«
Handhold »RedLine«

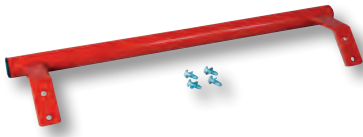

| Art.-Nr./Art.-No. | Beschr./Descr. | € |
|-------------------|----------------|--------------|
| 5997-001 | RedLine | 30,80 |

PROFESSIONAL PLUS STANDARD

5997-002

Handgriff »SuperBlue«/»ECOBlue«
Handhold »SuperBlue«/»ECOBlue«

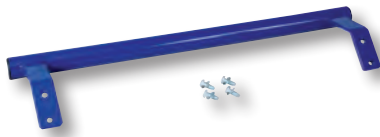

| Art.-Nr./Art.-No. | Beschr./Descr. | € |
|-------------------|-------------------|--------------|
| 5997-002 | SuperBlue/ECOBlue | 30,80 |

PROFESSIONAL PLUS STANDARD

5997-013

Handgriff »BlackLine«
Handhold »BlackLine«

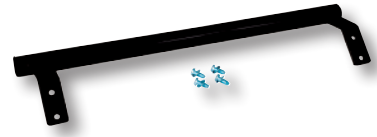

| Art.-Nr./Art.-No. | Beschr./Descr. | € |
|-------------------|----------------|--------------|
| 5997-013 | BlackLine | 30,80 |

PROFESSIONAL PLUS STANDARD

5997-003

Kugelgelagerter Schubfachauszug für »RedLine«, »SuperBlue«, »BlackLine« und »SpaceLine«
Ball Bearing Drawer Pullout for »RedLine«, »SuperBlue«, »BlackLine« and »SpaceLine«



| Art.-Nr./Art.-No. | Beschr./Descr. | € |
|-------------------|----------------|--------------|
| 5997-003 | Auszug | 30,80 |

PROFESSIONAL PLUS STANDARD

5997-014

Kugelgelagerter Schubfachauszug für »ECOBlue«
Ball Bearing Slides for »ECOBlue«



| Art.-Nr./Art.-No. | Beschr./Descr. | € |
|-------------------|----------------|--------------|
| 5997-014 | Auszug ECOBlue | 30,80 |

PROFESSIONAL PLUS STANDARD

5997-011 / 5997-012

Ersatzrollen für »RedLine«, »SuperBlue« und »BlackLine«
Spare Castor for »RedLine«, »SuperBlue« and »BlackLine«



5997-011
Bockrolle starr/
fixed castor

5997-012
Lenkrolle mit
Feststellfunktion/
dirigible castor with stopper

| Art.-Nr./Art.-No. | Beschr./Descr. | € |
|-------------------|----------------------------|--------------|
| 5997-011 | Bockrolle/fixed castor | 28,80 |
| 5997-012 | Lenkrolle/dirigible castor | 33,85 |

PROFESSIONAL PLUS STANDARD

5997-015 / 5997-016

Ersatzrollen für »ECOBlue«
Spare Castor for »ECOBlue«



| Art.-Nr./Art.-No. | Beschr./Descr. | € |
|-------------------|----------------------------|--------------|
| 5997-015 | Bockrolle/fixed castor | 24,90 |
| 5997-016 | Lenkrolle/dirigible castor | 30,00 |

5998-XXX (Bitte Nr. des Zylinders angeben)

Schließzylinder mit 2 Schlüsseln
Cylinder Lock and 2 Keys



| Art.-Nr./Art.-No. | Beschr./Descr. | € |
|-------------------|-----------------|--------------|
| 5998-XXX | Schließzylinder | 42,50 |

(Bitte Nr. des Zylinders angeben/Please state the cylinder number)

5996-XXX (Bitte Nr. des Zylinders angeben)

Schlüssel
Key



| Art.-Nr./Art.-No. | Beschr./Descr. | € |
|-------------------|----------------|--------------|
| 5996-XXX | Schlüssel | 13,20 |

(Bitte Nr. des Zylinders angeben/Please state the cylinder number)

Werkstattwagen Zubehör für alle PROJAHN Werkstattwagen

Roller Cabinet Accessories for every PROJAHN Roller Cabinet

Art.-Gruppe 173
Article Group 173

5914

Schubfachunterteiler: Basiselement
566 x 65,6 x 1 mm aus Metall
(pro Schublade 2 Stück erforderlich)
Drawer Divider of Front and Back Side
(2 pieces per drawer required)

5915

Schubfachunterteiler: gerade/längs
392 x 60 x 1,4 mm aus Metall
Drawer Divider of Straight

5916

Schubfachunterteiler „XL“
187,9 x 50 x 1,4 mm aus Metall
Drawer Divider „XL“

5917

Schubfachunterteiler „L“
149,9 x 50 x 1,4 mm aus Metall
Drawer Divider „L“

| Art.-Nr./Art.-No. | Beschr./Description | € |
|-------------------|---------------------|-------|
| 5914 | Basis | 9,21 |
| 5915 | gerade/längs | 6,00 |
| 5916 | XL | 2,29 |
| 5917 | L | 2,05 |
| 5918 | M | 1,80 |
| 5919 | S | 1,54 |
| 5920 | Set | 52,00 |

5918

Schubfachunterteiler „M“
111,9 x 50 x 1,4 mm aus Metall
Drawer Divider „M“

5919

Schubfachunterteiler „S“
79,4 x 50 x 1,4 mm aus Metall
Drawer Divider „S“

5920

Schubfachunterteiler Set
Drawer Divider Set
Inhalt/Contents:
2x Basiselement (5914)
4x Unterteiler „gerade“ (5915)
2x Unterteiler „XL“ (5916)
2x Unterteiler „L“ (5917)
3x Unterteiler „M“ (5918)
4x Unterteiler „S“ (5919)

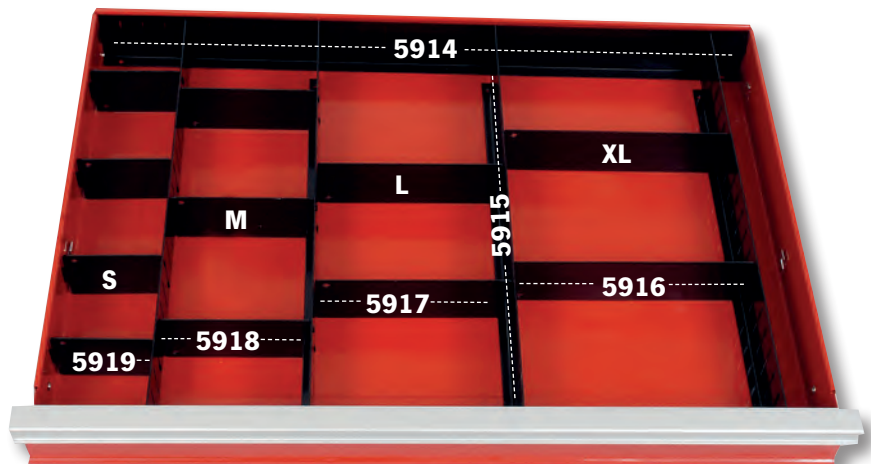

Wie in Artikel 5920 beschrieben / Similar to Art. 5920

Magnetschalen

Magnetic Trays

Mit starkem, gummiüberzogenen Dauermagneten.
Zum Aufbewahren von Kleinwerkzeugen und Kleinteilen
wie Schrauben und Muttern bei Montage und im
Garagengewerbe.
Magnetkraft bis 1200 g.

With strong, rubber protected continous magnets.
Optimal to store small tools and parts, such as screws and
nuts, at instalation jobs and in the automotive field.
Magnetic power up to 1200 g.



| Art.-Nr./Art.-No. | Größe/Size | € |
|-------------------|--------------------------------|-------|
| 2950 | Ø 150 mm rund/round | 13,90 |
| 2951 | 240 x 140 mm eckig/rectangular | 26,65 |

Werkstattwagen – Technische Daten

Roller Cabinets – Technical Data

5901, 5901-50, 5901-20

RedLine 7

SuperBlue

BlackLine

Material: Stahlblech, pulverbeschichtet
 Materialstärke: 0,9 mm
 Konstruktion: Doppelwandkonstruktion
 Farben: Blau, Rot, Schwarz
 Abmessungen (HxBxT): 1.000 x 676 x 459 mm
 Anzahl Schubfächer: 7
 Höhe Schubfächer: 2 x 154 mm, 5 x 75 mm
 Innenabm. Schubf. (BxT): 560 x 395 mm
 Belastbarkeit pro Schubfach: 40 kg
 Belastbarkeit insgesamt: 600 kg
 Gewicht: 63 kg
 Rollenabmessung (ØxB): 127 x 50 mm

Material: Steel plates, powder-coated
 Material thickness: 0,9 mm
 Construction: Double wall construction
 Colours: Blue, Red, Black
 Dimensions (HxWxD): 1.000 x 676 x 459 mm
 Number of drawers: 7
 Height of drawers: 2 x 154 mm, 5 x 75 mm
 Inside dimensions drawers (WxD): 560 x 395 mm
 Max. Capacity per drawer: 40 kg
 Max. overall Capacity: 600 kg
 Weight: 63 kg
 Dimensions rolls (ØxB): 127 x 50 mm

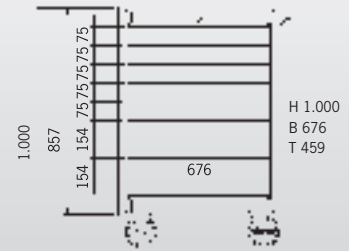

7901-50

SPACE Line

Material: Stahlblech, pulverbeschichtet
 Materialstärke: 0,8 - 0,9 mm
 Konstruktion: Doppelwandkonstruktion
 Farbe: Blau/Anthrazit
 Abmessungen (HxBxT): 990 x 910 (990 inkl. Griff) x 475 mm
 Anzahl Schubfächer: 7
 Höhe Schubfächer: 2 x 154, 5 x 75 mm
 Innenabm. Schubf. (BxT): 560 x 395 mm
 Belastbarkeit pro Schubfach: 40 kg
 Belastbarkeit insgesamt: 500 kg
 Gewicht: 72 kg
 Rollenabmessung (ØxB): 127 x 50 mm

Material: Steel plates, powder-coated
 Material thickness: 0,8 - 0,9 mm
 Construction: Double wall construction
 Colour: Blue/Anthracite
 Dimensions (HxWxD): 990 x 910 (990 incl. Handle) x 475 mm
 Number of drawers: 7
 Height of drawers: 2 x 154 mm, 5 x 75 mm
 Inside dimensions drawers (WxD): 560 x 395 mm
 Max. Capacity per drawer: 40 kg
 Max. overall Capacity: 500 kg
 Weight: 72 kg
 Dimensions rolls (ØxB): 127 x 50 mm

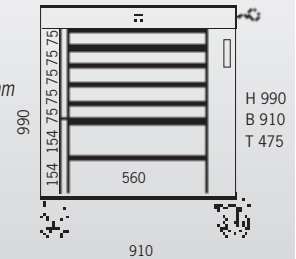

4901-50

ECOBlue

Material: Stahlblech, pulverbeschichtet
 Materialstärke: 0,8 mm
 Farbe: Blau
 Abmessungen (HxBxT): 1.010 x 676 x 459 mm
 Anzahl Schubfächer: 6
 Höhe Schubfächer: 3 x 154, 3 x 75 mm
 Innenabm. Schubf. (BxT): 560 x 395 mm
 Belastbarkeit pro Schubfach: 35 kg
 Belastbarkeit insgesamt: 400 kg
 Gewicht: 50 kg
 Rollenabmessung (ØxB): 127 x 32 mm

Material: Steel plates, powder-coated
 Material thickness: 0,8 mm
 Colour: Blue
 Dimensions (HxWxD): 1.010 x 676 x 459 mm
 Number of drawers: 6
 Height of drawers: 3 x 154 mm, 3 x 75 mm
 Inside dimensions drawers (WxD): 560 x 395 mm
 Max. Capacity per drawer: 30 kg
 Max. overall Capacity: 300 kg
 Weight: 50 kg
 Dimensions rolls (ØxB): 127 x 32 mm



PROForm-Box – Koffersystem für PROForm Werkstattwagen-Einlagen

PROForm-Box – Cases for PROForm Inlays

Art.-Gruppe 172/179
Article Group 172/179

5953

PROForm-Box 1: Mobiler Koffer für eine PROForm-Werkzeug-Einlage (395 x 186 mm)

PROForm-Box 1: Mobile Case for one PROForm Tool Inlay (395 x 186 mm)

Stellen Sie sich Ihren eigenen Werkzeugkoffer zusammen oder machen Sie Ihre Werkstattwagen-Werkzeuge noch mobiler!

Customize your own Tool Set or make your Roller Cabinet Tools available!

- ▶ **INDIVIDUELL und BEQUEM:** Konfigurieren Sie Ihren eigenen Werkzeugkoffer oder wählen Sie aus unseren Topseller-Konfigurationen
 - ▶ **KOMPAKT:** Platzsparend und daher ideal für unterwegs
 - ▶ **MOBIL und FLEXIBEL:** Benötigte Werkzeug-Einlage vom Werkstattwagen in die PROForm-Box umpacken und mitnehmen
 - ▶ **STABIL und LANGLEBIG:** Sichere und saubere Werkzeugaufbewahrung
-
- ▶ *INDIVIDUAL and COMFORTABLE:* Customize your own tool set or choose from our top-seller configurations
 - ▶ *COMPACT:* Space saving and therefore ideal for mobile use
 - ▶ *MOBILE and FLEXIBLE:* PROForm-Box is able to fit one PROForm inlay from your roller cabinet which makes your tools mobile
 - ▶ *DURABLE:* Tools are secured to be shock and jolt-proof



5953-011
PROForm-BOX mit Einlage Ringgabelschlüssel/
PROForm-BOX incl. Combination Wrench Inlay



5953-021
PROForm-BOX mit Einlage Doppelgabelschlüssel/
PROForm-BOX incl. Double Open End Wrench Inlay



5953-131
PROForm-BOX mit Einlage 1/2" Steckschlüssel/
PROForm-BOX incl. 1/2" Socket Inlay



5953-065
PROForm-BOX mit Einl. PH-/PZ-/Schlitz-Schraubendr./
PROForm-BOX incl. PH-/PZ-/Slotted Screwdriver Inlay



5953-082
PROForm-BOX mit Einlage Zangen/
PROForm-BOX incl. Pliers Inlay



5953-101
PROForm-BOX mit Einlage Schlagwerkzeuge/
PROForm-BOX incl. Hammer and Punch Inlay

Weitere PROForm-Werkstatteinlagen ab Seite /
More PROForm Inlays for Roller Cabinet from Page **H 32**

| Art.-Nr./Art.-No. | Beschreibung/Description | tlg./pcs | € |
|-------------------|---|----------|---------------|
| 5953 | PROForm-Box 1 – Leerkoffer/Empty Box | | 10,30 |
| 5953-011 | PROForm-Box mit Einlage Ringgabelschlüssel/ <i>incl. Combination Wrench Inlay</i> | 16 | 99,90 |
| 5953-021 | PROForm-Box mit Einlage Doppelgabelschlüssel/ <i>incl. Double Open End Wrench Inlay</i> | 8 | 74,50 |
| 5953-131 | PROForm-Box mit Einlage 1/2" Steckschlüssel/ <i>incl. 1/2" Socket Inlay</i> | 24 | 181,60 |
| 5953-065 | PROForm-Box mit Einlage PH-/PZ-/Schlitz-Schraubendreher/ <i>incl. PH-/PZ-/Slotted Screwdriver Inlay</i> | 8 | 87,20 |
| 5953-082 | PROForm-Box mit Einlage Zangen/ <i>incl. Pliers Inlay</i> | 4 | 149,00 |
| 5953-101 | PROForm-Box mit Einlage Schlagwerkzeuge/ <i>incl. Hammer and Punch Inlay</i> | 6 | 98,00 |

PROForm-Box – Koffersystem für PROForm Werkstattwagen-Einlagen

PROForm-Box – Cases for PROForm Inlays

Art.-Gruppe 172/179
Article Group 172/179

5954

PROForm-Box 3: Mobiler Koffer für eine PROForm-Werkzeug-Einlage (395 x 560 mm) oder drei Werkzeug-Einlagen (395 x 186 mm)

PROForm-Box 3: Mobile Case for one PROForm Tool Inlay
(395 x 560 mm) or Three Tool Inlays (395 x 186 mm)

Stellen Sie sich Ihren eigenen Werkzeugkoffer zusammen oder machen Sie Ihre Werkstattwagen-Werkzeuge noch mobiler!

Customize your own Tool Set or make your Roller Cabinet Tools available!

- ▶ **INDIVIDUELL:** Konfigurieren Sie Ihren eigenen Werkzeugkoffer aus bis zu drei PROForm-Einlagen
- ▶ **BEQUEM:** Oder wählen Sie aus unseren Topseller-Konfigurationen
- ▶ **MOBIL und FLEXIBEL:** Benötigte Werkzeug-Einlage vom Werkstattwagen in die PROForm-Box umpacken und mitnehmen
- ▶ **STABIL und LANGLEBIG:** Sichere und saubere Werkzeugaufbewahrung

- ▶ *INDIVIDUAL:* Customize your own tool set from up to three PROForm inlays
- ▶ *COMFORTABLE:* Or choose from our top-seller configurations
- ▶ *MOBILE and FLEXIBLE:* PROForm-Box is able to fit up to three PROForm inlays from your roller cabinet which makes your tools mobile
- ▶ *DURABLE:* Tools are secured to be shock and jolt-proof



5954-001 - Set, 48-tgl./48 pcs.
PROForm-BOX Set bestehend aus/
composed of 5999-011 + 5999-131 + 5999-065

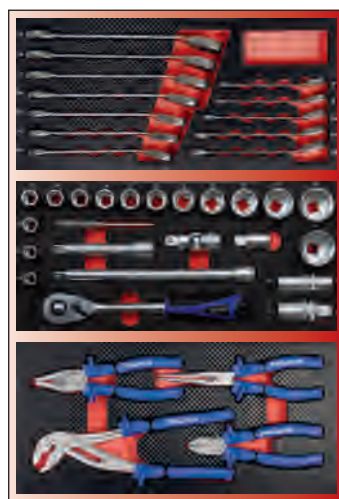

5954-002 - Set, 39-tgl./39 pcs.
PROForm-BOX Set bestehend aus/
composed of 5999-041 + 5999-531 + 5999-082

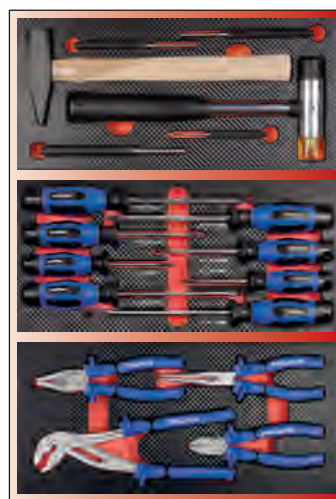

5954-003 - Set, 18-tgl./18 pcs.
PROForm-BOX Set bestehend aus/
composed of 5999-101 + 5999-065 + 5999-082

Weitere PROForm-Werkstatteinlagen ab Seite /
More PROForm Inlays for Roller Cabinet from Page **H 32**

| Art.-Nr./Art.-No. | Beschreibung/Description | tlg./pcs | € |
|-------------------|--|----------|---------------|
| 5954 | PROForm-Box 3 – Leerkoffer/Empty Box | | 32,00 |
| 5954-001 | PROForm-Box Set 3 bestehend aus/composed of 5999-011 + 5999-131 + 5999-065 | 48 | 373,00 |
| 5954-002 | PROForm-Box Set 3 bestehend aus/composed of 5999-041 + 5999-531 + 5999-082 | 39 | 535,50 |
| 5954-003 | PROForm-Box Set 3 bestehend aus/composed of 5999-101 + 5999-065 + 5999-082 | 18 | 350,70 |

Werkstattwagen-Bestückung für 2 Schubfächer, 67-teilig

Roller Cabinet Sets for 2 Drawers, 67 pieces

67
tlg./pcs.

Art.-Gruppe 171/172
Article Group 171/172

Wählen Sie Ihren Werkstattwagen mit Bestückung oder nur die Bestückung

Choose your Roller Cabinet with Sets
or only the sets



Legende auf Seite H 36

| Art.-Nr./Art.-No. | Produkt/Product |
|-------------------|--|
| 5995-001 | Bestückung 67-tlg./ Sets with 67 pcs. |
| € 612,00 | |
| 7901-501 | Werkstattw. »SpaceLine«, 7 Schubf. |
| € 1.529,00 | mit Bestückung/with Sets |
| 5901-101 | Werkstattw. »RedLine«, 7 Schubf. |
| € 1.455,00 | mit Bestückung/with Sets |
| 5901-551 | Werkstattw. »SuperBlue«, 7 Schubf. |
| € 1.455,00 | mit Bestückung/with Sets |
| 5901-201 | Werkstattw. »BlackLine«, 7 Schubf. |
| € 1.455,00 | mit Bestückung/with Sets |
| 4901-501 | Werkstattw. »ECOBlue«, 6 Schubf. |
| € 1.139,00 | mit Bestückung/with Sets |

7901-501

**Werkstattwagen »SpaceLine«
mit 7 Schubfächern, bestückt**
Roller Cabinet »SpaceLine«,
7 Drawers with Sets

5901-101

**Werkstattwagen »RedLine«
mit 7 Schubfächern, bestückt**
Roller Cabinet »RedLine«, 7 Drawers with Sets

5901-551

Werk. »SuperBlue« mit 7 Schubfächern, bestückt
Roller Cabinet »SuperBlue«, 7 Drawers with Sets

5901-201

Werkstattwagen »BlackLine« mit 7 Schubfächern, bestückt
Roller Cabinet »BlackLine«, 7 Drawers with Sets

4901-501

Werkstattwagen »ECOBlue« mit 6 Schubfächern, bestückt
Roller Cabinet »ECOBlue«, 6 Drawers with Sets



5995-001

Bestehend aus / Composed of

5999-131 + 5999-011 + 5999-021 + 5999-082 + 5999-065 + 5999-101



Werkstattwagen-Bestückung für 2 Schubfächer, 148-teilig

Roller Cabinet Sets for 2 Drawers, 148 pieces

148
tlg./pcs.

Art.-Gruppe 171/172
Article Group 171/172

Wählen Sie Ihren Werkstattwagen mit Bestückung oder nur die Bestückung

Choose your Roller Cabinet with Sets
or only the sets



Legende auf Seite H 36

| Art.-Nr./Art.-No. | Produkt/Product |
|-------------------|--|
| 5995-002 | Bestückung 148-tlg./ Sets with 148 pcs. |
| € 866,00 | |
| 7901-502 | Werkstattw. »SpaceLine«, 7 Schubf. |
| € 1.779,00 | mit Bestückung/with Sets |
| 5901-102 | Werkstattw. »RedLine«, 7 Schubf. |
| € 1.695,00 | mit Bestückung/with Sets |
| 5901-552 | Werkstattw. »SuperBlue«, 7 Schubf. |
| € 1.695,00 | mit Bestückung/with Sets |
| 5901-202 | Werkstattw. »BlackLine«, 7 Schubf. |
| € 1.695,00 | mit Bestückung/with Sets |
| 4901-502 | Werkstattw. »ECOBlue«, 6 Schubf. |
| € 1.299,00 | mit Bestückung/with Sets |

7901-502

**Werkstattwagen »SpaceLine«
mit 7 Schubfächern, bestückt**
Roller Cabinet »SpaceLine«,
7 Drawers with Sets

5901-102

**Werkstattwagen »RedLine«
mit 7 Schubfächer, bestückt**
Roller Cabinet »RedLine«, 7 Drawers with Sets

5901-552

Werkst. »SuperBlue« mit 7 Schubfächer, bestückt
Roller Cabinet »SuperBlue«, 7 Drawers with Sets

5901-202

Werkstattwagen »BlackLine« mit 7 Schubfächer, bestückt
Roller Cabinet »BlackLine«, 7 Drawers with Sets

4901-502

Werkstattwagen »ECOBlue« mit 6 Schubfächer, bestückt
Roller Cabinet »ECOBlue«, 6 Drawers with Sets



5995-002

Bestehend aus / Composed of

5999-111 + 5999-131 + 5999-191 + 5999-011 + 5999-082 + 5999-065

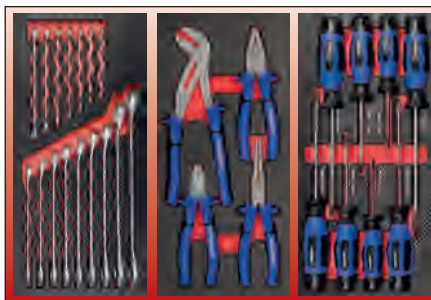

Werkstattwagen-Bestückung für 3 Schubfächer, 171-teilig

Roller Cabinet Sets for 3 Drawers, 171 pieces

171
tlg./pcs.

Art.-Gruppe 171/172
Article Group 171/172

Wählen Sie Ihren Werkstattwagen mit Bestückung oder nur die Bestückung

Choose your Roller Cabinet with Sets
or only the sets



Legende auf Seite H 36

| Art.-Nr./Art.-No. | Produkt/Product |
|-------------------|--|
| 5995-011 | Bestückung 171-tlg./ Sets with 171 pcs. |
| € 1.116,00 | |
| 7901-511 | Werkstattw. »SpaceLine«, 7 Schubf. |
| € 2.035,00 | mit Bestückung/with Sets |
| 5901-111 | Werkstattw. »RedLine«, 7 Schubf. |
| € 1.955,00 | mit Bestückung/with Sets |
| 5901-511 | Werkstattw. »SuperBlue«, 7 Schubf. |
| € 1.955,00 | mit Bestückung/with Sets |
| 5901-211 | Werkstattw. »BlackLine«, 7 Schubf. |
| € 1.955,00 | mit Bestückung/with Sets |
| 4901-511 | Werkstattw. »ECOBlue«, 6 Schubf. |
| € 1.559,00 | mit Bestückung/with Sets |

7901-511

Werkstattwagen »SpaceLine« mit 7 Schubfächern, bestückt

Roller Cabinet »SpaceLine«,
7 Drawers with Sets

5901-111

Werkstattwagen »RedLine« mit 7 Schubfächern, bestückt

Roller Cabinet »RedLine«, 7 Drawers with Sets

5901-511

Werkst. »SuperBlue« mit 7 Schubfächern, bestückt

Roller Cabinet »SuperBlue«, 7 Drawers with Sets

5901-211

Werkstattwagen »BlackLine« mit 7 Schubfächern, bestückt

Roller Cabinet »BlackLine«, 7 Drawers with Sets

4901-511

Werkstattwagen »ECOBlue« mit 6 Schubfächern, bestückt

Roller Cabinet »ECOBlue«, 6 Drawers with Sets



5995-011

Bestehend aus / Composed of

5999-111 + 5999-131 + 5999-191 + 5999-011 + 5999-321 + 5999-021 +
5999-082 + 5999-065 + 5999-101

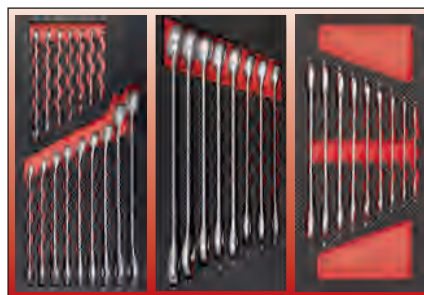

Werkstattwagen-Bestückung für 4 Schubfächern, 179-teilig

Roller Cabinet Sets for 4 Drawers, 179 pieces

179
tlg./pcs.

Art.-Gruppe 171/172
Article Group 171/172

Wählen Sie Ihren Werkstattwagen mit Bestückung oder nur die Bestückung

Choose your Roller Cabinet with Sets or only the sets



Legende S. H 36

| Art.-Nr./Art.-No. | Produkt/Product |
|-------------------|---|
| 5995-023 | Bestückung 179-tlg./ Sets with 179 pcs. |
| € 1.245,00 | |
| 7901-523 | Werkstattw. »SpaceLine«, 7 Schubf. mit Bestückung/with Sets |
| € 2.219,00 | |
| 5901-123 | Werkstattw. »RedLine«, 7 Schubf. mit Bestückung/with Sets |
| € 2.085,00 | |
| 5901-523 | Werkstattw. »SuperBlue«, 7 Schubf. mit Bestückung/with Sets |
| € 2.085,00 | |
| 5901-223 | Werkstattw. »BlackLine«, 7 Schubf. mit Bestückung/with Sets |
| € 2.085,00 | |
| 4901-523 | Werkstattw. »ECOBlue«, 6 Schubf. mit Bestückung/with Sets |
| € 1.825,00 | |

7901-523

Werkstattwagen »SpaceLine« mit 7 Schubfächern, bestückt
Roller Cabinet »SpaceLine«, 7 Drawers with Sets

5901-123

Werkstattwagen »RedLine« mit 7 Schubfächern, bestückt
Roller Cabinet »RedLine«, 7 Drawers with Sets

5901-523

Werkst. »SuperBlue« mit 7 Schubfächern, bestückt
Roller Cabinet »SuperBlue«, 7 Drawers with Sets

5901-223

Werkstattwagen »BlackLine« mit 7 Schubfächern, bestückt
Roller Cabinet »BlackLine«, 7 Drawers with Sets

4901-523

Werkstattwagen »ECOBlue« mit 6 Schubfächern, bestückt
Roller Cabinet »ECOBlue«, 6 Drawers with Sets



5995-023

Bestehend aus / Composed of

5999-111 + 5999-131 + 5999-191 + 5999-011 + 5999-321 + 5999-021 +
5999-065 + 5999-062 + 5999-101 + 5999-082 + 5999-171 + 5999-331

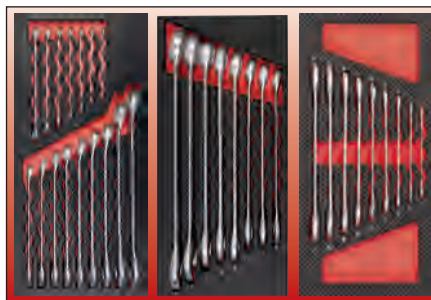

Werkstattwagen-Bestückung für 4 Schubfächern, 198-teilig

Roller Cabinet Sets for 4 Drawers, 198 pieces

198
tlg./pcs.

Art-Gruppe 171/172
Article Group 171/172

Wählen Sie Ihren Werkstattwagen mit Bestückung oder nur die Bestückung

Choose your Roller Cabinet with Sets
or only the sets



Legende S. H 36

| Art.-Nr./Art.-No. | Produkt/Product |
|-------------------|--|
| 5995-022 | Bestückung 198-tlg./ Sets with 198 pcs. |
| € 1.335,00 | |
| 7901-522 | Werkstattw. »SpaceLine«, 7 Schubf. mit Bestückung/with Sets |
| € 2.475,00 | |
| 5901-122 | Werkstattw. »RedLine«, 7 Schubf. mit Bestückung/with Sets |
| € 2.155,00 | |
| 5901-522 | Werkstattw. »SuperBlue«, 7 Schubf. mit Bestückung/with Sets |
| € 2.155,00 | |
| 5901-222 | Werkstattw. »BlackLine«, 7 Schubf. mit Bestückung/with Sets |
| € 2.155,00 | |
| 4901-522 | Werkstattw. »ECOBlue«, 6 Schubf. mit Bestückung/with Sets |
| € 1.865,00 | |

7901-522

Werkstattwagen »SpaceLine« mit 7 Schubfächern, bestückt

Roller Cabinet »SpaceLine«,
7 Drawers with Sets

5901-122

Werkstattwagen »RedLine« mit 7 Schubfächern, bestückt

Roller Cabinet »RedLine«, 7 Drawers with Sets

5901-522

Werkst. »SuperBlue« mit 7 Schubfächern, bestückt

Roller Cabinet »SuperBlue«, 7 Drawers with Sets

5901-222

Werkstattwagen »BlackLine« mit 7 Schubfächern, bestückt

Roller Cabinet »BlackLine«, 7 Drawers with Sets

4901-522

Werkstattwagen »ECOBlue« mit 6 Schubfächern, bestückt

Roller Cabinet »ECOBlue«, 6 Drawers with Sets



5995-022

Bestehend aus / Composed of

5999-111 + 5999-131 + 5999-191 + 5999-011 + 5999-321 + 5999-021 +
5999-065 + 5999-082 + 5999-101 + 5999-181 (Dreifacheinlage/Triple Set)

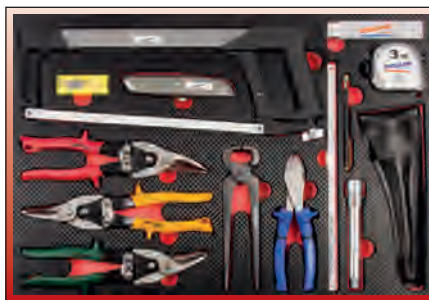
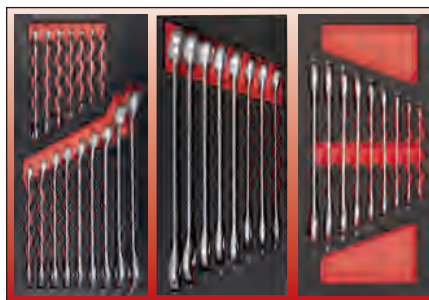

Werkstattwagen-Bestückung für 4 Schubfächern, 210-teilig

Roller Cabinet Sets for 4 Drawers, 210 pieces

210
tlg./pcs.

Art.-Gruppe 171/172
Article Group 171/172

Wählen Sie Ihren Werkstattwagen mit Bestückung oder nur die Bestückung

Choose your Roller Cabinet with Sets
or only the sets



Legende S. H 36

| Art.-Nr./Art.-No. | Produkt/Product |
|-------------------|--|
| 5995-021 | Bestückung 210-tlg./ Sets with 210 pcs. |
| € 1.245,00 | |
| 7901-521 | Werkstattw. »SpaceLine«, 7 Schubf. mit Bestückung/with Sets |
| € 2.185,00 | |
| 5901-121 | Werkstattw. »RedLine«, 7 Schubf. mit Bestückung/with Sets |
| € 2.085,00 | |
| 5901-521 | Werkstattw. »SuperBlue«, 7 Schubf. mit Bestückung/with Sets |
| € 2.085,00 | |
| 5901-221 | Werkstattw. »BlackLine«, 7 Schubf. mit Bestückung/with Sets |
| € 2.085,00 | |
| 4901-521 | Werkstattw. »ECOBlue«, 6 Schubf. mit Bestückung/with Sets |
| € 1.779,00 | |

7901-521

Werkstattwagen »SpaceLine«
mit 7 Schubfächern, bestückt
Roller Cabinet »SpaceLine«,
7 Drawers with Sets

5901-121

Werkstattwagen »RedLine«
mit 7 Schubfächern, bestückt
Roller Cabinet »RedLine«, 7 Drawers with Sets

5901-521

Werkst. »SuperBlue« mit 7 Schubfächern, bestückt
Roller Cabinet »SuperBlue«, 7 Drawers with Sets

5901-221

Werkstattwagen »BlackLine« mit 7 Schubfächern, bestückt
Roller Cabinet »BlackLine«, 7 Drawers with Sets

4901-521

Werkstattwagen »ECOBlue« mit 6 Schubfächern, bestückt
Roller Cabinet »ECOBlue«, 6 Drawers with Sets



5995-021

Bestehend aus / Composed of

5999-111 + 5999-131 + 5999-101 + 5999-011 + 5999-321 + 5999-021 + 5999-065 +
5999-062 + 5999-082 + 5999-331 + 5999-361 (Doppeleinlage/Double Set)

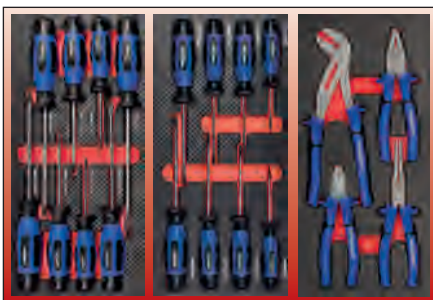
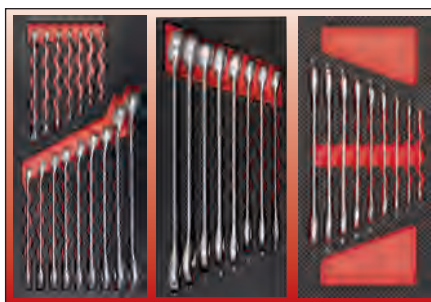
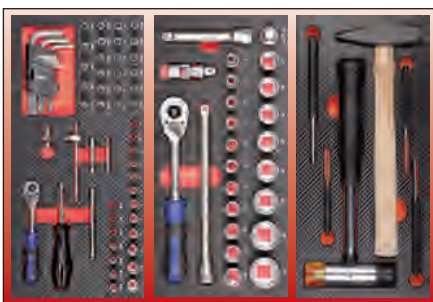

Werkstattwagen-Bestückung für 5 Schubfächer, 320-teilig

Roller Cabinet Sets for 5 Drawers, 320 pieces

320
tlg./pcs.

Art.-Gruppe 171/172
Article Group 171/172

Wählen Sie Ihren Werkstattwagen mit Bestückung oder nur die Bestückung

Choose your Roller Cabinet with Sets
or only the sets



| Art.-Nr./Art.-No. | Produkt/Product |
|-------------------|--|
| 5995-141 | Bestückung 320-tlg./ Sets with 320 pcs. |
| € 1.399,00 | |
| 7901-541 | Werkstattw. »SpaceLine«, 7 Schubf. |
| € 2.279,00 | mit Bestückung/with Sets |
| 5901-141 | Werkstattw. »RedLine«, 7 Schubf. |
| € 2.189,00 | mit Bestückung/with Sets |
| 5901-541 | Werkstattw. »SuperBlue«, 7 Schubf. |
| € 2.189,00 | mit Bestückung/with Sets |
| 5901-241 | Werkstattw. »BlackLine«, 7 Schubf. |
| € 2.189,00 | mit Bestückung/with Sets |
| 4901-541 | Werkstattw. »ECOBlue«, 6 Schubf. |
| € 1.895,00 | mit Bestückung/with Sets |

7901-541

Werkstattwagen »SpaceLine«
mit 7 Schubfächern, bestückt
Roller Cabinet »SpaceLine«,
7 Drawers with Sets

5901-141

Werkstattwagen »RedLine«
mit 7 Schubfächern, bestückt
Roller Cabinet »RedLine«, 7 Drawers with Sets

5901-541

Werkst. »SuperBlue« mit 7 Schubfächern, bestückt
Roller Cabinet »SuperBlue«, 7 Drawers with Sets

5901-241

Werkstattwagen »BlackLine« mit 7 Schubfächern, bestückt
Roller Cabinet »BlackLine«, 7 Drawers with Sets

4901-541

Werkstattwagen »ECOBlue« mit 6 Schubfächern, bestückt
Roller Cabinet »ECOBlue«, 6 Drawers with Sets



5995-141

Bestehend aus / Composed of

5999-111 + 5999-131 + 5999-191 + 5999-321 + 5999-011 + 5999-021 + 5999-065 + 5999-062 + 5999-341 +
5999-171 + 5999-082 + 5999-101 + 5999-331 + 5999-393 + 3789

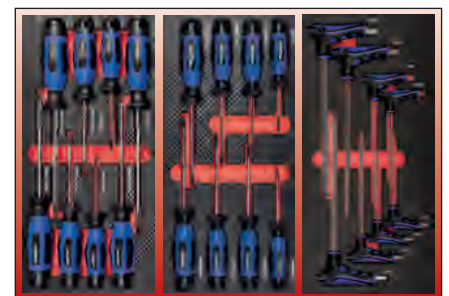

Bit-Box
mit allen
gängigen Bits

PROForm Werkstattwagen Einlagen

PROForm Inlays for Roller Cabinets

Art.-Gruppe 171
Article Group 171

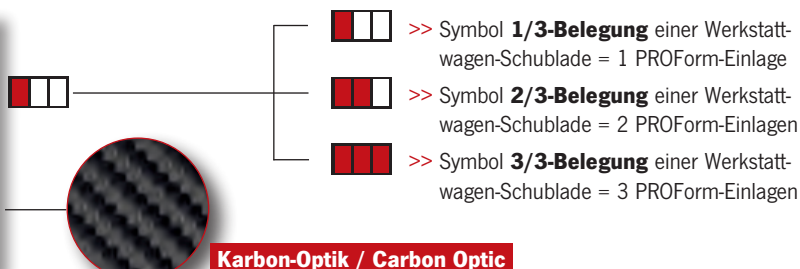

Die PROJAHN PROForm-Einlagen (2-Farben-Kontrast-System) sind passgenau auf alle PROJAHN Werkstattwagen und das PROForm-Box-Koffersystem abgestimmt. Diese PROForm-Einlagen gibt es als Einfach-Einlage (395 x 186 x 35mm), als Doppel-Einlage (395 x 378 x 35mm) oder als Dreifach-Einlage (395 x 568 x 35mm), wobei die Dreifach-Einlage einer kompletten Schublade entspricht. Die PROForm-Einlagen sind aus hochwertigem, bruch- und formstabilem Polymer-Kunststoff gefertigt und bieten Ihren Werkzeugen optimalen Halt und Schutz.

PROJAHN PROForm-Inlays (2-colour-system) are accurate'n produced for all PROJAHN Roller Cabinets and PROForm-Box Cases. These PROForm-Inlays are available as 1/3-inlay (395 x 186 x 35mm), as 2/3-inlay (395 x 378 x 35mm) or as 3/3-inlay (395 x 568 x 35mm). The 3/3-inlay fills a complete drawer. The PROForm-Inlays are produced by special, hard-to-brake, rubber foam and secure your tools.

5999-011 **PROFESSIONAL** PLUS STANDARD

PROForm Einlagesystem Ringgabelschlüssel, 16-teilig

PROForm Combination Wrench Inlay, 16 pieces

Inhalt/Contents:

6 - 7 - 8 - 9 - 10 - 11 - 12 - 13 - 14 - 15 - 16 - 17 - 18 - 19 - 22 - 24 mm



16
tlg./pcs.

395 x 186 x 35 mm

| Art.-Nr./Art.-No. | tlg./pcs. | L./L. | B./W. | H./H. | € |
|-------------------|-----------|-------|-------|-------|--------------------------------|
| 5999-011 | 16 | | | | 87,50 |
| 5999-01E | | 395 | 186 | 35 | Einlage leer/empty inlay 26,25 |

5999-321 **PROFESSIONAL** PLUS STANDARD

PROForm Einlagesystem Ringgabelschlüssel, 8-teilig

PROForm Combination Wrench Inlay, 8 pieces

Inhalt/Contents:

20 - 21 - 23 - 25 - 26 - 27 - 30 - 32 mm



8
tlg./pcs.

395 x 186 x 35 mm

| Art.-Nr./Art.-No. | tlg./pcs. | L./L. | B./W. | H./H. | € |
|-------------------|-----------|-------|-------|-------|--------------------------------|
| 5999-321 | 8 | | | | 102,00 |
| 5999-32E | | 395 | 186 | 35 | Einlage leer/empty inlay 26,25 |

PROForm Werkstattwagen Einlagen

PROForm Inlays for Roller Cabinets

Art-Gruppe 171
Article Group 171

5999-411 **PROFESSIONAL** PLUS STANDARD

PROForm Einlegesystem Ringgabelschlüssel Zoll, 12-teilig

PROForm Combination Wrench Inlay Inch, 12 pieces

Inhalt/Contents:

1/4" - 5/16" - 3/8" - 7/16" - 1/2" - 9/16" - 5/8" -
11/16" - 3/4" - 7/8" - 15/16" - 1"



395 x 186 x 35 mm

12
tlg./pcs.



| Art.-Nr./Art.-No. | tlg./pcs. | L./L. | B./W. | H./H. | | € |
|-------------------|-----------|-------|-------|-------|--------------------------|--------|
| 5999-411 | 12 | | | | | 104,00 |
| 5999-41E | | 395 | 186 | 35 | Einlage leer/empty inlay | 26,25 |

5999-021 **PROFESSIONAL** PLUS STANDARD

PROForm Einlegesystem Doppelgabelschlüssel, 9-teilig

PROForm Double Open End Wrench Inlay, 9 pieces

Inhalt/Contents:

6 x 7 - 8 x 9 - 10 x 11 - 12 x 13 - 14 x 15 - 16 x 17 - 18 x 19 - 20 x 22
- 21 x 23 mm



395 x 186 x 35 mm

9
tlg./pcs.



| Art.-Nr./Art.-No. | tlg./pcs. | L./L. | B./W. | H./H. | | € |
|-------------------|-----------|-------|-------|-------|--------------------------|-------|
| 5999-021 | 9 | | | | | 63,00 |
| 5999-02E | | 395 | 186 | 35 | Einlage leer/empty inlay | 26,25 |

5999-031 **PROFESSIONAL** PLUS STANDARD

PROForm Einlegesystem Doppelringschlüssel, 8-teilig

PROForm Double Ring Wrench Inlay, 8 pieces

Inhalt/Contents:

6 x 7 - 8 x 9 - 10 x 11 - 12 x 13 - 14 x 15 - 16 x 17 - 18 x 19 - 20 x 22 mm



395 x 186 x 35 mm

8
tlg./pcs.



| Art.-Nr./Art.-No. | tlg./pcs. | L./L. | B./W. | H./H. | | € |
|-------------------|-----------|-------|-------|-------|--------------------------|-------|
| 5999-031 | 8 | | | | | 75,00 |
| 5999-03E | | 395 | 186 | 35 | Einlage leer/empty inlay | 26,25 |

PROForm Werkstattwagen Einlagen

PROForm Inlays for Roller Cabinets

Art.-Gruppe 171
Article Group 171

5999-041

PROFESSIONAL PLUS STANDARD

PROForm Einlegesystem GearTech Ratschenschlüssel „umschaltbar“, 12-teilig

PROForm Reversible GearTech Ratcheting Wrench Inlay, 12 pieces

Inhalt/Contents:

8 - 9 - 10 - 11 - 12 - 13 - 14 - 15 - 16 - 17 - 18 - 19 mm



12
tlg./pcs.



395 x 186 x 35 mm

| Art.-Nr./Art.-No. | tlg./pcs. | L./L. | B./W. | H./H. | € |
|-------------------|-----------|-------|-------|-------|--------------------------------|
| 5999-041 | 12 | | | | 215,00 |
| 5999-04E | | 395 | 186 | 35 | Einlage leer/empty inlay 26,25 |

5999-051

PROFESSIONAL PLUS STANDARD

PROForm Einlegesystem GearTech Ratschenschlüssel „klassik“ ohne Umschaltknopf, 12-teilig

PROForm GearTech „classic“ Inlay, 12 pieces

Inhalt/Contents:

8 - 9 - 10 - 11 - 12 - 13 - 14 - 15 - 16 - 17 - 18 - 19 mm

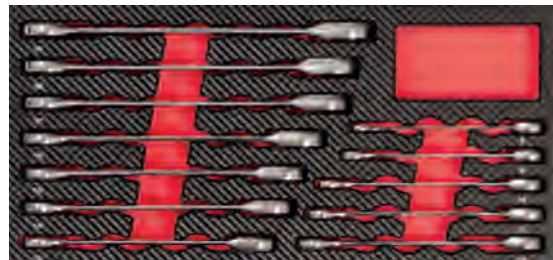

12
tlg./pcs.



395 x 186 x 35 mm

| Art.-Nr./Art.-No. | tlg./pcs. | L./L. | B./W. | H./H. | € |
|-------------------|-----------|-------|-------|-------|--------------------------------|
| 5999-051 | 12 | | | | 176,00 |
| 5999-05E | | 395 | 186 | 35 | Einlage leer/empty inlay 26,25 |

5999-052

PROFESSIONAL PLUS STANDARD

PROForm Einlegesystem GearTech Ratschenschlüssel „flexibel“ ohne Umschaltknopf, 12-teilig

PROForm GearTech „flexible“ Inlay, 12 pieces

Inhalt/Contents:

8 - 9 - 10 - 11 - 12 - 13 - 14 - 15 - 16 - 17 - 18 - 19 mm



12
tlg./pcs.



395 x 186 x 35 mm

| Art.-Nr./Art.-No. | tlg./pcs. | L./L. | B./W. | H./H. | € |
|-------------------|-----------|-------|-------|-------|--------------------------------|
| 5999-052 | 12 | | | | 238,00 |
| 5999-05E | | 395 | 186 | 35 | Einlage leer/empty inlay 26,25 |

PROForm Werkstattwagen Einlagen

PROForm Inlays for Roller Cabinets

Art.-Gruppe 171
Article Group 171

5999-111 **PROFESSIONAL** PLUS STANDARD

PROForm Einlegesystem

1/4" Steckschlüssel Satz, 58-teilig

PROForm 1/4" Socket Inlay, 58 pieces

Inhalt/Contents:

Knarre, Steckgriff, Gleitgriff, Winkelstiftschlüssel-Satz 9-teilig,

Verlängerungen 50 + 100 mm, Stecknuss Bit Adapter 50 mm,

Kardangeln, Innen TX Nüsse E4 - 5 - 6 - 7 - 8 - 10 - 11,

6-kant Nüsse 4 - 4,5 - 5 - 5,5 - 6 - 7 - 8 - 9 - 10 - 11 - 12 - 13 mm,

Bit Nüsse: PH1 - 2 - 3, PZ1 - 2 - 3, Schlitz 4 - 5,5 - 6,5 mm, TX8 - 9 - 10 - 15 - 20 - 25 - 27 - 30 - 40, Innensechskant 3 - 4 - 5 - 6 - 8 mm

Ratchet, Spinner Handle, Sliding T-Handle, Hex Key Set 9 pieces, Extension Bars 50 + 100 mm, Socket Adapter 50 mm, Universal Joint,

TX Sockets E4 - 5 - 6 - 7 - 8 - 10 - 11, Sockets 4 - 4,5 - 5 - 5,5 - 6 - 7 - 8 - 9 - 10 - 11 - 12 - 13 mm,

Bit Sockets: PH1 - 2 - 3, PZ1 - 2 - 3, Slotted 4 - 5,5 - 6,5 mm, TX8 - 9 - 10 - 15 - 20 - 25 - 27 - 30 - 40, Hex 3 - 4 - 5 - 6 - 8 mm

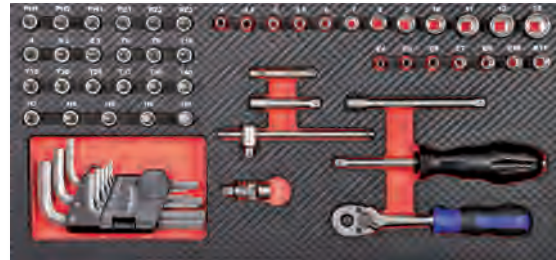

395 x 186 x 35 mm

58
tlg./pcs.

1/4"



| Art.-Nr./Art.-No. | tlg./pcs. | L./L. | B./W. | H./H. | € |
|-------------------|-----------|-------|-------|-------|---------------------------------------|
| 5999-111 | 58 | | | | 179,90 |
| 5999-11E | | 395 | 186 | 35 | Einlage leer/empty inlay 26,25 |

5999-121 **PROFESSIONAL** PLUS STANDARD

PROForm Einlegesystem 3/8" Steckschlüssel Satz, 23-teilig

PROForm 3/8" Socket Inlay, 23 pieces

Inhalt/Contents:

Knarre, T-Gleitadapter, Verlängerungen 75 + 250 mm,

Kardangeln, 6-kant Nüsse 6 - 7 - 8 - 9 - 10 - 11 - 12 - 13 - 14 -

15 - 16 - 17 - 18 - 19 - 22 - 24 mm,

Adapter von 3/8" (Knarre) auf 1/4" (Nuss),

Adapter von 3/8" (Knarre) auf 1/2" (Nuss), Adapter von 1/2" (Knarre) auf 3/8" (Nuss)

Ratchet, T-Adapter, Extension Bars 75 + 250 mm, Universal Joint, Sockets 6 - 7 - 8 - 9 - 10 - 11 - 12 - 13 - 14 - 15 - 16 - 17 - 18 - 19 - 22 - 24 mm,

Adapter 3/8" (Ratchet) x 1/4" (Socket), Adapter 3/8" (Ratchet) x 1/2" (Socket), Adapter 1/2" (Ratchet) x 3/8" (Socket)

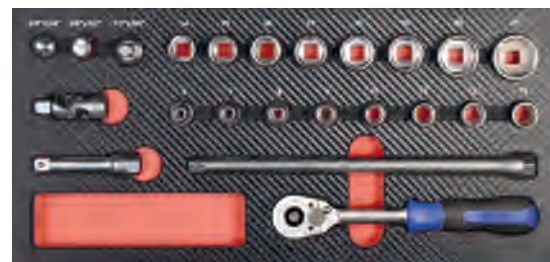

395 x 186 x 35 mm

23
tlg./pcs.

3/8"



| Art.-Nr./Art.-No. | tlg./pcs. | L./L. | B./W. | H./H. | € |
|-------------------|-----------|-------|-------|-------|---------------------------------------|
| 5999-121 | 23 | | | | 143,50 |
| 5999-12E | | 395 | 186 | 35 | Einlage leer/empty inlay 26,25 |

5999-131 **PROFESSIONAL** PLUS STANDARD

PROForm Einlegesystem 1/2" Steckschlüssel Satz, 24-teilig

PROForm 1/2" Socket Inlay, 24 pieces

Inhalt/Contents:

Knarre, T-Gleitadapter, Verlängerungen 125 + 250 mm,

Kardangeln, 6-kant Nüsse 8 - 9 - 10 - 11 - 12 - 13 - 14 - 15 -

16 - 17 - 18 - 19 - 20 - 21 - 22 - 24 - 27 - 30 - 32 mm

Ratchet, T-Adapter, Extension Bars 125 + 250 mm, Universal Joint,

Sockets 8 - 9 - 10 - 11 - 12 - 13 - 14 - 15 - 16 - 17 - 18 - 19 - 20 - 21 - 22 - 24 - 27 - 30 - 32 mm

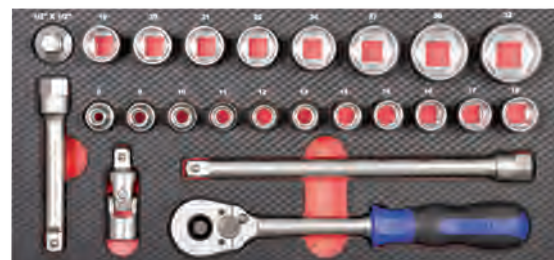

395 x 186 x 35 mm

24
tlg./pcs.

1/2"



| Art.-Nr./Art.-No. | tlg./pcs. | L./L. | B./W. | H./H. | € |
|-------------------|-----------|-------|-------|-------|---------------------------------------|
| 5999-131 | 24 | | | | 169,90 |
| 5999-13E | | 395 | 186 | 35 | Einlage leer/empty inlay 26,25 |

PROForm Werkstattwagen Einlagen

PROForm Inlays for Roller Cabinets

MULTISTECKNUSS
Xi-on

Art.-Gruppe 171
Article Group 171

5999-511 **Xi-on**

PROFESSIONAL PLUS STANDARD

PROForm Einlagesystem 1/4" Xi-on Steckschl. Satz, 18-teilig

PROForm 1/4" Xi-on Socket Inlay, 18 pieces

Inhalt/Contents:

Knarre, 72-Zahn, Steckgriff, Gleitgriff, Verlängerung 50 mm, Kardangeln, Austreiber, Xi-on Stecknüsse 4 - 4,5 - 5 - 5,5 - 6 - 7 - 8 - 9 - 10 - 11 - 12 - 13 mm

Ratchet, 72-Teeth, Spinner Handle, Extension Bars 125 + 250 mm,

Universal Joint, Extractor, Xi-on Sockets 4 - 4,5 - 5 - 5,5 - 6 - 7 - 8 - 9 - 10 - 11 - 12 - 13 mm



395 x 186 x 35 mm

18
tlg./pcs.

1/4"



| Art.-Nr./Art.-No. | tlg./pcs. | L./L. | B./W. | H./H. | | € |
|-------------------|-----------|-------|-------|-------|--------------------------|-------|
| 5999-511 | 18 | | | | | 69,50 |
| 5999-51E | | 395 | 186 | 35 | Einlage leer/empty inlay | 26,25 |

5999-521 **Xi-on**

PROFESSIONAL PLUS STANDARD

PROForm Einlagesystem 3/8" Xi-on Steckschl. Satz, 17-teilig

PROForm 3/8" Xi-on Socket Inlay, 17 pieces

Inhalt/Contents:

Knarre, 72-Zahn, Gleitgriff, Verlängerungen 75 + 150 mm, Kardangeln, Austreiber, Xi-on Stecknüsse 8 - 10 - 11 - 12 - 13 - 14 - 15 - 16 - 17 - 18 - 19 mm

Ratchet, 72-Teeth, Sliding T-Handle, Extension Bars 75 + 150mm,

Universal Joint, Extractor, Xi-on Sockets

8 - 10 - 11 - 12 - 13 - 14 - 15 - 16 - 17 - 18 - 19 mm



395 x 186 x 35 mm

17
tlg./pcs.

3/8"



| Art.-Nr./Art.-No. | tlg./pcs. | L./L. | B./W. | H./H. | | € |
|-------------------|-----------|-------|-------|-------|--------------------------|-------|
| 5999-521 | 17 | | | | | 89,00 |
| 5999-52E | | 395 | 186 | 35 | Einlage leer/empty inlay | 26,25 |

5999-531 **Xi-on**

PROFESSIONAL PLUS STANDARD

PROForm Einlagesystem

1/2" Xi-on Steckschl. Satz, 23-teilig

PROForm 1/2" Xi-on Socket Inlay, 23 pieces

Inhalt/Contents:

Knarre, 60-Zahn, Gleitgriffadapter, Verlängerungen 125 - 250 mm, Kardangeln, Austreiber, Xi-on Stecknüsse 10 - 11 - 12 - 13 - 14 - 15 - 16 - 17 - 18 - 19 - 22 - 24 - 27 - 30 - 32 mm, Zündkerzen-Stecknüsse 16 + 21 mm

Ratchet, 60-Teeth, Sliding T-Handle Adapter, Extension Bars 125 + 250 mm,

Universal Joint, Extractor, Xi-on Sockets 10 - 11 - 12 - 13 - 14 - 15 - 16 -

17 - 18 - 19 - 22 - 24 - 27 - 30 - 32 mm, Spark Plug Sockets 16 + 21 mm



395 x 186 x 35 mm

23
tlg./pcs.

1/2"



| Art.-Nr./Art.-No. | tlg./pcs. | L./L. | B./W. | H./H. | | € |
|-------------------|-----------|-------|-------|-------|--------------------------|--------|
| 5999-531 | 23 | | | | | 139,00 |
| 5999-53E | | 395 | 186 | 35 | Einlage leer/empty inlay | 26,25 |

PROForm Werkstattwagen Einlagen

PROForm Inlays for Roller Cabinets

Art.-Gruppe 171
Article Group 171

5999-551

PROFESSIONAL PLUS STANDARD

PROForm Einlegesystem GearTech Durchschraubknarre, 17-teilig

PROForm Go-Through-Socket Inlay, 17 pieces

Inhalt/Contents:

Durchgangsnüsse 10 - 11 - 12 - 13 - 14 - 15 - 16 - 17 - 18 - 19 - 21 - 22 - 24 mm, Verlängerung 80 mm, 1/4" Adapter, 3/8" Adapter, 3D-GearTech-FLEX-Durchschraub-Knarre

Go-Through-Sockets 10 - 11 - 12 - 13 - 14 - 16 - 17 - 18 - 19 - 21 - 22 - 24 mm, Extension 80 mm, 1/4" Adapter, 3/8" Adapter, 3D-GearTech-FLEX-Ratchet



17
tlg./pcs.



395 x 186 x 35 mm

| Art.-Nr./Art.-No. | tlg./pcs. | L./L. | B./W. | H./H. | | € |
|-------------------|-----------|-------|-------|-------|--------------------------|--------|
| 5999-551 | 17 | | | | | 123,00 |
| 5999-55E | | 395 | 186 | 35 | Einlage leer/empty inlay | 26,25 |

5999-421

PROFESSIONAL PLUS STANDARD

PROForm Einlegesystem Stecknuss, Zoll, 51-teilig (Doppelinlage)

PROForm Socket Inlay, Inch, 51 pieces (2/3 Inlay)

Inhalt/Contents:

1/4" + 1/2" Knarre, Stecknüsse 3/16" - 1 1/4", Tiefe Stecknüsse 3/16" - 15/16", Gleitgriff-Adapter, Zündkerzen-Stecknüsse 5/16" + 13/16", Kardangeln, Verlängerungen 2" - 3" - 5" - 10", Steckgriff

1/4" + 1/2" Ratchet, Sockets 3/16" - 1 1/4", Deep Sockets 3/16" - 15/16", Sliding T-Adapter, Spark Plug Sockets 5/16" + 13/16", Universal Joint, Extension Bars 2" - 3" - 5" - 10", Spinner Handle



51
tlg./pcs.



395 x 375 x 35 mm

| Art.-Nr./Art.-No. | tlg./pcs. | L./L. | B./W. | H./H. | | € |
|-------------------|-----------|-------|-------|-------|--------------------------|--------|
| 5999-421 | 51 | | | | | 299,00 |
| 5999-42E | | 395 | 375 | 35 | Einlage leer/empty inlay | 50,40 |

5999-441

PROFESSIONAL PLUS STANDARD

PROForm Einlegesystem Werkzeugsatz 3/4", 21-teilig (Dreifacheinlage, Höhe 90 mm)

PROForm Socket Inlay 3/4", 21 pieces (3/3 Inlay, High 90 mm)

Inhalt/Contents:

Knarre Verlängerungen 100 - 200 - 400 mm, Gleitgriff, Stecknüsse 19 - 21 - 22 - 23 - 24 - 26 - 27 - 29 - 30 - 32 - 35 - 36 - 38 - 41 - 46 - 50 mm

Ratchet Handle, Extension Bars 100 - 200 - 400 mm, Sliding T-Bar, Sockets 19 - 21 - 22 - 23 - 24 - 26 - 27 - 29 - 30 - 32 - 35 - 36 - 38 - 41 - 46 - 50 mm

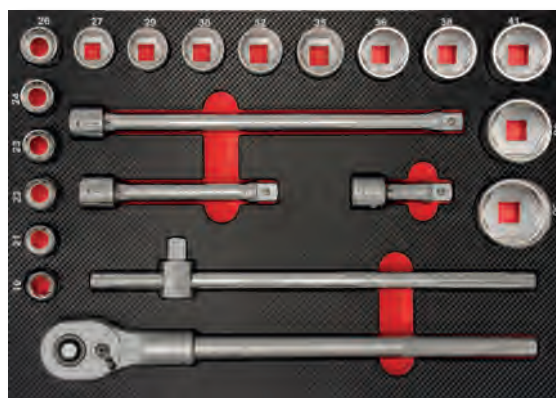

21
tlg./pcs.

3/4"



395 x 560 x 35 mm

| Art.-Nr./Art.-No. | tlg./pcs. | L./L. | B./W. | H./H. | | € |
|-------------------|-----------|-------|-------|-------|--------------------------|--------|
| 5999-441 | 21 | | | | | 395,00 |
| 5999-44E | | 395 | 560 | 35 | Einlage leer/empty inlay | 68,50 |

PROForm Werkstattwagen Einlagen

PROForm Inlays for Roller Cabinets

Art.-Gruppe 171
Article Group 171

5999-431 **PROFESSIONAL** PLUS STANDARD

PROForm Einlegesystem 1/2" lange Stecknuss, 12-teilig

PROForm 1/2" Deep Impact Socket Inlay, 12 pieces

Inhalt/Contents:

10 - 11 - 12 - 13 - 14 - 15 - 16 - 17 - 18 - 19 - 21 - 22 mm

16 + 21 mm = Zündkerzenstecknüsse / Spark Plug Sockets

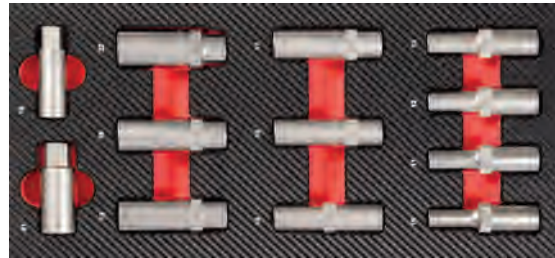

12
tlg./pcs.

1/2"



395 x 186 x 35 mm

| Art.-Nr./Art.-No. | tlg./pcs. | L./L. | B./W. | H./H. | | € |
|-------------------|-----------|-------|-------|-------|--------------------------|--------------|
| 5999-431 | 12 | | | | | 94,00 |
| 5999-43E | | 395 | 186 | 35 | Einlage leer/empty inlay | 26,25 |

5999-191 **PROFESSIONAL** PLUS STANDARD

PROForm Einlegesystem 1/2" KFZ Spezial-Einlage, 38-teilig

PROForm 1/2" Special Car Repairing Inlay, 38 pieces

Inhalt/Contents:

Innensechskant-Stecknuss 60 mm lang 5 - 6 - 7 - 8 - 10 - 12 mm,

Innensechskant-Stecknuss 100 mm lang 6 - 8 - 10 - 12 mm,

TX-Bit-Nuss 60 mm lang,

TX20 - 25 - 27 - 30 - 40 - 45 - 50 - 55 - 60,

TX-Bit-Nuss 100 mm lang TX30 - 40 - 50 - 60, Vielzahn-Bit-Nuss 60 mm lang M5 - 6 - 8 - 10,

Vielzahn-Bit-Nuss 100 mm lang M6 - 8 - 10 - 12, Innen-TX-Nuss E12 - 14 - 16 - 18 - 20 - 22 - 24



38
tlg./pcs.

1/2"



395 x 186 x 35 mm

Hex Bit Sockets (60 mm) 5 - 6 - 7 - 8 - 10 - 12 mm, Hex Bit Sockets (100 mm) 6 - 8 - 10 - 12mm,

TX Bit Sockets (60 mm) T20 - 25 - 27 - 30 - 40 - 45 - 50 - 55 - 60, TX Bit Sockets (100 mm) T30 - 40 - 50 - 60,

Spline Bit Sockets (60 mm) M5 - 6 - 8 - 10, Spline Bit Sockets (100 mm) M6 - 8 - 10 - 12, TX Sockets E12 - 14 - 16 - 18 - 20 - 22 - 24

| Art.-Nr./Art.-No. | tlg./pcs. | L./L. | B./W. | H./H. | | € |
|-------------------|-----------|-------|-------|-------|--------------------------|---------------|
| 5999-191 | 38 | | | | | 247,00 |
| 5999-19E | | 395 | 186 | 35 | Einlage leer/empty inlay | 26,25 |

PROForm Werkstattwagen Einlagen

PROForm Inlays for Roller Cabinets

Art.-Gruppe 171
Article Group 171

5999-151 **PROFESSIONAL** PLUS STANDARD

PROForm Einlagesystem 1/2" Schlagnuss, 30-teilig

PROForm 1/2" Impact Socket Inlay, 30 pieces

Inhalt/Contents:

Nuss 8 - 9 - 10 - 11 - 12 - 13 - 14 - 15 - 16 - 17 - 18 - 19 - 21 - 22 - 24 mm, tiefe Nuss 17 - 19 - 21 - 22 - 24 mm, tiefe Nuss für Alufelgen 17 - 19 - 21 mm, Kardangelenk, Verlängerung 125 mm, Adapter 3/4" (Maschine) auf 1/2" (Nuss), 2x Sicherungsring, 2x Sicherungsstift



395 x 186 x 35 mm

30
tlg./pcs.

1/2"



Sockets 8 - 9 - 10 - 11 - 12 - 13 - 14 - 15 - 16 - 17 - 18 - 19 - 21 - 22 - 24 mm, Deep Sockets 17 - 19 - 21 - 22 - 24 mm, Deep Thin Wall Sockets 17 - 19 - 21 mm, Universal Joint, Extension Bar 125 mm, Adapter 3/4" (Machine) x 1/2" (Socket), 2 pieces Ring for Impact Sockets, 2 pieces Pin for Impact Sockets

| Art.-Nr./Art.-No. | tlg./pcs. | L./L. | B./W. | H./H. | | € |
|-------------------|-----------|-------|-------|-------|--------------------------|--------|
| 5999-151 | 30 | | | | | 249,50 |
| 5999-15E | | 395 | 186 | 35 | Einlage leer/empty inlay | 26,25 |

5999-371 **PROFESSIONAL** PLUS STANDARD

PROForm Einlagesystem 1/2" Schlagnuss, 28-teilig

PROForm 1/2" Impact Socket Inlay, 28 pieces

Inhalt/Contents:

TX-Nuss TX20 - 25 - 27 - 30 - 40 - 45 - 50 - 55 - 60 - 70, Innensechskant-Stecknuss 4 - 5 - 6 - 8 - 10 - 12 - 14 - 17 - 19 mm, Innen-TX-Nuss E10 - 11 - 12 - 14 - 16 - 18 - 20 - 22 - 24



395 x 186 x 35 mm

28
tlg./pcs.

1/2"



TX-Sockets TX20 - 25 - 27 - 30 - 40 - 45 - 50 - 55 - 60 - 70, Hex-Sockets 4 - 5 - 6 - 8 - 10 - 12 - 14 - 17 - 19 mm, TX-Sockets E10 - 11 - 12 - 14 - 16 - 18 - 20 - 22 - 24

| Art.-Nr./Art.-No. | tlg./pcs. | L./L. | B./W. | H./H. | | € |
|-------------------|-----------|-------|-------|-------|--------------------------|--------|
| 5999-371 | 28 | | | | | 274,00 |
| 5999-37E | | 395 | 186 | 35 | Einlage leer/empty inlay | 26,25 |

5999-141* **PROFESSIONAL** PLUS STANDARD

PROForm Einlagesystem Pfeifenkopfschlüssel mit Bohrung, 12-teilig

PROForm Through-Hole Open-Socket Wrench Inlay, 12 pieces

Inhalt/Contents:

8 - 9 - 10 - 11 - 12 - 13 - 14 - 15 - 16 - 17 - 18 - 19 mm



395 x 186 x 35 mm

12
tlg./pcs.



| Art.-Nr./Art.-No. | tlg./pcs. | L./L. | B./W. | H./H. | | € |
|-------------------|-----------|-------|-------|-------|--------------------------|--------|
| 5999-141* | 12 | | | | | 246,00 |
| 5999-14E* | | 395 | 186 | 35 | Einlage leer/empty inlay | 26,25 |

*Lieferung nur solange der Vorrat reicht / Delivery while stocks last

PROForm Werkstattwagen Einlagen

PROForm Inlays for Roller Cabinets

Art.-Gruppe 171
Article Group 171

5999-065 PROFESSIONAL PLUS STANDARD

PROForm Einlegesystem

Phillips-, Pozidriv- und Schlitz-Schraubendreher, 8-teilig

PROForm Phillips-, Pozidriv- and Slotted Screwdriver Inlay, 8 pieces



8
tlg./pcs.



395 x 186 x 35 mm



| Art.-Nr./Art.-No. | tlg./pcs. | Inhalt/pcs. | L./L. | B./W. | H./H. | € |
|-------------------|-----------|---------------------------|-------------------------------|-------|----------------|---------------------------------------|
| 5999-065 | 8 | PH 1 - 2 - 3 PZ 1 - 2 - 3 | Schlitz 1,2 x 6,5 - 1,2 x 8,0 | | gemischt/mixed | 75,60 |
| 5999-065E | | | 395 | 186 | 35 | Einlage leer/empty inlay 26,25 |

5999-064 PROFESSIONAL PLUS STANDARD

PROForm Einlegesystem

Phillips- und Schlitz-Schraubendreher, 7-teilig

PROForm Phillips and Slotted Screwdriver Inlay, 7 pieces



7
tlg./pcs.



395 x 186 x 35 mm



| Art.-Nr./Art.-No. | tlg./pcs. | Inhalt/pcs. | L./L. | B./W. | H./H. | € |
|-------------------|-----------|--|-------|-------|----------------|---------------------------------------|
| 5999-064 | 7 | PH 1 - 2 - 3 Schlitz 0,8 x 4,0 - 1,0 x 5,5 - 1,2 x 6,5 - 1,2 x 8,0 | | | gemischt/mixed | 66,90 |
| 5999-064E | | | 395 | 186 | 35 | Einlage leer/empty inlay 26,25 |

5999-062 PROFESSIONAL PLUS STANDARD

PROForm Einlegesystem

Innen-TORX-Schraubendreher, 8-teilig

PROForm TX Screwdriver Inlay, 8 pieces



8
tlg./pcs.



395 x 186 x 35 mm



| Art.-Nr./Art.-No. | tlg./pcs. | Inhalt/pcs. | L./L. | B./W. | H./H. | € |
|-------------------|-----------|--|-------|-------|-------|---------------------------------------|
| 5999-062 | 8 | T8 - T10 - T15 - T20 - T25 - T27 - T30 - T40 | TX | | | 65,70 |
| 5999-062E | | | 395 | 186 | 35 | Einlage leer/empty inlay 26,25 |

PROForm Werkstattwagen Einlagen

PROForm Inlays for Roller Cabinets

Art.-Gruppe 171
Article Group 171

5999-481 PROFESSIONAL PLUS STANDARD

PROForm Einlegesystem Schraubendreher, 10-teilig (Doppeleinlage)

PROForm Screwdriver Inlay, 10 pieces



10
tlg./pcs.

395 x 375 x 35 mm



| Art.-Nr./Art.-No. | tlg./pcs. | Inhalt/pcs. | L./L. | B./W. | H./H. | € |
|-------------------|-----------|--|-------|-------|-------|---------------------------------------|
| 5999-481 | 10 | PH 1 - 2 - 3, Vergaser-Schraubendreher/Carburetor Screwdriver PH2, Schlitz/Slotted 0,5 x 3,0 / 0,8 x 4,0 / 1,0 x 5,5 / 1,2 x 6,5 / 1,2 x 8,0 mm, Vergaser-Schraubendreher/Carburetor Screwdriver 6,5 x 25 mm | | | | 92,90 |
| 5999-48E | | | 395 | 375 | 35 | Einlage leer/empty inlay 50,40 |

5999-061 PROFESSIONAL PLUS STANDARD

PROForm Einlegesystem Phillips- und Schlitz-Schraubendreher mit durchgehender Klinge und Schlagkappe, 6-teilig

PROForm Phillips and slotted Go-Through
Blade Screwdriver with Hammering Cap Inlay, 6 pieces



6
tlg./pcs.

395 x 186 x 35 mm



| Art.-Nr./Art.-No. | tlg./pcs. | Inhalt/pcs. | L./L. | B./W. | H./H. | € |
|-------------------|-----------|--|-------|-------|----------------|---------------------------------------|
| 5999-061 | 6 | PH 1 - 2 Schlitz 0,8 x 4,5 - 1,0 x 5,5 - 1,2 x 7,0 - 1,2 x 8,0 | | | gemischt/mixed | 75,00 |
| 5999-06E | | | 395 | 186 | 35 | Einlage leer/empty inlay 26,25 |

5999-071 PROFESSIONAL PLUS STANDARD

PROForm Einlegesystem Phillips-, Pozidriv- und Schlitz-Schraubendreher, 8-teilig

PROForm Phillips-, Pozidriv- and Slotted Screwdriver Inlay, 8 pieces



8
tlg./pcs.

395 x 186 x 35 mm



| Art.-Nr./Art.-No. | tlg./pcs. | Inhalt/pcs. | L./L. | B./W. | H./H. | € |
|-------------------|-----------|---|-------|-------|----------------|---------------------------------------|
| 5999-071 | 8 | PH 1 - 2 - 3 PZ 1 - 2 - 3 Schlitz 1,2 x 6,5 - 1,6 x 8,0 | | | gemischt/mixed | 65,60 |
| 5999-071E | | | 395 | 186 | 35 | Einlage leer/empty inlay 26,25 |

PROForm Werkstattwagen Einlagen

PROForm Inlays for Roller Cabinets

Art.-Gruppe 171
Article Group 171

5999-074 PROFESSIONAL PLUS STANDARD

PROForm Einlagesystem

Phillips-, Schlitz- und TORX-Schraubendreher, 8-teilig

PROForm Phillips, Slotted and TX Screwdriver Inlay, 8 pieces

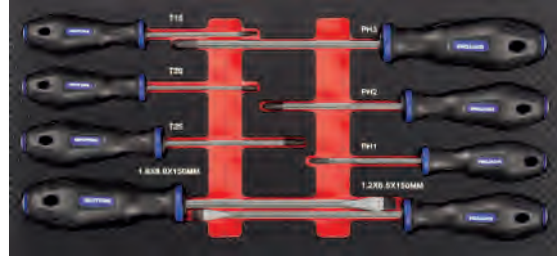

8
tlg./pcs.



395 x 186 x 35 mm



| Art.-Nr./Art.-No. | tlg./pcs. | Inhalt/pcs. | L./L. | B./W. | H./H. | € |
|-------------------|-----------|---|-------|-------|----------------|---------------------------------|
| 5999-074 | 8 | PH 1 - 2 - 3, Schlitz 1,2 x 6,5 - 1,6 x 8,0, TX15 - 20 - 25 | | | gemischt/mixed | 67,20 |
| 5999-074E | | | 395 | 186 | 35 | Einlage leer/empty 26,25 |

5999-072 PROFESSIONAL PLUS STANDARD

PROForm Einlagesystem

Innen-TORX-Schraubendreher, 8-teilig

PROForm TX Screwdriver Inlay, 8 pieces

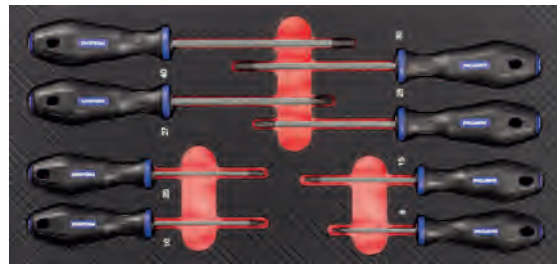

8
tlg./pcs.



395 x 186 x 35 mm



| Art.-Nr./Art.-No. | tlg./pcs. | Inhalt/pcs. | L./L. | B./W. | H./H. | € |
|-------------------|-----------|--|-------|-------|-------|---------------------------------------|
| 5999-072 | 8 | T8 - T10 - T15 - T20 - T25 - T27 - T30 - T40 | | | TX | 60,90 |
| 5999-072E | | | 395 | 186 | 35 | Einlage leer/empty inlay 26,25 |

5999-073 PROFESSIONAL PLUS STANDARD

PROForm Einlagesystem

Innen-TORX-Schraubendreher mit stirnseitiger Bohrung, 8-teilig

PROForm Tamper TX Screwdriver Inlay, 8 pieces



8
tlg./pcs.



395 x 186 x 35 mm



| Art.-Nr./Art.-No. | tlg./pcs. | Inhalt/pcs. | L./L. | B./W. | H./H. | € |
|-------------------|-----------|--|-------|-------|-----------|---------------------------------------|
| 5999-073 | 8 | T8 - T10 - T15 - T20 - T25 - T27 - T30 - T40 | | | tamper TX | 66,20 |
| 5999-072E | | | 395 | 186 | 35 | Einlage leer/empty inlay 26,25 |

PROForm Werkstattwagen Einlagen

PROForm Inlays for Roller Cabinets

Art.-Gruppe 171
Article Group 171

5999-355

PROFESSIONAL PLUS STANDARD

NEU/NEW

PROForm Einlagesystem

Sechskant T-Griff-Schraubendreher, 8-teilig

PROForm Hexagonal T-Handle Screwdriver Inlay, 8 pieces

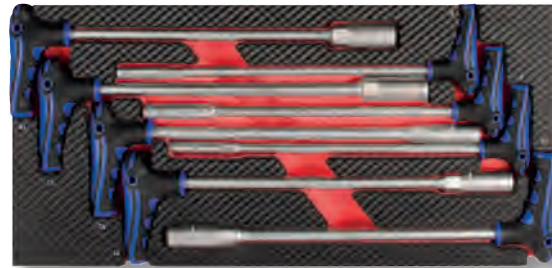

8
tlg./pcs.



395 x 186 x 35 mm



| Art.-Nr./Art.-No. | tlg./pcs. | Inhalt/pcs. | L./L. | B./W. | H./H. | € |
|-------------------|-----------|---------------------------------------|-------|---------------------|-------|--------------------------------|
| 5999-355 | 8 | 6 - 7 - 8 - 10 - 11 - 12 - 13 - 14 mm | | Sechskant/Hexagonal | | 97,00 |
| 5999-355E | | | 395 | 186 | 35 | Einlage leer/empty inlay 26,25 |

5999-341

PROFESSIONAL PLUS STANDARD

PROForm Einlagesystem

Kugelpfopf T-Griff-Schraubendreher, 8-teilig

PROForm Ball End T-Handle Screwdriver Inlay, 8 pieces

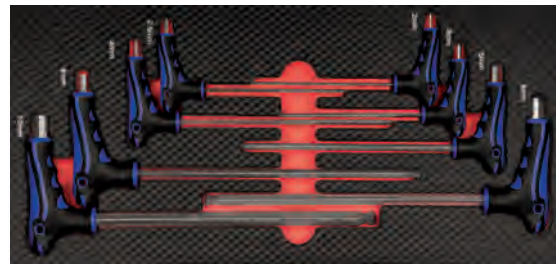

8
tlg./pcs.



395 x 186 x 35 mm



| Art.-Nr./Art.-No. | tlg./pcs. | Inhalt/pcs. | L./L. | B./W. | H./H. | € |
|-------------------|-----------|-------------------------------------|-------|---------------------|-------|--------------------------------|
| 5999-341 | 8 | 2 - 2,5 - 3 - 4 - 5 - 6 - 8 - 10 mm | | Kugelpfopf/ball end | | 74,50 |
| 5999-34E | | | 395 | 186 | 35 | Einlage leer/empty inlay 26,25 |

5999-351

PROFESSIONAL PLUS STANDARD

PROForm Einlagesystem

TX T-Griff-Schraubendreher, 9-teilig

PROForm TX T-Handle Screwdriver Inlay, 9 pieces

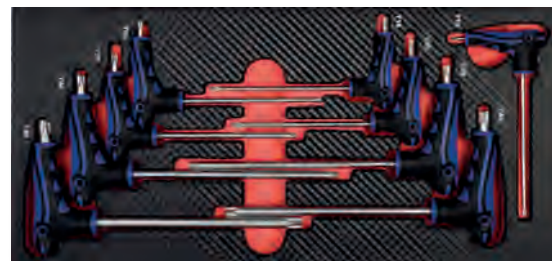

9
tlg./pcs.



395 x 186 x 35 mm



| Art.-Nr./Art.-No. | tlg./pcs. | Inhalt/pcs. | L./L. | B./W. | H./H. | € |
|-------------------|-----------|---|-------|-------|-------|--------------------------------|
| 5999-351 | 9 | T10 - T15 - T20 - T25 - T27 - T30 - T40 - T45 - T50 | | | TX | 86,60 |
| 5999-35E | | | 395 | 186 | 35 | Einlage leer/empty inlay 26,25 |

PROForm Werkstattwagen Einlagen

PROForm Inlays for Roller Cabinets

Art.-Gruppe 171
Article Group 171

5999-092 **PROFESSIONAL** PLUS STANDARD

PROForm Einlagesystem

Sicherungsringzangen, 4-teilig

PROFORM Circlip Pliers Inlay, 4 pieces

Inhalt/Contents:

Sicherungsringzangen A2 - A21 - J2 - J21

Circlip Pliers A2 - A21 - J2 - J21



4
tlg./pcs.



395 x 186 x 35 mm

| Art.-Nr./Art.-No. | tlg./pcs. | L./L. | B./W. | H./H. | € |
|-------------------|-----------|-------|-------|-------|--------------------------------|
| 5999-092 | 4 | | | | 109,00 |
| 5999-092E | | 395 | 186 | 35 | Einlage leer/empty inlay 26,25 |

5999-091 **PROFESSIONAL** PLUS STANDARD

PROForm Einlagesystem

Sicherungsringzangen, 4-teilig

PROFORM Circlip Pliers Inlay, 4 pieces

Inhalt/Contents:

Sicherungsringzangen A2 - A21 - J2 - J21

Circlip Pliers A2 - A21 - J2 - J21



4
tlg./pcs.



395 x 186 x 35 mm

| Art.-Nr./Art.-No. | tlg./pcs. | L./L. | B./W. | H./H. | € |
|-------------------|-----------|-------|-------|-------|--------------------------------|
| 5999-091 | 4 | | | | 86,00 |
| 5999-091E | | 395 | 186 | 35 | Einlage leer/empty inlay 26,25 |

5999-161 **PROFESSIONAL** PLUS STANDARD

PROForm Einlagesystem Präzision, 45-teilig

PROForm Precision Tool Inlay, 45 pieces

Inhalt/Contents:

31-teilige Bit Box 4071, kurzer Bithalter 1/4" mit Schnellspannfutter, Elektronik-Flachzange, Elektronik-Rundzange, Elektronik-Kettenzange, Elektronik-Kettenzange 45°, Elektronik-Seitenschneider
Präzisionssschraubendrehersatz 8-teilig mit 14 Schrauberklinken

31 pieces Bit ox 4071, Short Bit Screwdriver with Quick Release, Electronic Flat Nose Pliers, Electronic Round Nose Pliers, Electronic Chain Nose Pliers, Electronic Chain Nose Pliers 45°, Electronic Side Cutter, Precision Screwdriver Set with 14 Different Sizes/Tips



45
tlg./pcs.



395 x 186 x 35 mm

| Art.-Nr./Art.-No. | tlg./pcs. | L./L. | B./W. | H./H. | € |
|-------------------|-----------|-------|-------|-------|--------------------------------|
| 5999-161 | 45 | | | | 145,00 |
| 5999-161E | | 395 | 186 | 35 | Einlage leer/empty inlay 26,25 |

PROForm Werkstattwagen Einlagen

PROForm Inlays for Roller Cabinets

Art-Gruppe 171
Article Group 171

5999-082 PROFESSIONAL PLUS STANDARD

PROForm Einlegesystem Zangen, 4-teilig

PROForm Pliers Inlay, 4 pieces

Inhalt/Contents:

Kombizange 180 mm,
Seitenschneider 160 mm,
Telefonzange 205 mm,
Wasserpumpenzange 250 mm

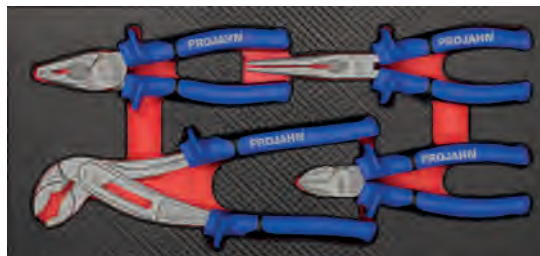

4
tlg./pcs.



395 x 186 x 35 mm

Combination Pliers 180 mm, Side Cutter 160 mm,
Long Nose Pliers 205 mm, Waterpump Pliers 250 mm

| Art.-Nr./Art.-No. | tlg./pcs. | L./L. | B./W. | H./H. | | € |
|-------------------|-----------|-------|-------|-------|--------------------------|--------|
| 5999-082 | 4 | | | | | 147,00 |
| 5999-082E | | 395 | 186 | 35 | Einlage leer/empty inlay | 26,25 |

5999-461 PROFESSIONAL PLUS STANDARD

PROForm Einlegesystem Schlagwerkzeuge, 13-teilig

PROForm Hammer and Punch Inlay, 13 pieces

Inhalt/Contents:

Schlosserhammer 500 g, Splintentreiber Satz 2 – 8 mm,
5-teilig Schlagwerkzeuge-Satz inkl. Durchschlag, Körner,
Kreuz- und Flachmeißel, Cutter Messer mit einziehbarer Klinge,
Klingenbreite: 18 mm



13
tlg./pcs.



395 x 186 x 35 mm

Machinist Hammer 500 g, Pin Punches 2 – 8 mm,
5 pieces of Striking Tools including Taper and Center Punch, Bolt and Flat Chisel, Utility Knife with Rectangular Blade, Blade Width: 18 mm

| Art.-Nr./Art.-No. | tlg./pcs. | L./L. | B./W. | H./H. | | € |
|-------------------|-----------|-------|-------|-------|--------------------------|-------|
| 5999-461 | 13 | | | | | 84,50 |
| 5999-46E | | 395 | 186 | 35 | Einlage leer/empty inlay | 26,25 |

5999-101 PROFESSIONAL PLUS STANDARD

PROForm Einlegesystem Schlagwerkzeuge, 6-teilig

PROForm Hammer and Punch Inlay, 6 pieces

Inhalt/Contents:

Schlosserhammer 500 g, Kunststoffhammer 35 cm,
Splintentreiber 3 - 4 - 5 - 6 mm



6
tlg./pcs.



395 x 186 x 35 mm

Machinist Hammer 500 g, Dead-Blow Hammer 35 cm,
Pin Punches 3 - 4 - 5 - 6 mm

| Art.-Nr./Art.-No. | tlg./pcs. | L./L. | B./W. | H./H. | | € |
|-------------------|-----------|-------|-------|-------|--------------------------|-------|
| 5999-101 | 6 | | | | | 89,80 |
| 5999-10E | | 395 | 186 | 35 | Einlage leer/empty inlay | 26,25 |

PROForm Werkstattwagen Einlagen

PROForm Inlays for Roller Cabinets

Art.-Gruppe 171
Article Group 171

5999-451 PROFESSIONAL PLUS STANDARD

PROForm Einlagesystem VDE-Werkzeug, 13-teilig (Doppelinlage)

PROForm VDE Screwdriver and VDE Pliers Inlay, 13 pieces (2/3-inlay)

Inhalt/Contents:

**VDE-Kombizange 180 mm, VDE-Seitenschneider 160 mm,
VDE-Kabelschneider 160 mm, VDE-Abisolierzange 160 mm,
VDE-Telefonzange 45° 200 mm, VDE-Telefonzange 200 mm,
Spannungsprüfer 3,5 x 90 mm,
VDE-Schraubendreher PH1, PH2, Schlitz 2,5 x 80 mm,
4,0 x 100 mm, 5,5 x 125 mm, 6,5 x 150 mm**

VDE Combination Pliers 180 mm, VDE Side Cutter 160 mm,
VDE Cable cutter 160 mm, VDE Wire Stripping Pliers 160 mm,
VDE Long nose pliers 45° 200 mm, VDE Long Nose Pliers 200 mm,
Voltage Tester 3,5 x 90 mm, VDE Screwdriver PH1, PH2,
VDE Slotted Screwdriver 2,5 x 80 mm,
4,0 x 100 mm, 5,5 x 125 mm, 6,5 x 150 mm

  **1000V**
EN 60900

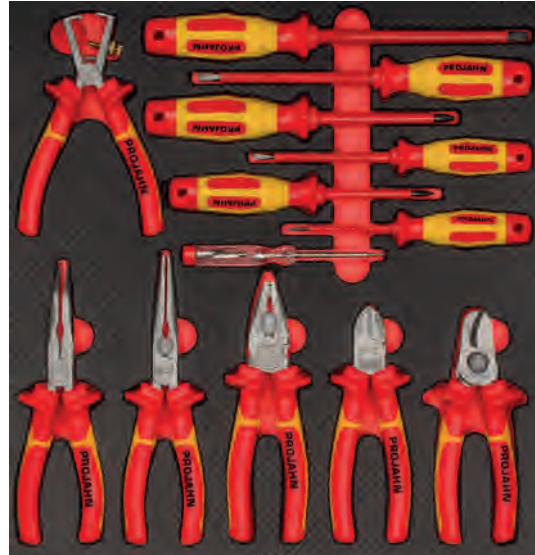

13
tlg./pcs.



395 x 375 x 35 mm

| Art.-Nr./Art.-No. | tlg./pcs. | L./L. | B./W. | H./H. | € |
|-------------------|-----------|-------|-------|-------|---------------------------------------|
| 5999-451 | 13 | | | | 329,00 |
| 5999-45E | | 395 | 375 | 35 | Einlage leer/empty inlay 50,40 |

5999-471 PROFESSIONAL PLUS STANDARD

PROForm Einlagesystem Zangen, 6-teilig (Doppelinlage)

PROForm Pliers Inlay, 6 pieces (2/3-inlay)

Inhalt/Contents:

**Flechtermetzze 260 mm,
Wasserpumpenzange 240 mm,
Gripzange 10"/250 mm, Telefonzange 205 mm,
Kombizange 180 mm, Seitenschneider 160 mm**

End Cutting Pliers 260 mm, Waterpump Wrench 240 mm,
Self Grip Pliers 10"/250 mm, Long Nose Pliers 205 mm,
Combination Pliers 180 mm, Side Cutter 160 mm

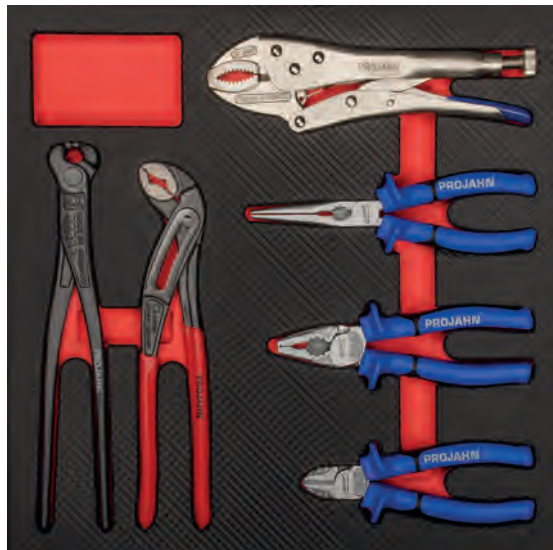

6
tlg./pcs.



395 x 375 x 35 mm

| Art.-Nr./Art.-No. | tlg./pcs. | L./L. | B./W. | H./H. | € |
|-------------------|-----------|-------|-------|-------|---------------------------------------|
| 5999-471 | 6 | | | | 185,00 |
| 5999-47E | | 395 | 375 | 35 | Einlage leer/empty inlay 50,40 |

PROForm Werkstattwagen Einlagen

PROForm Inlays for Roller Cabinets

Art.-Gruppe 171
Article Group 171

5999-361

PROFESSIONAL PLUS STANDARD

PROForm Einlegesystem Gewindeschneid-Werkzeug, 64-teilig (Doppeleinlage)

PROForm Tap and Die Tools Inlay, 64 pieces (2/3-inlay)

Inhalt/Contents:

Handgewindebohrer M3 - 4 - 5 - 6 - 8 - 10 - 12,
Schneideisen M3 - 4 - 5 - 6 - 8 - 10 - 12,
Windeisen verstellbar Nr. 1 – Nr. 2, Gewindegabel, Gewindegauge,
Schraubendreher, Werkzeughalter mit Knarre M5 - M12,
Schneideisenhalter 20x5 - 20x7 - 25x9 - 30x11 - 38x14 mm,
26 Stück Spiralbohrer HSS-G BASIC, 1 - 10,2 mm / 0,5 steigend,
inkl. Kernlochmaße

Hand Tap M3 - 4 - 5 - 6 - 8 - 10 - 12,

Circular Die M3 - 4 - 5 - 6 - 8 - 10 - 12,

Adjustable Tap Wrench No. 1 – No. 2, Tap Gauge,

Screwdriver, Tool-Holder with Ratchet M5 - M12,

Die Stock 20x5 - 20x7 - 25x9 - 30x11 - 38x14 mm,

HSS-G Twist Drill Bits BASIC, 1 - 10 mm / 0,5 Growing + 2,5 - 3,3 - 4,2 - 5,0 - 6,8 - 8,5 - 10,2 mm



64
tlg./pcs.

395 x 375 x 35 mm

| Art.-Nr./Art.-No. | tlg./pcs. | L./L. | B./W. | H./H. | | € |
|-------------------|-----------|-------|-------|-------|--------------------------|--------|
| 5999-361 | 64 | | | | | 259,50 |
| 5999-36E | | 395 | 375 | 35 | Einlage leer/empty inlay | 50,40 |

5999-181

PROFESSIONAL PLUS STANDARD

PROForm Einlegesystem Schneid- und Mess-Werkzeug, 27-teilig (Dreifacheinlage)

PROForm Cutting and Measuring Tools Inlay,
27 pieces (3/3-inlay)

Inhalt/Contents:

Säge mit 5 Ersatz-Sägeblättern,
Messer mit 10 Ersatz-Klingen,
3 Blechscheren,
Hebel Kraft-Seitenschneider 180 mm,
Beißzange 200 mm, Meßschieber,
Maßstab 1 m, Maßband 3 m,
Magnetheber, Taschenlampe

Hack Saw + 5 pieces Saw Blades,

Knife + 10 pieces Blades,

3 pieces Tinmans Shears,

Heavy Duty Side Cutter 180 mm, End Cutting Pliers 200 mm,

Vernier Caliper, Foldable Plastic Ruler 1m, Measuring Tape 3m, Magnetic Pick Up Tool, Flashlight



27
tlg./pcs.

395 x 560 x 35 mm

| Art.-Nr./Art.-No. | tlg./pcs. | L./L. | B./W. | H./H. | | € |
|-------------------|-----------|-------|-------|-------|--------------------------|--------|
| 5999-181 | 27 | | | | | 245,00 |
| 5999-18E | | 395 | 560 | 35 | Einlage leer/empty inlay | 68,50 |

PROForm Werkstattwagen Einlagen

PROForm Inlays for Roller Cabinets

Art.-Gruppe 171
Article Group 171

5999-331

PROFESSIONAL PLUS STANDARD

PROForm Einlagesystem Feilen, 5-teilig

PROForm File Inlay, 5 pieces

Inhalt/Contents:

**Flachfeile Hieb 2/200 mm, Halbrundfeile Hieb 2/200 mm,
Rundfeile Hieb 2/200 mm, Vierkantfeile Hieb 2/200 mm,
Dreikantfeile Hieb 2/200 mm**

Flat File Hieb 2/200mm, Half Round File Hieb 2/200mm,
Round File Hieb 2/200mm, Three Square File Hieb 2/200mm,
Square File Hieb 2/200mm

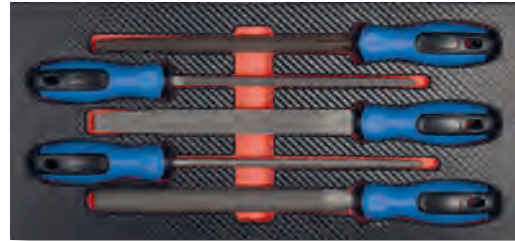

5
tlg./pcs.



395 x 186 x 35 mm

| Art.-Nr./Art.-No. | tlg./pcs. | L./L. | B./W. | H./H. | € |
|-------------------|-----------|-------|-------|-------|---------------------------------------|
| 5999-331 | 5 | | | | 60,40 |
| 5999-33E | | 395 | 186 | 35 | Einlage leer/empty inlay 26,25 |

5999-171

PROFESSIONAL PLUS STANDARD

PROForm Einlagesystem Gripzangen und Rollgabelschlüssel, 4-teilig

PROForm Rip Pliers

and Adjustable Wrenches Inlay, 4 pieces

Inhalt/Contents:

**Rollgabelschlüssel 8"/200 mm, 12"/300 mm,
Gripzange 10"/250 mm,
Langbeck Klemmzange 150 mm**

Adjustable Wrenches 8"/200 mm, 12"/300 mm,
Self Grip Pliers 10"/250 mm,
Long Jaws Grip Pliers 150 mm



4
tlg./pcs.



395 x 186 x 35 mm

| Art.-Nr./Art.-No. | tlg./pcs. | L./L. | B./W. | H./H. | € |
|-------------------|-----------|-------|-------|-------|---------------------------------------|
| 5999-171 | 4 | | | | 79,80 |
| 5999-17E | | 395 | 186 | 35 | Einlage leer/empty inlay 26,25 |

5999-391 / 5999-392 / 5999-393

PROFESSIONAL PLUS STANDARD

Leereinlagen für Schrauben und andere Kleinteile

Empty Inlays for Screws and other Small Items



5999-391



5999-392



5999-393

395 x 186 x 35 mm

| Art.-Nr./Art.-No. | tlg./pcs. | L./L. | B./W. | H./H. | € |
|-------------------|-------------------------|-------|-------|-------|---------------------------------------|
| 5999-391 | 6 Fächer/6 Compartments | 395 | 186 | 35 | Einlage leer/empty inlay 26,25 |
| 5999-392 | 5 Fächer/5 Compartments | 395 | 186 | 35 | Einlage leer/empty inlay 26,25 |
| 5999-393 | 7 Fächer/7 Compartments | 395 | 186 | 35 | Einlage leer/empty inlay 26,25 |

Bestückter Werkzeugkoffer »RedLine«, »BlackLine« oder »SuperBlue«

Sets for Tool Box »RedLine«, »BlackLine« or »SuperBlue«

Art.-Gruppe 172
Article Group 172

5902-01 / 5902-201 / 5902-501

PROFESSIONAL PLUS STANDARD

„Compact TS“

Werkzeugkoffer »RedLine«, »BlackLine« oder »SuperBlue«

bestückt mit 81 Werkzeugen in PROForm-Einlage

„Compact TS“ set for tool box »RedLine«, »BlackLine« or »SuperBlue« assembled with 81 tools in PROForm-inlay

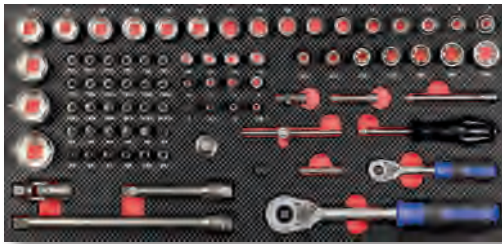

5999-211 269 x 568 x 35 mm

RedLine

BlackLine

SuperBlue



| Art.-Nr./Art.-No. | Schubfächer/Drw. | L./L. | B./W. | H./H. | tlg./pcs. | | € |
|-------------------|------------------|-------|-------|-------|-----------|-----------------------|--------|
| 5902-01 | 6 »RedLine« | 307 | 660 | 378 | 81 | bestückt „COMPACT TS“ | 795,00 |
| 5902-201 | 6 »BlackLine« | 307 | 660 | 378 | 81 | bestückt „COMPACT TS“ | 795,00 |
| 5902-501 | 6 »SuperBlue« | 307 | 660 | 378 | 81 | bestückt „COMPACT TS“ | 795,00 |

5902-02 / 5902-202 / 5902-502

PROFESSIONAL PLUS STANDARD

„Compact XL“

Werkzeugkoffer »RedLine«, »BlackLine« oder »SuperBlue«

bestückt mit 155 Werkzeugen in PROForm-Einlagen

„Compact XL“ sets for tool box »RedLine«, »BlackLine« or »SuperBlue«, assembled with 155 tools in PROForm-inlay



5999-211 269 x 568 x 35 mm

RedLine

BlackLine

SuperBlue



5999-221 269 x 568 x 35 mm



5999-231 269 x 568 x 35 mm

| Art.-Nr./Art.-No. | Schubfächer/Drw. | L./L. | B./W. | H./H. | tlg./pcs. | | € |
|-------------------|------------------|-------|-------|-------|-----------|-----------------------|----------|
| 5902-02 | 6 »RedLine« | 307 | 660 | 378 | 155 | bestückt „COMPACT XL“ | 1.169,00 |
| 5902-202 | 6 »BlackLine« | 307 | 660 | 378 | 155 | bestückt „COMPACT XL“ | 1.169,00 |
| 5902-502 | 6 »SuperBlue« | 307 | 660 | 378 | 155 | bestückt „COMPACT XL“ | 1.169,00 |

Einlagen zu Werkzeugkoffern

Inlays for Tool Boxes



Art.-Gruppe 171
Article Group 171

PROFESSIONAL PLUS STANDARD

5999-211

269 x 568 x 35 mm

1/4" Inhalt/Contents:

Knarre, Steckgriff, Gleitgriff, Verlängerungen 50 + 100 mm, Stecknuss Bit Adapter 50 mm, Kardangeln, Kupplungsstück für Bits, Innen TX Nüsse E4 - 5 - 6 - 7 - 8 - 10 - 11, 6-kant Nüsse 4 - 4,5 - 5 - 5,5 - 6 - 7 - 8 - 9 - 10 - 11 - 12 - 13 mm, Bit Nüsse: PH1 - 2 - 3, PZ1 - 2 - 3, Schlitz 4 - 5,5 - 6,5 mm, TX8 - 9 - 10 - 15 - 20 - 25 - 27 - 30 - 40, Innensechskant 3 - 4 - 5 - 6 - 8 mm

Ratchet, Spinner Handle, Sliding T-Handle, Extension Bars 50 + 100 mm, Socket Adapter 50 mm, Universal Joint, Bit Adapter, TX Sockets E4 - 5 - 6 - 7 - 8 - 10 - 11, Sockets 4 - 4,5 - 5 - 5,5 - 6 - 7 - 8 - 9 - 10 - 11 - 12 - 13 mm, Bit Sockets: PH1 - 2 - 3, PZ1 - 2 - 3, Slotted 4 - 5,5 - 6,5 mm, TX8 - 9 - 10 - 15 - 20 - 25 - 27 - 30 - 40, Hex 3 - 4 - 5 - 6 - 8 mm

1/2" Inhalt/Contents:

Knarre, T-Gleitadapter, Verlängerungen 125 + 250 mm, Kardangeln, 6-kant Nüsse 8 - 9 - 10 - 11 - 12 - 13 - 14 - 15 - 16 - 17 - 18 - 19 - 20 - 21 - 22 - 24 - 27 - 30 - 32 mm, Innen-TX-Nüsse E12 - 14 - 16 - 18 - 20 - 22 - 24

Ratchet, T-Adapter, Extension Bars 125 + 250 mm, Universal Joint, Sockets 8 - 9 - 10 - 11 - 12 - 13 - 14 - 15 - 16 - 17 - 18 - 19 - 20 - 21 - 22 - 24 - 27 - 30 - 32 mm, TX Sockets E12 - 14 - 16 - 18 - 20 - 22 - 24

| Art.-Nr./Art.-No. | L./L. | B./W. | H./H. | tlg./pcs. | | € |
|-------------------|-------|-------|-------|-----------|---------------------|---------------|
| 5999-211 | 269 | 568 | 35 | 81 | 1/4" + 1/2" Einlage | 438,00 |
| 5999-21E | 269 | 568 | 35 | 1 | Einlage leer | 56,50 |

PROFESSIONAL PLUS STANDARD



5999-221

269 x 568 x 35 mm

Inhalt/Contents:

Schraubendreher Phillips Nr. 1 + 2, Pozidriv Nr. 1 + 2, Schlitz 0,5 x 3 x 75 mm, 0,8 x 4 x 100 mm, 1 x 5,5 x 125 mm, 1,2 x 6,5 x 150 mm, 1,6 x 8 x 150 mm, Kombizange 180 mm, Seitenschneider 160 mm, Telefon-/Radiozange 200 mm, Wasserpumpenzange 250 mm

Phillips Screwdriver No. 1 + 2, Pozidriv Screwdriver No. 1 + 2, Slotted Screwdriver 0,5 x 3 x 75 mm, 0,8 x 4 x 100 mm, 1 x 5,5 x 125 mm, 1,2 x 6,5 x 150 mm, 1,6 x 8 x 150 mm, Combination Plier 180 mm, Side Cutter 160 mm, Long Nose Plier 200 mm, Waterpump Plier 250 mm

PROFESSIONAL PLUS STANDARD



5999-231

269 x 568 x 35 mm

Inhalt/Contents:

Gabelringsschlüssel 8 - 9 - 10 - 11 - 12 - 13 - 14 - 15 - 16 - 17 - 18 - 19 mm, Schlosserhammer 500 g, Splintentreiber-Satz 2 - 3 - 4 - 5 - 6 - 8 mm, Rollmeter 3 m, Universalmesser, Kugelkopf-Stiftschlüssel Satz extra lang 2 - 10 mm im Drehhalter, 1/4" BIT STOP Box (32-tlg.)

Combination Wrenches 8 - 9 - 10 - 11 - 12 - 13 - 14 - 15 - 16 - 17 - 18 - 19 mm, Machinist Hammer 500 g, Pin Punch Set 2 - 3 - 4 - 5 - 6 - 8 mm, Measuring Tape 3 m, Knife, Ball Point Keys Extra Long Version 2 to 10 mm, 1/4" BIT STOP Box (32 pieces)

| Art.-Nr./Art.-No. | L./L. | B./W. | H./H. | tlg./pcs. | | € |
|-------------------|-------|-------|-------|-----------|-------------------------------------|---------------|
| 5999-221 | 269 | 568 | 35 | 13 | Schraubendreher- u. Zangen- Einlage | 192,00 |
| 5999-22E | 269 | 568 | 35 | 1 | Einlage leer | 56,50 |
| 5999-231 | 269 | 568 | 35 | 61 | Schlüssel- und Werkzeug-Einlage | 209,00 |
| 5999-23E | 269 | 568 | 35 | 1 | Einlage leer | 56,50 |

Sätze & Einzelteile

Socket Sets and Accessories



Qualitätsabstufungen im Katalog

Quality Levels in Catalogue

Sehr geehrter Kunde, PROJAHN liefert Ihnen stets eine gleichbleibend hohe Qualität. Um Ihnen die Suche nach dem für Ihre Anforderungen optimalen Werkzeug so einfach wie möglich zu machen, finden Sie über jedem Produkt das PROJAHN-Qualitätssiegel. Folgende Qualitätsstufen gliedern zukünftig das gesamte PROJAHN-Sortiment:

Dear Customer, PROJAHN always provides you with consistently high quality. To make the search for the optimal tool for your needs as easy as possible, you find the PROJAHN Quality Seal on each product. The following grades are dividing the entire PROJAHN range:

Höchste Qualitätsstufe / Highest Quality Level:

PROFESSIONAL PLUS STANDARD

Mittlere Qualitätsstufe / Medium Quality Level:

PROFESSIONAL **PLUS** STANDARD

Standard Qualitätsstufe / Standard Quality Level:

PROFESSIONAL PLUS **STANDARD**

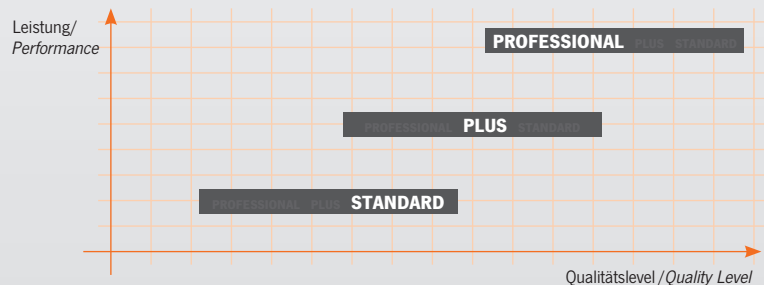
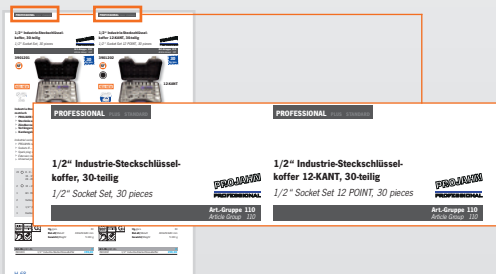

PROFESSIONAL

- ▶ Höchstes Qualitätsniveau für ausgezeichnete Präzision
- ▶ Übertrifft DIN- und ISO-Normen
- ▶ Für härteste Anwendungen bei geringem Verschleiß
- ▶ Sehr lange Lebensdauer
- ▶ Hochwertigste Materialien, professionelles Oberflächen-Finish
- ▶ Kompromisslose Qualität für höchste Ansprüche

PLUS

- ▶ Sehr hohes Qualitätsniveau für präzises Arbeiten
- ▶ Qualität über DIN- und ISO-Normen
- ▶ Werkzeuge für schwierige Anforderungen
- ▶ Für problemlösungsorientierte Anwender
- ▶ Hochwertige Herstellung, ergonomisches Design

STANDARD

- ▶ Gute Markenqualität
- ▶ Sehr attraktiver Preis für Profi-Niveau
- ▶ Qualität für alle Standard-Anwendungen

PROFESSIONAL

- ▶ Highest level of quality for excellent precision
- ▶ Exceeds DIN and ISO standards
- ▶ For the hardest applications by low wear
- ▶ Very long life time
- ▶ High-quality materials, professional finish
- ▶ Uncompromising quality for highest demands

PLUS

- ▶ Very high level of quality for highest precision
- ▶ Quality higher than DIN and ISO standards
- ▶ Tools for difficult requirements
- ▶ For problem-solving users
- ▶ High-quality manufacturing, ergonomic design

STANDARD

- ▶ Good brand quality
- ▶ Attractive price-performance ratio
- ▶ Quality for all standard applications

Übersicht Werkzeugkoffer







Summary Tool Cases

2

| | Auf Seite / On Page | Qualität / Quality | | Teile / Pieces | | | | 1/4" | 3/8" | 1/2" | 3/4" | 1" | Unschaltknarre / Ratchet Handle | Feinzahn-Unschaltknarre / Fine-Tooth Ratchet Handle | Durchsteckknarre / Go-Through Ratchet Handle | Stecknüsse / Sockets | Tiefe Stecknüsse / Deep Sockets | Zündkerzen-Stecknüsse / Spark Plug Sockets | Schlagnüsse / Impact Sockets | Tiefe Schlagnüsse / Deep Impact Sockets | Stecknuss-Bits / Bit Sockets | Standard-Bits / Bits | Doppelgabelschlüssel / Double Open End Wrench | Ringgabelschlüssel / Combination Wrench | Doppelringschlüssel / Double Ring Wrench | Gear Tech Ratschenschlüssel / Gear Tech Ratchet Wrench | Winkelstiftschlüssel / Hey/Keys | Schraubendreher, Steckgriff / Screwdriver, Spinner Handle | Zangen / Pliers | Hammer / Hammer | Säge / Saw | Wasservaaige / Spirit Level | Feile, Raspel / File, Rasp | Stechbeitel / Wood Chisel | | |
|--|---------------------|--------------------|------|----------------|------|------|------|------|------|------|------|----|---------------------------------|---|--|----------------------|---------------------------------|--|------------------------------|---|------------------------------|----------------------|---|---|--|--|---------------------------------|---|-----------------|-----------------|------------|-----------------------------|----------------------------|---------------------------|------|----|
| | | PROFESSIONAL | PLUS | STANDARD | 1/4" | 3/8" | 1/2" | | | | | | | | | | | | | | | | | | | | | | | | | | | | 3/4" | 1" |
|  1/4" Mini-Steckschlüsselkoffer / 1/4" Mini Socket Set Art.-Nr./Art.-No. 4078 B x L x H/W x L x H: 160 x 83 x 33 mm Gewicht/Weight: 450 g | H 79 | | + | 23 | + | | | | | | | + | | | + | | | | | | | | | | | | | | | | | | | | | |
|  3/8" Industrie-Steckschlüsselkoffer / 3/8" Industrial Socket Set Art.-Nr./Art.-No. 3903801 B x L x H/W x L x H: 400 x 290 x 80 mm Gewicht/Weight: 5.500 g | H 62 | + | | 76 | + | | | | | | | + | | | + | + | + | | | | + | | | | | | | | | | | | | | | |
|  3/8" Industrie-Steckschlüsselkoffer / 3/8" Industrial Socket Set Art.-Nr./Art.-No. 3903802 B x L x H/W x L x H: 360 x 260 x 75 mm Gewicht/Weight: 2.100 g | H 63 | + | | 23 | + | | | | | | | + | | | + | + | | | | | | | | | | | | | | | | | | | | |
|  3/8" Steckschlüsselkoffer US-Zoll / 3/8" Socket Set Inch Art.-Nr./Art.-No. 4018 B x L x H/W x L x H: 390 x 180 x 50 mm Gewicht/Weight: 3.340 g | H 63 | + | | 25 | + | | | | | | | + | | | + | + | + | | | | | | | | | | | | | | | | | | | |
|  3/8" Xi-on Steckschlüsselkoffer / 3/8" Xi-on Socket Set Art.-Nr./Art.-No. 4111 B x L x H/W x L x H: 260 x 145 x 50 mm Gewicht/Weight: 2.000 g | H 74 | | + | 17 | + | | | | | | | + | | | + | | | | | | | | | | | | | | | | | | | | | |
|  1/2" Industrie-Steckschlüsselkoffer / 1/2" Industrial Socket Set Art.-Nr./Art.-No. 3901201 B x L x H/W x L x H: 400 x 290 x 80 mm Gewicht/Weight: 5.100 g | H 64 | + | | 30 | + | | | | | | | + | | | + | + | + | | | | | | | | | | | | | | | | | | | |
|  1/2" Industrie-Steckschl. 12-KANT / 1/2" Industrial Socket Set 12 Point Art.-Nr./Art.-No. 3901202 B x L x H/W x L x H: 400 x 290 x 80 mm Gewicht/Weight: 5.100 g | H 64 | + | | 30 | + | | | | | | | + | | | + | + | + | | | | | | | | | | | | | | | | | | | |
|  1/2" Industrie-Steckschlüsselkoffer / 1/2" Industrial Socket Set Art.-Nr./Art.-No. 3901203 B x L x H/W x L x H: 360 x 260 x 75 mm Gewicht/Weight: 3.500 g | H 65 | + | | 20 | + | | | | | | | + | | | + | + | + | | | | | | | | | | | | | | | | | | | |
|  1/2" Steckschlüsselkoffer US-Zoll / 1/2" Socket Set Inch Art.-Nr./Art.-No. 4028 B x L x H/W x L x H: 450 x 275 x 55 mm Gewicht/Weight: 6.540 g | H 65 | + | | 28 | + | | | | | | | + | | | + | + | + | | | | | | | | | | | | | | | | | | | |
|  1/2" Xi-on Steckschlüsselkoffer / 1/2" Xi-on Socket Set Art.-Nr./Art.-No. 4121 B x L x H/W x L x H: 450 x 195 x 55 mm Gewicht/Weight: 4.530 g | H 75 | | + | 23 | + | | | | | | | + | | | + | + | | | | | | | | | | | | | | | | | | | | |
|  1/2" Spiralprofil-Steckschlüsselkoffer / 1/2" Twist Socket Set Art.-Nr./Art.-No. 3061 B x L x H/W x L x H: 160 x 120 x 50 mm Gewicht/Weight: 750 g | H 78 | | + | 10 | + | | | | | | | | | | + | | | | | | | | | | | | | | | | | | | | | |











Übersicht Werkzeugkoffer Summary Tool Cases

3

| Auf Seite / On Page | Qualität / Quality | | Teile / Pieces | 1/4" | 3/8" | 1/2" | 3/4" | 1" | Unschaltknarre / Ratchet Handle | Feinzahn-Unschaltknarre / Fine-Tooth Ratchet Handle | Durchsteck-Knarre / Go-Through Ratchet Handle | Stecknüsse / Sockets | Tiefe Stecknüsse / Deep Sockets | Zündkerzen-Stecknüsse / Spark Plug Sockets | Schlagnüsse / Impact Sockets | Tiefe Schlagnüsse / Deep Impact Sockets | Stecknuss-Bits / Bit Sockets | Standard-Bits / Bits | Doppelgabelschlüssel / Double Open End Wrench | Ringgabelschlüssel / Combination Wrench | Doppelring Schlüssel / Double Ring Wrench | Gear Tech Ratschenschlüssel / Gear Tech Ratchet Wrench | Winkelschlüssel / Hey Keys | Schraubendreher, Steckgriff / Screwdriver, Spinner Handle | Zangen / Pliers | Hammer / Hammer | Säge / Saw | Wasserwaage / Spirit Level | Feile, Raspel / File, Rasp | Stechbeitel / Wood Chisel |
|--|--------------------|------|----------------|------|------|------|------|----|---------------------------------|---|---|----------------------|---------------------------------|--|------------------------------|---|------------------------------|----------------------|---|---|---|--|----------------------------|---|-----------------|-----------------|------------|----------------------------|----------------------------|---------------------------|
| | PROFESSIONAL | PLUS | | | | | | | | | | | | | | | | | | | | | | | | | | | | |
|  1/2" Steckschlüsselkoffer/ 1/2" Socket Set Art.-Nr./Art.-No. 8661 B x L x H/W x L x H: 380 x 250 x 80 mm Gewicht/Weight: 3.500 g | H 80 | + | 21 | | | + | | | + | | | + | | | | | | | | | | | | | | | | | | |
|  1/2" Steckschlüsselkoffer/ 1/2" Socket Set Art.-Nr./Art.-No. 8662 B x L x H/W x L x H: 380 x 250 x 80 mm Gewicht/Weight: 3.500 g | H 80 | + | 21 | | | + | | | + | | | + | | | | | | | | | | | | | | | | | | |
|  1/2" Steckschlüsselkoffer/ 1/2" Socket Set Art.-Nr./Art.-No. 4027 B x L x H/W x L x H: 450 x 190 x 55 mm Gewicht/Weight: 4.600 g | H 80 | + | 22 | | | + | | | + | | | + | | | | | | | | | | | | | | | | | | |
|  3/4" Industrie-Steckschlüsselkoffer/ 3/4" Industrial Socket Set Art.-Nr./Art.-No. 3903401 B x L x H/W x L x H: 550 x 380 x 115 mm Gewicht/Weight: 15.000 g | H 67 | + | 21 | | | + | | | + | | | + | | | | | | | | | | | | | | | | | | |
|  1" Industrie-Steckschlüsselkoffer/ 1" Industrial Socket Set Art.-Nr./Art.-No. 2052 B x L x H/W x L x H: 730 x 320 x 150 mm Gewicht/Weight: 40.340 g | H 68 | + | 22 | | | | | + | + | | | + | | | | | | | | | | | | | | | | | | |
|  1/2" Industrie-Steckschlüsselkoffer/ 1/2" Industrial Socket Set Art.-Nr./Art.-No. 3901204 B x L x H/W x L x H: 400 x 290 x 100 mm Gewicht/Weight: 6.800 g | H 66 | + | 45 | | | + | | | + | | | + | | + | | | | | + | | | | | | | | | | | |
|  1/4" + 1/2" Industrie-Steckschlüsselkoffer/ 1/4" + 1/2" Industrial Socket Set Art.-Nr./Art.-No. 3904201 B x L x H/W x L x H: 400 x 290 x 100 mm Gewicht/Weight: 6.700 g | H 70 | + | 91 | + | | + | | | + | | | + | | + | | | | + | | | | | | + | | | | | | |
|  1/4" + 1/2" Xi-on Steckschlüsselkoffer/ 1/4" + 1/2" Xi-on Socket Set Art.-Nr./Art.-No. 4131 B x L x H/W x L x H: 450 x 200 x 55 mm Gewicht/Weight: 5.200 g | H 75 | + | 54 | + | | + | | | + | | | + | | + | | | | + | | | | | + | | | | | | | |
|  1/4" + 1/2" Steckschlüsselkoffer/ 1/4" + 1/2" Socket Set Art.-Nr./Art.-No. 8653 B x L x H/W x L x H: 400 x 310 x 85 mm Gewicht/Weight: 7.000 g | H 81 | + | 108 | + | | + | | | + | | | + | | + | | | | + | | | | | + | + | | | | | | |
|  1/4" + 1/2" Steckschlüsselkoffer/ 1/4" + 1/2" Socket Set Art.-Nr./Art.-No. 8654 B x L x H/W x L x H: 400 x 310 x 85 mm Gewicht/Weight: 7.000 g | H 81 | + | 108 | + | | + | | | + | | | + | | + | | | | + | | | | | + | + | | | | | | |

Übersicht Werkzeugkoffer

Summary Tool Cases

| | Auf Seite / On Page | Qualität / Quality | | Teile / Pieces | | | | Unschaltknarre / Ratchet Handle | Feinzahn-Unschaltknarre / Fine-Tooth Ratchet Handle | Durchsteckknarre / Go-Through Ratchet Handle | Stecknüsse / Sockets | Tiefe Stecknüsse / Deep Sockets | Zündkerzen-Stecknüsse / Spark Plug Sockets | Schlagnüsse / Impact Sockets | Tiefe Schlagnüsse / Deep Impact Sockets | Stecknuss-Bits / Bit Sockets | Standard-Bits / Bits | Doppelgabelschlüssel / Double Open End Wrench | Ringgabelschlüssel / Combination Wrench | Doppelringeschlüssel / Double Ring Wrench | Gear Tech Ratschenschlüssel / Gear Tech Ratchet Wrench | Winkelstiftschlüssel / Hey/Keys | Schraubendreher + Steckgriff / Screwdriver + Spinner Handle | Zangen / Pliers | Hammer / Hammer | Säge / Saw | Wasservaage / Spirit Level | Feile, Raspel / File, Rasp | Stechbeitel / Wood Chisel |
|---|---------------------|--------------------|------|----------------|------|------|------|---------------------------------|---|--|----------------------|---------------------------------|--|------------------------------|---|------------------------------|----------------------|---|---|---|--|---------------------------------|---|-----------------|-----------------|------------|----------------------------|----------------------------|---------------------------|
| | | PROFESSIONEL | PLUS | STANDARD | 1/4" | 3/8" | 1/2" | | | | | | | | | | | | | | | | | | | | | | |
|  1/4" + 3/8" + 1/2" Steckschlüsselkoffer/ 1/4" + 3/8" + 1/2" Socket Set Art.-Nr./Art.No. 8663 B x L x H/W x L x H: 400 x 310 x 85 mm Gewicht/Weight: ca. 8.500 g | H 83 | | + | 182 | + | + | + | | + | | + | + | + | | + | + | | | | | | + | + | | | | | | |
|  1/4" + 3/8" + 1/2" Steckschlüsselkoffer/ 1/4" + 3/8" + 1/2" Socket Set Art.-Nr./Art.No. 8664 B x L x H/W x L x H: 400 x 310 x 85 mm Gewicht/Weight: ca. 8.500 g | H 83 | | + | 182 | + | + | + | | + | | + | + | + | | + | + | | | | | | + | + | | | | | | |
|  3/8" Universal Werkzeugkoffer/ 3/8" Universal Tool Set Art.-Nr./Art.No. 3903803 B x L x H/W x L x H: 550 x 380 x 115 mm Gewicht/Weight: 7.800 g | H 69 | + | | 84 | | + | | + | | + | | + | | | + | + | | | | | | + | + | + | + | + | + | + | |
|  1/2" Universal Werkzeugkoffer/ 1/2" Universal Tool Set Art.-Nr./Art.No. 3901205 B x L x H/W x L x H: 460 x 350 x 90 mm Gewicht/Weight: 6.900 g | H 71 | + | | 67 | | | + | | + | | + | | | | + | + | | | | | | | + | + | + | | | | |
|  1/4" + 3/8" + 1/2" Industrie-Steckschl./ 1/4" + 3/8" + 1/2" Industrial Socket Set Art.-Nr./Art.No. 39048201 B x L x H/W x L x H: 550 x 380 x 115 mm Gewicht/Weight: 10.500 g | H 72 | + | | 122 | + | + | + | | + | | + | | | | + | + | | | | | | + | + | + | | | | | |
|  1/4" + 3/8" + 1/2" Industrie-Steckschlüsselk./ 1/4" + 3/8" + 1/2" Industrial Socket Set Art.-Nr./Art.No. 39048202 B x L x H/W x L x H: 550 x 380 x 115 mm Gewicht/Weight: 13.500 g | H 73 | + | | 195 | + | + | + | | + | | + | + | + | + | + | + | | | | | | + | + | | | | | | |
|  1/4" + 1/2" Werkzeugkoffer/ 1/4" + 1/2" Tool Set Art.-Nr./Art.No. 8655 B x L x H/W x L x H: 420 x 285 x 85 mm Gewicht/Weight: 6.000 g | H 82 | | + | 91 | + | | + | | + | | + | | | | + | + | | | | | | + | + | + | | | | | |
|  1/4" + 1/2" Werkzeugkoffer/ 1/4" + 1/2" Tool Set Art.-Nr./Art.No. 8656 B x L x H/W x L x H: 420 x 285 x 85 mm Gewicht/Weight: 6.000 g | H 82 | | + | 91 | + | | + | | + | | + | | | | + | + | | | | | | + | + | + | | | | | |
|  1/2" Metall-Werkzeugkoffer/ 1/2" Metal Tool Set Art.-Nr./Art.No. 8688 B x L x H/W x L x H: 490 x 225 x 380 mm Gewicht/Weight: 13.500 g | H 84 | | + | 84 | | | + | | + | | + | | | | + | + | | | | | | + | + | + | + | + | + | + | + |
|  1/4" + 1/2" Universal-Werkzeugtrolley/ 1/4" + 1/2" Universal Tool Trolley Art.-Nr./Art.No. 4963-01 B x L x H/W x L x H: 450 x 390 x 170 mm Gewicht/Weight: 17.500 g | H 86 | | + | 130 | + | | + | | + | | + | | | | + | + | | | | | | + | + | + | + | + | + | + | + |
|  1/4" + 1/2" Universal-Werkzeugkoffer/ 1/4" + 1/2" Universal Tool Case Art.-Nr./Art.No. 8681 B x L x H/W x L x H: 460 x 330 x 145 mm Gewicht/Weight: 12.240 g | H 85 | | + | 149 | + | | + | | + | | + | | | | + | + | | | | | | + | + | + | + | + | + | + | + |



Profi-Qualität

Professional Quality

- ▶ **Höchstes Qualitätsniveau für anspruchsvolle Anwender**
- ▶ **Präzision und Belastbarkeit weit über DIN-/ISO-Normen**
- ▶ **Ergonomisch optimiertes Kofferdesign – 2K-Koffergriff und klar strukturierte Anordnung der Werkzeuge**
- ▶ **Optimiert auf Langlebigkeit für höchste Ansprüche**
- ▶ *Highest level of quality for demanding users*
- ▶ *Precision and durability far beyond DIN/ISO standards*
- ▶ *Ergonomically optimized design – 2K-handle and clearly structured arrangement of the tools*
- ▶ *Optimized for durability for highest demands*

Einzigartiges Produktportfolio

Unique Product Range

- ▶ **Breites Produktsortiment für verschiedenste Anwendungen**
- ▶ **14 professionelle Werkzeugkoffer optimiert für individuelle Ansprüche**
- ▶ **Innovative, zukunftsorientierte Werkzeugzusammenstellung**
- ▶ *Wide product range enables universal use*
- ▶ *14 professional tool sets optimized for individual requirements*
- ▶ *Innovative and future-oriented assortment of tools*

Exklusive Persönlichkeit

Exclusive Personality

- ▶ **Hochwertige, ausdrucksstarke Premium-Optik**
- ▶ **Langlebige und stabile Design-Metallverschlüsse**
- ▶ **Werkzeuge passgenau eingebettet in Schaumeinlagen mit attraktiver metallischer Oberflächenoptik**
- ▶ *High-quality, expressive premium-look*
- ▶ *Durable and stable design metal locks*
- ▶ *Tools perfectly embedded in foam insert with attractive metallic surface appearance*

Leistungsstarker Service

Powerful Support

- ▶ **PROJAHN Qualitätsversprechen – 25 Jahre Garantie¹**
- ▶ **Alle Einzelteile problemlos nachbestellbar**
- ▶ **Inklusive Servicezertifikat**
- ▶ **Qualifizierte Produktberatung**
- ▶ *PROJAHN's promise of quality – 25 years warranty¹*
- ▶ *All individual parts easily orderable*
- ▶ *Including certificate of service*
- ▶ *Qualified product advice*

¹ Entsprechend unserer allgemeinen Garantiebedingungen
⁴ According to our general warranty conditions





Ergonomisches Design

Ergonomic Design

- ▶ **Sicherer Halt und ermüdungsfreies Arbeiten durch ergonomisch an die Hand angepasste Griffform**
- ▶ **2-Komponentenmaterial – bruchsicherer, stabiler Kern und griffige Ummantelung mit hoher Rutschhemmung**
- ▶ **Hoher Abgleitschutz durch spezielle Daumenmulden**
- ▶ **Geringere Belastung für Gelenke bei gleichzeitig höherem Drehmoment**
- ▶ **Leichte Einhandbedienung durch Schnelllöseknopf und Richtungsumschalter**
- ▶ *Secure grip and fatigue-free working due to ergonomically to the hand designed ratchet handle*
- ▶ *Two-component material – robust core combined with an ergonomic, slip-resistant surface*
- ▶ *High slip protection due to specially adapted thumb grips*
- ▶ *Less strain on joints combined with a higher torque*
- ▶ *Easy one-handed operation because of quick-release button and direction lever*

EINGETRAGENES DESIGN

REGISTERED DESIGN



Profi-Qualität

Professional Quality

- ▶ **Höchstes Qualitätsniveau für anspruchsvolle Anwender**
- ▶ **Präzision und Belastbarkeit weit über DIN-/ISO-Normen**
- ▶ **Hält extremen Drehmomenten bis 650 Nm stand²**
- ▶ **Leichtgängiger, hochpräziser Knarrenmechanismus**
- ▶ **Hohe Öl- und Säurebeständigkeit**
- ▶ *Highest level of quality for demanding users*
- ▶ *Precision and durability far beyond DIN/ISO standards*
- ▶ *Withstands extreme torques up to 650 Nm⁽²⁾*
- ▶ *Smooth-running, high-precision ratchet mechanism*
- ▶ *High oil and acid resistance*

Leistungsstarker Service

Powerful Support

- ▶ **PROJAHN Qualitätsversprechen – 25 Jahre Garantie¹**
- ▶ **Schneller Reparaturservice im Garantiefall**
- ▶ *PROJAHN's promise of quality – 25 years warranty¹*
- ▶ *Fast repair service during warranty time*



¹ Entsprechend unserer allgemeinen Garantiebedingungen / ¹ According to our general warranty conditions
² 1/2" PROJAHN-Umschaltknarre 39012900 / ² PROJAHN ratchet handle 39012900

1/4" Industrie-Steckschlüsselkoffer, 40-teilig

1/4" Industrial Socket Set, 40 pieces

PROJAHN
PROFESSIONAL

Art.-Gruppe 114
Article Group 114

3901401

1/4"

40
tlg./pcs.

GARANTIE
25
JAHRE



Industrie-Steckschlüsselkoffer mit 40 Werkzeugen, metrisch

- ▶ PROJAHN Umschaltknarre
- ▶ Stecknüsse 3,5 – 14 mm
- ▶ Bit-Schraubereinsätze für alle Schraubarbeiten
- ▶ Ergonomischer Steckgriff

Industrial socket set with 40 assorted tools, metric

- ▶ PROJAHN ratchet handle, reversible
- ▶ Sockets 3.5 – 14 mm
- ▶ Bit-sockets for all screws
- ▶ Ergonomical spinner handle

| | | | |
|----|---|---|--|
| 14 | ○ | 3.5 - 4 - 4.5 - 5 - 5.5 - 6 - 7 - 8 - 9 - 10 - 11 - 12 - 13 - 14 mm | |
| 3 | ● | 4 - 5.5 - 6.5 mm | |
| 3 | + | PH 1 - 2 - 3 | |
| 3 | + | PZ 1 - 2 - 3 | |
| 5 | ● | 3 - 4 - 5 - 6 - 8 mm | |
| 6 | ⊙ | T10 - 15 - 20 - 25 - 30 - 40 | |
| 1 | | Art. 39014900 | |
| 1 | | Steckgriff | |
| 2 | | Verlängerung 50 + 100 mm | |
| 1 | | Gleitgriff | |
| 1 | | Kardangelenke | |

1/4" Industrie-Steckschlüsselkoffer 39-teilig

1/4" Industrial Socket Set, 39 pieces

PROJAHN
PROFESSIONAL

Art.-Gruppe 114
Article Group 114

3901402

1/4"

39
tlg./pcs.

GARANTIE
25
JAHRE



Industrie-Steckschlüsselkoffer mit 39 Werkzeugen, metrisch

- ▶ PROJAHN Umschaltknarre, Stecknüsse 3,5 – 14 mm
- ▶ Bits für jeden Einsatz, Stecknuss-Bit-Adapter
- ▶ Magnetischer Bit-Schraubendreher

Industrial socket set with 39 assorted tools, metric

- ▶ PROJAHN ratchet handle, reversible, sockets 3.5 – 14 mm
- ▶ Bits for all screws, adapter-bit for socket
- ▶ Magnetic spinner handle

| | | | |
|----|---|---|--|
| 14 | ○ | 3.5 - 4 - 4.5 - 5 - 5.5 - 6 - 7 - 8 - 9 - 10 - 11 - 12 - 13 - 14 mm | |
| 2 | ● | 5.5 - 6.5 mm | |
| 3 | + | PH 1 - 2 - 3 | |
| 3 | + | PZ 1 - 2 - 3 | |
| 5 | ● | 3 - 4 - 5 - 6 - 8 mm | |
| 6 | ⊙ | T10 - 15 - 20 - 25 - 30 - 40 | |
| 1 | | Adapter 1/4" (Knarre) x 1/4" (Bit) | |
| 1 | | Art. 39014900 | |
| 1 | | Magn. Bitschraubendreher | |
| 1 | | Verlängerung 100 mm | |
| 1 | | Kardangelenke | |
| 1 | | 1/4" Stecknuss-Bit-Adapter | |



Größe/Size 1/4"
tlg./pcs. 40
BxLxH/WxLxH 260x160x60 mm
Gewicht/Weight 1.200 g



Größe/Size 1/4"
tlg./pcs. 39
BxLxH/WxLxH 260x160x60 mm
Gewicht/Weight 1.000 g

| Art.-Nr./Art.-No. | | € |
|-------------------|-------------------------------------|--------|
| 3901401 | 1/4" Industrie-Steckschlüsselkoffer | 105,00 |
| 3901402 | 1/4" Industrie-Steckschlüsselkoffer | 76,00 |

1/4" Steckschlüsselkoffer,**23-teilig, US-Zoll**





1/4" Socket Set, 23 pieces, Inch

PROJAHN
PROFESSIONAL**Art.-Gruppe 114**
Article Group 114**4008****1/4"****23**
tlg./pcs.**GARANTIE**
25
JAHRE**Industrie-Steckschlüsselkoffer mit 23 Werkzeugen,
Zoll im Metallkoffer**

- ▶ **Industrieknarre**
- ▶ **Stecknüsse 3/16" – 1/2"**
- ▶ **Tiefe Stecknüsse 3/16" – 1/2"**

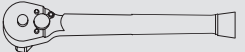
Industrial socket set with 23 assorted tools,
inch in metal case

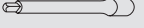
- ▶ **Industrial ratchet**
- ▶ **Sockets 3/16" – 1/2"**
- ▶ **Deep sockets 3/16" – 1/2"**

| | | | |
|---|---|---|---|
| 9 | ○ | 3/16" - 7/32" - 1/4" - 9/32" - 5/16" - 11/32" - 3/8" - 7/16" - 1/2" | |
| 9 | ○ | 3/16" - 7/32" - 1/4" - 9/32" - 5/16" - 11/32" - 3/8" - 7/16" - 1/2" |  |
| 1 | | Art. 4208 |  |
| 1 | | Steckgriff |  |
| 2 | | Verlängerung 2" + 3" |  |
| 1 | | Kardangelenk |  |

Größe/Size: 1/4" · **tlg./pcs.** 23 · **BxLxH/WxLxH:** 260x135x45 mm
Gewicht/Weight: 1.360 g

| Art.-Nr./Art.-No. | | € |
|-------------------|-----------------------------------|--------------|
| 4008 | 1/4" Steckschlüsselkoffer US-Zoll | 86,00 |

3/8" Industrie-Steckschlüsselkoffer, 76-teilig

3/8" Socket Set, 76 pieces

PROJAHN
PROFESSIONAL

Art.-Gruppe 114
Article Group 114

3903801

3/8"

76
tlg./pcs.



Industrie-Steckschlüsselkoffer mit 76 Werkzeugen, metrisch

- ▶ **PROJAHN Umschaltknarre**
- ▶ **Stecknüsse 6 – 24 mm**
- ▶ **Tiefe Stecknüsse 8 – 22 mm**
- ▶ **Bit-Stecknüsse für alle Schraubarbeiten**

Industrial socket set with 76 assorted tools, metric

- ▶ *PROJAHN ratchet handle, reversible*
- ▶ *Sockets 6 – 24 mm*
- ▶ *Deep sockets 8 – 22 mm*
- ▶ *Bit-sockets for all screws*

| | | | | | |
|----|---|--|----|--|--|
| 19 | ○ 6 - 7 - 8 - 9 - 10 - 11 - 12 - 13 - 14 - 15 - 16 - 17 - 18 - 19 - 20 - 21 - 22 - 23 - 24 mm | | 7 | ● 3 - 4 - 5 - 6 - 7 - 8 - 10 mm | |
| 11 | ○ 8 - 10 - 11 - 12 - 13 - 14 - 15 - 17 - 18 - 19 - 22 mm | | 10 | ⊕ T10 - 15 - 20 - 25 - 27 - 30 - 40 - 45 - 50 - 55 | |
| 2 | ○ 16 + 21 mm | | 10 | ⊕ T10 - 15 - 20 - 25 - 27 - 30 - 40 - 45 - 50 - 55 | |
| 4 | ● 5.5 - 6.5 - 8 - 10 mm | | 1 | 1/2" (Knarre) x 3/8" (Nuss) | |
| 4 | ⊕ PH 1 - 2 - 3 - 4 | | 2 | Verlängerungen 75 + 250 mm | |
| 4 | ⊕ PZ 1 - 2 - 3 - 4 | | 1 | Kardangeln | |
| | | | 1 | Art. 39038900 | |



Größe/Size 3/8"
tlg./pcs. 76
BxLxH/WxLxH 400x290x80 mm
Gewicht/Weight 5.600 g

| Art.-Nr./Art.-No. | | € |
|-------------------|-------------------------------------|---------------|
| 3903801 | 3/8" Industrie-Steckschlüsselkoffer | 269,00 |
| | | |
| | | |

3/8" Industrie-Steckschlüsselkoffer, 23-teilig

3/8" Socket Set, 23 pieces



Art.-Gruppe 114
Article Group 114

3903802



23
tlg./pcs.



Industrie-Steckschlüsselkoffer mit 23 Werkzeugen, metrisch

- ▶ PROJAHN Umschaltknarre
- ▶ Stecknüsse 6 – 22 mm
- ▶ Zündkerzen Stecknüsse 16 + 21 mm
- ▶ Verlängerungen 75 + 250 mm

Industrial socket set with 23 assorted tools, metric

- ▶ PROJAHN ratchet handle, reversible
- ▶ Sockets 6 – 22 mm
- ▶ Spark plug sockets 16 + 21 mm
- ▶ Extension bars 75 + 250 mm

| | | | |
|----|---|---|--|
| 17 | ○ | 6 - 7 - 8 - 9 - 10 - 11 - 12 - 13 - 14 - 15 - 16 - 17 - 18 - 19 - 20 - 21 - 22 mm | |
| 2 | ○ | 16 + 21 mm | |
| 1 | | Art. 39038900 | |
| 2 | | Verlängerungen 75 + 250 mm | |
| 1 | | 1/2" (Knarre) x 3/8" (Nuss) | |



Größe/Size 3/8"
tlg./pcs. 23
BxLxH/WxLxH 360x260x75 mm
Gewicht/Weight 2.100 g

| | |
|---|-------|
| Art.-Nr./Art.-No. | € |
| 3903802 3/8" Industrie-Steckschlüsselkoffer | 98,00 |

3/8" Steckschlüsselkoffer, 25-teilig, US-Zoll

3/8" Socket Set, 25 pieces, Inch



Art.-Gruppe 114
Article Group 114

4018



25
tlg./pcs.



Industrie-Steckschlüsselkoffer mit 25 Werkzeugen, Zoll, im Metallkoffer

Industrial socket set with 25 assorted tools, inch, in metal case

| | | | |
|----|---|--|--|
| 10 | ○ | 5/16" - 3/8" - 7/16" - 1/2" - 9/16" - 5/8" - 11/16" - 3/4" - 13/16" - 7/8" | |
| 9 | ○ | 3/8" - 7/16" - 1/2" - 9/16" - 5/8" - 11/16" - 3/4" - 13/16" - 7/8" | |
| 2 | ○ | 5/8" + 13/16" | |
| 1 | | Art. 4218 | |
| 2 | | Verlängerungen 3" + 6" | |
| 1 | | Kardangelenke | |

Größe/Size: 3/8" · tlg./pcs. 25 · BxLxH/WxLxH: 390x180x50 mm
Gewicht/Weight: 3.340 g

| | |
|--|--------|
| Art.-Nr./Art.-No. | € |
| 4018 3/8" Steckschlüsselkoffer US-Zoll | 129,00 |

1/2" Industrie-Steckschlüssel- koffer, 30-teilig

1/2" Socket Set, 30 pieces

PROJAHN
PROFESSIONAL

Art.-Gruppe 114
Article Group 114

3901201

1/2"



30
tlg./pcs.



Industrie-Steckschlüsselkoffer mit 30 Werkzeugen, metrisch

- ▶ PROJAHN Umschaltknarre
- ▶ Stecknüsse 8 – 34 mm
- ▶ Zündkerzen Stecknüsse 16 + 21 mm
- ▶ Verlängerungen 125 + 250 mm
- ▶ Kardangelen

Industrial socket set with 30 assorted tools, metric

- ▶ PROJAHN ratchet handle, reversible
- ▶ Sockets 8 – 34 mm
- ▶ Spark plug sockets 16 + 21 mm
- ▶ Extension bars 125 + 250 mm
- ▶ Universal joint

23 8 - 9 - 10 - 11 - 12 - 13 - 14 - 15 -
16 - 17 - 18 - 19 - 20 - 21 - 22 - 23 -
24 - 26 - 27 - 28 - 30 - 32 - 34 mm



2 16 + 21 mm

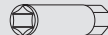

1 Art. 39012900

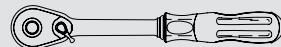

2 Verlängerungen 125 + 250 mm

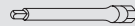

1 1/2" (Knarre) x 1/2" (Nuss)



1 Kardangelen



Größe/Size 1/2"
tlg./pcs. 30
BxLxH/WxLxH 400x290x80 mm
Gewicht/Weight 5.100 g

Art.-Nr./Art.-No. €
3901201 1/2" Industrie-Steckschlüsselkoffer 176,00

1/2" Industrie-Steckschlüssel- koffer 12-KANT, 30-teilig

1/2" Socket Set 12 POINT, 30 pieces

PROJAHN
PROFESSIONAL

Art.-Gruppe 114
Article Group 114

3901202

1/2"



30
tlg./pcs.



12-KANT

Industrie-Steckschlüsselkoffer mit 30 Werkzeugen, metrisch 12-KANT

- ▶ PROJAHN Umschaltknarre
- ▶ Stecknüsse 8 – 34 mm
- ▶ Zündkerzen Stecknüsse 16 + 21 mm
- ▶ Verlängerungen 125 + 250 mm
- ▶ Kardangelen

Industrial socket set with 30 assorted tools,
metric 12 POINT sockets

- ▶ PROJAHN ratchet handle, reversible
- ▶ Sockets 8 – 34 mm
- ▶ Spark plug sockets 16 + 21 mm
- ▶ Extension bars 125 + 250 mm
- ▶ Universal joint

23 8 - 9 - 10 - 11 - 12 - 13 - 14 - 15 - 16 -
17 - 18 - 19 - 20 - 21 - 22 - 23 - 24 -
26 - 27 - 28 - 30 - 32 - 34 mm



2 16 + 21 mm

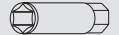

1 Art. 39012900

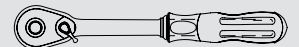

2 Verlängerungen 125 + 250 mm

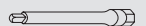

1 1/2" (Knarre) x 1/2" (Nuss)



1 Kardangelen



Größe/Size 1/2"
tlg./pcs. 30
BxLxH/WxLxH 400x290x80 mm
Gewicht/Weight 5.100 g

Art.-Nr./Art.-No. €
3901202 1/2" Industrie-Steckschlüsselkoffer 176,00

1/2" Industrie-Steckschlüsselkoffer, 20-teilig

1/2" Socket Set, 20 pieces

PROJAHN
PROFESSIONAL

Art.-Gruppe 114
Article Group 114

3901203

1/2"

20
tlg./pcs.



Industrie-Steckschlüsselkoffer mit 20 Werkzeugen, metrisch

- ▶ PROJAHN Umschaltknarre
- ▶ Stecknüsse 10 – 32 mm
- ▶ Zündkerzen Stecknüsse 16 + 21 mm
- ▶ Verlängerungen 125 + 250 mm

Industrial socket set with 20 assorted tools, metric

- ▶ PROJAHN ratchet handle, reversible
- ▶ Sockets 10 – 32 mm
- ▶ Spark plug sockets 16 + 21 mm
- ▶ Extension bars 125 + 250 mm

14 ○ 10 - 11 - 12 - 13 - 14 - 15 - 17 - 18 - 19 - 22 - 24 - 27 - 30 - 32 mm



2 ○ 16 + 21 mm

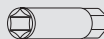

1 Art. 39012900

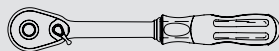

2 Verlängerungen 125 + 250 mm

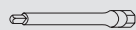

1 1/2" (Knarre) x 1/2" (Nuss)



Größe/Size 1/2"
tlg./pcs. 20
BxLxH/WxLxH 360x260x75 mm
Gewicht/Weight 3.500 g

Art.-Nr./Art.-No. 3901203 1/2" Industrie-Steckschlüsselkoffer € 132,00

1/2" Steckschlüsselkoffer, 28-teilig, US-Zoll

1/2" Socket Set, 28 pieces, Inch

PROJAHN
PROFESSIONAL

Art.-Gruppe 114
Article Group 114

4028

1/2"

28
tlg./pcs.



Industrie-Steckschlüssel Satz mit 28 Werkzeugen, Zoll, im Metallkoffer

- ▶ Industrieknarre
- ▶ Stecknüsse 7/16" – 1 1/4"
- ▶ Tiefe Stecknüsse von 15/16" – 1/2"

Industrial socket set with 28 assorted tools, inch, in metal case

- ▶ Industrial ratchet
- ▶ Sockets 7/16" – 1 1/4"
- ▶ Deep sockets 15/16" – 1/2"

13 ○ 7/16" - 1/2" - 9/16" - 5/8" - 11/16" - 3/4" - 13/16" - 7/8" - 15/16" - 1" - 1 1/16" - 1 1/8" - 1 1/4"

8 ○ 15/16" - 7/8" - 13/16" - 3/4" - 11/16" - 5/8" - 9/16" - 1/2"

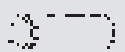

2 5/8" + 13/16"

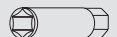

2 Verlängerungen 5" + 10"



1 1/2" (Knarre) x 1/2" (Nuss)



1 Kardangelenk



1 Art. 4228

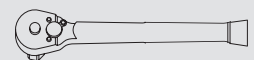

Größe/Size 1/2"
tlg./pcs. 28
BxLxH/WxLxH 450x275x55 mm
Gewicht/Weight 6.540 g

Art.-Nr./Art.-No. 4028 1/2" Steckschlüsselkoffer US-Zoll € 215,00

1/2" Industrie-Steckschlüsselkoffer mit Gabelringschlüsseln, 45-teilig

1/2" Socket Set with Combination Wrenches, 45 pieces



Art-Gruppe 114
Article Group 114

3901204

1/2"

45
tlg./pcs.



Industrie-Steckschlüsselkoffer mit 45 Werkzeugen

- ▶ PROJAHN Umschaltknarre
- ▶ Stecknüsse 8 – 34 mm
- ▶ Zündkerzen Stecknüsse 16 + 21 mm
- ▶ Verlängerungen 125 + 250 mm
- ▶ Ringgabelschlüssel 6 – 22 mm

Industrial socket set with 45 assorted tools

- ▶ PROJAHN ratchet handle, reversible
- ▶ Sockets 8 – 34 mm
- ▶ Spark plug sockets 16 + 21 mm
- ▶ Extension bars 125 + 250 mm
- ▶ Combination wrenches 6 – 22 mm

| | | | | | |
|----|---|--|----|---|--|
| 23 | 8 - 9 - 10 - 11 - 12 - 13 - 14 - 15 - 16 - 17 - 18 - 19 - 20 - 21 - 22 - 23 - 24 - 26 - 27 - 28 - 30 - 32 - 34 mm | | 2 | Verlängerungen 125 + 250 mm | |
| 2 | 16 + 21 mm | | 1 | 1/2" (Knarre) x 1/2" (Nuss) | |
| 1 | Art. 39012900 | | 1 | Kardangelen | |
| | | | 15 | 6 - 7 - 8 - 9 - 10 - 11 - 12 - 13 - 14 - 15 - 16 - 17 - 18 - 19 - 22 mm | |



Größe/Size 1/2"
 tlg./pcs. 45
 BxLxH/WxLxH 400x290x100 mm
 Gewicht/Weight 6.700 g

| Art.-Nr./Art.-No. | | € |
|-------------------|-------------------------------------|--------|
| 3901204 | 1/2" Industrie-Steckschlüsselkoffer | 255,00 |
| | | |
| | | |

3/4" Industrie-Steckschlüsselkoffer, 21-teilig

3/4" Socket Set, 21 pieces

3903401

3/4"

**Industrie-Steckschlüsselkoffer mit 21 Werkzeugen, metrisch**

- ▶ Umschaltknarre
- ▶ Stecknüsse 19 – 50 mm
- ▶ Schiebegriff mit Gleitstück
- ▶ Verlängerungen 100 + 200 + 400 mm

Socket set with 21 assorted tools, metric

- ▶ Ratchet
- ▶ Sockets 19 – 50 mm
- ▶ 1 sliding t-handle
- ▶ 3 extension bars

16 ○ 19 - 21 - 22 - 23 - 24 - 26 - 27 - 29 -
30 - 32 - 35 - 36 - 38 - 41 - 46 - 50 mm

3 Verlängerungen 100, 200 + 400 mm

1 Gleitgriff

1 Art. 400001

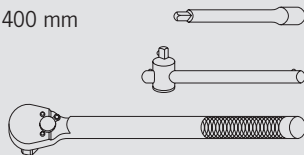

Größe/Size: 3/4" · **tlg./pcs.** 21 · **BxLxH/WxLxH:** 550x380x115 mm
Gewicht/Weight: 15.000 g

Art.-Nr./Art.-No.

3903401

3/4" Industrie-Steckschlüsselkoffer

€

398,00

Weitere PROForm-Werkstatteinlagen ab Seite /
 More PROForm Inlays for Roller Cabinet from Page H 32

1" Industrie-Steckschlüsselkoffer, 22-teilig

1" Socket Set, 22 pieces

PROJAHN
PROFESSIONAL

Art-Gruppe 114
Article Group 114

2052

1"

22
tlg./pcs.



Industrie-Steckschlüsselkoffer mit 22 Werkzeugen, metrisch

- ▶ Umschaltknarre
- ▶ Stecknüsse 36 – 80 mm
- ▶ Schiebegriff mit Gleitstück
- ▶ Verlängerungen 200 + 400 mm

Socket set with 22 assorted tools, metric

- ▶ Ratchet
- ▶ Sockets 36 –80 mm
- ▶ 1 sliding t-handle
- ▶ 2 extension bars

| | | |
|----|---|--|
| 17 | 36 - 38 - 41 - 46 - 50 - 54 - 55 - 58 - 60 - 63 - 65 - 67 - 70 - 71 - 75 - 77 - 80 mm | |
| 2 | Verlängerungen 200 + 400 mm | |
| 1 | Gleitgelenk | |
| 1 | Griff für Gleitgelenk 560 mm | |
| 1 | Art. 500000 | |

Größe/Size: 1" · tlg./pcs. 22 · BxLxH/WxLxH: 730x320x150 mm
Gewicht/Weight: 40.340 g

| Art.-Nr./Art.No. | € |
|------------------|--|
| 2052 | 1" Industrie-Steckschlüsselkoffer 849,00 |



Weitere PROForm-Werkstatteinlagen ab Seite /
More PROForm Inlays for Roller Cabinet from Page H 32

3/8" Universal Industrie-Werkzeugkoffer, 84-teilig

3/8" Universal Industrial Tool Set, 84 pieces

3903803

3/8"



Universal Industrie-Werkzeugkoffer mit 84 Werkzeugen, metrisch

- ▶ PROJAHN Umschaltknarre
- ▶ Stecknüsse 8 – 22 mm
- ▶ Ringgabelschlüssel 8 – 21 mm
- ▶ 31-teilige Bit-Box 1/4"
- ▶ Magnetisches Kugelkopf-Stiftschlüssel-Set 9-teilig

Universal industrial tool set with 84 assorted tools, metric

- ▶ PROJAHN ratchet handle, reversible
- ▶ Sockets 8 – 22 mm
- ▶ Combination wrenches 8 – 21 mm
- ▶ 31 pcs bit box 1/4"
- ▶ Magnetic ball end hex key set 9pcs

| | | | | | | |
|----|--|------|--|----|--|--|
| 13 | 8 - 10 - 11 - 12 - 13 - 14 - 15 - 16 - 17 - 18 - 19 - 21 - 22 mm | 3/8" | | 1 | Wasserpumpenzange 250 mm | |
| 2 | 16 + 21 mm | | | 1 | Kombizange 180 mm | |
| 1 | Kardangelenk | | | 1 | Seitenschneider 160 mm | |
| 1 | Verlängerung 150 mm | | | 1 | Universalmesser | |
| 1 | 3/8" (Knarre) x 1/4" (Bit) | | | 1 | Metallsägebogen 300 mm | |
| 1 | Art. 39038900 | | | 1 | Hammer 300 g | |
| 3 | 4 - 5.5 - 6.5 mm | 1/4" | | 1 | 1.0 x 5.5 x 125 mm | |
| 5 | PH1 - PH1 - PH2 - PH2 - PH3 | | | 1 | 1.6 x 8.0 x 150 mm | |
| 5 | PZ1 - PZ1 - PZ2 - PZ2 - PZ3 | | | 2 | PH 1 / PH 2 | |
| 9 | T8 - 9 - 10 - 15 - 20 - 25 - 27 - 30 - 40 | | | 1 | PZ 2 | |
| 8 | 2 - 2.5 - 3 - 4 - 5 - 6 - 7 - 8 mm | | | 1 | 110 bis/up to 250 V Spannungsprüfer | |
| 1 | Magn. Bit-Halter 60 mm | | | 1 | Teleskop-Magnetheber | |
| 1 | Magn. Bit-Schraubendreher | | | 1 | Maßband 3 m | |
| 9 | 1.5 - 2 - 2.5 - 3 - 4 - 5 - 6 - 8 - 10 mm | | | 10 | 8 - 9 - 10 - 11 - 12 - 13 - 14 - 17 - 19 - 21 mm | |



Größe/Size 1/4" + 3/8"
 tlg./pcs. 84
 BxLxH/WxLxH 550x380x115 mm
 Gewicht/Weight 7.800 g

Art.-Nr./Art.-No. 3903803 3/8" Universal Werkzeugkoffer € 385,00

1/4" + 1/2" Industrie-Steckschlüsselkoffer, 91-teilig

1/4" + 1/2" Socket Set, 91 pieces

PROJAHN
PROFESSIONAL

Art-Gruppe 114
Article Group 114

3904201

1/4"

1/2"

91
tlg./pcs.



Industrie-Steckschlüsselkoffer mit 91 Werkzeugen, metrisch

- ▶ 2 PROJAHN Umschaltknarren 1/4" + 1/2"
- ▶ Stecknüsse 3,5 – 32 mm
- ▶ Tiefe Stecknüsse 6 – 19 mm
- ▶ Zündkerzen Stecknüsse 16 + 21 mm
- ▶ 1/4" Bit Stecknüsse für alle Schraubarbeiten
- ▶ Industrie-Bits 5/16" und 1/2" Adapter für alle Schraubarbeiten
- ▶ Verlängerungen 50 + 100 + 125 + 250 mm
- ▶ Kardangelenke

Industrial socket set with 91 assorted tools, metric

- ▶ 2 PROJAHN ratchet handles, reversible 1/4"+1/2"
- ▶ Sockets 3,5 – 32 mm
- ▶ Deep sockets 6 – 19 mm
- ▶ Spark plug sockets 16 + 21 mm
- ▶ Bit sockets 1/4" for all screws
- ▶ Industrial bits 5/16" and 1/2" adapter for all screws
- ▶ Extension bars 50 + 100 + 125 + 250 mm
- ▶ Universal joints

| | | | | | | | |
|----|---|------|--|----|--|-------|--|
| 14 | ○ 3.5 - 4 - 4.5 - 5 - 5.5 - 6 - 7 - 8 - 9 - 10 - 11 - 12 - 13 - 14 mm | 1/4" | | 14 | ○ 10 - 13 - 15 - 16 - 17 - 18 - 19 - 20 - 21 - 22 - 24 - 27 - 30 - 32 mm | 1/2" | |
| 8 | ○ 6 - 7 - 8 - 9 - 10 - 11 - 12 - 13 mm | | | 4 | ○ 14 - 15 - 17 - 19 mm | | |
| 3 | ● 4 - 5.5 - 6.5 mm | | | 3 | ⊕ T50 - 55 - 60 | | |
| 3 | ⊕ PH 1 - 2 - 3 | | | 2 | ○ 16 + 21 mm | | |
| 3 | ⊕ PZ 1 - 2 - 3 | | | 1 | 1/2" (Knarre) x 1/2" (Nuss) | | |
| 4 | ● 3 - 4 - 5 - 6 mm | | | 2 | Verlängerungen 125 + 250 mm | | |
| 8 | ⊕ T8 - 9 - 10 - 15 - 20 - 25 - 27 - 30 | | | 1 | 1/2" (Knarre) x 5/16" (Bit) | | |
| 1 | Kardangelenke | | | 1 | Kardangelenk | | |
| 2 | Verlängerungen 50 + 100 mm | | | 1 | Art. 39012900 | | |
| 1 | Gleitgriff | | | | | | |
| 1 | Steckgriff | | | | | | |
| 1 | Art. 39014900 | | | | | | |
| | | | | 4 | ● 6.5 - 8 - 10 - 12 mm | 5/16" | |
| | | | | 3 | ⊕ PH 2 - 3 - 4 | | |
| | | | | 3 | ⊕ PZ 2 - 3 - 4 | | |
| | | | | 3 | ⊕ T30 - 40 - 45 | | |



Größe/Size 1/4" + 1/2" + 5/16"
 tlg./pcs. 91
 BxLxH/WxLxH 400x290x100 mm
 Gewicht/Weight 6.700 g

Art.-Nr./Art.-No. €
 3904201 1/4" + 1/2" Industrie-Steckschlüsselkoffer 315,00

1/2" Universal Industrie-Werkzeugkoffer, 67-teilig

1/2" Universal Industrial Tool Set, 67 pieces

3901205



Universal Industrie-Werkzeugkoffer mit 67 Werkzeugen, metrisch

- ▶ PROJAHN Umschaltknarre
- ▶ Stecknüsse 8 – 27 mm
- ▶ Zündkerzen-Stecknüsse 16 + 21 mm
- ▶ 31-teilige Bit-Box 1/4"
- ▶ Doppelgabelschlüssel, metrisch 6 – 22 mm
- ▶ Schlosserhammer 300 g
- ▶ Zangen mit 2-Komponenten-Griff
- ▶ Schraubendreher mit 2-Komponenten-Griff

Universal industrial tool set with 67 assorted tools, metric

- ▶ PROJAHN ratchet handles, reversible
- ▶ Sockets 8 – 27 mm
- ▶ Spark plug sockets 16 + 21 mm
- ▶ 31 pcs bit box 1/4"
- ▶ Double open end wrenches 6 – 22 mm
- ▶ Hammer 300 g
- ▶ Pliers with 2k-handle
- ▶ Screwdrivers with 2k-handle

| | | | | | | |
|----|--|------|--|---|--|--|
| 3 | 4 - 5.5 - 6.5 mm | 1/4" | | 2 | 5.5 x 1.0 - 8 x 1.6 mm | |
| 5 | PH1 - PH1 - PH2 - PH2 - PH3 | | | 1 | PH 2 | |
| 5 | PZ1 - PZ1 - PZ2 - PZ2 - PZ3 | | | 1 | Magn. Bit-Schraubendreher | |
| 9 | T8 - 9 - 10 - 15 - 20 - 25 - 27 - 30 - 40 | | | 1 | 110 bis/up to 250 V Spannungsprüfer | |
| 8 | 2 - 2.5 - 3 - 4 - 5 - 6 - 7 - 8 mm | | | 1 | 1.2 x 6.5 x 38 mm | |
| 1 | Magn. Bit-Halter 60 mm | | | 1 | PH 2 | |
| 11 | 8 - 10 - 12 - 13 - 14 - 15 - 17 - 19 - 22 - 24 - 27 mm | 1/2" | | 1 | Wasserpumpenzange 250 mm | |
| 2 | 16 + 21 mm | | | 1 | Kombizange 180 mm | |
| 2 | Verlängerungen 125 + 250 mm | | | 1 | Hammer 300 g | |
| 1 | Kardangeln | | | 8 | 6 x 7 - 8 x 9 - 10 x 11 - 12 x 13 - 14 x 15 - 16 x 17 - 18 x 19 - 20 x 22 mm | |
| 1 | 1/2" (Knarre) x 1/2" (Nuss) | | | | | |
| 1 | Art. 39012900 | | | | | |



Größe/Size 1/4" + 1/2"
 tlg./pcs. 67
 BxLxH/WxLxH 460x350x90 mm
 Gewicht/Weight 6.900 g

Art.-Nr./Art.-No. 3901205 1/2" Universal Werkzeugkoffer € 309,00

1/4" + 3/8" + 1/2" Universal Industrie-Steckschlüsselkoffer, 122-teilig

1/4" + 3/8" + 1/2" Universal Industrie Socket Set, 122 pieces



Art-Gruppe 114
Article Group 114

39048201

1/4"

3/8"

1/2"

122
tlg./pcs.



Universal Industrie-Steckschlüsselkoffer mit 122 Werkzeugen, metrisch

- ▶ 3 PROJAHN Umschaltknarren 1/4" + 3/8" + 1/2"
- ▶ Stecknüsse 4 – 32 mm
- ▶ Verlängerungen 50 + 75 + 100 + 125 + 150 + 250 mm
- ▶ Kugelpf Stiftschlüssel Satz 9-teilig, magnetisch
- ▶ Ringgabelschlüssel 6 – 22 mm
- ▶ 31-teilige BitBox 1/4"
- ▶ Kombizange, Seitenschneider, Wasserpumpenzange
- ▶ Sechs Schraubendreher + ein Spannungsprüfer

Universal industrial socket set with 122 assorted tools, metric

- ▶ PROJAHN ratchet handles, reversible 1/4" + 3/8" + 1/2"
- ▶ Sockets 4 – 32 mm
- ▶ Extension bars 50 + 75 + 100 + 125 + 150 + 250 mm
- ▶ Magnetic ball end hex key set 9pcs
- ▶ Combination wrenches 6 – 22 mm
- ▶ 31 pcs bit box 1/4"
- ▶ Pliers ▶ 6 screwdrivers and a voltage tester

| | | | | | | | |
|----|--|------|--|----|--|------|--|
| 12 | ○ 4 - 4.5 - 5 - 5.5 - 6 - 7 - 8 - 9 - 10 - 11 - 12 - 13 mm | 1/4" | | 2 | 1/2" (Knarre) x 1/2" (Nuss) | 1/2" | |
| 1 | 1/4" x 1/4" | | | 1 | 1/2" (Knarre) x 3/8" (Nuss) | | |
| 1 | Magn. Bit-Halter 60 mm | | | 1 | Kardangeln | | |
| 3 | ● 4 - 5.5 - 6.5 mm | | | 13 | ○ 17 - 18 - 19 - 20 - 21 - 22 - 23 - 24 - 26 - 27 - 28 - 30 - 32 mm | | |
| 8 | ● 2 - 2.5 - 3 - 4 - 5 - 6 - 7 - 8 mm | | | 2 | Verlängerungen 125 + 250 mm | | |
| 9 | ⊗ T8 - 9 - 10 - 15 - 20 - 25 - 27 - 30 - 40 | | | 1 | Art. 39012900 | | |
| 5 | ⊕ PH 1 - PH 1 - PH 2 - PH 2 - PH 3 | | | 1 | Wasserpumpenzange 250 mm | | |
| 5 | ⊕ PZ 1 - PZ 1 - PZ 2 - PZ 2 - PZ 3 | | | 1 | Kombizange 180 mm | | |
| 1 | Kardangeln | | | 1 | Seitenschneider 160 mm | | |
| 2 | Verlängerungen 50 + 100 mm | | | 1 | ● 1.0 x 5.5 x 125 mm | | |
| 1 | Magn. Bit-Schraubendreher | | | 1 | ● 1.6 x 8.0 x 150 mm | | |
| 1 | Gleitgriff | | | 2 | ⊕ PH1/PH2 | | |
| 1 | Art. 39014900 | | | 2 | ⊕ PZ1/PZ2 | | |
| 1 | Bit-Knarre, Art. 2700 | | | 1 | 110 bis/up to 250 V Spannungsprüfer | | |
| 1 | 1/4" x 1/4" | | | 9 | 1.5 - 2 - 2.5 - 3 - 4 - 5 - 6 - 8 - 10 mm | | |
| 1 | Steckgriff | | | 16 | 6 - 7 - 8 - 9 - 10 - 11 - 12 - 13 - 14 - 15 - 16 - 17 - 18 - 19 - 21 - 22 mm | | |
| 10 | ○ 10 - 11 - 12 - 13 - 14 - 15 - 16 - 17 - 18 - 19 mm | 3/8" | | | | | |
| 2 | Verlängerungen 75 + 150 mm | | | | | | |
| 1 | 3/8" (Knarre) x 1/4" (Bit) | | | | | | |
| 1 | Kardangeln | | | | | | |
| 1 | Art. 39038900 | | | | | | |



Größe/Size 1/4" + 3/8" + 1/2"
 tlg./pcs. 122
 BxLxH/WxLxH 550x380x115 mm
 Gewicht/Weight 10.500 g

| Art.-Nr./Art.-No. | € |
|--------------------------------|--------------------|
| 39048201 | 1/4" + 3/8" + 1/2" |
| Industrie-Steckschlüsselkoffer | 495,00 |

1/4" + 3/8" + 1/2" Industrie-Steckschlüsselkoffer, 195-teilig

1/4" + 3/8" + 1/2" Socket Set, 195 pieces

Art.-Gruppe 114
Article Group 114

39048202

1/4"

3/8"

1/2"

195
tlg./pcs.



Industrie-Steckschlüsselkoffer mit 195 Werkzeugen, metrisch

- ▶ 3 PROJAHN Umschaltknarren 1/4" + 3/8" + 1/2"
- ▶ Stecknüsse 4 – 32 mm ▶ Tiefe Stecknüsse 6 – 22 mm
- ▶ Verlängerungen 50 + 75 + 100 + 125 + 150 + 250 mm
- ▶ Innen-TX-Stecknüsse E4 – E20
- ▶ Kugelkopf Stiftschlüssel Satz 9-teilig, magnetisch
- ▶ Ringgabelschlüssel 6 – 22 mm
- ▶ Bit-Stecknüsse für alle Schraubarbeiten
- ▶ Tiefe Schlagnüsse 16 – 22 mm

Industrial socket set with 195 assorted tools, metric

- ▶ PROJAHN ratchet handles, reversible 1/4" + 3/8" + 1/2"
- ▶ Sockets 4 – 32 mm ▶ Deep sockets 6 – 22 mm
- ▶ Extension bars 50 + 75 + 100 + 125 + 150 + 250 mm
- ▶ TX-sockets E4 – E20 ▶ Combination wrenches 6 – 22 mm
- ▶ Ball end hex key set 9pcs, magnetic ▶ Bit-sockets for all screws
- ▶ Deep impact sockets 16 – 22 mm

- | | | | | |
|----|---|--|------|--|
| 12 | ○ | 4 - 4.5 - 5 - 5.5 - 6 - 7 - 8 - 9 - 10 - 11 - 12 - 13 mm | 1/4" | |
| 4 | ○ | 6 - 7 - 8 - 9 mm | | |
| 3 | ● | 4 - 5.5 - 6.5 mm | | |
| 2 | + | PH 1 - 2 | | |
| 2 | + | PZ 1 - 2 | | |
| 4 | ● | 3 - 4 - 5 - 6 mm | | |
| 8 | ● | T8 - 9 - 10 - 15 - 20 - 25 - 27 - 30 | | |
| 1 | | 1/4" x 1/4" | | |
| 1 | | Bit-Halter 60 mm | | |
| 4 | ● | 3 - 4 - 5 - 6 mm | | |
| 7 | ⊕ | T10 - 15 - 20 - 25 - 27 - 30 - 40 | | |
| 3 | + | PH 1 - 2 - 3 | | |
| 3 | + | PZ 1 - 2 - 3 | | |
| 1 | | Kardangelenk | | |
| 2 | | Verlängerungen 50 + 100 mm | | |
| 1 | | Magn. Bit-Schraubendreher | | |
| 1 | | Steckgriff | | |
| 1 | | Art. 39014900 | | |
| 1 | | Bit-Knarre, Art. 2700 | | |
| 1 | | Gleitgriff | | |

- | | | | | |
|----|---|--|------|--|
| 10 | ○ | 10 - 11 - 12 - 13 - 14 - 15 - 16 - 17 - 18 - 19 mm | 3/8" | |
| 6 | ○ | 10 - 11 - 12 - 13 - 14 - 15 mm | | |
| 2 | ○ | 16 + 21 mm | | |
| 2 | | Kippverlängerung 75 und 150 mm | | |

- | | | | | |
|----|---|---|--|--|
| 12 | ⊕ | E4 - 5 - 6 - 7 - 8 - 10 - 11 - 12 - 14 - 16 - 18 - 20 | | |
| 1 | | 1/2" (Knarre) x 3/8" (Nuss) | | |
| 1 | | 3/8" (Knarre) x 1/4" (Bit) | | |
| 1 | | Kardangelenk | | |
| 1 | | Art. 39038900 | | |

- | | | | | |
|----|---|---|------|--|
| 1 | | 1/2" (Knarre) x 5/16" (Bit) | 1/2" | |
| 1 | | 1/2" (Knarre) x 1/2" (Nuss) | | |
| 1 | | Kardangelenk | | |
| 2 | | Kippverlängerung 125 + 250 mm | | |
| 13 | ○ | 17 - 18 - 19 - 20 - 21 - 22 - 23 - 24 - 26 - 27 - 28 - 30 - 32 mm | | |
| 4 | ○ | 17 - 18 - 19 - 22 mm | | |
| 6 | | Tiefe Schlag-Stecknuss 16 - 17 - 18 - 19 - 21 - 22 mm | | |
| 2 | | Sicherungsring und -stift für Schlagnüsse | | |
| 1 | | Art. 39012900 | | |

- | | | | | |
|----|---|--|-------|--|
| 3 | ● | 8 - 10 - 12 mm | 5/16" | |
| 4 | ● | 4 - 5 - 6 - 8 mm | | |
| 4 | + | PH 1 - 2 - 3 - 4 mm | | |
| 4 | + | PZ 1 - 2 - 3 - 4 mm | | |
| 4 | ● | M6 - 8 - 10 - 12 | | |
| 5 | ● | T25 - 30 - 40 - 45 - 50 | | |
| 9 | ⊕ | T10 - 15 - 20 - 25 - 27 - 30 - 40 - 45 - 50 | | |
| 8 | ⊕ | T15 - 20 - 25 - 27 - 30 - 40 - 45 - 50 | | |
| 9 | | 1.5 - 2 - 2.5 - 3 - 4 - 5 - 6 - 8 - 10 mm | | |
| 16 | | 6 - 7 - 8 - 9 - 10 - 11 - 12 - 13 - 14 - 15 - 16 - 17 - 18 - 19 - 21 - 22 mm | | |



Größe/Size: 1/4" + 3/8" + 1/2" · tlg./pcs. 195

BxLxH/WxLxH: 550x380x115 mm · Gewicht/Weight: 13.500 g

Art.-Nr./Art.-No.

39048202

€

615,00

1/4" Xi-on Steckschlüsselkoffer, 18-teilig

1/4" Xi-on Socket Set, 18 pieces

Art.-Gruppe 110
Article Group 110

4101

1/4"



18
tlg./pcs.

Xi-on Steckschlüsselkoffer mit 18 Werkzeugen, metrisch

- ▶ Feinzahn-Umschaltknarre
- ▶ Xi-on Stecknüsse 4 – 13 mm
- ▶ Verlängerung 50 mm
- ▶ Kardangelen u.v.m.

Xi-on Socket Set with 18 assorted tools, metric

- ▶ Reversible Ratchet
- ▶ Xi-on sockets 4 – 13 mm
- ▶ Extension Bar 50 mm
- ▶ Universal Joint, etc.



| | | | |
|----|--|------------|--|
| 12 | ○ 4 - 4,5 - 5 - 5,5 - 6 - 7 - 8 - 9 - 10 - 11 - 12 - 13 mm | 1/4" Xi-on | |
| 1 | Verlängerung, 50 mm | | |
| 1 | Art. 5205, 1/4" 72 Zahn | | |
| 1 | Kardangelen | | |
| 1 | Gleitgriff | | |
| 1 | Steckgriff | | |
| 1 | Austreiber | | |

Größe/Size: 1/4" · tlg./pcs. 18 · BxLxH/WxLxH 225x125x45 mm
Gewicht/Weight: 1.020 g

| Art.-Nr./Art.-No. | | € |
|-------------------|---------------------------------|-------|
| 4101 | 1/4" Xi-on Steckschlüsselkoffer | 61,90 |

3/8" Xi-on Steckschlüsselkoffer, 17-teilig

3/8" Xi-on Socket Set, 17 pieces

Art.-Gruppe 110
Article Group 110

4111

3/8"



17
tlg./pcs.

Xi-on Steckschlüsselkoffer mit 17 Werkzeugen, metrisch

- ▶ Feinzahn-Umschaltknarre
- ▶ Xi-on Stecknüsse 8 – 19 mm
- ▶ Verlängerung 75 + 150 mm
- ▶ Kardangelen u.v.m.

Xi-on Socket Set with 17 assorted tools, metric

- ▶ Reversible Ratchet
- ▶ Xi-on sockets 8 – 19 mm
- ▶ Extension Bar 75 + 150 mm
- ▶ Universal Joint, etc.



| | | | |
|----|--|------------|--|
| 11 | ○ 8 - 10 - 11 - 12 - 13 - 14 - 15 - 16 - 17 - 18 - 19 mm | 3/8" Xi-on | |
| 2 | Verlängerungen, 75 + 150 mm | | |
| 1 | Art. 5215, 3/8" 72 Zahn | | |
| 1 | Kardangelen | | |
| 1 | Gleitgriff | | |
| 1 | Austreiber | | |

Größe/Size: 3/8" · tlg./pcs. 17 · BxLxH/WxLxH: 260x145x50 mm
Gewicht/Weight: 2.000 g

| Art.-Nr./Art.-No. | | € |
|-------------------|---------------------------------|-------|
| 4111 | 3/8" Xi-on Steckschlüsselkoffer | 81,90 |

1/2" Xi-on Steckschlüsselkoffer, 23-teilig

1/2" Xi-on Socket Set, 23 pieces

Art.-Gruppe 110
Article Group 110

4121

1/2"



23
tlg./pcs.

Xi-on Steckschlüsselkoffer mit 23 Werkzeugen, metrisch

- ▶ Feinzahn-Umschaltknarre
- ▶ Xi-on Stecknüsse 10 – 32 mm
- ▶ Verlängerungen 125 + 250 mm
- ▶ Kardangelenk u.v.m.

Xi-on Socket Set with 23 assorted tools, metric

- ▶ Reversible Ratchet
- ▶ Xi-on sockets 10 – 32 mm
- ▶ Extension Bars 125 + 250 mm
- ▶ Universal Joint, etc.



| | | | | |
|----|---|---|------------|--|
| 15 | ○ | 10 - 11 - 12 - 13 - 14 - 15 - 16 - 17 - 18 - 19 - 22 - 24 - 27 - 30 - 32 mm | 1/2" Xi-on | |
| 2 | ○ | 16 + 21 mm | | |
| 2 | | Verlängerungen 125 + 250 mm | | |
| 1 | | Art. 5225, 1/2" 60 Zahn | | |
| 1 | | Kardangelenk | | |
| 1 | | Gleitgriffadapter | | |
| 1 | | Austreiber | | |

Größe/Size: 1/2" · tlg./pcs. 23 · BxLxH/WxLxH: 450x195x55 mm
Gewicht/Weight: 4.530 g

| Art.-Nr./Art.-No. | | € |
|-------------------|--|--------|
| 4121 | 1/2" Xi-on Steckschlüsselkoffer | 129,90 |
| 4131 | 1/4" + 1/2" Xi-on Steckschlüsselkoffer | 173,00 |

1/4" + 1/2" Xi-on Steckschlüsselkoffer, 54-teilig

1/4" + 1/2" Xi-on Socket Set, 54 pieces

Art.-Gruppe 110
Article Group 110

4131

1/4"

1/2"



54
tlg./pcs.

Xi-on Steckschlüsselkoffer mit 54 Werkzeugen, metrisch

- ▶ 2 Feinzahn-Umschaltknarren
- ▶ Xi-on Stecknüsse 4 – 32 mm
- ▶ Verlängerungen 50 + 125 + 150 + 250 mm
- ▶ Kardangelenke u.v.m.

Xi-on Socket Set with 54 assorted tools, metric

- ▶ 2 Reversible Ratchets
- ▶ Xi-on sockets 4 – 32 mm
- ▶ Extension Bars 50 + 125 + 150 + 250 mm
- ▶ Universal Joints, etc.



| | | | | |
|----|---|---|------------|--|
| 11 | ○ | 4 - 4,5 - 5 - 5,5 - 6 - 7 - 8 - 9 - 10 - 11 - 13 mm | 1/4" Xi-on | |
| 2 | | Verlängerungen 50 + 150 mm | | |
| 1 | | Art. 5205, 1/4" 72 Zahn | | |
| 1 | | Kardangelenk | | |
| 1 | | Gleitgriffadapter | | |
| 1 | | Steckgriff | | |
| 1 | | Austreiber | | |
| 2 | ● | 5,5 - 7 mm | | |
| 2 | + | PH 1 - 2 | | |
| 6 | ● | 3 - 4 - 5 - 6 - 8 - 10 | | |

| | | | | |
|----|---|---|------------|--|
| 15 | ○ | 10 - 11 - 12 - 13 - 14 - 15 - 17 - 18 - 19 - 21 - 22 - 24 - 27 - 30 - 32 mm | 1/2" Xi-on | |
| 2 | ○ | 16 + 21 mm | | |
| 2 | | Verlängerungen 125 + 250 mm | | |
| 1 | | Art. 5225, 1/2" 60 Zahn | | |
| 1 | | Kardangelenk | | |
| 1 | | Gleitgriffadapter | | |
| 4 | | 1,27 - 1,5 - 2 - 2,5 mm | | |

Größe/Size: 1/4" + 1/2" · tlg./pcs. 54 · BxLxH/WxLxH: 450x200x55 mm
Gewicht/Weight: 5.200 g

1/4" + 3/8" Durchschraubknarrenkoffer, 25-teilig

1/4" + 3/8" Go-Through Socket Set, 25 pieces

Art.-Gruppe 110
Article Group 110

4016

1/4"

3/8"



25
tlg./pcs.

Durchschraubknarrenkoffer mit 25 Werkzeugen, metrisch

- ▶ 3/8" Durchgangsknarre
- ▶ 3/8" Durchgangsverlängerung 75 mm
- ▶ 3/8" Durchgangsnüsse 10 – 19 mm
- ▶ 1/4" Stecknüsse 4 – 14 mm
- ▶ 3/8" Nussadapter für 1/4" Nüsse

Go-Through socket set with 25 assorted tools, metric

- ▶ 3/8" go-through ratchet
- ▶ 3/8" go-through extension bar 75 mm
- ▶ 3/8" go-through sockets 10 – 19 mm
- ▶ 1/4" sockets 4 – 14 mm
- ▶ 3/8" adapter for 1/4" sockets

| | | | | |
|----|---|---|------|--|
| 13 | ○ | 4 - 4,5 - 5 - 5,5 - 6 - 7 - 8 - 9 - 10 - 11 - 12 - 13 - 14 mm | 1/4" | |
| 9 | ○ | 10 - 11 - 12 - 13 - 14 - 15 - 16 - 17 - 19 mm | 3/8" | |
| 1 | | Art. 4016-01 | | |
| 1 | | Verlängerung 75 mm | | |
| 1 | | 3/8" (Knarre) x 1/4" (Nuss) | | |



Größe/Size 1/4" + 3/8"
 tlg./pcs. 25
 BxLxH/WxLxH 245x122x45 mm
 Gewicht/Weight 1.200 g

| Art.-Nr./Art.-No. | € |
|--|-------|
| 4016 1/4" + 3/8" Durchsteckknarrenkoffer | 96,50 |

GearTech Durchschraubknarrenkoffer, 17-teilig

GearTech Go-Through Socket Set, 17 pieces

Art.-Gruppe 110
Article Group 110

4017

17
tlg./pcs.



- ▶ 3D-GearTech-FLEX-Knarre ermöglicht Arbeiten in drei Dimensionen
- ▶ Ideal für Arbeiten an extrem unzugänglichen Stellen
- ▶ Flexibel: Durchgangsnüsse für metrische und zöllige Schrauben sowie für Schrauben mit TORX®E-Profil

- ▶ 3D-GearTech-Flex ratchet allows working in 3 dimensions
- ▶ Easy to use for very narrow spaces
- ▶ Flexible to use: Go-Through Sockets fits with metric and inch screws and also with screws with TORX®E-profile



| | | | |
|----|---|---|--|
| 13 | ○ | 10 - 11 - 12 - 13 - 14 - 15 - 16 - 17 - 18 - 19 - 21 - 22 - 24 mm | |
| 1 | | 3D-GearTech-Flex Art. 4017-01 | |
| 1 | | Verlängerung 80 mm | |
| 1 | | Adapter 1/4" | |
| 1 | | Adapter 3/8" | |

Tlg./pcs. 17 · BxLxH/WxLxH: 300x175x65 mm
 Gewicht/Weight: 1.760 g

| Art.-Nr./Art.-No. | € |
|---|--------|
| 4017 GearTech Durchschraubknarrenkoffer | 125,00 |

1/4" Mini-Steckschlüssel- und Bit-Box, 38-teilig

1/4" Mini Socket Set and Bit Box, 38 pieces

Art.-Gruppe 110
Article Group 110

394072

1/4"

38
tlg./pcs.



- ▶ **Kombination aus Steckschlüsselsatz und Bit-Box**
- ▶ **Schnell das passende Werkzeug für nahezu jede Anwendung**
- ▶ **Übersichtliche Anordnung der Werkzeuge**
- ▶ **Color-Bits: Dank Farbleitsystem immer schnell den richtigen Bit**

- ▶ Combination of Socket-Set and Bit-Box
- ▶ Easy and fast accessibility of the tools
- ▶ Clearly assembled tools
- ▶ Color-Bits: very easy to find the right size, because of colored bits

- 10 Stecknüsse 5,5 - 6 - 7 - 8 - 9 - 10 - 11 - 12 - 13 - 14 mm
- 2 Verlängerungen 50 + 100 mm
- 1 Umschaltknarre 48-ZAHN
- 1 Kardangelenk
- 1 Steckgriff
- 1 Adapter 1/4" (Knarre) x 1/4" (Bit)
- 2 Schlitz (rot) 4,5 - 6,5 mm
- 4 Phillips (dunkelrot) PH1 - 2 - 2 - 3
- 4 Pozidriv (blau) PZ1 - 2 - 2 - 3
- 7 TORX® m. Bohr. (violett) TX10 - 15 - 20 - 25 - 27 - 30 - 40
- 4 Innensechskant (orange) 3 - 4 - 5 - 6 mm
- 1 Adapter 1/4" x 1/4"

Größe/Size: 1/4" · tlg./pcs. 38 · BxLxH/WxLxH: 188x110x40 mm
Gewicht/Weight: 900 g

Art.-Nr./Art.-No. 394072 1/4" Mini-Steckschlüssel- und Bit-Box € 65,00

1/4" MultiFit Steckschlüsselkoffer, 28-teilig

1/4" MultiFit Socket Set, 28 pieces

Art.-Gruppe 112
Article Group 112

8601

1/4"

28
tlg./pcs.



mit Feinzahn-Knarre, 72 Zahn

72 Teeth Ratchet

- ▶ **1 Schlüssel – 4 Schrauben**
MultiFit-Profil – Mit einem Steckschlüssel-Einsatz bis zu vier verschiedene Schrauben oder Muttern bearbeiten!
1 Socket – 4 Drives: With MultiFit profile you can even use only 1 socket for 4 kinds of drives!
- ▶ **6-kant, 12-kant, TORX® E-Profil und viele andere Zollgrößen**

| MultiFit | 6-kant | 12-kant | Zoll | E-TX |
|----------|--------|---------|--------|------|
| 4,0 mm | ✓ | ✓ | 5/32" | E5 |
| 4,5 mm | ✓ | ✓ | | E6 |
| 5,0 mm | ✓ | ✓ | 3/16" | |
| 5,5 mm | ✓ | ✓ | | |
| 6,0 mm | ✓ | ✓ | | E8 |
| 7,0 mm | ✓ | ✓ | 9/32" | |
| 8,0 mm | ✓ | ✓ | 5/16" | E10 |
| 9,0 mm | ✓ | ✓ | 11/32" | |
| 10,0 mm | ✓ | ✓ | 3/8" | E12 |
| 11,0 mm | ✓ | ✓ | 7/16" | E14 |
| 12,0 mm | ✓ | ✓ | 15/32" | E16 |
| 13,0 mm | ✓ | ✓ | 1/2" | |
| 14,0 mm | ✓ | ✓ | 9/16" | E18 |

- 13 4 - 4.5 - 5 - 5.5 - 6 - 7 - 8 - 9 - 10 - 11 - 12 - 13 - 14 mm
- 3 4 - 5 - 6 mm
- 3 PH 1 - 2 - 3
- 3 PZ 1 - 2 - 3
- 3 4 - 5 - 6 mm
- 1 1/4" Bit-Adapter
- 1 **72 Zahn, Art. 8603**
- 1 Verlängerung 50 mm

Größe/Size: 1/4" · tlg./pcs. 28 · BxLxH/WxLxH: 166x85x35 mm
Gewicht/Weight: 660 g

Art.-Nr./Art.-No. 8601 1/4" MultiFit Steckschlüsselkoffer € 54,90

1/4" Steckschlüsselkoffer, 15-teilig*1/4" Socket Set, 15 pieces***Art.-Gruppe 110**
Article Group 110**4009****1/4"****15**
tlg./pcs.**Größe/Size:** 1/4" **tlg./pcs.:** 15 **BxLxH/WxLxH:** 245x128x40 mm
Gewicht/Weight: 1.260 g

| Art.-Nr./Art.-No. | € |
|--------------------------------|--------------|
| 4009 1/4" Steckschlüsselkoffer | 48,50 |

Steckschlüsselkoffer mit 15 Werkzeugen inkl. Fingerratsche*Socket set with 15 assorted tools with finger-ratchet*

- | | | |
|----|---|--|
| 12 | ○ 4 - 4,5 - 5 - 5,5 - 6 - 7 - 8 - 9 - 10 - 11 - 12 - 13 mm | |
| 1 | Verlängerung 195, 220, 245, 270, 295 oder 320 mm | |
| 1 | Fingerratsche mit Auswurf, Art. 4283 <i>quick release finger ratchet</i> | |
| 1 | T-Griff-Ratsche mit Auswurf, Art. 4284 <i>T-handle quick release ratchet</i> | |

1/2" Spiralprofil-Steckschlüsselkoffer, 10-teilig*1/2" Twist Socket Set, 10 pieces***Art.-Gruppe 182**
Article Group 182**3061****1/2"****10**
tlg./pcs.**Größe/Size:** 1/2" **tlg./pcs.:** 10 **BxLxH/WxLxH:** 160x120x50 mm
Gewicht/Weight: 750 g

| Art.-Nr./Art.-No. | € |
|---|---------------|
| 3061 1/2" Spiralprofil-Steckschlüsselkoffer | 149,00 |

Ideal für problemloses Ausdrehen von abgerundeten Muttern und 6-kant Schrauben durch ein sich verjüngendes Spezialprofil mit aggressiven Spiralnuten.
Special Sockets for opening damaged nuts.

- | | | |
|---|---|--|
| 9 | ○ 10 - 11 - 12 - 13 - 14 - 15 - 16 - 17 - 19 mm Länge: 34 mm | |
| 1 | Verlängerung Ø 7,5 / 12 mm x L: 80 mm | |

1/4" Mini-Steckschlüsselkoffer 23-teilig

1/4" Mini Socket Set, 23 pieces

Art.-Gruppe 110
Article Group 110

4078

1/4"

23
tlg./pcs.



Mini-Steckschlüsselkoffer mit 23 Werkzeugen, metrisch

- ▶ Miniknarre
- ▶ Stecknüsse 4 – 13 mm
- ▶ Bits für jeden Einsatz
- ▶ Verlängerung
- ▶ Bit-Adapter

Mini socket set with 23 assorted tools, metric

- ▶ Mini ratchet
- ▶ Sockets 4 – 13 mm
- ▶ Bits for all screws
- ▶ Extension bar
- ▶ Bit adapter

| | | | |
|----|---|--|--|
| 12 | ○ | 4 - 4.5 - 5 - 5.5 - 6 - 7 - 8 - 9 - 10 - 11 - 12 - 13 mm | |
| 2 | + | PH 1 - 2 | |
| 2 | + | PZ 1 - 2 | |
| 4 | ⊙ | T15 - 20 - 25 - 30 | |
| 1 | | 1/4" Bit-Adapter | |
| 1 | | Art. 4299 | |
| 1 | | Verlängerung 100 mm | |



Größe/Size 1/4"
tlg./pcs. 23
BxLxH/WxLxH 160x83x33 mm
Gewicht/Weight 450 g

| Art.-Nr./Art.-No. | | € |
|-------------------|--------------------------------|--------------|
| 4078 | 1/4" Mini-Steckschlüsselkoffer | 42,50 |
| 8651 | 1/4" Steckschlüsselkoffer 48 Z | 49,90 |
| 8652 | 1/4" Steckschlüsselkoffer 72 Z | 49,90 |

1/4" Steckschlüsselkoffer, 46-teilig

1/4" Socket Set, 46 pieces

Art.-Gruppe 112
Article Group 112

1/4"

46
tlg./pcs.

8651
48-Zahn-
Knarre

8652
72-Zahn-
Knarre



Steckschlüsselkoffer mit 46 Werkzeugen, metrisch

- ▶ Mit Umschaltknarre 48 Zahn (Art.-Nr. 8651) oder mit Umschaltknarre 72 Zahn (Art.-Nr. 8652)
- ▶ Stecknüsse 4 – 14 mm

Socket set with 46 assorted tools, metric

- ▶ With ratchet, 48 teeth (Art.-No. 8651) or with ratchet, 72 teeth (Art.-No. 8652)
- ▶ Sockets 4 – 14 mm

| | | | |
|----|---|---|--|
| 13 | ○ | 4 - 4.5 - 5 - 5.5 - 6 - 7 - 8 - 9 - 10 - 11 - 12 - 13 - 14 mm | |
| 3 | ● | 4 - 5.5 - 7 mm | |
| 3 | + | PH 1 - 2 - 3 | |
| 3 | + | PZ 1 - 2 - 3 | |
| 6 | ⊙ | 3 - 4 - 5 - 6 - 7 - 8 mm | |
| 7 | ⊙ | T8 - 10 - 15 - 20 - 25 - 30 - 40 | |
| 1 | | 48 Zahn , Art. 5200 oder/or 72 Zahn , Art. 5201 | |
| 1 | | Steckgriff | |
| 2 | | Verlängerung 50 + 100 mm | |
| 1 | | Gleitgriff | |
| 1 | | Kardangelenk | |
| 1 | | Verlängerung flex. 150 mm | |
| 1 | | 1/4" x 1/4" | |
| 3 | | 1,5 - 2 - 2,5 mm | |

Größe/Size: 1/4" · **tlg./pcs.** 46 · **BxLxH/WxLxH:** 245x155x52 mm
Gewicht/Weight: 1.250 g

1/2" Steckschlüsselkoffer, 21-tlg.

1/2" Socket Set, 21 pieces

PROJAHN

Art-Gruppe 112
Article Group 112

1/2" **21**
tlg./pcs.



8661
48-Zahn-
Knarre

8662
72-Zahn-
Knarre

- Steckschlüsselkoffer mit 21 Werkzeugen, metrisch**
- ▶ Mit Umschaltknarre 48 Zahn (Art.-Nr. 8661) oder mit Umschaltknarre 72 Zahn (Art.-Nr. 8662)
 - ▶ Inkl. Zündkerzen-Stecknüsse 16 + 21 mm

Socket set with 21 assorted tools, metric

- ▶ With ratchet, 48 teeth (Art.-No. 8661) or with ratchet, 72 teeth (Art.-No. 8662)
- ▶ Incl. spark plug sockets 16 + 21 mm

- 15 ○ 10 - 11 - 12 - 13 - 14 - 15 - 16 - 17 - 18 - 19 - 22 - 24 - 27 - 30 - 32 mm
- 2 ○ 16 + 21 mm
- 1 **48 ZAHN**, Art. 5220 oder/or **72 ZAHN**, Art. 5221
- 1 Verlängerung 125 mm
- 1 Gleitgriff
- 1 Kardangelen

Größe/Size: 1/2" · **tlg./pcs.** 21 · **BxLxH/WxLxH:** 380x250x80 mm
Gewicht/Weight: 3.500 g

| Art.-Nr./Art.-No. | | € |
|-------------------|---|--------------|
| 8661 | 1/2" proficraft Steckschlüsselkoffer 48 Z | 69,90 |
| 8662 | 1/2" proficraft Steckschlüsselkoffer 72 Z | 69,90 |

1/2" Steckschlüsselkoffer, 22-teilig

1/2" Socket Set, 22 pieces

Art-Gruppe 110
Article Group 110

4027

1/2" **22**
tlg./pcs.



Steckschlüsselkoffer mit 22 Werkzeugen im hochwertigen Metallkoffer, metrisch

- ▶ Umschaltknarre 48 Zahn
- ▶ Stecknüsse 10 – 32 mm
- ▶ Zündkerzen Stecknüsse 16 + 21 mm
- ▶ Verlängerungen 125 + 250 mm

Industrial socket set with 22 assorted tools in metal case, metric

- ▶ Reversible ratchet 48 teeth
- ▶ Sockets 10 – 32 mm
- ▶ Spark plug sockets 16 + 21 mm
- ▶ Extension bars 125 + 250 mm

- 15 ○ 10 - 11 - 12 - 13 - 14 - 15 - 16 - 17 - 18 - 19 - 22 - 24 - 27 - 30 - 32 mm
- 2 ○ 16 + 21 mm
- 1 **48 Zahn**, Art. 5220
- 2 Verlängerungen 125 + 250 mm
- 1 3/8" (Knarre) x 1/2" (Nuss)
- 1 Kardangelen

Größe/Size: 1/2" · **tlg./pcs.** 22 · **BxLxH/WxLxH:** 450x190x55 mm
Gewicht/Weight: 4.600 g



| Art.-Nr./Art.-No. | | € |
|-------------------|---------------------------|--------------|
| 4027 | 1/2" Steckschlüsselkoffer | 99,50 |

1/4" + 1/2" Werkzeugkoffer, 91-teilig

1/4" + 1/2" Tool Set, 91 pieces

PROJAHN

Art-Gruppe 112
Article Group 112

91
tlg./pcs.

1/4"

1/2"

8655*

48-Zahn-Knarren

8656*

72-Zahn-Knarren



Werkzeugkoffer mit 91 Werkzeugen, metrisch

- ▶ 2 Umschaltknarren 1/4" + 1/2", 48 ZAHN (8655) oder 2 Umschaltknarren 1/4" + 1/2", 72 ZAHN (8656)
- ▶ Stecknüsse 4 – 24 mm
- ▶ Ringgabelschlüssel 8 - 10 - 12 - 13 - 14 - 17 mm
- ▶ Bits für jeden Einsatz
- ▶ Schraubendreher und Zangen

Tool set with 91 assorted tools, metric

- ▶ 2 ratchets 1/4" + 1/2", 48 TEETH (8655) or 2 ratchets 1/4" + 1/2", 72 TEETH (8656)
- ▶ Sockets 4 – 24 mm
- ▶ Combination wrenches 8 - 10 - 12 - 13 - 14 - 17 mm
- ▶ Bits for all screws
- ▶ Screwdrivers and pliers

| | | | | | | |
|----|---|------|--|---|---|--|
| 9 | ○ 4 - 5 - 6 - 7 - 8 - 9 - 10 - 11 - 12 mm | 1/4" | | 1 | Verlängerung 125 mm | |
| 1 | Verlängerung 75 mm | | | 1 | Kardangeln | |
| 1 | 1/4" (Knarre) x 1/4" (Bit) | | | 6 | 8 - 10 - 12 - 13 - 14 - 17 mm | |
| 3 | ● 4.5 - 6.5 - 8 mm | | | 9 | 1.5 - 2 - 2.5 - 3 - 4 - 5 - 6 - 8 - 10 mm | |
| 3 | ⊕ PH 1 - 2 - 3 | | | 7 | ⊕ TX20 - 25 - 30 - 40 - 45 - 50 - 55 | |
| 3 | ⊕ PZ 1 - 2 - 3 | | | 6 | ● 4 - 5 - 6 - 8 - 10 - 12 mm | |
| 7 | ⊗ TX10 - 15 - 20 - 25 - 27 - 30 - 40 | | | 1 | Telefonzange 160 mm | |
| 6 | ● 3 - 4 - 5 - 6 - 7 - 8 mm | | | 1 | Kombizange 180 mm | |
| 1 | 48 ZAHN , Art. 5200 oder/or 72 ZAHN , Art. 5201 | | | 1 | Wasserpumpenzange 250 mm | |
| 1 | Gleitgriff | | | 3 | ● 8 x 150 mm - 6 x 100 mm - 6 x 38 mm | |
| 1 | Quergriff-Bitschraubendreher | | | 1 | ⊕ PH 2 x 38 mm | |
| 14 | ○ 8 - 10 - 11 - 12 - 13 - 14 - 15 - 16 - 17 - 18 - 19 - 21 - 22 - 24 mm | 1/2" | | 2 | ⊕ PH 1 x 75 mm - PH 2 x 100 mm | |
| 1 | 1/2" (Knarre) x 10 mm (Bit) | | | | | |
| 1 | 48 ZAHN , Art. 5220 oder/or 72 ZAHN , Art. 5221 | | | | | |

Größe/Size: 1/4" + 1/2" · tlg./pcs. 91

BxLxH/WxLxH: 420x285x85 mm

Gewicht/Weight: 6.000 g

| Art.-Nr./Art.-No. | € |
|-------------------|--|
| 8655* | 1/4" + 1/2" Werkzeugkoffer 48 Z - ¹ |
| 8656* | 1/4" + 1/2" Werkzeugkoffer 72 Z - ² |

*Lieferung nur solange der Vorrat reicht / *Delivery while stocks last

¹ Nicht mehr lieferbar – Nachfolgeartikel 8665 / ¹ Out of stock – Successor 8665

² Nicht mehr lieferbar – Nachfolgeartikel 8666 / ² Out of stock – Successor 8666

1/4" + 3/8" + 1/2" proficraft Steckschlüsselkoffer 182-teilig

1/4" + 3/8" + 1/2" proficraft Socket Set, 182 pieces

1/4"

3/8"

1/2"

8663
48-Zahn-Knarren

8664
72-Zahn-Knarren



Steckschlüssel-Satz mit 182 Werkzeugen, metrisch

182
tlg./pcs.

- ▶ 3 Umschaltknarren 1/4" + 3/8" + 1/2", **48 ZAHN (8663) oder**
- 3 Umschaltknarren 1/4" + 3/8" + 1/2", 72 ZAHN (8664)**
- ▶ **Stecknüsse 4 – 32 mm**
- ▶ **1/4" Bit-Stecknüsse für alle Schraubarbeiten**

Socket Set with 182 assorted Tools, metric

- ▶ 3 ratchets 1/4" + 3/8" + 1/2", **48 TEETH (8663) or**
- 3 ratchets 1/4" + 3/8" + 1/2", 72 TEETH (8664)**
- ▶ Sockets 4 – 32 mm
- ▶ Bit sockets 1/4" for all screws

- | | | |
|--|------|--|
| 13 ○ 4 - 4.5 - 5 - 5.5 - 6 - 7 - 8 - 9 - 10 - 11 - 12 - 13 - 14 mm | 1/4" | |
| 7 ○ 4 - 5 - 6 - 7 - 8 - 9 - 10 - mm | | |
| 5 ⊕ E4 - E5 - E6 - E7 - E8 | | |
| 4 ● 4 - 5.5 - 6.5 - 7 mm | | |
| 3 ⊕ PH 0 - 1 - 2 | | |
| 3 ⊕ PZ 0 - 1 - 2 | | |
| 4 ● 3 - 4 - 5 - 6 mm | | |
| 8 ⊕ T8 - T9 - T10 - T15 - T20 - T25 - T27 - T30 | | |
| 8 ⊕ T8 - T9 - T10 - T15 - T20 - T25 - T27 - T30 | | |
| 1 Kardangelen | | |
| 2 Verlängerungen 50 + 100 mm | | |
| 1 Gleitgriff | | |
| 1 Steckgriff | | |
| 1 48 ZAHN, Art. 5200 oder/or 72 ZAHN, Art. 5201 | | |
| 4 ● 3 - 4 - 5,5 - 6 mm | | |
| 5 ⊕ PH 0 - 1 - 2 - 2 - 3 mm | | |
| 5 ⊕ PZ 0 - 1 - 2 - 2 - 3 mm | | |
| 10 ⊕ TX10 - 10 - 15 - 20 - 20 - 25 - 25 - 27 - 30 - 40 | | |
| 6 ● 2 - 2,5 - 3 - 4 - 5 - 6 | | |
| 1 1/4" (Knarre) x 1/4" (Bit) | | |

- | | | | |
|--|-------|------|--|
| 3 ● 8 - 10 - 12 mm | 5/16" | | |
| 2 ⊕ PH 3 - 4 mm | | | |
| 2 ⊕ PZ 3 - 4 mm | | | |
| 6 ⊕ TX40 - 45 - 50 - 55 - 60 - 70 mm | | | |
| 6 ⊕ TX40 - 45 - 50 - 55 - 60 - 70 mm | | | |
| 5 ● 7 - 8 - 10 - 12 - 14 mm | | | |
| 10 ○ 10 - 11 - 12 - 13 - 14 - 15 - 16 - 17 - 18 - 19 mm | 3/8" | | |
| 6 ○ 10 - 11 - 12 - 13 - 14 - 15 mm | | | |
| 1 Kardangelen | | | |
| 1 Verlängerung 150 mm | | | |
| 1 48 ZAHN, Art. 5210 oder/or 72 ZAHN, Art. 5211 | | | |
| 1 3/8" (Knarre) x 5/16" (Bit) | | | |
| 17 ○ 10 - 11 - 12 - 13 - 14 - 15 - 16 - 17 - 18 - 19 - 20 - 21 - 22 - 24 - 27 - 30 - 32 mm | | 1/2" | |
| 5 ○ 14 - 15 - 17 - 19 - 22 mm | | | |
| 8 ⊕ E10 - E11 - E12 - E14 - E16 - E18 - E20 - E24 | | | |
| 3 ○ 16 - 18 - 21 mm | | | |
| 1 3/8" (Knarre) x 1/2" (Nuss) | | | |
| 2 Verlängerungen 125 + 250 mm | | | |
| 1 Kardangelen | | | |
| 1 48 ZAHN, Art. 5220 oder/or 72 ZAHN, Art. 5221 | | | |
| 1 1/2" (Knarre) x 5/16" (Bit) | | | |
| 7 1,27 - 1,5 - 2 - 2,5 - 3 - 4 - 5 mm | | | |

Größe/Size: 1/4" + 3/8" + 1/2" · tlg./pcs. 182

BxLxH/WxLxH: 400x310x85 mm

Gewicht/Weight: ca. 8.500 g

| Art.-Nr./Art.-No. | | € |
|-------------------|---|--------|
| 8663 | 1/4"+3/8"+1/2" proficraft Steckschlüsselk. 48 Z | 189,00 |
| 8664 | 1/4"+3/8"+1/2" proficraft Steckschlüsselk. 72 Z | 189,00 |

1/2" Werkzeugkoffer, 84-teilig

1/2" Tool Case, 84 pieces

PROJAHNArt.-Gruppe 113
Article Group 113**8688**

1/2"

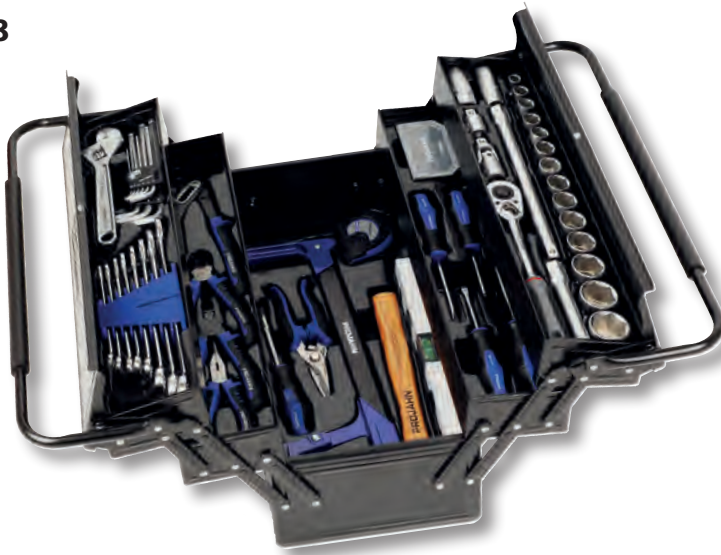
**Werkzeugkoffer mit 84 Werkzeugen, metrisch****84**
tlg./pcs.











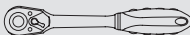
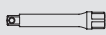

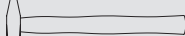



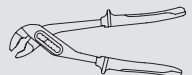
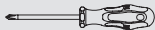

- ▶ **Universell einsetzbare Werkzeugbestückung**
- ▶ **Übersichtlich strukturierte Anordnung der Werkzeuge**
- ▶ **Hochwertiger, dreistufiger Metallkoffer**
- ▶ **Ergonomisches Handling durch schaumummantelte, anklappbare Bügelgriffe**

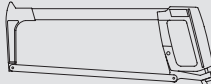
Tool Case with 84 assorted Tools, metric

- ▶ **Versatile usable Tools**
- ▶ **Clearly structured arrangement of the tools**
- ▶ **High-quality, three-level metal case**
- ▶ **Ergonomic handling by foam-encased, foldable handles**

14 ○ 10 - 12 - 13 - 14 - 15 - 16 - 17 - 19 - 20 -
22 - 24 - 27 - 30 - 32 mm

2 ○ 16 - 21 mm

1 **48 ZAHN**, Art. 5220 2 Verlängerungen 125 + 250 mm 1 Kardangelen 1 3-Wege-Adapter 3/8" x 1/2" 1 Hammer 300 g 8 Ringgabelschüssel
10 - 11 - 12 - 13 - 14 - 17 - 19 - 22 mm 1 Rollgabelschlüssel 8" / 200 mm 9 1.5 - 2 - 2.5 - 3 - 4 - 5 - 6 - 8 - 10 1 Kombizange 180 mm 1 Seitenschneider 160 mm 1 Telefonzange 170 mm 1 Wasserpumpenzange 250 mm 2 PH 1 - PH 2 2 Schlitz 5,5 mm - 6,5 mm 1 Magnetischer Bitschraubendreher 1 Universalschere 180 mm 1 Metallbügelsäge, 300 mm 1 Maßband 5 m 1 Wasserwaage 300 mm 5 ⊕ PH 0 - PH 1 - PH 2 - PH 3 - PH 4 5 ⊕ PZ 0 - PZ 1 - PZ 2 - PZ 3 - PZ 4 6 ⊕ TORX® T10 - 15 - 20 - 25 - 27 - 30 7 ⊖ Schlitz: 3 - 4 - 5 - 5,5 - 6 - 6,5 - 7 mm 7 ⊙ Innensechskant: 1,5 - 2 - 2,5 - 3 - 4 - 5 - 6 mm 1 1 Bit-Halter 60 mm 

Größe/Size: 1/2" · tlg./pcs. 84
BxLxH/WxLxH: 490x225x380 mm
Gewicht/Weight: 13.500 g

| Art.-Nr./Art.-No. | | € |
|-------------------|---------------------------------------|---------------|
| 8688 | 1/2" Werkzeugkoffer mit 84 Werkzeugen | 379,00 |

1/4" + 1/2" Universal-Werkzeugkoffer, 149-teilig

1/4" + 1/2" Universal Tool Case, 149 pieces

Art.-Gruppe 113
Article Group 113**8681**

1/4"

1/2"

149
tlg./pcs.**8681K**
Koffer, leer
empty case

| | | | | |
|----|---|--|--|------|
| 12 | ○ | 4 - 4,5 - 5 - 5,5 - 6 - 7 - 8 - 9 - 10 - 11 - 12 - 13 mm | | |
| 2 | | Verlängerungen 50 + 100 mm | | 1/4" |
| 1 | | 48 ZAHN , Art. 5200 | | |
| 1 | | Gleitgriff 110 mm | | |
| 1 | | Kardangelen | | |
| 1 | | 1/4" (Knarre) x 1/4" (Bit) | | |
| 3 | ● | 4,5 - 5,5 - 6,5 mm | | |
| 6 | + | 2x PH 1 - 2 - 3 | | |
| 6 | + | 2x PZ 1 - 2 - 3 | | |
| 9 | ⊕ | TX8 - 9 - 10 - 15 - 20 - 25 - 27 - 30 - 40 | | |
| 6 | ● | 3 - 4 - 5 - 6 - 7 - 8 mm | | |
| 1 | | Bit-Halter 60 mm | | |
| 1 | | 1/4" x 1/4" | | |
| 1 | | Magn. Bit-Schraubendreher | | |
| 14 | ○ | 10 - 13 - 14 - 15 - 16 - 17 - 18 - 19 - 21 - 22 - 24 - 27 - 30 - 32 mm | | 1/2" |
| 2 | | Verlängerungen 125 + 250 mm | | |
| 1 | | 48 ZAHN , Art. 5220 | | |
| 1 | | Kardangelen | | |
| 1 | | 1/2" x 3/8" | | |
| 1 | | 1/2" (Knarre) x 5/16" (Bit) | | |
| 1 | | Teleskop Magnetheber | | |
| 1 | | Maßband 5 m | | |
| 9 | ● | 1,5 - 2 - 2,5 - 3 - 4 - 5 - 6 - 8 - 10 mm | | |
| 10 | ○ | 8 - 10 - 11 - 12 - 13 - 14 - 15 - 17 - 19 - 22 mm | | |
| 1 | | Telefonzange 160 mm | | |
| 1 | | Kombizange 180 mm | | |
| 1 | | Wasserpumpenzange 240 mm | | |
| 1 | | Seitenschneider 160 mm | | |
| 1 | | Flechtermzange 250 mm | | |
| 2 | + | PH 1 - 2 | | |
| 1 | + | PZ 2 | | |
| 3 | ● | 3 - 5,5 - 6,5 mm | | |
| 1 | ● | 110 bis/up to 250 V Spannungsprüfer | | |
| 1 | | Universalmesser | | |
| 1 | | Hammer 300 g | | |
| 1 | | Metallsäge 300 mm | | |
| 1 | | Schieblehre 0 - 150 mm | | |
| 5 | | Schlag- und Meißelsatz | | |
| 1 | | Halbrundfeile | | |
| 1 | | Spachtel | | |
| 1 | | Stechbeitel | | |
| 1 | | Zimmermanns-Bleistift | | |
| 1 | | Taschenlampe | | |
| 20 | | Kabelbinder 3,5 x 150 mm | | |
| 2 | ● | 8 - 10 mm | | |
| 2 | + | PH 3 - 4 | | |
| 4 | ⊕ | TX40 - 45 - 50 - 55 | | |
| 3 | ● | 10 - 12 - 14 mm | | |

Größe/Size: 1/4" + 1/2" · tlg./pcs. 149

BxLxH/WxLxH: 460x330x145 mm · Gewicht/Weight: 12.240 g

| Art.-Nr./Art.-No. | | € |
|-------------------|----------------------------|---------------|
| 8681 | 1/4" + 1/2" Werkzeugkoffer | 482,00 |
| 8681-SCHLUESSEL | 2 Schlüssel | 4,50 |

1/4" + 1/2" Universal-Werkzeugtrolley, 130-teilig

1/4" + 1/2" Universal Tool Trolley, 130 pieces

PROJAHN

Art.-Gruppe 113
Article Group 113

4963-01

1/4"

1/2"

















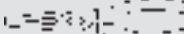

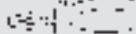







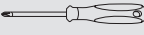

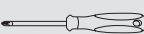

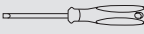



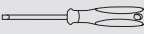

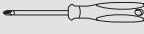

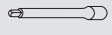
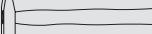
130
tlg./pcs.

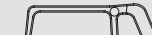
4963

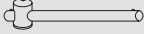
Trolley, leer
empty trolley



-  Robuste Rollen/
Robust Castors
-  Stabile Füße/
Solid Feet
-  Abschließbare Bügelschlösser/
Lockable U-Locks
-  Einrastender Teleskopgriff/
Telescopic Snap-Handle
-  Haltbare Scharniere/
Hard-Wearing Hinges

| | | | | | | | |
|----|---|--|---|----|---|--|---|
| 12 | ○ | 4 - 4,5 - 5 - 5,5 - 6 - 7 - 8 - 9 - 10 - 11 - 12 - 13 mm |  | 9 | ● | 1.5 - 2 - 2.5 - 3 - 4 - 5 - 6 - 8 - 10 mm |  |
| 2 | | Verlängerungen 100 + 150 mm |  | 9 | ⊕ | TX10 - 15 - 20 - 25 - 27 - 30 - 40 - 45 - 50 |  |
| 1 | | 48 ZAHN , Art. 5200 |  | 12 | | 8 - 9 - 10 - 11 - 12 - 13 - 14 - 16 - 17 - 18 - 19 - 22 mm |  |
| 1 | | Steckgriff |  | 1 | | Telefonzange 200 mm |  |
| 1 | | Kardangelen |  | 1 | | Kombizange 180 mm |  |
| 1 | | 1/4" (Knarre) x 1/4" (Bit) |  | 1 | | Wasserpumpenzange 250 mm |  |
| 3 | ● | 4.5 - 5,5 - 6,5 mm |  | 1 | | Seitenschneider 160 mm |  |
| 6 | ⊕ | 2x PH 1 - 2 - 3 |  | 1 | | Flechtermesser 250 mm |  |
| 6 | ⊕ | 2x PZ 1 - 2 - 3 |  | 2 | ⊕ | PH 1 - 2 |  |
| 9 | ⊕ | TX8 - 9 - 10 - 15 - 20 - 25 - 27 - 30 - 40 |  | 2 | ⊕ | PZ 1 - 2 |  |
| 6 | ● | 3 - 4 - 5 - 6 - 7 - 8 mm |  | 2 | ● | 4,0 - 8,0 mm |  |
| 1 | | Bit-Halter 60 mm |  | 1 | ● | 110 bis/up to 250 V Spannungsprüfer |  |
| 1 | | Bit-Knarre, Art. 2700 |  | 1 | ● | VDE/isolated 3,0 mm |  |
| 1 | | Magn. Bit-Schraubendreher |  | 2 | ⊕ | VDE/isolated PH1 - 2 |  |
| 16 | ○ | 10 - 11 - 12 - 13 - 14 - 15 - 16 - 17 - 18 - 19 - 21 - 22 - 24 - 27 - 30 - 32 mm |  | 1 | | Universalmesser |  |
| 2 | | Verlängerungen 125 + 250 mm |  | 1 | | Hammer 300 g |  |
| 1 | | 48 ZAHN , Art. 5220 |  | 1 | | Metallsäge 260 mm |  |
| 1 | | Kardangelen |  | 1 | | Schieblehre 0 - 150 mm |  |
| 1 | | Gleitgriff 300 mm |  | 1 | | Aluminium-Wasserwaage 400 mm |  |
| 1 | | Teleskop Magnetheber |  | 5 | | Schlag- und Meißelsatz |  |
| 1 | | Maßband 5 m |  | 1 | | Rollgabelschlüssel 10" / 250 mm |  |

Größe/Size: 1/4" + 1/2" · tlg./pcs. 130

BxLxH/WxLxH: 460x390x170 mm · Gewicht/Weight: ca. 17.500 g

| Art.-Nr./Art.-No. | | € |
|-------------------|---------------------------------------|---------------|
| 4963-01 | 1/4" + 1/2" Universal-Werkzeugtrolley | 599,00 |
| 8681-SCHLUESSEL | 2 Schlüsseln | 4,50 |

3/8" Universal-Werkzeugkoffer KOMPAKT, 164-teilig*3/8" Universal Tool Case COMPACT, 164 pieces*Art.-Gruppe 113
Article Group 113**8682****3/8"****164**
tlg./pcs.**8682K**
Koffer, leer
empty case

| | | | | |
|----|---|---|-------------|--|
| 17 | ○ | 6 - 7 - 8 - 9 - 10 - 11 - 12 - 13 - 14 - 15 - 16 - 17 - 18 - 19 - 21 - 22 - 24 mm | | |
| 1 | | Verlängerung 150 mm | 3/8" | |
| 1 | | 48 ZAHN , Art. 5210 | | |
| 1 | | Kardangelenk | | |
| 1 | | 3/8" (Knarre) x 1/4" (Bit) | | |
| 3 | ● | 4,5 - 5,5 - 6,5 mm | 1/4" | |
| 6 | + | 2x PH 1 - 2 - 3 | | |
| 6 | + | 2x PZ 1 - 2 - 3 | | |
| 9 | ⊕ | TX8 - 9 - 10 - 15 - 20 - 25 - 27 - 30 - 40 | | |
| 6 | ● | 3 - 4 - 5 - 6 - 7 - 8 mm | | |
| 1 | | Bit-Halter 60 mm | | |
| 1 | | Bit-Schraubendreher | | |
| 2 | + | PH 1 - 2 | | |
| 1 | + | PZ 2 | | |
| 3 | ● | 3,5 - 5,5 - 6,0 mm | | |
| 1 | ● | 125 bis/up to 230 V Spannungsprüfer | | |
| 4 | | Präzisionsschraubendreher-Satz ● 2,0 - 3,0 - 4,0 mm + PH00 - 0 - 1 | | |
| 1 | | Teleskop Magnetheber | | |
| 9 | ● | 1.5 - 2 - 2.5 - 3 - 4 - 5 - 6 - 8 - 10 mm | | |
| 10 | | 8 - 10 - 11 - 12 - 13 - 14 - 15 - 17 - 19 - 22 mm | | |
| 1 | | Telefonzange 200 mm | | |
| 1 | | Kombizange 180 mm | | |
| 1 | | Wasserpumpenzange 240 mm | | |
| 1 | | Seitenschneider 160 mm | | |
| 1 | | Flechtermzange 250 mm | | |
| 1 | | Universalschere 180 mm | | |
| 1 | | Crimpzange 240 mm | | |
| 40 | | Kabelschuhe | | |
| 6 | | 1 Universalmesser + 5 Ersatzklingen (inkl.) | | |
| 1 | | Hammer 300 g | | |
| 1 | | Metallsäge 260 mm | | |
| 3 | | Sägeblätter | | |
| 20 | | Kabelbinder 3,5 x 150 mm | | |
| 1 | | Wasserwaage 300 mm | | |
| 1 | | Maßband 5 m | | |

Größe/Size: 3/8" · tlg./pcs. 164
BxLxH/WxLxH: 425x280x130 mm
Gewicht/Weight: 9.400 g

| Art.-Nr./Art.-No. | | € |
|-------------------|-------------------------------|---------------|
| 8682 | 3/8" Universal-Werkzeugkoffer | 386,00 |
| 8681-SCHLUESSEL | 2 Schlüssel | 4,50 |

1/4" Schreiner-Werkzeugkoffer, 92-teilig

1/4" Carpenter Tool Case, 92 pieces

PROJAHN

Art.-Gruppe 113
Article Group 113

8684

1/4"

92
tlg./pcs.



8684K
Koffer, leer
empty case

| | | | | | | |
|---|--|------|--|---|---|--|
| 3 | 4,5 - 5,5 - 6,5 mm | 1/4" | | 9 | 1.5 - 2 - 2.5 - 3 - 4 - 5 - 6 - 8 - 10 mm | |
| 6 | 2x PH 1 - 2 - 3 | | | 8 | 8 - 10 - 11 - 12 - 13 - 14 - 17 - 19 mm | |
| 6 | 2x PZ 1 - 2 - 3 | | | 5 | Holzbohrer 4x75 - 5x85 - 6x90 - 8x110 - 10x120 mm | |
| 9 | TX8 - 9 - 10 - 15 - 20 - 25 - 27 - 30 - 40 | | | 1 | Beißzange 200 mm | |
| 6 | 3 - 4 - 5 - 6 - 7 - 8 mm | | | 1 | Seitenschneider 150 mm | |
| 1 | Bit-Halter 60 mm | | | 1 | Holzfeile, flach 150 mm | |
| 1 | Bit-Schraubendreher | | | 1 | Holzfeile, halbrund 150 mm | |
| 2 | PH 1 - 2 | | | 3 | Hand-Raspel | |
| 4 | 3 - 4 - 5,5 - 6,5 mm | | | 1 | Universalschere | |
| 1 | 120 bis/up to 250 V Spannungsprüfer | | | 1 | Universalmesser | |
| 3 | Zimmermanns-Bleistift | | | 1 | Schlosserhammer »Französische Form« | |
| 1 | Gliedermaßstab aus Holz, 2 m | | | 1 | Kleinhandsägebogen 150 mm | |
| 1 | Schmiege 230 mm | | | 1 | Handsäge 229 mm | |
| 1 | Vorstecher | | | 1 | Wasserwaage 400 mm | |
| 1 | Hobel 170 mm | | | 5 | Schlag- und Meißelsatz | |
| 1 | Winkel 90° 300 mm | | | 5 | Holz-Stechbeitel 6 - 12 - 16 - 20 - 26 mm | |

Größe/Size: 1/4" · tlg./pcs. 92
BxLxH/WxLxH: 460x330x145 mm
Gewicht/Weight: 9.060 g

| Art.-Nr./Art.-No. | | € |
|-------------------|-------------------------------|--------|
| 8684 | 1/4" Schreiner-Werkzeugkoffer | 457,00 |
| 8681-SCHLUESSEL | 2 Schlüssel | 4,50 |

1/4" + 1/2" Elektro-Werkzeugkoffer, 128-teilig

1/4" + 1/2" Electrician Tool Case, 128 pieces

8683

1/4"

1/2"

128
tlg./pcs.



8683K
Koffer, leer
empty case

| | | | | | | | | |
|----|---|--|------|--|----|---|--|--|
| 12 | ○ | 4 - 4,5 - 5 - 5,5 - 6 - 7 - 8 - 9 - 10 - 11 - 12 - 13 mm | 1/4" | | 9 | ● | 1.5 - 2 - 2.5 - 3 - 4 - 5 - 6 - 8 - 10 mm | |
| 2 | | Verlängerungen 50 + 100 mm | | | 9 | | 8 - 10 - 11 - 12 - 13 - 14 - 17 - 19 - 22 mm | |
| 1 | | 48 ZAHN , Art. 5200 | | | 1 | | Telefonzange 150 mm | |
| 1 | | Gleitgriff 115 mm | | | 1 | | Kombizange 150 mm | |
| 1 | | Kardangelenk | | | 1 | | Seitenschneider 150 mm | |
| 3 | ● | 4,5 - 5,5 - 6,5 mm | | | 1 | | VDE Abisolierzange 150 mm | |
| 6 | + | 2x PH 1 - 2 - 3 | | | 1 | | VDE Elektriker-Messer 150 mm | |
| 6 | + | 2x PZ 1 - 2 - 3 | | | 1 | | Universalschere | |
| 9 | ⊕ | TX8 - 9 - 10 - 15 - 20 - 25 - 27 - 30 - 40 | | | 1 | | Universalmesser | |
| 6 | ● | 3 - 4 - 5 - 6 - 7 - 8 mm | | | 1 | | Hammer 400 g | |
| 1 | | Bit-Halter 60 mm | | | 1 | | Handsägebogen 150 mm | |
| 1 | | Bit-Schraubendreher | | | 20 | | Kabelbinder 3,5 x 150 mm | |
| 2 | + | VDE/isolated PH1 - 2 | | | 1 | | Wasserwaage 400 mm | |
| 4 | ● | VDE/isolated 2,5 - 4 - 5,5 - 6,5 mm | | | 1 | | Maßband 5 m | |
| 1 | ● | 120 bis/up to 230 V Spannungsprüfer | | | 1 | | Rollgabelschlüssel 8" / 200 mm | |
| 12 | ○ | 10 - 11 - 12 - 13 - 14 - 15 - 16 - 17 - 18 - 19 - 21 - 22 mm | 1/2" | | 3 | | Zimmermanns-Bleistift | |
| 1 | | Verlängerung 125 mm | | | 1 | | Gliedermaßstab aus Holz, 2 m | |
| 1 | | 48 ZAHN , Art. 5220 | | | 1 | | Spachtel | |
| 1 | | Kardangelenk | | | 1 | | Flachmeißel 200 mm | |
| | | | | | 1 | | Spitzmeißel 200 mm | |

Größe/Size: 1/4" + 1/2" · tlg./pcs. 128

BxLxH/WxLxH: 460x330x145 mm

Gewicht/Weight: 10.200 g

Art.-Nr./Art.-No.

8683 1/4" + 1/2" Elektro-Werkzeugkoffer € **499,90**

8681-SCHLUESSEL 2 Schlüssel € **4,50**

1/4" + 1/2" Sanitär-Werkzeugkoffer, 95-teilig

1/4" + 1/2" Plumber Tool Case, 95 pieces

PROJAHN

Art.-Gruppe 113
Article Group 113

8685

1/4"

1/2"

95
tlg./pcs.



8685K
Koffer, leer
empty case

| | | | | | | |
|----|---|------|--|----|--|--|
| 3 | ● 4.5 - 5,5 - 6,5 mm | 1/4" | | 10 | 8x9 - 10x11 - 12x13 - 14x15 - 16x17 - 18x19 - 20x22 - 21x23 - 24x27 - 30x32 mm | |
| 6 | ⊕ 2x PH1 - 2 - 3 | | | 1 | Wasserpumpenzange 250 mm | |
| 6 | ⊕ 2x PZ1 - 2 - 3 | | | 1 | Eckrohrzange | |
| 9 | ⊗ TX8 - 9 - 10 - 15 - 20 - 25 - 27 - 30 - 40 | | | 1 | Hammer 600 g | |
| 6 | ● 3 - 4 - 5 - 6 - 7 - 8 mm | | | 1 | Flachmeißel 200 mm | |
| 1 | 60 mm Bit-Halter | | | 1 | Spitzmeißel 200 mm | |
| 1 | Magntischer Bit- Schraubendreher | | | 1 | Handsägebogen 150 mm | |
| 13 | ○ 10 - 11 - 12 - 13 - 14 - 15 - 16 - 17 - 18 - 19 - 21 - 22 - 24 mm | 1/2" | | 1 | Feile, halbrund, 150 mm | |
| 1 | Verlängerung 125 mm | | | 1 | Spachtel | |
| 1 | Kardangelen | | | 3 | Zimmermanns-Bleistift | |
| 2 | ⊕ PH1 - 2 | | | 1 | Sanitärkreuzschlüssel 200 x 200 mm | |
| 4 | ● 3 - 4 - 5,5 - 6,5 mm | | | 1 | Rohrabschneider 3 - 28 mm | |
| 1 | ● 120 bis 250 V Spannungsprüfer | | | 1 | Rohrabschneider 3 - 42 mm | |
| 1 | Gliedermaßstab aus Holz, 2 m | | | 1 | Umsteckknarre für 1/2" Vierkant-Antrieb | |
| 1 | Wasserwaage 400 mm | | | 1 | Vierkant-Adapter 1/2" | |
| 1 | Drahtbürste | | | 1 | Stufenschlüssel 5-stufig | |
| 9 | ● 1.5 - 2 - 2.5 - 3 - 4 - 5 - 6 - 8 - 10 mm | | | 1 | Standhahn-Mutterschlüssel | |
| | | | | 1 | Spezienschlüssel Sanitär | |

Größe/Size: 1/4" + 1/2" · tlg./pcs. 95
BxLxH/WxLxH: 460x330x145 mm
Gewicht/Weight: 12.760 g

| Art.-Nr./Art.-No. | | € |
|-------------------|------------------------------------|---------------|
| 8685 | 1/4" + 1/2" Sanitär-Werkzeugkoffer | 577,00 |
| 8681-SCHLUESSEL | 2 Schlüssel | 4,50 |

1/4" Werkzeugtasche, 106-teilig

1/4" Tool Bag, 106 pieces

Art.-Gruppe 113
Article Group 113**8686****1/4"****394901**
Tasche, leer
Empty bag**Werkzeugtasche mit 106 Werkzeugen, metrisch****106**
tlg./pcs.

- ▶ **Umfangreiche, universelle Bestückung**
- ▶ **1/4" proficraft-Satz, 45-tlg. (8659)**
- ▶ **Doppelgabelschlüssel-Set 6-tlg.**
- ▶ **Ermüdungsarmes Tragen durch ergonomisches Design**
- ▶ **Zusätzlicher Stauraum vorhanden**

Tool Bag with 106 assorted Tools, metric

- ▶ **High quality workmanship and materials**
- ▶ **1/4" proficraft Set, 45 pcs. (8659)**
- ▶ **Double open End wrench set, 6 pcs.**
- ▶ **Easy carrying due to ergonomic design**
- ▶ **Additional storage space inside**

- 3 4,5 - 5,5 - 6,5 mm **1/4"**
- 6 2x PH 1 - PH 2 - PH 3
- 6 2x PZ 1 - PZ 2 - PZ 3
- 9 T8 - T9 - T10 - T15 - T20
T25 - T27 - T30 - T40
- 6 3 - 4 - 5 - 6 - 7 - 8 mm
- 1 Bit-Halter 60 mm
- 13 4 - 4,5 - 5 - 5,5 - 6 - 7 - 8 -
9 - 10 - 11 - 12 - 13 - 14 mm
- 3 4 - 5,5 - 7 mm
- 3 PH 1 - PH 2 - PH 3
- 3 PZ 1 - PZ 2 - PZ 3
- 6 3 - 4 - 5 - 6 - 7 - 8 mm
- 7 T10 - T15 - T20 -
T27 - T30 - T40

- 1 **48 ZAHN**,
Art. 5200
- 1 Steckgriff
- 2 Verlängerungen
50 + 100 mm
- 1 Gleitgriff
- 1 Kardangelen
- 1 Verlängerung
flex. 150 mm
- 1 1/4" x 1/4"
- 3 1,5 - 2 - 2,5 mm
- 6 Doppelgabelschlüssel
6x7 - 8x9 - 10x11 - 12x13 - 14x15 -
16x17 mm in Rolltasche



- 9 Sechskant-Kugelpf-Winkelstiftschlüssel
1,5 - 2 - 2,5 - 3 - 4 - 5 - 6 - 8 - 10 mm
- 1 Rollgabelschlüssel 10" / 250 mm
- 1 Telefonzange 150 mm
- 1 Kombizange 175 mm
- 1 Wasserpumpenzange
- 1 Seitenschneider 150 mm
- 2 PH1 - PH 2
- 2 5,5 - 6,5 mm
- 1 Hammer 300 g
- 1 Magn. Bitschraubendreher
- 1 Universalmesser
- 1 LED-Taschenlampe
- 1 Gliedermaßstab 2 m

Größe/Size 1/4"
tlg./pcs. 106
BxLxH/WxLxH 340x440x250 mm
Gewicht/Weight 7.200 g

| Art.-Nr./Art.-No. | | € |
|-------------------|--|---------------|
| 8686 | 1/4" Werkzeugtasche mit 106 Werkzeugen | 346,00 |
| 394901 | 1/4" Werkzeugtasche, unbestückt | 148,00 |

Seite / Page
H 194



Ergonomisches Design

Ergonomic Design

- ▶ **Sicherer Halt und ermüdungsfreies Arbeiten durch ergonomisch an die Hand angepasste Griffform**
- ▶ **2-Komponentenmaterial – bruchsicherer, stabiler Kern und griffige Ummantelung mit hoher Rutschhemmung**
- ▶ **Hoher Abgleitschutz durch spezielle Daumenmulden**
- ▶ **Geringere Belastung für Gelenke bei gleichzeitig höherem Drehmoment**
- ▶ **Leichte Einhandbedienung durch Schnelllöseknopf und Richtungsumschalter**
- ▶ *Secure grip and fatigue-free working due to ergonomically to the hand designed ratchet handle*
- ▶ *Two-component material – robust core combined with an ergonomic, slip-resistant surface*
- ▶ *High slip protection due to specially adapted thumb grips*
- ▶ *Less strain on joints combined with a higher torque*
- ▶ *Easy one-handed operation because of quick-release button and direction lever*

INGETRAGENES DESIGN

REGISTERED DESIGN



Profi-Qualität

Professional Quality

- ▶ **Höchstes Qualitätsniveau für anspruchsvolle Anwender**
- ▶ **Präzision und Belastbarkeit weit über DIN-/ISO-Normen**
- ▶ **Hält extremen Drehmomenten bis 650 Nm stand²**
- ▶ **Leichtgängiger, hochpräziser Knarrenmechanismus**
- ▶ **Hohe Öl- und Säurebeständigkeit**
- ▶ *Highest level of quality for demanding users*
- ▶ *Precision and durability far beyond DIN/ISO standards*
- ▶ *Withstands extreme torques up to 650 Nm²*
- ▶ *Smooth-running, high-precision ratchet mechanism*
- ▶ *High oil and acid resistance*

Leistungsstarker Service

Powerful Support

- ▶ **PROJAHN Qualitätsversprechen – 25 Jahre Garantie¹**
- ▶ **Schneller Reparaturservice im Garantiefall**
- ▶ *PROJAHN's promise of quality – 25 years warranty¹*
- ▶ *Fast repair service during warranty time*



¹ Entsprechend unserer allgemeinen Garantiebedingungen / ¹ According to our general warranty conditions

² 1/2" PROJAHN-Umschaltknarre 39012900 / ² PROJAHN ratchet handle 39012900

1/4" + 3/8" + 1/2" Umschaltknarren

1/4" + 3/8" + 1/2" Ratchet Handle

1/4"

3/8"

1/2"

Art.-Gruppe 120
Article Group 120**Xi-on**
MULTISTECKNUSS**Feinzahn-Umschaltknarren mit
2-Komponenten-Griff**
Ratchet with 2K-Handle

| Art.-Nr./Art.-No. | Größe/Size | |
|-------------------|---------------------------|----------------|
| 5205 | 1/4" 72 Z, 70 Nm, 140 mm | € 27,60 |
| 5205-1 | Reparatur Set für 5205 | € 14,70 |
| 5215 | 3/8" 72 Z, 225 Nm, 191 mm | € 37,50 |
| 5215-1 | Reparatur Set für 5215 | € 17,30 |
| 5225 | 1/2" 60 Z, 600 Nm, 260 mm | € 43,60 |
| 5225-1 | Reparatur Set für 5225 | € 20,40 |

**Feinzahn-Umschaltknarren mit Drehgriff**
Ratchet with Twist Handle

| Art.-Nr./Art.-No. | Größe/Size | € |
|-------------------|---------------------------|--------------|
| 5204 | 1/4" 60 Z, 74 Nm, 182 mm | 54,00 |
| 5214 | 3/8" 60 Z, 242 Nm, 243 mm | 61,00 |
| 5224 | 1/2" 60 Z, 614 Nm, 292 mm | 69,50 |

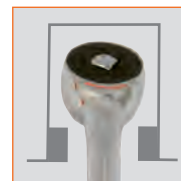

- ▶ Das ideale Werkzeuge für enge Arbeitsbereiche
 - z. B. an Auspuffanlagen, Stellmotoren, Heizungs- und Klimaanlageanlagen sowie am Automatikgetriebe u.v.m.
- ▶ Extrem leichte Ratschenfunktion durch Drehen des Zwei-Komponenten-Griffes
- ▶ Auch zum Einsatz als 'normale' Ratsche mit Feinverzahnung (60 Zähne) verwendbar
- ▶ Zusätzlich eine robuste 1/4" (6,35 mm)-Vierkantaufnahme zum Aufstecken einer Verlängerung oder eines T-Stücks
- ▶ Umschaltung von Rechts- auf Linkslauf durch Durchstecken des Antrieb-Vierkants
- ▶ The perfect tool for tight application area
 - e.g. for exhaust systems, motors, heating and air conditioning systems, automatic gearbox, etc.
- ▶ Extremely easy ratchet function by turning the two-component handle
- ▶ Also usable as a 'usual' ratchet handle with 60 teeth
- ▶ Additionally with a sturdy 1/4" (6,35 mm) square drive to plug an extension or a t-handle
- ▶ Reversible from right to left drive

Ideal für enge Stellen
Ideal for tight areas

1/2" Umschaltknarren, verlängerbar*1/2" Ratchet Handle, prolongable*

1/2"

Art.-Gruppe 120
Article Group 120**1/2" verlängerbare Umschaltknarre mit 3 Griffen***1/2" Extension Ratchet Handle*

| Art.-Nr./Art.-No. | Größe/Size | € |
|-------------------|------------------------|---------------|
| 4298 | 1/2" Knarre, 600 Nm | 105,00 |
| 4298-1 | Reparatur Set für 4298 | 20,50 |



- ▶ **Robuste Umschaltknarre für alle Einsatzbereiche**
- ▶ **Verlängerbar von 150 auf 290 oder 500 mm**
- ▶ **Ideale Kraftübertragung durch großen Hebel**
- ▶ **Umschaltung von Rechts- auf Linkslauf**
- ▶ **Inkl. Schnelllöseknopf**
- ▶ **Für hohe Belastungen bis 600 Nm ausgelegt**

- ▶ *Sturdy ratchet handle for diversity applications*
- ▶ *Prolongable from 150 to 290 or 500 mm*
- ▶ *Maximum power transmission through leverage*
- ▶ *Reversible from right to left drive*
- ▶ *Incl. quick release button*
- ▶ *Designed for heavy loads up to 600 Nm*

**1/2" Teleskop-Umschaltknarre***1/2" Extension Ratchet Handle,*

| Art.-Nr./Art.-No. | Größe/Size | € |
|-------------------|-------------------|--------------|
| 4289 | 1/2" Knarre, 48 Z | 56,00 |

- ▶ **Verlängerbar auf 6 Längen:**
305, 335, 365, 390, 420, 445 mm
- ▶ **Ideale Kraftübertragung durch großen Hebel**
- ▶ **Umschaltung von Rechts- auf Linkslauf**
- ▶ **Inkl. Schnelllöseknopf**
- ▶ **Für hohe Belastungen bis 600 Nm ausgelegt**

- ▶ *Prolongable to 6 lengths:*
305, 335, 365, 390, 420, 445 mm
- ▶ *Maximum power transmission through leverage*
- ▶ *Reversible from right to left drive*
- ▶ *Incl. quick release button*
- ▶ *Designed for heavy loads up to 600 Nm*

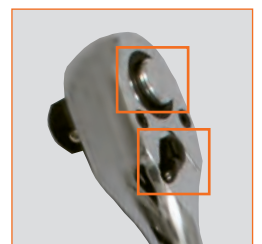

1/4" + 3/8" + 1/2" Umschaltknarren

1/4" + 3/8" + 1/2" Ratchet Handle



Art.-Gruppe 120
Article Group 120

Umschaltknarren mit 2-Komponenten-Griff

Ratchet with 2K-Handle



| Art.-Nr./Art.-No. | Größe/Size | € |
|-------------------|---------------------------|--------------|
| 5200 | 1/4" 48 Z, 78 Nm, 140 mm | 26,50 |
| 5200-1 | Reparatur Set für 5200 | 14,70 |
| 5210 | 3/8" 48 Z, 245 Nm, 191 mm | 36,00 |
| 5210-1 | Reparatur Set für 5210 | 17,60 |
| 5220 | 1/2" 48 Z, 646 Nm, 260 mm | 41,90 |
| 5220-1 | Reparatur Set für 5220 | 20,50 |

Feinzahn-Umschaltknarren mit 2-Komponenten-Griff

Ratchet with 2K-Handle



| Art.-Nr./Art.-No. | Größe/Size | € |
|-------------------|---|--------------|
| 5201 | 1/4" 72 Z, 66 Nm, 140 mm | 26,50 |
| 5201-2 | Reparatur Set für 5201 (Version ab 2014) | 14,70 |
| 5201-1 | Reparatur Set für 5201 (Version bis 2013) | 14,70 |
| 5211 | 3/8" 72 Z, 208 Nm, 195 mm | 36,00 |
| 5211-2 | Reparatur Set für 5211 (Version ab 2014) | 17,60 |
| 5211-1 | Reparatur Set für 5211 (Version bis 2013) | 17,60 |
| 5221 | 1/2" 72 Z, 549 Nm, 250 mm | 41,90 |
| 5221-2 | Reparatur Set für 5221 (Version ab 2014) | 20,50 |
| 5221-1 | Reparatur Set für 5221 (Version bis 2013) | 20,50 |

Mini-Umschaltknarre

Mini Ratchet Handle



| Art.-Nr./Art.-No. | Größe/Size | € |
|-------------------|-------------|--------------|
| 4299 | 1/4"/105 mm | 21,50 |
| | | |
| | | |
| | | |
| | | |
| | | |
| | | |
| | | |
| | | |
| | | |
| | | |

Umsteckknarre für 1/2" Vierkant-Antrieb

Ratchet Handle for 1/2" Drive



| Art.-Nr./Art.-No. | Größe/Size | € |
|-------------------|--|--------------|
| 4297 | 1/2" Knarre/ratchet 251 mm | 29,20 |
| 4297-1 | 1/2" Vierkant | 5,72 |
| 4297-2 | Stufenschlüssel, 5-stufig 3/8", 29/64", 31/64", 21/32", 53/64" | 20,25 |
| 4297-3 | Stufenschlüssel, 8-stufig 7/8", 27/32", 3/4", 35/64", 1/2", 15/32", 7/16", 3/8", Schraubendreher-Klinge für Schlitzschrauben | 26,50 |

Umsteckknarren-Set für 1/2" Vierkant-Antrieb, 3-tlg.

Ratchet Handle Set for 1/2" Drive, 3 pieces

3
tlg./pcs.



| Art.-Nr./Art.-No. | Größe/Size | € |
|-------------------|--|--------------|
| 4297-10 | 1/2" Knarre/ratchet 251 mm + Stufenschlüssel, 5-stufig 3/8", 29/64", 31/64", 21/32", 53/64", 1/2" Vierkant | 46,90 |
| | | |
| | | |
| | | |
| | | |
| | | |
| | | |
| | | |
| | | |
| | | |

1/4" + 10 mm Umschaltknarren

1/4" + 10 mm Ratchet Handle



Art.-Gruppe 120
Article Group 120

PROFESSIONAL PLUS STANDARD

10 mm Bit Ratsche umschaltbar
10 mm Bit Ratchet



| Art.-Nr./Art.-No. | Größe/Size | € |
|-------------------|--------------|----------------|
| 4295 | 10 mm/137 mm | - ¹ |

¹ Nicht mehr lieferbar / ¹ Out of stock

PROFESSIONAL PLUS STANDARD

1/4" Mini Bit Ratsche umschaltbar
1/4" Mini Bit Ratchet



| Art.-Nr./Art.-No. | Größe/Size | € |
|-------------------|-------------|-------|
| 4294 | 1/4"/103 mm | 19,90 |

PROFESSIONAL PLUS STANDARD

Dual Umschaltknarre für Bits + Nüsse
Dual Ratchet Handle for Bits + Sockets



| Art.-Nr./Art.-No. | Größe/Size | € |
|-------------------|---------------|-------|
| 4290 | 1/4" / 105 mm | 22,90 |

PROFESSIONAL PLUS STANDARD

1/4" Mini Bit Ratsche umschaltbar
1/4" Mini Bit Ratchet

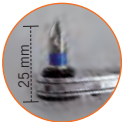

| Art.-Nr./Art.-No. | Größe/Size | € |
|-------------------|------------|-------|
| 4288 | 1/4"/88 mm | 17,90 |

PROFESSIONAL PLUS STANDARD

1/4" Mini Bit Ratsche umschaltbar
Bit Ratchet



| Art.-Nr./Art.-No. | Größe/Size | € |
|-------------------|------------|------|
| 2700 | 1/4"/98 mm | 8,52 |

1/4" Steckschlüssel und Antriebselemente

1/4" Sockets and Accessories



Art.-Gruppe 120
Article Group 120

6-kant, Steckschlüssel-Einsätze, metrisch

Sockets, Hex, Metric



| Art.-Nr./Art.-No. | Größe/Size | Länge/Length | € |
|-------------------|------------|--------------|------|
| 100035 | 3,5 mm | 25 mm | 2,48 |
| 100040 | 4,0 mm | 25 mm | 2,48 |
| 100045 | 4,5 mm | 25 mm | 2,48 |
| 100050 | 5,0 mm | 25 mm | 2,48 |
| 100055 | 5,5 mm | 25 mm | 2,48 |
| 100060 | 6,0 mm | 25 mm | 2,48 |
| 100070 | 7,0 mm | 25 mm | 2,48 |
| 100080 | 8,0 mm | 25 mm | 2,48 |
| 100090 | 9,0 mm | 25 mm | 2,48 |
| 100100 | 10,0 mm | 25 mm | 2,48 |
| 100110 | 11,0 mm | 25 mm | 2,60 |
| 100120 | 12,0 mm | 25 mm | 2,60 |
| 100130 | 13,0 mm | 25 mm | 2,88 |
| 100140 | 14,0 mm | 25 mm | 3,00 |

6-kant, extra tiefe Steckschlüssel-Einsätze, metrisch

Deep Sockets, Hex, Metric



| Art.-Nr./Art.-No. | Größe/Size | Länge/Length | € |
|-------------------|------------|--------------|------|
| 101060 | 6 mm | 50 mm | 3,78 |
| 101070 | 7 mm | 50 mm | 3,78 |
| 101080 | 8 mm | 50 mm | 3,78 |
| 101090 | 9 mm | 50 mm | 4,04 |
| 101100 | 10 mm | 50 mm | 4,04 |
| 101110 | 11 mm | 50 mm | 4,31 |
| 101120 | 12 mm | 50 mm | 4,57 |
| 101130 | 13 mm | 50 mm | 4,69 |

6-kant, Steckschlüssel-Einsätze, Zoll

Sockets, Hex, Inch



| Art.-Nr./Art.-No. | Größe/Size | Länge/Length | € |
|-------------------|------------|--------------|------|
| 100503 | 3/16" | 25 mm | 2,74 |
| 100504 | 7/32" | 25 mm | 2,74 |
| 100505 | 1/4" | 25 mm | 2,74 |
| 100506 | 9/32" | 25 mm | 2,74 |
| 100507 | 5/16" | 25 mm | 2,74 |
| 100508 | 11/32" | 25 mm | 2,74 |
| 100509 | 3/8" | 25 mm | 2,74 |
| 100510 | 7/16" | 25 mm | 3,00 |
| 100511 | 1/2" | 25 mm | 3,00 |

6-kant, extra tiefe Steckschlüssel-Einsätze, Zoll

Deep Sockets, Hex, Inch



| Art.-Nr./Art.-No. | Größe/Size | Länge/Length | € |
|-------------------|------------|--------------|------|
| 101503 | 3/16" | 50 mm | 4,44 |
| 101504 | 7/32" | 50 mm | 4,44 |
| 101505 | 1/4" | 50 mm | 4,44 |
| 101506 | 9/32" | 50 mm | 4,44 |
| 101507 | 5/16" | 50 mm | 4,44 |
| 101508 | 11/32" | 50 mm | 4,44 |
| 101509 | 3/8" | 50 mm | 4,44 |
| 101510 | 7/16" | 50 mm | 4,44 |
| 101511 | 1/2" | 50 mm | 4,44 |

Schlitz-Bit-Schraubereinsätze

Slotted Bit-Sockets



| Art.-Nr./Art.-No. | Größe/Size | Länge/Length | € |
|-------------------|------------|--------------|------|
| 102040 | 4,0 mm | 36 mm | 3,39 |
| 102055 | 5,5 mm | 36 mm | 3,39 |
| 102065 | 6,5 mm | 36 mm | 3,39 |

Phillips-Bit-Schraubereinsätze

Phillips Bit-Sockets



| Art.-Nr./Art.-No. | Größe/Size | Länge/Length | € |
|-------------------|------------|--------------|------|
| 103001 | PH 1 | 36 mm | 3,39 |
| 103002 | PH 2 | 36 mm | 3,39 |
| 103003 | PH 3 | 36 mm | 3,39 |

Pozidriv-Bit-Schraubereinsätze

Pozidriv Bit-Sockets



| Art.-Nr./Art.-No. | Größe/Size | Länge/Length | € |
|-------------------|------------|--------------|------|
| 104001 | PZ 1 | 36 mm | 3,39 |
| 104002 | PZ 2 | 36 mm | 3,39 |
| 104003 | PZ 3 | 36 mm | 3,39 |

TX-Bit-Schraubereinsätze

TX Bit-Sockets



| Art.-Nr./Art.-No. | Größe/Size | Länge/Length | € |
|-------------------|------------|--------------|------|
| 105008 | T8 | 36 mm | 3,39 |
| 105009 | T9 | 36 mm | 3,39 |
| 105010 | T10 | 36 mm | 3,39 |
| 105015 | T15 | 36 mm | 3,39 |
| 105020 | T20 | 36 mm | 3,39 |
| 105025 | T25 | 36 mm | 3,39 |
| 105027 | T27 | 36 mm | 3,39 |
| 105030 | T30 | 36 mm | 3,39 |
| 105040 | T40 | 36 mm | 3,39 |

Innensechskant-Bit-Schraubereinsätze

Hexagon Bit-Sockets



| Art.-Nr./Art.-No. | Größe/Size | Länge/Length | € |
|-------------------|------------|--------------|------|
| 106002 | 2 mm | 36 mm | 3,39 |
| 106003 | 3 mm | 36 mm | 3,39 |
| 106004 | 4 mm | 36 mm | 3,39 |
| 106005 | 5 mm | 36 mm | 3,39 |
| 106006 | 6 mm | 36 mm | 3,39 |
| 106007 | 7 mm | 36 mm | 3,39 |
| 106008 | 8 mm | 36 mm | 3,39 |

Steckschlüssel-Einsätze TX

TX Sockets



| Art.-Nr./Art.-No. | Größe/Size | Länge/Length | € |
|-------------------|------------|--------------|------|
| 120004 | E4 M3 | 25 mm | 3,53 |
| 120005 | E5 M4 | 25 mm | 3,53 |
| 120006 | E6 M5 | 25 mm | 3,53 |
| 120007 | E7 M6 | 25 mm | 3,53 |
| 120008 | E8 M6-7 | 25 mm | 3,53 |
| 120010 | E10 M8 | 25 mm | 3,53 |
| 120011 | E11 - | 25 mm | 3,53 |

1/4" Steckschlüssel und Antriebselemente

1/4" Sockets and Accessories



Art.-Gruppe 120
Article Group 120

Verlängerungen/Extension Bars

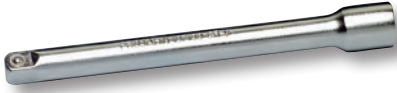

| Art.-Nr./Art.-No. | Länge/Length | € |
|-------------------|--------------|------|
| 107050 | 50 mm | 3,00 |
| 107100 | 100 mm | 4,18 |
| 107150 | 150 mm | 6,26 |

Verlängerungen mit Verriegelung

Locking Extension Bars



| Art.-Nr./Art.-No. | Länge/Length | € |
|-------------------|--------------|------|
| 107052 | 50 mm | 7,06 |
| 107102 | 100 mm | 8,47 |

Flexible Verlängerung

Flexible Extension Bar



| Art.-Nr./Art.-No. | Länge/Length | € |
|-------------------|--------------|------|
| 8605 | 150 mm | 5,36 |

Gleitgriff/Sliding T-Handle



| Art.-Nr./Art.-No. | Länge/Length | € |
|-------------------|--------------|------|
| 108100 | 110 mm | 5,48 |
| 108200 | 200 mm | 9,57 |

Adapter

Adapter



| Art.-Nr./Art.-No. | Knarre/Ratchet | Nuss/Socket | € |
|-------------------|----------------|-------------|------|
| 4248 | 1/4" | 3/8" | 2,15 |
| 4245 | 3/8" | 1/4" | 3,07 |

Kardangeln

Universal Joint



| Art.-Nr./Art.-No. | Größe/Size | Länge/Length | € |
|-------------------|------------|--------------|------|
| 110000 | Kardangeln | 35 mm | 7,18 |

Adapter für 1/4" Bits

Adapter for 1/4" Bits



| Art.-Nr./Art.-No. | Größe/Size | Länge/Length | € |
|-------------------|------------|--------------|------|
| 2760 | 1/4" | 25 mm | 3,73 |

Steckgriff/Spinner Handle



| Art.-Nr./Art.-No. | Länge/Length | € |
|-------------------|--------------|------|
| 109150 | 150 mm | 8,51 |

Universal Bit Schraubendreher, magnetisch

Bit Screwdriver, Magnetic

| Art.-Nr./Art.-No. | Größe/Size | Länge/Length | € |
|-------------------|------------|--------------|-------|
| 2128 | 1/4" | 188 mm | 10,33 |

1/4" Stecknuss-Schiene, kurze Nüsse, metrisch

1/4" Socket Rail, Short Sockets, Metric

7 tlg./pcs.



| Art.-Nr./Art.-No. | Größe/Size | € |
|-------------------|----------------------------------|-------|
| 4201 | 6 - 8 - 9 - 10 - 11 - 12 - 13 mm | 14,20 |
| 420000 | leere Schiene/empty rail | 9,49 |

1/4" Stecknuss-Schiene, tiefe Nüsse, metrisch

1/4" Socket Rail, Deep Sockets, Metric

7 tlg./pcs.



| Art.-Nr./Art.-No. | Größe/Size | € |
|-------------------|----------------------------------|-------|
| 4202 | 6 - 8 - 9 - 10 - 11 - 12 - 13 mm | 24,15 |
| 420000 | leere Schiene/empty rail | 9,49 |

1/4" Stecknuss-Schiene Innen-TX Nüsse

1/4" Socket Rail, E-TX Sockets

7 tlg./pcs.



| Art.-Nr./Art.-No. | Größe/Size | € |
|-------------------|------------------------------------|-------|
| 4203 | E4 - E5 - E6 - E7 - E8 - E10 - E11 | 24,15 |
| 420000 | leere Schiene/empty rail | 9,49 |

1/4" Stecknuss-Schiene TX Bit-Nüsse

1/4" Socket Rail, TX Bit Sockets

7 tlg./pcs.

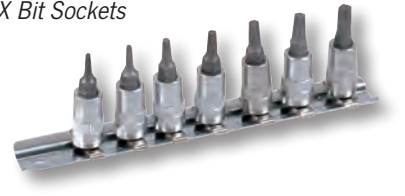

| Art.-Nr./Art.-No. | Größe/Size | € |
|-------------------|---|-------|
| 4204 | TX8 - TX10 - TX15 - TX20 - TX25 - TX27 - TX30 | 18,80 |
| 420000 | leere Schiene/empty rail | 9,49 |

1/4" Umschaltknarren

1/4" Ratchet Handle



Art.-Gruppe 120
Article Group 120

PROFESSIONAL PLUS STANDARD

PROJAHN Umschaltknarre mit säurebeständigem Griff, 36 Zähne
Ratchet Handle, 36 teeth



| Art.-Nr./Art.-No. | Größe/Size | |
|-------------------|----------------------------|---------|
| 39014900 | 1/4" 36 Z, 90 Nm, 147 mm | € 42,90 |
| 39014900-1 | Reparatur Set für 39014900 | € 14,90 |

PROFESSIONAL PLUS STANDARD



Feinzahn-Umschaltknarre mit 2-Komponenten-Griff, 72 Zähne
Ratchet with 2K-handle, 72 teeth



| Art.-Nr./Art.-No. | Größe/Size | |
|-------------------|--------------------------|---------|
| 5205 | 1/4" 72 Z, 70 Nm, 140 mm | € 27,60 |
| 5205-1 | Reparatur Set für 5205 | € 14,70 |

PROFESSIONAL PLUS STANDARD

Umschaltknarre mit 2-Komponenten-Griff, 48 Zähne
Ratchet with 2K-Handle, 48 teeth



| Art.-Nr./Art.-No. | Größe/Size | |
|-------------------|--------------------------|---------|
| 5200 | 1/4" 48 Z, 78 Nm, 140 mm | € 26,50 |
| 5200-1 | Reparatur Set für 5200 | € 14,70 |

PROFESSIONAL PLUS STANDARD

U.S. Umschaltknarre, 36 Zähne
Ratchet Handle, U.S. Style, 36 teeth



| Art.-Nr./Art.-No. | Größe/Size | |
|-------------------|--------------------------|---------|
| 4208 | 1/4" 36 Z, 90 Nm, 147 mm | € 32,55 |
| 4200-1 | Reparatur Set für 4208 | € 14,70 |

PROFESSIONAL PLUS STANDARD

Feinzahn-Umschaltknarre mit Drehgriff, 60 Zähne
Ratchet with Twist Handle, 60 teeth



| Art.-Nr./Art.-No. | Größe/Size | |
|-------------------|--------------------------|---------|
| 5204 | 1/4" 60 Z, 74 Nm, 182 mm | € 54,00 |



Ideal für enge Stellen
Ideal for tight areas

Weitere Informationen auf Seite H 94
Further Information On Page H 94

PROFESSIONAL PLUS STANDARD

Feinzahn-Umschaltknarre mit 2-Komponenten-Griff, 72 Zähne
Ratchet with 2K-Handle, 72 teeth



Verbesserte Ausführung /
improved Quality

| Art.-Nr./Art.-No. | Größe/Size | |
|-------------------|---|---------|
| 5201 | 1/4" 72 Z, 66 Nm, 140 mm | € 26,50 |
| 5201-2 | Reparatur Set für 5201 (Version ab 2014) | € 14,70 |
| 5201-1 | Reparatur Set für 5201 (Version bis 2013, rund) | € 14,70 |

3/8" Steckschlüssel und Antriebselemente

3/8" Sockets and Accessories



Art.-Gruppe 120
Article Group 120

6-kant, Steckschlüssel-Einsätze, metrisch

Sockets, Hex, Metric



| Art.-Nr./Art.-No. | Größe/Size | Länge/Length | € |
|-------------------|------------|--------------|-------------|
| 200060 | 6 mm | 25,5 mm | 3,13 |
| 200070 | 7 mm | 25,5 mm | 3,13 |
| 200080 | 8 mm | 25,5 mm | 3,13 |
| 200090 | 9 mm | 25,5 mm | 3,13 |
| 200100 | 10 mm | 25,5 mm | 3,13 |
| 200110 | 11 mm | 25,5 mm | 3,13 |
| 200120 | 12 mm | 25,5 mm | 3,13 |
| 200130 | 13 mm | 25,5 mm | 3,39 |
| 200140 | 14 mm | 27,0 mm | 3,39 |
| 200150 | 15 mm | 27,0 mm | 3,53 |
| 200160 | 16 mm | 27,0 mm | 3,53 |
| 200170 | 17 mm | 27,0 mm | 3,66 |
| 200180 | 18 mm | 27,0 mm | 3,93 |
| 200190 | 19 mm | 29,0 mm | 4,18 |
| 200200 | 20 mm | 29,0 mm | 4,57 |
| 200210 | 21 mm | 29,0 mm | 4,69 |
| 200220 | 22 mm | 31,0 mm | 4,97 |
| 200230 | 23 mm | 31,0 mm | 5,34 |
| 200240 | 24 mm | 31,0 mm | 5,48 |

6-kant, extra tiefe Steckschlüssel-Einsätze, metrisch

Deep Sockets, Hex, Metric



| Art.-Nr./Art.-No. | Größe/Size | Länge/Length | € |
|-------------------|------------|--------------|-------------|
| 201070 | 7 mm | 64 mm | 5,48 |
| 201080 | 8 mm | 64 mm | 5,48 |
| 201100 | 10 mm | 64 mm | 6,14 |
| 201110 | 11 mm | 64 mm | 6,14 |
| 201120 | 12 mm | 64 mm | 6,14 |
| 201130 | 13 mm | 64 mm | 6,14 |
| 201140 | 14 mm | 64 mm | 6,14 |
| 211214 | 14 mm | 64 mm | 6,65 |

12-kant Zündkerzen-Stecknuss

| | | | |
|--------|-------|-------|-------------|
| 201150 | 15 mm | 64 mm | 6,14 |
| 201160 | 16 mm | 61 mm | 6,14 |

Zündkerzen-Stecknuss

| | | | |
|--------|-------|-------|-------------|
| 201170 | 17 mm | 64 mm | 6,26 |
| 201180 | 18 mm | 64 mm | 6,66 |
| 201190 | 19 mm | 64 mm | 6,79 |
| 201210 | 21 mm | 65 mm | 7,06 |

Zündkerzen-Stecknuss

| | | | |
|--------|-------|-------|-------------|
| 201220 | 22 mm | 64 mm | 7,71 |
|--------|-------|-------|-------------|

Schlitz-Bit-Schraubereinsätze

Slotted Bit-Sockets



| Art.-Nr./Art.-No. | Größe/Size | Länge/Length | € |
|-------------------|------------|--------------|-------------|
| 202055 | 5,5 mm | 50 mm | 4,69 |
| 202065 | 6,5 mm | 50 mm | 4,69 |
| 202080 | 8,0 mm | 50 mm | 4,69 |
| 202100 | 10,0 mm | 50 mm | 6,01 |

Phillips-Bit-Schraubereinsätze

Phillips Bit-Sockets



| Art.-Nr./Art.-No. | Größe/Size | Länge/Length | € |
|-------------------|------------|--------------|-------------|
| 203001 | PH 1 | 50 mm | 4,83 |
| 203002 | PH 2 | 50 mm | 4,83 |
| 203003 | PH 3 | 50 mm | 4,83 |
| 203004 | PH 4 | 50 mm | 6,14 |

6-kant, Steckschlüssel-Einsätze, Zoll

Sockets, Hex, Inch



| Art.-Nr./Art.-No. | Größe/Size | Länge/Length | € |
|-------------------|------------|--------------|-------------|
| 200507 | 5/16" | 25 mm | 4,57 |
| 200509 | 3/8" | 25 mm | 4,57 |
| 200510 | 7/16" | 25 mm | 4,57 |
| 200511 | 1/2" | 25 mm | 4,57 |
| 200512 | 9/16" | 27 mm | 4,57 |
| 200513 | 5/8" | 27 mm | 4,57 |
| 200514 | 11/16" | 27 mm | 4,57 |
| 200515 | 3/4" | 29 mm | 4,57 |
| 200516 | 13/16" | 29 mm | 4,57 |
| 200517 | 7/8" | 31 mm | 4,57 |

6-kant, extra tiefe Steckschlüssel-Einsätze, Zoll

Deep Sockets, Hex, Inch



| Art.-Nr./Art.-No. | Größe/Size | Länge/Length | € |
|-------------------|------------|--------------|-------------|
| 201509 | 3/8" | 64 mm | 7,71 |
| 201510 | 7/16" | 64 mm | 7,71 |
| 201511 | 1/2" | 64 mm | 7,71 |
| 201512 | 9/16" | 64 mm | 7,71 |
| 201513 | 5/8" | 61 mm | 8,35 |

Zündkerzen-Stecknuss

| | | | |
|--------|--------|-------|-------------|
| 201514 | 11/16" | 64 mm | 8,35 |
| 201515 | 3/4" | 64 mm | 8,35 |
| 201516 | 13/16" | 65 mm | 8,35 |

Zündkerzen-Stecknuss

| | | | |
|--------|--------|-------|-------------|
| 201517 | 7/8" | 64 mm | 8,35 |
| 201518 | 5/8" | 64 mm | 8,35 |
| 201519 | 13/16" | 64 mm | 8,35 |

Pozidriv-Bit-Schraubereinsätze

Pozidriv Bit-Sockets



| Art.-Nr./Art.-No. | Größe/Size | Länge/Length | € |
|-------------------|------------|--------------|-------------|
| 204001 | PZ 1 | 50 mm | 4,83 |
| 204002 | PZ 2 | 50 mm | 4,83 |
| 204003 | PZ 3 | 50 mm | 4,83 |
| 204004 | PZ 4 | 50 mm | 6,14 |



3/8" Steckschlüssel und Antriebselemente

3/8" Sockets and Accessories



Art.-Gruppe 120
Article Group 120

PROFESSIONAL PLUS STANDARD

3/8" Durchgangsnüsse, metrisch

3/8" Go-Through Sockets, Metric



| Art.-Nr./Art.-No. | Größe/Size | € |
|-------------------|------------|------|
| 4016-10 | 10 mm | 3,93 |
| 4016-11 | 11 mm | 3,93 |
| 4016-12 | 12 mm | 3,93 |
| 4016-13 | 13 mm | 3,93 |
| 4016-14 | 14 mm | 3,93 |
| 4016-15 | 15 mm | 3,93 |
| 4016-16 | 16 mm | 3,93 |
| 4016-17 | 17 mm | 3,93 |
| 4016-19 | 19 mm | 3,93 |

PROFESSIONAL PLUS STANDARD

Durchgangsverlängerung

Go-Through Extension Bar



| Art.-Nr./Art.-No. | Länge/Length | € |
|-------------------|------------------------------|------|
| 4016-02 | Durchgangsverlängerung 75 mm | 9,74 |

PROFESSIONAL PLUS STANDARD

3/8" Stecknusschiene magnetisch

3/8" Magnetic Socket Rail



| Art.-Nr./Art.-No. | Größe/Size | € |
|-------------------|---|-------|
| 421001 | 3/8" Stecknusschiene magnetisch/ 3/8" magnetic socket holder inkl. 14 Halter/incl. 14 clips | 28,70 |
| 421011 | 3/8" Ersatzhalter, 10 Stück/ 3/8" Clips, 10 pieces | 9,54 |

PROFESSIONAL PLUS STANDARD

3/8" Stecknuss-Schiene, kurze Nüsse, metrisch

3/8" Socket Rail, Short Sockets, Metric



| Art.-Nr./Art.-No. | Größe/Size | € |
|-------------------|---|-------|
| 4211 | 7 - 8 - 10 - 11 - 12 - 13 - 14 - 15 - 17 - 18 - 19 - 22 mm | 38,30 |
| 421000 | leere Schiene/empty rail | 10,90 |

12
tlg./pcs.

PROFESSIONAL PLUS STANDARD

3/8" Stecknuss-Schiene, tiefe Nüsse, metrisch

3/8" Socket Rail, Deep Sockets, Metric



| Art.-Nr./Art.-No. | Größe/Size | € |
|-------------------|---|-------|
| 4212 | 7 - 8 - 10 - 11 - 12 - 13 - 14 - 15 - 17 - 18 - 19 - 22 mm | 67,80 |
| 421000 | leere Schiene/empty rail | 10,90 |

12
tlg./pcs.

PROFESSIONAL PLUS STANDARD

3/8" Stecknuss-Schiene, Innen-TX Nüsse

3/8" Socket Rail, E-TX Sockets



| Art.-Nr./Art.-No. | Größe/Size | € |
|-------------------|---|-------|
| 4213 | E4 - E5 - E6 - E7 - E8 - E10 - E11 - E12 - E14 - E16 - E18 - E20 | 43,70 |
| 421000 | leere Schiene/empty rail | 10,90 |

12
tlg./pcs.

PROFESSIONAL PLUS STANDARD

3/8" Stecknuss-Schiene, Bit-Nüsse kombiniert

3/8" Socket Rail, Bit Sockets



| Art.-Nr./Art.-No. | Größe/Size | € |
|-------------------|--|-------|
| 4214 | Posidriv PZ 1 - 2 - 3, Phillips PH 1 - 2 - 3 TX20 - TX27 - TX30 - TX40 - TX45 - TX50 mit Loch | 54,80 |
| 421000 | leere Schiene/empty rail | 10,90 |

12
tlg./pcs.

PROFESSIONAL PLUS STANDARD

Adapter für 1/4" Nüsse

Adapter for 1/4" Sockets



| Art.-Nr./Art.-No. | Größe/Size | € |
|-------------------|------------------------|------|
| 4016-03 | Adapter für 1/4" Nüsse | 9,74 |

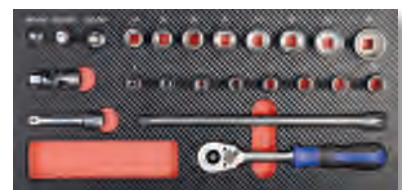

Weitere PROForm-Werkstatteinlagen ab Seite /
More PROForm Inlays for Roller Cabinet from Page H 32

3/8" Umschaltknarren

3/8" Ratchet Handle



Art.-Gruppe 120
Article Group 120

PROFESSIONAL PLUS STANDARD

PROJAHN Umschaltknarre mit säurebeständigem Griff, 38 Zähne
Ratchet Handle, 38 teeth



| Art.-Nr./Art.-No. | Größe/Size | |
|-------------------|----------------------------|----------------|
| 39038900 | 3/8" 38 Z, 280 Nm, 195 mm | € 50,90 |
| 39038900-1 | Reparatur Set für 39038900 | € 19,30 |

PROFESSIONAL PLUS STANDARD

Xi-on MULTISTECKNUS

Feinzahn-Umschaltknarre mit 2-Komponenten-Griff, 72 Zähne
Ratchet with 2K-handle, 72 teeth



| Art.-Nr./Art.-No. | Größe/Size | |
|-------------------|---------------------------|----------------|
| 5215 | 3/8" 72 Z, 225 Nm, 191 mm | € 37,50 |
| 5215-1 | Reparatur Set für 5215 | € 17,30 |

PROFESSIONAL PLUS STANDARD

Umschaltknarre mit 2-Komponenten-Griff, 48 Zähne
Ratchet with 2K-Handle, 48 teeth



| Art.-Nr./Art.-No. | Größe/Size | |
|-------------------|---------------------------|----------------|
| 5210 | 3/8" 48 Z, 245 Nm, 191 mm | € 36,00 |
| 5210-1 | Reparatur Set für 5210 | € 17,60 |

PROFESSIONAL PLUS STANDARD

U.S. Umschaltknarre, 38 Zähne
Ratchet Handle, U.S. Style, 38 teeth



| Art.-Nr./Art.-No. | Größe/Size | |
|-------------------|---------------------------|----------------|
| 4218 | 3/8" 38 Z, 280 Nm, 195 mm | € 46,30 |
| 4210-1 | Reparatur Set für 4218 | € 19,60 |

PROFESSIONAL PLUS STANDARD

Feinzahn-Umschaltknarre mit Drehgriff, 60 Zähne
Ratchet with Twist Handle, 60 teeth

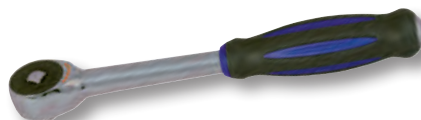

| Art.-Nr./Art.-No. | Größe/Size | |
|-------------------|---------------------------|----------------|
| 5214 | 3/8" 60 Z, 242 Nm, 243 mm | € 61,00 |



Ideal für enge Stellen
Ideal for tight areas

Weitere Informationen auf Seite H 94
Further Information On Page H 94

PROFESSIONAL PLUS STANDARD

Feinzahn-Umschaltknarre mit 2-Komponenten-Griff, 72 Zähne
Ratchet with 2K-Handle, 72 teeth



Verbesserte Ausführung /
improved Quality

| Art.-Nr./Art.-No. | Größe/Size | |
|-------------------|---|----------------|
| 5211 | 3/8" 72 Z, 208 Nm, 195 mm | € 36,00 |
| 5211-2 | Reparatur Set für 5211 (Version ab 2014) | € 17,60 |
| 5211-1 | Reparatur Set für 5211 (Version bis 2013, rund) | € 17,60 |

1/2" Steckschlüssel und Antriebselemente

1/2" Sockets and Accessories



Art.-Gruppe 120
Article Group 120

TX-Bit-Schraubereinsätze

TX Bit Sockets



| Art.-Nr./Art.-No. | Größe/Size | Länge/Length | € |
|-------------------|------------|--------------|------|
| 335010 | T10 | 60 mm | 6,39 |
| 335015 | T15 | 60 mm | 6,39 |
| 335020 | T20 | 60 mm | 6,39 |
| 335025 | T25 | 60 mm | 6,39 |
| 335027 | T27 | 60 mm | 6,39 |
| 335030 | T30 | 60 mm | 6,39 |
| 335040 | T40 | 60 mm | 6,39 |
| 335045 | T45 | 60 mm | 6,39 |
| 335050 | T50 | 60 mm | 6,39 |
| 335055 | T55 | 60 mm | 6,39 |
| 335060 | T60 | 60 mm | 6,39 |
| 335070 | T70 | 60 mm | 9,40 |

| | | | |
|--------|-----|--------|------|
| 325110 | T10 | 100 mm | 7,83 |
| 325115 | T15 | 100 mm | 7,83 |
| 325120 | T20 | 100 mm | 7,83 |
| 325125 | T25 | 100 mm | 7,83 |
| 325127 | T27 | 100 mm | 7,83 |
| 325130 | T30 | 100 mm | 7,83 |
| 325140 | T40 | 100 mm | 7,83 |
| 325145 | T45 | 100 mm | 7,83 |
| 325150 | T50 | 100 mm | 7,83 |
| 325155 | T55 | 100 mm | 7,83 |
| 325160 | T60 | 100 mm | 8,35 |

Innensechskant-Bit-Schraubereinsätze

Hexagon Bit Sockets



| Art.-Nr./Art.-No. | Größe/Size | Länge/Length | € |
|-------------------|------------|--------------|-------|
| 326005 | 5 mm | 60 mm | 6,39 |
| 326006 | 6 mm | 60 mm | 6,39 |
| 326007 | 7 mm | 60 mm | 6,39 |
| 326008 | 8 mm | 60 mm | 6,39 |
| 326010 | 10 mm | 60 mm | 6,39 |
| 326012 | 12 mm | 60 mm | 6,39 |
| 326014 | 14 mm | 60 mm | 9,40 |
| 326017 | 17 mm | 60 mm | 11,24 |
| 326019 | 19 mm | 60 mm | 12,60 |

| | | | |
|--------|-------|--------|-------|
| 326105 | 5 mm | 100 mm | 7,83 |
| 326106 | 6 mm | 100 mm | 7,83 |
| 326107 | 7 mm | 100 mm | 7,83 |
| 326108 | 8 mm | 100 mm | 7,83 |
| 326110 | 10 mm | 100 mm | 7,83 |
| 326112 | 12 mm | 100 mm | 8,35 |
| 326114 | 14 mm | 100 mm | 11,45 |
| 326117 | 17 mm | 100 mm | 13,65 |
| 326119 | 19 mm | 100 mm | 20,40 |

Steckschlüssel-Einsätze TX

TX Sockets



| Art.-Nr./Art.-No. | Größe/Size | Länge/Length | € |
|-------------------|------------|--------------|------|
| 320010 | E10/M8 | 40 mm | 5,48 |
| 320011 | E11/- | 40 mm | 5,48 |
| 320012 | E12/M10 | 40 mm | 5,48 |
| 320014 | E14/M12 | 40 mm | 5,48 |
| 320016 | E16/M12 | 40 mm | 5,48 |
| 320018 | E18/M14 | 40 mm | 5,48 |
| 320020 | E20/M16 | 40 mm | 5,48 |
| 320022 | E22/- | 40 mm | 6,14 |
| 320024 | E24/M18-20 | 40 mm | 6,14 |

TX-Bit-Schraubereinsätze mit stirnseitiger Bohrung

Tamper TX Bit Sockets



| Art.-Nr./Art.-No. | Größe/Size | Länge/Length | € |
|-------------------|------------|--------------|------|
| 325015 | T15 | 60 mm | 6,39 |
| 325020 | T20 | 60 mm | 6,39 |
| 325025 | T25 | 60 mm | 6,39 |
| 325027 | T27 | 60 mm | 6,39 |
| 325030 | T30 | 60 mm | 6,39 |
| 325040 | T40 | 60 mm | 6,39 |
| 325045 | T45 | 60 mm | 6,39 |
| 325050 | T50 | 60 mm | 6,39 |
| 325055 | T55 | 60 mm | 6,39 |
| 325060 | T60 | 60 mm | 6,39 |

Vielzahn-Bit-Schraubereinsätze

Spline Bit Sockets



| Art.-Nr./Art.-No. | Größe/Size | Länge/Length | € |
|-------------------|------------|--------------|-------|
| 327005 | M5 | 60 mm | 6,39 |
| 327006 | M6 | 60 mm | 6,39 |
| 327008 | M8 | 60 mm | 6,39 |
| 327010 | M10 | 60 mm | 6,39 |
| 327012 | M12 | 60 mm | 7,06 |
| 327014 | M14 | 60 mm | 9,40 |
| 327016 | M16 | 60 mm | 12,29 |

| | | | |
|--------|-----|--------|-------|
| 327105 | M5 | 100 mm | 7,83 |
| 327106 | M6 | 100 mm | 7,83 |
| 327108 | M8 | 100 mm | 7,83 |
| 327110 | M10 | 100 mm | 7,83 |
| 327112 | M12 | 100 mm | 8,35 |
| 327114 | M14 | 100 mm | 10,82 |
| 327116 | M16 | 100 mm | 13,97 |

Tiefe Steckschlüssel-Einsätze TX

Deep TX Sockets



| Art.-Nr./Art.-No. | Größe/Size | Länge/Length | € |
|-------------------|------------|--------------|------|
| 321010 | E10 | 77 mm | 7,57 |
| 321012 | E12 | 77 mm | 7,57 |
| 321014 | E14 | 77 mm | 7,57 |
| 321016 | E16 | 77 mm | 7,57 |
| 321018 | E18 | 77 mm | 7,57 |
| 321020 | E20 | 77 mm | 7,57 |
| 321022 | E22 | 77 mm | 8,22 |
| 321024 | E24 | 77 mm | 8,62 |

1/2" Steckschlüssel und Antriebselemente

1/2" Sockets and Accessories



Art.-Gruppe 120
Article Group 120

Verlängerungen

Extension Bars



| Art.-Nr./Art.-No. | Länge/Length | € |
|-------------------|--------------|--------------|
| 307125 | 125 mm | 7,43 |
| 307250 | 250 mm | 11,75 |

Kipp Verlängerungen

Wobble Extension Bars

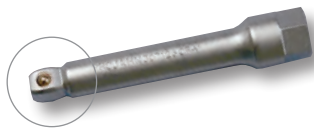

| Art.-Nr./Art.-No. | Länge/Length | € |
|-------------------|--------------|--------------|
| 307126 | 125 mm | 9,14 |
| 307251 | 250 mm | 13,65 |

Verlängerungen mit Verriegelung

Locking Extension Bars



| Art.-Nr./Art.-No. | Länge/Length | € |
|-------------------|--------------|--------------|
| 307127 | 125 mm | 15,95 |
| 307252 | 250 mm | 20,25 |

Gleitgriff

Sliding T-Handle



| Art.-Nr./Art.-No. | Länge/Length | € |
|-------------------|--------------|--------------|
| 308300 | 300 mm | 14,70 |

Gleitgriff Adapter

Sliding T-Adapter



| Art.-Nr./Art.-No. | Größe/Size | € |
|-------------------|----------------------------------|-------------|
| 308001 | T Gleitgriff Adapter 1/2" x 1/2" | 7,67 |

Kardangeln

Universal Joint



| Art.-Nr./Art.-No. | Größe/Size | Länge/Length | € |
|-------------------|------------|--------------|--------------|
| 310000 | Kardangeln | 67 mm | 10,82 |

Bit Adapter

Bit Adapter



| Art.-Nr./Art.-No. | Größe/Size | Länge/Length | € |
|-------------------|----------------------------|--------------|-------------|
| 311516 | 1/2" Adapter f. 5/16" Bits | 38 mm | 6,01 |

Adapter

Adapter



| Art.-Nr./Art.-No. | Knarre/Ratchet | Nuss/Socket | € |
|-------------------|----------------|-------------|--------------|
| 4249 | 3/8" | 1/2" | 4,54 |
| 4250 | 1/2" | 3/8" | 6,14 |
| 4246 | 1/2" | 3/4" | 13,70 |
| 4251 | 3/4" | 1/2" | 20,40 |

Sortiment auf Seite / Set on Page
H 118

1/2" Stecknuss-Schiene, kurze Nüsse, metrisch

1/2" Socket Rail, Short Sockets, Metric

10
tlg./pcs.



| Art.-Nr./Art.-No. | Größe/Size | € |
|-------------------|--|--------------|
| 4221 | 10 - 11 - 12 - 13 - 14 - 15 - 17 - 18 - 19 - 22 mm | 37,40 |
| 422000 | leere Schiene/empty rail | 10,90 |

1/2" Stecknuss-Schiene, tiefe Nüsse, metrisch

1/2" Socket Rail, Deep Sockets, Metric

10
tlg./pcs.



| Art.-Nr./Art.-No. | Größe/Size | € |
|-------------------|--|--------------|
| 4222 | 10 - 11 - 12 - 13 - 14 - 15 - 17 - 18 - 19 - 22 mm | 70,70 |
| 422000 | leere Schiene/empty rail | 10,90 |

1/2" Stecknuss-Schiene, Innen-TX Nüsse

1/2" Socket Rail, E-TX Sockets

7
tlg./pcs.



| Art.-Nr./Art.-No. | Größe/Size | € |
|-------------------|---|--------------|
| 4223 | E12 - E14 - E16 - E18 - E20 - E22 - E24 | 36,20 |
| 422000 | leere Schiene/empty rail | 10,90 |

1/2" Steckschlüssel und Antriebselemente

1/2" Sockets and Accessories



Art.-Gruppe 120
Article Group 120

1/2" Stecknuss-Schiene, TX Bit-Nüsse, 60 mm

1/2" Socket Rail, TX Bit Sockets

10
tlg./pcs.



| Art.-Nr./Art.-No. | Größe/Size | |
|-------------------|---|---------|
| 4236 | TX10 - TX15 - TX20 - TX25 - TX27 - TX30 - TX40 - TX45 - TX50 - TX55 | € 56,60 |
| 422000 | leere Schiene/empty rail | € 10,90 |

1/2" Stecknuss-Schiene, Vielzahn Bit-Nüsse, 60 + 100 mm

1/2" Socket Rail, Spline Bit Sockets

11
tlg./pcs.



| Art.-Nr./Art.-No. | Größe/Size | |
|-------------------|---|---------|
| 4233 | 60 mm: M5 - M6 - M8 - M10 - M12 - M14 - M16 100 mm: M5 - M6 - M8 - M10 | € 75,60 |
| 422000 | leere Schiene/empty rail | € 10,90 |

1/2" Stecknuss-Schiene, Innensechskant + Vielzahn Bit-Nüsse, 60 mm

1/2" Socket Rail, Hex + Spline Bit Sockets

11
tlg./pcs.



| Art.-Nr./Art.-No. | Größe/Size | |
|-------------------|--|---------|
| 4235 | 5 - 6 - 7 - 8 - 10 - 12 mm M5 - M6 - M8 - M10 - M12 | € 67,20 |
| 422000 | leere Schiene/empty rail | € 10,90 |

1/2" Stecknuss-Schiene, TX Bit-Nüsse, 100 mm

1/2" Socket Rail, TX Bit Sockets

11
tlg./pcs.



| Art.-Nr./Art.-No. | Größe/Size | |
|-------------------|--|---------|
| 4231 | TX10 - TX15 - TX20 - TX25 - TX27 - TX30 - TX40 - TX45 - TX50 - TX55 - TX60 | € 77,70 |
| 422000 | leere Schiene/empty rail | € 10,90 |

1/2" Stecknuss-Schiene, Innensechskant Bit-Nüsse, 60 + 100 mm

1/2" Socket Rail, Hex Bit Sockets

11
tlg./pcs.



| Art.-Nr./Art.-No. | Größe/Size | |
|-------------------|---|---------|
| 4234 | 60 mm: 5 - 6 - 8 - 10 - 12 mm 100 mm: 5 - 6 - 7 - 8 - 10 - 12 mm | € 69,95 |
| 422000 | leere Schiene/empty rail | € 10,90 |

1/2" Stecknuss-Schiene, Innensechskant + Vielzahn Bit-Nüsse, 100 mm

1/2" Socket Rail, Hex + Spline Bit Sockets

11
tlg./pcs.



| Art.-Nr./Art.-No. | Größe/Size | |
|-------------------|--|---------|
| 4232 | 5 - 6 - 7 - 8 - 10 mm M6 - M8 - M10 - M12 - M14 - M16 | € 86,00 |
| 422000 | leere Schiene/empty rail | € 10,90 |

1/2" Stecknuss-Schiene, TX Bit-Nüsse mit Loch, 60 mm

1/2" Socket Rail, Tamper TX Bit Sockets

10
tlg./pcs.



| Art.-Nr./Art.-No. | Größe/Size | |
|-------------------|---|---------|
| 4224 | TX15 - TX20 - TX25 - TX27 - TX30 - TX40 - TX45 - TX50 - TX55 - TX60 | € 57,25 |
| 422000 | leere Schiene/empty rail | € 10,90 |

PROFESSIONAL PLUS STANDARD

1/2" Stecknuss-Schiene magnetisch

1/2" Magnetic Socket Rail



| Art.-Nr./Art.-No. | Größe/Size | |
|-------------------|---|---------|
| 422001 | 1/2" Stecknuss-Schiene magnetisch/ 1/2" magnetic socket holder inkl. 14 Halter/incl. 14 clips | € 28,65 |
| 422011 | 1/2" Ersatzhalter, 10 Stück/ 1/2" Clips, 10 pieces | € 9,54 |



Weitere PROForm-Werkstatteinlagen ab Seite /
More PROForm Inlays for Roller Cabinet from Page H 32

1/2" Umschaltknarren

1/2" Ratchet Handle



Art.-Gruppe 120
Article Group 120

PROFESSIONAL PLUS STANDARD

PROJAHN Umschaltknarre mit säurebeständigem Griff, 40 Zähne

Ratchet Handle, 40 teeth



| Art.-Nr./Art.-No. | Größe/Size | |
|-------------------|----------------------------|----------------|
| 39012900 | 1/2" 40 Z, 640 Nm, 265 mm | € 59,50 |
| 39012900-1 | Reparatur Set für 39012900 | € 22,60 |

PROFESSIONAL PLUS STANDARD

Xi-on
MULTISTECKNUS

Feinzahn-Umschaltknarre mit 2-Komponenten-Griff, 60 Zähne

Ratchet with 2K-handle, 60 teeth



| Art.-Nr./Art.-No. | Größe/Size | |
|-------------------|---------------------------|----------------|
| 5225 | 1/2" 60 Z, 600 Nm, 260 mm | € 43,60 |
| 5225-1 | Reparatur Set für 5225 | € 20,40 |

PROFESSIONAL PLUS STANDARD

Umschaltknarre mit 2-Komponenten-Griff, 48 Zähne

Ratchet with 2K-Handle, 48 teeth



| Art.-Nr./Art.-No. | Größe/Size | |
|-------------------|---------------------------|----------------|
| 5220 | 1/2" 48 Z, 646 Nm, 260 mm | € 41,90 |
| 5220-1 | Reparatur Set für 5220 | € 20,50 |

PROFESSIONAL PLUS STANDARD

U.S. Umschaltknarre, 40 Zähne

Ratchet Handle, U.S. Style, 40 teeth



| Art.-Nr./Art.-No. | Größe/Size | |
|-------------------|---------------------------|----------------|
| 4228 | 1/2" 40 Z, 640 Nm, 265 mm | € 58,40 |
| 4220-1 | Reparatur Set für 4228 | € 23,40 |

PROFESSIONAL PLUS STANDARD

Feinzahn-Umschaltknarre mit Drehgriff, 60 Zähne

Ratchet with Twist Handle, 60 teeth



| Art.-Nr./Art.-No. | Größe/Size | |
|-------------------|---------------------------|----------------|
| 5224 | 1/2" 60 Z, 614 Nm, 292 mm | € 69,50 |



Ideal für enge Stellen
Ideal for tight areas

Weitere Informationen auf Seite H 94
Further Information On Page H 94

PROFESSIONAL PLUS STANDARD

Feinzahn-Umschaltknarre mit 2-Komponenten-Griff, 72 Zähne

Ratchet with 2K-Handle, 72 teeth



Verbesserte Ausführung /
Improved Quality

| Art.-Nr./Art.-No. | Größe/Size | |
|-------------------|---|----------------|
| 5221 | 1/2" 72 Z, 549 Nm, 250 mm | € 41,90 |
| 5221-2 | Reparatur Set für 5221 (Version ab 2014) | € 20,50 |
| 5221-1 | Reparatur-Set für 5221 (Version bis 2013, rund) | € 20,50 |

3/4" Steckschlüssel und Antriebselemente

3/4" Sockets and Accessories



Art.-Gruppe 120
Article Group 120

6-kant, Steckschlüssel-Einsätze, metrisch

Sockets, 6-point, Metric



| Art.-Nr./Art.-No. | Größe/Size | Länge/Length | € |
|-------------------|------------|--------------|-------|
| 400190 | 19 mm | 50,5 mm | 12,92 |
| 400210 | 21 mm | 50,5 mm | 12,92 |
| 400220 | 22 mm | 50,5 mm | 12,92 |
| 400230 | 23 mm | 50,5 mm | 12,92 |
| 400240 | 24 mm | 50,5 mm | 12,92 |
| 400260 | 26 mm | 50,5 mm | 13,60 |
| 400270 | 27 mm | 50,5 mm | 13,60 |
| 400290 | 29 mm | 52,0 mm | 14,39 |
| 400300 | 30 mm | 52,0 mm | 15,00 |
| 400320 | 32 mm | 55,0 mm | 15,00 |
| 400350 | 35 mm | 58,0 mm | 15,65 |
| 400360 | 36 mm | 58,0 mm | 15,65 |
| 400380 | 38 mm | 60,0 mm | 17,20 |
| 400410 | 41 mm | 64,0 mm | 20,50 |
| 400460 | 46 mm | 67,0 mm | 24,60 |
| 400500 | 50 mm | 72,0 mm | 27,30 |

Verlängerungen

Extension Bars



| Art.-Nr./Art.-No. | Länge/Length | € |
|-------------------|--------------|-------|
| 407100 | 100 mm | 18,50 |
| 407200 | 200 mm | 26,00 |
| 407400 | 400 mm | 45,15 |

Adapter

Adapter



| Art.-Nr./Art.-No. | Knarre/Ratchet | Nuss/Socke | € |
|-------------------|----------------|------------|-------|
| 4246 | 1/2" 49 mm | 3/4" | 13,70 |
| 4251 | 3/4" 53 mm | 1/2" | 20,40 |
| 4247 | 3/4" 62 mm | 1" | 26,15 |
| 4252 | 1" 73 mm | 3/4" | 34,00 |

Sortiment auf Seite /Set on Page
H 118

3/4" Umschaltknarre

Ratchet Handle

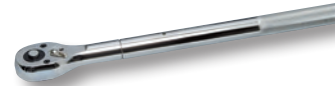

| Art.-Nr./Art.-No. | Größe/Size | € |
|-------------------|--------------------------|--------|
| 400001 | 3/4" | 119,00 |
| 400001-1 | Reparatur Set für 400001 | 66,00 |

T-Gleitgriff

Sliding T-Handle



| Art.-Nr./Art.-No. | Länge/Length | € |
|-------------------|--------------|-------|
| 408000 | 450 mm | 43,00 |

1" Steckschlüssel und Antriebselemente

1" Sockets and Accessories



Art.-Gruppe 120
Article Group 120

Steckschlüssel-Einsätze, metrisch

Sockets, Metric



| Art.-Nr./Art.-No. | Größe/Size | Länge/Length | € |
|-------------------|------------|--------------|--------|
| 500360 | 36 mm | 65 mm | 25,40 |
| 500380 | 38 mm | 65 mm | 25,90 |
| 500410 | 41 mm | 70 mm | 28,25 |
| 500460 | 46 mm | 75 mm | 32,45 |
| 500500 | 50 mm | 75 mm | 37,40 |
| 500540 | 54 mm | 79 mm | 45,00 |
| 500550 | 55 mm | 80 mm | 50,60 |
| 500580 | 58 mm | 80 mm | 52,00 |
| 500600 | 60 mm | 84 mm | 54,60 |
| 500630 | 63 mm | 87 mm | 60,30 |
| 500650 | 65 mm | 87 mm | 69,70 |
| 500670 | 67 mm | 89 mm | 71,40 |
| 500700 | 70 mm | 92 mm | 84,90 |
| 500710 | 71 mm | 92 mm | 89,00 |
| 500750 | 75 mm | 96 mm | 97,50 |
| 500770 | 77 mm | 103 mm | 99,90 |
| 500800 | 80 mm | 105 mm | 104,50 |

Verlängerungen

Extension Bars



| Art.-Nr./Art.-No. | Länge/Length | € |
|-------------------|--------------|-------|
| 507200 | 200 mm | 57,50 |
| 507400 | 400 mm | 88,20 |

Adapter

Adapter



| Art.-Nr./Art.-No. | Knarre/Ratchet | Nuss/Socket | € |
|-------------------|----------------|-------------|-------|
| 4247 | 3/4" 62 mm | 1" | 26,15 |
| 4252 | 1" 73 mm | 3/4" | 34,00 |

Gleitgriff Adapter

Sliding T-Adapter



| Art.-Nr./Art.-No. | Größe/Size | € |
|-------------------|------------|-------|
| 508000 | 1" x 1" | 39,10 |

1" Umschaltknarre

Ratchet Handle



| Art.-Nr./Art.-No. | Größe/Size | € |
|-------------------|------------|--------|
| 500000 | 1" | 209,00 |

Universalgriff

Universal Handle

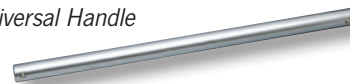

| Art.-Nr./Art.-No. | Länge/Length | € |
|-------------------|--------------|-------|
| 508560 | 560 mm | 62,90 |

Kardangeln

Universal Joint



| Art.-Nr./Art.-No. | Größe/Size | Länge/Length | € |
|-------------------|-------------------|--------------|-------|
| 510000 | Kardangeln 140 mm | 140 mm | 89,30 |

Xi-on MULTI-Steckschlüssel

Xi-on MULTI-Sockets

Art.-Gruppe 110
Article Group 110

MULTISTECKNUSS / MULTI SOCKET

Xi-on

Wenn nichts mehr geht, greift Xi-on.

- ▶ Extrem innovativ: Revolutionäres Xi-on Spezialprofil öffnet bis zu 85% abgerundete Schrauben und Muttern
- ▶ Greift auch da noch, wo herkömmliche Stecknüsse versagen
- ▶ Öffnet alle gängigen metrischen 6-kant-, 12-kant- und Vielzahn-Muttern & -Schrauben
- ▶ Empfohlen von der Redaktion »Technik und Motor« der FAZ

If Nothing Works, Xi-on Helps.

- ▶ Extremely innovative: Revolutionary Xi-on special construction opens up to 85% rounded screws and screw nuts
- ▶ Easy working where even conventional sockets fail
- ▶ Opens all standard metric hex, double hex, spline screw nuts and screws
- ▶ Recommended by »Technik und Motor« of FAZ (established reputed Frankfurt Newspaper, Germany)



Selbst stark beschädigte Schrauben können mit Xi-on geöffnet werden.

Even heavily damaged screws can be opened with Xi-on.

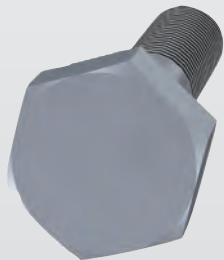

6-kant / Hex



85% abgerundet / rounded



12-kant / Double Hex



Vielzahn / Spline

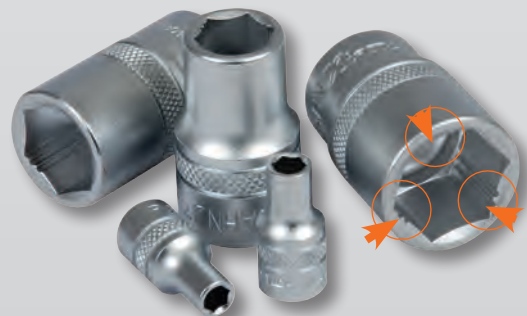
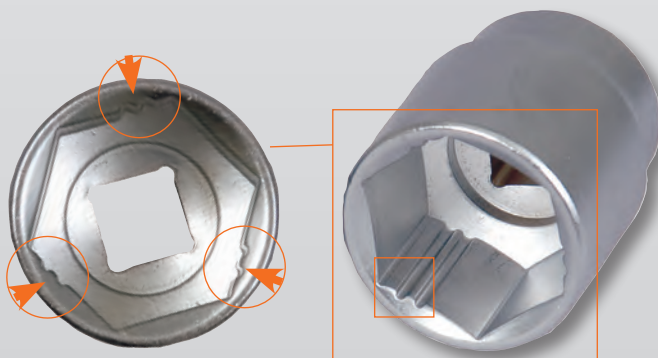

1/4" Xi-on Steckschlüssel und Antriebselemente

1/4" Xi-on Sockets and Accessories



Art.-Gruppe 120
Article Group 120

Xi-on 6-kant Steckschlüssel-Einsätze, metrisch

Xi-on Sockets, Hex, Metric



| Art.-Nr./Art.-No. | Größe/Size | Länge/Length | € |
|-------------------|------------|--------------|-------------|
| 411004 | 4,0 mm | 25 mm | 2,39 |
| 411045 | 4,5 mm | 25 mm | 2,39 |
| 411005 | 5,0 mm | 25 mm | 2,39 |
| 411055 | 5,5 mm | 25 mm | 2,39 |
| 411006 | 6,0 mm | 25 mm | 2,39 |
| 411007 | 7,0 mm | 25 mm | 2,39 |
| 411008 | 8,0 mm | 25 mm | 2,39 |
| 411009 | 9,0 mm | 25 mm | 2,39 |
| 411010 | 10,0 mm | 25 mm | 2,39 |
| 411011 | 11,0 mm | 25 mm | 2,51 |
| 411012 | 12,0 mm | 25 mm | 2,51 |
| 411013 | 13,0 mm | 25 mm | 2,78 |

Xi-on Phillips-Bit Schraubereinsätze, Xi-on Phillips Bit-Sockets



| Art.-Nr./Art.-No. | Größe/Size | Länge/Length | € |
|-------------------|------------|--------------|-------------|
| 411301 | PH1 | 32 mm | 3,28 |
| 411302 | PH2 | 32 mm | 3,28 |

Xi-on Innensechskant-Bit-Schraubereinsätze

Hexagon Bit-Sockets



| Art.-Nr./Art.-No. | Größe/Size | Länge/Length | € |
|-------------------|------------|--------------|-------------|
| 411603 | 3,0 mm | 32 mm | 3,28 |
| 411604 | 4,0 mm | 32 mm | 3,28 |
| 411605 | 5,0 mm | 32 mm | 3,28 |
| 411606 | 6,0 mm | 32 mm | 3,28 |
| 411608 | 8,0 mm | 32 mm | 3,28 |
| 411610 | 10,0 mm | 32 mm | 3,28 |

1/4" Xi-on Stecknuss-Schiene 6-kant

1/4" Xi-on Socket Rail, Hex



12
tlg./pcs.

| Art.-Nr./Art.-No. | Größe/Size | € |
|-------------------|--|----------------|
| 4109 | Ø 4 - 4,5 - 5 - 5,5 - 6 - 7 - 8 - 9 - 10 - 11 - 12 - 13 mm | € 29,20 |
| 423000 | leere Schiene/empty rail | € 9,45 |

Xi-on Kardangelen

Xi-on Universal Joint



| Art.-Nr./Art.-No. | Länge/Length | € |
|-------------------|--------------|-------------|
| 411100 | 41 mm | 6,91 |

Xi-on Gleitgriff-Adapter

Xi-on Sliding T-Adapter



| Art.-Nr./Art.-No. | Beschr./Descr. | € |
|-------------------|----------------|-------------|
| 411438 | 3/8" x 1/4" mm | 5,96 |

Xi-on Schlitz-Bit Schraubereinsätze,

Xi-on Slotted Bit-Sockets



| Art.-Nr./Art.-No. | Größe/Size | Länge/Length | € |
|-------------------|------------|--------------|-------------|
| 411255 | 5,5 mm | 32 mm | 3,28 |
| 411207 | 7,0 mm | 32 mm | 3,28 |

1/4" Stecknuss-Schiene magnetisch

1/4" Magnetic Socket Rail



| Art.-Nr./Art.-No. | Größe/Size | € |
|-------------------|---|----------------|
| 420001 | 1/4" Stecknuss-Schiene magnetisch/ 1/4" magnetic socket holder inkl. 14 Halter/incl. 14 clips | € 28,70 |
| 420011 | 1/4" Ersatzhalter, 10 Stück/ 1/4" Clips, 10 pieces | € 9,54 |

Xi-on Gleitgriff/Xi-on Sliding T-Handle



| Art.-Nr./Art.-No. | Länge/Length | € |
|-------------------|--------------|-------------|
| 411081 | 150 mm | 5,29 |

Xi-on Steckgriff/Xi-on Spinner Handle



| Art.-Nr./Art.-No. | Länge/Length | € |
|-------------------|--------------|-------------|
| 411915 | 150 mm | 8,18 |

Xi-on Verlängerung/Xi-on Extension Bars

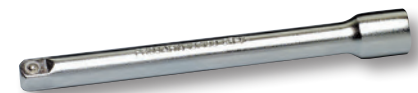

| Art.-Nr./Art.-No. | Länge/Length | € |
|-------------------|--------------|-------------|
| 411705 | 50 mm | 2,89 |
| 411715 | 150 mm | 6,04 |



Feinzahn-Umschaltknarre mit 2-Komponenten-Griff, 72 Zahn

Ratchet with 2K-handle, 72 teeth



| Art.-Nr./Art.-No. | Größe/Size | € |
|-------------------|--------------------------|----------------|
| 5205 | 1/4" 72 Z, 70 Nm, 140 mm | € 27,60 |
| 5205-1 | Reparatur Set für 5205 | € 14,70 |

3/8" Xi-on Steckschlüssel und Antriebselemente

3/8" Xi-on Sockets and Accessories



Art.-Gruppe 120
Article Group 120

Xi-on 6-kant Steckschlüssel-Einsätze, metrisch

Xi-on Sockets, Hex, Metric



| Art.-Nr./Art.-No. | Größe/Size | Länge/Length | € |
|-------------------|------------|--------------|-------------|
| 412008 | 8,0 mm | 30 mm | 3,02 |
| 412010 | 10,0 mm | 30 mm | 3,02 |
| 412011 | 11,0 mm | 30 mm | 3,02 |
| 412012 | 12,0 mm | 30 mm | 3,02 |
| 412013 | 13,0 mm | 30 mm | 3,28 |
| 412014 | 14,0 mm | 30 mm | 3,28 |
| 412015 | 15,0 mm | 30 mm | 3,40 |
| 412016 | 16,0 mm | 30 mm | 3,40 |
| 412017 | 17,0 mm | 30 mm | 3,53 |
| 412018 | 18,0 mm | 30 mm | 3,78 |
| 412019 | 19,0 mm | 30 mm | 4,02 |

Xi-on Verlängerung

Xi-on Extension Bars

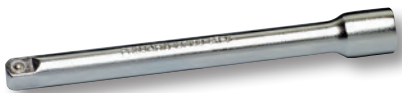

| Art.-Nr./Art.-No. | Länge/Length | € |
|-------------------|--------------|-------------|
| 412707 | 75 mm | 4,70 |
| 412715 | 150 mm | 5,80 |

Sortimente auf Seite / Sets on Page
H 74 - H 75



Weitere PROForm-Werkstatteinlagen ab Seite /
More PROForm Inlays for Roller Cabinet from Page H 36

3/8" Xi-on Stecknuss-Schiene 6-kant

3/8" Xi-on Socket Rail, Hex



11
tlg./pcs.

| Art.-Nr./Art.-No. | Größe/Size |
|-------------------|---|
| 4119 | Ø 8 - 10 - 11 - 12 - 13 - 14 - 15 16 - 17 - 18 - 19 mm |
| € 36,30 | |
| 421000 | leere Schiene/empty rail |
| € 10,90 | |

Xi-on Kardangelenk

Xi-on Universal Joint



| Art.-Nr./Art.-No. | Länge/Length | € |
|-------------------|--------------|-------------|
| 412100 | 57 mm | 8,81 |
| | | |
| | | |
| | | |
| | | |
| | | |
| | | |
| | | |
| | | |
| | | |

3/8" Stecknuss-Schiene magnetisch

3/8" Magnetic Socket Rail



| Art.-Nr./Art.-No. | Größe/Size |
|---|---|
| 421001 | 3/8" Stecknuss-Schiene magnetisch/ 3/8" magnetic socket holder |
| inkl. 14 Halter/incl. 14 clips € 28,70 | |
| 421011 | 3/8" Ersatzhalter, 10 Stück/ 3/8" clips, 10 pieces |
| € 9,54 | |

Xi-on Gleitgriff

Xi-on Sliding T-Handle



| Art.-Nr./Art.-No. | Länge/Length | € |
|-------------------|--------------|--------------|
| 412920 | 200 mm | 11,34 |



Feinzahn-Umschaltknarre mit 2-Komponenten-Griff, 72 Zahn

Ratchet with 2K-handle, 72 teeth



| Art.-Nr./Art.-No. | Größe/Size |
|-------------------|---------------------------|
| 5215 | 3/8" 72 Z, 225 Nm, 191 mm |
| € 37,50 | |
| 5215-1 | Reparatur Set für 5215 |
| € 17,30 | |
| | |
| | |
| | |
| | |

1/2" Xi-on Steckschlüssel und Antriebselemente*1/2" Xi-on Sockets and Accessories***1/2"****MULTISTECKNUSS**
Xi-on**Art.-Gruppe 120**
*Article Group 120***Xi-on 6-kant Steckschlüssel-Einsätze, metrisch***Xi-on Sockets, Hex, Metric,*

| Art.-Nr./Art.-No. | Größe/Size | Länge/Length | € |
|-------------------|------------|--------------|-------------|
| 413010 | 10,0 mm | 38 mm | 3,64 |
| 413011 | 11,0 mm | 38 mm | 3,64 |
| 413012 | 12,0 mm | 38 mm | 3,64 |
| 413013 | 13,0 mm | 38 mm | 3,64 |
| 413014 | 14,0 mm | 38 mm | 3,64 |
| 413015 | 15,0 mm | 38 mm | 3,64 |
| 413016 | 16,0 mm | 38 mm | 3,64 |
| 413017 | 17,0 mm | 38 mm | 4,28 |
| 413018 | 18,0 mm | 38 mm | 4,53 |
| 413019 | 19,0 mm | 38 mm | 4,65 |
| 413021 | 21,0 mm | 38 mm | 5,16 |
| 413022 | 22,0 mm | 38 mm | 5,66 |
| 413024 | 24,0 mm | 38 mm | 6,30 |
| 413027 | 27,0 mm | 45 mm | 7,80 |
| 413030 | 30,0 mm | 45 mm | 8,95 |
| 413032 | 32,0 mm | 45 mm | 9,44 |

1/2" Xi-on Stecknuss-Schiene 6-kant*1/2" Xi-on Socket Rail, Hex***10**
tlg./pcs.

| Art.-Nr./Art.-No. | Größe/Size | € |
|-------------------|---|----------------|
| 4129 | Ø 10 - 11 - 12 - 13 - 14 - 15 - 16 - 17 - 18 - 19 mm | € 38,65 |
| 422000 | leere Schiene/empty rail | € 10,90 |

Xi-on Kardangelen*Xi-on Universal Joint*

| Art.-Nr./Art.-No. | Länge/Length | € |
|-------------------|--------------|--------------|
| 413100 | 73 mm | 10,45 |

1/2" Stecknusschiene magnetisch*1/2" Magnetic Socket Rail*

| Art.-Nr./Art.-No. | Größe/Size | € |
|-------------------|---|----------------|
| 422001 | 1/2" Stecknusschiene magnetisch/ 1/2" magnetic socket holder inkl. 14 Halter/incl. 14 clips | € 28,65 |
| 422011 | 1/2" Ersatzhalter, 10 Stück/ 1/2" Clips, 10 pieces | € 9,54 |

Xi-on Gleitgriff-Adapter*Xi-on Sliding T-Adapter*

| Art.-Nr./Art.-No. | Beschr./Descr. | € |
|-------------------|----------------|-------------|
| 413812 | 3/8" x 1/2" | 7,43 |

Xi-on 6-kant Zündkerzen-Stecknuss, metrisch*Xi-on Spark Plug Sockets, Hex, Metric*

| Art.-Nr./Art.-No. | Größe/Size | Länge/Length | € |
|-------------------|------------|--------------|-------------|
| 413116 | 16,0 mm | 65 mm | 7,30 |
| 413121 | 21,0 mm | 65 mm | 8,32 |

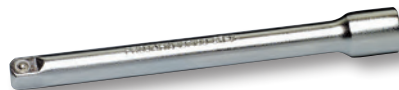
Xi-on Verlängerung*Xi-on Extension Bar*

| Art.-Nr./Art.-No. | Länge/Length | € |
|-------------------|--------------|--------------|
| 413712 | 125 mm | 7,17 |
| 413725 | 250 mm | 11,35 |

MULTISTECKNUSS
Xi-on**Feinzahn-Umschaltknarre mit 2-Komponenten-Griff, 60 Zahn***Ratchet with 2K-handle, 60 teeth*

| Art.-Nr./Art.-No. | Größe/Size | € |
|-------------------|---------------------------|----------------|
| 5225 | 1/2" 60 Z, 600 Nm, 260 mm | € 43,60 |
| 5225-1 | Reparatur Set für 5225 | € 20,40 |

Weitere PROForm-Werkstatteinlagen ab Seite /
More PROForm Inlays for Roller Cabinet from Page **H 36**Sortimente auf Seite / Sets on Page
H 74 - 75

Drehmomentschlüssel

Torque Wrenches



Drehmomentschlüssel TORQUE-PROFI PLUS

Torque Wrenches TORQUE PROFİ PLUS

Art.-Gruppe 121
Article Group 121

Auslöserichtung im und gegen den Uhrzeigersinn /
Operative direction clockwise and anti-clockwise

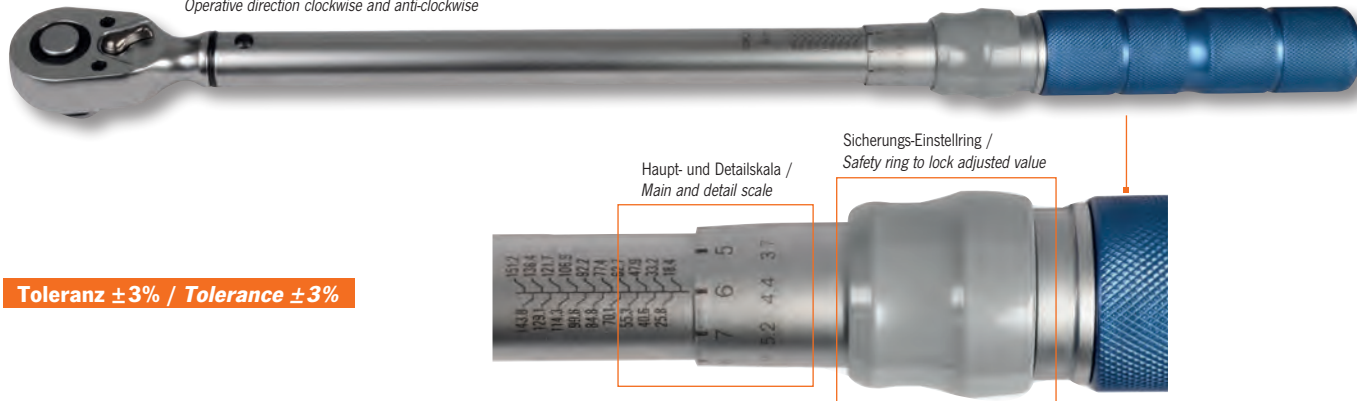

Toleranz $\pm 3\%$ / Tolerance $\pm 3\%$

TORQUE-PROFI PLUS

- ▶ **Mechanischer Zweigweg-Drehmomentschlüssel**
- ▶ **Leichte und sichere Einstellung des Drehmoments**
- ▶ **Sicherungsring zum Sperren der Einstellung**
- ▶ **Hohe Anwendungssicherheit**
 - Hör- und fühlbare automatische Kurzwegauslösung
 - Rutschhemmender, ergonomischer Handgriff
- ▶ **Extrem robust und langlebig**
- ▶ **Technische Daten:**
 - Typ mechanisch, Drehmomentbereich: 5 – 340 Nm
 - Auslöserichtung:
Zweigweg, im und gegen Uhrzeigersinn
 - Mit Schnelllöseknopf und Richtungsumschalter
 - Inklusive Kalibrierungszertifikat nach DIN EN ISO 6789:2003
- ▶ **Achtung:**
 - Drehmomentschlüssel nach Gebrauch auf den kleinsten Wert zurückstellen!
 - Drehmomentschlüssel sollen je nach Gebrauch einmal jährlich neu kalibriert werden. Nutzen Sie hierzu unseren Kalibrierungsservice auf Seite H 118.

TORQUE-PROFI PLUS

- ▶ *Mechanically dual way torque wrench*
- ▶ *Easy and safe adjustment of the torque*
- ▶ *Safety ring to lock the adjustable value*
- ▶ *High application safety*
 - *Audible and tactile automatic short path release*
 - *Ergonomic non-slip handle*
- ▶ *Extrem sturdy and durable*
- ▶ **Technically data:**
 - *Type mechanically, torque range: 5 – 340 Nm*
 - *Operative direction:*
Dual way, clockwise and anti-clockwise
 - *With quick release button and direction lever*
 - *Incl. certificate of calibration DIN EN ISO 6789:2003*
- ▶ **Attention:**
 - *After working please turn back to the smallest value of the wrench!*
 - *Torque wrenches have to be, depending on use, calibrated once a year. Simply use our calibration service on page H 118.*

TORQUE-PROFI PLUS

mechanischer Zweigweg-Drehmomentschlüssel

TORQUE-PROFI PLUS

mechanically dual way torque wrench



Toleranz $\pm 3\%$ / Tolerance $\pm 3\%$

| Art.-Nr./Art.-No. | Antrieb/Drive | Bereich/Array | Länge/Length | € |
|-------------------|--------------------------|---------------|--------------|--------|
| 394270 | 1/4" | 5 - 25 Nm | 245 mm | 169,50 |
| 394241-1 | Reparatur-Set für 394270 | | | 11,00 |
| 394271 | 3/8" | 20 - 100 Nm | 410 mm | 173,50 |
| 394242-1 | Reparatur-Set für 394271 | | | 12,00 |
| 394272 | 1/2" | 40 - 200 Nm | 520 mm | 185,00 |
| 394240-1 | Reparatur-Set für 394272 | | | 17,50 |
| 394273 | 1/2" | 60 - 340 Nm | 610 mm | 214,00 |
| 394243-1 | Reparatur-Set für 394273 | | | 17,50 |

Drehmomentschlüssel TORQUE-PROFI

Torque Wrenches TORQUE PROFI

Art.-Gruppe 121
Article Group 121



Toleranz $\pm 4\%$ / Tolerance $\pm 4\%$

TORQUE-PROFI

- ▶ **Mechanischer Einweg-Drehmomentschlüssel (Uhrzeigersinn)**
- ▶ **Erleichterte Ablesung durch farbig hinterlegte Skala**
- ▶ **Leichtgängiger Einstellring am Griff**
- ▶ **Sicherungsknopf zum Sperren des Einstellrings**
- ▶ **Hohe Anwendungssicherheit**
 - Hör- und fühlbare automatische Kurzwegauslösung
 - Rutschhemmender, ergonomischer Handgriff
- ▶ **Extrem robust und langlebig**
- ▶ **Technische Daten:**
 - Typ mechanisch, Drehmomentbereich: 5 – 340 Nm
 - Auslöserichtung: Einweg, im Uhrzeigersinn
 - Mit Schnelllöseknopf und Richtungsumschalter
 - Inklusive Kalibrierungszertifikat nach DIN EN ISO 6789:2003
- ▶ **Achtung:**
 - Drehmomentschlüssel nach Gebrauch auf den kleinsten Wert zurückstellen!
 - Drehmomentschlüssel sollen je nach Gebrauch einmal jährlich neu kalibriert werden. Nutzen Sie hierzu unseren Kalibrierungsservice auf Seite H 118.

TORQUE-PROFI

- ▶ Mechanically one-way torque wrench (clockwise rotation)
- ▶ Easy readability due to colored measured value display
- ▶ Smooth-running adjustment ring at the handle
- ▶ Safety button to lock the adjustment ring
- ▶ High application safety
 - Audible and tactile automatic short path release
 - Ergonomic non-slip handle
- ▶ Extrem sturdy and durable
- ▶ **Technically data:**
 - Type mechanically, torque range: 5 – 340 Nm
 - Operative direction: One-way, clockwise rotation
 - With quick release button and direction lever
 - Incl. certificate of calibration DIN EN ISO 6789:2003
- ▶ **Attention:**
 - After working please turn back to the smallest value of the wrench!
 - Torque wrenches have to be, depending on use, calibrated once a year. Simply use our calibration service on page H 118.

TORQUE-PROFI

mechanischer Einweg-Drehmomentschlüssel

TORQUE-PROFI

mechanically dual way torque wrench



Toleranz $\pm 4\%$ / Tolerance $\pm 4\%$

| Art.-Nr./Art.-No. | Antrieb/Drive | Bereich/Array | Länge/Length | € |
|-------------------|--------------------------|---------------|--------------|---------------|
| 394241 | 1/4" | 5 - 25 Nm | 245 mm | 147,50 |
| 394241-1 | Reparatur-Set für 394241 | | | 11,00 |
| 394242 | 3/8" | 20 - 100 Nm | 410 mm | 152,00 |
| 394242-1 | Reparatur-Set für 394242 | | | 12,00 |
| 394240 | 1/2" | 40 - 200 Nm | 520 mm | 163,00 |
| 394240-1 | Reparatur-Set für 394240 | | | 17,50 |
| 394243 | 1/2" | 60 - 340 Nm | 610 mm | 185,00 |
| 394243-1 | Reparatur-Set für 394243 | | | 17,50 |

1/2" Drehmomentschlüssel-Set TORQUE-PROFI

1/2" Torque Wrenche Set TORQUE PROFI

1/2"

Art.-Gruppe 121
Article Group 121**394260****1/2" Drehmomentschlüssel-Set, 11-teilig**
Drehmomentschlüssel mit den gebräuchlichsten Nüssen
für den universellen Einsatz

1/2" Torque Wrench Set, 11 pieces with Sockets

Inhalt/Contents:

1/2" Stecknüsse/Sockets 17 - 19 - 21 - 22 - 24 - 27 mm

1/2" Bit-Stecknüsse Innensechskant/Ex Bit Sockets 6 - 8 - 10 - 12 mm

1/2" Drehmomentschlüssel TORQUE-PROFI 40 - 200 Nm

Achtung:

- **Drehmomentschlüssel nach Gebrauch auf den kleinsten Wert zurückstellen!**
- **Drehmomentschlüssel sollen je nach Gebrauch einmal jährlich neu kalibriert werden. Nutzen sie hierzu unseren Kalibrierungsservice auf dieser Seite.**

Toleranz $\pm 4\%$ / Tolerance $\pm 4\%$ **Attention:**

- After working please turn back to the smallest value of the wrench!
- Torque wrenches have to be, depending on use, calibrated once a year. Simply use our calibration service on this page.

| Art.-Nr./Art.-No. | Antrieb/Drive | Bereich/Array | € |
|-------------------|--------------------------|---------------|---------------|
| 394260 | 1/2" | 40 - 200 Nm | 174,00 |
| 394240-1 | Reparatur-Set für 394260 | | 17,50 |

Drehmomentschlüssel sollen, je nach Gebrauch, einmal jährlich neu kalibriert werden. Nutzen Sie hierzu unseren Kalibrierungsservice. Wenden Sie sich dazu an unseren Kundenservice unter +49 (0) 60 74 / 69 666 - 66 oder verkauf@projahn.de.

Für jede Kalibrierung eines Drehmomentschlüssels berechnen wir 39,90 €.

Torque Wrenches should be, depending on use, calibrated once a year. Simply use our calibration service. Please contact our customer service at +49 (0) 60 74 / 69 666 - 66 or verkauf@projahn.de. For every calibration of a torque wrench we will charge 39,90 €.

Adapter Satz

Adapter Set

6
tlg./pcs.Art.-Gruppe 120
Article Group 120**4259****Adapter Satz, 6-tlg.**

Adapter Set, 6 pieces



| Art.-Nr./Art.-No. | Knarre/Ratchet | Nuss/Socket | € |
|-------------------|--------------------------|-------------|--------------|
| 4259 | Adapter-Satz/Adapter Set | | 27,90 |
| Inhalt/Content | 1/4" 25 mm | 3/8" | |
| | 3/8" 25 mm | 1/4" | |
| | 3/8" 33 mm | 1/2" | |
| | 1/2" 36 mm | 3/8" | |
| | 1/2" 49 mm | 3/4" | |
| | 3/4" 53 mm | 1/2" | |

Adapter

Adapter

Art.-Gruppe 120
Article Group 120

| Art.-Nr./Art.-No. | Knarre/Ratchet | Nuss/Socket | € |
|-------------------|----------------|-------------|--------------|
| 4248 | 1/4" 25 mm | 3/8" | 2,15 |
| 4245 | 3/8" 25 mm | 1/4" | 3,07 |
| 4249 | 3/8" 33 mm | 1/2" | 4,54 |
| 4250 | 1/2" 36 mm | 3/8" | 6,14 |
| 4246 | 1/2" 49 mm | 3/4" | 13,70 |
| 4251 | 3/4" 53 mm | 1/2" | 20,40 |
| 4247 | 3/4" 62 mm | 1" | 26,15 |
| 4252 | 1" 73 mm | 3/4" | 34,00 |

1/2" Schlag Stecknüsse

1/2" Impact Sockets



Art.-Gruppe 120
Article Group 120

PROJAHN Schlag Stecknüsse sind aus einem speziellen Chrom-Vanadium-Molybdän-Stahl (CMbd) gefertigt. Diese Nüsse sind für den harten Einsatz mit Druckluftschraubern konzipiert.

PROJAHN impact Sockets are produced by a special Chrom-Vanadium-Molybdenum-Steel (CMbd). Due to this these Sockets are for hard use with impact drill machines.

1/2" Schlag Stecknüsse Impact Sockets



| Art.-Nr./Art.-No. | Größe/Size | Länge/Length | € |
|-------------------|------------|--------------|-------|
| 380008 | 8 mm | 39 mm | 5,60 |
| 380009 | 9 mm | 39 mm | 5,60 |
| 380010 | 10 mm | 39 mm | 5,60 |
| 380011 | 11 mm | 39 mm | 5,60 |
| 380012 | 12 mm | 39 mm | 5,60 |
| 380013 | 13 mm | 39 mm | 5,60 |
| 380014 | 14 mm | 39 mm | 5,60 |
| 380015 | 15 mm | 39 mm | 6,27 |
| 380016 | 16 mm | 39 mm | 6,27 |
| 380017 | 17 mm | 39 mm | 6,27 |
| 380018 | 18 mm | 39 mm | 6,27 |
| 380019 | 19 mm | 39 mm | 7,07 |
| 380020 | 20 mm | 39 mm | 7,07 |
| 380021 | 21 mm | 39 mm | 7,74 |
| 380022 | 22 mm | 39 mm | 8,27 |
| 380023 | 23 mm | 39 mm | 8,27 |
| 380024 | 24 mm | 39 mm | 9,20 |
| 380025 | 25 mm | 39 mm | 10,14 |
| 380027 | 27 mm | 39 mm | 11,45 |
| 380028 | 28 mm | 39 mm | 12,18 |
| 380030 | 30 mm | 48 mm | 13,65 |
| 380032 | 32 mm | 48 mm | 14,60 |

1/2" Tiefe Schlag Stecknüsse Deep Impact Sockets



| Art.-Nr./Art.-No. | Größe/Size | Länge/Length | € |
|-------------------|------------|--------------|-------|
| 381008 | 8 mm | 77 mm | 8,81 |
| 381009 | 9 mm | 77 mm | 8,81 |
| 381010 | 10 mm | 77 mm | 8,81 |
| 381011 | 11 mm | 77 mm | 8,81 |
| 381012 | 12 mm | 77 mm | 8,81 |
| 381013 | 13 mm | 77 mm | 8,81 |
| 381014 | 14 mm | 77 mm | 8,81 |
| 381015 | 15 mm | 77 mm | 9,74 |
| 381016 | 16 mm | 77 mm | 9,74 |
| 381017 | 17 mm | 77 mm | 9,74 |
| 381018 | 18 mm | 77 mm | 9,74 |
| 381019 | 19 mm | 77 mm | 9,74 |
| 381020 | 20 mm | 77 mm | 10,14 |
| 381021 | 21 mm | 77 mm | 10,92 |
| 381022 | 22 mm | 77 mm | 12,18 |
| 381023 | 23 mm | 77 mm | 12,92 |
| 381024 | 24 mm | 77 mm | 14,49 |
| 381025 | 25 mm | 77 mm | 16,07 |
| 381027 | 27 mm | 78 mm | 17,48 |
| 381028 | 28 mm | 78 mm | 18,11 |
| 381030 | 30 mm | 78 mm | 19,00 |
| 381032 | 32 mm | 78 mm | 20,00 |

1/2" Tiefe Schlag Stecknüsse für Alu-Felgen Thin-Wall Deep Impact Sockets

Thin-Wall Deep Impact Sockets



Kunststoffummantelt zum beschädigungsfreien Arbeiten an Alu-Felgen, die farbliche Unterscheidung ermöglicht ein schnelles Auffinden der verschiedenen großen Nüsse.

Thin-wall deep impact Sockets with plastic sleeve for a free of damage work on your aluminium rims. More easier to find the right Size because of different colors.



| Art.-Nr./Art.-No. | Größe/Size | Länge/Length | € |
|-------------------|------------------|--------------|---------|
| 382017 | 17 mm blau | 85 mm | € 16,70 |
| | blue | | |
| 382019 | 19 mm gold | 85 mm | € 16,70 |
| | gold | | |
| 382021 | 21 mm rot | 85 mm | € 16,70 |
| | red | | |
| 382022 | 22 mm hellgrün | 85 mm | € 18,80 |
| | light green | | |
| 382024 | 24 mm dunkelgrün | 85 mm | € 20,30 |
| | dark green | | |



| Art.-Nr./Art.-No. | Größe/Size | Länge/Length | € |
|-------------------|---------------------|--------------|-------|
| 382117 | 17 mm, blau | 150 mm | 36,30 |
| 382117-1 | Plastiküberzug blau | | 1,20 |
| 382119 | 19 mm, gold | 150 mm | 36,30 |
| 382119-1 | Plastiküberzug gold | | 1,20 |
| 382121 | 21 mm, rot | 150 mm | 36,30 |
| 382121-1 | Plastiküberzug rot | | 1,20 |

Sortimente auf Seite /Sets on Page
H 121



Weitere PROForm-Werkstatteinlagen ab Seite /
More PROForm Inlays for Roller Cabinet from Page H 32

1/2" Schlag Stecknüsse und Zubehör

1/2" Impact Sockets And Accessories



Art.-Gruppe 120
Article Group 120

1/2" E-TX-Schlagnüsse

E-TX Impact Sockets



| Art.-Nr./Art.-No. | Größe/Size | Länge/Length | € |
|-------------------|------------|--------------|-------------|
| 384010 | E10 | 38 mm | 7,48 |
| 384011 | E11 | 38 mm | 7,48 |
| 384012 | E12 | 38 mm | 7,48 |
| 384014 | E14 | 38 mm | 7,48 |
| 384016 | E16 | 38 mm | 7,48 |
| 384018 | E18 | 38 mm | 7,48 |
| 384020 | E20 | 38 mm | 8,95 |
| 384022 | E22 | 45 mm | 8,95 |
| 384024 | E24 | 45 mm | 9,74 |

1/2" Innensechskant Schlagnüsse

Hex Impact Sockets



| Art.-Nr./Art.-No. | Größe/Size | Länge/Length | € |
|-------------------|------------|--------------|--------------|
| 386004 | 4 mm | 78 mm | 10,82 |
| 386005 | 5 mm | 78 mm | 10,82 |
| 386006 | 6 mm | 78 mm | 10,82 |
| 386008 | 8 mm | 78 mm | 10,82 |
| 386010 | 10 mm | 78 mm | 10,82 |
| 386012 | 12 mm | 78 mm | 10,82 |
| 386014 | 14 mm | 78 mm | 11,55 |
| 386017 | 17 mm | 78 mm | 11,55 |
| 386019 | 19 mm | 78 mm | 13,07 |

1/2" TX Schlagnüsse

TX Impact Sockets



| Art.-Nr./Art.-No. | Größe/Size | € |
|-------------------|------------|--------------|
| 385020 | TX20 | 10,82 |
| 385025 | TX25 | 10,82 |
| 385027 | TX27 | 10,82 |
| 385030 | TX30 | 10,82 |
| 385040 | TX40 | 10,82 |
| 385045 | TX45 | 10,82 |
| 385050 | TX50 | 10,82 |
| 385055 | TX55 | 11,55 |
| 385060 | TX60 | 11,55 |
| 385070 | TX70 | 13,07 |



| Art.-Nr./Art.-No. | Größe/Size | € |
|-------------------|----------------------------|----------------|
| 381000 | Kardangeln/Universal Joint | € 21,30 |

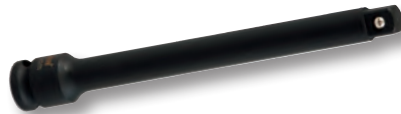

| Art.-Nr./Art.-No. | Länge/Length | € |
|-------------------|---|----------------|
| 387075 | Verlängerung 75 mm Extension Bar 75 mm | € 10,82 |
| 387125 | Verlängerung 125 mm Extension Bar 125 mm | € 12,39 |



| Art.-Nr./Art.-No. | Größe/Size | € |
|-------------------|--|----------------|
| 381214 | 1/2" Adapter für 1/4" Bits 1/2" Adapter For 1/4" Bits | € 15,33 |



| Art.-Nr./Art.-No. | Größe/Size | € |
|-------------------|--|----------------|
| 381234 | 1/2" Adapter für 3/4" Nüsse 1/2" Adapter for 3/4" Sockets | € 23,35 |



| Art.-Nr./Art.-No. | Größe/Size | € |
|-------------------|--|---------------|
| 381410 | Sicherungs-O-Ring zu Nuss 10-14 mm Ring for 1/2" Sockets 10-14 mm | € 1,27 |
| 383216 | Sicherungs-O-Ring zu Nuss 16-32 mm Ring for 1/2" Sockets 16-32 mm | € 1,27 |
| 391410 | Sicherungsstift zu Nuss 10-14 mm Pin for 1/2" Sockets 10-14 mm | € 0,50 |
| 393216 | Sicherungsstift zu Nuss 16-32 mm Pin for 1/2" Sockets 16-32 mm | € 0,50 |



Weitere PROForm-Werkstatteinlagen ab Seite /
More PROForm Inlays for Roller Cabinet from Page **H 32**

1/2" Schlag Stecknuss Sätze

1/2" Impact Socket Sets



Art.-Gruppe 120
Article Group 120

1/2" Schlagnuss Satz, 10-teilig

Impact Socket Set

10
tlg./pcs.



| Art.-Nr./Art.-No. | Größe/Size |
|-------------------|---|
| 3080 | 10 - 13 - 14 - 16 - 17 - 18 - 19 - 21 - 22 - 24 mm |
| € 62,90 | |

1/2" Schlagnuss Satz, 12-teilig

Impact Socket Set

12
tlg./pcs.



| Art.-Nr./Art.-No. | Größe/Size |
|-----------------------------------|---|
| 3086 | 10 - 11 - 13 - 14 - 17 - 19 - 21 - 22 - 23 - 24 mm |
| Verlängerung 125 mm - Kardangelen | |
| € 92,50 | |

1/2" Tiefer Schlagnuss Satz, 3-teilig

Deep Impact Socket Set

3
tlg./pcs.



| Art.-Nr./Art.-No. | Größe/Size |
|-------------------|-----------------|
| 3081 | 17 - 19 - 21 mm |
| € 27,00 | |

1/2" Schlagnuss Satz, 3-teilig für Alufelgen

Thin-Wall Deep Impact Socket Set

3
tlg./pcs.



| Art.-Nr./Art.-No. | Größe/Size |
|-------------------|-----------------|
| 3082 | 17 - 19 - 21 mm |
| € 45,50 | |

1/2" Schlagnuss Satz, 5-teilig für Alufelgen

Thin-Wall Deep Impact Socket Set

5
tlg./pcs.



| Art.-Nr./Art.-No. | Größe/Size |
|-------------------|---------------------------|
| 3084 | 17 - 19 - 21 - 22 - 24 mm |
| € 82,50 | |

1/2" Schlagnuss Satz, 6-teilig Extra tief für Alufelgen

Thin-Wall Extra Deep Impact Socket Set

6
tlg./pcs.



| Art.-Nr./Art.-No. | Größe/Size |
|-------------------|-----------------|
| 3083 | 17 - 19 - 21 mm |
| € 102,50 | |

1/2" Innensechskant Schlagnuss Satz, 9-teilig

Hex Impact Socket Set

9
tlg./pcs.



| Art.-Nr./Art.-No. | Größe/Size |
|-------------------|--|
| 3861 | 4 - 5 - 6 - 8 - 10 - 12 - 14 - 17 - 19 mm |
| € 95,00 | |

1/2" TX Schlagnuss Satz, 9-teilig

TX Impact Socket Set

9
tlg./pcs.



| Art.-Nr./Art.-No. | Größe/Size |
|-------------------|---|
| 3851 | TX20 - TX25 - TX27 - TX30 - TX40 - TX45 - TX50 - TX55 - TX60 |
| € 95,00 | |

1/2" Xi-on MULTI Schlag Stecknüsse und Zubehör

1/2" Xi-on MULTI Impact Sockets And Accessories



Art.-Gruppe 120
Article Group 120



Wenn nichts mehr geht, greift Xi-on.

- ▶ Extrem innovativ: Revolutionäres Xi-on Spezialprofil öffnet bis zu 85% abgerundete Schrauben und Muttern
- ▶ Greift auch da noch, wo herkömmliche Stecknüsse versagen
- ▶ Öffnet alle gängigen metrischen 6-kant-, 12-kant- und Vielzahn-Muttern & -Schrauben
- ▶ Empfohlen von der Redaktion »Technik und Motor« der FAZ

If Nothing Works, Xi-on Helps.

- ▶ Extremely innovative: Revolutionary Xi-on special construction opens up to 85% rounded screws and screw nuts
- ▶ Easy working where even conventional sockets fail
- ▶ Opens all standard metric hex, double hex, spline screw nuts and screws
- ▶ Recommended by »Technik und Motor« of FAZ (established reputed Frankfurt Newspaper, Germany)



1/2" Schlag Stecknüsse

Impact Sockets

Inklusive passendem Sicherheits-O-Ring und Sicherungsstift

Safety ring and pin inclusive



| Art.-Nr./Art.-No. | Größe/Size | Länge/Length | € |
|-------------------|------------|--------------|-------|
| 418008 | 8 mm | 39 mm | 7,49 |
| 418010 | 10 mm | 39 mm | 7,49 |
| 418013 | 13 mm | 39 mm | 7,49 |
| 418015 | 15 mm | 39 mm | 8,10 |
| 418016 | 16 mm | 39 mm | 8,10 |
| 418017 | 17 mm | 39 mm | 8,10 |
| 418018 | 18 mm | 39 mm | 8,10 |
| 418019 | 19 mm | 39 mm | 8,83 |
| 418021 | 21 mm | 39 mm | 9,57 |
| 418022 | 22 mm | 39 mm | 10,07 |
| 418024 | 24 mm | 39 mm | 11,03 |
| 418027 | 27 mm | 39 mm | 14,60 |
| 418030 | 30 mm | 48 mm | 15,44 |



1/2" Tiefe Schlag Stecknüsse

Deep Impact Sockets

Inklusive passendem Sicherheits-O-Ring und Sicherungsstift

Safety ring and pin inclusive



| Art.-Nr./Art.-No. | Größe/Size | Länge/Length | € |
|-------------------|------------|--------------|-------|
| 418108 | 8 mm | 77 mm | 10,71 |
| 418110 | 10 mm | 77 mm | 10,71 |
| 418113 | 13 mm | 77 mm | 10,71 |
| 418115 | 15 mm | 77 mm | 11,55 |
| 418117 | 17 mm | 77 mm | 11,55 |
| 418118 | 18 mm | 77 mm | 11,55 |
| 418119 | 19 mm | 77 mm | 11,55 |
| 418121 | 21 mm | 77 mm | 12,76 |
| 418122 | 22 mm | 77 mm | 13,95 |
| 418124 | 24 mm | 77 mm | 16,50 |
| 418130 | 30 mm | 78 mm | 20,95 |



1/2" Tiefe Schlag Stecknüsse für Alufelgen

Thin-Wall Deep Impact Sockets



| Art.-Nr./Art.-No. | Größe/Size | Länge/Length | € |
|-------------------|-------------|--------------|-------|
| 418217 | 17 mm, blau | 85 mm | 22,58 |
| 418219 | 19 mm, gelb | 85 mm | 23,20 |
| 418221 | 21 mm, rot | 85 mm | 23,85 |
| | | | |
| | | | |
| | | | |
| | | | |
| | | | |
| | | | |
| | | | |

- ▶ Kunststoffummantelung schützt vor Beschädigungen
- ▶ Schnelles Auffinden der passenden Stecknuss durch Farbleitsystem
- ▶ Alle Teile aus Chrom-Vanadium-Molybdän-Stahl (CMbd)
- ▶ Plastic coating reduces damages on aluminium rims
- ▶ Easy to find the right size because of the color coding system
- ▶ All parts produced by a special Chrom-Vanadium-Molybdenum-Steel (Cmbd)



1/2" Schlag Stecknuss Satz für Alufelgen, 3-teilig

Thin-Wall Deep Impact Socket Set, 3 pieces

3
tlg./pcs.



| Art.-Nr./Art.-No. | Größe/Size | € |
|-------------------|-----------------|-------|
| 4182 | 17 - 19 - 21 mm | 65,10 |

3/4" Schlag Stecknüsse und Sätze

3/4" Impact Sockets And Sets



Art.-Gruppe 120
Article Group 120

3/4" Schlag Stecknüsse Impact Sockets



| Art.-Nr./Art.-No. | Größe/Size | Länge/Length | € |
|-------------------|------------|--------------|--------------|
| 480017 | 17 mm | 51 mm | 13,70 |
| 480019 | 19 mm | 51 mm | 13,70 |
| 480020 | 20 mm | 51 mm | 14,54 |
| 480021 | 21 mm | 51 mm | 14,54 |
| 480022 | 22 mm | 51 mm | 14,54 |
| 480023 | 23 mm | 51 mm | 15,23 |
| 480024 | 24 mm | 51 mm | 15,23 |
| 480025 | 25 mm | 51 mm | 15,86 |
| 480026 | 26 mm | 51 mm | 15,86 |
| 480027 | 27 mm | 51 mm | 15,86 |
| 480028 | 28 mm | 54 mm | 16,54 |
| 480029 | 29 mm | 54 mm | 16,54 |
| 480030 | 30 mm | 54 mm | 16,54 |
| 480032 | 32 mm | 56 mm | 17,48 |
| 480033 | 33 mm | 57 mm | 18,80 |
| 480034 | 34 mm | 57 mm | 18,80 |
| 480035 | 35 mm | 57 mm | 20,30 |
| 480036 | 36 mm | 57 mm | 20,60 |
| 480038 | 38 mm | 57 mm | 23,20 |
| 480041 | 41 mm | 57 mm | 26,00 |
| 480046 | 46 mm | 65 mm | 34,65 |
| 480050 | 50 mm | 72 mm | 43,35 |

3/4" Tiefe Schlag Stecknüsse Deep Impact Sockets



| Art.-Nr./Art.-No. | Größe/Size | Länge/Length | € |
|-------------------|------------|--------------|--------------|
| 481017 | 17 mm | 89,5 mm | 23,10 |
| 481018 | 18 mm | 89,5 mm | 23,10 |
| 481019 | 19 mm | 89,5 mm | 23,10 |
| 481021 | 21 mm | 89,5 mm | 23,60 |
| 481022 | 22 mm | 89,5 mm | 23,60 |
| 481024 | 24 mm | 89,5 mm | 23,60 |
| 481027 | 27 mm | 89,5 mm | 24,20 |
| 481029 | 29 mm | 89,5 mm | 28,90 |
| 481030 | 30 mm | 89,5 mm | 28,90 |
| 481032 | 32 mm | 89,5 mm | 29,50 |
| 481036 | 36 mm | 89,5 mm | 36,70 |
| 481041 | 41 mm | 89,5 mm | 48,85 |
| 481046 | 46 mm | 89,5 mm | 57,55 |
| 481050 | 50 mm | 89,5 mm | 66,00 |



| Art.-Nr./Art.-No. | Größe/Size |
|-------------------|--|
| 483410 | 3/4" Adapter für 1" Nüsse 3/4" Adapter for 1" Sockets € 26,65 |
| 483412 | 3/4" Adapter für 1/2" Nüsse 3/4" Adapter for 1/2" Sockets € 19,65 |



| Art.-Nr./Art.-No. | Größe/Size |
|-------------------|---|
| 482619 | Sicherungs-O-Ring zu Nuss 19-26 mm Ring for 3/4" Sockets 19-26 mm € 2,29 |
| 4850273x | Sicherungs-O-Ring zu Nuss 27-70 mm 3x Rings for 3/4" Sockets 27-70 mm € 2,29 |
| 492619 | Sicherungsstift zu Nuss 19-26 mm Pin for 3/4" Sockets 19-26 mm € 0,58 |
| 495027 | 3x Sicherungsstift zu Nuss 27-70 mm 3x Pins for 3/4" Sockets 27-70 mm € 0,58 |

3/4" Schlag Stecknüsse Satz, 8-teilig Impact Socket Set, 8 pieces

8
tlg./pcs.



| Art.-Nr./Art.-No. | Größe/Size |
|-------------------|--|
| 3085 | 26 - 27 - 29 - 30 - 32 - 35 - 36 - 38 mm € 119,00 |

3/4" Zubehör Accessories



| Art.-Nr./Art.-No. | Größe/Size |
|-------------------|--|
| 481000 | Kardangeln/Universal Joint € 58,20 |

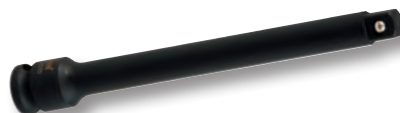

| Art.-Nr./Art.-No. | Länge/Length |
|-------------------|---|
| 487100 | Verlängerung 100 mm Extension Bar 100 mm € 29,60 |
| 487200 | Verlängerung 200 mm Extension Bar 200 mm € 39,75 |

1" Schlag Stecknüsse, Satz und Zubehör

1" Impact Sockets And Set and Accessories



Art.-Gruppe 120
Article Group 120

1" Tiefe Schlag Stecknüsse

Deep Impact Sockets



| Art.-Nr./Art.-No. | Größe/Size | Länge/Length | € |
|-------------------|------------|--------------|--------------|
| 580024 | 24 mm | 90 mm | 36,00 |
| 580027 | 27 mm | 90 mm | 36,00 |
| 580030 | 30 mm | 90 mm | 36,00 |
| 580032 | 32 mm | 90 mm | 39,75 |
| 580033 | 33 mm | 90 mm | 39,75 |
| 580034 | 34 mm | 90 mm | 40,45 |
| 580036 | 36 mm | 90 mm | 42,50 |
| 580038 | 38 mm | 90 mm | 48,30 |
| 580041 | 41 mm | 90 mm | 51,30 |
| 580046 | 46 mm | 100 mm | 57,00 |
| 580050 | 50 mm | 100 mm | 76,50 |

1" Tiefe Schlag Stecknüsse Satz 8-teilig

Deep Impact Socket Set



8
tlg./pcs.



| Art.-Nr./Art.-No. | Größe/Size |
|-------------------|--|
| 3088 | 24 - 27 - 30 - 32 - 33 - 34 - 36 - 38 mm |
| | € 299,00 |
| | |
| | |
| | |
| | |
| | |

1" Zubehör

Accessories



| Art.-Nr./Art.-No. | Größe/Size |
|-------------------|-----------------------------|
| 581000 | Kardangelen/Universal Joint |
| | € 99,00 |



| Art.-Nr./Art.-No. | Größe/Size |
|-------------------|--|
| 581034 | 1" Adapter für 3/4" Nüsse 1" Adapter for 3/4" Sockets |
| | € 38,30 |



| Art.-Nr./Art.-No. | Größe/Size |
|-------------------|--|
| 587019 | Sicherungs-O-Ring zu Nuss 19-70 mm Ring for 1" Sockets 19-70 mm |
| | € 3,18 |
| 597019 | Sicherungsstift zu Nuss 19-70 mm Pin for 1" Sockets 19-70 mm |
| | € 1,92 |



| Art.-Nr./Art.-No. | Länge/Length |
|-------------------|---|
| 587200 | Verlängerung 200 mm Extension Bar 200 mm |
| | € 89,90 |

Unser Highlight im Bereich Präzisionswerkzeuge – ROCKET Hammerbohrer
Our Highlight of the Precision Tools – ROCKET Hammer Drill Bits



ROCKET
DIE NEUEN HAMMERBOHRER
THE NEW HAMMER DRILL BITS

PROJAHN

PROJAHN

The advertisement features a man in a dark grey jacket with red accents, holding two silver metal drill bits. The background is a textured grey wall. The text is prominently displayed in orange and black, with the brand name 'PROJAHN' appearing on the man's jacket and in the bottom right corner.

Schraubenschlüssel

Wrenches



High Tech mit GearTech

High Tech with GearTech

Ergonomisch

Ergonomic

- ▶ Schlanke Ausführung der Ringseite ermöglicht den Einsatz an engsten Stellen wo herkömmliche Knarren und Steckschlüssel versagen
- ▶ Professioneller Ratschenmechanismus mit 72 Zähnen und 5° Rückholwinkel verbessert zusätzlich das Arbeiten auf engstem Raum
- ▶ Bis 10 mal schnellere Bearbeitung von Schrauben als mit herkömmlichen Schraubenschlüsseln
- ▶ Schnelles Umschalten durch ergonomische Ein-Hand-Bedienung (Ausführung »Umschaltbar«)

- ▶ Slimline version of the ring end side allows working on narrow places where traditional ratchets and sockets fail
- ▶ Professional inside of the ratchet with 72 tooth and 5° returning angle improves working in a limited space additional
- ▶ Open or close screws up to 10 times faster than traditional wrenches
- ▶ Quick reversing due to an ergonomic one-hand function (Version »Reversible«)



Vielseitig

Versatile

- ▶ Für jeden Anwender der richtige Problemlöser durch breites Produktsortiment mit 8 verschiedenen Versionen
- ▶ 63-in-2 GearTech-Set – Ob metrisch, Inch, Vierkant oder Innen-TX – 63 Funktionen mit 2 GearTech-Schlüssel
- ▶ Noch breitere Anwendungsvielfalt durch erweitertes Produktsortiment bis Größe 50 mm (Ausführung »Klassik«)
- ▶ Große Produktauswahl an perfekt abgestimmten Sets in schützender Rolltasche

- ▶ For every user the right tool due to a wide product range with 8 different versions
- ▶ 63-in-2 GearTech-Set – Whether metric, Inch, square or TX – 63 Functions with 2 GearTech wrenches
- ▶ Larger applying area due to an updated product range (Version »Classic«)
- ▶ Wide product range of perfect customized sets in a protective pouch

Strapazierfähig und langlebig

Hardwearing and Durable

- ▶ Langlebiger und dauerhaft belastbarer Ratschenmechanismus – speziell für den professionellen Einsatz aus vergütetem Spezialstahl präzisionsgefertigt
- ▶ Hoch belastbar – Übersteigt die Drehmoment-Normen nach DIN ISO 1711-1
- ▶ Mit widerstandsfähiger »Maul-Seite« zum Lösen extrem fest sitzender Schrauben
- ▶ Durable and long time resistant gear mechanism – produced of a special steel with a high level of precision specially for the professional work
- ▶ Hardwearing – exceeds the DIN ISO 1711-1 standards
- ▶ With a high resistant open end side to loosen extremely tightened screws

HINWEIS:

Extrem festsitzende Schrauben sind mit der Maul-Seite der GearTech Schlüssel zu lösen. Bei Überlastung droht Bruchgefahr!

Please note:

The GearTech wrenches are designed for fast screwing! In case of opening very hard fixed screws with the gear-side of the wrench, overstraining and breaking of the gear-mechanism is possible.

GearTech Ratschen-Ringgabelschlüssel

GearTech Ratchet Wrench



Art.-Gruppe 122
Article Group 122

GearTech Ratschenschlüssel klassik ohne Umschaltknopf, metrisch, verchromt

GearTech Ratchet Wrench „klassik“



Umschaltung links/rechts erfolgt einfach durch Umdrehen des Schlüssels.

Extrem festsetzende Schrauben sind mit der Maul-Seite der GearTech Schlüssel zu lösen.

Bei Überlastung droht Bruchgefahr!

Switch over is simply made by turning the wrench on the left/on the right.

The GearTech Wrenches are designed for fast screwing!
In case of opening very hard fixed screws with the gear-side of the wrench, overtorquing and breaking of the gear-mechanism is possible.

| Art.-Nr./Art.-No. | Größe/Size | Länge/Length | max Drehm./Max Torque | € |
|-------------------|------------|--------------|-----------------------|--------|
| 3406 | 6 mm | 135 mm | 27 Nm | 10,71 |
| 3407 | 7 mm | 135 mm | 33 Nm | 10,71 |
| 3408 | 8 mm | 140 mm | 43 Nm | 10,71 |
| 3409 | 9 mm | 140 mm | 57 Nm | 10,71 |
| 3410 | 10 mm | 155 mm | 86 Nm | 10,71 |
| 3411 | 11 mm | 170 mm | 98 Nm | 11,97 |
| 3412 | 12 mm | 170 mm | 112 Nm | 12,50 |
| 3413 | 13 mm | 180 mm | 143 Nm | 12,50 |
| 3414 | 14 mm | 185 mm | 191 Nm | 13,91 |
| 3415 | 15 mm | 200 mm | 250 Nm | 13,91 |
| 3416 | 16 mm | 215 mm | 264 Nm | 14,60 |
| 3417 | 17 mm | 230 mm | 319 Nm | 14,60 |
| 3418 | 18 mm | 240 mm | 359 Nm | 15,70 |
| 3419 | 19 mm | 250 mm | 385 Nm | 16,28 |
| 3421 | 21 mm | 280 mm | 435 Nm | 25,75 |
| 3422 | 22 mm | 285 mm | 506 Nm | 27,10 |
| 3424 | 24 mm | 325 mm | 630 Nm | 29,50 |
| 3427 | 27 mm | 360 mm | 699 Nm | 36,40 |
| 3430 | 30 mm | 425 mm | 837 Nm | 44,95 |
| 3432 | 32 mm | 425 mm | 987 Nm | 46,45 |
| 3434 | 34 mm | 482 mm | 987 Nm | 94,40 |
| 3436 | 36 mm | 482 mm | 987 Nm | 111,00 |
| 3438 | 38 mm | 482 mm | 1150 Nm | 116,00 |
| 34411 | 41 mm | 550 mm | 1300 Nm | 146,00 |
| 34461 | 46 mm | 640 mm | 1500 Nm | 182,00 |
| 34501 | 50 mm | 640 mm | 1700 Nm | 204,00 |

GearTech Ratschenschlüssel flexibel ohne Umschaltknopf metrisch, verchromt

GearTech Ratchet Wrench „flexible“

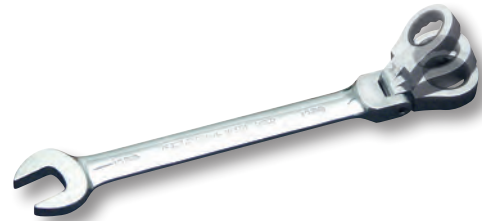

Umschaltung links/rechts erfolgt einfach durch Umdrehen des Schlüssels.

Extrem festsetzende Schrauben sind mit der Maul-Seite der GearTech Schlüssel zu lösen.

Bei Überlastung droht Bruchgefahr!

Switch over is simply made by turning the wrench on the left/on the right.

The GearTech Wrenches are designed for fast screwing!
In case of opening very hard fixed screws with the gear-side of the wrench, overtorquing and breaking of the gear-mechanism is possible.

| Art.-Nr./Art.-No. | Größe/Size | Länge/Length | max Drehm./Max Torque | € |
|-------------------|------------|--------------|-----------------------|-------|
| 3406F | 6 mm | 135 mm | 27 Nm | 15,00 |
| 3407F | 7 mm | 135 mm | 33 Nm | 15,00 |
| 3408F | 8 mm | 135 mm | 43 Nm | 15,00 |
| 3409F | 9 mm | 143 mm | 57 Nm | 15,12 |
| 3410F | 10 mm | 160 mm | 86 Nm | 15,59 |
| 3411F | 11 mm | 170 mm | 98 Nm | 16,17 |
| 3412F | 12 mm | 173 mm | 112 Nm | 16,75 |
| 3413F | 13 mm | 180 mm | 143 Nm | 17,75 |
| 3414F | 14 mm | 190 mm | 191 Nm | 18,70 |
| 3415F | 15 mm | 200 mm | 250 Nm | 19,90 |
| 3416F | 16 mm | 215 mm | 264 Nm | 21,15 |
| 3417F | 17 mm | 230 mm | 319 Nm | 22,00 |
| 3418F | 18 mm | 235 mm | 359 Nm | 23,40 |
| 3419F | 19 mm | 250 mm | 385 Nm | 24,50 |
| 3421F | 21 mm | 280 mm | 435 Nm | 36,35 |
| 3422F | 22 mm | 285 mm | 506 Nm | 38,85 |
| 3424F | 24 mm | 325 mm | 630 Nm | 43,95 |
| 3427F | 27 mm | 365 mm | 699 Nm | 54,10 |
| 3430F | 30 mm | 430 mm | 837 Nm | 70,00 |
| 3432F | 32 mm | 440 mm | 987 Nm | 72,00 |



GearTech Ratschen-Doppelringschlüssel

GearTech Ratchet Wrench

Art.-Gruppe 122
Article Group 122

GearTech Doppelringschlüssel klassik ohne Umschaltknopf, verchromt

Double Box GearTech Wrench



Umschaltung links/rechts erfolgt einfach durch Umdrehen des Schlüssels. Bei Überlastung droht Bruchgefahr!

Switch over is simply made by turning the wrench on the left/ on the right. The GearTech Wrenches are designed for fast screwing! In case of opening very hard fixed screws with the gear-side of the wrench, overtorquing and breaking of the gear-mechanism is possible.

| Art.-Nr./Art.-No. | Größe/Size | Länge/Length | max Drehm./Max Torque | € |
|-------------------|------------|--------------|-----------------------|--------------|
| 340810 | 8 x 10 mm | 130 mm | 43 Nm/ 86 Nm | 22,20 |
| 341013 | 10 x 13 mm | 170 mm | 86 Nm/143 Nm | 24,80 |
| 341213 | 12 x 13 mm | 170 mm | 112 Nm/143 Nm | 24,80 |
| 341415 | 14 x 15 mm | 190 mm | 191 Nm/250 Nm | 24,80 |
| 341618 | 16 x 18 mm | 230 mm | 264 Nm/359 Nm | 30,40 |
| 341719 | 17 x 19 mm | 230 mm | 319 Nm/385 Nm | 31,55 |



GearTech 4-in-1

umschaltbare Ratschen-Schlüssel

GearTech 4-in-1

Reversible Ratchet Wrenches



3463

| Art.-Nr./Art.-No. | Größe/Size | € |
|-------------------|---|--------------|
| 3463 | 8x10 - 9x11 - 12x13 - 14x15 - 16x17 - 18x19 mm Set 3-tlg. | 75,50 |
| 3465 | 8x10 - 12x13 - 16x17 - 18x19 mm Set 2-tlg. | 51,50 |
| 390813 | 8x10 - 12x13 mm einzeln/single | 25,50 |
| 390915 | 9x11 - 14x15 mm einzeln/single | 29,90 |
| 391019 | 10x13 - 17x19 mm einzeln/single | 34,20 |
| 391619 | 16x17 - 18x19 mm einzeln/single | 34,20 |

GearTech Bit-Doppelringschlüssel

*Umschaltbar, ergonomisch gebogen/
reversible, ergonomically curved*



| Art.-Nr./Art.-No. | Größe/Size | € |
|-------------------|--------------|--------------|
| 3914516 | 1/4" + 5/16" | 26,00 |
| | | |
| | | |
| | | |
| | | |

GearTech Ratschen-Ringgabelschlüssel

GearTech Ratchet Wrench

Art.-Gruppe 122
Article Group 122**3498 / 9981****GearTech Ratschenschlüssel Satz, metrisch klassik ohne Umschaltknopf, in Rolltasche**

GearTech Set, „klassik“ in Pouch

4
tlg./pcs.**5**
tlg./pcs.**3498 Inhalt/Contents:** je 1 GearTech Ratschenschl. 10 - 13 - 17 - 19 mm**9981 Inhalt/Contents:** je 1 GearTech Ratschenschl. 8 - 10 - 13 - 17 - 19 mm

| Art.-Nr./Art.-No. | | € |
|-------------------|-----------------------|--------------|
| 3498 | 4-tlg./pcs. | 47,50 |
| 9981 | 5-tlg./pcs. | 57,50 |
| 3499E | Rolltasche leer/empty | 14,80 |

**3499****GearTech Ratschenschlüssel Satz, metrisch klassik ohne Umschaltknopf, in Rolltasche**

GearTech Set, „klassik“ in Pouch

8
tlg./pcs.**Inhalt/Contents:**

je 1 GearTech Ratschenschlüssel 8 - 10 - 12 - 13 - 16 - 17 - 18 - 19 mm

| Art.-Nr./Art.-No. | | € |
|-------------------|-----------------------|--------------|
| 3499 | 8-tlg./pcs. | 89,00 |
| 3499E | Rolltasche leer/empty | 14,80 |

**3494****GearTech Ratschenschlüssel Satz, metrisch klassik ohne Umschaltknopf, in Rolltasche**

GearTech Set, „klassik“ in Pouch

14
tlg./pcs.**Inhalt/Contents:** je 1 GearTech Ratschenschlüssel

6 - 7 - 8 - 9 - 10 - 11 - 12 - 13 - 14 - 15 - 16 - 17 - 18 - 19 mm

| Art.-Nr./Art.-No. | | € |
|-------------------|-----------------------|---------------|
| 3494 | 14-tlg./pcs. | 159,00 |
| 3494E | Rolltasche leer/empty | 17,85 |

**3500****GearTech Ratschenschlüssel Satz, metrisch, klassik ohne Umschaltknopf, in Rolltasche**

GearTech Set, „klassik“ in Pouch

20
tlg./pcs.**Inhalt/Contents:** je 1 GearTech Ratschenschlüssel 6 - 7 - 8 - 9 - 10 - 11 -

12 - 13 - 14 - 15 - 16 - 17 - 18 - 19 - 21 - 22 - 24 - 27 - 30 - 32 mm

| Art.-Nr./Art.-No. | | € |
|-------------------|-----------------------|---------------|
| 3500 | 20-tlg./pcs. | 375,00 |
| 3500E | Rolltasche leer/empty | 24,55 |





GearTech Ratschen-Ringgabelschlüssel

GearTech Ratchet Wrench

Art.-Gruppe 122
Article Group 122

3496

**GearTech Ratschenschlüssel Satz,
metrisch, flexibel, in Rolltasche**

4
tlg./pcs.

GearTech Set, „flexible“ in Pouch

Inhalt/Contents: je 1 GearTech Ratschenschlüssel 10 - 13 - 17 - 19 mm

| Art.-Nr./Art.-No. | | € |
|-------------------|-----------------------|--------------|
| 3496 | 4-tlg./pcs. | 72,00 |
| 3499E | Rolltasche leer/empty | 14,80 |



3497

**GearTech Ratschenschlüssel Satz,
metrisch, flexibel, in Rolltasche**

8
tlg./pcs.

GearTech Set, „flexible“ in Pouch

Inhalt/Contents:

je 1 GearTech Ratschenschlüssel 8 - 10 - 12 - 13 - 16 - 17 - 18 - 19 mm

| Art.-Nr./Art.-No. | | € |
|-------------------|-----------------------|---------------|
| 3497 | 8-tlg./pcs. | 119,00 |
| 3499E | Rolltasche leer/empty | 14,80 |



3493

**GearTech Ratschenschlüssel Satz,
metrisch, flexibel, in Rolltasche**

14
tlg./pcs.

GearTech Set, „flexible“ in Pouch

Inhalt/Contents: je 1 GearTech Ratschenschlüssel

6 - 7 - 8 - 9 - 10 - 11 - 12 - 13 - 14 - 15 - 16 - 17 - 18 - 19 mm

| Art.-Nr./Art.-No. | | € |
|-------------------|-----------------------|---------------|
| 3493 | 14-tlg./pcs. | 209,00 |
| 3494E | Rolltasche leer/empty | 17,85 |



3502

**GearTech Ratschenschlüssel Satz,
metrisch, flexibel, in Rolltasche**

20
tlg./pcs.

GearTech Set, „flexible“ in Pouch

Inhalt/Contents: je 1 GearTech Ratschenschlüssel 6 - 7 - 8 - 9 - 10 -

11 - 12 - 13 - 14 - 15 - 16 - 17 - 18 - 19 - 21 - 22 - 24 - 27 - 30 - 32 mm

| Art.-Nr./Art.-No. | | € |
|-------------------|-----------------------|---------------|
| 3502 | 20-tlg./pcs. | 439,00 |
| 3500E | Rolltasche leer/empty | 24,55 |

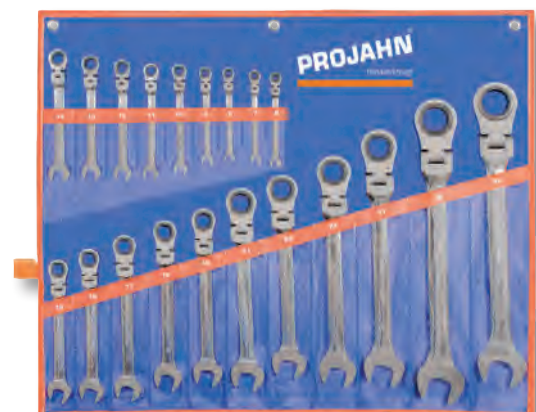

GearTech Ratschen-Ringgabelschlüssel

GearTech Ratchet Wrench

Art-Gruppe 122
Article Group 122**3993****GearTech Ratschenschlüssel Satz,
metrisch, umschaltbar, in Rolltasche**

GearTech Set „reversible“ in Pouch

4
tlg./pcs.

Inhalt/Contents: je 1 GearTech Ratschenschlüssel 10 - 13 - 17 - 19 mm

| Art.-Nr./Art.-No. | | € |
|-------------------|-----------------------|--------------|
| 3993 | 4-tlg./pcs. | 67,00 |
| 3499E | Rolltasche leer/empty | 14,80 |

**3999****GearTech Ratschenschlüssel Satz,
metrisch, umschaltbar, in Rolltasche**

GearTech Set „reversible“ in Pouch

8
tlg./pcs.

Inhalt/Contents:

je 1 GearTech Ratschenschlüssel 8 - 10 - 12 - 13 - 16 - 17 - 18 - 19 mm

| Art.-Nr./Art.-No. | | € |
|-------------------|-----------------------|---------------|
| 3999 | 8-tlg./pcs. | 109,00 |
| 3499E | Rolltasche leer/empty | 14,80 |

**3994****GearTech Ratschenschlüssel Satz,
metrisch, umschaltbar, in Rolltasche**

GearTech Set „reversible“ in Pouch

14
tlg./pcs.

Inhalt/Contents: je 1 GearTech Ratschenschlüssel

6 - 7 - 8 - 9 - 10 - 11 - 12 - 13 - 14 - 15 - 16 - 17 - 18 - 19 mm

| Art.-Nr./Art.-No. | | € |
|-------------------|-----------------------|---------------|
| 3994 | 14-tlg./pcs. | 179,00 |
| 3494E | Rolltasche leer/empty | 17,85 |

**3501****GearTech Ratschenschlüssel Satz,
metrisch, umschaltbar, in Rolltasche**

GearTech Set „reversible“ in Pouch

20
tlg./pcs.

Inhalt/Contents: je 1 GearTech Ratschenschlüssel 6 - 7 - 8 - 9 - 10 - 11 -

12 - 13 - 14 - 15 - 16 - 17 - 18 - 19 - 21 - 22 - 24 - 27 - 30 - 32 mm

| Art.-Nr./Art.-No. | | € |
|-------------------|-----------------------|---------------|
| 3501 | 20-tlg./pcs. | 399,00 |
| 3500E | Rolltasche leer/empty | 24,55 |





GearTech Ratschenschlüssel

GearTech Ratchet Wrenches

Art.-Gruppe 122
Article Group 122

3466

2
tlg./pcs.

GearTech 63-in-2 (Set 2-teilig)
umschaltbare Ratschen-Schlüssel in Rolltasche

GearTech 63-in-2 Reversible Ratchet Wrench in Pouch



Anwendungsübersicht / Application Overview

| Größe/Size | | Größe/Size | | Größe/Size | | Größe/Size | | Größe/Size | |
|----------------|-------|------------------------|-------|-------------------|-------|---------------------|--|------------|-----|
| | | | | | | | | | |
| 6-kant/ Hex | | 12-kant/ Double hex | | 4-kant/ Square | | Vielzahn/ Spline | | TORX®E | |
| mm | inch | mm | inch | mm | inch | mm | | | |
| 8 | 5/16 | 8 | 5/16 | 7 | 9/32 | 8 | | | E10 |
| 10 | 3/8 | 10 | 3/8 | | 11/32 | 10 | | | E12 |
| 11 | 7/16 | 11 | 7/16 | 9 | 3/8 | 11 | | | E14 |
| 13 | 1/2 | 13 | 1/2 | 11 | 7/16 | 13 | | | E16 |
| 14 | 9/16 | 14 | 9/16 | 12 | 15/32 | 14 | | | E18 |
| 16 | 5/8 | 16 | 5/8 | 13 | 17/32 | 16 | | | E20 |
| 17 | 11/16 | 17 | 11/16 | 14 | 9/16 | 17 | | | E22 |
| 19 | 3/4 | 19 | 3/4 | 16 | 5/8 | 19 | | | E24 |

- ▶ **Umschaltbarer GearTech Ratschenschlüssel mit Multifunktions-Ratscheneinsatz**
- ▶ **Jeder Schlüssel funktioniert an mehr als 30 verschiedenen Schraubenantrieben**
- ▶ **4-kant, 6-kant, 12-kant, Vielzahn und TORX®E mit einem Schlüssel bearbeiten**
- ▶ **Passend für metrische und zöllige Schraubenantriebe**
- ▶ *Reversible GearTech ratchet wrench with multifunctional ratchet insert*
- ▶ *Every wrench works on more than 30 different fasteners*
- ▶ *Square, hex, double hex, Spline, TORX®E handling with one wrench*
- ▶ *Fits for metric and inch fasteners*

| Art.-Nr./Art.No. | Größe/Size | € |
|------------------|--|--------------|
| 3466 | 8 - 10 - 11 - 13 - 14 - 16 - 17 - 19 mm, 5/16" - 3/8" - 7/16" - 1/2" - 9/16" - 5/8" - 11/16" - 3/4" | |
| | E10 - E12 - E14 - E16 - E18 - E20 - E22 - E24 | 69,00 |

3466-01

GearTech 31-in-1
umschaltbarer Ratschen-Schlüssel

GearTech 31-in-1 Reversible Ratchet Wrench



Anwendungsübersicht / Application Overview

| Größe/Size | | Größe/Size | | Größe/Size | | Größe/Size | | Größe/Size | |
|----------------|------|------------------------|------|-------------------|-------|---------------------|--|------------|-----|
| | | | | | | | | | |
| 6-kant/ Hex | | 12-kant/ Double hex | | 4-kant/ Square | | Vielzahn/ Spline | | TORX®E | |
| mm | inch | mm | inch | mm | inch | mm | | | |
| 8 | 5/16 | 8 | 5/16 | 7 | 9/32 | 8 | | | E10 |
| 10 | 3/8 | 10 | 3/8 | | 11/32 | 10 | | | E12 |
| 11 | 7/16 | 11 | 7/16 | 9 | 3/8 | 11 | | | E14 |
| 13 | 1/2 | 13 | 1/2 | 11 | 7/16 | 13 | | | E16 |

| Art.-Nr./Art.No. | Größe/Size | € |
|------------------|--|--------------|
| 3466-01 | 8 - 10 - 11 - 13 mm 5/16" - 7/16" - 3/8" - 1/2" | |
| | E10 - E12 - E14 - E16 | 34,00 |

3466-02

GearTech 32-in-1
umschaltbarer Ratschen-Schlüssel

GearTech 32-in-1 Reversible Ratchet Wrench



Anwendungsübersicht / Application Overview

| Größe/Size | | Größe/Size | | Größe/Size | | Größe/Size | | Größe/Size | |
|----------------|-------|------------------------|-------|-------------------|-------|---------------------|--|------------|-----|
| | | | | | | | | | |
| 6-kant/ Hex | | 12-kant/ Double hex | | 4-kant/ Square | | Vielzahn/ Spline | | TORX®E | |
| mm | inch | mm | inch | mm | inch | mm | | | |
| 14 | 9/16 | 14 | 9/16 | 12 | 15/32 | 14 | | | E18 |
| 16 | 5/8 | 16 | 5/8 | 13 | 17/32 | 16 | | | E20 |
| 17 | 11/16 | 17 | 11/16 | 14 | 9/16 | 17 | | | E22 |
| 19 | 3/4 | 19 | 3/4 | 16 | 5/8 | 19 | | | E24 |

| Art.-Nr./Art.No. | Größe/Size | € |
|------------------|--|--------------|
| 3466-02 | 14 - 16 - 17 - 19 mm 9/16" - 11/16" - 5/8" - 3/4" | |
| | E18 - E20 - E22 - E24 | 42,00 |

GearTech Ratschenschlüssel

GearTech Ratchet Wrenches



Art.-Gruppe 122
Article Group 122

3465

GearTech 4-in-1 (Set 2-teilig) umschaltbare Ratschen-Schlüssel in Rolltasche

GearTech 4-in-1 (2 pieces)
Reversible Ratchet Wrenches
in Pouch



2
tlg./pcs.

Nur 1 umschaltbarer GearTech Schlüssel um 4 Größen zu schrauben!
Jede Seite des doppelseitigen Schlüssels beinhaltet 2 Größen =
4 Größen pro Schlüssel. Jede Größe ist umschaltbar von links nach rechts.

Only one reversible GearTech ratchet wrench for 4 sizes!
Every side of the double-sided wrench includes 2 sizes =
4 sizes per wrench. Every size is reversible from left to right.

| Art.-Nr./Art.-No. | Größe/Size | € |
|-------------------|--|--------------|
| 3465 | 8x10 - 12x13 - 16x17 - 18x19 mm Set 2-tlg. | 51,50 |

3463

GearTech 4-in-1 (Set 3-teilig) umschaltbare Ratschen-Schlüssel in Rolltasche

GearTech 4-in-1 (3 pieces)
Reversible Ratchet Wrenches
in Pouch



3
tlg./pcs.

Nur 1 umschaltbarer GearTech Schlüssel um 4 Größen zu schrauben!
Jede Seite des doppelseitigen Schlüssels beinhaltet 2 Größen =
4 Größen pro Schlüssel. Jede Größe ist umschaltbar von links nach rechts.

Only one reversible GearTech ratchet wrench for 4 sizes!
Every side of the double-sided wrench includes 2 sizes =
4 sizes per wrench. Every size is reversible from left to right.

| Art.-Nr./Art.-No. | Größe/Size | € |
|-------------------|---|--------------|
| 3463 | 8x10 - 9x11 - 12x13 - 14x15 - 16x17 - 18x19 mm Set 3-tlg. | 75,50 |

Spezial Stecknuss Adapter für GearTech Schlüssel *Socket and Bit Adapter for GearTech Wrenches*

4
tlg./pcs.



| Art.-Nr./Art.-No. | Größe/Size | € |
|-------------------|--|--------------|
| 3690 | Satz 4-tlg./Set 4 pieces 1/4" - 3/8" - 1/2" - 1/4" Bit | 23,85 |

Schraubenschlüssel

Wrenches

Art.-Gruppe 123
Article Group 123

Ringgabelschlüssel

metrisch,
nach DIN 3113 Form A,
mattsatiniert

Combination Wrenches, Metric

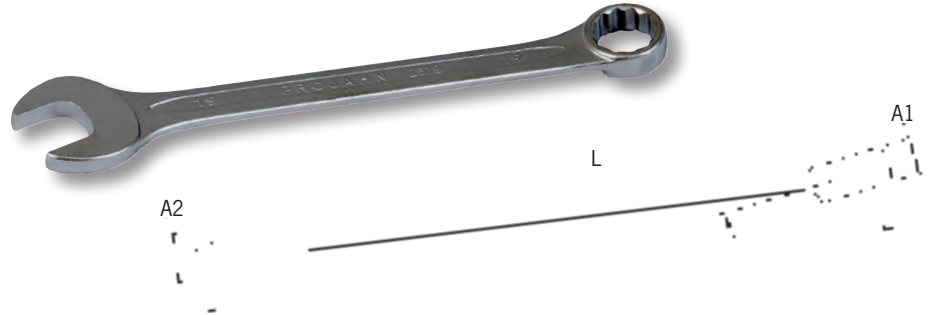

- ▶ Größere Auflagefläche, höhere Lebensdauer
- ▶ Anziehen mit der Schraubenfläche und nicht über die Schraubenkante
- ▶ Maulstellung 15°, Ringseite 15° abgewinkelt
- ▶ Vernickelt und verchromt matt satiniertes Oberflächenfinish
- ▶ Köpfe hochglanzpoliert

- ▶ Larger contact surface, higher service life
- ▶ Tightening by the screw surface, not by the edges of the screw
- ▶ Jaw position 15°, ring end 15° angled
- ▶ Nickel- and chromium-plated in satin mat finish
- ▶ Heads mirrorpolished

| Art.-Nr./Art.-No. | L x A2 x A1 | Größe/Size | € |
|-------------------|---------------------|------------|-------------|
| 2505 | 93 x 3,4 x 4,0 mm | 5,5 mm | 3,13 |
| 2506 | 100 x 3,7 x 4,5 mm | 6 mm | 2,69 |
| 2507 | 110 x 3,7 x 5,0 mm | 7 mm | 2,69 |
| 2508 | 120 x 4,1 x 5,5 mm | 8 mm | 2,81 |
| 2509 | 130 x 4,1 x 6,0 mm | 9 mm | 2,99 |
| 2510 | 140 x 4,6 x 6,5 mm | 10 mm | 3,20 |
| 2511 | 150 x 4,7 x 6,5 mm | 11 mm | 3,51 |
| 2512 | 160 x 4,8 x 7,0 mm | 12 mm | 3,61 |
| 2513 | 170 x 5,5 x 7,5 mm | 13 mm | 3,83 |
| 2514 | 180 x 5,6 x 8,0 mm | 14 mm | 4,27 |
| 2515 | 190 x 5,7 x 8,5 mm | 15 mm | 4,53 |
| 2516 | 200 x 5,8 x 9,0 mm | 16 mm | 4,83 |
| 2517 | 210 x 6,3 x 9,5 mm | 17 mm | 5,63 |
| 2518 | 220 x 6,8 x 10,0 mm | 18 mm | 6,04 |
| 2519 | 230 x 7,1 x 10,4 mm | 19 mm | 6,65 |
| 2520 | 240 x 7,2 x 10,9 mm | 20 mm | 7,50 |
| 2521 | 250 x 7,5 x 11,4 mm | 21 mm | 8,31 |
| 2522 | 260 x 8,0 x 11,9 mm | 22 mm | 8,55 |

| Art.-Nr./Art.-No. | L x A2 x A1 | Größe/Size | € |
|-------------------|----------------------|------------|---------------|
| 2523 | 260 x 8,0 x 11,9 mm | 23 mm | 9,33 |
| 2524 | 280 x 8,2 x 12,9 mm | 24 mm | 9,89 |
| 2525 | 295 x 8,7 x 13,4 mm | 25 mm | 10,61 |
| 2526 | 295 x 8,7 x 13,4 mm | 26 mm | 11,45 |
| 2527 | 310 x 8,9 x 14,4 mm | 27 mm | 12,34 |
| 2528 | 340 x 10,0 x 15,9 mm | 28 mm | 14,49 |
| 2529 | 340 x 10,0 x 15,9 mm | 29 mm | 14,49 |
| 2530 | 340 x 10,0 x 15,9 mm | 30 mm | 15,15 |
| 2532 | 360 x 10,8 x 16,9 mm | 32 mm | 16,55 |
| 25361 | 480 x 14,5 x 17,0 mm | 36 mm | 29,20 |
| 25411 | 540 x 16,0 x 20,0 mm | 41 mm | 38,85 |
| 25461 | 605 x 16,0 x 20,0 mm | 46 mm | 44,10 |
| 25501 | 615 x 17,0 x 21,0 mm | 50 mm | 49,60 |
| 25551 | 560 x 21,0 x 28,0 mm | 55 mm | 99,90 |
| 25601 | 600 x 23,0 x 30,0 mm | 60 mm | 161,00 |
| 25651 | 675 x 23,7 x 32,7 mm | 65 mm | 232,00 |
| 25701 | 675 x 23,7 x 32,7 mm | 70 mm | 305,00 |

Schraubenschlüssel

Wrenches

Art.-Gruppe 123
Article Group 123

**Ringgabelschlüssel
metrisch,
nach DIN 3113 Form B,
mattsatiniert**
Combination Wrenches, Metric

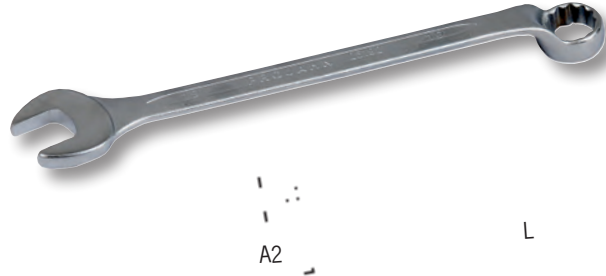

| Art.-Nr./Art.-No. | L x A2 x A1 | Größe/Size | € |
|-------------------|---------------------|------------|-------------|
| 25062 | 125 x 3,7 x 5,2 mm | 6 mm | 3,49 |
| 25072 | 135 x 3,7 x 5,7 mm | 7 mm | 3,49 |
| 25082 | 145 x 4,1 x 6,3 mm | 8 mm | 3,73 |
| 25092 | 155 x 4,1 x 7,3 mm | 9 mm | 3,97 |
| 25102 | 165 x 4,6 x 7,3 mm | 10 mm | 4,21 |
| 25112 | 172 x 4,9 x 8,1 mm | 11 mm | 4,53 |
| 25122 | 180 x 4,9 x 8,8 mm | 12 mm | 5,01 |
| 25132 | 195 x 5,9 x 9,6 mm | 13 mm | 5,43 |
| 25142 | 210 x 5,9 x 9,8 mm | 14 mm | 6,22 |
| 25152 | 215 x 6,4 x 10,0 mm | 15 mm | 6,53 |
| 25162 | 230 x 6,8 x 10,9 mm | 16 mm | 7,14 |
| 25172 | 240 x 7,1 x 11,6 mm | 17 mm | 8,06 |
| 25182 | 255 x 7,4 x 12,2 mm | 18 mm | 8,06 |

| Art.-Nr./Art.-No. | L x A2 x A1 | Größe/Size | € |
|-------------------|----------------------|------------|--------------|
| 25192 | 265 x 8,4 x 12,8 mm | 19 mm | 8,37 |
| 25212 | 280 x 7,5 x 11,5 mm | 21 mm | 10,08 |
| 25222 | 300 x 8,6 x 13,1 mm | 22 mm | 11,03 |
| 25232 | 320 x 9,0 x 14,0 mm | 23 mm | 13,34 |
| 25242 | 320 x 9,0 x 14,0 mm | 24 mm | 13,34 |
| 25252 | 348 x 9,0 x 14,0 mm | 25 mm | 15,65 |
| 25262 | 348 x 10,4 x 15,3 mm | 26 mm | 15,65 |
| 25272 | 348 x 10,4 x 15,3 mm | 27 mm | 17,96 |
| 25282 | 370 x 10,8 x 16,0 mm | 28 mm | 18,10 |
| 25292 | 390 x 11,4 x 16,5 mm | 29 mm | 20,35 |
| 25302 | 390 x 11,4 x 16,5 mm | 30 mm | 20,35 |
| 25322 | 412 x 12,0 x 17,5 mm | 32 mm | 23,85 |



Weitere PROForm-Werkstatteinlagen ab Seite /
More PROForm Inlays for Roller Cabinet from Page **H 32**

Lange Ringgabelschlüssel

Combination Wrenches XL

Art.-Gruppe 123
Article Group 123

Lange Ringgabelschlüssel metrisch, nach DIN 3113 Form A

Combination Wrenches, Metric, XL



- ▶ Größere Auflagefläche, höhere Lebensdauer
 - ▶ Anziehen mit der Schraubenfläche und nicht über die Schraubenkante
 - ▶ Maulstellung 15°, Ringseite 15° abgewinkelt
 - ▶ Vernickelt und verchromt matt satiniertes Oberflächenfinish
 - ▶ Lange Ausführung
- ▶ Larger contact surface, higher service life
 - ▶ Tightening by the screw surface, not by the edges of the screw
 - ▶ Jaw position 15°, ring end 15° angled
 - ▶ Nickel- and chromium-plated in satin mat finish
 - ▶ Long pattern

| Art.-Nr./Art.-No. | L x A2 x A1 | Größe/Size | € |
|-------------------|----------------------|------------|--------------|
| 25081 | 148 x 4,1 x 5,5 mm | 8 mm | 3,83 |
| 25091 | 167 x 4,1 x 6,0 mm | 9 mm | 4,21 |
| 25101 | 172 x 4,6 x 6,5 mm | 10 mm | 4,34 |
| 25111 | 186 x 4,7 x 6,5 mm | 11 mm | 4,63 |
| 25121 | 197 x 4,8 x 7,0 mm | 12 mm | 5,06 |
| 25131 | 207 x 5,5 x 7,5 mm | 13 mm | 5,20 |
| 25141 | 223 x 5,6 x 8,0 mm | 14 mm | 5,86 |
| 25151 | 233 x 5,7 x 8,5 mm | 15 mm | 6,42 |
| 25161 | 243 x 5,8 x 9,0 mm | 16 mm | 7,00 |
| 25171 | 261 x 6,3 x 9,5 mm | 17 mm | 7,44 |
| 25181 | 270 x 6,8 x 10,0 mm | 18 mm | 8,73 |
| 25191 | 280 x 7,1 x 10,4 mm | 19 mm | 9,22 |
| 25201 | 290 x 7,2 x 10,9 mm | 20 mm | 10,71 |
| 25211 | 301 x 7,5 x 11,4 mm | 21 mm | 11,97 |
| 25221 | 318 x 8,0 x 11,9 mm | 22 mm | 12,34 |
| 25241 | 338 x 8,2 x 12,9 mm | 24 mm | 13,91 |
| 25271 | 376 x 8,9 x 14,4 mm | 27 mm | 17,64 |
| 25301 | 394 x 10,0 x 15,9 mm | 30 mm | 21,65 |
| 25321 | 435 x 10,8 x 16,9 mm | 32 mm | 23,55 |

Ringgabelschlüssel, Zoll

Combination Wrenches, Inch

Art.-Gruppe 123
Article Group 123

Ringgabelschlüssel, Zoll, hochglanzpoliert

Combination Wrenches, Inch

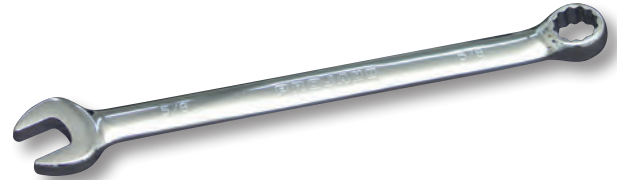

- ▶ Größere Auflagefläche, höhere Lebensdauer
 - ▶ Anziehen mit der Schraubenfläche und nicht über die Schraubenkante
 - ▶ Maulstellung 15°, Ringseite 15° abgewinkelt
 - ▶ Hochglanzpoliert
- ▶ Larger contact surface, higher service life
 - ▶ Tightening by the screw surface, not by the edges of the screw
 - ▶ Jaw position 15°, ring end 15° angled
 - ▶ Mirror polished

| Art.-Nr./Art.-No. | Größe/Size | Länge/Length | € |
|-------------------|------------|--------------|--------------|
| 2561 | 1/4" | 130 mm | 4,34 |
| 2562 | 5/16" | 145 mm | 4,34 |
| 2563 | 3/8" | 165 mm | 5,00 |
| 2564 | 7/16" | 185 mm | 5,63 |
| 2565 | 1/2" | 205 mm | 6,29 |
| 2566 | 9/16" | 220 mm | 7,11 |
| 2567 | 5/8" | 240 mm | 8,42 |
| 2568 | 11/16" | 260 mm | 9,09 |
| 2569 | 3/4" | 280 mm | 9,89 |
| 2570 | 7/8" | 315 mm | 12,82 |
| 2571 | 15/16" | 335 mm | 14,71 |
| 2572 | 1" | 355 mm | 16,90 |

DOLPHIN Ringgabelschlüssel*

DOLPHIN Combination Wrenches*

Art.-Gruppe 123
Article Group 123**DOLPHIN Ringgabelschlüssel,
metrisch**DOLPHIN Combination Wrenches,
Metric

- ▶ **Breiterer Anwendungsbereich**
- ▶ **25% höhere Kraftübertragung**
- ▶ **Hochwertige Verarbeitung und Materialien**
 - **Robuste, langlebige Qualität**
 - **Übertrifft DIN-/ANSI-Normen**
- ▶ **Innovative Ringgeometrie ermöglicht das Verschrauben in Vertiefungen**
- ▶ **Spezielle Winkelgeometrie maximiert die Kontaktfläche**

- ▶ *Wider scope as standard combination wrenches*
- ▶ *25% higher power transmission*
- ▶ *High-quality manufacture and materials*
 - *Sturdy, durable quality*
 - *Exceeds DIN-/ANSI-Standard*
- ▶ *Innovative ring geometry allows screwing in grooves*
- ▶ *Special angle geometry maximizes the contact area*

| Art.-Nr./Art.-No. | Größe/Size | Länge/Length | € |
|-------------------|------------|--------------|--------------|
| 25065* | 6 mm | 140 mm | 3,30 |
| 25075* | 7 mm | 145 mm | 3,40 |
| 25085* | 8 mm | 153 mm | 3,50 |
| 25095* | 9 mm | 162 mm | 3,75 |
| 25105* | 10 mm | 150 mm | 4,00 |
| 25115* | 11 mm | 175 mm | 4,30 |
| 25125* | 12 mm | 185 mm | 4,50 |
| 25135* | 13 mm | 175 mm | 4,85 |
| 25145* | 14 mm | 185 mm | 5,30 |
| 25155* | 15 mm | 215 mm | 5,85 |
| 25165* | 16 mm | 200 mm | 6,40 |
| 25175* | 17 mm | 235 mm | 7,00 |
| 25195* | 19 mm | 235 mm | 8,50 |
| 25225* | 22 mm | 290 mm | 11,50 |
| 25245* | 24 mm | 300 mm | 12,80 |
| 25275* | 27 mm | 350 mm | 20,50 |
| 25305* | 30 mm | 405 mm | 27,50 |
| 25325* | 32 mm | 410 mm | 30,50 |

*Lieferung nur solange der Vorrat reicht / *Delivery while stocks last

CLICKTECH Ratschen-Ringgabelschlüssel

CLICKTECH Ratchet Combination Wrenches

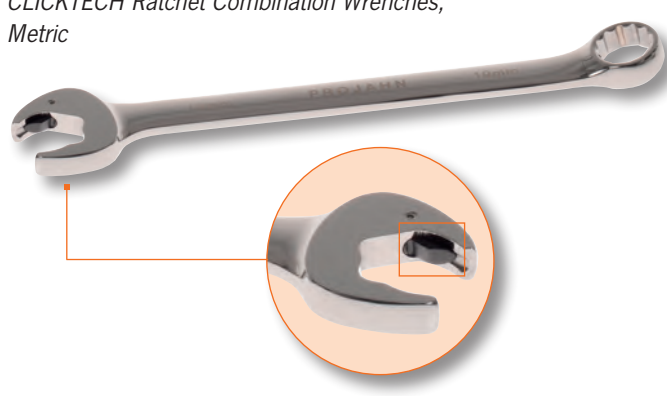
Art.-Gruppe 123
Article Group 123**CLICKTECH Ratschen-Ringgabelschlüssel,
metrisch**CLICKTECH Ratchet Combination Wrenches,
Metric

- ▶ **Ringgabelschlüssel mit Ratschenfunktion auf der Gabelseite**
 - **Ermöglicht Arbeiten bei extrem engem Arbeitsbereich**
 - **Verschraubung ohne wiederholtes Neu-Ansetzen des Schraubenschlüssels**
- ▶ **Hochwertige Verarbeitung und Materialien**
 - **Robuste, langlebige Qualität**
- ▶ **Lösen extrem festsitzender Verbindungen durch Ringseite möglich**

- ▶ *Combination wrench with ratchet function at the open end*
 - *Allows working on extremely narrow places*
 - *Screwing without repeated placing of the wrench*
- ▶ *High quality workmanship and materials*
 - *Sturdy, durable quality*
- ▶ *Loosen extremely tightened screws with ring end*

| Art.-Nr./Art.-No. | Größe/Size | Länge/Length | € |
|-------------------|------------|--------------|--------------|
| 25008 | 8 mm | 136 mm | 8,57 |
| 25010 | 10 mm | 161 mm | 8,94 |
| 25012 | 12 mm | 174 mm | 9,88 |
| 25013 | 13 mm | 180 mm | 10,12 |
| 25016 | 16 mm | 207 mm | 11,76 |
| 25017 | 17 mm | 227 mm | 12,50 |
| 25018 | 18 mm | 239 mm | 13,81 |
| 25019 | 19 mm | 250 mm | 14,18 |

Sortimente auf Seite/Sets on Page
H 147

Doppelgabelschlüssel

Double Open End Wrenches

Art.-Gruppe 123
Article Group 123

Doppelgabelschlüssel metrisch, nach DIN 3110

Double Open End Wrenches, Metric

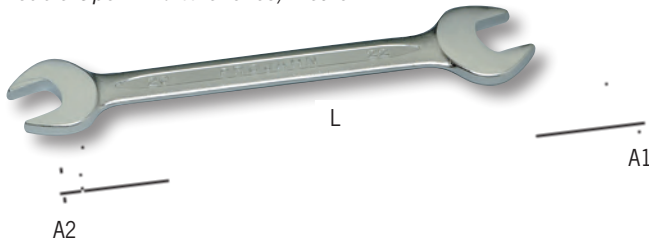

- ▶ Gabelstellung 15°
- ▶ Vernickelt + verchromt matt satiniertes Oberflächenfinish

- ▶ Open end position 15°
- ▶ Nickel- and chromium-plated in satin mat finish

| Art.-Nr./Art.-No. | L x A2/A1 | Größe/Size | € |
|-------------------|---------------|------------|--------------|
| 250607 | 122 x 3,3 mm | 6 x 7 mm | 3,06 |
| 250809 | 140 x 3,6 mm | 8 x 9 mm | 3,30 |
| 251008 | 140 x 3,6 mm | 8 x 10 mm | 3,30 |
| 251011 | 156 x 4,6 mm | 10 x 11 mm | 3,73 |
| 251013 | 172 x 5,1 mm | 10 x 13 mm | 4,03 |
| 251213 | 172 x 5,1 mm | 12 x 13 mm | 4,27 |
| 251317 | 188 x 5,6 mm | 13 x 17 mm | 5,86 |
| 251415 | 188 x 5,6 mm | 14 x 15 mm | 4,94 |
| 251617 | 204 x 6,1 mm | 16 x 17 mm | 5,86 |
| 251719 | 220 x 6,5 mm | 17 x 19 mm | 6,78 |
| 251819 | 220 x 6,5 mm | 18 x 19 mm | 6,78 |
| 251922 | 234 x 7,2 mm | 19 x 22 mm | 8,42 |
| 252022 | 234 x 7,2 mm | 20 x 22 mm | 8,73 |
| 252123 | 247 x 7,5 mm | 21 x 23 mm | 9,60 |
| 252224 | 247 x 7,5 mm | 22 x 24 mm | 9,60 |
| 252426 | 266 x 8,2 mm | 24 x 26 mm | 11,76 |
| 252427 | 266 x 8,2 mm | 24 x 27 mm | 11,76 |
| 252430 | 285 x 8,2 mm | 24 x 30 mm | 13,91 |
| 252528 | 285 x 8,4 mm | 25 x 28 mm | 13,91 |
| 252730 | 302 x 9,1 mm | 27 x 30 mm | 16,00 |
| 252732 | 302 x 9,1 mm | 27 x 32 mm | 16,00 |
| 253032 | 302 x 9,1 mm | 30 x 32 mm | 16,00 |
| 253641 | 380 x 12,2 mm | 36 x 41 mm | 34,90 |
| 254146 | 415 x 14,7 mm | 41 x 46 mm | 46,40 |
| 254650 | 465 x 15,7 mm | 46 x 50 mm | 53,50 |

Doppelringschlüssel

Double Ring Wrenches

Art.-Gruppe 123
Article Group 123

Doppelringschlüssel metrisch, nach DIN 838

Double Ring Wrenches, Metric

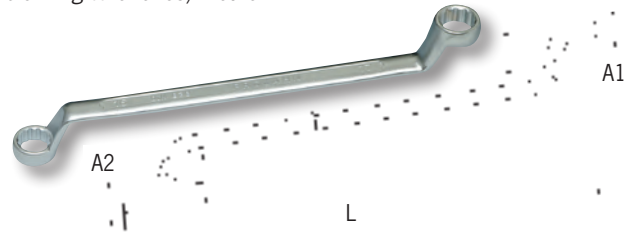

- ▶ Tief gekröpft 75°
- ▶ Vernickelt + verchromt matt satiniertes Oberflächenfinish

- ▶ 75° offset
- ▶ Nickel- and chromium-plated in satin mat finish

| Art.-Nr./Art.-No. | L x A2 x A1 | Größe/Size | € |
|-------------------|----------------------|------------|--------------|
| 240607 | 170 x 5,6 x 4,9 mm | 6 x 7 mm | 5,15 |
| 240809 | 182 x 6,8 x 6,0 mm | 8 x 9 mm | 5,62 |
| 241011 | 197 x 7,9 x 7,4 mm | 10 x 11 mm | 6,47 |
| 241013 | 213 x 8,9 x 8,4 mm | 10 x 13 mm | 6,96 |
| 241213 | 213 x 8,9 x 8,4 mm | 12 x 13 mm | 6,96 |
| 241317 | 250 x 8,9 x 11,4 mm | 13 x 17 mm | 8,55 |
| 241415 | 228 x 9,9 x 9,4 mm | 14 x 15 mm | 8,06 |
| 241617 | 246 x 10,9 x 10,4 mm | 16 x 17 mm | 9,17 |
| 241618 | 246 x 10,9 x 10,4 mm | 16 x 18 mm | 9,17 |
| 241719 | 265 x 11,9 x 11,4 mm | 17 x 19 mm | 10,50 |
| 241819 | 265 x 11,9 x 11,4 mm | 18 x 19 mm | 10,50 |
| 242022 | 288 x 12,9 x 12,4 mm | 20 x 22 mm | 12,33 |
| 242123 | 310 x 13,3 x 12,3 mm | 21 x 23 mm | 14,00 |
| 242426 | 330 x 14,3 x 13,7 mm | 24 x 26 mm | 16,60 |
| 242427 | 330 x 14,3 x 13,7 mm | 24 x 27 mm | 16,60 |
| 242528 | 348 x 14,7 x 14,2 mm | 25 x 28 mm | 18,10 |
| 243032 | 372 x 15,8 x 14,8 mm | 30 x 32 mm | 22,05 |
| 243641 | 570 x 18,0 x 19,5 mm | 36 x 41 mm | 50,90 |

Schraubenschlüssel

Wrenches

Art.-Gruppe 123
Article Group 123

Rohrsteckschlüssel

leichte Ausführung

Double Ended Socket Wrenches

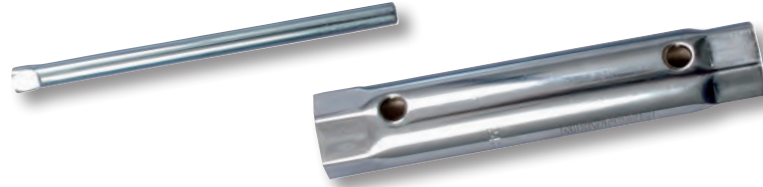

| Art.-Nr./Art.-No. | Größe/Size | € |
|-------------------|------------|-------------|
| 260607 | 6 x 7 mm | 3,61 |
| 260809 | 8 x 9 mm | 3,74 |
| 261011 | 10 x 11 mm | 3,99 |
| 261213 | 12 x 13 mm | 3,99 |
| 261415 | 14 x 15 mm | 4,12 |
| 261617 | 16 x 17 mm | 4,36 |
| 261719 | 17 x 19 mm | 4,60 |

| Art.-Nr./Art.-No. | Größe/Size | € |
|-------------------|---|-------------|
| 261819 | 18 x 19 mm | 5,16 |
| 262022 | 20 x 22 mm | 5,39 |
| 262123 | 21 x 23 mm | 5,52 |
| 262427 | 24 x 27 mm | 5,89 |
| 260001 | Drehstift/Tommy Bar 146 mm (6 – 13 mm) | 1,29 |
| 260002 | Drehstift/Tommy Bar 146 mm (14 – 27 mm) | 1,53 |

Sortiment auf Seite /Set on Page
H 148

Einmaulschlüssel nach DIN 894

Single Open End Wrench



- ▶ Aus extrem stabilem Stahl gefertigt
- ▶ Produced by special steel

| Art.-Nr./Art.-No. | Länge/Length | Größe/Size | € |
|-------------------|--------------|------------|--------------|
| 25244 | 195 mm | 24 mm | 8,02 |
| 25274 | 215 mm | 27 mm | 10,61 |
| 25304 | 240 mm | 30 mm | 13,13 |
| 25324 | 270 mm | 32 mm | 16,70 |
| 25364 | 295 mm | 36 mm | 21,60 |
| 25384 | 295 mm | 38 mm | 21,60 |
| 25414 | 335 mm | 41 mm | 26,90 |

| Art.-Nr./Art.-No. | Länge/Length | Größe/Size | € |
|-------------------|--------------|------------|--------------|
| 25424 | 335 mm | 42 mm | 26,90 |
| 25464 | 368 mm | 46 mm | 35,91 |
| 25484 | 410 mm | 48 mm | 49,75 |
| 25504 | 410 mm | 50 mm | 49,90 |
| 25554 | 490 mm | 55 mm | 65,80 |
| 25604 | 490 mm | 60 mm | 65,80 |
| 25654 | 490 mm | 65 mm | 66,90 |

Schraubenschlüssel

Wrenches

Art.-Gruppe 123
Article Group 123

PROFESSIONAL **PLUS** STANDARD

Offene Doppelringschlüssel Köpfe 15° abgewinkelt, nach DIN 3118, mattsatiniert verchromt

Flare Nut Wrenches

Head with 15°, Satin Mat Finish

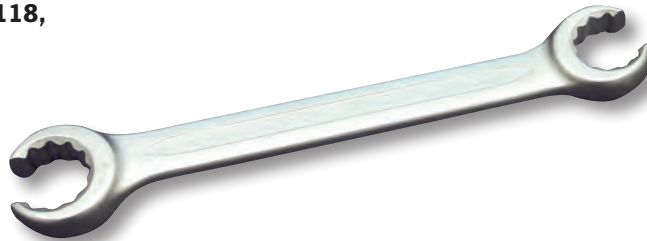

| Art.-Nr./Art.-No. | Größe/Size | Aufnahme/Drive | € |
|-------------------|------------|----------------|--------------|
| 220810 | 8 x 10 mm | 6 x 6-kant | 8,06 |
| 220911 | 9 x 11 mm | 6 x 6-kant | 8,06 |
| 221011 | 10 x 11 mm | 6 x 6-kant | 8,06 |
| 221012 | 10 x 12 mm | 6 x 6-kant | 8,06 |
| 221214 | 12 x 14 mm | 6 x 6-kant | 9,40 |
| 221315 | 13 x 15 mm | 12 x 12-kant | 9,40 |
| 221417 | 14 x 17 mm | 12 x 12-kant | 9,40 |
| 221618 | 16 x 18 mm | 12 x 12-kant | 13,44 |
| 221719 | 17 x 19 mm | 12 x 12-kant | 13,44 |
| 221922 | 19 x 22 mm | 12 x 12-kant | 14,70 |
| 222224 | 22 x 24 mm | 12 x 12-kant | 16,12 |

| Art.-Nr./Art.-No. | Größe/Size | Aufnahme/Drive | € |
|-------------------|---------------|----------------|--------------|
| 2203 | 3/8" x 7/16" | 6 x 6-kant | 8,06 |
| 2205 | 1/2" x 9/16" | 6 x 6-kant | 8,06 |
| 2207 | 11/16" x 3/4" | 12 x 12-kant | 13,44 |
| 2210 | 7/8" x 15/16" | 12 x 12-kant | 16,12 |

Sortimente auf Seite /Sets on Page
H 149 f.

PROFESSIONAL **PLUS** STANDARD

Rollgabelschlüssel nach DIN 3117

Adjustable Wrenches

- ▶ Gabelstellung 15°
- ▶ Mit Skala an der Maul-Seite
- ▶ Open end position 15°
- ▶ With scale at the open end side



| Art.-Nr./Art.-No. | Größe/Size | Länge/Length | max. Maulöffnung/max. Range | € |
|-------------------|------------|--------------|-----------------------------|--------------|
| 2404 | 4" | 100 mm | 13 mm | 14,12 |
| 2406 | 6" | 150 mm | 19 mm | 12,29 |
| 2408 | 8" | 200 mm | 24 mm | 13,49 |
| 2410 | 10" | 250 mm | 30 mm | 17,64 |
| 2412 | 12" | 300 mm | 34 mm | 24,40 |
| 2415 | 15" | 375 mm | 44 mm | 54,60 |

Schraubenschlüssel

Wrenches

Art.-Gruppe 123
Article Group 123

Automatischer Rollgabelschlüssel

Automatic Adjustable Wrenches

- ▶ **Selbständiges Anpassen an Schraubengrößen**
- ▶ **Automatisches Spannen durch entsprechende Drehbewegungen**
- ▶ **Integrierte Ratschenfunktion über Drehbewegung**
- ▶ **4 Größen passend für je 3 Schraubengrößen, metrisch und Zoll:**
8 – 10 / 11 – 13 / 14 – 16 / 17 – 19 mm
- ▶ **Auch passend für 4-kant, 12-kant, E-Torx**
- ▶ **Ideal für Sanitär und Automotive**

- ▶ *Automatic adjustment to screw sizes*
- ▶ *Automatic clamping by appropriate rotary motion*
- ▶ *Integrated ratchet function*
- ▶ *Every wrench fits to 3 screw sizes, metric and inch:*
8 – 10 / 11 – 13 / 14 – 16 / 17 – 19 mm
- ▶ *Also for square, 12-point, E-Torx*
- ▶ *Ideal for sanitary and automotive*

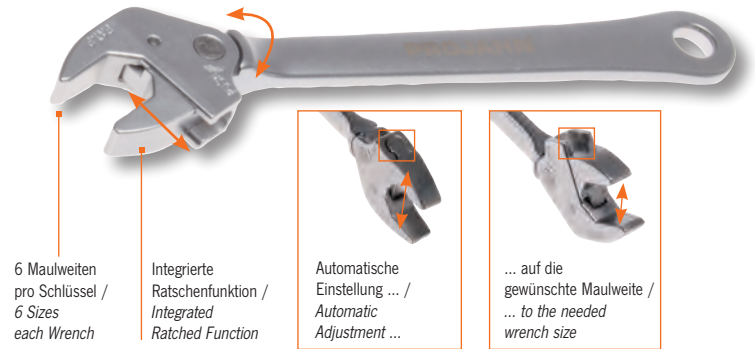

| Art.-Nr./Art.-No. | Größe/Size | Länge/Length | € |
|-------------------|--|--------------|--------------|
| 2440810 | 8 - 9 - 10 mm + 5/16" - 11/32" - 3/8" | 135 mm | 16,00 |
| 2441113 | 11 - 12 - 13 mm + 7/16" - 16/32" - 1/2" | 155 mm | 17,55 |
| 2441416 | 14 - 15 - 16 - 16 mm + 9/16" - 19/32" - 5/8" | 190 mm | 21,95 |
| 2441719 | 17 - 18 - 19 mm + 11/16" - 23/32" - 3/4" | 210 mm | 25,95 |

Sortimente auf Seite / Sets on Page
H 151

Schraubenschlüssel

Wrenches

Art.-Gruppe 123
Article Group 123

PROFESSIONAL PLUS STANDARD

Gerüstbauerschlüssel, metrisch

Construction Wrenches, Metric

Das Ende des Handgriffs ist als Dorn ausgeführt und ermöglicht ein schnelles Justieren der Bauteile.

- ▶ Doppelseitige Knarre mit speziell gehärteten, durchgehenden Nüssen
- ▶ Langer Dorn zur optimalen Kraftübertragung
- ▶ Working with two sockets
- ▶ Sockets are extreme hard and with go-through-system



| Art.-Nr./Art.-No. | Größe/Size | € | Art.-Nr./Art.-No. | Größe/Size | € |
|-------------------|------------|-------|-------------------|------------|-------|
| 231013 | 10 x 13 mm | 37,20 | 232427 | 24 x 27 mm | 63,40 |
| 231317 | 13 x 17 mm | 37,20 | 232430 | 24 x 30 mm | 67,20 |
| 231719 | 17 x 19 mm | 44,75 | 232732 | 27 x 32 mm | 67,20 |
| 231922 | 19 x 22 mm | 44,75 | 233236 | 32 x 36 mm | 74,70 |
| 231924 | 19 x 24 mm | 52,80 | | | |

PROFESSIONAL PLUS STANDARD

2319221

4-in-1 Gerüstbauerschlüssel mit Hammer und Nageleisen, 19 + 22 mm

4-in-1 Construction Wrench with Hammer and Nail Puller, 19 + 22 mm

- ▶ Mit ausgeschmiedetem Hammer und anklappbarem Nageleisen
- ▶ Größen 19 und 22 mm (in einem Schlüssel)
- ▶ Umschaltknarre, Spitzkegeldorn
- ▶ Langlebig aufgrund stabiler Ausführung
- ▶ With forged hammer and foldable nail puller
- ▶ Sizes 19 and 22 mm (in one wrench)
- ▶ Ratchet function, Taper Dorn
- ▶ Durable due to sturdy design

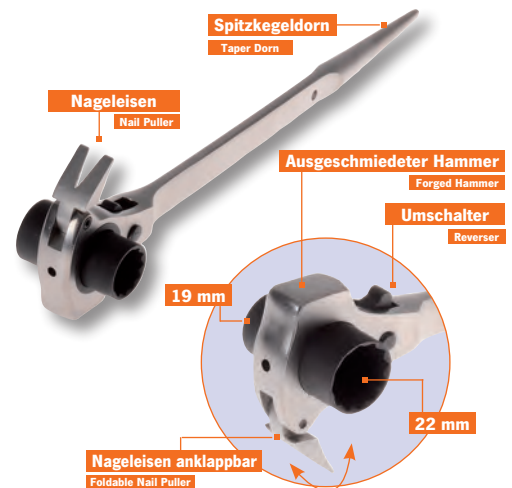

| Art.-Nr./Art.-No. | Größe/Size | € |
|-------------------|------------|-------|
| 2319221 | 19 + 22 mm | 49,95 |

PROFESSIONAL PLUS STANDARD

Pfeifenkopfschlüssel mit Bohrung metrisch, 12-kant x 6-kant

Through-Hole Open-Socket Wrenches, 12 point x 6 point

- ▶ Kurze Seite mit 12-kant Nuss
- ▶ Lange Seite mit 6-kant Nuss
- ▶ Short side with 12 point socket
- ▶ Long side with 6 point socket

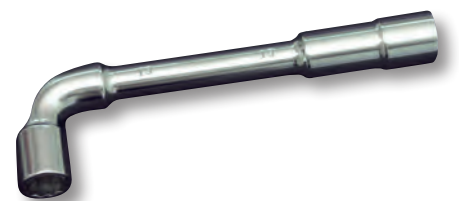

| Art.-Nr./Art.-No. | Größe/Size | € | Art.-Nr./Art.-No. | Größe/Size | € | Art.-Nr./Art.-No. | Größe/Size | € | Art.-Nr./Art.-No. | Größe/Size | € |
|-------------------|------------|-------|-------------------|------------|-------|-------------------|------------|-------|-------------------|------------|--------|
| 2588-08 | 8 mm | 12,86 | 2588-14 | 14 mm | 21,60 | 2588-20 | 20 mm | 29,70 | 2588-26* | 26 mm | 53,34 |
| 2588-09 | 9 mm | 12,86 | 2588-15 | 15 mm | 23,10 | 2588-21 | 21 mm | 31,15 | 2588-27 | 27 mm | 62,60 |
| 2588-10 | 10 mm | 13,49 | 2588-16 | 16 mm | 23,70 | 2588-22 | 22 mm | 36,30 | 2588-28* | 28 mm | 76,55 |
| 2588-11 | 11 mm | 15,59 | 2588-17 | 17 mm | 26,35 | 2588-23* | 23 mm | 40,85 | 2588-29* | 29 mm | 80,50 |
| 2588-12 | 12 mm | 16,22 | 2588-18 | 18 mm | 27,00 | 2588-24 | 24 mm | 44,60 | 2588-30 | 30 mm | 92,00 |
| 2588-13 | 13 mm | 16,80 | 2588-19 | 19 mm | 27,00 | 2588-25* | 25 mm | 47,75 | 2588-32* | 32 mm | 102,00 |

*Lieferung nur solange der Vorrat reicht
*Delivery while stocks last

Ringgabelschlüssel Sätze

Combination Wrench Sets

Art-Gruppe 123
Article Group 123

PROFESSIONAL PLUS STANDARD

4421

Ringgabelschlüssel Satz, 8-teilig metrisch, nach DIN 3113 Form A, in Kartonverpackung inkl. Cliphalter

Combination Wrench Set, 8 pieces
Metric, Paper Box incl. Clip

8
tlg./pcs.

Inhalt/Contents:

je 1 Ringgabelschlüssel/Combination Wrench
8 - 9 - 10 - 11 - 13 - 14 - 17 - 19 mm

| Art.-Nr./Art.-No. | | € |
|-------------------|-------------|-------|
| 4421 | 8-tlg./pcs. | 24,30 |



PROFESSIONAL PLUS STANDARD

4422

Ringgabelschlüssel Satz 12-teilig metrisch, nach DIN 3113 Form A, in Kartonverpackung inkl. Cliphalter

Combination Wrench Set 12 pieces
Metric, Paper Box incl. Clip

12
tlg./pcs.

Inhalt/Contents:

je 1 Ringgabelschlüssel
6 - 7 - 8 - 9 - 10 - 11 - 12 - 13 - 14 - 15 - 17 - 19 mm

| Art.-Nr./Art.-No. | | € |
|-------------------|--------------|-------|
| 4422 | 12-tlg./pcs. | 34,00 |



PROFESSIONAL PLUS STANDARD

4408

Ringgabelschlüssel Satz, metrisch, nach DIN 3113 Form A, in Rolltasche

Combination Wrench Set
Metric, in Pouch

14
tlg./pcs.

Inhalt/Contents:

je 1 Ringgabelschlüssel
8 - 10 - 11 - 12 - 13 - 14 - 15 - 16 - 17 - 18 - 19 - 20 - 21 - 22 mm

| Art.-Nr./Art.-No. | | € |
|-------------------|-----------------------|-------|
| 4408 | 14-tlg./pcs. | 65,90 |
| 4408E | Rolltasche leer/empty | 16,20 |

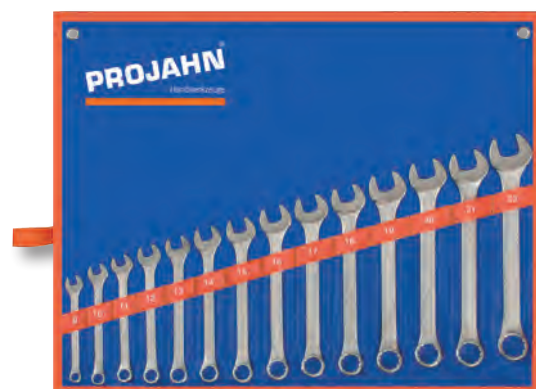

Ringgabelschlüssel Sätze

Combination Wrench Sets

Art-Gruppe 123
Article Group 123

PROFESSIONAL PLUS STANDARD

4410

Ringgabelschlüssel Satz, metrisch nach DIN 3113 Form A, in Rolltasche

Combination Wrench Set,
Metric, in Pouch

23
tlg./pcs.

Inhalt/Contents:

je 1 Ringgabelschlüssel

6 - 7 - 8 - 9 - 10 - 11 - 12 - 13 - 14 - 15 - 16 - 17 - 18 - 19 - 20 - 21 -
22 - 24 - 25 - 26 - 27 - 30 - 32 mm

| Art.-Nr./Art.-No. | | € |
|-------------------|-----------------------------|---------------|
| 4410 | 23-tlg./pcs. | 136,50 |
| 4410E | Rolltasche leer/Pouch empty | 19,95 |



PROFESSIONAL PLUS STANDARD

4407

Ringgabelschlüssel Satz, metrisch nach DIN 3113 Form A, in Rolltasche

Combination Wrench Set,
Metric, in Pouch

4
tlg./pcs.

Inhalt/Contents:

je 1 Ringgabelschlüssel

24 - 27 - 30 - 32 mm

| Art.-Nr./Art.-No. | | € |
|-------------------|-----------------------------|--------------|
| 4407 | 4-tlg./pcs. | 49,00 |
| 4407E | Rolltasche leer/Pouch empty | 16,20 |



PROFESSIONAL PLUS STANDARD

9961

Ringgabelschlüssel Satz, metrisch nach DIN 3113 Form A, in Rolltasche

Combination Wrench Set,
Metric, in Pouch

14
tlg./pcs.

Inhalt/Contents:

je 1 Ringgabelschlüssel

6 - 7 - 8 - 9 - 10 - 11 - 12 - 13 - 14 - 15 - 16 - 17 - 18 - 19 mm

| Art.-Nr./Art.-No. | | € |
|-------------------|-----------------------------|--------------|
| 9961 | 14-tlg./pcs. | 49,20 |
| 3494E | Rolltasche leer/Pouch empty | 17,85 |



Ringgabelschlüssel Sätze lange Schlüssel

Combination Wrench Sets XL-Version

Art.-Gruppe 123
Article Group 123

PROFESSIONAL PLUS STANDARD

4436

Ringgabelschlüssel Satz, lange Schlüssel, metrisch, nach DIN 3113 Form A, in Rolltasche

Combination Wrench Set, XL, Metric, in Pouch

8
tlg./pcs.

Inhalt/Contents:

je 1 Ringgabelschlüssel
8 - 10 - 12 - 13 - 16 - 17 - 18 - 19 mm

| Art.-Nr./Art.-No. | | € |
|-------------------|-----------------------------|-------|
| 4436 | 8-tlg./pcs. | 46,35 |
| 3499E | Rolltasche leer/Pouch empty | 14,80 |



PROFESSIONAL PLUS STANDARD

4438

Ringgabelschlüssel Satz, lange Schlüssel, metrisch, nach DIN 3113 Form A, in Rolltasche

Combination Wrench Set, XL, Metric, in Pouch

14
tlg./pcs.

Inhalt/Contents:

je 1 Ringgabelschlüssel
8 - 10 - 11 - 12 - 13 - 14 - 15 - 16 - 17 - 18 - 19 - 20 - 21 - 22 mm

| Art.-Nr./Art.-No. | | € |
|-------------------|-----------------------------|-------|
| 4438 | 14-tlg./pcs. | 92,80 |
| 4408E | Rolltasche leer/Pouch empty | 16,20 |



PROFESSIONAL PLUS STANDARD

4437

Ringgabelschlüssel Satz, lange Schlüssel, metrisch, nach DIN 3113 Form A, in Rolltasche

Combination Wrench Set, XL, Metric, in Pouch

4
tlg./pcs.

Inhalt/Contents:

je 1 Ringgabelschlüssel 24 - 27 - 30 - 32 mm

| Art.-Nr./Art.-No. | | € |
|-------------------|-----------------------------|-------|
| 4437 | 4-tlg./pcs. | 67,90 |
| 4407E | Rolltasche leer/Pouch empty | 16,20 |



Ringgabelschlüssel Sätze

Combination Wrench Sets

Art.-Gruppe 123
Article Group 123

PROFESSIONAL PLUS STANDARD

2580

Ringgabelschlüssel Satz, Zoll, in Rolltasche

Combination Wrench Set,
Inch, in Pouch

Inhalt/Contents:

je 1 Ringgabelschlüssel

1/4" - 5/16" - 3/8" - 7/16" - 1/2" - 9/16" - 5/8" - 11/16" -
3/4" - 7/8" - 15/16" - 1"

| Art.-Nr./Art.-No. | | € |
|-------------------|------------------------------|-------|
| 2580 | 12-tlg./pcs. | 94,60 |
| 2580E | Rolltasche, leer/Pouch empty | 16,20 |

12
tlg./pcs.



PROFESSIONAL PLUS STANDARD

4
tlg./pcs.

8
tlg./pcs.

4464* / 4466*

DOLPHIN Ringgabelschlüssel-Satz, metrisch in Rolltasche 90° verdrehte Schlüsselanordnung ermöglicht 25% höhere Kraftübertragung

DOLPHIN Combination Wrench Set, metric in Pouch

90° twisted wrench arrangement allows 25% higher power transmission

4464 Inhalt/Contents: je 1 DOLPHIN Schlüssel 10 - 13 - 17 - 19 mm

4466 Inhalt/Contents: je 1 DOLPHIN Schlüssel 8 - 9 - 10 - 11 - 13 - 14 - 17 - 19 mm

| Art.-Nr./Art.-No. | | € |
|-------------------|-------------|-------|
| 4464* | 4-tlg./pcs. | 27,00 |
| 4466* | 8-tlg./pcs. | 42,00 |



PROFESSIONAL PLUS STANDARD

4
tlg./pcs.

8
tlg./pcs.

4462 / 4463

CLICKTECH Ratschen-Ringgabelschlüssel-Satz, metrisch in Rolltasche

CLICKTECH Ratchet Combination Wrench Set,
metric in Pouch

4462 Inhalt/Contents: je 1 CLICKTECH Schlüssel 10 - 13 - 17 - 19 mm

4463 Inhalt/Contents: je 1 CLICKTECH Schlüssel 8 - 10 - 12 - 13 - 16 - 17 - 18 - 19 mm

| Art.-Nr./Art.-No. | | € |
|-------------------|-------------|-------|
| 4462 | 4-tlg./pcs. | 41,20 |
| 4463 | 8-tlg./pcs. | 79,00 |



*Lieferung nur solange der Vorrat reicht / *Delivery while stocks last

Doppelgabelschlüssel Sätze

Double Open End Wrench Sets

Art.-Gruppe 123
Article Group 123

PROFESSIONAL PLUS STANDARD

9988

Rohrsteckschlüssel Satz, leichte Ausführung in Rolltasche

Double Ended Socket Wrench Set,
Light Version in Pouch

10
tlg./pcs.

Inhalt/Contents:

je 1 Rohrsteckschlüssel

6x7 - 8x9 - 10x11 - 12x13 - 14x15 - 16x17 - 18x19 - 20x22,

Drehstift/tommy bar 146 mm (6 - 13 mm) + 146 mm (14 - 27mm)



| Art.-Nr./Art.-No. | | € |
|-------------------|------------------------------|-------|
| 9988 | 10-tlg./pcs. | 32,50 |
| 4405E | Rolltasche, leer/Pouch empty | 11,25 |

PROFESSIONAL PLUS STANDARD

4441

Doppelgabelschlüssel Satz, metrisch, nach DIN 3110, in Kartonverpackung inkl. Cliphalter

Double Open End Wrench Set,
Metric, Paper Box incl. Clip

6
tlg./pcs.

Inhalt/Contents:

je 1 Doppelgabelschlüssel

6 x 7 - 8 x 9 - 10 x 11 - 12 x 13 - 14 x 15 - 16 x 17 mm



| Art.-Nr./Art.-No. | | € |
|-------------------|-------------|-------|
| 4441 | 6-tlg./pcs. | 19,25 |

4405

Doppelgabelschlüssel Satz, metrisch, nach DIN 3110, in Rolltasche

Double Open End Wrench Set,
Metric, in Pouch

8
tlg./pcs.

Inhalt/Contents:

je 1 Doppelgabelschlüssel

6 x 7 - 8 x 9 - 10 x 11 - 12 x 13 - 14 x 15 - 16 x 17 -
18 x 19 - 20 x 22 mm



| Art.-Nr./Art.-No. | | € |
|-------------------|-----------------------------|-------|
| 4405 | 8-tlg./pcs. | 38,20 |
| 4405E | Rolltasche leer/Pouch empty | 11,25 |

Doppelringschlüssel Sätze / Offener Doppelringschlüssel Satz

Double Ring Wrench Sets / Flare Nut Wrench Set

Art.-Gruppe 123
Article Group 123

PROFESSIONAL PLUS STANDARD

4442

**Doppelgabelschlüssel Satz,
metrisch, nach DIN 3110,
in Kartonverpackung inkl. Cliphalter**

Double Open End Wrench Set,
Metric, Paper Box incl. Clip

8
tlg./pcs.

Inhalt/Contents:

je 1 Doppelgabelschlüssel 6 x 7 - 8 x 9 - 10 x 11 -
12 x 13 - 14 x 15 - 16 x 17 - 18 x 19 - 20 x 22 mm

| Art.-Nr./Art.-No. | | € |
|-------------------|-------------|--------------|
| 4442 | 8-tlg./pcs. | 27,95 |



PROFESSIONAL PLUS STANDARD

4411

**Doppelgabelschlüssel Satz,
metrisch, nach DIN 3110, in Rolltasche**

Double Open End Wrench Set,
Metric, in Pouch

11
tlg./pcs.

Inhalt/Contents:

je 1 Doppelgabelschlüssel
6 x 7 - 8 x 9 - 10 x 11 - 12 x 13 - 14 x 15 - 16 x 17 - 18 x 19 -
20 x 22 - 21 x 23 - 24 x 27 - 30 x 32 mm

| Art.-Nr./Art.-No. | | € |
|-------------------|-----------------------|--------------|
| 4411 | 11-tlg./pcs. | 69,95 |
| 4411E | Rolltasche leer/empty | 19,95 |



2216

**Offener Doppelringschlüssel Satz,
in Rolltasche**

Flare Nut Wrench Set,
Metric, in Pouch

6
tlg./pcs.

Inhalt/Contents:

je 1 Doppelringschlüssel
8 x 10 - 9 x 11 - 12 x 14 - 13 x 15 - 17 x 19 - 22 x 24 mm

| Art.-Nr./Art.-No. | | € |
|-------------------|-----------------------|--------------|
| 2216 | 6-tlg./pcs. | 59,50 |
| 2216E | Rolltasche leer/empty | 15,00 |



Doppelringschlüssel Sätze / Offener Doppelringschlüssel Satz

Double Ring Wrench Sets / Flare Nut Wrench Set

Art.-Gruppe 123
Article Group 123

PROFESSIONAL PLUS STANDARD

2218

Offener Doppelringschlüssel Satz, in Rolltasche

Flare Nut Wrench Set,
in Pouch

8
tlg./pcs.

Inhalt/Contents:

je 1 Doppelringschlüssel
9 x 11 - 10 x 12 - 13 x 15 - 14 x 17 mm
3/8" x 7/16" - 1/2" x 9/16" - 11/16" x 3/4" - 7/8" x 15/16"

| Art.-Nr./Art.-No. | | € |
|-------------------|-----------------------|-------|
| 2218 | 8-tlg./pcs. | 75,50 |
| 2218E | Rolltasche leer/empty | 15,00 |



PROFESSIONAL PLUS STANDARD

4451

Doppelringschlüssel Satz, metrisch, nach DIN 838, in Kartonverpackung inkl. Cliphalter

Double Ring Wrench Set,
Metric, Paper Box incl. Clip

6
tlg./pcs.

Inhalt/Contents:

je 1 Doppelringschlüssel
6 x 7 - 8 x 9 - 10 x 11 - 12 x 13 - 14 x 15 - 16 x 17 mm

| Art.-Nr./Art.-No. | | € |
|-------------------|-------------|-------|
| 4451 | 6-tlg./pcs. | 36,80 |



PROFESSIONAL PLUS STANDARD

4402

Doppelringschlüssel Satz, metrisch, nach DIN 838, in Rolltasche

Double Ring Wrench Set,
Metric, in Pouch

8
tlg./pcs.

Inhalt/Contents:

je 1 Doppelringschlüssel
6 x 7 - 8 x 9 - 10 x 11 - 12 x 13 - 14 x 15 - 16 x 17 - 18 x 19 -
20 x 22 mm

| Art.-Nr./Art.-No. | | € |
|-------------------|-----------------------|-------|
| 4402 | 8-tlg./pcs. | 49,60 |
| 4402E | Rolltasche leer/empty | 13,65 |



Doppelringschlüssel Sätze / Automatischer Rollgabelschlüssel Satz

Double Ring Wrench Sets / Automatic Adjustable Wrench Set

Art.-Gruppe 123
Article Group 123

PROFESSIONAL PLUS STANDARD

4452

**Doppelringschlüssel Satz,
metrisch, nach DIN 838,
in Kartonverpackung inkl. Cliphalter**

Double Ring Wrench Set,
Metric, Paper Box incl. Clip

Inhalt/Contents:

je 1 Doppelringschlüssel

6 x 7 - 8 x 9 - 10 x 11 - 12 x 13 - 14 x 15 - 16 x 17 -
18 x 19 - 20 x 22 mm

8
tlg./pcs.



Art.-Nr./Art.-No.

4452 8-tlg./pcs. € **48,10**

PROFESSIONAL PLUS STANDARD

4403

**Doppelringschlüssel Satz,
metrisch, nach DIN 838, in Rolltasche**

Double Ring Wrench Set,
Metric, in Pouch

Inhalt/Contents:

je 1 Doppelringschlüssel

21 x 23 - 24 x 27 - 25 x 28 - 30 x 32 mm

4
tlg./pcs.



Art.-Nr./Art.-No.

4403 4-tlg./pcs. € **62,50**

4403E Rolltasche leer/empty **13,65**

PROFESSIONAL PLUS STANDARD

4468

**Automatischer Rollgabelschlüssel Satz,
in Rolltasche**

Automatic Adjustable Wrench Set,
in Pouch

Inhalt/Contents:

je 1 Automatischer Rollgabelschlüssel

8 - 9 - 10 mm + 5/16" - 11/32" - 3/8"

11 - 12 - 13 mm + 7/16" - 16/32" - 1/2"

14 - 15 - 16 mm + 9/16" - 19/32" - 5/8"

17 - 18 - 19 mm + 11/16" - 23/32" - 3/4"

4
tlg./pcs.



Art.-Nr./Art.-No.

4468 4-tlg./pcs. € **81,90**

4468E Rolltasche leer/empty **13,65**



Technische Daten

Technical Details

Vergleichsliste

Gewinde zu Schlüsselweite (SW)/ Checklist Thread To Wrench Size

| Gewinde/Thread (norm. Reihe) | SW/Size |
|------------------------------|---------|
| M2 | 4 |
| M2,5 | 5 |
| M3 | 5,5 |
| M4 | 7 |
| M5 | 8 |
| M6 | 10 |
| M8 | 13 |
| M10 | 17 (16) |
| M12 | 19 (18) |
| M14 | 21 (22) |
| M16 | 24 |
| M18 | 27 |
| M20 | 30 |
| M22 | 32 (34) |
| M24 | 36 |
| M27 | 41 |
| M30 | 46 |
| M33 | 50 |
| M36 | 55 |
| M39 | 60 |
| M42 | 65 |
| M45 | 70 |
| M48 | 75 |
| M52 | 80 |

Schlüsselweiten-Toleranzen

Auszug aus DIN 475 Teil 2/ Wrench Size Tolerances

| Nennmaß/Nom. Dim. | min. | max. |
|-------------------|-------|-------|
| 3,5 | 3,52 | 3,60 |
| 4* | 4,02 | 4,12 |
| 4,5 | 4,52 | 4,62 |
| 5* | 5,02 | 5,12 |
| 5,5* | 5,52 | 5,62 |
| 6* | 6,03 | 6,15 |
| 7* | 7,03 | 7,15 |
| 8* | 8,03 | 8,15 |
| 9* | 9,03 | 9,15 |
| 10* | 10,04 | 10,19 |
| 11* | 11,04 | 11,19 |
| 12* | 12,04 | 12,24 |
| 13* | 13,04 | 13,24 |
| 14* | 14,05 | 14,27 |
| 15* | 15,05 | 15,27 |
| 16* | 16,05 | 16,27 |
| 17* | 17,05 | 17,30 |
| 18* | 18,05 | 18,30 |
| 19* | 19,06 | 19,36 |
| 20* | 20,06 | 20,36 |
| 21* | 21,06 | 21,36 |
| 22* | 22,06 | 22,36 |
| 23* | 23,06 | 23,36 |
| 24* | 24,06 | 24,36 |
| 25* | 25,06 | 25,36 |
| 26* | 26,08 | 26,48 |
| 27* | 27,08 | 27,48 |
| 28* | 28,08 | 28,48 |
| 30* | 30,08 | 30,48 |
| 32* | 32,08 | 32,48 |
| 34* | 34,10 | 34,60 |
| 36* | 36,10 | 36,60 |
| 41* | 41,10 | 41,60 |
| 46* | 46,10 | 46,60 |
| 50* | 50,10 | 50,60 |
| 55* | 55,12 | 55,72 |
| 60* | 60,12 | 60,72 |
| 65* | 65,12 | 65,72 |
| 70* | 70,12 | 70,72 |
| 75* | 75,15 | 75,85 |
| 80* | 80,15 | 80,85 |

Umrechnungstabelle

Zoll zu Metrisch/ Conversion Table: Inch To Metric

| Zoll/Inch | metrisch/metric (Ca.-Werte) |
|-----------|-----------------------------|
| 5/16" | 7,938 |
| 3/8" | 9,525 |
| 7/16" | 11,113 |
| 1/2" | 12,700 |
| 9/16" | 14,288 |
| 5/8" | 15,875 |
| 11/16" | 17,463 |
| 3/4" | 19,050 |
| 13/16" | 20,638 |
| 7/8" | 22,225 |
| 15/16" | 23,813 |
| 1" | 25,400 |
| 1 1/16" | 26,987 |
| 1 1/8" | 28,575 |
| 1 1/4" | 31,750 |
| 1/64" | 0,397 |
| 1/32 | 0,794 |
| 3/64" | 1,191 |
| 1/16" | 1,588 |
| 5/64" | 1,984 |
| 3/32" | 2,381 |
| 1/8" | 3,175 |
| 3/16" | 4,763 |
| 1/4" | 6,350 |
| 1 1/64" | 25,797 |
| 1 1/32" | 26,194 |
| 1 3/64" | 26,591 |
| 1 5/64" | 27,384 |
| 1 3/32" | 27,781 |
| 1 3/16" | 30,162 |
| 1 5/16" | 33,337 |
| 1 3/8" | 34,925 |
| 1 7/16" | 36,512 |
| 1 1/2" | 38,100 |
| 1 9/16" | 39,687 |
| 1 5/8" | 41,275 |
| 1 11/16" | 42,862 |
| 1 3/4" | 44,450 |
| 1 13/16" | 46,037 |
| 1 7/8" | 47,625 |
| 1 15/16" | 49,212 |
| 2" | 50,800 |
| 2 1/4" | 57,150 |
| 2 1/2" | 63,500 |
| 2 3/4" | 69,850 |

Die durch * gekennzeichneten Schlüsselweiten entsprechen internationalen Normen.
Die Schlüsselweiten 6, 9, 12, 14, 17, 19, 20, 22, 23, 25, 26, 28 und 32 sind in dem ISO/
DIN 691 eingeklammert und als Übergangswerte bezeichnet.
*Wrench sizes marked by * correspond to international standards. The wrench sizes 6, 9,
12, 14, 17, 19, 20, 22, 23, 25, 26, 28 and 32 are bracketed in the ISO/DIN 691 and
referred to as transitional values.*

Bit-Programm









Bits



Übersicht Bit-Boxen

Summary Bit Boxes

2

| Auf Seite / On Page | Qualität / Quality | | | Bit-Länge / Bit length | | Antriebsart / Drive Type | | | | | | | | | | | | | | Zubehör / Accessories | | | | | | | | | | | |
|--|--------------------|------|----------|------------------------|-------|--------------------------|-------------------|---------------|---------------|------------|----------------------------------|----------------------|---|-----------|-------------|---------------------|---------|-----------------|-------------------|-------------------------------------|------------------------------|---------------------------|-------------------------------------|------------------------------------|---------------------------------------|--|---|--|---------------------------|---|---|
| | PROFESSIONAL | PLUS | STANDARD | Teile / Pieces | 25 mm | 75 mm | Schlitz / Slotted | Phillips / PH | Pozidriv / PZ | TORX* / TX | TORX* mit Bohrung / Tamper TORX® | Innensechskant / Hex | Innensechskant mit Bohrung / Tamper Hex | Robertson | Torq / Torq | Tri-Wing / Tri-Wing | Spanner | Clutch / Clutch | Vielzahn / Spline | 5-Stern mit Bohrung / 5-Star Tamper | Stecknuss Bits / Bit Sockets | Bit-Adapter / Bit Adapter | Eindreh-Bit für Haken / Hook Driver | Stecknuss-Adapter / Socket Adapter | Mini-Bit-Knarre / Mini Ratchet Handle | Bit-Magnethalter / Magnetic Bit Holder | Magnetl. m. Schneispannhülse / Magnet. Bit-Holder Quick release | (Ratschen-)Schraubendreher / (Ratchet) Screwdriver | Verkaufsdisplay / Display | | |
|  1/4" Color-Bit-Box / 1/4" Color Bit Set Art.-Nr./Art.-No. 4093 B x L x H/W x L x H: 155 x 120 x 35 mm Gewicht/Weight: 490 g | H 177 | + | | 18 | + | + | + | + | + | + | + | | | | | | | | | | | | | | | | | | | | + |
|  1/4" Bit-Box mit Drehgriffknarre / 1/4" Bit Set with Twist Handle Ratchet Art.-Nr./Art.-No. 394073 B x L x H/W x L x H: 200 x 120 x 40 mm Gewicht/Weight: 620 g | H 179 | | + | 32 | + | + | + | + | + | + | + | | | | | | | | | | + | | | + | + | | | | | | |
|  1/4" SECURIBIT-Box / 1/4" SECURIBIT-Set Art.-Nr./Art.-No. 3790 B x L x H/W x L x H: 193 x 137 x 36 mm Gewicht/Weight: 900 g | H 180 | | + | 50 | + | + | + | + | + | + | + | + | + | + | + | + | + | + | + | | | | | | | | + | | | | |
|  1/4" Bit Box 75 mm / 1/4" Bit Set 75 mm Art.-Nr./Art.-No. 3788 B x L x H/W x L x H: 190 x 130 x 36 mm Gewicht/Weight: 720 g | H 180 | | + | 36 | + | + | + | + | + | + | + | | | | | | | | | | | | | | | | + | | | | |
|  1/4" SECURIBIT-Box / 1/4" SECURIBIT-Set Art.-Nr./Art.-No. 3789 B x L x H/W x L x H: 220 x 155 x 50 mm Gewicht/Weight: 1.160 g | H 181 | | + | 122 | + | + | + | + | + | + | + | + | + | + | + | + | + | + | + | + | + | + | + | + | + | + | + | + | + | + | |
|  1/4" SECURIBIT-Box / 1/4" SECURIBIT-Set Art.-Nr./Art.-No. 3787 B x L x H/W x L x H: 190 x 130 x 36 mm Gewicht/Weight: 700 g | H 181 | | + | 100 | + | + | + | + | + | + | + | + | + | + | + | + | + | + | + | | + | + | + | | | + | | | | | |
|  1/4" Bit Box XL / 1/4" Bit Set XL Art.-Nr./Art.-No. 8604 B x L x H/W x L x H: 120 x 205 x 45 mm Gewicht/Weight: 1.120 g | H 182 | | + | 113 | + | + | + | + | + | + | + | | | | | | | | | | | | | | | + | + | | | | |
|  1/4" Bit Box XXL / 1/4" Bit Set XXL Art.-Nr./Art.-No. 8606 B x L x H/W x L x H: 335 x 200 x 45 mm Gewicht/Weight: 2.000 g | H 183 | | + | 200 | + | + | + | + | + | + | + | + | + | + | + | + | + | + | + | + | + | + | + | + | + | + | + | + | + | + | |
| | | | | | | | | | | | | | | | | | | | | | | | | | | | | | | | |
| | | | | | | | | | | | | | | | | | | | | | | | | | | | | | | | |
| | | | | | | | | | | | | | | | | | | | | | | | | | | | | | | | |
| | | | | | | | | | | | | | | | | | | | | | | | | | | | | | | | |

Bit-Programm

Bit-Range



PROFESSIONAL PLUS STANDARD

PROFESSIONAL-Bits

- ▶ Höchste Passgenauigkeit und spezielle Härtung – sehr lange Lebensdauer und hochwertige Verschraubung
- ▶ Empfohlen für den professionellen Anwender
- ▶ Color-Ring-Bits, TiN-Bits, ACR-Bits, Diamant-Bits, Torsion-Bits
- ▶ Bester Rundlauf für ermüdungsfreies und schnelles Arbeiten
- ▶ Aus hochwertigstem S2-Spezialstahl gefertigt
- ▶ Große Auswahl an Einzelbits und Bitboxen

- ▶ *Best fitting accuracy and special hardening – gives extra long life and high class screw joint*
- ▶ *Recommended for professional use*
- ▶ *Color-Ring-Bits, TiN-Bits, ACR Bits, Diamant-Bits, Torsion-Bits*
- ▶ *Effortless and fast screwing*
- ▶ *Produced of high-performance S2-Steel*
- ▶ *Big product range of Bits and Bit-Boxes*



Color-Bits

- ▶ Dank Farbleitsystem immer schnell den richtigen Bit
- ▶ *Color ring helps to find the right bit easily*



TiN-Bits



- ▶ Extrem harte Titan-Nitrit-Beschichtung – höhere Oberflächenhärte und Zähigkeit des Bits
- ▶ Weniger Verschleiß am Bit und weniger Schäden an Schraubenköpfen
- ▶ *Titan-Nitrite-Coating – higher surface hardness and resistance of the bits*
- ▶ *Less wear at the bit as well as damage at the screws*

ACR-Bits (Anti-Cam-Out-Ribs)



- ▶ Rippen an der Antriebsspitze reduzieren das Herausrutschen des Bits aus der Schraube
- ▶ Sauberes Verschraubungsergebnis u. weniger Verschleiß an Werkzeug u. Schraube
- ▶ *Ribs at the tip of the bit reduce the risk of the "Cam-out-effect"*
- ▶ *High class work result*
- ▶ *Less wear at the tool and screw*

Diamant-Bits



- ▶ Mit Diamantpartikeln besetzte Antriebsspitze minimiert das Herausrutschen des Bits aus der Schraube
- ▶ Sicheres Verschrauben auf empfindlichen Oberflächen
- ▶ Ergonomischeres Arbeiten durch Reduzierung des Anpressdruckes
- ▶ Sauberes Verschraubungsergebnis und weniger Verschleiß
- ▶ *Diamond coated bit tip minimize the "Cam-out-effect"*
- ▶ *Safer screw driving on sensitive surfaces*
- ▶ *Less fatiguing work due to the reducing of contact pressure*
- ▶ *High class work result, less wear at the tool and screw*

Torsions-Bits



- ▶ Für höchste Belastung durch Hochleistungs-Spezialstahl ausgelegt
- ▶ Ideal für Schlagschrauber geeignet
- ▶ Spezielle Torsionszone leitet die Belastung der Bohrspitze in den Bit ab
- ▶ Reduzierung des Herausrutschens des Bits durch ACR-Profile
- ▶ *Produced of high-performance Steel – designed for maximum forces*
- ▶ *Especially suitable for use with impact drivers*
- ▶ *Special designed torsion zone absorbs forces into the bit*
- ▶ *Additional with Cam-out-rips*

PROFESSIONAL PLUS STANDARD

PLUS-Bits

- ▶ Erstklassiger Passsitz auf Grund sorgfältiger Verarbeitung auf modernen Produktionsanlagen
- ▶ Hervorragender Rundlauf für ermüdungsfreies und schnelles Arbeiten
- ▶ Aus hochwertigem S2-Spezialstahl gefertigt, ideal für den professionellen Anwender geeignet
- ▶ Breites Produktsortiment aus Einzelbits und Bitboxen – für jede Anwendung den richtigen Bit
- ▶ *Outstanding fit because of good workmanship on high technical machines*
- ▶ *Effortless and fast screwing*
- ▶ *Produced of S2-Steel, optimal for professional use*
- ▶ *Wide product range of Bits and Bit-Boxes – for every application the right bit*



PROFESSIONAL PLUS STANDARD

Standard-Bits



- ▶ Sehr guter Passsitz und Rundlauf für professionelle Einsätze
- ▶ Aus CR-V Stahl gefertigt
- ▶ Große Auswahl an Bit-Boxen

- ▶ *Good fit and concentricity for professional use*
- ▶ *Produced of CR-V steel*
- ▶ *Wide product range of Bit-Boxes*



1/4" BIT- Schraubendreher Einsätze

1/4" Bits



Art.-Gruppe 130
Article Group 130

PROFESSIONAL **PLUS** STANDARD

1/4" Schraubendreher-Einsätze für Kreuzschlitz-Schrauben Phillips

Phillips Bits



| Art.-Nr./Art.-No. | Größe/Size | Länge/Length | € |
|-------------------|------------|--------------|-------------|
| 2701 | PH 1 | 25 mm | 1,05 |
| 2702 | PH 2 | 25 mm | 1,05 |
| 2703 | PH 3 | 25 mm | 1,05 |
| 2704 | PH 4 | 25 mm | 1,56 |

| | | | |
|------|------|-------|-------------|
| 2801 | PH 1 | 50 mm | 1,56 |
| 2802 | PH 2 | 50 mm | 1,56 |
| 2803 | PH 3 | 50 mm | 1,56 |
| 2804 | PH 4 | 50 mm | 1,56 |

| | | | |
|------|------|-------|-------------|
| 2901 | PH 1 | 90 mm | 2,69 |
| 2902 | PH 2 | 90 mm | 2,69 |
| 2903 | PH 3 | 90 mm | 2,69 |

| | | | |
|------|------|--------|-------------|
| 2601 | PH 1 | 150 mm | 3,79 |
| 2602 | PH 2 | 150 mm | 3,79 |
| 2603 | PH 3 | 150 mm | 3,79 |

| | | | |
|------|------|--------|-------------|
| 3002 | PH 2 | 300 mm | 6,79 |
|------|------|--------|-------------|

| | | | |
|------|------|--------------------|-------------|
| 2706 | PH 2 | extra schmal 25 mm | 0,98 |
|------|------|--------------------|-------------|

| | | | |
|------|---------|-------------------|-------------|
| 2707 | 2x PH 2 | Tiefenstopp 25 mm | 3,92 |
|------|---------|-------------------|-------------|

| | | | |
|------|------|-------------------|-------------|
| 2708 | PH 2 | Tiefenstopp 25 mm | 2,10 |
|------|------|-------------------|-------------|

PROFESSIONAL **PLUS** STANDARD

| | | | |
|------|------|-----------|-------------|
| 3701 | PH 1 | TiN 25 mm | 1,91 |
| 3702 | PH 2 | TiN 25 mm | 1,91 |
| 3703 | PH 3 | TiN 25 mm | 1,91 |

PROFESSIONAL **PLUS** STANDARD



| Art.-Nr./Art.-No. | Größe/Size | Länge/Length | € |
|-------------------|------------|-------------------|-------------|
| 2707 | 2x PH 2 | Tiefenstopp 25 mm | 3,92 |
| 2708 | PH 2 | Tiefenstopp 25 mm | 2,10 |

PROFESSIONAL **PLUS** STANDARD

1/4" ACR Schraubendreher-Einsätze für Kreuzschlitz-Schrauben Phillips

ACR Phillips Bits

10er Pack ACR Bits

10 pcs Box ACR Bits



| Art.-Nr./Art.-No. | Größe/Size | Länge/Length | € |
|-------------------|------------|--------------|-------------|
| 3001-10 | PH 1 | 25 mm | 6,74 |
| 3002-10 | PH 2 | 25 mm | 6,74 |
| 3003-10 | PH 3 | 25 mm | 6,74 |

| | | | |
|---------|------|-------|--------------|
| 3101-10 | PH 1 | 50 mm | 11,50 |
| 3102-10 | PH 2 | 50 mm | 11,50 |
| 3103-10 | PH 3 | 50 mm | 11,50 |

PROFESSIONAL **PLUS** STANDARD

ACR Bits lose

ACR Bits Bulk



| Art.-Nr./Art.-No. | Größe/Size | Länge/Length | € |
|-------------------|------------|--------------|-------------|
| 3201 | PH 1 | 70 mm | 2,30 |
| 3202 | PH 2 | 70 mm | 2,30 |
| 3203 | PH 3 | 70 mm | 2,30 |

PROFESSIONAL **PLUS** STANDARD

1/4" Schraubendreher-Einsätze

100er Pack für Kreuzschlitz-Schrauben Phillips

Phillips Bits 100 pcs Box



| Art.-Nr./Art.-No. | Größe/Size | Länge/Length | € |
|-------------------|------------|--------------|--------------|
| 2701-100 | PH 1 | 25 mm | 40,45 |
| 2702-100 | PH 2 | 25 mm | 40,45 |
| 2703-100 | PH 3 | 25 mm | 40,45 |

PROFESSIONAL **PLUS** STANDARD

1/4" Schraubendreher-Einsätze 10er Pack für Kreuzschlitz-Schrauben Phillips

Phillips Bits

10pcs Box



| Art.-Nr./Art.-No. | Größe/Size | Länge/Length | € |
|-------------------|------------|--------------|--------------|
| 2700-10 | PH 0 | 25 mm | 5,15 |
| 2701-10 | PH 1 | 25 mm | 4,89 |
| 2702-10 | PH 2 | 25 mm | 4,89 |
| 2703-10 | PH 3 | 25 mm | 4,89 |
| 2704-10 | PH 4 | 25 mm | 11,13 |

| | | | |
|---------|------|-------|--------------|
| 2801-10 | PH 1 | 50 mm | 10,05 |
| 2802-10 | PH 2 | 50 mm | 10,05 |
| 2803-10 | PH 3 | 50 mm | 10,05 |

PROFESSIONAL **PLUS** STANDARD

Extra schmal

Reduced Nose



| Art.-Nr./Art.-No. | Größe/Size | Länge/Length | € |
|-------------------|------------|--------------------|-------------|
| 2706 | PH 2 | extra schmal 25 mm | 0,98 |

1/4" BIT- Schraubendreher Einsätze

1/4" Bits



Art.-Gruppe 130
Article Group 130

PROFESSIONAL **PLUS** STANDARD

1/4" Schraubendreher-Einsätze für Kreuzschlitz-Schrauben Pozidriv

Pozidriv Bits



| Art.-Nr./Art.-No. | Größe/Size | Länge/Length | € |
|-------------------|------------|--------------|------|
| 2711 | PZ 1 | 25 mm | 1,05 |
| 2712 | PZ 2 | 25 mm | 1,05 |
| 2713 | PZ 3 | 25 mm | 1,05 |
| 2714 | PZ 4 | 25 mm | 1,56 |
| | | | |
| 2811 | PZ 1 | 50 mm | 1,56 |
| 2812 | PZ 2 | 50 mm | 1,56 |
| 2813 | PZ 3 | 50 mm | 1,56 |
| 2814 | PZ 4 | 50 mm | 1,56 |

| | | | |
|------|------|-------|------|
| 2911 | PZ 1 | 90 mm | 2,69 |
| 2912 | PZ 2 | 90 mm | 2,69 |
| 2913 | PZ 3 | 90 mm | 2,69 |

| | | | |
|------|------|--------|------|
| 2611 | PZ 1 | 150 mm | 3,79 |
| 2612 | PZ 2 | 150 mm | 3,79 |
| 2613 | PZ 3 | 150 mm | 3,79 |
| | | | |
| 3012 | PZ 2 | 300 mm | 6,79 |

PROFESSIONAL **PLUS** STANDARD

| | | | |
|------|------|-----------|------|
| 3711 | PZ 1 | TiN 25 mm | 1,91 |
| 3712 | PZ 2 | TiN 25 mm | 1,91 |
| 3713 | PZ 3 | TiN 25 mm | 1,91 |
| | | | |
| | | | |
| | | | |
| | | | |

PROFESSIONAL **PLUS** STANDARD

1/4" ACR Schraubendreher-Einsätze für Kreuzschlitz-Schrauben Pozidriv

ACR Pozidriv Bits

10er Pack ACR Bits

10pcs Box ACR Bits

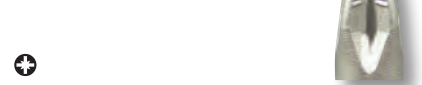

| Art.-Nr./Art.-No. | Größe/Size | Länge/Length | € |
|-------------------|------------|--------------|-------|
| 3011-10 | PZ 1 | 25 mm | 6,74 |
| 3012-10 | PZ 2 | 25 mm | 6,74 |
| 3013-10 | PZ 3 | 25 mm | 6,74 |
| | | | |
| 3111-10 | PZ 1 | 50 mm | 11,50 |
| 3112-10 | PZ 2 | 50 mm | 11,50 |
| 3113-10 | PZ 3 | 50 mm | 11,50 |

PROFESSIONAL **PLUS** STANDARD

1/4" ACR Bits lose

ACR Bits Bulk

| Art.-Nr./Art.-No. | Größe/Size | Länge/Length | € |
|-------------------|------------|--------------|------|
| 3211 | PZ 1 | 70 mm | 2,30 |
| 3212 | PZ 2 | 70 mm | 2,30 |
| 3213 | PZ 3 | 70 mm | 2,30 |

| | | | |
|--|--|--|--|
| | | | |
| | | | |
| | | | |
| | | | |
| | | | |
| | | | |
| | | | |

PROFESSIONAL **PLUS** STANDARD

1/4" Schraubendreher-Einsätze 10er Pack für Kreuzschlitz-Schrauben Pozidriv

Pozidriv Bits 10pcs Box



| Art.-Nr./Art.-No. | Größe/Size | Länge/Length | € |
|-------------------|------------|--------------|-------|
| 2710-10 | PZ 0 | 25 mm | 5,15 |
| 2711-10 | PZ 1 | 25 mm | 4,89 |
| 2712-10 | PZ 2 | 25 mm | 4,89 |
| 2713-10 | PZ 3 | 25 mm | 4,89 |
| 2714-10 | PZ 4 | 25 mm | 11,13 |
| | | | |
| 2811-10 | PZ 1 | 50 mm | 10,05 |
| 2812-10 | PZ 2 | 50 mm | 10,05 |
| 2813-10 | PZ 3 | 50 mm | 10,05 |

PROFESSIONAL **PLUS** STANDARD

1/4" Schraubendreher-Einsätze 100er Pack für Kreuzschlitz-Schrauben Pozidriv

Pozidriv Bits 100 pcs Box



| Art.-Nr./Art.-No. | Größe/Size | Länge/Length | € |
|-------------------|------------|--------------|-------|
| 2711-100 | PZ 1 | 25 mm | 40,45 |
| 2712-100 | PZ 2 | 25 mm | 40,45 |
| 2713-100 | PZ 3 | 25 mm | 40,45 |

1/4" BIT- Schraubendreher Einsätze

1/4" Bits



Art-Gruppe 130
Article Group 130

PROFESSIONAL **PLUS** STANDARD

1/4" Schraubendreher-Einsätze für Schlitz-Schrauben

Slotted Bits



| Art.-Nr./Art.-No. | Größe/Size | Länge/Length | € |
|-------------------|------------|--------------|-------------|
| 2721 | 4,0 mm | 25 mm | 1,05 |
| 2722 | 4,5 mm | 25 mm | 1,05 |
| 2727 | 5,0 mm | 25 mm | 1,05 |
| 2723 | 5,5 mm | 25 mm | 1,05 |
| 2724 | 6,0 mm | 25 mm | 1,05 |
| 2725 | 6,5 mm | 25 mm | 1,05 |
| 2726 | 8,0 mm | 25 mm | 1,17 |

| | | | |
|------|--------|-------|-------------|
| 2821 | 4,0 mm | 50 mm | 1,30 |
| 2822 | 4,5 mm | 50 mm | 1,30 |
| 2823 | 5,5 mm | 50 mm | 1,30 |
| 2824 | 6,0 mm | 50 mm | 1,30 |
| 2825 | 6,5 mm | 50 mm | 1,30 |
| 2826 | 8,0 mm | 50 mm | 2,23 |

| | | | |
|------|--------|-------|-------------|
| 3221 | 4,0 mm | 70 mm | 2,30 |
| 3222 | 4,5 mm | 70 mm | 2,30 |
| 3223 | 5,5 mm | 70 mm | 2,30 |
| 3224 | 6,0 mm | 70 mm | 2,30 |
| 3225 | 6,5 mm | 70 mm | 2,30 |
| 3226 | 8,0 mm | 70 mm | 2,30 |

| | | | |
|------|--------|-------|-------------|
| 2921 | 4,0 mm | 90 mm | 2,69 |
| 2922 | 4,5 mm | 90 mm | 2,69 |
| 2923 | 5,5 mm | 90 mm | 2,69 |
| 2924 | 6,0 mm | 90 mm | 2,69 |
| 2925 | 6,5 mm | 90 mm | 2,69 |
| 2926 | 8,0 mm | 90 mm | 2,69 |

PROFESSIONAL **PLUS** STANDARD

1/4" Schraubendreher-Einsätze 10er Pack für Schlitz-Schrauben

Slotted Bits 10 pcs Box



| Art.-Nr./Art.-No. | Größe/Size | Länge/Length | € |
|-------------------|------------|--------------|-------------|
| 2721-10 | 4,0 mm | 25 mm | 5,15 |
| 2722-10 | 4,5 mm | 25 mm | 5,15 |
| 2723-10 | 5,5 mm | 25 mm | 5,15 |
| 2724-10 | 6,0 mm | 25 mm | 5,15 |
| 2725-10 | 6,5 mm | 25 mm | 5,15 |
| 2726-10 | 8,0 mm | 25 mm | 7,71 |

1/4" BIT- Schraubendreher Einsätze

1/4" Bits



Art.-Gruppe 130
Article Group 130

PROFESSIONAL PLUS STANDARD

1/4" Schraubendreher-Einsätze für Innen-TX-Schrauben

TX Bits

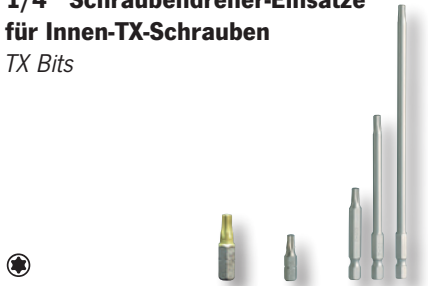

| Art.-Nr./Art.-No. | Größe/Size | Länge/Length | € |
|-------------------|------------|--------------|------|
| 2728 | T6 | 25 mm | 1,44 |
| 2729 | T7 | 25 mm | 1,44 |
| 2738 | T8 | 25 mm | 1,44 |
| 2739 | T9 | 25 mm | 1,44 |
| 2731 | T10 | 25 mm | 1,17 |
| 2732 | T15 | 25 mm | 1,17 |
| 2733 | T20 | 25 mm | 1,17 |
| 2734 | T25 | 25 mm | 1,17 |
| 2737 | T27 | 25 mm | 1,17 |
| 2735 | T30 | 25 mm | 1,17 |
| 2736 | T40 | 25 mm | 1,17 |
| | | | |
| 2831 | T10 | 50 mm | 1,56 |
| 2832 | T15 | 50 mm | 1,56 |
| 2833 | T20 | 50 mm | 1,56 |
| 2834 | T25 | 50 mm | 1,56 |
| 2837 | T27 | 50 mm | 1,56 |
| 2835 | T30 | 50 mm | 1,56 |
| 2836 | T40 | 50 mm | 1,56 |
| | | | |
| 3228 | T6 | 70 mm | 2,56 |
| 3229 | T7 | 70 mm | 2,56 |
| 3238 | T8 | 70 mm | 2,56 |
| 3239 | T9 | 70 mm | 2,56 |
| 3231 | T10 | 70 mm | 2,56 |
| 3232 | T15 | 70 mm | 2,56 |
| 3233 | T20 | 70 mm | 2,56 |
| 3234 | T25 | 70 mm | 2,56 |
| 3237 | T27 | 70 mm | 2,56 |
| 3235 | T30 | 70 mm | 2,56 |
| 3236 | T40 | 70 mm | 2,56 |
| 3274 | T45 | 70 mm | 2,56 |
| 3275 | T50 | 70 mm | 2,56 |



| Art.-Nr./Art.-No. | Größe/Size | Länge/Length | € |
|----------------------------|------------|--------------|------|
| 2931 | T10 | 90 mm | 2,95 |
| 2932 | T15 | 90 mm | 2,95 |
| 2933 | T20 | 90 mm | 2,95 |
| 2934 | T25 | 90 mm | 2,95 |
| 2937 | T27 | 90 mm | 2,95 |
| 2935 | T30 | 90 mm | 2,95 |
| 2936 | T40 | 90 mm | 2,95 |
| | | | |
| 2631 | T10 | 150 mm | 4,31 |
| 2632 | T15 | 150 mm | 4,31 |
| 2633 | T20 | 150 mm | 4,31 |
| 2634 | T25 | 150 mm | 4,31 |
| 2637 | T27 | 150 mm | 4,31 |
| 2635 | T30 | 150 mm | 4,31 |
| 2636 | T40 | 150 mm | 4,31 |
| | | | |
| 3031 | T10 | 300 mm | 6,79 |
| 3032 | T15 | 300 mm | 6,79 |
| 3033 | T20 | 300 mm | 6,79 |
| 3034 | T25 | 300 mm | 6,79 |
| 3035 | T30 | 300 mm | 6,79 |
| 3036 | T40 | 300 mm | 6,79 |
| | | | |
| PROFESSIONAL PLUS STANDARD | | | |
| 3731 | T10 | TiN 25 mm | 2,04 |
| 3732 | T15 | TiN 25 mm | 2,04 |
| 3733 | T20 | TiN 25 mm | 2,04 |
| 3734 | T25 | TiN 25 mm | 2,04 |
| 3737 | T27 | TiN 25 mm | 2,04 |
| 3735 | T30 | TiN 25 mm | 2,04 |
| 3736 | T40 | TiN 25 mm | 2,04 |

PROFESSIONAL PLUS STANDARD

1/4" Konische Schraubendreher-Einsätze 10er Pack für Innen-TX-Schrauben

1/4" TX Align-Tapered Bits



Die Bits laufen konisch zu, werden in die Schraube gedrückt und sind somit fest mit der Schraube verbunden.

The bit will fix in the screw and so the screw would not get loose.



| Art.-Nr./Art.-No. | Größe/Size | Länge/Length | € |
|-------------------|------------|--------------|-------|
| 3030-10 | T6W | 25 mm | 10,61 |
| 3031-10 | T7W | 25 mm | 10,61 |
| 3032-10 | T8W | 25 mm | 10,61 |
| 3033-10 | T9W | 25 mm | 10,61 |
| 3034-10 | T10W | 25 mm | 7,10 |
| 3035-10 | T15W | 25 mm | 7,10 |
| 3036-10 | T20W | 25 mm | 7,10 |
| 3037-10 | T25W | 25 mm | 7,10 |
| 3038-10 | T27W | 25 mm | 7,10 |
| 3039-10 | T30W | 25 mm | 7,10 |
| 3040-10 | T40W | 25 mm | 7,10 |
| | | | |
| 3130-10 | T6W | 50 mm | 13,28 |
| 3131-10 | T7W | 50 mm | 13,28 |
| 3132-10 | T8W | 50 mm | 13,28 |
| 3133-10 | T9W | 50 mm | 13,28 |
| 3134-10 | T10W | 50 mm | 12,08 |
| 3135-10 | T15W | 50 mm | 12,08 |
| 3136-10 | T20W | 50 mm | 12,08 |
| 3137-10 | T25W | 50 mm | 12,08 |
| 3138-10 | T27W | 50 mm | 12,08 |
| 3139-10 | T30W | 50 mm | 12,08 |
| 3140-10 | T40W | 50 mm | 12,08 |

1/4" BIT- Schraubendreher Einsätze

1/4" Bits



Art.-Gruppe 130
Article Group 130

1/4" Schraubendreher-Einsätze für Innensechskant-Schrauben

Hex Bits



1/4" Schraubendreher-Einsätze 10er Pack für Innensechskant-Schrauben

Hex Bits 10 pcs Box



1/4" Schraubendreher-Einsätze für Innensechskant-Schrauben mit stirnseitiger Bohrung

Tamper Hex Bits



| Art.-Nr./Art.-No. | Größe/Size | Länge/Length | € |
|-------------------|------------|--------------|-------------|
| 2696 | 1,5 mm | 25 mm | 0,74 |
| 2697 | 2,0 mm | 25 mm | 0,74 |
| 2698 | 2,5 mm | 25 mm | 0,74 |
| 2741 | 3,0 mm | 25 mm | 1,05 |
| 2742 | 4,0 mm | 25 mm | 1,05 |
| 2743 | 5,0 mm | 25 mm | 1,05 |
| 2699 | 5,5 mm | 25 mm | 1,05 |
| 2744 | 6,0 mm | 25 mm | 1,05 |
| 2745 | 7,0 mm | 25 mm | 1,17 |
| 2746 | 8,0 mm | 25 mm | 1,17 |

| Art.-Nr./Art.-No. | Größe/Size | Länge/Length | € |
|-------------------|------------|--------------|-------------|
| 2741-10 | 3,0 mm | 25 mm | 5,02 |
| 2742-10 | 4,0 mm | 25 mm | 5,02 |
| 2743-10 | 5,0 mm | 25 mm | 5,02 |
| 2744-10 | 6,0 mm | 25 mm | 5,02 |
| 2745-10 | 7,0 mm | 25 mm | 7,22 |
| 2746-10 | 8,0 mm | 25 mm | 7,84 |

| Art.-Nr./Art.-No. | Größe/Size | Länge/Length | € |
|-------------------|------------|--------------|-------------|
| 2676 | 2,0 mm | 25 mm | 1,23 |
| 2677 | 2,5 mm | 25 mm | 1,23 |
| 2678 | 3,0 mm | 25 mm | 1,23 |
| 2679 | 4,0 mm | 25 mm | 1,23 |
| 2680 | 5,0 mm | 25 mm | 1,23 |
| 2681 | 6,0 mm | 25 mm | 1,23 |
| 2683 | 5/32" | 25 mm | 1,23 |
| 2684 | 9/64" | 25 mm | 1,23 |
| 2685 | 1/8" | 25 mm | 1,23 |
| 2686 | 7/64" | 25 mm | 1,23 |
| 2687 | 3/32" | 25 mm | 1,23 |
| 2688 | 5/64" | 25 mm | 1,23 |

| | | | |
|------|--------|-------|-------------|
| 2841 | 3,0 mm | 50 mm | 1,30 |
| 2842 | 4,0 mm | 50 mm | 1,30 |
| 2843 | 5,0 mm | 50 mm | 1,30 |
| 2844 | 6,0 mm | 50 mm | 1,30 |
| 2845 | 7,0 mm | 50 mm | 1,71 |
| 2846 | 8,0 mm | 50 mm | 1,84 |

| | | | |
|------|--------|-------|-------------|
| 3247 | 1,5 mm | 70 mm | 2,30 |
| 3248 | 2,0 mm | 70 mm | 2,30 |
| 3249 | 2,5 mm | 70 mm | 2,30 |
| 3241 | 3,0 mm | 70 mm | 2,30 |
| 3242 | 4,0 mm | 70 mm | 2,30 |
| 3243 | 5,0 mm | 70 mm | 2,30 |

| | | | |
|------|--------|--------|-------------|
| 3041 | 3,0 mm | 300 mm | 6,79 |
| 3042 | 4,0 mm | 300 mm | 6,79 |
| 3043 | 5,0 mm | 300 mm | 6,79 |
| 3044 | 6,0 mm | 300 mm | 6,79 |
| 3045 | 7,0 mm | 300 mm | 6,79 |
| 3046 | 8,0 mm | 300 mm | 6,79 |

| | | | |
|------|-------|--------|-------------|
| 3093 | 5/32" | 300 mm | 6,79 |
| 3094 | 9/64" | 300 mm | 6,79 |
| 3095 | 1/8" | 300 mm | 6,79 |
| 3096 | 7/64" | 300 mm | 6,79 |
| 3097 | 3/32" | 300 mm | 6,79 |
| 3098 | 5/64" | 300 mm | 6,79 |

1/4" Schraubendreher-Einsätze mit Kugelkopf 10er Pack für Innensechskant-Schrauben

Ball Point Bits 10 pcs Box



| Art.-Nr./Art.-No. | Größe/Size | Länge/Length | € |
|-------------------|------------|--------------|--------------|
| 2780-10 | 1,5 mm | 25 mm | 6,48 |
| 2781-10 | 2,0 mm | 25 mm | 6,48 |
| 2782-10 | 2,5 mm | 25 mm | 6,48 |
| 2783-10 | 3,0 mm | 25 mm | 6,48 |
| 2784-10 | 4,0 mm | 25 mm | 6,48 |
| 2785-10 | 5,0 mm | 25 mm | 6,48 |
| 2786-10 | 6,0 mm | 25 mm | 6,48 |
| 2787-10 | 7,0 mm | 25 mm | 9,43 |
| 2788-10 | 8,0 mm | 25 mm | 10,76 |

1/4" BIT- Schraubendreher Einsätze 300 mm

1/4" Bits 300 mm

Art.-Gruppe 130
Article Group 130**Extra lange Ausführung**

Extra long Version

**1/4" Schraubendreher-Einsätze
für Kreuzschlitz-Schrauben Phillips**

Phillips Bits



| Art.-Nr./Art.-No. | Größe/Size | Länge/Length | € |
|-------------------|------------|--------------|-------------|
| 3002 | PH 2 | 300 mm | 6,79 |

**1/4" Schraubendreher-Einsätze
für Kreuzschlitz-Schrauben Pozidriv**

Pozidriv Bits



| Art.-Nr./Art.-No. | Größe/Size | Länge/Length | € |
|-------------------|------------|--------------|-------------|
| 3012 | PZ 2 | 300 mm | 6,79 |

**1/4" Schraubendreher-Einsätze
für Innen-TX-Schrauben**

TX Bits



| Art.-Nr./Art.-No. | Größe/Size | Länge/Length | € |
|-------------------|------------|--------------|-------------|
| 3031 | T10 | 300 mm | 6,79 |
| 3032 | T15 | 300 mm | 6,79 |
| 3033 | T20 | 300 mm | 6,79 |
| 3034 | T25 | 300 mm | 6,79 |
| 3035 | T30 | 300 mm | 6,79 |
| 3036 | T40 | 300 mm | 6,79 |

**1/4" Schraubendreher-Einsätze
für Innensechskant-Schrauben**

Hex Bits



| Art.-Nr./Art.-No. | Größe/Size | Länge/Length | € |
|-------------------|------------|--------------|-------------|
| 3041 | 3,0 mm | 300 mm | 6,79 |
| 3042 | 4,0 mm | 300 mm | 6,79 |
| 3043 | 5,0 mm | 300 mm | 6,79 |
| 3044 | 6,0 mm | 300 mm | 6,79 |
| 3045 | 7,0 mm | 300 mm | 6,79 |
| 3046 | 8,0 mm | 300 mm | 6,79 |
| 3093 | 5/32" | 300 mm | 6,79 |
| 3094 | 9/64" | 300 mm | 6,79 |
| 3095 | 1/8" | 300 mm | 6,79 |
| 3096 | 7/64" | 300 mm | 6,79 |
| 3097 | 3/32" | 300 mm | 6,79 |
| 3098 | 5/64" | 300 mm | 6,79 |

Bit-Display / Magazin

Bit Display / Storage

**Fragen Sie nach unseren Bestückungen –
das Display kann auch individuell nach
Kundenwunsch bestückt werden!**Please ask for different contents –
the display content can be individualised due to your needs!Art.-Gruppe 131
Article Group 131**11911-01**

615 x 503 x 150 mm

Reihe 1/Line 1:

| | |
|---------|--|
| ⊕ 25 mm | 30 x PH1 - 50 x PH2 - 30 x PH3 |
| ⊕ 25 mm | TiN 20 x PH1 - 30 x PH2 - 20 x PH3 |
| ⊕ 50 mm | 20 x PH2 |
| ⊕ 25 mm | 10 x Schraubvorsatz mit Tiefenstopp PH 2 |
| 50 mm | Stecknuss Bit Adapter 1/4" x 1/4" |

Reihe 2/Line 2:

| | |
|---------|------------------------------------|
| ⊕ 25 mm | 30 x PZ1 - 50 x PZ2 - 30 x PZ3 |
| ⊕ 25 mm | TiN 20 x PZ1 - 30 x PZ2 - 20 x PZ3 |
| ⊕ 50 mm | 10 x PZ1 - 20 x PZ2 - 10 x PZ3 |

Reihe 3/Line 3:

| | |
|---------|--|
| ⊕ 25 mm | 20 x TX10 - 20 x TX15 - 50 x TX20 - 50 x TX 25 - 50 x TX30 - 20 x TX 40 |
| ⊕ 25 mm | TiN 30 x TX15 - 30 x TX 20 - 30 x TX 25 |

Reihe 4/Line 4:

| | |
|---------|--|
| ○ 65 mm | Stecknuss Bit 6 x 8 mm - 6 x 10 mm - 5 x 13 mm |
| | 10 x Bit Magnethalter |
| | 10 x Magnethalter mit Schnellspannfutter |
| | 10 x Magnethalter mit „Ring-Magnet“ |

| Art.-Nr./Art.-No. | tlg./pcs. | | € |
|-------------------|-----------|---------------------------------------|-----------------|
| 11911-01 | 787 | bestückt mit 787 Bits / with 787 Bits | 1.089,00 |

1/4" Color-BIT-Schraubendreher Einsätze 25 + 75 mm

1/4" Color-Bits 25 + 75 mm



Art.-Gruppe 132
Article Group 132



Bits 25 mm
3er-Pack /
3 pcs Box



Bits 25 mm
10er-Pack /
10 pcs Box



Bits 25 mm
50er-Pack /
50 pcs Box



Bits 75 mm
3er-Pack /
3 pcs Box



1/4" Color-BIT-Schraubendreher-Einsätze, für Kreuzschlitz-Schrauben Phillips, 3er-Pack

Phillips Color-Bits, 3 pcs Box



| Art.-Nr./Art.-No. | Größe/Size | Länge/Length | € |
|-------------------|------------|--------------|------|
| 1701-03 | PH 1 | 25 mm | 3,23 |
| 1702-03 | PH 2 | 25 mm | 3,23 |
| 1703-03 | PH 3 | 25 mm | 3,23 |

| | | | |
|---------|------|-------|------|
| 1801-03 | PH 1 | 75 mm | 6,08 |
| 1802-03 | PH 2 | 75 mm | 6,08 |
| 1803-03 | PH 3 | 75 mm | 6,08 |

1/4" Color-BIT-Schraubendreher-Einsätze, für Kreuzschlitz-Schrauben Phillips, 10er-Pack

Phillips Color-Bits, 10 pcs Box



| Art.-Nr./Art.-No. | Größe/Size | Länge/Length | € |
|-------------------|------------|--------------|------|
| 1701-10 | PH 1 | 25 mm | 8,51 |
| 1702-10 | PH 2 | 25 mm | 8,51 |
| 1703-10 | PH 3 | 25 mm | 8,51 |

1/4" Color-BIT-Schraubendreher-Einsätze, für Kreuzschlitz-Schrauben Phillips, 50er Pack

Phillips Color-Bits, 50 pcs Box



| Art.-Nr./Art.-No. | Größe/Size | Länge/Length | € |
|-------------------|------------|--------------|-------|
| 1701-50 | PH 1 | 25 mm | 32,65 |
| 1702-50 | PH 2 | 25 mm | 32,65 |

1/4" Color-BIT-Schraubendreher-Einsätze, für Schlitz-Schrauben, 3er-Pack

Slotted Color-Bits, 3 pcs Box



| Art.-Nr./Art.-No. | Größe/Size | Länge/Length | € |
|-------------------|------------|--------------|------|
| 1721-03 | 3 mm | 25 mm | 3,23 |
| 1722-03 | 4 mm | 25 mm | 3,23 |
| 1723-03 | 5 mm | 25 mm | 3,23 |
| 1724-03 | 6 mm | 25 mm | 3,23 |

| | | | |
|---------|------|-------|------|
| 1822-03 | 4 mm | 75 mm | 6,08 |
| 1824-03 | 6 mm | 75 mm | 6,08 |

1/4" Color-BIT-Schraubendreher-Einsätze, für Pozidriv-Schrauben Pozidriv, 3er-Pack

Pozidriv Color-Bits, 3 pcs Box



| Art.-Nr./Art.-No. | Größe/Size | Länge/Length | € |
|-------------------|------------|--------------|------|
| 1711-03 | PZ 1 | 25 mm | 3,23 |
| 1712-03 | PZ 2 | 25 mm | 3,23 |
| 1713-03 | PZ 3 | 25 mm | 3,23 |

| | | | |
|---------|------|-------|------|
| 1811-03 | PZ 1 | 75 mm | 6,08 |
| 1812-03 | PZ 2 | 75 mm | 6,08 |
| 1813-03 | PZ 3 | 75 mm | 6,08 |

1/4" Color-BIT-Schraubendreher-Einsätze, für Pozidriv-Schrauben Pozidriv, 10er-Pack

Pozidriv Color-Bits, 10 pcs Box



| Art.-Nr./Art.-No. | Größe/Size | Länge/Length | € |
|-------------------|------------|--------------|------|
| 1711-10 | PZ 1 | 25 mm | 8,51 |
| 1712-10 | PZ 2 | 25 mm | 8,51 |
| 1713-10 | PZ 3 | 25 mm | 8,51 |

1/4" Color-BIT-Schraubendreher-Einsätze, für Pozidriv-Schrauben Pozidriv, 50er-Pack

Pozidriv Color-Bits, 50 pcs Box



| Art.-Nr./Art.-No. | Größe/Size | Länge/Length | € |
|-------------------|------------|--------------|-------|
| 1711-50 | PZ 1 | 25 mm | 32,65 |
| 1712-50 | PZ 2 | 25 mm | 32,65 |



Bits 25 mm
10er-Pack/10 pcs Box

Bits 25 mm
50er-Pack/50 pcs Box

1/4" Color-BIT-Schraubendreher Einsätze 25 + 75 mm

1/4" Color-Bits 25 + 75 mm



Art.-Gruppe 132
Article Group 132



Bits 25 mm
3er-Pack /
3 pcs Box



Bits 25 mm
10er-Pack /
10 pcs Box



Bits 25 mm
50er-Pack /
50 pcs Box



Bits 75 mm
3er-Pack /
3 pcs Box



1/4" Color-BIT-Schraubendreher-Einsätze, für TX-Schrauben TORX®, 3er-Pack

TORX® Color-Bits, 3 pcs Box



| Art.-Nr./Art.-No. | Größe/Size | Länge/Length | € |
|-------------------|------------|--------------|-------------|
| 1731-03 | TX 10 | 25 mm | 3,23 |
| 1732-03 | TX 15 | 25 mm | 3,23 |
| 1733-03 | TX 20 | 25 mm | 3,23 |
| 1734-03 | TX 25 | 25 mm | 3,23 |
| 1735-03 | TX 27 | 25 mm | 3,23 |
| 1736-03 | TX 30 | 25 mm | 3,23 |
| 1737-03 | TX 40 | 25 mm | 3,23 |

| | | | |
|---------|-------|-------|-------------|
| 1831-03 | TX 10 | 75 mm | 6,08 |
| 1832-03 | TX 15 | 75 mm | 6,08 |
| 1833-03 | TX 20 | 75 mm | 6,08 |
| 1834-03 | TX 25 | 75 mm | 6,08 |
| 1835-03 | TX 27 | 75 mm | 6,08 |
| 1836-03 | TX 30 | 75 mm | 6,08 |
| 1837-03 | TX 40 | 75 mm | 6,08 |

1/4" Color-BIT-Schraubendreher-Einsätze, für TX-Schrauben TORX®, 10er-Pack

TORX® Color-Bits, 10 pcs Box



| Art.-Nr./Art.-No. | Größe/Size | Länge/Length | € |
|-------------------|------------|--------------|-------------|
| 1731-10 | TX 10 | 25 mm | 8,51 |
| 1732-10 | TX 15 | 25 mm | 8,51 |
| 1733-10 | TX 20 | 25 mm | 8,51 |
| 1734-10 | TX 25 | 25 mm | 8,51 |
| 1735-10 | TX 27 | 25 mm | 8,51 |
| 1736-10 | TX 30 | 25 mm | 8,51 |
| 1737-10 | TX 40 | 25 mm | 8,51 |

1/4" Color-BIT-Schraubendreher-Einsätze, für TX-Schrauben TORX®, 50er-Pack

TORX® Color-Bits, 50 pcs Box



| Art.-Nr./Art.-No. | Größe/Size | Länge/Length | € |
|-------------------|------------|--------------|--------------|
| 1731-50 | TX 10 | 25 mm | 32,65 |
| 1732-50 | TX 15 | 25 mm | 32,65 |
| 1733-50 | TX 20 | 25 mm | 32,65 |
| 1734-50 | TX 25 | 25 mm | 32,65 |
| 1736-50 | TX 30 | 25 mm | 32,65 |

1/4" Color-BIT-Schraubendreher-Einsätze, für TX-Schrauben mit Bohrung TAMPER TORX®, 3er-Pack

Tamper TORX® Color-Bits, 3 pcs Box



| Art.-Nr./Art.-No. | Größe/Size | Länge/Length | € |
|-------------------|--------------|--------------|-------------|
| 1751-03 | Tamper TX 10 | 25 mm | 3,61 |
| 1752-03 | Tamper TX 15 | 25 mm | 3,61 |
| 1753-03 | Tamper TX 20 | 25 mm | 3,61 |
| 1754-03 | Tamper TX 25 | 25 mm | 3,61 |
| 1755-03 | Tamper TX 27 | 25 mm | 3,61 |
| 1756-03 | Tamper TX 30 | 25 mm | 3,61 |
| 1757-03 | Tamper TX 40 | 25 mm | 3,61 |

1/4" Color-BIT-Schraubendreher-Einsätze, für Sechskant-Schrauben, Innensechskant, 3er-Pack

Hex Color-Bits, 3 pcs Box



| Art.-Nr./Art.-No. | Größe/Size | Länge/Length | € |
|-------------------|------------|--------------|-------------|
| 1741-03 | Hex 3 | 25 mm | 3,23 |
| 1742-03 | Hex 4 | 25 mm | 3,23 |
| 1743-03 | Hex 5 | 25 mm | 3,23 |
| 1744-03 | Hex 6 | 25 mm | 3,23 |
| 1841-03 | Hex 3 | 75 mm | 6,08 |
| 1842-03 | Hex 4 | 75 mm | 6,08 |
| 1843-03 | Hex 5 | 75 mm | 6,08 |

1/4" Color-BIT-Schraubendreher-Einsätze, für Sechskant-Schrauben, Innensechskant, 10er-Pack

Hex Color-Bits, 10 pcs Box



| Art.-Nr./Art.-No. | Größe/Size | Länge/Length | € |
|-------------------|------------|--------------|-------------|
| 1742-10 | Hex 4 | 25 mm | 8,51 |
| 1743-10 | Hex 5 | 25 mm | 8,51 |



Bits 25 mm
10er-Pack/10 pcs Box

Bits 25 mm
50er-Pack/50 pcs Box

1/4" BIT-Schraubendreher-Einsätze, diamantbeschichtet

1/4" Bits, Diamond Coating



Art.-Gruppe 130
Article Group 130

1/4" BIT-Schraubendreher-Einsätze, diamantbeschichtet für Kreuzschlitz-Schrauben Phillips, 3er-Pack

Phillips Bits, Diamond Coating, 3 pcs Box



| Art.-Nr./Art.-No. | Größe/Size | Länge/Length | € |
|-------------------|------------|--------------|-------|
| 1750001-03 | PH 1 | 25 mm | 6,74 |
| 1750002-03 | PH 2 | 25 mm | 6,74 |
| 1750003-03 | PH 3 | 25 mm | 6,74 |
| <hr/> | | | |
| 1751001-03 | PH 1 | 50 mm | 10,41 |
| 1751002-03 | PH 2 | 50 mm | 10,41 |
| 1751003-03 | PH 3 | 50 mm | 10,41 |

1/4" BIT-Schraubendreher-Einsätze, diamantbeschichtet für Schlitz-Schrauben, 3er-Pack

Slotted Bits, Diamond Coating, 3 pcs Box



| Art.-Nr./Art.-No. | Größe/Size | Länge/Length | € |
|-------------------|------------|--------------|-------|
| 1750202-03 | 4,0 mm | 25 mm | 6,74 |
| 1750203-03 | 4,5 mm | 25 mm | 6,74 |
| 1750204-03 | 5,5 mm | 25 mm | 6,74 |
| <hr/> | | | |
| 1751202-03 | 4,0 mm | 50 mm | 10,41 |
| 1751203-03 | 4,5 mm | 50 mm | 10,41 |
| 1751204-03 | 5,5 mm | 50 mm | 10,41 |

1/4" BIT-Schraubendreher-Einsätze, diamantbeschichtet für Innen-TX-Schrauben, 3er-Pack

TX Bits, Diamond Coating, 3 pcs Box



| Art.-Nr./Art.-No. | Größe/Size | Länge/Length | € |
|-------------------|------------|--------------|-------|
| 1750310-03 | T10 | 25 mm | 6,74 |
| 1750315-03 | T15 | 25 mm | 6,74 |
| 1750320-03 | T20 | 25 mm | 6,74 |
| 1750325-03 | T25 | 25 mm | 6,74 |
| 1750330-03 | T30 | 25 mm | 6,74 |
| <hr/> | | | |
| 1751310-03 | T10 | 50 mm | 10,41 |
| 1751315-03 | T15 | 50 mm | 10,41 |
| 1751320-03 | T20 | 50 mm | 10,41 |
| 1751325-03 | T25 | 50 mm | 10,41 |
| 1751330-03 | T30 | 50 mm | 10,41 |

1/4" BIT-Schraubendreher-Einsätze, diamantbeschichtet für Kreuzschlitz-Schrauben Pozidriv, 3er-Pack

Pozidriv Bits, Diamond Coating, 3 pcs Box



| Art.-Nr./Art.-No. | Größe/Size | Länge/Length | € |
|-------------------|------------|--------------|-------|
| 1750101-03 | PZ 1 | 25 mm | 6,74 |
| 1750102-03 | PZ 2 | 25 mm | 6,74 |
| 1750103-03 | PZ 3 | 25 mm | 6,74 |
| <hr/> | | | |
| 1751101-03 | PZ 1 | 50 mm | 10,41 |
| 1751102-03 | PZ 2 | 50 mm | 10,41 |
| 1751103-03 | PZ 3 | 50 mm | 10,41 |

Diamantbeschichtete Bit-Schraubendreher-Einsätze

Diamond Coated Bits

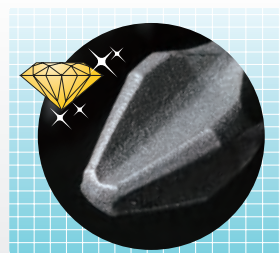

- ▶ Mit Diamantpartikeln besetzte Antriebsspitze minimiert das Herausrutschen des Bits aus der Schraube
 - ▶ Sicheres Verschrauben auf empfindlichen Oberflächen
 - ▶ Sauberes Verschraubungsergebnis und weniger Verschleiß
 - ▶ Kürzere Verschraubungszeiten
 - ▶ Leicht erkennbar durch weißen Farbring
 - ▶ Ergonomischeres Arbeiten durch Reduzierung des Anpressdruckes
 - ▶ Zusätzliche Torsionszone leitet Kraftspitzen in den Bit ab – reduziert Schäden am Bit
-
- ▶ Diamond coated bit tip minimize the "Cam-out-effect"
 - ▶ Safer screw driving on sensitive surfaces
 - ▶ Less fatiguing work due to the reducing of contact pressure
 - ▶ High class work result
 - ▶ Less wear at the tool and screw
 - ▶ Quicker fastening time
 - ▶ Torsion twist zone reduces bit breakage
 - ▶ Easily recognizable with their white color ring

1/4" TORSION BIT-Schraubendreher Einsätze

1/4" TORSION Bits



Art.-Gruppe 130
Article Group 130

1/4" TORSION BIT-Schraubendreher-Einsätze für Kreuzschlitz-Schrauben Phillips, mit ACR II – Profil, 3er Pack
Phillips TORSION Bits, ACR II - Profile, 3 pcs Box



| Art.-Nr./Art.-No. | Größe/Size | Länge/Length | € |
|-------------------|------------|--------------|-------------|
| 176001-03 | PH 1 | 25 mm | 4,27 |
| 176002-03 | PH 2 | 25 mm | 4,27 |
| 176003-03 | PH 3 | 25 mm | 4,27 |
| 176101-03 | PH 1 | 50 mm | 6,00 |
| 176102-03 | PH 2 | 50 mm | 6,00 |
| 176103-03 | PH 3 | 50 mm | 6,00 |

1/4" TORSION BIT-Schraubendreher-Einsätze für Schlitz-Schrauben, 3er Pack
Slotted TORSION Bits, 3 pcs Box



| Art.-Nr./Art.-No. | Größe/Size | Länge/Length | € |
|-------------------|------------|--------------|-------------|
| 1760202-03 | 4,0 mm | 25 mm | 3,54 |
| 1760203-03 | 4,5 mm | 25 mm | 3,54 |
| 1760205-03 | 5,5 mm | 25 mm | 3,54 |
| 1761202-03 | 4,0 mm | 50 mm | 5,25 |
| 1761203-03 | 4,5 mm | 50 mm | 5,25 |
| 1761205-03 | 5,5 mm | 50 mm | 5,25 |

1/4" TORSION BIT-Schraubendreher-Einsätze für Innen-TX-Schrauben, 3er Box
TX TORSION Bits, 3 pcs Box



| Art.-Nr./Art.-No. | Größe/Size | Länge/Length | € |
|-------------------|------------|--------------|-------------|
| 1760310-03 | T10 | 25 mm | 3,54 |
| 1760315-03 | T15 | 25 mm | 3,54 |
| 1760320-03 | T20 | 25 mm | 3,54 |
| 1760325-03 | T25 | 25 mm | 3,54 |
| 1760330-03 | T30 | 25 mm | 3,54 |
| 1760340-03 | T40 | 25 mm | 3,54 |
| 1761310-03 | T10 | 50 mm | 5,25 |
| 1761315-03 | T15 | 50 mm | 5,25 |
| 1761320-03 | T20 | 50 mm | 5,25 |
| 1761325-03 | T25 | 50 mm | 5,25 |
| 1761330-03 | T30 | 50 mm | 5,25 |
| 1761340-03 | T40 | 50 mm | 5,25 |

1/4" TORSION BIT-Schraubendreher-Einsätze für Kreuzschlitz-schrauben Pozidriv, mit ACR II – Profil, 3er Pack
Pozidriv TORSION Bits, ACR II - Profile, 3 pcs Box



| Art.-Nr./Art.-No. | Größe/Size | Länge/Length | € |
|-------------------|------------|--------------|-------------|
| 1760101-03 | PZ 1 | 25 mm | 4,27 |
| 1760102-03 | PZ 2 | 25 mm | 4,27 |
| 1760103-03 | PZ 3 | 25 mm | 4,27 |
| 1761101-03 | PZ 1 | 50 mm | 6,00 |
| 1761102-03 | PZ 2 | 50 mm | 6,00 |
| 1761103-03 | PZ 3 | 50 mm | 6,00 |

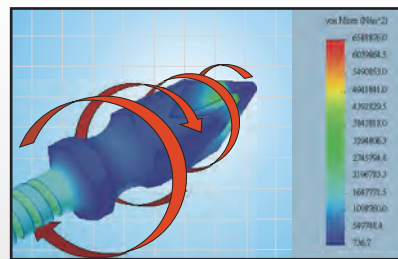

PROJAHN TORSION-Bit

Kräfte werden in den Bit abgeleitet / Forces will disperse at torsion zone

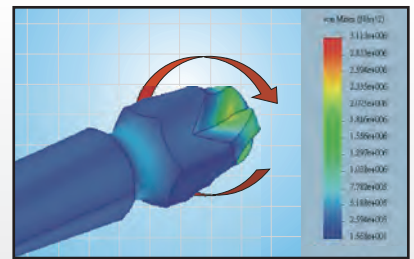

Standard-Bit

Kräfte werden an der Spitze zentriert / Forces will accumulated at the tip of bit

- ▶ Für höchste Belastung ausgelegt
- ▶ Ideal für Schlagschrauber geeignet
- ▶ Spezielle Torsionszone leitet die Belastung der Bohrspitze in den Bit ab
- ▶ Wesentlich längere Standzeit und geringere Bruchgefahr
- ▶ Reduzierung des Herausrutschens des Bits durch zusätzliche ACR-Profile

- ▶ Produced of high-performance Steel – Designed for maximum forces
- ▶ Especially suitable for use with impact drivers
- ▶ Special designed torsion zone absorbs forces into the bit
- ▶ Longer durability and less breakage
- ▶ Additional with Cam-out-rips

5/16" BIT- Schraubendreher Einsätze

5/16" Bits



Art.-Gruppe 130
Article Group 130

5/16" BIT-Schraubendreher-Einsätze für Kreuzschlitz-Schrauben Phillips

Phillips Bits



| Art.-Nr./Art.-No. | Größe/Size | Länge/Length | € |
|-------------------|------------|--------------|-------------|
| 303001 | PH 1 | 30 mm | 3,13 |
| 303002 | PH 2 | 30 mm | 3,13 |
| 303003 | PH 3 | 30 mm | 3,13 |
| 303004 | PH 4 | 30 mm | 3,13 |
| | | | |
| 313001 | PH 1 | 70 mm | 4,84 |
| 313002 | PH 2 | 70 mm | 4,84 |
| 313003 | PH 3 | 70 mm | 4,84 |

5/16" BIT-Schraubendreher-Einsätze für Schlitz-Schrauben

Slotted Bits



| Art.-Nr./Art.-No. | Größe/Size | Länge/Length | € |
|-------------------|---------------|--------------|-------------|
| 302055 | 5,5 x 0,8 mm | 30 mm | 3,13 |
| 302065 | 6,5 x 1,0 mm | 30 mm | 3,13 |
| 302080 | 8,0 x 1,2 mm | 30 mm | 3,13 |
| 302100 | 10,0 x 1,6 mm | 30 mm | 3,13 |
| 302120 | 12,0 x 2,0 mm | 30 mm | 3,13 |

5/16" BIT-Schraubendreher-Einsätze für Innen-TX-Schrauben

TX Bits



| Art.-Nr./Art.-No. | Größe/Size | Länge/Length | € |
|-------------------|------------|--------------|-------------|
| 305010 | T10 | 30 mm | 3,13 |
| 305015 | T15 | 30 mm | 3,13 |
| 305020 | T20 | 30 mm | 3,13 |
| 305025 | T25 | 30 mm | 3,13 |
| 305027 | T27 | 30 mm | 3,13 |
| 305030 | T30 | 30 mm | 3,13 |
| 305040 | T40 | 30 mm | 3,13 |
| 305045 | T45 | 30 mm | 3,13 |
| 305050 | T50 | 30 mm | 3,13 |
| 305055 | T55 | 30 mm | 3,28 |
| 305060 | T60 | 30 mm | 3,28 |
| 305070 | T70 | 30 mm | 3,40 |
| | | | |
| 315015 | T15 | 70 mm | 4,84 |
| 315020 | T20 | 70 mm | 4,84 |
| 315025 | T25 | 70 mm | 4,84 |
| 315027 | T27 | 70 mm | 4,84 |
| 315030 | T30 | 70 mm | 4,84 |
| 315040 | T40 | 70 mm | 4,84 |
| 315045 | T45 | 70 mm | 4,84 |
| 315050 | T50 | 70 mm | 4,84 |
| 315055 | T55 | 70 mm | 4,84 |
| 315060 | T60 | 70 mm | 4,84 |

5/16" BIT-Schraubendreher-Einsätze für Innen-TX-Schrauben mit stirnseitiger Bohrung

Tamper TX Bits



| Art.-Nr./Art.-No. | Größe/Size | Länge/Length | € |
|-------------------|------------|--------------|-------------|
| 305310 | T10 | 30 mm | 4,31 |
| 305315 | T15 | 30 mm | 4,31 |
| 305320 | T20 | 30 mm | 4,31 |
| 305325 | T25 | 30 mm | 4,31 |
| 305327 | T27 | 30 mm | 4,31 |
| 305330 | T30 | 30 mm | 4,31 |
| 305340 | T40 | 30 mm | 4,31 |
| 305345 | T45 | 30 mm | 4,31 |
| 305350 | T50 | 30 mm | 4,31 |
| 305355 | T55 | 30 mm | 4,31 |
| 305360 | T60 | 30 mm | 4,31 |
| 305370 | T70 | 30 mm | 4,31 |

5/16" BIT-Schraubendreher-Einsätze für Innensechskant-Schrauben

Hex Bits



| Art.-Nr./Art.-No. | Größe/Size | Länge/Length | € |
|-------------------|------------|--------------|-------------|
| 306004 | 4 mm | 30 mm | 3,13 |
| 306005K | 5 mm | 30 mm | 3,13 |
| 306006 | 6 mm | 30 mm | 3,13 |
| 306007 | 7 mm | 30 mm | 3,13 |
| 306008 | 8 mm | 30 mm | 3,13 |
| 306010 | 10 mm | 30 mm | 3,13 |
| 306012 | 12 mm | 30 mm | 3,13 |
| 306014 | 14 mm | 30 mm | 3,13 |
| | | | |
| 316004 | 4 mm | 70 mm | 4,97 |
| 316005 | 5 mm | 70 mm | 4,97 |
| 316006 | 6 mm | 70 mm | 4,97 |
| 316008 | 8 mm | 70 mm | 4,97 |

5/16" BIT-Schraubendreher-Einsätze für Kreuzschlitz-Schrauben Pozidriv

Pozidriv Bits



| Art.-Nr./Art.-No. | Größe/Size | Länge/Length | € |
|-------------------|------------|--------------|-------------|
| 304001 | PZ 1 | 30 mm | 3,13 |
| 304002 | PZ 2 | 30 mm | 3,13 |
| 304003 | PZ 3 | 30 mm | 3,13 |
| 304004 | PZ 4 | 30 mm | 3,13 |
| | | | |
| 314001 | PZ 1 | 70 mm | 4,84 |
| 314002 | PZ 2 | 70 mm | 4,84 |

10 mm BIT- Schraubendreher Einsätze

10 mm Bits



Art.-Gruppe 130
Article Group 130

10 mm BIT-Schraubendreher-Einsätze für Vielzahn-Schrauben

10 mm Spline Impact Bits



| Art.-Nr./Art.-No. | Größe/Size | Länge/Length | € |
|-------------------|------------|--------------|-------------|
| 348605 | M5 | 30 mm | 2,23 |
| 348606 | M6 | 30 mm | 2,23 |
| 348608 | M8 | 30 mm | 2,23 |
| 348610 | M10 | 30 mm | 2,23 |
| 348612 | M12 | 30 mm | 2,23 |
| 348614 | M14 | 30 mm | 2,23 |
| <hr/> | | | |
| 348705 | M5 | 75 mm | 3,01 |
| 348706 | M6 | 75 mm | 3,01 |
| 348708 | M8 | 75 mm | 3,01 |
| 348710 | M10 | 75 mm | 3,01 |
| 348712 | M12 | 75 mm | 3,28 |
| 348714 | M14 | 75 mm | 3,98 |

10 mm Schraubendreher-Einsätze für Innensechskant-Schrauben

10 mm Hex Bits



| Art.-Nr./Art.-No. | Größe/Size | Länge/Length | € |
|-------------------|------------|--------------|-------------|
| 306040 | 4 mm | 30 mm | 2,17 |
| 306050 | 5 mm | 30 mm | 2,17 |
| 306060 | 6 mm | 30 mm | 2,17 |
| 306080 | 8 mm | 30 mm | 2,17 |
| 306100 | 10 mm | 30 mm | 2,17 |
| 306120 | 12 mm | 30 mm | 2,17 |

10 mm Bit Ratsche umschaltbar

10 mm Bit Ratchet reversible



| Art.-Nr./Art.-No. | Größe/Size | Länge/Length |
|-------------------|------------|--------------|
| 4295 | 10 mm | 138 mm |
| - ¹ | | |
| <hr/> | | |
| <hr/> | | |

¹ Nicht mehr lieferbar / ¹ Out of stock

10 mm BIT-Schraubendreher-Einsätze für Innen-TX-Schrauben

10 mm TX Impact Bits



| Art.-Nr./Art.-No. | Größe/Size | Länge/Length | € |
|-------------------|------------|--------------|-------------|
| 305620 | T20 | 30 mm | 2,04 |
| 305625 | T25 | 30 mm | 2,04 |
| 305627 | T27 | 30 mm | 2,04 |
| 305630 | T30 | 30 mm | 2,04 |
| 305640 | T40 | 30 mm | 2,04 |
| 305645 | T45 | 30 mm | 2,04 |
| 305650 | T50 | 30 mm | 2,04 |
| 305655 | T55 | 30 mm | 2,04 |
| 305660 | T60 | 30 mm | 2,17 |
| 305670 | T70 | 30 mm | 2,30 |

| | | | |
|--------|-----|-------|-------------|
| 315620 | T20 | 75 mm | 3,01 |
| 315625 | T25 | 75 mm | 3,01 |
| 315627 | T27 | 75 mm | 3,01 |
| 315630 | T30 | 75 mm | 3,01 |
| 315640 | T40 | 75 mm | 3,01 |
| 315645 | T45 | 75 mm | 3,01 |
| 315650 | T50 | 75 mm | 3,01 |
| 315655 | T55 | 75 mm | 3,01 |
| 315660 | T60 | 75 mm | 3,40 |
| 315670 | T70 | 75 mm | 4,31 |

10 mm BIT-Schraubendreher-Einsätze für Innen-TX-Schrauben mit stirnseitiger Bohrung

10 mm Tamper TX Impact Bits



| Art.-Nr./Art.-No. | Größe/Size | Länge/Length | € |
|-------------------|------------|--------------|-------------|
| 305720 | T20 | 30 mm | 2,17 |
| 305725 | T25 | 30 mm | 2,17 |
| 305727 | T27 | 30 mm | 2,17 |
| 305730 | T30 | 30 mm | 2,17 |
| 305740 | T40 | 30 mm | 2,17 |
| 305745 | T45 | 30 mm | 2,17 |
| 305750 | T50 | 30 mm | 2,17 |
| 305755 | T55 | 30 mm | 2,17 |
| 305760 | T60 | 30 mm | 2,30 |
| 305770 | T70 | 30 mm | 2,43 |

| | | | |
|--------|-----|-------|-------------|
| 315720 | T20 | 75 mm | 3,01 |
| 315725 | T25 | 75 mm | 3,01 |
| 315727 | T27 | 75 mm | 3,01 |
| 315730 | T30 | 75 mm | 3,01 |
| 315740 | T40 | 75 mm | 3,01 |
| 315745 | T45 | 75 mm | 3,01 |
| 315750 | T50 | 75 mm | 3,01 |
| 315755 | T55 | 75 mm | 3,01 |
| 315760 | T60 | 75 mm | 3,40 |
| 315770 | T70 | 75 mm | 4,31 |

1/4" Spezial- und Sonder-BIT- Schraubendreher Einsätze

1/4" Special And Security Bits



Art.-Gruppe 130
Article Group 130

1/4" Schraubendreher-Einsätze Robertson für SpanoElecPlus-Schrauben

Robertson Bits



| Art.-Nr./Art.-No. | Größe/Size | Länge/Length | € |
|-------------------|------------|--------------|------|
| 2651 | R1/2,5 mm | 25 mm | 1,23 |
| 2652 | R2/3,0 mm | 25 mm | 1,23 |
| 2653 | R3/3,5 mm | 25 mm | 1,23 |
| 2656 | R1/2,5 mm | 50 mm | 2,17 |
| 2657 | R2/3,0 mm | 50 mm | 2,17 |
| 2658 | R3/3,5 mm | 50 mm | 2,17 |

1/4" Schraubendreher-Einsätze für Spanner-Schrauben

Spanner Bits

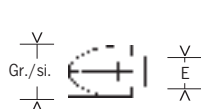

| Art.-Nr./Art.-No. | Größe/Size | Länge/Le. | E | € |
|-------------------|------------|-----------|------|------|
| 2665 | 4 mm | 25 mm | 1,52 | 1,23 |
| 2667 | 6 mm | 25 mm | 2,41 | 1,23 |
| 2668 | 8 mm | 25 mm | 3,00 | 1,23 |
| 2669 | 10 mm | 25 mm | 3,60 | 1,23 |
| 2691 | 12 mm | 25 mm | 3,81 | 1,77 |
| 2692 | 14 mm | 25 mm | 5,00 | 2,88 |

1/4" Schraubendreher-Einsätze für Clutch Schrauben

Clutch Bits



| Art.-Nr./Art.-No. | Größe/Size | Länge/Length | € |
|-------------------|------------|--------------|------|
| 3181 | 3/32 | 25 mm | 1,23 |
| 3182 | 1/8 | 25 mm | 1,23 |
| 3183 | 5/32 | 25 mm | 1,23 |
| 3184 | 3/16 | 25 mm | 1,23 |
| 3185 | 1/4 | 25 mm | 1,23 |

1/4" Schraubendreher-Einsätze für Torq-Schrauben

Torq Bits



| Art.-Nr./Art.-No. | Größe/Size | Länge/Length | € |
|-------------------|------------|--------------|------|
| 2661 | 6 mm | 25 mm | 1,23 |
| 2662 | 8 mm | 25 mm | 1,23 |
| 2663 | 10 mm | 25 mm | 1,23 |

1/4" Eindreh-Bit für Haken

Hook Driver



| Art.-Nr./Art.-No. | Größe/Size | € |
|-------------------|------------|------|
| 2690 | 1/4" | 2,17 |

1/4" Schraubendreher-Einsätze für Vielzahn Schrauben

Spline Bits



| Art.-Nr./Art.-No. | Größe/Size | Länge/Length | € |
|-------------------|------------|--------------|------|
| 3161 | M4 | 25 mm | 1,23 |
| 3162 | M5 | 25 mm | 1,23 |
| 3163 | M6 | 25 mm | 1,23 |
| 3164 | M8 | 25 mm | 1,91 |
| 3165 | M10 | 25 mm | 2,71 |

1/4" Schraubendreher-Einsätze für Tri-Wing-Schrauben

Tri-Wing Bits



| Art.-Nr./Art.-No. | Größe/Size | Länge/Length | € |
|-------------------|------------|--------------|------|
| 2671 | Nr. 1 | 25 mm | 1,23 |
| 2672 | Nr. 2 | 25 mm | 1,23 |
| 2673 | Nr. 3 | 25 mm | 1,23 |
| 2674 | Nr. 4 | 25 mm | 1,23 |

1/4" Schraubendreher-Einsätze für Assy®-Schrauben/SIT®-Bits

SIT® Bits

Spezial-Profil



| Art.-Nr./Art.-No. | Größe/Size | Länge/Length | € |
|-------------------|------------|--------------|------|
| 2890 | PW10 | 25 mm | 2,10 |
| 2891 | PW15 | 25 mm | 2,10 |
| 2892 | PW20 | 25 mm | 2,10 |
| 2893 | PW25 | 25 mm | 2,10 |
| 2894 | PW30 | 25 mm | 2,10 |
| 2895 | PW40 | 25 mm | 2,10 |

SIT® und Assy® sind eingetragene Warenzeichen der Adolf Würth GmbH / SIT® and Assy® are registered trade marks of company Adolf Würth GmbH

1/4" Schraubendreher-Einsätze für Keilzahn Schrauben

Ribe Bits



| Art.-Nr./Art.-No. | Größe/Size | Länge/Length | € |
|-------------------|------------|--------------|------|
| 3171 | M4 | 25 mm | 1,37 |
| 3172 | M5 | 25 mm | 1,37 |
| 3173 | M6 | 25 mm | 1,37 |
| 3174 | M7 | 25 mm | 1,91 |
| 3175 | M8 | 25 mm | 2,04 |

1/4" BIT-Stecknüsse, -Adapter, -Halter

1/4" Bits



Art.-Gruppe 130
Article Group 130

PROFESSIONAL PLUS STANDARD

Stecknuss Bit mit Dauermagnet Magnetic Nut Setter



| Art.-Nr./Art.-No. | Größe/Size | Länge/Length | € |
|-------------------|------------|--------------|------|
| 3783-06 | 6 mm | 45 mm | 5,88 |
| 3783-07 | 7 mm | 45 mm | 5,88 |
| 3783-08 | 8 mm | 45 mm | 5,88 |
| 3783-10 | 10 mm | 45 mm | 5,88 |
| 3783-11 | 11 mm | 45 mm | 6,36 |
| 3783-12 | 12 mm | 45 mm | 6,36 |
| 3783-13 | 13 mm | 45 mm | 6,36 |

| | | | |
|-----------|--------|-------|------|
| 3784-55 | 5,5 mm | 65 mm | 5,88 |
| 3784-06 | 6 mm | 65 mm | 5,88 |
| 3784-07 | 7 mm | 65 mm | 5,88 |
| 3784-08 | 8 mm | 65 mm | 5,88 |
| 3784-10 | 10 mm | 65 mm | 5,88 |
| 3784-11 | 11 mm | 65 mm | 6,36 |
| 3784-12 | 12 mm | 65 mm | 6,36 |
| 3784-13 | 13 mm | 65 mm | 6,36 |
| 3784-15 | 15 mm | 65 mm | 6,74 |
| 3784-16 | 16 mm | 65 mm | 6,74 |
| 3784-17 | 17 mm | 65 mm | 7,22 |
| 3784-1/4 | 1/4" | 65 mm | 5,72 |
| 3784-5/16 | 5/16" | 65 mm | 5,72 |
| 3784-3/8 | 3/8" | 65 mm | 5,72 |

Sortimente auf Seite / Sets on Page
H 184

PROFESSIONAL PLUS STANDARD

Stecknuss Bit für Edelstahlschrauben mit Haltefeder Nut Setter With Spring For Stainless Screws



| Art.-Nr./Art.-No. | Größe/Size | Länge/Length | € |
|-------------------|------------|--------------|------|
| 3785-08 | 8 mm | 45 mm | 7,35 |
| 3785-10 | 10 mm | 45 mm | 7,35 |
| 3785-1/4 | 1/4" | 45 mm | 5,65 |
| 3785-5/16 | 5/16" | 45 mm | 5,65 |
| 3785-3/8 | 3/8" | 45 mm | 5,65 |

PROFESSIONAL PLUS STANDARD

Eindrehwerkzeuge für Stockschrauben mit Innengewinde Screw Tight Tool for Setting Screws



| Art.-Nr./Art.-No. | Größe/Size | € |
|-------------------|------------|------|
| 3784-M6 | M 6 | 6,00 |
| 3784-M8 | M 8 | 6,00 |
| 3784-M10 | M10 | 6,00 |
| 3784-M12 | M12 | 6,00 |

PROFESSIONAL PLUS STANDARD

1/4" Stecknuss Bit Adapter für Nüsse Bit Adapter For Sockets



| Art.-Nr./Art.-No. | Größe/Size | Länge/Length | € |
|-------------------|-------------|--------------|------|
| 2770 | 1/4" x 1/4" | 25 mm | 1,08 |
| 2850 | 1/4" x 1/4" | 50 mm | 2,15 |
| 2862 | 1/4" x 1/4" | 100 mm | 4,27 |
| 2860 | 1/4" x 3/8" | 50 mm | 4,41 |
| 2864 | 1/4" x 3/8" | 100 mm | 8,81 |
| 2870 | 1/4" x 1/2" | 50 mm | 5,38 |

PROFESSIONAL PLUS STANDARD

1/4" Stecknuss Bit Adapter Satz, 3-tlg. 50 mm für Stecknüsse 1/4", 3/8", 1/2" Bit Adapter Set, 3 pieces 50 mm For Sockets 1/4", 3/8", 1/2"

3
tlg./pcs.



| Art.-Nr./Art.-No. | Größe/Size | Länge/Length | € |
|-------------------|-------------|--------------|-------|
| 2880 | 1/4" x 1/4" | 50 mm | |
| | 1/4" x 3/8" | 50 mm | |
| | 1/4" x 1/2" | 50 mm | |
| | | | 11,50 |

PROFESSIONAL PLUS STANDARD

Bit Halter Bit Holder



| Art.-Nr./Art.-No. | Größe/Size | € |
|-------------------|---|-------|
| 2769 | 1/4" Bit-Halter mit SDS-Aufnahme bit holder with quick release - SDS-shank | 13,00 |

PROFESSIONAL PLUS STANDARD

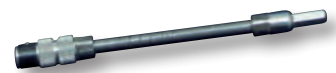

| Art.-Nr./Art.-No. | Länge/Length | € |
|-------------------|---|------|
| 107140 | Verlängerung flexibel 135 mm flexible extension bar 135 mm | 6,54 |

PROFESSIONAL PLUS STANDARD



| Art.-Nr./Art.-No. | Länge/Length | € |
|-------------------|---|------|
| 2750 | 1/4" Universal 60 mm magnetic bit holder 60 mm | 4,05 |

PROFESSIONAL PLUS STANDARD



| Art.-Nr./Art.-No. | Länge/Length | € |
|-------------------|---|------|
| 2764 | 1/4" Universal 142 mm magnetic bit holder 142 mm | 6,41 |

PROFESSIONAL PLUS STANDARD

Bit Adapter Bit Adapter



| Art.-Nr./Art.-No. | Größe/Size | € |
|-------------------|-----------------------------------|-------|
| 2760 | 1/4" Adapter für 1/4" Bits | 3,73 |
| 2761 | 3/8" Adapter für 1/4" Bits | 4,81 |
| 311516 | 1/2" Adapter für 5/16" Bits | 6,01 |
| 381214 | 1/2" Schlag-Adapter für 1/4" Bits | 15,33 |

1/4" BIT-Halter- und Antriebswerkzeuge

1/4" Bits



Art.-Gruppen 120/130/132/140
Article Groups 120/130/132/140

PROFESSIONAL PLUS STANDARD

1/4" Mini Bit Ratsche umschaltbar
1/4" Mini Bit Ratchet reversible



| Art.-Nr./Art.No. | Größe/Size | Länge/Length |
|------------------|------------|--------------|
| 4294 | 1/4" | 103 mm |
| € 19,90 | | |

Dual Umschaltknarre für Bits + Nüsse
Dual Ratchet Handle For Bits + Sockets



| Art.-Nr./Art.No. | Größe/Size | Länge/Length |
|------------------|------------|--------------|
| 4290 | 1/4" | 105 mm |
| € 22,90 | | |

10 mm Bit Ratsche umschaltbar
10 mm Bit Ratchet reversible



| Art.-Nr./Art.No. | Größe/Size | Länge/Length |
|----------------------|------------|--------------|
| 4295* | 10 mm | 138 mm |
| –¹ | | |

¹ Nicht mehr lieferbar / ¹ Out of stock

*Lieferung nur solange der Vorrat reicht / Delivery while stocks last

PROFESSIONAL PLUS STANDARD

1/4" XS Mini-Bit-Knarre, umschaltbar
1/4" Mini Ratchet Handle, Reversible



| Art.-Nr./Art.No. | Größe/Size | Länge/Length |
|------------------|------------|--------------|
| 4288 | 1/4" | 86 mm |
| € 17,90 | | |

PROFESSIONAL PLUS STANDARD

Magnetische Bit Schraubendreher für Handbetrieb 1/4"
Bit Screwdriver



| Art.-Nr./Art.No. | Größe/Size |
|---|---------------------------------|
| 2128 | 1/4" Universal, schwarzer Griff |
| <i>Magnetic Bit Screwdriver, Black Handle</i> | |
| € 10,33 | |



| Art.-Nr./Art.No. | Größe/Size |
|---------------------------------|----------------|
| 4190-01 | 1/4" Universal |
| <i>Magnetic Bit Screwdriver</i> | |
| € 11,00 | |



| Art.-Nr./Art.No. | Größe/Size |
|--------------------------------------|-----------------------------|
| 4690-02 | 1/4" mit Schnellspannfutter |
| <i>Quick Release Bit Screwdriver</i> | |
| € 19,50 | |



| Art.-Nr./Art.No. | Größe/Size |
|---|----------------------------------|
| 4190-03 | 1/4" kurz mit Schnellspannfutter |
| <i>Quick Release Bit Screwdriver, Short Version</i> | |
| € 11,65 | |

1/4" Mini Bit Ratsche umschaltbar
1/4" Mini Bit Ratchet



| Art.-Nr./Art.No. | Größe/Size | Länge/Length |
|------------------|------------|--------------|
| 2700 | 1/4" | 98 mm |
| € 8,52 | | |

PROFESSIONAL PLUS STANDARD

Bit Halter
Bit Holder

NEU/NEW



| Art.-Nr./Art.No. | Größe/Size | Länge/Length |
|---|-------------------------------------|--------------|
| 2768 | 1/4" TORSION mit Schnellspannfutter | 65 mm |
| <i>TORSION With Quick Release 65 mm</i> | | |
| € 14,20 | | |



| Art.-Nr./Art.No. | Größe/Size | Länge/Length |
|--|-----------------------------|--------------|
| 2765 | 1/4" mit Schnellspannfutter | 60 mm |
| <i>Bit Holder With Quick Release 60 mm</i> | | |
| € 9,79 | | |



| Art.-Nr./Art.No. | Größe/Size | Länge/Length |
|---|-----------------------------|--------------|
| 2766 | 1/4" mit Schnellspannfutter | 152 mm |
| <i>Bit Holder With Quick Release 152 mm</i> | | |
| € 13,00 | | |



| Art.-Nr./Art.No. | Größe/Size |
|---|-----------------------------|
| 2767 | 1/4" mit Schnellspannfutter |
| <i>Bit Holder With Quick Release 305 mm</i> | |
| € 17,25 | |

PROFESSIONAL PLUS STANDARD

1/4" Bit Halter mit Tiefeneinstellung
1/4" Bit Holder with Depth Adjustment



| Art.-Nr./Art.No. | Größe/Size |
|--|--|
| 3750 | 1/4" mit „Ring-Magnet“ und Tiefeneinstellung |
| <i>Magnetic Bit Holder with Screw-Cap and Depth Adjustment</i> | |
| € 9,05 | |

1/4" BIT-Sätze

1/4" Bit Sets

1/4"

Art.-Gruppe 131
Article Group 131

394074 PROFESSIONAL PLUS STANDARD

1/4" KOMBI BIT Box

Bit Set

1/4"

31
tlg./pcs.



| | | | |
|---|---|--|---|
| 3 | ⊖ | Schlitz/Slotted | 4 - 5.5 - 6.5 mm |
| 5 | ⊕ | Phillips/PH | PH 1 - PH 1 - PH 2 - PH 2 - PH 3 |
| 5 | ⊕ | Pozidriv/PZ | PZ 1 - PZ 1 - PZ 2 - PZ 2 - PZ 3 |
| 9 | ⊗ | TORX®/TX | T8 - 9 - 10 - 15 - 20 - 25 - 27 - 30 - 40 |
| 8 | ⦿ | Innensechskant/Hex | 2 - 2,5 - 3 - 4 - 5 - 6 - 7 - 8 mm |
| 1 | | Magnethalter mit Schnellspannfutter, 60 mm | |

| Art.-Nr./Art.-No. | G/S | tlg./pcs. | B | L | H |
|-----------------------------|------|-----------|-----|-----|----|
| 394074 | 1/4" | 31 | 105 | 65 | 41 |
| € 26,55 | | | | | |
| 39407412 | 1/4" | 12 x 31 | 323 | 277 | 72 |
| Display mit 12 Boxen 394074 | | | | | |
| € 302,50 | | | | | |

394075 PROFESSIONAL PLUS STANDARD

1/4" KOMBI BIT Box

Bit Set

1/4"

31
tlg./pcs.



| | | | |
|---|---|--|------------------------------------|
| 3 | ⊖ | Schlitz/Slotted | 4 - 5.5 - 6.5 mm |
| 5 | ⊕ | Phillips/PH | PH 1 - PH 1 - PH 2 - PH 2 - PH 3 |
| 5 | ⊕ | Pozidriv/PZ | PZ 1 - PZ 1 - PZ 2 - PZ 2 - PZ 3 |
| 9 | ⊗ | TORX® mit Bohrung/TX | T8 - 9 - 10 - 15 - 20 - |
| | | Tamper TX | 25 - 27 - 30 |
| 8 | ⦿ | Innensechskant/Hex | 2 - 2,5 - 3 - 4 - 5 - 6 - 7 - 8 mm |
| 1 | | Magnethalter mit Schnellspannfutter, 60 mm | |

| Art.-Nr./Art.-No. | G/S | tlg./pcs. | B | L | H |
|-----------------------------|------|-----------|-----|-----|----|
| 394075 | 1/4" | 31 | 105 | 65 | 41 |
| € 27,60 | | | | | |
| 39407512 | 1/4" | 12 x 31 | 323 | 277 | 72 |
| Display mit 12 Boxen 394075 | | | | | |
| € 313,00 | | | | | |

4085 PROFESSIONAL PLUS STANDARD

1/4" Allround-Bit Box, 22-teilig

Allround-Bit Set, 22 pieces

1/4"

22
tlg./pcs.



| | | | |
|---|---|-----------------|---------------------------------------|
| 3 | ⊖ | Schlitz/Slotted | 4,5 - 5,5 - 6,5 mm |
| 2 | ⊕ | Phillips/PH | PH 1 - PH 2 |
| 3 | ⊕ | Pozidriv/PZ | PZ 1 - PZ 2 - PZ 3 |
| 8 | ⊗ | TORX®/TX | T8 - 10 - 15 - 20 - 25 - 27 - 30 - 40 |
| 4 | ⦿ | Stecknuss Bit | 7 - 8 - 10 - 11 mm |
| 1 | | Magnethalter | |
| 1 | | Bit Adapter | 1/4" x 1/4" |

| Art.-Nr./Art.-No. | G./S. | tlg./pcs. | B | L | H |
|-------------------|-------|-----------|-----|----|----|
| 4085 | 1/4" | 22 | 115 | 95 | 32 |
| € 32,60 | | | | | |

Bits aus S2-Stahl

Größe/Size: 1/4" · tlg./pcs.: 22 · BxLxH/WxLxH: 115x95x32 mm

Gewicht/Weight: 280 g

1/4" + 5/16" BIT-Sätze

1/4" + 5/16" Bit Sets



Art.-Gruppe 131
Article Group 131

4092

PROFESSIONAL PLUS STANDARD

1/4" + 5/16" Kombi-Bit-Box, inkl. GearTech Doppelringschlüssel

1/4" + 5/16" Combi Bit Set,
incl. GearTech Bit Double Ring Wrench

1/4"

5/16"

32
tlg./pcs.



3914516

PROFESSIONAL PLUS STANDARD

1/4" + 5/16" GearTech Bit-Doppelringschlüssel

1/4" + 5/16" GearTech Bit Double Ring Wrench

GearTech

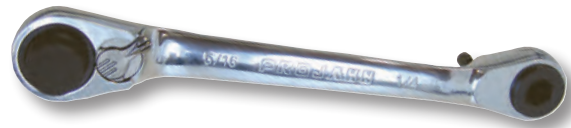

Umschaltbar, ergonomisch gebogen/reversible, ergonomically curved

| | | | | |
|---|---|--------------------|-------------------------------|-------|
| 3 | ☉ | Schlitz/Slotted | 4 - 5,5 - 6,5 mm | 1/4" |
| 2 | ⊕ | Phillips/PH | PH 1 - PH 2 | |
| 2 | ⊕ | Pozidriv/PZ | PZ 1 - PZ 2 | |
| 6 | ⊗ | TORX®/TX | TX8 - 10 - 15 - 20 - 25 - 27 | |
| 4 | ⊙ | Innensechskant/Hex | 3 - 4 - 5 - 6 mm | |
| 2 | ☉ | Schlitz/Slotted | 8 - 10 mm | 5/16" |
| 2 | ⊕ | Phillips/PH | PH 3 - PH 4 | |
| 2 | ⊕ | Pozidriv/PZ | PZ 3 - PZ 4 | |
| 6 | ⊗ | TORX®/TX | TX30 - 40 - 45 - 50 - 55 - 60 | |
| 2 | ⊙ | Innensechskant/Hex | 7 - 8 mm | |

1 GearTech Doppelringschlüssel 1/4" + 5/16"

| Art.-Nr./Art.-No. | G./S. | tlg./pcs. | B | L | H |
|-------------------|--------------|---------------------------------------|----------------|----|----|
| 4092 | 1/4" + 5/16" | 32 | 135 | 85 | 33 |
| | | | € 62,90 | | |
| 3914516 | 1/4" + 5/16" | GearTech Doppelringschlüssel (125 mm) | | | |
| | | | € 26,00 | | |

4193

PROFESSIONAL PLUS STANDARD

1/4" Stubby- Ratschenschraubendreher

1/4" Stubby Ratchet Screw Driver

1/4"

8
tlg./pcs.



235 x 185 x 120 mm
Höhe geöffnet/height open: 265 mm
Art. 419312

Display mit /with 12x 4193

| Art.-Nr./Art.-No. | G./S. | tlg./pcs | B | L | H |
|-----------------------|-------|----------|-----------------|--------|--------|
| 4193 | 1/4" | 8 | 95 mm | 38 mm | 38 mm |
| | | | € 11,40 | | |
| 419312 | 1/4" | 12 x 8 | 235 mm | 185 mm | 120 mm |
| Display mit 12 x 4193 | | | € 133,00 | | |

| | | | |
|---|---|--------------------------------|----------|
| 1 | ☉ | Schlitz/Slotted | 5,5 mm |
| 2 | ⊕ | Phillips/PH | PH 1 - 2 |
| 2 | ⊕ | Pozidriv/PZ | PZ 1 - 2 |
| 2 | ⊗ | TORX®/TX | T20 - 25 |
| 1 | | Stubby-Ratschenschraubendreher | |

1/4" BIT-Sätze

1/4" Bit Sets



Art.-Gruppe 131
Article Group 131

394089 PROFESSIONAL PLUS STANDARD

1/4" Color-Bit-Box, 32-teilig

1/4" Color Bit Set, 32 pieces



32
tlg./pcs.



394087 PROFESSIONAL PLUS STANDARD

NEU/NEW

1/4" TORSION Color-Bit-Box, 32-teilig

1/4" TORSION Color Bit Set, 32 pieces



32
tlg./pcs.



- 2 Schlitz/Slotted (rot/red) 4 - 5 mm
- 4 Phillips/PH (dunkelrot/dark red) PH 1 - 2 - 2 - 3
- 4 Pozidriv/PZ (blau/blue) PZ 1 - 2 - 2 - 3
- 7 TORX®/TX (gelb/yellow) TX10-15-20-25-27-30-40
- 7 TORX® mit Bo./Tamper TX (violett) TX10-15-20-25-27-30-40
- 6 Innensechskant/Hex (orange) 2 - 2,5 - 3 - 4 - 5 - 6 mm
- 1 Stecknuss Bit Adapter 1/4" x 1/4", 25 mm
- 1 Magnethalter mit Schnellspannfutter, 60 mm

- 2 Schlitz/Slotted (rot/red) 4 - 5 mm
- 4 Phillips/PH (dunkelrot/dark red) PH 1 - 2 - 2 - 3
- 4 Pozidriv/PZ (blau/blue) PZ 1 - 2 - 2 - 3
- 7 TORX®/TX (gelb/yellow) TX10-15-20-25-27-30-40
- 7 TORX® mit Bo./Tamper TX (violett) TX10-15-20-25-27-30-40
- 6 Innensechskant/Hex (orange) 2 - 2,5 - 3 - 4 - 5 - 6 mm
- 1 Stecknuss Bit Adapter 1/4" x 1/4", 25 mm
- 1 Magnethalter mit Schnellspannfutter, 60 mm

| Art.-Nr./Art.-No. | G./S. | tlg./pcs | B | L | H |
|-----------------------------|-------|----------|-----|-----|----|
| 394089 | 1/4" | 32 | 95 | 65 | 40 |
| € 32,50 | | | | | |
| 39408912 | 1/4" | 12 x 32 | 356 | 270 | 72 |
| Display mit 12 Boxen 394089 | | | | | |
| € 362,00 | | | | | |

| Art.-Nr./Art.-No. | G./S. | tlg./pcs | B | L | H |
|-----------------------------|-------|----------|-----|-----|----|
| 394087 | 1/4" | 32 | 95 | 65 | 40 |
| € 35,60 | | | | | |
| 39408712 | 1/4" | 12 x 32 | 356 | 270 | 72 |
| Display mit 12 Boxen 394087 | | | | | |
| € 393,00 | | | | | |

Praktische Kunststoff-Kassette mit Klarsichtdeckel. Passt bequem in jede Werkzeugtasche. Farbige markierte Bits erleichtern das Suchen der richtigen Größe.

Convenient plastic cases with transparent top cover. Best for every kind of tool bag. Very easy to find the right size, because of colored bits.



356 x 270 x 72 mm
Höhe geöffnet/height open: 340 mm
Art. 39408912
Display mit /with 12x 394089

Praktische Kunststoff-Kassette mit Klarsichtdeckel. Passt bequem in jede Werkzeugtasche. Farbige markierte Bits erleichtern das Suchen der richtigen Größe.

Convenient plastic cases with transparent top cover. Best for every kind of tool bag. Very easy to find the right size, because of colored bits.



Bithalter auf Seite / Bit Holder on Page
H 172

356 x 270 x 72 mm
Höhe geöffnet/height open: 340 mm
Art. 39408712
Display mit /with 12x 394087

1/4" BIT-Sätze

1/4" Bit Sets



Art-Gruppe 132
Article Group 132

4091 PROFESSIONAL PLUS STANDARD

1/4" Color-Bit-Box, 15-teilig
1/4" Color Bit Set, 15 pieces

1/4"
15
tlg./pcs.

Praktische Kunststoff-Kassette mit automatisch aufklappbarem Klarsichtdeckel. Passt bequem in jede Werkzeugtasche. Farblich markierte Bits erleichtern das Suchen der richtigen Größe.

Convenient plastic cases with automatically opening transparent lid. Best for every kind of tool bag. Very easy to find the right size, because of colored bits.



4095 PROFESSIONAL PLUS STANDARD

1/4" Color-Bit-Box mit Mini-Bit-Knarre
Color Bit Set With Mini-Ratchet-Handle

1/4"
33
tlg./pcs.



- 2 Schlitz/Slotted (rot/red) 4 - 6 mm
- 2 Phillips/PH (dunkelrot/dark red) PH 1 - PH 2
- 2 Pozidriv/PZ (blau/blue) PZ 1 - PZ 2
- 5 TORX®/TX (gelb/yellow) T10 - 15 - 20 - 25 - 30
- 3 Innensechskant/Hex (orange) 3 - 4 - 5 mm
- 1 Bit Magnethalter 60 mm

- 2 Schlitz/Slotted (rot/red) 4 - 5 mm
- 4 Phillips/PH (dunkelrot/dark red) PH 1 - 2 - 2 - 3
- 4 Pozidriv/PZ (blau/blue) PZ 1 - 2 - 2 - 3
- 6 Innensechskant (orange) 2 - 2,5 - 3 - 4 - 5 - 6 mm
- 7 TORX®/TX (gelb/yellow) T10 - 15 - 20 - 25 - 27 - 30 - 40
- 7 TORX® mit Bo./Tamper TX (violett) T10 - 15 - 20 - 25 - 27 - 30 - 40
- 1 Stecknuss Bit Adapter 25 mm
- 1 Bit Magnethalter 60 mm
- 1 XS Mini-Bit-Knarre (Art-Nr. 4288)

| Art.-Nr./Art.-No. | G./S. | tlg./pcs | B | L | H |
|---------------------------|-------|----------|-----|-----|-----|
| 4091 | 1/4" | 15 | 50 | 95 | 30 |
| € 19,40 | | | | | |
| 409124 | 1/4" | 24 x 15 | 315 | 320 | 100 |
| Display mit 24 Boxen 4091 | | | | | |
| € 443,00 | | | | | |

| Art.-Nr./Art.-No. | G./S. | tlg./pcs | B | L | H |
|---------------------------|-------|----------|-----|-----|----|
| 4095 | 1/4" | 33 | 125 | 70 | 35 |
| € 45,90 | | | | | |
| 409512 | 1/4" | 12 x 33 | 333 | 313 | 84 |
| Display mit 12 Boxen 4095 | | | | | |
| € 524,00 | | | | | |



315 x 320 x 100 mm
Höhe geöffnet/height open: 320 mm
Art. 409124
Display mit /with 24x 4091



310 x 333 x 84 mm
Höhe geöffnet/height open: 307 mm
Art. 409512
Display mit /with 12x 4095

1/4" BIT-Sätze

1/4" Bit Sets



Art-Gruppe 132
Article Group 132

4093 PROFESSIONAL PLUS STANDARD

1/4" Color-Bit-Box 75 mm, 18-teilig

Color Bit Set 75 mm, 18 pieces



18
tlg./pcs.



- 2 Schlitz/Slotted (rot/red) 4 - 6 mm
- 3 Phillips/PH (dunkelrot/dark red) PH 1 - 2 - 3
- 3 Pozidriv/PZ (blau/blue) PZ 1 - 2 - 3
- 3 Innensechskant (orange) 3 - 4 - 5 mm
- 7 TORX®/TX (gelb/yellow) T10 - 15 - 20 - 25 - 27 - 30 - 40

| Art.-Nr./Art.-No. | G./S. | tlg./pcs | B | L | H |
|--------------------------|-------|----------|-----|-----|-----|
| 4093 | 1/4" | 18 | 155 | 120 | 35 |
| € 42,50 | | | | | |
| 409306 | 1/4" | 6 x 18 | 180 | 275 | 120 |
| Display mit 6 Boxen 4093 | | | | | |
| € 246,00 | | | | | |

Farbig markierte Bits erleichtern das Suchen des richtigen Bits.

Very easy to find the right size, because of colored bits.



375 x 185 x 120 mm
Höhe geöffnet/height open: 270 mm
Art. 409306
Display mit /with 6x 4093

4090 PROFESSIONAL PLUS STANDARD

1/4" Color-Bit-Box XL

Color Bit Set „Color BIT Box XL“



71
tlg./pcs.



- 25 mm
- 6 Schlitz/Slotted (rot/red) 3x 4 mm / 3x 6 mm
- 12 Phillips/PH (dunkelrot/dark red) 3x PH 1 / 6x PH 2 / 3x PH 3
- 12 Pozidriv/PZ (blau/blue) 3x PZ 1 / 6x PZ 2 / 3x PZ 3
- 9 Innensechskant (orange) 3x 4 mm / 3x 5 mm / 3x 6 mm
- 21 TORX®/TX (gelb/yellow) 3x TX10 / 15 / 20 / 25 / 27 / 30 / 40

- 75 mm
- 2 Schlitz/Slotted (rot/red) 1x 4 mm / 1x 6 mm
- 3 Phillips/PH (dunkelrot/dark red) 1x PH 1 / 1x PH 2 / 1x PH 3
- 2 Pozidriv/PZ (blau/blue) 1x PZ 1 / 1x PZ 2
- 2 TORX®/TX (gelb/yellow) 1x TX20 / TX25

- 1 Bit Magnethalter
- 1 Bit Halter mit Schnellspannfutter

| Art.-Nr./Art.-No. | G./S. | tlg./pcs | B | L | H |
|--------------------------|-------|----------|-----|-----|-----|
| 4090 | 1/4" | 71 | 155 | 120 | 35 |
| € 79,80 | | | | | |
| 409006 | 1/4" | 6 x 71 | 185 | 375 | 120 |
| Display mit 6 Boxen 4090 | | | | | |
| € 463,00 | | | | | |



375 x 185 x 120 mm
Höhe geöffnet/height open: 270 mm
Art. 409006
Display mit /with 6x 4090

1/4" BIT-Sätze

1/4" Bit Sets



Art.-Gruppe 132
Article Group 132

4094 PROFESSIONAL PLUS STANDARD

1/4" Color-Bit-Box 25 + 75 mm
Color Bit Set 25 + 75 mm

1/4"
56
tlg./pcs.



4097 PROFESSIONAL PLUS STANDARD

Verbesserte Ausführung /
Improved Quality

1/4" Universal Color-Bit-Box mit Ratschenschraubendreher
Universal Color Bit Set with Ratchet Screwdriver

1/4"
60
tlg./pcs.



25 mm

- 6 Schlitz/Slotted (rot/red) 1x 4 - 5 - 6 mm
- 9 Phillips (dunkelrot/dark red) 3x PH 1 - 2 - 3
- 9 Pozidriv (blau/blue) 3x PZ 1 - 2 - 3
- 14 TORX® (gelb/yellow) 2x TX10-15-20-25-27-30-40
- 7 TORX® mit Loch (violett) 1x TX10-15-20-25-27-30-40
- 3 Innensechskant/Hex. (orange) 1x 2 - 2.5 - 3 - 4 - 5 - 6 mm

75 mm

- 1 Schlitz/Slotted (rot/red) 1x 6 mm
- 3 Phillips (dunkelrot/dark red) 1x PH 1 - 2 - 3
- 3 Pozidriv (blau/blue) 1x PZ 1 - 2 - 3
- 1 Bit Halter mit Schnellspannfutter/
Magnetic bit holder with quick release

25 mm

- 2 Schlitz/Slotted (rot/red) 4 - 5 mm
- 4 Phillips (dunkelrot/dark red) PH 1 - 2 - 2 - 3
- 4 Pozidriv (blau/blue) PZ 1 - 2 - 2 - 3
- 6 TORX® (gelb/yellow) TX10-15-20-25-30-40
- 6 TORX® mit Loch (violett) TX10-15-20-25-30-40
- 6 Innensechskant (orange) 2 - 2,5 - 3 - 4 - 5 - 6 mm
- 10 magn. Stecknuss-Bits (orange) 5 - 5,5 - 6 - 7 - 8 - 9 - 10 - 11 - 12 - 13 mm
- 1 Stecknuss-Bit (blau/blue) 4 mm

75 mm

- 2 Phillips (dunkelrot/dark red) PH 1 - 2
- 2 Pozidriv (blau/blue) PZ 1 - 2
- 3 TORX® (gelb/yellow) TX15 - 20 - 25
- 2 Innensechskant (orange) 4 - 5 mm
- 1 Bit-Halter mit Schnellspannfutter/
Magnetic bit holder with quick release
- 1 Ratschenschraubendreher inkl. 10 Color-Bits/
Ratchet Screwdriver incl. 10 Color-Bits (Art-Nr. 4192)
- 2 Schlitz/Slotted (rot/red) 4 - 6 mm
- 2 Phillips (dunkelrot/dark red) PH 1 - 2
- 2 Pozidriv (blau/blue) PZ 1 - 2
- 2 TORX® (gelb/yellow) TX20 - 25
- 2 Innensechskant/Hex. (orange) 3 - 5 mm

| Art.-Nr./Art.-No. | G./S. | tlg./pcs | B | L | H |
|-------------------|-------|----------|-----|----|----------------|
| 4094 | 1/4" | 56 | 127 | 95 | 34 |
| | | | | | € 68,00 |

| Art.-Nr./Art.-No. | G./S. | tlg./pcs | B | L | H |
|-------------------|-------|---|-----|-----|-----------------|
| 4097 | 1/4" | 60 | 268 | 187 | 60 |
| | | | | | € 95,00 |
| 4192 | 1/4" | 1/4" Ratschenschraubendreher inkl. 10 Color-Bits/ 1/4" Ratchet Screwdriver incl. 10 Color-Bits | | | € 36,50 |
| 419212 | 1/4" | 12 x 11 | 160 | 215 | 245 |
| | | | | | € 412,00 |

1/4" BIT-Sätze

1/4" Bit Sets

1/4"

Art-Gruppen 132/133
Article Groups 132/133

394073*

PROFESSIONAL PLUS STANDARD

1/4" Bit-Box mit Drehgriffknarre, 33-tlg.

1/4" Bit Set with Twist Handle Ratchet, 33 pcs.

1/4"
33
tlg./pcs.



Bit-Drehknarre: Ideal für das Arbeiten an extrem unzugänglichen Stellen

Bit twist ratchet: Ideal for working on extremely narrow spaces

25 mm

| | | | | |
|----|--|----------------------------------|--------------------------------|--|
| 1 | | Schlitz/Slotted (rot/red) | 4 mm | |
| 3 | | Phillips/PH (dunkelrot/dark red) | PH1 - 2 - 3 | |
| 3 | | Pozidriv/PZ (blau/blue) | PZ1 - 2 - 3 | |
| 3 | | TORX®/TX (gelb/yellow) | TX15 - 20 - 25 | |
| 3 | | Innensechskant/Hex (orange) | 3 - 4 - 5 mm | |
| 11 | | Stecknuss-Bits | 4-5-5,5-6-7-8-9-10-11-12-13 mm | |
| 2 | | Adapter | 1/4"x1/4" + 1/4"x3/8" | |

50 mm

| | | | | |
|---|--|---|-----------|--|
| 2 | | Phillips/PH (dunkelrot/dark red) | PH1 - 2 | |
| 2 | | TORX®/TX (gelb/yellow) | TX10 - 20 | |
| 2 | | Innensechskant/Hex (orange) | 4 - 6 mm | |
| 1 | | 1/4" Bit-Drehgriffknarre/Twist handle ratchet | | |

| Art.-Nr./Art.-No. | G./S. | tlg./pcs | B | L | H |
|-------------------|-------|----------|-----|-----|----|
| 394073* | 1/4" | 33 | 200 | 120 | 40 |

€ 79,00

*Lieferung nur solange der Vorrat reicht / Delivery while stocks last



1/4" BIT-Sätze

1/4" Bit Sets



Art.-Gruppen 132/133
Article Groups 132/133

3790 PROFESSIONAL PLUS STANDARD

1/4" SECURIBIT-Box 75 mm 50-teilig

SECURIBIT-Set 75 mm, 50 pieces



50
tlg./pcs.



3788 PROFESSIONAL PLUS STANDARD

1/4" Bit Box 75 mm, 36-teilig

Bit Set, 36 pieces



36
tlg./pcs.



| | | | |
|---|---|---|---|
| 3 | ☯ | Schlitz/Slotted | 4 - 5 - 6 mm |
| 2 | ⊕ | Phillips/PH | PH 1 - 2 |
| 2 | ⊕ | Pozidriv/PZ | PZ 1 - 2 |
| 3 | ⊙ | Innensechskant/Hex | 4 - 5 - 6 mm |
| 6 | ⊙ | Innensechskant mit Bohrung/ Tamper Hex | 2 - 2,5 - 3 - 4 - 5 - 6 mm |
| 5 | ⊗ | TORX®/TX | T10 - 15 - 20 - 25 - 30 |
| 9 | ⊗ | TORX® mit Bohrung/ Tamper TX | T8 - 10 - 15 - 20 - 25 - 27 - 30 - 35 - 40 |
| 2 | □ | Robertson | Nr. 1 - 2 |
| 3 | ⊕ | Torg | 6 - 8 - 10 mm |
| 4 | ⊕ | Tri-Wing | Nr. 1 - 2 - 3 - 4 |
| 4 | ⊕ | Spanner | 4 - 6 - 8 - 10 mm |
| 3 | ⊕ | Clutch | Nr. 1 - 2 - 3 |
| 1 | | Magnethalter | |

Bits aus CRV-Stahl · Gewicht/Weight: 900 g

| Art.-Nr./Art.No. | G./S. | tlg./pcs | B | L | H |
|------------------|-------|----------|-----|-----|----|
| 3790 | 1/4" | 50 | 193 | 137 | 36 |
| € 38,80 | | | | | |

| | | | |
|---|---|-------------------------|--|
| 4 | ☯ | Schlitz/Slotted | 3 - 4 - 5 - 6 mm |
| 5 | ⊕ | Phillips/PH | 2 x PH 1 - 2, 1 x PH 3 |
| 5 | ⊕ | Pozidriv/PZ | 2 x PZ 1 - 2, 1 x PZ 3 |
| 7 | ⊗ | TORX®/TX | T10 - 15 - 20 - 25 - 27 - 30 - 40 |
| 8 | ⊗ | TORX® mit Bo./Tamper TX | T8 - 10 - 15 - 20 - 25 - 27 - 30 - 40 |
| 6 | ⊙ | Innensechskant/Hex | 2 - 2,5 - 3 - 4 - 5 - 6 mm |
| 1 | | Magnethalter | |

Bits aus CRV-Stahl · Gewicht/Weight: 720 g

| Art.-Nr./Art.No. | G./S. | tlg./pcs | B | L | H |
|------------------|-------|----------|-----|-----|----|
| 3788 | 1/4" | 36 | 190 | 130 | 36 |
| € 29,90 | | | | | |

1/4" BIT-Sätze

1/4" Bit Sets



Art.-Gruppe 133
Article Group 133

3789

PROFESSIONAL PLUS STANDARD

1/4" SECURIBIT Box

„zu jeder Schraube den richtigen Bit“

SECURIBIT Set „for every screw the right bit“



122
tlg./pcs.



3787

PROFESSIONAL PLUS STANDARD

1/4" SECURIBIT Box

„zu jeder Schraube den richtigen Bit“

SECURIBIT Set „for every screw the right bit“



100
tlg./pcs.



| | | | |
|----|---|--|---|
| 9 | ⊖ | Schlitz/Slotted | 3 - 4 - 4,5 - 5 - 5,5 - 6 - 6,5 - 7 - 8 |
| 5 | ⊕ | Phillips/PH | PH 00 - 0 - 1 - 2 - 3 |
| 5 | ⊕ | Pozidriv | PZ 00 - 0 - 1 - 2 - 3 |
| 9 | ⊙ | Innensechskant/Hex | 1,5 - 2 - 2,5 - 3 - 4 - 5 - 5,5 - 6 - 8 mm |
| 10 | ⊙ | Innensechskant/Hex | 1/16" - 5/64" - 3/32" - 7/64" - 1/8" - 9/64" - 5/32" - 3/16" - 7/32" - 1/4" |
| 6 | ⊙ | Innensechskant mit Bohrung | 2 - 2,5 - 3 - 4 - 5 - 6 mm |
| 9 | ⊙ | 5-Stern mit Bohrung | TS10 - 15 - 20 - 25 - 27 - 30 - 40 - 45 - 50 |
| 13 | ⊙ | TORX®/TX | T5 - 6 - 7 - 8 - 9 - 10 - 15 - 20 - 25 - 27 - 30 - 40 - 45 |
| 9 | ⊙ | TORX® mit Bohrung/ Tamper TX | T8 - 10 - 15 - 20 - 25 - 27 - 30 - 35 - 40 |
| 4 | □ | Robertson | Nr. 0 - 1 - 2 - 3 |
| 3 | ⊕ | Torg | 6 - 8 - 10 mm |
| 4 | ⊕ | Tri-Wing | Nr. 1 - 2 - 3 - 4 |
| 4 | ⊙ | Spanner | 4 - 6 - 8 - 10 mm |
| 3 | ⊙ | Clutch | Nr. 1 - 2 - 3 |
| 3 | ⊙ | Vielzahn | M5 - 6 - 8 |
| 10 | ⊙ | Stecknuss Bit | 4 - 5 - 6 - 7 - 8 - 9 - 10 - 11 - 12 - 13 mm |
| 10 | ⊙ | Stecknuss Bit | 5/32" - 3/16" - 7/32" - 1/4" - 9/32" - 5/16" - 11/32" - 3/8" - 7/16" - 1/2" |
| 1 | | Eindreh-Bit für Haken | |
| 1 | | Magnethalter | |
| 1 | | Universal Bit- Schraubendreher mit Dauermagnet | |
| 1 | | Bit Adapter | 1/4" x 1/4" |
| 2 | | Stecknuss Adapter | 25 + 50 mm |

Bits aus CRV-Stahl · Gewicht/Weight: 1.160 g

| Art.-Nr./Art.-No. | G./S. | tlg./pcs | B | L | H |
|-------------------|-------|----------|-----|-----|----|
| 3789 | 1/4" | 122 | 220 | 155 | 50 |

€ 44,60

| | | | |
|----|---|---------------------------------|---|
| 9 | ⊖ | Schlitz/Slotted | 3 - 4 - 4,5 - 5 - 5,5 - 6 - 6,5 - 7 - 8 |
| 8 | ⊕ | Phillips/PH | PH 0 - 1 - 3, 5 x PH 2 |
| 8 | ⊕ | Pozidriv | PZ 0 - 1 - 3, 5 x PZ 2 |
| 9 | ⊙ | Innensechskant/Hex | 1,5 - 2 - 2,5 - 3 - 4 - 5,5 - 6 - 8 mm |
| 10 | ⊙ | Innensechskant/Hex | 1/16" - 5/64" - 3/32" - 7/64" - 1/8" - 9/64" - 5/32" - 3/16" - 7/32" - 1/4" |
| 6 | ⊙ | Innensechskant mit Bohrung | 2 - 2,5 - 3 - 4 - 5 - 6 mm |
| 6 | ⊙ | Innensechskant mit Bohrung | 5/64" - 3/32" - 7/64" - 1/8" - 9/64" - 5/32" |
| 9 | ⊙ | TORX®/TX | T8 - 10 - 15 - 20 - 25 - 27 - 30 - 35 - 40 |
| 9 | ⊙ | TORX® mit Bohrung/ Tamper TX | T8 - 10 - 15 - 20 - 25 - 27 - 30 - 35 - 40 |
| 4 | □ | Robertson | Nr. 0 - 1 - 2 - 3 |
| 3 | ⊕ | Torg | 6 - 8 - 10 mm |
| 4 | ⊕ | Tri-Wing | Nr. 1 - 2 - 3 - 4 |
| 4 | ⊙ | Spanner | 4 - 6 - 8 - 10 mm |
| 3 | ⊙ | Clutch | Nr. 1 - 2 - 3 |
| 3 | ⊙ | Vielzahn | M5 - 6 - 8 |
| 1 | | Eindreh-Bit für Haken | |
| 1 | | Magnethalter | |
| 1 | | Bit Adapter | 1/4" x 1/4" |
| 2 | | Stecknuss Adapter | 25 + 50 mm |

Bits aus CRV-Stahl · Gewicht/Weight: 700 g

| Art.-Nr./Art.-No. | G./S. | tlg./pcs | B | L | H |
|-------------------|-------|----------|-----|-----|----|
| 3787 | 1/4" | 100 | 190 | 130 | 36 |

€ 24,10

1/4" BIT-Sätze

1/4" Bit Sets



Art.-Gruppe 133
Article Group 133

8604

1/4" Bit Box XL, 113-teilig

Bit Set „BIT Box XL“ with 113 pieces



113
tlg./pcs.



25 mm

| | | | |
|----|---|-----------------------------|--|
| 7 | ☉ | Schlitz/Slotted | 4 - 4 - 4 - 6 - 6 - 6 - 6 mm |
| 14 | ⊕ | Phillips/PH | 4x PH 1 - 7x PH 2 - 3x PH 3 |
| 14 | ⊕ | Pozidriv/PZ | 4x PZ 1 - 7x PZ 2 - 3x PZ 3 |
| 7 | ⊙ | Innensechskant/Hex | 4 - 4 - 5 - 5 - 5 - 6 - 6 mm |
| 49 | ⊗ | TORX®/TX | 7x TX10 - 15 - 20 - 25 - 27 - 30 - 40 |
| 7 | ⊗ | TORX® mit Bo./ Tamper TX | TX10 - 15 - 20 - 25 - 27 - 30 - 40 |

75 mm

| | | | |
|---|---|-----------------------------------|---------------------------|
| 4 | ⊕ | Phillips/PH | PH 1 - PH 2 - PH 2 - PH 3 |
| 4 | ⊕ | Pozidriv/PZ | PZ 1 - PZ 2 - PZ 2 - PZ 3 |
| 5 | ⊗ | TORX®/TX | TX10 - 15 - 20 - 25 - 30 |
| 1 | | Bit Magnethalter | |
| 1 | | Bit Halter mit Schnellspannfutter | |

Bits aus CRV-Stahl

Größe/Size: 1/4" · tlg./pcs 113 · BxLxH/WxLxH: 120x205x45 mm

Gewicht/Weight: 1.120 g

| Art.-Nr./Art.-No. | G./S. | tlg./pcs | B | L | H |
|-------------------|-------|----------|-----|-----|----------------|
| 8604 | 1/4" | 113 | 205 | 120 | 45 |
| | | | | | € 58,95 |

1/4" BIT-Sätze

1/4" Bit Sets

1/4"

Art.-Gruppe 133
Article Group 133**8606****1/4" Bit-Box XXL, 200-teilig**
„zu jeder Schraube den richtigen Bit“Bit Box XXL 200 pieces
„for every screw the right bit“

1/4"

200
tlg./pcs.**25 mm**

| | | | |
|----|---|----------------------------|---|
| 12 | ☉ | Schlitz/Slotted | 2 - 2,5 - 3 - 3,5 - 4 - 4,5 - 5 - 5,5 - 6 - 6,5 - 7 - 8 mm |
| 18 | ⊕ | Phillips/PH | 1x PH 00 - 1x PH 0 - 5x PH 1 - 5x PH 2 - 5x PH 3 - 1x PH 4 |
| 17 | ⊕ | Pozidriv/PZ | 1x PZ 00 - 1x PZ 0 - 5x PZ 1 - 5x PZ 2 - 4x PZ 3 - 1x PZ 4 |
| 12 | ⊙ | Innensechskant/Hex | 1,5 - 2 - 2,5 - 3 - 3,5 - 4 - 4,5 - 5 - 5,5 - 6 - 7 - 8 mm |
| 10 | ⊙ | Innensechskant/Hex | 1/16" - 5/64" - 3/32" - 7/64" - 1/8" - 9/64" - 5/32" - 3/16" - 7/32" - 1/4" |
| 6 | ⊙ | Innensechskant mit Bohrung | 2 - 2,5 - 3 - 4 - 5 - 6 mm |
| 6 | ⊙ | Innensechskant mit Bohrung | 5/64" - 3/32" - 7/64" - 1/8" - 9/64" - 5/32" |
| 9 | ⊗ | 5-Stern mit Bohrung | TS10 - 15 - 20 - 25 - 27 - 30 - 40 - 45 - 50 |
| 13 | ⊗ | TORX®/TX | T5 - 6 - 7 - 8 - 9 - 10 - 15 - 20 - 25 - 27 - 30 - 40 - 45 |
| 14 | ⊗ | TORX® mit Bo./Tamper TX | T5 - 6 - 7 - 8 - 9 - 10 - 15 - 20 - 25 - 27 - 30 - 35 - 40 - 45 |
| 4 | ⊠ | Robertson | Nr. 0 - 1 - 2 - 3 |
| 3 | ⊕ | Torq | 6 - 8 - 10 mm |
| 4 | ⊖ | Tri-Wing | Nr. 1 - 2 - 3 - 4 |
| 4 | ⊗ | Spanner | 4 - 6 - 8 - 10 mm |
| 3 | ⊙ | Clutch | Nr. 1 - 2 - 3 |
| 3 | ⊙ | Vielzahn | M5 - 6 - 8 |

50 mm

| | | | |
|---|---|----------------------------------|-----------------------------------|
| 2 | ⊕ | Phillips/PH | PH 2 - 3 |
| 2 | ⊕ | Pozidriv/PZ | PZ 2 - 3 |
| 4 | ⊙ | Innensechskant/Hex | 3 - 4 - 5 - 6 mm |
| 7 | ⊗ | TORX® mit Bohrung/ /Tamper TX | T10 - 15 - 20 - 25 - 27 - 30 - 40 |
| 3 | ⊕ | Torq | 6 - 8 - 10 mm |
| 4 | ⊖ | Tri-Wing | Nr. 1 - 2 - 3 - 4 |
| 4 | ⊗ | Spanner | 4 - 6 - 8 - 10 mm |

75 mm

| | | | |
|---|---|----------------------------------|-----------------------------------|
| 2 | ⊕ | Phillips/PH | PH 2 - 3 |
| 4 | ⊙ | Innensechskant/Hex | 3 - 4 - 5 - 6 mm |
| 7 | ⊗ | TORX® mit Bohrung/ /Tamper TX | T10 - 15 - 20 - 25 - 27 - 30 - 40 |

38 mm

| | | | |
|----|--|---|---|
| 10 | | Stecknuss Bit | 4 - 5 - 6 - 7 - 8 - 9 - 10 - 11 - 12 - 13 mm |
| 10 | | Stecknuss Bit | 5/32" - 3/16" - 7/32" - 1/4" - 9/32" - 5/16" - 11/32" - 3/8" - 7/16" - 1/2" |
| 1 | | Magnethalter 60 mm | |
| 1 | | Magnethalter mit Schnellspannfutter 65 mm | |
| 1 | | Stecknuss Adapter | 1/4" 25 mm |

Bits aus CV-Stahl

Größe/Size: 1/4" · tlg./pcs 200 · BxLxH/WxLxH: 220x155x50 mm

Gewicht/Weight: 2.000 g

| Art.-Nr./Art.-No. | G./S. | tlg./pcs | B | L | H |
|-------------------|-------|----------|-----|-----|----------------|
| 8606 | 1/4" | 200 | 335 | 200 | 45 |
| | | | | | € 72,40 |

1/4" BIT-Sätze

1/4" Bit Sets



Art.-Gruppen 130/131
Article Groups 130/131

PROFESSIONAL PLUS STANDARD

1/4" Stecknuss Bit Adapter Satz, 3-tlg. 50 mm für Stecknüsse 1/4", 3/8", 1/2"

Bit Adapter Set, 3 pieces

50 mm For Sockets 1/4", 3/8", 1/2"

3
tlg./pcs.



| Art.-Nr./Art.-No. | Größe/Size | Länge/Length |
|-------------------|-------------|--------------|
| 2880 | 1/4" x 1/4" | 50 mm |
| | 1/4" x 3/8" | 50 mm |
| | 1/4" x 1/2" | 50 mm |
| € 11,50 | | |

PROFESSIONAL PLUS STANDARD

1/4" Sätze Stecknuss Bit mit Magnet, 65 mm 1/4" Magnetic Nut Setter Sets, 65 mm



| Art.-Nr./Art.-No. | Größe/Size |
|-------------------|--|
| 3784-91 | 7 - 8 - 10 - 13 mm (4-tlg. Satz) |
| € 21,50 | |
| 3784-92 | 1/4" - 3/8" - 5/16" (3-tlg. Satz) |
| € 17,12 | |
| 3784-93 | 5,5 - 6 - 7 - 8 - 10 - 12 - 13 - 17 mm (8-tlg. Satz) |
| € 38,60 | |

Bit-Display / Magazin

Bit Display / Storage



**Fragen Sie nach unseren Bestückungen –
das Display kann auch individuell nach
Kundenwunsch bestückt werden!**

Please ask for different contents –
the display content can be individualised due to your needs!

Art.-Gruppe 131
Article Group 131

11911-01

615 x 503 x 150 mm

Reihe 1/Line 1:

- ⊕ 25 mm 30 x PH1 - 50 x PH2 - 30 x PH3
- ⊕ 25 mm TiN 20 x PH1 - 30 x PH2 - 20 x PH3
- ⊕ 50 mm 20 x PH2
- ⊕ 25 mm 10 x Schraubvorsatz mit Tiefenstopp PH2
- 50 mm Stecknuss Bit Adapter 1/4" x 1/4"

Reihe 2/Line 2:

- ⊕ 25 mm 30 x PZ1 - 50 x PZ2 - 30 x PZ3
- ⊕ 25 mm TiN 20 x PZ1 - 30 x PZ2 - 20 x PZ3
- ⊕ 50 mm 10 x PZ1 - 20 x PZ2 - 10 x PZ3

Reihe 3/Line 3:

- ⊗ 25 mm 20 x TX10 - 20 x TX15 - 50 x TX20 -
50 x TX 25 - 50 x TX30 - 20 x TX 40
- ⊗ 25 mm TiN 30 x TX15 - 30 x TX 20 - 30 x TX 25

Reihe 4/Line 4:

- 65 mm Stecknuss Bit 6 x 8 mm - 6 x 10 mm - 5 x 13 mm
- 10 x Bit Magnethalter
- 10 x Magnethalter mit Schnellspannfutter
- 10 x Magnethalter mit „Ring-Magnet“

| Art.-Nr./Art.-No. | tlg./pcs. | | € |
|-------------------|-----------|---------------------------------------|-----------------|
| 11911-01 | 787 | bestückt mit 787 Bits / with 787 Bits | 1.089,00 |

Schraubendreher & Winkelstiftschlüssel

Screwdriver & Hex Keys

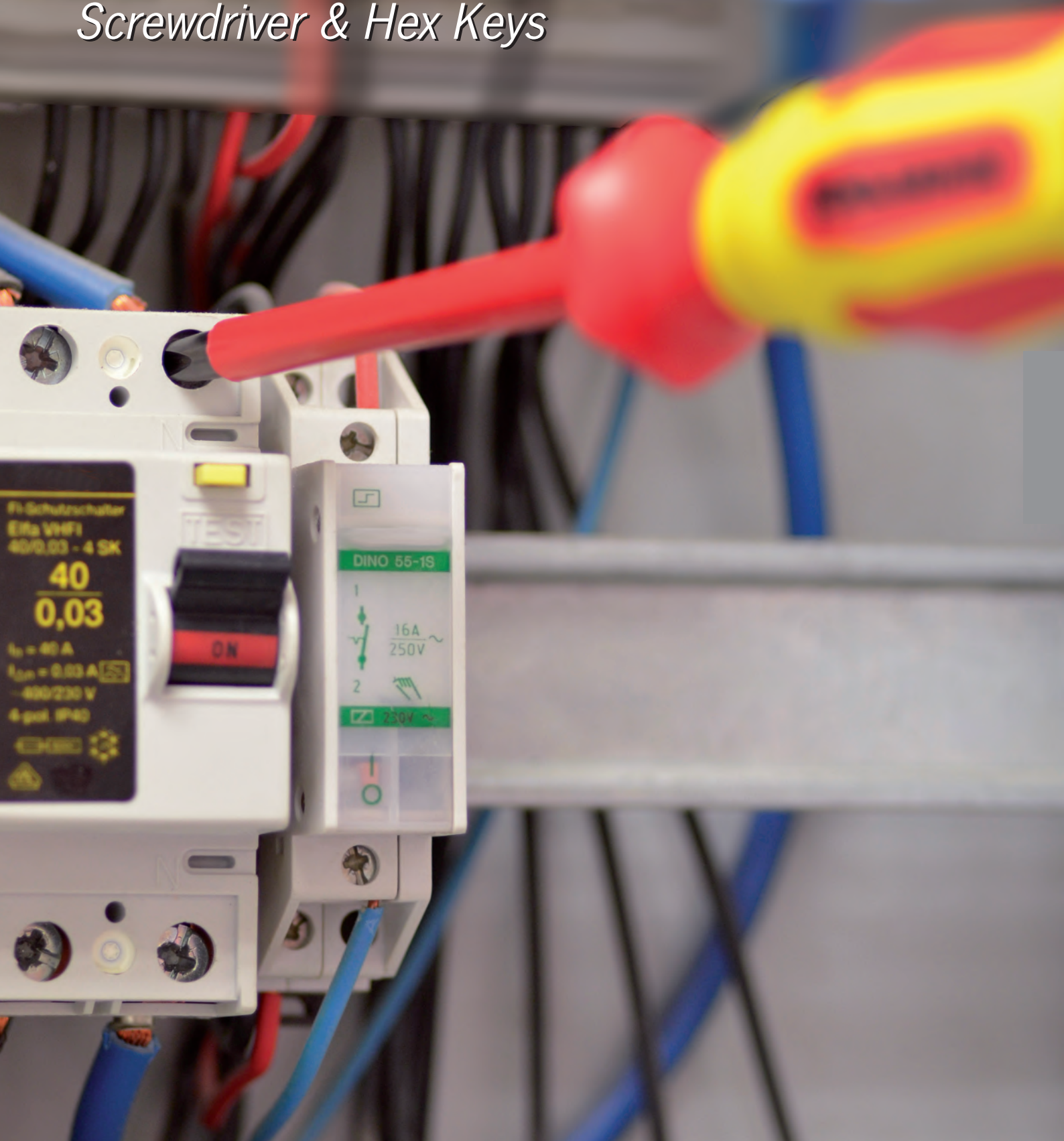

Schraubendreher – Die ergonomischen Allrounder

Screwdriver – The ergonomic all-rounders



Ergonomisch

Ergonomic

- ▶ Hohe Kraftübertragung durch optimale Anpassung des Mehrkomponentengriffs an die Hand
 - ▶ Kein Durchrutschen der Hand auf Grund der Kombination weicher und fester Werkstoffe für den Griff
 - ▶ Rutschfeste Oberfläche minimiert das Durchrutschen der Hand auch bei öligen oder fettigen Händen
 - ▶ Optimale Kraftübertragung von Griff auf Klinge durch komplett in den Griff eingearbeiteten Klingenschaft
 - ▶ 6-kant Schlüsselhilfe ermöglicht das Lösen von extrem fest sitzenden Schrauben (Ausführung mit Schlagkappe)
- ▶ High power transmission due to a optimized multi-component handle*
- ▶ No slipping of the hand because of a combination of soft and hard materials for the handle*
- ▶ Non-slip surface minimizes slipping also with oily or greasy hands*
- ▶ Optimized power transmission due to a secure connection between handle and blade*
- ▶ Hexagonal holding fixture enables the loosen of jammed screws (Version with impact cap)*



Strapazierfähig und langlebig

Hardwearing and Durable

- ▶ Speziell für den professionellen Einsatz durch hochlegierten Spezialstahl geeignet
 - ▶ Langlebige und stabile Klingenspitze durch optimierte Klingeneigenschaften in Bezug auf Härte und Zähigkeit
 - ▶ Weniger Verschleiß an Klingenspitze und Schraube durch präzise ausgearbeitete Klinge
 - ▶ Für besonders hohe Belastungen und Schlagkappe erhältlich
- ▶ Especially for the professional usage due to high alloyed special steel*
- ▶ Durable and robust tip because of an optimized hardness of the material*
- ▶ Less wearing at the tip and the screw due to a high quality blade tip*
- ▶ Version with impact cap for extreme demanding applications*

Vielseitig

Versatile

- ▶ Für jeden Anwender der richtiger Schraubendreher durch breites Produktsortiment
 - ▶ Für sicheres Arbeiten an elektrischen Anlagen als VDE-Version erhältlich
 - ▶ Für härteste Anwendungen auch als Version mit Schlagkappe
 - ▶ 6-in-1 Universal Schraubendreher für PH- und PZ-Schrauben der Größen 1 bis 3 – ein Schraubendreher für 6 Anwendungen
 - ▶ Große Produktauswahl an perfekt abgestimmten Sets
- ▶ For every user the right screwdriver due to a wide product range*
- ▶ As VDE-Versions available – Safety working on electrical installations*
- ▶ For extreme demanding applications also as version with impact cap available*
- ▶ 6-in-1 Universal Screwdriver for PH- and PZ-Drives with sizes from 1 to 3 – only one screwdriver for 6 applications*
- ▶ Wide product range of perfect customized sets*

Sicherheit

Safety

- ▶ Höchste Sicherheit bei Arbeiten an elektrischen Anlagen durch Prüfung nach DIN-EN 60900 und IEC 900 (VDE-Ausführung)
 - ▶ Verminderung der Abrutschgefahr der Hand durch optimierte Griffform
- ▶ Highest safety during working on electrical installations due to tests according to DIN-EN 60900 and IEC 900 (VDE-Version)*
- ▶ Optimized handle reduces the risk of slipping*

* Phillips® und Pozidriv® sind eingetragene Markenzeichen der Firma Phillips Screw Co.
TORX® und tamper TORX® sind eingetragene Markenzeichen der Firma Camcar/Textron

* Phillips® and Pozidriv® are registered trademarks of the company Phillips Screw Co.
TORX® and tamper TORX® are registered trademarks of the company Camcar/Textron

Schraubendreher für Schlitz-Schrauben

Slotted Screwdriver



Art.-Gruppen 140/145
Article Groups 140/145

Schraubendreher für Schlitz-Schrauben

Slotted Screwdriver



| Art.-Nr./Art.-No. | Klingenstärke/Blade Thickness | Klingenbreite/Blade Width | Klingenlänge/Blade Length | € |
|-------------------|-------------------------------|---------------------------|---------------------------|------|
| 4620-01 | 0,5 mm | 3,0 mm | 75 mm | 4,26 |
| 4620-02 | 0,8 mm | 4,0 mm | 100 mm | 4,85 |
| 4620-03 | 1,0 mm | 5,5 mm | 125 mm | 5,74 |
| 4620-04 | 1,2 mm | 6,5 mm | 150 mm | 6,52 |
| 4620-05 | 1,2 mm | 8,0 mm | 175 mm | 8,64 |
| 4622-01 | 1,2 mm | 6,5 mm | 25 mm | 5,26 |

Schraubendreher für Schlitz-Schrauben mit Schlagkappe

Slotted Screwdriver with Impact Cap



inkl. Schlüsselhilfe
incl. Wrench Adapter



Robuste Schlagkappe
Impact Cap



| Art.-Nr./Art.-No. | Klingenstärke/Blade Thickness | Klingenbreite/Blade Width | Klingenlänge/Blade Length | SW/Size | € |
|-------------------|-------------------------------|---------------------------|---------------------------|---------|-------|
| 5120-02 | 0,8 mm | 4,5 mm | 90 mm | 8 mm | 8,87 |
| 5120-03 | 1,0 mm | 5,5 mm | 100 mm | 10 mm | 9,23 |
| 5120-04 | 1,2 mm | 7,0 mm | 125 mm | 10 mm | 11,25 |
| 5120-05 | 1,2 mm | 8,0 mm | 150 mm | 13 mm | 14,45 |

Schraubendreher für Schlitz-Schrauben

Slotted Screwdriver



| Art.-Nr./Art.-No. | Klingenstärke/Blade Thickness | Klingenbreite/Blade Width | Klingenlänge/Blade Length | € | |
|-------------------|-------------------------------|---------------------------|---------------------------|----------|------|
| 4120-01 | 0,5 mm | 3,0 mm | 75 mm | 3,31 | |
| 4120-02 | 0,8 mm | 4,0 mm | 100 mm | 3,98 | |
| 4120-03 | 1,0 mm | 5,5 mm | 125 mm | 4,71 | |
| 4120-04 | 1,2 mm | 6,5 mm | 150 mm | 5,64 | |
| 4120-05 | 1,6 mm | 8,0 mm | 150 mm | 7,64 | |
| 4120-06 | 1,6 mm | 10,0 mm | 200 mm | 8,68 | |
| 4122-01 | 1,2 mm | 6,5 mm | 38 mm | Vergaser | 3,98 |

Schraubendreher für Kreuzschlitz-Schrauben Phillips

Phillips Screwdriver



Art.-Gruppen 140/145
Article Groups 140/145

Schraubendreher für Kreuzschlitz-Schrauben Phillips

Phillips Screwdriver



| Art.-Nr./Art.-No. | Größe/Size | Klingenlänge/Blade Length | € |
|-------------------|------------|---------------------------|------|
| 4600-00 | 0 | 60 mm | 4,26 |
| 4600-01 | 1 | 80 mm | 4,49 |
| 4600-02 | 2 | 100 mm | 5,74 |
| 4600-03 | 3 | 150 mm | 7,75 |
| 4602-01 | 1 | 25 mm | 5,15 |
| 4602-02 | 2 | 25 mm | 5,39 |

Schraubendreher für Kreuzschlitz-Schrauben Phillips mit Schlagkappe

Phillips Screwdriver with Impact Cap



inkl. Schlüsselhilfe
incl. Wrench Adapter



Robuste Schlagkappe
Impact Cap



| Art.-Nr./Art.-No. | Größe/Size | Klingenlänge/Blade Length | Schlüsselhilfe/Wrench Adapter | € |
|-------------------|------------|---------------------------|-------------------------------|-------|
| 5100-01 | 1 | 80 mm | 8 mm | 9,23 |
| 5100-02 | 2 | 100 mm | 10 mm | 10,75 |

Schraubendreher für Kreuzschlitz-Schrauben Phillips

Phillips Screwdriver



| Art.-Nr./Art.-No. | Größe/Size | Klingenlänge/Blade Length | € | Art.-Nr./Art.-No. | Größe/Size | Kl./Bl | € |
|-------------------|------------|---------------------------|------|-------------------|------------|--------|----------|
| 4100-00 | 0 | 60 mm | 3,17 | 4102-02 | 2 | 38 mm | Vergaser |
| 4100-01 | 1 | 80 mm | 4,46 | | | | 3,98 |
| 4100-02 | 2 | 100 mm | 5,15 | | | | |
| 4100-03 | 3 | 150 mm | 7,64 | | | | |

Schraubendreher für Kreuzschlitz-Schrauben Pozidriv

Pozidriv Screwdriver

Art-Gruppen 140/145
 Article Groups 140/145
Schraubendreher für Kreuzschlitz-Schrauben Pozidriv

Pozidriv Screwdriver



| Art.-Nr./Art.-No. | Größe/Size | Klingenlänge/Blade Length | € |
|-------------------|------------|---------------------------|------|
| 4610-00 | 0 | 60 mm | 4,26 |
| 4610-01 | 1 | 80 mm | 4,49 |
| 4610-02 | 2 | 100 mm | 5,74 |
| 4610-03 | 3 | 150 mm | 7,75 |

Schraubendreher für Kreuzschlitz-Schrauben Pozidriv

Pozidriv Screwdriver



| Art.-Nr./Art.-No. | Größe/Size | Klingenlänge/Blade Length | € |
|-------------------|------------|---------------------------|------|
| 4110-00 | 0 | 60 mm | 3,43 |
| 4110-01 | 1 | 80 mm | 4,46 |
| 4110-02 | 2 | 100 mm | 5,15 |
| 4110-03 | 3 | 150 mm | 7,64 |

6-in-1 Universal Schraubendreher für Kreuzschlitz-Schrauben Phillips und Pozidriv

6-in-1 Universal Phillips and Pozidriv Screwdriver

▶ **Ein Schraubendreher für 6 Schraubenantriebe:****Phillips 1 - 2 - 3 und Pozidriv 1 - 2 - 3**▶ *One Screwdriver for 6 screw drives:**PH 1 - 2 - 3 and PZ 1 - 2 - 3*

| Art.-Nr./Art.-No. | Größe/Size | Klingenlänge/Blade Length | € |
|-------------------|---------------------|---------------------------|-------|
| 4600-1230 | PH 1 - 3 / PZ 1 - 3 | 100 mm | 11,10 |
| 4600-1231 | PH 1 - 3 / PZ 1 - 3 | 25 mm | 7,34 |

Schraubendreher für Innen-TX-Schrauben

Tamper TX Screwdriver



Art.-Gruppen 140/145
Article Groups 140/145

Schraubendreher für Innen-TX-Schrauben

TX Screwdriver



| Art.-Nr./Art.-No. | Größe/Size | Klingenlänge/Blade Length | € |
|-------------------|------------|---------------------------|-------------|
| 4630-08 | T8 | 60 mm | 4,26 |
| 4630-10 | T10 | 80 mm | 4,49 |
| 4630-15 | T15 | 80 mm | 4,62 |
| 4630-20 | T20 | 100 mm | 4,62 |

| Art.-Nr./Art.-No. | Größe/Size | Klingenlänge/Blade Length | € |
|-------------------|------------|---------------------------|-------------|
| 4630-25 | T25 | 100 mm | 4,75 |
| 4630-27 | T27 | 115 mm | 5,15 |
| 4630-30 | T30 | 115 mm | 5,50 |
| 4630-40 | T40 | 130 mm | 6,76 |

Schraubendreher für Innen-TX-Schrauben

TX Screwdriver



| Art.-Nr./Art.-No. | Größe/Size | Klingenlänge/Blade Length | € |
|-------------------|------------|---------------------------|-------------|
| 4130-05 | T5 | 50 mm | 4,22 |
| 4130-06 | T6 | 60 mm | 4,22 |
| 4130-07 | T7 | 60 mm | 4,22 |
| 4130-08 | T8 | 60 mm | 3,98 |
| 4130-09 | T9 | 60 mm | 3,98 |
| 4130-10 | T10 | 80 mm | 4,22 |

| Art.-Nr./Art.-No. | Größe/Size | Klingenlänge/Blade Length | € |
|-------------------|------------|---------------------------|-------------|
| 4130-15 | T15 | 80 mm | 4,22 |
| 4130-20 | T20 | 80 mm | 4,36 |
| 4130-25 | T25 | 100 mm | 4,84 |
| 4130-27 | T27 | 115 mm | 5,02 |
| 4130-30 | T30 | 115 mm | 5,02 |
| 4130-40 | T40 | 130 mm | 5,51 |

Schraubendreher für Innen-TX-Schrauben mit stirnseitiger Bohrung

Tamper TX Screwdriver



| Art.-Nr./Art.-No. | Größe/Size | Klingenlänge/Blade Length | € |
|-------------------|------------|---------------------------|-------------|
| 4150-08 | T8 | 60 mm | 4,89 |
| 4150-10 | T10 | 80 mm | 5,51 |
| 4150-15 | T15 | 80 mm | 5,51 |
| 4150-20 | T20 | 100 mm | 5,51 |

| Art.-Nr./Art.-No. | Größe/Size | Klingenlänge/Blade Length | € |
|-------------------|------------|---------------------------|-------------|
| 4150-25 | T25 | 100 mm | 6,12 |
| 4150-27 | T27 | 115 mm | 6,48 |
| 4150-30 | T30 | 115 mm | 6,48 |
| 4150-40 | T40 | 130 mm | 6,85 |



Universal Schraubendreher

Universal Screwdriver

Art.-Gruppen 140/145
Article Groups 140/145

Schraubendreher mit Sechskant Steckschlüssel, Flexibler Schaft

Hex Metric Screwdriver, Flexible



| Art.-Nr./Art.-No. | Größe/Size | Länge/Length | € |
|-------------------|------------|--------------|-------|
| 4692-06 | 6 mm | 150 mm | 18,10 |
| 4692-07 | 7 mm | 150 mm | 18,85 |
| 4692-08 | 8 mm | 150 mm | 19,45 |

Schraubendreher mit 1/4" Bit Schnellspannfutter

Quick Release Bit Screwdriver



| Art.-Nr./Art.-No. | Größe/Size | € |
|-------------------|-----------------------------|-------|
| 4690-02 | 1/4" mit Schnellspannfutter | 19,50 |

Ratschenschraubendreher mit 1/4" Bit Magnethalter und 10 Color-Bits

Magnetic Bit Ratchet Screwdriver with 10 Color Bits



- ▶ Mit Ratschenfunktion
- ▶ Ratschenfunktion rechts/links umschaltbar
- ▶ With ratchet function
- ▶ Ratchet function right/left reversible

| | | | |
|---|---|----------------------------------|-----------|
| 2 | ⊖ | Schlitz/Slotted (rot/red) | 4 - 5 mm |
| 2 | ⊕ | Phillips/PH (dunkelrot/dark red) | PH 1 - 2 |
| 2 | ⊕ | Pozidriv/PZ (blau/blue) | PZ 1 - 2 |
| 2 | ⊗ | TORX®/TX (gelb/yellow) | TX20 - 25 |
| 2 | ⊙ | Innensechskant/Hex (orange) | 3 - 5 mm |
| 1 | | Ratschenschraubendreher | |



215 x 160 x 245 mm
Art. 419212
Display mit /with 12x 4192

| Art.-Nr./Art.-No. | Größe/Size | € |
|-------------------|--|--------|
| 4192 | 1/4" Ratschenschraubendreher inkl. 10 Color-Bits/Ratchet Screwdriver incl. 10 Color-Bits | 36,50 |
| 419212 | Display mit /with 12 x 4192 (1/4" Ratschenschraubendreher/Ratchet Screwdriver) | 412,00 |

Präzisions-Schraubendrehersätze und Spannungsprüfer

Precision Screwdriver Sets and Voltage Tester



Art-Gruppen 140/145
Article Groups 140/145

PROFESSIONAL **PLUS** STANDARD

4711

Präzisions-Schraubendreher Satz

Precision Screwdriver Set



8
tlg./pcs.



| Art.-Nr./Art.-No. | Größe/Size | Klingenlänge/Blade Length | € |
|-------------------|--|---------------------------|--------------|
| 4711 | PH00 x 2 mm / PH0 x 3 mm / PH1 x 4 mm T6 x T10 - T7 x T15 - T8 x T20 - T9 x T15 | Doppelklingen 120mm | 24,25 |

PROFESSIONAL **PLUS** STANDARD

4714

30-in-1 Präzisions-Bit-Schraubendreher Satz

30-in-1 Precision Bit Screwdriver Set



31
tlg./pcs.

| | | |
|---|--|--|
| 7 | Schlitz/Slotted | 1 - 1,5 - 2 - 2,5 - 3 - 3,5 - 4 mm |
| 4 | Phillips/PH | PH 000 - 00 - 0 - 1 |
| 2 | Pozidriv/PZ | PZ 0 - 1 |
| 9 | TORX®/TX | TX4 - 5 - 6 - 7 - 8 - 9 - 10 - 15 - 20 |
| 8 | Innensechskant/Hex | 0,7 - 0,9 - 1,3 - 1,5 - 2 - 2,5 - 3 - 4 mm |
| 1 | Präzisions-Bit-Schraubendreher/Precision Bit Screwdriver | |

| Art.-Nr./Art.-No. | € |
|-------------------|--------------|
| 4714 | 25,35 |

PROFESSIONAL PLUS **STANDARD**

EURO-Spannungsprüfer nach VDE 0680

Voltage Tester



1000V
EN 60900



| Art.-Nr./Art.-No. | Größe/Size | € |
|-------------------|-------------------------|-------------|
| 2137 | 3,0 x 60 mm 125 - 250 V | 3,42 |

PROFESSIONAL PLUS **STANDARD**

Phasenprüfer 230 V

Voltage Tester



1000V
EN 60900



| Art.-Nr./Art.-No. | Größe/Size | € |
|-------------------|-------------------------|-------------|
| 2138 | 3,0 x 60 mm 110 - 230 V | 3,79 |

VDE-Schraubendreher/Schraubendrehersortiment

Safety Insulated Screwdriver/Set



Art.-Gruppe 145
Article Group 145

Nach DIN EN 60900, IEC 900, Stückprüfung im Wasserbad mit einer Prüfspannung von 10.000 Volt.
Kälteschlagprüfung bei -40° (Kennzeichnung C)

According to DIN EN 60900, IEC 900. Tested by 10.000 Volt.

VDE Schraubendreher für Kreuzschlitz-Schrauben Phillips

Phillips VDE Screwdriver



| Art.-Nr./Art.-No. | Größe/Size | Klingenlänge/Blade Length | € |
|-------------------|------------|---------------------------|------|
| 5105-00 | 0 | 60 mm | 4,38 |
| 5105-01 | 1 | 80 mm | 4,85 |
| 5105-02 | 2 | 100 mm | 5,63 |

VDE Schraubendreher für Kreuzschlitz-Schrauben Pozidriv

Pozidriv VDE Screwdriver



| Art.-Nr./Art.-No. | Größe/Size | Klingenlänge/Blade Length | € |
|-------------------|------------|---------------------------|------|
| 5115-00 | 0 | 60 mm | 4,38 |
| 5115-01 | 1 | 80 mm | 4,85 |
| 5115-02 | 2 | 100 mm | 5,63 |

VDE Schraubendreher für Schlitz-Schrauben

Slotted VDE Screwdriver



| Art.-Nr./Art.-No. | Klingenstärke/Blade Thickness | Klingenbreite/Blade Width | Klingenlänge/Blade Length | € |
|-------------------|-------------------------------|---------------------------|---------------------------|------|
| 5125-01 | 0,4 mm | 2,5 mm | 75 mm | 4,14 |
| 5125-03 | 0,6 mm | 3,5 mm | 100 mm | 4,38 |
| 5125-04 | 0,8 mm | 4,0 mm | 100 mm | 4,38 |
| 5125-05 | 1,0 mm | 5,5 mm | 125 mm | 5,39 |
| 5125-06 | 1,2 mm | 6,5 mm | 150 mm | 6,10 |

6-in-1 Universal VDE Schraubendreher für Kreuzschlitz-Schrauben Phillips und Pozidriv

6-in-1 Universal VDE Phillips and Pozidriv Screwdriver

- ▶ Ein Schraubendreher für 6 Schraubenantriebe:
Phillips 1 - 2 - 3 und Pozidriv 1 - 2 - 3

- ▶ One Screwdriver for 6 screw drives:
PH 1 - 2 - 3 and PZ 1 - 2 - 3



| Art.-Nr./Art.-No. | Größe/Size | Klingenlänge/Blade Length | € |
|-------------------|---------------------|---------------------------|-------|
| 5105-1230 | PH 1 - 3 / PZ 1 - 3 | 100 mm | 11,15 |

VDE Schraubendreher Satz, 7-teilig

VDE Screwdriver Sets, 7 pieces



7
tlg./pcs.



| Art.-Nr./Art.-No. | Größe/Size | € |
|-------------------|---|-------|
| 5190 | 0,4 x 2,5 - 0,8 x 4,0 - 1,0 x 5,5 - 1,2 x 6,5 mm PH 1 - 2, Spannungsprüfer 230 V | 33,20 |

VDE Werkzeugsätze

VDE Tool Sets

Art.-Gruppe 113/145
Article Group 113/145

8687 PROFESSIONAL PLUS STANDARD

VDE Elektriker-Werkzeugmappe
VDE Electrical Tool Bag



PROJAHN
PROFESSIONAL

12
tlg./pcs.

- ▶ Alle wichtigen Elektrowerkzeuge im Set
- ▶ Ideal für Elektro-, Heizung-, Sanitär-, Klima- und Belüftungstechnik
- ▶ Alle Werkzeuge VDE-geprüft nach DIN EN ISO 60900 bis 1.000 V
- ▶ Hochwertige Verarbeitung und Materialien, ergonomisches Design
- ▶ All important electrical tools in one set
- ▶ Designed for electrical engineering, heating systems, sanitary installation, climate control and ventilation technology
- ▶ All tools are VDE-tested accordingly DIN ISO 60900 up to 1.000 V
- ▶ High-quality workmanship and materials, Ergonomic design

- 3 ⊕ Phillips VDE-Schraubendreher PH0 - 1 - 2
- 3 ⊖ Schlitz VDE-Schraubendreher 2,5 - 4 - 6,5 mm
- 1 Spannungsprüfer 125 - 250 V
- 1 VDE Abisolierzange 150 mm
- 1 VDE Elektriker-Messer 150 mm
- 1 VDE Kombizange 150 mm
- 1 VDE Seitenschneider 150 mm
- 1 VDE Telefonzange 200 mm



Art.-Nr./Art.-No. €
8687 155,00

5195 PROFESSIONAL PLUS STANDARD

VDE-Wechselklingen-Schraubendreher-Set
Electrical Screwdriver Set with interchangeable Blades



12
tlg./pcs.

- ▶ Alle wichtigen VDE-Schraubendreher im handlichen Set
- ▶ Schnelles und sicheres Wechseln durch patentiertes Wechselklingensystem
- ▶ Durch aufsteckbare Drehkappe und Weichmantelzone auch ideal für die Feinelektronik
- ▶ Sicherheitsgeprüft nach DIN ISO 60900 bis 1.000 V
- ▶ Handlicher, rutschfester Griff
- ▶ In exklusiver, praktischer und platzsparender Gürtel-Rolltasche
- ▶ Reduziere Gefahr von Kratzern auf empfindlichen Untergründen
- ▶ All important VDE screwdrivers in one ergonomic set
- ▶ Patented changeable system for a safety and fast change of the blade
- ▶ Secure fit of blades, quickrelease button on handle against unwanted extraction
- ▶ Precision cap and soft-crip zone on blade for low torque application
- ▶ Due to push-on twist cap and soft-grip zone also ideal for fine electronic engineering
- ▶ Safety tested accordingly DIN ISO 60900 up to 1.000 V
- ▶ Ergonomic and non-slip handle
- ▶ In exclusive, practically and space-saving roll bag
- ▶ Roll bag reduces the risk of scratches on sensitive surfaces

- 5 ⊖ 2,5 x 0,4 / 3,0 x 0,5 / 3,5 x 0,6 / 4,0 x 0,8 / 5,5 x 1,0 mm
- 2 ⊕ PH1 - PH 2 1 Wechselgriff
- 1 ⊕ PZ 2 1 Drehkappe
- 2 ⊗ TX15 - 20



Art.-Nr./Art.-No. €
5195 74,50

Quergriff-Schraubendreher

T-Handle Screwdriver



Art.-Gruppe 140
Article Group 140

Quergriff Schraubendreher mit Kugelkopf für Innensechskant-Schrauben

T-Handle Screwdriver Ball Point



| Art.-Nr./Art.-No. | Größe/Size | Länge/Length | € |
|-------------------|------------|--------------|-------|
| 4170-2 | 2,0 mm | 100 mm | 5,51 |
| 4170-25 | 2,5 mm | 100 mm | 5,64 |
| 4170-3 | 3,0 mm | 100 mm | 5,88 |
| 4170-4 | 4,0 mm | 150 mm | 6,85 |
| 4170-5 | 5,0 mm | 150 mm | 6,85 |
| 4170-6 | 6,0 mm | 200 mm | 8,57 |
| 4170-8 | 8,0 mm | 200 mm | 10,15 |
| 4170-10 | 10,0 mm | 200 mm | 12,50 |

Quergriff Schraubendreher Satz mit Kugelkopf für Innensechskant-Schrauben

T-Handle Screwdriver Ball Point Set

8
tlg./pcs.



| Art.-Nr./Art.-No. | Größe/Size | € |
|-------------------|-------------------------------------|-------|
| 4170 | 2 - 2,5 - 3 - 4 - 5 - 6 - 8 - 10 mm | 64,15 |

Quergriff Schraubendreher für Innen-TX-Schrauben

T-Handle Screwdriver TX

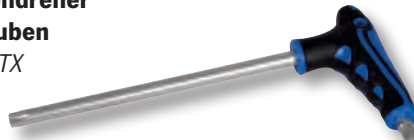

| Art.-Nr./Art.-No. | Größe/Size | Länge/Length | € |
|-------------------|------------|--------------|-------|
| 4180-10 | TX 10 | 100 mm | 7,22 |
| 4180-15 | TX 15 | 100 mm | 7,22 |
| 4180-20 | TX 20 | 100 mm | 7,58 |
| 4180-25 | TX 25 | 100 mm | 8,07 |
| 4180-27 | TX 27 | 100 mm | 8,68 |
| 4180-30 | TX 30 | 150 mm | 9,53 |
| 4180-40 | TX 40 | 150 mm | 10,25 |
| 4180-45 | TX 45 | 150 mm | 11,00 |
| 4180-50 | TX 50 | 150 mm | 11,60 |

Quergriff Schraubendreher Satz für Innen-TX-Schrauben

T-Handle Screwdriver TX Set

9
tlg./pcs.



| Art.-Nr./Art.-No. | Größe/Size | € |
|-------------------|--|-------|
| 4180 | TX10 - TX15 - TX20 - TX25 - TX27 - TX30 - TX40 - TX45 - TX50 | 70,50 |

Quergriff Schraubendreher für Außensechskant-Schrauben

T-Handle Nut Driver

NEU/NEW



| Art.-Nr./Art.-No. | Größe/Size | Länge/Length | € |
|-------------------|------------|--------------|-------|
| 4190-06 | 6 mm | 225 mm | 9,35 |
| 4190-07 | 7 mm | 225 mm | 9,77 |
| 4190-08 | 8 mm | 225 mm | 10,10 |
| 4190-10 | 10 mm | 235 mm | 11,45 |
| 4190-11 | 11 mm | 235 mm | 11,90 |
| 4190-12 | 12 mm | 235 mm | 12,20 |
| 4190-13 | 13 mm | 235 mm | 12,50 |
| 4190-14 | 14 mm | 235 mm | 12,90 |

Quergriff Schraubendreher Satz für Außensechskant-Schrauben

T-Handle Nut Driver Set

NEU/NEW

8
tlg./pcs.



| Art.-Nr./Art.-No. | Größe/Size | € |
|-------------------|---------------------------------------|-------|
| 4190 | 6 - 7 - 8 - 10 - 11 - 12 - 13 - 14 mm | 86,65 |

Schraubendrehersätze

Screwdriver Sets



Art.-Gruppe 145
Article Group 145

Schraubendreher Satz

Screwdriver Set

6
tlg./pcs.



| Art.-Nr./Art.-No. | Größe/Size |
|-------------------|---|
| 4621 | PH 1 - 2 / 0,8 x 4,0 - 1,0 x 5,5 - 1,2 x 6,5 - 1,2 x 8,0 mm Phillips + Schlitz € 34,95 |
| 4622 | PZ 1 - 2 / 0,8 x 4,0 - 1,0 x 5,5 - 1,2 x 6,5 - 1,2 x 8,0 mm Pozidriv + Schlitz € 34,95 |

Schraubendreher Satz

Screwdriver set

6
tlg./pcs.



| Art.-Nr./Art.-No. | Größe/Size |
|-------------------|--|
| 4623 | TX10 - TX15 - TX20 - TX25 - TX30 - TX40 TORX® € 29,80 |

Schraubendreher Satz

Screwdriver Set

8
tlg./pcs.



| Art.-Nr./Art.-No. | Größe/Size |
|-------------------|---|
| 4624 | PH 1 - 2 / PZ 1 - 2 / TX10 - TX15 - TX20 - TX25 Phillips + Pozidriv + TORX € 37,70 |

Schraubendreher Satz

Screwdriver Set

8
tlg./pcs.



| Art.-Nr./Art.-No. | Größe/Size |
|-------------------|--|
| 4625 | TX8 - TX10 - TX15 - TX20 - TX25 - TX27 - TX30 - TX40 TORX € 38,85 |

Schraubendreher Satz mit durchgehender Klinge und Schlagkappe

Go-Through Screwdriver Set with Hammering Cap

6
tlg./pcs.



| Art.-Nr./Art.-No. | Größe/Size |
|-------------------|---|
| 5199 | PH 1 - 2 / 0,8 x 4,5 - 1,0 x 5,5 - 1,2 x 7,0 - 1,2 x 8,0 mm Phillips + Schlitz € 56,90 |

inkl. Schlüsselhilfe
incl. Wrench Adapter



Robuste Schlagkappe
Hammering cap



Schraubendrehersätze

Screwdriver Sets



Art.-Gruppe 140
Article Group 140

Schraubendreher Sätze

Screwdriver Sets

8
tlg./pcs.



4725



| Art.-Nr./Art.-No. | Größe/Size |
|-------------------|--|
| 4721 | PH 1 - 2 / PZ 1 - 2 / TX10 - TX15 - TX20 - TX25 Phillips + Pozidriv + TORX® € 35,50 |
| 4722 | PH 1 - 2 / PZ 1 - 2 0,8 x 4,0 - 1,0 x 5,5 - 1,2 x 6,5 mm Bit-Magnethalter / Phillips + Pozidriv + Schlitz € 42,80 |
| 4725 | PH 1 - 2 / PZ 1 - 2 / TX20 - TX25 / 0,8 x 4,0 - 1,2 x 6,5 mm Phillips + Pozidriv + TORX® + Schlitz € 35,70 |

Schraubendreher Satz

Screwdriver Set

6
tlg./pcs.



| Art.-Nr./Art.-No. | Größe/Size |
|-------------------|---|
| 4727 | PH 1 - 2 / 0,5 x 3,0 - 0,8 x 4,0 - 1,0 x 5,5 - 1,2 x 6,5 mm Phillips + Schlitz € 26,00 |
| | |
| | |
| | |
| | |
| | |
| | |

Schraubendreher Sätze

Screwdriver Sets

8
tlg./pcs.



4723



| Art.-Nr./Art.-No. | Größe/Size |
|-------------------|---|
| 4723 | TX8 - TX10 - TX15 - TX20 - TX25 - TX27 - TX30 - TX40 TORX® € 35,85 |
| 4724 | TX8 - TX10 - TX15 - TX20 - TX25 - TX27 - TX30 - TX40 TX mit Bohrung/tamper TORX® € 45,15 |

Weitere PROForm-Werkstatteinlagen ab Seite /
More PROForm Inlays for Roller Cabinet from Page **H 32**

Winkelstiftschlüssel und Sätze

Hex Keys and Sets



Art-Gruppen 140/145
Article Groups 140/145

PROFESSIONAL PLUS **STANDARD**

Sechskant-Winkelstiftschlüssel matt-satiniert, verchromt, kurze Form nach DIN ISO 2936

Hex Keys, according to DIN ISO 2936, Short Version



| Art.-Nr./Art.-No. | Größe/Size | L1 | L2 | € |
|-------------------|------------|----|-----|--------------|
| 3601-1.5 | 1,5 mm | 14 | 45 | 0,38 |
| 3601-2 | 2,0 mm | 16 | 50 | 0,47 |
| 3601-2.5 | 2,5 mm | 18 | 56 | 0,43 |
| 3601-3 | 3,0 mm | 20 | 63 | 0,65 |
| 3601-4 | 4,0 mm | 25 | 70 | 0,83 |
| 3601-5 | 5,0 mm | 28 | 80 | 0,97 |
| 3601-6 | 6,0 mm | 32 | 90 | 1,39 |
| 3601-7 | 7,0 mm | 34 | 95 | 1,92 |
| 3601-8 | 8,0 mm | 36 | 100 | 2,11 |
| 3601-10 | 10,0 mm | 40 | 112 | 2,47 |
| 3601-12 | 12,0 mm | 45 | 125 | 4,44 |
| 3601-14 | 14,0 mm | 56 | 140 | 6,00 |
| 3601-17 | 17,0 mm | 63 | 160 | 9,49 |
| 3601-19 | 19,0 mm | 70 | 180 | 13,50 |

PROFESSIONAL PLUS **STANDARD**

Sechskant-Kugelkopf-Winkelstiftschlüssel, matt-satiniert, verchromt, extra lange Form nach DIN ISO 2936

Ball Point Hex Keys, according to DIN ISO 2936, Extra Long Version



| Art.-Nr./Art.-No. | Größe/Size | L1 | L2 | € |
|-------------------|------------|----|-----|--------------|
| 3602-1.5 | 1,5 mm | 14 | 90 | 1,33 |
| 3602-2 | 2,0 mm | 16 | 100 | 1,63 |
| 3602-2.5 | 2,5 mm | 18 | 112 | 1,38 |
| 3602-3 | 3,0 mm | 20 | 126 | 1,79 |
| 3602-4 | 4,0 mm | 25 | 140 | 2,07 |
| 3602-5 | 5,0 mm | 28 | 160 | 2,34 |
| 3602-6 | 6,0 mm | 32 | 180 | 2,90 |
| 3602-7 | 7,0 mm | 34 | 190 | 3,58 |
| 3602-8 | 8,0 mm | 36 | 200 | 3,70 |
| 3602-10 | 10,0 mm | 40 | 224 | 4,68 |
| 3602-12 | 12,0 mm | 45 | 250 | 8,96 |
| 3602-14 | 14,0 mm | 56 | 280 | 13,65 |
| 3602-17 | 17,0 mm | 63 | 320 | 18,90 |

3601 PROFESSIONAL PLUS **STANDARD**

Sechskant-Winkelstiftschlüssel Satz 9-teilig im Halter, matt-satiniert, verchromt, kurze Form nach DIN ISO 2936

Hex Key Set, 9 pieces, Short Version, according to DIN ISO 2936

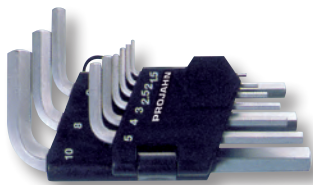

9
tlg./pcs.

| Art.-Nr./Art.-No. | Größe/Size | € |
|-------------------|---|----------------|
| 3601 | 1,5 - 2 - 2,5 - 3 - 4 - 5 - 6 - 8 - 10 mm | € 11,95 |

3602 PROFESSIONAL PLUS **STANDARD**

Sechskant-Kugelkopf-Winkelstiftschlüssel Satz 9-teilig im Halter, matt-satiniert, verchromt, extra lange Form nach DIN ISO 2936

Ball Point Hex Key Set, 9 pieces, according to DIN ISO 2936, Extra Long Version



9
tlg./pcs.

| Art.-Nr./Art.-No. | Größe/Size | € |
|-------------------|---|----------------|
| 3602 | 1,5 - 2 - 2,5 - 3 - 4 - 5 - 6 - 8 - 10 mm | € 24,90 |

3619 PROFESSIONAL PLUS **STANDARD**

Sechskant-Winkelstiftschlüssel Satz 8-teilig im Klapphalter, matt-satiniert, verchromt, nach DIN ISO 2936

Folding Hex Key Set, 8 pieces, according to DIN ISO 2936



8
tlg./pcs.

| Art.-Nr./Art.-No. | Größe/Size | € |
|-------------------|-------------------------------------|----------------|
| 3619 | 2,5 - 3 - 4 - 5 - 6 - 7 - 8 - 10 mm | € 13,55 |

3604 PROFESSIONAL PLUS **STANDARD**

Sechskant-Kugelkopf-Winkelstiftschlüssel Satz 8-teilig im Drehgriff-Halter, nach DIN ISO 2936

Ball Point Hex Key Set, 8 pieces, according to DIN ISO 2936, use the holder as a handle



8
tlg./pcs.

| Art.-Nr./Art.-No. | Größe/Size | € |
|-------------------|-------------------------------------|----------------|
| 3604 | 2 - 2,5 - 3 - 4 - 5 - 6 - 8 - 10 mm | € 28,25 |

Winkelstiftschlüssel und Sätze

Hex Keys and Sets



Art.-Gruppe 141
Article Group 141

PROFESSIONAL PLUS **STANDARD**

TX-Winkelstiftschlüssel matt-satiniert, verchromt, extra lange Form

TX Hex Keys, Extra Long Version



| Art.-Nr./Art.-No. | Größe/Size | L1 | L2 | € |
|-------------------|------------|----|-----|-------------|
| 3607-10 | T10 | 14 | 90 | 1,95 |
| 3607-15 | T15 | 16 | 100 | 2,10 |
| 3607-20 | T20 | 18 | 112 | 2,21 |
| 3607-25 | T25 | 20 | 126 | 2,59 |
| 3607-27 | T27 | 25 | 140 | 2,99 |
| 3607-30 | T30 | 28 | 160 | 3,12 |
| 3607-40 | T40 | 32 | 180 | 3,66 |
| 3607-45 | T45 | 36 | 200 | 4,02 |
| 3607-50 | T50 | 40 | 224 | 5,16 |

3607

PROFESSIONAL PLUS **STANDARD**

TX-Winkelstiftschlüssel Satz 9-teilig im Halter, matt-satiniert verchromt, extra lange Form

TX Hex Key Set, 9 pieces, Extra Long Version

9
tlg./pcs.

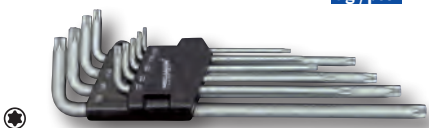

| Art.-Nr./Art.-No. | Größe/Size | € |
|-------------------|-----------------------------|----------------|
| 3607 | T10-15-20-25-27-30-40-45-50 | € 29,95 |

PROFESSIONAL PLUS **STANDARD**

BLUE EDITION Sechskant-Kugelkopf-Winkelstiftschlüssel, S2-Stahl, matt-satiniert, verchromt, extra lange Form, nach DIN ISO 2936

BLUE EDITION Ball Point Hex Key, S2 Steel, Extra Long Version, according to DIN ISO 2936



NEU/NEW

MAGNETISCHE KUGELKÖPFE

| Art.-Nr./Art.-No. | Größe/Size | L1 | L2 | € |
|-------------------|------------|----|-----|--------------|
| 3613-015 | 1,5 mm | 14 | 90 | 1,52 |
| 3613-020 | 2,0 mm | 16 | 100 | 1,79 |
| 3613-025 | 2,5 mm | 18 | 112 | 1,84 |
| 3613-030 | 3,0 mm | 20 | 126 | 2,15 |
| 3613-040 | 4,0 mm | 25 | 140 | 2,36 |
| 3613-050 | 5,0 mm | 28 | 160 | 2,68 |
| 3613-060 | 6,0 mm | 32 | 180 | 3,31 |
| 3613-070 | 7,0 mm | 34 | 190 | 4,10 |
| 3613-080 | 8,0 mm | 36 | 200 | 4,20 |
| 3613-100 | 10,0 mm | 40 | 224 | 5,36 |
| 3613-120 | 12,0 mm | 45 | 250 | 10,25 |
| 3613-140 | 14,0 mm | 56 | 280 | 15,65 |
| 3613-170 | 17,0 mm | 63 | 320 | 21,70 |
| 3613-190 | 19,0 mm | 70 | 360 | 31,40 |

3613

PROFESSIONAL PLUS **STANDARD**

BLUE EDITION Sechskant-Kugelkopf-Winkelstiftschlüssel Satz 9-teilig im Halter, matt-satiniert, verchromt, extra lange Form nach DIN ISO 2936

Ball Point Hex Key Set, 9 pieces, Extra Long Version, according to DIN ISO 2936

- Kugelkopf mit integriertem Magnet, Schlüssel blau eloxiert
- Magnetic ball point, blue anodic treatment

MAGNETISCHE KUGELKÖPFE

9
tlg./pcs.



| Art.-Nr./Art.-No. | Größe/Size | € |
|-------------------|---------------------------|----------------|
| 3613 | 1,5-2-2,5-3-4-5-6-8-10 mm | € 28,25 |

36131

PROFESSIONAL PLUS **STANDARD**

NEU/NEW

XXL BLUE EDITION Sechskant-Kugelkopf-Winkelstiftschlüssel Satz 13-teilig in Rolltasche, matt-satiniert, verchromt, extra lange Form nach DIN ISO 2936

XXL Ball Point Hex Key Set, 13 pieces, Extra Long Version, in pouch, according to DIN ISO 2936



MAGNETISCHE KUGELKÖPFE

13
tlg./pcs.

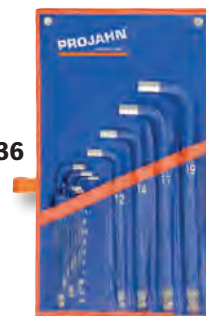

| Art.-Nr./Art.-No. | Größe/Size | € |
|-------------------|---|----------------|
| 36131 | 1,5 - 2 - 2,5 - 3 - 4 - 5 - 6 - 8 - 10 - 12 - 14 - 17 - 19 mm | € 93,40 |

Winkelstiftschlüssel Sätze

Hex Key Sets



Art.-Gruppe 141
Article Group 141

PROFESSIONAL PLUS STANDARD

3603

Sechskant-Kugelkopf-Winkelstiftschlüssel Satz 9-teilig im Halter, Zoll, matt-satiniert, verchromt, extra lange Form nach DIN ISO 2936

Ball Point Hex Key Set, 9 pieces, Inch, Extra Long Version according to DIN ISO 2936

9
tlg./pcs.

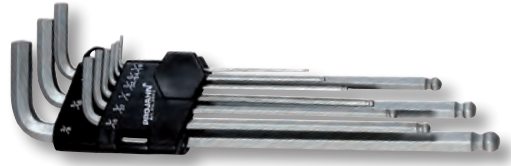

Art.-Nr./Art.-No.

3603

Größe/Size

1/16"-5/64"-3/32"-1/8"-5/32"-3/16"-1/4"-5/16"-3/8"

€ 24,90

PROFESSIONAL PLUS STANDARD

3617

Sechskant-Winkelstiftschlüssel Satz 9-teilig mit Multifunktionsgriff und TURBALL®-Kugelkopf, S2-Stahl, matt-satiniert, verchromt, extra lange Form nach DIN ISO 2936

TURBALL® Ball Point Hex Key Set with multifunction handle, Extra Long Version according to DIN ISO 2936

NEU/NEW

9
tlg./pcs.

- ▶ **Inklusive Multifunktionsgriff – ermöglicht Einsatz als T- oder Quer-Griff und erleichtert damit die Verschraubung**
- ▶ **TURBALL®-Kugelkopf**
 - Verschraubung auch bei schrägem Ansetzen möglich
 - Optimierte Kraftübertragung bei geradem Ansetzen gegenüber Standard-Kugelkopf
- ▶ **Mit integriertem Magnet (ab 3 mm)**
 - Schrauben aus Standard-Stahl haften am Werkzeug
- ▶ **Werkzeuge aus qualitativ hochwertigem S2-Stahl**
 - Hohe Festigkeit bei gleichzeitiger Flexibilität

- ▶ *Inclusive multifunction handle – allows use as T-handle or cross-handle*
- ▶ *TURBALL® ball head*
 - *Screwing also possible at angular collaring*
 - *Optimized force transmission compared to regular ball head*
- ▶ *With integrated magnet (from 3 mm on)*
 - *Standard steel screws adhere at the tool*
- ▶ *Made of high quality S2-steel*
 - *Low abrasion, high strength combined with flexibility*



Art.-Nr./Art.-No.

3617

Größe/Size

1,5 - 2 - 2,5 - 3 - 4 - 5 - 6 - 8 - 10 mm

€ 30,40

Zangen

Pliers



Zangen – Innovative Technik für clevere Handwerker

Pliers – Innovative Technique for Clever Craftsmen

Ergonomisch

Ergonomic

- ▶ Hohe Kraftübertragung durch optimale Anpassung des Mehrkomponentengriffs an die Hand
 - ▶ Rutschfeste Oberfläche minimiert das Abrutschen der Hand auch bei öligen oder fettigen Händen
 - ▶ Geringer Kraftaufwand und damit geringere Ermüdung durch ergonomisches und innovatives Design
 - ▶ Innovative Multifunktionszangen vermeiden lästige Werkzeugwechsel und sparen somit Zeit und Kosten
- ▶ High power transmission due to a optimized multi-component handle
- ▶ Non-slip surface minimizes slipping also with oily or greasy hands
- ▶ Minimized efforts and fatigues due to an ergonomic design
- ▶ Innovative multifunctional pliers avoid frequent change of tools and therefore save time and money

Vielseitig

Versatile

- ▶ Für jeden Anwender die richtige Zange durch breites und innovatives Produktsortiment
 - ▶ Für sicheres Arbeiten an elektrischen Anlagen als VDE-Version erhältlich
 - ▶ Viele Anwendungen mit nur einem Werkzeug durch innovative Multifunktionszangen
 - ▶ Große Produktauswahl an perfekt abgestimmten Sets
- ▶ For every user the right plier due to a wide product range
- ▶ As VDE-Versions available – Safety working on electrical installations
- ▶ Versatile applications with only one tool due to innovative multifunctional pliers
- ▶ Wide product range of perfect customized sets



Strapazierfähig und langlebig

Hardwearing and Durable

- ▶ Speziell für den professionellen Einsatz durch hochlegierten, Gesenk geschmiedeten und ölgehärteten Chrom-Vanadium-Stahl geeignet
 - ▶ Noch mehr Stabilität und Haltbarkeit durch induktiv gehärtete Präzisionsschneiden
 - ▶ Dauerhaft hohe Qualität durch prozessgesteuerte Fertigung entsprechend DIN- und ISO-Normen
- ▶ Especially for the professional usage due to high alloyed, drop-forged and oil-hardened Chrome-Vanadium-Steel
- ▶ Even more durability and hardwearing due to induction hardened precision cutting edges
- ▶ Permanent high quality due to process-controlled production according DIN- and ISO-Standards

Sicherheit

Safety

- ▶ Höchste Sicherheit bei Arbeiten an elektrischen Anlagen durch Prüfung nach DIN-EN 60900 und IEC 900 (VDE-Ausführung)
 - ▶ Verminderung der Abrutschgefahr der Hand durch optimierte Griffform
 - ▶ Minimierung der Verletzungsgefahr durch in die Griffe eingearbeiteten Aufprallschutz
- ▶ Highest safety during working on electrical installations due to tests according to DIN-EN 60900 and IEC 900 (VDE-Version)
- ▶ Optimized handle reduces the risk of slipping
- ▶ Minimization of the risk of injury due to handles with integrated anti-trap protection

Kombizangen und Seitenschneider

Combination Pliers and Side Cutters

Art.-Gruppe 155
Article Group 155

Kombizangen

Schneiden gehärtet

Combination Pliers

| Art.-Nr./Art.-No. | Größe/Size | € |
|-------------------|------------|-------|
| 4601-165 | 165 mm | 25,20 |
| 4601-180 | 180 mm | 25,20 |



Profi Winkel-Kombizange 45°

Schneiden gehärtet

Professional Angle Combination Plier 45°

| Art.-Nr./Art.-No. | Größe/Size | € |
|-------------------|---------------------------------|----------------|
| 4601-200 | 180 mm | 44,00 |
| 4601-20006* | Verkaufsdisplay mit 6x 4601-200 | - ¹ |

*Lieferung nur solange der Vorrat reicht / Delivery while stocks last ¹ Nicht mehr lieferbar / ¹ Out of stock

Induktiv gehärtete Schneide für harte und weiche Drähte, integrierter Ringschlüssel 11 – 17 mm / M8 – M10, spezielle Greifzone für Flach- und Rundmaterialien. Ideal für enge Stellen im Boden- und Deckenbereich. Größtmögliche Kraftübertragung, da die Hand in der natürlichen Position gehalten wird – kein Verdrehen des Handgelenkes. Perfekt geeignet für Arbeiten über Kopf



Induction hardened cutting edges for hard and soft wires, integrated ring wrench 11 to 17 mm / M8 to M10, special grip zones for flat and round materials. Best for tight spaces in floor and ceiling area. Maximum power transfer, when hand is in a natural position - no twisting of the hand joint. Perfect for working overhead

Seitenschneider

Schneiden gehärtet

Side Cutter

Induktiv gehärtete Präzisionsschneide, für Piano-Draht (D2-Qualität), enorme Schneidkraft, durch VPA-Remscheid ermittelt: 40 % Kraftersparnis

Precision cutting edges, induction hardened, for piano-wire (D2-quality), enormous cutting force, 40 % reduced effort attested by VPA-Remscheid



| Art.-Nr./Art.-No. | Größe/Size | Typ/Model | € |
|-------------------|------------|-----------------|-------|
| 4603-145 | 145 mm | Seitenschneider | 29,60 |
| 4603-160 | 160 mm | Seitenschneider | 29,60 |



| Art.-Nr./Art.-No. | Größe/Size | Typ/Model | € |
|-------------------|------------|-----------------------------|-------|
| 4604-180 | 180 mm | Hebel Kraft Seitenschneider | 44,80 |



| Art.-Nr./Art.-No. | Größe/Size | Typ/Model | € |
|-------------------|------------|-----------------------|-------|
| 4602-180 | 180 mm | Kraft Seitenschneider | 39,30 |

Telefon-, Radio- und Abisolierzangen

Long Nose and Wire Stripping Pliers

Art.-Gruppen 150/155
Article Groups 150/155

Telefon-/Radiozangen

Long Nose Pliers

DIN ISO 5745, induktiv gehärtete Schneide,
gezahnte Greifflächen, lange, gerade, flachrunde Backen

DIN ISO 5745, induction hardened cutting edges,
serrated inside jaws, long, straight, flatround jaws

| Art.-Nr./Art.-No. | Größe/Size | Typ/Model | € |
|-------------------|------------|------------------|-------|
| 4605-170 | 170 mm | Telefonzange | 28,60 |
| 4605-200 | 205 mm | Telefonzange | 32,95 |
| 4606-200 | 205 mm | Telefonzange 45° | 36,40 |



Abisolierzangen

mit Öffnungsfeder und V-förmiger Schneide
mit Stellschraube zum Einstellen für Drähte
und Litzen bis Ø 5 mm bzw. 10 mm²

Wire Stripping Pliers

| Art.-Nr./Art.-No. | Größe/Size | € |
|-------------------|------------|-------|
| 4607-160 | 160 mm | 31,95 |



Weitere PROForm-Werkstatteinlagen ab Seite /
More PROForm Inlays for Roller Cabinet from Page H 32

Wasserpumpenzangen, Armaturen-Zangenschlüssel und Eckrohrzangen

Waterpump Pliers, Plier Wrench for Fittings and Swedish Elbow Pipe Wrenches

Art.-Gruppe 155
Article Group 155

Wasserpumpenzangen

Waterpump Pliers

| Art.-Nr./Art.-No. | Größe/Size | € |
|-------------------|------------|-------|
| 4609-175 | 175 mm | 20,20 |
| 4609-240 | 240 mm | 20,50 |
| 4609-300 | 300 mm | 36,40 |
| 4609-400 | 400 mm | 57,80 |

Wasserpumpenzange

Waterpump Pliers

| Art.-Nr./Art.-No. | Größe/Size | € |
|-------------------|------------|-------|
| 4608-250 | 250 mm | 27,30 |

Wasserpumpenzangen „MAXI MX“ mit Druckknopf-Einhandverstellung

Waterpump Pliers „MAXI MX“

| Art.-Nr./Art.-No. | Größe/Size | € |
|-------------------|------------|----------------|
| 4516-250 | 250 mm | – ¹ |
| 4517-300 | 300 mm | 43,50 |

¹ Nicht mehr lieferbar – Nachfolgeartikel 4517-250 / ¹ Out of stock – Successor 4517-250

Armaturen-Zangenschlüssel mit glattpolierten Greifflächen

Plier wrench for fittings

With smoothly polished gripping surfaces

| Art.-Nr./Art.-No. | Größe/Size | Länge/Length | € |
|-------------------|------------|--------------|-------|
| 4618-250 | 1" | 250 mm | 44,20 |

Schwedische Eckrohrzangen

S-förmiges Maul

Swedish Elbow Pipe Wrench

| Art.-Nr./Art.-No. | Größe/Size | Länge/Length | € |
|-------------------|------------|--------------|-------|
| 4557-340 | 1" | 340 mm | 42,50 |
| 4557-430 | 1 1/2" | 430 mm | 58,00 |
| 4557-550 | 2" | 550 mm | 98,00 |

| Art.-Nr./Art.-No. | Größe/Size | Länge/Length | € |
|-------------------|------------|--------------|--------|
| 4559-340 | 1" 90° | 340 mm | 40,70 |
| 4559-430 | 1 1/2" 90° | 430 mm | 51,40 |
| 4559-550 | 2" 90° | 550 mm | 86,00 |
| 4559-650 | 3" 90° | 650 mm | 159,00 |



Wasserpumpen-, Eckrohr-, Flechter- und Kantenzangen

Waterpump Plier, Elbow Pipe Wrenches, KX-tower Pincers and Pincers

Art.-Gruppe 155
Article Group 155

Wasserpumpen- und Eckrohrzangen Satz, 3-tlg.

Waterpump and Elbow Pipe Wrench Set, 3 pcs.

3
tlg./pcs.

| Art.-Nr./Art.-No. | Größe/Size |
|-------------------|--|
| 9985 | Wasserpumpenzange/Waterpump Plier 240 mm + Schwedische Eckrohrzange/Elbow Pipe Wrench 1" + Schwedische Eckrohrzange/Elbow Pipe Wrench 1 1/2" |
| € 117,90 | |



Bestehend aus Artikel 4609-240 + 4557-340 + 4557-430

Content item 4609-240 + 4557-340 + 4557-430

KX-Solinger Flechterzangen

KX-Tower Pincers

Schneiden gehärtet

Hardened Cutting Edges

| Art.-Nr./Art.-No. | Größe/Size | € |
|-------------------|------------|--------------|
| 4640-230 | 230 mm | 20,90 |
| 4640-260 | 260 mm | 22,90 |



Beiß-/Kantenzangen

Pincers

| Art.-Nr./Art.-No. | Größe/Size | € |
|-------------------|------------|--------------|
| 4643-180 | 180 mm | 17,40 |
| 4643-210 | 210 mm | 18,80 |



Weitere PROForm-Werkstatteinlagen ab Seite /
More PROForm Inlays for Roller Cabinet from Page **H 32**

Zangen VDE/EN 60900

Pliers VDE/EN 60900



Art.-Gruppe 155
Article Group 155

Nach DIN EN 60900, IEC 900, Stückprüfung im Wasserbad mit einer Prüfspannung von 10.000 Volt.
Kälteschlagprüfung bei -40° (Kennzeichnung C)

According to DIN EN 60900, IEC 900. Tested by 10.000 Volt.



| Art.-Nr./Art.-No. | Größe/Size | Typ/Model | € |
|-------------------|------------|------------------|--------------|
| 4621-180 | 180 mm | Kraft Kombizange | 30,90 |



| Art.-Nr./Art.-No. | Größe/Size | Typ/Model | € |
|-------------------|------------|----------------|--------------|
| 4629-160 | 160 mm | Kabelschneider | 49,90 |
| 4629-210 | 210 mm | Kabelschneider | 66,90 |



| Art.-Nr./Art.-No. | Größe/Size | Typ/Model | € |
|-------------------|------------|-----------------|--------------|
| 4623-160 | 160 mm | Seitenschneider | 33,20 |



| Art.-Nr./Art.-No. | Größe/Size | Typ/Model | € |
|-------------------|------------|-----------------------|--------------|
| 4622-180 | 180 mm | Kraft Seitenschneider | 40,80 |



| Art.-Nr./Art.-No. | Größe/Size | Typ/Model | € |
|-------------------|------------|--------------|--------------|
| 4625-200 | 205 mm | Telefonzange | 36,80 |



| Art.-Nr./Art.-No. | Größe/Size | Typ/Model | € |
|-------------------|------------|------------------|--------------|
| 4626-200 | 205 mm | Telefonzange 45° | 39,90 |



| Art.-Nr./Art.-No. | Größe/Size | Typ/Model | € |
|-------------------|------------|----------------|--------------|
| 4627-160 | 160 mm | Abisolierzange | 35,20 |



| Art.-Nr./Art.-No. | Größe/Size | Typ/Model | € |
|-------------------|------------|-------------------|--------------|
| 4628-250 | 250 mm | Wasserpumpenzange | 36,50 |

Multifunktionszangen VDE/EN 60900

Functional Pliers VDE/EN 60900



Art.-Gruppe 155
Article Group 155

**Nach DIN EN 60900, IEC 900, Stückprüfung im Wasserbad mit einer Prüfspannung von 10.000 Volt.
Kälteschlagprüfung bei -40° (Kennzeichnung C)**

According to DIN EN 60900, IEC 900. Tested by 10.000 Volt.

Profi Winkel-Kombizange 45°

Schneiden gehärtet

Professional Angle Combination Plier 45°

| Art.-Nr./Art.-No. | Größe/Size | € |
|-------------------|---------------------------------|--------|
| 4621-200 | 180 mm | 47,00 |
| 4621-20006* | Verkaufsdisplay mit 6x 4621-200 | 279,00 |

*Lieferung nur solange der Vorrat reicht / Delivery while stocks last

Technische Details entnehmen Sie bitte der Seite H 211 (4601-200)
Please find technical information on page H 211 (4601-200).

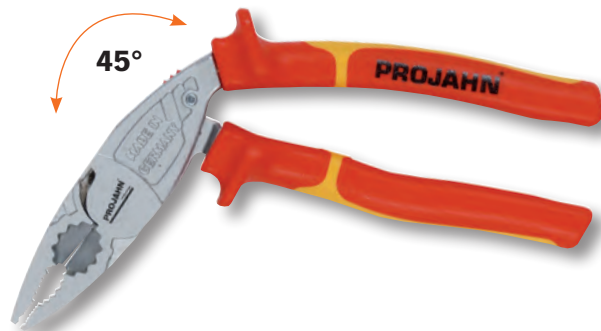

Multischneider 3-in-1

Multicutter 3-in-1

3 Funktionen mit einem Werkzeug

Abschneiden, Abmanteln, Abisolieren

One Tool – 3 Functions

Cut Off, Strip Cable, Strip Wire

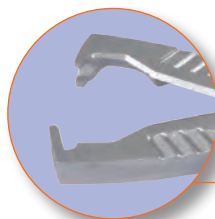

| Art.-Nr./Art.-No. | Größe/Size | Typ/Model | € |
|-------------------|------------|-----------------------|-------|
| 4630-180 | 180 mm | Multischneider 3-in-1 | 56,00 |



ERGO Multifunktions-Elektrozange 45°

ERGO Multifunctional Electrician's Pliers

Schonendes und ermüdungsarmes Arbeiten durch ergonomisches Zangendesign

Vereint viele Funktionen in einem Werkzeug

Strain-Free Working due to ergonomic design

Combines many different functions in one tool

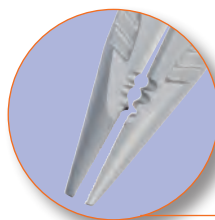

| Art.-Nr./Art.-No. | Größe/Size | Typ/Model | € |
|-------------------|------------|--------------------------------------|-------|
| 4631-200 | 200 mm | ERGO Multifunktions-Elektrozange 45° | 56,00 |



Sicherungsringzangen

Circlip Pliers

Art.-Gruppen 150/155
Article Groups 150/155

PROFESSIONAL PLUS STANDARD

Sicherungsringzangen

Circlip Pliers



| Art.-Nr./Art.-No. | Größe/Size | | | € |
|-------------------|------------|------------|-------------------------|-------|
| 4683-A2 | A2 | 19 - 60 mm | für Außenringe, gerade | 20,30 |
| 4683-A21 | A21 | 19 - 60 mm | für Außenringe, gebogen | 22,50 |
| 4683-J2 | J2 | 19 - 60 mm | für Innenringe, gerade | 18,90 |
| 4683-J21 | J21 | 19 - 60 mm | für Innenringe, gebogen | 20,50 |

PROFESSIONAL PLUS STANDARD

Sicherungsringzangen

Circlip Pliers



| Art.-Nr./Art.-No. | Größe/Size | | | € |
|-------------------|------------|-------------|-------------------------|-------|
| 4383-A1 | A1 | 10 - 25 mm | für Außenringe, gerade | 16,90 |
| 4383-A11 | A11 | 10 - 25 mm | für Außenringe, gebogen | 17,90 |
| 4383-A2 | A2 | 19 - 60 mm | für Außenringe, gerade | 18,40 |
| 4383-A21 | A21 | 19 - 60 mm | für Außenringe, gebogen | 19,60 |
| 4383-A3 | A3 | 40 - 100 mm | für Außenringe, gerade | 20,50 |
| 4383-A31 | A31 | 40 - 100 mm | für Außenringe, gebogen | 21,80 |
| 4383-J1 | J1 | 12 - 25 mm | für Innenringe, gerade | 14,95 |
| 4383-J11 | J11 | 12 - 25 mm | für Innenringe, gebogen | 16,20 |
| 4383-J2 | J2 | 19 - 60 mm | für Innenringe, gerade | 16,80 |
| 4383-J21 | J21 | 19 - 60 mm | für Innenringe, gebogen | 17,90 |
| 4383-J3 | J3 | 40 - 100 mm | für Innenringe, gerade | 18,70 |
| 4383-J31 | J31 | 40 - 100 mm | für Innenringe, gebogen | 19,80 |

Blech-/Figurenscheren, Mattenschneider, Bolzenschneider

Tinmans Shears, Mesh Cutter, Bolt Cutter

Art.-Gruppen 150/155
Article Groups 150/155

PROFESSIONAL PLUS STANDARD

Blech-/Figurenscheren

Schnittleistung: Stahlblech bis 1,2 mm

Tinmans Shears

Cutting Capacity: Sheet Steel 1,2 mm

| Art.-Nr./Art.-No. | | € |
|-------------------|-------------------------------------|-------|
| 4584 | Satz 3-tlg./pcs links/rechts/gerade | 54,50 |
| 4550 | rot/links | 19,50 |
| 4551 | grün/rechts | 19,50 |
| 4552 | gelb/gerade | 19,50 |



PROFESSIONAL PLUS STANDARD

Mattenschneider

Mesh Cutter

Spezial Mattenschneider

zum Schneiden von Baustahlgeweben

Mesh Cutter



| Art.-Nr./Art.-No. | L/L | max. Schneid-Ø bei 750 N/mm ² | max. Schneid-Ø bei 1250 N/mm ² | € |
|-------------------|--------|--|---|--------|
| 4555 | 900 mm | 12 mm | 10 mm | 154,00 |

PROFESSIONAL PLUS STANDARD

Bolzenschneider

Bolt Cutter

Bolzenschneider

Verschraubte, auswechselbare Köpfe
geschmiedete Backen aus Chrom-Molybdän-Stahl

Bolt Cutter



| Art.-Nr./Art.-No. | Größe/Size | L/L | Weich Mat. max/Soft Mat. Max | Hart Mat. max/Hart Mat. Max | € |
|-------------------|------------|--------------------|------------------------------|-----------------------------|--------|
| 4553-14 | 14" | 350 mm | 6 mm | 5 mm | 41,80 |
| 4553-18 | 18" | 450 mm | 7 mm | 6 mm | 54,90 |
| 4553-24 | 24" | 600 mm | 10 mm | 8 mm | 76,95 |
| 4553-30 | 30" | 750 mm | 13 mm | 10 mm | 102,00 |
| 4553-36 | 36" | 900 mm | 16 mm | 12 mm | 129,50 |
| 4554-14 | 14" | Ersatz-Schneidkopf | | | 28,80 |
| 4554-18 | 18" | Ersatz-Schneidkopf | | | 41,80 |
| 4554-24 | 24" | Ersatz-Schneidkopf | | | 56,20 |
| 4554-30 | 30" | Ersatz-Schneidkopf | | | 71,80 |
| 4554-36 | 36" | Ersatz-Schneidkopf | | | 90,20 |

Gripzangen

Self Grip Pliers

Art-Gruppe 150
Article Group 150

PROFESSIONAL PLUS STANDARD

Gripzangen

glanzvernickelt, mit Lösehebel und gebogenen Backen

Self Grip Pliers

| Art.-Nr./Art.-No. | Größe/Size | L/L | Spannweite/Capacity | € |
|-------------------|------------|--------|---------------------|--------------|
| 4556-175 | 7" | 175 mm | 41 mm | 17,75 |
| 4556-250 | 10" | 250 mm | 48 mm | 20,90 |



PROFESSIONAL PLUS STANDARD

Breitmaul-Gripzangen

Self Grip Plier With Wide Jaws

Besonders breite und flache Greifbacken mit Lösehebel, geeignet zum Halten, Biegen und Bördeln von Blechen

Special width and flat self grip pliers with quick release lever, useful for fixing, bending and beading of sheets and plates

| Art.-Nr./Art.-No. | Größe/Size | L/L | Spannweite/Capacity | € |
|-------------------|------------|--------|---------------------|--------------|
| 4561-205 | 8" | 205 mm | 60 mm | 28,80 |
| 4561-245 | 10" | 245 mm | 67 mm | 35,20 |



PROFESSIONAL PLUS STANDARD

Schweißer-Gripzange

Welding Self Grip Plier



U-Form-Greifbacken, obere Greifbacke 90° abgewinkelt, zum Spannen beim Verschweißen von Profil- oder Flachmaterial, usw. auf Stoß

U-form-grip, top grip 90° offset, for clamping the welding of profile or flat material, etc. on strike

| Art.-Nr./Art.-No. | Größe/Size | L/L | Spannweite/Capacity | € |
|-------------------|------------|--------|---------------------|--------------|
| 4562-225 | 9" | 225 mm | 45 mm | 32,13 |

PROFESSIONAL PLUS STANDARD

Klammer-Gripzange

Welding-Clip Self Grip Plier



Schmale Greifbacken mit hohem Bügel, tief ausladend, geeignet zum Spannen von Profil-Material mit hohen Stegen oder über sperrige Werkstücke

Narrow gripping jaws with high temple, deep overhangs, suitable for clamping profile material with high piers or bulky workpieces

| Art.-Nr./Art.-No. | Größe/Size | L/L | Spannweite/Capacity | € |
|-------------------|------------|--------|---------------------|--------------|
| 4563-275 | 11" | 280 mm | 73 mm | 34,65 |

Langbeck Klemmzangen, Elektronik Zangen

Self Grip Pliers, Electronic Pliers

Art.-Gruppe 150
Article Group 150

Langbeck Klemmzange

glanzvernickelt, mit Lösehebel und geraden, langen Backen

Self Grip Pliers, Long Jaws

| Art.-Nr./Art.-No. | Größe/Size | L/L | Spannweite/Capacity | € |
|-------------------|------------|--------|---------------------|-------|
| 4557-150 | 6" | 150 mm | 44,5 mm | 16,95 |



Elektronik Zangen

Electronic Pliers

Elektronik Zangen

Spezial-Serie für extrem feines Arbeiten auf engstem Raum und an schwer zugänglichen Stellen.

Electronic Pliers

Special line for extremely precise working in smallest spaces and in positions otherwise inaccessible.



| Art.-Nr./Art.-No. | Größe/Size | Typ/Model | € |
|-------------------|------------|------------|-------|
| 4330-130 | 130 mm | Flachzange | 13,95 |



| Art.-Nr./Art.-No. | Größe/Size | Typ/Model | € |
|-------------------|------------|-----------|-------|
| 4331-120 | 130 mm | Rundzange | 13,95 |



| Art.-Nr./Art.-No. | Größe/Size | Typ/Model | € |
|-------------------|------------|-------------|-------|
| 4332-130 | 130 mm | Kettenzange | 13,95 |



| Art.-Nr./Art.-No. | Größe/Size | Typ/Model | € |
|-------------------|------------|-----------------|-------|
| 4333-120 | 130 mm | Kettenzange 45° | 13,95 |



| Art.-Nr./Art.-No. | Größe/Size | Typ/Model | € |
|-------------------|------------|-----------------|-------|
| 4334-110 | 110 mm | Seitenschneider | 13,95 |

Zangen-Sätze

Pliers Sets

Art.-Gruppe 155
Article Group 155

4680

Zangen Set 3-teilig

- ▶ **Kombizange 180 mm** ▶ *Combination pliers 180 mm*
- ▶ **Seitenschneider 160 mm** ▶ *Side Cutter 160 mm*
- ▶ **Wasserpumpenzange 250 mm** ▶ *Waterpump Pliers 250 mm*

Pliers Set 3 pieces

| Art.-Nr./Art.-No. | € |
|-------------------|--------------|
| 4680 3-tlg./pcs | 87,00 |

3
tlg./pcs.



4681

Zangen Set 3-teilig

- ▶ **Kombizange 180 mm** ▶ *Combination pliers 180 mm*
- ▶ **Seitenschneider 160 mm** ▶ *Side cutter 160 mm*
- ▶ **Telefonzange 205 mm** ▶ *Long nose plier 205 mm*

Pliers Set 3 pieces

| Art.-Nr./Art.-No. | € |
|-------------------|--------------|
| 4681 3-tlg./pcs | 85,00 |

3
tlg./pcs.



Zangen Set VDE 3-teilig

Pliers Set VDE 3 pieces



4691

Zangen Set VDE 3-teilig VDE/EN 60900

- ▶ **Kombizange 180 mm** ▶ *Combination pliers 180 mm*
- ▶ **Seitenschneider 160 mm** ▶ *Side Cutter 160 mm*
- ▶ **Telefonzange 205 mm** ▶ *Long nose pliers 205 mm*

*Pliers Set VDE 3 pieces
VDE/EN 60900*

| Art.-Nr./Art.-No. | € |
|-------------------|--------------|
| 4691 3-tlg./pcs | 97,00 |

3
tlg./pcs.



Zangen-Sätze

Pliers Sets

Art.-Gruppen 150/155
Article Groups 150/155

PROFESSIONAL PLUS STANDARD

4683

Sicherungsringzangen Satz, 4-teilig

Circlip Pliers Set, 4 pieces

4
tlg./pcs.

Art.-Nr./Art.-No.

€

4683

A2 - A21 - J2 - J21

79,00

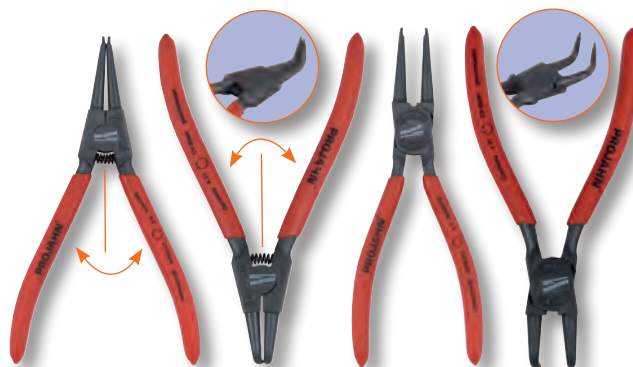

PROFESSIONAL PLUS STANDARD

4383

Sicherungsringzangen Satz, 4-teilig

Circlip Pliers Set, 4 pieces

4
tlg./pcs.

Art.-Nr./Art.-No.

€

4383

A2 - A21 - J2 - J21

66,50

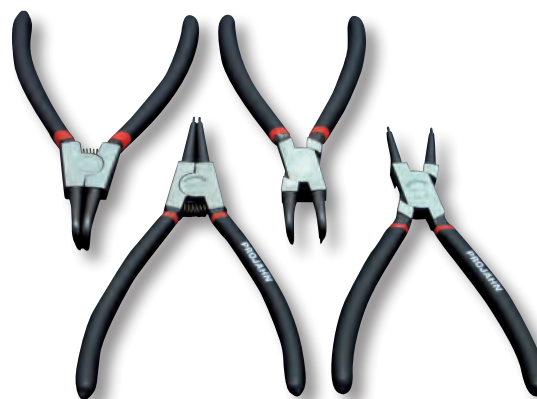

PROFESSIONAL PLUS STANDARD

Blech-/Figurescheren Satz, 3-teilig

Tinmans Shears Set, 3 pieces

4584

Blech-/Figurescheren Satz 3-teilig

Schnittleistung: Stahlblech bis 1,2 mm

Tinmans shears set 3 pieces

Cutting capacity: sheet steel 1,2 mm

3
tlg./pcs.

Art.-Nr./Art.-No.

€

4584

Satz 3-tlg./pcs links/rechts/gerade

54,50



Taschenlampen & Arbeitsleuchten

Flashlights & Working Lamps



Power-LED-Taschenlampen & Arbeitsleuchten

Power LED Flashlights and Working Lamps

PROLUMAX



398211

- ▶ **Neueste LED-Technologie**
 - Hohe Lichtleistung + Helligkeit, große Leuchtwerte, nahezu weißes Licht
 - Lange LED-Lebensdauer
 - 10 Jahre Funktionsgarantie auf alle PROLumax-Leuchten mit Cree®, SMD®- und COB®-LED-Technologie
- ▶ **Hochwertige Verarbeitung & Materialien**
 - Aus robustem, langlebigem und stoßfestem Flugzeugaluminium
 - Spritzwasserdicht nach IP54
- ▶ **Schlankes und modernes Design verknüpft mit durchdachten Mehrwerten**
 - Kein unnötiger Ballast und ausgeglichenes Handling
 - Sowohl mit handelsüblichen Batterien als auch mit Standardakkus funktionsfähig
 - Wiederaufladbare Lithium-Ionen-Akkus (bei Modellen 398250, 398251)
 - Ergonomische, rutschhemmende Oberfläche
- ▶ **Innovative Funktionen**
 - Mit Handschuh bedienbarer Schalter, zusätzlich Wegrollschutz
 - 2 Lichtleistungen über Schalter wählbar bzw. stufenlos dimmbar (nicht bei Art.-Nr. 398210/398213/398214)
 - Variabler Leuchtwinkel durch fokussierbare Linse (nicht bei Art.-Nr. 398213/398214/398215)

- ▶ **Latest LED technology**
 - High luminous power + brightness, extensive light distance, almost white light
 - Long life LED
 - 10 year life guarantee on all PROLumax-flashlights with Cree®, SMD®- and COB®-LED-technology
- ▶ **High-quality workmanship & materials**
 - Made of sturdy, durable and impact-resistant aircraft aluminium
 - Impermeable to splash-water by IP54
- ▶ **Slim and modern design associated with sophisticated added values**
 - No dead weight and easy handling
 - Usable with standard batteries as well as with rechargeable batteries
 - Rechargeable Lithium-Ion batteries (398250, 398251)
 - Ergonomic, non slip surface
- ▶ **Innovative Features**
 - Easily operable with gloves
 - 2 light power levels selectable or continuously dimmable (not for Art.-No. 398210/398213/398214)
 - Roll away protection
 - Variable angle of illumination by focusable lens (not for Art.-No. 398213/398214/398215)

* Alle Werte gemessen entsprechend ANSI FL1-Prüfverfahren
 * All data scaled according to ANSI FL1-method of test

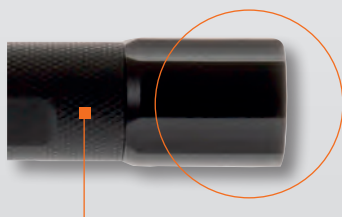

Einkerbungen verhindern Wegrollen /
 Roll away protection

Extrem griffsicher durch rutschfeste Rändelung /
 Extremely secure grip due to non-slip knurling



Aus Flugzeugaluminium – stoßfest aus 1,5 m Höhe /
 Made of aircraft aluminium – durable + impact resistant



1

2

Variabler Leuchtwinkel durch fokussierbare Linse /
 Variable angle of illumination by focusable lens

Zwei Lichtleistungen wählbar / Two Light Power Levels selectable



Ein/Aus-Knopf /
 On/Off Switch

Kein ungewolltes Ein/Ausschalten, durch tief liegenden Ein/Aus-Knopf. Selbst mit Handschuhen bedienbar! / Backside switch, easily operable even with gloves!

Power-LED-Taschenlampen & Arbeitsleuchten

Power LED Flashlights and Working Lamps

Art.-Gruppen 184
Article Groups 184

398215

PROLumax Cree®-Power LED-Taschenlampe PJ 500

PROLumax Cree® Power LED Flashlight PJ 500



stufenlos dimmbar /
continuously dimmable

Cree®-Power LED-Taschenlampe PJ 500

Technische Daten / Technical Details:

| | |
|-------------------------------|----------------------------------|
| Leuchtmittel/Illuminant: | 10 Watt CREE® CM-L2 T6 Power-LED |
| Leuchtdauer/Fluorescent time: | ca. 8 Stunden/hours* |
| Lichtleistung/Light Power: | 500 Lumen* |
| Leuchtweite/Light Distance: | 300 Meter* |
| Material/Material: | Aluminium, eloxiert |
| Gewicht/Weight: | 225 Gramm |
| Batterien/Batteries: | 3x C-Cell (inklusive) |

- ▶ 10 Jahre Funktionsgarantie auf LED/
10 year functional guarantee on LED
- ▶ IP 67 = wasser- und staubdicht,
über Ein-/Ausschalter stufenlos dimmbar/
IP 67 = water and dust proof,
continuously dimmable

| Art.-Nr./Art.-No. | Modell/Model | Farbe/Color | Länge/Length | Ø | € |
|-------------------|--------------|---------------|--------------|-------|-------|
| 398215 | PJ500 | Schwarz/Black | 236 mm | 42 mm | 59,90 |

398211

PROLumax Cree®-Power LED-Taschenlampe PJ 120

PROLumax Cree® Power LED Flashlight PJ 120



Cree®-Power LED-Stiftlampe PJ 120

Technische Daten / Technical Details:

| | |
|-------------------------------|-----------------------------|
| Leuchtmittel/Illuminant: | 3 Watt CREE® white XP-E LED |
| Leuchtdauer/Fluorescent time: | ca. 2,5 Stunden/hours* |
| Lichtleistung/Light Power: | 120 Lumen* |
| Leuchtweite/Light Distance: | 65 Meter* |
| Material/Material: | Aluminium, eloxiert |
| Gewicht/Weight: | 85 Gramm |
| Batterien/Batteries: | 2x AA (inklusive) |

- ▶ 10 Jahre Funktionsgarantie auf LED/
10 year functional guarantee on LED
- ▶ Fokussierbare Linse, zwei Lichtleistungen/
Focusable lens, two light power levels

| Art.-Nr./Art.-No. | Modell/Model | Farbe/Color | Länge/Length | Ø | € |
|-------------------|--------------|---------------|--------------|-------|-------|
| 398211 | PJ120 | Schwarz/Black | 151 mm | 29 mm | 25,50 |

398212

PROLumax Cree®-Power LED-Taschenlampe PJ220

PROLumax Cree® Power LED Flashlight PJ220



Cree®-Power LED-Stiftlampe PJ220

Technische Daten / Technical Details:

| | |
|-------------------------------|--------------------------------|
| Leuchtmittel/Illuminant: | 5 Watt CREE® XP-G R5 Power-LED |
| Leuchtdauer/Fluorescent time: | ca. 1,5 Stunden/hours* |
| Lichtleistung/Light Power: | 220 Lumen* |
| Leuchtweite/Light Distance: | 130 Meter* |
| Material/Material: | Aluminium, eloxiert |
| Gewicht/Weight: | 171 Gramm |
| Batterien/Batteries: | 3x AAA (inklusive) |

- ▶ 10 Jahre Funktionsgarantie auf LED/
10 year functional guarantee on LED
- ▶ Fokussierbare Linse, zwei Lichtleistungen/
Focusable lens, two light power levels

| Art.-Nr./Art.-No. | Modell/Model | Farbe/Color | Länge/Length | Ø | € |
|-------------------|--------------|---------------|--------------|-------|-------|
| 398212 | PJ220 | Schwarz/Black | 138 mm | 41 mm | 46,20 |

* Alle Werte gemessen entsprechend ANSI FL1-Prüfverfahren / All data scaled according to ANSI FL1-method of test

Power-LED-Taschenlampen & Arbeitsleuchten

Power LED Flashlights and Working Lamps

Art.-Gruppen 184
Article Groups 184

398210

PROFESSIONAL PLUS STANDARD

PROLumax Cree®-Power-LED-Taschenlampe PJ45

PROLumax Cree® Power LED Flashlight PJ45



Cree®-Power LED-Taschenlampe PJ45

Technische Daten / Technical Details:

| | |
|-------------------------------|----------------------------|
| Leuchtmittel/Illuminant: | 3 Watt Cree® white XPE LED |
| Leuchtdauer/Fluorescent time: | ca. 6 Stunden/hours* |
| Lichtleistung/Light Power: | 45 Lumen* |
| Leuchtweite/Light Distance: | 45 Meter* |
| Material/Material: | Aluminium, eloxiert |
| Gewicht/Weight: | 51 Gramm |
| Batterien/Batteries: | 1x AA (inklusive) |

- ▶ 10 Jahre Funktionsgarantie auf LED/
10 year functional guarantee on LED
- ▶ Fokussierbare Linse, leicht und handlich/
Focusable lens, light weight and handy size

| Art.-Nr./Art.-No. | Modell/Model | Farbe/Color | Länge/Length | Ø | € |
|-------------------|--------------|---------------|--------------|-------|-------|
| 398210 | PJ45 | Schwarz/Black | 99 mm | 25 mm | 21,50 |

398213GB

PROFESSIONAL PLUS STANDARD

PROLumax Power-LED-Stiftlampe PJ15

PROLumax Power LED Penlight PJ15



Power-LED-Stiftlampe PJ15

Technische Daten / Technical Details:

| | |
|-------------------------------|----------------------|
| Leuchtmittel/Illuminant: | 0,5 Watt Power-LED |
| Leuchtdauer/Fluorescent time: | ca. 4 Stunden/hours* |
| Lichtleistung/Light Power: | 15 Lumen* |
| Leuchtweite/Light Distance: | 13 Meter* |
| Material/Material: | Aluminium, eloxiert |
| Gewicht/Weight: | 31 Gramm |
| Batterien/Batteries: | 1x AAA (inklusive) |

- ▶ Mit Karabinerhaken ideal für den Schlüsselbund/
With carabiner fits perfect to your bunch of keys



| Art.-Nr./Art.-No. | Modell/Model | Farbe/Color | Länge/Length | Ø | € |
|-------------------|---------------------------------------|---------------|--------------|-------|--------|
| 398213GB | PJ15 | Schwarz/Black | 95 mm | 17 mm | 15,90 |
| 39821314D | Display mit 9 x 398213 und 9 x 398214 | | | | 205,00 |

398214GB

PROFESSIONAL PLUS STANDARD

PROLumax Power-LED-Stiftlampe PJ23

PROLumax Power LED Penlight PJ23



Power-LED-Stiftlampe PJ23

Technische Daten / Technical Details:

| | |
|-------------------------------|----------------------|
| Leuchtmittel/Illuminant: | 0,5 Watt Power-LED |
| Leuchtdauer/Fluorescent time: | ca. 4 Stunden/hours* |
| Lichtleistung/Light Power: | 23 Lumen* |
| Leuchtweite/Light Distance: | 16 Meter* |
| Material/Material: | Aluminium, eloxiert |
| Gewicht/Weight: | 36 Gramm |
| Batterien/Batteries: | 2x AAA (inklusive) |

- ▶ Mit Halteclip ideal für Jacken- oder Westentasche/
With clip perfect for your waist coat pocket



| Art.-Nr./Art.-No. | Modell/Model | Farbe/Color | Länge/Length | Ø | € |
|-------------------|---------------------------------------|---------------|--------------|-------|--------|
| 398214GB | PJ23 | Schwarz/Black | 139 mm | 17 mm | 16,90 |
| 39821314D | Display mit 9 x 398214 und 9 x 398213 | | | | 205,00 |

H 218

Power-LED-Taschenlampen & Arbeitsleuchten

Power LED Flashlights and Working Lamps

Art.-Gruppen 182
Article Groups 182

398231

PROLumax Cree®-Power LED-Universal-Spotlight PJ100 UNI

PROLumax Cree® Power LED Universal Spotlight PJ100 UNI



Cree®-Power LED Taschenlampe PJ100 UNI

NEU/NEW

Technische Daten / Technical Details:

| | |
|---|----------------------|
| Leuchtmittel/Illuminant: | 3 W CREE® XP-E2 LED |
| Leuchtdauer/Fluorescent time: | ok. 3 Stunden/hours* |
| Lichtleistung/Light Power: | 100 Lumen* |
| Leuchtweite/Light Distance: | 90 Meter* |
| Material/Material: | Aluminium, eloxiert |
| Gewicht/Weight: | 66 Gramm |
| Batterien/Batteries: | 1x AAA (inklusive) |
| Spritzwasserdicht IPX4/Splashproof IPX4 | |

- ▶ 10 Jahre Funktionsgarantie auf LED/
10 year functional guarantee on LED
- ▶ Fokussierbare Linse, leicht und handlich/
Focusable lens, light weight and handy size

| Art.-Nr./Art.-No. | Modell/Model | Farbe/Color | Länge/Length | Ø | € |
|-------------------|--------------|---------------|--------------|-------|-------|
| 398231 | PJ100UNI | Schwarz/Black | 99 mm | 25 mm | 19,90 |

398230

PROLumax Cree®-Power LED-Stirnlampe PJ 100S

PROLumax Cree® Power LED Headlamp PJ 100S



Cree®-Power LED-Stirnlampe PJ 100S

Technische Daten / Technical Details:

| | |
|-------------------------------|---|
| Leuchtmittel/Illuminant: | 1x 3 Watt CREE® XP-E LED 1x Standard-LED (weiß) 2x Standard-LED (rot) |
| Leuchtdauer/Fluorescent time: | ca. 6 Stunden/hours* |
| Lichtleistung/Light Power: | 100 Lumen* |
| Leuchtweite/Light Distance: | 50 Meter* |
| Material/Material: | Kunststoff/plastic |
| Gewicht/Weight: | 140 Gramm |
| Batterien/Batteries: | 3x AAA (inklusive) |

- ▶ 10 Jahre Funktionsgarantie auf LED/
10 year functional guarantee on LED
- ▶ Hoher Tragekomfort,
2 Lichtleistungen und 3 Leucht-/Blinkmodi einstellbar/
Greater wearing comfort,
2 light power levels and 3 light/twinking levels selectable

| Art.-Nr./Art.-No. | Modell/Model | Farbe/Color | € |
|-------------------|--------------|---------------|-------|
| 398230 | PJ100S | Schwarz/Black | 17,30 |

398251

PROLumax LED-Arbeitslampe PJ-AL 150

PROLumax LED Working Lamp PJ-AL 150



Power-LED-Arbeitslampe PJ-AL 150

Technische Daten / Technical Details:

| | |
|--|--|
| Leuchtmittel/Illuminant: | 1x 1,5 Watt COB-Power-LED |
| Leuchtdauer/Fluorescent time: | ca. 5 Stunden/hours* |
| Ladedauer/Charging Periode: | ca. 4 Stunden/hours |
| Material/Material: | Kunststoff/plastic |
| Gewicht/Weight: | 165 Gramm |
| Lichtleistung/Light Power: | 150 Lumen* |
| Leuchtwinkel/Light Angle: | 120° |
| Akku/Battery: | Lithium-Ionen-Akku, wieder aufladbar/ rechargeable lithium ions battery |
| Kapazität/Capacity: | 1.800 mAh |
| Inkl. 110 - 240 V Netzteil und Kfz-Ladekabel/ Incl. 110 - 240 V Power Unit and Car Charger | |

- ▶ 10 Jahre Funktionsgarantie auf LED/ 10 year functional guarantee on LED
- ▶ Extrem schlanke Bauform, rückseitiger Magnet/
Extremely slim design, back side with magnetic area
- ▶ Wiederaufladbarer Lithium-Ionen-Akku/Rechargeable lithium ions battery
- ▶ Rutschfeste Oberfläche/Non-slip surface

| Art.-Nr./Art.-No. | Modell/Model | Farbe/Color | Maße/Dimensions | € |
|-------------------|--------------|---------------|------------------|-------|
| 398251 | PJ-AL 150 | Schwarz/Black | 13 x 45 x 320 mm | 64,90 |

Power-LED-Taschenlampen & Arbeitsleuchten

Power LED Flashlights and Working Lamps

Art.-Gruppen 184
Article Groups 184

398250

PROLumax LED-Hand-Arbeitslampe PJ-AL 120

PROLumax LED Hand Working Lamp PJ-AL 120



Als Powerbank nutzbar

Power-LED-Hand-Arbeitslampe PJ-AL 120

Technische Daten / Technical Details:

Leuchtmittel/Illuminant: 4x 0,5 Watt SMD-Power-LED
 Leuchtdauer/Fluorescent time: ca. 3 Stunden/hours*
 Lichtleistung/Light Power: 120 Lumen*
 Leuchtwinkel/Light Angle: 100°
 Ladedauer/Charging Periode: ca. 4 Stunden/hours
 Material/Material: Kunststoff/plastic
 Gewicht/Weight: 150 Gramm
 Akku/Battery: Lithium-Ionen-Akku, wiederaufladbar/
 rechargeable lithium ions battery
 Kapazität/Capacity: 1.800 mAh
 Inkl. 110 - 240 V Netzteil und Kfz-Ladekabel/
 Incl. 110 - 240 V Power Unit and Car Charger

- ▶ 10 Jahre Funktionsgarantie auf LED/
10 year functional guarantee on LED
- ▶ Als Powerbank nutzbar, integrierter Kippfuß mit Magnet/
Usable as Powerbank, integrated tilt food with magnet
- ▶ Wiederaufladbarer Lithium-Ionen-Akku/
Rechargeable lithium ions battery
- ▶ Rutschfeste, ergonomische Oberfläche/
Non-slip surface

| Art.-Nr./Art.-No. | Modell/Model | Farbe/Color | Maße/Dimensions | € |
|-------------------|--------------|---------------|------------------|-------|
| 398250 | PJ-AL120 | Schwarz/Black | 60 x 25 x 120 mm | 59,90 |

*Praxisbeispiel. Mobiltelefon nicht im Lieferumfang enthalten.

398252

PROLumax Power LED-Werkstattlampe PJ-AL250

PROLumax Power LED Workshop Lamp PJ-AL250

NEU/NEW



Geknickt

Haken

Hinten

Zweit-LED

Zubehör

Power-LED-Werkstattlampe PJ-AL250

Technische Daten / Technical Details:

Leuchtmittel/Illuminant: 6x 0,5 W SMD-Power-LED
 1x Standard-LED (weiß/white)
 Leuchtdauer/Fluorescent time: ca. 3 Stunden/hours*
 Lichtleistung/Light Power: 250 Lumen*
 Leuchtwinkel/Light Angle: 100°
 Leuchtweite/Light Distance: 7 Meter*
 Ladedauer/Charging Periode: ca. 4 Stunden/hours
 Material/Material: Kunststoff/plastic
 Gewicht/Weight: 315 Gramm
 Akku/Battery: Lithium-Ionen-Akku, wiederaufladbar/
 rechargeable lithium ions battery
 Kapazität/Capacity: 2.200 mAh
 Inkl. 110 - 240 V Netzteil und Kfz-Ladekabel/
 Incl. 110 - 240 V Power Unit and Car Charger

- ▶ 10 Jahre Funktionsgarantie auf LED/
10 year functional guarantee on LED
- ▶ Wiederaufladbarer Lithium-Ionen-Akku/
Rechargeable lithium ions battery
- ▶ Rutschfeste, ergonomische Oberfläche/
Non-slip surface
- ▶ Integrierter Schwenkfuß mit Magnet/
10 year functional guarantee on LED

| Art.-Nr./Art.-No. | Modell/Model | Farbe/Color | Maße/Dimensions | € |
|-------------------|--------------|---------------|------------------|-------|
| 398252 | PJ-AL250 | Schwarz/Black | 65 x 45 x 275 mm | 66,00 |

* Alle Werte gemessen entsprechend ANSI FL1-Prüfverfahren / All data scaled according to ANSI FL1-method of test

Sonstige Werkzeuge

Other Tools



Hämmer und Stemmeisen

Hammer and Wood Chisel Sets

Art.-Gruppen 160/182
Article Groups 160/182

PROFESSIONAL PLUS STANDARD

Schlosserhämmer mit Stielschutz

Machinist Hammer with Protection



| Art.-Nr./Art.-No. | Größe/Size | € |
|-------------------|------------|--------------|
| 2363 | 300 g | 19,85 |
| 2365 | 500 g | 22,60 |
| 2368 | 800 g | 31,30 |
| 2369 | 1.000 g | 34,00 |
| | | |
| | | |
| | | |
| | | |

Schlosserhämmer

Machinist Hammer



| Art.-Nr./Art.-No. | Größe/Size | € |
|-------------------|------------|--------------|
| 2301 | 100 g | 6,37 |
| 2302 | 200 g | 7,40 |
| 2303 | 300 g | 9,98 |
| 2304 | 400 g | 9,98 |
| 2305 | 500 g | 12,60 |
| 2308 | 800 g | 15,95 |
| 2310 | 1.000 g | 17,10 |
| 2315 | 1.500 g | 19,10 |

Latthammer

Roofing Hammer



| Art.-Nr./Art.-No. | Größe/Size | € |
|-------------------|------------|--------------|
| 2321 | 600 g | 15,35 |
| | | |
| | | |
| | | |

- ▶ Mit Nagelmagnet zum Halten der Nägel
- ▶ With magnet for nails

Handfäustel

Stoning Hammer



| Art.-Nr./Art.-No. | Größe/Size | € |
|-------------------|------------|--------------|
| 2325 | 1.000 g | 16,20 |
| 2324 | 1.250 g | 18,40 |
| 2326 | 1.500 g | 20,30 |
| | | |
| | | |

Kunststoffhammer

Dead-Blow Hammer



| Art.-Nr./Art.-No. | Größe/Size | € |
|-------------------|--|--------------|
| 2341 | Ø 35 mm | 36,75 |
| 2341-1 | Ersatzkopf schwarz/ Hammer Head black | 5,48 |
| 2341-2 | Ersatzkopf gelb/ Hammer Head yellow | 9,56 |

PROFESSIONAL PLUS STANDARD

Stemmeisen Sätze

NEU/NEW

Wood Chisel Sets



Art-Nr. 3362

| Art.-Nr./Art.-No. | Größe/Size | € |
|-------------------|---------------------------------------|-----------------|
| 3361 | 12 - 16 - 20 - 24 mm, 4-tlg. | € 89,00 |
| 3363 | 6 - 12 - 16 - 20 - 25 mm, 5-tlg. | € 115,00 |
| 3362 | 6 - 10 - 14 - 18 - 22 - 26 mm, 6-tlg. | € 125,00 |

- 4 tlg./pcs.
- 5 tlg./pcs.
- 6 tlg./pcs.

Splintentreiber, Durchschläge und Meißel

Pin Punches, Taper Punches and Chisels

Art.-Gruppe 160
Article Group 160

Splintentreiber-, Durchschlag- und Meißelsätze

Pin Punches, Taper Punches and Chisels



| Art.-Nr./Art.-No. | Teile/pieces | Größe/Size | | € |
|-------------------|--------------|--|---------------------------|-------|
| 3350 | 6 | 2-3-4-5-6-8 mm | Splintentreiber/Pin Punch | 32,55 |
| 3355 | 5 | 2-3-4-5-6 mm | Durchschlag/Taper Punch | 19,10 |
| 3370 | 5 | Splintentreiber 4 mm, Durchschlag 3 mm, Körner Nr. 2, Kreuzmeißel 5 x 130 mm, 8-kant Flachmeißel 12 x 130 mm | | 25,20 |

Einzelteile

Single Parts



| Art.-Nr./Art.-No. | Größe/Size | Länge/Length | | € |
|-------------------|------------|--------------|---|------|
| 3350-2 | 2 mm | 115 mm | Splintentreiber/Pin Punch | 5,36 |
| 3350-3 | 3 mm | 125 mm | Splintentreiber/Pin Punch | 5,36 |
| 3350-4 | 4 mm | 150 mm | Splintentreiber/Pin Punch | 5,36 |
| 3350-5 | 5 mm | 165 mm | Splintentreiber/Pin Punch | 5,99 |
| 3350-6 | 6 mm | 180 mm | Splintentreiber/Pin Punch | 7,65 |
| 3350-8 | 8 mm | 180 mm | Splintentreiber/Pin Punch | 7,65 |
| 3355-2 | 2 mm | 120 mm | Durchschlag/Taper Punch | 4,45 |
| 3355-3 | 3 mm | 120 mm | Durchschlag/Taper Punch | 4,45 |
| 3355-4 | 4 mm | 120 mm | Durchschlag/Taper Punch | 4,45 |
| 3355-5 | 5 mm | 120 mm | Durchschlag/Taper Punch | 4,45 |
| 3355-6 | 6 mm | 120 mm | Durchschlag/Taper Punch | 4,45 |
| 3370-1 | Nr. 2 | 120 mm | Körner/Center Punch | 4,45 |
| 3370-2 | 5 mm | 130 mm | Kreuzmeißel/Cross Chisel | 7,40 |
| 3370-3 | 12 mm | 130 mm | 8-kant Flachmeißel/Flat Chisel, 8-flank | 7,40 |



| Art.-Nr./Art.-No. | Größe/Size | Länge/Length | | € |
|-------------------|------------|--------------|--|-------|
| 3371-1 | 16 mm | 200 mm | 8-kant Spitzmeißel/Pointed Chisel, 8-flank | 13,30 |
| 3371-2 | 16 mm | 200 mm | 8-kant Flachmeißel/Flat Chisel, 8-flank | 13,30 |

Sanitärwerkzeuge

Sanitary Tools

Art.-Gruppe 190
Article Group 190

Rohrabschneider Mini Mini Tube Cutter



Rohrabschneider KOMPAKT Mini Mini Tube Cutter KOMPAKT



Rohrabschneider Tube Cutter



- **Zum Schneiden von Aluminium, Kupfer und dünnwandigen Stahlrohren**
- *For cutting aluminum, copper, and thin-walled steel tubes*

| Art.-Nr./Art.-No. | Größe/Size | € |
|-------------------|--|--------------|
| 396202 | 3 – 25 mm | 14,90 |
| 6299-01 | Ersatzrädchen 19 x 5 für AL, Cu, INOX | 4,90 |
| 6299-07 | Ersatzrädchen 22 x 5 für Plastik | 7,20 |

| Art.-Nr./Art.-No. | Größe/Size | € |
|-------------------|--|--------------|
| 6211 | 3 – 30 mm | 19,50 |
| 6299-01 | Ersatzrädchen 19 x 5 für AL, Cu, INOX | 4,90 |
| 6299-07 | Ersatzrädchen 22 x 5 für Plastik | 7,20 |

| Art.-Nr./Art.-No. | Größe/Size | € |
|-------------------|--|--------------|
| 396205 | 3 – 35 mm | 20,50 |
| 6299-01 | Ersatzrädchen 19 x 5 für AL, Cu, INOX | 4,90 |
| 6299-07 | Ersatzrädchen 22 x 5 für Plastik | 7,20 |

Rohrabschneider mit Entgrater Telescopic Tube Cutter with Deburrer



Rohrabschneider KOMPAKT mit Entgrater Telescopic Tube Cutter KOMPAKT with Deburrer



Rohrabschneider KOMPAKT QUICK mit Entgrater Telescopic Tube Cutter KOMPAKT QUICK with Deburrer



- **Zum Schneiden von Aluminium, Kupfer und dünnwandigen Stahlrohren, inkl. 1 Ersatzrädchen im Drehknopf, mit 4 Führungsrollen für einen optimalen Halt des Rohres beim Schneiden, Schneidrädchen-Wechsel ohne Werkzeug**
- **Artikel 396212 + 396213 mit integrierter NOGA-Entgraterklinge** ► **Artikel 6214 mit Schnellvorschub**
- *For cutting aluminum, copper, and thin-walled steel tubes, incl. 1 cutting wheel in rotary handle, with 4 rollers for optimum support of the pipe during cutting, cutting wheel changing without tools*
- *Article 396212 + 396213 with integrated NOGA deburring blade* ► *Article 6214 with fast feed*

| Art.-Nr./Art.-No. | Größe/Size | € |
|-------------------|--|--------------|
| 396212 | 3 – 35 mm | 35,50 |
| 6299-01 | Ersatzrädchen 19 x 5 für AL, Cu, INOX | 4,90 |
| 6299-07 | Ersatzrädchen 22 x 5 für Plastik | 7,20 |

| Art.-Nr./Art.-No. | Größe/Size | € |
|-------------------|--|--------------|
| 396213 | 3 – 45 mm | 40,90 |
| 6299-01 | Ersatzrädchen 19 x 5 für AL, Cu, INOX | 4,90 |
| 6299-07 | Ersatzrädchen 22 x 5 für Plastik | 7,20 |

| Art.-Nr./Art.-No. | Größe/Size | € |
|-------------------|--|--------------|
| 6214 | 6 – 67 mm | 72,50 |
| 6299-05 | Ersatzrädchen 19 x 6,2 für AL, Cu, INOX | 5,40 |

Sanitärwerkzeuge

Sanitary Tools

Art.-Gruppe 190
Article Group 190

Rohrabschneider KOMPAKT PT QUICK

Tube Cutter KOMPAKT PT QUICK



- ▶ Zum Schneiden von Kunststoff und Verbundrohren, inkl. 1 Ersatzrädchen im Drehknopf mit 4 Führungsrollen für einen optimalen Halt des Rohres beim Schneiden, Schneidrädchen-Wechsel ohne Werkzeug
- ▶ For cutting plastic tubes, incl. 1 cutting wheel in rotary handle, with 4 rollers for optimum support of the pipe during cutting, cutting wheel changing without tools

| Art.-Nr./Art.-No. | Größe/Size | € |
|-------------------|--|--------------|
| 6215 | 6 – 67 mm | 79,50 |
| 6299-06 | Ersatzrädchen 26 x 6,2 für Kunststoff- und Verbundrohre | 9,60 |

Rohrabschneider für Stahlrohre

Tube Cutter for Steel Tubes



- ▶ Zum Schneiden von Stahl- und INOX-Rohren – das Federandruck-System garantiert verbesserten Schnitt und längere Lebensdauer des Schneidrädchens
- ▶ For cutting steel- and INOX tubes – a special system ensures improved cutting and longer life of the cutting wheel

| Art.-Nr./Art.-No. | Größe/Size | € |
|-------------------|---|--------------|
| 6216 | 10 – 60 mm (1/8" – 2") | 82,50 |
| 6299-02 | Ersatzrädchen 31 x 19 für Stahl und INOX | 10,70 |

Rohrabschneider INOX Mini

Mini Tube Cutter INOX



Rohrabschneider INOX KOMPAKT mit Entgrater

Tube Cutter INOX KOMPAKT with Deburrer



Rohrabschneider INOX KOMPAKT mit Entgrater

Tube Cutter INOX KOMPAKT with Deburrer



- ▶ Zum Schneiden von Aluminium, Kupfer und dünnwandigen Stahlrohren (speziell für V2A-/INOX-Rohre geeignet), inkl. 1 Ersatzrädchen im Drehknopf, Schneidrädchen-Wechsel ohne Werkzeug, Artikel 396222 + 396223 mit 4 Führungsrollen für einen optimalen Halt des Rohres beim Schneiden und integrierter NOGA-Entgraterklinge
- ▶ For cutting aluminum, copper, and thin-walled steel tubes (especially for V2A-/INOX tubes), incl. 1 cutting wheel in rotary handle, cutting wheel changing without tools, article 396222 + 396223 with 4 rollers for optimum support of the pipe during cutting and integrated NOGA deburring blade

| Art.-Nr./Art.-No. | Größe/Size | € |
|-------------------|--------------------------------------|--------------|
| 396221 | 3 – 30 mm | 27,30 |
| 396297-01 | Ersatzrädchen 19 x 5 für INOX/V2A | 5,10 |

| Art.-Nr./Art.-No. | Größe/Size | € |
|-------------------|--------------------------------------|--------------|
| 396222 | 3 – 35 mm | 40,70 |
| 396297-01 | Ersatzrädchen 19 x 5 für INOX/V2A | 5,10 |

| Art.-Nr./Art.-No. | Größe/Size | € |
|-------------------|--------------------------------------|--------------|
| 396223 | 3 – 45 mm | 56,90 |
| 396297-01 | Ersatzrädchen 19 x 5 für INOX/V2A | 5,10 |

Sanitärwerkzeuge

Sanitary Tools

Art.-Gruppe 190
Article Group 190

Rohrabschneider INOX KOMPAKT QUICK

Tube Cutter INOX KOMPAKT QUICK



- ▶ Zum Schneiden von Aluminium, Kupfer und dünnwandigen Stahlrohren (speziell für V2A-/INOX-Rohre geeignet), inkl. 1 Ersatzrädchen im Drehknopf, Schneidrädchen-Wechsel ohne Werkzeug, mit 4 Führungsrollen für einen optimalen Halt des Rohres beim Schneiden und Schnellvorschub

- ▶ For cutting aluminum, copper, and thin-walled steel tubes (especially for V2A-/INOX tubes), incl. 1 cutting wheel in rotary handle, cutting wheel changing without tools, with 4 rollers for optimum support of the pipe during cutting and fast feed

| Art.-Nr./Art.-No. | Größe/Size | € |
|-------------------|-------------------------------------|-------|
| 396224 | 6 – 67 mm | 97,50 |
| 396297-05 | Ersatzrädchen 19 x 6,2 für V2A/INOX | 5,20 |

Rohrabschneider Satz

Tube Cutter Set

2
tlg./pcs.



- ▶ Zum Schneiden von Aluminium, Kupfer und dünnwandigen Stahlrohren

- ▶ For cutting aluminum, copper and thin-walled steel tubes

| Art.-Nr./Art.-No. | Größe/Size | € |
|-------------------|--|-------|
| 9986 | KOMPAKT Mini 3 – 30 mm + KOMPAKT 3 – 45 mm | 57,50 |

Bestehend aus Artikel 6211 + 396213
Content item 6211 + 396213

Wasserhahnventil-Sitzfräser

Water Tap Milling Cutter



Fräse

Milling Cutter

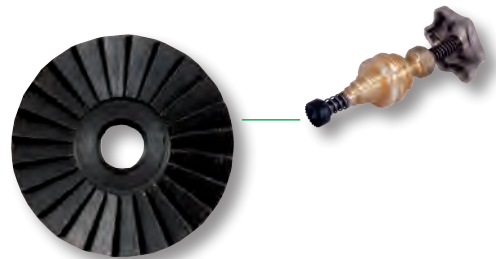

- ▶ inkl. 4 Fräser (3/8" – 1/2" – 3/4" – 1")
- ▶ incl. 4 Milling Cutter (3/8" – 1/2" – 3/4" – 1")

| Art.-Nr./Art.-No. | Größe/Size | € |
|-------------------|------------------------|-------|
| 6271 | 3/8" – 1" (14 – 28 mm) | 72,20 |
| | | |
| | | |
| | | |
| | | |
| | | |

| Art.-Nr./Art.-No. | Größe/Size | € |
|-------------------|--------------|------|
| 6271-10 | 1/8" (10 mm) | 7,62 |
| 6271-12 | 1/4" (12 mm) | 7,62 |
| 6271-14 | 3/8" (14 mm) | 7,85 |
| 6271-17 | 1/2" (17 mm) | 8,10 |
| 6271-20 | 5/8" (20 mm) | 8,56 |
| 6271-24 | 3/4" (24 mm) | 8,56 |
| 6271-28 | 1" (28 mm) | 8,91 |

Sanitärwerkzeuge

Sanitary Tools

Art.-Gruppe 190
Article Group 190

PROFESSIONAL PLUS STANDARD

Kunststoff-Rohrschere Plastic Tube Cutter



6261-01



6261

- ▶ Zum Schneiden von Kunststoff und Verbundrohren mit optimaler Kraftübertragung
- ▶ Klingenwechsel ohne Werkzeug
- ▶ Mit INOX-Klinge 'Made in Solingen'
- ▶ Automatischer Klingen-Rückzug
- ▶ For cutting plastic tubes with optimal power transmission
- ▶ Cutting wheel changing without tools
- ▶ With INOX blade 'Made in Solingen'
- ▶ Automatic blade return

| Art.-Nr./Art.-No. | Größe/Size | € |
|-------------------|---------------------|-------|
| 6261 | 26 mm / 1" | 29,00 |
| 6261-01 | Ersatz-Klinge/Blade | 16,00 |

PROFESSIONAL PLUS STANDARD

Kunststoff-Rohrschere Plastic Tube Cutter



6263-01



6263

- ▶ Zum Schneiden von Kunststoff und Verbundrohren mit optimaler Kraftübertragung
- ▶ Klingenwechsel ohne Werkzeug
- ▶ Mit INOX-Klinge 'Made in Solingen'
- ▶ Schnellrückzug der Klinge durch Knopfdruck
- ▶ For cutting plastic tubes with optimal power transmission
- ▶ Cutting wheel changing without tools
- ▶ With INOX blade 'Made in Solingen'
- ▶ Fast blade return by pushing the button

| Art.-Nr./Art.-No. | Größe/Size | € |
|-------------------|---------------------|-------|
| 6263 | 42 mm / 1 5/8" | 49,00 |
| 6263-01 | Ersatz-Klinge/Blade | 28,00 |

PROFESSIONAL PLUS STANDARD

Spezienschlüssel Sanitär Sanitary Wrench



| Art.-Nr./Art.-No. | Größe/Size | € |
|-------------------|-----------------|-------|
| 6252 | 17 x 19 mm, M10 | 19,70 |

PROFESSIONAL PLUS STANDARD

Umsteckknarren-Set für 1/2" Vierkant-Antrieb, 3-tlg.

Ratchet Handle for 1/2" Drive,
Set 3 pieces

3
tlg./pcs.



| Art.-Nr./Art.-No. | Größe/Size | € |
|-------------------|---|-------|
| 4297-10 | 1/2" Knarre/ratchet, 251 mm, 1/2" Vierkant, Stufenschlüssel 3/8", 29/64", 31/64", 21/32", 53/64" | 46,90 |

PROFESSIONAL PLUS STANDARD

Sanitärkreuzschlüssel Sanitary Cross Wrench



| Art.-Nr./Art.-No. | Größe/Size | € |
|-------------------|---|-------|
| 6253 | 200 x 200 mm 10 mm - 3/8" 12 mm - 1/2" - M8 17 mm - 3/4" - M10 22 mm - 1" - M12 | 26,00 |

PROFESSIONAL PLUS STANDARD

Umsteckknarre für 1/2" Vierkant-Antrieb

Ratchet Handle
for 1/2" Drive



| Art.-Nr./Art.-No. | Größe/Size | € |
|-------------------|---|-------|
| 4297 | 1/2" Knarre/Ratchet, 251 mm | 29,20 |
| 4297-1 | 1/2" Vierkant | 5,72 |
| 4297-2 | Stufenschlüssel, 5-stufig 3/8", 29/64", 31/64", 21/32", 53/64" | 20,25 |
| 4297-3 | Stufenschlüssel, 8-stufig 7/8", 27/32", 3/4", 35/64", 1/2", 15/32", 7/16", 3/8" Schraubendreher-Klinge für Schlitzschrauben | 26,50 |

Sanitärwerkzeuge / Teleskop-Magnetheber

Sanitary Tools / Magnetic Pick Up Tools

Art.-Gruppe 190
Article Group 190

Standhahn-Mutter Schlüssel

Basin Wrench



| Art.-Nr./Art.-No. | Länge/Length | € |
|-------------------|--------------|-------|
| 6251 | 240 mm | 38,75 |

Blech-Locher

3-schneidig, Bleche bis 1,5 mm/
VA-Bleche bis 1,2 mm

3-blade Hole Punch
Steel Sheet up to 1,5 mm/
VA-Steel Sheet up to 1,2 mm



| Art.-Nr./Art.-No. | Größe/Size | € |
|-------------------|-------------------------------|----------------|
| 6241* | 32 mm | 27,50 |
| 6242* | 35 mm | - ¹ |
| 6241-1* | Ersatz-Schraube/Screw M10 x 1 | 2,14 |

*Lieferung nur solange der Vorrat reicht / Delivery while stocks last

¹ Nicht mehr lieferbar / ¹ Out of stock

3196

Teleskop-Magnetheber

Magnetic Pick Up Tool

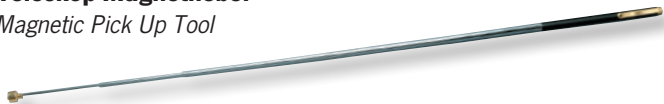

- ▶ Bis 2 kg Hubkraft
- ▶ 130 – 630 mm ausziehbar
- ▶ Großer Dauermagnet und Clip
- ▶ Up to 2 kg
- ▶ 130 – 630 mm
- ▶ With big magnet

| Art.-Nr./Art.-No. | Länge/Length | € |
|-------------------|-------------------------|-------|
| 3196 | 130 - 630 mm ausziehbar | 10,45 |

3197

2-in-1 Pick-up Magnetheber

2-in-1 Magnetic Pick Up Tool



- ▶ Heben von Kleinteilen aus Hohl- u. Zwischenräumen
- ▶ Hebekraft ca. 6 – 8 N, entspricht ca. 0,6 – 0,8 kg
- ▶ Greifer für nichtmetallische Teile
- ▶ Flexibel: Auch um Ecken und Kanten einsetzbar
- ▶ Lifting small things in narrow spaces
- ▶ Lifting force ca. 6 – 8 N, according ca. 0,6 – 0,8 kg
- ▶ Picker for non-metallic things
- ▶ Flexible: Can also be used around corners and edges

| Art.-Nr./Art.-No. | Länge/Length | € |
|-------------------|-----------------|-------|
| 3197 | 600 mm flexibel | 14,90 |

PROFESSIONAL PLUS STANDARD

Innen- und Außen-Rohrentgrater

Inside/Outside
Tube Deburrer

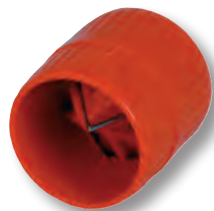

- ▶ Zum Entgraten von harten Kunststoff- + Metall-Rohren
- ▶ Körper aus ABS
- ▶ Klängen 'Made in Solingen'
- ▶ For deburring of hard plastic + metal tubes • ABS body
- ▶ Blades 'Made in Solingen'

| Art.-Nr./Art.-No. | Größe/Size | € |
|-------------------|------------|-------|
| 6258 | 3 – 42 mm | 10,90 |

Feilen und Raspeln

Files and Rasps

Art.-Gruppe 181
Article Group 181

Raspel, flach, 200 mm

Flat Rasp, 200 mm



| Art.-Nr./Art.-No. | Typ/Model | € |
|-------------------|-----------------------|------|
| 3386-2 | Hieb 2 (Halbschlicht) | 8,56 |

Raspel, halbrund, 200 mm

Half Round Rasp, 200 mm



| Art.-Nr./Art.-No. | Typ/Model | € |
|-------------------|-----------------------|-------|
| 3387-1 | Hieb 1 (Bastard) | 11,45 |
| 3387-2 | Hieb 2 (Halbschlicht) | 12,20 |
| 3387-3 | Hieb 3 (Schlicht) | 12,50 |

Raspel, rund, 200 mm

Round Rasp, 200 mm



| Art.-Nr./Art.-No. | Typ/Model | € |
|-------------------|-----------------------|------|
| 3388-2 | Hieb 2 (Halbschlicht) | 7,61 |

Flachfeile, 200 mm

Flat File, 200 mm



| Art.-Nr./Art.-No. | Typ/Model | € |
|-------------------|-----------------------|------|
| 3381-1 | Hieb 1 (Bastard) | 8,30 |
| 3381-2 | Hieb 2 (Halbschlicht) | 8,93 |
| 3381-3 | Hieb 3 (Schlicht) | 9,56 |

Rundfeile, 200 mm

Round File, 200 mm



| Art.-Nr./Art.-No. | Typ/Model | € |
|-------------------|-----------------------|------|
| 3383-1 | Hieb 1 (Bastard) | 8,19 |
| 3383-2 | Hieb 2 (Halbschlicht) | 8,93 |
| 3383-3 | Hieb 3 (Schlicht) | 9,56 |

Dreikantfeile, 200 mm

Three Square File, 200 mm



| Art.-Nr./Art.-No. | Typ/Model | € |
|-------------------|-----------------------|-------|
| 3385-1 | Hieb 1 (Bastard) | 9,56 |
| 3385-2 | Hieb 2 (Halbschlicht) | 10,10 |
| 3385-3 | Hieb 3 (Schlicht) | 10,80 |

Halbrundfeile, 200 mm

Half Round File, 200 mm



| Art.-Nr./Art.-No. | Typ/Model | € |
|-------------------|-----------------------|-------|
| 3382-1 | Hieb 1 (Bastard) | 10,80 |
| 3382-2 | Hieb 2 (Halbschlicht) | 11,45 |
| 3382-3 | Hieb 3 (Schlicht) | 12,15 |

Vierkantfeile, 200 mm

Square File, 200 mm



| Art.-Nr./Art.-No. | Typ/Model | € |
|-------------------|-----------------------|------|
| 3384-1 | Hieb 1 (Bastard) | 8,19 |
| 3384-2 | Hieb 2 (Halbschlicht) | 8,93 |
| 3384-3 | Hieb 3 (Schlicht) | 9,56 |

5-teiliger Satz in Rolltasche

5 Pieces Set in Pouch

5
tlg./pcs.



Flachfeile, Rundfeile, Dreikantfeile, Halbrundfeile, Vierkantfeile, Hieb 2

Flat File, Round File, Three Square File, Half Round File, Square File, Hieb 2

| Art.-Nr./Art.-No. | € |
|-------------------|----------------------------------|
| 3380 | Set 5-teilig 48,20 |
| 3380E | Rolltasche leer/empty pouch 8,82 |



Weitere PROForm-Werkstatteinlagen ab Seite /
More PROForm Inlays for Roller Cabinet from Page H 32

Drahtbürsten

Wire Hand Brushes

Art.-Gruppe 181
Article Group 181

Stahl-Drahtbürste
glatt, Ø 0,30 – 0,35 mm,
vergüteter Stahldraht



Steel Wire Hand Brush
Straight Wire, Ø 0,30 – 0,35 mm,
Tempered Steel Wire



| Art.-Nr./Art.-No. | Typ/Model | € |
|-------------------|-----------------|------|
| 3375-2 | 2-Reihig/2 Rows | 1,60 |
| 3375-3 | 3-Reihig/3 Rows | 1,90 |
| 3375-4 | 4-Reihig/4 Rows | 2,08 |
| 3375-5 | 5-Reihig/5 Rows | 2,26 |

Messing-Drahtbürste
gewellt, Ø 0,25 – 0,30 mm

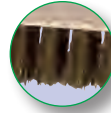

Brass Wire Hand Brush
Crimped, Ø 0,25 – 0,30 mm



| Art.-Nr./Art.-No. | Typ/Model | € |
|-------------------|-----------------|------|
| 3377-3 | 3-Reihig/3 Rows | 4,40 |
| 3377-4 | 4-Reihig/4 Rows | 5,36 |

V2A-Drahtbürste
gewellt, Ø 0,30 – 0,35 mm

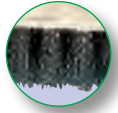

Stainless Steel Wire Hand Brush
Crimped, Ø 0,30 – 0,35 mm



| Art.-Nr./Art.-No. | Typ/Model | € |
|-------------------|-----------------|------|
| 3376-3 | 3-Reihig/3 Rows | 4,45 |
| 3376-4 | 4-Reihig/4 Rows | 5,17 |

Zündkerzen-Bürste
gewellt, Messing-Draht,
Ø 0,15 mm

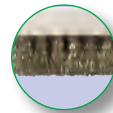

Spark Plug Hand Brush
Crimped, Brass Wire, Ø 0,15 mm



| Art.-Nr./Art.-No. | Typ/Model | € |
|-------------------|-----------------|------|
| 3379 | 3-Reihig/3 Rows | 1,79 |

Feilen-Bürste
Nutzfläche ca. 115x40 mm

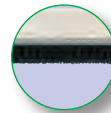

File Cleaner Hand Brush
Useable Surface ca. 115x40 mm



| Art.-Nr./Art.-No. | Typ/Model | € |
|-------------------|-------------|------|
| 3378 | 115 x 40 mm | 4,03 |

Messwerkzeuge

Measuring Tools

Art.-Gruppen 180/182
Article Groups 180/182

PROFESSIONAL PLUS STANDARD

Maßband

Measuring Tape



- ▶ Abnehmbarer Gürtelclip
- ▶ Bandfeststeller und automatischer Bandrücklauf
- ▶ Nach CE-Norm, Präzisionsklasse II

- ▶ Removable belt-clip
- ▶ Blade-lock and automatic-return
- ▶ According to CE-Norms, precision-class II

| Art.-Nr./Art.-No. | Länge/Length | € |
|-------------------|--------------|-------|
| 3963 | 3 m | 5,30 |
| 3965 | 5 m | 7,99 |
| 3968 | 7,5 m | 13,60 |

PROFESSIONAL PLUS STANDARD

Maßband

Measuring Tape

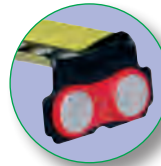

zusätzlich mit
starkem Magnet/
additional with
strong magnet



397312
Display mit/with 12x 3973



397512
Display mit/with 12x 3975

| Art.-Nr./Art.-No. | Länge/Length | € |
|-------------------|----------------------|-------|
| 3973 | 3 m | 5,70 |
| 397312 | Display mit 12x 3973 | 64,00 |
| 3975 | 5 m | 8,55 |
| 397512 | Display mit 12x 3975 | 97,00 |

PROFESSIONAL PLUS STANDARD

Gliedermaßstab aus Kunststoff

Folding Plastic Ruler

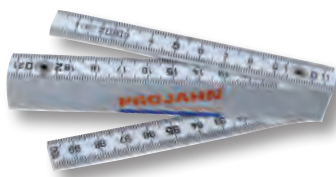

| Art.-Nr./Art.-No. | Länge/Length | € |
|-------------------|--------------|------|
| 3961 | 1 m | 1,74 |

PROFESSIONAL PLUS STANDARD

Gliedermaßstab aus Holz

Folding Wooden Ruler



| Art.-Nr./Art.-No. | Länge/Length | € |
|-------------------|------------------|------|
| 2978 | EG-Klasse 3, 2 m | 6,80 |

PROFESSIONAL PLUS STANDARD

Zimmermanns-Bleistift, ungespitzt, eckig-oval

Carpenter's Pencil,
Unsharpened, Square-Oval



| Art.-Nr./Art.-No. | Länge/Length | € |
|-------------------|--------------|------|
| 2979 | 18 cm | 1,63 |

Wasserwaagen

Water Levels

NEU/NEW

Art.-Gruppe 94
Article Group 94

PROFESSIONAL **PLUS** STANDARD

Aluminium-Wasserwaage mit Spiegel-Libelle

Aluminium Spirit Level with „Plumb Site Dual View“

- ▶ **Zwei festverbaute Libellen, darunter eine patentierte Vertikal-Spiegel-Libelle**
 - Einfaches frontales Ablesen der vertikalen Libelle auch an engen Stellen
 - Ergonomisches Arbeiten
 - ▶ **Toleranz: 0,5 mm/m (<0,0005 in/in)**
 - ▶ **1,5 mm Profilstärke**
 - Lange Lebensdauer
 - Genaue Messergebnisse auch bei großen Längen
 - ▶ **Stoßabsorbierende Endkappen**
 - Robustes Werkzeug
 - Verhindert Beschädigungen bei Herunterfallen
- ▶ *Two solid acrylic epoxy locked vials including one patented „Plumb Site Dual View“ vertical vial*
 - *Easy reading of the vertical vial even in narrow spaces*
 - *Ergonomic working*
 - ▶ *Tolerance: 0,5 mm/m (<0,0005 in/in)*
 - ▶ *1,5 mm profile strength*
 - *Long tool lifetime*
 - *Accurate results even with long lengths*
 - ▶ *Shock absorbing end caps*
 - *Robust tool*
 - *Prevents damage when falling*



NEU/NEW



Vertikal-Spiegel-Libelle
zum einfachen
frontalen Ablesen
„Plumb Site Dual View“
vertical vial for easy
reading

Einzeln mit Aufhänger/Single Packaging with Hanger

| Art.-Nr./Art.-No. | Länge/Length | € |
|-------------------|--------------|---------------|
| 2976-030 | 30 cm | 19,50 |
| 2976-040 | 40 cm | 20,50 |
| 2976-060 | 60 cm | 29,08 |
| 2976-080 | 80 cm | 33,94 |
| 2976-100 | 100 cm | 38,89 |
| 2976-120 | 120 cm | 64,00 |
| 2976-150 | 150 cm | 75,00 |
| 2976-180 | 180 cm | 93,00 |
| 2976-200 | 200 cm | 102,00 |

Wasserwaagen

Water Levels

NEU/NEW

Art.-Gruppe 94
Article Group 94

PROFESSIONAL **PLUS** STANDARD

NEU/NEW

Aluminium-Wasserwaage mit Spiegel-Libelle und Magnet

Aluminium Spirit Level with „Plumb Site Dual View“ and Magnet

- ▶ **Zum Befestigen auf metallischen Oberflächen**
- ▶ **Einfaches Arbeiten, da die Wasserwaage von alleine hält**
- ▶ **Alle weiteren Details siehe „Aluminium-Wasserwaage mit Spiegel-Libelle“ auf Seite H 232**
- ▶ For fixing on metal surfaces
- ▶ Spirit Level adheres on its own for easy working
- ▶ Further details please refer to „Aluminium Spirit Level with Plumb Site Dual View“ on page H 232



| Art.-Nr./Art.-No. | Länge/Length | € |
|-------------------|--------------|--------------|
| 2976-031 | 30 cm | 33,00 |
| 2976-041 | 40 cm | 35,00 |
| 2976-061 | 60 cm | 45,96 |
| 2976-081 | 80 cm | 54,60 |
| 2976-101 | 100 cm | 61,28 |



PROFESSIONAL PLUS **STANDARD**

NEU/NEW

Aluminium-Wasserwaage

Aluminium Spirit Level

- ▶ **Zwei festverbaute UV-beständige Libellen zur Horizontal- und Vertikalmessung**
- ▶ **Toleranz: 0,5 mm/m (<0,0005 in/in) für genaue Messergebnisse**
- ▶ **1,0 mm Profilstärke**
- ▶ **Stoßabsorbierende Endkappen zur Verhinderung von Beschädigungen bei Herunterfallen**
- ▶ **In 8 unterschiedlichen Längen verfügbar**
- ▶ Two solid acrylic epoxy locked UV-protecting horizontal and vertical vials
- ▶ Tolerance: 0,5 mm/m (<0,0005 in/in) for accurate results
- ▶ 1,0 mm profile strength
- ▶ Shock absorbing end caps prevents damage when falling
- ▶ 8 different length available



| Art.-Nr./Art.-No. | Länge/Length | € | Art.-Nr./Art.-No. | Länge/Length | € |
|-------------------|--------------|--------------|-------------------|--------------|--------------|
| 2975-040 | 40 cm | 12,14 | 2975-120 | 120 cm | 28,00 |
| 2975-060 | 60 cm | 14,42 | 2975-150 | 150 cm | 32,00 |
| 2975-080 | 80 cm | 17,22 | 2975-180 | 180 cm | 41,00 |
| 2975-100 | 100 cm | 19,73 | 2975-200 | 200 cm | 44,00 |

Messwerkzeuge / Sonstige Werkzeuge

Measuring Tools / Other Tools

Art.-Gruppen 180/182
Article Groups 180/182

PROFESSIONAL PLUS STANDARD

Schlagschnur-Roller 30 m, Kunststoffgehäuse

Chalk Liner
30 m, Plastic Cover



| Art.-Nr./Art.-No. | Länge/Length | € |
|-------------------|--------------|-------|
| 2390 | 30 m | 15,10 |

PROFESSIONAL PLUS STANDARD

Farbpulver für Schlagschnur-Roller

Powder for Chalk Liner



| Art.-Nr./Art.-No. | Farbe/Color | Menge/Quantity | € |
|-------------------|-------------|----------------|------|
| 2393-1 | Blau/Blue | 100 g | 4,10 |
| 2393-2 | Rot/Red | 100 g | 4,10 |
| 2394-1 | Blau/Blue | 500 g | 9,90 |
| 2394-2 | Rot/Red | 500 g | 9,90 |

PROFESSIONAL PLUS STANDARD

Schieblehre aus rostfreiem Stahl, Schieber + Schiene matt verchromt, für Außen-, Innen- und Tiefenmessungen

Precision Vernier Caliper



| Art.-Nr./Art.-No. | Messbereich/Range | Ablesung/Graduation | € |
|-------------------|-------------------|---------------------|-------|
| 2970 | 0-150 mm/0-6" | 1/20 mm 1/128" | 28,25 |

PROFESSIONAL PLUS STANDARD

Knie- und Werkzeugunterlage 440 x 270 x 32 mm

Workpad 440 x 270 x 32 mm



| Art.-Nr./Art.-No. | Größe/Size | € |
|-------------------|---------------------------------|-------|
| 398001 | Knieunterlage 440 x 270 x 32 mm | 20,90 |

PROFESSIONAL PLUS STANDARD

90° Bohr-Adapter

90° Drilling Adapter
Max. Drehmoment: 40 Nm
Max. torque: 40 Nm

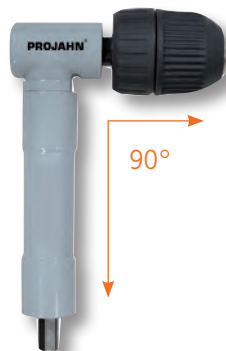

Schnellspannfutter
Quick Chuck

| Art.-Nr./Art.-No. | € |
|-------------------|-------|
| 398050 | 83,00 |

NEU/NEW

PROFESSIONAL PLUS STANDARD

90° Schraub-Adapter

90° Screwing Adapter
Max. Drehmoment: 40 Nm
Max. torque: 40 Nm



1/4" Bit-Aufnahme
1/4" Bit Shank

| Art.-Nr./Art.-No. | € |
|-------------------|-------|
| 398051 | 94,00 |

NEU/NEW

Messer und Sägen

Knives and Saws

Art.-Gruppe 180
Article Group 180

PROFESSIONAL PLUS STANDARD

3311

**Cutter Messer mit einziehbarer Klinge,
Klingenbreite: 18 mm**

Utility Knife with Rectangular Blade,
Blade width: 18 mm



3311-1

10 Ersatzklingen für 3311
10 blades for 3311

331112

Display mit/with 12x 3311

| Art.-Nr./Art.-No. | Beschreibung/Discription | € |
|-------------------|---------------------------|-------|
| 3311 | Cutter Messer, 18 mm | 6,87 |
| 3311-1 | 10 Ersatzklingen für 3311 | 2,78 |
| 331112 | Display mit 12x 3311 | 79,00 |

PROFESSIONAL PLUS STANDARD

3303

**10 Ersatzklingen
zu 3301 / 3306 / 3312**
10 Blades



| Art.-Nr./Art.-No. | Beschreibung/Discription | € |
|-------------------|---------------------------------------|------|
| 3303 | 10 Ersatzklingen für 3301, 3306, 3312 | 4,10 |

PROFESSIONAL PLUS STANDARD

3312

SICHERHEITS-Cutter Messer mit Automatik-Klinge

- ▶ **Automatischer Klingeneinzug verhindert Verletzungen**
SECURITY Utility Knife with Automatic Blade
- ▶ *Automatic blade prevents physical injury*



331224

Display mit/with 24x 3312

| Art.-Nr./Art.-No. | Beschreibung/Discription | € |
|-------------------|---------------------------------|-------|
| 3312 | Cutter Messer, Automatik-Klinge | 3,71 |
| 331224 | Display mit 24x 3312 | 83,50 |

PROFESSIONAL PLUS STANDARD

3301

**Messer mit einziehbarer
Klinge und Schutzköchler**

Knife with
Rectangular Blade



| Art.-Nr./Art.-No. | Beschreibung/Discription | € |
|-------------------|--------------------------|-------|
| 3301 | Cutter mit Köcher | 15,65 |

PROFESSIONAL PLUS STANDARD

3306

**Messer
mit einziehbarer Klinge**

Knife with
Rectangular Blade

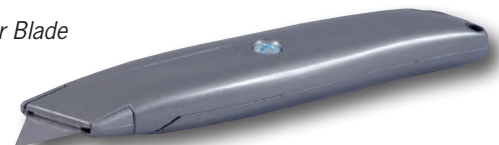

| Art.-Nr./Art.-No. | Beschreibung/Discription | € |
|-------------------|--------------------------------|------|
| 3306 | Messer mit einziehbarer Klinge | 9,40 |

Messer und Sägen / Schaltschrankschlüssel

Knives and Saws / Control Cabinet Key

Art.-Gruppe 180
Article Group 180

PROFESSIONAL **PLUS** STANDARD

Metallsägebogen 300 mm

Hack Saw



Bi-Metall

- ▶ Mit verchromtem Vierkant-Stahlrohrbügel
- ▶ Ersatzsägeblätter/Single Blades (Art. 6530024)

| Art.-Nr./Art.-No. | Beschreibung/Description | € |
|-------------------|-----------------------------|--------------|
| 3305 | Metallsägebogen/Hack Saw | 34,13 |
| 6530024 | Ersatzblätter/Single Blades | 2,11 |

PROFESSIONAL **PLUS** STANDARD

Kleinhandsägebogen 260 mm

Mini Hack Saw 260 mm

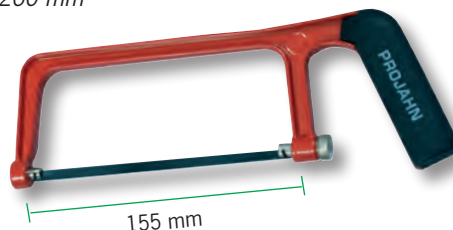

| Art.-Nr./Art.-No. | Größe/Size | € |
|-------------------|----------------------------|-------------|
| 3304 | Kleinhandsägebogen 260 mm | 7,14 |
| 3304-1 | Sägeblatt/Saw Blade 155 mm | 0,12 |

PROFESSIONAL **PLUS** STANDARD

PUK Handsäge

PUK Hand Saw

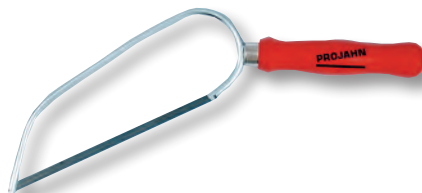

| Art.-Nr./Art.-No. | Beschreibung/Description | Nr. | € |
|-------------------|---|---------|--------------|
| 3307 | PUK Handsäge | Nr. 305 | 13,55 |
| 3307-1 | Universal-Sägeblatt 10 Zähne pro cm / 10 teeth per cm 25 Zähne pro Zoll / 25 teeth per inch | Nr. 310 | 1,26 |
| 3307-2 | Metall-Sägeblatt 12 Zähne pro cm / 12 teeth per cm 32 Zähne pro Zoll / 32 teeth per inch | Nr. 312 | 1,26 |

PROFESSIONAL **PLUS** STANDARD

Schraubenausdreher Satz

Screw Extractor Set

6
tlg./pcs.



Zum Ausdrehen von abgebrochenen Schrauben und Bolzen

To extract broken screws and nuts

| Art.-Nr./Art.-No. | Nummer/no. | Größe/Size | Vorböhr-Ø/Size of drill | € |
|-------------------|------------|---------------------------|-------------------------|--------------|
| 3059 | Nr. 1 | M3 - M6 (1/8" - 1/4") | 1,8 mm | 16,40 |
| | Nr. 2 | M6 - M8 (1/4" - 5/16") | 3,2 mm | |
| | Nr. 3 | M8 - M11 (5/16" - 7/16") | 4,5 mm | |
| | Nr. 4 | M11 - M14 (7/16" - 9/16") | 6,5 mm | |
| | Nr. 5 | M14 - M18 (9/16" - 3/4") | 8,5 mm | |
| | Nr. 6 | M18 - M24 (3/4" - 1") | 12,0 mm | |

PROFESSIONAL **PLUS** STANDARD

TORX® Schraubenausdreher-Set, 18-teilig

TORX® Screw Extractor Set, 18 pieces



18
tlg./pcs.

Auch geeignet für Innensechskant-Antrieb

Also suitable for HEX drive

NEU/NEW

| | | |
|---|--|------------------------------------|
| 7 | 25 mm TORX®/TX (gelb/yellow) | T10 - 15 - 20 - 25 - 27 - 30 - 40 |
| 7 | 50 mm E-TORX® Schraubenausdreher Screw Extractor | TE10 - 15 - 20 - 25 - 27 - 30 - 40 |
| 2 | 38 mm E-TORX® Schraubenausdreher Screw Extractor | TE50 - 55 |
| 1 | Bit-Adapter/Bit Adapter | 1/4" - 10 mm |
| 1 | Magn. Bithalter/Magn. Bit Holder | 1/4", 60 mm |

| Art.-Nr./Art.-No. | L./L. | B./W. | H./H. | € |
|-------------------|-------|-------|-------|--------------|
| 398006 | 155 | 115 | 35 | 39,00 |

Schraubzwingen

Screw Clamps

Art.-Gruppe 181
Article Group 181

Temperguss Schraubzwinde nach DIN 5117 schwere verzinkte Spannarme, verzinkte Hohlprofil-Schiene mit 6-seitiger Riffelung

Screw clamps according to DIN 5117

*arms of best malleable cast iron, zincered, double-profiled bar
with 6-sides grooved*



| Art.-Nr./Art.-No. | Größe/Size | Schiene/Bar | € |
|-------------------|---------------|-------------|--------------|
| 2941-0160 | 160 x 80 mm | 25 x 6 mm | 14,20 |
| 2941-0200 | 200 x 100 mm | 30 x 8 mm | 19,95 |
| 2941-0250 | 250 x 120 mm | 30 x 8 mm | 23,50 |
| 2941-0300 | 300 x 140 mm | 35 x 9 mm | 31,50 |
| 2941-0400 | 400 x 175 mm | 35 x 9 mm | 35,90 |
| 2941-0500 | 500 x 120 mm | 35 x 11 mm | 42,50 |
| 2941-0600 | 600 x 120 mm | 35 x 11 mm | 45,50 |
| 2941-0800 | 800 x 120 mm | 35 x 11 mm | 49,90 |
| 2941-1000 | 1000 x 120 mm | 35 x 11 mm | 57,90 |
| 2941-1250 | 1250 x 120 mm | 35 x 11 mm | 69,90 |

Ganzstahl Schraubzwinde Festbügel aus kaltgezogenem Profilstahl, Gleitbügel gesenkgeschmiedet

All-steel clamps

*spring tempered profiled bar,
moveable arm drop-forged*

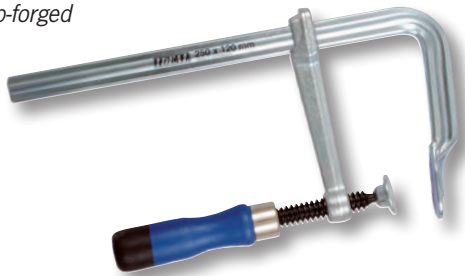

| Art.-Nr./Art.-No. | Größe/Size | Schiene/Bar | € |
|-------------------|--------------|----------------|--------------|
| 2942-0160 | 160 x 80 mm | 16,0 x 7,5 mm | 25,50 |
| 2942-0200 | 200 x 100 mm | 19,5 x 9,5 mm | 35,50 |
| 2942-0250 | 250 x 120 mm | 22,0 x 10,5 mm | 42,50 |
| 2942-0300 | 300 x 140 mm | 25,0 x 12,0 mm | 51,50 |
| 2942-0400 | 400 x 120 mm | 25,0 x 12,0 mm | 59,80 |
| 2942-0500 | 500 x 120 mm | 25,0 x 12,0 mm | 63,50 |

Ganzstahl Hebelzwinde zum schnellen und mühelosen Spannen mit hohem Spanndruck mit selbstarretierendem spannhebelbetätigtem Rastzahnsegment

All-steel clamps with quick-lever handle



| Art.-Nr./Art.-No. | Größe/Size | Schiene/Bar | € |
|-------------------|--------------|----------------|--------------|
| 2943-0160 | 160 x 80 mm | 16,0 x 7,5 mm | 57,50 |
| 2943-0250 | 250 x 120 mm | 22,0 x 10,5 mm | 72,50 |
| 2943-0400 | 400 x 120 mm | 25,0 x 12,0 mm | 88,90 |

Werkzeugkoffer

Tool Case

Art.-Gruppe 111
Article Group 111

4963

Werkzeug-Trolley

Tool Trolley

 Abschließbare Bügelschlösser/
Lockable U-Locks

 Einrastender Teleskopgriff/
Telescopic Snap-Handle

 Haltbare Scharniere/
Hard-Wearing Hinges

 Robuste Rollen/
Robust Castors

 Stabile Füße/
Solid Feet



| Art.-Nr./Art.-No. | L./L. | B./W. | H./H. | tlg./pcs. | | € |
|-------------------|-------|-------|-------|-----------|--|---------------|
| 4963 | 390 | 450 | 170 | 1 | Werkzeug-Trolley leer/empty tool trolley | 249,90 |

8681K

Werkzeugkoffer

Tool Case



| Art.-Nr./Art.-No. | L./L. | B./W. | H./H. | tlg./pcs. | | € |
|-------------------|---|-------|-------|-----------|-------------------------------------|---------------|
| 8681K | 460 | 330 | 145 | 1 | Werkzeugkoffer leer/empty tool case | 138,00 |
| 8682K | 425 | 280 | 130 | 1 | Werkzeugkoffer leer/empty tool case | 122,00 |
| 8683K | 460 | 330 | 145 | 1 | Werkzeugkoffer leer/empty tool case | 138,00 |
| 8684K | 460 | 330 | 145 | 1 | Werkzeugkoffer leer/empty tool case | 138,00 |
| 8685K | 460 | 330 | 145 | 1 | Werkzeugkoffer leer/empty tool case | 138,00 |
| 8681-SCHLUESSEL | Ersatzschlüssel (Set á 2 Stück) für 8681, 8682, 8683, 8684, 8685, 4963-01 | | | | | 4,50 |



**Alle Module aus dem Kapitel
SYSTEMWAND finden Sie unter:**

All System Wall Racks you find at:

www.projahn.de/qr/pos/systemwand



**Alle Produkte aus dem Kapitel
WERBEMITTEL finden Sie unter:**

All Give-Aways you find at:

www.projahn.de/qr/werbemittel

Allgemeine Geschäftsbedingungen der PROJAHN Präzisionswerkzeuge GmbH

Gültig seit 1. April 2013. Hiermit verlieren alle vorherigen AGB ihre Gültigkeit!

1. Allgemeines

- 1.1 Unsere Lieferungen, Leistungen und Angebote erfolgen ausschließlich auf Grund dieser Geschäftsbedingungen. Diese gelten somit auch für alle künftigen Geschäftsbeziehungen, auch wenn sie nicht nochmals ausdrücklich vereinbart werden. Spätestens mit der Entgegennahme der Ware oder Leistung gelten diese Bedingungen als angenommen. Gegenbestätigungen des Käufers unter Hinweis auf seine Geschäfts- bzw. Einkaufsbedingungen wird hiermit widersprochen.
- 1.2 Alle Vereinbarungen, die zwischen uns und dem Käufer zwecks Ausführung dieses Vertrages getroffen werden, sind schriftlich niederzulegen.

2. Erfüllungsort, Gefahrübergang, Versicherung

- 2.1 Erfüllungsort für Lieferung und Zahlung ist Erftzweck.
- 2.2 Die Gefahr geht auf den Käufer über, sobald die Sendung, an die den Transport ausführende Person, übergeben worden ist oder zwecks Versendung unser Lager verlassen hat. Wird der Versand auf Wunsch des Käufers verzögert, geht die Gefahr mit der Meldung der Versandbereitschaft auf ihn über.

3. Angebote und Preise

- 3.1 Die Darstellung unserer Waren im Internet oder im Katalog beinhaltet kein bindendes Angebot. Es handelt sich um eine Aufforderung an unsere Kunden, uns ein verbindliches Angebot zu unterbreiten.
- 3.2 Die Bestellung unseres Kunden stellt ein verbindliches Angebot auf Abschluss eines Kaufvertrages über die bestellte Ware dar. Soweit wir den Zugang der Bestellung bestätigen, stellt dies keine verbindliche Annahme der Bestellung dar.
- 3.3 Der Kaufvertrag kommt erst zu Stande, wenn wir dem Käufer eine verbindliche Auftragsbestätigung übermitteln oder die bestellte Ware an ihn versenden.
- 3.4 Wenn wir ein Angebot unterbreiten, ist dieses freibleibend und unverbindlich. Annahmeerklärungen und sämtliche Bestellungen bedürfen zur Rechtswirksamkeit unserer schriftlichen oder fernschriftlichen Bestätigung.
- 3.5 Sowohl Preisänderungen, als auch technische Änderungen bleiben uns vorbehalten. Unsere Produktabbildungen im Katalog und im Internet sind unverbindlich. Des weiteren wird jegliche Haftung für Druckfehler ausgeschlossen.
- 3.6 Es gilt jeweils die am Tage der Bestellung gültige Preisliste.
- 3.7 Die Preise verstehen sich zuzüglich der jeweiligen gesetzlichen Umsatzsteuer.
- 3.8 Im Katalog sind zu den jeweiligen Produkten die entsprechenden Verpackungseinheiten genannt. Die Verpackungseinheiten verstehen sich als Mindestabnahmemenge. Im Falle einer Minderbestellung erhöhen wir diese automatisch auf die entsprechende Verpackungseinheit. Diese Vorgehensweise bedarf nicht der ausdrücklichen Zustimmung des Bestellers.

4. Versandkosten

Sind keine abweichenden Vereinbarungen getroffen, gilt folgendes:

- 4.1 Unsere Preise verstehen sich „ab Werk“, ausschließlich Verpackung.
- 4.2 Ab Euro 250,- Nettom Auftragswert liefern wir innerhalb Deutschlands frei Haus, inklusive Verpackung.
- 4.3 Bei Inlandsaufträgen unter Euro 50,- Nettom Auftragswert wird ein Mindermengenzuschlag von Euro 5,- berechnet.

5. Liefer- und Leistungszeit

- 5.1 Liefertermine oder -fristen, die verbindlich oder unverbindlich vereinbart werden können, bedürfen der Schriftform.
- 5.2 Liefer- und Leistungsverzögerungen auf Grund höherer Gewalt und auf Grund von Ereignissen, die uns die Lieferung nicht nur vorübergehend wesentlich erschweren oder unmöglich machen – hierzu gehören insbesondere Streik, Aussperrung, behördliche Anordnungen usw., auch wenn sie bei unserem Lieferanten oder deren Unterlieferanten eintreten – haben wir auch bei verbindlich vereinbarten Fristen und Terminen nicht zu vertreten. Sie berechtigen uns, die Lieferung bzw. Leistung um die Dauer der Behinderung, zuzüglich einer angemessenen Anlaufzeit, hinauszuschieben oder wegen des noch nicht erfüllten Teils ganz oder teilweise vom Vertrag zurückzutreten. Wenn die Behinderung länger als drei Monate dauert, ist der Käufer nach angemessener Nachfristsetzung berechtigt, hinsichtlich des noch nicht erfüllten Teils vom Vertrag zurückzutreten. Verlängert sich die Lieferzeit oder werden wir von unserer Verpflichtung frei, so kann der Käufer hieraus keine Schadensersatzansprüche herleiten. Auf die genannten Umstände können wir uns nur berufen, wenn wir den Käufer unverzüglich benachrichtigt haben.
- 5.3 Wir sind zu Teillieferungen und Teilleistungen jederzeit berechtigt, es sei denn die Teillieferung oder Teilleistung ist vom Käufer bei Vertragsschluss ausgeschlossen worden.
- 5.4 Die Einhaltung der Liefer- und Leistungsverpflichtungen unsererseits, setzt die rechtzeitige und ordnungsgemäße Erfüllung der Verpflichtungen des Käufers voraus.
- 5.5 Kommt der Käufer in Annahmeverzug, so sind wir berechtigt, Ersatz des uns entstehenden Schadens zu verlangen. Schadensersatz wegen Nichterfüllung können wir pauschaliert in Höhe von 15% des vereinbarten Kaufpreises verlangen, es sei denn, der Käufer beweist, dass unser Schaden geringer ist oder wir weisen nach, dass der Schaden höher ist.
- 5.6 Mit Eintritt des Annahmeverzugs geht die Gefahr der zufälligen Verschlechterung und des zufälligen Untergangs auf den Käufer über.

6. Sonderwerkzeuge

Wenn wir einen Auftrag für Sonderwerkzeuge annehmen und schriftlich bestätigen, sind wir berechtigt, die Lieferung um eine angemessene Stückzahl zu über- oder unterschreiten.

7. Gewährleistung, Mängelrügen

- 7.1 Die von uns gelieferte Ware ist unverzüglich nach dem Eintreffen am Bestimmungsort mit der Sorgfalt eines ordentlichen Kaufmanns zu untersuchen und zu behandeln. Unterbleibt die Untersuchung, haften wir nicht für Mängel der Ware. Dies gilt entsprechend, wenn später erkennbare Mängel nicht unverzüglich gerügt werden. Mängel sind uns schriftlich, spätestens innerhalb von 8 Tagen nach Warenerhalt, mitzuteilen.
- 7.2 Sachmängel liegen nur vor, wenn die Mängel zum Zeitpunkt der Übergabe vorhanden sind. Deshalb liegen keine Sachmängel vor, wenn die Beanstandungen auf ungeeignete oder unsachgemäße Verwendung unserer Werkzeuge, natürliche Abnutzung, fehlerhafte oder nachlässige Behandlung, sowohl übermäßige Beanspruchung und den Einsatz von ungeeigneten Betriebsmitteln, als auch chemische, elektrochemische oder elektrische Einflüsse zurückzuführen sind, soweit die Verwendbarkeit unter entsprechenden Sonderbedingungen nicht vereinbart war.

- 7.3 Liegen Sachmängel vor, steht uns das Wahlrecht zu, ob die Nacherfüllung durch Nachbesserung oder Nachlieferung erfolgt. Wir haben auch das Recht, eine entsprechende Gutschrift für den gelieferten Artikel zu erstellen.
- 7.4 Auf Sachmängel, die den Wert und die Tauglichkeit der Ware nur unerheblich mindern, kann der Käufer einen Rücktrittsanspruch nicht stützen.

8. Zahlungsbedingungen, Zahlungsverzug

- 8.1 Eine Zahlung gilt erst dann als erfolgt, wenn wir über den Betrag verfügen können. Im Falle von Schecks gilt die Zahlung erst als erfolgt, wenn der Scheck eingelöst wird.
- 8.2 Bei Zahlungen innerhalb von 8 Tagen ab Rechnungsdatum (Eingang Konto) gewähren wir 2% Skonto.
- 8.3 Wir sind berechtigt, trotz anders lautender Bestimmungen des Käufers, Zahlungen zunächst auf dessen ältere Schulden anzurechnen. Wir werden den Käufer über die Art der erfolgten Verrechnung informieren. Sind bereits Kosten und Zinsen entstanden, so sind wir berechtigt, die Zahlung zunächst auf die Kosten, dann auf die Zinsen und zuletzt auf die Hauptleistung anzurechnen.
- 8.4 Der Käufer gerät, ohne dass es einer gesonderten Mahnung bedarf, am 30. Tage nach Rechnungsdatum in Verzug. Bei Zahlungsverzug ist die offene Forderung mit 8% Prozentpunkten über dem jeweiligen Basiszinssatz zu verzinsen. Sie sind dann niedriger anzusetzen, wenn der Käufer eine geringere Belastung nachweist; der Nachweis eines höheren Schadens durch uns ist zulässig.
- 8.5 Der Käufer ist zur Aufrechnung, Zurückbehaltung oder Minderung, auch wenn Mängelrügen oder Gegenansprüche geltend gemacht werden, nur berechtigt, wenn wir ausdrücklich zustimmen oder wenn die Gegenansprüche rechtskräftig festgestellt worden oder unstreitig sind. Zur Zurückbehaltung ist der Käufer nur wegen Gegenansprüchen aus demselben Vertragsverhältnis berechtigt.

9. Eigentumsvorbehalt

- 9.1 Bis zur Erfüllung aller Forderungen (einschließlich sämtlicher Saldoforderungen aus Kontokorrent), die uns aus jedem Rechtsgrund gegen den Käufer jetzt oder künftig zustehen, bleibt die gelieferte Ware in unserem Eigentum.
- 9.2 Der Käufer ist berechtigt, die Vorbehaltsware im ordnungsgemäßen Geschäftsverkehr zu veräußern, solange er nicht in Verzug ist. Verpfändungen oder Sicherungsübereignungen sind unzulässig. Die aus dem Weiterverkauf oder einem sonstigen Rechtsgrund (Versicherung, unerlaubte Handlung) bezüglich der Vorbehaltsware entstehenden Forderungen (einschließlich sämtlicher Saldoforderungen aus Kontokorrent) tritt der Käufer bereits jetzt sicherungshalber in vollem Umfang an uns ab. Wir ermächtigen ihn widerruflich, die an uns abgetretenen Forderungen für dessen Rechnung im eigenen Namen einzuziehen. Diese Einziehungsermächtigung kann nur widerrufen werden, wenn der Käufer seinen Zahlungsverpflichtungen nicht ordnungsgemäß nachkommt.
- 9.3 Bei Zugriffen Dritter auf die Vorbehaltsware, insbesondere Pfändungen, wird der Käufer auf unser Eigentum hinweisen und uns unverzüglich benachrichtigen, damit wir unsere Eigentumsrechte durchsetzen können. Soweit der Dritte nicht in der Lage ist, uns die in diesem Zusammenhang entstehenden gerichtlichen oder außergerichtlichen Kosten zu erstatten, haftet hierfür der Käufer.

- 9.4 Bei vertragswidrigem Verhalten des Käufers – insbesondere Zahlungsverzug – sind wir berechtigt, vom Vertrag zurückzutreten und die Vorbehaltsware heraus zu verlangen.

10. Haftungsbeschränkung

- 10.1 Schadensersatzansprüche sind unabhängig von der Art der Pflichtverletzung, einschließlich unerlaubter Handlungen, ausgeschlossen, soweit nicht vorsätzliches oder grob fahrlässiges Handeln vorliegt.
- 10.2 Bei Verletzung wesentlicher Vertragspflichten haften wir für jede Fahrlässigkeit, jedoch nur bis zur Höhe des vorhersehbaren Schadens. Ansprüche auf entgangenen Gewinn, ersparte Aufwendungen, aus Schadensersatzansprüchen Dritter sowie auf sonstige mittelbare- und Folgeschäden können nicht verlangt werden, es sei denn, ein von uns garantiertes Beschaffenheitsmerkmal bezweckt gerade, den Käufer gegen solche Schäden abzusichern.
- 10.3 Die Haftungsbeschränkungen und -ausschlüsse in den Absätzen 10.1 und 10.2 gelten nicht für Ansprüche, die wegen arglistigen Verhaltens auf unserer Seite entstanden sind, sowie bei einer Haftung für garantierte Beschaffenheitsmerkmale, für Ansprüche nach dem Produkthaftungsgesetz sowie Schäden aus der Verletzung des Lebens, des Körpers oder der Gesundheit.
- 10.4 Soweit unsere Haftung ausgeschlossen oder beschränkt ist, gilt dies auch für unsere Angestellten, Arbeitnehmer, Vertreter und Erfüllungsgehilfen.

11. Datenschutz

Personen- und firmenbezogene Daten werden von uns gespeichert und verarbeitet, soweit dies zur Durchführung der Aufträge notwendig und nach dem Bundesdatenschutzgesetz zulässig ist.

12. Anwendbares Recht, Gerichtsstand, Teilnichtigkeit

- 12.1 Für die gesamten Rechtsbeziehungen zwischen uns und dem Käufer gilt das Recht der Bundesrepublik Deutschland. Die Bestimmungen des UN-Kaufrechts finden keine Anwendung.
- 12.2 Gerichtsstand für alle sich aus dem Vertragsverhältnis unmittelbar oder mittelbar ergebenden Streitigkeiten ist unser Hauptsitz. Wir haben das Recht, Ansprüche auch an einem anderen gesetzlichen Gerichtsstand geltend zu machen.
- 12.3 Sollte eine der vorstehenden Bestimmungen unwirksam sein, bleibt die Wirksamkeit der übrigen Bestimmungen unberührt und die betroffene Bestimmung ist durch eine wirksame Regelung zu ersetzen, die der unwirksamen Bestimmung wirtschaftlich am nächsten kommt.

General Terms and Conditions : PROJAHN Präzisionswerkzeuge GmbH

Valid since April 1, 2013. All foregoing general terms and conditions herewith lose their validity.

Please be advised that general terms and conditions below are a translation of the German general terms and conditions.

The German general terms and conditions are also valid for international business.

1. General

- 1.1 Our deliveries, services and offers are made exclusively on the basis of these terms and conditions, which will also apply to all future business relations even if they are not expressly agreed anew. These terms and conditions are considered agreed upon receipt of the goods or services at the latest. Counter-confirmations on the part of the purchaser with reference to the purchaser's own terms of business or purchase are hereby rejected.
- 1.2 All agreements made between the purchaser and ourselves for the purpose of performance of this contract must be recorded in writing.

2. Place of Performance, Passing of Risk, Insurance

- 2.1 The place of performance for delivery and payment is Dietzenbach.
- 2.2 The risk passes to the purchaser as soon as the consignment has been transferred to the person carrying out the transportation or as soon as it has left our warehouse for the purpose of dispatch. If the dispatch is delayed at the purchaser's request, the risk passes to the purchaser on notification that the consignment is ready for dispatch.

3. Offers and Prices

- 3.1 The presentation of our goods on the internet or in the catalogue does not constitute an offer to which we are bound. It is an invitation to our customers to make us a binding offer.
- 3.2 The order placed by our customer represents a binding offer to conclude a contract of sale relating to the ordered goods. Insofar as we acknowledge receipt of the order, this does not represent binding acceptance of the order.
- 3.3 The contract of sale is brought about only when we forward a binding order confirmation to the purchaser or send the ordered goods to the purchaser.
- 3.4 If we submit an offer, it is non-binding and without engagement. Declarations of acceptance and all orders require our confirmation by letter or by written telecommunication to attain legal validity.
- 3.5 We reserve the right to change prices and to make technical modifications. The images of our products in the catalogue and on the internet are not binding. Furthermore, no liability for printing errors is accepted.
- 3.6 The price list valid on the order date applies.
- 3.7 The prices are subject to VAT at the respective statutory rate.
- 3.8 The catalogue indicates the packaging units corresponding to the respective products. The packaging units are the minimum purchase quantity. If an order for a reduced quantity is placed, we increase the order automatically to the relevant packing unit. This procedure does not require the orderer's express consent.

4. Shipping Costs

- Unless agreed otherwise, the following applies:
- 4.1 Our prices are "ex works", excluding packaging.
 - 4.2 From a net order value of Euro 250.- upwards, we deliver free domicile within Germany, including packaging.
 - 4.3 A mark-up of Euro 5.00 is charged for orders from domestic customers with a net order value of less than Euro 50.-.

5. Delivery and Performance Time

- 5.1 Delivery dates or delivery periods, which may be agreed on a binding or non-binding basis, have to be stated in writing.
- 5.2 We cannot be held responsible for delays in delivery and performance due to force majeure and events which significantly impede or render delivery by us impossible, not merely on a temporary basis – including, in particular, strikes, lock-outs, official rulings etc., and inclusive of such events affecting our suppliers and sub-suppliers, even in case of bindingly agreed dates and deadlines. They entitle us to postpone delivery or performance for the duration of the hindrance plus a reasonable lead time, or to withdraw from the contract in whole or in part on account of the part not fulfilled. If the hindrance lasts longer than three months, the purchaser is entitled to withdraw from the unfulfilled part of the contract after having granted a reasonable extension of time. If the delivery period is prolonged or if we are released from our obligations, the purchaser cannot derive any claims for damages from this. We will only have the right to plead the aforementioned circumstances if we have notified the purchaser promptly.
- 5.3 We are entitled to make partial deliveries and render partial performance at any time unless the purchaser excluded partial delivery or partial performance when the contract was concluded.
- 5.4 The adherence to the delivery and performance duties on our part presupposes the punctual and orderly fulfilment of the purchaser's obligations.
- 5.5 If the purchaser defaults on acceptance, we are entitled to claim compensation for the damage or loss we incur. We are entitled to claim liquidated damages for non-fulfilment to the amount of 15% of the agreed purchase price unless the purchaser proves that the damage or loss we incurred is lower or we prove that the damage or loss is higher.
- 5.6 Upon default of acceptance the risk of accidental deterioration and accidental loss passes to the purchaser.

6. Special Tools

If we accept an order for special tools and confirm it in writing, we are entitled to deliver a reasonably higher or lower number of units.

7. Warranty, Notification of Defects

- 7.1 Immediately after the goods we deliver have arrived at their destination, they have to be inspected and handled with the due care and diligence of a prudent businessman. If the goods are not inspected, we cannot be held liable for any defects. This applies analogously if defects identifiable at a later stage are not promptly notified. We are to be notified of any defects in writing, at the latest within 8 days from receipt of the goods.

- 7.2 Defects of quality are constituted only if the defects exist at the time of delivery. Therefore defects of quality are not constituted if the complaints can be put down to unsuitable or improper use of our tools, natural wear, faulty or negligent handling, excessive workloads, the use of unsuitable operating resources, as well as chemical, electrochemical or electrical influences, insofar as the usability under corresponding special conditions was not agreed.
- 7.3 If defects of quality are constituted, we have the right to choose whether the supplementary performance takes the form of rectification or replacement. We also have the right to issue a commensurate credit note for the article supplied.
- 7.4 The buyer is not entitled to base a rescission claim on defects of quality which only insignificantly reduce the value or fitness for use of the goods.

8. Terms of Payment, Default in Payment

- 8.1 Payment will be deemed to have been made only when the sum is at our disposal. In the case of cheques, payment will be deemed to have been made only when the cheque has been cashed.
- 8.2 For payments within 8 days from the date of invoice (receipt on the account) we grant a 2 % discount.
- 8.3 We are entitled, notwithstanding any purchaser's stipulations to the contrary, to post payments first against the purchaser's older debts. We will inform the purchaser of the nature of this settlement. If costs and interest have accrued, we are entitled to post the payment first against the costs, then against the interest and finally against the principal debt.
- 8.4 The purchaser will be in default on the 30th day after the date of invoice, without a separate notice of default having to be served. In case of default in payment, the unsettled claim bears interest at the rate of 8 percentage points above the respective base rate. The interest is to be set at a lower rate if the purchaser provides evidence of a lower burden. It is admissible for us to produce evidence of higher loss.
- 8.5 The purchaser does not have the right to offset, retain or reduce payments, even in the event of complaints or counterclaims, unless we expressly agree to such or the counterclaims have been res judicata or are undisputed. The buyer has a right of retention only due to counterclaims under the same contractual relationship.

9. Reservation of Title

- 9.1 The goods supplied remain our property until settlement of all claims (including all current account balance claims) to which we are entitled from the purchaser on any legal grounds, now or in future.
- 9.2 The goods subject to retention of title may be sold by the purchaser in the ordinary course of business as long as the purchaser is not in default. Pledging or transfer of ownership by way of security is inadmissible. The claims (including all current account balance claims) accruing from the resale or on any other legal grounds (insurance, tort) with respect to the goods subject to retention of title are herewith assigned to us in their entirety by the buyer by way of security. We revocably authorize the purchaser to collect the claims assigned to us, for his account

and in his name. This authorization for collection can be revoked only if the purchaser does not duly fulfil his payment obligations.

- 9.3 If a third party attempts to seize the goods subject to retention of title, in particular in case of attachment, the purchaser will draw attention to our ownership and notify us without delay so that we are in a position to enforce our title. If the third party is not in a position to reimburse us for the court and out-of-court costs incurred in this connection, the purchaser will be liable for them.
- 9.4 In case of breach of contract by the purchaser – in particular, default in payment – we are entitled to withdraw from the contract and to demand the return of the goods.

10. Limitation of Liability

- 10.1 Claims for damages are excluded, irrespective of the nature of the breach of obligations, including tort, unless deliberate or grossly negligent acts are involved.
- 10.2 In case of breach of fundamental contractual obligations, we are liable for every act of negligence, but only to the extent of the foreseeable damage or loss. Claims for loss of profit, saved expenditure, third-party claims for damages, and other indirect and consequential damage cannot be made unless a quality feature we guarantee has the express purpose of protecting the purchaser from such damage or loss.
- 10.3 The limitations and exclusions of liability set forth in paragraphs 10.1 and 10.2 do not apply to claims arising as a result of fraudulent conduct on our part, nor to liability for guaranteed quality features, claims under product liability law or damage resulting from injury to life, body and health.
- 10.4 To the extent that our liability is excluded or limited, this also applies to our employees, representatives and persons we engage for fulfilling our obligations.

11. Protection of Data Privacy

We store and process personal and company-related data as far as is necessary for executing the orders and as far as is admissible under the German Federal Data Protection Act (BDSG).

12. Applicable Law, Legal Venue, Severability

- 12.1 All legal relations between the purchaser and ourselves are governed by the laws of the Federal Republic of Germany to the exclusion of the provisions of the United Nations Convention on Contracts for the International Sale of Goods.
- 12.2 The legal venue for all disputes arising directly or indirectly from the contractual relationship is our principal place of business. We have the right to also assert claims at another place of jurisdiction.
- 12.3. Should any one of the above provisions be inoperative, the validity of the other provisions will remain unaffected. The provision concerned is to be replaced by an operative one that most closely resembles the economic intent of the original provision.

Artikelnummern-Verzeichnis

Articlenumber List

| Art.-Nr. / No. | Seite / Page | Art.-Nr. / No. | Seite / Page | Art.-Nr. / No. | Seite / Page | Art.-Nr. / No. | Seite / Page | Art.-Nr. / No. | Seite / Page |
|----------------|--------------|----------------|--------------|----------------|--------------|----------------|--------------|----------------|--------------|
| 100035 | H98 | 1702-10 | H164 | 1760325-03 | H167 | 201518 | H101 | 2302 | H222 |
| 100040 | H98 | 1702-50 | H164 | 1760330-03 | H167 | 201519 | H101 | 2303 | H222 |
| 100045 | H98 | 1703-03 | H164 | 1760340-03 | H167 | 202055 | H101 | 2304 | H222 |
| 100050 | H98 | 1703-10 | H164 | 1761001-03 | H167 | 202065 | H101 | 2305 | H222 |
| 100055 | H98 | 1711-03 | H164 | 1761002-03 | H167 | 202080 | H101 | 2308 | H222 |
| 100060 | H98 | 1711-10 | H164 | 1761003-03 | H167 | 202100 | H101 | 2310 | H222 |
| 100070 | H98 | 1711-50 | H164 | 1761101-03 | H167 | 203001 | H101 | 231013 | H143 |
| 100080 | H98 | 1712-03 | H164 | 1761102-03 | H167 | 203002 | H101 | 231317 | H143 |
| 100090 | H98 | 1712-10 | H164 | 1761103-03 | H167 | 203003 | H101 | 2315 | H222 |
| 100100 | H98 | 1712-50 | H164 | 1761202-03 | H167 | 203004 | H101 | 231719 | H143 |
| 100110 | H98 | 1713-03 | H164 | 1761203-03 | H167 | 204001 | H101 | 231922 | H143 |
| 100120 | H98 | 1713-10 | H164 | 1761205-03 | H167 | 204002 | H101 | 2319221 | H143 |
| 100130 | H98 | 1721-03 | H164 | 1761310-03 | H167 | 204003 | H101 | 231924 | H143 |
| 100140 | H98 | 1722-03 | H164 | 1761315-03 | H167 | 204004 | H101 | 2321 | H222 |
| 100503 | H98 | 1723-03 | H164 | 1761320-03 | H167 | 205010 | H102 | 2324 | H222 |
| 100504 | H98 | 1724-03 | H164 | 1761325-03 | H167 | 205015 | H102 | 232427 | H143 |
| 100505 | H98 | 1731-03 | H165 | 1761330-03 | H167 | 205020 | H102 | 232430 | H143 |
| 100506 | H98 | 1731-10 | H165 | 1761340-03 | H167 | 205025 | H102 | 2325 | H222 |
| 100507 | H98 | 1731-50 | H165 | 1801-03 | H164 | 205027 | H102 | 2326 | H222 |
| 100508 | H98 | 1732-03 | H165 | 1802-03 | H164 | 205030 | H102 | 232732 | H143 |
| 100509 | H98 | 1732-10 | H165 | 1803-03 | H164 | 205040 | H102 | 233236 | H143 |
| 100510 | H98 | 1732-50 | H165 | 1811-03 | H164 | 205045 | H102 | 2341 | H222 |
| 100511 | H98 | 1733-03 | H165 | 1812-03 | H164 | 205050 | H102 | 2341-1 | H222 |
| 101060 | H98 | 1733-10 | H165 | 1813-03 | H164 | 205055 | H102 | 2341-2 | H222 |
| 101070 | H98 | 1733-50 | H165 | 1822-03 | H164 | 2052 | H68 | 2363 | H222 |
| 101080 | H98 | 1734-03 | H165 | 1824-03 | H164 | 205310 | H102 | 2365 | H222 |
| 101090 | H98 | 1734-10 | H165 | 1831-03 | H165 | 205315 | H102 | 2368 | H222 |
| 101100 | H98 | 1734-50 | H165 | 1832-03 | H165 | 205320 | H102 | 2369 | H222 |
| 101110 | H98 | 1735-03 | H165 | 1833-03 | H165 | 205325 | H102 | 2390 | H234 |
| 101120 | H98 | 1735-10 | H165 | 1834-03 | H165 | 205327 | H102 | 2393-1 | H234 |
| 101130 | H98 | 1736-03 | H165 | 1835-03 | H165 | 205330 | H102 | 2393-2 | H234 |
| 101503 | H98 | 1736-10 | H165 | 1836-03 | H165 | 205340 | H102 | 2394-1 | H234 |
| 101504 | H98 | 1736-50 | H165 | 1837-03 | H165 | 205345 | H102 | 2394-2 | H234 |
| 101505 | H98 | 1737-03 | H165 | 1841-03 | H165 | 205350 | H102 | 2404 | H141 |
| 101506 | H98 | 1737-10 | H165 | 1842-03 | H165 | 205355 | H102 | 2406 | H141 |
| 101507 | H98 | 1741-03 | H165 | 1843-03 | H165 | 206003 | H102 | 240607 | H139 |
| 101508 | H98 | 1742-03 | H165 | 200060 | H101 | 206004 | H102 | 2408 | H141 |
| 101509 | H98 | 1742-10 | H165 | 200070 | H101 | 206005 | H102 | 240809 | H139 |
| 101510 | H98 | 1743-03 | H165 | 200080 | H101 | 206006 | H102 | 2410 | H141 |
| 101511 | H98 | 1743-10 | H165 | 200090 | H101 | 206007 | H102 | 241011 | H139 |
| 102040 | H98 | 1744-03 | H165 | 200100 | H101 | 206008 | H102 | 241013 | H139 |
| 102055 | H98 | 1750001-03 | H166 | 200110 | H101 | 206010 | H102 | 2412 | H141 |
| 102065 | H98 | 1750002-03 | H166 | 200120 | H101 | 207075 | H102 | 241213 | H139 |
| 103001 | H98 | 1750003-03 | H166 | 200130 | H101 | 207076 | H102 | 241317 | H139 |
| 103002 | H98 | 1750101-03 | H166 | 200140 | H101 | 207077 | H102 | 241415 | H139 |
| 103003 | H98 | 1750102-03 | H166 | 200150 | H101 | 207150 | H102 | 2415 | H141 |
| 104001 | H98 | 1750103-03 | H166 | 200160 | H101 | 207151 | H102 | 241617 | H139 |
| 104002 | H98 | 1750202-03 | H166 | 200170 | H101 | 207152 | H102 | 241618 | H139 |
| 104003 | H98 | 1750203-03 | H166 | 200180 | H101 | 207250 | H102 | 241719 | H139 |
| 105008 | H98 | 1750204-03 | H166 | 200190 | H101 | 208001 | H102 | 241819 | H139 |
| 105009 | H98 | 1750310-03 | H166 | 200200 | H101 | 210000 | H102 | 242022 | H139 |
| 105010 | H98 | 1750315-03 | H166 | 200210 | H101 | 211214 | H101 | 242123 | H139 |
| 105015 | H98 | 1750320-03 | H166 | 200220 | H101 | 2128 | H172 | 242426 | H139 |
| 105020 | H98 | 1750325-03 | H166 | 200230 | H101 | 2128 | H99 | 242427 | H139 |
| 105025 | H98 | 1750330-03 | H166 | 200240 | H101 | 2137 | H192 | 242528 | H139 |
| 105027 | H98 | 1751-03 | H165 | 200507 | H101 | 2138 | H192 | 243032 | H139 |
| 105030 | H98 | 1751001-03 | H166 | 200509 | H101 | 220004 | H102 | 243641 | H139 |
| 105040 | H98 | 1751002-03 | H166 | 200510 | H101 | 220005 | H102 | 2440810 | H142 |
| 106002 | H98 | 1751003-03 | H166 | 200511 | H101 | 220006 | H102 | 2441113 | H142 |
| 106003 | H98 | 1751101-03 | H166 | 200512 | H101 | 220007 | H102 | 2441416 | H142 |
| 106004 | H98 | 1751102-03 | H166 | 200513 | H101 | 220008 | H102 | 2441719 | H142 |
| 106005 | H98 | 1751103-03 | H166 | 200514 | H101 | 220010 | H102 | 250008 | H138 |
| 106006 | H98 | 1751202-03 | H166 | 200515 | H101 | 220011 | H102 | 250010 | H138 |
| 106007 | H98 | 1751203-03 | H166 | 200516 | H101 | 220012 | H102 | 250012 | H138 |
| 106008 | H98 | 1751204-03 | H166 | 200517 | H101 | 220014 | H102 | 250013 | H138 |
| 107050 | H99 | 1751310-03 | H166 | 201070 | H101 | 220016 | H102 | 250016 | H138 |
| 107052 | H99 | 1751315-03 | H166 | 201080 | H101 | 220018 | H102 | 250017 | H138 |
| 107100 | H99 | 1751320-03 | H166 | 201100 | H101 | 220020 | H102 | 250018 | H138 |
| 107102 | H99 | 1751325-03 | H166 | 201110 | H101 | 2203 | H141 | 250019 | H138 |
| 107140 | H171 | 1751330-03 | H166 | 201120 | H101 | 2205 | H141 | 2505 | H135 |
| 107150 | H99 | 1752-03 | H165 | 201130 | H101 | 2207 | H141 | 2506 | H135 |
| 108100 | H99 | 1753-03 | H165 | 201140 | H101 | 220810 | H141 | 250607 | H139 |
| 108200 | H99 | 1754-03 | H165 | 201150 | H101 | 220911 | H141 | 25062 | H136 |
| 109150 | H99 | 1755-03 | H165 | 201160 | H101 | 2210 | H141 | 25065 | H138 |
| 110000 | H99 | 1756-03 | H165 | 201170 | H101 | 221011 | H141 | 2507 | H135 |
| 11911-01 | H163 | 1757-03 | H165 | 201180 | H101 | 221012 | H141 | 25072 | H136 |
| 11911-01 | H184 | 1760001-03 | H167 | 201190 | H101 | 221214 | H141 | 25075 | H138 |
| 120004 | H98 | 1760002-03 | H167 | 201210 | H101 | 221315 | H141 | 2508 | H135 |
| 120005 | H98 | 1760003-03 | H167 | 201220 | H101 | 221417 | H141 | 250809 | H139 |
| 120006 | H98 | 1760101-03 | H167 | 201509 | H101 | 2216 | H149 | 25081 | H137 |
| 120007 | H98 | 1760102-03 | H167 | 201510 | H101 | 221618 | H141 | 25082 | H136 |
| 120008 | H98 | 1760103-03 | H167 | 201511 | H101 | 2216E | H149 | 25085 | H138 |
| 120010 | H98 | 1760202-03 | H167 | 201512 | H101 | 221719 | H141 | 2509 | H135 |
| 120011 | H98 | 1760203-03 | H167 | 201513 | H101 | 2218 | H150 | 25091 | H137 |
| 1701-03 | H164 | 1760205-03 | H167 | 201514 | H101 | 2218E | H150 | 25092 | H136 |
| 1701-10 | H164 | 1760310-03 | H167 | 201515 | H101 | 221922 | H141 | 25095 | H138 |
| 1701-50 | H164 | 1760315-03 | H167 | 201516 | H101 | 222224 | H141 | 2510 | H135 |
| 1702-03 | H164 | 1760320-03 | H167 | 201517 | H101 | 2301 | H222 | 251008 | H139 |

Artikelnummern-Verzeichnis

Articlenumber List

| Art.-Nr. / No. | Seite / Page | Art.-Nr. / No. | Seite / Page | Art.-Nr. / No. | Seite / Page | Art.-Nr. / No. | Seite / Page | Art.-Nr. / No. | Seite / Page |
|----------------|--------------|----------------|--------------|----------------|--------------|----------------|--------------|----------------|--------------|
| 25101 | H137 | 253032 | H139 | 2633 | H160 | 2728-10 | H161 | 2813-10 | H158 |
| 251011 | H139 | 25304 | H140 | 2634 | H160 | 2729 | H160 | 2814 | H158 |
| 251013 | H139 | 25305 | H138 | 2635 | H160 | 2729-10 | H161 | 2821 | H159 |
| 25102 | H136 | 2532 | H135 | 2636 | H160 | 2731 | H160 | 2822 | H159 |
| 25105 | H138 | 25321 | H137 | 2637 | H160 | 2731-10 | H161 | 2823 | H159 |
| 2511 | H135 | 25322 | H136 | 2651 | H170 | 2731-100 | H161 | 2824 | H159 |
| 25111 | H137 | 25324 | H140 | 2652 | H170 | 2732 | H160 | 2825 | H159 |
| 25112 | H136 | 25325 | H138 | 2653 | H170 | 2732-10 | H161 | 2826 | H159 |
| 25115 | H138 | 25361 | H135 | 2656 | H170 | 2732-100 | H161 | 2831 | H160 |
| 2512 | H135 | 25364 | H140 | 2657 | H170 | 2733 | H160 | 2831-10 | H161 |
| 25121 | H137 | 253641 | H139 | 2658 | H170 | 2733-10 | H161 | 2832 | H160 |
| 251213 | H139 | 25384 | H140 | 2661 | H170 | 2733-100 | H161 | 2832-10 | H161 |
| 25122 | H136 | 25411 | H135 | 2662 | H170 | 2734 | H160 | 2833 | H160 |
| 25125 | H138 | 25414 | H140 | 2663 | H170 | 2734-10 | H161 | 2833-10 | H161 |
| 2513 | H135 | 254146 | H139 | 2665 | H170 | 2734-100 | H161 | 2834 | H160 |
| 25131 | H137 | 25424 | H140 | 2667 | H170 | 2735 | H160 | 2834-10 | H161 |
| 251317 | H139 | 25461 | H135 | 2668 | H170 | 2735-10 | H161 | 2835 | H160 |
| 25132 | H136 | 25464 | H140 | 2669 | H170 | 2735-100 | H161 | 2835-10 | H161 |
| 25135 | H138 | 254650 | H139 | 2671 | H170 | 2736 | H160 | 2836 | H160 |
| 2514 | H135 | 25484 | H140 | 2672 | H170 | 2736-10 | H161 | 2836-10 | H161 |
| 25141 | H137 | 25501 | H135 | 2673 | H170 | 2736-100 | H161 | 2837 | H160 |
| 251415 | H139 | 25504 | H140 | 2674 | H170 | 2737 | H160 | 2837-10 | H161 |
| 25142 | H136 | 25551 | H135 | 2676 | H162 | 2737-10 | H161 | 2841 | H162 |
| 25145 | H138 | 25554 | H140 | 2677 | H162 | 2738 | H160 | 2842 | H162 |
| 2515 | H135 | 25601 | H135 | 2678 | H162 | 2738-10 | H161 | 2843 | H162 |
| 25151 | H137 | 25604 | H140 | 2679 | H162 | 2739 | H160 | 2844 | H162 |
| 25152 | H136 | 2561 | H137 | 2680 | H162 | 2739-10 | H161 | 2845 | H162 |
| 25155 | H138 | 2562 | H137 | 2681 | H162 | 2741 | H162 | 2846 | H162 |
| 2516 | H135 | 2563 | H137 | 2683 | H162 | 2741-10 | H162 | 2850 | H171 |
| 25161 | H137 | 2564 | H137 | 2684 | H162 | 2742 | H162 | 2851 | H161 |
| 251617 | H139 | 2565 | H137 | 2685 | H162 | 2742-10 | H162 | 2852 | H161 |
| 25162 | H136 | 25651 | H135 | 2686 | H162 | 2743 | H162 | 2853 | H161 |
| 25165 | H138 | 25654 | H140 | 2687 | H162 | 2743-10 | H162 | 2854 | H161 |
| 2517 | H135 | 2566 | H137 | 2688 | H162 | 2744 | H162 | 2855 | H161 |
| 25171 | H137 | 2567 | H137 | 2690 | H170 | 2744-10 | H162 | 2856 | H161 |
| 251719 | H139 | 2568 | H137 | 2691 | H170 | 2745 | H162 | 2857 | H161 |
| 25172 | H136 | 2569 | H137 | 2692 | H170 | 2745-10 | H162 | 2860 | H171 |
| 25175 | H138 | 2570 | H137 | 2696 | H162 | 2746 | H162 | 2862 | H171 |
| 2518 | H135 | 25701 | H135 | 2697 | H162 | 2746-10 | H162 | 2864 | H171 |
| 25181 | H137 | 2571 | H137 | 2698 | H162 | 2747 | H161 | 2870 | H171 |
| 251819 | H139 | 2572 | H137 | 2699 | H162 | 2748 | H161 | 2880 | H171 |
| 25182 | H136 | 2580 | H147 | 2700 | H172 | 2749 | H161 | 2880 | H184 |
| 2519 | H135 | 2580E | H147 | 2700 | H97 | 2750 | H171 | 2881 | H161 |
| 25191 | H137 | 2588-08 | H143 | 2700-10 | H157 | 2751 | H161 | 2882 | H161 |
| 25192 | H136 | 2588-09 | H143 | 2701 | H157 | 2752 | H161 | 2883 | H161 |
| 251922 | H139 | 2588-10 | H143 | 2701-10 | H157 | 2753 | H161 | 2884 | H161 |
| 25195 | H138 | 2588-11 | H143 | 2701-100 | H157 | 2754 | H161 | 2885 | H161 |
| 2520 | H135 | 2588-12 | H143 | 2702 | H157 | 2755 | H161 | 2886 | H161 |
| 25201 | H137 | 2588-13 | H143 | 2702-10 | H157 | 2756 | H161 | 2887 | H161 |
| 252022 | H139 | 2588-14 | H143 | 2702-100 | H157 | 2757 | H161 | 2890 | H170 |
| 2521 | H135 | 2588-15 | H143 | 2703 | H157 | 2758 | H161 | 2891 | H170 |
| 25211 | H137 | 2588-16 | H143 | 2703-10 | H157 | 2760 | H171 | 2892 | H170 |
| 25212 | H136 | 2588-17 | H143 | 2703-100 | H157 | 2760 | H99 | 2893 | H170 |
| 252123 | H139 | 2588-18 | H143 | 2704 | H157 | 2761 | H102 | 2894 | H170 |
| 2522 | H135 | 2588-19 | H143 | 2704-10 | H157 | 2761 | H171 | 2895 | H170 |
| 25221 | H137 | 2588-20 | H143 | 2706 | H157 | 2764 | H171 | 2901 | H157 |
| 25222 | H136 | 2588-21 | H143 | 2706 | H157 | 2765 | H172 | 2902 | H157 |
| 252224 | H139 | 2588-22 | H143 | 2707 | H157 | 2766 | H172 | 2903 | H157 |
| 25225 | H138 | 2588-23 | H143 | 2707 | H157 | 2767 | H172 | 2911 | H158 |
| 2523 | H135 | 2588-24 | H143 | 2708 | H157 | 2769 | H171 | 2912 | H158 |
| 25232 | H136 | 2588-25 | H143 | 2708 | H157 | 2770 | H171 | 2913 | H158 |
| 2524 | H135 | 2588-26 | H143 | 2710-10 | H158 | 2771-10 | H161 | 2921 | H159 |
| 25241 | H137 | 2588-27 | H143 | 2711 | H158 | 2772-10 | H161 | 2922 | H159 |
| 25242 | H136 | 2588-28 | H143 | 2711-10 | H158 | 2774-10 | H161 | 2923 | H159 |
| 252426 | H139 | 2588-29 | H143 | 2711-100 | H158 | 2775-10 | H161 | 2924 | H159 |
| 252427 | H139 | 2588-30 | H143 | 2712 | H158 | 2777-10 | H161 | 2925 | H159 |
| 252430 | H139 | 2588-32 | H143 | 2712-10 | H158 | 2778-10 | H161 | 2926 | H159 |
| 25244 | H140 | 260001 | H140 | 2712-100 | H158 | 2780-10 | H162 | 2931 | H160 |
| 25245 | H138 | 260002 | H140 | 2713 | H158 | 2781-10 | H162 | 2932 | H160 |
| 2525 | H135 | 2601 | H157 | 2713-10 | H158 | 2782-10 | H162 | 2933 | H160 |
| 25252 | H136 | 2602 | H157 | 2713-100 | H158 | 2783-10 | H162 | 2934 | H160 |
| 252528 | H139 | 2603 | H157 | 2714 | H158 | 2784-10 | H162 | 2935 | H160 |
| 2526 | H135 | 260607 | H140 | 2714-10 | H158 | 2785-10 | H162 | 2936 | H160 |
| 25262 | H136 | 260809 | H140 | 2721 | H159 | 2786-10 | H162 | 2937 | H160 |
| 2527 | H135 | 261011 | H140 | 2721-10 | H159 | 2787-10 | H162 | 2941-0160 | H237 |
| 25271 | H137 | 2611 | H158 | 2722 | H159 | 2788-10 | H162 | 2941-0200 | H237 |
| 25272 | H136 | 2612 | H158 | 2722-10 | H159 | 2801 | H157 | 2941-0250 | H237 |
| 252730 | H139 | 261213 | H140 | 2723 | H159 | 2801-10 | H157 | 2941-0300 | H237 |
| 252732 | H139 | 2613 | H158 | 2723-10 | H159 | 2802 | H157 | 2941-0400 | H237 |
| 25274 | H140 | 261415 | H140 | 2724 | H159 | 2802-10 | H157 | 2941-0500 | H237 |
| 25275 | H138 | 261617 | H140 | 2724-10 | H159 | 2803 | H157 | 2941-0600 | H237 |
| 2528 | H135 | 261719 | H140 | 2725 | H159 | 2803-10 | H157 | 2941-0800 | H237 |
| 25282 | H136 | 261819 | H140 | 2725-10 | H159 | 2804 | H157 | 2941-1000 | H237 |
| 2529 | H135 | 262022 | H140 | 2726 | H159 | 2811 | H158 | 2941-1250 | H237 |
| 25292 | H136 | 262123 | H140 | 2726-10 | H159 | 2811-10 | H158 | 2942-0160 | H237 |
| 2530 | H135 | 262427 | H140 | 2727 | H159 | 2812 | H158 | 2942-0200 | H237 |
| 25301 | H137 | 2631 | H160 | 2727-10 | H161 | 2812-10 | H158 | 2942-0250 | H237 |
| 25302 | H136 | 2632 | H160 | 2728 | H160 | 2813 | H158 | 2942-0300 | H237 |

Artikelnummern-Verzeichnis

Articlenumber List

| Art.-Nr. / No. | Seite / Page | Art.-Nr. / No. | Seite / Page | Art.-Nr. / No. | Seite / Page | Art.-Nr. / No. | Seite / Page | Art.-Nr. / No. | Seite / Page |
|----------------|--------------|----------------|--------------|----------------|--------------|----------------|--------------|----------------|--------------|
| 2942-0400 | H237 | 301019 | H105 | 3046 | H162 | 3098 | H162 | 320018 | H106 |
| 2942-0500 | H237 | 301021 | H105 | 3046 | H163 | 3098 | H163 | 320020 | H106 |
| 2943-0160 | H237 | 301022 | H105 | 305010 | H168 | 310000 | H107 | 320022 | H106 |
| 2943-0250 | H237 | 3011-10 | H158 | 305015 | H168 | 3101-10 | H157 | 320024 | H106 |
| 2943-0400 | H237 | 3012 | H158 | 305020 | H168 | 3102-10 | H157 | 3201 | H157 |
| 2950 | H21 | 3012 | H163 | 305025 | H168 | 3103-10 | H157 | 3202 | H157 |
| 2951 | H21 | 3012-10 | H158 | 305027 | H168 | 3111-10 | H158 | 3203 | H157 |
| 2961 | H161 | 301208 | H105 | 305030 | H168 | 3112-10 | H158 | 321010 | H106 |
| 2962 | H161 | 301209 | H105 | 305040 | H168 | 311214 | H105 | 321012 | H106 |
| 2963 | H161 | 301210 | H105 | 305045 | H168 | 311215 | H105 | 321014 | H106 |
| 2964 | H161 | 301211 | H105 | 305050 | H168 | 311217 | H105 | 321016 | H106 |
| 2970 | H234 | 301212 | H105 | 305055 | H168 | 311219 | H105 | 321018 | H106 |
| 2975-040 | H233 | 301213 | H105 | 305060 | H168 | 3113-10 | H158 | 321020 | H106 |
| 2975-060 | H233 | 301214 | H105 | 305070 | H168 | 311516 | H107 | 321022 | H106 |
| 2975-080 | H233 | 301215 | H105 | 305310 | H168 | 311516 | H171 | 321024 | H106 |
| 2975-100 | H233 | 301216 | H105 | 305315 | H168 | 3130-10 | H160 | 3211 | H158 |
| 2975-120 | H233 | 301217 | H105 | 305320 | H168 | 313001 | H168 | 3212 | H158 |
| 2975-150 | H233 | 301218 | H105 | 305325 | H168 | 313002 | H168 | 3213 | H158 |
| 2975-180 | H233 | 301219 | H105 | 305327 | H168 | 313003 | H168 | 3221 | H159 |
| 2975-200 | H233 | 301220 | H105 | 305330 | H168 | 3131-10 | H160 | 3222 | H159 |
| 2976-030 | H232 | 301221 | H105 | 305340 | H168 | 3132-10 | H160 | 3223 | H159 |
| 2976-031 | H233 | 301222 | H105 | 305345 | H168 | 3133-10 | H160 | 3224 | H159 |
| 2976-040 | H232 | 301223 | H105 | 305350 | H168 | 3134-10 | H160 | 3225 | H159 |
| 2976-041 | H233 | 301224 | H105 | 305355 | H168 | 3135-10 | H160 | 3226 | H159 |
| 2976-060 | H232 | 301226 | H105 | 305360 | H168 | 3136-10 | H160 | 3228 | H160 |
| 2976-061 | H233 | 301227 | H105 | 305370 | H168 | 3137-10 | H160 | 3229 | H160 |
| 2976-080 | H232 | 301228 | H105 | 305620 | H169 | 3138-10 | H160 | 3231 | H160 |
| 2976-081 | H233 | 301230 | H105 | 305625 | H169 | 3139-10 | H160 | 3232 | H160 |
| 2976-100 | H232 | 301232 | H105 | 305627 | H169 | 3140-10 | H160 | 3233 | H160 |
| 2976-101 | H233 | 301234 | H105 | 305630 | H169 | 314001 | H168 | 3234 | H160 |
| 2976-120 | H232 | 301236 | H105 | 305640 | H169 | 314002 | H168 | 3235 | H160 |
| 2976-150 | H232 | 3013-10 | H158 | 305645 | H169 | 315015 | H168 | 3236 | H160 |
| 2976-180 | H232 | 301511 | H105 | 305650 | H169 | 315020 | H168 | 3237 | H160 |
| 2976-200 | H232 | 301512 | H105 | 305655 | H169 | 315025 | H168 | 3238 | H160 |
| 2978 | H231 | 301513 | H105 | 305660 | H169 | 315027 | H168 | 3239 | H160 |
| 2979 | H231 | 301514 | H105 | 305670 | H169 | 315030 | H168 | 3241 | H162 |
| 300008 | H105 | 301515 | H105 | 305720 | H169 | 315040 | H168 | 3242 | H162 |
| 300009 | H105 | 301516 | H105 | 305725 | H169 | 315045 | H168 | 3243 | H162 |
| 300010 | H105 | 301517 | H105 | 305727 | H169 | 315050 | H168 | 3247 | H162 |
| 300011 | H105 | 301518 | H105 | 305730 | H169 | 315055 | H168 | 3248 | H162 |
| 300012 | H105 | 301519 | H105 | 305740 | H169 | 315060 | H168 | 3249 | H162 |
| 300013 | H105 | 301520 | H105 | 305745 | H169 | 315620 | H169 | 325015 | H106 |
| 300014 | H105 | 302055 | H168 | 305750 | H169 | 315625 | H169 | 325020 | H106 |
| 300015 | H105 | 302065 | H168 | 305755 | H169 | 315627 | H169 | 325025 | H106 |
| 300016 | H105 | 302080 | H168 | 305760 | H169 | 315630 | H169 | 325027 | H106 |
| 300017 | H105 | 302100 | H168 | 305770 | H169 | 315640 | H169 | 325030 | H106 |
| 300018 | H105 | 302120 | H168 | 3059 | H236 | 315645 | H169 | 325040 | H106 |
| 300019 | H105 | 3030-10 | H160 | 306004 | H168 | 315650 | H169 | 325045 | H106 |
| 300020 | H105 | 303001 | H168 | 306005K | H168 | 315655 | H169 | 325050 | H106 |
| 300021 | H105 | 303002 | H168 | 306006 | H168 | 315660 | H169 | 325055 | H106 |
| 300022 | H105 | 303003 | H168 | 306007 | H168 | 315670 | H169 | 325060 | H106 |
| 300023 | H105 | 303004 | H168 | 306008 | H168 | 315720 | H169 | 325110 | H106 |
| 300024 | H105 | 3031 | H160 | 306010 | H168 | 315725 | H169 | 325115 | H106 |
| 300026 | H105 | 3031 | H163 | 306012 | H168 | 315727 | H169 | 325120 | H106 |
| 300027 | H105 | 3031-10 | H160 | 306014 | H168 | 315730 | H169 | 325125 | H106 |
| 300028 | H105 | 3032 | H160 | 306040 | H169 | 315730 | H169 | 325127 | H106 |
| 300030 | H105 | 3032 | H163 | 306050 | H169 | 315740 | H169 | 325130 | H106 |
| 300032 | H105 | 3032-10 | H160 | 306060 | H169 | 315745 | H169 | 325140 | H106 |
| 300034 | H105 | 3033 | H160 | 306080 | H169 | 315750 | H169 | 325145 | H106 |
| 300036 | H105 | 3033 | H163 | 3061 | H78 | 315755 | H169 | 325150 | H106 |
| 3001-10 | H157 | 3033-10 | H160 | 306100 | H169 | 315760 | H169 | 325155 | H106 |
| 3002 | H157 | 3034 | H160 | 306120 | H169 | 315770 | H169 | 325160 | H106 |
| 3002 | H163 | 3034 | H163 | 307125 | H107 | 316004 | H168 | 326005 | H106 |
| 3002-10 | H157 | 3034-10 | H160 | 307126 | H107 | 316005 | H168 | 326006 | H106 |
| 3003-10 | H157 | 3035 | H160 | 307127 | H107 | 316006 | H168 | 326007 | H106 |
| 300509 | H105 | 3035 | H163 | 307250 | H107 | 316008 | H168 | 326008 | H106 |
| 300510 | H105 | 3035-10 | H160 | 307251 | H107 | 3161 | H170 | 326010 | H106 |
| 300511 | H105 | 3036 | H160 | 307252 | H107 | 3162 | H170 | 326012 | H106 |
| 300512 | H105 | 3036 | H163 | 3080 | H121 | 3163 | H170 | 326014 | H106 |
| 300513 | H105 | 3036-10 | H160 | 308001 | H107 | 3164 | H170 | 326017 | H106 |
| 300514 | H105 | 3037-10 | H160 | 3081 | H121 | 3165 | H170 | 326019 | H106 |
| 300515 | H105 | 3038-10 | H160 | 3082 | H121 | 3171 | H170 | 326105 | H106 |
| 300516 | H105 | 3039-10 | H160 | 3083 | H121 | 3172 | H170 | 326106 | H106 |
| 300517 | H105 | 3040-10 | H160 | 308300 | H107 | 3173 | H170 | 326107 | H106 |
| 300518 | H105 | 304001 | H168 | 3084 | H121 | 3174 | H170 | 326108 | H106 |
| 300519 | H105 | 304002 | H168 | 3085 | H123 | 3175 | H170 | 326110 | H106 |
| 300520 | H105 | 304003 | H168 | 3086 | H121 | 3181 | H170 | 326112 | H106 |
| 300521 | H105 | 304004 | H168 | 3088 | H124 | 3182 | H170 | 326114 | H106 |
| 300522 | H105 | 3041 | H162 | 3093 | H162 | 3183 | H170 | 326117 | H106 |
| 301010 | H105 | 3041 | H163 | 3093 | H163 | 3184 | H170 | 326119 | H106 |
| 301011 | H105 | 3042 | H162 | 3094 | H162 | 3185 | H170 | 327005 | H106 |
| 301012 | H105 | 3042 | H163 | 3094 | H163 | 3196 | H228 | 327006 | H106 |
| 301013 | H105 | 3043 | H162 | 3095 | H162 | 3197 | H228 | 327008 | H106 |
| 301014 | H105 | 3043 | H163 | 3095 | H163 | 320010 | H106 | 327010 | H106 |
| 301015 | H105 | 3044 | H162 | 3096 | H162 | 320011 | H106 | 327012 | H106 |
| 301016 | H105 | 3044 | H163 | 3096 | H163 | 320012 | H106 | 327014 | H106 |
| 301017 | H105 | 3045 | H162 | 3097 | H162 | 320014 | H106 | 327016 | H106 |
| 301018 | H105 | 3045 | H163 | 3097 | H163 | 320016 | H106 | 327105 | H106 |

Artikelnummern-Verzeichnis

Articlenumber List

| Art.-Nr. / No. | Seite / Page | Art.-Nr. / No. | Seite / Page | Art.-Nr. / No. | Seite / Page | Art.-Nr. / No. | Seite / Page | Art.-Nr. / No. | Seite / Page |
|----------------|--------------|----------------|--------------|----------------|--------------|----------------|--------------|----------------|--------------|
| 327106 | H106 | 3406 | H127 | 3500E | H130 | 3783-11 | H171 | 382117 | H119 |
| 327108 | H106 | 3406F | H127 | 3500E | H131 | 3783-12 | H171 | 382117-1 | H119 |
| 327110 | H106 | 3407 | H127 | 3500E | H132 | 3783-13 | H171 | 382119 | H119 |
| 327112 | H106 | 3407F | H127 | 3501 | H132 | 3784-06 | H171 | 382119-1 | H119 |
| 327114 | H106 | 3408 | H127 | 3502 | H131 | 3784-07 | H171 | 382121 | H119 |
| 327116 | H106 | 340810 | H129 | 3601 | H198 | 3784-08 | H171 | 382121-1 | H119 |
| 3274 | H160 | 3408F | H127 | 3601-1.5 | H198 | 3784-1/4 | H171 | 383216 | H120 |
| 3275 | H160 | 3409 | H127 | 3601-10 | H198 | 3784-10 | H171 | 384010 | H120 |
| 3301 | H235 | 3409F | H127 | 3601-12 | H198 | 3784-11 | H171 | 384011 | H120 |
| 3303 | H235 | 3410 | H127 | 3601-14 | H198 | 3784-12 | H171 | 384012 | H120 |
| 3304 | H236 | 341013 | H129 | 3601-17 | H198 | 3784-13 | H171 | 384014 | H120 |
| 3304-1 | H236 | 3410F | H127 | 3601-19 | H198 | 3784-15 | H171 | 384016 | H120 |
| 3305 | H236 | 3411 | H127 | 3601-2 | H198 | 3784-16 | H171 | 384018 | H120 |
| 3306 | H235 | 3411F | H127 | 3601-2.5 | H198 | 3784-17 | H171 | 384020 | H120 |
| 3307 | H236 | 3412 | H127 | 3601-3 | H198 | 3784-3/8 | H171 | 384022 | H120 |
| 3307-1 | H236 | 341213 | H129 | 3601-4 | H198 | 3784-5/16 | H171 | 384024 | H120 |
| 3307-2 | H236 | 3412F | H127 | 3601-5 | H198 | 3784-55 | H171 | 385020 | H120 |
| 3311 | H235 | 3413 | H127 | 3601-6 | H198 | 3784-91 | H184 | 385025 | H120 |
| 3311-1 | H235 | 3413F | H127 | 3601-7 | H198 | 3784-92 | H184 | 385027 | H120 |
| 331112 | H235 | 3414 | H127 | 3601-8 | H198 | 3784-93 | H184 | 385030 | H120 |
| 3312 | H235 | 341415 | H129 | 3602 | H198 | 3784-M10 | H171 | 385040 | H120 |
| 331224 | H235 | 3414F | H127 | 3602-1.5 | H198 | 3784-M12 | H171 | 385045 | H120 |
| 3350 | H223 | 3415 | H127 | 3602-10 | H198 | 3784-M6 | H171 | 385050 | H120 |
| 3350-2 | H223 | 3415F | H127 | 3602-12 | H198 | 3784-M8 | H171 | 385055 | H120 |
| 3350-3 | H223 | 3416 | H127 | 3602-14 | H198 | 3785-08 | H171 | 385060 | H120 |
| 3350-4 | H223 | 341618 | H129 | 3602-17 | H198 | 3785-1/4 | H171 | 385070 | H120 |
| 3350-5 | H223 | 3416F | H127 | 3602-2 | H198 | 3785-10 | H171 | 3851 | H121 |
| 3350-6 | H223 | 3417 | H127 | 3602-2.5 | H198 | 3785-3/8 | H171 | 386004 | H120 |
| 3350-8 | H223 | 341719 | H129 | 3602-3 | H198 | 3785-5/16 | H171 | 386005 | H120 |
| 335010 | H106 | 3417F | H127 | 3602-4 | H198 | 3787 | H181 | 386006 | H120 |
| 335015 | H106 | 3418 | H127 | 3602-5 | H198 | 3788 | H180 | 386008 | H120 |
| 335020 | H106 | 3418F | H127 | 3602-6 | H198 | 3789 | H181 | 386010 | H120 |
| 335025 | H106 | 3419 | H127 | 3602-7 | H198 | 3790 | H180 | 386012 | H120 |
| 335027 | H106 | 3419F | H127 | 3602-8 | H198 | 380008 | H119 | 386014 | H120 |
| 335030 | H106 | 3421 | H127 | 3603 | H200 | 380009 | H119 | 386017 | H120 |
| 335040 | H106 | 3421F | H127 | 3604 | H198 | 380010 | H119 | 386019 | H120 |
| 335045 | H106 | 3422 | H127 | 3607 | H199 | 380011 | H119 | 3861 | H121 |
| 335050 | H106 | 3422F | H127 | 3607-10 | H199 | 380012 | H119 | 387075 | H120 |
| 335055 | H106 | 3424 | H127 | 3607-15 | H199 | 380013 | H119 | 387125 | H120 |
| 335060 | H106 | 3424F | H127 | 3607-20 | H199 | 380014 | H119 | 3901201 | H64 |
| 335070 | H106 | 3427 | H127 | 3607-25 | H199 | 380015 | H119 | 3901202 | H64 |
| 3355 | H223 | 3427F | H127 | 3607-27 | H199 | 380016 | H119 | 3901203 | H65 |
| 3355-2 | H223 | 3430 | H127 | 3607-30 | H199 | 380017 | H119 | 3901204 | H66 |
| 3355-3 | H223 | 3430F | H127 | 3607-40 | H199 | 380018 | H119 | 3901205 | H71 |
| 3355-4 | H223 | 3432 | H127 | 3607-45 | H199 | 380019 | H119 | 39012900 | H109 |
| 3355-5 | H223 | 3432F | H127 | 3607-50 | H199 | 380020 | H119 | 39012900 | H93 |
| 3355-6 | H223 | 3434 | H127 | 3613 | H199 | 380021 | H119 | 39012900-1 | H109 |
| 3361 | H222 | 3436 | H127 | 3613-015 | H199 | 380022 | H119 | 39012900-1 | H93 |
| 3362 | H222 | 3438 | H127 | 3613-020 | H199 | 380023 | H119 | 3901401 | H60 |
| 3363 | H222 | 34411 | H127 | 3613-025 | H199 | 380024 | H119 | 3901402 | H60 |
| 3370 | H223 | 34461 | H127 | 3613-030 | H199 | 380025 | H119 | 39014900 | H100 |
| 3370-1 | H223 | 34501 | H127 | 3613-040 | H199 | 380027 | H119 | 39014900 | H93 |
| 3370-2 | H223 | 3463 | H129 | 3613-050 | H199 | 380028 | H119 | 39014900-1 | H100 |
| 3370-3 | H223 | 3463 | H134 | 3613-060 | H199 | 380030 | H119 | 39014900-1 | H93 |
| 3371-1 | H223 | 3465 | H129 | 3613-070 | H199 | 380032 | H119 | 3903401 | H67 |
| 3371-2 | H223 | 3465 | H134 | 3613-080 | H199 | 381000 | H120 | 3903801 | H62 |
| 3375-2 | H230 | 3466 | H133 | 3613-100 | H199 | 381008 | H119 | 3903802 | H63 |
| 3375-3 | H230 | 3466-01 | H133 | 3613-120 | H199 | 381009 | H119 | 3903803 | H69 |
| 3375-4 | H230 | 3466-02 | H133 | 3613-140 | H199 | 381010 | H119 | 39038900 | H104 |
| 3375-5 | H230 | 348605 | H169 | 3613-170 | H199 | 381011 | H119 | 39038900 | H93 |
| 3376-3 | H230 | 348606 | H169 | 3613-190 | H199 | 381012 | H119 | 39038900-1 | H104 |
| 3376-4 | H230 | 348608 | H169 | 36131 | H199 | 381013 | H119 | 39038900-1 | H93 |
| 3377-3 | H230 | 348610 | H169 | 3617 | H200 | 381014 | H119 | 3904201 | H70 |
| 3377-4 | H230 | 348612 | H169 | 3619 | H198 | 381015 | H119 | 39048201 | H72 |
| 3378 | H230 | 348614 | H169 | 3690 | H128 | 381016 | H119 | 39048202 | H73 |
| 3379 | H230 | 348705 | H169 | 3690 | H134 | 381017 | H119 | 3906 | H128 |
| 3380 | H229 | 348706 | H169 | 3691 | H128 | 381018 | H119 | 3907 | H128 |
| 3380E | H229 | 348708 | H169 | 3692 | H128 | 381019 | H119 | 3908 | H128 |
| 3381-1 | H229 | 348710 | H169 | 3693 | H128 | 381020 | H119 | 390813 | H129 |
| 3381-2 | H229 | 348712 | H169 | 3694 | H128 | 381021 | H119 | 3909 | H128 |
| 3381-3 | H229 | 3493 | H131 | 3701 | H157 | 381022 | H119 | 390915 | H129 |
| 3382-1 | H229 | 3494 | H130 | 3702 | H157 | 381023 | H119 | 3910 | H128 |
| 3382-2 | H229 | 3494E | H130 | 3703 | H157 | 381024 | H119 | 391019 | H129 |
| 3382-3 | H229 | 3494E | H131 | 3711 | H158 | 381025 | H119 | 3911 | H128 |
| 3383-1 | H229 | 3494E | H132 | 3712 | H158 | 381027 | H119 | 3912 | H128 |
| 3383-2 | H229 | 3494E | H145 | 3713 | H158 | 381028 | H119 | 3913 | H128 |
| 3383-3 | H229 | 3496 | H131 | 3731 | H160 | 381030 | H119 | 3914 | H128 |
| 3384-1 | H229 | 3497 | H131 | 3732 | H160 | 381032 | H119 | 391410 | H120 |
| 3384-2 | H229 | 3498 | H130 | 3733 | H160 | 381214 | H120 | 3914516 | H129 |
| 3384-3 | H229 | 3499 | H130 | 3734 | H160 | 381214 | H171 | 3914516 | H174 |
| 3385-1 | H229 | 3499E | H130 | 3735 | H160 | 381234 | H120 | 3915 | H128 |
| 3385-2 | H229 | 3499E | H130 | 3736 | H160 | 381238 | H120 | 3916 | H128 |
| 3385-3 | H229 | 3499E | H131 | 3737 | H160 | 381410 | H120 | 391619 | H129 |
| 3386-2 | H229 | 3499E | H131 | 3750 | H172 | 382017 | H119 | 3917 | H128 |
| 3387-1 | H229 | 3499E | H132 | 3783-06 | H171 | 382019 | H119 | 3918 | H128 |
| 3387-2 | H229 | 3499E | H132 | 3783-07 | H171 | 382021 | H119 | 3919 | H128 |
| 3387-3 | H229 | 3499E | H146 | 3783-08 | H171 | 382022 | H119 | 3921 | H128 |
| 3388-2 | H229 | 3500 | H130 | 3783-10 | H171 | 382024 | H119 | 3922 | H128 |

Artikelnummern-Verzeichnis

Articlenumber List

| Art.-Nr. / No. | Seite / Page | Art.-Nr. / No. | Seite / Page | Art.-Nr. / No. | Seite / Page | Art.-Nr. / No. | Seite / Page | Art.-Nr. / No. | Seite / Page |
|----------------|--------------|----------------|--------------|----------------|--------------|----------------|--------------|----------------|--------------|
| 3924 | H128 | 400360 | H110 | 412010 | H113 | 418022 | H122 | 4228 | H109 |
| 3927 | H128 | 400380 | H110 | 412011 | H113 | 418024 | H122 | 4228 | H93 |
| 3930 | H128 | 400410 | H110 | 412012 | H113 | 418027 | H122 | 423000 | H112 |
| 3932 | H128 | 400460 | H110 | 412013 | H113 | 418030 | H122 | 4231 | H108 |
| 393216 | H120 | 400500 | H110 | 412014 | H113 | 418108 | H122 | 4232 | H108 |
| 394072 | H77 | 4008 | H61 | 412015 | H113 | 418110 | H122 | 4233 | H108 |
| 394073 | H179 | 4009 | H78 | 412016 | H113 | 418113 | H122 | 4234 | H108 |
| 394074 | H173 | 4016 | H76 | 412017 | H113 | 418115 | H122 | 4235 | H108 |
| 39407412 | H173 | 4016-02 | H103 | 412018 | H113 | 418117 | H122 | 4236 | H108 |
| 394075 | H173 | 4016-03 | H103 | 412019 | H113 | 418118 | H122 | 4245 | H102 |
| 39407512 | H173 | 4016-10 | H103 | 4121 | H75 | 418119 | H122 | 4245 | H118 |
| 394087 | H175 | 4016-11 | H103 | 412100 | H113 | 418121 | H122 | 4245 | H99 |
| 39408712 | H175 | 4016-12 | H103 | 4122-01 | H187 | 418122 | H122 | 4246 | H107 |
| 394089 | H175 | 4016-13 | H103 | 412707 | H113 | 418124 | H122 | 4246 | H110 |
| 39408912 | H175 | 4016-14 | H103 | 412715 | H113 | 418130 | H122 | 4246 | H118 |
| 394240 | H117 | 4016-15 | H103 | 4129 | H114 | 4182 | H122 | 4247 | H110 |
| 394240-1 | H116 | 4016-16 | H103 | 412920 | H113 | 418217 | H122 | 4247 | H110 |
| 394240-1 | H117 | 4016-17 | H103 | 4130-05 | H190 | 418219 | H122 | 4247 | H118 |
| 394240-1 | H118 | 4016-19 | H103 | 4130-06 | H190 | 418221 | H122 | 4248 | H102 |
| 394241 | H117 | 4017 | H76 | 4130-07 | H190 | 4190 | H195 | 4248 | H118 |
| 394241-1 | H116 | 4018 | H63 | 4130-08 | H190 | 4190-01 | H172 | 4248 | H99 |
| 394241-1 | H117 | 4027 | H80 | 4130-09 | H190 | 4190-03 | H172 | 4249 | H102 |
| 394242 | H117 | 4028 | H65 | 4130-10 | H190 | 4190-06 | H195 | 4249 | H107 |
| 394242-1 | H116 | 407100 | H110 | 4130-15 | H190 | 4190-07 | H195 | 4249 | H118 |
| 394242-1 | H117 | 407200 | H110 | 4130-20 | H190 | 4190-08 | H195 | 4250 | H102 |
| 394243 | H117 | 407400 | H110 | 4130-25 | H190 | 4190-10 | H195 | 4250 | H107 |
| 394243-1 | H116 | 4078 | H79 | 4130-27 | H190 | 4190-11 | H195 | 4250 | H118 |
| 394243-1 | H117 | 408000 | H110 | 4130-30 | H190 | 4190-12 | H195 | 4251 | H107 |
| 394260 | H118 | 4085 | H173 | 4130-40 | H190 | 4190-13 | H195 | 4251 | H110 |
| 394270 | H116 | 4090 | H177 | 413010 | H114 | 4190-14 | H195 | 4251 | H118 |
| 394271 | H116 | 409006 | H177 | 413011 | H114 | 4192 | H178 | 4252 | H110 |
| 394272 | H116 | 4091 | H176 | 413012 | H114 | 4192 | H191 | 4252 | H110 |
| 394273 | H116 | 409124 | H176 | 413013 | H114 | 419212 | H178 | 4252 | H118 |
| 394901 | H91 | 4092 | H174 | 413014 | H114 | 419212 | H191 | 4259 | H118 |
| 3961 | H231 | 4093 | H177 | 413015 | H114 | 4193 | H174 | 4288 | H172 |
| 396202 | H224 | 409306 | H177 | 413016 | H114 | 419312 | H174 | 4288 | H97 |
| 396205 | H224 | 4094 | H178 | 413017 | H114 | 4200-1 | H100 | 4289 | H95 |
| 396212 | H224 | 4095 | H176 | 413018 | H114 | 4200-1 | H93 | 4290 | H172 |
| 396213 | H224 | 409512 | H176 | 413019 | H114 | 420000 | H99 | 4290 | H97 |
| 396221 | H225 | 4097 | H178 | 413021 | H114 | 420000 | H99 | 4294 | H172 |
| 396222 | H225 | 4100-00 | H188 | 413022 | H114 | 420000 | H99 | 4294 | H97 |
| 396223 | H225 | 4100-01 | H188 | 413024 | H114 | 420000 | H99 | 4295 | H169 |
| 396224 | H226 | 4100-02 | H188 | 413027 | H114 | 420001 | H112 | 4295 | H172 |
| 396297-01 | H225 | 4100-03 | H188 | 413030 | H114 | 420011 | H112 | 4295 | H97 |
| 396297-01 | H225 | 4101 | H74 | 413032 | H114 | 4201 | H99 | 4297 | H227 |
| 396297-01 | H225 | 4102-02 | H188 | 4131 | H75 | 4202 | H99 | 4297 | H96 |
| 396297-05 | H226 | 4109 | H112 | 413100 | H114 | 4203 | H99 | 4297-1 | H227 |
| 3963 | H231 | 4110-00 | H189 | 413116 | H114 | 4204 | H99 | 4297-1 | H96 |
| 3965 | H231 | 4110-01 | H189 | 413121 | H114 | 4208 | H100 | 4297-10 | H227 |
| 3968 | H231 | 4110-02 | H189 | 413712 | H114 | 4208 | H93 | 4297-10 | H96 |
| 3973 | H231 | 4110-03 | H189 | 413725 | H114 | 4210-1 | H104 | 4297-2 | H227 |
| 397312 | H231 | 411004 | H112 | 413812 | H114 | 4210-1 | H93 | 4297-2 | H96 |
| 3975 | H231 | 411005 | H112 | 4150-08 | H190 | 421000 | H103 | 4297-3 | H227 |
| 397512 | H231 | 411006 | H112 | 4150-10 | H190 | 421000 | H103 | 4297-3 | H96 |
| 398001 | H234 | 411007 | H112 | 4150-15 | H190 | 421000 | H103 | 4298 | H95 |
| 398006 | H236 | 411008 | H112 | 4150-20 | H190 | 421000 | H103 | 4298-1 | H95 |
| 398050 | H234 | 411009 | H112 | 4150-25 | H190 | 421000 | H113 | 4299 | H96 |
| 398051 | H234 | 411010 | H112 | 4150-27 | H190 | 421001 | H103 | 4330-130 | H212 |
| 398210 | H218 | 411011 | H112 | 4150-30 | H190 | 421001 | H113 | 4331-120 | H212 |
| 398211 | H217 | 411012 | H112 | 4150-40 | H190 | 421011 | H103 | 4332-130 | H212 |
| 398212 | H217 | 411013 | H112 | 4170 | H195 | 421011 | H113 | 4333-120 | H212 |
| 39821314D | H218 | 411045 | H112 | 4170-10 | H195 | 4211 | H103 | 4334-110 | H212 |
| 39821314D | H218 | 411055 | H112 | 4170-2 | H195 | 4212 | H103 | 4383 | H214 |
| 398213GB | H218 | 411081 | H112 | 4170-25 | H195 | 4213 | H103 | 4383-A1 | H209 |
| 398214GB | H218 | 4111 | H74 | 4170-3 | H195 | 4214 | H103 | 4383-A11 | H209 |
| 398215 | H217 | 411100 | H112 | 4170-4 | H195 | 4218 | H104 | 4383-A2 | H209 |
| 398230 | H219 | 411207 | H112 | 4170-5 | H195 | 4218 | H93 | 4383-A21 | H209 |
| 398231 | H219 | 411255 | H112 | 4170-6 | H195 | 4220-1 | H109 | 4383-A3 | H209 |
| 398250 | H220 | 411301 | H112 | 4170-8 | H195 | 4220-1 | H93 | 4383-A31 | H209 |
| 398251 | H219 | 411302 | H112 | 4180 | H195 | 422000 | H107 | 4383-J1 | H209 |
| 398252 | H220 | 411438 | H112 | 4180-10 | H195 | 422000 | H107 | 4383-J11 | H209 |
| 3993 | H132 | 411603 | H112 | 4180-15 | H195 | 422000 | H107 | 4383-J2 | H209 |
| 3994 | H132 | 411604 | H112 | 4180-20 | H195 | 422000 | H108 | 4383-J21 | H209 |
| 3999 | H132 | 411605 | H112 | 4180-25 | H195 | 422000 | H108 | 4383-J3 | H209 |
| 400001 | H110 | 411606 | H112 | 4180-27 | H195 | 422000 | H108 | 4383-J31 | H209 |
| 400001 | H93 | 411608 | H112 | 4180-30 | H195 | 422000 | H108 | 4402 | H150 |
| 400001-1 | H110 | 411610 | H112 | 4180-40 | H195 | 422000 | H108 | 4402E | H150 |
| 400190 | H110 | 411705 | H112 | 4180-45 | H195 | 422000 | H108 | 4403 | H151 |
| 400210 | H110 | 411715 | H112 | 4180-50 | H195 | 422000 | H108 | 4403E | H151 |
| 400220 | H110 | 4119 | H113 | 418008 | H122 | 422000 | H114 | 4405 | H148 |
| 400230 | H110 | 411915 | H112 | 418010 | H122 | 422001 | H108 | 4405E | H148 |
| 400240 | H110 | 4120-01 | H187 | 418013 | H122 | 422001 | H114 | 4405E | H148 |
| 400260 | H110 | 4120-02 | H187 | 418015 | H122 | 422011 | H108 | 4407 | H145 |
| 400270 | H110 | 4120-03 | H187 | 418016 | H122 | 422011 | H114 | 4407E | H145 |
| 400290 | H110 | 4120-04 | H187 | 418017 | H122 | 4221 | H107 | 4407E | H146 |
| 400300 | H110 | 4120-05 | H187 | 418018 | H122 | 4222 | H107 | 4408 | H144 |
| 400320 | H110 | 4120-06 | H187 | 418019 | H122 | 4223 | H107 | 4408E | H144 |
| 400350 | H110 | 412008 | H113 | 418021 | H122 | 4224 | H108 | 4408E | H146 |

Artikelnummern-Verzeichnis

Articlenumber List

| Art.-Nr. / No. | Seite / Page | Art.-Nr. / No. | Seite / Page | Art.-Nr. / No. | Seite / Page | Art.-Nr. / No. | Seite / Page | Art.-Nr. / No. | Seite / Page |
|----------------|--------------|----------------|--------------|----------------|--------------|----------------|--------------|----------------|--------------|
| 4410 | H145 | 4621-20006 | H208 | 483412 | H123 | 5211-2 | H104 | 5914 | H21 |
| 4410E | H145 | 4622 | H196 | 485027 | H123 | 5211-2 | H96 | 5915 | H21 |
| 4411 | H149 | 4622-01 | H187 | 487100 | H123 | 5214 | H104 | 5916 | H21 |
| 4411E | H149 | 4622-180 | H207 | 487200 | H123 | 5214 | H94 | 5917 | H21 |
| 4421 | H144 | 4623 | H196 | 4901-50 | H18 | 5215 | H104 | 5918 | H21 |
| 4422 | H144 | 4623-160 | H207 | 4901-501 | H25 | 5215 | H113 | 5919 | H21 |
| 4436 | H146 | 4624 | H196 | 4901-502 | H26 | 5215 | H94 | 5920 | H21 |
| 4437 | H146 | 4625 | H196 | 4901-511 | H27 | 5215-1 | H104 | 5921 | H19 |
| 4438 | H146 | 4625-200 | H207 | 4901-521 | H30 | 5215-1 | H113 | 5922 | H19 |
| 4441 | H148 | 4626-200 | H207 | 4901-522 | H29 | 5215-1 | H94 | 5953 | H23 |
| 4442 | H149 | 4627-160 | H207 | 4901-523 | H28 | 5220 | H109 | 5953-011 | H23 |
| 4451 | H150 | 4628-250 | H207 | 4901-541 | H31 | 5220 | H96 | 5953-021 | H23 |
| 4452 | H151 | 4629-160 | H207 | 492619 | H123 | 5220-1 | H109 | 5953-065 | H23 |
| 4462 | H147 | 4629-210 | H207 | 495027 | H123 | 5220-1 | H96 | 5953-082 | H23 |
| 4463 | H147 | 4630-08 | H190 | 4963 | H238 | 5221 | H109 | 5953-101 | H23 |
| 4464 | H147 | 4630-10 | H190 | 4963-01 | H86 | 5221 | H96 | 5953-131 | H23 |
| 4466 | H147 | 4630-15 | H190 | 500000 | H110 | 5221-1 | H109 | 5954 | H24 |
| 4468 | H151 | 4630-180 | H208 | 500000 | H93 | 5221-1 | H96 | 5954-001 | H24 |
| 4516-250 | H205 | 4630-20 | H190 | 500360 | H110 | 5221-2 | H109 | 5954-002 | H24 |
| 4517-300 | H205 | 4630-25 | H190 | 500380 | H110 | 5221-2 | H96 | 5954-003 | H24 |
| 4550 | H210 | 4630-27 | H190 | 500410 | H110 | 5224 | H109 | 597019 | H124 |
| 4551 | H210 | 4630-30 | H190 | 500460 | H110 | 5224 | H94 | 5995-001 | H25 |
| 4552 | H210 | 4630-40 | H190 | 500500 | H110 | 5225 | H109 | 5995-002 | H26 |
| 4553-14 | H210 | 4631-200 | H208 | 500540 | H110 | 5225 | H114 | 5995-011 | H27 |
| 4553-18 | H210 | 4640-230 | H206 | 500550 | H110 | 5225 | H94 | 5995-021 | H30 |
| 4553-24 | H210 | 4640-260 | H206 | 500580 | H110 | 5225-1 | H109 | 5995-022 | H29 |
| 4553-30 | H210 | 4643-180 | H206 | 500600 | H110 | 5225-1 | H114 | 5995-023 | H28 |
| 4553-36 | H210 | 4643-210 | H206 | 500630 | H110 | 5225-1 | H94 | 5995-141 | H31 |
| 4554-14 | H210 | 4680 | H213 | 500650 | H110 | 580024 | H124 | 5996-001 | H20 |
| 4554-18 | H210 | 4681 | H213 | 500670 | H110 | 580027 | H124 | 5996-002 | H20 |
| 4554-24 | H210 | 4683 | H214 | 500700 | H110 | 580030 | H124 | 5996-003 | H20 |
| 4554-30 | H210 | 4683-A2 | H209 | 500710 | H110 | 580032 | H124 | 5996-004 | H20 |
| 4554-36 | H210 | 4683-A21 | H209 | 500750 | H110 | 580033 | H124 | 5996-005 | H20 |
| 4555 | H210 | 4683-J2 | H209 | 500770 | H110 | 580034 | H124 | 5996-006 | H20 |
| 4556-175 | H211 | 4683-J21 | H209 | 500800 | H110 | 580036 | H124 | 5996-007 | H20 |
| 4556-250 | H211 | 4690-02 | H172 | 507200 | H110 | 580038 | H124 | 5996-008 | H20 |
| 4557-150 | H212 | 4690-02 | H191 | 507400 | H110 | 580041 | H124 | 5996-009 | H20 |
| 4557-340 | H205 | 4691 | H213 | 508000 | H110 | 580046 | H124 | 5996-010 | H20 |
| 4557-430 | H205 | 4692-06 | H191 | 508560 | H110 | 580050 | H124 | 5996-011 | H20 |
| 4557-550 | H205 | 4692-07 | H191 | 508560 | H93 | 581000 | H124 | 5996-012 | H20 |
| 4559-340 | H205 | 4692-08 | H191 | 5100-01 | H188 | 581034 | H124 | 5996-013 | H20 |
| 4559-430 | H205 | 4711 | H192 | 5100-02 | H188 | 587019 | H124 | 5996-014 | H20 |
| 4559-550 | H205 | 4714 | H192 | 510000 | H110 | 587200 | H124 | 5996-015 | H20 |
| 4559-650 | H205 | 4721 | H197 | 5105-00 | H193 | 5901 | H14 | 5996-016 | H20 |
| 4561-205 | H211 | 4722 | H197 | 5105-01 | H193 | 5901-101 | H25 | 5996-017 | H20 |
| 4561-245 | H211 | 4723 | H197 | 5105-02 | H193 | 5901-102 | H26 | 5996-018 | H20 |
| 4562-225 | H211 | 4724 | H197 | 5105-1230 | H193 | 5901-111 | H27 | 5996-019 | H20 |
| 4563-275 | H211 | 4725 | H197 | 5115-00 | H193 | 5901-121 | H30 | 5996-020 | H20 |
| 4584 | H210 | 4727 | H197 | 5115-01 | H193 | 5901-122 | H29 | 5996-021 | H20 |
| 4584 | H214 | 480017 | H123 | 5115-02 | H193 | 5901-123 | H28 | 5996-022 | H20 |
| 4600-00 | H188 | 480019 | H123 | 5120-02 | H187 | 5901-141 | H31 | 5996-023 | H20 |
| 4600-01 | H188 | 480020 | H123 | 5120-03 | H187 | 5901-20 | H14 | 5996-024 | H20 |
| 4600-02 | H188 | 480021 | H123 | 5120-04 | H187 | 5901-201 | H25 | 5996-025 | H20 |
| 4600-03 | H188 | 480022 | H123 | 5120-05 | H187 | 5901-202 | H26 | 5996-026 | H20 |
| 4600-1230 | H189 | 480023 | H123 | 5125-01 | H193 | 5901-211 | H27 | 5996-027 | H20 |
| 4600-1231 | H189 | 480024 | H123 | 5125-03 | H193 | 5901-221 | H30 | 5996-028 | H20 |
| 4601-165 | H203 | 480025 | H123 | 5125-04 | H193 | 5901-222 | H29 | 5996-029 | H20 |
| 4601-180 | H203 | 480026 | H123 | 5125-05 | H193 | 5901-223 | H28 | 5996-030 | H20 |
| 4601-200 | H203 | 480027 | H123 | 5125-06 | H193 | 5901-241 | H31 | 5996-031 | H20 |
| 4601-20006 | H203 | 480028 | H123 | 5190 | H193 | 5901-50 | H14 | 5996-032 | H20 |
| 4602-01 | H188 | 480029 | H123 | 5195 | H194 | 5901-511 | H27 | 5996-033 | H20 |
| 4602-02 | H188 | 480030 | H123 | 5199 | H196 | 5901-521 | H30 | 5996-034 | H20 |
| 4602-180 | H203 | 480032 | H123 | 5200 | H100 | 5901-522 | H29 | 5996-035 | H20 |
| 4603-145 | H203 | 480033 | H123 | 5200 | H96 | 5901-523 | H28 | 5996-036 | H20 |
| 4603-160 | H203 | 480034 | H123 | 5200-1 | H100 | 5901-541 | H31 | 5996-037 | H20 |
| 4604-180 | H203 | 480035 | H123 | 5200-1 | H96 | 5901-551 | H25 | 5996-038 | H20 |
| 4605-170 | H204 | 480036 | H123 | 5201 | H100 | 5901-552 | H26 | 5996-039 | H20 |
| 4605-200 | H204 | 480038 | H123 | 5201 | H96 | 5902 | H15 | 5996-040 | H20 |
| 4606-200 | H204 | 480041 | H123 | 5201-1 | H100 | 5902-01 | H49 | 5996-041 | H20 |
| 4607-160 | H204 | 480046 | H123 | 5201-1 | H96 | 5902-02 | H49 | 5996-042 | H20 |
| 4608-250 | H205 | 480050 | H123 | 5201-2 | H100 | 5902-20 | H15 | 5996-043 | H20 |
| 4609-175 | H205 | 481000 | H123 | 5201-2 | H96 | 5902-201 | H49 | 5996-044 | H20 |
| 4609-240 | H205 | 481017 | H123 | 5204 | H100 | 5902-202 | H49 | 5996-045 | H20 |
| 4609-300 | H205 | 481018 | H123 | 5204 | H94 | 5902-50 | H15 | 5996-046 | H20 |
| 4609-400 | H205 | 481019 | H123 | 5205 | H100 | 5902-501 | H49 | 5996-047 | H20 |
| 4610-00 | H189 | 481021 | H123 | 5205 | H112 | 5902-502 | H49 | 5996-048 | H20 |
| 4610-01 | H189 | 481022 | H123 | 5205 | H94 | 5907 | H19 | 5996-049 | H20 |
| 4610-02 | H189 | 481024 | H123 | 5205-1 | H100 | 5907-20 | H19 | 5996-050 | H20 |
| 4610-03 | H189 | 481027 | H123 | 5205-1 | H112 | 5907-50 | H19 | 5996-051 | H20 |
| 4618-250 | H205 | 481029 | H123 | 5205-1 | H94 | 5908 | H19 | 5996-052 | H20 |
| 4620-01 | H187 | 481030 | H123 | 5210 | H104 | 5908-20 | H19 | 5996-053 | H20 |
| 4620-02 | H187 | 481032 | H123 | 5210 | H96 | 5908-50 | H19 | 5996-054 | H20 |
| 4620-03 | H187 | 481036 | H123 | 5210-1 | H104 | 5909 | H19 | 5996-055 | H20 |
| 4620-04 | H187 | 481041 | H123 | 5210-1 | H96 | 5910 | H19 | 5996-056 | H20 |
| 4620-05 | H187 | 481046 | H123 | 5211 | H104 | 5911 | H19 | 5996-057 | H20 |
| 4621 | H196 | 481050 | H123 | 5211 | H96 | 5912 | H19 | 5996-058 | H20 |
| 4621-180 | H207 | 482619 | H123 | 5211-1 | H104 | 5912-10 | H19 | 5996-059 | H20 |
| 4621-200 | H208 | 483410 | H123 | 5211-1 | H96 | 5913 | H19 | 5996-060 | H20 |

Artikelnummern-Verzeichnis

Articlenumber List

| Art.-Nr. / No. | Seite / Page | Art.-Nr. / No. | Seite / Page | Art.-Nr. / No. | Seite / Page | Art.-Nr. / No. | Seite / Page | Art.-Nr. / No. | Seite / Page |
|----------------|--------------|----------------|--------------|----------------|--------------|----------------|--------------|-----------------|--------------|
| 5996-061 | H20 | 5996-149 | H20 | 5998-073 | H20 | 5999-05E | H34 | 5999-53E | H36 |
| 5996-062 | H20 | 5996-150 | H20 | 5998-074 | H20 | 5999-05E | H34 | 5999-551 | H37 |
| 5996-063 | H20 | 5997-001 | H20 | 5998-075 | H20 | 5999-061 | H41 | 5999-55E | H37 |
| 5996-064 | H20 | 5997-002 | H20 | 5998-076 | H20 | 5999-062 | H40 | 6211 | H224 |
| 5996-065 | H20 | 5997-003 | H20 | 5998-077 | H20 | 5999-062E | H40 | 6214 | H224 |
| 5996-066 | H20 | 5997-011 | H20 | 5998-078 | H20 | 5999-064 | H40 | 6215 | H225 |
| 5996-067 | H20 | 5997-012 | H20 | 5998-079 | H20 | 5999-064E | H40 | 6216 | H225 |
| 5996-068 | H20 | 5997-013 | H20 | 5998-080 | H20 | 5999-065 | H40 | 6241 | H228 |
| 5996-069 | H20 | 5997-014 | H20 | 5998-081 | H20 | 5999-065E | H40 | 6241-1 | H228 |
| 5996-070 | H20 | 5997-015 | H20 | 5998-082 | H20 | 5999-06E | H41 | 6242 | H228 |
| 5996-071 | H20 | 5997-016 | H20 | 5998-083 | H20 | 5999-071 | H41 | 6251 | H228 |
| 5996-072 | H20 | 5997-026 | H17 | 5998-084 | H20 | 5999-071E | H41 | 6252 | H227 |
| 5996-073 | H20 | 5997-027 | H17 | 5998-085 | H20 | 5999-072 | H42 | 6253 | H227 |
| 5996-074 | H20 | 5997-028 | H17 | 5998-086 | H20 | 5999-072E | H42 | 6258 | H228 |
| 5996-075 | H20 | 5997-029 | H17 | 5998-087 | H20 | 5999-072E | H42 | 6261 | H227 |
| 5996-076 | H20 | 5998-001 | H20 | 5998-088 | H20 | 5999-073 | H42 | 6261-01 | H227 |
| 5996-077 | H20 | 5998-001SPACE | H17 | 5998-089 | H20 | 5999-074 | H42 | 6263 | H227 |
| 5996-078 | H20 | 5998-002 | H20 | 5998-090 | H20 | 5999-074E | H42 | 6263-01 | H227 |
| 5996-079 | H20 | 5998-003 | H20 | 5998-091 | H20 | 5999-082 | H45 | 6271 | H226 |
| 5996-080 | H20 | 5998-004 | H20 | 5998-092 | H20 | 5999-082E | H45 | 6271-10 | H226 |
| 5996-081 | H20 | 5998-005 | H20 | 5998-093 | H20 | 5999-091 | H44 | 6271-12 | H226 |
| 5996-082 | H20 | 5998-006 | H20 | 5998-094 | H20 | 5999-092 | H44 | 6271-14 | H226 |
| 5996-083 | H20 | 5998-007 | H20 | 5998-095 | H20 | 5999-09E | H44 | 6271-17 | H226 |
| 5996-084 | H20 | 5998-008 | H20 | 5998-096 | H20 | 5999-09E | H44 | 6271-20 | H226 |
| 5996-085 | H20 | 5998-009 | H20 | 5998-097 | H20 | 5999-101 | H45 | 6271-24 | H226 |
| 5996-086 | H20 | 5998-010 | H20 | 5998-098 | H20 | 5999-10E | H45 | 6271-28 | H226 |
| 5996-087 | H20 | 5998-011 | H20 | 5998-099 | H20 | 5999-111 | H35 | 6299-01 | H224 |
| 5996-088 | H20 | 5998-012 | H20 | 5998-100 | H20 | 5999-11E | H35 | 6299-01 | H224 |
| 5996-089 | H20 | 5998-013 | H20 | 5998-101 | H20 | 5999-121 | H35 | 6299-01 | H224 |
| 5996-090 | H20 | 5998-014 | H20 | 5998-102 | H20 | 5999-12E | H35 | 6299-01 | H224 |
| 5996-091 | H20 | 5998-015 | H20 | 5998-103 | H20 | 5999-131 | H35 | 6299-01 | H224 |
| 5996-092 | H20 | 5998-016 | H20 | 5998-104 | H20 | 5999-13E | H35 | 6299-02 | H225 |
| 5996-093 | H20 | 5998-017 | H20 | 5998-105 | H20 | 5999-141 | H39 | 6299-05 | H224 |
| 5996-094 | H20 | 5998-018 | H20 | 5998-106 | H20 | 5999-14E | H39 | 6299-06 | H225 |
| 5996-095 | H20 | 5998-019 | H20 | 5998-107 | H20 | 5999-151 | H39 | 6299-07 | H224 |
| 5996-096 | H20 | 5998-020 | H20 | 5998-108 | H20 | 5999-15E | H39 | 6299-07 | H224 |
| 5996-097 | H20 | 5998-021 | H20 | 5998-109 | H20 | 5999-161 | H44 | 6299-07 | H224 |
| 5996-098 | H20 | 5998-022 | H20 | 5998-110 | H20 | 5999-16E | H44 | 6299-07 | H224 |
| 5996-099 | H20 | 5998-023 | H20 | 5998-111 | H20 | 5999-171 | H48 | 6299-07 | H224 |
| 5996-100 | H20 | 5998-024 | H20 | 5998-112 | H20 | 5999-17E | H48 | 6530024 | H236 |
| 5996-101 | H20 | 5998-025 | H20 | 5998-113 | H20 | 5999-181 | H47 | 7901-50 | H16 |
| 5996-102 | H20 | 5998-026 | H20 | 5998-114 | H20 | 5999-18E | H47 | 7901-501 | H25 |
| 5996-103 | H20 | 5998-027 | H20 | 5998-115 | H20 | 5999-191 | H38 | 7901-502 | H26 |
| 5996-104 | H20 | 5998-028 | H20 | 5998-116 | H20 | 5999-19E | H38 | 7901-511 | H27 |
| 5996-105 | H20 | 5998-029 | H20 | 5998-117 | H20 | 5999-211 | H50 | 7901-521 | H30 |
| 5996-106 | H20 | 5998-030 | H20 | 5998-118 | H20 | 5999-21E | H50 | 7901-522 | H29 |
| 5996-107 | H20 | 5998-031 | H20 | 5998-119 | H20 | 5999-221 | H50 | 7901-523 | H28 |
| 5996-108 | H20 | 5998-032 | H20 | 5998-120 | H20 | 5999-22E | H50 | 7901-541 | H31 |
| 5996-109 | H20 | 5998-033 | H20 | 5998-121 | H20 | 5999-231 | H50 | 8601 | H77 |
| 5996-110 | H20 | 5998-034 | H20 | 5998-122 | H20 | 5999-23E | H50 | 8604 | H182 |
| 5996-111 | H20 | 5998-035 | H20 | 5998-123 | H20 | 5999-321 | H32 | 8605 | H99 |
| 5996-112 | H20 | 5998-036 | H20 | 5998-124 | H20 | 5999-32E | H32 | 8606 | H183 |
| 5996-113 | H20 | 5998-037 | H20 | 5998-125 | H20 | 5999-331 | H48 | 8651 | H79 |
| 5996-114 | H20 | 5998-038 | H20 | 5998-126 | H20 | 5999-33E | H48 | 8652 | H79 |
| 5996-115 | H20 | 5998-039 | H20 | 5998-127 | H20 | 5999-341 | H43 | 8653 | H81 |
| 5996-116 | H20 | 5998-040 | H20 | 5998-128 | H20 | 5999-34E | H43 | 8654 | H81 |
| 5996-117 | H20 | 5998-041 | H20 | 5998-129 | H20 | 5999-351 | H43 | 8655 | H82 |
| 5996-118 | H20 | 5998-042 | H20 | 5998-130 | H20 | 5999-355 | H43 | 8656 | H82 |
| 5996-119 | H20 | 5998-043 | H20 | 5998-131 | H20 | 5999-355E | H43 | 8661 | H80 |
| 5996-120 | H20 | 5998-044 | H20 | 5998-132 | H20 | 5999-35E | H43 | 8662 | H80 |
| 5996-121 | H20 | 5998-045 | H20 | 5998-133 | H20 | 5999-361 | H47 | 8663 | H83 |
| 5996-122 | H20 | 5998-046 | H20 | 5998-134 | H20 | 5999-36E | H47 | 8664 | H83 |
| 5996-123 | H20 | 5998-047 | H20 | 5998-135 | H20 | 5999-371 | H39 | 8681 | H85 |
| 5996-124 | H20 | 5998-048 | H20 | 5998-136 | H20 | 5999-37E | H39 | 8681-SCHLUESSEL | H238 |
| 5996-125 | H20 | 5998-049 | H20 | 5998-137 | H20 | 5999-391 | H48 | 8681K | H238 |
| 5996-126 | H20 | 5998-050 | H20 | 5998-138 | H20 | 5999-392 | H48 | 8682 | H87 |
| 5996-127 | H20 | 5998-051 | H20 | 5998-139 | H20 | 5999-393 | H48 | 8682K | H238 |
| 5996-128 | H20 | 5998-052 | H20 | 5998-140 | H20 | 5999-411 | H33 | 8683 | H89 |
| 5996-129 | H20 | 5998-053 | H20 | 5998-141 | H20 | 5999-41E | H33 | 8683K | H238 |
| 5996-130 | H20 | 5998-054 | H20 | 5998-142 | H20 | 5999-421 | H37 | 8684 | H88 |
| 5996-131 | H20 | 5998-055 | H20 | 5998-143 | H20 | 5999-42E | H37 | 8684K | H238 |
| 5996-132 | H20 | 5998-056 | H20 | 5998-144 | H20 | 5999-431 | H38 | 8685 | H90 |
| 5996-133 | H20 | 5998-057 | H20 | 5998-145 | H20 | 5999-43E | H38 | 8685K | H238 |
| 5996-134 | H20 | 5998-058 | H20 | 5998-146 | H20 | 5999-441 | H37 | 8686 | H91 |
| 5996-135 | H20 | 5998-059 | H20 | 5998-147 | H20 | 5999-44E | H37 | 8687 | H194 |
| 5996-136 | H20 | 5998-060 | H20 | 5998-148 | H20 | 5999-451 | H46 | 8688 | H84 |
| 5996-137 | H20 | 5998-061 | H20 | 5998-149 | H20 | 5999-45E | H46 | 9961 | H145 |
| 5996-138 | H20 | 5998-062 | H20 | 5998-150 | H20 | 5999-461 | H45 | 9981 | H130 |
| 5996-139 | H20 | 5998-063 | H20 | 5999-011 | H32 | 5999-46E | H45 | 9985 | H206 |
| 5996-140 | H20 | 5998-064 | H20 | 5999-01E | H32 | 5999-471 | H46 | 9986 | H226 |
| 5996-141 | H20 | 5998-065 | H20 | 5999-021 | H33 | 5999-47E | H46 | 9988 | H148 |
| 5996-142 | H20 | 5998-066 | H20 | 5999-02E | H33 | 5999-481 | H41 | | |
| 5996-143 | H20 | 5998-067 | H20 | 5999-031 | H33 | 5999-48E | H41 | | |
| 5996-144 | H20 | 5998-068 | H20 | 5999-03E | H33 | 5999-511 | H36 | | |
| 5996-145 | H20 | 5998-069 | H20 | 5999-041 | H34 | 5999-51E | H36 | | |
| 5996-146 | H20 | 5998-070 | H20 | 5999-04E | H34 | 5999-521 | H36 | | |
| 5996-147 | H20 | 5998-071 | H20 | 5999-051 | H34 | 5999-52E | H36 | | |
| 5996-148 | H20 | 5998-072 | H20 | 5999-052 | H34 | 5999-531 | H36 | | |

Stichwortverzeichnis Handwerkzeuge deutsch

Index German

Artikel Seite

A

| | |
|-------------------------------|--------------------|
| Abisolierzangen | 204 |
| Abisolierzangen VDE | 207 |
| ACR Bits 1/4" | 156, 157, 158, 167 |
| Adapter 1/2" | 107 |
| Adapter 1/4" | 99 |
| Adapter 3/4" | 110 |
| Adapter 3/8" | 102 |
| Adapter 1" | 110 |
| Adapter-Satz | 118 |
| Adapter für Ratschenschlüssel | 128 |
| Armaturen Zangenschlüssel | 205 |
| ASSY-Bits | 170 |
| Arbeitslampen | 216, 219, 220 |

B

| | |
|--|---------------------|
| Beißzangen | 206 |
| Bestückte Werkstattwagen | 25 - 31 |
| Bestückungen zu Werkstattwagen | 25 - 31 |
| Bestückungen zu Werkzeugkoffern | 49, 50 |
| Bit Adapter | 99, 102, 107, 171 |
| Bit Display 1/4" | 163, 184 |
| Bit Halter | 171, 172 |
| Bit Knarre für 10 mm Bits | 97, 169, 172 |
| Bit Knarren | 97, 172 |
| Bit Ratsche 1/4" | 97, 172 |
| Bit Ratschenschlüssel | 129, 174 |
| Bit Sätze | 154, 155, 173 - 183 |
| Bit Schraubendreher 99, 172, 174, 178, 191 | 172 |
| Bits | 153 - 172 |
| Bits, diamantbeschichtet | 156, 166 |
| Bits mit Farbmarkierung | 164, 165 |
| Blech-Locher | 228 |
| Blechscheren | 210 |
| Bolzenausdreher | 236 |
| Bolzenschneider | 210 |
| Breitmaul Gripzangen | 211 |
| Bremsschleifschlüssel | 141 |
| Bremsschleifschlüssel Sätze | 149 |
| Bügelsäge | 236 |
| Bürsten | 230 |

C

| | |
|------------------|-----|
| Clutch Bits 1/4" | 170 |
| Cutter Messer | 235 |

D

| | |
|----------------------------------|---------------|
| Diamant-Bits | 166 |
| Displays für Bits | 163, 184 |
| Dolphin Ringgabelschlüssel | 138 |
| Dolphin Ringgabelschlüssel-Sätze | 147 |
| Doppelgabelschlüssel | 139 |
| Doppelgabelschlüssel-Sätze | 148, 149 |
| Doppelmaulschlüssel | 139 |
| Doppelmaulschlüssel-Sätze | 148, 149 |
| Doppelring-Ratschenschlüssel | 129, 133, 134 |
| Doppelringsschlüssel | 139 |
| Doppelringsschlüssel-Sätze | 150, 151 |
| Drahtbürsten | 230 |
| Drehmomentschlüssel | 115 - 118 |
| Durchgangsnüsse 3/8" | 103 |
| Durchgangsverlängerung 3/8" | 103 |
| Durchschläge | 223 |
| Durchschraubknarren-Sätze | 76 |

Artikel Seite

E

| | |
|--------------------------------------|----------|
| Eckrohrzangen | 205, 206 |
| Eindreh Bit für Haken 1/4" | 170 |
| Eindrehwerk. für Stockschrauben 1/4" | 171 |
| Einlagen zu Werkstattwagen | 32 - 48 |
| Einmaulschlüssel | 140 |
| Elektriker Schraubendreher Schlitz | 193 |
| Elektronikzangen | 212 |
| Engländer | 141 |

F

| | |
|------------------------------------|---------------------|
| Farb-Bits | 164, 165, 175 - 178 |
| Farbpulver für Schlagschnur-Roller | 234 |
| Fäustel | 222 |
| Feilen | 229 |
| Feilen-Bürste | 230 |
| Flachmeißel | 223 |
| Flachzange | 212 |
| Flechther Zangen | 206 |
| Flexible Ratschenschlüssel | 127, 131 |
| Flexible Verlängerung 1/4" | 99 |
| Fräsen | 226 |

G

| | |
|--------------------------------|-----------|
| Gabelringsschlüssel | 135 - 138 |
| Gabelringsschlüssel-Sätze | 144 - 147 |
| Ganzstahl-Schraubzwingen | 237 |
| GearTech Ratschenschlüssel | 127 - 134 |
| Gemischte Stecknuss-Sätze | 69 - 83 |
| Gemischte Steckschlüsselkoffer | 69 - 83 |
| Gerüstbauerschlüssel | 143 |
| Gliedermaßstab | 231 |
| Gleitgriff 1/2" | 107 |
| Gleitgriff 1/4" | 99 |
| Gleitgriff 3/8" | 113 |
| Gleitgriff Adapter 1/2" | 107 |
| Gleitgriff Adapter 3/8" | 102 |
| Gleitgriff Adapter 1" | 110 |
| Gripzangen | 211 |

H

| | |
|-------------|-----|
| Hämmer | 222 |
| Handfäustel | 222 |
| Hebelzwinde | 237 |

I

| | |
|--------------------------------------|-----------|
| Innensechskant Bits 1/4" | 162 - 165 |
| Innensechskant Bits 10 mm | 169 |
| Innensechskant Bits 5/16" | 168 |
| Innensechskant Bits mit Bohrung 1/4" | 162 |
| Innensechskant-Bit-Stecknüsse 1/2" | 106 |
| Innensechskant-Bit-Stecknüsse 1/4" | 98 |
| Innensechskant-Bit-Stecknüsse 3/8" | 102 |
| Innensechskant Schraubendreher | 195 |
| Innensechskant Stiftschlüssel | 198 - 200 |

K

| | |
|--------------------|-----|
| Kantenzangen | 206 |
| Kardangeln 1" | 110 |
| Kardangeln 1/2" | 107 |
| Kardangeln 1/4" | 99 |
| Kardangeln 3/8" | 102 |
| Keilzahn Bits 1/4" | 170 |
| Kettensäge | 212 |
| Klemmzange | 212 |

Artikel Seite

| | |
|---|-------------------------|
| Klingen für Messer | 235 |
| Knarre 1" | 93, 11 |
| Knarre 1/2" | 93 - 96, 109 |
| Knarre 1/4" | 93 - 97, 100 |
| Knarre 3/4" | 93, 110 |
| Knarre 3/8" | 93 - 96, 104 |
| Kniekissen, Knieauflage | 234 |
| Kombizangen | 203, 213 |
| Kombizangen VDE | 207, 208, 213 |
| Körner | 223 |
| Kreuzmeißel | 223 |
| Kreuzschlitz Bits 1/4" | 157, 158, 164, 166, 167 |
| Kreuzschlitz Bits 5/16" | 168 |
| Kreuzschlitz-Bit-Stecknüsse 1/4" | 98, 99 |
| Kreuzschlitz-Bit-Stecknüsse 3/8" | 101, 102 |
| Kreuzschlitz Schraubendreher 188, 189, 196, 197 | 193, 194 |
| Kreuzschlitz Schraubendreher VDE | 193, 194 |
| Kugelkopf Bits 1/4" | 162 |
| Kugelkopf Schraubendreher | 195 |
| Kugelkopf Stiftschlüssel | 198 - 200 |
| Kunststoffhammer | 222 |
| Kunststoff-Rohrschere | 227 |

L

| | |
|---------------------------------|-----------|
| Langbeck Klemmzange | 212 |
| Lange Gabelringsschlüssel | 137 |
| Lange Gabelringsschlüssel Sätze | 146 |
| Latthammer | 222 |
| LED-Taschenlampe | 216 - 219 |
| LED-Arbeitslampen | 219, 220 |

M

| | |
|------------------------------------|-----|
| Magnetheber | 228 |
| Magnetische Stecknuss Bits 1/4" | 171 |
| Magnetische Stecknusschienen 1/2" | 114 |
| Magnetische Stecknusschienen 1/4" | 112 |
| Magnetische Stecknusschienen 3/8" | 113 |
| Magnetschalen | 21 |
| Maßbänder | 231 |
| Maßstab | 231 |
| Mattenschneider | 210 |
| Meißel | 223 |
| Messer | 235 |
| Messing-Drahtbürste | 230 |
| MultiFit Steckschlüsselkoffer 1/4" | 77 |
| Multifunktions-Zangen VDE | 208 |

N

O

| | |
|-----------------------------------|----------|
| Offene Doppelringsschlüssel | 141 |
| Offene Doppelringsschlüssel Sätze | 149, 150 |

P

| | |
|------------------------------|--------------------|
| Pfeifenkopfschlüssel | 143 |
| Phasenprüfer | 192, 193 |
| Phillips Bits 1/4" | 157, 164, 166, 167 |
| Phillips Bits 5/16" | 168 |
| Phillips Schraubendreher | 188, 196, 197 |
| Phillips Schraubendreher VDE | 193, 194 |
| Phillips-Bit-Stecknüsse 1/4" | 98 |
| Phillips-Bit-Stecknüsse 3/8" | 101 |

Artikel Seite

| | |
|--------------------------------------|--------------------|
| Pozidriv Bits 1/4" | 158, 164, 166, 167 |
| Pozidriv Bits 5/16" | 168 |
| Pozidriv-Bit-Stecknüsse 1/4" | 98 |
| Pozidriv-Bit-Stecknüsse 3/8" | 101 |
| Pozidriv Schraubendreher | 189, 196, 197 |
| Pozidriv Schraubendreher VDE | 193, 194 |
| Präzisions Schraubendreher | 192 |
| proficraft Steckschlüsselkoffer | 79 - 83 |
| proficraft Steckschlüsselkoffer 1/4" | 79 |
| proficraft Werkzeugkoffer | 82, 84 - 91 |
| PROForm Einlagen | 32 - 50 |
| PROForm Box | 23, 24 |
| PUK Säge | 236 |

Q

| | |
|---------------------------|-----|
| Quergriff Schraubendreher | 195 |
|---------------------------|-----|

R

| | |
|-----------------------------|---------------------|
| Radiozangen | 204, 207 |
| Raspeln | 229 |
| Ratsche 1" | 93, 110 |
| Ratsche 1/2" | 93 - 96, 109 |
| Ratsche 1/4" | 93 - 97, 100 |
| Ratsche 3/4" | 93, 110 |
| Ratsche 3/8" | 93 - 96, 104 |
| Ratschenschlüssel | 127 - 129, 133, 134 |
| Ratschenschlüssel-Sätze | 130 - 134 |
| Ratschengabelringsschlüssel | 127, 128 |
| Ringgabelschlüssel | 135 - 138 |
| Ringgabelschlüssel-Sätze | 144 - 147 |
| Ringmaulschlüssel | 135 - 138 |
| Ringmaulschlüssel-Sätze | 144 - 147 |
| Robertson Bits 1/4" | 170 |
| Rohrabschneider | 224 - 226 |
| Rohrentgrater | 228 |
| Rohrschere | 227 |
| Rohrsteckschlüssel | 140 |
| Rohrsteckschlüssel-Sätze | 148 |
| Rohrzangen | 205, 206 |
| Rollgabelschlüssel | 141, 142 |
| Rollgabelschlüssel-Sätze | 151 |
| Rollmeter | 231 |
| Rundzange | 212 |

S

| | |
|----------------------------------|--------------------|
| Sägebogen | 236 |
| Sägen | 236 |
| Sanitär-Schlüssel | 227 |
| Sanitär-Umsteckknarre | 227 |
| Sanitär-Werkzeuge | 227 |
| Sanitärkreuzschlüssel | 227 |
| Schieblehre | 234 |
| Schlag-Adapter | 120, 123, 124 |
| Schlag-Stecknüsse 1" | 124 |
| Schlag-Stecknüsse 3/4" | 123 |
| Schlag-Stecknüsse 1/2" | 119 - 122 |
| Schlag-Stecknüsse Xi-on 1/2" | 122 |
| Schlag-Stecknüsse für Alu-Felgen | 121, 122 |
| Schlag-Verlängerungen | 120, 123, 124 |
| Schlagkardangeln | 120, 123, 124 |
| Schlagschnur-Roller | 234 |
| Schlagwerkzeuge | 222 |
| Schlitz Bits 1/4" | 159, 164, 166, 167 |
| Schlitz Bits 5/16" | 168 |
| Schlitz Schraubendreher | 187, 196, 197 |
| Schlitz Schraubendreher VDE | 193, 194 |

Stichwortverzeichnis Handwerkzeuge deutsch

Index German

| Artikel | Seite | Artikel | Seite | Artikel | Seite | Artikel | Seite |
|---------------------------------------|------------------|------------------------------------|---------------------|------------------------------------|---------------------|-------------------------------|----------|
| Schlitz-Bit-Stecknüsse 1/4" | 98 | Stiftschlüssel | 198 - 200 | TX Stecknüsse 1/4" | 98 | Zangen Sätze VDE | 213 |
| Schlitz-Bit-Stecknüsse 3/8" | 101 | Stufenschlüssel | 227 | TX Stecknüsse 3/8" | 102 | Zimmermanns-Bleistift | 231 |
| Schlosserhämmer | 222 | T | | TX Stiftschlüssel | 199 | Zoll Gabelringschlüssel | 137 |
| Schraubenausdreher | 236 | Taschenlampen | 216 - 220 | U | | Zoll Gabelringschlüssel Sätze | 147 |
| Schraubendreher | 186 - 197 | Telefonzangen | 204 | Umschaltbare Ratschenschlüssel | 128 - 134 | Zoll Ratschenschlüssel | 133 |
| Schraubendreher mit Wechselklinge VDE | 194 | Telefonzangen VDE | 207 | Umschaltknarre 1" | 93, 110 | Zoll Ringgabelschlüssel | 137 |
| Schraubendreher-Sätze | 196, 197 | Teleskop-Magnetheber | 228 | Umschaltknarre 1/2" | 93 - 96, 109 | Zoll Ringgabelschlüssel Sätze | 147 |
| Schraubzwingen | 237 | Temperguss-Schraubzwingen | 237 | Umschaltknarre 1/4" | 93 - 97, 100 | Zoll Stecknuss Bits 1/4" | 171 |
| Schweißer-Gripzangen | 211 | T-Gleitgriff 3/4" | 110 | Umschaltknarre 3/4" | 93, 110 | Zoll Stecknüsse 1/2" | 105 |
| Seegerring-Zangen | 209, 214 | Tiefe Schlagstecknüsse 1" | 124 | Umschaltknarre 3/8" | 93 - 96, 104 | Zoll Stecknüsse 1/4" | 98 |
| Seitenschneider | 203 | Tiefe Schlagstecknüsse 1/2" | 119, 121 | Universalgriff 1" | 93, 110 | Zoll Stecknüsse 3/8" | 101 |
| Seitenschneider VDE | 207 | Tiefe Schlagstecknüsse Xi-on 1/2" | 122 | Universalschraubendreher PH/PZ | 189 | Zoll Stiftschlüssel | 200 |
| Sicherheits Bit Sätze | 180 - 183 | Tiefe Schlagstecknüsse 3/4" | 123 | Universalschraubendreher PH/PZ VDE | 193 | Zollstock | 231 |
| Sicherheits Bits 1/4" | 170 | Tiefe Stecknüsse 1/2" | 105 | V | | Zündkerzen-Bürste | 230 |
| Sicherheits-Messer | 235 | Tiefe Stecknüsse 1/4" | 98 | V2A-Drahtbürste | 230 | Zündkerzen-Nüsse | 101, 105 |
| Sicherungs-O-Ringe | 120, 123, 124 | Tiefe Stecknüsse 3/8" | 101 | VDE Schraubendreher | 193, 194 | | |
| Sicherungsring-Zangen | 209, 214 | Tiefe Steckschlüssel-Einsätze 1/2" | 105 | VDE Zangen | 207, 208, 213 | | |
| Sicherungsstifte | 120, 123, 124 | Tiefe Steckschlüssel-Einsätze 1/4" | 98 | Vergaser Schraubendreher | 187, 188 | | |
| SIT Bits 1/4" | 170 | Tiefe Steckschlüssel-Einsätze 3/8" | 101 | Verlängerung 1" | 110 | | |
| Spanner Bits 1/4" | 170 | Torsion-Bits | 156, 167 | Verlängerung 1/2" | 107 | | |
| Spannungsprüfer | 192 | Torsion-Bit-Box | 175 | Verlängerung 1/4" | 99 | | |
| Spitzmeißel | 223 | Torq Bits 1/4" | 170 | Verlängerung 3/4" | 110 | | |
| Splintentreiber | 223 | TORX Bits 1/4" | 160, 161, 165 - 167 | Verlängerung 3/8" | 102 | | |
| Stahl-Drahtbürste | 230 | TORX Bits 10 mm | 169 | Vielzahn Bits 1/4" | 170 | | |
| Standhahn-Mutter-Schlüssel | 228 | TORX Bits 5/16" | 168 | Vielzahn Bits 10 mm | 169 | | |
| Steckgriff 1/4" | 99, 112 | TORX Bit Stecknüsse 1/2" | 106 | Vielzahn Bits 5/16" | 168 | | |
| Stecknuss Bit Adapter | 171 | TORX Bit Stecknüsse 1/4" | 98 | Vielzahn-Bit-Stecknüsse 1/2" | 106 | | |
| Stecknuss Bits 1/4" | 171 | TORX Bit Stecknüsse 3/8" | 102 | W | | | |
| Stecknüsse 1" | 110 | TORX Doppelringschlüssel | 133 | Wasserhahnventil-Sitzfräser | 226 | | |
| Stecknüsse 1/2" | 105 - 108 | TORX Doppelringschlüssel Sätze | 133 | Wasserpumpenzangen | 205, 206, 213 | | |
| Stecknüsse Xi-on 1/2" | 114 | TORX mit Loch Bits 1/4" | 161 | Wasserpumpenzangen VDE | 207 | | |
| Stecknüsse 1/4" | 98 - 99 | TORX mit Loch Bits 10 mm | 169 | Wasserwaagen | 232, 233 | | |
| Stecknüsse Xi-on 1/4" | 112 | TORX mit Loch Bits 5/16" | 168 | Wechselklingen-Schraubendreher VDE | 194 | | |
| Stecknüsse 3/4" | 110 | TORX mit Loch Schraubendreher | 190 | Werkstattwagen | 12 - 31 | | |
| Stecknüsse 3/8" | 101 - 103 | TORX Ratschenschlüssel | 133 | Werkstattwagen Zubehör | 12 - 31, 49 | | |
| Stecknüsse Xi-on 3/8" | 113 | TORX Schlagnüsse 1/2" | 120 | Werkstattwagen Zubehör | 12 - 31, 49 | | |
| Stecknuss-Satz 1" | 68 | TORX Schraubendreher | 190 | Werkzeugauflage | 234 | | |
| Stecknuss-Sätze 1/2" | 64 - 66, 80 - 83 | TORX Schraubendreher Sätze | 196, 197 | Werkzeugkoffer | 69, 71, 72, 84 - 91 | | |
| Stecknuss-Sätze Xi-on 1/2" | 75 | TORX Schraubendr. mit Quergriff | 195 | Werkzeugkoffer für Werkstattwagen | 15, 49, 50 | | |
| Stecknuss-Sätze 1/4" | 60 - 61, 79 | TORX Stecknüsse 1/2" | 106 | Werkzeugmappe VDE | 194 | | |
| Stecknuss-Sätze Xi-on 1/4" | 74, 75 | TORX Stecknüsse 1/4" | 98 | Werkzeugtasche | 91 | | |
| Stecknuss-Sätze 3/4" | 67 | TORX Stecknüsse 3/8" | 102 | Werkzeugtrolley | 86, 238 | | |
| Stecknuss-Sätze 3/8" | 69 | TORX Stiftschlüssel | 199 | Winkelstiftschlüssel | 198 - 200 | | |
| Stecknuss-Sätze Xi-on 3/8" | 74 | Tri-Wing Bits 1/4" | 170 | X | | | |
| Stecknusssschienen, magnetisch 1/2" | 108, 114 | Trolley | 86, 238 | Xi-on Schlag-Stecknüsse 1/2" | 122 | | |
| Stecknusssschienen, magnetisch 1/4" | 112 | TX Bits 1/4" | 160, 161, 165 - 167 | Xi-on Stecknüsse 1/2" | 114 | | |
| Stecknusssschienen, magnetisch 3/8" | 103, 113 | TX Bits 10 mm | 169 | Xi-on Stecknüsse 1/4" | 112 | | |
| Steckschlüssel-Schraubendreher | 191, 195 | TX Bits 5/16" | 168 | Xi-on Stecknüsse 3/8" | 113 | | |
| Steckschlüssel-Einsatz 1" | 110 | TX Bit Schlagnüsse 1/2" | 120 | Xi-on Steckschlüssel-Einsätze 1/2" | 114 | | |
| Steckschlüssel-Einsatz 1/2" | 105 - 108 | TX Bit Stecknüsse 1/2" | 106 | Xi-on Steckschlüssel-Einsätze 1/4" | 112 | | |
| Steckschlüssel-Einsatz Xi-on 1/2" | 114 | TX Bit Stecknüsse 1/4" | 98 | Xi-on Steckschlüssel-Einsätze 3/8" | 113 | | |
| Steckschlüssel-Einsatz 1/4" | 98, 99 | TX Bit Stecknüsse 3/8" | 102 | Xi-on Steckschlüsselkoffer 1/2" | 75 | | |
| Steckschlüssel-Einsatz Xi-on 1/4" | 112 | TX Doppelringschlüssel | 133 | Xi-on Steckschlüsselkoffer 1/4" | 74, 75 | | |
| Steckschlüssel-Einsatz 3/4" | 110 | TX Doppelringschlüssel Sätze | 133 | Xi-on Steckschlüsselkoffer 3/8" | 74 | | |
| Steckschlüssel-Einsatz 3/8" | 101 - 103 | TX mit Loch Bits 1/4" | 161 | | | | |
| Steckschlüssel-Einsatz Xi-on 3/8" | 113 | TX mit Loch Bits 10 mm | 169 | | | | |
| Steckschlüsselkoffer 1" | 68 | TX mit Loch Bits 5/16" | 168 | | | | |
| Steckschlüsselkoffer 1/2" | 64 - 66, 80 - 83 | TX mit Loch Schraubendreher | 190 | | | | |
| Steckschlüsselkoffer Xi-on 1/2" | 75 | TX Ratschenschlüssel | 133 | | | | |
| Steckschlüsselkoffer 1/4" | 60, 61, 79 | TX Schlagnüsse 1/2" | 120 | | | | |
| Steckschlüsselkoffer Xi-on 1/4" | 74, 75 | TX Schraubendreher | 190 | | | | |
| Steckschlüsselkoffer 3/4" | 67 | TX Schraubendreher Sätze | 196, 197 | | | | |
| Steckschlüsselkoffer 3/8" | 69 | TX Schraubendreher mit Quergriff | 195 | | | | |
| Steckschlüsselkoffer Xi-on 3/8" | 74 | TX Stecknüsse 1/2" | 106 | | | | |
| Stemmeisen | 222 | | | | | | |

Stichwortverzeichnis Handwerkzeuge englisch

Index Hand Tools English

| Article | Page |
|--------------------------------|--------------------|
| A | |
| accessories for roller cabinet | 12 - 31, 49 |
| ACR bits 1/4" | 156, 157, 158, 167 |
| adapter 1/2" | 107 |
| adapter 1/4" | 99 |
| adapter 3/4" | 110 |
| adapter 3/8" | 102 |
| adapter for ratchet wrenches | 128 |
| adjustable wrenches | 141, 142 |
| all steel clamps | 237 |
| Assy bits 1/4" | 170 |

| | |
|----------------------------|-----------------------|
| B | |
| ball point bits 1/4" | 162 |
| ball point hex keys | 198 - 200 |
| ball point screwdriver | 195 |
| basin wrench | 228 |
| bit adapter | 99, 102, 107, 171 |
| bit display 1/4" | 163, 184 |
| bit holder | 171, 172 |
| bit ratchet for 10 mm bits | 97, 169, 172 |
| bit ratchet wrench | 129, 174 |
| bit ratchets | 97, 172 |
| bit screwdriver | 180, 182, 186 |
| bit screwdriver 1/4" | 99, 172, 74, 178, 191 |
| bit sets | 154, 155, 173 - 183 |
| bits | 153 - 172 |
| blades for knives | 235 |
| bolt cutter | 210 |
| brass wire hand brush | 230 |
| brushes | 230 |

| | |
|-------------------------|---------------------|
| C | |
| carpenters pencil | 231 |
| center punch | 223 |
| chalk liner | 234 |
| chisels | 222, 223 |
| circlip pliers | 209 |
| Clutch bits 1/4" | 170 |
| color bits | 164, 165, 175 - 178 |
| combination pliers | 203, 213 |
| combination wrench sets | 144 - 147 |
| combination wrenches | 135 - 138 |
| construction wrenches | 143 |
| chross-chisel | 223 |
| cutter knives | 235 |

| | |
|------------------------------|----------|
| D | |
| dead-blow hammer | 222 |
| deep impact sockets 1/2" | 119, 121 |
| deep sockets 1/2" | 105 |
| deep sockets 1/4" | 98 |
| deep sockets 3/8" | 101 |
| diamond coated bits | 166 |
| displays for bits | 163, 184 |
| Dolphin combination wrenches | 138 |
| double box wrench sets | 150, 151 |
| double box wrenches | 139 |
| double open end wrench sets | 148, 149 |
| double open end wrenches | 139 |
| double ring ratchet wrenches | 133, 134 |
| double ring wrench sets | 150, 151 |
| double ring wrenches | 139 |

| | |
|---------------------|----------|
| E | |
| elbow pipe wrenches | 205, 206 |
| electronic pliers | 218 |
| end cutting nippers | 206 |
| extension bar 1" | 110 |
| extension bar 1/2" | 107 |
| extension bar 1/4" | 99 |
| extension bar 3/4" | 110 |
| extension bar 3/8" | 102 |

| | |
|-----------------------------|----------|
| F | |
| file cleaner | 230 |
| files | 229 |
| flare nut wrench sets | 216, 217 |
| flare nut wrenches | 141 |
| flat chisel | 224 |
| flexible extension bar 1/4" | 99 |
| flexible ratchet wrenches | 127, 131 |
| foldable wooden ruler | 231 |

| | |
|-------------------------------|-----------|
| G | |
| GearTech ratchet wrenches | 126 - 134 |
| go-through extension bar 3/8" | 103 |
| go-through sockets 3/8" | 103 |
| go-through sockets sets | 76 |
| grip pliers | 211, 212 |

| | |
|----------------------|-----------|
| H | |
| hack saw | 236 |
| hammer | 222 |
| hex bit socket 1/2" | 106 |
| hex bit sockets 1/4" | 98 |
| hex bit sockets 3/8" | 102 |
| hex bits 1/4" | 162, 165 |
| hex bits 10 mm | 169 |
| hex bits 5/16" | 168 |
| hex keys | 198 - 200 |
| hex screwdriver | 195 |
| hole punch | 223 |
| hook driver 1/4" | 170 |

| | |
|--------------------------------------|---------------|
| I | |
| impact adapter | 120, 123, 124 |
| impact extension bars | 120, 123, 124 |
| impact sockets 1" | 124 |
| impact sockets 1/2" | 119 - 122 |
| impact sockets 3/4" | 131 |
| impact universal joint | 120, 123, 124 |
| inch bits 1/4" | 162 |
| inch combination wrench sets | 147 |
| inch combination wrenches | 137 |
| inch hex keys | 200 |
| inch nut setter 1/4" | 171 |
| inch ratchet wrenches | 133 |
| inch sockets 1/2" | 105 |
| inch sockets 1/4" | 98 |
| inch sockets 3/8" | 101 |
| inlays for roller cabinets | 32 - 48 |
| inlays for tool boxes | 49, 50 |
| interchangeable screwdriver sets VDE | 194 |

| | |
|----------|-----|
| K | |
| knives | 235 |

| | |
|------------------------------|-----------|
| L | |
| LED lights | 216 - 220 |
| lights | 216 - 220 |
| long combination wrench sets | 146 |
| long combination wrenches | 137 |
| long nose pliers | 204, 207 |

| | |
|------------------------------|-----|
| M | |
| machinist hammer | 222 |
| magnetic nut setter 1/4" | 171 |
| magnetic pick up tool | 228 |
| magnetic socket holders 1/2" | 114 |
| magnetic socket holders 1/4" | 112 |
| magnetic socket holders 3/8" | 113 |
| magnetic trays | 21 |
| measuring tapes | 231 |
| mesh cutter | 210 |
| milling cutter | 226 |
| MultiFit socket sets 1/4" | 77 |
| multifunctional pliers VDE | 208 |

| | |
|-----------------|-----|
| N | |
| nut setter 1/4" | 171 |

| | |
|-----------------------------|-------------------------|
| O | |
| P | |
| Phillips bits 1/4" | 157, 164, 166, 167 |
| Phillips bits 5/16" | 168 |
| Phillips screwdriver | 188, 193, 194, 196, 197 |
| Phillips bit sockets 1/4" | 98 |
| Phillips bit sockets 3/8" | 101 |
| pick up tool | 228 |
| pin for impact sockets | 120, 123, 124 |
| pin punches | 223 |
| pincers | 206 |
| pipe wrenches | 205, 206 |
| plastic tube cutter | 227 |
| plier wrench for fittings | 205 |
| pliers | 202 - 214 |
| pliers sets | 213, 214 |
| pointed chisel | 223 |
| Pozidriv bits 1/4" | 158, 164, 166, 167 |
| Pozidriv bits 5/16" | 168 |
| Pozidriv screwdriver | 189, 193, 194, 196, 197 |
| Pozidriv bit sockets 1/4" | 98 |
| Pozidriv bit sockets 3/8" | 101 |
| precision screwdriver | 192 |
| proficraft socket sets 1/4" | 79 - 83 |
| proficraft tool sets | 82, 84 - 91 |
| PROForm Box | 23, 24 |
| PROForm inlays | 32 - 50 |
| powder for chalk liner | 234 |
| PUK saw | 236 |
| punches | 223 |

| | |
|---------------------|--------------|
| R | |
| rasp | 229 |
| ratchet handle 1" | 93, 11 |
| ratchet handle 1/2" | 93 - 96, 109 |
| ratchet handle 1/4" | 93 - 97, 100 |
| ratchet handle 3/4" | 93, 110 |

| | | | |
|-----------------------------|---------------------|-------------|--|
| Article | | Page | |
| ratchet handle 3/8" | 93 - 96, 104 | | |
| ratchet wrench sets | 130 - 134 | | |
| ratchet wrenches | 127 - 129, 133, 134 | | |
| reversible ratchet wrenches | 128, 132 - 134 | | |
| ring for impact sockets | 120, 123, 124 | | |
| Robertson bits 1/4" | 170 | | |
| roller cabinet | 12 - 31 | | |
| roofing hammer | 222 | | |
| ruler | 231 | | |

| | |
|--|-------------------------|
| S | |
| sanitary cross wrench | 227 |
| sanitary ratchet handle | 227 |
| sanitary tools | 234 - 228 |
| sanitary wrench | 227 |
| saws | 236 |
| screw clamps | 237 |
| screw extractor | 236 |
| screw tight tool for setting screws 1/4" | 171 |
| screwdriver | 186 - 197 |
| screwdriver sets | 194 - 197 |
| security bit sets | 180 - 183 |
| security bits 1/4" | 170 |
| security utility knife | 235 |
| self grip pliers | 211, 212 |
| side cutter | 203, 207, 212, 213 |
| single open end wrenches | 140 |
| SIT bits 1/4" | 170 |
| sliding t-handle 3/4" | 110 |
| sliding t-handle 1/2" | 107 |
| slotted bit sockets 1/4" | 98 |
| slotted bit sockets 3/8" | 101 |
| slotted bits 1/4" | 159, 164, 166, 167 |
| slotted bits 5/16" | 168 |
| slotted screwdriver | 187, 193, 194, 196, 197 |
| sockets 1" | 110 |
| sockets 1/2" | 105 - 108 |
| sockets Xi-on 1/2" | 114 |
| sockets 1/4" | 98, 99 |
| sockets Xi-on 1/4" | 112 |
| sockets 3/4" | 110 |
| sockets 3/8" | 101 - 103 |
| sockets Xi-on 3/8" | 113 |
| socket screwdriver | 191, 195 |
| Socket sets 1" | 68 |
| socket sets 1/2" | 64 - 66, 80 - 83 |
| socket sets Xi-on 1/2" | 75 |
| socket sets 1/4" | 60 - 61, 79 |
| socket sets Xi-on 1/4" | 74 - 75 |
| socket sets 3/4" | 67 |
| socket sets 3/8" | 69 |
| socket sets Xi-on 3/8" | 74 |
| Spanner bits 1/4" | 170 |
| spark plug hand brush | 230 |
| spark plug sockets | 101, 105 |
| spinner handle 1/4" | 99, 112 |
| spirit level | 232, 233 |
| spline bit sockets 1/2" | 106 |
| spline bits 1/4" | 170 |
| spline bits 10 mm | 169 |
| stainless steel wire hand brush | 230 |
| steel wire hand brush | 230 |
| stoning hammer | 222 |

Stichwortverzeichnis Handwerkzeuge englisch

Index Hand Tools English

| Article | Page | Article | Page | Article | Page | Article | Page |
|-----------------------------------|---------------------|--------------------------------|---------------------|---------------------------------|---------------|---------|------|
| T | | | | | | | |
| tamper bits 1/4" | 161, 162 | TORX screwdriver | 190 | U | | | |
| tamper bits 5/16" | 168 | TORX screwdriver with T-handle | 195 | universal handle 1" | 110 | | |
| tamper hex bits 1/4" | 162 | TORX sockets 1/2" | 106 | universal joint 1" | 110 | | |
| tamper TORX bits 10 mm | 169 | TORX sockets 1/4" | 98 | universal joint 1/2" | 107 | | |
| tamper TORX screwdriver | 190 | TORX sockets 3/8" | 102 | universal joint 1/4" | 99 | | |
| tamper TORX bits 10 mm | 169 | tower pincers | 206 | universal joint 3/8" | 102 | | |
| taper punches | 223 | Tri-Wing bits 1/4" | 170 | universal key | 242 | | |
| telescopic pick up tool | 228 | trolley | 191, 244 | universal screwdriver PH/PZ | 189 | | |
| T-handle screwdriver | 195 | tube cutter | 224 - 227 | universal screwdriver PH/PZ VDE | 193 | | |
| through-hole open-socket wrenches | 143 | tube deburrer | 228 | utility knives | 235 | | |
| tinmans shears | 210 | TX bit sockets 1/2" | 106 | V | | | |
| tool bags | 91, 194 | TX bit sockets 1/4" | 98 | VDE pliers | 207, 208, 213 | | |
| tool cases | 69, 71, 72, 84 - 91 | TX bit sockets 3/8" | 102 | VDE screwdriver | 193, 194 | | |
| tool chests | 15, 49, 50 | TX bits 1/4" | 160, 161, 165 - 167 | vernier caliper | 234 | | |
| tool sets | 69, 71, 72, 84 - 91 | TX bits 10 mm | 169 | voltage tester | 192, 193 | | |
| tool sets VDE | 194 | TX bits 5/16" | 168 | W | | | |
| tool trolley | 86, 238 | TX double ring wrench sets | 133 | water tap milling cutter | 226 | | |
| torsions-bits | 167, 175 | TX double ring wrenches | 133 | waterpump pliers | 205, 206, 213 | | |
| Torq bits 1/4" | 170 | TX hex keys | 199 | welding grip pliers | 211 | | |
| torque wrenches | 116 - 118 | TX impact sockets 1/2" | 120 | wire hand brushes | 230 | | |
| TORX Bits 1/4" | 160, 161, 165 - 167 | TX impact bit socket 1/2" | 120 | wire stripping pliers | 204, 207 | | |
| TORX bits 10 mm | 169 | TX ratchet wrench | 133 | wood chisel | 222 | | |
| TORX bits 5/16" | 168 | TX screwdriver | 190 | working lights | 216, 219, 220 | | |
| TORX bit sockets 1/2" | 106 | TX screwdriver with T-handle | 195 | workpad | 234 | | |
| TORX bit sockets 1/4" | 98 | TX sockets 1/2" | 106 | X | | | |
| TORX bit sockets 1/4" | 98 | TX sockets 1/4" | 98 | Xi-on impact sockets 1/2" | 122 | | |
| TORX bit sockets 3/8" | 102 | TX sockets 3/8" | 102 | Xi-on sockets 1/2" | 114 | | |
| TORX double ring wrench sets | 133 | | | Xi-on sockets 1/4" | 112 | | |
| TORX double ring wrenches | 133 | | | Xi-on sockets 3/8" | 113 | | |
| TORX impact sockets 1/2" | 120 | | | Xi-on socket sets 1/2" | 75 | | |
| TORX impact bit socket 1/2" | 120 | | | Xi-on socket sets 1/4" | 74, 75 | | |
| TORX ratchet wrench | 141 | | | Xi-on socket sets 3/8" | 74 | | |

Bestellmöglichkeiten bei PROJAHN

Ordering options at PROJAHN

Telefonisch

By Phone

+49 (0) 6074 / 69 666 - 66

nexmart

nexmart

National: Bei Rückfragen zu nexmart hilft Ihnen unser Serviceteam gerne weiter +49 (0) 6074 / 69 666 - 66
Weitere Informationen finden Sie auf Seite H 253
International: We only provide this service in Germany

E-Mail

E-Mail

National: verkauf@projahn.de
International: sales@projahn.de

Onlineshop

Online Shop

www.projahn.de

Fax

Fax

National: 0 800 / 22 44 888
International: +49 (0) 6074 / 69 666 - 99



Professionelle Beratung
Flexibilität Customer Relationship Personal Support E-Commerce
Produkterschulungen Online-Competence
E-Commerce nexmart
Online-Kompetenz Delivery on Customer Request
Lieferung zum Wunschtermin E-Commerce
POS-Material **Sofortige Lieferung**
Immediate Delivery nexmart Beziehungsmanagement BME cat
Flexibility 24/7 Service
Individueller Marketingservice
Professional Support Immer erreichbar Customized Marketing Support
Product Training POS-Material

nexmart – Einfach eBusiness*

nexmart – Simply eBusiness*

Bestellen rund um die Uhr:

nexmart

Das zentrale Branchennetzwerk mit über 230 Lieferanten und über 5 Millionen Artikeldaten bietet Ihnen online mehr Überblick in der Datenflut, tagesaktuelle Artikeldaten, reibungslose Bestellabwicklung und effiziente Prozesse – so sparen Sie Zeit und Kosten.

Informieren

Recherchieren Sie unsere Produkte und Artikeldaten, tagesaktuelle Preise und Verfügbarkeiten ganz bequem online:

- ▶ Zugriff auf unser gesamtes Katalogsortiment
- ▶ Sofortige Information zu Ihren individuellen Einkaufspreisen und der Artikelverfügbarkeit in Echtzeit
- ▶ Katalogdatenservice für Ihre Stammdatenpflege: alle Artikeldaten in verschiedenen Formaten (z.B. BMEcat) verfügbar

Bestellen

Bestellen Sie einfach und schnell direkt im Katalog, über die Warenkorb-Schnellbestellung oder mit direkter Anbindung Ihres Warenwirtschaftssystems:

Manuell

- ▶ Einfache Bedienung mit branchengerechten Funktionen
- ▶ Alle Artikel im Katalog mit Bestellbutton
- ▶ Schnelleingabe als Artikelliste direkt im Warenkorb möglich
- ▶ Direkte Information zu Preisen und Verfügbarkeit über Bestellanfrage

Elektronisch

- ▶ Direkte Anbindung ihres Warenwirtschaftssystems
- ▶ Automatische Übertragung aller Daten von und zu Ihrem Warenwirtschaftssystem
- ▶ Schnelle Bestellung ohne manuellen Aufwand
- ▶ Elektronische Rücknachrichten mit Auftragsbestätigung, Lieferavis und Rechnung im von Ihnen gewünschten Format
- ▶ Auswahl verschiedener Schnittstellen, Übertragungswege und Formate

Interessiert?

Sie möchten die Vorteile der Bestellung über nexmart nutzen? Das geht ganz einfach:

1. Beantragen Sie bei nexmart kostenfrei Ihre Kundennummer und Ihre Logindaten.
2. Lassen Sie sich über die Lieferantenseite den PROJAHN-Katalog freigeben.

Und schon können Sie bestellen!

Bei Rückfragen hilft Ihnen unser Serviceteam unter +49 (0) 6074 / 69 666 - 66 gerne weiter.

* PROJAHN bietet diesen Service innerhalb Deutschlands an.

* PROJAHN provides this service in Germany.

Ihr Fachhändler/*Your Retailer:*

201704HKATMP_DE

PROJAHN

Handwerkzeuge
Hand Tools