

# General Tools



General Tools

# General Tools

From professional contractors to weekend hobbyists, our massive range of General Hand Tools is suitable for just about any job.

Builders, plumbers, mechanics,

carpenters, engineers and more can find quality, branded hand tools that are tough and guaranteed for life.

Browse through hundreds of products that have been carefully selected to

offer you just the right hand tool for any job.



270-281

Screwdrivers



282-287

Allen Keys

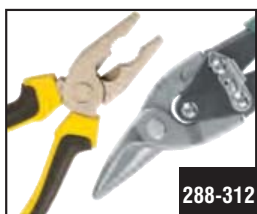

288-312

Pliers, Cutters & Snips

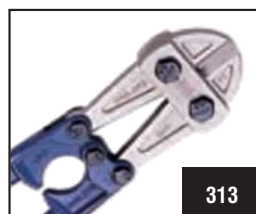

313

Bolt Cutters



314-316

Wrenches & Shifters



317-322

Hammers



323-325

Chisels & Bars



326-332

Punches

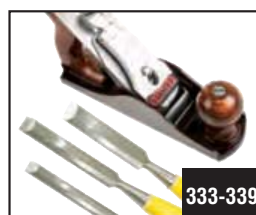

333-339

Wood Chisels & Planes

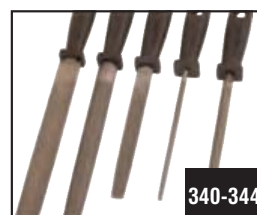

340-344

Files & Rasps



345

Hand Drills



346-360

Saws & Blades

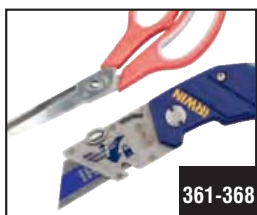

361-368

Scissors, Knives & Cutters



369-371

Riveters & Rivets

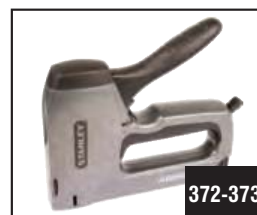

372-373

Staple Guns & Staples



374-375

Glue Guns



375

Caulking Guns



376-378

Painting & Decorating



379-386

Builder's Tools



387

Blowtorches



388-396

Plumber's Tools



397

Tiling Tools



398-401

Soldering & Brazing



402-408

Vices & Clamps



409-411

Wire Brushes & Wheels



412-413

Wire Stretchers



## SCREWDRIVER - D-CLASSIC MECHANICS PATTERN 35527H

- Professional quality mechanics pattern screwdrivers combine comfort and durability to drive screws tighter with less effort
- Heavy round shank blades made of high quality chrome vanadium steel hardened, tempered and satin chrome finish
- Standard tips are precisely cross ground with BLACK-POINT for perfect grip and fit
- Generous size handle is manufactured from high quality translucent PVC with a comfortable grip
- All blades have magnetic tips for screw holding

Code	Size
RIC3240	6 x 38mm
RIC3250	6 X 100mm
RIC3255	6 x 150mm
RIC3260	8 x 150mm
RIC3270	8 x 200mm



## SCREWDRIVER - MECHANIC'S - CLASSIC

- For slotted screws
- Round, chrome plated blade made from high quality bits material
- Tip: DIN 5264-A, ISO 2380
- Kraftform handle black, one component
- Hexagon shoulder prevents tool roll
- Black point tip blade for accurate dimensions

Code	Size
WEA8013B	6.5 x 100mm
WEA8040B	6.5 x 125mm
WEA8014B	6.5 x 150mm
WEA8015B	6.5 x 200mm
WEA8032B	8 x 100mm
WEA8044B	8 x 125mm
WEA8016B	8 x 150mm
WEA8017B	8 x 200mm
WEA8018B	8 x 250mm
WEA8019B	10 x 150mm
WEA8020B	10 x 200mm
WEA8021B	10 x 250mm
WEA8022B	10 x 300mm



## MECHANIC'S SCREWDRIVERS

- Round steel bars are fully hardened and tempered with forged and ground black tips
- Comfortable plastic handles are impact resistant and clearly indicate screwdriver size and type

Code	Size
MTS4310	3.5 x 75mm
MTS4315	4 x 75mm
MTS4318	4 x 100mm
MTS4320	6 x 100mm
MTS4322	6 x 150mm
MTS4325	8 x 150mm
MTS4327	8 x 200mm
MTS4330	10 x 200mm

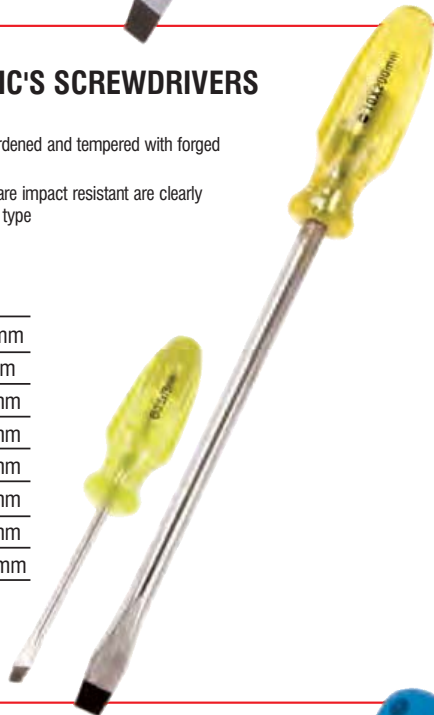

## SCREWDRIVER – MECHANIC – BLACK POINT

- For slotted screws
- Round, chrome plated blade made from high quality bits material
- Tip: DIN 5264-A, ISO 2380
- Kraftform handle of high impact cellulose acetate
- Hexagon shoulder prevents tool roll, one component
- Black point tip blade for accurate dimensions

Code	Size
WEA6013C	6.5 x 100mm
WEA6040C	6.5 x 125mm
WEA6014C	6.5 x 150mm
WEA6043C	6.5 x 175mm
WEA6044C	8 x 125mm
WEA6016C	8 x 150mm
WEA6041C	8 x 175mm
WEA6017C	8 x 200mm
WEA6019C	10 x 150mm
WEA6042C	10 x 175mm
WEA6020C	10 x 200mm
WEA6021C	10 x 250mm
WEA6045C	12 x 200mm
WEA6047C	12 x 300mm



## SCREWDRIVER - MECHANIC'S 150MS-400N

- For slotted screws
- Round blade made from CHROME VANADIUM MOLYBDENUM steel
- Chrome plated
- Satin finish

Code	Size
GED36861	5.5 x 125mm
GED36864	6.5 x 150mm
GED36865	8 x 175mm
GED36862	10 x 200mm





## SCREWDRIVER – WORKSHOP DRALL 4620-1

- DIN ISO 2380-1, -2, DIN 5264, ISO 2380-1, -2
- Parallel blade
- Chrome alloy steel
- Chrome Plated
- Black tip
- 2-component green and black handle

Code	Size
STW46201035	3.5 x 75mm
STW46201040	4 x 100mm
STW46201055	5.5 x 125mm
STW46201065	6.5 x 150mm
STW46201080	8 x 175mm
STW46201100	10 x 200mm
STW46202100	12 x 250mm



## SCREWDRIVER – WORKSHOP DRALL 4621-1

- DIN ISO 2380-1, -2, DIN 5264, ISO 2380-1, -2
- Parallel blade
- Chrome alloy steel
- Chrome Plated
- Black tip
- 2-component green and black handle

Code	Size
STW46211025	2.5 x 80mm
STW46211040	4 x 100mm
STW46211055	5.5 x 120mm
STW46211065	6.5 x 140mm
STW46211080	8 x 160mm



## SCREWDRIVER - D-CLASSIC MECHANICS PATTERN 35521H

- Professional quality mechanics pattern screwdrivers combine comfort and durability to drive screws tighter with less effort
- Heavy round shank blades made of high quality chrome vanadium steel hardened, tempered and satin chrome finish
- Standard tips are precisely cross ground with BLACK-POINT for perfect grip and fit
- Generous size handle is manufactured from high quality translucent PVC with a comfortable grip
- All blades have magnetic tips for screw holding

Code	Size
RIC3220	3.2 x 75mm
RIC3225	4 x 100mm
RIC3230	5 x 150mm



Slotted



## SCREWDRIVER – WORKSHOP DRALL 4622-1

- DIN ISO 2380-1, -2, DIN 5264, ISO 2380-1, -2
- With hexagon
- Chrome alloy steel
- Chrome Plated
- Black tip
- 2-component green and black handle

Code	Size
STW46221055	5.5 x 100mm
STW46221065	6.5 x 125mm
STW46221080	8 x 150mm
STW46221100	10 x 175mm
STW46221140	14 x 250mm



## SCREWDRIVER-ELECTRICIANS 170ELS 410N

- Screwdriver for slotted screws
- Round, chrome plated blade
- Tip: DIN 5264-A, ISO 2380
- Kraftform handle with anti-roll protection, one component

Code	Size
GED36686	2.5 x 75mm
GED36683	3 x 100mm
GED36687	4 x 125mm
GED36688	6.5 x 200mm



Slotted



## SCREWDRIVER – ELECTRICIAN BLACK POINT

- For slotted screws
- Round, chrome plated blade made from high quality bits material
- Tip: DIN 5264-A, ISO 2380
- Kraftform handle of high impact cellulose acetate
- Hexagon shoulder prevents tool roll, one component
- Black point tip blade for accurate dimensions

Code	Size
WEA6000C	2.5 x 75mm
WEA6002C	3.5 x 100mm
WEA6001C	3.5 x 75mm
WEA6005C	4 x 100mm
WEA6006C	4 x 150mm
WEA6004C	4 x 75mm
WEA6008C	5.5 x 100mm
WEA6009C	5.5 x 150mm



Slotted

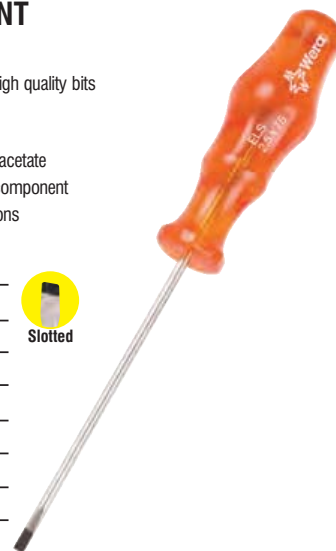



## SCREWDRIVER – ELECTRICIANS - CLASSIC

- For Phillips screws
- Round, chrome plated blade made from high quality bits material
- Tip: DIN 5264-A, ISO 2380
- Kraftform handle black, one component
- Hexagon shoulder prevents tool roll
- Black point tip blade for accurate dimensions

Code	Size
WEA8115B	2.5 x 75mm
WEA8001B	3.5 x 75mm
WEA8002B	3.5 x 100mm
WEA8025B	3.5 x 125mm
WEA8003B	3.5 x 150mm
WEA8004B	4 x 75mm
WEA8005B	4 x 100mm
WEA8006B	4 x 150mm
WEA8007B	4 x 200mm
WEA8026B	4 x 250mm
WEA8008B	5.5 x 100mm
WEA8009B	5.5 x 150mm
WEA8010B	6 x 200mm
WEA8011B	6 x 250mm
WEA8012B	6 x 300mm



Slotted



## SCREWDRIVERS - ELECTRICIAN'S VDE - 4660

- Blade gun finished
- Chrome alloy steel
- 2-component red and yellow handle

Code	Ref	Size
STW46601025	VDE 1	2.5 x 75mm
STW46601030	VDE 2	3 x 100mm
STW46601035	VDE 3	3.5 x 100mm
STW46601040	VDE 4	4 x 100mm
STW46601055	VDE 5	5.5 x 125mm
STW46601065	VDE 6	6.5 x 150mm
STW46601080	VDE 7	8.0 x 175mm



Slotted



## SCREWDRIVER - D-CLASSIC MECHANICS PATTERN 35535H

- Professional quality mechanics pattern screwdrivers combine comfort and durability to drive screws tighter with less effort
- Heavy round shank blades made of high quality chrome vanadium steel hardened, tempered and satin chrome finish
- Standard tips are precisely cross ground with BLACK-POINT for perfect grip and fit
- Generous size handle is manufactured from high quality translucent PVC with a comfortable grip
- All blades have magnetic tips for screw holding
- Hardened tempered satin chrome finish

Code	Size
RIC3280	PH0 x 75mm
RIC3285	PH1 x 75mm
RIC3290	PH2 x 38mm
RIC3295	PH2 x 100mm
RIC3298	PH2 x 150mm
RIC3305	PH3 x 150mm



Phillips



## SCREWDRIVER - PLASTIC HANDLE

- Round steel bars are fully hardened and tempered with forged and ground black tips
- Comfortable plastic handles are impact resistant
- Clearly indicate screwdriver size and type

Code	Size
MTS4335	PH0 x 75mm
MTS4338	PH1 x 100mm
MTS4340	PH2 x 100mm
MTS4343	PH3 x 150mm



Phillips



## SCREWDRIVER – PHILLIPS DRALL 4630

- Phillips-Recess®
- DIN ISO 8764-1, -2, ISO 8764-1, -2
- Chrome Alloy Steel
- Chrome Plated
- Black tips

Code	Size
STW46301000	PH0 x 60mm
STW46301001	PH1 x 80mm
STW46301002	PH2 x 100mm
STW46301003	PH3 x 150mm



Phillips



## SCREWDRIVER-PHILLIPS 160PHS 420N

- For Phillips- Recess screws
- Round blade made from CHROME VANADIUM MOLYBDENUM steel
- Chrome plated
- Satin finish

Code	Size
GED36689	1 x 80mm
GED36890	2 x 100mm
GED36691	3 x 150mm



Phillips





## SCREWDRIVER – PHILLIPS BLACK POINT

- For phillips screws
- Round, chrome plated blade made from high quality bits material
- Tip: DIN 5264-A, ISO 2380
- Kraffform handle of high impact cellulose acetate
- Hexagon shoulder prevents tool roll, one component
- Black point tip blade for accurate dimensions

Code	Size
WEA6028C	0 x 60mm
WEA6029C	1 x 80mm
WEA6030C	2 x 100mm
WEA6031C	2 x 150mm
WEA6033C	3 x 150mm



Phillips



## SCREWDRIVER - PHILLIPS CLASSIC

- For phillips screws
- Round, chrome plated blade made from high quality bits material
- Tip: DIN 5260-PH, ISO 8764-PH
- Kraffform handle black, one component
- Hexagon shoulder prevents tool roll
- Black point tip blade for accurate dimensions

Code	Size
WEA8028B	0 x 60mm
WEA8029B	1 x 80mm
WEA8038B	1 x 200mm
WEA8030B	2 x 100mm



Phillips

Code	Size
WEA8031B	2 x 150mm
WEA8039B	2 x 300mm
WEA8033B	3 x 150mm
WEA8034B	4 x 200mm



## SCREWDRIVER – VDE PHILLIPS DRALL 4665

- Phillips-Recess®, IEC 60900 C
- Safety insulated
- Black gun finish
- Chrome alloy steel
- 2-component red and yellow handle

Code	Size
STW46651001	PH1 x 80mm
STW46651002	PH2 x 100mm



Phillips



## SCREWDRIVER – POZIDRIV 4640

- Pozidriv/Supadriv
- DIN ISO 8764-1, -2, ISO 8764-1, -2
- Chrome alloy steel
- Chrome Plated
- Black tip
- 2-component green and black handle

Code	Size
STW46401001	PZ1 x 80mm
STW46401002	PZ2 x 100mm



Pozi



## POZI SCREWDRIVERS

- Professional quality Pozidriv screwdriver
- Black tips are precisely ground for accuracy
- Handles are high quality translucent PVC
- Shafts / blades are high quality C.V.steel
- Hardened tempered satin chrome finish

Code	Size
RIC3315	PZ1 x 75mm
RIC3320	PZ2 x 100mm



Pozi



## SCREWDRIVER – POZIDRIV BLACK POINT

- For pozidriv screws
- Round, chrome plated blade made from high quality bits material
- Tip: DIN 5264-A, ISO 2380
- Kraffform handle of high impact cellulose acetate
- Hexagon shoulder prevents tool roll, one component
- Black point tip blade for accurate dimensions

Code	Size
WEA6081C	PZ1 x 80mm
WEA6082C	PZ2 x 100mm



Pozi



## SCREWDRIVER - POZIDRIV CLASSIC

- For phillips screws
- Round, chrome plated blade made from high quality bits material
- Tip: ISO 8764-PZ
- Kraffform handle black, one component
- Hexagon shoulder prevents tool roll
- Black point tip blade for accurate dimensions transparent orange

Code	Size
WEA8081B	PZ1 x 75mm
WEA8082B	PZ2 x 100mm



Pozi



## SCREWDRIVER – PHILLIPS -STUBBY DRALL 4734

- PHILLIPS-RECESS
- DIN ISO 8764-1, -2, ISO 8764-1, -2
- Chrome Alloy Steel
- Chrome plated
- Black tip

Code	Size
STW47341001	PH1 x 25mm
STW47341002	PH2 x 25mm



Phillips





## SCREWDRIVER – CARBURETTOR DRALL - 4727

- DIN ISO 2380-1, -2, DIN 5264 ISO 2380-1, -2
- With impact cap and hexagon shank
- Chrome Alloy Steel
- Chrome Plated
- Black tips

Code	Size
STW47241045	3.5 x 25mm
STW47241060	5.5 x 25mm
STW47241080	8 x 25mm



## SCREWDRIVER – POZIDRIV STUBBY DRALL - 4744

- POZIDRIV/SUPRADRIV®
- DIN ISO 8764-1, -2, ISO 8764-1, -2
- Chrome Alloy Steel
- Chrome plated
- Black tip

Code	Size
STW47441001	PZ1 x 25mm
STW47441002	PZ2 x 25mm



## SCREWDRIVER – STUBBY BLACK POINT

- For slotted screws
- Round, chrome plated blade made from high quality bits material
- Tip: DIN 5264-A, ISO 2380
- Kraffform handle of high impact cellulose acetate
- Hexagon shoulder prevents tool roll, one component
- Black point tip blade for accurate dimensions

Code	Size
WEA6027C	5.5 x 40mm
WEA6023C	PH1 x 30mm
WEA6024C	PH2 x 40mm



## SCREWDRIVER - MECHANICS STUBBY CLASSIC

- For slotted screws
- Round, chrome plated blade made from high quality bits material
- Kraffform handle black, one component
- Hexagon shoulder prevents tool roll
- Black point tip blade for accurate dimensions

Code	Size
WEA8027B	5.5 x 40mm
WEA8023B	PH01 x 30mm
WEA8024B	PH02 x 40mm



## SCREWDRIVER-STUBBY

- For slotted screws
- Round blade made from CHROME VANADIUM
- MOLYBDENUM STEEL
- Chrome Plated
- Satin finish

Code	Size	Ref
GED36692	5.5 x 25mm	440N
GED36693	PH2 x 25mm	PHS441N



## SCREWDRIVER – OFFSET – SET 3 PIECE RT35/146B

- Ideal for hard-to-reach places
- Fully hardened and chrome plated alloy steel
- Centre handle, knurled for better grip
- Accurately cross ground tips for an exact fit
- Contents: Flat 5, 6, 8mm  
Phillips No 1, No 2, No 3

Code  
RIC3135



## OFFSET SCREWDRIVERS - 10546

- DIN 5200
- For Slotted screws
- Centre handle, covered with impact proof plastic
- Chrome Vanadium
- Chrome plated

Code	Size	Size
STW73272001	3.5 x 90mm	10546-1
STW73272002	4 x 100mm	10546-2
STW73272003	5.5 x 125mm	10546-3
STW73272004	8 x 150mm	10546-4



## OFFSET SCREWDRIVERS - 10551

- DIN 5200
- For Slotted screws
- Centre handle, covered with impact proof plastic
- Chrome Vanadium
- Chrome plated

Code	Size
STW73282012	PH1 x 2 x 125mm
STW73282023	PH2 x 3 x 125mm



## Wera REVERSIBLE SCREWDRIVER

- Reversible 2 bladed
- Plastic handle
- Fluted grip
- Plated blades
- Carded

Code	Size
WEA8197C	PH2 x 6.5mm



## SCREWDRIVER – BLACK TIP - SET 6 PIECE RT35/556

- Mechanics pattern screwdrivers combine comfort and durability to drive screws tighter with less effort
- Heavy round shank blades made of high quality chrome vanadium steel hardened, tempered and satin chrome finish
- Standard tips are precisely cross ground with "Black-point" for perfect fit and grip
- The generous size handle is manufactured from high quality translucent PVC with comfortable grip
- All blades have magnetic tips for screw holding
- Contents:  
Flat electricians 3.2 x 75, 4 x 100mm  
Flat mechanics 6 x 100, 8 x 150mm  
Phillips No 1 x 80, No 2 x 100mm



Code
RIC3160



## MTS® SCREWDRIVER SET - PLASTIC HANDLE 6 PIECE

- Round steel bars are fully hardened and tempered with forged and ground black tips
- Comfortable plastic handles are impact resistant
- Clearly indicate screwdriver size and type
- Contents:  
3.5 x 75mm  
4.0 x 100mm  
6.0 x 100mm  
8.0 x 150mm  
PH1 x 75mm  
PH2 x 100mm



Code
MTS4350

## MTS® SCREWDRIVER SET - RUBBER HANDLE 7 PIECES

- Comfortable rubber handles are colour coded for ease of recognition - red for slotted and yellow for Phillips
- Contents:  
3.5 x 75mm  
4.0 x 100mm  
6.0 x 100mm  
8.0 x 150mm  
PH0 x 75mm  
PH1 x 75mm  
PH2 x 100mm



Code
MTS4580



## MECHANICS SCREWDRIVER SET 9 PIECES - 4693

- Contents:  
4622: Size 1 5.5 x 100mm  
Size 2 6.5 x 125mm  
Size 3 8.0 x 150mm  
Size 4 10.0 x 175mm  
4628: Size 1 2.5 x 60mm  
4632: Size 1  
Size 2  
4724: Size 2 5.5 x 25mm  
4734: Size 2



Code
STW96469310



## MECHANIC'S SCREWDRIVER SET 7 PIECES - 4691

- Contents:  
4620: Size 1 3.5x 75mm  
Size 2 4.0 x 100mm  
Size 3 5.5 x 125mm  
Size 4 6.5 x 150mm  
4628: Size 1 2.5 x 60mm  
4630: Size 1  
Size 2



Code
STW96469110



## MECHANICS SCREWDRIVER – SET 5 PIECES 4688A

- Mechanics screwdrivers
- Contents:  
4620: Size 1 3.5 x 75mm  
Size 3 5.5 x 120mm  
Size 4 6.5 x 150mm  
4630: Size 1  
Size 2



Code	Size
STW91792082	5 Piece



## SCREWDRIVER SET 6 PIECE MS/6SD

- Mechanic's screwdrivers
- For slotted and recessed screws
- Round blade made from CHROME VANADIUM MOLYBDENUM steel
- Chrome plated, satin finish
- Contents:  
150MS 6.5 x 150mm  
8.0 x 175mm  
160PHS PH1 x 80mm  
PH2 x100mm  
PH3 x150mm  
170ELS 4.0 x 125mm



Code
GED96680



**GEDORE** MADE FOR LIFE **SCREWDRIVER SET 6 PIECE ELS/6SD**

- Electricians screwdrivers
- For slotted and recessed screws
- Round blade made from CHROME VANADIUM MOLYBDENIUM steel
- Chrome plated, satin finish
- Contents:
 

150MS	6.5 x 150mm
160PHS	PH1 x 80mm
	PH2 x 100mm
170ELS	3.0 x 100mm
	4.0 x 125mm
	6.5 x 200mm



**Code**  
**GED96690**



**Wera** **SCREWDRIVER KRAFTFORM RANGE – BLACK POINT – SET 6**

- For slotted & Phillips screws
- Round, chrome plated blade made from high quality bits material
- Kraftform handle of high impact cellulose acetate
- Hexagon shoulder prevents tool roll, one component
- Black point tip blade for accurate dimensions
- Contents:
 

ELS	3 x 80, 4 x 100mm
MS	6.5 x 125, 8 x 150mm
Phillips	1 x 80, 2 x 100mm
- In display carton



Code	Size
<b>WER10001</b>	6 Piece

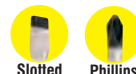

**Wera** **SCREWDRIVER KRAFTFORM RANGE – BLACK POINT – SET 9**

- For slotted & Phillips screws
- Round, chrome plated blade made from high quality bits material
- Kraftform handle of high impact cellulose acetate
- Hexagon shoulder prevents tool roll, one component
- Black point tip blade for accurate dimensions
- Contents:
 

ELS	3 x 80, 4 x 100,
	5.5 x 150mm
MS	6.5 x 125, 8 x 150,
	10 x 150mm
Phillips	1 x 80, 2 x 100mm
Stubby	5.5 x 40mm
- In display carton

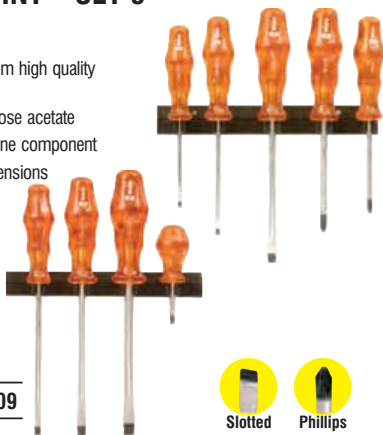

**Code**  
**WER10009**



**STANLEY** **SCREWDRIVER CUSHION GRIP SET 4 PIECES 0-65-244**

- Chrome plated blade ensuring resistance to corrosion
- Soft grip handle for excellent comfort and control
- Smooth domed end ensures fast spinning action with speed and comfort
- Large diameter handle which offers great torque
- Tip identification for easy choice of correct screwdriver
- Magnetic tips
- Contents:
 

Mechanics	5 x 100mm, 6.5 x 150mm
Phillips	No.1 x 100mm, No.2 x 150mm



**Code**  
**STA4800**



**STANLEY** **SCREWDRIVER - SET CUSHION GRIP 6 PIECES 0-65-242**

- Chrome plated blade ensuring resistance to corrosion
- Soft grip handle for excellent comfort and control
- Smooth domed end ensures fast spinning action with speed and comfort
- Large diameter handle which offers great torque
- Tip identification for easy choice of correct screwdriver
- Magnetic tips
- Contents:
 

Mechanics	5 x 100mm, 6.5 x 150mm
Electricians	5 x 100mm, 5 x 150mm
Phillips	No.1 x 100mm, No.2 x 150mm
- Supplied in plastic wallet



**Code**  
**STA4802**



**STANLEY** **SCREWDRIVER - SET 6 PIECES 64 P6**

- Heat treated alloy steel blades
- Hardened tips give non slip fit for use on most stripped screws
- Rust resistant nickel plated blade
- Contents:
 

Slotted:	4.5 x 75 mm
	4.5 x 150 mm
	6.5 x 150 mm
	6.5 x 100 mm
Phillips:	1 x 75 mm
	2 x 100 mm



**Code**  
**STA4815**



**STANLEY** **SCREWDRIVER - SET WITH WALL RACK 6 PIECES 60-060**

- Heat treated alloy steel blades
- Hardened tips give non slip fit for use on most stripped screws
- Rust resistant nickel plated blade
- Contents:
 

Phillips	No.1 x 75mm, No.2 x 100mm
Electricians	5 x 75mm, 5 x 100mm
Mechanics	6 x 100mm, 6 x 150mm



**Code**  
**STA4793**



**STANLEY** **SCREWDRIVER - SET MECHANICS 14 PIECES 65-750**

- Heat treated alloy steel blades
- Hardened tips give non slip fit for use on most stripped screws
- Rust resistant nickel plated blade
- Contents:
 

Slotted:	3 x 45mm, 4 x 75mm
	6 x 38mm, 5 x 100mm
	5 x 150mm, 6 x 150mm
	8 x 200mm, 10 x 250mm
Phillips:	0 x 60 mm
	1 x 35mm
	1 x 100mm
	2 x 150mm
	2 x 200mm
	3 x 150mm



**Code**  
**STA4850**



## STANLEY SCREWDRIVER - SET 20 PIECE 60-220

- Heat treated alloy steel blades
- Hardened tips give non slip fit for use on most stripped screws
- Rust resistant nickel plated blade

Contents:

6 Piece precision 0.1, 1.4, 2.0, 2.4, 3.0mm	Electricians	2 x 75mm
Stubby No2 x 25mm		1 x 150mm
6 x 25mm	Phillips	2 x No.1 x 75mm
Mechanics 1 x 75mm		2 x No.2 x 100mm
2 x 100mm	Offset	No.1Ph x 4mm flat
1 x 150mm		No.1PH x No.2PH

Code

**STA4805**



## RACO SCREWDRIVER INSULATED - SET 6 PIECE RT35/696

- Expert quality, fully insulated according to standard
- DIN, VDE and GS specifications
- Suitable for live line work up to 1000 volts
- Burnished chrome vanadium steel sheathed blades for maximum safety
- Blade and handle are inseparable guaranteeing greater strength high torque and long life
- Ergonomic combination handle with hard – soft touch significantly improves the load factor and prevents slipping in the hand



Top end of handle marked tip type

- Contents: Flat 2.5 x 75, 3 x 100, 5.5 x 125mm
- Phillips No1 x 80, No2 x 100mm
- Electric tester 4 x 100mm

Code

**RIC3098**



## MTS QUALITY TOOLS ELECTRICIANS SCREWDRIVER SET 1000V WITH TESTER

- 7 piece Insulated set
- Burnished chrome blades
- Sheathed for safety
- Suitable for live work to 1000Volts
- Includes electric tester
- Convenient carry case
- Sizes: Slotted: 3.5 x 75mm, 4 x 100mm, 5.5 x 125mm
- Phillips: 0 x 75, 1 x 100, 2 x 100
- Electric tester: 4 x 100



Code	Size
<b>HON7810</b>	7 Piece

## STAHLWILLE ELECTRICIAN'S SCREWDRIVER SET VDE 4695

- IEC 60900 C
- SAFETY INSULATED
- AC 1000 V

- Contents: 4660 VDE: size 1 2.5 x 75mm, size 3 3.5 x 100mm, size 5 5.5 x 125mm, size 6 6.5 x 150mm
- 4665 VDE: size 1, size 2



Code

**STW96469510**

Size

6 Pieces



## STAHLWILLE SCREWDRIVER - ELECTRONICS 7 PIECES 4797

- Contents: 4751: size 4 1.5 x 40mm, size 6 2.0 x 60mm, size 7 2.5 x 75mm, size 8 3.0 x 75mm
- 4752: size 00, size 0, size 1



Code

**STW96479710**

Size

7 Pieces

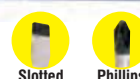

## Wera SCREWDRIVER CLASSIC RANGE - BLACK POINT - SET 6

- For slotted & Phillips screws
- Round, chrome plated blade made from high quality bits material
- Kraffform handle black
- Hexagon shoulder prevents tool roll, one component
- Black point tip blade for accurate dimensions
- Contents: ELS 3 x 80, 4.0 x 100, MLS 5.5 x 125mm, 6.5 x 150mm, Phillips PH1 x 80, PH2 x 100mm
- In display carton

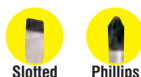

Code

**WER17346**

## Wera SCREWDRIVER CLASSIC RANGE - BLACK POINT - SET 9

- For slotted & Phillips screws
- Round, chrome plated blade made from high quality bits material
- Kraffform handle black
- Hexagon shoulder prevents tool roll, one component
- Black point tip blade for accurate dimensions
- Contents: ELS 3.5 x 75, 4.0 x 100, 5.5 x 150, 6 x 125, 8 x 150, 10 x 175mm, Stubby 5.5 x 40mm, Phillips PH1 x 80, PH2 x 100mm
- In display carton



Code

**WER17349**



## SCREWDRIVER - SET – MAGNETIC 6-IN-1 RT35/135B

- Deluxe design with high security insulated handle
- Ideal for auto, workshop or DIY use
- Hardened steel shaft is vinyl coated for complete insulation with built in hexagon socket end for interchangeable bits
- Extra large plastic handle for comfort and grip with storage space for bits
- Contents: Flat 4, 7mm  
Phillips No 1, No 2  
Pozi driv No 1, No 2



**Code**  
**RIC3125**



## JEWELER'S SCREWDRIVER SET

- Chrome vanadium steel nickel plated
- Swivel head tool bit holder
- Handy plastic box
- Tweezer
- Slotted: 1.4 mm, 2.0 mm, 2.4 mm
- Phillips 0, 1

Code	Size
RIC3115	6 Piece

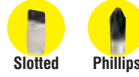

## JEWELER'S SCREWDRIVER SET

- Chrome vanadium steel nickel plated
- Swivel head tool bit holder
- Handy plastic box
- Slotted: 1.4 mm, 2.0 mm, 2.4 mm, 3.0 mm
- Phillips: No.1, No.2

Code	Size
RIC3105	6 Piece



## JEWELER'S 6 PIECE SCREWDRIVER SET

- Each set contains 6 precision jewelers screwdrivers in a clear plastic display case
- Slotted 1.0mm - 1.2mm - 1.8mm - 2.4mm
- Phillips PH0 - PH1

**Code**  
**MTS4360**



## SCREWDRIVER - SET PRECISION 6 PIECE 66-052

- Precision screwdrivers for electronic work
- Swivel head handles provide precision and reach
- Tough plastic shaft with soft cushion grips ensures greater comfort
- Supplied in plastic case
- Contents: Phillips 0, 1  
Flat tips 1.4, 2.0, 20.4, 3.0mm

**Code**  
**STA4857**

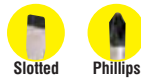

## SCREWDRIVER HOLDER – 10 PIECES

- Handy 270mm telescopic magnetic pick-up tool
- Holder doubles up as a powerful handle
- 8 precision screwdrivers: Slotted 2.0 x 40, 3.0 x 40, 4.0 x 40mm  
Phillips PH00 x 40, PH0 x 40, PH1 x 40mm  
Torx T6 x 40, T7 x 40mm

Code	Size
HON7800	10 Pieces



## SCREWDRIVER - TORX® - SET 5 PIECE RT34/409B

- Precision torx® screwdrivers
- Manufactured fro chrome vanadium steel
- In clear plastic case
- Contents: T6, T7, T8, T9, T10

**Code**  
**RIC3185**



## SCREWDRIVER - RACO-D-TUF TORX® – SET 6 PIECE TR35/665

- Torx® drivers are rapidly taking over conventional driving types, providing faster more efficient driving without slippage
- Transmits more torque to the fastener
- Unique screw tip offers many advantages particularly in automotive industry
- These professional quality screwdrivers with high quality chrome vanadium steel blades and satin chrome finish have special tips with precisely rounded corners
- Hexagon torque profile eliminates tension points on both the screw head and the screwdriver reducing wear and damage
- Contents: T10, T15, T20, T25, T27, T30

**Code**  
**RIC3183**





## SCREWDRIVER – TORX® DRALL 4650

- Inside TORX® screws
- Chrome alloy steel
- Chrome Plated
- Black tip
- 2-component green and black handle



Code	Size
STW46501006	T6
STW46501007	T7
STW46501008	T8
STW46501009	T9
STW46501010	T10
STW46501015	T15
STW46501020	T20
STW46501025	T25
STW46501027	T27
STW46501030	T30
STW46501040	T40
STW46501045	T45



## SCREWDRIVER - MAGNETIC KIT 12 PIECE RT35/84B

- Impact resistant plastic T handle for high torque transmission with storage space for bits
- Hardened steel shaft
- Interchangeable bits
- Contents:  
Magnetic T - handle  
Flat 3, 4, 5, 6, 8mm  
Phillips No 0, No 1, No 2  
Pozi driv No 1, No 2, No 3



Code  
**RIC3120**



## SCREWDRIVER – TORX – BLACK POINT

- For Torx screws
- Round, chrome plated blade made from high quality bits material
- Tip: DIN 5264-A, ISO 2380
- Kraftform handle of high impact cellulose acetate
- Hexagon shoulder prevents tool roll, one component
- Black point tip blade for accurate dimensions



Code	Size	Code	Size
WEA6306C	TX6	WEA6315C	TX15
WEA6307C	TX7	WEA6320C	TX20
WEA6308C	TX8	WEA6325C	TX25
WEA6309C	TX9	WEA6327C	TX27
WEA6310C	TX10	WEA6330C	TX30
		WEA6340C	TX40



## SCREWDRIVER – TORX® T-HANDLE 10769

- For inside TORX® screws
- Shaft nickel plated and chrome plated
- Tips hardened
- Chrome Vanadium
- Matt chrome plated
- Black tips



Code	Size
STW43290008	T8
STW43290009	T9
STW43290010	T10
STW43290015	T15
STW43290020	T20
STW43290025	T25
STW43290027	T27
STW43290030	T30
STW43290040	T40
STW43290045	T45
STW43290050	T50
STW43290055	T55



## SCREWDRIVER – TORX – BLACK POINT – SET 11

- Screwdriver for Torx screws
- Round, chrome plated blade
- Kraftform handle with anti-roll protection, one component
- Content: TX6, TX7, TX8, TX9, TX10, TX15, TX20, TX25, TX27, TX30, TX40
- In display carton



Code  
**WER6334**



General Tools



## SCREWDRIVER – RATCHET KIT 23 PIECE RT35/117B

- With hexagon bit holding adaptor
  - 3-position ratchet for left or right hand rotation and lock
  - Comfortable grip is moulded from impact plastic with attractive two colours
  - Chrome vanadium hexagon bits
  - Contents:
- Ratchet stubby screwdriver  
Extension bit holder  
Socket adaptor  
1/4" dr sockets: 5, 5.5, 6, 7, 8, 9, 10, 11mm  
Flat : 4, 5, 6mm  
Hex bits : H4, H5, H6  
Phillips : No 1, No 2, No 3  
Pozi driv : No 1, No 2, No 3



**Code**  
**RIC3145**



## SCREWDRIVER – RATCHET - STUBBY RT35/11B

- With hexagon bit holding adaptor
  - 3-position ratchet for left or right hand rotation and lock
  - Comfortable grip is moulded from impact plastic with attractive two colours
  - Chrome vanadium hexagon bits
  - Contents:
- Flat 4, 6mm  
Phillips No 1, No 2  
Pozi driv No 1, No 2



**Code** | **Size**  
**RIC3140** | 7 Piece



## **STANLEY** SCREWDRIVER – YANKEE HEAVY DUTY 3-68-131

- Top quality spiral ratchet screwdriver with automatic spring return with spiral locks to allow use in a closed position
- Designed for hard work with smooth operation 3 position ratchet shifter and comfortable moulded handle
- Supplied with 2 standard slotted blades and 2 phillips bits

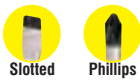

**Code** | **Length**  
**STA4775** | 714mm



## IMPACT DRIVER KIT

- Machine from selected alloy tool steel, hardened and tempered for long service life
  - Strike anvil end with hammer to loosen stubborn screws
  - Reverse direction to tighten screws
  - Knurled chrome plated handle
  - Contents:
- 1/2" square drive hex adaptor  
Flat bits 36mm long - 8, 10mm  
Phillips bits 36mm long - No 2, No 3



**Code** | **Desc.**  
**RIC1850** | Driver Kit  
**RIC1860** | Spare Bits



## IMPACT DRIVER SET - 040101

- An impact driver is a tool that delivers a strong, sudden rotational and downward force
- In conjunction with toughened screwdriver bits they are often used by mechanics to loosen larger screws (bolts) and (nuts) that are corrosively "frozen" or over-torqued
- The direction can also be reversed
- Use with a medium weight hammer, to loosen stubborn screws and nuts
- Ideal for removal of door hinge brackets
- Supplied with a range of inter-changeable bits

**Code**  
**SYK040101**





## POWER SCREWDRIVER BIT DOUBLE - LONG PATTERN - 65mm

- Manufactured from special chrome molybdenum vanadium
- Tempered and hardened to HRC58-62
- Long pattern allows for increased visibility of workpiece
- Accurately ground tips for perfect fit
- Bits are shot blasted anodize finish
- For use with electric power tools, air tools and bit holder screwdrivers
- 1/4" hexagon shank



### Bit - Power Double Philips X

Code	Size	Ref	Pack
<b>RIC0500</b>	PH No.1 x PZ No.1	352135B	1
<b>RIC0502</b>	PH No.2 x PZ No.2	352136B	1
<b>RIC0504</b>	PH No.3 x PZ No.3	352137B	1

### Bit - Power Double Pozi X

Code	Size	Ref	Pack
<b>RIC0505</b>	PZ No.1 x PZ No.2	352115B	1

### Bit - Power Double Slot X

Code	Size	Ref	Pack
<b>RIC0510</b>	4mm x 5mm Slot	352102B	1
<b>RIC0512</b>	6mm x 7mm Slot	352105B	1



## POWER SCREWDRIVER BIT SHORT PATTERN

- Manufactured from special chrome molybdenum vanadium
- Tempered and hardened to HRC58-62
- Accurately ground tips for perfect fit
- Bits are shot blasted anodize finish
- For use with electric power tools, air tools and bit holder screwdrivers
- 1/4" hexagon shank



### Bit - Power Pozi

Code	Size	Ref	Pack
<b>RIC0534</b>	PZ No.2	353032B	100

### Bit - Power Slot

Code	Size	Ref	Pack
<b>RIC0550</b>	0.6 x 4.5 x 25mm	352002B	2
<b>RIC0552</b>	0.8 x 5.5 x 25mm	352004B	2
<b>RIC0554</b>	1.0 x 6.0 x 25mm	352005B	2
<b>RIC0556</b>	1.2 x 6.5 x 25mm	352006B	2
<b>RIC0558</b>	1.6 x 8.0 x 25mm	352008B	2

### Bit - Power Philips

Code	Size	Ref	Pack
<b>RIC0535</b>	PH No.1 x 25mm	352021B	2
<b>RIC0537</b>	PH No.2 x 25mm	352022B	2
<b>RIC0540</b>	PH No.3 x 25mm	352023B	2

### Bit - Power Pozi

Code	Size	Ref	Pack
<b>RIC0545</b>	PZ No.1 x 25mm	352031B	2
<b>RIC0546</b>	PZ No.2 x 25mm	352032B	2
<b>RIC0548</b>	PZ No.3 x 25mm	352033B	2

### Bit - Power Hex

Code	Size	Ref	Pack
<b>RIC0515</b>	3mm x 25mm	352051B	2
<b>RIC0520</b>	4mm x 25mm	352052B	2
<b>RIC0525</b>	5mm x 25mm	352053B	2
<b>RIC0530</b>	6mm x 25mm	352054B	2

# Awls



## PIERCING AWL

- Used primarily for starting holes for screws to prevent the wood from splitting



Code	Size
<b>HON0523</b>	6.5 x 100mm

## STANLEY BRADAWL 1-69-014

- Strong plastic handle
- Hardened and tempered chisel point blade
- Nickel plated, for best protection
- Blade shaft cranked to avoid turning in handle



Code	Size
<b>STA2480</b>	2.5 x 32mm



## ALLEN KEYS - STANDARD SERIES METRIC/SAE

- Special steel
- Hardened & tempered
- Black finish



Code	Size	Code	Size	Code	Size
FUH0910	1.0mm	FUH0995	11.0mm	FUH1080	1/16
FUH0920	1.5mm	FUH1000	12.0mm	FUH1085	5/64
FUH0925	2.0mm	FUH1005	13.0mm	FUH1090	3/32
FUH0930	2.5mm	FUH1010	14.0mm	FUH1095	7/64
FUH0940	3.0mm	FUH1015	15.0mm	FUH1100	1/8
FUH0945	3.5mm	FUH1020	16.0mm	FUH1105	9/64
FUH0950	4.0mm	FUH1025	17.0mm	FUH1110	5/32
FUH0955	4.5mm	FUH1030	18.0mm	FUH1115	3/16
FUH0960	5.0mm	FUH1035	19.0mm	FUH1120	7/32
FUH0965	5.5mm	FUH1040	20.0mm	FUH1125	1/4
FUH0970	6.0mm	FUH1045	21.0mm	FUH1135	5/16
FUH0975	7.0mm	FUH1050	22.0mm	FUH1145	3/8
FUH0980	8.0mm	FUH1055	24.0mm	FUH1150	7/16
FUH0985	9.0mm	FUH1060	27.0mm	FUH1155	1/2
FUH0990	10.0mm			FUH1160	9/16
				FUH1165	5/8
				FUH1170	3/4
				FUH1175	7/8



## ALLEN KEYS - LONG SERIES METRIC/SAE

- Special steel
- Hardened & tempered
- Black finish



Code	Size	Code	Size
FUH0280	1.5mm	FUH0405	1/16
FUH0285	2.0mm	FUH0410	5/64
FUH0290	2.5mm	FUH0415	3/32
FUH0295	3.0mm	FUH0420	1/8
FUH0300	3.5mm	FUH0425	9/64
FUH0305	4.0mm	FUH0430	5/32
FUH0310	4.5mm	FUH0435	3/16
FUH0315	5.0mm	FUH0440	7/32
FUH0320	5.5mm	FUH0445	1/4
FUH0325	6.0mm	FUH0455	5/16
FUH0330	7.0mm	FUH0465	3/8
FUH0335	8.0mm	FUH0475	1/2
FUH0340	9.0mm	FUH0480	9/16
FUH0345	10.0mm	FUH0485	5/8
FUH0350	11.0mm	FUH0490	3/4
FUH0355	12.0mm		
FUH0360	13.0mm		
FUH0365	14.0mm		
FUH0370	15.0mm		
FUH0380	17.0mm		
FUH0390	19.0mm		
FUH0395	22.0mm		



## ALLEN KEYS - HEXAGON 10760CV/10760ACV METRIC/SAE

- DIN ISO2936 (metric) for socket head screws
- Chrome Vanadium
- Nickel plated



Code	Size	Code	Size	Code	Size
STW43150150	1.5mm	STW43150009	9.0mm	STW43550005	5/64
STW43150002	2.0mm	STW43150010	10.0mm	STW43550006	3/32
STW43150250	2.5mm	STW43150011	11.0mm	STW43550007	7/64
STW43150003	3.0mm	STW43150012	12.0mm	STW43550008	1/8
STW43150350	3.5mm	STW43150014	14.0mm	STW43550009	9/64
STW43150004	4.0mm	STW43150017	17.0mm	STW43550012	3/16
STW43150005	5.0mm	STW43150019	19.0mm	STW43550016	1/4
STW43150006	6.0mm	STW43150022	22.0mm	STW43550018	9/32
STW43150007	7.0mm	STW43150024	24.0mm	STW43550024	3/8
STW43150008	8.0mm	STW43150027	27.0mm		



## ALLEN KEYS - HEXAGON EXTRA LONG - 10765 - METRIC

- DIN ISO 2936 (metric) for socket head screws
- Chrome Vanadium
- Nickel plated



Code	Size
STW43210025	2.5mm
STW43210003	3.0mm
STW43210004	4.0mm
STW43210005	5.0mm
STW43210006	6.0mm
STW43210008	8.0mm
STW43210009	9.0mm
STW43210017	17.0mm



## ALLEN KEY SET - 25 PIECE - METRIC/SAE

- A professional quality combination set with 13 short arm metric keys and 12 long arm SAE keys
- All keys are manufactured from chrome molybdenum / vanadium steel, correctly hardened and tempered for maximum torque
- Black, rust proof finish
- Sizes: 13 short arm (metric)  
1.5, 2, 2.5, 3, 4, 4.5, 5, 5.5, 6, 7, 8, 9, 10mm
- Sizes: 12 long arm (SAE)  
1/16, 5/64, 3/32, 7/64, 1/8, 9/64, 5/32, 3/16, 7/32, 1/4, 5/16, 3/8"
- Supplied in a convenient pocket pouch

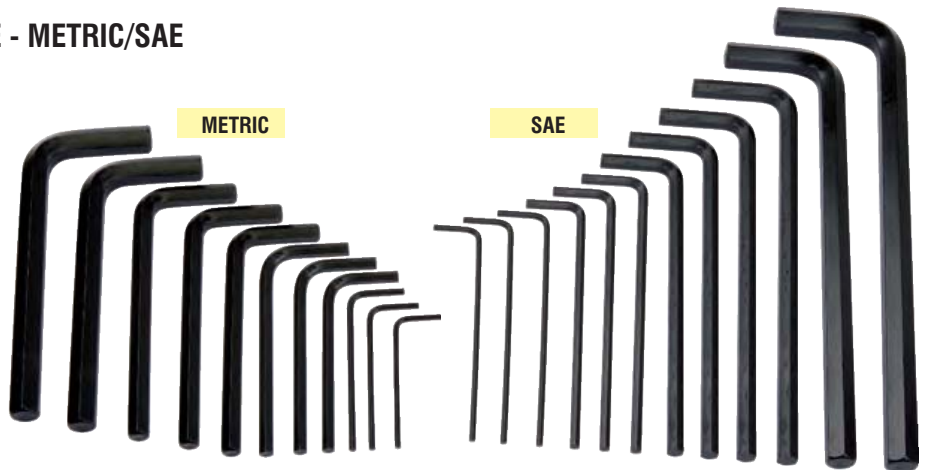

Code  
RICO230



## HEX KEY SET - 25 PIECE - METRIC/SAE

- Heavy duty
- Super long
- Carbon steel
- Short arm series metric 13 pieces, 1,5 - 10mm
- Long arm series S.A.E. 12 pieces, 1/16" - 3/8"
- Supplied in a convenient PVC pouch

Code	Size
MTS1653	25 pce

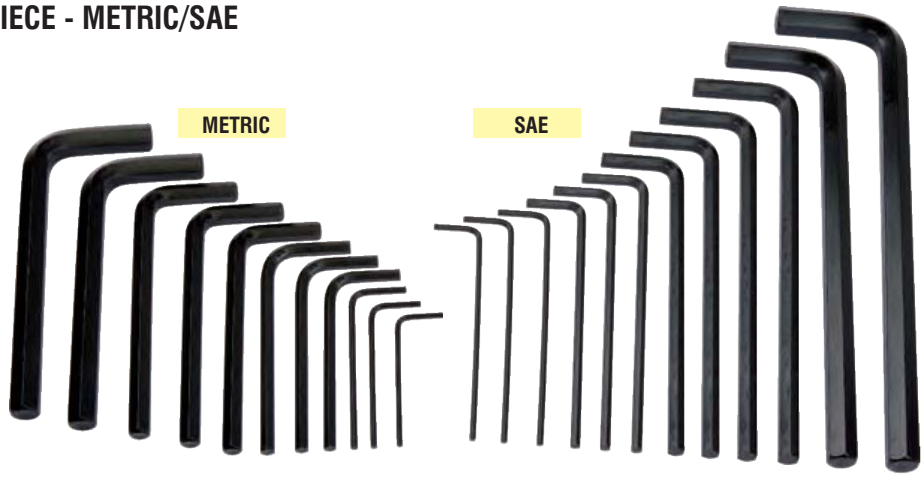

## ALLEN KEY SET - 11 PIECE STANDARD SERIES

- Sizes: 1,5; 2; 2,5; 3; 4; 5; 6; 7; 8; 10; 12
- Chrome Vanadium-Molybdenum-Steel (59Cr-mo-V4)
- Steel grey
- Supplied in a PVC wallet



Code
FUH1430



## ALLEN KEY SET - 14 PIECE STANDARD SERIES

- Sizes: 1,5; 2; 2,5; 3; 4; 5; 6; 7; 8; 10; 12; 14; 17; 19
- Chrome Vanadium-Molybdenum-Steel (59Cr-mo-V4)
- Steel grey
- Supplied in a PVC wallet



Code
FUH1440



## ALLEN KEY SET - 11 PIECE STANDARD SERIES

- Sizes: 1/16; 5/64; 3/32; 1/8; 5/32; 3/16; 1/4; 5/16; 3/8; 7/32; 1/2
- Chrome Vanadium-Molybdenum-Steel (59Cr-mo-V4)
- Steel grey
- Supplied in a PVC wallet



Code
FUH1470



## ALLEN KEY SET - 11 PIECE LONG SERIES

- Sizes: 1,5; 2; 2,5; 3; 4; 5; 6; 7; 8; 10; 12mm
- Chrome Vanadium-Molybdenum-Steel (59Cr-mo-V4)
- Steel grey
- Supplied in a PVC wallet



Code
FUH1420



## ALLEN KEY SET - 11 PIECE LONG SERIES

- Sizes: 1/16; 5/64; 3/32; 1/8; 5/32; 3/16; 1/4; 5/16; 3/8; 7/32; 1/2
- Chrome Vanadium-Molybdenum-Steel (59Cr-mo-V4)
- Steel grey
- Supplied in a PVC wallet



Code
FUH1460



## ALLEN KEY SET - 8 PIECE STANDARD SERIES

- 1,5, 2, 2,5, 3, 4, 5, 5,5, 6mm
- A professional quality key set manufactured from chrome molybdenum/vanadium steel, correctly hardened and tempered for maximum torque
- Black rust-proof finished and with key ring



Code
RIC0210

General Tools





### ALLEN KEY SET - 10 PIECE STANDARD SERIES

- Sizes: 1.5, 2, 2.5, 3, 4, 5, 5.5, 6, 8, 10mm
- Professional quality key set manufactured from chrome molybdenum / vanadium steel, correctly hardened and tempered for maximum torque
- Black, rust proof finish with key ring



**Code**  
**RIC0215**



### ALLEN KEY SET - 10 PIECE STANDARD SERIES

- Sizes: 1/16, 5/64, 3/32, 1/8, 5/32, 3/16, 7/32, 1/4, 5/16, 3/8"
- Professional quality key set manufactured from chrome molybdenum / vanadium steel, correctly hardened and tempered for maximum torque
- Black, rust proof finish with key ring



**Code**  
**RIC0220**



### HEX KEY SET - 8 PIECE STANDARD SERIES

- Sizes: 1.5, 2, 2.5, 3, 4, 5, 6mm
- Carbon steel
- Chrome plated



**Code**  
**MTS1650**



### HEX KEY SET - 8 PIECE STANDARD SERIES

- Sizes: 2-10mm
- Carbon steel
- Chrome plated



**Code**  
**MTS1651**



### ALLEN KEY HEXAGON SET 9 PIECES - 10760CV9PC

- For Socket head screws
- Chrome Vanadium
- Nickel plated
- In holder
- Contents: 1.5, 2, 2.5, 3, 4, 5, 6, 8, 10mm



**Code**  
**STW96431501**



### ALLEN KEY HEXAGON SET 9 PIECES - 10760ACV10PC

- For socket head screws
- Chrome Vanadium
- Nickel plated
- In holder
- Contents: 1/16", 5/64", 3/32", 1/8", 5/32", 3/16", 7/32", 1/4", 5/16", 3/8"



**Code**  
**STW96435501**



### HEX KEY SET - 8 PIECE - 42-88M STANDARD SERIES

- For hexagon socket head bolts
- Chrome Vanadium Steel – 59CrV14
- Gun metal finish
- Short series
- Plastic holder
- Contents: 42 2, 2.5, 3, 4, 5, 6, 8, 10mm



**Code**  
**GED012104**



### HEX KEY SET - 10 PIECE - 42-100M STANDARD SERIES

- For hexagon socket head bolts
- Chrome Vanadium Steel – 59CrV14
- Gun metal finish
- Short series
- Plastic wallet
- Contents: 42 2, 2.5, 3, 4, 5, 6, 7, 8, 9, 10mm



**Code**  
**GED012111**



### HEX KEY SET - 8 PIECE - 42-8M STANDARD SERIES

- For hexagon socket head bolts
- Chrome Vanadium Steel – 59CrV14
- Gun metal finish
- Short series
- Plastic holder
- Contents: 42 3, 4, 5, 6, 8, 10, 12, 14mm



**Code**  
**GED012102**



### HEX KEY SET - 9 PIECE - 42-9 PIECE STANDARD SERIES

- For hexagon socket head bolts
- Chrome Vanadium Steel – 59CrV14
- Gun metal finish
- Short series
- Plastic holder
- Contents: 42 1/16", 5/64", 3/32", 1/8", 5/32", 3/16", 1/4", 5/16", 3/8"

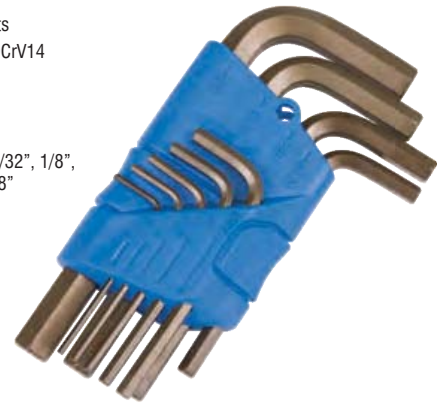

**Code**  
**GED012154**



### ALLEN KEY SET - HEXAGONAL - BELT CLIP 12 PIECE

- Sizes: 050, 1/16, 5/64, 3/32, 7/64, 1/8, 9/64, 5/32, 3/16, 7/32, 1/4, 5/16
- Chrome -Vanadium-Molybdenum-Steel (59Cr-mo-V4)
- Black finish
- Ball clip



**Code**  
**FUH1473**



### ALLEN KEY SET - KNIFE TYPE - 7 PIECE

- Sizes: 2.5, 3, 4, 5, 6, 8, 10mm
- Manufactured from chrome molybdenum / vanadium steel
- Black rust proof finish and specially heat treated
- Hardened nickel plated heavy-gauge steel holder / handle
- Key wrenches can be used straight or at a right angle for extra leverage



**Code**  
**RIC0227**



### ALLEN KEY SET - KNIFE TYPE - 6 PIECE

- Sizes: 1/8; 5/32; 3/16; 7/32; 1/4; 5/16
- Chrome -Vanadium-Molybdenum-Steel (59Cr-mo-V4)
- Black finish



**Code**  
**FUH1475**



### ALLEN KEY SET - KNIFE TYPE - 7 PIECE

- 1.5 2, 2.5, 3, 4, 5, 6mm
- Fold up knife type set
- Chrome -Vanadium-Molybdenum-Steel (59Cr-mo-V4)
- Strength: Following the specifications of the licensor Camcar Textron USA
- Folder nickel plated
- Steel grey



**Code**  
**FUH1450**



### ALLEN KEYS - T HANDLE

- Chrome-Vanadium-Molybdenum-Steel (59 Cr-Mo-V4)
- Nickel plated - key ends chamfered
- Handle: ABS Terpolymer - shock resistant red with a hook hole



Code	Size
FUH1500	2.0 x 100mm
FUH1510	2.5 x 100mm
FUH1520	3.0 x 100mm
FUH1530	4.0 x 100mm

Code	Size
FUH1540	5.0 x 100mm
FUH1550	6.0 x 150mm
FUH1560	8.0 x 150mm
FUH1570	10.0 x 200mm



### ALLEN KEY SET - T HANDLE - 7 PIECE

- Sizes: 2 x 100; 2.5 x 100; 3 x 100; 4 x 150; 5 x 150; 6 x 200; 8 x 200
- Chrome-Vanadium-Molybdenum-Steel (59 Cr-Mo-V4)
- Nickel plated - key ends chamfered
- Handle: ABS Terpolymer - shock resistant red with a hook hole
- With metal stand



**Code**  
**FUH1485**



## ALLEN KEY - BALL POINT LONG SERIES

- Long series
- Chrome Vanadium-Molybdenum-Steel (59Cr-mo-V4)
- Ball end allows angle access up to 30% off vertical
- Special steel
- Hardened and tempered
- Black finish

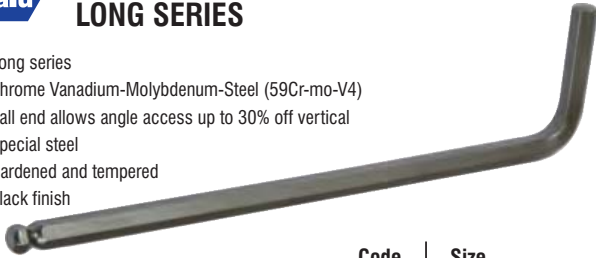

Code	Size	Code	Size
FUH0220	1.5mm	FUH0240	4.0mm
FUH0225	2.0mm	FUH0245	5.0mm
FUH0230	2.5mm	FUH0250	6.0mm
FUH0235	3.0mm	FUH0255	8.0mm
		FUH0260	10.0mm



## HEX KEY SET - BALL POINT - LONG 7 PIECE

- Sizes: 2.5, 3, 4, 5, 6, 8, 10mm
- Carbon steel



**Code**  
**MTS1655**



## ALLEN KEY SET - BALL POINT - LONG 7 PIECE

- Sizes: 2.5, 3, 4, 5, 6, 8, 10mm
- Professional quality key set manufactured from chrome molybdenum / vanadium steel, correctly hardened and tempered for maximum torque
- Set in a handy plastic case for convenience



**Code**  
**RIC0205**



## ALLEN KEY SET - BALL POINT - LONG 7 PIECE

- Sizes: 3/32, 1/8, 5/32, 3/16, 1/4, 5/16, 3/8"
- Professional quality key set manufactured from chrome molybdenum / vanadium steel, correctly hardened and tempered for maximum torque
- Set in a handy plastic case for convenience



**Code**  
**RIC0200**



## ALLEN KEY SET - BALL POINT - LONG 9 PIECE

- Sizes: 1.5, 2, 2.5, 3, 4, 5, 6, 8, 10mm
- Professional quality key set manufactured from chrome molybdenum / vanadium steel, correctly hardened and tempered for maximum torque
- Extra long pattern with satin-nickel finish
- Set in a handy plastic case for convenience



**Code**  
**RIC0195**



## ALLEN KEY SET - BALL POINT - LONG 9 PIECE

- Sizes: 1.5, 2, 2.5, 3, 4, 5, 6, 8, 10mm
- Chrome -Vanadium-Molybdenum-Steel (59Cr-mo-V4)
- Angle entry up to 30°
- Black finish
- Ball clip



**Code**  
**FUH1410**



## ALLEN KEYS - BALL TYPE - T HANDLE

- Raco T handle design provides greater leverage for maximum torque
- Manufactured from high quality S2 steel with satin nickel finish
- Precision drawn to close tolerances for accurate fit and chamfered ends for easy insertion
- Large comfortable plastic handle with soft-touch TPR grip



Code	Size
RIC6450	2,0mm
RIC6455	2,5mm
RIC6460	3,0mm
RIC6465	4,0mm
RIC6470	5,0mm
RIC7475	6,0mm
RIC6480	7,0mm
RIC6485	8,0mm
RIC6490	10,0mm



## ALLEN KEY SET - BALL TYPE - T HANDLE 7 PIECE

- Sizes: 2.5, 3, 4, 5, 6, 8, 10mm
- Raco T handle design provides greater leverage for maximum torque
- Manufactured from high quality S2 steel with satin nickel finish
- Precision drawn to close tolerances for accurate fit and chamfered ends for easy insertion
- Large comfortable plastic handle with soft-touch TPR grip



**Code**  
**RIC6500**



### ALLEN KEY SET - TORX - CLIP 9 PIECE

- Sizes: T10, T15, T20, T25, T27, T30, T40, T45, T50
- Professional quality key set manufactured from chrome molybdenum / vanadium steel, correctly hardened and tempered for maximum torque
- Long pattern with satin-nickel finish
- Set in a handy plastic case for convenience



Code  
**RIC0197**



### ALLEN KEY SET - TORX - KNIFE TYPE 8 PIECE

- Sizes: T9, T10, T15, T20, T25, T27, T30, T40
- Manufactured from chrome molybdenum / vanadium steel
- Black rust proof finish and specially heat treated
- Hardened nickel plated heavy-gauge steel holder / handle
- Key wrenches can be used straight or at a right angle for extra leverage



Code  
**RIC0208**



### ALLEN KEY SET - TORX - KNIFE TYPE 8 PIECE

- Sizes: T9, T10, T15, T20, T25, T27, T30, T40
- Carbon steel
- Black finish



Code  
**MTS1663**



### ALLEN KEY SET - TORX - KNIFE TYPE 8 PIECE

- Sizes: T9, T10, T15, T20, T25, T27, T30, T40
- Chrome-Vandium-Molybdenum-Steel (59Cr-mo-V4)
- Folder nickel plated
- Steel grey



Code  
**FUH1400**

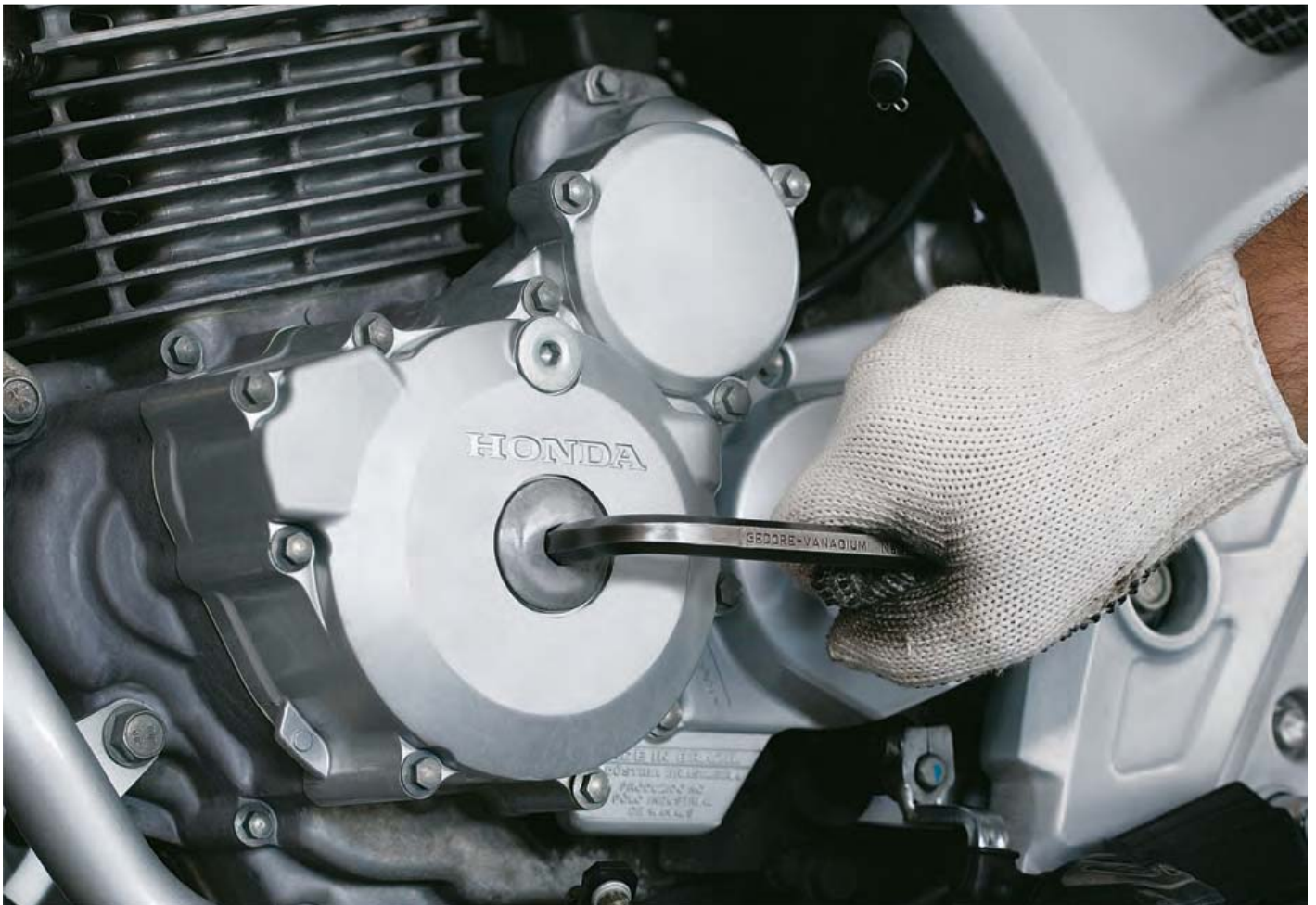



### COMBINATION PLIERS YELLOW/BLACK HANDLE

- All purpose plier for cutting and gripping
- Satin finish
- Drop forged carbon steel for strength
- Induction hardened edges for cleaner cutting and durability
- Non-slip double cushion grips for comfort
- Nickel Plated
- Lifetime guarantee



Code	Size
MTS3780	150mm
MTS3784	180mm
MTS3786	200mm



### COMBINATION PLIERS

- All purpose plier for cutting and gripping
- Drop forged carbon steel for strength
- Induction hardened edges for cleaner cutting and durability
- Non-slip cushion grips for comfort

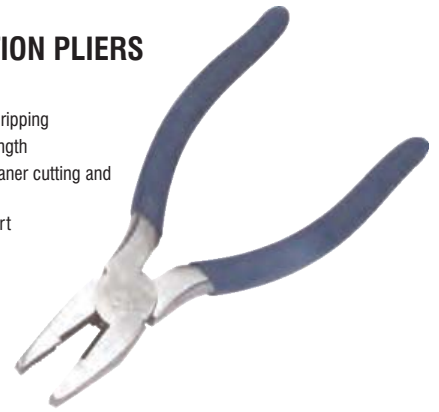

Code	Size
MTS3790	160mm
MTS3800	180mm
MTS3810	200mm



### COMBINATION PLIER - PROFI-PLUS RT22/250-7H

- Manufactured from high grade chrome vanadium tool steel to DIN specification 5244
- Hardened tempered Cutting edges are induction hardened to 60HRC to guarantee efficient cutting performance and increased durability
- For hard and soft wire
- Head smoothly ground and satin chrome plated for protection against rust
- Extra heavy duty insulated handle with slip guards and comfortable soft-touch grip provide maximum protection



Code	Size
RIC2415	175mm



### COMBINATION PLIERS

- Manufactured from high grade chrome vanadium tool steel to DIN specification 5244
- Smoothly ground satin-chrome plated head
- Cutting edges induction hardened to 60HRC
- For hard and soft wire



Code	Size	Ref.
RIC2420	175mm	RT22/152H
RIC2430	200mm	RT22/153H



### COMBINATION PLIERS HEAVY DUTY

- Dynagrip
- General purpose
- Comfort grip handles



Code	Size	Ref
STA7300	150mm	84-623
STA7310	180mm	84-855



### COMBINATION PLIERS

- DIN ISO 5746
- Precision cutter for all wires including piano wire
- Induction hardened cutting edges ± 62 HRC for long life



Code	Size	Ref
STW64016160	160mm	6501-160
STW64016180	180mm	6501-180
STW64016200	200mm	6501-200

### Will COMBINATION PLIERS

- General purpose use
- Hardened and tempered
- PVC coated handle A3

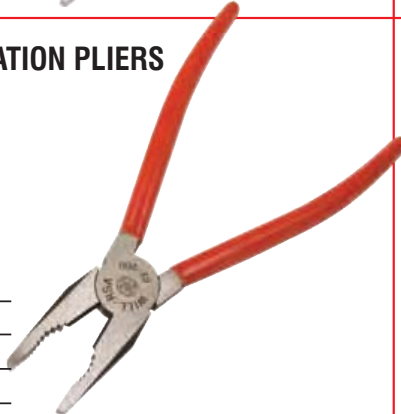

Code	Size	Ref
WIL0265	160mm	62-160
WIL0270	180mm	62-180
WIL0275	200mm	62-200

### Will COMBINATION PLIER HEAVY DUTY

- Professional quality
- High leverage handle
- Extra long cutting edge
- Special steel
- Pipe grip

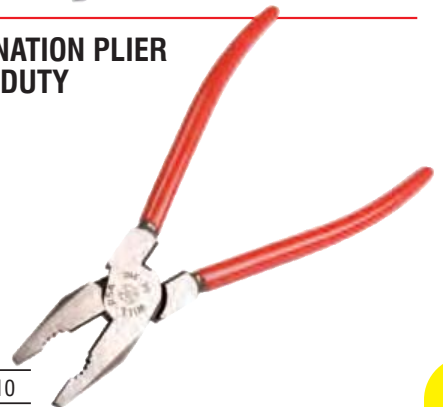

Code	Size	Ref
WIL0280	210mm	66-210

### Will COMBINATION PLIERS - VDE

- General purpose use
- Hardened and tempered
- Heavy duty insulation handle

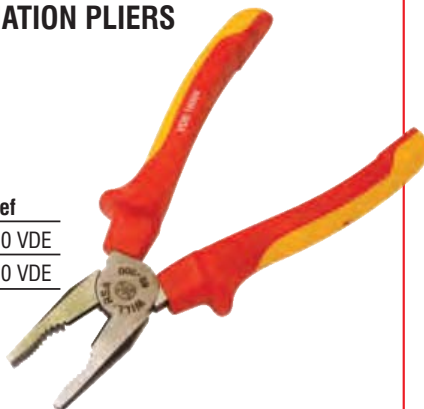

Code	Size	Ref
WIL0264	180mm	62-180 VDE
WIL0273	200mm	62-200 VDE

### Crescent COMBINATION PLIERS

- Professional quality
- Insulated handles

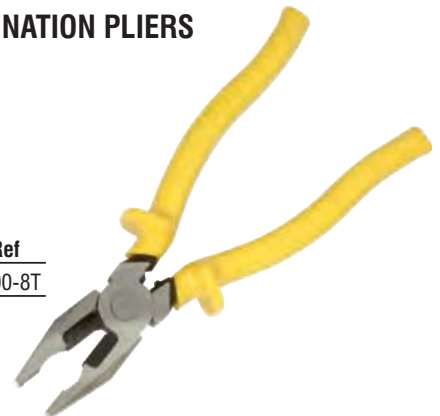

Code	Size	Ref
CRE0040	200mm	3800-8T



### COMBINATION PLIERS HEAVY DUTY

- For heavy continuous
- Good lever action for easy cutting
- Induction- hardened precision cutting edges
- Hardness ± 63 HRC
- To cut all wire types including piano wire
- Copyrighted design
- DIN ISO 5746

Code	Size	Ref
GED6707070	180mm	8250-180JC
GED6707310	200mm	8250-200JC



### COMBINATION PLIERS HEAVY DUTY

- For heavy continuous
- Good lever action for easy cutting
- Induction- hardened precision cutting edges
- Hardness ± 63 HRC
- To cut all wire types including piano wire
- Copyrighted design
- DIN ISO 5746

Code	Size	Ref
GED6708040	225mm	8250-225TL



### COMBINATION PLIERS

- Universal model with slimline head
- Induction hardened precision cutting edges
- Hardness ± 62 hrc
- For medium-hard and hard wire
- DIN ISO 5746

Code	Size	Ref
GED6730050	160mm	8245-160TL
GED6730210	180mm	8245-180TL
GED6730720	200mm	8245-200TL



### COMBINATION PLIERS FATMAX

- Bi-Material handle with secure grip grooving
- Heat treated high chrome steel forging for long life and durability
- Hand ground, induction hardened blade
- Interlocking joint assembly for smooth cutting

Code	Size	Ref.
STA7316	180mm	0-89-867
STA7317	200mm	0-89-868



### LINESMAN PLIERS HEAVY DUTY

- Forged from carbon steel
- Induction hardened and tempered for longer performance
- Close fit machined jaws
- Bi- Material handles for comfort and grip even with oily hands

Code	Size	Size
STA7455	200mm	0-84-056
STA7435	228mm	84-154

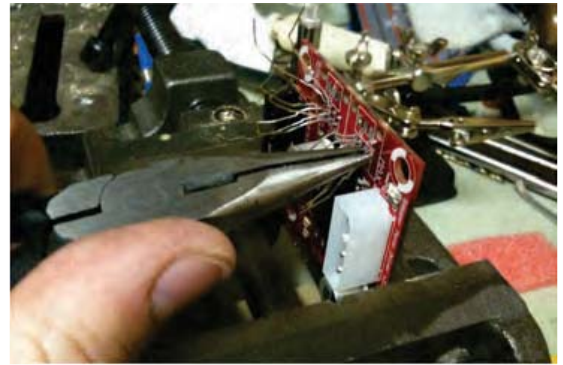

### LONG NOSE PLIERS

- Long, fine serrated jaws for electrical and general work
- Drop forged carbon steel
- Induction hardened edges for cleaner cutting and durability
- Non-slip cushion grips for comfort

Code	Size
MTS3840	150mm
MTS3850	200mm



### LONG NOSE PLIERS

- Manufactured from high grade chrome vanadium tool steel
- to DIN specification 5236A
- Smoothly ground satin-chrome plated head
- Cutting edges induction hardened to 60HRC
- For hard and soft wire 150 mm

Code	Size	Ref.
RIC2560	150mm	RT22/252-6C
RIC2565	200mm	RT22/252-8C

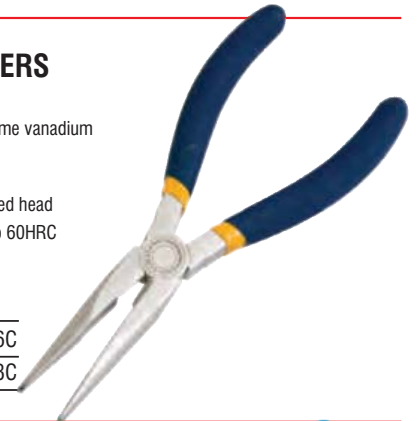

### LONG NOSE PLIERS YELLOW/BLACK

- Long, fine serrated jaws for electrical and general work
- Satin finish
- Drop forged carbon steel for strength
- Induction hardened edges for cleaner cutting and durability
- Non-slip double cushion grips for comfort
- Nickel plated

Code	Size
MTS3852	150mm
MTS3853	200mm

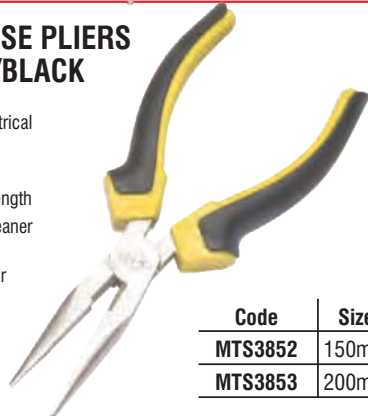

### TELEPHONE PLIERS - STRAIGHT TL

- Flat round tapered jaws
- Straight gripping faces, serrated
- Induction-hardened precision cutting edges
- Hardness ± 62 HRC
- DIN ISO 5745

Code	Size	Ref
GED6710610	140mm	8132-140TL

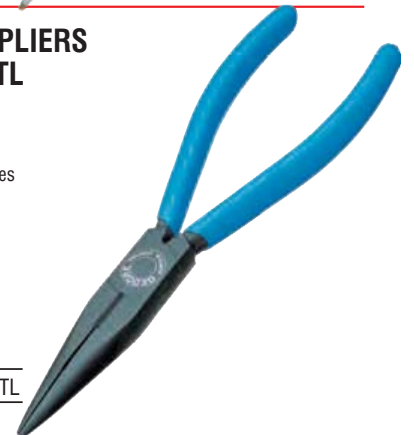

General Tools

**GEDORE** Tools For Life **TELEPHONE PLIERS  
- STRAIGHT JC**

- Flat round tapered jaws
- Straight gripping faces, serrated
- Induction-hardened precision cutting edges
- Hardness  $\pm$  62 HRC
- DIN ISO 5745

Code	Size	Ref
GED6718860	140mm	8132-140JC
GED6719240	160mm	8132-160JC
GED6719670	200mm	8132-200JC



**GEDORE** Tools For Life **TELEPHONE PLIERS  
- STRAIGHT TL**

- Flat round tapered jaws
- Cross-hatching gripping surface and fine-tipped nose
- DIN ISO 5745

Code	Size	Ref
GED6722460	140mm	8135-140TL
GED6722620	160mm	8135-160TL



**GEDORE** Tools For Life **MECHANICS PLIERS**

- Without wire cutter
- Flat round tapered jaws
- Cross-hatched gripping faces
- Fine tipped nose, for safe work in confined spaces
- DIN ISO 5745

Code	Size	Ref
GED6722890	200mm	8136-200TL



**Crescent** Small **LONG NOSE STRAIGHT  
PLIERS**

- For confined areas
- Chain nose makes bends and loops
- Hardened, serrated edges, side cutter
- Cushion grips

Code	Size	Ref.
CRE0210	150mm	654-6CV/N
CRE0225	180mm	654-7CV/N



**Will** **LONG NOSE PLIERS**

- Chrome vanadium steel
- Light duty red PVC insulation
- Long jaws
- Side cutter
- Hardened jaws

Code	Size	Ref
WIL0150	140mm	35-140
WIL0155	160mm	35-160
WIL0160	200mm	35-200



**STANLEY** **LONG NOSE PLIERS  
HEAVY DUTY**

- Forged from carbon steel
- Induction hardened and tempered for longer performance
- Close fit machined jaws
- Bi- Material handles for comfort and grip even with oily hands

Code	Size	Ref.
STA7500	150mm	0-84-053
STA7520	200mm	0-84-625



**Will** **LONG NOSE PLIERS  
- VDE 1000V**

- Side cutter
- Hardened jaw
- Heavy duty insulation

Code	Size	Ref
WIL0157	160mm	35-160 VDE
WIL0161	200mm	35-200 VDE



**STANLEY** **LONG NOSE PLIERS  
FATMAX**

- Bi-Material handle with secure grip grooving
- Heat treated high chrome steel forging for long life and durability
- Hand ground, induction hardened blade
- Interlocking joint assembly for smooth cutting

Code	Size	Ref
STA7481	150mm	0-89-869
STA7482	200mm	0-89-870



**GEDORE** Tools For Life **TRIPLE PLIER - STRIP & CRIMP**

- Flat round tapered jaws
- With wire cutter and stripper
- Crimper for conductor end-sleeves, with normal nose
- Chrome plated

Code	Size	Ref
GED6722110	180mm	8133-180JC



**GEDORE** Tools For Life **TELEPHONE PLIERS  
- ANGLED TL**

- Flat round tapered jaws, straight gripping faces, serrated
- Induction-hardened precise cutting edges
- Hardness  $\pm$  62 HRC



Code	Size	Ref
GED6720920	160mm	8132AB-160JC
GED6721300	200mm	8132AB-200JC

**GEDORE** Look For Life **TELEPHONE PLIERS  
- ANGLED JC**

- Flat round tapered jaws, straight gripping faces, serrated
- Induction-hardened precise cutting edges
- Hardness ± 62 HRC

Code	Size	Ref
GED6711180	160mm	8132AB-160TL
GED6711260	200mm	8132AB-200TL



**Will** **LONG NOSE PLIERS  
- BENT**

- 45° bent
- Side cutter
- Hardened jaws
- PVC insulated handle A3

Code	Size	Ref
WIL0185	200mm	36-200



**GEDORE** Look For Life **FLAT NOSE PLIERS**

- Serrated gripping surfaces
- Long jaws
- DIN ISO 5745

Code	Size	Ref
GED6715170	160mm	8120-160JC



**GEDORE** Look For Life **FLAT NOSE PLIERS**

- Serrated gripping surfaces
- Long jaws
- DIN ISO 5745

Code	Size	Ref
GED6710370	160mm	8120-160TL



**Will** **FLAT NOSE PLIERS**

- Long jaws
- Flat tapered
- A3 Red PVC insulation

Code	Size	Ref
WIL0140	160mm	15-160



**GEDORE** Look For Life **ROUND NOSE PLIERS**

- Serrated gripping surfaces
- Short jaws
- DIN ISO 5745

Code	Size	Ref
GED6713200	140mm	8112-140TL



**GEDORE** Look For Life **ROUND NOSE PLIERS**

- Serrated gripping surfaces
- Short jaws
- DIN ISO 5745

Code	Size	Ref
GED6713390	140mm	8112-140JC



**Will** **ROUND NOSE PLIERS**

- Long nose
- Round jaws - form loops in wire
- Red P.V.C. insulation

Code	Size	Ref
WIL0145	160mm	25-160

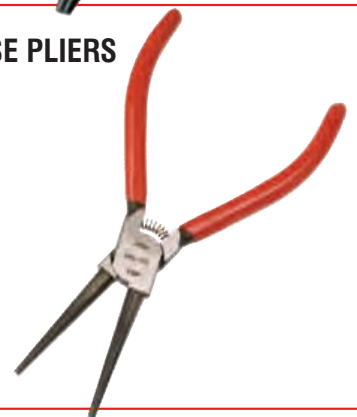

**RACO** **DIAGONAL CUTTER PLIERS  
PROFI-PLUS**

- Manufactured from high grade chrome vanadium tool steel to DIN specification 5238B
- Hardened tempered Cutting edges are induction hardened to 62HRC to guarantee efficient cutting performance and increased durability
- For hard and soft wire
- Head smoothly ground and satin chrome plated for protection against rust
- Extra heavy duty insulated handle with slip guards and comfortable soft-touch grip provide maximum protection

Code	Size	Ref.
RIC2485	150mm	RT22/253-6H
RIC2487	200mm	RT22/254-8H

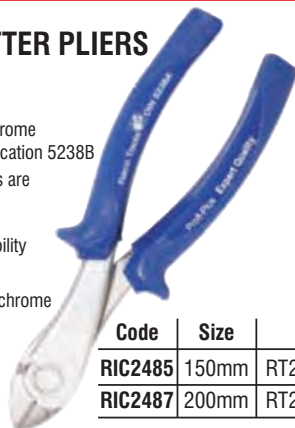

**RACO** **DIAGONAL CUTTER PLIERS**

- Manufactured from high grade chrome vanadium tool steel to DIN specification 5238B
- Smoothly ground satin-chrome plated head
- Cutting edges induction hardened to 62HRC
- For hard, medium hard and soft wire

Code	Size	Size
RIC2490	150mm	RT22/160H
RIC2495	175mm	RT22/162H
RIC2500	200mm	RT22/164H



General Tools





### DIAGONAL CUTTERS - HEAVY DUTY

- Durable hardened edge for easy wire cutting and electrical work
- Drop forged carbon steel
- Induction hardened edges for cleaner cutting and durability
- Non-slip cushion grips for comfort



Code	Size
MTS3816	180mm
MTS3818	200mm



### DIAGONAL CUTTERS

- Durable hardened edge for easy wire cutting and electrical
- Drop forged carbon steel
- Induction hardened edges for cleaner cutting and durability
- Non-slip cushion grip for comfort



Code	Size
MTS3820	160mm
MTS3830	200mm



### SIDE CUTTERS - AMERICAN PATTERN JC

- For hard wire including piano wire
- Induction-hardened precision cutting edges
- Hardness ± 64 HRC
- DIN ISO 5749



Code	Size	Ref
GED6744190	140mm	8316-140JC
GED6744510	160mm	8316-160JC
GED6745080	200mm	8316-200JC



### DIAGONAL CUTTERS

- Durable hardened edge for wire cutting and electrical work
- Satin finish
- Drop forged carbon steel
- Induction hardened edges for cleaner cutting and durability
- Non-slip cushion rubber grips for comfort
- Nickel plated



Code	Size
MTS3832	150mm
MTS3834	180mm
MTS3836	200mm



### SIDE CUTTERS - AMERICAN PATTERN TL

- For hard wire including piano wire
- Induction-hardened precision cutting edges
- Hardness ± 64 HRC
- DIN ISO 5749



Code	Size	Ref
GED6711930	140mm	8316-140TL



### SIDE CUTTERS - HEAVY DUTY

- Forged from carbon steel
- Induction hardened and tempered for longer performance
- Close fit machined jaws
- Bi- Material handles for comfort and grip even with oily hands



Code	Size	Ref
STA7380	150mm	0-84-054
STA7395	180mm	0-84-622



### SIDE CUTTER LIGHT DUTY 6601

- Form B
- Precision cutter for all wires including piano wire
- High quality alloy steel
- Mini bevelled cutting edges
- Fitted with double leaf spring
- Induction hardened approximately 63 HRC
- Dip coated with sure grip handles
- Polished head



Code	Size
STW67016110	110mm



### PLIER - SIDE CUTTER FATMAX

- Bi-Material handle with secure grip grooving
- Heat treated high chrome steel forging for long life and durability
- Hand ground, induction hardened blade
- Interlocking joint assembly for smooth cutting



Code	Size	Ref
STA7402	150mm	0-89-858
STA7403	190mm	0-89-859
STA7404	200mm	0-89-861



### DIAGONAL CUTTERS

- A3 - red PVC insulation
- Swedish pattern



Code	Size	Ref
WIL0195	125mm	40-125
WIL0200	140mm	40-140
WIL0205	160mm	40-160
WIL0207	180mm	40-180



### SIDE CUTTER HEAVY DUTY 6602

- Precision cutter for all wires including piano wire
- Bevelled cutting edges
- Induction hardened edges, approximately 63 HRC
- High quality alloy steel
- Dip coated - sure grip handles
- Polished head



Code	Size	Ref
STW67026180	180mm	6602-180
STW67026200	200mm	6602-200

General Tools



## Crescent DIAGONAL CUTTERS - HEAVY DUTY

- Hardened cutting edges
- Square joint design
- Forged alloy steel
- Cushion grip handles

Code	Size	Ref
CRE0050	180mm	542-7C
CRE0060	200mm	542-8C



## Crescent DIAGONAL CUTTERS

- Hardened cutting edges
- Square joint design
- Forged alloy steel
- Cushion grip handles

Code	Size	Ref
CRE0100	150mm	933-6C



## Will DIAGONAL CUTTERS - ELECTRONIC

- High precision pliers
- Used for electronics, jewellery and crafts
- Yellow PVC handle

Code	Size	Ref
WIL0300	120mm	240-120



## Will DIAGONAL CUTTERS - HEAVY DUTY

- For hardened steel wire
- Made of special steel
- Spring handle
- Red PVC insulation

Code	Size	Ref
WIL0220	160mm	47-160
WIL0225	180mm	47-180
WIL0227	200mm	47-200



## Will DIAGONAL CUTTERS - VDE 1000V

- BS heavy duty insulation
- 1000V
- Swedish pattern

Code	Size	Ref
WIL0203	160mm	40-160 VDE
WIL0210	180mm	40-180 VDE



## Will DIAGONAL CUTTERS - HEAVY DUTY - VDE 1000V

- VDE 1000v
- American pattern
- For hardened steel wire
- Professional quality
- Heavy duty insulation handle

Code	Size	Ref
WIL0233	205mm	49-205 VDE



## Will DIAGONAL CUTTERS - HEAVY DUTY

- American pattern
- For hardened steel wire
- Professional quality
- Heavy duty insulation handle A3

Code	Size	Ref
WIL0230	205mm	49-205



## Crescent END NIPPER

- Top quality end cutting tool
- Hardened cutting edges
- Forged alloy tool steel
- Designed throat clearing

Code	Size	Ref
CRE0125	200mm	72-8CV



## FENCING PLIERS

- Multi-usage joint construction
- Oval jaws with deep cut teeth for pipe work
- Pulling point jaws with wire stretcher and heavy duty wire cutter
- Drop forged carbon steel for strength
- Non-slip cushion grips for comfort

Code	Size
HON7036	250mm
HON7038	300mm





## FENCING PLIERS

- Heavy duty tool drop-forged from finest steel
- Polished head
- Multi-usage joint construction, oval jaws with deep cutting teeth for pipe work and pulling wire
- Wire stretcher and wire cutter on both sides



Code	Size
RIC2530	250mm
RIC2535	300mm

## Crescent FENCING PLIERS

- Heavy duty tool - drop forged
- For wire fencing
- 3 wire cutters
- Pipe grips & teeth in nose
- Hardened jaws



Code	Size	Ref
CRE0130	250mm	1000-10
CRE0135	300mm	1000-12

## Will FENCING PLIERS

- Heavy duty pattern
- 3 wire cutters
- Induction hardened

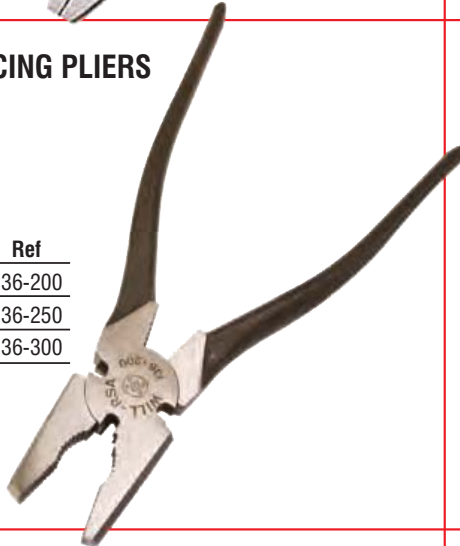

Code	Size	Ref
WIL0045	200mm	136-200
WIL0050	250mm	136-250
WIL0055	300mm	136-300



## WIRE TWISTING PLIER

- Registered design, for wire locking of metal fasteners with side cutter, serrated jaws for positive grip
- 40° angled jaws suitable for locking wires up to ø 1.6mm for clockwise and anti-clockwise use, with automatic return function
- Chrome Vanadium



Code	Size
STW65751220	230mm
STW65751280	280mm



## 3 PCE MECHANIC PLIER SET

- Drop forged carbon steel
- Induction hardened edges for cleaner cutting and durability
- Non-slip cushion grips for comfort
- Combination plier - 180mm
- Side Cutter - 160mm
- Long Nose - 150mm



Code
MTS3855



## 3 PCE MECHANIC PLIER SET

- Drop forged carbon steel
- Induction hardened edges for cleaner cutting and durability
- Non-slip double cushion grip for comfort
- Nickel Plated
- Combination pliers - 180 mm
- Side Cutter - 150 mm
- Long Nose Plier - 150mm



Code
MTS3856

## GEDORE Pliers - JC SET S 8003-JC

- Contents:
- 8132-200 JC telephone plier
- 8250-200 JC combination plier
- 8316-200 JC side cutter



Code	Size
GED6701110	200mm

## STANLEY 12-IN-1 MULTI-TOOL

- Stainless steel construction
- High quality nylon holster Includes the following tools:
- Long nose pliers
- Wire cutter
- Saw
- Standard screwdriver (1/4")
- Small knife
- Bottle opener
- Curve jaw pliers
- Standard screwdriver (5/16")
- File
- Large knife
- Phillips® screwdriver
- Standard screwdriver (1/8")



Code	Ref
STA7600	0-84-519



### MINI COMBINATION PLIERS

- Ideal for hobbies, electronics and model making
- Drop forged carbon steel for strength
- Induction hardened edges for cleaner cutting and durability
- Non-slip cushion grips for comfort

Code	Size
MTS3865	115mm



### MINI FLAT NOSE PLIERS

- Ideal for hobbies, electronics and model making
- Drop forged carbon steel for strength
- Induction hardened edges for cleaner cutting and durability
- Non-slip cushion grips for comfort

Code	Size
MTS3890	115mm

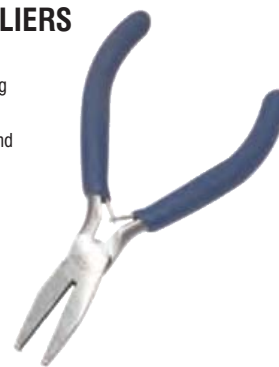

### MINI LONG NOSE PLIERS

- Ideal for hobbies, electronics and model making
- Drop forged carbon steel for strength
- Induction hardened edges for cleaner cutting and durability
- Non-slip cushion grips for comfort

Code	Size
MTS3900	115mm

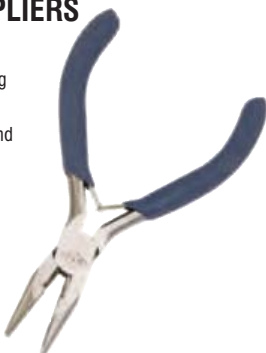

### MINI DIAGONAL CUTTERS

- Ideal for hobbies, electronics and model making
- Drop forged carbon steel for strength
- Induction hardened edges for cleaner cutting and durability
- Non-slip cushion grips for comfort

Code	Size
MTS3870	115mm



### MINI BENT NOSE PLIERS

- Ideal for hobbies, electronics and model making
- Drop forged carbon steel for strength
- Induction hardened edges for cleaner cutting and durability
- Non-slip cushion grips for comfort

Code	Size
MTS3860	115mm

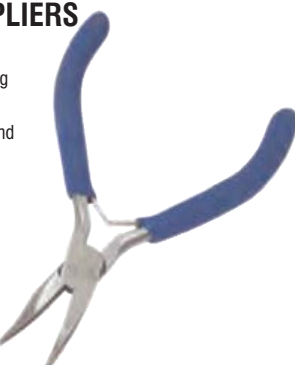

### MINI END CUT PLIERS

- Ideal for hobbies, electronics and model making
- Drop forged carbon steel for strength
- Induction hardened edges for cleaner cutting and durability
- Non-slip cushion grips for comfort

Code	Size
MTS3880	115mm



### MINI LONG NOSE PLIERS - RT22/233B

- Forged from special stainless steel, heat treated for extreme toughness and rigidity
- Cutting edges are electronically hardened
- Precision machined to exacting tolerances to maintain perfect alignment to tips and cutting edges
- Pliers are spring loaded and have vinyl coated handles for comfortable operation
- Essential pliers for home electronics, jewellery repairs, craft work and hobbies

Code	Size
RIC2595	115mm



### MINI DIAGONAL CUTTERS RT22/232B

- Forged from special stainless steel, heat treated for extreme toughness and rigidity
- Cutting edges are electronically hardened
- Precision machined to exacting tolerances to maintain perfect alignment to tips and cutting edges
- Pliers are spring loaded and have vinyl coated handles for comfortable operation
- Essential pliers for home electronics, jewellery repairs, craft work and hobbies

Code	Size
RIC2590	122mm



### MINI BENT NOSE PLIERS RT22/235B

- Forged from special stainless steel, heat treated for extreme toughness and rigidity
- Cutting edges are electronically hardened
- Precision machined to exacting tolerances to maintain perfect alignment to tips and cutting edges
- Pliers are spring loaded and have vinyl coated handles for comfortable operation
- Essential pliers for home electronics, jewellery repairs, craft work and hobbies

Code	Size
RIC2585	147mm

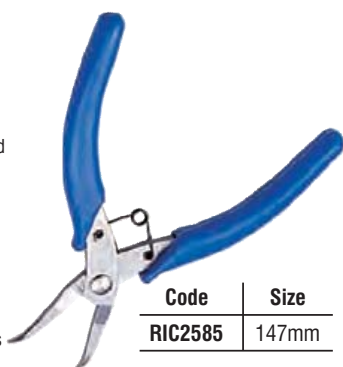

### MINI PLIERS SET - 5 PCE RT22/230D

- Same specifications as RIC2585/90/95
- Contents:
  - Mini end cutter
  - Mini bent nose
  - Mini diagonal cutter
  - Mini flat nose
  - Mini long nose

Code
RIC2600



## STANLEY® MINI LONG NOSE PLIERS

- Forged from carbon steel
- Ground heat treated cutting edges for longer life, durability and accuracy
- Polished heads
- Comfort grip handle s Spring loaded handle



Code	Size	Ref
STA7480	100mm	84-119

## STANLEY® PLIERS – MINI SIDE CUTTER

- Forged from carbon steel
- Ground heat treated cutting edges for longer life, durability and accuracy
- Polished heads
- Comfort grip handle s Spring loaded handle



Code	Size	Ref
STA7350	100mm	84-124



## WATER PUMP PLIERS

- Manufactured from chrome vanadium tool steel
- Hardened and tempered, provides additional strength
- Chrome plated for corrosion protection
- Precision machined grooved joint for perfect interlocking fit and trouble-free operation
- Multiple parallel jaw positions grip objects firmly
- Comfort cushion-grip handles



Code	Size	Ref.
RIC2640	250mm	RT22/320-10B
RIC2645	300mm	RT22/320-12B



## WATER PUMP PLIERS - PROFI-PLUS RT22/319-10C

- Manufactured from chrome vanadium tool steel
- Hardened and tempered to DIN5231D specification
- Satin chrome finish
- Smoothly ground jaws, joint faces and an accurately formed box joint
- Seven position adjustment
- Parallelogram-shaped gripping surface have specially hardened teeth for positive grip on pipes and nuts
- Extra heavy insulated handles with slip guards provide maximum safety and comfort



Code	Size	Ref
RIC2635	250mm	RT22/319-10



## WATER PUMP PLIERS

- Versatile plier for plumbing and general work
- Multi-purpose jaws to suit large and small objects
- Non-slip double cushion grips for safety and comfort



Code	Size
MTS3918	200mm
MTS3920	250mm
MTS3922	300mm
MTS3924	400mm



## WATER PUMP PLIERS

- Versatile plier for plumbing and general work
- Multi-purpose jaws to suit large and small objects
- Non-slip double cushion grips for safety and comfort
- Yellow and black handle
- Nickel plated

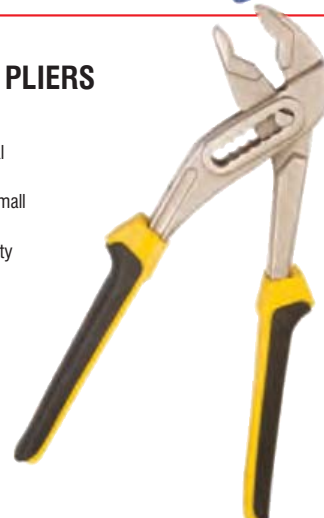

Code	Size
MTS3915	250mm



## WATER PUMP PLIERS

- With rapid adjustments
- Box joint
- "Hook" adjustment jaw with slot
- Chrome plated
- Chrome plated chequered handle



Code	Size	Ref
STW65544250	250mm	6554
STW65544375	375mm	6554



## WATER PUMP PLIERS

- Registered design, box joint with dual support, fast adjustment on the work piece via push button, freely adjustable, easy super fine adjustment
- 12 snap-in points
- induction hardened jaw toothing
- safety clamping protection against squeezing injuries



Code	Size	Ref
STW65726240	240mm	6572

**GEDORE**  **UNIVERSAL PLIERS**

- CHROME VANADIUM steel – 31CrV3
- Chrome plated
- 5 Position notch lock
- Precision milled channels
- Induction hardened teeth



Code	Size	Ref
GED641022	250mm	141/250

**GEDORE**  **UNIVERSAL PLIERS**

- CHROME VANADIUM steel – 31CrV3
- Chrome plated
- 6 Position notch lock
- Precision milled channels
- Induction hardened teeth
- Pinch protector



Code	Size	Ref
GED641081	250mm	143/250

**GEDORE**  **UNIVERSAL PLIERS**

- CHROME VANADIUM steel – 31CrV3
- Chrome plated
- 7 Position notch lock
- Precision milled channels
- Induction hardened teeth
- Pinch protector



Code	Size	Ref
GED641200	250mm	145/250

**STANLEY**  **PLIERS – GROOVE JOINT**

- Forged from carbon steel
- Ground heat treated cutting edges for longer life, durability and accuracy
- Polished heads
- Comfort grip handles



Code	Size	Ref
STA7550	250mm	84-110
STA7560	300mm	84-111

**STANLEY**  **GROOVE JOINT**

- Bi-material handle with secure grip grooving
- Heat treated high chrome steel forging for long life and durability
- Hand ground, induction hardened blade for long life and high quality accuracy
- Interlocking joint assembly for smooth cutting



Code	Size	Ref
STA7603	200mm	0-84-647
STA7604	250mm	0-84-648
STA7606	300mm	0-84-649

**Will**  **WATER PUMP PLIERS**

- Box joint
- 7 adjustment positions
- Anti squeeze protection
- Chrome vanadium
- Black lacquered polished jaws
- Black lacquered box frame polished
- Dip coated A3



Code	Size	Ref
WIL0023	250mm	120-250

**Will**  **WATER PUMP PLIERS**

- Multi grip
- Groove joint
- Bruise protection pattern
- Chrome vanadium
- Black lacquered polished jaws
- Black lacquered box frame polished
- Dip coated A3



Code	Size	Ref
WIL0025	250mm	121-250
WIL5000	315mm	121-315

**Will**  **PLIERS – WATERPUMP**

- Multi-grip
- Slip joint
- Bruise protection pattern
- Chrome Vanadium
- Black lacquered polished jaws
- Dip coated A3



Code	Size	Ref
WIL0021	250mm	125-250

## Crescent WATER PUMP PLIER

- Made from finest quality tool steel
- Designed to grip all shapes like rods, pipes and cable connections
- Precision milled ribs assure smooth, positive interlock between two halves with no chance of halves separating or jumping out of grooves
- Straight jaws and self-locking jaw adjustments
- Forged hardened and tempered
- Red non slip cushion handle grip
- 6 Jaw positions

Code	Size	Jaw Opening	Ref
CRE0300	250mm	38mm	RT410CV



## Crescent WATER PUMP PLIER

- Made from finest quality tool steel
- Designed to grip all shapes like rods, pipes and cable connections
- Precision milled ribs assure smooth, positive interlock between two halves with no chance of halves separating or jumping out of grooves
- Straight jaws and self-locking jaw adjustments
- Forged hardened and tempered
- Red non slip cushion handle grip
- 12 Jaw positions

Code	Size	Jaw Opening	Ref
CRE0310	500mm	138mm	HL120P

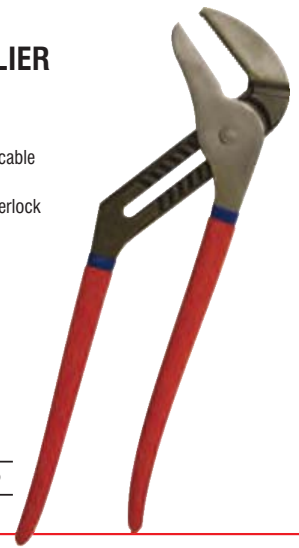

## Crescent WATER PUMP PLIER

- Made from finest quality tool steel
- Designed to grip all shapes like rods, pipes and cable connections
- Precision milled ribs assure smooth, positive interlock between two halves with no chance of halves separating or jumping out of grooves
- Straight jaws and self-locking jaw adjustments
- Forged hardened and tempered
- Red non slip cushion handle grip
- 6 Jaw positions

Code	Size	Jaw Opening	Ref
CRE0270	250mm	38mm	RT210CV
CRE0285	300mm	64mm	RT212CV
CRE0295	400mm	108mm	RT216CV



## STANLEY SLIP JOINT PLIER - PUSHLOCK

- Bi-material handle with secure grip grooving
- Heat treated high chrome steel forging for long life and durability
- Hand ground, induction hardened blade for long life and high quality accuracy
- Interlocking joint assembly for smooth cutting

Code	Size	Ref
STA7602	200mm	0-84-646



## MTS CIRCLIP PLIERS - INSIDE BENT

- Accurately ground tips
- Drop forged carbon steel for strength
- Non-slip cushion grips for comfort

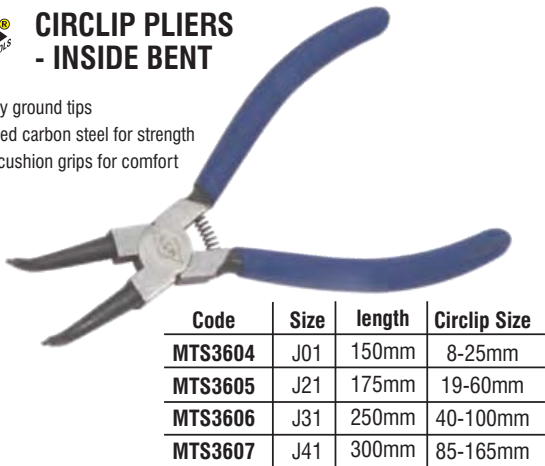

Code	Size	length	Circlip Size
MTS3604	J01	150mm	8-25mm
MTS3605	J21	175mm	19-60mm
MTS3606	J31	250mm	40-100mm
MTS3607	J41	300mm	85-165mm

## RACO CIRCLIP PLIERS - INSIDE BENT

- Accurately ground tips
- Drop forged carbon steel for strength
- Non-slip cushion grips for comfort

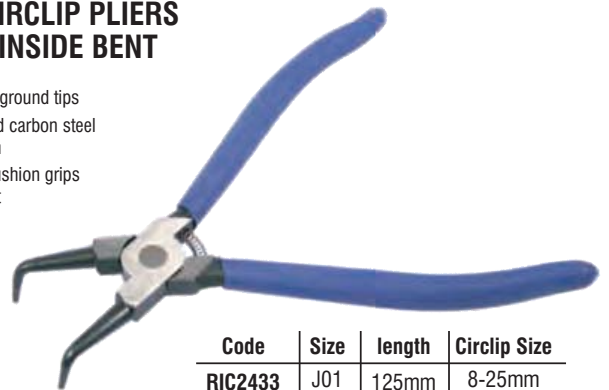

Code	Size	length	Circlip Size
RIC2433	J01	125mm	8-25mm
RIC2434	J21	175mm	19-60mm
RIC2435	J31	225mm	40-100mm

## GEDORE CIRCLIP PLIERS - INTERNAL ANGLED - 8000-J

- DIN 5256 form D
- For internal retaining rings
- Enamelled black
- Blue dipped handles



Code	Size	Length	Circlip Size
GED6704130	J01	129mm	8-13mm
GED6704210	J11	129mm	12-25mm
GED6704480	J21	169mm	19-60mm
GED6704560	J31	214mm	40-100mm
GED6704640	J41	282mm	85-140mm

## GEDORE CIRCLIP PLIERS - INTERNAL ANGLED - 8000-J

- DIN 5256 form D
- Bent nose 90°
- Galvanised tips and lock lever
- Lever handle and blue dip insulated
- Finger protection, reinforced safety arms

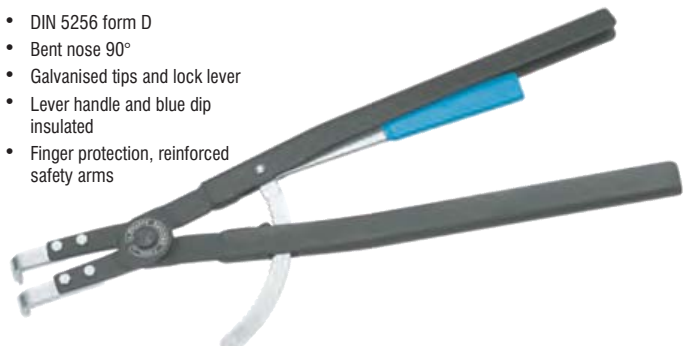

Code	Size	Length	Circlip Size
GED6704720	J51	575mm	122-300mm



### CIRCLIP PLIERS - EXTERNAL ANGLED - 8000-A

- DIN 5254 form B
- For external retaining rings
- With opening spring
- Enamelled black
- Red dipped handles



Code	Size	Length	Circlip Size
GED6702270	A01	130mm	3-10mm
GED6702350	A11	130mm	10-25mm
GED6702430	A21	170mm	19-60mm
GED6702510	A31	210mm	40-100mm
GED6702780	A41	305mm	85-140mm



### CIRCLIP PLIERS - EXTERNAL ANGLED - 8000-A

- DIN 5256 form D
- Bent nose 90°
- Galvanised tips and lock lever
- Lever handle and red dip insulated
- Finger protection, reinforced safety arms



Code	Size	Length	Circlip Size
GED6702860	A51	560mm	122-300mm



### CIRCLIP PLIERS - INSIDE BENT

- DIN 5256 D
- Bent 90°
- Drop forged
- Precision points
- Dip coated with sure-grip surface
- Polished head



Code	Size	Length	Circlip Size
STW64446001	J01	130mm	8-13mm
STW64446011	J11	130mm	12-25mm
STW64446021	J21	170mm	19-60mm
STW64446031	J31	215mm	40-100mm
STW64446041	J41	300mm	85-140mm



### CIRCLIP PLIERS - INSIDE BENT - 142

- Bent 90°
- CHROME VANADIUM steel
- Red PVC insulation A3



Code	Size	Length	Circlip Size
WIL0100	J11	140mm	12-25mm
WIL0105	J21	180mm	19-60mm
WIL0110	J41	310mm	85-140mm



### CIRCLIP PLIERS - INSIDE STRAIGHT

- Accurately ground tips
- Drop forged carbon steel for strength
- Non-slip cushion grips for comfort



Code	Size	Length	Circlip Size
MTS3598	J1	150mm	8-25mm
MTS3600	J2	175mm	19-60mm
MTS3602	J3	250mm	40-100mm
MTS3603	J4	300mm	85-165mm



### CIRCLIP PLIER - INSIDE STRAIGHT

- Accurately ground tips
- Drop forged carbon steel for strength
- Non-slip cushion grips for comfort



Code	Size	Length	Circlip Size
RIC2437	J1	125mm	8-25mm
RIC2438	J2	175mm	19-60mm
RIC2439	J3	225mm	40-100mm



### CIRCLIP PLIERS - INTERNAL STRAIGHT - 8000J

- DIN 5256, Form C
- For internal retaining rings
- With opening spring
- Enamelled black
- Blue dipped handles



Code	Size	Length	Circlip Size
GED6703240	J0	141mm	8-13mm
GED6703320	J1	141mm	12-25mm
GED6703400	J2	183mm	19-60mm
GED6703590	J3	230mm	40-100mm
GED6703670	J4	302mm	85-140mm



### CIRCLIP PLIERS - INTERNAL STRAIGHT - 8000J

- DIN 5256 form D
- Bent nose 90°
- Galvanised tips and lock lever
- Lever handle and blue dip insulated
- Finger protection, reinforced safety arms

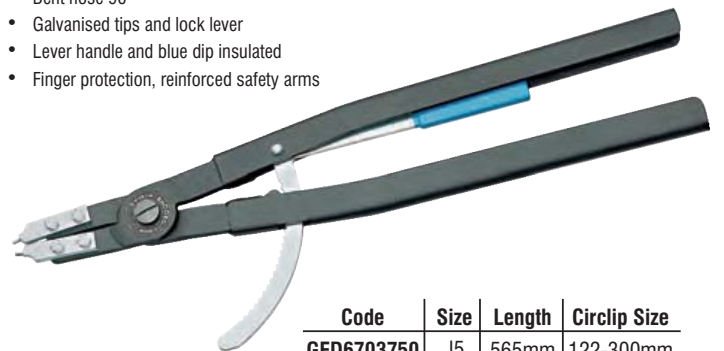

Code	Size	Length	Circlip Size
GED6703750	J5	565mm	122-300mm

General Tools





### CIRCLIP PLIERS - INSIDE STRAIGHT - 6543

- DIN 5256 C
- Straight
- Drop forged
- Precision points
- Dip coated with sure-grip surface
- Polished head



Code	Size	Length	Circlip Size
STW64436000	J0	140mm	3-10mm
STW64436001	J1	140mm	10-25mm
STW64436002	J2	180mm	19-60mm
STW64436003	J3	225mm	40-100mm
STW64436004	J4	320mm	85-140mm

### Will CIRCLIP PLIERS - INSIDE STRAIGHT - 143

- Straight
- CHROME VANADIUM steel
- Red PVC insulation A3



Code	Size	Length	Circlip Size
WIL0117	J1	140mm	12-25mm
WIL0125	J2	180mm	19-60mm
WIL0130	J3	310mm	85-140mm



### CIRCLIP PLIER - OUTSIDE BENT

- Accurately ground tips
- Drop forged carbon steel for strength
- Bent 90°
- Non-slip cushion grips for comfort



Code	Size	Length	Circlip Size	Ref.
RIC2441	A11	125mm	10-25mm	RT22/441H
RIC2442	A21	175mm	19-60mm	RT22/442H
RIC2443	A31	225mm	40-100mm	RT22/443H



### CIRCLIP PLIERS - OUTSIDE BENT

- Accurately ground tips
- Drop forged carbon steel for strength
- Non-slip cushion grips for comfort



Code	Size	Length	Circlip Size
MTS3613	A11	150mm	10-25mm
MTS3615	A21	175mm	16-60mm
MTS3616	A31	250mm	40-100mm
MTS3617	A41	300mm	85-165mm



### CIRCLIP PLIERS - OUTSIDE BENT - 6546

- DIN 5254 B
- Bent 90°
- Dip coated with sure-grip surface
- With wear resistant compression spring
- Drop forged
- Precision points
- Polished head



Code	Size	Length	Circlip Size
STW64466001	A01	125mm	3-10mm
STW64466011	A11	125mm	10-25mm
STW64466021	A21	170mm	19-60mm
STW64466031	A31	200mm	40-100mm
STW64466041	A41	290mm	85-140mm

### Will CIRCLIP PLIERS - OUTSIDE BENT - 140

- Bent 90°
- Chrome vanadium steel
- Red PVC insulation A3



Code	Size	Length	Circlip Size
WIL0060	A11	140mm	10-25mm
WIL0065	A21	180mm	19-60mm
WIL0070	A41	310mm	85-140mm



### CIRCLIP PLIERS - OUTSIDE STRAIGHT

- Accurately ground tips
- Drop forged carbon steel for strength
- Non-slip cushion grips for comfort



Code	Size	Length	Size
MTS3608	A1	150mm	10-25mm
MTS3610	A2	175mm	16-60mm
MTS3611	A3	250mm	40-100mm
MTS3612	A4	300mm	85-165mm



### CIRCLIP PLIER - OUTSIDE STRAIGHT

- Accurately ground tips
- Drop forged carbon steel for strength
- Non-slip cushion grips for comfort



Code	Size	Length	Circlip Size
RIC2446	A11	125mm	10-25mm
RIC2447	A21	175mm	19-60mm
RIC2448	A31	225mm	40-100mm



### CIRCLIP PLIERS OUTSIDE STRAIGHT - 8000-A

- DIN 5254, Form A
- For external retaining rings
- With opening spring
- Enamelled black
- Red dipped handles



Code	Size	Circlip Size
GED6701380	A0	3-10mm
GED6701460	A1	10-25mm
GED6701540	A2	19-60mm
GED6701700	A4	85-140mm



### CIRCLIP PLIERS - EXTERNAL STRAIGHT - 8000A

- Galvanised tips and lock lever
- Lever handle end red dip insulated
- Finger protection
- Reinforced safety arms

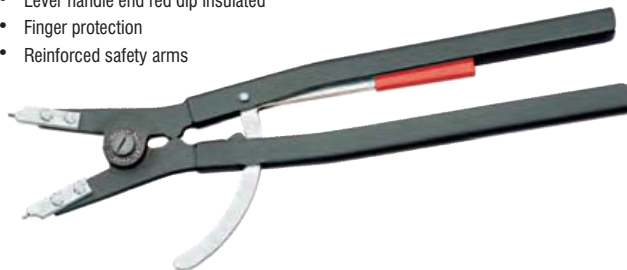

Code	Size	Length	Circlip Size
GED6701890	A5	550mm	122-300mm



### CIRCLIP PLIERS - OUTSIDE STRAIGHT - 6545

- DIN 5254 A
- Straight
- With wear resistant compression spring
- Dip coated with sure-grip surface
- Drop forged
- Precision points
- Polished head



Code	Size	Length	Circlip Size
STW64456000	A0	140mm	3-10mm
STW64456001	A1	140mm	10-25mm
STW64456002	A2	180mm	19-60mm
STW64456003	A3	210mm	40-100mm
STW64456004	A4	315mm	85-140mm



### CIRCLIP PLIERS - OUTSIDE STRAIGHT - 141

- Straight
- Chrome vanadium steel
- Light duty red PVC insulation



Code	Size	Length	Circlip Size
WIL0080	A1	140mm	10-25mm
WIL0085	A2	180mm	19-60mm
WIL0090	A4	310mm	85-140mm



### CIRCLIP PLIERS - FLAT TIP - 144

- Chrome vanadium steel
- Light duty red PVC insulation



Code	Length
WIL0133	210mm



### CIRCLIP PLIERS - SPECIAL FOR SLOTTED - 6547

- For slotted circlips (as used on shafts of engines, gearboxes, differentials, clutches)
- With wear resistant compression spring
- Chrome plated, chequered
- Head mat chrome plated



Code	Length
STW64474170	170mm



### CIRCLIP PLIERS - SET 4-IN-1

- Accurately ground tips
- 10 - 50 mm capacity
- 4 interchangeable sets of jaws
- 6 different internal / external applications
- Moulded PVC grips for comfort



Code
MTS3625



### CIRCLIP PLIER SET - 4-IN-1 - RT22/261B

- Combination circlip plier set for internal and external circlips with capacity range of 10 - 50mm
- Set comes complete with four interchangeable sets of jaws
- Six different internal /external applications
- Jaw heads are manufactured from selected steel, hardened and tempered
- Comfort cushion grips



Code
RIC2400

**GEDORE** CIRCLIP PLIERS - SET S 8000

- Contents:  
External: 8000-A2 straight  
8000-A21 angled  
Internal: 8000-J2 straight  
8000-J21 angled

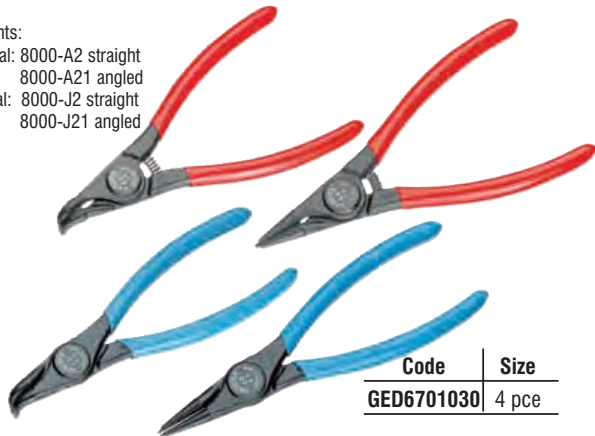

Code	Size
GED6701030	4 pce



**CRIMPING KIT - 121 PCE**

- Crimping Plier 5 way
- Assortment of copper-sleeve insulated terminals
- Selection includes the most often used connectors
- Convenient storage box with clear lid for easy visibility
- Crimps insulated terminals (1.5, 2.5, 4.0 & 6mm<sup>2</sup>)
- Crimps non-insulated terminals (4-6, 2.5 & 1.5mm<sup>2</sup>)
- Strips and cuts wire (6.4, 2.5, 1.5, 1.0 & 0.75mm<sup>2</sup>)
- Cuts bolts (ISO) M2.6, M3, M3.5, M4 & M5



Code	Size
RIC2445	



**CRIMPING SET 66 PCE**

- A multi-purpose tool which combines wire stripping, wire cutting, and terminal crimping
- Included in the kit:  
• 20 spade terminals  
• 20 ring terminals  
• 25 x 100mm cable ties  
• Crimper and stripper



Code	Size
MTS3814	



**5 WAY CRIMPING PLIER - RT21/101B**

- Manufactured from hardened steel, heat treated
- Black oxide finish with easy-to-read markings
- Non-slip, comfortable, insulated vinyl grips
- Easily cuts and strips wire, cuts bolts and crimps all popular terminals
- Capacities:  
Crimps insulated terminals 1.5, 2.5, 4.0, 6mm<sup>2</sup>  
Crimps non insulated terminals 1.5, 2.5, 4.0, 6mm<sup>2</sup>  
Strips & cuts wire 0.75, 1.0, 1.5, 2.5, 6.4mm<sup>2</sup>  
Cuts bolts (ISO) M2.6, M3, M3.5, M4, M5

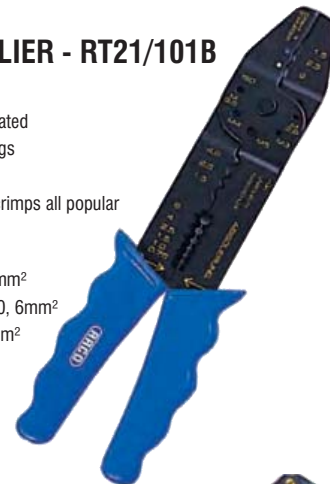

Code	Size
RIC2440	225mm



**CRIMPING PLIER - HEAVY DUTY RT21/71B**

- Heavy duty model for professional use
- Ratchet mechanism for maximum crimp
- Left or right hand operation
- Capacities:  
Copper tube terminals 1.5, 2.5, 4, 6, 10mm<sup>2</sup>  
Non insulated terminals 1.25, 2, 3.5, 5.5, 8mm<sup>2</sup>
- Comfortable, non-slip, moulded vinyl grip handles



Code	Size
RIC2450	275mm



**CRIMPING PLIER - HEAVY DUTY RT21/72B**

- Heavy duty model for professional use
- Ratchet mechanism for maximum crimp
- Left or right hand operation
- Capacities:  
Copper tube terminals 1.5, 2.5, 4, 6, 10, 16mm<sup>2</sup>  
Non insulated terminals 1.25, 2, 3.5, 5.5, 8, 14mm<sup>2</sup>
- Comfortable, non-slip, moulded vinyl grip handles



Code	Size
RIC2455	300mm



**INDUSTRIAL CRIMPING PLIER RT21/40B**

- Industrial model for roll pressing non-insulated flat junction terminals 0.5-1.0mm<sup>2</sup>, 1.1-2.5mm<sup>2</sup>
- Six section pressure adjustment
- Automatic locking device with power gear makes opening of the tool impossible until the correct pressure is applied
- Comfortable handle grips with reinforced nylon and 30% glass fibre



Code	Size
RIC2465	200mm



**INDUSTRIAL CRIMPING PLIER RT21/42**

- Industrial model for roll pressing non-insulated flat junction terminals and crimps for most popular sizes 0.5-1.0mm<sup>2</sup>, 1.1-2.5mm<sup>2</sup>, 4.0-6.00mm<sup>2</sup>, 8.0mm<sup>2</sup>-10mm<sup>2</sup>
- Six section pressure adjustment
- Put terminal into die on top of crimper and press the cushion handle slowly then ratchet will automatically stop to make the terminal fixed in the die
- Automatic locking device with power gear makes opening of the tool impossible until the correct pressure is applied
- Comfortable handle grips with reinforced nylon and 30% glass fibre



Code	Size
RIC2470	230mm

General Tools



## HEAVY DUTY CRIMPING PLIER YYT1

- Heavy duty model for professional use
- Ratchet mechanism for maximum crimp
- Left or right hand operation
- Suitable for crimping a range of copper tube and non-insulated terminals
- Comfortable, non-slip, moulded vinyl grip handles



Code	Size
RIC2475	250mm



## CRIMPING TOOL - AK1MA

- Controlled cycle tool ensures proper crimp every time
- Double compound action delivers maximum crimp force with minimum effort
- Specially designed nest compresses all copper strands together
- Resulting in low resistance quality connections
- For copper wires non insulated terminals, butt connectors and parallels
- Release knob



Code	Terminal size	Crimping capacity	Tool Nest Size
LOB0003	1.25mm <sup>2</sup>	0.25-1.65mm <sup>2</sup>	1mm
	2.00mm <sup>2</sup>	1.04-2.63mm <sup>2</sup>	2mm



## CRIMPING PLIER - AK100

- Controlled cycle tool ensures proper crimp every time
- Double compound action delivers maximum crimp force with minimum effort
- Specially designed nest compresses all copper strands together
- Uses copper sleeves and terminals butt and parallel
- Lever action



Code	Terminal size	Crimping capacity	Tool Nest Size
LOB0025	22mm	16.78-26.66mm <sup>2</sup>	22mm
	38mm	26.66-42.42mm <sup>2</sup>	38mm
	60mm	42.42-60.57mm <sup>2</sup>	60mm
	80mm	76.28-96.30mm <sup>2</sup>	80mm
	100mm	96.30-117.20mm <sup>2</sup>	100mm



## CRIMPING PLIER - AK60

- Controlled cycle tool ensures proper crimp every time
- Double compound action delivers maximum crimp force with minimum effort
- Specially designed nest compresses all copper strands together
- Uses copper sleeves and terminals butt and parallel
- Lever action



Code	Terminal size	Crimping capacity	Tool Nest Size
LOB0020	14mm <sup>2</sup>	10.52-16.78mm <sup>2</sup>	14mm
	22mm <sup>2</sup>	6.78-26.66mm <sup>2</sup>	22mm
	38mm <sup>2</sup>	26.66-42.42mm <sup>2</sup>	38mm
	60mm <sup>2</sup>	42.42-60.57mm <sup>2</sup>	60mm



## CRIMPING RATCHET - AK15A

- Controlled cycle tool ensures proper crimp every time
- Double compound action delivers maximum crimp force with minimum effort
- Specially designed nest compresses all copper strands together
- Resulting in low resistance quality connections
- For copper wires non insulated terminals, butt connectors and parallels
- Release knob



Code	Terminal size	Crimping capacity	Tool Nest Size
LOB0005	1.25mm <sup>2</sup>	0.25-1.65mm <sup>2</sup>	1.25mm
	2.00mm <sup>2</sup>	1.04-2.63mm <sup>2</sup>	2mm
	5.5mm <sup>2</sup>	2.63-6.64mm <sup>2</sup>	5.5mm
	8mm <sup>2</sup>	6.64-10.52mm <sup>2</sup>	8mm



## CRIMPING RATCHET - AK19A

- Controlled cycle tool ensures proper crimp every time
- Double compound action delivers maximum crimp force with minimum effort
- Specially designed nest compresses all copper strands together
- Resulting in low resistance quality connections
- For copper wires non insulated terminals, butt connectors and parallels
- Release knob



Code	Terminal size	Crimping capacity	Tool Nest Size
LOB0010	5.5mm <sup>2</sup>	2.63-6.64mm <sup>2</sup>	5.5mm
	8mm <sup>2</sup>	6.64-10.52mm <sup>2</sup>	8mm
	14mm <sup>2</sup>	10.52-16.78mm <sup>2</sup>	14mm



## AUTOMATIC STRIPPER/CRIMPER HEAVY DUTY - RT21/535B

- Automatic self-adjusting, Multi-function tool for stripping, cutting and crimping
- Unique for wire stripping - steel jaws self adjust to strip copper or aluminium wire, solid or stranded
- Only light pressure is needed to make wire stripping fast and easier
- Sharp cutters are made of high grade steel, hardened to HRC40-50 and precision machined
- Handles insulated with tough ABS plastic for safety & comfort
- Specifications:

Stripping wire AWG 10 - 22 gauge (0.5 - 6.0mm<sup>2</sup>)

Insulated terminals AWG 22 - 10 (1.5 - 6.0mm<sup>2</sup>)

Non insulated terminals AWG 22 - 10 (1.5 - 6.0mm<sup>2</sup>)

Auto ignition terminals 7 - 8mm

Code	Size
RIC4010	210mm



## AUTOMATIC WIRE STRIPPER RT21/531BB

- Designed for one-hand, quick stripping
- Automatic feature holds jaws open for removing wire without crushing end
- Tough construction, high grade alloy steel blades are accurately notched and honed
- Insulated, vinyl coated handles are spring action loaded for operator comfort
- For stripping wire 1.0, 1.6, 2.0, 2.6, 3.2mm

Code	Size
RIC4020	170mm



## AUTO WIRE STRIPPER

- This automatic wire stripper grips the wire and strips in one easy movement
- The length of strip can be adjusted up to 20 mm
- Wire with diameters of 1.0, 1.6, 2.0, 2.6, 3.2 mm can be accommodated



Code	Size
MTS4595	170mm



## WIRE STRIPPER

- Range 1.0mm to 3.2mm

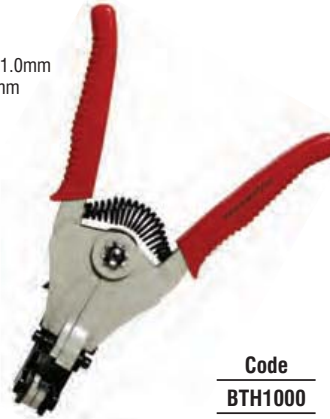

Code
BTH1000

## STANLEY WIRE STRIPPER 84/214

- Forged from carbon steel
- Ground heat treated cutting edges for longer life, durability and accuracy
- Comfort vinyl grip handles
- Convenient hole for looping or bending wire
- Ideal for cutting and stripping speaker wire and appliance cords
- Slide adjust for various gauge wire



Code
STA5600

## Will WIRE STRIPPER - 79

- For stripping cable & flex
- Adjustable for wire thickness
- Spring loaded
- Red P.V.C. handle



Code	Size
WIL0281	160mm



## CABLE/WIRE CUTTER - RT215/16B

- Light and compact, one hand action pocket tool
- Cuts wire and cable cleanly up to 3mm
- Hardened and tempered high carbon alloy steel blades and cutting edges are smooth ground for easier cutting
- Hardened leverage handles have vinyl dipped grips and are spring loaded with a safety latch lock



Code	Size
RIC0945	190mm



## CABLE CUTTER

- Hardened and tempered head cuts up to 17mm copper cable
- Drop forged carbon steel for strength
- Induction hardened edges for cleaner cutting and durability
- Non-slip double cushion grips for comfort



Code	Size
MTS3770	225mm



## CABLE CUTTER PLIER 0-89-874

- Bi-Material handle with secure grip grooving
- Heat treated high chrome steel forging for long life and durability
- Hand ground, induction hardened blade
- Interlocking joint assembly for smooth cutting



Code	Size
STA7700	215mm

**IRWIN**  
Record. **CABLE CUTTER - WC16**

- The drop forged steel head with specially profiled cutting edges
- Providing a cutting capacity for steel and armoured cable
- Long tubular steel handles with rubber grips provide ample leverage to cut
- Capacity:  
21mm OD steel (armoured cable)  
16mm OD  
Wire Rope



Code	Size
REC5410	710mm

**Will** **CABLE CUTTER PLIER - 1000V 537**

- Specially formed cutting jaws to grip cable securely
- Cuts cable up to 8mm Ø
- Also up to 38mm<sup>2</sup>
- Has class A3 insulation
- Cutting edges additionally hardened



Code	Size
WIL0146	210mm

**IRWIN**  
Record. **CABLE CUTTER - 1505518**

- Induction hardened cutting edges which stay sharp for longer
- For cutting cable



Code	Size
REC5395	200mm

**IRWIN**  
Record. **CABLE CUTTER - MEDIUM DUTY - CC26**

- The drop forged steel head is contoured to surround the cable before the cut is made
- Long tubular steel handles with rubber grips provide ample leverage to cut
- Unarmoured copper or aluminium cables



Code	Size	Capacity
REC5405	610mm	26mm

**IRWIN**  
Record. **WIRE ROPE & STEEL CUTTER - WC6**

- Light duty wire rope cutter
- 6.5mm mild Steel & unarmoured electric cable
- 5mm HT steel rope, soft steel wire & aluminium rod
- 2.5mm spring steel wire
- 4mm steel rod



Code	Size
REC5645	200mm



**CONCRETE NIPPER**

- Known as steel fixing pliers
- Used for concrete reinforcing wire
- Twist and cut binding wire in one operation
- Drop forged carbon steel for strength
- Non-slip cushion grip for comfort

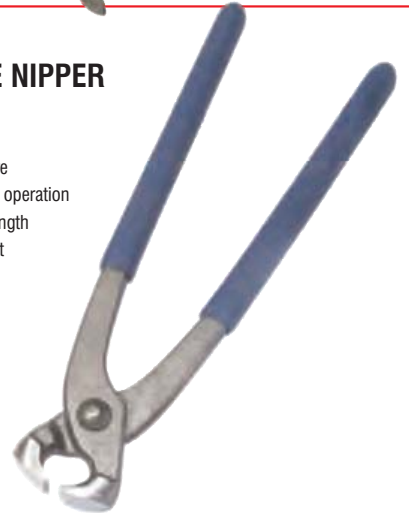

Code	Size
MTS3812	250mm

**GROZ**  
tools to trust **CONCRETE NIPPER**

- Used for fixing steel reinforcing in concrete slabs, beams and columns



Code	Size
GRO3005	250mm



**CONCRETE NIPPER - 6660**

- DIN ISO 9242
- Limit on opening angle to ensure single handed closure (registered design)
- Little effort required due to optimized cutter geometry
- Induction hardened cutters provide excellent resistance to wear
- Special steel
- Drop forged
- Oil hardened
- Used for fixing steel reinforcing in concrete slabs, beams and columns



Code	Size
STW67601250	250mm

## Will CONCRETE NIPPER - 170

- Used for fixing steel reinforcing in concrete slabs, beams and columns
- Long jaws



Code	Size
WIL0137	250mm

## GEDORE TOWER PINCERS

- Heavy duty wire braid and mesh cutting pincers
- Induction-hardened precision cutting edges
- Hardness  $\pm$  62 HRC
- Heads ground black with blue dipped handle protectors
- DIN ISO 9242, Form A



Code	Size	Ref
GED6752020	225mm	8380-225TL
GED6752100	250mm	8380-250TL



## MTS CARPENTER'S PINCER

- Pincers with beveled edges and polished head
- Ideal for removing nails and pins
- Drop forged carbon steel for strength
- Non-slip cushion grips for comfort



Code	Size
MTS3700	200mm

## GEDORE PINCERS

- Standard heavy duty pincer
- Induction-hardened precision cutting edges
- Hardness  $\pm$  62 HRC
- Heads ground black with blue dipped handle protectors
- DIN ISO 9243 Form A



Code	Size	Ref
GED6752370	160mm	8381-160TL
GED6751990	200mm	8381-200TL
GED6752450	225mm	8381-225TL

## Will CARPENTER'S PINCER - 160

- For removing panel pins, Small nails and tacks



Code	Size
WIL0136	200mm

## Will GLASS PLIERS

- Used for breaking off narrow strips of glass
- Has very wide, deep jaws



Code	Size
WIL0143	200mm

## GROZ REVOLVING PUNCH PLIER

- Made from heavy gauge pressed sheet steel
- Spring loaded revolving head incorporates 6 punches of sizes, 2 mm, 2.5 mm, 3 mm, 3.5 mm, 4 mm, 4.5 mm
- Punches are accurately treated for extended life and are exposed to a brass anvil which prevents the edges from getting damaged in use
- Each punch locates exactly in position locking in place with the pawl and ratchet mechanism

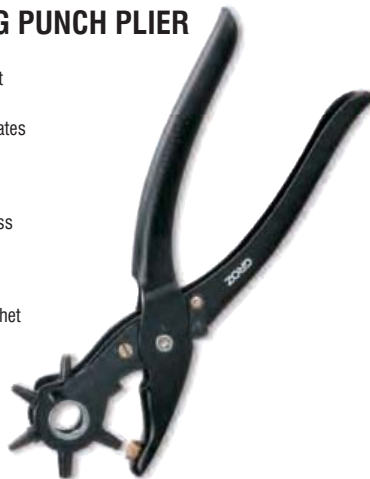

Code	Size
GRO3075	220mm

## Will REVOLVING PUNCH PLIER 150

- Heavy duty sheet metal
- Changeable heat treated cutting tubes
- 6 Sizes 2.0, 2.5, 2.8, 3.2, 4mm
- Centred ratchet mechanism

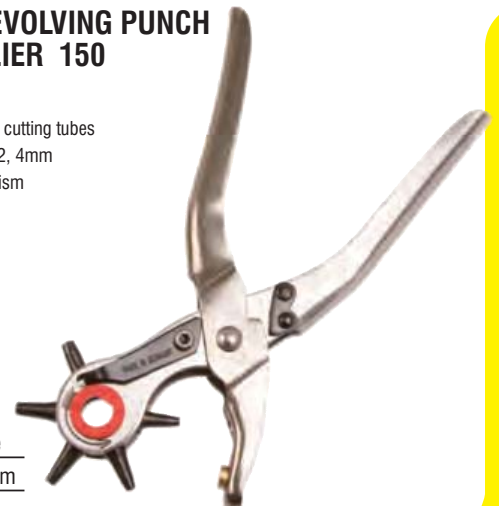

Code	Size
WIL0147	205mm

## KRAUSE LEAD SEALING PLIER

- For sealing locks, doors, box - hasps
- Uses tamper proof wire and lead seals



Code	Size
GER4000	200mm
GER4010	Spare Anvil



## LOCKGRIP PLIERS

- A practical, versatile plier for clamping and holding
- Adjustable jaws to suit many sizes
- Quick release lever
- Serrated gripping jaws with strong locking action



Code	Size
MTS6500	175mm
MTS6510	250mm



## LOCKGRIP PLIERS

- Heavy duty tool, rugged and strong for maximum clamping performance
- Curved jaws are manufactured from hot forged chrome vanadium steel hardened and tempered
- Handles are manufactured from high quality heavy gauge pressed steel with hardened rivets
- Pliers adjust easily to lock at any size with desired amount of pressure and release lever opens jaws fully
- Corrosion nickel plated

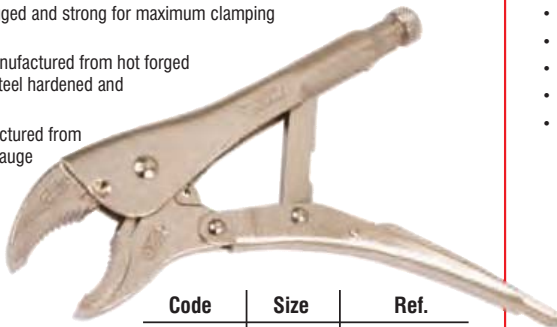

Code	Size	Ref.
RIC5470	180mm	RT23/131-5B
RIC5480	250mm	RT23/131-10B



## UNIVERSAL SELF GRIP - 6563

- Forged jaws(one straight, one contoured)
- Quick release lever
- Chrome Vanadium
- Handle bright nickel plated
- Head bright nickel plated



Code	Size
STW65632250	250mm



## PLIERS - SELF GRIP - 6564

- Forged contoured jaws
- Quick release lever
- Wire cutter
- Chrome Vanadium
- Handle bright nickel plated
- Head bright nickel plated

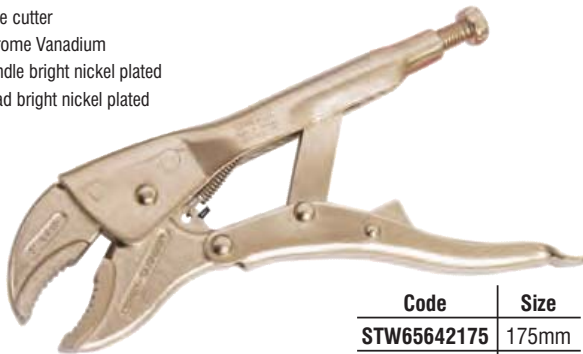

Code	Size
STW65642175	175mm
STW65642250	250mm

## IRWIN Record CURVED JAW VICEGRIP WITH WIRECUTTER

- Locking pliers are equipped with a hex adjusting screw on the adjustment bolt
- Adds an additional controlled release of the tool and allows fine adjustment
- Curved jaws provide a better fit when holding round stock
- Used as non slip pipe wrench
- Emergency handle, added leverage to screwdriver handles or as multipurpose clamp



Code	Size	Ref
PET2600	100mm	4WR
PET2610	125mm	5WR
PET2620	180mm	7WR
PET2630	250mm	10WR

## IRWIN Record VICEGRIP - LOCKING - STRAIGHT

- Locking pliers are equipped with a hex adjusting screw on the adjustment bolt
- Adds an additional controlled release of the tool and allows fine adjustment
- Straight jaw allows for maximum contact on flat, square or hex work
- Suitable for welding and other metal work applications

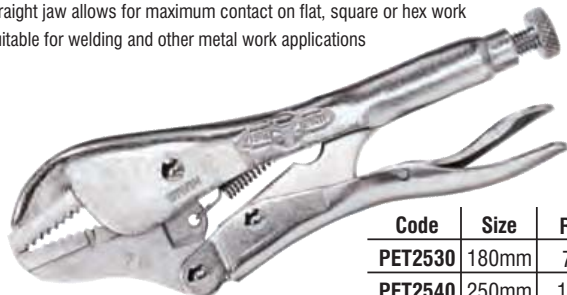

Code	Size	Ref
PET2530	180mm	7R
PET2540	250mm	10R

## STANLEY CURVED LOCKING PLIER

- Curved jaws for greater pressure on nuts and screws
- Chrome Vanadium steel jaws
- Easy-release handle



Code	Size	Ref
STA6320	180mm	84-368
STA6330	250mm	84-369



## STANLEY LOCKING PLIER - STRAIGHT

- Chrome Vanadium steel jaws
- Straight jaws for greater pressure on nuts and screws
- Easy release handle



Code	Size	Ref
STA6331	180mm	84-370
STA6332	250mm	84-371

## GEDORE Plier - GRIP - 137

- For secure clamping, gripping and holding
- Chrome vanadium steel 31CrV3
- Nickel plated
- Induction hardened jaws
- 3 Point shape bottom jaw, upper jaw with wire groove
- With adjusting screw and release lever with moulded plastic grip



Code	Size
GED640662	175mm
GED640670	250mm

## IRWIN Record CURVED JAW VICEGRIP

- Locking pliers are equipped with a hex adjusting screw on the adjustment bolt
- Adds an additional controlled release of the tool and allows fine adjustment
- Curved jaws provide a better fit when holding round stock
- Used as non slip pipe wrench
- Emergency handle, added leverage to screwdriver handles or as multipurpose clamp



Code	Size	Ref
PET2370	175mm	7CR
PET2360	250mm	10CR

## IRWIN Record LOCKING PLIERS - PINCH OFF TOOL

- Locking pliers are equipped with a hex adjusting screw on the adjustment bolt
- Adds an additional controlled release of the tool and allows fine adjustment
- Pinch off tool provide a temporary seal when applied to tubing leaving both hands free for other work
- This provides an ideal solution for the accurate alignment of both round and square shapes tubing
- U shaped jaws allow for the visibility of the weld area during welding

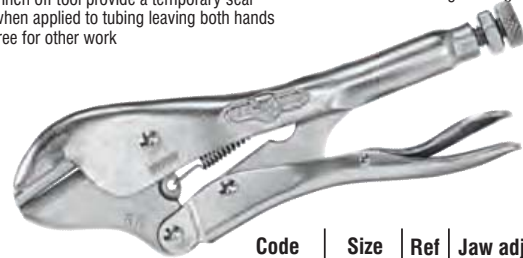

Code	Size	Ref	Jaw adjustment
PET2480	180mm	RR	up to 25.4mm

## IRWIN Record PLIERS - LOCKING PINCH OFF TOOL

- Locking pliers are equipped with a hex adjusting screw on the adjustment bolt
- Adds an additional controlled release of the tool and allows fine adjustment
- Pinch off tool provides a temporary seal when applied to tubing, leaving both hands free for other work



Code	Size	Ref
PET2625	250mm	10VR

## IRWIN Record LONG NOSE VICEGRIP WITH CUTTER

- Locking pliers are equipped with a hex adjusting screw on the adjustment bolt
- Adds an additional controlled release of the tool and allows fine adjustment
- Long straight nose of this tool allows for use in confined narrow spaces making it ideal for precision work



Code	Size	Ref
PET2440	100mm	4LN
PET2450	150mm	6LN
PET2460	230mm	9LN

## GEDORE WELDING GRIP - 138

- For clamping bands and profile sections when welding
- Chrome vanadium steel 31CrV3
- Nickel plated
- Strong malleable cast iron jaws, flame resistant
- With adjusting screw and release lever



Code	Size
GED640735	280mm

## IRWIN Record LOCKING WELDING CLAMP

- Locking pliers are equipped with a hex adjusting screw on the adjustment bolt
- Adds an additional controlled release of the tool and allows fine adjustment
- This provides an ideal solution for the accurate alignment of both round and square shapes tubing
- U shaped jaws allow for the visibility of the weld area during welding



Code	Size	Ref	Jaw adjustment
PET2560	225mm	9R	up to 25.4mm

**IRWIN** *Record.* **LOCKING SHEET METAL TOOL**

- Locking pliers are equipped with a hex adjusting screw on the adjustment bolt
- Adds an additional controlled release of the tool and allows fine adjustment in the forming and shaping of sheet material
- Sheet metal tool allows for the safe handling of the metal

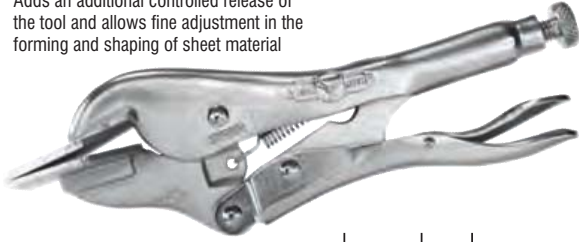

Code	Size	Ref	Jaw adjustment
PET2520	200mm	8R	up to 45mm

**IRWIN** *Record.* **PLIERS - LOCKING - C CLAMP REGULAR TIPS**

- Locking pliers are equipped with a hex adjusting screw on the adjustment bolt
- Adds an additional controlled release of the tool and allows fine adjustment
- Wider opening of jaws and greater throat depth make C- Clamp range a particular favourite with welder and steel fabricators



Code	Size	Ref	Jaw adjustment
PET2320	150mm	6R	up to 50mm
PET2240	275mm	11R	up to 100mm
PET2270	455mm	18R	up to 200mm
PET2290	600mm	24R	up to 3170mm

**IRWIN** *Record.* **LOCKING CHAIN CLAMP**

- Locking pliers are equipped with a hex adjusting screw on the adjustment bolt
- Adds an additional controlled release of the tool and allows fine adjustment
- Holds and locks any shape or size up to 455mm
- Extension chains are available to extend to any length required
- Up to capacity of 36"



Code	Size	Ref
PET2350	225mm	20R

**MTS** *QUALITY TOOLS* **AVIATION TINSNIP - LEFT RED**

- Cuts sheet metal up to 1.2mm and stainless steel up to 0.7mm
- Professional quality
- Quality steel blades
- Colour coded for easy identification of direction of cut



Code	Size
HON9025	250mm

**IRWIN** *Record.* **LOCKING C CLAMP WITH SWIVEL PADS**

- Locking pliers are equipped with a hex adjusting screw on the adjustment bolt
- Adds an additional controlled release of the tool and allows fine adjustment
- Swiveling pads allows this clamp to be used in the holding of irregular shapes as well as tapered work pieces
- Added advantages of greater throat depth



Code	Size	Ref	Jaw adjustment
PET2310	100mm	4SP	up to 41mm
PET2330	150mm	6SP	up to 54mm
PET2250	275mm	11SP	up to 102mm
PET2280	455mm	18SP	up to 200mm

**GEDORE** *MADE IN GERMANY* **PLIER - "C" GRIP - 138Y**

- For clamping bulky profiles and angle sections
- Chrome vanadium steel 31CrV3
- Nickel plated
- Forged hardened jaws
- With adjusting screw and release lever



Code	Size
GED640786	280mm

**RACO** **AVIATION TINSNIP - LEFT RED - RT27/213D**

- Expert quality, these professional shears are manufactured to DIN 6438 specifications
- High quality cutting strength, toughness and durability for the most demanding professional
- Compound leverage design makes for easy cutting of a wide range of materials from sheet
- metal up to 1,2mm and stainless steel sheet up to 0,7mm
- Blades are drop forged from high quality chrome molybdenum steel, hardened and tempered to HRC55-58
- Cutting edges are serrated to prevent slipping and are additionally hardened to HRC60-62 for long service life
- The blades are wear resistant with a stain-matt industrial finish
- Rugged heavy gauge steel handles and all screws are heat treated for additional strength
- High leverage handles are spring loaded with colour coded vinyl grips for comfort

Code	Size
RIC4540	250mm



General Tools

**IRWIN** AVIATION TINSNIP - LEFT RED  
10504309N

- Precision formed blades for longer cutting life
- Ergonomically designed over moulded soft grips for a perfect balance of comfort and performance in the hand
- Long life torsion spring for smooth and consistent cut
- Straight, and left curves
- Cut Capacity - 1.19mm sheet metal 0.84mm in stainless steel
- length cut - 3.34cm



Code	Size
GIL0250	250mm

**STANLEY** AVIATION TINSNIP - LEFT RED  
2-14-562

- Compound leverage design makes for easy cutting in a wide range of materials
- Sheet metal up to 1.2mm and stainless steel up to 0.7mm
- Blades are dropped forged from high quality chrome molybdenum steel, hardened and tempered to HRC55-58°
- Cutting edges are serrated to prevent slipping and are additionally hardened to HRC 60-62° for long service life
- Blades are wear resistant with satin mat industrial finish
- Rugged heavy gauge steel handles and screws are heat treated
- High leverage handles are spring loaded with colour vinyl grips Bi-Material easy grip handle



Code	Size
STA6200	254mm



AVIATION TINSNIP - RIGHT GREEN

- Cuts sheet metal up to 1.2mm and stainless steel up to 0.7mm
- Professional quality
- Quality steel blades
- Colour coded for easy identification of direction of cut



Code	Size
HON9026	250mm



AVIATION TINSNIP - RIGHT GREEN - RT27/212D

- Expert quality, these professional shears are manufactured to DIN 6438 specifications
- High quality cutting strength, toughness and durability for the most demanding professional
- Compound leverage design makes for easy cutting of a wide range of materials from sheet metal up to 1,2mm and stainless steel sheet up to 0,7mm
- Blades are drop forged from high quality chrome molybdenum steel, hardened and tempered to HRC55-58
- Cutting edges are serrated to prevent slipping and are additionally hardened to HRC60-62 for long service life
- The blades are wear resistant with a stain-matt industrial finish
- Rugged heavy gauge steel handles and all screws are heat treated for additional strength
- High leverage handles are spring loaded with colour coded vinyl grips for comfort



Code	Size
RIC4550	250mm

**IRWIN** AVIATION TINSNIP - RIGHT GREEN  
10504310N

- Precision formed blades for longer cutting life
- Ergonomically designed over moulded soft grips for a perfect balance of comfort and performance in the hand
- Long life torsion spring for smooth and consistent cut
- Straight and right curves
- Cut capacity - 1.19mm sheet metal 0.84mm in stainless steel
- length cut - 3.34cm



Code	Size
GIL0255	250mm

**STANLEY** AVIATION TINSNIP - RIGHT GREEN  
2-14-564

- Cuts up to 18 gauge mild steel 0.7 to 1.2m
- Serrated cutting edges prevent slippage when cutting
- Made from forged alloy steel for strength and durability
- Double pivot action for high cutting power
- One handed automatic latch release
- Bi-material easy grip handles



Code	Size
STA6205	254mm



AVIATION TINSNIP - STRAIGHT YELLOW

- Cuts sheet metal up to 1.2mm and stainless steel up to 0.7mm
- Professional quality
- Quality steel blades
- Colour coded for easy identification of direction of cut



Code	Size
HON9027	250mm

General Tools



## AVIATION TINSNIP - STRAIGHT YELLOW RT27/211D

- Expert quality, these professional shears are manufactured to DIN 6438 specifications
- High quality cutting strength, toughness and durability for the most demanding professional
- Compound leverage design makes for easy cutting of a wide range of materials from sheet metal up to 1,2mm and stainless steel sheet up to 0,7mm
- Blades are drop forged from high quality chrome molybdenum steel, hardened and tempered to HRC55-58
- Cutting edges are serrated to prevent slipping and are additionally hardened to HRC60-62 for long service life
- The blades are wear resistant with a stain-matt industrial finish
- Rugged heavy gauge steel handles and all screws are heat treated for additional strength
- High leverage handles are spring loaded with colour coded vinyl grips for comfort

Code	Size
RIC4560	250mm



## IRWIN® AVIATION TINSNIP - STRAIGHT YELLOW 10504311N

- Precision formed blades for longer cutting life
- Ergonomically designed over moulded soft grips for a perfect balance of comfort and performance in the hand
- Long life torsion spring for smooth and consistent cut
- Designed for numerous consumer applications when a long cut in lightweight material is desired
- Cut capacity - 1.19mm sheet metal 0.84mm in stainless steel
- Length cut - 3.34cm

Code	Size
GIL0260	250mm

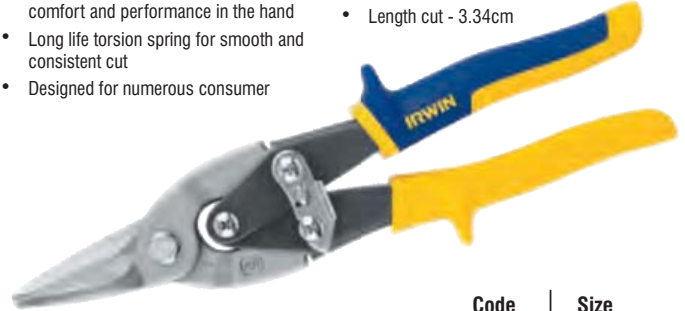

## STANLEY® AVIATION TINSNIP - STRAIGHT YELLOW - 2-14-563

- Compound leverage design makes for easy cutting in a wide range of materials
- Sheet metal up to 1.2mm and stainless steel up to 0.7mm
- Blades are dropped forged from high quality chrome molybdenum steel, hardened and tempered to HRC55-58°
- Cutting edges are serrated to prevent slipping and are additionally hardened to HRC 60-62° for long service life
- Blades are wear resistant with satin matt industrial finish
- Rugged heavy gauge steel handles and screws are heat treated
- High leverage handles are spring loaded with colour vinyl grips Bi-Material easy grip handle

Code	Size
STA6210	254mm



## TINSNIP - STRAIGHT

- Cuts sheet metal up to 1.2mm and stainless steel up to 0.7mm
- Professional quality
- Quality steel blades



Code	Size
MTS5030	250mm
MTS5035	300mm

## GILBOW TINSNIP - STRAIGHT

- Unique non slip joint, should be re-adjusted after sharpening
- Double, hollow ground blades reduce friction for easier cutting
- Induction hardening means cutting edges are held even longer
- Drop forged carbon tool steel handles and blades
- Hardened, tempered and hollow ground
- Safety stop prevents trapped fingers



Code	Size	Ref
GIL0345	200mm	G245-8
GIL0350	250mm	G245-10
GIL0355	300mm	G245-12
GIL0360	350mm	G245-14



## TINSNIP - STRAIGHT - RT27/112B

- Expert quality, universal right hand cranked pattern, popular for general purpose, straight cutting of sheet metal up to 0,8mm
- Drop forged from selected tool steel with induction hardened blades hardened to HRC58-60 and accurately ground
- Curved cutting edges improves performance by gripping the material being cut
- No nip lacquered handles with spring
- Spare spring is available - please quote code RIC4580



Code	Size
RIC4570	250mm



## TINSNIP - STRAIGHT

- English pattern
- Selected carbon steel
- Drop forged and heat treated
- Precision ground cutters
- Blue epoxy powder coated

Code	Size	Ref
GED675784	200mm	8531-200
GED675792	250mm	8531-250
GED675806	300mm	8531-300



## SCISSOR TINSNIPS

- American pattern
- Selected carbon steel
- Drop forged and heat treated
- Precision ground cutters
- Blue epoxy powder coated

Code	Size	Ref
GED675504	250mm	8516-250
GED675547	300mm	8516-300



## CRANKED TINSNIP - HEAVY DUTY G67

- Unique non slip joint, should be re-adjusted after sharpening
- Double, hollow ground blades reduce friction for easier cutting
- Induction hardening means cutting edges are held even longer
- Drop forged carbon tool steel handles and blades
- Hardened, tempered and hollow ground
- Safety stop prevents trapped fingers
- These crank-handled shears can be used for off-straight cutting
- G 67 is left hand cranked for working clockwise

Code	Size
GIL0310	275mm



## CRANKED TINSNIP - HEAVY DUTY G69

- Unique non slip joint, should be re-adjusted after sharpening
- Double, hollow ground blades reduce friction for easier cutting
- Induction hardening means cutting edges are held even longer
- Drop forged carbon tool steel handles and blades
- Hardened, tempered and hollow ground
- Safety stop prevents trapped fingers
- These crank-handled shears can be used for off-straight cutting
- G 69 is right-hand cranked for working anti-clockwise

Code	Size
GIL0315	275mm



## CRANKED TINSNIP - HEAVY DUTY TG691

- Unique non slip joint, should be re-adjusted after sharpening
- Double, hollow ground blades reduce friction for easier cutting
- Induction hardening means cutting edges are held even longer
- Drop forged carbon tool steel handles and blades
- Hardened, tempered and hollow ground
- Safety stop prevents trapped fingers
- These crank-handled shears can be used for off-straight cutting
- G69 is right-hand cranked for working anti-clockwise

Code	Size
GIL0320	350mm





## MINI BOLT CUTTERS

- Powerful, pocket sized wire cutters for fencing and thin gauge mesh
- One-hand operation
- Cutting capacity for mild steel 4mm
- Spring loaded handles
- Comfortable vinyl grips
- Locking clip



Code	Size
MTS2078	200mm



## BOLT CUTTERS - MIDGET

- One-hand action pocket tool for use on mild steel soft non-ferrous metals or plastics
- Centre cut jaws are drop forged from high carbon steel, correctly hardened and tempered to HRC56-58
- Cutting edges have accurately ground and machined smooth surfaces for longer life
- Hardened, heavy gauge steel handle is spring loaded with locking clip
- Comfortable cushion grips



Code	Size
RIC0670	200mm



## BOLT CUTTER - HEAVY DUTY

- Professional quality, well constructed, all-purpose bolt cutter cuts soft to hard materials
- Jaws are centre cut pattern, drop forged from high quality chrome vanadium steel scientifically hardened, tempered and heat treated to HRC55-60 for strength
- Jaws are precision ground and strap connection bolts will not work loose ensuring safe operation
- High leverage handles have rubber grips for operator comfort
- 300 & 350mm, handles are drop forged steel - 450-900mm handles are tubular steel



Code	Size	Soft Cut	Hard Cut	Code	Size	Soft Cut	Hard Cut
RIC0675	300mm	5mm	4mm	RIC0683	600mm	9mm	8mm
RIC0677	350mm	6mm	5mm	RIC0685	750mm	13mm	8mm
RIC0680	450mm	8mm	6mm	RIC0687	900mm	16mm	10mm



## BOLT CUTTER - COMPACT - 909

- Drop Forged Steel Jaws
- Double Fulcrum Action
- Capacity 4mm diameter on soft wire
- Capacity 1.5mm diameter on hard steel wire



Code	Size
REC5020	235mm



## BOLT CUTTERS - HEAVY DUTY

- High-tensile heat treated jaws for cutting hard materials
- Cam Adjusting

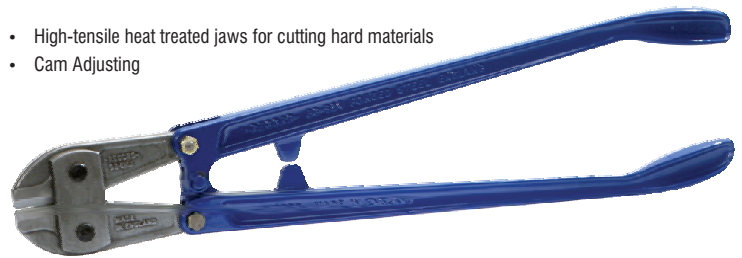

Code	Size	Ref No.	High Tensile Capacity	Low Tensile Capacity
REC5025	355mm	BC914H	5mm	7.9mm
REC5030	450mm	BC918H	6.4mm	9.5mm
REC5035	610mm	BC924H	7.9mm	11.1mm
REC5036	760mm	BC930H	9.5mm	14.3mm
REC5067	915mm	BC936H	11.1mm	15.9mm

## IRWIN Record BOLT CUTTERS - HEAVY DUTY

- High-tensile heat treated jaws for cutting hard materials
- Adjusting Arms



Code	Size	Ref No.	High Tensile Capacity	Low Tensile Capacity
REC5038	460mm	918H	6.4mm	9.5mm
REC5039	610mm	924H	7.9mm	11.1mm
REC5040	750mm	930H	9.5mm	14.3mm
REC5045	915mm	936H	11.1mm	15.9mm
REC5050	1070mm	942H	12.7mm	19.0mm



## BOLT CUTTER - SPARE JAWS

- Drop forged from a special steel
- Machined to precise specifications
- Heat treated
- Jaws and spare fulcrum pin only

Code	Size	Ref No.
REC5070	355mm	J914H
REC5075	460mm	J918H
REC5080	610mm	J924H
REC5085	760mm	J930H
REC5090	915mm	J936H
REC5095	1070mm	J942H

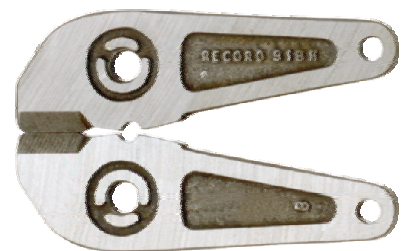



## BLACK SHIFTER - ADJUSTABLE

- Precision ground jaws with rule
- Forged from high grade steel
- Heat treated



Code	Size
HON8000	150mm
HON8010	200mm
HON8020	250mm
HON8030	300mm
HON8040	375mm



## BLACK SHIFTER - ADJUSTABLE

- Expert quality manufactured to DIN3117 specifications and GS approved No 77/94
- Drop forged from high quality chome-vanadium steel with black phosphate finish



Code	Size
RIC3340	100mm
RIC3345	150mm
RIC3350	200mm
RIC3355	250mm
RIC3360	300mm
RIC3365	375mm

## STANLEY ADJUSTABLE WRENCH

- Strong durable with narrow head design for use in limited space
- Forged from alloy steel for maximum strength
- Extra wide jaw capacity with Bi-Metal handle for comfortable grip



Code	Size	Ref.
STA6358	150mm	0-90-947
STA6360	200mm	0-90-948
STA6362	250mm	0-90-949
STA6365	300mm	0-90-950



## ADJUSTABLE WRENCH - No. 62

- Chrome Vanadium steel 31CrV3
- Swedish pattern
- Jaw set at 15°
- Blackened finish
- Ground head



Code	Size
GED636800	150mm
GED636819	200mm
GED636827	250mm
GED636835	300mm
GED636843	375mm
GED636851	450mm



## ADJUSTABLE WRENCH

- Adjustable wrench
- High quality steel
- Use on Hexagon head bolts and nuts
- Adjusting screw in the head

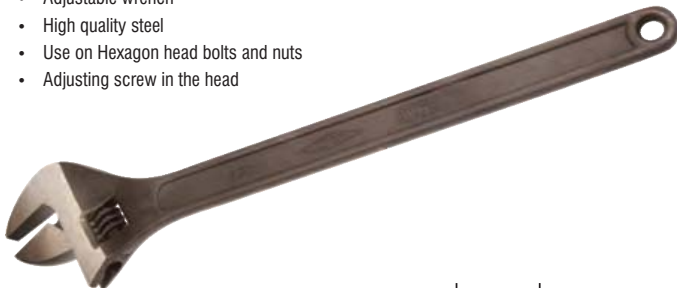

Code	Length	Capacity
MIT4800024	600mm	62mm



## PIPE WRENCH

- Drop forged handles and jaws
- High grade cast malleable iron frames
- Accurately machined screw threads



Code	Size
HON9100	250mm
HON9110	300mm
HON9120	350mm
HON9130	450mm
HON9140	600mm
HON9150	900mm



## PIPE WRENCH - HEAVY DUTY

- Universal pipe wrench, quality construction suitable for general purpose pipe work
- Handle is a one-piece ductile construction
- Heel jaw and hook jaw are drop forged from carbon steel, correctly hardened, tempered and heat ed for maximum strength
- Deep milled teeth are pitched to force work into the jaws
- Adjusting nut is spring suspended for quick and easy adjustment



Code	Size
RIC5800	250mm
RIC5805	300mm
RIC5810	350mm
RIC5815	450mm
RIC5820	600mm
RIC5825	900mm



## PIPE WRENCH - AMERICAN PATTERN 227

- For heavy duty applications
- Cast handle
- Drop forged hook, hardened and tempered
- Selected carbon steel
- Jaw teeth induction hardened
- Malleable cast iron handle
- Blue epoxy powder coated

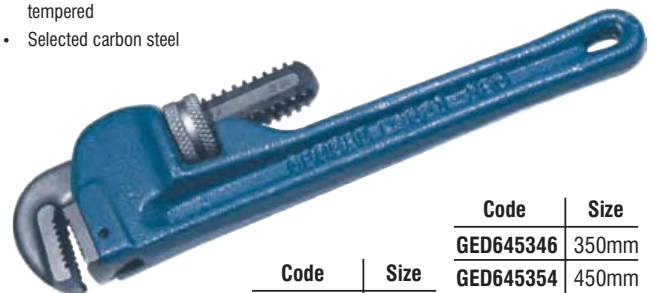

Code	Size
GED645303	200mm
GED645311	250mm
GED645346	350mm
GED645354	450mm
GED645362	600mm
GED645370	900mm



## PIPE WRENCH - STILLSON PATTERN 225

- Drop forged handle and hook, hardened and tempered
- Selected carbon steel
- Jaw teeth induction hardened
- Blue epoxy powder coated

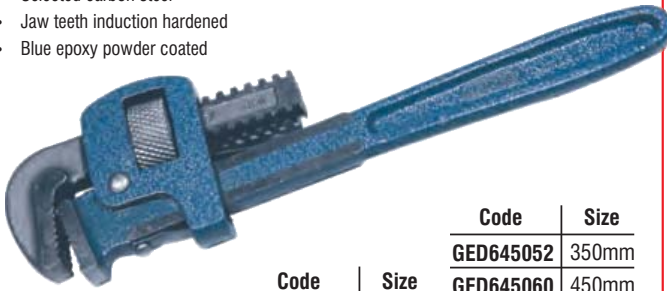

		Code	Size
		GED645052	350mm
		GED645060	450mm
Code	Size		
GED645036	250mm	GED645079	600mm
GED645044	300mm	GED645087	900mm

## IRWIN Record PIPE WRENCHES - LEADER - HEAVY DUTY

- Wrench body combines the frame and handle into one piece ductile iron casting
- Jaws made from drop-forged steel with hardened and tempered teeth to resist wear, distortion and give longer life
- Guaranteed for life against breakage



Code	Size	Capacity	Ref.
REC6325	600mm	76mm	350-24
REC6330	900mm	127mm	350-36
REC6335	1200mm	152mm	350-48

## RIDGID PIPE WRENCH - STRAIGHT

- Sturdy cast-iron housing
- I-beam handle with full floating hook jaw
- Non-stick adjustment nut
- Replaceable heat-treated hook and heel jaws

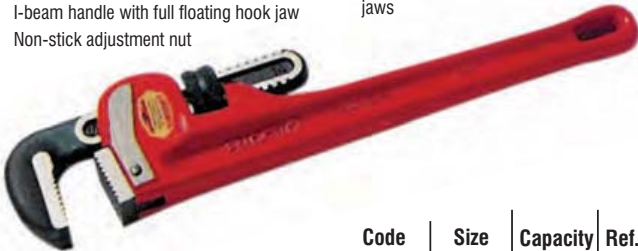

				Code	Size	Capacity	Ref.
				RID31020	350mm	60mm	14
				RID31025	450mm	76mm	18
				RID31030	600mm	89mm	24
				RID31035	900mm	141mm	36
				RID31040	1200mm	168mm	48
Code	Size	Capacity	Ref.				
RID31000	150mm	27mm	6				
RID31005	200mm	34mm	8				
RID31010	250mm	48mm	10				
RID31015	300mm	60mm	12				

## RIDGID PIPE WRENCH - HEX PATTERN - OFFSET E-110

- Hex jaw design gives multi-sided secure grip on all hex nuts, square nuts, unions and valve packing nuts
- The extra wide opening, offset model is ideal for securing drain nuts on sinks and bath tubs



Code	Length	Capacity
RID31305	240mm	29-67mm



## 3-IN-1 MULTI WRENCH - RT25/25B

- Ideal for all kinds of repair jobs, DIY and mechanics
- 3-in-1 wrench converts quickly as an open end wrench a pipe wrench or a multi-wrench
- Wrench adjusts automatically to the size of the pipe, nut or bolt
- Easy to use, revolutionary but simple ratchet action
- Forged, heavy-duty, chrome plated steel construction hardened and heat treated

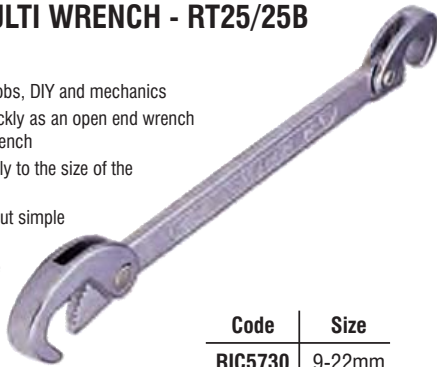

Code	Size
RIC5730	9-22mm



## SPEED WRENCHES

- A useful mechanic's tool, combines all the functions of an adjustable angle wrench, a pipe and multi-wrench
- Wrench has a spring loaded moving jaw which closes automatically to the size required and maintains pressure for one hand operation
- Heavy duty construction, drop forged from chrome vanadium steel and hold-tight serrated jaws
- Correctly hardened and tempered for maximum durability and convenience
- Chrome plated and polished



Code	Size	Ref.
RIC6000	250mm	RT26/105C
RIC6005	300mm	RT25/28C



## BASIN WRENCH

- Universal gripping jaws manufactured from hardened, forged carbon steel
- Swivel action jaws with serrated faces are spring loaded and self adjusting to fit standard basin nuts
- Solid steel handle with sliding tommy bar is chrome plated for protection and corrosion resistance



Code	Size
RIC5700	280mm



## BASIN WRENCH

- Heat treated carbon steel construction
- Chrome plated for durability
- Coarse jaws for sure grip and swivel action to reach difficult places
- Ideal for plumbing repairs on sinks in bathrooms, kitchens and utility rooms



Code	Size
MTS6650	300mm

General Tools



## RIDGID BASIN WRENCH - 1010

- Spring-loaded jaws of forged alloy steel provide fast, one-handed ratcheting
- Tension plug holds head in any position up to 90° angle

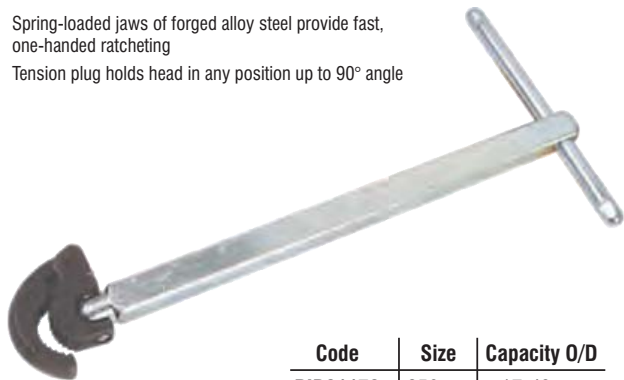

Code	Size	Capacity O/D
RID31170	250mm	17-43mm

## RIDGID BASIN WRENCH - TELESCOPIC - 1017

- Spring loaded jaws of forged alloy steel provide fast, one-hand ratcheting
- Tension plug holds head in any position up to 90° angle

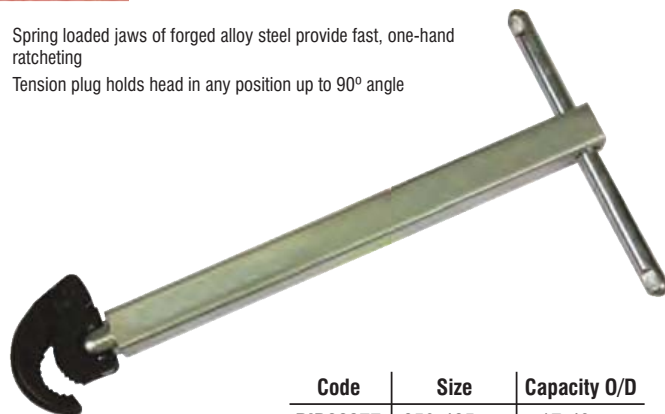

Code	Size	Capacity O/D
RID93377	250-425mm	17-43mm

## RIDGID CHAIN PIPE WRENCH - LIGHT DUTY

- A double jaw gives fast, ratchet-like action in either direction
- Heavy duty models have replaceable alloy steel jaws
- The light-duty model has a one-piece forged alloy steel handle and jaw
- Ideal for use in close quarters



Code	Ref	Length	Chain Length	Rated Pipe Capacity	Actual O/D Capacity
RID31310	C12	300mm	390mm	50mm	100mm
RID31315	C14	320mm	460mm	50mm	125mm

## GEDORE CHAIN PIPE WRENCH - 210

- Double sided replaceable serrated jaws
- Selected carbon steel
- Drop forged, heat treated
- Red epoxy powder coated handle

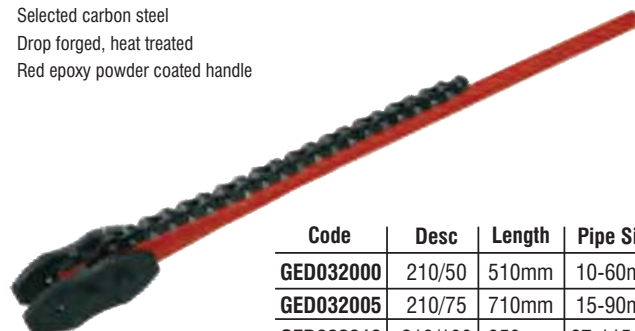

Code	Desc	Length	Pipe Size
GED032000	210/50	510mm	10-60mm
GED032005	210/75	710mm	15-90mm
GED032010	210/100	950mm	27-115mm
GED032020	210/150	1140mm	35-165mm

## RACO STRAP WRENCH - HEAVY DUTY - RT12/273B

- Lever handle made from hardened heavy gauge steel
- Heavy duty bonded strap for extra strength
- Comfortable vinyl grip
- Ideal for use on automotive oil filters and pipes



Code	Size
RIC6030	225mm

## STAHLWILLE STRAP WRENCH - 12005

- For oil filters
- Up to 140mm diameter



Code	Length
STW76500001	450mm

## RIDGID STRAP WRENCHES

- Designed for clamping polished surfaces
- Strong, woven nylon strap gives tight grip
- Polyurethane coated strap prevents scratching
- Replacement straps available

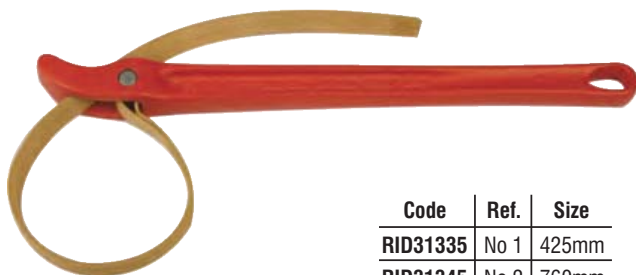

Code	Ref.	Size
RID31335	No 1	425mm
RID31345	No 2	760mm

## GEDORE OIL FILTER - STRAP WRENCH 36

- Chrome Vanadium steel 31CrV3
- Chrome plated
- Strong wide strap
- Light duty



Code	Size
GED632732	220mm

Strap Only Code	Ref.
GED532738	E36/1



### CLAW HAMMER - STEEL

- Polished steel heads are precision ground and hardened
- Rubber handle for secure grip
- One piece construction



Code	Size
MTS3475	500g



### CLAW HAMMER - STEEL

- Professional hammer for wood working
- Superbly balanced hammer with head and shaft forged in one piece from selected tool steel with a full mirror polish surface
- All striking faces are induction hardened
- Claws have accurately machined inner edges tapering to a fine point and are double tempered for extra strength



Code	Size
RIC1700	450g

### STANLEY CLAW HAMMER - STEEL

- Finest claw hammer
- Top professional quality
- Precision balanced
- Magnetic nail starter
- 24 Torque stabilising bars
- Shock dampening core
- Anti vibrate patented
- Revolutionary curved handle
- Reduces impact and shock



Code	Size
STA2967	450g
STA2968	570g



### GAUNTLET TOOLS CLAW HAMMER - STEEL

- Steel polished head
- Drop forged
- Extra heavy duty
- Reinforced handle
- Handle consists of welded steel rods
- Handle is completely covered with rubber



Code	Size
GAU0035	700g



### CLAW HAMMER - STEEL

- Forged from high quality carbon steel
- Epoxy powder coated with anti corrosive coating on polished surfaces
- Wood shaft



Code	Size
LAS2555	450g
LAS2560	600g
LAS2565	700g



### CLAW HAMMER - FIBREGLASS

- Polished steel heads are precision ground and hardened
- Rubber handle for secure grip
- Fibreglass handle to reduce vibration



Code	Size
MTS3480	500g



### CLAW HAMMER - FIBREGLASS

- Forged from high quality carbon steel
- Epoxy powder coated with anti corrosive coating on polished surfaces
- Suregrip handle with unbreakable steel core
- Poly propylene with soft pvc grip for comfort



Code	Size
LAS2550	500g



### CLAW HAMMER - FIBREGLASS

- Professional hammer for wood working
- Manufactured to exacting standards
- Perfectly balanced head, drop forged from selected tool steel and heat treated
- All striking faces are induction hardened
- Claws have accurately machined inner edges tapering to a fine point
- Unbreakable fibreglass shaft with rubber grip



Code	Size
RIC1705	500g



### CLAW HAMMER - TUBULAR

- Polished steel heads are precision ground and hardened
- Rubber handle for secure grip
- The tubular steel shaft is securely fitted to the head
- Wedges to secure head to handle



Code	Size
MTS3500	500g



### CLAW HAMMER - TUBULAR

- Professional hammer for wood working
- The tubular steel shaft is securely fitted to the head providing maximum leverage
- All striking faces are induction hardened
- Claws have accurately machined inner edges tapering to a fine point and are double tempered for extra strength
- Comfortable rubber handle



Code	Size
RIC1710	500g

## STANLEY CLAW HAMMER - TUBULAR

- Polished high carbon steel head
- Tubular steel chrome plated handle
- Contoured tough vinyl grip



Code	Size
STA2956	450g
STA2957	570g



## CLAW HAMMER - WOODEN HANDLE

- Polished steel heads are precision ground and hardened
- Wooden handle for maximum vibration reduction
- Wedges to secure head to handle



Code	Size
MTS3508	500g



## CLAW HAMMER - WOODEN HANDLE

- Professional hammer for wood working
- Manufactured to exacting standards
- Perfectly balanced head, drop forged from selected tool steel and heat treated
- All striking faces are induction hardened
- Claws have accurately machined inner edges tapering to a fine point
- Hickory handle, securely wedged for permanent tightness



Code	Size
RIC1715	500g
RIC1718	600g
RIC1720	700g

## STANLEY CLAW HAMMER - WOODEN HANDLE

- Drop forged head
- Conical neck
- Selected hardwood handle - epoxy bonded



Code	Size
STA2958	450g
STA2959	570g



## CLAW HAMMER - LADIES

- Polished steel heads are precision ground and hardened
- Wooden handle for maximum vibration reduction
- Lightweight and convenient for smaller jobs
- Wedges to secure head to handle



Code	Size
MTS3505	250g



## JOINER'S HAMMER

- Designed for general carpentry work
- Forged from high quality carbon steel
- Epoxy powder coated with anti corrosive coating on polished surfaces
- Wood handle



Code	Size
LAS2605	225g



## BALLPEIN HAMMER - ALL STEEL

- A universal engineer's metalworking hammer
- Precision ground with hardened and tempered striking surfaces
- One piece unbreakable handle and head
- Rubber handle grip is bonded to the shaft during production



Code	Size
MTS3454	500g
MTS3456	700g



## BALLPEIN HAMMER - WOODEN HANDLE

- A universal engineer's metalworking hammer
- Precision ground with hardened and tempered striking surfaces
- Wedges to secure head to handle



Code	Size
MTS3440	100g
MTS3442	300g
MTS3444	500g
MTS3446	700g
MTS3448	900g



## BALLPEIN HAMMER - WOODEN HANDLE

- Expert quality for general purpose use
- Drop forged head with striking face and ball pein individually hardened and tempered
- Finely balanced with polished faces and cheeks
- Solid hardwood handle, securely metal wedged



Code	Size
RIC1655	200g
RIC1657	300g
RIC1660	500g
RIC1662	700g
RIC1664	900g



## BALLPEIN HAMMER

- Designed for driving cold chisels, punches and for riveting, shaping and straightening metal and peening the end of metal tubes
- Forged from high quality carbon steel
- Heat treated
- Hammer heads are epoxy powder coated with anti corrosive coating on polished surfaces



Code	Size
LAS2500	100g
LAS2505	200g
LAS2510	300g
LAS2515	500g
LAS2520	700g
LAS2525	900g
LAS2530	1100g

## STANLEY BALLPEIN HAMMER

- Drop forged head
- Conical neck
- Selected hardwood handle - epoxy bonded



Code	Size
STA2951	230g
STA2952	340g
STA2954	450g
STA2964	680g
STA2966	910g



## GAUNTLET TOOLS BALLPEIN - RUBBER HANDLE

- Steel polished head
- Drop forged
- Extra heavy duty
- Reinforced handle
- Handle consists of welded steel rods
- Handle is completely covered with rubber



Code	Size
GAU0060	900g

## GEDORE BALLPEIN - WOODEN HANDLE

- Drop forged head
- Striking faces induction hardened and precision ground
- Blue epoxy powder coated
- Hardwood handle



Code	Size
GED676438	500g
GED676446	700g

## STAHLWILLE BALLPEIN HAMMER - WOODEN HANDLE

- Dropforged with striking face and ball pien individually hardened and tempered
- Solid ash handle securely metal wedged



Code	Size
STW70120005	320g



## ENGINEER'S DIN HAMMER

- All purpose engineer's / fitter's hammer
- Selected carbon steel
- Hardened, polished and tempered head
- Finest quality varnished wooden handle



Code	Size
MTS3511	500g



## ENGINEER'S DIN HAMMER

- A general purpose hammer, also known as engineers, continental or fitters hammer
- Forged from high quality carbon steel
- Epoxy powder coated with anti corrosive coating on polished surfaces
- Wood handle

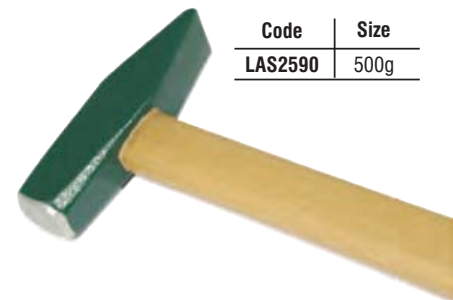

Code	Size
LAS2590	500g



## BRICK HAMMER - ALL STEEL

- Designed for setting (splitting) bricks, masonry, tiles and concrete blocks
- Precision ground with hardened and tempered striking surfaces
- One piece unbreakable handle and head
- Rubber handle grip is bonded to the shaft during production



Code	Size
MTS3433	500g



## BRICK HAMMER - FIBREGLASS

- Designed for setting (splitting) bricks, masonry, tiles and concrete blocks
- Fibreglass handle to reduce vibration



Code	Size
MTS3435	700g



## BRICK HAMMER

- Designed for setting (splitting) bricks, masonry, tile and concrete blocks
- Forged from high quality fine grained carbon steel
- Heat treated
- Hammer heads are epoxy powder coated with anti corrosive coating on polished surfaces
- Wooden handles are varnished



Code	Size
LAS2535	800g



## SCUTCH HAMMER - FIBREGLASS

- Accepts replaceable combs or chisel bits
- Designed for setting (splitting) bricks, masonry, tiles and concrete blocks
- Fibreglass handle to reduce vibration



Code	Size
MTS3521	800g



## SCUTCH HAMMER

- Designed for setting (splitting) bricks, masonry, tile and concrete blocks
- Can take replaceable inserts in the form of combs
- Loose combs are available
- Forged from high quality fine grained carbon steel
- Heat treated
- Hammer heads are epoxy powder coated with anti corrosive coating on polished surfaces
- Wooden handles are varnished



Code	Size
LAS2625	800g



## CLUB HAMMER - ALL STEEL

- One piece unbreakable handle and head
- Rubber handle grip is bonded to the shaft during production
- Polished and chamfered striking surfaces make this an ideal tool for use with cold chisels



Code	Size
MTS3513	1.8kg



## CLUB HAMMER - WOODEN HANDLE

- Polished steel heads are precision ground, hardened and chamfered
- Wooden handle for maximum vibration reduction
- Wedges to secure head to handle
- British style



Code	Size
HON3000	1.8kg



## CLUB HAMMER - WOODEN HANDLE

- Suitable for delivering close, heavy blows
- The head has precision ground striking surfaces which are chamfered and hardened and heat treated
- Fitted with a selected, fully treated hickory handle

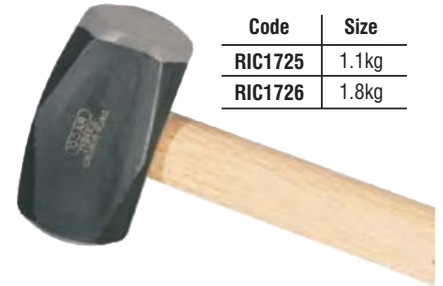

Code	Size
RIC1725	1.1kg
RIC1726	1.8kg



## CLUB HAMMER - WOODEN HANDLE

- Versatile general purpose hammer
- Forged from high quality carbon steel
- Epoxy powder coated with anti corrosive coating on polished surfaces
- Wood handle



Code	Size
LAS2575	1.1kg
LAS2580	1.8kg



## CLUB HAMMER - WOODEN HANDLE

- Drop forged head
- Selected hardwood handle
- One large metal wedge



Code	Size
STA2962	1kg
STA2961	2kg



## CLUB HAMMER - FIBREGLASS

- Polished steel heads are precision ground, hardened and chamfered
- Rubber handle for secure grip
- The fibreglass shaft is securely bonded to the steel head



Code	Size
MTS3515	1.2kg
MTS3520	2.0kg



## SLEDGEHAMMERS

- Designed for striking wood, metal, concrete or stone
- Forged from high quality fine grained carbon steel
- Hammer heads are epoxy powder coated with anti corrosive coating on polished surfaces
- Wooden handle

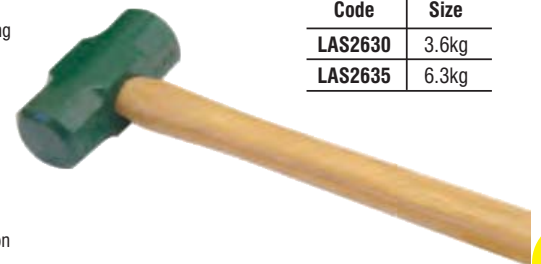

Code	Size
LAS2630	3.6kg
LAS2635	6.3kg



## SLEDGEHAMMERS

- Steel polished head
- Drop forged
- Heavy duty sledge hammer
- Handle consists of welded steel rods
- Handle is completely covered with rubber



Code	Size
GAU0005	1.8kg
GAU0020	3.6kg
GAU0030	6.3kg



## COPPER HAMMERS - RUBBER HANDLE

- Copper head
- Heavy duty sledge hammer
- Handle consists of welded steel rods
- Handle is completely covered with rubber
- Used extensively where a "no-sparking" type hammer is needed



Code	Size
GAU0040	1.8kg
GAU0045	3.6kg
GAU0050	6.3kg



## LASHER SLEDGEHAMMER HEADS

- Designed for striking wood, metal, concrete or stone
- Common uses are drifting heavy timbers, spikes, cold chisels and rock drills
- Head only



Code	Size
LAS2640	1.8kg
LAS2641	3.6kg
LAS2642	6.3kg

## THOR COPPER / RAWHIDE HAMMER

- Malleable iron head
- Fitted: One face pure electrolytic copper
- Fitted: One face compressed buffalo hide
- Copper face gives a safe, high impact blow
- Rawhide face gives a firm resilient non-marking blow
- Excellent dual purpose workshop hammer
- Wooden Handle
- Spare Rawhide face THR0275



Code	No	Weight	Face Size
THR0055	210	725g	32mm

## THOR NYLON FACE HAMMERS

- Chrome plated zinc heads
- Two hard white nylon faces
- Worn faces instantly replaceable
- All faces are one piece moulded
- Wooden handle
- No metal pegs or inserts to damage work
- Faces cannot loosen in use



Code	No	Weight	Face Size
THR0085	708	250g	25mm
THR0090	710	500g	32mm
THR0095	712	750g	38mm
THR0100	714	1.0kg	44mm
THR0105	716	1.5kg	50mm

## Wera DEADBLOW HAMMER - NYLON

- A dead blow hammer controls strike force with minimum rebound from the struck surface
- Heads are commonly hollow and filled with sand or shot
- This absorbs the impact and reduces the bounce back
- Usually constructed of polyurethane or nylon
- Can be a one piece moulding or have a separate handle



Code	Size	Weight
WER9002	30mm	631g
WER9004	40mm	820g
WER9006	50mm	1181g
WER9007	60mm	1974g

## THOR SPARE FACES - PLASTIC

- Plastic - red
- Double face hammer
- Faces - screw in to metal head
- Spare faces available and can be fitted by hand instantly
- All faces are one piece mouldings
- For light hammering and assembly of precision parts



Code	No	Size
THR0245	408NF	25mm
THR0250	410NF	32mm
THR0255	412NF	38mm
THR0260	414NF	44mm
THR0265	416NF	50mm

## THOR COPPER HAMMERS

- Malleable iron head - extra heavy construction
- Two pure electrolytic copper faces
- Wooden handle
- For heavy duty hammering
- For safe blows of maximum weight and impact



Code	No	Weight	Face Size
THR0025	308	500g	25mm
THR0030	310	1.1kg	32mm
THR0035	312	1.5kg	38mm
THR0040	314	2.2kg	44mm
THR0045	316	3.5kg	50mm

## THOR PLASTIC FACE HAMMERS

- Chrome plated zinc heads
- Two medium orange plastic faces
- Worn faces instantly replaceable
- Nylon handle
- No metal pegs or inserts to damage work
- Faces cannot loosen in use



Code	No	Weight	Face Size
THR0115	408	250g	25mm
THR0120	410	500g	32mm
THR0125	412	750g	38mm
THR0130	414	1.0kg	44mm
THR0135	416	1.375kg	50mm

## THOR RAWHIDE FACE HAMMERS

- Two rawhide faces
- Genuine water buffalo rawhide faces
- Wooden handle
- No metal pegs or inserts to damage work
- Faces cannot loosen in use



Code	No	Weight	Face Size
THR0150	010	750g	32mm
THR0155	012	1.0kg	38mm
THR0160	014	1.5kg	44mm
THR0165	016	2kg	50mm

## THOR SPARE FACES - NYLON

- Nylon - white
- Double face hammer
- Faces - screw in to metal head
- Spare faces available and can be fitted by hand instantly
- All faces are one piece mouldings
- Nylon is the best face for all purpose use
- For light and heavy assembly work



Code	No	Size
THR0215	708NF	25mm
THR0220	710NF	32mm
THR0225	712NF	38mm
THR0230	714NF	44mm
THR0235	716NF	50mm

## THOR SPARE FACES - RAWHIDE

- Genuine rawhide
- Double face hammer
- Spare faces available and can be fitted by hand instantly
- Rawhide faces give a firm blow that will not mar the work



Code	No	Size
THR0275	010R	32mm
THR0280	012R	38mm
THR0285	014R	44mm
THR0290	016R	50mm

## Wera SPARE FACES - DEADBLOW HAMMERS

- Nylon faces for deadblow hammers
- Sold per pair



Code	Size
WER9009	30mm
WER9011	40mm
WER9013	50mm
WER9014	60mm

## RUBBER Mallet - STEEL SHAFT

- A hard wearing black rubber mallet
- The head is securely mounted on a steel shaft



Code	Size
MTS3585	450g
MTS3586	800g

## RUBBER Mallet - WOODEN HANDLE

- Quality mallet with resilient, live rubber head
- Lacquered wooden handle



Code	Size
RIC2200	450g

## RUBBER Mallet - STEEL HANDLE

- Solid rubber head
- Steel tubular handle
- Does not mark materials when hammered



Code	Size
LIVM14	500g

## WOODEN Mallet

- Carpenter's wooden mallet made from solid Parmafin
- Used in conjunction with wood working chisels



Code	Size
PTL0005	112mm

## FAULD SCUTCH COMBS

- Scutch hammers are intended for the same purpose as brick hammers.
- Take replaceable inserts in the form of combs

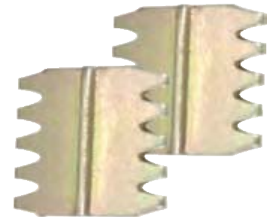

Code	Size
FLD0010	5TPI

## ANVILS

- Professional quality
- Cast steel superior to conventional cast iron
- Anvil face is precision ground
- Pritchel and hardy holes
- Strong beak can be used for bending applications
- Attractive oven baked finish
- Unbreakable workshop tool



Code	Size
GRO0320	30kg
GRO0340	80kg



## aftool CROWBAR

- Hexagonal shaped bar of SS1083 tool steel
- Diamond shaped point one end, chisel point other end
- Tested for hardness at factory
- Used in construction and engineering industries
- For digging holes, levering heavy objects



Code	Size
AFT0150	25x1200mm
AFT0155	25x1500mm
AFT0160	25x1800mm
AFT0165	32x1800mm

## aftool PINCH BARS

- Hexagonal shaped bar of SS1083 tool steel
- Similar to crow bar but chisel end is offset
- Diamond shaped point one end, bent chisel point other end
- Tested for hardness at factory
- Used in construction and engineering industries
- For digging holes, levering heavy objects etc

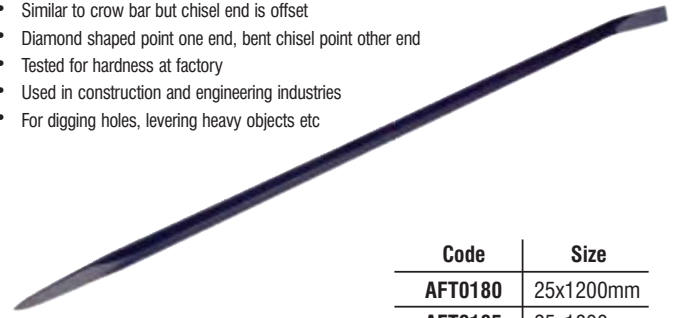

Code	Size
AFT0180	25x1200mm
AFT0185	25x1800mm
AFT0190	32x1800mm

## aftool TOMMY BARS

- Chisel one end and tapered point on other end
- The tapered end of a tommy bar is used as a marlin spike for the alignment of holes in steel construction work
- Both ends off-set

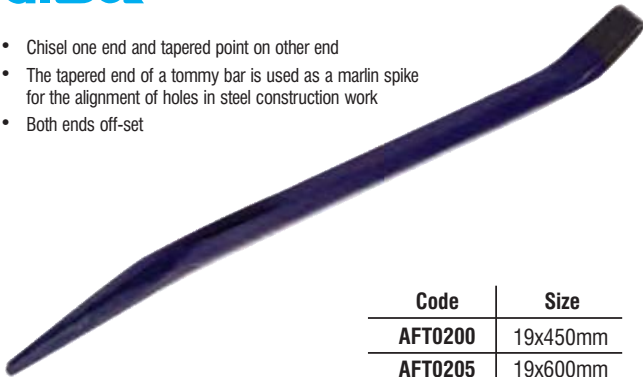

Code	Size
AFT0200	19x450mm
AFT0205	19x600mm
AFT0210	25x900mm

## aftool WRECKING BARS

- Wrecking bars are used to open boxes, lever items apart, remove nails and roofing screws
- There is chisel on one end a claw on the other end



Code	Size
AFT0250	19x450mm
AFT0255	19x600mm
AFT0260	19x750mm
AFT0265	19x900mm

## GROZ PRY BARS

- Manufactured from Chrome Vanadium Steel, fully hardened and tempered
- Specially designed for heavy prying and fulcrum prying especially in automotive applications with the tempered end used for aligning applications



Code	Size
GRO0594	150mm
GRO0595	300mm
GRO0596	400mm
GRO0597	500mm

## STABILWILLY PRY BAR

- Chisel end for prying
- Pointed end as drift
- Special steel
- Bright nickel plated

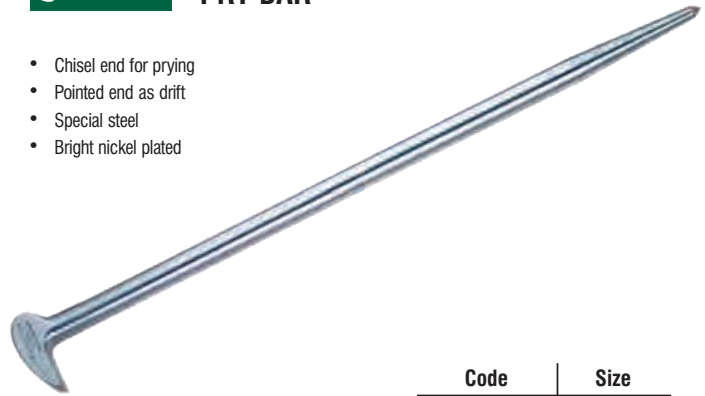

Code	Size
STW72090000	14x410mm

## aftool MARLIN SPIKE

- Formed from hexagon ss1083 tool steel
- It has a long round taper
- It's main function is to align holes in steel work so that bolts can be easily inserted
- Can also be used to drive out bolts



Code	Size
AFT0195	25x300mm

## STABILWILLY FLAT COLD CHISELS - 102

- DIN 6453
- Chrome vanadium steel
- Flat
- Lacquered silver

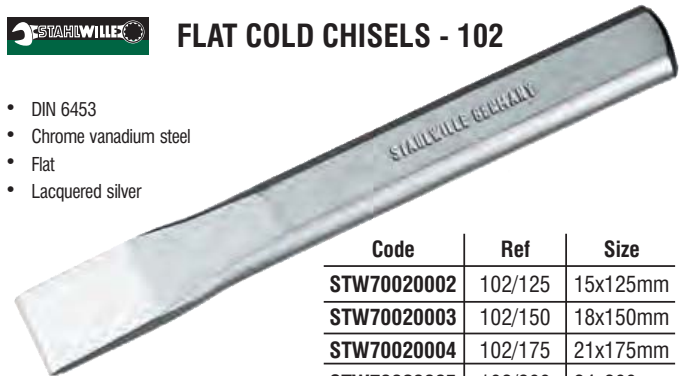

Code	Ref	Size
STW70020002	102/125	15x125mm
STW70020003	102/150	18x150mm
STW70020004	102/175	21x175mm
STW70020005	102/200	24x200mm
STW70020007	102/250	25x250mm
STW70020008	102/300	26x300mm





## FLAT COLD CHISELS

- Formed from Hexagonal tool steel SS1083
- The body is tapered to the edge where a primary and secondary cutting edge are formed
- Each chisel is individually hardness tested to maintain our high standards
- These chisels are used by the construction and engineering industries
- Chopping concrete and masonry, cutting mild steel bolts and plates
- Each chisel is dip paint coated after manufacture
- Used with ball peen or club type hammers
- Eye protection should be worn at all times



Loose Chisels	
Code	Size
AFT0060	13x150mm
AFT0065	16x150mm
AFT0070	16x200mm
AFT0075	19x200mm
AFT0080	19x250mm
AFT0085	25x250mm
AFT0090	25x300mm
AFT0095	25x350mm

Carded Chisels	
Code	Size
AFT0415	7x100mm
AFT0420	10x150mm
AFT0430	13x150mm
AFT0450	16x150mm
AFT0460	16x175mm
AFT0465	13x200mm
AFT0470	16x200mm
AFT0480	19x200mm
AFT0490	19x250mm
AFT0500	25x250mm
AFT0510	25x300mm



## RIBBED COLD CHISELS - 100

- Forged blade
- Web thickness constant for full length of the blade
- Of tough tempered special steel
- Chrome plated
- Can be ground



Code	Size	Size
STW70010004	400/4	15x100mm
STW70010006	400/6	20x150mm
STW70010008	400/8	26x200mm
STW70010010	400/10	30x250mm
STW70010012	400/12	35x300mm



## FLAT GROOVING CHISEL - 112/240

- 110 chisel
- Chrome vanadium steel
- Flat
- Lacquered silver



Code	Size
STW70080002	26x240mm



## CONCRETE CHISEL

- The concrete cold chisel is used in various trades for rough cutting of brick and concrete
- Epoxy powder coated

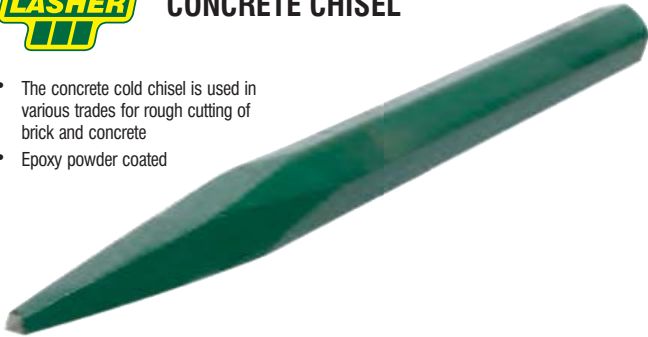

Code	Size
LAS2200	25x300mm



## DIAMOND POINT CHISEL

- The diamond point chisel is used to cut "V" grooves and clean corners in metal work
- Epoxy powder coated



Code	Size
LAS2205	6x12x150mm



## ROUND NOSE CHISEL

- The round nose chisel is used to cut semi-circular grooves in metal and masonry
- Epoxy powder coated

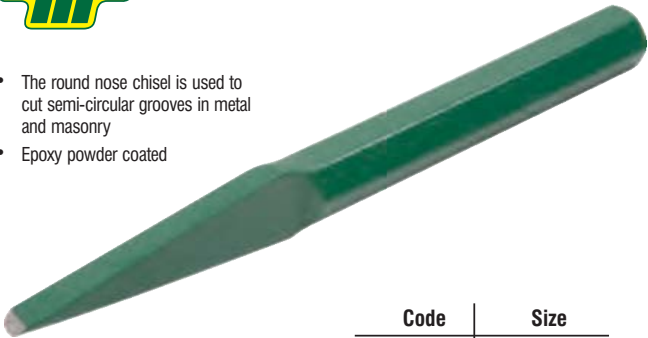

Code	Size
LAS2255	10x20x200mm



## CROSS CUT CHISEL

- The cross cut cold chisel is used to make narrow cuts or grooves in metal and masonry
- Epoxy powder coated



Code	Size
LAS2265	10x20x200mm
LAS2270	6x12x150mm

**oftool** BRICK BOLSTER

- A brick bolster is similar to a wide cold chisel
- It is used by bricklayers to cut bricks
- A narrower version (55 mm) is used by electricians
- Usually a 1.8 kg Club hammer is used with this

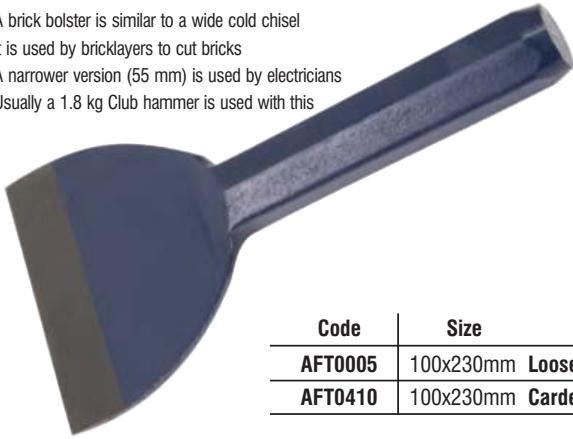

Code	Size
AFT0005	100x230mm Loose
AFT0410	100x230mm Carded

**oftool** ELECTRICIAN'S BOLSTER

- An electrician's bolster is similar to a wide cold chisel
- It is used by electricians to cut bricks
- A larger version (100 mm) is used by builders
- Usually a 1,8 kg Club hammer is used with this



Code	Size
AFT0010	55x210mm Loose
AFT0400	55x210mm Carded



**CHISEL/PUNCH SET - 6 PIECE 102/5/6D**

- Contents: 106 /125, 106/150mm, 107/125mm, 104/120x2, 104/120x4mm, 105/120x10mm
- In plastic stand



Code	Size
STW98812201	6 Piece



**CHISEL/PUNCH SET - 6 PIECE 102/5/6PC**

- Contents: 106 /125, 106/150mm, 107/125mm, 104/120x2, 104/120x4mm, 105/120x10mm
- In plastic wallet



Code	Size
STW98812202	6 Piece



**CHISEL/PUNCH SET - 6 PIECE**

- Contents:
- Cold chisels 7 x 100mm, 10 x 150mm, 13 x 150mm, 16 x 150mm
  - Centre punch 3 x 100mm
  - Pin punch 5 x 100mm
  - Plastic stand and cover



Code	Size
MTC3070002	6 Pieces



**CHISEL/PUNCH SET - 12 PIECE**

- Contents:
- Cold chisels 7 x 100mm, 10 x 150mm, 13 x 150mm, 16 x 175mm
  - Centre punch 3, 6mm
  - Pin punch 3, 4, 5, 6mm
  - Drive punches 3, 5mm
  - Plastic stand and cover

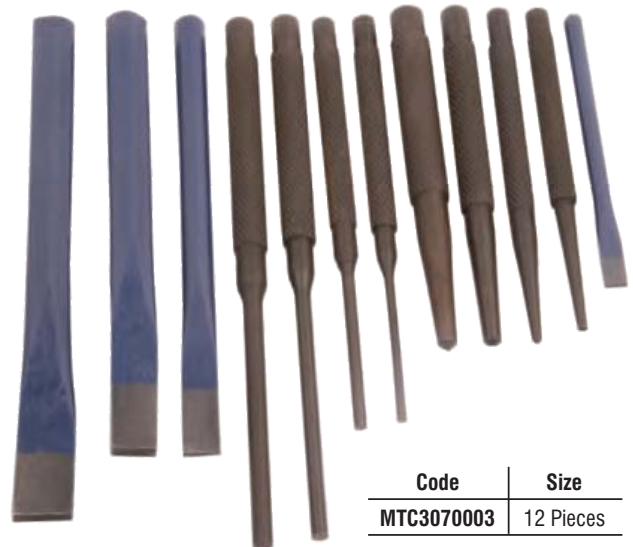

Code	Size
MTC3070003	12 Pieces

General Tools

**GROZ** tools to trust **PRICK PUNCH**

- Used for marking metals in work layouts
- 60° angle point
- Suitable where precise marking/scoring is required



Code	Size
GRO4550	2.0 x 100mm
GRO4555	4.0 x 100mm



**AUTOMATIC CENTRE PUNCH**

- Fully automated single hand operation
- Spring loaded mechanism delivers a punch just by pressing of the head
- Knurled brass body, chrome plated with hardened and tempered alloy steel point for long wear life



Code	Size
RIC2740	125mm

**GROZ** tools to trust **AUTOMATIC CENTRE PUNCH**

- Fully automated single hand operation
- Spring loaded mechanism delivers a punch just by pressing of the head
- The depth of the impression is variable and can be adjusted from light marking to heavy blows by turning the knurled head



Code	Size
GRO4020	120mm

**GROZ** tools to trust **CENTRE PUNCH (HEAVY DUTY)**

- Ideal for marking metal and making indentations in a workpiece before drilling
- Manufactured from selected carbon steel, accurately hardened for increased life
- Working tips are centred and ground to correct angles (90° included angle) for increased efficiency and the striking end is beveled to prevent breakage



Code	Size
GRO4040	6 x 150mm
GRO4042	10 x 150mm

**GROZ** tools to trust **CENTRE PUNCH - ROUND HEAD**

- Ideal for marking metal and making indentations in a workpiece before drilling
- Manufactured from selected carbon steel, accurately hardened for increased life
- Working tips are centred and ground to correct angles (90° included angle) for increased efficiency and the striking end is beveled to prevent breakage

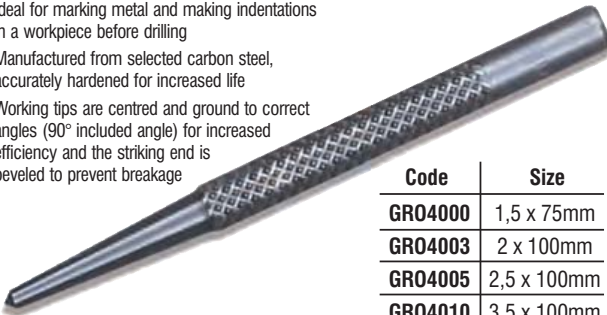

Code	Size
GRO4000	1,5 x 75mm
GRO4003	2 x 100mm
GRO4005	2,5 x 100mm
GRO4010	3,5 x 100mm
GRO4015	4 x 100mm
GRO4017	5 x 100mm

**GROZ** tools to trust **CENTRE PUNCH - SQUARE HEAD**

- Ideal for marking metal and making indentations in a workpiece before drilling
- Manufactured from selected carbon steel, accurately hardened for increased life
- Working tips are centred and ground to correct angles (90° included angle) for increased efficiency and the striking end is beveled to prevent breakage

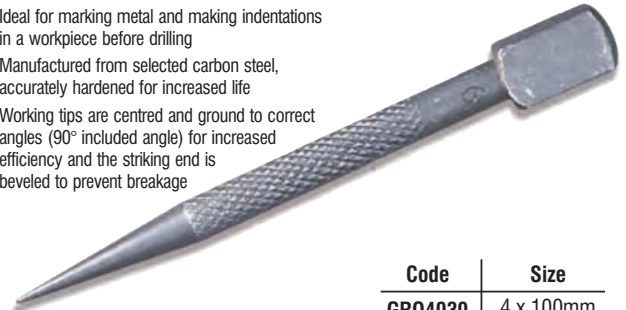

Code	Size
GRO4030	4 x 100mm
GRO4032	5 x 100mm



**CENTRE PUNCH - 105**

- Chrome vanadium steel
- Octagonal
- Steel lacquered silver



Code	Ref	Size
STW70050001	105/100	10 x 100mm
STW70050002	105/120	12 x 120mm



**CENTRE PUNCH**

- Used to mark hole centres to guide the point of a drill
- Phosphated finish

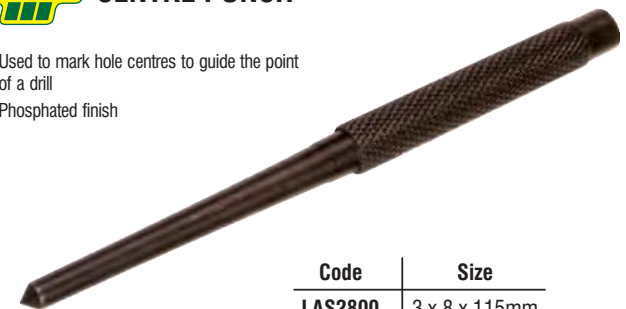

Code	Size
LAS2800	3 x 8 x 115mm
LAS2805	4 x 8 x 115mm
LAS2810	5 x 10 x 140mm
LAS2815	6 x 12 x 160mm



## CENTRE PUNCH SET

- 0,8mm, 1,6mm, 2,3mm
- Colour coded for easy identification
- Heat treated alloy steel
- PVC shroud for shock-resistant sure grip
- Square section striking head

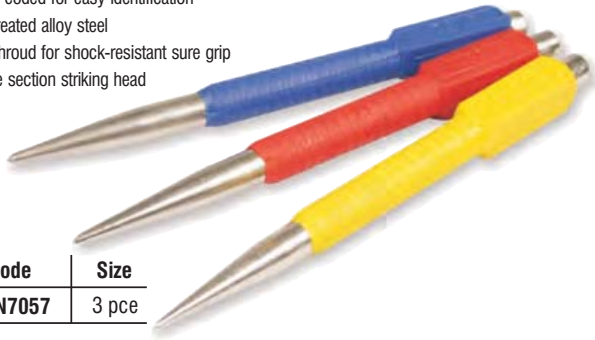

Code	Size
HON7057	3 pce



## CENTRE PUNCH

- Tip diameters of 3.0, 4.0 and 5.0mm x 100mm
- Ideal for marking metal and making indentations in a workpiece before drilling
- Manufactured from selected carbon steel, accurately hardened for increased life
- Working tips are centred and ground to correct angles (90° included angle) for increased efficiency and the striking end is beveled to prevent breakage



Code	Size
RIC2750	3 pce

## GROZ CENTRE PUNCH SET (BOXED)

- 8 piece, round head set comprising sizes 1.5 - 2 - 2.5 - 3 - 3.5 - 4 - 4.5 - 5.5mm x 100mm
- Ideal for marking metal and making indentations in a workpiece before drilling
- Manufactured from selected carbon steel, accurately hardened for increased life
- Working tips are centred and ground to correct angles (90° included angle) for increased efficiency and the striking end is beveled to prevent breakage



Code	Size
GRO4023	8 pce

## GROZ CENTRE PUNCH SET (WALLET)

- 5 piece, round head set comprising sizes 1.5, 2, 2.5, 3.5, and 4mm x 100mm
- Ideal for marking metal and making indentations in a workpiece before drilling
- Manufactured from selected carbon steel, accurately hardened for increased life
- Working tips are centred and ground to correct angles (90° included angle) for increased efficiency and the striking end is beveled to prevent breakage



Code	Size
GRO4025	5 pce

## GROZ NAIL PUNCHES

- The working end is cupped to follow the nail head without sliding off
- Punches have a knurled round shank that provides a positive, non-slip grip with a square striking end and the 9.5 mm square head provides a larger striking area and also prevents the punch from rolling off
- The striking end is beveled to prevent breakage
- These are manufactured from selected carbon steel with a black oxide finish, accurately hardened for increased service life (52-58 Rockwell)



Code	Size
GRO4300	1.5 x 100 mm
GRO4305	3.0 x 100 mm
GRO4310	4.0 x 100 mm
GRO4315	5.0 x 100 mm



## NAIL PUNCH SET

- 0,8mm, 1,6mm, 2,4mm
- Colour coded for easy identification
- Sets nails & brads for a smooth professional finish
- Square section striking head
- Hardened & tempered carbon steel
- PVC shroud for shock-resistant sure grip



Code	Size
HON7055	3 pce



## NAIL PUNCH SET

- High quality chrome-vanadium steel and heat treated
- Knurled body
- Tips are cupped and chamfered
- Fully black oxidized but polished ends
- Square head 23 mm long prevents rolling
- 3 x 100 mm
- 4 x 100 mm
- 5 x 100 mm



Code	Size
RIC2755	3 pce



## NAIL/CENTRE PUNCH SET

- High quality chrome-vanadium steel and heat treated
- Knurled body
- Tips are cupped and chamfered
- Fully black oxidized but polished ends
- Square head 23mm long prevents rolling
- Points are ground and hardened



Code	Size
RIC2760	6 pce

Nail: 3, 4, 5 x 100mm  
Centre: 3, 4, 5 x 100mm

General Tools

## STANLEY NAIL – SET 3 PIECE - 58-230

- Square head, round knurled body
- Alloy steel hardened and tempered
- Cupped chamfered tip
- Contents: 0.8, 1.6, 2.4mm



Code	Size
STA3750	3 Pce

## GROZ PIN PUNCHES

tools to trust

- Precision-matched roll pin punches are specifically designed to remove spring / roll pins
- Manufactured from selected carbon steel, these are accurately hardened for increased life (52-58 Rockwell)
- Single piece construction with a cylindrical shaft and chamfered striking end that helps reduce mushrooming and chipping



Code	Size	Code	Size
GRO4500	1.5 X 150mm	GRO4520	5.0 X 150mm
GRO4505	2.5 X 150mm	GRO4530	6.0 X 150mm
GRO4510	3.0 X 150mm	GRO4535	8.0 X 150mm
GRO4515	4.0 X 150mm		

## STABILWILLE PIN PUNCH - 109

- Manufactured from Chrome Vanadium
- With guide bush for use on retraining pins on disc brake pads



Code	Size	Code	Size
STW70090001	0.9x80mm	STW70090005	2.8x97mm
STW70090002	1.4x82mm	STW70090006	3.4x100mm
STW70090003	1.8x86mm	STW70090007	3.9x100mm
STW70090004	2.4x95mm	STW70090008	5.9x103mm

## STABILWILLE PIN PUNCH PARALLEL - 108

- DIN 6450
- Octagonal
- Chrome vanadium steel
- Lacquered silver



Code	Size	Code	Size
STW70070009	3x175mm	STW70070004	5x150mm
STW70071152	2x115mm	STW70070005	6x150mm
STW70070001	2.5x150mm	STW70070006	8x150mm
STW70070002	3x150mm	STW70070010	4x175mm
STW70070003	4x150mm	STW70070008	8x200mm

## LASHER PIN PUNCH

- Used to drive out a pin from an assembly
- Phosphated finish



Code	Size	Code	Size
LAS2840	3 x 8 x 115mm	LAS2855	6 x 10 x 140mm
LAS2845	4 x 8 x 115mm	LAS2860	8 x 12 x 160mm
LAS2850	5 x 10 x 140mm	LAS2865	10 x 12 x 160mm

## RAGO PIN PUNCH SET

- For knocking out spring pins, roll pins
- Chrome Vanadium steel
- Hardened and tempered parallel shafts
- Driving out studs
- 6 Piece set in wallet
- SIZES : 3,4 ,5 ,6 ,7 & 8 mm



Code	Size
RIC2770	6 pce

## GROZ PIN PUNCH SET WALLET

tools to trust

- Same specifications as pin punches above 1,5 - 2,5 - 3 - 4 - 5 - 5,5 - 6 - 8 x 100 mm



Code	Size
GRO4540	8 Pc. 1.5 - 8 mm

## LASHER PIN PUNCH SET

- Used to drive out a pin from an assembly
- Phosphated finish
- 6 piece set

3 x 8 x 115mm	6 x 10 x 140mm
4 x 8 x 115mm	8 x 12 x 160mm
5 x 10 x 140mm	10 x 12 x 160mm

Code	Size
LAS2835	6 Pce



## LASHER PIN PUNCH SET

- Used to drive out a pin from an assembly
- Phosphated finish
- 4 piece set

3 x 8 x 115mm  
4 x 8 x 115mm  
6 x 10 x 140mm  
8 x 12 x 160mm

Code	Size
LAS2830	4 Pce



## MITCO PIN PUNCH SET

- Parallel shaft
- Knurled handle for better grip

Code	Size
MTC3160005	7 Pce - 2, 3, 4, 5, 6, 7, 8 & 10mm



## GROZ PIN PUNCH SET BOXED

- 8 piece set comprising sizes 1,5 - 2,5 - 3 - 4 - 5 - 5,5 - 6 - 8 x 100 mm
- Precision-matched roll pin punches are specifically designed to remove spring / roll pins
- Manufactured from selected carbon steel, these are accurately hardened for increased life (52-58 Rockwell)
- Single piece construction with a cylindrical shaft and chamfered striking end that helps reduce mushrooming and chipping

Code	Size
GR04538	8 Pce. 1.5 - 8 mm



## STABHWILLE PUNCH - PARALLEL PIN - SET 6 PIECES - 108/6PC

- Contents 6 Pieces
- 150 x 2.50mm
- 150 x 3.00mm
- 150 x 4.00mm
- 150 x 5.00mm
- 150 x 6.00mm
- 150 x 8.00mm

Code	Size
STW96700702	6 Pce



## STABHWILLE PUNCH - PARALLEL PIN - SET 6 PIECES - 108/6D

- Contents 6 Pieces
- 150 x 2.50, 150 x 3.00, 150 x 4.00, 150 x 5.00, 150 x 6.00, 150 x 8.00mm

Code	Size
STW96700701	6 pce



## GROZ DRIFT PUNCHES

- Drift punches are ideal for lining up holes in two or more pieces of metal and drawing pins through various assemblies
- A single piece construction with a hexagonal shank, manufactured from hardened carbon steel, they are accurately hardened for extended service life (52-58 Rockwell)
- The working ends are machine ground with the body in a premium powder coated finish



Code	Size
GR04050	4.0 x 225mm
GR04052	6.0 x 300mm

## STABHWILLE DRIFT PUNCH - 104

- Chrome vanadium steel
- Octagonal
- Steel lacquered silver



Code	Size
STW70060002	4x120mm

## STABHWILLE PUNCH SET 104-5/6

- Strong, extremely tough and durable
- Manufactured from chrome vanadium steel
- Meet all accepted industry standards
- Contents 6 Pieces
- 120 x 2.00mm
- 120 x 3.00mm
- 120 x 4.00mm
- 120 x 5.00mm
- 120 x 6.00mm
- 120 x 10.00mm
- Supplied in plastic stand

Code	Size
STW96700601	6 Pce





## ROOFING PUNCH

- Used to punch holes through sheet metal or corrugated sheets to take fastenings
- Precision turned from the finest quality tool steel
- Phosphated finish



Code	Size
LAS2870	6x12x160mm
LAS2875	8x16x200mm



## PUNCH & CHISEL SET

- General work shop and engineering use
- Selection of most useful tools
- Chrome Vanadium steel
- Cold chisels : 3 x 10,13 & 16 mm
- Taper drifts : 2 x 3.20 & 4,00 mm
- Pin punch : 1 x 150 mm
- Centre punch : 1 x 10 mm



Code	Size
RIC2720	7 pce



## PUNCH & CHISEL SET - P10

- Roofing punches are used to punch holes through sheet metal of corrugated sheets to take fastenings
- Phosphated finish
- 10 piece sets are available in plastic wallets

Pin punch 4x8x115mm  
 Pin punch 6x10x140mm  
 Pin punch 8x12x160mm  
 Drive punch 3x8x115mm  
 Drive punch 5x10x140mm  
 Roofing punch 6x12x160mm  
 Centre punch 3x8x115mm  
 Centre punch 5x10x140mm  
 Flat cold chisel 12x150mm  
 Round nose chisel 6x12x150mm



Code	Size
LAS2790	10 Pce



## PUNCH & CHISEL SET - P5

- Roofing punches are used to punch holes through sheet metal of corrugated sheets to take fastenings
- Phosphated finish
- 5 piece sets are available in plastic wallets

Roofing punch 6x12x160mm  
 Centre punch 3x8x115mm  
 Pin punch 4x8x115mm  
 Cold chisel 16x175mm  
 Drive punch 5x10x140mm



Code	Size
LAS2795	5 Pce



## NUMBER & LETTER PUNCHES

- For hand held, hammer strike applications
- High quality steel, induction hardened
- Striking end is softer than the punch end to prevent splintering
- Striking end is beveled for safety
- Supplied in convenient boxed sets

Code	Size
GRO4100	Figure 3 mm
GRO4105	Figure 5 mm
GRO4110	Figure 6 mm
GRO4115	Figure 8 mm
GRO4120	Figure 10 mm
GRO4125	Figure 12 mm

Code	Size
GRO4200	Letter 3 mm
GRO4205	Letter 5 mm
GRO4210	Letter 6 mm
GRO4215	Letter 8 mm
GRO4220	Letter 10 mm
GRO4225	Letter 12 mm



## BELT PUNCHES

- These hollow steel punches are ideal for use on leather, plastic, fibre etc.
- The precisely ground cutting edge is induction hardened and tempered for longer life reduced wear
- Special design of the cutting tip prevents jamming of materials inside the punch
- These are manufactured in sizes ranging from 2 mm to 25 mm

Code	Size
GRO3800	2 mm
GRO3805	3 mm
GRO3810	4 mm
GRO3815	5 mm
GRO3820	6 mm
GRO3823	7 mm

Code	Size
GRO3825	8 mm
GRO3828	9 mm
GRO3830	10 mm
GRO3835	11 mm
GRO3840	12 mm
GRO3843	13 mm

Code	Size
GRO3845	14 mm
GRO3850	16 mm
GRO3855	19 mm
GRO3860	22 mm
GRO3865	25 mm





## BELT PUNCH SET - 9 PIECE

- For punching holes in leather, rubber, canvas, cardboard etc.
- Made from tempered and heat treated tool steel with clearance honed cutting edge to allow easy removal of waste
- Set contains: 2.5, 3, 4, 5, 6, 7, 8, 9 & 10mm punches



Code	Size
RIC2730	9 pce



## BELT PUNCH SET - 9 PIECE

- 2mm, 3mm, 4mm, 5mm, 6mm, 7mm, 8mm, 9mm, 10mm
- Precision ground
- Knurled grip
- Punch leather, plastic and many other materials
- Supplied in a handy storage case



Code	Size
HON7050	9 pce

## GROZ WAD PUNCH

- These punches with bell shaped construction are manufactured in sizes ranging from 30 mm to 40 mm
- The shank is powder coated with a ground finish cutting edge



Code	Size
GRO4600	30mm
GRO4605	32mm
GRO4610	35mm
GRO4615	38mm
GRO4620	40mm

## GROZ WAD PUNCH SET

- Supplied in a convenient plastic pouch
- Available in set of 7: comprises the following sizes: 6, 8, 10, 11, 13, 16 and 19 mm
- Available in set of 10: comprises the following sizes: 6, 8, 10, 11, 13, 16, 19, 22 and 25 mm



Code	Size
GRO3880	6 - 19mm
GRO3882	6 - 25mm

## GROZ WAD PUNCH SET

- Supplied in a professional wooden case
- Available in set of 14
- Comprises the following sizes: 6, 8, 10, 11, 13, 14, 16, 19, 22, 25, 30, 32, 35 and 38mm



Code	Size
GRO3884	6 - 38mm



## WAD PUNCH SET - SET 10 PIECES

- For punching holes in leather, rubber, canvas, cardboard, and other materials
- Tempered and heat resistant steel
- Honed cutting edge allows for easy removal of punched materials
- Metal box
- Contents: 5, 6, 8, 10, 12, 15, 16, 20, 25, 32mm



Code	Size
SHA1470	5-32mm

## PROTOOL CHASSIS PUNCH - Q MAX

- Used for marking holes in sheet-metal
- Punch is bolted through a pre-drilled hole
- Tighten the nut and the hole is punched
- Car aeralis, distribution boxes etc



Code	Size	Code	Size
QMX0010	12.5mm	QMX0070	25mm
QMX0020	14.0mm	QMX0080	27.5mm
QMX0030	16.0mm	QMX0090	30.0mm
QMX0040	17.5mm	QMX0095	32.5mm
QMX0050	20.0mm	QMX0100	35.0mm
QMX0060	22.5mm	QMX0110	40.0mm

Code	Size
QMX0120	45.0mm
QMX0130	50.0mm
QMX0140	60.0mm
QMX0150	70.0mm

## STANLEY SCREW HOLE PUNCH

- Centres screw starting hole quickly and accurately from hinges, butts, locks, straps, etc



Code	Size
STA3745	80mm





## REVOLVING PUNCH

- Professional quality and strength for many applications
- Drop forged from carbon alloy steel, heat treated for maximum strength
- Industrial black finish with comfortable vinyl grips
- Hardened and tempered punch wheel with sizes: 2.6, 3, 3.4, 3.8, 4.2 and 4.8mm



Code	Size
RIC2620	300mm



## REVOLVING PUNCH

- Made from heavy gauge pressed sheet steel
- Spring loaded revolving head incorporates 6 punches of sizes, 2mm, 2.5mm, 3mm, 3.5mm, 4mm, 4.5mm
- Punches are accurately treated for extended life and are exposed to a brass anvil which prevents the edges from getting damaged in use
- Each punch locates exactly in position locking in place with the pawl and ratchet mechanism.



Code	Size
GR03075	220mm



## GROMMET TOOL KIT

- Heavy duty tool includes 10 set brass finished grommets
- Ideal for hundreds of uses as snap fastener kit for canvas, leather, plastic and fabrics, webbing kit for attaching webbing to beach and garden furniture, eyelet tool kit for inserting eyelets in belts, sneakers, bookbinders etc



Code	Size
RIC1498	9.5mm
RIC1500	12.5mm



## SPARE GROMMETS

- 12.5mm and 9.5mm available
- 25 piece set



Code	Size
RIC1490	12.5mm
RIC1512	9.5mm

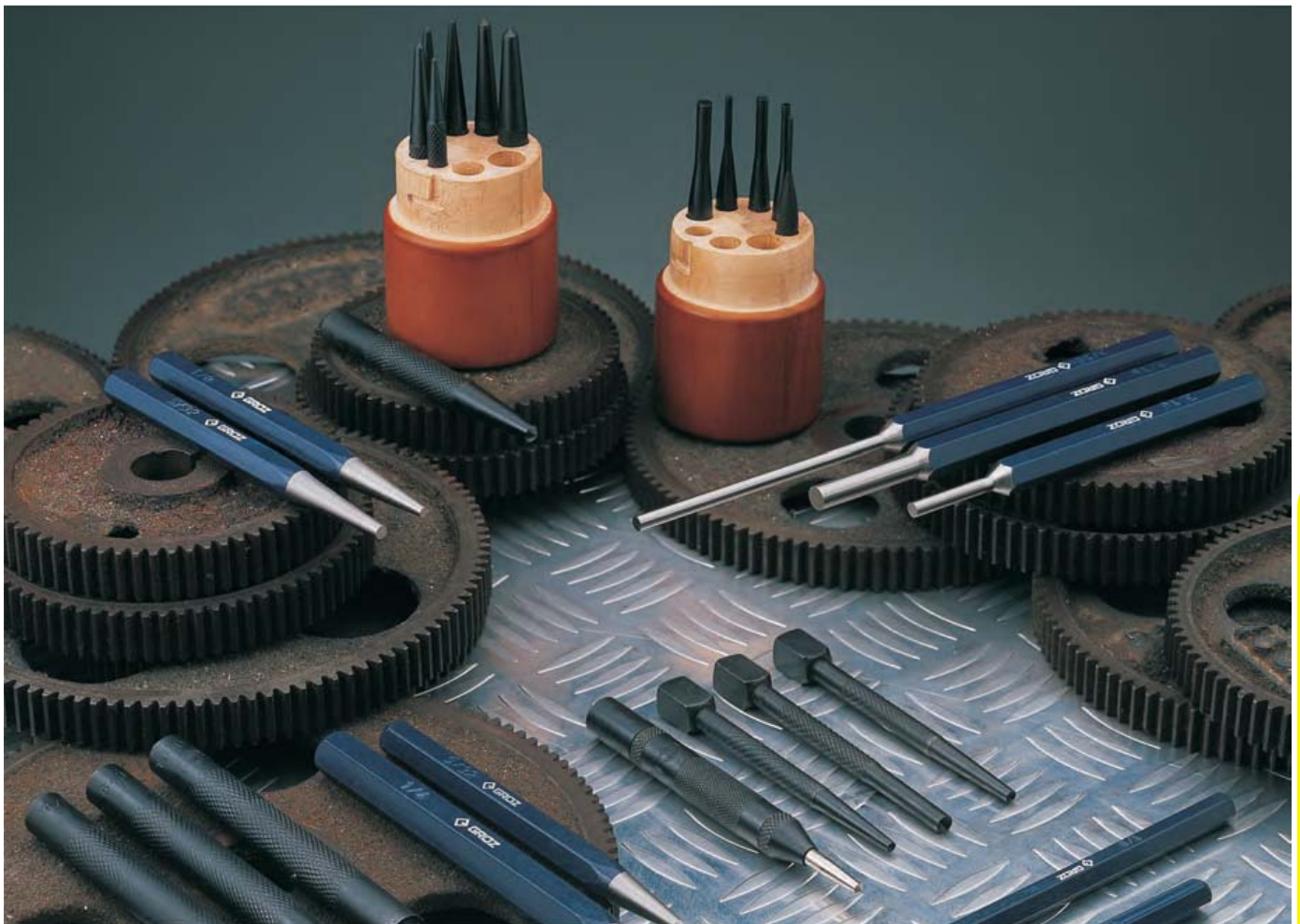



## WOOD CHISELS

- Bolster construction blades are hardened and tempered so that the blade can be re-sharpened to the last inch
- Tough, impact resistant plastic handles
- All come honed ready for use with plastic blade guards



Code	Size
HON0808	6mm
HON0809	10mm
HON0811	13mm
HON0813	16mm
HON0815	19mm
HON0817	25mm



## WOOD CHISELS

- Expert quality, heavy duty chisels designed for use with a mallet but will accept incidental use with a hammer
- Blade and tang forged in one piece from high grade chrome vanadium steel
- Precision ground bevels and cutting edges
- Tough impact resistant plastic handle with comfortable soft touch TRP grip for prolonged use
- Supplied with plastic end guard for safety and protection



Code	Size
RIC0830	6mm
RIC0835	10mm
RIC0840	12mm
RIC0845	16mm

Code	Size
RIC0850	19mm
RIC0855	25mm
RIC0860	32mm
RIC0865	38mm

## STANLEY WOOD CHISELS - BEVEL EDGE

- Fully heat treated forged steel blade for longer life
- Polypropylene handle for a comfortable grip, practically unbreakable
- Lacquered blade for rust prevention
- Blade guard for safety



Code	Size	Ref.
STA2634	6mm	16-151
STA2635	10mm	16-149
STA2637	12mm	16-152
STA2639	16mm	16-153
STA2642	18mm	16-154
STA2645	22mm	16-155
STA2646	25mm	16-156
STA2647	32mm	16-157
STA2648	38mm	16-161

## IRWIN WOOD CHISELS - BEVELED EDGE - M444

- Blade hardened up to last 25mm for long working life
- For an edge that is slow to blunt yet easy to sharpen
- Solid one-forged blade ensures structural integrity
- Blade lacquered for rust protection
- Large strong tang keeps handle firmly attached
- Designed for use with mallet
- Impact resistant handle will absorb the occasional hammer blow



Code	Size
MAR0010	10mm
MAR0015	13mm
MAR0020	16mm

Code	Size
MAR0025	19mm
MAR0030	25mm
MAR0035	32mm
MAR0040	38mm



## WOOD CHISEL SET WITH OILSTONE

- Bolster construction blades are hardened and tempered so that the blade can be re-sharpened to the last inch
- All come honed ready for use with plastic blade guards
- Supplied in a convenient carry case with a 150mm combination oilstone
- Shock absorbing plastic handles



Code	Size
HON0820	6, 13, 19, 25mm



## 4 PCE WOOD CHISEL SET

- Expert quality, heavy duty chisels designed for use with a mallet but will accept incidental use with a hammer
- Blade and tang forged in one piece from high grade chrome vanadium steel
- Precision ground bevels and cutting edges
- Tough impact resistant plastic handle with comfortable soft touch TRP grip for prolonged use
- Supplied with plastic end guard for safety and protection



Code	Size
RIC0875	6, 12, 19, 25mm

General Tools

## IRWIN® WOOD CHISEL - BEVELED EDGED, SET 3 - M444/S3

- Blade hardened up to the last 25mm for long working life
- For an edge that is slow to blunt yet easy to sharpen
- Solid one-forged blade ensures structural integrity
- Blade lacquered for rust protection
- Large strong tang keeps handle firmly attached
- Designed for use with mallet
- Impact resistant handle will absorb the occasional hammer blow



Code	Contents
MAR0055	13, 19, 25mm

## IRWIN® WOOD CHISEL - BEVELED EDGED, SET 4 - M444/S4

- Blade hardened up to the last 25mm for long working life
- For an edge that is slow to blunt yet easy to sharpen
- Solid one-forged blade ensures structural integrity
- Blade lacquered for rust protection
- Large strong tang keeps handle firmly attached
- Designed for use with mallet
- Impact resistant handle will absorb the occasional hammer blow



Code	Contents
MAR0045	6, 13, 19, 25mm

## IRWIN® WOOD CHISEL - BEVELED EDGED, SET 5 - M444/S5

- Blade hardened up to the last 25mm for long working life
- For an edge that is slow to blunt yet easy to sharpen
- Solid one-forged blade ensures structural integrity
- Blade lacquered for rust protection
- Large strong tang keeps handle firmly attached
- Designed for use with mallet
- Impact resistant handle will absorb the occasional hammer blow



Code	Contents
MAR0050	6, 10, 13, 19, 25mm

## IRWIN® CHISEL IRWIN 13MM-25MM SET 3 - 10507931

- Blade hardened up to the last 25mm for long working life
- For an edge that is slow to blunt yet easy to sharpen
- Solid one-forged blade ensures structural integrity
- Blade lacquered for rust protection
- Large strong tang keeps handle firmly attached
- Designed for use with mallet
- Impact resistant handle will absorb the occasional hammer blow



Code	Contents
MAR0060	13-25mm

## STANLEY® WOOD CHISEL - BEVELED EDGE, SET 3 16-158

- Fully heat treated forged steel blade for longer life
- Polypropylene handle for a comfortable grip, practically unbreakable
- Lacquered blade for rust prevention
- Blade guard for safety



Code	Contents
STA2669	12, 18, 25mm

## STANLEY® WOOD CHISEL - BEVELED EDGE, SET 4 16-159

- Fully heat treated forged steel blade for longer life
- Polypropylene handle for a comfortable grip, practically unbreakable
- Lacquered blade for rust prevention
- Blade guard for safety



Code	Contents
STA2670	6, 12, 18, 25mm



## TURNING CHISELS 3 PIECE SET

- Expert quality, contains most popular sizes for craftsmen
- Durable blades manufactured from high carbon cutlery tool steel, hardened and tempered and heat treated
- Blades are finely ground and polished for keen and long lasting cutting edges
- Lacquered hardwood handles are grooved for a positive safe grip and comfort
- 3 Piece set contains: 1 x 12mm Skew Chisel - 1 x 12mm Gouge - 1 x 3mm Parting Tool



Code

**RIC0820**



## CARVING CHISEL SET - 6 PIECE

- Wooden handles
- Standard quality blades
- Most popular blade configurations for carving wood, linoleum & other materials



Code

**MTS2160**



## CARVING CHISEL SET - 12 PIECE

- Wooden handles
- Standard quality blades
- Most popular blade configurations for carving wood, linoleum & other materials



Code

**HON0818**



## SMOOTH PLANE - A3

- Fully adjustable, for cutter alignment and depth of cut
- General purpose planes for workshop, site or fine finishing of high quality work
- Fine grey iron bases with handle and knob in fine lacquered wood
- Chrome carbon steel cutters
- Spare blades are available



Code

**AMB1000**

Size

240x45mm



## SMOOTH PLANE - A4

- Fully adjustable, for cutter alignment and depth of cut
- General purpose planes for workshop, site or fine finishing of high quality work
- Fine grey iron bases with handle and knob in fine lacquered wood
- Chrome carbon steel cutters
- Spare blades are available



Code

**AMB1010**

Size

245x50mm

## STANLEY PLANE - GOBAL

- Kidney shaped lever cap screw hole prevents accidental slipping of cutter
- Chrome carbon steel cutter hardened and tempered to retain a keen cutting edge
- Fully adjustable frog for all tasks and timber types
- Finger tip adjustment for depth of cut and cutter alignment
- Tight fitting spring steel cap iron for perfect shaving flow
- Precision cast fine grey iron base for stability and wear resistance
- Precision ground base and sides ensure performance to highest tolerance
- Virtually unbreakable handle polypropylene handle and knob shaped for comfort



Code

**STA3583**

Size

235x45mm

Ref.

12-163

**STA3586**

245x50mm

12-164

**STA3591**

355x50mm

12-165

## STANLEY PLANE - BAILEY SMOOTH

- General purpose planes for workshop, site or fine finishing of high quality work
- Kidney shaped lever cap screw hole prevents accidental slipping of cutter
- Chrome carbon steel cutter hardened and tempered to retain a keen cutting edge
- Fully adjustable frog for all tasks and timber types
- Finger tip adjustment for depth of cut and cutter alignment
- Tight fitting spring steel cap iron for perfect shaving flow
- Precision cast fine grey iron base for stability and wear resistance
- Precision ground base and sides ensure performance to highest tolerance
- Virtually unbreakable handle polypropylene handle and knob shaped for comfort



Code	Size	Ref.
STA3640	240x45mm	1-12-003

## STANLEY PLANE - BAILEY SMOOTH

- General purpose planes for workshop, site or fine finishing of high quality work
- Kidney shaped lever cap screw hole prevents accidental slipping of cutter
- Chrome carbon steel cutter hardened and tempered to retain a keen cutting edge
- Fully adjustable frog for all tasks and timber types
- Finger tip adjustment for depth of cut and cutter alignment
- Tight fitting spring steel cap iron for perfect shaving flow
- Precision cast fine grey iron base for stability and wear resistance
- Precision ground base and sides ensure performance to highest tolerance
- Virtually unbreakable handle polypropylene handle and knob shaped for comfort



Code	Size	Ref.
STA3645	245x50mm	1-12-004

## MTS JACK PLANE - A5

- For rapid stock removal prior to commencing construction work. Depending on plane setting, can also make a good general purpose plane
- Fully adjustable, for cutter alignment and depth of cut
- Fine grey iron bases with handle and knob in fine lacquered wood
- Chrome carbon steel cutters
- Used for stock removal when preparing timber
- Spare blades are available



Code	Size
AMB1020	355x50mm

## GROZ NO 5 JACK PLANE

- Used for rapid stock removal prior to commencing construction work
- Fully adjustable alignment and cutting depth
- Precision ground base
- Handle and knob in lacquered hardwood
- Chrome carbon steel blade
- Spare blades are available



Code
GRO3000

## STANLEY PLANE - BAILEY JACK

- For rapid stock removal prior to commencing construction work
- Depending on the plane setting, this plane can also make a good general purpose plane
- Kidney shaped lever cap screw hole prevents accidental slipping of cutter
- Chrome carbon steel cutter hardened and tempered to retain a keen cutting edge
- Fully adjustable frog for all tasks and timber types
- Finger tip adjustment for depth of cut and cutter alignment
- Tight fitting spring steel cap iron for perfect shaving flow
- Precision cast fine grey iron base for stability and wear resistance
- Precision ground base and sides ensure performance to highest tolerance
- Virtually unbreakable handle polypropylene handle and knob shaped for comfort



Code	Size	Ref.
STA3650	355x50mm	1-12-005

## STANLEY PLANE - BAILEY JOINTER/TRY

- For rapid stock removal prior to commencing construction work
- Depending on the plane setting, this plane can also make a good general purpose plane
- Kidney shaped lever cap screw hole prevents accidental slipping of cutter
- Chrome carbon steel cutter hardened and tempered to retain a keen cutting edge
- Fully adjustable frog for all tasks and timber types
- Finger tip adjustment for depth of cut and cutter alignment
- Tight fitting spring steel cap iron for perfect shaving flow
- Precision cast fine grey iron base for stability and wear resistance
- Precision ground base and sides ensure performance to highest tolerance
- Virtually unbreakable handle polypropylene handle and knob shaped for comfort



Code	Size	Ref.
STA3595	560x60mm	1-12-007
STA3600	460x60mm	1-12-006

### STANLEY BLOCK PLANE ADJUSTABLE

- Made from fine grey iron with all working surfaces accurately machined for precision results
- General purpose block plane
- Adjustable for depth of cut and alignment



Code	Size	Ref.
STA3550	180x40mm	1-12-220



### STANLEY BLOCK PLANE - NON-ADJUSTABLE

- Made from fine grey iron with all working surfaces accurately machined for precision results
- General purpose block plane
- Depth of cut only adjustable by disassembling the plane



Code	Size	Ref.
STA3555	140x35mm	1-12-102

### STANLEY PLANE - DUPLEX

- Made from fine grey iron with all working surfaces accurately machined for precision results
- Two cutter position for regular and bull nose work
- Supplied with adjustable fence, depth gauge and cutting spur for cross work grain



Code	Size	Ref.
STA3620	255x38mm	1-12-078

### STANLEY SURFORM - PLANER FILE METAL

- Tough polypropylene handle
- Adjustable for use as a plane or file
- Black die cast body
- Fitted with standard cut blades



Code	Size	Ref.
STA5760	254mm	5-21-122

### STANLEY SURFORM - PLANE

- Plane with tough polypropylene handle
- Black die cast body
- Fitted with standard cut blade

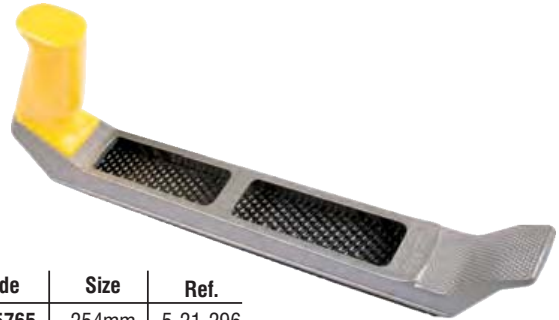

Code	Size	Ref.
STA5765	254mm	5-21-296

### STANLEY SURFORM - FLAT FILE

- Flat file with tough polypropylene handle
- Black die cast body
- Fitted with standard cut blade



Code	Size	Ref.
STA5735	254mm	5-21-295

### STANLEY SURFORM - BLOCK PLANE METAL

- Black painted die-cast alloy body
- Fitted with fine cut blade



Code	Size	Ref.
STA5755	140mm	5-21-399

## STANLEY SURFORM SHAVER TOOL - 5-21-115

- Polypropylene body
- Compact and effective tool with curved blade for increased stock removal
- Click action blade replacement
- Works on pull action



Code	Size
STA5785	60mm



## STANLEY SURFORM - ROUND FILE

- Round file with tough polypropylene handle
- Particularly useful for sculpturing, shaping or enlarging holes
- Front piece removable for blade change

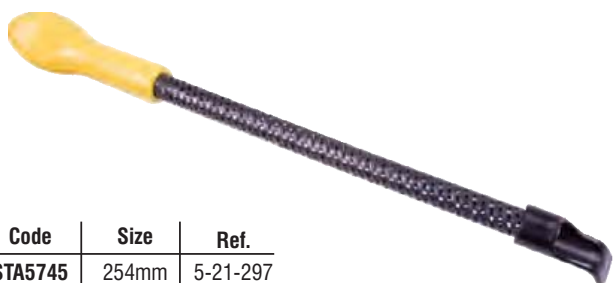

Code	Size	Ref.
STA5745	254mm	5-21-297

## STANLEY SPOKESHAVE - ROUND ADJUSTABLE

- Fine grey iron body with black painted finish
- Fully adjustable for depth cut and alignment
- Round base for concave surfaces



Code	Size	Ref.
STA5300	54mm	1-12-152

## STANLEY SPOKESHAVE - FLAT ADJUSTABLE

- Fine grey iron body with black painted finish
- Fully adjustable for depth cut and alignment
- Flat base for flat surfaces



Code	Size	Ref.
STA5305	54mm	1-12-151

## STANLEY SPOKESHAVE - CABINET 1-12-080

- Fine grey iron body with black painted finish
- Fully adjustable for depth cut and alignment



Code	Size
STA3940	290 x 70mm

## STANLEY SPOKESHAVE - SPARE CUTTERS

- Made from chrome carbon steel
- hardened and tempered
- Fits 12-151 and 12-152



Code	Size	Ref.
STA5318	54mm	1-12-350

## MTS PLANE BLADES

- Chrome carbon steel
- For #3, 4 & 5 smoothing plane

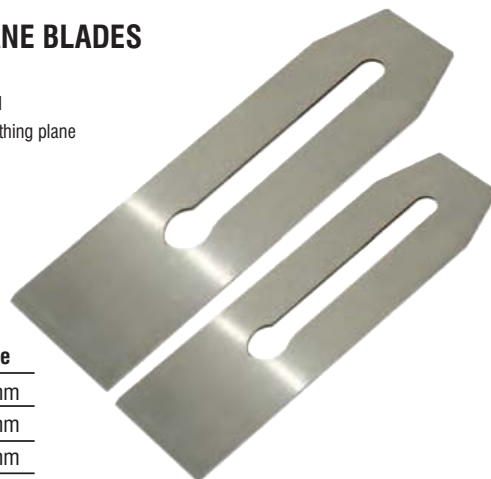

Code	Size
AMB1070	43mm
AMB1080	50mm
AMB1090	60mm

## STANLEY SPARE PLANE BLADE - IRON

- Made from chrome carbon steel for excellent edge retention
- Fine rotary ground to give a flat surface which is easy to sharpen.
- Accurately ground edge of 25°
- Before use an additional honed angle of 30° should be applied
- Good quality steel
- Heat treated and tempered



Code	Part No.	Blade Width	Fits Planes
STA3525	0-12-315	60mm	12-405/055 & 12-006/007
STA3530	0-12-312	45mm	12-203
STA3540	0-12-313	50mm	12-004/005 & 12-204/205

## STANLEY SURFORM BLADE - STANDARD CUT

- Fully hardened and tempered steel blade

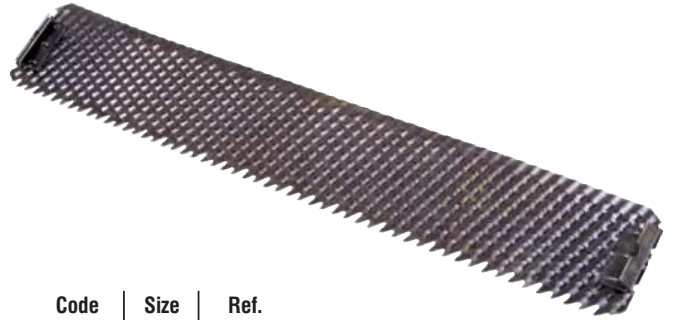

Code	Size	Ref.
STA5730	254mm	5-21-293

## STANLEY SURFORM BLOCK PLANE BLADE

- Fully hardened and tempered steel blade

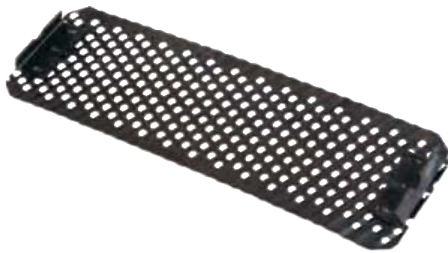

Code	Size	Ref.
STA5700	140mm	5-21-398

## STANLEY SURFORM BLADE - FINE CUT

- Fully hardened and tempered steel blade

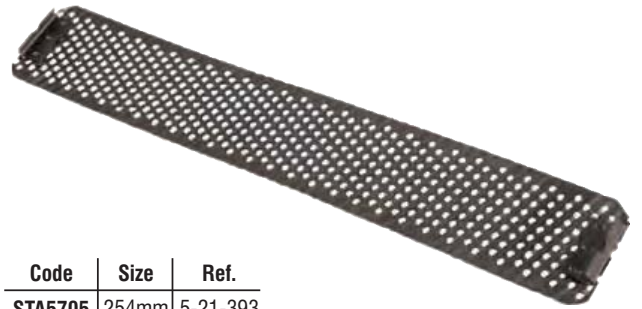

Code	Size	Ref.
STA5705	254mm	5-21-393

## STANLEY SURFORM BLADE - HALF ROUND

- Fully hardened and tempered steel blade

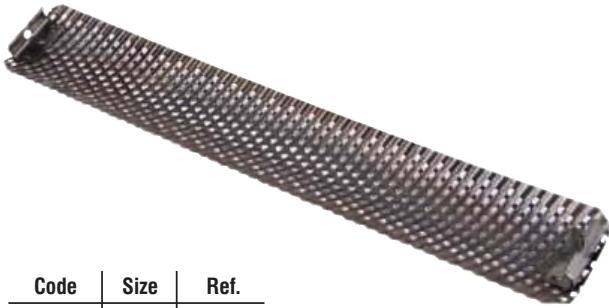

Code	Size	Ref.
STA5710	254mm	5-21-299

## STANLEY SURFORM BLADE - METAL / PLASTIC

- Fully hardened and tempered steel blade

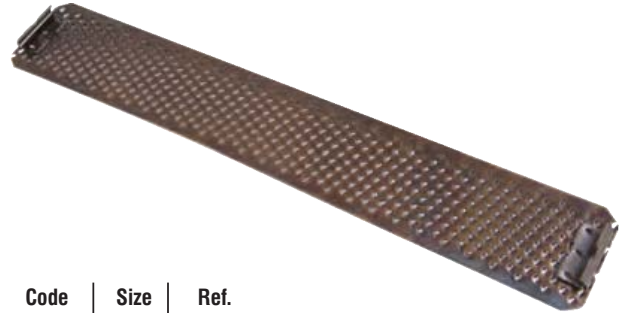

Code	Size	Ref.
STA5715	254mm	5-21-508

## STANLEY SURFORM BLADE - ROUND

- Fully hardened and tempered steel blade

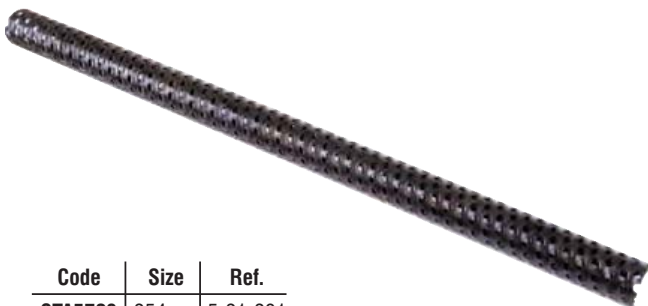

Code	Size	Ref.
STA5720	254mm	5-21-291

## STANLEY SURFORM BLADE - FOR SHAVER TOOL

- Fully hardened and tempered steel blade
- For 5-21-115 shaver tool



Code	Size	Ref.
STA5725	60mm	5-21-515





## FLAT FILES



ALL SLEEVED FILES SUPPLIED COMPLETE WITH HANDLES

- Shape: Edges tapered towards the point
- Surface double cut
- Edges single cut
- Uses: For filing flat surfaces, corners and shoulders
- Deburring
- Also useful for sharpening of certain implements



Loose Code	Size	Sleeved Code
AFT5005	100mm	AFT3995
AFT5006	150mm	AFT4000
AFT5007	200mm	AFT4005
AFT5008	250mm	AFT4010
AFT5009	300mm	AFT4015
AFT5010	350mm	AFT4016



Loose Code	Size	Sleeved Code
AFT5015	100mm	AFT4045
AFT5016	150mm	AFT4050
AFT5017	200mm	AFT4055
AFT5018	250mm	AFT4060
AFT5019	300mm	AFT4065
AFT5020	350mm	



Loose Code	Size	Sleeved Code
AFT5025	100mm	AFT4020
AFT5026	150mm	AFT4025
AFT5027	200mm	AFT4030
AFT5028	250mm	AFT4035
AFT5029	300mm	AFT4040
AFT5030	350mm	



## FARMER'S FRIEND FILE



- Shape: Edges parallel
- Surfaces single cut
- Safe edges
- Uses: For sharpening cutting knives and implements
- Can be used as a lathe file



Code	Size
AFT3985	200mm



## FARMER'S FRIEND FILE - 2ND CUT



- Shape: Edges parallel
- Surfaces single cut
- Safe edges
- Uses: For sharpening cutting knives and implements
- Can be used as a lathe file



Code	Size
AFT5197	250mm



## MILL SAW FILES - 2ND CUT



- Shape: Parallel thin
- Surfaces and edges single cut
- One round edge, one square edge
- Uses: For sharpening wood saws, circular saws, felling and gang saws with fine teeth and band saws.
- Excellent for draw and fine filing, polishing and deburring work
- Often used in engineering industry as lathe and deburring tool



Code	Size
AFT5200	250mm
AFT5201	300mm



## WARDING FILE - 2ND CUT/BASTARD CUT



- Shape: Edges full tapered
- Surface double cut, edges single cut
- Uses: For filing narrow grooves and passages



Code	Size
AFT5161	150mm
AFT5162	200mm



Code	Size
AFT5156	150mm





## HALF ROUND FILES



ALL SLEEVED FILES SUPPLIED COMPLETE WITH HANDLES

- Shape: Edges taper towards the point • Double cut and single cut • Uses: For filing concave and flat surfaces



Loose Code	Size	Sleeved Code
	100mm	AFT4070
AFT5096	150mm	AFT4075
AFT5097	200mm	AFT4080
AFT5098	250mm	AFT4085
AFT5099	300mm	AFT4090
AFT5100	350mm	AFT4091



Loose Code	Size	Sleeved Code
AFT5105	100mm	AFT4123
AFT5106	150mm	AFT4125
AFT5107	200mm	AFT4130
AFT5108	250mm	AFT4135
AFT5109	300mm	AFT4140
AFT5110	350mm	AFT4141



Loose Code	Size	Sleeved Code
	100mm	AFT4095
AFT5116	150mm	AFT4100
AFT5117	200mm	AFT4105
AFT5118	250mm	AFT4110
AFT5119	300mm	



## ROUND FILES



ALL SLEEVED FILES SUPPLIED COMPLETE WITH HANDLES

- Shape: Tapered towards the point • Double cut single cut and spiral cut • Uses: for filing holes, mouldings and half round grooves



Loose Code	Size	Sleeved Code
AFT5035	100mm	AFT4185
AFT5036	150mm	AFT4190
AFT5037	200mm	AFT4195
AFT5038	250mm	AFT4200
AFT5039	300mm	AFT4205



Loose Code	Size	Sleeved Code
AFT5045	100mm	AFT4235
AFT5046	150mm	AFT4240
AFT5047	200mm	AFT4245
AFT5048	250mm	AFT4250
AFT5049	300mm	AFT4255
AFT5050	350mm	AFT4256



Loose Code	Size	Sleeved Code
AFT5055	100mm	AFT4203
AFT5056	150mm	AFT4215
AFT5057	200mm	AFT4220
AFT5058	250mm	AFT4225
AFT5059	300mm	AFT4230



## CHAINSAW FILE - ROUND



- A round parallel sided file
- Used especially for sharpening chainsaw chain



Code	Size
AFT1950	200x4.75mm
AFT1955	200x5.55mm



## SQUARE FILES



ALL SLEEVED FILES SUPPLIED COMPLETE WITH HANDLES

- Shape: Tapered towards the point • Double cut
- Uses: For filing grooves, square holes, inside corners and for finishing cutting tools



Loose Code	Size	Sleeved Code
	100mm	AFT4290
AFT5066	150mm	AFT4295
AFT5067	200mm	AFT4300
AFT5068	250mm	AFT4305
AFT5069	300mm	AFT4310



Loose Code	Size	Sleeved Code
AFT5075	100mm	AFT4340
AFT5076	150mm	AFT4345
AFT5077	200mm	AFT4350
AFT5078	250mm	AFT4355
AFT5079	300mm	AFT4360

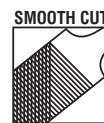

Loose Code	Size	Sleeved Code
AFT5085	150mm	AFT4320
AFT5086	200mm	AFT4325
AFT5087	250mm	AFT4330



## THREE SQUARE FILES



ALL SLEEVED FILES SUPPLIED COMPLETE WITH HANDLES

- Shape: Triangular section • Tapered towards the point • No cut on edges • Double cut on flat sides
- Uses: For filing flat surfaces, corners and grooves



Loose Code	Size	Sleeved Code
AFT5126	150mm	AFT4400
AFT5127	200mm	AFT4405
AFT5128	250mm	AFT4410
AFT5129	300mm	AFT4415



Loose Code	Size	Sleeved Code
AFT5135	100mm	AFT4490
AFT5136	150mm	AFT4495
AFT5137	200mm	AFT4500
AFT5138	250mm	AFT4505
AFT5139	300mm	



Loose Code	Size	Sleeved Code
	100mm	AFT4450
AFT5146	150mm	AFT4455
AFT5147	200mm	AFT4460
AFT5148	250mm	AFT4465

General Tools



- Shape: Slim taper are narrower than standard three square taper files
- Files are triangular in section
- The edges taper towards the point
- Surfaces and edges are single cut
- Dimensions are the width of the flat surface
- For sharpening all saws with fine cross teething
- Uses: Taper saw files can be substituted with one another where the cross dimensions are the same

Loose		Sleeved	
Code	Size	Code	Code
AFT5180	100mm	AFT4260	
AFT5181	125mm	AFT4265	
AFT5182	150mm	AFT4270	
AFT5183	175mm	AFT4275	
AFT5184	200mm	AFT4280	
AFT5185	250mm		



**MTS** QUALITY TOOLS **STEEL FILE SET**

- Quality engineer and saw files
  - Top quality file steel with fine sharpening edges
  - Anti-rust protection
  - Comfortable plastic handles
  - Supplied in a convenient storage pouch
- Contents:
- Flat - 250 & 150mm
  - Half round - 200mm
  - Round - 150mm
  - Slim taper - 150mm

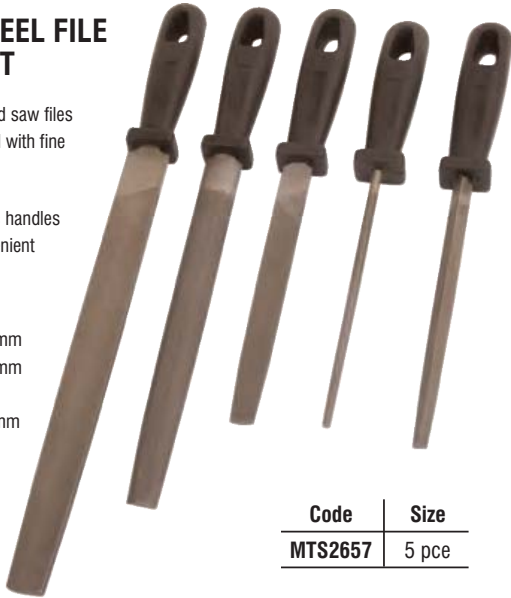

Code	Size
MTS2657	5 pce

**RACO** **FILE SET**

- Hot forged from the finest special analysis steel, hardened with fine sharpened edges for fast cutting
  - Fully finished for rust resistance
  - Comfortable ergonomic handle with soft-touch rubber grip and hanging hole
- Contents:
- Flat 250mm
  - Mill 200mm
  - Half round 200mm
  - Round 150mm
  - Slim taper 150mm



Code	Size
RIC1300	5 pce

**oftool** **FILE SET**

- Assortment of most commonly used files
- Assorted shapes
- Useful for workshop, farm, DIY
- In plastic wallet



- Contents:
- Flat 200mm
  - Half round 200mm
  - Round 200mm
  - Square 200mm
  - Mill 200mm
  - File cleaning brush
  - Complete with handles



Code	Size
AFT2405	200mm

**MTS** QUALITY TOOLS **NEEDLE FILE SET**

- For fine filing and polishing jobs
- Used by engravers, precision engineers, instrument makers, watchmakers and goldsmiths
- A selection of 10 most popular profiles
- Supplied in a convenient storage pouch



Code	Size
HON0900	10 pce

**oftool** **NEEDLE FILE SET**

- Needle files are short round handled files
- Come in assorted shapes
- Used by locksmiths, jewelers and for fine work



Code	Size	Set
AFT2210	160mm	12 pce





## FLAT WOOD RASP



- Shape: Edges are parallel
- Surfaces are rasp cut
- Edges single cut
- Uses: For work in wood, plywood, wallboard, plastics and other soft materials



Code	Size	Code	Size	Code	Size
AFT5205	250mm	AFT5206	300mm	AFT5207	350mm



## HALF ROUND RASP



ALL SLEEVED FILES SUPPLIED COMPLETE WITH HANDLES

- Shape: Edges are parallel
- Surfaces are rasp cut
- Edges single cut
- Uses: For work in wood, plywood, wallboard, plastics and other soft materials



Loose Code	Size	Sleeved Code	Loose Code	Size	Sleeved Code	Loose Code	Size	Loose Code	Size
AFT5210	200mm	-	AFT5211	250mm	AFT4120	AFT5212	300mm	AFT5213	350mm



## CABINET RASP



- Shape: Thin, half round
- Edges and surfaces taper towards the point
- Edges single cut
- Surfaces rasp cut
- Uses: For work in wood, plywood, wallboard, plastics and other soft materials



Code	Size	Code	Size
AFT3990	250mm	AFT3992	300mm



## SHOE RASP



- Shape: Edges parallel
- Flat side rasp cut and double cut
- Curved side rasp cut and double cut
- Uses: Primarily by blacksmiths, farriers, and cobblers



Code	Size
AFT5215	200mm



## BODYFILE - FLAT



- A coarse body file for the rapid removal of body filler used in panel repair jobs
- Mounting holes at either end allow the blade to be firmly fixed to a body file holder



Code	Size
HON0535	9 TPI



GUARANTEED PRODUCTS FOR WORKSHOP SOLUTIONS

## BODYFILE BLADE - STANDARD FLAT CUT - 057121



- Specially treated alloy steel – very hard while still flexible
- Fits 057101 body blade holder



Code	Size	Length
SYK057121	9 TPI	356mm



GUARANTEED PRODUCTS FOR WORKSHOP SOLUTIONS

## BODYFILE BLADE – PLASTICUT FLAT - 057125



- Specially treated alloy steel – very hard while still flexible
- Fits 057101 body blade holder



Code	Size	Length
SYK057125	6.5 TPI	356mm



## BODYFILE HOLDER - ADJUSTABLE

- Light and rigid over a wide range of concave or convex surfaces
- Adjustable for standard 356mm blades
- Ideal for body repair and sheet metal work
- Large strong aluminium alloy handles provide ample grip for large hands
- Heat treated turnbuckle screws insure positive adjustment
- Blade not included



Code	Size
RIC0645	356mm



## BODYFILE HOLDER ADJUSTABLE - 057101

- Adjustable blade holder, suitable for forming and shaping fillers
- and metal during body repair work
- Made from aluminium with steel adjuster and base plate



Code	Size
SYK057101	356mm



## FILE HANDLES - PLASTIC

- Should be used with every file, to prevent possible hand injury
- Plastic construction with comfort grip
- Holed to fit file tang-simple tap in
- Small size for files 150mm -200mm



Code	Size
AFT5300	85mm
AFT5305	95mm
AFT5310	110mm



## FILE CLEANING BRUSH

- Wooden handle
- Has rows of very stiff steel bristles
- Used for cleaning teeth of most files, wood and steel



Code	Size
AFT1900	230mm



## FILE HANDLES - WOODEN

- Solid wood replacement handles to suit square tangs
- Available in 4 convenient sizes
- Fitted with metal reinforcement
- Unvarnished

Code	Size
HND0045	75mm
HND0050	100mm
HND0055	130mm
HND0060	150mm



## ENGINEERS SCRAPER SET

- Hand scrapers are designed for the removal of high spots on machined surfaces
- To create a smooth surface on slide ways, bearings, cast iron surface plates and precision marking out plates
- Made from high grade steel, suitably hardened to maintain a very keen cutting edge



Code	Size
ECP4625	4 pce



## FLAT ENGINEERING SCRAPER

- Designed for removing high spots on machined surfaces, bearings and cast iron surface plates

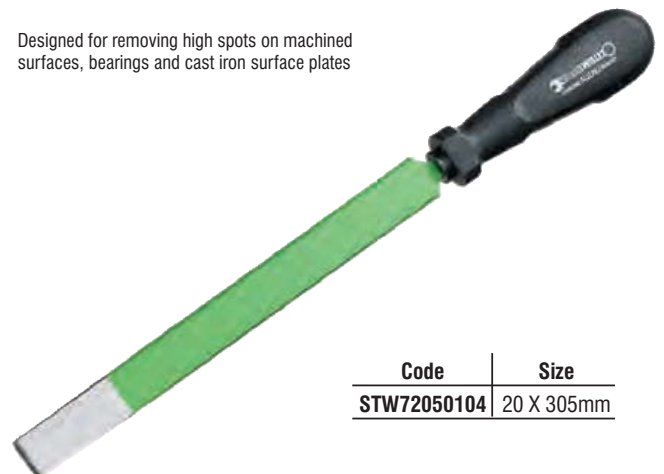

Code	Size
STW72050104	20 X 305mm



## HEAVY DUTY HAND DRILL

- Good quality, heavy duty hand drill for drilling most materials
- Die cast zinc speed gear and double pinions are machine cut for smooth operation
- Parallel side housing for high leverage and protection of pinions
- Heavy duty 3 jaw steel chuck has 1/4" capacity
- High impact hollow plastic handle and operating grip are attractively striped with trim



Code	Size
RIC1130	280mm



## 4 JAW BRACE

- Heavy duty construction with ball bearing quill to suit the most demanding professional
- Heavy gauge 13mm diameter steel frame and box ratchet fully bright chrome plated
- Tough black plastic grips
- Hardened, high grade steel 4 jaw chuck accepts square or round shank bits



Code	Size
RIC0695	300mm

## **STANLEY** BIT BRACES - 4 JAW PROFESSIONAL 1-02-715

- Chromium plated for corrosion resistance
- Ball bearing mounting head for smooth operation
- 12-Point, 3 way ratchet for use in confined spaces
- 13mm diameter chuck size



Code	Size
STA2460	254mm

## **STANLEY** BIT BRACES - 4 JAW 02-110

- Chromium plated for corrosion resistance
- Ball bearing mounting head for smooth operation
- 12-Point, 3 way ratchet for use in confined spaces
- 13mm diameter chuck size



Code	Size
STA2475	254mm

## **IRWIN** *Record* CARPENTER'S BRACE - 2 JAW 5000

- For use with auger bits, gimlet bits and screwdriver bits
- With ratchet
- Nickel plated
- Wooden handles



Code	Sweep
IRW3100	254mm

## **IRWIN** *Record* SPARE JAWS FOR CARPENTER'S BRACE 5015

- Spare Jaws for IRW3100 2 Jaw Carpenter's Brace



Code	Size
IRW3120	-

General Tools



## HANDSAW, WOODEN HANDLE

- Traditional wooden handle
- A medium toothed universal blade configuration which cuts both across and along the grain
- Cut Plywood, PVC pipe, chipboard, drywall board and all hard/soft woods

Code	Size	Point
MTS4020	550mm	6
MTS4030	600mm	6



## HANDSAW - HARD POINT, WOODEN HANDLE

- Traditional wooden handle
- Hard point saw with blue/black toothed edge indicates a special high frequency hardening process
- Blade stays sharp longer but cannot be re-sharpened
- Cut Plywood, PVC pipe, chipboard, drywall board and all hard/soft woods
- Cross Cut or rip

Code	Size	Point
MTS4040	550mm	6
MTS4050	600mm	6



## STANLEY HANDSAW - CROSSCUT, WOODEN HANDLE

- SAE 1070 hardened steel blade
- Aggressive teeth design cuts 37% faster
- Saw teeth protected with plastic cover
- Hardwood handle
- Locked and polished

Code	Size	Points	Ref
STA3870	510mm	8	20-503
STA3875	550mm	8	20-504
STA3880	610mm	8	20-505



## STANLEY HANDSAW - CROSSCUT, PROFESSIONAL

- Finely crafted hand saw made with special alloy steel
- Aggressive teeth design
- Cuts in both directions
- Hardwood handle

Code	Size	Points	Ref
STA3885	550mm	8	15-560
STA3890	610mm	8	15-561
STA3865	660mm	8	15-562



## HANDSAW, WOODEN HANDLE

- A high quality handsaw with a weatherproof hard wood handle
- Manufactured from superior quality imported steel
- Skewed backed for balance
- Universal toothing
- For the craftsman and DIY users

Code	Size	Points	Pitch
LAS3050	600mm	8	3.5





## HANSAW, RUBBER HANDLE

- Superior rubber handle for comfort also doubles up as a marking out guide
- A medium toothed universal blade configuration which cuts both across and along the grains
- Cut Plywood, PVC pipe, chipboard, drywall board and all hard/soft woods

Code	Size	Point
MTS4017	550mm	6
MTS4018	600mm	6



## IRWIN® Record. HANSAW, FINE

- Triple ground teeth
- 1mm rigid blade for maximum stability
- Soft grip handle with finger guide
- Hard point teeth
- High quality C75 steel blade

Code	Size	Point	Ref
JAK0140	550mm	11	10505543



## IRWIN® Record. HANSAW, UNIVERSAL

- Triple ground teeth
- 1mm rigid blade for maximum stability
- Soft grip handle with finger guide
- Hard point teeth
- High quality C75 steel blade

Code	Size	Point	Ref
JAK0125	500mm	9	10505540
JAK0130	550mm	9	10505541



## IRWIN® Record. HANSAW, COARSE

- Triple ground teeth
- 1mm rigid blade for maximum stability
- Deep gullets for enhance performance and greater volume removal of waste material
- Soft grip handle with finger guide
- Hard point teeth
- High quality C75 steel blade

Code	Size	Point	Ref
JAK0135	550mm	9	10505542



## LASHER HANSAW "SUPER" WITH POLY HANDLE

- A superior handsaw with a straight back
- Universal toothing
- Shock resistant
- Polypropylene handle moulded directly onto the blade

Code	Size	Point	Pitch
LAS3040	500mm	11	2.5
LAS3041	550mm	10	2.5
LAS3043	600mm	8	3.5
LAS3046	600mm	5	6.5



General Tools





## HANDSAW, POLY HANDLE

- A superior handsaw with a straight back
- Universal tooting
- Shock resistant
- Polypropylene handle moulded directly onto the blade

Code	Size	Point	Pitch
LAS3065	550mm	11	2.5
LAS3070	600mm	8	3.5
LAS3075	650mm	5	6.5
LAS3080	650mm	7	4.25



## HANDSAW - COARSE CROSSCUT - XP3033

- Designed for coarse jobs where high speed is preferred and coarse cut is acceptable
- Supplied with non-hardened teeth and can be sharpened
- Soft grip handle with finger guide

Code	Size	Point
JAK0180	600mm	4



## TOOLBOX SAW, PTFE COATED - 10505544

- Triple ground teeth
- 1mm rigid blade for maximum stability
- Fine nose teeth for easy start
- Soft grip handle with finger guide
- Hard point teeth
- High quality C75 steel blade

Code	Size	Point
JAK0160	375mm	9



## NEST OF SAWS

- A general purpose saw for cutting wood, metal, plastic and pruning
- The wooden handle will take a choice of 5 different blades, which can easily adjusted to any angle for optimum performance

350mm hand saw  
250mm back saw  
300mm pruning saw  
300mm hacksaw  
250mm keyhole saw

Code
MTS4060



## DOVETAIL SAW, WOODEN HANDLE

- Generally used for cutting fine joints
- This saw features a shaped, comfortable wooden handle and a steel backed hardened blade

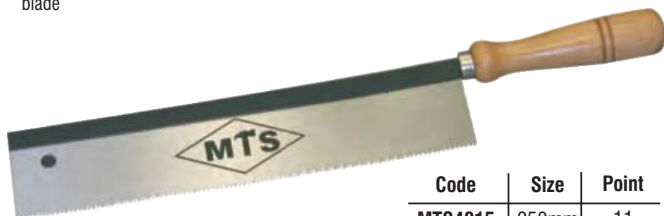

Code	Size	Point
MTS4015	250mm	11



## DOVETAIL SAW, PLASTIC HANDLE

- A fine tooth saw specifically designed for cutting either soft or hard wood in dovetail and cabinet work
- Easy grip handle for the amateur and DIY user
- Flat ground blade with straight tooth line and reinforced steel back



Code	Size	Points	Pitch
LAS3035	250mm	17	1.59



## METAL MITREBOX WITH SAW

- A die-cast mitre box with 550mm saw included
- Accurate angle settings for 30°, 45°, 60°, 75° and 90° angles
- Both saw guide height and saw guide thickness are adjustable
- The base is grooved for through cuts
- Maximum cutting depth approximately 100 mm
- Spare blades for aluminium and wood are available

Code	Size
HON3770	550mm



## BACKSAW, WOODEN HANDLE

- Straight bladed saw for fine cutting of tenons, and smaller sections of wood to length
- Additional steel strengthening along the back provides rigidity
- Perfectly balanced, tempered steel blade for soft and hard woods
- Traditional wooden handle

Code	Size	Point
MTS3995	250mm	10
MTS4000	300mm	10
MTS4010	350mm	10



## TENON SAW - XP3055

- Triple ground teeth
- Reinforced back for optimum stability
- Fine tooth saw ideal choice for fine carpentry and can be used in a mitre box
- Soft grip handle with finger guide
- Hard point teeth
- High quality C75 steel blade

Code	Size	Point
JAK0050	300mm	13



## BACKSAW - PROFESSIONAL

- Finely crafted saw made with special alloy steel
- Laquered hardwood handle
- Teeth finely set - 13 Point

Code	Size	Ref	Point
STA3840	305mm	15-884	13
STA3845	356mm	15-886	13



## BACKSAW WITH POLY HANDLE

- For accurate cabinet work
- The backsaw or tenon saw will cut both with and across the grain
- Universal fine toothing for mitre sawing and wood moldings
- Flat ground blade with reinforced steel

Code	Size	Points	Pitch
LAS3000	250mm	13	2.0
LAS3005	300mm	13	2.0
LAS3010	350mm	13	2.0



General Tools



## PLASTIC MITREBOX AND SAW

- Robust PVC mitre box with accurate slots for 45° and 90° cutting
- Base is grooved for through cuts
- 350mm back saw with sturdy blade stiffener, tempered steel blade and plastic handle is set and sharpened

Code	Size	Point
MTS3587	350mm	13



## STANLEY PLASTIC MITREBOX AND SAW - 19-800

- Lightweight, high impact ABS plastic for strength and durability
- Holes in base for fastening work to bench
- Allows for 90°, 45° and 22½° right and left cuts as well as 45° scarf cut guide
- Front lip butts up against workbench to prevent slipping in use
- Saw storage in mitrebox

Code
STA3306



## STANLEY CLAMPING MITREBOX PLUS SAW - 20-600

- One piece injection moulded for strength and durability
- Patented cam lock clamping system holds workpiece securely in place
- Built in saw stop to prevent damaging the mitrebox
- Holes in base for fastening work to bench
- Allows for 90°, 45° and 22½° right and left cuts as well as 45° scarf cut guide

Code
STA3307

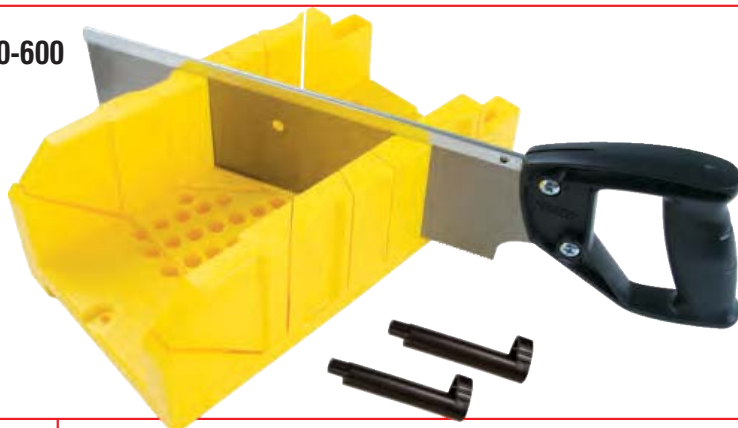

## PLASTIC MITREBOX

- Robust PVC mitre box with accurate slots for 45° and 90° cutting
- Base is grooved for through cuts

Code	Size
MTS3589	300mm



## STANLEY MITREBOX - 19-212

- Lightweight, high impact ABS plastic for strength and durability
- Holes in base for fastening work to bench
- Allows for 90°, 45° and 22½° right and left cuts as well as 45° scarf cut guide
- Front lip butts up against workbench to prevent slipping in use

Code	Size
STA3310	300mm



## PROTOOL PINE MITREBOX

- Wooden pine body
- Allows 90° and 45° left and right hand cuts

Code	Size
PTL0015	100 x 50mm



## HAND & BACKSAW TOOTH SETTER

- Calibrated anvil wheel allows setting teeth of most handsaws
- Single action plunger
- Comfortable handles for easy action
- 4 - 12 points per inch

Code	Size
HON7730	4 - 12 points



## ECLIPSE SAW - COPING - 70-CP1R

- Blade can be swivelled to cut at any angle
- Blade is tensioned by turning handle
- Well balanced saw with rigid steel frame C.P
- Comfortable wooden handle
- Complete with one blade



Code
ECP4560

## STANLEY COPING SAW – FAT MAX - 15-106A

- High grade carbon hardened and tempered blade
- Durable comfortable moulded handle
- Accepts replacement blades 15-058, 15-059, 15-061



Code	Size
STA3805	160 x 170mm



## HACKSAW - ALUMINIUM HANDLE

- Strong comfortable die-cast aluminium handle
- Tubular oval cross-section bow which can hold spare blades
- Frame is adjustable to hold 250mm blades



Code	Size
MTS3400	300mm

## GROZ HACKSAW - SQUARE TUBE

- An adjustable hacksaw frame with outstanding design and superior quality
- The aluminium die cast handle, unbreakable in normal use provides a comfortable grip and also directs pressure in the correct line of thrust for maximum efficiency
- The blade cuts fully through to a 90° angle, alternatively it can also be set at 45°
- A handy storage compartment in the square bow allows for storing spare blades. Includes 300mm blade



Code	Size
GRO2430	300mm

## ECLIPSE HACKSAW - TUBULAR FRAME - 20T

- Heavy duty oval tubular frame
- Die cast handle for superb control
- Perfect combination of balance and rigidity
- Guarded grip design protects knuckles
- Blade can be angled to 90°
- Storage space in frame for spare blades
- Includes one 300 mm blade



Code	Size
SOS5600	300mm

## ECLIPSE HACKSAW - FLAT FRAME - 18TND

- Strong light flat frame for greater comfort and control
- Bi-Metal steel blade
- 90° blade adjustment



Code	Size
SOS5990	300mm

**ECLIPSE****HACKSAW - GENERAL PURPOSE - 72-66XR**

- General purpose saw for cutting through wood, plastics and soft metals (such as nails)
- Polyester coated blade
- Die cast 9 position handle to enable cutting in difficult positions



Code	Size
SOS5900	300mm

**HACKSAW - TUBULAR - 95VC**

- Chrome plated tubular frame hacksaw
- Die cast aluminium handle
- Supplied with one HSS Blade
- Wing nut tightens blade
- Store spare blade in frame



Code	Size
VIC3000	300mm

**HACKSAW - BLACK FLAT (D.I.Y)**

- Black, steel frame with comfortable PVC handle
- Square section at the end of the frame allows for four different blade positions



Code	Size
MTS3410	300mm

**HACKSAW - PROFESSIONAL OPEN HANDLE**

- Chrome plated steel frame with die cast open handle
- High frequency welded steel
- Adjustable to take 250mm blade

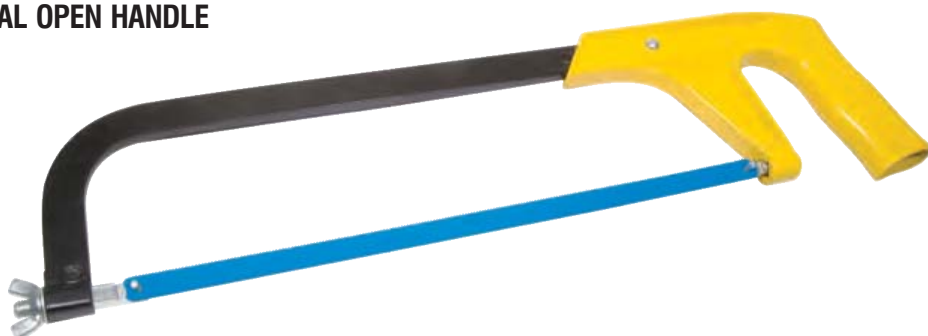

Code	Size
MTS3402	300mm

**ECLIPSE****HACKSAW - FLAT FRAME - 40PG**

- A strong, rigid and well-balanced hacksaw with a die-cast pistol grip handle and solid bow
- The saw blade can be angled at 90° to the frame if necessary
- Includes 300 mm blade



Code	Size
ECP4150	300mm

## STANLEY HACKSAW - FLAT FRAME - 15-200

- Rigid steel frame adjustable
- Plastic handle for comfort
- Chrome plated



Code	Size
STA2940	300mm

## STANLEY HACKSAW - FIXED FRAME - 20-206

- Flat steel frame non-adjustable
- Plastic handle for comfort

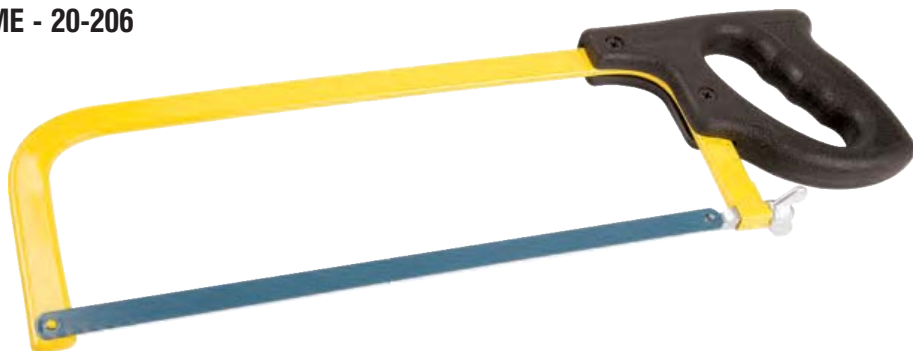

Code	Size
STA2943	300mm



## HACKSAW - SQUARE TUBE

- Extra strong frame for unbeatable rigidity and exceptional blade tension
- Lightweight aluminium handle with comfortable rubber grip
- Flush cutting at 45° and 90° angles
- Includes spare blade



Code	Size
MTS3412	300mm



## HACKSAW - PROFESSIONAL SQUARE TUBE

- Expert quality, patented, heavy duty hacksaw ideal for professional
- Hardened, heavy gauge pressed steel frame with industrial black finish
- Extremely rigid- tension
- Solid, high impact handle
- Ball-end with screw for fine adjustment and optimal blade tensioning giving higher cutting performance
- Blade can be positioned for vertical or horizontal cutting
- Supplied with 300mm blade



Code	Size
RIC1620	300mm



## HACKSAW - SQUARE TUBE

- Expert quality, high tension professional hacksaw for efficient cutting action and reduced blade twisting and binding
- Special screw pivot lever device for easy tensioning
- Blade cuts fully through to a flat surface and is easily changeable from vertical to 45 degree cutting
- Robust aluminium handle with rubber grip for greater comfort and increased control
- Box frame stores extra blades
- Supplied with 300mm blade



Code	Size
RIC1622	300mm



## HACKSAW - TUBULAR 10506437

- Mushroom pins prevent blade from being released when dropped
- Ergonomic handles ensure a comfortable sawing grip
- Metal tensioning mechanism for a longer lasting tool
- 90°- 180° blade mounting for sawing large objects



Code	Size
IRW3510	300mm



## HACKSAW - SQUARE TUBE 10504407

- Ergonomic metal frame for higher blade tension
- Soft touch handles ensure a comfortable sawing grip
- Metal tensioning mechanism for a longer lasting tool
- Integral blade storage inside frame
- 90°- 55° blade mounting for sawing large objects



Code	Size
IRW3500	300mm



## HACKSAW - SQUARE TUBE

- Professional hacksaw frame enables the user to cut straight
- and fast without fear of buckling the saw blade
- One piece frame
- Only one hand is required to install a new blade
- Includes 300 mm blade



Code	Size
MTC3370002	300mm



## HACKSAW - PROFESSIONAL - 15-166

- Aluminium handle with rubber grip for extra comfort
- Two blade position 90° and 45°



Code	Size
STA2938	300mm



## JUNIOR HACKSAW

- Chrome plated steel wire frame is designed to give perfect blade tension during use
- Supplied with 150mm shatterproof blade
- Blade can be angled to 90°
- Finger guard for comfort and prevention of injury
- Storage space in frame for spare blades
- Includes one 300 mm blade



Code	Size
HON1795	150mm



## JUNIOR HACKSAW

- Steel rod frame, hardened and nickel plated
- Easy to hold and control when cutting with a plastic finger guard for comfort
- Overall length 238mm with 150mm junior hacksaw blade

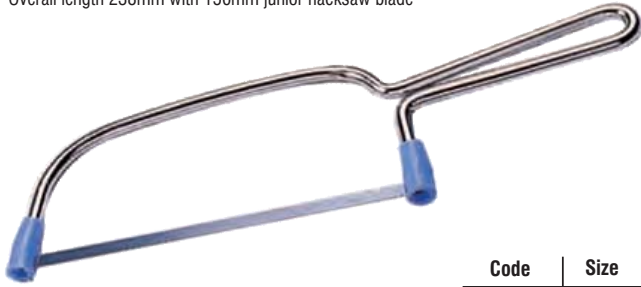

Code	Size
RIC1600	150mm



## JUNIOR HACKSAW

- Superior quality chrome plated steel wire frame is designed to give perfect blade tension during use
- Finger guard prevents injury to the user
- Comes complete with 150mm shatterproof blade



Code	Size
GRO2400	150mm



## JUNIOR HACKSAW - 70-14J

- Hardened nickel plated
- Plastic finger guard for comfort gripping
- Easy to hold and control when cutting



Code	Size
ECP4155	150mm



## MINI HACKSAW

- Specially designed for small cutting jobs where space is limited
- Hardened and chrome plated steel rod frame with die cast aluminium alloy handle
- Overall length 275mm with 150mm junior hacksaw blade



Code	Size
RIC1610	150mm



## MINI HACKSAW

- The compact steel frame is light, yet strong and has a blade tensioning device that locks when the correct blade tension is reached
- Ergonomically designed pistol grip handle is made from high quality ABS plastic
- Comes complete with 150mm shatterproof blade



Code	Size
GRO2410	150mm



## MINI HACKSAW - 70-675

- A more substantial version of the Junior hacksaw with plastic moulded pistol grip handle, steel frame
- Blade tensioning device incorporated in the handle
- Fitted with blade



Code	Size
ECP4160	250mm



## HACKSAW - METAL HANDLE & BLADE

- Handle is made from die cast zinc alloy offering rigidity and weight for controlled cutting
- Uses regular hacksaw blades (supplied with 250mm blade)
- Ideal for cutting in hard to reach places



Code	Size
RIC1593	250mm



## HACKSAW PLASTIC - HANDLE & BLADE

- Durable, moulded ABS plastic frame for maximum comfort
- Uses regular hacksaw blades (supplied with 250mm blade)
- Ideal for cutting in hard to reach places



Code	Size
RIC1595	250mm



## STANLEY MINI HACKSAW, HEAVY DUTY - 15-521

- Durable comfortable moulded handle
- Supplied with carbon steel blade
- Accepts broken blades
- Ideal for confined spaces



Code	Size
STA2950	220mm

## GROZ JUNIOR HACKSAW BLADES

- These are manufactured from high quality steel and are accurately heat treated to give the correct combination of hardness and toughness
- Teeth are properly shaped and set to ensure speed of cutting and ease of turning
- Fits all junior hacksaw frames

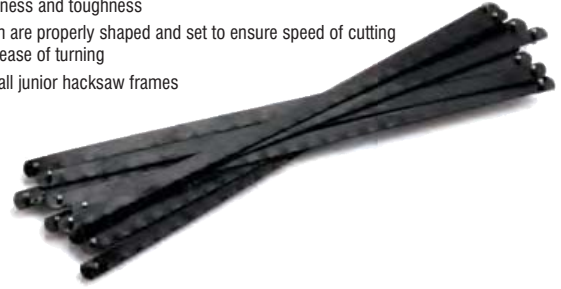

Code	Size	TPI
GRO1000	150mm	32

## ECLIPSE BI-METAL HACKSAW BLADES

- A virtually unbreakable bimetal blade for superb cutting performance
- Wear resistance and safety
- The combination of an M2 High Speed cutting edge, electron-beam welded to a flexible alloy back, gives a level of cutting power and flexibility that is far superior to edge hardened or conventional flexible blades
- Cuts through all types of materials including alloy and stainless steels

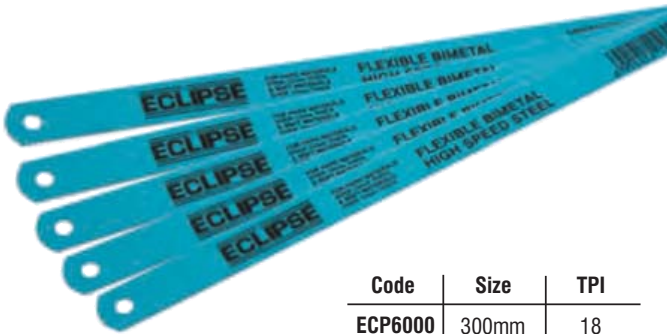

Code	Size	TPI
ECP6000	300mm	18
ECP6010	300mm	24
ECP6020	300mm	32

## ECLIPSE JUNIOR SAW BLADES - 71/132R

- Manufactured from high quality steel
- Heat treated for hardness and toughness
- Teeth properly shaped and set for speed and cutting ease
- Fit all standard JUNIOR saw frames



Code	Size	TPI
GRO2330	150mm	32

## ECLIPSE SHATTER PROOF HACKSAW BLADES

- A virtually unbreakable, edge hardened blade
- Offers flexibility and safety
- Less wear resistance than an all hard or bimetal blade



Code	Size	TPI	Pack	Code	Size	TPI	Pack
ECP6052	300mm	18	100	ECP6068	300mm	18	2
ECP6055	300mm	24	100	ECP6070	300mm	24	2
ECP6058	300mm	32	100	ECP6072	300mm	32	2

## ECLIPSE LOW ALLOY HACKSAW BLADES

- Ideal for general purpose sawing of mild steel, brass, aluminium, copper and other soft metals and plastics
- General Purpose
- Shatterproof Blade
- A virtually unbreakable blade suitable for DIY use



Code	Size	TPI	Pack	Code	Size	TPI	Pack
ECP6030	300mm	18	100	ECP6060	300mm	18	2
ECP6040	300mm	24	100	ECP6062	300mm	24	2
ECP6050	300mm	32	100	ECP6065	300mm	32	2

## ECLIPSE DOUBLE EDGED HACKSAW BLADES

- High carbon steel
- A double width blade
- Ideally suitable for large diameter plastic piping
- A favorite with plumbers



Code	Size	TPI	Pack
ECP6025	300mm	24	50 Box
ECP6027	300mm	24	Wallet

## ECLIPSE POWERSAW BLADES

- This High Speed Steel All Hard blade will give accuracy in sawing
- Manufactured from M2 High Speed Steel
- It is capable of cutting even the more difficult materials
- To get best out of your Eclipse blade refer to the appropriate cutting commendations

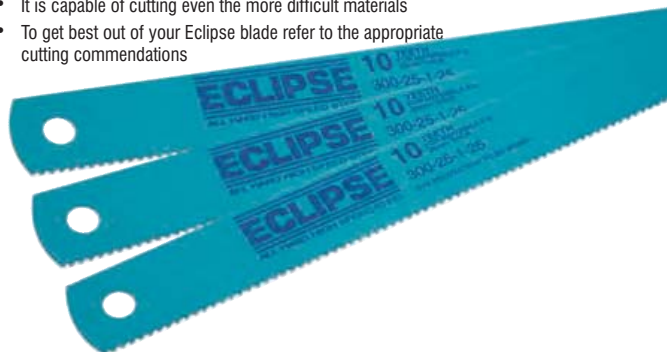

Code	Size(mm)	TPI	Code	Size(mm)	TPI
ECP6200	300 x 25	10	ECP6240	400 x 32	10
ECP6205	300 x 25	14	ECP6242	400 x 32	14
ECP6210	350 x 25	10	ECP6245	450 x 32	6
ECP6215	350 x 25	14	ECP6250	450 x 32	10
ECP6217	350 x 25	14	ECP6255	500 x 40	6
ECP6220	350 x 32	6	ECP6257	500 x 50	6
ECP6225	350 x 32	10	ECP6265	550 x 50	6
ECP6230	350 x 32	14	ECP6275	600 x 50	6
ECP6235	400 x 32	6	ECP6285	650 x 50	6

## ECLIPSE COPING SAW BLADES - 71/CP/7R

- Manufactured from high quality steel
- Heat treated for hardness and toughness
- Teeth properly shaped and set for speed and cutting ease
- Fit all standard coping saw frames



Code	Size	TPI
ECP2200	165mm	14

## ECLIPSE GENERAL PURPOSE SAW BLADES

- Polyester coated blade
- Fits SOS5900



Code	Size
SOS3280	465mm

## ECLIPSE RODSAW BLADES

- Tungsten carbide blade-used in a hacksaw frame
- Specially for cutting slots, angles and curves in tiles, glassware, fibreglass, metal and plastic
- Can also cut hard steel such as files

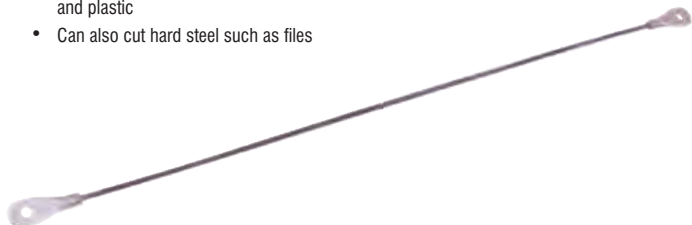

Code	Length
ECP6510	300mm

## IRWIN Record BLADE - RECIPROCATING DEMOLITION

- Bi-Metal blade cuts composition materials such as plastic, wood, pipe, carbon steel and stainless steel
- Suitable for materials 3.2mm and thicker



Code	Ref No	Size	TPI
IRW3730	618R	150mm	18
IRW3740	818R	200mm	18

## IRWIN Record BLADE - RECIPROCATING DEMOLITION

- Bi-Metal blade for use on heavy duty & demolition applications in both wood and metal
- Suitable for materials 5mm and thicker



Code	Ref No	Size	TPI
IRW3700	966R	225mm	6
IRW3710	960R	225mm	10

AVAILABLE FROM SELECTED DISTRIBUTORS NATIONWIDE

357 Saw Blades

**IRWIN** *Record* **BLADE – RECIPROCATING DEMOLITION**

- Bi-Metal blade cuts composition materials such as plastic, wood, pipe, carbon steel and stainless steel
- Suitable for materials 3.2mm and thicker

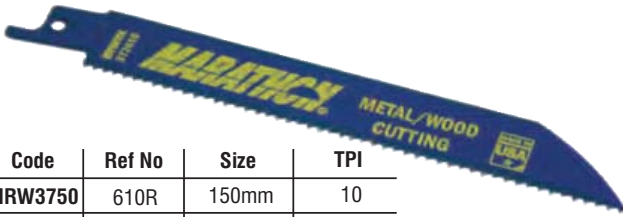

Code	Ref No	Size	TPI
IRW3750	610R	150mm	10
IRW3760	810R	200mm	10
IRW3770	110R	300mm	10

**IRWIN** *Record* **BLADE – RECIPROCATING NAIL-EMBEDDED WOOD**

- Bi-Metal blade cuts all metals including non ferrous, pipe conduit, stainless steel and sheet metal
- Suitable for use with materials 1.5 – 10mm thick depending on the TPI of the blade



Code	Ref No	Size	TPI
IRW3780	656R	150mm	6
IRW3790	956R	225mm	6



**BANDSAW BLADES - CARBON FLEXIBLE - BLACK**

- Produced from high quality carbon steel which allows the blade to withstand stress and strain in the most arduous conditions
- Cutting edge is hardened to give sharp and lasting teeth
- Supported by a sturdy, yet flexible back
- Blades are Raker set
- Supplied in 30 metre rolls



Code	Size
SOS3015	6 x 14T 30m
SOS3020	6 x 18T 30m
SOS3055	10 x 10T 30m
SOS3105	13 x 14T 30m
SOS3110	13 x 18T 30m



**MITRE SAW BLADES**

- Replacement blade for mitre saw for aluminium and wood



Code	Size
HON0525	550mm Alum
HON0527	550mm Wood

Mitre Saw not included



**JIGSAW BLADE ASSORTMENT**

- Assortment of universal jig saw blades
- 2 X 100mm steel / plastic
- 2 x 70mm steel / plastic
- 2 x 100mm wood
- 2 x 70mm wood
- 2 x 100mm general purpose



Code	Size
HON0530	70 - 100mm



General Tools

HCS : High Carbon Steel  
HSS : High Speed Steel  
HM : Hard Metal

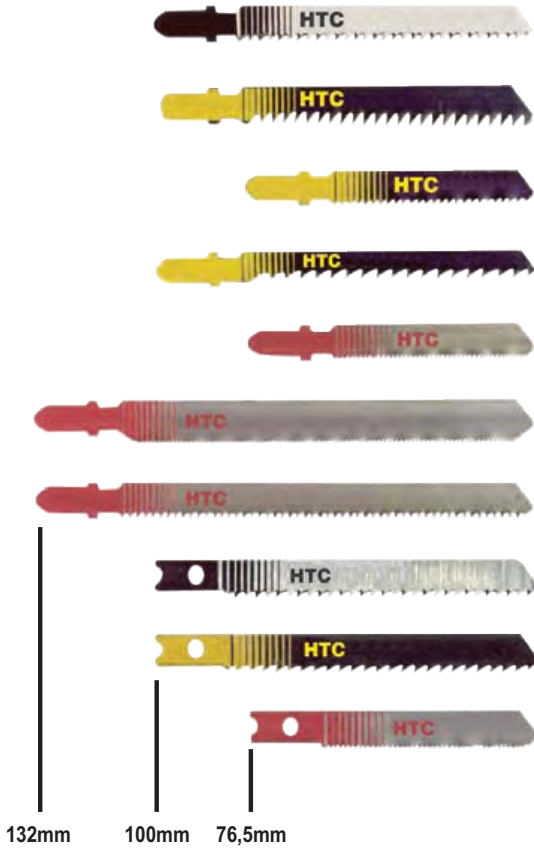

Jigsaw Blades Type Numbers		Hardwood, Softwood, Chipboard, Furniture Board	Plastic Coated chipboard	Plywood	Polystyrene, Leather, Carton, Rubber, Carpeting	Wood containing Nails
HTC	BOSCH					
HTC-1075	T101BR	very fine cutting to 30mm		fine cutting to 30mm		
HTC-1015	T101B	fine cutting to 60mm	fine cutting to 60mm	fine cutting to 60mm		
HTC-1080	T101D	very fine and fast cutting to 60mm		very fine and fast cutting to 60mm		
HTC-1020	T111C	coarse cutting to 60mm		coarse cutting to 60mm		
HTC-1045	T119B	coarse cutting to 30mm		coarse cutting to 30mm	coarse cutting to 30mm	
HTC-1070	T144D	coarse and fast cutting to 60mm				
HTC-1050	T118A					
HTC-1055	T118AF					
HTC-1065	T118BF					to 30mm
HTC-1000	T127D					
HTC-1085	T244D					
HTC-1005	T318A			Multiplex		
HTC-1010	T318B					
HTC-1030	U101B	very fine cutting to 30mm		very fine cutting to 30mm		
HTC-1025	U111C	coarse cutting to 60mm		coarse cutting to 60mm		
HTC-1040	U118A					
HTC-1035	U118B					
<b>COOLING</b>						

**General Tools**

Steel, Mild steel, Sheet metal	Stainless steel	Aluminium, Non-ferrous Metals	Lead, Tin	PVC, Plastics	Fiberglass, Reinforced Plastics	Toothed length	Tooth pitch (mm)	Materials	HTC Part No.
				fine cutting to 30mm		75mm	2.5	ground HCS	HTC-1075
				fine cutting to 30mm		75mm	2.5	ground HCS	HTC-1015
				to 60mm		75mm	4	ground HCS	HTC-1080
		coarse cutting		coarse cutting to 60mm		75mm	3	side-set HCS	HTC-1020
				Insulants Pertinax Perspex		50mm	2	wavy-set HCS	HTC-1045
						75mm	4	Side-set and ground HCS	HTC-1070
1,5 - 4mm		1,5 - 4mm		Agrilic glass Insulants Canvas Linoleum		50mm	1.2	wavy-set high speed steel HSS	HTC-1050
thin steel 1,5 - 4mm suitable for curved cutting	1,5 - 3mm	tin 1,5 - 4mm suitable for curved cutting				50mm	1.2	wavy-set Bi-metal	HTC-1055
Fast cutting 3 - 10mm	2 - 3mm	fast cutting 3 - 10mm		Plexiglass To 30mm		50mm	1.2	wavy-set Bi-metal	HTC-1065
Coarse cutting 3 - 6mm			to 20mm	coarse cutting to 30mm	to 20mm	75mm	3	side-set high speed steel HSS	HTC-1000
Curved coarse cutting 3 - 6mm				Curved coarse cutting to 30mm		75mm	4	side-set high speed steel HSS	HTC-1085
1,5 - 4mm		1,5 - 4mm		Insulants		100mm	1.2	wavy-set high speed steel HSS	HTC-1005
3 - 6mm		3 - 10mm		Composite board		100mm	2	wavy-set high speed steel HSS	HTC-1010
				fine cutting to 30mm		75mm	2.5	HSC ground	HTC-1030
		coarse cutting		coarse cutting to 60mm		75mm	3	HSC side-set	HTC-1025
1,5 - 4mm		1,5 - 4mm		Agrilic glass Insulants Canvas Linoleum		50mm	1.2	wavy-set high speed steel HSS	HTC-1040
3 - 6mm		3 - 10mm				50mm	2	wavy-set high speed steel HSS	HTC-1035
Cutting oil or white spirit	Cutting oil	Cutting oil or white spirit	Cutting oil	Water Pertinax with silicone oil	Water				



### HOUSEHOLD SCISSORS

- General purpose scissors for everyday household use
- Ergonomically designed for optimum comfort, balance and control
- Hardened steel blades are designed for long-lasting performance and are suitable for cutting many different materials



Code	Size
MTS4062	138mm



### HOUSEHOLD SCISSORS

- General purpose scissors for everyday household use
- Ergonomically designed for optimum comfort, balance and control
- Hardened steel blades are designed for long-lasting performance and are suitable for cutting many different materials



Code	Size
MTS4063	215mm



### HOUSEHOLD SCISSORS

- General purpose scissors for everyday household use
- Ergonomically designed for optimum comfort, balance and control
- Hardened steel blades are designed for long-lasting performance and are suitable for cutting many different materials

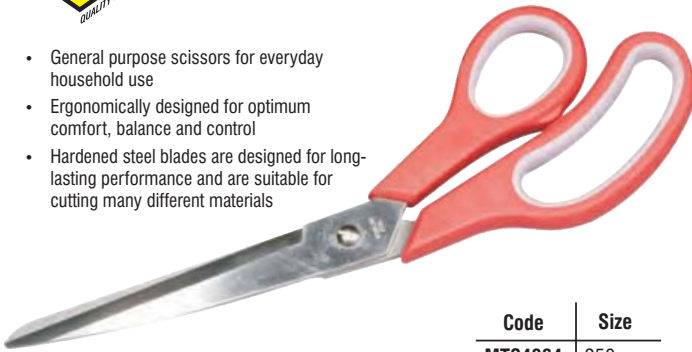

Code	Size
MTS4064	250mm



### MULTI-PURPOSE SCISSORS

- Ergonomically designed for optimum comfort, balance and control
- Hardened steel blades are designed for long-lasting performance and are suitable for cutting many different materials
- The handles feature built-in steel grips

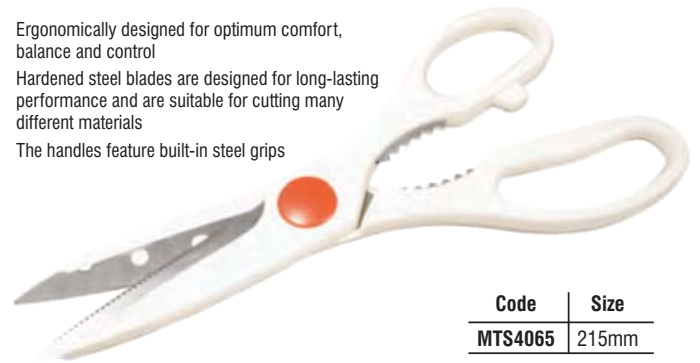

Code	Size
MTS4065	215mm



### MULTI-PURPOSE SCISSORS

- Lightweight kitchen scissors with multiple uses for cutting, bottle opening, nut cracking, cap turning etc
- Stainless steel blades are hardened and the bottom blade is serrated to improve cutting
- Tough, comfortable contoured handles



Code	Size
RIC2970	213mm



### TAILOR'S SCISSORS

- Ergonomically designed for optimum comfort, balance and control
- All steel construction with hardened blades, designed for long-lasting performance
- Traditional black lacquered handles



Code	Size
HON0790	250mm



### TAILOR'S SCISSORS

- Ergonomically designed for optimum comfort, balance and control
- All steel construction with hardened blades, designed for long-lasting performance
- Traditional black lacquered handles



Code	Size
HON0792	300mm



### GLASS CUTTER - 6 WHEEL

- Consisting of high quality carbon steel wheels, precision ground and inspected
- Suitable for General purpose cutting



Code	Size
MTS2410	180mm



### GLASS CUTTER - DIAMOND TIP

- This diamond tip glass cutter has a shaped hard wood handle
- Suitable for cutting glass up to 6mm thick, including plate glass



Code	Size
HON0930	180mm



### GLASS CUTTER - SINGLE WHEEL

- For general purpose use
- Tungsten carbide rolling wheel with well balanced zinc alloy body and sure grip handle
- Baked enamel blue finish



Code	Size
RIC1440	125mm

### DIAMANTOR GLASS CUTTER - SINGLE WHEEL

- Single wheel
- Wooden Handle
- Slots for breaking glass



Code	Size
DIM0005	200mm



### KNIFE CUTTER SET - No. 100

- Light duty cutter suitable for smaller cutting jobs
- Retractable blades for safety
- Supplied with blade and 10 extra blades
- Blade lock
- Snap-off blades are replaceable



Code	Size
MTS3540	2 pce



### SNAP OFF KNIFE - 13 POINT

- A compact, lightweight cutter with one piece plastic reinforced handle and pocket clip
- Adjustable, positive locking action
- Includes one snap-off blade with 13 cutting points
- Spare blades are available



Code	Size
RIC1960	9mm



### IRWIN Record TRIMMING KNIFE –SNAP OFF - 10504557

- Self locking blade slider for fast blade adjustment on medium duty tasks
- Blade storage for 2 blades inside the removable cartridge
- Strong ABS body with steel blade guide
- Texture grip provides improved control
- Slim nose for maximum visibility of cutting edge
- Hinged end cap cannot be separated from body
- Carbon steel blades



Code	Size
IRW3390	9mm



### IRWIN Record TRIMMING KNIFE –SNAP OFF - 10504556

- Self locking blade slider for fast blade adjustment on medium duty tasks
- Blade storage for 2 blades inside the removable cartridge
- Strong ABS body with steel blade guide
- Texture grip provides improved control
- Slim nose for maximum visibility of cutting edge
- Hinged end cap cannot be separated from body
- Carbon steel blades



Code	Size
IRW3395	18mm



### IRWIN Record TRIMMING KNIFE - PRO TOUCH - 10504555

- Auto-load mechanism enables fast blade changes
- Self locking blade slider for fast blade adjustment on medium duty tasks
- Blade storage for 3 blades inside removable cartridge
- Durable solid cast aluminium body with steel blade guide
- Slim nose for maximum visibility of cutting surface
- Impact resistant
- Carbon steel blades



Code	Size
IRW3375	9mm



## IRWIN® TRIMMING KNIFE - PRO-TOUCH

Record®

- Auto load mechanism enables fast blade changes
- Self locking blade slider for fast blade adjustment on medium duty tasks
- Blade storage for 3 blades inside the removable cartridge
- Durable solid cast aluminium body with steel blade guide
- Pro Touch grip provides excellent control
- Slim nose for maximum visibility
- Impact resistant hinged end cap
- Carbon steel blades
- Snap-off blades



Code	Size
IRW3380	18mm



## STANLEY® TRIMMING KNIFE - SNAP-OFF - 0-10-150

- Two part moulded body that allows rapid blade changing
- Multi-position push button for quick, easy use
- Blade snapper included in handle for safety
- Supplied with 1 blade



Code	Size
STA3077	9.5mm



## MTS® KNIFE CUTTER SET - No. 200

- Medium duty cutter suitable for general purpose use
- Retractable blades for safety
- Supplied with blade and 10 extra blades
- Blade lock
- Snap-off blades are replaceable

10 HIGH QUALITY BLADES INCLUDED



Code	Size
MTS3542	2 pce



## RACO SNAP OFF KNIFE - 8 POINT

- An economical, heavy duty cutter designed for more intricate work
- One piece impact resistant, reinforced plastic handle with push button blade positioner with positive locking action
- Includes one snap-off blade with 8 cutting points
- Spare blades are available

1 HIGH QUALITY BLADE INCLUDED



Code	Size
RIC1965	150mm

## STANLEY® TRIMMING KNIFE - SNAP-OFF - 0-10-151

- Two part moulded body that allows rapid blade changing
- Multi-position push button for quick and easy use
- Blade snapper included in handle for safety
- Supplied with 1 blade



Code	Size
STA3075	18mm



## IRWIN® TRIMMING KNIFE - SNAP-OFF BLADE 10507106

- Feature-rich heavy duty knife with manual screw tightening at the nose for user controlled blade security
- Cartridge for storing 2 blades
- Durable cast aluminium body with stainless steel blade guide
- Hinged end cap
- Pro-Touch grip for a secure grip and greater comfort



Code	Size
IRW2675	18mm



## STANLEY® TRIMMING KNIFE - SNAP-OFF - 0-10-018

- Two part moulded body that allows rapid blade changing
- Multi-position push button for quick and easy use
- Blade snapper included in handle for safety
- Supplied with 6 blades



Code	Size
STA3076	18mm



## STANLEY® TRIMMING KNIFE - INTERLOCKING SNAP-OFF - 0-10-018

- Die cast metal body or strength and durability
- 'Anti slip' ergonomic shape
- Interlock patented blade locking system for greater safety during cutting
- Supplied with 1 blade



Code	Size
STA3050	18mm





**STANLEY** TRIMMING KNIFE - INTERLOCKING SNAP-OFF - 0-10-018

- Die cast metal body or strength and durability
- 'Anti slip' ergonomic shape
- Interlock patented blade locking system for greater safety during cutting
- Supplied with 1 blade



Code	Size
STA3072	18mm

1 HIGH QUALITY BLADE INCLUDED



UTILITY KNIFE CUTTER SET 3 PIECE - 300

- All purpose cutting set, ideal for hobby and craft work
- Retractable blades for safety
- Snap-off blades are replaceable



Code	Size
MTS3544	3 pce



KNIFE CLEAR CUTTER SET 5 PIECE - 600

- All purpose cutting set, ideal for hobbies, crafts and decorating
- Retractable blades for safety
- Snap-off blades are replaceable
- Includes slim-line window scraper with blade
- Modern clear PVC handles



Code	Size
MTS3550	5 pce



KNIFE CUTTER SET 5 PIECE - 400

- All purpose cutting set, ideal for hobbies, crafts and decorating
- Retractable blades for safety
- Snap-off blades are replaceable
- Includes conventional and slim-line window scrapers with blades



Code	Size
MTS3546	5 pce



KNIFE CUTTER SET 5 PIECE - 500

- All purpose cutting set, ideal for hobbies, crafts and decorating
- Retractable blades for safety
- Snap-off blades are replaceable
- Includes conventional and slim-line window scrapers with blades



Code	Size
MTS3548	5 pce



UTILITY KNIFE - FIXED BLADE

- A standard duty utility knife with fixed blade
- Supplied with 5 blades stored in handle
- Sturdy die-cast aluminium body knurled for improved grip
- Spare blades are available



Code	Size
HON3220	120mm

5 HIGH QUALITY BLADES INCLUDED



UTILITY KNIFE - RUBBER GRIP FIXED BLADE

- A standard duty utility knife with fixed blade
- Supplied with 5 blades stored in handle
- Sturdy die-cast aluminium body
- Comfortable rubber grip
- Spare blades are available



Code	Size
HON3240	135mm

5 HIGH QUALITY BLADES INCLUDED

**IRWIN** TRIMMING KNIFE PRO ENTRY FIXED  
*Record* 1050749

- Professional entry-level fixed knife is highly durable and lightweight
- Features an optimised cutting angle for minimal fatigue



Code
IRW3410

1 BI-METAL BLADE INCLUDED

**IRWIN** TRIMMING KNIFE - FIXED  
*Record*

- Feature-rich fixed knife featuring greater blade exposure
- Easy-tool free entry
- Convenient storage for 5 blades
- Magnetic blade retention
- Optimised cutting angle for minimal fatigue
- Pro Touch for a secure grip and greater comfort



**Code**  
**IRW3430**

**3 BI-METAL BLADES INCLUDED**



**UTILITY KNIFE - RETRACTABLE BLADE**

- A standard duty utility knife
- Retractable blade for safety
- Supplied with 5 spare blades stored in the handle
- Sturdy die-cast aluminium body
- Spare blades are available



**Code** | **Size**  
**HON3235** | 150mm

**5 HIGH QUALITY BLADES INCLUDED**



**UTILITY KNIFE - FINGER GRIP - RETRACTABLE BLADE**

- A standard duty utility knife
- Retractable blade for safety
- Comfortable moulded handle fits the hand for improved grip
- Supplied with 5 spare blades stored in the handle
- Sturdy die-cast aluminium body



**Code** | **Size**  
**HON3225** | 145mm

**5 HIGH QUALITY BLADES INCLUDED**



**UTILITY KNIFE - RUBBER GRIP - RETRACTABLE BLADE**

- A standard duty utility knife
- Retractable blade for safety
- Comfortable moulded handle with rubber grips
- Supplied with 5 blades stored in the handle
- Sturdy die-cast aluminium body
- Spare blades are available



**Code** | **Size**  
**HON3250** | 150mm

**5 HIGH QUALITY BLADES INCLUDED**



**TRIMMING KNIFE - RETRACTABLE**

- Standard, heavy duty model designed for professional or general purpose use
- Retractable blade adjusts to 3 positions
- Accepts all common utility knife blades
- Rugged, heavy duty handle made from die cast zinc alloy with baked enamel finish
- Supplied with two spare blades in handle
- Spare blades are available



**Code** | **Size**  
**RIC1990** | 156mm

**2 HIGH QUALITY BLADES INCLUDED**



**IRWIN** TRIMMING KNIFE PRO TOUCH - 10504236  
*Record*

- Quick change mechanism allows for fast blade removal or reversal
- Performance design using a lightweight but hard-wearing aluminium construction
- Pro Touch grip provides excellent control
- Ergonomic form allows for maximum comfort and minimum wrist distortion
- One touch quick access to spare blades
- Internal blade storage for up to 5 blades
- Bi-Metal blades last up to 3 times longer
- Retractable blade



**Code**  
**IRW3400**

**6 BI-METAL BLADES INCLUDED**



**IRWIN** TRIMMING KNIFE PRO ENTRY RETRACTABLE - 10507448  
*Record*

- Professional entry-level fixed knife is highly durable and lightweight
- Features an optimised cutting angle for minimal fatigue



**Code**  
**IRW3415**

**1 HIGH QUALITY BLADE INCLUDED**



**STANLEY** TRIMMING KNIFE - RETRACTABLE

- Interlock nose firmly secures blade into knife
- Plastic handle
- Supplied with 1 blade



**Code**  
**STA3042**

**1 HIGH QUALITY BLADE INCLUDED**



**STANLEY** TRIMMING KNIFE -  
RETRACTABLE - 2-10-099

- Interlock nose firmly secures blade into knife
- Die cast zinc body both strong and lightweight
- 5 Blade position allows wider usage for variety of cutting applications
- Blades stored in handle
- Supplied with 3 blades



Code  
**STA3085**



**STANLEY** CARPET TRIMMING KNIFE - 2-10-199

- Interlock nose firmly secures blade into knife
- Die cast zinc body both strong and lightweight
- 5 Blade position allows wider usage for variety of cutting applications
- Blades stored in handle
- Supplied with 3 blades



Code  
**STA3080**



**STANLEY** TRIMMING KNIFE - SELF  
RETRACTING - 10-189

- Safety knife with self retracting blade
- Blade remains outside as long as a thumb is kept on the push button
- Retracts when released
- Supplied with special rounded end blade for ultimate safety
- Supplied with 1 blade



Code  
**STA3038**



**IRWIN** TRIMMING KNIFE HIGH VISIBILITY  
*Record* 10506454

- High visibility orange coating to minimise risk of loss
- Captive screw entry
- Smooth 3 step retraction for multiple cutting depths
- Storage for 5 blades
- Magnetic blade retention
- Optimised cutting angle for minimum fatigue
- Retractable blade



Code  
**IRW3385**



**IRWIN** TRIMMING KNIFE - FOLDING - 10507406  
*Record*

- High quality and compact knife design features a 45° quick change mechanism to increase both productivity and safety
- Anchor belt clip
- Extended thumb edge and wire stripper
- Complete with Bi-Metal utility blade



Code  
**IRW3418**



**STANLEY** TRIMMING KNIFE - SLIDING  
POCKET UTILITY - 10-810

- Die cast body with soft grip handle for comfort
- Standard utility blades for multi purpose cutting
- Supplied with 1 blade



Code  
**STA3067**



**STANLEY** TRIMMING KNIFE - INSTANT FRONT  
LOAD RETRACTABLE - 10-788

- Interlock nose firmly secures blade into knife
- Die cast zinc body both strong and light
- Supplied with 3 blade



Code  
**STA3081**



**STANLEY** TRIMMING KNIFE - FOLDING UTILITY  
- 0-10-855

- One hand open / close for fast easy access
- Aluminium body - lightweight yet very strong
- Instant blade change
- Accepts standard trimming knife blades
- Supplied with 1 blade



Code  
**STA2390**



## STANLEY TRIMMING KNIFE - QUICK SLIDE SPORT - 10-813

- Multi blade and multi function knife
- Metallic body with soft grip handle for comfort
- 75mm serrated sport blade and standard utility blade ideal for home, garden and leisure applications
- One handed operation blade slider – extends blade quickly and easily
- For security the blades cannot be used simultaneously



Code

STA3100

3 HIGH QUALITY  
BLADES INCLUDED



## MTS SHOE KNIFE - WOODEN HANDLE

- An all purpose knife with a clipt blade and wooden handle for use around the house, garden, warehouse, factory and office



Code      Size

MTS3565      100mm

## MTS CUTTER BLADES

- 10mm blades are 13 point
- Supplied in a safe plastic sheath
- Ideal for professional and hobbyists



Code      Size

MTS3562      13pt x 10mm



## RAGO KNIFE - SPARE BLADES - 13 POINT

- Precision honed blades for use with knives shown on previous pages



Code      Size

RIC1985      13pt x 10mm

## IRWIN Record BLADE – SNAP-OFF CARBON STEEL

- Revolutionary snap-off blades last 3x longer
- Blades are shatterproof for ultimate safety, which makes them suitable for universal use in most cases
- Soft snap technology for safer segment breakage

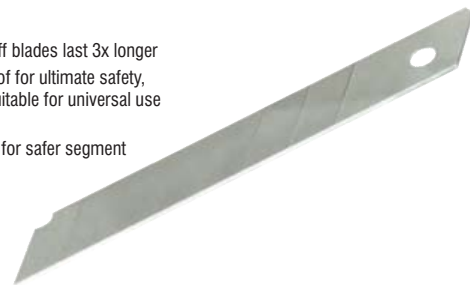

Code      Size      Ref

IRW2681      13pt x 9mm      10504566

IRW2682      13pt x 9mm      10504567

## STANLEY TRIMMING KNIFE - BLADES SNAP-OFF 0-11-300

- Quality high carbon steel
- Precision honed
- Fits 0-10-150 knife



Code      Size/Ref

STA2285      13pt x 9.5mm

## MTS CUTTER BLADES

- 18mm blades are 8 point
- Supplied in a safe plastic sheath
- Ideal for professional and hobbyists



Code      Size

MTS3560      8pt x 18mm





## KNIFE - SPARE BLADES - 8 POINT

- Precision honed blades for use with knives shown on previous pages



Code	Size
RIC1975	8pt x 18mm



## BLADE – SNAP-OFF CARBON STEEL 10504562

- Revolutionary snap-off blades last 3x longer
- Blades are shatterproof for ultimate safety, which makes them suitable for universal use in most cases
- Soft snap technology for safer segment breakage



Code	Size
IRW2680	8pt x 18mm

## STANLEY TRIMMING KNIFE - BLADES SNAP-OFF 0-11-301

- Quality high carbon steel
- Precision honed
- Fits 0-10-151, 0-10-480, 0-10-018 knives



Code	Size
STA2280	8pt x 18mm



## CUTTER BLADES

- Heavy duty, general purpose blades
- Ideal for professional and hobbyists
- Convenient safety dispenser



Code	Pack
HON0533	100



## SPARE UTILITY BLADES

- Precision made from high carbon cutlery steel, polished with accurately ground cutting edges
- For use with knife RIC1990 or any other utility knife



Code	Pack
RIC1980	5



## SPARE UTILITY BLADES

- Carbon steel blades for universal use in most trimming knives

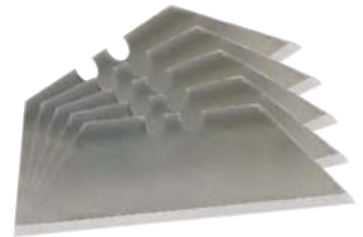

Code	Pack	Ref
IRW2695	5	10504245
IRW2696	10	10504246



## BI-METAL BLADES

- Bi-Metal technology fuses two premium steels together
- Creates utility blades that are exceptionally durable, shatterproof and last 3x longer
- Suitable for universal use in most applications

Code	Size	Ref
IRW2690	5 pack	10504240
IRW2692	10 pack	10504241
IRW2693	100 pack	10504243



## STANLEY TRIMMING KNIFE - SPARE BLADES

- Quality high carbon steel
- Accurate ground cutting edge
- Precision honed
- Fits all standard trimming knives
- Ideal for carpet, vinyl and any other material requiring a stiffer and stronger blade



Normal/Heavy duty



Hooked



Code	Ref No.	Type
STA2380	0-11-911	Normal duty 1 x 5
STA2305	1-11-911	Normal duty 100 pack
STA2345	1992-20	Heavy duty 1 x 20 card
STA2385	0-11-921	Heavy duty 1 x 5
STA2310	1-11-921	Heavy duty 100 pack
STA2340	11-921T	Heavy duty 1x10 cartridge
STA2323	4-11-921	400 bulk in 100's
STA2341	11-931	Extra heavy duty 1 x 5
STA2350	0-11-983	Hooked 1x5
STA2315	1-11-983	Hooked 100 sharp point



## HAND RIVETER

- A sturdy tool for fastening a wide variety of materials together, using aluminium or steel rivets
- Spring-loaded handle for easy rivet loading and ejection
- Suitable for rivet sizes 2.4mm, 3.2mm, 4.0mm and 4.8mm

Code	Rivet Sizes
MTS3940	2.4, 4.8mm



## HAND RIVETER

- Expert quality and robust for professional or industrial applications with body manufactured from hardened, heavy gauge carbon steel and scratch-free enameled finish
- Chrome molybdenum hardened steel jaws with three interchangeable nozzles to accept 3.2mm, 4.0mm and 4.8mm diameter rivets
- Hardened fulcrum pin and tempered spring loaded handle for automatic ejection of mandrel
- One hand operation - smooth, fast and easy
- High leverage handle with soft-touch moulded vinyl grips for comfortable operation
- Steel handle holder acts as a nozzle change spanner
- Spare jaws are available. Quote code RIC2850

Code	Rivet Sizes
RIC2835	3.2, 4.8mm



## Fascor® HAND RIVETER - FH10MK11

- Ideal for high quality low cost hand riveting
- Three nozzles to accept 3.2, 4.0, and 4.80 mm diameter rivets
- Hand assembly ergonomically designed to suite all hand sizes with durable PVC handle
- Steel fabricated epoxy coated tool body
- Supplied with spanner & additional nose pieces in a handy location on the tool body
- Jaw can be cleaned without totally disassembling the tool
- Spare jaw set FH10-15L - quote code FAS0005
- Spare return spring FH10-10 - quote code FAS0080

Code	Rivet Sizes
FAS-FH10	3.2, 4.8mm



## STANLEY® RIVETER - HEAVY DUTY - 69-799

- Chrome molybdenum hardened steel jaws
- Interchangeable nozzles
- Hardened fulcrum pin and tempered spring loaded handle for automatic ejection of mandrel
- High leverage handle with soft-touch moulded vinyl grips
- Includes a wrench for changing nozzles stored in handle

Code	Rivet Sizes
STA3680	2.4, 3.2, 4.0, 4.8mm



## Fascor® HAND RIVETER - FOR THREADED INSERTS - FH20

- Threaded insert setting tool ideal for DIY enthusiast and the tradesman
- Places threaded inserts M4 M5 & M6
- Presented in a robust easy carry pouch with selection of threaded inserts
- Kit includes a set of nose pieces and attachments, a spanner threaded inserts
- Rivet nut conversion FH20-1 - quote code FAS0400

Code
FAS-FH20



General Tools

## Fascor® SCISSOR TYPE RIVETER - FH2448

- A powerful "scissor" type riveting tool for Light Industrial use
- Sets aluminium and Steel blind rivets
- Strong enough to set a 4.8mm steel rivet
- Advantage of this tool is that it pushes away from the work surface when setting a rivet, ensuring no scratching of work piece
- Design of the tool ensures no scratching of the work piece
- "Scissor type" action allows for easy use above your head
- Presented in a robust easy carry pouch



Code	Rivet Sizes
FAS-FH2448	3.2, 4.0, 4.8mm

## Fascor® SCISSOR TYPE HEAVY DUTY - FH2464

- Powerful "scissor type" riveting tool for Heavy Industrial use
- Sets steel rivets
- Strong enough to set a 6.4mm steel rivet
- Advantages of this tool is that it pushes away from work surface when setting a rivet, ensuring no scratching of the work piece
- "Scissor type" action for easy use above your head
- Presented in a robust easy carry pouch

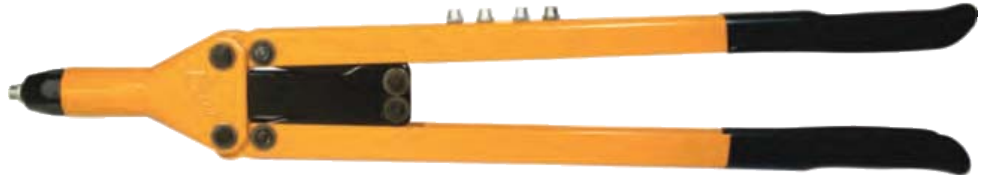

Code	Rivet Sizes
FAS-FH2464	3.2, 4.0, 4.8, 6.4mm



## CONCERTINA RIVETER

- A tough, durable hand riveter designed for heavy-duty repetitive work on machinery and fabrications particularly where a long reach is required
- The riveter can be operated with one hand



Code	Rivet Sizes
MTS3936	2.4, 3.2, 4.0, 4.8mm

## Fascor® LAZY TONG RIVETER - FH44

- Powerful "lazy tong" concertina type tool for light industrial use
- Sets aluminium and steel blind rivets
- FH-44 is tough enough to take the worst abuse
- Strong enough to set a 4.8mm steel rivet
- Cast in nose bush that does not work loose
- Improved lattice to body fixing
- Riveted lattice to handle fixing
- Presented in robust easy carry case
- Spare jaw set FH44-15/2 - quote code FAS0010
- Spare 4.8mm nose piece - quote code FAS0070



Code	Size
FAS-FH44	3.2, 4.0, & 4.8mm

## Fascor® LAZY TONG RIVETER - HEAVY DUTY - FH64

- Powerful "lazy tong" concertina type tool for Heavy Industrial use
- Sets aluminium and steel rivets
- FH-64 is tough enough to take the worst abuse
- Solid steel end cap for access to jaws for cleaning and replacement
- Improve lattice to body fixing
- Riveting lattice to handle fixing
- Narrow lattice to increase leverage and allow setting of stainless steel rivets up to 6.4mm diameter
- Presented in a robust easy carry pouch
- Spare 6.4mm nose piece - quote code FAS0200



Code	Size
FAS-FH64	3.2, 4.0, 4.8, & 6.4mm



## BLIND RIVETS

- Aluminium head
- Zinc plated steel mandrels
- Pre-packed



Code	Size	Code	Size
FAR3206	3.2 x 6mm	FAR4015	4.0 x 15mm
FAR3208	3.2 x 8mm	FAR4018	4.0 x 18mm
FAR3210	3.2 x 10mm	FAR4806	4.8 x 6mm
FAR3212	3.2 x 12mm	FAR4808	4.8 x 8mm
FAR3215	3.2 x 15mm	FAR4810	4.8 x 10mm
FAR3218	3.2 x 18mm	FAR4812	4.8 x 12mm
FAR4006	4.0 x 6mm	FAR4815	4.8 x 15mm
FAR4008	4.0 x 8mm	FAR4818	4.8 x 18mm
FAR4010	4.0 x 10mm	FAR4821	4.8 x 21mm
FAR4012	4.0 x 12mm		

## Fascor® POP RIVETS

- Aluminium body
- Zinc plated steel mandrel



Code	Diameter	Length	Grip Range	Drill Size
FAS3206	3.2mm	6mm	Up to 3mm	3.2mm
FAS3208	3.2mm	8mm	2.5 - 5mm	3.3mm
FAS3210	3.2mm	10mm	4 - 7mm	3.3mm
FAS3212	3.2mm	12mm	6 - 8.5mm	3.3mm
FAS3215	3.2mm	15mm	7.5 - 11mm	3.3mm
FAS3218	3.2mm	18mm	10.5 - 14.5mm	3.3mm
FAS4006	4.0mm	6mm	Up to 3mm	4.05mm
FAS4008	4.0mm	8mm	2.5 - 5mm	4.05mm
FAS4010	4.0mm	10mm	4 - 6.5mm	4.05mm
FAS4012	4.0mm	12mm	5.5 - 8mm	4.05mm
FAS4015	4.0mm	15mm	7 - 11mm	4.05mm
FAS4018	4.0mm	18mm	10 - 13.5mm	4.05mm
FAS4806	4.8mm	6mm	Up to 2mm	4.85mm
FAS4808	4.8mm	8mm	2.5 - 4mm	4.85mm
FAS4810	4.8mm	10mm	3.5 - 6mm	4.85mm
FAS4812	4.8mm	12mm	5 - 8mm	4.85mm
FAS4815	4.8mm	15mm	7 - 10.5mm	4.85mm
FAS4818	4.8mm	18mm	10 - 13.5mm	4.85mm
FAS4821	4.8mm	21mm	12.5 - 16mm	4.85mm



## RIVET WASHERS

- Three common sizes to suit rivets above
- Supplied in convenient pre-packs with clear indication of size



Code	Size
FARW3	W3 / 3.2mm
FARW4	W4 / 4.0mm
FARW5	W5 / 4.8mm

## Fascor® RIVET WASHERS

- Three common sizes to suit rivets above
- Supplied in convenient pre-packs with clear indication of size



Code	Size
FASW3	W3 / 3.2mm
FASW4	W4 / 4.0mm
FASW5	W5 / 4.8mm

## Fascor® FH20-1 THREADED INSERT

- Three common sizes to suit rivets above
- Supplied in convenient pre-packs with clear indication of size



Code	Size
FAS0402	M4
FAS0404	M5
FAS0406	M6

## Fascor® RIVET NUT SLEEVES



Code	Size	Ref
FAS0410	4mm	FH20-6/4
FAS0420	5mm	FH20-6/5
FAS0430	6mm	FH20-6/6

## Fascor® RIVET NUT ATTACHMENT

- Three common sizes to suit rivets above
- Supplied in convenient pre-packs with clear indication of size

Code	Size	Ref
FAS0440	4mm	FH20-7/4
FAS0450	5mm	FH20-7/5
FAS0460	6mm	FH20-7/6







## STAPLE GUN - STANDARD DUTY

- A handy plastic staple gun for DIY projects and general home use
- 10mm Crown staples with 4-8mm leg length



Code	Size
HON8054	4-8mm



## STAPLE GUN - LIGHT DUTY

- Lightweight, easy-action staple gun for household, DIY, upholstery etc
- Impact resistant ABS plastic housing with power-tacking construction and chrome plated steel handle
- Uses Raco staples - RIC3940 - RIC3945



Code	Size
RIC3900	6-8mm



## STAPLE GUN - HEAVY DUTY

- Professional quality, powerful hand tacker with jam-proof mechanism
- Powerful high compression spring drives into most materials for light to heavy duty jobs
- Heavy duty steel construction with precision engineered high carbon hardened steel working parts for long life and trouble free operation
- Supplied with 600 x 10mm staples and spanner
- Uses Raco staples RIC3915 / RIC3920 / RIC3925 / RIC3930 / RIC3935



Code	Size
RIC3910	6-14mm



## STAPLE GUN - LIGHT DUTY - TR45

- "Sharpshooter"
- Household staple gun
- Lightweight with convenient handle lock for safe storage
- Easy jam clear mechanism
- Chrome plated steel construction for durability
- Staples: STA5533, STA5544, STA5550



Code	Size
STA5505	6, 8 & 10mm



## STAPLE GUN, BRAD NAILER & CABLE TACKER - TR250

- Heavy duty aircraft- aluminium housing for long lasting durability
- Hi/Lo power lever for hard and soft materials
- Flush nose design solves the problem of stapling in tight spots
- All metal drive channel ensures better penetration
- Less force to squeeze and move driving power
- Nails: STA5515 - 12mm
- Staples: STA5530 - 6mm, STA5540 - 8mm, STA5550 - 10mm, STA5525 - 12mm, STA5573 - 14mm



Code	Nail Size	Staple Size
STA5503	12mm	6 & 8mm
	15mm	10,12 & 14mm



## STAPLES - LIGHT DUTY

- Professional quality, staples supplied in convenient quantities
- Packaging clearly indicates size and quantity



Code	Size	Packaging
RIC3940	6mm	1000 p/box
RIC3945	8mm	1000 p/box



## STAPLES - HEAVY DUTY

- Professional quality, staples supplied in convenient quantities
- Packaging clearly indicates size and quantity



Code	Size	Packaging
RIC3915	6.4mm	1000 p/box
RIC3920	8mm	1000 p/box
RIC3925	10mm	1000 p/box

Code	Size	Packaging
RIC3930	12mm	1000 p/box
RIC3935	14mm	1000 p/box

## STANLEY STAPLES - LIGHT DUTY

- Light duty staples for use in stapling machines
- Supplied in packs of 1000

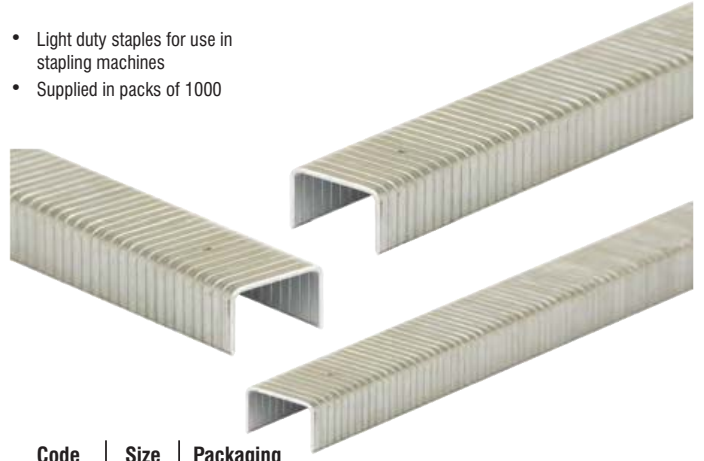

Code	Size	Packaging
STA5530	6mm	1000 p/box
STA5540	8mm	1000 p/box
STA5550	10mm	1000 p/box

## STANLEY STAPLES - HEAVY DUTY

- Heavy duty staples for use in stapling machines
- Supplied in packs of 1000

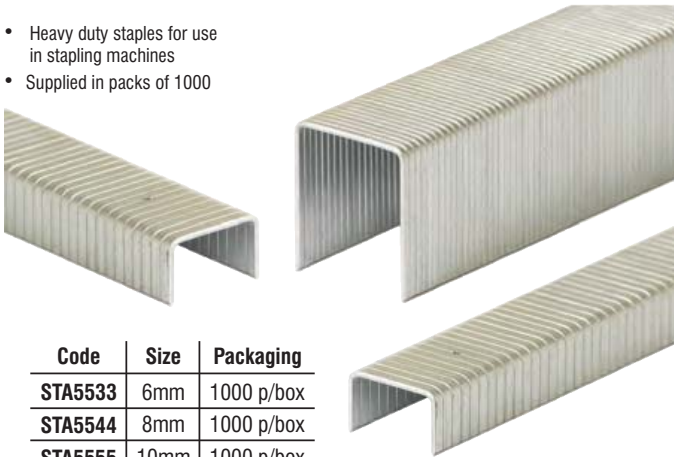

Code	Size	Packaging
STA5533	6mm	1000 p/box
STA5544	8mm	1000 p/box
STA5555	10mm	1000 p/box
STA5525	12mm	1000 p/box
STA5565	13mm	1000 p/box
STA5573	14mm	1000 p/box

## STANLEY BRAD NAILS - HEAVY DUTY SWKBN050S

- Heavy duty brad nails for use in stapling machines
- Supplied in packs of 1000



Code	Size	Packaging
STA5515	12mm	1000 p/box





### MINI GLUE GUN

- Ideal for bonding cables, decorations, cardboard, artificial flowers etc
- Glue sticks included



Part No.	Type	Rating
MTS2426	Mini	20W



### HOBBYIST GLUE GUN

- Ideal for bonding cables, decorations, cardboard, artificial flowers etc
- Glue sticks included



Part No.	Type	Rating
MTS2427	Hobby	55W



### PROFESSIONAL GLUE GUN

- Ideal for bonding cables, decorations, cardboard, artificial flowers etc
- Glue sticks included



Part No.	Type	Rating
MTS2428	Professional	80W



### MINI GLUE GUN

- GS and CE approved
- Trigger feed controls glue flow
- Quality construction with reliable solid state PTC heating system
- High impact resistant housing
- Ideal for gluing, sealing, jointing etc



Code	Size
RIC1445	15W



### TRIGGER GLUE GUN

- GS and CE approved
- Trigger feed controls glue flow
- Quality construction with reliable solid state PTC heating system
- High impact resistant housing
- Front stand keeps gun upright when not in use
- Ideal for gluing, sealing, jointing etc



Code	Size
RIC1450	40W



### GLUE GUN – HEAVY DUTY - 69-665

- Advance solid state PTC heating element to control glue temperature
- Trigger feed mechanism regulates glue flow
- Feeding system to prevent glue from backing up
- Wire stand allows gun to be placed on work surface
- SABS approved
- Includes 3 glue sticks



Code	Size
STA2920	40W



## GLUE GUN - PROFESSIONAL - GR100

- Patented auto shut off for safety and extended tool life
- Dual heater
- Consistent flow and 40% more glue output
- Hi/Low temperature switch
- Covered nozzle for burn prevention
- Convenient fold down stand
- Spreader tip to lay a wide glue line
- Extender tip for hard to reach places
- Includes 18 glue sticks
- SABS approved



Code	Size
STA2918	80W



## CAULKING GUN

- Lightweight standard duty caulking gun for DIY use
- Epoxy powder coated pressed steel with chromium plated iron



Code	Size
HON0970	310ml



## CAULKING GUN

- A heavy duty caulking gun for everyday use
- Die-cast aluminium handles with hot dip galvanised mechanism and ram
- Epoxy powder coated



Code	Size
HON0971	310ml



## ALUMINIUM CAULKING GUN

- A lightweight, professional caulking gun with exceptional features
- Aluminium construction with hot dip galvanised mechanism and ram
- Totally enclosed cartridge chamber



Code	Size
MTS2135	310ml



## CHROME CAULKING GUN

- A superior quality caulking gun with chrome cradle
- Built-in cartridge opener and nozzle cleaner
- Positive ratchet mechanism



Code	Size
MTS2140	310ml





## PAINT BRUSH - D.I.Y.

- A DIY range of brushes manufactured from pure bristle, set in a rust resistant ferrule and fitted with a painted wooden handle

Code	Size
HON6000	12mm
HON6002	19mm
HON6004	25mm
HON6006	38mm
HON6008	50mm
HON6009	64mm
HON6010	75mm
HON6012	100mm
HON6013	125mm
HON6014	150mm



## PAINT BRUSH - SEMI PROFESSIONAL

- A semi-professional, quality range of brushes manufactured from pure bristle, set in a rust resistant ferrule and fitted with a painted wooden handle

Code	Size
HON6030	12mm
HON6032	19mm
HON6034	25mm
HON6036	38mm
HON6038	50mm
HON6039	64mm
HON6040	75mm
HON6042	100mm
HON6043	125mm
HON6044	150mm



## PAINT BRUSH - D.I.Y.

- A professional range of top quality brushes with superior paint holding and application qualities
- Manufactured from thick, pure bristle, set in a rust resistant ferrule and fitted with a painted wooden handle

Code	Size
HON6050	25mm
HON6052	38mm
HON6054	50mm
HON6056	75mm
HON6058	100mm



## PAINT BRUSH SET

- A DIY set of 3 brushes manufactured from pure bristle, set in a rust resistant ferrule and fitted with a painted wooden handle

Code	Size
HON6018	13/25/50mm



## PAINT BRUSH SET

- A DIY set of 3 brushes manufactured from pure bristle, set in a rust resistant ferrule and fitted with a painted wooden handle

Code	Size
HON6020	25/50/75mm



## SYNTHETIC PAINT ROLLER SET

- High quality synthetic paint roller
- Supplied with plastic tray

Code	Size
UNS0095	230mm



## PAINT MIXERS

- These sturdy, well balanced heavy duty mixers for mixing and stirring paint
- Also for tile cement, insulating compound, fillers and plaster, mortar and other material
- NB! Not for use with lacquer or flammable liquids**

Code	Size
GRO2890	60mm
GRO2895	80mm

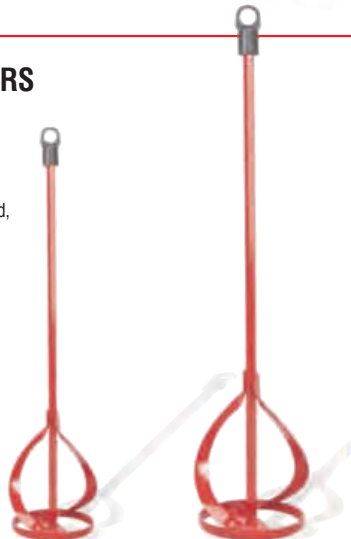

## PAINT SCRAPER - RUBBER HANDLE

- A selection of popular decorators scrapers supplied with mirror polished blades
- Comfortable rubber handle is securely fitted to the blade

Code	Size
MTS4180	30mm
MTS4182	40mm
MTS4184	50mm
MTS4186	70mm
MTS4188	90mm
MTS4190	100mm
MTS4192	125mm





### PAINT SCRAPER - WOODEN HANDLE

- A selection of popular decorators scrapers supplied with mirror polished blades
- Comfortable rubber handle is securely fitted to the blade

Code	Size
MTS4200	30mm
MTS4210	40mm
MTS4220	50mm
MTS4230	75mm
MTS4240	90mm
MTS4250	100mm
MTS4260	125mm



### PAINT SCRAPER - WOODEN HANDLE 3 PCE SET

- A selection of the 3 most popular decorators scrapers supplied with mirror polished blades
- Sizes: 30, 50 and 75mm
- Traditional wooden handle is securely fitted to the blade

Code	Size
MTS4265	30/50/75mm



### PAINT SCRAPER - WOODEN HANDLE BEVELED EDGE

- A popular decorators scraper supplied with mirror polished blades
- Traditional wooden handle is securely fitted to the blade

Code	Size
MTS4160	75mm



### FLEXIBLE SCRAPER

- Scrape paint and varnish off walls and furniture
- Flexible bright steel blade
- Plastic handle riveted to blade

Code	Size
VIC3300	75mm
VIC3310	100mm



### STRIPPING/KNIFE SCRAPER

- Scrape paint and varnish off walls and furniture
- Stiff bright steel blade
- Wooden handle riveted to blade

Code	Size
VIC3330	75mm



### PUTTY KNIFE/SCRAPER

- Flexible steel blade
- Plastic handle -rivetted

Code	Size
VIC3250	32mm



### PUTTY SCRAPER - LINO TANGED

- A 25mm blade for stripping wallpaper, paint or applying putty
- Mirror polished blade
- Plastic handle

Code	Size
MTS4270	25mm



### SCRAPER SET - 4 PCE

- For filling small gaps, cracks and holes
- Rust proof, tempered spring steel with acid resistant plastic grip
- 4 sizes: 40, 80, 100 and 120mm

Code	Size
MTS4275	4pce



General Tools



## SHAVEHOOK - HEART

- The three cutting surfaces are shaped to aid the removal of paint from contoured surfaces
- The blade is securely fastened to the shaft and both are chromium plated
- Rigid plastic handle is bonded to the shaft in manufacture



Code	Size
MTS4597	175mm



## SHAVEHOOK - HEART

- Heart shaped blade on a steel shaft
- All edges are very sharp
- Use on very small curved shapes
- For scraping of paint and varnish
- Use for very delicate work
- Wooden handle - varnished

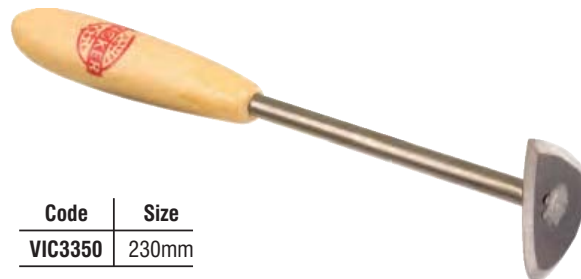

Code	Size
VIC3350	230mm



## SHAVEHOOK - TRIANGLE

- The equilateral triangle shavehook is ideal for removing paint from flat surfaces
- The blade is securely fastened to the shaft and both are chromium plated
- Rigid plastic handle is bonded to the shaft in manufacture



Code	Size
MTS4598	175mm



## SHAVEHOOK - TRIANGLE

- Triangular shaped blade on a steel shaft
- All edges are very sharp
- Use on very small straight or V shaped surfaces
- Sharp vee points get into tight corners
- For scraping of paint and varnish
- Use for very delicate work
- Wooden handle --varnished



Code	Size
VIC3360	230mm



## WINDOW SCRAPER

- A plastic window scraper fitted with scraper blade and protective blade cover



Code	Size
MTS4280	140mm



## WINDOW SCRAPER

- Safety plastic window scraper with blade
- Uses standard trimming knife blade
- Plastic handle
- Spare blades available



Code	Size
STA3945	175mm



## RAZOR SCRAPER - RETRACTABLE

- A plastic window scraper with retractable blade for safety
- Razor sharp blades are replaceable
- 5 additional blades included
- Spare blades available



Code	Size
MTS4278	100mm



## CABINET SCRAPER

- Used by cabinet makers for fine finishing of flat wooden surfaces
- Specially hardened thin steel plate
- Edges are very sharp and formed into very small hook shape
- Generally used with both hands with a pulling motion



Code	Size
VIC3290	115x70mm



### GAUGING TROWEL

- Made of top quality steel with a comfortable wooden handle with steel ferrule
- Rounded tip to blade



Code	Size
MTS6350	150mm
MTS6352	175mm
MTS6354	200mm



### GAUGING TROWEL - 36

- Has a rounded tip and normal V shape behind the tip
- Used to transfer small quantities of plaster or adhesive onto the wall
- Ideal for mixing plaster and adhesive in a container
- Used mainly by tilers and plumbers
- Round tip prevents digging in



Code	Size
VIC3730	150mm
VIC3740	175mm
VIC3750	200mm



### GAUGING TROWEL - 153 DIY

- Has a rounded tip and normal V shape behind the tip
- Used to transfer small quantities of plaster or adhesive onto the wall
- Ideal for mixing plaster and adhesive in a container
- Used mainly by tilers and plumbers
- Round tip prevents digging in



Code	Size
VIC3720	150mm



### BRICK TROWEL - ABS HANDLE

- The blade and tang are welded to form a solid, well constructed trowel
- Taper ground blade offers flexibility and overall balance
- Comfortable plastic handle



Code	Size
MTS6180	280mm
MTS6182	300mm



### BRICK TROWEL - INGWE 1533A

- Bricklayer's trowel
- High quality steel blade
- Wooden handle varnished
- DIY Medium duty
- New York pattern
- Broad steel
- Plastic handle (PVC)



Code	Size
VIC3460	280mm
VIC3470	300mm



### BRICK TROWEL - INGWE 1632A

- Bricklayer's trowel
- High quality steel blade
- Wooden handle varnished
- DIY Medium duty
- London pattern
- Broad steel
- Plastic handle (PVC)



Code	Size
VIC3475	280mm



### BRICK TROWEL - ROSA - 33A

- Bricklayer's trowel
- High quality steel blade
- 33A - Plastic handle
- 33B - Plastic handle



Code	Size
VIC3540	33A 280mm
VIC3550	33A 300mm



### BRICK TROWEL - ROSA - 33B

- Bricklayer's trowel
- High quality steel blade
- 33A - Plastic handle
- 33B - Leather handle



Code	Size
VIC3560	33B 280mm



### BRICK TROWEL - RUBBER HANDLE

- The blade and tang are welded to form a solid, well constructed trowel
- Taper ground blade offers flexibility and overall balance
- Superior rubber handle for comfort in prolonged use



Code	Size
MTS6190	250mm
MTS6192	280mm
MTS6194	300mm



### BRICK TROWEL - WOODEN HANDLE

- The blade and tang are welded to form a solid, well constructed trowel
- Taper ground blade offers flexibility and overall balance
- Traditional wooden handle



Code	Size
MTS6200	250mm
MTS6220	280mm
MTS6240	300mm





### BRICK TROWEL - WOODEN HANDLE - 32

- Bricklayer's trowel
- Through tang and capped
- High quality steel blade
- London Pattern



Code	Size
VIC3490	250mm
VIC3500	280mm
VIC3510	300mm



### BRICK TROWEL - WOODEN HANDLE - 151

- Bricklayer's trowel
- High quality steel blade
- Wooden handle varnished
- Medium duty DIY
- London Pattern



Code	Size
VIC3450	280mm



### BRICK TROWEL - ROSA PATTERN - 33

- Bricklayer's trowel
- High quality steel blade
- Wooden handle



Code	Size
VIC3520	280mm
VIC3530	300mm



### POINTING TROWEL

- A conventional pointing trowel with wooden handle



Code	Size
MTS6300	125mm
MTS6302	150mm
MTS6304	175mm
MTS6306	200mm



### POINTING TROWEL - 37

- A smaller version of the normal brick trowel
- Use to separate concrete from moulds
- Small repair jobs
- Spreads material in tight spots
- Wooden handle - varnished



Code	Size
VIC5080	150mm
VIC5090	175mm
VIC6000	200mm



### POINTING TROWEL - INGWE - 152 DIY

- A smaller version of the normal brick trowel
- Use to separate concrete from moulds
- Small repair jobs
- Spreads material in tight spots
- Wooden handle - varnished



Code	Size
VIC6010	150mm



### TILER'S TROWEL - 35

- Used by professional tilers
- A short, very wide trowel
- Large round nose
- Can carry lots of tiling cement



Code	Size
VIC6100	150mm



### SMALL TOOL TROWEL - 1563

- Has small flat blade on one end and pointed blade on the other end
- One of the best tools for pointing brick and stone work
- For patching, plastering and cleaning
- Use in hard to get to areas



Code	Size
VIC6080	20mm



### CORNER TROWEL - INSIDE

- Designed for forming perfect cove or sharp variation after plastering
- Inner corner trowels are available in cove and sharp variations
- Light and easy to handle with comfortable wooden handles



Code	Size
MTS6245	75mm Cove
MTS6246	150mm Cove
MTS6248	75mm Sharp
MTS6249	150mm Sharp



### CORNER TROWEL - OUTSIDE

- Designed for forming perfect cove or sharp variations after plastering
- Outer corner trowels are available in cove and sharp variations
- Light and easy to handle with comfortable wooden handles



Code	Size
MTS6251	75mm Cove
MTS6252	150mm Cove
MTS6254	75mm Sharp
MTS6255	150mm Sharp



### CORNER TROWEL - INSIDE

- Produces small radius smooth inside corners
- Wooden handle - varnished
- Bright steel blade
- Used by plasterers

Code	Ref	Size
VIC3580	43	75mm Cove
VIC3590	44	150mm Cove
VIC3600	41	75mm Sharp
VIC3610	42	150mm Sharp



### CORNER TROWEL - OUTSIDE

- Produces small radius smooth outside corners
- Wooden handle - varnished
- Bright steel blade
- Used by plasterers

Code	Ref	Size
VIC3630	43A	75mm Cove
VIC3640	44A	150mm Cove
VIC3650	41A	75mm Sharp
VIC3660	42A	150mm Sharp



### NOSING TROWEL - 45

- Used for front edge of steps to form rounded corner
- Can also be used on kerbing, concrete columns
- Wooden handle - varnished

Code	Size
VIC4020	150x75mm
VIC4030	150x115mm



### NOSING TROWEL - INGWE - 153

- Used for front edge of steps
- Can also be used as a small corner trowel
- Plastic handle

Code	Size
VIC4015	150x75mm



### SKIRTING TROWEL - 46

- Form skirting at joint of wall and floor
- Plaster is trowelled onto the wall and the skirting trowel is used to form concrete skirting
- Form nosing on concrete steps

Code	Size
VIC6060	230x75mm
VIC6070	230x100mm



### GRANO JOINTER - SINGLE GROOVE

- Designed for finishing off between concrete floor slabs
- Manufactured from cast steel
- Wooden handle

Code
MTS3538



### GRANO JOINTER - SINGLE GROOVE - 53

- For detailing joints in concrete slabs and floors
- Cast steel - painted
- Wooden handle - varnished

Code
VIC3220



### GRANO JOINTER - 6 GROOVE

- Designed for finishing off between concrete floor slabs and stair treads
- Manufactured from cast steel
- Wooden handle

Code
MTS3539



### GRANO JOINTER - 6 GROOVE - 55

- Used to groove steps for anti-slip
- Cast steel - painted
- Wooden handle - varnished

Code
VIC3230



### GRANO JOINTER - ADJUSTABLE - 54

- Used for detailing joints in concrete slabs and floors
- Adjustable for depth
- Cast construction
- Painted finish with wooden handle

Code
VIC3070





### BRICK JOINTER WITH WHEELS

- Adjustable brick jointer
- Hardened steel scraper



Code
DYN1000



### CROSS BRICK JOINTER

- Used for finishing the cement joints between brickwork joints to ensure a good and consistent finish
- Solid steel construction in round or square configurations
- Comfortable wooden handle
- Used between vertical joints and in confined areas

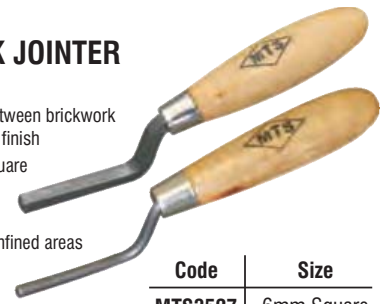

Code	Size
MTS3523	6mm Round
MTS3524	8mm Round
MTS3525	9.5mm Round

Code	Size
MTS3527	6mm Square
MTS3528	8mm Square
MTS3529	9.5mm Square



### CROSS BRICK JOINTER

- For use for cleaning and detailing vertical joints in brick work
- Round or square steel construction
- Wooden handle - varnished

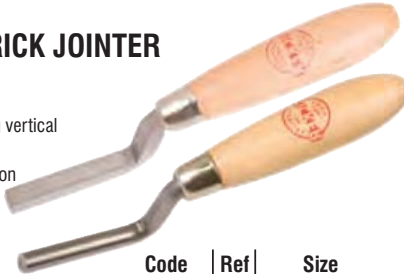

Code	Ref	Size
VIC3090	50	6mm Round
VIC3095	50	8mm Round
VIC3100	50	9.5mm Round

Code	Ref	Size
VIC3120	49	6mm Square
VIC3125	49	8mm Square
VIC3130	49	9.5mm Square



### LONG BRICK JOINTER

- Used for finishing the cement joints between brickwork joints to ensure a good and consistent finish
- Solid steel construction in round or square configurations
- Comfortable wooden handle
- Used between horizontal joints and in continuous lengths

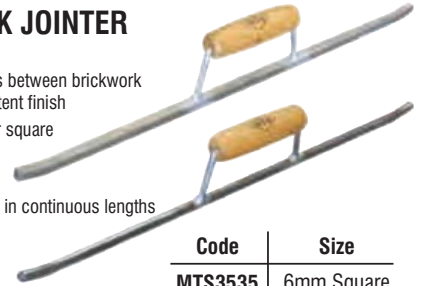

Code	Size
MTS3531	6mm Round
MTS3532	8mm Round
MTS3533	9.5mm Round

Code	Size
MTS3535	6mm Square
MTS3536	8mm Square
MTS3537	9.5mm Square



### LONG BRICK JOINTER

- Cleans up the horizontal joints in brickwork
- Polished round or square steel rod body
- Wooden handle - varnished



Code	Ref	Size
VIC3150	51	6mm Round
VIC3155	51	8mm Round
VIC3160	51	9.5mm Round

Code	Ref	Size
VIC3180	52	6mm Square
VIC3185	52	8mm Square
VIC3190	52	9.5mm Square



### MASTIC TROWEL - 38

- A small narrow trowel
- Used in tight spaces to spread and level plaster and adhesive
- Wooden handle - varnished
- Semi-flexible blade



Code	Size
VIC3780	150x12mm



### PLASTER TROWEL - PLASTIC HANDLE

- Plastic mounting is securely fastened to the blade
- The flexible blade is tempered, ground and polished
- Comfortable plastic handle



Code	Size
MTS6260	280mm



### PLASTER TROWEL - 4200244

- For plastering walls and columns
- Bright steel blade
- DIY quality
- Blue plastic handle



Code	Size
VIC5040	280x120mm



### PLASTER TROWEL - 244 DIY

- For plastering walls and columns
- Bright steel blade
- 6 rivets
- Plastic handle and tang



Code	Size
VIC5030	290x120mm



### PLASTER TROWEL - 724

- For plastering walls and columns
- Plastic blade
- DIY quality
- Plastic handle and blade



Code	Size
VIC5045	290x115mm



### PLASTER TROWEL - RUBBER HANDLE

- Aluminium alloy mounting, as strong as steel but very light
- The flexible blade is tempered, ground and polished
- Superior rubber handle for comfort in prolonged use



Code	Size
MTS6265	280mm



### PLASTER TROWEL - WOODEN HANDLE

- Aluminium alloy mounting, as strong as steel but very light
- The flexible blade is tempered, ground and polished
- Traditional wooden handle



Code	Size
MTS6280	280mm



### PLASTER TROWEL - 23

- For plastering walls and columns
- Bright steel blade
- DIY quality
- Wooden handle - varnished
- Flexible blade



Code	Size
VIC4090	250x120mm
VIC5000	292x120mm



### PLASTER TROWEL - 224

- Imported banana shaped fine grained wood handle affixed by a brass nut
- High carbon hardened and tempered steel blade
- 10 butt-welded rivets
- The blade is cross ground so that the trowel does not have to be worked in
- Aluminium tang for strength and lightness



Code	Size
VIC5020	290x120mm



### POOL TROWEL - RUBBER HANDLE

- Rounded end profile specially designed for pool plastering
- Aluminium alloy mounting, as strong as steel but very light
- The flexible blade is tempered, ground and polished
- Superior rubber handle for comfort in prolonged use



Code	Size
MTS6330	355mm



### POOL TROWEL - 226

- Has rounded edges, will not leave marks
- Flexible blade
- For smoothing swimming pool surfaces
- Use for Marbelite, plaster
- Wooden handle



Code	Size
VIC6020	290x120mm



### FLOORING TROWEL

- Extra long profile for rapid and level floor plastering
- Aluminium alloy mounting, as strong as steel but very light
- The flexible blade is tempered, ground and polished
- Traditional wooden handle

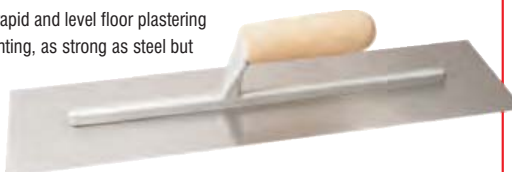

Code	Size
MTS6256	355x110mm



### FLOORING TROWEL - 27

- For smoothing "finishing off" concrete floors and slabs
- Bright steel blade



Code	Size
VIC3680	355x120mm



### FLOORING TROWEL - 27A

- For smoothing "finishing off" concrete floors and slabs
- Bright steel blade
- Has sharp point, gets into tight spaces
- Extra strong aluminium tang



Code	Size
VIC3690	355x120mm
VIC3700	405x120mm



### PLASTER TROWEL - NOTCHED

- Plastic mounting is securely fastened to the blade
- The flexible blade is tempered, ground and polished
- Comfortable plastic handle



Code	Size
MTS6257	280x6mm
MTS6259	280x8mm



## PLASTER TROWEL - NOTCHED

- Aluminium alloy mounting, as strong as steel but very light
- The flexible blade is tempered, ground and polished
- Superior rubber handle for comfort in prolonged use



Code	Size
MTS6258	280x6mm



## SERRATED TROWEL - FINE - 25A

- Similar in shape to a plastering trowel
- Serrated on all edges for spreading adhesive evenly
- Front edge offset to get into corners



Code	Size
VIC6050	280x120mm



## SERRATED TROWEL - 24A

- Similar in shape to a plastering trowel
- Serrated on all edges for spreading adhesive evenly
- Front edge offset to get into corners



Code	Size	Notch
VIC6030	280x120mm	Fine
VIC6040	280x120mm	Coarse



## NOTCHED TROWEL - 22477

- Spreads floor, tile, carpet adhesive evenly and regularly
- Spreads in parallel lines and avoids wastage
- Use fine notches for thin Vinyl tiles and larger notches for carpets and carpet tiles
- Wooden handle - varnished



Code	Size	Notch
VIC4050	280x120mm	6mm



## PLASTIC FLOAT

- A one-piece polyurethane moulded float
- The non-absorbent face is used for scrubbing plaster, cement or other building material



Code	Size
MTS2700	270x125x5mm



## PLASTIC FLOAT

- A one-piece polyurethane moulded float
- The non-absorbent face is used for scrubbing plaster, cement or other building material
- Lightweight and comfortable



Code	Size
UNS1450	280x115x12mm



## WOODEN FLOAT

- Used for floating cement plaster / floors - walls



Code	Size
UNS1500	300mm



## RHINOLITE TROWEL

- A 10mm thick black neoprene pad bonded to a sturdy PVC handle
- Designed for the smooth finishing of rhinolite



Code	Size
MTS6370	280x140x10mm



## RUBBER BASE TROWEL - 724R

- Similar in shape to a plastering trowel
- Has a rubber base
- Used mainly for dry wall plaster
- Will not leave marks



Code	Size
VIC6025	280x120mm



## ALUMINIUM PLASTER HAWK

- This lightweight aluminium hawk is robust and versatile
- Comfortable plastic handle is securely attached to the carrying face



Code	Size
MTS3420	280mm



## PLASTIC PLASTER HAWK

- This lightweight plastic hawk is robust and versatile
- The one piece injection moulding is rigid and hard wearing



Code	Size
UNS5300	280mm



## ALUMINIUM PLASTER HAWK - 1621

- Used to hold small amounts of plaster
- Plasterer uses a plastering trowel to transfer plaster from hawk to wall
- Aluminium plate, with plastic handle
- Medium duty for professional use



Code	Size
VIC3030	300x300mm



## ALUMINIUM PLASTER HAWK - 21

- Used to hold small amounts of plaster
- Plasterer uses a plastering trowel to transfer plaster from hawk to wall
- Aluminium plate heavy duty, with wooden screw in handle
- For professional use



Code	Size
VIC3040	300x300mm



## PLASTIC PLASTER HAWK - INGWE - P21

- Used to hold small amounts of plaster
- Plasterer uses a plastering trowel to transfer plaster from hawk to wall
- Plastic plate with plastic handle
- Light duty use - DIY

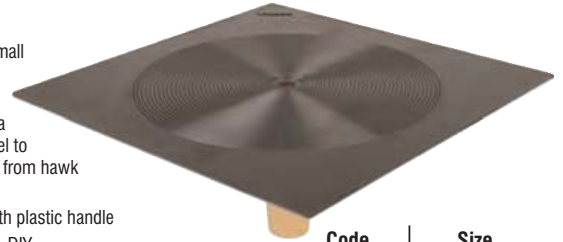

Code	Size
VIC3055	300x300mm



## TYROLEAN MACHINE

- A hand operated machine, used for the application of Tyrolean and weatherproof wall coatings
- Ideal for use on both inside and outside walls in the home and commercial premises
- Used to create a "spattered" effect on plastered walls
- Has special insert to reduce spray patterns for small areas
- Spare inserts are readily available



Code	Size
HON9040	-
HON9042	Insert



## ROAD STAMPERS

- Solid steel handle
- Available in square or round
- Heavy base
- Use for ramming and compacting loose soil



Code	Profile	Size
DYN1140	Round	10kg
DYN1160	Square	10kg



## LINE PIN - 2 PIECE

- Galvanised steel pins
- 6 metre nylon line



Code	Size
MTS3584	150mm



## LINE PIN

- Large headed Line Pins are made from forged steel and are bright zinc plated
- Used in conjunction with builder's line for marking out positions or aligning courses of brickwork



Code
VIC3260



## FISH LINE

- Nylon monofilament builders fish line
- Supplied in 100m rolls
- Sold per 6



Code	Size	Breaking Strain
RIC1310	.35mm	5.45kg
RIC1312	.45mm	9.08kg
RIC1314	.70mm	22.7kg
RIC1316	.80mm	27.3kg
RIC1318	.85mm	31.8kg
RIC1320	.90mm	36.4kg
RIC1322	1.0mm	40.9kg



## CONCRETE WHEELBARROW

- Easy to transport
- Solid rubber wheel
- Cushion grip handles
- Strong and lightweight



**ASSEMBLED  
IN MINUTES WITH  
BASIC TOOLS**

Code  
**HON9098**



## BUILDER'S STRAIGHTEDGE

- Lightweight aluminium with end caps
- Used for leveling plaster
- Available in 4 convenient lengths

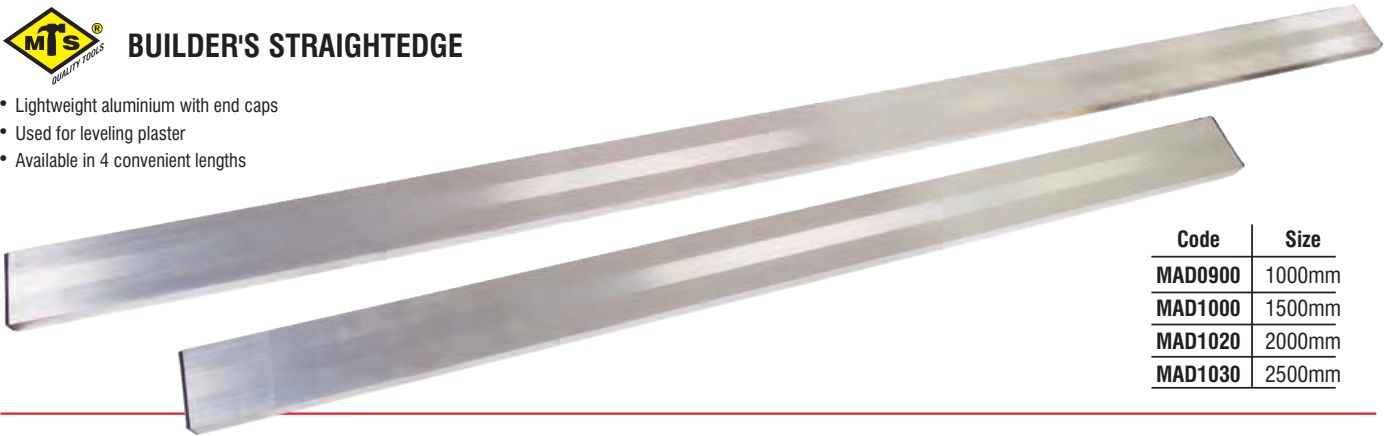

Code	Size
MAD0900	1000mm
MAD1000	1500mm
MAD1020	2000mm
MAD1030	2500mm



**General Tools**



### GAS BLOW TORCH - TYPHOON LOOP - PORTABLE - NORMAL STRIKE

- Portable gas operated blow torch
- Use only with a 190gm butane gas cartridge (C202) with direct pressure
- Use only in well ventilated areas
- Use strictly in accordance with manufacturers usage conditions
- Heat range 1300Watts / 1850°C



Code

RIC1362



### GAS BLOW TORCH - TYPHOON LOOP - PORTABLE - PIEZO SELF IGNITING

- Portable gas operated blow torch
- Use only with a 190gm butane gas cartridge (C202) with direct pressure
- Use only in well ventilated areas
- Use strictly in accordance with manufacturers usage conditions
- Heat range 1300Watts / 1850°C



Code

RIC1364



### GAS BLOW TORCH - HURRICANE 100 - PORTABLE - PIEZO SELF IGNITING

- Portable gas operated blow torch
- Anti-flare
- Used in any position
- Use only with a 190gm butane gas cartridge (C202) with direct pressure
- Use only in well ventilated areas
- Use strictly in accordance with manufacturers usage conditions
- Heat range 1300Watts / 1350°C



Code

RIC1366



### SELF IGNITING BLOWTORCH

- Gas fuelled L/D blow torch
- Uses 190 gm piercable butane gas cartridges. (Recommended butane 190G/48300)
- Very handy for small works
- Operating temperature +/- 850°C



Code

OXY0200



### STANDARD BLOWTORCH

- Gas fuelled L/D blow torch
- Uses 190 gm piercable butane gas cartridges. (Recommended butane 190G/48300)
- Very handy for small works
- Operating temperature +/- 850°C



Code

OXY0210



### GAS BLOW TORCH KIT

- Portable gas operated blow torch with 1mtr hose and 4 burners
- Use only with a 190gm butane gas cartridge (C202) with direct pressure
- Use only in well ventilated areas
- Use strictly in accordance with manufacturers usage conditions
- Heat range 1300Watts / 1850°C



Code

RIC1368



### FLEX HOSE BLOWTORCH

- Gas fuelled L/D blow torch
- Uses 190gm piercable butane gas cartridges (Recommended butane 190G/48300)
- Very handy for small works
- Operating temperature +/- 850°C



Code

OXY0220



### GAS REFILL - BUTANE/ PROPANE & ANTI FLARE

- Gas refill canister with a 7/16" screw fitting
- Suitable for RIC1380 Cyclone Point Blowtorch



Code

RIC1383

Size

400ml



### SPARE BUTANE CARTRIDGE

- Butane
- Piercable
- Use with all models
- Do not dispose of empty cartridge in any form of fire



Code

OXY0330

General Tools





### MINI TUBE CUTTER, 3-16mm

- Designed for use in tight quarters where other cutters won't fit
- Accurate cutting of copper, brass and aluminium tubing
- Compact body and sliding block
- Grooved rollers for close-to-flare cuts
- Large knurled feed screw knob with chemical black finish
- Body is baked enamel blue finish
- Spare cutter wheel is available - please quote code RIC1025



Code	Size
RIC1010	3-16mm



### MINI TUBE CUTTER - THPC125

- Compact and accurate cutters have steel wheels & rollers mounted in precision die-cast bodies
- Strong and lightweight they are designed to cut copper, brass aluminium & thin wall steel
- This cutter is ideal for tight corners and confined spaces



Code	Size
REC5550	3-25mm

### RIDGID MIDGET TUBE CUTTERS

- Designed for use in restricted spaces on small diameter, hard and soft copper, aluminium, brass thin walled steel and plastic tubing
- Strong, lightweight slide and wheel housing
- Large knurled feed screw knob gives easy control on cutting pressure for clean cuts
- Compact and accurate cutters have steel wheels and rollers mounted in precision bodies
- Spare cutter wheel included
- Uses standard wheel RID33185



Code	Ref	Size
RID32975	103	3-16mm
RID32985	104	5-24mm



### TUBE CUTTER

- Cut tubes from 3 - 28mm
- Suitable for all common, small gauge copper, steel & aluminium pipes
- Flip out de-burring blade for quick and easy pipe end cleaning



Code	Size
HON0843	3-28mm

### RIDGID TUBE CUTTERS

- Clean square cut is easily made on copper, brass aluminium, and thin walled conduit
- Feature a convenient fold away reamer
- Screw feed cutter
- Uses standard wheel RID33160



Code	Ref	Size
RID32915	10	3-25mm
RID93382	15	5-28mm



### TUBE CUTTER

- An inexpensive tube cutter for the handyman or DIYer
- For cutting copper, brass and aluminium tubing
- Die cast body with hardened steel blades and two flare groove rollers
- The adjustable knob also incorporates a retractable reamer for cleaning burrs on cut ends
- Spare cutter wheel is available - please quote code RIC1025



Code	Size
RIC1020	3-29mm

### IRWIN Record TUBE CUTTERS - 200-30C

- For cutting copper, brass, aluminium and thin walled steel
- Spare cutter wheel is located in the handle
- Has steel de-bur that folds into the body when not in use



Code	Size
REC5555	3-30mm

### STANLEY TUBE CUTTER - 93-020

- Cuts copper, brass, aluminium tubing
- Thin wall conduit
- Heavy duty rollers
- Deburring attachment
- Extra cutting wheel in handle



Code	Size
STA2780	3-30mm



### TUBE CUTTER - 153

- For use on Copper, Brass, light alloy, PVC and thin wall steel tubes
- Has deburring tool (3 cutting edges) inside handle
- Forged
- Chrome plated



Code	Capacity
STW60010000	3-35mm

### IRWIN® TUBE CUTTERS – INOX PRO Record.

- Heavy duty telescopic action high precision tube cutting
- Zinc Die-Cast Body and stainless steel rolls
- Cuts 3-35mm (1/8" - 1-3/8") Inox Steel cleanly and easily
- De-burr pipes with the replaceable machinist's reamer
- Ergonomic grip with Inox cutting wheel fixed in the handle-knob



Code	Size
REC5565	3-35mm

### RIDGID TUBE CUTTER QUICK ACTION - 150L

- Enclosed feed screw to eliminate clogging and jamming
- Grooved rollers for close-to-flare cuts
- Cuts copper, brass and aluminium tubing and thin walled conduit
- Fold away reamer
- Made from high-strength aluminium alloy
- Spare cutter wheel (RID33185) in handle



Code	Size
RID66737	6-35mm

### RIDGID TUBE CUTTER - QUICK ACTION - 151

- Quick-acting design
- I-beam construction
- Hardened wear surfaces
- Thrust bearing slide assemblies for smooth operation
- Fold away reamer



Code	Size
RID31632	6-42mm

### IRWIN® TUBE CUTTER – COMPACT PRO Record. THPC145

- Heavy duty, high-precision tube cutter with telescopic action
- Easy and quick to operate due to special arbour and ergonomic knob
- Won't walk during cutting thanks to its four-roller tracking system
- Oversized handle for quick and smooth operation and convenient wheel storage
- Includes a reamer and 1 additional universal cutting wheel (19 x 5mm) fixed inside the handle



Code	Size
REC5730	3-45mm

### IRWIN® TUBE CUTTER – STANDARD Record. T200-45

- Compact and accurate cutter has steel wheels and rollers mounted in precision die-cast body
- Strong and lightweight, designed primarily to cut copper, brass, aluminium or thin walled steel
- Exceptional thin, fast cutting wheel and 2 rollers to ensure the cutting wheel is held squarely on the tube resulting in a square cut



Code	Size
REC5725	15-45mm



### TUBE CUTTER

- Expert quality, spring loaded cutter wheel feeding system allows for slide action adjustment and quick release
- Heavy duty aluminium body with fold away reamer and slide bar with stop to protect cutting wheels
- Hardened, thin section cutting wheel and extra long grooved rollers for close-to-flare cuts every time
- Clean accurate cutting of copper, brass or aluminium tubing and thin-wall steel conduit
- Contoured easy grip knob is manufactured from die cast aluminium alloy and stores spare blade
- Spare cutter wheel is available - please quote code RIC1030



Code	Size
RIC1022	6-50mm

### RIDGID TUBE CUTTER - QUICK ACTION - 152

- Quick-acting design
- I-beam construction
- Hardened wear surfaces
- Thrust bearing slide assemblies for smooth operation
- Fold away reamer



Code	Size
RID31642	6-66mm

General Tools

## RIDGID PIPE CUTTER - HEAVY DUTY 1-A

- Fast clean pipe cutting by hand or power
- Extra long shank protects adjustment threads
- Extra large handle is provided for quick, easy adjustment



Code	Size
RID32810	3-32mm

## RIDGID PIPE CUTTER - HEAVY DUTY - 2-A

- Fast clean pipe cutting by hand or power
- Extra long shank protects adjustment threads
- Extra large handle is provided for quick, easy adjustment



Code	Size
RID32820	3-50mm

## IRWIN Record PIPE CUTTER - 202 ROLLER PATTERN

- This tool, designed to cut steel pipe
- One fast cutting wheel and two wide rollers
- These rollers keep the cutter squarely on track and also smooth down the burr leaving a smooth clean cut ready for jointing or threading



Code	Size
REC5455	10-60mm

## RACO PIPE CUTTER

- Professional quality, lightweight but heavy duty cutter for copper, brass and aluminium tubing and all non-ferrous pipes
- Compact aluminium alloy body and adjusting handle
- Comfortable handle with fine pitch threads assures easy cuts with the minimum of effort
- Flare groove rollers and hardened steel cutting wheel, factory tested to ensure perfect tracking
- Fold-away reamer is easily stowed when not in use
- Spare cutter wheel is available - please quote code RIC1003



Code	Size
RIC1005	16-54mm

## RIDGID PIPE CUTTER HEAVY DUTY - 4-S

- Fast clean pipe cutting by hand or power
- Extra long shank protects adjustment threads
- Extra large handle is provided for quick, easy adjustment



Code	Size
RID32840	50-100mm

## RACO CUTTER PVC

- Expert quality, 4 position, ratchet type shear for fast clean cutting of plastic pipes and other pipes of synthetic resins up to 42mm diameter
- Compact aluminium body with high carbon steel blade, correctly hardened and tempered
- Accurately ground cutting edge for smoother cutting and longer life
- Ratchet jaws hold pipe in cutting position without slipping



Code	Size
RIC1000	42mm

## RIDGID PIPE & TUBE CUTTER SPARE WHEELS

- Replacement tube cutting wheels

For steel pipe and ductile iron

Code	Size
RID44185	E1032
RID44190	E1032S
RID33125	F229
RID33105	F3
RID33145	F367
RID33150	F367S
RID33100	F514
RID33120	F515



For stainless steel

Code	Size
RID33165	E1240
RID33190	E4546
RID33160	F158



## PIPE CUTTER SPARE WHEELS

- Cutting wheels for pipe cutters



Code	Size
STW69020101	SR150/1
STW69020201	SR150/2
STW69020301	SR150/3/4
STW69010001	SR153

## STANLEY TUBE CUTTER CUTTING WHEEL

- Replacement cutting wheel
- Fits 93-020 cutter



Code	Ref.
STA2777	93-019

## IRWIN® Record. MINI BENDER - 210

- Manufactured from strong precision die-castings with integral formers and guides
- No loose components
- Bends three sizes of copper, brass, aluminium or steel tube
- Calibrated for 90 degrees and return bends in annealed copper, steel, aluminium and stainless steel

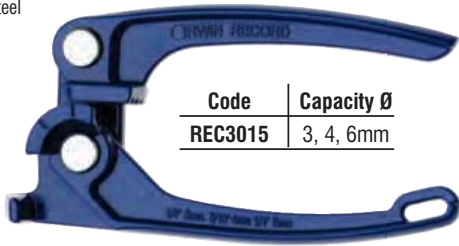

Code	Capacity Ø
REC3015	3, 4, 6mm

## IRWIN® Record. MINI BENDER - 211

- Manufactured from strong precision die-castings with integral formers and guides
- No loose components
- Bends three sizes of copper, brass, aluminium or steel tube
- Ideal for "microbar" central heating system
- Accurately calibrated for left-hand, right-hand or offset bends in copper, brass, aluminium or steel



Code	Capacity Ø
REC3020	6, 8, 10mm



## TUBE BENDER

- Designed for bending small diameter copper, aluminium, stainless steel and steel tubes
- Calibrated markings for making accurate left hand, right hand and offset bends
- Makes smooth short radius bends up to 180° with less effort
- Wide fixed hook simplifies the operation and holds tubing securely
- Open side slips onto tubing at any point
- Bend and handle made from die cast aluminium to be lightweight and sturdy



Code	Capacity Ø
RIC0465	6, 8, 10mm

## IRWIN® Record. HAND BENDING MACHINE - T591057

- Flat edges to the bracket arm also allow machine to be used in workshop vice for convenient bending
- Pimple bungs on bending levers prevent the arms slipping if they are used on the floor
- Steel inserts to the bungs eliminate piercing and increase durability
- 15 and 22mm formers have degree marks on casting for 'at a glance accuracy'



Code
REC3010

## RIDGID LEVER BENDERS

- Combine accuracy with easy operation
- Offset cushion grip handles eliminate knuckle cracking when forming 180° bends
- A 90° start angle and unique oil-absorbing shoe minimize bending effort while forming accurate bends in copper, steel and stainless steel tubing



Code	Ref	Tube Size	Bend Radius
RID36092	405	5/16"	15/16"
RID36097	406	3/8"	15/16"
RID36102	410M	10mm	24mm
RID36112	406M	6mm	16mm
RID36122	404	1/4"	5/8"
RID36127	412M	12mm	38mm
RID36132	408	1/2"	1 1/2"

## IRWIN® Record. BENDER - UNIVERSAL STAND ONLY - UL223

- Features include a single universal roller for all forms of pipe
- Dual position tube locator for copper or conduit, and an adjustable quadrant for precise repeat bends
- Can be used by a wide range of artisans including heating and ventilation engineers, electricians, plumbers, gas fitters, mechanical maintenance engineers and motor vehicle engineers
- The ability to bend large diameter copper tube is easily within the range of the universal bender
- Multi adjustment to the tubular legs and feet ensures maximum safety in use



Code	Size	Size	Type
REC8405	F3B1511	15mm	Former
REC8407	T563082	20mm	Former
REC8400	F3H2552	25mm	Former
REC8408	F3L3212	32mm	Former
REC8415	G3A1511	15mm	Guide
REC8427	G3S013	20mm	Guide
REC8420	G3S2551	25mm	Guide
REC8410	T560794	32mm	Guide

Code
REC3025
Capacity Ø
Light gauge copper up to 42 mm
Medium gauge Copper up to 42 mm
Light gauge Stainless Steel up to 35 mm
Steel conduit up to 32 mm

## RIDGID TUBE BENDER - SPRING TYPE

- For fast, free-form bending of soft copper and aluminium tube



Code	Ref	Size
RID35265	D1379	1/2"
RID35275	D1381	3/4"
RID35270	D1380	5/8"

General Tools



## PIPE BENDERS

- Easily bend steel pipes of varying diameters up to 75mm
- Ideal for fabricators and hobbyists
- Integral rollers prevent damage to the workpiece
- Bend angles up to 90°
- Quick change pipe shoes

Code	Capacity (Tons)	Capacity (mm)	Ram Stroke (mm)	Gross Weight (kg)
MOB0020	12	13-50	232	41.0
MOB0025	15	13-75	238	61.5



**Not for thin wall bending!**  
**For steam and water pipes at 3-4mm wall thickness ONLY!**  
**NOT SUITABLE FOR EXHAUST PIPE BENDING.**



## STOCK & DIE SET

- Stock & die set for threading steel pipe
- Sturdy die cast stock with positive ratchet mechanism
- Two stage handle for increased leverage
- Four part dies with precision ground cutting edges

Code	Size
HON8063	1/2-2" BSP



## RIDGID RATCHET THREADER SET - 11R-13088

- Uses 11 R series heads
- Heavy duty cast iron Die Head construction, rigidity and robustness
- Easy start die geometry for easier thread starting
- New die profile for superior thread quality
- Larger cooling slots, better access with pump gun and improved cooling
- Cast iron coverplate, improved rigidity and more consistent thread quality
- 11R Die Heads can be used with 600 & 690 Power Threaders



Code	Size
RID13088	1/2 - 2" BSPT



## HANDLE SET

- Replacement handle set for HON8063 stock and die set

Code	Size
HON9002	3 pce



## RIDGID RATCHET THREADER—EXPOSED 12-R-65255

- The die-heads lock into ratchet assembly and are removed by pulling out ratchet knob
- Ratchet and handle lock complete



Code	Size
RID65255	1/2 - 2" BSPT

## RIDGID RATCHET THREADER - EXPOSED 00R-65175

- The die-heads lock into ratchet assembly and are removed by pulling out ratchet knob
- Ratchet and handle lock complete



Code	Size
RID65175	1/2 - 1" BSPT

## RIDGID PIPE THREADER – 3 WAY 31-A 65320

- Each model cuts three thread sizes.
- Each die set is locked in place

Code	Size
RID65320	1/2 / 3/4 / 1" BSPT



General Tools

## RIDGID RATCHET & HANDLE

- Heavy duty cast iron construction head
- With handle
- For various ratchet die heads

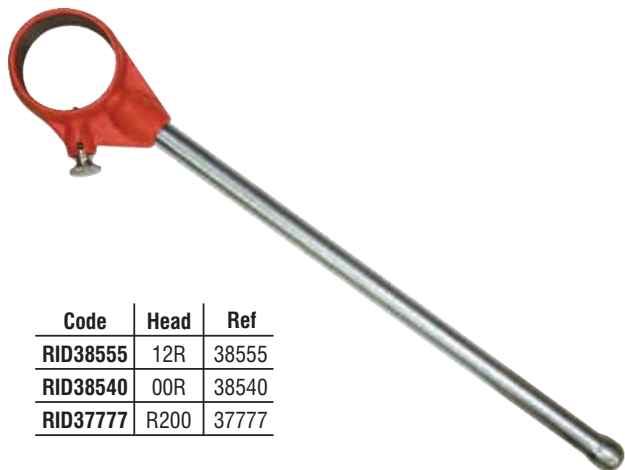

Code	Head	Ref
RID38555	12R	38555
RID38540	00R	38540
RID37777	R200	37777

## RIDGID PIPE DIE HEAD COMPLETE FOR MANUAL THREADER - 11R

- Alloy Dies
- Recommended for threading regular steel pipes
- Alloy R/H



Code	Size
RID65565	1/2" BSPT
RID65570	3/4" BSPT
RID65575	1" BSPT

## RIDGID PIPE DIE HEAD COMPLETE FOR MANUAL THREADER - 00R

- Alloy Dies
- Recommended for threading regular steel pipes
- Alloy R/H



Code	Size
RID65710	1/2" BSPT
RID65725	3/4" BSPT
RID65730	1" BSPT



## STOCK DIE HEADS

- Replacement stock die heads for HON8063 stock and die set

Code	Size
HON8092	3/4" BSP
HON8093	1/2" BSP
HON8094	1" BSP
HON8095	1 1/2" BSP
HON8096	2" BSP
HON8097	1 1/4" BSP



## STOCK DIE HEADS

- Replacement dies for HON8063 stock and die set

Code	Size
HON9003	1/2" BSP
HON9004	3/4" BSP
HON9005	1" BSP
HON9006	1 1/4" BSP
HON9007	1 1/2" BSP
HON9008	2" BSP



## RIDGID PIPE DIE HEAD COMPLETE FOR MANUAL THREADER - 12R

- Alloy Dies
- Recommended for threading regular steel pipes
- Alloy R/H



Code	Size BSPT
RID65955	1/4"
RID65960	3/8"
RID65965	1/2"
RID65970	3/4"
RID65975	1"
RID65980	1 1/4"
RID65985	1 1/2"
RID65990	2"

## RIDGID PIPE DIES FOR MANUAL THREADERS - 12R

- Pipe dies for 11-R, 12-R, 00-R, 31-A threaders
- Recommended for threading regular steel pipes

Code	Size BSPT	Thread/Inch
RID66110	1/8"	28
RID66115	1/4"	19
RID66120	3/8"	19
RID66125	1/2"	14
RID66130	3/4"	14
RID66135	1"	11
RID66140	1 1/4"	11
RID66145	1 1/2"	11
RID66150	2"	11



## RIDGID THREADING MACHINE - NO STAND - 1224

- **Capacity:** Pipe 1/4" 4", 4"-6" using 161 geared threader  
Bolt: 1/4"-2", (6-52mm) up to 30 Rockwell C
- **Technical Specifications:**  
Motor: 1.1kw, single phase 50Hz induction type  
Motor control: Reverse/off/forward heavy duty, rotary type and integral foot switch  
Spindle speed: 36/12 RPM  
Gearbox: Two speed gear box 3:1 Ratio  
Chuck: Hammer type with replaceable jaw inserts  
Rear centering device: Cam action  
Cutter: Model 764 full floating, self centering 1/4"-4" with F229 cutter wheel  
Reamer: Model 744, 1/4"-4" blade type  
Oiling: Adjustable flow through the head  
Pump: Self-priming, Geroter type, automatic reversing constant flow
- **Standard equipment**  
Oil: 5 liters thread cutting fluid  
Tools and equipment: 4 hex keys, HD F229 cutter wheel, 3/4" combination Wrench, tool box  
Die heads: 1 Model 911 1/4"-2",  
1 Model 914 2 1/2"-4"  
Dies: 1set each 1/2"-3/4", 1"-2" euro dies and 2 1/2"-4" HS di

Code	Model
RID26107	1224



## RIDGID THREADING MACHINE - NO STAND - 535

- The model 535 threading machine with its new heavy duty design offers a powerful combination of speed and ruggedness that is ideal for industrial applications
- A choice of motors and die heads allows the machine to be ideally adapted to the work requirements
- **Standard Equipment:**  
Cutter: Model 820  
Reamer: Model 341  
Oil: 5 Litres Thread Cutting Fluid  
Spare: E-1023 Cutter Wheel  
2 hex wrenches (5/32", 3/16")
- **Capacity:**  
Pipe: 1/8"-2", 2 1/2"-4", 4"-6" with 141 and 161 geared threaders  
Bolts: 1/4"-2" (6 mm-52 mm)
- **Technical Specifications:**  
Manual Chuck  
Motor: Choice of Universal or Three Phase Induction Motors  
Spindle Speed: 36 (Universal) or Electrically switched 35/70 (3 phase)  
Switches: Forward/Off/Reverse and Integral safety foot switch  
Chuck: RIDGID speed chuck with replaceable rocker action jaw inserts  
Rear Centering Device: Cam action turns with chuck  
Cutters: No. 820 Wheel Type Self Centering, full floating  
Oil Pump: Adjustable self priming geroter

Code	Model
RID75575	535

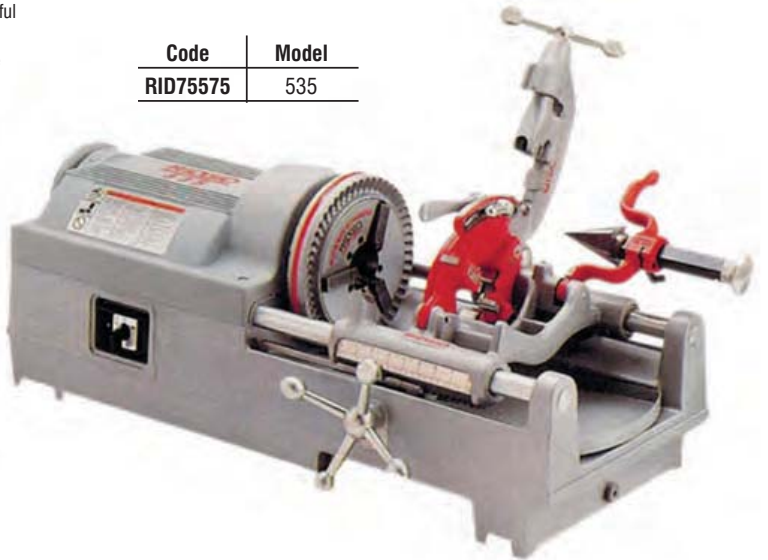

## RIDGID COMPACT THREADER - 300

- Provides high quality threading and performance
- The new design offers the convenience of less noise, weight and bulk, plus a built-in oil and chip pan
- **Standard Equipment:**  
Die Head: Model 815A (BSPT) 1/2"-2" Self-Opening  
Dies: 1/2"-3/4" BSPT Euro, 1"-2" BSPT Euro  
Cutter: Model 360, 1/8"-2" full floating, self-centering with E-1032 Cutter Wheel  
Reamer: Model 344 (1/8"-2")  
Oil: 5 Litres Thread Cutting Fluid
- **Capacity:** Pipe: 1/8"-2"
- **Technical Specifications:**  
Motor: 1.7kW universal 25--60Hz  
Motor Control: Reverse/Off/Forward, heavy duty, rotary-type plus integral foot switch  
Spindle Speed: 38 RPM  
Chuck: Hammer-type with replaceable, rocker-action jaw inserts  
Rear Centering Device: Cam action  
Oil System: Through-the-head, with the integral oil reservoir  
Self-priming, constant flow, geroter pump

Code	Model
RID50697	300



**RIDGID** STAND FOR 300 COMPACT - 250

- Leg tray stand



Code	For Model
RID58077	300

**RIDGID** STAND ONLY FOR 535 / 1224 - 100A

- Leg tray stand



Code	For Model
RID92457	535, 1224

**RIDGID** THREADER POWER DRIVE - 690

- **Pipe Capacity:** 1/2" - 2"
- **Technical Specifications:**
  - Motor: Universal, reversible 1020 W motor 25-60Hz
  - Switch: Heavy duty paddle type switch with safety lock-off switch, separate Forward / Reverse Switch
  - Gear Head: Spur gear reduction drive
  - Gear Housing: Die cast aluminium
  - Body & Handle: Heavy-duty fiberglass reinforced plastic
  - Spindle Speed: 32 RPM (No Load)
  - Die heads: 11-R
  - Carrying case



Code
RID41732

**RIDGID** BOLT DIE HEAD - 531

- Used on all 2" Threading Machines
- Quick opening
- Manually flipping throw out lever retracts dies when thread length is cut
- Thread direction Right hand & left hand
- Uses 500B dies
- Does NOT include dies



Code	Size
RID97045	1/4 - 1"

**RIDGID** BOLT DIE HEAD - 532

- Used on all 2" Threading Machines
- Quick opening
- Manually flipping throw out lever retracts dies when thread length is cut
- Thread direction Right hand & left hand
- Uses 500B dies
- Does NOT include dies



Code	Size
RID97050	1 1/4 - 2"

**RIDGID** PIPE DIES - UNIVERSAL

- Alloy Dies
- Recommended for threading regular steel pipe with universal motor machine
- Pipe dies for Machine Die Heads 811A



Code	Size	Pitch
RID66660	1/4 - 3/8"	19
RID18951	1/2 - 3/4"	14
RID18961	1 - 2"	11

General Tools



## RIDGID MACHINE BOLT DIES - 500B

- Bolt dies for 531 Die Heads
- Right Hand high speed steel

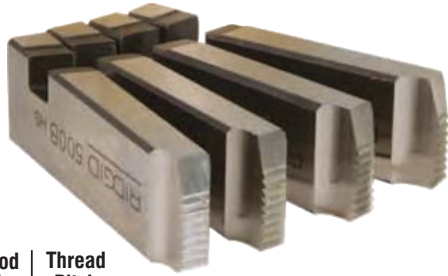

Code	Rod Size	Thread Pitch	Code	Rod Size	Thread Pitch
RID49815	M10	1.5mm	RID50480	M20	2.5mm
RID49825	M12	1.75mm	RID50490	M24	3mm
RID49830	M14	2mm	RID50505	M30	3.5mm
RID49835	M16	2mm			

## RIDGID THREADER - JAW INSERT SET

- Rocker- action jaw inserts for threading machines
- Contents: Spring  
Plunger  
Jaws



Code  
RID44715

## RIDGID PIPE DIES FOR MANUAL THREADERS R200

- Replaceable dies for R200 manual pipe threader
- Alloy dies
- Recommended for threading regular steel pipes



Code	Size BSPT	Pitch
RID38692	1/2"	14
RID38697	3/4"	14
RID38702	1"	11
RID38717	2"	11
RID38707	1 1/4"	11
RID38712	1 1/2"	11

## RIDGID VICE - CHAIN PIPE - 560

- Top screw chain type / alloy frame / cast iron jaws
- Vice and rear support only (no legs or brace included)
- Includes pipe rest, pipe bender and tool tray



Code | Capacity  
RID40165 | 3-125mm

## RIDGID NUCLEAR THREADING OIL

- High grade mineral oil for all threading applications
- Carefully monitored ingredients: fatty oil, sulphur, anti-foam agent and emulsifier



Code | Size  
RID11931 | 5 litre

## MTS CUTTING PASTE

- The ideal medium for screwing pipes, tapping, threading and cutting
- Makes work easy and saves tools
- Suitable for hand and machine tools



Code | Size  
ELC0650 | 500g

## MTS SINK & DRAIN CLEANER

- Flat spring steel "snake"
- Revolving coil spring point
- Effectively clears local blockages in household waste pipes



Code | Size  
HON0825 | 5m

## RACO TAP RESEATER

- B.S.P. right hand thread guides and turning T handle
- All steel and chemical black finish
- Two interchangeable cutter wheels for 1/2" and 3/4" taps made from hardened, high grade SCM steel



Code | Size  
RIC4200 | 1/2 & 3/4"



## TILE CUTTERS - HEAVY DUTY

- Expert quality and heavy duty construction for the most demanding professional
- Cuts and breaks tiles in one easy operation
- Extra heavy gauge sheet steel base offers robust and torsion-free stability and strength
- Base surface has a foam cushion for tile stability whilst cutting
- Aluminium graduated measuring gauge
- Spare cutter wheel is available - quote code RIC4500

Code	Size
RIC4460	300mm
RIC4470	355mm



## TILE CUTTER - 3 IN 1

- Torsion free steel base for precision work
- Rotating stop allows for cutting at any angle up to 45°
- Adjustable tile cutter cuts holes in diameters from 30 - 80mm
- Hardened tile cutter wheel for longer life
- Spare cutter wheel is available - quote code HON9023

Code	Size
HON9022	450mm

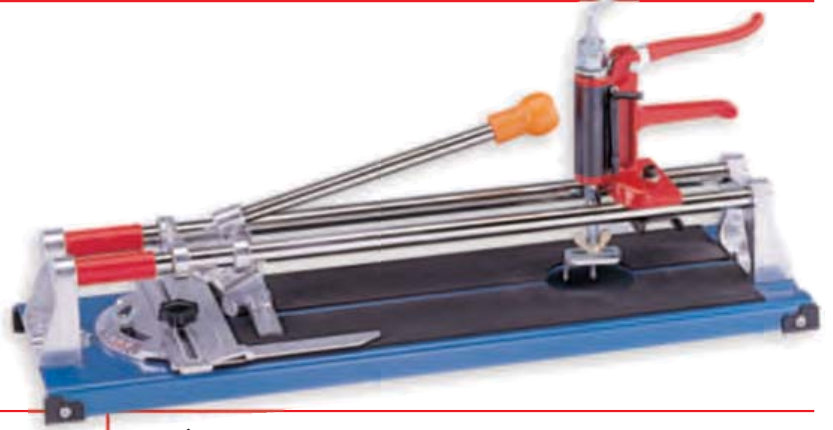

## TILE CUTTER - CARBIDE TIP

- Expert quality, tungsten carbide tipped ceramic tile cutter
- Rugged hardened steel handle with vinyl grip and trimming rack



Code	Size
RIC4450	200mm



## TILE CUTTER - TILE NIPPER

- For cutting or trimming all types of ceramic or stone tiles
- Spring loaded action with tungsten carbide tipped cutting edge



Code	Size
HON9066	200mm



## TILE CUTTER - NIPPER PLIER

- Expert quality, professional tool for cutting or trimming all types of ceramic or stone tiles
- Drop forged from hardened carbon alloy steel with tungsten carbide tipped cutting edges
- Comfortable vinyl grip handles
- Spring loaded action



Code	Size
RIC4475	200mm



## TILE CUTTER - TILE BREAKER

- Dynamically curved edges make circling and cutting work easy around holes
- Spring loaded action



Code	Size
HON9062	190mm



## TILE CUTTER - TILE PLIER

- Suitable for cutting glass or ceramic tiles, swivel top plates ensure an even break
- Hardened tungsten carbide cutting wheel scores the surface to be cut
- Glass or tile is then placed in the plier jaws and even pressure is applied to produce the cut



Code	Size
HON9064	200mm



## TILE CUTTER - TILE PLIER

- This useful tool will cut glass or ceramic tiles
- Hardened tungsten carbide cutting wheel scores the surface to be cut
- Swivel top plates ensures an even break
- Chrome plated hardened steel with comfortable vinyl grips



Code	Size
RIC4480	210mm



### SOLDERING IRON - 30W - R21/613-3B

- This compact soldering iron has been designed for industrial use
- Handle is designed for comfort and safety
- Supplied with resting stand
- **Spare elements and tips are available**



Code	Size
RIC3500	30W



### SOLDERING IRON - 40W - R21/613-4B

- This compact soldering iron has been designed for industrial use
- Handle is designed for comfort and safety
- Supplied with resting stand
- **Spare elements and tips are available**



Code	Size
RIC3505	40W



### SOLDERING IRON - 60W - R21/613-6B

- This compact soldering iron has been designed for industrial use
- Handle is designed for comfort and safety
- Supplied with resting stand
- **Spare elements and tips are available**



Code	Size
RIC3510	60W



### SOLDERING IRON - 80W - R21/613-8B

- This compact soldering iron has been designed for industrial use
- Handle is designed for comfort and safety
- Supplied with resting stand
- **Spare elements and tips are available**



Code	Size
RIC3515	80W

## Weller® SOLDERING IRON - FINE DUTY - SP15LZA

- For fine duty work such as in home electronics, light duty electrical repairs and hobby work
- Medium duty iron for most general soldering repairs where a little more power is required
- All purpose iron for general electrical repairs in the home and hobby workshop
- Fitted with straight tip nickel-plated 2.0mm (type MT10)
- ON/OFF indicator light

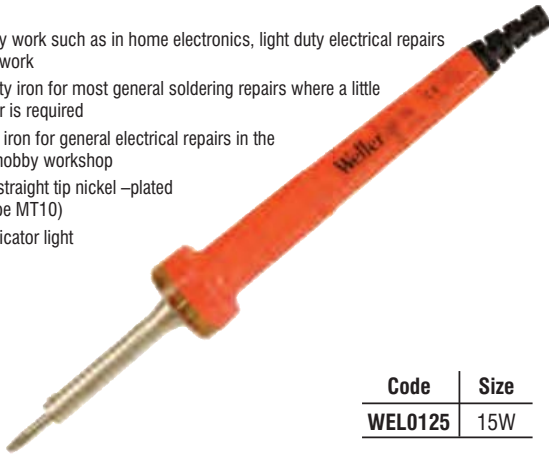

Code	Size
WEL0125	15W

## Weller® SOLDERING IRON- GENERAL DUTY - SP25LZA

- All purpose iron for general electrical repairs in the home and hobby workshop
- Fitted with straight tip nickel-plated 0.8mm (type MT1)
- ON/OFF indicator light



Code	Size
WEL0110	25W

## STANLEY® SOLDERING IRONS

- These soldering irons have been designed for industrial use
- Handles designed for comfort and safe grip
- SABS approved
- Supplied with 2 tips



Code	Size	Ref
STA5125	30W	69-031
STA5130	45W	69-033

## Weller® TEMPERATURE CONTROLLED SOLDERING STATION - WHS40

- Temperature range controlled between 200°C - 450°C
- Rules out the risk of temperature shocks which can occur with conventional soldering bits
- Desired temperatures can be set precisely in such a way that you no longer have to worry about overheating sensitive areas
- Consists of power unit, soldering iron with nickel plated tip 2mm and support



Code	Size
WEL0300	40W

General Tools

## Weller® SOLDERING IRON- MEDIUM DUTY - SP40LZA

- Medium duty iron for most general soldering repairs where a little more power is required
- All purpose iron for general electrical repairs in the home and hobby workshop
- Fitted with straight tip nickel –plated 6.3mm (type MT10)
- ON/OFF indicator light



Code	Size
WEL0115	40W-6.3mm Tip

## Weller® SOLDERING IRON- HEAVY DUTY - SP80LZA

- Iron suitable for making metal repairs
- Such as battery connections and small metal joining tasks
- Fitted with straight tip, iron plated (type MTG20)
- ON/OFF indicator light



Code	Size
WEL0145	80W - 9.5mm Tip

## Weller® SOLDERING IRON - HEAVY DUTY

- Suitable for heavy duty soldering
- Bent nickel plated copper tip
- Chisel point

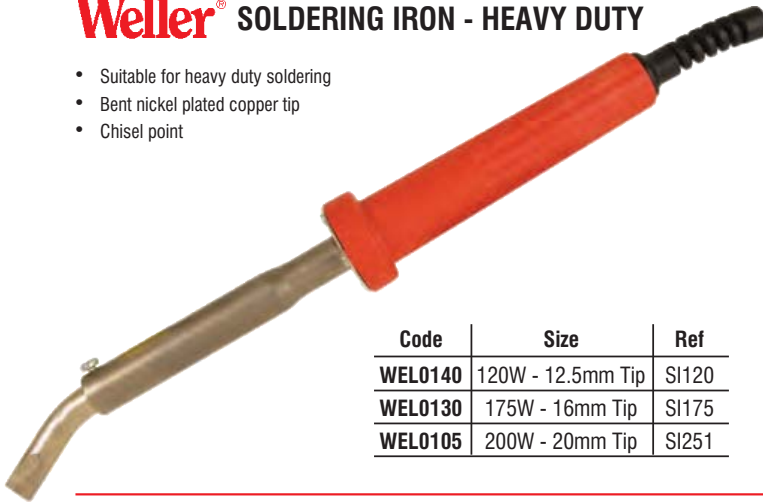

Code	Size	Ref
WEL0140	120W - 12.5mm Tip	SI120
WEL0130	175W - 16mm Tip	SI175
WEL0105	200W - 20mm Tip	SI251



## SOLDERING GUN - RT21/632D

- An industrial gun with a high-insulated bakelite housing and built-in copper coil for instant heat
- The gun has a three second warm-up time
- Trigger switch and work piece illumination light
- Complete with two tips and coil of multi-purpose solder



Code	Size
RIC3545	100W

## Weller® SOLDERING GUN - EXPERT 8100UC

- Red housing with built-in illumination of solder-joint and copper soldering tip
- All purpose gun that tackles soldering, cutting, sealing and pokerwork with instant heat through interchangeable tips
- Operated by fingertip trigger this gun is ready to solder in 7 seconds



Code	Size
WEL0160	100W

## Weller® SOLDERING GUN- STANDARD 9200UC

- Blue housing with copper soldering tip
- Universal soldering gun with instant heat fingertip trigger, ready to solder in 7 seconds
- Ideal for hobbies, model making and home repairs



Code	Size
WEL0175	100W



## SOLDERING BOLTS

- Solid copper bit
- Wooden handle and steel shaft
- Used for plumbing and sheet metal work

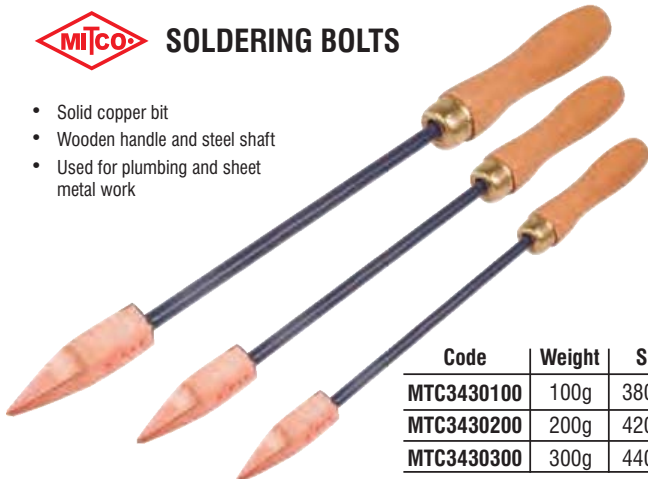

Code	Weight	Size
MTC3430100	100g	380mm
MTC3430200	200g	420mm
MTC3430300	300g	440mm



## SOLDERING IRON - STAND - RT21/610

- A quality stand with heavy gauge metal base
- Features a reinforced spring safety holder to prevent flex tangling
- Supplied complete with cleaning sponge



Code
RIC3520



## SOLDER SUCKER - RT21/651B

- Aluminium body, vacuum de-soldering pump
- Compressed spring system makes de-soldering quick and easy
- Designed for one-hand operation
- Tool is lightweight and easy to use

Code

**RIC3555**



Spare tip is available, quote code RIC3557



## SOLDERING TIPS

- Spare tip for RIC3545



Code

**RIC3550**



## SOLDERING TIPS FOR 8100 STANDARD GUN - 7315

- Copper soldering tip



Code

**WEL5005**



## SOLDERING TIPS

- Spare tips for soldering irons



Code	Type	Watt
<b>RIC3565</b>	Bent	40
<b>RIC3570</b>	Bent	60
<b>RIC3575</b>	Bent	80
<b>RIC3580</b>	Straight	30
<b>RIC3585</b>	Straight	40
<b>RIC3590</b>	Straight	60
<b>RIC3595</b>	Straight	80

## NASCO RESINCORE - 40T2

- Manufactured from the purest virgin base metals, highest quality natural resins and a small quantity of highly effective activators
- Excellent "wetting" properties
- Triple core to ensure even distribution on work surfaces
- Flux within triple core is non-corrosive and non-conductive
- Used for copper bit soldering of electrical, electronic and general work that is not particularly susceptible to heat damage and does not require optimum penetration
- Ideally suited for all electronic and electrical work
- On card



Code	Size
<b>NSO0020</b>	1.6mm/15g

## NASCO RESINCORE - 40T2

- Manufactured from the purest virgin base metals, highest quality natural resins and a small quantity of highly effective activators
- Excellent "wetting" properties
- Triple core to ensure even distribution on work surfaces
- Flux within triple core is non-corrosive and non-conductive
- Used for copper bit soldering of electrical, electronic and general work that is not particularly susceptible to heat damage and does not require optimum penetration
- Ideally suited for all electronic and electrical work
- On reels



Code	Size	Ref
<b>NSO0025</b>	2.0mm/250g	40T
<b>NSO0030</b>	2.0mm/500g	40T
<b>NSO0033</b>	0.71mm/500g	60T
<b>NSO0034</b>	0.9mm/500g	60T
<b>NSO0035</b>	1.25mm/500g	60T
<b>NSO0037</b>	1.6mm/500g	60T

## NASCO SOLDER ACID CORE - 30S

- Has excellent "wetting" properties with extremely fast cleaning action
- Uses: plumbing, electrical lamp manufacture, car body filing and general metal work
- On card



Code	Size
<b>NSO0005</b>	2.5mm/15g

## NASCO SOLDER ACID CORE - 30S

- Has excellent "wetting" properties with extremely fast cleaning action
- Uses: plumbing, electrical lamp manufacture, car body filing and general metal work
- On reels



Code	Size
<b>NSO0010</b>	2.5mm/250g
<b>NSO0015</b>	2.5mm/500g

## NASCO SOLID WIRE SOLDER - 97/3

- Lead-free, no toxic, soft solder alloy which is primarily used for soldering copper piping, sheet metal work, plumbing and metal ware
- To be used with flux
- On reel



Code	Size
NS00080	2.0mm/250g
NS00085	2.0mm/500g

## NASCO SOLDERING STICKS - 40T

- Non-antimonial solder which may be used for soldering of electrical joints
- Suitable for soldering zinc, zinc plated, galvanized and cadmium plated metals
- Can be applied by machine soldering
- S4 sticks are 40% lead and 60% tin



Code	Size
NS00040	S4



## SOLDERING PASTE

- Enables easy soldering of most metals
- Not suitable for Aluminium



Code	Size
ELC0655	25g

## NASCO SOLDERING PASTE

- Non-corrosive flux for general purpose soldering of most materials (except aluminium and stainless steel)
- This flux gives excellent "wetting" properties and enables the solder to penetrate the metals to be soldered



Code	Size
NS00055	200g

## NASCO SOLDERING CLEANER FLUX

- Self cleaning flux with capillary action suitable for most applications
- Slightly corrosive flux and must be wiped clean with damp cloth after soldering



Code	Size
NS00019	200g

## NASCO ALUMINIUM FLUX

- Self cleaning flux with capillary action suitable for most applications
- Slightly corrosive flux and must be wiped clean with damp cloth after soldering



Code	Size
NS00018	50g



## BRAZING FLUX

- For most soldering and brazing
- Cannot be used for aluminium



Code	Size
ELC0500	500g

## NASCO SALAMONIAC BLOCK

- Compressed white block used mainly for cleaning irons
- Composition: Ammonium chloride base with binding elements
- Application: Apply hot soldering iron to block until tip is cleaned
- Add small amount of solder to tin tip of iron



Code	Size
NS00002	250g

**GROZ** ENGINEER'S VICES - HEAVY DUTY  
tools to trust

- All steel body with integrated anvil
- Front jaw beam with machined construction fully encloses the vice spindle protecting the threads from contaminants and damage
- The long unbreakable malleable iron nut securely locked in the body ensures maximum thread surface contact and constant alignment between body and sliding jaw
- Perfect alignment of main screw and nut reduces wear and gives long trouble free service
- Vices have attractive blue finish with main screw and handle chrome plated
- Forged tommy bar for added strength
- Safety stopper provided at the end of slide to prevent slide from fall
- Built to withstand the toughest use
- Spare jaws are available
- Spare handle and nut are available

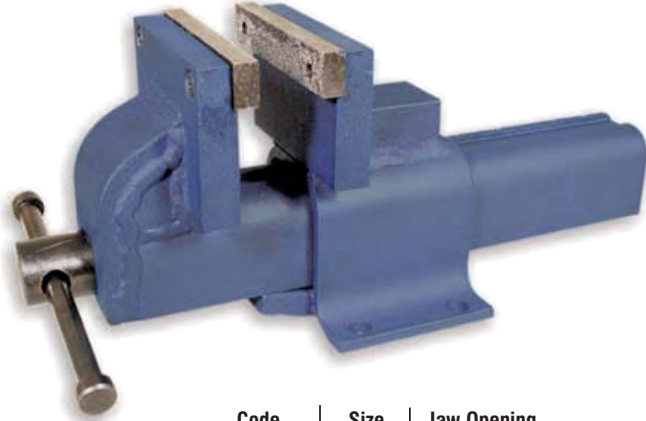

Code	Size	Jaw Opening
GR06716	100mm	125mm
GR06717	150mm	175mm
GR06723	200mm	200mm

**IRWIN** ENGINEER'S BENCH VICES - HEAVY DUTY  
Record.

- Heavy duty steel vice with plain screw action
- Steel anvil provides support for heavy hammering
- Hardened steel jaws
- Unbreakable nut
- Guaranteed against breakage



Code	Ref	Jaw Width	Jaw Opening
REC5930	EV100	100mm	130mm
REC5935	EV125	125mm	165mm
REC5940	EV150	150mm	205mm
REC5945	EV200	200mm	235mm

**IRWIN** WORKSHOP VICE, SWIVEL BASE  
Record. HEAVY DUTY

- Cast from close grained grey iron
- For use in workshops and garages
- Precision machined has anvil
- The swivel base allows the vice to be rotated through 360° and locked in any position



Code	Ref	Capacity	Jaw Width	Jaw Opening	Jaw Depth
REC6052	3VS	3 Ton	100mm	120mm	70mm
REC6053	6VS	6 Ton	150mm	205mm	90mm

**IRWIN** ENGINEER'S VICE - STANDARD DUTY  
Record.

- All Steel
- Hardened steel jaws
- Light duty use

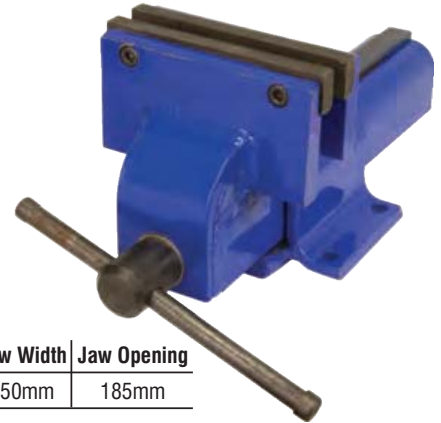

Code	Ref.	Jaw Width	Jaw Opening
REC5950	LV150	150mm	185mm

**IRWIN** HOME WORKSHOP VICE  
Record.

- Cast from close grained grey iron
- Precision CNC machined
- Ideal for the hobbyist



Code	Ref	Jaw Width	Jaw Opening
REC6008	1 TON-E	100mm	100mm

**GROZ** tools to trust **JAWS FOR ENGINEER'S VICE**

- Suits Engineers Vices GRO6716, 6717 and 6723
- Supplied with fixing screws



Code	Size
GR06736	100mm
GR06737	150mm
GR06738	200mm

**IRWIN** *Record* **VICE JAWS**

- All steel
- Hardened
- Supplied with fixing screws



Code	Ref	Size
REC6010	EV100D	100mm
REC6015	EV125D	125mm
REC6020	EV150D	150mm
REC6025	EV200D	200mm

**IRWIN** *Record* **FIBRE GRIP JAWS**

- Clip onto vice
- For holding & protecting delicate work pieces
- Fits EV150, and LV150



Code	Size
REC5965	150mm

**GROZ** tools to trust **HANDLE & NUT FOR ENGINEER'S VICES**

- Suits Engineers Vices GRO6716, 6717 and 6723



Code	Size
GR06744	100mm
GR06746	150mm
GR06748	200mm

**IRWIN** *Record* **SCREW HANDLE - ENGINEER'S VICES**

- All steel
- Hardened
- Fits record engineer's vices

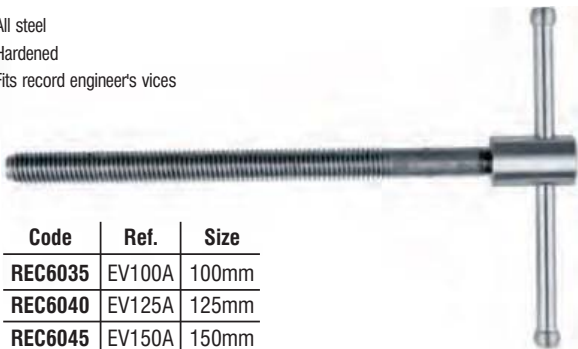

Code	Ref.	Size
REC6035	EV100A	100mm
REC6040	EV125A	125mm
REC6045	EV150A	150mm
REC6050	EV200A	200mm

**IRWIN** *Record* **NUT FOR ENGINEER'S VICES**

- All steel
- Hardened
- Fit record engineer's vices



Code	Ref.	Size
REC6055	EV100B	100mm
REC6060	EV125B	125mm
REC6065	EV150B	150mm
REC6070	EV200B	200mm

**IRWIN** *Record* **SPRING/PIN/WASHER KIT FOR ENGINEER'S VICES**

- All steel
- Hardened
- Fit all record engineer's vices



Code	Ref.	Size
REC6028	EV/RV100	100mm
REC6029	EV/RV125	125mm
REC6030	EV/RV150	150mm
REC6031	EV/RV200	200mm

**RAGO** **TABLE VICE**

- This lightweight hobby bench vice is made from high quality aluminium alloy for strength but is light enough to carry anywhere
- Ideal for use with portable benches
- 60mm wide jaws have a maximum opening capacity of 50mm
- The vice is finished in blue enamel with polished jaw faces
- The vice is secured with a turning knob which also allows for speedy removal



Code	Size
RIC5445	64mm



**GROZ** TABLE VICE  
tools to trust

- A portable vice ideal for the hobbyist or model maker
- The built-in clamp allows the vice to be easily and quickly attached to a table or bench
- Manufactured from high quality grey iron casting, these are machined to close tolerances resulting in smooth operation and reliability
- Vices have an attractive enamel finish with main screw and handle in chrome plated finish

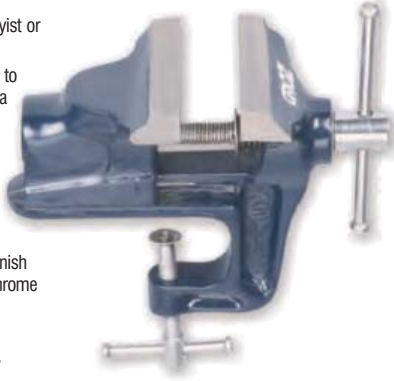

Code	Size
GRO6750	50mm

**GROZ** HAND VICE - SPRING TYPE  
tools to trust

- Manufactured from drop forged steel, the hardened jaws have a chequer finish for a sure grip
- Ideal for firm gripping of small items
- Spring loaded for effortless opening



Code	Size
GRO6730	100mm

**IRWIN** WOODWORKING VICE - QUICK RELEASE  
*Record.*

- Manufactured in three capacities
- Full size workshop vice is designed for bench mounting
- Cast grey iron body and front plate are precision machined to house two solid steel guide rods giving vice a smooth, true parallel action free of side or cross movement
- Steel main screw has a two start acme thread for fast accurate adjustment
- Squeeze trigger and a quick release vice can be opened and closed without using the main screw
- THE ADJUSTABLE FRONT DOG allows oversize work (in conjunction with bench stop) to be held securely on the bench top

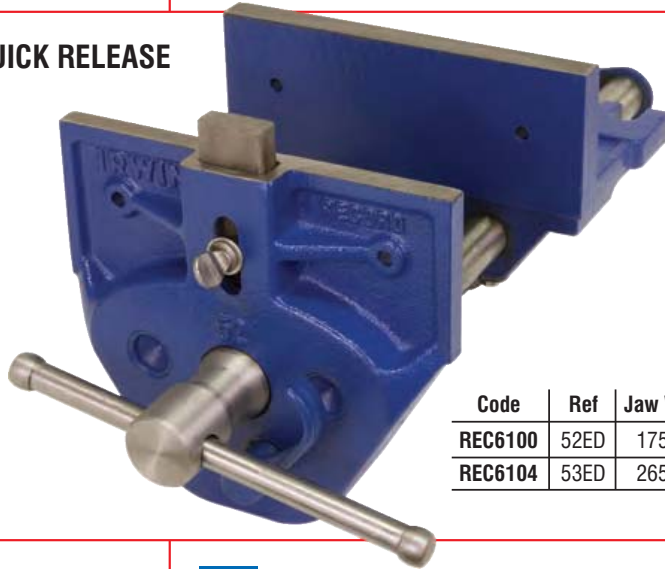

Code	Ref	Jaw Width	Jaw Opening
REC6100	52ED	175mm	330mm
REC6104	53ED	265mm	380mm

**IRWIN** DRILL PRESS VICE - 414  
*Record.*

- Light duty
- Unique swivel Jaw for any shape of work piece
- Cross drilled handle with tommy bar for extra leverage
- Precision machined base and end face for stable horizontal or vertical mounting
- Precision machined sides
- Horizontal and vertical "V" grooved jaws for round selection work
- High quality cast body and sliding jaw for guaranteed strength

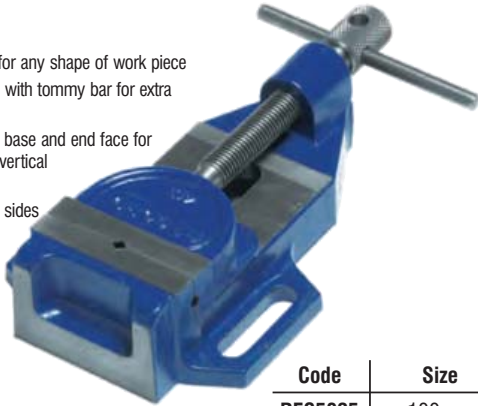

Code	Size
REC5925	100mm

**RACO** DRILL PRESS VICE

- Manufactured from graded cast iron
- Precision ground base and vice bed for smooth lateral movement of the jaw



Code	Size
RIC5430	100mm
RIC5440	150mm

**RACO** MITRE CORNER CLAMP

- Die-cast aluminium frame with baked enamel finish
- Two cramps set at 90 with recessed, plated screws and large non-rotating clamp plates
- 75mm capacity clamps corners for glueing, nailing, dowelling



Code	Size
RIC0920	75mm

**IRWIN** MITRE CUTTING CORNER CLAMP  
*Record.* LIGHT DUTY

- Accurate mitre clamping is provided with light duty clamp
- Solid grey iron body and precision machined clamping give a positive location and easy access for glueing and nailing
- Can be secured to work surface



Code	Ref.	Size
REC5200	M140	50mm
REC5205	M141	108mm

## IRWIN® CHAIN PIPE VICE - 181C

Record.

- Generates a powerful grip due to its sturdy construction
- Drop forged, heat treated steel jaws and high tensile steel chain
- Body cast from ductile iron that is guaranteed unbreakable
- Flexible chain means vice is compact and easy to store when not in use



Code	Pipe O/D Capacity
REC5900	3-50mm

## IRWIN® CHAIN PIPE VICE - 182C

Record.

- Generates a powerful grip due to its sturdy construction
- Drop forged, heat treated steel jaws and high tensile steel chain
- Body cast from ductile iron that is guaranteed unbreakable
- Flexible chain means vice is compact and easy to store when not in use



Code	Pipe O/D Capacity
REC5905	6-100mm
REC5910	12-200mm

## IRWIN® HINGED PIPE VICE

Record.

- Frame and base are strong S.G. ductile iron castings
- Replaceable steel jaws - hardened and tempered
- Ideal for fast repetitive work



Code	Ref	Size
REC5980	92½	3-60mm
REC5985	92	3-50mm
REC5990	93½	3-90mm
REC6000	96	3-150mm

## IRWIN® TRIPOD STAND - 500

Record.

- For use with 181C, 182C, 92 and 921/2 Pipe Vices
- Hinged tool tray
- Fold down platform
- Complete unit folds flat for ease of transport



Code
REC6075

## RIDGID STRAIGHT WELDING PIPE VICE - 461

- Made of durable performance-proven material
- Designed to resist strain, heat and warp age during tacking
- Machined swivel nuts and pins
- Special chain screws, give smooth trouble free assembling of the vice onto pipe



Code	Capacity
RID40220	21-219mm

## GROZ RIBBED "G" CLAMPS

tools to trust

- Frames are manufactured from high grade ductile iron castings making them suitable for a wide variety of metalworking and woodworking applications
- The spindle has Acme threads for smooth operation and maximum clamping pressure
- The swivelling pad adopts the correct angle and applies pressure evenly
- Frames have an attractive textured powder coated finish with spindle in black oxide finish for increased resistance to corrosion



Code	Size	Code	Size
GR01390	75mm	GR01405	200mm
GR01395	100mm	GR01410	250mm
GR01400	150mm	GR01415	300mm

## IRWIN® G CLAMPS - HEAVY DUTY Record.

- Strongest G-Clamps you can buy with the drop forged steel frames
- The steel main screw has a large swivel shoe to cater for uneven surfaces and a fast acting thread that is rolled into the steel for strength and resilience
- Recommended particularly for metalworking and fabrication work where very high clamping pressures are demanded



Code	Size	Ref	Frame Proof Load
REC5225	75mm	121-3	2720kg
REC5230	100mm	121-4	3170kg
REC5235	150mm	121-6	4080kg
REC5240	200mm	121-8	5670kg
REC5245	250mm	121-10	6240kg
REC5250	300mm	121-12	6800kg

## IRWIN® G-CRAMPS - GENERAL PURPOSE - CAST Record.

- For both metal and woodworking applications
- Guaranteed unbreakable frame is cast from S.G. Ductile iron
- "Fused" handle is designed to bend before the frame can be overstressed
- Main screw is fitted with a steel swivel shoe to apply even pressure on angled surfaces



Code	Size	Ref	Frame Proof Load
REC5255	75mm	120-3	455kg
REC5260	100mm	120-4	545kg
REC5265	150mm	120-6	635kg
REC5270	200mm	120-8	775kg
REC5275	250mm	120-10	1000kg
REC5280	300mm	120-12	1135kg



## "C" CLAMP SET - 3 PIECE

- Steel Screw, Handle & Swivel Shoe
- Drop Forged Construction
- 25, 50, 75mm



Code
HON0828

## IRWIN® "G" CLAMP - MED DUTY - 119-2 Record.

- Thin Frame for getting into tight corners and confined spaces
- Very strong and rigid



Code	Size
REC5220	50mm

## IRWIN® CLAMP SPEED - PRO M Record.

- Ergonomically designed three-component handle allows the end-user a higher torque transfer to the work piece
- A patented floating lock minimises the risk of the lower jaw sliding down the bar
- Zinc plated I-beam/ribbed design provides higher mechanical strength and less torsion
- Soft hexed handle
- TPE pads provide excellent friction to the work surface, reduces marking of workpiece



Code	Size	Throat Depth	Ref.
REC5325	300mm	120mm	10503569
REC5330	400mm	120mm	10503570
REC5335	600mm	120mm	10503571
REC5336	800mm	120mm	10503572
REC5337	1000mm	120mm	10503573

## IRWIN® CLAMP - QUICK GRIP XP

Record.

- Maximum gripping strength with one hand
- Designed for gluing applications
- Full face pads and a supporting foot
- Lockable swivel jaws to ensure both jaws are always parallel and pressure is evenly distributed when gluing
- Quick change screw no tools required
- Low explosive release mechanism
- Free sliding I-beam bar

Code	Size	Spread	Ref
PET1450	150mm	216-420mm	10505942
PET1455	300mm	216-570mm	10505943
PET1460	450mm	216-720mm	10505944
PET1465	600mm	216-870mm	10505945
PET1470	900mm	216-1170mm	10505946
PET1475	1250mm	216-1520mm	10505947



## IRWIN® QUICK GRIP CLAMP

Record.

- 135kg of clamping pressure
- Lockable swivel jaw allows the even distribution of clamping pressure and
- also the capabilities to clamp uneven surfaces
- Heat treated steel I-beam bar gives resistance to bending and wear
- Screw quick change mechanism holds the jaw firmer on the bar

Code	Size	Ref
PET1500	150mm	T506QCEL7
PET1512	300mm	T512QCEL7
PET1520	455mm	T518QCEL7
PET1530	610mm	T524QCEL7
PET1540	900mm	T536QCEL7



## IRWIN® SASH CLAMPS

Record.

- Heavy duty clamps have a bar section of 32mm x 6mm
- Slide and head are guaranteed unbreakable
- Slide is secured by a solid steel pin passing through one of the locating holes spaced along the steel bar
- Slide and heads are flat bottomed so that the clamp will stand without support

Code	Clamp Capacity	Bar Length	Ref.
REC5300	610mm	760mm	135-2
REC5305	760mm	915mm	135-3
REC5310	1070mm	1220mm	135-5
REC5313	1220mm	1370mm	135-6
REC5315	1370mm	1525mm	135-7
REC5320	1680mm	1830mm	135-9



## IRWIN® T-BAR SASH CLAMPS

Record.

- Heavy Duty "T" Section Bar
- Resists Twisting and distortion under clamping pressure as high as 1.9 tons
- Both the head and slide are guaranteed unbreakable

Code	Clamp Capacity	Bar Length	Ref.
REC5350	1680mm	1830mm	136-9
REC5355	1980mm	2135mm	136-11

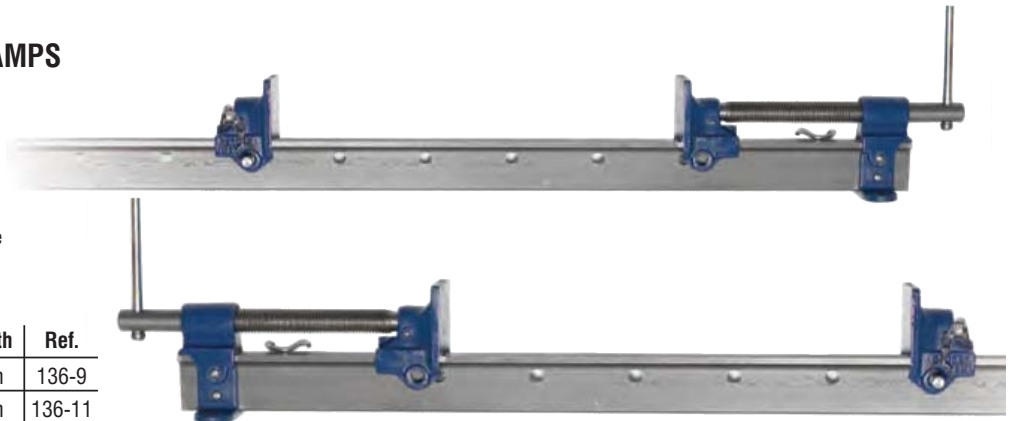

**SPEED CLAMP - PRO S**

- Ergonomically designed three-component handle allows the end-user a higher torque transfer to the work piece
- A patented floating lock minimises the risk of the lower jaw sliding down the bar
- Zinc plated I-beam/ribbed design provides higher mechanical strength and less torsion
- Soft hexed handle
- TPE pads provide excellent friction to the work surface, reduces marking of workpiece

Code	Size	Throat Depth	Ref.
REC5323	200mm	80mm	10503564
REC5324	300mm	80mm	10503565



**GLUEING CLAMP**

- Use with a 3/4" pipe to make a gluing clamp of any length required
- Crank handle provides an excellent grip for quick tightening
- Spring lever locks jaw at any position on the pipe and allows for quick release
- Pipe not included

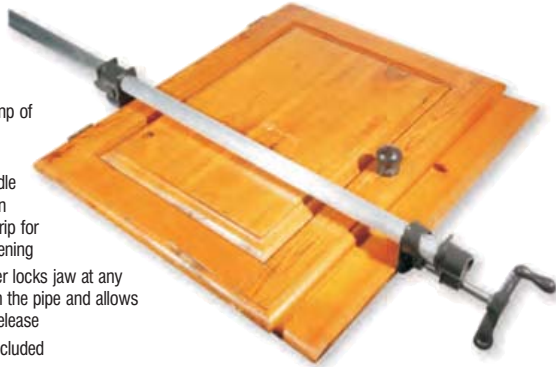

Code	Size
HON0826	3/4"



**SPRING CLAMP SET 5 PIECE**

- Swivel jaws are "V" grooved allowing round and flat objects to be held securely
- Rigid plastic construction with powerful springs
- Sizes: 2 x 25mm, 2 x 40mm, 1 x 75mm



Code
HON0827



## WERNER MOUNTED WIRE WHEELS

- Wire wheel composed of crimped carbon steel wire 0.3mm
- Designed for application on a drill or pneumatic apparatus
- This mounted crimped brush is used to remove less resilient surface contaminants from steel or for more of a polishing application
- In a DIY setting or small difficult to reach areas



Code	Ref. No.	Diameter	Width	Shank Ø	Max Safe Speed (RPM)
WRN0170	MW902	40mm	12mm	6mm	15000
WRN0175	MW912	50mm	25mm	6mm	10000
WRN0180	MW914	50mm	12mm	6mm	15000
WRN0185	MW922	76mm	12mm	6mm	15000
WRN0190	MW932	100mm	12mm	6mm	12000

## WERNER CRIMPED WIRE WHEELS UNMOUNTED (NO BUSHES)

- Wire wheel composed of crimped carbon steel wire 0.3mm
- Designed for application on a bench grinder
- Crimped brush is by its very nature is more flexible than its crimped counterpart
- Is used to remove less resilient surface contaminants from steel or for more of a polishing application
- The brush is also used for preparing surfaces for adhesives by roughening softer exteriors or for removing burrs from steel



Code	Ref. No.	Diameter	Width	Bore	Max. Safe Speed (RPM)
WRN0035	W509	100mm	12mm	12.7mm	6000
WRN0050	W510	100mm	25mm	12.7mm	6000
WRN0045	W580	100mm	20mm	12.7mm	6000
WRN0055	W512	127mm	12mm	16mm	6000
WRN0060	W513	127mm	19mm	16mm	6000

## WERNER CRIMPED WIRE WHEELS UNMOUNTED (BUSHED)

- Wire wheel composed of crimped carbon steel wire 0.3mm
- Designed for application on a bench grinder
- Crimped brush is by its very nature is more flexible than its crimped counterpart
- Is used to remove less resilient surface contaminants from steel or for more of a polishing application
- The brush is also used for preparing surfaces for adhesives by roughening softer exteriors or for removing burrs from steel
- 5 Reducing bushes are supplied to adjust bore size to 12.7mm, 18.88mm, 19.05mm, 22.23mm and 25.4mm



Code	Ref. No.	Diameter	Width	Bore	Max Safe Speed (RPM)
WRN0080	W518	150mm	19mm	-	6000
WRN0085	W519	150mm	25mm	-	6000
WRN0087	W557	200mm	20mm	-	4500
WRN0095	W526	200mm	25mm	-	4500
WRN0110	W529	200mm	40mm	-	3500
WRN0115	W531	250mm	25mm	-	3500
WRN0117	W550	305mm	50mm	-	3500

## WERNER MOUNTED CUP BRUSH

- Cup brush composed of crimped carbon steel wire 0.3mm
- Designed for application on a drill or pneumatic apparatus
- This mounted crimped brush is used to remove less resilient surface contaminants from steel or for more of a polishing application
- In a DIY setting or small difficult to reach areas



Code	Ref. No.	Diameter	Width	Shank	Max Safe Speed (RPM)
WRN0165	MC1001	50mm	30mm	6mm	6500

General Tools

## WERNER KNOTTED CUP BRUSH CARBON STEEL

- Cup brush composed of knotted carbon steel wire 0.8mm
- Designed for application on a 230mm angle grinder
- Knotted brush is by its very nature is more abrasive than its crimped counterpart
- Due to its rigidity and is used to remove more resilient surface contaminants such as powder coating
- Brush is also used for cleaning surfaces like concrete, preparing surfaces for adhesives by roughening softer exteriors
- For removing burrs from steel



Code	Ref. No.	Diameter	Width	Bore	Max Safe Speed (RPM)
WRN0004	KC681142	140mm	2 Row	14x2mm	6500

## WERNER CRIMPED CUP BRUSH CARBON STEEL

- Cup brush composed of crimped carbon steel wire 0.4mm
- Designed for application on a 230mm angle grinder
- Crimped brush is by its very nature is more flexible than its knotted counterpart
- Used to remove less resilient surface contaminants from steel or for more of a polishing application
- Brush is also used for cleaning surfaces like concrete, preparing surfaces for adhesives by roughening softer exteriors
- For removing burrs from steel



Code	Ref. No.	Diameter	Bore	Thread Pitch	Max. Safe Speed (RPM)
WRN0005	C663142	76mm	14x2mm	2mm	9000
WRN0010	C657142	100mm	14x2mm	2mm	8500
WRN0015	C652058	140mm	5/8"	BSW	8500
WRN0018	C662142	60mm	14x2mm	2mm	9000
WRN0020	C652142	140mm	14x2mm	2mm	8500
WRN0023	CH650142	150mm	14x2mm	2mm	6500
WRN0024	Z250	76mm	3/8"	UNF	9000

## WERNER PORT CLEANING BRUSH

- Port cleaning brush composed of crimped carbon steel wire
- Designed for application on a drill or pneumatic apparatus
- This brush is designed for the cleaning of cylindrical shapes such as valve ports



Code	Ref. No.	Cup Size	Shank Ø	Shape
WRN0120	PC850	6mm	6mm	Flat Trim
WRN0125	PC851	15mm	6mm	Flat Trim
WRN0130	PC852	20mm	6mm	Flat Trim
WRN0135	PC853	25mm	6mm	Flat Trim
WRN0140	PC855	20mm 38mm Head	6mm	Bushby
WRN0143	PC867	20mm	6mm	Pointed Trim



## WERNER DE-CARBONISING SET - 7 BRUSHES

- Set containing a variety of port cleaning brushware
- Designed for use on a drill or pneumatic apparatus



Code	Ref. No.	Size
WRN0025	DC1165	7 Piece

## WERNER HANDYMAN SET - 4 BRUSHES

- Set containing a variety of mounted brushware
- Designed for use on a drill and perfect for DIY applications



Code	Ref. No.	Size
WRN0030	HM1150	4 Piece



## WELDER'S WIRE BRUSH

- Heavy duty steel/stainless steel bristles
- Wooden handle
- For cleaning mild steel, stainless steel & aluminium before and after welding or brazing

SPR2070



SPR2060

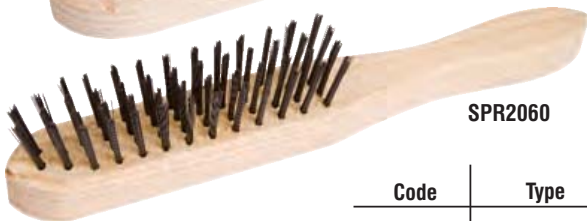

Code	Type
SPR2070	5 Row S/Steel
SPR2060	4 Row Steel



Transvaal  
Brush Co.  
(Pty) Ltd.

## WIRE BRUSH BLOCK - COARSE

- Composed of a wooden back
- With 6 rows of coarse carbon steel bristles

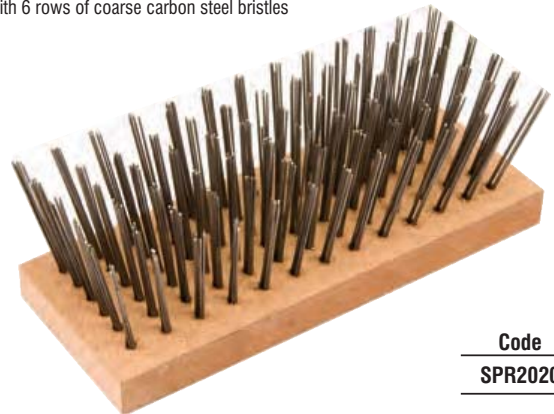

Code  
SPR2020



Transvaal  
Brush Co.  
(Pty) Ltd.

## WIRE BRUSH BLOCK - FINE

- Composed of a wooden back
- With 6 rows of fine carbon steel bristles

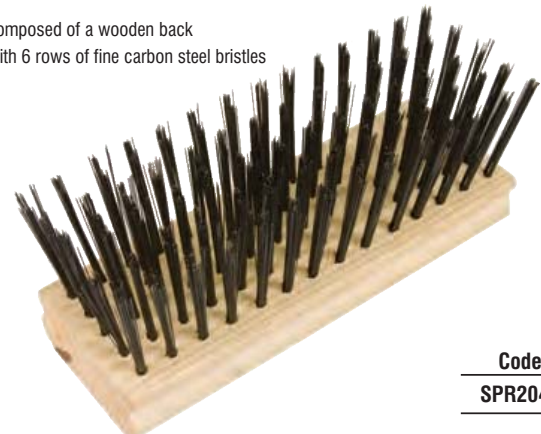

Code  
SPR2040



## WELDER'S WIRE BRUSH - 6 ROW

- A strong and durable wire brush with comfortable wooden handle



Code  
HON0700

General Tools





## WIRE STRETCHER - AUTOCHAIN

- Semi-automatic operation
- Spring controlled claws
- Effectively strains all types of wire
- Use at post or any point along fence



Code	Chain Length
DON0005	0.67m



## WIRE STRETCHER - BOBBEJAAN

- The big chain / "Bobbejaan" a heavy duty unit
- Semi-automatic operation
- Spring controlled claws
- Secure grips of hardened steel
- Swivels on each grip
- Particularly suitable for plastic coated wire



Code	Chain Length
DON0010	1.3m



## WIRE STRETCHER - HOLDFAST

- Lion/Hold-Fast
- Uses knotted chain
- Fitted with pressed steel grips
- Very popular, low cost model



Code
DON0013



## WIRE STRETCHER - MULTIGRIP

- Ideal for the professional fence erector
- Takes up unlimited length of wire
- Strains all types of wire
- Can be used as a lever puller for tree stumps, bogged cars etc



Code
DON0015



Fence stretchers are used to provide the proper amount of tension on wire fences.

A tight fence protects livestock and wildlife from getting tangled in the fence which could cause injury or even death.

There are several different styles of wire fence stretchers on the market. They all work the same with some type of clamp to attach to the wire and a ratcheting system to tighten it.

Donald's Wire Stretchers are proudly manufactured in South Africa and are built to withstand years of hard work and abuse.

1

C

The first wire you should stretch is the top wire.

2

S

3

4

I

### Tips & Warnings

To check the tension of your wire, go to the middle of the section you are stretching and test the tension from that point.

Check the entire run of the wire to be sure it is not wrapped around anything before stapling the wire to the brace post.

Wear gloves and goggles when stretching wire.

