

Practical LED

Including

X1LED & **VL LED**

UPDATED
More LED Fixtures

Expanded LED Product Line

- **Specification Grade LED Fixtures at Value Prices**
- **Fixtures with LED Arrays, X1LED or VL LED**
- **Linear Lines of Light (Recessed, Surface, Pendant)**
- **More Manufacturing & Design/Engineering Resources**

The Only Thing That Hasn't Changed Is Our Name

TEXAS FLUORESCENTS

Practical LED and **X1LED**

Best Sellers at Special Values

March 2017

Recessed Linear



LED Recessed Troffer

ITEM NO.	DESCRIPTION
131A24LF35W3650LDMV40K*	2x4 / 35W, 3650L / Color Temp - 30, 35, 40, 50
131A24LF45W5500LDMV40K*	2x4 / 48W, 5500L / Color Temp - 30, 35, 40, 50
131A24LF56W6050LDMV40K*	2x4 / 56W, 6050L / Color Temp - 30, 35, 40, 50
131A14LF35W4100LDMV40K*	1 x 4 / 35W, 4100L / Color Temp - 30, 35, 40, 50
131A14LF48W5400LDMV40K*	1 x 4 / 48W, 5400L / Color Temp - 30, 35, 40, 50
131A22LF24W2600LDMV40K*	2 x 2 / 24W, 2600L / Color Temp - 30, 35, 40, 50
131A22LF28W3000LDMV40K*	2 x 2 / 28W, 3000L / Color Temp - 30, 35, 40, 50
131A22LF35W3600LDMV40K*	2 x 2 / 35W, 3600L / Color Temp - 30, 35, 40, 50

Change lens to Frosted (FR).
For Surface Mount, add SH to prefix.
Add "R" after 131A for Air Return.

VL LED Troffer

ITEM NO.	DESCRIPTION
131A24LV46W5500LDMV40K	2x4 / 46W, 5500L / Color Temp 40

Introducing VL LED

VL LED is our newest *LED Engineered Fixture Option*. This new product line offers all the latest features in LED array technology but without the price tag. Now you can experience all the **Benefits of LEDs: Energy Savings, Excellent Performance, Durability, Long Life and Tremendous Fixture Efficiency** without the expense of some options like Programmable Driver, allowing us to produce a more economical LED Solution! Looking to make the switch to LED but on a tight budget? VL LED may be the best solution for you!



Flat Panel LED Edge Lit

ITEM NO.	DESCRIPTION
FPELP22LED40DMVWH40*	2x2 / 40W, 5000L, 4000K, 0-10V Dim, Color Temp - 35,40, 50
FPELP14LED40DMVWH40*	1x4 / 40W, 5000L, 4000K, 0-10V Dim, Color Temp - 35,40, 50
FPELP24LED50DMVWH40*	2x4 / 50W, 6250L, 4000K, 0-10V Dim, Color Temp - 35,40, 50
FPEL24LED75DMVWH40	2x4 / 75W, 6845L, 4000K, 0-10V Dim, Color Temp - 40, 50

For Surface Mount with Shroud - Add SH in front of item number.

Frame-in-kits available to mount in hard ceilings.

LED Parabolic



LED Recessed Parabolic

ITEM NO.	DESCRIPTION
PARA9C22LS24W3000LDMV40K	2 x 2 / 9 Cell /24W, 3000L / Color Temp - 30, 35, 40, 50
PARA9C22LS30W3600LDMV40K	2 x 2 / 9 Cell /30W, 3600L / Color Temp - 30, 35, 40, 50
PARA9C22LS42W4700LDMV40K	2 x 2 / 9 Cell /42W, 4700L / Color Temp - 30, 35, 40, 50
PARA9C22LS54W6150LDMV40K	2 x 2 / 9 Cell /54W, 6150L / Color Temp - 30, 35, 40, 50
PARA18C24LS48W6000LDMV40K	2 x 4 / 18 Cell /48W, 6000L / Color Temp - 30, 35, 40, 50
PARA18C24LS60W7300LDMV40K	2 x 4 / 18 Cell /60W, 7300L / Color Temp - 30, 35, 40, 50
PARA18C24LS85W9600LDMV40K	2 x 4 / 18 Cell /85W, 9600L / Color Temp - 30, 35, 40, 50

Add Matte White Overlay to Hide LED's. Add MW after PARA for 2x2 and for 2x4.
Add EM for Emergency.

TEXAS FLUORESCENTS

LED Center Basket



Surface mount any recessed by adding "SH" to prefix.

Air Return

ITEM NO.	DESCRIPTION
UCLL22LF24W2400LDMV40K*	2x2 / 24W, 2400L / Color Temp - 30, 35, 40, 50
UCLL22LF28W2700LDMV40K*	2x2 / 28W, 2700L / Color Temp - 30, 35, 40, 50
UCLL22LH35W4200LDMV40K	2x2 / 35W, 4200L / Color Temp - 30, 35, 40, 50
UCLL24LF48W4800LDMV40K*	2x4 / 48W, 4800L / Color Temp - 30, 35, 40, 50
UCLL24LF57W5400LDMV40K*	2x4 / 57W, 5400L / Color Temp - 30, 35, 40, 50
UCLL14LF32W3450LDMV40K	1x4 / 32W, 3450L / Color Temp - 30, 35, 40, 50
UCLL14LF48W4800LDMV40K	1x4 / 48W, 4800L / Color Temp - 30, 35, 40, 50
UCRLL22LF28W2700LDMV40K	2x2 / 28W, 2700L / Color Temp - 30, 35, 40, 50
UCRLL22LH35W4200LDMV40K	2x2 / 35W, 4200L / Color Temp - 30, 35, 40, 50
UCRLL24LF48W4800LDMV40K	2x4 / 48W, 4800L / Color Temp - 30, 35, 40, 50
UCRLL24LF57W5400LDMV40K	2x4 / 57W, 5400L / Color Temp - 30, 35, 40, 50

Add EM for Emergency. Consult for 1x1 and 1x2. For perforated basket change LL to PF. * DLC Listed

VL LED Center Basket



ITEM NO.	DESCRIPTION
CBF24LV46W5700LDMV40K	2x4 46W, 5700L 4000K, 0-10V Dim

LED Dual Basket



ITEM NO.	DESCRIPTION
UDLL22LF28W2700LDMV40K	2x2 / 28W, 2700L Color Temp 30, 35, 40, 50
UDLL22LH35W3200LDMV40K	2x2 / 35W, 3200L Color Temp 30, 35, 40, 50
UDLL24LF48W4800LDMV40K	2x4 / 48W, 4800L Color Temp 30, 35, 40, 50
UDLL24LF57W5400LDMV40K	2x4 / 57W, 5700L Color Temp 30, 35, 40, 50

Add EM for Emergency.



LED Decorative Center Basket



ITEM NO.	DESCRIPTION
LXT22L36W3550LDMV40K	2x2 / 36W, 3550L Color Temp 30, 35, 40, 50
LXT24L52W5800LDMV40K*	2x4 / 52W, 5800L Color Temp 30, 35, 40, 50

Add EM for Emergency.



LED Concave Lensed



ITEM NO.	DESCRIPTION
VLT22L36W3200LDMV40K	2x2 / 36W, 3200L Color Temp 30, 35, 40, 50
VLT24LS48W4800LDMV40K	2x4 / 48W, 4800L Color Temp 30, 35, 40, 50
VLT24L52W5100LDMV40K*	2x4 / 52W, 5100L Color Temp 30, 35, 40, 50

Add EM for Emergency.

LED Curve Lit Sides Center Basket



ITEM NO.	DESCRIPTION
CRVRL22LS28W2700LDMV40K	2x2 / 28W, 2700L Color Temp 30, 35, 40, 50
CRVRL22LH35W3400LDMV40K	2x2 / 35W, 3400L Color Temp 30, 35, 40, 50
CRVRL24LS32W3450LDMV40K	2x4 / 32W, 3450L Color Temp 30, 35, 40, 50
CRVRL24LS48W4800LDMV40K	2x4 / 48W, 4800L Color Temp 30, 35, 40, 50
CRVRL24LS57W5400LDMV40K	2x4 / 57W, 5400L Color Temp 30, 35, 40, 50

Add EM for Emergency.

TEXAS FLUORESCENTS

Recessed Linear



For continuous runs, see ordering on page 12



For continuous runs, see ordering on page 12

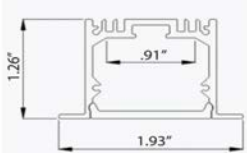
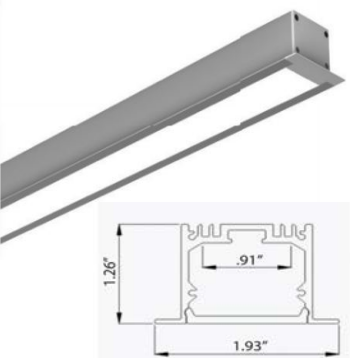

Recessed Linear 2"x 3"

ITEM NO.	SIZE (W X L)	Watts / Lumens	Color Options (X100 Kelvins)
23RSF48LR26W2600LDMV40KWH	2" x 47.32"	26 / 2600	30, 35, 40, 50
23RSF48LR38W3800LDMV40KWH	2" x 47.32"	38 / 3800	30, 35, 40, 50
23RSF48LR45W4500LDMV40KWH	2" x 47.32"	45 / 4500	30, 35, 40, 50
23RSF96LR52W5200LDMV40KWH	2" x 96"	52 / 5200	30, 35, 40, 50
23RSF96LR76W7600LDMV40KWH	2" x 96"	76 / 7600	30, 35, 40, 50
23RSF96LR90W9000LDMV40KWH	2" x 96"	90 / 9000	30, 35, 40, 50

23R - Recessed for T-Bar Grid, 23RF - Flanged- 23RR(XXX) - Flangeless Hard Ceiling (XXX for sheetrock depth). EM remote on 4 ft. See Specification sheet for flange option details.

Recessed Linear 4"x 4"

ITEM NO.	SIZE (W X L)	Watts / Lumens	Color Options (X100 Kelvins)
44RSF48LR24W2400LDMV40KWH	4" x 48"	24 / 2400	30, 35, 40, 50
44RSF48LR48W4800LDMV40KWH	4" x 48"	48 / 4800	30, 35, 40, 50
44RSF96LR48W4800LDMV40KWH	4" x 96"	48 / 4800	30, 35, 40, 50
44RSF96LR96W9600LDMV40KWH	4" x 96"	96 / 9600	30, 35, 40, 50

44R - For T-Bar Grid Ceiling, 44RF - Flanged
44RR(XXX) - Flangeless Hard Ceiling (XXX for sheetrock depth).
See Specification sheet for flange option details.

Recessed Linear 6"x 6"

ITEM NO.	SIZE (W X L)	Watts / Lumens	Color Options (X100 Kelvins)
66RMW48LR24W2400LDMV40KWH	6" x 48"	24 / 2400	30, 35, 40, 50
66RMW48LR48W4800LDMV40KWH	6" x 48"	48 / 4800	30, 35, 40, 50
66RMW96LR48W4800LDMV40KWH	6" x 96"	48 / 4800	30, 35, 40, 50
66RMW96LR96W9600LDMV40KWH	6" x 96"	96 / 9600	30, 35, 40, 50

66R - For T-Bar Grid Ceiling, 66RF - Flanged.
66RR(XXX) - Flangeless Hard Ceiling (XXX for sheetrock depth).
For Blade Louver change MW to BL.
To add with overlay add BLMW..

Recessed LLLSR w/Flange and Remote Driver (order separately)

ITEM NO.	DESCRIPTION
LLLSR47L42W2488L30KSA	47" Square 1.93" SR Channel w/lens and 2 end caps and tape 30K installed with 10' clear wire
LLLSR96L83W4976L30KSA	96" Square 1.93" SR Channel w/lens and 2 end caps and tape 30K installed with 10' clear wire

Change 30K to 40K for 4000 color temperature. Order driver separately.

Remote Driver (Dimmable with any standard MLV Triac (leading edge) control)

ITEM NO.	DESCRIPTION	Watts
MTIM60L24DC	Magnitude Magnetic Driver 60W 24VDC Encased	60
MTIM100L24DC	Magnitude Magnetic Driver 96W 24VDC Encased	96
MTIM150L24DC	Magnitude Magnetic Driver 150W 24VDC Encased	150

Consult for other drivers and wattages.

TEXAS FLUORESCENTS

LED High Bays



LED Premium High Bay w/ optional accessories

ITEM NO.	DESCRIPTION
HBIP12L110W14680LMV50K	11.8"Wx21.5"Lx2"H High Bay 110W, 14680 Lumens 50K
HBIP22L165W22000LMV50K	16.0"Wx21.5"Lx2"H High Bay 165W, 22000 Lumens 50K
HBIP24L220W29370LMV50K	11.8"Wx43"Lx2"H High Bay 220W 29370 Lumens 50K

For Emergency Add EM. For Occupancy Sensor, add MDT4. Fixtures include chain kits.

LED I-Beam High Bay (optional door frame available)



ITEM NO.	DESCRIPTION
HBI12L110W11000LM23MV50KWH*	1x2** High Bay 110 W, 11000 Lumens, 50K 11.80"W x 21.5"L x 2"H
HBI22L170W16400LM23MV50KWH*	2x2** High Bay 170 W, 16400 Lumens, 50K 16.0"W x 21.5"Lv x 2"H
HBI24L230W22000LM23MV50KWH*	2x4** High Bay 230 W, 22000 Lumens, 50K 11.80"W x 43.0"L x 2"H

For EM Emergency. For Occupancy Sensor, add MDT4. Fixtures include chain kits.

Accessories

Add Accessories (Add Item No. below to End of HBI Item Number and Add Adder to Price)

ITEM NO.	DESCRIPTION
HBI12DFMW	1x2** High Bay Door Frame Set w/ Matte White Lens
HBI22DFMW	2x2** High Bay Door Frame Set w/ Matte White Lens
HBI24DFMW	2x4** High Bay Door Frame Set w/ Matte White Lens
HBI12WG	1x2 Wire Guard White
HBI22WG	2x2 Wire Guard White
HBI24WG	2x4 Wire Guard White
HBIFMK	Flush Mounting Kit 6"L x 2"W x 0.8"H
HBIPDMK	Pendant Mounting Kit 3.4"L x 2.3"W x 2"H



Door Frame
Lens options.

LED Enclosed High Bay

NEW



ITEM NO.	DESCRIPTION
HILFR24LT80W10000LDMV50K	24"L W/FROSTED LENS 80W AND 10,000 LUMENS 50K
HILFR24LY122W15000LDMV50K	24"LW/FROSTED LENS 122W AND 15,000 LUMENS 50K
HILFR48LT80W10000LDMV50K	45"L W/FROSTED LENS 80W AND 10,000 LUMENS 50K
HILFR48LY122W15000LDMV50K	45"L W/FROSTED LENS 122W AND 15,000 LUMENS 50K
HILFR48LA149W20000LDMV50K	45"L W/FROSTED LENS 149W AND 20,000 LUMENS 50K
HILFR48LA186W25000LDMV50K	45"L W/FROSTED LENS 186W AND 25,000 LUMENS 50K
HILFR48LA224W30000LDMV50K	45"L W/FROSTED LENS 224W AND 30,000 LUMENS 50K
HILFR48LA273W35000LDMV50K	45"L W/FROSTED LENS 273W AND 35,000 LUMENS 50K
HILFR48LA364W50000LDMV50K	45"L W/FROSTED LENS 364W AND 50,000 LUMENS 50K

For Clear Lens change FR to CL.
For No Lens Remove FR.
For Occupancy Sensor on End add MDT4.

Add Uplight Accessory to HIL (Add item number below after HILFR to get uplight)

ITEM NO.	DESCRIPTION
UV45W	Uplight Accessory Module 45W and 5500 Lumens to either 2x2 or 2x4

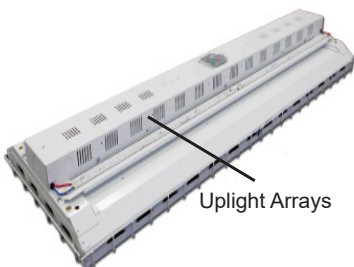

Uplight Arrays

TEXAS FLUORESCENTS

HBC High Bays

High Bay



See Accessories & Options Below

ITEM NO.	DESCRIPTION
HBC48LN127W18000LA10DMV50K	16"Wx48"L / 127W, 18000L Color Temp 30, 35, 40, 50
HBC48LN162W24000LA10DMV50K	16"Wx48"L / 162W, 24000L Color Temp 30, 35, 40, 50
HBC48LN216W30000LA10DMV50K	16"Wx48"L / 216W, 30000L Color Temp 30, 35, 40, 50
HBC48LN272W36000LA10DMV50K	16"Wx48"L / 272W, 36000L Color Temp 30, 35, 40, 50

Low Bay



Consult for Door Frame and Lens

ITEM NO.	DESCRIPTION
HBC48LS61W7040LW30DMV40K	16"Wx48"L / 61W, 6450L Color Temp 30, 35, 40, 50
HBC48LF97W11300LW30DMV40K*	16"Wx48"L / 97W, 11300L Color Temp 30, 35, 40, 50
HBC48LH118W13500LW30DMV50K*	16"Wx48"L / 118W, 13500L Color Temp 30, 35, 40, 50

See Accessories & Options Below

Aisle Light (Ideal to light products in racks)



Shown with Optional Wire Guard

ITEM NO.	DESCRIPTION
4FT	
HBCA48LN110W16000LA10DMV50K	8"Wx48"L / 110W, 16000L Color Temp 30, 35, 40, 50
HBCA48LN144W20000LA10DMV50K	8"Wx48"L / 144W, 20000L Color Temp 30, 35, 40, 50
8FT	
HBCA96LN162W24000LA10DMV50K	8"Wx96"L / 162W, 24000L Color Temp 30, 35, 40, 50
HBCA96LN220W32000LA10DMV50K	8"Wx96"L / 220W, 32000L Color Temp 30, 35, 40, 50
HBCA96LN288W40000LA10DMV50K	8"Wx96"L / 288W, 40000L Color Temp 30, 35, 40, 50

For Wire Guard Add WG.

Mini High Bay



Shown with Optional Doorframe and center hub

ITEM NO.	DESCRIPTION
HBC22LN63W9000LA10DMV50K	20"Wx24"L / 63W, 9000L Color Temp 30, 35, 40, 50
HBC22LN110W16000LA10DMV50K	20"Wx24"L / 110W, 16000L Color Temp 30, 35, 40, 50
HBC22LN144W20000LA10DMV50K	20"Wx24"L / 144W, 20000L Color Temp 30, 35, 40, 50

For Door Frame and Lens add DFFR.

High Bay Accessory Options

(Add Item No Below to End of HBC Item Number and Add Adder to Price)

ITEM NO.	DESCRIPTION
-MDT4	External Mounted Occupancy Sensor
-WG	Wire Guard for HBC Full Size
-GT310	Gripple Style Cable Kit 10 FT
-HC101	Chain Kit - 4 "S" Hooks & 20 FT Chain
-EM	Emergency Driver
-HBC7	Center Hub for 3/4" Pipe

For Larger Job Quantities, Call For A Quote

Dimensions are nominal. See spec sheet for exact dimensions.

TEXAS FLUORESCENTS

NEW



HIS Series

ITEM NO.	DESCRIPTION
HIS48LFR105W13650LDMV50K	12.59" X 3.54" X 23.6", 105W 13650L 5000K

Consult for other sizes and lumen options.

NEW



Vapor Tight High Bay Wet Location (Ideal for Cold Storage and Wash Down)

ITEM NO.	DESCRIPTION
CITACL48LV80W8730LDMV50K	51.91" x 14.61, Clear with Frosted Ends Lens 80W / 8730L
CITACL48LV100W11100LDMV50K	51.91" x 14.61, Clear with Frosted Ends Lens 100W / 11100L
CITACL48LA120W13350LDMV50K	51.91" x 14.61, Clear with Frosted Ends Lens 120W / 13350L
CITACL48LA140W15550LDMV50K	51.91" x 14.61, Clear with Frosted Ends Lens 140W / 15550L
CITACL48LA150W16500LDMV50K*	51.91" x 14.61, Clear with Frosted Ends Lens 150W / 16500L
CITACL48LA180W19000LDMV50K*	51.91" x 14.61, Clear with Frosted Ends Lens 180W / 20000L

For Emergency add EM.

LED High Bay Conventional Style

ITEM NO.	DESCRIPTION
LHB60WMV50KCONE	60W MV 4650L 50K 90° REF, 19"Dia x 7.5"H
LHB60WMV50KDOME	60W MV 4650L 50K 45° REF, 16.5"Dia x 10"H
LHB100WMV50KCONE	100W MV 10,000L 50K 90° REF, 19"Dia x 7.5"H
LHB100WMV50KDOME	100W MV 10,000L 50K 45° REF, 16.5"Dia x 10"H
LHB150WMV50KCONE	150W MV 13,500L 50K 90° REF, 19"Dia x 7.5"H
LHB150WMV50KDOME	150W MV 13,500L 50K 45° REF, 16.5"Dia x 10"H
LHB200WMV50KCONE	200W MV 19,350L 50K 90° REF, 19"Dia x 7.5"H
LHB200WMV50KDOME	200W MV 19,350L 50K 45° REF, 16.5"Dia x 10"H

For Acrylic Frosted Dome, add FR or Acrylic Clear Dome, add CR at end of item number.



Consult for Acrylic Reflectors.



Retrofit your existing high bays and eliminate rewiring and the need for an electrician. Our engineering department can make a custom retrofit.

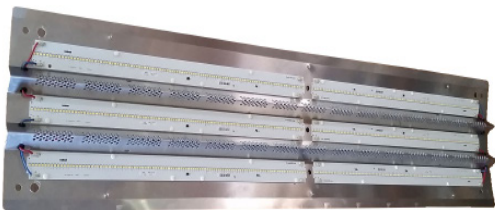

Add this Emergency to most LED Fixtures with Array and Driver.

The **ILB-CP10** from IOTA Engineering is a UL Classified LED emergency driver that allows the same LED fixture to be used for both normal and emergency operation. In the event of a power failure, the **ILB-CP10** switches to the emergency mode and operates the existing fixture for **90 minutes**. The unit contains a battery, charger, and converter circuit in a single can and is available in different mounting configurations for individual fixture requirements. The **ILB-CP10** will operate an LED array load at 10 watts with constant power at a rated output voltage of 10V-60V. The Constant Power design of the **ILB-CP10** maintains the output wattage even as the system voltage diminishes. Also suitable for field installation.



TEXAS FLUORESCENTS

Industrial Strip Family (1 Style, 3 Configurations)

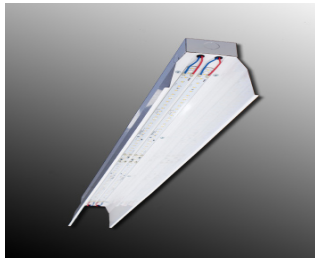
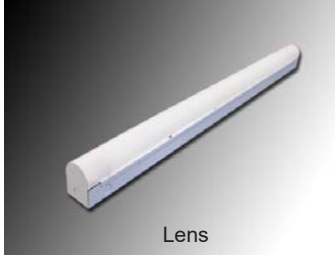

ITEM NO.	DESCRIPTION
Enclosed with Hinged Frosted Lens	
RRSFR48LE28W2700LDMV40K	48" Enclosed w/ FR Hinged Lens 28W/ 2700L
RRSFR48LE48W4600LDMV40K	48" Enclosed w/ FR Hinged Lens 48W/ 4600L
RRSFR48LE57W5400LDMV40K	48" Enclosed w/ FR Hinged Lens 57W/ 5400L
RRSFR96LE57W5400LDMV40K	96" Enclosed w/ FR Hinged Lens 57W/ 5400L
RRSFR96LE96W9200LDMV40K	96" Enclosed w/ FR Hinged Lens 96W/ 9200L
RRSFR96LE114W10400LDMV40K	96" Enclosed w/ FR Hinged Lens 114W/ 10400L
Deep Enhanced White Reflector	
RRS48LE28W2700LW30DMV40K	48" with White Reflector 28W / 2700L
RRS48LE48W4600LW30DMV40K	48" with White Reflector 48W / 4600L
RRS48LE57W5400LW30DMV40K	48" with White Reflector 57W / 5400L
RRS96LE57W5400LW30DMV40K	96" with White Reflector 57W/ 5400L
RRS96LE96W9200LW30DMV40K	96" with White Reflector 96W/ 9200L
RRS96LE114W10400LW30DMV40K	96" with White Reflector 114W/ 10400L
Open Strip	
RRS48LE28W2700LDMV40K	48" Open 28W /2700L
RRS48LE48W4600LDMV40K	48" Open 48W /4600L
RRS48LE57W5400LDMV40K	48" Open 57W /5400L
RRS96LE57W5400LDMV40K	96" Open 57W /5400L
RRS96LE96W9200LDMV40K	96" Open 96W /9200L
RRS96LE114W10400LDMV40K	96" Open 114W /10400L

Available in 3000K, 3500K and 5000K. For Emergency add EM. Consult for other sizes.

Industrial LED



ITEM NO.	SIZE (W x L)	WATTS/LUMENS	COLOR OPTIONS (x100) Kelvins)
IND48LS32W4050LW30DMV40K*	10" x 48"	32 / 4050	30, 35, 40, 50
IND48LS48W5650LW30DMV40K*	10" x 48"	48 / 5650	30, 35, 40, 50
IND48LS57W6400LW30DMV40K*	10" x 48"	57 / 6400	30, 35, 40, 50
IND96LS48W5650LW30DMV40K	10" x 96"	48 / 5650	30, 35, 40, 50
IND96LS97W11300LW30DMV40K	10" x 96"	97 / 11300	30, 35, 40, 50
IND96LS114W12800LW30DMV40K	10" x 96"	114 / 12800	30, 35, 40, 50

For Emergency add EM. Add wire guard IND48WGWH.

Economy Lensed Strip (Ideal for Concealed spaces for Continuous Run Or Economy Application)



ITEM NO.	SIZE (W x L)	WATTS/LUMENS	COLOR OPTIONS (x100) Kelvins)
RKDFR24LE12W1200LDMV40KWH	2" x 24"	12 / 1200	30, 35, 40, 50
RKDFR48LE28W2700LDMV40KWH	2" x 46"	28 / 2700	30, 35, 40, 50
RKDFR48LH35W3400LDMV40KWH	2" x 46"	35 / 3400	30, 35, 40, 50
RKDFR96LE57W5400LDMV40KWH	2" x 92"	57 / 5400	30, 35, 40, 50
RKDFR96LF62W6200LDMV30KWH	2" x 92"	62 / 6200	30, 35, 40, 50
RKDFR96LH72W7000LDMV40KWH	2" x 92"	72 / 7000	30, 35, 40, 50

For Emergency add EM.

TEXAS FLUORESCENTS

Linear Strips



Two Widths: DKS - 2" wide
DKSWB - 3" wide

New Designer White Ends ideal for variety of applications.



BEST SELLER

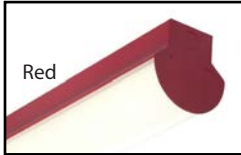

Consult for other color finish options.

Linear Round Strip **Compare to Cree LS Series**

ITEM NO.	DESCRIPTION
DKSMW24LH18W1750LDMV40KWH	2 ft x 2" / 24W, 1750L / Color Temp - 30, 35, 40, 50
DKSMW48LH35W3400LDMV40KWH	4 ft x 2" / 48W, 3400L / Color Temp - 30, 35, 40, 50
DKSWB48LE40W4000LDMV40KWH	4 ft x 3" / 40W, 4000L / Color Temp - 30, 35, 40, 50
DKSWB96LE80W8000LDMV40KWH	8 ft X3" / 80W, 800L / Color Temp - 30, 35, 40, 50

For emergency, add EM (only to WB). Available in BN, BK or BZ and consult for adder. Consult for other wattages & lumens.

LED Contoured Strip

Wall or Ceiling mount, surface or pendant mounted, vertical or horizontal this fixture available standard in 3 sizes can be used individually or joined together for a continuous run. Standard in white but with a variety of finish options. Eight foot has one piece lens for a great look.

ITEM NO.	DESCRIPTION
SERFR24LR14W1400LDMV40KWH	3.79"W x 23.60"L x 3.93"H / 14W, 1400L, 4000K
SERFR24LR20W2000LDMV40KWH	3.79"W x 23.60"L x 3.93"H / 20W, 2000L, 4000K
SERFR48LR28W2800LDMV40KWH	3.79"W x 47.20"L x 3.93"H / 28W, 2800L, 4000K
SERFR48LR40W4000LDMV40KWH	3.79"W x 47.20"L x 3.93"H / 40W, 4000L, 4000K
SERFR96LR56W5600LDMV40KWH	3.79"W x 94.40"L x 3.93"H / 56W, 5600L, 4000K
SERFR96LR80W8000LDMV40KWH	3.79"W x 94.40"L x 3.93"H / 80W, 8000L, 4000K

For emergency, add EM. Available in 3000K, 3500K, and 5000K.

Low Profile Linear Strip



ITEM NO.	SIZE (W X L)	Watts / Lumens	Color Options (X100 Kelvins)
SKDFR24LE12W1200LDMV40KWH	2" x 22.5"	12 / 1200	30, 35, 40, 50
SKDFR48LE28W2700LDMV40KWH	2" x 46"	28 / 2700	30, 35, 40, 50
SKDFR48LH35W3400LDMV40KWH	2" x 46"	35 / 3400	30, 35, 40, 50
SKDFR96LE57W5400LDMV40KWH	2" x 92"	57 / 5400	30, 35, 40, 50
SKDFR96LH72W7000LDMV40KWH	2" x 92"	72 / 7000	30, 35, 40, 50

Consult for other finishes and adder.

Wide Body Linear Strip



ITEM NO.	DESCRIPTION
SKDWBFR24LH35W3400LDMV40KWH	2 ft / 35W, 3400L / Color Temp 30, 35, 40, 50
SKDWBFR48LE40W4000LDMV40KWH	4 ft / 40W, 4000L / Color Temp 30, 35, 40, 50
SKDWBFR48LH72W7000LDMV40KWH	4 ft / 72W, 7000L / Color Temp 30, 35, 40, 50
SKDWBFR96LH80W8000LDMV40KWH	8 ft / 80W, 8000L / Color Temp 30, 35, 40, 50
SKDWBFR96LE114W10800LDMV40KWH	8 ft / 114W, 10800L / Color Temp 30, 35, 40, 50

For Brushed Nickel, Change WH to BN. For Bronze, Change WH to BZ. For Emergency, add EM.

Linear Strip (Ideal replacement for Fluorescent Strips)

ITEM NO.	DESCRIPTION
JSR48L40W5400LDMV40K*	42.44"L x 3.75"H x 3.25"W / 40W, 5400L, 4000K
JSR96L68W9400LDMV40K*	90.47"L x 3.75"H x 3.25"W / 68W, 9400L, 4000K

Change 40K to 35K or 50K.



TEXAS FLUORESCENTS

Linear Strips



Lens End Cap accessory. CENDCAPLENS
Frosted lens accessory reduces LED brightness. C48FRLN



Frosted lens accessory reduces LED brightness. S48FRLN



Linear Fixture with Sensor (Fixture ON when occupied, OFF when not)

ITEM NO.	DESCRIPTION
SSSESFR48LS31W3100LDMV40KWH	2.36"W x 47.25"L x 2.83"H / 31W, 3200L, 4000K
SSSESFR96LS62W6200LDMV40KWH	2.36"W x 94.43"L x 2.83"H / 62W, 6200L, 4000K
SSSESFR24LH20W2000LDMV40KWH	2.36" x 2.36", 20W 2000L with 50% Step Dim
SSSESFR48LS31W3100LSTMV40KWH	2.36" x 47.3", 31W 3100L with 50% Step Dim
SSSESFR96LS62W6200LSTMV40KWH	2.36" x 47.3", 62W 6200L with 50% Step Dim

Step Dim w/Sensor (Fixture ON when occupied, 50% when not). Available in 3000K, 3500K, and 5000K.

Linear Fixture without Sensor

SESEFR48LS31W3100LDMV40KWH	2.36"W x 47.25"L x 2.83"H / 31W, 3100L, 4000K
SESEFR96LS62W6200LDMV40KWH	2.36"W x 94.43"L x 2.83"H / 62W, 6200L, 4000K

Consult for other finishes. Pendant mount available. Available in 3000K, 3500K, and 5000K.

LED Linear w/Daylight Harvesting Sensor

ITEM NO.	DESCRIPTION
DSSESFR24LH20W2000LDMV40KWH	2.36" x 2.36", 20W 2000L, Daylight Harvesting
DSSESFR48LS31W3100LDMV40KWH	2.36" x 47.3", 31W 3100L, Daylight Harvesting
DSSESFR96LS62W6200LDMV40KWH	2.36" x 47.3", 62W 6200L, Daylight Harvesting

Available in 3000K, 3500K, and 5000K.

LED Open Strip (4.25" wide)

ITEM NO.	SIZE (W x L)
C24LF24W3350LDMV40K*	4.25" x 24" / 24W, 3350L, 4000K
C24LF30W3900LDMV40K*	4.25" x 24" / 30W, 3900L, 4000K
C48LF35W4900LDMV40K*	4.25" x 48" / 35W, 4900L, 4000K
C48LF48W6500LDMV40K*	4.25" x 48" / 48W, 6500L, 4000K
C48LF57W7800LDMV40K*	4.25" x 48" / 57W, 7800L, 4000K
C96LF70W9800LDMV40K*	4.25" x 96" / 70W, 9800L, 4000K
C96LF97W13000LDMV40K*	4.25" x 96" / 97W, 13000L, 4000K
C96LF118W15500LDMV40K*	4.25" x 96" / 118W, 15500L, 4000K

Order lens to hide LED arrays. Available in 3000K, 3500K and 5000K.

LED Open Strip (2.75" wide)

ITEM NO.	SIZE (W X L)
S24LS12W1400LDMV40K	2.75" x 1.80" x 24.00" / 12W, 1400L, 4000K
S48LS24W2800LDMV40K	2.75" x 1.80" x 48.00" / 24W, 2800L, 4000K
S48LS28W3200LDMV40K	2.75" x 1.80" x 48.00" / 28W, 3200L, 4000K
S48LH35W3400LDMV40K	2.75" x 1.80" x 48.00" / 35W, 3400L, 4000K
S96LS57W6400LDMV40K	2.75" x 1.80" x 96.00" / 57W, 6400L, 4000K
S96LH72W8200LDMV40K	2.75" x 1.80" x 96.00" / 72W, 8200L, 4000K

Order lens to hide LED arrays. Available in 3000K, 3500K and 5000K.

LED Open Strip (1.62" wide) Ideal for Coves

ITEM NO.	SIZE (W X L)
KDS48LS24W2800LDMV40K	1.62" x 1.62" x 48.00" / 24W, 2800L, 4000K
KDS48LS28W3200LDMV40K	1.62" x 1.62" x 48.00" / 28W, 3200L, 4000K
KDS48LH35W4000LDMV40K	1.62" x 1.62" x 48.00" / 35W, 4000L, 4000K
KDS96LS48W5650LDMV40K	1.62" x 1.62" x 96.00" / 48W, 5650L, 4000K
KDS96LS57W6400LDMV40K	1.62" x 1.62" x 96.00" / 57W, 6400L, 4000K
KDS96LH72W7000LDMV40K	1.62" x 1.62" x 96.00" / 72W, 7000L, 4000K

For emergency, add EM. Consult for other strips. Available in 3000K, 3500K and 5000K.

Linear Pendants

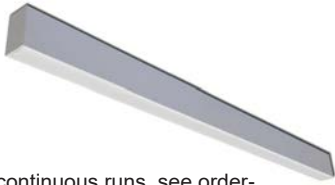

For continuous runs, see ordering on page 12

Linear 2"x 3" Pendant - Downlight only

ITEM NO.	SIZE (W X L)	Watts / Lumens	Color Options (X100 Kelvins)
23PSF48LR26W2600LDMV40KWH-HC301WH	2" x 48"	26 / 2600	30, 35, 40, 50
23PSF48LR38W3800LDMV40KWH-HC301WH	2" x 48"	38 / 3800	30, 35, 40, 50
23PSF48LR45W4500LDMV40KWH-HC301WH	2" x 48"	45 / 4500	30, 35, 40, 50
23PSF96LR52W5200LDMV40KWH-HC301WH	2" x 96"	52 / 5200	30, 35, 40, 50
23PSF96LR76W7600LDMV40KWH-HC301WH	2" x 96"	76 / 7600	30, 35, 40, 50
23PSF96LR90W9000LDMV40KWH-HC301WH	2" x 96"	90 / 9000	30, 35, 40, 50

For surface mount remove HC301WH. Consult for EM option.

For Dimming add "5W" after HC301.

Linear 2"x 3" Pendant - Uplight and Downlight

ITEM NO.	SIZE (W X L)	Watts Up/Down	Color Options (X100 Kelvins)
23PSF48LUR12WD24WDMV40KWH-HC301WH	2" x 48"	12 / 24	30, 35, 40, 50
23PSF48LUR18WD36WDMV40KWH-HC301WH	2" x 48"	18 / 36	30, 35, 40, 50
23PSF96LUR24WD48WDMV40KWH-HC301WH	2" x 96"	24 / 48	30, 35, 40, 50
23PSF96LUR36WD72WDMV40KWH-HC301WH	2" x 96"	36 / 72	30, 35, 40, 50

For surface mount remove HC301WH. Consult for EM option.

For Dimming add "5W" after HC301.

Linear 4"x 4" Pendant (Downlight Only)

ITEM NO.	SIZE (W X L)	Watts / Lumens	Color Options (X100 Kelvins)
44PSF48LR24W2400LDMV40KWH-HC301WH	4" x 48"	24 / 2400	30, 35, 40, 50
44PSF48LR48W4800LDMV40KWH-HC301WH	4" x 48"	48 / 4800	30, 35, 40, 50
44PSF96LR48W4800LDMV40KWH-HC301WH	4" x 96"	48 / 4800	30, 35, 40, 50
44PSF96LR96W9600LDMV40KWH-HC301WH	4" x 96"	96 / 9600	30, 35, 40, 50

For surface mount remove HC301WH. For emergency, add EM.

For Dimming add "5W" after HC301.

Linear 4"x 5" Pendant (Up and Downlight)

ITEM NO.	SIZE (W X L)	Watts Up / Down	Color Options (X100 Kelvins)
45PSF48LUR12WD24WDMV40KWH-HC301WH	4" x 48"	12 / 24	30, 35, 40, 50
45PSF48LUR18WD36WDMV40KWH-HC301WH	4" x 48"	18 / 36	30, 35, 40, 50
45PSF96LUR24WD48WDMV40KWH-HC301WH	4" x 96"	24 / 48	30, 35, 40, 50
45PSF96LUR36WD72WDMV40KWH-HC301WH	4" x 96"	36 / 72	30, 35, 40, 50

For surface mount remove HC301WH. For emergency, add EM..

For Dimming add "5W" after HC301.

Linear 6"x 6" Pendant

ITEM NO.	DESCRIPTION
Direct	
66PMW48LR24W2400LDMV40KWHHC401WH	6.00" X 6.00" X 48" / 24W, 2400L, 4000K
66PMW48LR48W4800LDMV40KWHHC401WH	6.00" X 6.00" X 48" / 48W, 4800L, 4000K
66PMW96LR48W4800LDMV40KWHHC401WH	6.00" X 6.00" X 96" / 48W, 4800L, 4000K
66PMW96LR97W9600LDMV40KWHHC401WH	6.00" X 6.00" X 96" / 97W, 9600L, 4000K

For emergency, add EM. For Dimming add "5W" after HC301WH

For Dimming add "5W" after HC301WH.

Linear 6"x 6" Pendant (Up and Downlight)

ITEM NO.	DESCRIPTION	Watts Up / Down	Color Options (X100 Kelvins)
66PMW48LUR12WD24WDMV40KWHHC401WH	6.00" X 6.00" X 48"	12 / 24	30, 35, 40, 50
66PMW48LUR24WD48WDMV40KWHHC401WH	6.00" X 6.00" X 48"	24 / 48	30, 35, 40, 50
66PMW96LUR24WD48WDMV40KWHHC401WH	6.00" X 6.00" X 96"	24 / 48	30, 35, 40, 50
66PMW96LUR36WD72WDMV40KWHHC401WH	6.00" X 6.00" X 96"	36 / 72	30, 35, 40, 50

Wall washer option for asymmetrical reflector

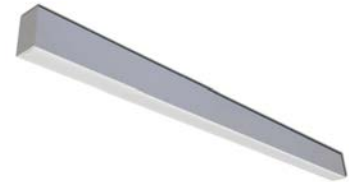

For continuous runs, see ordering on page 12



For continuous runs, see ordering on page 12



For matching wall version, see p 18.

4x4 Square in 4ft Sq and 8ft Sq (Downlight) (6 or 8 watts per foot)



**Consult for
Different Configuration
(including rectangles)**

ITEM NO.	SIZE	Watts / Lumens	
44PSF4X4R96WDMV40KWHHC401WH	4x4" 4ft. Sq	96 / 9600	White 3 Wire Cord
44PSF4X4R96WDMV40KWHHC4015WWH	4x4" 4ft. Sq	96 / 9600	White 5 Wire Cord for 0-10V Dim
44PSF4X4R128WDMV40KWHHC401WH	4x4" 4ft. Sq	128 / 12800	White 3 Wire Cord
44PSF4X4R128WDMV40KWHHC4015WWH	4x4" 4ft. Sq	128 / 12800	White 5 Wire Cord for 0-10V Dim
44PSF8X8R192WDMV40KWHHC401WH	4x4" 8ft. Sq	192 / 19200	White 3 Wire Cord
44PSF8X8R192WDMV40KWHHC4015WH	4x4" 8ft. Sq	192 / 19200	White 5 Wire Cord for 0-10V Dim
44PSF8X8R256WDMV40KWHHC401WH	4x4" 8ft. Sq	256 / 25600	White 3 Wire Cord
44PSF8X8R256WDMV40KWHHC4015WWH	4x4" 8ft. Sq	256 / 25600	White 5 Wire Cord for 0-10V Dim

For Emergency, add EM. Consult for up and downlight. Available in 3000k, 3500K and 5000K.

Ordering Patterns

Texas Fluorescents can create patterns with 23, 44, 45 and 66 Series. Patterns are available for recessed and pendant mounting versions with lit corners or unlit corners. See below for some of the possibilities and consult factories for exact ordering numbers and pricing.



Continuous Run Ordering for 23, 44, 45, 66, LPLIN and SLP Series

1. Determine the run length and whether the run will be dimmed or not.
2. Use the above 2, 4 or 8 ft. runs from the Series Specified to add up to total run length. Use the largest individual fixtures to achieve run lengths (i.e. for 20 ft. run, use 2x8 ft. individuals and 1x4 ft. individual from above with the correct ordering info for your series). Watts and lumens for each section should be proportional for the size (i.e. If 48W with 4 ft then 8 ft should be 96W). Consult for other lengths.
3. Designate each length required in the run whether it will be the beginning of the run "B", joiner in the run "J" or the end "E" of the run. **Add the letter designation to the end of the part number.**
4. For Plug and Play electrical wiring between individual fixtures in the run, add one of the following harnesses. The number of wires is based on whether the run will be dimmable, with emergency or just ON/OFF.

Add Wiring Harness Code After the Driver Designation

- PI1 - 3 Wire Harness (normally for non-dim applications)
- PI2 - 4 Wire Harness (normally for emergency circuit)
- PI3D - 5 Wire Harness (normally for 0-10V dimming)
- PI4D - 6 Wire Harness (normally for 0-10V dimming and emergency)

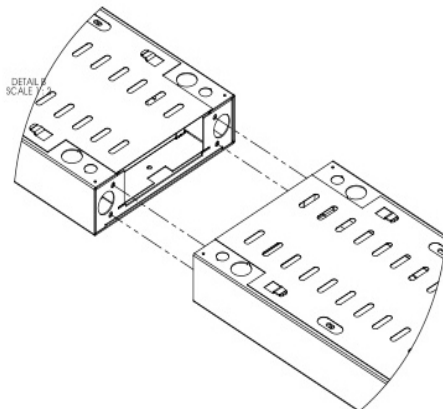
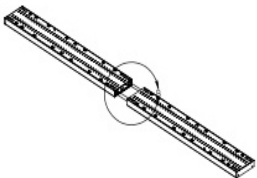

Engineered ends either accept end cap to complete run or to join two fixtures together for continuous runs.

For continuous runs, first remove the end plates on the fixtures you want to join together; then using bolts and nuts (4X), attach the two ends together. Be sure both fixtures are properly aligned before tightening the bolts. Repeat steps for as long as you would like to continuous run the fixtures. Finish run with the end plate attached to the last fixture in the run.

TEXAS FLUORESCENTS

LPLIN LED with Direct/Indirect Lighting (New LED Version)



See page 12 on ordering continuous runs

ITEM NO.	SIZE	Watts	Color Temp
LPLINFRSS48LUS12WD24WDMV40KWH-HC401WH	48"	12W Up 24W Down	30, 35, 40, 50
LPLINFRSS48LUS18WD36WDMV40KWH-HC401WH	48"	18W Up 36W Down	30, 35, 40, 50
LPLINFRSS96LUS24WD48WDMV40KWH-HC401WH	96"	24W Up 48W Down	30, 35, 40, 50
LPLINFRSS96LUS36WD72WDMV40KWH-HC401WH	96"	36W Up 72W Down	30, 35, 40, 50

For 0-10 Dimming. Change 401WH to 4015WWH. For Emergency, add EM.
Consult for other Direct/Indirect Options.

Linear Window LED with Direct/Indirect Lighting

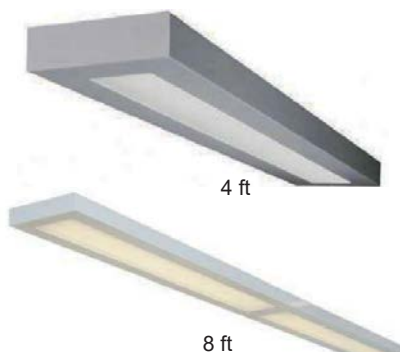

See page 18 for Wall Version

See page 12 on ordering continuous run

ITEM NO.	SIZE	Watts	Color Temp
SLPFR48LS48W4800LDMV40KWH-HC401WH	7.6" x 48" 48W, 4800L, All downlight, Color Temp 30, 35, 40, 45		
SLPF96LS96W9600LDMV40KWH-HC401WH	7.6" x 96" 96W, 9600L, All downlight, Color Temp 30, 35, 40, 45		
SLPMW48LUS12WD24WDMV40KWH-HC401WH	48"	12W Up 24W Down	30, 35, 40, 50
SLPMW48LUS18WD36WDMV40KWH-HC401WH	48"	18W Up 36W Down	30, 35, 40, 50
SLPMW96LUS24WD48WDMV40KWH-HC401WH	96"	24W Up 48W Down	30, 35, 40, 50
SLPMW96LUS36WD72WDMV40KWH-HC401WH	96"	36W Up 72W Down	30, 35, 40, 50

For 0-10 Dimming. Change 401WH to 4015WWH. For Emergency, add EM.
Consult for other Direct/Indirect Options. Change WH to BN for Brushed Nickel.

Linear Indirect Lighting

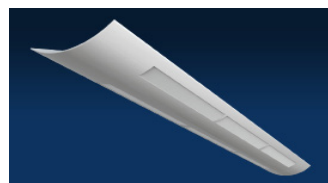

LINMW



LINLV

ITEM NO.	SIZE	WATTS/LUMENS	Color Temp (X100 Kelvins)
LINMW48LUS24WD12WDMV40KWH-HC301WH	48"	24W Up 12W Down	30, 35, 40, 50
LINMW48LUS36WD18WDMV40KWH-HC301WH	48"	36W Up 18W Down	30, 35, 40, 50
LINMW96LUS48WD24WDMV40KWH-HC301WH	96"	48W Up 24W Down	30, 35, 40, 50
LINMW96LUS72WD36WDMV40KWH-HC301WH	96"	72W Up 36W Down	30, 35, 40, 50

For 0-10 Dimming. Change 301WH to 3015WWH. For Emergency, add EM.
Consult for other Direct/Indirect Options. Change WH to BN for Brushed Nickel.
For Louver, change MW to LV.
For Perforated, change MW to PF.

LED High Bay Baffle



Lensed version available

ITEM NO.	DESCRIPTION
FHBL48LS32W4050LM20DMV40K	HI BAY BAFFLE 11.25"W x 48"L x 4.25"H - 4050lm - 4000K - 0-10V dimmable
FHBL48LS48W5650LM20DMV40K	HI BAY BAFFLE 11.25"W x 48"L x 4.25"H - 5650lm - 4000K - 0-10V dimmable
FHBL48LS57W6400LM20DMV40K	HI BAY BAFFLE 11.25"W x 48"L x 4.25"H - 6400lm - 4000K - 0-10V dimmable
FHBL48LH72W8200LM20DMV40K	HI BAY BAFFLE 11.25"W x 48"L x 4.25"H - 8200lm - 4000K - 0-10V dimmable
FHBL96LS97W11300LM20DMV40K	HI BAY BAFFLE 11.25"W x 96"L x 4.25"H - 11300lm - 4000K - 0-10V dimmable
FHBL48LS114W12800LM20DMV40K	HI BAY BAFFLE 11.25"W x 96"L x 4.25"H - 12800lm - 4000K - 0-10V dimmable

Consult for lensed version. Add EM for Emergency. Available in 3000K, 3500K and 5000K.

TEXAS FLUORESCENTS

All-In-One LED Linear Channel - Easiest Channel to Install for Individual or Continuous Runs



- Aluminum Channel
- Integral Driver
- Snap Fit Lens
- Magnetic Light Leak Block
- Integral Wire Harness

Based on your feedback, this all new All-In-One LED Linear Channel is new and improved to provide the easiest channel in the industry to specify, order and install. Whether you are surface mounting, pendant mounting and even recessed mounting, in some applications, this integral driver channel in two different profiles is the ideal solution for both individual fixtures in 4 or 8 foot and to join multiple channels for longer continuous runs in 4 foot or 8 foot multiples. This beautifully finished aluminum channel is so easy to install that the do-it-yourselfer can do it in minutes or the professional installer will do it quickly and inexpensively. A specially designed integral wiring harness (order separately) makes joining two channels electronically easy. A unique, mechanical joiner bracket with a clever special tool allows you to join two or more channels together with no light leak and a clean connection. See spec sheet for details.

LED Linear Channel in 2 Sizes

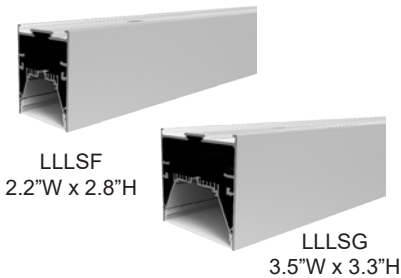

ITEM NO.	DESCRIPTION
LLLSF - Alum. Channel 2.2"W x (48"L or 96"L) x 2.8"H	
LLLSF48L30W3000LDMV40KSA	30W 3000L, 4000K 0-10V Dimming Multi-Volt
LLLSF96L60W6000LDMV40KSA	60W 6000L, 4000K 0-10V Dimming Multi-Volt
LLLSG - Alum. Channel 3.5"W x (48"L or 96"L) x 3.3"H	
LLLSG48L48W5040LDMV40KSA	48W 5040L, 4000K 0-10V Dimming Multi-Volt
LLLSG96L96W10080LDMV40KSA	96W 10080L, 4000K 0-10V Dimming Multi-Volt

Change 40K to 30K for 3000K

Join Two or More Channels Together

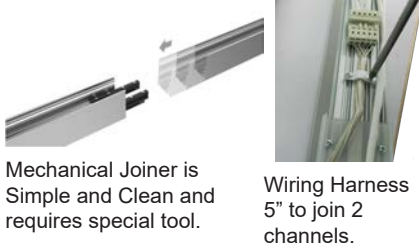

Mechanical Joiner is Simple and Clean and requires special tool.

Wiring Harness 5" to join 2 channels.

ITEM NO.	DESCRIPTION
LLLSFJOINER	Mechanical Joiner to Join 2 LLLSF Channels
LLLSGJOINER	Mechanical Joiner to Join 2 LLLSG Channels
LLLSGJOINERTOOL	Tool Required to Use Mechanical Joiner (1 per Installation)
LLLSFLENSTOOL	Tool Required to Remove Lens; 1 per installation needed
LLLSF5WMFH*	Wiring Harness 5" to Join 2 Channels

*Included with Channels only need to purchase for replacements

3 Mounting Options (Surface, Pendant and Recessed)

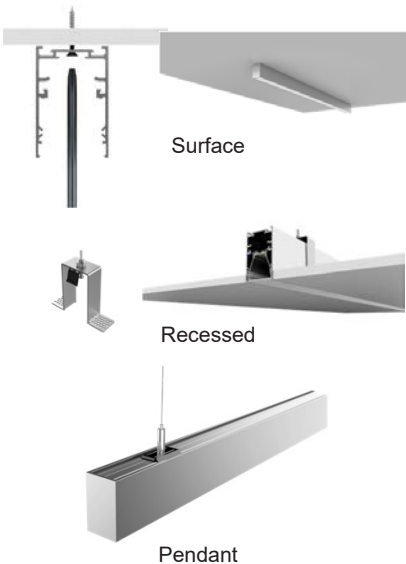

ITEM NO.	DESCRIPTION
LLLSFSURFKIT	Surface Mount Screw and Toggle Set of 3 (Includes 24 inch power cord)
LLLSFRECKIT*	Recessed Mounting Brackets for LLLSF (Set of 2) (Includes 24 inch power cord)
LLLSGRECKIT*	Recessed Mounting Brackets for LLLSG (Set of 2) (Includes 24 inch power cord)
LLLSFHCPF605WWH**	Pendant Mounting Power Feed Canopy Kit 5 Wire for up to 6FT Drop
LLLSFHCPF6125WWH**	Pendant Mounting Power Feed Canopy Kit 5 Wire for up to 12FT Drop
LLLSFHCPNF605WWH	Pendant Mounting Non-Power Canopy Kit, 6 FT Cable with Canopy
LLLSFHCPNF612WWH	Pendant Mounting Non-Power Canopy Kit, 12 FT Cable with Canopy

* Aluminum Channel has no flange so review Recessed Application to ensure this will work.

** Use One Power Feed Canopy Kit every place mounting to Power.

Non Power Feed Version Order Separately for Mounting where No Power Feed is Required.

TEXAS FLUORESCENTS

LED Linear Channels w/ Remote Drivers (LLL Series)



LLLRA

ITEM NO.	DESCRIPTION	Watts
LLLRA48L35W2246L30KSA	47.75" Round 1.6" Dia. RA Channel w/Lens and 2 End Caps and Tape 30K Installed with 10' Clear Wire	35
LLLRA97L69W4492L30KSA	92" Round 1.6" Dia. RA Channel w/Lens and 2 End Caps and Tape 30K Installed with 10' Clear Wire	69

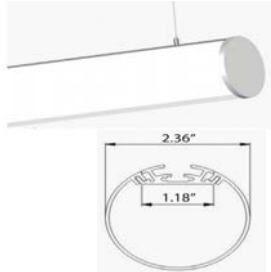

LLLRB

ITEM NO.	DESCRIPTION	Watts
LLLRB47L42W2488L30KSA	47.75" Round 2.36" Dia. RB Extrusion w/Lens and 2 End Caps and Tape 30K Installed with 10' Clear Wire	42
LLLRB99L96W4976L30KSA	96" Round 2.36" Dia. RB Extrusion w/Lens and 2 End Caps and Tape 30K Installed with 10' Clear Wire	83

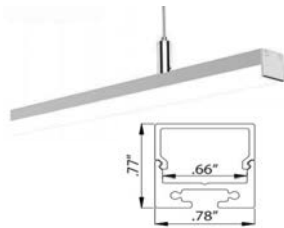

LLLSA

ITEM NO.	DESCRIPTION	Watts
LLLSA48L23W1500L30KSA	47.75" Square 0.77" SA Channel w/Lens and 2 End Caps and Tape 30K Installed with 10' Clear Wire	23
LLLSA97L46W3000L30KSA	97" Square 0.77" SA Channel w/Lens and 2 End Caps and Tape 30K Installed with 10' Clear Wire	46

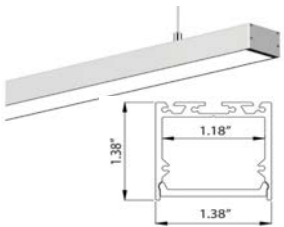

LLLSB

ITEM NO.	DESCRIPTION	Watts
LLLSB47L42W2488L30KSA	47" Square 1.38" SB Channel w/Lens and 2 End Caps and Tape 30K Installed with 10' Clear Wire	42
LLLSB96L83W4976L30KSA	96" Square 1.38" SB Channel w/Lens and 2 End Caps and Tape 30K Installed with 10' Clear Wire	83

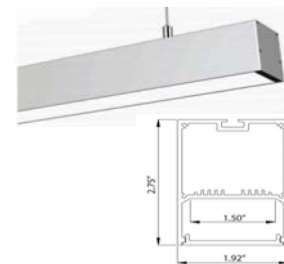

LLLSC

ITEM NO.	DESCRIPTION	Watts
LLLSC48L58W3456L30KSA	47.75" Rect. 1.92W" x 2.75H" SC Extrusion w/Lens and 2 End Caps and Tape 30K Installed with 10' Clear Wire	58
LLLSC97L115W6912L30KSA	97" Rect. 1.92W" x 2.75H" SC Extrusion w/Lens and 2 End Caps and Tape 30K Installed with 10' Clear Wire	115



Drivers and Accessories

ITEM NO.	DESCRIPTION
MTIM40L24DC	Magnitude Magnetic Driver 40W 24VDC Encased
MTIM60L24DC	Magnitude Magnetic Driver 60W 24VDC Encased
MTIM100L24DC	Magnitude Magnetic Driver 96W 24VDC Encased
MTIM150L24DC	Magnitude Magnetic Driver 150W 24VDC Encased
Cable Kits	
HC601WH	Cable kit with 6' cable and power feed/cable incl. and white canopy
HC602WH	Cable kit with 12' cable and power feed/cable incl. and white canopy
Joiners	
LLLRAJOIN	Mechanical joiner spline for RA and SC
LLLSAJOIN	Mechanical joiner spline for RB, SA and SB

Change 30K to 40K for 4000 color temperature
Consult for surface mount to order channel and tape separately

Consult for accessories
to make patterns

TEXAS FLUORESCENTS

Surface Linear LED



LED Surface Troffer

ITEM NO.	SIZE (W X L)	Watts / Lumens	Color Options (X100 Kelvins)
153A24LF35W3640LDMV40K	2 x 4	35 / 3650	30, 35, 40, 50
153A24LF48W4800LDMV40K	2 x 4	48 / 4800	30, 35, 40, 50
153A24LF56W6050LDMV40K	2 x 4	56 / 6050	30, 35, 40, 50
153A14LF32W3450LDMV40K	1 x 4	32 / 3450	30, 35, 40, 50
153A14LF48W4800LDMV40K	1 x 4	48 / 4800	30, 35, 40, 50
153A22LF24W2400LDMV40K	2 x 2	24 / 2400	30, 35, 40, 50
153A22LF28W2700LDMV40K	2 x 2	28 / 2700	30, 35, 40, 50
153A22LF35W3200LDMV40K	2 x 2	35 / 3200	30, 35, 40, 50

Add EM for Emergency.

Dress up with higher efficient Frosted Lens made special for LED. Replace "A" with "FR".

LED Wraparound 7"



Consult for 8ft. LED Wrap.

ITEM NO.	SIZE (W X L)
207A224LS24W3100LDMV40K	7.625"W" x 24"L x 3"H / 24W, 3100L, 4000K
207A224LS28W3400LDMV40K	7.625"W" x 24"L x 3"H / 28W, 3400L, 4000K
207A224LF30W3600LDMV40K	7.625"W" x 24"L x 3"H / 30W, 3600L, 4000K
207A248LS32W3450LDMV40K	7.625"W" x 48"L x 3"H / 32W, 3450L, 4000K
207A248LS48W4800LDMV40K	7.625"W" x 48"L x 3"H / 48W, 4800L, 4000K
207A248LS57W5400LDMV40K	7.625"W" x 48"L x 3"H / 57W, 5400L, 4000K
207A448LS65W7000LDMV40K	13"W" x 48"L x 3"H / 65W, 7000L, 4000K
207A448LS97W9600LDMV40K	13"W" x 48"L x 3"H / 97W, 9600L, 4000K
207A448LS114W10800LDMV40K	13"W" x 48"L x 3"H / 114W, 10800L, 4000K

Available in 3000K, 3500K and 5000K.

LED Wraparound 9"



ITEM NO.	SIZE (W X L)	Watts / Lumens	Color Options (X100 Kelvins)
209A48LF32W3450LDMV40K*	9" x 48"	32 / 3800	30, 35, 40, 50
209A48LF48W5100LDMV40K*	9" x 48"	48 / 5100	30, 35, 40, 50
209A48LF57W6000LDMV40K*	9" x 48"	57 / 6000	30, 35, 40, 50
209A48LH72W8200LDMV40K	9" x 48"	72 / 8200	30, 35, 40, 50

Add EM for Emergency. For Frosted lens on 209A248, change "A" to "FR".

VL LED Wraparound

ITEM NO.	DESCRIPTION
207A248LV45W4900LDMV40K	7" x 48" / 45W, 4900L / Color Temp 40
209A248LV45W4900LDMV40K	9" x 48" / 45W, 4900L / Color Temp 40

LED Linear Wall Washer



ITEM NO.	DESCRIPTION
W4ASSF48LR24W2400LDMV40KWH	Linear Wall Washer 4"W x 48"L x 4"H, 0-10V Dimmable
W4ASSF48LR24W4800LDMV40KWH	Linear Wall Washer 4"W x 48"L x 4"H, 0-10V Dimmable
W4ASSF96LR24W4800LDMV40KWH	Linear Wall Washer 4"W x 96"L x 4"H, 0-10V Dimmable
W4ASSF96LR24W9600LDMV40KWH	Linear Wall Washer 4"W x 96"L x 4"H, 0-10V Dimmable

Available in 3000K, 3500K and 5000K.

TEXAS FLUORESCENTS

Low Profile Cloud (Exclusively for LED Arrays - Shallowest Ever)



ITEM NO.	DESCRIPTION
LPCMW24LV22W1750LG120	11" x 24" x 3" / 22W, 1750L / Color Temp 30, 35, 40, 50
LPCMW48LP40W3400LG120	11" x 48" x 3" / 40W, 3400L / Color Temp 30, 35, 40, 50

120V only. Consult for 2 wire dimming.

Eclipse

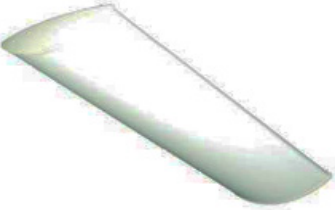

ITEM NO.	SIZE (W X L)	Watts / Lumens	Color Options (X100 Kelvins)
ECLMW224LS24W2000DMV40KWH	9.5" x 24"	24 / 2000	30, 35, 40, 50
ECLMW224LH36W2900LDMV40KWH	9.5" x 24"	36 / 2900	30, 35, 40, 50
ECLMW424LS48W4000LDMV40KWH	16.5" x 24"	48 / 4000	30, 35, 40, 50
ECLMW248LS32W2900LDMV40KWH	9.5" x 48"	32 / 2900	30, 35, 40, 50
ECLMW248LS48W4000LDMV40KWH	9.5" x 48"	48 / 4000	30, 35, 40, 50
ECLMW248LS57W4500LDMV40KWH	9.5" x 48"	57 / 4500	30, 35, 40, 50
ECLMW248LH72W5800LDMV40KWH	9.5" x 48"	72 / 5800	30, 35, 40, 50
ECLMW448LS96W8000LDMV40KWH	16.5" x 48"	96 / 8000	30, 35, 40, 50

Finishes for End Caps: SL-Silver, BM-Black Marble, TO- Tortoise, IM-Ivory, WM-White Marble, WH-White
Available in 3000K, 3500K and 5000K.



Contemporary Cloud



ITEM NO.	SIZE (W X L)	Watts / Lumens	Color Options (X100 Kelvins)
CLMMW248LS32W3450LDMV40K	9.75" x 48"	32 / 3450	30, 35, 40, 50
CLMMW248LS48W4800LDMV40K	9.75" x 48"	48 / 4800	30, 35, 40, 50
CLMMW248LS57W5400LDMV40K	9.75" x 48"	57 / 5400	30, 35, 40, 50
CLMMW448LS72W7000LDMV40K	13.75" x 48"	72 / 7200	30, 35, 40, 50
CLMMW448LS97W9600LDMV40K	13.75" x 48"	97 / 9600	30, 35, 40, 50

Available in 3000K, 3500K and 5000K.

LED PUF Series



ITEM NO.	SIZE (W X L)	Watts / Lumens	Color Options (X100 Kelvins)
PUF248LS32W3450LDMV40K	11" x 48"	32 / 3450	30, 35, 40, 50
PUF248LS48W4800LDMV40K	11" x 48"	48 / 4800	30, 35, 40, 50
PUF248LS57W5500LDMV40K	11" x 48"	57 / 5500	30, 35, 40, 50
PUF248LH72W7000LDMV40K	11" x 48"	72 / 7000	30, 35, 40, 50
PUF448LS65W7000LDMV40K	17" x 48"	65 / 7000	30, 35, 40, 50
PUF448LS97W9600LDMV40K	17" x 48"	97 / 9600	30, 35, 40, 50
PUF448LS114W10800LDMV40K	17" x 48"	114 / 10800	30, 35, 40, 50

Add EM for Emergency. Available in 3000K, 3500K and 5000K.

LED Spill Ring



ITEM NO.	DESCRIPTION
FL48LS32W3450LDMV40KSN	SPILL RING 11.75"W x 48"L x 4.5"H, 3450lm - 4000K - 0-10V dimmable
FL48LS48W4800LDMV40KSN	SPILL RING 11.75"W x 48"L x 4.5"H, 4800lm - 4000K - 0-10V dimmable
FL48LS57W5400LDMV40KSN	SPILL RING 11.75"W x 48"L x 4.5"H, 5400lm - 4000K - 0-10V dimmable
FL48LH72W7000LDMV40KSN	SPILL RING 11.75"W x 48"L x 4.5"H, 7000lm - 4000K - 0-10V dimmable

Consult for Bronze. Add EM for Emergency. Available in 3000K, 3500K and 5000K.

Most Linear Fixtures Are Dimmable 0-10V.

TEXAS FLUORESCENTS

Linear Wall



Available in 3000K, 3500K and 5000K.

See Matching Pendants on page 11

Wall Linear 2" x 3.5"

ITEM NO.	DESCRIPTION		
23WSF48LR26W2600LDMV40KWH	2.00" X 3.50" X 48.00" / 26W, 2600L, 4000K		
23WSF48LR38W3800LDMV40KWH	2.00" X 3.50" X 48.00" / 38W, 3800L, 4000K		
23WSF48LR45W4500LDMV40KWH	2.00" X 3.50" X 48.00" / 45W, 4500L, 4000K		
23WSF96LR52W5200LDMV40KWH	2.00" X 3.50" X 96.00" / 52W, 5200L, 4000K		
23WSF96LR76W7600LDMV40KWH	2.00" X 3.50" X 96.00" / 76W, 7600L, 4000K		
23WSF96LR90W9000LDMV40KWH	2.00" X 3.50" X 96.00" / 90W, 9000L, 4000K		
Direct/Indirect	Size	Watts Up/Down	Color Options
23WSF48LUR12WD24WDMV40KWH	2.00" X 3.50" X 48"	12 / 24	30, 35, 40, 50
23WSF48LUR18WD36WDMV40KWH	2.00" X 3.50" X 48"	18 / 36	30, 35, 40, 50
23WSF96LUR24WD48WDMV40KWH	2.00" X 3.50" X 96"	24 / 48	30, 35, 40, 50
23WSF96LUR36WD72WDMV40KWH	2.00" X 3.50" X 96"	36 / 72	30, 35, 40, 50



Available in 3000K, 3500K and 5000K.

Wall Linear 4" x 4"

ITEM NO.	DESCRIPTION
Direct	
44WSF48LW24W2400LDMV40KWH	4.00" X 4.00" X 48" / 24W, 2400L, 4000K
44WSF48LW48W4800LDMV40KWH	4.00" X 4.00" X 48" / 48W, 4800L, 4000K
44WSF96LW48W4800LDMV40KWH	4.00" X 4.00" X 96" / 48W, 4000K, 4000K
44WSF96LW96W9600LDMV40KWH	4.00" X 4.00" X 96" / 96W, 9600L, 4000K

Wall Linear 4" x 5" Direct / Indirect

ITEM NO.	Size	Watts Up/Down	Color Options
45WSF48LUR12WD24WDMV40KWH	4.00" X 5.50" X 48"	12 / 24	30, 35, 40, 50
45WSF48LUR24WD48WDMV40KWH	4.00" X 5.50" X 48"	18 / 36	30, 35, 40, 50
45WSF96LUR24WD48WDMV40KWH	4.00" X 5.50" X 96"	24 / 48	30, 35, 40, 50
45WSF96LUR36WD72WDMV40KWH	4.00" X 5.50" X 96"	36 / 72	30, 35, 40, 50



Available in 3000K, 3500K and 5000K.

Wall Linear 6" x 6"

ITEM NO.	DESCRIPTION		
66WMW48LR24W2400LDMV40KWH	6.00" X 6.00" X 48" / 24W, 2400L, 4000K		
66WMW48LR48W4800LDMV40KWH	6.00" X 6.00" X 48" / 48W, 4800L, 4000K		
66WMW96LR48W4800LDMV40KWH	6.00" X 6.00" X 96" / 48W, 4800L, 4000K		
66WMW96LR97W9600LDMV40KWH	6.00" X 6.00" X 96" / 97W, 9600L, 4000K		
Direct/Indirect	Size	Watts Up/Down	Color Options
66WMW48LUR12WD24WDMV40KWH	6.00" X 6.00" X 48"	12 / 24	30, 35, 40, 50
66WMW48LUR24WD48WDMV40KWH	6.00" X 6.00" X 48"	18 / 36	30, 35, 40, 50
66WMW96LUR24WD48WDMV40KWH	6.00" X 6.00" X 96"	24 / 48	30, 35, 40, 50
66WMW96LUR36WD72WDMV40KWH	6.00" X 6.00" X 96"	36 / 72	30, 35, 40, 50



See Matching Pendants or Surface Mounts on page 11

Available in 3000K, 3500K and 5000K.

Wall Linear Window LED with Direct/Indirect Lighting

ITEM NO.	DESCRIPTION		
SLWMW48LS48W4800LDMV40KWH	7.60" x 1.9" x 48" / 48W, 4800L, 4000K		
SLWMW96LS96W9600LDMV40KWH	7.60" x 1.9" x 96" / 96W, 9600L, 4000K		
Direct/Indirect	Size	Watts Up/Down	Color Options
SLWMW48LUS12WD24WDMV40KWH	7.60" x 1.9" x 48"	12 / 24	30, 35, 40, 50
SLWMW48LUS18WD36WDMV40KWH	7.60" x 1.9" x 48"	18 / 36	30, 35, 40, 50
SLWMW96LUS24WD48WDMV40KWH	7.60" x 1.9" x 96"	24 / 48	30, 35, 40, 50
SLWMW96LUS36WD72WDMV40KWH	7.60" x 1.9" x 96"	36 / 72	30, 35, 40, 50



All available with Emergency. Add EM.

Available in 3000K, 3500K and 5000K.

NEW



SSSTR



SSSTS

Stairwell Linear LED with Step Dim Driver (consult for other Driver Options)

ITEM NO.	DESCRIPTION
SSSTRMW24LE27W2400LSTMV40K	2 ft / 27W, 2400L with 50% Step Dim, Color Temp 30, 35, 40, 50
SSSTRMW48LE36W3500LSTMV40K	4 ft / 36W, 3500L with 50% Step Dim, Color Temp 30, 35, 40, 50
SSSTSMW24LE27W2400LSTMV40K	2 ft / 27W, 2400L with 50% Step Dim, Color Temp 30, 35, 40, 50
SSSTSMW48LE36W3500LSTMV40K	4 ft / 36W, 3500L with 50% Step Dim, Color Temp 30, 35, 40, 50

Add EM for Emergency. Available in 3000K, 3500K and 5000K

Stairwell Linear LED with Step Dim Driver (consult for other options)



ITEM NO.	SIZE	WATTS/LUMENS	COLOR OPTIONS (X100 Kelvins)
SS213A24LE15W2050LSTMV40K	4.4" x 24"	15 / 2050	30, 35, 40, 50
SS213A24LE24W3000LSTMV40K	4.4" x 24"	24 / 3000	30, 35, 40, 50
SS213A48LE48W6000LSTMV40K	4.4" x 48"	48 / 6000	30, 35, 40, 50
SS213A48LE57W6900LSTMV40K	4.4" x 48"	57 / 6900	30, 35, 40, 50

Add EM for Emergency.

4" Wall Linear



ITEM NO.	SIZE	WATTS/LUMENS	COLOR OPTIONS (X100 Kelvins)
555MW24LS24W2400LDMV40KWH	4.3" x 24"	24 / 2400	30, 35, 40, 50
555MW24LS28W2700LDMV40KWH	4.3" x 24"	28 / 2700	30, 35, 40, 50
555MW24LS35W3200LDMV40KWH	4.3" x 24"	35 / 3200	30, 35, 40, 50
555MW48LS30W4100LDMV40KWH	4.3" x 48"	30 / 4100	30, 35, 40, 50
555MW48LS48W6000LDMV40KWH	4.3" x 48"	48 / 6000	30, 35, 40, 50
555MW48LS57W6900LDMV40KWH	4.3" x 48"	57 / 6900	30, 35, 40, 50
555MW48LS72W7000LDMV40KWH	4.3" x 48"	72 / 7000	30, 35, 40, 50

For Emergency Add EM.

LED Spill Ring Bath



ITEM NO.	DESCRIPTION
HOTBD24L23W2195LMVSN30K	24.5"L x 5.7"W x 4.5"E 23W, 2195 Lumens 3000K, Multi-Volt Satin Nickel
HOTBD36L34W3260LMVSN30K	36.5"L x 5.7"W x 4.5"E 34W, 3261 Lumens 3000K, Multi-Volt Satin Nickel
HOTBD48L48W4590LMVSN30K	48.5"L x 5.7"W x 4.5"E 48W, 4594 Lumens 3000K, Multi-Volt Satin Nickel

VAN Series



ITEM NO.	DESCRIPTION
VAN24LS24W2250LDMV40KSW	4.75" x 4.00" x 24.125" / 24W, 2250L, 4000K
VAN24LS28W2550LDMV40KSW	4.75" x 4.00" x 24.125" / 28W, 2550L, 4000K
VAN48LS32W3250LDMV40KSW	4.75" x 4.00" x 48.125" / 32W, 3250L, 4000K
VAN48LS48W4500LDMV40KSW	4.75" x 4.00" x 48.125" / 48W, 4500L, 4000K
VAN48LS57W5100LDMV40KSW	4.75" x 4.00" x 48.125" / 57W, 5100L, 4000K

Change SW to BM (Black Marble), IV (Ivory Marble), etc for end cap in different finish. See specification for more end cap choices. Available in 3000K, 3500K and 4000K

Large Job Quantities, Call For A Quote.

TEXAS FLUORESCENTS

LED Retrofits



Install in Minutes:
Place Rails between fixture and T-Bar on each side. Then latch and secure All-In-One-LED-Retrofit into place.



Watch Installation Video on YouTube.com, Texas Fluorecents Channel
<https://www.youtube.com/channel/UCxulbwrIXpLi2xxyGhGe3YQ>



All-In-One Retrofit LED Troffer Kits

Convert an existing linear fluorescent fixture to a state-of-the-art Linear LED fixture in minutes with this LED All-In-One Retrofit Kit. Choose from two great styles of Linear LED fixtures that will not only increase lighting performance, save energy and reduce maintenance but provide a fresh new look for the space. The LED Center Basket All-In-One Retrofit provides the look of a popular direct/indirect linear fixture with a special designed reflector and LED lens to provide comfortable, abundant lighting. The Chicklet Retrofit Kit provides a luminous pillow styled lends and a high level of lighting with a dramatic appearance. Each kit mounts in minutes with all the LED components neatly engineered in one simple frame that mounts to two side rails that mount between the existing fixture body and the T-bar. Available in 2x2 or 2x4 sizes and a variety of wattage, lumens and color temperatures.

Center Basket

ITEM NO.	ITEM NO.
DFUCLL22LF24W3000LDMV40K*	Door Frame Center Basket Retro 2x2 24W, 2400 Lumen, 40K, 0-10V Dimming Capable
DFUCLL22LF28W3350LDMV40K*	Door Frame Center Basket Retro 2x2 28W, 2800 Lumen, 40K, 0-10V Dimming Capable
DFUCLL22LF35W4300LDMV40K*	Door Frame Center Basket Retro 2x2 32W, 3200 Lumen, 40K, 0-10V Dimming Capable
DFUCLL24LF32W4650LDMV40K*	Door Frame Center Basket Retro 2x4 32W, 3200 Lumen, 40K, 0-10V Dimming Capable
DFUCLL24LF48W6750LDMV40K*	Door Frame Center Basket Retro 2x4 48W, 4800 Lumen, 40K, 0-10V Dimming Capable
DFUCLL24LF57W7800LDMV40K*	Door Frame Center Basket Retro 2x4 57W, 5700 Lumen, 40K, 0-10V Dimming Capable
DFUCLL24LF62W8100LDMV40K*	Door Frame Center Basket Retro 2x4 62W, 8100 Lumen, 40K, 0-10V Dimming Capable

For other color temperatures, replace 40K with 30K, 35K or 50K.
Consult for other wattage and lumen options and emergency driver.

Chicklet Frosted Lens

ITEM NO.	ITEM NO.
DFCKFR22LF24W2400LDMV40K	Door Frame Chicklet Frosted Lens Retro 2x2 24W, 2400 Lumen, 40K, 0-10V Dimming Capable
DFCKFR22LF28W2800LDMV40K	Door Frame Chicklet Frosted Lens Retro 2x2 28W, 2800 Lumen, 40K, 0-10V Dimming Capable
DFCKFR22LF32W3200LDMV40K	Door Frame Chicklet Frosted Lens Retro 2x2 32W, 3200 Lumen, 40K, 0-10V Dimming Capable
DFCKFR24LF32W3200LDMV40K	Door Frame Chicklet Frosted Lens Retro 2x4 32W, 3200 Lumen, 40K, 0-10V Dimming Capable
DFCKFR24LF40W4000LDMV40K	Door Frame Chicklet Frosted Lens Retro 2x4 40W, 4000 Lumen, 40K, 0-10V Dimming Capable
DFCKFR24LF48W4800LDMV40K	Door Frame Chicklet Frosted Lens Retro 2x4 48W, 4800 Lumen, 40K, 0-10V Dimming Capable
DFCKFR24LF57W5700LDMV40K	Door Frame Chicklet Frosted Lens Retro 2x4 57W, 5700 Lumen, 40K, 0-10V Dimming Capable

For other color temperatures, replace 40K with 30K, 35K or 50K.
Consult for other wattage and lumen options and emergency driver.

U.S. Pat. No. 9206948

VL LED Center Basket Retrofit

ITEM NO.	DESCRIPTION
RKCB22L36W4680LDMV40K	22.52" x 20.67" x 2.6" / 36W, 4680 Lumens, 4000K
RKCB22L36W4680LDMV50K	22.52" x 20.67" x 2.6" / 36W, 4680 Lumens, 5000K
RKCB24L36W4900LDMV40K	20.67" x 47.8" x 2.6" / 36W, 4902 Lumens, 4000K
RKCB24L36W4900LDMV50K	20.67" x 47.8" x 2.6" / 36W, 4902 Lumens, 5000K

TEXAS FLUORESCENTS

Troffer Retrofits

LED Troffer Retrofit Kit

ITEM NO.	DESCRIPTION
22CF24W2600LW10DMV40K*	2x2 / 24W, 2600L / Color Temp - 30, 35, 40, 50
22CF28W3000LW10DMV40K*	2x2 / 28W, 3000L / Color Temp - 30, 35, 40, 50
22CF35W3600LW10DMV40K*	2x2 / 35W, 4400L / Color Temp - 30, 35, 40, 50
24CF35W3650LW10DMV40K*	2x4 / 35W, 3650L / Color Temp - 30, 35, 40, 50
24CF48W5650LW10DMV40K*	2x4 / 48W, 5650L / Color Temp - 30, 35, 40, 50
24CF56W6050LW10DMV40K*	2x4 / 56W, 6050L / Color Temp - 30, 35, 40, 50

VL LED Troffer Retrofit

ITEM NO.	DESCRIPTION
24CV46W6200LDMV40K	2x4 / 46W, 6200L / Color Temp 40



Consult for
Parabolic Retrofit Kit

Strip Retrofit (Convert Fluorescent Strips to LED)

LED Strip Retrofit Kit Round Profile

ITEM NO.	DESCRIPTION
RSR48LT20W2700LDMV40K	4.25" 48" Strip LED Round Frost Lens 20W 2700 Lumens 4000K
RSR48LT30W3450LDMV40K	4.25" 48" Strip LED Round Frost Lens 30W 3450 Lumens 4000K
RSR48LT41W4300LDMV40K	4.25" 48" Strip LED Round Frost Lens 41W 4300 Lumens 4000K
RSR48LT58W6700LDMV40K	4.25" 48" Strip LED Round Frost Lens 58W 6700 Lumens 4000K
RSR96LT40W4700LDMV40K	4.25" 96" Strip LED Round Frost Lens 40W 4700 Lumens 4000K
RSR96LT60W6900LDMV40K	4.25" 96" Strip LED Round Frost Lens 60W 6900 Lumens 4000K
RSR96LT82W8900LDMV40K	4.25" 96" Strip LED Round Frost Lens 82W 8900 Lumens 4000K
RSR96LT116W13400LDMV40K	4.25" 96" Strip LED Round Frost Lens 116W13400 Lumens 4000K

Add EM for Emergency. Available in 3000K, 3500K, and 5000K.



Complete fixture available. Add
"C" in front of item number.

LED Strip Retrofit Kit Flat Profile

ITEM NO.	DESCRIPTION
RSF48LT20W2700LDMV40K	4.25" 48" Strip LED Flat Frost Lens 20W 2700 Lumens 4000K
RSF48LT30W3450LDMV40K	4.25" 48" Strip LED Flat Frost Lens 30W 3450 Lumens 4000K
RSF48LT41W4300LDMV40K	4.25" 48" Strip LED Flat Frost Lens 41W 4300 Lumens 4000K
RSF48LT58W6700LDMV40K	4.25" 48" Strip LED Flat Frost Lens 58W 6700 Lumens 4000K
RSF96LT40W4700LDMV40K	4.25" 96" Strip LED Flat Frost Lens 40W 4700 Lumens 4000K
RSF96LT60W6900LDMV40K	4.25" 96" Strip LED Flat Frost Lens 60W 6900 Lumens 4000K
RSF96LT82W18900LDMV40K	4.25" 96" Strip LED Flat Frost Lens 82W 8900 Lumens 4000K
RSF96LT116W13400LDMV40K	4.25" 96" Strip LED Flat Frost Lens 116W13400 Lumens 4000K

Add EM for Emergency. Available in 3000K, 3500K and 5000K.



Complete fixture available. Add
"C" in front of item number.

Need a Custom LED Retrofit Kit. Contact Us. Our Engineers can develop and sample the perfect retrofit for your project.

TEXAS FLUORESCENTS

Strip Retrofits

LED Strip Ballast Cover Retrofit Kit



Frosted lens accessory reduces LED brightness. C48FRLN

ITEM NO.	SIZE (W X L)	Watts / Lumens	Color Options (X100 Kelvins)
4RB421F24W2800LDMV40K	4.25" x 48"	24 / 2800	30, 35, 40, 50
4RB421F48W5650LDMV40K	4.25" x 48"	48 / 5650	30, 35, 40, 50
4RB421F57W6400LDMV40K	4.25" x 48"	57 / 6400	30, 35, 40, 50
4RB501F24W2800LDMV40K	5" x 48"	24 / 2800	30, 35, 40, 50
4RB501F48W5650LDMV40K	5" x 48"	48 / 5650	30, 35, 40, 50
4RB501F57W6400LDMV40K	5" x 48"	57 / 6400	30, 35, 40, 50
8RB421F48W5650LDMV40K	4.25" x 96"	48 / 5650	30, 35, 40, 50
8RB421F97W11300LDMV40K	4.25" x 96"	97 / 11300	30, 35, 40, 50
8RB421F114W12800LDMV40K	4.25" x 96"	114 / 12800	30, 35, 40, 50
8RB501F48W5650LDMV40K	5" x 96"	48 / 5650	30, 35, 40, 50
8RB501F97W11300LDMV40K	5" x 96"	97 / 11300	30, 35, 40, 50
8RB501F114W12800LDMV40K	5" x 96"	114 / 12800	30, 35, 40, 50

Add EM for Emergency.



CTC / WALL Fixture Retrofits (AC with Driver on Board and Heat Sink) Energy Star Rated



ITEM NO.	DESCRIPTION
EOS12W900LD12030KSQ	EOS Array w/6" Sq Alum Heat Sink - 12W, 900L, 3000K
EOS12W1000LD12040KSQ	EOS Array w/6" Sq Alum Heat Sink - 12W, 1000L, 4000K
EOS15W1350LD12030KSQ	EOS Array w/8" Sq Alum Heat Sink - 15W, 1350L, 3000K
EOS15W1400LD12040KSQ	EOS Array w/8" Sq Alum Heat Sink - 15W, 1400L, 4000K
EOS22W1850LD12030KSQ	EOS Array w/8" Sq Alum Heat Sink - 22W, 1850L, 3000K
EOS22W1900LD12040KSQ	EOS Array w/8" Sq Alum Heat Sink - 22W, 1900L, 4000K

Dimmable with standard dimmer. UL Classified for retrofit



CTC Retrofit for 11" or 14" with Heat Sink - Dimmable w/standard dimmer

ITEM NO.	DESCRIPTION
DAC15W1350L30K	LED Array 120V for 11" CTC 15W, 1350L / Color Temp 30, 40, 50
DAC14L25W1850L30K	LED Array 120V for 14" CTC 25W, 1850L / Color Temp 30, 40, 50

Retrofit Your Store To Stand Out

(See the difference using LED Troffer Retrofit from page 21)



Need a Custom LED Retrofit Kit. Contact Us.

TEXAS FLUORESCENTS

LED Close-To-Ceiling



LED Spill Ring Close-To-Ceiling

ITEM NO.	DESCRIPTION
HOTCD12L18W1400LMVSN30K	11.8"D x 4.2"H 18W, 1439 Lumens, 3000K, Multi-Volt Satin Nickel
HOTCD14L24W2250LMVSN30K	14.5"D x 4.6"H 24W, 2267 Lumens, 3000K, Multi-Volt Satin Nickel*
HOTCD18L33W3300LMVSN30K	11.8"D x 4.2"H 33W, 3300 Lumens, 3000K, Multi-Volt Satin Nickel

Consult for 16 inch Version. For 4000K change 30K to 40K

NEW!!

CTC 11" Twist Lock Brushed Nickel LED 120V (Dimmable)



ITEM NO.	DESCRIPTION
HTCA11L15W800LD12040KBN	11" Brushed Nickel/Frosted Glass 15W, 800L, 4000K, Dimmable 120V, 50000 Hrs

Change 40K to 30K or 50K

CTC 11" & 14" Sleek Brushed Nickel LED 120V (Dimmable)



ITEM NO.	DESCRIPTION
HTCB11L15W900LD12040KBN	11" Brushed Nickel/Polycarbonate Diffuser 15W, 900L 4000K, Dimmable 120V, 50000 Hrs
HTCB14L25W1200LD12040KBN	14" Brushed Nickel/Polycarbonate Diffuser 25W, 1200L 4000K, Dimmable 120V, 50000 Hrs

Change 40K to 30K or 50K

CTC 11" & 14" Mushroom LED 120V (Dimmable)



ITEM NO.	DESCRIPTION
MUS11L15W1000LD12040K	11" Mushroom White/Polycarbonate Diffuser 15W, 1000L 4000K, Dimmable 120V, 50000 Hrs
MUS14L25W1600LD12040K	14" Mushroom White/Polycarbonate Diffuser 25W, 1600L 4000K, Dimmable 120V, 50000 Hrs

Change 40K to 30K or 50K

LED Drum Fixture



ITEM NO.	DESCRIPTION
CIRDC11L13W900LD12030K	11" Drum 13W 900 Lumens, Dimmable 120V 3000K
CIRDC11L14W1350LD12030K	11" Drum 14W 1350 Lumens, Dimmable 120V 3000K
CIRDC14L14W1350LD12030K	14" Drum 14W 1350 Lumens, Dimmable 120V 3000K
CIRDC14L23W1850LD12030K	14" Drum 23W 1850 Lumens, Dimmable 120V 3000K

Consult for multi-volt and other wattage and lumen options.

LED Mushroom Fixture



ITEM NO.	DESCRIPTION
TFC11L13W900LD12030K	11" Mushroom 13W 900 Lumens, Dimmable 120V 3000K
TFC11L14W1350LD12030K	11" Mushroom 14W 1350 Lumens, Dimmable 120V 3000K
TFC14L14W1350LD12030K	14" Mushroom 14W 1350 Lumens, Dimmable 120V 3000K
TFC14L23W1850LD12030K	14" Mushroom 23W 1850 Lumens, Dimmable 120V 3000K

Change 30K to 40K for 4000K. Consult for multi-volt and other wattage and lumen options.

LED Dome Fixture



ITEM NO.	DESCRIPTION
HOTCE11L13W900LD12030K	11" Dome 13W 900 Lumens, Dimmable 120V 3000K
HOTCE11L14W1350LD12030K	11" Dome 14W 1350 Lumens, Dimmable 120V 3000K
HOTCE14L14W1350LD12030K	14" Dome 14W 1350 Lumens, Dimmable 120V 3000K
HOTCE14L23W1850LD12030K	14" Dome 23W 1850 Lumens, Dimmable 120V 3000K

Change 30K to 40K for 4000K. Consult for multi-volt and other wattage and lumen options.

Surface Mount Discs Wet Location

Ultra Thin Faux Downlight **Wet Location**

Choose either a round or square silhouette in two sizes and two finishes, white and brushed nickel with a special regressed lens to provide even, comfortable illumination from these edge-lit fixtures. Wet location for indoor and outdoor use. 120V only. Dims to 10% with standard dimmers.



ITEM NO.	DESCRIPTION
RCS5L10W660L30KWH	Square 6.3 inches Diagonal, 10W, 660 Lumens, 3000K, 120V, White
RCS5L10W660L30KBN	Square 6.3 inches Diagonal, 10W, 660 Lumens, 3000K 120V, Brushed Nickel
RCS7L15W1000L30KWH	Square 8.0 inches Diagonal, 15W, 1000 Lumens, 3000K, 120V, White
RCS7L15W1000L30KBN	Square 8.0 inches Diagonal, 15W, 1000 Lumens, 3000K, 120V, Brushed Nickel
RCR5L10W660L30KWH	Round, 5.5 inches Diameter, 10W, 660 Lumens, 3000K, 120V White
RCR5L10W660L30KBN	Round, 5.5 inches Diameter, 10W, 660 Lumens, 3000K, 120V Brushed Nickel
RCR7L15W1000L30KWH	Round, 7.0 inches Diameter, 15W, 1000 Lumens, 3000K, 120V White
RCR7L15W1000L30KBN	Round, 7.0 inches Diameter, 15W, 1000 Lumens, 3000K, 120V Brushed Nickel

Micro LED Surface Mount **Wet Location**



ITEM NO.	DESCRIPTION
SMC4L12W900L30KWH	4" (5.9" OD) White, 12W 876L, CRI > 80, 3000K, 120V, with 20W Dimmable Driver. Surface Mount.
SMC6L15W1100L30KWH	6" (7.4" OD) White, 15W 1095L, CRI > 80, 3000K, 120V, Dimmable Driver. Surface Mount.
SMC9L26W2100L30KWH	9" Diameter, 26W, 2100 Lumen, 30K in White Dimmable Driver, Surface Mount
SMC4RECACC	Recessed Accessory Kit to Retro SMC4L Series into 4" Recessed White Can Housings
SMC6RECACC	Recessed Accessory Kit to Retro SMC6L Series into 6" Recessed White Can Housings

Consult for bronze and satin nickel. Also available in 9 inch version - 26 watt.

Now Available in 277V and Emergency. See page 18.

SMC Emergency and 277V Version



ITEM NO.	DESCRIPTION
SMC6L15W1100L30KWH-277V	Surface Disc in 277V 15W, 1100L, 30K in White
SMC6L15W1100L30KWH-EM	Surface Disc with Integral Emergency Back-Up in recessed junction Box; 15W 1100L; EM mode 6w 400L 3000K White

Emergency version comes with junction box.

Micro Economy LED Surface Mount



ITEM NO.	DESCRIPTION
LMC6L15W1000L12030KWH	Surface Mount LED 15W 1000L, Dimmable. 35000 Hours. 7.4"OD x 1.26"H, White
LMC6L15W1000L12030KBN	Surface Mount LED 15W 1000L, Dimmable. 35000 Hours. 7.4"OD x 1.26"H, Brushed Nickel

TEXAS FLUORESCENTS

Surface Discs 11" and 15"



ITEM NO.	DESCRIPTION
SMC11L28W1700LD12030KBN	SURFACE Disc 11" Dia LED 28W 1700 lumen BN
SMC11L28W1700LD12030KWH	SURFACE Disc 11" Dia LED 28W 1700 lumen WH
SMC15L40W2500LD12030KBN	SURFACE Disc 15" Dia LED 40W 2500 lumen BN
SMC15L40W2500LD12030KWH	SURFACE Disc 15" Dia LED 40W 2500 lumen WH

Stylish and Really Economical LED Disk, Ideal for C-T-C



ITEM NO.	DESCRIPTION
TDL6L15W1100L30KWH	7 3/8"D x 1 1/2"H DISK LIGHT 15W/1100 Lumen 120V AC 3000K WHITE
TDL6L15W1100L30KBA	7 3/8"D x 1 1/2"H DISK LIGHT 15W/1100 Lumen 120V AC 3000K BRUSHED ALUMINUM
TDL6L15W1100L30KBZ	7 3/8"D x 1 1/2"H DISK LIGHT 15W/1100 Lumen 120V AC 3000K BRONZE
TDL6RECACC	Recessed Accessory Kit for TDLG

Change 30K to 40K

LED Undercabinet



LED Linkable Undercabinet

ITEM NO.	DESCRIPTION
LUC9L5WE120	9" LED undercabinet lights, Dimmable, linkable, 5w
LUC12L6WE120	12" LED undercabinet lights, Dimmable, linkable, 6w
LUC18L9WE120	18" LED undercabinet lights, Dimmable, linkable, 9w
LUC24L11WE120	24" LED undercabinet lights, Dimmable, linkable, 11w
LUC33L13WE120	33" LED undercabinet lights, Dimmable, linkable, 13w
LUC42L16WE120	42" LED undercabinet lights, Dimmable, linkable, 16w

Undercabinets come with power cord, joiner cable and a BX connector.

LED Dimmable Undercabinet Task Lighting

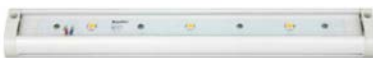

ITEM NO.	SIZE	WATTS / LUMENS	COLOR OPTIONS (x100) Kelvins
LEDDUCL12WH30	2" 12"	5 / 250	30
LEDDUCL18WH30	2" x 18"	8 / 400	30
LEDDUCL24WH30	2" x 24"	11 / 525	30
LEDDUCLJBOXWH	Junction Box for hardwire		

For Large Job Quantities, Call for Quote.

TEXAS FLUORESCENTS

Enclosures/Parking Garage

Enclosures Low Bay



ITEM NO.	SIZE (W X L)	Watts / Lumens	Color Options (X100 Kelvins)
CITE48LRFF48W5600LLBDMV40K	7.3" x 51.8"	48 / 5600	30, 35, 40, 50
CITE48LRFF57W6800LLBDMV40K	7.3" x 51.8"	57 / 6800	30, 35, 40, 50
CITE96LRFF97W11200LLBDMV40K	7.3" x 98.5"	97 / 11200	30, 35, 40, 50
CITE96LRFF114W13600LLBDMV40K	7.3" x 98.5"	114 / 13600	30, 35, 40, 50

For emergency, add EM. Consult for sensors. Consult for stainless steel latches.

Consult for New Narrow Economy Version 48 inch.

Enclosures Parking Garage



ITEM NO.	SIZE (W X L)	Watts / Lumens	Color Options (X100 Kelvins)
CITE48LRFF48W4500LPGDMV40K	7.3" x 51.8"	48 / 4500	30, 35, 40, 50
CITE48LRFF57W5100LPGDMV40K	7.3" x 51.8"	57 / 5100	30, 35, 40, 50
CITE48LRFF72W7000LPGDMV40K	7.3" x 51.8"	72 / 7000	30, 35, 40, 50
CITE96LRFF57W5100LPGDMV40K	7.3" x 98.5"	57 / 5100	30, 35, 40, 50
CITE96LRFF97W9050LPGDMV40K	7.3" x 98.5"	97 / 9050	30, 35, 40, 50

For emergency. Consult for sensors. Consult for stainless steel latches.



Outdoor Wet Location Wall/Ceiling (Bug Proof) IP65

ITEM NO.	DESCRIPTION
OUTMW15W1200LD120BK40K	LED Round 12" diameter - Black 120V only 1200 Lumens 4000K
OUTMW15W1200LD120BK30K	LED Round 12" diameter - Black 120V only 1200 Lumens 3000K
OUTMW15W1200LD120WH40K	LED Round 12" diameter -White 120V only 1200 Lumens 4000K
OUTMW15W1200LD120WH30K	LED Round 12" diameter -White 120V only 1200 Lumens 3000K

Consult for eyelid shield and occupancy sensor.

* LED Canopy Wet Location



ITEM NO.	SIZE (W x L)
CPY10L45W4200LMV50K*	CANOPY LED - 45W - 4200 Lumen - 100-277V - 5000K - CRI 70- Finish: Bronze - uL/CuL/DLC
CPY10L65W6600LMV50K*	CANOPY LED - 65W - 6600 Lumen - 100-277V - 5000K - Finish: Bronze - uL/CuL/DLC

* LED Canopy **Wet Location**



ITEM NO.	DESCRIPTION
CPY10L40W3600LMV50K*	10 Inch Square, 40 Watt, 3600 Lumen, 120V or 277V, 5000K

1/2in threaded conduit entries on two sides - 3/4in threaded. Minimum starting temperature is - 40° C. Non dimmable.

Garage Quad LED



ITEM NO.	DESCRIPTION
PGL55W4300LMV50K	LED Parking Garage 55W 4300 Lumens 50K 17.3"W x 17.3"L x 4"H

TEXAS FLUORESCENTS

Outdoor Wall Pack & Floods

Economy Wall Pack



ITEM NO.	DESCRIPTION
DC150E45W5300LMV50KC*	ECONOMY WALLPACK LED - 45W - 5000K - 5300 LUMENS - 100-277V - FINISH: BRONZE - UL/cUL/DLC
DC150E70W8100LMV50K*	ECONOMY WALLPACK LED - 70W - 5000K - 8100 LUMENS - 100-277V - FINISH: BRONZE - UL/cUL/DLC
DC200E90W11200LMV50K*	ECONOMY WALLPACK LED LARGE - 90W - 5000K - 11000 LUMENS - 100-277V - FINISH: BRONZE - UL/cUL/DLC
DC200E135W16400LMV50K*	ECONOMY WALLPACK LED LARGE - 135W - 5000K - 15600 LUMENS - 100-277V - FINISH: BRONZE - UL/cUL/DLC

Mini LED Wall Pack



ITEM NO.	DESCRIPTION
DC056L17W1850LMV50K*	WALL MOUNT LED - 17W - 1850 Lumen - 120-277V - 5000K - Finish: Bronze - Frosted Lens - cUL/DLC * non dimmable ** no photocell **
DC056L17W1850LMV50KPC*	WALL MOUNT LED - 17W - 1850 Lumen - 120-277V - 5000K - Finish: Bronze - Frosted Lens - cUL/DLC ** non dimmable ** 120-277V installed photocell **
DC056L25W2450LMV50K*	WALL MOUNT LED - 25W - 2450 Lumen - 120-277V - 5000K - Finish: Bronze - Frosted Lens - cUL/DLC ** non dimmable ** no photocell **
DC056L25W2450LMV50KPC*	WALL MOUNT LED - 25W - 2450 Lumen - 120-277V - 5000K - Finish: Bronze - Frosted Lens - cUL/DLC ** non dimmable ** 120-277V installed photocell **

LED Cutoff Wall Pack



ITEM NO.	DESCRIPTION
DCC150E45W4900LMV50K*	ECONOMY CUTOFF WALLPACK LED - 45W - 5000K - 4900L 100-277V - BRONZE - DIM Type III beam angle
DCC200E90W9500LMV50K*	ECONOMY CUTOFF WALLPACK LED - 90W - 5000K - 9500L 100-277V - BRONZE - DIM Type III beam angle
DCC200E135W14000LMV50K*	ECONOMY CUTOFF WALLPACK LED - 135W - 5000K - 14000L 100-277V - BRONZE - DIM Type III beam angle

Area Light



ITEM NO.	DESCRIPTION
PLF15L150W20000LDMV50K*	AREA LIGHT LED - 150W - 5000K - 20000L - 100-277V - BRONZE - 0-10V DIM Type III beam angle
PLF15L200W24500LDMV50K*	AREA LIGHT LED - 200W - 5000K - 24500L - 100-277V - BRONZE - 0-10V DIM Type III beam angle
PLF23L300W39000LDMV50K	AREA LIGHT LED - 300W - 5000K - 39000L - 100-277V - BRONZE - 0-10V DIM Type III beam angle **
PLF23L300W39000LD48050K	AREA LIGHT LED - 300W - 5000K - 39000L - 347-480V - BRONZE - 0-10V DIM Type III beam angle **

Accessories for Area Light



ITEM NO.	DESCRIPTION
PLFSARM	Square pole mntg. arm for PLF Series BRZ 6.97" x 8.578" x 2.55"
PLFRARM	Round pole mntg. arm for PLF Series BRZ 6.97" x 8.578" x 2.55"
PLFSW	Slip fitter mntg. arm for PLF Series BRZ 9.989" x 3.346"
PLF15TR	Trunnion fitter for PLF Series BRZ 13.268" x 8.661" x 1.457"
PLF23TR	Trunnion fitter for PLF Series BRZ 13.3" x 12.3" x 1.457"
PLFWARM	Wall mntg. arm for PLF Series BRZ 7.99" x 5.98" x 8.027"

TEXAS FLUORESCENTS



LED Small Round Flood

ITEM NO.	DESCRIPTION
LFS4L8W650LMV40KBZ	8W 650L MV 40K BZ

Available in white.



Mini Flood

ITEM NO.	DESCRIPTION
LFS46L20W1500LMV40KBZ	LED FLOOD SQ 20W 1500L MV 40K BZ 6"W x 4.75"H x 6"Ext
LFS46L20W1500LMV40KWH	LED FLOOD SQ 20W 1500L MV 40K WH 6"W x 4.75"H x 6"Ext



ITEM NO.	DESCRIPTION
LFS57L30W2700LMV40KBZ	LED FLOOD SQ 30W 2700L MV 40K BZ 7.75"W x 5.75"H x 6.5"Ext
LFS57L30W2700LMV40KWH	LED FLOOD SQ 30W 2700L MV 40K WH 7.75"W x 5.75"H x 6.5"Ext



LED Vapor Proof

ITEM NO.	DESCRIPTION
VPC6L14W900LMV50K	CEILING MOUNT VAPOR PROOF LED VPC, 8.75X12.1, 14W, 900L 120-277V DRIVER, 5000K
VPW6L14W900LMV50K	VAPORPROOF LED WALL MOUNT - FROST GLASS - 14W 900 LUMEN 5000K, 120-277V

Outdoor Ceiling

Wet Location Close-To-Ceiling



F1303 - Round



F1302 - Square



ITEM NO.	DESCRIPTION
F13032INCLPLEDWH	ROUND CEILING WET 2Incand. socket & LED Lamp 9.5W A19 27K Incl. White Dimmable 120V
F1303L23W1900LD120WH40K	ROUND CEILING WET 23W 1900L White Dimmable 120V
F1303L22W1824LMVWH40K	ROUND CEILING WET 22W 1824L White Multi-Volt
F13022INCLPLEDWH	SQUARE CEILING WET 2 Incand. socket & LED Lamp 9.5W A19 27K Incl. White Dimmable 120V
F1302L23W1900LD120WH40	SQUARE CEILING WET 23W 1900L White Dimmable 120V
F1302L22W1824LMVWH40K	SQUARE CEILING WET 22W 1824L White Multi-Volt

For 3000K change 40K to 30K. For Black body, change WH to BK. See LED Lamp spec on page 30

TEXAS FLUORESCENTS

Outdoor Ceiling



Outdoor Octagon Series

ITEM NO.	DESCRIPTION
OCLINCLPLEDWH	OCTAGON CEILING Incand. socket & LED Lamp 9.5W A19 27K Incl. White Dimmable 120V
OCL10L14W1400LD120WH40K	OCTAGON CEILING 14W 1400L White Dimmable 120V
OCL10L23W1900LD120WH40K	OCTAGON CEILING 23W 1900L White Dimmable 120V

For 3000K change 40K to 30K. For Black, change WH to BK

Square Ceiling LED

ITEM NO.	DESCRIPTION
CBPINCLPLEDWH	8.25" SQUARE Ceiling Incand. socket & LED Lamp 9.5W A19 27K Incl. White Dimmable 120V
CBPL13W1000LD120WH40K	8.25" SQUARE CEILING 13W 1000L White Dimmable 120V
CBPL11W912LMVWH40K	8.25" SQUARE CEILING 11.3W 912L White Multi-Volt



ITEM NO.	DESCRIPTION
BBPINCLPLEDWH	10.25" SQUARE Ceiling Incand. socket & LED Lamp 9.5W A19 27K Incl. White Dimmable 120V
BBPL23W1900LD120WH40K	10.25" SQUARE CEILING 23W 1900L White Dimmable 120V
BBPL22W1824LMVWH40K	10.25" SQUARE CEILING 22W 1824L White Multi-Volt

For Black base lamp change WH to BK

Ceiling Globes

ITEM NO.	DESCRIPTION
BCCINCLPLEDWHCAG	CEILING MOUNT 6" SCREW NECK GLOBE-Incand. socket & LED Lamp 9.5W A19 27K Incl. - White Dimmable 120V



ITEM NO.	DESCRIPTION
BPCINCLPLEDWHWAG	CEILING MOUNT 6" SCREW NECK GLOBE TAPER-Incand. socket & LED Lamp 9.5W A19 27K Incl. - White Dimmable 20V



For Black base lamp change WH to BK

Cylinder Classic Globes

ITEM NO.	DESCRIPTION
BCCINCLPLEDWHWSJ	CEILING MOUNT HARBOR SCREW NECK-Incand. socket & LED Lamp 9.5W A19 27K Incl. - White Dimmable 120V



ITEM NO.	DESCRIPTION
WPCINCLPLEDWHCSJ	CEILING MOUNT HARBOR SCREW NECK TAPER-Incand. socket & LED Lamp 9.5W A19 27K Incl. - White Dimmable 20V



ITEM NO.	DESCRIPTION
BPCINCLPLEDWHWPJ	CEILING MOUNT LONG BEACH TAPER-Incand. socket & LED Lamp 9.5W A19 27K Incl.- White Dimmable 120V

For Black base lamp change WH to BK. For other lens options, consult factory.

ITEM NO.	DESCRIPTION
F1010CLAC2INCLPLED	SQUARE SENTINEL 2 Incand. socket & LED Lamp 9.5W A19 27K Incl. White, Dimmable 120V
F1010CLAC10L14W1400LD12040K	SQUARE SENTINEL, 10.25 SQ.14W 1400L White Dimmable 120V
F1010CLAC10L23W1900LD12040K	SQUARE SENTINEL, 10.25 SQ. 23W 1900L White Dimmable 120V



TEXAS FLUORESCENTS

Outdoor Wall



(Turtle Friendly)



CEO



CEOG



EOS



CEOC



CER



CERG



CERC



Utility LED

ITEM NO.	DESCRIPTION
SWPFRACINCLPLED	Small Wall Pack 5" x 8" Incand. socket & LED Lamp 9.5W A19 27K Incl. White Dimmable 120V
SWPFRACL13W1000LD12040K	Small Wall Pack 13W 1000L White Dimmable 120V
MWPFRACINCLPLED	Medium Wall Pack, Incand. socket & LED Lamp 9.5W A19 27K Incl. White 6" x 10.8" Dimmable 120V
MWPFRACL13W1000LD12040K	Medium Wall Pack 13W 1000L White Dimmable 120V
LWPF15W1500LMV40K	Large Wall Pack Clear Lens 15W 1500L Multi-Volt 40K

For 3000K change 40K to 30K

Wall Cylinders LED

ITEM NO.	DESCRIPTION
WCD10LINCWH	Wall Mount Tall Cylinder- w/Medium Socket White 120V
WCD8LINCWH	Wall Mount Short Cylinder-w/Medium Socket - White 120V

For Black change WH to BK. Lamps sold separately. Ideal for LED Par 30 Lamp

LED Nautical Wall or Ceiling

ITEM NO.	DESCRIPTION
EOINCLPLEDWH	Euro Oval Wall or Ceiling Incand. socket & LED Lamp 9.5W A19 27K Incl. White Dimmable 120V
CEOL13W1000LD120WH40K	Euro Oval Wall or Ceiling 13W 1000L White Dimmable 120V
CEOL11W912LMVWH40K	Euro Oval Wall or Ceiling 11.3W 912L White Multi-Volt

ITEM NO.	DESCRIPTION
EOGINCLPLEDWH	Euro Oval Wall or Ceiling Incand. socket & LED Lamp 9.5W A19 27K Incl. White Dimmable 120V
CEOGL13W1000LD120WH40K	Euro Oval Wall or Ceiling w/Grill 13W 1000L White Dimmable 120V
CEOGL11W912LMVWH40K	Euro Oval Wall or Ceiling w/Grill 11.3W 912L White Multi-Volt

ITEM NO.	DESCRIPTION
EOSINCLPLEDWH	Euro Oval Wall or Ceiling Incand. socket & LED Lamp Incl. White Dimmable 120V
CEOSL13W1000LD120WH40K	Euro Oval Wall or Ceiling w/Eyelid 13W 1000L White Dimmable 120V
CEOSL11W912LMVWH40K	Euro Oval Wall or Ceiling 11.3W 912L White Multi-Volt

For Full Grill change EOS to EOC and CEO to CEOC

ITEM NO.	DESCRIPTION
ERLINCLPLEDWH	Euro Round Wall or Ceiling Incand. socket & LED Lamp Incl. White Dimmable 120V
CERL23W1900LD120WH40K	Euro Round Wall or Ceiling 23W 1900L White Dimmable 120V
CERL22W1824LMVWH40K	Euro Round Wall or Ceiling 22W 1824L White Multi-Volt

ITEM NO.	DESCRIPTION
ERGINCLPLEDWH	Euro Round Wall or Ceiling w/Grill-9.5W A19 27K- White dimmable 120V
CERGL23W1900LD120WH40K	Euro Round Wall or Ceiling w/Grill 23W 1900L White Dimmable 120V
CERGL22W1824LMVWH40K	Euro Round Wall or Ceiling w/Grill 22W 1824L White Multi-Volt

ITEM NO.	DESCRIPTION
ERCINCLPLEDWH	Euro Round Wall or Ceiling w/Mask-9.5W A19 27K- White dimmable 120V
CERCL23W1900LD120WH40K	Euro Round Wall or Ceiling w/Mask 23W 1900L White Dimmable 120V
CERCL22W1824LMVWH40K	Euro Round Wall or Ceiling w/Mask 22W 1824L White Multi-Volt

For 3000K change 40K to 30K. For Black, change WH to BK. See page 30 for LED A19 Lamp spec.



NOB



NOP



NOW



Nautical Lanterns and Post Tops

ITEM NO.	DESCRIPTION
NOBINCLPLEDWH	Nautical Bollard-9.5W A19 27K - White Dimmable 120V
NOBL13W1000LD120WH40K	Nautical Bollard 12W 1000L White Dimmable 120V
NOP2INCLPLEDWH	Double Nautical Post-9.5W A19 27K - White Dimmable 120V
NOP2L26W2000LD120WH40K	Double Nautical Post 26W 2000L White Dimmable 120V
NOPINCLPLEDWH	Single Nautical Post-9.5W A19 27K - White Dimmable 120V
NOPL11W912LMVWH40K	Single Nautical Post 11.3W 912L White Multi-volt
NOPL13W1000LD120WH40K	Single Nautical Post 13W 1000L White Dimmable 120V
NOPL22W1824LMVWH40K	Double Nautical Post 22W 1824L White Multi-volt
NOWINCLPLEDWH	Nautical Wall Incand. socket & LED Lamp 9.5W A19 27K incl. White Dimmable 120V
NOWL11W912LMVWH40K	Nautical Wall 11.3W 912L White Multi-volt
NOWL13W1000LD120WH40K	Nautical Wall 13W 1000L White Dimmable 120V

For 3000K change 40K to 30K. For Black, change WH to BK

Energy Star not available on Post Lanterns

LED Globe Lanterns and Post Tops



GP12



GOW



GP10



ITEM NO.	DESCRIPTION
GOWINCLPLEDWH	8" Globe Wall Mount - Incand. socket & LED Lamp 9.5W A19 27K incl. - White Dimmable 120V
GP10INCLPLEDWH	10" Globe Post Top - Incand. socket & LED Lamp 9.5W A19 27K incl. - White Dimmable 120V
GP12INCLPLEDWH	12" Globe Post Top - Incand. socket & LED Lamp 9.5W A19 27K incl. - White Dimmable 120V
GP14INCLPLEDWH	14" Globe Post Top - Incand. socket & LED Lamp 9.5W A19 27K incl. - White Dimmable 120V
GP16INCLPLEDWH	16" Globe Post Top - Incand. socket & LED Lamp 9.5W A19 27K incl. - White Dimmable 120V

For 3000K change 40K to 30K. For Black, change WH to BK

Energy Star not available on Post Lanterns

Consult for traditional Acorn and Flame Top Post Tops in clear or frosted finishes.

Bradford LED Lanterns and Post Tops



BRP



BRL



BRW

ITEM NO.	DESCRIPTION
BRLINCLPLEDWH	Bradford Long Wall - Incand. socket & LED Lamp 9.5W A19 27K incl. - White Dimmable 120V
BRLL13W1000LD120WH40K	Bradford Long Wall 13W 1000L White Dimmable 120V
BRPINCLPLEDWH	Bradford Post Top Incand. socket & LED Lamp incl. White Dimmable 120V
BRPL13W1000LD120WH40K	Bradford Post Top 13W1000L White Dimmable 120V
BRWINCLPLEDWH	Bradford Short Wall-9.5W A19 27K White Dimmable 120V
BRWL13W1000LD120WH40K	Bradford Short Wall 13W 1000L White Dimmable 120V

Energy Star not available on Post Lanterns

LED A19/E26

- 9.5W
- 800 Lumens 120V 2700K
- Replaces 60W Incandescent or 13W CFL
- CRI 80
- 15,000 Hour Life
- 270 Beam Angle, Dimmable

NOTE: Now fixtures with LED A Lamps can qualify for Energy Star



Consult for 4000K Lamp

TEXAS FLUORESCENTS



Colonial LED Lanterns and Post Tops

ITEM NO.	DESCRIPTION
COLINCLPLEDWH	Colonial Long Wall - Flemish Lens - Incand. socket & LED Lamp 9.5W A19 27K incl. - White Dimmable 120V
COLL13W1000LD120WH40K	Colonial Long Wall - Flemish Lens 13W 1000L, White Dimmable 120V
COPL13W1000LD120WH40K	Colonial Post Top - Flemish Lens 13W 1000L, White Dimmable 120V
COWINCLPLEDWH	Colonial Short Wall - Flemish Lens - Incand. socket & LED Lamp 9.5W A19 27K incl. White Dimmable 120V
COWL13W1000LD120WH40K	Colonial Short Wall - Flemish Lens 13W 1000L, White Dimmable 120V



For 3000K change 40K to 30K. For Black, change WH to BK. See A Lamp specs on page 31.

Energy Star not available on Post Lanterns



Princeton LED Lanterns and Post Tops

ITEM NO.	DESCRIPTION
PRLINCLPLEDWH	Princeton Long Wall - Incand. socket & LED Lamp 9.5W A19 27K incl. - White Dimmable 120V
PRL13W1000LD120WH40K	Princeton Long Wall 13W 1000L, White Dimmable 120V
PRPINCLPLEDWH	Princeton Post Top - Incand. socket & LED Lamp 9.5W A19 27K incl. - White Dimmable 120V
PRPL13W1000LD120WH40K	Princeton Post Top 13W 1000L White Dimmable 120V
PRWINCLPLEDWH	Princeton Short Wall - Incand. socket & LED Lamp 9.5W A19 27K incl. White Dimmable 120V
PRWL13W1000LD120WH40K	Princeton Short Wall 13W 1000L, White Dimmable 120V



For 3000K change 40K to 30K. For Black, change WH to BK. See A Lamp specs on page 31.

Energy Star not available on Post Lanterns



Stagecoach LED Lantern

ITEM NO.	DESCRIPTION
SCWINCLPLEDWH	Wall Mount Stage Coach - Incand. socket & LED Lamp 9.5W A19 27K incl. - White Dimmable 120V
SCWL13W1000LD120WH40K	Wall Mount 13W 1000L White Dimmable 120V

For 3000K change 40K to 30K. For Black, change WH to BK. See A Lamp specs on page 31.

Energy Star not available on Post Lanterns



Economy Wall

ITEM NO.	DESCRIPTION
APWINCLPLEDWH	Wall Mount Small Acorn - Incand. socket & LED Lamp 9.5W A19 27K incl. - White Dimmable 120V
APWL11W912LMV/WH40K	Wall Mount Small Acorn 13W 912L, White Multi-volt
APWL13W1000LD120WH40K	Wall Mount Small Acorn 13W 1000L, White Dimmable 120V
DHINCLPLEDWH	Wall Mount Cottage - Incand. socket & LED Lamp 9.5W A19 27K incl. - White Dimmable 120V
DHL13W1000LD120WH40K	Wall Mount Cottage 13W 1000L White Dimmable 120V



See A Lamp specs on page 31.

Energy Star not available on Post Lanterns

Add Photocell to all LED wall versions PC120.

TEXAS FLUORESCENTS



Amherst LED Lanterns and Post Tops

ITEM NO.	DESCRIPTION
AOLINCLPLEDWH	Amherst Long Wall - Incand. socket & LED Lamp 9.5W A19 27K incl. - White Dimmable 120V
AOLL13W1000LD120WH40K	Amherst Long Wall 13W 1000L, White Dimmable 120V
AOPINCLPLEDWH	Amherst Post Top w/Incand. socket & LED Lamp 9.5W A19 27K incl. White Dimmable 120V
AOPL13W1000LD120WH40K	Amherst Post Top 13W 1000L, White Dimmable 120V
AOWINCLPLEDWH	Amherst Short Wall - Incand. socket & LED Lamp 9.5W A19 27K incl. - White Dimmable 120V
AOWL13W1000LD120WH40K	Amherst Short Wall 13W 1000L White Dimmable 120V

For 3000K change 40K to 30K. For Black, change WH to BK. See A Lamp specs on page 31.
Energy Star not available on Post Lanterns



Hexagon LED Lanterns and Post Tops

ITEM NO.	DESCRIPTION
HOPINCLPLEDWH	Hexagon Post Top - Incand. socket & LED Lamp 9.5W A19 27K incl. - White Dimmable 120V
HOPL13W1000LD120WH40K	Hexagon Post Top 13W 1000L, White Dimmable 120V
HOWINCLPLEDWH	Hexagon Short Wall-9.5W A19 27K -White Dimmable 120V
HOWL13W1000LD120WH40K	Hexagon Short Wall 13W 1000L, White Dimmable 120V
HOLINCLPLEDWH	Hexagon Long Wall - White Dimmable 120V
HOLL13W1000LD120WH40K	Hexagon Long Wall 13W 1000L White Dimmable 120V

For 3000K change 40K to 30K. For Black, change WH to BK. See A Lamp specs on page 31.
Energy Star not available on Post Lanterns



Hatch LED Lanterns and Post Tops

ITEM NO.	DESCRIPTION
HTPINCLPLEDWH	Post Top Hatch - Incand. socket & LED Lamp 9.5W A19 27K incl. - White Dimmable 120V
HTPL13W1000LD120WH40K	Post Top Hatch 13W 1000L, White Dimmable 120V
HTWINCLPLEDWH	Petite Hatch - Incand. socket & LED Lamp 9.5W A19 27K incl. - White Dimmable 120V
HTWL13W1000LD120WH40K	Petite Hatch 13W 1000L, White Dimmable 120V
HTSINCLPLEDWH	Short Hatch - Incand. socket & LED Lamp incl. White Dimmable 120V
HTSL13W1000LD120WH40K	Short Hatch 13W 1000L White Dimmable 120V
HTLINCLPLEDWH	Long Hatch - Incand. socket & LED Lamp 9.5W A19 27K incl. - White Dimmable 120V
HTLL13W1000LD120WH40K	Long Hatch 13W 1000L White Dimmable 120V

For 3000K change 40K to 30K. For Black, change WH to BK. See A Lamp specs on page 31.
Energy Star not available on Post Lanterns



Kingston LED Lanterns and Post Tops

ITEM NO.	DESCRIPTION
KRLINCLPLEDWH	KINGSTON LONG WALL-Incand. socket & LED Lamp 9.5W A19 27K Incl. - White Dimmable 120V
KRLL13W1000LD120WH40K	KINGSTON LONG WALL13W 1000L White Dimmable 120V
KRPINCLPLEDWH	KINGSTON POST TOP Incand. socket & LED Lamp 9.5W A19 27K Incl. White Dimmable 120V
KRPL13W1000LD120WH40K	KINGSTON POST TOP 13W 1000L White Dimmable 120V
KRWINCLPLEDWH	KINGSTON SHORT WALL-Incand. socket & LED Lamp 9.5W A19 27K Incl. - White Dimmable 120V
KRWL13W1000LD120WH40K	KINGSTON SHORT WALL13W 1000L White Dimmable 120V

For 3000K change 40K to 30K. For Black, change WH to BK. See A Lamp specs on page 31.
Energy Star not available on Post Lanterns

TEXAS FLUORESCENTS

Tudor LED Post Tops



ITEM NO.	DESCRIPTION
TOLINCLPLEDBK*	Tudor Long Wall - Incand. socket & LED Lamp 9.5W A19 27K incl. - Black Dimmable 120V
TOLL13W1000LD120BK40K*	Tudor Long Wall 13W 1000L, Black Dimmable 120V
TOPINCLPLEDWH	Tudor Post Top w/Incand. socket & LED Lamp 9.5W A19 27K incl. White Dimmable 120V
TOPL13W1000LD120WH40K	Tudor Post Top 13W 1000L, White Dimmable 120V
TOP10INCLPLEDWH	10.5" IMPERIAL POST TOP-Incand. socket & LED Lamp 9.5W A19 27K Incl. - White Dimmable 120V
TOP10L23W1900LD120WH40K	10.5" IMPERIAL POST TOP23W 1900L White Dimmable 120V
TOP13INCLPLEDWH	13" IMPERIAL POST TOP-Incand. socket & LED Lamp 9.5W A19 27K Incl. - White Dimmable 120V
TOP13L23W1900LD120WH40K	13" IMPERIAL POST TOP 23W 1900L White Dimmable 120V
LTOPINCLPLEDBK*	LARGE TUDOR POST TOP-Incand. socket & LED Lamp 9.5W A19 27K Incl. - Black Dimmable 120V
LTOPL13W1000LD120BK40K*	LARGE TUDOR POST TOP13W 1000L Black Dimmable 120V
LTOLINCLPLEDBK*	LARGE TUDOR WALL-Incand. socket & LED Lamp 9.5W A19 27K Incl. - Black Dimmable 120V
LTOLL13W1000LD120BK40K*	LARGE TUDOR WALL13W 1000L Black Dimmable 120V

For 3000K change 40K to 30K. For Black, change WH to BK. See LED A19 Specs on page 31.

*Not available in White



Harbour LED Wall Mount



ITEM NO.	DESCRIPTION
BPWINCLPLEDWHWPJ	WALL MOUNT HARBOR-Incand. socket & LED Lamp 9.5W A19 27K Incl.- White Dimmable 120V
BPWL13W1000LD120WH40KWSJ	WALL MOUNT HARBOR13W 1000L White Dimmable 120V
BPWL11W912LMVWH40KWSJ	WALL MOUNT HARBOR11.3W 912L White Multi-Volt



For 3000K change 40K to 30K. For Black, change WH to BK. See LED A19 Specs on page 31

Long Beach LED Wall Mount



ITEM NO.	DESCRIPTION
BPWINCLPLEDWHWPJ	WALL MOUNT LONG BEACH-9.5W A19 27K - White Dimmable 120V
BPWL13W1000LD120WH40KWPJ	WALL MOUNT LONG BEACH13W 1000L White Dimmable 120V
BPWL11W912LMVWH40KWPJ	WALL MOUNT LONG BEACH11.3W 912L White Multi-Volt



For 3000K change 40K to 30K. For Black, change WH to BK. See LED A19 Specs on page 31

Classic LED Wall Pocket



ITEM NO.	DESCRIPTION
WPWINCLPLEDWHWAG	WALL MOUNT 6" GLOBE-9.5W A19 27K - White Dimmable 120V
WPWL13W1000LD120WH40KWAG	WALL MOUNT 6" GLOBE13W 1000L White Dimmable 120V
WPWL11W912LMVWH40KWAG	WALL MOUNT 6" GLOBE11.3W 912L White Multi-Volt



For 3000K change 40K to 30K. For Black, change WH to BK. See LED A19 Specs on page 31

Add Photocell to all LED wall versions PC120.

TEXAS FLUORESCENTS



DC



DCC



Budget Wall Pack CLOSE-OUT WHILE QUANTITIES LAST

ITEM NO.	DESCRIPTION
DC150E48W4800LMV50K	LED Wall Pack 48W and 4800 Lumens 50K 14.25"L x 9"W x 7.25"H
DC200E98W9000LMV50K	LED Wall Pack 98W and 9000 Lumens 50K 18"W x 12.75"W x 9"H
DCC150E37W2998LMV50K	LED Full Cut Off 37W and 2998 Lumens 50K 9"W x 14.25"L
DCC150E58W5200LMV50K	LED Full Cut Off 58W 5200 Lumens 50K 14.25"L x 9"W x 9"H

*DLC Listed

High Wattage Flood CLOSE-OUT WHILE QUANTITIES LAST



ITEM NO.	DESCRIPTION
DCL150W13100LMV50KBZ	LED Wall Pack/Flood 150W 13100 Lumens 50K 14.17"L x 12.8"H x 4.9"Ext

Consult for accessories.



LED Wall Pack CLOSE-OUT WHILE QUANTITIES LAST

ITEM NO.	SIZE (W X L)	Watts / Lumens	Color Options (X100 Kelvins)
WLL10L29W2100LMV57KBZ	9.4" x 9.76"	29 / 2100	57
WLL15L73W6231LMV50KBZ	11.7" x 14.95"	73 / 6231	57

Consult for white version.



LED Wall Pack CLOSE-OUT WHILE QUANTITIES LAST

ITEM NO.	SIZE (W X L)	Watts / Lumens	Color Options (X100 Kelvins)
WPL6L14W1164LMV50KBZ	6.2" x 3.8"	14 / 1164	50
WPL6L29W2346LMV50KBZ	6.2" x 3.8"	29 / 2346	50



Low Wattage Area Light CLOSE-OUT WHILE QUANTITIES LAST

ITEM NO.	DESCRIPTION
LFL10L52W5550LMV50KBZ*	LED Flood Light 52W 5500 Lumens 50K 7"W x 10"L x 2.71"H x 6.53"Ext



High Wattage Area Flood CLOSE-OUT WHILE QUANTITIES LAST

ITEM NO.	DESCRIPTION
LFL20L120W12550LMV50KBZ*	LED Flood Light 120W 12550 Lumens 50K 16"W x 20.7"L x 4.9"H
LFL20L200W24000LMV50KBZ*	LED Flood Light 240W 20650 Lumens 50K 16"W x 20.7"L x 4.9"H
DC570SW	Slip Fitter
DC570BR	Trunion Mount
LFLARM6	6" Arm
LFLARM10	10" Arm

The Simple LED Solution

X1LED

The Benefits of LED with
Ease, Practicality and Flexibility

THE SIMPLE LED SOLUTION

X1LED

The most economical, practical and user friendly series of LED fixtures with the energy savings, quality of light, long life and hassle-free maintenance. X1 LED fixtures are UL Listed with the latest LED T8 Bypass lamps. Fixtures provide over 40% energy savings over comparable fluorescent fixtures utilizing less expensive fixtures than the fluorescent version and have flexibility to change wattage and color temperature any time. Fixture performance will evolve over time with the evolution of the T8 LED lamp technology. Concerned about maintenance with an LED array and driver fixture, X1LED solves that by utilizing LED T8 lamps that fit into the fixture just like a fluorescent lamp.



LED System

A complete UL Listed LED fixture with no ballast or driver to fail. Special red sockets to identify fixtures made for LED T8 lamps.



Flexibility and Long Life

Change the LED T8 lamp any time to different wattage, color temperature or lumens.



Premium LED T8 Lamps

Texas Fluorescents use top quality LED T8 lamps that are field tested for demanding applications.

RECESSED LINEAR

Troffer

ITEM NO.	DESCRIPTION
131A23212X1LN18W40	1x4 4200 Lumen Troffer w/2x18W LED T8 4000K Lamps included
131A217X1LN15W40	2x2 3400 Lumen Troffer w/2x15W LED T8 4000K Lamps included
131A317X1LN15W40	2x2 5100 Lumen Troffer w/3x15W LED T8 4000K Lamps included
131A417X1LN15W40	2x2 6800 Lumen Troffer w/4x15W LED T8 4000K Lamps included
131A232X1LN18W40	2x4 4200 Lumen Troffer w/2x18W LED T8 4000K Lamps included
131A332X1LN18W40	2x4 6300 Lumen Troffer w/3x18W LED T8 4000K Lamps included
131A432X1LN18W40	2x4 8400 Lumen Troffer w/4x18W LED T8 4000K Lamps included

Change 40 to 35 or 50 for different Kelvin. Change Lamp Wattage to 15W on 2FT or 15W on 4FT



For Emergency Option, see page 47.

TEXAS FLUORESCENTS

Parabolic



ITEM NO.	DESCRIPTION
PARA8C23212X1LN18W40	1x4 4200 Lumen Parabolic 8C w/2x18W LED T8 4000K Lamps included
PARA9C217X1LN15W40	2x2 3400 Lumen Parabolic 9C w/2x15W LED T8 4000K Lamps included
PARA9C317X1LN15W40	2x2 5100 Lumen Parabolic 9C w/3x15W LED T8 4000K Lamps included
PARA9C417X1LN15W40	2x2 6800 Lumen Parabolic 9C w/4x15W LED T8 4000K Lamps included
PARA12C232X1LN18W40	2x4 4200 Lumen Parabolic 12C w/2x18W LED T8 4000K Lamps included
PARA18C232X1LN18W40	2x4 4200 Lumen Parabolic 18C w/2x18W LED T8 4000K Lamps included
PARA18C332X1LN18W40	2x4 6300 Lumen Parabolic 18C w/3x18W LED T8 4000K Lamps included
PARA18C432X1LN18W40	2x4 8400 Lumen Parabolic 18C w/4x18W LED T8 4000K Lamps included
PARA32C432X1LN18W40	2x4 8400 Lumen Parabolic 32C w/4x18W LED T8 4000K Lamps included

Change 40 to 35 or 50 for different Kelvin. Change Lamp Wattage to 15W on 2FT or 15W on 4FT

Shallow, High Efficient Parabolic



ITEM NO.	DESCRIPTION
PES9C217X1LN15W40	2x2 3400 Lumen Parabolic 9C w/2x15W LED T8 4000K Lamps Included
PES9C317X1LN15W40	2x2 5100 Lumen Parabolic 9C w/3x15W LED T8 4000K Lamps Included
PES9C417X1LN15W40	2x2 6800 Lumen Parabolic 9C w/4x15W LED T8 4000K Lamps Included
PES12C232X1LN18W40	2x4 4200 Lumen Parabolic 12C w/2x18W LED T8 4000K Lamps Included
PES18C232X1LN18W40	2x4 4200 Lumen Parabolic 18C w/2x18W LED T8 4000K Lamps Included
PES18C332X1LN18W40	2x4 6300 Lumen Parabolic 18C w/3x18W LED T8 4000K Lamps Included
PES18C432X1LN18W40	2x4 8400 Lumen Parabolic 18C w/4x18W LED T8 4000K Lamps Included

Change 40 to 35 or 50 for different Kelvin. Change Lamp Wattage to 15W on 2FT or 15W on 4FT
Change PES to PEW for White Louver

Frame-In-Kits Available for Recessed Fixtures to mount in hard ceilings

FIK 1x4
FIK 2x2
FIK 2x4

For Emergency Option, see page 47.

Consult for Fixtures Wired for LED T8 Lamps with Lamps Sold Separately

For Dimmable Version - Change X1 to JLD MV and LN18W to LN18D
Example: Item No. 131A432JLD MV LN18D40K 0-10V Dimming



For Large Quantities, Call For Quote

TEXAS FLUORESCENTS

Center Basket



ITEM NO.	DESCRIPTION
UCPF23212X1LN18W40	1x4 4200 Lumen Center Basket w/2x18W LED T8 4000K Lamps Included
UCPF217X1LN15W40	2x2 3400 Lumen Center Basket w/2x15W LED T8 4000K Lamps Included
UCPF317X1LN15W40	2x2 5100 Lumen Center Basket w/3x15W LED T8 4000K Lamps Included
UCPF232X1LN18W40	2x4 4200 Lumen Center Basket w/2x18W LED T8 4000K Lamps Included
UCPF332X1LN18W40	2x4 6300 Lumen Center Basket w/3x18W LED T8 4000K Lamps Included

Change 40 to 35 or 50 for different Kelvin. Change Lamp Wattage to 15W on 2FT or 15W on 4FT
Change PF to LL for Linear Ribbed Lens

Dual Basket



ITEM NO.	DESCRIPTION
UDPF217X1LN15W40	2x2 3400 Lumen Troffer w/2x15W LED T8 4000K Lamps Included
UDPF417X1LN15W40	2x2 6800 Lumen Troffer w/4x15W LED T8 4000K Lamps Included
UDPF232X1LN18W40	2x4 4200 Lumen Dual Basket w/2x18W LED T8 4000K Lamps Included
UDPF432X1LN18W40	2x4 8400 Lumen Dual Basket w/4x18W LED T8 4000K Lamps Included

Change 40 to 35 or 50 for different Kelvin. Change Lamp Wattage to 15W on 2FT or 15W on 4FT
Change PF to LL for Linear Ribbed Lens

Deep, Center Basket



ITEM NO.	DESCRIPTION
RDI217X1LN15W40	2x2 3400 Lumen Center Basket w/2x15W LED T8 4000K Lamps Included
RDI317X1LN15W40	2x2 5100 Lumen Center Basket w/3x15W LED T8 4000K Lamps Included
RDI232X1LN18W40	2x4 4200 Lumen Center Basket w/2x18W LED T8 4000K Lamps Included
RDI332X1LN18W40	2x4 6300 Lumen Center Basket w/3x18W LED T8 4000K Lamps Included

Change 40 to 35 or 50 for different Kelvin. Change Lamp Wattage to 13W on 2FT or 15W on 4FT

For Emergency Option, see page 47.

For Dimmable Version - Change X1 to JLDMV and LN18W to LN18D
Example: Item No. 131A432JLDMVLN18D40K 0-10V Dimming



For Large Quantities, Call For Quote

4x4 Recessed Linear (For T-Bar Ceiling)

ITEM NO.	DESCRIPTION
44RSF117X1WHLN15W40K	4" x 24" 1700 Lumen Recessed TBAR 1x 15W LED T8 4000K Lamps Included
44RSF217X1WHLN15W40K	4" x 24" 3400 Lumen Recessed TBAR 2x 15W LED T8 4000K Lamps Included
44RSF132X1WHLN18W40K	4" x 48" 2100 Lumen Recessed TBAR 1x 18W LED T8 4000K Lamps Included
44RSF232X1WHLN18W40K	4" x 48" 4200 Lumen Recessed TBAR 2x 18W LED T8 4000K Lamps Included
44RSF1328X1WHLN15W40K	4" x 96" 4200 Lumen Recessed TBAR 2x 18W LED T8 4000K Lamps Included
44RSF2328X1WHLN15W40K	4" x 96" 8400 Lumen Recessed TBAR 4x 18W LED T8 4000K Lamps Included

Change 40 to 35 or 50 for different Kelvin. Change Lamp Wattage to 15W on 2FT or 15W on 4FT
Change SF (Snap Fit Frosted Lens) to MW for Matte White Regressed Lens
Change 44R to 44RF for Recessed Flanged or 44RRXX for Recessed Flangeless for XX" sheetrock depth.
For Baffled Louver, change MW to BL.



Special red sockets to identify fixtures made for LED T8 lamps.

6x6 Recessed Linear (For T-Bar Ceiling)

ITEM NO.	DESCRIPTION
66RMW117X1WHLN15W40K	6" x 26" 1700 Lumen Recessed TBAR 1x 15W LED T8 4000K Lamps Included
66RMW217X1WHLN15W40K	6" x 26" 3400 Lumen Recessed TBAR 2x 15W LED T8 4000K Lamps Included
66RMW132X1WHLN18W40K	6" x 48" 2100 Lumen Recessed TBAR 1x 18W LED T8 4000K Lamps Included
66RMW232X1WHLN18W40K	6" x 48" 4200 Lumen Recessed TBAR 2x 18W LED T8 4000K Lamps Included
66RMW1328X1WHLN18W40K	6" x 96" 4200 Lumen Recessed TBAR 2x 18W LED T8 4000K Lamps Included
66RMW2328X1WHLN18W40K	6" x 96" 8400 Lumen Recessed TBAR 4x 18W LED T8 4000K Lamps Included

Change 40 to 35 or 50 for different Kelvin. Change Lamp Wattage to 15W on 2FT or 15W on 4FT
Change 66R to 66RF for Recessed Flanged or 66RRXX for Recessed Flangeless for XX" sheetrock depth.
For Baffled Louver, change MW to BL.



2.5 Recessed Linear (Flanged for Hard Ceilings)

ITEM NO.	DESCRIPTION
SES25RFSF117X1WHLN15W40K	4"x24" 1700 Lumen Recessed 2.5" Flanged 1x15W LED T8 4000K Lamps Included
SES25RFSF132X1WHLN18W40K	4"x48" 2100 Lumen Recessed 2.5" Flanged 1x18W LED T8 4000K Lamps Included
SES25RFSF1328X1WHLN18W40K	4"x96" 4200 Lumen Recessed 2.5" Flanged 2x18W LED T8 4000K Lamps Included

Change 40 to 35 or 50 for different Kelvin. Change Lamp Wattage to 15W on 2FT or 15W on 4FT
Change SES25RF to 44R for Recessed TBAR or SES25RRXX for Recessed Flangeless for XX" sheetrock depth.



For Dimmable Version - Change X1 to JLD MV and LN18W to LN18D
Example: Item No. 131A432JLDMVLN18D40K 0-10V Dimming



For Large Quantities, Call For Quote

TEXAS FLUORESCENTS

LINEAR PENDANT



PLIN Louver Blade Linear Pendant

ITEM NO.	DESCRIPTION
PLIN232X1WHLN18W40-HC401WH	48" PLIN 90% DOWN 4200 Lumen 2x18W LED T8 4000K Lamps included w/5 ft cable kit
PLIN2328X1WHLN18W40-HC401WH	96" PLIN 90% DOWN 8400 Lumen 4x18W LED T8 4000K Lamps included w/5 ft cable kit

Change 40 to 35 or 50 for different Kelvin. Change Lamp Wattage to 15W on 4FT.
Change WH TO BK (Black), RD (Red), IR (Iron), SL (Silver) or BR (Bronze).

4x4 Linear Pendant



ITEM NO.	DESCRIPTION
44PSF117X1WHLN15W40-HC301WH	4" x 24" 1700 Lumen Pendant w/Cable Kit 1x15W LED T8 4000K Lamps Included
44PSF217X1WHLN15W40-HC301WH	4" x 24" 3400 Lumen Pendant w/Cable Kit 2x15W LED T8 4000K Lamps Included
44PSF132X1WHLN18W40-HC301WH	4" x 48" 2100 Lumen Pendant w/Cable Kit 1x18W LED T8 4000K Lamps Included
44PSF232X1WHLN18W40-HC301WH	4" x 48" 4200 Lumen Pendant w/Cable Kit 2x18W LED T8 4000K Lamps Included
44PSF1328X1WHLN18W40-HC301WH	4" x 96" 4200 Lumen Pendant w/Cable Kit 2x18W LED T8 4000K Lamps Included
44PSF2328X1WHLN18W40-HC301WH	4" x 96" 8400 Lumen Pendant w/Cable Kit 4x18W LED T8 4000K Lamps Included

Change 40 to 35 or 50 for different Kelvin. Change Lamp Wattage to 15W on 2FT or 15W on 4FT
Change SF (Snap Fit Frosted Lens) to MW for Matte White Regressed Lens
Change HC301WH to HC302WH for 10" Cable Kit
Change WH to BK (Black), IR (Iron), SL (Silver) or BR (Bronze)
For surface mount, remove HC301WH

6x6 Linear Pendant



ITEM NO.	DESCRIPTION
66PMW117X1WHLN15W40-HC301WH	6" x 26" 1700 Lumen Pendant w/Cable Kit 1x15W LED T8 4000K Lamps Included
66PMW217X1WHLN15W40-HC301WH	6" x 26" 3400 Lumen Pendant w/Cable Kit 2x15W LED T8 4000K Lamps Included
66PMW132X1WHLN15W40-HC301WH	6" x 48" 2100 Lumen Pendant w/Cable Kit 1x18W LED T8 4000K Lamps Included
66PMW232X1WHLN15W40-HC301WH	6" x 48" 4200 Lumen Pendant w/Cable Kit 2x18W LED T8 4000K Lamps Included
66PMW1328X1WHLN15W40-HC301WH	6" x 96" 4200 Lumen Pendant w/Cable Kit 2x18W LED T8 4000K Lamps Included
66PMW2328X1WHLN15W40-HC301WH	6" x 96" 8400 Lumen Pendant w/Cable Kit 4x18W LED T8 4000K Lamps Included

Change 40 to 35 or 50 for different Kelvin. Change Lamp Wattage to 15W on 2FT or 15W on 4FT.
Change HC301WH to HC302WH for 10" Cable Kit.
Change WH to BK (Black), IR (Iron), SL (Silver) or BR (Bronze).
For surface mount, remove HC301WH.
For Baffled Louver, change MW to BL.

For Dimmable Version - Change X1 to JLD MV and LN18W to LN18D
Example: Item No. 131A432JLDMVLN18D40K 0-10V Dimming



For Large Quantities, Call For Quote

TEXAS FLUORESCENTS

Louvered 8" Decorative Linear



ITEM NO.	DESCRIPTION
LVS232X1WHLN18W40-HC301WH	48" LVS WHITE 4200 Lumen 2x18W LED T8 4000K Lamps included w/5 ft cable kit
LVS2328X1WHLN18W40-HC401WH	96" LVS WHITE 8400 Lumen 4x18W LED T8 4000K Lamps included w/5 ft cable kit

Change 40 to 35 or 50 for different Kelvin. Change Lamp Wattage to 15W on 2FT or 15W on 4FT Change WH TO BK (Black), IR (Iron), SL (Silver) or BR (Bronze).

Louvered 6" Decorative Linear



ITEM NO.	DESCRIPTION
LVS6232X1WHLN18W40-HC301WH	48" LVS WHITE 4200 Lumen 2x18W LED T8 4000K Lamps included w/5 ft cable kit
LVS62328X1WHLN18W40-HC401WH	96" LVS WHITE 8400 Lumen 4x18W LED T8 4000K Lamps included w/5 ft cable kit

Change 40 to 35 or 50 for different Kelvin. Change Lamp Wattage to 15W on 2FT or 15W on 4FT Change WH TO BK (Black), IR (Iron), SL (Silver) or BR (Bronze).

1 Light 2.5 in. Enclosed Strip

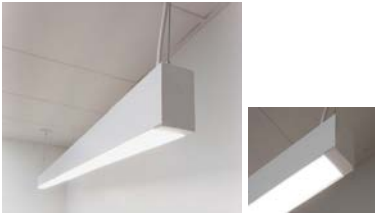

Detail View

ITEM NO.	DESCRIPTION
SES25FR132X1LN18W40-HC301WH	2.5"x48" PENDANT or SURFACE LINEAR 2100 Lumen 1x18W LED T8 4000K Lamps included
SES25FR1328X118W40-HC301WH	2.5"x96" PENDANT or SURFACE LINEAR 4200 Lumen 2x18W LED T8 4000K Lamps included

Change 40 to 35 or 50 for different Kelvin. Change Lamp Wattage to 15W on 2FT or 15W on 4FT Change WH TO BK (Black), IR (Iron), SL (Silver) or BR (Bronze).

SURFACE

Surface Troffer



ITEM NO.	DESCRIPTION
153A23212X1LN18W40	1x4 4200 Lumen Troffer w/2x18W LED T8 4000K Lamps Included
153A217X1LN18W40	2x2 3400 Lumen Troffer w/2x15W LED T8 4000K Lamps Included
153A317X1LN18W40	2x2 5100 Lumen Troffer w/3x15W LED T8 4000K Lamps Included
153A417X1LN18W40	2x2 6800 Lumen Troffer w/4x15W LED T8 4000K Lamps Included
153A232X1LN18W40	2x4 4200 Lumen Troffer w/2x18W LED T8 4000K Lamps Included
153A332X1LN18W40	2x4 6300 Lumen Troffer w/3x18W LED T8 4000K Lamps Included
153A432X1LN18W40	2x4 8400 Lumen Troffer w/4x18W LED T8 4000K Lamps Included

Change 40 to 35 or 50 for different Kelvin. Change Lamp Wattage to 15W on 2FT or 15W on 4FT For Frosted Lens change A to FR.

For Emergency Option, see page 47.

For Dimmable Version - Change X1 to JLD MV and LN18W to LN18D
Example: Item No. 131A432JLD MV LN18D40K 0-10V Dimming



For Large Quantities, Call For Quote

TEXAS FLUORESCENTS

Surface Parabolic

ITEM NO.	DESCRIPTION
SHPARA8C23212X1LN18W40	1x4 4200 Lumen Parabolic 8C w/2x18W LED T8 4000K Lamps Included
SHPARA9C217X1LN15W40	2x2 3400 Lumen Parabolic 9C w/2x15W LED T8 4000K Lamps Included
SHPARA9C317X1LN15W40	2x2 5100 Lumen Parabolic 9C w/3x15W LED T8 4000K Lamps Included
SHPARA9C417X1LN15W40	2x2 6800 Lumen Parabolic 9C w/4x15W LED T8 4000K Lamps Included
SHPARA12C232X1LN18W40	2x4 4200 Lumen Parabolic 12C w/2x18W LED T8 4000K Lamps Included
SHPARA18C232X1LN18W40	2x4 4200 Lumen Parabolic 18C w/2x18W LED T8 4000K Lamps Included
SHPARA18C332X1LN18W40	2x4 6300 Lumen Parabolic 18C w/3x18W LED T8 4000K Lamps Included
SHPARA18C432X1LN18W40	2x4 8400 Lumen Parabolic 18C w/4x18W LED T8 4000K Lamps Included
SHPARA32C432X1LN18W40	2x4 8400 Lumen Parabolic 32C w/4x18W LED T8 4000K Lamps Included



Special red sockets to identify fixtures made for LED T8 lamps.

Change 40 to 35 or 50 for different Kelvin. Change Lamp Wattage to 15W on 2FT or 15W on 4FT

Surface High Efficient Parabolic

ITEM NO.	DESCRIPTION
SHPES9C217X1LN15W40	2x2 3400 Lumen Parabolic 9C w/2x15W LED T8 4000K Lamps Included
SHPES9C317X1LN15W40	2x2 5100 Lumen Parabolic 9C w/3x15W LED T8 4000K Lamps Included
SHPES9C417X1LN15W40	2x2 6800 Lumen Parabolic 9C w/4x15W LED T8 4000K Lamps Included
SHPES12C232X1LN18W40	2x4 4200 Lumen Parabolic 12C w/2x18W LED T8 4000K Lamps Included
SHPES18C232X1LN18W40	2x4 4200 Lumen Parabolic 18C w/2x18W LED T8 4000K Lamps Included
SHPES18C332X1LN18W40	2x4 6300 Lumen Parabolic 18C w/3x18W LED T8 4000K Lamps Included
SHPES18C432X1LN18W40	2x4 8400 Lumen Parabolic 18C w/4x18W LED T8 4000K Lamps Included



(Surface Mount has shroud)

Change 40 to 35 or 50 for different Kelvin. Change Lamp Wattage to 15W on 2FT or 15W on 4FT
Change PES to PEW for White Louver

For Emergency Option, see page 47.

For Dimmable Version - Change X1 to JLDMV and LN18W to LN18D
Example: Item No. 131A432JLDMLN18D40K 0-10V Dimming



For Large Quantities, Call For Quote

TEXAS FLUORESCENTS

Surface Center Basket



ITEM NO.	DESCRIPTION
SHUCPF23212X1LN18W40	1x4 4200 Lumen Center Basket w/2x18W LED T8 4000K Lamps Included
SHUCPF217X1LN18W40	2x2 3400 Lumen Center Basket w/2x15W LED T8 4000K Lamps Included
SHUCPF317X1LN18W40	2x2 5100 Lumen Center Basket w/3x15W LED T8 4000K Lamps Included
SHUCPF232X1LN18W40	2x4 4200 Lumen Center Basket w/2x18W LED T8 4000K Lamps Included
SHUCPF332X1LN18W40	2x4 6300 Lumen Center Basket w/3x18W LED T8 4000K Lamps Included

Change 40 to 35 or 50 for different Kelvin. Change Lamp Wattage to 15W on 2FT or 15W on 4FT
Change PF to LL for Linear Ribbed Lens

Consult for Wired for LED T8 Lamps with Lamps Sold Separately

Surface Dual Basket



ITEM NO.	DESCRIPTION
SHUDPF217X1LN15W40	2x2 3400 Lumen Dual Basket w/2x15W LED T8 4000K Lamps Included
SHUDPF417X1LN15W40	2x2 6800 Lumen Dual Basket w/4x15W LED T8 4000K Lamps Included
SHUDPF232X1LN18W40	2x4 4200 Lumen Dual Basket w/2x18W LED T8 4000K Lamps Included
SHUDPF432X1LN18W40	2x4 8400 Lumen Dual Basket w/4x18W LED T8 4000K Lamps Included

Change 40 to 35 or 50 for different Kelvin. Change Lamp Wattage to 15W on 2FT or 15W on 4FT
Change PF to LL for Linear Ribbed Lens

Eclipse



ITEM NO.	DESCRIPTION
ECLMW217X1WHLN15W40K (TO, BM, IM, SI, WM)	9"x24" 3400 Lumen w/2x15W LED T8 4000K Lamps Included
ECLMW232X1WHLN18W40K (TO, BM, IM, SI, WM)	9"x48" 4200 Lumen w/2x18W LED T8 4000K Lamps Included
ECLMW417X1WHLN15W40K (TO, BM, IM, SI, WM)	17"x24" 6800 Lumen w/4x15W LED T8 4000K Lamps Included
ECLMW432X1WHLN18W40K (TO, BM, IM, SI, WM)	17"x48" 8400 Lumen w/4x18W LED T8 4000K Lamps Included

Change 40 to 35 or 50 for different Kelvin. Change Lamp Wattage to 15W on 2FT or 15W on 4FT

For Emergency Option, see page 47.

For Dimmable Version - Change X1 to JLDMV and LN18W to LN18D
Example: Item No. 131A432JLDMVLN18D40K 0-10V Dimming



For Large Quantities, Call For Quote

TEXAS FLUORESCENTS

PUF Surface Linear



ITEM NO.	DESCRIPTION
PUF23211X1LN18W40K	11x48 inches 4200 Lumen w/2x18W LED T8 4000K Lamps Included
PUF41717X1LN15W40K	17x24 inches 6800 Lumen w/4x15W LED T8 4000K Lamps Included
PUF43217X1LN18W40K	17x48 inches 8400 Lumen w/4x18W LED T8 4000K Lamps Included

Change 40 to 35 or 50 for different Kelvin. Change Lamp Wattage to 15W on 4FT.

Crown



ITEM NO.	DESCRIPTION
CRWNMW217X1WHLN15W40K	9x24 inches 3400 Lumen w/2x15W LED T8 4000K Lamps Included
CRWNMW417X1WHLN15W40K	17x24 inches 6800 Lumen w/4x15W LED T8 4000K Lamps Included
CRWNMW232X1WHLN18W40K	9x48 inches 4200 Lumen w/2x18W LED T8 4000K Lamps Included
CRWNMW432X1WHLN18W40K	17x48 inches 8400 Lumen w/4x18W LED T8 4000K Lamps Included

Change 40 to 35 or 50 for different Kelvin. Change Lamp Wattage to 15W on 2FT or 15W on 4FT Consult for Alternate Wood Finishes

HIGH BAYS



Premiere High Bay

ITEM NO.	DESCRIPTION
HBC432M23X1LN18W50	High Bay 48 inch 8400 Lumens w/4x18W LED T8 5000K Lamps Included
HBC632M23X1LN18W50	High Bay 48 inch 12600 Lumens w/6x18W LED T8 5000K Lamps Included
HBC832M23X1LN18W50	High Bay 48 Inches 16800 Lumens w/8x18W LED T8 5000K Lamps Included
HBC1032M23X1LN18W50	High Bay 48 Inches 21000 Lumens w/10x18W LED T8 5000K Lamps Included
HBC1232M23X1LN18W50	High Bay 48 Inches 25200 Lumens w/12x18W LED T8 5000K Lamps Included

Change 50 to 35 or 40 for different Kelvin. Change Lamp Wattage to 15W on 4FT.

For Emergency Option, see page 47.

Industrialized Galvanized High Bay



ITEM NO.	DESCRIPTION
HBG432M23X1LN18W50	High Bay 48 Inches 8400 Lumens w/4x18W LED T8 5000K Lamps Included
HBG632M23X1LN18W50	High Bay 48 Inches 12600 Lumens w/6x18W LED T8 5000K Lamps Included
HBG832M23X1LN18W50	High Bay 48 Inches 16800 Lumens w/8x18W LED T8 5000K Lamps Included
HBG1032M23X1LN18W50	High Bay 48 Inches 21000 Lumens w/10x18W LED T8 5000K Lamps Included
HBG1232M23X1LN18W50	High Bay 48 Inches 25200 Lumens w/12x18W LED T8 5000K Lamps Included

Change 50 to 35 or 40 for different Kelvin. Change Lamp Wattage to 15W on 4FT.

TEXAS FLUORESCENTS

H6L Series



ITEM NO.	DESCRIPTION
H6L4328M23X1LN18W50	High Bay 96 Inches Tandem 16800 Lumens w/8x18W LED T8 5000K Lamps Included
H6L432M23X1LN18W50	High Bay 48 Inches Tandem 8400 Lumens w/4x18W LED T8 5000K Lamps Included
H6L6328M23X1LN18W50	High Bay 96 Inches Tandem 21000 Lumens w/10x18W LED T8 5000K Lamps Included
H6L632M23X1LN18W50	High Bay 48 Inches Tandem 12600 Lumens w/6x18W LED T8 5000K Lamps Included

Change 50 to 35 or 40 for different Kelvin. Change Lamp Wattage to 15W on 4FT



H2L Series

ITEM NO.	DESCRIPTION
H2L132M23X1LN18W50	High Bay 48 Inches 2100 Lumens w/1x18W LED T8 5000K Lamps Included
H2L232M23X1LN18W50	High Bay 48 Inches 4200 Lumens w/2x18W LED T8 5000K Lamps Included

Change 50 to 35 or 40 for different Kelvin. Change Lamp Wattage to 15W on 4FT.

Baffled High Bay



ITEM NO.	DESCRIPTION
FHBL232X1LN18W50	Linear Louvered 48 Inches 4200 Lumens w/2x18W LED T8 5000K Lamps Included
FHBL332X1LN18W50	Linear Louvered 48 Inches 6300 Lumens w/3x18W LED T8 5000K Lamps Included
FHBL4328X1LN18W50	Linear Louvered 48 Inches 8400 Lumens w/4x18W LED T8 5000K Lamps Included
FHBL2328X1LN18W50	Linear Baffled Louver 96 Inches Tandem 8400 Lumens w/4x18W LED T8 5000K Lamps Included
FHBL3328X1LN18W50	Linear Baffled Louver 96 Inches Tandem 12600 Lumens w/6x18W LED T8 5000K Lamps Included
FHBL4328X1LN18W50	Linear Baffled Louver 96 Inches Tandem 16800 Lumens w/8x18W LED T8 5000K Lamps Included

Change 50 to 35 or 40 for different Kelvin. Change Lamp Wattage to 15W on 4FT.



Special red sockets to identify fixtures made for LED T8 lamps.

For Emergency Option, see page 47.

For Dimmable Version - Change X1 to JLD MV and LN18W to LN18D
Example: Item No. 131A432JLD MV LN18D40K 0-10V Dimming



For Large Quantities, Call For Quote

TEXAS FLUORESCENTS

RETROFIT KITS



Retrofit LED T8 Lamp Kit (Convert Existing Fluorescent Fixtures to LED)



ITEM NO.	DESCRIPTION
RLK1X1WR	Retrofit Lamp Kit Prewired Unshunted Sockets For 1 LED T8 Lamp Includes Companion Sockets
RLK2X1WR	Retrofit Lamp Kit Prewired Unshunted Sockets For 2 LED T8 Lamp Includes Companion Sockets
RLK3X1WR	Retrofit Lamp Kit Prewired Unshunted Sockets For 3 LED T8 Lamp Includes Companion Sockets
RLK4X1WR	Retrofit Lamp Kit Prewired Unshunted Sockets For 4 LED T8 Lamp Includes Companion Sockets
RLK1X1WRLI18W40	Retrofit Lamp Kit Prewired Unshunted Sockets For 1 LED T8 Lamp Included Plus Companion Sockets
RLK2X1WRLI18W40	Retrofit Lamp Kit Prewired Unshunted Sockets For 2 LED T8 Lamp Included Plus Companion Sockets
RLK3X1WRLI18W40	Retrofit Lamp Kit Prewired Unshunted Sockets For 3 LED T8 Lamp Included Plus Companion Sockets
RLK4X1WRLI18W40	Retrofit Lamp Kit Prewired Unshunted Sockets For 4 LED T8 Lamp Included Plus Companion Sockets

UL Listed kit to bypass Fluorescent Ballast w/LED tubes.
 Add "8" after RLK for tandem version.
 To wire for Troffer Retrofit, add "TR" after "RLK".

Consult for Dimmable LED Lamps Retrofit Kit



4 Ft. Wiring Harness
 (This kit will change a two lamp fluorescent to a dimmable two lamp with LED T8 lamps)

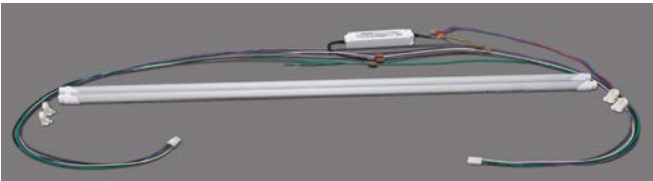

LED Dimming Kit for 8 FT. Tandem 1 Light Strip
 (Shown w/Optional Wiring Harness for Continuous Run)

Retrofit Reflector Kit for Parabolics/Troffers



ITEM NO.	DESCRIPTION
22C2M20BL11X1LI15W40	2x2 Retrofit Kit 4200 Lumen Mirrored Reflector Includes 2x15W 4000K Lamps
22C2W10BL11X1LI15W40	2x2 Retrofit Kit 4200 Lumen Enhanced White Reflector Includes 2x15W 4000K Lamps
22C3M20BL11X1LI15W40	2x2 Retrofit Kit 6300 Lumen Mirrored Reflector Includes 3x15W 4000K Lamps
22C3W10BL11X1LI15W40	2x2 Retrofit Kit 6300 Lumen Enhanced White Reflector Includes 3x15W 4000K Lamps
24C2M20BL11X1LI18W40	2x4 Retrofit Kit 4200 Lumen Mirrored Reflector Includes 2x18W 4000K Lamps
24C2W10BL11X1LI18W40	2x4 Retrofit Kit 4200 Lumen Enhanced White Reflector Includes 2x18W 4000K Lamps
24C3M20BL11X1LI18W40	2x4 Retrofit Kit 6300 Lumen Mirrored Reflector Includes 3x18W 4000K Lamps
24C3W10BL11X1LI18W40	2x4 Retrofit Kit 6300 Lumen Enhanced White Reflector Includes 3x18W 4000K Lamps

Change 40 to 35 or 50 for different Kelvin. Change Lamp Wattage to 15W on 2FT or 15W on 4FT.

For Dimmable Version - Change X1 to JLD MV and LN18W to LN18D
 Example: Item No. 131A432JLDMVLN18D40K 0-10V Dimming



For Large Quantities, Call For Quote

TEXAS FLUORESCENTS

Ballast Cover Refit Kit

ITEM NO.	DESCRIPTION
4RB421T8L11X1LI18W40	4.25" Strip Retrofit Kit 48 In. 2100 Lumen Included 1x18W 4000K Lamp
4RB422T8L11X1LI18W40	4.25" Strip Retrofit Kit 48 In. 4200 Lumen Included 2x18W 4000K Lamp
4RB501T8L11X1LI18W40	5" Strip Retrofit Kit 48 In. 2100 Lumen Included 1x18W 4000K Lamp
4RB502T8L11X1LI18W40	5" Strip Retrofit Kit 48 In. 4200 Lumen Included 2x18W 4000K Lamp
8RB421X2T8L11X1LI18W40	4.25" Strip Retrofit Kit 96 In. 4200 Lumen Included 2x18W 4000K Lamp
8RB422X2T8L11X1LI18W40	4.25" Strip Retrofit Kit 96 In. 8400 Lumen Included 4x18W 4000K Lamp
8RB501X2T8L11X1LI18W40	5" Strip Retrofit Kit 96 In. 4200 Lumen Included 2x18W 4000K Lamp
8RB502X2T8L11X1LI18W40	5" Strip Retrofit Kit 96 In. 8400 Lumen Included 4x18W 4000K Lamp

Change 40 to 35 or 50 for different Kelvin. Change Lamp Wattage to 15W on 2FT or 15W on 4FT

Consult for Fixtures Wired for LED T8 Lamps with Lamps Sold Separately

How To Add Emergency to X1LED



Separate LED Array added for Emergency.



KEYSTONE KT-EMERG-LED-12-1200-K1 LED EMERGENCY LIGHTING KIT

12W Constant Wattage - Ballast Battery Backup - Damp Location - 120-277V

Includes driver, separately housed 1200mAh Ni-Cd battery and 0.7" x 8" 1200 Lumen LED module for complete emergency lighting installations. When AC power fails, the driver will power the LED for a minimum of 90 minutes emergency illumination. Easy installation in existing LED or fluorescent fixtures with wiring diagrams and labels on all parts. Mounting hardware included. Full 5 year warranty on all components. Output Current 1000 mA-200mA - Output Voltage 12 ~41 Vdc

To order, add EMKT12 to end of X1LED item number.

TEXAS FLUORESCENTS

Universal Strip Retrofit Kit

Choice of Reflectors or Ballast Cover

For ballast cover, choose strip width 4.25" or 5"



For enhanced light output add a mirrored specular reflector (M20) or white reflector (W10).

Universal socket bar SKRUSB is ideal to retrofit 4.25" to 5" strips with either reflector or ballast cover.



ITEM NO.	DESCRIPTION
SKB132B4L11X1LI18W40	4.25" Strip Retrofit Kit 48". 2100 Lumen Included 1x18W 4000K Lamps
SKB232B4L11X1LI18W40	4.25" Strip Retrofit Kit 48". 4200 Lumen Included 2x18W 4000K Lamps
SKB1328B4L11X1LI18W40	4.25" Strip Retrofit Kit 96". 4200 Lumen Included 2x18W 4000K Lamps
SKB2328B4L11X1LI18W40	4.25" Strip Retrofit Kit 96". 8400 Lumen Included 4x18W 4000K Lamps
SKB132B5L11X1LI18W40	5" Strip Retrofit Kit 48". 2100 Lumen Included 1x18W 4000K Lamps
SKB232B5L11X1LI18W40	5" Strip Retrofit Kit 48". 4200 Lumen Included 2x18W 4000K Lamps
SKB1328B5L11X1LI18W40	5" Strip Retrofit Kit 96". 8400 Lumen Included 2x18W 4000K Lamps
SKB2328B5L11X1LI18W40	5" Strip Retrofit Kit 96". 4200 Lumen Included 4x18W 4000K Lamps
SKR132W10L11X1LI18W40	Strip Reflector Enhanced White Kit 48" 2100 Lumen Included 1x18W 4000K Lamp
SKR232W10L11X1LI18W40	Strip Reflector Enhanced White Kit 48" 4100 Lumen Included 2x18W 4000K Lamp
SKR1328W10L11X1LI18W40	Strip Reflector Enhanced White Kit 96" 4200 Lumen Included 2x18W 4000K Lamp
SKR2328W10L11X1LI18W40	Strip Reflector Enhanced White Kit 96" 8400 Lumen Included 4x18W 4000K Lamp
SKR132M20L11X1LI18W40	Strip Reflector Mirror Kit 48" 2100 Lumen Included 1x18W 4000K Lamp
SKR232M20L11X1LI18W40	Strip Reflector Mirror Kit 48" 4100 Lumen Included 2x18W 4000K Lamp
SKR1328M20L11X1LI18W40	Strip Reflector Mirror Kit 96" 4200 Lumen Included 2x18W 4000K Lamp
SKR2328M20L11X1LI18W40	Strip Reflector Mirror Kit 96" 8400 Lumen Included 4x18W 4000K Lamp
SKRUSB	

Change 40 to 35 or 50 for different Kelvin. Change Lamp Wattage to 15W on 2FT or 15W on 4FT

Optional Dimming Options

The 4 FT. lamps are available with a dimming option. Specially designed dimming lamps require an external driver that runs up to 4 lamps. Dimming driver is installed in the fixture with dimming lamps to dim with 0-10V to 10%.

For Dimmable Version - Change X1 to JLDMV and LN18W to LN18D
Example: Item No. 131A432JLDMLN18D40K 0-10V Dimming



For Large Quantities, Call For Quote

TEXAS FLUORESCENTS

WRAPAROUNDS

Wraparound 7"



Ideal for Residential Use

ITEM NO.	DESCRIPTION
207A217X1LN15W40	7" x 24" 3400 Lumen 2 Light Wraparound w/2x15W LED T8 4000K Lamps Included
207A232X1LN18W40	7" x 48" 4200 Lumen 2 Light Wraparound w/2x18W LED T8 4000K Lamps Included
207A332X1LN18W40	13" x 48" 6300 Lumen 3 Light Wraparound w/3x18W LED T8 4000K Lamps Included
207A432X1LN18W40	13" x 48" 8400 Lumen 4 Light Wraparound w/4x18W LED T8 4000K Lamps Included

Change 40 to 35 or 50 for different Kelvin. Change Lamp Wattage to 15W on 2FT or 15W on 4FT

Wraparound 9"



ITEM NO.	DESCRIPTION
209A232AX1LN18W40	9" x 48" 4200 Lumen 2 Light Wraparound w/2x18W LED T8 4000K Lamps Included

Change 40 to 35 or 50 for different Kelvin. Change Lamp Wattage to 15W on 2FT or 15W on 4FT

Wraparound Specification Grade



ITEM NO.	DESCRIPTION
200A217X1LN15W40	11" x 24" 3400 Lumen 2 Light Wraparound w/2x15W LED T8 4000K Lamps Included
200A232X1LN18W40	11" x 48" 4200 Lumen 2 Light Wraparound w/2x18W LED T8 4000K Lamps Included
200A2328X1LN18W40	11" x 96" 8400 Lumen 4 Light Wraparound w/4x18W LED T8 4000K Lamps Included
200A432X1LN18W40	16" x 48" 8400 Lumen 4 Light Wraparound w/4x18W LED T8 4000K Lamps Included
200A4328X1LN18W40	16" x 96" 16800 Lumen 8 Light Wraparound w/8x18W LED T8 4000K Lamps Included

Change 40 to 35 or 50 for different Kelvin. Change Lamp Wattage to 15W on 2FT or 15W on 4FT

Narrow Wraparound



ITEM NO.	DESCRIPTION
201A117X1LN18W40	5" x 24" 1700 Lumen 1 Light Wraparound w/1x15W LED T8 4000K Lamps Included
201A132X1LN18W40	5" x 48" 2100 Lumen 1 Light Wraparound w/1x18W LED T8 4000K Lamps Included

Change 40 to 35 or 50 for different Kelvin. Change Lamp Wattage to 15W on 2FT or 15W on 4FT

Consult for Fixtures Wired for LED T8 Lamps with Lamps Sold Separately

For Emergency Option, see page 47.

For Dimmable Version - Change X1 to JLD MV and LN18W to LN18D
Example: Item No. 131A432JLD MV LN18D40K 0-10V Dimming



For Large Quantities, Call For Quote

TEXAS FLUORESCENTS

Corridor Linear



ITEM NO.	DESCRIPTION
159A117X1LN18W40	5" x 24" 1700 Lumen 1 Light Wraparound w/1x15W LED T8 4000K Lamps Included
159A132X1LN18W40	5" x 48" 2100 Lumen 1 Light Wraparound w/1x18W LED T8 4000K Lamps Included
159A1328X1LN18W40	5" x 96" 4200 Lumen 1 Light Wraparound w/2x18W LED T8 4000K Lamps Included

Change 40 to 35 or 50 for different Kelvin. Change Lamp Wattage to 15W on 2FT or 15W on 4FT

LINEAR STRIP

BEST SELLER



2 or 3 Light Strip 4.25"

ITEM NO.	DESCRIPTION
C217X1LI18W40	2ft. Strip 3400 Lumen 2x15W LED T8 4000K Lamps Included
C317X1LI18W40	2ft. Strip 5400 Lumen 3x15W LED T8 4000K Lamps Included
C232X1LI18W40	4ft. Strip 4200 Lumen 2x18W LED T8 4000K Lamps Included
C332X1LI18W40	4ft. Strip 6300 Lumen 3x18W LED T8 4000K Lamps Included
C2328X1LI18W40	8ft. Tandem Strip 8400 Lumen 4x18W LED T8 4000K Lamps Included

Change 40 to 35 or 50 for different Kelvin. Change Lamp Wattage to 15W on 2FT or 15W on 4FT

1 Light Strip 2.75"



ITEM NO.	DESCRIPTION
S117X1LI18W40	2ft. Strip 1700 Lumen 1x15W LED T8 4000K Lamps Included
S132X1LI18W40	4ft. Strip 2100 Lumen 1x18W LED T8 4000K Lamps Included
S1328X1LI18W40	8ft. Tandem Strip 4200 Lumen 2x18W LED T8 4000K Lamps Included

Change 40 to 35 or 50 for different Kelvin. Change Lamp Wattage to 15W on 2FT or 15W on 4FT

Mini Strip (1.6 In.) 1 Light



ITEM NO.	DESCRIPTION
KDST8117X1LI18W40	1.6 " 2 ft. Strip 1700 Lumen 1x15W LED T8 4000K Lamps Included
KDST8132X1LI18W40	1.6 " 4 ft. Strip 2100 Lumen 1x18W LED T8 4000K Lamps Included

Change 40 to 35 or 50 for different Kelvin. Change Lamp Wattage to 15W on 2FT or 15W on 4FT

1 Light Low Profile Strip



ITEM NO.	DESCRIPTION
LLS132X1LI18W40	49.5"L x 1.38"W . 1.69" 1 Light Strip w/LED T8 18W Lamp Included

Change 40 to 35 or 50 for different Kelvin. Change Lamp Wattage to 15W on 2FT or 15W on 4FT

For Emergency Option, see page 47.

For Dimmable Version - Change X1 to JLDMV and LN18W to LN18D
Example: Item No. 131A432JLDMLN18D40K 0-10V Dimming



For Large Quantities, Call For Quote

TEXAS FLUORESCENTS



Side Mount Strip

ITEM NO.	DESCRIPTION
SM117X1L115W40	2ft. Strip 1700 Lumen 1x15W LED T8 4000K Lamps Included
SM217X1L118W40	2ft. Strip 3400 Lumen 2x15W LED T8 4000K Lamps Included
SM132X1L118W40	4ft. Strip 2100 Lumen 1x18W LED T8 4000K Lamps Included
SM232X1L118W40	4ft. Strip 4200 Lumen 2x18W LED T8 4000K Lamps Included

Change 40 to 35 or 50 for different Kelvin. Change Lamp Wattage to 15W on 2FT or 15W on 4FT



Industrial

ITEM NO.	DESCRIPTION
IND232W30X1L118W40	4ft. Industrial 4200 Lumen 2x18W LED T8 4000K Lamps Included
IND332W30X1L118W40	4ft. Industrial 6300 Lumen 3x18W LED T8 4000K Lamps Included
IND2328W30X1L118W40	8ft. Tandem Industrial 8400 Lumen 4x18W LED T8 4000K Lamps Included
IND3328W30X1L118W40	8ft. Tandem Industrial 12600 Lumen 6x18W LED T8 4000K Lamps Included

Change 40 to 35 or 50 for different Kelvin. Change Lamp Wattage to 15W on 2FT or 15W on 4FT



Recessed Strip ITB

ITEM NO.	DESCRIPTION
ITB132X1L118W40	4ft. Industrial 2100 Lumen 1x18W LED T8 4000K Lamps Included
ITB232X1L118W40	4ft. Recessed Linear 4200 Lumen 2x18W LED T8 4000K Lamps Included
ITB1328X1L118W40	8ft. Tandem Recessed Linear 4200 Lumen 2x18W LED T8 4000K Lamps Included
ITB2328X1L118W40	8ft. Tandem Recessed Linear 8400 Lumen 4x18W LED T8 4000K Lamps Included

Change 40 to 35 or 50 for different Kelvin. Change Lamp Wattage to 15W on 2FT or 15W on 4FT

ENCLOSURES/ALL WEATHER

Citadel Enclosures



ITEM NO.	DESCRIPTION
CITCL232X1LN18W40	4ft. Enclosure w/Clear Lens 4200 Lumen 2x18W LED T8 4000K Lamps Included
CITCL332X1LN18W40	4ft. Enclosure w/Clear Lens 6300 Lumen 2x18W LED T8 4000K Lamps Included
CITLB2328X1LN18W40	8ft. Enclosure w/Linear Ribbed Lens 8200 Lumen 4x18W LED T8 4000K Lamps Included

Change 40 to 35 or 50 for different Kelvin. Change Lamp Wattage to 15W on 2FT or 15W on 4FT
Consult for different lens options and sensors.

Change CL lens on 4ft to LB (linear ribbed) to match 8 ft. lens.

For Dimmable Version - Change X1 to JLDMV and LN18W to LN18D
Example: Item No. 131A432JLDMLN18D40K 0-10V Dimming



For Large Quantities, Call For Quote

TEXAS FLUORESCENTS

Wide Body Garage Light



ITEM NO.	DESCRIPTION
CITOL332 SBA3X1LN18W40	4 FT Deep Clear Enclosure 6300 Lumens with 4200 lumens for wide distribution and 2100 lumens for downlight. 3x18W LED T8 4000K lamps included. Surface Mounting brackets.
CITOL332 SBA3X1LN18W40MDT4(21) (Pictured)	4 Ft Deep Clear Enclosure 6300 Lumens with 4200 lumens for wide distribution and 2100 lumens for downlight. 3x18W LED T8 4000K lamps included. Surface Mounting brackets and Occupancy Sensor included. Occupancy sensor wired to two wide area lamps.

MDT4 is for Standard Indoor Occupancy Sensor. For Wet Location change to MDT4W or for Cold Weather Sensor change to MDT4C. Change 40 to 35 or 50 for different Kelvin. Change Lamp to 15W on 4FT. Consult for different lens and mounting options.

WALL FIXTURES

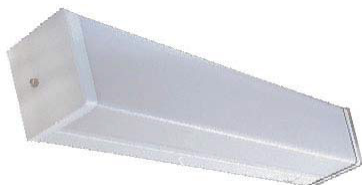

Wall Fixture 4 Ft.

ITEM NO.	DESCRIPTION
555MW232X1LN18W40	4ft. Wall 4200 Lumen 2x18W LED T8 4000K Lamps Included



Stairwell 4Ft. with Ultrasonic Sensor

ITEM NO.	DESCRIPTION
SS213A232X1LN18W40	4ft. Wall 4200 Lumen 2x18W LED T8 4000K Lamps Included

1 Light on Always, 1 Light on Sensor

4x4 Linear Wall



ITEM NO.	DESCRIPTION
44WSF117X1WHLN15W40	4" x 24" 1700 Lumen Pendant w/Cable Kit 1x15W LED T8 4000 Lamps Included
44WSF217X1WHLN15W40	4" x 24" 3400 Lumen Pendant w/Cable Kit 2x15W LED T8 4000 Lamps Included
44WSF132X1WHLN18W40	4" x 48" 2100 Lumen Pendant w/Cable Kit 1x18W LED T8 4000 Lamps Included
44WSF232X1WHLN18W40	4" x 48" 4200 Lumen Pendant w/Cable Kit 2x18W LED T8 4000 Lamps Included
44WSF1328X1WHLN18W40	4" x 96" 4200 Lumen Pendant w/Cable Kit 2x18W LED T8 4000 Lamps Included
44WSF2328X1WHLN18W40	4" x 96" 8400 Lumen Pendant w/Cable Kit 4x18W LED T8 4000 Lamps Included

Change 40 to 35 or 50 for different Kelvin. Change Lamp Wattage to 15W on 2FT or 15W on 4FT
Change SF (Snap Fit Frosted Lens) to MW for Matte White Regressed Lens
Change WH to BK (Black), IR (Iron), SL (Silver) or BR (Bronze).
For Baffled Louver, Change MW to BL.

For Emergency Option, see page 47.

For Dimmable Version - Change X1 to JLDMV and LN18W to LN18D
Example: Item No. 131A432JLDMLN18D40K 0-10V Dimming



For Large Quantities, Call For Quote

TEXAS FLUORESCENTS

6x6 Linear Wall

ITEM NO.	DESCRIPTION
66WMW117X1WHLN15W40	6" x 26" 1700 Lumen Pendant w/Cable Kit 1x15W LED T8 4000 Lamps Included
66WMW217X1WHLN15W40	6" x 26" 3400 Lumen Pendant w/Cable Kit 2x15W LED T8 4000 Lamps Included
66WMW132X1WHLN18W40	6" x 48" 2100 Lumen Pendant w/Cable Kit 1x18W LED T8 4000 Lamps Included
66WMW232X1WHLN18W40	6" x 48" 4200 Lumen Pendant w/Cable Kit 2x18W LED T8 4000 Lamps Included
66WMW1328X1WHLN18W40	6" x 96" 4200 Lumen Pendant w/Cable Kit 4x18W LED T8 4000 Lamps Included
66WMW2328X1WHLN18W40	6" x 96" 8400 Lumen Pendant w/Cable Kit 4x18W LED T8 4000 Lamps Included

Change 40 to 35 or 50 for different Kelvin. Change Lamp Wattage to 15W on 2FT or 15W on 4FT
Change WH to BK (Black), IR (Iron), SL (Silver) or BR (Bronze).
For Baffled Louver, Change MW to BL.



Special red sockets to identify fixtures made for LED T8 lamps.



Bed Light

ITEM NO.	DESCRIPTION
215A1U1D17DFX1LN15W40	24" Direct/Indirect 3400 Lumens 2x15W LED T8 4000K Lamps Included
215A1U1D32DFX1LN18W40	48" Direct/Indirect 3400 Lumens 2x18W LED T8 4000K Lamps Included
215A1U2D17DFX1LN15W40	24" Direct/Indirect 5100 Lumens 3x15W LED T8 4000K Lamps Included
215A1U2D32DFX1LN18W40	48" Direct/Indirect 6300 Lumens 3x18W LED T8 4000K Lamps Included
215A2U1D17DFX1LN15W40	24" Direct/Indirect 5100 Lumens 3x15W LED T8 4000K Lamps Included
215A2U1D32DFX1LN18W40	48" Direct/Indirect 6300 Lumens 3x18W LED T8 4000K Lamps Included
215A2U2D17DFX1LN15W40	24" Direct/Indirect 6800 Lumens 4x15W LED T8 4000K Lamps Included
215A2U2D32DFX1LN18W40	48" Direct/Indirect 8400 Lumens 4x18W LED T8 4000K Lamps Included

Change 40 to 35 or 50 for different Kelvin. Change Lamp Wattage to 15W on 2FT or 15W on 4FT
Add SW4 for 4 Way Switch

Consult for Fixtures Wired for LED T8 Lamps with Lamps Sold Separately

For Emergency Option, see page 47.

For Dimmable Version - Change X1 to JLD MV and LN18W to LN18D
Example: Item No. 131A432JLD MV LN18D40K 0-10V Dimming



For Large Quantities, Call For Quote

TEXAS FLUORESCENTS

Spill Ring Bath

ITEM NO.	DESCRIPTION
HOTBD217X1SNLN15W40	2ft. Wall 3400 Lumen 2x15W LED T8 4000K Lamps Included
HOTBD232X1SNLN18W40	4ft. Wall 4200 Lumen 2x18W LED T8 4000K Lamps Included

Change 40 to 35 or 50 for different Kelvin. Change Lamp Wattage to 15W on 2FT or 15W on 4FT



End Cap Bath

ITEM NO.	DESCRIPTION
VAN217X1LN15W40 (AL, SW, IV, BM, TO, WM)	2ft. Wall 3400 Lumen 2x15W LED T8 4000K Lamps Included
VAN232X1LN18W40 (AL, SW, IV, BM, TO, WM)	4ft. Wall 4200 Lumen 2x18W LED T8 4000K Lamps Included

Change 40 to 35 or 50 for different Kelvin. Change Lamp Wattage to 15W on 2FT or 15W on 4FT



Wall Puff

ITEM NO.	DESCRIPTION
WPU217X1LN15W40	2ft. Wall 3400 Lumen 2x15W LED T8 4000K Lamps Included
WPU232X1LN18W40	4ft. Wall 4200 Lumen 2x18W LED T8 4000K Lamps Included

Change 40 to 35 or 50 for different Kelvin. Change Lamp Wattage to 15 W on 2FT or 15W on 4FT



LED T8 LAMPS



LED T8 Lamp Choices

ITEM NO.	DESCRIPTION
LED24T815W1700LRK35K	LED T8 Lamp, Instafit or Bypass, 24In., 15W 1700 Lumen 3500K
LED24T815W1500LRK40K	LED T8 Lamp, Instafit or Bypass, 24In., 15W 1700 Lumen 4000K
LED24T815W1500LRK50K	LED T8 Lamp, Instafit or Bypass, 24In., 15W 1700 Lumen 5000K

ITEM NO.	DESCRIPTION
LED48T815W1800LRK35K	LED T8 Lamp, Instafit or Bypass, 48In., 15W 1800 Lumen 3500K
LED48T815W1800LRK40K	LED T8 Lamp, Instafit or Bypass, 48In., 15W 1800 Lumen 4000K
LED48T815W1800LRK50K	LED T8 Lamp, Instafit or Bypass, 48In., 15W 1800 Lumen 5000K
LED48T818W2100LRK35K	LED T8 Lamp, Instafit or Bypass, 48In., 18W 2100 Lumen 3500K
LED48T818W2100LRK40K	LED T8 Lamp, Instafit or Bypass, 48In., 18W 2100 Lumen 4000K
LED48T818W2100LRK50K	LED T8 Lamp, Instafit or Bypass, 48In., 18W 2100 Lumen 5000K



Consult for U-Bend, Dimmable and other T8 LED Lamp Options

Consult for Fixtures Wired for LED T8 Lamps with Lamps Sold Separately

About T8 LED Lamps

Our T8 LED lamps are available in 2 or 4 ft. sizes in different wattages, lumens and color temperature options.

- 50,000 Hour Life with 5 Year Warranty
- Beam Angle 140 Degree
- Aluminum Base and Aluminum Housing with Glass Cover
- Operating Temperature: -20°C to 50°C
- Color Temperature: 3500K, 4000K, 5000K
- G13 Pins (Same as Fluorescent Linear T8 Bipins)
- AC100 - 277V without Ballast
- Single Ended Power

TEXAS FLUORESCENTS

INDEX

(Fixtures with LED arrays and drivers are on pages 2-34 and X1LED are on pages 35-54)

Series	Page #	Series	Page #	Series	Page #	Series	Page #
4RB.....	22, 47	COW.....	32	KRL.....	33	RRS.....	8
8RB.....	47	CPY.....	26	KRP.....	33	RSF.....	21
22C.....	21, 46	CRV.....	3	LED24.....	54	RSR.....	21
23P.....	11	CRWN.....	44	LED48.....	54	S.....	10, 50
23R.....	4	DAC.....	22	LEDD.....	25	SCW.....	32
23W.....	18	DC.....	27, 35	LFL.....	35	SER.....	9
24C.....	21, 46	DCC.....	27	LFS.....	28	SES.....	10
44P.....	11, 12, 40	DCL.....	35	LHB.....	7	SES25.....	39, 41
44R.....	4, 39	DFCKF.....	20	LIN.....	13, 40	SHPARA.....	42
44W.....	18, 52	DFUCLL.....	20	LLLRA.....	15	SHPES.....	42
45P.....	11	DH.....	32	LLLRB.....	15	SHUCP.....	43
45W.....	18	DKS.....	9	LLLSA.....	15	SHUDP.....	43
66P.....	11, 40	DSSSES.....	10	LLLSB.....	15	SKB.....	48
66R.....	4, 39	ECL.....	17, 43	LLLSC.....	15	SKD.....	9
66W.....	18, 53	EO.....	30	LLLSF.....	14	SKR.....	48
131.....	2, 36	EOS.....	22, 30	LLLSG.....	14	SLP.....	13
153.....	16, 41	ER.....	30	LLLSR.....	4	SLW.....	18
159.....	50	F1010.....	29	LLS.....	50	SM.....	51
200.....	49	F1302.....	28	LMC.....	24	SMC.....	24, 25
201.....	49	F1303.....	28	LPC.....	17	SS213.....	52
207.....	16, 49	FHBL.....	13, 45	LPLIN.....	13	SSSES.....	10
209.....	16, 49	FL.....	17	LTOP.....	34	SSSTR.....	19
215.....	53	FPELP.....	2	LUC.....	25	SSSTS.....	19
555.....	19, 52	GOW.....	31	LVS.....	41	SWP.....	30
AOL.....	33	GP.....	31	LWP.....	30	TDL.....	25
AOP.....	33	H2L.....	45	LXT.....	3	TFC.....	23
AOW.....	33	H6L.....	45	MTIM.....	4,15	TOL.....	34
APW.....	32	HBC.....	6, 44	MUS.....	23	TOP.....	34
BBP.....	29	HBG.....	44	MWP.....	30	UCLL.....	3
BCC.....	29	HBI.....	5	NOB.....	31	UCPF.....	38
BPC.....	29	HBIP.....	5	NOP.....	31	UDLL.....	3
BPW.....	34	HIL.....	5	NOW.....	31	UDPF.....	38
BRL.....	31	HOL.....	33	OCL.....	29	UV.....	5
BRP.....	31	HOP.....	33	OUT.....	26	VAN.....	19, 54
BRW.....	31	HOTBD.....	19, 54	PARA.....	2, 37	VLT.....	3
C.....	10, 50	HOTCD.....	23	PES.....	37	VPC.....	28
CBF.....	3	HOTCE.....	23	PGL.....	26	W4A.....	16
CBP.....	29	HOW.....	33	PLF.....	27	WCD.....	30
CEO.....	30	HTCA.....	23	PRL.....	32	WLL.....	35
CER.....	30	HTCB.....	23	PRP.....	32	WPC.....	29
CIRDC.....	23	HTL.....	33	PRW.....	32	WPL.....	35
CIT.....	51, 52	HTP.....	33	PUF.....	17, 44	WPU.....	54
CITA.....	7	HTW.....	33	RCS.....	24	WPW.....	34
CITE.....	26	IND.....	8, 51	RDI.....	38		
CLM.....	17	ITB.....	51	RKCB.....	20		
COL.....	32	JSR.....	9	RKD.....	8		
COP.....	32	KDS.....	10, 50	RLK.....	46		

NOTE: Specifications are subject to change without notice.

TEXAS FLUORESCENTS



Dallas

2055 Luna Rd., Ste. 142
Carrollton, TX 75006
972-247-3171
Fax: 972-247-0200

Houston

4205 Pinemont Dr.
Houston, TX 77018
713-686-5899
Fax: 713-686-5899

New England

22 Thomas Street
East Hartford, CT 06108
972-247-3171
Fax: 972-247-0200

Chicago

1525 Greenleaf Ave.
Elk Grove Village, IL 60007
847-981-1003
Fax: 847-981-1006

Los Angeles

5921 Sheila St.
Commerce, CA 90040
231-623-7730
Fax: 213-623-7739

Maryland

8200 Stayton Dr., Ste. 500
Jessup, MD 20794
301-953-2960
Fax: 301-953-9310

**Check our local warehouses for
in stock specials and close-outs.**

Scan to Call Us



www.texasfluorescents.com