

# FAX Option Type 7500

## Operating Instructions Facsimile Reference

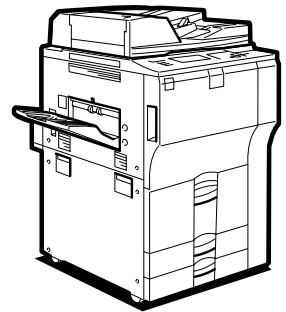

- 
- 1** Transmission
  - 2** Other Transmission Features
  - 3** Reception
  - 4** Changing/Confirming Communication Information
  - 5** Storing a Document
  - 6** Fax via Computer
  - 7** Appendix

## **Introduction**

This manual contains detailed instructions and notes on the operation and use of this machine. For your safety and benefit, read this manual carefully before using the machine. Keep this manual in a handy place for quick reference.

## **Important**

Contents of this manual are subject to change without prior notice. In no event will the company be liable for direct, indirect, special, incidental, or consequential damages as a result of handling or operating the machine.

## **Notes:**

Some illustrations in this manual might be slightly different from the machine.

Certain options might not be available in some countries. For details, please contact your local dealer.

## **Caution:**

Use of controls or adjustments or performance of procedures other than those specified in this manual might result in hazardous radiation exposure.

Two kinds of size notation are employed in this manual. With this machine refer to the metric version.

# Manuals for This Machine

Refer to the manuals that are relevant to what you want to do with the machine.

## Important

- Media differ according to manual.
- The printed and electronic versions of a manual have the same contents.
- Adobe Acrobat Reader/Adobe Reader must be installed in order to view the manuals as PDF files.
- Depending on which country you are in, there may also be the html manuals. To view these manuals, a Web browser must be installed.

## ❖ About This Machine

Be sure to read the Safety Information in this manual before using the machine. This manual provides an introduction to the functions of the machine. It also explains the control panel, preparation procedures for using the machine, how to enter text, and how to install the CD-ROMs provided.

## ❖ Troubleshooting

Provides a guide to solving common problems, and explains how to replace paper, toner, and other consumables.

## ❖ Copy/ Document Server Reference

Explains Copier and Document Server functions and operations. Also refer to this manual for explanations on how to place originals.

## ❖ Facsimile Reference

Explains Facsimile functions and operations.

## ❖ Printer Reference

Explains Printer functions and operations.

## ❖ Scanner Reference

Explains Scanner functions and operations.

## ❖ Network Guide

Explains how to configure and operate the machine in a network environment, and use the software provided.

This manual covers all models, and includes descriptions of functions and settings that might not be available on this machine. Images, illustrations, and information about operating systems that are supported might also differ slightly from those of this machine.

## ❖ General Settings Guide

Explains User Tools settings, and Address Book procedures such as registering fax numbers, e-mail addresses, and user codes. Also refer to this manual for explanations on how to connect the machine.

❖ **Security Reference**

This manual is for administrators of the machine. It explains security functions that you can use to prevent unauthorized use of the machine, data tampering, or information leakage. For enhanced security, we recommend that you first make the following settings:

- Install the Device Certificate.
- Enable SSL (Secure Sockets Layer) Encryption.
- Change the user name and password of the administrator using Web Image Monitor.

For details, see “Setting Up the Machine”, Security Reference.

Be sure to read this manual when setting the enhanced security functions, or user and administrator authentication.

❖ **PostScript 3 Supplement**

Explains how to set up and use PostScript 3.

❖ **UNIX Supplement**

For “UNIX Supplement”, please visit our Web site or consult an authorized dealer.

❖ **Other manuals**

- Manuals for DeskTopBinder Lite
  - DeskTopBinder Lite Setup Guide
  - DeskTopBinder Introduction Guide
  - Auto Document Link Guide

 **Note**

- Manuals provided are specific to machine types.
- “PostScript 3 Supplement” and “UNIX Supplement” include descriptions of functions and settings that might not be available on this machine.
- The following software products are referred to using general names:

Product name	General name
DeskTopBinder Lite and DeskTopBinder Professional *1	DeskTopBinder
ScanRouter EX Professional *1 and ScanRouter EX Enterprise *1	the ScanRouter delivery software

\*1 Optional

# TABLE OF CONTENTS

<b>Manuals for This Machine</b> .....	<b>i</b>
<b>How to Read This Manual</b> .....	<b>1</b>
Symbols .....	1
Names of Major Functions .....	1
<b>Reading the Display</b> .....	<b>2</b>
Reading the Display Panel and Using Keys.....	3
Simplified Display .....	5
<b>Function List</b> .....	<b>6</b>
<b>About Data Security for Copying</b> .....	<b>9</b>

## 1. Transmission

---

<b>Transmission Modes</b> .....	<b>11</b>
Selecting Type of Transmission .....	12
Memory Transmission .....	13
Sending multiple originals using the exposure glass.....	16
Parallel Memory Transmission .....	17
Automatic Redial .....	18
Dual Access.....	18
Simultaneous Broadcast.....	18
Immediate Transmission .....	19
Sending multiple originals using the exposure glass.....	21
Displaying Confirmation of Transmission .....	22
<b>IP-Fax Functions</b> .....	<b>23</b>
Terminology .....	25
Notes on Using IP-Fax .....	26
Functions Not Available for IP-Fax Transmission .....	26
<b>Internet Fax Functions</b> .....	<b>27</b>
Notes on Using Internet Fax .....	28
Functions Not Available by E-mail Transmission .....	29
Functions Not Available by E-mail Reception .....	30
E-mail Subject .....	30
T.37 Full Mode .....	31
<b>Placing Originals</b> .....	<b>32</b>
Setting the Original Orientation .....	34
Scanning Two-Sided Originals.....	35
Acceptable Original Sizes .....	38
Paper Size and Scanned Area.....	39
Original Sizes Difficult to Detect.....	41
Transmission with Image Rotation .....	42

<b>Scan Settings</b> .....	<b>43</b>
Scan Type .....	43
JBIG Transmission .....	45
Resolution .....	45
Scan Size .....	47
Auto Detect .....	48
Regular .....	49
Area .....	50
Mixed Original Sizes .....	52
Density (Contrast) .....	54
Mixing Scan Settings for a Multiple Page Original .....	56
<b>Changing the Line Port</b> .....	<b>57</b>
Simultaneous Broadcast Using Multiple Line Ports .....	59
<b>Specifying a Destination</b> .....	<b>60</b>
Sending Over a Fax Line .....	60
Entering a pause .....	61
Entering a tone .....	62
Sending by IP-Fax .....	63
Regarding IP-Fax destinations .....	65
Sending to an E-mail Address .....	66
Bypassing the SMTP server .....	69
Using the Address Book to Specify Destinations .....	72
Switching the titles in the Address Book .....	73
Specifying Group Destinations .....	74
Selecting Destinations from Recent Destinations .....	75
<b>Programming Destinations in the Address Book</b> .....	<b>77</b>
Registering Entered Destinations to the Address Book .....	79
<b>Searching for a Destination in the Address Book</b> .....	<b>80</b>
Search by Destination Name .....	81
Search by Fax Number/IP-Fax Destination .....	83
Search by E-mail Address .....	86
Search Using Advanced Search .....	88
Search by Registration Number .....	91
<b>On Hook Dial</b> .....	<b>93</b>
<b>Manual Dial</b> .....	<b>95</b>
<b>Sender Settings</b> .....	<b>97</b>
<b>Advanced Features</b> .....	<b>100</b>
Setting SUB Codes for Transmission .....	100
Setting a password .....	103
Setting SEP Codes for Reception .....	103
Entering a password .....	106
SEP Code RX Reserve Report .....	106
SEP Code RX Result Report .....	107
<b>Canceling a Transmission</b> .....	<b>108</b>
Before the Original Is Scanned .....	108
While the Original Is Being Scanned .....	108
While the Original Is Being Transmitted .....	109
Before the Transmission Is Started .....	111
<b>Confirming a Transmission</b> .....	<b>114</b>
<b>Checking the Storage Result (Memory Storage Report)</b> .....	<b>116</b>

## 2. Other Transmission Features

---

<b>Sending at a Specific Time (Send Later)</b> .....	117
<b>Requesting a Reception Notice</b> .....	119
<b>Setting an E-mail Destination as a BCC</b> .....	121
<b>Confirming Transmission Results by E-mail</b> .....	122
<b>Entering the Subject</b> .....	124
<b>Entering the Text</b> .....	127
<b>Transmission Options</b> .....	129
Standard Message Stamp.....	129
Auto Reduce .....	130
Label Insertion.....	132
Closed Network.....	134
SUB Code Transmission.....	135
SEP Code Reception .....	136
Fax Header Print .....	138

## 3. Reception

---

<b>Types of Reception</b> .....	141
Immediate Reception .....	141
Memory Reception .....	142
Substitute Reception .....	143
Receiving documents unconditionally .....	144
Receiving documents according to parameter-specified settings .....	144
<b>Reception Modes</b> .....	146
Manual Reception .....	146
Auto Reception.....	146
Switching the Reception Mode.....	147
<b>Receiving Internet Fax Documents</b> .....	148
Auto E-mail Reception .....	148
Manual E-mail Reception .....	149
Received Images .....	149
<b>Reception Functions</b> .....	151
Routing Received Documents.....	151
Routing received documents with SUB Code.....	151
Transferring Received Documents.....	152
SUB Code Transfer Report .....	152
Forwarding Received Documents .....	153
SMTP Reception Using Internet Fax.....	154
Routing e-mail received via SMTP .....	155
JBIG Reception .....	156
Auto Fax Reception Power-Up.....	156

<b>Printing Options</b> .....	<b>157</b>
Print Completion Beep .....	157
Checkered Mark.....	157
Centre Mark .....	158
Reception Time .....	158
Two-Sided Printing.....	159
180-degree rotation printing .....	160
Multi-Copy Reception.....	160
Image Rotation.....	161
Page Separation and Length Reduction .....	162
Page Reduction.....	163
TSI Print (Transmitting Subscriber Identification Print) .....	163
If There Is No Paper of the Correct Size .....	164
Setting priority trays.....	164
Just size printing.....	165
Having incoming documents printed on paper from the bypass tray.....	165
Where Incoming Documents Are Delivered - Output Tray.....	166
Specifying tray for lines .....	166
Tray Shift .....	167

## **4. Changing/Confirming Communication Information**

---

<b>Changing the Settings of Files in Memory</b> .....	<b>169</b>
Deleting a Destination from a Simultaneous Broadcast.....	170
Adding a Destination .....	172
Changing the Transmission Time .....	174
Changing the SMTP Server Setting.....	176
<b>Printing a File from Memory</b> .....	<b>179</b>
<b>Printing a List of Files in Memory (Print TX File List)</b> .....	<b>181</b>
<b>Resending a File</b> .....	<b>183</b>
<b>Checking the Transmission Result (Transmission File Status)</b> .....	<b>185</b>
Confirming on Display .....	185
Confirming by Report .....	186
Confirming by E-mail.....	187
Confirming by Report and E-mail.....	187
Communication Result Report (Memory Transmission) .....	188
Immediate TX Result Report (Immediate Transmission) .....	188
Communication Failure Report .....	189
<b>Checking the Reception Result (Reception File Status)</b> .....	<b>190</b>
Confirming on Display .....	190
Confirming by Report .....	191
Journal.....	191
<b>Print Journal</b> .....	<b>192</b>
Printing the Journal .....	192
All.....	193
Print per File No.....	194
Print per User .....	195
Journal .....	197
Transmitting Journal by E-mail.....	199
Journal by e-mail .....	199



<b>Printing/Deleting Received and Stored Documents</b>	
<b>(Print/Delete Stored Reception File)</b> .....	<b>200</b>
Printing Received and Stored Documents .....	201
Deleting Received and Stored Documents .....	202
<b>Printing a File Received with Memory Lock</b> .....	<b>203</b>
<b>Personal Boxes</b> .....	<b>205</b>
Personal Boxes .....	205
Printing Personal Box Documents .....	206
Confidential File Report.....	207
<b>Information Boxes</b> .....	<b>208</b>
Information Boxes .....	208
Storing Documents in Information Boxes .....	209
Printing Information Box Documents.....	211
Deleting Information Box Documents.....	212

## 5. Storing a Document

---

<b>Sending a Stored File</b> .....	<b>215</b>
Storing a Document .....	216
Programming a user name .....	218
Setting a file name .....	219
Setting a password .....	219
Sending Stored Documents .....	220
Specifying documents from <b>[File List]</b> .....	223
Specifying documents by <b>[User Name]</b> .....	223
Specifying documents by <b>[File Name]</b> .....	224
Displaying a preview.....	224
Printing Stored Documents .....	225
Changing Stored Document Information .....	227
Changing a user name .....	229
Changing the file name.....	230
Changing the password.....	230
Deleting a Stored Document.....	231

## 6. Fax via Computer

---

<b>Sending Fax Documents from Computers</b> .....	<b>233</b>
Before Use .....	234
Using the Software .....	234
LAN-Fax Driver .....	234
Address Book .....	235
LAN-Fax Cover Sheet Editor .....	235
Auto Run program .....	235
Installing Individual Applications .....	236
Setting LAN-Fax Driver Properties .....	237
Setting print properties .....	237
Making settings for option configuration .....	238
Basic Transmission .....	239
Specifying a destination using a destination list .....	240
Specifying a destination using Address Book.....	241
Specifying a destination by directly entering a fax number, Internet Fax destination, or IP-Fax destination.....	242

Specifying Options .....	243
To send a fax document at a specific time .....	243
To print a sender stamp.....	243
To attach a cover sheet.....	243
To specify two-sided printing.....	244
To display preview.....	244
Saving as files .....	244
To store the fax document on the Document Server.....	245
Checking Transmission Using LAN-Fax Driver.....	245
Confirming Transmission Results by E-mail .....	246
LAN-Fax Result Report.....	247
Printing and Saving.....	247
Editing Address Book.....	248
Programming new destinations .....	248
Editing programmed destinations.....	249
Deleting programmed destinations.....	250
Using the Machine's Address Book Data in the Destination List of the LAN-Fax....	250
Editing Fax Cover Sheets .....	251
Creating a cover sheet .....	251
Attaching a created cover sheet.....	252
Managing Facsimile Functions Using SmartDeviceMonitor for Admin .....	253
LAN-Fax Operation Messages.....	253
<b>Viewing Fax Information Using a Web Browser .....</b>	<b>254</b>
Viewing, Printing, and Deleting Received Fax Documents Using a Web Image Monitor...	255
Viewing received fax documents using a Web browser .....	255
Printing fax information using a Web browser.....	256
Deleting fax information using a Web browser.....	256
Programming Destination Information from Web Browser.....	257
To edit machine properties already programmed.....	257
To add new receiver.....	258
<b>Delivering Files Received by Fax .....</b>	<b>259</b>
<b>7. Appendix</b>	
<hr/>	
<b>Checking the Memory Status.....</b>	<b>261</b>
<b>Programs .....</b>	<b>262</b>
Registering and Changing Keystroke Programs .....	262
Registering a priority function using a program .....	264
Changing a program name.....	265
Deleting a Program .....	266
Using a Program .....	267
<b>Optional Equipment.....</b>	<b>268</b>
Expansion Memory (28MB: DIMM) .....	268
Extra G3 Interface Unit.....	268
<b>Specifications.....</b>	<b>269</b>
Specifications Required for the Internet Fax Destination Machines.....	271
<b>Maximum Values.....</b>	<b>272</b>
<b>INDEX.....</b>	<b>274</b>

# How to Read This Manual

---

## Symbols

---

This manual uses the following symbols:

 **WARNING:**

Indicates important safety notes.

Ignoring these notes could result in serious injury or death. Be sure to read these notes. They can be found in the “Safety Information” section of About This Machine.

 **CAUTION:**

Indicates important safety notes.

Ignoring these notes could result in moderate or minor injury, or damage to the machine or to property. Be sure to read these notes. They can be found in the “Safety Information” section of About This Machine.

 **Important**

Indicates points to pay attention to when using the machine, and explanations of likely causes of paper misfeeds, damage to originals, or loss of data. Be sure to read these explanations.

 **Note**

Indicates supplementary explanations of the machine's functions, and instructions on resolving user errors.

 **Reference**

This symbol is located at the end of sections. It indicates where you can find further relevant information.

**[ ]**

Indicates the names of keys that appear on the machine's display panel.

**[ ]**

Indicates the names of keys on the machine's control panel.

---

## Names of Major Functions

---

This machine's major functions are referred to in this manual as follows:

- Internet Fax (by specifying an e-mail address) → Internet Fax
- Internet Fax (by specifying an IPv4 address) → IP-Fax

# Reading the Display

This section explains how to use control panel and screen-displayed keys.

The display guides you through operations, shows messages, machine status, and destinations registered in the destination lists.

If you press the **[Facsimile]** or **[Clear Modes]** key during operation, the standby display appears.

## **Note**

- This machine automatically returns to standby mode if you do not use the machine for a certain period of time. You can select the period using the Facsimile Auto Reset Timer in System Settings.
- You can have the machine return to standby mode after each transmission using User Parameters (switch 17, bit 3) in the Facsimile Features menu.
- To manually return to the standby display, do one of the following:
  - If you have placed the original in the Auto Document Feeder (ADF) and have not pressed the **[Start]** key, remove the original.
  - If you have not placed an original, press the **[Clear Modes]** key.
  - If you are in User Tools mode, press the **[User Tools/Counter]** key.

## **Reference**

“System Settings”, General Settings Guide

“Facsimile Features”, General Settings Guide

“Registering Addresses and Users for Facsimile/Scanner Functions”, General Settings Guide

# Reading the Display Panel and Using Keys

This section explains key functions and messages that appear on the control panel.

## ❖ Initial Display

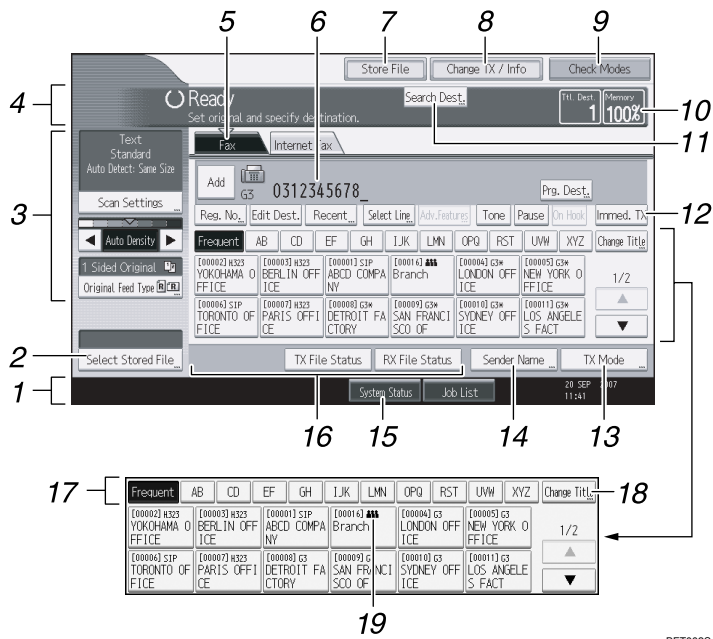

BFT002S

**1.** Displays the date, time, and machine status. Displays the name, facsimile number of the destination, and the size of the original when transmitting.

When user authentication is set, a login user name appears.

**2.** Allows you to send or print the documents stored in the Document Server.

**3.** Allows you to set scan settings and original feed types.

**4.** Displays messages and the machine status.

**5.** Press this tab to switch the type of transmission between fax/IP-Fax and Internet Fax.

When “Internet Fax Settings” is set to “On” in the Facsimile Features menu, **Internet Fax** appears.

- When **[Fax]** is selected, you can specify fax numbers or IP-Fax destinations.
- When **[Internet Fax]** is selected, you can specify e-mail addresses.

**6.** Displays the entered number of a destination.

**7.** Allows you to store documents in the Document Server.

**8.** Press to display various information about communication.

See “Changing/Confirming Communication Information”.

**9.** Allows you to confirm the transmission settings.

**10.** Displays the percentage of free memory space.

**11.** Allows you to search for a destination by destination name, fax number, e-mail address or registration number.

**12.** Switches transmission mode to Immediate Transmission.

When **[Immed. TX]** is not highlighted, the machine is in the Memory Transmission mode.

**13. Allows you to set various features for transmission.**

See "Other Transmission Features".

**14. Allows you to set a sender.**

**15. Allows you to check the number of "Transmission Standby File(s)", "Memory Lock File(s)", and "RX Print Standby File(s)".**

**16. Displays Quick Operation keys set for frequently used functions. [TX File Status] and [RX File Status] are pre-set.**

**17. Title word keys appear. Allows you to switch from one page (display) to another on the destination list.**

**18. Switches the title word keys.**

**19. Appears on Destination keys programmed as a group destination.**

 **Note**

- The display will differ depending on installed optional units.
- You can change "Internet Fax Settings" under "Initial Settings" in the Facsimile Features menu.
- Information about documents sent using the facsimile function cannot be checked in [Job List]. Use [Change TX / Info].
- To use the Internet Fax or IP-Fax functions, the optional printer/scanner unit must be installed.

 **Reference**

p.11 "Transmission Modes"

p.73 "Switching the titles in the Address Book"

p.80 "Searching for a Destination in the Address Book"

p.215 "Sending a Stored File"

p.261 "Checking the Memory Status"

"Facsimile Features", General Settings Guide

"Registering Addresses and Users for Facsimile/Scanner Functions", General Settings Guide

# Simplified Display

This section explains how to switch to the simplified display.

When you press the **[Simplified Display]** key, the screen changes from the initial display to the simplified display.

Letters and keys are displayed at a larger size, making operations easier.

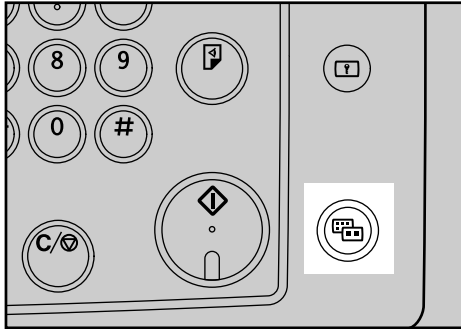

## ❖ Example of a simplified display

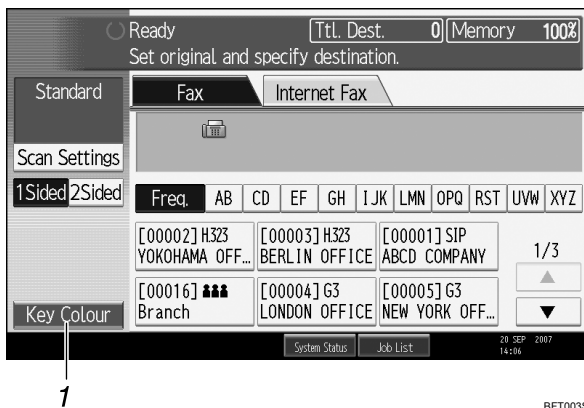

### 1. [Key Colour]

Press to increase screen contrast.

This is available only for the simplified display.

#### Note

- ❑ To return to the initial display, press the **[Simplified Display]** key again.
- ❑ Certain keys do not appear on the simplified display.

# Function List

This section explains various items that can be specified in the Facsimile Features menu.

Press the **[User Tools/Counter]** key to display the Facsimile Features menu. For details about the settings, see "Facsimile Features", General Settings Guide.

## ❖ General Settings

Function name	Description
Quick Operation Key	Frequently used functions programmed as Quick Operation keys are shown on the menu immediately after the power is turned on.
Switch Title	Select the title to be shown on the destination list.
Search Destination	Select a destination list to be used in "Search Destination".
Communication Page Count	Checks the transmission and reception, and totals on the display.
Adjust Sound Volume	Adjust the sound volume during On Hook Mode and Immediate Transmission.
Box Setting	The following functions are for delivery and transfer of documents: Personal Box, Information Box, and Transfer Box.
Box Setting: Print List	You can print a list or the currently registered Personal Boxes, Information Boxes, and Transfer Boxes.
On Hook Mode Release Time	Use this function to specify a time to cancel On Hook mode after you transmit using On Hook dialing.

## ❖ Scan Settings

Function name	Description
Program / Change / Delete Scan Size	You can program, change, or cancel frequently used scan sizes.



## ❖ Send Settings

Function name	Description
Max. E-mail Size	When the other party has a limit on the size of e-mail messages that can be received, or sending data heavy e-mail causes problems, you can make settings to limit the size of sent e-mail.
Program / Change / Delete Standard Message	Program standard messages to be printed at the top of the first page of the original of the opposite party.
Backup File TX Setting	You can specify whether or not to send to a selected folder the backup of a file sent by Memory Transmission.

## ❖ Reception Settings

Function name	Description
Switch Reception Mode	Specify the method for receiving fax documents.
Program Special Sender	By programming particular receivers as Special Sender in advance, you can have Special Senders treated differently.
Program Special Sender: Print List	You can print the Special Sender List.
Forwarding	Specify whether or not received fax documents are to be forwarded to a programmed receiver.
Reception File Setting	Selects whether received documents are saved on the hard disk to be printed later or printed immediately without being saved.
Stored Reception File User Setting	The administrator can be specified for managing documents stored on the machine after fax documents are received.
SMTP RX File Delivery Settings	This function is available on systems that allow routing of e-mail received via SMTP.
2 Sided Print	Specify whether or not received fax documents are to be printed on both sides of the paper.
Checkered Mark	Specify whether or not a checkered mark is to be printed on the first page of received fax documents.
Centre Mark	Specify whether or not a centre mark is to be printed halfway down the left side and at the top centre of each page received.
Print Reception Time	Specify whether or not the received date, time, and file number are printed at the bottom of received fax documents.
Reception File Print Quantity	Specify the number of copies to be printed for each fax document received.

Function name	Description
Paper Tray	Use this function to print fax documents received from programmed senders and fax documents from other senders, using different paper trays.
Specify Tray for Lines	Specify a paper tray for each line (telephone, Internet Fax, IP-Fax).
Folder Transfer Result Report	You can set whether the Folder Transfer Result Report is transmitted to the specified e-mail address, when folders are programmed as the forwarding destinations to which documents are sent from all senders or Special Senders.
Memory Lock Reception	When you switch Memory Lock on, received documents are stored in memory and not printed automatically.

## ❖ Initial Settings

Function name	Description
Parameter Setting	User Parameters allow you to customize various settings to suit your needs.
Parameter Setting: Print List	Prints a list to see the current User Parameter settings.
Program Closed Network Code	Register an ID required for Closed Network communication.
Program Memory Lock ID	Program a Memory Lock ID to be entered before printing documents when the Memory Lock function is activated.
Internet Fax Settings	You can select to display the Internet Fax icon or not.
Select Dial / Push Phone	Use this function to select a line type when the machine is connected to a G3 analog line.
Program Fax Information	Program information to be shown on the display of the other machine and printed as a report.
Enable H.323	Specify whether or not H.323 is used for IP-Fax transmission.
Enable SIP	Specify whether or not SIP is used for IP-Fax transmission.
H.323 Settings	Set the IPv4 address or host name, and alias telephone number of the gatekeeper.
SIP Settings	Set the SIP server's IPv4 address or host name, and SIP user name.
Program / Change / Delete Gateway	Register, change, or delete the gateway used for transmission to IP-Fax.
Menu Protect	Using Menu Protect, you can prevent unauthenticated users from changing the user tools.

## Reference

“Facsimile Features”, General Settings Guide

# About Data Security for Copying

When the optional Copy Data Security Unit is installed, if you scan a document that was printed using the Data Security for Copying function, the scanned image that is sent or stored is entirely grayed out. For details, ask the administrator.

## Important

- When a document that was printed using the Data Security for Copying function is scanned, the machine does not beep and an entry is not added to the unauthorized copying log.
- Sending or storing a document that has been printed using the Data Security for Copying function takes longer than normal.



# 1. Transmission

This section explains basic transmission operations such as specifying a transmission mode or destination.

## Transmission Modes

There are two types of transmission:

- Memory Transmission
- Immediate Transmission

### Important

- It is recommended that you call the receiver and confirm with them when sending important documents.

### ❖ Memory Transmission

Transmission starts automatically after the original is stored in memory. This is convenient when you are in a hurry and want to take the document away with you. You can also send the same original to several destinations.

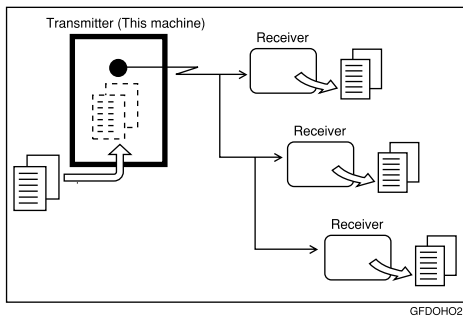

### ❖ Immediate Transmission

Immediately dials the destination number, and while scanning the original, sends it. It is very convenient when you want to send an original quickly or when you want to check the destination you are sending to. When using this type of transmission, the original is not stored in memory. You can only specify one address.

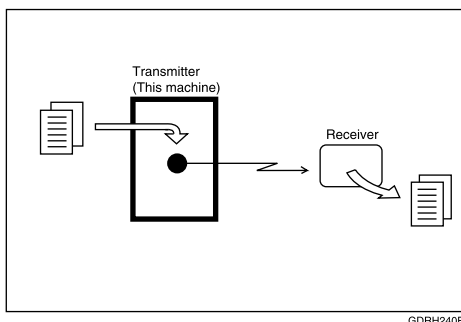

Normally the machine is in the Memory Transmission mode. To switch the mode to Immediate Transmission, press **[Immed. TX]**.



### Note

- ❑ You can set the machine to enter Memory Transmission mode or Immediate Transmission mode right after the power is turned on or the **[Clear Modes]** key is pressed. See “Registering a priority function using a program”.

### Reference

- p.17 “Parallel Memory Transmission”
- p.18 “Simultaneous Broadcast”
- p.264 “Registering a priority function using a program”

## Selecting Type of Transmission

You can select the transmission type: standard fax, IP-Fax, or Internet Fax. Press the tab in the standby display to select the transmission type.

- ❖ **When sending to a standard fax or IP-Fax destination**  
Make sure that **[Fax]** is selected.

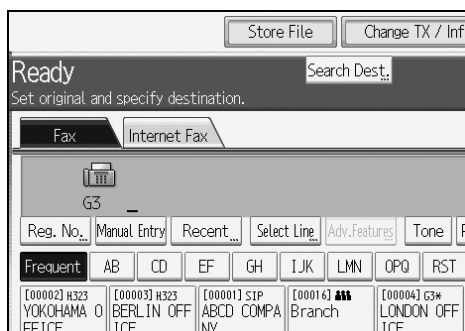

## ❖ When sending to an Internet Fax destination

Press **[Internet Fax]** to switch the type of transmission to Internet Fax.

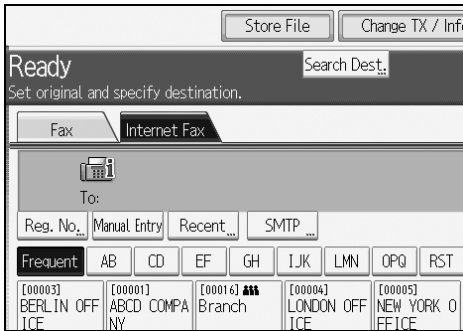

## 🔍 Reference

p.23 “IP-Fax Functions”

p.27 “Internet Fax Functions”

## Memory Transmission

Memory transmission mode has standard fax, Internet Fax and IP-Fax.

### ⚠ Important

- ❑ If there is a power failure (the main power switch is turned off) or the machine is unplugged for about one hour, all the documents stored in memory are deleted. As soon as the main power switch is turned on, the Power Failure Report is printed to help you identify deleted files. Simply turning off the power by pressing the operation switch does not delete stored documents. See “Troubleshooting When Using the Facsimile Function”, Troubleshooting.
- ❑ If memory is full (0% appears in “Memory” at the upper right of the screen), Memory Transmission is disabled. Use Immediate Transmission instead.

### 1 Make sure [Immed. TX] is not highlighted.

Normally Memory Transmission mode is selected.

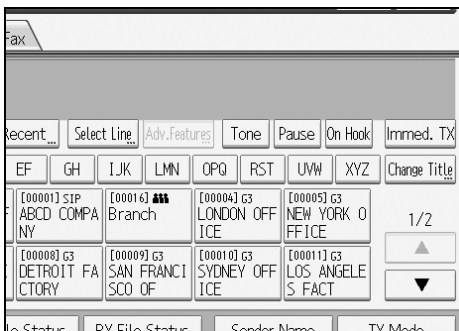

### 2 Place the original.

**3** Make the scan settings you require.

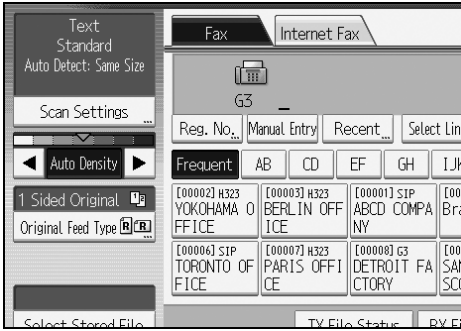

**4** Using the number keys or a Destination key, specify a destination.

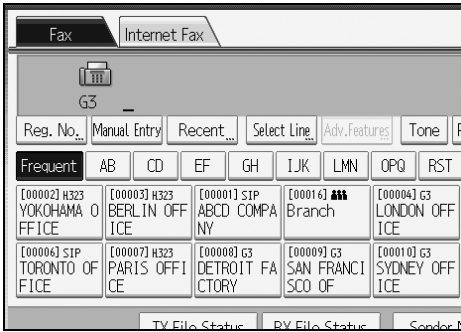

If you make a mistake, press the **[Clear/Stop]** key, and then enter the correct number.

To select a destination from the Address Book, see “Using the Address Book to Specify Destinations”.

**5** When sending the same original to several destinations (broadcasting), press **[Add]** to specify the destinations.

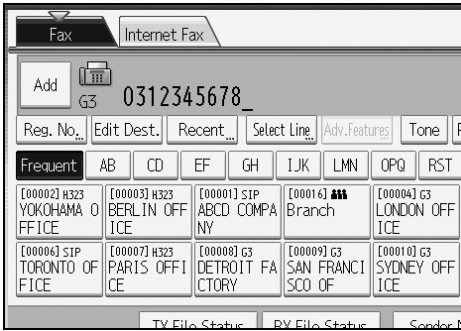

You do not have to press **[Add]** when adding a destination using the destination list.



## 6 Specify the next destination.

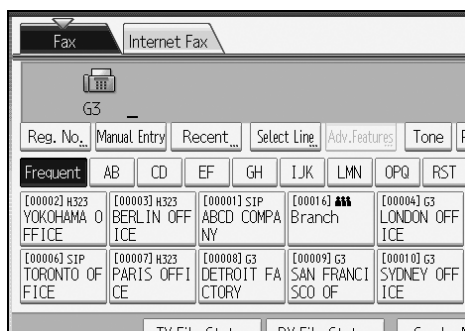

Press **[Fax]** or **[Internet Fax]** to switch the transmission type between fax/IP-Fax and Internet Fax.

A fax number, e-mail address and IP-Fax destination can be specified simultaneously.

## 7 Press the **[Start]** key.

### Note

- If the combined total number of programmed destinations exceeds the maximum value, only Immediate Transmission is possible.
- For the maximum number of destinations you can specify per file, see "Maximum Values".
- For the maximum number of destinations you can specify for all files (including files in memory), see "Maximum Values".
- For the maximum number of documents you can store in memory for Memory Transmission, see "Maximum Values".
- For the maximum number of pages you can store in memory (using A4 Standard <ITU-T #1 Chart>), see "Maximum Values".

### Reference

p.43 "Scan Type"

p.45 "Resolution"

p.54 "Density (Contrast)"

p.60 "Sending Over a Fax Line"

p.63 "Sending by IP-Fax"

p.66 "Sending to an E-mail Address"

p.72 "Using the Address Book to Specify Destinations"

p.74 "Specifying Group Destinations"

p.75 "Selecting Destinations from Recent Destinations"

p.272 "Maximum Values"

"Facsimile Features", General Settings Guide

"Troubleshooting When Using the Facsimile Function", Troubleshooting

## Sending multiple originals using the exposure glass

Follow these steps to send multiple originals using the exposure glass.

**1** Make sure [Immed. TX] is not highlighted.

**2** Place the first page of the original face down on the exposure glass.

**3** Specify a destination.

**4** Make the scan settings you require.

**5** Press the [Start] key.

The machine starts scanning.

**6** Place the next original on the exposure glass within 60 seconds after the machine has finished scanning the first original.



**7** Repeat steps **4** to **6** for all originals.

**8** Place the last original, and then press the [#] key.

The machine dials the destination and starts transmission.

---

## Parallel Memory Transmission

---

This function dials while the original is being scanned.

Standard Memory Transmission stores the original in memory, then dials the destination. However, Parallel Memory Transmission allows you to confirm the connection status quickly. In addition, this function scans the original faster than Immediate Transmission. This is useful when you are in a hurry and need to use the original for another purpose.

### Important

- Standard Memory Transmission is used instead of Parallel Memory Transmission in the following cases:
  - When the line is busy and could not be connected to
  - With Send Later
  - When you store an original for Memory Transmission while another communication is in progress
  - When two or more destinations are specified
  - When an original is placed on the exposure glass, and then sent
  - When you send documents stored in the Document Server

### Note

- You can turn this function on or off with the User Parameters (switch 07, bit 2) in the Facsimile Features menu.
- Standard Memory Transmission may be used instead of Parallel Memory Transmission depending on the optional equipment installed if there is not enough free memory left.
- If you use this function, the Memory Storage Report will not be printed.
- If the **[Clear/Stop]** key is pressed, the original jams or memory runs out, Parallel Memory Transmission will stop. The Communication Result Report is printed and files are deleted.
- When using Parallel Memory Transmission, only the page number is printed on the header of the fax, the total number of originals is not automatically printed.

### Reference

“Facsimile Features”, General Settings Guide

---

## Automatic Redial

---

1 If a fax document could not be sent because the line was busy or an error occurred during transmission, the line is switched to another at five-minute intervals and redial is attempted up to five times.

If redialing fails after four redials, the machine cancels the transmission and prints a Communication Result Report or Communication Failure Report.

### Note

- If there are a large number of files stored in memory, documents might not be sent in the order they were scanned.

---

## Dual Access

---

The machine can scan other documents into memory even while sending a fax document from memory, receiving a document into memory, or automatically printing a report. Since the machine starts sending the second document immediately after the current transmission ends, the line is used efficiently.

### Note

- During Immediate Transmission or when in User Tools mode, the machine cannot scan an original.

---

## Simultaneous Broadcast

---

Use this function to send the same original to multiple destinations simultaneously. To specify multiple destinations, specify the first destination, and then specify the next destination by pressing **[Add]**.

If you dial several destinations for the same document (broadcasting), the documents are sent in the order in which they were dialed. If the fax document could not be transmitted, the machine redials that destination after the last destination specified for broadcasting. For example, if you specify four destinations, A through D, for broadcasting, and if the lines to destinations A and C are busy, the machine dials the destinations in the following order: A, B, C, D, A, and C.

To check the transmission progress, print the TX file list.

If the optional extra G3 interface unit is installed, you can use the Simultaneous Broadcast function to send faxes simultaneously on different phone lines.

If you specify a second transmission while broadcasting to several destinations, faxes are transmitted alternately to each remaining destination in the current and second broadcast.

For example, if you specify a broadcast to destinations A and B, and then specify a broadcast to destinations C and D while transmission to destination A is in progress, the machine sends the faxes in the following order: A, C, B, and then D.

If the previous file and next file are both on standby, these are also sent in the same order.

**Note**

- ❑ To avoid accidentally pressing the wrong Destination key, you can set the machine so that each time a destination is added using a Destination key, **[Add]** must be pressed. Make the setting in User Parameters (switch 17, bit 2) in the Facsimile Features menu.

**Reference**

p.59 “Simultaneous Broadcast Using Multiple Line Ports”

p.181 “Printing a List of Files in Memory (Print TX File List)”

---

## Immediate Transmission

---

Immediate Transmission is possible with standard fax transmission and IP-Fax transmission.

**Important**

- ❑ Internet Fax is executed in only Memory Transmission that starts transmission automatically after storing documents in memory. If you switch the type of transmission to Internet Fax while the machine is in the Immediate Transmission mode, the transmission mode is automatically switched to the Memory Transmission mode.
- ❑ Group cannot be used for Immediate Transmission. You cannot send the same document to multiple destinations (broadcasting). If you specify broadcast or transmission for a group, the machine changes automatically to Memory Transmission.

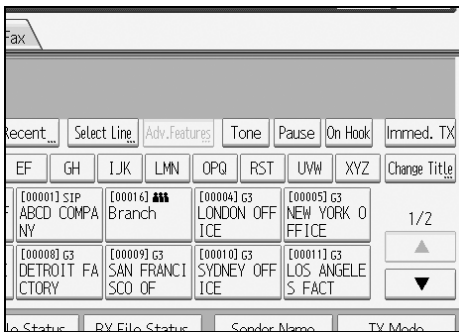
**1** Press **[Immed. TX]**.**2** Place the original.

### 3 Select the scan settings you require.

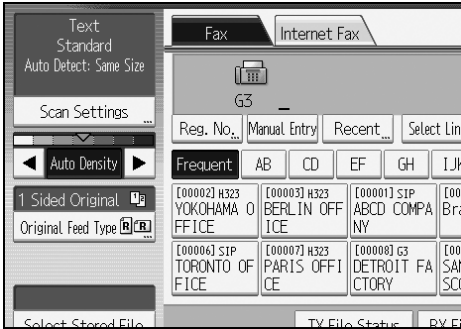

### 4 Using the number keys or a Destination key, specify a destination.

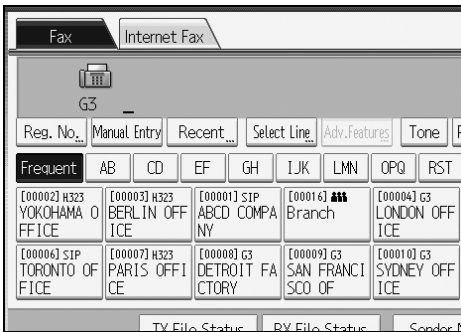

If you make a mistake, press the **[Clear/Stop]** key, and then enter the correct number.

To select a destination from the Address Book, see “Using the Address Book to Specify Destinations”.

### 5 Press the **[Start]** key.

The machine dials a destination.

#### Note

- Documents are not stored in memory.

#### Reference

- p.43 “Scan Type”
- p.45 “Resolution”
- p.54 “Density (Contrast)”
- p.60 “Sending Over a Fax Line”
- p.63 “Sending by IP-Fax”
- p.72 “Using the Address Book to Specify Destinations”
- p.74 “Specifying Group Destinations”
- p.75 “Selecting Destinations from Recent Destinations”

## Sending multiple originals using the exposure glass

Follow these steps to send multiple originals using the exposure glass.

- 1** Press [Immed. TX].
- 2** Place the first page face down on the exposure glass.
- 3** Specify a destination.
- 4** Make the scan settings you require.
- 5** Press the [Start] key.
- 6** Place the next original on the exposure glass within 10 seconds after the machine has finished scanning the first original.



- 7** Repeat steps **4** to **6** for all originals.
- 8** Place the last original, and then press the [#] key.

## Displaying Confirmation of Transmission

On this screen you can check the destination, transmission mode, and other transmission settings before transmitting.

1

**1** Press **[Check Modes]**, and then check the transmission settings.



The following display appears.

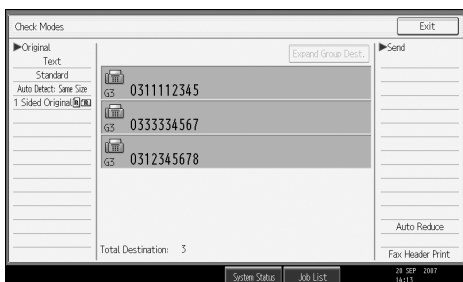

**2** After checking the settings on the display, press **[Exit]**.



# IP-Fax Functions

The IP-Fax function sends or receives documents between two facsimiles directly via a TCP/IP network.

This function has the following advantages and is suitable for communication within the same LAN:

- Reducing communication costs
- Communicating between IP-Faxes at higher speed than by standard fax

IP-Fax uses SIP and H.323 as the network protocol.

Specify an IPv4 address or host name instead of a fax number for sending. When using a gatekeeper, specify its alias telephone number. Specify addresses of the gatekeeper or SIP server (proxy server, register server, redirect server) as appropriate in Initial Settings in the Facsimile Features menu.

When using a SIP server, you can send by specifying SIP user name.

You can also transmit to a G3 facsimile connected to the public switched telephone network (PSTN) via a gateway (T.38-compliant).

You can receive IP-Faxes in the same manner as standard faxes.

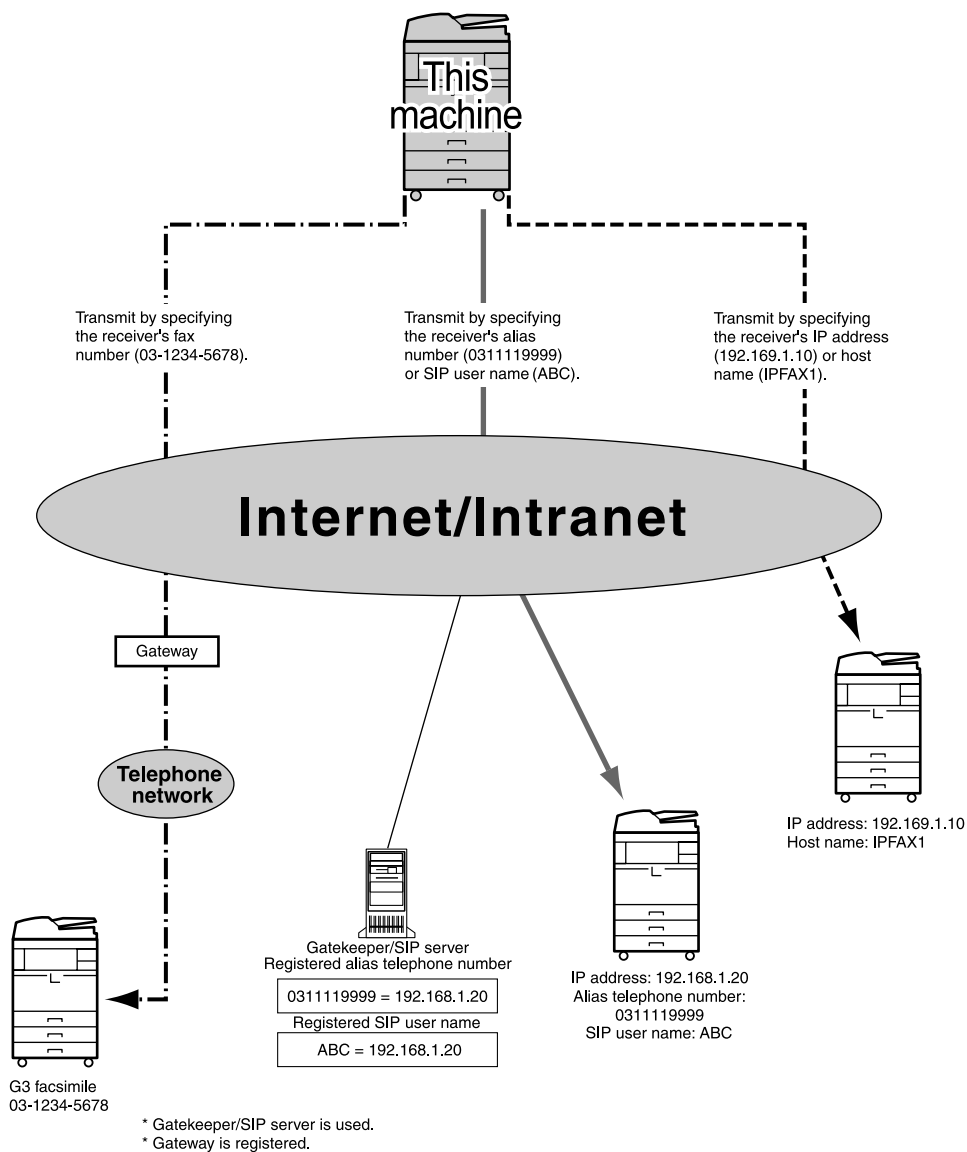

ALT001S

### Important

- To use this function, the optional printer /scanner unit must be installed.
- To use IP-Fax functions, this machine must be connected to a LAN and set up correctly under Initial Settings in the Facsimile Features menu.
- The facsimile function of this machine cannot be used with IPv6.
- Before using this function, configure the network in the System Settings menu.

### Note

- IP-Fax supported by this machine is ITU-T Recommendation T.38 compliant.

## Reference

p.141 “Types of Reception”

“Connecting the Machine”, General Settings Guide

“System Settings”, General Settings Guide

“Facsimile Features”, General Settings Guide

1

---

## Terminology

---

The following are words you should know when using IP-Fax:

### ❖ H.323

A multimedia communication protocol that sends or receives files via one-to-one communication over a LAN or the Internet.

### ❖ SIP

A communication control protocol for Internet telephone that utilizes VoIP (which converts voice information to IP packets) and is equipped with functions such as creating, modifying, and terminating sessions with one or more participants.

### ❖ Gatekeeper (VoIP gatekeeper)

A gatekeeper manages devices connected to an IP network and converts alias telephone numbers to IPv4 addresses and performs authentication functions. In addition, a gatekeeper governs band (transmission rate assignment) and access control.

### ❖ SIP server

A SIP server mediates connection requests between devices connected to an IP network and is composed mainly of servers that have the following three functions:

- Proxy server: Receives SIP requests and forwards them on behalf of the requestor.
- Register server: Receives information about a device's address within an IP network and registers them in the database.
- Redirect server: Used to inquire the destination address.

### ❖ Gateway (VoIP gateway)

A gateway connecting a telephone network and IP network, it has functions such as protocol conversion for connecting these different networks, and also connects communication devices (telephones, facsimiles, etc.) to a LAN or other network.

---

## Notes on Using IP-Fax

---

The following are notes about using IP-Fax:

- You may not be able to send to a firewall-protected network.
- You cannot use telephones on a LAN.
- If a power outage lasts about an hour, or the machine is disconnected from the power outlet for about an hour, documents stored in the fax machine's memory are deleted. If any document is deleted, the Power Failure Report is automatically printed out when the main power switch is turned on. Use this report to check which documents were deleted. Simply turning off the power by pressing the operation switch does not delete stored documents. See "Troubleshooting When Using the Facsimile Function", Troubleshooting.

### Reference

"Troubleshooting When Using the Facsimile Function", Troubleshooting

---

## Functions Not Available for IP-Fax Transmission

---

You can use the following functions with standard fax transmission, but not IP-Fax transmission:

- On hook dial
- Manual dial

# Internet Fax Functions

This machine converts scanned document images to e-mail format and transmits the data over the Internet.

The e-mail sent by this machine can be received by another Internet Fax machine. Instead of dialing the telephone number of the destination you want to send to, you enter the relevant e-mail address.

You can also print or forward received e-mail messages.

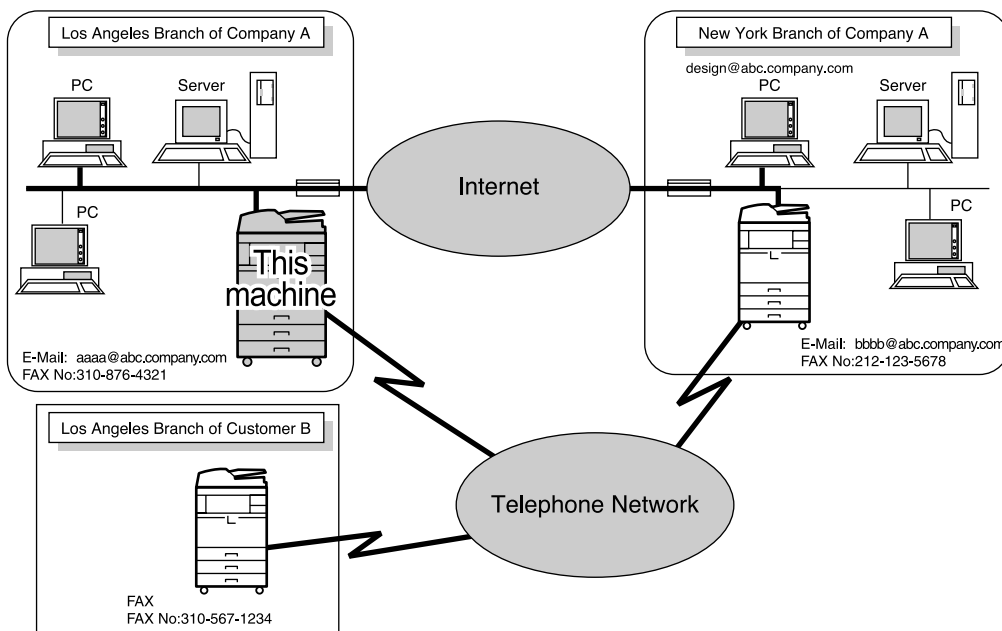

ALT0025

## Important

- To use this function, the optional printer/scanner unit must be installed.
- To use Internet Fax functions, this machine must be connected to a LAN and set up correctly in "System Settings".
- The facsimile function of this machine cannot be used with IPv6.
- To send Internet Fax documents, in the Facsimile Features menu, under Initial Settings, set **[Internet Fax Settings]** to **[On]**. However, documents can still be forwarded or delivered to Internet Fax destinations even if **[Off]** is selected.
- To receive Internet Fax documents, in the System Settings menu, in File Transfer, under **[Fax E-mail Account]**, set **[Account]** to **[Receive]**.

 **Note**

- The Internet Fax function supported by this machine is compliant with ITU-T Recommendation T.37.
- You can receive e-mail messages with an attached TIFF-F image from computers.
- Though Internet Fax documents are normally sent via an SMTP server, you can also send Internet Fax documents directly to their destinations without going through an SMTP server. To do this, set whether or not to bypass the SMTP server on the standby display.
- When sending Internet Fax documents, "Subject", "Text", "Reception Notice", and "BCC Transmission" can be selected in **[TX Mode]**.
- You can limit the size of transmitted e-mail messages in "Send Settings" of "Facsimile Features".
- See "Received Images" for how e-mail is actually received by the computer.
- For details about how to confirm the transmission result, see "Checking the Transmission Result (Transmission File Status)".

 **Reference**

- p.69 "Bypassing the SMTP server"
- p.119 "Requesting a Reception Notice"
- p.121 "Setting an E-mail Destination as a BCC"
- p.124 "Entering the Subject"
- p.127 "Entering the Text"
- p.149 "Received Images"
- p.185 "Checking the Transmission Result (Transmission File Status)"
- "Connecting the Machine", General Settings Guide
- "System Settings", General Settings Guide
- "Facsimile Features", General Settings Guide

---

## Notes on Using Internet Fax

---

The following are notes about using Internet Fax:

- When using the Internet Fax function, originals are sent at A4 size. Originals larger than A4 are reduced to A4 size. If the receiver is in compliance with the T.37 full mode, originals are sent at the size specified in the Address Book.
- When using Internet Fax transmission, documents are sent at "Detail" resolution, even if you specify "Super Fine". To send a document at "Super Fine", configure the Full Mode when registering the destinations in the Address Book.
- If a transmission is not successful, this machine usually receives an e-mail error notification. However, e-mail error notifications may not be transmitted for various reasons. It is recommended that you confirm receipt of important document by calling the other party.

- The level of security for Internet communications is low. It is recommended that you use the telephone network for confidential communications.
- Voice communication is not supported over a LAN.
- Internet Fax delivery might be delayed due to network congestion. Use Internet Fax transmission that bypasses the SMTP server, a public telephone line fax, or IP-Fax whenever communication time is a concern.
- If a power outage lasts about an hour, or the machine is disconnected from the power outlet for about an hour, documents stored in the fax machine's memory are deleted. If any document is deleted, the Power Failure Report is automatically printed out when the main power switch is turned on. Use this report to check which documents were deleted. Simply turning off the power by pressing the operation switch does not delete stored documents. See "Troubleshooting When Using the Facsimile Function", Troubleshooting.
- You may not be able to send large files as e-mail, depending on e-mail environment conditions.
- When available memory is low, you may not be able to send Internet Fax documents.
- Because the machine sends documents as e-mail messages with an attached TIFF-F image, viewer applications are required in order to view documents when they are received on a computer.
- With a large volume of document, it may take some time before transmission starts. This is due to the time the machine requires to convert the data in memory.

### Reference

p.31 "T.37 Full Mode"

p.39 "Paper Size and Scanned Area"

p.69 "Bypassing the SMTP server"

"Troubleshooting When Using the Facsimile Function", Troubleshooting

---

## Functions Not Available by E-mail Transmission

---

The following functions are supported with standard fax transmission, but not with Internet Faxing.

- Immediate Transmission
- Closed Network transmission
- SUB Code Transmission
- On Hook Dial
- Manual Dial
- JBIG Transmission
- ECM (Error Correction Mode)

---

## Functions Not Available by E-mail Reception

---

The following functions are supported with standard fax reception, but not with Internet Faxing.

- Memory Lock Reception
- SEP Code Reception
- Authorized Reception per Sender
- Reception File Print Quantity per Sender

---

## E-mail Subject

---

If you send e-mail without specifying a subject, a subject is automatically inserted. Subjects differ depending on Stamp Sender Name settings.

❖ **When Stamp Sender Name is set to on:**

From Sender Name(Fax Message NO.xxxx)

❖ **When Stamp Sender Name is set to off:**

- If Own Fax Number and Own Name are programmed:  
From "Own Fax Number"("Own Name")(Fax Message NO.xxxx)
- If only Own Fax Number is programmed:  
From "Own Fax Number"(Fax Message NO.xxxx)
- If only Own Name is programmed:  
From "Own Name"(Fax Message NO.xxxx)
- If neither Own Fax Number nor Own Name are programmed:  
Fax Message NO.xxxx

 **Note**

☐ "xxxx" is the document number that appears in the Journal.

 **Reference**

p.97 "Sender Settings"



---

## T.37 Full Mode

---

This machine is T.37 full mode compatible. T.37 full mode is an international standard for Internet Fax transmission. (ITU-T Recommendation, RFC2532)

When an Internet Fax communication is made between T.37 full mode compatible machines, the receiver side sends the return receipt (dispatched) in response to the reception notice request attached to the sent e-mail. This return receipt includes the receiver's reception capability information (compression type, paper size, and resolution). When the receiver is programmed in the Address Book as the full mode destination, the sender side automatically registers the received information in the Address Book. This allows you to send a subsequent Internet Fax document to that receiver based on this information.

### ❖ Returning a Return Receipt

When e-mail is received, if the sender requests reception notice, the receiver sends a return receipt that includes the receiving machine's capability (compression type, paper size, and resolution).

### ❖ Registering the Received Reception Confirmation Contents

When the sender receives the return receipt that includes the receiver's reception capability, the sender checks that the final recipient address sent is programmed in the Address Book. If it is programmed as a full mode destination, the sender automatically registers the receiver's reception capability. The registered reception capability is updated each time the sender receives new reception capability information. The sender can send documents to the receiver based on this information.

If the receiver is programmed as the simple mode machine or not programmed in the Address Book, the receiver's reception capability cannot be registered.

If you know the receiver's reception capability, you can set it manually.

### ❖ Requesting a Reception Notice

When the receiver's machine supports T.37 full mode and is programmed as a full mode machine in the Address Book, the machine requests the reception notice from the receiver. Then, the machine will receive the return receipt (sent) that includes the receiver's reception capability.

### Note

- Use Web Image Monitor to manually program a receiver's reception capability information.
- If you use Internet Fax transmission, you can send documents to multiple destinations at once. However, if you specify full mode destinations, since each destination may have a different reception capability, transmission is done one by one in the specified transmission order.

### Reference

p.119 "Requesting a Reception Notice"

p.257 "Programming Destination Information from Web Browser"

# Placing Originals

Place the original on the exposure glass or the ADF. For details about how to place originals, see the following:

- Placing originals on the exposure glass  
“Placing Originals on the Exposure Glass”, Copy/Document Server Reference
- Placing originals into the ADF  
“Placing Originals in the Auto Document Feeder”, Copy/Document Server Reference  
“Non-compatible originals for the Auto Document Feeder”, Copy/Document Server Reference

Note that **[Special Original]** of the copy function cannot be used with the facsimile function.

Place the originals according to their paper size.

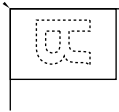
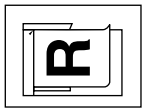
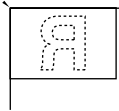
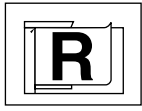
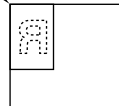
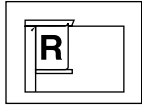
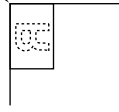
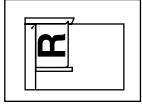
Original size	Placing on the exposure glass	Placing into the ADF
A4, B4 JIS, A3, 8 1/2"×11", 8 1/2"×14", 11"×17"		
A4, B4 JIS, A3, 8 1/2"×11", 8 1/2"×14", 11"×17"		
A5, B5 JIS, B6 JIS, 5 1/2"×8 1/2", 10"×14", 7 1/4"×10 1/2"		
A5, B5 JIS, B6 JIS, 5 1/2"×8 1/2", 10"×14", 7 1/4"×10 1/2"		

## Important

- If you place A5, B6 JIS, 5 1/2"×8 1/2", 10"×14", or 7 1/4"×10 1/2" size originals on the exposure glass, they are not detected. Place A5, B6 JIS, 5 1/2"×8 1/2", 10"×14", or 7 1/4"×10 1/2" size originals into the ADF.
- Do not lift the ADF while using it to scan originals.

 **Note**

- ❑ To scan multiple originals using the Auto Document Feeder (ADF), set originals in a stack.
- ❑ When sending a fax, the image output at the other end depends on the size and orientation of paper used in the receiver's machine. If the receiver does not use paper of the same size and orientation as that of the original, the fax image may be reduced in size, trimmed at both edges, or divided across two or more sheets. When sending an important original, ask the receiver about the size and orientation of the paper in their machine.
- ❑ When sending an original of irregular (i.e. custom) size or part of a large original, you can specify the scan area precisely.
- ❑ Custom size originals are scanned as regular size originals, so the receiver may find extra blank margins or edges of images missing. If you specify a scan area, only that area is scanned regardless of the actual size of the original.
- ❑ Documents longer than 800 mm (32") must be sent by Memory Transmission (Immediate Transmission may not be possible).
- ❑ If an original jams, press the **[Clear/Stop]** key, and then carefully remove the original.
- ❑ Make sure that all ink, correcting fluid etc., has completely dried before placing your original. If it is still wet, the exposure glass will become marked and those marks will appear on the received image.
- ❑ Generally, place A4, 8 1/2"×11" originals in the landscape orientation (☐). If you place an A4, 8 1/2"×11" original in the portrait orientation (☐), the image is sent rotated by 90 degrees.
- ❑ You can send the first page from the exposure glass then the remaining pages from the ADF. You cannot change from the ADF to the exposure glass.
- ❑ When using the Internet Fax function, originals are sent at A4 size. Originals larger than A4 are reduced to A4 size. If the receiver's machine is compliant with the T.37 full mode, originals are sent at the size specified in the Address Book.
- ❑ Information about this machine is printed at the destination. This information is printed on the side of the paper that is to your left when placing the documents on the exposure glass or the ADF. However, the information is also printed rotated by 90 degrees if an A4, 8 1/2"×11" original is placed in the portrait orientation (☐).
- ❑ For acceptable types of originals, see "Acceptable Original Sizes", "Paper Size and Scanned Area" and "Original Sizes Difficult to Detect".
- ❑ You can set the original feed types that are selected right after the power is turned on or the **[Clear Modes]** key is pressed. See "Registering a priority function using a program".

## Reference

- p.16 “Sending multiple originals using the exposure glass”
- p.21 “Sending multiple originals using the exposure glass”
- p.31 “T.37 Full Mode”
- p.38 “Acceptable Original Sizes”
- p.39 “Paper Size and Scanned Area”
- p.41 “Original Sizes Difficult to Detect”
- p.42 “Transmission with Image Rotation”
- p.47 “Scan Size”
- p.264 “Registering a priority function using a program”  
“Facsimile Features”, General Settings Guide
- “Placing Originals”, Copy/Document Server Reference

## Setting the Original Orientation

When you store documents in the Document Server, set “Original Orientation”.

- 1** Place the original, and then select the scan settings you require.
- 2** Press [Original Feed Type].

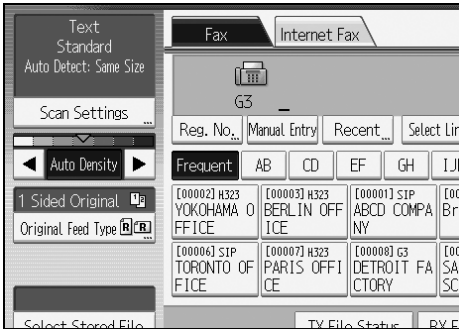

- 3** Specify the original orientation.

Check the orientation of the placed document, and then press [R/R] or [L/L].

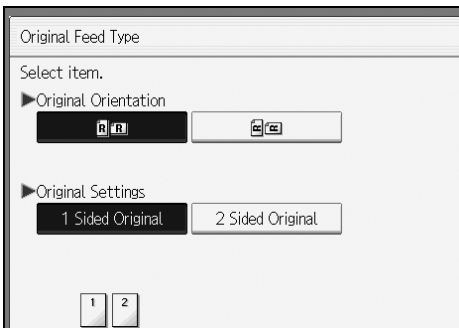

**4** Press [OK].

The selected original orientation appears in “Original Feed Type”.

**5** Specify a destination, and then press the [Start] key.
 **Reference**













p.216 “Storing a Document”

1

## Scanning Two-Sided Originals

Use this function to send two-sided originals.

The front and back of the scanned original will be printed in order on separate sheets at the other end. The orientation of alternate sheets may be reversed at the other end. If you want to print the original with the same orientation at the other end, specify the “Original position” and “Page opening orientation”.

	Original	Original position	Page opening orientation	Output at the other end
A3, B4, JIS, A4, 11" x 17", 8 1/2" x 14", 8 1/2" x 11"			Top to Top	
	Top to Bottom			
			Top to Top	
	Top to Bottom			
B5, JIS, A5, 8 1/2" x 5 1/2"			Top to Top	
	Top to Bottom			
			Top to Top	
	Top to Bottom			

GHPY020E

### Important

- When you use [2 Sided Original] under [Original Feed Type], the originals cannot be sent by using just the exposure glass.
- Two-sided originals are only sent with Memory Transmission. Immediate Transmission is not possible.

**1** Place the original, and then select the scan settings you require.

**2** Press [Original Feed Type].

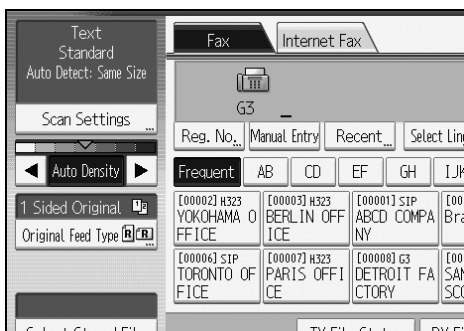

**3** Specify the original orientation.

Check the orientation of the placed document, and then press [R/R] or [L/L].

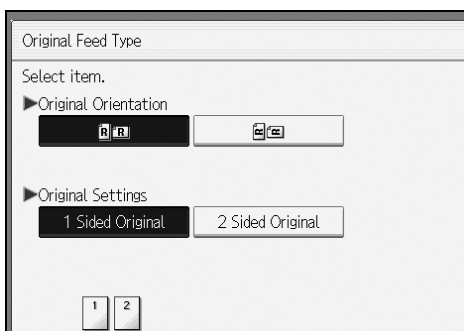

Make sure that the specified original orientation matches the orientation of originals loaded in the ADF.

**4** Press [2 Sided Original].

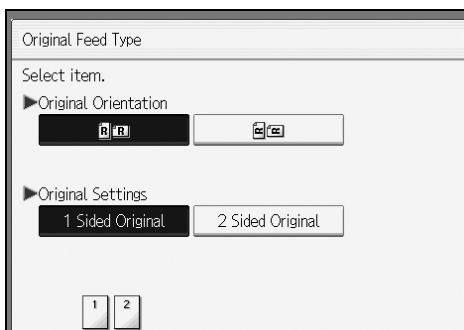

## 5 Select [Top to Top] or [Top to Bottom].

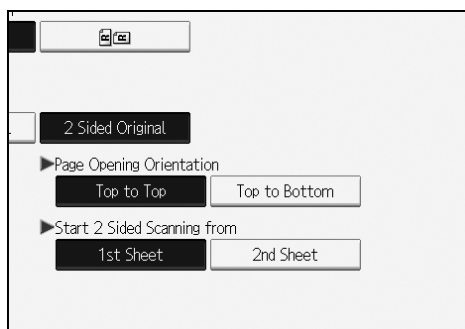

## 6 Select [1st Sheet] or [2nd Sheet].

To cancel two-sided transmission, press [1 Sided Original]. The display returns to that of step 4.

Select [2nd Sheet] if you want to send a cover sheet as the first page.

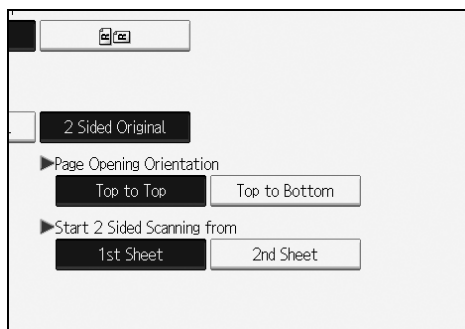

## 7 Press [OK].

“2 Sided Original” appears above [Original Feed Type].

## 8 Specify a destination, and then press the [Start] key.

### Note

- You can set the original feed types that are selected right after the power is turned on or the [Clear Modes] key is pressed. See “Registering a priority function using a program”.

### Reference

p.264 “Registering a priority function using a program”

## Acceptable Original Sizes

Where original is set	Acceptable original size	Maximum number of sheets	Paper thickness
Exposure glass	Up to A3 (297 × 420 mm), 11" × 17" (279 × 432 mm)	1	----
ADF, one-sided document	B6 JIS ☐ to A3 ☐ (up to 1200 mm long) 5 <sup>1</sup> / <sub>2</sub> " × 8 <sup>1</sup> / <sub>2</sub> " ☐ to 11" × 17"☐	100 sheets (80.0 g/m <sup>2</sup> , 20 lb)	40-128 g/m <sup>2</sup> (11-34 lb)
ADF, two-sided document	A5 ☐ to A3 ☐ (up to 432 mm long) 5 <sup>1</sup> / <sub>2</sub> " × 8 <sup>1</sup> / <sub>2</sub> " ☐ to 11" × 17"☐	100 sheets (80.0 g/m <sup>2</sup> , 20 lb)	52-128 g/m <sup>2</sup> (14-34 lb)

### Note

- ☐ The weight range for originals in the Mixed Original Sizes mode is 52–81 g/m<sup>2</sup>, 13.8–21.5 lb.



## Paper Size and Scanned Area

### Important

- ❑ If you place an original larger than A3, 11"×17" on the exposure glass, only an A3, 11"×17" area is scanned.

### ❖ Exposure Glass

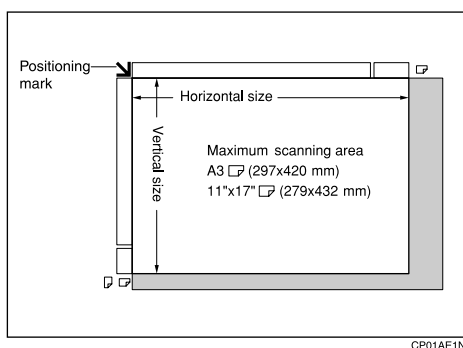

### ❖ ADF

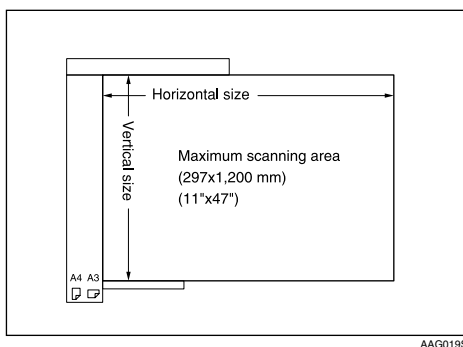

### ❖ Maximum scan area

The following shows the maximum scan area:

- Memory Transmission: 297 × 1200 mm/11" × 47" (W × L) from the ADF
- Immediate Transmission: 297 × 1200 mm/11" × 47" (W × L) from the ADF
- 297 × 432 mm/11" × 17" (W × L) (from the exposure glass)

**Note**

- ❑ There may be a difference in the size of the image when it is printed at the destination.
- ❑ Even if an original is correctly placed on the exposure glass or in the ADF, a margin of 3 mm (0.1") around each edge of the original may not be sent.
- ❑ If the receiver uses paper of a smaller width than the original, the image is reduced to fit that paper.
- ❑ During Immediate Transmission, the length of the scanning range can become narrower than 1200 mm (47"), depending on the resolution as well as the settings on the destination machine.
- ❑ The machine detects paper sizes in the following ways:
  - When you place an original in the ADF, an original wider than about 263 mm (10.4") is scanned as A3, 11"×17" size.  
An original narrower than about 230 mm (9.1") is sent as A4 or 8<sup>1</sup>/<sub>2</sub>"×14" size, and an original narrower than about 263 mm (10.4") is scanned as B4 JIS (Japanese Industrial Standard).  
Originals up to 1200 mm (47.2") in length can be scanned.
  - See the following table for sizes the machine can detect when you place an original on the exposure glass. Because the machine scans custom size documents in a standard size, part of the image may be truncated depending on the length of the document. For details about how to set custom size documents, see "Scan Size".

**❖ Metric Version**

		Length		
		-215.9 mm	215.9 mm-297 mm	297 mm-
Width	-182 mm	×	B5 JIS❑	×
	182 mm-210 mm	A5❑	A4❑	8 <sup>1</sup> / <sub>2</sub> "×13"❑
	215.9 mm-254 mm	B5 JIS❑	×	B4 JIS❑
	257 mm-	A4❑	×	A3❑

BFT011S

**❖ Inch Version**

		Length		
		-8.5"	8.5"-11.7"	11.7"-
Width	-7.2"	×	×	×
	7.2"-8.3"	8 <sup>1</sup> / <sub>2</sub> "×5 <sup>1</sup> / <sub>2</sub> "❑	8 <sup>1</sup> / <sub>2</sub> "×11"❑	8 <sup>1</sup> / <sub>2</sub> "×13"❑
	8.5"-10"	×	×	8 <sup>1</sup> / <sub>2</sub> "×14"❑
	10.1"-	11"×8 <sup>1</sup> / <sub>2</sub> "❑	×	11"×17"❑

BFT012S

× - Unable to auto detect

## Reference

p.47 "Scan Size"











### Original Sizes Difficult to Detect

The machine has difficulty detecting the size of the following kinds of originals. (When this happens, the receiving machine may not select print paper of the correct size.)

- documents placed on the exposure glass of sizes other than those listed in the following table
- originals with index tabs, tags, or protruding parts
- transparent originals, such as OHP transparencies or translucent paper
- dark originals with dense text or drawings
- originals that contain areas of solid print
- originals that have solid print around their edges
- originals with glossy surfaces
- bound originals of more than 10 mm (0.3") in thickness, such as books.

The following paper sizes are automatically detected in facsimile mode.









#### ❖ Metric Version

Papersize where original is placed	A3 	8 1/2"×13" (F4)	B4 JIS 	A4  	B5 JIS  	A5  	B6 JIS  
Exposure glass	○	○	○	○	○	×	×
ADF	○	○	○	○	○	○	○

○ - Auto detect

× - Unable to auto detect

#### ❖ Inch Version

Paper size where original is placed	11"×17" 	8 1/2"×14" 	8 1/2"×11"  	5 1/2"×8 1/2"  	10"×14" 	7 1/4"×10 1/2" 
Exposure glass	○	○	○	×	×	×
ADF	○	○	○	○	○	○

○ - Auto detect

× - Unable to auto detect

 **Reference**

“System Settings”, General Settings Guide

---

**1**

---

**Transmission with Image Rotation**

---

Generally, place A4, 8<sup>1</sup>/<sub>2</sub>"×11" originals in the landscape orientation (☐). If you place an A4, 8<sup>1</sup>/<sub>2</sub>"×11" original in the portrait orientation (☐), the image is sent rotated by 90 degrees. Providing the receiver has A4, 8<sup>1</sup>/<sub>2</sub>"×11" landscape paper (☐), the document is printed the same size as the original.

 **Note**

- This function is unavailable with Immediate Transmission.
- When Image Rotation is used, all documents are sent by normal Memory Transmission.
- This function is unavailable when using Mixed Original Sizes.

# Scan Settings

You may want to send many different types of fax documents. Some of these may be difficult to reproduce at the receiver's end. However, the machine has three settings that you can adjust to help you transmit the document with the best possible image quality.

❖ **Scan Type:**

Text, Text / Line Art, Text / Photo, Photo

❖ **Resolution:**

Standard, Detail, Super Fine (optional)

❖ **Scan Size:**

Auto Detect, Regular, Area, Mixed Original Sizes

❖ **Density (Contrast):**

Auto Density, Manual Density (seven levels), Combined Auto and Manual Density

---

## Scan Type

---

If the original contains photographs, illustrations, or diagrams with complex shading patterns or grays, select the appropriate scan type to optimize image clarity.

❖ **Text**

Select **[Text]** to send high-contrast black-and-white image originals. Use this setting when you only want to send clearer text, even if the original contains text and photographs.

❖ **Text / Line Art**

Select **[Text / Line Art]** to send high-contrast black-and-white graphic originals at improved resolution. The **[Text]** mode gives priority to scanning speed; **[Text / Line Art]** mode gives priority to scanning quality.

❖ **Text / Photo**

Select **[Text / Photo]** to send an original containing both a high-contrast black-and-white image, such as text, and a halftone image, such as a photograph.

❖ **Photo**

Select **[Photo]** to send an original containing a halftone image, such as a photograph or a colour original.

## 1 Press [Scan Settings].

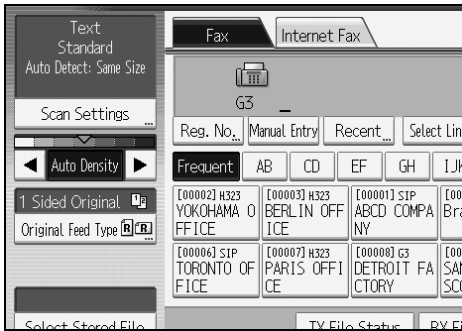

## 2 Make sure that [Scan Type] is selected.

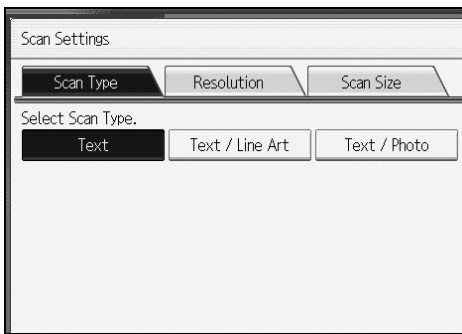

## 3 Select the scan type you require, and then press [OK].

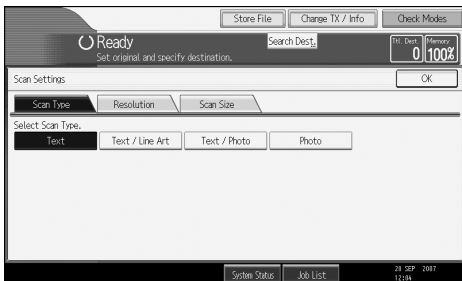

### Note

- If you select **[Text / Line Art]**, **[Text / Photo]**, or **[Photo]**, the transmission will take longer than when **[Text]** is selected.
- If you send a fax document with **[Text / Line Art]**, **[Text / Photo]**, or **[Photo]** and the background of the received image is dirty, reduce the density setting and resend the fax.
- You can set the scan type that is selected right after the machine is turned on or the **[Clear Modes]** key is pressed. See "Registering a priority function using a program".

### Reference

p.54 "Density (Contrast)"

p.264 "Registering a priority function using a program"

---

## JBIG Transmission

---

If you use JBIG (Joint Bi-level Image experts Group) compression, you can send originals scanned using **[Photo]** faster than with other compression methods.

### Important

- This function is not available with Internet Fax function.
- This function requires that the other party's fax machine has both the JBIG function and ECM function (G3 communication only).

---

## Resolution

---

This section explains how to set the resolution of the original.

Images and text are scanned into the machine by converting them to a sequence of dots. The density of the dots determines the quality of the image and how long it takes to transmit. Therefore, images scanned at high resolution (Super Fine) have high quality but transmission takes longer. Conversely, low resolution (Standard) scanning results in lower quality but the original is sent more quickly. Select the setting that matches your needs based upon this trade off between speed and image clarity.

### ❖ **Standard (8 x 3.85 lines/mm, 200 x 100 dpi)**

Select for originals containing normal size characters.

### ❖ **Detail (8 x 7.7 lines/mm, 200 x 200 dpi)**

Select for originals containing small characters or when you require greater clarity. This resolution is twice as fine as Standard.

### ❖ **Super Fine (optional expansion memory required: 16 x 15.4 lines/mm, 400 x 400 dpi)**

Select for originals with very fine details or when you require the best possible image clarity. This resolution is eight times finer than Standard.

# 1 Press [Scan Settings].

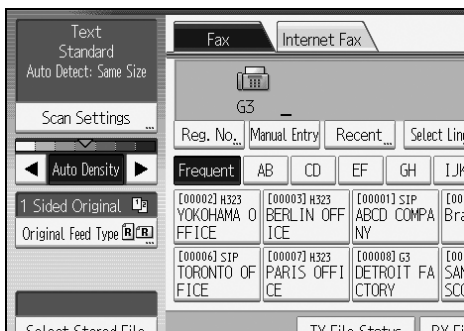

# 2 Press [Resolution].

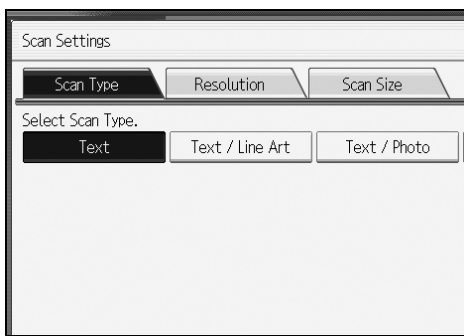

# 3 Select the resolution you require, and then press [OK].

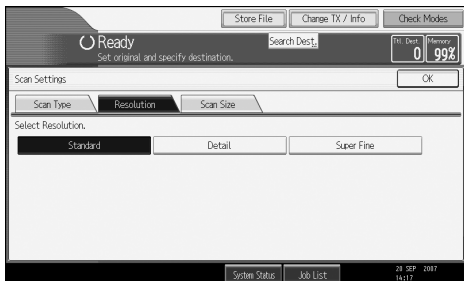



 **Note**

- If you install the optional expansion memory, “Super Fine” appears in the Resolution screen.
- If the other party's machine does not support the resolution at which you are sending, this machine automatically switches to a resolution that is supported. You can check the resolution at which you actually sent by printing the Journal.
- Sending with Super Fine resolution requires that the machine has the optional expansion memory, and the other party's machine has the capability to receive fax documents at Super Fine resolution.
- The machine supports Standard, Detail, Fine (with the optional expansion memory), and Super Fine (with the optional expansion memory) resolutions for reception.
- You can set the resolution type that is selected right after the machine is turned on or the **[Clear Modes]** key is pressed. See “Registering a priority function using a program”.
- When using Internet Fax transmission, documents are sent at “Detail” resolution, even if you have specified “Super Fine”. To send a document at “Super Fine”, configure the Full Mode when registering the destinations in the Address Book.

 **Reference**

p.31 “T.37 Full Mode”

p.192 “Print Journal”

p.264 “Registering a priority function using a program”

---

## Scan Size

---

Normally, a placed original is scanned according to the automatically detected size. If a scan area is specified, the original is scanned accordingly. Thus, originals can be sent without extra space or blank margins.

 **Note**

- When placing different size originals into the ADF, adjust the document guide to the largest original.
- Small-size originals may be sent at a slight slant since they do not match the document guide.

 **Reference**

p.41 “Original Sizes Difficult to Detect”

## Auto Detect

Detects the size of the first page and scans all pages using that size.

If the machine cannot detect the original size, a confirmation message appears. Place the original again.

**1** Place the originals.

**2** Press [Scan Settings].

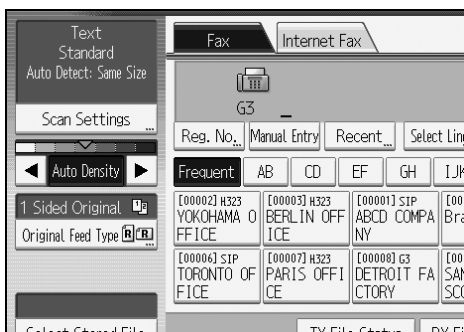

**3** Press [Scan Size].

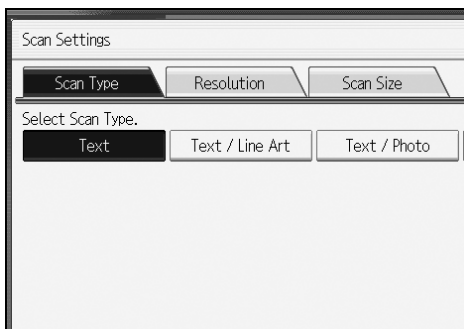

**4** Make sure that [Auto Detect] is selected.

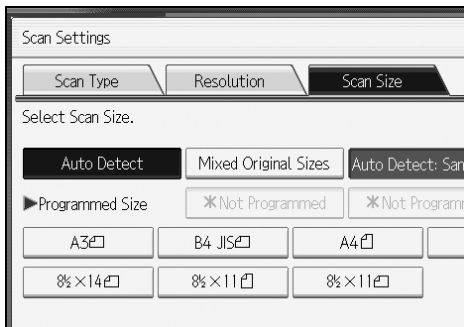



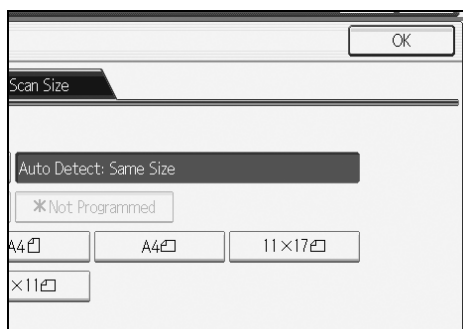



If it is not, press [Auto Detect].

**5** Press [OK].

"Auto Detect: Same Size" appears above [Scan Settings].

**6** Specify a destination and press the [Start] key.**Regular**

The placed original is scanned according to specified size regardless of actual size.

The sizes that can be specified are A4 , B4 JIS , A3 , 8<sup>1</sup>/<sub>2</sub>"×11" , 8<sup>1</sup>/<sub>2</sub>"×14" , and 11"×17" .

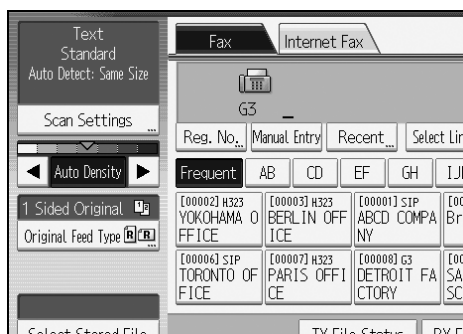
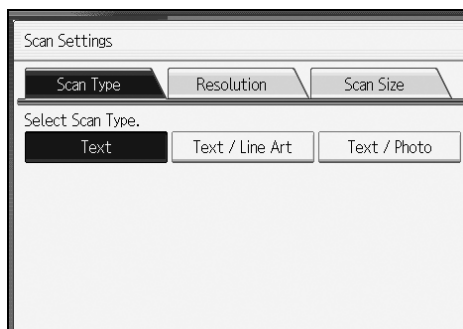
**1** Place the originals.**2** Press [Scan Settings].**3** Press [Scan Size].

#### 4 Press the size of the originals to be sent.

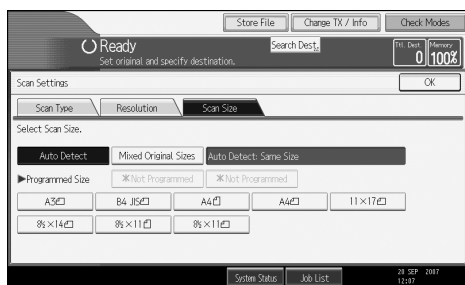

8<sup>1</sup>/<sub>2</sub>"×11" indicates LT. 8<sup>1</sup>/<sub>2</sub>"×14" indicates LG. 11"×17" indicates DLT.

#### 5 Press [OK].

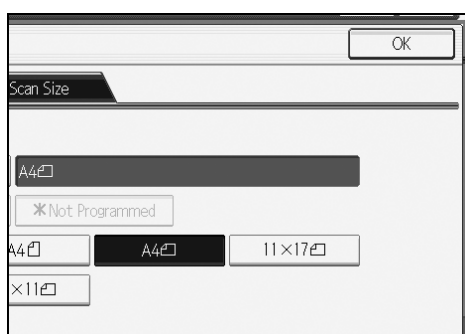

The selected size appears above [Scan Settings].

#### 6 Specify a destination and press the [Start] key.

##### Note

- To cancel the selected scan size, select [Auto Detect].

### Area

Program the sizes of the originals to be scanned in advance. Only the area in the specified size is scanned regardless of the actual size of a placed original.

#### 1 Place the originals.

#### 2 Press [Scan Settings].

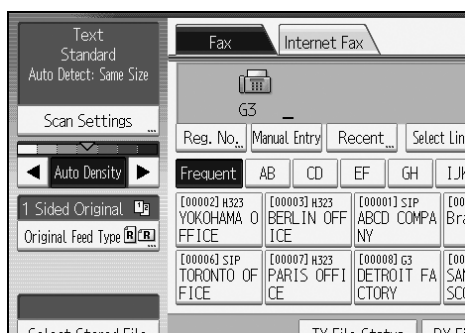

### 3 Press [Scan Size].

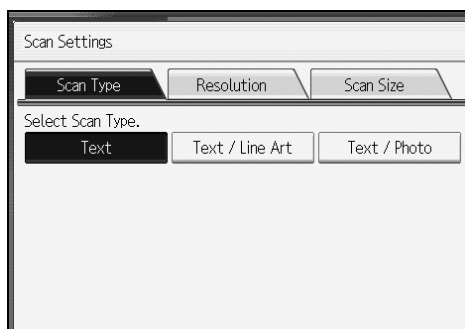

### 4 Press [Area 1] or [Area 2].

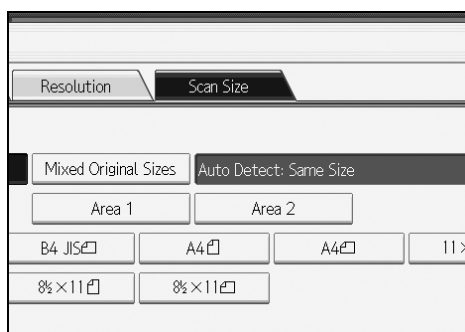

### 5 Press [OK].



The specified size appears above [Scan Settings].

### 6 Specify a destination and press the [Start] key.

#### Note

- To cancel the selected scan size, select [Auto Detect].

## Mixed Original Sizes

Select this to individually scan the size of originals loaded into the ADF. For example, when A3 and A4 size originals are sent together, usually all are sent using the size of the first original. By selecting Mixed Original Sizes, the machine scans and sends each original according to its size.

### Important

- The sizes of the originals that can be placed in this mode are as follows:
  - Metric Version: A3, B4 JIS, A4, B5 JIS
  - Inch Version: 11"×17", 8 1/2"×14", 8 1/2"×11"
- When placing originals in the ADF, align their rear and left edges against the ADF, and adjust the document guide according to the largest original.
- Since small originals may not be correctly aligned with the original guide, the scanned image may be slanted.

**1** Place the originals.

**2** Press [Scan Settings].

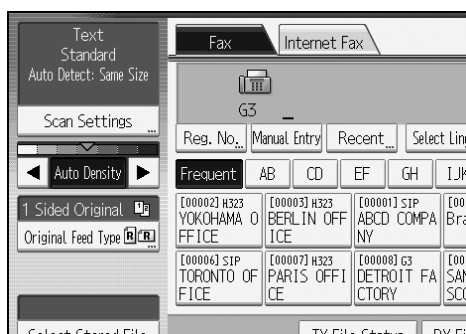

**3** Press [Scan Size].

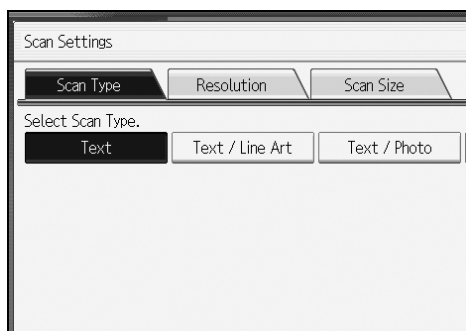

#### 4 Press [Mixed Original Sizes].

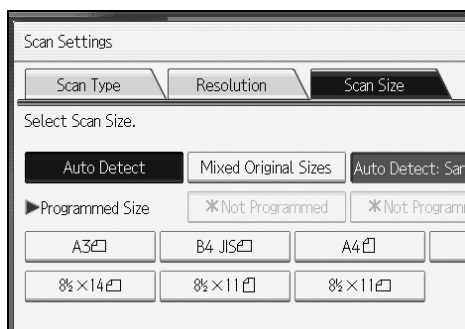

#### 5 Press [OK].

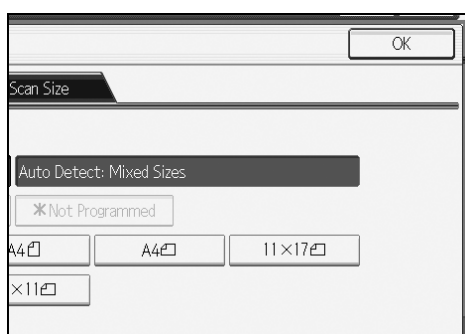

“Auto Detect: Mixed Sizes” appears above [Scan Settings].

#### 6 Specify a destination and press the [Start] key.

##### Note

- To cancel Mixed Original Sizes, press [Mixed Original Sizes] again before pressing [OK] in step 4.
- When using Mixed Original Sizes, the machine sends the originals by Memory Transmission.
- When using Mixed Original Sizes, rotation transmission is disabled.
- You can have the machine select Mixed Original Sizes right after the power is turned on or the [Clear Modes] key is pressed. See “Registering a priority function using a program”.

##### Reference

p.42 “Transmission with Image Rotation”

p.264 “Registering a priority function using a program”

## Density (Contrast)

The text and diagrams on originals should stand out clearly from the paper they are on. If the original has a darker background than normal (for example, a newspaper clipping), or if the writing is faint, adjust the density.

### ❖ Auto Density

The appropriate density setting for the original is automatically selected.

- ① Make sure that **[Auto Density]** is selected.

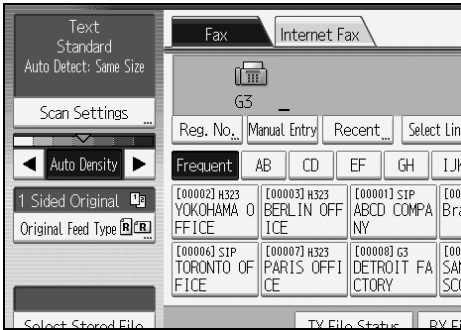

### ❖ Manual Density

Use manual density to set density manually. You can select one of seven density levels.

- ① If **[Auto Density]** is selected, press **[Auto Density]** to turn it off.
- ② Press **[◀]** or **[▶]** to adjust the density. The cursor moves.

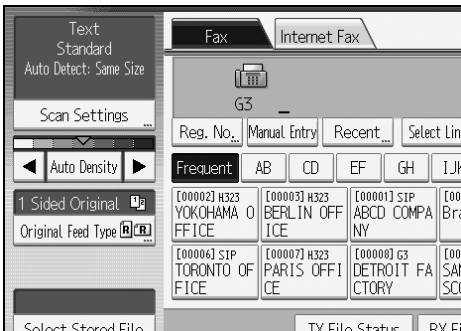



### ❖ Combined Auto and Manual Density

You can only adjust density for photographs, illustrations, or diagrams if the original has a dark background.

You can select one of seven density levels.

- ① Make sure that **[Auto Density]** is selected.
- ② Press [**◀**] or [**▶**] to adjust the density.  
The cursor moves.

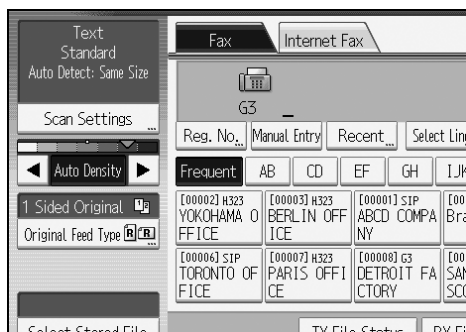

### Note

- Selecting **[Text]**, **[Text / Line Art]**, or **[Text / Photo]** for the scan type causes **[Auto Density]** to be selected.
- You can set the density that is selected right after the machine is turned on or the **[Clear Modes]** key is pressed. See “Registering a priority function using a program”.

### Reference

p.264 “Registering a priority function using a program”

## Mixing Scan Settings for a Multiple Page Original

When sending an original of several pages, you can select a different density, resolution, and scan type setting for each page.

It is recommended that originals be placed on the exposure glass when mixing scan settings for a multiple page original.

### ❖ When placing originals on the exposure glass

- ① Check which pages you want to scan with different settings.
- ② Remove the previous page and place the next page that you checked on the exposure glass.
- ③ Select the density, resolution, and scan type.  
You have about 60 seconds (10 seconds for Immediate Transmission) to select density, resolution, and scan type. The time remaining is shown on the display.



Adjust the settings for each page before you press the **[Start]** key.

### ❖ When placing originals in the Auto Document Feeder (ADF)

- ① Check which pages you want to scan with different settings.
- ② Select the density, resolution, and scan type before the page you want to change the settings for starts being scanned.

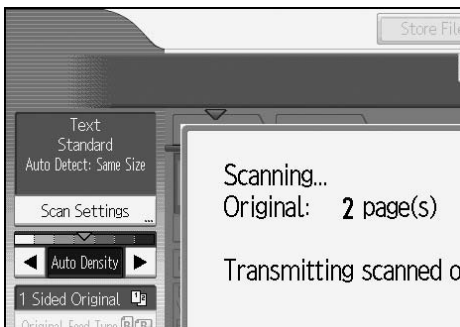

Depending on what time the scan settings are adjusted, the settings may not be reflected in the resulting operation.

# Changing the Line Port

Select a line port or protocol to be used for standard fax or IP-Fax transmission. When the extra G3 interface unit is installed, you can connect to a maximum of three ports.

## Important

To add more fax lines, the optional extra G3 interface unit is required.

## G3

G3 is selected after power up or when the machine is reset. If you install the extra G3 interface unit, you can select “G3-1”, “G3-2”, “G3-3”, or “G3 Auto” depending on the number of the installed unit.

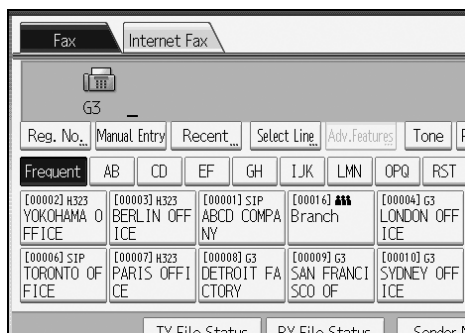

## Multi-port

When the extra G3 interface unit is installed, communications can take place simultaneously through three lines at once.

The following list shows protocol combinations available for each line type.

Option	Available line types	Available protocol combinations
Without option	PSTN	G3
Extra G3 interface unit	PSTN + PSTN	G3 + G3
Extra G3 interface unit + Extra G3 interface unit	PSTN + PSTN + PSTN	G3 + G3 + G3

## IP-Fax

When sending an IP-Fax, select either “SIP” or “H.323” as the protocol.

To display “SIP” and “H.323” on the screen, make the settings in “Initial Settings” in the Facsimile Features menu.

Ask your administrator whether you should select “SIP” or “H.323” as the protocol.

**1** Press [Select Line].

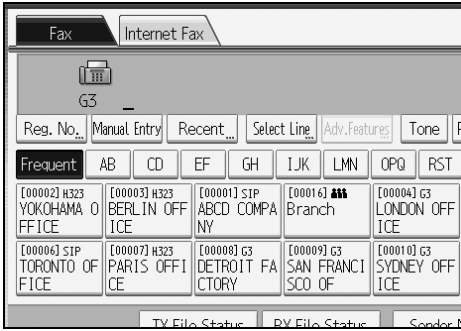

**2** Select the line you want to use.

If you select “G3 Auto”, the machine will use any available line. This increases efficiency.

When one optional extra G3 unit is installed

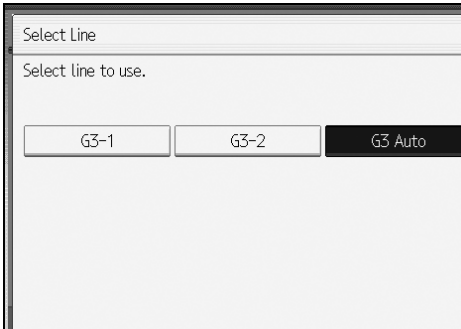

When two optional extra G3 units are installed

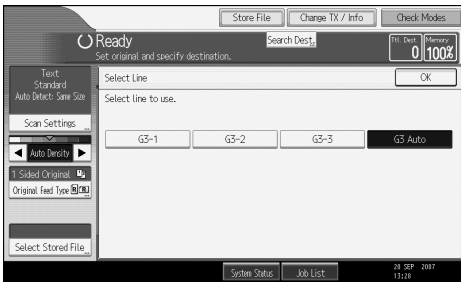

When H.323/SIP are set to “On”

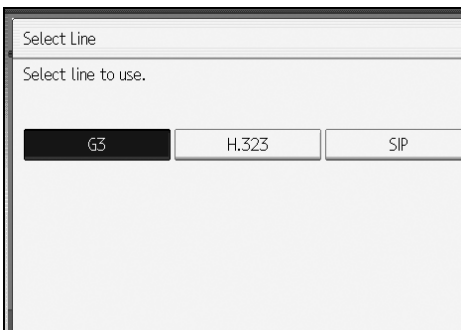

**3** Press [OK].

The standby display appears.

**Note**

- When you install the extra G3 interface unit, you can specify the line port home position. See “Registering a priority function using a program”.
- When sending a fax, you can select the line port if dialing with the number keys.
- A maximum of three simultaneous communications are possible. You cannot perform three Immediate Transmissions simultaneously.
- If three communications are in progress, the display shows the first communication that was initiated.

**Reference**

p.264 “Registering a priority function using a program”  
“Facsimile Features”, General Settings Guide

---

## Simultaneous Broadcast Using Multiple Line Ports

---

The Standard Broadcast function sends faxes one at a time to multiple destinations in the order of specified destinations.

However, the Simultaneous Broadcast function can simultaneously send faxes to multiple destinations using different lines.

This results in a shorter overall transmission time.

**Important**

- The optional extra G3 interface unit is required.

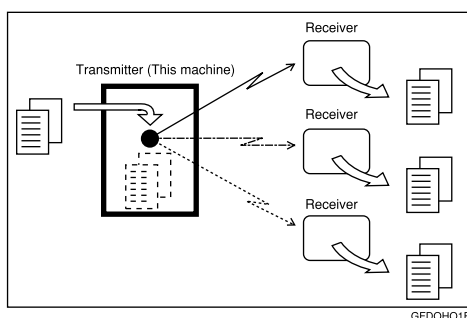
**Note**

- A maximum of three simultaneous transmissions (including LAN) are possible.
- When using the optional extra G3 interface unit, if you set the line selection as “G3 Auto” beforehand, the machine will use whichever G3 line is not busy. This increases efficiency.

# Specifying a Destination

This section explains how to specify a destination.

Fax numbers, IP-Fax destinations, and e-mail addresses can be specified.

## Note

- The display shows the percentage of free memory space for storing originals. Since fax numbers, IP-Fax destinations and e-mail addresses are programmed in separate memory, dialing fax numbers using the number keys does not change the percentage on the display.

## Sending Over a Fax Line

Enter numbers directly using the number keys on the right side of the control panel.

**1** Make sure that **[Fax]** is selected.

**2** Enter the fax number using the number keys.



If you make a mistake, press the **[Clear/Stop]** key, and then enter again.

If the optional extra G3 interface unit is installed, select the line you want to use before pressing the **[Start]** key.

To select a destination from the Address Book, see “Using the Address Book to Specify Destinations”.

**3** Press the **[Start]** key.

The machine starts to scan the original and stores it in memory. When scanning ends, the Communicating indicator lights and transmission starts.

## Note

- You can insert pauses and tones in a fax number.
- Press **[Prg. Dest.]** after entering the fax number to store the fax number in the destination list.
- For the maximum number of digits for a destination, see “Maximum Values”.

## Reference

p.57 “Changing the Line Port”

p.61 “Entering a pause”

p.62 “Entering a tone”

p.72 “Using the Address Book to Specify Destinations”

p.79 “Registering Entered Destinations to the Address Book”

p.272 “Maximum Values”

1

## Entering a pause

Press **[Pause]** when dialing or storing a number to insert a pause of about two seconds.

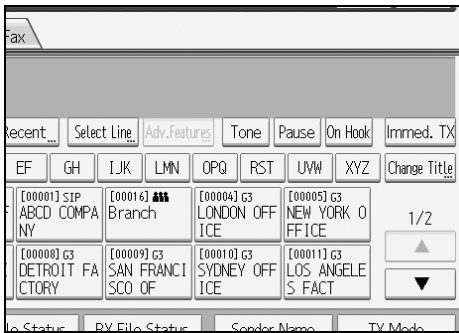

## Note

- A pause is shown as a “-” on the display.

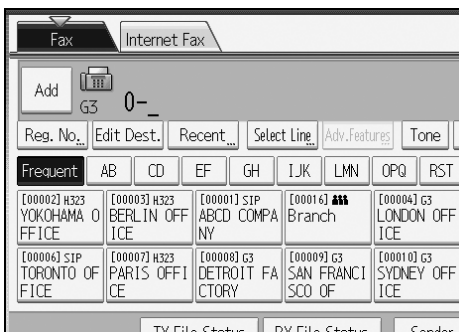

- You can also program numbers including pauses in the destination list.

## Entering a tone

This function allows a machine connected to a pulse dialing line to send tonal signals (for example if you want to use a special service on a tone dialing line). When you press **[Tone]**, the machine dials the number using tonal signals.

This section explains how to use the tone function with On Hook Dial as an example.

### 1 Press **[On Hook]**.

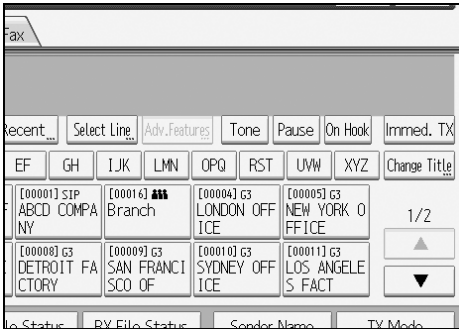

### 2 Enter the fax number using the number keys.

### 3 Press **[Tone]**.

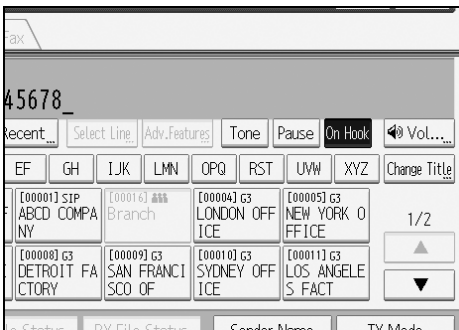

### 4 Enter the number you want to tone dial using the number keys.

### 5 Press the **[Start]** key.

The machine starts to scan the original and stores it in memory. When scanning ends, the Communicating indicator lights and transmission starts.

#### Note

- Certain services may be unavailable even when using Tone function.
- A tone is shown as a "T" on the display and the next numbers are dialed using tonal signals.



## Sending by IP-Fax

This section explains how to specify a destination using IP-Fax transmission.

When using IP-Fax transmission, specify the IP-Fax destination (IPv4 address, host name, or alias telephone number) in place of the fax number.

### Important

Specify the protocol to be used in **[Select Line]** in advance.

**1** Make sure that **[Fax]** is selected.

**2** Press **[Manual Entry]**.

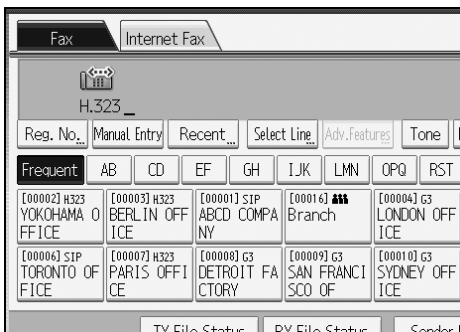

To select a destination from the Address Book, see “Using the Address Book to Specify Destinations”.

**3** Enter the IP-Fax destination, and then press **[OK]**.



If you enter an incorrect character, press **[Backspace]** or **[Delete All]**. Then, re-enter the characters correctly.

To change the IP-Fax destination after pressing **[OK]**, press **[Edit Dest.]**, re-enter an IP-Fax destination, and then press **[OK]**.

#### 4 To add a destination, press [Add].

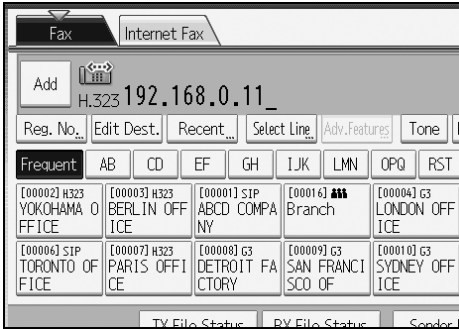

When you press **[Prg. Dest.]**, you can register an entered destination in the destination list.

#### 5 Specify the next destination.

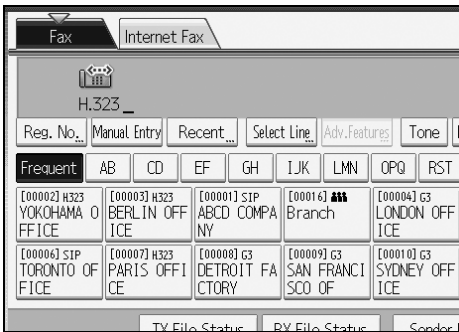

To add another destination, repeat steps **4** and **5**.

#### 6 Press the [Start] key.

The machine starts to scan the original and stores it in memory. When scanning ends, the Communicating indicator lights and transmission starts.

#### Note

- Depending on security settings, **[Manual Entry]** may not appear, and you may be unable to enter the IP-Fax destination.
- For a list of gateways (T.38-compliant), gatekeepers, or SIP servers that are certified as operable with this machine, contact your local reseller or service representative.
- Methods of entering a destination vary depending on the network settings made by the administrator. Ask the machine administrator for details. For details about entering the IP-Fax destination, see “Regarding IP-Fax destinations”.
- To avoid accidentally pressing the wrong Destination key, you can set the machine so that each time a destination is added using a Destination key, **[Add]** must be pressed. Make the setting in User Parameters (switch 17, bit 2) in the Facsimile Features menu.
- For the maximum number of digits for a destination, see “Maximum Values”.

## Reference

- p.23 “IP-Fax Functions”
- p.57 “Changing the Line Port”
- p.65 “Regarding IP-Fax destinations”
- p.72 “Using the Address Book to Specify Destinations”
- p.79 “Registering Entered Destinations to the Address Book”
- p.272 “Maximum Values”
- “Entering Text”, About This Machine
- “Facsimile Features”, General Settings Guide

---

## Regarding IP-Fax destinations

---

Depending on the network to which this machine is connected or this machine's configuration, enter the IP-Fax destination as follows:

### ❖ When not using a gatekeeper/SIP server

- From IP-Fax to IP-Fax  
Specify the IPv4 address or host name of the receiving machine.  
Example: 192.168.1.10 (IPv4 address)  
Example: IPFAX1 (host name)
- From IP-Fax to G3 fax  
Specify the G3 fax telephone number of the receiving machine.  
Example: 0312345678

### ❖ When using a gatekeeper server

- From IP-Fax to IP-Fax  
Specify the alias telephone number of the receiving machine.  
Example: 0311119999 (alias telephone number)
- From IP-Fax to G3 fax  
Specify the G3 fax telephone number of the receiving machine.  
Example: 0312345678

### ❖ When using a SIP server

- From IP-Fax to IP-Fax  
Specify the SIP user name of the receiving machine.  
Example: ABC (SIP user name)
- From IP-Fax to G3 fax  
Specify the G3 fax telephone number of the receiving machine.  
Example: 0312345678

 **Note**

- ❑ To send to a G3 fax via a gateway connected to a public telephone line, you must specify it's the receiver's machine telephone number. For example, if the receiver's fax number is "0312345678", specify "5678". To send from an IP-Fax to G3 fax without using gatekeeper or SIP server, you must register the gateway also.
- ❑ When you specify a destination with IP-Fax, depending on the receiver's network configuration, you may need to specify the IPv4 address and port number of the receiving machine. For example, if the receiver's IPv4 address is "192.168.1.10" and the port number is "2100", specify "192.168.1.10:2100". Ask the network administrator for details.
- ❑ When you specify a host name, depending on the receiver's network configuration, you may need to specify the host name and port number of the receiving machine. For example, if the receiver's host name is "IPFAX1" and the port number is "2100", specify "IPFAX1:2100". Ask the network administrator for details.
- ❑ An alias telephone number is a number that is registered in the gatekeeper, and is available only in the network to which the gatekeeper is connected.
- ❑ Pay attention to the number of telephone number digits set in the gateway/IPv4 address conversion table to avoid transmission error.

---

## Sending to an E-mail Address

---

This section explains how to specify an e-mail address as a destination.

When using Internet Fax transmission, specify the e-mail address in place of the fax number.

 **Important**

- ❑ In the destination list, register senders, specify their e-mail addresses, and set the User Name as **[Sender]** in advance using "Address Book Management" in "System Settings".
- ❑ Internet Fax is executed in only Memory Transmission that starts transmission automatically after storing documents in memory. If you switch the type of transmission to Internet Fax while the machine is in the Immediate Transmission mode, the transmission mode is automatically switched to the Memory Transmission mode.

- 1 Press **[Internet Fax]** to switch the type of transmission to Internet Fax.

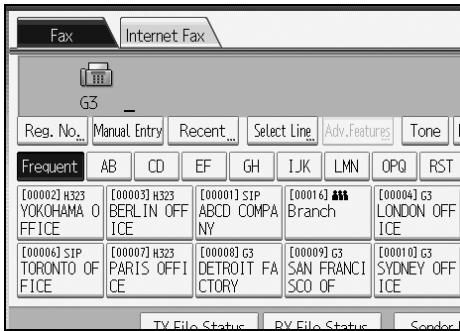

- 2 Specify the sender.

For details about specifying senders, see “Sender Settings”.

- 3 Press **[Manual Entry]**.

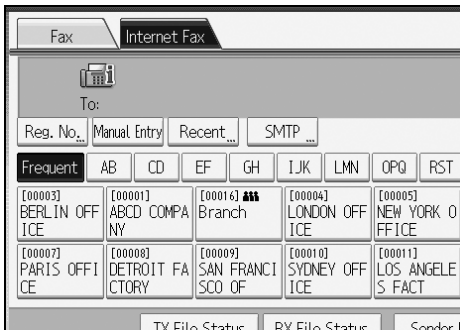

To select a destination from the Address Book, see “Using the Address Book to Specify Destinations”.

- 4 Enter the e-mail address destination, and then press **[OK]**.

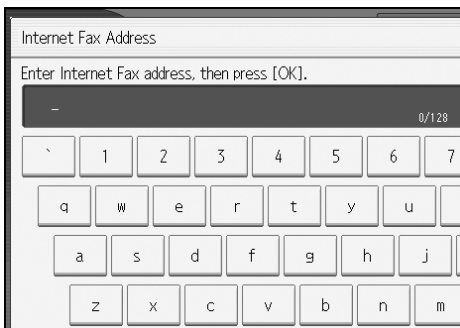

If you enter an incorrect character, press **[Backspace]** or **[Delete All]**. Then, re-enter the characters correctly.

To change the e-mail address after pressing **[OK]**, press **[Edit Dest.]**, re-enter an e-mail address, and then press **[OK]**.

## 5 To add a destination, press [Add].

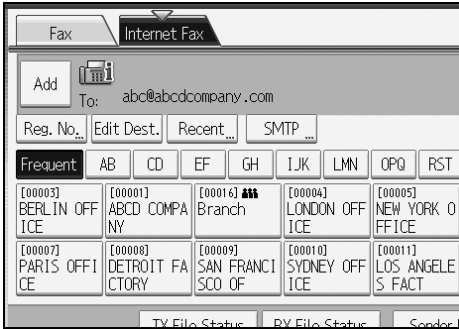

When you press [**Prg. Dest.**], you can register an entered destination in the destination list.

## 6 Specify the next destination.

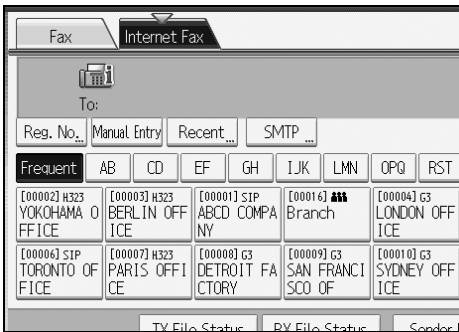

To add another destination, repeat steps 5 and 6.

## 7 Press the [Start] key.

The machine starts to scan the original and stores it in memory. When scanning ends, the Communicating indicator lights and transmission starts.

### Note

- Depending on security settings, [**Manual Entry**] may not appear, and you may be unable to enter the e-mail address.
- For details about canceling a transmission, see “Canceling a Transmission”.
- To avoid accidentally pressing the wrong Destination key, you can set the machine so that each time a destination is added using a Destination key, [**Add**] must be pressed. Make the setting in User Parameters (switch 17, bit 2) in the Facsimile Features menu.
- For the maximum number of digits for a destination, see “Maximum Values”.
- If “Auto Specify Sender Name” is set to “On” in “System Settings”, the sender is automatically specified and you can omit the procedure for specifying a sender. If “On” is selected, the specified e-mail address is printed at “From:”. If no e-mail address is specified for the sender, or if the specified e-mail address is not programmed in the destination list, Internet Fax documents cannot be sent.

## Reference

p.27 "Internet Fax Functions"

p.72 "Using the Address Book to Specify Destinations"

p.97 "Sender Settings"

p.108 "Canceling a Transmission"

p.272 "Maximum Values"

"Entering Text", About This Machine

"System Settings", General Settings Guide

"Facsimile Features", General Settings Guide

"Registering Addresses and Users for Facsimile/Scanner Functions", General Settings Guide

---

## Bypassing the SMTP server

---

You can send Internet Fax documents directly to their destinations without going through the SMTP server.

### Important

- To use this function, the following settings must be made. For details about these settings, see "System Settings", General Settings Guide and "Special Operations under Windows", Network Guide.
  - In "System Settings", "SMTP" in "E-mail Communication Port", set the port number to "25".
  - To specify the host name of the other party as the domain part of the e-mail address, program the host name of the other party on the DNS server.
- If the other party's IPv4 address is not registered on the DNS server, specify the IPv4 address at the domain part of the e-mail address.
- To use this function, the other party's fax machine must be:
  - compatible with Internet Fax
  - connected to the same LAN as this machine
  - have its reception protocol set to SMTP
- SMTP authentication set on the other party's fax machine is disabled when Internet Fax is transmitted using this function.
- If an Internet Fax is transmitted from the other party using this function, even if reception is not successful, an Error Mail Notification is not sent to the sender.
- When an Internet Fax is transmitted using this function, even if transmission is not successful, the error e-mail is not sent from the server.
- When using this function, you cannot send Internet Fax documents to the administrator's e-mail address programmed on this machine.

You can send Internet Fax documents directly to their destinations without going through the SMTP server. Internet Faxes are normally transmitted via the SMTP server. However, with this feature the domain part of the destination's e-mail address is read as the SMTP server's address and transmissions bypass the SMTP server. Since this reduces load on the server, you can send faxes without having to take server to destination transfer time into account.

There are two ways of specifying a destination, as follows:

❖ **Specify the other party's host name**

Specify a destination's e-mail address by adding the other party's host name to the domain part of the e-mail address. Specify the address to the right of @ as follows: "host name", ". (dot)", and "domain name".

xxxx@host name of the other party.domain name

Example: The other party's e-mail address is "abc@defcompany.com" and the host name is "HOST"; abc@HOST.defcompany.com

❖ **Specify the other party's IPv4 address**

Specify a destination's e-mail address by changing the domain part of the e-mail address to the other party's IPv4 address.

xxxx@[the other party's IPv4 address]

Example: The other party's e-mail address is "abc@defcompany.com" and the IPv4 address is "192.168.1.10"; abc@[192.168.1.10]

Follow these steps to bypass the SMTP server.

**1** Press [SMTP].



**2** Press [No].





### 3 Press [OK].

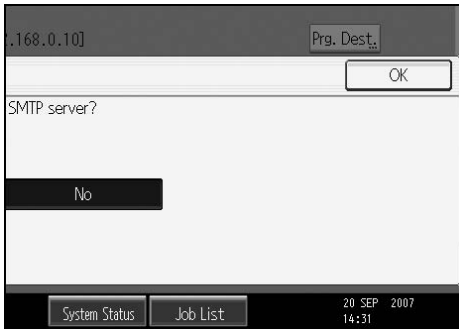

#### Note

- When you specify destinations directly using the number keys, you can specify whether or not to use the SMTP server for each destination.
- When you select destinations in the destination list, the SMTP server setting specified in the Address Book is enabled.
- To send Internet Fax documents from a computer, use the LAN-Fax Driver to specify whether or not to bypass the SMTP server. When sending with the **[Use device address]** check box selected, the SMTP server setting specified on this machine is enabled.

#### Reference

p.233 "Sending Fax Documents from Computers"

"System Settings", General Settings Guide

"Registering Addresses and Users for Facsimile/Scanner Functions", General Settings Guide

"Special Operations under Windows", Network Guide

## Using the Address Book to Specify Destinations

When destinations are programmed in a destination list, you can specify a destination by selecting a Destination key from the destination list.

The programmed name appears on Destination key.

Press **[Fax]** or **[Internet Fax]** to switch the transmission type between fax/IP-Fax and Internet Fax.

### Important

- ❑ In the destination list, program an individual fax number, IP-Fax destination, e-mail address and/or groups of destinations.

**1** Press **[Fax]** or **[Internet Fax]** to switch the transmission type to fax/IP-Fax or Internet Fax.

**2** Press the title word key where the desired destination is programmed.

For example, if you want to specify “NewYork Office” programmed in “LMN”, press **[LMN]**.

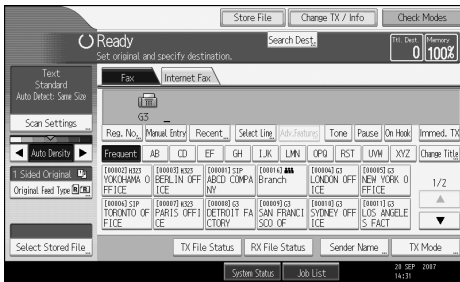

**3** Press the Destination key programmed with the desired destination.



If the desired Destination key is not shown, press **[▲]** and **[▼]** to look through the list.

To cancel the selection, press the selected Destination key again. You can also press the **[Clear / Stop]** key to cancel the selection.

To select more destinations, repeat steps **2** and **3**.

The destination is set and the Destination key is highlighted.

**4** Press the **[Start]** key.

 **Note**

- To check the contents of Destination keys, print the destination list.

 **Reference**

“System Settings”, General Settings Guide

“Registering Addresses and Users for Facsimile/Scanner Functions”, General Settings Guide

---

## Switching the titles in the Address Book

---

There are three types of titles for destination lists; “Title 1”, “Title 2”, and “Title 3”. The above display shows “Title 1”.

**1** Press [Change Title].

**2** Select the type of the title, and then press [OK].

## Specifying Group Destinations

If you program multiple destinations into a Group, you can send documents to all destinations in that Group using just a few keystrokes. Destinations programmed in a group are indicated by **▲▲▲**.

### **▲** Important

- In the destination list, program an individual fax number, IP-Fax destination, e-mail address and/or groups of destinations.
- Group destination can be used only for Memory Transmission; it cannot be used for Immediate Transmission. The machine automatically changes to Memory Transmission when you use group destination.
- The total number of destinations programmed in multiple groups should not exceed the maximum number of destinations you can specify for one file. For details, see “Maximum Values”.

**1** Press **[Fax]** or **[Internet Fax]** to switch the transmission type to fax/IP-Fax or Internet Fax.

**2** Press the Destination key programmed with the desired group.

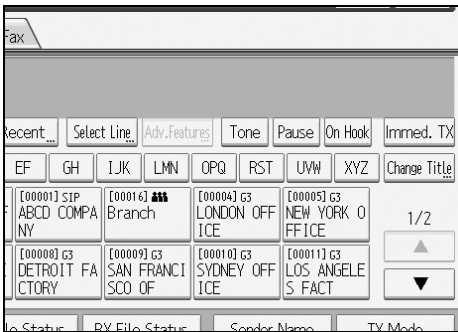

The destination is set and the Destination key is highlighted.

To select more groups, repeat step **2**.

**3** Press the **[Start]** key.

 **Note**

- Destinations programmed in groups can be checked using “Print Group Dial List” in “System Settings”.
- If a destination where a fax number, e-mail address, or IP-Fax destination is not programmed is included in the specified group, the confirmation message appears. Press **[Select]** to specify destinations where the fax number, the e-mail address, or IP-Fax destination is programmed. Press **[Cancel]** to change the destination. You can select the priority order used to specify an alternative destination if there is no destination of the specified type. Make this setting with User Parameters (switch 32, bit 0) in the Facsimile Features menu.
- To cancel any destination(s) among the group, press **[Expand Group Dest.]** in **[Check Modes]**. Then, on the standby display, press **[▲]** and **[▼]** to display the desired destination, and then press the **[Clear/Stop]** key. You can also cancel a transmission by pressing the highlighted Destination key to deselect it.

 **Reference**

p.272 “Maximum Values”

“System Settings”, General Settings Guide

“Facsimile Features”, General Settings Guide

“Registering Addresses and Users for Facsimile/Scanner Functions”, General Settings Guide

---

## Selecting Destinations from Recent Destinations

---

The machine stores the latest destinations specified for each transmission method. This function saves time when you are sending to the same destination repeatedly, as you do not have to enter the destination again.

 **Important**

- The following kinds of destinations are not stored:
  - Destinations specified using the destination list
  - Destinations specified as a group destination
  - Destinations dialed using the external telephone
  - Destinations selected from Recent Destinations (regarded as already stored in memory)
  - Second and later destinations broadcasted to
  - Destinations specified in the LAN-Fax Driver on the computer

**1** Place the original, and then select the scan settings you require.

**2** Press [Recent].

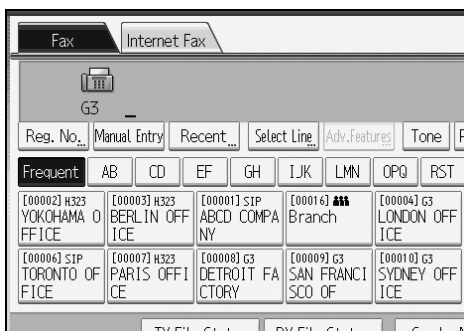

**3** Select the destination you want to redial to, and then press [OK].

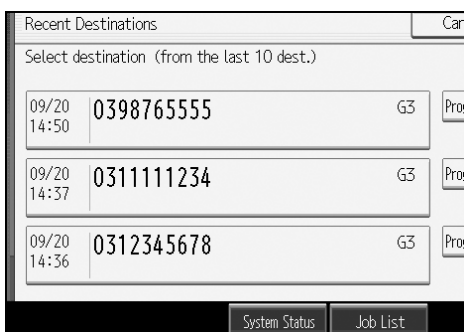

**4** Press the [Start] key.

#### Note

- You can select Internet Fax and IP-Fax destinations from Recent Destinations as well.
- When you press [Program Dest.], you can register a selected recipient in the destination list.
- For the maximum number of recent destinations the machine can store, see "Maximum Values".

#### Reference

- p.79 "Registering Entered Destinations to the Address Book"
- p.272 "Maximum Values"

# Programming Destinations in the Address Book

You can program fax numbers, e-mail addresses, IP-Fax destinations, and folder destinations using Address Book Management in Administrator Tools in the System Settings menu.

- 1 Press the [User Tools/Counter] key.

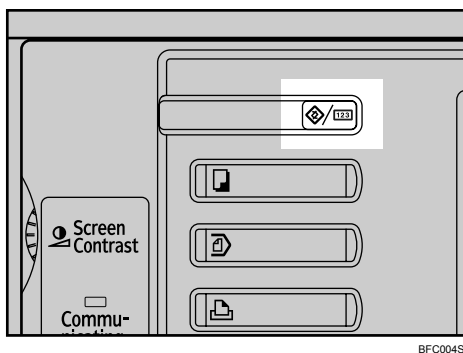

- 2 Press [System Settings].

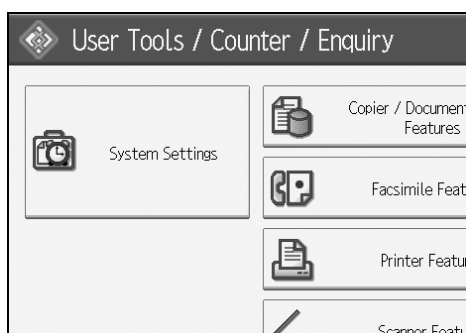

- 3 Press [Administrator Tools].
- 4 Press [Address Book Management].
- 5 Check that [Program / Change] is selected.
- 6 Press [New Program].

For a description of the subsequent procedure, see "System Settings", General Settings Guide.

 **Note**

- You can also register programmed fax numbers, e-mail addresses, IP-Fax destinations, and folder destinations in a Group.
- When the facsimile initial display is shown, after changing the contents of the Address Book, the “Destination list / machine settings are updated.” message appears. Press **[Exit]** to bring up the facsimile's initial display.
- You can register in the Address Book using Web Image Monitor or Smart-DeviceMonitor for Admin. For details about installation, see “Monitoring and Configuring the Printer”, Network Guide, or, for information about the Address Book, see the relevant Help.

 **Reference**

“System Settings”, General Settings Guide

“Registering Addresses and Users for Facsimile/Scanner Functions”, General Settings Guide

“Monitoring and Configuring the Printer”, Network Guide



## Registering Entered Destinations to the Address Book

This section explains how to register a directly entered fax number, e-mail address, or IP-Fax destination to the Address Book.

When registering a destination directly entered or displayed on the Recent Destination screen in the Address Book, **[Prg. Dest.]** appears in the destination field.

### 1 Press **[Prg. Dest.]**.

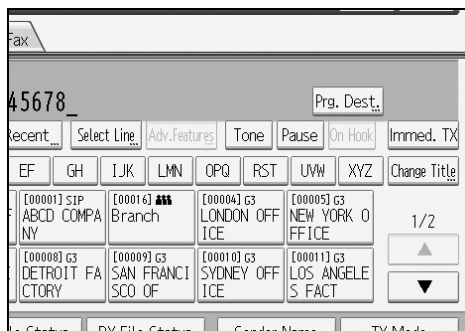

### 2 Press **[Names]** and enter any necessary information.

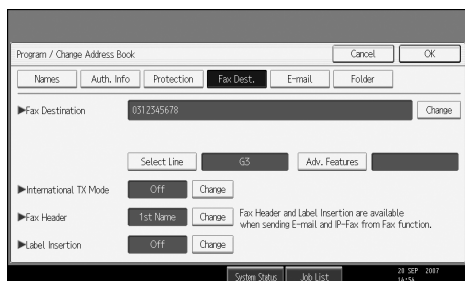

For details about registering destinations, see “Registering Addresses and Users for Facsimile/Scanner Functions”, General Settings Guide.

### 3 Press **[OK]**.

#### Note

- Depending on security settings, **[Prg. Dest.]** may not appear, and you may be unable to register the destination.
- When the facsimile initial display is shown, after changing the contents of the Address Book, the “Destination list / machine settings are updated.” message appears. Press **[Exit]**. The standby display appears.

#### Reference

p.75 “Selecting Destinations from Recent Destinations”

“Registering Addresses and Users for Facsimile/Scanner Functions”, General Settings Guide

# Searching for a Destination in the Address Book

1

Use this function to search for a destination registered in the destination list or on the LDAP server.

## Important

- ❑ To search for a destination from an LDAP server, the LDAP server must be registered in advance. For details about registering LDAP servers, see “System Settings”, General Settings Guide.

## Note

- ❑ Press **[Fax]** or **[Internet Fax]** on the Search Destination screen to switch the transmission type between fax/IP-Fax and Internet Fax.
- ❑ The search returns only destinations whose first characters match the entered characters.
- ❑ A warning message appears if the search returns more than the maximum number of destinations you can search for at a time. Press **[Exit]** and change the destination name to view fewer destinations.
- ❑ For the maximum number of destinations you can search at a time, see “Maximum Values”.
- ❑ Although one user can program multiple e-mail addresses, only one address can be retrieved by the search. The address retrieved by the search depends on the searching method supported by the LDAP server. However, the address programmed first is normally retrieved.

## Reference

p.272 “Maximum Values”

“System Settings”, General Settings Guide

## Search by Destination Name

Follow these steps to search for a destination registered in the Address Book by name.

- 1 Press **[Search Dest.]**.



- 2 Select a search destination.

To search through the Address Book, select **[Address Book]**.

To search through an LDAP server, select the relevant LDAP server.



- 3 Press **[Fax]** or **[Internet Fax]** to switch the transmission type to fax/IP-Fax or Internet Fax.



**4** Press **[Name]**.**5** Enter the destination name you want to search for, and then press **[OK]**.

If you enter a wrong destination name, press **[←]**, **[→]**, **[Backspace]**, and **[Delete All]**, and then enter the destination name again.

**6** Confirm the characters you entered, and then press **[Start Search]**.

When the search is finished, a result appears.

**7** Select a destination.

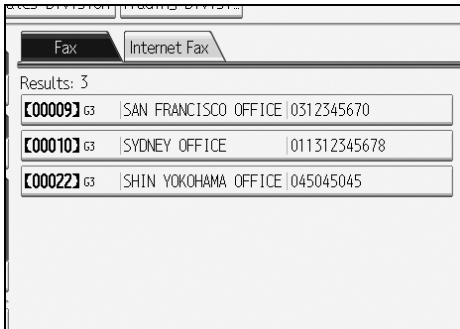

If the desired destination does not appear, use [▲] or [▼] to scroll through the list.

Press [Details] to display the detailed information of the selected destination.

**Reference**

“Entering Text”, About This Machine

## Search by Fax Number/IP-Fax Destination

Follow these steps to search for a destination registered in the Address Book by fax number or IP-Fax destination.

**1** Press [Search Dest.].



**2** Select a search destination.

To search through the Address Book, select **[Address Book]**.

To search through an LDAP server, select the relevant LDAP server.

1

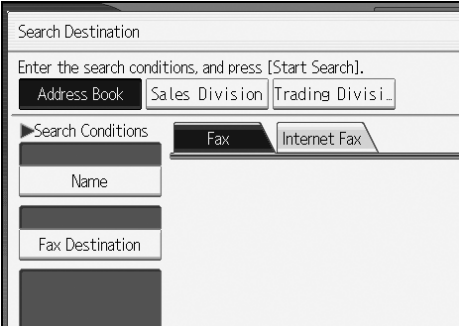

**3** Press **[Fax Destination]**.



**4** Enter the number you want to search for, and then press **[OK]**.

To search for an IP-Fax destination, enter the IP-Fax destination that you want to find.



If you enter a wrong number, press **[←]**, **[→]**, **[Backspace]**, or **[Delete All]**, and then enter the number again.

- 5** Confirm the entered fax numbers, and then press **[Start Search]**.



The screenshot shows a search interface with the following elements:

- A text input field labeled "Name" containing the value "03".
- A text input field labeled "Fax Destination" which is currently empty.
- A button labeled "Advanced Search ...".
- A button labeled "Start Search".
- A "System Status" indicator in the bottom right corner.

When the search is finished, a result appears.

- 6** Select a destination.

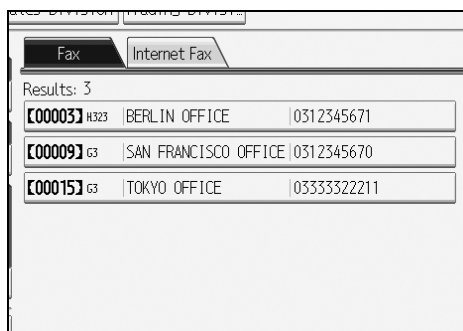

The screenshot shows the search results interface with the following elements:

- Two tabs: "Fax" (selected) and "Internet Fax".
- A header "Results: 3".
- A list of three results:

<b>[00003]</b>	H323	BERLIN OFFICE		0312345671
<b>[00009]</b>	G3	SAN FRANCISCO OFFICE		0312345670
<b>[00015]</b>	G3	TOKYO OFFICE		03333322211

If the desired destination does not appear, use **[▲]** or **[▼]** to scroll through the list.

Press **[Details]** to display the detailed information of the selected destination.

# Search by E-mail Address

Follow these steps to use an e-mail address to search for a destination registered in the destination list.

1

**1** Press **[Search Dest.]**.

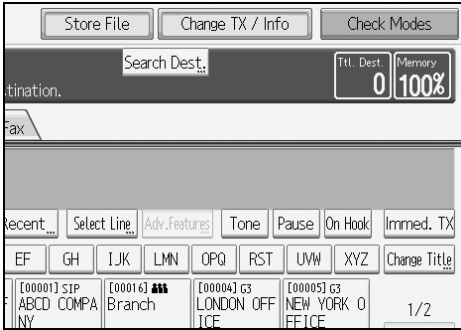

**2** Select a search destination.

To search through the Address Book, select **[Address Book]**.

To search through an LDAP server, select the relevant LDAP server.



**3** Press **[Internet Fax]** to switch the type of transmission to Internet Fax.

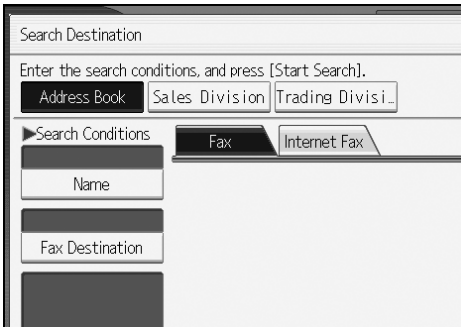

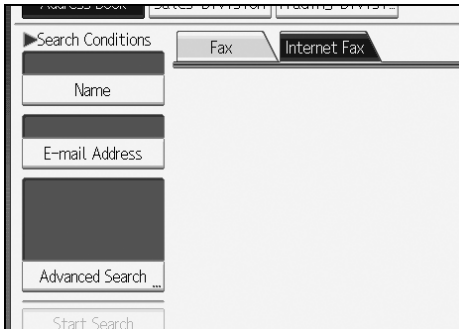

**4** Press **[E-mail Address]**.**5** Enter the e-mail address you want to search for, and then press **[OK]**.

If you enter a wrong e-mail address, press **[←]**, **[→]**, **[Backspace]**, or **[Delete All]**, and then enter the e-mail address again.

**6** Confirm the entered characters, and then press **[Start Search]**.

When the search is finished, a result appears.

### 7 Select a destination.

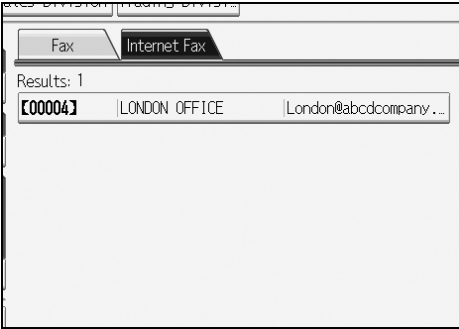

If the desired destination does not appear, use [▲] or [▼] to scroll through the list.

Press [Details] to display the detailed information of the selected destination.

---

## Search Using Advanced Search

---

Follow these steps to search for a destination registered in the Address Book by specifying search criteria.

### 1 Press [Search Dest.].



### 2 Select a search destination.

To search through the Address Book, select [Address Book].

To search through an LDAP server, select the relevant LDAP server.

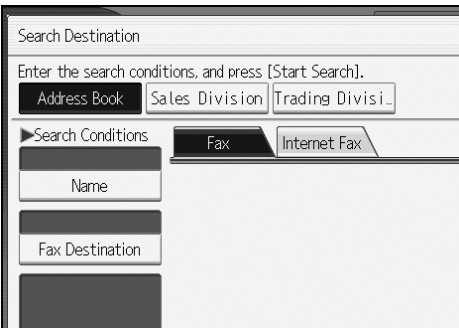

- 3** Press **[Fax]** or **[Internet Fax]** to switch the transmission type to fax/IP-Fax or Internet Fax.



- 4** Press **[Advanced Search]**.

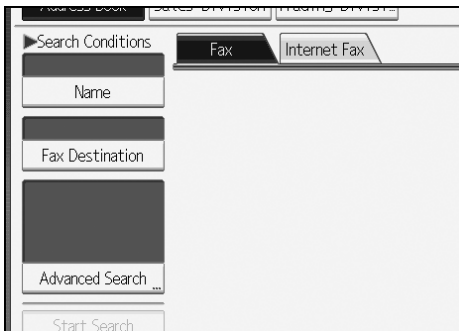

- 5** Press the key for each condition, and then enter a partial string.

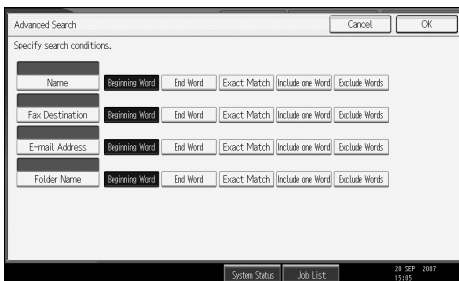

The following conditions can be specified for Address Book searches: Name, Fax Destination, E-mail Address, and Folder Name.

The following conditions can be specified for LDAP server searches: Name, Fax Destination, E-mail Address, Company Name, and Department Name.

## 6 Select search criteria for each condition.

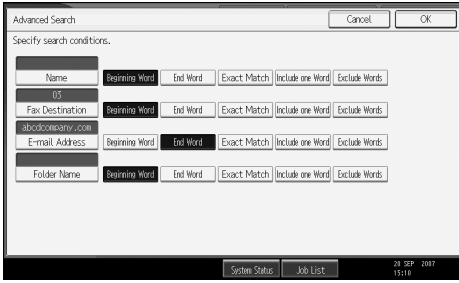

The meanings of the search criteria are as follows:

- **[Beginning Word]:** Search for strings that start with the specified character. Example: When searching for “ABC”, enter “A”.
- **[End Word]:** Search for strings that end with the specified character. Example: When searching for “ABC”, enter “C”.
- **[Exact Match]:** Search for strings that fully match the specified character. Example: When searching for “ABC”, enter “ABC”.
- **[Include one Word]:** Search for strings that include the specified character. Example: When searching for “ABC”, enter “A”, “B”, or “C”.
- **[Exclude Words]:** Search for strings that do not include the specified character. Example: When searching for “ABC”, enter “D”.
- **[Fuzzy Search]:** Perform a fuzzy search. This item appears when selecting an LDAP server in step 2. The performance of fuzzy search depends on the search method supported by the LDAP server.

## 7 Press [OK].

## 8 Press [Start Search].



When the search is finished, the search result appears.

## 9 Select a destination.

If the required destination does not appear, press [▲] or [▼] to display it.

Press [Details] to display the detailed information of the selected destination.

**Note**

- ❑ You can add one additional search condition for LDAP servers by specifying the Search Options under Program / Change / Delete LDAP Server under System Settings. For details about setting Search Options, see “System Settings”, General Settings Guide.
- ❑ The string you enter in the **[Name]** condition field is read as the first or last name, depending on the administrator's setting. For example, to search for the name “John Smith”, ask the system administrator whether you should enter “John” or “Smith”.

**Reference**

“Entering Text”, About This Machine

“System Settings”, General Settings Guide

---

## Search by Registration Number

---

Follow these steps to search for a destination by specifying a registration number stored in the destination list.

- 1** Press **[Fax]** or **[Internet Fax]** to switch the transmission type to fax/IP-Fax or Internet Fax.

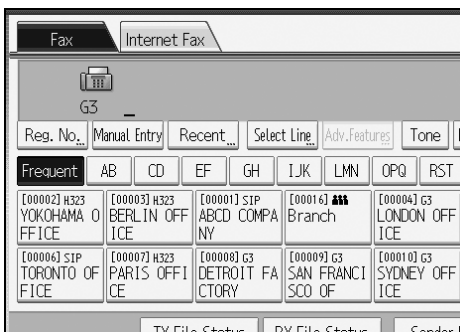

- 2** Press **[Reg. No.]**.

The registration number entry display appears.

**3** Enter a registration number using the number keys, and then press [**#**].

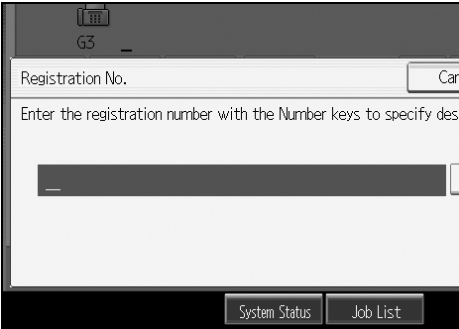

While usually a registration number is displayed in the five-digit format, you do not need to enter the first zeros of a registration number.

If you make a mistake, press [**Clear**] or the [**Clear/Stop**] key, and then try again.

**4** Press [**OK**].

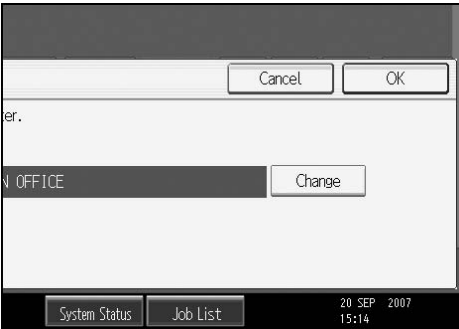

The corresponding destination appears.



**Note**

- ❑ If the “Cannot find the specified Registration No.” message appears, the specified registration number or selected type of transmission is wrong or does not exist. Press [**Exit**], check the registration number again, and then follow the procedure from step **2**.

# On Hook Dial

The On Hook Dial function allows you to dial while listening to the tone from the internal speaker. You can send a fax checking the connection.

## Important

- ❑ This function is not available for the optional extra G3 interface unit, Internet Fax and IP-Fax.

**1** Place the original, and then select the scan settings you require.

**2** Press [On Hook].

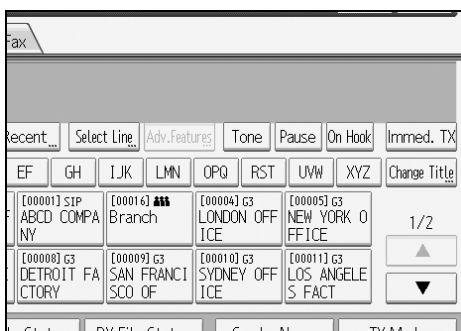

You will hear a low tone from the internal speaker.

If you want to cancel this operation, press [On Hook] again.

**3** Dial.

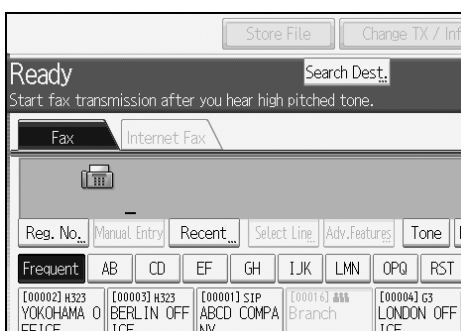

The machine immediately dials the destination.

If you make a mistake, press [On Hook] or the [Clear Modes] key, and then try again.

To select a destination from the Address Book, see “Using the Address Book to Specify Destinations”.

**4** When the line is connected and you hear a high-pitched tone, press the **[Start]** key.

The transmission starts.

If you want to cancel a transmission, press the **[Clear/Stop]** key, and then remove the originals.

After transmission, the standby display appears.

**Note**

- This function is unavailable in some countries.
- Press **[Vol...]** to display the Adjust Sound Volume screen, and then press **[Louder]** or **[Lower]** to adjust the volume of the on-hook sound. The volume can also be preprogrammed in the Facsimile Features menu.
- If you have an external telephone on the fax machine, you can speak with the other party when you hear a voice. If you hear a voice before pressing the **[Start]** key, pick up the external telephone and tell the receiver you want to send a fax document (ask them to switch to facsimile mode).
- For details about On Hook Mode Release Time, see "Facsimile Features", General Settings Guide.

**Reference**

p.72 "Using the Address Book to Specify Destinations"  
"Facsimile Features", General Settings Guide



# Manual Dial

Pick up the handset of the external telephone and dial. When the line is connected and you hear a high-pitched tone, press the **[Start]** key to send your fax document. If, on the other hand, you hear a voice at the other end, continue conversation as normal.

## Important

- The external telephone is required.
- This function is not available for the optional extra G3 interface unit, Internet Fax and IP-Fax.
- If Immediate TX Result Report (Immediate Transmission) is printed, the result of a transmission with Manual Dial is not mentioned in the report.

**1** Place the original, and then select the scan settings you require.

**2** Pick up the handset.

You will hear a dial tone.

**3** Dial.



The machine immediately dials the destination.

If you make a mistake, replace the handset, and then try again from step **2**.

To select a destination from the Address Book, see “Using the Address Book to Specify Destinations”.

**4** When the line is connected and you hear a high-pitched tone, press the **[Start]** key to send your fax document.

If you hear a voice, tell the receiver that you want to send them a fax document (ask them to switch to facsimile mode).

The transmission starts.

**5** Replace the handset.

If you want to cancel a transmission, press the **[Clear/Stop]** key, and then remove the originals.

After transmission, the standby display appears.

 **Note**

- When the operation switch is off, even if the main power switch is on, you cannot operate this machine using only the handset of the external telephone. You must first press the operation switch to turn on the machine.

 **Reference**

p.72 “Using the Address Book to Specify Destinations”

# Sender Settings

Use this function to set sender information.

If the sender's e-mail address is registered in the destination list, the sender can receive transmission results by e-mail.

Also, if you enable the Stamp Sender Name, the registered sender's name (user name) appears on the receiver's sheet, lists, and report.

## Important

- In the destination list, register senders, specify their e-mail addresses, and set the User Name as **[Sender]** in advance using "Address Book Management" in "System Settings".
- If user authentication is set, the user logged in is set as sender. The transmission result is sent to the logged-in user's e-mail address.

**1** Place the original, and then select the scan settings you require.

**2** Press **[Sender Name]**.

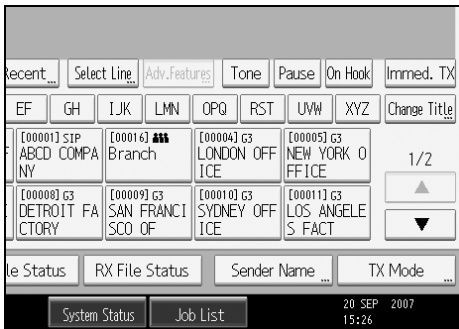

**3** Select a sender.

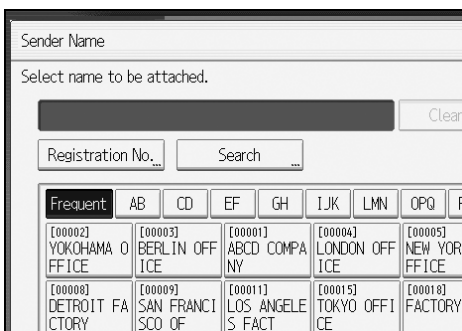

To select a sender by specifying the registration number registered in the Address Book, press **[Registration No.]**.

To search for a sender from the Address Book, press **[Search]**.

If a destination protection code is set, the entry screen appears. Enter the protection code for destination using the number keys, and then press **[OK]**.

1

**4** Confirm the selected sender, and then press [OK].

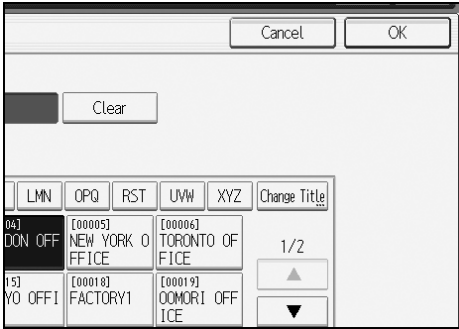

**5** To print the sender's name on the receiver's sheet, press [Stamp Sender Name] to highlight it.

If you enable this function, the sender's name (user name) appears on the receiver's sheet, lists, and report.

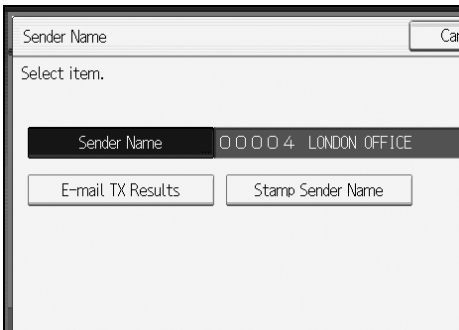

**6** To confirm the transmission results by e-mail notification, press [E-mail TX Results] to highlight it.

If the sender's e-mail address is registered, you can send the transmission result to the registered e-mail address.

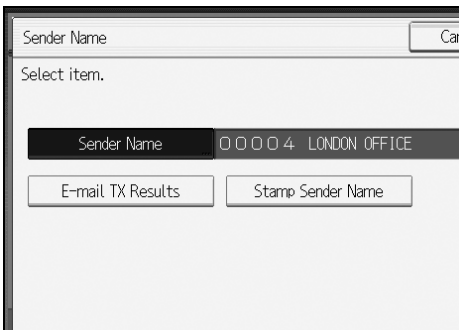

**7** Press [OK].

The standby display appears.

To check the settings, press [Sender Name].

**8** Specify the destination, and then press the [Start] key.

 **Note**

- You can confirm transmission results by using both the E-mail TX Results function, which sends the results by e-mail, and the Communication Result Report printed by the machine. You can set whether to use both of these together in User Parameters (switch 10, bit 6) in the Facsimile Features menu.
- You can use Communication Result Report, etc. to check usage status by specified users. If user authentication is set, you can check usage by logged-in users. If User Code is set to sender, you can count the number of uses by each user.
- To cancel the Sender Name, cancel the transmission. See “Canceling a Transmission”.

 **Reference**

p.108 “Canceling a Transmission”

“Facsimile Features”, General Settings Guide

“Registering Addresses and Users for Facsimile/Scanner Functions”, General Settings Guide

# Advanced Features

This section describes how to specify a destination using advanced features.

1

## Setting SUB Codes for Transmission

Follow these steps to send a document with a SUB Code as a confidential transmission.

A SUB Code is an ID consisting of numbers, #, \*, and spaces. Document transmitted with a SUB Code is stored in the other party's memory, and not printed automatically. The other party inputs the SUB Code to print the received document. Privacy can be mutually protected when transmitting a confidential document intended for a particular receiver, since only a person who knows the SUB Code can print the document.

Documents can also be sent via facsimiles that have the Transfer Station function. This function helps you save costs when you send the same document to more than one place in a distant area, and saves time since many documents can be sent in a single operation.

### Important

- Documents can be sent to facsimiles that have the Personal Box function.
- A SUB Code cannot be used with Internet Fax.
- To use this function, set **[SUB Code Transmission]** to on.
- Obtain the SUB Code of the other party in advance.
- When sending a confidential document, inform the other party of the SUB Code in advance.

**1** Place the original, and then select the scan settings you require.

**2** Press **[TX Mode]**.

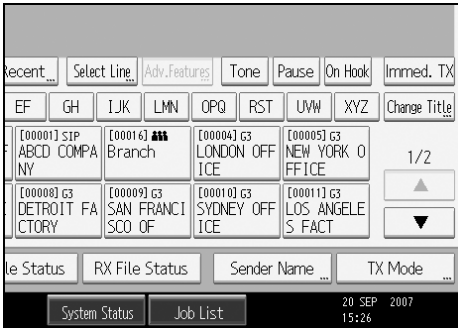

### 3 Press [Option Setting].

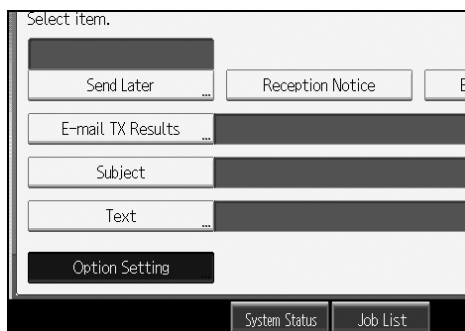

### 4 Press [SUB Code Transmission].

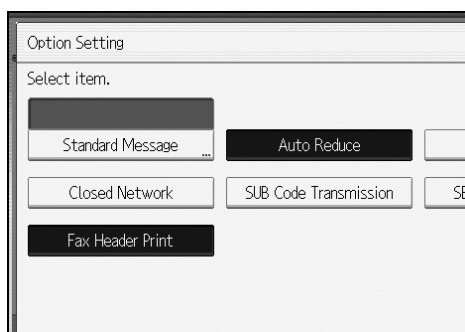

### 5 Press [OK] twice.

The standby display appears.

### 6 Enter the fax number of a destination or an IP-Fax destination.

### 7 Press [Adv.Features].

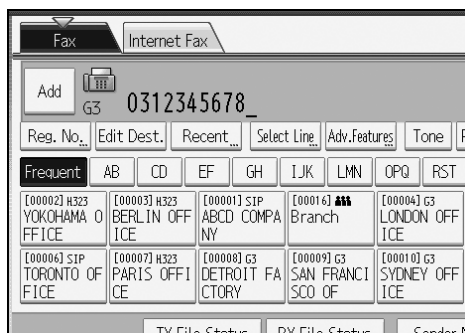

### 8 Make sure that [SUB Code] is selected.

### 9 Press [Transmission SUB Code].

## 10 Enter a SUB Code, and then press [OK].

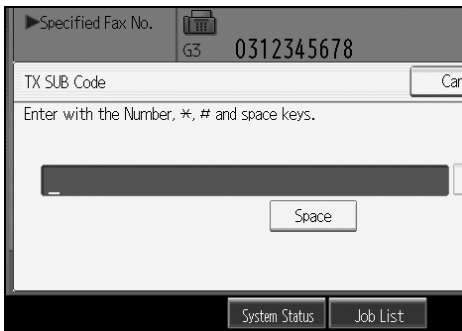

If you make a mistake, press **[Clear]** or the **[Clear/Stop]** key before pressing **[OK]**, and then try again.

## 11 When a password is required, press [Password (SID)], enter the password with the number keys, and then press [OK].

## 12 Press [OK].

## 13 Press the [Start] key.

If you use Immediate Transmission and the fax machine at the destination does not support the SUB Code function, a message will appear on the display to inform you of this. When this happens, press **[Exit]** to cancel the transmission.

### Note

- Make sure the number of digits in the SUB Code matches the specification of the machine to which you are sending. For the maximum number of digits for the SUB Code of this machine, see "Maximum Values".
- You can store SUB Codes as well as names and fax numbers in the destination list and Keystroke Programs.
- When a SUB Code is stored in the destination list, the SUB Code can be modified or deleted after selecting a destination using the Destination keys.
- The SUB Code is printed on lists and reports.

### Reference

p.135 "SUB Code Transmission"

p.152 "Transferring Received Documents"

p.262 "Registering and Changing Keystroke Programs"

p.272 "Maximum Values"

"Registering Addresses and Users for Facsimile/Scanner Functions", General Settings Guide



## Setting a password

There are times when you may want to use an “SID” (Sender ID) when sending confidential faxes with the SUB Code function. When you use a Transfer Box that has a password, enter the SID Code as the password.

### Note

- For the maximum number of digits for the SID Code, see “Maximum Values”.
- You can enter numbers, \*, #, and spaces.
- You can store SID Codes as well as names and fax numbers in the destination list and Keystroke Programs.
- The SID Code is printed on lists and reports.

### Reference

p.262 “Registering and Changing Keystroke Programs”

p.272 “Maximum Values”

“Registering Addresses and Users for Facsimile/Scanner Functions”, General Settings Guide

## Setting SEP Codes for Reception

Follow these steps to enter a SEP Code to request the destination to transmit a document.

You can receive a document stored in the destination's memory if the document has the same SEP Code as the SEP Code you entered.

This function enables the machine to utilize services that use the polling function or receive documents from multiple destinations.

### Important

- Documents can be received from facsimiles that have Information Boxes and the SUB Code Transmission function.
- A SEP Code cannot be used with Internet Fax.
- To use this function, set **[SEP Code Reception]** to on.

### 1 Press [TX Mode].

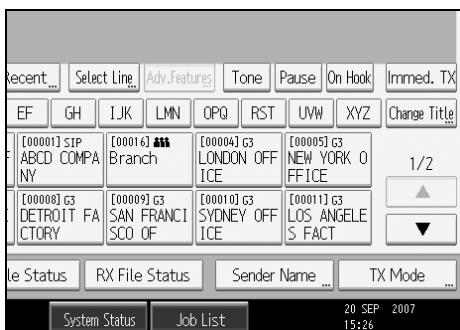

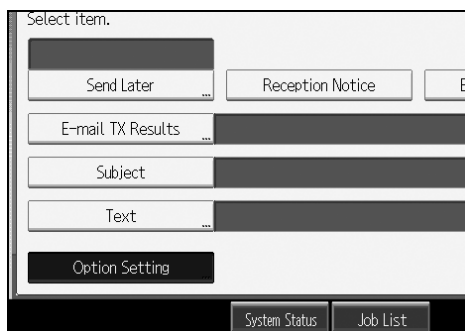
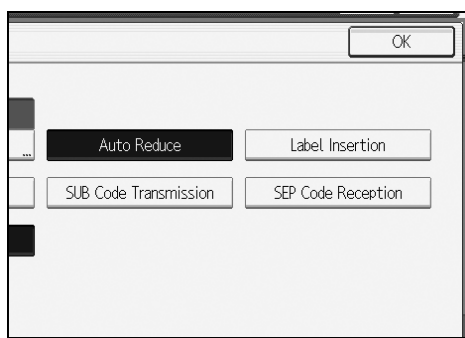
**2** Press [Option Setting].**3** Press [SEP Code Reception].**4** Press [OK] twice.

The standby display appears.

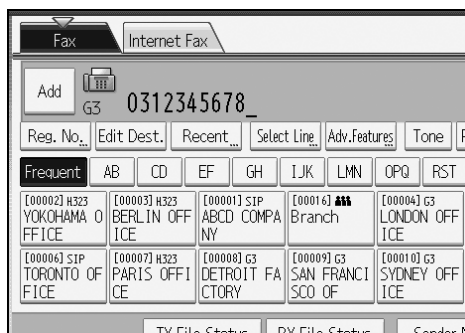
**5** Enter the fax number of a destination or an IP-Fax destination.**6** Press [Adv.Features].**7** Make sure that [SEP Code] is selected.**8** Press [Reception SEP Code].

## 9 Enter a SEP Code, and then press [OK].

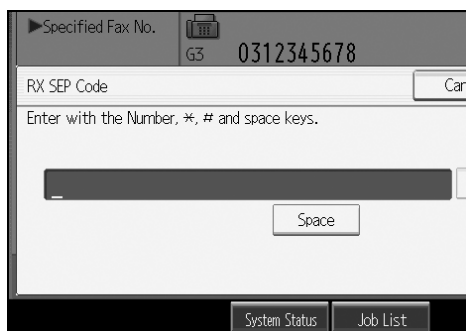

If you make a mistake, press **[Clear]** or the **[Clear/Stop]** key before pressing **[OK]**, and then try again.

## 10 When a password is required, press **[Password (PWD)]**, enter the password using the number keys, and then press **[OK]**.

## 11 Press **[OK]**.

## 12 Press the **[Start]** key.

### Note

- Make sure the number of digits in the SEP Code matches the specification of the machine from which you are receiving. For the maximum number of digits for the SEP Code of this machine, see "Maximum Values".
- You can enter numbers, **\***, **#**, and spaces.
- You can store SEP Codes as well as names and fax numbers in the destination list and Keystroke Programs.
- When a SEP Code is stored in the destination list, the SEP Code can be modified or deleted after selecting a destination using the Destination keys.
- The SEP Code is printed on lists and reports.

### Reference

p.136 "SEP Code Reception"

p.262 "Registering and Changing Keystroke Programs"

p.272 "Maximum Values"

"Registering Addresses and Users for Facsimile/Scanner Functions", General Settings Guide

---

## Entering a password

---

There are times you may want to use a password when receiving faxes by SEP Code Reception.

### **Note**

- For the maximum number of digits for the PWD Code, see “Maximum Values”.
- You can enter numbers, **\***, **#**, and spaces.
- You can store PWD Codes as well as names and fax numbers in the destination list and Keystroke Programs.
- The PWD Code is printed on lists and reports.

### **Reference**

p.262 “Registering and Changing Keystroke Programs”

p.272 “Maximum Values”

“Registering Addresses and Users for Facsimile/Scanner Functions”, General Settings Guide

---

## SEP Code RX Reserve Report

---

This report is printed after SEP Code Reception is set up. You can use this report to check the reservations for SEP Code Reception.

### **Note**

- You can turn this function on or off with the User Parameters (switch 03, bit 3) in the Facsimile Features menu.
- You can have a destination displayed with the User Parameters (switch 04, bit 4) in the Facsimile Features menu.
- You can display a sender name with the User Parameters (switch 04, bit 5) in the Facsimile Features menu.

### **Reference**

“Facsimile Features”, General Settings Guide

---

## SEP Code RX Result Report

---

This report is printed after each SEP Code Reception is completed and shows its result.

If E-mail TX Results is programmed in a Quick Operation key, you can select whether a report e-mail is sent after reception.

### **Note**

- You can also check the result of a SEP Code Reception with the Journal.
- You can turn this function on or off with the User Parameters (switch 03, bit 4) in the Facsimile Features menu.
- To view the report without text disruption, select a font of even character width in your e-mail application's settings.
- You can display a destination with the User Parameters (switch 04, bit 4) in the Facsimile Features menu.
- You can display a sender name with the User Parameters (switch 04, bit 5) in the Facsimile Features menu.

### **Reference**

p.197 "Journal"

"Facsimile Features", General Settings Guide

# Canceling a Transmission

This section explains how to cancel a fax transmission.

1

## Important

- ❑ Remember that the Communicating indicator turns off almost immediately when an Internet Fax is being sent.

---

## Before the Original Is Scanned

---

Use this procedure to cancel a transmission before pressing the **[Start]** key.

- 1 Press the **[Clear Modes]** key.

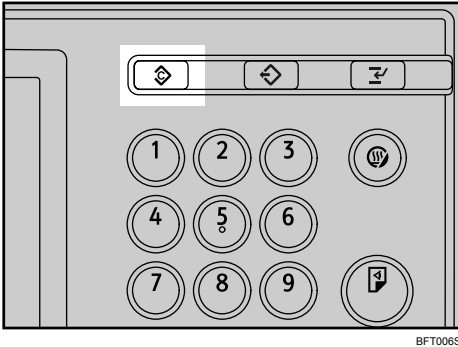

## Note

- ❑ When originals are placed into the ADF, you can cancel transmission simply by removing them.

---

## While the Original Is Being Scanned

---

Use this procedure to cancel a transmission while the originals are being scanned after the **[Start]** key has been pressed.

- 1 Press the **[Clear/Stop]** key.

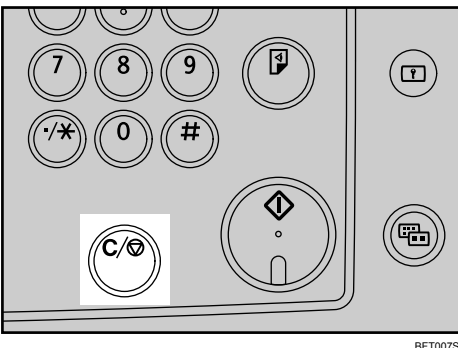

The machine stops scanning.

**Note**

- Scanning may be completed while you are performing the cancel operation.

## While the Original Is Being Transmitted

1

Follow these steps to cancel a transmission while the Communicating indicator is lit.

- 1 Press the **[Clear/Stop]** key.

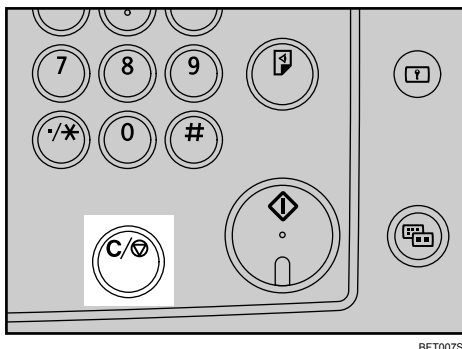

BFT007S

You can also cancel a Memory Transmission by pressing **[Change TX / Info]**.

- 2 Select the file you want to cancel.

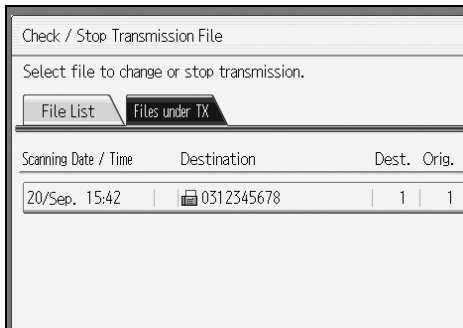

If the desired file is not shown, press **[▲]** or **[▼]** to find it.

There are cases when a destination may not be selected as the destination appears as “\*”, depending on the security settings.

- 3 Press **[Stop Transmission]**.

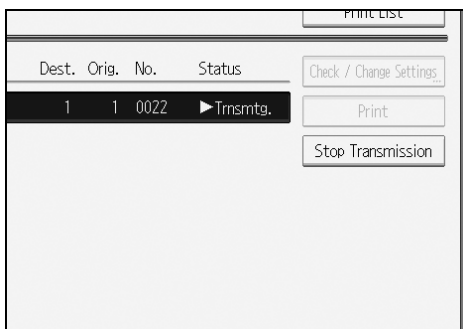

**4** Press [OK].

To cancel another file, repeat steps **2** and **4**.

To cancel stopping transmission, press [**Cancel**].

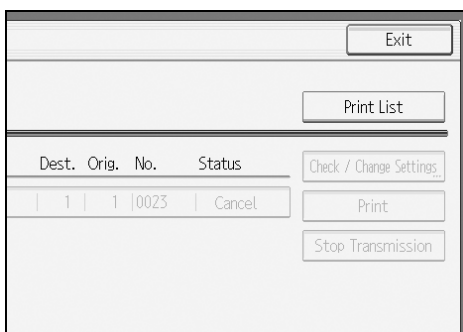
**5** Press [Exit].

The standby display appears.

**Note**

- If you cancel a document while it is being sent, the transmission is halted as soon as you finish the cancellation procedure. However, some pages of the document may already have been sent and received at the other end.
- If the transmission finishes while you are carrying out this procedure, it will not be canceled.
- If multiple destinations were specified, only one destination number appears.



## Before the Transmission Is Started

Use this procedure to cancel a transmission after the original is scanned.

This function is useful to cancel a transmission when you notice a mistake in destination or with the originals after storing. To cancel Memory Transmission, search for the file to be canceled among the files stored in memory, and then delete it.

You can cancel transmission of a file while the file is being sent, stored in memory, or fails to transmit. All the scanned data is deleted from memory.

### Important

- This function is unavailable with Immediate Transmission.

#### **1** Press [Change TX / Info].



#### **2** Press [Check / Stop Transmission File].

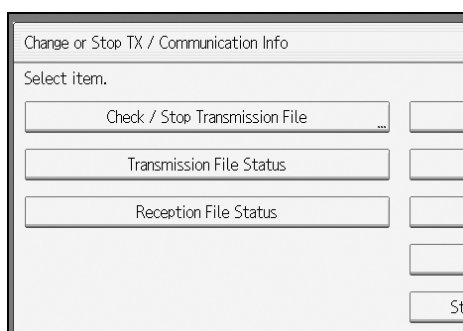

The list of stored files being transmitted or waiting for transmission appears. To display only the files being sent, press **[Files under TX]**.

### 3 Select the file you want to cancel.

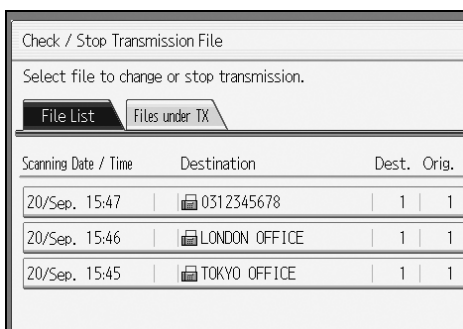

If the desired file is not shown, press [▲] or [▼] to find it.

There are cases when a destination may not be selected as the destination appears as “✖”, depending on the security settings.

### 4 Press [Stop Transmission].

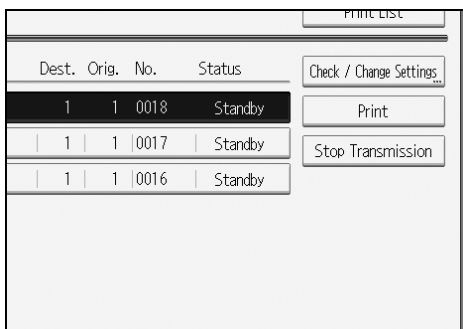

### 5 Press [OK].



To cancel another file, repeat steps 3 and 5.

To cancel stopping transmission, press [Cancel].

**6** Press [Exit] twice.

The screenshot shows a window with a table of destinations and several control buttons. The table has columns for Dest., Orig., No., and Status. The buttons include Exit, Print List, Check / Change Settings, Print, and Stop Transmission.

Dest.	Orig.	No.	Status
1	1	0018	Cancel
1	1	0017	Standby
1	1	0016	Standby

The standby display appears.

**Note**

- To delete some destinations from a broadcast, see “Deleting a Destination from a Simultaneous Broadcast”.
- If you cancel a transmission while the file is being sent, some pages of your file may have already been sent and is received at the other end.
- If the transmission finishes while you are carrying out this procedure, transmission cannot be canceled.
- If multiple destinations were specified, only the number of the destinations that have not received the document you sent is shown.
- If multiple destinations were specified, only one destination number appears. To display all destinations, press **[Check / Change Settings]**.

**Reference**

p.170 “Deleting a Destination from a Simultaneous Broadcast”

# Confirming a Transmission

**1** Press [Change TX / Info].



**2** Press [Check / Stop Transmission File].

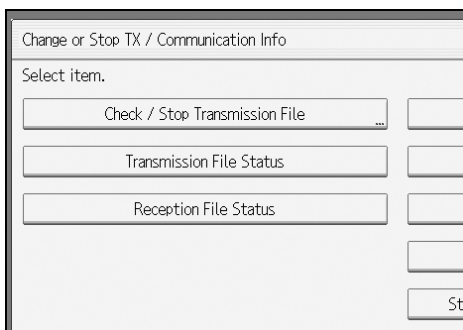

**3** Select a file to check.

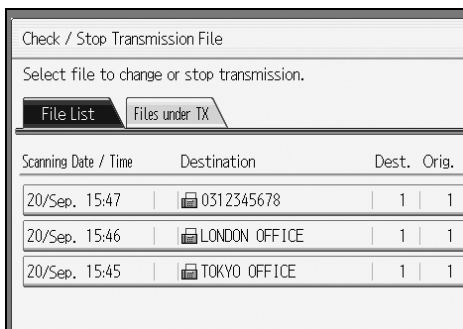

If multiple destinations were specified, only the name of the destination you specify first and only the number of destinations that have not received the document you sent are shown.

**4** Press [Check / Change Settings].

Dest.	Orig.	No.	Status
1	1	0030	Standby
1	1	0029	Standby
1	1	0028	Standby

**5** Confirm a transmission, and then press [Exit].**6** Press [Exit] twice.

The standby display appears.

# Checking the Storage Result (Memory Storage Report)

1

This report is printed after an original is stored in memory. It helps you review the contents and the destinations of stored originals.

## Important

- If you use Parallel Memory Transmission, the Memory Storage Report is not printed.

## Note

- You can turn this report on and off with the User Parameters (switch 03, bit 2) in the Facsimile Features menu.
- Even if the machine is set up not to print this report, it is still printed if an original could not be stored.
- You can select whether to include part of the original image on the report with the User Parameters (switch 04, bit 7) in the Facsimile Features menu.
- You can select whether to display a destination with the User Parameters (switch 04, bit 4) in the Facsimile Features menu.
- You can display a sender name with the User Parameters (switch 04, bit 5) in the Facsimile Features menu.

## Reference

“Facsimile Features”, General Settings Guide

# 2. Other Transmission Features

This section explains the features of [TX Mode], which you can use to apply transmission functions.

## Sending at a Specific Time (Send Later)

Using this function, you can instruct the machine to delay transmission of your fax document until a specified later time. This allows you to take advantage of off-peak telephone charges without having to be by the machine at the time.

### Important

- If the machine is switched off for about one hour, all fax documents stored in memory are lost. If documents are lost for this reason, a Power Failure Report is automatically printed when the operation switch is turned on. Use this report to identify lost documents. For details, see “Troubleshooting When Using the Facsimile Function”, Troubleshooting.
- This function is unavailable with Immediate Transmission. Use Memory Transmission.

**1** Place the original, and then select the scan settings you require.

**2** Press [TX Mode].

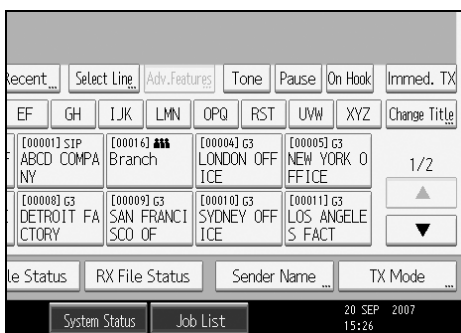

**3** Press [Send Later].

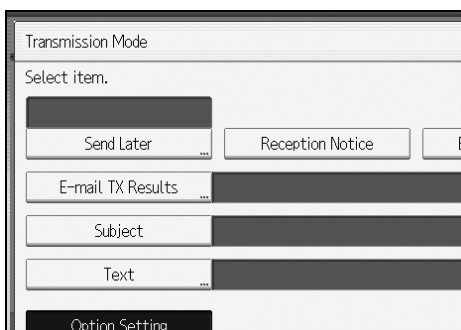

#### 4 Enter the time (24 hour format) using the number keys, and then press [OK].

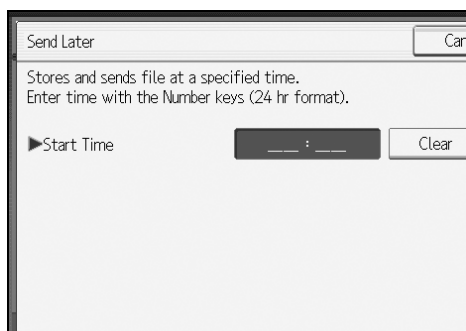

When entering numbers smaller than 10, add a zero at the beginning.

If you make a mistake, press **[Clear]** or the **[Clear/Stop]** key before pressing **[OK]**, and then try again.

To cancel Send Later, press **[Cancel]**. The display returns to that of step 3.

The specified time is shown above the highlighted **[Send Later]**.

#### 5 Press [OK].

The standby display appears.

To check the settings, press **[TX Mode]**.

#### 6 Specify a destination, and then press the [Start] key.

##### Note

- You can specify a time within 24 hours of the current time.
- If the current time shown is not correct, change it.
- You can program one of the Quick Operation keys with operations for this function. Using the Quick Operation key allows you to omit step 2.
- You can cancel the transmission setup for Send Later. See “Canceling a Transmission”.

##### Reference

p.108 “Canceling a Transmission”

“System Settings”, General Settings Guide

“Facsimile Features”, General Settings Guide

“Troubleshooting When Using the Facsimile Function”, Troubleshooting



# Requesting a Reception Notice

You can confirm sent e-mail documents were properly received using e-mail or the Journal.

The receiver sends back a reception notice message. Once the reception notice message is received, "OK" appears in the Result column of the Journal, allowing the originator to verify the transmission was received.

## Important

- The Reception Notice feature is only available if the receiver supports MDN (Message Disposition Notification).

**1** Place the original, and then select the scan settings you require.

**2** Press [TX Mode].

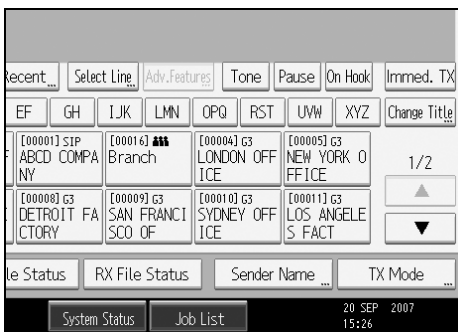

**3** Press [Reception Notice] to highlight it.

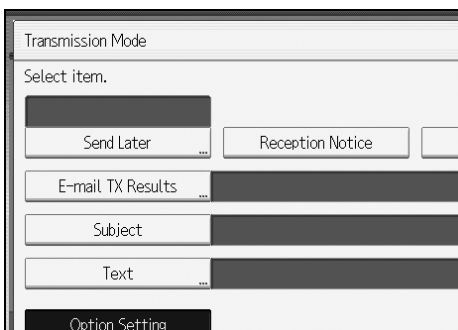

**4** Press [OK].

The standby display appears.

To check the settings, press [TX Mode].

**5** Specify a destination, and then press the [Start] key.

 **Note**

- If the fax is not received normally, "Error" appears in the Result column.
- Only the last 50 communications appear in the Journal. If you do not receive a reception notice message before the last 50 communications are finished, "OK" might not be printed in the Journal's Result column. This may happen even if the mail is received normally at the other end.
- If you specify mailing list addresses, do not set for Reception Notice. Otherwise, you will receive multiple reception notice messages from e-mail recipients, and the Result column will be overwritten each time a new notice message is received. However, if you receive a reception notice message indicating an error, "Error" appears in the Result column and will not be overwritten, even if you subsequently receive a reception notice message as "OK" following the error message.
- Reception notice results are only shown in the Journal. The Result column in all other files, lists, and transmission reports show "- -".
- Reception notice messages themselves are not recorded in the Journal.
- You can select whether or not to print the Reception Notice. This can be set with User Parameters (switch 21, bit 0) in the Facsimile Features menu.
- You can program one of the Quick Operation keys with operations for this function. Using the Quick Operation key allows you to omit step 2.
- You cannot broadcast e-mail using Reception Notice. The documents are sent to the destinations in the order in which they were specified.

 **Reference**

"Facsimile Features", General Settings Guide

# Setting an E-mail Destination as a BCC

E-mail is sent to all specified destinations as bcc.

**1** Place the original, and then select the scan settings you require.

**2** Press [TX Mode].

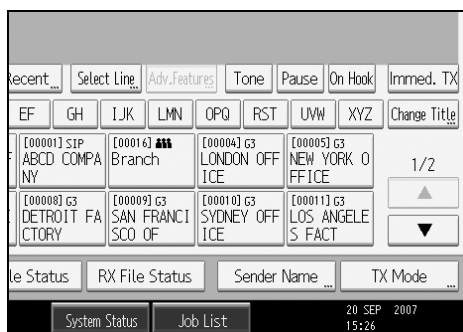

**3** Press [BCC Transmission] to highlight it.

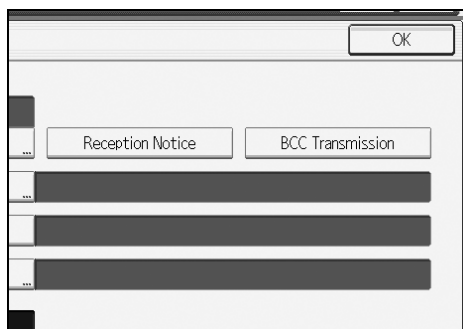

**4** Press [OK].

The standby display appears.

To check the settings, press [TX Mode].

**5** Specify a destination, and then press the [Start] key.

#### Note

- You can program one of the Quick Operation keys with operations for this function. Using the Quick Operation key allows you to omit step **2**.

#### Reference

“Facsimile Features”, General Settings Guide

## Confirming Transmission Results by E-mail

Use this function to confirm the transmission results by sending an e-mail notification to the specified destination.

### Important

- Register the e-mail address of the destination for e-mail notification in the destination list in advance.

**1** Place the original, and then select the scan settings you require.

**2** Press [TX Mode].

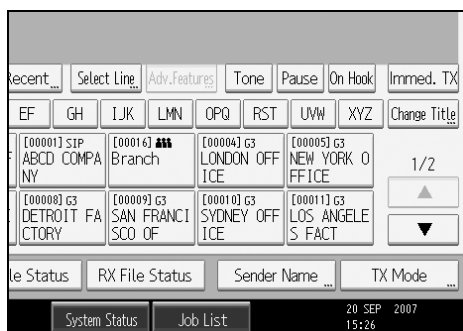

**3** Press [E-mail TX Results].

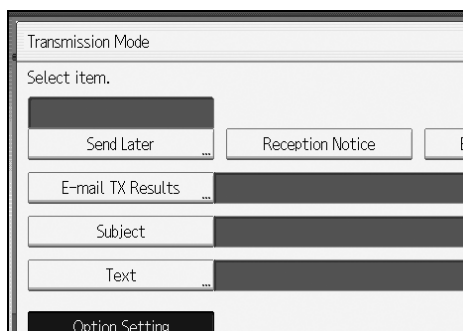

**4** Select the destination of notification, and then press **[OK]**.

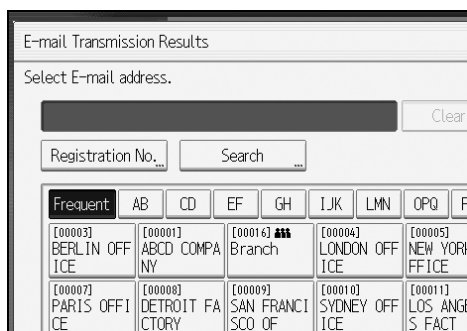

2

If you make a mistake, before pressing **[OK]**, press **[Clear]** or press the selected Destination key again to turn the highlight off.

**[E-mail TX Results]** gets highlighted and the destination of notification selected appears.

**5** Press **[OK]**.

The standby display appears.

To check the settings, press **[TX Mode]**.

**6** Specify a destination, and then press the **[Start]** key.

**Note**

- You can program one of the Quick Operation keys with operations for this function. Using the Quick Operation key allows you to omit step **2**.

**Reference**

“Facsimile Features”, General Settings Guide

## Entering the Subject

Allows you to enter a subject for the e-mail document you want to send.

**1** Place the original, and then select the scan settings you require.

**2** Press [TX Mode].

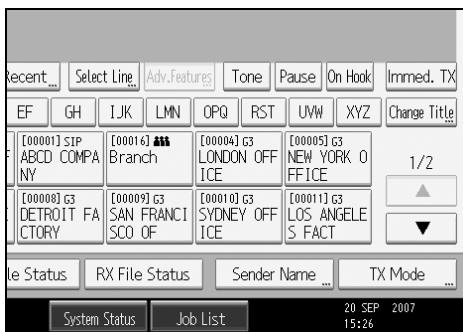

**3** Press [Subject].

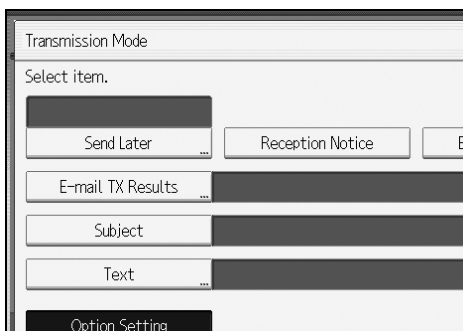

**4** Enter the subject.



- 5** To enter the character strings programmed in the machine, press [User Text], and then select the character strings you want to enter.

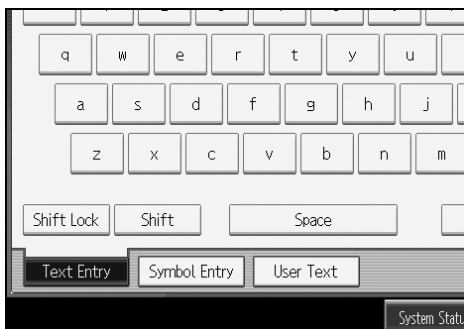

- 6** Press [OK].

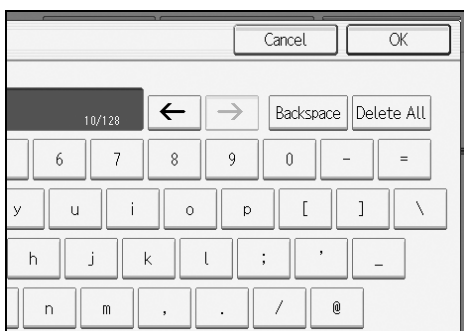

The entered subject appears in the Subject field.

- 7** Press [OK].

The standby display appears.

- 8** Specify a destination, and then press the [Start] key.

 **Note**

- For convenience, program frequently-used subjects in advance in “Program / Change / Delete User Text” in “System Settings”.
- If you send e-mail without setting a subject, a subject is automatically inserted. For details about how the subject is automatically inserted, see “E-mail Subject” and “Received Images”.
- You cannot send a subject only as e-mail without an original.
- You can program one of the Quick Operation keys with operations for this function. Using the Quick Operation key allows you to omit step **2**.
- For the maximum number of characters for an e-mail subject, see “Maximum Values”.

 **Reference**

p.30 "E-mail Subject"

p.149 "Received Images"

p.272 "Maximum Values"

"Entering Text", About This Machine

"System Settings", General Settings Guide

"Facsimile Features", General Settings Guide



# Entering the Text

Allows you to enter the text for the e-mail document you want to send.

## Important

- Program text strings in advance in “Program / Change / Delete E-mail Message” in “System Settings”.

**1** Place the original, and then select the scan settings you require.

**2** Press [TX Mode].

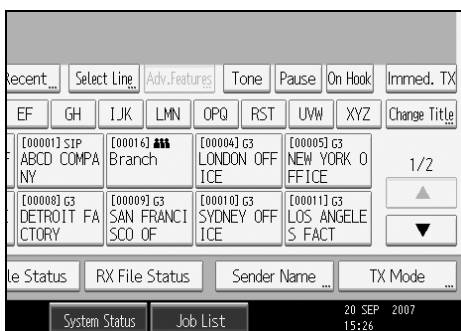

**3** Press [Text].

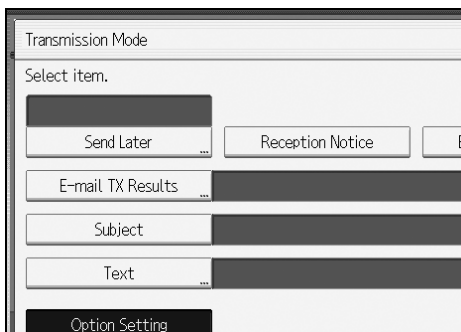

**4** Select a text, and then press [OK].

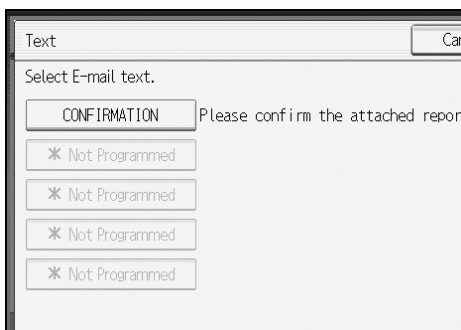

**5** Press [OK].

The standby display appears.

**6** Specify a destination, and then press the **[Start]** key.

 **Note**

- You cannot send text only without an original.
- You can program one of the Quick Operation keys with operations for this function. Using the Quick Operation key allows you to omit step **2**.

 **Reference**

“System Settings”, General Settings Guide

“Facsimile Features”, General Settings Guide

# Transmission Options

This section describes various functions that you can switch on and off for any particular transmission, following the procedures given here.

## Standard Message Stamp

Use this function to stamp a standard message at the top of the first original sent. There are four types of standard messages: “Confidential”, “Urgent”, “Please phone”, and “Copy to corres. section”

You can also program other messages.

### Important

- While this function is in use, the third line of the Label Insertion is not printed.
- When there is an image around the area where the standard message is to be stamped, that image is deleted.
- Program a standard message in “Program / Change / Delete Standard Message” in the Facsimile Features menu. See “Facsimile Features”, General Settings Guide.

**1** Place the originals, and then select the scan settings you require.

**2** Press [TX Mode].

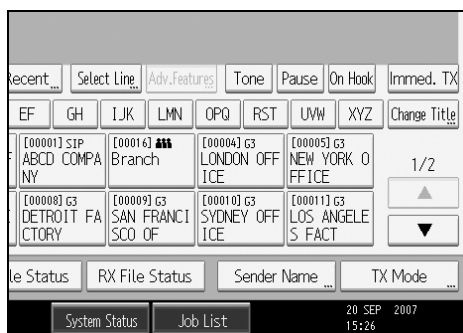

**3** Press [Option Setting].

**4** Press [Standard Message].

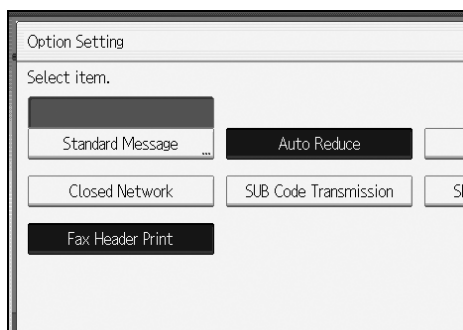

- 5** Select the standard message to be stamped, and then press [OK].

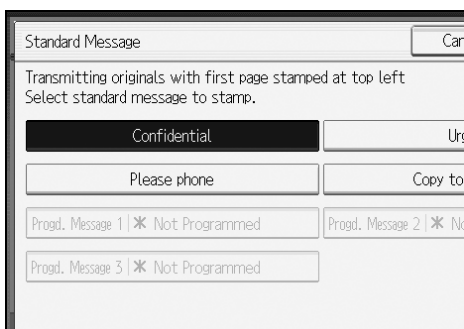

The selected standard message is shown above the highlighted [Standard Message].

- 6** Press [OK] twice.

- 7** Specify the destination, and then press the [Start] key.

The machine cannot stamp multiple standard messages.

 **Note**

- You can program one of the Quick Operation keys with operations for this function. Using the Quick Operation key allows you to omit step **2** and step **3**.

 **Reference**

p.132 "Label Insertion"

"Facsimile Features", General Settings Guide

---

## Auto Reduce

---

When this function is turned on, if the receiver's paper is smaller than the size of the original you are sending, the document is automatically reduced to fit onto the paper available at the other end.

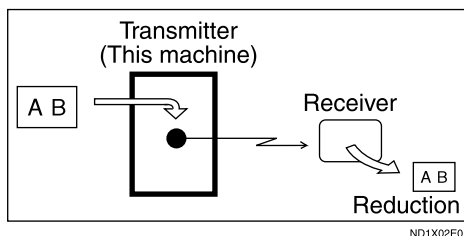

ND1X02E0

## Important

- ❑ If you turn this function off, the scale of the original is maintained and some parts of the image may be deleted when printed at the other end.

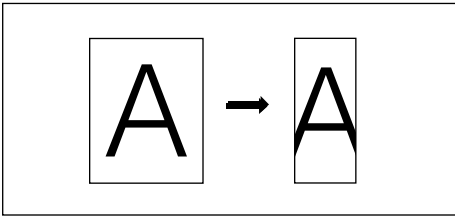

ND1X02E1

2

- 1 Place the original, and then select the scan settings you require.
- 2 Press [TX Mode].

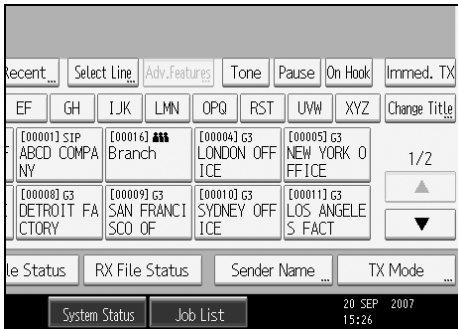

- 3 Select [Option Setting].
- 4 Make sure that [Auto Reduce] is highlighted.

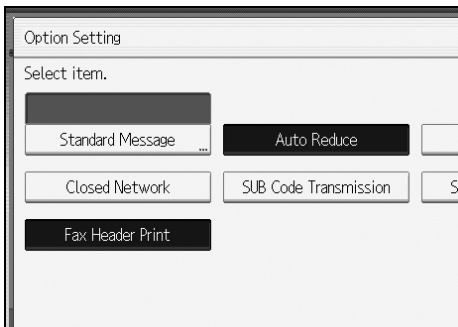

To cancel an Auto Reduce, press [Auto Reduce] to turn the highlight off.

- 5 Press [OK] twice.
- 6 Specify the destination, and then press the [Start] key.

## Label Insertion

With this function you can have the receiver's name printed on the document that is received at the other end.

### Important

- To use this function, set Label Insertion to **[On]** when registering fax destinations in the Address Book, and also set "Label Insertion" to on when sending fax documents.
- When there is an image around the area where the Label is to be printed, that image is deleted.

The receiver's name is printed as follows:

- Receiver's name: printed at the top of the page and preceded by "To:".
- Standard message: the programmed message is printed within the next two lines.

Set this function as follows:

- Set Label Insertion to **[On]** when programming fax destinations.
- Set Label Insertion to on when sending fax documents.
- On the Standard Message screen, select the standard message you want to print.

**1** Place the original, and then select the scan settings you require.

**2** Press [TX Mode].

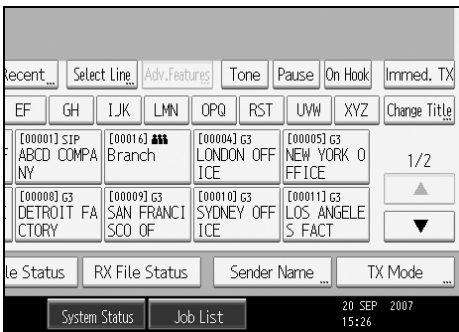

**3** Select [Option Setting].

- 4** Press **[Label Insertion]** to highlight it.

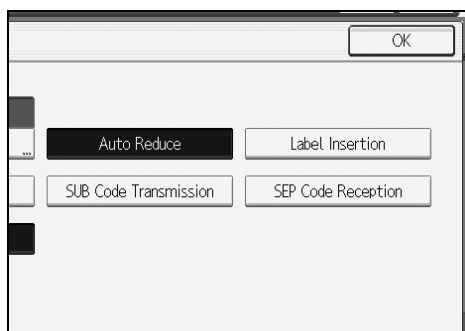

To cancel Label Insertion, press **[Label Insertion]** again.

- 5** Press **[OK]** twice.

- 6** Specify the destination, and then press the **[Start]** key.

 **Note**

- You can program one of the Quick Operation keys with operations for this function. Using the Quick Operation key allows you to omit step **2** and step **3**.
- To print a standard message that is not programmed as a default, program it in advance in “Program / Change / Delete Standard Message” in the Facsimile Features menu.

 **Reference**

p.129 “Standard Message Stamp”

“Facsimile Features”, General Settings Guide

## Closed Network

If you turn this function on, transmission will only take place if the destination's Closed Network Code is the same as yours. This function can stop you accidentally sending information to the wrong place.

### Important

- You need to register a Closed Network Code beforehand in the Facsimile Features menu.
- This function is not available with Internet Fax.

**1** Place the original, and then select the scan settings you require.

**2** Press [TX Mode].

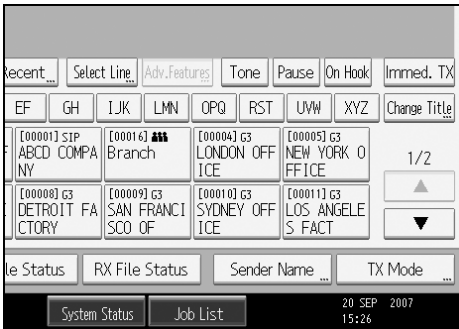

**3** Select [Option Setting].

**4** Press [Closed Network] to highlight it.

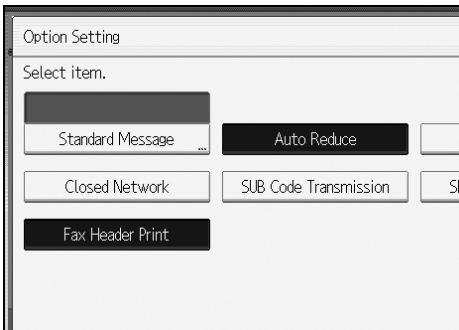

To cancel a Closed Network transmission, press [Closed Network] again.

**5** Press [OK] twice.

**6** Specify the destination, and then press the [Start] key.

### Note

- You can program one of the Quick Operation keys with operations for this function. Using the Quick Operation key allows you to omit step **2** and step **3**.



## Reference

“Facsimile Features”, General Settings Guide

# SUB Code Transmission

Enable this function to perform SUB Code Transmission.

## Important

- This function is not available with Internet Fax.
- To perform SUB Code Transmission, a SUB Code must be set in **[Adv.Features]**, the Address Book, or Keystroke Programs in advance. Even though “SUB Code Transmission” is set to on, if the SUB Code is not appended to the specified destination, transmission is in standard fax mode.
- When you select a destination that has a registered SUB Code from the Address Book, if “SUB Code Transmission” is set to off, the SUB Code is not appended and transmission is in standard fax mode.

**1** Place the original, and then select the scan settings you require.

**2** Press [TX Mode].

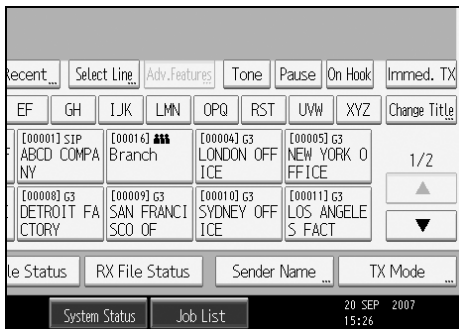

**3** Select [Option Setting].

**4** Press [SUB Code Transmission] to highlight it.

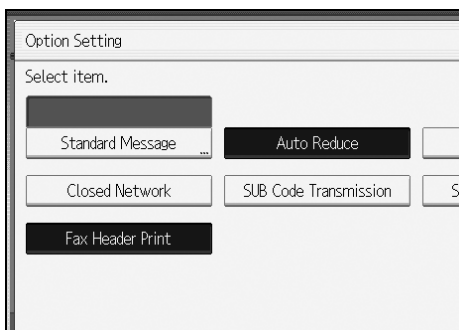

To cancel a SUB Code Transmission, press **[SUB Code Transmission]** again.

**5** Press [OK] twice.

**6** Specify the destination, and then press the **[Start]** key.

**Note**

- You can program one of the Quick Operation keys with operations for this function. Using the Quick Operation key allows you to omit step **2** and step **3**.

**Reference**

- p.100 "Setting SUB Codes for Transmission"
- p.262 "Programs"
- "Facsimile Features", General Settings Guide
- "Registering Addresses and Users for Facsimile/Scanner Functions", General Settings Guide

2

## SEP Code Reception

Enable this function to perform SEP Code Reception.

**Important**

- This function is not available with Internet Fax.
- To perform SEP Code Reception, a SEP Code must be set in **[Adv.Features]**, the Address Book, or Keystroke Programs in advance. Otherwise, even if "SEP Code Reception" is set to on, reception is not performed. If the other party's fax machine has a polling transmission function, the machine performs polling reception.
- When you select a destination that has a registered SEP Code from the Address Book, if "SEP Code Reception" is set to off, the SEP Code is not appended and transmission is in standard fax mode.

**1** Place the original, and then select the scan settings you require.

**2** Press **[TX Mode]**.

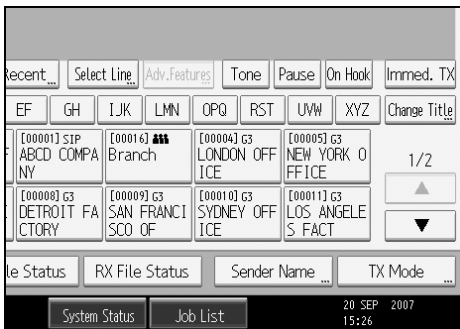

**3** Select **[Option Setting]**.

- 4** Press **[SEP Code Reception]** to highlight it.

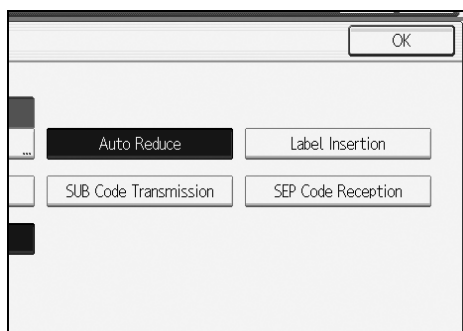

To cancel SEP Code Reception, press **[SEP Code Reception]** again.

- 5** Press **[OK]** twice.

- 6** Specify the destination, and then press the **[Start]** key.

 **Note**

- You can program one of the Quick Operation keys with operations for this function. Using the Quick Operation key allows you to omit step **2** and step **3**.

 **Reference**

p.103 "Setting SEP Codes for Reception"

p.262 "Programs"

"Facsimile Features", General Settings Guide

"Registering Addresses and Users for Facsimile/Scanner Functions", General Settings Guide

## Fax Header Print

When the Fax Header is set to on, the stored name is printed on the receiver's paper.

In some cases, you may want the other party to receive an unmarked copy of your original. To do this, switch Fax Header off.

You can store two Fax Headers; "First Name" and "Second Name".

For example, if you store your department name in one and your organization name in the other, you could use the first when sending internal faxes and the second for external faxes.

**1** Place the original, and then select the scan settings you require.

**2** Press [TX Mode].

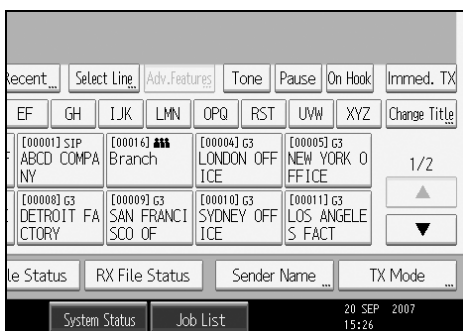

**3** Select [Option Setting].

**4** Make sure that [Fax Header Print] is highlighted.

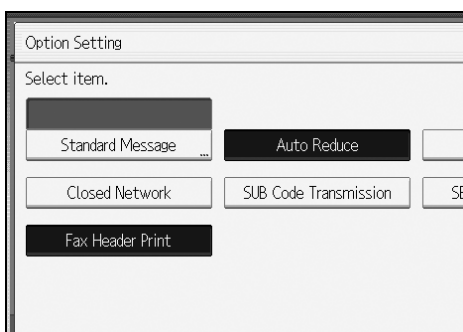

To cancel Fax Header Print, press [Fax Header Print] to turn the highlight off.

**5** Press [OK] twice.

**6** Specify the destination, and then press the [Start] key.

 **Note**

- You can program fax header names using the Program Fax Information function in the Facsimile Features menu.
- You can select whether or not dates, fax header names, file numbers, or page numbers are printed by changing their respective User Parameters (switch 18, bit 3, 2, 1, 0) in the Facsimile Features menu.
- If you used the number keys to specify the receiver, the first header name is printed on the receiver's paper. To print the second header name, contact your service representative.
- You can program one of the Quick Operation keys with operations for this function. Using the Quick Operation key allows you to omit step **2** and step **3**.

 **Reference**

“Facsimile Features”, General Settings Guide



# 3. Reception

This section explains reception and reception functions such as printing received documents or routing received documents to other fax machines.

## Types of Reception

This section explains different ways of receiving fax documents.

---

### Immediate Reception

---

Each page of a fax document is printed as soon as it is received. This method is used for standard fax documents.

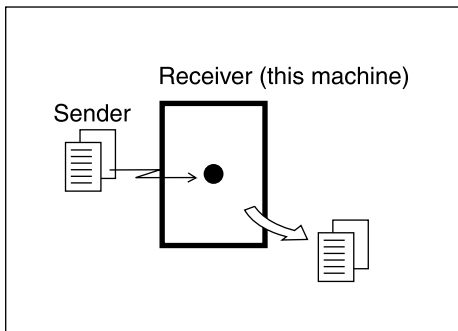

ND1X00E2

#### Important

- When receiving important fax documents, it is recommended that you confirm the contents of the received documents with the senders.
- The machine may not be able to receive fax documents when free memory space is low.
- If free memory reaches 0% during Immediate Reception, any further reception becomes impossible and the current communication is terminated.

#### Note

- Reception is always by Immediate Reception unless **[2 Sided Print]** is set to "On" or **[Reception File Print Quantity]** is set to "2" or higher, in which cases the machine switches to Memory Reception.
- If the Substitute Reception is used, a fax document is not printed: it is stored in memory.
- This machine supports Standard, Detail, Fine (with the optional expansion memory), and Super Fine (with the optional expansion memory) resolutions for reception. If you do not have the optional expansion memory, faxes sent at Super Fine resolution is printed on your machine at Detail resolution. This may differ from the sender's intended resolution.

## Reference

- p.45 "Resolution"
- p.142 "Memory Reception"
- p.143 "Substitute Reception"
- p.157 "Printing Options"

## Memory Reception

The machine waits until all pages of the document have been received into memory before printing it.

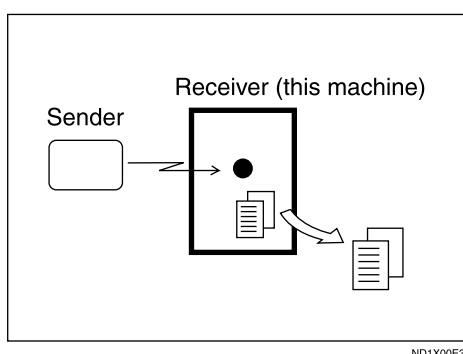

## Important

- About one hour after the machine is turned off, all fax documents stored in memory are lost. If any documents are lost in this way, a Power Failure Report is automatically printed when the operation switch is turned on. Use this report to identify lost documents. See "Troubleshooting When Using the Facsimile Function", Troubleshooting.
- The machine might not be able to receive large numbers of documents or documents with high data content. If this is the case, we recommend that you set "Reception File Print Quantity" to "1" and disable "2 Sided Print". Alternatively, install the optional expansion memory.
- The machine may not be able to receive fax documents when free memory space is low.
- If free memory reaches 0% during Memory Reception, any further reception becomes impossible and the current communication is terminated.

## Note

- Reception is always by Immediate Reception unless **[2 Sided Print]** is set to "On" or **[Reception File Print Quantity]** is set to "2" or higher, in which cases the machine switches to Memory Reception.
- If you have selected Store for Reception File Setting, received document is saved on the hard disk and will not be printed. You can print those documents by operating the machine or a connected computer, as necessary.



## Reference

“Facsimile Features”, General Settings Guide

“Troubleshooting When Using the Facsimile Function”, Troubleshooting

## Substitute Reception

Substitute Reception is used when the machine cannot print any fax documents. In Substitute Reception, a received fax document is stored in memory instead of being printed. Fax documents received using Substitute Reception are automatically printed when the condition which caused the machine to use Substitute Reception is rectified.

Depending on why the machine cannot print, Substitute Reception might be used for all fax documents received, or for only those documents that match a condition specified in the User Parameters in the Facsimile Features menu.

The Receive File indicator lights to let you know when fax documents have been received using Substitute Reception.

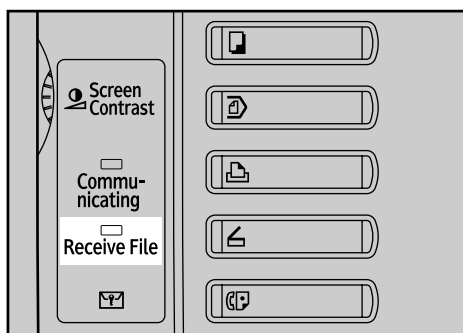

BFT004S

## Important

- Reception may not take place if there is not enough free memory.
- If free memory reaches 0% during Substitute Reception, any further reception becomes impossible and the current communication is terminated.

## Note

- When a fax document is received after Store is selected for Reception File Setting in the Facsimile Features menu, the Receive File indicator lights.
- The Receive File indicator may light even when receiving documents using Immediate Reception.

## Reference

“Facsimile Features”, General Settings Guide

### Receiving documents unconditionally

If one of the conditions in the following list occurs, the machine receives all fax documents using Substitute Reception.

Problems	Causes	Solutions
The machine is printing with a different function.	The machine is busy printing with a different function.	The document is automatically printed after the current job finishes.
The message "Output Tray is full. Remove paper." appears.	The output tray is full.	Remove paper from the output tray.
⏏ is lit.	The cover is open.	Close the cover shown in the display.

### Receiving documents according to parameter-specified settings

If one of the conditions in the following list occurs, the machine receives only those documents that match the conditions specified in the User Parameters (switch 05, bit 2, 1) in the Facsimile Features menu.

Problems	Causes	Solutions
⏏ is lit.	Paper is jammed.	Remove the jammed paper. For details about removing the paper, see "Clearing Misfeeds", Troubleshooting.
⏏ is lit.	All trays are out of paper.	Add paper. For details about adding paper, see "Adding Paper, Toner and Staples", Troubleshooting.
⏏ is lit.	Toner is empty.	Replace the toner cartridge. For details about replacing the toner cartridge, see "Adding Paper, Toner and Staples", Troubleshooting.
The message "This tray is out of order." appears.	All trays are out of action.	Call your service representative.

You can specify the following conditions with the User Parameters (switch 05, bit 2, 1) in the Facsimile Features menu.

- When Own Name or Own Fax Number is received  
The machine switches to Substitute Reception only when the sender has programmed their Own Name or Own Fax Number. If the power is switched off for more than an hour, all the documents stored in memory are deleted. In this case, the Journal can be used to identify the senders of the deleted documents, so you can ask them to resend.  
If a sender has not programmed their Own Name or Own Fax Number, the machine may fail to receive an important fax document. It is recommended that you ask important senders to program an Own Name or Own Fax Number in advance.
- Free  
The machine switches to Substitute Reception regardless of whether or not the sender has programmed their Own Name or Own Fax Number.
- Closed Network Code match  
The machine switches to Substitute Reception only when the programmed Closed Network Code of the other end matches the Closed Network Code of this machine.
- Disable  
The machine does not receive any documents.



### Reference

“Facsimile Features”, General Settings Guide

“Adding Paper, Toner and Staples”, Troubleshooting

“Clearing Misfeeds”, Troubleshooting

## Reception Modes

There are two ways you can set up the machine to handle incoming calls:

- Manual Reception (an external telephone required)
- Auto Reception

You can change the reception mode only if a standard G3 line is used.

You cannot change the reception mode when a line other than the standard G3 line (G3-2 or G3-3) is used.

**3**

### Note

- An external telephone is required to use this machine as a telephone.

---

### Manual Reception

---

When a telephone call comes in, the machine rings. If the call is a fax document, you must switch manually to facsimile mode.

- 1** When the machine rings, pick up the handset of the external telephone.
- 2** If you hear beeps, press the **[Start]** key, or hold the **[Facsimile]** key down for a few seconds. (The **[Start]** key is only available in facsimile mode when an original is not placed.)
- 3** Replace the handset of the external telephone. The machine will start receiving.

### Note

- When the operation switch is off, even if the main power switch is on, you cannot operate this machine using only the handset of the external telephone. You must first press the operation switch to turn on the machine.

---

### Auto Reception

---

When a telephone call comes in, the machine automatically receives it as a fax document. Use this setting on a dedicated fax line.

## Switching the Reception Mode

You can switch reception modes using Reception Settings in the Facsimile Features menu.

If you program a Quick Operation key with Switch Reception Mode, you can switch the reception mode quickly.

### 1 Press [Switch RX Mode].

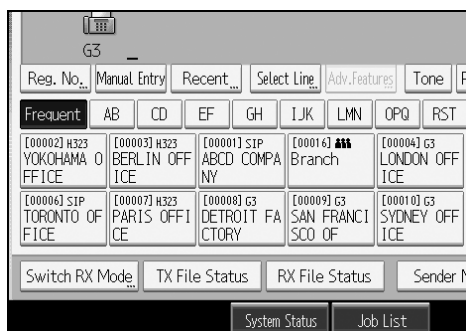

### 2 Select the reception mode, and then press [OK].

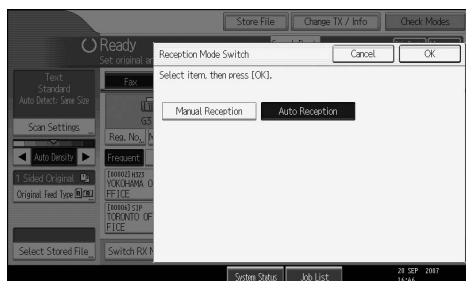

The standby display appears.

To cancel the selection, press [Cancel].

### 🔍 Reference

“Facsimile Features”, General Settings Guide

# Receiving Internet Fax Documents

You can receive e-mail documents by Internet Fax.

There are two methods of receiving e-mail: Auto E-mail Reception and Manual E-mail Reception.

## Important

- E-mail with attachments other than TIFF-F format files cannot be received. Senders receive an Error Mail Notification if their e-mail contains attachments. You can select whether or not the machine sends this message with User Parameters (switch 21, bit 7) in the Facsimile Features menu. However, TIFF-F documents created by the Saving function of DeskTopBinder can be received.
- If **[Require Secure Password Authentication (SPA) for all client connections]** is selected in Windows Server 2003/2003 R2, reception is not possible.

## Note

- When Reception Protocol is set to POP3 or IMAP4, you can set the machine to retain incoming e-mail or delete it from the server in “System Settings”.
- With User Parameters (switch 21, bit 1) in the Facsimile Features menu, you can have the machine send the return receipt in response to the reception notice request attached to the sent e-mail.

## Reference

“System Settings”, General Settings Guide

“Facsimile Features”, General Settings Guide

---

## Auto E-mail Reception

---

When this function is turned on, the machine periodically checks the e-mail server for incoming e-mail and downloads it as necessary.

## Note

- If memory runs out, e-mail will not be received at the specified intervals. Reception will resume when sufficient memory becomes available.
- E-mail auto-reception should be set in “System Settings”. When you select auto-reception, set the reception interval in minutes.
- E-mail can be received manually.

## Reference

p.149 “Manual E-mail Reception”

“System Settings”, General Settings Guide

## Manual E-mail Reception

Follow these steps to receive a fax by accessing the e-mail server manually.

### Important

- Program the Manual E-mail RX function to a Quick Operation key beforehand.

#### 1 Press [Manual E-mail RX].

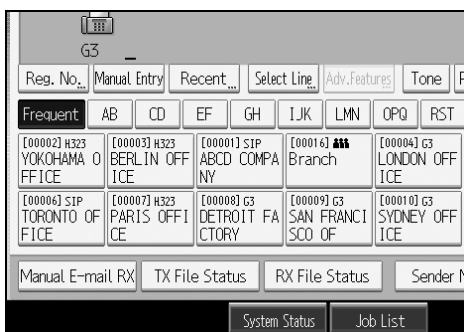

The machine accesses the server to check for e-mail and receives any new e-mail.

#### 2 Check the message, and then press [Exit].



The standby display appears.

### Reference

“Facsimile Features”, General Settings Guide

## Received Images

Here is an example of an Internet Fax document sent from this machine and received on a computer using the Outlook Express e-mail application.

The received image varies according to the e-mail application.

### Important

- When Internet Fax e-mail is sent to computer, the following information is always inserted in the e-mail text: “This E-mail was sent from “Host Name” (product name) Queries to: “Administrator’s e-mail address”” To check the host name and e-mail address, see “System Settings”, General Settings Guide.

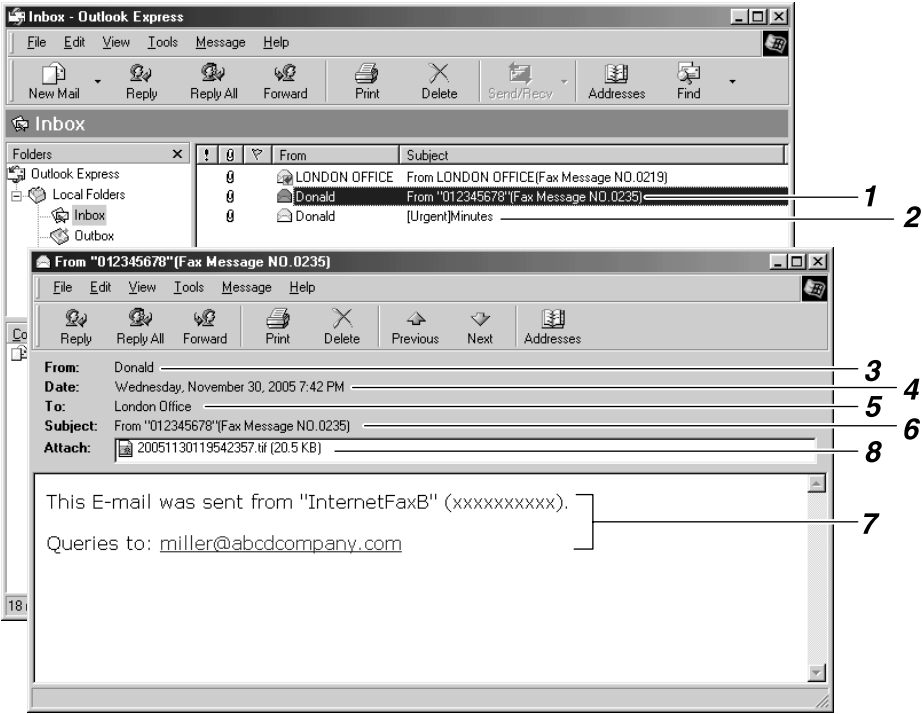

ALV011S

**1. E-mail transmitted without specifying a subject in "TX Mode".**

**2. E-mail transmitted with a subject specified in "TX Mode".**

**3. From**

The name (e-mail address) of the sender

**4. Date**

The date and time of e-mail transmission

**5. To**

The e-mail address of the recipient

**Note**

- The display format of the sender name differs according to that of the Stamp Sender Name setting and other functions.
- The display format of the subject varies according to Stamp Sender Name and other settings.

**Reference**

p.30 "E-mail Subject"

"System Settings", General Settings Guide

**6. Subject**

Shows the subject specified in "TX Mode" at the time of transmission. If no subject is specified, one is automatically assigned in the format shown in 1 above.

**7. The message is inserted in all e-mail. "xxxx" is the machine name.**

**8. Attachment File**

Any document included by the sender is displayed as an attached document.



# Reception Functions

This section explains useful functions for receiving fax documents.

## Routing Received Documents

This section describes how to route received documents using SUB Codes.

### Important

- Documents cannot be routed to folders using this function.

### Routing received documents with SUB Code

This machine can route received documents using SUB Codes.

When a document is received, its SUB Code is compared to SUB Codes programmed in Personal Boxes, and if a match is found, the document is routed to the destination whose SUB Code is specified.

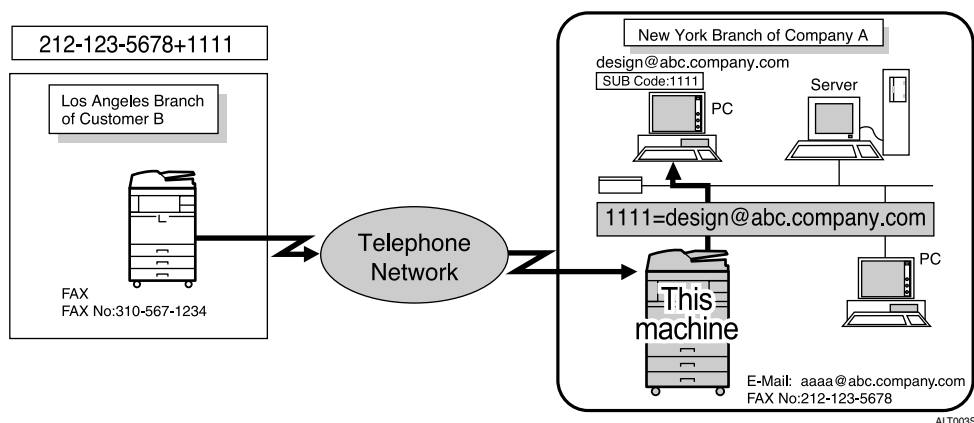

### Important

- You must set the Personal Box and register a delivery destination beforehand. Personal Boxes can be programmed in “Box Setting” in the Facsimile Features menu.
- This function is not available when you set received documents to be delivered to the network delivery server. Delivery of received documents can be set in “System Settings”.

### Note

- If the destination specified is an e-mail address, the received document is routed to that destination as e-mail.
- You can route documents received from any fax machine, regardless of manufacturer.

### Reference

“System Settings”, General Settings Guide

“Facsimile Features”, General Settings Guide

---

## Transferring Received Documents

---

The machine can transfer received documents by using SUB Codes.

Originals sent with a SUB Code that matches the SUB Code programmed as a Transfer Box are received then relayed to the programmed receiver.

### Important

- Transfer Boxes and Receiving Stations must be set up in order to transfer received documents. Transfer Boxes can be programmed in “Box Setting” in the Facsimile Features menu.

### Note

- When e-mail addresses are programmed as receivers, received documents are sent in an e-mail format to the receivers.
- Transfer results are not sent back to the requesting party.
- You can transfer data received from any fax machine, regardless of manufacturer.

### Reference

“Facsimile Features”, General Settings Guide

---

## SUB Code Transfer Report

---

You can check the results of transmission to Receiving Stations. The machine prints this report when it has finished transmitting to Receiving Stations.

### Note

- You can select whether the SUB Code Transfer Report be automatically printed using the User Parameters (switch 04, bit 1) in the Facsimile Features menu.
- You can set whether a portion of the original image is printed on the report with the User Parameters (switch 04, bit 7) in the Facsimile Features menu.
- “Unprogrammed” indicates the document could not be sent because the end receiver is not programmed.
- “--” indicates that the Internet Fax document was sent to the mail server programmed in this machine.
- For the maximum number of destinations you can program in a group, see “Maximum Values”.

### Reference

p.272 “Maximum Values”

“Facsimile Features”, General Settings Guide

## Forwarding Received Documents

This machine can forward received documents to other destinations programmed in this machine.

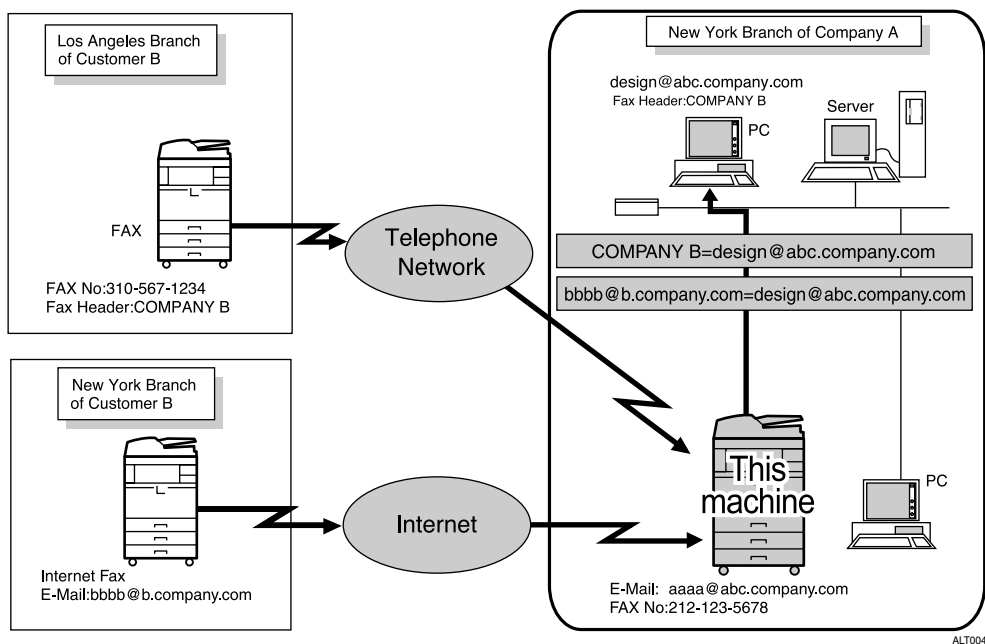

### Note

- A fax number, Internet Fax address, IP-Fax destination, or folder address can be set as a forwarding destination.
- If an e-mail address is programmed as the destination, documents received are forwarded as e-mail.
- You need to specify the forwarding destination in advance. Forwarding can be set under Reception Settings, in the Facsimile Features menu.
- If you would like the machine to forward received documents to a particular destination according to the sender, specify the Forwarding destination for each sender under Facsimile Features, Reception Settings, Program Special Sender. Documents from other senders are forwarded to the default Forwarding destination specified for this function.
- You can select whether the machine prints out the documents it forwards with User Parameters (switch 11, bit 6) in the Facsimile Features menu.
- You can set whether or not the Folder Transfer Result Report is transmitted to the specified e-mail address if folders are programmed as the forwarding destinations to which documents are sent from all senders or Special Senders. For details, see "Facsimile Features", General Settings Guide.
- For the maximum number of destinations you can program in a group, see "Maximum Values".

## Reference

p.272 “Maximum Values”  
 “Facsimile Features”, General Settings Guide

## SMTP Reception Using Internet Fax

You can receive a document sent by Internet Fax using SMTP reception.

With SMTP reception, e-mail is received as soon as it is sent to the e-mail address set by the machine.

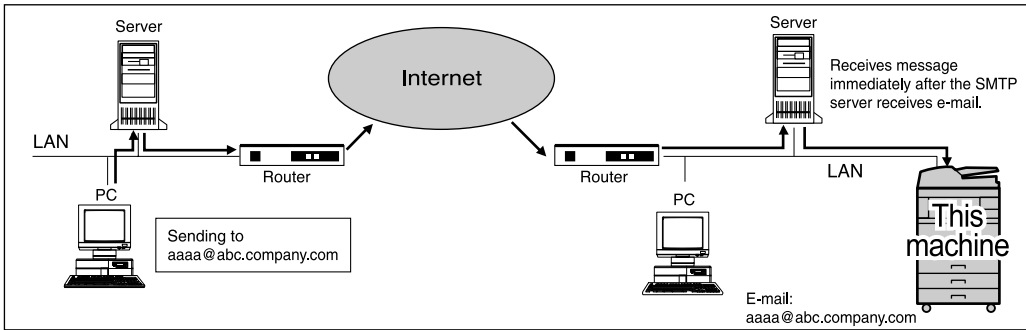

ALT005S

## Important

- Set this machine beforehand using the MX record of the DNS server to enable SMTP reception.
- Set the reception protocol to SMTP under “System Settings”.

## Note

- You can route received e-mail to other Internet Fax machines as well.
- Even if SMTP reception is enabled on the DNS server, e-mail sent from the SMTP server will not be received and the machine reports an error if SMTP reception is not set under “System Settings”. Also, the SMTP server sends an error notification to the originator.
- If an error occurs while receiving e-mail, reception is aborted, the e-mail is deleted, and Error Report is printed. Also, the SMTP server will send an error notification to the originator.
- When the SMTP server attempts to route received documents to this machine while the machine is transmitting e-mail, the machine will respond to the SMTP server with a “busy” signal. Then, the SMTP server usually tries re-sending the documents until the set timeout.

## Reference

p.148 “Auto E-mail Reception”  
 “System Settings”, General Settings Guide

## Routing e-mail received via SMTP

E-mail received via SMTP can be routed to other fax machines.

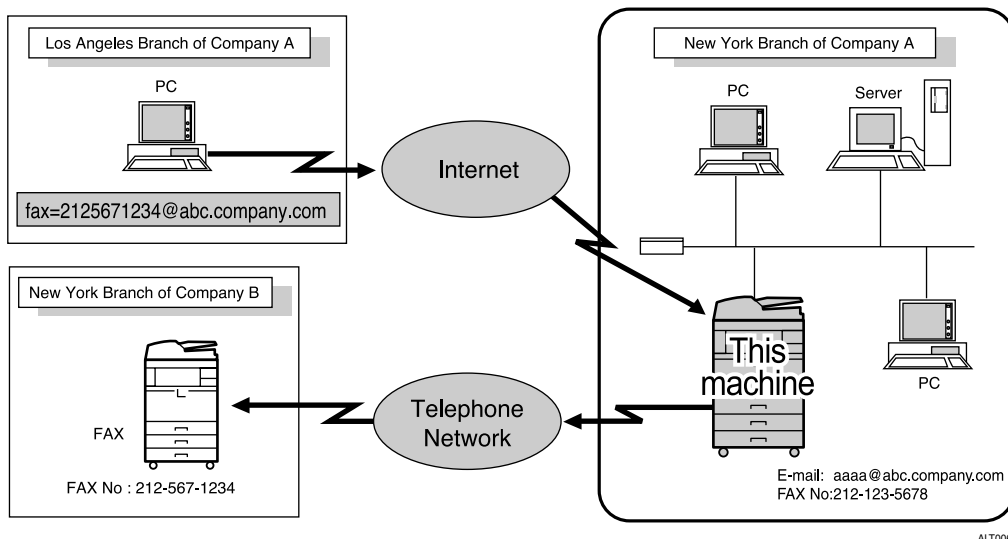

### Important

- Before routing e-mail received via SMTP, you first must set “SMTP RX File Delivery Settings” to “On” in the Facsimile Features menu.
- Depending on security settings, this function may not be available.

The originator can request transfer of e-mail sent to another fax machine by specifying the e-mail address as follows:

#### ❖ Fax Number

fax=destination fax number@host name of this machine.domain name  
 Example: to transfer to fax number 212-123-4567:  
 fax=2121234567@abc.company.com

#### ❖ Single destination programmed in the destination list

fax=#registration number of 5 digits or less@host name of this machine.domain name  
 Example: to transfer to the destination number 00001:  
 fax=#00001@abc.company.com

#### ❖ Group destination programmed in the destination list

fax=#\*#\*registration number of 5 digits or less@host name of this machine.domain name  
 Example: to transfer to the destination programmed under Group number 00004:  
 fax=#\*#\*00004@abc.company.com

 **Note**

- E-mail received via SMTP can also be routed to single or group destinations programmed in the destination list.
- If an e-mail transfer request is received when the “SMTP RX File Delivery Settings” is “Off” in the Facsimile Features menu, this machine responds with an error message to the SMTP server.
- You can make settings that limit transfer to specified originators.
- Using this function, you can also send documents from your e-mail application to e-mail addresses and G3 fax machines' destinations through this machine simultaneously.
- For the maximum number of destinations you can program in a group, see “Maximum Values”.

 **Reference**

p.272 “Maximum Values”  
“Facsimile Features”, General Settings Guide

---

## JBIG Reception

---

If you use JBIG (Joint Bi-level Image Experts Group) compression, you can send photographic originals faster than with other methods of compression. It allows you to receive documents sent in the JBIG format through JBIG Transmission.

 **Important**

- This function is not available with Internet Fax function.

---

## Auto Fax Reception Power-Up

---

This machine can be set to shut down automatically if no one has used it for a while. In these situations, even though the operation switch is off, the machine can still receive incoming documents as long as the main power switch is on.

 **Important**

- Reception is not possible if both the operation switch and main power switch are turned off.

 **Note**

- You can set whether documents are printed as soon as they are received (Immediate Reception) with the User Parameters (switch 14, bit 0) in the Facsimile Features menu.
- You can also have fax documents received by Memory Reception (Substitute Reception) printed after the machine is turned on.

 **Reference**

“Facsimile Features”, General Settings Guide

# Printing Options

This section explains useful functions for printing received documents.

---

## Print Completion Beep

---

When this function is turned on, the machine beeps to let you know when a received document is printed.

### Note

- You can alter the volume of the beep or turn it off completely using “Adjust Sound Volume” in the Facsimile Features menu (set the volume to the minimum level).

### Reference

“Facsimile Features”, General Settings Guide

---

## Checkered Mark

---

When this function is turned on, a Checkered Mark is printed on the first page of fax documents to help you separate them.

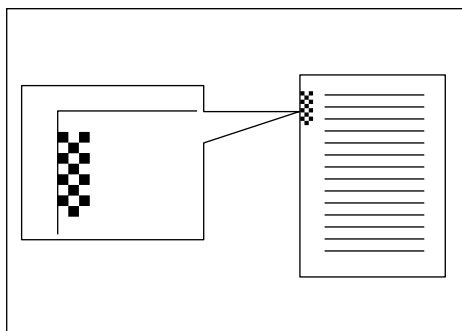

ND1X00E5

### Note

- You can turn this function on or off using Checkered Mark in the Facsimile Features menu.

### Reference

“Facsimile Features”, General Settings Guide

## Centre Mark

When this function is enabled, marks are printed halfway down the left side and at the top centre of each page received.

This makes it easy for you to position a hole puncher correctly when you file received documents.

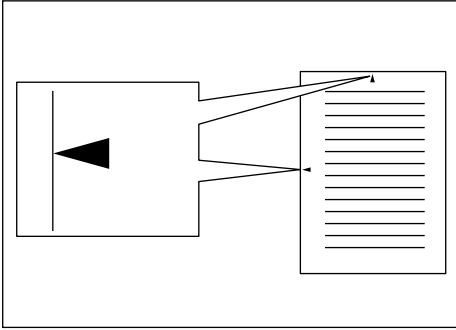

3

### Note

- The Centre Mark may deviate a little from the exact centre of the edge.
- You can enable or disable this function using Centre Mark in the Facsimile Features menu.

### Reference

“Facsimile Features”, General Settings Guide

## Reception Time

You can have the date, time, and file number printed at the bottom of the document when it is received.

### Note

- You can turn this function on or off using Print Reception Time in the Facsimile Features menu.
- When a received document is printed on two or more sheets, the reception time is printed on the last page.
- The time when the document was printed can also be recorded on the document. If you need this function, contact your service representative.

### Reference

“Facsimile Features”, General Settings Guide



## Two-Sided Printing

You can have a received document printed on both sides of a sheet.

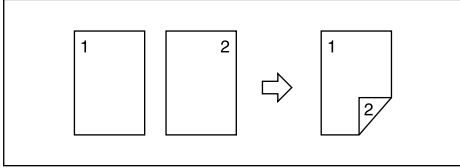

### Important

- To use this function, all pages of the received document must be of the same size-inform the sending party of this beforehand if necessary. You must also have paper set in the machine of the same size as that sent by the sending party. In Two-Sided Printing, this machine will correctly receive in A3, B4 JIS (Japanese Industrial Standard), A4, B5 JIS, A5 (11"×17", 8<sup>1</sup>/<sub>2</sub>"×14", 8<sup>1</sup>/<sub>2</sub>"×11", 5<sup>1</sup>/<sub>2</sub>"×8<sup>1</sup>/<sub>2</sub>"). The following table shows the results that can be achieved when receiving with this machine.

	Originals	Top binding	Side binding
A4, B5 JIS, A5, 8 <sup>1</sup> / <sub>2</sub> " × 11", 5 <sup>1</sup> / <sub>2</sub> " × 8 <sup>1</sup> / <sub>2</sub> "			
A3, B4 JIS, 11" × 17", 8 <sup>1</sup> / <sub>2</sub> " × 14"			

BFT001S

- This function works only when all pages are of the same width and received into memory.

**Note**

- You can turn this function on or off using 2 Sided Print in the Facsimile Features menu.
- Printouts may vary depending on how the sender sets the originals.
- You can select to have documents only from selected senders printed in this way.
- Stored documents of the same size are printed on the same paper. Some stored documents may be unavailable for this printing option.

**Reference**

“Facsimile Features”, General Settings Guide

**180-degree rotation printing**

When printing on both sides of the paper, this machine rotates images as shown in the diagram.

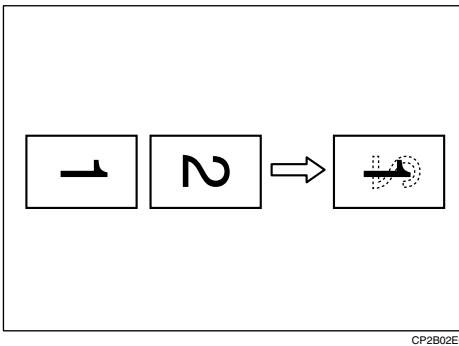
**Multi-Copy Reception**

If you switch this function on, multiple copies of each incoming fax document is printed.

You can also select to have multiple copies made of documents from particular senders.

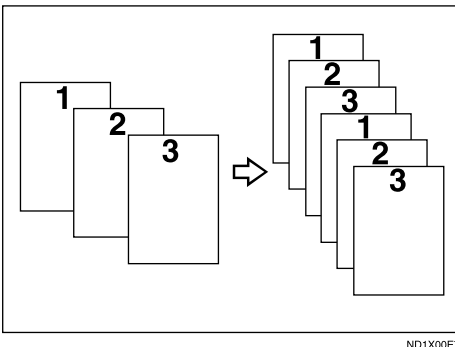

**Note**

- The maximum number of copies that can be made for each document is 10.
- When using the Multi-copy function with specified senders, the maximum number of copies is 10.
- You can turn this function on or off using Reception File Print Quantity in the Facsimile Features menu.
- The machine will use Memory Reception for Multi-copy Reception.

**Reference**

“Facsimile Features”, General Settings Guide

3

---

## Image Rotation

---

If you have set paper in the standard tray , incoming fax documents are automatically rotated to fit onto the paper.

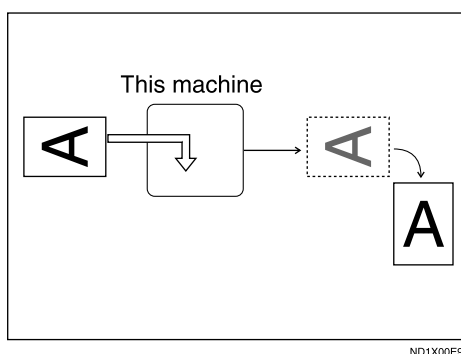
**Note**

- If you specified a tray for “Paper Tray” in the Facsimile Features menu, the paper loaded in the specified tray is selected.

## Page Separation and Length Reduction

If the size of a received document is longer than the paper loaded in the machine, each page of the document can be split and printed on several sheets, or reduced and printed on a single sheet.

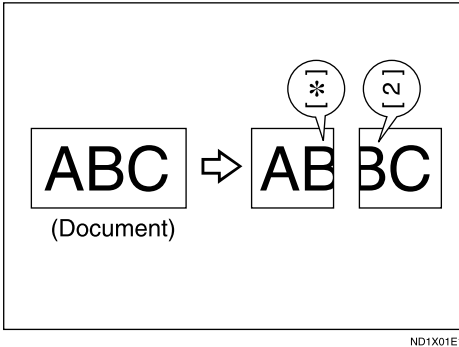

For example, this function splits the document if the document length is 20 mm (0.79") or longer than the paper used. The document is reduced if it is less than 20 mm (0.79"). When a document is split, an asterisk (✱) is inserted at the split position and about 10 mm (0.39") of the split area is duplicated on the top of the second sheet.

### Note

- Your service representative can customize this function with the following settings:
  - Reduction
  - Print split mark
  - Overprinting
  - Overprinting length
  - Guideline for split
- You can adjust the overprinting and reduction lengths within the following ranges:
  - Overprinting length: 4 mm (0.16"), 10 mm (0.39"), 15 mm (0.59")
  - Guideline for split: 5-155 mm (5 mm steps)/0.2-6.1" (0.2" steps)

## Page Reduction

If you receive a document that is longer than the paper in the tray, the machine usually prints it on two pages. If you turn this function on, the machine reduces the width and length of the received image so that it will fit on one page.

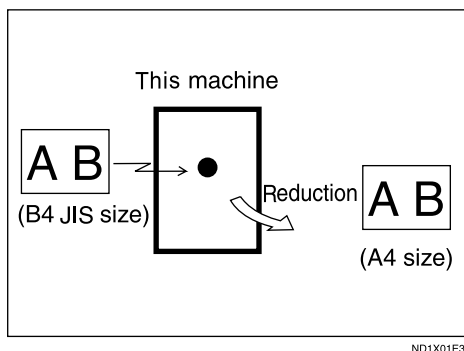

ND1X01E3

If A4 paper is loaded and a document of B4 JIS size is received, the machine will reduce the document to a single A4 sheet.

### Note

- You can turn this function on or off with the User Parameters (switch 10, bit 3) in the Facsimile Features menu.
- When this function is used, the printing quality may not be as good as usual.

### Reference

p.162 "Page Separation and Length Reduction"  
"Facsimile Features", General Settings Guide

## TSI Print (Transmitting Subscriber Identification Print)

Usually the sender's Fax Header is printed on received documents. When you receive an Internet Fax document, the e-mail address of the sender is printed. If the sender has not programmed their Fax Header, you will not be able to identify them. However, if you turn this function on, the sender's Own Name or Own Fax Number is printed instead so you can find out where the document came from.

### Note

- You can turn this function on or off in the User Parameters (switch 02, bit 3) in the Facsimile Features menu.

### Reference

"Facsimile Features", General Settings Guide

## If There Is No Paper of the Correct Size

If there is no paper in the machine that matches the size of a received document, the machine will choose a paper size based on the paper available.

Page reduction	Disabled
Reduction in Sub-scan Direction	Enabled
Page Separation Threshold	20 mm (0.79")
Width or Length Priority	Width

3

### Note

- The document is split over two sheets of paper depending on the paper size.
- Paper placed in the bypass tray is not usually selected for printing a received document. However, you can use this tray if you select the bypass tray as the main paper tray using Reception with Specified Senders.
- Widths that this machine can receive are A4, B4 JIS, LT (8<sup>1</sup>/<sub>2</sub>"×11") and A3. Any documents narrower than A4 or LT (8<sup>1</sup>/<sub>2</sub>"×11") are received at A4 or LT (8<sup>1</sup>/<sub>2</sub>"×11") width. The length of documents depends on the document.
- The paper size used to print a received document may be different from the size of the sent original.

### Reference

p.161 "Image Rotation"

p.162 "Page Separation and Length Reduction"

p.163 "Page Reduction"

"Facsimile Features", General Settings Guide

## Setting priority trays

With the same size of paper loaded into multiple trays, you can make the machine use one tray for one function and another tray for another function.

For example, you may load white A4 paper into tray 1 to use when making copies, and yellow A4 paper into tray 2 to use when printing received faxes. You can then easily identify for which purpose paper has been output. You can perform this setting in "Paper Tray Priority: Facsimile" in "System Settings".

### Note

- When a different size of document from the priority tray is received, the tray containing the same size of paper as the received document is used.

### Reference

"System Settings", General Settings Guide

## Just size printing

If you enable this function, received documents are printed on the sheet that has the highest priority.

This function is enabled with User Parameters (switch 05, bit 5) in the Facsimile Features menu.

If the paper tray is not stocked with paper of a suitable size to print a received document, a message appears on the display prompting you to load paper of the required size. When you have loaded new paper, press **[Exit]** to print the document.

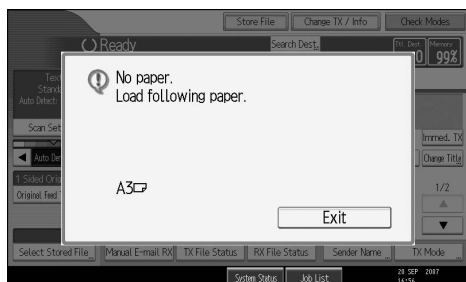

### Note

- After pressing **[Exit]**, procedure varies depending on machine status when the message occurred.
  - If any received documents or reports were being printed automatically, the printer automatically continues printing from where it left off.
  - If any documents or reports were being printed manually, the printer does not resume printing. Perform the operation from the beginning again.

### Reference

“Facsimile Features”, General Settings Guide

## Having incoming documents printed on paper from the bypass tray

You can print documents sent from Specified Senders on paper from the bypass tray.

Set as follows:

- Program a special sender and select the Bypass Tray for the paper tray type.
- In “Program Special Sender” in the Facsimile Features menu, turn on the “Special Reception Function” in “Initial Set Up”.

### Important

- When using this function, documents are not stacked in page number order because the machine stacks received documents face up.

 **Note**

- You can load a maximum of 100 sheets of standard paper in the bypass tray.
- You can use a size of paper not loaded in the paper tray(s) in the bypass tray.
- The machine can detect A6, A5, A4, A3 (5 1/2"×8 1/2", 8 1/2"×11", 11"×17") paper sizes. When you load any other size, specify the paper size. However, if the specified paper size and size of paper set in the bypass tray do not match, paper jams may occur, or the image may be shortened.
- Documents printed on paper smaller than A4 may be shortened, or split across sheets.
- Paper longer than 600 mm may be creased, not sent, or jam.
- Print area depends on optional expansion memory, resolution, and vertical length of originals.
- If you use this function, Image Rotation and 180-degree rotating printing are not possible.

 **Reference**

“Facsimile Features”, General Settings Guide

---

## Where Incoming Documents Are Delivered - Output Tray

---

You can specify the output tray or output position to facilitate separation of received documents.

---

### Specifying tray for lines

---

Use this function to specify the output tray for each line port.

You can specify the document feeding tray for each port (telephone, Internet Fax, IP-Fax). For example, you can specify documents received through the G3-1 port to be fed to the “Finisher Upper Tray” and documents received through the G3-2 port to be fed to the “Finisher Shift Tray”, facilitating separation of files. You can also set the machine to output Internet Fax documents and ordinary faxes onto different trays.

 **Important**

- The optional 3,000Sheet-50Sheet Staple Finisher or the optional booklet finisher is required.
- The optional extra G3 interface unit is required to use the extra G3 line.

 **Note**

- To use this function, specify the port and destination using **[Specify Tray for Lines]** in the Facsimile Features menu.

 **Reference**

“Facsimile Features”, General Settings Guide



---

## Tray Shift

---

Use this function to shift the output position for each document, so you can separate received documents easily.

### Important

- The optional 3,000Sheet-50Sheet Staple Finisher or the optional booklet finisher is required.
- The optional finisher or shift sort tray unit is required.

When the optional finisher unit is selected for fax output, you can use the Tray Shift function whenever a fax or report is printed.

This is useful for separating faxes stacked in the finisher output tray. For example, if the previous incoming fax was output to the left, the next incoming fax will be output to the right and vice-versa.

### Note

- You can turn this function on or off with the User Parameters (switch 19, bit 0) in the Facsimile Features menu.

### Reference

“Facsimile Features”, General Settings Guide



# 4. Changing/Confirming Communication Information

This section explains the features of **[Change TX / Info]**, which you can use to confirm communication results on the screen or printed reports.

## Changing the Settings of Files in Memory

After you have pressed the **[Start]** key (after scanning originals), you can check and edit the destination or settings of Memory Transmission. You can also cancel a transmission, change the settings of a transmission, print a stored file, print a list of stored files, and resend a file which the machine failed to transmit.

### Note

- If the “No transmission files found.” message appears on the screen after you press **[Check / Stop Transmission File]**, no files are being stored or sent by Memory Transmission.
- You cannot check or edit a file being sent. Also a SUB Code Transmission file or stored file to be printed as a report cannot be checked or edited.
- There are cases when a destination may not be selected as the destination appears as “✖”, depending on the security settings.

## Deleting a Destination from a Simultaneous Broadcast

You can delete selected broadcasting destinations.

### Important

- If you delete a destination that is the only destination for a transmission, the transmission is canceled.

### 1 Press [Change TX / Info].



### 2 Press [Check / Stop Transmission File].

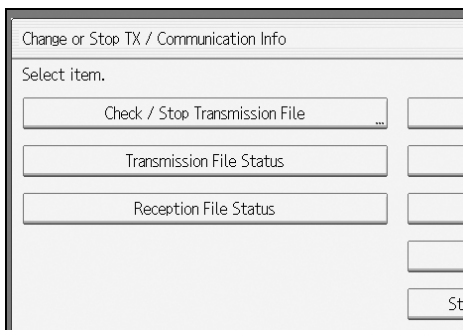

### 3 Select the file from which you want to delete a destination.

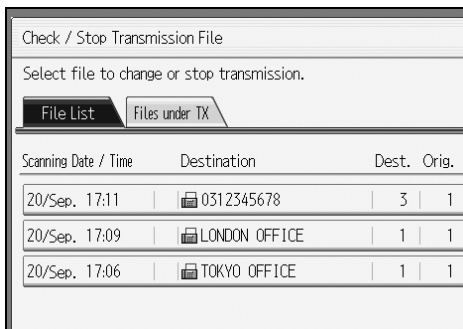

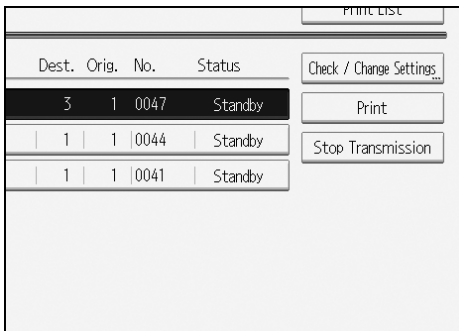
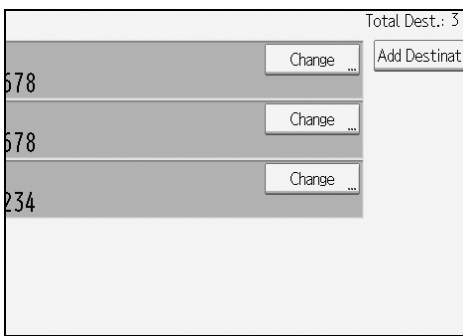
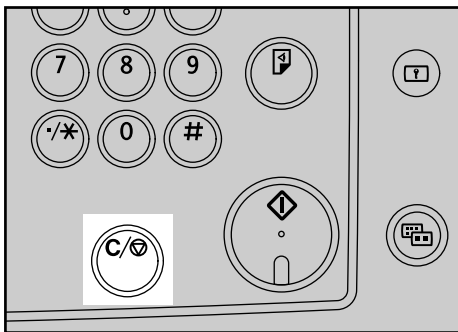
**4** Press **[Check / Change Settings]**.**5** Press **[Change]** for the destination you want to delete.**6** Press the **[Clear/Stop]** key to delete the destination, and then press **[OK]**.

BFT007S

Pressing the **[Clear/Stop]** key deletes by single digits the fax number or IP-Fax address. The Internet Fax address can be entirely deleted at once by pressing the **[Clear/Stop]** key.

**7** Press **[Exit]**.

To delete another destination, repeat from step **3**.

**8** Press **[Exit]** twice.

The standby display appears.

## Adding a Destination

You can add a destination for broadcasting.

**1** Press [Change TX / Info].



**2** Press [Check / Stop Transmission File].

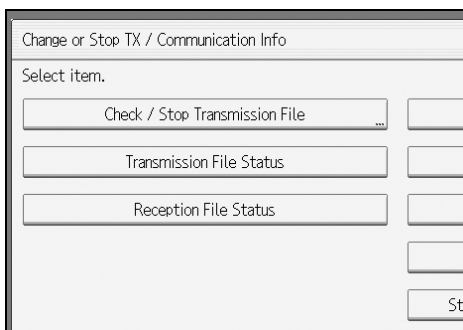

**3** Select the file to which you want to add a destination.

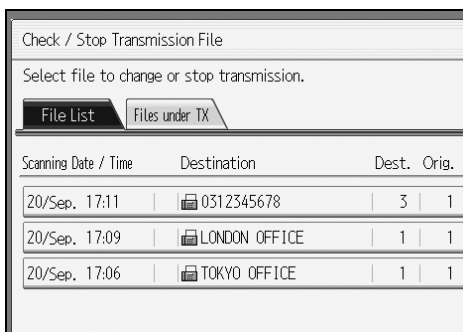

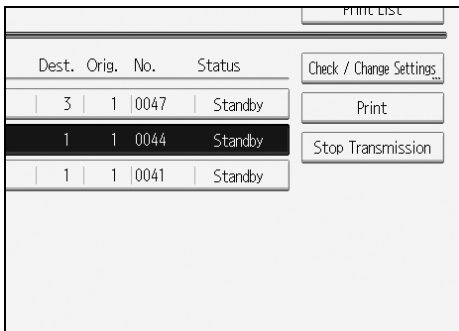
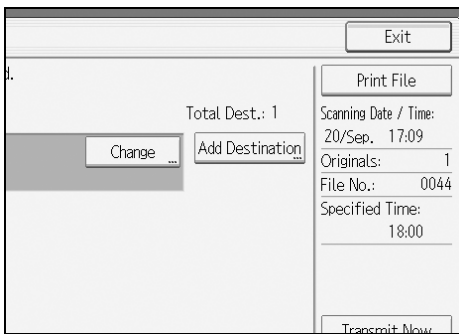
**4** Press **[Check / Change Settings]**.**5** Press **[Add Destination]**.

4

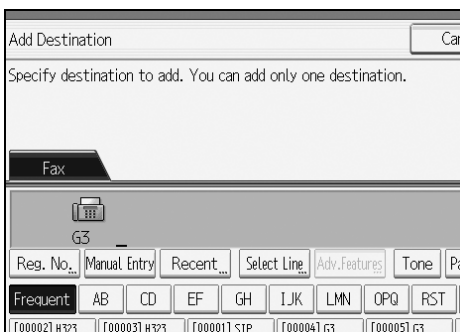
**6** Specify the destination using the number keys or Destination keys, and then press **[OK]**.

You can switch the transmission type between fax/IP-Fax and Internet Fax by pressing **[Fax]** or **[Internet Fax]**.

To add an e-mail address, switch the type of transmission to Internet Fax by pressing **[Internet Fax]**. Then, press **[Manual Entry]** and enter the e-mail address.

You can also program a SUB Code or SEP Code by pressing **[Adv.Features]**.

**7** Press **[Exit]**.

Repeat from step **5**, if you want to add another destination.

**8** Press **[Exit]** twice.

The standby display appears.

## Changing the Transmission Time

You can change the transmission time specified with Send Later.

You can also delete the transmission time. If the transmission time is deleted, the file is transmitted immediately.

**1** Press [Change TX / Info].



**2** Press [Check / Stop Transmission File].

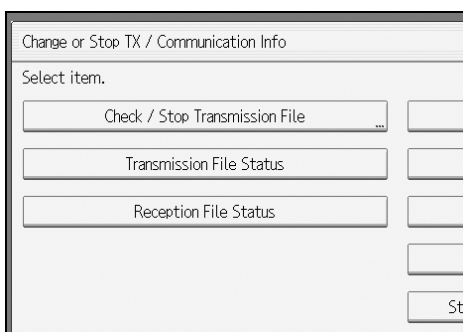

**3** Select the file for which you want to change or cancel the transmission time.

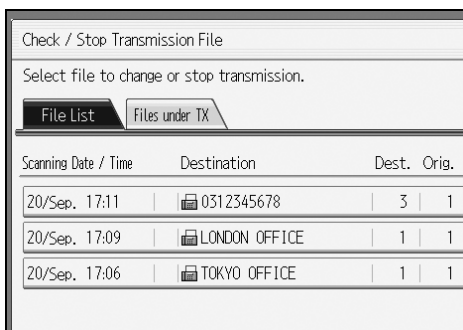

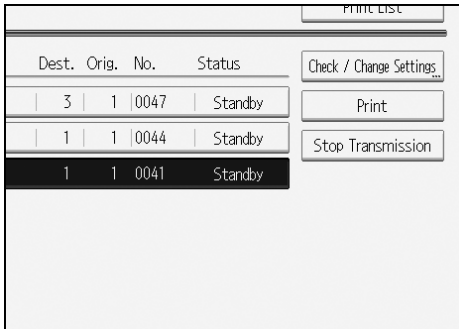
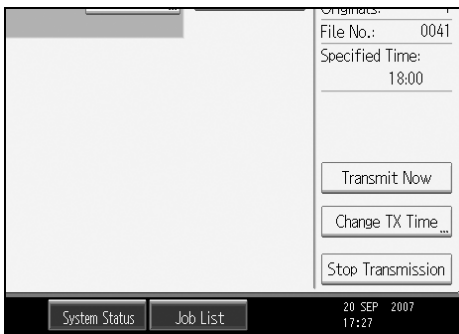

**4** Press **[Check / Change Settings]**.**5** Press **[Change TX Time]**.

4

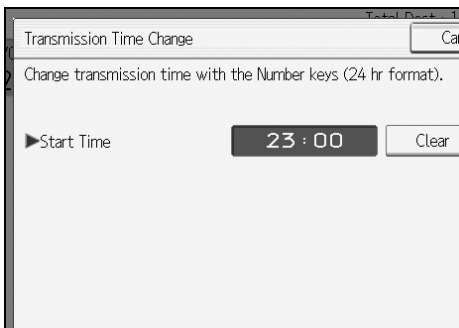
**6** Press **[Clear]**, re-enter the transmission time using the number keys, and then press **[OK]**.

If you press **[Transmit Now]**, the file is transmitted immediately. However, if there is a file on standby, that file is sent first.

**7** Press **[Exit]**.

Repeat from step **3**, if you want to change another transmission time.

**8** Press **[Exit]** twice.

The standby display appears.

## Changing the SMTP Server Setting

You can change the settings for whether or not to bypass the SMTP server.

**1** Press [Change TX / Info].



4

**2** Press [Check / Stop Transmission File].

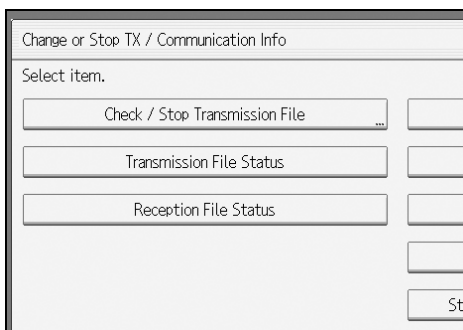

**3** Select a file whose SMTP server setting you want to change.

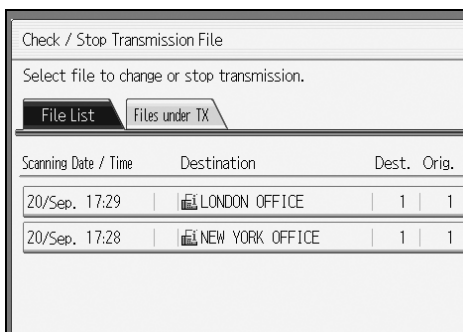

**4** Press [Check / Change Settings].

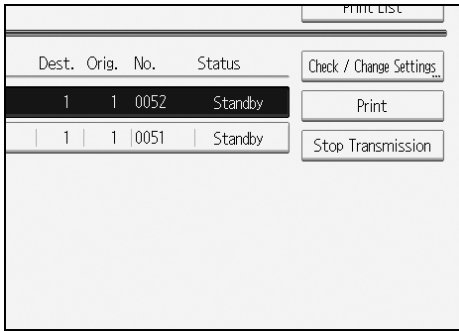

**5** Press [Change].

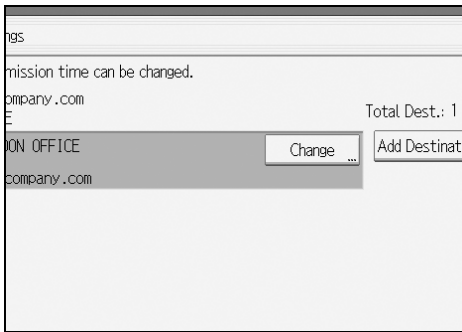

4

**6** Press [SMTP].

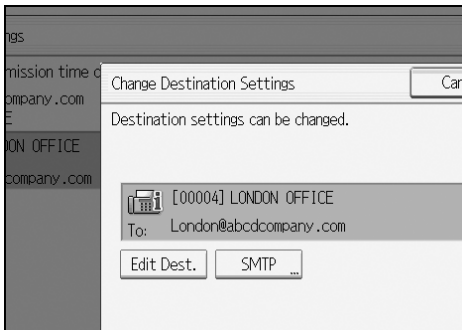

**7** Select [Yes] or [No], and then press [OK].



**8** Press [OK].

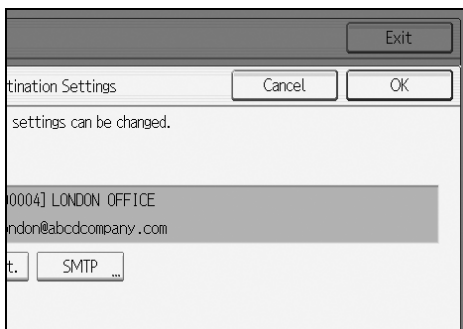

**9** Press [Exit].

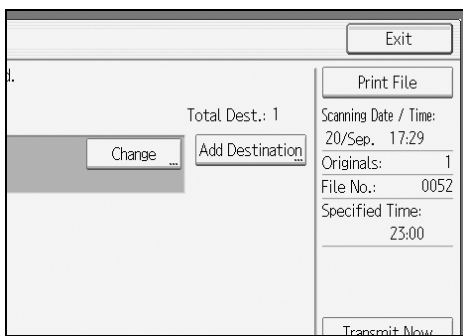

Repeat from step **8** to change the SMTP server settings of other recipients.

**10** Press [Exit] twice.

The standby display appears.

# Printing a File from Memory

If you want to check the contents of a file that is stored in memory and not yet sent, use this procedure to print it out.

**1** Press [Change TX / Info].



**2** Press [Check / Stop Transmission File].

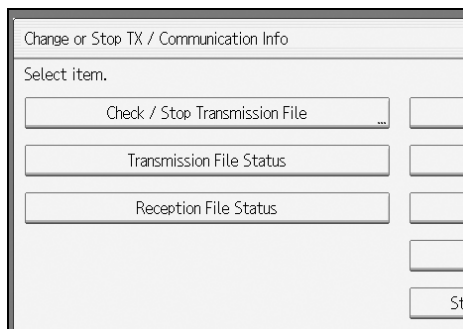

**3** Select the file you want to print.

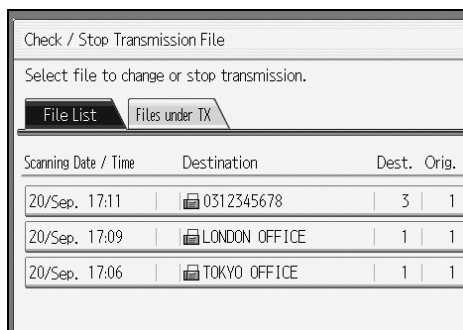

If multiple destinations were specified, only the number of the destinations that have not received the document you sent is shown.

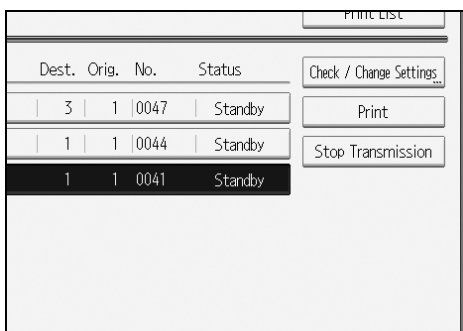
**4** Press **[Print]**.

If you want two-sided printing, press **[Print on 2 Sides]**.

To cancel printing, press **[Cancel]**. The display returns to that of step **3**.

4

**5** Press the **[Start]** key.

To cancel printing after pressing the **[Start]** key, press **[Stop Printing]**. The display returns to that of step **3**.

Repeat from step **3**, if you want to print another file.

**6** Press **[Exit]** twice.

The standby display appears.

**Note**

- You can also print files that have not been successfully transmitted.

# Printing a List of Files in Memory (Print TX File List)

Print this list if you want to find out which files are stored in memory and what their file numbers are. Knowing the file number can be useful (for example when erasing files).

**1** Press **[Change TX / Info]**.



4

**2** Press **[Check / Stop Transmission File]**.

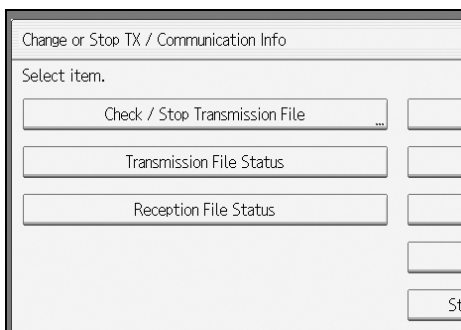

**3** Press **[Print List]**.

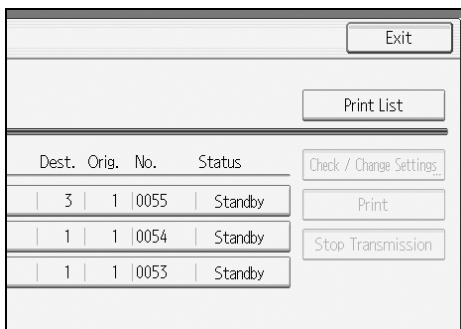

To cancel printing before pressing the **[Start]** key, press **[Cancel]**. The screen returns to that displayed before pressing **[Print List]**.

**4** Press the **[Start]** key.

To cancel printing after pressing the **[Start]** key, press **[Stop Printing]**. The display returns to that of step **3**.

**5** Press **[Exit]** twice.

The standby display appears.

 **Note**

- The contents of a file stored in memory can also be printed.
- You can set whether or not to display a sender name with the User Parameters (switch 04, bit 5) in the Facsimile Features menu.

 **Reference**

“Facsimile Features”, General Settings Guide



# Resending a File

Machine memory stores documents that could not be successfully transmitted using Memory Transmission. Use this procedure to resend these documents.

## Important

- Set “Store documents in memory that could not be transmitted” to “On” in User Parameters (switch 24, bit 0) in the Facsimile Features menu.

### 1 Press [Change TX / Info].



### 2 Press [Check / Stop Transmission File].

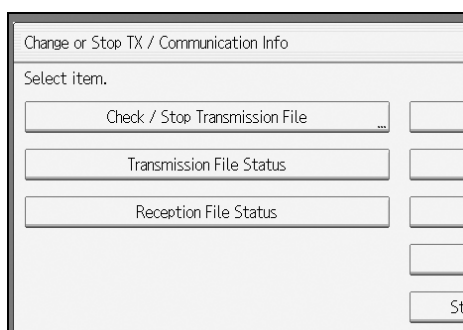

### 3 Select the file you want to resend.

“TX failed” is displayed for files that could not be sent.

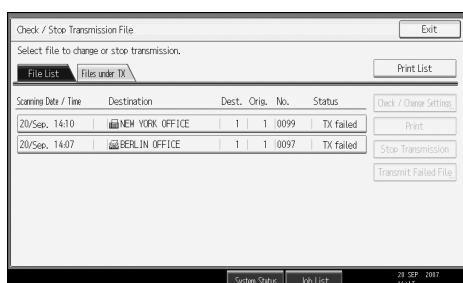

If multiple destinations were specified, only the name of the destination you specify first and only the number of destinations that have not received the document you sent are shown.

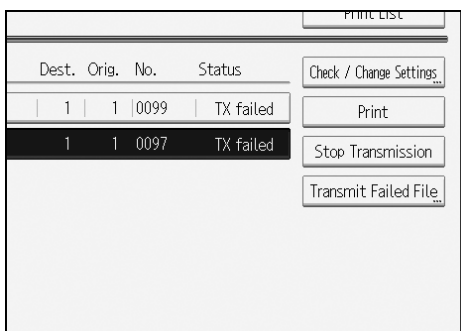
**4** Press **[Transmit Failed File]**.

To add a destination, press **[Add Destination]**, and then specify the destination.

**4****5** Press **[OK]**.

Repeat from step **3** to resend another file.

To cancel transmissions, press **[Cancel]**. The display returns to that of step **4**.

**6** Press **[Exit]** twice.

The standby display appears.

Transmission starts.

 **Note**

- Files that could not be transmitted are kept for either 24 or 72 hours, depending on the setting you make in User Parameters (switch 24, bit 1) in the Facsimile Features menu.

 **Reference**

“Facsimile Features”, General Settings Guide

# Checking the Transmission Result (Transmission File Status)

You can confirm transmission by the display, report, or e-mail.

## Confirming on Display

Follow these steps to display the transmission results.

- 1 Press [Change TX / Info].



- 2 Select [Transmission File Status].

- 3 Check the transmission results.

The screenshot shows the 'Transmission File Status' screen. At the top, there is an 'Exit' button. Below it, the text 'Displaying transmission file status.' is shown. The main area contains a table with the following columns: Date / Time, Destination, Dest., Sender Name, Orig., No., and Status. The table lists several completed transmissions from 20/See to 20/See, with destinations like NEW YORK OFFICE, TOKYO OFFICE, LONDON OFFICE, and PARIS OFFICE. At the bottom, there is a '1/2' indicator and a scroll bar.

Date / Time	Destination	Dest.	Sender Name	Orig.	No.	Status
20/See, 11:52	NEW YORK OFFICE	1		5	0084	Completed
20/See, 11:51	055555678	1		3	0085	Completed
20/See, 11:50	TOKYO OFFICE	1		1	0082	Completed
20/See, 11:49	LONDON OFFICE	1		2	0081	Completed
20/See, 11:45	0512345678	1		1	0077	Completed
20/See, 11:32	TOKYO OFFICE	1		1	0073	Completed
20/See, 11:26	LONDON OFFICE	1		3	0070	Completed
20/See, 11:19	NEW YORK OFFICE	1		2	0066	Completed
20/See, 11:13	PARIS OFFICE	1		1	0063	Completed

Transmission results are displayed, from the latest result down, in groups of nine.

When a fax is sent, "Destination" shows the Own Fax Number or Fax Header information of the receiver. When an Internet Fax is sent, the e-mail address and name programmed in the destination list appears. For a transmission from a computer, "-- LAN-Fax -->" is shown.

Depending on security settings, the destination may appear as ✖.

- 4 Press [Exit] twice.

The standby display appears.

 **Note**

- Only the transmission results of the latest communications are displayed. For the maximum number of communication results you can check on this machine, see "Maximum Values".
- You can view sent fax documents and their lists, using a Web Image Monitor on a network computer. For details, see the Web Image Monitor's Help.
- If a transmission is completed while you are using this function, the result will not appear. To view the latest result, exit Transmission File Status, and then try again.
- You can program one of the Quick Operation keys with operations for this function. Using the key allows you to omit step 1.
- When documents are transmitted from the computer to the machine, "--LAN-Fax -->" appears. To check if the documents are sent to the receiver, confirm the same File No.

 **Reference**

p.272 "Maximum Values"

"Facsimile Features", General Settings Guide

4

---

## Confirming by Report

---

Print reports for confirmation.

**❖ Memory Transmission**

If a document cannot be sent, a Communication Failure Report is automatically printed. Or, you can use the Communication Result Report to check each transmission result regardless of status.

This report is printed each time a Memory Transmission is completed if turned on with User Parameters (switch 03, bit 0) in the Facsimile Features menu. You can also print the report by programming the TX Status Report to a Quick Operation key and pressing this when specifying a destination.

If you turn the Communication Result Report on, the Communication Failure Report is not printed.

**❖ Immediate Transmission**

You can confirm the result with an Immediate TX Result Report.

Select to print this report in User Parameters (switch 03, bit 5) in the Facsimile Features menu. A report is printed after every Immediate Transmission is completed.

You can also print the report by programming the TX Status Report to a Quick Operation key and pressing this when specifying a destination.

 **Reference**

p.188 "Communication Result Report (Memory Transmission)"

p.188 "Immediate TX Result Report (Immediate Transmission)"

p.189 "Communication Failure Report"

"Facsimile Features", General Settings Guide

---

## Confirming by E-mail

---

Use the E-mail TX Results function to send reports by e-mail to a computer, and then confirm them on the computer.

The available reports are:

- Communication Result Report.
- Immediate TX Result Report.
- Polling with SEP Rx Result.

### Important

- You must first register the e-mail addresses of the destinations the report is to be sent to on the destination list.

### Note

- By programming the E-mail TX Results to a Quick Operation key in advance, you can send transmission results by e-mail after each transmission is completed. Select the destination for notification from the Internet Fax destinations in the destination list.
- When using the Sender Name function to select the sender, the transmission results are sent to senders' e-mail addresses that have been registered. Select the sender from the Internet Fax destinations in the destination list.
- If you send fax documents from a computer, use LAN-Fax Driver to specify whether or not the LAN-Fax Result Report is sent to the computer.

### Reference

p.97 "Sender Settings"

p.103 "Setting SEP Codes for Reception"

p.188 "Immediate TX Result Report (Immediate Transmission)"

p.192 "Print Journal"

"Facsimile Features", General Settings Guide

"Registering Addresses and Users for Facsimile/Scanner", General Settings Guide

---

## Confirming by Report and E-mail

---

You can confirm transmission results using both the E-mail TX Results function, which sends the results by e-mail, and the Communication Result Report printed by the machine.

You can set whether to use both of these together in User Parameters (switch 10, bit 6) in the Facsimile Features menu.

### Reference

"Facsimile Features", General Settings Guide

---

## Communication Result Report (Memory Transmission)

---

This report is printed when a Memory Transmission is completed, so you can check the result of the transmission.

### **Note**

- If E-mail TX Results is programmed in a Quick Operation key, you can select whether a report e-mail is sent after transmission.
- If two or more destinations are specified, this report is printed after the fax document is sent to all the destinations.
- If the machine is set up not to print this report and the fax document could not be successfully transmitted, a Communication Failure Report is printed.
- You can turn this function on or off with the User Parameters (switch 03, bit 0) in the Facsimile Features menu.
- You can display a sender name with the User Parameters (switch 04, bit 5) in the Facsimile Features menu.
- You can select whether to include part of the original image on the report with the User Parameters (switch 04, bit 7) in the Facsimile Features menu.
- To view the report without text disruption, select a font of even character width in your e-mail application's settings.
- You can set whether or not to display a destination with the User Parameters (switch 04, bit 4) in the Facsimile Features menu.
- The Pg(s) column gives the total number of pages. The Page Not Sent column gives the number of pages that could not be sent successfully.
- "--" indicates that the Internet Fax document was sent to the mail server programmed in this machine. (However, this does not mean the e-mail was delivered.)

### **Reference**

p.189 "Communication Failure Report"  
"Facsimile Features", General Settings Guide

---

## Immediate TX Result Report (Immediate Transmission)

---

If you turn this report on, a report is printed after every Immediate Transmission so you have a record of whether the transmission was successful or not.

If the machine is set up not to print this report and the fax document could not be successfully transmitted, the Error Report is printed instead.

 **Note**

- If E-mail TX Results is programmed in a Quick Operation key, you can select whether a report e-mail is sent after transmission.
- You can switch this report on or off in the User Parameters (switch 03, bit 5) in the Facsimile Features menu.
- To view the report without text disruption, select a font of even character width in your e-mail application's settings.
- You can set whether or not to display a destination with the User Parameters (switch 04, bit 4) in the Facsimile Features menu.
- If the page was sent successfully, the Page column gives the total number of pages sent successfully.

 **Reference**

“Facsimile Features”, General Settings Guide

---

## Communication Failure Report

---

This report is printed when a document could not be successfully transmitted with Memory Transmission.

If the machine is set up to print a Communication Result Report, this report is not printed. Use it to keep a record of failed transmissions so you can send them again.

 **Note**

- You can select whether the Communication Failure Report is automatically printed using the User Parameters (switch 04, bit 1) in the Facsimile Features menu.
- This report is only printed if the Communication Result Report is turned off and a document could not be successfully transmitted with Memory Transmission.
- You can select whether to include part of the original image on the report with the User Parameters (switch 04, bit 7) in the Facsimile Features menu.
- You can display a destination with the User Parameters (switch 04, bit 4) in the Facsimile Features menu.
- You can set whether or not to display a sender name with the User Parameters (switch 04, bit 5) in the Facsimile Features menu.
- The Pg(s) column gives the total number of pages. The Page Not Sent column gives the number of pages that could not be sent successfully.
- “Unprogrammed” indicates that the document could not be sent because the forwarding destination is not programmed.
- “--” indicates that the Internet Fax document was sent to the mail server programmed in this machine. (However, this does not mean the e-mail was delivered.)

 **Reference**

“Facsimile Features”, General Settings Guide

# Checking the Reception Result (Reception File Status)

Confirm the reception result on the screen or in a report.

## Confirming on Display

Follow these steps to display the reception result.

**1** Press [Change TX / Info].



**2** Press [Reception File Status].

**3** Check the reception results.

The screenshot shows the 'Reception File Status' screen with a table of received fax records. The table has columns for Reception Date, Sender, Orig. No., and Status. The records are sorted by date, with the most recent at the top.

Reception Date	Sender	Orig. No.	Status
20/Sep. 11:56	TOKYO OFFICE	2 0087	Completed
20/Sep. 11:55	LONDON OFFICE	3 0086	Completed
20/Sep. 11:54	PARIS OFFICE	5 0085	Completed
20/Sep. 11:47	NEW YORK OFFICE	2 0079	Completed
20/Sep. 11:44	0312345678	1 0076	Completed
20/Sep. 11:27	TOKYO OFFICE	2 0072	Completed
20/Sep. 11:25	0355555678	2 0069	Completed
20/Sep. 11:18	NEW YORK OFFICE	3 0065	Completed
20/Sep. 11:12	PARIS OFFICE	1 0062	Completed

At the bottom of the screen, there are buttons for 'System Status' and 'Job List', and a date/time display showing '20 SEP 2007 11:57'.

Reception results are displayed, from the latest result, in groups of nine.

When a fax or IP-Fax is received, "Sender" shows the Own Fax Number or Fax Header information. When an Internet Fax is received, the sender's e-mail address appears.

**4** Press [Exit] twice.

The standby display appears.



 **Note**

- Only the reception results of the latest communications are displayed. For the maximum number of communication results you can check on this machine, see “Maximum Values”.
- You can view received fax documents and their lists, using a Web Image Monitor on a network computer. For details, see the Web Image Monitor's Help.
- If a document is received while you are using this function, the result will not appear. To view the latest result, exit Reception File Status, and then try again.
- You can program one of the Quick Operation keys with operations for this function. Using the key allows you to omit step **1**.

 **Reference**

p.272 “Maximum Values”

“Facsimile Features”, General Settings Guide

---

## Confirming by Report

---

Print a report to confirm reception results.

---

### Journal

---

Print the Journal to confirm the latest reception results. For details, see “Journal”.

 **Reference**

p.197 “Journal”

# Print Journal

You can print the Journal manually.

## Important

- The contents of a Journal printed automatically are deleted after printing. Keep the journal if you require a record of transmissions and receptions.

---

## Printing the Journal

---

To print the Journal manually, select the printing method: “All”, “Print per File No.”, or “Print per User”.

**4**

## Note

- You can set whether the Journal is automatically printed after every 50 communications in User Parameters (switch 03, bit 7) in the Facsimile Features menu.
- You can display a sender name with the User Parameters (switch 04, bit 5) in the Facsimile Features menu.
- Depending on security settings, the Journal is not automatically printed.
- If the optional extra G3 interface unit is installed, you can set whether the Journal is printed by line type with the User Parameters (switch 19, bit 1) in the Facsimile Features menu.
- You can program one of the Quick Operation keys with operations for this function. Using the key allows you to omit the step where you press **[Change TX / Info]**.
- Depending on security settings, the destination may not appear.
- For the maximum number of communication results printed in the Journal, see “Maximum Values”.

## Reference

p.272 “Maximum Values”

“Facsimile Features”, General Settings Guide

## All

Prints the results of communications in the order made.

- 1 Press **[Change TX / Info]**.



- 2 Press **[Print Journal]**.

- 3 Select **[All]**.

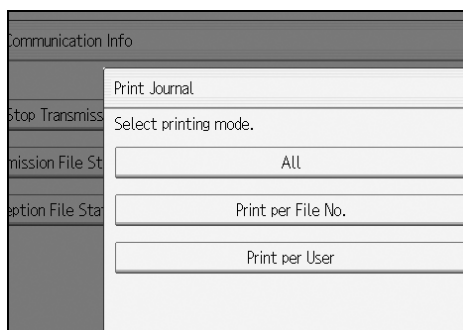

- 4 Press the **[Start]** key.

To cancel a file printing, press **[Stop Printing]**. The display returns to that of step 3.

- 5 Press **[Exit]** twice.

The standby display appears.

## Print per File No.

Prints only the results of communications specified by file number.

**1** Press **[Change TX / Info]**.



**2** Press **[Print Journal]**.

**3** Select **[Print per File No.]**.

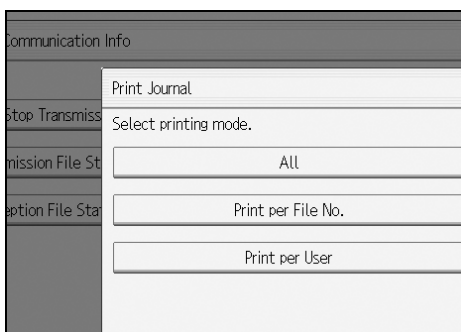

**4** Enter a 4-digit file number.

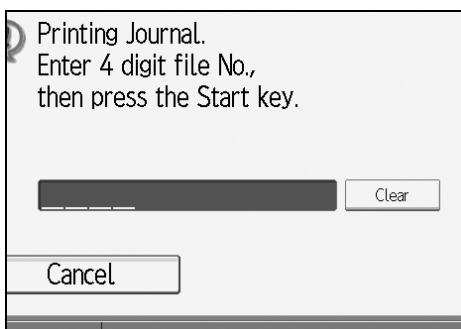

If you make a mistake, press **[Clear]** or the **[Clear/Stop]** key, and then try again.

**5** Press the **[Start]** key.

To cancel a file printing, press **[Stop Printing]**. The display returns to that of step **3**.

**6** Press **[Exit]** twice.

The standby display appears.

## Print per User

Prints the results of communications by individual senders.

- 1 Press **[Change TX / Info]**.



- 2 Press **[Print Journal]**.

- 3 Select **[Print per User]**.

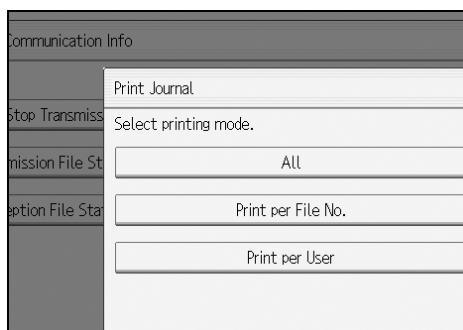

- 4 Select a user.

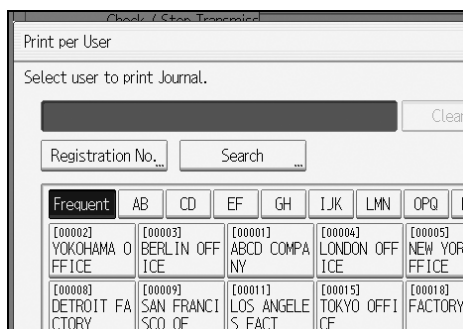

Press **[Cancel]** if the user is not registered. The display returns to that of step **3**.

- 5 Press **[OK]** after checking the user name shown on the display.

Press **[Cancel]** if a wrong user name is selected. The display returns to that of step **3**.

**6** Press the **[Start]** key.

To cancel a file printing, press **[Stop Printing]**. The display returns to that of step **3**.

**7** Press **[Exit]** twice.

The standby display appears.

# Journal

This section explains the items printed in the Journal.

P. 1

\* \* \* Journal ( 2. Nov. 2005 18:38) \* \* \*

<TX>	Date	Time	Destination	Mode	TXtime	Page	Result	User Name	File No.
	2. Nov.	14:35	NEW YORK OFFICE	G3TESM	0'31"	P.1	OK		0528
		14:36	LONDON OFFICE	G3TESM	0'07"	P.2	OK		0529
		14:40	SHARE FOLDER	TSM@	0'01"	P.1	OK		0530
		18:27	--LAN-Fax-->	*DM	0'02"	P.1	---	DESIGN	0536
		18:28	NEW YORK OFFICE	G3TEDM	0'53"	P.1	OK	DESIGN	0536
		18:35	aaa@abc.company.com:3	TS	0'01"	P.1	---		0537
<RX>	Date	Time	Sender	Mode	RXtime	Page	Result	User Name	File No.
	2. Nov.	14:45	PARIS OFFICE	G3RES	0'04"	P.1	OK		0531
		14:49	NEW YORK OFFICE	G3RESC	0'11"	P.2	OK		0532
		15:00	LONDON OFFICE	G3RED	0'03"	P.1	OK		0533
		15:30	LA FACTORY	G3RES	0'02"	P.1	OK		0534
		15:32	BERLIN OFFICE	G3REF	0'03"	P.1	+OK		0535

TX Count 00021      RX Count 00020  
 # : Batch            C : Confidential      \$ : Transfer            P : SEP Code  
 M : Memory          L : Send later        @ : Forwarding        E : ECM  
 S : Standard        D : Detail            F : Fine                U : Super Fine  
 > : Reduction       H : Stored/D.Server   \* : LAN-Fax            + : Delivery  
 Q : RX Notice Req.   A : RX Notice        <=> : IP-FAX  
 □ : Folder

## 1. Printing date

Shows the date and time the report was printed.

## 2. Programmed Fax Header

Shows the sender name programmed for printing.

## 3. Date

Shows the transmission or reception date.

## 4. Time

Shows the transmission or reception start time.

## 5. Other end

- For fax destinations  
Shows the name (for display) programmed by the other end.  
Shows the programmed fax number if the name (for display) was not programmed.  
If neither name nor fax number was programmed by the other end, an entered fax number or a name programmed in a destination list is shown for transmissions.

- For Internet Fax destinations  
At time of transmission, it shows the e-mail address or name programmed in the destination list. At time of reception, it shows the e-mail address of the sender.  
At time of broadcasting transmission, it shows the number of destinations after the e-mail addresses or names of destination.  
When documents are transmitted from the computer to the machine, "--LAN-Fax -->" appears. To check if the documents are sent to the receiver, confirm the same File No.
- For IP-Fax destinations  
Shows the IP-Fax destination or name programmed in the destination list. The fax destination details appear on the reception report.
- For Folder destinations  
Shows the name programmed in the destination list.

## 6. Communication mode

- For fax transmissions and receptions  
After the line type, "T" for outgoing faxes or "R" for incoming faxes, and the communication mode appear in alphabetical letters or symbols. If the optional extra G3 interface unit is installed, "G3-1", "G3-2", or "G3-3" appears.
- For Internet Fax transmissions and receptions  
After , "T" for outgoing e-mail or "R" for incoming e-mail, and the communication mode appear in alphabetical letters or symbols. A "Q" indicates outgoing e-mail for which a Reception Notice is set in "TX Mode", whereas an "A" indicates reception notice e-mail.

- For IP-Fax transmissions and receptions  
After <->, "T" for outgoing faxes or "R" for incoming faxes, and the communication mode appear in alphabetical letters or symbols.
- For forwarding to the folder destinations  
After , "T" for outgoing faxes, the communication mode appears in alphabetical letters or symbols.

## 7. Communication time

Shows time taken for transmissions or receptions.

## 8. Number of pages

Shows the number of pages transmitted or received.

## 9. Communication result

Shows the result of transmissions or receptions.

OK: All pages were properly transmitted or received. When Reception Notice is activated using "TX Mode", receipt of Reception Notice is shown. The results of received documents that were routed are preceded by "+".

--: The Internet Fax document was sent to the mail server programmed in this machine. (However, this does not mean the e-mail was delivered.) When using LAN-Fax, the results of communication from a computer to this machine are shown.

Error: A communication error occurred.

D: Power was disconnected during communication. Not all fax documents were transmitted.

## 10. User name

Shows the sender's name.

## 11. File number

Shows file management numbers.

### Note

- ☐ To prioritize a fax number or name programmed in the destination list, contact your service representative.



---

## Transmitting Journal by E-mail

---

Use this function to send the Journal to the administrator's e-mail address.

The Journal is sent automatically after every 50 communications. A CSV format Journal is attached to the e-mail.

### Important

- To transmit the Journal by e-mail, it is necessary to make settings with User Parameters (switch 21, bit 4) in the Facsimile Features menu.
- This machine does not store sent CSV files. It is recommended that you double-check the e-mail address of an administrator before the Journal is transmitted. If the e-mail address of the administrator is not correct, your important Journal may be lost. Sent CSV files are not left on the fax machine.

### Note

- If the administrator's address is wrong, you may not be able to acquire the Journal.
- If the Journal fails to be transmitted in e-mail format, the Journal is printed out.
- The name of an attached CSV file is "JOURNAL+year, month, date, hours, minutes". For example, the file name transmitted in 14:40 on 20th, December, 2006 is "JOURNAL200612201440.csv".
- The subject of a Journal sent by e-mail begins with "Journal".

### Reference

"Facsimile Features", General Settings Guide

---

## Journal by e-mail

---

If the setting is made so that the Journal is transmitted as e-mail, it is transmitted to the e-mail address of an administrator.

### Note

- To transmit the Journal, it is necessary to make settings with the User Parameters (switch 21, bit 4) in the Facsimile Features menu.
- You can set whether or not to display a sender name with the User Parameters (switch 04, bit 5) in the Facsimile Features menu.
- To set the administrator e-mail address, see "System Settings", General Settings Guide.
- Depending on security settings, the Destination/Sender name may not appear.

### Reference

"System Settings", General Settings Guide

"Facsimile Features", General Settings Guide

## Printing/Deleting Received and Stored Documents (Print/Delete Stored Reception File)

You can print documents that are received and stored on the hard disk. You can also delete unwanted documents.

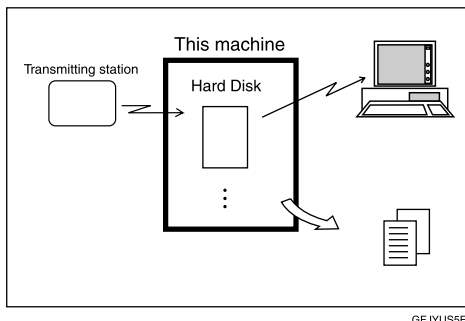

### **Important**

- To use this function, the optional printer/scanner unit must be installed.
- Make the settings for received and stored documents in “Reception File Setting” in the Facsimile Features menu before using this function.

### **Note**

- If you have selected to store received documents and specified an e-mail address for notification of receipt, fax reception notification can be sent to that e-mail address.
- For the maximum number of received documents you can store on the machine's hard disk, see “Maximum Values”.
- You can view and print received and stored documents using a Web Image Monitor or DeskTopBinder.

### **Reference**

p.254 “Viewing Fax Information Using a Web Browser”

p.272 “Maximum Values”

“Facsimile Features”, General Settings Guide

DeskTopBinder's manuals and Help

## Printing Received and Stored Documents

Use the following procedure to print documents saved on the hard disk.

**1** Press **[Change TX / Info]**.



**2** Press **[Print / Delete Stored Reception File]**.

**3** Select a file to be printed, and then press **[Print]**.

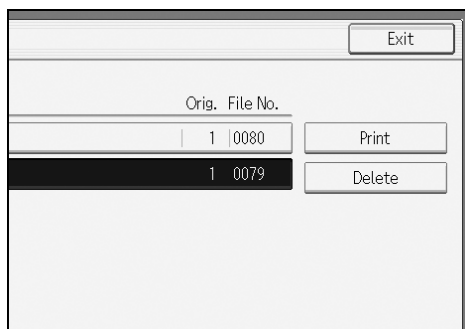

To cancel printing, press **[Cancel]**.

To delete the document after printing, press **[Delete File after Printing]**.

To perform two-sided printing, press **[Print on 2 Sides]** before pressing the **[Start]** key.

**4** Press the **[Start]** key.

To stop printing after pressing the **[Start]** key, press **[Stop Printing]**. The display returns to that of step **3**.

**5** Press **[Exit]** twice.

The standby display appears.

### Note

- This function allows you to print only received and stored documents.
- You cannot print and delete received documents using the Document Server function.
- You can program one of the Quick Operation keys with operations for this function. Using the Quick Operation key allows you to omit step **1**.
- You can specify and print multiple documents. For the maximum number of documents you can specify at a time, see "Maximum Values".

**Reference**

p.272 “Maximum Values”  
“Facsimile Features”, General Settings Guide

---

## Deleting Received and Stored Documents

---

Use the following procedure to delete documents stored on the hard disk.

**1** Press [Change TX / Info].

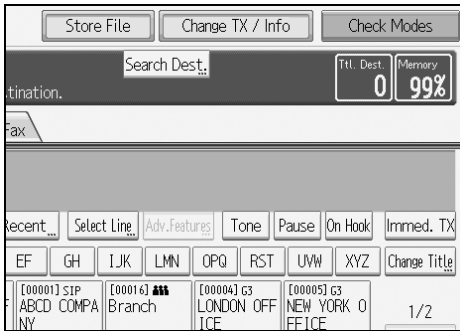

**2** Press [Print / Delete Stored Reception File].

**3** Select a file to be deleted, and then press [Delete].

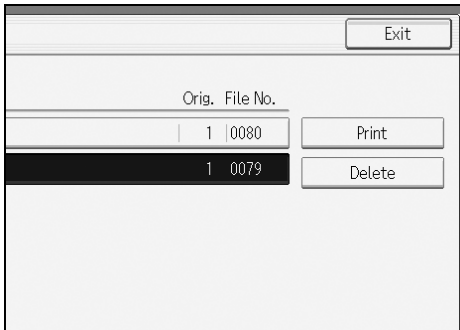

**4** Press [Yes].

To cancel a deletion, press [No]. The display returns to that of step **3**.

**5** Press [Exit] twice.

The standby display appears.

**Note**

- You cannot delete a document while another person is previewing or printing it using a Web Image Monitor or DeskTopBinder.
- You can specify and delete multiple documents. For the maximum number of documents you can specify at one time, see “Maximum Values”.

**Reference**

p.272 “Maximum Values”

# Printing a File Received with Memory Lock

This is a security function designed to prevent unauthorized users from reading your documents. If Memory Lock Reception is switched on, all received documents are stored in memory and are not automatically printed. To print the documents, you have to enter the Memory Lock ID. When your machine has received a document with Memory Lock Reception, the Confidential File (🔒) indicator blinks.

Before using this function, the following preparations are required in the Facsimile Features menu.

- Program your Memory Lock ID.
- Set Memory Lock Reception to On.

## ⚠ Important

- ❑ If the main power switch is turned off for about an hour, all documents protected by Memory Lock Reception are deleted. When this happens, the Power Failure Report is printed so you can confirm which documents have been deleted. For details, see “Troubleshooting When Using the Facsimile Function”, Troubleshooting.

## 1 Confirm that the Confidential File indicator is blinking.

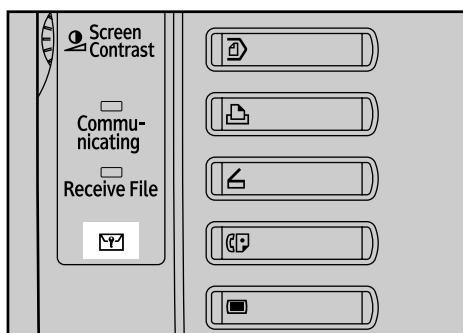

BFT005S

## 2 Press [Change TX / Info].



## 3 Press [Print Memory Lock].

If no documents were received while Memory Lock Reception was switched on, the message “No reception file.” is shown. Press [Exit].

- 4** Enter a 4-digit Memory Lock ID with the number keys, and then press the **[Start]** key.

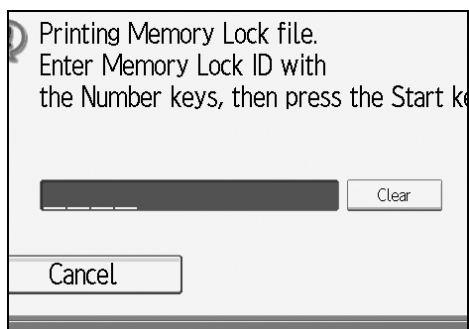

If you make a mistake, press **[Clear]** or the **[Clear/Stop]** key, and then try again. To cancel printing, press **[Cancel]**.

If the Memory Lock ID does not match, the "Specified code does not correspond to programmed Memory Lock ID." message appears. Press **[Exit]** and retry after checking the Memory Lock ID.

- 5** Press **[Exit]**.

The standby display appears.

#### Note

- If Memory Lock Reception and received document storage are both set to on, Memory Lock Reception is unavailable and received documents become stored documents.
- Even when Memory Lock Reception is available, if free memory is insufficient, reception is not possible.
- You can also apply a Memory Lock Reception to documents that come only from certain senders.
- Documents received by SEP Code Reception are automatically printed even if this function is switched on.
- You can program one of the Quick Operation keys with operations for this function. Using the key allows you to omit step **2**.
- If you print a Memory Lock File, it is deleted.

#### Reference

p.200 "Printing/Deleting Received and Stored Documents (Print/Delete Stored Reception File)"

"Facsimile Features", General Settings Guide

"Troubleshooting When Using the Facsimile Function", Troubleshooting

# Personal Boxes

You can receive confidential documents to Personal Boxes.

## **Important**

- Before using this function, set the Personal Box in advance.

## Personal Boxes

Storing your documents in a Personal Box prevents unauthorized users reading them.

When you specify a receiver for the Personal Box, incoming documents are forwarded directly to the destination you specify. You can specify a fax number, e-mail address, or IP-Fax destination as the receiver.

To be able to receive documents into a Personal Box, you must inform the sender of the SUB Code programmed for that Personal Box and ask them to send the document using SUB Code Transmission with that SUB Code. When your machine has received a confidential document, the Confidential File (🔒) indicator lights.

## **Important**

- If the main power switch is turned off for about an hour, all documents received into Personal Boxes are deleted. When this happens, the Power Failure Report is printed so you can confirm which documents have been deleted. For details, see “Troubleshooting When Using the Facsimile Function”, Troubleshooting.
- Documents delivered to registered destinations are deleted from Personal Boxes.

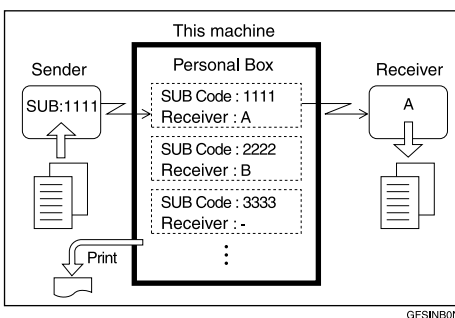

## **Note**

- If a receiver is not assigned, you can print the received documents on this machine. See “Printing Personal Box Documents”.

## **Reference**

p.206 “Printing Personal Box Documents”

p.207 “Confidential File Report”

“Troubleshooting When Using the Facsimile Function”, Troubleshooting

## Printing Personal Box Documents

Follow these steps to print a document received into a Personal Box.

- 1** Make sure that the Confidential File indicator is lit.

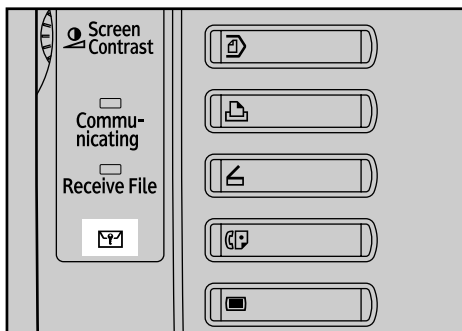

BFT0055

- 2** Press [Change TX / Info].



- 3** Press [Print Personal Box File].
- 4** Select the box with the document you want to print.

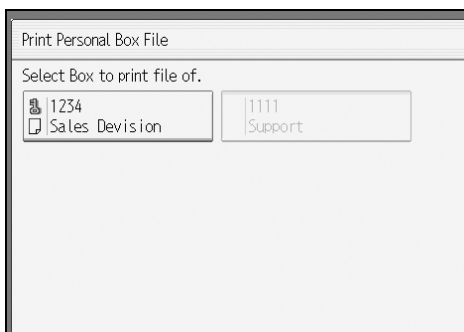



- 5** If a password has been set for the box, enter the password, and then press **[OK]**.

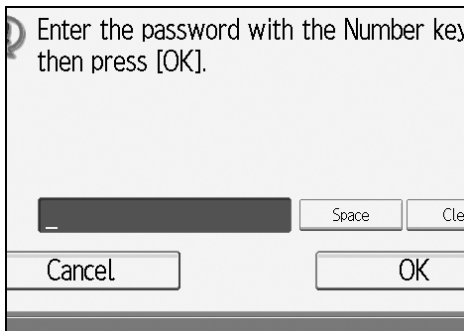

If you make a mistake, press **[Clear]** or the **[Clear/Stop]** key before pressing **[OK]**, and then try again.

To cancel entering a password, press **[Cancel]**. The display returns to that of step **4**.

- 6** Press the **[Start]** key.

To stop printing, press **[Stop Printing]**. The display returns to that of step **4**.

To print a document in another Personal Box, repeat from step **4**.

- 7** Press **[Exit]** twice.

The standby display appears.

 **Note**

- If you print a Personal Box document, it is deleted.
- The passwords for Personal Boxes can be programmed under “Box Setting” in the Facsimile Features menu.

 **Reference**

“Facsimile Features”, General Settings Guide

---

## Confidential File Report

---

You can check whether a document was received to a Personal Box.

 **Note**

- You can turn this function on or off with the User Parameters (switch 04, bit 0) in the Facsimile Features menu.

 **Reference**

“Facsimile Features”, General Settings Guide

## Information Boxes

This section describes how to use Information Boxes.

### Important

- Before using this function, set the Information Box in advance.

---

## Information Boxes

---

Use the Information Box function to set up the machine as a document server.

Program a document into an Information Box for others to pick up. When a request is made by another party, the SEP Code they specify is matched against the SEP Codes programmed in that Information Box. If a code matches the code of the document stored in the Information Box the document is sent to the other party automatically.

Other parties can receive these documents whenever they request them.

### Important

- If the main power switch is turned off for about an hour, all documents stored in Information Boxes are deleted. When this happens, the Power Failure Report is printed so you can confirm which documents have been deleted. For details, see “Troubleshooting When Using the Facsimile Function”, Troubleshooting.
- For other parties to be able to retrieve a document programmed in an Information Box, you need to inform the other party of the SEP Code assigned to that Information Box.

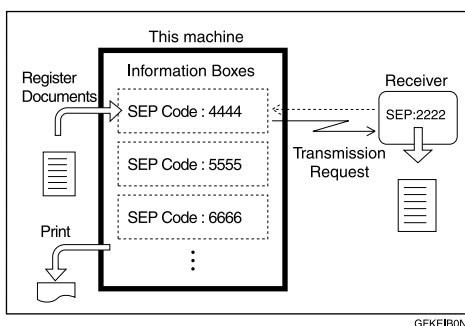

### Note

- For details about storing documents in the Information Boxes, see “Storing Documents in Information Boxes”.
- You can set a password for Information Boxes in advance. A password can be set in “Box Setting” in the Facsimile Features menu.

### Reference

p.209 “Storing Documents in Information Boxes”

“Facsimile Features”, General Settings Guide

“Troubleshooting When Using the Facsimile Function”, Troubleshooting

## Storing Documents in Information Boxes

Follow these steps to store a document in an Information Box.

- 1 Press **[Change TX / Info]**.



- 2 Press **[Store / Delete / Print Information Box File]**.

- 3 Select the box in which you want to store the file.

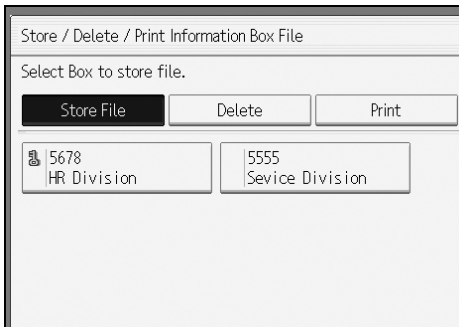

When there are pre-programmed files, a file mark appears to the left of the box name.

A message is displayed if you select a box with a file stored in it. Press **[Yes]** when changing the file. The stored original file is overwritten.

- 4 If a password has been set for the box, enter the password, and then press **[OK]**.

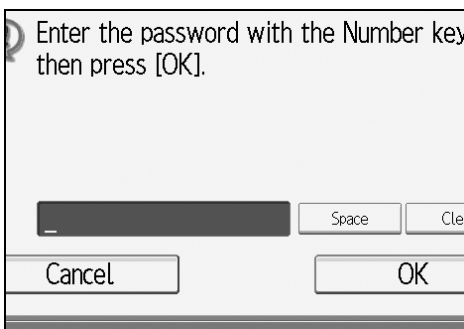

If you make a mistake, press **[Clear]** or the **[Clear/Stop]** key before pressing **[OK]**, and then try again.

To cancel entering a password, press **[Cancel]**. The display returns to that of step 3.

## 5 Place the original, and then select the scan settings you require.

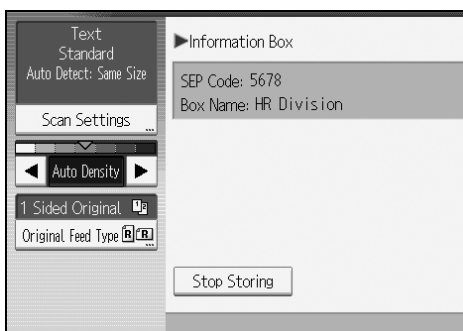

You can also select the following settings:

- Original Orientation
- Original Settings

## 6 Press the **[Start]** key.

The machine starts to scan the original.

To stop scanning, press **[Stop]**. The display returns to that of step 5.

To store a document in another Information Box, repeat from step 5.

## 7 Press **[Exit]** twice.

The standby display appears.

### Note

- One Information Box stores one file.
- The stored file is not deleted automatically. If you want to delete a stored file, see “Deleting Information Box Documents”.

### Reference

p.212 “Deleting Information Box Documents”

## Printing Information Box Documents

Follow these steps to print a document stored in an Information Box.

- 1 Press **[Change TX / Info]**.



- 2 Press **[Store / Delete / Print Information Box File]**.

- 3 Press **[Print]**.

- 4 Select the box that contains the stored file you want to print.

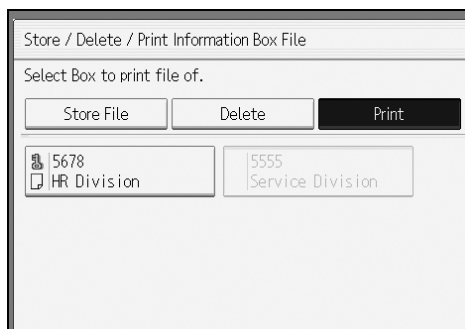

You cannot select a box that has no stored file.

- 5 If a password has been set for the box, enter the password, and then press **[OK]**.

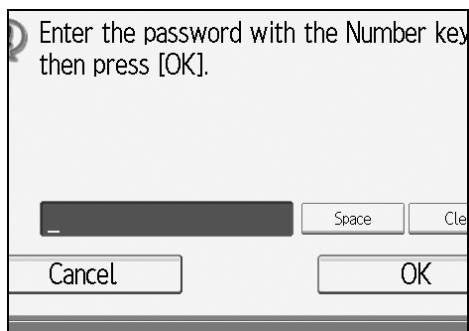

If you make a mistake, press **[Clear]** or the **[Clear/Stop]** key before pressing **[OK]**, and then try again.

To cancel entering a password, press **[Cancel]**. The display returns to that of step 4.

**6** Press the **[Start]** key.

If you want two-sided printing, press **[Print on 2 Sides]** before pressing the **[Start]** key.

To stop printing before pressing the **[Start]** key, press **[Cancel]**. The display returns to that of step **4**.

To stop printing after pressing the **[Start]** key, press **[Stop Printing]**. The display returns to that of step **4**.

Repeat from step **4** to print another stored file in the box.

**7** Press **[Exit]** twice.

The standby display appears.

## 4 Deleting Information Box Documents

Follow these steps to delete a file stored in an Information Box.

**1** Press **[Change TX / Info]**.



**2** Press **[Store / Delete / Print Information Box File]**.

**3** Press **[Delete]**.

**4** Select the box that contains the stored file you want to delete.

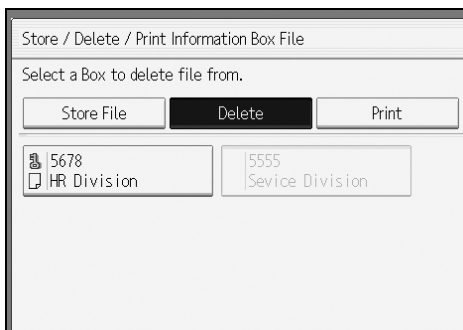

- 5** If a password has been set for the box, enter the password, and then press **[OK]**.

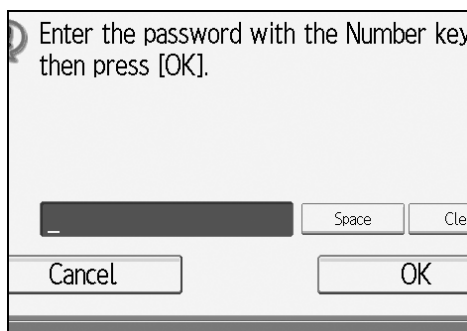

If you make a mistake, press **[Clear]** or the **[Clear/Stop]** key before pressing **[OK]**, and then try again.

To cancel entering a password, press **[Cancel]**. The display returns to that of step **4**.

- 6** Press **[Yes]**.

To stop deleting, press **[No]**. The display returns to that of step **4**.

Repeat from step **4** to delete another stored file in another box.

- 7** Press **[Exit]** twice.

The standby display appears.





# 5. Storing a Document

This section explains storing and managing documents in the Document Server.

## Sending a Stored File

This section describes how to store and manage fax documents in the Document Server.

The Document Server can store documents from various applications.

The documents that are stored using the facsimile function are available to transmit by facsimile.

Storing in the Document Server enables the following:

- Once stored, a document can be sent out as many times as you want, just by selecting it.
- Storing a document does not use facsimile memory.

You can send and print multiple stored documents as a single document, and also send them with scanned originals at the same time. Follow the instructions under **[Select Stored File]** when sending or printing stored documents.

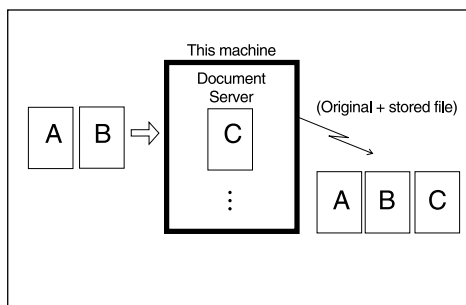

GHPY010E

### Important

- Data stored in the machine can be lost if there is an error on the machine's hard disk. The manufacturer is not responsible for any damage that might result from the loss of data.

 **Note**

- ❑ Stored documents are not deleted even if there is a power failure, or the main power switch is turned off.
- ❑ You can specify whether or not the machine automatically deletes documents from the Document Server after a certain number of days. You can change this setting using “Auto Delete File in Document Server” under “System Settings”. See “System Settings”, General Settings Guide.
- ❑ You cannot check received and stored documents through the Document Server.
- ❑ Documents in the Document Server can be sent, printed, or deleted, and their information can be changed using the Web Image Monitor.
- ❑ Using the DeskTopBinder or Web Image Monitor, documents you stored in the Document Server can be downloaded and managed on the computer. See “Document Server”, Copy/Document Server Reference.
- ❑ For the maximum values of the following items, see “Maximum Values”.
  - Number of documents you can store in the Document Server using the facsimile function
  - Number of pages per document you can store in the Document Server
  - Number of pages you can store in the Document Server (in total – copy function, facsimile function, printer function, and scanner function)

 **Reference**

p.272 “Maximum Values”

“Utilizing Stored Documents”, About This Machine

“System Settings”, General Settings Guide

“Document Server”, Copy/Document Server Reference

---

## Storing a Document

---

You can store and send a document at the same time. You can also just store a document.

❖ **File names**

Scanned documents are automatically assigned names like “FAX0001” or “FAX0002”.

❖ **User Names**

You can set this function if necessary to know who and what departments stored documents in the machine.

❖ **Password**

You can set this function so as not to send to unspecified people.

**1** Place the original, and then select the scan settings you require.

Set “Original Orientation” correctly. If you do not, the top/bottom orientation of the original will not be displayed correctly in the preview.

**2** Press [Store File].



**3** Select [Send & Store] or [Store Only].

Select [Send & Store] to send documents after they are stored.

Select [Store Only] to store documents.



**4** Set the user name, file name, and password as necessary.

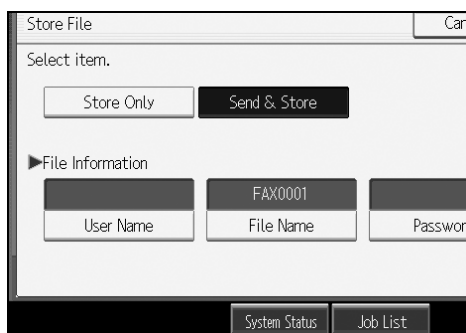

If you are not setting a user name, file name, or password, proceed to step **5**.

You cannot change multiple documents at once.

**5** Press [OK].

The file name appears to the left of [Store File].

**6** If you have selected **[Send & Store]**, specify the receiver.  
If you have selected **[Store Only]**, proceed to step **7**.

**7** Press the **[Start]** key.

 **Note**

You can change file names and user names.

 **Reference**

p.34 “Setting the Original Orientation”  
“System Settings”, General Settings Guide

---

## Programming a user name

---

**1** Press **[User Name]**.



**2** Press the user name to be programmed.

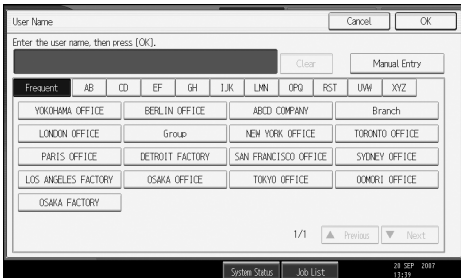

Press the title key to switch between titles.

To set a non-programmed user name, press **[Manual Entry]**, and then enter the name. User names entered by pressing **[Manual Entry]** are not programmed into the user code.

**3** Press **[OK]**.

 **Note**

Depending on the security settings, **[Access Privileges]** might be displayed instead of **[User Name]**. For details about setting **[Access Privileges]**, ask the administrator.

## Reference

“Entering Text”, About This Machine

### Setting a file name

#### 1 Press [File Name].

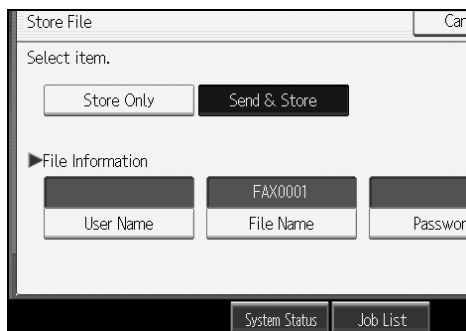

#### 2 Enter the file name.



#### 3 Press [OK].

## Reference

“Entering Text”, About This Machine

### Setting a password

#### 1 Press [Password].

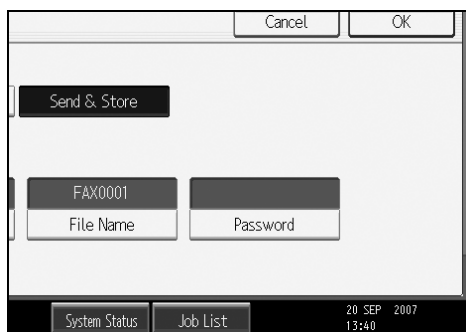

**2** Enter a password using the number keys, and then press [OK].

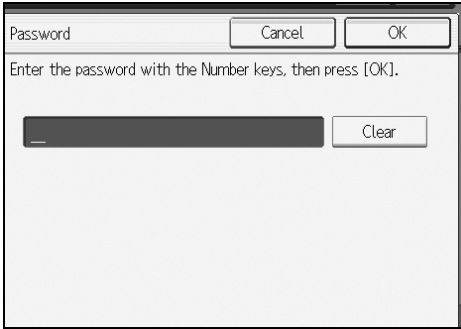

If you make a mistake, press [Clear] or the [Clear/Stop] key before pressing [OK], and then reenter your password.

You can enter up to four to eight digits.

**3** Enter the password again, and then press [OK].

5

---

## Sending Stored Documents

---

The machine sends documents stored in the Document Server.

The documents stored in the Document Server can be sent again and again until they are deleted. Once sent, documents are stored in the Document Server. Therefore, you can send them in just one operation without having to set your originals again.



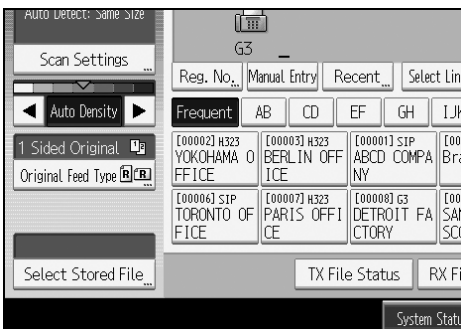

**Important**

- Store the documents to be sent in advance. You can program a password for this function. You can change the user names, file names, and passwords of stored documents.
- You cannot use the following transmission methods:
  - Immediate Transmission
  - Parallel Memory Transmission
  - On Hook Dial
  - Manual Dial

**1** Press [Select Stored File].



## 2 Select the documents to be sent.

Type	User Name	File Name	Date	Page	Queue
  NEW YORK OFFICE		FAX0002	20/Sep.	1	
  LONDON OFFICE		SAMPLE	20/Sep.	1	

When multiple documents are selected, they are sent in the order of selection.

- Press **[Queue]** to arrange the order of the documents to be sent.
- Press **[File Name]** to place the documents in alphabetical order.
- Press **[User Name]** to place the documents in order by programmed user name.
- Press **[Date]** to place the documents in order of programmed date.

To view details about stored documents, press **[Details]**.

Press the Thumbnails key to switch the screen to thumbnail display.

## 3 If you select a document with a password, enter the password, and then press [OK].

Enter the password with the Number key then press [OK].

If the document does not have a password, proceed to step **4**.

**4** When you want to add your originals to stored documents and send them all at once, press **[Original + Stored File]** or **[Stored file + Original]**.

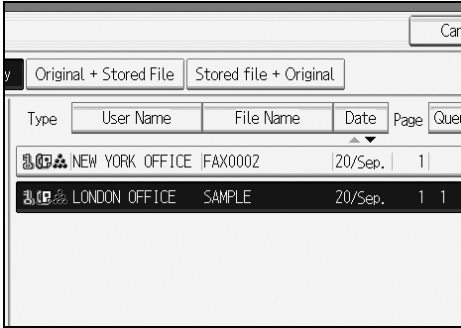

When sending only stored documents, proceed to step **5**.

When **[Original + Stored File]** is pressed, the machine sends the originals, and then stored files. When **[Stored file + Original]** is pressed, the machine sends the stored files, and then originals.

**5**

**5** Press **[OK]**.

**6** Specify the destination, and then press the **[Start]** key.

To add an original to stored documents, place the original, and then select any scan settings you require.

The added originals are not stored.

**Note**

- You can send only documents saved with the facsimile function in the Document Server. You cannot send documents stored in the Document Server using the copy, printer, or scanner functions.
- The specified documents are sent with the scan settings made when they were stored.
- To see details of the selected document, press **[Details]**. To return to the display in step **2**, press **[Exit]**.
- For the maximum number of stored documents you can specify at a time, see “Maximum Values”.
- For the maximum number of stored pages you can send in one operation, see “Maximum Values”.

**Reference**

p.272 “Maximum Values”



## Specifying documents from [File List]

- 1 Press [▲] or [▼] to display the documents to be sent.
- 2 Select the file.

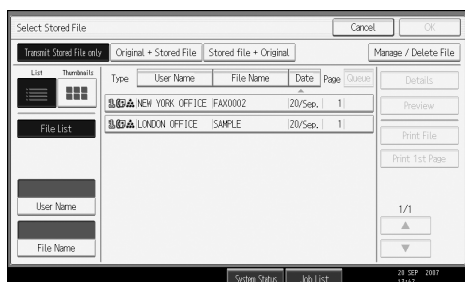

## Specifying documents by [User Name]

- 1 Select [User Name].

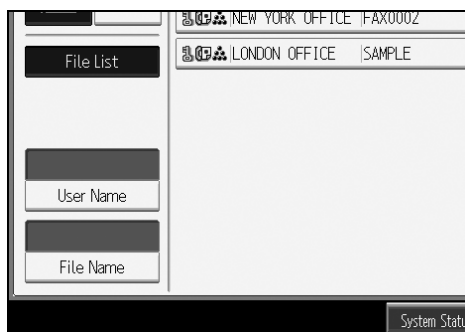

- 2 Select the user name of the programmed document, and then press [OK].

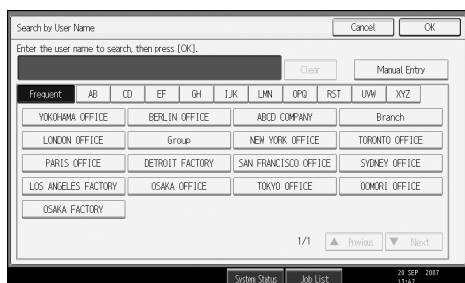

To search by directly entering a user name, press **[Manual Entry]**, and then enter the user name. Forward matching is used when searching for a user name.

- 3 Select the file to be sent.

---

## Specifying documents by [File Name]

---

### 1 Select [File Name].

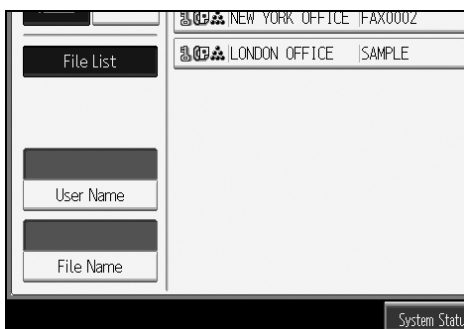

### 2 Enter the name of the document to be sent, and then press [OK].

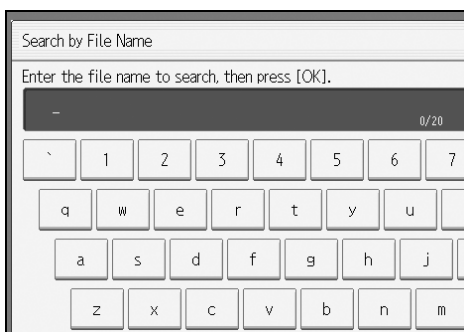

Forward matching is used when searching for a file name.

### 3 Select the file to be sent.

---

## Displaying a preview

---

### 1 Select the document OK you want to send.

Press the Thumbnail key to switch the screen to thumbnail display.

### 2 Press [Preview].

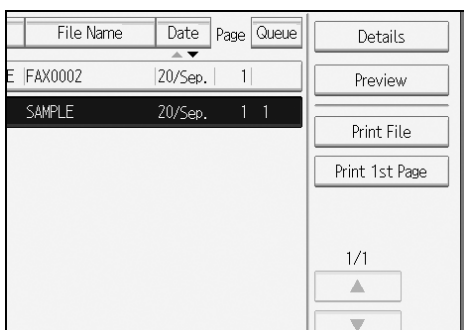

### 3 Check the preview.

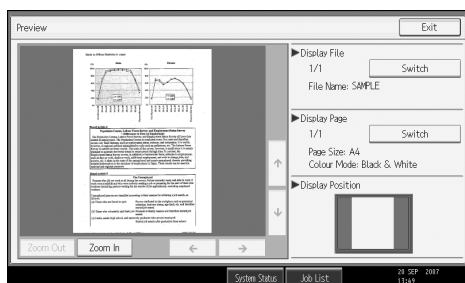

- Press **[Zoom Out]** or **[Zoom In]** to reduce or enlarge the preview image.
- Press **[←]****[→]****[↑]****[↓]** to scroll the preview image.
- Press **[Switch]** for "Display File" to display another selected file.
- Press **[Switch]** for "Display Page" to change the displayed page.

### 4 Press **[Exit]**.

#### Note

- If image files are corrupt or are larger than A3, they are not displayed on the preview window.
- If the image file is corrupt, store it again.
- If you stored originals that had multiple mixed-size pages without using the Mixed Original Sizes function, the displayed size might differ from the actual size for pages after the first page.

5

## Printing Stored Documents

Use this function to print documents stored in the Document Server.

### Important

- When **[Print 1st Page]** is selected, originals larger than A4 size are printed after they are reduced to A4 size.

### 1 Press **[Select Stored File]**.

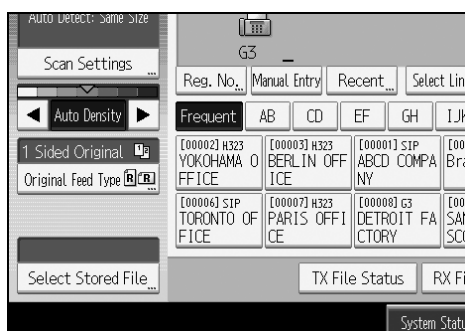

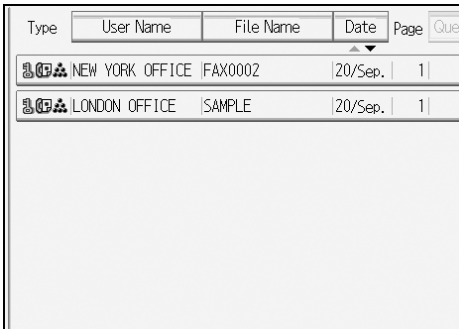
**2** Select the document to be printed.

Press the Thumbnail key to switch the screen to thumbnail display.

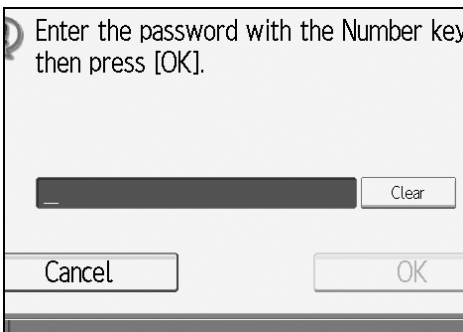
**3** If you select a document with a password, enter the password, and then press [OK].

If the document does not have a password, proceed to step **4**.

**4** Press [Print File] or [Print 1st Page].

When [Print File] is pressed, the machine prints all the pages. When [Print 1st Page] is pressed, the machine prints only the first page.

To print both sides, press [Print 2 Sides]. When multiple files are specified they are printed per file.

To cancel printing, press [Stop Printing].

**5** Press the [Start] key.

When only the first page is printed, the file name is printed at the top of the paper.

To cancel printing after pressing the [Start] key, press [Stop Printing].

**6** Press [Cancel].

The standby display appears.

**Note**

- Only documents stored using the facsimile function can be printed.
- When printing originals that were not stored using the Mixed Original Sizes function, paper sizes might differ according to whether printing is through the facsimile function or the Document Server.
- You can also print the first page only to check the content of the original.
- You can specify and print multiple documents at one time.
- For the maximum number of stored documents you can print at a time using **[Print 1st Page]**, see “Maximum Values”.
- For the maximum number of stored pages you can print at a time, see “Maximum Values”.

**Reference**

p.272 “Maximum Values”

## Changing Stored Document Information

5

You can change the file name, user name, and password of stored documents. To change a stored document, delete the document you no longer need, and then reprogram the new document.

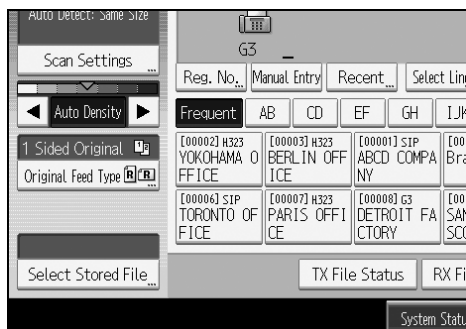
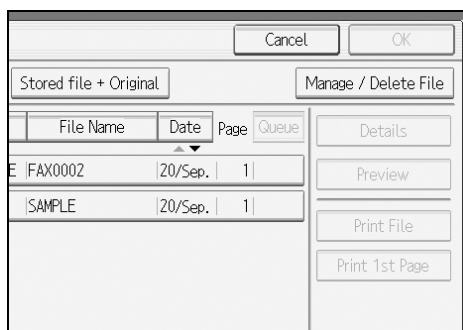
**1** Select **[Select Stored File]**.**2** Select **[Manage / Delete File]**, and then press the document to be changed.

- 3** If you select a document for which a password is set, enter the password, and then press [OK].

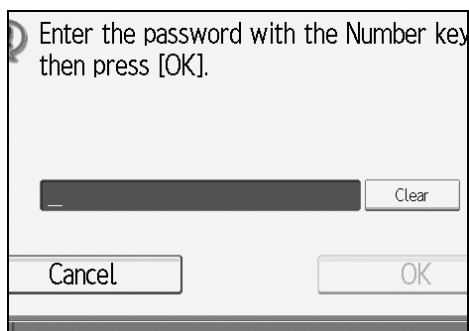

When a selected file does not have a password, proceed to step **4**.

- 4** Change the desired information of the stored document.

Press the keys for the items you want to change.

**5**

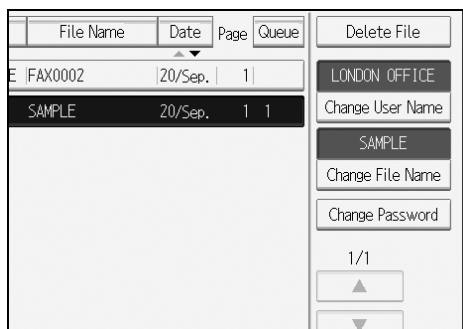

- 5** Press [Exit].

The standby display appears.

## Changing a user name

**1** Press **[Change User Name]**.

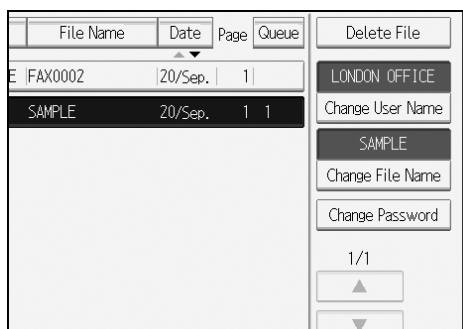

**2** Press **[Clear]**.

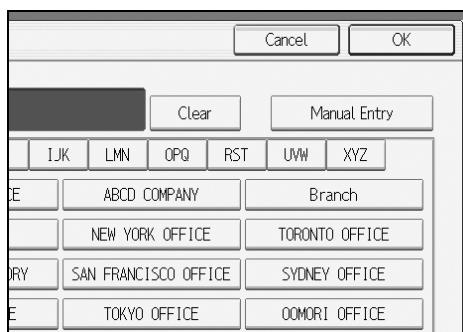

The user name is deleted.

**3** Enter the new user name, and then press **[OK]**.

Press the title word keys to switch between titles.

To set a non-programmed user name, press **[Manual Entry]**, and then enter the name.

User names entered by pressing **[Manual Entry]** are not programmed into the user code.

### Note

- Depending on the security settings, **[Change Access Priv.]** might be displayed instead of **[Change User Name]**. For details about setting **[Change Access Priv.]**, ask the administrator.

### Reference

“Entering Text”, About This Machine

## Changing the file name

---

**1** Press [Change File Name].

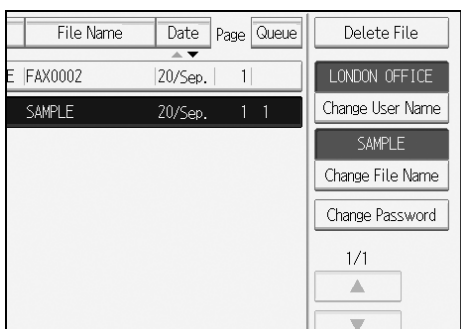

**2** Press [Backspace] or [Delete All], and then re-enter the file name.

5



**3** Press [OK].

 **Reference**

“Entering Text” About This Machine

---

## Changing the password

---

**1** Press [Change Password].

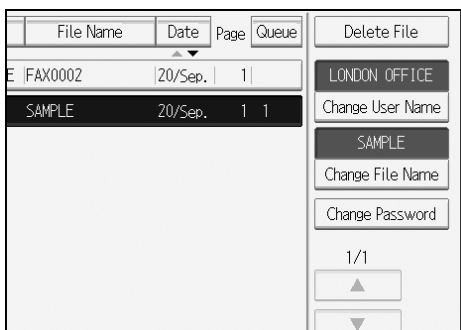



- 2** Enter a new password using the number keys, and then press [OK].

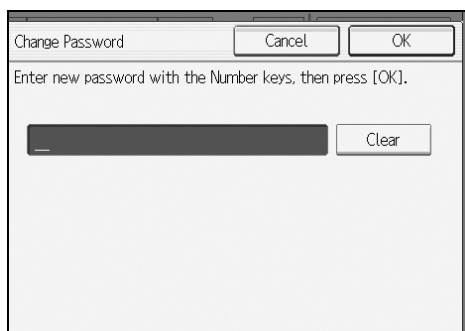

- 3** Enter the password again, and then press [OK].

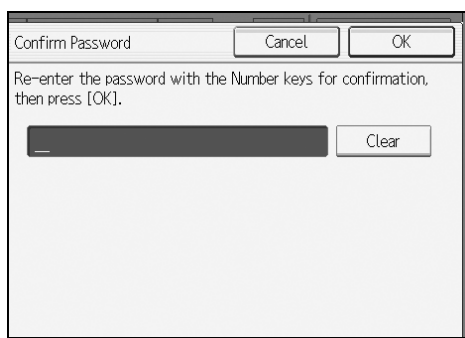

5

## Deleting a Stored Document

Use this function to delete stored documents.

- 1** Press [Select Stored File].

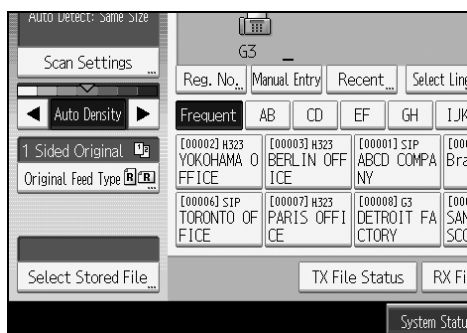

**2** Press **[Manage / Delete File]**.

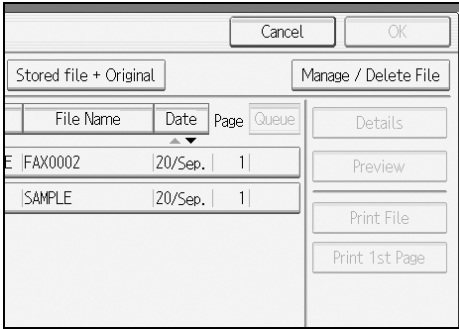

**3** Select the document you want to delete.

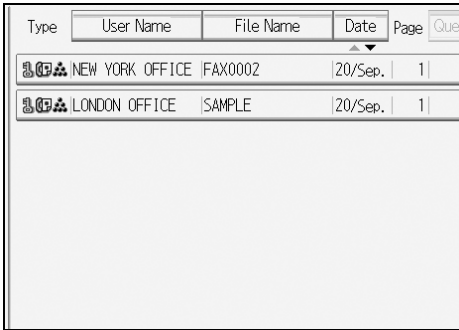

You can also delete multiple documents at once.

**4** Enter a password using the number keys, and then press **[OK]**.

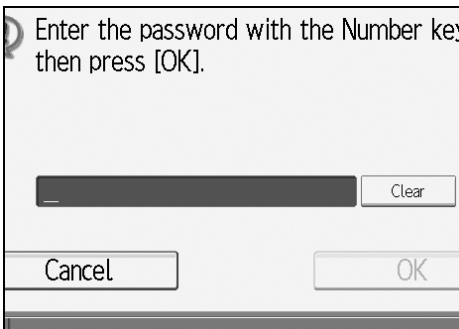

**5** Press **[Delete File]**.

**6** Press **[Yes]**.

If you do not want to delete the document, press **[No]**.

**7** Press **[Exit]**.

The standby display appears.

# 6. Fax via Computer

This section explains how to use this machine's facsimile function from a computer via a network.

## Sending Fax Documents from Computers

You can send a document created with a Windows application from a computer connected to the machine to another fax machine.

Connect computers to the machine via parallel port, LAN, IEEE 802.11b (wireless LAN), or USB 2.0.

- To send a fax, simply select **[Print]** from the Windows application, then select LAN-Fax as the printer, and then specify a destination. LAN-Fax enables paperless faxing from your computer to the other destinations.
- In addition to sending faxes, the LAN-Fax Driver allows this machine to be used for printing out documents prepared on a computer for proof checking.
- To use the LAN-Fax Driver, connect this machine to a LAN and make the necessary network settings, and then install the LAN-Fax Driver and the related utilities on your computer.

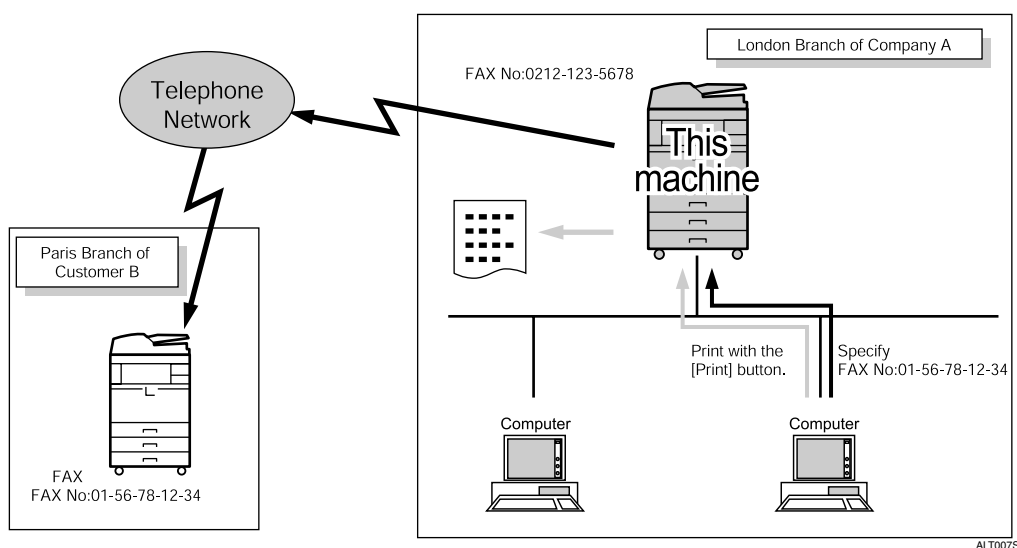

### **Important**

- To use this function, the optional printer/scanner unit must be installed.
- Errors occurring when the machine is used as a LAN-Fax will not be displayed on the computer. Check for errors by using a Web Image Monitor. See Web Image Monitor help.
- The facsimile function of this machine cannot be used with IPv6.

 **Note**

- ❑ It is recommended that you use a Web Image Monitor running under the same network environment as this machine. Otherwise, the Web browser may not open and an error may occur.

---

## Before Use

---

To use these features, a LAN-Fax Driver must be installed on your computer. Use the LAN-Fax Driver included on the printer CD-ROM. You must also make the required computer to fax network settings on the machine, according to the type of connection.

 **Note**

- ❑ When a personal computer and the machine are connected in parallel: See “Preparing the Machine”, Printer Reference.
- ❑ When using Ethernet or IEEE 802.11b (wireless LAN): See “Connecting the Machine”, General Settings Guide.

 **Reference**

- “Connecting the Machine”, General Settings Guide
- “System Settings”, General Settings Guide
- “Preparing the Machine”, Printer Reference

---

## Using the Software

---

This section provides information about LAN-Fax Driver, Address Book, and LAN-Fax Cover Sheet Editor.

---

### LAN-Fax Driver

---

This driver allows you to use LAN-Fax functions.

 **Important**

- ❑ All operations cannot be guaranteed depending on the system environment.

❖ **Location of the file**

The following folder is on the CD-ROM:

- LAN-Fax Driver for Windows 2000/XP/Vista and Windows Server 2003/2003 R2  
  \DRIVERS\LAN-FAX\XP\_VISTA

### ❖ Operating environment

- Computer  
PC/AT compatible
- Operating systems  
Microsoft Windows 2000/XP/Vista  
Microsoft Windows Server 2003/2003 R2
- Display  
VGA 640×480 pixels or more

### Note

- Before beginning installation, exit all other applications.

---

## Address Book

---

Address Book helps you edit LAN-Fax transmission destinations.

### ❖ Operating systems

Microsoft Windows 2000/XP/Vista  
Microsoft Windows Server 2003/2003 R2

---

## LAN-Fax Cover Sheet Editor

---

LAN-Fax Cover Sheet Editor helps you edit LAN-Fax cover sheets.

### ❖ Operating systems

Microsoft Windows 2000/XP/Vista  
Microsoft Windows Server 2003/2003 R2

---

## Auto Run program

---

The installers for various drivers and utilities launch automatically as Auto Run programs when you insert the CD-ROM.

LAN-Fax Driver, Address Book, and LAN-Fax Cover Sheet Editor can be installed by Auto Run.

### Important

- If the plug and play function starts, click **[Cancel]** in the **[Found New Hardware]** dialog box, and then insert the CD-ROM.
- Auto Run might not work automatically with certain OS settings. If this is the case, double-click "Setup.exe", located on the CD-ROM root directory.
- If you want to cancel Auto Run, hold down the **[SHIFT]** key (when your system is Windows 2000/XP or Windows Server 2003/2003 R2, hold down the left **[SHIFT]** key) while inserting the CD-ROM. Keep the **[SHIFT]** key held down until the computer stops reading the CD-ROM.
- Clicking **[Cancel]** during installation aborts the installation. If you cancel the installation, restart your computer and install the rest of the software or printer driver.

 **Note**

- If your operating system is Windows 2000/XP/Vista or Windows Server 2003/2003 R2, installing a printer driver using Auto Run requires Administrator permissions. When you install LAN-Fax Driver using Auto Run, log on using an account that has Administrator permissions.

---

## Installing Individual Applications

---

You need to install a LAN-Fax Driver on your computer before using the LAN-Fax functions. The LAN-Fax Driver is on the CD-ROM included with this machine.

Address Book and LAN-Fax Cover Sheet Editor are installed with the LAN-Fax Driver. Address Book helps you edit LAN-Fax transmission destinations. LAN-Fax Cover Sheet Editor helps you edit LAN-Fax cover sheets.

Use the following procedure to install LAN-Fax Driver, Address Book, and LAN-Fax Cover Sheet Editor at one time.

 **Important**

- Before installing the above applications, install SmartDeviceMonitor for Client.

**1** Quit all applications currently running.

**2** Insert the CD-ROM included with this machine into the CD-ROM drive of your computer.

The installer launches automatically, and the language selection window appears.

Depending on your operating system settings, the installer may not launch automatically. If it does not, double-click "Setup.exe" in the CD-ROM root directory to launch the installer.

**3** Select the interface language of the software, and then click [OK].

**4** Click [LAN-Fax Driver].

The software license agreement window appears.

**5** Read all of the terms and, if you agree, select [I accept the agreement.], and then click [Next].

If you select [I don't accept the agreement.], you cannot complete the installation.

**6** Select the [LAN-Fax Driver] check box, and then click [Next].

**7** Confirm that the [Printer Name:<LAN-Fax M8>] check box is selected, and then click [Continue].

Select the desired port.

**8** Click [Finish].

The installation completion dialog box appears.

**9** Click [Finish].

**10** Click [Exit].

---

## Setting LAN-Fax Driver Properties

---

This section explains how to set properties required for using the LAN-Fax Driver.

 **Note**

- If your operating system is Windows 2000/XP/Vista, or Windows Server 2003/2003 R2, log on using an account that has Administrator rights.

---

### Setting print properties

---

This section explains how to make settings such as paper size or resolution.

**1** On the **[Start]** menu, select **[Control Panel]**. Then select **[Printers and Other Hardware]**, and then **[Printers and Faxes]**.

In Windows 2000, point to **[Settings]** on the **[Start]** menu, and then click **[Printers]**.

In Windows XP Professional or Windows Server 2003/2003 R2, select **[Printers and Faxes]** on the **[Start]** menu.

In Windows Vista, select **[Control Panel]** on the **[Start]** menu. Then select **[Hardware and Sound]**, and then **[Printers]**.

**2** Select to highlight **[LAN-Fax M8]**, then click **[Properties]** on the **[File]** menu.

**3** Click **[Printing Preferences...]** to set the following properties.

- Paper Size
- Orientation
- Tray
- Resolution

**4** Click **[OK]**.

---

## Making settings for option configuration

---

Make settings for optional units installed in this machine.

**1** On the **[Start]** menu, select **[Control Panel]**. Then select **[Printers and Other Hardware]**, and then **[Printers and Faxes]**.

In Windows 2000, point to **[Settings]** on the **[Start]** menu, and then click **[Printers]**.

In Windows XP Professional or Windows Server 2003/2003 R2, select **[Printers and Faxes]** on the **[Start]** menu.

In Windows Vista, select **[Control Panel]** on the **[Start]** menu. Then select **[Hardware and Sound]**, and then **[Printers]**.

**2** Select to highlight **[LAN-Fax M8]**, then click **[Properties]** on the **[File]** menu.

**3** Click the **[Accessories]** tab, and then make the settings for the option configuration.

**4** When the machine is connected to a network, option configuration is automatically performed. If the settings do not match the installed optional units, click **[Load from Device]**.

**5** When this machine is connected locally to your computer, select the check boxes for the installed optional units.

**6** Click **[Apply]**.

Option configuration settings are complete.

**7** Click **[OK]**.

### **[Accessories] tab**

The **[Accessories]** tab contains the following items besides option configuration items.

- Prohibit manual destination entry  
Check this option to inhibit direct destination specification.
- Enable E-mail  
Check this when using Internet Fax with the LAN-Fax function.
- IP-Fax  
Check this option when using IP-Fax.  
After checking this option, select a protocol by clicking an appropriate radio button.

### **Note**

- If the options on this machine are not configured as instructed, LAN-Fax functions may fail.
- When this machine is connected to a network and the port is set via the "SmartDeviceMonitor for Client" port, option configuration is automatically performed. For details about automatic option configuration, see LAN-Fax Deriver's Help.



---

## Basic Transmission

---

This section explains how to send fax documents created using Windows applications. To send a fax, simply select **[Print...]** from the Windows application, then select **[LAN-Fax M8]** as the printer, and then specify a destination in the **[LAN-Fax]** dialog box. Open the application document you want to send or create a new document, and then perform the following procedure.

For details, see LAN-Fax Driver's Help.

### Important

- When using SmartDeviceMonitor for Client, you cannot send documents to this machine using more than one LAN-Fax at the same time.

**1** On the **[File]** menu, click **[Print...]**.

**2** Select **[LAN-Fax M8]** in the list.

**3** Click **[Print]**.

The LAN-Fax dialog box appears.

The setting method may differ depending on the application you are using. In all cases, select **[LAN-Fax M8]** for the printer.

**4** Specify the destination.

You can specify the destination using the following methods:

- “Specifying a destination using a destination list”
- “Specifying a destination using Address Book”
- “Specifying a destination by directly entering a fax number, Internet Fax destination, or IP-Fax destination”

For details about specifying a destination, see the LAN-Fax Driver's Help.

When user authentication is used with this machine, click **[User Settings...]**.

**5** Specify necessary options.

**6** Click **[Send]**.

When you click **[Send & Print]**, the fax is sent to the destination and your machine prints a copy of the document you sent.

### Note

- The machine can retain documents sent from a LAN-Fax Driver as files to be sent. For the maximum number of documents the machine can retain, see “Maximum Values”.
- For the maximum number of destinations you can specify per file, see “Maximum Values”.

 **Reference**

- p.240 "Specifying a destination using a destination list"
- p.241 "Specifying a destination using Address Book"
- p.242 "Specifying a destination by directly entering a fax number, Internet Fax destination, or IP-Fax destination"
- p.243 "Specifying Options"
- p.246 "Confirming Transmission Results by E-mail"
- p.248 "Editing Address Book"
- p.272 "Maximum Values"

---

**Specifying a destination using a destination list**

---

 **Important**

- To use a destination list to specify a destination, you must insert the machine's address book data into the destination table of the LAN-Fax Driver. See "Using the Machine's Address Book Data in the Destination List of the LAN-Fax".

**6****1** Click the **[Address Book]** or **[Specify Destination]** tab.

The **[Address Book]** or **[Specify Destination]** tab appears.

**2** Select the **[Device Address]** (or **[Use device address]**) check box.

Device addresses that were registered by selecting the **[Use device address]** check box in the Address Book appear in the destination list of the **[Address Book]** tab.

**3** The address is displayed in the **[Device Address]** field on the **[Address Book]** tab. On the **[Specify Destination]** tab, enter the registration number of the Destination key in the **[Device Address]** box.**4** Click **[Set as Destination]**.

The entered destination is added and appears in the **[List of Destination:]** box. If you add a destination by mistake, click the wrong destination, and then click **[Delete from List]**.

**5** To specify more destinations, repeat steps **3** and **4**. **Reference**

- p.250 "Using the Machine's Address Book Data in the Destination List of the LAN-Fax"

## Specifying a destination using Address Book

### Important

- In order to use this method, you need to register destinations in the address list using Address Book.
- To use device address data as the LAN-Fax Driver destination table, you must convert the destinations registered on the machine to a CSV file and send that file to your computer. For details, see “Using the Machine’s Address Book Data in the Destination List of the LAN-Fax”.

#### **1** Click the **[Address Book]** tab.

The **[Address Book]** tab appears.

#### **2** Select a CSV file containing the desired destination list, from the **[Address Book:]** dropdown menu.

Up to the three most recently used files appear in the dropdown menu. To use a destination list that did not appear, click **[Browse...]**, and then select the file.

#### **3** Select **[Contact]** or **[Group]** in the **[Name:]** dropdown menu as the display format.

Destination list contents change as follows, depending on the option selected:

- Contact: Individual name, company name, department name, fax number
- Group: Group name

If you selected **[Group]**, proceed to step **5**.

#### **4** If you selected **[Contact]** in step **3**, select the type of fax from the **[Type:]** dropdown menu.

To send by standard fax or IP-Fax, select **[Fax]**. To send by Internet Fax, select **[E-mail]**.

#### **5** Click the destination in the destination list to highlight it, and then click **[Set as Destination]**.

The selected destination is added and appears in the **[List of Destination:]** box.

If you add a destination by mistake, click the wrong destination, and then click **[Delete from List]**.

In the Address Book list box, directly enter the name you want to search for. You can then jump to the name you entered.

#### **6** To specify more destinations, repeat steps **2** through **5**.

#### Note

- Destination list contents can be narrowed down by selecting the first letter of a contact name, company name or group name in the **[Search]** dropdown menu.

#### Reference

p.250 “Using the Machine’s Address Book Data in the Destination List of the LAN-Fax”

---

## Specifying a destination by directly entering a fax number, Internet Fax destination, or IP-Fax destination

---

### **1** Click the **[Specify Destination]** tab.

The **[Specify Destination]** tab appears.

### **2** Select the type of fax from the **[Type:]** dropdown menu.

To send by standard fax or IP-Fax, select **[Fax]**. To send by Internet Fax, select **[E-mail]**.

After you select the fax type, the items corresponding to the selected type appear.

### **3** Specify the destination.

Specify the destination depending on the selected fax type as follows:

- If you selected **[Fax]**: enter the fax number. To send by IP-Fax, enter the IP-Fax destination.
- If you selected **[E-mail]**: enter the e-mail address.

To enter a pause in the fax number, click **[Pause]**. If you selected **[E-mail]** in step **2**, **[Pause]** is not available.

### **4** Specify settings according to the type of fax transmission.

Specify settings according to the type of fax transmission selected in step **2**, as follows:

- If you selected **[Fax]**, select a line or a protocol in the **[Line:]** list.
- If you selected **[E-mail]**, select the **[Do not use SMTP server]** check box if you want to bypass the SMTP server.

### **5** Click **[Set as Destination]**.

The entered destination is added and appears in the **[List of Destination:]** box.

If you add a destination by mistake, click the wrong destination, and then click **[Delete from List]**.

### **6** To specify more destinations, repeat steps **2** through **5**.

#### **Note**

- For the maximum number of digits for a destination, see “Maximum Values”.
- When specifying multiple destinations, if you select different lines, the document is sent using the Simultaneous Broadcast function. For details about the Simultaneous Broadcast function, see “Simultaneous Broadcast Using Multiple Line Ports”.

#### **Reference**

p.59 “Simultaneous Broadcast Using Multiple Line Ports”

p.60 “Sending Over a Fax Line”

p.63 “Sending by IP-Fax”

p.66 “Sending to an E-mail Address”

p.272 “Maximum Values”

---

## Specifying Options

---

You can specify the following transmission options when sending a fax. For details about transmission options, see the LAN-Fax Driver's Help.

- Sending at specific time
- Print Fax Header
- Attach a Cover Sheet
- 2 sided printing
- Preview
- Save as file
- Document Server

---

### To send a fax document at a specific time

---

**1** Click **[Send Options]**.

The **[Send Options]** tab appears.

**2** Select the **[Sending at specific time]** check box, and then specify a transmission time.

---

### To print a sender stamp

---

**1** Click **[Send Options]**.

The **[Send Options]** tab appears.

**2** Select the **[Print Fax Header]** check box.

---

### To attach a cover sheet

---

**1** Click **[Send Options]**.

The **[Send Options]** tab appears.

**2** Select the **[Attach a Cover Sheet]** check box.

A cover sheet is added to the first page of a transmission file.

Click **[Edit Cover Sheet...]** to edit the cover sheet.

 **Reference**

p.251 "Editing Fax Cover Sheets"

---

## To specify two-sided printing

---

- 1** Click **[Send Options]**.

The **[Send Options]** tab appears.

- 2** Select the **[2 sided printing]** check box.
- 

## To display preview

---

Selecting the **[Preview]** check box allows you to check how the fax document will be output at the destination.

- 1** Click **[Send Options]**.

The **[Send Options]** tab appears.

- 2** Select the **[Preview]** check box.

- 3** Click **[Send]**, **[Print]**, or **[Send & Print]**.

The **[Preview]** window appears.

- 4** Click **[Next]** or **[Previous]** to check the image.

To close the **[Preview]** window, click **[Cancel]**.

---

## Saving as files

---

You can save the fax document in TIFF format (TIFF-F).

- 1** Click **[Send Options]**.

The **[Send Options]** tab appears.

- 2** Select the **[Save as file]** check box.

- 3** Click **[Save to...]**.

- 4** Select a folder on the folder tree.

- 5** Select a method of file naming.

To enter a file name manually, select the **[Specify file name when saving]** check box. To have the file assigned a name and saved automatically, select the **[Automatically create a new file]** check box.

- 6** Click **[OK]**.

- 7** Click **[Save]** or **[Save & Send]**.

If you select **[Automatically create a new file]**, the image file is assigned a name and saved under the specified folder.

The file name will be RicHHMMSS.tif (HH: hours, MM: minutes, SS: seconds).

**8 Enter a file name.**

You can also change the folder in this step.

**9 Click [Save].**

The image file is saved in the specified folder.

**Note**

- Single-page documents are saved as single TIFF files, and multiple-page documents are saved as multiple TIFF files.

---

**To store the fax document on the Document Server**

---

**Important**

- If [**Hard Disk Unit**] is not selected in [**Accessories**] on the printer properties dialog box, you cannot select [**Document Server**].

**1 Click [Send Options].**

The [**Send Options**] tab appears.

**2 Select the [Send to Document Server] check box, and then enter a user name, file name, and password.**

6

---

**Checking Transmission Using LAN-Fax Driver**

---

From "SmartDeviceMonitor for Admin", "SmartDeviceMonitor for Client", or Web Image Monitor, you can check information about files sent using LAN-Fax Driver. For the maximum number of transmission results you can check, see "Maximum Values".

Also, you can save the contents of the Journal in a personal computer as a CSV file using [**Load Fax Journal**] in "SmartDeviceMonitor for Admin".

**Note**

- When data is transmitted from the LAN-Fax Driver via the "SmartDeviceMonitor for Client" port, the "Data-transmission complete." message appears on the computer's display, so you can easily ascertain the communication progress. However, if the volume of communication data from the LAN-Fax to this machine increases, the message may appear during the operation, due to the differences in memory capacity between this machine and "SmartDeviceMonitor for Client". For more accurate fax transmission results, use "E-mail TX results".
- The job history may differ from the machine's transmission results. In that case, refer to the machine's transmission results.
- See the relevant Help for details.

**Reference**

p.272 "Maximum Values"

---

## Confirming Transmission Results by E-mail

---

After communicating in the LAN-Fax mode, this function transmits the communication results with the computer by e-mail.

When you have done **[Send]** or **[Send & Print]** using the LAN-Fax, and when the communication was successful, it transmits e-mail of the transmission result.

Result notification e-mail is sent when printing is complete, or if an error occurs during communication between this machine and a computer.

- 1** Click the **[E-mail Settings]** tab.
- 2** Select the **[Notify]** check box under **[E-mail TX results]**.
- 3** Enter the destination.

When entering the e-mail address directly, click the **[Specify destinations]** radio button, and then enter the e-mail address in the **[Specify destinations]** field.

When entering the machine's programmed address, click the **[Device Address]** radio button, and then enter the registration number of the Destination key in the **[Device Address]** box.

The **[Device Address]** box is unavailable when the **[Specify destinations]** is selected, and you cannot enter anything in the text box.

- 4** Click **[Send]** or **[Send & Print]**.

### Note

- You can confirm transmission results using the E-mail TX Results function and the Communication Result Report. You can set whether to use both of these together in User Parameters (switch 10, bit 6) in the Facsimile Features menu.
- If there be any insufficient configurations in the e-mail menu on this machine, or if "Auto Specify Sender Name" is set to "Off", the LAN-Fax result notification e-mail is not transmitted, and the LAN-Fax Result Report is printed. See "System Settings", General Settings Guide for the e-mail settings, and see "LAN-Fax Result Report" for the LAN-Fax Result Report.

### Reference

p.188 "Communication Result Report (Memory Transmission)"

p.247 "LAN-Fax Result Report"

"System Settings", General Settings Guide

"Facsimile Features", General Settings Guide



---

## LAN-Fax Result Report

---

This section explains the LAN-Fax Result Report.

If “E-mail TX results” is set to “Notify”, if there be any insufficient configurations in the e-mail menu on this machine, or if “Auto Specify Sender Name” is set to “Off”, the LAN-Fax result notification e-mail is not transmitted, and the LAN-Fax Result Report is printed. If the “E-mail TX Results” of “Sender Name” has not been set to on, the LAN-Fax Result Report is printed.

### Note

- Whether or not the LAN-Fax Result Report is printed, can be configured with User Parameters (Switch 20, bit 0) in the Facsimile Features menu.
- When executing **[Send]** or **[Send & Print]** with the LAN-Fax Driver, and when the E-mail TX Result Report has not arrived, the Communication Result Report is printed.

### Reference

p.188 “Communication Result Report (Memory Transmission)”  
“Facsimile Features”, General Settings Guide

---

## Printing and Saving

---

You can print documents created using Windows applications.

Open the application document you want to print or create a new document, and then perform the following procedure.

For details about printing the fax image, see the LAN-Fax Driver's Help.

**1** On the **[File]** menu, click **[Print...]**.

**2** Select **[LAN-Fax M8]** in the list, and then click **[Print]**.

The **[LAN-Fax]** dialog box appears.

The setting method may differ depending on the application you are using. In all cases, select **[LAN-Fax M8]** for the printer.

**3** Click **[Print]** or **[Send & Print]**.

You can save the fax image in a file. See “Specifying Options”.

### Note

- You can also save documents in TIFF format. For details about saving in TIFF format, see “Saving as files”.
- You can select the length of time the machine keeps document data in memory if print fails due to problems such as a paper shortage or paper jams. Make this setting with User Parameters (switch 20, bit 2, 3, 4, 5) in the Facsimile Features menu. Data is deleted when the specified length of time elapses.

 **Reference**

p.243 "Specifying Options"

p.244 "Saving as files"

"Facsimile Features", General Settings Guide

---

## Editing Address Book

---

You can program and edit destinations in the address list using the Address Book.

For details about the Address Book, see the LAN-Fax Driver's Help.

 **Note**

- You can use files created in CSV format as Address Book data. For this purpose, create CSV files that conform to a certain format. For more information, see Help.

---

### Programming new destinations

---

- 1** On the [Start] menu, point to [All Programs], [LAN-Fax Utilities], and then click [Address Book].

The [Address Book] dialog box appears.

If LAN-Fax Driver has already started up, click [Edit Address Book...].

- 2** Click [New/Browse...], and then select the CSV file containing the address list to be edited.

- 3** Enter the destination and name.

You can enter a contact name, company name, department name, fax number, e-mail address, and IP-Fax address. The name and destination (Fax Number, E-mail address or IP-Fax address) cannot be omitted.

- 4** Click [Add].

The destination is added to the destination list.

- 5** Click [Close].

- 6** If you made changes to a destination, a confirmation message appears. To save the changes, click [Yes].

If you do not want to save the changes and want to quit editing, click [No].

To return to the editing display, click [Cancel].

The confirmation dialog box does not appear when you have not made any changes after starting Address Book.

 **Note**

- To program the contents of the destination list of this machine to the Address Book, select the **[Use device address]** check box, then enter the Destination key's registration number in the **[Device Address]** field.
- For **[Line:]** under **[Fax Number:]**, the following line types are selectable; G3, G3-2, G3-3, G4, G3 Dir. Auto, G3 PABX Auto, or I-G3. However, this machine does not support G4.
- For **[Protocol:]** under **[IP-Fax address:]**, select **[H.323]** or **[SIP]**.
- To bypass the SMTP server, under the **[E-mail address:]** box, select the **[Do not use SMTP server]** check box.

---

**Editing programmed destinations**

---

**1** On the **[Start]** menu, point to **[All Programs]**, **[LAN-Fax Utilities]**, and then click **[Address Book]**.

The **[Address Book]** dialog box appears.

If LAN-Fax Driver has already started up, click **[Edit Address Book...]**.

**2** Click **[New/Browse...]**, and then select the CSV file containing the address list to be edited.

**3** Select the destination you want to edit so it is highlighted in the list.

**4** Edit the data.

**5** Click **[Update]**.

**6** Click **[Close]**.

**7** If you made changes to a destination, a confirmation message appears. To save the changes, click **[Yes]**.

If you do not want to save the changes and want to quit editing, click **[No]**.

To return to the editing display, click **[Cancel]**.

The confirmation dialog box does not appear when you have not made any changes after starting Address Book.

---

## Deleting programmed destinations

---

- 1** On the [Start] menu, point to [All Programs], [LAN-Fax Utilities], and then click [Address Book].

The [Address Book] dialog box appears.

If LAN-Fax Driver has already started up, click [Edit Address Book...].

- 2** Click [New/Browse...], and then select the CSV file containing the address list to be edited.

- 3** Select the destination you want to delete so it is highlighted in the list.

- 4** Click [Delete].

- 5** Click [Yes].

- 6** Click [Close].

- 7** If you made changes to a destination, a confirmation message appears. To save the changes, click [Yes].

If you do not want to save the changes and want to quit editing, click [No].

To return to the editing display, click [Cancel].

The confirmation dialog box does not appear when you have not made any changes after starting Address Book.

6

---

## Using the Machine's Address Book Data in the Destination List of the LAN-Fax

---

[Address Management Tool] in SmartDeviceMonitor for Admin allows you to save the Address Book's information registered on this machine as a CSV file that you can save on a computer. Saved CSV files can be used as the LAN-Fax Driver destination table.

### Note

- When destinations registered in groups by this machine are inserted into Address Book, each person's destination is determined according to the following order of priority (check before inserting and changing the order of priority, if necessary): IP-Fax destination → Fax number → Mail address
- Depending on the machine type, you may not be able to use the machine when it is updating the Address Book using CSV files (retrieved using SmartDeviceMonitor for Admin) that contain user codes.
- For details, see "SmartDeviceMonitor for Admin" Help.

---

## Editing Fax Cover Sheets

---

LAN-Fax Cover Sheet Editor allows you to edit the format for fax cover sheets.

### Important

- It is necessary to create a cover sheet file before attaching a cover sheet to fax document using LAN-Fax Driver.

---

### Creating a cover sheet

---

Use the following procedure to create a fax cover sheet.

You can edit the following items using LAN-Fax Cover Sheet Editor.

- Company name as destination information
- Department name as destination information
- Person name as destination information
- Company name as sender information
- Department name as sender information
- Person name as sender information
- Telephone number as sender information
- Fax number as sender information
- Date
- Message

**1** On the [Start] menu, point to [All Programs], [LAN-Fax Utilities], and then click [LAN-Fax Cover Sheet Editor].

The [LAN-Fax Cover Sheet Editor] dialog box appears.

**2** Edit the cover sheet.

For details about operations, see Help.

**3** Click [Save as...] on the [File] menu.

**4** Select a folder, and then enter a file name.

**5** Click [Save].

### Note

- Cover sheet data is stored in its own format (using “fcp” as its extension).

---

## Attaching a created cover sheet

---

Use the following procedure to attach a created cover sheet file to a fax document.

**1** On the **[File]** menu, click **[Print...]**.

**2** Select **[LAN-Fax M8]** in the list, and then click **[Print]**.

The **[LAN-Fax]** dialog box appears.

**3** Click **[Edit Cover Sheet...]**.

The **[Cover Sheet]** dialog box appears.

**4** Select a cover sheet file from the dropdown list or after clicking **[Browse...]** in **[Select Cover Sheet]**.

The selection made in **[Select Cover Sheet]** is not canceled unless you select another file. If you want to change only destination information, omit this step and proceed to step **5**.

**5** Select the type of information from **[To:]**.

You can select **[Use Address Book]**, **[To Whom It May Concern]**, **[Edit Names]**, or **[(None)]**. Selecting **[Edit Names]** allows you to enter company, department, and contact names.

**6** To print the date, select the **[With a Date]** check box.

**7** Enter the sender information.

You can enter company, department, and contact names, and telephone and fax numbers.

To add a message, select the **[With a Message]** check box, and then enter a message.

**8** Click **[OK]**.

**9** Specify a destination.

**10** Click the **[Send Options]** tab, and then select the **[Attach a Cover Sheet]** check box.

**11** Click **[Send]** or **[Send & Print]**.

## Managing Facsimile Functions Using SmartDeviceMonitor for Admin

You can check information about this machine's fax functions using a computer and save files on a computer using SmartDeviceMonitor for Admin.

### Note

- For details about SmartDeviceMonitor for Admin and its installation, see "Monitoring and Configuring the Printer", Network Guide.
- For details, see Network Guide and SmartDeviceMonitor for Admin Help.

### Reference

"Monitoring and Configuring the Printer", Network Guide

## LAN-Fax Operation Messages

This section explains typical operation error messages displayed on the computer when using the LAN-Fax Driver, and solutions to those messages.

Message	Causes and Solutions
The number of entries in Destinations exceed the limits. Up to 500 entries can be entered.	The number of destinations specified exceeds the maximum possible. The maximum number of destinations that can be specified at one time is 500.
"LAN-Fax" has already been launched. Cannot launch it again.	The <b>[LAN-Fax]</b> dialog box is already open. Quit LAN-Fax once, and then start it up again.
Failed to allocate memory.	Available memory on the computer is insufficient. Quit applications currently not in use.

## Viewing Fax Information Using a Web Browser

You can view received fax documents and their lists or print these documents using a Web Image Monitor on a network computer.

### **Important**

- To use this function, the optional printer/scanner unit must be installed.

### **Note**

- It is recommended that you use a Web Image Monitor running under the same network environment as this machine. Otherwise, the Web browser may not open and an error may occur.
- When entering an IPv4 address, do not begin segments with zeros. For example: If the address is "192.168.001.010", you must enter it as "192.168.1.10" to connect to the machine.
- You need to select "Store" as the "Reception File Setting" in the Facsimile Features menu.
- You can also check and manage the documents using DeskTopBinder.

### **Reference**

"Monitoring and Configuring the Printer", Network Guide

"Facsimile Features", General Settings Guide

DeskTopBinder's manual and Help



## Viewing, Printing, and Deleting Received Fax Documents Using a Web Image Monitor

Use the following procedure to view and/or print received fax documents using a Web Image Monitor.

### Viewing received fax documents using a Web browser

- 1** Start a Web browser.
- 2** Enter the machine's IPv4 address in the **[Address]** field.
- 3** Click **[Fax Received File]** in the left pane.
- 4** If you have programmed a user code for the stored reception file, enter the code, and then press **[OK]**.

A list of the received fax documents appears.

If the programmed user code was deleted using the Address Book Management function under System Settings, a message indicating incorrect user code entry appears. If this is the case, reprogram a user code.

- 5** Click  of the desired fax document.

When viewing a list of the fax documents, you can select the thumbnail display, icon display, or detail display. Click , , or .

- 6** View the content of the fax document.

To enlarge the preview image, click **[Enlarge Image]**. Enlargement cannot be performed without Acrobat Reader installed. For more information, see Help on the Web Image Monitor.

- 7** To download the received fax document, click **[PDF]** or **[Multi-page TIFF]**, and then click **[Download]**.

A downloading confirmation dialog box appears.

When you select **[PDF]**, make the necessary "PDF File Security Settings" before clicking **[Download]**. Acrobat Reader starts and the selected document is displayed.

#### **Note**

- If your computer cannot be connected to Web Image Monitor, see Network Guide.
- To download the document data on the list of received fax documents, click **[TIFF]** or **[PDF]**. For details about downloading, see the Web Image Monitor Help.
- The method for downloading differs depending on the selected format. For more information, see Help on the Web Image Monitor.

#### **Reference**

Network Guide

---

## Printing fax information using a Web browser

---

**1** Start a Web browser.

**2** Enter the machine's IPv4 address in the **[Address]** field.

**3** Click **[Fax Received File]** in the left pane.

The list of received fax documents appears.

**4** Select the check box of the fax document to be printed.

When viewing a list of the fax documents, you can select the thumbnail display, icon display, or detail display. Click , , or .

**5** Click **[Print]**.

**6** Click **[Print]**.

To cancel printing, press **[Cancel]** before clicking **[Print]**.

You can change the printing order of selected multiple documents. You can also have documents printed on both sides of the paper. For more information, see Help on the Web Image Monitor.

**7** Click **[OK]**.

The display returns to that of step **5**.

---

## Deleting fax information using a Web browser

---



**1** Start a Web browser.

**2** Enter the machine's IPv4 address in the **[Address]** field.

**3** Click **[Fax Received File]** in the left pane.

The list of received fax documents appears.

**4** Select the check box of the fax document to be deleted.

To view a list of the fax documents, select the thumbnail display, icon display, or detail display. Click , , or .

**5** Click **[Delete]**.

**6** Click **[Delete File(s)]**.

To cancel deletion, press **[Cancel]** before clicking **[Delete File(s)]**.

After selecting multiple documents, you can also cancel deletion of some of the selected documents. For more information, see Help on the Web Image Monitor.

**7** Click **[OK]**.

The display returns to that of step **5**.

---

## Programming Destination Information from Web Browser

---

If the receiving machine is compliant with T.37 full mode Internet Fax, you can program the receiver's properties from Web Image Monitor. You can program the following properties:

- Compression Type
- Paper size
- Resolution

### Note

- For a detailed description, see Help for Web Image Monitor.
- When a receiver that is programmed as full mode in the Address Book returns a Reception Notice e-mail, the contents of the newly received e-mail overwrite the existing information.

### Reference

p.31 "T.37 Full Mode"

---

### To edit machine properties already programmed

---

Follow these steps to use Web Image Monitor to edit information about the destination machine registered in the Address Book.

**1** Start the Web browser.

**2** Enter the IPv4 address of the machine you want to monitor after "http://" in the address field.

The top screen is displayed.

**3** Click [Login], and then enter the Administrator's name and password.

**4** Click [Address Book] in the left pane.

The Address Book is displayed.

**5** Click the radio button to the left of the machine you want to modify, and then click [Change].

The [Change User] page appears.

**6** Set the properties for Internet Fax data format other than the mode selection.

If you change the mode to "Simple Mode", you cannot set machine properties.

**7** Click [OK] at the upper-left of the screen.

To cancel the setting, click [Cancel] in the upper-left of the screen.

The Address Book is displayed.

**8** Close the Web browser.

---

## To add new receiver

---

Follow these steps to use Web Image Monitor to add a new destination to the Address Book.

**1** Start the Web browser.

**2** Enter the IPv4 address of the machine you want to monitor after “http://” in the address field.

The top screen is displayed.

**3** Click [Login], and then enter the Administrator's name and password.

**4** Click [Address Book] in the left pane.

The Address Book is displayed.

**5** Click [Add User].

The [Add User] page appears.

**6** Enter the registration number, name, and e-mail address, then set the necessary properties.

You can set the Internet Fax data format after entering the e-mail address.

**7** Click [Full Mode] under [Internet Fax Data Format], and set the properties according to the receiver's properties.

If you change the mode to “Simple Mode”, you cannot set machine properties.

**8** Click [OK] in the upper-left of the screen.

To cancel the setting, click [Cancel] in the upper-left of the screen.

The Address Book is displayed.

**9** Close the Web browser.

# Delivering Files Received by Fax

Documents received by the machine can be viewed on or downloaded to a computer using the network delivery server ScanRouter delivery software. This is a useful function, enabling you to view and store documents on your computer without printing them.

## Important

- To use this function, the optional printer/scanner unit must be installed.
- The ScanRouter delivery software is required as a delivery server. DeskTopBinder must be installed on your computer.

Using the delivery server, you can eliminate the task of retrieving and delivering documents.

## Functions

Delivery server provides the following functions:

- Use the delivery server to associate incoming documents (SUB Code, Own Name, and Own Fax Number) with receivers, so documents are delivered to the intended receivers.
- You can select the delivery method for incoming documents: “Save in the delivery server inbox”, “Send as an e-mail attachment”, or “Save in the designated folder on the computer”. Incoming documents with no SUB Code, Own Name, or Own Fax Number are saved in the delivery server inbox. You can also set it so that the received documents are stored in the specified delivery server inbox according to the line used for reception.
- You can check or download received documents stored in the delivery server inbox using DeskTopBinder.

## Note

- Documents received in Personal Boxes are also forwarded to the delivery server.
- To view or download documents stored in the delivery server inbox, you need to install DeskTopBinder on your computer.
- To send received documents to your computer as e-mail attachments, your computer must have an e-mail application that is compatible with the ScanRouter delivery software.
- To create a network using the delivery server, settings must be specified in the User Tools of the machine. Settings must also be specified on the delivery server.
- For details about the delivery server (ScanRouter delivery software), see the ScanRouter delivery software's Help or instructions.
- For information about DeskTopBinder, see DeskTopBinder's manual and Help.

## Reference

“System Settings”, General Settings Guide

DeskTopBinder's manual and Help



This section explains features and specifications of the facsimile function.

## Checking the Memory Status

Use this function to display a summary of current memory usage.

On the standby display you can check the percentage of free memory space. In addition, in **[System Status]** you can check the number of “Transmission Standby File(s)”, “Memory Lock File(s)”, and “RX Print Standby File(s)”. “Others” shows the total number of documents registered in Information Boxes and received in Personal Boxes. See “When the Machine Does Not Operate As Wanted”, Troubleshooting.

### **Note**

- If you set the “Reception File Setting” in the Facsimile Features menu to “Store”, you can check the number of received documents using “RX Print Standby File(s)”.

### **Reference**

p.3 “Reading the Display Panel and Using Keys”

p.205 “Personal Boxes”

p.208 “Information Boxes”

“Facsimile Features”, General Settings Guide

“When the Machine Does Not Operate As Wanted”, Troubleshooting

## Programs

If you regularly send documents to a particular destination or transmit using the same functions, you can save repetitive number keys operations by registering this information in a Keystroke Program. Programs can be recalled by just pressing a programmed key.

### Registering and Changing Keystroke Programs

The following procedure can be used to program a new Keystroke Program or overwrite an old one.

You can register the following items in Keystroke Programs:

- Memory Transmission, Immediate Transmission, type of transmission, destinations, Scan Type, Resolution, Scan Size, Mixed Original Sizes, Auto Density, Manual Density, Original Orientation, Original Settings, Select Line, SUB/SID/SEP/PWD Code entry, Send Later, Reception Notice, BCC Transmission, E-mail TX Results, Text, Standard Message, Auto Reduce, Label Insertion, Closed Network, SUB Code Transmission, SEP Code Reception, Fax Header Print, TX Status Report, Store File
- Program name

#### **1** Make the settings you want to register in the program.

The procedure for programming differs depending on the items you want to register.

Press the **[Clear Modes]** key to cancel programming.

To register a program using Send Later with the fax number "0123456789", press **[0]**, **[1]**, **[2]**, **[3]**, **[4]**, **[5]**, **[6]**, **[7]**, **[8]**, **[9]** using the number keys, and then continue doing the Send Later setting until the standby display appears when you press **[OK]**.

#### **2** Make sure that the machine is in facsimile mode and the standby display is shown.

If the standby display is not shown, press the **[Facsimile]** key.

#### **3** Press the **[Program]** key.

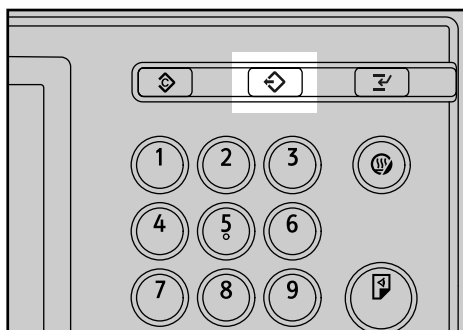

BFT008S



**4** Press **[Program]**.

When no programs are registered, proceed to step **5**.

Program (Fax)	
Select program No. to recall.	
<input type="button" value="Recall"/>	<input type="button" value="Program"/> <input type="button" value="Change Name"/>
<input type="button" value="001   Send Later"/>	<input type="button" value="002   * Not"/>
<input type="button" value="003   * Not Programmed"/>	<input type="button" value="004   * Not"/>
<input type="button" value="005   * Not Programmed"/>	<input type="button" value="006   * Not"/>
<input type="button" value="007   * Not Programmed"/>	<input type="button" value="008   * Not"/>
<input type="button" value="009   * Not Programmed"/>	<input type="button" value="010   * Not"/>

**5** Select a program number in which “Not Programmed” is shown.

Program (Fax)	
Select No. to program.	
<input type="button" value="Recall"/>	<input checked="" type="button" value="Program"/> <input type="button" value="Change Name"/> <input type="button" value="Delete"/> <input type="button" value="Program as Defaults"/>
<input type="button" value="001   Send Later"/>	<input type="button" value="002   * Not Programmed"/>
<input type="button" value="003   * Not Programmed"/>	<input type="button" value="004   * Not Programmed"/>
<input type="button" value="005   * Not Programmed"/>	<input type="button" value="006   * Not Programmed"/>
<input type="button" value="007   * Not Programmed"/>	<input type="button" value="008   * Not Programmed"/>
<input type="button" value="009   * Not Programmed"/>	<input type="button" value="010   * Not Programmed"/>
<input type="button" value="011   * Not Programmed"/>	<input type="button" value="012   * Not Programmed"/>
<input type="button" value="013   * Not Programmed"/>	<input type="button" value="014   * Not Programmed"/>
<input type="button" value="015   * Not Programmed"/>	<input type="button" value="016   * Not Programmed"/>

If you make a mistake, press **[Cancel]** and select a program number again.

When you change a Keystroke Program, press **[Yes]** after pressing the program number you want to change. If you make a mistake, press **[No]** and try again.

**6** Enter the program name, and then press **[OK]**.

The standby display appears.

If the program name is already registered, the name is displayed. To change the program name, press **[Backspace]** or **[Delete All]**, and then try again.

You should register the program name.

To cancel a program, press **[Cancel]**. The display returns to that of step **5**.

**Note**

- Use the same procedure to register and change programs. In step **5**, select the program number you want to change.
- For the maximum number of Keystroke Programs you can register, see “Maximum Values”.
- For the maximum number of characters you can enter for a program name, see “Maximum Values”.
- For the maximum number of destinations you can register to a Keystroke Program, see “Maximum Values”.
- The method of registering or changing programs for the copy function is different from that of the fax function.

**Reference**

- p.117 “Sending at a Specific Time (Send Later)”
- p.272 “Maximum Values”
- “Entering Text”, About This Machine

---

**Registering a priority function using a program**

---

Set the functions registered in a program as priority functions, so you can have the machine select these functions right after the power is turned on or the **[Clear Modes]** key is pressed.

To set the priority functions, register the desired settings to a program. Then, recall the registered program, and then press **[Program as Defaults]** on the Program screen. The recalled settings are registered as priority functions.

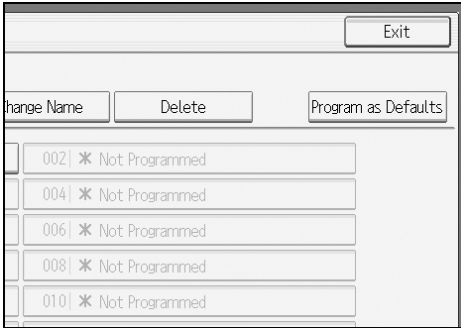

7

**Important**

- ❑ Destinations and SUB/SID/SEP/PWD Code entries cannot be registered as priority functions.

**Reference**

- “Facsimile Features”, General Settings Guide

## Changing a program name

Follow these steps to change a program name.

- 1** Make sure that the machine is in facsimile mode and the standby display is shown.

If the standby display is not shown, press the **[Facsimile]** key.

- 2** Press the **[Program]** key.

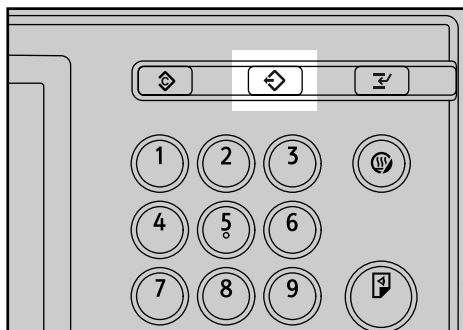

BFT0085

- 3** Press **[Change Name]**.

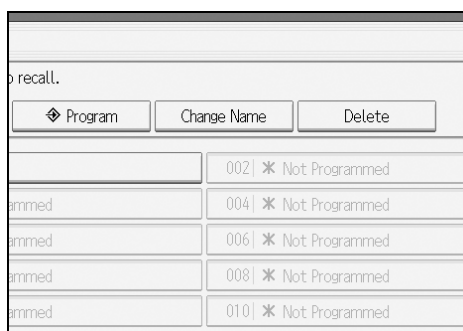

- 4** Select the program number of the name you want to change.

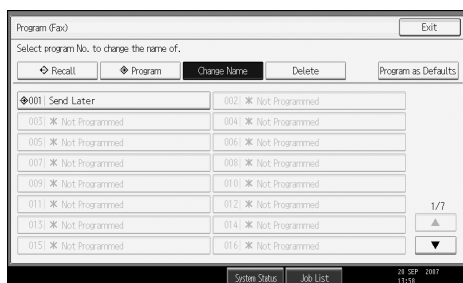

- 5** Enter a new program name, and then press **[OK]**.

The standby display appears.

Press **[Cancel]** to cancel the change.

## Deleting a Program

Follow these steps to delete an unnecessary program:

- 1** Make sure that the machine is in facsimile mode and the standby display is shown.

If the standby display is not shown, press the **[Facsimile]** key.

- 2** Press the **[Program]** key.

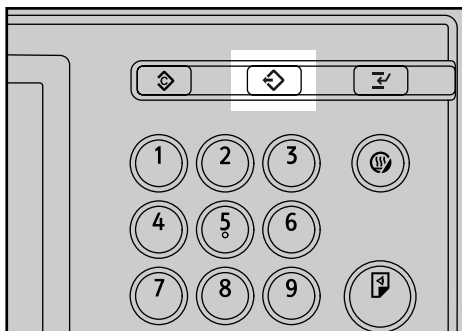

BFT0085

- 3** Press **[Delete]**.

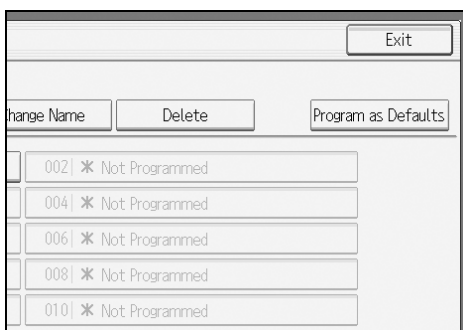

- 4** Select the program number you want to delete.

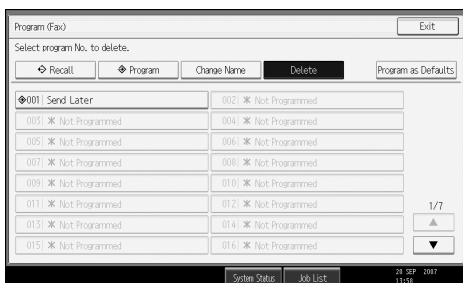

- 5** Press **[Yes]**.

The standby display appears.

Press **[No]** not to delete the program. The display returns to that of step **4**.

## Using a Program

Follow these steps to recall and use a registered program:

- 1** Make sure that the machine is in facsimile mode and the standby display is shown.

If the standby display is not shown, press the **[Facsimile]** key.

- 2** Place the original.

- 3** Press the **[Program]** key.

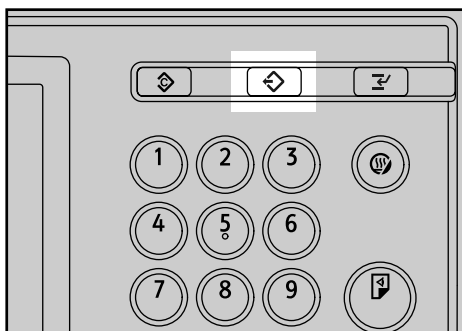

BFT008S

- 4** Confirm that **[Recall]** is selected, and press the registered program number.

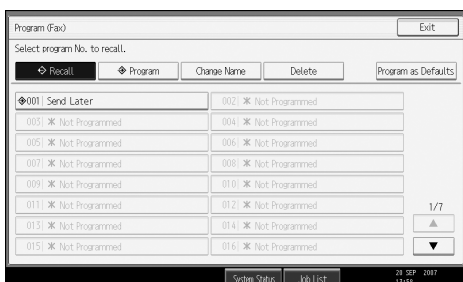

The standby display appears.

The programmed fax number appears and the registered settings are recalled.

- 5** Press the **[Start]** key.

The machine starts to scan the original.

Then, transmission starts with the recalled transmission settings.

### Note

- Using the program causes the previous settings to be cleared.
- If you have no programmed destinations or scan settings as programs, select the program number, and then enter the fax number of the destination and select the scan settings you require.

## Optional Equipment

This section explains the functions of options.

---

### Expansion Memory (28MB: DIMM)

---

This allows you to send fax documents at high resolution (Super Fine). This also allows you to receive fax documents at high resolution (Fine or Super Fine). If you require this option, consult your service representative.

#### Reference

p.272 "Maximum Values"

---

### Extra G3 Interface Unit

---

This option provides one extra G3 line connection.

A maximum of two G3 interface units can be installed.

# Specifications

## ❖ Fax Transmission and Reception

Standard	G3
Resolution	G3: 8 × 3.85/mm, 200 × 100 dpi (Standard character), 8 × 7.7/mm, 200 × 200 dpi (Detail character), 8 × 15.4/mm (Fine character: optional), 16 × 15.4/mm, 400 × 400 dpi (Super Fine character: optional)
Transmission time	G3: 3 seconds at 28,800 bps, Standard resolution (JBIG transmission: 2 seconds)
Data compression method	MH, MR, MMR, JBIG
Maximum original size	Standard size: A3☐, 11" × 17" Custom size: 297 × 1200 mm/11" × 47"
Maximum scanning size	297 × 1200 mm/11" × 47"
Print process	Printing on standard paper using a laser
Transmission speed	G3: 33,600 / 31,200 / 28,800 / 26,400 / 24,000 / 21,600 / 19,200 / 16,800 / 14,400 / 12,000 / 9,600 / 7,200 / 4,800 / 2,400bps (auto shift down system)

## ❖ Power Consumption

Immediate Transmission	approx. 370 W
Memory Transmission	approx. 330 W
Memory Reception	approx. 330 W
Reception	approx. 830 W

## ❖ IP-Fax Transmission and Reception

Network	LAN: Local Area Network Ethernet/10base-T, 100base-TX, IEEE802.11b (wireless LAN)
Scan line density	8 × 3.85 mm, 200 × 100 dpi (Standard character), 8 × 7.7 mm, 200 × 200 dpi (Detail character), 8 × 15.4 mm (Fine character: optional), 16 × 15.4 mm, 400 × 400 dpi (Super Fine character: optional)
Maximum original size	Standard size: A3☐, 11" × 17" Custom size: 297 × 1200 mm/11" × 47"
Maximum scanning size	297 × 1200 mm/11" × 47"
Transmission protocol	Recommendation: T.38, TCP, UDP/IP communication, SIP (RFC 3261 compliant), H.323 v2
Compatible machines	IP-Fax compatible machines

IP-Fax transmission function	Specify an IPv4 address and send faxes to an IP-Fax compatible fax through a network. Also capable of sending faxes to a G3 fax connected to a telephone line via a VoIP gateway.
IP-Fax reception function	Receive faxes sent from an IP-Fax compatible fax through a network. Also capable of receiving faxes from a G3 fax connected to a telephone line via a VoIP gateway.

### ❖ Internet Fax Transmission and Reception

Network	LAN : Local Area Network Ethernet/10Base-T, 100Base-TX, IEEE802.11b (wireless LAN)
Transmit function	E-mail
Scan line density	200 × 100 dpi (Standard character), 200 × 200 dpi (Detail character), 200 × 400 dpi (Fine character: optional) <sup>*1</sup> , 400 × 400 dpi (Super Fine character: optional) <sup>*1</sup>
Original size : Scanning width	A3 <sup>*1</sup> , B4 JIS <sup>*1</sup> , A4
Communication Protocols	<ul style="list-style-type: none"> <li>• Transmission SMTP, TCP/IP</li> <li>• Reception POP3, SMTP, IMAP4, TCP/IP</li> </ul>
E-mail format	Single/Multi-part, MIME Conversion Attached file forms: TIFF-F (MH, MR <sup>*1</sup> , MMR <sup>*1</sup> compression)
Authentication method	SMTP-AUTH, POP before SMTP, A-POP
Internet communication	Send and receive e-mail with a computer that has an e-mail address
E-mail send functions	Automatic conversion of sent documents to e-mail format and e-mail transmission. Memory transmission only.
E-mail receive functions	Automatic detection and printing of appended TIFF-F (MH) files and ASCII text. Memory reception only.

<sup>\*1</sup> Full mode



## Specifications Required for the Internet Fax Destination Machines

This machine can communicate with Internet Fax machines that satisfy the following specification requirements.

When communicating with full mode compatible machines, you can take advantage of higher specifications for coding, original size, and resolution. For details about the specifications available in full mode, see “Internet Fax Transmission and Reception” in “Specifications”.

Communication protocols	<ul style="list-style-type: none"> <li>• Transmission SMTP</li> <li>• Reception POP3, SMTP, IMAP4</li> </ul>
E-mail format	<ul style="list-style-type: none"> <li>• Format MIME, Base64</li> <li>• Content-Type Image/tiff Multipart/mixed (text/plain, Image/tiff (attached file forms))</li> </ul>
Data format	<ul style="list-style-type: none"> <li>• Profile TIFF Profile S</li> <li>• Coding MH</li> <li>• Original size A4</li> <li>• Resolution (dpi) 200×100/200×200, 204×98/204×196</li> </ul>



### Reference

p.269 “Specifications”

## Maximum Values

The following list contains the maximum value for each item.

Item	Standard	Expansion memory (Optional)
Memory	4 MB	28 MB
Number of documents you can store in memory for Memory Transmission	400	400
Number of pages you can store in memory (using A4 Standard <ITU-T #1 Chart>)	Approx. 320	Approx. 2,240
Number of destinations you can register in the destination list	2,000	2,000
Number of groups you can register	100	100
Number of destinations you can register in a group	500	500
Number of destinations you can specify per file	500	500
Number of destinations you can specify for all files (including files in memory)	500	500
Number of destinations you can search at a time using <b>[Search Dest.]</b>	100	100
Number of recent destinations the machine can store	10	10
Number of digits for a destination	128	128
Number of digits for a SEP/SUB/PWD/SID Code	20	20
Number of characters you can enter in the e-mail subject line	128	128
Number of communication results you can check on this machine	200	200
Number of communication results printed in the Journal	50	50
Number of special senders you can register	30	30
Number of LAN-Fax Driver transmission results you can check from a network computer "Smart-DeviceMonitor for Admin", "DeskTopBinder", or Web Image Monitor.	70	70
Number of documents sent from a LAN-Fax Driver that the machine can retain as files to be sent	400	400
Number of destinations you can register into a Keystroke Program	500	500
Number of Keystroke Programs you can register	100	100

Item	Standard	Expansion memory (Optional)
Number of characters you can enter for a program name	20	20
Number of received documents you can store on the machine's hard disk	400	400
Number of documents you can print at a time in <b>[Print / Delete Stored Reception File]</b>	30	30
Number of documents you can delete at a time in <b>[Print / Delete Stored Reception File]</b>	30	30
Number of stored documents you can specify at a time in <b>[Select Stored File]</b>	30	30
Number of stored pages you can send in one operation in <b>[Select Stored File]</b>	1,000	1,000
Number of stored documents you can print at a time using <b>[Print 1st Page]</b>	30	30
Number of stored documents you can print at a time using <b>[Print File]</b>	30	30
Number of documents you can store in the Document Server using the facsimile function	2,000	2,000
Number of pages per document you can store in the Document Server	1,000	1,000
Number of pages you can store in the Document Server (in total – copy function, facsimile function, printer function, and scanner function) (Using ITU-T #4 Chart)	Approx. 9,000	Approx. 9,000

 **Note**

- The maximum number of pages that can be stored or transmitted may decrease depending on the contents of documents.

# INDEX

- 
- 180-degree rotation printing, 160
  - 1st Sheet, 35
  - 2nd Sheet, 35
  - 2 Sided Original, 35
  - 2 Sided Print, 6
  - 2 sided printing, 244

## A

---

- Acceptable original sizes, 38
- Add, 18
- Add Destination, 172
- Adding a destination, 172
- Address Book, 235, 248
- Add User, 258
- Adjust Sound Volume, 6
- Advanced Features, 100
- Advanced Search, 88
- Adv.Features, 100
- All, 193
- Area, 50
- Area 1, 50
- Area 2, 50
- Attach a Cover Sheet, 243
- Attaching a created cover sheet, 252
- Authorized Reception per Sender, 6
- Auto Density, 54
- Auto Detect, 48
- Auto e-mail reception, 148
- Auto fax reception power-up, 156
- Automatic Redial, 18
- Auto Reception, 146
- Auto Reduce, 130
- Auto Run program, 235

## B

---

- Backup File TX Setting, 6
- Basic Transmission, 239
- BCC Transmission, 121
- Before use, 234
- Box Setting, 6
- Box Setting: Print List, 6
- Broadcasting sequence, 18
- Bypassing the SMTP server, 69

## C

---

- Canceling a Memory Transmission, 108
- Canceling an Immediate Transmission, 108
- Canceling a transmission, 108
- Canceling a transmission before the original is scanned, 108
- Canceling a transmission before the transmission is started, 111
- Canceling a transmission of an Internet Fax, 108
- Canceling a transmission while the original is being scanned, 108
- Canceling a transmission while the original is being transmitted, 109
- Centre Mark, 6, 158
- Change File Name, 230
- Change Name, 265
- Change Password, 230
- Change / Stop Transmission File, 114
- Change Title, 73
- Change TX / Info, 169, 179, 181
- Change User Name, 229
- Changing a program name, 265
- Changing Keystroke Programs, 262
- Changing Stored Document Information, 227
- Changing the line port, 57
- Changing the settings of files in memory, 169
- Changing the SMTP server setting, 176
- Changing the transmission time, 174
- Check / Change Settings, 114, 170, 172, 174, 176
- Checkered Mark, 6, 157
- Checking a transmission file, 169
- Checking files stored in memory, 181
- Checking the memory status, 261
- Checking the reception result, 190
- Checking the result of the communication, 188
- Checking the result of the Immediate Transmission, 188
- Checking the storage result, 116
- Checking the transmission result, 185
- Checking transmission using LAN-Fax Driver, 245
- Check Modes, 22
- Check / Stop Transmission File, 111, 169
- Clear Modes key, 2, 108
- Clear/Stop key, 108, 109
- Closed Network, 134
- Closed Network Code, 134, 144
- Combined Auto and Manual Density, 54

Communicating indicator, 109  
Communication Failure Report, 189  
Communication Page Count, 6  
Communication Result Report, 188  
Compatible machines, 271  
Confidential File indicator, 203  
Confidential File Report, 207  
Confirming a transmission, 114  
Confirming by e-mail, 187  
Confirming by report, 186, 191  
Confirming by report and e-mail, 187  
Confirming on display, 185, 190  
Confirming the reservations for  
SEP Code Reception, 106  
Confirming the result of a  
SEP Code Reception, 107  
Confirming the results of transfer, 152  
Confirming transmission results by  
e-mail, 122, 246  
Creating a cover sheet, 251  
CSI - Own Fax Number, 144

## D

---

Data security for copying, 9  
Delete, 202, 212, 266  
Delete File, 231  
Deleting a destination from a  
Simultaneous Broadcast, 170  
Deleting a program, 266  
Deleting a stored document, 231  
Deleting fax information using a  
Web browser, 256  
Deleting Information Box documents, 212  
Deleting programmed destinations, 250  
Deleting received and  
stored documents, 200, 202  
Delivering files received by fax, 259  
Density (contrast), 54  
Destination key, 72, 74  
Detail, 45  
Displaying a preview, 224  
Displaying confirmation of transmission, 22  
Document Server, 245  
Dual Access, 18

## E

---

Edit Cover Sheet..., 252  
Edit Dest., 63, 66  
Editing Address Book, 248  
Editing fax cover sheets, 251  
Editing programmed destinations, 249  
E-mail Address, 86  
E-mail subject, 30  
E-mail text, 149  
E-mail TX Results, 97, 122, 187  
E-mail TX results, 246  
Enable H.323, 6  
Enable SIP, 6  
Entering an e-mail address, 66  
Entering an IP-Fax destination, 63  
Entering a pause, 61  
Entering a tone, 62  
Entering numbers using the number keys, 60  
Expansion memory, 268  
External telephone, 95  
Extra G3 interface unit, 268

## F

---

Facsimile Features, 6  
Facsimile key, 2, 146  
Fax, 12  
Fax Destination, 83  
Fax Header Print, 138  
Fax via computer, 233  
File List, 223  
File Name, 219  
First Name, 138  
Folder Transfer Result Report, 6  
Forwarding, 6  
Forwarding destination, 153  
Forwarding received documents, 153  
Full mode, 31, 257  
Function list, 6  
Functions not available by  
e-mail reception, 30  
Functions not available by  
e-mail transmission, 29  
Functions not available for  
IP-Fax transmission, 26

## G

---

G3, 57  
G3 Auto, 57  
Gatekeeper (VoIP gatekeeper), 25  
Gateway (VoIP gateway), 25  
General Settings, 6

## H

---

H.323, 25  
H.323 Settings, 6  
Having incoming documents printed on  
paper from the bypass tray, 165  
How to Read This Manual, 1

## I

---

If there is no paper of the correct size, 164  
Image Rotation, 161  
Immediate Reception, 141  
Immediate Transmission, 11, 19  
Immediate TX Result Report, 188  
Information Box, 208  
Initial display, 3  
Initial Settings, 6  
Installing individual applications, 236  
Internet Fax, 12  
Internet Fax functions, 27  
Internet Fax Settings, 6  
IP-Fax functions, 23

## J

---

JBIG reception, 156  
JBIG transmission, 45  
Journal, 191, 197  
Journal by e-mail, 199  
Just size printing, 165

## K

---

Key Colour, 5  
Keystroke Programs, 262

## L

---

Label Insertion, 132  
LAN-Fax Cover Sheet Editor, 235, 251  
LAN-Fax Driver, 233, 234  
LAN-Fax operation messages, 253  
LAN-Fax Result Report, 247  
LDAP server, 80  
Louder, 93  
Lower, 93

## M

---

Making settings for option configuration, 238  
Manage / Delete File, 227, 231  
Managing facsimile functions using  
SmartDeviceMonitor for Admin, 253  
Manual Density, 54  
Manual Dial, 95  
Manual e-mail reception, 149  
Manual E-mail RX, 149  
Manual Entry, 63, 66, 218, 223  
Manual Reception, 146  
Manuals for this machine, i  
Max. E-mail Size, 6  
Maximum values, 272  
MDN, 119  
Memory, 261  
Memory Lock Reception, 6  
Memory Reception, 142  
Memory Storage Report, 116  
Memory Transmission, 11, 13  
Memory Transmission sequence, 18  
Menu Protect, 6  
Mixed Original Sizes, 52  
Mixing scan settings for a  
multiple page original, 56  
Multi-copy reception, 160  
Multi-port, 57

## N

---

Name, 81  
Names, 79  
Names of major functions, 1  
Notes on using Internet Fax, 28  
Notes on using IP-Fax, 26

## O

---

On Hook, 93  
On Hook Dial, 93  
On Hook Mode Release Time, 6  
Operation switch, 156  
Optional equipment, 268  
Option Setting, 129  
Original Feed Type, 34, 35  
Original size, 32, 38  
Original sizes detected automatically, 41  
Original sizes difficult to detect, 41  
Original + Stored File, 220

## P

---

Page reduction, 163  
Page separation and length reduction, 162  
Paper size and scanned area, 39  
Paper Tray, 6  
Parallel Memory Transmission, 11, 17  
Parameter Setting, 6  
Parameter Setting: Print List, 6  
Password, 219  
Password (PWD), 106  
Password (SID), 103  
Pause, 61  
Personal Box, 151, 205  
Photo, 43  
Placing into the ADF, 32  
Placing on the exposure glass, 32  
Placing originals, 32  
Preview, 224, 244  
Prg. Dest., 79  
Print, 179, 201  
Print 1st Page, 225  
Print completion beep, 157  
Print / Delete Stored Reception File, 201, 202  
Print Fax Header, 243  
Print File, 225  
Printing a file from memory, 179  
Printing a file received with Memory Lock, 203  
Printing a list of files in memory, 181  
Printing and saving, 247  
Printing fax information using a  
    Web browser, 256  
Printing Information Box documents, 211  
Printing on both sides, 159  
Printing options, 157  
Printing Personal Box documents, 206  
Printing received and  
    stored documents, 200, 201  
Printing stored documents, 225  
Printing the Journal, 192  
Print Journal, 192  
Print List, 181  
Print Memory Lock, 203  
Print per File No., 194  
Print Personal Box File, 206  
Print per User, 195  
Print Reception Time, 6  
Program, 262  
Program as Defaults, 264  
Program / Change / Delete Gateway, 6  
Program / Change / Delete Scan Size, 6  
Program / Change / Delete  
    Standard Message, 6  
Program Closed Network Code, 6

Program Dest., 75  
Program Fax Information, 6  
Program key, 262  
Program Memory Lock ID, 6  
Programming a user name, 218  
Programming destination information  
    from Web browser, 257  
Programming destinations in the  
    Address Book, 77  
Programming new destinations, 248  
Programs, 262  
Program Special Sender, 6  
Program Special Sender: Print List, 6  
Properties, 237  
PWD Code, 106

## Q

---

Quick Operation Key, 6

## R

---

Reading the display, 2  
Reading the display panel and using keys, 3  
Recall, 267  
Received images, 149  
Receive File indicator, 143  
Receiving documents according to  
    parameter-specified settings, 144  
Receiving documents unconditionally, 144  
Receiving Internet Fax documents, 148  
Recent, 75  
Reception File Print Quantity, 6  
Reception File Setting, 6  
Reception File Status, 190  
Reception functions, 151  
Reception modes, 146  
Reception Notice, 119  
Reception notice message, 119  
Reception SEP Code, 103  
Reception Settings, 6  
Reception time, 158  
Regarding IP-Fax destinations, 65  
Registering a priority function using a  
    program, 264  
Registering entered destinations to the  
    Address Book, 79  
Registering Keystroke Programs, 262  
Reg. No., 91  
Regular, 49  
Report, 106, 107, 116, 152, 181, 188, 189,  
    197, 207, 247  
Resending a file, 183  
Resolution, 45

Returning the machine to the  
standby mode, 2  
Routing e-mail received via SMTP, 155  
Routing received documents, 151  
Routing received documents with  
SUB Code, 151  
RTI - Own Name, 144

## S

---

Saving as files, 244  
Scanning Two-Sided Originals, 35  
Scan Settings, 6, 43  
Scan Size, 47  
Scan Type, 43  
Search by destination name, 81  
Search by e-mail address, 86  
Search by fax number, 83  
Search by IP-Fax destination, 83  
Search by registration number, 91  
Search criteria, 88  
Search Dest., 80  
Search Destination, 6  
Searching for a destination in the  
Address Book, 80  
Searching through an LDAP server, 80  
Search using Advanced Search, 88  
Second Name, 138  
Select Dial / Push Phone, 6  
Selecting a protocol, 57  
Selecting destinations from  
Recent Destinations, 75  
Selecting type of transmission, 12  
Select Line, 57  
Select Stored File, 220, 225, 227  
Sender Name, 97  
Sender settings, 97  
Sending a stored file, 215  
Sending at a specific time, 117  
Sending at specific time, 243  
Sending by Internet Fax, 66  
Sending by IP-Fax, 63  
Sending fax documents from computers, 233  
Sending multiple originals using the  
exposure glass, 16, 21  
Sending over a fax line, 60  
Sending stored documents, 220  
Sending to an e-mail address, 66  
Send Later, 117  
Send Settings, 6  
Send & Store, 216  
SEP Code, 103, 136  
SEP Code Reception, 103, 136  
SEP Code RX Reserve Report, 106

SEP Code RX Result Report, 107  
Setting an e-mail destination as a BCC, 121  
Setting LAN-Fax Driver properties, 237  
Setting print properties, 237  
Setting priority trays, 164  
Setting the Original Orientation, 34  
SID Code, 103  
Simplified display, 5  
Simplified Display key, 5  
Simultaneous Broadcast, 18  
Simultaneous Broadcast using  
multiple line ports, 59  
SIP, 25  
SIP server, 25  
SIP Settings, 6  
SMTP, 69, 176  
SMTP reception using Internet Fax, 154  
SMTP RX File Delivery Settings, 6  
Specifications, 269  
Specifying a destination, 60  
Specifying a destination by  
directly entering, 242  
Specifying a destination using  
Address Book, 241  
Specifying a destination using a  
destination list, 240  
Specifying a host name, 65  
Specifying an alias telephone number, 65  
Specifying an IPv4 address, 63  
Specifying a SIP user name, 65  
Specifying documents by File Name, 224  
Specifying documents by User Name, 223  
Specifying documents from File List, 223  
Specifying group destinations, 74  
Specifying options, 243  
Specifying tray for lines, 166  
Specify Tray for Lines, 6  
Stamp Sender Name, 97  
Standard, 45  
Standard Message Stamp, 129  
Stop Transmission, 109, 111  
Store / Delete / Print  
Information Box File, 209, 211, 212  
Stored file + Original, 220  
Stored Reception File User Setting, 6  
Store File, 216  
Store Only, 216  
Storing a document, 215, 216  
Storing documents in Information Boxes, 209  
SUB Code, 100, 135, 151, 152, 205  
SUB Code Transfer Report, 152  
SUB Code Transmission, 100, 135  
Subject, 124  
Substitute Reception, 143



Super Fine, 45  
Switching between Memory and  
  Immediate Transmission, 11  
Switching the reception mode, 147  
Switching the titles in the Address Book, 73  
Switch Reception Mode, 6  
Switch RX Mode, 146, 147  
Switch Title, 6  
Symbols, 1  
System Status, 261

## T

---

T.37 full mode, 31, 257  
Terminology, 25  
Text, 43, 127  
Text / Line Art, 43  
Text / Photo, 43  
TIFF-F format, 27  
Title 1, 73  
Title 2, 73  
Title 3, 73  
Title word key, 3  
To add new receiver, 258  
To edit machine properties  
  already programmed, 257  
Tone, 62  
Top to Bottom, 35  
Top to Top, 35  
Transfer Box, 152  
Transferring received documents, 152  
Transmission, 13, 19  
Transmission File Status, 185  
Transmission modes, 11  
Transmission SUB Code, 100  
Transmission with Image Rotation, 42  
Transmit Failed File, 183  
Transmit Stored File only, 220  
Transmitting Journal by e-mail, 199  
Tray Shift, 167  
TSI Print (Transmitting Subscriber  
  Identification Print), 163  
TSI - Transmitting  
  Subscriber Identification, 163  
Two-Sided Printing, 159  
TX File List, 181  
TX Mode, 117, 119, 121, 122, 124, 127  
Types of reception, 141

## U

---

User Name, 218  
User Text, 124  
User Tools/Counter key, 6  
Using a program, 267  
Using the Address Book to  
  specify destinations, 72  
Using the Document Server, 215  
Using the machine's Address Book  
  data in the destination  
  list of the LAN-Fax, 250  
Using the software, 234

## V

---

Viewing fax information using a  
  Web browser, 254  
Viewing received fax documents using a  
  Web browser, 255  
Vol..., 93

## W

---

Web Image Monitor, 255  
Where incoming documents are  
  delivered - output tray, 166





## Declaration of Conformity

### Notice to Users in EEA Countries

This product complies with the essential requirements and provisions of Directive 1999/5/EC of the European Parliament and of the Council of 9 March 1999 on radio equipment and telecommunications terminal equipment and the mutual recognition of their conformity.

### Notice to Users Accessing Analog PSTN in EEA Countries

This product is designed to be able to access analog PSTN in all EEA countries. Local PSTN compatibility is dependent on software switch settings. Please contact your service representative if relocating this product to another country. In the event of problems, please contact your service representative in the first instance.

The CE Declaration of Conformity is available by accessing the URL:  
[http://www.rioh.co.jp/fax/ce\\_doc/](http://www.rioh.co.jp/fax/ce_doc/) and selecting the product applicable.

### Trademarks

Microsoft®, Windows®, Windows Server®, Windows Vista™, and Outlook® are either registered trademarks or trademarks of Microsoft Corporation in the United States and/or other countries.

PowerPC® is a trademark of International Business Machines Corporation in the United States, other countries, or both.

Adobe, Acrobat, Acrobat Reader, PostScript, and Reader are either registered trademarks or trademarks of Adobe Systems Incorporated in the United States and/or other countries.

Other product names used herein are for identification purposes only and might be trademarks of their respective companies. We disclaim any and all rights to those marks.

The proper names of the Windows operating systems are as follows:

- The product names of Windows 2000 are as follows:
  - Microsoft® Windows® 2000 Professional
  - Microsoft® Windows® 2000 Server
  - Microsoft® Windows® 2000 Advanced Server
- The product names of Windows XP are as follows:
  - Microsoft® Windows® XP Professional
  - Microsoft® Windows® XP Home Edition
  - Microsoft® Windows® XP Media Center Edition
  - Microsoft® Windows® XP Tablet PC Edition
- The product names of Windows Vista are as follows:
  - Microsoft® Windows Vista™ Ultimate
  - Microsoft® Windows Vista™ Enterprise
  - Microsoft® Windows Vista™ Business
  - Microsoft® Windows Vista™ Home Premium
  - Microsoft® Windows Vista™ Home Basic
- The product names of the Windows Server 2003 are as follows:
  - Microsoft® Windows Server® 2003 Standard Edition
  - Microsoft® Windows Server® 2003 Enterprise Edition
  - Microsoft® Windows Server® 2003 Web Edition
  - Microsoft® Windows Server® 2003 Datacenter Edition
- The product names of the Windows Server 2003 R2 are as follows:
  - Microsoft® Windows Server® 2003 R2 Standard Edition
  - Microsoft® Windows Server® 2003 R2 Enterprise Edition
  - Microsoft® Windows Server® 2003 R2 Datacenter Edition

**FAX Option Type 7500 Operating Instructions Facsimile Reference**

